

LAFAYETTE

RADIO ELECTRONICS

PHONOGRAPHS

See Pages 52-60



HIGH FIDELITY COMPONENTS

See Pages 1-54



RADIOS

See Pages 61-65



CLEARANCE!*

*SEE YELLOW SECTION—PAGES 75-82

MANY ITEMS BELOW COST! ALL PRICES REDUCED

QUANTITIES LIMITED

Prices in Effect Till MARCH 1, 1965

Model HB-115A



WALKIE-TALKIES

Model HE-100



Model HB-500

TRANSCIVERS



HEADQUARTERS FOR CB EQUIPMENT

See Pages 126-140

Winter
Catalog
No. 652

LAFAYETTE

MAIL ORDER & L. I.,
SALES CENTER

111 JERICHO TURNPIKE
(West of So. Oyster Bay Rd.)

SYOSSET,
L. I., N. Y. 11791

Shop-by-Phone Dept.
516 Walnut 1-7500

Other Departments
516 Walnut 1-7700

Other Stores

NEW YORK
BRONX
BROOKLYN
JAMAICA
NEW YORK
SCARSDALE

MASS.
BOSTON
NATICK

NEW JERSEY
NEWARK
PARAMUS
PLAINFIELD

FOR COMPLETE
ADDRESSES AND
STORE HOURS
See Page 3

FOR LAFAYETTE
"ASSOCIATE STORE"
LOCATIONS—
See Page 141

FOR EASY PAY
INFORMATION
See Center Insert A

For INDEX
See Page 3

"LIVE BETTER ELECTRONICALLY WITH LAFAYETTE"

NEW! LAFAYETTE MODEL LR-800 70-WATT COMPLETE AM-FM STEREO RECEIVER



- Nuvistor "Front-end" with 1.5 μ v Sensitivity
- FM "Stereo Search" Circuitry—Signals Presence of Stereo Broadcasts
- Complete Preamplifier Control Facilities—70-watt Amplifier
- Variable AFC control
- Front Panel Stereo Headphone Jack
- Bar-Type Tuning Indicator for AM and FM

199⁵⁰

\$10 monthly

The deluxe Model LR-800 contains on one compact chassis all the electronics necessary for a superb complete home music system. Just add speakers to enjoy the magnificent fidelity of FM, FM Stereo or high quality standard AM broadcast. Addition of a phono or tape transport completes your high fidelity system. Features: Extremely sensitive 'Nuvistor' front end pulls in FM stations free of noise and spurious signal interference. Amazing "Stereo Search" circuit pinpoints stereo stations quickly and positively with a tone signal heard through your loudspeakers. Bar-type electron-ray tuning indicator and large easy-to-read slide rule dial, with flywheel tuning action make tuning FM or AM a pleasure. Variable AFC controls "locks-in" stations. Powerful 70-watt stereo amplifier reproduces all program material with clean sound even with inefficient speaker systems. The audio control center features separate friction-lock bass and treble controls for each channel, balance control, rumble and FM noise filter; loudness switch and front panel stereo headphone jack/speaker "off" switch for private listening. Tape monitor lets you evaluate recorded material as you tape it. Separate Mode selector

permits choice of Left channel, Right channel, Stereo, Mix and Reverse. Input selector controls access to AM, FM, FM stereo tuner, Phono, Tape and Auxiliary program sources. Handsome gold extruded aluminum panel and contrasting case go well with any decor. 17Wx 5 $\frac{7}{8}$ Hx14"D. For 117V 50/60 cycles AC. Shpg. wt., 40 lbs. Imported. 99 K 0005WX \$10 Monthly Net 199.50

SPECIFICATIONS

Tuner Section—FM Sensitivity: 1.5 μ v for 20 db quieting. MPX Separation: 37 db @ 400 cps, Frequency Response: FM Mono—20-20,000 cps \pm 1db, FM Stereo 50-15,000 cps \pm 1db. Harmonic Distortion: Less than 0.5% @ 1KC. Amplifier Section—Power Output: 35 watts per channel Music Power, Hum and Noise: 55 db low level, 80 db high level. Harmonic Distortion: 1% at full output. Output Impedances: 8 & 16 ohms, switch selected. Equalization: RIAA (Mag), NAB (tape Head). Tubes: 24 Inclu. EM-84 tuning eye, 9 diodes, 1 selenium rectifier. 2 AC receptacles, 1 switched.

LAFAYETTE 70-WATT STEREO SYSTEMS FEATURING MODEL LR-800 AM-FM STEREO RECEIVER



GARRARD AT60

CHOICE OF STEREO CARTRIDGE



Pickering V-15/AT-1

Empire 880

Shure M7/N21D

AS LOW AS

28850

13.50 Monthly

2 SK-270

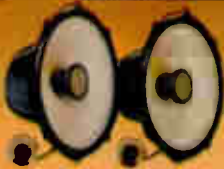

2 SK-58



2 SK-300 DECORETTE V



2 ELIPTOFLEX

- Lafayette LR-800 70 Watt AM-FM Stereo Receiver
- Garrard Model AT60 4 Speed Record Changer
- Pickering V15/AT-1 Diamond Needle Cartridge*
- Wood Base for Changer (Specify Oiled Walnut or Mahogany)
- 2 Lafayette SK-300 "Decor-ette V" 5-Speaker Slim Speaker Systems (Oiled Walnut).

Above stereo system with your *choice of Pickering V15/AT-1, Shure M7/N21D, or Empire 880 diamond needle cartridge; complete with all necessary cables and instructions. Shpg. wt., 96 lbs.

21 K 9746CWX Net 295.50

Same as above except with 2 Lafayette famous SK-58 12" Free Edge Coaxial Speakers instead of SK-300 "Decor-ette V" Speaker systems. Shpg. wt., 84 lbs.

21 K 9753CWX Net 288.50

Same as 21 K 9753CWX plus 2 Lafayette famous patented Eliptoflex enclosures. Shpg. wt., 132 lbs. (Specify Oiled Walnut or Mahogany).

21 K 9754CWX Net 345.95

Same as 21 K 9746CWX except with 2 Lafayette superb SK-270 Decor-ette II 5-speaker slim speaker systems (oiled walnut) instead of Decor-ette V speaker systems. Shpg. wt., 110 lbs.

21 K 9749CWX Net 350.50

You Can Depend On LAFAYETTE...

Mail Order Division

Our modern Mail Order Headquarters, located on over 8 acres of land, includes expanded warehouse facilities plus the most modern handling equipment to give you quicker service. Within 24 hours after receipt, most orders are processed, picked, wrapped and shipped on their way.

Retail Store Division

12 Convenient Locations

Visit any Lafayette store and see a wide assortment of merchandise from this catalog as well as many non-catalog items. Also be sure to see the custom-designed Sound Studios and Lafayette's Ham Shack. Trained, courteous sales personnel will help you with your selections.
For Associate Store Locations See Page 141

| | | | | | |
|---|---|---|---|---|---|
| OUR 2 NEWEST STORES | | NEW YORK - 45th St. | | BROOKLYN, N. Y. | |
| Mail Order and Sales Center SYOSSET, L. I., N. Y. 111 Jericho Turnpike (West of So. Oyster Bay Rd.) Shop By Phone Dept. 516 WAINUT 1-7500 All Departments 516 WAINUT 1-7700 Open Mon., Thurs. & Fri. 'til 9:30 P.M. | | 71 West 45 St. (between 5-6 Aves.) Phone 212 757-3121 Open Thurs. 'til 9:00 P.M. | | 2265 Bedford Avenue (cor. Snyder Ave.) 212 IN 9-8900 Open Mon., Wed., Thurs., Fri. 'til 9:30 P.M. | |
| | | SCARSDALE, N. Y. | NEW YORK, N. Y. | JAMAICA, N. Y. | BRONX, N. Y. |
| | | 691 Central (Park) Ave. (½ mile north of Ardley Rd.) 914 GR 2-2700 Open Mon. Thurs., Fri. 'til 9:30 P.M. | 100 Sixth Avenue (1 block north of Canal St.) 212 WO 6-5300 Open Thurs. 'til 8:45 P.M. | 165-08 Liberty Avenue. (off Merrick Rd.) 212 AX 1-7000 Open Mon., Thurs., Fri. 'til 8:45 P.M. | 542 E. Fordham Road (3 blocks east of Webster Ave.) 212 FO 7-8813 Open Thurs. 'til 8:45 P.M. |
| NATICK, MASS. | BOSTON, MASS. | NEWARK, N.J. | PLAINFIELD, N.J. | PARAMUS, N.J. | |
| 1400 Worcester Street (Rt. 9 opposite Shopper's World) Phone: 617 875-6146 Open Wed., Thurs., Fri. 'til 9:30 P.M. | 584 Commonwealth Ave. (½ block above Kenmore Sq.) Phone: 617 267-8900 Open Mon. thru Fri. 'til 9:00 P.M. | 24 Central Avenue (just west of Broad St.) 201 MA 2-1661 Open Wed. 'til 8:45 P.M. | 139 W. 2nd Street (1 block E. of Front St.) 201 PL 6-5100 Open Thurs. 'til 8:45 P.M. | 182 Route 17 (1 mile north of Garden State Plaza) 201 CO 1-8800 Open Mon., Wed., Fri. 'til 9:30 P.M. | |

INDEX

| | | | | | |
|---------------------------|----------------------|--------------------------------|--------------|-----------------------------|-------------------------|
| Amateur Gear | 151-155 | HI-FIDELITY SYSTEMS | | Receivers, Special Purpose | 150 |
| Amplifiers, Hi-Fi | 6-12, 16, 18-21 | AND COMPONENTS | 2, 4-21, 76 | Receivers, Stereo | 2, 4, 5, 15, 18, 52, 53 |
| Kits | 21, 84 | Intercoms | 68, 69 | Record Changers | 52, 53 |
| Antennas, TV and FM | 98-101 | Lamps & Electrical Accessories | 73, 74 | Serviceman's Parts | 81, 93-95, 97 |
| ASSOCIATE STORE ADDRESSES | 141 | Microphones | 70, 71, 136 | Shortwave Radios | 63, 64, 83 |
| Auto Accessories | 102-110 | Movie Cameras | 112, 113 | SPEAKERS AND SPEAKER | |
| Batteries & Chargers | 110, 111 | Multitesters | 142, 144 | SYSTEMS | 35-46, 75, 93 |
| BELOW COST SPECIALS | 75-82 | Musical Instruments | | Tape Recorders & Acc. | 26-34, 77, 156 |
| Cabinets, Hi-Fi & Spkr. | 47-50 | & Accessories | | Telephone Equipment | 67, 68 |
| Cameras and Accessories | 82, 112-116 | Needles | 22-25 | Telescopes, Binoculars | 117, 118 |
| Cartridges, Hi-Fi | 51, 59 | Ordering Information | See Insert B | TELEVISION SETS | 61 |
| CITIZENS BAND | | Phono Accessories | 55, 58, 59 | Test Equipment | 107, 142-148, 153 |
| EQUIPMENT | 78, 79, 126-140, 153 | Phonographs | 56, 57, 61 | Timers & Counters | 149 |
| Drafting & Drawing | 120 | PICTURE TUBES | | Tools, Std. & Power | 86, 105, 121-125 |
| EASY PAY PLAN | CENTER INSERT A | Public Address | 72 | TRANSISTOR RADIOS | 62-64 |
| Educational Kits | 83, 85, 86 | RADIOS | | Tuners | 13, 14, 19-21, 84, 89 |
| Experimenter Specialties | 81, 85-93, 97 | Auto | 102, 103 | Turntables | 54 |
| Headphones, Stereo | 51 | Portable | 62-64 | WALKIE-TALKIES | 130, 132-135 |
| Hearing Aids, Earphones | 66, 81 | Table | 65 | | |

Industrial Electronics Division

Industrial, Institutional and Government Agency Buyers

| | | |
|--|---|--|
| NEW ENGLAND | NEW JERSEY | METROPOLITAN NEW YORK—LONG ISLAND |
| 1400 Worcester St., Natick, Mass. Phone: 617 875-1358 | 24 Central Ave., Newark 2, N. J. 201 Mitchell 3-6868 | 165-08 Liberty Ave., Jamaica 33, N. Y. 212 Olympia 8-5050 |

International Sales Division

SERVICES BUYERS WORLDWIDE.
WRITE TO:
International Sales Division
Lafayette Radio Electronics Corporation
P.O. Box P
Syosset, L.I., N.Y., U.S.A.

EXPORT TERMS

Full payment must accompany the order. Enclose check or draft; or remit international Postal Money Order or confirmed, irrevocable Letter of Credit. All payments should be in U.S. Dollars payable at U.S. Bank. Include 20% above merchandise value to cover international postage, insurance, consular fees and other export shipping costs. Overpayments are promptly refunded. All prices F.O.B. our warehouses and subject to change without notice.

FREE!

LAFAYETTE'S NEW 1965 CATALOG No. 650

Over 500 Pages

Featuring Everything in Electronics for
Home • Industry • Laboratory

from the
"World's Hi-Fi & Electronics Center"

44 Years of Dependable Service at Lafayettes' Traditionally Low, Low Prices.

If you do not have the FREE Lafayette Catalog 650, or if you want a copy for a friend, fill out and mail the coupon now!

Lafayette Cat. No. 652 3



LAFAYETTE
RADIO
ELECTRONICS

Dept. 652, P.O. Box 10

Syosset, L. I., N. Y. 11791

Send the FREE 1965 Lafayette Catalog No. 650

Name _____ Please Print
Address _____
City _____ State _____ Zip _____

NEW LAFAYETTE 30-WATT AM-FM STEREO RECEIVER MODEL LR-400

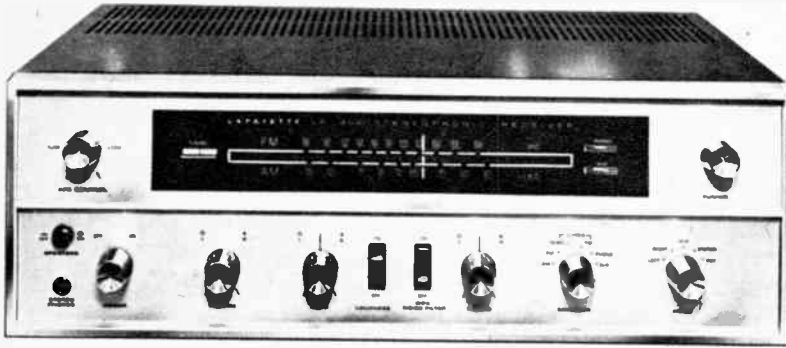

Only
169⁵⁰

\$8 Monthly

- Sensitive Nuvistor Front End
- 16 Tubes plus 9 Diodes
- 30-Watt Fully Integrated Stereo Amplifier
- Tone Stereo "Searcher" For Locating Stereo Stations Easily and Positively
- FM Stereo Noise Filter
- Front Panel Stereo Headphone Jack
- Bar-Type "Magic-Eye" For Precise Tuning
- Complete Stereo Controls

JUST ADD SPEAKERS FOR A COMPLETE FM/AM STEREO SYSTEM

Make the LR-400 the heart of your stereo system. Combines on one compact chassis a sensitive stereo FM-AM tuner, a powerful 30-watt stereo amplifier and complete control facilities for extraordinary performance. Highly sensitive nuvistor provides an additional RF stage to a wide-band tuner circuit to bring in fringe signals with ease. The tuner also utilizes Lafayette's famous stereo "Search" circuit which takes the guesswork out of finding FM stereo stations. During tuning for stereo, a continuous tone is heard through your loudspeakers when a stereo station is on the air. Switchable filter reduces hiss and background noise during reception of weak stereo signals. A superb 30-watt stereo push-pull amplifier brings out the rich sound present in FM and modern stereo records. Annoying Hum and noise are virtually reduced to the vanishing point. A complete complement of operating controls provide optimum flexibility. As added conveniences, a front panel stereo headphone jack and speaker on-off switch for your private listening pleasure, and phono and aux., indicator lights are provided. Controls include: Variable AFC, Tuning, Power on/off, Concentric friction lock Volume, Base and Treble; Selector (AM, FM Stereo Search, Stereo FM, Phono Aux.); Mode

Switch (Left, Right, Mix, Stereo, Rev.) and switches for loudness and MPX Noise Filter. Rear panel controls are: Impedance selector switch, speaker phone switch and hum balance. AC Convenience receptacle. Handsome tilted gold extruded aluminum panel for easier view and contrasting case harmonize with any decor. 17 1/4"Wx5 5/8"Hx12 1/4"D. For 117V, 50/60 cycles AC. Shpg. wt., 36 lbs. Imported.

99 K 0004WX Net 169.50

SPECIFICATIONS

TUNER: FM 88-108MC, AM 550-1600KC; SENSITIVITY: 2 1/2 UV For 20 db S/N ratio; FM SEPARATION: 25 db @ 400 cps; FREQUENCY RESPONSE: 20-20,000 cps ± 2 db. AFC, MPX, Noise Filter. AMPLIFIER: Output: 15 watts per channel (music Power); TONE CONTROLS ± 10 db boost & cut; EQUALIZATION: RIAA; HUM & NOISE: Mag. Phono —55 db; Aux. —68 db. INPUTS: 4 Pair, SPEAKER IMPEDANCE: 8-16 ohms. TUBES: 16 Tubes, 9 diodes, plus EM84 Tuning eye.

MATCHED STEREOPHONIC SYSTEMS FEATURING MODEL LR-400 30-WATT AM-FM STEREO RECEIVER

AS LOW AS

234⁹⁵

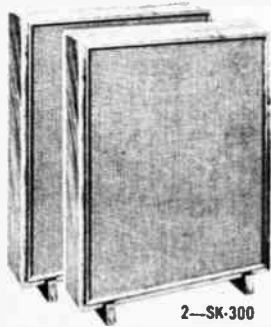

2—SK-300



Garrard Model 50

CHOICE OF STEREO CARTRIDGE



Pickering V-15/AT-1



Empire 880



Shure M7/N210



2—SK-180

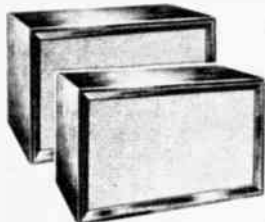

2—Eliptoflex Enclosures



Garrard Changer AT-60

LAFAYETTE LR-400 30 WATT AM-FM STEREO Tuner-Amplifier
Garrard Model 50 4-Speed Record Changer
Pickering Model V15/AT-1 Diamond Needle Cartridge*
Wood Base for Changer (Specify Oiled Walnut or Mahogany)
2 LAFAYETTE SK-300 "Decor-ette V" 5-Speaker Slim Speaker Systems (Oiled Walnut)

Above Hi-Fi Stereophonic system with * choice of Pickering V15/AT-1, Shure M7/N21D, or Empire 880 diamond needle cartridge complete with all necessary cables and instructions. Shpg. wt., 86 lbs.
21 K 9521CWX 11.50 Monthly Net 249.95
Same as above except with Garrard Model AT-60 record changer instead of Garrard Model 50. Shpg. wt., 88 lbs.
21 K 9522CWX 12.50 Monthly Net 264.95
Same as 21 K 9521WX system except with 2 Lafayette Model SK-180 10" Trihelix® 3-way speakers instead of 2 SK-300 speaker systems; Shpg. wt., 68 lbs.
21 K 9523CWX 11.00 Monthly Net 234.95
Same as 21 K 9523WX stereo system plus 2 Lafayette famous patented Eliptoflex speaker enclosures (specify oiled walnut, walnut, or mahogany). Shpg. wt., 116 lbs.
21 K 9524CWX 15.00 Monthly Net 294.95

LAFAYETTE MODEL LA-215 COMPLETE AM-FM STEREO RECEIVER



ONLY
109⁵⁰
\$9.00 monthly

- 15 Tubes plus 6 Diodes • Frant Panel Stereo Headphone Jack • Complete Stereo Preamp Facilities • 11 Front Panel Controls • Just Add Speakers for Complete Stereo System

A Fine AM-FM Tuner with Built-in-Multiplex plus a 12-WATT COMPLETELY INTEGRATED STEREO AMPLIFIER

A complete stereo control center with AM/FM tuner with built-in multiplex and a 12-watt stereo amplifier. FM section features advanced stereo "Search" circuit which introduces a tone when a multiplex signal is tuned in. Changing the selector switch from stereo search to FM stereo permits normal MPX reception, AFC assures low drift FM reception. MPX noise filter eliminates unwanted station noise. AM section features superhet circuit and a built-in antenna. Front panel controls; power on/off; concentric volume/balance; master bass; master treble; 6-position selector switch (AM, FM, Stereo Search, Stereo FM, Phono, Aux.); tuning, stereo-mono mode switch; MPX noise filter on/off; AFC on/off; speakers on/off. Rear panel has speaker phase switch and

8 & 16 ohm impedance selector; stereo inputs for mag phono, crystal phono, auxiliary; stereo outputs for tape recorder; AC receptacle. Illuminated, easy-to-read slide rule dial and flywheel tuning. Finished in gold and brown, with metal cabinet, 117 volts, 50/60 cps AC. 16½Wx5½Hx11½"D. Imported. Shpg. wt., 27 lbs. 99 K 0018WX Model LA-215 Net 109.50

SPECIFICATIONS

TUNER FM Sensitivity: 3µv for 20 db S/N ratio—Frequency Response: FM, 20-20,000 cps ±2 db; FM Stereo, 50-15,000 cps ±2 db—Harmonic Distortion: FM, less than 1% @ 400 cps; FM Stereo, less than 2% @ 400 cps—FM Stereo Separation: 25 db @ 400 cps.
AMPLIFIER Power Output: 6 watts music power per channel—Sensitivity: Mag. Phono, 3.5 mv @ 4.5 watts output Crystal, 30 mv @ 4.5 watts output—Hum and Noise—55 db for low level input—75 db for high level input—Output Impedance: 8 & 16 ohms switched—Phono Equalization: RIAA.

LAFAYETTE COMPLETE STEREOPHONIC HI-FI SYSTEMS FEATURING THE LA-215 12-WATT AM-FM STEREO RECEIVER

Lafayette LA-215 12-watt AM-FM Stereo Tuner-Amplifier.

Lafayette-Webcor Model PK-770 4 Speed Automatic Record Changer with Astatic Turnover Cartridge and Diamond LP Stylus.

Wood Base for Changer (Oiled Walnut).

2 Lafayette SK-265 "Slenderette III" 2-Speaker Slim Speaker Systems with all necessary cables and instructions.

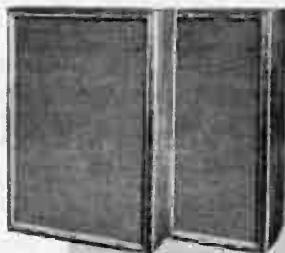

LAFAYETTE-WEBCOR
PK-770

Complete system as above. Shpg. wt., 75 lbs.
21 K 9956WX Net 164.50

Same as above except with Garrard Model 50 4 speed changer with choice of Pickering V15/AT-1, Shure M7/N21D or Empire 880 diamond stylus cartridge instead of Lafayette-Webcor Model PK-770 changer. Shpg. wt., 75 lbs.

21 K 9957WX Net 179.50

Same as 21 K 9956WX except with 2 Lafayette SK-123 Ultra—Compliance speaker system (oiled walnut finish) instead of SK-265 speaker systems. Shpg. wt., 75 lbs.

21 K 9663 Net 172.50

Same as 21 K 9957WX except with 2 Lafayette SK-123 ultra—Compliance speaker system (oiled walnut finish) instead of SK-265 speaker systems. Shpg. wt., 75 lbs.

21 K 9664 Net 189.50

Same as 21 K 9957WX except with 2 Lafayette famous SK-58 12" free-edge coaxial speakers instead of SK-265 "Slenderette III" speaker systems. Shpg. wt., 65 lbs.

21 K 9962WX Net 199.50

Same as 21 K 9962WX plus 2 Lafayette famous patented Eliptoflex speaker enclosures (specify oiled walnut, walnut, or mahogany). Shpg. wt., 112 lbs.

21 K 9963WX Net 259.50

2 SK-265
SLENDERETTE III



GARRARD MODEL 50

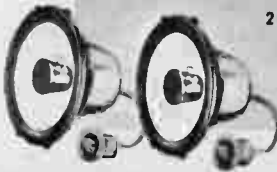

2 SK-123A



LAFAYETTE-WEBCOR
PK-770



2 SK-123A



2 ELIPTOFLEX

ONLY
164⁵⁰

As Little As
\$8 Monthly

Hi-Fi Systems are Available on Easy Pay Plan—See Center Insert A

Lafayette Cat. No. 651 5

LAFAYETTE 44-WATT ALL-TRANSISTOR STEREO AMPLIFIER MODEL LA-200



109⁵⁰

55 Monthly

19 Transistors
5 Silicon Diodes

• Complete Stereophonic Control Facilities • Modern Styling, Compact Size • Cool Running, Reliable Transistor Circuitry • 20-20,000 cycles ± 1 db • Smooth, Fast Transient Response • Freedom From Hum and Noise • Instantaneous Warmup

YEARS AHEAD FEATURES

- | | |
|---|---|
| 1 Smooth Positive Action Controls and Switches | 6 Massive Heat Sink to Insure Cool operation of Power Transistors |
| 2 Front Panel Stereo Phone Jack | 7 Speaker Phase Switch |
| 3 Oversize Electrolytic Capacitors for Better Power Supply Filtering, and Longer Life | 8 2 AC Convenience Outlets, One Switched |
| 4 Military-type Terminal Boards Give Greater Reliability | 9 Fused AC Line |
| 5 Heat Shield for extra component protection | 10 Massive Power Transformer |
| | 11 Complete Overload or Short Circuit Protection |
| | 12 19 Transistors, 5 Silicon Diodes |

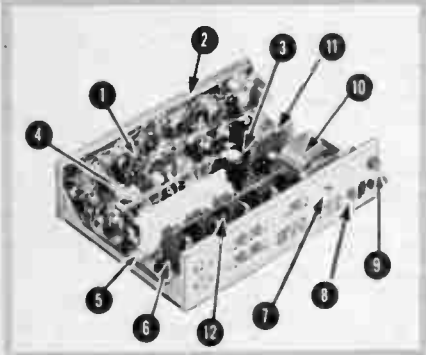

SPECIFICATIONS

IHF Music Power: 44 watts; 22 watts per channel; 18 watts continuous sine wave power per channel. Frequency Response ± 1 db, 20-20,000 cps. Harmonic Dist.: 1%. Hum & Noise: Tuner, -74 db; Mag. Phono, -54 db. Tone Controls: ± 10 db. Inputs: (5 pairs); Tape Head; Mag. Phono; Cer. Phono; Tuner; Aux. Outputs: Tape Recorder, 4 ohms (also for 8 and 16 ohm speakers).

The LA-200 combines a complete stereophonic preamplifier and a dual channel 44-watt power amplifier on one compact chassis. All-transistor circuit offers advantages not found in tube sets . . . The initial performance level is maintained for years without adjustments when operated properly, features include: Front panel stereo headphone receptacle, scratch and rumble filters, separate on-off power switch, bass and treble controls for each channel, 4-position mode switch, volume, balance and 5-position input selector switch, speaker on/off switch, Phase switch on rear panel; 2 AC convenience receptacles, one switched; pilot light. Operates with 4, 8 or 16-ohm speakers. Brown textured finish case, gold finish aluminum panel and knobs. For 105-125V 50/60 cycles AC. Size: 13Wx 4 1/2 Hx 9" C (with legs). Shpg. wt., 15 lbs. Imported.

99 K 0012WX Model LA-200 Net 109.50

44-WATT HI-FI STEREO SYSTEMS WITH LAFAYETTE MODEL LA-200 ALL-TRANSISTOR STEREO AMPLIFIER

CHOICE OF STEREO CARTRIDGE



Garrard Model 50

Lafayette LA-200 44-Watt All-Transistor Stereo Amplifier
Garrard Model 50 4-Speed Stereo Changer
Pickering V15/AT-1 Diamond Needle Cartridge*
Wood Base for Changer (Oiled Walnut or Mahogany)
2-Lafayette SK-300 "Decor-ette V" 5-Speaker Slim Speaker System (Oiled Walnut)



2 SK-300



As Low As
187⁵⁰
\$9 Monthly



Garrard Model AT60



2 SK-180



2-Eliptoflex Enclosures

Complete system as above plus all necessary cables and instructions. Shpg. wt., 64 lbs.

21 K 9701CWX \$9 Monthly Net 188.50

Same system as 21 K 9701CWX except with Garrard Model AT60 record changer instead of model 50. Shpg. wt., 66 lbs.

21 K 9702CWX \$10 Monthly Net 199.50

Same as 21 K 9701CWX except with 2 Lafayette SK-180 10" Trihelix® three way speakers instead of Decor-ette V speaker systems. Shpg. wt., 46 lbs.

21 K 9707CWX \$9 Monthly Net 187.50

Same as 21 K 9707CWX plus 2 Lafayette famous patented Eliptoflex speaker enclosures (specify oiled walnut, walnut, or mahogany). Shpg. wt., 94 lbs.

21 K 9710CWX \$11.50 Monthly Net 245.25

* Specify your choice of Pickering V15/AT-1, Shure M7/N21D or Empire 880 diamond needle cartridge.

NEW! LAFAYETTE 40-WATT ALL-TRANSISTOR STEREO AMPLIFIER MODEL LA-340

- Big 40 Watts of Music Power (IHFM)
- Extremely Cool Running
- Instant Warm Up—Plays Immediately
- Tape Recording Outputs
- Transformerless Output Circuit For Lower Distortion
- 19 Transistors, 4 Diodes
- Slim-Modern Styling



79⁹⁵

\$5 Monthly

Low in cost, high in performance! If you wanted the thrilling sound of transistor amplification but found it too expensive—the Lafayette LA-340 is your answer. New slim styling with virtually no heat production lets you place it anywhere in the room. Full range sound is achieved with a frequency response of 30-20,000 cycles. Five pairs of stereo inputs accommodate a tuner, phono using magnetic or ceramic cartridges, tape recorder and auxiliary sources. Accepts 4, 8 or 16 ohm speakers. Terminal board wiring assures mechanical stability. Other features include, front panel stereo headphone jack and switch to silence loudspeakers, and concentric volume control, 2 AC receptacles for convenience in connecting other components. Beautiful gold panel and matching knobs. Size: 11 $\frac{3}{4}$ Wx3 $\frac{3}{4}$ Hx10 $\frac{1}{2}$ " deep incl. knobs and dark brown metal case. For 117V 50/60 cycles AC. Shpg. wt., 10 lbs.

99.K 0011WX Model LA-340 Imported Net 79.95

SPECIFICATIONS

Power Output: 40 Watts IHFM; 20 watts IHFM music power per channel. 12 watts continuous sine wave power per channel. Frequency Response: ± 1 db 30-20,000 cps. Harmonic Distortion: 1% Hum and Noise: -70db on Tuner, Aux., -56 db Magnetic Phono, Tape Head. Cross talk: 52 db @ 100 cps. Sensitivity: Tuner 0.25 volts, .75 volts Aux. Inputs: 5 pairs—Tape Head, Magnetic Phono, Ceramic Phono, Tuner, Auxiliary. Outputs: 4, 8, 16 ohm, two high impedance for tape recording; Front panel stereo headphone jack. Equalization: NAB; RIAA. Controls: Switches — Power on/off, spkr./Phono, Bass, Treble, Mode (Left, Right, Stereo, Rev). 2 AC receptacles, one switched.

LAFAYETTE 40-WATT STEREO SYSTEMS WITH MODEL LA-340 ALL-TRANSISTOR STEREO AMPLIFIER

186⁵⁰

\$9 monthly

Lafayette LA-340 40-Watt All-Transistor Stereo Amplifier

Garrard Model 50 4-Speed Record Changer
Wood Base for Changer (Specify oiled walnut or Mahogany)

Pickering V15/AT-1 Diamond Needle Cartridge*

2 Lafayette SK-300 "Decor-ette V" 5 Speaker Slim Speaker System (oiled walnut)

Complete 40 watt stereo system as above with choice of Pickering V15/AT-1, Shure M7/N21D, or Empire 880 diamond needle cartridge; and with all necessary cables and instructions. Shpg. wt., 64 lbs.

21 K 9785CWX Net 186.50

Same as above except with Garrard AT60 4 speed record changer instead of Garrard Model 50 record changer. Shpg. wt., 66 lbs.

21 K 9786CWX Net 197.50

Same as 21 K 9785CWX except with 2 Lafayette famous SK-58 12" free edge coaxial speakers in 2 Lafayette patented Eliptoflex speaker enclosures. (Specify oiled walnut, walnut or mahogany)—instead of 2 Decor-ette V speaker systems. Shpg. wt., 100 lbs.

21 K 9790CWX Net 234.95

Same as 21 K 9790CWX except with Garrard AT60 instead of Garrard Model 50 record changer. Shpg. wt., 102 lbs.

21 K 9792CWX Net 245.50

CHOICE OF
STEREO
CARTRIDGE



GARRARD MODEL 50
ON BASE



2 SK-300

2 SK-300
DECOR-ETTE V

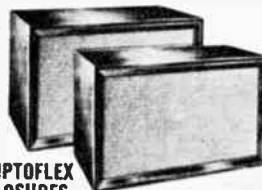

2 ELIPTOFLEX
ENCLOSURES



GARRARD AT60
ON BASE

LAFAYETTE MODEL LA-224A 30-WATT STEREO AMPLIFIER



59⁹⁵

\$5 MONTHLY

- Stereo Headphone Jack
- Independent Concentric Bass & Treble Controls For Each Channel
- Concentric Volume/Balance Control

FIRST RATE—a Brilliant Stereo Performer... an amplifier with wide-range frequency response, low distortion, low hum and noise characteristics you can expect of a quality hi-fi amplifier designed for placement anywhere in your home. A full range of control facilities have been provided to assure complete Stereo capability and flexibility. Two dual concentric Bass and Treble controls provide separate and individual tone controls for each channel. A dual concentric volume control acts as an independent level control for each channel and allows precise channel balancing. Fast, easy operation between Stereo, Reverse Stereo, Monophonic Left channel and Monophonic Right channel is furnished by a Mode switch. A selector Switch furnishes switching from Aux, Tuner or Phono music sources. In addition slide switches are included for: Rumble Filter (off-on) Phase (normal-reverse) and to take full advantage of the front panel Headphone jack a switch is provided for speaker or phone operation. Paired inputs located on the rear panel accommodate any of the ordinary stereo sound sources—inputs are included for magnetic, crystal or ceramic cartridges; Tuner, tape or auxiliary (high output) plus Tape Out jacks for recording through

- Frequency Response: 25-25,000 CPS ± 1.5 db Average at Rated Output
- Hum & Noise—75 db Below Rated Output
- High Sensitivity Allows Use With Most Stereo Cartridges

your tape recorder. Beautifully styled in a low silhouette enclosure, color keyed to do justice to any decor. Ivory and gold front panel is contrasted by gold metal knobs and enclosure. Complete with cage and legs. Size: 5 $\frac{1}{2}$ Lx13 $\frac{3}{4}$ Wx8 $\frac{1}{2}$ "D. For 115V 60 cycle AC operation. Shpg. wt., 20 lbs. Imported.
99 K 0026WX Net **59.95**

SPECIFICATIONS

Power Output: 15 watts rms per channel stereo. 30-watts rms monaural operation. Frequency Response: 25-25,000 CPS ± 1.5 db average at rated output. Hum and Noise: Mag Phone —56db below rated output. Tuner —75db below rated output. Distortion: 1.25% total harmonic distortion at 15 watts (1KC), less than .25% total harmonic distortion at 1 watt (1KC). Sensitivity: Low Level (Mag Input) 5.5mv at full output, High Level .6v at full output. Tone Controls: ± 11 db. Outputs: Dual 8 and 16-ohm impedance speaker outputs. Dual Tape outputs. Tube Complement: Total of 10, 5-12AX7, 4-6BQ5, 1-5AR4.

LAFAYETTE 30 WATT MATCHED STEREO PHONO SYSTEMS WITH LA-224A STEREO AMPLIFIER

137⁵⁰

\$7.00 Monthly



GARRARD 50

CHOICE OF STEREO CARTRIDGE



Pickering V 15/AT-1



Empire 880



Shure M7, N210

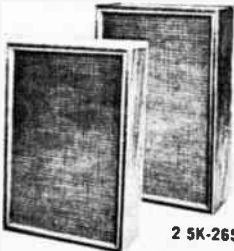

2 SK-265

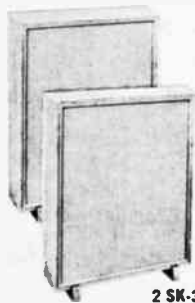

2 SK-300



2 SK-58

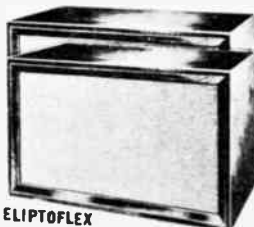

2 ELIPTOFLEX

Lafayette Model LA-224A 30-watt Stereo Amplifier. Garrard Model 50 4-speed Record Changer. Pickering V15/AT-1 Diamond Needle Cartridge*. Wood Base for Changer (Specify Oiled Walnut or Mahogany).

2 Lafayette Model SK-265 "Slenderette III" 2-Speaker Slim Speaker Systems. (Oiled Walnut).

Above stereophonic hi-fi system complete with necessary cables and instruction. Shpg. wt., 65 lbs.
21 K 9665WX Net **137.50**

Same as 21 K 9665WX except with 2 Lafayette Model SK-300 "Decor-ette V" 5 speaker slim speaker systems (oiled walnut) instead of 2 Model SK-265 speaker systems. Shpg. wt., 69 lbs.

21 K 9666WX Net **137.50**

Same system as 21 K 9665WX except with 2 Lafayette famous SK-58 12" free-edge coaxial speakers instead of Slenderette III speaker systems. Shpg. wt., 57 lbs.

21 K 9667WX Net **136.50**

Same as 21 K 9667WX plus 2 Lafayette patented Eliptoflex speaker enclosures (Specify oiled walnut, walnut, or mahogany). Shpg. wt., 105 lbs.

21 K 9668WX Net **214.50**

* Specify choice of Pickering V15/AT-1, Shure M7/N210, or Empire 880 Cartridge.

NEW! LAFAYETTE MODEL LA-260 40-WATT STEREO AMPLIFIER

79⁹⁵

\$5 Monthly



- Concentric Volume, Bass & Treble Controls
- Less Than 1% Harmonic Distortion At Rated Output
- Frequency Response: ± 1 db 40-20,000 @ Rated Output
- Front Panel Stereo Headphone and Tape Output Jacks
- High Sensitivity — Will Accept Majority of Stereo Cartridges

If you are interested in owning an outstanding high fidelity system, then the heart of it should be the Model LA-260. 40 big watts of output gives you full bass, solid midrange and brilliant treble response — even with popular low efficiency speakers. Complete master control facilities include concentric bass, treble and volume controls to customize the sound to suit your taste and listening area. Low cut rumble filter eliminates possible annoying rumble from record players; selector switch gives choice of phono, tuner, tape head and auxiliary program sources. Mode switch (Left, Right, Stereo

SPECIFICATIONS

Music Power Output: 40 watts, 20 watts each channel. Harmonic Distortion: Less than 1% at rated output. Frequency Response: ± 1 db 40-20,000 cps. Hum and Noise: Tuner —75 db; Magnetic phono —58 db. Sensitivity: For full output—Mag Phono 4.5 mv; High level: .5 v. Inputs (5 pairs): Tape Head, Mag Phono, ceramic phono, Tuner, Aux. Outputs: 2-pair tape recorder, stereo headphone jack, 8 and 16-ohm per channel speaker impedance. Tubes: (3) 12AX7, (2) 6BL8, (4) 6BQ5, 5AR4, GZ34, rectifier.

& Rev) positions. Panel Speaker-Phonesswitch for choice of headphone or loudspeaker listening. Phase switch corrects speaker phasing without changing wires. In addition tape recorder outputs are provided on front and rear panels for your convenience. Tape head inputs permit direct playback from your recorders tape heads. AC outlet. Ivory and Gold front panel with case. For 115V 60 cycle AC. Size: 14 $\frac{1}{2}$ "Wx5 $\frac{1}{4}$ "Hx11"D. Shpg. wt., 30 $\frac{1}{2}$ lbs. Imported. 99 K 0018WX Net 79.95

LAFAYETTE 40-WATT MATCHED STEREO PHONO SYSTEMS WITH MODEL LA-260 STEREO AMPLIFIER

174⁵⁰

\$9 monthly

- Lafayette LA-260 40-Watt Stereo Amplifier
- Garrard Model 50 4-Speed Record Changer
- Wood Base for Changer (Specify oiled walnut or mahogany)
- Pickering V-15/AT-1, Diamond Needle Cartridge*
- 2 Lafayette SK-300 "Decor-ette V" 5-Speaker Slim Speaker Systems (oiled walnut)

Complete featured stereo system above with all necessary cables and instructions plus * choice of Pickering V-15/AT-1, Shure M7/M21D, or Empire 880 diamond needle cartridge. Shpg. wt., 80 lbs.

21 K 9742CWX Net 174.50

Same as above but with Garrard Model AT60 4 speed record changer instead of Garrard Model 50 changer. Shpg. wt., 82 lbs.

21 K 9730CWX Net 186.50

Same as 21 K 9742CWX except with 2 Lafayette SK-180 10" Trihelix 3 way speakers instead of SK-300 speaker systems. Shpg. wt., 62 lbs.

21 K 9737CWX Net 170.50

Same as 21 K 9737CWX plus 2 Lafayette patented Eliptoflex speaker enclosures. (specify oiled walnut, walnut, or mahogany). Shpg. wt., 110 lbs.

21 K 9738CWX Net 227.75

Same as 21 K 9738CWX except with Garrard Model AT-60 4 speed record changer instead of Garrard Model 50 changer. Shpg. wt., 112 lbs.

21 K 9740CWX Net 238.50

GARRARD
MODEL 50
ON BASE



CHOICE OF STEREO CARTRIDGE

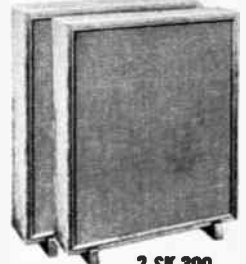

2 SK-300
Decor-ette V



GARRARD AT 60
ON BASE

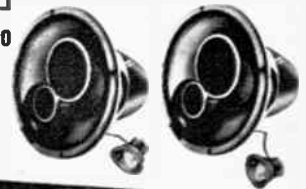

2 SK-180

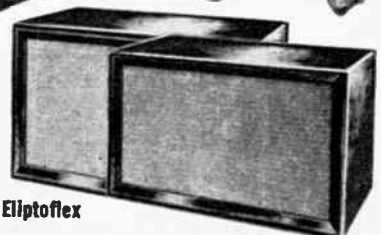

2 Eliptoflex

NEW! LAFAYETTE 70-WATT STEREO AMPLIFIER MODEL LA-350



Only
99⁵⁰
\$5 monthly

- Six Pairs of Stereo Inputs For All Sources
- Handsome Extruded Aluminum Front Panel
- DC On Preamp Filaments For Minimum Hum
- Tape Monitor Switch
- Stereo Headphone Jack On Front Panel
- Separate Channel Tone Controls

The deluxe Lafayette LA-350 is packed with power, features and handsome styling. 70 watts of sonic power produces tonal beauty to match its good looks. Delivers plenty of reserve power to drive even inefficient speakers to full listening levels. Eleven comprehensive front panel controls provide utmost flexibility—assures "custom" sound reproduction in your home. Six position program selector enables instant selection of music sources including tape head inputs for direct playback of tapes from a stereo tape recorder. Mode switch provides choice of left or right channels, mix, stereo and reverse channels. Separate bass and treble controls are friction-locked and are adjustable independently or simultaneously. Friction-locked balance controls adjust each stereo channel for perfect separation. Separate volume control and power switch makes possible undisturbed control settings — simplicity of

operation. Also features: tape monitor switch which lets you listen to tapes while recording, rumble filter, loudness switch and a convenient front panel stereo headphone jack with a switch to silence speakers for real private listening. Rugged construction and quality components will provide years of dependable performance. DC on preamplifier filaments and hum adjust controls on both DC and AC filament lines minimizes hum to extremely low levels. Two AC convenience outlets on rear panel apron permits simple connection of tuner and phono AC line. Handsome brushed gold extruded aluminum front panel and knobs with contrasting case fits in any decor. 14 $\frac{1}{2}$ "x5 $\frac{1}{4}$ "x10"D. For 117V, 60 cycles AC. Imported. Shpg. wt., 30 lbs.
99 K 0007WX Net **99.50**

SPECIFICATIONS

Power Output: 70 watts Music Power: 28 watts per channel continuous. Frequency Response: ± 1 db 15 to 30,000 cps at normal listening level. Harmonic Distortion: Less than 1%. Hum and Noise: 55 db down and Phono inputs, 76 db down on auxiliary inputs. Channel Separation: 50 db at 1KC. Inputs and Sensitivity: Tape Head and Phono 1,1.5 mv; Phono 2. 6 mv; Tuner, 200 mv; Auxiliary 1. 10 mv; Aux. 2. 750 mv. Output Impedances: 8 and 16 ohms. Tape Outputs: 2 pair. Tubes: (3) 12AX7/EGG83, (2) 6AN8, (4) 7198A; 5 diodes. 2 AC Outlets, 1 switched.

LAFAYETTE 70-WATT MATCHED STEREO SYSTEMS WITH MODEL LA-350 STEREO AMPLIFIER

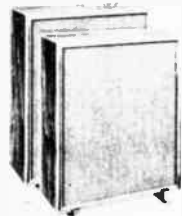

2 SK-300
Decor-ette V



GARRARD MODEL 50
ON BASE

AS LOW AS

184⁵⁰
\$9 monthly

Lafayette LA-350 70 Watt Stereo Amplifier
Garrard Model 50 4-Speed Record Changer
Wood Base for Changer (Specify oiled walnut or mahogany)
Pickering V15/AT-1 Diamond Needle Cartridge*
2 Lafayette SK-300 "Decor-ette V" 5 Speaker Slim Speaker Systems
(Oiled Walnut)

Complete featured system as above with your * choice of Pickering V15/AT-1, Shure M7/N21D, or Empire 880 diamond needle cartridge, and with all necessary cables and instructions. Shpg. wt., 30 lbs.
21 K 9601CWX Net **194.50**

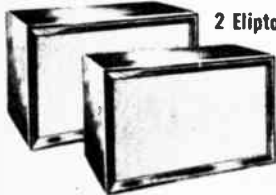

2 Eliptoflex®

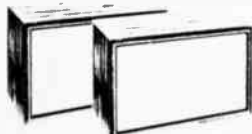

2 SK-275
Decor-ette III



2 SK-58



GARRARD MODEL
AT 60 ON BASE

ALTERNATE SYSTEMS

| System | Amp | Chang- er | Base | Cartridge | Speaker/ Speaker System | Speaker Cabinet | Wt. Lbs. | Net |
|--------------|--------|--------------|------|-----------|-------------------------------|--------------------|-------------|--------|
| 21 K 9602CWX | LA-350 | AT60 | † | Choice of | 2 SK-300 | Decor-ette V* | 81 | 204.50 |
| 21 K 9604CWX | LA-350 | 50 | † | Pickering | 2 SK-58 | ----- | 67 | 184.50 |
| 21 K 9605CWX | LA-350 | 50 | † | V15/AT-1 | 2 SK-58 | 2 Eliptoflex† | 115 | 242.25 |
| 21 K 9606CWX | LA-350 | AT60 | † | or Shure | 2 SK-58 | ----- | 69 | 194.50 |
| 21 K 9607CWX | LA-350 | AT60 | † | M7/N21D | 2 SK-58 | 2 Eliptoflex† | 117 | 252.95 |
| 21 K 9613CWX | LA-350 | 50 | † | or Empire | 2 SK-275 | Decor-ette III* | 115 | 269.50 |
| 21 K 9614CWX | LA-350 | AT60 | † | 880 | 2 SK-275 | Decor-ette III* | 117 | 279.95 |

† Specify oiled walnut or mahogany.
‡ Oiled Walnut, walnut or mahogany.
* Oiled walnut only.

Any of above systems with addition of Lafayette MODEL LT-250 FM Multiplex Stereo Tuner add \$74.25 to price of system and 13 lbs to shpg. wt.

Any of above systems with addition of Lafayette MODEL LT-325 AM-FM Multiplex Stereo Tuner add \$82.50 to system price and 17 lbs. to shpg. wt.

LAFAYETTE 10-WATT STEREO AMPLIFIER MODEL LA-214



39⁵⁰

\$5 Monthly

- 5 Watts of Power Each Channel
- Frequency Response 50 to 20,000 cps ± 1 db
- Front Panel Stereo Phone Jack
- Dual Concentric Bass and Treble Controls
- Rumble Filter
- Inputs for Ceramic and Crystal Phono, Tuner, High Level Tape
- Beautifully Styled

The Lafayette model LA-214 is a complete amplifier/preamplifier in a highly styled metal cabinet. It will faithfully reproduce such program sources as stereo or monophonic record changers, tuners, and stereo tape player. Features concentric bass and treble controls, rumble filter and front panel jack for stereo headphones. Other controls include Power/on; Volume, Mode selector (4 positions); 3-position program selector and Speaker/Phone switch. On rear panel 8 or 16 ohm speaker impedances may be selected and there is a handy speaker phase switch. Also included are a hum adjust and AC convenience outlet. Rugged hand wired circuit is fused for maximum component protection. Power output: 5 watts music power each stereo channel or 10 watts if used monophonically. The amplifier is compact enough to fit in any convenient location such as a shelf, table or bookcase. For 105-125 volts 50/60 cycles AC only. Tube complement: 2-6BQ5, 12AX7, 6CA4. Imported. Size 12½Wx5Hx7¾"D. (with legs). Shpg. wt., 15 lbs.

99 K 0023W

Net 39.50

10-WATT MATCHED STEREO PHONO SYSTEMS with LA-214 AMPLIFIER



LAFAYETTE WEBCOR
RECORD CHANGER

COMPLETE SYSTEM

As low
as **88⁵⁰**
\$5 monthly

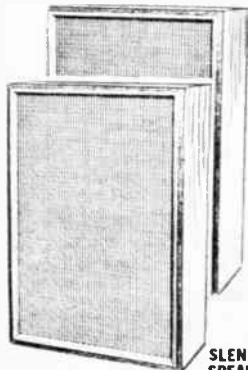

SK-265
SLENDERETTE III
SPEAKER SYSTEM

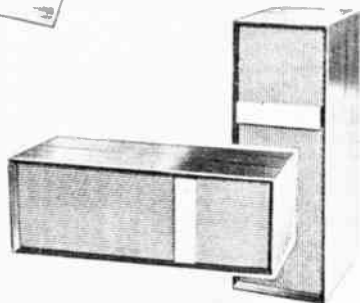

LAFAYETTE SK-181
"MINUETTE" SPEAKER
SYSTEM

Lafayette LA-214 10 Watt Stereo Amplifier
Lafayette-Webcor 4-Speed Record Changer with Wide-Range Ceramic Turnover Cartridge with Synthetic Sapphire Stylus and LP Diamond Stylus
Wood Base for Changer (Specify Mahogany or Walnut)
Two Lafayette SK-181 "Minuette" Speaker Systems (Walnut)

Complete system above with all necessary cables and interconnecting instructions. Shpg. wt., 43 lbs.
21 K 9927CWX Net 88.50

Same system as above except with two Lafayette oiled walnut finished Minuette speaker systems instead of walnut Minuette systems. Shpg. wt., 43 lbs.
21 K 9928CWX Net 90.50

Same as above except with two Lafayette SK-265 SLENDERETTE III oiled walnut 2-speaker 2-way slim speaker systems instead of Minuette speaker systems. Shpg. wt., 62 lbs.
21 K 9929CWX Net 96.50

LAFAYETTE 15-WATT MONAURAL HI-FI AMPLIFIER

MODEL LA-218



44⁵⁰

Only \$5 monthly

- Hum & Noise 75 db Below Rated Output
- Power Output 15-Watts
- Sensitivity: 3 mv. Magnetic Phono
- 5 Input Selections
- Frequency Response: 30-20,000 cps ± 1.5 db At Normal Listening Level

The New Lafayette LA-218 is a perfect combination of outstanding performance, beautiful styling, and low price. It can easily be integrated into a fully equipped hi-fi system utilizing the 5 input selections. Because of its high input sensitivity, either magnetic or ceramic cartridges may be used, achieving full power output. A tape deck, even without playback preamplifiers, may be used in direct recording through tape output jack and in playing back through tape-head input. Also may be used with AM, FM or TV tuner music sources. A loudness control compensates for the loss of low frequencies when listening at low levels—you do not have to listen at high volume level to achieve full tonal quality. A scratch filter is useful in reducing noise of dusty or damaged records. Headphone jack is provided for private listening. Individual bass and treble controls each provide a boost of 10 db and cut of 14 db for adjusting to individual listening areas and tastes. Full 15 watts is sufficient power to adequately drive most speaker systems. Perfect for use as a second amplifier for converting to stereo or for starting out monophonically and adding stereo at a later date. Engineered to include every practical feature at a low, low price. Beautifully styled in popular low silhouette enclosure and will add beauty to any room decor. Size: 12 $\frac{3}{4}$ Wx5 $\frac{1}{4}$ Hx8 $\frac{1}{4}$ "D. Shpg. wt., 18 lbs. Imported.

99 K 0043WX

Net 44.50

SPECIFICATIONS:

Power Output: 15-watts; Frequency response: 30-20,000 cps ± 1.5 db (at normal listening level). Input Sensitivity: High level .23V, Magnetic phono 3 mv. Hum and Noise Level: Volume control at maximum—High level inputs 75 db below rated output. Magnetic phono and tape head inputs 58 db below rated output. Harmonic distortion: less than 1% at full power output. Outputs: 8 and 16 ohm impedance speaker outputs; tape output. Tube complement: 2-12AX7, 2-6BQ5, 1-12AU7, 1-6CA4.

LAFAYETTE 15-WATT MATCHED HI-FI PHONO SYSTEMS

Lafayette LA-218 15-Watt Complete Integrated Monaural Amplifier.
Garrard Model 50 4-Speed Record Changer.

Wood Base for Changer (Specify Mahogany or Oiled Walnut).

Pickering V-15/AT-1 Diamond Needle Cartridge

Lafayette SK-265 SLENDERETTE III, 2-Speaker 2-Way Slim Speaker System (oiled walnut).

Above system complete with choice of Pickering V15/AT-1, Shure M7/N21D, or Empire 880 diamond needle cartridge plus interconnecting cables and necessary instructions. Shpg. wt., 50 lbs.

21 K 9930CWX Net 99.95

Same as 21 K 9930CWX system except with Lafayette SK-300 Decorette V 5-Speaker Slim Speaker System (oiled walnut) instead of SK-265 speaker system. Shpg. wt., 52 lbs.

21 K 9931CWX Net 114.95

Same as 21 K 9931CWX except with Lafayette famous 12" Free-Edge Coaxial Speaker SK-58 instead of SK-300 speaker system. Shpg. wt., 46 lbs.

21 K 9932CWX Net 109.95

Same as 21 K 9932CWX system above plus Lafayette patented Eliptoflex speaker enclosure (specify oiled walnut, walnut, or mahogany). Shpg. wt., 70 lbs.

21 K 9933CWX Net 138.95

12 Lafayette Cat. No. 652

CHOICE OF STEREO CARTRIDGE



SK-265 Slenderette III



SK-300 Decorette V



GARRARD MODEL 50

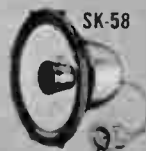

SK-58

AS LOW AS
99⁹⁵
\$5 monthly



ELIPTOFLEX

Lafayette Hi-Fi Systems Are a Sound Investment

LAFAYETTE AM/FM STEREO TUNER

Model
LT-325

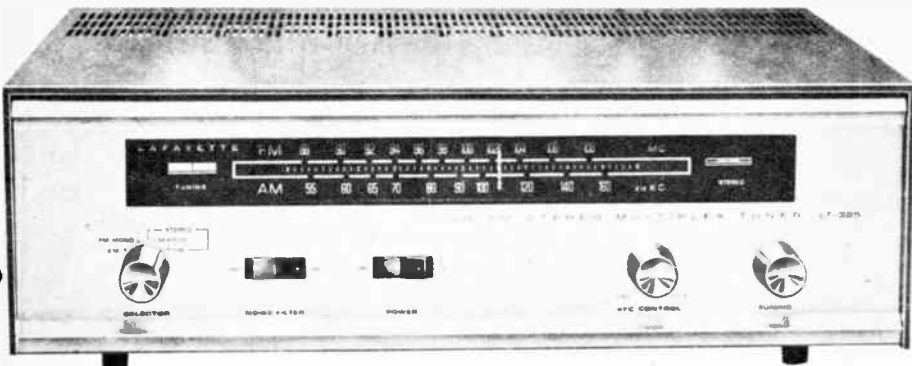

93⁹⁵

\$5 Monthly

Features New Audible Tone Stereo Search System. Two 3-Gang Tuning Condensers With added Tuned RF Stage For Superb Sensitivity and Selectivity.

Simplicity, Flexibility and Superb Styling have been carefully integrated in this quality tuner. Offering unlimited versatility, the LT-325 features new Automatic Stereo Monitor which shows automatically when you are tuned to a stereo broadcast. Tuning eye helps to tune all stations accurately. New "Stereo Search" circuitry provides an audible signal through both left and right channel speakers to let you know when you have tuned to a station broadcasting in FM stereo multiplex. Its new low silhouette enclosure can be placed proudly on an open bookshelf or custom installation anywhere in your home. On the front panel there is a mode selection

• 20-TUBE PERFORMANCE—12 TUBES PLUS TUNING EYE AND RECTIFIER AND 9 DIODES • MPX SEPARATION 38 DB @ 400 CPS • LESS THAN 1% DISTORTION • DUAL TUNED CASCADE LIMITERS AND WIDE BAND RATIO DETECTOR • GROUNDED GRID RF FRONT END FOR LOW NOISE • VARIABLE AFC CONTROL • FLYWHEEL TUNING • STEREO NOISE FILTER SWITCH • AUTOMATIC STEREO MODE INDICATOR

switch with a choice of AM, FM, FM Stereo, and Stereo Search; power on/off Multiplex noise filter see-saw switches; a variable Automatic Frequency Control; and the main tuning control. Flywheel tuning for smooth rapid station selection. Plate follower output permits using the tuner up to 50 ft. from an amplifier. FM circuitry features a grounded grid low noise front end and wide-band ratio detector; superheterodyne AM circuit with 3 stages. AVC and ferrite loopstick antenna. Decorator finished extruded aluminum front panel with complementary case and metal knobs. Imported.

99 K 0001WX Shpg. wt., 17½ lbs. Net 93.95

SPECIFICATIONS

Frequency Response: FM and FM stereo 15-15,000 cps \pm 1 db. FM Stereo Separation: more than 38 db @ 400 cps. Harmonic Distortion: FM and FM Stereo less than 1% @ 400 cps; MPX Noise Filter: -7db @ 10KC. SCA Rejection: better than 50 db. Tuner Sensitivity: FM 2 μ v for 20 db of

S/N. Variable FM AFC lock control, stereo tone search. Tubes: 6BE6, (3) 6BA6, (3) 6AU6, EM84, 6AV6, 6X4, 6BL8/ECF80, (2) 6AQ8/ECC85, 12AX7/ECC83. Power: 117V 50/60 cps AC, 60 watts. Dimensions: 14¾Wx4¾Hx9½"D. Legs add ¾" to height. Shpg. wt., 17½ lbs.

LAFAYETTE FM STEREO TUNER

Model
LT-250

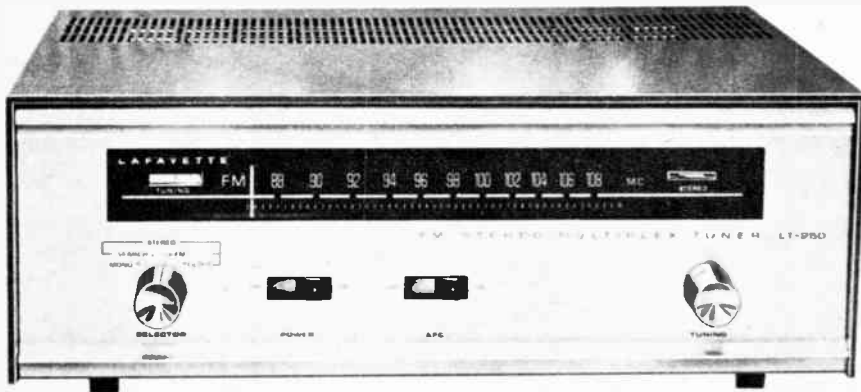

83⁹⁵

\$5 Monthly

• New Audible Stereo Search System To Locate Stations Broadcasting In FM Multiplex Stereo • 3-Gang Tuning Condenser Provides A Tuned RF Stage For Excellent Sensitivity and Selectivity.

TRULY remarkable, quality performance and styling that will delight both your eye and your ear. Features the new stereo search control. When this circuit is energized by a station broadcasting in FM multiplex stereo, it sends an audible signal through both the left and the right channels. Tuning eye facilitates accurate tuning of all signals with pin point sharpness. Automatic stereo indicator lights when control is set to the FM stereo position. Engineered to provide high-quality FM and FM stereo reception, the LT-250 has a grounded grid low noise front end. The multiplex circuit provides a stereo separation of 38 db at 400 cps. with less than 1% distortion. Front panel controls consist of the Mode selector: (mono, stereo search,

• STEREO SEARCH SYSTEM • MPX NOISE FILTER • BUILT-IN MULTIPLEX CIRCUIT WITH 38 DB SEPARATION @ 400 CPS. • RATIO DETECTOR AND DUAL TUNED LIMITERS • AFC SWITCH • STEREO MODE INDICATOR • FREQUENCY RESPONSE 20-20,000 CPS \pm 1 DB • LOW SILHOUETTE STYLING

FM stereo, FM stereo noise filter); see-saw AFC and power switches; and main tuning. Stereo dimension control to custom blend stereo reception (in-rear). Flywheel tuning control gives velvet smooth tuning action. Two stereo output jacks on rear panel. Tube complement: (2) 6BA6, (3) 6AU6, EM84, 6AV6, 6BL8/ECF80, (2) 6AQ8/ECC85, 12AX7/ECC83 and 6X4. Seven Germanium diodes and one Silicon diode. Extruded aluminum front panel with complementary case and metal knobs. Complete with case and legs. Dimensions: 12¾Wx4¾Hx9½"D. For 117V 50/60 cps AC. Imported.

99 K 0002WX Shpg. wt., 13 lbs. Net 83.95

NEW! LAFAYETTE AM/FM TUNER MODEL LT-100



**A BUDGET PRICED AM-FM TUNER
PACKED WITH FEATURES!**

49⁹⁵
\$5.00 Monthly

- FM Ratio Detector plus Limiter
- Grounded Grid RF Stage
- AFC for Simplicity of Tuning—"Locks-In" Stations

Carefully designed and engineered for outstanding performance, the new LT-100 offers many fine features including an FM multiplex output jack for connection to a multiplex adapter and smooth, easy-to-use flywheel tuning. Front Panel Controls: 4-position selector switch including FM AFC; Tuning. Has built-in AM ferrite loop antenna and rear apron terminals for external AM and FM antennas. Large, illuminated slide rule dial is easy-to-read for accurate tuning. FM Specifications: Sensitivity, 3- μ v; Frequency Response, 20-20,000

- Transformer Power Supply
- AFC Defeat for Tuning Weaker Stations
- FM Multiplex Output Jack
- 10-Tube Performance—7 Tubes (3 Dual Purpose)
- Attractive Low Silhouette Styling—Complete with Case.

cps \pm 1 db; Harmonic Distortion, less than 1% @ 400 cps. Attractively styled low silhouette metal enclosure has brown finish to contrast with gold front panel with brown knobs. Complete with case and legs. Overall Dimensions: 12 $\frac{1}{2}$ "Wx4 $\frac{7}{8}$ "Hx9 $\frac{1}{2}$ "D. For 110-125 volts, 50/60 cps AC. Power consumption 40 watts. Shpg. wt., 15 lbs. Imported.

99 K 0006WX AM-FM Tuner Net 49.95

EICO ST-97 FM STEREO TUNER KIT

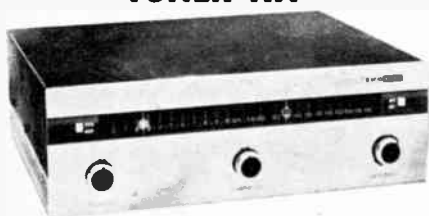

Quality FM Stereo Tuner with built-in multiplex circuitry. Employs pre-wired and pre-aligned front end, IF strip and wide-band ratio detector. Features AFC with defeat, Cathode follower driven. Slide rule tuning with tuning indicator. Stereo indicating pilot lamp, automatically lit by stereo pilot carrier. Controls: Tuning, Separation, AFC on-off, stereo-mono, and power on-off switches. SPECIFICATIONS: IHFM Sensitivity: 3 μ V (1.5 μ V for 20 db quieting); IHFM S/N Ratio: 55 db; Harmonic Distortion 0.6%; IHFM Distortion 0.2%; IHFM capture ratio; 3 db; Drift; 0.2% without AFC; 5 to 1 correction with AFC. Frequency Response \pm 1 db 20 cps—15KC; Channel Separation 30 db. Size: HWD—5 $\frac{1}{4}$ "x15 $\frac{1}{2}$ "x11 $\frac{3}{8}$ ". Shpg. wt., 17 lbs

21 K 2501WX FM Tuner kit Net 99.95
21 K 2502WX Same as above, but Factory wired Net 149.95

EICO MODEL HFT-90AK FM TUNER KIT



Factory pre-wired and pre-aligned front end. Pre-wired tuning eye assembly. Features "traveling" tuning indicator, fly-wheel tuning and AGC. SENSITIVITY: 1.5 μ V for 20 db quieting; 2.5 μ V for 30 db quieting; full limiting from 25 μ V. OUTPUTS: Cathode follower and multiplex. HUM: 60db below 1 volt. For 110-120 volts AC, 50-60 cycles. Complete with instructions. 12x8 $\frac{1}{4}$ x3 $\frac{3}{8}$ ". Shpg wt., 10 lbs.

21 K 2554 Kit Net 44.95
HFT-90A Same as above, but factory wired Net 63.95
E-3A Cover for HFT-90A. Shpg. wt., 3 lbs. Net 3.95
21 K 2556

LAFAYETTE MULTIPLEX ADAPTER KIT MODEL KT-220



MADE IN
U.S.A.

- Separation 30db at 400 cycles
- Self-powered
- Ideal for Lafayette tuners equipped with MPX output jacks

Enjoy thrilling FM Stereophonic sound from any recent Lafayette Tuner or any other quality wide-band FM or FM-AM tuner equipped with Multiplex jacks by simply adding this low-cost Lafayette Multiplex adapter kit. Engineered for anyone to build and operate, the KT-220 is easily connected to your tuners built-in multiplex output and special instructions are provided for connection to tuners without MPX output jacks. Coils are pre-aligned and only minimum adjustments are necessary. Self-powered, the unit may be hidden out of sight or installed remotely from your tuner.

Specifications: Separation—30db at 400 CPS. Distortion—below 1%. Controls: Noise filter on-off, power on-off with pilot light, separation control (rear). Front panel is finished in beige and ivory trim with contrasting beige and brown cabinet. Size 8 $\frac{1}{2}$ "Wx4 $\frac{3}{8}$ "x4 $\frac{3}{8}$ "H for 110-125 volts, 60 cycle AC.

19 K 0907 Shpg. wt., 4 lbs. Net 19.50

QUALITY STEREO
FM MULTIPLEX
AT MINIMUM COST

19⁵⁰

FISHER 500B 65 WATT FM STEREO RECEIVER

Lafayette Offers This Famous
FM Stereo Receiver At Only

249⁵⁰

Check These Outstanding Features and
Technical Specifications.



This magnificent FM Stereo Receiver has complete facilities for handling every possible stereo and monophonic program source through its stereophonic master control center, powerful 65 watt stereo amplifier, and super sensitive FM Stereo Multiplex Tuner. Features Stereo Beam, an exclusive Fisher invention that tells you instantly whether or not an FM Station is broadcasting in stereo multiplex. Completely eliminates the "try and find" stereo multiplex broadcast problem. A switchable filter reduces hiss and background noise on stereo programs without affecting the frequency response. **SPECIFICATIONS:** Amplifier distortion less than 0.5%. Frequency response 25-25,000 cps \pm 1.5 db; FM sensitivity 0.7 μ v into 72 ohm load; IHFM sensitivity 2.2 μ v. S/N & hum 70 db. IF bandwidth 190 Kc; channel selectivity 52 db; FM response 30-15,000 cps; Tubes: 4-ECC85, 6-6AU6, 4-12AX7, 2-7591, 2-EM84A, 1N-542, plus special multiplex tubes. Size: 17 $\frac{1}{2}$ Wx5 $\frac{9}{16}$ Hx13 $\frac{1}{4}$ "D. Shpg. wt., 35 lbs.

21K 3651WX

Walnut Wood Cabinet for Model 500B. Shpg. wt., 6 lbs.

21K 3615W

Net 249.50

Net , 22.45

- Exclusive Stereo Beam • Tuning Indicator • Linear Logging Scale • CONTROLS: MPX Filter, Station Selector, Dual Bass and Treble, Six-Position Selector (Tape Head, Phono, MPX Stereo, FM, Aux, Tape), Balance, Volume. SWITCHES: High Filter, Low Filter, Tape Monitor, Mono-Stereo, Channel Reverse, Loudness Contour • Low-level audio tube filaments heated by a separate DC supply • Magnificent architectural brass-finish control panel.

FM TUNER Wide-band design. Sensitivity: 0.7 microvolts (72 ohms, 20 db. quieting), 2.2 microvolt (IHFM Standard.) Four IF Stages. FM-Stereo separation, 35 db. **AMPLIFIER:** Power output, 65 Watts. Harmonic Distortion, 0.5%. Hum and Noise, -85 db. RIAA sensitivity, 3.3 mv. Aux. Sensitivity, 230 mv. Output Impedances: 4, 8 and 16 ohms.

65 WATT FM STEREO PHONO SYSTEMS FEATURING "FISHER 500B"

FAMOUS SELLING STEREO SYSTEM

Now everybody can enjoy the thrill of beautiful music reproduction at only a moderate cost with this outstanding FM Stereo Phono System. System includes: Fisher 500B 65 watt FM Stereo Receiver less case, Garrard Model 50 4 speed automatic Turntable with oil walnut wood base, choice of Pickering V15/AT-1, Empire 880 or Shure M7/N21D stereo cartridge, and lastly, 2 of Lafayette's best selling speaker systems—the Decorette V—featuring 5 specially engineered speakers designed to achieve optimum performance in a thin type enclosure only 4 $\frac{1}{2}$ inches in thickness.

21K 9625WX Shpg. wt., 82 lbs. Net 324.50

Same system as above but with Garrard AT60 4 speed Automatic Turntable in place of Garrard Model 50. Shpg. wt., 85 lbs.

21K 9626WX Net 339.50

CUSTOM STEREO SYSTEM

Now for the audio enthusiast who desires to mount his components in a custom cabinet—Lafayette offers this exciting FM Stereo System. System includes Fisher 500B 65 watt FM Stereo Receiver less case, Garrard Model AT60 4 speed automatic Turntable with oil walnut wood base, choice of Pickering V15/AT-1, Empire 880, or Shure M7/N21D stereo cartridge, and 2 famous Lafayette SK 210 3 way speakers with 2 $\frac{1}{4}$ lb. magnet.

21K 9627CW Shpg. wt., 78 lbs. Net 358.50

Same system as above but with SK210 speakers mounted in patented Lafayette Eliptoflex Enclosure (oil wal. finish). Shpg. wt., 126 lbs.

21K 9628CW Net 418.50

DELUXE STEREO SYSTEM

For the audio enthusiast who wants a deluxe FM Stereo-Phono System. System includes Fisher 500B-65 watt FM Stereo Receiver, Super Garrard Model A70 4 speed automatic Turntable with oil walnut wood base, choice of new Pickering V15/AM-1 or Empire 880P Stereo cartridge and 2 of Lafayette's finest Bookshelf speaker systems—the Decorette III which features a 12" poly-foam woofer with 1 lb. magnet, 6" mid range, and 3 $\frac{1}{2}$ super tweeter mounted in a specially engineered "Tuned" enclosure with Tube-Type Duct. Enclosures are finished in oil walnut. Shpg. wt., 128 lbs.

21K 9629CW Net 427.50

FAMOUS SELLING STEREO SYSTEM

AS LOW AS

324⁵⁰

CHOICE OF STEREO CARTRIDGE

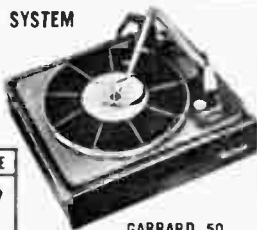

GARRARD 50

DECOR-ETTE V



CUSTOM STEREO SYSTEM

AS LOW AS

358⁵⁰

CHOICE OF STEREO CARTRIDGE



GARRARD AT60

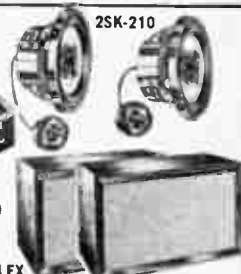

ELIPTOFLEX

DELUXE STEREO SYSTEM

only

427⁵⁰

CHOICE OF STEREO CARTRIDGE

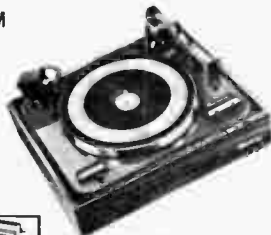

GARRARD A70

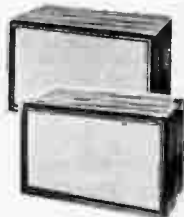

Decorette III

FISHER X-101-C 60 WATT STEREO AMPLIFIER



A Deluxe 60 Watt
Stereophonic Master
Audio Control -
Amplifier at only

139⁵⁰
\$7 monthly

This deluxe 60 watt Stereophonic Master Audio Control Amplifier features the exclusive "New Look" by Fisher, an elegantly styled, functional, operational, panel. Only the Program Selector, Mode Selector and Volume control are in view. The other infrequently used controls are hidden behind a pull-down panel. Offers 30 Watts of music power output per channel, center channel, output, 14 inputs (2 phonos), output selector switch, front panel jack, loudness control, jack for "SpaceXpander." Exclusive Fisher Direct-Tape-Monitor. 10 tubes, 2 silicon rectifiers. Response 20-20,000 cps ± 1 db. Hum and noise 88 db below rated output. Harmonic distortion .5% at rated output. 1% intermodulation @ rated power. Size 15 $\frac{1}{2}$ "Wx4 $\frac{1}{2}$ "Hx12 $\frac{1}{2}$ "D. Less cabinet. Shpg. wt., 28 lbs.

21 K 3603WX \$7 monthly
21 K 3609W MC-2 Metal Cabinet for X-101-C. Shpg. wt., 9 lbs. Net 14.36
21 K 3610W Walnut Cabinet for X-101-C. Shpg. wt., 7 lbs. Net 22.46

OUTSTANDING FEATURES

- 60 Watts Power Output
- Beautiful Styling
- Direct Connection of Center Channel or Extension Speaker

60 WATT STEREO-PHONO SYSTEMS FEATURING FISHER X-101-C

SHELF SYSTEMS—As Low As 206.50



System I—A moderately priced 60 watt Stereo-Phono system enhanced by the elegant styling of the Fisher X-101-C 60 watt stereo amplifier. The other fine components which complete this system are: Garrard Model 50 4-speed automatic turntable with oil walnut base, choice of Pickering V-15/AT-1, Shure M7/N21-D, or Empire 880 stereo cartridge, and a pair of Lafayette Slenderette III slim-type, 2-speaker—2-way systems with oil coat finish. wt., 55 lbs.
21 K 9634CWX \$10 monthly Net 206.50

System II—same as above except with Garrard AT60 4-speed automatic turntable in place of Garrard 50. Shpg. wt., 57 lbs.
21 K 9635CWX \$11 monthly Net 219.50

System III—Same as 21 K 9634CWX except with a pair of Lafayette Decorette II, 5-speaker—3-way systems with oil walnut finish in place of Lafayette Slenderette III speaker system. Shpg. wt., 63 lbs.
21 K 9636CWX \$13.50 monthly Net 286.50

System IV—Same as 21 K 9636CWX except with Garrard AT60 4-speed, automatic turntable in place of Garrard 50. Shpg. wt., 64 lbs.
21 K 9637CWX \$15 monthly Net 299.50

CUSTOM SYSTEMS—as low as 232.50

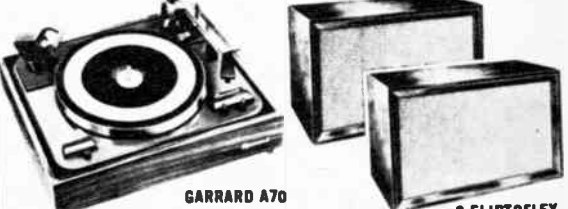

System J—A superb custom 60 watt stereophonic system featuring the Fisher X-101-C 60 watt stereo amplifier, Garrard Model AT60 4-speed automatic turntable with oil walnut base, choice of Pickering V-15/AT-1, Shure M7/N21-D, or Empire 880 stereo cartridge, and lastly, a pair of world-famous Lafayette SK-58 12" coaxial speakers with 1 $\frac{1}{4}$ lb. magnet. Shpg. wt., 63 lbs.
21 K 9638CWX \$11.50 monthly Net 232.50

System II—Same as above except with deluxe Garrard type A70 4-speed automatic turntable in place of Garrard AT60. Shpg. wt., 70 lbs.
21 K 9639CWX \$12.50 monthly Net 252.50

System III—Same as 21 K 9638CWX but with SK-58 speakers mounted in a pair of patented Lafayette Eliptoflex enclosures with oil walnut finish. Shpg. wt., 111 lbs.
21 K 9640CWX \$15 monthly Net 292.50

System IV—Same as 21 K 9640CWX except with deluxe Garrard type A70 4-speed automatic turntable in place of Garrard AT60. Shpg. wt., 118 lbs.
21 K 9641CWX \$17 monthly Net 312.50

FISHER

Model X100 40 Watt Stereo Amplifier

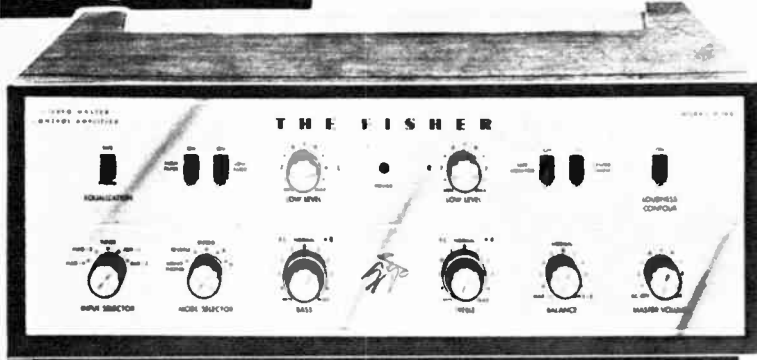

LOOK AT OUR
LOW, LOW, PRICE

99⁵⁰

\$5 monthly

OUTSTANDING
FEATURES

The X100 40 watt stereo integrated amplifier is an excellent buy for the audio enthusiast with a limited budget. This fine stereo amplifier offers simplicity of operation and a full complement of control facilities for maximum flexibilities. **OUTSTANDING FEATURES** Controls: Balance, Dual Bass and Treble, Five-Position Mode Selector, Five-Position Input Selector including two positions for magnetic cartridges, High and Low Filter Switches and Loudness Contour. **SPECIFICATIONS:** Power Output 40 watts. Harmonic

distortion 0.5%. Hum and noise 90 db below rated output. Frequency Response 20-20,000 cps, within 1 db. Sensitivity (low level inputs) 3.5 mv; (high level inputs) 180 mv. High filter 12 db/octave above 5 Kc. Low filter 12 db/octave below 50 cps. 11 tubes. **DIMENSIONS:** 15 1/2" W x 4 1/2" H x 11 1/2" D. Shpg. wt., 22 lbs. less cabinet
 21 K 3652WX Model X100 Net 99.50
 21 K 3609W Metal Cabinet for X100 Net 14.38
 Oil Walnut wood cabinet for X100
 21 K 3610W Net 22.46

- Front panel has sixteen controls and switches to permit wide flexibility in either monophonic or stereophonic operations
- Power output—40 watts
- Center channel output
- Full Tape Recording Facilities

40 Watt Stereo Phono System Featuring the Fisher X100

SHELF SYSTEMS as low as **164⁵⁰**

CUSTOM SYSTEMS as low as **184⁵⁰**



Slenderette III

Garrard 50

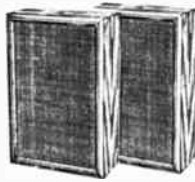

X100 (less cabinet)

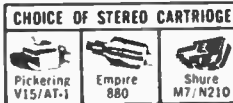

CHOICE OF STEREO CARTRIDGE
Pickering V15/AT-1 Empire 880 Shure M7/N210

OPTIONAL COMPONENTS



Garrard AT-60

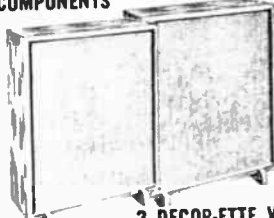

2 DECOR-ETTE V



Garrard 50



SK-58

\$9 monthly

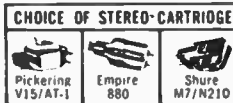

CHOICE OF STEREO-CARTRIDGE
Pickering V15/AT-1 Empire 880 Shure M7/N210

OPTIONAL COMPONENTS



Garrard AT-60

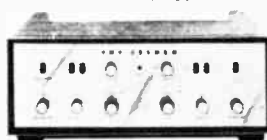

X100 (less cabinet)

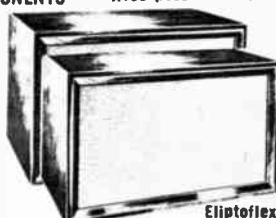

Eliptoflex

SYSTEM I—A complete 40 watt stereo phono system for the music lover at so little in price—System includes Fisher X100 40 watt stereo integrated amplifier, Garrard Model 50 4 speed automatic turntable with oil walnut wood base, choice of Pickering V15/AT-1 Empire 880, or Shure M7N21D Stereo cartridge, and lastly, a pair of famous Lafayette "Slenderette" III Slim 2-speaker 2 way speakers systems with oil walnut finish on 4 sides.

21 K 9511CWX Shpg. wt., 66 lbs. \$8 monthly Net 164.50

SYSTEM II—same as above except with Garrard Model AT60 automatic Turntable in place of Garrard Model 50.

21 K 9512CWX Shpg. wt., 68 lbs. \$9 monthly Net 179.50

SYSTEM III—same as 21 9511CWX except with a pair of Lafayette Decorette V speaker systems in place of Lafayette Slenderette III Speaker Systems.

21 K 9513CWX Shpg. wt., 78 lbs. \$10 monthly Net 194.50

SYSTEM IV—same as 21 9513CWX except with Garrard Model AT60 automatic Turntable in place of Garrard Model 50.

21 K 9514CWX Shpg. wt., 80 lbs. \$10 monthly Net 209.50

SYSTEM I—A popular priced 40 watt stereo phono system for custom installations features the Fisher X100 40 watt stereo integrated amplifier, Garrard Model 50 4 speed automatic turntable with oil walnut wood base, choice of Pickering V15AT-1, Empire 880, or Shure M7N21D stereo cartridge, and lastly a pair of the world famous Lafayette SK58 12" coaxial speakers with 1 1/4 magnets.

21 K 9515CWX Shpg. wt., 61 lbs. \$9 monthly Net 184.50

SYSTEM II—same as above except with Garrard Model AT60 automatic Turntable in place of Garrard Model 50.

21 K 9516CWX Shpg. wt., 63 lbs. \$10 monthly Net 199.50

SYSTEM III—same as 21 9515CWX but with SK58 speakers mounted in a pair of 2 famous Lafayette patented Eliptoflex Enclosures with Oil Walnut finish.

21 K 9517CWX Shpg. wt., 131 lbs. \$11.50 monthly Net 244.50

SYSTEM IV—same as 21 9516CWX but with SK58 speakers mounted in a pair of 2 famous Lafayette patented Eliptoflex Enclosures with Oil Walnut finish.

21 K 9518CWX Shpg. wt., 133 lbs. \$12.50 monthly Net 259.50

See Our Catalog 650 For Additional Hi-Fi Equipment

Lafayette Cat. No. 652 17

Sherwood STEREO HI-FI COMPONENTS

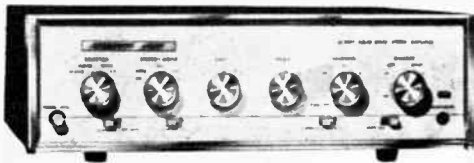

NEW MODEL S-9500S 50-WATT SILICON SOLID STATE STEREO AMPLIFIER

179⁵⁰

\$9 Monthly

- 20 Silicon Transistors, 4 Silicon Rectifiers
- Transformerless Output
- Completely Non-Microphonic

A deluxe solid-state stereo amplifier for the discriminating music listener. Engineered into this compact unit are military-type silicon transistors with less heat sensitivity than low cost germanium types; transistor short-circuit protection and an extremely low harmonic distortion of 1/2% at rated output. Hefty 50-watts of music power. Also features phono input noise less than -70db with no microphonics or hum; professional Baxandall tone controls, tape monitoring and tape head playback, stereo headphone, jack and 4-position selector switch. Response: 12-35,000 cps. Outputs 4, 8 and 16 ohms. Compact 14Wx4 1/2Hx10"D. For 115-125V. 60 cycles AC. Shpg. wt., 20 lbs. Less Case.

21 G 6120WX Model S-9500S **179.50**
Walnut tone Leatherette Case for Model S-9500S.
21 K 6113W Net **7.50**

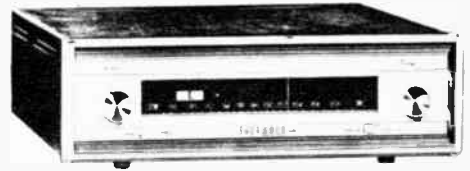

S-3000V FM STEREO TUNER

165⁰⁰

\$8 Monthly

- Stereo Indicator Light Gives Instant Identification of FM Stereo Broadcasts
- FM Interchannel Hush
- Wide-Band 3-MC Gated Beam Limiter and 1 MC Balanced Ratio Detector

This deluxe FM stereo tuner provides top quality FM and FM multiplex reception. Features zero-center tuning meter, stereo indicator light which shows when you are tuned to a stereo broadcast, interchannel hush to quiet noise between FM stations and expanded slide-rule tuning scale. Wide-band 3-MC gated beam limiter and 1 MC balanced ratio detector combine to create a capture ratio of 2.4 db. Sensitivity: 1.8 μ V for 30 db quieting (IHFM). Response \pm 1/2 db 20-20,000 cps. IM distortion: below 1/2% @ 100% mod. 11 tubes plus rectifier. Size: 14Wx4Hx10 1/2"D. Less case. For 115-125V 60 cycles AC. Shpg. wt., 15 lbs.

21 K 6104WX Net **165.00**
Walnut Tone Leatherite Case for Model S-3000 V.
21 K 6113W Net **7.50**

50-WATT SHERWOOD STEREO PHONO SYSTEM

Featuring Model S9500S



Sherwood S9500S



Garrard AT-60



SK-58



A quality custom stereo system for the audio enthusiast featuring: Sherwood S9500S 50-watt Silicon Solid State Stereo amplifier (less case), Garrard Model AT60 4-speed automatic turntable with oiled wal. wood base; choice of Pickering V15/AT-1, Empire 880, or Shure M7/N21D stereo cartridge; and 2 famous Lafayette SK-58 12" Coaxial speakers. 21 K 9533WX Shpg. wt., 60 lbs. Net 273.95

Same system as above but with SK-58 speakers mounted in patented Lafayette Elliptoflex Enclosures (oiled wal. finish). Shpg. wt., 130 lbs.
21 K 9534 WX Net **324.95**

Complete System as low as
324⁹⁵

Optional Elliptoflex Enclosures

NEW harman kardon SOLID STATE FM STEREO RECEIVERS

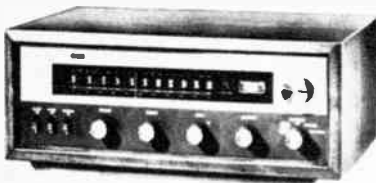

MODEL SR300 SOLID STATE 36-WATT FM STEREO RECEIVER

235⁰⁰

\$11.50 Monthly

A solid-state FM stereo receiver for budget-minded music lovers. Controls include hi- and low-cut, separate bass, treble and balance, off/on volume, contour and program selection. Response: 10-23,000 cps at rated output. Distortion: Less than 1%. Sensitivity: 2.9 μ V (IHFM). FM channel Separation: 30db. For 110-120V, 50/60 cycles AC. Less Case. Size: 14 1/2Wx4 1/2Hx9 3/4"D. Shpg. wt., 14 lbs.

21 K 4245WX Net **235.00**
21 K 4247W Oiled Walnut Enc. For SR300. 9 lbs. Net **22.45**

MODEL SR600 SOLID STATE 50-WATT FM STEREO RECEIVER

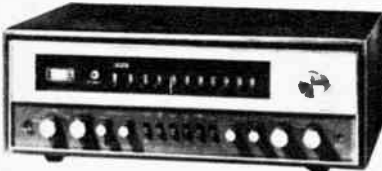

310⁰⁰

\$15 Monthly

A handsome, powerful, solid state FM stereo receiver. Features flat response of 8 to 40,000 cps at 50 watts. Less than 1% distortion Complete for every stereo function, front panel stereo headphone jack. Hum and Noise suppression 90db. Tuner Features FM channel separation of 35 db. Sensitivity 1.95 μ V (IHFM). Stereo Multiplex indicator light, automatic switching to stereo. Tuning Meter. Size: 16 1/4Wx5Hx11 1/4"D. Less Case. For 110-120V 50/60 cycles AC. Shpg. wt., 26 lbs.

21 K 4246WX Net **310.00**
21 K 4244W Oiled Walnut Enc. For SR600. 10 lbs. Net **24.95**

MODEL SR900 SOLID STATE 75-WATT FM STEREO RECEIVER

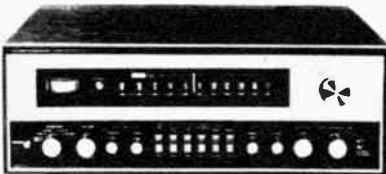

395⁰⁰

\$19 Monthly

A deluxe solid state receiver featuring a powerful 75-watt stereo amplifier with flat frequency response from below 5 to 300,000 cps! Complete stereo control facilities include separate balance, bass, treble, tape monitor, filters, tone control defeat. Contour, push-button off. Headphone output. All Solid State tuner has 1.85 μ V (IHFM) sensitivity, more than 35 db stereo separation; Tuning meter, Automatic stereo switching. Hum down 95 db. Distortion, less than 0.5%. Impedance 4-16 ohms. 16 1/4Wx5Hx11 1/4"D. Less Case. For 110-120V, 60 cycles AC. Shpg. wt., 28 lbs.

24 K 4243WX Net **395.00**
21 K 4244W Oiled Walnut Enclosure for SR900. 10 lbs. Net **24.95**

McIntosh Professional Hi-Fi Components

MODEL MX110 STEREO FM TUNER-PREAMPLIFIER

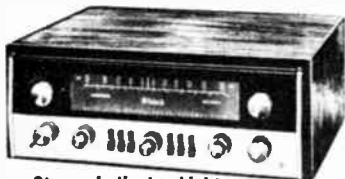

- Stereo Indicator Light
- Nuvistor RF, 4 IF Stages, and 2 Limiters
- "Panloc" for Professional Built-in Installation

Engineered for the discriminating listener, the MX110 combines in one unit an FM Tuner with Multiplex and a Stereo Preamplifier. "Panloc" system included permits a professional built-in installation. Features a complete stereo control center. Choice of 6 different program sources. A stereo indicator lights only when a stereo station is broadcasting. Tuner bandwidth is 200KC and sensitivity is better than 2.5 μ v at 100% modulation. Uses cascade RF stage with 6DS4 nuvistor, 4 IF stages and 2 limiters. Response: 20 to 20,000 cps, $\pm 1/2$ db; Distortion: less than 0.2%. Anodized gold and black panel. Size: 15 $\frac{1}{2}$ Wx15 $\frac{1}{4}$ Hx13"D. Shpg. case. For 105-125V 50/60 cycles AC. Shpg. wt., 36 lbs.
 21 K 5106WX \$19 Monthly Net 399.00
 Wood Cabinet for MX110, Oiled walnut. Shpg. wt., 11 lbs.
 21 K 5111W Net 25.00

DELUXE MODEL MR-71 FM STEREOPHONIC TUNER

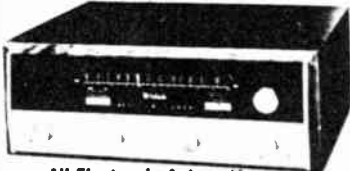

- All-Electronic Automatic Stereo-Mono Switching
- FM Multipath Reception Indicator

Magnificently engineered to bring you outstanding reception of FM monophonic and FM stereophonic broadcasts. A new computer designed filter reduces noise from stations broadcasting subcarrier music sources; automatic all-electronic stereo-mono switching that is clickless; stereo light activated by 19KC carrier only. Two D'Arsonval signal strength and tuning meters of high sensitivity; multipath indicator to eliminate multipath distortion; double tuned input circuits before Nuvistor R.F. amplifier; 5 IF stages. Also has "Panloc" system for ease of custom installation. Sensitivity: better than 2.5 microvolts, response: ± 0.5 db 20 cps to 20KC. Capture ratio: 1.5 db; Hum: better than 70 db below 100% modulation; Separation: better than 30 db; Distortion: less than 0.5%. Anodized gold and black panel. 16Wx5 $\frac{1}{2}$ Hx13"D. For 105-125 volts 50/60 cycles AC. Shpg. wt., 37 lbs.
 21 K 5114WX \$19 Monthly Net 399.00
 Wood Cabinet for MR71, oiled walnut. Shpg. wt., 11 lbs.
 21 K 5111W Net 25.00

MODEL MA-230 DUAL 30-WATT STEREO INTEGRATED AMPLIFIER

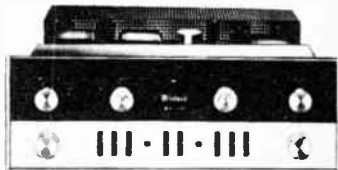

- Exclusive McIntosh Silicon Planar Solid State Preamplifier
- Superb Dual 30-Watt Stereophonic Tube Power Amplifier

A professional quality combination preamplifier and power amplifier. Exclusive silicon planar preamplifier uses 12 solid state devices. Has only 1/10 of 1% distortion. Power amplifier features 30 watts per channel continuous or 44 watts IHFM music power. Distortion is less than 0.5% at rated output. Response: ± 0.5 db 20-20,000 cycles. Hum and Moise: 75 db down on high level inputs, 65 db down on low level inputs. Controls include: dual concentric bass and treble; volume, balance, 6 position input selector, Mode selector. Switches: Equalization, Tape monitor, Phase, Speaker on-off, power on-off. Low and high frequency filters and loudness. Also features exclusive "Panloc" system for custom mounting. Front panel stereo headphone jacks for private stereo listening. Size: 16Wx5 $\frac{1}{2}$ Hx15W. Anodized gold and black finish. For 105-125V, 60 cycles AC. Shpg. wt., 56 lbs.
 21 K 5151WX ..\$17 Monthly Net 349.00
 Cabinet Oiled Walnut for MA-230. 11 lbs.
 21 K 5118W Net 29.00

DELUXE PROFESSIONAL AUDIO COMPONENTS

By

marantz

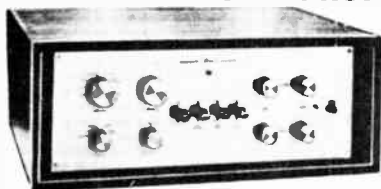

MODEL 7C STEREO CONSOLE PREAMPLIFIER

A deluxe self-powered stereo preamplifier combines Marantz's remarkable quality construction with complete versatility and ease of operation. Front Panel Controls feature: 8-pos. Selector (Mic, Phono 1, Phono 2, Tapehead, FM-AM, FM Multiplex, TV, Auxiliary) 5-pos. Mode (Stereo, Stereo Reverse, Ch A, Ch B, Ch A+B), Volume, Balance, 4-Independent Base and Treble Tone Controls. Record Equalizer, Tape Playback on Monitor, High Filter, Rumble Filter and Power Switch. Rear Controls feature: Output Level-setter, 3 Pairs of Outputs, Tape-head Equalizer Adjustments, 9 Pairs of Inputs, 6 AC Convenience Outlets and System Grounding Point. Frequency Response: $1/2$ db 20-20,000 cps. IM Distortion: 0.1%. Total Noise: in 20-20,000 cps audio range, 80 db below 10 mv phono input with RIAA curve. Tubes: 6-ECC83/12AX7. Size: 15 $\frac{1}{2}$ Wx5 $\frac{1}{4}$ Hx8 $\frac{1}{2}$ "D. For 105-125 volts, 50/60 cps. AC. Shpg. wt., 16 lbs.
 21 K 5001WX Marantz Model 7C-Less Cabinet Net 285.00
 WOOD CABINET FOR ABOVE: Oiled Walnut. Shpg. wt., 4 lbs.
 21 K 5002W Net 24.00

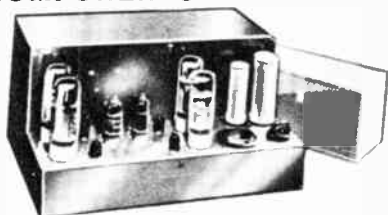

MODEL 8B

DUAL 35-WATT STEREOPHONIC POWER AMPLIFIER

Professional in every respect, the Model 8B Stereo Amplifier furnishes performance and workmanship found in high quality Broadcast or Laboratory equipment. Built-in Bias Meter. Power Output is 35 Watts per channel (70 watts peak). Response: 0.1 db from 20-20,000 cps at 30-watts. Distortion: harmonic, less than 0.1%; I.M., less than 0.5%. Hum: -90 db. Input Sensitivity 1.3 volts. Output Impedance: 4, 8, and 16 ohms. Tubes: 2-6BH6, 2-6CG7, 4-EL34/6CA7. Overall Size: 13 $\frac{1}{2}$ Wx7 $\frac{1}{4}$ Hx10 $\frac{1}{2}$ "D. For 105-125 volts, 50/60 cps AC. Shpg. wt., 57 lbs.
 21 K 5003WX Marantz Model 8B Less Cabinet Net 285.00
 Model 8G Gold Finish Perforated Snap-On Grille For Above. 21 K 5004W Shpg. wt., 1 lb. Net 9.00
MODEL 9. Superb massive single channel 70-watt amplifier—exceptional stability & low distortion. 2-6DJ8/ECC88, 1-6CG7, 4-CA7/EL34, 1 Zener Diode, 5 silicon rectifiers, 15 $\frac{1}{2}$ Wx8 $\frac{1}{4}$ Hx10 $\frac{1}{2}$ "D.
 21 K 5005WX Not illus. Shpg. wt., 63 lbs. Net 384.00



ACOUSTECH V SOLID STATE STEREO INTEGRATED AMPLIFIER

New deluxe 22 transistor stereo integrated amplifier delivers 30 watts per channel into 8 ohms (less than 1 db reduction at 16 and 4 ohms). Unit consists of five plug-in boards for power supply, two preamps, and two power amps. Use of transistors offers lack of heat and elimination of bulky output transformers making this a compact unit. Specifications: I.M. and harmonic distortion under .95% at 30 watts from 20-20,000 cps. Hum and noise: phono, -55 db; hi-level, -75 db. Front panel controls: continuous level and tone controls; Muting; input selector; and tape monitor switch. 15 $\frac{1}{2}$ Wx5Hx12"D. Shpg. wt., 27 lbs.
 21 K 7702WX Net 299.00

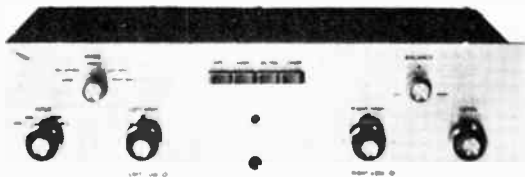

ACOUSTECH V

SCOTT SOLID STATE STEREO HI-FI COMPONENTS

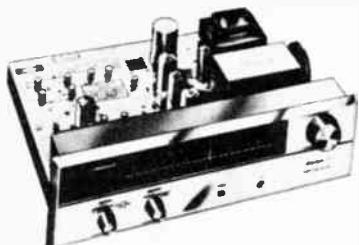

MODEL 312 FM STEREO TUNER

Using solid-state circuitry, this tuner offers superb FM reception, plus all the benefits of transistors. The silver-plated nuvistorized front end provides high sensitivity. Scott's famous time-switch multiplex circuit assures wide stereo separation and low distortion. Features include: completely automatic stereo operation, professional-type tuning meter, large slide-rule dial, stereo indicator light, front panel tape output, individual level controls for each channel (rear), stereo noise filter. Specifications: 2.2 μ V Sensitivity, 30-15,000 cps Response, 0.8% Harmonic Distortion, 35 db Separation, less than 0.02% frequency drift. Dimensions: 16 $\frac{1}{2}$ Wx5 $\frac{1}{2}$ Hx16 $\frac{3}{4}$ "D. Shpg. wt., 14 lbs. Less case.

21 K 6033WX Net 219.95
Metal Case for Model 312. Shpg. wt., 5 lbs.
21 K 6009W Net 12.50

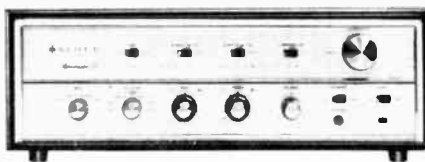

NEW MODEL 260 70-WATT STEREO INTEGRATED AMPLIFIER

A deluxe 70-watt stereo amplifier of advance silicon solid state design. 35-watts music power each channel gives power to spare for reproducing all the dynamic peaks in music. Massive heat sinks assure conservative cool operation. Full Tape facilities including monitor and tape head. Specifications: Frequency Response: 20-20,000 cps, Harmonic Distortion: 0.8% at full power, Damping Factor: 20. Controls: Inputs (Tape Head, Phono, Tuner, Extra), Selector (7-positions) Dual Bass and Treble Controls, Balance and Loudness. Switches include: Tape Monitor, Rumble Filter, Scratch Filter, Loudness Compensation, Separate on-off switch and speaker on-off switch. Front panel headphone jack. Styled to match Model 312 Tuner. 15Wx4 $\frac{1}{2}$ Hx13 $\frac{1}{4}$ "D. For 110-120V, 60 cycles AC. Shpg. wt., 18 lbs., Less Case.

21 K 6043WX Net 219.95
Metal Case for Model 260. Shpg. wt., 5 lbs.
21 K 6009W Net 12.50

Deluxe Scott 70-Watt Stereo Phono Systems

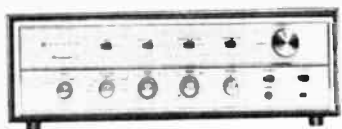

Scott 260



Garrard AT60

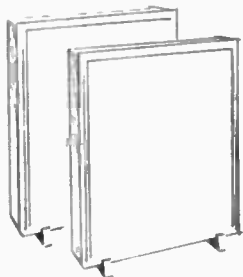

SK-300

COMPLETE SYSTEM ONLY

304⁹⁵
\$15 monthly

CHOICE OF STEREO CARTRIDGE



Pickering V15/AT-1



Empire 880



Shure M7/N21D

Consists of SCOTT 260 WATT SILICON SOLID STATE STEREO INTEGRATED AMPLIFIER; Garrard AT60 4-speed automatic stereo turntable with walnut base; choice of Pickering V15/AT-1, Empire 880, or Shure M7/N21D stereo cartridge; and lastly—2 superb Lafayette SK-300 "Decorette V" Speaker Systems with oil walnut finish. Shpg. wt., 80 lbs.

21 K 9529WX 304.95
Same as 21 K 9529 except with deluxe Lafayette SK-275 "Decorette III" Speaker Systems with oil walnut finish in place of Lafayette SK-300 Speaker Systems. Shpg. wt., 116 lbs.
21 K 9530WX \$19 monthly 379.95
Same as 21 K 9529 with addition of Scott 312 FM Stereo Tuner. Shpg. wt., 94 lbs.
21 K 9531WX \$29 monthly 512.95
Same as 21 K 9530 with addition of Scott 312 FM Stereo Tuner. Shpg. wt., 130 lbs.
21 K 9532WX \$29 monthly 587.95

OPTIONAL COMPONENTS

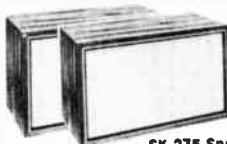

SK-275 Speakers



Scott 312 FM Stereo Tuner

Bogen AT600 60 WATT SOLID STATE STEREO AMPLIFIER-PREAMPLIFIER

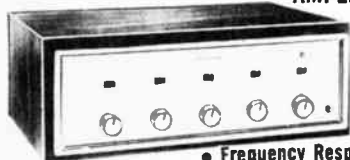

179⁹⁵
\$9 monthly

• Frequency Response 25 to 50,000 cps

A solid state, 60-watt-amplifier (30 watts per channel IHF music waveform). The AT600 features long life, instant warm-up, absence of noise, and advanced transistor circuitry. All the power is available to drive even the lowest efficiency speakers. Frequency response \pm 1 db, 25 to 50,000 cps; IM distortion less than 1%. Headphone outlet for private listening. Noise and Hum: (relative to full output) Tuner, —65 db; Auxiliary, —65 db; Phono mag., —60 db; Tape, —55 db. Channel cross-talk: —50 db @ 1,000 cps. Output impedance 4/8/16 ohms. Complete stereo control facilities. For 117V, 60 cycles AC. Size: 15x10x4 $\frac{1}{2}$ ". Shpg. wt., 15 lbs.

21 K 1719WX Model AT600. Less cabinet. Net 179.95
New Bogen FT-60 Solid State FM Stereo Tuner. Features Stereo "Minder Light."
21 K 1716WX Shpg. wt., 11 $\frac{1}{2}$ lbs. Net 187.95
Cabinet, walnut for AT600, FT-60. Shpg. wt., 8 lbs.
21 K 1720W Net 22.35

NEW Bogen MODEL RF-35 35-WATT FM STEREO PHONIC RECEIVER



187⁹⁵
\$9 monthly

• Automatic "Stereo-Minder" Indicator

A complete home entertainment center—just add speakers to receive brilliant FM stereo. 35 watts of power (IHFM). Features Time division multiplex circuitry, automatic "Stereo Minder" which lights-up when you receive a stereo broadcast. Frequency Response: 20-20,000 cps. \pm 1db. Hum & Noise: —50 db mag. and tape, —65 db aux. and tuner. FM Sensitivity: 0.85 μ V For 20 db quieting. Controls: 4 pos. programming selector, 2 pos. mode, loudness-volume, balance, bass & treble, power, tuning, AFC. Stereo Separation 35 db. Outputs: 8 & 16 ohms. Size: 15 $\frac{1}{2}$ Wx5 $\frac{1}{4}$ Hx15"D. For 110-120 V 50/60 cycles AC. Shpg. wt., 30 lbs.

21 K 1801WX Model RF-35 FM Stereo Receiver Net 187.95
21 K 1802W Walnut Wood Enclosure For RF-35 Net 26.95

FAMOUS NAME HI FIDELITY KITS



62⁹⁵
KIT

93⁴⁵
WIRED

DYNAKIT "PAS-3" STEREO PREAMPLIFIER KIT

Top-performing stereo preamp for use with high quality basic amplifiers. Includes two independent high gain, low noise preamplifier-control channels. All critical circuitry is pre-assembled on 2 printed circuit boards. Features "Dyna-Blend" for variable channel separation, DC heated tube filaments. Inputs: 3 stereo low level and 4 stereo high level. Frequency response: ± 0.5 db 10-40,000 cps. Distortion: less than .05%. Noise: less than 2 μ v. Gain, 60 db at 1000 cps on RIAA, 20 db on high level. For 110-120V, 50/60 cycles AC. Deluxe gold panel. Size: 13x8x4". Shpg. wt., 11 lbs.

21 K 2301WX PAS-3 Kit. \$5 Monthly Net 62.95
21 K 2302WX PAS-3A Wired. \$5 Monthly Net 93.45

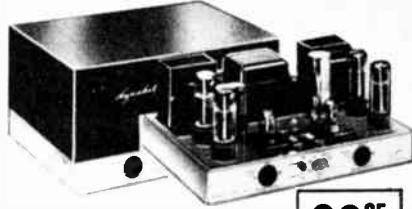

89⁹⁵
KIT

110⁴⁵
WIRED

DYNAKIT "STERED 70" 70-WATT STEREO BASIC AMPLIFIER KIT

The stereo 70 provides outstanding reproduction, firm bass, and smooth natural highs. Delivers 35-watts per channel. Frequency response: ± 0.5 db from 10 cps to 40,000 cycles. IM distortion: less than 1% at 35 watts. Sensitivity 1.3 volts rms input for 35 watts output. Hum and Noise: better than 90 db below rated output. Output impedance: 4, 8 and 16 ohms. Nickel-finished chassis; vinyl-coated charcoal brown cover. For 110-120V 50/60 cycles AC. Size 9Wx6 $\frac{1}{2}$ Hx 13"D. Shpg. wt., 32 lbs.

21 K 2303WX Stereo 70/A Kit. \$5 Monthly Net 89.95
21 K 2304WX Stereo 70/A Wired. \$5 Monthly Net 110.45

SCOTT MODEL LK-48B 48-WATT STEREO AMPLIFIER KIT

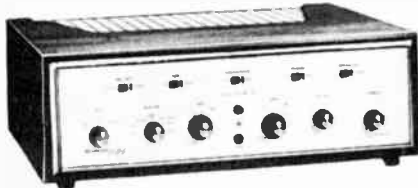

114⁹⁵
KIT

\$8 Monthly

This popular amplifier kit gives a clean 24 watts output per channel—enough power for virtually any music system. Completely versatile, offering phono, tuner, extra, and tapehead inputs. Features a powered center channel output for three-channel stereo or for extension speakers without the need of an additional amplifier. A tape monitor switch permits integration with a three-head tape deck in direct monitoring of recordings. Front panel stereo earphone jack and speaker "on-off" switch facilitates private earphone listening. SPECIFICATIONS: Power Output: 24 watts/channel IHF standard. Frequency Response: 20-20,000 cps ± 1 db. Harmonic distortion: 0.8%. Hum Level: —80 db. Sensitivity: phono, 3 mv. tape head, 9 mv. Dimensions: 15 $\frac{1}{2}$ Wx5 $\frac{1}{4}$ Hx13 $\frac{1}{4}$ "D. Shpg. wt., 35 lbs. (less case). 21 K 8037WX Net 114.95

Leatherette Metal Case for LK-48B. Shpg. wt., 2 lbs.
21 K 8009W Net 12.50
Wooden Walnut Case for LK-48B. Shpg. wt., 7 lbs.
21 K 8024W Net 22.50

EICO ST-70K 70 WATT STEREO INTEGRATED AMPLIFIER KIT

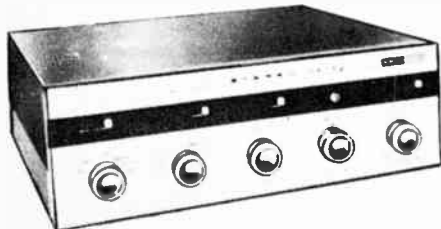

99⁹⁵
KIT

\$5 monthly

Consists of 2-35 watt amplifiers and a complete stereophonic hi-fi control center on one chassis. Stereo inputs in switched sets including: 2 magnetic phono (one for turntable, one for changer); tape head, preamplified tape, FM-AM stereo tuner, FM-FM Multiplex, and Auxiliary. Controls: Level with balance check switch and loudness/level switch; bass, treble, six-position mode selector, blend, tape speed, tape monitor, scratch, and rumble. Output: 4, 8, and 16 ohm speaker. Third channel output available. Specifications: IM distortion —2% at 70-watts. Harmonic Distortion — $\frac{1}{2}$ % at 70 watts. Frequency response— $\pm \frac{1}{2}$ db, 20-20,000 cps. Shpg. wt., 35 lbs.

21 K 2508WX Model ST-70K Net 99.95
Model ST-70 as above, but factory wired Net 149.95
21 K 2509WX

SCOTT MODEL LT-110B WIDE BAND FM STEREO TUNER KIT



124⁹⁵
KIT

\$8.50 Monthly

This popular FM stereo tuner kit boasts beautiful new styling, refined Scott performance, and extremely easy to follow building methods. Critical multiplex section and silverplated front end are wired and pre-tested at the factory. You need only align the tuner's wide-bandpass IF's and detector stage using the meter on the tuner itself. SCOTT's sonic monitor eliminates guesswork in identifying FM Stereo broadcasts. Features also include precision front panel tape output, stereo subchannel filter, stereo noise filter and precision tuning meter. Newly restyled to match all Scott amplifiers and amplifier kits. SPECIFICATIONS: Sensitivity: 2.2 microvolts. Frequency response: 30-15,000 cps. Signal-to-Noise Ratio 60 db. Separation: better than 30 db. Uses 8 tubes, 11 diodes plus rectifier. Size: 15Wx4 $\frac{3}{4}$ Hx10"D. Shpg. wt., 20 lbs. Less case.

21 K 8034WX Net 124.95

Leatherette metal case for LT-110B. Shpg. wt., 2 lbs.
21 K 8009W Net 12.50
Wooden Walnut Case for LT-110B. Shpg. wt., 7 lbs.
21 K 8024W Net 22.50

FISHER KX-200 80-WATT STEREO CONTROL AMPLIFIER KIT

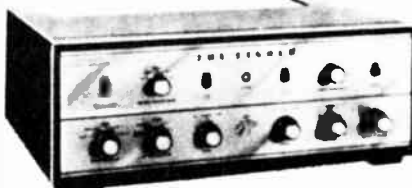

152⁵⁰
KIT

\$8 monthly

The KX-200 amplifier/preamp kit has been created to provide an amplifier, in kit form, which has reserve power and flexible audio control on one chassis. Other features include a special power output for center channel or remote listening. No additional amplifier is required. SPECIFICATIONS: 80 WATTS IHFm music power output; (35 watts RMS per channel) HARMONIC DISTORTION — (at rated output) 0.4%; IM DISTORTION (SMPTe, at rated output 0.8%); FREQUENCY RESPONSE (overall 20-20,000 cps ± 1 db — total hum and noise —80 db. CHANNEL SEPARATION at 1 kc better than 50 db. 10 tube — 2 silicon rectifier circuit — Built-in D'Arsonval calibration meter. For 117V, 60 cycles AC. Size 15 $\frac{1}{2}$ W, 12 $\frac{1}{2}$ D, 5 $\frac{1}{4}$ H. KX-200 Amplifier, less case, Shpg. wt., 30 lbs.

21 K 3828WX Net 152.90
Metal Cabinet for KX-200 Net 14.95
21 K 3808W

AMPLIVOX T.M.
ALL-TRANSISTOR
SPEAKER-AMPLIFIER



34⁰⁰ \$5 Monthly

- Cabinet Coupled Bass Driver
- 2 Speakers For Full Instrument Range
- Molded Royalite Case

A new 5-watt all transistorized audio amplifier. Features 2 Hi-Fi speakers with cabinet coupled bass driver for full instrument range. Three instrument inputs allows use with bass as well as standard guitar or accordion. Features advanced, up-to-date solid state circuitry which assures utmost reliability. No warmup necessary; ready to use instantly. Custom designed cabinet. Separate volume and tone controls. Acoustical case of handsome molded Royalite (used in finest luggage) for durability. Controls are located at the top for convenient adjustment. 117V AC Powered. Size: 10x14x5". Shpg. wt., 8 lbs. **13 K 8201WX** Net 34.00



5-WATT
SPEAKER-
AMPLIFIER
WITH
TREMOLO
41⁵⁰

\$5 Monthly

A complete 5-watt amplifier with exciting tremolo control. UL approved. Has Hi-Fi speaker for faithful sound reproduction. One speed and one strength control for tremolo. Case covered with silver and tan tweed keratol. Control panel in black and gold with large matching black and gold control knobs. For 115V 60 cps, AC. Size: 19x16x6". Shpg. wt., 18 lbs. **13 K 8719WX** 41.50

5-WATT
SPEAKER
AMPLIFIER

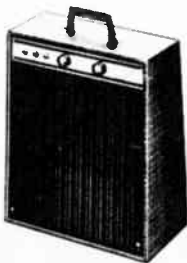

29⁹⁵

Features 8" speaker for faithful reproduction. Top-mounted control panel has tone and volume control and inputs for three instruments. Three-tube chassis. Housed in 2-tone cabinet with attractive lattice-work grille cloth. Case size: 16Wx6Dx13"H. AC-DC 60-cycle operation. Shpg. wt., 18 lbs. **13 K 8718WX** Net 29.95

(A) NEW! The "BIG BEAT".

Exclusive with Lafayette

Built in-Completely Transistorized Amplifier!

- Double Cut Away Solid Mahogany Body
- 3 Piece Laminated Neck With Adjustable Truss Rods
- Rosewood Fingerboard With 10 Position Markers
- Individual Machines With White Markers
- Precision Fretted-Uniform "FEEL"

An Exceptionally fine guitar with a "Show-Stopper" finish. PLUS a built in specially designed and engineered miniature transistorized amplifier! A new concept incorporating all the fine professional features; lucid, sparkling tone; easy action; up to date styling; sleek, slim, double cut-away design; powerful magnetic pick-up; separate tone and volume controls; exciting "sparkling burgundy" finish; blonde maple neck, hand rubbed and polished; auditorium size, 40 3/4"x13 1/2". The self contained amplifier affords perfect portability with the tone range and volume of "stationary" amplifier units. May also be used with any external guitar amplifier. Equipped with external jack and cord. Shpg. wt., 15 lbs.

99 K 8087WX **79.95**
 Batteries for above (2 required)
99 K 8021 Net ea. **.21**

(B) LAFAYETTE PROFESSIONAL CUTAWAY ELECTRIC GUITAR

- Auditorium Size—42 1/2"x17 1/2"
- Dual Adjustable Pickups
- Five Controls—including Solo/Rhythm Switch
- Laminated Arched Top and Back

Grand auditorium size—plus professional design—engineered for professional performance. Laminated maple neck with oval rosewood fingerboard. Six large inlaid position markers and nickel silver frets. White, pin-striped celluloid binding on top and back edges. Nickel plated hardware, deluxe machine heads, two sensitive pickups with individually adjustable pole pieces. Five controls permit choice of units, vary tone and volume, select between bridge pick-up for solo and forward pick-up for rhythm work. Arched laminated top and back in a shaded walnut finish with golden sunburst. Size. 42 1/2"x17 1/2"x3 1/2" Less case. Shpg. wt., 18 lbs. Imported.

99 K 9058WX Net **59.95**

GUITAR-AMPLIFIER COMBINATION

Consists of 99 K 9058WX guitar, 99 K 9078WX 20-watt amplifier, and 99 K 9043 Tremolo foot switch. Shpg. wt., 50 lbs.
99 K 9901WX Net **129.95**

(C) LAFAYETTE MODEL LA-75 20-WATT MUSIC AMPLIFIER

- For Presenting Amplifier Live Music and Voice to an Audience
- Adjustable Tremolo for "Quivering" Effect
- Separate Volume and Tone Controls for Instrument and Voice Inputs

Delivers 20 watts of clean power, to a built-in 12" heavy-duty 20-watt speaker or to an external 4, 8 or 16-ohm speaker. 3 inputs: two instrument inputs and one microphone input for voice. Frequency response: ± 3 db from 33 cycles to 20Kc on voice input; ± 3 db from 33 cycles to 15Kc on instrument inputs. Mike input sensitivity is 9 mv RMS. 6 tubes. 15 3/4"H (including rubber feet) x 19 1/2"Wx8 1/2"D. Carrying handle. Imported. Shpg. wt., 30 lbs.

99 K 9078WX Net **89.50**
FOOT SWITCH to remotely control the tremolo in the LA-75. Equipped with cable terminated in standard phone plug to fit corresponding jack on 1L-75. Shpg. wt., 1 1/2 lbs.
99 K 9043 Net **5.95**

(D) LAFAYETTE® DOUBLE CUTAWAY—DUAL PICKUP
ELECTRIC GUITAR with Tremolo Tailpiece

- 2 Adjustable Pickups
- Individual Tone and Volume Controls
- Individual Rocker Switches
- Solid Mahogany Body—3 Piece Laminated Neck

Elegant double cutaway design features tremolo tailpiece and detachable steel reinforced warpproof neck. Solid Mahogany Gleaming, hand rubbed finish body. Rosewood fingerboard with 8 white inlaid markers and 20 frets. 2 microphone pickups each adjustable for tone and volume balance. Separate tone and volume controls. Sensitive pickups have individual adjustment screws for each string. Chrome plated guard plate. Highly polished shaded mahogany finish. Size 39Lx12Wx11 1/4"D. Less case. Shpg. wt., 10 lbs. Imported.

99 K 9060WX **49.95**
 Carrying Case
13 K 8715WX Shpg. wt., 3 lbs. **8.95**

GUITAR—AMPLIFIER OUTFIT

Consists of above Guitar, 5 watt amplifier with 8" speaker, tone and volume controls and carrying case. Shpg. wt., 35 lbs. **79.95**
13 K 9004WX

(E) "VALUE" ELECTRIC GUITAR

- Magnetic Pick-up
- Individual Adjusting Screws
- Individual Tone and Volume Controls

The perfect instrument for the budget-minded musician. Features double cut-away solid body construction for that true, "twangy" electric guitar sound and rugged dependability. Other features are a sensitive magnetic pick-up with individual adjusting screws, individual tone and volume controls, 20 frets with 6 marked positions. Comes complete with connecting cord with standard plugs on each end. Deep mahogany color with sunburst. Shpg. wt., 12 lbs. Imported

99 K 9022WX Net **34.50**
GUITAR OUTFIT: Includes 99 K 9022WX guitar, 13 K 8718 amplifier, and 13 K 8712WX case. Shpg. wt., 35 lbs.
13 K 9003WX Net **85.50**
CARRYING CASE ONLY. Shpg. wt., 3 lbs.
13 K 8712WX Net **8.95**

NEW! The "BIG BEAT".

(A)
79⁹⁵
\$5 monthly

**Fabulous Tone
Fabulous Quality
Fast Action**

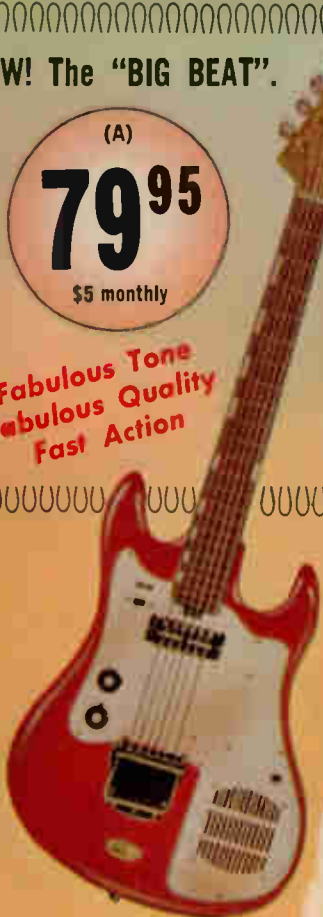

LAFAYETTE PROFESSIONAL
CUTAWAY ELECTRIC GUITAR

(B)
59⁹⁵
\$5 monthly

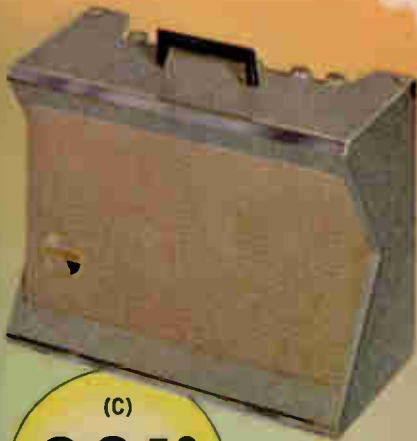

(C)
89⁵⁰
\$5 monthly

LAFAYETTE MODEL LA-75
20-WATT MUSIC
AMPLIFIER

LAFAYETTE® DOUBLE
CUTAWAY ELECTRIC
GUITAR

(D)
49⁹⁵
\$5.00 monthly



(E)
"VALUE" ELECTRIC
GUITAR
34⁵⁰
\$5.00 monthly

**DELUXE DUAL
PICKUP
GUITAR/AMPLIFIER
COMBINATION**

GUITAR ONLY

89⁹⁵

\$5 monthly

(A)

**TRIPLE PICKUP
DOUBLE-CUTAWAY
ELECTRIC GUITAR
COMBINATION**

GUITAR ONLY

109⁹⁵

\$5 monthly

(B)

(C)

GUITAR ONLY

34⁹⁵

\$5.00 monthly

**COMPLETE ELECTRIC
ACOUSTIC GUITAR
OUTFIT**

**7 PIECE
ECONOMY
OUTFIT**

21⁹⁵

(D)

**ARCHED TOP
GUITAR**

(E)

19⁹⁵

FOLK GUITAR

(F)

39⁹⁵

\$5.00 monthly

**CLASSIC SPANISH
GUITAR**

(G)

32⁹⁵

\$5.00 monthly

**BARITONE
UKULELE**

(H)

14⁹⁵

**ELECTRIC
BASS**

(I)

94⁹⁵

\$5 monthly

**DRUM COMBO
OUTFIT**

(J)

109⁹⁵

\$5 monthly

**PROFESSIONAL
TUNABLE BONGOS**

(K)

15⁹⁵

**ELECTRIC
METRONOME**

(L)

14⁹⁵

**SNARE
DRUM**

(M)

34⁹⁵

**"RENE DUVAL"
CLARINET OUTFIT**

(N)

89⁹⁵

\$5 monthly

**TRUMPET
OUTFIT**

(P)

79⁹⁵

\$5 monthly

**"RENE DUVAL"
ALTO SAX OUTFIT**

(R)

159⁹⁵

\$8.00 monthly

OUTSTANDING MUSICAL INSTRUMENTS

(A) DELUXE DUAL PICKUP

GUITAR/AMPLIFIER COMBINATION

An outstanding double cutaway guitar in mahogany solid body with hand rubbed finish. Reinforced steel neck, oval rosewood fingerboard, 20 frets, inlaid pearl markers. Dual magnetic pickups with individual string adjustment. Controls: 2 volume, 1 tone, 2 selector switches. Also LA-75 20-watt hi-fi amplifier with heavy-duty 12" speaker. Shpg. wt., 45 lbs. Imported.

Guitar Case and Amplifier
13 K 9001WX Net 159.95
 Deluxe Guitar only. Wt., 15 lbs.
13 K 8714WX Net 89.95
 Carrying Case only. Wt., 3 lbs.
13 K 8715WX Net 8.95

(B) TRIPLE PICK-UP DOUBLE-CUTAWAY ELEC. GUITAR COMBO

A 3-piece outfit featuring Triple-pickup professional guitar in double-cutaway style. Maple reinforced neck with adjustable steel rod and 2 parallel truss rods. Adjustable bridge. 3 magnetic pickups, individual adjustments, 3 volume, 1 tone control, selector switch. LA-75 20-watt hi-fi amplifier with heavy-duty 12" speaker. Shpg. wt., 48 lbs. Imported.

Guitar, case and Amplifier.
13 K 9002WX Net 179.95
 Guitar only. Shpg. wt., 15 lbs.
13 K 8716WX Net 109.95
 Case only. Shpg. wt., 3 lbs.
13 K 8717WX Net 9.95

(C) COMPLETE ELECTRIC ACOUSTIC GUITAR OUTFIT

This complete 7-piece guitar outfit features a standard-size electric acoustic guitar that can be used with or without amplifier. Outfit includes 5-watt speaker/amplifier, imitation alligator case, pick, neckstrap, connecting cord, E-Z Method Guitar book. Shpg. wt., 35 lbs. Imported.

13 K 8725WX Guitar Outfit Net 64.95
 Guitar Only; wt., 10 lbs.
13 K 8726WX Net 34.95
 Case only; wt., 3 lbs.
13 K 8727WX Net 7.95

(D) 7 PIECE "ECONOMY" OUTFIT

6-piece special guitar outfit with beginner's record course. You get: guitar, guitar bag, record course, 3 guitar picks, extra set of strings, neck cord. Guitar has hardwood body and steel reinforced neck. Imported Complete Outfit.

13 K 8723WX Shpg. wt., 9 lbs. Net 21.95
 Guitar Only.
13 K 8724WX Shpg. wt., 7 lbs. Net 16.88

(E) ARCHED TOP GUITAR

A grand concert size, F hole guitar with glossy mahogany finish. White celluloid-bound ebony finish fingerboard. Has adjustable bridge and nickel-plated adjustable tail-piece. Heavy gauge shell celluloid pick guard and nickel-plated machines with white buttons. Shpg. wt., 7 lbs.

13 K 8728WX Net 19.95

(F) FOLK GUITAR

A fine mellow toned, easy playing guitar ... features the wide classic type neck. Comes with metal strings but can be used with gut or nylon strings. Natural white spruce top, genuine maple back and sides; highly polished walnut finish on back and sides. Rosewood fingerboard. Individual tuning pegs. Shpg. wt., 11 lbs.

13 K 8721WX Net 39.95

(G) CLASSIC SPANISH GUITAR

A carmenita classic-type guitar combining outstanding craftsmanship and materials. Back, sides and neck are of genuine mahogany and top is of spruce. Steel reinforced neck and nylon strings. Top edge is bound with heavy sparkling brown celluloid. Slotted headpiece, white button machines. Shpg. wt., 11 lbs. Imported.

13 K 8729WX Net 32.95
 Case for above.
13 K 8720WX Shpg. wt., 4 lbs. Net 8.95

(H) BARITONE UKULELE

Highly polished mahogany back, sides and neck. Inlaid pearl position markers, white patent pegs, white bone nut. Strings are carefully gauged nylon. Sound hole bound with black and white celluloid and decorated with inlaid purfling. Gives the warmth of tone and ease of response to satisfy any player. Shpg. wt., 4 lbs. Imported.

13 K 8730WX Net 14.95

(I) ELECTRIC BASS

Deep-voiced bass tones with quick, easy response. Contour-cut solid body and 30-piece adjustable steel reinforced neck. Rosewood fingerboard with 20 frets. Heavy duty pickup with individual tuning screw for each string. 45" long, 12 3/4" wide. Polished, hand rubbed finish. Shpg. wt., 15 lbs. Imported.

13 K 8702WX Guitar only Net 94.95
13 K 8703WX Case for above Net 19.95

(J) DRUM COMBO OUTFIT

14x20" single-tension bass drum with tom-tom and cymbal holders. 14x5 1/2" snare drum with separate tension, flanged hoop, metal snare, professional throw-off. 12x8" matching tom-tom with separate tension, flanged hoops. Accessories include a 12" cymbal, drum pedal with adjustable beater and springs, disappearing spurs, sturdy snare-drum stand, holder for tom-tom and sticks. Imported.

13 K 8701WX Shpg. wt., 45 lbs. Net 109.95

(K) TUNABLE BONGOS

Pure white perfect calfskin heads for best rhythm effect. Sparkling color finish. Sturdy construction with heavy plated hardware. Four tuning lugs on each bongo. Head sizes: 7 3/4" and 6 1/2". Overall 7" deep. Complete with Tuning Key. Shpg. wt., 5 lbs. Imported.

13 K 8704 Net 15.95

(L) ELECTRONIC METRONOME

A smart, modern electronic metronome that uses transistors and is battery operated. Features a bright neon light which flashes in synchronization with an audible beat. Dial also provides adjustment for suitable tempo (40-208). Battery lasts almost indefinitely. 6" high and 7" wide at base. Shpg. wt., 2 lbs. Imported.

99 K 9083 Net 14.95

(M) SNARE DRUM

An exciting 14x5 1/2" separate tension snare drum with metal snares, tone modulator, heavy-duty throw-off, flanged hoops, rolled rims, nickel plated hardware. Bright sparkle finish. Complete with norwood metal stand, sticks, brushes, instruction book. Shpg. wt., 15 lbs. Imported.

13 K 8705WX Net 34.95

(N) "DUVAL" CLARINET OUTFIT

Quality clarinet made entirely of selected grenadilla wood. Tuned for the key of Bb, Boehm system, 17 keys, 6 rings. Mouth-piece, cap, ligature, reed, music lyre, swab, grease cup and quality case of plush-lined fabric covered veneer. Shpg. wt., 8 lbs. Imported.

13 K 8710WX Net 89.95

(P) TRUMPET OUTFIT

An outstanding trumpet with beautiful professional styling with nickel-silver tubing and trim. Valves feature nickel silver construction with top springs and slotted no-twist guides. Body is of brass, clear lacquered finish. With mouthpiece, music lyre and plush-lined case with large accessory compartment. Shpg. wt., 14 lbs. Imported.

13 K 8709WX Net 78.95

(R) "DUVAL" ALTO SAX OUTFIT

A professional instrument with smooth, light key action and rich, full tone. Integral one-piece tone holes, drawn from the body. Has removable key guards, genuine mother-of-pearl-fingertips on keys, and extra-heavy reinforced bottom guard. Equipped with popular C#, Bb, C# with articulated G and automatic high F key. Bb, B, C# and C keys located on right side are facing forward to prevent contact with clothing. Gladstone type case with silk plush lining. Shpg. wt., 20 lbs.

13 K 8711 Imported Net 159.95

NEW "ARTISTRY" CLASSIC GUITAR

- Violin Finish Maple
- True Classic Design
- Superior Materials Used Throughout

57⁵⁰
 \$5 monthly



The "Artistry" classic guitar features two-piece violin finish maple back and sides with narrow grained spruce top. Excellent tonal qualities meet the critical demands of the most discriminating classic guitarist. Fan braced with steel reinforced maple neck. All edges bound with heavy black celluloid. Sound hole is inlaid and bound. Nylon strings are used for ease of positioning and excellence of tone. Utilizes slotted headpiece. Has 19 frets for full coverage. Shpg. wt., 11 lbs.

13 K 8722WX Net 57.50

METHOD FOR GUITAR By JOE FAVA



As Low As **149**

A contemporary approach towards comprehensive mastery of the guitar written in a clear concise manner by a professional. The strings are learned in order of their difficulty with musical arrangements for study. Profusely illustrated.

13 K 8706 Book I
 (1st position) 40 pages Net 1.49
13 K 8707 Book II
 (2nd position) 40 pages Net 1.49
13 K 8708 Book III
 (Higher positions) 48 pages Net 1.98

HOW TO PLAY THE GUITAR

Famous "Music Minus One" Records!

350



The easy way to learn all the chords and rhythms on your guitar. Has vocal accompaniment; ballad styles; folk, country and western; rhythm and blues; shuffle beats. Features guitar demonstration and text by George Barnes, spoken commentary by Bob Mersey.

24 K 4506 Shpg. wt., 1 lb. Net 3.50

MINIATURE SOLID STATE PORTABLE TAPE RECORDER

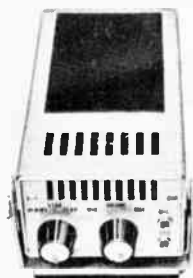

TAKE IT ANYWHERE!

Outstanding
For Dictation



Only

1795

- Compact—only 3½Wx7½Lx2½"H
- Makes Direct Telephone Recordings
- Complete with Lapel Microphone, Earphone, Telephone Pickup, Batteries and 3" Take-up Reel

Take this recorder anywhere! Offers reliable solid-state circuitry, compact size, and low cost battery operation to make it a true personal portable. It is ideal for oral note taking, homework, dictation and all-around family fun. Can record and play back in any position—even with the lid closed. Positive action controls (Rev., Stop, Play, Rec.) and Volume are up front where you can operate them easily. Crystal mike has lapel clip for inconspicuous use. Motor is powered by 2 "C" type cells; amplifier by one 9-volt battery. Handy telephone pickup makes possible direct telephone recording for your permanent records. Housed in rugged metal case with carrying handle. Total recording time approximately 24 minutes. Complete with built-in speaker, earphone for personal listening, telephone pickup, batteries and 3" empty take-up reel. Shpg. wt., 3 lbs. Imported.

| | | |
|------------|-------------------------------------|-------------|
| 27 K 1005L | | Net 17.95 |
| 32 K 4801 | Extra "C" cell battery (2 required) | Net ea. .13 |
| 99 K 6021 | Extra 9-volt battery (1 required) | Net .21 |

DELUXE 6 TRANSISTOR PUSHBUTTON TAPE RECORDER



3995

\$5 monthly

- 6 Transistors: 1 Diode, 1 Thermistor
- 3¼ & 1½ ips—Capstan Driven for Constant Speed
- Up to One Hour Recording Time without Turning Tape Over
- Takes 3¼" Reels

New 6-transistor tape recorder features capstan drive with governed motor for accurate and constant speed. 3¼ or 1½ ips, allows a full recording time of up to two hours on 600 foot tape—one hour without stopping to turn tape over. Equipped with record level meter and battery strength indicator. Features sensitive dynamic microphone with remote control switch making a perfect unit for dictation and speech practicing purposes. Also records directly from radio, TV, phono, telephone, or other tape recorder. Specially designed "dashboard type" push-buttons give speedy yet accurate operation. Complete with remote-control dynamic microphone, magnetic earphone, tape, empty reel and batteries. Size: 9¾Wx 8¾Dx2½"H. Shpg. wt., 5 lbs. Imported.

| | | |
|-----------------------------------|---------------------------------|-------------|
| 27 K 1001L | | Net 39.95 |
| 27 K 1002 AC Power Pack for above | | Net 12.95 |
| 32 K 4801 | Extra "C" Cell Battery (4 req.) | Net ea. .13 |

NORELCO MODEL 101 TRANSISTORIZED PORTABLE RECORDER



9950

\$5 monthly

- Records up to 3 Hours
- 1½" Constant Speed Capstan Drive
- Recording and Battery Condition Indicator

As simple to operate as a portable radio. Carry it everywhere. Works on six ordinary flashlight batteries. Push two buttons, you're recording up to 3 hours on a 4" reel of tape. Push one button you're playing back. Dial your favorite bass or treble tone. Special speaker provides big clear sound. Rewinds in seconds. High quality dynamic microphone picks up sound from the farthest points in a room. Constant speed capstan drive lets you play tapes on any 1½" 2-track recorder with no loss in sound quality. Record and battery life meter shows recording level plus exact battery condition. Frequency response: 80-8,000 cps. S/N ratio: better than 45 db. Complete with transparent cover, mike cables. Size: 11Wx8Hx3¼"D. Shpg. wt., 8½ lbs. Imported.

| | | |
|---|-------|-------------|
| 27 K 4801WX | | Net 99.50 |
| 'D' cell batteries for "101" (6 req.) | | Net ea. .13 |
| 32 K 4804 | | Net .13 |
| CC-86 Texon Carrying Case for Model "101" | | Net 7.95 |
| 21 K 4806 | | Net 7.95 |

5 TRANSISTOR PORTABLE PUSHBUTTON TAPE RECORDER

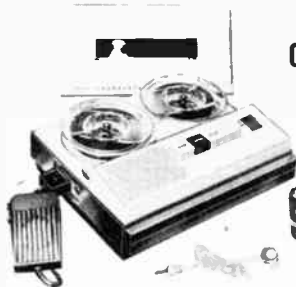

Features Remote
Control Microphone

ONLY

1995

Includes:
Mike, Earphone
Batteries and
3" Tape Reel

- Small, Compact—weighs only 2 lbs.
- Uses 2-Track System—Doubles Recording Time
- Battery Operated
- Takes 3" Reels

A deluxe, miniature 2-track tape recorder measuring only 7½x6¼x 2½" and weighing a mere 2 lbs. Records and plays up to 20 minutes (both tracks) on a 300 ft. 3" reel. Special switch on the sensitive microphone lets you stop or start reels remotely—makes the unit ideal for dictating purposes. Has simple push-button operation for Record, Play, Rewind and Stop functions. Circuit is completely transistorized and has push-button audio output with built-in speaker... offers clear, crisp sound reproduction. Special earphone receptacle for monitoring during recording or for private listening during playback. Special design allows recorder to be operated with cover closed... lets you record or play with the unit in any position—even while walking! Housed in a high-impact plastic cabinet in black and gray with silver trim, push-buttons, volume control, carrying handle. Supplied complete with remote control microphone, earphone, 3" reel of tape, empty reel, batteries. Imported.

| | | |
|------------------------------|-------------------------------------|-------------|
| 27 K 1006L Shpg. wt., 3 lbs. | | Net 19.95 |
| 32 K 4801 | Extra "C" cell battery (3 required) | Net ea. .13 |
| 99 K 6021 | Extra 9-Volt Battery | Net .21 |

CONCORD 330 VOICE OPERATED PORTABLE RECORDER



14950

\$7.50 Monthly

- Automatic Voice Operation—Sound Starts it—Sound Stops It!
- Automatic Slide Advance for Unattended Slide Projector Operation
- Automatic Movie Sync—Synchronize Sound with Movie Projector
- Automatic Tape Threading
- Fully Transistorized—Runs on Flashlight Batteries

The New Concord Model 330 is a fully automatic voice operated portable tape recorder incorporating many deluxe features. Automatic voice operation provides almost unlimited recording applications—the 330 starts recording whenever a sound is present and stops during silent periods. Frequency response is 50 to 10,000 cps for excellent musical reproduction. Takes up to 5 inch reels and operates at both 1½ and 3¼ ips. Complete with dynamic microphone, earphone, empty reel, sensing tape, and slide projector plug. Uses 6 size "D" cells. Dimensions: 12Wx8¾Dx3¾"H. Shpg. wt., 6 lbs.

| | | |
|-------------------------------------|------------------------|------------|
| 27 K 3502WX Model 330 | | Net 149.50 |
| 27 K 3501 | AC Adaptor for 330 Net | 12.95 |
| "D" Size Batteries for 330 (6 req.) | | Net .13 |
| 32 K 4804 | | Net .13 |

WORLD FAMOUS TAPE RECORDERS

NEW NORELCO DELUXE CARRY-CORDER™ "150"



only
119⁵⁰
\$6 Monthly

COMPLETE WITH:

Mike, Deluxe Carrying Case and Mike Pouch, 4 tape Cartridges and Patch cord

- All Transistor—Cordless
- Uses Tape Cartridges
- Compact—Take it Anywhere

A marvel of tape recorder engineering. Extremely lightweight—weighs less than 3 lbs, including batteries. Carry it everywhere . . . ideal for students, salesman, busy executives. Records voice and music on 2 tracks at 1 1/2 ips with perfect fidelity. Fully transistorized for instant record/playback. No warmup. Easy to use. Single master control starts, stops, winds and rewinds tape. Microphone has remote switch for start-stop. 300 ft. triple-play tape cartridge provides up to 1 hour play/record time, can be removed at any time—no need to wind or rewind tape. Uses 5 "C" size flashlight cells. Has recording level/battery life meter. Can be used with external amplifier, headphones. Complete with mike, patch cord, vinyl carrying case, 4 tape cartridges and separate microphone pouch. Size: 7 3/4 x 4 1/2 x 2 1/4". Shpg. wt., 4 lbs. Imported.

| | | |
|--|---------|--------|
| 27 K 4804XL Model 150 | Net | 119.50 |
| 27 K 4805 Extra Blank Tape Cartridge | Net | 3.65 |
| 32 K 4801 "C" Type Battery, 5 required | Net ea. | .13 |

FAMOUS Wollensak T-524 4-SPEED TAPE RECORDER



ONLY
99⁰⁰
\$5.00 MONTHLY

- 4-Speeds; 7 1/2, 3 3/4, 1 1/2, 3/8 ips
- Push-button Operation
- Instant Pause Control
- Tone Control
- Neon Record Level Indicators
- Records/Plays—2-Track Mono

A terrific performer, ideal for students. Slowest speed (3/8 ips) is perfect for dictation, homework, lectures etc. Records 2 track mono. Big 5x7" speaker gives true voice and music reproduction. Other features include, easy-to-use push button tape drive control, instant pause and tone controls, external speaker outputs, 2 record indicators (normal and distort) and safety record interlock to prevent accidental tape erasure. Frequency response: 80-12,000 cps; signal-to-noise ratio, 45 db; wow and flutter, less than .3% at 7 1/2 ips; 3 watts audio output at 5% distortion. Handsome, lightweight black and grey vinyl clad steel case 7x13x10". Complete with mike, 7" reel of recording tape, 7" take-up reel and power cord. For 110-120 V, 60 cycle AC. Shpg. wt., 28 lbs.
27 K 7003WX \$5.00 monthly Net 99.00

EICO MODEL RP-100K STEREO TAPE DECK KIT



NEW
LOW PRICE
249⁹⁵

Sold for ~~299.95~~ in
1965 Cat. 650

- Separate Transistor Stereo Record and Playback Amplifiers
- 1/4-Track Heads for Erase/Record/Playback
- New Hysteresis-Synchronous Capstan Motor

A precision stereo/monaural tape deck, the RP-100 provides stereo/mono 1/4-track-erase, record, and playback; plus 1/2-track stereo/mono playback. Sound-on-sound. Features: Dual meters for monitoring stereo record levels; professional hysteresis-synchronous capstan motor; 2-take-up and rewind motors, automatic end of tape switch and improved drive system. SPECIFICATIONS: Tape Speed — 7 1/2 or 3 3/4 ips; up to 7" reel size; Flutter and Wow 0.15% at 7 1/2 ips, 0.2% @ 3 3/4 ips; Frequency response: 30-17,000 cps @ 7 1/2 ips, 40-15,000 cps @ 3 3/4 ips; Signal-to-noise ratio — 55 db. RP-100K Semikit: Includes transport completely assembled and tested with 3 heads; stereo record, and stereo playback preamps in kit form. Dimensions: 15 1/4 wide, 13 3/8" front-to-back, 7" deep. Shpg. wt., 28 lbs.

| | | |
|---|-----|--------|
| 27 K 3101WX | Net | 249.95 |
| MODEL CC-2 Luggage Type with detachable cover for RP-100. | | |
| 27 K 3103W Shpg. wt., 13 lbs | Net | 29.95 |

DELUXE CONCERTONE MODEL 801 STEREO TAPE RECORDER



featuring

- 6 Heads
- Automatic Reversing for Playback or Recording
- Solid State Circuitry
- 3 Motors
- Push Button Controls

397⁴⁶

\$19 monthly

The New Concertone 801 is one of the most advanced stereo recorder — reproducers available today for the serious hobbyist. Offers extreme versatility by employing six heads—two play, two record, two erase—arranged symmetrically on both sides of the center capstan. This 1/4 track stereo Bi-Directional recorder allows continuous playback or recording in either direction without reel turnover thus permitting an entire evening of uninterrupted music. SPECIFICATIONS: Two Speeds: 3 3/4 and 7 1/2 ips. Frequency Response: 30-18,000 cps @ 7 1/2 ips and 40-12,000 cps @ 3 3/4 ips. Wow and Flutter: Less than .2% at 7 1/2 ips. Signal to Noise Ratio: 50 db. Three Motors, Rewind time: 1200 feet in 45 sec. Output level 1.0 volt. Completely self contained portable with integrated speakers, monitor amplifiers, dynamic microphones, and handsome two-tone carrying case. Size 19 1/4 x 14 1/4 x 8 5/8" D. Shpg. wt., 49 lbs.

| | | |
|--|-----|--------|
| 27 K 1405WX | Net | 397.46 |
| MODEL 802—Stereo Phonic Tape Deck version of famous Model 801. | | |
| Shpg. wt., 30 lbs. | | |
| 27 K 1406WX | Net | 334.36 |

Lafayette is Headquarters For the Tape Recorder Enthusiast

Lafayette Cat. No. 652 27

(A) LAFAYETTE RK-675 DELUXE PUSHBUTTON 4-TRACK STEREO TAPE RECORDER

- Records 4-Track Stereo, 4 Track Monaural
- Plays 4 and 2-Track Stereo and 4-Track Monaural
- 6 Pushbutton Controls • 2 Speeds
- Sound-with-Sound
- Automatic Shut-off of Tape Transport
- Wide Frequency Response for "Life-Like" Reproduction
- Heavy duty 4 pole Capacitor Start Motor
- Individual Channel Volume Controls
- Separate Interlocking Record Buttons
- Magnificent Tone From 2 Full Range Self-Contained Matched Hi Fi Speakers
- Pause Control Provides Instant Stop for Editing
- 2 Individual Record Level Meters
- Digital Tape Counter

• Designed To Record FM Stereo Broadcasts!

An extraordinary self-contained portable tape recorder with professional quality features. Records and plays back 4-track stereo and monophonic tapes at 2 speeds, 7½ and 3¾ ips. Records from any source—radios, FM tuners. Hi-Fi stereo amplifiers or "live" from the quality dynamic microphones supplied. Make sound-with-sound tapes . . . accompany yourself in a duet or add your voice to prerecorded music. The rugged tape mechanism features a heavy duty 4-pole capacitor-start motor. Gives smooth tape run low flutter and wow. Automatic shut-off of entire transport at end of tape . . . disengages controls to neutral position . . . prevents tape spillage. Easy-to-use push-buttons provide positive control of tape motion. Has separate interlocking record buttons. Magnificent tone is assured with 2 big 6x4" full tone speakers and side flaps for better stereo separation. Other features include digital tape counter, pause control for editing, 2 record level meters, and individual channel volume controls. Complete with luxurious simulated leather case, 2 dynamic microphones, cables and take-up reel. For 105-125V 60 cycles AC. Size: 16½Wx7Hx12½"D. Shpg. wt., 35 lbs. Imported.

SPECIFICATIONS
 Frequency Response, Record/Playback: 40-18,000 cps @ 7½ ips; 40-12,000 cps @ 3¾ ips. Audio Output: 3-watts per channel. Signal-to-Noise Ratio: —45 db. Interchannel Separation: 45 db or better; Wow & Flutter: 0.2% @ 7½ ips, 0.25% @ 3¾ ips. Bias & Erase: 80KC; Rewind Time: Less than 4 minutes for 1200 ft. of tape. Speed Accuracy: 98%.

99 K 1504WX Model RK-675 Net 179.95
 28 K 0101 7" Reel of Lafayette Recording Tape Net 1.59

(B) MAGNIFICENT LAFAYETTE MODEL RK-600A 4 TRACK STEREO TAPE RECORDER

featuring Sound-with-Sound

SUPERBLY STYLED . . . WITH THESE DELUXE FEATURES

Heads — Separate record/playback and erase heads, mu-metal shielded.
INDIVIDUAL CHANNEL RECORD BUTTONS — Permit sound-with-sound recording.
INDIVIDUAL CHANNEL VOLUME CONTROLS — Provide volume adjustment on playback, act as input level controls during recording.
POSITIVE-ACTION CONTROL LEVER — Assures easy control of rewind, fast forward and record/playback functions.
2 SPEEDS — Choice of 7½ ips or 3¾ ips by means of simple capstan adjustment.
PAUSE CONTROL — Provides safe, instant stop for editing. Control is self-holding.
SOUND DEFLECTOR SIDE PANELS — Let you deflect speaker sound for best stereo effect.
HI and LO LEVEL INPUTS — Stereo inputs for recording from microphones, FM stereo tuners, stereo amplifier, radios, etc.
MONITOR OUTPUTS — For playback through stereo amplifier, or for headphone monitoring during recording.
INDIVIDUAL RECORDING LEVEL INDICATORS — Provide indication of correct volume adjustment on record.

- PLAYS—4-Track Stereo Tapes, 2-Track Stereo Tapes, Monaural 2-Track Tapes, Monaural Full Track Tapes • RECORDS—4-Track Stereo, 4-Track Monaural
- Two Speeds: 3¾ & 7½ ips • 2 6x4" Hi-Fi Speakers

SPECIFICATIONS

Frequency Response: 40-15,000 cps at 7½ ips, 40-9,000 cps at 3¾ ips. Stereo Separation: .45 db. Wow & Flutter: As low as 0.25%. S/N Ratio: 45 db. Reel Capacity: 7" reel. Speakers: (2) built-in 4x6" oval. Audio Output: 1.5 watts per channel. Erase Frequency: 80 kc. Heads: 4 track — separate record/playback and erase heads, mu-metal shielded.

The RK-600A is a complete 4-track, 2-speed stereo tape recorder . . . needs no extra amplifiers or speakers. Plug in the microphones supplied and make "live" stereo recordings anywhere . . . play the tape back and hear your recording in full-dimension stereo—you'll be amazed how wonderfully easy it is! RK-600A also has inputs for recording from radios, FM tuners, Hi-Fi amplifiers. The recorder also makes "sound-with-sound" recordings—a feature that allows you to accompany yourself in a duet, add your voice to pre-recorded music, etc. And, "sound-with-sound" allows you to re-record one track if you are dissatisfied with it—without removing the recording on the other track! Other features include fast-forward and fast-rewind facilities, simple tape threading arrangement, individual neon recording level indicators, a hi-lo tone switch, speaker muting switch, plus extension speaker outputs. The RK-600A is housed in a smart vinyl covered case with handle and is supplied complete with 2 dynamic microphones, patch cords and empty 7" reel. For 117V. 60 cycles AC. Dimensions: 16½Wx11Dx7½"H. Imported. Shpg. wt., 31 lbs.

Model RK-600A Stereo Tape Recorder
 99 K 1506WX Net 129.50
 7" reel of 1200 ft. Lafayette Recording Tape Net 1.59
 28 K 0101

(C) LAFAYETTE Model RK-142 DELUXE PORTABLE TAPE RECORDER

Takes up to 7" Reels

- With Recording Level Indicator
- ½-Track Doubles Play and Record Time
- Two Speeds—3¾ or 7½ IPS

- 4 x 6" Speaker For Fine Tonal Reproduction
- Provision For External Speaker
- Permits Direct Recording From Radio Or Phono

SPECIFICATIONS — Tape speed: 7.5 and 3.75 ips in two speeds. S/N ratio: —42 db or better at 7.5 ips tape speed. Rewind time: 3 min. for 7" reel. Fast Take-up Time: 3 min. for 7" reel. Response: Record-playback response essentially flat with tone at max. treble. Wow-Flutter: 0.2% or better at 7.5 ips; 0.3% at 3.75 ips.

Perfect for home, school or office. At home, the RK-142 proves ideal for parties or recording your favorite musical performance. Handy fool-proof operation has been provided by a specially designed lever type record switch which completely eliminates the chance of accidental erasure. At 3¾ ips, the RK-142 provides more than 4 hours recording on long play ½ mil 2400 ft. tape reel. A special 4x6 inch heavy-duty permanent magnet speaker furnishes an exceptionally fine tonal quality. Record level indicator facilitates recording by showing you when the volume control is correctly set. Jacks provided for microphone, phono and extension speaker (special alligator clip cord is supplied). Complete with sensitive dynamic microphone. Finished in attractive scuff-resistant material. Dimensions: 11¾x9¾x7½". For 110 volts, 60 cycles. Imported.

99 K 1512WX Model RK-142 Deluxe Tape Recorder Net 59.95

(A) LAFAYETTE RK-675 DELUXE PUSHBUTTON 4-TRACK STEREO TAPE RECORDER

Beautiful Carrying Case for
RK-675



only

179⁹⁵

\$9 Monthly

COMPLETE WITH Carrying case, 2 dynamic
mikes, output cables, and 7-inch empty tape
reel.

(B) Famous Lafayette RK-600A Stereo Tape Recorder

Complete Self-Contained at only



129⁵⁰

\$6.50 monthly

Complete with 2 dynamic micro-
phones, patch cord, and 7" take-up
reel.

(C) Lafayette Model RK-142 Deluxe Portable Recorder

Takes Reels up to 7"



59⁹⁵

\$5 monthly

Complete with dynamic microphone,
patch cord, and 7" take-up reel.

THE PROFESSIONAL LAFAYETTE Criterion 1000 4-TRACK STEREO SELF-CONTAINED TAPE RECORDER

featuring
**MAGNIFICENT
TEAK CABINETRY**



2 DYNAMIC
MICROPHONES

only
199⁵⁰

\$10 monthly

ENGINEERED TO RECORD FM STEREO

- Plays: 2 & 4-Track Stereophonic and 4-Track Monophonic Tapes
- Records: 4-Track Stereo and Mono
- Transistorized Stereo Preamplifiers
- Push Pull Power Amplifiers
- Sound With Sound
- Six Pushbutton Tape Motion Controls
- Automatic Shut-off Electrically and Mechanically Returns Recorder to Stop Position
- 3-Speeds: 7½, 3¾, 1⅞ ips

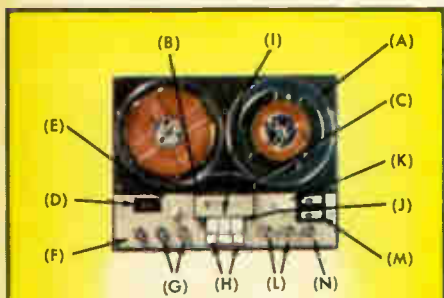

OPERATING FEATURES

- (A) Supply Reel up to 7" Size
- (B) Automatic Tape Stop Switch
- (C) Heads-Separate Record/Play & Erase
- (D) Tape Position Indicator
- (E) Power Switch-Speed Selector
- (F) Stereo-Mono-Mute Output Selector
- (G) Left Channel Volume Control & Tone Controls
- (H) Individual Channel Record Push-Buttons
- (I) Positive Stop Switch
- (J) Fast Forward, Play/Record, Fast Rewind Push Buttons
- (K) Instant Pause Control
- (L) Right Channel Tone & Volume Controls
- (M) Record Level Meters
- (N) Mike, Radio, M/R Mixer Input Selector

SPECIFICATIONS

Speeds: 1⅞, 3¾, 7½ ips. Frequency Response: ±3 db 50-15,000 cps @ 7½ ips, ±3 db 50-10,000 cps @ 3¾ ips, ±3 db 55-5 000 cps @ 1⅞ ips. Motor: 4-pole capacitor-start, Signal-to-Noise ratio: 50 db. Wow & Flutter: 0.2% @ 7½ ips. Rewind Time: 1200 ft. reel, 130 sec. Inputs: 2 microphone, 2 high level. Speakers: 2 6x4" oval; Two external speaker outputs. Power output: 6 watts per channel. Bias & Erase: 80 kc. Reel Size: 7" maximum.

Another outstanding achievement by Lafayette engineers in tape recorder design. The Criterion 1000 records and plays 4-track stereophonic tapes with "ultra" realism through its own transistorized, preamplifiers, push-pull power amplifiers and matched self-contained high fidelity speakers. Speaker wing panels deflect the sound into the room with the proper stereo separation. Three finger-tip selected speeds of 7½, 3¾ and 1⅞ give you up to 8 hours playing time on a single 7" reel. Positive pushbutton controls coupled to a husky, heavy duty, low slip capacitor-start motor enable smooth tape control with exceptional record-playback characteristics. Dual volume and tone controls, index counter, separate level meters and an automatic shut-off which electrically and mechanically returns recorder to "stop" position are additional Criterion features. Has 4 inputs for microphones and radio connections plus mike/radio mixer control and two output jacks for external speakers. Cabinet is genuine teakwood—a modern classic! With 2 dynamic microphones, cables and 7" take up reel. For 117 volts, 60 cycles AC. 17¼Wx7¼Hx12¾"D. Shpg. wt., 43½ lbs. Imported

| | |
|--|------------|
| 99 K 1501WX Criterion 1000 Stereo Recorder | Net 199.50 |
| 28 K 0101 7" reel of 1200 ft. Lafayette recording tape | Net 1.59 |

LAFAYETTE MODEL RK-650 PROFESSIONAL 4-TRACK STEREO RECORD & PLAYBACK TAPE DECK

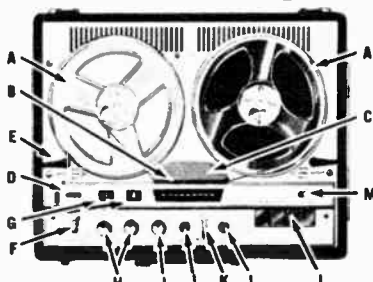

PROFESSIONAL OPERATING FEATURES

- A. TAPE REELS—TAKE UP TO 7" SIZE
- B. AUTOMATIC TAPE CUT-OFF SWITCH
- C. HEADS—SEPARATE RECORD/PLAY & ERASE
- D. TAPE POSITION INDICATOR
- E. INPUT SELECTOR SWITCH
- F. SPEED SELECTOR/POWER ON-OFF
- G. RECORD LEVEL METERS
- H. INDIVIDUAL VOLUME CONTROLS
- I. MASTER VOLUME CONTROL
- J. SEPARATE CHANNEL RECORD BUTTONS
- K. PAUSE CONTROL
- L. 4 PUSHBUTTON TAPE MOTION CONTROLS
- M. ON-OFF PILOT LIGHT

109⁹⁵
\$5 monthly

- Deluxe Pushbutton Operation
- Complete with Built-in Transistorized Record & Playback Preamps

- Automatic Cut-off Switch Stops Recorder at End of Tape or When Tape Breaks
- Separate Record/Play and Erase Heads
- Smooth, 4-Pole Capacitor—Start Motor
- 2 Level Indicator Meters

The RK-650 abounds in professional-type features making it suitable to meet every stereo and monophonic recording situation. Tape transport and electronic components are integrated into one light-weight unit, for use in either a portable carrying case or a handsome built-in home installation. Has an ultra quiet 4-pole heavy duty, low slip capacitor-start motor and belt-drive for double flutter filtering. Automatic tape and machine stop at end of the tape or during a break in the tape. The Pause control assists in making "pro" recordings by stopping the tape momentarily for editing. Separate channel recording permits sound-with-sound. Clear FM multiplex recording is assured by high (80 KC) bias operation.

All tape transport and electronic controls are located on the top panel for easy access. Has positive action pushbutton motor control. For 117V, 60 cycles AC. Tape Deck is complete with preamps, 4 connecting cables and empty reel. Shpg. wt., 20 lbs. Less Case and Microphones. Size: 15 1/4"Wx6 1/4"Hx11 1/4"D. Imported.

| | |
|---|--------------|
| 99 K 1502WX Model RK-650 | Net 109.95 |
| Model RK-650 with deluxe carrying case | |
| 99 K 1503WX | Net 124.95 |
| 99 K 1510W Oiled Walnut base for RK-650 | Net 6.95 |
| 99 K 4502 Dynamic Microphone for RK-650 | Net ea. 4.75 |
| | 2 for 8.95 |

SPECIFICATIONS

Frequency Response, Record/Playback: 40-18,000 cps @ 7 1/2; 40-12,000 cps @ 3 3/4 ips. 4 transistors, 4 tubes; 1 full-wave bridge rectifier. Audio Output: .8 volts per channel. Signal-to-Noise Ratio:

—45 db. Interchannel Separation: 45 db or better; Wow & Flutter: 0.2% @ 7 1/2 ips, 0.25% @ 3 3/4 ips. Bias & Erase: 80KC; Outputs: 2 audio, 2 monitor. Inputs: 4.

LAFAYETTE 2-SPEED STEREO PLAYBACK TAPE DECK

with 6-TRANSISTOR DUAL STEREO PREAMPS



Model RK141

ONLY
59⁵⁰
\$5 monthly

SPECIFICATIONS

Frequency Response: @ 7 1/2 IPS, 50-15,000 CPS ± 1.5 db; @ 3 3/4 IPS, 50-9,000 CPS ± 2 db. Wow & Flutter: .15% @ 7 1/2 IPS, 0.2% @ 3 3/4 IPS. Cross Talk & Stereo Channel Separation: 50 db. Signal to Noise Ratio: 50 db. Playback Output: with Built-in Stereo Playback Preamplifiers 0.5V. Power: 110-120V 60 cycles AC operation.

PLAYS BACK

- Stereo 1/4-Track; 1/2-Track
- Monaural 1/2-Track; Full-Track

- Dual NAB Equalized Transistorized Stereo Playback Preamps Allows Use With Virtually Any Stereo Amplifier
- Frequency Response: 50-15,000 cps @ 7 1/2 ips
- Accepts Full-Size 7-inch Reels
- Automatic Shut-Off At End Of Tape

Precision engineered to satisfy the most discriminating music listener, the RK-141 will playback with uncompromising fidelity 1/4-track and 1/2-track stereo tapes plus 1/2-track and full-track monaural tapes. The RK-141 is equipped with its own built-in 6-transistor dual stereo playback preamplifiers equalized for the NAB tape curve . . . allows use with virtually any stereo amplifier by merely connecting to the auxiliary, tuner, or hi-level tape inputs. Precision laminated playback head. Automatic shut-off at the end of the tape. The 4-pole, heavy-duty, constant speed induction motor has front panel speed selector switch. In addition, two rugged lever-action controls provide for Rewind, Off, Play and Fast Forward functions. Accepts all size tape reels up to and including 7". Measures 10 3/4"Dx14 3/4"Wx5 1/2"H. Complete with shielded hook-up cables. Shpg. wt., 17 lbs. Imported.

| | |
|---|-----------|
| 99 K 1513WX Model RK-141 Stereo Playback Tape deck | Net 59.50 |
| Furniture Grade Walnut Base for RK-141. Shpg. wt., 4 lbs. | |
| 99 K 1514W | Net 6.95 |
| Portable Carrying Case for RK-141. Shpg. wt., 5 lbs. | |
| 99 K 1515W | Net 9.95 |

LAFAYETTE RECORDING TAPES

LAFAYETTE'S FAMOUS MONEY-BACK GUARANTEE
YOU BE THE JUDGE!



Lafayette's tape is made by outstanding nationally known manufacturers. It is first quality, splice free, red oxide coated, with full frequency response, uniform output and no "drop-outs." Resistant to moisture, heat, cold and abrasion.

We guarantee absolute satisfaction or your money back. If for any reason you are dissatisfied, return the tape at once and we will refund your money less only transportation charges. You are the sole judge.

LAFAYETTE ACETATE BASE RECORDING TAPE

Acetate base magnetic recording tape with uniform standard red oxide coating provides wide range high fidelity response over the audio spectrum. Features noise free reproduction, low abrasion and uniform output. In 1 mil and 1 1/2 mil thickness.

| Stock No. | Feet | Reel | Mils | Wt. Lbs. | Net Per Reel | | |
|-----------|------|------|-------|----------|--------------|------|-------|
| | | | | | 1-4 | 5-24 | 25 Up |
| 28 K 0102 | 600 | 5" | 1 1/2 | 1/2 | .99 | .90 | .85 |
| 28 K 0103 | 900 | 5" | 1 | 3/4 | 1.20 | 1.10 | .99 |
| 28 K 0101 | 1200 | 7" | 1 1/2 | 1 | 1.59 | 1.49 | 1.35 |
| 28 K 0104 | 1800 | 7" | 1 | 1 1/4 | 1.98 | 1.88 | 1.79 |

LAFAYETTE MYLAR BASE RECORDING TAPE

Mylar base is especially strong, durable and break resistant, and is virtually impervious to heat, cold or humidity. All in clear plastic reels, individually boxed.

| Stock No. | Feet | Reel | Mils | Wt. Lbs. | Net Per Reel | | |
|-----------|------|------|------|----------|--------------|------|-------|
| | | | | | 1-4 | 5-24 | 25 Up |
| 28 K 0105 | 1200 | 5" | 1/2 | 3/4 | 1.75 | 1.58 | 1.42 |
| 28 K 0106 | 1800 | 7" | 1 | 1 1/4 | 2.49 | 2.25 | 2.13 |
| 28 K 0107 | 2400 | 7" | 1/2 | 1 1/4 | 3.10 | 2.79 | 2.51 |

LAFAYETTE TENSILIZED MYLAR TAPES



These tapes are of the same high quality as the standard acetate and mylar Lafayette tapes with the added advantages of the tensilized mylar base. Super-strong mylar is prestretched and is highly resistant to breakage, moisture, heat, cold, and humidity. Highly polished, splice-free, quiet, non-abrasive finish. Smooth output throughout the entire audio spectrum. Tensilized mylar gives you the most permanent type of base and is therefore ideal for your most treasured recordings. All are 1/2 mil, thus permitting the maximum amount of footage per reel. Individually boxed.

| STOCK NO. | FEET | REEL SIZE | WT., LBS. | NET PER REEL | | |
|-----------|------|-----------|-----------|--------------|------|-------|
| | | | | 1-4 | 5-24 | 25-UP |
| 28 K 0109 | 300 | 3" | 1/2 | .69 | .63 | .59 |
| 28 K 0110 | 600 | 3 1/4" | 1/2 | 1.00 | .90 | .80 |
| 28 K 0111 | 1200 | 5" | 1/2 | 2.25 | 2.03 | 1.83 |
| 28 K 0108 | 2400 | 7" | 1/2 | 3.69 | 3.39 | 3.05 |

NEW KINEMATIX "VOICE-MATIC" VOICE ACTUATED CONTROLS

Model KX5000

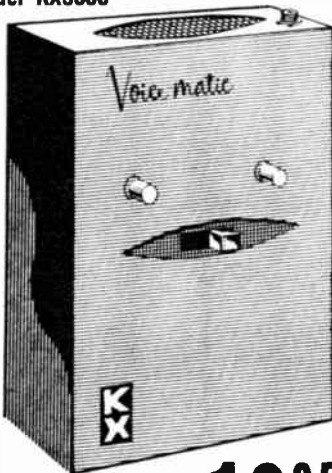

As low as **19⁹⁵**

Made in U.S.A.

- Converts your Battery operated Tape Recorder to a Voice-Actuated Tape Recorder
- Sound Starts your Tape Recorder—Absence of Sound stops your tape Recorder
- No tools needed—no soldering required

Model KX4000—A new concept in a tape recording accessory. Contact board of KX4000 is inserted between contacts and battery of your present battery operated tape recorder. No soldering required—no tools needed. Now your tape recorder will start whenever a sound is present. The recorder will stop when sound source stops. Has .5amp switching capacity. Complete with sensitivity control which permits you to operate a recorder from as far away as 15 feet. Requires 2 standard 9 volt batteries (not supplied with KX4000). Dim. 3 1/2"x1"x2 1/4". Shpg. wt., 1 lb.

28 K 3101L Net 19.95

Model KX5000—Deluxe Version of Model KX4000—Switching capacity —2amp. 2 controls—Sensitivity control and adjustable Pause control which keeps recorder from turning off immediately during pauses between sentences. Includes input jack for external mike—and accessory input jack for use with various household appliances enabling you to turn these appliances on and off.

28 K 3102L Net 29.95

99 K 6021 Standard 9 Volt battery for KX4000 and KX5000 2 req. Net .21
Miniature phone plug—fits input jack of Model KX4000 and KX5000

99 K 6210 Net .17

See Our Catalog 650 For Additional Tape Recording Accessories

LAFAYETTE RECORDING ACCESSORIES

LAFAYETTE BULK TAPE ERASER AND DEMAGNETIZERS

PROFESSIONAL MODEL

- Completely Erases Tape
- Two Erasing Coils
- Erases up to 1" Tapes
- Erases 1/4" Tapes in One Operation—No Reversing
- For 3", 5", 7" or 10 1/2" Reels

1250

Standard Model

1895

Professional Model

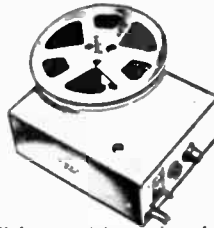

A carefully designed and precisely manufactured tape "degausser" for complete erasing of tapes. Just place the tape reel on spindle of demagnetizer, slowly rotate 2 or 3 turns, take off, and that's all. Reduce tape hiss to the level of new "virgin" tape. Two completely separate coils are used for doubly-effective erasures, even of large, 10 1/2" reels. Will erase 1" wide tape. An extra powerful unit for heavy-duty use—draws over 9 amperes. Can be used to demagnetize tape, magnetically stripped film, plus tools and watches. Has a heavy, custom finished case, a rugged non-magnetic top, heavy duty on-off switch and power cord. Has built-in fuse. Pilot light prevents accidentally leaving it turned on. Size 6 1/4 x 7 x 3 1/2". 105-125V, 60 cycle. Shpg. wt., 14 lbs. Imported.

*99 K 1516 Professional Model Net 18.95

STANDARD MODEL

Similar to professional model for all size reels but handles only standard size 1/4" tapes or smaller and reel must be turned over once. Has separate spindle positions for 10 1/2" and 3, 5, and 7" reels; non-magnetic bakelite plate for reel rest. One powerful coil consumes 5 amps. Metal case 7 1/2 x 4 3/4 x 3 1/2". Shpg. wt., 9 lbs. Imported.

99 K 1518 Net 12.50

LAFAYETTE TAPE HEAD DEMAGNETIZERS

395 DELUXE MODEL WITH 3 REMOVABLE POLE PIECES

Has 3 complete sets of removable pole pieces: straight, 45° and 90° for quick easy use with any tape head. Removes magnetism that accumulates in every tape head insuring optimum signal-to-noise ratio. For 110 Volt 60 cycle. Shpg. wt., 1 lb.

24 K 0901 Net 3.95

298 ECONOMY MODEL

Features very strong field with a single probe. Its thin cross-sectional size allows it to be used on all heads. For 110V 60 cycle. Shpg. wt., 12 oz. Imported.

99 K 6198 Net 2.89



EDITALL TAPE EDITING KIT



All you need for a complete professional editing job. The cutting block is made of duraluminum precisely machined and polished (makes straight or diagonal cut). All accessories such as grease pencil, blades, splicing tape (66 ft. roll of 1/2") supplied. Comes with instruction booklet—in a smart metal case. Shpg. wt., 1 lb.

28 K 3805 EDITALL KIT Net 8.82

TAPE CLEANER

149

Tape is impregnated with special formula cleaner. Simply run through like regular roll of tape. Entire job done in 2 minutes. Can be reused many times. 100' roll on 5" reel. Shpg. wt., 8 oz.

28 K 2001 Net 1.49

28 K 2002 3" Reel Net .99



TELEPHONE PICKUP FOR RECORDING TELEPHONE CONVERSATIONS



195

Induction telephone pickup. Telephone conversations can now be picked up with no tapping of wires or special telephone circuits. Simply place the phone base, either cradle or upright type, on the pickup platform and connect the leads to the high impedance input of any medium gain audio amplifier, or directly to any tape, disc or wire recorder. Shpg. wt., 8 ozs.

28 K 0901 Net 1.95

NEW TELEPHONE PICKUP COIL



189

Designed to feed into the microphone input of either a tape recorder or any high gain amplifier. Easily attached to the telephone by suction rubber type attachment. The coil is electrostatically shielded to minimize hum pick-up. When properly positioned on telephone handset, the output of this device is more than adequate for a fully modulated tape recording. Complete with 5' shielded cable. Shpg. wt., 6 ozs.

99 K 6197 Imported Net 1.89

SCRIBER ELECTRO TELEPHONE PICKUP



Electro Scriber telephone pickup will enable you to amplify, record and make a permanent record of any telephone conversation. Simply place phone base on phono Scriber and plug Scriber into amplifier or tape recorder input. Amplifies cleanly. Shpg. wt., 1 lb.

For standard cradle phone. Net 7.35

28 K 2501 Net 7.35

For push-button phone. Net 8.53

28 K 2502 Net 8.53

TOP QUALITY LAFAYETTE-RECORDING HEADS

Each Set Contains 2 Heads For Record-Playback and Erase.

395

FOR MINIATURE TRANSISTORIZED TAPE RECORDERS

A two-piece set consisting of one record/playback and one erase tape head. Designed for use in dual track miniature tape recorder. Will replace the heads in most Japanese-built recorders. Record/playback head specifications: impedance 5.5K at 1 KC; DC resistance; 1K ohm; reproduction level: -52 db (recording at +2 db); bias frequency: 35KC; bias current: 1ma; voice current: 0.03ma; response: 100-7000 cps \pm 5 db; S/N ratio: better than 45 db; bias system: AC & DC reproduction: gap: .00024 in. (.006mm); dimensions: approx. 1 1/4 x 3/4 x 1 1/4". Erase head same dimensions. Total ship. wt., 3 oz. Imported.

99 K 6194 Net 3.95

1/4 TRACK STEREO SET



795

A complete 2 piece set. Consists of one 1/4 track record—playback head and one erase head, both with mounting brackets. RECORD HEAD SPECS: Impedance, 3.3K @ 1 KC; DC resistance: 700 ohms; Sensitivity: -55db; Cross talk -45db; bias current 0.5MA; voice current; 37.5uA @ 1 KC; response: 100-12,000 cps. Inductance 0.5H. CAP: .0002 in. ERASE HEAD: DC resistance .65 ohms; GAP: .004 in; erase current 18A; bias freq: 30-65KC; Erasure -60 db. Size: 1/4 x 1 1/4". Shpg. wt., 4 oz. Imported.

99 K 6195 Net 7.95

LAFAYETTE RECORD—PLAYBACK & ERASE HEADS



445

Recording head: 4K ohm impedance @ 1000 cps; recording current, 20 microamps \pm 20%; bias current 500 microamps; bias frequency, 45 to 50 KC; Playback output, -48DB \pm 2 db; Response to 10KC \pm 3db. Erase head: Erasing current 150 milliamps; Impedance, 30 ohms \pm 25% @ 10KC, DC resistance 0.5 ohms \pm 20%. Size 3/4 x 1 1/4 x 1 1/4". Shpg. wt., 5 oz. Imported.

99 K 6196 Net 4.45

All Prices and Specifications in This Catalog Subject to Change Without Notice.

Lafayette Cat. No. 652 33

TAPE RECORDING ACCESSORIES

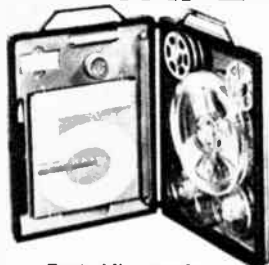

TAPE ACCESSORY KITS WITH CARRYING CASE

As Low As
695

Each kit contains actual recording tape and is loaded with needed accessories. Packed in a beautiful, functional carrying case.

TK7—7" TAPE KIT. Contains: Two 3" reels, two 3 1/4" reels, two 5" reels, two 7" reels, two reels Tape 1200'A, 1 Splicer, 1 Splicing Tape, 2 Leader Tapes, 1 Strobe Tape, 6 Tape Clips, 1 Book—"How To Make Better Tape Recordings," 1 Marking Pencil.

28 K 2901 7" Tape Kit. Shpg. wt., 6 lbs. Net 9.95

TK3—3" TAPE KIT. Contains: Three 3" reels, two 3 1/4" reels, one 3" reel tape, 1-3 1/4" reel Tape, 1 Splicer, 1 Splicing Tape, 2 Leader Tapes, 1 Strobe Tape, 6 Tape Clips, 1 Book—"How To Make Better Tape Recordings," 1 Marking Pencil.

28 K 2902 3" Tape Kit. Shpg. wt., 3 1/2 lbs. Net 6.95



TWIST-LOCK STYRENE CANS

• Buy the set — save and GET THE CHEST FREE!

12 dust-free, moisture-proof unbreakable styrene tape cans in storage chest. Can has foolproof twist lock feature and is ribbed for convenient stacking. Center locking stud prevents reel movement on all 7" reels and most 3" and 5" reels. Shpg. wt., 6 lbs. 28 K 6510 Net 4.75

TWIST LOCK CANS ONLY

28 K 6511 Lots of 6 ea. .40 Single ea. .45

7" TAPE CHEST



Durable chipboard storage cases covered in simulated leather. Holds 5 7" reels in separate compartments. Size: 8x7x4 1/2". Shpg. wt., 1/2 lb. 28 K 6512 Net .95

REEL LOCKS



45¢
Set of Two

Holds tape recorder reel in place by locking spindle to reel. Especially useful if recorder is in vertical position. Will not interfere with normal operation of reels. Easily removable. Shpg. wt., 6 oz. Imported. 99 K 1519 Set of two Net .45

MAGNETIC TAPE SPLICER

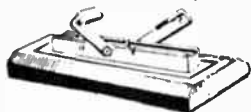

An excellent accessory that splices tapes accurately and eliminates joint noise. Both ends cut simultaneously. Nicked brass finish. Shpg. wt., 1 lb. 28 K 3910 Net 1.47

FILMAGIC TAPE MAINTENANCE KIT

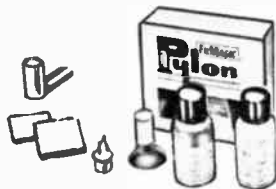

Adds life and performance to tape and tape recorders. The Kit contains all the elements needed for cleaning and conditioning both tapes and critical recorder parts. Consists of: Either Flange or Suction cup type Pylon with sleeve; Tape conditioner fluid; and head condenser fluid. Can be used to clean capstans, rubber idler rollers also. Shpg. wt., 3 1/2 oz.

Kit with suction cup Pylon. 28 K 4005 Net 3.45

Kit with flange-type Pylon. 28 K 4006 Net 3.45

REPLACEMENT PARTS

28 K 4007 2 oz. Head Cleaner Net .98

28 K 4008 2 oz. Tape Conditioner Net .98

28 K 4009 Pkg. of 6 sleeves Net .75

28 K 4010 Wick-Tip Applicator Net .39

34 Lafayette Cat. No. 652

CLEAR PLASTIC REELS

23¢
IN LOTS OF 6



Individually boxed plastic reels for recording tape. Av. shpg. wt., 4 oz. singly.

28 K 2903 3 1/4" reel lots of 6, Ea. .23

..... Singly, Ea. .26

28 K 2904 5" reel lots of 6, Ea. .26

..... Singly, Ea. .29

28 K 2905 7" reel lots of 6, Ea. .38

..... Singly, Ea. .45

ROBINS® SPLICER



ROBINS TS-80 GIBSON GIRL® "STERED 4" TAPE SPLICERS produce precise splicing of 4 track tapes without loss of program material on the outside tracks. Works equally well on single and 2 track tapes. Unit has blade centering adjustment for lifetime accuracy, and replaceable cartridge. "See thru" windows indicating "Cut" and "Trim" positions for easy operation. Tape guide and fingers secure tape during splicing. Easy threading integral tape dispenser with roll of 1/2"x100" splicing tape. Safety lock protects blades when not in use. With instructions. Wt., 1 lb. 28 K 6009 Net 7.65

COLOR-CODED TAPE SPLICING KIT

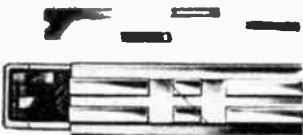

Everything you need for fast, professional tape editing and repairing. Easy-to-use gold anodized aluminum splicing block has special slide-out plastic storage compartment. Complete with blade and full assortment of color coded Quik Splice Mylar splicing and editing strips—will not shrink or become brittle with age. Shpg. wt., 8 oz. 28 K 3601 Net 1.49

METAL STORAGE CANS

18¢
lots of 6



Cans are ribbed for easy storage. Precision fit. Finished in grey. Av. shpg. wt., 8 ozs.

28 K 6305 3" Can lots of 6, Ea. .18

..... Singly, Ea. .20

28 K 6306 5" Can lots of 6, Ea. .27

..... Singly, Ea. .30

28 K 6307 7" Can lots of 6, Ea. .36

..... Singly, Ea. .39

RECORDER PATCH CORD

67¢



Ideal For Making Connections From Radio, Phono or TV To Tape Recorder

Handy 6 ft. lead has insulated alligator clips at one end and RCA phono plug at the other. Supplied with shielded phono plug adapter to adapt the RCA phono plug to standard phono plug if necessary. Attach alligator clips to speaker terminals and simply plug other end into tape recorder. Ideal for recording from Radio, Phono or TV. Shpg. wt., 8 oz. Imported. 99 K 1517 Net .67

METAL TAPE STORAGE CHEST

2.99



STANDARD CASE: Sturdy all steel carrying case. Holds 12 7" or 5" reels and cans. Twin snap locks. Platinum gray hammered finish. Metal separators. Includes index cords. Shpg. wt., 5 lbs. 28 K 1501 Net 2.99

Your Order Receives Prompt, Efficient Service At Lafayette

FAMOUS LAFAYETTE "SLENDERETTE III" SLIM 2-SPEAKER 2-WAY SYSTEM

*Fine Speaker Performance Offering Rich
Clean Sound At Lafayette's Low, Low Price*

**NEW
LOW PRICE**

- Ideal Choice for Floor, Shelf or Wall Mounting
- Perfect for low cost Stereophonic or Monophonic Systems
- Improves Fidelity of Phonographs, TV Sets, AM and FM Radios
- Room-Filling Music Everywhere In Your Home

17⁹⁵
WAS 19.95 IN 1964 CAT. 651
2 FOR 34.95

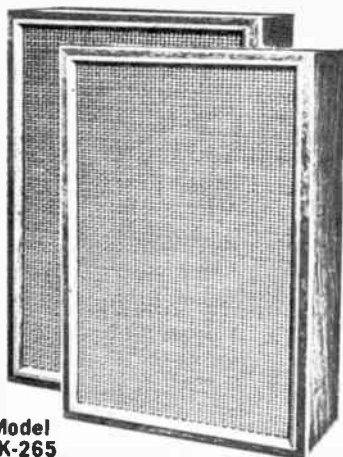

Model
SK-265

The Lafayette Slenderette III is the ideal choice as a floor, shelf, or wall type speaker system for low-cost stereo or monophonic systems, and for top quality extension speaker use. Can be used for improving fidelity of existing TV sets, AM and FM radios, tape recorders, and phonographs. Enjoy smooth, wide-range sound in every room of your house. The slim styling enhances the decor of your room. Contains a special 6½" high compliance woofer and a matched 2½" cone tweeter with crossover network. Offers fine speaker performance — clear natural bass, full midrange reproduction, and wide-dispersion of high frequencies. The speakers are mounted in a superbly constructed and finished oil walnut cabinet. Oil walnut finish is on all four sides. With walnut picture frame molding. Measures 12x18 inches with a depth of 5¼ inches. Freq. response—50-10,000 cps. Impedance 8 ohms. Shpg. wt., 15 lbs. Imported.

99K 0009WX Model SK-265 Slenderette III Net 17.95
2 for 34.95

SELECT "SLENDERETTE II" SLIM 3-WAY 3-SPEAKER SYSTEM

*Featuring Jensen Speakers
and Universal Woodcrafters
Cabinet at Lafayette's Low, Low Price*

- 3-Speaker 3-Way System
- Utilizes Jensen 8" High Compliance Woofer, Jensen 6" Mid-Range Driver & Jensen 3" Tweeter
- For Shelf, Floor or Wall
- Beautifully Styled Cabinet Finished on all 4 Sides In Finest Genuine Walnut Veneer With Cane Grille & White Enamel Border

29⁹⁵

Made in U.S.A.

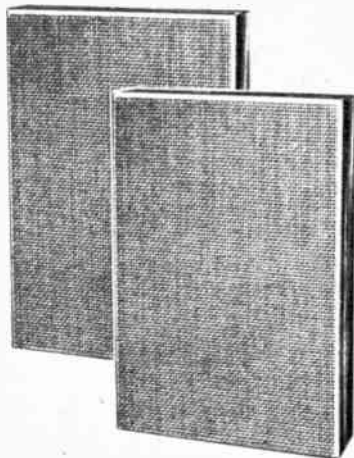

The "Slenderette II" is an outstanding system offering superb styling and rich, deep sound. Incorporates the latest advanced acoustic design at Lafayette's low, low, price. Contains a 3-speaker 3-way system engineered by Jensen with newly developed Jensen components. Utilizes a Jensen 8" high compliance woofer with rubber suspension for extra wide excursion, a Jensen six-inch midrange driver in rubber suspension, and a special Jensen 3-inch tweeter. Woofer electric crossover at 400 cycles, mid-range electric crossover at 2000 cycles. Response 50 to 15,000 cycles. Power capacity: 18 watts continuously, 36 watts peak. Superbly styled cabinet finished on all 4 sides in finest genuine walnut veneer with protruding cane grille & white enamel border. Ideal for shelf, floor or wall mounting. Includes wall bracket. Impedance 8 ohms. 21¼Wx14¼Hx4¼"D. Shpg. wt., 22 lbs.

21K 0101WX Net 29.95

LAFAYETTE "MINUETTE" HIGH-FIDELITY SPEAKER SYSTEM

- Shelf Size — 8¼Dx15¾Lx5¾"H
- Genuine Walnut Finish on 4 Sides
- Complete with 6' Extension Cable and Phone Plug

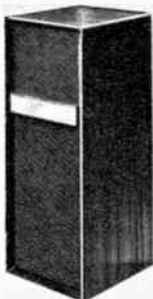

12⁵⁰

**2350 TWO FOR
STEREO**

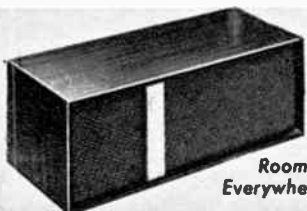

Room Filling Music
Everywhere in Your Home!

The Lafayette "Minuette" Hi-Fi Speaker System will bring music to any room in your home — and for a remarkably low cost. Designed for use where space is at a premium — ideal for the small apartment or listening area. Expand your stereo system to other areas of your home . . . easily used in the den, kitchen, patio or bedroom. Employs a specially designed 5x7" speaker in a rear loaded reflex type enclosure. Provides an exceptionally fine musical quality yet measures only 8¼Dx15¾Hx5¾" — small enough to fit anywhere. Superb Walnut finish on 4 sides allows placing speaker horizontally or vertically. Frequency Response 100-12,000 cps. Impedance 8 ohms. Rated at 10 watts. Supplied with 6 ft. of extension cable and phone plug. Shpg. wt., 5½ lbs. Imported

99K 0042 Walnut Net 12.50
Set of two for Stereo—Save 1.50 Net 23.50
99K 0038 Oiled Walnut Net 13.95
Set of two for Stereo—Save 1.40 Net 26.50

Take Advantage of Lafayette's Low Speaker System Prices

Lafayette Cat. No. 652 35

THE 5 MOST IMPORTANT SPEAKERS YOU MAY EVER OWN ARE IN

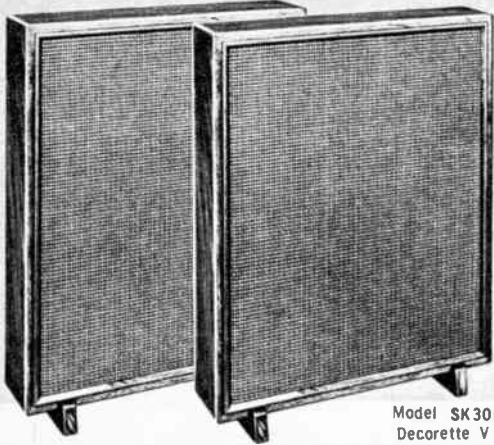

Model SK 300
Decorette V

Lafayette is proud to offer a dazzling 5-speaker system—magnificently styled and engineered. The "Decorette V" incorporates a specially designed audio panel speaker system consisting of four 6½" low resonance speakers, and one 2½" cone tweeter mounted in a flat enclosure of only 4¼ inches thickness. The results achieved are remarkable; clear natural bass response, smooth midrange and pure, rich highs. These are mounted in a superbly styled oil walnut veneer enclosure with magnificent walnut picture frame molding, bordering a fine decorative cane grille. Ideal for floor mounting, bookshelf mounting, or wall mounting. Can even be used as a room divider. Overall frequency response 50-18,000 cps. Power handling capacity 15 watts, peak load power—30 watts. Complete with decorator styled legs. Impedance 8 ohms—size 21¾Hx4¼Dx17¾"W. Shpg. wt., 17 lbs. Imported.

99 K008WX Model SK-300 Decorette V Speaker System Net 39.95
2 for 78.50

Lafayette's "decor-ette V"^{T.M.} SLIM 5-SPEAKER SYSTEM

- Four Specially Engineered 6½-inch Low Resonance Speakers—One 2½-inch Cone Type Tweeter Designed to achieve optimum performance in a new type audio-panel enclosure of only 4¼ inches in thickness.
- A superbly styled oil walnut veneer enclosure with magnificent walnut picture frame molding, bordering a fine decorative Cane Grille.
- Freq. response 50-18,000 cps
- Power handling Capacity continuous 15 watts, peak level power—30 watts.
- Crossover Electrical 2,500 Cycles
- Impedance—8 ohms

Only
39⁹⁵
\$5 monthly
78⁵⁰
PAIR
\$5 monthly

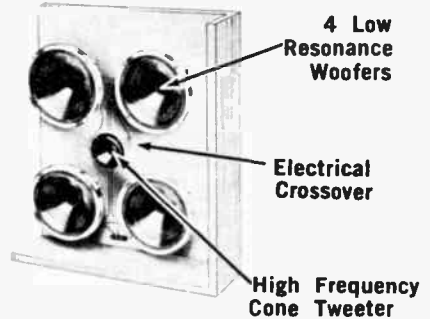

DELUXE LAFAYETTE "decor-ette II"^{T.M.} SLIM 5-SPEAKER 3-WAY SYSTEM

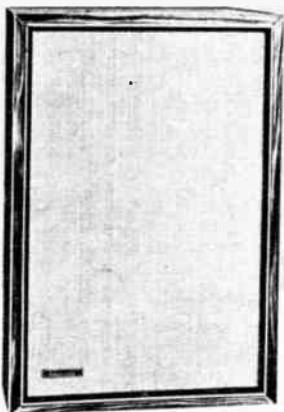

SK-270
DECORETTE II

59⁹⁵
Only
\$5.00 Monthly

Designed by Lafayette engineers—built by the foremost English Hi-Fi speaker manufacturer to Lafayette's rigid specifications.

Designed by Lafayette engineers—built by the foremost English Hi-Fi Speaker manufacturer to Lafayette's rigid specifications. The genuine, hand-rubbed oiled walnut veneer cabinet with smart ebony black and gold picture frame molding, has been designed and styled for either vertical or horizontal placement. A real space-saver, it is slim in appearance and can be placed on a bookshelf, mounted on the floor, used as a room divider or hung on the wall. The "decor-ette II" is a 5-speaker 3-way system utilizing the latest advanced acoustic designs. Two 8" woofers with ½-lb. magnets incorporate a "Rigidflex" Floating Piston Hyperbolic Cone resulting in a free floating cone rim and a completely rigid cone center to provide maximum distortionless bass from 500 cycles down to 40 cycles. The

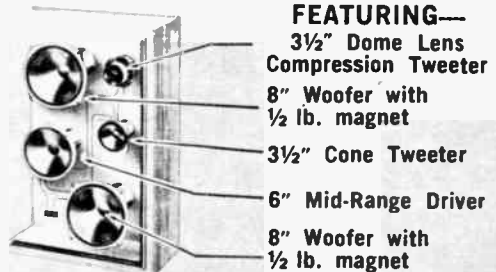

- Custom Assembled in a Genuine Hand-Rubbed Oiled Walnut Veneer Cabinet of Extra Heavy ¾" Stock
- Frequency Response, 40-20,000 cps
- Power Handling Capacity, Continuous 30 Watts; Instantaneous Peak Load Power, 60 Watts
- Impedance 8 Ohms

specially designed 6" mid-range open back driver provides uniform response from 500 to 7500 cycles. The 3½" cone type tweeter gives wide dispersion of the mid-highs smoothly from 1000 to 10,000 cycles. The dome lens type compression tweeter response is from 5000 to 35,000 cycles. Omni-directional, this tweeter gives 360° sound dispersion to add overall brilliance to the system. RC electrical crossover frequency is 5000 cps. Instantaneous peak load power, 60 watts. Impedance, 8 ohms. Size: 25"Hx17"Lx4¾"W. Supplied with 4 1" round walnut decorator legs which can be mounted on the cabinet for either vertical or horizontal placement. Shpg. wt., 24 lbs.

21 K0106WX SK-270 Decorette II Net 59.95

Deluxe LAFAYETTE "Decorette III" 3 Speaker 3-Way System

Designed by Lafayette engineers—built by the foremost English Hi-Fi Speaker manufacturer to Lafayette's rigid specifications.

Features:

- Newly Developed 12" Poly-Foam Woofer with 1 lb. magnet and A Free-Air Response of 35 cps.
- 6" Closed-Back Mid-Range Speaker
- 3½" Sealed Cone-Type "Super" Tweeter
- Specially Engineered "Tuned" Enclosure with Tube-Type Duct For Superior Bass Response
- Smooth Overall Response From 30 to 30,000 cps
- Crossover At 5,000 cps
- Power Rating—Up To 25 Watts Continuous, 50 Watts Instantaneous Peak
- Nominal 8 ohms Impedance

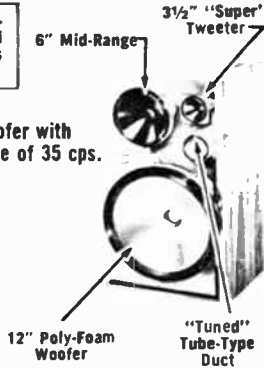

79.95
\$5 Monthly

Decorette III
Model SK275

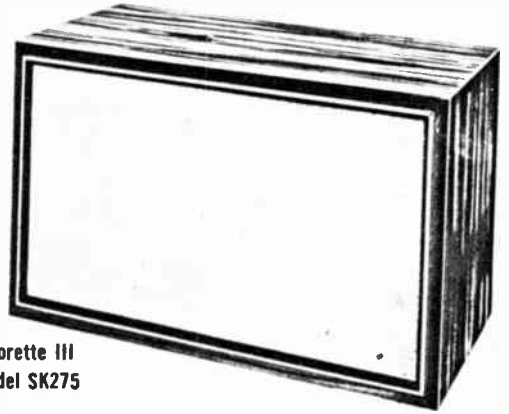

Designed by Lafayette engineers—built by the foremost English Hi-Fi Speaker manufacturer to Lafayette's rigid specifications, the Decorette III employs three separate speakers to provide smooth, realistic musical reproduction over the entire audible range—you'll hear deep effortless bass . . . clear precise mid-range . . . shimmering highs.

The particularly low bass response of this bookshelf system is achieved by means of a specially engineered enclosure and the use of a newly-developed 12" low-resonance woofer which covers the range of 30 to 2000 cycles. The 6" mid-range Speaker and the 3½"

"Super" tweeter act as direct radiators and provide smooth reproduction from 2,000 cps to beyond audibility. The enclosure is finished on all four sides in a hand rubbed oiled walnut veneer, tastefully framed in an ebony and gold picture frame molding with white and gold acoustic grill material. Designed for either horizontal or vertical placement, the "Decor-ette III" is a handsome addition to any listening room. For 10-watt amplifiers or larger. Dimensions: 14x24x12"D. Shpg. wt., 35 lbs.

21 K 0107WX Model SK275 Decor-ette III Net **79.95**
Two for **158.95**

SYSTEM DESIGN

The enclosure is a bass reflex design using a ducted port of the tube type which is proportioned to provide correct acoustic "tuning" of the enclosure. This arrangement provides a special path for the sound waves radiated from the rear of the woofer so that they emerge "in-step" with those radiated from the front of the woofer. This provides a substantially greater bass sound power from the system. Solid ¾" wood construction, internally braced, plus the liberal use of sound absorbent material, ensures an extremely rigid enclosure, free of undesirable resonances. A

special 12" woofer covers the range to 2,000 cycles and employs a foam-treated cone that contributes greatly to the efficient, distortion-free bass reproduction. A 6" midrange speaker covers the 2000 to 5000 cycle range and is of the closed back type to prevent interaction with the woofer. A 3½" cone-type "Super" tweeter, also with closed back, provides coverage from 5000 cycles to beyond audibility (30,000 cps). All three speakers are acoustically matched and provide a well-balanced and smooth sound output over the entire range of the system.

NEW LAFAYETTE ULTRA-COMPLIANCE 2-WAY SPEAKER SYSTEMS



AS
LOW **19.95**
AS

These Ultra-Compliance 2 Way Systems feature a unique dual cone speaker with heavy magnet structure, employed in a specially designed tuned ducted port enclosure. Both tweeter and woofer "float" on flexible, corrugated edges, with the outer edge of the tweeter cone attached to the mid-section of the woofer. This results in a mechanical crossover so that both cones operate in phase at low frequencies, but only the tweeter cone radiates high frequencies. The same type of wide-range frequency response as found in true coaxial or multiple speaker systems is achieved in these unique "Ultra-Compliance" Speaker Systems. Frequency response is 40-16,000 cps—Impedance: 8-16 ohms.

VERY SMALL IN SPACE—LESS THAN 1 CU. FT.

- Frequency Response 40-16,000 cps
- Especially Designed Vented, Tuned Duct Type Enclosures
- Unique Mechanical 2-Way Speaker With Heavy Magnet
- Enclosure Finished on 4 Sides • Excellent For Stereo

FULL SIZE PERFORMANCE—These outstanding Lafayette Ultra-Compliance 2-way speaker Systems achieves a purity of sound and musical quality that is astounding from a speaker system occupying less than one cu. ft. of space. A perfect speaker for use anywhere in your home or office . . . makes ideal extension units or use in pairs for stereo.

Available in rich mahogany or oiled walnut. Finished on four sides—place it horizontally on its side or vertically on its base. Easily adapts to bookshelf placement or modular use. Dimensions are only 10½Hx18½Lx8¾"D. Shpg. wt., 15 lbs. Imported.

99 K 0122WX Model SK-124A Mahogany Net **19.95**
Set of Two Speaker Systems Net **38.90**
99 K 0118WX Model SK-123A Oiled Walnut Net **19.95**
Set of Two Speaker Systems Net **38.90**

DELUXE LAFAYETTE ELIPTOFLEX® ENCLOSURE

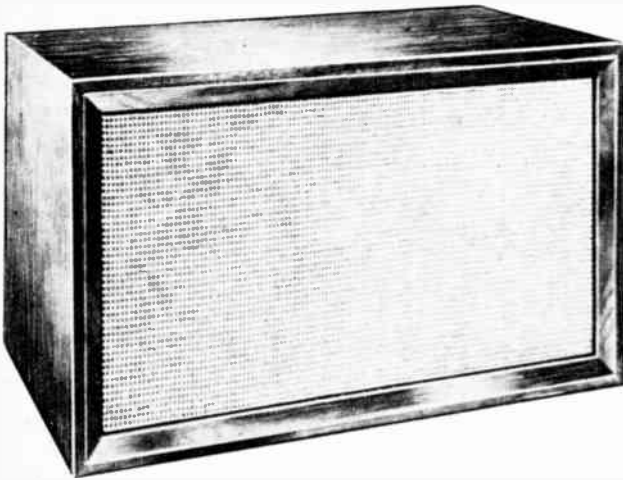

FINISHED ON 4 SIDES
Adapts to any room arrangement. Place horizontally on shelves or vertically on the floor.

As Low As
29⁵⁰

The "Eliptoflex"....

PHENOMENAL ELIPTOFLEX PERFORMANCE

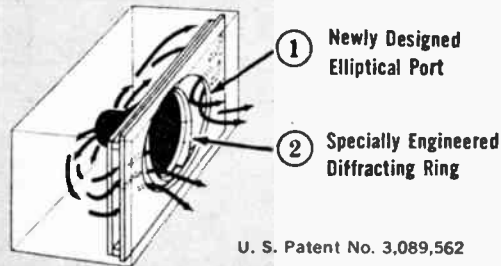

The loudspeaker is mounted on a baffle recessed in the cabinet shell with the front-plate extending partially across the front surface of the baffle forming ducts or tubes from the port openings to the outside air. The elliptical cutout changes the effective length of the duct across its area. This variation in path lengths provide an extremely smooth transition from duct to free air; broadens the frequency response and provide better transient response. A triangular shaped diffracting ring mounted on the front of the baffle board virtually eliminates undesirable cancellation effects normally produced by close coupling of front and rear cone radiation. This results in a "lens" effect, changing relative particle velocities and consequently, phase relationships so as to produce a smooth transition from front to rear radiation. Comparative laboratory and listening tests indicate that "Eliptoflex" performance is demonstratively superior throughout the audio spectrum.

- 1 Meets space requirements of stereo.
- 2 Utilizes the full advantages of efficient 12" speaker performance.
- 3 Provides optimum performance without use of large wattage, expensive amplifiers.

The "Eliptoflex" utilizes a unique elliptical port which broadens frequency response and provides better transient response. A specially engineered diffracting ring eliminates cancellation effects between front and rear radiation. These engineering advances when coupled with the famous Lafayette free-edge SK-58 12" coaxial speaker with 3" cone type tweeter, 1¼ lb. TSK-5 high flux density magnet, — special ¾" wide sheepskin cone-edge suspension and built-in crossover network level control offer a magnificent speaker system. (See listing below).

"Eliptoflex" achieves a degree of natural smoothness, low-distortion and rich robust bass hitherto found only in large enclosure speaker systems or inefficient bookshelf speakers requiring high powered amplifiers. Due to its highly efficient design characteristics the "Eliptoflex" does not require costly high wattage amplification.

The "Eliptoflex" speaker system is beautifully finished on 4 sides in a variety of hardwood veneers for attractive room placement either horizontally or vertically. Dimensions are 14Hx23¼Wx13¼"D. Shpg. wt., 35 lbs.

ELIPTOFLEX ENCLOSURE LESS SPEAKER — FINISHED ON 4 SIDES

| | |
|---|-----------|
| 20 K 0127WX "Eliptoflex" Enclosure—Mahogany | Net 36.50 |
| 20 K 0128WX "Eliptoflex" Enclosure—Walnut | Net 36.50 |
| 20 K 0129WX "Eliptoflex" Enclosure—Oiled Walnut | Net 36.50 |
| 20 K 0130WX "Eliptoflex" Enclosure—Unfinished Birch | Net 29.50 |

LAFAYETTE ELIPTOFLEX with FAMOUS SK-58 12" COAXIAL SPEAKER with 1 LB. MAGNET

AS LOW AS **59⁵⁰**

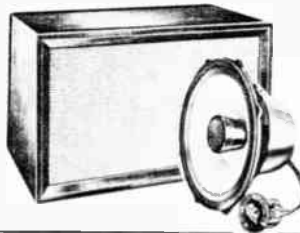

Superb performance from a speaker system featuring the famous Lafayette SK-58 12" coaxial speaker with 2-3" cone type tweeters and 1¼ lb. magnet mounted in the patented Lafayette Eliptoflex enclosure. Enclosure comes finished on 4 sides.

Eliptoflex/SK58 Speaker System

| | |
|------------------------------|-----------|
| 21 K 0115WX Mahogany | Net 64.50 |
| 21 K 0116WX Walnut | Net 64.50 |
| 21 K 0112WX Oil Walnut | Net 64.50 |
| 21 K 0117WX Unfinished Birch | Net 59.50 |

See Page 39 For Full description of SK-58

LAFAYETTE ELIPTOFLEX with SK-180 10" TRIHELIX 3-WAY SPEAKER

61⁵⁰

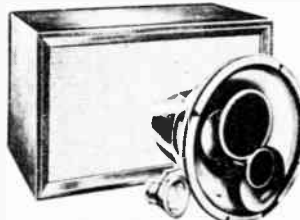

An ideal combination of speaker and enclosure that furnishes optimum 3-way speaker performance. Eliptoflex enclosures are finished on all four sides for vertical or horizontal placement. Shpg. wt., 32 lbs.

Eliptoflex/SK180 Speaker System

| | |
|------------------------------|-----------|
| 21 K 0118WX Mahogany | Net 66.50 |
| 21 K 0119WX Walnut | Net 66.50 |
| 21 K 0120WX Oiled Walnut | Net 66.50 |
| 21 K 0114WX Unfinished Birch | Net 61.50 |

See Page 39 For Full description of SK-180

THE WIDELY ACCLAIMED LAFAYETTE® SK-58® 12" COAXIAL SPEAKER

**SUPERB PERFORMANCE GUARANTEED*—
OR YOUR MONEY BACK!**

29⁵⁰

- 1¼ LB. MAGNET WEIGHT
- RESPONSE 30-15,000 CPS
- SHEEPSKIN "FREE EDGE" CONE MOUNTING
- 3" COAXIALLY MOUNTED TWEETER
- BUILT-IN LC NETWORK
- RATED AT 20 WATTS CONTINUOUS POWER



*The World Renowned
Original Lafayette SK-58*

Lafayette's exclusive 12" coaxial is a precision-made high fidelity loudspeaker, universally acclaimed by music lovers, hi-fi enthusiasts and professional experts alike. It provides a truly faithful reproduction of sound without any "coloration" or distortion, its excellence being responsible for its use in innumerable high fidelity music systems today. The SK-58 incorporates such features as heavy, high flux density TSK-5 magnets for high efficiency; ¾" wide sheepskin cone-edge suspension and special composition fibre cone material, specially treated for ultra-linear, distortion-free response; heavy rugged cast metal frame for freedom from resonances and for greater rigidity. The coaxially-mounted 3" cone-type tweeter has a bell shaped mounting for maximum dispersion of high frequencies with no back radiation. With the built-in

3000 cps crossover network it contributes its share to the smooth delivery of the overall wide range response of 30-15,000 cps. Woofer resonance in free air is 40 cps. Speaker power handling capacity is 20 watts continuous sine wave, 35 watts peak program material. Impedance of the voice coil is 8 ohms, connections being made to chromeplated screw terminals. Finished in gray-brown opalescent enamel, the speaker is supplied complete with "brilliance" level control. Shpg. wt., 11 lbs. Imported.

99K0019W SK-58 12" Coaxial Speaker Net 29.50

*Try your SK-58 at home. If for any reason you are dissatisfied, you may return it at once and your money will be refunded (less transportation charges).

LAFAYETTE TRIHELIX®

**3 COMPLETELY INDEPENDENT SPEAKERS
WITH 3 SEPARATE VOICE COILS
IN A SINGLE 10" COMPACT UNIT**

- Frequency Response 20 to 20,000 cps (30-18,000 cps ± 3 db)
- Revolutionary "Conical Stiffener"
- Eccentric Baffle Mounting of Midrange & Tweeter Eliminates Interaction Between Speaker Cones
- Built-in Crossover Network and Brilliance Control
- Extremely Efficient
- High Excursion Woofer
- Ideal For Stereo

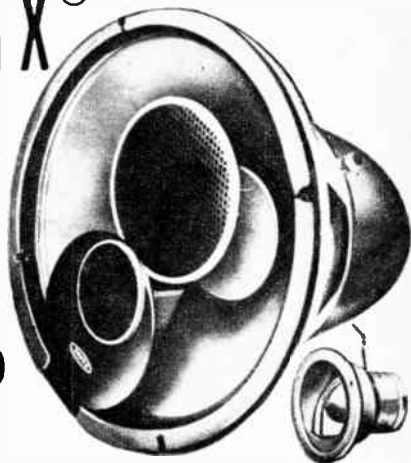

32⁵⁰

\$5.00 Monthly

Recreates The Entire Audio Spectrum With Concert Hall Faithfulness—The Lafayette "Trihelix." Fresh engineering concepts have resulted in a single 10-inch speaker designed expressly for use in bookshelf size enclosures. The "Trihelix" is in effect a complete three-way high-fidelity speaker system, with three mechanically and electronically independent speakers mounted within a single 10-inch frame.

Although they are individual units the 2-inch tweeter and 5-inch midrange speakers have been especially designed to compliment the woofer. Special treatment of the cones and cone edges with polyester resins provides an even distribution of mid and high frequencies without peaks or resonances. To minimize interaction between the three cones both the midrange and tweeter units are mounted eccentrically or off center in relation to the woofer and are completely enclosed by a specially designed baffle. These unusual design features result in effectively eliminating intermodulation distortion—a common fault in conventionally designed 3-way speakers. The specially treated woofer cone employs a revolutionary "conical stiffener" located at the apex of the cone in order to stiffen the diaphragm and eliminate "breakup," thus

providing a true piston action. This carefully designed cone-stiffening procedure, in addition to its very high compliance, enables the woofer to deliver a smooth, crisp, solid bass that balances naturally against a crystal clear midrange and natural treble. A built-in electrical crossover network with crossover points at 1500 cps and 5000 cps, allows each speaker to reproduce its portion of the audio range smoothly and efficiently. An adjustable brilliance control permits matching of sound to room acoustics. SPECIFICATIONS: Overall Response 20-20,000 cps (30 to 18,000 cps ± 3 db). Free Air Resonance 35-55 cps. Impedance 16 ohms. Power Rating: 20 watts Average Program Material. Crossover Points: 1500 & 5000 cps. Overall Diam: 10". Overall Depth: 7". Baffle cut-out: 8¾". Screw type terminals are color coded for quick easy connection of amplifier leads. Shpg. wt., 8 lbs. Imported.

99K0020W SK-180 10" Trihelix Speaker Net 32.50

20K0109W Adaptor Board To Fit above to 12" cutout.... Net .88

Lafayette Hi-Fi Provides Quality and Performance

Lafayette Cat. No. 652 39

LAFAYETTE'S Popular **MINI-DUCT**[®]

SPEAKER ENCLOSURE

A universal ducted-port bookshelf enclosure engineered for use with 1, 2 or 3-way speaker systems.

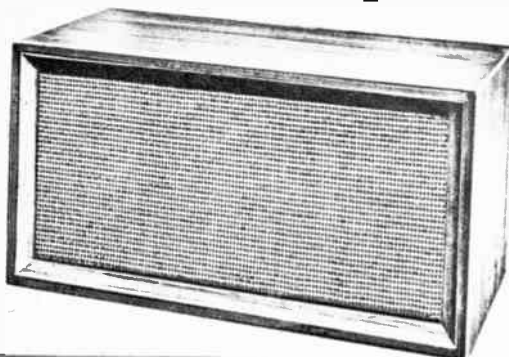

- SOLIDLY CONSTRUCTED OF ¾" WOODS
- START WITH A SINGLE SPEAKER AND BUILD INTO 2- OR 3-WAY SYSTEM LATER
- ACOUSTICALLY LINED THROUGHOUT
- AVAILABLE IN A VARIETY OF 4-SIDED FINISHES

Now limited space need not necessarily mean limited sound. The Lafayette Mini-Duct is acoustically designed to achieve smooth, distortion-free reproduction with a remarkably full, clean extended bass response that gives no indication as to its small size. Reducing boards are supplied so that the Mini-Duct will accept an 8" Woofer, 6" Mid-Range and a variety of tweeters. This versatility makes it possible to start with an 8" speaker and eventually build into a 2-way or 3-way speaker system. Solidly constructed of ¾" woods the Mini-Duct is beautifully finished in a variety of fine veneers on 4 sides. Designed for attractive horizontal or vertical placement anywhere in your home with dimensions 23Wx11½Hx11¼"D. Shpg. wt., 23¾ lbs.

| | |
|-----------------------------|-----------|
| 20 K0123WX Walnut | Net 24.95 |
| 20 K0124WX Mahogany | Net 24.95 |
| 20 K0125WX Oiled Walnut | Net 24.95 |
| 20 K0126WX Unfinished Birch | Net 21.50 |

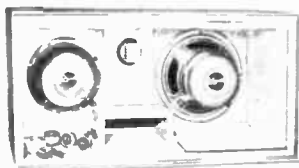

AS LOW AS
21⁵⁰

Mounting boards accept all types of tweeters

LAFAYETTE SK-98[®] 8" DUO-CONE HI-FI SPEAKER

- Mechanical 2-Way Design
- Overall Response 40-16,000 Cps.
- Large Magnet Structure
- Patented Cone Construction and Material High Excursion Woofer

9⁹⁵



The dual-cone construction used in these high quality 8" speakers, provides the same type of wide-range response normally found in true coaxial speakers or multiple speaker systems. The woofer and tweeter cones "float" on flexible corrugated edges. This mounting results in true mechanical crossover, so that both cones operate at low frequencies, but only the tweeter cone operates at high frequencies. This gives improved high frequency directional characteristics and minimum distortion. Patented cone materials provide extremely smooth response over the range of 40-16,000 cps. Magnets are large and heavy, with a flux density of 10,500 gauss and total flux of 56,000 maxwells. Terminals are screw-type for solderless connections. Sensitivity is 99.5 db/watt; free air resonance is 55-70 cps; voice coil impedance is 8 ohms. Size is 8" diam., 4¼" deep and requires 6¾" diam. baffle opening. Shpg. wt., 5½ lbs. Imported.

| | |
|---------------------------|-----------|
| 99 K0027 8" 2-WAY SPEAKER | Net 9.95 |
| 2 FOR STEREO | Net 18.95 |

MINIDUCT[®] SPEAKER ENCLOSURE WITH LAFAYETTE SK-98 8" PATENTED DUAL CONE SPEAKER

As Low As

31²⁵



A PERFECT COMBINATION: The "Mini-Duct" enclosure and the famous Lafayette SK-98 8" mechanical 2-way speaker with patented dual cone construction. This speaker combined with the Lafayette "Mini-Duct" enclosure will give the wide-range frequency response (40-16,000 cps) normally found in the coaxial speakers or multiple speaker systems. Shpg. wt., 29¼ lbs.

| | |
|---|-----------|
| Combination unfinished "Mini-Duct" enclosure with SK-98 Speaker | Net 31.25 |
| 21 K 9990WX | Net 31.25 |
| Combination mahogany "Mini-Duct" enclosure with SK-98 Speaker | Net 34.25 |
| 21 K 9991WX | Net 34.25 |
| Combination walnut "Mini-Duct" enclosure with SK-98 Speaker | Net 34.25 |
| 21 K 9992WX | Net 34.25 |
| Combination oiled walnut "Mini-Duct" enclosure with SK-98 Speaker | Net 34.25 |
| 21 K 9993WX | Net 34.25 |

LAFAYETTE SK-130 8" WIDE-RANGE HI-FI SPEAKER

Made in England To Our Own Rigid

Specifications

CHECK THESE PHENOMENAL SPECIFICATIONS

- Frequency Response: 40-18,000 cps
- Flux Density: 13,500 Maxwells
- Power Handling Capacity: 15 Watts
- Magnet Weight: 1 lb. High Efficiency
- Cone Resonance: 55 cps
- Voice Coil: 1-Inch
- Impedance: 16 Ohms Alcomax Magnet



12.95

ASTONISHING FIDELITY from a speaker of this size and modest price. Designed and finished with typical British craftsmanship, the SK-130 features an especially designed hyperbolic cone with a plastic surround suspension for wide compliance performance. Bass response is robust and full bodied, while the midrange and highs are virtually transparent, with never a trace of shrillness or harshness. The excellent wide-range response of the SK-130 make it ideal for stereo when used in pairs or perfect for use as a high quality extension speaker. Overall Diam. 8½"x4" Deep. Baffle cut-out 7½". Rigid vibration-free frame is equipped with screw type terminals. Imported.

| | |
|----------------------------|-----------|
| 21 K0113 Shpg. wt., 3 lbs. | Net 12.95 |
|----------------------------|-----------|

FAMOUS LAFAYETTE MINI-DUCT[®] BOOKSHELF ENCLOSURE WITH SK-130 8" WIDE-RANGE SPEAKER

As low as

33⁹⁵

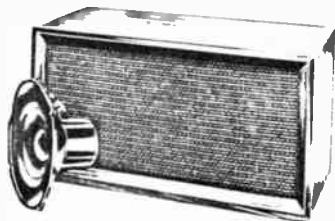

A combination that rivals the performance of much larger speaker systems. This fine enclosure assures optimum performance from the SK-130. Only 23Wx11½Hx11¼"D—ideal for mounting in a bookcase or record shelf. Finished on 4 sides in a variety of fine furniture finishes. Shpg. wt., 27 lbs.

| | |
|--------------------------|-----------|
| 21 K 9994WX Mahogany | Net 36.95 |
| 21 K 9995WX Walnut | Net 36.95 |
| 21 K 9996WX Oiled Walnut | Net 36.95 |
| 21 K 9997WX Unfinished | Net 33.95 |

LAFAYETTE ULTRA-LINEAR SK-128[®] FULL RANGE 8-Inch BIAXIAL SPEAKER with Acoustic Tweeter Baffle Design

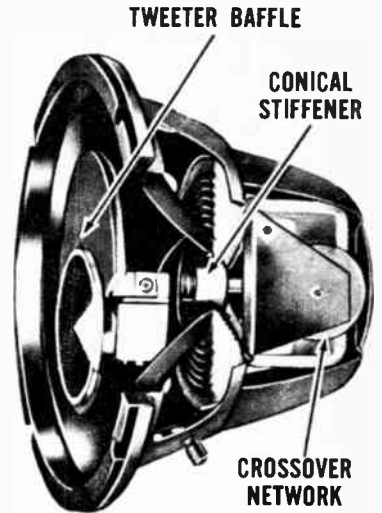

ONLY
19⁵⁰
2 for 38.95

The SK-128 combines the best features of a multiple speaker system in one compact and economical unit. It offers full, even coverage of the entire audible range, with no distortion or coloration to mar your listening pleasure. The specially treated woofer cone has a unique "Conical Stiffener" at the apex which, coupled with its high compliance, enables the cone to operate in a piston-like manner—delivering a clean, powerful bass response. The 2-inch tweeter has its own voice coil and magnetic field. Special treatment of cone and cone edge provides even distribution of the high frequencies, with no peaks or resonances. The unusual off-center mounting of the tweeter and its elliptical baffle minimizes interaction between tweeter and woofer and insures an overall response free of intermodulation distortion. Electrical crossover from the woofer cone to the tweeter unit is provided by a built-in network. An adjustable brilliance control permits matching of sound to room acoustics. Efficiency of the speaker is such that it will operate from any amplifier with an output of 1 watt or more. Installed in a bass-reflex type of enclosure, it performs outstandingly, and is recommended for all high-quality music systems—whether monaural or stereophonic. **SPECIFICATIONS:** Overall Response: 20-20,000 cps (40-16,000 cps \pm 3 db). Free air Resonance: 45-65 cps. Impedance: 8 ohms. Power Rating: 20 watts Integrated Program Material. Crossover: 2,500 cps. Overall Diam. 8 $\frac{1}{2}$ ". Overall Depth: 5 $\frac{1}{2}$ ". Baffle cut-out: 7 $\frac{1}{2}$ ". Rugged, vibration-free speaker frame with color-coded screw-type terminals for quick, easy connection of amplifier leads. Shpg. wt., 5 lbs. Imported. 99 K0032 Full Range 8" Biaxial Speaker Net 19.50

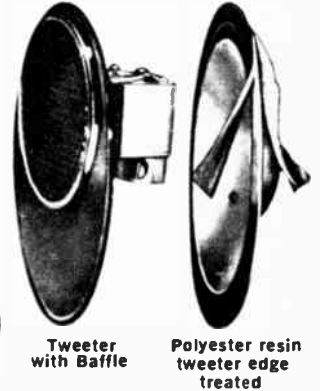

Eccentric Tweeter Mounting & Unique Elliptical Baffle Completely Eliminates Interaction Between Woofer & Tweeter

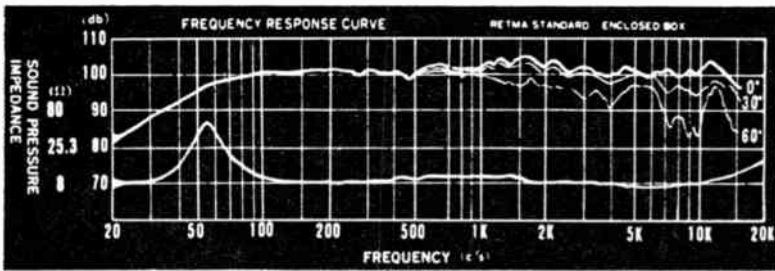

■ 20 TO 20,000 CPS (40 TO 16,000 CPS \pm 3 DB) ■ HIGH EFFICIENCY ■ HIGH EXCURSION WOOFER WITH UNIQUE "CONICAL STIFFENER" ■ HANDLES HEAVY BASS PASSAGES WITHOUT "DOUBLING"

LAFAYETTE MINI-DUCT[®] BOOKSHELF ENCLOSURE WITH SK-128[®] 8" ULTRA-LINEAR SPEAKER

The perfect answer for those who demand realistic sound reproduction even where space is limited. Two of these systems are ideal for stereo. Beautifully finished on all 4 sides for horizontal or vertical placement. Shpg. wt., 28 lbs.

| | | |
|------------|------------------------------------|-----------|
| 21 K0108WX | Speaker System in Walnut | Net 39.50 |
| 21 K0109WX | Speaker System in Oiled Walnut | Net 39.50 |
| 21 K0110WX | Speaker System in Mahogany | Net 39.50 |
| 21 K0111WX | Speaker System in Unfinished Birch | Net 37.50 |



LAFAYETTE'S WORLD FAMOUS

15" COAXIAL HI-FI SPEAKER



1795

- 30-20,000 CPS—35 Watts Peak
- Large 13 oz. Ceramic Magnet

A high quality, budget priced speaker system consisting of specially designed 15" woofer with a full 5" high-frequency tweeter coaxially mounted with a 1½" voice coil. SPECIFICATIONS: Frequency response, 30-20,000 cps. Crossover frequency, 3500 cps. Cone resonance, 45 cps. Power handling capacity, 20 watts continuous and 35 watts peak. Impedance, 8 ohms. Rugged, lasting seamless cone. Has 4-way binding posts for easy installation. Shpg. wt., 12 lbs.

21 K 4711W

Net 17.95

12" WIDE-RANGE HI-POWER HI-FI SPEAKER



1495

- 1¼ lb. Ceramic Magnet • Rated at 30 Watts • Response 20-14,000 CPS
- Seamless Cone
- Special Heavy-Duty Construction • Ideal for P.A. Work

This wide-range 12" FM high fidelity speaker is rated at 30 watts and is excellent for use with any hi-fi system. Voice coil impedance 8 ohms. Outside diameter 12¼", mounting diameter 11¼", depth 6¾". Color-coded 4-way binding-post terminals. Shpg. wt., 8 lbs.

21 K 4712

Net 14.95

12" THREE-WAY HI-FI SPEAKER



1195

- 10 oz. Ceramic Magnet
- 20 Watts Power Capacity
- Frequency Response 35-17,500 cps

Features a 10 oz. ceramic magnet, and when correctly baffled, will reproduce bass notes down to 35 cps. A special elliptical tweeter extends response to 17,500 cps and gives improved sound dispersion over the usual cylindrical types. Voice coil diameter is 1½". Impedance is 8 ohms. Power Capacity is 20 watts. Plated steel frame finished in brown baked enamel. Has 4-way binding posts. Shpg. wt., 8 lbs.

21 K 4714

Net 11.95

ECONOMY 12" COAXIAL SPEAKER



875

- Frequency Response 40-15,000 cps
- Voice Coil Diameter 1"

An economical way to improve the sound of existing inexpensive hi-fi consoles or portables or as the main speaker system of a budget priced high-fidelity system. A built-in filter correctly divides the frequency spectrum and distributes the different frequencies to the woofer and tweeter. Power rating: 12 watts. Impedance: 8 ohms. Shpg. wt., 5½ lbs.

21 K 4715

Net 8.75

15" HI-FI WOOFER



2395

- Heavy 2 lb. Alnico Magnet
- 20 to 5000 Cycles
- Peak Watts—35 Watts

Efficient 15" woofer with 2 lb. Alnico V magnet. Ideal for 2- and 3-way speaker systems. Handles 35 watts of audio power. Frequency response ±2 db 20 CPS to 1000 CPS, and ±5 db from 20 CPS to 5,000 CPS with proper baffling. Voice coil dia. 2", impedance 8 ohms. Finished in beautiful brown enamel. Has 4-way binding posts. Shpg. wt., 13¼ lbs. Cone resonance 45 cycles.

21 K 4719W

Net 23.95

12" HI-FI WOOFER WITH 2 LB. MAGNET

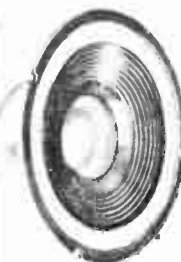

2295

- 30 Watts
- 20-2500 Cps
- 2" Voice Coil Diameter
- Cone Resonance at 30 Cps

This sturdily constructed 12" Woofer is rated at a full 30 watts audio power. Frequency response from 20 to 2500 cps with the speaker resonant frequency at 30 cps. Heavy 2 lb. Alnico V magnet and 2" diameter voice coil. Plated steel frame finished in brown baked enamel. Has 4 way binding posts. 8 ohm impedance. Shpg. wt., 10½ lbs.

21 K 4720

Net 22.95

12" HI-FI WOOFER WITH 1¼ LB. MAGNET



1550

- 25 Watt Power Capacity
- Response 30-9,000 Cps
- 1½" Voice Coil Diameter
- Cone Resonance 50 Cps

Ideal for assembling 2- and 3-way speaker systems at a budget price. Enclosed magnet structure — completely dust-proof. Compliance of outer cone and inner spider carefully calculated for best bass response. 1¼ lb. ceramic magnet, 8 ohm impedance. Has 4-Way binding posts. Cone Resonance 50 cycles. Shpg. wt., 8 lbs.

21 K 4716

Net 15.50

8 INCH WOOFER

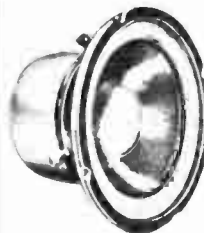

1065

- Rated 25 Watts
- 1¼ lb. Ceramic Magnet
- 35 to 7500 cps
- Free Edge Cone
- High Compliance

This 8" woofer is an ideal choice for use in 2 or 3 way speaker systems where space is of great importance. The 1¼ lb. ceramic magnet insures clean, boom-free response in the low end. A free-edge, high compliance cone is utilized for high efficiency. Power handling capacity is 25 watts peak. Voice coil diameter 1½". Cone resonance is 50 cycles. 8 ohm impedance. Has 4-way binding posts for simple installation. Shpg. wt., 6 lbs.

21 K 4721

Net 10.65

8" MID-RANGE SPEAKER

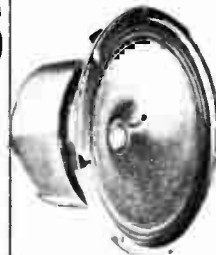

650

- 25 Watts Capacity
- Response 350-14,000 cps
- Enclosed Back

Capable of reproducing virtually undistorted sound from 350 to 14,000 cps, the recommended crossover frequencies are at 350 cps and 5,000 cps. Power handling capacity: 25 watts. Cone Resonance: 150 cps. Impedance: 8 ohms. 10 oz. ceramic magnet. Voice coil diameter: 1". Plated steel frame finished in brown baked enamel. Has 4-way binding posts. Shpg. wt., 4½ lbs.

21 K 4718

Net 6.50

BUDGET PRICED HI-FI SPEAKERS

ROYAL DANISH 12" DUAL CONE SPEAKER

795



- Frequency Response 45 to 14,000 cps
- 1" Diameter Voice Coil
- High Flux Density

You will be pleasantly surprised at the quality of this fine speaker which Lafayette brings you at this low price. An exclusive, special formula cone rim treatment eliminates cone rim resonance and distortion. Overall depth, 5 1/4". Completely enclosed. 1" diameter voice coil with an impedance of 8 ohms. Shpg. wt., 6 lbs. Imported.

12" Dual Cone Hi-Fi Speaker Net 7.95
21 K 7101

6 1/2" COAXIAL HI-FI SPEAKER

695

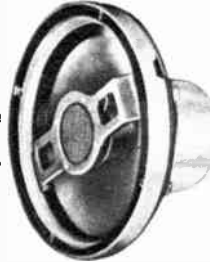

- Overall Response 50-16,000 Cps.
- Space Saving & Economical For Stereo
- Built-in L C Network
- Large, Heavy Magnets

An excellent speaker with all the best features of coaxial design. 6 1/2" woofer is equipped with large, heavy magnet for maximum efficiency and low distortion. 2" tweeter is a separate speaker coaxially mounted in a housing which completely seals off back radiation. Voice coil impedance, 8 ohms. Requires 5 1/2" diam. cutout. Size is 6 1/2" diam., 3 3/4" deep. Shpg. wt., 3 1/2 lbs. Imported.

99 K 0028 6 1/2" Coaxial Speaker Net 6.95
2 for Stereo Net 12.95

LAFAYETTE 6 1/2" THINLINE SPEAKER

495



- Rigid Die-Cast Frame
- Ideal for Economy Music Systems or Extension Speaker Use

Low-cost, 3-way, full-range speaker with 3 diaphragms performing as woofer, mid-range and tweeter. Its small size, only 2" deep, makes it excellent for use in a wide variety of space-saving applications. Frequency response, 75-12,000 cps. Power handling capacity, 3 watts of program material. Impedance, 8 ohms. Shpg. wt., 2 1/2 lbs. Imported.

99 K 0031 Net 4.95

LAFAYETTE 6"x9" WIDE RANGE SPEAKER

495

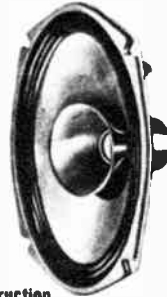

- High Sensitivity Magnetic Circuit
- 55 to 14,000 cps
- Space Saver Construction

This hi-fi extended range speaker is definitely a must for add-on stereo application and lends itself to many new applications such as adding hi-fi to autos, TV, radio sets, and also where space limitations are paramount. It has an outside diameter of 6 7/8 x 9 1/4"; Mtg. hole dimensions are 4 9/16 x 6 1/4"; Depth is 3 3/4". Has 4-way binding posts.

21 K 4709 Shpg. wt., 2 lbs. Net 4.95

6" MID-RANGE SPEAKER

525



- 4.8 oz. Ceramic Magnet
- Freq. Response 700-7000 cps

An excellent mid-range direct-radiator type speaker for installation in 3-way or 4-way speaker systems. Gives clean, distortion-free reproduction at rated power. Features closed back to eliminate interaction with sound waves generated from other speakers in the same enclosure. Rated power handling capacity; 10 watts. Frequency response from 700 to 7000 cps. 4.8 oz. Ceramic Magnet. Voice coil diameter 3/4". Impedance: 8 ohms. Plated steel frame finished in brown baked enamel. Has 4-way binding posts. Shpg. wt., 3 lbs.

21 K 4706 Net 5.25

DELUXE LAFAYETTE-GOODMAN "DOME LENS" ULTRA HIGH FREQUENCY COMPRESSION TWEETER

895

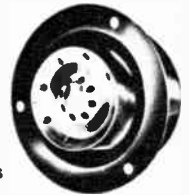

- Omni-directional compression tweeter for 2, 3, and 4 way systems
- Handles up to 30 watts of power.

Offers 360° sound dispersion, quality high frequency response of sharp transients. Capable of handling frequencies from 5000 cps. to beyond the limits of human audibility. Has built in crossover at 5000 cps. Voice coil impedance 8-16 ohms. Dimensions: 4D x 2 1/2" length. Shpg. wt., 1 1/2 lbs. Imported from England.

21 K 0131 Net 8.95

LAFAYETTE LOW COST HI-FI TWEETER

225



Frequency Response 3,000-16,000 Cps.

Reproduces high frequencies without losing clarity and volume. Even sound dispersion is insured by use of a round cone. Metal cased with completely sealed rear housing. Frequency response 3,000-16,000 cps. Diameter 2 3/4 inches. Depth 1 3/4 inches. Voice coil impedance 8 ohms. Shpg. wt., 1 lb. Imported.

99 K 0117 Net 2.25

2 AND 3-WAY L/C CROSSOVER NETWORK

1495

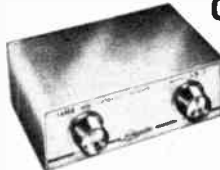

- 4 crossover frequencies: 350, 700, 2000, 3000, 5000 cycles
- 6 crossover combinations
- Built-in brilliance and presence controls

This versatile unit can be used either as a 2-way or 3-way 6 db per octave network. For 8-16 ohm speakers. Suitable for mounting inside enclosure or leaving out in the open. Brilliance and Presence controls — are mounted on the front panel. If desired, these level controls may be removed, escutcheon plate, for external mounting; controls are wired with 3-foot long leads. Shpg. wt., 6 lbs. Imported.

99 K 0022 Net 14.95

LAFAYETTE 2-WAY CROSSOVER NETWORK

795



- Adjusts to Either 2500 or 5000 cps Crossover Freq.

Has a built-in continuously variable high-frequency "Brilliance" level control. Control has a 2 1/2 ft. cable to mount on rear or side of speaker cabinet, and a long shaft for thick wood panels. For use with 8-16 ohm speakers. Easily accessible screw terminals. Metal case 5 1/2 x 2 1/2 x 2 1/2" D. Shpg. wt., 5 lbs. Imported.

99 K 0021 Net 7.95

LAFAYETTE 3-WAY 12 INCH "SLENDER-LINE" HI-FI SPEAKER



- Only 3½" depth — can be mounted in virtually any "thin-type" cabinet
- Special low-resonance woofer cone
- Independent horn type super tweeter for wide dispersion of highs
- Frequency response 30-18,000 cps
- Heavy duty die cast frame
- Complete with brilliance level control.

ONLY
1995
2 for 38.95

This new superb 3-way "slender-line" 12" high fidelity speaker incorporates the latest advanced techniques in speaker design. Constructed to Lafayette rigid specifications, the Lafayette SK-260 is an unbelievable value offering rich, brilliant sound reproduction. Engineered to faithfully reproduce the complete audio spectrum from 30 to 18,000 cps, this fine speaker is but 3½" in depth, can be mounted in virtually any thin-type cabinet or shelf type enclosure. Incorporates a special low-resonance woofer cone, for clean natural bass response without boom, mechanical mid-range, and independent horn-type tweeter for wide dispersion of highs. Offers full-bodied mid-range and quality high frequency response enabling you to hear all the fine transients and high notes of the higher frequencies. Features heavy duty die-cast frame. Built-in mechanical crossover at 1,800 cps and electrical crossover at 5,000 cps. Power handling capacity 20 watts, peak 40 watts. Complete with brilliance level control. Impedance 8 ohms. Shpg. wt., 10 lbs. Imported.

99 K 0029 Net 19.95 2 for 38.95

LAFAYETTE 2-WAY 12-INCH "SLENDER-LINE" HI-FI SPEAKER



ONLY
1395
2 for 26.95

- Dual Cone Construction
- Heavy Duty Magnet
- 2" Edgewound "Voice Coil"
- Frequency Response: 20-13,000 cps
- Shallow Depth for Custom Mounting

Here is a high quality, low cost, dual-cone speaker featuring outstanding sound and a heavy-duty die cast frame to permanently center the sound reproducing elements. This insures low distortion for the life time of the speaker. The shallow frame design of the SK-255 permits simple custom installation in walls, "thin-type" enclosures, ready-made consoles or wall baffle extension speaker use. The big 12" high compliance woofer delivers plenty of solid bass while the separate high frequency whizzer cone handles the middle and high frequencies clearly to the upper audio spectrum. Other features are 2" edgewound voice coil assembly and a built-in mechanical crossover at 1800 cycles. Has convenient binding post terminals for fast, easy connections to any amplifier.

SPECIFICATIONS—Frequency Response: 20-13,000 cycles. Power Handling Capacity: 20 watts, 40 watts peak. Voice Coil Impedance: 8 ohms. Cone resonance: 45 cps ± 10 cps. Voice Coil Diameter: 2 inches. Size: 12¼" diameter x 3½" deep. Shpg. wt., 7 lbs. Imported.

99 K 0030

Net 13.95 2 for 26.95

DELUXE LAFAYETTE REVERBERATION AMPLIFIER/SPEAKER SYSTEM



5950

\$5 monthly

WORKS WITH



- Excellent for Mono or Stereo Systems
- Adds a Delightful Dimension to Sound Without Affecting Fidelity
- Completely Self-Contained System with Amplifier and Speaker.

A self-contained reverberation amplifier/speaker system with built-in power supply, that hooks into any existing stereophonic or monaural component sound system, FM or AM radio, TV set, tape recorder or electric organ to add acoustic dimension to your listening area. Controls: 3-position selector switch for reverb, stereo center channel, crystal phono functions plus push-pull on-off/volume. Output power is 3 watts into an 8" PM speaker. Inputs: stereo high level, stereo low level, mono crystal phono. For 110-117 volts, 50-60 cps AC. Oiled walnut finished cabinet measures 21½Wx11½Hx8¼"D. Shpg. wt., 23 lbs. Imported.

99 K 0041WX

Net 59.50

FIBRE GLASS INSULATION



Excellent sound absorbing material. For lining interiors of speaker cabinets, consoles, phonos, TV's, etc. 9 sq. ft., 1" thick with glue and applicator. Shpg. wt., 1 lb.

20 K 8001 Net 1.49

DELUXE BASS REFLEX KIT: 20 square feet, 16x16x1" Bonded fibre-glass. Shpg. wt., 2 lbs.

20 K 8002 Net 2.70

JENSEN speakers + UNIVERSAL WOODCRAFTERS cabinet + LAFAYETTE low prices

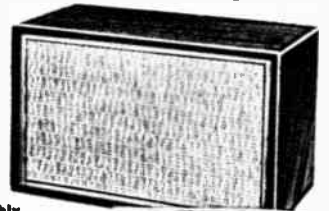

3895

\$5.00 Monthly

- Heavy 7-Ply Furniture Veneer Cabinet
- Fiberglass-loaded Cabinet for Better Bass Response
- Jensen 12" Woofer, 8" Midrange Driver, 3½" Enclosed Tweet



Now you can get outstanding speaker performance at a low, low Lafayette price—The Uni-Voice hi-fi speaker system is a thrilling blend of fully integrated, unified 3-speaker systems engineered by Jensen with specially developed Jensen components, with cabinetry by Universal Woodcrafters. Contains special 12" woofer; 8" midrange driver independently pneumatically damped in its own hermetically enclosed acoustic surroundings, completely separated from woofer cavity; 3½" fully enclosed, independently baffled tweeter. Woofer electric crossover at 600 cycles, midrange electric crossover at 2000 cycles. Impedance 8 ohms. Response: 35-18,000 cycles. Walnut finish on 4 sides. Speaker grille completely framed with brass inlay. 24Wx14¼Hx13"D.

21 K 8401 Walnut finish. Shpg. wt., 32 lbs. Net 38.95

NEW MAXIMUS 1 SPEAKER SYSTEM by GOODMAN'S



MAXIMUS 1
A Speaker System Developed
by the UTC Sound Division,
Garden City, New York

only **59⁵⁰**
\$5 Monthly

IMPORTED FROM ENGLAND

One Of The Smallest, True High Fidelity Speaker Systems
In The World! Actual Size 10½x5½x7¼"

- Sufficient Handling Capacity—With Ease
- Crisp Voice Articulation—Natural Presence
- Real Treble, Solid Bass
- Unusual Compactness—Fits Anywhere

The MAXIMUS 1 is only 10½x5½x7¼" and fits everywhere—book shelf, end table, or wall. Inside each miniature mastercrafted oiled walnut enclosure are precision direct-radiator drive units with specially designed crossover networks to give uniform response from 45 to 20,000 cps. Exceptionally smooth bass is achieved by the utilization of a massive magnet in the woofer section. Power handling capacity is 15 watts, making it compatible with most amplifiers. A uniquely designed L-C crossover network transfers power at 900 cps to a newly developed backloaded mid-range/high frequency unit. Shpg. wt., 11 lbs.
21 K 8301WX Walnut Finish Net 59.50

EMI CUSTOM QUALITY SPEAKER SYSTEMS

POPULAR MODEL 319 BOOKSHELF SYSTEM

A bookshelf speaker system with remarkable performance for its price. Frequency response is essentially flat from 50 to 15,000 cps. Low frequencies are reproduced from a 13½x8¼" woofer with patented aluminum cone and molded suspension. High frequency response is obtained from a 3¾" diameter ceramic magnet tweeter. A specially designed crossover network provides extremely smooth transition from lows to highs. The walnut cabinet is an infinite baffle enclosure measuring 23x11½x10¼" and having a woven metal speaker grille. Impedance is 8 ohms. Shpg. wt., 35 lbs.

21 K 5905WX Hand-Rubbed Oiled Walnut \$5 Monthly Net 99.75

MODEL 630 SHELF SYSTEM

An ideal bookshelf-size speaker system measuring 20½x11x9¾". Frequency response is relatively flat from 60 to 15,000 cps. The bass frequency unit is 10¾x6¾" incorporating a patented aluminum cone and molded suspension. The high frequency response is obtained from a 3¾" diameter tweeter with a ceramic magnet. A specially designed crossover network is provided for smooth transition from lows to highs. The speaker grille is made of woven metal, and the enclosure is an infinite baffle type. Impedance is 8 ohms. Shpg. wt., 25 lbs.

21 K 5906WX Oiled Walnut \$5 Monthly Net 69.75
21 K 5907WX Unfinished Gumwood \$5 Monthly Net 64.75

IMPORTED FROM ENGLAND

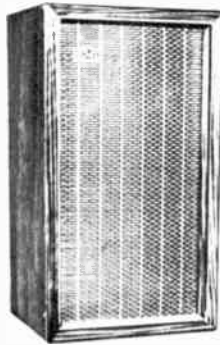

Model 319

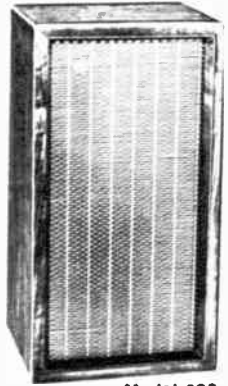

Model 630

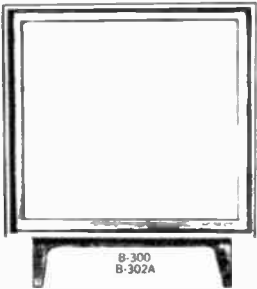

B-300
B-302A

DELUXE

Bozak

**SPEAKER
SYSTEMS**

B300 2 WAY SYSTEM

A 2-way wide range system of modest cost in a beautiful wood cabinet with hand-rubbed matte walnut finish. Comes with a B-199A 12" high efficiency woofer, and a B200Y tweeter with provisions to add a B200Y midrange, and a N-10102A crossover to convert your present B300 2 way system to a deluxe B302A 3-way system. Response 40 to 20,000 cps — Crossover, 6 db/octave at 2500 cycles — imp. 8 ohms — power rating 20 watts. Size: 30Hx24Wx20"D. 21 K 1930WX Shpg. wt., 88 lbs. \$9 Monthly Net 179.50

B-302A 3-WAY SYSTEM

A deluxe three-way range system incorporating a B-199A high efficiency woofer, B-209B, midrange speaker, and a B-200Y tweeter and N-10102A crossover network in beautiful hand rubbed wood cabinet of matte walnut finish. A freq. resp.: 40 to 20,000 cps. LC network crossover: bass to mid-range, 800 cycles; mid-range to treble, 2,500 cycles. Imp. 8 ohms; power rating 20 watts. 30Hx24Wx20"D. Shpg. wt., 95 lbs.
21 K 1901WX \$11.50 Monthly Net 261.50

ALTEC LANSING LOUDSPEAKERS



Left—Coronado System



Above—Lido System

MODEL 841A "CORONADO" SPEAKER SYSTEM

Altec's "Coronado" combines high audio performance and contemporary styling in a convenient sized enclosure. Occupies only 1.2 square feet of floor space. Often used in recording and broadcast studios for playback or live performances. Composed of an Altec 414 12" base speaker, an Altec 3000 horn and driver, and a two-section N-3000 crossover to correctly divide and distribute the high and low frequencies. Enclosure is acoustically lined with fiberglass insulation to eliminate resonances and reflections. Response: 40-22,000 cps. Power capacity: 20 watts. Dim. 30Hx19Wx14"D.
21 K 7606WX Walnut \$10 Monthly Net 204.00

MODEL 836A "LIDO" SHELF SYSTEM

The Altec "LIDO" provides excellent reproduction where space-saving is of great importance. Incorporates two 8-inch speakers which work in phase at lower reproduction of bass notes usually found only in far larger systems. Specially designed dividing network utilizes an Altec 755C reproducer for the high frequencies. Frequency range: 40-15,000 cycles. Power rating: 15 watts. Impedance: 8 ohms. Dimensions: 12¾Hx26Wx12¾"D.
21 K 7807WX Walnut \$6 Monthly Net 112.50

NEW LOW PRICES ON AR SPEAKER SYSTEMS

Prices Reduced 15% From Our 1965 Catalog 650 Prices

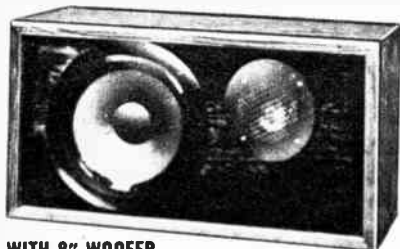

AR-4 WITH 8" WOOFER AND 3 1/2" DIRECT RADIATOR

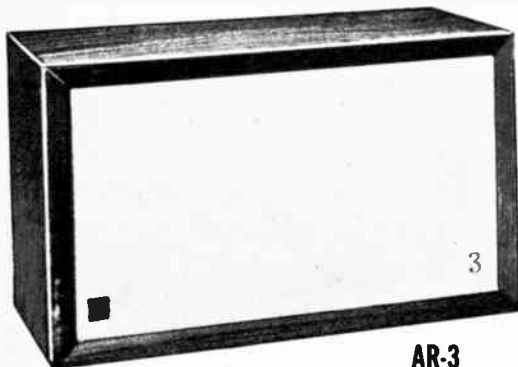

AR-3

AR-4 ACOUSTIC SUSPENSION SPEAKER SYSTEMS

The AR-4 is a low cost acoustic suspension speaker system. It is designed to give a superbly clean, realistic bass response and clear, crisp highs by utilizing the famous acoustic suspension principle. It incorporates an 8 inch woofer and a 3 1/2 inch direct radiator tweeter with level control to compensate for different acoustic conditions of your listening room. A compact (19Wx10Hx9"D) unit for floor or shelf-mounting. Suitable for use with amplifiers of 15 watts or more per channel. Shpg. wt., 20 lbs.

| | | |
|-----------------------------|-------------|------------|
| 21 K 7238WX Oiled Walnut | \$5 Monthly | Net 48.45* |
| 21 K 7239WX Unfinished Pine | \$5 Monthly | Net 43.35* |

AR-3 ACOUSTIC SUSPENSION SPEAKER SYSTEMS

A deluxe, space-saving 3-way speaker system combining the renowned mid and hi-frequency speakers. Incorporates 12" woofer, 2" mid-range dome radiator with 3.3 lb. magnet, and dome tweeter with 1.1 lb Alnico 5 magnet. This unique speaker system represents a complete departure from conventional design and provides a linear response from 38 to 20,000 cps (± 2 db.) LC network crossover at 1,000 and 7,500 cps with individual level controls. Requires 25 watts (each channel) to drive. Impedance 4 ohms. Dimensions 14Hx25Wx11 1/2"D. Shpg. wt., 60 lbs.

| | |
|-----------------------------|-------------|
| 21 K 7229WX Oiled Walnut | Net 191.25* |
| 21 K 7230WX Walnut | Net 191.25* |
| 21 K 7231WX Mahogany | Net 183.60* |
| 21 K 7232WX Unfinished Pine | Net 172.55* |

* Price in effect thru March 15, 1965

NEW AR2-AX ACOUSTIC SUSPENSION SPEAKER SYSTEM

| | |
|------------------------------------|--------|
| 21 K 7207 AR2-AX Oil Walnut | 108.80 |
| 21 K 7206 AR2-AX Walnut | 108.80 |
| 21 K 7204 AR2-AX Mahogany | 103.70 |
| 21 K 7205WX AR2-AX Unfinished Pine | 92.65 |

POPULAR FRAZIER DELMAR SYSTEM



7950

- Flat Response From 40 to 15,000 Cycles
- Special Helmholtz Type Enclosure

Highly efficient, compact two-way speaker system consisting of a special full range 8 inch speaker and a 3 1/2 inch high frequency unit. Modified Helmholtz type enclosure using two tuning tubes which provide low frequencies down to 40 cycles. One inch thick fiberglass insulation for smooth bass response. Frequency response 40 to 15,000 cycles ± 5 db. Power capacity: 15 watts. Impedance: 8 ohms. Dimensions: 23 1/2"Wx 19Hx11 1/2"D. Shpg. wt., 30 lbs.

| | |
|--------------------------|-----------|
| 21 K 8501WX Oiled Walnut | Net 79.50 |
|--------------------------|-----------|

EV SONDCASTER PORTABLE OUTDOOR HI-FI SPEAKER

- Rugged All-Weather Housing
- Produces Fine, Full-Range Sound
- Compact—Lightweight

2822

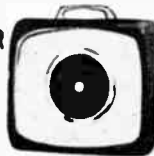

An outdoor speaker with full-sized sound—connects to any portable radio, TV, console or component hi-fi system. Small and light enough to go anywhere—Uses special, high-efficiency 8 inch coaxial speaker for true hi-fi sound. Attractive housing is made of unbreakable plastic and fully weatherproofed—Response: 70-13,000 cps. Power Handling: 30 watts, peak. Impedance: 8 ohms. Color: Dune Beige. Size 16 1/4"Hx17Wx5 1/2"D. Shpg. wt., 10 lbs.

| | |
|-----------|-----------|
| 21 K 3021 | Net 28.22 |
|-----------|-----------|

TANNOY DUAL CONCENTRIC QUALITY HI-FI SPEAKERS AND ENCLOSURES

MONITOR 15" DUAL CONCENTRIC SPEAKER



A 15" dual concentric speaker of unusual design. Cone of woofer acts as part of exponential horn for tweeter. Frequency response from 23 to 20,000 cps. Impedance is 16 ohms. External crossover network with 1,000 cps crossover. Handles 50 watts less than 2% inter-modulation distortion. Flux density 13,500 gauss in tweeter, 13,500 gauss in woofer. Resonant frequency 32 cps. 9" deep. Overall diameter, 15 1/4". wt., 25 lbs.

| | | |
|---|-------------|------------|
| 21 K 6401WX | \$9 Monthly | Net 179.00 |
| "12" Monitor, 12" version of Monitor 15, 30 watts power handling capacity. Shpg. wt., 20 lbs. | | |
| 21 K 6402WX | \$7 Monthly | Net 138.00 |

BELVEDERE SENIOR ENCLOSURE

Designed for the 15" Tannoy Dual Concentric loud-speaker. Constructed of 1 1/2" bonded material, using dual damped port principle. Available in oil walnut finish. Size: 31 1/2x23 3/4x16" deep. Shpg. wt., 76 lbs.

| | | |
|---|-------------|-----------|
| 21 K 6425WX | \$5 Monthly | Net 85.00 |
| Belvedere Jr. Enclosure — designed for Tannoy 12" speaker systems. Available in oil walnut finish. Size: 26x18x12" deep. Shpg. wt., 40 lbs. | | |
| 21 K 6426WX | \$5 Monthly | Net 85.00 |

ECONOMY 3-WAY SPEAKER SYSTEM KIT

Ideal for the "do-it-yourself" audio Enthusiast Features: Matched 8" woofer, 5" mid range, and 2" Tweeter.

3275
\$5 Monthly

A 3 way speaker system, consisting of an 8" Woofer, with 10.7 oz. magnet, 5" mid-range, 2" tweeter, and crossover network completely wired and mounted on a front panel and covered with attractive grey grill cloth. Specifications: Frequency range—35-18,000 cps, Crossover frequency 4,000 cps. Impedance 8 ohms. Front panel. Size: 20x8 1/2". Power rating 15 watts. Shpg. wt., 10 lbs.

| | |
|------------|-----------|
| 21 K 7102W | Net 32.75 |
|------------|-----------|

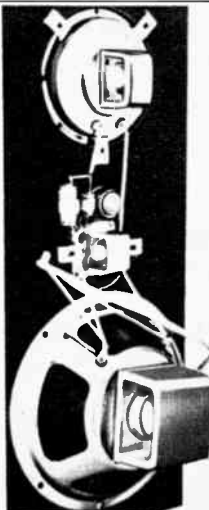

"BUILD-YOUR OWN"

EASY-TO-ASSEMBLE HI-FI ENCLOSURE KITS

LAFAYETTE UNIVERSAL HI-FI BASS REFLEX ENCLOSURE KITS

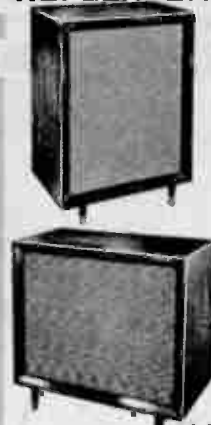
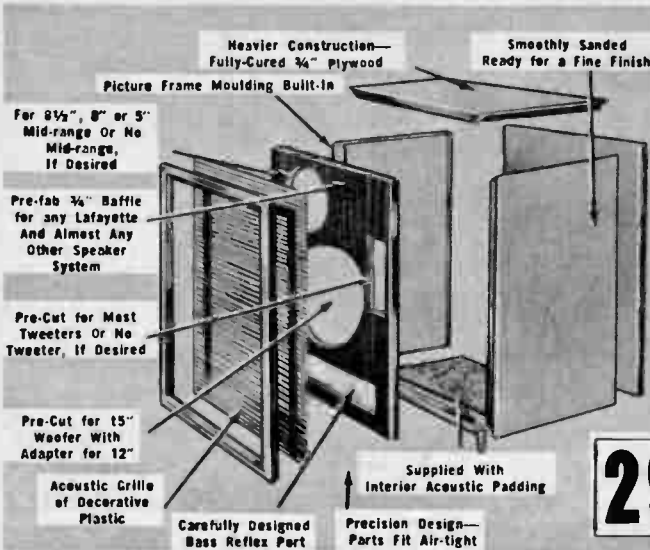

- EASY TO ASSEMBLE
- 3/4" WHITE BIRCH
- PRECISION-CUT — FITS TOGETHER SMOOTHLY
- IDEAL FOR SINGLE WIDE RANGE, 2-WAY OR 3-WAY SPEAKER SYSTEMS
- HIGHBOY OR LOWBOY STYLE



LAFAYETTE OILED WALNUT FINISHING KIT

29⁹⁵



Use this professional walnut oiling kit to achieve a beautiful oil finish on all unfinished walnut furniture. Materials are identical to those used by professional finishers; kit contains walnut oiling mixture, walnut paste wax, sandpaper and instructions. Shpg. wt., 2 lbs. **13K1801** Net **2.69**
OILED WALNUT STAIN FOR LIGHT WOODS. To be used with above for an attractive walnut-colored finish on lightcolored woods, such as birch, etc. **13K1802** Shpg. wt., 1 lb. Net **.89**

All pieces of these carefully designed bass reflex high fidelity speaker enclosures are accurately precut of 3/4" Plywood to fit snugly together and eliminate spurious resonances. Surface is white birch veneer. Front panels have picture-frame moulding and plastic acoustic grilles to blend with any finish and room decor. Tapered offset legs are protected by brass ferrules. Acoustic lining material prevents reverberation and cabinet resonance. Cutouts are provided for 15" speaker plus adapter for 12", 8 1/2" or 8" midrange plus adapter for 5" and blank wood block if no midrange speaker is used; cutout with adapter boards for 2 sizes of rectangular and 3 sizes of round compression horn tweeters plus blank block if no tweeter used. Kits are supplied unfinished, smoothly sanded and ready for finishing. The lowboy-style cabinet dimensions are (less legs) 28 7/8" x 23 1/2" x 16 3/4" D; legs are 7" high. Highboy has same dimensions with height and width interchanged. Instructions, all parts, hardware, and grille are included. Shpg. wt., 54 lbs.
20 K0121WX Unfinished Highboy Enclosure Kit Net **29.95**
20 K0122WX Unfinished Lowboy Enclosure Kit Net **29.95**

Lafayette BASS REFLEX SPEAKER BOOKSHELF ENCLOSURE KIT FOR 8" or 6" SPEAKERS

AS LOW AS

Assembles In Less Than 30 Minutes!

10⁹⁵

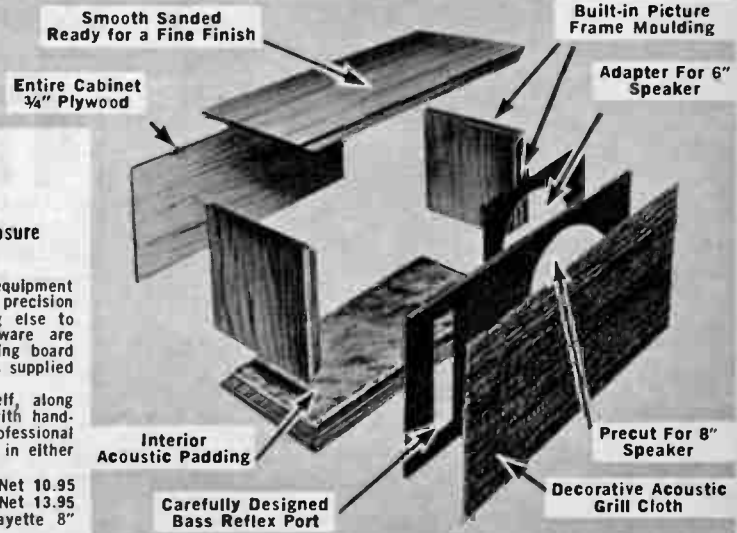

- Precision Cut — Fits Together Smoothly
- Adapts For 8" or 6" Speakers
- Easy To Follow Pictorial Instructions
- Versatile — Use As Floor or Bookshelf Enclosure

BUILD IT YOURSELF . . . Expensive woodworking equipment isn't needed—each cabinet component has been precision cut and fits together perfectly. There's nothing else to buy . . . acoustic padding, grill cloth and hardware are provided. Use any 8" or 6" speaker; the mounting board has been precut for 8" speakers and an adapter is supplied for 6" speakers. Designed for horizontal placement in a bookshelf, along a wall, etc. Constructed of veneers on 3 sides with handsome picture frame moulding. (See Lafayette's professional finishing kits). Dimensions: 23x9 1/2 x 11". Available in either birch or walnut unfinished veneers.
20 K0112WX Birch Kit. Shpg. wt., 15 lbs. Net **10.95**
20 K0113WX Walnut Kit Net **13.95**
 Speakers for Lafayette Cabinet Kit (above). Lafayette 8" Duo-Cone Speaker; 40-16,000 cps response. **99K0027** Shpg. wt., 5 1/2 lbs. Net **9.95**
 Lafayette 6 1/2" Coaxial Speaker; 50-16,000 cps response. **99K0028** Shpg. wt., 3 1/2 lbs. Net **6.95**

Not 1/2" But 3/4" Furniture Grade White Birch Plywood or Walnut Veneer on Flaked Core Plywood

THE FAMOUS LAFAYETTE ELIPTOFLEX SPEAKER CABINET

Ready-To-Finish, Easy-To-Assemble KIT FORM

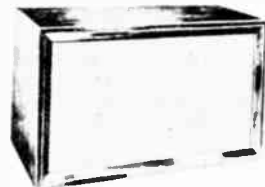
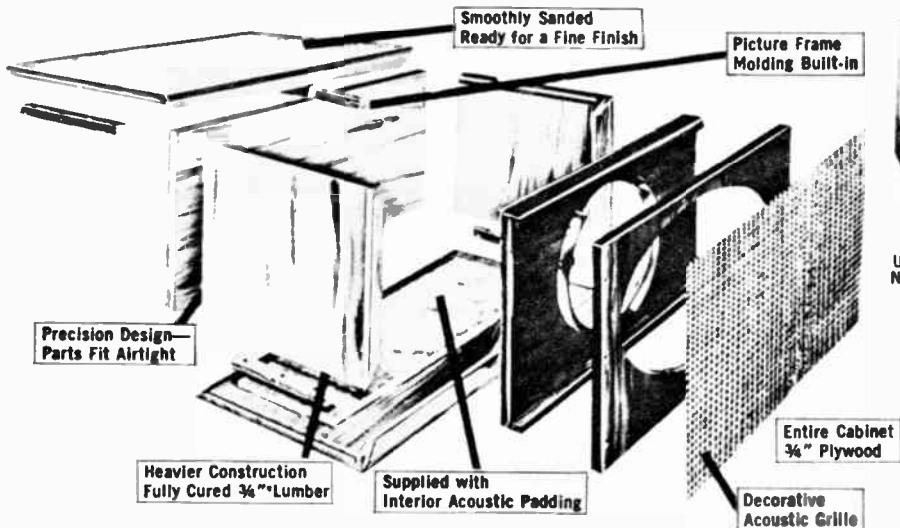

U.S. PATENT
NO. 3089562

HERE IS THE
ELIPTOFLEX
COMPLETELY
ASSEMBLED

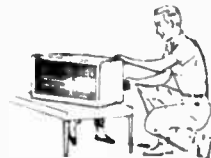

**EASY
TO ASSEMBLE!**

AS LOW AS

21⁵⁰

**A Bookshelf-Size Enclosure Engineered
by Lafayette Research—ASSEMBLE IT, FINISH IT, and SAVE!**

• The Same Speaker Cabinet That Set A New Standard of Excellence • Utilizes the Full Advantages of Efficient 12" Speaker Performance • Provides Optimum Performance Without Use of Expensive Large Wattage Amplifiers • 3 Sides Prepared For Finishing. For Horizontal Placement

This is the same Lafayette Eliptoflex Speaker Cabinet that set a new standard of speaker enclosure excellence—now available in ready-to-finish easy-to-assemble kit form. The easy-to-follow instruction sheet, with large pictures, guide you step-by-step for easy assembling. When completely assembled and highlighted with your favorite finish—you'll be amazed at the professional looking results.

You'll also appreciate the engineering excellence of this speaker cabinet. The Eliptoflex utilizes a unique elliptical port which broadens frequency response and provides better transient response. A specially engineered diffracting ring eliminates cancel-

lation effects between front and rear radiation. The "Eliptoflex" achieves a degree of natural smoothness, low distortion and rich robust bass. Due to its highly efficient design characteristics, costly high wattage amplification not required. The Kit is available in either ready-to-finish birch or in ready-to-finish genuine walnut veneer. Assembled the "Eliptoflex" measures 14Hx23⁷/₈Wx13¹/₂"D. Shpg. wt., 24 lbs.

20 K 0110WX Ready-To-Finish Kit in Birch Net 21.50
Ready-To-Finish Kit with Walnut Veneered Acoustically Correct
Flake Core.
20 K 0111WX Net 24.50

LAFAYETTE HI-FI COMPONENT SHELF/CONSOLE

Decorator Inspired!!



| | |
|---|---|
| <p>47⁵⁰</p> <p>\$5 monthly</p> <p>OILED WALNUT FINISH</p> | <p>28⁹⁵</p> <p>UNFINISHED</p> |
|---|---|

• Room For All Your Components • Sturdy 3/4" Wood Non-Warp Construction • Holds Over 150 Records • An Attractive Addition To Any Home—Place Along A Wall Or Use As A Room Divider



DIMENSIONS
Top Shelf
11"Hx16"Dx31¹/₂"W
Lower Shelf
15¹/₄"Hx15¹/₂"Dx31¹/₂"W
Speaker Compartments
27"Hx16"Dx14³/₄"W
Overall Dimensions
33³/₄"Hx16"Dx62¹/₂"W
(including 5" legs)

The ideal answer to your Hi-Fi Stereo component placement problems—measures 62¹/₂" long, yet holds over 150 records with more than enough room for your amplifier, turntable or record changer, tape deck and stereo speakers. Veneered rear panel, finished on both sides, permits its use as a room divider. Speaker compartments spaced to achieve proper separation for stereo. Shipped knocked down—Assembles in minutes. Shpg. wt., 65 lbs.

Oiled Walnut Finish on Genuine Walnut, Veneered Flake Core
20 K 0114WX Net 47.50
20 K 0115WX Unfinished Flake Board Net 28.95

See Page 3 for Lafayette Addresses and Store Hours

Deluxe LAFAYETTE Criterion® Hi-Fi Cabinetry

... to decorate your home with music



LAFAYETTE'S CRITERION LINE—
The standard of construction and design by which all others are judged.

TAMBOUR
EQUIPMENT
CABINET ONLY
89⁵⁰
\$5 monthly

Speaker Cabinet
59⁵⁰
\$5 monthly

THE Criterion® TAMBOUR EQUIPMENT CABINET

Classic simplicity and elegance together with truly functional design characterize this new equipment cabinet. "Component Engineered" by Lafayette's audio experts to provide ample, convenient, well-ventilated accommodations for all of your components. When matched with its companion Criterion Elliptoflex speaker enclosure (described below) it forms a complete music center and perfectly matched furniture ensemble. The construction and design reflect the quality contained in these units: cabinets employ rigid tongue and groove construction of 3/4" lumber core woods throughout, with matched veneers inside as well as out. Smartly styled with tambour sliding doors and tapered legs for graceful, decorative harmony, as well as for room space saving. Four compartments provide space for housing turntable or changer, amplifier, tuner, etc., with room for record storage. Each upper compartment is 10Hx19 1/2Wx15 1/2D; each lower compartment is 12 1/2Hx19 1/2Wx16 3/4D. Available in your choice of three finishes. Overall Dimensions: 44Wx18Dx32 1/2H including legs. Shpg. wt., 70 lbs.

- 20 K 0101WX Walnut Net 89.50
- 20 K 0102WX Oiled Walnut Net 89.50
- 20 K 0103WX Mahogany Net 89.50

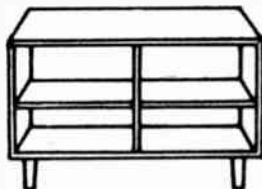

Interior Dimensions
of Tambour Equipment Cabinet

each upper compartment
10"Hx19 1/2"Wx15 1/2"D

each lower compartment
12 1/2"Hx19 1/2"Wx16 3/4"D

THE Criterion® ELIPTOFLEX SPEAKER CABINET

The same graceful, timeless styling and fine construction as the CRITERION equipment cabinet, which it matches. Designed to accommodate any 12" speaker, this enclosure incorporates the inner construction and acoustic principles of the famous Lafayette "Elliptoflex" enclosure. A specially designed elliptical port with diffracting ring broadens frequency response, increases transient response and eliminates cancellation effects between front and rear radiation. This results in low distortion, natural smoothness and unequalled performance in the low ranges. Constructed of 3/4" lumber core woods with hand-rubbed natural wood veneers. Smartly styled with matching grille cloth, decorative tambour borders, and tapered legs. Overall Dimensions: 32 1/2Hx18Dx16"W. Shpg. wt., 50 lbs.

- 20 K 0104WX Walnut Net 59.50
- 20 K 0105WX Oiled Walnut Net 59.50
- 20 K 0106WX Mahogany Net 59.50

LAFAYETTE CUSTOM CRAFTED EQUIPMENT CABINET



- Rigid 3/4" Wood Warp-Proof Construction
- Genuine Walnut Veneer Outside and Inside
- "Component Engineered" To Provide Adequate Circulation For Your Equipment

52⁵⁰
\$5 Monthly

A magnificent example of contemporary furniture design—its slender, graceful styling is sure to win approval in virtually every fine music room/living room arrangement. Features rigid 3/4" wood warp-proof construction with two adjustable center shelves to accommodate virtually any amplifier and tuner. The bottom section has room for a pull-out drawer to provide easy access to your record changer. Proper circulation of air around components is maintained by use of a perforated rear panel. Precision fitted swing-out front doors are equipped with magnetic latches. Size: 33 1/4"H overall (including 5" legs) x 18x20"W. Shpg. wt., 60 lbs.

- 20-K 0107WX Oiled Walnut Finish Net 52.50
- 20 K 0108WX Lacquered Walnut Satin Finish Net 52.50

DELUXE LAFAYETTE "UNIVERSAL" BASE REFLEX ENCLOSURE

ONLY

52⁵⁰

\$5 Monthly

Choice of Walnut or Mahogany finish

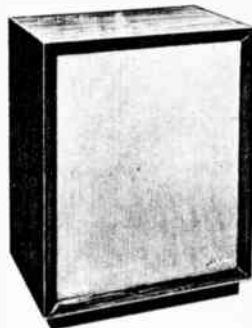

This beautifully styled Lafayette "universal" Bass Reflex enclosure will enhance the decor of any room. Solidly constructed of 3/4" stock, this fine enclosure is lined with acoustical material to prevent reverberation and cabinet resonance. Cutouts are provided for 15" speaker plus adapter for 12" speaker, 8 1/2" speaker or 8" mid-range; cutouts with adapter boards for either round or rectangular compression tweeters are provided. Blank blocks are furnished if no mid-range speaker or tweeter is used. Finished in walnut and mahogany. Dimensions 28 1/2Hx23 1/2Wx16"D. Shpg. wt., 54 lbs.

- 20 K 0131WX Walnut Finish Net 52.50
- 20 K 0132WX Mahogany Finish Net 52.50

DELUXE HI-FI CABINETRY

CONTEMPORARY "ALL-IN-ONE" STEREO EQUIPMENT CABINET

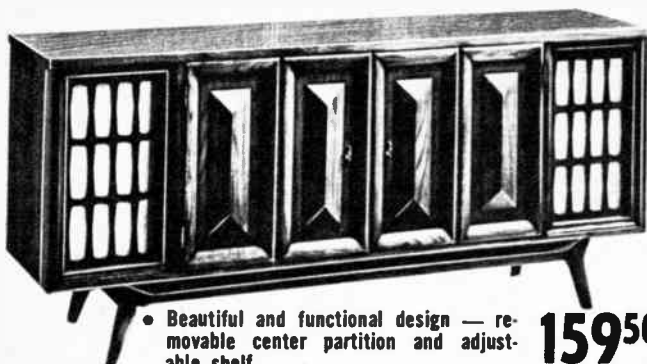

- Beautiful and functional design — removable center partition and adjustable shelf

159⁵⁰
\$8 monthly

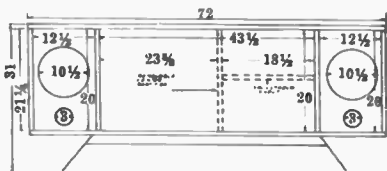

A handsome equipment cabinet with two acoustically-designed speaker enclosure sections . . . each houses a 12" and 3 1/2" speaker. The removable center partition and adjustable shelf give you the necessary flexibility in installing your components. May be arranged to house most turntables, amplifiers, tuners, and tape recorders. Long length of 72 inches is both attractive and functional for speaker separation. Walnut finish. Shpg. wt., 165 lbs.
20 K 3802WX Net 159.50

CONTEMPORARY ALL-IN-ONE STEREO EQUIPMENT CABINET

Elegantly Styled and Crafted

AT ONLY **149⁵⁰** \$7.50 Monthly

This beautifully styled 70" cabinet has been designed with everything you need in utility as well as the finest appearance in contemporary simplicity. The meticulous custom craftsmanship, rich, matched mature wood veneers and custom hand-rubbed finish will please the most discriminating taste. Includes dual 12" speaker enclosures, with baffle plates, 2 sliding doors, sliding changer carriage, record partition and equipment section. Overall size: 70Wx18Dx33 1/4"H. Leg 10 1/2". Inside speaker compartment: 15 1/2x20"H. 2 Equipment sections, 1 blank panel, 1 shelf: 17 3/4Wx7 1/2Hx15 1/2"D. Record storage section. Shpg. wt., 160 lbs.
20 K 6101WX Net 149.50

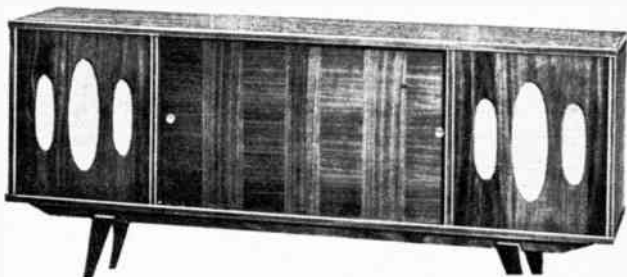

FRENCH PROVINCIAL STEREO EQUIPMENT CABINET

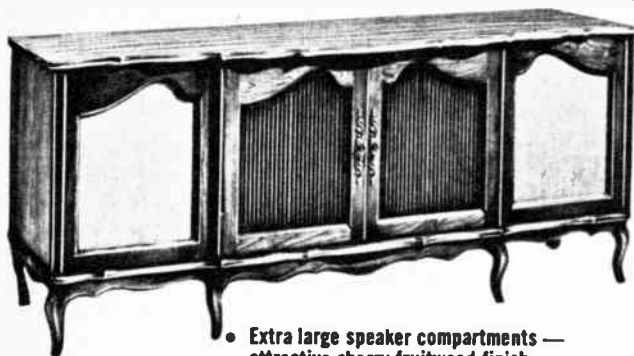

- Extra large speaker compartments — attractive cherry fruitwood finish

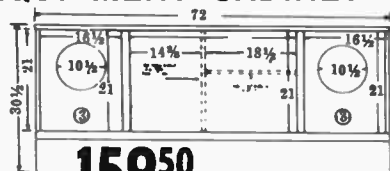

159⁵⁰ \$8 monthly

This attractive French Provincial multi-purpose cabinet finished in cherry fruitwood features large acoustically designed speaker compartments which house a 12" woofer or multi-element speaker and a 3 1/2" tweeter. Inside compartment dimensions: 14"Wx21"H and 18 1/2"Wx21"H. Removable center partition and adjustable shelf add to versatility and simple installation. Overall dimensions: 72Wx31Hx18"D. Cherrywood finish. Shpg. wt., 165 lbs.
20 K 3803WX Net 159.50

ELEGANT MULTI-PURPOSE EQUIPMENT CABINET

ONLY
99⁵⁰
\$5 monthly

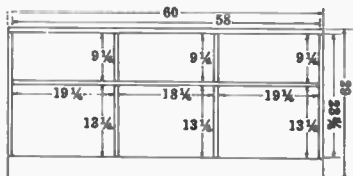

Add elegant charm to your decor with this beautiful "American Contemporary" multipurpose equipment cabinet crafted in fine woods, and finished beautifully in walnut. This spacious cabinet will hold all of your Hi-Fi equipment in an ideal arrangement for your pleasure and convenience. The cabinet has 6 roomy compartments. The top three are 9 1/4Hx15 1/2"D. Each lower side compartment is 19 1/4Wx13 1/4"H. The lower center compartment is 18 1/4Wx13 1/4"D. Overall dimensions: 60Wx29Hx18"D. Three sculptured sliding doors make access to components easy without taking up space in your room. Shpg. wt., 110 lbs.
20 K 3809WX Walnut Finish Net 99.50

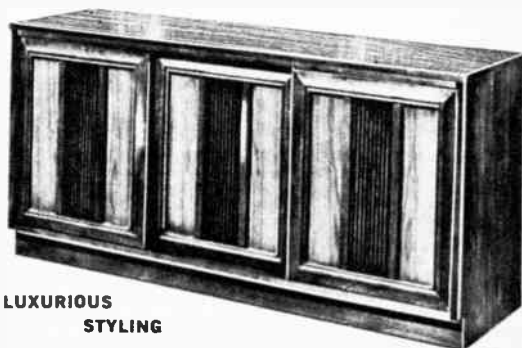

LUXURIOUS
STYLING

FAMOUS LAFAYETTE F-767 STEREO HEADPHONES

Widely Acclaimed Headphones For The Hi-Fi Enthusiast



1188

- Air-Cushioned Headband • Soft Foam Rubber Ear Cushions for Maximum Comfort and Bass Response • High Sensitivity

Lafayette's Famous F-767 stereo headphone offers outstanding sound reproduction to the listener. Extremely comfortable, the F-767 headband is covered with an air-filled vinyl bag which serves as a gentle air cushion. Soft foam rubber ear pads keep out external noise, provide maximum bass response. Sensitivity is very high—a signal power of 1 to 2 mw will produce adequate listening volume. Frequency response, 30-15,000 cycles. Impedance, 8 ohms per phone. Supplied with cylindrical overload control box for connection of the headphones to equipment that does not have stereo headphone jacks. Phones plug into box and two pairs of leads from the box connect to speaker output terminals; may also be attached to two separate 2-conductor phone plugs for connection to units having two separate extension speaker jacks for stereo. This headphone and control box not recommended for transistor amplifiers that do not have a stereo headphone jack—use Model FA-60 headphone set (below) in such cases. F-767 supplied complete with attached stereo phone plug, overload junction box and instructions. Imported. 99 K 0035 Shpg. wt., 2½ lbs. Net 11.88

MODEL FA-60 STEREO HEADPHONES

- For Use With Transistor Amplifiers That Do Not Have A Stereo Headphone Jack

Same quality headphones as above, but comes with 4 separate leads terminated in spade lugs, plus over-load junction box with 4 screw-type input terminals and 4 output leads (all 4 leads isolated). Designed for connection to speaker terminals of transistor amplifiers or whenever complete isolation of all four wires is desired. Imported. 99 K 0048 Shpg. wt., 2½ lbs. Net 11.88

STEREO HEADPHONE CONTROL BOX

F-641 stereo control box is designed to connect F-767 stereo headphones to an existing system without the need of continually disconnecting speakers (cannot be used with FA-60). Impedance 4-16 ohms. Has separate earphone jacks for stereo or monaural, separate volume controls for each side of the headset, and a speaker on-off switch. 4¾Wx1¼Hx1¾D. Imported. 99 K 0036 Shpg. wt., 1¼ lbs. Net 4.59

CONTROL BOX
459

DELUXE LAFAYETTE F-770 STEREO-PHONES



- Private Listening • No Space Problem • Exceptionally Fine Quality • Stereo and Monaural
- Actually 2 High Fidelity Dynamic Speakers
- Soft Foam Rubber Ear Pads • Frequency Response 25 to 15,000 Cycles

1995

The Lafayette F-770 combines broad frequency response and faithful reproduction with a compact-oriented design to make listening with them a real pleasure. The Stereo-phones are actually two 2½" high fidelity dynamic speakers with a frequency response range of 25 to 15,000 cycles. Perfect for stereo and monaural operation, the headphones are rated at ½ watt maximum input; impedance, 8 ohms per phone. The soft foam rubber ear pads provide extremely comfortable listening, help to keep out noise and maintain an excellent bass response. Imported. 99 K 0034 Shpg. wt., 2 lbs. Net 19.95

Control Box for F-770

Permits flexible one-switch change-over from speakers to Stereo phones. Imported. 99 K 0037 Net 4.95
"Y" connector for connecting 2 or more sets of headphones to a single source. 99 K 0044 Net 2.45

UP DATE YOUR HI FI SYSTEM WITH THESE FINE PREMIUM HI FI STEREO CARTRIDGES COMPLETE WITH DIAMOND STYLUS



Pickering V15/AT-1 19⁹⁵
21 K 5315L

Pickering Mark IIC 7⁵⁰
21 K 5339L

ADC-660 19⁹⁵
21 K 1307L

Empire 880P 19⁹⁵
21 K 3402L

Pickering V15/AM-1 21⁹⁵
21 K 5316L

Pickering U38/AT 12⁷⁵
21 K 5301L

ADC-770 17⁹⁵
21 K 1308L

Empire 880 17⁹⁵
21 K 3401L

Pickering V15/AME-1 29⁹⁵
21 K 5344L

GE Model VR1000-7 10⁴⁹
21 K 3803L

Ortofon Spu/T 50⁰⁰
21 K 3208L

Empire 880PE 29⁹⁵
21 K 3412L

Elliptical Hand Polished Diamond Stylus replacement for EMPIRE 880P 14.95
21 K 3413L

25 FT. UNIVERSAL STEREO HEADPHONE EXTENSION CORD ONLY



229

Listen to the finest high fidelity stereophonic sound reproduction through your favorite stereo headphone anywhere in the room. Ideal for use with Lafayette, Koss, Superex, Jensen, Sharpe and many other headsets. Flexible 3-conductor cable, grey vinyl jacket. 25 ft. in length. With ¼" 3-circuit plug on one end and a 3-circuit jack on the other end. Shpg. wt., 1 lb. Imported. 99 K 0116 Net 2.29

FAMOUS SHURE STEREO CARTRIDGES WITH DIAMOND STYLUS



M7/N21-D

M-44-5

12⁰⁰

M-3D
21 K 6201L

17⁹⁵

M7/N21-D
21 K 6206L

21⁹⁵

M-44-5
21 K 6215L

19⁹⁵

M-44-7
21 K 6216L

35⁵⁰

M-55E*
21 K 6221L

*Elliptical Diamond Stylus

Deluxe LAFAYETTE/WEBCOR Automatic Record Changer

A Superb Automatic 4-Speed Record Changer Made for Lafayette by Webcor

- Automatic 4-Speed Changer Plays 16 $\frac{2}{3}$, 33 $\frac{1}{3}$, 45 and 78 RPM Records Automatically or Manually • Outstanding For Either Stereo or Monaural Use • Intermixes Records of the Same Speed • Heavy Duty 4-Pole 4-Coil Motor • Ribbed Rubber Turntable Mat Prevents Slippage, Cushions Records • Jam-Proof Tone Arm Mechanism • Die-Cast Aluminum One-Piece Tone Arm • Automatic Shut-off After the Last Record has Been Played • Astatic Turnover Cartridge with .7 Mil Diamond Stylus for Microgroove Records, 3 mil Synthetic Sapphire Stylus For 78 RPM Records

29⁹⁵



COMPLETE WITH .7 MIL DIAMOND NEEDLE



RECESSED BASE



45 SPINDLE



MOUNTING BOARD

A superb 4-speed automatic record changer made for Lafayette by Webcor, an outstanding leader in the development and manufacturing of top quality record changers in the United States. This Lafayette/Webcor automatic record changer has been designed to give a very high standard of performance and dependability. Plays stereo or monaural records superbly. Plays 16 $\frac{2}{3}$, 33 $\frac{1}{3}$, 45 and 78 RPM records automatically or manually. Intermixes a one-inch stack of 78 rpm 10 and/or 12-inch records, or a one-inch stack of 7 and/or 12-inch standard hole records of the same speed. Utilizes dynamically balanced 4-pole 4-coil motor. Mainplate has scientifically constructed ribs that absorb vibration, reducing rumble. The heavy turntable has an extra long turntable bearing that also virtually eliminates rumble and wow. Spindle prevents double record drop; enlarging of record hole. On-off reject switch permits manual record play without causing an automatic change cycle. Changer

automatically shuts off after last record has played. Jam-proof tone-arm, "Torsion Spring" action permits moving tone-arm at any time without damaging changer. Adjustable stylus set-down comes equipped with Astatic turnover stereo cartridge with .7 mil diamond stylus for microgroove records, and 3 mil synthetic sapphire tip for 78 RPM records. Minimum mounting dimensions: 14 $\frac{3}{4}$ " wide, 13 $\frac{1}{2}$ " deep, 5 $\frac{1}{2}$ " above and 4 $\frac{1}{4}$ " below mounting board. With 2-36" connector cables. Attractive finish in charcoal gray, aluminum and black. For 110-120 V., 60 cycles AC. Shpg. wt., 11 lbs.

| | |
|--|-----------|
| 21 K0102W Less base | Net 29.95 |
| 21 K0103 45 RPM spindle—for above | Net 2.50 |
| 24 K0112W Oil walnut recessed base for above | Net 3.95 |
| 24 K0113W Mahogany recessed base for above | Net 3.95 |
| 24 K0114W Unfinished mtg. board for above | Net 1.10 |

Made By ADMIRAL for LAFAYETTE The Admiral ENSIGN



ONLY

19⁹⁵

- 4-Speed—16 $\frac{2}{3}$, 33 $\frac{1}{3}$, 45 and 78 RPM • Plays Stereo or Monaural Records • Quality Ceramic Turnover Stereo Cartridge • Single Knob Speed/Function Control • Automatic 3-Way Shut-Off • Intermixes Records of Same Speed • Heavy-Duty, Constant-Speed Motor



The Admiral "Ensign" is a fine 4-speed automatic record changer made by Admiral for Lafayette offering outstanding performance at a low, low price. Built for compatibility with both stereophonic and monaural records. The balanced featherweight tone arm operates at only 5.7 grams of needle pressure to minimize record wear. Arm is equipped with Flip-type Ronette ceramic stereo cartridge. Heavy precision turntable delivers no noticeable hum, rumble, or wow. Drive wheel disengages in neutral position, thus preventing rumble producing flat spots. Plays 16 $\frac{2}{3}$, 33 $\frac{1}{3}$, 45 and 78 RPM records. Intermixes 10" & 12" records of the same speed. Plays records manually if desired. Single knob speed/function control. Automatic 3-way shut-off after last record. 117VAC, 60 cycles. Compact and exceptionally functional, only 13 $\frac{1}{2}$ x12x7 $\frac{1}{2}$ ". 3" below and 5 $\frac{1}{2}$ " above mounting board. Beautiful brown & gold finish. Shpg. wt., 12 lbs.

| | |
|--|-----------|
| 21 K0104W Admiral "Ensign" less base | Net 19.95 |
| 24 K0107W Walnut Base for above | Net 3.95 |
| 24 K0108W Mahogany Base for above | Net 3.95 |
| 24 K0109W Mounting Board for above | Net 1.10 |
| 21 K0105 45 RPM Spindle for above | Net 1.65 |

Garrard **AUTOMATIC TURNTABLES**

PLUS Your Choice Of Famous Stereo Cartridges For Only **1¢** MORE

CHOICE OF STEREO CARTRIDGE

| | | |
|---|--|---|
|  |  |  |
| Pickering V-15/AT-1 | Empire 880 | Shure M7/N21D |



GARRARD LAB 80 AUTOMATIC TURNTABLE

plus choice of PICKERING, SHURE, OR EMPIRE CARTRIDGE

99⁵¹

Precision automatic transcription turntable for professional reproduction of 33 $\frac{1}{3}$ and 45 rpm LP records only. Dynamically balanced tone arm is of low resonant afrormosia wood. Tracking force adjustable with audible/visual guide. Bias compensator cancels out tone arm skating force. Features integral cueing device, automatic shut off, heavy 12" balanced cast non-magnetic turntable, and advanced Garrard Lab series 4-pole shaded motor. Stereo wired. For 110-130V—17x14 $\frac{1}{4}$ " less base. Shpg. wt., 22 lbs. Imported from England.

- | | |
|--|-----------|
| 21 K 3715WXM Lab 80 with Pickering V15/AT-1 | Net 99.51 |
| 21 K 3716WXM Lab 80 with Empire 880PE Cartridge | Net 99.51 |
| 21 K 3717WXM Lab 80 with Shure M7/N21D Cartridge | Net 99.51 |
| 21 K 3705WX Lab 80 less cartridge | Net 99.50 |



GARRARD TYPE A70 AUTOMATIC TURNTABLE

plus choice of PICKERING, SHURE, OR EMPIRE CARTRIDGE

84⁵¹

Successor to the world-famous "A" the 4-speed A70 automatic turntable features a completely new dynamically balanced tone arm. Built-in bias compensator—enables arm to track even the lightest and most compliant cartridges accurately, without distortion. Other outstanding features include: double shielded Lab Series 4-pole shaded motor, full-sized heavy balanced cast "sandwich" turntable. Stereo wired. Size: 16 $\frac{1}{4}$ "x14 $\frac{1}{8}$ ". For 110-130V, 60 cycles AC. Less base. Shpg. wt., 20 lbs. Imported from England.

- | | |
|---|-----------|
| 21 K 3718WXM A70 with Pickering V-15/AT-1 Cart. | Net 84.51 |
| 21 K 3719WXM A70 with Empire 880 Cartridge | Net 84.51 |
| 21 K 3720WXM A70 with Shure M7/N21D Cartridge | Net 84.51 |
| 21 K 3706WX A70 Less Cartridge | Net 84.50 |



GARRARD TYPE AT60 AUTOMATIC TURNTABLE

plus choice of PICKERING, SHURE, OR EMPIRE CARTRIDGE

59⁵¹

The AT60 combines turntable performance with record changer convenience. Plays all 4-speeds: 16 $\frac{2}{3}$; 33 $\frac{1}{3}$; 45 and 78 rpm. Automatic intermix operation when desired. Features a heavy cast, oversized turntable (formally exclusive to the type A) . . . dynamically balanced and non-magnetic. The tone arm is the tubular, counterweight adjusted, dynamically balanced design with built-in stylus pressure gauge legible from the top. Stereo wired. Size 15 $\frac{1}{2}$ "x13 $\frac{1}{4}$ "x4". For 110-130V, 60 cycles AC. Less base. Shpg. wt., 13 lbs. Imported from England.

- | | |
|---|-----------|
| 21 K 3721WM AT60 with Pickering V-15/AT-1 cartridge | Net 59.51 |
| 21 K 3722WM AT60 with Empire 880 cartridge | Net 59.51 |
| 21 K 3723WM AT60 with Shure M7/N210 cartridge | Net 59.51 |
| 21 K 3707W AT60 less cartridge | Net 59.50 |



GARRARD MODEL 50 AUTOMATIC TURNTABLE

plus choice of PICKERING, SHURE, OR EMPIRE CARTRIDGE

44⁵¹

Quality in the Garrard tradition at a modest price. Features the same oversized turntable and handsome mat styling of the renowned AT-6. New counter-weighted cast aluminum tone arm with finger-touch stylus pressure adjustment. Convenient plug-in head. 4-pole shaded motor provides 4 accurate speeds: 16 $\frac{2}{3}$, 33 $\frac{1}{3}$, 45 and 78 rpm. Smooth changer mechanism offers automatic intermix operation. Size: 14 $\frac{1}{4}$ "x12 $\frac{1}{2}$ "x4". Stereo wired. Less base and 45 rpm spindle. For 110-130 volts, 60 cycles AC. Shpg. wt., 11 lbs. Imported from England.

- | | |
|--|-----------|
| 21 K 3724W Model 50 with Pickering V-15/AT-1 cart. | Net 44.51 |
| 21 K 3725WM Model 50 with Empire 880 cartridge | Net 44.51 |
| 21 K 3726WM Model 50 with Shure M7/N21D cartridge | Net 44.51 |
| 21 K 3708W Model 50 less cartridge | Net 44.50 |

DELUXE GARRARD TURNTABLES PLUS YOUR CHOICE OF FAMOUS ELLIPTICAL STEREO CARTRIDGE AT LAFAYETTE'S LOW LOW PRICES



Pickering V15/AME-1

Now buy the deluxe Garrard Lab 80 or the Type A70 Automatic Turntable plus your choice of the Famous Pickering V15/AME-1 or Empire 880PE Elliptical Stereo cartridge at Lafayette's Low, Low combination prices. Elliptical Diamond Stylus reduces tracking, IM and harmonic distortion. Elliptical cartridge should not be utilized at a tracking force of over 3 grams.



Empire 880PE

| Stock No. | Turntable/Elliptical Cartridge Combination | Net |
|--------------|--|--------|
| 21 K 9535WXM | Garrard Lab 80 plus Pickering V15/AME-1 | 109.50 |
| 21 K 9536WXM | Garrard Lab 80 Plus Empire 880PE | 109.50 |
| 21 K 9537WXM | Garrard A70 Plus Pickering V15/AME-1 | 94.50 |
| 21 K 9538WXM | Garrard A70 Plus Empire 880PE | 94.50 |

LAFAYETTE ACCESSORIES FOR GARRARD TURNTABLES

RECESSED WOOD BASES. Sturdy, recessed, finely finished. Shpg. wt., 4 lbs. (not illus.)

| Stock No. | Finish | For Models | Net |
|------------|------------|----------------------------|------|
| 24 K 1201W | Oil Walnut | A70 and A | 3.95 |
| 24 K 1202W | Mahogany | A70 and A | 3.95 |
| 24 K 1203W | Oil Walnut | Lab 80 | 3.95 |
| 24 K 1204W | Mahogany | Lab 80 | 3.95 |
| 24 K 1205W | Oil Walnut | AT60, 50, AT6 and Autoslim | 3.95 |
| 24 K 1206W | Mahogany | AT60, 50, AT6 and Autoslim | 3.95 |

MOUNTING BOARDS. Unfinished, smooth sanded. Shpg. wt., 1 $\frac{1}{2}$ lbs. (not illus.)

| | | |
|--------------------|---------------|------|
| 24 K 1207W | For LAB 80 | 1.10 |
| 24 K 1208W | For A70 and A | 1.10 |
| For AT60, 50, AT6; | Autoslim | |
| 24 K 1209W | | 1.10 |

STEREO INTEGRATED TURNTABLES

RENOWNED AR 2-SPEED STEREO TURNTABLE

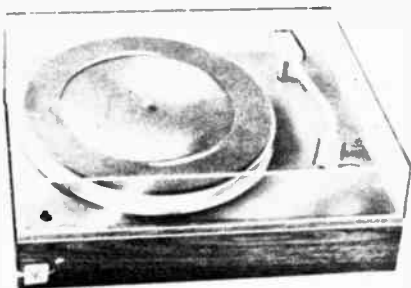

- Complete With Precision Tone Arm, Oiled Walnut Base, and Transparent Dust Cover

Only
78⁰¹
\$5 Monthly

WITH CHOICE OF STEREO CARTRIDGE



Empire 880P



Pickering V15/AM-1

An outstanding turntable featuring a precision arm, oil walnut base and transparent dust cover in one compact unit. The rugged 3.3 lb. balanced aluminum platter is belt driven from synchronous motors operating at 33 $\frac{1}{3}$ and 45 RPM. Turntable and arm are shock-mounted from the top plate eliminating vibration. Tone arm floats down to the record if dropped, but dampening mechanism is disengaged as soon as the needle touches the record. Meets NAB specifications for broadcast equipment on wow, flutter and speed accuracy. Also includes cables, overhang adjustment device and needle force gauge. Size with cover—12 $\frac{3}{4}$ x16 $\frac{1}{4}$ x5 $\frac{1}{4}$ ". Shpg. wt., 18 lbs.

| | |
|---|-----------|
| 21 K 7201WX | Net 78.00 |
| AR Turntable plus Empire 880P stereo cartridge | |
| 21 K 7202WX | Net 78.01 |
| AR Turntable plus Pickering V15/AM-1 stereo cartridge | |
| 21 K 7203WX | Net 78.01 |

WEATHERS "TOWNSEND 82" STEREO TURNTABLE



- Complete With Precision Tone Arm And Oil Walnut Base

Only
59⁹⁶
\$5 Monthly

WITH CHOICE OF STEREO CARTRIDGE



Empire 880P



PICKERING V15/AM-1

Encased in walnut, the slim and compact Weathers "Townsend 82" is a low contour 33 $\frac{1}{3}$ rpm stereo turntable, 17 $\frac{1}{2}$ " wide by 14 $\frac{1}{2}$ " deep by 5 $\frac{1}{4}$ " high, including oil walnut tone arm. The arm will accept any standard cartridge and is adjustable to the stylus pressure and tracking angle recommended for each cartridge. Incorporates a 12 pole synchronous motor to achieve wow and flutter of less than 0.065%. Rumble is -50 db. "Delta shaped platform" suspension system isolates the turntable from floor-bounce shocks or acoustic feedback. Aluminum turntable platter. Shpg. wt., 12 lbs.

| | |
|---|-----------|
| 21 K 6904WX Model 82 Turntable | Net 59.95 |
| Model 82 Turntable plus Empire 880P Stereo Cartridge | Net 59.96 |
| 21 K 6908WX | Net 59.96 |
| Model 82 Turntable plus Pickering V15/AM-1 Stereo Cartridge | Net 59.96 |
| 21 K 6909WX | Net 59.96 |

BENJAMIM MIRACORD

STUDIO 10H AUTOMATIC TURNTABLE

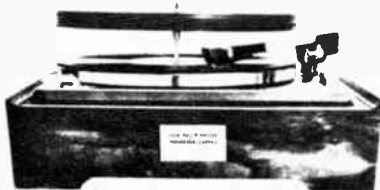

Only
99⁵¹
\$5 monthly

WITH CHOICE OF STEREO CARTRIDGE



Empire 880P



Pickering V15/AM-1

The Miracord Studio 10H features a hysteresis motor, the famous "magic wand" spindle and a rectangular mass-suspended tone arm with interchangeable plug in cartridge head. Tracks and trips as low as 1 gram. Push-buttons select automatic or manual operation at any speeds playing all records including the new 33 $\frac{1}{3}$ 7" type. Satin chrome finish on all machined parts. Imported from W. Germany.

| | |
|--|-----------|
| 21 K 1601WX Model 10H less bass and cartridge | Net 99.50 |
| Model 10H plus Empire 880P stereo cartridge | |
| 21 K 1606WX | Net 99.51 |
| Model 10H plus Pickering V15/AM-1 Stereo cartridge | |
| 21 K 1620WX | Net 99.51 |

ACCESSORIES FOR MIRACORD TURNTABLES

| | |
|--|-----------|
| 21 K 1603W Oiled Walnut Wood Base. Shpg. wt., 4 lbs. | Net 8.95 |
| 21 K 1604W Unfinished Wood Base. Shpg. wt., 4 lbs. | Net 8.95 |
| 21 K 1626 Automatic 45 RPM Spindle. Shpg. wt., 1 lb. | 5.00 |
| Oil Walnut Integrated Base with Plastic Dust Cover. | |
| 21 K 1628W | Net 19.95 |



MODEL PE-34 STEREO INTEGRATED TURNTABLE

- Complete with Precision Tone Arm, Strobe Disc and 45 RPM Adapter



72⁰⁰ \$5 Monthly

A deluxe 4-speed turntable and arm ensemble which will satisfy your requirements for high quality disc reproduction. Features include belt plus idler wheel drive for low rumble; built-in lowering (cueing) device; high torque 4-pole motor; heavily weighted, non-magnetic turntable for accurate speed, low wow and flutter; vernier speed control (3%) for perfect pitch or "tuning" and professional-type low resonance tone arm. Cartridge mounting slide accepts all modern cartridges. Also has automatic tone arm lift at end of record. With strobe disc and 45 rpm adapter. 13Wx10 $\frac{3}{4}$ Dx3 $\frac{1}{2}$ H, above and 3 $\frac{3}{8}$ " below mounting board. Shpg. wt., 19 lbs. Imported from W. Germany. Less Base (below).

| | |
|--|-----------|
| 21 K 2101WX Model PE-34 Stereo Turntable | Net 72.00 |
| 21 K 2102W Satin Walnut base for PE-34 5 lbs. | Net 6.00 |
| 21 K 2103 Extra Cartridge Mounting Slide for PE-34 | Net 3.50 |

PHONO AMPLIFIERS AND HI-FI ACCESSORIES

Trutest® STEREO/8 AMPLIFIER



Compact Low Silhouette Styling!

17⁹⁵

- Separate Stereo Volume-Balance Controls
- Variable Tone Control With On-Off Switch
- Front-Panel Phono-Tuner Switch for Selection of Phono or Tuner
- Selector Switch for Monaural or Stereo Operation

Ideal for that low cost stereo system you are planning for your living room, den, bedroom or business. It's petite size lends itself easily to any location—it's attractive low silhouette styling will blend beautifully with the furniture decor in any room of your home or business. Excellent for converting your present monaural console or portable to stereo.

Controls include separate Left Channel and Right Channel Volume-Balance Controls, Stereo/Monaural Mode switch, Variable Tone control with On-Off switch, Phono/Tuner Selector switch; 4 jacks in rear for stereo tuners and stereo crystal or ceramic phono cartridges; 2 pair of 4-ohm output terminals accept most speakers. Tubes and components mounted horizontally for compactness. Complete with case. Tube complement: 1-12AX7, 2-35C5, and 1-35W4. Size: 7½Wx2½Hx5½"D. Imported.

99 K 0047 Shpg. wt., 6 lbs. Net 17.95

Trutest® STEREO/5 AMPLIFIER



10⁹⁵

- Individual Stereo Volume-Balance Controls
- For Both Stereo and Monaural
- Fully Wired—Ready For Stereo

A stereo amplifier priced to fit everyone's purse. This rugged, precision made dual channel stereo amplifier will amaze you with its fine quality . . . Ideal for that low cost stereo system you're planning for your home or business. Perfect for converting your present console or portable to stereo. Controls include separate left channel and right channel volume controls, stereo-monaural mode switch, tone control switch and on-off switch. Provision for crystal or ceramic cartridge. 4-ohm output terminals accept most speakers. Tube complement: 2-35C5, 1-35W4 and 1-12AX4. Size: 4½Hx5½Wx4½"D. 115 volt 60 cycles. Shpg. wt., 5 lbs. Imported.

99 K 0046 Net 10.95

COMPLETE STEREO PHONO SYSTEMS

Featuring Lafayette/Webcor 4-Speed 4-Pole Automatic Changer

Complete system consists of Trutest Stereo/8 Stereo Amplifier, Lafayette—Webcor Automatic 4-speed Record Changer with wide-range stereo turnover cartridge, with diamond stylus. 2 Lafayette SK-109 Miniature Speaker Systems in Attractive Mahogany veneer finish. Above system supplied complete with 25' speaker cable for each speaker, less changer base. Shpg. wt., 26 lbs.

99 K 9902WXM Net 62.50

Same system as above except with Stereo/5 stereo amplifier instead of Stereo/8 stereo amplifier. 99 K 9903WXM Shpg. wt., 25 lbs. Net 57.50

24 K 0113W Mahogany base for changer Net 3.95

AS LOW AS

57⁵⁰

\$\$ monthly



Trutest Stereo/8



Lafayette—Webcor Record Changer On Base

Diamond Stylus

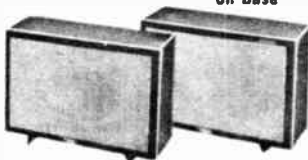

2 Lafayette SK-109



Stereo/5 (Alternate)

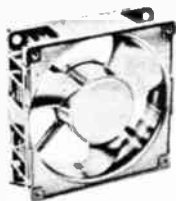

ROTRON WHISPER FAN

- Super Silent, Compact
- Reduces Service Costs
- Ideal For Cooling Hi-Fi Equipment

14⁸⁵

The ideal fan for cooling hi-fi equipment. Extremely quiet, introduces no distortion, yet it moves 60 cubic feet of cool air per minute. Lets your equipment last up to 40% longer! Compact in design, easily installed in any position. Airflow is reversible. Advanced heavy system; slow speed, and prelubrication will provide years of maintenance-free operation. For 115VAC, 60 cps, 7 watts. Size: 1½" deep and 4¼" square.

24 K 7501 Shpg. wt., 1 lb. Net 14.85

MULTI-INPUT SELECTOR CONTROL

1⁷⁶

Connects any one of 5 inputs to 1 output AM, FM, phono, tape, aux. Completely shielded to prevent hum. Complete with mounting hardware. 5 phono jacks input, 1 phone jack output. Shpg. wt., 1 lb. Imported.

99 K 1029 Multi Input Selector Net 1.76

For Additional Test Equipment See Pages 142-148

NEW Lafayette® STEREO VU BALANCE METER



11⁹⁵

- Two Meters in One
- Balances Stereo Systems

Ends the problem of balancing your stereo system. Two precisely damped loudness meters provide a continuous comparison of speaker levels. Scales calibrated in "Volume Units" and percent, 1.2 volts input sensitivity for 0 VU or 100 percent indication. The special calibrating switch and 20 db attenuation controls permit exact matching of channels. Greater than 8,000 ohm impedance permits connecting to output circuits without loading. The entire unit is housed in an attractive plastic case 6 Wx3¼Hx2½"D. Imported.

99 K 5038 Shpg. wt., 3 lbs. Stereo Balance Meter Net 11.95

Lafayette Cat. No. 652 55

POPULAR PRICED PHONOGRAPHS



LAFAYETTE "JUNIOR" 4 Speed MANUAL PHONO

- For the young. Plays all records, all speeds

Plays up to 12" monaural records at 16 $\frac{2}{3}$, 33 $\frac{1}{3}$, 45 or 78 RPM. A single lever selects any speed. The lightweight pickup arm is equipped with a single all-purpose needle for all records. Has volume control with on-off switch. Retractable 45 RPM chuck. Fine quality Alnico V PM speaker. Attractive 2-tone leatherette covered case. For 110-120 volts, 60 cycles. Size: 11 $\frac{3}{4}$ Wx10 $\frac{1}{2}$ Dx 5 $\frac{1}{2}$ "H. Shpg. wt., 8 lbs.
24 K 6101

14⁹⁵

Net 14.95

ALL TRANSISTOR 3-SPEED BATTERY OPERATED PHONOGRAPH



39⁹⁵

\$5 Monthly

- Take It Everywhere!
- Play It Everywhere!
- Outstanding Sound Qualities

Ideal for the beach, picnics or anywhere electricity is not available. Operates on 6 standard low-cost batteries and plays 7", 10" and 12" records. Has turnover cartridge with diamond LP stylus and synthetic sapphire stylus. Plays all types of monaural records. Will also play stereo records monaurally. 3 speeds: 33 $\frac{1}{3}$, 45 and 78 rpm. Automatically shuts off at end of record. Speaker is in removable cover. Has volume control and 45 rpm adapter. Entire unit closes into convenient carrying case. Size: 10 $\frac{1}{4}$ Wx6 $\frac{1}{2}$ Hx 4"D. Shpg. wt., 6 lbs. Imported.
24 K 7401 Less Batteries

Net 39.95

32 K 4819 Batteries (6 req.) Net ea. .16



QUALITY LAFAYETTE 4 Speed MANUAL PHONO

19⁹⁵

- Full Size Case; Plays 12" Records with Lid Closed
- Separate Tone and Volume Controls

With this portable phonograph you can play any record up to 12" size at 16 $\frac{2}{3}$, 33 $\frac{1}{3}$, 45 or 78 RPM with the lid closed. Has retractable 45 RPM chuck. A single lever selects any speed. The lightweight pickup arm is equipped with a turnover cartridge with dual synthetic sapphire styli. Has both tone control and volume control with on-off switch. Fine quality Alnico V PM speaker. Attractive 2-tone wedgewood blue and white case; decorative escutcheon plate is chrome finished. For 110-120 volts, 60 cps, AC. Dimensions: 13Wx 12 $\frac{1}{2}$ Dx6 $\frac{3}{4}$ "H. Shpg. wt., 10 lbs.
24 K 4204W

Net 19.95

DELUXE LAFAYETTE AUTOMATIC 4-SPEED PORTABLE PHONOGRAPH

- Features Deluxe "Maestro" 4 Speed Automatic Record Changer
- Plays 16 $\frac{2}{3}$, 33 $\frac{1}{3}$, 45, and 78 RPM Records
- Intermixes Different Size Records of the Same Speed
- Automatic Shut-Off After Last Record



37⁹⁵

\$5 Monthly

A deluxe automatic phonograph in a beautiful two-tone interlaced blue and white case. Plays 16 $\frac{2}{3}$, 33 $\frac{1}{3}$, 45, and 78 RPM records. Intermixes different size records of the same speed. Automatic shut-off after last record has been played — motor shuts off and arm returns to rest position automatically. Separate tone and volume controls, on-off reject switch. Fine Alnico V PM speaker for magnificent sound reproduction. Turnover cartridge with dual synthetic sapphire stylus. For 110-120 volt 60 cycle AC. Size: 15x14x7". Shpg. wt., 15 lbs.
24 K 4201W

Net 37.95

45 RPM Spindle for above phonograph.
24 K 4203 Shpg. wt., 1/2 lb.

Net 1.49

LAFAYETTE SOLID STATE AUTOMATIC STEREO PHONOGRAPH



- New Tilt-Down Stereo Phonograph—
- Solid State Circuitry
- 2 Removable Wing Speakers

57⁹⁵

\$5 Monthly

- Deluxe "Maestro" 4-Speed Automatic Changer
- 6 Transistors—2 Silicon Diodes
- Instantaneous-Warm-Up
- 4 Controls
- Compatible—Plays Stereo and Monaural

A handsome new solid state stereo phonograph with drop lid design and detachable wing speakers. Equipped with deluxe "Maestro" 4-speed automatic changer with turnover stereo cartridge and dual synthetic sapphire stylus. Plays all size records and all speeds. Automatic shutoff after last record. Front slide speed selector and record size selector. Precision built solid state stereo amplifier features 6 transistors and 2 silicon diodes. 4 controls — channel 1 volume, channel 2 volume; channel 1 tone, channel 2 tone. Heavy duty 5" Alnico V PM speaker in each wing department. Beautifully styled all wood case is covered in rich charcoal grey and white trim with silver overlay. For 110-125V 60 cycle AC. Dim.: 24 $\frac{1}{2}$ x14 $\frac{1}{2}$ x8 $\frac{1}{4}$ ".
24 K 4202WX Shpg. wt., 24 lbs.
24 K 4203 45 RPM Spindle for Above Phono

Net 57.95

Net 1.49

LAFAYETTE'S FINEST SOLID STATE HI-FIDELITY STEREO PHONOGRAPHS

LAFAYETTE SOLID STATE PORTABLE STEREO PHONO

- Garrard 4-Speed Intermix Automation Changer
- Solid State Stereo Amplifier—6 Transistor, 2 Silicon Diode Full Wave Rectifiers
- Instantaneous Warm Up
- Diamond Stylus
- Compatible—Plays Stereo and Monaural

A beautifully designed solid state stereo phonograph. Features famous Garrard 4 speed intermix automatic changer that will handle all sizes and all speeds of both stereo and monaural records and will intermix different size records of the same speed. Automatic shut off after last record has been played. Contains on-off and reject switch. Deluxe stereo amplifier features 6 transistors and 2 silicon full wave rectifiers. Equipped with heavy "Power transformer," 3 stages of amplification—4 audio control functions—separate full range compensated loudness and balance controls plus separate treble and bass controls. Each detachable speaker wing contains a high efficiency 5" extended range speaker with 1.47 oz. magnet. Turnover Stereo cartridge with synthetic sapphire and diamond stylus—attractive charcoal black case. For 110-120VAC, 60 cycle. Size 17½x13x9½". Shpg. wt., 24 lbs.

24 K0206WX Net 69.95
21 K3711 45 RPM Spindle for Garrard changer ... Net 3.80

Smartly designed solid state stereo — folds up into a self-contained suit case for easy portability

69⁹⁵
\$5 monthly



DELUXE LAFAYETTE SOLID STATE PORTABLE STEREO PHONO

- Solid State Circuitry — 8 transistors — 2 silicon diode full wave rectifiers
- Garrard 4-speed Intermix Automatic Changer
- 4 Speakers—4 Controls—Superb tone
- Diamond Stylus
- Drop Lid Construction

A superb solid state Lafayette Portable stereo phono with outstanding tone quality. Powerful push-pull 8-transistor amplifier circuit produces 20 watts peak music output. Amplifier is equipped with heavy duty Power transformer. 4 Controls: loudness, balance, bass, treble. Each detachable wing has one 8" heavy duty extended range speaker and one 3" tweeter plus a built in 8-ft. extension cord for wall-to-wall full dimensional sound realism when separating speakers. Wide range turnover stereo cartridge is equipped with a diamond stylus for LP and stereo records and a synthetic sapphire stylus for standard 78 RPM record. The famous Garrard 4-speed Intermix Automatic changer will handle all sizes and all speeds of both stereo and mono records. Intermixes different size records of the same speed. Automatic shut off. Housed in beautifully styled all-wood case with charcoal gray covering and fine white backing. Dim. 23x16¼x8¼" for 110-120V 60 cps AC. Shpg. wt., 34 lbs.

24 K0207WX Net 89.95
21 K3711 45 RPM Spindle for Garrard changer ... Net 3.80



89⁹⁵
\$5 monthly

MAGNIFICENT LAFAYETTE SOLID STATE "TABLE TYPE" PHONO

- Powerful 24-watt amplifier — 10 Transistors, 2 Silicon Diode Full Wave Rectifiers
- 2 Deluxe Separate Matching Speaker Systems with high Efficiency 8" Extended Range Speakers for Rich Brilliant Sound Reproduction
- Famous Garrard AT-5 4-Speed precision automatic Turntable

An elegantly styled Solid State Stereo "Table Type" phonograph which will enhance the decor of any room. Offers rich brilliant sound reproduction. The control center consists of a 10-transistor integrated amplifier which produces 24 watts peak music output—amplifier features push-pull output, heavy duty power transformer. Four audio control functions—separate variable bass and treble, loudness, and balance. 2 separate matching speaker systems feature high efficiency 8" extended range speakers. Famous Garrard "AT5" 4-speed precision automatic turntable plays 7", 10", and 12" records in all 4 speeds. Intermixes different size records of the same speed. Wide range turnover stereo cartridge is equipped with a diamond stylus for LP and stereo records, and a synthetic sapphire-stylus for standard 78 RPM records. The phonograph and matching speakers are housed in Genuine walnut wood cabinets with beautiful all walnut finish. Dimensions: Cabinet 19¼x14x8". Speaker Encl. 13½x10x4". For 110-120V 60 cycle AC. Shpg. wt., 40 lbs.

24 K 0208WX Net 119.95
21 K 3712 45 RPM Spindle for Garrard AT5 ... Net 3.80



119⁹⁵
\$6 monthly

● Elegantly styled genuine walnut wood cabinet with beautiful ailed walnut finish.

SELECTED PHONO ACCESSORIES

GARRARD ACCESSORIES

RADIO BROADCASTER/PHONO OSCILLATOR

475

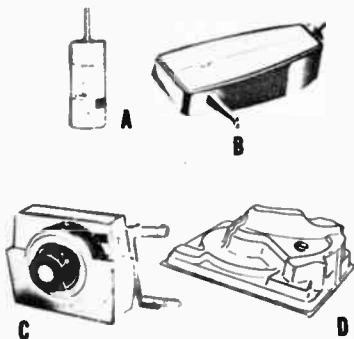

45 RPM AUTOMATIC SPINDLES (FIG. A)
Avg. wt., 10 oz.

- 21 K 3709 For Lab 80 3.80
- 21 K 3710 For A70 and A 3.80
- 21 K 3711 For AT60 and 50 3.80
- 21 K 3712 For AT6 3.80
- 21 K 3713 For Autoslim 3.80

- PLUG-IN HEADS (FIG. B)**
With mtg. accessories. Shpg. wt., 6 oz.
- 21 K 3727 For LAB 80 and A70 2.50
 - 21 K 3728 For AT60 and 50 1.75
 - 21 K 3729 For A 1.75
 - 21 K 3730 For AT6 and Autoslim 1.75

- GARRARD PRESSURE GAUGE (FIG. C)**
Model SP63. Insures correct pressure. Large, legible scale with widely spaced, easy-reading 1/2-gram markings. Swiveling balance scale pan. With 5-gram brass weight "standards" to check accuracy. Shpg. wt., 6 oz.
- 21 K 3731 Net 2.95

- DUST COVERS (FIG. D)**
Molded of clear sparkling vinyl to fit contours of Garrard changers. Shpg. wt., 1 1/2 lbs.
- 21 K 3733 For Lab 80 A70 and A Net 4.95
 - For AT-60, 50, Autoslim and AT-6 Net 4.95
 - 21 K 3734 Net 4.95

RECORD CLEANING KIT



129

Deep clean your records the modern way. Specially prepared detergent anti-static record cleaning fluid protects your valuable records as it cleans. Just a few drops on new velvet-foam rubber applicator mitt will give your records a professional cleaning job. Supplied with anti-static fluid, velvet applicator mitt and polyurethane pad.

- 24 K 8502 Shpg. wt., 10 oz. Net 1.29

TONE ARM CONTROL



195

Ends groove and stylus damage caused by accidental dropping of tone arm onto record, greatly extending record life. Accurately and smoothly lowers tone arm into run-in groove and lifts arm off record at end of play. Ideal for "cueing." Designed to fit practically every known turntable arm as well as record changer with manual features. For temporary and permanent installation. Shpg. wt., 6 oz. Imported.

- 99 K 1031 Net 1.95

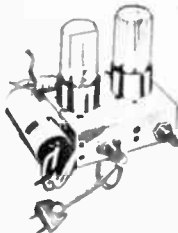
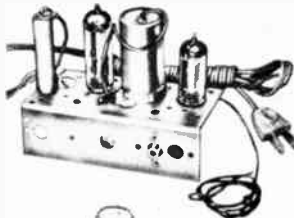

Fig. A

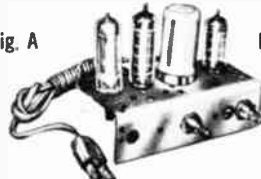

Fig. B



Fig. C

Have fun making announcements and broadcasting music through your own radio — with this broadcaster. Simply connect high impedance microphone or phono pickup to broadcaster and tune in broadcaster on radio. No wiring between the broadcaster and radio set. Pretuned to 1600 on radio dial but easily retuned. With 12BE6 and 35W4 tubes, phono jack, 2 feet of antenna, schematic and line cord. Completely wired. Chassis size: 4x2". For 110-125V AC/DC operation. Shpg. wt., 2 lbs.

- 24 K 1301 Net 4.75

2 TUBE AMPLIFIER WITH TUBES

(Fig. A) Uses a 50L6 and 35Z5 rectifier tube. Has volume control with switch and tone control. Chassis size: 2 1/2 x 3 1/2". For 110-125V, AC or DC. With cord and plug, tubes, diagram but less output transformer. Shpg. wt., 3 lbs.

- 24 K 1302 Net 4.90

THREE TUBE AC-DC PHONO AMPLIFIER

(Fig. B) Equipped with a variable tone control and a separate volume control with off position. Delivers up to two watts output. Phonograph motor connects to the amplifier. Uses 3 tubes: 12AV6, 50C5, and 35W4 rectifier. For 110-125V AC or DC. 2 1/2 x 4 1/2" steel chassis. With cord and plug, schematic, but less tubes and output transformer. Shpg. wt., 2 lbs.

- 24 K 1303 Net 3.75

(Fig. C) OUTPUT TRANSFORMER matches output tube to 3-4 ohm voice coil. Shpg. wt., 1/2 lb.

- 33 K 3701 Singly ea. .49
- In lots of 5 ea.45

STEREO/MONAURO PICKUP



195

Employs a high-output crystal turnover cartridge for either stereo or monaural operation. Frequency response, 20-18,000 cycles; output, 1 volt per channel. Crosstalk between channels is 15 db or more down. Each channel has a separate shielded output cable. Travel lock arm rest prevents accidental damage to records. The pickup arm is designed to be mounted in a single, circular hole, 3/8" in diameter. Equipped with side attachment for easy lifting and setting down. Durable plastic construction. Shpg. wt., 7 oz.

- Imported. Net 1.95
- 99 K 1024 Synthetic Sapphire LP replacement needle for above. Net 4.9
- 99 K 1027 Synthetic Sapphire STD replacement needle for above. Net .49
- 99 K 1028 Net .49



LAFAYETTE STEREO AUDIO CABLES

Two shielded insulated cables, of different color tones, for easy identification of channels (inside a common chrome grey plastic jacket), providing two completely isolated channels. Avg. shpg. wt., 6 oz. Imported.

- | Type | Length | Net |
|-----------|--------|----------------|
| 99 K 0113 | 36" | Phono pin 1.17 |
| 99 K 0114 | 6' | plugs at 1.35 |
| 99 K 0115 | 10' | all ends. 1.62 |

THE "DUST BUG"



Automatically removes dirt and dust on each playing. Light plastic arm mounts by suction cup. Can be permanently mounted by rubber cement. The bottle of antistatic cleaning fluid has a built-in wick for application to a brush and pad at the end of arm. Shpg. wt., 6 oz.

- 24 K 2501 Standard model (A) Imported. Net 5.95
- CHANGER DUST BUG (B). The tuft and pad assembly clips onto arm of changer. Performs the same as the standard model. Shpg. wt., 4 oz. Net 4.95
- 24 K 2502 Changer model (B) Imported. Net 1.25
- DISPENSER OF ACTIVATING FLUID. For Dust Bugs. Net 1.25
- 24 K 2504 Net 1.25

- 24 K 2503 Replacement Plush Pad and Nylon Brush Net 1.50

RECORD STATIC and DUST ELIMINATOR

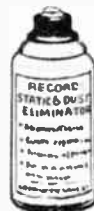

88¢

Sprays a fine mist which keeps your record clear of surface noise created by static (common to all vinyl records) and clean of dust attracted by the static charge. Prevents groove and needle wear caused by static-dust and keeps records lustrous. Extends their life. Two applications a year is sufficient. Enough for hundreds of records. Shpg. wt., 8 oz.

- 24 K 6801 Net .88

PHONO CARTRIDGES AND ACCESSORIES

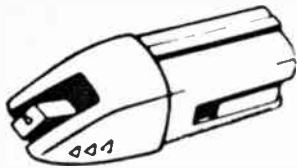

EXACT REPLACEMENTS FOR PLUG-IN AND POWER POINT CARTRIDGES

As Low As
1.73

Exact replacements for the popular Electrovoice power points, Astatic Sound-flow and Jensen combination cartridge-styli. Made in U.S.A. Shpg. wt., 6 oz.
Replacement for Astatic 13TX, Electrovoice 13D, and Jensen A-44XSD. Has diamond .7 mil and synthetic sapphire 3 mil styli.
24 K 3703 Net 3.95
Replacement for Astatic 13T, Electrovoice 13, and Jensen A-44X. Same as above but both tips synthetic sapphire.
24 K 3702 Net 2.95
Replacement for Astatic 81T, Electrovoice 81, and Jensen A-41. Has 1 mil and 3 mil styli—both synthetic sapphire.
24 K 3701 Net 1.73

MONAURAL PHONO CARTRIDGES 3.5 VOLT OUTPUT

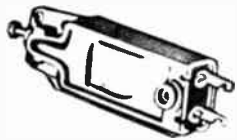

1.29

High quality high output cartridges for direct replacement of all standard cartridges such as L70, L82, L92, W60B, N10, and many others. Pin plug connectors for all 78 r.p.m. Shpg. wt., 12 oz. Imported.
99 K 1003 each 1.29

SONOTONE 2TA-S CERAMIC CARTRIDGES



2.95

This high fidelity turnover cartridge is equipped with dual styli to play all types of both monaural and stereo records. Has .7 mil and 3 mil synthetic styli. Replaces a host of cartridges including previous Sonotone models of 2T series, 9980 series which were used in thousands of record changers and players. Frequency response: 20-20,000 cps—flat to 12,000 cps; output 1-volt; compliance 2.0X10⁻⁶ cm/dyne; tracking force 6 grams. Ceramic element highly sensitive to heat and humidity.
24 K 7911 Net 2.95



REPLACEMENT CARTRIDGES FOR VACO and RONNETTE

Replacements for thousands of changers and players both imported and domestic. All types equipped with synthetic sapphire styli and turnover mechanism. Imported. Shpg. wt., 6 oz.

Stereo/monaural with .7 mil and 3 mil styli, mtg. bracket and knob. Output .7 volts. Replaces VACO ST-2, ST2X, ST-20, ST20X, ST-100, ST-100X; Ronnette types 1, 2, 3, 4, 92 and 105 series, stereo OV series and stereo T series; Astatic 86TSB, 80TS, and EV 95 and 97. Imported.
99 K 1016 Net 1.65

REPLACEMENT STYLI

99 K 1017 .7 mil for stereo Net .69
99 K 1018 3 mil for 78 Net .69
Diamond .7 mil for stereo
24 K 6305 Net 1.69
Stereo/monaural. Same as above but output is 2 volts. Replaces VACO ST4, ST4X, ST40, ST40X, ST200, ST200X and Ronnette 106 series, 208 series, Astatic 76TSB, 70TS and E.V. 96 and 98.
24 K 7910 Net 1.65

Stereo/monaural with .7 mil and 3 mil styli with bracket and knob. For stereo records and LP monaural. Replaces VACO ST5, ST5X. Output 2.5 volts. Very high compliance.
24 K 4003 Net 2.15

Monaural with 1 mil and 3 mil styli, mtg. bracket and knob. Output: 2-3 volts. Replaces VACO types T45, T045, T045X. Ronnette types 15, 18, 21, 24, 7825, DC395, DC395S, DC400, DC400-222, DC400-222S, DC500, T0-284 series, T0285T, T0287 series, T0-395 series, T0-400-200, T0-400-222; Astatic 420, 120 and E.V. 80, 88.
99 K 1022 Net 1.20

Monaural. Same as above but to replace Ronnette cartridges with wider frequency response and lower output. Output: .7 volt.
99 K 1021 Net 1.20

BSR STEREO AND MONAURAL TURNOVER CARTRIDGES



The BSR TC8S and TC8H high output monaural cartridges are designed for quality performance. Both are turnover types.
STEREO CARTRIDGE: sensitivity, 240 mv/cm/sec; compliance, 1.4X10⁻⁶ cm/dyne; channel separation, 16 db at 1000 cps, 20 db at 4000 cps; balance between channels, within 3 db; tracking force, 5-9 grams.
MONAURAL CARTRIDGE: sensitivity 500 mv/cm/sec; compliance, 2.0X10⁻⁶ cm/dyne; tracking force, 7-10 grams. Complete with turnover mechanism, shpg. wt., 3 oz. Imported.

MONAURAL TYPE

Replaces BSR TV8M, TC8H/1 and TC8H/2. With 1 and 3 mil styli, mtg. bracket and knob.
24 K 4001 Net 1.75

STEREO/MONAURAL

Replaces BSR TC8S and TC8SM. With .7 and 3 mil styli, mtg. bracket and knob.
24 K 4002 Net 2.15

SLIDE-OUT DRAWER FOR RECORD CHANGERS

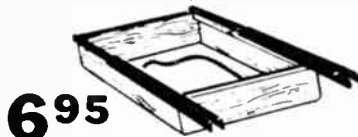

6.95

Designed for custom installations of record changers in bookcases, cabinets, tables, etc. Made of durable plywood and equipped with heavy duty steel slides which operate smoothly and quietly on ball-bearings. Slides extend drawer up to 10 3/4" beyond edge of cabinet. Supplied with uncut blank top. Unfinished wood permits your painting to suit your own decor. Size: 15 3/4 x 15 3/4 x 3 1/2".
20 K 4101 Shpg. wt., 7 lbs. Net 6.95

LAFAYETTE STYLUS PRESSURE GAUGE



Lafayette's stylus pressure gauge is an accurate device that allows you to read with the pickup in normal playing position. Range, 0-30 gm. No spring and minimum moving parts. Shpg. wt., 1 lb. Imported.
99 K 1011 Net .99

REPLACEMENT CARTRIDGES FOR RCA



1.25

● Replacement for cartridges in many thousands of RCA45 and many LP record changers ● 1 mil Synthetic Sapphire Stylus ● 2.3 volt output ● High Impedance Crystal ● Takes 7-10 grams pressure ● 3/4" Mounting Centers

Exact replacement for many standard 45 RPM and 33 1/2 RPM cartridges. For RCA: 74067, 74625, 75476, 75575, 76318; and Shure: W31AR, P73, P73A, P73AR, P73R.
99 K 1008 Net 1.25
Synthetic Sapphire replacement stylus for above.
24 K 5801 Net .69

BALL BEARING HEAVY DUTY SLIDES



AS LOW AS **1.50**

Drawer slides made of 16 gauge steel. Supports 50 lbs. Ball bearing, double-extension type, drawer slides. Length 15", travel length 11", extended 22". Shpg. wt., 5 lbs.
20 K 5201 per pair Net 1.75
SHORT TYPE. Same construction as above but 13" long; travels 9"; extends to 22".
20 K 5202 per pair Net 1.50

LAFAYETTE STYLUS INSPECTION MICROSCOPE



With this pocket-sized inspection microscope you can examine your stylus tip for signs of wear, imperfections, general condition. Its 50X magnification is enough to provide a good, clear image for observation. Size 3 3/4" long x 1/2" diam. Shpg. wt., 8 oz.
99 K 1012 Imported Net .99

LAFAYETTE T & L PADS FADERS - MIXERS - SWITCHES

STEREO LEVEL BALANCE CONTROL



- Dual Concentric 8 ohm L Pads
- Logarithmic Curve

Provides individual level control for stereo speakers. Varies "brilliance" or "presence" Controls stereo extensions without mismatching. Dual control mounted on concentric shaft. Gold-finished brass plate and attractive black knobs with gold trimming. L pad for B ohm circuits. Plate is 2 1/2" across; overall depth 3/4". Shpg. wt., 10 oz. Imported.

99 K 6140 Level Control Net 2.89

DELUXE STEREO LEVEL BALANCE CONTROL



- Dual Concentric 8 ohm L Pads
- Logarithmic Curve

Two phono jacks enable you to plug in extension or monitoring speakers from the front. Screw terminals in the rear provide for a simple, permanent hookup. Control mounted on concentric shaft. Brushed brass plate with attractive black with gold-trim knobs. Concentric 8 ohm L pads. Use it to control volume on a second set of speakers. Plate is 4 1/2 x 2 3/4"; from front of knob to plate 1"; Overall depths 3 3/8". Shpg. wt., 1 lb. Imported.

99 K 6141 Deluxe Level Control Net 3.95

LAFAYETTE L PADS



L pads for use as "brilliance" controls to vary tweeter level, or as "presence" controls to vary midrange speaker level. Both wire-wound elements are concentrically mounted within one plastic housing. With gold-finished metal escutcheon plate, mtg screws, and attractive black knob. Size: 1 3/4" dia., 7/8" deep (less shaft), 2 1/2" deep overall. Shpg. wt., 6 oz. Imported.

L pad for 8 ohm circuits Net 1.39

L pad for 16 ohm circuits Net 1.39

99 K 6135 Net 1.39

LAFAYETTE T PADS

T Pads Constant impedance control to adjust speaker volume. With brass satin plate for wall mounting. With all parts and instructions. Shpg. wt., 10 oz.

8 ohm T Pad Imported Net 3.85

99 K 6136 Net 3.85

16 ohm T Pad Imported Net 3.85

99 K 6137 Net 3.85

LAFAYETTE REMOTE SPEAKER FADERS

69¢

Remote Speaker Fader Provides adjustable volume level for Radio, TV, Hi-Fi and remote speaker. Gradually increases volume on one speaker while diminishing volume on the other. May also be used to adjust volume for 1 speaker. Gold plate for front panel mounting. With instructions. Shpg. wt., 6 oz. Imported.

99 K 6138 Net .69

Remote Speaker Fader. Same as above except for wall mounting. Shpg. wt., 6 oz. Imported.

99 K 6139 Net .89

LAFAYETTE MINIATURE HI-FI AUDIO MIXERS

With this handy, small mixer you can announce titles before playing records, mix two high impedance microphone inputs or perform any other mixing operation where 2 high impedance input channels are converted to a single mixed high impedance input channel. Each input channel has its own easy acting level control for quiet mixing; all mounting in shielded, chrome plated housing. Has momentary switch to protect speaker while inserting into system. Has 2 RCA type female input jacks and one male RCA plug on output side. Overall size 2 3/4 x 1 3/4 x 7/8". Shpg. wt., 1/2 lb. Imported.

99 K 1013 AUDIO MIXER Net 1.29

AUDIO MIXER—Same quality and characteristics as above except output is standard Phone Plug. Size 3 1/4 x 1 3/4 x 1 1/4" overall. Imported.

99 K 1014 Net 1.39

AUDIO MIXER—Same quality and characteristics as above except output is standard Female Mike Connector. Inputs consist of 2 Male Mike Connectors. Size 2 3/4 x 1 3/4 x 7/8" overall. Imported.

99 K 1015 Net 1.59

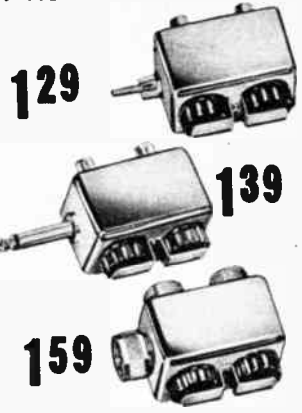

LAFAYETTE VC-64 STEREO LEVEL CONTROL



3.98

- Logarithmic Curve

Two precision 8-ohm level controls concentrically mounted for stereo. Ideal for controlling individual volume control of stereo extension speakers without fear of mismatch or affecting volume of main speakers. Also may be used to vary "brilliance" or "presence." Screw terminals. Handsome cream finish with gold panel plate. Overall Size 3 3/4 x 4 1/2 x 2 3/4" D. Shpg. wt., 1 1/2 lbs. Imported.

99 K 6147 Net 3.98

STEREO SELECTOR SWITCHES



(Fig. A)



(Fig. B)

- PERMITS REMOTE SELECTION OF ANY 3 PAIRS OF SPEAKERS

(Fig. A) A constant impedance speaker selector switch for multiple-speaker Stereo Hi-Fi. Selects 3 sets of speakers in any combination, with up to 60 watts of audio power. Mounted on an attractive, gold-finished, steel, electric outlet plate. 2 3/4 x 4 1/2". Shpg. wt., 1 lb. Imported.

99 K 0098 Net 1.59

(Fig. B) As above in enclosed case 2Hx4Wx3"D.

99 K 0101 Net 2.10

VOLUME CONTROL ADAPTER STEREO LINE BALANCE



Built-in volume control circuit permits high volume signals to be fed into the high gain input of tape recorders without overloading. Phono jack input to phono plug output. Completely shielded. Designed for use in unbalanced stereo channels; use in pairs for dual stereo channel control. Shpg. wt., 6 oz.

99 K 0100 Imported Net .79

VOLUME CONTROL ADAPTER—Same as above except has phono jack input to a 2-conductor standard phone plug output. Shpg. wt., 6 oz.

99 K 0099 Imported Net .89

LAFAYETTE MULTIPLE 6 SPEAKER SWITCHES

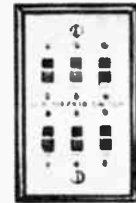

Multiple Speaker Switch Constant impedance device for controlling any 6 remote speakers; up to 63 different combinations. Wall mounting with brass plate. Shpg. wt., 10 oz. With instructions and hardware.

99 K 0054 Imported Net 2.10

Multiple speaker Switch Identical to above but mounted on flat, gold-embossed plate for mounting on flat panel. 3 1/4 x 2 3/4". Shpg. wt., 10 oz. Imported.

99 K 0066 Net 1.19

LAFAYETTE REMOTE SPEAKER SWITCHES



(Fig. A)



(Fig. B)

(Fig. A) Selects any one of 3, or any combination of 2 or 3 speakers with up to 60 watts of audio power. A constant impedance device. On gold finished steel electric outlet plate with black and ivory knob. 2 3/4 x 4 1/2". Shpg. wt., 1 lb. Imported.

99 K 0053 Net 1.39

(Fig. B) Same as above in enclosed case 3 1/4 x 4 1/2 x 2 3/8".

99 K 0083 Imported Net 1.89

LAFAYETTE 3-SPEAKER SELECTOR SWITCHES



59¢

Remote Speaker Switch Connects remote speaker to any existing set. Turns both on or either speaker on or off. With gold embossed plate for front panel mounting. Shpg. wt., 6 oz. Imported.

With all parts and instructions

99 K 0055 Net .59

ALL-CHANNEL TV SETS AT LAFAYETTE'S LOW PRICES

ARVIN UHF-VHF 12" * PORTABLE T.V.

- Completely Equipped For All Channel UHF-VHF Reception, Channel 2-83
- Two-Stage High Gain Frame Grid IF Amplification For Super Fringe Area Sensitivity and Performance
- Two Speed Transistorized UHF-Tuner With Speed Vernier Drives For Fast, Simplified VHF-Station Selection
- 12" Aluminized Picture Tube
- Arvin "Memory" VHF Fine Tuning

This modern UHF-VHF TV combines advanced circuitry with the most up to date styling to provide pleasurable TV viewing. High fringe area sensitivity utilizing 2 stages of high gain IF amplification. Automatic Gain Control Circuit assures locked in pictures and constant signal strength despite varying signal conditions. Unique VHF fine tuning system. Adjust picture and sound only once for each station. Channel trap eliminates adjacent interference. Built in 39" VHF antenna and rotating UHF loop gives big signal performance in strong signal areas. Easy-to-use front facing controls and easily accessible tubes and components. 13 tubes, including 5 multi-purpose tubes, 1 transistor and 3 diodes. Uses 120 watts (120 V) 60 cycles. 11½Hx16Wx11"D. Shpg. wt., 22 lbs.

17 K 2002WX Net 99.88
 ARVIN all channel UHF-VHF 16" portable TV. Same fine features as above except with 16" Aluminized Picture tube. Shpg. wt., 32 lbs.
 17 K 2001WX \$6.00 Monthly Net 118.88

ONLY
99⁸⁸

UHF-VHF
 \$5 Monthly



*Overall Diagonal Measurement

LIGHTWEIGHT 19-INCH * PORTABLE UHF-VHF TV

- Completely Equipped for All Channel Reception (2-83)
- Thin-Line, Brief-Case Styling
- 3 Stages Picture IF, 2 Stages Sound IF
- Aluminized Picture Tube For Crisp, Brilliant Pictures
- Completely Handwired Chassis

Here is a handsome, lightweight portable TV with slim, brief-case styling that offers a big 19-inch screen and all-channel reception (2-83). The 114° bonded aluminized picture tube provides crisp, brilliant pictures, even in a brightly lit room. Completely hand-wired chassis uses a 17-tube circuit with a cascade tuner, adjacent channel traps, and 3 stages of picture IF to assure strong, clear pictures even in outlying areas. Other deluxe features include: front-mounted speaker for best sound, built-in dual telescopic antennas for maximum signal pick-up, illuminated channel dial, jacks for private earphone listening and extension speaker, side-mounted controls, and convenient carrying handle. All tubes are accessible from rear of set. Smartly styled in black with brushed chrome trim. Size: 18½Wx18¼Hx12"D (overall). For 110-120V, 60 cycles AC. Imported. Shpg. wt., 55 lbs.
 17 H 1701WX 19" Port. all-channel (2-83) TV Net 128.88

ONLY
128⁸⁸

UHF-VHF
 \$6.50 monthly



*Overall Diagonal Measurement

23-INCH * UHF-VHF TV CONSOLETTTE

- 114° Bonded Aluminized Tube For Brilliant Pictures Even In Brightly Lit Rooms
- 3 Stages of Picture IF, 2 Stages Sound IF
- Elegant Low-Boy Styling with Slim-line Construction

An elegantly styled TV consolette for all channel reception (2-83). Performance and dependability are built into this 23-inch television receiver which features elegant low-boy styling, with slim line construction. Completely hand wired chassis uses a 16-tube circuit with cascade tuner, adjacent channel traps and 3 stages of picture IF for strong, interference-free pictures even in fringe areas. Two stages of sound IF and built-in 4x6" oval speaker assure fine static free FM sound. Has conveniently located front panel controls (selector/Fine tuning, Volume/on-off, Brightness, Contrast, Horizontal, Vertical), built-in antenna, and terminals for external speaker. Available in handsome walnut finish, dimensions 29¾Wx15Dx28¾"H. (inc. legs). Imported. Shpg. wt., 88 lbs. F.O.B. New York City or Los Angeles. Shipping charges collect—no CDD.
 17 K 1703WXY 23" TV Consolette—VHF/UHF (ch 2-83) Net 164.88

ONLY
164⁸⁸

VHF-UHF
 \$8.00 Monthly

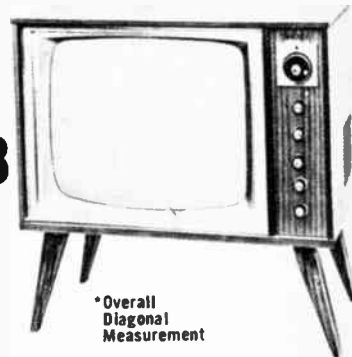

*Overall Diagonal Measurement

ALL NEW COLUMBIA 360 STEREO PHONOGRAPH

- 30 Watt Solid State Stereo Amplifier
- Six Matched Speakers
- Garrard Intermix Record Changer
- Hand Rubbed Oiled Walnut Cabinet

A NEW SHAPE OF SOUND FROM COLUMBIA
 UTILIZING AN ACOUSTICAL SOUND CHAMBER

The Columbia 360 ushers in amazing power and performance in a compact table-model stereo phonograph utilizing a specially designed acoustic sound chamber by columbia engineers. The specially designed chamber cancels out speaker feedback and changer vibration. Two full-range transistorized amplifiers deliver 30 watts of peak music power to six balanced and specially developed speakers facing outward for broad stereo separation. Frequency Response is 40 to 16,000 cps. Garrard intermix record changer includes CBS high compliance stereo cartridge with diamond needle styli, which tracks quietly at 2 grams pressure for superb reproduction. Four front mounted controls, Loudness, Balance, Bass and Treble insure precise tonal adjustments. The lustrous hand rubbed oiled walnut hardwood cabinet contains blue-green tweed grilles on each side. Size: 22¼Wx9¼Hx17½"D. Shpg. wt., 33 lbs.
 24 K 4802WX \$11.50 Monthly Net 250.00

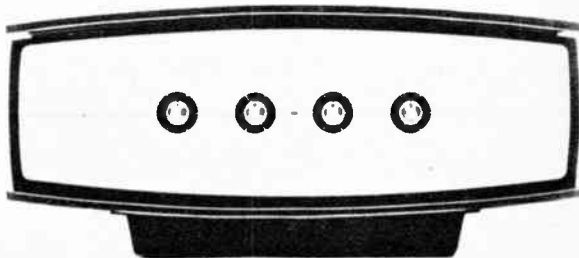

QUALITY TRANSISTOR PORTABLE RADIOS

NEW! LAFAYETTE "BIG 6" 6-TRANSISTOR RADIO SUPERHETERODYNE CIRCUIT FOR POWERFUL RECEPTION



Only **588**

Complete With
Carrying Case,
Earphone, Battery



- Shirt Pocket Size: 4Hx1½" Deep
- 6 Transistors, 1 Diode, 1 Thermistor
- Push-Pull Output For Tonal Clarity

Economy Price . . . compact size . . . big performance. Push-pull output circuit and 2" round PM speaker delivers strong, clear, AM broadcasts. Has 6-transistor superheterodyne circuit with built-in ferrite antenna. Slips into your pocket or purse for easy carrying. Take it with you everywhere. Direct-dial tuning. Flush thumbwheel control. Case is high import plastic. With earphone for personal listening, earphone pouch, leather case, carrying strap, and single 9-volt battery. Only 4½Hx2½Wx1½"D. Shpg. wt., 1 lb. Imported.
17 K 0101L Big 6 Radio Net 5.88
99 K 6021 Extra 9-volt battery. 2 oz. Net .21

LAFAYETTE "MIGHTY 9" 9-TRANSISTOR RADIO

- Compact, Shirt-Pocket Size
- Powerful Superheterodyne Circuit
- Clear, Crisp Tone

Precision-made and handsomely styled, this feature-packed transistor radio uses 9 transistors in a powerful superheterodyne circuit with built-in ferrite antenna to really pull in those AM Stations. Push-pull audio output circuit with 2¼" speaker assures exceptionally clear, crisp tonal quality. Automatic volume control circuit minimizes fadeout and sudden blasts of volume. Slim & compact, it can easily be slipped into pocket or purse — it's an ideal traveling companion wherever you go. Has handy thumbwheel controls, easy-view dial window, earphone jack, and operates on a single low-cost 9-volt battery. Comes complete with leather case, earphone (for private listening), and 9-volt battery. Shpg. wt., 1 lb. Imported.
99 K 3513L Net 9.95
99 K 6021 Extra Battery. Shpg. wt., 2 oz. Net .21

995

Complete With
Leather Case,
Earphone and
Battery



10 TRANSISTOR TWIN SPEAKER RADIO

Separate Twin Speaker Design Offers Magnificent Full Fidelity



Includes Leather Case,
Earphone and Batteries



1995

- 10 Matched Transistors, 1 Diode, 1 Varistor
- Sensitive Superheterodyne Circuit
- Push-Pull Power Amplifier

A superbly designed high quality AM portable radio. Twin speakers act together to combine hi and low tones into a magnificent full fidelity sound. Powerful 10 transistor, 1 diode, 1 varistor superhet circuit is equipped with an automatic gain control stage. Virtually eliminates blasting and fading. Powerful push-pull amplifier delivers 180 mw of power. Super sensitive built-in ferrite core antenna assures greater sensitivity and selectivity. Easy to use magnified slide rule tuning is incorporated in the beautiful golden metal panel. Plays for hours on 4 penlite cells. Tuning range, 535-1605KC. Fine quality leather cases are included for the radio and separate earphone. Complete with batteries and earphone. Size: 6¾Wx3¾Hx1¾"D. Shpg. wt., 1½ lbs. Imported.

17 K 3403L Net 19.95
32 K 4802 Extra Battery for above (4 required) Net .13

DELUXE MINIATURE AM-FM PORTABLE RADIO

- With Automatic Frequency Control
- Brilliant, Full Tone 3" Speaker
- 10 Transistors, 4 Diodes
- 2 Earphone Jacks • Handsome Styling
- Includes Earphone, Batteries

2995

A quality portable for listeners who enjoy the added tonal quality of FM sound. Practical miniature, its leather-like plastic case has a built-in retractable handle — does not require an external case for outdoor use. 10-transistor 4-diode superheterodyne circuit and rich tone 3" speaker provide plenty of pulling power and magnificent sound quality on both AM and FM bands. AFC locks in FM for listening with virtually no drift. Large easy-to-read slide rule dial and vernier tuning make selecting stations simple. Telescoping Antenna For FM, Ferrite core for AM. Two jacks for personal-earphone listening . . . one shuts off speaker. Only 4¾Wx5¾Hx2¼"D. Chrome front panel. Operates on 4-inexpensive penlight cells. Complete with earphone, batteries. Shpg. wt., 2 lbs. Imported.

17 K 2101L Net 29.95
32 K 4802 Extra Battery For Above. (4 req.) Net .13



LAFAYETTE 10 TRANSISTOR AM/FM PORTABLE MAGNIFICENT TONE QUALITY



24⁹⁵

- Big Set Performance
- Telescoping FM antenna
- 2 Band Slide Rule Dial
- Adjustable tone control



Complete with batteries and earphone.



Tubeless, cordless static-free FM are yours with this thrilling performer. High efficiency true-tone 2½x3½" oval dynamic speaker and push-pull audio output deliver a full range of sound on FM or AM to enhance your radio listening pleasure. FM drift is virtually eliminated. Super-powered circuit employs 10 transistors, 1 thermistor and 3 diodes, AVC. Only 4½x8¼x2", it offers undreamed of convenience—take it anywhere. Features: precision vernier dial tuning, built-in ferrite AM antenna, chrome plated telescoping 27" FM whip antenna, earphone jack for private listening. Operates on 4 inexpensive penlite cells. Low current drain gives long battery life. Complete with batteries, leather case and earphone. Imported. Shpg. wt., 3½ lbs. **17 K 6902L** Net **24.95**
32 K 4802 Extra batteries. Uses 4: Wt., 2 oz. Net ea. .13

14-TRANSISTOR 3-BAND FM/AM/SW PORTABLE RADIO

TWIN TUNING DIALS — FOR USE AS A PORTABLE OR TABLE RADIO



Complete with batteries and earphone.

NEW LOW PRICE

48⁸⁸

\$5 monthly



- Tunes 540-1600 KC, 4-12 MC, 88-108 MC

New functional design creates a fully flexible AM/FM/SW portable. 2 large slide rule dials allow either vertical or horizontal positioning. Enjoy great reception both outdoors and in the home. Advanced engineering features a superheterodyne AM and ratio detector FM circuit assembled on 2 separate chassis for low drift and good sensitivity. An adjustable tone control and 5" PM dynamic speaker insure faithful audio reproduction. 14 transistors, 6 diodes, and 2 thermistors for superior performance. Frequency Range: AM 540-1600KC, 4-12mc and FM 88-108 mc. Automatic gain and frequency control. Telescoping whip antenna extends 31". External antenna jack can be used to connect to auto antenna for mobile use. Operates on 4, 1½ volt standard "D" cells. Low current drain. Complete with batteries, earphone and external antenna wire. Shpg. wt., 8 lbs. Imported. **17 K 6904L** Net **48.88**
32 K 4804 Batteries for above (4 required) Net ea. .13

DELUXE 15 TRANSISTOR 3 BAND FM/AM/SW PORTABLE RADIO

- Tunes 590-1600KC, 3.5-10MC, 88-108MC
- Operates as an Audio Amplifier
- Effective Automatic Frequency Control
- Low Current Drain



54⁵⁰

\$5 monthly

Complete with batteries and earphone.



A hi-quality portable receiver which not only performs as a radio, but also operates as an audio amplifier for you to play your records through. Advanced audio output circuit is coupled directly to the speaker for better overall frequency response. This direct coupling and a large 4x6" PM dynamic loudspeaker combine to deliver excellent tonal quality. 15 transistors plus 5 diodes assure high sensitivity. Automatic frequency control is incorporated for stable performance. The large "easy to read" dial is controlled by a 12:1 tuning ratio drive. Easy positive dial settings. Covers 3 Bands—540-1600KC (Standard Broadcast), 3.5-10 mc (shortwave), and 88-108MC (FM). Auxiliary input for multiple adapter—expandable circuitry. Complete with 4 standard D-cell batteries, earphones and vinyl leather case. Size 7.4Hx11Wx3.4"D. Case covered with vinyl leather. Shpg. wt., 7 lbs. Imported.

17 K 0104L Net **54.50**
32 K 4804 Batteries for above (4 required) Net ea. .13

POWERFUL 9-TRANSISTOR AM PORTABLE AND TABLE RADIO

24⁵⁰

FULL RICH TONE

- 9 Transistors, 1-Diode, 1-Thermistor
- Big Tone 3½" PM Speaker
- Precision Vernier Tuning
- Genuine Top Grade Cowhide Cabinet



Receive top performance and glorious tone from this highly attractive portable radio. Entire cabinet is made of genuine top grain cowhide. 3½" PM speaker gives "big-set" tone even in noisy outdoor areas. Superior tone and cabinetry make this deluxe set ideal for use anywhere in your home. Powerful 9-transistor circuit really pulls in stations. Uses six readily obtainable flashlight batteries. Features, vernier tuning for easy station selection, built-in ferrite rod antenna, earphone, integral leather case with handle, and batteries. Dimensions: 7¾Wx5¼Hx2½"D. Shpg. wt., 5 lbs. **99 K 3504** Net **24.50**
32 K 4801 Extra "C" batteries, (use 6) wt., 2 oz. Net ea. .13

DELUXE LAFAYETTE 9-TRANSISTOR VHF AIRCRAFT AND BROADCAST PORTABLE RECEIVER



- Tunes: S35-160SKC and 108-135MC
- Powerful 9-Transistor Superheterodyne Circuitry
- Separate VHF RF Amplifier Stage
- Thermistor to Compensate for Temperature Changes



39⁹⁵

\$5.00 Monthly

Complete with Earphone and Batteries

Hear thrilling plane-to-plane, plane-to-tower communications which give flight patterns, vital landing instructions, exacting weather forecasts, plus standard broadcast band on one superbly engineered and crafted portable receiver.

A must for aviation enthusiasts! Take it with you wherever you go — it plays anywhere on its self contained battery operated power supply. Now you can hear thrilling plane-to-plane and plane-to-tower communications which give exacting weather forecasts, flight patterns, and vital landing instructions. Features advanced transistor circuitry (9 transistors, 3 diodes) and a varistor as a temperature compensating device. Super Sensitive; has an extra VHF RF amplifier. Tunes the important VHF band from 108-135MC in addition to the standard broadcast band (.535 — 1.60MC). Has its own telescoping VHF antenna which may be folded over when not in use. Provisions are made to couple an external antenna to the receiver to obtain a stronger signal in areas of weak reception. Instant band switching is accomplished through use of a band selecting lever. Audio output is through a powerful 3" speaker. A separate tone control is provided to "custom blend" the highs and lows for ones own listening pleasure. Slide rule type tuning indicator for ease of station selection. Comes complete with earphone, carrying case, and 6 penlite batteries. Size: 4 1/2 x 7 1/2 x 2" Shpg. wt. 2 1/2 lbs.

99 K 3514L Net 39.95
32 K 4802 Extra batteries, 6 req. Net .13

THE TRANSCONTINENTAL "SOLID STATE" 11 BAND AM-FM SHORTWAVE PORTABLE

SUPERB PERFORMANCE MAGNIFICENT TONE

- 16 Transistors
- 8 Diodes
- Super Sensitive Tuner
- Variable Selectivity
- Automatic Frequency Control

only **99⁵⁰**

\$5 monthly

Complete with Earphone and Batteries



11 BANDS:

| | |
|----------------|----------------|
| MW 540-1600Kc | SW 20.5-22.5Mc |
| LW 150-400Kc | FM 66.5-72.5Mc |
| SW 2-4Mc | FM 78-88Mc |
| SW 4-9Mc | FM 88-108Mc |
| SW 9-12Mc | FM 118-132Mc |
| SW 14.5-18.5Mc | |

The TRANSCONTINENTAL is an extremely versatile multiband portable radio receiver and offers 11 reception bands making it useful anywhere in the world. Besides the standard Medium and Long Wave bands, the four FM bands can be used for standard FM broadcast and as a monitor for airdrome control towers. The five short wave bands include ship-to-ship, marine, weather, amateur and international broadcasts. Features special module components which can be easily replaced in the event of set failure. Three major circuit boards are designed for easy, immediate replacement. A single tuner is used in the LW, MW, and FM bands to eliminate duplication and simplify service. FM circuit can be locked for stable operation with switchable AFC. Selectivity can be

switched for improved audio reproduction and extended side band reception. Large ferrite bar antenna for LW and MW bands, and 5.6 foot multi-section whip antenna for SW and FM broadcasts. A 2-Way speaker system consisting of a 4" woofer and 1 1/2" tweeter offers excellent reproduction. Separate jacks for external antenna, earphone, speaker, and microphone/phonograph. Uses six 1.5 volt batteries. Shpg. wt., 12 lbs. Imported.

17 K 6903WX Net 99.50

32 K 4801 Extra Size "C" Batteries. (6 required) Net ea. .13

QUALITY 8-TRANSISTOR AM-MARINE BAND PORTABLE RADIO

- Covers AM and Marine Bands
- Highly Sensitive Rod-Antenna Plus Built-In Ferrite Core Antenna

This fine transistorized portable covers both the general broadcast band plus the 1.6-4.6 MC marine band. Your perfect listening companion even when at sea. A built-in antenna is used for the broadcast band and a telescoping antenna for the marine band. The receiver circuitry utilizes 8 transistors, 1-diode, and 1-varistor. Superheterodyne system with A.G.C. The built-in speaker can be shut off by inserting an external earphone (supplied) for personal listening. Operates on 4 inexpensive Z cells giving up to 3 times longer life than ordinary 6-volt batteries. Comes complete with telescoping antenna, carrying case and earphone. Measures: 6 1/2 x 3 3/4 x 1 1/4" Shng. wt., 2 lbs. Imported.

17 K 3401L Net 19.95

32 K 4802 Extra Z cells for above Net ea. .13

AM-SW 8-TRANSISTOR PORTABLE RADIO

Same deluxe circuitry as above but covers AM (530-1600 KC) and the 3.9-12MC band for short-wave listening.

17 K 3402L Net 19.95



1995

Complete with Leather case, earphones, and battery

LAFAYETTE FOR QUALITY RADIOS AT LOW PRICES

QUALITY FM/AM TABLE RADIO

- Distinctive Styling
- Rich Tone 4" Speaker
- Effective AFC For Stable FM Reception
- Built-in Ferrite Rod AM Antenna

Smartly styled table-top or shelf radio which receives rich, static-free FM and quality AM broadcasts. Completely self-contained, requires no external FM or AM antennas. These are built-in for superb reception. Powerful 4" speaker offers full-bodied FM sound and clear AM broadcasts. Effective AFC circuit keeps FM stations tuned-in with low drift; enjoy many hours of pleasant, relaxed listening. AVC prevents blasting, keeps sound level relatively even. Handsome, easy-to-read slide rule dial has precision vernier control for simpler tuning. Superheterodyne circuit has 6 tubes, 2 diodes. Stylish hi-impact plastic cabinet finished in ivory and gold. Imported. Size: 9 $\frac{1}{2}$ "Wx6 $\frac{1}{2}$ "Hx5 $\frac{1}{2}$ "D. For 110-120 volts 50/60 cycles AC. Shpg. wt., 5 lbs. Imported. 17 K 3002 Net 29.95



29⁹⁵

DELUXE LAFAYETTE FM/AM DUAL SPEAKER TABLE RADIO

- Two 4-inch PM Speakers for Full Dynamic Range
- External 300-Ohm Antenna Input Terminals
- Greater Sensitivity
- Provision for Extension Speaker
- AFC for Low Drift FM

Magnificent Rich Tone!

High Fidelity FM/AM table radio. Fine furniture styling. Dual 4-inch PM speakers, in an acoustically correct cabinet, produce rich full-frequency sound on both FM and AM. Features improved AFC action which "locks-in" FM stations. A super-sensitive AM antenna brings in distant stations clearly while reducing unwanted noise. An FM wire antenna is provided to assure clear FM reception. An external 300-ohm FM antenna can be attached to built-in input terminals for improved reception of distant stations. Beautifully finished Oiled Walnut cabinet and easy-to-read slide rule dial with an on-off neon indicator light Meets FCC requirements for radiation shielding. A receptacle on the rear of the radio allows easy, quick addition of an extension speaker. For 110-120 volts, 60 cps AC or DC. Size: 17 $\frac{1}{2}$ "Wx7 $\frac{3}{4}$ "Hx5 $\frac{1}{2}$ "D. Shpg. wt., 8 lbs. Imported. 99 K 3502 Net 39.50

39⁵⁰

\$5 Monthly



Beautifully Styled Oil Walnut Cabinet

MAGNIFICENT FM/AM CLOCK RADIO

- Automatic Telechron Clock
- Wake-to-Music Plus Alarm
- Sleep-Switch—Lulls you to Sleep
- Powerful Alnico V PM Speaker
- Loudness Control

Combines a fully automatic Telechron clock with luminous hands and a superb FM/AM radio. Handy sleep-switch permits you to slowly drift-off to dreamland while the radio shuts itself off at a preset time. Beautiful AM or FM music awakens you pleasantly. Optional buzzer alarm also included. In addition to a standard AM broadcast radio, a quality FM radio, with AFC will expand your listening pleasure. FM antenna is built into line cord. External FM antenna terminals built-in for fringe area use. Slide rule dial for easier tuning. Beautiful molded plastic cabinet in antique white and gray with silver trim. Tubes: 50C5, 12AV6, (2) 12BA6, 12BE6, 12D18 plus selenium rectifier. Size: 13 $\frac{1}{2}$ "Wx7"Hx5 $\frac{1}{2}$ "D. For 110-120 volts, 60 cps AC only. Imported 17 K 3001 Shpg. wt., 7 lbs. Net 39.95

39⁹⁵

\$5 Monthly

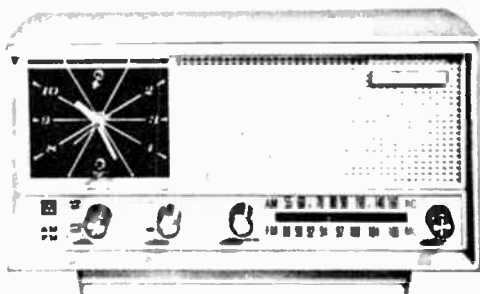

MINIATURE SOLID STATE AM TABLE RADIO

14⁹⁵

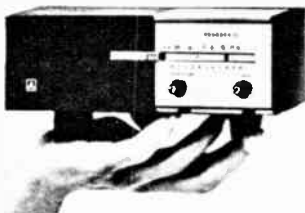

- 6 Transistor — 1 Diode Circuit
- Only 7x3x3"
- Battery Powered

A finely engineered miniature table radio. Use anywhere you want to enjoy your favorite programs. Advanced 6 transistor—1 diode circuit delivers full size table radio sound. Operates on 3 economical penlite batteries. Does not require an external power source. Convenient compartment for cigarette clips, pins, etc. Small size won't take up precious room. 17 K 3005 Model R-8. Shpg. wt., 4 lbs. Imported Net 14.95

DELUXE FM/AM FM-STEREO TABLE RADIO

- True Stereo Reproduction
- Wide range 6 $\frac{1}{2}$ " speakers
- Stereo Tuning Eye

Precision circuit has 11 tubes and 9 diodes. Two full range 6 $\frac{1}{2}$ " PM speakers in swing up or swing out enclosures for best channel separation. AFC control and Monaural FM blocking switch combine with convenient stereo tuning eye to assure stable stereo reception. Has variable tone and balance controls. Built-in AM and FM antenna. 1 $\frac{1}{2}$ watts audio output per channel. Walnut finish cabinet and 2 speaker extension cables. Dimensions: 35 $\frac{1}{2}$ "x7 $\frac{3}{4}$ "x6 $\frac{3}{4}$ " (opened). For 110-120V, 60 cycles AC. Shpg. wt., 22 lbs. Imported 17 K 3004WX Net 99.95

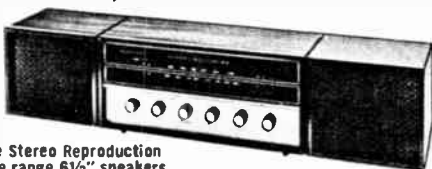

Take Advantage of Lafayette's Low Radio Prices

Lafayette Cat. No. 652 65

HEARING AIDS-HEADSETS-SILENT LISTENERS

SUB-MINIATURE HEARING AIDS



- 2½Lx1½Wx¾"D
Only 2 ounces!
- 2½Lx¾Wx¾"D
Only One ounce!

(1) A high quality, completely adjustable, hearing aid which weighs only 2 ounces. Features an advanced 4 transistor circuit, wide range volume control, crystal microphone, magnetic earphone, and a 4 position tone converter control. Three tiny ear plugs and a 3 ft. flexible cord are included. Supplied with leather carrying case, earphone, and battery. Shpg. wt., 1 lb. Imported.

| | | |
|------------|---------------------------------|-----------|
| 99 K 9068L | | Net 24.95 |
| 32 K 4812 | Extra Battery, Burgess Net type | Net .08 |
| 99 K 9069 | Extra Plug in cord | Net .55 |
| 99 K 9070 | Extra Earphone | Net 1.59 |

(2) Good sound intensity and fine tonal reproduction make this an ideal hearing aid. The tiny unit is only 2½x¾x¾ inches and weighs less than 1 ounce! Powered by a tiny, long life, mercury cell. A three transistor circuit provides the amount of amplification necessary for many different sound conditions. The large hold down spring clip keeps the hearing aid comfortably in place. A special telephone circuit provides for clear reception of telephone calls. Supplied with three interchangeable ear plugs, 3-feet of flesh-tinted cord, velvet-lined leather case, mercury cell, and instructions. Shpg. wt., 1 lb. Imported.

| | | |
|------------|-------------------------------|-----------|
| 99 K 9071L | | Net 22.95 |
| 33 K 1101 | Extra Battery, Mallory RM625R | Net .42 |

BEHIND-THE-EAR HEARING AID



- Flesh Colored Plastic
- Self-Contained Miniature Unit—No Cords
- Complete with Battery Changer, 2 Rechargeable Batteries and Case

A fine unit combining good performance and very small size. Designed as a light and compact "ear-lobe" hearing aid. All components are contained in the flesh-colored high impact case, which is worn behind the ear. Weighs only ½ of one ounce! Sound travels to the ear through a clear tube. Independent on-off switch and volume control. Operates 8-10 hours on a rechargeable alkali battery and 80-100 hours with a mercury cell. Complete with a handy battery charger capable of charging cells overnight. Shpg. wt., 1 lb. Imported.

| | | |
|-----------|------------------------|-----------|
| 99 K 9072 | | Net 62.95 |
| 32 K 1448 | Mercury cell for above | Net .26 |

REMOTE CONTROL FOR SILENT TV VIEWING

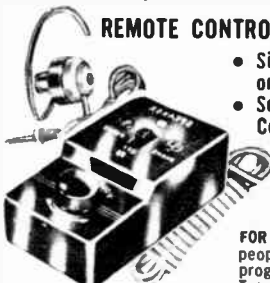

- Simple to Attach to any TV set or Radio
- See and hear — Noiselessly — Conveniently

FOR LATE LISTENERS. One or two people can both see and hear the program with the loudspeaker cut off. Tops for enjoying the late-late show without disturbing the rest of the household or the neighbors.

FOR HARD-OF-HEARING. Hear without turning the set volume so high that others can't stand the noise. It is possible to listen either with the loudspeaker cut off or, if everyone wants to hear, with the speaker on.

FOR NOISY PROGRAMS view with the speaker off. FOR NORMAL OPERATION it does not affect the regular use of the TV set. It does not have to be disconnected.

REMOTE CONTROL comes complete with 20 ft. of cable so it can be operated comfortably from a distance. Has its own volume control, speaker on-off switch, and two sets of jacks so either 1 or 2 earphones can be connected. Supplied with a miniature dynamic earphone. Highly sensitive and efficient. Complete with 1 earphone with 3 ft. of cord and plug and control box with 20 feet of cable. Only 37x2x1½". Instructions included. Shpg. wt., 3 lbs.

| | | |
|--------------------|---------------------------|----------|
| 13 K 9091 | | Net 6.50 |
| EXTRA EARPHONE. | Shpg. wt., 8 oz. Imported | |
| 99 K 2548 | | Net .79 |
| 10' EXTENSION CORD | for above. Imported | |
| 99 K 2549 | | Net .39 |



"PRIVATE EAR"



- Remote Control Radio-TV/Earphone Adapter
- Operates Up To 2 Speakers and/or Earphones

Relax in the most comfortable spot in the room and enjoy the benefits of private listening to your TV, radio or phonograph. Connect one or two extension speakers or earphones and control the volume of each separately. 25 foot, flat, flexible extension cord on control unit. Includes earphone control unit and instructions.

| | | |
|-----------|----------------------------------|----------|
| 99 K 9074 | Imported | Net 3.29 |
| 99 K 2548 | Extra Earphone for "Private Ear" | Net .79 |
| 99 K 2549 | 10 ft. Earphone Extension Cord | Net .39 |

"WHISPER" BONE-CONDUCTION PILLOW SPEAKER

- "Sonic Transducer" cannot be heard at a distance



Sound is actually conducted through your pillow and bone to the inner ear. Not just another "pillow speaker," this patented device produces sound vibrations which are heard best when conducted to the inner ear by a solid pathway, rather than air. No danger of disturbing others—even husband or wife asleep in the same bed! 2½" diameter round ivory plastic case is only ¾" thick. Supplied jack permits easy plugging into radio or TV. Shpg. wt., 8 oz. Imported.

| | | |
|-----------|--|----------|
| 99 K 9073 | | Net 2.25 |
|-----------|--|----------|

DYNAMIC STEREOPHONIC HEADPHONES

- True Binaural Reproduction
- Frequency Response 40-16,000 cps
- Magnetic Elements
- Lightweight—only 2 ozs. Imported

BINAURAL HEADPHONES

| | |
|---------------------------------------|------|
| Binaural-Magnetic-6 ohms impedance | |
| 99 K 1001 | 2.35 |
| Binaural-Magnetic-5000 ohms impedance | |
| 99 K 1002 | 2.45 |

MONAURAL-MAGNETIC HEADPHONES

| | |
|---------------------------------------|------|
| Monaural-Magnetic-6 ohms impedance | |
| 99 K 2546 | 1.75 |
| Monaural-Magnetic-5000 ohms impedance | |
| 99 K 2547 | 1.95 |

LAFAYETTE HEAD SET



- 4000 ohm DC Resistance
- Double Permanent Magnet

A real bargain—the convenience and advantages of earphone listening at an especially low price. This is an extremely efficient, double headset with adjustable headband, for private listening or for greater intelligibility when there are distracting sounds and external noise. 4,000 ohms DC resistance. Has durable permanent magnets, removable earpiece and 3½ feet of extension cord terminated with standard headphone tips. Shpg. wt., 12 oz. Imported.

| | | |
|-----------|--|----------|
| 99 K 2504 | | Net 1.59 |
|-----------|--|----------|

SUPER POWER DYNAMIC EARPHONE FOR TRANSISTOR CIRCUITS

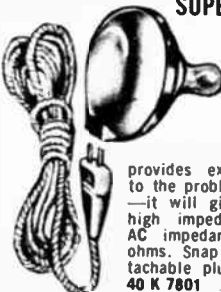

- Powerful Efficient Magnet

Not to be confused with run-of-the-mill earphones. Extra efficient construction and a powerful magnet provides exceptional performance. Ideal solution to the problem of low output in transistor circuits. —it will give delightful performance wherever a high impedance dynamic earphone is required. AC impedance 7000 ohms, DC resistance 1500 ohms. Snap on earpiece. Complete with 3 ft. detachable plug-in cord. Shpg. wt., 4 oz. Imported.

| | | |
|-----------|--|----------|
| 40 K 7801 | | Net 2.95 |
|-----------|--|----------|



Telephones For Intercoms and Private Phone Systems



DIAL PHONE

Have your own
Private Intercom

6⁹⁵

- For Intercoms, Extensions, Private Systems

Popular, modern dial phone. Can be used to make complete private systems. Equipment taken from service, reconditioned and ready to work. Simple 3-wire hook-up. Complete with handset, dial, bell, induction coil and connecting cable. General appearance may vary slightly from catalog illustration. Shpg. wt., 8 lbs.
44 K 1801 Net 6.95

CRADLE PHONE

Less Dial



3⁸⁵

2-for-7.50

Popular type Stromberg-Carlson cradle phone. Can be used as private telephone intercom. Reconditioned and ready to work. Consists of handset and cradle, less dial. General appearance may vary slightly from catalog picture. Shpg. wt., 6 lbs.
44 K 6501 Net ea. 3.85
2-for-7.50

30 FT. TELEPHONE EXTENSION CORD

- Ideal Extension Cord for Your Telephone Intercom
- Use with Dial Phone and Cradle Phone Listed

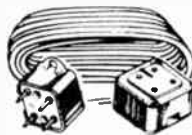

Add flexibility to your telephone intercom. Now be able to move your telephone intercom from room to room. 30 feet of telephone extension cord with standard 4-pin plug and jack. Color-coded cord to match screw terminals on plug and socket. Imported.

99 K 4539 Net 2.85
99 K 4540 Extra Phone Jack Net 1.25

Combination male & female telephone plug & phone jack only.

99 K 4538

100-Ft. 2-Cond. twisted pair—unshielded telephone wire

32 K 1303

Net ea. 1.95

Net 1.95

TELEPHONE PICKUP COIL



1⁸⁹

Designed to feed into the microphone input of either a tape recorder or any high gain amplifier. Easily attached to the telephone by suction rubber type attachment. The coil is electrostatically shielded to minimize hum pick-up. When properly positioned on telephone handset, the output of this device is more than adequate for a fully modulated tape recording. Complete with 5' shielded cable. Shpg. wt., 6 ozs.
99 K 6197 Imported Net 1.89

WESTERN ELECTRIC HANDSET with 3-Conductor Coiled Cord



3²⁵

Dependable, rugged Western Electric F-1 Handset. Has countless valuable applications for intercom, private phone, etc. Reconditioned for fool-proof service. Complete with 3-conductor coiled cord. Shpg. wt., 1 lb.

44 K 1805

Net 3.25

TELEPHONE OPERATORS HEADSET



1⁹⁹⁵

- Ideal for Hobbyists, Marine Radio-Telephone Operators, Hams, etc.
- Leaves Both Hands Free for Operation of Equipment

Headset is lightweight and manufactured to the most exacting standards. All Parts are interchangeable. The Headset consists of the body (Cycloc), ear and mouthpiece, adjustable headband, for proper fit and maximum comfort, receiver unit, transmitter unit, cord and plug. Shpg. wt., 1 lb.
44 K 6001 Net 19.95

AUTHENTIC DANISH ANTIQUE TELEPHONE



- Not A Reproduction
- Ideal for the Antique lovers
- Add Elegant Continental charm to your decor
- For Private Phone Systems, Extension or intercoms

Lafayette's
low, low
price,

3^{4⁹⁵}

Add continental charm to your home with this authentic Danish antique telephone. Not a reproduction. These imported phones have been rebuilt like new to include modern transmitting and receiving elements, and are ready to work. Complete with handset, dial, bell, induction coil, and 4 ft. cord with 4-pin telephone plug. Phone comes in black with nickel handset. Shpg. wt., 10 lbs. Imported.

44 K 4401W

Net 34.95

WESTERN ELECTRIC SOUND POWERED TYPE SG-1 HANDSETS

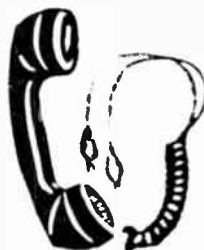

5⁹⁵

- No Batteries Required

Simple 2-way communications for miles. No batteries required. Just connect phone clips to two conductor wire. Excellent for Private Intercom System, Construction, TV Installer, Motels, Camps, Farms, Factories, Stores, Homes, Ski Resorts, etc. Any number of handsets can be installed on one line. Complete with retractable cord and alligator clips. Shpg. wt., 4 lbs.

44 K 1803

Net 5.95

Set of two Handsets with 100 ft. of 2 Conductor Inside-Outside Wire

44 K 1804

Net 12.95

DELUXE TELEPHONE INTERCOMS AND ACCESSORIES

LAFAYETTE EASY-PHONE TELEPHONE AMPLIFIER

17⁵⁰

- Amplifies Telephone To Room Volume
- 4 Transistors + Varistor
- No Dangling Wires, Pickups To Connect
- No Warm-Up, Instant Operation

The Easy-Phone amplifier is ideal for group conversation with one telephone in the room. Easy to operate: simply place the telephone on the amplifier, adjust the volume and everyone can listen, leaving both hands free for writing or typing. The Easy-Phone is a 4-transistor battery powered amplifier and inductive pick-up, in an attractive plastic case. 5" dynamic speaker; volume control; on/off switch activated by telephone's weight. Sturdy chrome plated runners. 8 1/4 L x 3 1/4 W x 2 1/4" H. With miniature plug and jack for recorder input. Shpg. wt., 3 lbs. Imported.

99 K 9020 With batteries Net 17.50
32 K 4802 Extra Penlight Battery Net .13

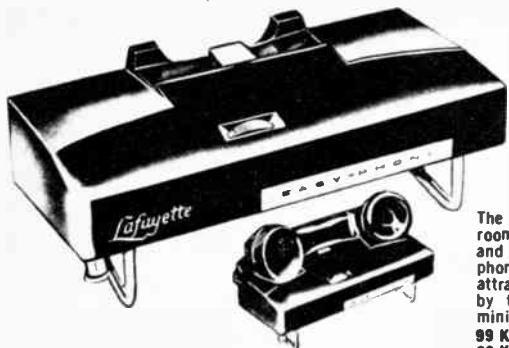

LAFAYETTE TELEPHONE AMPLIFIER

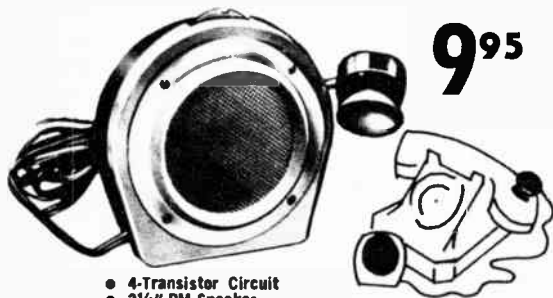

9⁹⁵

- 4-Transistor Circuit
- 2 1/4" PM Speaker
- Several People Can Listen In on Conversation Simultaneously
- Battery Operated

An efficient battery operated telephone amplifier which can be applied to and used with any type of telephone. Amplifies incoming voice and projects it through a 2 1/4" PM speaker. Suction cup on pickup coil attaches easily to telephone and makes permanent installation unnecessary. Volume control (with on-off switch) permits adjustment of volume to appropriate level for up to several people to listen in on conversation at the same time. 4-transistor amplifier is powered by inexpensive, long-lasting 9-volt battery (supplied). Unit is housed in a two-tone ivory and grey high-impact plastic case measuring 3 1/4 W x 3 1/4 H x 2 1/4" D. Shpg. wt., 1 lb. Imported.

99 K 9085 Net 9.95
99 K 6021 Replacement 9V Battery Net .21

NEW LAFAYETTE TELEPHONE INTERCOM

- Handy As A Telephone To Use
- Full Solid State Circuitry



19⁹⁵ PAIR

Designed for real utility in the home and in business. Powerful, solid state circuitry transmits your voice over amazingly long ranges. No current drain between transmission due to separate push buttons for transmit and receive. Handy location of push buttons facilitate ease of hand-held operation. May be used wherever private telephone communications are desired. Ideal for applications for the home—between rooms, upstairs and downstairs, kitchen, workshop, etc. For industry between offices and warehouse, receptionist and offices, or for interdepartmental needs, etc. Beautifully finished in grey to match any decor. Shpg. wt., 1 1/2 lbs. Imported. Requires 2 batteries listed below.

99 K 9079 Set of two Net 19.95
99 K 9080 Singly Net ea. 10.95
32 K 4802 Battery for above, 2 req. Net ea. .13
32 K 3002 Additional 100 ft. roll of 2-cond. wire Net 1.88

ELECTRONIC 5-POSITION SWITCHBOARD!



AS LOW AS

9⁸⁸

- Real Switchboard Action—Lights, Buzzer, Dial
- Hold Calls—Switch Calls—Call to or From All Phones
- Great Play Value . . . Use As An Intercom

Great fun for the entire family, practical too. Perfect for play or adult use between living room, kitchen, bedroom, sickroom. Functions like real unit, with 4 plug-ins and 4 signal switches, which ring bell. Operator has own master phone. Call in-switchboard lights up, rings. Operator can receive all incoming calls, can connect phone to phone. Operates on two inexpensive "D" size flashlight batteries. Complete set includes regular operations dial, message pad, one operators phone and one extension phone. Takes 3 additional extension phones (optional at extra cost). Molded of high impact plastic. Shpg. wt., 4 lbs.

13 K 8401 Net 9.88
32 K 4804 "D" cells for above; 2 req. Net ea. .13
EXTRA PHONES with hanger and wire for above.
13 K 8402 Net 2.25
"C" Battery for Extension Phones, 1 each.
32 K 4801 Net ea. .13

BOGEN TSL TELEPHONES

SELECTIVE RING — SELECTIVE TALK SYSTEMS



100% Trunkage (Multi-Conversation) Fast Operating; No Dialing; No Relays; No Central Exchange.

These new Bogen-Phones will permit you to reach other individuals in their offices without depending upon an over-burdened telephone switchboard. 100% trunkage permits as many as 8 conversations to take place at the same time, making these phones an ideal choice for busy applications. Select the station with which you wish to converse, press the ring button. When the called party lifts his handset, he is in direct communication with you. Phones may be desk or wall mounted. Each phone is furnished with snarl-proof handset cord, 6' master cable and junction box. PRS-16 Power supply required to power each system.

44 K 1201 TSL-8 8-station phone, less wire Net 34.25
44 K 1202 TSL-16 16-station phone, less wire Net 39.95
44 K 1203 PRS-16 Power supply (1 req. per system) Net 36.60

WIRE REQUIREMENTS: Use 3 more unshielded conductors than the total number of phones in the system. Those listed below may be used "between phones."

32 K 3004 7 conductor unshielded cable/100 ft. 5.51
32 K 1301 12 conductor unshielded cable/100 ft. 6.17
32 K 1305 22 conductor unshielded cable/100 ft. 10.73
Connect PRS-16 power supply to any junction box with a short 3 conductor cable.
32 K 3003 3 conductor unshielded cable/100 ft. Net 2.13

FAMOUS LAFAYETTE INTERCOMS

LAFAYETTE 2-STATION SOLID STATE INTERCOM

A Thousand Uses For
The Entire Family!

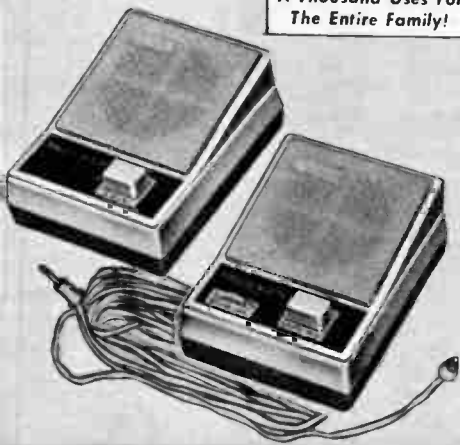

9 95
2 UNITS
COMPLETE

- Inter-Unit Tone Calling • Beautifully Styled • Battery Operated • Simple Plug-in Connecting cord • Push-Button Operation

A beautifully styled, miniature 2-station intercom that is fully transistorized and operates from one inexpensive 9-volt battery. The system consists of one master and one remote with 66 feet of lightweight interconnecting cord. Plug at each end of cord lets you hook-up system fast — no tools or wiring connection required. Master unit has power on/off/volume control and listen-talk to the master without having push-button for calling only — you can listen or talk to the master without operating any buttons. Master and remote can call each other even when master is switched off — pressing any of the push buttons signals the person at the other end by means of a tone. Each unit is housed in a high-impact plastic case and supplied complete with interconnecting cord and 9-volt battery. Dimensions (each unit): 3Wx1 3/4Hx4"D. Shpg. wt., 1 1/2 lbs. Imported.

| | |
|---|----------|
| 99 K 4526 2-Station Transistorized intercom | Net 9.95 |
| 99 K 6021 Extra 9-volt battery | Net .21 |
| AC power supply and battery charger for above | |
| 44 K 3001 Shpg. wt., 2 lbs. | Net 3.20 |

NEW LAFAYETTE 4-STATION SOLID STATE INTERCOM SYSTEM

- Instant Communications—No Warm up, Heat or Hum
- 4-Way Selector Switch—3 Remote Stations
- Remote Tone Call
- 2-Wire Distribution System
- Battery Powered

Deluxe solid state 4-station intercom system that combines smart styling, and portability with high quality performance. All interstation calling is accomplished with one 4-way selector switch. Push-button listen-call switch on all units. Call signal operates even when master switch is "off" Simple coded interruption of buzzer signal lets master operator know which remote is calling. Cool, efficient solid state master unit runs on a single, economical 9-volt battery. With selector switch in "wait" position battery life is further extended. Master unit has its own volume control with "on-off" switch. Easy hook-up is facilitated by inclusion of three 60 foot lengths of 2-conductor wire with jacks at each end. Just plug in and talk. Additional wire is available at extra cost. See below. Complete set consists of, master control unit, 3-remote units, 9-volt battery and wire. Size: Master: 4 1/2 Wx3 1/2"D; Remotes: 2Wx4"D. Imported. Shpg. wt., 2 1/2 lbs.

| | |
|---|-----------|
| 99 K 4555 Complete 4-station System | Net 19.95 |
| 99 K 6021 Replacement 9-volt Battery (1 Req.) | Net .21 |
| 32 K 3052 Additional wire, 100 Ft. Coil | Net .94 |

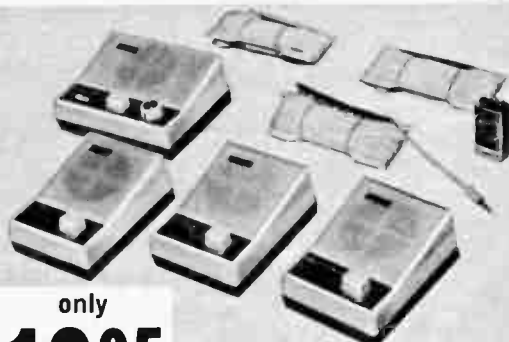

only
19 95

Complete System Includes:
1 Master Control Unit
3 Remote units
3—60 Ft. lengths of hook-up wire
1—9 volt battery

Deluxe LAFAYETTE WIRELESS INTERCOM

2-Station Wireless Intercom System

32 50
2 UNITS COMPLETE

- Operates from any 117V AC/DC Outlet • No Wires to Connect • Ideal for Home or Office • Add as Many Extra Stations as Desired

Lafayette offers a high quality 2-station wireless intercom. Handsomely styled, these units offer quality performance for home or business use. Each unit features a 3-position bar-control lever: Dictate (for use as "baby sitter," lengthy talking). Talk (has spring return to Listen position), and Listen. No wires to connect—simply plug into any 117V AC/DC outlet. Front panel volume control and pilot light; adjustable squelch control at rear reduces interference during quiet periods. Dependable 3" speaker. Add as many remotes as needed. Shpg. wt., 10 lbs. Imported.

| | |
|---|-----------|
| 99 K 4547M 2-Station System | Net 32.50 |
| Extra Station. Shpg. wt., 5 lbs. Imported. | |
| 99 K 4544 | Net 16.75 |



Take Advantage of Lafayette's Low Intercom Prices

Lafayette Cat. No. 652 69

LAFAYETTE FINE QUALITY MICROPHONES



LAFAYETTE STUDIO CRYSTAL MICROPHONE

4.95

- DUAL CRYSTAL CARTRIDGES
- ALL DIRECTIONAL
- HIGH OUTPUT

Here is a microphone with a 360° pickup, and the added power and sensitivity of two individually shock mounted and phased crystal cartridges. This arrangement assures you of maximum pickup from all sides. Swivel mounted to give fuller flexibility. Case is chrome plated. Standard 3/8"-27 thread. Overall size 7Hx3"W complete with 4 ft. cable. Shpg. wt., 2lbs. Imported
99 K 4511 Net 4.95



LAFAYETTE GENERAL PURPOSE CRYSTAL MIKE **1.95**



- For Desk-Top, Hand-Held Use
- Full —55 DB Output Level
- Excellent Frequency Response

An attractive, specially engineered general purpose crystal mike for desk-top or hand-held use. Excellent frequency response. Output level —55db. Only 1 1/4" in diameter. Includes 5-ft. of shielded cable for connection to tape recorders, public address amplifiers and radios. Chrome plated stand. Imported.
99 K 4543 Shpg. wt., 1 1/4 lbs. Net 1.95

MUSICAL CONTACT MICROPHONE

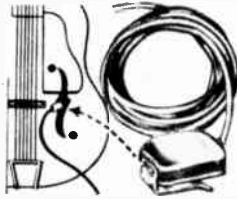

1.95

Easily Attaches to All String Instruments

This high quality contact microphone is ideal for amplification of single stringed instruments such as guitars, banjos, mandolins, cellos, ukuleles, etc. Provides rich, natural reproduction of the actual tone with sufficient amplification to be heard in a large hall. The clamp bar on the mike slides directly under the sounding board cutout to give a secure fit. Comes equipped with 8 ft. cable for connection to public address amplifiers, tape recorders or radios. Frequency response 40-9,000 cps. High impedance. Size: 1 1/2Lx1 1/4Wx3/8"D. Shpg. wt., 12 ozs.
99 K 4519 Imported Net 1.95



3.95

LAFAYETTE DIE CAST CRYSTAL MICROPHONE

Excellent for PA systems, home recorders and general applications. Frequency response 50 to 10,000 cycles. Output level —52 db provides ample output for use with low gain amplifiers. Uses quality moisture sealed crystal; Die cast case in rich green baked enamel finish, with chrome grill. Completely equipped with 5 feet of shielded cable. Mike may be used on any stand with 3/8"-27 thread. Grill diameter 2 3/4", depth 4 1/4", height 4 1/2". Shpg. wt., 3 1/2 lbs. Imported.
99 K 4512 Net 3.95

LAPEL MICROPHONE

1.95



- Full —55 db. Output Level!
- Ideal General Purpose Mike

Ideal general purpose mike. Specially engineered crystal Microphone. Attaches to lapel. Only 1 1/4" in diameter. Excellent frequency response. Output level —55 db. Chrome plated case and clip for attaching to lapel. Includes 5 ft. of shielded cable. Shpg. wt., 1 lb.
99 K 4510 Imported Net 1.95

MINIATURE CRYSTAL MICROPHONE

1.49



- ONLY 1 1/4"x2 1/4"

For the experimenter, student or dealer. An extremely sensitive and small crystal microphone used in hearing aids and other small apparatus. Can be used as lapel mike—miniature transmitter mike—for concealed locations, etc. Its size and performance gives it versatility. Size only 1 1/4"x2 1/4" deep. Shpg. wt., 6 ozs. Imported
99 K 4509 Net 1.49

ROUND HOLE GUITAR MIKE

5.50



Convert your Spanish guitar or Ukulele into an electric. Single pickup with separate tone and volume controls. Detachable cord 8 ft. long. Shpg. wt., 1 lb. Imported.
99 K 4537 Net 5.50

GUITAR MICROPHONE

- FOR F HOLES

6.95



Add brilliant rich tone to your present guitar. Features controlled output power for each string, separate tone and volume controls and removable amplifier cord. Complete with mounting accessories. 10 1/2" long. Shpg. wt., 10 ozs. Imported.
99 K 4536 Net 6.95

HIGH IMPEDANCE DYNAMIC MIKE FOR HOME RECORDING

- Ideal Mike for Home Recording Use
- Frequency Response: 60-10,000 CPS

An outstanding Lafayette microphone for home use. Frequency Response: 60-10,000 CPS ± 10db. Output Level: —57db @ 1000 CPS. Impedance: 50,000 ohms. Complete with 6 1/2' shielded cable with plug. Size 1 1/4"Wx 2 3/4"Hx 7/8"D. Shpg. wt., 8 oz. Imported.
99 K 4553 Net ea. 4.75
2 for 8.95

Our Low, Low Price

4.75



NEW Low Price 4.95

NEW REMOTE CONTROL HAND DYNAMIC MIKE

Now, you may control your tape recorder by a handy, built-in push-to-talk switch that also features a slide-to-record position. Press to record for on-the-spot recordings or slide switch for more lengthy material. Case is of high-impact plastic. Perfect for either home or field use. Specs: 200-9,000 cps; Impedance 600, 50KΩ; sensitivity —77 db @ 600 r, —57 db @ 50KΩ; Size: 1 1/2"x5 1/4"x1 1/4". Imported
99 K 4554 Net 4.95

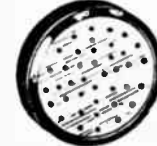

CRYSTAL MICROPHONE CARTRIDGE

1.49 • Replacement for Astatic Shure, and Many Other Popular Microphones

Crystal microphone cartridge with heavy flexible rubber cushioned rim designed for speedy, economical repair. Fits tens of thousands of the most popular microphones such as the astatic JT30 etc. Overall diameter 2 1/8", depth 1/2". Output —52 db. Excellent frequency response. Shpg. wt., 8 oz. Imported
99 K 4513 Net 1.49

LAFAYETTE DELUXE MICROPHONES

LAFAYETTE DUAL IMPEDANCE SLIM DYNAMIC MICROPHONE



1195

- 600 & 50,000 Ohm Impedances Selected By Simple Rotation of Plug
- Ruggedly Constructed
- On-Off Switch

Beautiful, professional-looking dynamic with solidly-cast, tapered, slim case with satin-chrome finish. Heavy duty slide-type on-off switch. Built-in transformer supplies dual unbalanced impedances—low Z is 600 ohms, high Z is 50,000 Ohms. Swivel mount fits all standard 5/8"-27 threaded stands. Blast filter eliminates unpleasant "pops" with voice use. Omnidirectional when used vertically—cardioid pattern when tilted. Engineering design and finish are of the highest quality, making this microphone excellent for any application. Complete with 5 ft. plug-in cable. Shpg. wt., 2 1/2 lbs. Imported.
99 K 4523

Net 11.95

LAFAYETTE STUDIO DYNAMIC MICROPHONE



ONLY

1195

- Frequency Response 50-11,000 cps.
- High Impedance 50,000 Ohms
- High Output

Omni-directional microphone has a swirl ridged aluminum diaphragm completely sealed and gasketed against high humidity and temperature conditions, for a wide variety of applications. The 360° stirruped shaped bracket provides for mounting with any 5/8"-27 thread stand. Finished in an attractive gunmetal grey with 4 1/2" shielded cable. Shpg. wt.. 1 lb. Imported
99 K 4525

Net 11.95

ARGONNE ALL-PURPOSE DYNAMIC MICROPHONE

- IDEAL FOR TAPE RECORDING, PAGING, COMMUNICATIONS
- DUAL IMPEDANCE—250 & 50,000 OHMS
- USABLE RESPONSE 50-18,000 CPS
- FOR HAND-HELD, DESK OR FLOOR STAND USE



COMPLETE WITH BALL-JOINT DESK STAND

1395

Here is a flexible dynamic microphone with characteristics suitable for almost any application. Ruggedly constructed, with tapered cast-metal body and removable base for desk use. Mounts to the base by means of a 360° swivel adjustable ball joint and fitted with an adapter for standard 5/8"-27 floor stand. SPECIFICATIONS: FREQUENCY RESPONSE—Practically flat 80-10,000 cps; ± 5 db 70-13,000 cps. OUTPUT—70 db below 1 volt/microbar at 1,000 cps. DUAL IMPEDANCE: Low (250 ohms), High (50,000 ohms) unbalanced. Size 9" high (with base), 2" diam. at head, tapering down to 3/4". Base diam. 4 1/4" x 1 3/4" high. Shpg. wt., 6 lbs. Dynamic microphone, complete with base, floor stand adapter, and 8" cable. Imported.
99 K 4501

Net 13.95

3 WAY SLIM CRYSTAL MICROPHONE



- May be hand-held, stand mounted or suspended by lavalier cord!
- RESPONSE 60-10,000 CPS
- On-Off Switch

Here is a fine slim-line design, only 4 1/8"x1 1/2" diam. Comes complete with swivel adapter to fit all standard mike stands, and lavalier cord and bracket which leaves both hands free. Smooth wide range response. Locking type on-off slide switch. Detachable 7 ft. cable and connector. Shpg. wt., 2 lbs. Imported.
99 K 4515

Net 3.95

LAFAYETTE DUAL IMPEDANCE UNIDIRECTIONAL DYNAMIC MIKE



ONLY **2150**

- Hi or Low Impedance
- Unidirectional Pick up Pattern
- Hand-held or Stand Mounted

Highly desirable cardioid pattern provides a significant front-to-back signal ratio to suppress noise, reverberations, and feedback. Impedance output (HI—50K, low 600Ω). Comfortable hand-held design or may be mounted on any standard thread stand (5/8"—27 thread). Frequency response is from 90 to 10,000 cps. Comes complete with 10 feet of 2-conductor shielded wire (balance type). Attractively finished in contrasting black and silver. Equipped with on-off switch. Shpg. wt., 2 1/2 lbs. Imported.
99 K 4841

Net 21.50

LAFAYETTE DUAL IMPEDANCE OMNI-DIRECTIONAL DYNAMIC MIKE

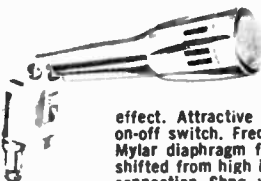

- Designed Specifically for High Quality PA Applications
- Omni-directional Pattern at all Frequencies

A superb dual impedance, omni-directional Dynamic microphone. Designed for high quality PA applications. Superior anti-feedback properties. Allows close talking without boom or bass accentuation. Features pop-proof wire mesh grille. Special filter minimizes wind effect. Attractive chrome plated frame of modern design. Equipped with on-off switch. Freq. Response 100-10,000 cps. Sensitivity—30K at —60 db. Mylar diaphragm for "pop" and "blast" proofing. Dual impedance: may be shifted from high impedance to 250 ohm low impedance by means of a cable connection. Shpg. wt., 2 lbs. Imported.
99 K 4546

Net 11.95

"DYNA-SLIM" MICROPHONE

- High Impedance—50,000 Ohms
- On-Off Switch
- Omnidirectional
- Tiltable For Multi-Angle Use
- "Quick-Slip" Adapter

Dynamic, high output microphone with streamlined styling. Output level —55db. Smooth response from 60 to 10,000 cycles. Omnidirectional head. External on-off switch. Slips on or off stand adapter in a wink. Standard 5/8"—27 adapter permits tilting mike for multi-angle use. Satin black and chrome finish. Complete with detachable cable and connector. 8" long, 1 1/4" max. dia. tapered barrel 7/8". Shpg. wt., 2 lbs. Imported.
99 K 4521

Net 6.95

LAFAYETTE GENERAL PURPOSE DYNAMIC MICROPHONE



1095

- A Hi-Fidelity Omni-directional Microphone For Recording, Radio Broadcasting, and PA Applications

A high quality omni-directional dynamic microphone in such an unusually low price. Beautifully styled in a chrome-plated diecast frame that is equipped with an on-off switch. Specifically designed for recording, radio broadcasting, and public address applications. Features a "pop-proof" and "blast-proof" mylar diaphragm, and superior anti-feedback properties. Frequency response 100-10,000 cps. Sensitivity 30K at 60 db, 600 ohms at —70 db. Shpg. wt., 2 lbs. Imported.
99 K 4543

Net 10.95

Take Advantage of Lafayette's Low Microphone Prices

Lafayette Cat. No. 652 71

PA SPEAKERS AND MEGAPHONES

DELUXE LAFAYETTE PISTOL-GRIP POWER MEGAPHONE



29⁵⁰

- Weighs only 4¼ lbs. complete with batteries • Ideal for lifeguards, coaches, construction gangs, sporting events — plus hundreds of other applications!

A lightweight megaphone notable for its extreme economy in battery power despite its high sound volume output. Uses 4 large size D flashlight batteries and has a patented non-linear current-limiting device to give maximum possible battery life. The reflexed air column in the horn plus its special shape serve to concentrate and direct the amplified sound and throw it for a considerable distance! The rubber-rimmed horn is of lightweight spun aluminum and construction is extremely sturdy throughout. Microphone is built into the base of the horn. Unit measures 12½" long; mouth diameter is 8¼". Shpg. wt., 6 lbs. Imported.

99 K 4504 Power Megaphone Net 29.50
 BATTERIES FOR ABOVE—Burg. No. 2 or equiv. (4 required).
 Shpg. wt., 1 oz. ea.
 32 K 4804 Net ea. .13

ALL-TRANSISTOR BULL HORN



Only **685**

Made in U.S.A.

- Weighs only 2½ lbs.
- Range up to 400 feet
- For Hunting, Camping, Boating Sports

A fully transistorized directional megaphone at Lafayette's low price. Lightweight, it carries your voice hundreds of yards or above noise. Just press the trigger and talk. Features variable volume control and carrying strap. Uses 4-standard "D" cells (not supplied with unit). 11 inches long. Shpg. wt., 3 lbs.

44 K 1509 Net 6.85
 1½-volt D batteries, 4 required
 32 K 4804 Net ea. .13

90° DISPERSION PAGING SPEAKER



44 K 2501 Net 16.50

The high power handling capacity combined with maximum intelligibility make this a superior unit for paging and talk-back applications. Frequency Response 250-15,000 cps. Power capacity 30 watts. Impedance 8-ohms. 90° Dispersion. Equipped with a universal mounting bracket, weather proofed, tropicalized with hermetically sealed driver unit. 9¾" diam. x 8¼" deep the speaker lends itself to use in any P.A. situation. Shpg. wt., 8½ lbs.

LAFAYETTE HI-FI "THIN LINE" BAFFLE SPEAKER

- Measures Only 2¼" Deep
- Perfect for Hi-Fi Extension Speaker or PA Use

The perfect speaker to furnish music or paging throughout your home, office or factory, this unique ceiling and wall baffle speaker offers dazzling audio reproduction. Advanced design employs an inverted magnet, placing the 12 oz. magnetic structure in front of the speaker rather than behind as in conventional speakers. Only 2¼" deep with its own metal baffle plate, it easily mounts in any wall, ceiling, closet or ordinary wood enclosure. Two are perfect for stereo. Voice coil is 1" Diam. Frequency Response: 90-9,000 cps. Impedance: 8 ohms. Overall size including metal baffle is 9½". Requires 6¾" wall cutout. Shpg. wt., 3 lbs. Imported. 89 K 4505 Net 5.95

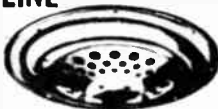

OUTDOOR WEATHER-PROOF SPEAKER

479



- Frequency Response: 100 to 10,000 CPS
- Compact—3¼Wx3¾Hx2½"D
- Enclosed in a Cadmium Plated 20-Gauge Steel Case
- Specifically Designed Plastic Impregnated Cloth Speaker Cone

Compact, Weatherproof, Dustproof. Will withstand immersion in boiling water, and is impervious to salt spray. Utilizes a plastic impregnated cloth cone, spider and dust cap material with an aluminum voice coil and zinc plated frame. Constructed of 20-gauge cadmium-plated steel with 2 coats of baked electrostatic enamel. Equipped with an RCA type phone jack, key slot mounting hole plus a mounting cutout to accept a volume control, on-off or push-to-talk switch. Shock Test: withstands up to 50 G's. Voltage: withstands up to 100 volts RMS. Temperature Extremes: from -80°F to 160°F. 3-4 ohm impedance.

44 K 5201 Shpg. wt., 5 lbs. Net 4.79

LAFAYETTE MINIATURE HORN PAGING SPEAKER

- Mounts Easily
- 90° Dispersion
- Weatherproof

795



An excellent general purpose paging speaker of amazingly compact size. Ideal for portable PA systems, patios, etc. Long throw projection of 90° dispersion offers maximum speech intelligibility in high noise areas. Compact size enables it to be mounted anywhere in almost any position. Frequency response 400-12,000 CPS. Impedance 8 ohms. Power handling capacity 5 watts, 8 watts maximum. Complete with mounting bracket, 2-conductor cable. Horn diameter 5½", Depth 4¾". Imported.

99 K 4508 Shpg. wt., 11 lbs. 4 oz. Net 7.95

LAFAYETTE 25-WATT DRIVER UNIT FITS ALL TRUMPETS AND PROJECTORS

985



Hermetically sealed weatherproof driver unit. Delivers 25 watts of power. Perfect for any location where high volume with low distortion is desired. Will fit any trumpet or projector of your choice without modification. The w.d. range frequency response of 120-7,100 cps assures excellent reproduction of music and speech. 16 Ohm impedance. Size 4" Diameter, 3-5/8" depth. Shpg. wt., 3¾ lbs. Imported.

99 K 4507 Net 9.85

KINEMATIX "IMP II" FM WIRELESS MIKE

- Transmits Clearly Up To 200 Ft.
- Can Be Used With Any 88 — 108 Mc FM Tuner, FM Radio, FM Portable, FM Auto Radio
- Compact—Fits Into Shirt Pocket

As Low As **39⁹⁵**



FCC Type-Approval Number: WM 101

A transistorized FM transmitter and microphone, so small it can be concealed in shirt pocket or cigarette box, yet transmits up to 200 feet with perfect clarity to any 88-108 MC FM receiver. Has hundreds of practical uses — for theatrical and TV productions, PA systems, security & surveillance work, plant inventory, babysitter, guard against prowlers, survey work and many other applications requiring remote sound pick-up (Concealed or otherwise) without bothersome wires. Approved by FCC. Comes complete with leather case and built-in super-sensitive pin-head mike. Also has input for any low impedance (1000 ohms) mike. Tunable between 88-108 MC, freq. response 30-20,000 cps. Size: 3x1½x2¾". Requires 1 battery (listed below). Shpg. wt., 1 lb.

44 K 4301 Model IMP11/M-222 Net 49.95
 44 K 4302 Model IMP11-221, less built-in mike Net 39.95
 33 K 1428 Battery for above units. Shpg. wt., 1 oz. Net 1.05

LAMPS FOR INDUSTRY-LAB-OFFICE-HOME

NEW LAFAYETTE CLAMP-TYPE "DRAFTING LAMP"

For Factory, Office,
Studying, Drafting,
Home, Kitchen
only

799

A deluxe new lamp from Lafayette for perfect illumination wherever you require it. Ideal for benches, tables, and drafting boards. Clamps securely to any surface up to 3" thick. Spring controlled swivel joints and double arm action moves light in any direction. Protects your eyes. Arm extends to 30". Comes in neutral color to blend with all decor. For 110-125V, 60 cycles AC. Shpg. wt., 9 lbs. Comes less bulb. Imported.
99 K 9077 Net 7.99



NEW LAFAYETTE "DAY LIGHT" • High Intensity Miniature Lamp

1288

Portable daylight lamp enables you to carry a high intensity concentrated light source in a briefcase. Glare free light equal to daylight (150 ft. candles at average working distances and up to 5000 foot candles for close up work.) Compact only 2½x2½x10", when collapsed. Reflector swivels in all directions and arm extends out to 15". 3 Friction joints on arm provides for many different positions. Hi-lo intensity switch. All metal with nylon feet. G.E. bulbs supplied (#1133). Shpg. wt., 6 lbs.
13 K 0108 Net 12.88



ALL PURPOSE LAMP

1438

Ideal for factory benches, tables and drafting boards. Two bolts clamp base securely to any surface up to 3" thick. Spring-controlled swivel joints and double arm action give you light in any desired position. Arm extends 36". Uses two T8, 15-W lamps. For 110-125V., 60 cycles AC. Bronze finish. Less lamps. Shpg. wt., 10 lbs.
12 K 1001 Net 14.38
T8, 15-watt, cool white lamp Net ea. .82
12 K 1002



NEW HIGH INTENSITY POWER LITE **599**

Perfect desk and reading lamp, but has dozens of other uses—crafts, hobbies, sewing, reading in bed, piano light, etc. All metal construction with a brass finished metal gooseneck which swivels and turns to any position provides pure white, concentrated light with an intensity of 40 ft. candles. Lamp is complete with full length cord and plug, and comes equipped with G.E. #1156 12 volt bulb, guaranteed for 600 hrs. Available everywhere for replacement. Shpg. wt., 4 lbs.
12 K 1200 Net 5.99

MAGNIFYING INSPECTION LAMP

Designed for precision work, features a 5" diameter magnifying glass with a powerful 13" focus, surrounded by a 22 watt shadow-free fluorescent tube. A custom-engineered arm permits complete directional mobility—special adjustment knobs insure the proper tension and steadiness for any desired position. 45" arm reach. Ideal for assembly, laboratory, quality control and other detail work. In kit or assembled form. Shpg. wt., 8 lbs.
12 K 8901 Kit, less lamp Net 19.85
12 K 1003 Assembled less lamp Net 24.88
T9, 22-watt, cool white lamp Net ea. 2.80
12 K 7501



NEW! HIGH INTENSITY LAMP WITH MAGNIFIED LENS

ONLY

1395

- Magnified For Concentrated Light
- Beautifully Styled
- Neutral Color to Match Furniture

A beautifully styled high intensity lamp featuring a magnified lens for concentrated and increased light brightness. Fully adjustable—telescopes up to 17". Folds down to a compact 5½". Shade swivels a full 360°. Extremely versatile for reading, hobbies, sewing, piano light, etc. Can be hung on wall with built-in clip. Unbreakable phenolic shade and base. Bulb included. Neutral tan color. Shpg. wt., 2 lbs.
12 K 1601 Net 13.95

ALL-PURPOSE LAMP **559**

Smart and versatile... ideal for use in shop, office, home—wherever positioned lighting is needed for close work or reading. Flexible gooseneck and swivel shade permit positioning light exactly where it's wanted. Streamlined flair shade and louvers for air cooling. Concentric louver gives diffused, glare-free light. Spring clip mounting for easy insertion and removal of bulb.
12 K 1005 Less Lamp. Shpg. wt., 3 lbs. Net 5.59



ADJUSTABLE UTILITY LAMP **249**

- All-Purpose Work-Bench, Hobby-Lamp
- Stands on Bench or Desk—Hangs on Wall—Clamps to Shelf
- Swivel-Tilt Head Directs Light

An all-purpose lamp with an adjustable shade that permits you to direct the light where you want it. Lamp can be pinned-up to a wall, stand upright or can be clamped to a bed, workbench, shelf, etc. Contrasting black and chrome finish. Shpg. wt., 2 lbs.
12 K 6002 Net 2.49



EXTENSION WALL LAMP **850**

- Extends 15 to 24"

A smartly styled wall-lamp for use in the den, office, shop, even the living room. Wall bracket swivels 180° horizontally and the arm extends to 24"—enough light in any direction over a large area. Arm closed is 15". Adjustable shade. Arm, wall mounting brackets and screws are brass-plated. Uses a 22-watt Circline fluorescent tube. Shpg. wt., 4 lbs.
12 K 1006 Less Lamp Net 8.40
12 K 7501 T9, 22-watt, Cool White lamp Net 2.80



LAFAYETTE FOR ALL OF YOUR ELECTRICAL ACCESSORIES

ELECTRIC OUTLET CONTROL CENTER



ONLY **499**

- Adds 6 Extra Outlets Wherever Needed
- For use in Home, Office, Industry
- Mount on Bench or Wall, or Keep Portable

If you need extra outlets, you need this Electric Outlet Control Center. Has six individual outlets with its own built-in fuse box. Finger-touch control on-off rocker switch with jeweled on-off indicator panel light. Heavy duty line cord for use in the home, office and industry too. Complete with mounting screws for permanent installation on wall or bench, or use it as a portable control center. For 110/120 V AC/DC, 1500 watts, 15 amps. Less fuse. Shpg. wt., 1 lb. Imported.

14 K 2103 Net 4.99
 13 K 1170 Box of 5 10-amp fuses Net .28
 13 K 1171 Box of 5 15-amp fuses Net .28

HOMELIGHTER AUTOMATIC LIGHT CONTROL

750



- Turns lights on and off Automatically
- Handles up to 1000 watts

A completely automatic light-sensitive photo-electric switch which will turn lights on and off at dusk and dawn. Never needs setting and requires no wiring or installation. Plug it in and it works. Has a 1000-watt lamp load rating which permits it to control not just one, but several fixtures. A multiple connection extension cord may be used if desired. Prowlers are discouraged, and your property is protected with "private eye" electronic control. Housed in decorative clear plastic case measuring 3 3/4 x 1 1/2 x 1 3/4". Complete with 6-ft. flexible 3-wire cord with adapter plug. For 110-130 volts, 50/60 cps AC. Shpg. wt., 1 lb.

12 K 3801 Net 7.50

"ADJUST-A-LITE" ELECTRONIC LIGHT DIMMER CONTROL

Replaces Ordinary Wall Switch for Variable Dimming Control

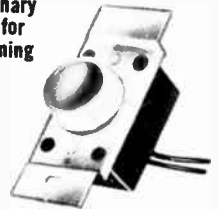

825

Complete variable control from off to 50% (normal dimming range), then instant switch-over to full bright. Fits into standard single gang wall box and uses same two wires as regular wall switch. Any standard wall plate can be used because knob is large enough to cover slot. Furnished with ivory plastic knob having brass-finish insert. For 120 volts, 60 cps AC with incandescent bulbs only, up to 600 watts. Size: 1 1/2" W x 2 1/2" H x 1 1/2" D. Shpg. wt., 1 lb.

12 K 2055 Net 8.25

ELECTRIC LAMP LIGHT DIMMER

- Modernizes Present Lamps
- Very Simple to Install



Set the mood with a light level that's right for you—off-dim-bright. Use dimmer with your table, floor, or pole lamps up to 300 watts incandescent only. Can be placed anywhere. Just plug into wall outlet and plug lamp into control socket. Remote control unit may be up to 8' away. Satin brass styling with ivory cord. Shpg. wt., 1 lb. 8 oz.

12 K 4201 Net 3.75

50 ft. TROUBLE LAMP



- 2 Side Outlets
- Heavy Rubber Construction

All rubber sheath—all copper wire! Flip-Lok cage eliminates removing from handle to re-lamp. Uses any standard lamp. Heavy rubber plug-push switch—rugged rubber handles. Shpg. wt., 4 lbs.

12 K 7801 Net 1.80

CORDOMATIC HANDY LIGHT



- Portable light and power
- Locks at any length of 20 ft.
- Retracts automatically

Provides light and power up to 20 feet from installation. Swivels 180° when wall mounted—360° rotation when ceiling mounted. Detaches easily to change location. Simply hang it up and plug it in. Eliminates the inconvenience and hazards of tangled cords. U.L. approved. Shpg. wt., 5 lbs.

13 K 8302 Net 7.47

MINI BREAKER



- U.L. Approved—Not A Fuse—A True Circuit Breaker
- Don't Replace—Just Reset

Lifetime circuit protection—fits in standard edison base fuse receptacle! Trips instantly on overload. Never needs replacing—just reset! Built-in line log handles temporary starting leads and line surges. Available in 5, 10, 15, 20 or 30 amps. Shpg. wt., 2 oz.

| Stock No. | Amps | 1-3 | 4 | Net Each |
|-----------|------|------|---|----------|
| 12 K 7001 | 5 | 1.28 | | 1.13 |
| 12 K 7002 | 10 | 1.28 | | 1.13 |
| 12 K 7003 | 15 | 1.28 | | 1.13 |
| 12 K 7004 | 20 | 1.28 | | 1.13 |
| 12 K 7005 | 30 | 1.28 | | 1.13 |

LAFAYETTE HOME FIRE ALARM

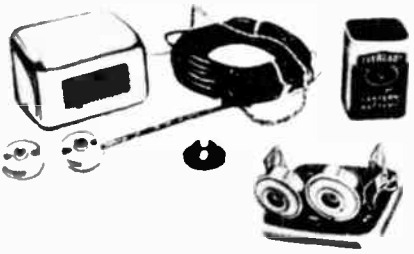

- Loud—Clear Alarm
- Complete Signal Unit—8 Detectors

2995

Sensitive thermostatic detectors—located in every potential fire area—react to heat instantly. The alarm alerts you and your family before flames spread. The system does not depend on house current for operation. Long life, heavy duty battery will last at least one year. System is readily checked by means of a heat button. The push button kept within easy reach of bed, serves as an intruder alarm. Provision is made in the signal unit for attaching another alarm (6 volt bell, buzzer or horn) for outside or remote locations. The signal unit is completely enclosed in a chrome plated steel housing. Measuring only 4 1/2 x 5 1/2 x 3 1/2" overall—can be located in any convenient area. Detectors, only 2" in diameter, are unobtrusive and cover areas up to 400 sq. ft. System includes signal unit with 2 horns and provision for a 3rd, 6 thermostatic detector switches (five 135°, one 200°) 150 ft. of 18 gauge twisted pair control wire, test button, 2 boxes of staples, battery and instruction book. Shpg. wt., 8 lbs.

| | | |
|--------------------------------------|--|--------------|
| 14 K 8201 | | Net 29.95 |
| 14 K 8202 | 135° Detector Switches. Shpg. wt., 3 ozs. | Net ea. 1.95 |
| 14 K 8203 | 200° Detector Switches. Shpg. wt., 3 ozs. | Net ea. 1.95 |
| 13 K 8101 | Test Button, Shpg. wt., 3 ozs. | Net .18 |
| 18 Gauge, twisted pair control wire. | Shpg. wt., 3 lbs. per 100 ft. | |
| 34 K 4615 | 100 ft. | Net 1.85 |
| 34 K 4616 | 500 ft. | Net 7.50 |
| 32 K 4689 | Replacement battery, Eveready 509. Shpg. wt., 1 1/4 lbs. | Net .79 |

EXTENSION CORDS INDOORS-OUTDOORS



- 2-Wire and 3-Wire, 16 Gauge
- Molded Connectors

Use indoors and out, with power tools, refrigerators, mowers, fans, etc. All are 16-gauge, 3 cond. cords have 3 prong plug. * 2-conductor † 3-conductor.

| Stock No. | Feet | Amp. | Shpg. Wt. | Net |
|------------|---------|---------|------------|------|
| 12 K 2301* | 25 ft. | 7 amp. | 2 lbs. | 1.35 |
| 12 K 1301* | 50 ft. | 5 amp. | 3 lbs. | 2.43 |
| 12 K 3402* | 100 ft. | 5 amp. | 3 lbs. | 4.48 |
| 12 K 3403† | 25 ft. | 10 amp. | 1 1/2 lbs. | 2.13 |
| 12 K 2302† | 50 ft. | 7 amp. | 2 1/2 lbs. | 3.51 |
| 12 K 3404† | 100 ft. | 5 amp. | 3 1/2 lbs. | 6.41 |

QUANTITIES LIMITED — ORDER NOW

8" HI-FI WIDE RANGE SPEAKER



5.95 Our
Lowest Price
Ever

- 50-13,000 cps
- Alnico V Magnet

An extremely smooth single cone reproducer — ideally suited for Hi-Fi systems. Excellent for limited space — good overall balance — power handling capacity: 10 watts — 6.8 oz. Alnico V magnet — frequency response: 50-13,000 CPS when properly baffled. Voice coil impedance: 8 ohms. Cone Resonance 85 cycles. Plated steel frame finished in brown baked enamel. Has 4-way binding posts. Shpg. wt., 4 lbs.

7 SK-69 Net 5.95

8" MID-RANGE SPEAKER

Our
Lowest Price
Ever

5.95



- 350-13,500 cps
- Handles up to 25 watts

Ideal for use with tweeter and crossover networks to make up a 2- or 3-way system. Capable of producing undistorted response down to 350 cps, the crossover frequency. Back is enclosed. Power handling capacity: 25 watts. Frequency response 350-13,500 cycles. Recommended to crossover at 5000 cycles to a tweeter. Cone resonance 150 cycles. Impedance: 8 ohms. Plated steel frame finished in brown baked enamel. Has 4-way binding posts. Shpg. wt., 4 lbs.

7 SK-74 Net 5.95

LAFAYETTE 8" WOOFER

Our Lowest
Price Ever

8.95



- Rated 20 Watts
- 14.7 oz. alnico V magnet
- High Compliance
- Free-edge cone
- 35 to 7500 cps

Ideal for 2 or 3-way systems where space is at a premium, this 8" woofer provides coverage from 35 to 7500 cps. The 14.7 oz. magnet is extraordinarily heavy for this size speaker for clean response. Other features include free-edge, high compliance cone, 20-watt power dissipation, voice coil dust cover. Cone resonance 50 cycles, 8 ohm V.C. Has 4-way binding posts. Shpg. wt., 4½ lbs.

7 SK-164 Net 8.95

12" THREE-WAY HI-FI SPEAKER

Our Lowest
Price
Ever

9.95



- 35-17,500 cps
- Wide Dispersion Elliptical Tweeter

Featuring an 8 oz. Alnico V magnet; it has a frequency response of 35-17,500 cps. The elliptical tweeter gives improved sound dispersion over cylindrical types. Voice coil: diam-1¼", impedance 8 ohms. Plated steel frame finished in brown baked enamel. Has 4-way binding posts. Shpg. wt., 6½ lbs.

7 SK-163 Net 9.95

OUTSTANDING HI-FI SPEAKERS

OUR LOWEST PRICES EVER

LAFAYETTE REVERBERATION AMPLIFIER & SPEAKER SYSTEM



24.95

Was ~~39.50~~
Cat. 644, Nov. 1964

- Ideal for Stereo or Mono Systems
- Does Not Affect Fidelity
- Self-Contained Amplifier/Speaker System with Built-in Power Supply

A compact, space saving self-contained reverberation amplifier speaker system that works with your existing component Hi-Fi system, AM or FM radio, tape recorder to bring the realism of concert hall sound to your listening area. 3-tube amplifier delivers 2½ watts to a 6½" PM speaker. Inputs provided are stereo/mono high level and stereo/mono low level. For 110-117 volts, 50-60 cps AC. Oiled walnut cabinet measures 11¼" W x 7½" H x 5¾" D. Shpg. wt., 7 lbs. Imported.

7 SK-256 Net 24.95

12" COAXIAL SPEAKER HI-FI

11.95

Our Lowest
Price Ever



- 40-20,000 cps
- 10 Oz. Alnico V Magnet
- Rated 25 Watts

Consists of specially designed 12" Woofer, a 3½" high-frequency tweeter, coaxially mounted and a 1¼" voice coil. Powerful 10 oz. Alnico V magnet provides high efficiency and smooth response. Response: 40-20,000 cps. Crossover: 35,000 cps. Power rating 25 watts. Cone Resonance: 50 cps. Impedance 8 ohms. Rugged seamless cone. 4-way binding posts. Shpg. wt., 12 lbs.

7 SK-136 Net 11.95

LAFAYETTE "BIG 8" 3-WAY HI-FI SPEAKER

Our Lowest
Price
Ever

22.95



- Precision Crafted in England to Lafayette's Rigid Specifications
- 35-20,000 cps
- 1¾ lb. Alcomax Magnet

Features axially mounted woofer, midrange radiator and tweeter. For wide-range performance. Mechanical crossover at 2,000 cycles, 5,000 cycle electrical crossover provides a smooth transition from midrange to a deluxe compression driver-tweeter. A high frequency level control allows matching of sound to individual taste and room acoustics.

Shpg. wt., 11½ lbs.
7 SK-212 Net 22.95

QUANTITIES LIMITED — ORDER NOW

LAFAYETTE FM STEREO TUNER MODEL LT-81C



OUTSTANDING MULTIPLEX STEREO TUNER WITH 10 TUBES, PLUS RECTIFIER AND 8 DIODES. 3 GANG TUNING PROVIDES TUNED RF STAGE FOR EXCELLENT SENSITIVITY & SELECTIVITY.

WAS
~~83.95~~
Cat. 644,
JUNE 1964

69⁹⁵

\$5 Monthly

- Automatic Stereo Monitor
- Built-in Multiplex Circuit with 30 db Separation @ 400 CPS
- Ratio Detector and Dual Tuned Limiters
- AFC
- AFC Off
- Extremely Sensitive—2.0 uv for 20 db Quieting
- 15-Tube Performance
- Freq. Response 20-20,000 CPS \pm 2 db
- Low Silhouette Styling.

TRULY remarkable, quality performance and styling that will delight both your eye and your ear. Features Automatic Stereo Monitor tuning eye which automatically indicates an FM stereo broadcast and makes accurate tuning of mono stations easier too! Engineered to provide high quality FM and FM stereo multiplex reception, the LT-81 has an Armstrong circuit and a ratio detector with dual tuned limiters. The multiplex circuit provides a stereo separation of 30 db at 400 cycles with less than 1% distortion. Controls consist of Power on/selector switch for FM, Stereo MULTIPLEX, noise filters; AFC slide switch with "off" position, Stereo dimension control to custom blend stereo

reception (in-rear) and Flywheel action tuning control gives velvet smooth tuning action. Two stereo output jacks on rear panel. Tube Complement: (1) 12AU7, (1) 12AX7, (1) 6AV6, (3) 6AU6, (2) 6BA6, (2) 6AQ8, EM-84 tuning eye, plus 6X4 rectifier, and 8 semiconductors. Handsome low silhouette enclosure looks good in any room setting. Beautifully finished in gold and white with a contrasting black illuminated dial face. Complete with cage and legs. Dimensions: 5 $\frac{3}{4}$ "x13 $\frac{1}{2}$ "x9 $\frac{1}{8}$ "D. 110-120V, 60 cycles AC. Shpg. wt., 12 lbs. Imported.

7LT-81CWx Net 69.95



Was 19.95
Cat. 644 June 1964

11⁹⁵

LAFAYETTE STEREO SEARCHER

- Provides Instant Identification of Stereo Stations
- Designed For FM Tuners Using External Multiplex Adapters

A specially designed accessory to be used with an FM Tuner and separate multiplex adapter. It gives you instant identification of those FM stations broadcasting stereo by producing an audible tone in the loudspeakers. Small enough to mount in cabinet space beside your FM Tuner. Single switch controls the stereo searcher. Complete with connecting cable. Tubes: 6BE6, 1 diode. Size: 2 $\frac{1}{4}$ "x3x3Hx 9 $\frac{1}{2}$ "D. Shpg. wt., 4 $\frac{1}{2}$ lbs. For 117V 50/60 cps AC. Imported.

7LT-87 Stereo Searcher Net 11.95

LAFAYETTE **Criterion** KT 600A STEREO PRE-AMPLIFIER MASTER CONTROL CENTER

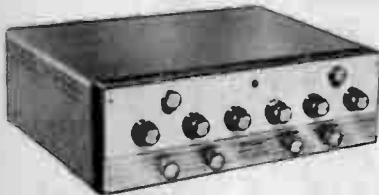

52⁵⁰

\$5 Monthly

**Below
Cost!**

- Response 5-40,000 cps
- Four auxiliary AC outlets
- Versatility of a Studio Control Console

The KT-600A has a total of 12 input jacks (6 stereo pairs) for program sources of any type and level. Separate turnover and roll-off switches provide 24 positions of correct equalization—Independent for each channel. A Bridge Control provides continuously variable channel separation. Low Impedance Plate Follower outputs are used, and a host of many other professional type features. W/case. 7KT-600AWX Stereo Preamp Kit. Shpg. wt., 16 lbs. Net 52.50

SPECIFICATIONS

Frequency Response: 5-40,000 cps \pm 1 db. Distortion: Less than 0.05% IM at 2-volts out; less than 0.1% Harmonic, at 2 volts out. Sensitivity: Low Level 2.2 mv for 1 volt out; high level 94 mv for 1 volt out; Tape Head inputs 1.8 mv for 1 volt out. Hum and Noise: High level inputs better than 80 db below 2.0 volts; low inputs better than 62 db below 2.0 volts. Input Impedance: High level—250K ohms; Mag—96K ohms; Ceramic—96K ohms in series with 68 uuf; Tape Head—470K ohms. Tone Control Range: Bass \pm 15 db at 30 cps; Treble \pm 15 db at 10K. Auxiliary AC Outlets: 4. Tubes: 7-7025, 2-Selenium Rectifiers. Power Requirements: 35 Watts, 105-125 volts AC, 50/60 cycles. Size: 14x4 $\frac{1}{2}$ "x11 $\frac{1}{2}$ "D, not including projections.

POWERFUL 12-TRANSISTOR 4-BAND PUSHBUTTON SW/AM PORTABLE

29⁹⁵

Below Cost!



- 2 Speakers
- Fine Tuning Control
- 3 Built-in Antennas
- Tone Control
- Tuned RF Stage
- Complete with Batteries and Dynamic Earphone
- Big Easy-To-Read Slide Rule Dial
- Extraordinary Tone Quality
- 4 Bands { 540—1600KC 4.5—12MC
1.6—4.5MC 12—24MC

A really superb shortwave portable with more sensitivity and pulling power than many table model SW receivers. Four bands: Pushbutton selected AM Broadcast and 3 Shortwave Bands. Listen to Police, Maritime, Mobile Phone, WWV, 75, 40, 20 and 15-meter Amateur, Aircraft and all the exciting and informative international Shortwave broadcasts from most anywhere in the world! Uses 12 Transistors, 2 diodes and a varistor. Two dynamic speakers (3 $\frac{1}{2}$ " and 2") give you rich table-model tone, plenty of volume. Fast pushbutton band selection for all four bands. Includes 7-section 2 $\frac{1}{2}$ " chrome shortwave monopole antenna, ferrite AM antenna, ferrite booster antenna, earphone for private listening and six "C" batteries. Can also be run on standard AC house current (117v, 60 cycles) when used with FS-255 Adapter. Size: 10Wx4 $\frac{1}{4}$ "xHx2 $\frac{3}{4}$ "D. Shpg. wt., 5 lbs. Imported. 7FS-252L Net 29.95

32 K 4801 Additional Batteries for Above. Net ea. .13
"C" cell, 6 required. Net 4.69
7FS-255 117v AC Adapter for Above. Imported, 2 $\frac{1}{2}$ lbs. Net 4.69

QUANTITIES LIMITED — ORDER NOW

Deluxe LAFAYETTE RK-155 PROFESSIONAL-TYPE 4-TRACK STEREO RECORDER

SPECIALLY DESIGNED TO RECORD
FM MULTIPLEX BROADCASTS!

Complete With Carrying Case

- Records 4-Track Stereo/4-Track Monaural
- Plays 4- and 2-Track Stereo and 4-Track Monaural
- Two Speeds 3¾ & 7½ ips
- Wide Frequency Response for Life-Like Reproduction
- Sound-With-Sound
- Automatic Tape Stop
- Outstanding for Recording FM Multiplex Broadcasts
- 2 Full-Tone, Self-Contained 4x6" Stereo Speakers



149⁹⁵

\$7.50 Monthly

Was ~~169.95~~

Cat. 644 June 1964

The RK-155 is a complete 4-track stereo tape recorder—you need no external amplifiers or speakers to record or play back in stereo. Records from any source—radios, FM tuners, Hi-Fi stereo amplifiers, or you can use the microphones supplied. Also equipped with outputs for operation with external speakers or external amplifiers if desired. The recorder also features "Sound-with-Sound" recording that allows you to accompany yourself in a duet, add your voice to pre-recorded music, etc. The outstanding tape mechanism features a 4-pole heavy-duty air-cooled induction motor and rubber belt drive for double flutter filtering. Tape heads are mu-metal shielded to prevent hum pickup. Superb electronics consists of stereo transistor preamps and vacuum tube stereo power amplifiers with built-in 4x6" speakers for rich, full-tone sound. 80KC bias operation ensures perfect FM stereo multiplex recordings. Useful automatic tape stop feature prevents tape spillage if tape breaks. Other features include fast forward & rewind facilities, 2 level meters, digital tape counter,

Pause control, and positive action motor controls. Complete with luxurious simulated leather case, 2 dynamic microphones, and empty tape reel. Shpg. wt., 34 lbs. Imported.
7 RK-155WX Net 149.95

SPECIFICATIONS

Frequency Response: 40-18,000 cps @ 7½ ips; 40-12,000 cps @ 3¾ ips. Amplifiers: 4 transistors, 6 tubes, full-wave bridge rectifier. S/N Ratio: 45 db. Inter-channel Separation: 45 db or better; Wow & Flutter: Less than 0.25% @ 7½ ips. Under 0.4% @ 3¾ ips; Bias & Erase: 80 KC; Controls: Pause; 2 Record Buttons W/Safety Interlocks, Rewind/Stop/Play; Stop/Fast Forward, Tone control switch, Stereo/Mono Speaker Switch, 2 volume controls, 4 input jacks, 6 output jacks. For 117 volts 60 cycles AC. Size: 15¼Wx7½Hx11¼"D.

LAFAYETTE PROFESSIONAL 4-TRACK STEREO RECORD/PLAYBACK TAPE DECK

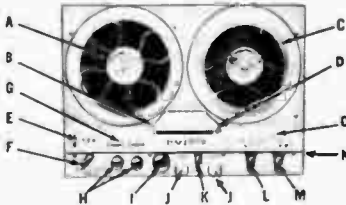

99⁹⁵

\$5 Monthly

Was ~~114.50~~

Cat. 644 June 1964

Includes
Portable
Carrying Case

Famous Tape deck version of deluxe RK-155 recorder listed above. Features built-in transistorized stereo record and playback preamplifiers; reliable 4-pole air-cooled induction motor, automatic tape stop at end of tape; sound-with-sound recording; and pause control for tape editing—Jacks are included for stereo microphones (not supplied). See microphones on pages 70 and 71. Records FM stereo multiplex. All controls are top mounted for easy access. Response: 40-18,000 cps, @ 7½ ips. 40-12,000 @ 3¾ ips; S/N ratio 45 db; stereo separation: 45 db. 3 digit index counter. Takes up to 7" reels. Size: 15Wx6½Hx10½"D. For 117 volts, 60 cycles AC. Complete with preamps, 4 connecting cables and empty tape reel. Shpg. wt., 25 lbs. Imported Deck with Carry Case, less Mikes
7 RK-143WX Net 99.95

PROFESSIONAL OPERATING FEATURES

- SUPPLY REEL
- AUTOMATIC CUT-OFF SWITCH
- TAKE-UP REEL
- HEADS
- INDEX COUNTER
- SPEED CHANGE LEVER/POWER ON-OFF
- LEVEL INDICATORS
- INDIVIDUAL VOLUME CONTROLS
- MASTER VOLUME CONTROL
- RECORD BUTTONS
- PAUSE CONTROL
- REWIND/STOP/PLAY LEVER
- STOP/FAST FORWARD
- MICROPHONE JACKS
- ON/OFF PILOT LIGHT

1200 FT. 1½ MIL MYLAR BASE RECORDING TAPE



89¢

Was ~~1.19~~

Cat. 644 June 1964

Lafayette brings you this 1½ mil mylar base quality recording tape at an unbelievable low price. This 1½ mil mylar tape features the exceptional strength and resistance to heat, cold, humidity and abrasion that are characteristic of mylar. 7" reel. Shpg. wt., 1 lb.
7 RT-22 Each Net 89

Telephone Pick-up for Recording Telephone Conversation



149

Was ~~3.95~~
Cat. 642 Jan. 1964

Telephone conversations can easily be recorded with this fine telephone pick-up. Designed to feed into the microphone input of a tape recorder. Easily attaches to the telephone by means of a suction rubber-type attachment. Comes complete with readily replaceable miniature plug. Imported.
7 RK-128 Net 1.49

Take Advantage of Lafayette's Low Tape Recorder Prices

Lafayette Cat. No. 652 77

QUANTITIES LIMITED — ORDER NOW

LAFAYETTE HE-90 CITIZENS BAND TRANSCEIVER

WAS
~~89⁹⁵~~

Cat. 644, June 1964

NOW
69⁵⁰



MADE IN
U.S.A.

- 6-Channel Crystal Controlled Transmit/Receive—23-Channel Variable Tuning Receiver • 5-Watt Transmitter—Nuvistor RF Amplifier • Electronic Switching • Automatic Noise Limiter, Adjustable Squelch, Full AVC • Dependable Push-to-Talk Ceramic Microphone • Illuminated "S" Meter—For

- Direct Relative RF Power and "S" Readings • Spotting Switch for Positive Channel Location On Tunable Receive • With Channel 9 Transmit and Receive Crystals • Headphone Jack • Wired to Accept Lafayette PRIVA-COM Selective Call Unit!

Features illuminated dial and planetary tuning mechanism for accurate tuning. 3-transformer IF circuit provides razor sharp selectivity; Nuvistor RF amplifier in receiver gives 1- μ v sensitivity. Transmitter features 5-watt input power, Pi-network output matches 30-100 ohm antennas and TVI filter. Controls: On/Off Volume, Squelch, Tuning, Spot Switch, Channel Selector, Meter Switch, Tune-Fixed Selector. For 117V AC. 15-tube function. Includes set of crystals for Channel 9,

Push-to-Talk highly dependable ceramic mike and coiled cord with plug. 11 $\frac{1}{2}$ x5x6 $\frac{1}{8}$ ". Shpg. wt., 14 lbs.
7 HE-90WX Less Mobile Power Supply Net 69.50
42 K 0102W 12-Volt Mobile Power Supply for HE-90WX.
Shpg. wt., 4 lbs. Net 11.50
42 K 4201C Transmit Crystal (Specify Channel or Freq.) Net 2.25
42 K 4202C Receive Crystal (Specify Channel) Net 2.25

LAFAYETTE 2-METER CONVERTER

Model HE-71

Below Cost!

18²⁵

- Neutralized Cascode RF Amp
- Low Noise—High Stability
- 7-11 MC Output

Response of this top-quality 2-meter converter is essentially flat over the 144-148 MC range. Uses dual triodes in a neutralized cascode RF amplifier for low noise. Calibration and stability is assured by crystal-controlled oscillator. Has two antenna inputs, one for the main antenna, the other for the 2-meter antenna. Handy control switch connects the main antenna directly to the converter output in the "off" position—converts signals in the 2-meter band to 7-11 MC when "on." Freq. range 144-148 MC. Crystal Freq. 45.66 MC. Sensitivity 1 microvolt for 10 db S/N ratio. Image Rejection—40 db. Antenna input impedance 52 ohms. For 117 VAC, 50-60 cps. Size: 7 $\frac{1}{2}$ Hx3 $\frac{1}{2}$ Wx5 $\frac{1}{8}$ "D. Imported.
7 HE-71 Shpg. wt., 6 lbs. Net 18.25



LAFAYETTE NEW UNIVERSAL 6-METER AND BROADCAST MOBILE ANTENNA

Below Cost!
2²⁵

Here is a highly efficient 6 meter antenna that replaces your Auto radio antenna for operation on both 6 meters and for regular AM broadcast reception. 59" stainless steel mast, all chrome ball type base adjustable to 180° for front rear or side mount. Complete with 54" lead. Highly versatile and durable. Shpg. wt., 4 lbs. Imported.
7 HE-801WX Net 2.25



LAFAYETTE MODEL TE-18 GRID DIP METER

COMPLETE WITH ALL COILS FOR ALL FREQUENCY RANGES FROM 360 KC TO 220 MC

- Compact—True One-Hand Operation • Covers 360 Kc to 220 Mc @ Functions as a Grid Dip Oscillator, Absorption Wave-meter and Oscillating Detector • Completely Wired—Not A Kit

Our Lowest Price Ever!

25⁹⁵

The TE-18 can determine the resonant frequencies of tuned circuits, detect stray resonances in transmitters, check neutralization, etc. Frequency range 360 Kc to 220 Mc, in 8 accurately calibrated ranges. Grid current meter has a 500 μ a movement. Uses a 6AF4A tube, powered by a built-in, transformer-operated power supply with selenium rectifier. For 117 V. AC. 50-60 cps. Dimensions: 7 $\frac{1}{4}$ Hx2 $\frac{3}{4}$ Wx2"D. Shpg. wt., 3 lbs. Imported.
7 TE-18 Net 25.95



LAFAYETTE GUARANTEES

When you buy from Lafayette, you buy with confidence. Lafayette's pledge to you, of "Satisfaction Guaranteed or Money Refunded," is your assurance that we mean what we say. For 44 years we have kept this pledge to you . . . and shall continue to do so in the future.

SATISFACTION GUARANTEED OR MONEY REFUNDED

See your purchase at home. If for any reason you are not satisfied return it to us at once in the original factory carton and we will exchange it or return your money (less transportation charges). Merchandise returned must be in good condition and not soldered or abused—no holes drilled or changes made in any other way. This policy does not apply to kits (kit guarantee listed below), nor to pre-recorded tape, records, books, repair parts, or merchandise not regularly stocked that has been ordered especially for you.

SERVICE AND REPLACEMENT GUARANTEES

All merchandise is guaranteed to be free of defects in material and workmanship for the period of time specified in the listing of the product. Where no time is specified the guarantee is for 90 days. Wherever so indicated in our listing of the product we will replace it. Wherever our listing does not specify we will either replace it or repair it at our option. Item must be returned prepaid for our inspection.

LAFAYETTE KITS

All parts in kits are guaranteed to be free from defects in material or workmanship, and if properly wired, to meet the published specifications for performance. Parts are guaranteed for the time specified in the listing. Where no time is specified guarantee is for 90 days. During this period we will replace or repair at our option any defective part returned to us.

If your kit does not function properly when fully wired it may be returned to us prepaid for inspection. If failure to function is due to improper wiring or handling, we will make the necessary corrections or repairs at modest charges. These charges vary with each kit and are shown in a price sheet enclosed with each kit.

OTHER KITS

Kits of manufacturers other than Lafayette carry the same guarantee as above, except that Lafayette does not repair or rewire them. They may be returned to us and we will forward them to the manufacturer who will determine the charges, where applicable.

REA EXPRESS INFORMATION

Large, bulky or delicate articles are shipped by Railway Express, the fastest and most economical way to ship merchandise which is unavailable. (If you desire other shipping methods, please specify). These packages travel on fast passenger trains and get preferred attention and special handling at no extra charge. The letter "X" after our stock number (i.e. 21 K 4417WX) identifies the item exceeding parcel post size or weight limits, or too delicate for parcel post handling.

DO NOT SEND MONEY for express charges with your order. Express charges are collected upon delivery at no extra cost to you. Insurance is included in your express rates. Be sure to specify your nearest Express Office if there is no agent in your town.

APPROXIMATE EXPRESS CHARGES

| Weight | 100 Miles | 150 Miles | 300 Miles | 500 Miles | 1000 Miles | 2000 Miles | 2400 Miles |
|----------|-----------|-----------|-----------|-----------|------------|------------|------------|
| 20 lbs. | 3.85 | 4.00 | 4.45 | 4.75 | 4.85 | 5.95 | 7.15 |
| 30 lbs. | 4.20 | 4.40 | 5.15 | 5.55 | 5.85 | 7.50 | 9.30 |
| 40 lbs. | 4.55 | 4.85 | 5.80 | 6.35 | 6.85 | 9.10 | 11.50 |
| 50 lbs. | 4.95 | 5.25 | 6.50 | 7.15 | 7.85 | 10.65 | 13.65 |
| 60 lbs. | 5.30 | 5.70 | 7.15 | 8.00 | 8.90 | 12.25 | 15.80 |
| 70 lbs. | 5.70 | 6.10 | 7.85 | 8.80 | 9.90 | 13.80 | 17.95 |
| 80 lbs. | 6.05 | 6.50 | 8.50 | 9.60 | 10.90 | 15.35 | 20.15 |
| 90 lbs. | 6.40 | 6.95 | 9.15 | 10.40 | 11.95 | 16.95 | 22.30 |
| 100 lbs. | 6.75 | 7.35 | 9.75 | 11.15 | 12.85 | 18.35 | 24.25 |

C.O.D. FEES

If you order C.O.D., the post office collects a handling charge, plus a money order fee, in addition to the regular parcel post charge. (We cannot accept COD's for APO's, FPO's or for special-order merchandise). Here are the extra C.O.D. fees:

| Amount of Order | Money Order Fee | COD Fee |
|----------------------|-----------------|---------|
| Minimum order \$5.00 | 20c | 40c |
| \$5.01 to 10.00 | 20c | 50c |
| 10.01 to 25.00 | 30c | 70c |
| 25.01 to 50.00 | 30c | 80c |
| 50.01 to 100.00 | 35c | 90c |

Subject to post office rate changes

PARCEL POST RATES FOR ALL ZONES

NOTE: Hawaii and Alaska are in the 8th zone. Puerto Rico and the Virgin Islands in the 7th zone. All other U.S. possessions and territories in the 8th zone.

AIR SHIPMENTS

For fast delivery, you may specify Air Parcel Post, Air Express or Air Freight. For Air Express Rates see your local REA Agent. For Air Freight see your nearest commercial airport office. Air Parcel Post limits are 70 lbs. in weight, 100" in length and girth combined, except APO and FPO which are 2 lbs. and 20"

AIR PARCEL POST RATES

ZONES 1,2,3, 4 5 6 7 8
1st lb. .68 .73 .78 .83 .88 .88
For each add add add add add add
extra lb. .48 .50 .56 .64 .72 .80
U.S. Possessions, Territories, APO's, FPO's—.80 per lb.

UNITED PARCEL DELIVERY

If your area is serviced by UPS and the service or rates are to your benefit, we will route your order via United Parcel Service. This fast, economical service is available from New York to most of the eastern states for parcels up to 50 lbs. and 108 inches in length and girth.

SHIPMENTS OUTSIDE OF THE UNITED STATES

We ship all over the free world. Allow up to 60 days for delivery. Write to our International Sales Division for details.

| SHIPPING WEIGHT Up to but not including 16 ozs. | Local | ZONES | | | | | | | |
|---|--------|--|--------------------|--------------------|----------------------|------------------------|------------------------|--------------------|--|
| | | 1-2 up to 150 Miles | 3 151 to 300 Miles | 4 301 to 600 Miles | 5 601 to 1,000 Miles | 6 1,001 to 1,400 Miles | 7 1,401 to 1,800 Miles | 8 Over 1,800 Miles | |
| | | 4c for the first 2 ounces and 2c for each additional ounce | | | | | | | |
| to 2 lbs. | \$0.29 | \$0.40 | \$0.42 | \$0.46 | \$0.52 | \$0.59 | \$0.66 | \$0.72 | |
| 3 | .31 | .46 | .49 | .55 | .64 | .73 | .83 | .93 | |
| 4 | .33 | .51 | .55 | .64 | .75 | .88 | 1.01 | 1.13 | |
| 5 | .35 | .57 | .62 | .72 | .87 | 1.02 | 1.18 | 1.34 | |
| 6 | .37 | .62 | .68 | .80 | .97 | 1.15 | 1.34 | 1.53 | |
| 7 | .39 | .68 | .75 | .88 | 1.07 | 1.28 | 1.50 | 1.73 | |
| 8 | .41 | .73 | .81 | .90 | 1.18 | 1.41 | 1.66 | 1.92 | |
| 9 | .43 | .78 | .87 | 1.03 | 1.28 | 1.53 | 1.82 | 2.12 | |
| 10 | .45 | .83 | .93 | 1.10 | 1.38 | 1.66 | 1.98 | 2.31 | |
| 11 | .47 | .88 | 1.00 | 1.18 | 1.48 | 1.78 | 2.14 | 2.48 | |
| 12 | .49 | .93 | 1.06 | 1.26 | 1.58 | 1.90 | 2.29 | 2.66 | |
| 13 | .51 | .98 | 1.12 | 1.33 | 1.69 | 2.02 | 2.44 | 2.83 | |
| 14 | .53 | 1.03 | 1.18 | 1.41 | 1.79 | 2.14 | 2.60 | 3.01 | |
| 15 | .55 | 1.08 | 1.24 | 1.48 | 1.89 | 2.25 | 2.75 | 3.18 | |
| 16 | .57 | 1.13 | 1.30 | 1.56 | 1.99 | 2.37 | 2.90 | 3.36 | |
| 17 | .59 | 1.18 | 1.36 | 1.64 | 2.09 | 2.49 | 3.06 | 3.53 | |
| 18 | .61 | 1.23 | 1.42 | 1.71 | 2.20 | 2.61 | 3.21 | 3.71 | |
| 19 | .63 | 1.28 | 1.48 | 1.79 | 2.30 | 2.73 | 3.36 | 3.88 | |
| 20 | .65 | 1.32 | 1.54 | 1.86 | 2.40 | 2.85 | 3.51 | 4.06 | |
| FOR EA. ADDED LB. ADD 2c | 4c | 5c | 7c | 9c | 11c | 14c | 17c | | |

PARCEL POST HANDLING CHARGES

| | | | |
|---------------|-----|----------------|-----|
| up to 5.00 | .05 | 10.01 to 25.00 | .15 |
| 5.01 to 10.00 | .10 | 25.01 to 50.00 | .20 |

ALL PRICES AND SPECIFICATIONS IN THIS CATALOG SUBJECT TO CHANGE WITHOUT NOTICE

LAFAYETTE'S 3-in-1 EASY-PAY CREDIT PLAN

MAKES IT EASIER FOR YOU TO BUY NOW!

★ As Little as \$5 Monthly ★ Up to 24 Months to Pay

★ Low Down Payment—\$5 down on orders up to \$100;
\$10 down on orders over \$100

— minimum order \$30 —

CHOOSE THE PLAN THAT SUITS YOU BEST:

- REGULAR PLAN**—Monthly payments as low as \$5!
- E-X-T-E-N-D-E-D PLAN**—Up to 24 months to pay!
- ALTERNATE 30-DAY PLAN**—No credit service charge. Select the Regular or Extended Plan. When your first payment is due within 30 days as scheduled, simply pay the entire amount and you automatically **SAVE THE ENTIRE SERVICE CHARGE.**

OPEN A LAFAYETTE EASY-PAY ACCOUNT AND ENJOY THESE 10 BIG ADVANTAGES!

- IT'S EASY TO START YOUR ACCOUNT!
- EASIER TO ORDER!
- ONE LOW MONTHLY PAYMENT!
- ADD-ON PURCHASES AS LOW AS \$10!
- UP TO 24 MONTHS TO PAY!
- LOW CREDIT SERVICE CHARGES!
- FIRST INSTALMENT NOT DUE FOR 30 DAYS!
- NO WAITING FOR MONTHLY STATEMENTS!
- YOU ALWAYS KNOW YOUR EXACT BALANCE!
- EASY TO REORDER ONCE YOU HAVE ESTABLISHED CREDIT!

Here's How To Open Your Easy-Pay Account:-

Use the regular Lafayette order blank (more will be supplied upon request.) Complete both sides of the form carefully, following the step-by-step instructions and illustration. Accuracy will speed handling of the form from the moment of receipt and permit immediate shipment upon approval of credit. Be sure to sign the agreement and indicate which Easy-Pay Plan you prefer—the liberal Regular or special Extended.

Minimum order as low as \$30.

Easy-Pay privileges are available to qualifying U.S. citizens and permanent residents of all 50 States, and Puerto Rico. Any responsible individual over 21 years old with a steady source of income can apply.

No Credit Service Charge for the alternate 30-Day Plan. For the Regular and Extended Plans, you are privileged to prepay the balance in full at any time to obtain a partial rebate of normal credit service charges.

'DOLLAR POWER PLUS'

You Get "DOLLAR POWER PLUS" with Lafayette's 3-IN-1 Easy-Pay Plan. One Low Monthly Payment Buys More For You.

| Monthly Payments | Unpaid Balance (Total amount less down payment) | |
|------------------|--|---|
| FOR ONLY | YOU CAN BUY UP TO | |
| \$ 5 | \$100.00 | See Complete E.P. Schedule on Contract |
| 6 | 110.00 | |
| 7 | 130.00 | |
| 8 | 160.00 | |
| 9 | 180.00 | |
| 10 | 200.00 | |
| 11 | 220.00 | |
| 15 | 300.00 | |
| 17 | 340.00 | |
| 19 | 400.00 | |
| 22 | 440.00 | |
| 23 | 460.00 | |
| 24 | 500.00 | |

For monthly payments on balances over \$500, please write us.

"EASY PAY PLAN" PAYMENT SCHEDULE

| If Unpaid Balance Is | Standard Plan | | Extended Plan | |
|----------------------|-----------------------|-----------------|-----------------------|-----------------|
| | Credit Service Charge | Monthly Payment | Credit Service Charge | Monthly Payment |
| UP to 20.00 | 2.00 | 5.00 | | |
| 20.01 -- 30.00 | 3.00 | 5.00 | | |
| 30.01 -- 40.00 | 4.00 | 5.00 | | |
| 40.01 -- 50.00 | 5.00 | 5.00 | | |
| 50.01 -- 60.00 | 6.00 | 6.00 | 7.00 | 5.00 |
| 60.01 -- 70.00 | 7.00 | 7.00 | 8.00 | 5.00 |
| 70.01 -- 80.00 | 8.00 | 8.00 | 10.00 | 5.00 |
| 80.01 -- 90.00 | 9.00 | 8.50 | 12.00 | 5.00 |
| 90.01 -- 100.00 | 10.00 | 9.00 | 14.00 | 5.00 |
| 100.01 -- 110.00 | 11.00 | 10.00 | 15.00 | 6.00 |
| 110.01 -- 120.00 | 12.00 | 10.00 | 17.00 | 6.50 |
| 120.01 -- 130.00 | 13.00 | 10.00 | 19.00 | 7.00 |
| 130.01 -- 140.00 | 14.00 | 11.00 | 21.00 | 7.50 |
| 140.01 -- 150.00 | 16.00 | 11.50 | 24.00 | 8.00 |
| 150.01 -- 160.00 | 17.00 | 12.00 | 24.00 | 8.00 |
| 160.01 -- 180.00 | 19.00 | 12.50 | 28.00 | 9.00 |
| 180.01 -- 200.00 | 21.00 | 14.00 | 32.00 | 10.00 |
| 200.01 -- 220.00 | 23.00 | 15.00 | 35.00 | 11.00 |
| 220.01 -- 240.00 | 26.00 | 16.00 | 38.50 | 11.50 |
| 240.01 -- 260.00 | 30.00 | 17.00 | 41.50 | 12.50 |
| 260.01 -- 280.00 | 33.00 | 18.00 | 45.00 | 13.50 |
| 280.01 -- 300.00 | 36.00 | 19.00 | 48.00 | 15.00 |
| 300.01 -- 320.00 | 39.00 | 21.00 | 51.00 | 17.00 |
| 320.01 -- 340.00 | 42.00 | 22.00 | 54.50 | 17.00 |
| 340.01 -- 360.00 | 45.00 | 24.00 | 58.00 | 19.00 |
| 360.01 -- 380.00 | 48.00 | 25.00 | 61.00 | 19.00 |
| 380.01 -- 400.00 | 52.00 | 26.00 | 64.00 | 19.00 |
| 400.01 -- 420.00 | 55.00 | 27.00 | 67.00 | 22.00 |
| 420.01 -- 440.00 | 58.00 | 28.00 | 70.00 | 22.00 |
| 440.01 -- 460.00 | 61.00 | 30.00 | 74.00 | 23.00 |
| 460.01 -- 480.00 | 64.00 | 31.00 | 77.00 | 24.00 |
| 480.01 -- 500.00 | 67.00 | 33.00 | 80.00 | 24.00 |

Write us for monthly payments on balances over \$500.

FOR EASY PAY PURCHASE USE THIS SIDE AFTER FILLING IN MERCHANDISE ON REVERSE SIDE
 Before filling out amounts see EASY PAY PLAN SCHEDULE and example. Figure your sums first on separate paper to avoid errors. USE INK. DO NOT ERASE OR CROSS OUT.

RETAIL INSTALMENT CONTRACT

MINIMUM ORDER \$30.00 TOTAL CASH PRICE

ADDITIONAL PURCHASES: Once you establish credit, you can "add-on" to your account. No down payment required on "add-ons." Just list the items you want on the order blank, write "add to my account," give your account number, also indicate if you want instalment payments combined. Minimum add-on order \$10.00. Make certain you sign the Retail Instalment Contract.

NOTICE TO THE BUYER: 1. Do not sign this agreement before you read it or if it contains any blank space. 2. You are entitled to a completely filled in copy of this agreement. 3. Under the law, you have the right to pay off in advance the full amount due and under certain conditions to obtain a partial refund of the credit service charge.

LAFAYETTE RADIO ELECTRONICS CORPORATION (SELLER)
 111 JERICHO TURNPIKE, SYOSSET, L. I. N. Y.

sells and buyer purchases merchandise as described on reverse side hereof to be kept in good repair and unencumbered at buyer's stated address. Seller shall retain title to and right to possession of merchandise until fully paid. The unpaid balance of this order together with applicable credit service charge, may be added to an existing unpaid account for convenience of both buyer and seller. Should the buyer place subsequent orders, unpaid balances on such orders may be combined with any balance owing on this order together with applicable credit service charge, if buyer so authorizes and seller accepts in appropriate spaces elsewhere in this contract. Upon default of any payment or payments seller may declare entire unpaid balance due at once and may also repossess merchandise retaining previous payments as compensation for the use thereof. If proceeds of resale of merchandise are insufficient to cover buyer's obligation, buyer will pay the deficiency to seller; if proceeds result in overage, seller will pay such overage to buyer. Payments will be made to the place and/or to any party designated by the seller in writing.

LAFAYETTE RADIO ELECTRONICS CORPORATION
 (SELLER)

**BUYER
 SIGN
 HERE** →

Signed

(Please Print)
 Name _____
 Present (A)
 Home Address _____
 City _____ State _____ Zip No. _____
 How Long At This Address _____ Telephone _____

To fill in spaces below correctly refer to EASY PAY PLAN Schedule on this sheet and note example.

1. Total Cash Price _____
2. Sales Tax (N.Y.C. only) _____
3. Total (items 1 + 2) _____
4. Down Paym't (\$5 down on orders up to \$100; \$10 down on orders over \$100) _____
5. Unpaid Balance (item 3 minus item 4) _____
6. Credit Service Charge (See EASY PAY Schedule) _____
7. EASY PAY BALANCE (Add items 5 + 6)
8. Total EASY PAY Price (Add items 3 + 6) _____

EXAMPLE (Standard Plan)

| | | |
|---|---|--------|
| If Item (5) Unpaid Balance | = | 106.50 |
| Item (6) Credit Service Charge | = | 11.00 |
| Item (7) EASY PAY Balance | = | 117.50 |
| Your Monthly Payment (See Schedule) is | | 10.00 |
| You will pay \$10.00 for 11 months or | | 110.00 |
| And your FINAL Monthly payment will be | | 7.50 |

Do not include shipping charges. Easy Pay orders are sent shipping charges collect, except for PARCEL POST CHARGES which are added to your account.

Beginning one month after shipment BUYER AGREES TO PAY \$ _____ per month for _____ months, and a **FINAL** monthly payment of \$ _____ to the place and/or to any party designated in writing by the Seller.

RETAIL INSTALMENT CONTRACT

(L.S.) **DATE**

By _____

To combine additional purchase with a previous account, indicate

PRESENT ACCT. # EP DATE DUE UNPAID BALANCE \$ Combined Am't. you wish to pay monthly \$

For purpose of receiving credit for above EASY PAY PLAN purchase, the buyer makes the following representation:

With Whom Living Spouse Alone Permanent Previous Landlord's Name and Address (Check which)

Permanent or previous address if (A) above is temporary or occupied less than two years.

How Long
 (Years) | (Months)

Single

previous or more.

Fill in if you are a new account, or if your account has been paid up for 12 months

Married Divorced Widowed Single Dependent Spouse Other Employed by _____ (Address) _____ Salary _____
 Draft Classification _____ Service Serial # _____ Have you bought from Lafayette before? Yes No On Time Payment? Yes No If yes, please give your Lafayette Time Payment Account Number. _____ E.P. _____
 Real Estate Owned—Address _____ City _____ State _____
 Recorded In Name of _____ Present Value \$ _____ Mortgage \$ _____
 Name _____ If self-employed, give nature of self-employment. _____ Position _____ Weekly _____ How Long _____
 Present Employer _____ Soc. Sec. # _____ Salary _____ Monthly _____ (Years) _____ (Months) _____
 Business Address _____ Any Other Income _____ Source _____ \$ _____
 Name & Address Former Employer _____ How Long _____ (Years) _____ (Months) _____
 Checking Instalment Loan (Address) _____
 Bank Reference _____
 1. Instal. Trade Reference _____ Instal. Account No. _____ Name & Street Address _____ (City and State) _____ Highest Credit \$ _____ Still Owing \$ _____ Monthly Payment \$ _____
 2. Instal. Trade Reference _____ Name & Complete Address _____
 Parent, If Living at Another Address _____
 Other Nearest Relative _____ Name _____ (DO NOT LIST THOSE WITH WHOM YOU RESIDE) _____ Address _____ Relationship _____

NEW "EASY PAY PLAN" PAYMENT SCHEDULE

How to Convert to Alternate 30-Day Plan. Pay the entire amount when the 1st installment is due within 30 days of shipment. You Save the Entire Credit Service Charge.

| STANDARD PLAN | | | EXTENDED PLAN | | | STANDARD PLAN | | | EXTENDED PLAN | | | STANDARD PLAN | | | EXTENDED PLAN | | |
|----------------------|---------------------|-----------------|---------------------|-----------------|----------------------|---------------------|-----------------|---------------------|-----------------|----------------------|---------------------|-----------------|---------------------|-----------------|----------------------|---------------------|-----------------|
| If Unpaid Balance Is | Credit Svce. Charge | Monthly Payment | Credit Svce. Charge | Monthly Payment | If Unpaid Balance Is | Credit Svce. Charge | Monthly Payment | Credit Svce. Charge | Monthly Payment | If Unpaid Balance Is | Credit Svce. Charge | Monthly Payment | Credit Svce. Charge | Monthly Payment | If Unpaid Balance Is | Credit Svce. Charge | Monthly Payment |
| UP to 20.00 | 2.00 | 5.00 | | | 120.01-130.00 | 13.00 | 10.00 | 19.00 | 7.00 | 300.01-320.00 | 39.00 | 21.00 | 51.00 | 17.00 | 400.01-420.00 | 55.00 | 27.00 |
| 20.01- 30.00 | 3.00 | 5.00 | | | 130.01-140.00 | 14.00 | 11.00 | 21.00 | 7.50 | 320.01-340.00 | 42.00 | 22.00 | 54.50 | 17.00 | 420.01-440.00 | 58.00 | 28.00 |
| 30.01- 40.00 | 4.00 | 5.00 | | | 140.01-150.00 | 16.00 | 11.50 | 24.00 | 8.00 | 340.01-360.00 | 45.00 | 24.00 | 58.00 | 19.00 | 440.01-460.00 | 61.00 | 30.00 |
| 40.01- 50.00 | 5.00 | 5.00 | | | 150.01-160.00 | 17.00 | 12.00 | 24.00 | 8.00 | 360.01-380.00 | 48.00 | 25.00 | 61.00 | 19.00 | 460.01-480.00 | 64.00 | 31.00 |
| 50.01- 60.00 | 6.00 | 6.00 | 7.00 | 5.00 | 160.01-180.00 | 19.00 | 12.50 | 28.00 | 9.00 | 380.01-400.00 | 52.00 | 26.00 | 64.00 | 19.00 | 480.01-500.00 | 67.00 | 33.00 |
| 60.01- 70.00 | 7.00 | 7.00 | 8.00 | 5.00 | 180.01-200.00 | 21.00 | 14.00 | 32.00 | 10.00 | 400.01-420.00 | 55.00 | 27.00 | 67.00 | 22.00 | | | |
| 70.01- 80.00 | 8.00 | 8.00 | 10.00 | 5.00 | 200.01-220.00 | 23.00 | 15.00 | 35.00 | 11.00 | 420.01-440.00 | 58.00 | 28.00 | 70.00 | 22.00 | | | |
| 80.01- 90.00 | 9.00 | 8.50 | 12.00 | 5.00 | 220.01-240.00 | 26.00 | 16.00 | 38.50 | 11.50 | 440.01-460.00 | 61.00 | 30.00 | 74.00 | 23.00 | | | |
| 90.01-100.00 | 10.00 | 9.00 | 14.00 | 5.00 | 240.01-260.00 | 30.00 | 17.00 | 41.50 | 12.50 | 460.01-480.00 | 64.00 | 31.00 | 77.00 | 24.00 | | | |
| 100.01-110.00 | 11.00 | 10.00 | 15.00 | 6.00 | 260.01-280.00 | 33.00 | 18.00 | 45.00 | 13.50 | | | | 80.00 | 24.00 | | | |
| 110.01-120.00 | 12.00 | 10.00 | 17.00 | 6.50 | 280.01-300.00 | 36.00 | 19.00 | 48.00 | 15.00 | | | | | | | | |

Write us for monthly payments on balances over \$500.

IMPORTANT: Please sign this form before mailing. Be sure to give age. (Must be over 21).

QUANTITIES LIMITED — ORDER NOW

FAMOUS LAFAYETTE HE-20C

Deluxe Citizens-Band Transceiver

**EXCELLENT FOR BUSINESS,
FARM, INDUSTRY, CAR, BOAT,
PERSONAL AND SPORTS USE**

Made In U.S.A.

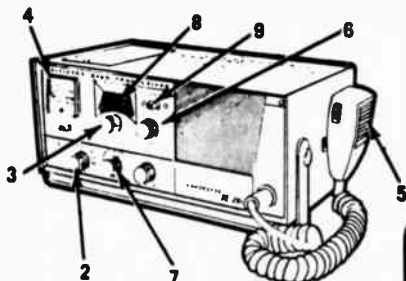

LOOK AT THESE QUALITY FEATURES

- 1 14-Tube Performance, 2 Diodes, 3 Rectifiers
- 2 8 Crystal-Controlled Transmit Positions
- 3 8 Crystal-Controlled Receive Positions
- 4 Tuneable Receiver over all 23 channels
- 5 Illuminated Direct Reading "S" Meter for Relative RF Power Output, and Receiver "S" Readings
- 6 Dependable Push-To-Talk Ceramic Microphone
- 7 Adjustable Squelch Control
- 8 Receive Tuneable or Fixed Crystal Selector Switch
- 9 Illuminated Dial
- 10 Spotting Switch for Positive Frequency Location on Tuneable Receive
- 11 Highly Effective Automatic Series Gate Noise Limiter
- 12 Built-in 12-volt Power Supply for Mobile Use
- 13 Complete with channel 9 Transmit & Receive Crystals
- 14 Dependable Relay Switching

98⁹⁵

**Our Lowest
Price Ever!**

\$5 Monthly

- 8 CRYSTAL RECEIVE POSITIONS
- 8 CRYSTAL TRANSMIT POSITIONS • SPOTTING SWITCH for Positive Frequency Location on Tuneable Receive
- BUILT-IN SELECTIVE CALL CIRCUITRY AND SOCKET!
- DEPENDABLE RELAY SWITCHING

Not A Kit! COMPLETELY WIRED!

| | | |
|------------|---|-----------|
| 7 HE-20CWX | 115 AC/12V DC. Shpg. wt., 14 lbs. | Net 98.95 |
| 42 K 4201C | Transmit Crystal (Specify Channel or Frequency) | Net 2.25 |
| 42 K 4202C | Receive Crystal (Specify Channel) | Net 2.25 |

LAFAYETTE 23-CHANNEL CRYSTAL CONTROLLED CITIZENS BAND TRANSCEIVER MODEL HB-222

149⁵⁰

\$7.50 Monthly

Was 169.50

Cat. 644, June 1964



Made in U.S.A.

WITH THESE QUALITY FEATURES

- 23-Channel Crystal Controlled Receiver—All Crystals Supplied!
- 23-Channel Crystal Controlled Transmitter—All Crystals Supplied!
- A Flip of The Channel Selector Switch Gets You Any One of 23 Active Channels With Crystal Accuracy.
- Dual Conversion Superheterodyne Receiver Using 1850KC and 262KC IF's For High Selectivity and Sensitivity.
- Push-to-Talk Relay Switching Using Noise Cancelling Ceramic Microphone.
- 10-Tubes plus 3 Silicon Power Rectifiers For 17 Tube Performance.

7 HB-222WX Net 149.50

1. Illuminated Meter Indicates Relative RF Output Power, "S" reading, and Modulation.
2. Noise Cancelling Push-To-Talk Ceramic Microphone.
3. Adjustable Squelch Control with Automatic Noise Limiter Switching.
4. Illuminated Channel Selector Dial.
5. Earphone Jack.
6. Channel Fine Tuning Control.
7. Built-in 117V AC Power Supply with 12 Volts DC Mobile Transistorized Power Supply.
8. Wired to Accept HA-200 PRIVA-COM.

Lafayette is America's Citizens Band Headquarters

Lafayette Cat. No. 652 79

QUANTITIES LIMITED — ORDER NOW

LAFAYETTE STYLOCHRON

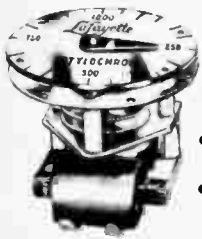

285

Below Cost!

- Protect Your Precious Recordings
- No More Guess Work—Keeps An Accurate Record of Needle Use

Lafayette Stylochron lets you know just how long your needle has been in use so that you can replace the worn needle at the proper time, before it can do damage to your records. The Stylochron is quickly and easily mounted on your motor board or other convenient place. The moment your record changer or turntable starts, the Stylochron begins to register. It stops when the turntable stops. The 1000 hour dial will tell you at any time how long you have been using the needle. Dial is marked off in 50 hour units. You can remove your stylus for inspection at any predetermined number of hours, diameter at the face plate is 3/32". Extends 1 1/2" below or behind panel. Complete with instructions. Shpg. wt., 2 lbs. 7 PK-224 Net 2.85

SONOTONE 2T-S Turnover Ceramic Cartridge (Supersedes 9980-S)



170 Below Cost!

This cartridge is used to replace Astatic AC, ACD, CAC, GC, LQD, ELECTRO-VOICE 16TT, 33, 43, 46T, 96T; SHURE VC series from WC22 to WC36, W26; WEBSTER ELECTRIC AX, A1, A9-1. Used on VM, Columbia 360. Webster, Crescent record changers and many other types now in use. Excellent hi-fi characteristics extended frequency range and low distortion. All with the added advantages of ceramic safety from humidity and heat. Has 1 mil stylus for LP records and 3 mil for standard—both synthetic sapphire. Shpg. wt., 8 oz. 7 PK-40 Net 1.70

ASTATIC TURNOVER ACD-C2 CARTRIDGE

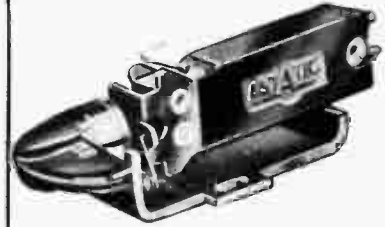

170 Our Lowest Price Ever!

This popular Astatic Cartridge is complete with 2 styli, turnover bracket and knob. To protect your sensitive LP records, the LP needle has a .001 tip; the standard needle for 78 r.p.m. has .003 tips. Long life ceramic element is practically impervious to humidity and heat. 7 PK-41 Net 1.70



DIAMOND NEEDLES Our Lowest Price Ever!

119

PRICE IN EFFECT THROUGH MARCH 15, 1965

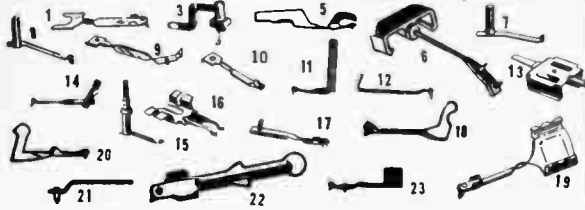

KEY TO POINT CODES HOW TO ORDER

THE SYMBOLS IN THE COLUMN HEAD "PT. SIZE" are as follows: D1—1 MIL DIAMOND, D.7—7 MIL DIAMOND, D1—S3—1 MIL DIAMOND AND 3 MIL SYNTHETIC SAPPHIRE, D.7—S3—7 MIL DIAMOND AND 3 MIL SYNTHETIC SAPPHIRE.

| Stock No. | Fig. | Pt. Size | Fit Cartridge No. |
|-----------|------|----------|--|
| 24 K 0179 | 1 | D1 | All RONETTE Monaural; ASTATIC; BSR; MAGNAVOX |
| 24 K 0158 | 1 | D.7 | BSR—TC-8S, H-series; ASTATIC 70, 80; series |
| 24 K 0123 | 3 | D1-S3 | ASTATIC 57—T series |
| 24 K 0124 | 3 | D1-S3 | ASTATIC GCD, 409, 55—T series |
| 24 K 0156 | 5 | D.7 | COLUMBIA SC-1-2-7-8 |
| 24 K 0170 | 6 | D.7-S3 | ELAC-MIROTWIN KST-104 series; PE-182 series |
| 24 K 0129 | 7 | D.7 | ASTATIC 64, 66, 68, 94, 405, 406 series |
| 24 K 0121 | 8 | D1 | ASTATIC AC series 40, 41, 42, 90T series RCA 76257, (988370-2) |
| 24 K 0169 | 6 | D.7-S3 | ELAC-MIROTWIN KST-100, PE-180 |
| 24 K 0148 | 9 | D1-S3 | TELEFUNKEN T7SA |
| 24 K 0150 | 10 | D1 | WEBSTER ELECTRIC A-100, B-100 series A-200, B-200 series |
| 24 K 0149 | 11 | D1 | WEBSTER ELECTRIC AISM, A12M-1 A1 thru A-11 |
| 24 K 0126 | 12 | D1 | RCA 74984, 76297, SONOTONE 7590—LB—1S |
| 24 K 0145 | 13 | D1 | RONETTE TX-88, A |
| 24 K 0120 | 14 | D1 | ADMIRAL 409 A30, ASTATIC CAC-D, LQD, 44-TB, 44-2, 46-2 and 62TY |
| 24 K 0125 | 15 | D1 | RCA 74625, 75575 |
| 24 K 0118 | 16 | D1-S3 | ADMIRAL 409B20, MAGNAVOX 560177 560188-1 series, SHURE ML-44 series |
| 24 K 0122 | 15 | D1 | ASTATIC 408, 410L series, RCA 74067 |
| 24 K 0133 | 17 | D1 | GARRARD GC 2PA |
| 24 K 0100 | 18 | D1 | NORELCO AG 1003, 3003, 3010, 3012, 3013, 3015, 3109, 3113, and 3114 |
| 24 K 0101 | 19 | D1 | VACO T-45, S-45 |
| 24 K 0102 | 20 | D1 | NORELCO AG-3016-D, AG-3019 |
| 24 K 0103 | 21 | D1 | SHURE PC 42AD, W-72 ADMIRAL 409 B 19-8 |
| 24 K 0104 | 22 | D1 | ACOS GP-37, 1-3 HGP 37-1-1C |
| 24 K 0105 | 23 | D1-S3 | UNITED AUDIO CDS—2, 3, 3/4, 3/24, and CNS-3 |

PIONEER STEREOSCOPE

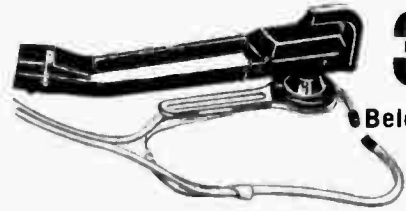

395

Below Cost!

- Attaches in Minutes
- Frequency Response—30-15,000 CPS
- Comes complete with one head set—up to 4 people can listen by adding accessory earphones!

Listen to your stereo records as you've never heard them before—without amplifier or speaker—no electronic devices of any sort between your ear and the record. A separate volume control for each channel and a mixing control to govern channel separation (from full stereo to monaural operation). Accessory earphone kits permit as many as 4 persons to enjoy the same recording. Easily mounted on virtually any turntable. Complete with special pick-up arm, sapphire needle, earphones and mounting hardware. Shpg. wt., 4 lbs. Imported.

7 PK-596 SH-100 Stereo Scope Net 3.95
7 PK-597 SH-101 Additional earphone Kit Net .95

BENDIX RADIATION MEASUREMENT SET



BELOW COST! **1395**

- Simple To Use
- Direct Reading
- Pocket Size
- Rugged—Reliable—Portable

Certified by Bendix to Meet or Exceed Office of Civil Defense Mobilization Specifications.

The Ratemeter measures the amount of radiation at a given moment. There are two scales: one calibrated from 0-120 r/hr for reading one minute after exposure; the second calibrated from 0-12 r/hr for reading 10 minutes after exposure should the first reading be below 10 r/hr. The Ratemeter may also be used in industry for determining protection in any isotope program. The Dosimeter records total radiation exposure and is calibrated from 0-600 roentgens. Charger resets scales to zero.

7 TE-666 Complete Set. Shpg. wt., 5 lbs. Net 13.95

QUANTITIES LIMITED — ORDER NOW

"TRANSOTHERM" PRECISION ELECTRONIC CLINICAL THERMOMETER

- Direct Reading—Large Easy-to-Read Dial
- Portable—Use It Anywhere • Unbreakable Corrosion Resistant Stainless Steel Probe
- Teflon[®] Insulated Cable • Light Weight—Only 4½ oz.
- Accurate to ± 1% • Battery powered

Below Cost!

24⁹⁵

Made In U.S.A.

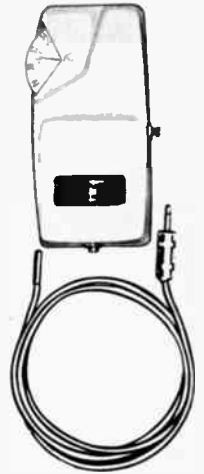

An advanced space age device which is infinitely superior to ordinary glass or metal thermometers and rivals similar units costing two to five times as much. The perfect temperature instrument for a variety of industrial and laboratory uses such as viscosity, calorimetric, distillations, cloud chambers, etc. Gives accurate readings in less time than it takes you to read this paragraph! The fantastic accuracy of ±1% is achieved through its 94° to 108°F range by individually calibrating each probe during manufacture. The non-corrosive stainless steel probe is integrally attached to a highly flexible teflon cable. This construction makes the cable inert to almost all chemicals and solvents except molten alkali metals and fluorine at certain elevated temperatures. Readings are unaffected by vibration which is useful with checking stirrers of blowers. Unlike other electronic thermometers, the accuracy of the Transotherm is not affected by battery fatigue or meter precision eliminating the need for periodic recalibration or battery replacement. Fully contained in rugged, hi-impact plastic case. Size: 4¾x2¼x1¼". Includes compartmented case and instructions. Shpg. wt., 3¼ lbs. 7F-824L Clinical Thermometer 94-108°F..... Net 24.95

SELENIUM RECTIFIER

Below Cost!

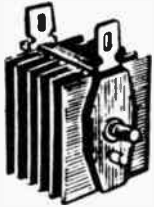

29¢

RCA—FEDERAL and other famous brands

All Rated 130 VAC

| | | |
|-----------|------|----------|
| Stock No. | Mils | Net Each |
| 7SP-211 | 300 | .29 |

MINIATURE VOLUME CONTROL

15¢ Each

Below Cost!

10 for 99¢



¾" diameter, overall depth only 0.4". 0-3 meg., audio taper, threaded shaft.
7VC-20 Net ea. .15
10 for .99

3-WAY SWITCH-O-LET

- 3-Way Surface Outlet With Built-in Switching!

26¢

Below Cost!



Unique mechanical design permits individual control of each of 3 outlets. Designed as a standard 3-way surface outlet—each individual receptacle switches on and off by means of a ½ turn. Positive contact and spring action maintained by phosphor bronze contact strips. Ideal as a "bench" outlet—built-in safety—prevents tampering. Sturdy "stop" prevents damage from excessive torque. Mounts easily on bench or wall. Can be used to terminate an extension cord. Rated 20A. at 125V. Shpg. wt., 5 ozs. Imported.
7EL-91 Net .26

2-in-1 EYELET TOOL

PUNCHES HOLE—SETS EYELET AT SAME TIME

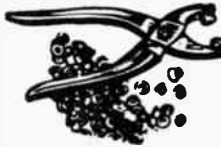

Below Cost!

39¢

Punches holes and sets eyelets in fabric—canvas—leather—paper. Use it on belts, shoes, sneakers, tarpaulin, luggage, sports equipment, flags, banners, shower curtains. Complete with 300 assorted eyelets and instruction. Wt., 1 lb. Imported
7HD-668 Net .39
7HD-669 Pkg. of 300 Eyelets Net .09

KIT OF 10 PHONO PLUGS

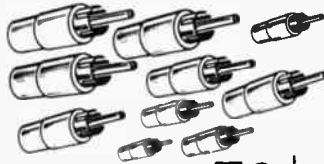

OUR LOWEST PRICE EVER! 79¢

Kit contains 10 RCA-type phono plugs in assorted colors—Black, Red, Yellow, Blue, and White. Plastic shell with finger grip. Plugs are semi-solderless type—need only spot solder at tip. Fit standard RCA type phono jacks. Imported. Shpg. wt., 2 oz.
99 K 6327 Net .79

4 TOP HAT SILICON RECTIFIERS

750 Mil 100 PIV



Below Cost!

43¢

Package of 4 top-hat axial lead silicon rectifiers rated 750 milliamps, 100 Peak Inverse Volts. Shpg. wt., 6 oz.
7SP-276 Net .43

RADIO/WALKIE-TALKIE EARPHONE



our lowest price ever!

only 35¢

Enjoy private listening—Fits most transistor radios and walkie-talkies. Imported
7 MS-970 Net .35

WOODWORKERS VISE

Below Cost!

1 19



A fine, practical tool for the small shop-home-farm or garage. Guides are of finely machined cold rolled steel. Gray iron jaws—face ground and finished. 5/8" diameter screw—6 thread per inch. Shpg. wt., 6 lbs. Imported.
7HD-182 Net 1.19

QUANTITIES LIMITED — ORDER NOW

CINE "X" METER Below Cost! 2.99



- Mounts on Turret
- Fast, Easy Direct Reading
- Accurate, Versatile, Compact Imported

7F-499L Shgp. wt., 8 oz. Net 2.99

AIREQUIPT VARI-MOUNT PLASTIC MAGAZINE

Our Lowest Price Ever 99¢



Economy magazine accepts all slide mounts up to 1/8" thickness. Non-spill.

7 F-908

Net each .99

AIREQUIPT "SPRITE" PROJECTOR AND TABLE SET

You get a superb 35mm projector plus a matching fold-a-way projection table at a single low price.



29.95

Our Lowest Price Ever



- Bright 300 Watt Output
- 4-inch F/3.5 Coated Lens

A compact semi-automatic projector for your favorite 35 mm or 2x2 slides. Push-pull movement picks, shows and replaces 36 slides in sequence. Features 4" F/3.5 color-corrected lens, thumb-wheel focus and elevate adjustments. 300-watt lamp fills a 30x40" screen at only 8 ft. Accepts both Airequipt metal or Vari-Mount plastic magazines. Grey and black. With cover and magazine. 10 1/2 x 7 1/4 x 7 1/2" H. For 117 Volts, 60 cycles. Matching projection table holds sprite steady for better viewing. Takes up no more room than projector itself. Chrome plated legs.

7 FA-54WM Shgp. wt., 25 lbs.

Net 29.95

LAFAYETTE TV/FM 4-SET POWER BOOSTER

was 9.95
Cat. 640, 1964

NOW 7.95



- Boost Signal For Up To 4 TV Sets
- Ideal for Master "Home" Installation
- Equally Useful in Primary and Fringe Areas
- Electro-Matched to Lafayette TV-FM Antennas
- Updates and improves any TV/FM Antenna Installation

Provides a stronger TV or FM signal for up to 4 sets anywhere in the home. Low-Noise, High-Output amplifier boosts and distributes the signal over ordinary twin lead. Special isolation circuitry prevents interaction and interference between sets. Provides as much as 7 to 10 db gain on all channels 2 through 13 when used with one TV set. From 2.5 to 5 db when used with 2 sets. Requires no tuning. Installs with just a screwdriver. Uses ordinary twin lead to "antenna-matched" terminals. Mounts behind set—or in any convenient location. Measures 5 3/4 x 3 3/8 x 1 1/4". For 117 volts, 60 cps AC. Imported

7 TL-75 Shgp. wt., 2 lbs.

Net 7.95

"MIRASCREEN" for 35MM PROJECTORS

Below Cost! 23.50

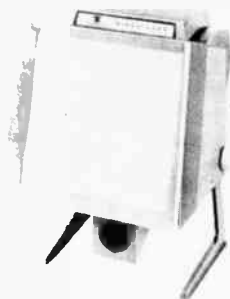

- Projects as Bright in Daylight as in a Dark Room
- Home — Office — On the Road
- Big 9"x9" Picture

The "Mirascreen" gives you a bright, sharp picture from your 35MM slides at any time—projects as bright in a sunlit room as in a dark room needed with a regular screen. Specially-treated, 9x9" glass screen makes it ideal for group viewing—like watching television. Can be used with any 35MM projector—automatic, semi-automatic and manual. Uses full 500-watt projection brilliance. Handles slide trays and singles too. Ideal for editing. Shgp. wt., 5 lbs.

7 F-895

Net 23.50

LAFAYETTE AUXILIARY PA SPEAKER



Below Cost! 5.49

- Ideal for Outdoor Use
- Excellent as a Paging Speaker

Specially designed speaker and housing for superior voice reproduction. Versatile mounting base, easily installs on any flat surface. Excellent as a paging speaker or extension speaker. Gray and finished chrome color combination matches most modern equipment. Frequency response 150 to 10,000 cps. Rapid drop beyond cut-off point. Perfect for mobile installations. Input impedance 4 ohms. Measures 5 1/4 dia. x 5 deep x 7" high including base. Shgp. wt., 4 1/2 lbs. Imported.

7 HE-13

Net 5.49

8" TRIGONOMETRIC SLIDE RULE

Was 1.95 Cat. 640, 1964

Now 1.25



Laminated, selected bamboo. Face of white plastic with engraved, accurate calibrations. Satin-finished facing provides a high readability, virtually glare-free face. Scales are A, B, C1, C, D, and K on one face—S, L, and T on reverse of slide. Table of formulae and equivalents printed on metal back. C scale has convenient conversion marks for changing degrees to radians, and for calculations involving areas of circles. Shgp. wt., 8 oz. Imported

7 F-361 8" Trig Slide Rule

Net 1.25

Interested in Electronics?
The Ideal Gift For Young and Old!
LAFAYETTE "EXPLOR-AIR"™
4-BAND RECEIVER KIT

• 4 Bands for Total Coverage

22⁹⁵

550KC—1600KC 1650KC—5.5MC
5.5MC—16MC 16MC—30MC
• Covers 10, 15, 20, 40, 80, 160
Meter Amateur Bands • Tunes
International Broadcast, Citizens
Band, Maritime, Aeronautical and
WWV Time Signals • Complete
Band Switching from Front Panel
• Bandspeed Tuning • Built-
in 4" Speaker.



MADE IN U.S.A.

TUNE IN
THE
WORLD!

Lafayette's sensational shortwave receiver kit is a complete shortwave and standard broadcast set which covers the entire region from 550 kilocycles to 30 megacycles. Four whole bands of fascinating programming. Perfect for language students and shortwave listeners.

Only a regenerative circuit can offer such amazing performance and yet be so simple to build. Building this fine kit is an absolute pleasure—it's so well designed you can't go wrong. Kit includes all the parts you need, and the detailed step-by-step instruction book with its giant pictorial drawings shows you just how to put them together. One front panel knob does all the bandswitching, immediately taking you from band to band. All

coils are prewound for greater accuracy. Complete 4 band coverage of broadcast stations, international broadcast bands, amateur, maritime, and WWV time signals. Big 4" speaker and sensitive circuit with 50C5 output stage and 12AT7 regenerative detector and amplifier stages give you all the volume you want. Phone jack for privacy automatically disconnects speaker. All controls are on the front panel: On-Off Volume, Main Tuning, Band Spread, Bandswitch, Antenna Tuning, and Regeneration. 110 volt 50-60 cycle AC-DC power supply. Size: 10x7x5".

19 K 0905 (Less Cabinet) wt., 5 lbs. 22.95
Leatherette covered Wooden Cabinet for above. 1 lb.
19 K 0906 Net 2.85

**ANALOG
COMPUTER KIT**

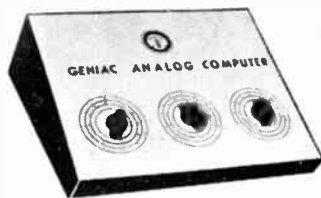

9⁹⁵

- Ideal Introduction to Basic Elements of Analog Computers
- Work Over 50 Experiments
- Easy-to-Assemble with Screwdriver and Pliers
- Learn the Way to Sound Scientific Knowledge

The latest Analog Computer Kit offering a basic introduction to computer theory—gives accurate answers to practical problems. Perform over 50 experiments—multiplication, division, powers, square roots, rocketry, interest, radioactive decay, light, kinetic energy, etc. Level of accuracy better than 5%. The computer consists of a masonite, solid instrument panel, kits, potentiometers, meter, specially calibrated scales, guide and operating booklet. Easy-to-assemble. 19 K 3805 Shpg. wt., 6 lbs. Net 9.95

BASIC EDUCATIONAL COMPUTER KITS

**GENIAC PORTABLE
MEMORY CARD FILE**

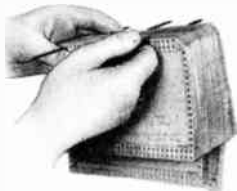

How to file a card in 25 places simultaneously.

only **17⁹⁶**

For the busy scientist, engineer, teacher, businessman or student who must keep basic information on file. NOW the Geniac Portable Memory Unit, (PMU), a low cost information retrieval system can conservatively sort 400 cards per minute—using no electrical parts or gadgets. Sorting is by rods. Information is coded into the cards by matching prepunched holes around the edge of the card. No previous knowledge is necessary. Once coded the card is filed at random and will automatically appear during sorts for the various categories. Serves as a useful adjunct to company integrated information systems. The basic PMU contains a matching hand punch, sorting rods and 300 cards.
19 K 3801 Shpg. wt., 6 lbs. Net 17.98
Additional Cards, pkg. of 100
19 K 3802 Net 3.92

GENIAC® COMPUTER KITS



Over 800 Parts For Schools,
For Science Fairs, For
Advanced Experimenters

- COMPUTES, REASONS, PLAYS GAMES
- COMPOSES MUSIC, FORECASTS WEATHER
- DESIGN YOUR OWN COMPUTERS
- OVER 400 PARTS AND COMPONENTS

DOUBLE GENIAC

The newest kit in famous Geniac® series! The "Double" Geniac contains over 800 parts. Two of everything in the Standard model. Offers the advanced experimenter a far wider range of activities. Perfect for school demonstration. Multiple setup is ideal for Science Fair projects—submit one or more designs. Build "electric trains" that test intelligence—code and decode—add,

subtract, multiply and divide—solve puzzles—play games—forecast weather—reason in syllogisms—information and logic circuits. No soldering required. Easily assembled and operated. 64 page guide and reference book, beginners manual, wiring diagrams and many extra pamphlets outlining projects and methods. Complete with mounting rack and batteries. Shpg. wt., 12 lbs.
19 K 3803 Net 15.95

STANDARD GENIAC

You build up to 125 exciting "electric brain" machines. Has special circuits for forecasting weather. No soldering required. Comes complete with extra pamphlets including 64-page "Simple Electronic Brains and How To

Make Them," "Symbolic Analysis of Relay and Switching Circuits," "Beginner's Manual, Machine to Compose Music. Wiring Diagrams, etc. Complete with battery. 16 1/2 x 11 1/4". Shpg. wt., 6 lbs.
19 K 3804 Net 9.95

LAFAYETTE KITS EASY-TO-BUILD-ENJOYABLE-TO-USE

LAFAYETTE KT-92 5-WATT PUSH-PULL AMPLIFIER KIT

10⁹⁵

Made in U.S.A.

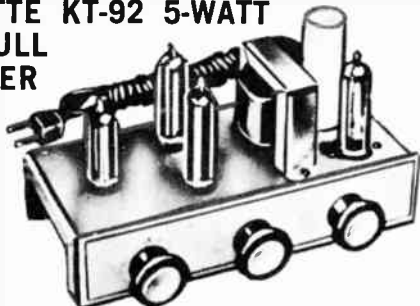

- Push-Pull Audio Output Stage • Inverse Feedback Circuit
- Separate Volume, Bass & Treble Controls • AC or DC Operation

Here in kit form is an AC-DC hi-fi amplifier that presents deluxe features despite its amazingly low price. The separate bass and treble controls permit adjustment of both low and high frequency response and balance. Works equally well with both crystal or ceramic cartridges. Tube line-up consists of a 12AX7 amplifier and phase inverter, a pair of 35C5's in push-pull, having a power-packed low-distortion output plus a 35W4 rectifier. The circuit utilizes an inverse feedback loop to reduce the level of hum and distortion. Kit is complete containing all essential parts, tubes and detailed instruction manual showing pictorial and schematic diagrams. Shpg. wt., 4 lbs.

19 K 0101 Net 10.95

COMPLETE MONAURAL PHONO SYSTEM KIT



LAFAYETTE
ENSIGN

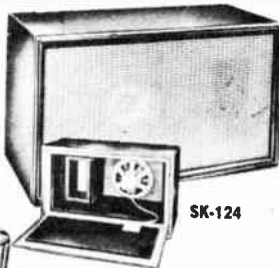

SK-124

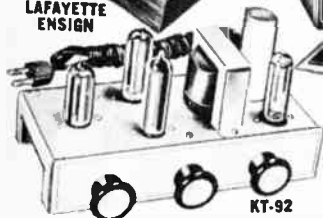

KT-92

47⁵⁰

\$5 monthly

For those who prefer a monaural system, this package consists of the Lafayette KT-92 push-pull amplifier kit, the Lafayette-Ensign 4-speed automatic record changer complete with stereo-monoaural cartridge and the Lafayette SK-124 2-way speaker system. When ordering specify mahogany or walnut finish, less base. Shpg. wt., 28 lbs.

21 K 9797WX Net 47.50
24 K 0107 Walnut Base for changer Net 3.95
24 K 0108 Mahogany Base for changer Net 3.95

FM-AM TUNER KIT

- Pre-wired and Pre-aligned Front End,
- Automatic Frequency Control



\$5 monthly **36⁹⁵**

12-WATT HI-FI AMPLIFIER KIT with BUILT-IN PRE-AMPLIFIER

ONLY

19⁵⁰

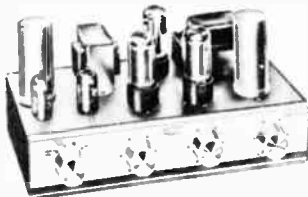

FEATURES: Separate full-range bass boost and controls. 4, 8 and 16 ohms speaker output. Amplifier, pre-amplifier and power supply on single open pre-punched chassis for the easiest construction. 4 input connections located at rear of chassis for magnetic phono or tape, crystal phono, tuner/radio, and mike or auxiliary. Self-balance phase inverter system and full range tone control amplifier. Inverse feedback circuit. Removable front panel for professional appearance in custom installations. Amplifier can be used with electric guitar, etc., or in a Public Address System. Frequency Response: 1 db 20 to 20,000 cycles; Distortion: 1% at rated output; Hum: Tuner/Crystal Phono 80 db below 12 watts; Magnetic Phono/Tape 60 db below 12 watts. Sensitivity: Magnetic Phono/Tape 3mv. Crystal Phono 0.5 volt. Tuner/Radio 0.5 volt. 4 Controls: Function, Loudness, Bass, Treble/Power Switch; Tube Complement: 12AX7/ECC83 Preamp; 12AT7 Phase Inverter; Tone Control Amplifier; 2-6V6 Push-pull Beam Power Amplifier; 1 Rectifier. Complete with 24-page instruction book complete with diagrams, illustrations and step-by-step construction details. Baked Hammertone. Golden Brown Finish Chassis. 11Wx7Dx 5"H. Power Consumption 55 watts; 117 VAC; 50-60 cycles.

19 K 0102 Shpg. wt., 11 lbs. Net 19.50

19 K 4004 Cover for above. Shpg. wt., 3 lbs. Net 3.95

STEREO 30-WATT WILLIAMSON TYPE DUAL AMPLIFIER/PREAMPLIFIER KIT

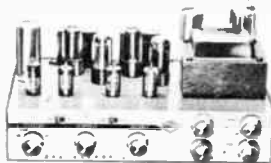

- A Complete Stereo Control Center • 15 Watts Each Channel, 30 Watts Monaural • Easy To Build

only **36⁵⁰**
\$5 monthly

A Stereophonic 30-Watt Williamson Type Dual Amplifier/Preamplifier Kit. **FEATURES:** Stereo Inputs for Tape/Low Level Phono, High Level Phono, FM/AM Tuner, High Level Tape/Auxiliary. Dual tape outputs, Output Impedances: 4, 8 and 16 ohms. 3rd channel output. Equalization: (Tape) NAB; (Phono) RIAA. Separate full-range bass boost and treble controls for each channel. Frequency Response: ± 1 db 20 to 20,000 cps. Distortion: Less than 1% harmonic distortion. Hum: Tuner/Hi Phono/Aux. 70 db below 15 watts; Low Phono 60 db below 15 watts; Tape 55 db below 15 watts. 9 Front Panel Controls: Function, Loudness, Balance, Treble A/Off, Treble B, Bass A, Bass B, Equalization, Mode. Tubes: 2-12AX7/ECC83, 2-12AT7/ECC81, 4-7408, 1-5U4. Operates on 117 volts, 50-60 cps AC. Baked Hammertone, Golden Brown Finish Chassis. Complete with "Foolproof" instruction book having diagrams, illustrations and step-by-step construction details. Size: 15Wx6Hx8"D. Shpg. wt., 18 lbs.

19 K 0103 Net 36.50

19 K 4005 Cover for above. Shpg. wt., 3 lbs. Net 3.95

Features smooth counter-weight tuning with built in AFC defeat switch, advanced AFC circuitry that prevents drift as it locks in your station after selection, and special temperature-compensated oscillator circuit as additional aid in preventing drift. The powerful 7 tube circuit Plus Selenium Rectifier has an Armstrong FM Circuit . . . with ratio detector, and a low noise FM pre-wired and pre-aligned front end, and offers a 20-20,000 cps. response. The AM section features a Superheterodyne Circuit with AVC and a powerful Ferrite Loopstick Antenna with multiplex stereo output jack. **SPECIFICATIONS:** Frequency response: FM $\pm 1/2$ db. 20-20,000 cps. FM drift ± 5 KC Maximum. Sensitivity: FM 5 μ v for 30 db. Quieting: AM 25 μ v. Distortion: Less than 1% on FM. Hum Level: 60 db. Controls (2): Off-AM-FM, tuning with AFC incorporated. Power Drain: 30 watts at 105-125 volts AC. Size: 12" wide — 6" deep. Shpg. wt., 15 lbs. Front panel finish: Mahogany, Ivory, and Gold. **TUBE COMPLEMENT:** 1-6BE6, 1-6BA6, 2-ECC85, 1-6AL5, 2-6AU6, 1-rectifier.

19 K 4002W Net 36.95

19 K 4006 Cover for FM-AM Tuner. Shpg. wt., 3 lbs. Net 5.95

FM TUNER KIT

Same as FM-AM Tuner Kit less AM circuitry and less 6BE6. Shpg. wt., 10 lbs.

19 K 4003W Net 29.95

19 K 4006 Cover for FM Tuner Kit. Shpg. wt., 3 lbs. Net 5.95

Take Advantage of Lafayette's Low Kit Prices.

LAFAYETTE EASY TO BUILD EDUCATIONAL KITS

20-IN-1 TRANSISTOR EXPERIMENTERS KIT

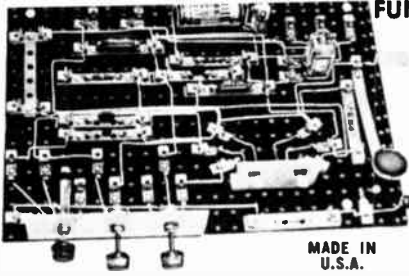

MADE IN U.S.A.

FUN TO BUILD—EDUCATIONAL—
and ALL 20 projects result in
a useful working instrument!

16⁹⁵

PROJECTS YOU BUILD

1. TRANSISTOR TESTER
2. VOICE ACTUATED ALARM
3. PHOTO TIMER
4. AUDIO AMPLIFIER
5. CRYSTAL SET
6. SOLAR RADIO
7. RAIN ALARM
8. TIMER
9. ONE TRANSISTOR RECEIVER
10. CODE PRACTICE OSCILLATOR

11. METROPHONE
12. TWO TRANSISTOR RECEIVER
13. ELECTRONIC RELAY
14. HOME BROADCASTER
15. PHOTO ELECTRIC RELAY
16. BURGLAR ALARM
17. WIRELESS TRANSMITTER
18. MEGENERATIVE RECEIVER
19. CITIZENS BAND MONITOR
20. AUDIO OSCILLATOR

Excellent for beginners as well as advanced experimenters, this kit enables you to build and learn about 20 interesting and useful transistor circuits. By utilizing "Breadboard" construction, each project can be simply wired and traced. After building the basic circuit, any of the 20 projects can be built by simply inserting a few preassembled component blocks and interconnecting leads between them. A soldering iron is only required for the basic wiring and not for subsequent projects. All wiring is covered in a step-by-step manner by the instruction manual. Each of the 20 projects is clearly presented with step-by-step instructions, large easy-to-read pictorial wiring diagrams, schematic diagrams, and an explanation of the circuit behavior. The kit is complete with perforated mounting board, 2-transistors, 1-diode, earphone, and all other parts required for construction. The detailed 28-page instruction manual contains a wealth of information about each project. Less batteries and tools.

| | |
|---|-----------|
| 19 K 0902 Complete. Shpg. wt., 6 lbs. | Net 16.95 |
| 32 K 4802 Z Cell Battery for Kit projects | Net .13 |
| 32 K 4723 22½ Volt Battery for Kit projects | Net 1.61 |

SHORTWAVE AND SUPERHET BROADCAST RADIO KIT



17⁹⁵

2 bands cover both standard broadcast 540-1700 KC and shortwave 5.8-18 MC which includes international broadcast, 40 and 20-meter ham bands and some of the aeronautical and marine bands. Superheterodyne circuit has high gain IF's, built-in broadcast band loop antenna. Comes complete with walnut cabinet, 4" PM speaker, tubes (12SA7, 12SK7, 12SQ7, 50L6 plus 35Z5 rectifier) and all parts. Easy to follow step-by-step instructions. Shortwave band requires external antenna (not supplied). Size 9¾x6x5½" D. For 110V AC or DC. Shpg. wt., 6 lbs.

19 K 4001 Net 17.95

LAFAYETTE WIRELESS BROADCAST/AMPLIFIER KIT



12²⁵

Use it either as a

Wireless Broadcaster or AM Audio Amplifier!

- CLEAN, MODERN STYLING • POWERFUL SIGNAL
- WORKS WITH ALL CRYSTAL AND MAGNETIC MIKES AND PHONO CARTRIDGES
- PLAYS THROUGH ALL AM RADIOS

Treat yourself and your family to hours of fun with this Lafayette Kit. Make your own radio programs, announcements, etc., through AM radios anywhere in the house, without wires or extra gadgets. Designed for easy construction by youngsters or adults, it combines in one compact unit a powerful 3-tube wireless broadcaster and an audio amplifier. Clearly written instruction manual makes it a cinch to build. Operates on any frequency between 900 and 1600 kilocycles on your radio dial. It will accept any crystal or magnetic microphone. In addition, it may be used directly as a phono or microphone amplifier. No external preamp is required. Simple slide switch permits either form of operation. Just connect it to a PM speaker (4-16 ohms). Conforms to FCC regulations and is designed to provide high quality voice or record broadcasts.

No license or permit is necessary. Complete with crystal clear instruction manual. Less Mike. For 105-125V AC or DC. Attractively styled metal cabinet. Size 4Hx8Wx4¾" D. Shpg.

19 K 0903 Net 12.25

Same as above, but factory wired & tested

19 K 0908 Net 14.95

Crystal microphone for above, Desk or hand held. 8 ft. cable. Shpg. wt., 1 lb.

99 K 4503 Net 2.95

LAFAYETTE SUPER-SENSITIVE PHOTOCELL ELECTRONIC RELAY KIT



Made in U.S.A.

12⁹⁵

- WITH CLAIREX CADMIUM SULPHIDE PHOTOCELL • ADJUSTABLE SUPER SENSITIVITY—WORKS WITH JUST A FLASHLIGHT AT 250 FEET!
- NEEDS NO SPECIAL HIGH-INTENSITY LIGHTS • INSTANTANEOUS OR SUSTAINED OPERATION ON THE FLIP OF A SWITCH!

Ideal for sustained operation required for burglar alarms, door buzzers and for instantaneous on-off operation required for counters, packaging, door opening, motor activation plus countless industrial applications. Switch converts unit from instantaneous "on-off" to sustained "on" operation. "RESET" switch opens the external circuit and turns off the alarm. The unit operates on 110 volts AC and incorporates the efficient 5823 cold cathode tube. A simple change in wiring (in instructions), as well as convenient input terminals, enables you to supply the external circuit with any desired voltage. Relay contacts rated at 3 amps permitting up to 300 watts external load on 110 Volts AC. Complete with all parts, photocell, tube chassis, silkscreened metal cabinet and easy-to-follow illustrated instructions. Size: 3x4x5". Shpg. wt., 3 lbs.

ACCESSORIES FOR ABOVE

| | |
|--|-----------|
| 19 K 0904 Complete Kit | Net 12.95 |
| 99 K 9023 Electric Bell, 110V AC. Shpg. wt., 2 oz. | Net 1.49 |
| 99 K 9024 Electric Buzzer, 110V AC. Shpg. wt., 10 oz. | Net 1.29 |
| 99 K 9011 6-Digit Electric Counter. Shpg. wt., 1½ lbs. | Net 9.95 |

LIGHT SOURCE

FOR ELECTRONIC RELAY KIT



- COMPLETELY WIRED
- INCLUDES RED FILTER

7⁵⁰

Completely wired and assembled light source with AC line cord and plug. Will actuate the relay at 70 feet w/o red filter, up to 30 feet with red filter. Removable red filter makes light beam invisible by day and very difficult to detect at night. Metal case. Size: 5¼x3x4". For 110V 60 cycle AC. Shpg. wt., 4 lbs. Imported.

99 K 9026 Net 7.50

Replacement Bulb for above.

99 K 9027 Net .21

All Prices and Specifications Subject to Change Without Notice

Lafayette Cat. No. 652 85

"WINDICATOR"™ ANEMOMETER



48⁹⁵

\$S monthly

- Wind Direction and Velocity on One Dial
- Indicates Velocity from 0 to 100 mph
- New "Gyro" Design Starting Speed 5 mph
- Accuracy for Speed $\pm 5\%$

A precision velocity/direction system designed to register wind velocity and direction on a single dial. Completely self contained—no outside power source is required. The transmitter assembly may be mounted on any suitable elevated position. Utilizes any 1 1/4" O.D. pipe or mast. Indicating unit can be wall mounted or set on a desk. The indicator is housed in a handsome wooden cabinet. 5 1/2 x 2 1/2 x 7 7/8", finished in black and gold. Highly legible dial face 4 1/2 x 3 1/2". Two scales for speed, 0 to 25 M.P.H. and 0 to 100 M.P.H. plus third scale for direction. Outdoor parts of aluminum and specially treated steel. Self contained battery—no drain except when reading wind direction. Simple installation. New "Gyro" design for maximum stability and minimum wind loading. Complete with 60 ft. of 5 conductor, color coded cable, 1 1/2 volt battery and instructions. Shpg. wt., 15 lbs. Imported.

99 K 9007WX Net 48.95
 Wired for extended runs. 5 conductor, color coded cable.
 32 K 9001 Shpg. wt., 2 1/2 lbs. Net per 100 ft. 4.70

LAFAYETTE AUTOMATIC PHOTO-ELECTRIC 'LUMINATOR'

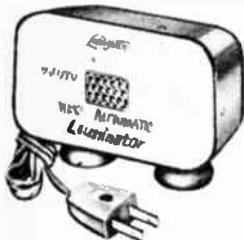

- Automatic Light Switch
- Lights on at sunset—off at sunrise

Photo-electronic, light-sensitive switch turns lights on and off at dusk and dawn. Better than a clock—no setting and re-setting of timer. Variance in "on-off" cycle adds extra protection when away from home. You need never come home to a darkened house. The controlled lamps go on as darkness falls—stay on until sufficient day light returns or until manually turned off. Just plug it in for protection from prowlers—to turn on night lights—illuminate outdoor areas—light up brooders—green houses—displays—show windows—any place you require automatic illumination. Mounts most anywhere on rubber suction cup feet. Unobtrusive—measures only 3 3/4 x 2 1/2 x 2 1/4". Use on 117-volt AC only. Maximum 300 watts lamp load. Instructions included. Shpg. wt., 1 lb. Imported

ONLY 4⁹⁵

99 K 9084 Net 4.95

"THE BIG EAR"



12⁹⁵

- Big 18" Reflector Disk Concentrates Sound Waves Into Transistor Unit Which Amplifies Them Loud and Clear

Powerful new transistorized listening device. Not just a toy—works on the same principle as the fabulous Missile Tracking Antennas. Pick up sounds too distant for you to hear. Make your own wildlife recordings or carry on long range 2-way communications (using a "Bull Horn"). Ideal for experimenters, etc. Complete with sturdy tripod and stethoscope-type earphones. Uses one 9V Battery (not supplied). Shpg. wt., 5 lbs.

13 K 2510W Net 12.95
 99 K 6021 9V Battery for above Net .21

LABORATORY MAGNET KIT



Specially designed for schools, laboratories, and technicians demonstrating the magnetic properties of permanent magnets. Fine hardwood case contains a pair of bar magnets 2" x 1/2" diam., a horse-shoe magnet 1 3/4" high x 1 3/4" x 3/8" deep with 3/8" spacing between poles, and a bridge magnet 3/4" high x 7/8" x 3/4" deep with 1/4" spacing between poles. Shpg. wt., 1 1/2 lbs. Imported from England.

14 K 3301 Net 5.95

MAGIC-GLO BLACK LIGHT TEKNIKIT®

- Learn Invisible Detection
- Write Secret Messages
- Educational—Scientific
- Enjoyable—Interesting

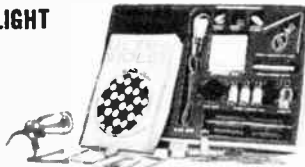

The Black Light Kit enables you to see the invisible. Guaranteed completely safe and harmless. This kit allows children to study the phenomena of fluorescence and phosphorescence. Set contains black light, socket and cord, laboratory lamp stand, 4 jars of fluorescent paint, invisible ink, invisible crayon, tracer powder, 3 fluorescent mineral specimens, phosphorogram, optical bleach, brushes and pen, and a box of fluorescent specimens. Enables the student to perform endless numbers of fascinating experiments. The amply illustrated 48 page booklet "The Story of Black Light—The Unseen World Around Us," explains the use of black light in fields such as mineralogy, electronics, crime detection, medicine, stamp collecting, and many others. Shpg. wt., 4 lbs.

19 K 1301 Net 9.95
 19 K 1302 Replacement U.V. Bulb for above Net 2.70

FLEXI-SHAFT HOBBY TOOL

- Powerful-versatile
- Hi speed—hi torque



Flexible shaft and motor combination for all grinding, polishing, drilling, buffing, and engraving. 1 amp. motor delivers power for continuous use. Light weight finger tip control. 36" flexible shaft is a sealed unit. Chuck accommodates 3/32nd and 1/8th in. tool shanks. 110/120 V AC or DC. Shpg. wt., 3 lbs.

13 K 9008 Net 6.60

NOVATRON

A SCIENTIFIC INSTRUMENT FOR THE EXPERIMENTERS

- POWERFUL 110 VOLT AC/DC MOTOR
- MINIATURE ATOM SMASHER
- PRODUCES 75,000 VOLTS
- ABSOLUTELY SAFE

COMPLETELY WIRED (NOT A KIT)

In no sense of the word a toy or gadget. This machine is a scientific instrument capable of producing 75,000 volts—makes sparks up to 2" long—yet it is absolutely safe because the current is infinitesimal. The science teacher—science lover—or hobbyist can perform experiments to astound students—friends—family. Makes smoke disappear—defy gravity—turns propellers at a distance—transforms atomic energy into light—makes artificial lightning—smashes atoms—demonstrates ionic space ship drive—and many other experiments. Will hold an audience spellbound as it performs trick after amazing trick. Includes an experimental kit and illustrated experiment manual. Manual explains the "how" and "why." You will invent many new experiments of your own. A fine research tool that will give years of beneficial service to the institution or individual who owns one. 110 V. AC or DC, Imported. 99 K 9008 Assembled—Shpg. wt., 4 lbs. Net 12.95



6-PC. MOUNTED STONE SET



Six assorted grinding stones and wheels. Set of mounted grinding points, stones, and wheels. Mounted on 1/8" and 3/32" shafts. An ideal accessory for the flexi-shaft tool. Shpg. wt., 8 oz.

13 K 5001 Net 1.20

SEMICONDUCTOR MODULES — SEMICONDUCTOR SPECIALS



- ALL SOLID STATE • ICE CUBE SIZE
- COMPLETELY WIRED
- SHOCKPROOF • WATERPROOF



PUBLIC ADDRESS AMPLIFIER MODULE

1.98

- Will Drive Any PM Speaker with Carbon Mike; 6 Volt Battery

Fully encapsulated, this module is complete and ready to operate when connected to a carbon mike, battery and speaker. Its frequency response is tailored for excellent speech intelligibility. Can drive a 15 inch speaker at enough volume to carry several hundred yards. Complete with instructions. Size: 1½x1½x¾". Shpg. wt., 8 oz. 19 K 1509 Net 1.98

DUAL FLASHER MODULE (FLIP FLOP)

1.98

Build auto road warning lights, display attention getters, model train grade crossing flasher, etc., with this ingeniously constructed Dual Flasher Module (Flip Flop). Using a 6 volt battery (lantern type) and two #47 pilot light bulbs, this module will alternately flash these bulbs about one hundred times per minute. Size: 1½x1½x¾". 19 K 1510 Shpg. wt., 8 oz. Net 1.98 6 Volt Battery for above 32 K 4818 Net .83 No. 47 lamp (2 req.) ea. Net .10 32 K 7708

2-WATT PHONO AMPLIFIER MODULE

3.45

- Excellent Tonal Quality

A low-cost 2-watt phono amplifier in module form for use with crystal phono cartridges. Needs only a 6 volt battery and any 8 ohm PM speaker to produce far above average volume for listening. One megohm potentiometer recommended for volume control. Excellent tonal quality makes it ideal for use as phonograph amplifier. Very easy to connect—simple instructions included. 19 K 1511 Shpg. wt., 8 oz. Net 3.45

C.B. MICROPHONE PREAMP MODULE

3.50

- More Modulation

Powered by any 1½ volt battery, this tiny ready-to-use preamp will increase C.B. modulation for more dependable communication. Instructions included. Shpg. wt., 8 oz. 19 K 1517 Net 3.50

METRONOME MODULE

1.98

- Low Battery Drain

Complete encapsulated solid state circuit for a modern efficient metronome. Needs only a 6 volt battery, any PM speaker, and a 2 megohm potentiometer for speed control. Produces accurate beat tone at adjustable rates from under 40 to over 208 beats per minute. Low battery drain. Simple connecting instructions and schematic included. 19 K 1512 Shpg. wt., 8 oz. Net 1.98

INTERCOM MODULE

3.50

• Maximum Speech Intelligibility
Just connect two speakers, a battery and a switch to this indestructible, encapsulated, waterproof module for an efficient intercom. Shpg. wt., 8 oz. 19 K 1518 Net 3.50

BABY NURSE MODULE

3.50

• Ultrasensitive
Contains all circuitry for an efficient baby nurse. Will amplify all baby's crib movements and even normal breathing sounds. Shpg. wt., 8 oz. 19 K 1519 Net 3.50

TELEPHONE AMPLIFIER MODULE

3.50

Permits group listening to any phone conversation simply by connecting a battery, speaker and telephone pickup coil. Simple instructions included. Shpg. wt., 8 oz. 19 K 1520 Net 3.50

ELECTRONIC SIREN MODULE

3.50

This module is ready for immediate use as a modern efficient high volume siren. When powered by 6 volts D.C. it will drive any 8 ohm PM speaker to a very high level of attention getting volume with an upward scream and downward wail. Complete with instructions. Shpg. wt., 8 oz. 19 K 1528 Net 3.50

MODEL RAILROAD AND TOY SIREN MODULE

3.50

These modules, when connected to a 6-volt battery and a small P.M. speaker, are designed to reproduce the upward scream and downward wail of police, fire and emergency sirens at a toy volume level. Excellent for model railroad and toy uses. Simple instructions included. Shpg. wt., 8 oz. 19 K 1530 Net 3.50

BURGLAR ALARM MODULE

3.50

This module contains complete electronic circuitry ready for immediate use as a modern efficient burglar alarm with a built-in electronic high volume upward screaming siren as the alarm sounder. Requires 8 ohm PM speaker, one 6-volt battery and 2 switches. Complete with simple instructions. Shpg. wt., 8 oz. 19 K 1529 Net 3.50

CODE OSCILLATOR MODULE

- Matchbook Size
- Drives Any PM Speaker
- Produces Clear CW Note
- Operates on 1½ to 6V



98c

Transistorized code oscillator module ready to connect to your telegraph key, any 1½ to 6 volt battery and any PM speaker. Provides clear tone—ideal for learning Morse code or developing speed in receiving or sending. Produces pleasant room level volume with 1½V battery—volume may be increased by using higher voltage battery up to 6 volts. Simple connecting instructions and schematic included. Shpg. wt., 8 oz. 19 K 1513 Net .98

EXPERIMENTERS' BONANZA!

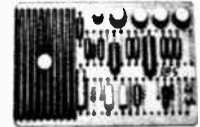

PRINTED CIRCUIT TRANSISTOR COMPONENT BOARDS

Manufactured for Famous Brand Computer

PACKAGE OF 3 BOARDS

CONTAIN
12 TOP BRAND HIGH GRADE TRANSISTORS
MANY 1% TOLERANCE RESISTORS
MANY 5% TOLERANCE RESISTORS
GLASS and MOLOED DIODES

plus
TOP QUALITY, PRECISION TOLERANCE
ASSORTED CAPACITORS.
Each package contains 3 assorted boards.
Each board 3½x2½". Shpg. wt., 8 oz.
19 K 4902 Package of 3 Boards . . . Net .99

SILICON RECTIFIERS



As low as
39c ea.

Top hat lead type silicon rectifiers, excellent for TV Radio and power supplies as half-wave, full wave rectifiers and voltage doublers.

Type A: 750 Ma, 400 PIV @ 25°C.
500 Ma, 400 PIV @ 90°C.
19 K 4209 Shpg. wt., 4 oz. Net .49
100 for 39.50
Type B: 750 Ma, 200 PIV @ 25°C.
500 Ma, 200 PIV @ 90°C.
19 K 4210 Shpg. wt., 4 oz. Net .39
100 for 31.20
Type C: 750 Ma, 700 PIV @ 25°C.
500 Ma, 700 PIV @ 90°C.
19 K 5008 Shpg. wt., 4 oz. Net .59
100 for 47.20

EXPERIMENTER'S AND HOBBYIST'S SPECIALTIES

5-TRANSISTOR PUSH-PULL AUDIO AMPLIFIER

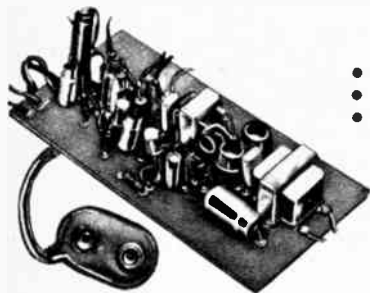

- 360 MW OUTPUT
- COMPLETELY WIRED
- DIRECT WIRING

695

ONLY 3 1/16" x 1 1/16" x 1 1/16"

A more powerful and more sensitive version of the 4-transistor amplifier on right, this amplifier employs 3 stages of audio driving a push-pull output stage. Power output is 360 mw, designed for speakers with a voice coil impedance of 8-11 ohms. Low impedance input has sensitivity of 300 microvolts. Input transformer for matching high impedance to the amplifier input available as an accessory (see below). Comes with leads for low impedance input, speaker, volume control/on-off switch. Battery clips and leads supplied for 9 volt miniature battery (one required). Shpg. wt., 5 oz. Imported.

99 K 9037 Net 6.95

ACCESSORIES FOR ABOVE

99 K 6021 9 volt battery. Shpg. wt., 2 oz. Net .21

10,000 ohm volume control w/switch. Shpg. wt., 2 oz. Net .69

32 K 7364 Net 1.49

99 K 6099 8 ohm 3" speaker. Shpg. wt., 10 oz. Net 1.49

99 K 6036 8 ohm 2" speaker. Shpg. wt., 8 oz. Net 1.49

Input transformer for matching high impedance (mike, etc.) to amplifier. Net .89

99 K 6034 Net .89

4 TRANSISTOR SUBMINIATURE PUSH-PULL AUDIO AMPLIFIER



495

OUTPUT 100-MW

- TERRIFIC FOR THE EXPERIMENTER, HOBBYIST AND KIT BUILDER!
- COMPLETELY WIRED, NOT A KIT!
- PRINTED CIRCUIT BOARD
- COMPLETE WITH TRANSISTORS

A tiny, transistorized push-pull audio amplifier with a multitude of applications. Only 3" x 1 1/16" x 1 1/16", it can be mounted inside other equipment to serve as a subminiature phono amplifier, tape recorder, amplifier, etc. Can be the complement of a homebuilt project which needs only an audio amplifier to make it complete and self-contained. Two stages of audio are followed by a push-pull output stage designed to deliver 100 mw to an 8-11 ohm impedance. Low impedances input, with a sensitivity of 0.9 mv. Input transformer for matching high impedances to the amplifier available as an accessory (see below). Includes leads for input, speaker, and volume control/on-off switch. Battery clips and leads supplied for 9-volt miniature battery (one required). Shpg. wt., 5 oz. Imported.

99 K 9042 Net 4.95

ACCESSORIES FOR ABOVE

99 K 6021 9-volt battery. Shpg. wt., 2 oz. Net .21

50K ohm volume control w/switch. Shpg. wt., 2 oz. Net .69

32 K 7367 Net 1.49

99 K 6099 8 ohm voice coil speaker. Shpg. wt., 10 oz. Net 1.49

99 K 6036 8 ohm voice coil speaker. Shpg. wt., 8 oz. Net 1.49

Input transformer for matching high impedance (mike, etc.) to amplifier. Net .89

99 K 6034 Net .89

4-TRANSISTOR SUBMINIATURE AM/SW TUNER WITH VERNIER TUNING DIAL

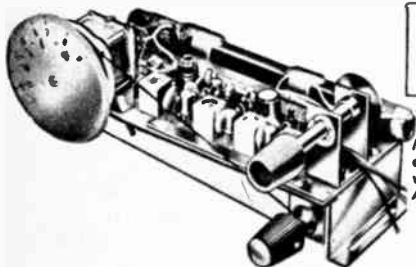

1495

Makes Superb Superhet AM/SW Radio with Any Transistor Audio Amplifier

- 2 Bands—530-1600 KC, 4.5-12 MC
- Completely Wired Printed Circuit Board • 4 Transformers: 3 IF Plus 1 Oscillator, for Fine Superheterodyne Performance

Vernier type tuning mechanism makes precise AM/SW tuning a cinch with this extremely powerful and sensitive 4-transistor tuner. Outstanding features include: completely wired printed circuit board, 3 IF and 1 oscillator transformers for exceptional sensitivity and selectivity, built-in ferrite antenna for both AM & SW reception, superhet circuit with BC & SW band switch. S/N Ratio: 14 db on AM; 20 db on SW. Supplied complete with 3 long leads for connecting to external amplifier and/or to a separate 9v battery (only 3 ma. drain), mounting brackets and operating instructions. Overall Dimensions: 6 1/8" x 3 3/8" x 2 1/4" H. Shpg. wt., 1 lb. Imported.

99 K 9041 Net 14.95

"MITY-AMP" POWERFUL 2-WATT AUDIO AMPLIFIER MODULE

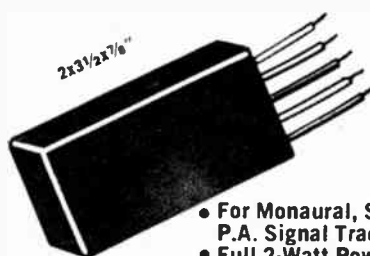

895

- For Monaural, Stereo, Intercom, P.A. Signal Tracer, etc.
- Full 2-Watt Power
- Ruggedly Constructed & Completely Encapsulated

With Applications Booklet and Schematics

Specifically designed to offer compactness, versatility and quality. Adaptable to hundreds of audio applications. Full 2-watt power yet fits in the palm of your hand. Completely encapsulated in high quality epoxy—will not be affected by high humidity or salt content in air: water-proof and shock-proof. Frequency Response: 20 cycles to 15KC ± 2 db at 1 watt. Input Impedance: 45 ohms to 50K ohms; Output Impedance: 3.2 ohms to 45 ohms; Power Requirements: 6 to 12 volts at 300 to 700 ma. Overall 2x3 1/2 x 7/8". Shpg. wt., 10 oz.

19 K 4401 Net 8.95

SPECIALTIES FOR HOBBYIST and EXPERIMENTER

NEW! 1-WATT 4-TRANSISTOR PUSH-PULL AUDIO AMPLIFIER

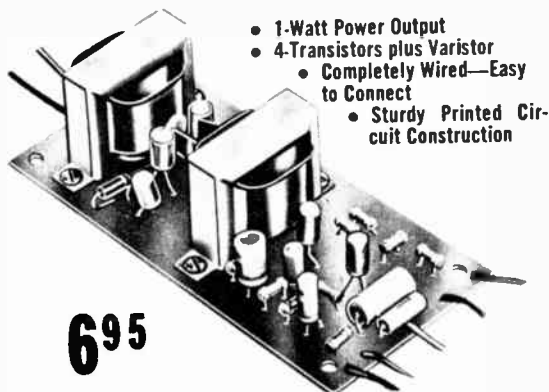

695

- 1-Watt Power Output
- 4-Transistors plus Varistor
- Completely Wired—Easy to Connect
- Sturdy Printed Circuit Construction

Our most powerful miniature amplifier. It has many direct uses in audio frequency applications for tuners, test equipment, etc. Push-pull circuit is very sensitive and has an output of 1-watt! Using only 4 transistors, it requires a 12-volt source supplied by Standard 'D' cells in series. Outputs from record players with magnetic cartridge, tape heads, microphones, etc. (not exceeding 20 millivolts) can be connected directly. Higher output devices may be easily connected with a resistor in series. Components are neatly laid out on a printed circuit board with pre-drilled holes for mounting the entire unit in a vertical or horizontal position. Built-in leads are supplied for a volume control, on-off switch, battery and 8 ohm loudspeaker. Dimensions: 4 7/8" x 1 1/2" x 2 1/4" W. Shpg. wt., 12 ozs. Imported.

| | | |
|--|-----------------------|-------------|
| 99 K 9038 | ACCESSORIES FOR ABOVE | Net 6.95 |
| 32 K 4804 8 "D" Cells Required | | Net ea. .13 |
| 99 K 6019 5K ohm Volume control w/switch. Shpg. wt., 2 oz. Net | | .69 |
| 32 K 2405 Miniature Knob for above | | Net .09 |

3-TRANSISTOR SUBMINIATURE AUDIO AMPLIFIER

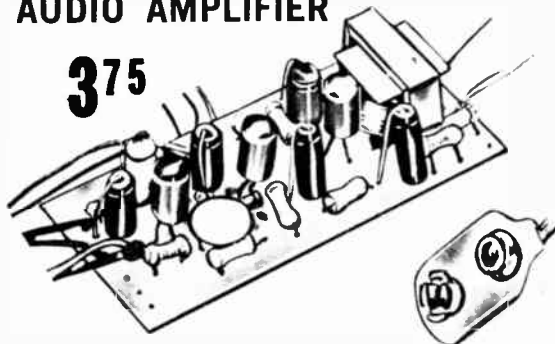

375

- FOR THE EXPERIMENTER, HOBBYIST, AND KIT BUILDER!
- PRINTED CIRCUIT • COMPLETE WITH TRANSISTORS

Here is an amazing little audio amplifier with a multitude of challenging applications: i.e., subminiature phono amplifier, tape recorder amplifier, hand-held public address amplifier, telephone pick-up amplifier, etc. Output sufficient for average listening. Has leads for any one of the following inputs: Tape recorder record/playback heads, radio-tuner, crystal or ceramic phono cartridge, and crystal or ceramic microphone. Has lead terminations for ON-OFF switch, Volume Control, 4 to 10 ohm speaker, and leads terminating in clips for a 9-volt miniature battery. Size: 2 1/8" x 1 1/4" x 3/4". Can be readily mounted on chassis. Shpg. wt., 8 oz. Imported.

| | | |
|---|--|----------|
| 99 K 9039 | | Net 3.75 |
| 99 K 6021 9-Volt Battery | | Net .21 |
| 5K ohm Volume Control with SPST Switch and Knob; Shpg. wt., 2 oz. | | Net 1.49 |
| 99 K 6019 | | Net .59 |
| Miniature Crystal Microphone 1 1/8" Diam. x 3/8" Deep. Shpg. wt., 6 oz. | | Net 1.49 |
| 99 K 4509 | | Net 1.49 |
| Miniature Speaker 2 1/2" Diam. 10 ohms Voice Coil Impedance. Shpg. wt., 8 oz. | | Net 1.49 |
| 99 K 6097 | | Net 1.49 |

3-TRANSISTOR SUBMINIATURE AM BROADCAST TUNER

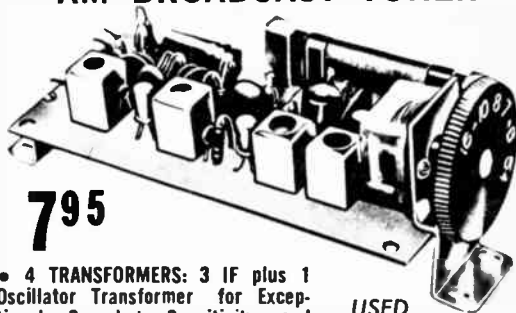

795

- 4 TRANSFORMERS: 3 IF plus 1 Oscillator Transformer for Exceptional Superhet Sensitivity and Selectivity • 540 KC to 1600 KC
- FEATURES COMPLETELY WIRED PRINTED CIRCUIT BOARD.

USED
IN MANY
IMPORTED
RADIOS!

AN OUTSTANDING AM BROADCAST RADIO WHEN CONNECTED TO ANY TRANSISTOR AUDIO AMPLIFIER ON THESE PAGES OR ELSEWHERE!

A deluxe 3-transistor subminiature AM broadcast tuner that features 3 dependable transistors, 3 IF plus 1 oscillator transformer, and ferrite antenna in an efficient, completely wired superheterodyne circuit on a sturdy printed-circuit board. Now you can build your own highly efficient broadcast receiver by simply adding this exceptional tuner to any of the transistor audio amplifiers listed. The long tuner leads for connecting to external amplifier and/or to a separate 9-volt battery, makes this easy as pie. Also features a large clearly visible calibrated tuning dial. The printed circuit board layout permits either vertical or horizontal mounting. Supplied complete with mounting brackets and detailed instructions. Size: 4x1 3/4x2" H with brackets. Shpg. wt., 8 oz. Imported.

99 K 9040

Net 7.95

An Exclusive Lafayette Publication



TRANSISTORIZED MINIATURE AMPLIFIER AND TUNER APPLICATIONS

By Rufus P. Turner

Many original Applications
Not Found Elsewhere!

150

96 Pages . . . Over 61 Circuits . . . 60 Illustrations . . . 6- Chapters—Audio, Amateur & Citizens Band, Controls, Test Instruments, Tuners, Hearing Aids, Intercoms, Etc.

An inspiring new book written by a registered Professional Engineer and author of 13 technical books and of more than 2000 magazine articles. Deals primarily with over 60 challenging and interesting applications, many of them original, of the Lafayette transistorized miniature amplifiers and tuners described on these pages. Consists of 6 interesting chapters.

1. Audio Applications—Amplifiers, Preamplifiers, Modular Amplifiers, Stereo Amps, etc.
2. Ham Radio and Citizens Band-Selective Call Alarms, Speech Clipper, Speech Amplifier Modulator, etc.
3. Control—AM RF Relay, Capacitance Relay, Sound Operated Relay, etc.
4. Test Instruments—AF RF Signal Tracer, Percent Modulation Meter, A-F Watt-meter, Sound Level Meter, etc.
5. Tuners—No License Radio Communication System, Broadcast/Short-Wave Tuner, etc.
6. Miscellaneous—Hearing Aids, Intercoms, Electronic Stethoscopes, Light Beam Transmitter & Receive, Gieger Counter, Electronic Announcer, etc.

An excellent source of information for the kit builder, experimenter and for workers in various areas of electronics.

10 K 0101

Net 1.50

SEMICONDUCTOR SPECIALS

FOR KIT BUILDER, HOBBYIST, EXPERIMENTER,



2-10-WATT POWER TRANSISTORS
Pkg. of 2 **77¢**

Package of 2 PNP 10 Watt germanium power transistors in popular TO-3 case. Similar to 2N155, 2N176, 2N235, 2N351, 2N242, 2N257, 2N268, 2N301A, 2N255, 2N554, 2N555, etc. Shpg. wt., 8 oz.
19 K 1501 Pkg. of 2 Net .77

2 PNP GERMANIUM TRANSISTORS AF AMPLIFIERS (Up to 12 Volts)



69¢ Pkg. of 2 PNP Germanium AF amplifier transistors that replace: 2N133A, 2N138A, 2N138B, 2N151, 2N186A, 2N187A, 2N215, 2N217, 2N319, 2N320, 2N359, 2N360-363, 2N407, 2N408, 2N1008, A, B, GT81R, GT109, 2S56, 2S838, etc. Shpg. wt., 4 oz.
19 K 2701 Pkg. of 2 Net .69



10 SILICON DIODES
Pkg. of 10 **89¢**

Package of 10 silicon diodes. Replaces 1N34, 1N34A, 1N46, 1N48, 1N51, 1N60, 1N87, 1N295, etc. Shpg. wt., 4 oz.
19 K 6001 Pkg. of 10 Net .89



2 PNP TRANSISTORS
Pkg. of 2 **77¢**

Mixer/Oscillator Converter—Replaces 2N112, 2N114, 2N135, 2N136, 2N137, 2N140, 2N219, 2N411, 2N412, 2N414B, 2N415, CK760, CK766, 2S52, etc. Shpg. wt., 4 oz.
19 K 4201 Pkg. of 2 Net .77

STUD-MOUNT SILICON POWER RECTIFIERS

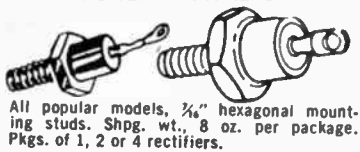

All popular models, 1/8" hexagonal mounting studs. Shpg. wt., 8 oz. per package. Pkgs. of 1, 2 or 4 rectifiers.

2 Ampere Rectifiers as low as .39 pkg. of 2

| Stock No. | PIV | Pkg. of | Net |
|-----------|-----|---------|-----|
| 19 K 5007 | 50 | 4 | .49 |
| 19 K 5008 | 100 | 2 | .39 |
| 19 K 5005 | 200 | 2 | .59 |
| 19 K 5006 | 400 | 2 | .97 |

12 Ampere Rectifiers

| Stock No. | PIV | Pkg. of | Net |
|-----------|-----|---------|------|
| 19 K 5003 | 50 | 2 | 1.19 |
| 19 K 5004 | 100 | 1 | .77 |
| 19 K 4207 | 200 | 1 | .98 |
| 19 K 4208 | 400 | 1 | 1.69 |

50 Ampere Rectifiers 1 1/4" Hex.

| Stock No. | PIV | Pkg. of | Net |
|-----------|-----|---------|------|
| 19 K 1514 | 50 | 1 | 2.49 |
| 19 K 1521 | 100 | 1 | 3.45 |
| 19 K 1522 | 200 | 1 | 4.25 |

PNP AUDIO TRANSISTOR AS LOW AS



24¢ ea.
Lots of 100

General audio type PNP transistor for experimenters and hobbyists, for code practice oscillators and similar small signal devices. In new JETC 30 welded case. wt., 2 oz.
19 K 4206 Net, singly, each .29
100 for 24.00

4 PNP GERMANIUM TRANSISTORS
Pkg. of 4 **88¢**



Package of 4 PNP General Purpose Type Transistors similar in performance to: 2N107, 2N218, 2N1265, CK722, GT222, TR722, 2N1191, etc. Shpg. wt., 6 oz.
19 K 1502 Pkg. of 4 Net .88

2 PNP GERMANIUM IF AMPLIFIER TRANSISTORS
Pkg. of 2 **59¢**



Pkg. of 2 PNP germanium IF amplifier transistors that replace: 2N111, 2N111A, 2N112A, 2N139, 2N218, 2N409, 2N410, 2N413, 2N413A, 2N414, 2N414A, 2N416, GT760, 2S53, etc. Shpg. wt., 4 oz.
19 K 1504 Pkg. of 2 Net .59

1 TOP HAT SILICON RECTIFIER
750 Mii 750 PIV **59¢**



Package of 1 top-hat axial lead silicon rectifier rated 750 millamps, 750 Peak Inverse Volts. Shpg. wt., 4 oz.
19 K 4203 Net .59

GENERAL PURPOSE DIODES ONLY **10¢**



Excellent Detector for Transistor and Vacuum Tube Radio Receivers
EQUIVALENT TO: 100 for 850
1N34 1N34A 1N38A 1N48 1N56 1N69
19 K 4901 General Purpose Diode Net .10 each; 10 for .90

49¢ Lots of 100
POPULAR POWER TRANSISTORS
MEDIUM POWER TRANSISTORS

Beta=30, BV_{cer}=36 Volts: Shpg. wt., 12 oz. Similar to: 2N155, 2N176, 2N235, 2N242, 2N255, 2N256, 2N301, 2N307, 2N554, AR-5, CTP-1104, TS-176, etc.
19 K 1507 Net ea. .59
In Lots of 100, Each Net .49

HIGH POWER TRANSISTORS
Beta=50; BV_{cer}=36 Volts Min. Shpg. wt., 12 oz. Similar to: 2N157A, 2N176B, 2N235B, 2N257, 2N285A, 2N301A, 2N353, 2N399, etc.
19 K 4205 High Power Transistor Net ea. .69
In lots of 100, Each Net .59

TRANSISTOR MOUNTING KITS
30¢ FOR "DIAMOND SHAPE" TO-3 TYPE



Includes Diamond Shape mica washer, 2 round mica washers, 2 steel washers, 1 lug, 2 nuts and transistor socket. Shpg. wt., 4 oz.
19 K 1531 Net .30

FOR "OOR KNOB" TO-36 TYPE
Includes square mica washer, round mica washer, steel washer, lug and nut. Shpg. wt., 4 oz.
19 K 1532 Net .30

40-WATT HIGH POWER TRANSISTOR 87¢



19 K 1503

Amazing value is this 40-Watt high power PNP germanium transistor! Excellent for experimenter, hobbyist and kit builder for power supplies, auto replacement, audio output, etc. Similar to 2N173, CTP1504, SFT266, etc. Bolt mounted. Shpg. wt., 8 oz.
Net .87

2 NPN TRANSISTORS
Pkg. of 2 **59¢**



Package of 2 NPN germanium transistors similar to 2N170 for Audio & RF. Beta 20 minimum. Shpg. wt., 4 oz.
19 K 2702 Pkg. of 2 Net .59

10 GERMANIUM DIODES
Pkg. of 10 **77¢**



Pkg. of 10 germanium diodes that replace 1N34, 1N34A, 1N46, 1N48, 1N51, 1N60, 1N64, 1N64A, 1N87, 1N105, 1N109, 1N147, 1N267, 1N268, 1N295, etc. Shpg. wt., 6 oz.
19 K 1505 Pkg. of 10 Net .77

2 TOP HAT SILICON RECTIFIERS
750 MIL - 400 PIV **79¢**



Pkg. of 2 top hat type silicon rectifiers rated at 750 millamps, 400 PIV. Shpg. wt., 6 oz.
19 K 4202 Pkg. of 2 Net .79

PHOTO-MULTIPLIER POWER TRANSISTOR
A COMPLETE PHOTOELECTRIC SYSTEM IN ONE UNIT
179



Complete with Instructions, Data and Diagrams for photo control systems, photo-electronic amplifiers; Relays, Alarms, etc. Shpg. wt., 6 oz.
19 K 1506 Ea. Net 1.79 3 for 4.77

30 MC HIGH GAIN TRANSISTOR



High Quality PNP RF Transistor — Excellent for 27MC Citizens Band Walkie Talkie Transceivers, etc. 30 to 35 MC. Average Beta — 25. Shpg. wt., 6 oz.
19 K 4211 ea. Net .59
Lots of 10 ea. Net .53

PHOTOCELLS AND EXPERIMENTER ITEMS

CADMIUM SULPHIDE PHOTOCELL



1 59

- For Sensitive Relay Actuation
- For Photo Electric Control

A neatly constructed crystal photocell that has countless applications in counting, relay actuation, etc. Resistance varies with light from 1 megohm in total darkness to approx. 1500 ohms at 100 foot candles. Responds to entire visible spectrum and has 1/10 sec. response for relay operation. Minimum current output 60 ma at 50 ft. candles at 90 volts. Power dissipation 2 watts for 5 seconds, 1/2 watt continuous. Output as low as .08 ma at 1 ft. candle at 6 volts, varying with illumination intensity and applied voltage. Neatly encapsulated for easy mounting with leads for electrical connection. 1 1/2 x 1/2 x 1/8" overall. Shpg. wt., 4 oz. Imported. 24 K 8827 Net .159

LAFAYETTE SUPER-VALUE SUN BATTERY



1 29

- Excellent for Experimenter, Kit Builder, etc.
- 0.27 ma Output at 100 ft. Candles

Specifications: 0.9 ma Current Output at 100 ft. candles with 100 ohm load; 0.27 ma Current Output at 100 ft. candles with 1000 ohm load. 1 1/2" diameter. With colored pig-tail leads. Shpg. wt., 3 ozs. Imported. 99 K 6318 Net 1.29

LAFAYETTE CADMIUM SULPHIDE PHOTOCELL

- Only 3/8" D x 1/2" W

95¢



New head-type window cadmium sulphide photocell. Maximum Ratings: 200 volts DC or AC peak. Temperature is -40°C and +60°C; Resistance is over 10 megohms at zero ft. candles, 100,000 ohms to 10 megohms 1 foot candle, 100,000 to 350,000 ohms at 10 foot candles; Range of sensitive wave length is 4000 to 8000 angstroms. Size: 3/8" diam. x 1/2" L. o/a. Standard screw mount: miniature base. Imported. 99 K 6309 Shpg. wt., 4 oz. Net .95

SELF GENERATING SELENIUM PHOTOELECTRIC CELLS



As Low As 53¢

- Complete with leads
- No external power needed
- Output in sunlight up to 60 MA
- Up to 750 µa at 100 ft. Candles

Sensitive to a wide spectrum including white, colored or ultra-violet light. All unmounted, complete with leads. Outputs in table below taken at 100 foot candle illumination with 100 ohm load. Shpg. wt., 3 oz. Imported.

| Stock No. | Out µa | Size | NET EACH | | |
|-----------|--------|----------------------|----------|------|------|
| | | | 1-4 | 5-9 | 10 |
| 99 K 6243 | 100 | 1 1/2 x 1/4 x 3/8" | .59 | .56 | .53 |
| 99 K 6244 | 250 | 1 1/2 x 1/4 x 3/8" | .69 | .66 | .63 |
| 99 K 6245 | 350 | 1 1/2 x 1/4 x 3/8" | .89 | .85 | .80 |
| 99 K 6246 | 750 | 1 1/2 x 1 1/4 x 3/8" | 2.80 | 2.66 | 2.52 |

SELENIUM PHOTOCELL

- Excellent for
- Burglar Alarms
- Door Openers
- Counters



4 95

OPERATES 600 MICROAMPS RELAYS DIRECTLY

Barrier layer, self-generating type; light striking upon cell generates current sufficient to operate relays that pull in at 600 microamps directly without the use of auxiliary power. Lifetime of cell is unlimited. 600 microamperes output at 100 foot candles. 2 inches in diameter. Mounted in a handsome plug-in plastic case. Imported. 99 K 6305 Photocell, Wt. 8 oz. Net 4.95 32 K 2041 Socket for above Net .14



RESISTOR PHOTOCELL

89¢

A cadmium-sulphide light-activated resistor used to actuate door openers, burglar alarms, relays, light controls, production counters, etc. Resistance varies from 75 ohms at approx. 93 foot-candles to over 10 megohms in total darkness. Maximum volts: 110VAC (peak) 110VDC; maximum dissipation: .2 watt @ 40°C, .1 watt @ 50°C, 0 @ 60°C. Capacity approx. 6 mmf. 1/2" diam. x 1/8" thick. Shpg. wt., 3 oz. Imported. 19 K 2101 Net .89

LAFAYETTE CADMIUM PHOTOCELL



1 19

- 3/8" Light Area

A quality cadmium photocell, perfect for transistor and printed circuit use. Employs sensitive film element with 3/8" light area. Rated at 200V; 10ma; 0.1W power dissipation @ 20°C. Sensitivity is 610±50. Resistance Value Characteristics - 0 Ft. Candles: 2M ohms/up; 1 Ft. Candles: 100K ohms; 10 Ft. Candles: 25K ohms; Size 3/8" Diam. x 1/4" Depth. Imported. 99 K 6315 Net 1.19



FLEA CLIPS FOR TRANSISTOR AND SUBMINIATURE CONTACTS

"Flea" clips are specially designed for subminiature work. Fit perfectly in holes in perforated copper-clad and unclad boards listed above. Made of beryllium copper, silver plated finish. Simply insert wire thru hole for positive grip contact.

| | | | |
|-----------|-------------------|-----|--------|
| 19 K 3301 | Package of 12 | Net | .25 |
| 19 K 3302 | Package of 1000 | Net | 15.75 |
| 19 K 3303 | Package of 5000 | Net | 76.15 |
| 19 K 3304 | Package of 10,000 | Net | 149.30 |

VECTOR PUSH-IN TERMINALS



For Vectorboards listed at right.

Fit T9.4 brass, tin-plated with serrated slots; T28 beryllium copper tin plated; T30N nickel plated brass, T30N holds up to 6 wires without soldering. No staking required on any terminals. Shpg. wt., 3 oz. per pkg. of 100.

| Hole Size | Mfr. Type | Net Per Pkg. of 100 | | |
|-----------|-----------|---------------------|--------------------------|-------|
| | | Stock No. | 1-19 | 20-99 |
| .093" | T9.4 | 19 K 8301 | 1.22 | 1.13 |
| .062" | T28 | 19 K 8302 | 1.55 | 1.40 |
| .093" | T30N | 19 K 8303 | 0.45 | 7.61 |
| | | 19 K 8304 | Pkg. of 10 T30N Net 1.15 | |

INSERTION TOOLS

Type P-92A for T30N and T9.4 19 K 8305 Net .50 19 K 8306 Type P-91 for T28 Net .50

MASONITE BREADBOARD

- Ideal for Kit Builders

Tempered masonite board with holes spaced 1/2" apart to facilitate mounting of parts. Size 7 1/2" x 11 1/2" x 1/8" thick. Shpg. wt., 12 oz. 19 K 1701 Net .25

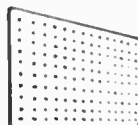

PERFORATED COPPER-CLAD AND UNCLAD BOARDS

- Ideal For Transistor And Subminiature Circuitry

These sturdy, perforated boards are the ideal base for builders, experimenters, and labs to mount miniaturized components. Two types available; either high grade bakelite for wired circuits, or one side copper-clad for "printed" circuitry. Holes are 3/16" diameter with 3/16" between hole centers. All boards are 3/16" thick. For contacts, the MS-263 flea clips listed on this page are ideal. Avg. shpg. wt., 6 oz.

COPPER CLAD BOARDS

| Stock No. | Size | No. of Holes | Net Each Lots of | | |
|-----------|-----------------|--------------|------------------|------|------|
| | | | 1 | 100 | 250 |
| 19 K 3601 | 2 1/2 x 3 3/4" | 17x12 | .35 | .30 | .24 |
| 19 K 3602 | 3 1/2 x 6 3/4" | 35x19 | .55 | .50 | .45 |
| 19 K 3603 | 7 1/2 x 6 3/4" | 39x35 | 1.15 | .96 | .87 |
| 19 K 3604 | 10 1/2 x 7 1/2" | 56x38 | 1.90 | 1.58 | 1.42 |

UNCLAD BOARD

| Stock No. | Size | No. of Holes | Net Each Lots of | | |
|-----------|-----------------|--------------|------------------|------|------|
| | | | 1 | 100 | 250 |
| 19 K 3605 | 2 1/2 x 3 3/4" | 17x12 | .25 | .20 | .18 |
| 19 K 3606 | 3 1/2 x 6 3/4" | 35x19 | .45 | .40 | .35 |
| 19 K 3607 | 7 1/2 x 6 3/4" | 39x35 | .75 | .65 | .60 |
| 19 K 3608 | 10 1/2 x 7 1/2" | 56x38 | 1.20 | 1.08 | .97 |
| 19 K 3609 | 18 x 7 1/2" | 95x38 | 1.89 | 1.71 | 1.55 |



EXPERIMENTER PARTS - MINIATURE COILS, VARIABLE CONDENSERS, CONTROLS AND ANTENNAS

TINY TUNING CONDENSER—with DIAL



- 385 MMF.
- POLYETHYLENE DIELECTRIC
- ONLY 1" SQUARE, 3/16" DEEP
- FOR TRANSISTOR & MINIATURE CIRCUITS

A new "Poly-Vari-Con" model for use in TRF broad-cast-band and experimental receivers. Complete with good-looking clear plastic tuning dial with calibrations from 530 to 1600 KC. Capacity variable from 10 to 365 mmf. Knurled dial is 1 1/4" diam.; rotation is 180°. Dial is mounted to condenser shaft by 3/16" diam. chrome-plated threaded retainer. Shpg. wt., 5 oz. Imported.

99 K 6217 Net .59

TRANSISTOR MINIATURE 2 GANG SUPER-HET VARIABLE CONDENSER

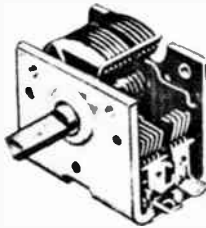

Lightweight—both the frame and plates are aluminum. Smooth ball bearing action over entire 180° rotation. Bakelite stafor insulation. Capacity of 11 plate R.F. section is 6.3 to 123.1 mmfd; 9 plate oscillator section is 5.7 to 78.2 mmf. Effective range of trimmers 15 mmf. These add 2 mmf to minimum capacity. Capacity increases in counter clockwise direction. Flatted shaft. 1/4" diameter by 1 1/4" long.

Frame size only 1 3/8" Dx 1 3/8" W x 1 3/8" H. Shpg. wt., 5 oz.

32 K 1106 Net .95

TRANSISTOR LOOP ANTENNA AND OSC. COIL LOOP ANTENNA



A loop antenna with a primary inductance of 700 microhenry, especially designed with the proper tap to match the input impedance required in transistor circuits. Covers the entire broadcast band from 540-1650 KC when used with latest miniature type variable condensers such as used in G.E. Regency and other subminiature sets. (Lafayette 32 G 1106 is ideal.) Requires maximum capacity of 123 mmf in RF section of variable condenser. Wound on high efficiency iron core 4" long x 1/4" diam. Shpg. wt., 4 ozs.

Osc. Coil 32 K 4101 Net .95
32 K 4102 Matching Oscillator Coil. In lots of 6, Each .89
In lots of 6, Each .79 Singly, Each .89

TRANSISTOR FLAT FERRITE TAPPED ANTENNA COIL FOR USE WITH MINIATURE SETS

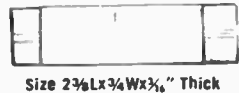

Small in size, 2 3/8" L x 3/4" W x 3/16" Thick, for miniaturized circuits. For use with 365 mmfd Variable Condensers, such as 32 K 1102, and 99 K 6217. Inductance 230 μh. Shpg. wt., 4 oz.

32 K 4105 Transistor Antenna Coil Net .98

FERRITE ANTENNA KIT

- 3 ANTENNAS FOR TRANSISTOR RADIOS
 - HIGH "Q" FOR TOP RECEPTION
- All three for **79¢**



Three sizes of flat ferrite antennas. Each has a high inductance of 480 microhenries. Tapped leads are color coded. Designed to match most AM transistor radios. Matches tuning condenser sect. 167.5—8mmfd., osc. sect. 75.5 mmfd.—8mmfd. Sizes: (1) 1 3/4" x 3/8" x 1/16" (2) 2 1/8" x 3/8" x 1/16" (3) 2 3/8" x 3/8" x 1/16". Imported. Shpg. wt., 5 oz.

99 K 6227 Net .79

SUB-MINIATURE VARIABLE RESISTORS

SIZE—3/8" Dia. 1/8" Thick
29c each

Carbon composition potentiometers built for the most compact installations. Ideal for printed circuits. Shpg. wt., 2 oz. Imported.

99 K 6142 1000 ohms, 99 K 6143 5K ohms, 99 K 6144 10K ohms, 99 K 6145 50K ohms, 99 K 6146 500K ohms.

Any of above Net ea. .29

REPLACEMENT 5,000 OHM VOLUME CONTROL FOR JAPANESE TRANSISTOR RADIOS

A volume control with the proper resistance, dimensions and mounting for replacement in thousands of Japanese transistor radios. A 5,000 ohms potentiometer with S.P.S.T. switch. Only 3/8" dia., 1/2" total depth. Easily installed in printed circuits. Comes with 1/4" dia. knob Shpg. wt., 2 ozs. Imported

99 K 6019 Net .59

MATCHED TRANSISTOR 455 KC I.F.'S

- FERRITE CORE—SLUG TUNED
- ONLY 1/2" SQ. 3/16" H.

89¢

These 455 KC transistor I.F. transformers are designed with improved primary to secondary turn and capacity to inductance ratios for good impedance matching. 1st and 2nd I.F.'s have a primary impedance of 25,000 ohms and a secondary impedance of 600 ohms. The 3 IF has a primary impedance of 25,000 ohms and a secondary impedance of 1,000 ohms. Gives outstanding results in transistor superhet circuits. Shpg. wt., 4 ozs.

1st or 2nd IF primary impedance 25,000 ohms, secondary 600 ohms.

32 K 1104 Net .89

3rd IF-Primary impedance 25,000 ohms, secondary 1,000 ohms.

32 K 1105 Net .89

ULTRA-SUBMINIATURE SUPERHET TRANSISTOR COIL KIT

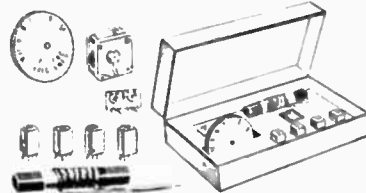

- 2-Gang Variable Condenser only 3/16" Square
- 3 IF's and OSC. only 3/16" High
- 2 1/2" Ferrite High "Q" Loop Antenna

Just add the transistors, and other necessary components and you can build a quality superheterodyne radio receiver. Ultra-miniature components are ideal for experimenter use in compact circuits. Kit consists of 3 slug tuned IF transformers with a Q above 40 and oscillator coil. All have pin contacts and PC mounts. Each is 3/8" square x 3/16" H. 2-gang variable condenser is only 3/16" square. Has Q above 600. Tuning dial 1 3/8" dia. marked 53 to 16KC trimmer and padder capacitor 1 1/2" long. 2 1/2" loop antenna on ferrite cone. Complete with screws and circuit diagram for constructing a fine transistor radio. Shpg. wt., 1 lb. Imported

99 K 6326 Net 3.45

MINIATURE IF TRANSFORMERS AND OSCILLATOR COILS

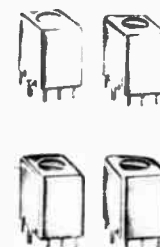

Slug-tuned printed circuit mounted miniature IF transformers. All have 455 KC intermediate frequency. Each with schematic and pin contacts. Ideal replacements for Japanese 6-transistor radios. Shpg. wt., 6 oz. Imported.

All Units only 3/8" Sq. and 3/16" High.

- 99 K 6300 Oscillator coil Inductance 270 μh.
- 99 K 6301 1st IF: pri. 70,000 ohms, sec. 1500 ohms.
- 99 K 6302 2nd IF: pri. 50,000 ohms, sec. 1000 ohms.
- 99 K 6303 3rd IF: pri. 30,000 ohms, sec. 5000 ohms.

Any of above Net ea. .59

SUB-MINIATURE TRANSFORMERS ONLY 3/8" SQ. AND 3/16" HIGH



Same as miniature IF transformers above except size. Imported.

- 99 K 6247 Oscillator Coil Net .69
- 99 K 6248 1st IF Net .69
- 99 K 6249 2nd IF Net .69
- 99 K 6329 3rd IF Net .69

EXPERIMENTER PARTS - REPLACEMENT GEMS

COILMASTER DELUXE

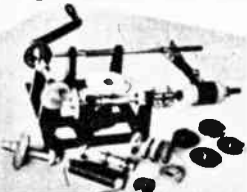

ACCURATE
COIL
WINDER

6 75

Latest redesigned model gives even greater accuracy than ever to meet modern requirements. Easy-to-use set winds honeycomb, spiderweb and solenoid coils of various widths and diameters—equal in appearance to a factory job. Also suitable for winding chokes, transformers and filter inductors. Indicator counts number of turns on coil. Supplied with accessories including wood spools, metal pegholders and extension for making long solenoid coils. Instructions included, but less coil form and pegs. Shpg. wt., 6 lbs.

32 K 8701 Net 6.75

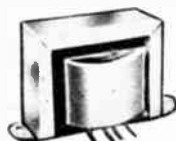

MINIATURE
TRANSISTOR
TRANSFORMERS

- Truly Miniature—Only $\frac{3}{4} \times \frac{3}{4} \times \frac{3}{4}$ "
- Matches Any 3.2 Ohm Speaker
- Excellent For Receiver Replacement Transistor Output
- Transistor Output Transformer

Popular transistor output transformer for 3.2 ohm speakers. May be used either single-ended or push-pull. Wound on nylon bobbins with mylar outer wrap with laminations on nickel-steel and silicon-steel. Rated power is 100 milliwatts. Primary impedance is 500 ohms. Center-tapped and secondary 3.2 ohms. DC resistance of primary is 20 ohms and secondary is .3 ohms. Color coded leads. Net wt., $1\frac{1}{4}$ oz. Shpg. wt., 4 oz. Imported.

99 K 6123 Net .89

TRANSISTOR DRIVER TRANSFORMER

Single-ended transformer for driving transistor power-stage. Impedances 10,000 ohms pri., 2000 ohm C.T. sec.; dc res. 500 ohms pri., 50 ohms sec. 1.5 ma. dc unbalanced pri. current. Rated 100 mw. $\frac{3}{4} \times \frac{3}{4} \times \frac{3}{4}$ ". Shpg. wt., 4 oz. Imported.

99 K 6124 Net .89

LAFAYETTE SPECIAL! HIGH SENSITIVITY METER RELAY



- METER MOVEMENT
- CLOSSES CIRCUIT AT 2 MILS

Extremely sensitive meter type relay. Normally open. Ideally suited for uses with model railroad, photoelectric relay circuit, baby-tenders, remote control toys, remote control boats, fire alarm, and many other practical applications. Precision-built meter movement provides virtually friction-free movement. Contact will close at 2 milliamperes. Internal resistance 100 ohms. Meter movement rated 5 ma continuous, 10 ma momentary; contacts rated 500 ma continuous, momentary 1 amp at 3v and 250 ma at 6v with resistive load. Sensitivity: 2.5-.6 mw. Internally adjustable. Relay is enclosed entirely and transparent cover permits observation. Solder pins are placed externally for easy connections. Size: $1\frac{1}{4} \times 1\frac{1}{4} \times 1\frac{1}{4}$ ". Shpg. wt., 8 ozs. Imported

99 K 6199 Net 3.95



TRANSISTOR
OUTPUT
TRANSFORMERS
RATED 150 MW

Here is an outstanding value in the most popular transistor output transformer for 10 to 11 ohm speakers. Rated power is 150 milliwatts. Primary impedance is 400 ohms, center-tapped and secondary 11 ohms. DC resistance of primary is 20 ohms and secondary .9 ohms. Size: $\frac{3}{4} \times \frac{3}{4}$ ". Shpg. wt., 4 ozs. Imported

99 K 6209 Net .89

100 MW TRANSISTOR DRIVER TRANSFORMER

Primary impedance 20,000 ohms. Secondary impedance 1000 ohms. DC resistance of primary 400 ohms. of secondary 50 ohms. Unbalanced primary current 1 ma DC. Rated 100 mw. Size: $\frac{3}{4} \times \frac{3}{4} \times \frac{3}{4}$ ". Shpg. wt., 4 ozs. Imported

99 K 6002 Net .89

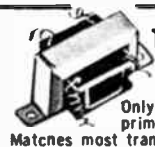

TRANSISTOR OUTPUT
TRANSFORMER

Only $\frac{3}{4} \times \frac{3}{4} \times 1\frac{1}{4}$ ". 2000 ohm primary to 10 ohm voice coil. Matches most transistor outputs. Shpg. wt., 8 ozs. Imported

99 K 6101 Net .69



SUBMINIATURE TRANSISTOR AUDIO TRANSFORMERS

ONLY $\frac{1}{2}$ " x $\frac{1}{2}$ " x $\frac{1}{2}$ "

ONLY
79c

A new series of miniature transformers for transistor and experimental miniature circuits. Ideal for miniature radio receivers, amplifiers, hearing aids, etc., using standard transistors. Incorporate special heat-treated high permeability magnetic cores treated to resist corrosion. Designed for improved frequency response with low distortion. 3" color-coded leads. Average shpg. wt., 4 oz. Imported

| Stock No. | Circuit | Impedance Pri. Ohms | Sec. Ohms | O.C. Resistance Pri. Ohms | Sec. Ohms | Net |
|-----------|---------|---------------------|-----------|---------------------------|-----------|-----|
| 99 K 6125 | INPUT | 100,000 | 1000 | 1000 | 1000 | .79 |
| 99 K 6126 | DRIVER | 10,000 | 2000 C.T. | 240 | 60 C.T. | .79 |
| 99 K 6127 | OUTPUT | 500 C.T. | 3.2 | 42 C.T. | 0.7 | .79 |
| 99 K 6034 | INPUT | 200,000 | 1000 | 1400 | 50.5 | .69 |
| 99 K 6129 | OUTPUT | 500 C.T. | 8 | 50 C.T. | 1.7 | .79 |

EXACT REPLACEMENT MINIATURE SPEAKERS

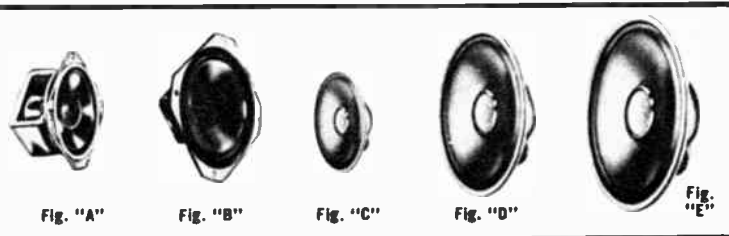

- Ideal both for replacement and miniature builders
- From only $\frac{1}{8}$ " to $\frac{1}{4}$ " deep
- From $1\frac{1}{2}$ to 3" diameter

Lafayette brings you this selection of fine quality Alnico PM speakers both to solve the problem of replacement in the hundreds of models of Japanese transistor portable sets now requiring service and to provide the experimenter with miniature speakers.* have mtg. holes on 2" centers; \uparrow on $1\frac{1}{2}$ " centers. OHMS is Voice coil impedance. Dimensions given are overall. Imported.

| Stock No. | Fig. | Diam. | Depth | Ohms | Wt. | Net |
|------------|------|-------------------|-------------------|------|--------|------|
| 99 K 6035† | A | 1 $\frac{1}{2}$ " | 1 $\frac{1}{8}$ " | 10 | 6 oz. | 1.49 |
| 99 K 6036 | C | 2" | 1 $\frac{1}{8}$ " | 8 | 8 oz. | 1.49 |
| 99 K 6037 | C | 2 $\frac{1}{4}$ " | 1 $\frac{1}{8}$ " | 8 | 8 oz. | 1.49 |
| 99 K 6038 | C | 2 $\frac{1}{2}$ " | 1 $\frac{1}{8}$ " | 8 | 8 oz. | 1.49 |
| 99 K 6039* | B | 2 $\frac{1}{2}$ " | 1 $\frac{1}{4}$ " | 3-4 | 8 oz. | 1.49 |
| 99 K 6097* | B | 2 $\frac{1}{2}$ " | 1 $\frac{1}{4}$ " | 10 | 8 oz. | 1.49 |
| 99 K 6098 | D | 2 $\frac{3}{4}$ " | 1 $\frac{1}{4}$ " | 8 | 8 oz. | 1.49 |
| 99 K 6032 | E | 3" | 1 $\frac{1}{4}$ " | 8 | 10 oz. | 1.49 |

BAKELITE CASES and PANELS

Ideal for building test equipment and small electronic devices. All black bakelite with rounded corners and recessed threaded inserts for mounting panels. Walls $\frac{1}{8}$ " except * is $\frac{3}{16}$ ". Avg. shpg. wt., 11 oz.



| Stock No. | Size | Net Each 1-4 | 5-10 |
|-----------|---|--------------|------|
| 19 K 2001 | 6 $\frac{1}{4}$ x 3 $\frac{3}{4}$ x 2" | .65 | .59 |
| 19 K 3701 | Panel for above | .39 | .36 |
| 19 K 2002 | 6 $\frac{3}{4}$ x 5 $\frac{1}{4}$ x 2 $\frac{1}{4}$ " | 1.20 | 1.08 |
| 19 K 3702 | Panel for above | .60 | .54 |
| 19 K 2003 | 8 $\frac{3}{8}$ x 7 $\frac{3}{8}$ x 3" | 1.59 | 1.43 |
| 19 K 3703 | Panel for above | .75 | .69 |



LAFAYETTE
MINIATURE
SILICON
RECTIFIER

Premium quality and small size make this precision rectifier ideal for prototype and miniature applications. Measures $\frac{3}{4}$ Dx $\frac{1}{2}$ " W plus $\frac{1}{4}$ " mounting lip. Rated AC input voltage 100V. DC output current 20MA. Intermittent 40ma. Maximum Input Capacitance 80MF. Imported.

99 K 6317 Shpg. wt., 2 oz. Net .49

POPULAR SERVICEMEN'S PARTS

POWER TRANSFORMER FOR SELENIUM RECTIFIER CIRCUITS

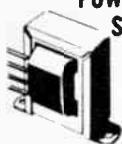

159

Most popular replacement power transformer for circuits using selenium rectifiers or rectifier tubes such as 6AX5, 6X4, 6X5. Primary is 117V 60 Cycles A.C. Plate supply is 125 VAC 1/2 wave at 15 ma with 6.3V 0.6 amp filament winding. Size: 2x2 3/4 x 1 3/4"; mounting centers 2". Shpg. wt., 1 lb. 33 K 3405 Net 1.59

LAFAYETTE SPECIAL



70.7 VOLT LINE-TO-VOICE COIL TRANSFORMER

- 10 watts max
- 5-8-16 ohms

70 volt line-to-voice coil matching transformer. Primary tapped 10, 5, 2.5, 1.25 and .625 watts. Secondary tapped 5, 8 and 16 ohms. Size: 2x1 1/2". Mtg. Centers 2 3/4". Shpg. wt., 1 lb.

33 K 3709 Lot of 10 each 1.70
Singly ea. 1.98

SPECIAL LAFAYETTE TRANSFORMERS



AS LOW AS
41¢
EACH

50L6 OUTPUT (FIG. B)

Matches 50L6, 35L6, 25L6, etc. to 3-4 ohm voice coil. Shpg. wt., 1/2 lb.
33 K 3701—Singly, each49
Lots of 5, Ea. .45 Lots of 10, Ea. .41

6.3 VOLT FILAMENT TRANSFORMER
Primary 115V. Secondary 6.3V at 1 amp. Shpg. wt., 3/4 lb.
33 K 3702—Singly, each89
Lots of 5, Ea.81

UNIVERSAL OUTPUTS (FIG. A)

Match any single or push-pull output tubes to any voice coil. Shpg. wt., 3/4 lb.
33 K 7503—4 watt—Singly, each 1.39
In lots of 5, each 1.26
33 K 7504—8 watt—Singly, each 1.53
In lots of 5, each 1.38

47 PILOT LAMPS

10 for **45¢**



Most often used pilot light. Replaces pilot in most electronic entertainment equipment. Shpg. wt., 5 oz. Imported.
99 K 6304 pkg. of 1045
10 pkgs. 4.00

LAFAYETTE SPECIAL NEON ASSEMBLY



For operation on 110 volts AC. Requires 100k resistor in series. When used with 200 v, use 250k resistor in series. AC starting voltage 60v. Servicing life, 5000 to 10,000 operating hours. Chrome finish. Shpg. wt., 2 oz. Imported

| Stock No. | Color | Net. ea. | ea. |
|-----------|------------|----------|-----|
| 99 K 6224 | Yellow | .39 | .35 |
| 99 K 6225 | Amber | .39 | .35 |
| 99 K 6226 | Red | .39 | .35 |
| 32 K 6944 | Rpd, Brass | .39 | .35 |

94 Lafayette Cat. No. 652



455 KC UNIVERSAL I.F. TRANSFORMER FOR BROADCAST AND CITIZENS BAND

59¢

• Only 3/4" Square

The most popular replacement I.F. Ideal for experimenters. Exceptionally high gain powdered iron core, compression tuned 455 KC midget I.F.—only 3/4" square by 1 1/2" high. For both input and output circuits. Supplied with mounting clip and adapter plate to replace both midget and larger size cans. Used in Lafayette HE-15B CB Transceiver. Shpg. wt., 4 oz.
32 K 0946 Singly, each .59
Lots of 10 each .49

POPULAR MIKE CONNECTORS

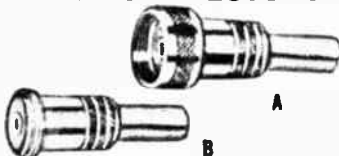

Standard single contact, cord mounted, nickel plated brass, knurl grips, 5/8"-27 thread. Shpg. wt., 3 oz.
32 K 6417 Female connector Fig. A Net .22
32 K 6418 Male connector Fig. B Net .21

STANDARD LAFAYETTE 2-CONDUCTOR PHONE PLUGS

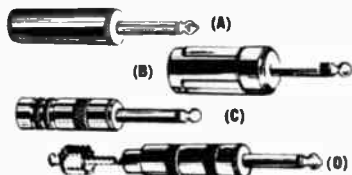

Phone plugs for a wide variety of applications with choice of handle sizes and materials. All sleeves fit standard 1/4" phone jacks. Avg. shpg. wt., 8 oz.

FIG. A. SLIM PHONE PLUG Smooth bakelite handle. Solder terminals with cable clamp. Imported.
99 K 6221 Net .25 ea.—10 for 2.15
FIG. B. BARREL PHONE PLUG Rubbed plastic barrel handle. Screw terminals. Imported.
99 K 6223 Net .22 ea.—10 for 1.90
FIG. C. SHIELDED SLIM PLUG Ribbed chromed metal handle. Solder terminals with cable clamp. Imported.
99 K 6215 Net .29 ea.—10 for 2.50
FIG. D. PHONE TO PHONO PLUG ADAPTER. Adapts from standard phone plug to RCA type phono plug. Overall length 2 7/8 x 1/2" diam. Imported.
99 K 6216 Net .39 ea.—10 for 3.25

STANDARD LAFAYETTE PHONE JACKS FOR 1/4" PLUGS



FIG. E. OPEN CIRCUIT JACK Standard open circuit phone jack. 3/8" bushing, 1/2" long. Complete with mounting hardware. Imported.
99 K 6213 Net .19 ea.—10 for 1.75
FIG. F. CLOSED CIRCUIT JACK Same as above but closed-circuit phone jack. Imported.
99 K 6222 Net .19 ea.—10 for 1.75
FIG. G. EXTENSION CABLE JACK Fit standard 1/4" phone plug. Screw terminals. Barrel plastic handle matches Barrel plug above. Imported. Shpg. wt., 10 oz.
99 K 6214 Net .22 ea.—10 for 1.90

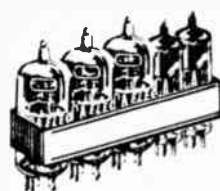

5-TUBE AC-DC KIT

Low Price!

198

Used in most popular AC-DC Superheterodyne Radio Receivers. Kit Consists of 1 each: 50C5, 35W4, 12AV6, 12BA6 and 12BE6. Imported.
36 K 8201 Net 1.98

SERVICEMAN'S UNIVERSAL CONTROLS WITH SWITCH-AUDIO TAPER



MOST POPULAR REPLACEMENT CONTROLS

2 1/2" Long Round Shaft 1/4" Dia.

3/8" Bushing. Shpg. wt., 3 ozs.
32 K 7267 1 meg. lots of 10 ea. .39
Singly .49
32 K 7268 1/2 meg. lots of 10 ea. .39
Singly .49

50 PIECE TV KNOB KIT



195

- A Great Value
- Less Than 4c Each

Selection contains 50 assorted TV knobs including such types as channel selector, fine tuning, volume, etc. Useful and attractive. Many with gold lettering or gold inserts. Shpg. wt., 3 lbs.
32 K 6902 1.95

LAFAYETTE CERAMIC DISCS

RATED 1000 DCWV



These Lafayette ceramic discs are ideal for bypassing, blocking and coupling applications. replacements for paper and mica capacitors. Capacity, leakage resistance and breakdown to assure dependable performance. Available in the following values. Shpg. wt., 2 oz.

| µF | µF | µF | µF | µF | µF | µF |
|-----|----|-----|-----|-----|-------|-------|
| 5 | 22 | 50 | 150 | 330 | .001 | .0027 |
| 6.8 | 25 | 56 | 180 | 390 | .0012 | .003 |
| 10 | 27 | 68 | 200 | 470 | .0015 | .0033 |
| 12 | 30 | 75 | 220 | 500 | .0018 | .004 |
| 15 | 33 | 82 | 250 | 560 | .002 | .0047 |
| 18 | 39 | 100 | 270 | 680 | .0022 | .005 |
| 20 | 47 | 120 | 300 | 750 | .0025 | .01 |

Assort any of above for quantity price.
32 K 0943C 10 for .72, Singly, Ea. .08

HIGH CAPACITY DISCS

.015 µf. Shpg. wt., 2 oz. 10 for .89
34 K 5628 Singly, Ea. .11
.02 µf. Shpg. wt., 2 oz. 10 for 1.08
34 K 5629 Singly, Ea. .12

For Fastest Service Use Lafayette's Convenient Order Blank

QUALITY PARTS FOR THE SERVICEMAN

**KIT OF 100 ALLEN BRADLEY
AND IRC 1/2 WATT—10%
RESISTORS**



450

with box

| Quant. | Ohms |
|------------------|----------------------|
| 3 | 100 |
| 3 | 470 |
| 4 | 1,000 |
| 3 | 2,200 |
| 4 | 4,700 |
| 5 | 10,000 |
| 4 | 22,000 |
| 4 | 27,000 |
| 4 | 33,000 |
| 4 | 47,000 |
| 10 | .1 meg |
| 4 | .15 meg |
| 4 | .27 meg |
| 10 | .47 meg |
| 10 | .1 meg |
| 4 | 2.2 meg |
| 20 | Other popular values |
| 100 TOTAL | |

Designed especially for the serviceman. Here is a selection of 100 resistors of the most popular values used in general service work. All brand-new 1/2 watt 10%, full lead length Allen Bradley and IRC. Color coded. This is no random assortment. You get exactly the values in the list at right. Comes complete with hinged, plastic box. Shpg. wt., 2 lbs.

32 K 8901 Net 4.50

**PORCELAIN CASED TUBULAR CAPACITORS
VALUE PACKED KITS**

Rated 600 W.V.D.C.

Tested At 3 Times Working Voltage
Exceptionally Resistant to High
Temperatures and Moisture

AS LOW AS **275**

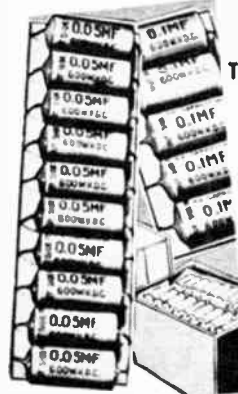

| KIT OF 100 600V W V DC QTY. | MFD. | KIT OF 50 600V W V DC QTY. | MFD. |
|-----------------------------------|------|----------------------------------|------|
| 10 | .001 | 5 | .001 |
| 10 | .002 | 5 | .002 |
| 10 | .003 | 5 | .003 |
| 20 | .01 | 10 | .01 |
| 20 | .02 | 10 | .02 |
| 20 | .05 | 10 | .05 |
| 10 | .1 | 5 | .1 |

99 K 6112 Kit of 50. Shpg. wt., 3/4 lbs. Net 2.75
99 K 6113 Kit of 100. Shpg. wt., 1 1/2 lbs. Net 4.95

LAFAYETTE TUBULAR ELECTROLYTICS

Lafayette electrolytic capacitors are specifically designed for service replacement applications. All are sealed in aluminum cans. All have wax impregnated cardboard outer insulating sleeves, have solid tinned copper wire leads with negative terminal grounded to can. For operations as high as 85°C. Avg. shpg. wt., 4 oz. ea.



| Stock No. | Mfd. | W.V. | Net Each | Net Each In Lots of 10 |
|--|-------|------|----------|---------------------------|
| 32 K 0110 | 10 | 25 | .29 | .27 |
| 32 K 0111 | 25 | 25 | .31 | .28 |
| 32 K 0112 | 20 | 150 | .30 | .27 |
| 32 K 0113 | 40 | 150 | .35 | .32 |
| 32 K 0114 | 8 | 450 | .35 | .32 |
| 32 K 0115 | 20 | 450 | .49 | .45 |
| 32 K 0116 | 40 | 450 | .59 | .56 |
| Dual Section Tubular Electrolytic | | | | |
| 32 K 0117 | 20-20 | 150 | .37 | .33 |
| 32 K 0118 | 30-30 | 150 | .39 | .34 |
| 32 K 0119 | 40-40 | 150 | .41 | .37 |
| 32 K 0120 | 50-30 | 150 | .41 | .37 |
| 32 K 0121 | 50-50 | 150 | .44 | .40 |

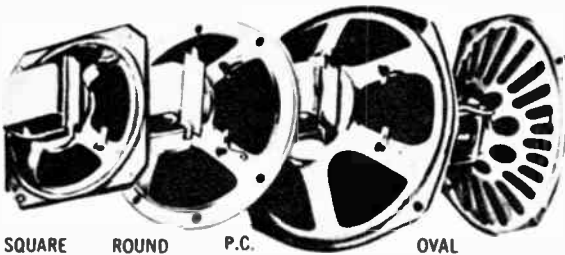

SQUARE ROUND P.C. OVAL
**LAFAYETTE ECONOMY-LINE
PM SPEAKERS**

Top Quality replacement speakers. Selected for universal application—rugged construction—standard configurations. All have 3.2 ohm voice coils.

| STOCK NO. | SIZE | SHAPE | MAG. WT. | PEAK WATTS | SHPG. WT. | NET EA. |
|-----------|------|--------|----------|------------|-----------|---------|
| 32 K 0101 | 4" | Square | .68 oz | 3.0 | 1 | 1.11 |
| 32 K 0102 | 5" | P.C. | .68 oz | 4.0 | 1 | 1.29 |
| 32 K 0105 | 6" | Round | 1.0 oz | 8.0 | 1 1/2 | 1.75 |
| 32 K 0106 | 8" | P.C. | 2.15 oz | 10.0 | 2 1/4 | 2.29 |
| 32 K 0103 | 10" | Round | 1.47 oz | 10.0 | 3 3/4 | 3.80 |
| 32 K 0108 | 12" | Round | 3.16 oz | 12.0 | 5 | 3.85 |

| STOCK NO. | SIZE | SHAPE | MAG. WT. | PEAK WATTS | SHPG. WT. | NET EA. |
|-----------|------|-------|----------|------------|-----------|---------|
| 32 K 0109 | 5X7" | Oval | 1.0 | 5 | 1 1/2 | 1.59 |
| 32 K 0107 | 6X9" | Oval | 1.47 | 7 | 2 | 2.15 |
| 32 K 0104 | 6X9" | Oval | 2.15 | 8 | 2 1/2 | 2.95 |

NEW! LAFAYETTE 4"x6" EXTENSION SPEAKER AND BAFFLE

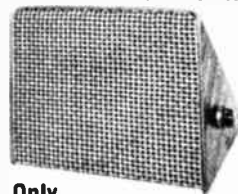

Only **544**

- For Wall, Shelf or Desk
- Walnut Decorator Baffle with Cane Grille

A fine extension speaker suitable for desk or shelf use or it can be hung neatly on the walls of extra rooms, patio, lobbies, waiting rooms or anywhere you wish to direct voice or music. Complete with volume control and 22 ft. of wire. Impedance 8 ohms. Imported. Shpg. wt., 3 1/4 lbs.

99 K 0121 Net 5.44

AUDIO-PIX TV AND MUSIC OUTLET SYSTEM

31⁵⁴
\$5.00 Monthly

- Distributes TV and FM Antenna Signals to each Audio Pix Outlet
- Feeds Hi-Fi Sound to the Same Outlets Simultaneously!

Now you can have the convenience of TV outlets in every room plus your favorite FM or Hi-Fi music available from the same outlets. A special coupler feeds TV and FM antenna signals and music from your radio or record player (or tape deck) to each outlet over a common wire. Play up to 6 sets at the same time in the kitchen, bedroom, porch or patio without interference! Audio Pix outlets are convenient, easy-to install. Designed to match standard AC wall plates. The complete Winegard Audio Pix kit contains a special 6-outlet coupler, 4 audio pix outlets and plugs (any number of additional outlets may be added if desired) special Audio-Pix Hi-Fi extension speaker, Audio-Pix diplexer for FM and Hi-Fi, 100 ft. of lead-in wire and installation instructions. Shpg. wt., 10 lbs.

18 K 6003 Net 31.54



Lafayette's 44th Year of Low Prices, Service and Dependability

Lafayette Cat. No. 652 95

SWITCHES For SERVICE—INDUSTRY—EXPERIMENTERS

3-WAY POWER CONTROL

249



• Individually Switched Outlets With Indicator Lights
Switchable power outlet box for wall or bench mounting. Three individually controlled outlets, each with its own indicator light. Measures 4x2½x1¾". Equipped with 3 polarized receptacles, 3 toggle switches, 3 indicator lights, 6 ft. line cord. Rated 5 amps at 125 volts AC/DC. Shpg. wt., 1 lb. Imported.
99 K 8007 Net 2.49

SINGLE POLE SINGLE THROW TOGGLE SWITCH



22¢

• Standard Replacement

SPST Bat Handle: Rated 3 amps—125V. Body size 1½x¾x½" behind panel. Bushing ¼" diam., ¾" long. Bat handle ½" long. Shpg. wt., 3 oz. Imported
99 K 6150 Net, ea. .22
In lots of 10, ea. .19

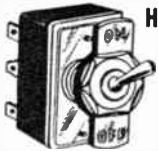

HEAVY DUTY 6 AMP DPDT SWITCH

AS LOW AS
29¢

Heavy Duty 6 Amp DPDT: Rated 250V at 3 Amps or 125V at 6 amps. Switch body 1½x¾x¾" behind panel including terminals. Bushings 1½" Dia., ¾" long. Bat handle ½" long. Shpg. wt., 3 oz. Imported
99 K 6151 Net, ea. .32
In lots of 10, ea. .29

HEAVY DUTY 10 AMP SPOT CENTER OFF TOGGLE SWITCH

39¢



Heavy Duty 10 Amp. SPDT center off: Rated 10 amps at 125V. Silvered lugs for low loss connections. Body size 1½x¾x¾" depth behind panel. Imported. Bushings ¾" Dia., ¾" long. Bat handle ½" long.
99 K 6155 Net, ea. .39
In lots of 10, ea. .35



HEAVY DUTY 6 AMP OPDT CENTER OFF TOGGLE SWITCH

AS LOW AS
45¢

6 Amp OPDT Center Off: For P.A. lighting circuits, etc. Rated 6 amps 125 V.A.C. 1½x¾x¾" behind panel including screw terminals. Bushing ¾x¾". ¾" bat handle. Shpg. wt., 3 oz. Imported
99 K 6148 Net, ea. .49
In lots of 10, ea. .45

RUGGED LEVER SWITCH FOR AUDIO AND INTERCOMS

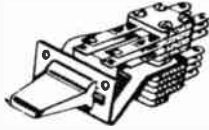

85¢

4 PDT Audio Lever Switch: Has 4 sets of single pole, double throw contacts. Switch has three position with positive & spring return. Panel mounting, mtg. centers 1" apart. Size 2¼" long behind panel. 1¾" W 1" H. Shpg. wt., 3 oz. Imported
99 K 6158 Net, ea. .85

SUB MINIATURE PUSH BUTTON SWITCH



18¢ ea. in lots of 10

Momentary contact push button switch. SPST, non-snap action. Rated 115V AC at 100 ma. Overall dimensions ¾x¾"L. Bushing ¼" long. Shpg. wt., 1 oz. Imported.
99 K 6159 Net ea. .20
In lots of 10, ea. .18

MINIATURE PUSH BUTTON SWITCH



19¢

Momentary contact push-button switch ideal for all miniaturized applications. Single pole two circuit push-to-make type. Beryllium copper leaf contacts. Overall diameter ½". Overall depth 1¼", protrudes ¾" behind panel. Bushing ¼" dia., ¾" long. Supplied with washer and mounting nut. Shpg. wt., 3 oz. Imported
99 K 6218 Net .19

ILLUMINATED PUSH-BUTTON SWITCH



175

A compact illuminated switch which will indicate mode of operation at a glance. Button lights in "IM" position takes no more space than conventional switches. Lamp is built into push handle. SPST Type. Current capacity, 10 Amps @ 125V AC, 6A @ 250V AC; Insulation resistance, 100 meg ohms or more at 500V DC. Solder terminals. Single-hole mtg. Mount in 1¾" hole, 1½" behind panel.
99 K 6192 Imported Net 1.75

ROTARY SWITCHES



4 POLE-3 POSITION

39¢

Four pole rotary selector switch, 3 positions per pole. Useful in hi-fi preamps and stereo applications. Spring loaded, positive detent action. Shorting type. Over-all diameter 1¼". Depth behind panel, including lugs, ¾". Bushing ¾x¾". ¼" knurled shaft. 1½" long. Shpg. wt., 3 oz. Imported.
99 K 6156 Net ea. .39 Lots of 10, ea. .35

RUGGED TELEPHONE TYPE 4PDT LEVER SWITCH CHROME PLATED CAM

69¢



Telephone Type 4 PDT. Lever switch: 3 position lever action switch of non induction construction. Has 4 sets of SPDT contacts — Has 3 locking positions — Heavy insulated rollers. Panel mount, 1¾" mounting centers. Size: 2½" long behind panel, ¾x1¾"H. Shpg. wt., 3 oz. Imported.
99 K 6149 Net, ea. .69
In lots of 10, ea. .65

SPST "SEE SAW" SWITCH

39¢



• Rocker Arm actuated Flush Mounting

"Touch" action rocker arm type, equipment switch. Mounts flush in panel up to ½" thick. Requires rectangular mounting hole ¾" wide by 1" long. Mtg. centers 1¾". Mtg. holes tapped for 4-36 machine screws. Overall behind panel dimensions ¾x¾x1¼". Rated 3 amps at 125V AC. Shpg. wt., 2 oz.
99 K 6208 Imported Net ea. .39
Lots of 10, ea. .35

MAGNETIC PROXIMITY SWITCH



174¢

Magnet Switch
• Circuit Closes When Magnet Approaches Switch
• For Industry and Business Hermetically Sealed

An ingenious little device that has untold uses in the home—in a burglar alarm system, electric trains, "magic tricks," and many more. As the magnet approaches the switch, the circuit closes. Hermetically sealed; precious metal contacts; 1 milli-second actuation. 15 watts resistive max. up to 1 amp to 250 volts. Size: 2¾" with leads.
34 K 4401 Shpg. wt., 3 oz. Net 1.74

MIDGET-BAKELITE KNIFE SWITCHES

AS LOW AS

12¢



Complete switches mounted on black bakelite base with insulated knob handle of black bakelite. Plated brass contacts provide positive low-resistance connection. Imported.

SPDT KNIFE SWITCH

Overall size 1½x2¾". Shpg. wt., 6 oz.
99 K 6152 Net .12 ea. — 10 for .99

OPDT KNIFE SWITCH

Overall size 1½x2¾". Shpg. wt., 4 oz.
99 K 6153 Net .19 ea. — 10 for 1.75

SLIDE SWITCHES AT LOW PRICES!



Compact slide switches in cadmium steel housings. All rated 125V AC. 1½" mounting centers. Shpg. wt., 3 oz.

| Stock No. | Circuit | Ea. | Lots 10 Ea. |
|-----------|---------|-----|-------------|
| 34 K 3703 | SPST | .09 | .08 |
| 34 K 3704 | SPDT | .10 | .09 |
| 34 K 3911 | DPST | .20 | .18 |
| 34 K 3912 | DPDT | .22 | .20 |

LAFAYETTE'S REVOLUTIONARY LVL*

**NEW HIGH GAIN ALL
CHANNEL* LAFAYETTE
VECTOR LOG[®] EXCEPTIONALLY
EFFICIENT LOG-
PERIODIC VEE DESIGN**

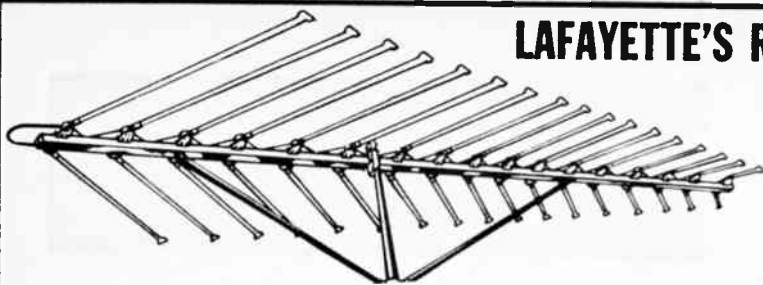

- Extremely High Gain and Front-to-Back Ratio
- For Reception of Black and White or Color TV, FM and FM Multiplex
- Great Selectivity and Sharpness in Any Location
- Flat Response From Lowest to Highest TV Channel

Your choice of six Lafayette LVL models gives you the ideal antenna for your particular needs. Built to last longer and pre-assembled for fast, easy installation. Receives black and white or color TV and FM and FM Multiplex stations with outstanding clarity. Simply select the antenna that will cover your range (up to 175 miles).

| | | | | |
|-----------|-----------------|--------------|--------------------|-----------|
| 18 K 0108 | 50 mile range. | 4 elements. | Shpg. wt., 4 lbs. | Net 8.79 |
| 18 K 0109 | 75 mile range. | 6 elements. | Shpg. wt., 6 lbs. | Net 12.91 |
| 18 K 0110 | 100 mile range. | 8 elements. | Shpg. wt., 8 lbs. | Net 17.61 |
| 18 K 0111 | 125 mile range. | 11 elements. | Shpg. wt., 11 lbs. | Net 23.45 |
| 18 K 0112 | 150 mile range. | 15 elements. | Shpg. wt., 13 lbs. | Net 29.37 |
| 18 K 0113 | 175 mile range. | 18 elements. | Shpg. wt., 16 lbs. | Net 35.25 |

FAMOUS COLOR 'TENNA

**UP TO 125
MILES OF
POWER FRINGE
RECEPTION**

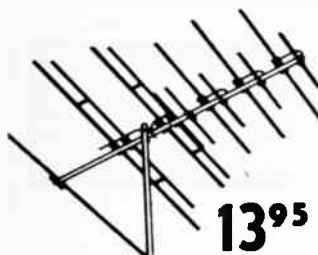

13⁹⁵

- 19 Electrical Elements
- Engineered for Superior Color & Black and White Reception
- High Gain on All VHF Channels

Twin-driven elements work with carefully tuned, phased and spaced directors and reflectors to extend flat high gain response across entire VHF band. Cuts out ghosts and unwanted signals. Rugged reinforced aluminum elements and brackets stand up under most severe wind and ice loading. 100% pre-assembled for easy installation. Less mast, lead-in. Shpg. wt., 7 lbs.

18 K 0101WX Net 13.95
Select a complete antenna installation kit from listing below.

FAMOUS SUPER COLOR 'TENNA

**UP TO 150 MILES OF EXTRA POWER
FRINGE RECEPTION**

- 27 Electrical Elements
- Inline Twin-Driven, Yagi Design
- Deep Fringe Gain on All VHF Channels
- Completely Pre-assembled

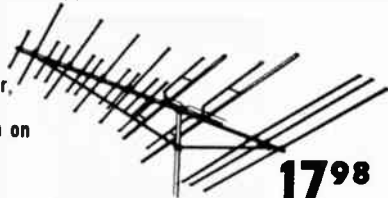

17⁹⁸

Delivers the extra picture power needed for crisp, clear pictures in remote areas. Inline twin driven yagi design provides more gain and higher front-to-back ratio. Result: More TV stations, more picture power. Factory preassembled for snap-out assembly. Reinforced gold anodized aluminum construction. Less mast and twin lead. Shpg. wt., 10 lbs.

18 K 0103WX Net 17.98
Select a complete antenna installation kit from listing below.

POWER BEAM VHF ANTENNA

7⁶⁴

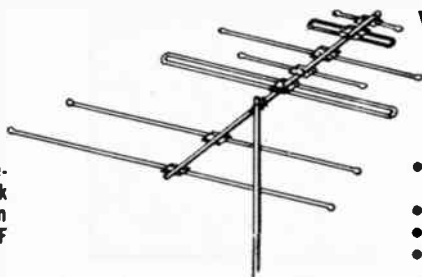

- For Local And Suburban Reception
- Fast Installation
- No Loose Parts
- Time Proven Design

The ideal metropolitan and suburban VHF TV antenna. Broad-band, sharply directive. Full length elements, all aluminum construction, famous in-line design. 300-ohm impedance match reduces stray reflections and ghosts. Fiberglass insulators for maximum strength and weather protection. Less mast and lead-in. Shpg. wt., 6 lbs.

18 K 0102WX Net 7.64
Select a complete antenna installation kit from listing below.

MAXIMUM PERFORMANCE FRINGE ANTENNA

11⁸⁸

Range to 100 Miles

- 21 Active Elements
- Snap Open Design
- Fiberglass Insulators
- Compound Yagi Array

GOLD ANODIZED

Field proven design for fringe reception. Gold anodized to combat corrosion. Compound yagi array to "suck-in" signals where other designs fail. "Tension-lok" hardware. Heavy wall tubing throughout. Less Mast. Shpg. wt., 8 1/2 lbs.

18 K 0104WX Net 11.88
Select a complete antenna installation kit from listing below.

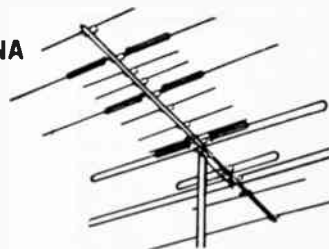

Select A Complete Antenna Installation Kit From Listing Below.

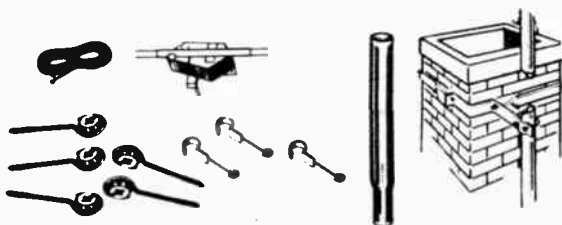

"U-INSTALL-IT" KITS

All the items for simple installation. Your choice of an all angle roof mount or chimney mount—lightning arrestor—75 feet of 300 ohm twin lead—screw eyes—mast stand offs and 5 ft. 1 1/4" O.D. steel mast. Shpg. wt., 7 lbs.

| | | |
|-------------|---|----------|
| 18 K 0118W | With roof mount | Net 2.95 |
| 18 K 0106W | With 2-5 ft. masts. Shpg. wt., 10 lbs. | Net 3.55 |
| 18 K 0119W | Same as 18 K 0118W with chimney mount | Net 3.25 |
| 18 K 0127W | Same as 18 K 0106W with chimney mount | Net 3.85 |
| 18 K 0120WM | Same as 18 K 0118W with alum wall bracket | Net 2.95 |
| 18 K 0121WM | Same as 18 K 0106W with alum wall bracket | Net 3.55 |

LAFAYETTE'S OUTSTANDING SELECTION OF TV ANTENNAS

ALL CHANNEL'S "RIVIERA" POWERFUL ULTRA-FRINGE VHF-UHF-FM ELECTRONIC ROTATING ANTENNA



1985

MONEY BACK GUARANTEE
If not completely satisfied with any ALL CHANNEL product, return at once for full refund, less only transportation charges.

THE RIVIERA MUST BE USED WITH THE LOW LOSS LEAD IN WIRE LISTED BELOW

Special 4 conductor, matched impedance transmission line. Low loss, mica-filled Polymacelene copperweld conductors.

| | | |
|------------|----------------|----------|
| 32 K 1001W | 50 ft. length | Net 5.00 |
| 32 K 1002W | 75 ft. length | Net 7.50 |
| 32 K 1003W | 100 ft. length | Net 8.90 |

- Guaranteed 200 Mile VHF Reception or Your Money Back
- Broadband UHF-VHF and FM, motorless all direction reception
- Receives channel 2-83 from all directions without a rotor
- All aluminum flip-out assembly

Field tests reception on VHF of up to 200 miles has made possible this unprecedented guarantee. This powerful ultrafringe antenna may be used for receiving TV channels 2-83 and the FM broadcast frequencies. Perfect for application where color TV or FM multiplex signals are extremely weak due to distance from transmitting antenna and to other receiving conditions. Here is an antenna with only one transmission line for all UHF, VHF, and FM stations in all directions within a 200 mile radius without the use of a motorized rotor. The nine position selector switch conveniently connected at the set electronically rotates the antenna beam pattern instantly without physically moving the antenna. Superb gain on channels 2-6 comparable to stacked 10-element single channel yagi; on channels 14-83 comparable to bow-tie reflector. 16 1/2" doweled aluminum elements are 60 inches long. Complete with switch, coupler, 45" stacking bars and 2-7 1/2" angle type most insulators for Polymacelene line listed below. Shpg. wt., 10 lbs.

18 K 1201WX Less Mast "U-Install-It" kit: Includes Riviera antenna, chimney mount, two five ft. masts, 100 ft. of Polymacelene 4-conductor lead-in wire, 8 stand off insulators and complete instructions. Net 19.85
18 K 1202WX Shpg. wt., 16 lbs. Net 27.32

LAFAYETTE UNI-TENNA

- One Array for FM & TV
- Range To 75 Miles

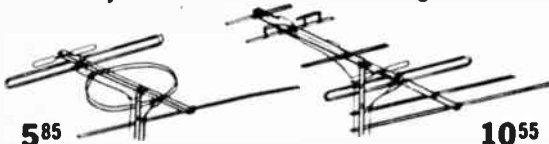

Excellent pattern and high gain provide top reception of color and black-white TV and is ideal for FM multiplex stereo. Uses combination TV and FM antenna on one boom with separate transmission lines. 4 Element yagi is used for TV, 3 elements yagi for FM, 10 Elements operating on high band as patented colinear yagi. 18 K 0114WX Shpg. wt., 6 lbs. Net 10.55
Similar to 18 K 0114WX but with less elements and use of omnidirectional FM halo. Designed for local and suburban use. Provides all response operation for TV, FM and Multiplex. 18 K 0115WX Shpg. wt., 3 1/2 lbs. Net 5.85

SUPER UNI-TENNA

- 4 Directional Elements on FM
- Pre-Assembled Snap Out Construction
- 15 Elements Colinear on High Band TV

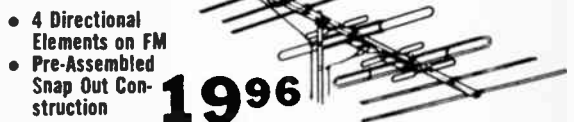

Top response for black and white, color TV and FM or multiplex reception. Fringe area combination high gain TV and FM antenna on one 100" boom. Uses two separate transmission lines for maximum efficiency. 5 elements for low band, 15 elements on high band in twin-driven yagi arrangement. Special twin phased FM driven element, with 2 parasitics produce full 3-element gain across FM band. Sturdy 1" dia. boom. Pre-assembled, aluminum snap-out construction. Shpg. wt., 9 1/2 lbs. Net 19.96
18 K 0124W

Lafayette TRIPLE-DRIVEN POWER BEAM

1795

- For Fringe Areas Up to 150 Miles
- 24 Working Elements
- Goldenized

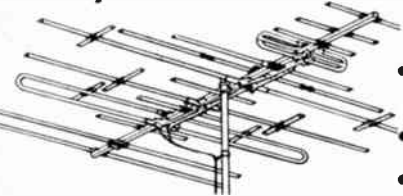

Charge weak deep-fringe VHF signals with brilliant picture detail. Individual reverse phase twin-driven low band and high band collectors, reflectors, and directors. Extremely high signal-to-noise level. Sharpened directivity, interference-free pictures, rich, deep contrast. Ultra-modern inline construction. Completely pre-assembled. Less mast and 300-ohm twin line. Shpg. wt., 10 lbs. Net 17.95
18 K 0125W

20 ELEMENT STACKED SNAP OPEN CONICAL ANTENNA

5²⁵

- All Aluminum
- No Loose Parts
- Fastest Installations

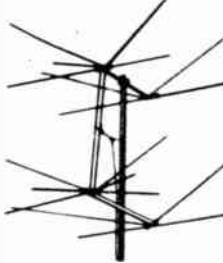

GOLDENIZED
All elements snap open and lock in without tools. Efficient conical design for all reception areas. Two complete bays with Q bars, less mast. Shpg. wt., 8 lbs. Net 5.25
18 K 0105WX Singly, ea. 4.95
Lots of 3, ea.

REMBRANDT TV DIRECTION FINDER

- Receives From All Directions
- Boosts The Pickup Power!
- Filters Out Interference
- No Installation Problem



Electrically rotates the polar-receiving pattern of your existing antenna and phases the ground wave picked up by the electrical wiring system with the sky wave picked up by the antenna. Improves any existing antenna: indoor, outdoor, master or built-in. Boosts pickup power of any antenna — old or new. Just a flick of the selector control tunes out ghosts — filters out interference — tunes in those "hard-to-get" problem channels. Automatically amplifies TV signal strength for "snow" free, brighter, clearer pictures. Works on every channel — in any location — with any antenna — for any TV set. No installation problem — simply attach to antenna terminals in back of TV set — and plug into 110V AC/DC socket. Complete satisfaction guaranteed or your money back. 18 K 1206 Shpg. wt., 2 lbs. Net ea. 9.95
In lots of 6 ea. 5.00

TV-FM BOOSTER COUPLER

1058

- Ideal For Color TV
- Improves Fringe Area Reception

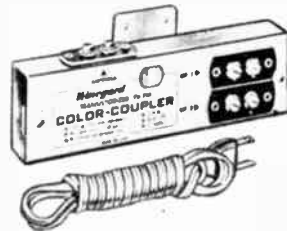

Permits reception from 2 TV or FM sets equal to or better than was possible for just one set operation. Especially useful in fringe and weak signal areas. Completely isolates each set from interfering with each other. Requires single antenna down lead. Average gain 7-10 db. Isolation: 15 db. Input and Output 300 ohms. Steel case: 1 7/8 x 6 1/2 x 3/8". For 117 volts 60 cps. AC. Shpg. wt., 1 lb. Net 10.58
18 K 6004

LAFAYETTE FM ANTENNAS AND ACCESSORIES

LAFAYETTE "MULTIPLEX 10" EXTENDED RANGE FM ANTENNA

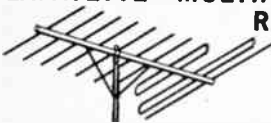

988

GOLD ANODIZED

Ideally suited to Multiplex FM reception. This 10-element, double-driven, yagi array has the necessary added gain, sensitivity and directivity to compensate for the lack of signal strength. All-aluminum gold anodized construction. Fibreglas insulators. Torsion lock hardware. sure-lock mast clamp. Shpg. wt., 7 lbs.

18 K 0128WX

Net 9.88

FM STEREO-PLEX ANTENNA

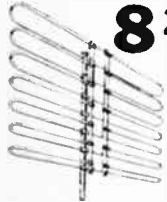

825

The Model FM-88 Seven-Element Stereo-Plex FM antenna is the first antenna designed specifically for Multiplex Stereo FM. An omni-directional antenna with triple the power of crossed dipoles... and four times the power of "S" shaped FM antennas. All-aluminum construction. Receives from any direction at distances up to 40 miles from the station. Shpg. wt., 4 lbs.

18 K 2400W

Net 8.25

VHF-UHF-FM COUPLER/SPLITTER

Only

323



For maximum performance from any VHF-VHF-FM antenna using a single downlead. Signal is "split" by unit permitting 3 independent leads to 3 separate receiver terminals. VHF, VHF, TV and FM. Conjugate Filter network gives high isolation and low signal loss. Includes instructions and mounting hardware for back of set or antenna mast. Wt. 6 oz.

18 K 3021

Net 3.23

MODEL 3007 FM BAND PASS FILTER

398



- Engineered To Mount Anywhere
- Eliminates Interference to FM Reception

Eliminates interference from citizen band, amateur operators, electric motors, aircraft, fluorescent lamps and auto ignition. Provides up to 40 db attenuation of all interfering signals outside the FM band. Less than 1 db insertion loss in 88 to 108 mc band. Recommended to be mounted at FM radio set for maximum effectiveness but may be mounted anywhere in line for less serious applications. Shpg. wt., 8 oz.

18 K 3016

Net 3.98

TRI-SET COUPLER

229



Highly efficient 3 set coupler. For coupling 2 or 3 TV or FM sets to one antenna of any type. No interaction—less than 60db insertion loss. 40 to 50 db rejection ratio. Shpg. wt., 1 lb. Imported.

99 K 4010

Net 2.29

TV-FM HI-PASS FILTER

239



- Eliminates Interference in Antenna Circuits

Hi-pass filter passes all frequencies above 40 mc. Rejects all frequencies below 40 mc. Automatically eliminates electrical disturbances in the antenna circuit. Clears disturbances caused by neon, X-Ray, ignition, appliances, diathermy, short wave, etc. Shpg. wt., 1 lb. Imported.

99 K 4009

Net 2.39

LAFAYETTE "HI-5" YAGI

GOLD ANODIZED

- DESIGNED EXPRESSLY FOR FM

595

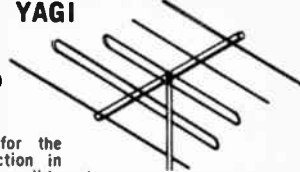

High gain antenna design for the audiophile who seeks perfection in FM reception. Extra elements on this antenna serve to pull in stations where others fail. Trouble free operation even under severe weather conditions. The fully automatic snap-lock brackets insure easy, rapid and secure installation.

18 K 0149WX Shpg. wt., 3 lbs.

Net ea. 5.95

FM ANTENNA KIT

- Ready To Install
- Fully Assembled
- All Directional
- 40 Mile Range

398



Provides excellent gain for areas up to 35 miles from the station. Gold anodized aluminum. Complete with 50 ft. of 300-ohm twin lead, mast standoff, screw eye standoffs, mast mount.

18 K 0132 Shpg. wt., 5 lbs.

Net 3.98

FM ANTENNA ONLY. Shpg. wt., 3 lbs.

18 K 0133

Net 2.85

LAFAYETTE TRANSISTORIZED 4-SET TV/FM BOOSTER

ONLY

1498

- Amplifies Signals for Top Reception on Up to 4 Sets
- Easy to Connect and Economical to Operate
- Can be Mounted in any Location, in any Position

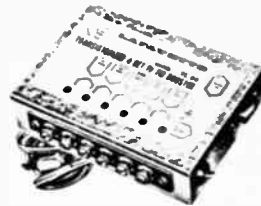

If your antenna isn't pulling in signals of sufficient strength then this Lafayette Booster Amplifier is just what you need. Screw-on terminals make wire connections easy, no cutting is necessary. Transistor circuit runs cool, draws little current. Signal strength is boosted 3 to 5 times. Will operate up to 4 TV and/or FM sets on the same antenna. Input impedance is matched to antenna impedance. Needs no adjustment. Isolated outputs insure maximum set separation. Can be mounted in any convenient location where adequate ventilation is provided. Size: 4 1/4" x 1 1/4" x 3 1/2" O. For 117 volts, 60 cps AC. Shpg. wt., 1 lb. Imported.

99 K 4011

Net 14.98

TELESCOPING TV MASTS

Heavy-duty telescoping masts, ideal for any TV antenna array. Hot-dip zinc galvanizing inside and outside provides unusual ruggedness and impenetrable corrosion resistance. Designed for easy installation and assembly. Husky bolts lock sections automatically. No slipping, no twisting. Precision fitting assures lasting service. 18 and 20 gauge walls. Supplied complete with all guy rings, clamps and necessary hardware. Total 5 10-ft. sections for height up to 50 ft.: 0.0: #1 (1 1/4"), #2 (1 1/2"), #3 (1 3/4"), #4 (2"), #5 (2 1/4"). Shipping express only.

50-FT. MAST—Consists of all 5 sections listed above: Nos. 1, 2, 3, 4 and 5. Height 50 feet. Shpg. wt., 39 lbs.

18 K 5609WX Net 12.99

40-FT. MAST. Consists of 4 sections: Nos. 1, 2, 3 and 4. Height 40 feet. Shpg. wt., 28 lbs.

18 K 5610WX Net 9.49

30-FT. MAST. Consists of 3 section. Nos. 1, 2 and 3. Height 30 feet. Shpg. wt., 21 lbs.

18 K 5611WX Net 6.98

20-FT. MAST. Consists of 2 sections. Nos. 1 and 2. Height 20 feet. Shpg. wt., 14 lbs.

18 K 5612WX Net 4.29



LIFELINE COPPERWELD TWIN LEAD



Guarantee: If this deluxe 300 ohm line fails to last the life of your antenna we will replace it at no charge. 20 Gauge Copperweld (steel clad copper) conductors with finest brown polyethylene insulation. Chemically protected against deterioration. Special "waste free" dispenser package. Shpg. wt., 3 1/4 lbs. Minimum length 100 ft.

34 K 4613 100 ft. package Net 1.98

34 K 4614K Bulk per ft. (over 100 ft.) Net .018

UNIVERSAL TV-FM PLUG & SOCKET

35¢



Compact, low loss—300 ohm plug and socket. Surface mounting socket—low loss polystyrene plug. Solderless screw terminals. Shpg. wt., 2 oz. Imported.

99 K 4006 Plug & Socket Net .35

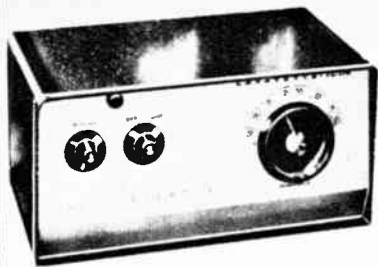

LAFAYETTE ALL-CHANNEL UHF CONVERTER

- Makes Your TV Set a Modern 82-Channel Receiver
- For Use with Any VHF Set
- Easy to Install—Easier to Operate
- Vernier Tuning

The compact Lafayette low-noise UHF converter will add all UHF channels 14-83 to channel 5 or 6 of your present TV set. Precise tuning with dual-knob Vernier selector. UHF/OFF knob for instant selection of UHF or VHF reception. UHF signal light. Maximum signal power with precise 300-ohm input and output impedance. Highly styled, durable metal cabinet. Overall size: 8Wx4Hx4½"D. For 110-120 volts, 60 cps AC. Shpg. wt., 6 lbs. **18 K 0145** Net 15.95

SPECIAL HIGH-GAIN UHF RECEPTION PACKAGE

Consists of Lafayette Converter; completely pre-assembled, 18-0142WX 4-bay UHF antenna; UHF/VHF antenna coupler. Shpg. wt., 11 lbs. **18 K 9000WX** Net 22.95

Only **15⁹⁵**

POWERSCOPE UHF ANTENNA

True Parabolic Focal Design
The Most Powerful UHF Fringe Antenna

- Positive Big Screen Ghost Rejection
- 18 db Gain at Translator Frequencies
- 13 db Gain over UHF Spectrum
- Quick, Strong Installation

The most powerful UHF fringe antenna—proven by performance in the toughest fringe and translator UHF areas. Unique parabolic design exceeds the capture area of 12 and 16 bay car's whisker type arrays. Single dipole provides maximum signal without phasing harness. All metal construction reduces signal loss due to weather deterioration. Pre-assembled screen and dipole are installed in minutes for maximum performance and reliability. Shpg. wt., 10 lbs. **18 K 2401WX** Net 12.99

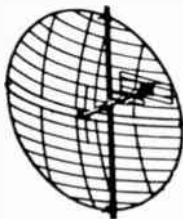

12⁹⁹

ECONOMY UHF ANTENNA

- Highest Gain on 70 UHF Channels
- Completely Preassembled
- Excellent Directivity
- Flat Response Across Each Channel

Four bay, UHF bowtie antenna. Exceptionally high (12db) gain — relatively flat across the entire spectrum . . . Fully factory assembled. Quickest and easiest to install. High efficiency screen grid reflector boosts front to back ratio. Unique "cross-over" phasing bars — open V elements, Rugged—rigid — corrosion resistant construction. Shpg. wt., 5 lbs. **18 K 0142WX** Net 4.50



4⁵⁰

UHF "TRANSLATOR" 4-BAY ANTENNA

Four bay bow-tie and screen reflector—tuned to the UHF translator frequencies. Average 16db gain on channels 70-83. Completely preassembled. Shpg. wt., 5 lbs. **18 K 0143WX** Net 4.50

LPV UHF ANTENNAS

AS LOW AS

4⁵⁰

An extremely efficient antenna utilizing the famous log periodic design. Narrow beam rejects interfering multipath signals on UHF. Provides higher gain than corner reflectors. Is less bulky and less susceptible to wind and ice than ordinary UHF antennas. Also operate on UHF ch. 7-13.

| | |
|--------------------------------|-------|
| LPV-U5, 5 cells, to 25 miles | 4.50 |
| 18 K 3834 | |
| LPV-U9, 9 cells, to 40 miles | 7.35 |
| 18 K 3833 | |
| LPV-U15, 15 cells, to 60 miles | 11.14 |
| 18 K 3832W | |
| LPV-U21, 21 cells, to 80 miles | 16.43 |
| 18 K 3831W | |

SOUTH RIVER SUPER MOUNT

For all UHF TV reception areas. Designed to cover channels 14-83. Features a highly sensitive single bay, colinear design. 100% aluminum for maximum conductance. Gold anodized for permanent corrosion protection. Factory pre-assembled. Heavy duty construction throughout. One-piece mast clamps automatically align antenna parallel to mast. Shpg. wt., 4 lbs. **18 K 5601** Each 5.88
Lots of 3, Each 5.29



ALL-CHANNEL UHF "ULTRA-BEAM"

7³⁵

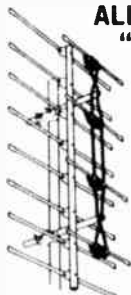

For all UHF TV reception areas. Designed to cover channels 14-83. Features a highly sensitive single bay, colinear design. 100% aluminum for maximum conductance. Gold anodized for permanent corrosion protection. Factory pre-assembled. Heavy duty construction throughout. One-piece mast clamps automatically align antenna parallel to mast. Shpg. wt., 4 lbs. **18 G 6001W** Net 7.35

ALUMINUM TENNA TOWER



Extremely light (weighs only 1/3 as much as steel) yet incredibly strong. Made completely of aluminum. Roof-mounts are designed to fit any pitch roof for easy house or store top mounting. House brackets may be used for ground installations and are available in two sizes: adjusts to 18" and to 36". Roof-mount is hinged so that the need to "climb the tower" is eliminated for servicing. Will support itself or may be guyed for added strength. May be used with any rotator. 10 ft. Top section. Shpg. wt., 10 lbs.

| | |
|---|-----------|
| 18 K 8901WX | Net 19.87 |
| 10 ft. Center or bottom section. Shpg. wt., 10 lbs. | |
| 18 K 8902WX | Net 19.87 |
| 18" House bracket. Shpg. wt., 4 lbs. | |
| 18 K 8903 | Net 6.54 |
| 36" House bracket. Shpg. wt., 7 lbs. | |
| 18 K 8904 | Net 7.90 |
| Roof Mounts. Shpg. wt., 3 lbs. | |
| 18 K 8905 | Net 4.62 |

TV TUBE RESTORER



- 120 Different Combinations
- Corrects Open Cathode — Heater to Cathode Short — Open Control Grid — Control Grid to Cathode Short — Low Emission

One simple unit provides the cure for most ailing picture tubes. Latest model features slide switches — not pin plugs as older units do. Rugged, well made socket — compact, single unit design. Works on electrostatic or electromagnentic focusing tubes, in series or parallel circuits. Includes instructions. Shpg. wt., 1 lb. 4 ozs. Net 3.23
18 K 4604 Net 4.88
18 K 4605 For RCA Type 110° Tubes Net 4.88
For Sylvania Type 110° Tubes
18 K 4606 Net 4.88

WIZARD 300 MASTER COUPLER

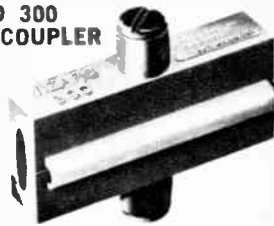

- Ideal for Unlimited Set Coupling
 - Connects TV Sets Directly to Antenna Line
- Provides for the coupling of any number of TV (color or black and white) and FM sets to one antenna line. The first set is connected directly to the line, and each additional set is connected through a separate WIZARD 300, without the need for an amplifier or booster. Shpg. wt., 3 oz. **18 K 6901** Net 11.15
In lots of 3 Net ea. 1.03



MOTOROLA

ALL NEW SOLID STATE AUTOMOBILE RADIOS

7-TRANSISTOR MANUAL CAR RADIO

- For 6-Volt Systems
- 8-Tuned Circuits

Compact, universal set designed to fit 6-volt sports cars, trucks, boats and older cars under dash or with optional in-dash installation. Solid state circuitry with 7 transistors, 2 diodes and 1 thermistor has advantage of low battery drain, cool operating chassis and "instant play"—no warmup necessary. Also features: 8-tuned circuits for improved selectivity, built-in 5" Golden-Voice™ speaker, thumbscrew antenna trimmer, rear speaker jack and black "leather texture" front panel. For 6-volt cars—reverse polarity. Size 6 $\frac{1}{2}$ "x2 $\frac{1}{2}$ "x7 $\frac{1}{4}$ "D. Shpg. wt., 6 lbs.

17 K 1018 Model TM 415M Net 39.95
 Custom Mounting Kit for In-dash Installation, Specify Make, Model, Year of Car. Shpg. wt., 1/2 lb.
 17 K 1019CY Net 2.95

DELUXE 7-TRANSISTOR PUSHBUTTON CAR RADIO

- For 6-Volt Systems
- 8 Tuned Circuits

Custom deluxe, solid-state radio delivers standard AM broadcasts with rich tone through an external 5" Golden Voice Speaker. 7 transistors, 2 diodes and 1 thermistor operate with low battery drain and cool chassis for long life. With Solid-state circuitry radio plays instantly—no waiting for warmup. Features 8 tuned circuits for improved selectivity, 5 fingertip push buttons, thumbscrew antenna adjustment and variable tune control for more enjoyment of musical programs. For 6-volt cars, reversible polarity. Size: 6 $\frac{1}{2}$ "x2 $\frac{1}{2}$ "x7 $\frac{1}{4}$ "D. Shpg. wt., 7 lbs.

17 K 1020CM Model TM 625A Net 59.95

5-TRANSISTOR MANUAL CAR RADIO

- For 12-Volt Systems
- 8 Tuned Circuits

Compact universal set designed to fit 12-volt cars—under dash or with optional in-dash installation. Solid state electronics provides low battery drain, cool operation, instant-play—no waiting for warmup. Features 5-transistors, 2 diodes, 1 thermistor, 8 tuned circuits for improved selectivity and interference rejection, variable tune control and built-in 5" Golden Voice Speaker. Beautiful panel has "leather texture" look. For 12-volt cars reverse polarity. Size: 6 $\frac{1}{2}$ "x2 $\frac{1}{2}$ "x7 $\frac{1}{4}$ "D. Shpg. wt., 7 lbs.

17 K 0121 Model TM 325M Net 39.95
 CUSTOM MOUNTING KIT For In-Dash Installations. Specify Make, Model, Year of Car. Wt., 1/2 lb.
 17 K 1022CY Net 2.95

DELUXE 6-TRANSISTOR MANUAL CAR RADIO

- For 12-Volt Systems
- Push-Pull Audio For Hi-Fi Sound.

Custom universal AM radio featuring push-pull audio for full power hi-fi sound. Adjustable shafts fits most cars. Cool running solid state circuit has 6 transistors, 2 diodes and 1 thermistor. 8-tuned circuits for improved selectivity, variable tone control for sound balancing and thumbscrew antenna trimmer. 5x7" Golden voice external speaker. For 12 volt negative ground systems only. Size 7 $\frac{1}{2}$ "x2 $\frac{1}{2}$ "x5 $\frac{1}{4}$ "D. Shpg. wt., 7 $\frac{1}{2}$ lbs.

17 K 1023CM Model TM5M Net 51.95

DELUXE 6-TRANSISTOR PUSHBUTTON CAR RADIO

- For 12-Volt Systems
- Push Pull Audio For Hi-Fi Sound
- Unique LumaAlert Warning Device

High quality custom AM radio featuring cool operating, reliable solid state circuitry, push-button tuning push-pull audio output for greater power less distortion, and unique LumaAlert warning device which signals through cars speaker when headlights are left on. 8 tuned circuits 7 transistors, 2 diodes, 1 thermistor. Adjustable shaft fits most cars. With 5x7" Golden Voice Speaker, variable tone control, thumbscrew antenna trimmer. For 12-volt negative ground electrical systems only. Size: 7 $\frac{1}{2}$ "x2 $\frac{1}{2}$ "x5 $\frac{1}{4}$ "D. Shpg. wt., 8 lbs.

17 K 1024CM Net 59.95



39⁹⁵

\$5 Monthly

For Under Dash Mounting



59⁹⁵

\$5 Monthly

Plus Free Mounting Kit. Specify Make, Model, Year of Car.



39⁹⁵

\$5 Monthly

For Under Dash Mounting



51⁹⁵

\$5 Monthly

Plus Free Custom Mounting Kit. Specify Make, Model, Year of Car.



59⁹⁵

\$5 Monthly

Plus Free Custom Mounting Kit. Specify Make, Model, Year of Car.

LAFAYETTE SOLID STATE AUTOMOBILE REVERBERATION SOUND SYSTEM

FROM LAFAYETTE . . . AUTO REVERBERATION — A 3rd DIMENSION IN SOUND

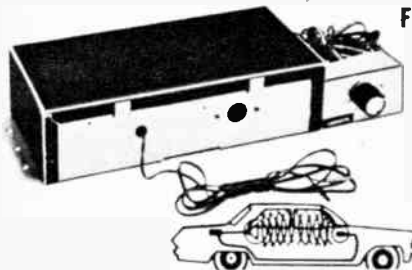

23⁹⁵

Made in U.S.A.

- For all 12-volt Negative Ground AM & FM Auto Radios
- Simple—Easy Installation

The Lafayette solid state Automobile Reverberation sound system consists of the transistorized amplifier chassis with the reverberation unit, under dash control plate with on-off switch, fader control, and interconnecting cables. Includes simple instructions for connecting the verb unit to your regular under dash auto speaker, and to a separate rear seat speaker (if your auto does not have a rear seat speaker, see listing of rear seat speakers on page 104. Reverberation is an entirely different approach to sound reproduction. Normal sound reproduction from a single source has a flat, one dimensional effect; with proper sound delay through "REVERBERATION," tones are created with a truly third dimension for concert hall originality. Mounts conveniently in the trunk of your car. For all 12-volt negative ground AM or FM auto radios. Dim: 10 $\frac{1}{2}$ "x1x6". Shpg. wt., 3 lbs.

17 K 0105 Net 23.95

NEW BLAUPUNKT DERBY FM/AM, SW and MB PORTABLE CAR RADIO



Only
84⁹⁵

\$5 monthly

2 Quality Car
Radios in One

- Use It As a Portable—Install it in your Car
- 4 Bands—FM, AM, Shortwave and Marine Band
- 11 Transistors

Carry it as a portable or install it in your car using an optional easy-to-install adapter that disappears under the dash when not in use. Plays for approx. 300 hours on 6 inexpensive 1½-volt flashlight batteries (not supplied). A built-in ferrite antenna is used for AM reception; a retractable, pivoting telescopic antenna for shortwave/FM reception. Has push/pull output stage and sockets for earphone, tape recorder and record player. Also has a variable tone control for true hi-fi music reproduction. Attractively housed in a black leatherette case. Size: 9¼x7¾x3½". Shpg. wt., 7 lbs. Made in West Germany. **17 K 1517XL** Net **84.95**

Universal Mounting Bracket, with lock, for auto use (6 or 12 volts—reverse polarity) **17 K 1516** Net **19.00**

"D" size flashlight battery (6 req.) for portable use. **32 K 4804** Net ea. **.13**

ALL-TRANSISTOR MANUAL AUTO RADIO COMPLETE with FREE ANTENNA

29⁹⁵



- 5 transistors and 2 diodes
- Large easy to read illuminated dial
- Convenient underdash mounting
- For 12-volt negative ground installations

MADE IN U.S.A.

A fine quality AM radio that utilizes "solid state" construction in a Superheterodyne circuit for trouble-free operation. Finger-tip control to adjust tone as you desire. Also contained is an electronic automatic volume control to keep signals strong and steady. This unit is exclusively hand wired for ruggedness—no printed circuitry. Fits under-dash or in-dash utilizing standard trim plates. Available for 12-volt negative ground installations. Neutral gray-tan baked enamel finish. Overall size: 5½Dx6½Wx2"H. Shpg. wt., 4½ lbs. **17 K 7405M** Net **29.95**

DELUXE TRANSISTORIZED CAR STEREO TAPE PLAYER

- Hear the Music You Want, When You Want It
- Easier To Operate Than a Car Radio
- Up to TWO HOURS of Listening Pleasure

149⁹⁵

\$7.50 Monthly



You can now forget about tuning problems, fading, static and other annoying features that you have come to expect with the auto radio. The quality of the stereo music has the same undistorted timbre and brilliance no matter where you drive. Easier and more simple to operate than a car radio! The completely self-contained prerecorded plastic cartridge has been standardized by all manufacturers. Simply slip the cartridge onto the deck. Push the starting lever and that's all. The endless loop tape will give you up to 2 hours of music of your choice. Tape player and cartridges are shock proof. The roughest roads will not affect the performance. Installation is simple and fool proof. Electrical connections consist of one power lead, when the unit is well grounded to the vehicle, and one lead each to each speaker. Specifications: Tape speed 3¾ ips; Controls—volume, balance, tone controls, starting lever and track selector. Amplifier—10 transistors. Output 2 watts per stereo channel. Size 9¾Wx9Dx3¾"H. Shpg. wt., 20 lbs. **17 K 5501WX** Net **149.95**

Switch and Wiring Harness. Can be used with any car stereo tape player when using front and rear speakers in car for stereo. Shpg. wt., 1 lb. **17 K 5502** Net **8.95**

ALL TRANSISTOR FM-AM AUTO RADIO



MADE IN U.S.A.

only
79⁹⁵

\$5 Monthly

- Push-pull Hi-Fi Output
- Convenient Under-Dash Installation
- 12-volt, Negative Ground Operation
- AFC for FM Drift-Free Performance
- High Sensitivity for Super Distant Reception on Both AM and FM
- 11 Transistors, 6 Diodes, 1 Thermistor
- Four Stages of I.F. Amplification on FM for Maximum Noise Limiting

A fully transistorized AM-FM radio with many HI-FI features. Instant play—just turn it on and immediately enjoy either AM or FM listening pleasure. Extremely sensitive for "pulling in" distant stations. A push-pull Hi-Fi output provides 10 watts of peak power which is more than enough to fill your auto with sound. Low battery drain—1 amp @ 8 watts output. Specs: 11 transistors, 6 diodes, 1 thermistor; tuned circuits—7 on FM, 5 on AM; Sensitivity: 3 µV for 20 db quieting; Speaker—external 3.16 oz. Alnico magnet; for 12-volt; negative ground installations. Dimensions: 6¼Wx2¼Hx6¼"D. Shg. wt., 8 lbs. **17 K 7701** Net **79.95**

DELUXE PUSH-BUTTON VOLKSWAGEN RADIO with FREE VW ANTENNA

44⁹⁵

- 5 Watts Superb Audio Power
- Easy Installation
- Transistorized Circuitry

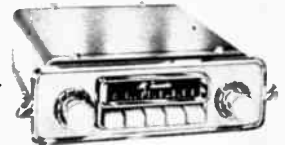

Now, the Volkswagen owner can enjoy music in his auto with this deluxe push-button radio that was especially designed to compliment the Volkswagen. Features an all-transistor circuit which gives a full 5 watts of superb audio power. Automatic volume control provides constant, even, comfort-level listening. Continuously variable tone control allows precision adjustment of both high and low frequencies so that bass and treble may easily and effectively be adjusted to the individual taste of the listener. Five quick-set push buttons mean instantaneous, fluid, finger-tip station tuning. Seven tuned circuits, including RF stage, give maximum sensitivity and selectivity in station choice. May be installed in the instrument panel in a matter of minutes. Lastly, to complete the package, includes a free antenna which is designed for the Volkswagen. Shpg. wt., 7½ lbs. **17 K 7408** \$5 Monthly Net **44.95**

PRE-RECORDED TAPES FOR CAR STEREO TAPE PLAYER

- "On A Visit To Spain" D'Artega conducts Symphony of the Air. **28 K 8101** Shpg. wt., 1 lb. Net **6.95**
- Lerner & Loewe's "My Fair Lady." Shpg. wt., 1 lb. **28 K 6102** Net **6.95**
- Familiar Favorites from the World's Greatest Music. **28 K 6107** Shpg. wt., 1 lb. Net **6.95**
- The Fabulous Pied Pipers serenade Tommy Dorsey. **28 K 6108** Shpg. wt., 1 lb. Net **6.95**
- The Fabulous Frank Loesser "In Percussion." **28 K 6110** Shpg. wt., 1 lb. Net **6.95**

AUTO SPEAKER KITS-ACCESSORIES

REAR SEAT SPEAKER KITS FOR TRANSISTORIZED RADIOS



- Features Multi-impedance Match For 40, 20, 8 ohms or less
- New Slim Line Construction

SPEAKER KITS
Complete 6x9" rear seat kit featuring new multi-impedance Slim line 6x9" speaker; chrome grille, 100 ohm Fader control, 40 ohm adaptor for Motorola Radios, and a 20 ohm adaptor for Automatic radios. Shpg. wt., 6 lbs.

32 K 2202 Net 6.69
Special Custom Rear Speaker Kit. Same as above but for the following cars: Impala, Bonneville, Invicta, and 2 door Custom Autos equipped with 40 ohm Motorola or 20 ohm Automatic radios—less grill 5 lbs.
32 K 2203 Net 3.39

MULTI IMPEDANCE SPEAKERS IN NEW SLIMLINE CONSTRUCTION

| Stock No. | Size | Shpg. wt. Net |
|-----------|------------------------|-----------------|
| 32 K 2204 | 6x9" w. jumper wires | 2 1/2 lbs. 3.25 |
| 32 K 2205 | 6" Rd. w. jumper wires | 2 lbs. 2.75 |
| 32 K 2206 | 4x6" w. jumper wires | 1 1/2 lbs. 2.46 |

LAFAYETTE REAR SEAT SPEAKER KIT



275

- Fits Compacts, Station Wagons
- Fits Foreign Cars, Sports Cars
- Prewired—Self Contained
- 3-Position Switch

Easy to install, it will fit any auto radio in any domestic or foreign car. Finished in a gleaming chrome shock resistant case, it can be hung up or clipped on almost anywhere. Includes all necessary wire, instructions and 3-position switch for front, rear or 2-speaker operation. Shpg. wt., 12 oz.
99 K 6122 Net 2.75

REAR SEAT AUTO SPEAKER KITS



AS LOW AS **298**

6" x 9" Kit with Chrome Grille
Complete kit for adding second speaker in rear of your car. Includes a 6x9" PM speaker, 3-position selector switch for cutting in front, rear, or both speakers; dial plate with mounting bracket, knob, and hardware; chrome grille; wire; and wiring instructions. Simple to install. Shpg. wt., 5 lbs.
32 K 2207 Speaker kit Net 3.45
Deluxe 6" x 9" Kit with 2.15 oz. Alnico V Magnet

Same as above but with deluxe speaker with extra-heavy Alnico V magnet (2.15 oz.). This is same speaker used in kits selling at twice the price. Shpg. wt., 5 lbs.
32 K 2208 Speaker kit chrome grille Net 4.65
5" x 7" Kit

Same as 32 G 2207 but with 5x7" speaker and grille. 5 lbs.
32 K 2209 Chrome grille Net 2.90

Fader Type Auto Kits

Rear-seat speaker kits identical to those above except with fader-type controls to cut either speaker in or out or balance both. Shpg. wt., 5 lbs.

6x9" Kit. Same as 32 K 2207 but with fader 32 K 2210 control Chrome grille Net 3.69

Deluxe 6" x 9" Fader Kit
Deluxe kit with extra-heavy-magnet 6x9" speaker, plus fader control. Shpg. wt., 5 lbs.

6x9" Kit. Same as 32 K 2208 but with fader. 32 K 2211 Chrome grille Net 4.89

CHROME AND GOLD



Handsome perforated metal grilles for rear-seat speaker use or other installations. Avg. Shpg. wt., 1 lb.

CHROME GRILLES

| | | |
|-----------|-------------|---------|
| 32 K 3401 | 5x7" Fig. A | Net .79 |
| 32 K 3402 | 6x9" Fig. B | Net .99 |

GOLD GRILLES

| | | |
|-----------|-------------|---------|
| 32 K 3403 | 5x7" Fig. A | Net .79 |
| 32 K 3404 | 6x9" Fig. B | Net .99 |

CARDIO-MASTER
Cardio master is a magnetic device designed to hold a portable transistor radio in the area of a car's windshield to make it operate as an auto radio. Car's owner can remove a radio from the Cardio master for use as portable or to avoid theft while the car is parked. Fits any "pocket" transistor radio. Will not come loose in the bumpiest roads. Includes magnetic base, brackets, hardware, adjustable band and complete, illustrated instructions. Shpg. wt., 2 lbs.
11 K 1303 Net 2.90

INSTA MOUNT SPEAKER

- New Design Concept
- Remarkable Versatility
- Exceptional Sound Quality
- Mounts Anywhere—House, Car, Boat, Patio

Insta-mount is a unique speaker concept which allows you to flush mount this slim unit anywhere. Only the handsome triple chrome plated grill shows. Hundreds of applications for this truly versatile unit. Mounts in walls, doors, ceilings, desk top, cars, (perfect for station wagons), moisture resistant for outdoor and marine installations. The powerful 5 1/4" hi-fi speaker needs no baffling. Insta-Mount provides its own infinite baffling systems. Quality sound reproduction for AM FM Radio, Hi-Fi Phonograph, T.V., Tape recorder. Use 2 for stereo. Mounts quickly and easily in minutes. No electronic experience necessary. Enclosure is included for use on tables, bookshelves or portable use. No special tools required. All hardware included. Easy to follow instructions included. Shpg. wt., 3 lbs.
32 K 3405 Net 7.95

DUAL HI-FI REAR-SEAT SPEAKER KIT



Woofers-Tweeter-Crossover

"Universal" speaker kit includes two Alnico V units—a 5 1/2" woofer and 3" tweeter with electronic crossover network; chrome grille and baffle which fits regular 6x9" cut-out; plus pre-wired, pre-soldered, 3-position switch. Shpg. wt., 4 lbs.
32 K 2212 Net 5.95

STATION WAGON REAR-SEAT KITS



• Fully Assembled—Self Contained
A fully assembled, easy-to-install auxiliary speaker for all station wagons. Single 4x6" Alnico V speaker, chrome grille, swivel bracket, 3-position switch with dial plate and knob. Comes complete with installation instructions and wiring diagram. Shpg. wt., 3 lbs.
32 K 2201 Net 6.80

3-WAY PUSH-BUTTON SWITCH



89¢

Just push a button to select either front speaker alone, rear speaker alone or both together. Comes completely assembled on black & silver metal plate with cable, hardware and simple instructions. Imported. Shpg. wt., 1/2 lb.
99 K 8510 Lots of 3, ea. .75 singly, ea. .89

DUAL-SPEAKER FADER CONTROL



64¢

Controls the volume of both front and rear speakers. Gradually reduces volume on one speaker while increasing volume on the other. Control comes completely mounted on black and silver metal plate with ivory pointer knob plus attached wiring for connections to both speakers. With mtg. hardware and instructions. Shpg. wt., 1/2 lb.
99 K 8507 Imported Net .64

3-WAY SPEAKER SWITCH



49¢

For use with two speakers. Three-position switch gives choice of front speaker alone, rear speaker alone, or both together. Comes completely assembled on black and silver metal plate with ivory indicator knob and attached wiring for connection to both speakers. With hardware and simple instructions. Shpg. wt., 1/2 lb.
99 K 8508 Imported Net .49



CARDIO-MASTER

- Convert your Transistor Radio into a Car Radio
- For all Makes of Cars, Cabs, Trucks

298

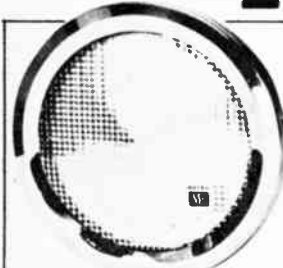

795

sound reproduction for AM FM Radio, Hi-Fi Phonograph, T.V., Tape recorder. Use 2 for stereo. Mounts quickly and easily in minutes. No electronic experience necessary. Enclosure is included for use on tables, bookshelves or portable use. No special tools required. All hardware included. Easy to follow instructions included. Shpg. wt., 3 lbs.
32 K 3405 Net 7.95

AUTOMOTIVE TOOLS AND ACCESSORIES

100 PC. TOOL KIT

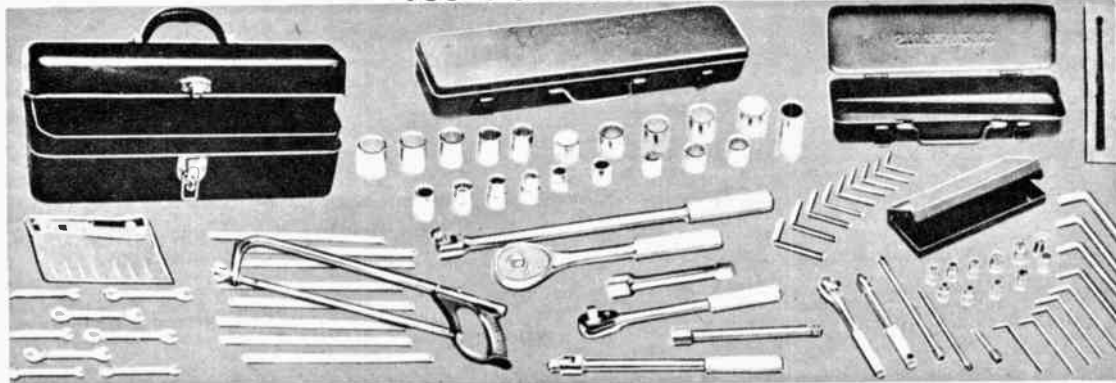

- 13 piece 1/2" Drive Socket Set
- 15 piece 3/8" Drive Socket Set
- 17 piece 1/4" Drive Socket Set

Professional quality tool kit. Rugged chrome alloy withstands tough use. Kit contains 15 pc. 3/8" drive socket set, 13 pc. 1/2" drive socket set, 17 pc. 1/4" drive socket set, 18 piece Hex Key Wrench set, Tubular Hack saw, 24 Hack saw blades (10"), 8 piece midjet box and open end wrench set, 1 ignition point file, guaranteed to file any tungsten or platinum contact point, keeps ignition points clean for easy starting, ratchet sets each come packed in individual heavy gauge metal box with handle. Box wrenches also serve as

- Chrome Alloy Steel Sockets
- Over 100 carefully chosen pieces
- Steel carrying case with liftout tray

ignition wrench set. Entire kit comes packed in steel tool box (18x6x6 3/4") with lift out tote tray. Actually 7 different sets packed into one fabulous package. Not a toy kit, these are precision tools that will delight the most competent mechanic. A terrific value for homeowners, craftsmen, do-it-yourselfers, hobbyists etc. Shpg. wt., 23 lbs.

13 K 5554 29.95

ELECTRONIC CRUISE CONTROL



- Maintains Any Selected Highway Speed
- Does Not Affect Braking or Instant Acceleration
- Increases Gas Mileage By Eliminating Wasteful Speed Variance
- Helps You To Adhere To Posted Speed Limits
- Sets Fast Idle for Quick Cold-Weather Warm-Up

New Electronic Cruise Control enables you to drive at a constant speed by automatically holding the throttle steady. Eliminates the need to keep foot glued to accelerator on long trips. Once you reach desired speed, simply pull out knob and Cruise Control will automatically hold that speed. Allows instant acceleration for passing but takes over again when the foot is taken off the gas pedal. Ceases to function the moment the brake is depressed and completely disengages in the event of any malfunction. Designed to fit all cars and trucks. Shpg. wt., 1 1/2 lbs.

11 K 5901 Net 19.95

EASY TO INSTALL

2 WAY CHOKE CONVERSION KIT



179

- Stops Costly Gas Waste and Engine Stalling
- Converts Automatic Choke to Manual Control

Gives you finger tip control of your carburetor choke for faster starts, maximum gas savings. Dual choke never interferes with normal operation of your automatic choke. No carburetor adjustment necessary. Control bracket screws easily to lip of dash panel. You'll get proper gas mixture, improved starting and gas mileage in any kind of weather.

11 K 2301 Net 1.79

NEW! UTILITY AND TOW CHAIN



A tow chain with many useful applications other than towing around the home, farm and factory. Made of strong welded 1/4" steel links—14 ft. long, with drop forge grab hooks on each end, not ordinary S hooks. Rust resistant electro-galvanized finish for long life. Shpg. wt., 8 lbs.

11 K 5401 14 Ft. Tow Chain Net 2.99

DELAY ACTION HEADLIGHT SWITCH



- Automatic Headlight Control For Safe Departure
- Fits All Cars

A true night time safety device. The delayed action switch permits your cars headlights to remain on for up to a minute after you leave, then shuts-off automatically. No more tripping around in the dark. Easy to install—fits all cars, 6 or 12 V. and does not interfere with operation of regular light switch. Shpg. wt., 6 oz.

34 K 4601 Net 2.19

INFRA-RED WINDSHIELD DEFROSTER



- Cleans Front or Back Windshield in Seconds
- Plugs into Cigarette Lighter
- Suction Cups Mount to Windshield in Seconds

New infra-red electric windshield defroster utilizes the concept of penetrating infra-red instant heat to quickly melt away mist, ice, and snow. You no longer have to wait for car to warm up before cleaning windshield—just plug it into your cigarette lighter, and start defrosting windshield immediately. Complete with 12 foot cable for reaching back windshield. Two suction cups make mounting fast and easy.

Length: 15" Shpg. wt., 1 lb.
11 K 1307 Net 2.88

TWIN-DICATOR

- Warns cars left and right you wish to turn
- Simple to attach to existing electrical wiring

Chrome plated twin-dicators can be installed almost anyplace on the front fenders of your car. Gives drivers on both sides of you warning of turns and eliminates turn indicator blind spots. Three feet of wire is supplied on each indicator to allow quick and easy installation. Units are also useful as fender guides. Shpg. wt., 1 lb.

11 K 4701 Pair 6.98

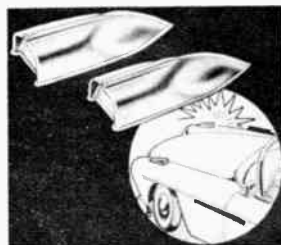

MOTOROLA TRANSISTOR IGNITION SYSTEM

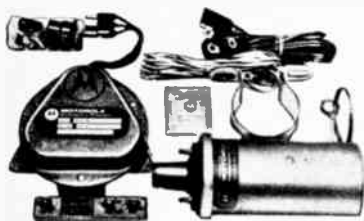

37⁵⁰

\$5 Monthly

Automatic ignition systems long have been responsible for a large share of car and truck maintenance, as well as emergency servicing. Deterioration of breaker-points, condenser and spark plugs are the most frequent causes as trouble. As plugs become fouled, it takes more voltage to fire them — voltage that conventional systems do not provide because the breaker points would have even shorter life. With this transistorized system, only a small amount of current is needed to "trigger" the much larger coil current and the condenser is eliminated. Circuits are separated so only the triggering current passes through the points. An advanced high turns ratio coil is incorporated. Voltage does not roll off at higher engine speeds. Points do not burn. Gas mileage increases as does the acceleration "snap." Transistor amplifier is protected by 2 Zener diodes and sealed to prevent dust and dirt build-up. For 12-volt negative ground ignition systems. Complete with simple installation instructions. Shpg. wt., 5 lbs.

11 K 7504 Net 37.50
Hi-Power Switching Relay for above. Insures "cold" starting. Bypass relay provides maximum current flow. Shpg. wt., ½ lb.
11 K 7505 Net 5.65

LAFAYETTE ILLUMINATED AMMETER & OIL PRESSURE GAUGES

499

- Complete with Cable and All Standard Fittings



Keep a constant check on the condition and performance of your car's electrical and oil pressure systems. The ammeter calibrated in 60-0-60 scale measures the actual rate of current flow . . . helps prevent generators from burning out and overcharging or discharging the battery. Exact oil pressure from 0 to 80 lbs. is indicated. Easily installs in any 6 or 12 volt car below the dash, without drilling or can be mounted right in the dash. Both meters are mounted in an attractive chrome panel. Easy to read meters feature 1¾" diam. black dial faces with calibrations in white. Size: 5½x2¾x2¼"D. Supplied with 6 and 12 volt bulbs and wire, all necessary fittings plus full instructions.

89 K 8501 Imported. Shpg. wt., 1½ lbs. Net 4.99
11 K 8004 Tee Fitting Net .49

MOTOROLA ALL-ELECTRONIC ALTERNATOR SYSTEM

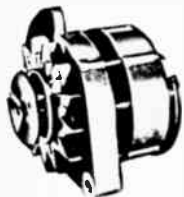

35-Amp System 50.63
40-Amp System 57.38
55-Amp System 60.75

- All-Transistor Voltage Regulator and 7-Diode Alternator
- Extends Battery Life

• **Guaranteed For 3 Years (or 30,000 Miles)***

Low cost solution to the heavy demands made by your car on its electrical system . . . Unlike D.C. generators, it supplies a charge at idle speeds and keeps the battery at a uniform high level of charge. The all-transistor voltage regulator has no contact points to stick or burn. Fits all domestic cars with 12-volt, negative ground electrical systems. The complete system includes: Alternator (with standard-size pulley); all-transistor regulator (with all connecting wires); universal mounting bracket; instructions for installation.

11 K 7501 35-Amp (wt., 12 lbs.) Net 50.63
11 K 7502 40-Amp (wt., 13 lbs.) Net 57.38
11 K 7503 55-Amp (wt., 15 lbs.) Net 60.75

*Manufacturer's guarantee covers repair or replacement of parts proven defective in normal use within 3 years or 30,000 miles (whichever occurs first).

LAFAYETTE 2-TRANSISTOR ELECTRONIC IGNITION SYSTEM

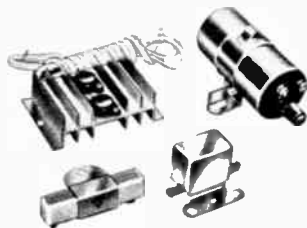

24⁹⁵

- FULL POWER AT HIGH RPM
- ELIMINATES POINT PITTING AND CONDENSER
- EASIER STARTING ESPECIALLY IN WINTER
- INCLUDES RELAY FOR HIGH CURRENT SWITCHING

This 2-transistor Ign. system will take the needless burden of high current off of your points and deliver a constant high power spark even at speeds exceeding 10,000 RPM. Modern 2-transistor circuit switches and controls the coil primary circuit through a combination amplifier-electronic switch action. Reduces point current to a low value and with proper use extends their life to the life of the car. Carries 100% primary current to over 20,000 RPM. A special low-inductance design coil delivers constant full voltage at all speeds. Full high spark voltage to over 10,000 RPM. Spark plugs last longer due to complete burning of fuel. Condenser replacement and problems are eliminated because the circuit eliminates the condenser altogether. Switching relay relieves ignition switch drain and loss of power due to long wires. High gas mileage and low timing drift make use very efficient. Transistors are removable and unit is serviceable! System includes double insulated coil, epoxy potted amplifier, ballast, and relay. Shpg. wt., 5 lbs.

11 K 0103 For Negative Ground Systems Net 24.95
POINT INSULATION KIT: adapts transistor ign. kits to permit uses with positive ground systems.
11 K 0104 Shpg. wt., 3 oz. Net 2.50

ILLUMINATED VOLTMETER KIT

649



- Indicates Battery Voltage
- Large 2" Illuminated Meter

Designed for the car owner who desires more than a red light to indicate electrical system performance. May be installed on any generator equipped auto having either a 12-volt positive or negative ground system. Complete with bracket, 6/12-volt illuminating kit, hardware and instructions.
11 K 8002 Shpg. wt., 1 lb. Net 6.49

ILLUMINATED WATER TEMPERATURE GAUGE KIT

488



- Range 100-220°F
- 2" Diameter Dial
- Hermetically Sealed

Heavy-duty vapor tension thermometer which indicates from 100 to 220 degrees Fahrenheit on a 2" diameter dial. Has 72" of armored capillary tubing with ¼" male pipe thread adapter plus hose adapter for installation direct to radiator hose or motor block. Includes mounting bracket, 6/12-volt illuminating kit, hardware and instructions. Shpg. wt., 2 lbs. Imported.
99 K 8506 Net 4.88

Lafayette HOT CAR-GO Starts Your Car INSTANTLY



- Starts Wet or Cold Motors Instantly
- Saves Battery and Gasoline
- Installs Easily and Quickly
- 6 and 12 Volt Cars

295

Avoid excess wear and tear on your motor and battery—install Lafayette's Hot Car-Go. Provides 5 times the normal spark for fast starting in any weather, and automatically disconnects when engine is running. Will not damage plugs or distributor. Simple to install—instructions included. Shpg. wt., 1 lb. Imported.
99 K 8511 Net 2.95

LAFAYETTE ELECTRONIC TUNE-UP LAB

- Compact, Self-Contained Units
- Checks Dwell Angle, Points, Coils, Alternators, Generators, Regulators
- Completely Portable Testers
- Large, Easy-To-Read Meters
- Accurate, Do-It-Yourself Engine Testing

SALE Complete 59⁹⁵

Precise, compact hand-held testers with easy-to-read 2 1/2" meter scales. Rugged phenolic case with long alligator clip leads. Complete instructions included. Overall dimensions approx. 4x2 1/2x 1 1/2". COIL TESTER. Tests coils on or off engine. Also checks shorted condensers. Shpg. wt., 1.5 lbs.

11 K 5502 Net 14.95

REGULATOR-GENERATOR TESTER. 0-8, 0-16 V. DC ranges for 6 & 12 volt systems with external 1/4 ohm resistor. Shpg. wt., 1.5 lbs.

11 K 5503 Net 10.00

TACHOMETER. Checks engine rpm, cylinder balance. 2 ranges: 0-1200 rpm, 0-1600 rpm. For 4, 6 and 8 cylinder cars. No jitter. Color coded scale. Shpg. wt., 1.5 lbs.

11 K 5504 Net 21.00

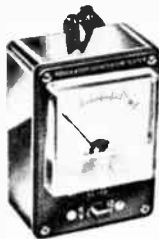

DWELL METER. Accurately measures cam angle at all engine speeds. 2 scales. For 4, 6, 8 cylinder engines; 6 or 12 volt. Uses solid state circuitry. Shpg. wt., 1.5 lbs.

11 K 5505 Net 14.95

ALTERNATOR DIODE AND IGNITION WIRE TESTER. Tests diodes in and out of alternator. Checks windings and ignition wire. Simple to use. Shpg. wt., 1.5 lbs.

11 K 5506 Net 11.50

Complete Tune-up Lab plus case. Includes all 5 Testers.

11 K 5501 Shpg. wt., 8 lbs. Net 59.95

11 K 5507 Case only. Shpg. wt., 1/2 lb. Net 3.95

LAFAYETTE DWELL TACHOMETER

- Tunes up electronically, any car ever made
- Three Dwell Scales
- Giant, Easy-to-Read Scale
- Use to Adjust Carburetors

Completely Wired—
Not a Kit!

A complete ready-to-use Dwell Meter and Tachometer which will operate on any car ever made. Tests cam Dwell angle and engine RPM on 4, 6 or 8 cylinder cars, 6 or 12 volt right on the engine. Giant, 6 1/2" easy-to-read meter makes it simple for anyone to adjust points which are slightly worn or pitted. Adjusts carburetors to insure maximum gas economy and quiet engine running. RPM readings are also essential to properly service automatic transmissions. Three dwell angle scales are provided: 0 to 45 degrees, 0-60 degrees, and 0 to 90 degrees. This instrument is suitable for dwell angle adjustment on all foreign and domestic cars. Dual range tachometer 0 to 1000 rpm for precise carburetor adjustments, 0 to 5000 rpm, suitable for making all other tests at high engine speeds. Shpg. wt., 4 lbs.

11 K 0101

Net 28.50

28⁵⁰

Made in
U.S.A.



AUTOMOTIVE TESTING EQUIPMENT

(A) MOTOR ANALYZER
15⁹⁵

All the advantages of a well-equipped service shop in a light, hand-held package. Ideal for do-it-yourselfers, sports car Rallyers, etc. The Analyzer enables you to test ignition coil output, spark plugs, insulation breakdowns; locates poorly adjusted carburetor, sticky or burnt valves, weak valve springs; checks valve timing, choke, muffler, vacuum tank, manifold, fuel pump vacuum and pressure and vacuum operated equipment. 14Wx 7 3/4x3 1/2" D. Shpg. wt., 5 1/2 lbs.

11 K 1701 Net 15.95

(B) REMOTE STARTER SWITCH
1⁰⁰

Eliminates the need of a second man when making compression, fuel pump, generator, starter, and electrical tests. Permits the mechanic to crank the engine from any position. Shpg. wt., 1/2 lb.

11 K 1702 Net 1.00

(C) MOTOR GUIDE-VACUUM FUEL PUMP TESTER
2⁹⁵

Combination motor guide, vacuum and fuel pump tester, 4 color zones: Economy Driving, Fast Pick-up, Coasting and Idle. Promotes good driving habits and economical gas mileage. Warns when tuneups are necessary. Shpg. wt., 12 oz.

11 K 1703 Net 2.95

(D) COMPRESSION TESTER
2⁷⁹

Gives quick, accurate readings of compression pressure. Merely unscrew the spark plug, plug tester into spark plug hole and read pressure. 2 1/2" dial reads to 300 lbs. Stem is offset 15° for reaching back cylinders. Complete with instructions. Shpg. wt., 12 oz.

11 K 1704 Net 2.79

(E) STANDARD TIMING LIGHT
2⁶⁹

Employs the stroboscopic principle of light synchronized with motion for adjustment and setting of ignition timing under actual operating conditions. Shpg. wt., 1 lb.

11 K 1705 Net 2.69

(F) TACHOMETER
2⁸⁵⁰

Here's the instrument for the most important check of an engine's performance: the RPM test. Tests 4, 6 and 8 cylinder engines with both 6 and 12 volt systems. Operated by two inexpensive penlight batteries which last about a year. Large dial read 0-1000 and 0-5000 RPM. Shpg. wt., 2 1/2 lbs.

11 K 1706 Net 28.50



395 CAM-DWELL INDICATOR

A high quality instrument for solving all CAM-DWELL problems. Checks the number of degrees a distributor can rotate while the breaker points remain closed. Too much rotation means points are set too close, too little means breaker points are not closed long enough for adequate build up of the magnetic field in primary coil, permitting arcing across points. Requires no electrical outlet. Distributor need not be removed. Compact, portable. Complete with case and includes chart showing specifications for all popular cars.

11 K 1009 Shpg. wt., 2 lbs. Net 3.95



HANSEN BATTERY CELL TESTER

479

The Hansen Model 12 Tests battery cells under load . . . simply, accurately! Special alloy shunt between adjustable legs places 200 amp load on battery during test. Eliminates guesswork of unloaded testing. 3-color dial reads bad, weak, and good battery condition. Rugged molded grip design . . . fits all batteries. Indicates ability of battery to deliver power. Locates corroded cables, loose connections, etc.

11 K 1707 Shpg. wt., 1 1/2 lb. Net 4.79

Take Advantage of Lafayette's Low Auto Accessory Prices

Lafayette Cat. No. 652 107



4-LITE EMERGENCY FLASHER



- Converts Front and Rear Lights to Emergency Flashers

3⁵⁹

Easy to install — it may save your life. Commands instant attention by flashing front parking light and rear brake tails on and off. For use during emergency road stops, flats, double parking. Helps bring emergency repair truck or police when needed, prevents collisions. Only minutes to install. Complete with instructions.

11 K 2701 Net 3.59

MAGNA-CLOCK with ALARM



ONLY **4^{95*}**

- Powerful Magnet in Base for Sure-Grip Attachment to Dash
- Clock Pivoted to Swing to Any Position Even on A 90° Surface
- Accurate, Dependable 30-Hour Movement with Alarm

A beautifully styled car clock with powerful magnet in the base for sure-grip attachment to any steel surface. Contour-molded plastic case has a convex glass front framed in a beveled, gold-finish metal band. All hands and numerals are luminous. Imported 30-hour movement with alarm is precision-made and is not affected by magnet in the base. Easily removed and used whenever you go. Choice of 3 colors. Shpg. wt., ½ lb.

11 K 2205 (Silver) Net 4.95*
 11 K 2206 (Blue) Net 4.95*
 11 K 2207 (Red) Net 4.95*
 *Plus 10% F.E.T.

REVOLVING BEACON 685



- Rotates Like a Light-house Beacon
- Signals Help for Miles Around
- Suction Mounts In Seconds

A red warning light that rotates 360 degrees and flashes in all directions. Suction mount holds the beacon firmly in place. Signals for help for miles around; creates a safety zone during a traffic emergency. For use on autos, boats, trucks, docks, etc. For 12 volt use; complete with cigarette lighter adapter plug. Shpg. wt., 2 lbs.

11 K 1304 Net 6.85

BLUE TURRET LENS

Converts Revolving Beacon for use by emergency vehicles, volunteer fire depts., CD units, etc.

11 K 1305 Shpg. wt., 1 lb. Net .98

PRIMETTA

"FOGGLES"



- FOR SAFER DRIVING: • AT NIGHT
- IN SNOW • IN FOG • IN RAIN

A Zeiss Formulation Newly Developed Insures True Color Contrast

Night driving is safer and easier with Primetta Radar Night Glasses. Scientifically designed to protect the eye from the glare of headlights, street lights, etc. without materially reducing vision. Ideal while driving at night the rain, fog and snow. The filter lens exclude all ultra violet rays. Designed for 20-20 vision. With heavy, suede-lined leather case. Shpg. wt., 6 oz.

11 K 3201 Net 1.98
 Clip-on "Foggles," with case, for use over existing glasses.
 11 K 3202 Net 1.50

WINDOW DEFROSTING FAN



7⁹⁵

- Defrosts, Demists, Cools
- Plugs in Cigarette Lighter
- Harmless 6" Rubber Blades
- Choice of 6 or 12-volt Models

A practical automotive accessory which keeps windshield free from frost or fog while you drive. High speed 3,000 rpm motor controlled from drivers seat by 2-speed switch. Plugs into cigarette lighter socket for quick easy installation, no wires to attach. Complete with cord; universal swivel joint on sturdy base. Shpg. wt., 2½ lbs.

11 K 3401 for 6 volt cars Net 7.95
 11 K 3402 for 12 volt cars Net 7.95

NEW! SNOW AND ICE MELTER

- Clears All Your Windows Of Ice and Snow
- Easy To Operate—Uses Cars Hot Exhaust
- Notched Ice Scraper
- 20 Ft. Length

1⁹⁹



Use your car's hot exhaust to melt snow and ice on your car's windshield, rear window and around tires in minutes. No Fuss—No strain. 20 foot heavy duty hose gets heat where it is needed. Clears all your cars windows, front, side and rear easily. Notched ice scraper removes heavy accumulations and flexible squeegee prevents re-freezing on windshield. Does not harm your car. Shpg. wt., 2½ lbs.

11 K 5402 Net 1.99

NEW! BATTERY AND ENGINE WARMER

For Fast Winter Starting

- Faster Warm-ups — Reduced Battery and Engine Wear
- Washable Heavy Duty Vinyl
- Fireproof — Waterproof — Acid Resistant

4⁴⁹

BATTERY & ENGINE WARMER

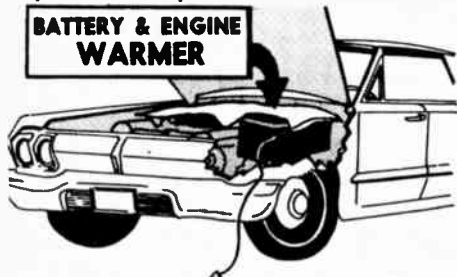

Rid yourself of cold weather starting problems. Easy to use—operates from any 110-115V AC/DC outlet. Large 16x24 blanket heats evenly over entire area. Placed in your engine compartment it will keep your battery approximately 40° above the outdoor temperature. In addition, it will keep the engine and carburetor warm and melt snow off the hood. Has 6 ft. U.L. cord, weather protected. Low electric operating cost. Shpg. wt., 1½ lbs.

11 K 7201 Net 4.49

ELECTRO-DIP DIPSTICK HEATER

2⁵⁹

- For Fast Cold Weather Starts

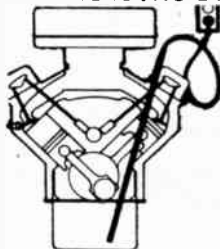

Designed to keep crankcase oil warm while your car is turned off for the night. Permits easier starts in cold weather and faster engine warm-up. Uses about the same amount of electricity as a 100-watt light bulb. Costs only pennies a night to operate. Shpg. wt., 1½ lbs.

11 K 7601 Net 2.59

TANK TYPE ENGINE HEATER

- Get Fast Summer Starts In Coldest Weather
- Saves Batteries—Gas—Oil

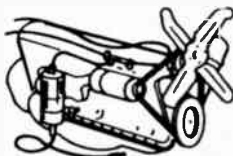

A thermostatically controlled heater which will solve your hard starting problems in cold weather. Circulates warm water through entire engine. Eliminates battery drain, carbon buildup and high gas consumption during starting and warmup. Easy to install, operates on ordinary AC house current. 850 watt capacity. 110-120 volt AC-DC element. Complete with all fittings except for heater hose. Shpg. wt., 2½ lbs.

11 K 3107 Net 9.29

LAFAYETTE VALUES IN AUTO ACCESSORIES

warns of radar traffic zones

DRIVER ALERT *

- Dual Band Circuit Detects Radar Beams on Both "S" and "X" Frequencies
- Gives Advance Warning Within 1/2 Mile Range • Miniature and Completely Transistorized • No Wires or Antennas Needed

SALE 29⁹⁵

Driver Alert, the miniature electronic detector, warns you of radar affic zones in advance—up to 1/2 mile away. The Dual-Band circuit detects all commonly used police radar speed meters and traffic control devices to promote safer driving. Miniaturized and completely transistorized. Driver Alert does not require wires or antennas. Constructed of top quality components; printed wiring; 8 transistors; no 1,000 hour mercury cell, self-testing batteries (equivalent to 5,000 miles of driving at 35 M.P.H.) Magnesium case eliminates radio, TV and other interference. Weighs only 13 ozs., measures 5/8x2 1/4x3 1/4"D; clips to sunvisor. Complete with batteries, sunvisor clip. Instructions included.

1 K 4201 Shpg. wt., 1 1/2 lbs. Net 29.95
This item not intended for resale in States where its use is forbidden in motor vehicles by public regulation.

SIT-RITE AUTO BACK REST

OUR LOW, LOW PRICE

5³⁷

- Cool and Comfortable Driving
- Pillows No Longer Needed

Scientifically designed to give drivers proper back support. Backrest lessens the danger of back-ache and discomfort from poor driving posture which can lead to driver fatigue, a prime cause of accidents. Constructed with a spring steel frame covered with a sturdy washable woven fabric. Nylon for air circulation—no sticking to seats, cord lacing retains elasticity. Wide mesh Moves Driver closer to pedals while eliminating the need for pillows. Fits all cars—no tool installation. Neutral beige to blend with any color. Shpg. wt., 3 lbs.

1 K 1801 Net 5.37

AUTO SEAT BELTS

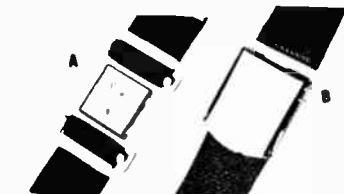

- Positive Latching
- Exceeds SAE and GSA Standard.

Fig. (A) A new engineering concept in auto seat belts. Slide-lock, metal to metal buckle mechanism for positive safe action. Simple to unlock even if buckle turns over. Slide lock and dual grip buckle are formed of aircraft steel—custom chromed with a gold emblem insert. A full 90° belt made of quality, wrinkle-proof material. Pebble weave webbing comes in 8 colors. Shpg. wt., 2 lbs.

Fig. (B) A quality belt designed of heavy duty aircraft steel and triple stitched webbing. Conventional flip buckle with positive latching and release. Don't let the price fool you. These belts exceed all state, SAE and GSA standards. 8 colors. All hardware provided. Shpg. wt., 2 lbs.

| Stock No. (A) | Color | Stock No. (B) |
|---------------|-------------|---------------|
| 11 K 5701 | Black | 11 K 5709 |
| 11 K 5702 | Grey | 11 K 5710 |
| 11 K 5703 | Beige | 11 K 5711 |
| 11 K 5704 | Flame Red | 11 K 5712 |
| 11 K 5705 | Maroon | 11 K 5713 |
| 11 K 5706 | Powder Blue | 11 K 5714 |
| 11 K 5707 | Royal Blue | 11 K 5715 |
| 11 K 5708 | Turquoise | 11 K 5716 |
| Net ea. 4.75 | | Net ea. 2.98 |

AUTO SEAT BELT RETRACTORS

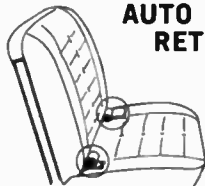

- Rolls Up Seat Belts Automatically When Not in Use
- No Belts Caught in Doors
- Keeps Seats Neat

Auto seat belt retractors fit any car seat. belt — installs quickly on belts without removing them from car. Belts roll up automatically when not in use — cannot catch in doors. Lightweight, stainless steel and aluminum construction. Installs in seconds — no tools necessary. Shpg. wt., 1/2 lb.
11 K 2403 Net pair 1.49



1⁴⁹

AH-OOO-GAH! HORN



10²⁹

- Chrome Plated Bell

A real joy for the sports car enthusiast. An authentic meter driven horn approved as an exact reproduction in sound and appearance by members of antique car, hot rod, and horseless carriage clubs the world over. Chrome plated bell with black wrinkle painted housing.

11 K 3001 6-volt Net 10.29
11 K 3002 12-Volt Net 10.29

CUSTOM-FIT HEADREST

Makes Any Car Seat A Contour Chair!

6⁹⁵



Now you can make your car seat really comfortable with this advanced design headrest. Helps prevent whiplash too. Dorsal contilever design keeps headrest snug against back of neck and head. Locks to seat automatically. 3 Knobs, finely calibrated gives 4-way adjustment to custom fit any individual, chair or car seat. Full 5" vertical adjustment; 4" forward and back. Looks like original equipment. Made of soft vinyl plastic with molded wing rests. Shpg. wt., 2 lbs.

11 K 1201 Black only Net 6.95

TRANSISTORIZED ILLUMINATED TACHOMETER



- 4-6-8 cylinder, 6 or 12 Volt, Neg. or Pos. Ground!
- Accurate 0-8,000 RPM Scale
- Regular or Transistor Ignition
- Heavy Chrome Die Cast Case
- 360 Degree Mounting Adjustment

only **19⁹⁵**

Here is the modern electronic guide to make your driving more efficient and more fun. Illuminated 3" dial face and electro magnetic meter movement, accurately measures engine speed from 0 to 8000 RPM. Helps reduce gas, oil bills, prevents over speeding and eliminates costly repairs due to improper engine operation. Factory calibrated, no adjustments required. Separate sending unit is a transistORIZED magnetic amplifier for constant accuracy; easy installation. Universal mounting for above, or below dash or steering column. For regular or transistORIZED, 6 or 12 volt and negative or positive ground ignition systems. Works with 4, 6 or 8 cylinder cars. Chrome tach head. With clamp. Shpg. wt., 2 lbs.

11 K 4202 Net 19.95

CHILD'S SEAT BELT HARNESS

6⁸⁹

"Sit and Stand" Model for Maximum Freedom of movement. Safety-Tested to Exceed 2,000 lbs. Easily Installed in Any Car.

Scientifically designed seat belt harness for children up to 6 years of age. Complies with Society of Automotive Engineers' standards. Shoulder harness supports upper torso; leg straps give pelvic support to child whether sitting or standing — offers complete protection to active children. Has quick-release aircraft-type metal-to-metal buckles, strong all-nylon webbing. Fully adjustable for size to give child maximum freedom and comfort. Complete with patented floor hardware for firm anchoring. Shpg. wt., 1 1/2 lbs.

11 K 2404 Net 6.89

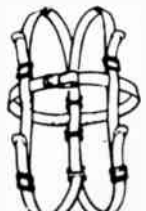

BATTERY CHARGERS, CONVERTERS and INVERTERS

TRANSISTORIZED POWER CONVERTER

- Small Enough To Mount In Any 12-Volt Car Or Boat
- Converts 12 VDC To 117 VAC
- Supplies Voltage For Any Equipment Requiring From 10 to 125 Watts



2995

Rated at 125 watts continuous duty, this fully transistorized, highly efficient converter plugs into your car's cigarette lighter socket to supply 117 volts AC to operate any equipment requiring 10 to 125 watts including electric shavers, recorders, record players, radio, TV and many others. Has "Power to Spare" for extra years of dependable service. Shpg. wt., 5 lbs.

11 K 7301

Net 29.95

COLD-START BOOSTER-CHARGER



2395

Our First Combination Battery Charger and Booster.

- 50 Amp Booster (6 volt)
- 25 Amp Booster (12 volt)
- 10 Amp Charger (6/12 v)

Perfect for starting 6V, 8V, 12V cars. Works as a booster—as a charger. Supplied with heavy copper cables; thermal switch prevents overheating; works up to 200-ft. away from AC power source. Power output: 12V Boost, 25 amps maximum; 6V Boost, 50 amps max.; 6/12V Charge, 10 amps tapering to 5 amps max.; Power Input: 5 amps max. at 117V AC, 60 cycles. Shpg. wt., 9½ lbs.

11 K 4001

Net 23.95

2-IN-1 BATTERY CHARGER

End dead battery trouble in your car, boat, truck or tractor. This powerhouse battery charger keeps all 6 and 12 volt batteries fully charged for peak performance even at 40° below freezing. Full 1 amp. "safe" charge rate prevents flacking and plate buckling—same method used by storage battery dealers. Easy to use—plug the line cord into any 110V outlet, connect the two terminals and forget it. Can't overcharge—automatically tapers off. Welded constructed steel. Shpg. wt., 3½ lbs.

11 K 7602

Net 4.25

Only

425



UL Approved

3-AMP. BATTERY CHARGER WITH BUILT-IN METER FOR BOTH 6 AND 12 VOLT BATTERIES

825

Edge view meter shows actual rate of charge and indicates battery condition. Reset circuit breaker gives automatic overload protection. Has 6 and 12 volt selector switch. Delivers tapering charge. Vented steel case. 6 ft. battery leads with 50 amp clips. Size 6"x5"x5". For operation from 105-125 Volt, 50-60 cycle A.C. Shpg. wt., 5 lbs.

11 K 7604

Net 8.25

U.L. Approved



TRANSISTORIZED 40-50 WATT INVERTER

1818

- Ideal for Salesman, Sportsman, Executive
- For Dictating Machines, Razors, Port. Tape Recorders, Etc.
- Use In Car, Boat or Private Airplane

2 power transistor inverter supplies 40 watts continuous, 50 watts intermittent from 12.6 volt storage battery. Silent operation. Attractively finished green Hammerloid steel case. Epoxy filled to insure longer life. Supplied complete with 3 foot cord and plug for immediate insertion into cigarette lighter receptacle. Dim: 4¾x2¾x2¼"D. Shpg. wt., 3½ lbs.

34 K 4001

Net 18.18



CORNELL DUBILIER 12TV12 DC TO AC INVERTER

2995

- Especially Designed to Power Portable TV Sets with Power Requirements up to 120 watts
- Ideal for Automotive, Marine, House Trailers, Campers, etc., as a Source of AC Power Independent of Power Lines



The Model 12TV12 converts 12 volt DC from any 12V storage battery, to 110-120 volt AC at 60 cycles.

Designed primarily for television receivers, tape recorders, phonographs and other frequency sensitive devices, the 12TV12 employs a resonant reed tuning component to assure frequency stability. No loss of B+ in TV brilliance. Will power any TV, ham rig, CB station, or Hi-Fi unit within the 120/140 watt power requirement rating. Perfect for car or boat.

SPECIFICATIONS

Input: 12 volts @ 12 amperes (full load); Output 120 watts continuous, 140 watts intermittent; RF filtering on both input and output; Finish: Zinc Chromate corrosion resistant undercoat, crinkle paint black bottom and smokerise grey top. 8¾Lx7½Wx3¾"H. Wt., 13¾ lbs. Shpg. wt., 16 lbs.

34 K 5501

Net 29.95

Model MK-3544-5 Mounting Kit for 12TV12—Provides safe, secure mounting to bulkhead, wall, or floor. Supplied with all necessary mounting hardware. Shpg. wt., 2 lbs.

34 K 5502

Net 3.60

BATTERY BOOSTER CABLES

As Low As Standard equipment for starting stalled cars, charging batteries, etc. Made with heavy duty, flexible rubber-covered cable. Rugged copper-clad positive action grips identified by Black and Red heavy vinyl covered handles. Shpg. wt., 3 lbs.

149



11 K 2901 8 ft. long, set of 2 Net 1.49

11 K 2902 12 ft. long, set of 2 Net 2.25

12 ft. long, 6 gauge copper cable.

11 K 2903

Net 3.15

Battery Booster Clip only.

11 K 2904C (specify Red or Black) Net .49

INVERT O-CHARGE



- Combination Power Inverter and 8 Amp Battery Charger

This dual purpose unit will operate 120 volt equipment from a 12 volt battery or charge a 12 volt battery from a 120 volt source! 175 watts cont., 225 watt intermittent operation; metered input and output; Push button solid state operation; Protective circuit breaker; Operates any AC device within its power limitations. Shpg. wt., 10 lbs.

11 K 3701

Net 38.25

DRY CHARGERS—INVERTERS—ELIMINATORS—LIGHTS



"STORAGE CELL" for TRANSISTOR RADIOS!

ONE CHARGEABLE BATTERY OUTLASTS DOZENS OF CONVENTIONAL BATTERIES

269



- Replaces 2UG, 8L-006P and 99 G 9021
- Fluid Storage Type
- Plays About 15 Hours on One Charging
- Battery Recharges Overnight
- Battery Can Be Used Over and Over Again
- Complete—Battery Plus Charger

9V Battery complete with charger. Battery 1 7/8x1 1/4"; charger 3 3/4x1 1/4x7/8". Imported.

99 K 9016 Battery and Charger. Shpg. wt., 6 oz. Net 2.69
99 K 6026 Battery Replacement for above, wt., 3 oz. Net 1.29

As little as **20¢** 9-VOLT TRANSISTOR RADIO BATTERY

Replaces RCA VS323, Burgess 2UG, Eveready 216, Zenith Z216, Ray-O-VAC 1604, NEDA 1604. Shpg. wt., 2 oz. Imported.

ea. in lots of 10 99 K 6021 Net ea. .21
Lots of 10 .20



LAFAYETTE 9-VOLT TRANSISTOR RADIO BATTERY CHARGER AND ELIMINATOR



- Charge Battery, Operate Set On AC, or Both
- Isolated Transformer—Shock-Proof

345

Just plug into any 117-volt AC receptacle and recharge your old 9-volt battery for many hours of extra use; or operate your set indoors without using the battery at all; or you can both charge battery and operate set at the same time. Has 4-position switch for above functions plus off position and pilot light. Size: 4Wx1 1/4xHx 2 3/4"D. Imported.

99 K 9021 Shpg. wt., 1 lb. Net 3.45

DYNAMIC BATTERY CHARGER FOR 6-VOLT LANTERN BATTERIES

- Extends Battery Life 15-30 Times

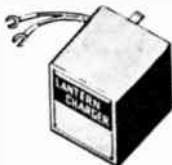

Keep lantern batteries like new for months—far exceeding their normal life. Pays for itself many times over. Equipped with an isolating step-down power transformer, it is safe from shock hazard. Just connect charger leads to battery binding posts and plug charger into any 117-volt AC outlet. Chart showing chargeable battery types and charging time required is included. Size: 1 3/4x1 3/4x2 1/4"

34 K 4201 Shpg. wt., 3/4 lb. Net 4.95

TERADO "DYNAMO" DC TO AC INVERTER

Convert Your Table Model Radio to a Car or Boat Radio



Operate any small radio in any 12 volt car, truck, boat or trailer. No installation—just plug into cigar lighter. Needs no outside antenna—table radios will operate on their own built-in antenna. Will also operate your electric shaver or any electric appliance up to 20 watts. Complete with generator condenser and ignition noise suppressor. Measures only 2x2x3 3/4". Shpg. wt., 2 lbs.

33 K 5302 Net 8.87

TERADO "QUIK-SHAVE" AC TO DC INVERTER



Any shaver, new or old, gives super performance with QUIK-SHAVE, which changes household AC electricity into jet powered DC. Lengthens shaver life. Up to 88% more cutting power for faster, closer, more comfortable shaves. Plug QUIK-SHAVE into wall outlet, attach shaver cord, and shave twice as fast!

33 K 5301 Shpg. wt., 8 ozs. U.I. Approved Net 3.85

BATTERY RECHARGER and ELIMINATOR

4.95

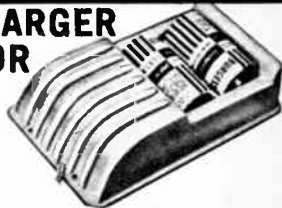

The new dry cell battery recharger and eliminator will replenish your supply of flashlight batteries. Recharges "C," "D" and "Z" cell batteries in 2 to 4 hours—keeps battery-operated toys always on the go. It's a battery eliminator too—simply plug into any 110V AC outlet. Delivers 4 to 6 V. DC for "recharge" or "eliminate."

Net 4.95
33 K 7701 Shpg. wt., 1 1/2 lbs.

NEW CHART CHARGE NICKEL-CADMIUM BATTERY CHARGER

- Charges 1 to 10 Cells in Series Up to 250 MA

Designed to meet the demands for Nickel-Cadmium Cells in the industrial and hobby fields. Charges 1 to 10 cells in series and is continuously variable from 10 to 250 MA. No meter required for accurate calibration. Use of isolation transformer eliminates shock hazard. Full wave silicon diode rectification. Visual red on-off indicator lamp and UL approved line cord. 6 1/4x3 3/4x2". Shpg. wt., 2 lbs.



Net 9.95
34 K 4101

"B" BATTERY ELIMINATOR and CHARGER

245

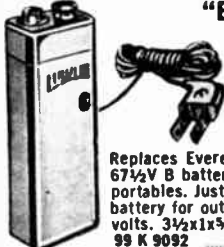

Replaces Eveready 416, Burgess UX-45, and RCA VS 318 67 1/2 V B batteries used in Radio Control units and many portables. Just plug in the AC cord and you can save your battery for outdoor use. Also recharges your battery. 110 volts. 3 1/2x1x3/8". Shpg. wt., 7 oz. Imported.

Net 2.45
99 K 9032

RADIO TRANSVERTER

- Fits all Cars
- Converts Transistor Radio to Car Radio
- For all 9-Volt Transistor Radios
- Plugs into Cigarette Lighter

147



Now you can avoid the expense of buying a car radio with this new radio transverter. Simple to operate—remove 9-volt battery from your transistor radio, connect contacts from transverter to battery contacts in the radio, and then plug into the cigarette lighter. Fits all cars. Shpg. wt., 6 oz.

11 K 4801 For 12-Volt Cars Net 1.47
11 K 4802 For 6-Volt Cars Net 1.47

RECHARGEABLE FLASHLIGHT

Always ready for use—no more batteries to buy. Simply plug into the nearest 110V. A.C. wall outlet—leave overnight—for a complete recharge. Self contained charger and cells need no service or replacement in normal use. 4x1 3/4" overall. Shpg. wt., 6 ozs. Imported.

14 K 2102 Net 2.59

BIG BEAM LANTERN

Powerful, versatile sealed beam hand lamp. Operates as a lamp, a flashing red beacon or both. The flashing beacon may be positioned up or down. Sealed beam bulb keeps mirrored reflector dust free. 4" chrome-plated steel lamphead. Steel weatherproof case with hinged cover and snap catch. Operates on one battery. Shpg. wt., 3 lbs.

13 K 7901 Less Battery Net 6.98

No. F4H battery, wt., 1 1/2 lbs. Net .85

32 K 4869 Net .85



LAFAYETTE 8 MM MOVIE CAMERAS



LAFAYETTE AUTOMATIC ELECTRIC EYE CAMERA

59⁹⁵

- Fast f/1.9 Zoom Lens
- Fully Automatic Exposure
- Viewfinder Zooms with Lens
- Trigger Action Pistol Grip

Precision-made 8mm movie camera has built-in electric eye which automatically sets correct exposure for any film (color or black and white) from ASA 10 to ASA 40. Fast, f/1.9 lens zooms from wide-angle, through normal to telephoto. Picture-window viewfinder zooms with lens. Features include manual exposure control, single frame exposure (for animated titles, etc.), film counter, cable release socket, sturdy pistol-grip handle for easy trigger action, and fast drop-in spool loading. Shpg. wt., 5 lbs. Imported.

99 K 7179L Net 59.95

ZOOM MOVIE OUTFIT

A complete zoom movie outfit with matched components to assure success in taking and showing home movies. The Camera is Lafayette's Zoom f1.9 Auto 8, "Ultra" 500 projector, 30x40" fo'iding screen, Hi-Lite movie gun, 2 sets of 400' reels & cans, zoom camera case. Shpg. wt., 40 lbs.

15 K 9003 \$6 Monthly Net 119.95

TRIPLE-TURRET f/1.8 ELECTRIC EYE CAMERA



29⁹⁵

- Automatic, Cross-Coupled Electric Eye
- 3 Quick Change, Turret Mounted f/1.8 Lens
- Built-in "A" Conversion and UV Haze Filters
- Pistol Grip with Trigger Release
- "Combo-View" Finder for Normal, Wide-angle and Telephoto Shooting

You get perfectly exposed movies automatically simply by aligning the needle in the viewfinder. Film speed selector dial adjusts for speeds of ASA 10-40. A quick twist of the turret dials the effect you want; from Normal to Wide-angle or Telephoto for thrilling close ups of distant subjects. The fast f/1.8 fixed-focused lenses are color-corrected and coated. Etched optical view finder shows exact field for each lens. Economical drop-in spool loading. Includes instructions and pistol grip handle. Imported.

99 K 7178L Shpg. wt., 5 lbs. Net 29.95
15 K 1601 Holster case Net 2.95

COMPLETE MOVIE OUTFIT

Everything you need for movie-making and showing fun. You get all this; triple turret—f1.8 Electric Eye Movie Camera, camera case, 500 watt projector, 30x40" screen, 500 watt bar light with lamp, two 400' reels with storage-cans. Unbeatable for foolproof shooting and showing of indoor and outdoor movies. Shpg. wt., 30 lbs.

15 K 9002 \$5 Monthly Net 79.95



16⁹⁸

LAFAYETTE SUPER 8 MOVIE CAMERA

- Fast f/1.9 4-element lens
- Electric drive—no winding
- Enclosed optical viewfinder
- No focusing necessary

A truly modern, versatile, and inexpensive movie camera. Fast f/1.9 4-element lens captures all the exciting action in brilliant color or black and white. Fixed focus lens never needs adjustment because of a change in the distance between camera and subject. Electric motor drive with built-in standard "C" batteries eliminates bothersome hand winding. Just aim and shoot—even beginners get perfect movies every time. Automatic reset footage meter is easily readable. Variable, click-stop, lens aperture opens from f/16 to f/1.9. "Drop-in" spool loading is easy and economical. Exposure guide on side of case. Shpg. wt., 4 lbs. Imported.

99 K 7180L Net 16.98

Batteries for above (2 required) Net .13

32 K 4801 Net 2.95

15 K 1601 Carrying case Net 2.95

15 K 3406 Pistol grip handle Net 1.83

DELUXE ZOOM MOVIE CASE

- 10½x9x3½"
- Black Vinyl Covering
- Aluminum Trim



6⁹⁵

Takes all 8mm zoom movie cameras (including those with pistol grip attached) plus supply of extra film. Case is covered with attractive black vinyl and is reinforced with aluminum trim. Has handy "Presto" lock. Overall Size: 10½x9x3½"D. Shpg. wt., 1½ lbs.

15 K 1602 Net 6.95

NEW! VERNON 8mm Cds REFLEX/ZOOM MOVIE CAMERA



69⁹⁵

complete with remote control

\$5 Monthly

- Fully-Automatic Cds
- All-Electric Drive
- Thru-the-Lens Viewing

This ultra-compact 8mm zoom movie camera provides professional quality results for the movie aficionado. Here are some of the features that make the Vernon 18/28 Zoom a "best value": Precision f1.8 zoom lens with a 12-30mm zoom range; All-electric drive powered by 4 penlight batteries. Fully-automatic Cds electric-eye, with visible signal in viewfinder; meter, calibrated ASA 10 to 320, indicates lens openings; Automatic resetting film footage counter; Battery strength indicator. Run, lock, or continuous trigger release; Heavy gauge die-cast construction, luxuriously finished. Shpg. wt., 5 lbs. Imported.

15 K 3404L Net 69.95

Penlight cells (4 req.) Net ea. .13

32 K 4802 Net ea. .13

DELUXE 8mm MOVIE CAMERAS

MINOLTA ZOOM 8



119⁹⁵
\$8.00 Monthly

- CdS Electric Eye Automatic Exposure
- 10-Element f/1.8 Rokkor Lens
- Micromotor Electric Drive

A fine, battery powered, 8mm camera featuring a sensitive cadmium sulfide light meter that automatically sets the right exposure for any film (ASA 10-400), color or black and white. Just sight and shoot... that's all. Zoom 8 does the rest. A warning signal shows in the viewfinder in case of insufficient light for perfect exposures. Rokkor f/1.8 lens zooms from wide-angle to telephoto (10-30mm) with the touch of a finger. Filming Speeds: 12, 16 and 24 fps. High-efficiency micro-motor is powered by four inexpensive penlight batteries (included). Has manual control for special effects, single lens reflex viewfinder for through-the-lens focusing and viewing, built-in battery level indicator. Spool loading. Shpg. wt., 4 lbs. Imported.

| | |
|--|-------------|
| 15 K 3401L | Net 119.95 |
| Repl. Penlight Batteries (4 req.) | |
| 32 K 4802 | Net ea. .13 |
| Minolta Zoom 8 Case, Shpg. wt., 2 lbs. | |
| 15 K 3405L | Net 12.95 |
| Remote Control Switch and Cord. | |
| 15 K 3407 Shpg. wt., 4 oz. | Net 3.98 |

VERNON 18/28 AUTOMATIC 8mm MOVIE CAMERA



29⁹⁵

- Fully Automatic Electric Eye
- Electric Drive
- No Winding
- Sharp f/1.8 Lens
- Built-In Handle
- Remote Control*

An outstanding value in automatic 8mm movie cameras. Rugged die-cast construction. Fast, sharp f/1.8 13mm lens does not require focusing. Built-in automatic electric eye adjusts lens opening from f/1.8 to f/16 according to light conditions. Adjustable for film speeds ASA 10 to 50. All-electric drive runs on 4 inexpensive penlight cells. Shoots up to 20 rolls without a battery change. Run, lock or continuous run release trigger lets you get into your own movies. *And best of all, a remote control (10-ft. cable) is available at extra cost. Imported.

| | |
|---|-----------|
| 15 K 3402L Shpg. wt., 5 lbs. | Net 29.95 |
| Remote control Switch and Cable | |
| 15 K 3403 | Net 3.98 |
| 32 K 4802 Penlight cells 4 req. Net ea. | .13 |

YASHICA U-MATIC Cds REFLEX ZOOM 8



99⁹⁵

- \$5 Monthly
- CdS Automatic Exposure System
- Trigger Pistol Grip
- 3 Filming Speeds
- Electric Motor Driven

The U-Matic 8 combines the convenience of automatic CdS electric eye exposure with wind-back and fade controls for lap dissolves and complex trick effects. High speed Yashinon f/1.8 lens zooms from 9mm wide-angle to 28mm telephoto. Focus from 3 1/2 feet to infinity. Parallax-free reflex viewfinder permits "through-the-lens" viewing. 12, 16 and 24 fps. ASA film speed 10-40. Battery tester; manual exposure control; spool loading. With 16-ft. remote control and switch, trigger pistol grip and four penlight batteries. Imported

| | |
|-----------------------------------|-----------|
| 15 K 3604L Shpg. wt., 3 1/2 lbs. | Net 99.95 |
| Repl. penlight batteries (4 req.) | Net .13 |

NEW VERNON 808 SUPER EDITOR

- 4"x5" Giant Screen
- Bright Viewing

29⁹⁵

This professional quality 8mm movie editor has a fresnel lens screen almost three times the size of the average movie editor. Fresnel lens gives over-all brightness without center hot spots. Editor has convenient frame marker and fine focusing wheel. Rewind arm is geared for speedy rewinding. Large hood shields picture area so editor can be used in a lighted room. Arms fold for easy compact storage. Shpg. wt., 6 lbs. Imported.

| | |
|-----------|-----------|
| 15 K 3429 | Net 29.95 |
|-----------|-----------|



8mm PROJECTOR SCOPE



5³³

- Previews Films
- Fits Most 8mm Projectors

The projectionists friend... The HPI Projector-Scope attachment lets you preview films as soon as you get them. Can be attached easily to most 8mm projectors by simply removing the original lens. Large 4 1/2 x 3 1/2" screen with a 6-element lens lets you see or show sharp movies without darkening room or setting up a screen. Edit films right on the projector. Can not be used with Basken and Kodak Brownie models A10 and A15. Includes handy frame marker for easier editing. Shpg. wt., 1 lb.

| | |
|-----------|----------|
| 15 K 3427 | Net 5.33 |
|-----------|----------|

DIAL-A-BOUNCE MOVIE LIGHT

749

with camera mounting Bracket

A versatile lamp that is a must for indoor movie making. Features long life sealed beam superfood lamp. Calibrated knob on handle adjusts lamp to desired angle up or down for indirect "bounce" or direct lighting. Telescoping handle fits all movie cameras; keeps light from affecting electric eye when in extended position. Air vented shield cools unit, protects lamp from shock. Camera bracket mounts left or right for user convenience. Average lamp life 8 hours. UL and CSA approved. Shpg. wt., 4 lbs.

| | |
|-----------|----------|
| 15 K 2801 | Net 7.49 |
|-----------|----------|



MANSFIELD "ULTRA" 8mm MOVIE PROJECTOR

53⁹⁵

Only \$5.00 monthly

- Fast, Easy Loading
- Forward, Still & Reverse
- Self-Contained Carrying Case

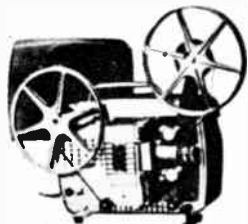

The "Ultra" 8 mm projector features several unusual conveniences to uncompliment movie showing. Has swing-out gate for fast threading. Forward, Still and Reverse positions. Brilliant, new DFA lamp gives uniformly bright picture. Cinepar f/1.6 lens. Self-contained carrying case. Shpg. wt., 10 lbs.

| | |
|-------------|-----------|
| 15 K 8201WX | Net 53.95 |
|-------------|-----------|

De Jur "DUO-VISTA" 8mm Projector

129⁹⁵

- Brilliant f/1.2 15-25 zoom lens
- 2 slow-motion speeds
- Built in Viewing Screen

A new concept in 8mm projection — the UNIMATIC-DRIVE. Eliminates home movie flicker and light fall-off in slow motion. Professional movie quality. Features 8 position controls — forward, reverse, still, off, normal, fast, very slow and slow speeds — built-in viewing screen (or regular projection at the twist of a knob), automatic reel to reel threading, sharp f/1.2 zoom lens with 15-25mm range. Separate cooling motor for longer lamp and film life. Positive chain and gear drive. Room light control and film trimmer. Shpg. wt., 20 lbs.

| | | |
|-------------|----------------|------------|
| 15 K 5202WX | \$6.50 Monthly | Net 129.95 |
|-------------|----------------|------------|



OLYMPUS PEN SINGLE LENS REFLEX

With Interchangeable Automatic Lens

- Automatic F/1.8 Lens • Single Frame—Twice the Number of 35 mm Exposures
- Solid Titanium High Speed Rotary Shutter • Weighs only 18 oz.!

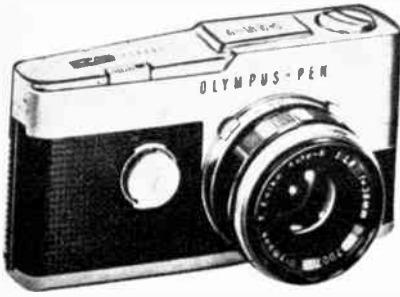

LYNX-5000 35mm



A complete compact single lens reflex camera only 5 inches long and 2½ high. Using standard 35 mm film you get twice as many exposures as standard double frame 35's. Features bright through the lens view finder, a rotary-type focal plane shutter which allows full flash sync with bulb and electronic flash up to 1/500 sec.! Standard lens is fully automatic F 1.8 with instant-reopen diaphragm and preview button for depth-of-field check. Also features double stroke rapid wind lever, instant return mirror and double exposure prevention. One-step bayonet Pen lens mount quickly accepts interchangeable accessory lens listed below. Shutter speed dial couples to accessory CdS meter. Shpg. wt., 2 lbs. Imported.

| | | |
|---|-------------|------------|
| 15 K 7601L Pen F Less case | \$7 Monthly | Net 139.95 |
| 15 K 7602L Case For Pen F | | Net 9.95 |
| CdS Meter for Pen F Couples to Shutter Speed Dial | | |
| 15 K 7603L | | Net 24.95 |
| 15 K 7604L 100mm Auto TF/3.5 lens | \$5 Monthly | Net 99.95 |
| 15 K 7605L 25mm Auto F/4 | \$5 Monthly | Net 79.95 |



- All-in-one Finder
- Sharp, Super-fast f/1.8 lens
- Shutter Speeds to 1/1000 Sec.
- Two-Stage CdS Meter

Set the needle in the finder and SHOOT! To assure you of fine 35mm prints or slides every time the LYNX-5000 combines an easy-to-operate match needle CdS exposure meter with a super-speed f/1.8 lens and a high speed (up to 1/1000 sec.) shutter. Features a split-image focus rangefinder, sensitive two-stage CdS meter with on-off switch and ASA range 10-800. Viewfinder lets you set perfect exposure without removing eye from finder as you compose and focus. Shpg. wt., 3 lbs. With case. Imported. 15 K 3613L \$5 monthly Net 79.98

FRONT PHOTO FOCUS MONOCULAR



AS LOW AS **14⁹⁵**

MAKES YOUR CAMERA TELEPHOTO
—Bring Distant Object from 6 to 8 Times Nearer

Take-super-telephoto pictures with your single lens or twin-lens reflex camera. The front focus system is specially made for on-camera operation. There is no need to miss those once-in-a-lifetime shots. Increases focal length of your camera lens 6X, 7X or 8X depending on model selected (i.e. 50mm lens plus 8X monocular equals 400mm telephoto). Rugged, lightweight construction — weight only 7½ ounces; is only 5 inches long. Includes series VI adapter ring and leather case. Shpg. wt., 1 lb. Imported.

| | |
|-------------------|-----------|
| 99 K 7072 6x30 mm | Net 14.95 |
| 99 K 7073 7x35 mm | Net 16.95 |
| 99 K 7074 8x30 mm | Net 18.95 |

MIRANDA "F" 35 MM SLR



- Speed to 1/1000th Second
- Internally Coupled f/1.9 Lens

A deluxe 35 mm single lens reflex camera which features a sharp, fast f/1.9 lens internally coupled and interchangeable with every other lens in the extensive Miranda system, plus lens of most other 35's. Pentaprism is interchangeable too with other types of finders and the new brilliant viewfinder brings out details even in the dimmest light. Shutter speed ranges from 1/1000 to 1 sec. Multigrad center spot permits precise focusing to as close as 17". The "F" also has instant return mirror, depth-of-field preview button, single-action rapid advance lever and many other features. Complete with case. Shpg. wt., 5 lbs. Imported. 15 K 3704L \$8 monthly Net 159.95

REMOTE SHUTTER RELEASE



- 20 Ft. Long

Designed to permit the camera to be used from distances up to 20 feet from the photographer. Simplifies nature shots. Excellent for candid shots of children. Has a professional rubber bulb. Shpg. wt., 8 ozs. 15 K 4902L Net 3.98

KOWA "H" AUTOMATIC SLR



- Fully Automatic Programmed Shutter
- Brilliantly Clear 48 mm f2.8 Lens
- Manual Over-ride
- Trigger Type Film Device

Here is a fully automatic single lens reflex 35mm camera. No need to fuss with F stops, shutter settings or meter readings. Just set the film speed on the easy to read dial, focus and shoot perfect pictures. Everything is automatic. Provides easy focusing, even in dimly lit surroundings. Manual over-ride allows you to set lens and shutter for different exposures. New minimal movement, trigger film advance. 48mm coated, prominent-type lens gives excellent resolution and color reproduction. 8 shutter speeds to 1/300 sec. with case. M and X flash synch. Shpg. wt., 3 lbs. 15 K 6301L \$5 monthly Net 79.50

NEW-COMBO-GRIP & FLASH BRACKET

- Firm Grip for Any Camera
- Provides Mount for Accessories
- Pistol Quick Use of Camera

This new combination grip and utility bracket is better than a third hand. Molded pistol grip provides solid grip for any camera. Particularly useful for SLR's and twin lens reflex. Accessory bracket provides mount for flash guns, meters and strobe lights. Affords ultra safe carry for valuable cameras and accessories. Imported. 99 K 7162 Shpg. wt., 1 lb. Net 2.98

500 WATT SLIDE PROJECTOR



29⁹⁵

- Automatic Slide Changer
- Color Corrected 4" f/3.5 lens
- Holds up to 40 Slides
- 500 Watt

Designed and engineered for simplicity of operation, ease of maintenance, and long life. 4" color corrected, hard coated f/3.5 lens. Sharp, brilliant pictures assured by 500 watt lamp. No slide trays required. Project any 35mm, Bantam, 127, or Instamatic slides. Loads up to 36 slides. Different size slides can be loaded together. Unit is completely self contained and requires no tools for a bulb change. Uses standard projection lamp. Compact 5½Hx14Lx8½"W. For 105-120 volt 50/60 cycle operation. Shpg. wt., 7½ lbs. 15 K 8401 Net 29.95

Lafayette Offers VALUE - VARIETY - VERSATILITY

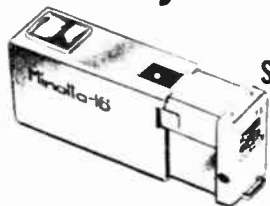

MINOLTA "16 II" SUBMINIATURE CAMERA

29⁹⁵

- Rokkor 3-Element f/2.8 lens
- Automatic Film Advance & Shutter Cocking
- Direct Viewfinder

An extremely easy-to-operate, palm-size camera that you can carry with you always. No need to miss those once-in-a-lifetime shots. Sliding camera in and out of built-in case advances film, clicks shutter, counts exposure and prevents double exposure—all automatically. 6 shutter speeds from 1/30 to 1/500 sec. plus B. Click-stop settings. Internally synchronized for electronic flash and bulb. Takes regular black and white pictures or color slides that fit any 35 mm projector. Direct viewfinder shows picture exactly as it will appear on film. Lens opening from f/2.8 to f/16. Click-stop settings. Complete with case. Shpg. wt., 1 lb. Imported.

| | |
|---|-----------|
| 15 K 3416L | Net 29.95 |
| MINOLTA 16 II Accessories. Avg. Shpg. wt., 6 oz. | |
| 15 K 3421 Baby BC Flash with Capacitor and Case | Net 4.95 |
| 15 K 3422 Bracket for Flash and Tripod Mtg. | Net 1.95 |
| 15 K 3423 Aux. Lens Set—2 closeup, 1 distance, 1 Y filter | Net 3.95 |
| 15 K 3424 Color Filter Set—1 ea. 1A, 80A, 81B | Net 3.95 |

| | |
|--|----------|
| FILM FOR "16 II" and 16 Cds—All are 20-exposure magazines. | |
| Shpg. wt., 3 oz. | |
| 15 K 3417 Kodak Panatomic X | Net .98 |
| 15 K 3418 Kodak Tri-X | Net .98 |
| 15 K 3419 Kodachrome II | Net 1.25 |



DROPFONT "PRO" BAG

A heavy-duty professional bag. Zippered for easy access. Styled for easy hand or over-the-shoulder carrying. Removable, adjustable straps. Chrome plated snap-lock, feet and hardware. Handsome, heavy black simulated cowhide with leather and corduroy lining. Front tripod carrying straps. Measures 13" long x 7" wide and 9½" high. Shpg. wt., 3 lbs. All imported.

| | |
|--|-----------|
| 15 K 3413 | Net 9.95 |
| "PRO" II | |
| Same as above except measures 11x6¼x8¾". Shpg. wt., 3 lbs. | |
| 15 K 3412 | Net 8.80 |
| SUPER-PRO 16". Same as above measures 16x7¾x11". Shpg. wt., 4 lbs. | |
| 15 K 4924 | Net 13.95 |

MINOLTA 16 Cds SUBMINIATURE CAMERA



- Automatic Cds Electric Eye
- Rokkor 25 mm F/2.8 lens
- Just 4½x1½x2"

69⁹⁵

A compact, completely automatic camera which makes picture taking more enjoyable and virtually foolproof. Sensitive, accurate Cds electric eye sets lens automatically for perfect exposures under different light conditions. Takes 16mm film with speeds of 25-320 ASA. Sharp Rokkor F/2.8 lens has built-in sunshade. 3-way shutter dial sets correct shutter/diaphragm combination for bright or normal light and flash. Also has bright-frame viewfinder with warning signal, rapid film advance, 2-position zone focusing and instant drop-in loading. Only 4½x1½x2". With case. Shpg. wt., 1½ lbs.

| | |
|---|-----------|
| 15 K 3438 Imported | Net 69.95 |
| MINOLTA 16 Cds ACCESSORIES Av. Shpg. wt., 6 oz. | |
| 15 K 3421 Baby BC Flash with capacitor and case | Net 4.95 |
| 15 K 3429 Bracket for Flash and Tripod Mounting | Net 1.95 |
| 15 K 3437 Filter Set—2 close-up, 1 Y-48 Yellow Filter | Net 3.49 |
| 15 K 3436 Color Filter Set—1 ea. 1A, 80A, 81B | Net 2.49 |
| FILM FOR 16 CDS—See film listing under Model 16 II. | |

MINI-"16" COLOR SLIDE PROJECTOR

29⁹⁵

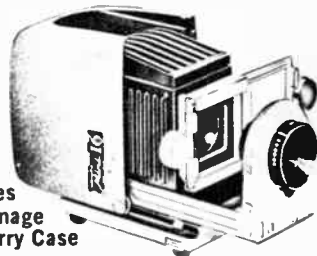

- For All 16 mm Sub-Miniature Slides
- Projects Brilliant Image
- Includes Deluxe Carry Case

Compact, lightweight projector to match Minolta and other 16 mm sub-miniature cameras. Fold compactly for storage. Sharp 40 mm Rokkor F/2.5 lens projects brilliant images equal in size to a 35 mm slide in a 35 mm projector at the same distance. Can be used on table or tripod. Includes deluxe vinyl carrying case, standard slide carrier and 75 watt projector lamp. For 110-120 volts AC-DC. Shpg. wt., 3½ lbs. Imported.

15 K 3435 Net 29.95

TRANSISTORIZED ELECTRONIC STROBE FLASH

Operates from Batteries and AC

- Lightweight & Compact —No Power Pack Needed
- Fully Transistorized
- Operates on 4 Economical "Z" Cell Batteries
- Fits any Camera Shoe

19⁹⁵

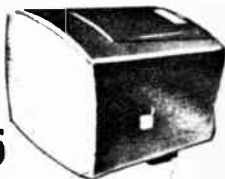

Now you can have a high-powered transistorized electronic flash that operates from standard AC house-current or 4 economical "Z" cell batteries. Compact and featherweight — no power pack is required. Flash duration of 1/2000 sec. for fast pictures. Recycling time: 6-10 seconds; color temperature: 6000° Kelvin. Guide number dial for F top on back. Complete with AC cord. Less batteries. Shpg. wt., 2 lbs. 99 K 7168 Imported.

32 K 4802 Batteries for above (4 required). Net ea. 1.13

MICRO-FLASH AG BC FLASH GUN

149

- Compact, Light Weight
- Fits Any Camera with Accessory Shoe
- Uses Powerful, Low Cost AG-1 Bulbs



A lightweight, compact flash gun you can put into your pocket. One-piece construction, uses miniature AG-1 bulbs. Fits any camera's accessory shoe. Features BC action for powerful uniform flashes every time; Square horizontal reflector; bulb ejector button. Uses 15V photoflash battery. Complete with flash cord, less battery. Shpg. wt., 6 oz. Imported.

| | |
|---------------------------|----------|
| 15 K 4901 | Net 1.49 |
| 15 Volt battery for above | |
| 32 K 4835 | Net .81 |

Ultrablitz MONO/ET ELECTRONIC FLASH GUN

49⁹⁵

\$5 Monthly

The perfect electronic flash unit for the all around camera man. Small, lightweight, it fits all cameras. Features guide No. 50 for Kodachrome II, even light over wide 70° angle; rechargeable nicad battery with AC adapter which fits any 110-220 volt wall outlet. Flash duration of 1/1000 sec. "freezes" fastest action. Transistorized monitor relay maintains constant light output for 70-80 flashes per charge. Has retractable PC shutter cord. Size: 4½x2½x1¾". Shpg. wt., 1½ lbs. Imported.

15 K 3705 Net 49.95

FOLDING BC FLASHGUN

299

- Capacitor-Type for Sure Fire Flashes
- Includes: Built-in Bulb Tester, Exposure Guide, Case.
- Weighs only 4 oz.!

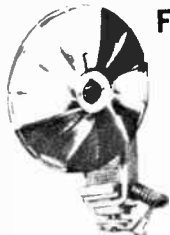

Efficient 4½" diameter metal reflector folds down for easy carrying, storage. Slip-on shoe with lock fits all cameras with standard accessory clip and PC type fitting. BC power for sure fire and hi-voltage. Features built-in circuit tester, exposure calculator, bulb ejector and coiled cord. Dual socket takes M base, bayonet base and AG bulbs. With plastic carrying case. Imported. Shpg. wt., 1 lb.

| | |
|-----------------------------------|----------|
| 15 K 3621 Flash Gun, less battery | Net 2.99 |
| 32 K 4835 15V Battery For above | Net .81 |

Take Advantage of Lafayette's Low Camera Prices

Lafayette Cat. No. 652 115

LOW COST CAMERA — FILM — ACCESSORIES



SNAPSHOT CAMERA

COLOR OR BLACK AND WHITE

- ★ Priced Low Enough For Kids
- ★ Good Enough For Adults

99¢

- For Indoor and Outdoor Use
- Takes up to 16 Color or Black/White Pictures

An amazing camera offer from Lafayette — a snapshot camera that looks like an expensive 35mm camera, yet sells for a sensational low price. Has three adjustments for sunny, cloudy or overcast conditions plus 3 adjustments for close-up to infinity. Takes 16 color or black/white pictures on standard roll of 120 film. With lens cover and strap. Shpg. wt., 1 lb. Imported.
15 K 2501

Net .99

FILM FOR ABOVE

Pkg. of 2 rolls, 16 exposures each, 120 B & W. Wt., 2 oz.
15 K 1812

Net .59

New Dynachrome II

COLOR FILM WITH PROCESSING

- Beats the High Cost of Color Film
- Same Fine Pictures
- Processing Included Direct To Your Home



New Dynachrome II film is the newer, faster color film now in demand. Same reversal type, same natural colors, same superb quality. Only the price is different—it's almost like getting the processing free. And the low price includes processing direct to your home

| | | |
|-----------|-----------------------------|----------|
| 15 K 1808 | 8mm, 25 ft. Daylite ASA 25 | Net 2.49 |
| 15 K 1809 | 8mm, 25 ft. Indoor ASA 40 | Net 2.49 |
| 15 K 1810 | 35mm 20 Exp. Daylite ASA 25 | Net 2.19 |
| 15 K 1811 | 35mm 36 Exp. Daylite ASA 25 | Net 3.11 |

NEW! OYNAPAN—BLACK & WHITE ROLL FILM

High quality black & white film for all your snap shot requirements. 2 Rolls of fine grain, fast black & white film per pkg.
15 K 1812 120, 2 rolls per pkg. Net .59
15 K 1813 127, 2 rolls per pkg. Net .59
15 K 1814 620, 2 rolls per pkg. Net .59

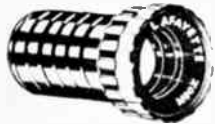

LAFAYETTE ZOOM LENS

695

- Zoom to Dramatic Close-ups!
- Fill the Screen from 12 to 15' then ZOOM In!

Coated f/1.5, 15 to 25mm focusable zoom lens fits most popular priced projectors. Converts "Holiday" and "Ultra" into modern, zoom projectors. Adds realism and depth to old "reels." Fills a 30x40" screen at from 12' to 15'—then zooms in for exciting closeups. Show your movies at the size you want—without moving projector or screen. Shpg. wt., 6 oz.
99 K 7103L Imported Net 6.95

"PRO" ELEVATOR TRIPOD

- Holds Heaviest Equipment
- Velvet Smooth Panning Action
- Extends to 46½"—Elevator Adds 10"—Closes to 22"

All aluminum construction. Gear drive elevator with positive lock. Large, cushioned pan head fits any camera. Head pans 360°—tilts 180°. Legs lock at any height. Lock and unlock with a half twist. Completely rigid, even when fully extended. Long section construction for maximum stability. Oversize thumb locks and handle for ease of use. Velvet smooth action in all planes of motion. Positive leg stops prevent overspread. Rubber tipped feet for solid footing on any surface. Satin black and aluminum finish—chrome trimmed. Shpg. wt., 4 lbs. Imported.
99 K 7202

Net 11.95



DELUXE LENTICULAR SCREEN

- Greater Brilliance
- Durable Vinyl Fabric

1188

Specially-designed, optically-correct lenticular screen is free of glare, sheen and hot spots. Amazing sharpness and color rendition. Durable vinyl fabric resists fire and fungus. Sturdy chrome tripod legs. Screen is 40x40". Shpg. wt., 12 lbs.
15 K 5005W

Net 11.88



PRE-VIEWER 8MM MOVIE VIEWER

Ideal for on-the-spot viewing of 8mm home movies. Lightweight, only 14 oz. Just insert movie film in viewer and turn crank. Eye level viewing lens provides 20X magnification. Built-in illumination using inexpensive penlight cells. Film winds forward or backward or stills. Accepts standard 50 ft. reel of 8mm movie film. Hi-impact case. Shpg. wt., 1 lb.
15 K 3408 Net 6.95
1.5 volt batteries for above ea. Net .13
32 K 4802

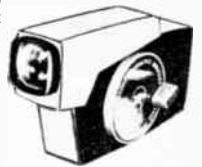

KALIMAR CdS-430 EXPOSURE METER

- ON/OFF Push-Button to Conserve Battery
- ASA Scale 6 to 12,000 (DIN Scale 9-42)
- f/1 to f/32 Lens Aperture Scale

1188

An extremely sensitive Cadmium Sulfide photoelectric exposure meter. Perfect for still or movie photography either indoors or outdoors. Designed to be used either as a hand meter or can be mounted to the accessory shoe of still cameras. Has EV indicator for Polaroid and other cameras equipped with LVS numbers. Uses readily obtainable mercury battery. Measures reflected or incident light; supplied with incident light attachment. Lightweight and very compact. Measures only 1x1½x1½". Complete with mercury battery and leather carrying case. Shpg. wt., ½ lb. Imported.
15 K 4920 Net 11.88

PHOTOFLASH BULBS



BUY IN QUANTITY AND SAVE

- "My-T-Myte" and "Synchro Sure" Photoflash Bulbs
- Standard Sizes — Highest Quality — Pre-Tested

| Stock No. | Lamp Type | Pkg. Quan. | Per Pkg. | Ea. Pkg. In Lots of 3 |
|-----------|-----------|------------|----------|-----------------------|
| 15 K 1001 | AG-1 | 12 | 1.03 | .96 |
| 15 K 1002 | AG-1B | 12 | 1.20 | 1.12 |
| 15 K 1003 | M2 | 12 | 1.11 | 1.04 |
| 15 K 1004 | M2B | 12 | 1.30 | 1.20 |
| 15 K 4701 | M3 | 12 | 1.30 | 1.20 |
| 15 K 4702 | M3B | 12 | 1.54 | 1.44 |
| 15 K 1005 | 5 | 8 | 1.30 | 1.20 |
| 15 K 1006 | 5B | 8 | 1.54 | 1.44 |

BOOSTER EXPOSURE METER

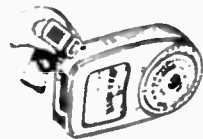

645

WITH BOOSTER

- Includes booster, leather cases, neck cord
- Stills or Movies
- ASA Scale—LVS Scale

Extremely versatile — extremely simple. Highly legible direct reading dial. Speeds from 4 sec. to 1/1000 sec. Lens aperture settings from f:1 to f:32. ASA scale 6 to 800. LVS scale 1 to 18. Cine scale 8, 16, 24 and 32 frames per second. Booster cell makes possible readings at extremely low light levels. Small-rugged-lightweight. Includes booster cell, leather cases, neck cord and instructions. Shpg. wt., 1 lb. Imported.
99 K 7033 Net 6.45

LAFAYETTE Telescopes and Binoculars

26950
As Little As \$12.50
Monthly



Arcturus 3" EQUATORIAL REFRACTOR

Our Finest telescope. Ultra-precise helicoid focusing. Seven coated eyepieces plus Barlow lens, 76.2 mm clear aperture. Advanced Equatorial mount, 42 mm. Finder scope, 25X, with rack and pinion focusing. Micromotion controls with extended Flexible Shafts. Separate wooden case for telescope and mount. Imported. Shpg. wt., 100 lbs. Via EXPRESS ONLY.
99 K 7042WX

Net 269.50

• 454x with
Barlow Lens



18900
As Little As
\$9 Monthly

Galactic RESEARCH QUALITY 3" EQUATORIAL REFRACTOR

Viewfinder scope 25X, 42-mm, 910mm focal length. Hard coated objective lens has 76.2 mm clear aperture. Seven coated eyepieces with magnifications to 227X plus Barlow lens to 454X. Resolving power 1.6. Micromotion controls for declination and right ascension. With 42mm viewfinder scope. Shpg. wt., 60 lbs. Via EXPRESS ONLY. Imported.
99 K 7053WX

Net 189.00

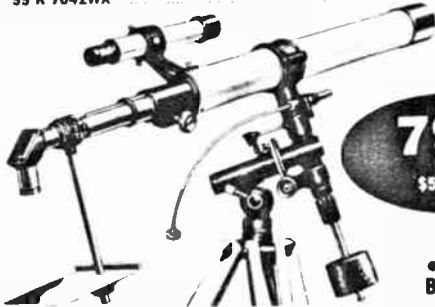

7950
\$5 Monthly

Polaris 2.4" EQUATORIAL REFRACTOR

Objective is Fraunhofer-type achromat, hard coated 62.5 mm. Eyepieces for 160X, 88X, 40X. Barlow lens included gives 320X, 176X and 80X additional ranges. Finder scope is 6X 30 mm. Micromotion adjustments on both axes. Rack and pinion focusing. Heavy plating to prevent rust. Imported. Shpg. wt., 30 lbs.
99 K 7032WX

Net 79.50

• 320x with
Barlow Lens

4mm Orthoscopic eyepiece For 20XX
99 K 7043L (400X with Barlow lens)

Net 8.95



- All Lenses Are Coated!
- Sealed Against Dust & Moisture

Precise design, quality material and expert workmanship. All center focus; adjustable right eye-piece. Leather case, neckstraps included. Imported.

7x35 Popular, versatile, all-purpose binoculars.

99 K 7018 Shpg. wt., 3 lbs. Net 21.95*

7x50 Navy style night glasses. Favored for marine use.

99 K 7016 Shpg. wt., 3½ lbs. Net 26.75*

20x50 King of the long range.

99 K 7020 Shpg. wt., 4½ lbs. Net 29.95*

*Add 10% F.E.T.



- Wide angle view
- Fully adjustable

A multi-purpose 7x35 mm binocular which is especially useful in field studies. Wide angle view allows brilliant and close-up views of sporting events without cutting the image as regular narrow angle binoculars do. Field of view at 1000 yards, is 525 feet! Center focus and right eye adjustment insures perfect focus. All optics are coated. Lined leather case provides protection when not in use. Imported.
99 K 7019

Net 32.95*

*Add 10% F.E.T.



TRU-ZOOM™

- Not a "Vari-Power," One Control Zooms both barrels! • Center Focus, Adjustable Right Eyepiece, plus Single Synchronous Zoom Control!

Sight in subject at 7 power—then Zoom up to 12 power (or any four in between) for closeup viewing power. 40 mm objective lenses are hard coated achromats. Field of view is 290 feet at 1000 yards at 12 power (5.5°). Prisms in shock-resistant mounts. Lightweight alloy frame and body. Includes lined hard leather case and straps. Shpg. wt., 5 lbs. Imported.
99 K 7108

Net 41.95*

*Add 10% F.E.T.

SELECTED FEATURE VALUES



MAGNA-SIGHTER® 3-D BINOCULAR MAGNIFIER

- Leaves Hands Free
- Reduces Eyestrain
- 3-Dimensional!

A precision optical instrument enabling anyone to do very close work and see it clearly in 3 dimensions. Adjusts to any head size comfortably. No moving parts to replace. Ideal for hobbyists, repairmen, inspectors and technicians. Available in 4 sizes. Shpg. wt., 3/4 lb.

| | |
|---------------------------------------|----------|
| 15 K 2001 1.75X, 14" Working Distance | Net 7.88 |
| 15 K 2002 2.25X, 10" Working Distance | Net 7.88 |
| 15 K 2003 2.75X, 8" Working Distance | Net 7.88 |
| 15 K 2004 3.5X, 4" Working Distance | Net 9.38 |



NEW! PEDIOMETER Shows You How Far You Walk!

Do you walk a lot? Want to Know how Far? This easy to use pedometer is the answer. A precision instrument, no larger than a wristwatch, accurately registers up to 24 miles. Easily reset. Complete with ankle strap and instructions. Weighs 2 1/2 oz. Made in West Germany. Shpg. wt., 8 oz.

12 K S100 Net 4.49



SPECTROLINE UV PHILATELITE

14⁹⁵

• IDENTIFY TAGGED STAMPS

A UL approved hand held lightweight lamp of sufficient output of short waves to clearly identify tagged U.S. and foreign stamps. Ground and polished short wave filter provides a narrow band monochromatic light source. Life of bulb is 6000 hours. Convenient on and off switch. Operates on 110V. AC. A 16 page booklet "An Introduction to Ultra Violet Fluorescence."

15 K 4511 Shpg. wt., 2 lbs. Net 14.95

SPECTROLINE DUO PHILATELITE

This remarkable unit provides two high-output tubes—one short wave and one long wave—with ballasts and switches permitting independent operation. Long tube life, swivel desk stand, and handle are provided for convenient operation. An informational booklet on Fluorescence is included. Shpg. wt., 4 lbs.

15 K 4512 Net 29.95

COMBO COMPASS

Here is an unusual gift for the outdoorsman—boy scout, camper, or boatsman. Combines four useful instruments in one compact unit. Compass—transparent for accurate course plotting. Calendar—indicates any day of the week up to 1977. Magnifier—also ideal for fire starting. Mirror—located on back of unit; can be used for signalling. Compass on one pivot arm, magnifier on other; unit folds down to 2 3/4 x 1 3/4 x 3/4". Shpg. wt., 4 ozs. Imported.

99 K 9064 Net 1.89



MICRO-VIEW MAGNIFIER

- 2X to 9X Variable Power
- Engraved Metric and Inch Scales
- Folding—Portable—Compact
- Highly Corrected Lens Systems

A portable, compact magnifier ideal for thousands of uses—coins, maps, stamps, rocks, gems, material, engraving, etc. Adjusts for near, far or normal sight from 2 to 9 power magnification. Two engraved measurement gauges. Black enamel finish—folds to a compact 1.6"x1.7"x8". Complete with convenient leather carrying case. Shpg. wt., 6 oz. Imported.

99 K 7167 Net 1.88



4X RIFLESCOPE

- Lightweight—only 6 1/2 ozs.
- Hard Coated Lenses
- Internal Adjustments
- Cross Hair Reticule

5⁸⁸

Popular, all-around scope for the small game hunter. Bright field, approx. 30 feet at 100 yards. Eye relief distance from 3 1/2 to 4 1/2 inches. Eyepiece diameter, 1" tube diameter 3/4". Hard coated, achromatic lenses reduce glare. Internal windage and elevation adjustments for positive "zero-in." Fine, cross hair reticule pinpoints target. Featherweight, weather-resistant, precision built. Easy, fast installation with all .22's with grooved receivers, some air rifles. Imported. Shpg. wt., 1 lb.

99 K 7160 Net 5.88

SMALL FRY PORTABLE ALCOHOL STOVE



3⁷⁵

Made of lightweight aluminum with the A ceramic insert that completely absorbs the alcohol fuel. This remarkable alcohol stove is so safe you can roll it along the floor while it is burning. Boils water in 12 minutes. Burns for 3 hours for 10c of fuel. Weighs only 24 ounces and measures a compact 5x5". Shpg. wt., 2 lbs.

13 K 5210 Net 3.75

"TINY" MINIATURE IMPROVED HOIST

6⁹⁹

With just one hand, plus an extra 15 oz., you can lift up to 2000 lbs. The unique "Tiny" hoist weighs only 15 oz., is small enough to fit in your pocket, yet is so strong that you can lift up to one ton with it. Ideal for anyone who does heavy lifting—in home, factory, farm, etc. Df highgrade aluminum with steel axles, prelubricated for life. Two lifting slings with heavy steel welded steel rings. With 100-ft. Nylon cable, 7-1 ratio, 2,000 lbs. test. Carrying bag; instructions. Shpg. wt., 2 lbs.

13 K 1901 Net 6.99

ZOOM SPOTTING SCOPE



39⁹⁵

- Any Power from 15X to 30X

Any power from 15X to 30X! Ideal for any "Spotting" Need. Pan-head, elevator tripod mount included. Perfect all round scope. Powerful, small lightweight, brilliant viewing. All aluminum and chromed brass. Imported. Shpg. wt., 5 lbs.

99 K 7101 39.95

10X30mm TELESCOPE with TRIPOD



6⁵⁰

- Full 10 Power
- Portable-Compact-Lightweight

A 10 power, 30mm internal (front) focus telescope that is compact, lightweight and portable—ideal for taking it everywhere you go. Features coated achromatic lenses. Has built-in camera tripod socket. Complete with tripod with rubber-tipped legs that prevent scratching. Imported.

99 K 7071 Shpg. wt., 2 lbs. Net 6.50

30X, 60mm SPOTTING SCOPE



16⁹⁵

The perfect companion for shooting, hunting and nature fans. Field of view is 85 feet at 1000 yds! High relative brilliance due to 60mm objective lens. All optics are coated. Equipped with a 1 1/2" tripod and zippered leather carrying case. Exceptionally small and light. Shpg. wt., 3 lbs. Imported.

99 K 7015 Net 16.95

Lafayette Engine Divided Slide Rules

NEW! LAFAYETTE® VECTORLOG™ SLIDE RULE

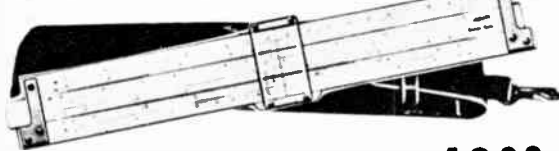

The Slide Rule for Communications Engineers and Physicists

16⁸⁸

- Laminated Bamboo Construction • P, P', and Q Scales — For Direct Vector Addition • Hyperbolic Sine and Tangent Scales • Two Sine Scales — One Marked in Degrees, One Marked in Radians • 5 Log Log Scales Plus a Voltage DB Scale • Complete With Belt Carrying Loop and Leather Case

The Lafayette VECTORLOG Slide Rule provides a new concept in scientific calculation, incorporating scales and arrangement designed for quick-easy-manipulation. Twenty-seven (27) scales incorporate the many problems encountered in Electrical Engineering and Physics. The unique P, P', and Q scales allow direct right angle vector addition. No longer are several settings required to obtain right angle vector sums—these scales work in the same manner as the C and D for multiplication. The two Hyperbolic Sine and one Hyperbolic Tangent Scale, the voltage db scale, and the five Log Log scales, provide maximum coverage of these dynamic fields. VECTORLOG is the result of extensive tests for ease of manipulation. Several of these features are: C and D scales on both the front and back of the rule; Sine scales in both degrees and radians, removing the necessity of bothersome conversion of units; A problem-tested location of scales; and adjustment screws to allow variable tension on the slide. Scales include: (FRONT) Tr-1, TR-2, P', P, Q, ST, S-1, S-O, C, D, LL01, LL02, LL03, LL1'; (REAR) Sh-1, Sh-2, DF, A, B, CI, CF, Th, C, D, LL3, LL2, db. With instruction book, leather carrying case, and belt carrying loop. Imported. Net 16.88
99 K 7102 Shpg. wt., 1½ lbs.

DELUXE LOG LOG DUPLI DECIMAL TRIGONOMETRIC SLIDE RULE

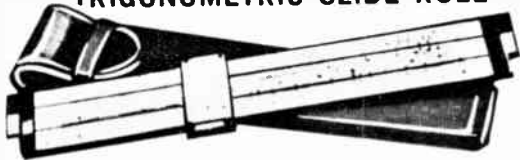

- 25 Scales with 8 Log Log Scales
- Extended Range Avoids "Going Off Scale"
- Extra P Scale Simplifies Computations
- Two Color Scales

15⁹⁵

10" log log dupli decimal trigonometric slide rule contains 25 scales including 8 Log Log Scales. Troublesome end-for-end resetting is eliminated by extensions of C and D scales. Twin set of Log Log scales run from 1.001 to 100,000 and .999 to .00001, enlarging the scale by one scale length each compared with ordinary log log slide rules. Extra features include P scale which enables direct "readout" of cosine value. Scales include LL01, LL02, LL03, DF, CF, C, F, CI, C, D, LL3, LL2, LL1, LL00, L, K, A, B, S, ST, T, C, D, DI, P, and LL0. With instruction book, leather case. Overall length is 14". Imported. Net 15.95
99 K 7055 Shpg. wt., 1½ lbs.

NEW! DECIMA-DYNE™ SLIDE RULE

• A Dynamic Reactance Slide Rule

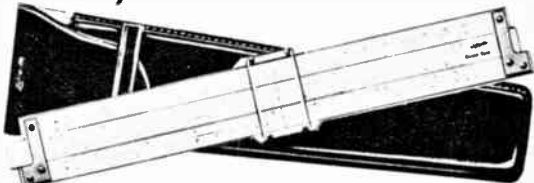

- Automatic π Multiplication on DF Scale
- Continuous Resonant Frequency Scale—Simplifies Surge Impedance Calculations
- Direct Power Factor Read-out
- Simplifies and Speeds Up CRL Calculations

13⁹⁵

Specially designed to speed up calculations for radio and electrical communication engineering, for decibel, inductive reactance, capacitive reactance, resonance frequency, surge impedance, etc. Feature scales include: DB—for computation of electric communication circuit; DF and CF—same as D and C scales, except that they are "folded" at π ; XC—for computation of capacitive reactance; XL—for computation of inductive reactance; F₁ and F₂—for calculating resonance frequency. The 17 scales are: DB, DF, CF, C, F, CI, C, D, A, XC, XL, K, Kl, S, T, F₁, F₂, DI. With instruction book, leather carrying case, belt carrying loop. Imported. Shpg. wt., 1 lb. Net 13.95
99 K 7128

DECIMA-LOG™ DELUXE 5" LOG LOG DUPLI DECIMAL TRIGONOMETRIC SLIDE RULE



ONLY **6⁸⁸**

- Pocket Version of Lafayette's Most Popular Slide Rule
- P Scale (Pythagorean) permits direct "readout" of Cosine Values • Includes Leather Case With Pocket Clip • 24 Scales including 8 Log Log Scales

A pocket version of our 10" Log Log Dupli Decimal Trigonometric slide rule. Contains all the scales of the 10" rule except the "ST" scale. Two color scales—positioned for ease in use and rapid calculations. "C" and "D" scales on both sides of the rule, "P" scale for direct, cursor line reading of cosines of angles. Scales— front face: LL1, LL2, LL3, DF, CF, C, F, CI, C, D, LL3, LL2, LL1. Back face: LL0, L, K, A, B, S, T, C, D, DI, LL0. Engine divided rule of laminated, non-hygroscopic bamboo. Complete with instruction book and leather case with pocket clip. Imported. Net 6.88
99 K 7099 Shpg. wt., 8 oz.

Using The Slide Rule In Electronic Technology



USING THE SLIDE RULE IN ELECTRONIC TECHNOLOGY by Charles Alvarez is written for electronic students, both beginners and advanced. It can also serve as auxiliary text in math theory. All scales are discussed separately with detailed examples, graded in difficulty to develop speed and accuracy in use of the slide rule. 120 pp, 5½x8½ paperback. 10 K 1162 Shpg. wt., 8 oz. Net 2.45

NEW! DURO LABEL-MATE

- Wide ¾" Self-Stick Plastic Tape
- Large Easy to Read Letters
- Easy to Use—For Home—Office—Industry

588

Precision built Label-Mate prints large easy-to-read, raised letters instantly. Features wide ¾" tape with self-stick backing. Tape addresses permanently to all smooth, clean surfaces — indoors or outdoors. Full-view 44 character wheel permits fast, easy operation. See each character as you emboss. Instant start — no back up, no unnecessary waste of tape. Tough durable shock-resistant plastic housing for long service. Shpg. wt., 1 lb. Net 5.88
12 K 3504

| | | | |
|---|-------|-----------|-------|
| Embossing Tape Magazines—¾" wide, 144" long. Shpg. wt., ¼ lb. | | Net each | .98 |
| Stock No. | Color | Stock No. | Color |
| 12 K 3505 | Red | 12 K 3501 | Clear |
| 12 K 3502 | Blue | 12 K 3500 | Black |
| 12 K 3503 | Green | | |



LAFAYETTE Drafting & Drawing Essentials

PROFESSIONAL GIANT BOW



350

- 6" Size with Center Wheel Adjustment
- Finely Balanced—Professional Type

Professional quality utility set in a fitted, velvet lined case. Made in Western Germany of nickel plated brass. 6" giant bow has preferred center wheel adjustment. Makes circles from 1/8" to over 10" in diameter. Set includes 6" giant bow, interchangeable pen and pencil parts, extra needle for using bow as divider, handle for use with pen and pencil parts, lead, lead box and repair parts. Shpg. wt., 1 lb. Imported.

99 K 7083 Net 3.50

SUPER DRAWING KIT

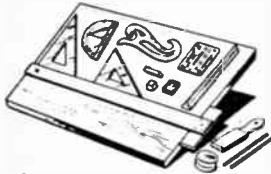

795

Contains all the necessary equipment for drafting, mechanical drawing, designing. Sturdy accurate components. Includes — 18x24" drawing board, 24" T square, 10" 30°/60° triangle, 8" 45° triangle, french curve, 12" triangular rule, 6" 180° protractor, 4 pencils, pencil pointer, erasing shield, thumb tacks, and art gum.

15 K 5701 Shpg. wt., 10 lbs. Net 7.95

ACRYLIC T SQUARE

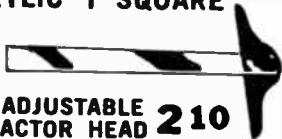

WITH ADJUSTABLE PROTRACTOR HEAD 210

Adjustable protractor head clearly marked to 180°—easily set and fastened. Transparent arm gives clear full view of subject matter. All plastic—light weight. Adapted for ink ruling. Head fits snugly against board. Shpg. wt., 1/2 lb.

15 K 1426—18" long Net 2.10
15 K 1427—24" long Net 2.35

NEW RUBBER TYPE SET

- Easily Changed
- Simple to Operate



225

An easy to use printing kit that comes complete with 14-point (1/2") rubber type, 22 numerals, over 100 capital letters, punctuation marks, ink pad and tweezers. Print anything from one to four lines long. Special "base-lock" type for perfect alignment. Neat, clean, and clear results. Many printing uses in the home or business. Instructions included. Shpg. wt., 1 1/2 lbs.

15 K 6001 Net 2.25
Extra set of (1/2") rubber type, 22 numerals, over 100 capital letters, punctuation marks.
15 K 6000 Net 1.49

TECHNICAL DRAFTING SET

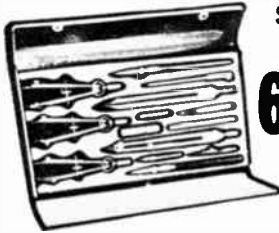

685

- Center Wheel Adjustment
- Professional Quality
- Made in Germany of nickel plated brass

Contains 6 1/4" self-centering compass, one leg knuckle joint with divider, pencil, pen parts and lengthening bar; 6 1/4" self-centering divider; spring bow divider 4 1/4", center wheel adjustment with interchangeable needle points; spring bow pencil and spring bow pen, both 4 1/4" with center wheel adjustment and interchangeable needle point; two 5 1/2" ruling pens; extra handle for pen and pencil parts; adjustment tool; lead case and leads; and spare parts kit, all in velvet lined snap closing case. Imported

99 K 7003 Shpg. wt., 1 1/2 lbs. Net 6.85

draftette PORTABLE DRAFTING MACHINE

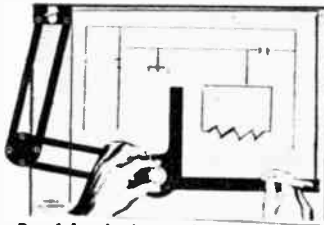

- Precision Instrument

Sketch, design, draw diagrams and schematics like a professional. The new Draftette gives you all the advantages of a portable drafting instrument. One piece aluminum scale features, 2 graduations—top in 16ths and bottom in eighths and fourths, a 360° protractor mounted on a 16x21" drawing board. Draftette can be removed from its board and folded like a jack-knife, to be stored. It is easily attached, to any stiff-backed pad of paper without screws. Finest satin black anodized aluminum construction. Assembled and ready for use as a T square, triangle or protractor. Perfect for students. Clear vinyl plastic carrying case.

15 K 7401 Shpg. wt., 2 1/2 lbs. Net 13.98
Draftette =12-B Senior with 6x9" scale, 360° protractor on 20x26" drafting board.
15 K 7403 Shpg. wt., 6 lbs. Net 19.95
Draftette =12 Senior less board.
15 K 7404 Shpg. wt., 2 lbs. Net 15.30

LETTERING GUIDE SET



Made of transparent plastic. Simple to use with either sharp pencil or ink. Each has complete alphabet, all numbers plus commonly used signs. Most letters formed with one operation. Set consists of six guides. Sizes 1/8", 1/4", 3/8", 1/2". Shpg. wt., 1/2 lb.

15 K 1432—Complete Set Net 6.79

HARD MAPLE PANTOGRAPH

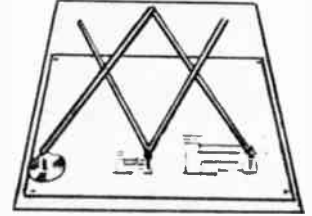

- Enlarges • Reproduces!

A 21" adjustable pantograph with 21 different ratios from 1 1/2 to 8. Enlarges, reduces or reproduces drawings, etc. Most rapid, accurate means of reducing or enlarging to scale. Lacquered highly finished bars are 21" long and 3/4" wide. Heavy ball bearing standard. Chrome plated hardware, ratio thumb screws and nuts. Complete with lead, accessories and detailed instructions. Shpg. wt., 2 lbs.

15 K 5602 Net 3.75

"draftette" SKETCH KIT

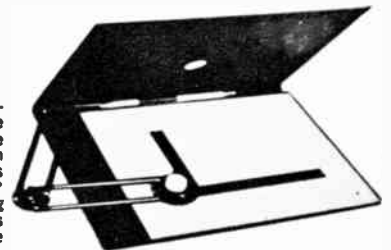

A completely portable drafting drawing machine permanently mounted in a Vinyl binder (self-locking). A weather protected unit, it can be used for sketching, designing, drawing, and drafting. Great for traveling. Contains a precision portable drafting instrument with a 4x6" scale, 180 degree protractor, pad of 50 sheets, drawing-tracing paper 8 1/2x11", all in one compact binder. Does not require tape or tacks to hold paper in place for use. Only 9 1/2x13x1".

15 K 7402 Net 7.60



NEW Graphos "COLLEGE" SET

A complete college assortment for ruling, technical drawing, and sketching. Drawing ink flows freely and uniformly—producing a well covered and sharply defined line. Lines of over 1000 yards can be accurately drawn with one filling of the pen. No smudges or blots! Set includes pen, black ink cartridge, 6 assorted nibs, and instructions. Housed in a plastic case. Shpg. wt., 8 oz.

15 K 5603 Net 5.98



- Simple As Using A Pencil
- Professional Results

LAFAYETTE *Super* POWER TOOLS EQUIPPED *with* GE MOTORS

LAFAYETTE 1/4" HEAVY DUTY POWER DRILL

only
12⁶⁶

- Burn-out Proof Armatures
- Dynamically Balanced G.E. Motor
- Ball-Thrust Bearings

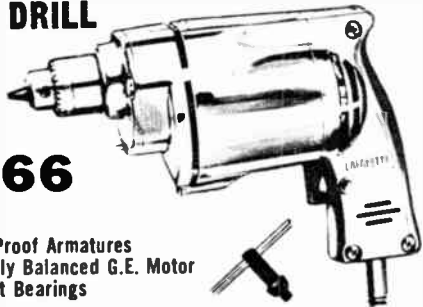

A heavy duty power tool for wood, masonry or even steel. 2.75 amp. motor does the job smoothly and quickly. Use it for a buffer, grinder, polisher, sander. Other top quality features include, ball-thrust bearings, Jacobs geared key chuck and automatic trigger release switch. Capacity—1/4" in steel, 1" in hardwood; Speed—2200 RPM; Motor 1/4 H.P., 2.75 amps, 115V, 60 cycles AC-DC. 3 conductor, 6 ft. rubber covered cord. UL and CSA approved. Die-cast aluminum housing. Shpg. wt., 4 lbs.

13 K 0101 Net 12.66

LAFAYETTE 3/8" HEAVY DUTY POWER DRILL

only
18⁴⁴

- Burn-out Proof Armatures
- Dynamically Balanced G.E. Motor
- Ball-Thrust Bearings
- 1250 RPM



A rugged, heavy duty tool that's loaded with power for smooth performance. Can go through practically any material—cement, plaster brick, hardwood—even tough 3/8" steel! Precision built motor is cool running, trouble-free and stall-proof. Jacobs geared keyed chuck, hand pistol grip, 3 conductor, 6 ft. rubber covered cord. Capacity: 3/8" in steel, 1 1/2" in hardwood; Motor: 1/2 HP AC-DC, 115 V, 60 cycles. Durable mirror finish. Diecast aluminum housing. UL and CSL approved. Shpg. wt., 4 1/4 lbs.

13 K 0102 Net 18.44

LAFAYETTE 1/2" HEAVY DUTY POWER DRILL

22⁵⁰

- New Compact Design
- Burn-out Proof Armature
- Dynamically Balanced G.E. Motor
- Ball Thrust Bearing
- 550 RPM

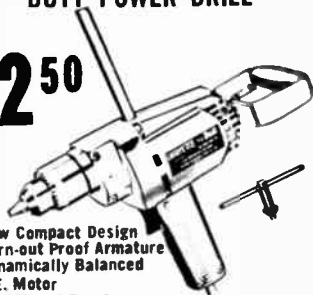

Packed with extra hi-torque power for really tough jobs . . . yet compact and easy to handle. 3.5 amp motor for drilling in heavy lumber and metal. Can be used with hole saws and extra large wood augers. Dynamically balanced and equipped with ball thrust bearings and micro-machined alloy gears. Jacobs geared keyed chuck, top handle and rear spade grip for greater control. Capacity 1/2" in steel, 2" in hardwood; Motor—1/2 HP, 3.5 amp, AC-DC, 115V 60 cycles; length 12". Mirror-finished polished aluminum casing. UL and CSA approved. Shpg. wt., 5 1/2 lbs.

13 K 0103 Net 22.50

LAFAYETTE 7" HEAVY DUTY POWER SAW

27⁹⁵

- Ball Bearing Slip Clutch
- Dynamically Balanced G.E. Motor
- Oversize, Heavy Gauge Base Plate
- Multiple Ball Thrust Bearing



A big 7" chrome nickel hardened steel combination blade—cuts through the hardest woods . . . masonite, plywood, plastic, wall board and dozens of other materials. Easily cuts finished 2x4 at 45°. Heavy duty universal motor, safety slip-clutch to eliminate kickbacks, spring-back blade guard, and calibrated adjustable rip guide. Motor develops 2 HP @ 10.25 amps.; No load speed 5000 RPM. Complete with auxiliary side knob, 3 conductor 6 ft. rubber-covered cord. UL and CSA approved. Shpg. wt., 14 lbs.

13 K 0104 Net 27.95

LAFAYETTE HEAVY DUTY SABRE SAW

19⁴⁹

- Oversize 45° Tilt Base
- Dynamically Balanced G.E. Motor
- Cuts 6" Lumber at 90°
- Compact and Lightweight

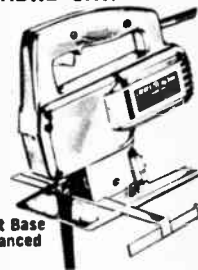

Capable of handling dozens of cutting jobs with ease. Use as rip, crosscut, coping or keyhole saw. Powerful, precision 3.5 amp motor—for greater accuracy with less work. Cuts up to 6" in woods! Also cuts plastics, metals and most other materials. Extra large adjustable base enables accurate bevel cuts up to 45° angle. Sawdust blower removes sawdust as you cut. Makes its own starting hole. 4800 strokes per minute. Complete with 5 blade assortment and 3 wire 6 ft. rubber covered cord. For 115 V; 60 cycles AC-DC. Shpg. wt., 4 1/4 lbs. UL and CSA approved.

13 K 0105 Net 19.49

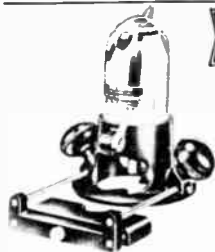

RAM ROUTER **29⁹⁵**

- With Cutting Guide
- 20,000 R.P.M.
- 1/4" Cutting Tool Chuck
- Uses Standard Router Bits

Light weight for ease in handling. Designed to provide heavy duty performance for a variety of woodworking jobs. Rout, Groove, Mortise, Dado, Dovetail, Babbet, and Jointing cuts. Ideal for decorative cuts. Features threaded base with positive lever-locked depth of cut adjustment; veneer cutting guide and wrench included. 1/4" chuck uses standard router bits, 20,000 RPM cutting speed, 1/4 HP 115 volt AC-DC, 3-conductor, 6 ft. cord. Height: 8".

13 K 7108 Shpg. wt., 5 lbs. Net 29.95

• Selection of 4 Most Often Used Router Bits.
4 Piece Router Bit Set. Net 10.49
13 K 7113 Shpg. wt., 1 lb.



RAM 2-WAY ELECTRIC SANDER MODEL R-120

Orbital or Straight Line **16⁸⁸**

- Positive Slide Switch
- 3/16" Stroke Orbital or Straight

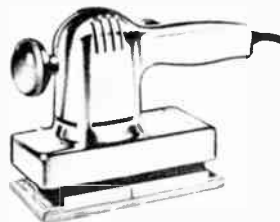

A heavy-duty electric sander with 3/16" stroke in orbital or straight line. Features 2.4 amp. universal sleeve wound motor. Heavy-duty ball bearing and self-lubricating sleeve bearings. Pad size: 3 1/4" x 7 1/8"; sandpaper size: 3 1/2" x 9". Industrial mirror finish. 6-ft., UL approved cord. 115V, 60 cycles, AC-DC. Shpg. wt., 5 lbs.

13 K 7102 Net 16.88

72 PIECE "POWER SHOP" ³/₈" DRILL KIT



- A Complete Workshop For Do-It-Yourself Jobs
- Drill, Sand, Grinds, Buffs, Saws
- Home, Garage, Shop

ONLY

19⁹⁵

A complete electric power workshop at Lafayette's typically low price. You can do almost every at-home job with this versatile 72-piece set. Look at what you get: Powerful 2.5 amp. ³/₈" electric drill; 6-pc. power boring set with bits from ³/₈" to 1"; 14-pc. twist drill set with metal index; 29-pc. sanding and polishing set; 7-pc. grind and buff set; 9-pc. 7-size hole saw; 7-pc. countersink and drill saw set; 3-pc. power screwdriver attachment. The ³/₈" drill has 2.5 amp, 110 VAC motor. No-load speed, 1750 rpm; full load speed, 1150 rpm. Special alloy bearings throughout. U.L. approved. Shpg. wt., 10 lbs.

13 K 9005

Net 19.95

RAM "FURY" ¹/₄" DRILL DUR TOP DRILL VALUE



788

- 2 Amp. Motor
- U/L Approved
- Jacobs Geared Chuck and Key
- Multiple Thrust Ball Bearings

Lafayette's top drill value. ¹/₄" geared chuck drill rated at a full 2.0 amps. U/L approved. ¹/₄" capacity in steel, ¹/₂" capacity in steel, ¹/₂" capacity in hardwood. 1200 rpm speed under full load, 2000 rpm no load speed. Precision anti-friction bearings. Automatic trigger switch. Specially designed gear train for maximum torque transfer. Overall length 8". For 115 volts, 25-60 cps AC. Shpg. wt., 4 lbs.

13 K 7101

Net 7.88

SPEEDWAY HUSKY ³/₈" DRILL



SALE

10⁸⁸

- "Thermoweld" 3-Amp Motor—that Won't Burn Out!

Get the balance and feel of a ¹/₄" drill—with the power and work capacity of a husky ³/₈". Industrially rated to handle really rugged work. Special bronze alloy bearings. Precision-gear chuck and key. No-load speed 1750 rpm, full-load about 1150 rpm. Locking trigger switch. Cast aluminum alloy housing. 6-ft. 3-wire cord and plug. U/L and CSA approved. 115V., 25-60 cps AC. Shpg. wt., 5 lbs.

13 K 5302

Net 10.88

SPEEDWAY JIG SAW

- With 3 Assorted Wood and Metal Cutting Blades

13⁸⁸

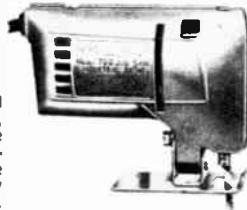

Enjoy new versatility sawing curves, scrolls, straight and rip cuts "THERMOWELD" 3-amp motor cuts 2" in wood, ¹/₂" in steel. Adjustable plate permits accurate angle cutting to 45° on either side—cuts 2x4's at 45°. No-load speed 3000 strokes per minute; AC/DC positive push-through switch; self-oiling bronze bearings. Auxiliary knob handle; rip guide. Base tilts to 45°. 6-ft., 3-wire cord. Standard 115V. Shpg. wt., 5 lbs.

13 K 5307

Net 13.88

13 K 5532 Pkg. 5 Wood & Metal Cutting Blades

Net 15.98

SPEEDWAY ORBITAL POWER SANDER



- Ball and Bronze Bearings Throughout

1128

Motor-driven power sander for home and shop use. Ideal for rough or finish sanding. Lightweight and easy to handle, it produces perfect finishes every time. Uses 2-pole induction-type burnout-proof motor rated at 1.8 amps. No-load speed is 3450 rpm; push-button switch. Special alloy self-oiling bronze bearings; teflon coated thrust washer and ball bearing on sander drive plate. Sanding area 4¹/₂x5¹/₈". Sturdy cast aluminum alloy housings with attractive metallic finish and black crackle trim. 6-ft. 3-wire cord. For 115 volts, 60 cps AC only. Shpg. wt., 6 lbs.

13 K 5304

Net 11.28

13 K 5305 Lambswool Polishing Pad Net .79

13 K 5306 18 Sheets Assorted Sandpaper Net .98

THOR

COMPACT ¹/₄" ELECTRIC DRILL



29⁹⁵

- Sensationally Small—Only Half The Size of Conventional Drill
- Diode Input Circuit
- Stator Guaranteed for Life

The compactness of the new Thor Compact Drill comes from a completely new approach to electric drill design. Built-in diode rectifier feeds only DC to the motor, which, because of its unique construction, is rated without qualification as the most efficient electric motor ever built into a portable electric tool. Uses a permanent magnet solid stator (no-wire windings) which is guaranteed for life. Capacity ¹/₄" in steel, ¹/₂" in hardwood. Free speed 1250 rpm. Spindle offset ¹/₂". Supplied complete with 3-jaw geared chuck and key, 3-cond. cord with 3-prong grounding plug. For 115 volts, 25-60 cps AC only. Overall length 6¹/₄". Shpg. wt., 2 lbs.

13 K 5303

Net 29.95

UNIVERSAL DRILL PRESS STAND

1044



- Adjustable Depth Stop
- Spring Return Tension
- Adjustable Cradle
- Adjustable Depth Gauge Dial

Can be used for any ¹/₄" pistol grip electric drill. Features rack and pinion gear feed, and adjustable depth stage. 15 to 1 leverage. Drill press head is clamped in rigid position. 2¹/₄" stroke. Square base is provided with slots for drill bit and for bolting work to base. Other features include spring return tension, fast hand-action, head clamps and adjustable depth gauge dial. Shpg. wt., 6 lbs.

14 K 3804

Net 10.44

54-PIECE SUPER DUTY 3/8" DRILL KIT

- Super Powered 3.0 Amp. 3/8" Drill with Multiple Ball Thrust Bearing, Jacobs Chuck & Key, Micro-Machined Gears, Gleaming Mirror finish
- Drill and Practical Accessories Selected for Power and Performance
- Everything You Need to Make the TOUGH Jobs EASY

only **29⁹⁵**

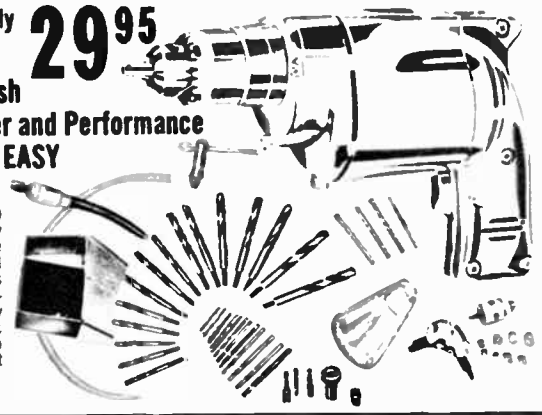

A drill kit deliberately designed to make the tough jobs easy. Big 3.0 amp 3/8" drill packed with power to spare when you need it! A husky right angle gear drive—can halve or double drill speed! Increase torque or speed to suit your needs. A powerful 12-piece, screw and nut driver set with screw driver bits, Phillips head bit, eight sockets for hex and square nuts and bolts, powerful non-slip clutch. 36" flexible shaft for all your intricate drilling, grinding, buffing or hobby work. 5-pc. Carbide drill set for boring concrete, masonry, tile, plastic from 3/8" to 3/4" dia. holes. Plus 29 full jobbers length twist drills from 3/8" to 1/2" by 64th in a metal index. All the really needed tools left out of most drill kits. Shpg. wt., 12 lbs.
13 K 9006

Net 29.95

6 1/2" SKILSAW

SALE!

29⁸⁸



- Over 1-HP Motor
- Burn-Out Protection

Top quality circular saw with full 6 1/2" hard-tooth combination blade. Cuts 2" dressed lumber at 45° bevel. 1 hp motor with Burn-Out protection and rugged helical gearing. Has safety clutch, depth and bevel controls, sawdust ejection and bind-free lower blade guard. Depth of cut 3/4", 2 3/4" at 90°; 1 3/4" at 45°. No-load speed 6300 RPM, draws 9 amps. Supplied with blade, blade wrench, 3-wire cord and plug, 2-prong adaptor. U.L. Approved. For 110-120V AC or DC. Shpg. wt., 12 1/2 lbs.
13 K 6915

Net 29.88



As Low As

ABRASIVE CUT-OFF BLADES

Saw through Concrete, Brick, Stone, Metal

1⁸⁸

General purpose and metal cutting blades for all portable saws. Fit all "Diamond" arbors and 3/8" and 1/2" round arbors. Extra-bonded, resinoid blades, arbors metal-reinforced—shatterproof. Will not burn or load. Cut smoothly.

GENERAL PURPOSE BLADES

| | |
|-----------------------|----------|
| 14 K 4601 6" Dia. | Net 1.88 |
| 14 K 4602 6 1/2" Dia. | Net 1.95 |
| 14 K 4603 7" Dia. | Net 2.07 |
| 14 K 4604 8" Dia. | Net 2.25 |

FOR ALL TYPES METAL

| | |
|-----------------------|----------|
| 14 K 4605 6" Dia. | Net 1.99 |
| 14 K 4606 6 1/2" Dia. | Net 2.07 |
| 14 K 4607 7" Dia. | Net 2.18 |
| 14 K 4608 8" Dia. | Net 2.37 |

RAM "FURY" 7" HEAVY-DUTY POWER SAW

Only **19⁸⁸**

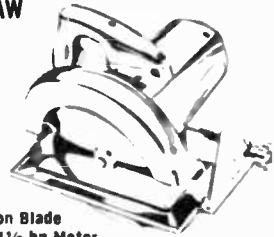

- 7-Inch Combination Blade
- Universal 1 1/2 hp Motor
- Safety Retracting Handle
- Heavy Duty 3 Conductor Cord
- Approved by UL and CSA

A powerful 8 ampere motor provides this big 7" circular saw plenty of reserve power to zip through straight or angle cuts. Cuts vertically to 2 1/4" at 90°, to 2 1/8" at 45°. Features self-lubricating bronze bearings, floating blade guard, safety retracting handle, combination rip and cross-cut blade and 3-wire cord and plug. No load speed, 5000 rpm. Motor is a universal 1 1/2 hp AC-DC 115 volts. UL Approved. Shpg. wt., 15 lbs.
13 K 7103

Net 19.88

SAW TABLE. Perfect complement to the above Saw. Allows cutting at any angle between 45° and 90°. Complete with miter gauge and rip fence. Shpg. wt., 12 lbs.
13 K 7104 Saw table

Net 11.65

NEW! SKIL VARIABLE SPEED DRILLS

- Trigger Speed Control
- Speed from 0 to 2,000 RPM
- Complete with Carrying Case
- No Dials—No Buttons—No Rheostats

25⁴⁸



EXCLUSIVE TRIGGER SPEED CONTROL! 0 to 2,000 R.P.M.

Absolute speed control at your fingertips. No dial or buttons. No rheostats. You get the exact speed you need for every conceivable task. You actually sense the correct bit speed with your "trigger finger." Make holes in steel, accurately, without center punching. Use as a precision driver. All that is required is a driver bit. The variable speed feature lets you start a screw at low speed, run it down fast at a higher speed and finally set it snug by slowing to a stop. "Super Burnout Protected Motor" rated at a full 2.5 amps., 115 V AC. Equipped with geared chuck and key, 3 wire cord and 3 prong-plug with 2 prong adaptor. 9 inches long. Complete with carrying case.

| | |
|---------------------------------|------------|
| 13 K 6901 Shpg. wt., 4 lbs. | Net 25.48 |
| Model 569 TSC 3/8" Drill | |
| 13 K 6917 Shpg. wt., 4 1/2 lbs. | Net 33.95. |
| Model 545 TSC 1/2" Drill | |
| 13 K 6919 Shpg. wt., 5 lbs. | Net 36.50 |



FREE CASE

MODEL W-300L REVERSE-O-MATIC



- TAPPING
- DRILLING
- NUT DRIVING
- REVERSIBLE SCREWDRIVER
- INCREASES TORQUE

9⁵⁰

Can be fitted to any electric drill or drill press quickly and easily. Heavy duty industrial type for instant 11 to 1 speed reduction. Develops high torque when more power is required for oversize drilling. Easy stop-start action with hand clutch control. Accessories include yankee type — 3/8" standard bit — 3/8" phillips bit — socket adaptor—adaptable for 1/2" chuck plus a 3/8" female adaptor to fit drill chuck onto unit. Shpg. wt., 1 1/2 lbs.

14 K 7901

Net 9.50

SPECIAL WORKSHOP VALUES

NEW! Wen 950 Multi-Speed 1/2" Reversible Drill

- Multiple speeds From 340 to 2400 RPM
- Powerful 6 Amp., 1/2 HP Burnout-Proof Motor
- Double Reduction Gears for Super Torque
- UL Industrially Rated

32⁸⁸

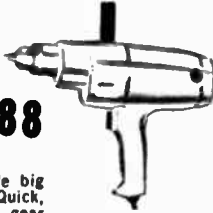

A versatile heavy duty 1/2" drill to handle big jobs — where great power is required. Quick, easy two-lever control of electronic and gear reduction speed changes permit efficient use of drill for any type of material or size of hole. All 4 speeds are reversible too with extra safety double switch. 6 amp. 1/2 horsepower motor, 120V AC/DC, 6 ft. 3-wire cord. UL and CSA approved. Size: 11x 8 1/2 x 3 1/2" (LHW). Die Cast aluminum housing, balanced for continuous operation. Shpg. wt., 9 lbs.

13 K 6533 Net 32.88



M-4 HOME LABEL MAKER

- Makes Permanent Self-Sticking Raised-Letter Plastic Labels

6⁶⁴



A precision tool designed especially for home use. Just dial letters, numbers, symbols — squeeze the embossing handle — pull the cut-off trigger and that's it. Embossing wheel has 44 characters. Prints a crisp white message on durable moisture-resistant tape. Made of heavy duty plastic. Size: 6 1/2 x 6" H. Shpg. wt., 2 lbs.

14 K 4101 Net 6.64
 Embossing tape Magazine for Model M-4. Each contains 144" of 1/4" glossy vinyl tape with adhesive backing. Shpg. wt., 1/4 lb.

14 K 4102 Blue Net ea. .98
 14 K 4103 Green
 14 K 4104 Red
 14 K 4105 Clear
 14 K 4106 Brown
 14 K 4107 Black
 14 K 4130 Orange
 14 K 4131 Yellow
 14 K 4132 Gold

Cloth Printer Kit. Provides a clean, fast and easy way to mark all clothing when used with your Dymo Home Labelmaker. Use directly on clothing or use the iron-on label provided. Shpg. wt., 1/2 lb.
 14 K 4108 Net 4.75
 14 K 4109 72 Assort. Iron-On Tapes for above Net .95

NEW STEVENS WALDEN 13 Pc. 3/8" DRIVE SOCKET WRENCH SET

625

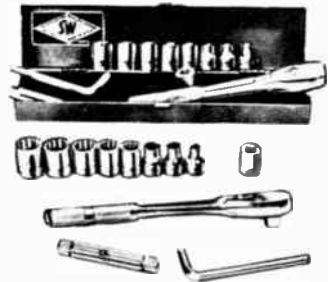

- Alloy Steel Sockets
- Round Head Ratchets
- Double Chrome Plated Over Nickel

These alloy steel socket wrenches are made in USA for durable use. Chrome plated, professional tools, find thousands of applications in electrical work, autos, shop, household, boats and many others. Kit includes 1 combination spinner connector 3/8" sq., 1 reversible ratchet, 1 1/4" set screw key, 3" extension male, 8 sockets 1/4" to 1 1/4" sizes increase by 1/8" will fit standard size parts. Round head design gives positive control over operation. Turns those wrist breaking jobs into simple tasks. Entire kit comes packed in rugged metal box that will hold sockets neatly.

13 K 5701 Shpg. wt., 3 lbs Net 6.25

PISTOL GRIP FLEXIBLE SHAFT

With 1/4" Chuck!

- 36" Long Flex. Shaft
- Comfortable Pistol Grip
- Like Owning A Flexible 1/4" Drill



With this attachment any electric motor becomes a tough work horse. No need to hold a heavy or hot motor. Sturdy metal pistol grip will allow accurate and comfortable work when using this handy item. Operates at speeds up to 6000 R.P.M. Will accommodate shanks up to 1/4" dia. and accepts all 1/4" drill attachments. Includes 1/4" chuck. Long flexible 36" shaft will allow you to "walk around" your work. Perfect for grinding—polishing—buffing—drilling—sawing—routing or carving. For use on wood—metals—glass and plastic. Shpg. wt., 3 lbs.
 14 K 7006 Net 2.75

NEW RIVET-ALL RIVET KIT

399



A professional tool which joins virtually anything, metal to metal, plastic to wood, fabric to fabric. Easy to operate, just insert rivet into tool, place in pre-drilled hole and squeeze gun and you have a strong rivet joint. KLIK rivets are strong, neat and permanent. Ideal for Hobbyists, Electronics, Household and Auto repairs. Kit includes Riveter, supply of rivets of various sizes. Extra rivets available at low cost. Shpg. wt., 2 lb.

13 K 5401 Net 3.99
 25 Rivets for Work to 1/8" Thick
 13 K 5402 Net .44
 20 Rivets for Work to 1/4" Thick
 13 K 5403 Net .44
 15 Rivets for Work to 1/2" Thick
 13 K 5404 Net .44
 40 Back-up (Reinforcing) Plates
 13 K 5405 Net .44

COMPASS CIRCLE CUTTER

- Uses special bit with side-cutting Action
- Simple and safe to use

298

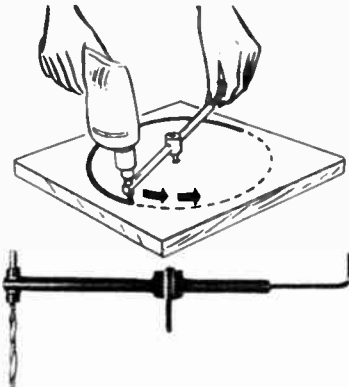

Simple and safe to use, makes perfect circles in wood in seconds. Use with any electric drill to cut speaker holes, vents, pipes, ceiling lights, etc. Can also be used to make discs, rings and fancy shapes. Cuts circles 1 1/2" to 12" in diameter. Shpg. wt., 1 lb.
 12 K 4100 Net 2.98

"ADJUST-A-BOX" WRENCH

AS LOW AS

298



- A full set of box wrenches in one tool
- Narrow Head: Gets into tight places
- Non-Slip Jaw Grip, Prevents Slipping, Saves Knuckles
- Fits Metric Sizes as well as U.S. Standard

Covers range of eight or more double-end box wrenches—a complete box wrench set in just one tool. Off-set and upward slanted handle provides excellent knuckle clearance and full hand grip at all times. A perfect holding tool behind wall and other obstructions. Made of drop-forged alloy steel, heat treated and nickel—chromium plated. Long bolts extend through opening in jaws. Presents no problem as encountered with sockets. Requires less than half the lateral operating space of regular adjustable wrenches of same size and capacity. Comes in 2 sizes. Shpg. wt., 1 1/2 lb.
 8" Cap. 1/4"x1" Net 2.98
 14 K 4501
 12" Cap. 1/2"x1 1/4" Net 5.95
 14 K 4502

SPECIAL WORKSHOP VALUES

ELECTRIC POWER PLANT

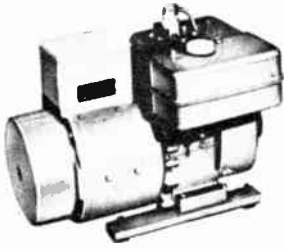

NEW LOW PRICE

129⁹⁵

1000 WATT

- 3-HP Engine • 90-Day Parts Warranty • Regulating Governor • 1000 Watts Continuous • 1250 Watts Intermittent

A compact, rugged direct coupled power plant. Supplies 115V AC, 60 cycles at 1000 watts continuous, 1250 watts intermittent duty. The engine is a 3 h.p., 4 cycle, air cooled Briggs & Stratton. Operates on regular gasoline. Uses standard weight motor oils. Recoil manual start. Drip-proof, continuous duty, self excited, 2 pole, 3600 RPM generator. Features a pre-lubricated, sealed, ball-bearing commutator, mica insulated, 3 cycle maximum frequency variation, $\pm 5\%$ voltage regulation. Gas consumption at 1000 watts: 0.2 gal. per hr.; at 1250 watts, 0.39 gal. per hr. Includes instructions, parts lists and 90 day parts warranty. Made in U.S.A. Shpg. wt., 70 lbs. VIA EXPRESS ONLY.

| | |
|---|------------|
| 7ML-266WX | Net 129.95 |
| 1750/2000 WATT POWER PLANT: Similar to above with 4 h.p., 4 cycle engine. Shpg. wt., 110 lbs. | |
| 7ML-267WX | Net 194.50 |
| 2500/3000 WATT POWER PLANT: Similar to above with 5 1/2 h.p., 4 cycle engine. Shpg. wt., 156 lbs. | |
| 7ML-268WX | Net 249.95 |

STEEL STORAGE UNITS

- Shelves Adjustable on 1/2" Centers
- Braced on Back & Sides
- Triple Bent Shelves
- Heavy Angle Posts

5⁹⁵
For 4 shelves
30x12x60"

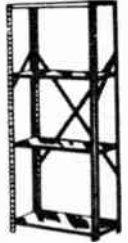

For stores, offices, garages, basements, pantries, closets—just what you need to solve your storage problems, you'll find dozens of uses for these rugged racks. And now, Lafayette offers them at a bargain price. Available in two sizes to fit virtually anywhere—30Wx12Dx60"H with 4 shelves, or 36Wx12Dx72"H with 5 shelves. Corner post and all edges are rounded and snag-proof with back and side braces providing added strength and rigidity. Gray enamel finish. Shipped unassembled with all necessary hardware for fast easy assembly. Size: 12x30x60". Shpg. wt., 25 lbs.

| | |
|-------------------------------------|----------|
| 13 K 2301WX | Net 5.95 |
| Size: 12x36x72". Shpg. wt., 33 lbs. | |
| 13 K 2302WX | Net 6.89 |

| | |
|---|--------------|
| Extra shelves for above | |
| 13 K 2303 12"x30" shpg. wt., 2 lbs. | Net ea. 1.25 |
| 13 K 2304 12"x36" shpg. wt., 2 1/4 lbs. | Net ea. 1.35 |

CORNER SHELVING UNIT

- Matches Units Shown
- Puts corner space to work
- Ideal for use in garage, workshop, basement

Puts even corners to work to solve your storage problems! These functionally styled units have a lustrous gray, baked enamel finish that defies chipping, scraping. Shpg. wt., 3 1/2 lbs.
13 K 2305 Corner shelf* Requires 72" upright below Net 1.59
*72" upright. One required for corner shelf installation. Shpg. wt., 2 lbs.
13 K 2306 72" upright Net .83

SPEEDWAY 4 1/2" BENCH

GRINDER

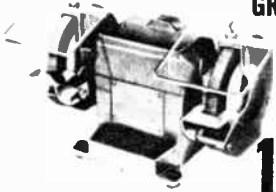

14⁹⁹

Ideal for sharpening all workshop, hobby and garden tools—drill bits, planes, knives, chisels, hoes, etc. Base equipped with rubber feet: drilled for bolting to bench or truck. Heavy-duty steel wheel guards; adjustable tool rests; built-in front water cooling tray; castin top parts tray; rear duct exhaust. Bronze alloy bearings. Two 4 1/2 x 1/2" wheels (one 40-grit, one 70-grit). 2.5 amp. 115V, 60-cycle AC motor; no-load speed 3450 rpm. 6-ft. 3-wire cord. Shpg. wt., 10 lbs.
13 K 5309 Less eyeshields Net 14.99

VARI-SPEED



- Continuous Regulation of Lights & Motors
- Regulates Speed of Power Tools

Full range solid state speed control with built in automatic circuit breaker. Allows continuous varying speed from max. RPM to min. Also controls light intensity. Fingertip speed control for power tools, home appliances and lighting. Handles up to 900 watts. Can be mounted permanently or remain portable. 3 wire receptacle and 6 ft. 3 wire power cord provides maximum safety. Shpg. wt., 2 lbs.
12 K 1301 Net 9.95

18 COMPACT DRAWERS

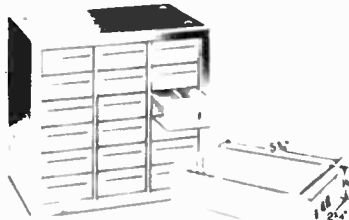

MODEL 18HBA **3⁹⁹**

Both cabinets are 9" High and 6" Deep

| Stock No. | Model | No. of Drawers | W | H | Net ea. |
|-----------|-------|----------------|-----|--------|---------|
| 13 K 7616 | 18HBA | 18 | 10" | 4 1/2" | 3.99 |
| 13 K 7617 | 24HBA | 24 | 13" | 6 1/2" | 4.99 |

SELF LOCKING HASP-LOC



2²⁵

Security's new self locking unit is self contained: no need to purchase a separate padlock. No keys required to lock: keys used for opening only. Heavy-duty and rust proof. Takes little effort to install—all you need is a screwdriver. Size 4 1/2". Shpg. wt., 1 lb.
13 K 7505 2.25

ALL PURPOSE BENCH FRAME

- Makes A Bench for Every Purpose
- Heavy-Gauge Steel
- Combine 2 or More for Larger Sizes

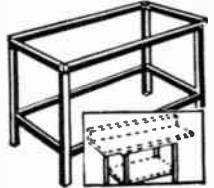

5⁵⁰

It's easy to make a bench for every purpose — in the garage, store, house, laundry room, playroom, etc. Heavy-gauge steel, completely pre-drilled, ready-to-assemble — just add the top. For larger benches, combine 2 or more. Overall: 22 1/2 x 47 1/2 x 34" high. Shpg. wt., 19 lbs.

| | |
|--|----------|
| 13 K 3501W | Net 5.50 |
| TOOL RACK. Prepunched to fit frame. 46"L, 4 1/2"H. | |
| 13 K 3502 Shpg. wt., 2 lbs. | Net 1.95 |
| CASTERS For easy moving. Sets of 4. | |
| 13 K 3503 Shpg. wt., 1 lb. | Net 1.35 |

18" BENDING AND FORMING BRAKE



- For Experimenters—Servicemen—Shops
- Clean Smooth Bends
- Forms up to 90°
- Handles up to 18" width in up to 16 Gauge thickness

Unique design permits forming chassis, boxes, covers, trays, etc. by means of 1" deep slots in brake-bar which allow corners to fold in. Provides flange edges up to 1" high. Easy to adjust for thickness, accuracy, angle of bend. Rugged construction offers a life time of service. Shpg. wt., 14 lbs. Imported.
99 K 8064 Net 9.95

NEW! LAFAYETTE Deluxe ALL-TRANSISTOR 5-Watt Dual Conversion CITIZENS BAND TRANSCEIVER HB-500

ONLY 3 3/8" HIGH

- ✓ 100% Solid-State . . . Full 5-Watt Performance
- ✓ Authentic Mechanical Filter for Superb Selectivity
- ✓ 15 Transistors (9 Silicon Mesa Type), 4 Diodes, 1 Thermistor
- ✓ Small, compact—only 3 3/8" High
- ✓ Dual conversion superheterodyne receiver
- ✓ 12 Crystal Transmit and Receive Positions
- ✓ 23 Channel Tunable Receiver
- ✓ Push-to-talk Dynamic Microphone
- ✓ Dependable sealed relay switching
- ✓ Automatic Noise Limiter
- ✓ Adjustable squelch
- ✓ ±.003% Crystals Exceed FCC Spec.

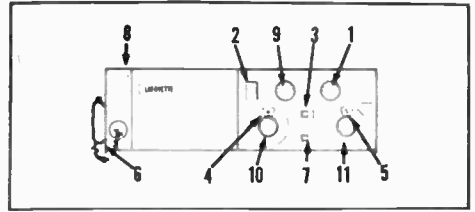

- | | |
|---|---------------------------------------|
| 1 Volume Control | Tuning Dial |
| 2 "S" Meter For Indicating Signal Strength | 6 Push-To-Talk Dynamic Microphone |
| 3 Spotting Switch For Exact Frequency Location on Tunable Receive | 7 Xtal-Tune Selector Switch |
| 4 Illuminated Channel Selector Dial | 8 Earphone Jack For Private Listening |
| 5 Illuminated Receive | 9 Adjustable Squelch |
| | 10 Channel Selector |
| | 11 Receiver Vernier Tuning |

Lafayette introduces an ingeniously designed 5-watt solid state, dual conversion superheterodyne, CB transceiver. The exciting Lafayette HB-500 packs a real wallop over distances up to 20 miles or more depending on terrain and antenna height. Its 15 transistors (9 are silicon mesa), 3 diodes, 1 zener diode and 1 thermistor provide instant and cool performance with low current drain.

The 100% modulated 5-watt, crystal-controlled transmitter may be operated on any 12 of the 23 channels. The receiver circuits provide for 12 crystal-controlled channels plus a tuneable superhet receiver that covers all 23 channels with a sensitivity of better than 1/2 microvolt for 10 db S/N ratio. The receiver employs a specially designed 455KC mechanical filter for 50 db adjacent channel rejection and excellent selectivity. An automatic noise limiter and adjustable squelch circuit assures low noise performance. The receiver terminates in a 3x5" speaker fed by a 2.7 watt push-pull amplifier. Other features include: a spotting switch, illuminated channel select-

tor and vernier dial tuning, an "S" meter and earphone jack. Complete with mobile mounting bracket, push to talk dynamic microphone, pair of transmit and receive crystals for channel 12 plus a crystal for dual conversion, and a DC cable. Operates on 12 volt pos. or neg. ground. 1 1/4"x3 3/8"x6 1/4" Shpg. wt., 12 lbs.

- | | |
|--|------------|
| 99 K 3027WX 12 VDC | Net 139.50 |
| 99 K 3043C Receive crystal (specify channel) ±.003% | Net 2.50 |
| 99 K 3042C Transmit crystal (specify channel) ±.003% | Net 2.50 |
| Direct plug-in antenna (shpg. wt., 1 lb.) | |
| 99 K 3015 | Net 3.95 |

Model HB-501 Solid State AC Power Supply

Matching solid state AC power supply for HB-500 for fixed station operation (at home, business, office). Transceiver rests on power supply to form an attractive integrated unit. Size: 1 1/4"x6 5/8"x2 1/2". Shpg. wt., 10 lbs.

- | | |
|------------|-----------|
| 99 K 3028W | Net 16.95 |
|------------|-----------|

NEW! LAFAYETTE Deluxe 23 Channel Crystal Controlled Dual Conversion 5 Watt CB TRANSCEIVER MODEL HB-400

With ADVANCED FULL WAVE "RANGE BOOST" CIRCUIT.

- ★ Frequency Synthesized Circuit Provides 23 Crystal-Controlled Transmit & Receive Channels—No Extra Crystals to Buy!
- ★ Dual Conversion Receiver With 3/10 uv Sensitivity
- ★ Advanced Dual Zener Diode Full-Wave "Range Boost" Circuit
- ★ Triple Crystal Delta Tuning Offers "Fine Tuning" of ± 2.5 KC on Receive
- ★ Push-to-Talk Microphone & Electronic Switching
- ★ Variable Squelch, Variable Noise Limiter
- ★ Built-in 117V AC & 12V DC Power Supply
- ★ "Vari-Tilt" Mounting Bracket for Easy Mobile Installation

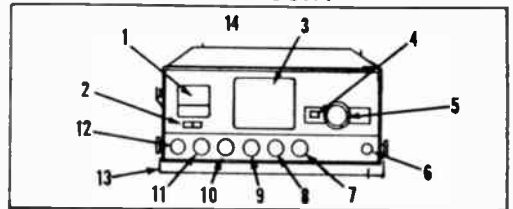

- | | |
|---------------------------------|-------------------------------|
| 1 Illuminated Meter | 7 Delta Tune |
| 2 Meter Switch | 8 Range Boost |
| 3 Speaker | 9 Variable squelch |
| 4 Illuminated channel indicator | 10 Volume-on/off |
| 5 Channel Selector | 11 Variable noise limiter |
| 6 Phone Jack | 12 Microphone socket |
| | 13 Vari-tilt mounting bracket |
| | 14 Selective call socket |

Efficient, dependable 2-way communications in any fixed or mobile application is assured with this rugged, new 5-watt CB transceiver. A military-type frequency synthesizing circuit makes it possible to transmit and receive over the full range of 23 channels with crystal-controlled accuracy—no extra crystals to buy and install! A zener diode full wave range-boost circuit increases the average depth of modulation during transmission and thus increases the average power in the sidebands—let's you transmit further within the 5-watt limitation imposed by the FCC! And, the "Range-Boost" system in the HB-400 is fully compatible with existing CB transceivers. Highly efficient circuit design uses 13 tubes (including two nuvistors) and 8 diodes to provide top performance under a wide range of operating conditions. Dual-conversion receiver offers .3 uv sensitivity and low noise, plus excellent adjacent channel rejection. Includes every needed feature for optimum reception—crystal-controlled "fine tuning" capability of ±2.5Kc (Delta Tuning), high-efficiency variable

noise limiter, variable squelch, and Automatic Volume Control. Also included is an illuminated meter which indicates relative RF power output or received signal strength in "S" units. The transmitter is equipped with ceramic push-to-talk microphone and uses reliable electronic transmit-receive switching. Operates in a fixed or mobile location with equal ease . . . has built-in power supply for either 117V AC or 12V DC. Specially designed "Vari-Tilt" mounting bracket simplifies mobile installation—permits fast removal of the transceiver top! And, there's nothing else to buy—you get all crystals and a built-in vibrator for 12V DC, plus 2 power cables. Measures a compact 12"W x 5"H x 10"D (including controls and plugs at rear). Shpg. wt., 20 lbs.

- | | |
|-------------|------------|
| 99 K 3001WX | Net 169.50 |
|-------------|------------|

- | | |
|--|------------|
| Model HB-400 plus HA-200 PRIVA-COM Selective Call Unit | |
| 40 K-9007WX Shpg. wt., 23 1/2 lbs. | Net 200.75 |

MODEL HB-500

99 K 3027WX

139⁵⁰

\$7 monthly



LOW CURRENT DRAIN
350 MA. RECEIVE
850 MA. TRANSMIT

DESIGNED AND BUILT FOR RELIABILITY

- Silicon Mesa Transistors for Utmost Reliability
- .003% Tolerance Crystals For Frequency Stability

HIGHLY SELECTIVE MECHANICAL FILTER

For Unsurpassed Rejection of Adjacent Channel Interference

With CB channels only 10 Kc apart, selectivity is important! In the HB-500, ultra-sharp selectivity is achieved by means of a true mechanical bandpass filter in the 455 Kc IF section. At 10 Kc on either side of the center frequency, the filter provides 60 db of attenuation.

The filter consists of three sections—an input transducer, a mechanically resonant filter, and an output transducer. The mechanically resonant section consists of six metal disks supported and coupled by a thin rod.

The use of this filter results in an IF bandpass curve which is almost rectangular in shape, with superior "skirt" selectivity.

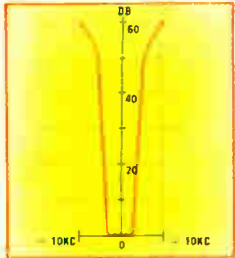

MODEL HB-400



99 N 3001WX

169⁵⁰

\$8 monthly

Double Sideband Full Carrier Modulated
Advanced Dual Zener Diode Full-Wave "Range Boost" Circuit

- 17 tube performance with 13 tubes and 8 diodes
- Low noise nuvistor "Front End"

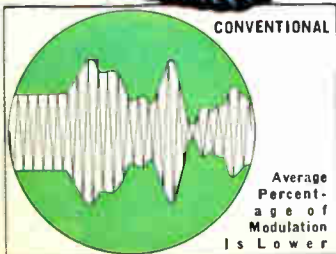

ADVANCED FULL WAVE "RANGE BOOST" CIRCUIT.

Increases Your Effective Range—Lets You Get Through Where Others Fail!

Want to effectively increase your range? You can—with Range-Boost! A simple turn of a switch on the HB-400 increases the average percentage of modulation and lets your voice cut through QRM and noise to reach further . . . gives you more "talk-power" when you need it—without overmodulating!

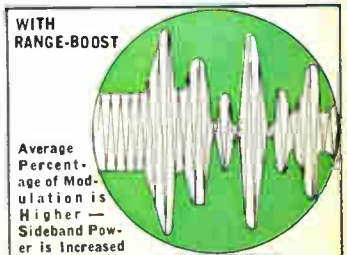

CB Equipment is Available on Easy Pay Plan—See Center Insert A

Lafayette Cat. No. 652 127



only **109⁵⁰**

Model HB-200

\$5.00 monthly

- Dual Conversion For Exceptional Selectivity and Gain
- 9 Tubes plus 3 Silicon Diodes plus 2 Crystal Diodes for 17 Tube Performance
- 8-Crystal Receive Positions plus 8-Crystal Transmit Positions plus 23 Channel Tunable Receive

- Spotting Switch for Exact Frequency Location on Tunable Receive
- Wired to Accept "PRIVA-COM" Selective Call Unit
- Super Sensitivity—1 Microvolt or Less
- Built-in 117 Volt AC Power Supply with 12 Volt DC Mobile Transistorized Power Supply

MADE IN U.S.A.



Model HB-115A

59⁹⁵

MADE IN U.S.A.

\$5.00 monthly

- 12 Tube Functions, Plus 1-Diode, Plus 2 Silicon Rectifiers
- 8 Crystal-Controlled Transmitting Positions
- Tunable Superheterodyne Receiver Over All 23 Channels
- Electronic Push-to-Talk Switching
- Push to Talk Ceramic Microphone

- Pi-Network for Maximum Power Output
- External Speaker Earphone Jack on Front Panel
- Full-Wave Variable Noise Limiter
- Separate On-Off Power Switch
- Supplied with Channel 14 Transmitting Crystal
- Attractively Styled, Ruggedly Built

NEW! LAFAYETTE DUAL CONVERSION DELUXE CITIZENS BAND TRANSCEIVER MODEL HB-200

--Illustrious Successor to Famous HE-20C--

LOOK AT THESE SPARKLING FEATURES

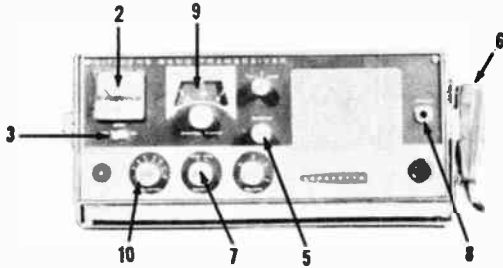

1. 13 MC Transmit Crystal for Extra Stability
2. Illuminated Meter With 3 Position Switch Indicates "S" Readings, Relative Power Output, and Modulation.
3. Spotting Switch.
4. Dual Cascade Series Gate Noise Limiter.
5. Adjustable Squelch.
6. Relay Switching Push-To-Talk Ceramic Microphone.
7. Tunable Receive or Crystal Selector Switch.
8. Phone Jack for Quiet Listening.
9. Illuminated Dial.
10. Channel Selector Switch
11. Attractive Styling With Chrome Plated Bezel.
12. Supplied With Pair of Transmit/Receive Crystals for Channel 14 plus Crystal for Dual Conversion.

Lafayette advances its leadership in the Citizens Band field with this superb Dual Conversion Deluxe Citizens Band Transceiver. The excellent selectivity and gain of its dual conversion receiver makes the Lafayette HB-200 a natural for efficient fixed and mobile communications over distances of up to 20 miles or more, depending on the terrain and the height of the antenna. The 5-watt input highly efficient crystal-controlled transmitter may be operated on any 8 of the 23 channels assigned by the FCC. The dual conversion receiver circuit provides for 8 crystal controlled receiving channels plus a tuneable superheterodyne receiver that covers all 23 assigned channels with a sensitivity of 1 microvolt or less. An adjustable squelch circuit quiets the receiver when no signal is being received. A dual cascade series gate noise limiter effectively reduces ignition, static and unwanted noises. A sensitive illuminated panel meter is utilized with a 3-position switch to indicate incoming signal strength, relative power output and modulation. The HB-200 also features dependable relay switching; a Spotting Switch for locating exact frequency on tunable receive, and a front panel phone jack for quiet listening. It incorporates a Pi-network for matching the output to 30-100 ohm antennas for maximum

signal output; input socket on rear of chassis for silent communications between calls when used with Lafayette PRIVACOM selective call unit. A rear mounted low-loss antenna jack accepts PL-259 connector used with dipole, ground plane, rod and direct mounting antennas (listed below). Attractively styled low silhouetted transceiver and rugged case with chrome plated bezel. Complete with bracket handle, efficient Push-to-Talk Ceramic Microphone, pair of transmit and receive crystals for channel 14 plus crystal for dual conversion, and built-in 117-volt AC Power Supply with 12 volt DC Mobile Transistorized Power Supply. Size: 12x5x 8½"D. Shpg. wt., 15 lbs.

| | | |
|--|-----|--------|
| 42 K 0118WX | Net | 109.50 |
| 42 K 4701C 13 MC Transmit Crystal (Specify Channel) | Net | 2.25 |
| 42 K 4202C Receive Crystal (Specify Channel) | Net | 2.25 |
| Direct Plug-in Antenna for Short Distances. Shpg. wt., 1 lb. | | |
| 99 K 3015 | Net | 3.95 |

SELECTIVE CALL PACKAGE

HB-200 CB Transceiver plus "PRIVA-COM" Selective Call Unit.
42 K 9006WX Shpg. wt., 18½ lbs. Net 140.75

LAFAYETTE HB-115A PUSH-TO-TALK CITIZENS BAND TRANSCEIVER

Lafayette's new CB sensation consists of an attractive compact transceiver with exceptional performance on Class "D" Citizens Band. Two or more HB-115A's will supply you with reliable communications over distances of up to 20 miles or more depending on antenna height and terrain. The HB-115A features 8 crystal-controlled transmitting channels operating at the maximum legal input power of 5 watts fully modulated; a pi-network output which matches 30-100 ohm antennas for maximum output; RF stage in transmit and receive sections. The superheterodyne receiver is tunable on all 23 channels with over 2 watts audio output. Has Automatic Volume Control and a very effective fullwave variable Noise Limiter. Features a front panel speaker/earphone jack for an extra external speaker or for an earphone or headset for quiet listening; a separate on-off power switch for trouble-free economy of operation. The HB-115A has accurate planetary vernier tuning. Controls: Tuning, Volume, Variable Noise Limiter, 8-position Crystal Selector and Power indicator. Power receptacle in rear for 115-volt

AC line cord and 6 or 12 volt external mobile power supply. Supplied complete with Channel 14 transmitting crystal, efficient push-to-talk ceramic microphone, and mounting brackets. 6 or 12-volt power supply optional (see below). Size 11½Wx5Hx6¾"D. Shpg. wt., 13 lbs.

| | | |
|-------------|-----|-------|
| 42 K 0101WX | Net | 59.95 |
|-------------|-----|-------|

POWER SUPPLY: Adapts HB-115A for mobile operation. Complete with cable and mounting flanges. Size 6Wx4Hx4¼"D. Shpg. wt., 4 lbs.

| | | |
|-------------------------|-----|-------|
| 42 K 0102W For 12 Volts | Net | 11.50 |
| 42 K 0103W For 6 Volts | Net | 11.50 |

TRANSMITTING CRYSTALS: For any of the 23 channels.

| | | |
|---|-----|------|
| 42 K 4201C Specify channel or frequency | Net | 2.25 |
|---|-----|------|

ANTENNA: Base-loaded telescoping whip antenna with PL-259 coax connector. For short distance operation. Mounts directly on rear of cabinet. Telescopes to only 15". Shpg. wt., 2 lbs. Imported.

| | | |
|-----------|-----|------|
| 99 K 3015 | Net | 3.95 |
|-----------|-----|------|

LAFAYETTE "PRIVA-COM"™ SELECTIVE CALLER

The "Priva-Com" Selective Caller, when in "Standby" position, silences the speaker of the transceivers to which it is connected. When the "Priva-Com" call switch is actuated at either base or mobile, the transmitted dual tone signal is received by the other "Priva-Com". Its indicator light goes on and the speaker is automatically activated. You can now speak or listen to the calling station. The light stays on until manually reset. If the car horn or an external alarm is connected to the "Priva-Com" terminals the received dual-tone signal causes the horn or alarm to sound for 1 second. Both base and mobile stations can initiate calls and monitor the air at anytime. Cable terminates in plug which mates with Lafayette CB Transceiver. Complete with mounting bracket and instructions. Size 3½Wx 3½Hx5½"D. Shpg. wt., 3½ lbs.

| | | |
|-----------|-------|-----------|
| 42 K 0110 | Each | Net 32.50 |
| | 2 for | 62.50 |

*Not recommended for Transceivers with carbon microphones less preamplifiers.

- For Quiet Private Communications
- Choice of 10 Dual Tone Frequencies—Minimizes Interference by Unwanted Signals
- Activates car Horn or External Alarm for 1 second If Operator is Away from Equipment
- Outstanding Performer with Lafayette HE-20, HE-15, HE-90, HB-111, HB-115, HB-115A, HB-222, HB-333, HB-200 & HB-400 as well as with any Push-to-Talk CB Transceiver*
- Compatible with Lafayette HA-100 "Priva-Com"

32.50 \$5.00 MONTHLY
2 for 62.50



MODEL HA-200

LAFAYETTE ALL-TRANSISTOR CITIZENS BAND "WALKIE-TALKIE" MODEL HA-70A

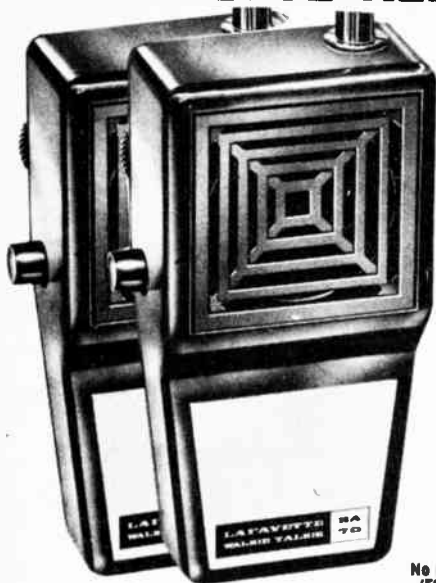

GREAT FOR: HOME, HUNTING, FISHING, PICNICKING, CYCLING, CAMPING, GOLFING, ETC.

NOT A KIT — COMPLETELY WIRED
Great fun for the kids!
At a price even they can afford!

- 3 Transistors
- Crystal Transmit
- Sensitive Super-regenerative Circuit

Our Low, Low Price

9⁸⁸ 2 FOR 18⁸⁸

No License Required
(FCC Reg. part 15)

No Time Wasted in Building—Use This Terrific Little Walkie Talkie As Soon As You Receive It! Attractive, Neatly Styled Plastic Case—Slip it into Your Shirt Pocket!

A great new CB challenge to young and old for countless exciting short range applications. This compact Lafayette Citizens Band Walkie Talkie is a 3-transistor transceiver with crystal control on transmit and with an efficient superregenerative receiver. Super-regenerative has minimum external ignition noise pickup when voice signal is being received. Excellent for camping, picnicking, hunting, fishing, golfing, surveying, cycling, construction and many other applications requiring up to ¼ mile communications. Has Push-to-Talk Button, On-Off Switch and efficient speaker that is used as speaker and microphone. Complete with built-in telescope antenna, transmitting crystal, one 9-volt battery and plastic carrying case. Size: Approx. 5½x2½x1¾". Shpg. wt., 1 lb. Imported.

99 K 3011L Model HA-70A

Net ea. 9.88
2 for 18.88
Net .21

99 K 6021 Replacement battery for above



NEW! LAFAYETTE CB TRANSCEIVER TESTER

Get Top Performance From Your CB Transceiver!



3795

\$5 Monthly

- Measures: RF Power Output
- Relative Field Strength
- Standing Wave Ratio (SWR)
- Percent Modulation
- Relative Crystal Activity
- Generates: Crystal Controlled RF Signal
- Modulated Audio Signal
- IKC Audio Signal
- Permits: Aural Monitoring of Local Transmitters
- Visual Transmitter Monitoring with 'scope
- Provides: In-Circuit instapt connection to antenna without removing cables from transmitter.
- Sensitive O'Arsonval Meter for Accurate Measurements

CB operators, technicians and servicemen will find the Lafayette CB Transceiver Tester a convenient, highly efficient and accurate instrument for improving the performance and range of CB transceivers. By providing in-circuit testing it makes it unnecessary to remove the cables and permits instantaneous reverting to normal antenna connections. A precision internal non-inductive load permits direct measurement on convenient easy to read scales of transmitters capable up to 6 watts output. SWR measurements are made in a jiffy with a flick of a sturdy 3-position rocker switch returning your transmitter to the antenna without loss. The super sensitive RF Field Strength function facilitates adjustment of base and mobile transmitters and antennas for maximum performance. Indicates relative crystal activity with instantaneous conversion of RF signal generator function either unmodulated or modulated with a IKC audio tone. The RF generator is disabled by activation of switch, providing audio tone for audio circuits. Has front panel jacks for aural and visual monitoring, audio generator output and RF signal generator output; and ceramic jacks for standard miniature crystal sockets. Controls include Function Selector, Antenna selector, Generator Selector, Modulation Calibrate Switch, Modulation Calibrate Control and Meter Adjust Control. Sturdy professional type SO-239 sockets accept standard PL-259 connectors. Enclosed in a sturdy attractive molded case with brushed aluminum front panel. 7½x5½x2¾". Shpg. wt., 4 lbs. Includes 9 volt battery and 30" telescoping antenna.

42 K 0128

Net 37.95

NEW! LAFAYETTE CB LOW PASS FILTER



5⁹⁵

- Avoid TV Set Interference!
- 50 db Attenuation of Radiated Spurious and Undesirable Signals!

Designed to effectively reduce TVI which may be emanating from your CB Transmitter. This professional quality filter attenuates radiated spurious and other undesirable harmonic signals higher than 50 MC approximately 50 db! Minimizes interference with your own or your neighbor's TV Set. Simple to connect with two built-in SO-239 connectors. Impedance 50-75 ohms (reversible). Size: 5x2x1¾". Shpg. wt., 1½ lbs. 42 K 0123

Net 5.95

Improve Your CB and Ham Gear Performance

LAFAYETTE HA-115 AUDIO COMPRESSOR AMPLIFIER FOR CITIZENS

BAND TRANSCEIVERS

only **25⁹⁵**

- For 6 volt, 12 volt or 117 volt Base and Mobile Transceivers
- Illuminated Meter Directly Reads Modulation Percentage
- Printed Circuitry, Advanced Design
- Works with all Popular CB Units



Made in U.S.A.

The audio compressor instantly and automatically increases the "talking power" by increasing the average modulation of CB transmitters. This, however, is accomplished without the side effects of over modulation. Final power input remains within the legal 5-watt limit (as per FCC decree) but effective talk power is increased many times. This compressor amplifier is easily connected to CB transceivers operating on either 6 or 12 volts DC or 117 volts AC. Requires very little power for operation hence existing power supplies may be utilized. Comes complete with operating and installation instructions. Size: 3Hx3³/₈Wx5"D. Shpg. wt., 2 lbs. 42 K 0117

Net 25.95

LAFAYETTE SQUELCHER

Squelch that interference!

only **10⁹⁵**

- Provides full squelch and noise limiting to most superheterodyne transceivers or receivers
- Vastly improves mobile transceivers when vehicle is in traffic
- Reduces noise from ignition systems and other sources



Made in U.S.A.

The Lafayette "Squelcher" noise eliminator was carefully designed to improve reception and reliability in most superheterodyne transceivers or receivers other than those using solid-state detectors. Recommended for the Lafayette HE-20A, HE-20B, HE-20C, HE-30, KT-320, HE-45, HE-45B, HE-90, HB-111, HB-200, and HB-222. Reduces noise from ignition systems and other sources. Quiets receiver when no signal is received. Vastly improves sensitivity of mobile transceivers when operating in traffic. Complete with 2 tubes (6AL5 and 12AX7) and instructions for installation. In satin aluminum with blue gray perforated cover. Furnished with cable. Size: 2³/₈x3¹/₂x4¹/₄"

42 K 0904 Shpg. wt., 1¹/₄ lbs. Net 10.95

NEW! LAFAYETTE AUTHENTIC MECHANICAL FILTER

- Super Selectivity
- 80 db Attenuation of Unwanted signals
- Complete Adjacent Channel Rejection
- For 455 KC IF Tube Circuits

only **19⁹⁵**



Precision Filter Design

The Mechanical Filter consists of input and output Transducer elements plus six carefully machined resonant metal discs which are made of a ferro-nickel chromium alloy for extreme hardness and complete resistance to corrosion.

EXCELLENT FOR: Citizens Band Transceivers; Amateur; AM, CW, SSB Receivers; Short-wave and Standard Broadcast.

Now you can achieve razor-sharp selectivity with AM, standard broadcast, shortwave, CW and SSB Communications receivers, and CB transceivers, having an intermediate frequency of 455 Kc. Update your present receiver to cope with today's crowded bands. Pick up distant stations formally masked by strong signals. The Mechanical Filter provides a steep-skirted, flat top, ideal band pass response. At 2.5 Kc on either side of the center frequency, the filter provides 60 db attenuation. The complete filter network consists of a mechanical filter and 2 coupling transformers. Easily installed between mixer and 1st I.F. stages. Size: 2³/₈Wx5¹/₂Hx1³/₈D (overall). Shpg. wt., 8 oz. 99 K 0123 Imported.

Net 19.95

SPECIFICATIONS

Center Frequency: 455KC
6 db Bandwidth: 2KC
60 db Bandwidth: 6KC
Input/Output Impedance: 10K
Insertion Loss: 1.5-3 db

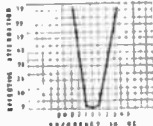

Take Advantage of Lafayette's Low Prices

NEW! LAFAYETTE QUIAT-COMTM

SOLID STATE VIBRATOR
TRANSISTORIZED REPLACEMENT FOR
YOUR 12 VOLT CB
VIBRATOR . . .
HEAR THE DIFFERENCE!
ONLY **5⁹⁵**

- No Vibrator Hash Noise
- Much Longer Vibrator Life
- No Mechanical Noise
- More Efficient, Cooler Operation
- Uses Top Grade Transistors from Famous Manufacturer . . . NO Surplus Transistors!



Exceptionally efficient replacement for CB vibrators, as well as for vibrators used in Amateur and communications equipment rated up to 85-watt consumption. Available in POSITIVE Model and in NEGATIVE Model. For 12 Volt operation only. Shpg. wt., 1 lb.

Quiat-Com Positive Model

Replaces vibrators with Pin 1 Positive as in the following units: Bendix CB-12; Citifone CD-12, SS; Eico 771, 772; Globe 100, 100A, 200; Gonset G-14, G-12; Hallicrafters CB 3, A; Heath GW-42; Knight C22, Lafayette HE-20, A, B, C, HE-45, B, HB-400; Metrotec All; Olson "Spotter"; "Side Bander"; Raytheon TWR-1.3; RCA Mark 7, 8; Regency "Range Gain"; Realistic TRC8; Sonar E; Utica MC-27 & TC2; Webster 411; etc. 42 K 0121 Positive Quiat-Com Net 5.95

Quiat-Com Negative Model

Replaces vibrators with Pin 1 Negative as in the following units: Apelco AR-9; Arkay SQ9, SQ9W; Courier 1-M; Dewald TR-12; Gonset G11; Hallmark 512; Hammarlund CB-23, 500; Heath GW-10, 11; International Executive Model 50; Johnson 127, 128, 129; Messenger 1, 2; Karr TR-322, 327a, 327b; Lafayette HE-15, A, B, HE-90, HB-115, 115A, HB-266, HB-333; Morrow CB-1, 2, 3, Polycorn PCN12, 2-12, SR23. Pro; Regency CB-27, Vocaline FRC-400, 425. 42 K 0122 Negative Quiat-Com Net 5.95

LAFAYETTE AUTO-MARINE ENGINE NOISE SUPPRESSOR KIT



- A Must For Mobile CB & Ham Operators
- 14 Components Plus Hook-Up Wire

This easily installed kit will effectively suppress ignition, generator and voltage regulator noise. Consists of 8 spark plug suppressors; 1 distributor suppressor, 1 voltage regulator suppressor; 4 coaxial capacitors; shielded cable and braid for wiring filter system. All necessary hardware and instructions for installation are included. Shpg. wt., 2 lbs. 42 K 0905

Net 9.45

LAFAYETTE GENERATOR NOISE FILTER

- Freq. Range 3-30 mcs
 - Simple to Install
 - Maximum Current 25 Amps
 - Adjustable
- Enables quiet receiver operation for Citizens Band, Amateur and Industrial frequencies. Standard frequency range 3-30 mcs. Maximum current 25 amps. 99 K 6018 Shpg. wt., 1 lb. Imported Net 2.49



A LAFAYETTE 12-TRANSISTOR CITIZENS BAND "WALKIE TALKIE" MODEL HE-100 with noise Squelch

Separate Microphone and Speaker for
Better Modulation & Increased Range

- Advanced Walkie-Talkie Design
 - Separate Microphone and Speaker for Better Modulation & Increased Range
 - 12 Transistors, Diode, and Thermistor
 - Crystal Controlled Transmit and Receive
 - Superhet Receiver has AVC, Squelch, Push-Pull Audio Output
 - Optional Plug-in 117 Volt AC Power Pack
- A GIGANTIC STEP FORWARD IN THE DESIGN AND PERFORMANCE OF 100-MW POWER WALKIE-TALKIES!

The use of a separate microphone and speaker results in excellent modulation with greatly improved transmitting range and maximum effective signal intelligibility. . . . Superhet receiver has variable squelch to reduce background noise. 12-transistor advanced design circuit is crystal-controlled for both receive and transmit functions. Sensitivity is better than 1 microvolt for 10 db signal-to-noise ratio. Easy-to-use, lightweight. . . . carry it anywhere for sports or business. Housed in a rugged hi-impact plastic case. Handy controls include push-to-talk switch, volume and variable squelch. Power is supplied by 8 miniature penlight batteries. To conserve battery power, a 117V AC power pack is available as an optional plug-in accessory. Complete with leather case, earphone, for private monitoring. 44" telescoping antenna, batteries and crystals for channel 10. Size: 3Wx9Hx2 3/4"D. Shpg. wt., 2 lbs. Imported.

99 K 3022L Net 39.95
2 for 78.88

Same as HE-100 but specify channel other than 10 (2-23).
99 K 3023L Net 39.95
2 for 78.88

CRYSTALS FOR HE-100

42 K 4204C Transmit Crystal only. Specify Frequency Net 2.25
42 K 4203C Receive Crystal only. Specify Frequency Net 2.25

AC POWER PACK FOR HE-100

Heavy Duty 117 Volt 60 Cycle AC Power Supply to 12V D.C. Replaces 8 "Z" Cells. Wt. 1 lb.

99 K 3024 Net 7.45
99 K 3025 Net .49
CANADIAN APPROVED HE-100 D.O.T. Approval No. 169361066.
99 K 3002L Net 39.95
2 for 78.88

C LAFAYETTE 9-TRANSISTOR SUPERHETERODYNE CITIZENS BAND "WALKIE TALKIE" MODEL HE-29C

- Transmits & Receives Up to 1.5 Miles
- Crystal Control on Both Transmit & Receive
- Leather Case with Shoulder Strap
- Push-To-Talk Operation
- Earphone for Personal Listening

Complete portable two-way communications for everyone, everywhere—hunting, fishing, boating, virtually all sports; at work in construction, warehouse, office, farm or for in-plant communications. Receives and transmits up to 1.5 miles under average conditions (no intervening obstructions.) Weighs only 16 ounces and slips into your pocket. Two controls provide fast, efficient operation, on/off volume and push-to-talk. Private monitoring or conversation by means of a special jack and earphone.

Full-transistor circuitry employs 9 transistors, 1 diode. Crystal-controlled transmitter section delivers 100 milliwatts of power to the final RF amplifier. Crisp, clear reception furnished by the efficient superheterodyne receiver. Power supplied by 6 penlight batteries with life expectancy of up to 55 hours.

Housed in black and brushed aluminum metal case with leather carrying case and shoulder strap. With earphone, antenna, batteries and a pair of crystals for the channel of your choice. 6 7/8x2 1/2x1 3/8". Shpg. wt., 2 1/2 lbs. Imported.

99 K 3020CL Model HE-29C Specify Channel Net 25.95
2 for 49.95

42 K 4204C Replacement Transmit Crystal, Specify Channel Net 2.25
42 K 4205C Replacement Receiver Crystal, Specify Channel Net 2.25
99 K 3021 Replacement Earphone for HE-29C Net .49

Replacement batteries for HE-29C "Walkie-Talkie," 6 required
32 K 4802 Z Cells Net ea. .13

AC Power Supply

Use in place of batteries for operation on 110 VAC. Shpg. wt., 2 lbs.
99 K 3012 Net 6.95

B LAFAYETTE 10-TRANSISTOR CITIZENS BAND "WALKIE TALKIE" MODEL HA-60

Separate Microphone and Speaker for
Better Modulation & Increased Range

- Crystal Controlled Superheterodyne Receiver with RF Stage, AVC
- Separate Microphone and Speaker For Better Modulation & Increased Range
- 1 μ V Sensitivity For 10 DB S/N Ratio
- 10 Transistors, Diode, Thermistor
- Crystal Controlled Transmitter
- Range 1-3 Miles

Ideal for use in business, industry, or personal use. Features automatic volume control and push-pull audio. Separate speaker and microphone provides better modulation and improved transmission range. Simple operation is made possible with sturdy push-to-talk switch and volume control. Earphone is provided for private reception. 44" whip antenna collapses fully when not used. Power is supplied by 8 inexpensive penlight batteries. To conserve battery power, a 117V AC power converter is available as an optional plug-in accessory. Housed in rugged hi-impact plastic case. Complete with leather case, earphone, antenna, batteries and crystals for channel 10. Size: 3Wx9Hx2 3/4"D. Shpg. wt., 2 lbs. Imported.

99 K 3009L Net 33.95
2 for 82.90

OTHERS ARE AVAILABLE. . . . If desired with any channel other than channel 10 order 99 K 3010L and specify channel (2-23). Same as HA-60 but specify channel other than 10 (2-23).
99 K 3010L Net 33.95
2 for 82.90

CRYSTALS FOR HA-60

42 K 4204C Transmit Crystal only. Specify frequency Net 2.25
42 K 4203C Receive crystal only. Specify frequency Net 2.25

AC POWER PACK FOR HA-60

Heavy duty AC power supply Replaces 8 "Z" cells. Wt. 1 lb.
99 K 3024 Net 7.45
99 K 3025 REPLACEMENT EARPHONE FOR HA-60 Net .49
CANADIAN APPROVED HA-60. D.O.T. APPROVAL No. 189361073.
99 K 3003L Net 33.95
2 for 82.90

D LAFAYETTE 6-TRANSISTOR SUPERHETERODYNE CB "WALKIE TALKIE" MODEL HA-85

- 6 Transistors plus 2 Diodes
- Transmits and Receives up to 1 Mile
- Crystal Controlled Transmit and Receive
- Efficient Superheterodyne Receiver
- Push-to-Talk Operation
- Leather Case with Shoulder Strap
- Earphone for Personal Listening

Ideal for sports, boating, hunting, fishing and construction. Weighs only 15 oz. and is small enough to slip into your pocket. Its DN-OFF Volume Control and efficient Push-to-Talk switch provides easy one-hand operation. Superheterodyne receiver supplies clean reception. Circuit employs 6 transistors and 2 diodes. Transceiver conforms to FCC requirements for 100 milliwatt units. In attractive metal case with leather carrying case and shoulder strap. Complete with earphone for personal listening in addition to built-in speaker, telescoping antenna, 6 penlight batteries and a pair of crystals for the channel of your choice. 6 7/8x2 1/2x1 3/8". Shpg. wt., 2 1/2 lbs. Imported.

99 K 3013CL Model HA-85, Specify Channel Net 19.95
2 for 38.75

42 K 4204C Replacement Transmit Crystal, Specify Channel Net 2.25
42 K 4005C Replacement Receive Crystal, Specify Channel Net 2.25
99 K 3021 Replacement Earphone for HA-85 Net .49
32 K 4802 Replacement "Z" batteries, 6 required Net ea. .13

AC Power Supply

Use in place of batteries for operation on 110 VAC. Shpg. wt., 2 lbs.
99 K 3012 Net 6.95

Fig. A MODEL HE-100

Fig. B MODEL HA-60



39⁹⁵

\$5.00 Monthly

2 For 78.88

No License Required
(FCC Reg. Part 15)



LEATHER CARRYING CASE
ANTENNA



EARPHONE
CRYSTALS
OPTIONAL AC POWER PACK

33⁹⁵

\$5.00 Monthly

2 For 62.90

No License Required
(FCC Reg. Part 15)



LEATHER CARRYING CASE
ANTENNA



EARPHONE
CRYSTALS



Fig. C MODEL HE-29C

Fig. D MODEL HA-85



25⁹⁵

2 For 49.95



EARPHONE
BATTERIES



LEATHER CARRYING CASE

No License Required
(FCC Reg. Part 15)

only

19⁹⁵

2 For 38.75



BATTERIES
EARPHONE



LEATHER CARRYING CASE

No License Required
(FCC Reg. Part 15)



A MODEL HA-150



MODEL
HA-150

79⁹⁵

\$5 monthly
2 for 154.95

1. EXTERNAL PUSH-TO-TALK DYNAMIC MICROPHONE FOR RELAY SWITCHING
2. CHANNEL SELECTOR
3. SQUELCH
4. AUTOMATIC NOISE LIMITER
5. MODULATION-BATTERY INDICATOR SWITCH
6. MODULATION-BATTERY INDICATOR METER
7. POWER ON-OFF/VOLUME
8. TELESCOPING WHIP ANTENNA
9. EXTERNAL BATTERY SOCKET
10. EARPHONE SOCKET

Model HA-150 Ideal for Builders, Contractors, Surveyors, Hunters, Campers, Plant Watchmen, etc.



B MODEL HA-300

COMPLETE

99⁹⁵

\$5 Monthly
Set of 2 194.95



Conforms with all FCC Regulations
Just fill out license form enclosed

PRICE INCLUDES

- ✓ Nickel Cadmium Batteries
- ✓ Battery Charger
- ✓ Earphone
- ✓ Crystals for 2 Channels
- ✓ Leather Case

A Personal 2-Way Radio With
Hundreds Of Uses

Ideal for builders, contractors,
surveyors construction, hunters,
campers, plant security, ware-
house personnel, etc.

C MODEL HB-333



Made in U.S.A.

199⁵⁰ \$10 monthly

1. Illuminated 'S' Meter Indicates Signal Strength and Relative Power Output
2. Push-to-Talk Noise Cancelling Ceramic Microphone for advanced Electronic Switching Circuitry
3. Variable Floating Series Gate Noise Limiter
4. Adjustable Squelch
5. Range Boost ON-OFF
6. Delta Tuning for Increased Crystal Tuning Accuracy
7. Phone Jack for Phones or External Speaker
8. Channel Selector
9. PRIVA-COM Selective Call Socket
10. Illuminated Channel Selector Dial
11. Built-in 117V AC Power Supply with 12 Volts DC Mobile Vibrator Power Supply

D MODEL HE-75

with
Squelch

59⁹⁵

\$5 monthly
2 For 118.95



OTHER CHANNELS ARE AVAILABLE
if desired with any channel other
than channel 13, order 99 K 3029L
and specify channel (1-23)

A LAFAYETTE 2-CHANNEL 1-WATT ALL-TRANSISTOR PORTABLE CB TRANSCEIVER Model HA-150

THE SUPER WALKIE-TALKIE... A NEW CONCEPT IN 2-WAY CB RADIO

DELUXE FEATURES

- Meter for Indicating Battery Strength & Modulation Level.
- An External Push-to-Talk Dynamic Microphone for Greater Effective Range.
- Complete with 2-pair Transmit/Receive Crystals.
- 13-Transistor 5-Diode Circuit.
- Push-Button Operated.
- Self-Contained Batteries or Powered by External 12-Volt DC Supply.
- Lightweight—Weighs only 4 lbs.

Here is a fully transistorized 2-way CB radio that offers the portability of a walkie-talkie, yet has features found only on large mobile transceivers. It has full 1-watt RF input... up to 6-mile range... quick-release battery compartment that uses 8 inexpensive flashlight cells for long, heavy-duty service. 4 convenient push buttons give you complete control. It can be used in or out of its leather case... as a base station or remote... carried, or used on a desk, table, car or boat—its uses are virtually unlimited! It has a high-efficiency 59-inch antenna which collapses to 7½ inches. Receiver has high 1µv sensitivity, push-pull audio, and large 3-inch speaker for clear, full-tone reproduction. The transceiver has plug-in crystals that let you change to any other 2 channels in the Citizens Band—without any circuit retuning or readjustments. Complete with channel 10 and 15 crystals (2 transmit, 2 receive), batteries, push-to-talk dynamic microphone, a leather carrying case, earphone, cord and plug for external battery connections with shoulder strap for transceiver.

Dimensions: 9½x2¼x5½"D. Operates from self-contained 12-volt battery pack or 12-volt DC external supply. Imported. Shpg. wt., 7 lbs.

99 K 3014L Net 79.95
Set of 2 134.95

Replacement batteries for HA-150
32 K 4801 1.5-volt "C" cell (8 required) Net ea. 13
42 K 4204C Transmit-Crystal. Specify Channel Net 2.25
42 K 4205C Receive Crystal. Specify Channel Net 2.25
REPLACEMENT ANTENNA FOR HA-150
99 K 3017 Antenna Net 1.95

B NEW! LAFAYETTE 2-WATT, 2-CHANNEL CB "WALKIE TALKIE" Model HA-300

A Compact, Hand-Held 2-Way Radio With All These Features...

- Powerful 2 Watts
- 2-Channel Operation
- Self-Contained Rechargeable Batteries
- Plug-in Battery Charger
- Provision For External Antenna
- 13 Transistors, 2 Diodes
- Fully Crystal-Controlled
- Lightweight—Weighs Less Than 2½ lbs.

Full 2 watts RF input lets you get through... offers up to 10 mile range over favorable terrain. 2-channel operation—a flip of a switch lets you transfer from one channel to another. Other extras include 2 built-in heavy-duty nickel-cadmium batteries and a plug-in battery charger that enables you to maintain the transceiver's maximum power capabilities at all times. 13 transistors and 2 diodes are used in a fully miniaturized transmitter and receiver, both crystal-controlled for precise, dependable operation. Receiver employs a superheterodyne circuit with 1 RF and 2 IF stages for high sensitivity, push-pull audio for high output and undistorted sound, plus a variable squelch control that silences the receiver on "stand-by." An automatic gain control circuit prevents overloading on strong signals and maintains uniform sound output. A full-time Automatic Noise Limiting circuit reduces ignition and other electrical noise. Powerful 2-stage transmitter output circuit uses two rugged silicon transistors for greater reliability and longer life. The 10-section, chrome-plated telescopic antenna extends to 56½ inches and there's also a special receptacle that lets you plug in any existing mobile or ground station antenna for extended range! A push-to-talk bar and thumb-operated volume and squelch controls permit simple, one-hand operation.

The HA-300 is equipped with crystals for channels 10 and 15, but may be operated on any two other channels in the Citizens Band by simply changing the plug-in crystals. Supplied complete with 2 self-contained nickel cadmium batteries, 117 volt 50/60 cycle AC operated battery charger, earphone, and leather case with strap. Dimensions: 8¼x3½x2". Black metal case with chrome trim and silvered grill. Imported. Shpg. wt., 4½ lbs.

99 K 3006L Net 99.95
Set of 2 Net 194.95

EXTRA CRYSTALS FOR HA-300
42 K 4204C Transmit crystal only. Specify channel Net 2.25
42 K 4205C Receive crystal only. Specify channel Net 2.25
99 K 3019 Replacement earphone for HA-300 Net .48

C LAFAYETTE DELUXE "RANGE BOOST" 23-Channel CRYSTAL-CONTROLLED CB TRANSCEIVER Model HB-333

Double Side Band Full Carrier—100% Modulated

- Exceeds FCC Requirement For Spurious and Harmonic Output
 - Includes 2 Section Harmonic Filter to Eliminate TV Interference
 - Will Not Become Obsolete—Works with Existing CB Transceivers
 - Meets All FCC Regulations
- Made in U.S.A.

Unlike other types of "range boost" circuitry, the Lafayette system maintains the full carrier at all times ensuring excellent audio at maximum range. The modulation density of the audio contained in both sidebands is increased. In addition, the "Range Boost" features continuous crystal-control for both transmit and receive on all 23 channels. Triple crystal Delta tuning ±3 KC of channel center frequency assures accurate station tuning when stations transmit slightly off frequency. Its highly efficient transmitter features: 5 watts plate power input to final (20 Watts PEP) with at least 3 watts power output to the antenna; up to 100% modulation at average speaking level, with "Range Boost." Illuminated D'Arsonval "S" Meter reads signal strength and relative RF output. Audio output is 3-4 watts into 365" pm speaker. An antenna matching adjustment permits resistive antenna loads of 52 or 72 ohms. Has phone jack on front panel for private listening or for remote external speaker. Includes all crystals, efficient noise cancelling microphone, AC & DC cables, and mobile mounting bracket. Includes 2-section harmonic filter to eliminate TVI. Built-in receptacle accepts Lafayette "Private Com" Selective Call unit. Complies with all FCC rules. Dual built-in 117 volt AC, 12 V DC vibrator power supply. Size: 12Wx4½x8½"D. Shpg. wt., 16 lbs.

42 K 0105WX Net 199.50
HB 333 plus Selective Call Unit. Shpg. wt., 19½ lbs.
42 K 9001WX Net 230.75

D LAFAYETTE HE-75 1-WATT 13-TRANSISTOR CITIZENS BAND "WALKIE TALKIE" with Squelch

- 10 Times More Powerful Than 100MW Units—With Far Greater Range
- Uses Powerful Silicon Transistors in Output Stage
- Crystal-Controlled Receive and Transmit
- Automatic Noise Limiter, Squelch AVC
- Push-Pull Audio Output
- Plug-in Battery Case for Both Penlight and Optional Rechargeable Nickel Cadmium Batteries
- Meets FCC Requirements for Licensed Operation Part 95.

A full 1-watt RF input Crystal controlled 2-way radio with 13 transistors, 3 diodes and a thermistor, that is compact enough to fit in your hand. Powerful 2-stage transmitter delivers a clean signal even at extreme ranges. Superhet receiver features a push-pull audio section for utmost intelligibility and quality voice reproduction. Superior automatic noise limiter effectively reduces ignition & other background noise while a variable squelch silences reception between calls and prolongs battery life. Local/Distance switch and AVC stop distortion at close range—helps in pulling in weak distant signals. Other features include: heavy-duty printed circuit board, rugged high-impact case, push-to-talk switch, and interchangeable battery compartment—for either penlight cells or rechargeable nickel cadmium battery. Also includes plated telescoping whip antenna, plug-in earphone, leather carrying case, 8 penlight batteries and crystals for channel 13. Size 3x8x2"D. Imported.

99 K 3016L Shpg. wt., 2 lbs. Net 59.95
2 for 118.95

Rechargeable nickel cadmium battery in sealed compartment.
99 K 3018 Net 14.50

CRYSTALS FOR HE-75
42 K 4204C Transmit Crystal only. Specify Frequency Net 2.25
42 K 4205C Receive Crystal only. Specify Frequency Net 2.25
99 K 3019 REPLACEMENT EARPHONE FOR HE-75 Net .48

CANADIAN APPROVED HE-75 (D.O.T. Approval No. 169361071)
99 K 3004L Net 59.95
2 for 118.95

Take Advantage of Lafayette's Low Citizens Band Prices

CITIZEN BAND HEADSETS AND MICROPHONES

CB SPECIAL SAFETY HEADSET-MICROPHONE



Only
2950

- Keep Both Hands on the Wheel at All Times!
- Listen and Talk with Perfect Ease

For convenience and safety, the earphone is on the right hand side allowing the mobile operator to hear the traffic. The push-to-talk switch can be held in the hand permitting "both hands on the wheel" driving. No longer are mobile communications unsafe! The microphone is an efficient high impedance, high output, noise cancelling, ceramic type. Impedance of the dynamic earphone is 8 ohms and is housed in a high impact cycloac cup. The headband and earseals are removable permitting cleansing with mild detergents. Easily connects to Lafayette HE-20C, HE-43C, HB-111, and HB-200. Also connects to any other transceiver merely by connecting earphone in place of speaker and the microphone to the microphone input terminals. Full instructions included. Shpg. wt., 2 lbs.
42 K 8401 Net 29.50

CB CRADLE HANDSET

- Attach To Side Of Transceiver Or To Car Dashboard
- Weight-Actuated Cradle Switch Disconnects Speaker and Connects Handset
- Industrial CB—Equip Your Mobile Fleet For Convenient And Private Operation

As Low As **1975**



Modernize your present fixed or mobile CB station with this new telephone style handset. Easily attaches to the dashboard, a side of unit or even to a wall or panel in fixed station locations. A switch in the cradle automatically disconnects the speaker when the handset is lifted. This switch also connects the highly-sensitive earpiece element providing no loss in listening time and private—operator-only, listening. The microphone, a high output ceramic type, is activated by means of a push-button push-to-talk switch on the standard model and a push bar switch on the deluxe model. Easily modified, if desired, so that speaker remains on until mike is activated. Ideal for use in heavy traffic, loud background noise areas, at home, or in the office. Easy to install—just plug into microphone jack and attach two wires to speaker circuit. Unit comes complete with coiled cord between handset and cradle and with standard microphone cable between cradle and CB transceiver. Excellent with Lafayette HE-20C, HE-43C, HB-200, HB-400, HB-115A, HB-111, HB-222, HB-333, HE-90, HE-15B. Shpg. wt., 2 lbs.
42 K 6501 Push-Button Actuator type Net 19.75
42 K 6502 Deluxe Push-Bar Type Net 21.45

LAFAYETTE CITIZENS BAND PUSH-TO-TALK NOISE CANCELLING CERAMIC MICROPHONE



588

Lafayette's noise cancelling, high output ceramic push-to-talk microphones are designed to reproduce clean, crisp audio with full modulation with as little noise pickup as possible. High level, high impedance output. Molded, tough, gray Cycloac, TM, case assures long life and protection from accidental shock damage. DPDT switch. Wired for standard Relay Switching as used in Lafayette HE-20, 20A, 20B, HE-43, 43A, 43B, HB-111, HB-222, etc. or for Electronic Switching as used in Lafayette HE-20C, HE-90, etc. Size: 2 1/2 x 7 1/4 x 3 1/4". 3-conductor coiled cord, 10' retracted, 1 conductor shielded. Complete with hang-up bracket and Amphenol 91-MPM5L plug attached for Lafayette Transceivers. Shpg. wt., 1 lb. Made in U.S.A.
42 K 0115 For Relay Switching Net 5.88
42 K 0116 For Electronic Switching Net 5.88

LAFAYETTE CB PUSH-TO-TALK CERAMIC MICROPHONE



Top Quality Mike Used with FAMOUS LAFAYETTE HB-115 SERIES CB TRANSCEIVER

450

Efficient, economical push-to-talk ceramic microphone. Straight 3 conductor plus shielded cable terminated in Amphenol type 99MPM5L plug. Hi-impact plastic case. Used with Lafayette HB-115 Series CB Transceiver. Shpg. wt., 1 lb.
44 K 3901 Net 4.50

LAFAYETTE DYNAMIC CB PUSH-TO-TALK MICROPHONE



895

Top quality dynamic microphone. Specifically designed for citizens band and communication transceivers. High impedance dynamic transducer will not be adversely affected by heat and smooth frequency response of 100 to 11,000 cycles make it most suitable for communications work — indoors or out. Comes with a momentary push-to-talk switch, coiled rubber cable with a 5-prong plug and a convenient hang-up bracket. Shpg. wt., 1 lb. Imported.
99 K 4533 Net 8.95

TURNER 350C CB COMMUNICATIONS MIKE

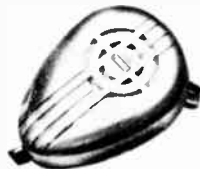

575

- Ideal For CB Use
- With Push-To-Talk Switch

A rugged push-to-talk ceramic microphone wired for relay operation. Extra-tough polystyrene case; hanger button and standard dash bracket are included. Also neoprene coiled cord, 11 inch retracted, 5-ft. extended. Output, —54 db. Response, 80-7000 cps. Dark grey finish. Shpg. wt., 1 lb.
44 K 7002 Net 5.75

TURNER 254C CB PUSH-TO-TALK CERAMIC MIKE



- Push-to-Talk plus Lock Switch
- DPDT Switch for Relay or Electronic Switching
- Excellent for Lafayette Push-To-Talk CB Transceivers

Attractive Ceramic microphone with DPDT push-to-talk switch plus lock switch for fixed station operation. 7' 3 conductor (one shielded) cable. Response 60-8,000 cps. Output level—52 db. Gray hammettone finish with chrome trim 7/4x3 3/4x5/4" base. Shpg. wt., 3 lbs.
44 K 7003 Net 13.82

POPULAR CITIZEN BAND TRANSCEIVER CRYSTALS

LAFAYETTE'S low Price

2²⁵

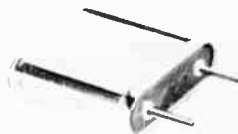

A complete listing of transmitting and receiving crystals for the most popular Citizen Band Transceivers and Walkie-Talkies on the market today. These crystals are available for any channel from 1 to 23. When ordering be sure to specify stock number and channel

desired. Extremely accurate 3rd overtone crystals are precision made and meet F.C.C. tolerance requirements of .005%. *No crystal required in receiver circuit of these transceivers. Shpg. wt., 3 oz. Specify stock number and channel desired Net ea. 2.25

| MODEL | STOCK NUMBER | | MODEL | STOCK NUMBER | | MODEL | STOCK NUMBER | |
|----------------------|--------------|------------|-----------------------|--------------|------------|----------------------|--------------|------------|
| | TRANSMIT | RECEIVE | | TRANSMIT | RECEIVE | | TRANSMIT | RECEIVE |
| Arkey | 42 K 4201C | 42 K 4211C | Hallcrafters CB-5A | 42 K 4215C | 42 K 4227C | Laf'tte HE-88, 100A | 42 K 4204C | 42 K 4205C |
| Arvin Mod. 42R99 | 42 K 4201C | 42 K 4233C | Hallmark Duo-Comm. | 42 K 4201C | * | Lafayette HA150, 300 | 42 K 4204C | 42 K 4205C |
| Browning S-9 | 42 K 4201C | * | Hallmark 212, 512 | 42 K 4201C | 42 K 4233C | Lafayette HB111, 200 | 42 K 4201C | 42 K 4202C |
| Browning T2700S | 42 K 4201C | * | Hammarl HQ105TR | 42 K 4201C | * | Lasalle, LA101, | 42 K 4201C | 42 K 4233C |
| Browning 23/9 | 42 K 4212C | * | Heath CB-1 | 42 K 4201C | * | Lasalle, LA101-AN | 42 K 4201C | 42 K 4233C |
| Cadre C-75 | 42 K 4213C | 42 K 4223C | Heath CB-2 | 42 K 4201C | 42 K 4211C | Metrotack Starfire | 42 K 4201C | 42 K 4211C |
| Cadre 510, 510A | 42 K 4213C | 42 K 4224C | Heath GW-10, 11, 12, | 42 K 4201C | 42 K 4211C | Met "Spacestation" | 42 K 4201C | 42 K 4211C |
| Citifone CD5, CD6, | 42 K 4214C | 42 K 4225C | Heath GW-22, 32, 42 | 42 K 4201C | 42 K 4211C | Philmore TC-90 | 42 K 4201C | 42 K 4233C |
| Citifone CD7 | 42 K 4214C | 42 K 4225C | Heath MW-33 | 42 K 4201C | 42 K 4211C | Philmore TC-11, | 42 K 4201C | * |
| Com Pak 800 | 42 K 4201C | 42 K 4233C | Heath GW-51, GW-52 | 42 K 4216C | 42 K 4228C | Philmore TC-6-12 | 42 K 4201C | * |
| Daystrom DM348 | 42 K 4201C | 42 K 4211C | Heath GW-30, R220 | 42 K 4216C | * | Poly Comm. PC-11, | 42 K 4220C | 42 K 4231C |
| Demco CB 1A | 42 K 4701C | * | Heath GW-31 | 42 K 4216C | * | Poly Comm. PC-11G, | 42 K 4220C | 42 K 4231C |
| Demco TW110A | 42 K 4701C | * | Int. Exec. 10 | 42 K 4701C | * | Poly Comm. PC-12G, | 42 K 4220C | 42 K 4231C |
| Eico 760, 760A | 42 K 4214C | 42 K 4210C | Int. Exec. 50, 100, | 42 K 4701C | 42 K 4230C | Poly Comm. PC-N, | 42 K 4220C | 42 K 4231C |
| Eico 770, 771, 772, | 42 K 4214C | 42 K 4210C | Int. Exec. 100A | 42 K 4701C | 42 K 4230C | Poly Comm. PC-4 | 42 K 4220C | 42 K 4231C |
| Eico 777 | 42 K 4214C | 42 K 4210C | Johnson Mess. I, II | 42 K 4215C | 42 K 4235C | Poly Comm. PRO | 42 K 4220C | 42 K 4231C |
| Fanon FCB-9, MCB-99 | 42 K 4201C | 42 K 4233C | Johnson Mess. III | 42 K 4219C | 42 K 4237C | Poly Comm. PC-8 | 42 K 4220C | 42 K 4231C |
| Fonet 101 | 42 K 4201C | 42 K 4233C | Knight C-11 | 42 K 4201C | * | Radfon RT101 | 42 K 4201C | 42 K 4233C |
| Fonet 102B | 42 K 4204C | 42 K 4205C | Knight C-100 | 42 K 4216C | * | Regency CBM27 | 42 K 4201C | * |
| Gen. Rad. MC-1 | 42 K 4201C | 42 K 4233C | Knight 2500 | 42 K 4201C | 42 K 4202C | Sampson T-110A | 42 K 4701C | * |
| Gen. Rad. MC-2, MC-3 | 42 K 4201C | 42 K 4233C | Knight 2550 | 42 K 4201C | 42 K 4202C | Shell CB12 | 42 K 4201C | * |
| Gen. Rad. MC-4, MC-5 | 42 K 4218C | 42 K 4233C | Lafayette HE-15, 15B | 42 K 4201C | * | Sonar D | 42 K 4201C | 42 K 4233C |
| Gen. Rad. Echo 9 | 42 K 4201C | 42 K 4233C | Laf'tte HB-115, 115A | 42 K 4201C | * | Sonar G | 42 K 4221C | 42 K 4232C |
| Globe CB100 | 42 K 4201C | 42 K 4226C | Laf'tte HE-20, 20-A, | 42 K 4201C | 42 K 4202C | Teirad | 42 K 4201C | * |
| Globe CB100A | 42 K 4201C | 42 K 4233C | Lafayette 20B, 20C, | 42 K 4201C | 42 K 4202C | Utica MC-27, TC-27, | 42 K 4201C | 42 K 4226C |
| Globe Pocket Phone | 42 K 4204C | 42 K 4205C | Lafayette 43, 90 | 42 K 4201C | 42 K 4202C | Utica T, C11 | 42 K 4201C | 42 K 4226C |
| Hallcrafters CB-2, | 42 K 4215C | 42 K 4227C | Laf'tte HE-29, 29A, | 42 K 4201C | 42 K 4233C | Utica Mariner | 42 K 4201C | * |
| Hallcrafters CB-3, | 42 K 4215C | 42 K 4227C | Laf'tte 29B, 66, 82 | 42 K 4201C | 42 K 4233C | Vocaline ED276, | 42 K 4222C | * |
| Hallcrafters CB-3A, | 42 K 4215C | 42 K 4227C | Lafayette HE-29C, | 42 K 4204C | 42 K 4205C | Vocaline ED27M | 42 K 4222C | * |
| Hallcrafters CB-5, | 42 K 4215C | 42 K 4227C | Lafayette HE-60, 75L, | 42 K 4204C | 42 K 4205C | World Radio ECBK | 42 K 4201C | * |

Kolin SOLID STATE SUBMINIATURE NOISE LIMITER



- For Hams, CB'ers
- Suppresses Noise From Any Type Ignition System, Motors, Atmosphere

The Kolin solid state noise limiter is an extremely effective self-adjusting device, which suppresses impulse noise in your receiver when receiving AM. Small enough to mount directly inside most receivers, it will work on supply voltages of 6 to 220 volts AC or DC. Only 3 connections are required. A switch is used to disable unit in normal quiet areas. Works on all Tube and Hybrid receivers employing a diode detector. All necessary instructions and mounting hardware is supplied. Size: 1 3/8 x 1 1/4 x 1/2".
42 K 4510 Shpg. wt., 8 oz. Net 7.95

AMECO MODEL PV-27 NUVISTOR PREAMPLIFIER FOR 27 MC



1367

- Over 20 DB Gain

The PV-27 Nuvistor Preamplifier will improve your gain and noise figure considerably when used ahead of your present citizen band receiver, or transceiver. 2 tuned circuits and a 6DS4 Nuvistor are used for a gain of 20 db and a noise figure of 2.0 db at 27 Mc. Power requirements are 100-150 V. at 8 ma. and 6.3 V. at .135A. Only 2 1/2 x 3 1/2 x 7". Shpg. wt., 2 lbs.
42 K 8901 PV-27 wired & tested .. Net 13.87

UNIVERSAL LAFAYETTE CITIZENS BAND AMATEUR SPRING & SWIVEL BALL-MOUNT BASE



Chrome Plated Swivel Ball Jointed Mount Base
Universal Lafayette chrome plated swivel ball mount base with lug terminals for use with mobile antennas. Can be mounted vertically or horizontally on any surface. With lug terminals for use with mobile antennas. Imported. Shpg. wt., 3 lbs.
99 K 3030 Net 1.95



Heavy-Duty Chrome Plated Stainless Steel Spring
Universal Lafayette Heavy duty chrome plated Stainless steel spring. Provide maximum support for long whips and heavy center-loaded whips. Shpg. wt., 2 lbs.
99 K 3036 Imported Net 2.98

CDR AR-22 AUTOMATIC ROTOR FOR CITIZENS BAND



3131

This heavy-duty rotor unit will handle antennas up to 150 lbs. Simply set the control unit pointer to the desired direction, and the antenna will automatically rotate to this position and stop. Perfect for TV, Ham or Citizen Band application. Rotor unit employs 12 heavy duty ball bearings in two 6 1/2" races. Reversible clamps on rotor will take masts from 7/8" to 2". O.D. Control unit is marked in compass points. N.S.E.W. NW, NE, SW, and SE. Housed in attractive brown plastic cabinet with rubber feet. For 110-120 volts, 50-60 cps AC. Requires 4 conductor cable. Shpg. wt., 14 lbs.
42 K 8605WX Net 31.31

New Deluxe CDR Model TR-44 Rotor
Deluxe version of AR-22. Increased rotational torque. 48-ball bearing movement. Finished with famous CDR "HAM-M" Type control box. Dimensionally identical to AR-22. Shpg. wt., 18 lbs.
42 K 8608WX Net 58.75

4 conductor cable for AR-22 and TR-44
32 K 8910 100' coil Net 2.50
32 K 8911 less than 100' per ft. Net .03
over 100' per foot Net .025

LAFAYETTE CHROME PLATED MOBILE BUMPER MOUNT with Stainless Steel Strap



- Completely Adjustable For Use With Most Types of Automobile Bumpers
- Highly Reliable and Durable!

An outstanding Lafayette chrome bumper mount featuring chrome plated mount and stainless steel strap which is completely adjustable for vertical mounting on most types of automobile bumpers. Eliminates need of cumbersome link type chain mounts. Shpg. wt., 1 1/2 lbs.
99 K 3035 Imported Net 3.95

395

LAFAYETTE BASE STATION CITIZENS BAND ANTENNAS

FAMOUS LAFAYETTE "STARFIRE V" DELUXE 5 ELEMENT CITIZEN BAND BEAM ANTENNA

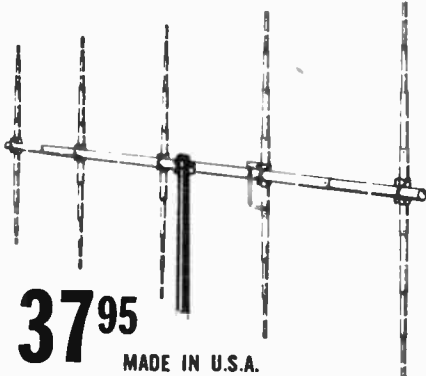

ONLY **37⁹⁵**

MADE IN U.S.A.

Check these outstanding specifications

ELECTRICAL

- GAIN—10db Forward gain
- F-B ratio: —25 db
- V.S.W.R. under 1.5:1 across 27MC band
- Gamma Matched to 52 ohm Coax Transmission Lines

MECHANICAL

- Boom Length 17'
- Height: 18'6"
- Turning Radius: 8'6"
- Mounts on Masts up to 2" in diameter
- All aluminum construction

The STARFIRE "V" 5 Element vertical beam is one of the most powerful CB antennas ever offered by Lafayette. Tremendous forward gain multiplies your effective radiated power by as much as 10 times. Front-to-back ratio 25 db. V.S.W.R. under 1.5:1. Gamma matched to 52 ohm coax-transmission lines. All aluminum construction for greater weather resistance. Boom length 17 ft. Reflector element (highest 18½ feet. Mounts on masts up to 2" in diameter. Turning radius 8'6". Vertical wind load 125 lbs. STARFIRE "V" is furnished with complete mounting instructions. Less mast and coax cable. Shpg. wt., 15 lbs.

42 K 0114WX

Net 37.95

LAFAYETTE "RANGE-BOOST"™™™ END FED ½-WAVE CB ANTENNA

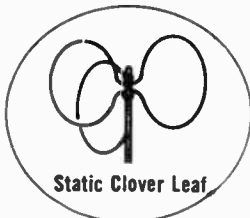

AMAZING
PERFORMANCE
AT ONLY

19⁹⁵

Static Clover Leaf

- Static Clover Leaf Ball Design Reduces Receiver Noise
- 3.75 db True Omni-Directional Gain
- Forward Power Measurement—5 watts
- VSWR—1.17

The "Range-Boost" ½-wave CB base station is the latest addition to Lafayette's famous line of high performance CB antennas. Specially designed anti-static clover-leaf ball drastically reduces receiver noise by continuous dissipation of static discharge. Offers a 3.75 db true omni-directional gain. Forward power measurement: full 5 watts; VSWR is 1.17. Includes a phasing transformer, rubber covered for moisture resistance. Vertical radiator consists of 3 seamless aluminum tube sections topped by a solid aluminum 108" top section. 3 54" radials provide proper transmission line decoupling. Direct ground lightning protection. 50 ohm. 17'6" over-all length. Accepts PL-259 cable connector. Shpg. wt., 10 lbs.

42 K 0111WX

Net 19.95

Made in U.S.A.

60 FT. RG8A/U FOAM POLYETHYLENE COAX CABLE ASSEMBLY



Ready to Use. Extremely Low Line Loss PL-259 Termination on Both Ends.

Boost your operating range by increasing the efficiency of your antenna system. Ideal for Citizens Band Amateur or Commercial Fixed Station use. Low loss impedance 50 ohms. 60 Foot length complete with PL-259 plug on each end. Shpg. wt., 7 lbs.

42 K 7003

9.50

LAFAYETTE'S "STAR-FIRE"™.M. 3-ELEMENT VERTICAL BEAM CB ANTENNA



16⁹⁵

Made in U.S.A.

- Multiplies Power 8 Times
- Completely Precision Tuned and Ready to Assemble and Install
- Steel Parts Irridite Treated to MIL Specs

An exceptionally high gain, directional antenna system for Citizen's Band communications. It develops a forward gain of 8 db. Front-to-back ratio is 25 db; front-to-side, 40 db. 50 ohm feedline match for maximum efficiency. Comes with bracket for vertical or horizontal mounting. The 1¼" O.D. aluminum boom is 8 feet long. ¾" to 1¼" O.D. aluminum elements are approximately 16½ ft. long. All steel hardware is irridite treated to MIL specs. Completely factory pretuned, the "Star-Fire" is furnished with complete instructions. Shpg. wt., 11 lbs.

42 K 0113WX

Net 16.95

DELUXE LAFAYETTE GROUND PLANE ANTENNA

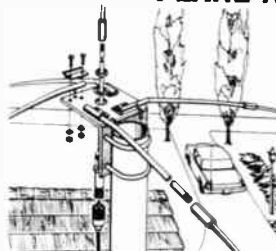

- The Ideal Antenna For Your CB Base Station
- High Efficiency Ground Plane Antenna
- All Aluminum Construction
- Accepts PL-259 Connector

11⁹⁵

Solid aluminum 108" heat-treated radials and radiator. Elements supplied in two 54" lengths joined by threaded coupling nuts. Radials droop for 50 ohm match. Accepts 1¼" tubing RG-58/U cable and PL-259 connector. Shpg. wt., 4 lbs. Imported.

99 K 3031W

Net 11.95



BLITZ BUG LIGHTNING PROTECTOR

Designed to fit any standard coaxial cable, the "Blitz Bug" employs the spark gap principle to eliminate static build up on coaxial cables. Provides a constant drain off, reducing chances of a direct lightning strike and in many cases eliminating noise problems. Constructed of ¾" O.D. brass by 2¼" long. Employs one PL-259 plug and one DKCB connector (takes PL-259 plug.) Shpg. wt., 1 lb.

42 K 2001

Net 3.95

LAFAYETTE MOBILE CITIZEN BAND ANTENNAS

LAFAYETTE ALL STAINLESS STEEL CB MOBILE ANTENNA



6⁹⁵

OUTSTANDING FEATURES

- 102" Stainless Steel Whip For Optimum 11-Meter Performance
- Heavy-Duty Chrome Plated Stainless Steel Spring
- Chrome Plated Swivel Ball Jointed Mount Base

Chrome plated swivel mount base designed to be mounted on any surface. Stainless steel spring holds rod in properly adjusted position and prevents rod damage from shocks and blows. Stainless steel whip for maximum resiliency and strength. Shpg. wt., 4 lbs. Has lug terminals for 42 K 7002 cable assembly.

99 K 3034WX Imported Net 6.95

NEW LAFAYETTE BASE LOADED "AUTO-TOP" CITIZEN BAND ANTENNA

- Automobile rooftop application affords ideal Omnidirectional signal pattern
- Mounts neatly from outside vehicle 3/4" hole
- Base loaded Phasing Transformer completely weatherproof
- 39" Stainless Steel whip

Only

7⁹⁹

MADE IN U.S.A.

The new Lafayette Base Loaded "Auto-Top" Citizen-Band antenna offers the CB'er the ideal omni-directional signal pattern with very low signal to noise. This quality antenna consists of an inconspicuous base loaded, neutral gray weatherproof phasing transformer (only 4" high, and 1" in diameter), a 39" stainless steel whip, and all mounting hardware including complete and simple mounting instruction sheets. Antenna mounts in 3/4" hole. Comes less cable. Shpg. wt., 2 lbs.

42 K 0120 Net 7.99.



Superb Lafayette Fiberglass 48" CENTER LOADED CITIZENS BAND COWL MOUNT ANTENNA

6⁹⁵ MADE IN
U.S.A.

- Rugged Fiberglass Construction
- Easily Mounts On Cowl or Rear Deck

Lafayette makes antenna news with this ideal center loaded fiberglass antenna—only 48" high but performs like 102" antennas. Designed for cowl mounting, this latest development in mobile antennas provides an excellent radiation pattern. Substitutes for conventional 1/4 wave whips as well as base-loaded antennas in the 27 mc band. The four foot whip eliminates the possibility of striking overhead objects. A black plastic covering of whip insures against shorting. Specially designed rocker support assures 8-point grounding and permits mounting up to 35° angle on fender, cowl or rear deck—fits any 1 1/2" to 1 1/4" mounting hole. Complete with 5 ft. of RG-58/U cable.

42 K 0112W Shpg. wt., 3 lbs. Net 6.95



LAFAYETTE "PROFESSIONAL" DOUBLE CHAIN BUMPER MOUNT CB ANTENNA

THE LONG-LIFE BUMPER
MOUNT ANTENNA
THAT FITS THEM ALL!

15⁹⁵

- Heavy Duty Double Chain Bumper Mount
- Heavy Duty Aluminum Plated Spring
- 102" Stainless Steel Whip
- Includes Whip Hold-down Clip

MADE
IN
U.S.A.

Complete heavy duty double-chain bumper mount assembly. No holes to drill; assembles in minutes. Consists of professional heavy-duty double-chain bumper mount with "Z" shaped links, cadmium plated shock absorbing springs that can bend through 90° without damage. 102" stainless steel whip with removable plated steel adapter and whip hold-down gutter clip. Built for long, satisfactory service and performance. Less cable. Shpg. wt., 8 lbs.

42 K 0119WX Net 15.95



LAFAYETTE CB BUMPER MOUNT ANTENNA WITH STAINLESS STEEL STRAP

8⁹⁵

- Chrome Plated Bumper Mount with Stainless Steel Strap
- 102" Stainless Steel Whip, Heavy Duty Chrome Plated Stainless Steel Spring

An outstanding Lafayette CB antenna featuring a full-size 102" stainless steel whip and a fully adjustable chrome plated mount with a stainless steel strap which was specially designed to fit most cars. Heavy duty chrome plated stainless steel spring is built for extremely rugged mobile use. Shpg. wt., 3 lbs. Imported.

99 K 3032WX Net 8.95



20 FT. COAXIAL CABLE ASSEMBLIES FOR CITIZENS BAND EQUIPMENT



(A) These cable assemblies are necessary for connection (B) between Citizens Band Transceiver and Antenna.

TYPE A—Consists of 20 ft. RG-58/U cable with PL-259 plus UG-175/U on both ends. Required for Ground Plane and Coaxial and Mobile Antennas terminating in a coaxial jack. Shpg. wt., 8 oz. 42 K 7001 Type A; 20 ft. length Net 2.49

TYPE B—Same as type A except one end is terminated with PL-259 plus UG-175/U and other end with universal ring type terminal lugs for mobile antennas. Shpg. wt., 8 oz. RECOMMENDED FOR USE WITH LAFAYETTE ALL STAINLESS STEEL MOBILE ANTENNA ABOVE. 42 K 7002 Type B; 20 ft. length Net 2.15

SELECTED CB ANTENNAS AND ACCESSORIES

NEW DELUXE LAFAYETTE CB/AM CENTER LOADED COWL MOUNT ANTENNA



Complete With Automatic Dividing Harness

ONLY **13⁹⁹**

Made in USA

- Permits outstanding Reception and Transmission on CB —and Reception on AM

Lafayette's exciting new antenna serves the "CB'er" with two functions in one—CITIZENS BAND AND BROADCAST BAND. Eliminates the need of two antennas. This single, sturdy— heavily chromed center-loaded cowl mount antenna fits easily in the 7/8" to 1 1/4" hole left by the auto antenna. Only 32" long, this superb antenna package incorporates an automatic dividing harness which includes a 1 ft. low loss cable with pin plug to your AM Set, a 2 ft. RG58/U Cable with PL-259 connector to your CB set, and a 5 ft. RG58/U cable with PL-259 connector to your antenna. The dividing harness fits snugly out of sight under the dash. Shpg. wt., 4 lbs. 42 K 0124W Net 13.99

NEW LAFAYETTE CENTER-LOADED MOBILE CB GUTTER CLAMP ANTENNA



Gutter Clamp Assembly

ONLY **10⁸⁸**

Made in USA

- EASILY SNAPS ON RAIN GUTTER OF AUTOMOBILE
- OFFERS OUTSTANDING 11 METER PERFORMANCE
- PORTABLE—Easily Removable When Not in Use — Prevents Theft or Damage

This portable CB Center-loaded antenna is ideal for the CB'er. Easily removable when not in use—prevents theft or damage. Gutter clamp snaps on rain gutter of automobile. Heavy spring assures positive grip. Clamp is heavily plated to resist corrosion. Only 20 inch in length—outstanding 11 meter performance SWR 1:1. Furnished with 12 ft. of RG58/U cable with PL-259 Connector. Shpg. wt., 3 lbs.

42 K 0125 10.88



LAFAYETTE "DUMMY" ANTENNA LOAD FOR CB TRANSCEIVERS

A 52 ohm non-inductive load for testing and tuning-up Citizens Band transmitters up to 5 watts. It permits tune-up into a non-radiating element instead of into antenna — in compliance with F.C.C. regulations. Built-in PL-259 coaxial plug is easily connected and disconnected from equipment. Shpg. wt., 1 lb. 42 K 0902 Net .98

Net .98

New Antenna Specialists M-119 "SCANNER" OMNI-BEAM CB Antenna



Scan Control Unit, with Indicator Lights, Instantly Switches Signal Direction — Just Flip the Switch

only **64⁶⁸**

- Unique New Electronic 3 Sector-phased Omni-beam Base Station Antenna.
- No Mechanical Rotator Needed

With this unique "Scanner" antenna the signal is rotated, not the antenna. No mechanical rotor is required. Scan control unit changes signal direction instantly by a flip of the switch. Compact array of 3 sector-phased 17 1/2 ft. vertical elements extend less than 3 feet from the mounting boom. Full circle scan coverage — no blind spots. Resists over 100 mph winds. 7.75 db directional gain — 23 db front to back ratio. Shpg. wt., 18 lbs. 42 K 1002WX Net 64.68

4 Conductor Rotor Cable for use between Scanner Control Unit and Antenna. 32 K 8910 100" coil 2.50

LAFAYETTE CITIZENS BAND WALKIE-TALKIE ANTENNA REPLACEMENT GUIDE

- Fits All Lafayette and many Famous name Walkie-Talkies

Designed for the various Lafayette "Walkie-Talkie" portable CB Transceivers indicated. Will also fit many of the other "Walkie-Talkie" units manufactured by companies other than Lafayette. Check the specs of the antennas listed on the chart below for the antenna best suited to your present "Walkie-Talkie." Average shpg. wt., 1 lb. Imported.

| Antenna Stock No. | Sections | Diam. of Base | Collapsed Length | Extended Length | For Lafayette Walkie-Talkie Models | Net-Ea. |
|-------------------|----------|---------------|------------------|-----------------|------------------------------------|---------|
| 99 K 3008 | 12 | 1/2 | 6 | 52 3/4 | HE-29, HE-29B | 1.95 |
| 99 K 3037 | 11 | 1/2 | 6 1/4 | 54 1/2 | HA-60, HA-61, HE-86, HE-88 | 1.95 |
| 99 K 3038 | 9 | 3/8 | 7 1/4 | 52 3/4 | HE-75, HE-88 | 1.95 |
| 99 K 3039 | 11 | 3/8 | 5 3/4 | 50 | HE-66, HE-82, HE-83 | 1.49 |
| 99 K 3040 | 9 | 3/8 | 5 7/8 | 43 1/4 | HA-70 | .98 |
| 99 K 3041 | 11 | 3/8 | 5 3/4 | 51 | HE-29C | 1.95 |
| 99 K 3017 | 10 | 3/8 | 7 | 58 | HA-150 | 1.95 |
| 99 K 3007 | 11 | 3/8 | 7 1/4 | 62 3/4 | HA-300 | 2.25 |

LOW-COST ECONOMY C B GROUND PLANE ANTENNA

- Lightweight Tubular aluminum elements

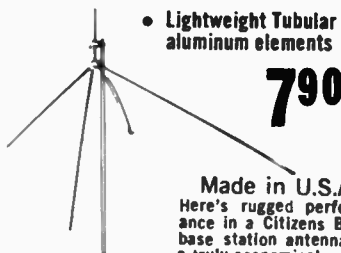

790

Made in U.S.A.

Here's rugged performance in a Citizens Band base station antenna at a truly economical price.

Incorporating a special "drooping radial" design for improved impedance characteristics, this excellent ground plane antenna utilizes a 360° polar pattern to provide complete coverage in any direction. Made-to-last construction features a rugged 1 inch diameter radiating element. A double U-bolt arrangement provides the strongest possible mount under the most severe conditions. 42 K 7401WX Shpg. wt., 6 lbs. Net 7.90

LAFAYETTE CHROME PLATED MOBILE BUMPER MOUNT with Stainless Steel Strap



- Completely Adjustable For Use With Most Types of Automobile Bumpers
- Highly Reliable and Durable!

An outstanding Lafayette mobile Bumper Mount featuring chrome plated mount and stainless steel strap which is completely adjustable for vertical mounting on most types of automobile bumpers. Eliminates need of cumbersome link type chain mounts. Shpg. wt., 1 1/2 lbs. 99 K 3035 Imported Net 3.95

395

LAFAYETTE TELESCOPIC C B WHIP ANTENNA



395

Sturdy, attractive chrome plated whip antenna that telescopes from approx. 45" fully extended to only 15" to facilitate portability and storage. Ideal for shorter distances up to several miles. Has enclosed base loading coil for proper impedance matching. Complete with removable PL-259 connector that permits direct top, side or rear mounting to transceiver. Imported. 99 K 3015 Shpg. wt., 1 lb. Net 3.95

CB to AM ANTENNA COUPLER

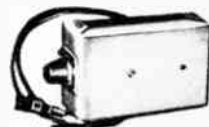

Specially designed network permits any Citizen's band mobile antenna to be used also for broadcast reception. No switching necessary. With SO-239 antenna receptacle, 2 ft. lead with coaxial auto plug for broadcast radio connection and 2 ft. lead with PL-259 coaxial plug for transceiver connection. Shpg. wt., 1/4 lb. 42 G 0903 Net 5.95

LAFAYETTE RADIO ELECTRONICS

All mail orders to: 111 JERICHO TPKE., SYOSSET, L.I., N.Y. 11791

Lafayette Radio Electronics "Associate Store" Dealers own and operate their own stores as independent franchised dealers. They establish their own terms and prices, which may vary slightly and do not handle mail orders.

**"ASSOCIATE STORE"
DEALER LOCATIONS**

| | | | | |
|---|---|---|--|---|
| BIRMINGHAM ALA. 9 North 77 St. | TALLAHASSEE FLA. 505 W. Gaines St. | GRAND RAPIDS MICH. 7 Burton St., S.E. | WELLSVILLE N.Y. 50 No. Main St. | WILKES-BARRE PA. 115 No. Main St. |
| FLORENCE U.S. Hwy. 43 & 72 at Shoals Creek | TAMPA 3328 Henderson Bl. | IRONWOOD 114 S. Lowell St. | CHARLOTTE NO. CAR. 1310 N. Independence Blvd. | YORK 601 W. Market St. |
| HUNTSVILLE 2112 Memorial Pkwy So. | VERO BEACH 862 20th Place | KALAMAZOO 519 Mills St. | FAYETTEVILLE 2733 Bragg Blvd. | PROVIDENCE R.I. 1023 Chalkstone Ave. |
| MOBILE 174 So. Ann St. | ATLANTA GA. 512 W. Peachtree N.W. | LANSING 805 W. Holmes Rd. | MORGANTON 407 So. Sterling St. | COLUMBIA SO. CAR. 948 Harden St. |
| PHOENIX ARIZONA 4225 N. 7th Ave. | COLUMBUS 2611 Lumpkin Rd. | PORT HURON 1503 24th St. | AKRON OHIO 34 North Main | GREENVILLE -2109 Augusta Rd. |
| N. LITTLE ROCK ARK. 1920 Pike Ave. | IDAHO FALLS IDAHO 1363 N. Yellow- stone Ave. | MINNEAPOLIS MINN. 7815 Southtown Ctr. | CANTON 300 Walnut St. | CHATTANOOGA TENN. 3748 Ringgold Rd. |
| BAKERSFIELD CALIF. 626 Bernard St. | PEORIA 706 Wayne St. | BILOXI MISS. 3305 Pass Rd. | CINCINNATI 606 Walnut St. | MEMPHIS 1057 N. Watkins St. |
| BUENA PARK 6186 Beach Blvd. | RANTOUL 421 S. Century Blvd. | HATTIESBURG 1106 Hardy St. | CLEVELAND 2001 Euclid Ave. | OAK RIDGE 39 E. Tenn. Ave. |
| CULVER CITY 8553 Washington Blvd. | SPRINGFIELD 1413 S. 11 St. | TUPELO 917 So. Gloster | COLUMBUS 122 E. Long St. | AUSTIN TEX. 4101 Interregional Hwy. |
| FRESNO 4510 E. Belmont | FORT WAYNE IND. 3101 N. Clinton St. | ST. LOUIS MO. 6431 Hampton Ave. | LOGAN 31 E. Main St. | EL PASO 4317 Dyer St. |
| SAN CLEMENTE 220-B So. Ola Vista Rd. | INDIANAPOLIS 4730 E. 10 St. | GREAT FALLS MONT. 210 4th St., South | PROSPECT Highway 318 | FT. WORTH 3510 "A" Section— E. Lancaster St. |
| SAN DIEGO 472 3rd Ave. & Island | SIOUX CITY IOWA 500 W. 7th St. | OMAHA 4720 S. 24 St. | SPRINGFIELD 217 N. Belmont | HOUSTON 8691 Long Pt. Rd. 6315 So. Park Blvd. |
| SAN FRANCISCO 271 9th St. | OVERLAND PARK KANS. 7202 W. 79 St. | CLAREMONT 222 Washington St. | STUEBENVILLE 411 Washington St. | LAREDO 1910 San Bernardo |
| SANTA BARBARA 2700 De La Vina | SALINA 314 West Cloud | KEENE 55 Main St. | STRONGSVILLE 14484 Pearl Rd. | LUBBOCK 1722 Ave. H |
| SUNNYVALE 942 W. El Camino Real | WICHITA 220 W. Harry St. | MANCHESTER 40 Bridge St. | TOLEDO 5429 Detroit St. | SAN ANTONIO 5090 Blanco Rd. |
| VAN NUYS 13630 Sherman Way | MADISONVILLE KY. 2408 South Main St. | SALEM Rte. 28 at H'way 93 | ZANESVILLE 925 Linden Ave. | SALT LAKE CITY UTAH 147 E. Sixth South |
| BRIDGEPORT CONN. 2710 Fairfield Ave. | MIDWAY 125 E. Main | ASBURY PARK N.J. 1109 H'way No. 35 | OKLA. CITY OKLA. 3837 N.W. 10 St. | BLACKSBURG VA. Christiansburg Rd. |
| GROTON 565 Long Hill Road | ALEXANDRIA LA. 1306 Murray St. | CAMDEN 5057 Rte. 38 | EUGENE ORE. 62 W. B'way | HAMPTON 802 W. Mercury Blvd. |
| HAMDEN 913 Dixwell Ave. | BATON ROUGE 2610 Florida Blvd. | RIO GRANDE Marlyn Manor | MEDFORD 1080 S. Riverside | LYNCHBURG 1624 Park Ave. |
| WATERBURY 386 W. Main St. | NEW ORLEANS 2231 Banks St. | Shopping Center | PORTLAND 4001 N. Interstate Ave. | RICHMOND 3012 W. Broad St. |
| NEW CASTLE DEL. 1420 Dupont Blvd. | LEWISTON MAINE 131 Lisbon Street | TRENTON 4 Brunswick | AKRON 127 No. 7th St. | BELLEVUE WASH. 10845 N.E. 8 Ave. |
| EAU GALLIE FLA. 418 Harbor City Blvd. | ROCKLAND 464 Main St. | ALBUQUERQUE N. MEX. 11017 Central, N.E. | ALBANY N.Y. 79 Central Ave. | SEATTLE 1210 First Ave. |
| FT. LAUDERDALE 2534 N. Federal H'way. | BALTIMORE MD. 2014 N. Charles St. | ALBANY 79 Central Ave. | BUFFALO 747 Main St. | SPOKANE 5315 N. Market St. |
| GAINESVILLE 101 S. E. 1st St. | BEL-AIR 139 Thomas St. | BUFFALO 747 Main St. | DRYDEN 14 W. Main St. | TACOMA 8805 Bridgeport Way |
| JACKSONVILLE 1905 Hendricks Ave. | SALISBURY 819 Priscilla St. | ELMIRA 403 East Third St. | ELMIRA 403 East Third St. | MARTINSBURG W. VA. 809 N. Queen St. |
| LAKE WORTH 213 N. Dixie H'way | AYER MASS. 45 Groton-Harvard Rd. | POUGHKEEPSIE 105 Dutchess Tpke. | POUGHKEEPSIE 105 Dutchess Tpke. | WHEELING 1217 Chapline St. |
| N. MIAMI BEACH 346 NE 167 St. | SPRINGFIELD 527 Belmont Ave. | ROCHESTER 792 W. Main St. | ROCHESTER 792 W. Main St. | KENOSHA WISC. 620-58th St. |
| ORLANDO 1225 No. Mills St. | WORCESTER 23 Foster St. | SCHENECTADY 141 Erie Blvd. | UTICA 1415 Oriskany St. West | MILWAUKEE 1840 W. Atkinson Ave. |
| PENSACOLA 727 N. Warrington Rd. | ANN ARBOR MICH. 3382 Washtenaw Ave. | SYRACUSE 2740 Erie Blvd. E. | UTICA 1415 Oriskany St. West | SOUTH BELOIT 1016 Blackhawk Blvd. |
| ST. PETERSBURG Central Ave. & 40 St. | BAY CITY 408 E. Midland St. | VESTAL 253 Vestal Pkway, East | VESTAL 253 Vestal Pkway, East | U.S. POSSESSIONS |
| | BIRMINGHAM 315 Hamilton Ave. | | | GUAYNABO P.R. San Patricio Shopping Center |
| | DETROIT 1326 Broadway | | | SAN JUAN The Texas Bldg. 654 Ponce De Leon, Hato Re |
| | FLINT 1115 So. Dort H'way. | | | |

How Would You Like to Own A

LAFAYETTE RADIO ELECTRONICS

"ASSOCIATE STORE"?

EXCLUSIVE FRANCHISES NOW AVAILABLE

Basic Requirements Include:

1. Knowledge of Retailing, or of Radio, Television or Electronics
2. Financial Investment of \$10,000 to \$30,000

Lafayette—Since 1921 Everything In Electronics

If you have the basic requirements, and would like complete details without obligation, write for full information to:

Mr. Robert Laub
Lafayette Radio Electronics Corp.
Dept. AS-652
111 Jericho Turnpike,
Syosset, L.I., N.Y. 11791

WORLD FAMOUS LAFAYETTE MULTITESTERS



17⁹⁵
Factory Wired

DELUXE LAFAYETTE 30,000 OHMS PER VOLT MULTITESTER FOR PRECISION MEASUREMENTS

- 30,000 Ohms per Volt DC, 15,000 Ohms per Volt AC
- 1% Precision Resistors for High Accuracy
- Unique "Buzzer" for Fast Short Tests
- 27 Meter Ranges on 2-Color Scale

A deluxe portable Volt-Ohm-Milliammeter with a high order of accuracy. Completely wired and portable, it provides wide voltage, current, resistance and db ranges clearly visible on a big 4" meter with 2 color calibrations. Sensitivity is 30,000 ohms-per-volt DC and 15,000 ohms-per-volt AC. All multipliers used are 1% precision resistors for maximum accuracy and years of dependable service. Sensitive 33-micro-amp meter provides full scale readings down to 1/4 volt on DC and 0.05 milliamps. Features a unique self-contained buzzer to give you fast in-circuit checks on opens, shorts. Audio output jack with DC blocking capacitor. Handsome, dust proof black plastic case. Complete with leads, batteries. Size: 3 1/2" x 6 1/2" x 2 3/4" D. Shpg. wt., 2 lbs. Imported.

99 K 5004 Net 17.95
99 K 5005 Pigskin Carrying Case for above Net 1.95

SPECIFICATIONS

Sensitivity: 30,000 ohms/volt DC, 15,000 ohms/volt AC. Ranges: DC volts: 0-.25, 1, 2.5, 10, 25, 100, 250, 500, 1000; AC volts: 0-2.5, 10, 25, 100, 250, 500, 1000. Direct Current: 0-0.05, 5, 50, 500 ma; 0-12 amps Ohmmeter: 0-60K, 6M, 60 Megohms, Decibels: -20 to +56 db. Short Test: Internal Buzzer. Audio Output Jack. Controls: Range Switch, Ohms Adjust. Batteries: 1 type Z cell, 15-volt.

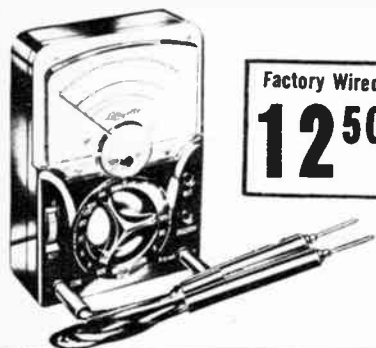

Factory Wired
12⁵⁰

Deluxe 20,000 Ohms-Per-Volt Multitester

- 20,000 Ohms Per Volt DC—10,000 Ohms Per Volt AC
- Measures: 0-1200V DC, 0-1200V AC, 0-10 Megohms, 0-60 μ a, 0-600 ma, -20 to +63 db, 200 mmf-0.2 mfd.

Easy visibility is provided by the large 3 1/2" meter with large two color scales. The 40-microampere D'Arsonval meter movement permits a high input resistance on all ranges: 20,000 ohms per volt on DC; 10,000 ohms per volt on AC. 1% tolerance resistors permits the measuring of voltages without unduly loading the circuit, preserving accuracy of readings. Measures 0-0.6, 6, 30, 120, 600, 1200 DC volts, 0-6, 30, 120, 600, 1200 AC volt, Resistance 0-10K, 100K, 1M, 10 Megohms, DC Current 0-60 microamperes, 0-6, 60, 600 milliamperes, -20 to +63 decibels. Features a capacitance measurement range, 200 mmf to 0.2 mfd capacity. Complete with batteries, test leads and operating instructions. Size 5 1/4" x 3 3/4" x 1 7/8" D. Shpg. wt., 1 1/2 lbs. Imported.

99 K 5006 Net 12.50
99 K 5007 Pigskin Carrying Case for above Net 1.95

20,000 Ohms-Per-Volt Multitester

- 20,000 Ohms/Volt DC, 10,000 Ohms/Volt AC
- 1% Precision Resistors
- Compact, lightweight, Accurate
- Easy-to-Read 3" Meter

SPECIFICATIONS

Sensitivity: 20,000 ohm/volt DC, 10,000 ohms/volt AC. Range DC Volts: 0-3, 30, 60, 300, 600, 3,000V. AC Volts: 0-6, 60, 120, 1,200V. DC Current: 0-60 μ A, 0-12, 0-300 ma. Resistance: 0-60K, 0-6 Megohms. Decibels: -20 to +63db. Audio Output Jack. Type "Z" 1.5V cell for resistance measurements.

This handy pocket multi-tester has every needed range. Ideal for repair and service work on appliances, radio, etc. 40 micro-ampere meter movement permits a high input resistance on all ranges—does not load down circuits while testing. Has a single range/function control for quick, simple operation, plus zero ohms adjust. Supplied with 1 1/2V penlight cell and test leads. Rugged, high impact plastic case. Size 3 1/4" x 4 1/2" x 1". Shpg. wt., 1 lb. Imported.

99 K 5008 Net 9.95
99 K 5009 Pigskin Carrying Case for above Net 1.75

Pocket AC-DC VOM

- Extremely Compact, Measures Only 3 1/2" x 2 1/2" x 1" • Weighs 5 Ozs.
- 1,000 Ohms Per Volt Sensitivity • 1% Precision Resistors
- Reads: 0-1000 Volts AC-DC, 0-100K Ohms, 0-150 MA

The Lafayette pocket multitester features small physical size, and a wide selection of useful ranges. It can be used for trouble-shooting any type of electronic circuits or electrical appliances such as irons, lamps, radios, television, hi-fi equipment, etc. 1000 ohms per volt sensitivity, and 1% precision resistor components assure accurate, precise readings. Operation is extremely easy, no switching or fidgeting required. Ranges Volts: 0-15-150-1000 AC and DC. Ohms: 0-100K; MA: 0-150. The VOM comes completely wired and tested, and is enclosed in durable plastic case. All accessories including battery are rubber insulated, color coded, flexible test leads are supplied. Shpg. wt., 1 lb. Imported.

99 K 5010 AC-DC POCKET VOM Net 4.95



4⁹⁵
Factory Wired

LAFAYETTE Quality Panel Meters

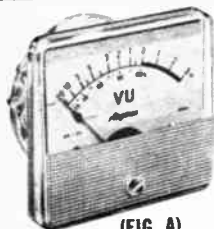

(FIG. A)

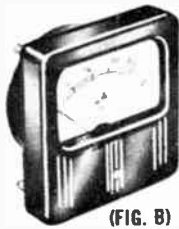

(FIG. B)



(FIG. C)

Square and Miniature PANEL METERS with high quality D'Arsonval Movements

- Jewelled Bearings
- Accuracy 2% Full Scale

High quality, precision built meters with better than 2% of full scale accuracy. All meters have 4 threaded mounting studs in corners, zero adjust screw and clear plastic fronts except (Fig. B) which has black bakelite. Terminal polarity on DC models is identified. Fig. A standard 3900 ohm "B" scale VU indicator. Includes full wave bridge rectifier, built-in bulb. Ammeters are highly damped, use linear calibrations. Dimensions: Fig. A, B, — 3 1/4" square, 2 1/4" x 1 3/8" dial faces. 1 1/4" overall depth, 1 3/4" behind panel including terminals. Require 2 1/4" diameter mounting hole. Fig C miniature meters with silvered dials, black pointers — 1 1/4" square fronts, 1 1/2" overall front-to-back, with 1 1/4" behind panel including 1/4" terminals. Require 1 1/2" diameter round hole in panel. 1 1/4" dial face. Supplied with mounting screws. Shpg. wt., 1 lb. Imported.

| STOCK NO. | TYPE | FIG. | RANGE | NET EA. |
|-----------|-----------|------|-----------------------|---------|
| 99 K 5043 | Square | A | *Illuminated Scale VU | 6.75 |
| 99 K 5042 | Square | B | 0-50 DC Microammeter | 5.95 |
| 99 K 5040 | Square | B | 0-1 DC Milliammeter | 3.25 |
| 99 K 5039 | Square | B | 0-150 AC Voltmeter | 2.75 |
| 99 K 5052 | Miniature | C | 0-1 DC Milliammeter | 2.95 |
| 99 K 5053 | Miniature | C | 0-5 DC Milliammeter | 2.95 |
| 99 K 5054 | Miniature | C | 0-50 DC Milliammeter | 2.95 |
| 99 K 5055 | Miniature | C | 0-100 DC Milliammeter | 2.95 |
| 99 K 5049 | Miniature | C | 0-50 DC Microammeter | 4.45 |
| 99 K 5060 | Miniature | C | 0-10 DC Ammeter | 2.75 |
| 99 K 5047 | Miniature | C | 0-15 DC Voltmeter | 2.75 |
| 99 K 5050 | Miniature | C | 0-150 AC Voltmeter | 2.75 |
| 99 K 5051 | Miniature | C | 0-300 AC Voltmeter | 2.75 |

*Standard 3900 ohm "B" scale volume indicator, 0-100% modulation scale, —20 to +3VU scale.

MINIATURE LAFAYETTE ILLUMINATED VU METER

- D'Arsonval Movements
- Accuracy 2% of Full Scale
- Jewelled Bearings
- Bakelite Case



Illuminated dial for easy, wide-angle readability at all times. Volume level indicator, calibrated in standard—20 to +3 VU and 0-100% ranges. Uses precision carbon film multiplier resistor and full wave rectifier. Damped in accordance with standard VU meter requirements. Reference level 1 mw in 600 ohm line. 3,900 ohms internal resistance. "D" VU is 1.228 volts sine wave AC across meter connected to 600 ohm source with 600 ohm load. May be used with T-pad attenuator. Size: 1 1/4" x 1 1/4" Sq. face, 1 1/4" overall behind panel. Shpg. wt., 8 oz. Imported.

99 K 5024 Net 3.95

LAFAYETTE EDGE-WISE PANEL METERS



(FIG. A)



(FIG. B)

Has precision D'Arsonval meter with 2% or better full scale accuracy. Overall depth is 3 1/2" behind panel including terminals. Has stud-type solder terminals and zero adjustment screw. Shpg. wt., 3/4 lbs. Imported.

VU METER (FIG. A)

VU METER—Calibrated and damped in accordance with standard VU meter practice. Upper scale reads —20 to +3 VU. Lower scale reads 0-100% modulation. Accurate to ±0.5 VU from 30-15,000 cps.

99 K 5033 Size 3 3/4" x 1 1/4". Imported Net 5.95

0-150 AC VOLTMETER (FIG. A)

0-150 AC VOLTMETER—Full-wave bridge rectifier type. 1000 ohms per volt. 5 volts per division, linear scale.

99 K 5032 Size 3 3/4" x 1 1/4". Imported Net 3.75

0-1 DC MILLIAMMETER (FIG. A)

0-1 DC MILLIAMMETER—CALIBRATED from 0-1 ma in 0.02 ma. divisions. Black scale, red pointer.

99 K 5031 Size 1 1/4" x 1 1/4". Imported Net 4.75

BALANCE & TUNING METER (FIG. B)

Use these precision moving coil DC Ammeter meter movements as stereo balance indicators or as tuning indicators for FM tuners. Pointer at center of the scale indicates zero or null position. Current Sensitivity: ±100 μa. Complete with installation schematics.

99 K 5034 Ship. wt., 1 lb. Size 2 3/8" W x 1 3/8" D x 7/8" H. Imported Net 2.50

MINIATURE LAFAYETTE LEVEL METER

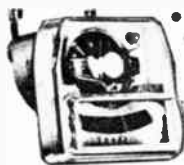

- Highly Sensitive
- Front Panel Area Only 3/4" W x 1 1/4" H
- Rubber Cushion Mount

1.95

A miniature clear plastic front level meter which will indicate relative audio levels for tape recorders, FM sets or transistorized audio equipment. Actual size of meter is 1 1/4" x 1 W x 1 1/4" L. Sensitivity: 250 ma; internal resistance—260 ohms. Full scale 500 microamps. Shpg. wt., 1 oz. Imported. 99 K 5036 Net 1.95

SUB-MINIATURE LAFAYETTE TUNING & BATTERY METER



- FOR TRANSISTOR CIRCUITS
- ONLY 3/4" W x 1 1/4" H x 3/4" DEEP

2.45

Make your miniature transistor radio a deluxe receiver with this tuning and battery meter. Sensitive 300 μ amp. D'Arsonval movement. Easy to read—clearly marked scale — red pointer. Meter has shielded case. Plastic bumpers protect pointer. With hook-up circuit. Scale marked: DFF, TUNE AND BATT. with intermediate graduations. Shpg. wt., 4 ozs. Imported.

99 K 5028 Net 2.45

LAFAYETTE ULTRA-MINIATURE TUNING AND BATTERY METER



1.50

ONLY 3/8" IN DIA., 3/4" IN LENGTH

This ultra-miniature meter can be installed easily in a 3/8" diameter hole. Its total length (front to back, including lugs for connections) is 3/4" and its reading face is circular, 1/2" in diameter (taking up an area of less than 1/5 square inch!) Current sensitivity: 200 Ma. Internal resistance: 320 ohms ± 10%. Shpg. wt., 3 oz. Imported.

99 K 5035 Net 1.50

LAFAYETTE FILAMENT CONTINUITY TUBE CHECKER



- Compact, Ideal For Tube Caddy

1.69

Small and compact as a cigarette box. Quickly checks filament continuity in a matter of seconds. Ideal for the serviceman or the technician working in the field. Tests filaments of radio, TV picture tubes. Also can be used to test many other electrical devices and line cords, fuses, lamps and bulbs. Has sockets for TV picture tube and loctal, octal, 9-pin, as well as 7-pin sockets. Provided with two test leads. Grey hammertone finish. Size: 4x3x 1 1/2". Shpg. wt., 12 oz. Imported.

99 K 5016 Net 1.69

EXCLUSIVE LAFAYETTE TEST EQUIPMENT



LAFAYETTE TUBE TESTER

for HOME, SHOP BENCH
or LABORATORY

Packed With Features at
A Price You Can Afford

1995 NOT A KIT—
COMPLETELY WIRED

- Checks New Compactrons, Nuvistors, New T-9 Types 7-pin Miniatures, Octals, Lock-in's and 9-pin Miniatures
- Fast-Setting Slide Switches Covering All Elements of 12-Pin Compactron Tubes • Accurately Checks Over 1600 Different Tubes • Tests for Cathode Emission, Leakage and Shorts plus Filament Continuity • Completely Portable—Weights Only 6 lbs. • Highly Accurate Easy-to-Read Meter with Replace—Good Scale • Slide-Out Tube Chart

**FULL
SIZE**
9 $\frac{3}{4}$ "Wx8 $\frac{1}{8}$ "Dx2 $\frac{1}{2}$ "H

A modern, dependable tube checker designed for fast, accurate testing—the ideal low-cost tube tester for any radio-TV serviceman, experimenter, technician, etc. This outstanding instrument tests most of the tube types employed in Radio, Hi-Fi, Monochrome and Color TV, including the new 12-pin compactrons, nuvistors, T-9's, 7 and 9-pin miniatures—actually tests over 1600 different tubes! A special alligator clip lead is furnished for testing tubes with top caps. Slide switches are employed to connect the various tube elements to their respective test circuits. A 3-position tube slide switch adjust for checking shorted elements, cathode emission and filament continuity. A leakage indicator light glows when an inter-element short or leakage is present in a tube. A power switch turns the unit on and additionally serves to adjust for various AC

line voltages. Large easy-to-read meter calibrated 0-100 has a red-green "Replace—Good" scale, plus a special scale for checking diodes.

A handy slide out metal tray contains tube charts which facilitate rapid selection of test settings. Metal case is attractively finished in cream and steel gray. Completely portable—weights only 6 lbs. and measures 8 $\frac{1}{2}$ "Dx9 $\frac{3}{4}$ "Wx2 $\frac{1}{2}$ "H. Supplied with carrying case. For 105-125 volts, 60 cycle AC. Shpg. wt., 7 lbs. Imported.

99 K 5011 Tube Checker Net 19.95

DELUXE TUBE TESTER IN CARRYING CASE. Same as our Tube Tester above, but housed in portable wood case with grey vinyl trim. Imported.

99 K 5012 Net 23.95

DELUXE LAFAYETTE 20,000 Ohms-Per-Volt VOM with GIANT 6" Meter

Not a Kit—Completely Wired and Tested

2695

- Giant 6" Full-View Meter
- Expanded Easier-To-Read 2-Color Scale
- 20,000 Ohms-per-volt DC
- 1% Multiplier Resistors
- DC Volts From 0-5000V in 8 Ranges
- AC Volts From 0-5000V in 6 Ranges

A precision VOM with varied ranges for accurate measurement of voltage, current, resistance and decibels. This deluxe VOM gives you accuracy comparable to bench type units, with the added feature of complete portability. Expanded 6" meter scale in red and black gives you top visibility. 50-microamp meter sensitivity provides 20,000 ohms per-volt input resistance on DC and 5,000 ohms per-volt on AC—Wide-range frequency response measures 10 to 100,000 cycles within ± 0.5 db. A single 1.5V battery in the ohmmeter circuit prevents burnout to low current drain devices. All multiplier resistors are 1% precision type. Heavy gauge steel case with high impact plastic panel. Includes test leads, batteries and leather carrying handle. Size 6 $\frac{1}{2}$ "Wx7 $\frac{3}{4}$ "Hx3 $\frac{1}{8}$ "D. Shpg. wt., 4 $\frac{1}{2}$ lbs. Imported.

99 K 5013 Net 26.95

SPECIFICATIONS

Sensitivity: 20,000 ohm/volt DC, 5000 ohms/volt AC. Range: AC: 0-5000 volts (in 6 ranges): 2.5, 10, 50, 250, 1000, 5000V; DC: 0-5000 volts (in 8 ranges): 0.25, 1, 2.5, 10, 50, 250, 1000, 5000V. DC Current, 0-10 amps (in 6 ranges): 0-50 μ a, 1 ma, 10 ma, 100 ma, 500 ma, 10 amps. Ohmmeter: 0-20 megohms (in 3 ranges): 0-2K, 200K, 20M. Decibels: —20 to +50 db. Accuracy: DC: $\pm 3\%$ Full Scale. AC: $\pm 4\%$ Full Scale. Resistance: $\pm 3\%$ Full Scale.



LAFAYETTE V.T.V.M. WITH 6½" METER

- Wide Band RMS Measurements on any Waveform from 30 cps to Over 5MC, Without Additional Probes or Accessories
- 11 Megohm Input Resistance—Negligible Loading Effects on DC Circuits
- Direct Reading DB Scale
- Balanced Push-Pull Amplifier-Isolates and Protects Meter
- Pilot Light Indicates When Unit is "On"
- Selected 1% Zero Temperature Coefficient Multiplier Resistors for Dependable, Accurate Readings
- Silicon Rectifier in Power Supply Reduces Effects of Heat on Component Values

NOT A KIT...
FULLY WIRED
AND TESTED

ONLY

26⁹⁵

Made in U.S.A.



- ACCURATELY MEASURES AC PEAK-TO-PEAK VOLTAGE, AC RMS VOLTAGE, DC VOLTAGE AND RESISTANCE
- GIANT 6½" FULL-VIEW METER WITH EASY-TO-READ TWO-COLOR SCALES

This high quality V.T.V.M. is an indispensable test instrument for the service technician, engineer, or experimenter. It is a highly accurate DC voltmeter, AC voltmeter and ohmmeter employing a giant 6½" easy reading 400 μ a meter. With a high input impedance of 11 megohms, this V.T.V.M. can accurately measure DC voltages up to 1500 volts, while presenting a negligible load to the circuit under test. As a wide band AC voltmeter, it will measure AC peak-to-peak voltages up to 800 on any waveform be it sinusoidal, sawtooth, square or of any other complex form; all this from 30 cps to above 5 Mc — without any accessory probes! AC RMS voltages may be read directly up to 1,500 volts if the waveform is sinusoidal. Resistances can be read directly on the Ohms scale from 0 to 1,000 megohms in 5 overlapping scales. A direct reading scale is calibrated from —10 to +45db (reference 1.73 volts, 6 mw into a 500 ohm line). The meter

is isolated from the measuring circuits by a DC amplifier, making it virtually impossible to burn it out. Multiplier resistors are 1% zero temperature coefficient types. Function Selector—selects power off, AC volts, P-P volts, D.C.V. Neg., D.C.V. Positive, Ohms; Range Selector—for 7 voltage and resistance ranges; Ohms Adjust; Balance (zero) Adjustment. There are 3 probes: Common A.C. volts—ohms, and shielded DC volts probe with 1 megohm isolating resistor. Silicon rectifier power supply for 110-120 VAC, 60 cps. Dimensions: 7½Hx 6½Wx5"D. Comes with 1½ volt battery for ohmmeter circuit and complete instructions. Shpg. wt., 7 lbs.

- 38K0101 Above V.T.V.M. Net 26.95
- 38K0103 Accessory RF probe for V.T.V.M. Net 3.95
- 38K1501 Leather Case For V.T.V.M. Net 2.95

SPECIFICATIONS

DC VOLTMETER RANGES: 0 to 3, 30, 150, 300, 1500 volts. Input resistance: 11 megohms (1 megohm in probe) on all ranges.
A.C. VOLTMETER RMS RANGES: 0 to 3, 30, 150, 300, 1500 volts.
PEAK-TO-PEAK RANGES: 0 to 8, 80, 400, 800 volts. DECIBEL RANGES: —10 to +5, +6 to +25, +26 to +45 db. Response: 30 cps to above 5 Mc.

OHMMETER RANGES: 0 to 1000 megohms in 5 overlapping ranges.
ZERO CENTER VOLTMETER RANGES: 0-1.5, 15, 75, 150, 750 volts.
TUBES: 1-6211 twin triode balanced meter bridge; 2-9006 peak-to-peak rectifiers; silicon rectifier power supply.
POWER: 110-120 VAC, 60 cps.

LAFAYETTE COMBINATION SIGNAL GENERATOR AND SIGNAL TRACER

NOT A KIT — FACTORY WIRED AND TESTED

SIGNAL GENERATOR

- Covers From 250 KC to 120 MC in 5 Bands
- High Stability Electron Coupled Oscillator
- Attenuator For Both RF and Audio Circuits
- Most Used Frequencies Marked on Panel in Color
- Utilizes New Ruggedized Industrial Types Tubes

SIGNAL TRACER

- Hi-gain Cascode Pre-amplifier
- Front Panel Output For VTVM, Scope or Phones
- Low Distortion Triode Output Stage
- Separate R.F. and Audio Signal Probes

ONLY **24⁹⁵**

Two test instruments in one! The Signal Generator will serve as a full service instrument and the Signal Tracer will follow any signal whether generated by a broadcasting station or injected by the Signal Generator section. When used in combination, with no dependence on outside signals, the unit provides ideal service, for unlike any standard signal tracer, it first injects its own signal then traces that controllable signal to locate the source by standard signal tracing technique. Designed for use with AM, FM, TV and audio circuitry. Features 5 frequency ranges and an attenuator switch to control both the R.F. signal (either modulated or unmodulated) and the 400 cycle audio tone. Front panel output jacks which can be used for oscilloscope, VTVM or earphone connections. Housed in a beautiful crackle finish steel cabinet with a deep etched aluminum panel. Dimensions: 7½x9½x5¾". Complete with 2 probes. Shpg. wt., 9 lbs.
38K0102 Net 24.95

SPECIFICATIONS

RANGE: Band A: 250KC to 850KC; B: 850KC-3000KC; C: 3.0MC to 11MC; D: 11MC to 45MC; E: 35MC to 120MC; 400cps audio signal; modulation slide switch, RF/AF attenuator and power switch; Signal output jack; AF input jack, 2 Preamp. output jacks. 4½" alnico 5 speaker. Tubes: 5687, 6350, 6AG5 plus sel. rectifier.



Made in U.S.A.

See Our Catalog 650 For Additional Test Equipment

LAFAYETTE RF SIGNAL GENERATOR



- FACTORY CALIBRATED AND TESTED • SIX BANDS: 120 KC · 260 MC
- DUAL OUTPUT RF TERMINALS • SEPARATE VARIABLE AUDIO OUTPUT
- DIAL CALIBRATION $\pm 2\%$ • ETCHED CIRCULAR DIAL - (Vernier Tuned)

A stable, wide-range signal generator engineered to fill the need for an accurate low cost service instrument. The delicate oscillator coils and tuning assembly are factory mounted and adjusted for optimum performance. This top-flight unit can be used for IF-RF alignment, audio signal tracing of TV, FM and AM sets. TV linearity checks and 400 cycle audio testing. In addition, it can serve as a marker generator when used with a suitable sweep generator. Incorporates a large 4 1/4" etched circular dial for easy, accurate frequency adjustments. Provides a fundamental frequency output of 120 KC to 130 MC in 6 bands plus a calibrated harmonic output of 120 mc to 260 MC. The built-in audio oscillator operates at 400 KC with adjustable output to 8 volts. Continuously variable RF attenuator for proper signal attenuation and two plug-in RF output terminals provide a choice of high and low outputs for maximum flexibility. High output and tuning dial calibration of $\pm 2\%$. Imported 99 K5015 Net 27.95

27⁹⁵

SPECIFICATIONS

Full frequency range: 6 Fundamental bands—120-320 Kc 320-1000 Kc. 1-3.5 MC, 3.2-11 MC, 11-38 MC, 36-130 MC; One harmonic band 120-260 MC. Frequency Accuracy: $\pm 2\%$. Audio Output: to 8 volts. Large 4 1/4" Etched Circular Dial (Vernier tuned) High-Low

RF Output Terminals. Tube Complement: 12BH7A, 6AR5, Selenium Rectifier. Power Requirements: 105-125VAC 50/60 Cps., 12 Watts. Attractive gray wrinkle steel case with leather carrying handle. Complete with test leads. Size: 7Hx10 1/2Wx5 3/8"D. Shpg. wt., 9 lbs.

LAFAYETTE SINE/SQUARE WAVE GENERATOR

- FACTORY CALIBRATED AND TESTED • LOW DISTORTION • FREQUENCY RANGE · SINE WAVE: 20 cps—200 KC IN 4 BANDS; SQUARE WAVE 20-25 KC (Vernier Tuned) • ETCHED CIRCULAR DIAL • FREQUENCY RESPONSE - $\pm 1.5\text{DB}$, 60CPS — 150KC 4 1/2" VERNIER DIAL

Especially designed for radio-TV servicemen, Hi-Fi fans and students who require a dependable sine and square wave generator at low prices. An outstanding instrument . . . factory wired, tested and calibrated. Among its many applications are square wave testing of audio amplifiers, determining the frequency and transient response of loudspeakers, TV audio circuit testing and many other uses. Quality features and specifications consist of a frequency range of 20 cps to 200,000 cycles in 4 bands. A large easy-to-read and set etched dial (vernier tuned) adds a professional quality touch. Variable attenuator adjusts amplitude of output signal. A full wave power supply is incorporated to provide low distortion and constant output. Factory wiring and calibration insure accuracy of $\pm 3\%$. Output voltage is 7 volts across a 1 megohm load. Rugged steel cabinet and shock-proof mountings protect components. Complete with instructions and test leads. For 117 V 50/60 cps AC. Size: 10 1/2Wx7 1/2Hx5 3/8"D. Shpg. wt., 10 lbs. Imported.



Net 35.95

SPECIFICATIONS

Frequency range: Sine wave; 20-200,000 cps in 4 bands. Square wave—60-30,000 cps. Output Voltage—Sine: 7V RMS; Square 7V P-P. Output Impedance—0-5000 Ohms. Frequency Accuracy: $\pm 3\%$. Distortion: Less than 2%. Tube

Complement: 1-6BM8, 1-12AT7, 1-6X4. Power requirements: 117V 50/60 cps, 19W. Gray wrinkle steel case with leather carrying handle. Complete with a pair of test leads. Size: 7Hx10 1/2Wx5 3/8"D. Shpg. wt., 10 lbs.

35⁹⁵

\$5.00 monthly

DELUXE SIGNAL GENERATOR



MADE IN U.S.A.

ONLY

37⁷³

\$5.00 monthly

- Genometer—7 Signal Generators in one • RF Signal Generator for AM
- RF Signal Generator for FM • Audio Frequency Generator • Bar Generator • Cross Hatch Generator • Color Dot Pattern Generator • Marker Generator

A versatile all-inclusive Generator which provides all the outputs for servicing: AM Radio, FM Radio, Amplifiers, Black and White TV, Color TV. SPECIFICATIONS: RF Signal Generator—Provides complete coverage for AM and FM alignment. Generates radio frequencies from 250 KC to 45 MC on fundamentals and from 35 MC to 120 MC on powerful harmonics. Cross Hatch Generator—Will project a cross-hatch pattern on any TV picture tube. The pattern will consist of non-shifting, horizontal and vertical lines interlaced to provide a stable cross-hatch effect. Variable AF Generator—Provides a fixed 400 cycle sine-wave or a variable 300-20,000 cycle peaked wave audio signal. Dot Pattern Generator—The dot pattern projected on any Color TV picture tube enables you to adjust for proper color convergence. Bar Generator—Projects an actual bar pattern of 4-16 horizontal bars or 7-20 vertical bars on any TV receiver screen. Marker Generator—Provides 9 most frequently needed marker points (262 KC, 456 KC, 600 KC, 1000 KC, 1600 KC, 2500 KC, 3,579 MC, 4.5 MC, 10.7 MC). Complete with shielded leads and operating instructions. Size: 10Wx7Hx5 3/8"D. Shpg. wt., 7 lbs. 38K 1001 Net 37.73

FACTORY ASSEMBLED Ready-to-Use TEST EQUIPMENT

LAFAYETTE CAPACITANCE-RESISTANCE ANALYZER

- Capacitance Bridge Circuit
- Direct Reading Scales
- "Magic-Eye" Null Indicator And Meter
- Measures Electrolytic Power Factor

39⁵⁰

\$5.00 Monthly

Tests capacitors of all types for value, shorts, opens, leakage, insulation resistance and power factor. Measures resistance from 2 ohms to 200 Megohms. Invaluable for determining the turns and impedance ratios of audio and power transformers. All readings are made directly on expanded easy-to-read etched dial scales. Leakage current and insulation resistance of capacitors are read directly on meter. Bridge circuit accurately measures resistance and capacity. "Magic-eye" indicator permits fast visual results for "null" opens or shorts. Complete with instructions and test leads. For 117V 50/60 cycles AC. Grey wrinkle finish steel with carrying handle. 10½Wx7Hx5¼"D. Shpg. wt., 12 lbs. Imported.

99 K5017

Net 39.50

SPECIFICATIONS

Capacity Ranges: 20 mmf to 2000 µf in 4 ranges. Resistance Ranges: 2 ohms to 200 megohms in 4 ranges. Leakage Test: 3-600 volts; Current 0-1 ma; 0-10 ma. Transformer Turns Ratio: 1:1 to 200:1. Transformer Impedance Ratios: 1:1 to 40K:1.

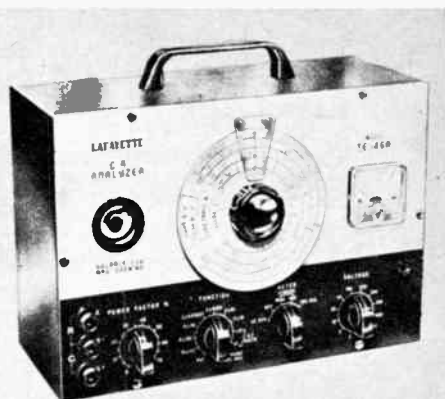

LAFAYETTE DELUXE CRT REJUVENATOR TESTER

39⁵⁰

\$5.00 Monthly

- Checks and Corrects Each Gun of Color Tube Separately
- Rejuvenates All TV Picture Tubes Including Color and 110° Types

Rapidly checks and corrects black and white and color TV picture tubes including 110° types without removing them from the set. Restores brightness and emission to old CRTs. Determines quality of CRTs by means of an emission test. Large 4½" meter gives legible readings at a glance. Selector switch provides a choice of dual filament voltages of 6.3 V and 12.6 V. Checks and corrects each gun of color tube separately. Repairs interelement shorts and open circuits. Includes 3 additional tube socket adaptors for 110° deflection type tubes. For 105-125V 60 cycle AC. Handsome portable leatherette covered gray case with detachable top. Size: 4¾x7½x13½". Shpg. wt., 9 lbs. Imported.

99 K5018 Deluxe CRT Tester Net 39.50

Adapter for 23EP4 picture tube. Shpg. wt., ½ lb. Imported.

99 K5019 Net 1.50



CAPACITANCE SUBSTITUTION BOX

- 36" Color Coded Test Leads & Clips
- 9 Ranges From .0001 to .22 MFD

295

600 volts working capacity. 9 capacitance ranges are .0001, .0022, .0047, .01, .022, .047, .1 plus 22 MFD. Complete with 36" red and black test leads and alligator clips. Size: 4¾x2¾x1¾". Shpg. wt., 1½ lbs. 99 K5020 Imported Net 2.95

LAFAYETTE IN-CIRCUIT CAPACITOR CHECKER



1495

- Checks Capacitors in Circuit
- Magic Eye Indicator
- Wide Range 10 MMF to 2000 MMF

Allows you to check most capacitors from 10 mmf to 2000 mmf for open or shorted conditions without unsoldering. Just connect the test leads across the component you wish to test, press the switch and note the eye tube's face for an open or short condition. Checks coupling, by-pass, filter and blocking capacitors. Accurate readings are made in seconds—an important factor in today's complex electronic equipment. It also indicates capacitor leakage. Tests for opens on capacitors of 10 mmf. or more; for shorts up to 2,000 MF. Shunted by not less than 10 ohms. Complete with test leads and instructions. For 117 VAC. Size: 7¼Wx5Hx4¼"D. Shpg. wt., 5 lbs. Imported. 99K 5022 Net 14.95

RESISTANCE SUBSTITUTION BOX

- 24 Resistance Ratings
- Two Ranges—Low 15-10K Ohms. High 15K-10 Megohms
- 36" Red & Black Test Leads with Alligator Clips

395

ranges—Low: 15 ohm—10K ohms (1 watt resistors) High: 15K ohm—10 Megohms (½ watt resistors). Two rotary switches (12 steps each) selects 24 separate resistances. Size: 4¾x2¾x1¾". Shpg. wt., 1½ lbs. 99 K5021 Imported Net 3.95



A must for the serviceman, experimenter or student. Fast accurate selection of any one of 9 capacitor values from .0001 to 22 MFD. Condensers are porcelain cased tubular type impervious to moisture and are rated at

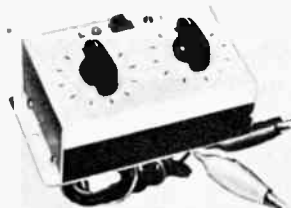

Ideal for laboratory or service application. Substitute resistance values fast and accurately in trouble shooting circuits where values may be changed. Easy to find bias resistance in experimental vacuum tube or transistor circuits. Slide switch selects two

Test Equipment is Available on Easy Pay Plan—See Center Insert A

Lafayette Cat. No. 652 147

WORLD FAMOUS TEST EQUIPMENT KITS

LAFAYETTE TRANSISTOR ANALYZER KIT



Lafayette's 6-in-1 Transistor Analyzer is a tester capable of testing transistors of all types including power types. The in-circuit test couples the transistor to an oscillator circuit within the tester for an actual performance check. Externally the transistor is checked for leakage on a multi-colored scale and for beta gain in 3 ranges up to 200. Makes trouble shooting transistor radios easy by supplying a 5kc test signal with harmonics for checking the RF, IF, and AF circuits. This signal can also be coupled to an oscilloscope for a visual circuit function

6-IN-1 TESTER

- In-Circuit and Out-Of-Circuit Transistor Checker (Including Power Types)
- Diode and Rectifier Checker
- Signal Generator
- Battery Tester
- Voltmeter
- Milliammeter

ONLY **13.50** MADE IN U.S.A.

test. This analyzer also checks the condition of diodes and rectifiers. Features a voltmeter which can check up to 12 volts DC and for testing transistor radio batteries. This analyzer can check current drain up to 80 milliamperes. Complete with test leads and step-by-step illustrated instructions. Attractive black case and anodized aluminum front panel. 6 $\frac{1}{2}$ "x 5 $\frac{3}{4}$ "x2 $\frac{1}{2}$ ". Shpg. wt., 3 $\frac{1}{2}$ lbs.
19 K 0901 Complete Kit Net 13.50
Extra 1 $\frac{1}{2}$ volt Battery (2 required)
32 K 4801 Net ea. **13**

RCA MODEL WV-77EK JUNIOR VOLTOHMST KIT



29.95

46.95 WIRED

This kit makes possible substantial savings in a high quality vacuum-tube voltmeter. Its 28 ranges include 7 DC voltages: 0-1.5, 5, 15, 50, 150, 500, 1500, with $\pm 3\%$ of full scale accuracy and input resistance of 11 megohms; 7rms AC voltages: 0-1.5, 5, 15, 50, 150, 500, 1500, with $\pm 5\%$ of full scale accuracy; 7 peak-to-peak AC voltages: 0-4, 14, 40, 140, 400, 1400, 4000 volts, with 5% accuracy; 7 overlapping ohms ranges from 0.2 ohms to 1000 megohms with center-scale values of 10, 100, 1000, 10K, 100K, 1 meg, and 10 meg. ohms. Other important features include zero center for discriminator alignment; frequency response of 40 cps to 5mc, flat to within $\pm 5\%$ on the 1.5 to 15 volt rms and 4 to 40 volt p-to-p ranges; 1% deposited-carbon resistors; meter electronically protected against burnout. Power requirement is 5 watts at 105-125 v., 50-60 cps AC and VS035 battery. Supplied complete with DC and AC/ohms probes and cables and ground leads, battery, and instruction booklet.

38 K 4602 Shpg. wt., 5 $\frac{1}{2}$ lbs. Net 29.95
WV-77E wired and factory-calibrated.
38 K 4603 Net 46.95

RCA MODEL WV-38AK VOLT-OHM MILLIAMMETER KIT



29.95

47.95 WIRED

Here is a VOM by RCA that you can get either as a kit or as a factory wired instrument. A must for any kind of electronic servicing. DC voltage has 8 ranges: 0-0.25, 1.0, 2.5, 10, 50, 250, 1000, 5000 volts, with $\pm 3\%$ of full scale accuracy. DC input resistance is 20,000 ohms per volt. AC voltage has 6 ranges: 2.5, 10, 50, 250, 1000, 5000 volts, with $\pm 5\%$ full scale accuracy. Input resistance is 5000 ohms-per-volt. Frequency response, measured with reference at 1000 cps is flat within $\frac{1}{2}$ db from 10 cps to 50K for 2.5, 10, 50-volt ranges. Resistance from 0-2,000—200,000—20,000,000 ohms in three ranges. DC current has 6 ranges: 0-1-10-100-500 milliamperes, and 0-10 amps, with full scale accuracy of $\pm 3\%$. Complete with batteries, ground lead and instruction booklet. Size: 5 $\frac{1}{4}$ "x3 $\frac{1}{2}$ "x6 $\frac{7}{8}$ "

38 K 4604 Shpg. wt., 4 lbs. Net 29.95
WV-38A Completely wired and factory tested.
38 K 4605 Net 47.95
Model WG-270A Leather Carrying Case for WV-38A(K)
38 K 4606 Shpg. wt., 2 lbs. Net 4.95

EICO TEST EQUIPMENT

Kits and Factory wired

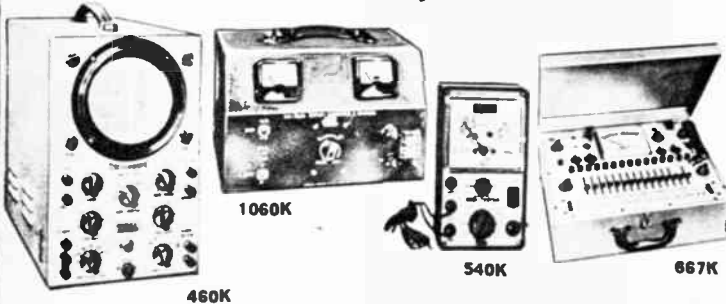

DELUXE MODEL 460K 5" WIDE-BAND SCOPE KIT

Lab quality. For color and monochrome TV. Response flat from DC to 4.5 Mc, usable to 10 Mc. Easily reproduces 3.58 Mc color or TV sync boost. Direct coupled push-pull vertical amplifier sensitivity, 25 MV/inch. Sweep: 10 cps to 100 Kc, plus low frequency sweep. Input impedance 3 megs. 2 X full screen horizontal positioning. 4-step freq. compensated attenuator. 13x8 $\frac{1}{2}$ "x16". For 105-125 VAC. 50-60 cycles. 30 lbs.
38 K 2643WX Model 460 Kit Net 89.95
Model 460. As above, but factory wired.
38 K 2644WX Net 129.50

MODEL 1060K 6-12 VOLT BATTERY ELIMINATOR & CHARGER

Reliable source of 6 and 12 volt DC power for transistor, hybrid or vacuum tube work. Current range automatically adjusts with voltage range selection. Very low ripple. DC Ranges: 8 and 16 volts. AC Ripple 12V: 0.3% @ 2 amps; 1% @ 6 amps; 1.5% @ 10 amps; 6V: 1.5% @ 2 amps, 2% @ 6 amps, 4.5% @ 10 amps. Current ranges: 8V-10 amps, continuous, 20 amps intermittent, 16V-6 amps cont., 10 amps. inter. Meter scales: 0-20 volts, 0-10, 0-20 amms. For 105-125 VAC, 60 cps. Size: 10 $\frac{1}{2}$ "x8 $\frac{3}{4}$ "x7 $\frac{3}{4}$ "D. 19 lbs.
38 K 2705 Kit Net 39.95
Model 1060 as above, but factory wired.
38 K 2706 Net 49.95

MODEL 540K UTILITY TESTER KIT

An all-in-one Multi-Range AC/DC voltmeter, ammeter, ohmmeter, wattmeter and leakage checker. Indispensable in home repairs of electrical appliances, and in automotive trouble-shooting of batteries, generators, distributors, etc. 3 $\frac{1}{2}$ " meter, ranges: Volts AC/DC 0-7.5-15-150-300. AC/DC current: 0-15-amps. Ohms: 0-1000 ohms. Capacitor leakage test. All components and instructions supplied. 3 $\frac{3}{4}$ "x6 $\frac{1}{2}$ "x3 $\frac{1}{2}$ " Shpg. wt., 3 lbs.

38 K 2624 Model 540 Kit Net 12.95
Model 540. As above, but factory wired.
38 K 2625 Net 15.95

MODEL 667K DYNAMIC TUBE AND TRANSISTOR TESTER KIT

Combines mutual conductance and plate conductance test with peak emission test for a single reading of tube quality. Also checks transistors for leakage and beta. Tests most receiving tubes including: nuvistors, novars, compactrons, miniatures, subminiatures, localts and octals. Also checks special purpose and foreign tubes. Multi-circuit level switch, 15 push-button leakage switches. 4 $\frac{1}{2}$ " 200 μ D'Arsonval meter. Roll chart. For 105-130 VAC. 60 cps. Steel case. 12x15x4 $\frac{1}{2}$ ". 20 lbs.

38 K 2652WX Kit Net 79.95
Model 667 as above, but factory wired.
38 K 2653WX Net 129.95

AUTOMATIC TIMERS AND COUNTERS

INTERMATIC MODEL A211-4 TIME-ALL

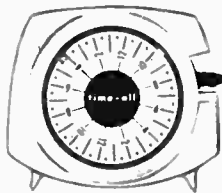

797

Makes practically everything electrical completely automatic. Will handle loads up to 1875 watts. Turns radio on and off—does not have to be reset each night. Defrosts refrigerator—turns lights on and off—controls roaster, electric blanket, washing machine, coffee makers, vaporizers, etc. 30 min. minimum on time—23 hours maximum. As easy to set as an electric clock. Stands on any surface—can be hung on wall. Easy-to-read 24 hour "day and night" dial. Operates day after day without attention. Special alloy "T". Can be controlled manually without automatic reset. Plug-in receptacle for equipment to be controlled. For 110 volt 60 cycle AC only. Complete with 6 ft. cord and plug. Instructions included. 5x4x2½". Shpg. wt., 2 lbs.

13 K 2715 Net 7.97
 MODEL A221-4 TIME-ALL. Similar to A211 except has capacity of 875 watts. Shpg. wt., 2 lbs.
 13 K 2716 Net 7.29

TELECHRON TIMER SWITCH



Turn on any Appliance up to 1650 watts.



395

Genuine Telechron mechanism. Complete 12 hour movement. Can be set to turn on any radio, TV or similar electrical appliance at any preset time. Gold finish dial—black lettering. Timer sets from rear. On-off-auto switch in front. Size 3½" square. 1¾" deep. Set shaft extends 5½" to rear. SPST switch, rated 15 amps at 115 volts. For 110-120V, 60 cy. AC only. Shpg. wt., 2 lbs.

*Plus 10% F.E.T.
 13 K 4408 Net 3.95

TELECHRON TIMER SWITCH



- Radio — TV — Appliance Timer
- 60 Minute Sleep Switch
- Simple Installation
- 1650 Watts

Automatically turns on radios—TV sets—etc.—at any preset time in a 12 hour period. "Sleep-Switch" allows up to 60 minutes of continuous run prior to "shut-off." Built in signal alarm. All controls on front. On-off-auto. 0 to 60 sleep switch, alarm set and time set. Gold finish dial—black lettering. 3½" square bezel. 1¾" deep. SPST rated 15 amps at 115 volts, 1650 watt load capacity. For 110-120V, 60 cy. AC only. Shpg. wt., 2 lbs.
 *Plus 10% F.E.T.
 13 K 4409 Net 4.98

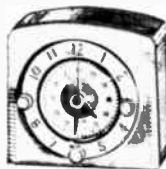

INTERMATIC MODEL A401-4 CLOCK TIMER

877

Not only tells time, but turns appliances both on and off automatically for periods of 15 minutes to 5½ hours. Cooks dinner while you're away, wakes you to music, controls electric fans, heaters, radios, TV sets, etc. No installation problem—just plug it in and set. Capacity 1875 watts. 4¾Wx4½Hx2¼"D. 6 ft. cord. For 110V 60 cycle AC. Guaranteed for 1 year. Shpg. wt., 3 lbs.

13 K 2717 Includes F.E.T. Net 8.77



INTERMATIC TYPE T101 TIME SWITCH

777

Turns equipment "on" and "off" once in 24 hours, or from 1-12 "on" and "off" operations a day can be obtained by use of extra trippers—can be added without removing dial. Min. on or off time 1 hr., max. 23 hours. Can be turned on or off manually with reset SPST switch rated at 40 amps, 4375 watt capacity. Mounting holes and knockouts. Gray steel case. UL approved. Operates on 110 volt 60 cycle AC. 7¾Lx5Wx3"D. Shpg. wt., 4 lbs.

13 K 2702 Net 7.77

5-DIGIT STROKE-ACTUATED RESET COUNTER



269

- Registers up to 99,999
- For Machine Mounting
- Complete with Arm and Spring

Easy-to-mount rugged counter for counting machine operations. One count per stroke. Drilled mounting flange; actuating arm and spring. May be manually or solenoid actuated. Reads up to 99,999; side knob easily resets to zero from any number. Overall size: 2½x1½x1¾". Shpg. wt., ½ lb. Imported
 99 K 9029 Net 2.69

UTILITY HOUSEHOLD TIMER



290

This reliable, low-priced timer in a neat durable white plastic case has innumerable household timing uses, i.e., cooking, baking, home permanents, games, remembering appointments, TV and radio programs, etc. Attractive modern design. Times any interval up to one hour accurately and gives resonant bell signal at end of period. Large easy to set and easy to read dial. 3½x3x1½" Shpg. wt., ¾ lb.

13 K 8056 Net 2.90

TIMED EXTENSION CORD

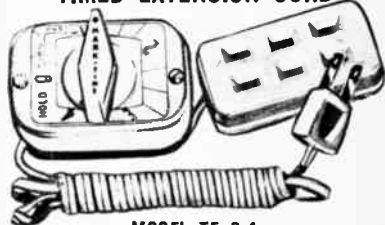

MODEL TE C-4

Set It and Forget It

- Automatic Time Switch & Extension Cord + 3-Way Outlet • Controls up to 3 Appliances at Same Time
- Reduces Electric Bills

A 3-way combination for every home—an automatic time switch, extension cord, convenient outlet. 0-4 hour time cycle. Easy to operate—plug it into any wall outlet, connect one, two or three devices to be controlled, and turn the knob to the time period desired. At the end of this time period, the electricity is turned off automatically. 6-foot cord. Shpg. wt., 1 lb.

13 K 8501 Net 5.11

APPLIANCE MINDER

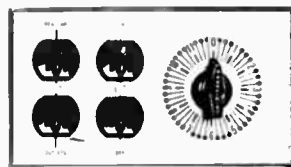

- Adds Space—Convenience—Versatility
- Wall or Panel Mounting

Add new space to the new or remodeled kitchen... more time for the harried housewife. Simply plug in the coffee-maker, rotisserie, electric frying pan, etc... set the timer up to 12 hours ahead... let the appliance minder do the rest. Easily installed in a 4-gang wall box—or surface mounted. Contains two timed outlets (one turns "on," the other turns "off") and two regular outlets. Allows advance planning of meals—go out and return home hours later to a cooked meal. Rated at 15 amps—125 volts AC. UL inspected. Shpg. wt., 1½ lbs.

13 K 8511 Net 10.99

HAND TALLY REGISTER



229

- 4 Digit Capacity
- Counts 0-9999
- Single Turn Reset Knob

Registers 0 to 9999. Highly polished chromium plated brass case. Attached finger-ring and compact shape for comfort in holding. Plunger operated for smooth, easy action. Large, clearly read numerals. Knurled reset knob sets register to zero in one turn. Precision accuracy for lab, school and industrial users. Invaluable for inventory control — gate checking — traffic, etc. Small Size, approximately 1¾x1¾", permits concealed operation. Shpg. wt., ½ lb. Imported
 99 K 9030 Net 2.29

DELUXE LAFAYETTE FM COMMUNICATIONS RECEIVERS

MONITOR CALLS FROM STATE, COUNTY AND MUNICIPAL POLICE — FIRE DEPARTMENT —
— CIVIL DEFENSE — RAILROADS — TRUCKING — HIGHWAY MAINTENANCE — FORESTRY
CONSERVATION — PETROLEUM AND INDUSTRIAL ACTIVITIES

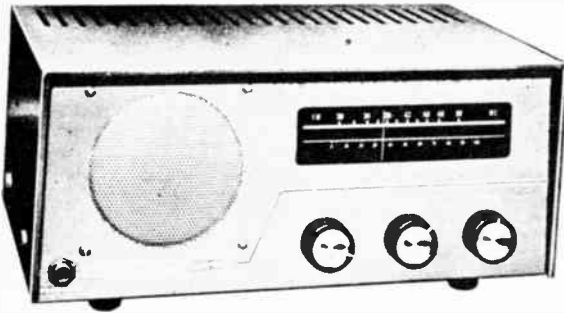

Two deluxe FM communications receivers for the office, field or home. Excellent sensitivity of 4 μ v or less for 20 db quieting and built-in adjustable squelch for dependable all-day monitoring of emergency, commercial, or industrial communications. Both units feature 3 IF stages and fully tuned RF stage. Model HA-52 incorporates 6CW4 nuvistor "front-end". A built-in 4" speaker gives clear voice reproduction . . . and as a special feature a front panel phone jack may be used for private listening. Large, easy-

Model HA-50 30-50 MC
Model HA-52 152-174 MC

- Variable Squelch
- Solid State Power Supply
- Extremely Sensitive Circuitry
- Built-in 4" Speaker
- 8 Tubes for 10-Tube Performance
- Nuvistor Front End*

59⁹⁵ \$5 monthly

to-read slide rule dial is illuminated for night operation. Housed in attractive blue-grey metal cabinet . . . makes a handsome addition to any home or office. Power requirements: 117 volts AC at 50/60 cps. Size: 11 $\frac{1}{2}$ x 5 $\frac{1}{4}$ x 7 $\frac{3}{8}$ ". Shpg. wt., 14 lbs. Imported. *Model HA-52 Only.

99 K 2525WX Model HA-50 30-50 mc Net 59.95
99 K 2526WX Model HA-52 152-174 mc Net 59.95

MONITORADIO FM MOBILE RECEIVERS



- M-40; Tunable 30-50 MC
- M-160; Tunable 152-174 MC

114⁹⁵

High quality mobile receivers for governmental, municipal and industrial uses. These tuneable receivers cover the entire FM communications bands with excellent sensitivity. 10 tube circuit features a fully tuned RF amplifier, dual conversion, and two stages of limiting followed by the discriminator. Power output is 8 watts, built-in 4" speaker. For 12v. DC 3.9 amperes. Housed in attractive cabinet, only 4 $\frac{1}{2}$ x 6 $\frac{1}{2}$ x 8 $\frac{3}{4}$ ". Shpg. wt., 10 lbs.

MODEL M-40 Tunable over 30-50 MC band.

40 K 6001WX Net 114.95

MODEL M-160 Tunable over 152-174 MC band. Sensitivity 4 μ v for 20 db quieting. Wt., 12 lbs.

40 K 6003WX Net 114.95

B & W 550A ANTENNA COAXIAL SWITCH



- No Loss When Switching Antennas

Lets you instantly select any one of five transmitters, antennas, exciters, receivers, etc., using 52 or 75 ohm line. The switch handles up to 1 kw of modulated power with a maximum crosstalk of -45 db at 30mc.

40 K 1602 Shpg. wt., 2 lbs. Net 8.25

40 K 1603 Model 902-Knob for 550A Net 1.02

40 K 1604 3818-Dial plate for 550A Net .75

DELUXE LAFAYETTE HA-55 AIRCRAFT RECEIVER

Listen To Aviation Control Towers and Aircraft

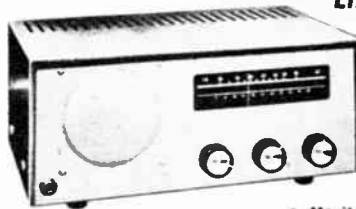

59⁹⁵ \$5 monthly

- Monitors Aircraft Frequencies from 108 to 136 Mc
- 8 Tubes for 11-Tube Performance
- Two RF Stages with A 6CW4 Nuvistor For High Sensitivity
- Solid State Power Supply
- Built-in Adjustable Squelch
- Illuminated Slide Rule Dial For Night Operation
- Built-in 4" Speaker With Front Panel Phone Jack

Now monitor the exciting frequencies of aircraft communications in your home or office with this deluxe receiver. The use of multi-purpose tubes gives 11 tube performance offering high sensitivity and selectivity. Two RF stages including a 6CW4 nuvistor really pulls in the stations. A variable squelch adjustable from front panel facilitates absolute quieting. A built-in 4" speaker provides excellent voice reproduction, and a front panel phone jack makes private listening possible. Large, easy-to-read slide rule dial is illuminated for night operation. Attractive blue-grey metal cabinet. For 117 volts AC at 50/60 cps. Size 11 $\frac{1}{2}$ x 5 $\frac{1}{4}$ x 7 $\frac{3}{8}$ ". Shpg. wt., 14 lbs. Imported.

99 K 2527WX Model HA-55 108-136 mc Net 59.95

ANTENNAS FOR LAFAYETTE COMMUNICATIONS RECEIVERS

Window mount antenna: 30-50MC; Shpg. wt., 2 lbs.

40 K 1301W Net 7.35

Ground Plane antenna; 108-470MC; Shpg. wt., 2 lbs.

40 K 1302W Net 5.39

ANTENNA SPECIALISTS MOBILE COMMUNICATIONS ANTENNAS

ASP-144 Disguise antenna for 30-50 MC. Supplied with 16 ft. RG-58/U cable and connector. Specify an exact freq. Allow 3 weeks delivery

40 K 1312WX Net 17.64

ASP-146 Disguise antenna designed to operate between 130 and 174 MC. Supplied with 16 ft. of RG-58/U cable and connector. Mounts in $\frac{7}{8}$ " hole. Shpg. wt., 3 lbs.

40 K 1313W Net 14.11

SUPEREX AMATEUR PHONES 24⁹⁵



Comfortable poly-foam ear cushions. 600 ohm impedance. High sensitivity and crisp, clear reproduction for that hard to read station. Shpg. wt., 2 lbs.

40 K 8501 Net 24.95

BUY YOUR AMATEUR EQUIPMENT AT LAFAYETTE

NEW **SWAN** 350 5-BAND SSB AMATEUR TRANSCEIVER



- 5 BANDS: 3.5-4.0MC, 7.0-7.5 MC, 13.85-14.35 MC, 21.0-21.5 MC, 28.5-29.0 MC
- 400 WATTS SSB INPUT, 320 WATTS CW INPUT 125 WATTS AM INPUT

A compact 5-band 400-watt SSB transceiver for fixed, portable or mobile operations. Frequency coverage 3.5-4.0 MC, 7.0-7.5MC, 13.85-14.35 MC, 21.0-21.5 MC, 28.5-29.0 MC with lower sideband operation on 80 and 40 Meters, and upper sideband on 20, 15 and 10 meters. This highly stable transceiver has a transistorized VFO, which is temperature and voltage stabilized, precision dual-ratio tuning, crystal lattice filter, ALC and AGC, S-meter, plus provision for plug-in VOX. Sideband suppression is 40 db, carrier suppression 50 db. Third order distortion is 30 db down. Dimensions: 5½Hx13Wx11"D. Shpg. wt., 18 lbs.

- 40 K 7008WX Model 350 Net 395.00
- AC Power Supply, Matching Speaker with Cabinet. Shpg. wt., 11 lbs. Net 85.00
- 40 K 7009WX Net 85.00
- 12V DC Power Supply for Model 350. Shpg. wt., 8 lbs. Net 130.00
- 40 K 7006WX Net 130.00
- 40 K 7007 Model VX-1 Plug-in VOX ADAPTER Net 35.00

NEW **AMECO** MODEL TX-62 2 AND 6 METER TRANSMITTER



149⁹⁵

- Frequency Coverage 50-54 MC and 144-148 MC
- Power Input: 75 Watts CW, 75 Watts peak on Phone
- Meter Reads Final Cathode Current, Final Grid Current and RF Output.
- Built-in Solid State Power Supply

A complete 75-watt phone and CW transmitter with a built-in power supply and modulator designed to operate on 50-54 and 144-148 MC. All circuits up to the final are broadbanded and only the final plate and loading capacitors have to be tuned when you QSY. Crystal controlled or can be used with a VFO. Crystals used are the 8 MC type. Mike/key jack and crystal socket are on front panel. Power input to the final is 75 watts on CW and 75 watts peak on AM phone. Controls: power switch, phone-CW switch, meter selector switch, crystal-VFO switch, audio gain control, drive control, bandswitch, final plate tuning and loading. Tube lineup: 6GK6-osc, tripler; 6GK6 doubler, 7868 tripler (on 2 meters); 7984 final; 12AX7 and 6GK6 modulator. Size: 11½x9½x6". Shpg. wt., 36 lbs. Net 146.95

LAFAYETTE SEMI-AUTOMATIC "BUG"



• SUPER SPEED KEY

A quality "Bug" designed for clear, easy sending and wide range of speed. 7 adjustments for speed and comfort. Precision-tooled, anti-rust nickel-plated brass and stainless steel operating parts. Speed adjustable 10 wpm to as high as desired. ¼" silver contacts; weight scale for reproducible speed settings. 6¾Lx3Wx2¼"H. exclusive of knobs and feet. Shpg. wt., 3½ lbs. Imported.

99 K 2552 Net 9.95

12 LESSON CODE COURSE

12 LESSONS ON A 12" LP RECORD



Learn Morse Code the modern practical way. Supplied with 12 lessons on a nonbreakable high quality 33½ rpm long playing record, recorded with code sound to provide further aid. Perfect for home studying. Speed progresses steadily from 3 to 16½ wpm. Complete with sturdy record album and instruction manual. Shpg. wt., 1½ lbs.

40 K 8901 Code Course Net 3.50



DRAKE TV-100LP LOW-PASS FILTER

Low-pass filter, Attenuates above 54 MCS. Handles 100 watts, 10-160 meters, 20 watts on 6 meters. For 529 line.

40 K 6513 Net 5.83

TV-1000LP. As above, but handles 1-KW on 10-160 meters, 200 watts on 6 meters.

40 K 6514 Net 16.61

B & W MINIDUCTORS

Highly efficient miniature coils offering extremely low losses and real space-saving economy. Ideal for compact circuits. Air wound, polystyrene insulation. Easily cut to size. All are 2" long except miniductors with 1" diameter are 3" long. Shpg. wt., 6 oz.

| 4 TURNS PER IN. | | | | 8 TURNS PER IN. | | | |
|------------------|-----------|------|-----|------------------|-----------|------|-----|
| DIAM. | STOCK # | TYPE | NET | DIAM. | STOCK # | TYPE | NET |
| ½" | 40 K 1610 | 3001 | .44 | ½" | 40 K 1611 | 3002 | .44 |
| ¾" | 40 K 1614 | 3005 | .53 | ¾" | 40 K 1615 | 3006 | .53 |
| ¾" | 40 K 1618 | 3009 | .62 | ¾" | 40 K 1619 | 3010 | .62 |
| 1" | 40 K 1622 | 3013 | .68 | 1" | 40 K 1623 | 3014 | .68 |
| 16 TURNS PER IN. | | | | 32 TURNS PER IN. | | | |
| ½" | 40 K 1612 | 3003 | .44 | ½" | 40 K 1613 | 3004 | .44 |
| ¾" | 40 K 1616 | 3007 | .53 | ¾" | 40 K 1617 | 3008 | .53 |
| ¾" | 40 K 1620 | 3011 | .62 | ¾" | 40 K 1621 | 3012 | .62 |
| 1" | 40 K 1624 | 3015 | .68 | 1" | 40 K 1625 | 3016 | .68 |

FAMOUS DOW-KEY ACCESSORIES



(Fig. A)



(Fig. B)

MODEL OK60 COAXIAL RELAYS (Fig. A)

Low-loss coaxial relay designed for dependable antenna switching. Low contact resistance with contact force at least 50 grams in transmit and 35 grams in receive position. Breakdown voltage in excess of 1000 volts rms. Insulation resistance at least 50,000 megohms. Coil impregnated with epoxy resin. Heavy phosphor bronze contact tongue with pure silver contacts. Size: 3¼x2¾x1½". Mtg. holes 6-32 clearance or 8-32 tapping. Shpg. wt., 1 lb. DK60-G2C with 115 VAC Coil

40 K 5201 Net 15.65

DK-60-G2C with 12VDC Coil Net 15.65

40 K 5202 Net 15.65

MODEL OK60-P PANEL MOUNTING COAXIAL CONNECTOR (Fig. B)

A panel mounting coaxial connector that can be permanently installed on panel in just a few minutes, without screws. Only a single ¾" diameter hole is required. Two serrated jam nuts hold connector securely in position. Will not loosen from frequent use. Easy to solder terminal. Shpg. wt., 6 oz.

40 K 5204 Net .70



AMECO HP-45 HIGH-PASS FILTER

High-pass TVI filter placed in the amateur and TV antenna line for attenuations of 40 db at 14 MC and 20 db at 28 MC. Balanced constant K circuit accepts 300 ohm twin line. Negligible insertion loss. Shpg. wt., 3 oz.

40 K 1005 Net ea. .93



AMECO AC-1T AMATEUR TRANSMITTER KIT

- Ideal for Novice
- Self Contained

The ideal unit for beginner or novice. Contains transformer powered AC power supply. Uses a Pi-network output circuit to load random length wire antenna. No antenna tuner required. Has full 15-watt input on 40 and 80 meters. Easy to build and operate. Complete with punched chassis, all parts, tubes (6V6 and 6X5) and instructions. Shpg. wt., 8 lbs.

40 K 1009 Transmitter Kit Net 19.55

40 K 1010 CK1 extra coil kit Net .73

Take Advantage of Lafayette's Low Amateur Equipment Prices

Lafayette Cat. No. 652 151

LAFAYETTE AMATEUR STATION ACCESSORIES

LAFAYETTE "PRECON" AMATEUR PRESELECTOR CONVERTER



4950

\$5.00 Monthly

- Crystal Controlled • For 80-40-20-15-10 Meter Bands • As a Converter—Converts Receiver to Dual Conversion Operation • Improves Selectivity • Widens Band Spread

The "Precon" is a crystal-controlled dual function unit for the price of one. As a preselector, it can be used ahead of any receiver to greatly improve gain, image rejection, and sensitivity. Tuned interstage circuits and 2 stages of RF amplification assures a high signal-to-noise ratio... As a converter, receiver range can be extended to 30 MC (receiver must tune

3.5-5.2 MC). Sensitivity and stability are excellent. Antenna trimmer on front panel. 3 crystals are included for 20, 15 and 10-meter bands. 52-ohm antenna co-axial connector is built-in. PL-259 connector required for output cable. Attractive modern steel cabinet with 4 rubber feet. Operates on 117 V 50/60 cycles. AC. Size: 10Wx6Hx8"D. Shpg. wt., 10 lbs. Imported. 99 K 2530 Net 49.50

LAFAYETTE 6 and 2 METER VFO

A Deluxe Self-Powered VFO For 6 and 2 Meters



- Voltage Regulated For Stability

A high quality variable frequency oscillator designed to operate with modern transmitters using crystal oscillators in the 8-9 Mc region. It provides dependable coverage of both the 6 and 2 meter amateur bands. High electrical stability is achieved by a series-tuned clapp oscillator. OB2 voltage regulator tube protects unit from line voltage variations. Completely self-powered, needs no power from your rig. Uses low-heat half-wave silicon rectifier. Illuminated plexiglass dial is calibrated from 50-54 Mc (6M) and 144-148 Mc (2M). Output voltage is 10-15 V rms. Tubes: 6BA6, OB2. Rigid mechanical construction. Complete with 24" low loss coaxial cable. For 117 Volts 50/60 cycles AC. Size: 6¼Wx4½Hx 4"D. Shpg. wt., 6 lbs. Imported. 99 K 2536 Net 29.95

LAFAYETTE SWR and FIELD STRENGTH METER



LOW, LOW PRICE

12⁹⁵

- Measures SWR, Relative Forward And Reflected Power to 1 KW
- Reads Field Strength

A handy 2-in-1 meter for use in the amateur radio station to check transmitters for SWR measurements. Can be left continuously in the circuit for monitoring transmitter outputs, SWR: 1:1 to 3:1; Accuracy ±5 db, 2 to 30 MC; Impedance: 52 Ohms; Antenna: 5-section, collapsible. Comparative RF field strengths can be easily determined with this fine meter. Sensitive 100 micro-ammeter movement with easy to read 2-color dial. Impedance matches 52 Ohm coaxial lines. Attractive grey hammertone aluminum case. Size: 1¼Wx5¼Hx2¼"D. Shpg. wt., 1 lb. Imported. 99 K 2537 Net 12.95

LAFAYETTE DELUXE SELF-POWERED VFO

- Covers 80 through 10 Meter Amateur Bands
- High Output to Drive Any Modern Transmitter

A deluxe variable frequency oscillator providing full coverage of the five bands from 80 to 10 meters. Employs a high "Q" series tuned Clapp oscillator, remarkable for its low drift. A VR tube eliminates frequency shift due to variations in line voltage. High output of 10-20 volts is sufficient to drive any modern transmitter. Features large easy-to-read illuminated slide rule dial with smooth tuning drive. Dual output impedance. Low heat silicon diode power supply prevents drain on transmitter power supply. Tubes 6AU6, 6AQ5, OA2. Size: 6½Wx5¼Hx7½"D. For 117 volts 50/60 cps AC. Shpg. wt., 7½ lbs. Imported. 99 K 2501 Net 34.50



LAFAYETTE NUVISTOR GRID DIP METER

Complete with All Coils

29⁵⁰

- Nuvistor Oscillator
- Compact, True One-Hand Operation
- Slim Color-Matched Coils for High Accessibility
- Covers 1.7 to 180 MC in 6 Bands

A compact unit designed for easy circuit coupling in hard-to-reach places. Thumb tuning. Sensitive Nuvistor oscillator/detector is ideal for checking resonant frequencies of tuned circuits, detecting stray resonances in transmitters, checking neutralization. Frequency range 1.7 to 180 MC in 6 accurately calibrated ranges. Powered by built-in 117V AC 50/60 cycle transformer power supply with silicon rectifier. Precision plug-in coils supplied in protective case. Solid finish aluminum panel. Size: 2¼Wx5¼Lx1¼"D. Shpg. wt., 2 lbs. Imported. 99 K 2503 Net 29.50



LAFAYETTE 10 TO 80 METERS ALL-BAND VERTICAL TUNEABLE ANTENNA

- 10 To 80 Meters
- For Fixed Operation
- Omni-Directional, Vertically Polarized
- Irridite Treated To Mil Specs

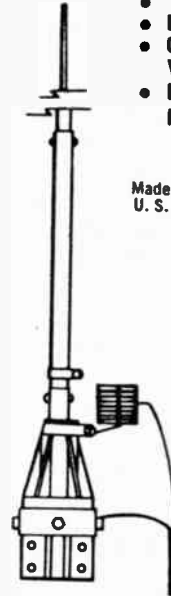

Made in U. S. A.

14⁹⁵

LOW, LOW PRICE

Our best buy multi-band antenna. Can be tuned to any amateur band 10 through 80 meters by a single adjustment. Has amazing efficiency for DX or local contacts. Ground or roof top or tower installation. Can survive winds in excess of 50 mph. Overall height 18'; knocks down to only 5'. Uses 3½" diameter air wound coil as matching inductor. All steel parts irridite treated to Mil. Specs. Impedance 52 ohms. Maximum power 1000 watts AM or CW—2 KW PEP. Omni-directional, vertically polarized. Shpg. wt., 5 lbs. 40 K 0104WX Net 14.95

LAFAYETTE QUALITY METERS AND TESTERS

for the CB'er & AMATEUR — Improved Performance — Low, Low Prices

LAFAYETTE MINIATURE ILLUMINATED MODULATION "S" METER

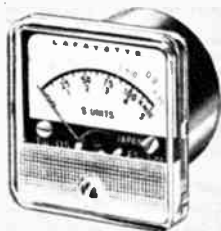

- Combination "S" Meter, % Modulation Meter and RF Power Output Meter
- Accurate D'Arsonval Movement
- Jewel Bearings

2⁹⁵

Highly accurate. Features wide viewing angle and 3-color scale. Front panel zero adjustment. Calibrated scales (1 MA full scale), 0 to 100% modulation, "S" units 0-9, also +10 and +30. Linear full scale markings of 0 to 5. Dimensions: dial face, 1 3/8"; depth 1 1/4" overall. Supplied with 4 mounting screws and lugs. For 6 or 12 volts. Dust resistant case. Shpg. wt., 8 oz. Imported.

99 K 2507 Net 2.95

SWR BRIDGE AND RF POWER METER



- Measures RF Output Power into Built-in 52 Ohm Dummy Load, Up to 15 Watts
- Direct SWR Measures from 1:1 to 10:1 and REL Power to 1 KW • 50 μ a Meter Movement

21⁹⁵

Highly accurate SWR and direct power readings up to 50Mc. The unit may be permanently inserted in the transmission line for SWR and relative power monitoring. For 52 or 75 ohm lines. Insertion loss is negligible. Meter has 50 μ a movement; calibrated directly in watts from 0.15 and in SWR from 1 to 10 IF (reads infinity at full scale) . . . Housed in an attractive grey metal cabinet, 3 1/4 x 7 1/4 x 2 3/8". Sits on 4 rubber feet. Imported.

99 K 2508 Shpg. wt., 2 lbs. Net 21.95

LAFAYETTE RADIO FIELD INDICATOR



- Continuously indicates transmitter output
- Rugged 200 μ a meter movement
- Requires no Electricity, Batteries, or Transmitter Connection
- Powerful Magnet on Bottom Plate for Mounting on Dashboard or Other Metal Surface

Our Low, Low Price

6⁷⁵

A MUST FOR ALL HAM AND CB OPERATORS

Checks performance of your marine, mobile or fixed transmitter. Features a 200 μ a meter movement with variable sensitivity control. Earphones can be plugged in for an aural check of output. Antenna extends from 3 1/4" to 10 3/4". Powerful magnet allows easy mounting. Use anywhere . . . requires no electricity or batteries. Dimensions: (less antenna) 3 1/8 x 2 1/4 x 2" D. Imported.

99 K 2509 Shpg. wt., 7 oz. Net 6.75
99 K 2515 High output crystal earpiece for above Net 1.09

LAFAYETTE WAVE-METER for AMATEUR and CITIZENS BAND



- For Amateur and CB Use
- Instant Readings of Transmitter RF Output
- Requires No Power
- Compact, Portable, Accurate

6⁷⁵

A miniature wavemeter for checking transmitter output. Determines relative strength of fundamental frequency and any harmonic or parasitic radiation. Complete and self-contained, requires no power. Telescoping antenna is included. Tunes 1.6 to 150 mc in four calibrated bands. Only 3 1/8 x 2 1/4 x 1 1/2" D. Antenna is 10 3/4" extended. 3 1/4" telescoped, is fitted with a banana plug and is removable. Total shpg. wt., 8 oz. Imported.

99 K 2511 Net 6.75

LAFAYETTE MINIATURE ILLUMINATED "S" METER



- Jeweled Bearings
- Clear Plastic Front
- Accuracy 2% of Full Scale
- High Quality D'Arsonval Movement

2⁹⁵

Durable wrap-around plastic front panel provides wide-angle readability. Zero adjustment screw on front panel; jeweled bearing movement. Calibrated in "S" units from 0-9 with the scale terminating in +10 and +30 calibrations. Additional full scale calibrations of 0-5 and 0-10 in linear scale divisions. Silvered dials; black numerals and pointers. Illuminating lamp for either 6 or 12 volt operation. 1 3/8" dial face; 1 1/4" overall behind panel. Supplied with mounting screws. Imported. Shpg. wt., 8 oz.

99 K 2513 Net 2.95

ILLUMINATED COMMUNICATIONS "S" METER



- 2 Jewel Movement
- Clear Plastic Front
- Calibrated to S9 + 40 db

3⁹⁵

A quality "S" meter (basic 1 ma, 2 jewel movement) designed to replace many "S" meters used in communications receivers. Clear plastic front measures 2 3/8" square and meter fits standard 2 1/2" round hole. Perfect for the experimenter and amateur. Complete with mounting screws, instructions for installation and use. For 6 volt or 12 volt operation. Zero adjustment control on front panel. Imported. Shpg. wt., 1 lb.

99 K 2514 Net 3.95

LAFAYETTE TRANSISTORIZED FIELD STRENGTH METER



- Permits Easy Tune-Up For Maximum Transmitter Output
- Earphone Jack to Monitor Audio
- Tuned Input from 2.53 to 57 MC

15⁹⁵

Covers 2.530 Mc to 57.000 Mc in 3 bands. Ideal for use with ham, Citizens Band or other transmitters within this frequency range. Enables user to tune his transmitter and antenna for maximum RF output. 200 μ a meter is calibrated from 0 to 10. Earphone jack provided. Front panel controls: gain on-off switch, tuning, and band selector switch. Battery powered—can be operated anywhere. With telescoping antenna and battery. Imported. Shpg. wt., 2 lbs.

99 K 2510 Net 15.95
99 K 2515 High output earpiece for above Net 1.09
32 K 4802 Replacement battery for above Net .13

DELUXE LAFAYETTE "S" METER

- Now for Hams, SWL's and CB'ers—A Signal Strength Meter Using VTVM Principles
- Easy To Install and Operate
- Magnetic Feet For Mobile Dashboard Mounting
- Sensitivity and Zero Adjust Controls



Only **8⁹⁵**

Designed for use with any superheterodyne receiver employing AVC. Meter is calibrated in "S" units from 1 to 9, and in db up to 30db over S9. Partial peak clipping is provided for noise limiting. Simple installation—B+, filament and ground. It is adaptable to either 6 or 12-volt equipment, and to receivers using 150 ma or 300 ma series string filament systems. Requires 150-200 VDC for B+. Complete with 12AU7 and installation instructions. Imported. Shpg. wt., 2 lbs.

99 K 2512 Net 8.95

A New! LAFAYETTE Professional-Quality 8-TUBE AMATEUR COMMUNICATIONS RECEIVER Model HA-230 4 BANDS:

• 8 Tube Superhet Circuit • 1 RF + 2 IF Stages for High Gain Reception • Easy-to-Read, Illuminated, Slide Rule Dial • Built-in Q-Multiplier for Crowded Phone Operation • Antenna Trimmer for Optimum Performance on All Bands • Calibrated Electrical

Outstanding Bandsread, Selectivity with built-in Q-multiplier, and sensitivity combine to make the HA-230 one of the "hottest" general coverage bandsread receivers we have ever offered. Special filament transformer provides continuous voltage on critical oscillator and mixer stages, maintains frequency stability . . . prolongs tube life . . . faster "warmup." For the crowded amateur bands—illuminated Slide Rule Dial, bandsread with markings every 5 KCS on 80 and 40 meters, every 20 KCS on 20 and 15 meters, and every 50 KCS on 10-meters, plus an edgewise S-meter. For the SWL—a 0-100 logging scale for "instant reset" to a desired station, an RF Stage with an antenna trimmer for peak performance PLUS 2 IF stages for improved selectivity. Receiver sensitivity—1.0 microvolts for 10 db Signal-to-Noise Ratio. The Built-in BFO can be used to separate CW stations by means of the pitch control, while the Q-multiplier adds the selectivity needed for crowded phone band operation. Front panel controls: FUNCTION

Bandsread on Amateur Bands 80 thru 10 Meters • 0-100 Logging Scale for SWL's • Effective Automatic Noise Limiter • AVC-MVC Selector on Front Panel • Stable Oscillator and BFO for Clear AM CW and SSB Reception • Built-in Edgewise S-Meter

SWITCH, AUDIO GAIN, SELECTIVITY (Q-Multiplier), FREQUENCY (BFO), BAND SELECTOR, IF GAIN, TRIMMER, AVC-MVC SWITCH, ANL SWITCH, MAIN TUNING, BANDSPREAD TUNING, and headphone jack. Selectivity—60 db at 10KC, 0.8 KC @ 6db (with Q-multiplier), IF—455KC. Speaker—External PM type (not supplied), 4 or 8 ohms impedance, Audio Output—1.5 Watts. Tubes: 3-6BA6, 2-6BE6, 1-6AV8, 1-6AV6, 1-6AQ5, 1-5Y3. Size: 7Hx15Wx10"D. For 105-120, 60 cps AC, 50 watts. Imported. 99 K 2522WX Shpg. wt., 25 lbs. Net 89.50
99 K 2532 Model HE-48 Matching 3x5" speaker, 4 lbs. Net 7.95

KT-340 SEMI KIT

This receiver is also available in kit form with all major components and front end premounted and pre-calibrated. Minor components are easily installed. Imported.

99 K 2521WX Model KT-340, Semi-Kit Net 74.50

B New! LAFAYETTE 10-80 METER DUAL CONVERSION AMATEUR RECEIVER Model HA-350 with Mechanical Filter For High Selectivity

• Dual Conversion • 12 Tubes • Complete With Crystals For 80, 40, 20, 15 and 10 Meters • Product Detector—Selectable Upper Lower Sideband Reception • 100 KC Crystal Calibrator and Crystal BFO • Automatic Noise Limiter • WWV Reception • "S" Meter—Calibrated in "S" Units 1-9 and dB scale to +40 db

Features Dual Conversion giving an Image Rejection of more than 40 db and IF Rejection of more than 40 db. One control tuning utilizing an 8-position band-switch. Product Detector, provides selectable upper or lower SSB reception. Tuneable preselector circuit gives sensitivity of less than 1 microvolt for 10 db signal-to-noise ratio. Selectivity: Bandwidth of 2KC at 6 db down and 6KC at 60 db down using Mechanical Filter in IF. Front panel 100KC crystal calibrator reset control used in conjunction with the 15 MC WWV National Bureau of Standards station assures consistent and accurate calibration. Remote control socket on back permits simultaneous control of HA-350 with a transmitter. Audio output: 1-watt maximum. Speaker impedance: 8, 500 ohms (speaker not supplied). Front panel controls:

5 HAM BANDS PLUS WWV

| | |
|-------------|-------------|
| 3.5—4.0MC | 28.5—29.1Mc |
| 21.0—21.5Mc | 14.0—14.5Mc |
| 7.0—7.5Mc | WWV at 15Mc |

Preselector; Cal—On/off; Band Selector; Receive/Send; Tuning Cal Reset; Function—Off/AM/SSB1-CW/SSB2; RF gain; AF Gain; ANL; Phone jack. Tube complement: 6BZ6—RF amp.; 6BL8—Ktat controlled 1st mixer; 6BE6—2nd mixer; 6BZ6—VFO; 6BA6—IF amp.; 6BA6—IF amp.; 6AL5—AVC rectifier and AM noise limiter; 6AQ8—product detector and crystal calibrator; 6AV6—1st audio amplifier; 6AQ5 audio output; 6BA6—BFO; 0B2—regulator, Silicon Full wave rectifier. Size: 15Wx7½Hx10"D. For 115V 50/60 cps AC. Imported. Shpg. wt., 25 lbs. 99 K 2524WX Less Calibrator Crystal Net 189.50
40 K 0901L Optional 100KC Calibrator Crystal Net 3.95
99 K 2532 Model HE-48 3x5" Speaker in cabinet Net 7.95

C New! DELUXE LAFAYETTE Professional-Quality 14-TUBE AMATEUR COMMUNICATIONS RECEIVER Model HA-225 Dual Conversion On 6 Meters

• 14-Tube Superheterodyne Circuit • Extra RF Stage, Mixer/Osc For Dual Conversion On 6 Meters • 1 RF Plus 2 IF Stages For High Gain Reception On All Other Bands • New Product Detector Circuit For Improved SSB Reception • Separate BFO And Q-Multiplier Circuits (Can be Used Simultaneously) • Crystal Calibrator For Checking Receiver Calibration Markings • Effective Automatic Noise Limiter • Voltage Regulated Power Supply

The HA-225 features full amateur band coverage of 80 through 10 meters plus Marine Beacon Band. Special filament transformer provides continuous filament voltage to oscillator and mixer tubes . . . maintains critical frequency stability . . . prolongs tube life . . . reduces warmup time. Sensitivity is .5 Microvolt for 10 db s/n ratio. Selectivity is variable from 60 db to 93 db in Q-Multiplier operation with ± 10 KC detuning. Calibrated electrical bandsread on amateur bands 80 thru 10 meters (6 meters is tuned with main tuning controls). Dual conversion on 6 meters provides average of 50 db image rejection. Other features include antenna trimmer for optimum performance on all bands, built-in edgewise "S" meter, special recording jack in rear permits easy connection to tape recorder, remote control socket on the back allows simultaneous control of HA-225 with a transmitter.

5 BANDS

| | |
|--------------|---------------|
| • 150-400 Kc | • 10.5-30 Mc |
| • 1.6-4.8 Mc | • 4.8-14.5 Mc |
| | • 48-54 Mc |

Front Panel Controls: AF Gain, RF Gain, 5-Position Function Switch, BFO Frequency, Band Selector, Q-Multiplier Selectivity, Q-Multiplier Frequency, Band Spread Tuning, Main Tuning; Antenna Trimmer, Power On-off Switch, MVC-AVC Switch, Rec-Send Switch and Headphone Jack, IF—455 KC. Audio Output—1.5 Watts. Output Impedance—8 and 500 ohms (speaker not supplied). Tubes: 4-6AQ8, 3-6BA6, 2-6BE6, 1-6BL8, 1-6AL5, 1-6AQ5, 1-0A2 plus 6CA4 rectifier. Size: 17Wx7½Hx10"D. Shpg. wt., 28 lbs. Imported.

99 K 2523WX Model HA-225, Less Calibrator Crystal Net 139.50
Optional Calibrator Crystal, 100KC, Type HC/13U

40 K 0901L Net 3.95

99 K 2532 Model HE-48 Matching 3x5" speaker, 4 lbs. Net 7.95

D LAFAYETTE DELUXE 7-TUBE SWL BROADCAST RECEIVER Model HA-63

• Superhet Circuit; Illuminated "S" Meter • 1.5 Microvolt Sensitivity • 3-Section Tuning Capacitor With Electrical Bandsread • Antenna Trimmer For Optimum Performance On All Bands • Front Panel AVC-MVC Selector, ANL and BFO • For Headphones or External Speaker • AC Transformer Operated • Big Slide Rule Dial

Provides full fingertip coverage of AM broadcast, marine and aeronautical bands, civil defense, WWV, amateur and foreign frequencies. The BFO permits (CW) code reception too. BFO pitch is not variable. Full electrical bandsread on all frequencies with 0-100 logging scale and built in "S" meter assures you of accurate tuning. Superheterodyne circuit includes RF amplifier and three-section tuning gang condenser with separate tuning coils for each band. These provide outstanding selectivity and a sensitivity of 1.5 microvolts. Big slide-rule dial is easy-to-read. Other features are switchable AVC/MVC to reduce blasting or fading; automatic noise limiter (ANL) for maximum noise rejection; and an antenna trimmer control which assures optimum reception on all bands. All controls are conveniently located on front panel. Headphone jack for private listening. An external PM type speaker is required (not supplied). Impedance 4-8 ohms. Beautifully styled in modern steel cabinet. Tubes: (2) 6BA6, (2) 6BE6, (2) 6AV6, (1) 6AR5 plus selenium rectifier. Audio output: 1.5 watts. AC transformer operated. 117 volts 50/60 cycles AC. Size: 13Wx 7-4/5Hx10"D. Shpg. wt., 19 lbs. Imported.

99 K 2534WX Net 64.50
99 K 2532 Model HE-48 Matching Speaker Net 7.95

4 BANDS

| | |
|------------------|------------------|
| • 550 Kc-1600 Kc | • 4.8 Mc-14.5 Mc |
| • 1.6 Mc-4.8 Mc | • 10.5 Mc-30 Mc |

MODEL HE-48 SPEAKER

795



3x5" speaker in handsome styled cabinet for Lafayette HE-30, KT-320, HE-80, HA-63, HA-350, HA-230, KT-340, HA-225 receivers, also ideal receiver speaker mate for many other communication receivers. Gives clean audio response, 8 ohm impedance. 7¾Hx3½Wx5"D. Shpg. wt., 4 lbs. Imported. 99 K 2532 Net 7.95

A MODEL HA-230

| | |
|------------------------|------------------------|
| MODEL HA-230 WIRED | MODEL KT-340 KIT |
| 89⁵⁰ | 74⁵⁰ |
| \$5 Monthly | \$5 Monthly |

4 BANDS:

- 550-1600 Kc
 - 1.6-4.8 Mc
 - 4.8-14.5 Mc
 - 10.5-30 Mc
- NEW "ALWAYS ON" FILAMENT VOLTAGE FOR MIXER AND OSCILLATOR STAGES FOR FREQUENCY STABILITY!



B MODEL HA-350

5 HAM BANDS PLUS WWV

189⁵⁰
\$9.00 monthly

- 3.5—4.0Mc
- 7.0—7.5Mc
- 14.0—14.5Mc
- 21.0—21.5Mc
- 28.0—29.7Mc
- WWV at 15Mc

MECHANICAL FILTER

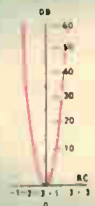

Gives ultra-sharp selectivity in the 455 Kc IF section. Consists of input transducer, 6 non-corrosive nickel alloy resonators and an output transducer. The "skirt" selectivity is greatly increased as shown by the almost rectangular I.F. band-pass curve.



C MODEL HA-225

5 BANDS:

- 150-400 Kc
- 1.6-4.8 Mc
- 4.8-14.5 Mc
- 10.5-30 Mc
- 48-54 Mc

139⁵⁰
\$7.00 Monthly

Available Feb. 15, 1965

Dual Conversion On 6 Meters



D MODEL HA-63

A HANDSOME FEATURE-PACKED RECEIVER FOR THE SHORTWAVE LISTENER AND NOVICE

64⁵⁰
\$5 Monthly

4 BANDS

- 550 kc-1600 kc
- 1.8 mc-4.8 mc
- 4.8 mc-14.5 mc
- 10.5 mc-30 mc

Electrical Bandwidth on the 80, 40, 20, 15 and 10 Meter Bands



LAFAYETTE
RADIO
ELECTRONICS
 111 JERICHO TURNPIKE
 SYOSSET, L.I., N.Y. 11791

BULK RATE
 U.S. Postage
PAID
 LOUISVILLE
 KENTUCKY
 Permit No. 599

POSTMASTER
 IF UNDELIVERABLE DO NOT RETURN

LAFAYETTE'S TOP-RATED MODEL RK-137A TAPE RECORDER

FEATURING **4-TRACK STEREO PLAYBACK***
4-TRACK MONAURAL RECORD PLAYBACK

With **ELECTRONIC TRACK SELECTOR SWITCH**, **VU RECORDING LEVEL METER** and **PAUSE SWITCH FOR INSTANT EDITING**



- Pause Lever Provides Instant Stop for Editing
- Specially Designed Heavy-Duty 6x4" PM Speaker
- VU Meter Recording Level Indicator
- Electronic Track Selector Switch
- Separate Erase and Record Heads
- High Impedance Monitoring Jack
- Fast, Rugged Shift Lever Control
- Record—Erase Safety Switch
- Two Speeds—3 3/4 & 7 1/2 ips
- Extension Speaker Jack

89⁵⁰

\$5 monthly

TAKE FULL 7"
 REEL OF TAPE

Includes 4-Track Stereo
 Carrying Case

SPECIFICATIONS:

RESPONSE: 40-15,000 cps at 7 1/2 ips, 40-9,000 cps at 3 3/4 ips.
S/N RATIO: 40 db. **WOW/FLUTTER:** less than 0.3%. **CHANNEL SEPARATION:** 45 db. **INPUTS:** Radio, Mic. **OUTPUTS:** Stereo Tape Head, External Spkr, Monitor. **AMPLIFIERS:** Single Channel, tube-type preamp and power amp. **TAPE HEADS:** 4-Track Stereo record/playback and erase heads.

switching between tape tracks 1-4 and 3-2. In addition a VU recording level meter has been incorporated to indicate correct volume-setting for recording. Speeds are adjustable from 3 3/4 to 7 1/2 inches per second by means of a simple capstan adjustment. From a standard 7" 1200 ft. reel the RK-137A provides over 2 hours monaural record/playback time at 7 1/2 ips and over 4 hours at 3 3/4 ips. Jacks are furnished for microphone input, High impedance Radio-Phono Inout, Extension Speaker Output Monitor Output and Stereo Head Output for playback of 2nd stereo channel. Shpg. wt., 22 lbs. Imported.

99 K 1511WX Model RK-137A Tape Recorder — Net **89.50**

7" reel of 1200 ft. Lafayette Recording Tape

28 K 0101

Net **1.59**

See Our Catalog 650 For Additional Photographic Equipment



COMPLETE
 with MIKE

SHIELDED
 PATCH CORDS

EMPTY
 7" REEL.

The RK-137A Tape Recorder contains a fine, quality constructed, smooth performing tape mechanism. Engineered to provide virtually every wanted tape recorder feature, the RK-137A performs brilliantly, with facilities for 4-track monaural record playback and 4-track stereo playback *(when used with a second channel containing a tape head input such as found in a component Hi-Fi system). Controls are completely functional and are designed and arranged to make the RK-137A a genuine pleasure to use. Features include: a rugged, easy to use shift lever for fast rewind, fast forward, play and record functions; a special push-button safety record switch assures against accidental erasure of tapes; velvet-smooth volume and on-off tone controls; a pause lever instantly stops tape in motion, especially useful for editing; track switch provides fast, dependable electronic