

It's

# Lafayette

for...

## THE BEST..THE MOST..at the LEAST!

### NEW! TRANSISTORIZED POWER MEGAPHONE

**Portable Sound Broadcaster**

- IDEAL FOR OUTDOOR HAMFESTS
- EFFICIENT HORN PROJECTS SOUND 1000 FT.
- MICROPHONE DETACHABLE ON 3 FT. CORD
- SHOULDER STRAP FOR EASE OF USE

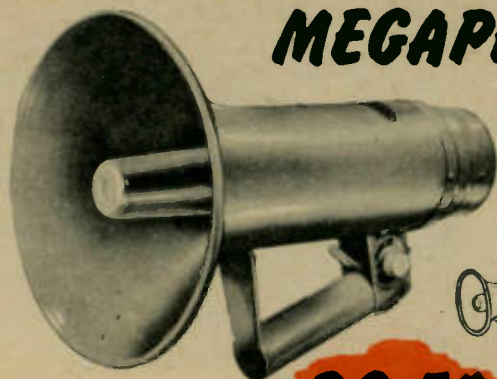

**29.50**

A transistORIZED power megaphone with many unusual features and many applications. Basically a highly efficient sound projector horn with a built-in microphone capable of amplifying and projecting the voice with a range of 1000 feet. The microphone is a telephone-type element, easily replaceable, and may be detached and extended up to 3 feet from the horn. The reflex-type horn is extremely light weight, of sturdy spun aluminum construction with a strap for carrying or placing on the shoulder. A press-to-talk switch on the handle provides

for economy of power use—power is used only when actually talking. No warm-up time required—amplification is instantaneous. Has control for setting three different volume levels to suit any environment. A patented non-linear current limiting device restricts current flow to safe levels for longest battery life. Uses a 9-volt transistor battery. Access to battery can be easily reached by removing the microphone unit. Size 12 1/2" long overall; horn mouth is 7 1/2" diam. Shpg. wt., 3 1/2 lbs.

PA-56.....Net 29.50

### NEW! "ELECTRO-STRIKE-OMETER"®

- WARNS THE ANGLER OF THE BITE
- BEST FITTED FOR ALL KINDS OFF-SHORE FISHING
- EASILY ATTACHED TO RODS
- ACCURATE METER READING

Modern angler's dream materialized at last! Successful fishing requires patience, alertness and excellent timing. Many good strikes have been missed due to reliance upon mere sixth sense. Illustrated above is a simple device that is the result of researches made to develop an easier and more dependable way of fishing. Now, with this new ELECTRO-STRIKE-OMETER any novice angler will be able to catch timely and exactly the warning of fish bite. Fish bite is indicated by the movement of a meter needle. When fish strikes, the needle will swing within the "Care" section of the dial. As the fish proceeds to swallow the bait further, the needle will come to the "Pull Up" section on the dial. The fish will surely be caught if the line is pulled up promptly. A separate adjusting knob permits adjustment of maximum swing as well as sensitivity of needle. Screw type adjustment in the back permits adjustment of zero position of the needle. This lightweight unit can be easily mounted on any reel rods or short rods for off-shore fishing. The 1.5V dry cell can be replaced easily. The whole unit is housed in a rugged metal-gray plastic body. Can be used under any weather conditions. Size 6x1x1". Shpg. wt., 4.5 oz.



(Pat. Applied For)

Reg. 12.50

**6.29**

FT-536.....Net 6.29

### NEW! 10,000 OHMS PER VOLT MULTITESTER

**Outperforms Instruments Many Times its Size**

- EXTRA LARGE 3 1/2" METER FACE
- COMPLETELY WIRED (NOT A KIT)
- ALL ACCESSORIES INCLUDED

**FULL SCALE RANGES**

DC VOLTS: 0-6; 0-30; 0-120; 0-600; 0-1200; AC VOLTS: 0-6; 0-30; 0-120; 0-600; 0-1200; DC CURRENT: 0-120μA; 0-3M; 0-300M RESISTANCE: 0-30K; 0-3 MEG DECIBELS -20 to +63 in 5 scales; Capacity 50 μμF to .01 μF; and .001 μF to .15U; OUTPUT RANGES 0-6; 0-30; 0-120; 0-600; 0-1200.

Unbelievable Bargain. Lafayette's new multitester is a complete factory wired and tested instrument (not a kit). It can be conveniently carried in the pocket, and features unusually sensitive 10,000 ohms-per-volt AC-DC meter, 1% precision resistors, and the largest meter ever placed on an instrument of this size. Single easy-to-use range selector switch can be appreciated by the novice and the engineer alike. Case and panel are made of durable bakelite. First capacity range requires 120 volts AC, second range requires 6 volts AC. Probes and flexible leads are plastic coated and color coded. Size 4 1/2" x 3 1/2" x 1 1/2". Complete with leads and battery.

TE-10.....Net 8.95

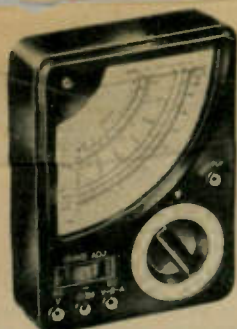

**8.95**

### NEW! REVOLUTIONARY SPECTA-RADIO®

- IDEAL FOR SPORTS EVENTS, OUTDOOR USES
- GOOD TONAL QUALITY
- ATTRACTIVE AND LIGHT WEIGHT
- EXCELLENT FOR SUNWEAR



**24.50**

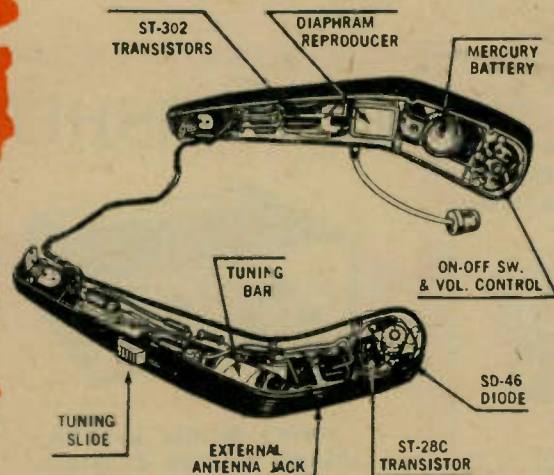

- 3 TRANSISTORS PLUS GERMANIUM DIODE
- SEPARATE VOLUME AND TUNING CONTROLS
- BUILT IN EARPHONE JACK FOR PRIVATE LISTENING

This revolutionary SPECTA-RADIO design is ideal for wearing in ball games, sports events and any outdoor settings. Provided with superior quality glare-proof sunglasses for easy viewing. Its 3-transistor circuit provides high amplification, good tone quality, and quiet operation. A smooth operating volume control permits

easy adjustment for different listening conditions. Slide-type dial allows easy tuning. Light and attractive. It is suitable for both men and women. Complete with built-in earphone. Shpg. wt., 8 oz.

F5-201.....Net 24.50

### NEW! GOLF RANGE FINDER

- PRECISION 6X LENS
- MEASURES FROM 40 TO 250 YARDS
- HANDY POCKET SIZE
- WITH LEATHER CARRYING CASE



**9.95**

This exciting new Range-Finder is bound to prove an invaluable addition to your Golfing Equipment. Featuring a precision 6X lens capable of measuring from 40 to 250 yards, this handy pocket size instrument enables the golfer by means of a simple focusing adjustment to easily compute the distance to the next hole. Guess work is completely eliminated and choosing the correct club is greatly simplified. Supplied with suede leather carrying case and simple instructions. Shpg. wt., 1/2 lb.

F-427 Golf Range Finder.....Net 9.95

**CATALOG**

**594**

NEW YORK 13, N.Y.  
100 6th Ave.  
Worth 6-5300  
Open THUR.  
'til 8:45 P.M.

BOSTON 10, Mass.  
110 Federal St.  
HUBBARD 2-7850  
Open MON.-WED.  
'til 8:45 P.M.

OTHER LOCATIONS  
BRONX 58, N.Y.  
542 E. Fordham Rd.  
FORDHAM 7-8813  
Open THUR.  
'til 8:45 P.M.

NEWARK 2, N. J.  
24 Central Ave.  
MARKET 2-1661  
Open WED.  
'til 8:45 P.M.

PLAINFIELD, N.J.  
139 W. 2nd St.  
PLAINFIELD 6-4718  
Open THUR.  
'til 8:45 P.M.

\*EXCEPT DURING JULY AND AUGUST

**Lafayette Radio**

165-08 LIBERTY AVE.  
JAMAICA 33, N. Y.  
AXtel 1-7000  
OPEN MON. AND FRI.  
TILL 8:45 P.M.



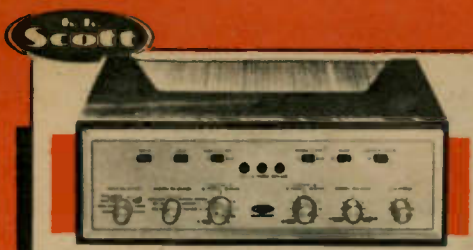

**NEW 299  
COMPLETE STEREO AMPLIFIER**

Features dual 20 watt amplifiers and dual preamplifiers on one chassis. Includes a 3rd channel output for the ultimate in stereo reproduction. Has separate Bass and Treble controls for each channel; low level stereo cartridge inputs for cartridges with exceptionally low outputs; Balance Control for precisely balancing both channels; Master Volume Control with loudness switch for tonal balance; Phase Reversal Switch; corrects reversed phasing on improperly made recordings; Master Function Selector switches to: stereo records to-level or hi-level cartridges, stereo FM/AM broadcasts, use of stereo cartridge for monaural records, for a monaural source through both amplifiers. Unit is also used as a monaural electric crossover. Inputs: 2 low-level, 2 high channel. Outputs: Tape recorder output; center channel output, and speaker impedance of 4, 8, and 16 ohms/ for each channel. Freq. Response: 20-20,000 cps. Power output per section 20 watts, 40 watts peak; Harmonic Distortion: 0.8% 1M 0.3%. 11 tubes Size: 4 1/2" x 15" x 12". Shpg. wt., 35 lbs.

H. H. SCOTT 299—Less case ..... Net 199.95  
Type C Steel Case ..... 9.95  
Wood Case—Moh., Blonde or Wal. .... 19.95

**NEW SCOTT 222  
24 WATT STEREO AMPLIFIER**



This is a new 24 watt Stereo Amplifier (12 watts per channel) with numerous features found only on more expensive amplifiers. Dual preamps and control facilities provide complete flexibility in the control and reproduction of all stereo or monaural sources. Outputs are available for stereo tape recording plus a third channel output for connection to another amplifier to provide the ultimate in stereo realism. Loudspeaker output impedances are 4, 8 and 16 ohms for each channel. Inputs: 4 dual (3 high level, 1 low level) Mag High, Mag Low, Tuner, Tape Playback. Outputs: Tape Out (dual) Center Channel (single). Specifications: Frequency response; 20 to 20,000 cps; Harmonic Distortion; less than 0.8% at 12 watts output; IM 0.3% (CCIF method); all aluminum chassis and DC on preamplifier tube heaters result in a hum level of 80 db below full output; Phono sensitivity 3 mv for full output; Size: 13 1/2" wide x 5" high x 9 1/2" deep. Shpg. wt., 24 lbs.

H. H. SCOTT 222—(less case)—13.99 down. Net 139.95  
Type C steel case for Scott 222 ..... 9.95

**NEW BOGEN DB212  
24-WATT STEREO AMPLIFIER**



With this "Stereo-Control Center" you can precisely control all stereo sources and feed them through the self contained dual amplifiers to your speaker systems. When you use monaural program sources you have 24 watts of power available to the speaker system. You can also feed one channel monaurally through the tweeter and mid-range speakers, and the other monaurally through the low range speaker. Output Power; 24 watts (two 12 watt channels) peak power 48 watts. Harmonic Distortion: 0.5% of rated output. Frequency Responses: 20 to 20,000 cycles  $\pm$  1 db. Speaker Output: 4, 8, and 16 ohms. Tone Controls: Bass  $\pm$  10 db of 60 cycles; Treble  $\pm$  10 db of 10,000 cycles. Controls: 4 position selector switch (tape, phono, radio, aux.); Function switch (Monaural: Channel 1, Channel 2, Channels 1 and 2; Stereophonic; normal, inverted). Volume; Bass; Treble; Hi-filter (flat, 4 kc). Lo-filter (flat, 100 cps); Speaker (2 position). Power on-off switch. Tubes: (9) two 12AX7/7025, two 6U8, four 6V6GT, one EZ81. Dimensions: 15" W x 4 1/2" H x 12 1/2" D. For 110-120 V. 60 cycles AC. Shpg. wt., 20 lbs.

BOGEN DB212—Stereo amplifier, less cabinet  
Net 119.95 — 12.00 Down  
BOGEN BEG—Pearl-gray cabinet, with legs for DB212  
Net 7.50

**NEW BOGEN DB230A  
60-WATT STEREO AMPLIFIER**

- SEPARATE BASS AND TREBLE FOR EACH CHANNEL
- DUAL VOLUME CONTROLS



The ultimate in a stereo amplifier for top quality and design. With this system you can control all types of stereo and monaural program sources, and feed them through the dual 30-watt amplifiers. When you use it monaurally you have the combined 60 watts available, with a special switching arrangement for monaural phono cartridges. Features are CPF output circuit, Phasing Switch which eliminates hole in middle effect, a provision for remote balance control. Specifications: Power Outputs: 30 watts (60 watts peak) each channel for stereo, 60 watts (120-watts peak) for monaural. Harmonic Distortion: less than 1% at rated output. Frequency Response: 20 to 20,000 cps.  $\pm$  0.5 db. IM Distortion: less than 2% of rated output. Hum and Noise: (below rated output) fundamental —85 db. Inputs: (10 inputs—5 channel 1, 5 channel 2) magnetic cartridge, crystal cartridge, tape, tuner, auxiliary. Outputs: channel 1 speaker, channel 2 speaker, channel 1 tape, channel 2 tape. Dimensions: 15" W x 5 1/2" H x 13 1/2" D. Shpg. wt., 39 lbs.

BOGEN DB230A—Stereo amplifier, less cabinet  
8.95 Down ..... Net 189.50  
BOGEN CEG—Cabinet with legs for DB230 ..... Net 8.00

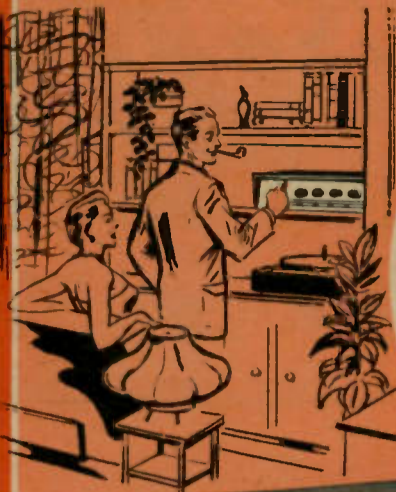

**NEW! Lafayette 50-WATT  
STEREO AMPLIFIER MODEL LA-250**

*Impressive Performance... Handsome Styling... Another Unbeatable Lafayette Value!*

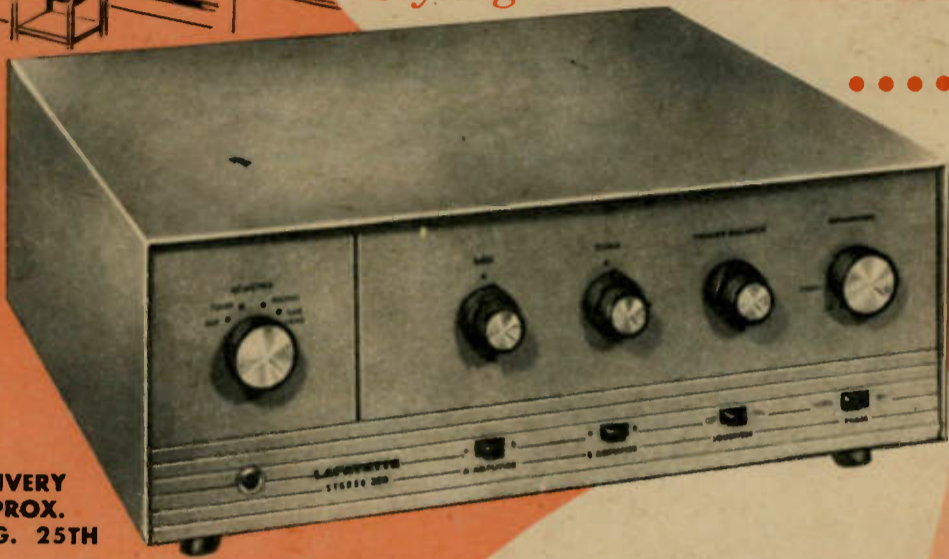

DELIVERY APPROX. AUG. 25TH

- 50 WATTS MONAURAL—25 WATTS EACH STEREO CHANNEL
- RESPONSE 17-21,000 CPS  $\pm$  1 DB (at normal listening level)
- UNIQUE "BLEND" CONTROL
- PREMIUM EL86 OUTPUT TUBES
- SEPARATE BASS & TREBLE CONTROLS
- CLUTCH-TYPE VOLUME-BALANCE CONTROL
- 3RD CHANNEL OUTPUT

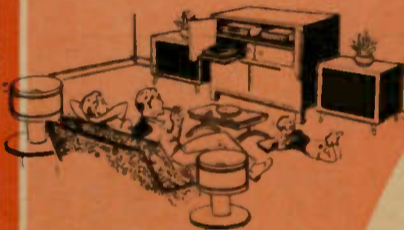

**COMPLETE STEREO AMPLIFIER**  
**89.50**

COMPARABLE TO AMPLIFIERS COSTING UP TO **179.50**

*The Stereo 250*

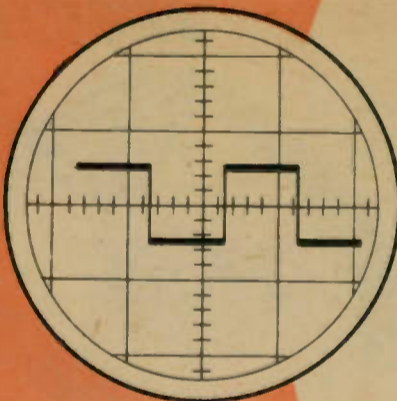

The Stereo 250... a completely new stereo high fidelity amplifier with a high quality of reproduction, remarkable versatility and new distinctive styling—worthy of a place in the finest stereo hi-fi music system. A full range of controls enables you to enjoy the utmost in listening pleasure in any situation. A unique "blend" control which provides continuously variable channel separation—from full monaural to full stereo—may be used to eliminate the exaggerated channel separation found in some stereo source material. Included is a clutch-type Volume balance control for independent or simultaneous control of both channels, concentric Bass and Treble controls which provide independent tonal control of each channel and a 4-position switch which selects phono, tuner, auxiliary or tape head stereo inputs. Simple slide switches provide channel reversal and phase reversal—or you can reproduce either channel through both amplifiers. A loudness switch permits the volume balance control to function as a compensated loudness control. The LA-250 also features a 3rd channel output which may be used to feed a 3rd single channel amplifier and speaker to provide a wider sound spread, a

Tape Output jack for recording purposes, plus dual terminations for 4, 8 or 16 ohm speakers. Advanced circuitry includes DC operated preamp and tone control tube fittings for hum-free operation, premium 6CW5/EL86 push-pull output tubes, individual bias and balance adjustments on each channel and a hum balance control. SPECIFICATIONS: POWER OUTPUT: 50 watts—25 per channel (speech & music rating). FREQUENCY RESPONSE: 17-21,000 CPS  $\pm$  1 db (at normal listening level). HARMONIC DISTORTION: less than 0.25%. IM DISTORTION: less than 1%. HUM AND NOISE: 74 db below rated output at full volume (high level inputs), 54 db below rated output at full volume (low level inputs). CHANNEL SEPARATION: Greater than 50 db. OUTPUT IMPEDANCE: 4, 8 and 16 ohms per channel. Attractive beige vinyl laminated steel case. Handsomely designed brass anodized aluminum front panel. Sienna brown molded legs and matching knobs with polished brass inserts. Dimensions with legs and knobs, 14 1/2" w x 12 1/2" d x 5 1/2" h. Shpg. Wt., 26 lbs. LA-250 50 Watt Stereo Amplifier 8.95 down Net 89.50

**THE FISHER**



**NEW! MODEL X-101A  
STEREO MASTER CONTROL  
AND DUAL 20 WATT AMPLIFIERS**

Features separate Bass and Treble control for either ganged or independent channel operation. Has 12 inputs or 6 pairs for stereo, 3 record-monitor jacks. 8 controls plus six chassis adjustments. Has input selector (7B, LP, RIAA-1, RIAA-2, Tape, Tuner, Aux-1, Aux-2); output selector; (Rev., Sid., Channel A + B, Channel B + A); rumble filter; Vol./AC power; channel balance; loudness; separate bass and treble for each channel. Freq. response: 20-20,000 cps. Distortion: 0.7% at rated output. 50 db channel separation. Hum and noise inaudible. Sensitivity: 3 mv for phono, 2 mv for tape, 0.2v for high level to obtain rated output. Less cabinet. Size: 15 1/2" x 4 1/2" x 13". Shpg. wt., 30 lbs.

Model X-101A ..... Net 199.50  
Custom cabinets for X-101A in mahogany, walnut, and blonde. Size: 15 1/2" x 12 1/2" x 6". Shpg. wt., 6 lbs.  
Model 10U. (Specify finish) ..... Net 24.95

**COMPLETELY NEW!  
THE FISHER 600  
STEREO FM-AM  
TUNER AMPLIFIER**



Designed for those who want the convenience of an all-in-one instrument, the new Fisher 600 incorporates a stereo FM-AM Tuner, Master Audio Control and a 40 Watt Stereo Amplifier on one compact chassis. Dual tuning arrangements permit the use of the unit as an individual FM or AM tuner. Input level adjustments are furnished for all input connections to the Fisher 600. The amplifier section features two well-designed 20 watt amplifiers with connections for 4, 8 or 16 ohm speakers. Features included in the Tuner: Cascode RF Stage on FM; Bridge-type low-noise triode mixer; Individual MicroRay tuning indicators for FM and AM; Features included in the Amplifier: 5-position input selector; 5-position Stereo-Monophonic switch; Dual bass and treble controls; Phase Reversing switch; DC filament Supply for minimum hum; Frequency response, 25 to 20,000 cps  $\pm$  1db. Dimensions: 17" W x 14 1/2" D x 3-13/16" H. For 110-120 V 60 Cycles AC. Shpg. wt., 42 lbs.

Fisher TA-600 Stereo Receiver less cabinet Net 349.50  
TA-6 Metal Case for above ..... 17.95

**HARMAN-KARDON  
"EPIC" A-250  
STEREO  
AMPLIFIER**



A complete stereo amplifier with two 25 watt channels or a complete monaural amplifier of 50 watts. Specifications: Frequency Response: 20 to 20,000 cps; Output level: 25 Watts per channel at less than 1% harmonic distortion; Peak Power: 50 watts per channel; Hum: 95db below 20 watts on minimum volume; Channel Separation: better than 50db; Tone Control Range:  $\pm$  16 db at 50 cps on bass,  $\pm$  16 db at 10,000 cps on treble; Damping Factor: 8; Panel Controls: Treble/Power, Bass, Loudness, Balance, mode (Stereo Normal, Stereo Reverse, Monaural Right, Monaural Left), Function Selector (Aux 1, Aux 2, Tuner, Phono, tape head), Rumble Filter, Scratch Filter, Contour, 2 Speaker Selector switches and Equalization Selector. Speaker output impedances: 4, 8, 16 & 32 ohms. Size: 15 1/2" W x 4 1/2" H x 13 1/2" D. Shpg. wt., 40 lbs. Decor: Panel is copper colored anodized aluminum. Case is brushed copper with black display panel.

HARMAN-KARDON A-250 (less case) ..... Net 179.95  
H-K AC-50 Enclosure ..... Net 12.50

# LAFAYETTE FOR LEADING STEREO COMPONENTS

## NEW! Lafayette 50-WATT COMPLETE STEREO PHONO SYSTEM

The Excitement and Realism of The Concert Hall!

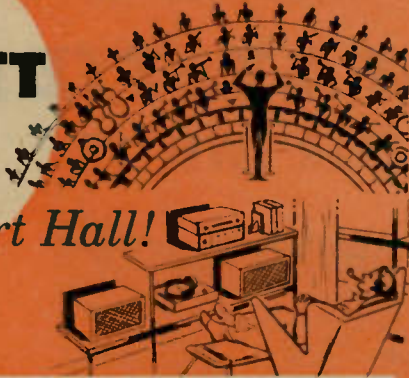

LAFAYETTE LA-250  
50-WATT STEREO AMPLIFIER

COMPLETE  
STEREO SYSTEM

774.50

YOUR  
GUARANTEED BEST  
STEREO SYSTEM BUY!

- LAFAYETTE LA-250 50-WATT STEREO AMPLIFIER . . . 89.50
- GARRARD RC121/11 STEREO CHANGER . . . 41.65
- NEW GE VR-22 (.7 MIL) DIAMOND STEREO CARTRIDGE . . . 24.45
- LAFAYETTE PK-111 WOOD CHANGER BASE . . . 3.95
- 2-LAFAYETTE SK-58 FAMOUS FREE EDGE  
12" COAXIAL SPEAKERS at 29.50 . . . 59.00

Regular Catalog Price 218.55

You Save 44.05

This superb system will add a new dimension in living to your home with all the excitement and realism of a live concert. The new Lafayette LA-250 50-watt stereo amplifier (25 watts each channel) forms the heart of this outstanding stereo hi-fi phonograph music system—the features, versatility and advanced circuitry of this unit are second to none—all the necessary inputs and outputs are provided if you wish to add stereo tape and stereo FM/AM later. A unique blend control allows continuously variable channel separation—from full monoaural to full stereo. Also included is the famous Garrard RC121/11 intermix 4-speed automatic record changer with full manual or automatic operation supplied with your choice of stereo cartridges—the new GE VR-22 (.7 mil) diamond stereo cartridge, Pickering 371.7D (.7 mil) diamond stereo cartridge, Shure M7D (.7 mil) diamond stereo cartridge or the new Electro-Voice 31MD7 (.7 mil) diamond stereo cartridge. Supplied with the Lafayette PK-111 wood base cut for the RC121 in your choice of finishes. These outstanding components are coupled with the 2-famous free edge Lafayette SK-58 12" Coaxial speakers with built-in crossover network and brilliance level control. System supplied with plugs, cables and simple instructions. Shpg. Wt., 67 lbs.

MF-681. HI-FI STEREO PHONO SYSTEM with choice of cartridge and mahogany, walnut or blond changer base (please specify).  
Net 174.50  
17.45 Down 12.00 Monthly

MF-683. Same as MF-681, but with choice of 2-Lafayette Eliptoflex Series Bookshelf Enclosures or 2-Lafayette CAB-16 Series Resonator Enclosures (please specify cabinet model and finish.) Shpg. Wt., 143 lbs. Net 229.95  
22.99 Down 15.00 Monthly

MF-684. Same as MF-681, except speakers furnished are 2-University 312. 12" 3-way speakers. Shpg. Wt. 67 lbs. Net 237.50  
23.75 Down 15.00 Monthly

MF-685. Same as MF-684, but with choice of 2-Lafayette Eliptoflex Series Bookshelf Enclosures or 2-Lafayette CAB-16 Series Resonator Enclosures (please specify cabinet model and finish.) Shpg. Wt., 143 lbs. Net 294.50  
29.45 Down 17.00 Monthly

MF-682. STEREO AM-FM-PHONO SYSTEM. Same as MF-681 but including the new Lafayette LT-50 stereo tuner. Shpg. Wt., 85 lbs. Net 287.50  
28.75 Down 17.00 Monthly

### SELECT YOUR OWN CARTRIDGE

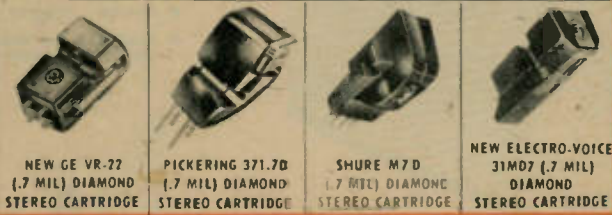

NEW GE VR-22  
(.7 MIL) DIAMOND  
STEREO CARTRIDGE

PICKERING 371.7D  
(.7 MIL) DIAMOND  
STEREO CARTRIDGE

SHURE M7D  
(.7 MIL) DIAMOND  
STEREO CARTRIDGE

NEW ELECTRO-VOICE  
31MD7 (.7 MIL)  
DIAMOND  
STEREO CARTRIDGE

You may substitute any of the above cartridges at no additional cost.



LAFAYETTE  
SK-58  
FAMOUS  
FREE  
EDGE 12"  
COAXIAL  
SPEAKER



GARRARD  
RC121/11



PK-111  
WOOD BASE



LAFAYETTE  
ELIPTOFLEX  
SERIES BOOKSHELF  
ENCLOSURE

### ALTERNATE ENCLOSURES



LAFAYETTE CAB-16  
SERIES RESONATOR ENCLOSURE

## LAFAYETTE LT-40 DELUXE FM-AM TUNER Specially Priced—Quantity Limited

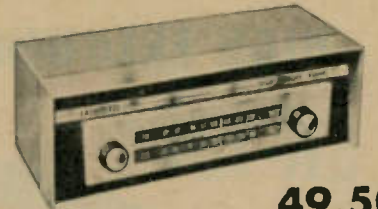

49.50

- ARMSTRONG CIRCUIT
- AFC DEFEAT
- AUTOMATIC FREQUENCY CONTROL
- TEMPERATURE COMPENSATED OSCILLATOR
- MEETS FCC RADIATION REQUIREMENTS
- FOSTER-SEELEY DISCRIMINATOR

A sensitive, selective, stable FM-AM tuner with all the basic features for a deluxe hi-fi system. FM circuit features Armstrong Circuit with limiter and Foster-Seeley Discriminator, and AFC. AM circuit is a superheterodyne with AVC. FM section: Sensitivity: 5 microvolts for 30 db quieting. Selectivity: 200 KC BW 6 db down. Frequency response: 20-20,000 cycles  $\pm 1$  db. AM Section: Sensitivity: 5  $\mu$ v for 20 db S/N. Selectivity: 8 KC BW 6 db down. Frequency response: 20-5000  $\pm 3$  db. Distortion: less than 1%. Hum inaudible. Controls: Tuning selector, AFC defeat, power. Has built-in antennas. 6 tubes plus matched pair crystal diodes plus rectifier. Finished in attractive dark maroon and gold. Size: 13 1/2" x 5 1/2" x 4-3/16". Shpg. wt., 10 lbs. Net 49.50

## NEW! HARMAN-KARDON MADRIGAL ST350 STEREO TUNER

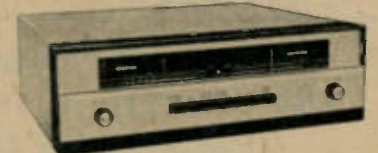

This latest Harman-Kardon unit incorporates the most recent advances in stereo-tuner circuitry. The AM and FM front ends are completely separated for AM/FM simulcast (stereo) reception. Each section has its own highly efficient electronic bar tuning indicator and with the exception of the tuning function the instrument is operated entirely by push-buttons. Looking toward the future, Harman-Kardon has provided for direct chassis installation of the MA350 Multiplex Adapter. FM section employs an Armstrong circuit with zero time constant Gated Beam Limiter, Foster Seeley Discriminator, Automatic Frequency Control and Cathode Follower Output. Sensitivity of 0.95 microvolts for 20 db quieting, 1.9 microvolts for 30 db permits reception of the most distant FM stations. AM circuitry incorporates an exclusive noise filter for noise-free long distance reception, separate AVC circuit, 10kc whistle filter, two broad band IF stages, and low noise. High Gain RF Pentode followed by a Pentagrid converter. Included is a built-in Ferrite Loopstick with low impedance terminal for external antenna. Finished in attractive brushed copper with block display panel. Dimensions are 15 1/2" W x 4 1/4" H x 12 1/2" D. Shpg. wt., 26 lbs. Net 199.95

HARMAN-KARDON ST350 AM FM STEREO TUNER  
CX50 Matching Cage  
Net 12.50

## MULTIPLEX ADAPTER HARMAN-KARDON MA350 COMPATIBLE STEREO



The MA350 is a plug-in stereo adapter designed expressly for use with the ST350 tuner to provide reception of the new Crosby compatible FM stereo broadcasts. Specifications are essentially the same as the MX20 multiplex adapter, the difference being the MA350 mounts easily within the tuner enclosure with signal and power requirements supplied by the tuner. Net 49.95

HARMAN-KARDON MA350 MULTIPLEX ADAPTER  
Net 49.95

## HARMAN-KARDON MX20 SELF POWERED MULTIPLEX ADAPTER

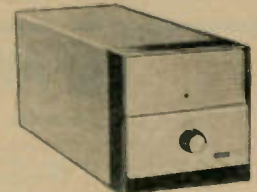

This extremely stable unit is designed for use with tuners which do not provide space and power supply for "plug-in" adapters. Completely self powered the MX20 easily plugs into any tuner with multiplex facilities. When switched to Multiplex (if an MX20 adapter is connected) the compatible stereo broadcast will be heard in full stereo. A convenient stereo dimension control located on the front enclosure is provided for adjusting the degree of stereo to optimum. SPECIFICATIONS: Output Level 1 volt, Input Level 30 millivolt. Distortion 1% total harmonic distortion maximum, Noise Level -60 db, Crosstalk -40 db and Frequency Response 1 db 30 to 15,000 cps. Tube complement 1 E2-80, 3-12AU7, 1-12X7, 2-1N34 crystal diodes. Supplied less cage, dimensions are only 10" W x 5" H x 6" D. Shpg. wt., 12 lbs. Net 69.95

HARMAN-KARDON MX20 SELF POWERED MULTIPLEX ADAPTER  
MC-20 CAGE FOR ABOVE  
B.95

harman kardon

## HARMAN-KARDON MODEL TA230 STEREO FESTIVAL COMPLETE STEREO ELECTRONIC CENTER

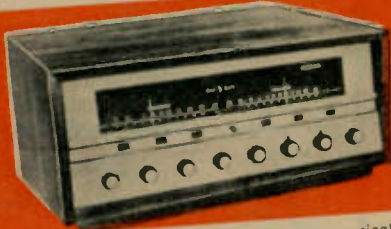

Here is the most complete unit ever offered on one single chassis. A complete stereophonic electronic center: dual preamplifiers with input facility and control for every stereo function including the awaited FM multiplex service. Separate sensitive AM and FM tuners for simulcast stereo reception. New 30 watt power amplifier (15 watts each channel) employs four of the latest 740B output tubes in self-biased push-pull circuits. Output impedance is 8 and 16 ohms. Friction-Clutch tone controls put bass and treble adjustments as gauged controls. Separate bass and treble adjustments or conventionally as gauged controls. D.C. heated preamplifier filaments insure transient response and Silicon power supply provides superior Response. 0.5db 15-stable tuner performance. Frequency Response: 20-20,000 cps. Hum is 85 db below 15 watts at minimum volume. 30,000 cps. FM receiver employs Armstrong circuit, wideband Foster-Seeley FM discriminator and automatic Frequency Control. Sensitivity is 2.5 microvolts for 20db of quieting. Separate electronic tuning bar for AM and FM, new swivel high Q ferrite loopstick for increased AM sensitivity. Ideal for limited space (only 15-13/16" wide, 6 1/2" high, 12 1/2" deep—excluding enclosure) the TA230 is beautifully finished with copper escutcheon and black display panel. Net 259.95  
25.99 Down  
Harman-Kardon TA230 (less enclosure) Net 12.95  
AC 30 Copper and Black metal enclosure Net 12.95  
WW 30 Walnut or FW 30 Fruitwood hardwood enclosure Net 39.95

## HARMON-KARDON MODEL "LUTE" A220 STEREO AMPLIFIER



An amplifier designed to bring quality component stereo within the reach of everyone. The "Lute" incorporates dual stereo preamps and two hum-free, distortion free 10 watt power amplifiers all in one handsome copper and black chassis. Peak power is 20 watts for each channel. The A220 is equally effective as a single 20 watt monoaural amplifier; for those preferring to start out with one speaker with the thought of eventually enlarging their system for stereo. With the new illuminated push button on/off switch you need only see the controls once—and simply press the button for superb performance every time. Controls include an extremely effective balance control, separate ganged treble and bass controls, a manual function switch. Provided are inputs for magnetic phono, crystal or ceramic phono, tuner/aux, 2 stereo tape output receptacles and an AC convenience receptacle. Frequency response is 20-20,000 cycles  $\pm 1$  db at normal listening level with harmonic distortion at less than 2% at 10 watts and 1/2% at 5 watts with readings taken at 1,000 cycles. Tube complement consists of 3 12AX7, 1-12AU7, 4-740B. Dimensions are 14 1/2" W x 10 1/2" D x 4 5/16" H (excluding knobs) Shpg. wt., 14 lbs. Net 79.95

HARMON-KARDON A-220 Stereo Amplifier Net 79.95

# NEW REVOLUTIONARY HIGH-FREQUENCY SPEAKER

## THE NEW LAFAYETTE HIGH FREQUENCY SUPER TWEETER SK-131

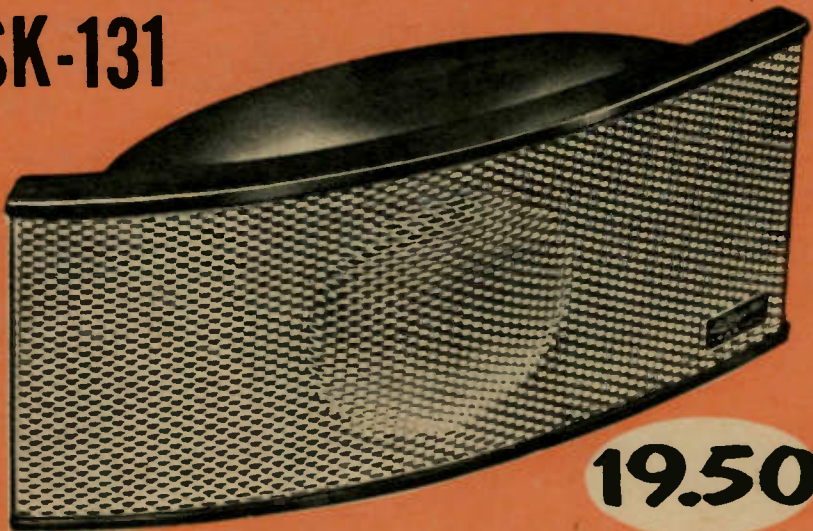

**19.50**

At long last the breakthrough in High-Frequency Speaker design. Here is a tweeter with unequalled performance, engineered for today's high compliance stereo speaker systems. The Lafayette Sphericon represents a complete departure from Electrostatic tweeters, which are extremely inefficient—indeed so much so that it is often necessary to utilize an L-pad on the woofer in order to hear the tweeter properly, thereby lowering the efficiency of the woofer to the same level as that of the Electrostatic tweeter. In the case of many high compliance low effi-

ciency units this is disastrous, as an already inefficient speaker is made even less efficient. The Lafayette Sphericon, due to its high sensitivity may be coupled to any speaker system with no loss in speaker efficiency. As a result less amplification is needed assuring lower distortion. Equipped with a built-in 3000 cycle crossover network the Sphericon produces a smooth linear response from 3,000 cps to beyond 40,000 cps; within plus or minus 1 db from 3000 cps to supersonic frequencies. A specially designed domed phenolic diaphragm delivers



THE MOST SIGNIFICANT ADVANCE IN TWEETER DESIGN OF THE STEREO AGE

- FREQUENCY RESPONSE FROM 3,000 CPS TO BEYOND 40,000 CPS.
- UNIFORM DISPERSION OVER 120° IN ALL DIRECTIONS
- HIGH-SENSITIVITY ALLOWS USE WITH ANY 4-16 OHM SPEAKER
- UNIQUE DOMED PHONOLIC DIAPHRAM
- POWER CAPACITY 30 WATTS
- REQUIRES NO HIGH VOLTAGE OR POWER SUPPLY

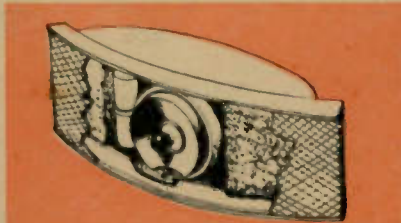

SK-131—LAFAYETTE SPHERICON SUPER TWEETER ..... Net 19.50

### ELECTROSTATIC 3 ELEMENT TWEETER

WAS ~~27.50~~  
NOW ONLY **17.50**



SK-150 Mahogany Finish }  
SK-151 Walnut Finish } ..... Net 17.50  
SK-152 Blonde Finish }  
(Please specify finish)

#### RECOMMENDED INSTALLATION ACCESSORIES

Select crossover networks and L pads to match impedance

#### CROSSOVER NETWORK KITS

Consists of coils and condensers and detailed assembly instructions. Shpg. wt., 2 lbs.  
KT-128—8 ohm crossover kit (for AR-1, AR-2 & KLH-6) ..... Net 2.75  
KT-129—16 ohm crossover kit (for KLH-4) ..... Net 2.75

#### LAFAYETTE "L" PAD ATTENUATORS

VC-49—8 ohm (for AR-2 & KLH6) Shpg. wt., 6 oz. ..... Net 1.49  
VC-50—16 ohm. Shpg. wt., 16 oz. ..... Net 1.49

### LAFAYETTE Sphericon TWEETER AND ACOUSTIC RESEARCH AR-2 SPEAKER SYSTEM COMBINATIONS AT MONEY SAVING PRICES

SPHERICON EXTENDS THE RESPONSE OF YOUR AR SPEAKER TO BEYOND 40,000 CPS

AR-2 10" Acoustic suspension speaker and tweeter assembly; 42-14,000 cps.  $\pm 5$  db; Size 13 1/2" x 11" x 24". Shpg. wt., 52 lbs.  
SY-339—Consists of Lafayette SK-131 Sphericon Tweeter and AR-2 Mahogany Finish ..... Net 98.60  
SY-340—Consists of Lafayette SK-131 Sphericon Tweeter and AR-2 Walnut Finish ..... Net 103.00  
SY-341—Consists of Lafayette 131 Sphericon Tweeter and AR-2 Korina (Blond) Finish ..... Net 113.50  
SY-342—Consists of unfinished AR-2 speaker system and Lafayette SK-131 Sphericon Tweeter ..... Net 92.65



### SOLVE THE SPACE PROBLEM WITH NEW! LAFAYETTE Trioette BOOKSHELF SPEAKER SYSTEM

- FOR BOTH STEREO & MONAURAL
- FREQUENCY RESPONSE 35 TO 18,000 CPS
- UNIQUE 8" WOOFER-MIDRANGE ASSEMBLY
- COMPRESSION — HORN TWEETER
- 6 DB PER OCTAVE ELECTRONIC CROSSOVER WITH LEVEL CONTROL
- SOLID 3/4" VENTED DUCT PORT BOOKSHELF ENCLOSURE

"Trioette"—The perfect blending of attractive bookshelf cabinetry and advanced audio design (years ahead of other engineering efforts along these lines). The exceptional smoothness and cleanliness of the bass and midrange is the product of a unique 8" woofer-midrange speaker design employed in a solid 1/2" acoustically lined vented duct port enclosure. Two separate cones are coupled through a common voice coil, with the outer edge of the midrange cone attached and floating on the flexible corrugated edges of the woofer cone. This results in a mechanical crossover with an absolute minimum of distortion, so that both cones operate in phase at low frequencies, but only the midrange cone transmits the midfrequencies. The heavy magnets provide high efficiency and excellent transient characteristics. Smooth extended high frequencies are brilliantly reproduced by use of a com-

pression horn tweeter utilized with an electronic crossover and level control provided for balancing the system according to individual listening tastes. Impedance 8-16 ohm. Integrated power handling capacity 20 Watts. Dimensions: 23" W x 11 1/2" H x 11 1/2" D. Complete with easy to follow speaker installation instructions.  
SY-353 "TRIOETTE" BOOKSHELF SPEAKER SYSTEM UNFINISHED ..... Net 39.95—only 3.95 DOWN  
SY-354 "TRIOETTE" BOOKSHELF SPEAKER SYSTEM MAHOGANY FINISH ..... Net 42.50—only 4.25 DOWN  
SY-355 "TRIOETTE" BOOKSHELF SPEAKER SYSTEM WALNUT FINISH ..... Net 42.50—only 4.25 DOWN  
SY-356 "TRIOETTE" BOOKSHELF SPEAKER SYSTEM OILED WALNUT FINISH ..... Net 42.50—only 4.25 DOWN  
SY-357 "TRIOETTE" BOOKSHELF SPEAKER SYSTEM BLONDE FINISH ..... Net 42.50—only 4.25 DOWN

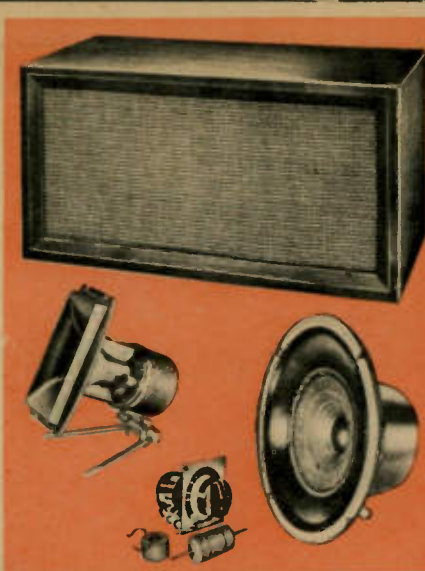

### NEVER BEFORE AT THIS SPECIAL LOW PRICE

LAFAYETTE SK-132 12" COAXIAL SPEAKER



CHECK THESE FEATURES! **22.50**

Built in electronic cross-over with level control. Superior shallow curved form woofer cone. New curved corrugated tweeter cone.

- EXTREMELY FLAT FREQUENCY RESPONSE FROM 35 TO 18,000 CPS.
- WOOFER FREE-AIR CONE RESONANCE OF 40 CPS.
- 1 1/2 LB. MAGNET WEIGHT.
- ABSOLUTE MINIMUM DISTORTION.
- HANDLES 20 WATTS OF CONTINUOUS POWER.
- PERFECT FOR STEREO

Here is one of the greatest speaker values Lafayette has ever offered. Manufactured of the finest materials—clean, crisp response down to the lowest frequencies with the woofer cone utilizing a shallow curved form thereby preventing deterioration of its superior characteristics resulting from sustained usage. The sturdily built voice coil is made with fluoroc bonding agents and easily withstands high peaks. By mounting the tweeter slightly off center of the woofer, interference between the two are eliminated. Impedance: 16 ohms. Shpg. wt., 13 lbs.  
SK-132 12" COAXIAL SPEAKER ..... Net 22.50

### NEW! LAFAYETTE SK-130 8" EXTENDED RANGE HIGH-FIDELITY SPEAKER



- FREQUENCY RESPONSE 40 TO 18,000 CPS.
- 15 OUNCE HIGH EFFICIENCY "ALCOMAX" MAGNET
- FLUX DENSITY 13,000 GAUSS
- 1" VOICE COIL

Made with typical British craftsmanship—this is one of the sweetest, smoothest sounding 8" speakers we have heard. A 15 ounce Alcomax ring magnet plus a hyperbolic cone are utilized to make it ideal for use as extension or midrange speaker—or utilizing two—just the thing for stereo. Capable of handling a full 15 Watts of power and has a voice coil impedance of 16 ohms. Shpg. wt., 3 lbs.  
SK-130 8" EXTENDED RANGE SPEAKER ..... Net 11.95

### NEW! 6 1/2" COAXIAL SPEAKER

- FOR EXCELLENT HI-FI SOUND
- ECONOMICAL & A SPACE-SAVER FOR STEREO
- RESPONSE 50-16,000 CPS!
- BUILT-IN CROSSOVER NETWORK
- LARGE, HEAVY MAGNETS

An excellent speaker, with all the best features of coaxial design, especially recommended for use in stereo high fidelity systems where space and/or cost are factors. The 6 1/2" woofer is provided with extra-heavy large magnets for good power sensitivity and low distortion. The 2" tweeter is a separate speaker coaxially mounted in a housing which completely seals off back radiation and with a mesh dispersion screen to provide smooth, wide-angle dispersion high frequency response. The built-in electrical crossover

contributes to the overall smooth tonal response of 50-16,000 cps. Woofer resonance is 70 cps, voice coil impedance is 8 ohms. Color-coded, screw-type terminals. Requires 5/8" diameter cutout. Mounts with 4 equally-spaced holes. Size is 6 1/2" diam., 3 3/4" deep. Shpg. wt., 3 1/2 lbs.

SK-97 6 1/2" COAXIAL SPEAKER ..... Net 6.95  
GET 2 FOR STEREO ..... Only 12.95 Net



ONLY **6.95**

BUY 2 FOR STEREO **12.95**

### NEW! LAFAYETTE SPACE SAVER SPEAKER ENCLOSURE

- PERFECT FOR STEREO
- FITS INTO BOOKSHELF
- THE IDEAL REMOTE SPEAKER

Only careful Lafayette planning can result in such a handy enclosure priced so low! A beautifully built cabinet with smooth, shining finish available in mahogany, walnut or striking blonde, this enclosure will match any type of room decor. Ruggedly constructed of 1/2" wood sides, top and bottom 1/2" wood front and back. Sturdy enough to withstand even very high volume levels without vibrating. This handsome enclosure has a thousand and one uses. These units make the ideal two or three-channel stereo system or can be used to supplement existing speakers either as the second channel speaker, or as a center stereo speaker for better balance. Ideally suited as the remote speaker in stereo table-model phonographs. Although meant primarily for stereo use, this enclosure can, of course, be used wherever a small hi-fi speaker is desired. Anywhere you use it, you will find its appearance just right. Put it in a bookshelf in the library, on a table or a cabinet in the den or living room, even mount it on the wall. One of the three finishes will match any room. Takes a 6" or 6 1/2" speaker for optimum reproduction of both lows and highs, has a small port for port-loading

of speaker. Completely enclosed back. Will make any speaker sound better. Only 9 1/2" high, 14 1/2" long, 8" deep. Rubber feet protect other furniture. Shpg. wt., 12 lbs.  
CAB-31—Speaker enclosure, specify mahogany, or walnut ..... Net 9.95

COMBINATION DEAL  
—SPECIAL PRICE  
A fantastic money-saving combination of the above enclosure plus Lafayette's SK-97 6 1/2" coaxial speaker, with completely electrical crossover unit, large heavy magnets, 50-16,000 cycle response at 8-10 watts. Must be heard to be believed. Shpg. wt., 16 lbs.  
SY-167—Speaker System ..... Net 15.45

ONLY **9.95** EACH

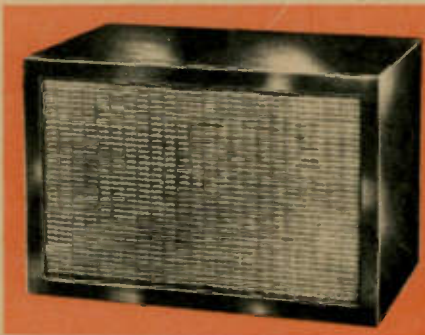

### COMPRESSION HORN TWEETER WITH 2 OR 3 WAY CROSSOVER



Versatility is the byword in this combination of the famous Lafayette SK-105 tweeter and LN-7 crossover. The Lafayette LN-7 6 db per octave crossover may be utilized as a 2-way at 500 cps or 3300 cps now—and in the future, by the addition of a midrange speaker, it will become a 3-way, crossing over at 500 cps and 3300 cps. Rated at 20 watts of continuous power the Lafayette SK-105 tweeter will extend system response up to 16,000 cps. The very high flux density of 13,500 gauss guarantees excellent efficiency and essentially flat frequency response. Ruggedly built from a one-piece casting and carefully designed to eliminate unwanted resonance in the audio range, its attractive styling permits mounting on top of the speaker enclosure or, optionally, within the enclosure. Impedance 8-16 ohms. Shpg. wt., 5 1/2 lbs.  
SY-364—Combination Tweeter and Crossover System ..... Net 16.50

# THE ELIPTOFLEX

Brought To You By Lafayette Research—  
Engineered To Set A New Standard Of Speaker Enclosure Excellence



## NEW! LAFAYETTE

**SK-127 12" COAXIAL SPEAKER WITH DUAL WIDE-ANGLE TWEETERS**



**14<sup>95</sup>**

- FREQUENCY RESPONSE 40-16,000 CPS
- HIGH QUALITY SEAMLESS CONE
- BUILT-IN CROSSOVER NETWORK WITH BRILLIANCE LEVEL CONTROL
- HEAVY DUTY CONSTRUCTION

This speaker must be considered as one of the foremost High-Fidelity values today. Its tonal quality and features equal that of speakers many times its price. The woofer section is constructed of one piece seamless cone with a 1 1/2" voice coil set in a rigid non-resonant frame. Employing a unique dual cone wide-angle tweeter assembly (approximately 125° horizontal dispersion angle) which electrically crosses over at 2500 cycles. A brilliance level control is provided making it possible to vary tweeter level according to personal taste. The speaker has an overall frequency response of 40-16,000 cps. Voice coil impedance 8 ohms. Shpg. wt., 8 lbs. **SK-127 12" COAXIAL SPEAKER** Net 14.95

### SPECIAL COMBINATION



FAMOUS LAFAYETTE-GOODMAN 15" 3-WAY SPEAKER WITH HIGHBOY OR LOWBOY CABINET

**89:50**

**8.95 DOWN**

Now you can obtain what is conceded to be the greatest performance value on the hi-fi market—and save up to 29.50! Available with either SK-111 15" 3-way speaker with 1 1/4 lb. magnet or SK-113 3-way with 3 1/2 lb. magnet.

These are both highly efficient integrated 3-way speakers made by world renowned Goodmans of England. Supplied complete with genuine 12 db/octave crossover network with L-pad high frequency level control.

The enclosure is the renowned Lafayette bass reflex in either highboy or lowboy styling and in a choice of mahogany, walnut or blonde. Solidly constructed of 3/4" stock, these units have picture frame moldings, attractive plastic grilles, tapered legs, brass ferrules, internal acoustic linings, and are finished in genuine wood veneers. Size of lowboy (less legs) 28 1/4" w x 23 1/4" h x 16 1/4" d. Same size for highboy with height and width interchanged.

WHEN ORDERING, SPECIFY CHOICE OF BOTH: STYLE — HIGHBOY OR LOWBOY FINISH—MAHOGANY, BLONDE, WALNUT

SY-281 SK-111 15" with 1 1/4 lb. magnet 3-WAY SPEAKER & ENCLOSURE COMBINATION—Net 89.50 Only 8.95 Down  
SY-338 SK-113 15" with 3 1/2 lb. magnet 3-WAY SPEAKER & ENCLOSURE COMBINATION—Net 99.50 Only 9.95 Down

● NOW IT IS POSSIBLE TO HAVE ALL THE ADVANTAGES OF A HIGH EFFICIENCY SPEAKER IN A BOOKSHELF SIZE ENCLOSURE ● NEWLY DESIGNED ELLIPTICAL PORT BROADENS FREQUENCY RESPONSE AND PROVIDES BETTER TRANSIENT RESPONSE ● NEW DIFFRACTING RING ELIMINATES CANCELLATION EFFECTS BETWEEN FRONT AND REAR RADIATION

# THE ELIPTOFLEX

**THE PROBLEM:** With the advent of stereo, the use of two massive unwieldy speaker systems became unfeasible in most of today's combination living room—music room areas. One answer to this problem was the air-tight bookshelf speaker systems of which there are many excellent variations. However this design is inherently inefficient and requires costly high wattage amplification.

**THE SOLUTION:** The "Eliptoflex" is the latest development from Lafayette's acoustic laboratories. It is the result of an intensive research program to develop a bookshelf enclosure that may be utilized with any efficient 12" full range, coaxial or triaxial speaker. It may also be used with a 12" woofer, separate tweeter and crossover. Utilized with a proper speaker the "Eliptoflex" achieves a degree of natural smoothness coupled with low distortion and a rich, robust bass hitherto found only in large speaker consoles or inefficient bookshelf systems many times its price powered by large amplifiers. With the "Eliptoflex" there is no need for costly high wattage amplification due to its highly efficient design characteristics.

There are two departures from convention which contribute to the excellence of the "Eliptoflex" performance:

one, the elliptical port, and two, the diffracting ring. The loudspeaker is mounted on a baffle recessed in the cabinet shell with the front-plate extending partially across the front surface of the baffle forming ducts or tubes from the port openings to the outside air. The elliptical cutout changes the effective length of the duct across its area. This variation in path lengths provides an extremely smooth transition from duct to free air; broadens the frequency response of which it is effective and provides better transient response. Mixing the front and rear radiation from the loudspeaker diaphragm in this manner produces a truly coaxial presentation over the complete frequency spectrum. The tonal unity is such that no separation of source can be detected between high, middle and low frequencies. A triangular shaped diffracting ring mounted on the front of the baffle board virtually eliminates undesirable cancellation effects normally produced by close coupling of front and rear cone radiation. The result is a "lens" effect, changing relative particle velocities and consequently, phase relationships so as to produce a smooth transition from front to rear radiation.

Comparative laboratory and listening tests indicate that "Eliptoflex" performance is demonstrably superior throughout the audio spectrum.

The "Eliptoflex" is beautifully finished in a variety of hardwood veneers for attractive room placement. Dimensions are 14" H x 23-7/16" W x 13-5/16" D.

- CAB-41WX "ELIPTOFLEX" BOOKSHELF ENCLOSURE (mahogany) Shpg. wt., 24 lbs. Net 32.50
- CAB-42WX "ELIPTOFLEX" BOOKSHELF ENCLOSURE (walnut) Shpg. wt., 24 lbs. Net 32.50
- CAB-43WX "ELIPTOFLEX" BOOKSHELF ENCLOSURE (blonde) Shpg. wt., 24 lbs. Net 32.50
- CAB-52WX "ELIPTOFLEX" BOOKSHELF ENCLOSURE (oiled walnut) Shpg. wt., 24 lbs. Net 32.50
- CAB-44W SET OF WOOD RUNNER FEET FOR CAB-41 (mahogany) Net 1.45
- CAB-45W SET OF WOOD RUNNER FEET FOR CAB-42 (walnut) Net 1.45
- CAB-46W SET OF WOOD RUNNER FEET FOR CAB-43 (blonde) Net 1.45

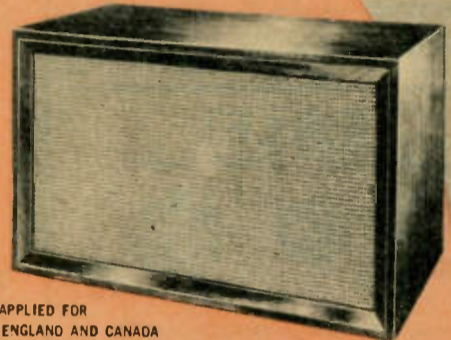
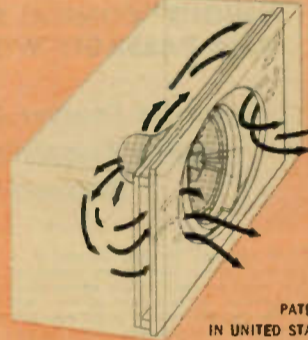

PATENTS APPLIED FOR IN UNITED STATES, ENGLAND AND CANADA



UNIVERSITY 312



UNIVERSITY UXC-122



STOCK #	ENCLOSURE	SPEAKER	REG. PRICE	SPECIAL PRICE
SY-302WX	CAB-41WX	LAFAYETTE-SK-58W	62.00	59.00 ea. 115.00 for 2
SY-303WX	CAB-42WX	LAFAYETTE-SK-58W	62.00	59.00 ea. 115.00 for 2
SY-304WX	CAB-43WX	LAFAYETTE-SK-58W	62.00	59.00 ea. 115.00 for 2
SY-305WX	CAB-52WX	LAFAYETTE-SK-58W	62.00	59.00 ea. 115.00 for 2
SY-306WX	CAB-41WX	LAFAYETTE-GOODMANS SK-110WX	80.00	79.50 ea. 153.00 for 2
SY-307WX	CAB-42WX	LAFAYETTE-GOODMANS SK-110WX	80.00	79.50 ea. 153.00 for 2
SY-308WX	CAB-43WX	LAFAYETTE-GOODMANS SK-110WX	80.00	79.50 ea. 153.00 for 2
SY-309WX	CAB-52WX	LAFAYETTE-GOODMANS SK-110WX	80.00	79.50 ea. 153.00 for 2
SY-310WX	CAB-41WX	LAFAYETTE-GOODMANS SK-112WX	102.00	97.50 ea. 190.00 for 2
SY-311WX	CAB-42WX	LAFAYETTE-GOODMANS SK-112WX	102.00	97.50 ea. 190.00 for 2
SY-312WX	CAB-43WX	LAFAYETTE-GOODMANS SK-112WX	102.00	97.50 ea. 190.00 for 2
SY-313WX	CAB-52WX	LAFAYETTE-GOODMANS SK-112WX	102.00	97.50 ea. 190.00 for 2
SY-314WX	CAB-41WX	LAFAYETTE-GOODMANS SK-114WX	112.00	109.50 ea. 210.00 for 2
SY-315WX	CAB-42WX	LAFAYETTE-GOODMANS SK-114WX	112.00	109.50 ea. 210.00 for 2
SY-316WX	CAB-43WX	LAFAYETTE-GOODMANS SK-114WX	112.00	109.50 ea. 210.00 for 2
SY-317WX	CAB-52WX	LAFAYETTE-GOODMANS SK-114WX	112.00	109.50 ea. 210.00 for 2
SY-318WX	CAB-41WX	UNIVERSITY 312	104.04	89.50 ea. 173.00 for 2
SY-319WX	CAB-42WX	UNIVERSITY 312	104.04	89.50 ea. 173.00 for 2



FAMOUS LAFAYETTE FREE EDGE SK-58 12" COAXIAL 2-WAY SPEAKER. STOCK # SK-58WX



LAFAYETTE-GOODMANS SK-110 12" 3-WAY SPEAKER WITH 1 3/4 LB. MAGNET. STOCK # SK-110WX



LAFAYETTE-GOODMANS SK-112 12" 3-WAY SPEAKER WITH 3 1/2 LB. MAGNET. STOCK # SK-112WX

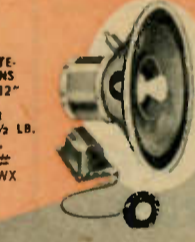

LAFAYETTE-GOODMANS SK-114 12" 3-WAY SPEAKER WITH 5 1/4 LB. MAGNET. STOCK # SK-114WX



JENSEN M-223F



E-V SP12B



E-V 12TRXB



JENSEN M-223F

## NEW! LAFAYETTE SK-125 HI-COMPLIANCE 3-WAY SPEAKER SYSTEM

8" Woofer - 6 1/2" Mid-Range 2 1/2" Tweeter



INCLUDES 3-WAY CROSSOVER NETWORK

- HIGH COMPLIANCE SPEAKERS
- VARIABLE BALANCING CONTROL
- FREQUENCY RESPONSE FROM BELOW 35 TO 18,000 CPS
- SOLID VENTED, DUCTED-PORT TYPE ENCLOSURE
- PERFECT FOR STEREO

Lafayette has succeeded in achieving a standard of performance formerly associated only with very large speaker systems. This complete 3-way speaker system, incorporates advanced Hi-Compliance speaker design in an extra rigid vented, ducted-port type enclosure, lined throughout with acoustic material. The natural, full bass, faithful mid-range and clear sparkling highs are startling from a speaker system of such small proportions. Employing a 3-way LC crossover network with a variable 10-position balancing control, it is possible to match the speaker system to individual room acoustics and listening tastes. Frequency response is from below 35 to 18,000 cps. with a power handling capacity of 25 watts. Impedance 8-16 ohms. Finished on all 4 sides in attractive hand-rubbed mahogany or walnut veneers (please specify). Dimensions are 24" W x 11" H x 10 1/4" D. Shpg. wt., 26 lbs.

SK-125 HI-COMPLIANCE 3-WAY SPEAKER SYSTEM SET OF 2-SK-125 SPEAKER SYSTEMS FOR STEREO



Only 4.95 Down . . . 5.00 Monthly Net 49.50  
Only 9.80 Down . . . 8.00 Monthly Net 98.00

## A SMALL MIRACLE FROM LAFAYETTE—THE NEW SK-124

ULTRA-COMPLIANCE MECHANICAL 2-WAY SPEAKER SYSTEM

- FREQUENCY RESPONSE 40-16,000 CPS
- ESPECIALLY DESIGNED VENTED, TUNED, DUCT TYPE ENCLOSURE
- UNIQUE MECHANICAL 2-WAY SPEAKER WITH EXTRA HEAVY MAGNET
- EXCELLENT FOR STEREO

**\$17<sup>50</sup>** OUTPERFORMS SPEAKERS DOUBLE LAFAYETTE'S LOW PRICE

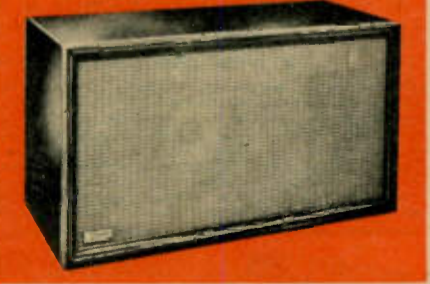

SK-124 MECHANICAL 2-WAY SPEAKER SYSTEM Specify Finish SET OF TWO SK-124 SPEAKER SYSTEMS FOR STEREO

Lafayette has indeed wrought a small miracle in engineering such acoustic excellence into so small a package. Smooth, distortion free response with a deep fundamental bass and clean pure highs that give no indication of its small size and price. The perfect speaker for that high quality installation in your home, office or restaurant—two are ideal for stereo. The speaker features unique dual cone construction with extra heavy magnets. Both tweeter and woofer "float" on flexible, corrugated edges with the outer edge of the tweeter cone attached to the mid-section of the woofer cone. This results in a mechanical crossover so that both cones operate in phase at low frequencies, but only the tweeter cone operates at high frequencies. The same type of wide-range frequency response normally found only in true coaxial or multiple speaker systems is provided. Frequency response of 40-16,000 cps. Impedance 8-16 ohms. Cabinet is finished on 4-sides in hand-rubbed mahogany and walnut for attractive horizontal or vertical placement anywhere in the room. Dimensions are 10 1/4" H x 18-7/16" L x 8-7/16" D. Shpg. wt., 15 lbs.

Only 3.40 Down — 5.00 Monthly Net 17.50 Net 34.00

# AN EXCITING NEW SPEAKER DEVELOPMENT

## OUTSTANDING VALUE! LAFAYETTE AUDIO CABLE ASSEMBLIES

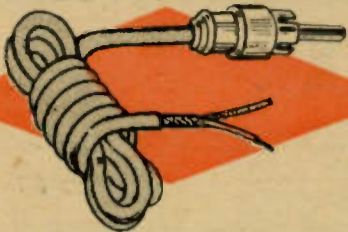

A high quality single conductor shielded cable consisting of a straight molded RCA type phono plug at one end with stripped and tinned terminators at the other end. Perfect for interconnecting phonographs, tuners, amplifiers, and high impedance microphones.

M5-573 36" RCA type phono plug to stripped and tinned ends	Net .34
M5-574 48" RCA type phono plug to stripped and tinned ends	Net .36
M5-579 60" RCA type phono plug to stripped and tinned ends	Net .39
M5-576 72" RCA type phono plug to stripped and tinned ends	Net .41
M5-577 144" RCA type phono plug to stripped and tinned ends	Net .69

## SALE!

### LAFAYETTE KNOB KITS



.89 .79 .69

- MOLDED FROM HI-IMPACT PLASTIC
- BRASS SCREW AND SHAFT INSERT
- ACCEPTS UP TO 1/4" ROUND OR FLAT SHAFT

You'll want these trim distinctive, functionally styled knobs to add a custom or professional appearance to your HI-FI, Ham, Test and Experimental Equipment. Finished in an attractive steel gray and molded from tough hi-impact plastic, the knob is of cylinder design with sure-grip fluted sides and an aluminum ring-set in a recessed face. Rugged brass screw and mounting shaft insert will accept up to 1/4" round or flat shaft. Each kit contains 5 knobs.

K1-55 Size: 1 1/2" Diameter 3/8" Deep	Net .89
K1-56 Size: 1 1/2" Diameter 11/16" Deep	Net .79
K1-57 Size: 1" Diameter 11/16" Deep	Net .69

## LAFAYETTE SCOOPS THE TAPE RECORDER INDUSTRY THE NEW LAFAYETTE RK-103 DUAL SPEED TAPE RECORDER PROFESSIONAL QUALITY AT A PRICE YOU CAN AFFORD!

ONLY  
**99.50**



- PUSH-BUTTON CONTROLS ● DUAL SPEED ● TWIN SPEAKER
- TAPE INDEX COUNTER ● WIDE RANGE FREQUENCY RESPONSE
- SIGNAL TO NOISE RATIO BETTER THAN 40 DB
- WOW AND FLUTTER LESS THAN 0.35%

Lafayette has it! We are not at liberty to divulge the nationally famous name of this instrument's manufacturer, however, we are confident that its features will speak for themselves—rugged fool proof push-button controls for play, record, rewind, forward and stop. Automatic interlocked switching makes it impossible to accidentally erase, spill, or break tape. Dual speeds—7 1/2 and 3 1/2 ips. Record level indicator to facilitate recording. Fast forward and rewind—1200" in 80 seconds. Accepts 7" reel size. Twin

matched speakers for 360° sound distribution. Tape index counter. Provision for connecting to external speaker and external amplifier. Input jack for your Radio-Phono or T.V. Complete with microphone, 600 ft. of tape and extra reel. Attractively finished in black and white scuff-resistant pyroxylin material. Dimensions are 14" H x 14" W x 10" D. Shpg. wt., 33 1/2 lbs.  
**RK-103 LAFAYETTE DUAL SPEED TAPE RECORDER**  
v.00 Down 8.00 Monthly **NET 99.50**

## 20,000 OHM PER VOLT MULTITESTER

- 20,000 OHMS PER VOLT DC SENSITIVITY
- 10,000 OHMS PER VOLT AC SENSITIVITY
- 40 MICROAMPERE 3" D'ARSONVAL METER MOVEMENT
- HIGH INPUT RESISTANCE ON ALL DC & AC RANGES

A new multitester with extra-luxury features, at a down-to-earth price. Here is the ideal all-purpose multitester for trouble-shooting. Uses a sensitive, rugged 40 micro-ampere basic meter, a d'Arsonval movement with jeweled bearings. Input resistance 20,000 ohms per volt on DC; 10,000 ohms per volt on AC. 1% tolerance resistors. Single knob selector switch greatly simplifies operation. Break-proof zero-ohms knob permits easy adjustment. Measures 0.10-50-250-500-1000 DC volts, 0.10-50-250-500-1000 AC volts, 0.10K-100K megohms, 0.500 micro-ampere, 0.10-250 milliampere, -20 to +36 decibels, PLUS two special ranges 0-5000 henry inductance and 250 mfd to .02 mfd capacity. Size 3 1/2" x 5 1/2" x 1 1/2". Shpg. wt., 3 lbs.  
**MODEL RW-60 Multitester**  
**ONLY 13.50**



NET 13.50

## Lafayette Presents

### THE NEW ULTRA-LINEAR SK-128 FULL RANGE 8-INCH DUAXIAL SPEAKER WITH NEWLY DEVELOPED TWEETER BAFFLE DESIGN.

- 40 TO 16,000 CPS—FLAT WITHIN 3 DB ■ HIGH EFFICIENCY
- HIGH EXCURSION WOOFER WITH UNIQUE "CONICAL STIFFENER" ■ HANDLES HEAVY BASS PASSAGES WITHOUT "DOUBLING"

*Eccentric Tweeter Mounting & Unique Elliptical Baffle Completely Eliminates Interaction Between Woofer & Tweeter*

The SK-128 combines the best features of a multiple speaker system in one compact and economical unit. It offers full, even coverage of the entire audible range, with no distortion or coloration to mar your listening pleasure. The specially treated woofer cone has a unique "Conical Stiffener" at the apex which, coupled with its high compliance, enables the cone to operate in a piston-like manner—delivering a clean, powerful bass response. The 2-inch tweeter has its own voice coil and magnetic field. Special treatment of cone and cone edge provides even distribution of the high frequencies, with no peaks or resonances. The unusual off-center mounting of the tweeter and its elliptical baffle minimizes interaction between tweeter and woofer and insures an overall response free of intermodulation distortion. Electrical crossover from the woofer cone to the tweeter unit is provided by a

built-in network. An adjustable brilliance control permits matching of sound to room acoustics. Efficiency of the speaker is such that it will operate from any amplifier with an output of 1 watt or more. Installed in a bass-reflex type of enclosure, it performs outstandingly, and is recommended for all high-quality music systems—whether monaural or stereophonic. SPECIFICATIONS: Overall Response: 20-20,000 cps (40-16,000 cps ± 3 db). Free air Resonance: 45-65 cps. Impedance: 8 ohms. Power Rating: 20 watts Integrated Program Material. Crossover: 2,500 cps. Overall Diam. 8-5/32". Overall Depth: 5-17/32". Baffle cut-out: 7-1/32". Rugged, vibration-free speaker frame with color-coded screw-type terminals for quick, easy connection of amplifier leads. Shpg. wt., 5 lbs.  
**SK-128 Full Range 8" Duaxial Speaker** .....Net 19.50

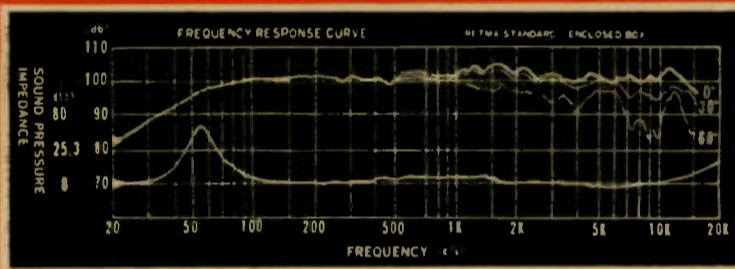

### LAFAYETTE MINI-DUCT BOOKSHELF ENCLOSURE WITH SK-128 8" ULTRA-LINEAR SPEAKER

The perfect answer for those who demand realistic sound reproduction even where space is limited. Two of these systems are ideal for stereo.

SY-343WX Speaker System in Walnut	Net 39.50
SY-344WX Speaker System in Mahogany	Net 39.50
SY-345WX Speaker System in Blonde	Net 39.50
SY-346WX Speaker System in Oiled Walnut	Net 39.50
SY-347WX Speaker system in unfinished birch	Net 37.50

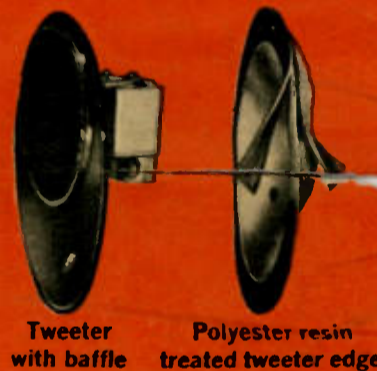
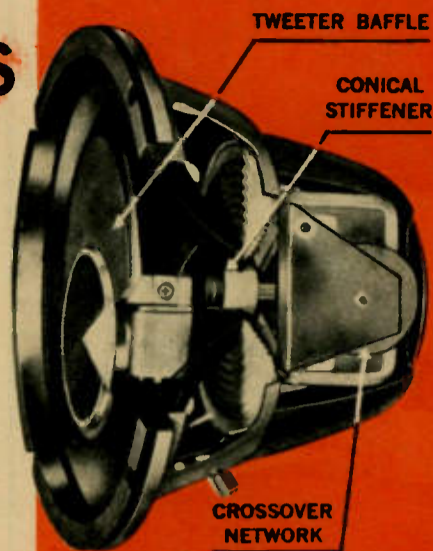

## STEREO AUDIO ANALYST SINGLE NEEDLE—DUAL CHANNEL VU BALANCE METER



TM-66  
**11.95**

- UNIQUE TWO COIL GALVANOMETER TYPE PRECISION METER MOVEMENT
- SEVEN RANGES OF METER SENSITIVITY
- EFFORTLESS BALANCING OF STEREO SYSTEMS
- PROVISION FOR USE AS VU METER AND TAPE RECORDER LEVEL INDICATOR
- MAXIMUM METER SENSITIVITY 120 uV

The TM-66 provides the solution to all stereo balancing problems. This unique precision meter movement utilizes 2 separate coils set in a single magnetic field. Each stereo channel feeds a separate coil through a full wave bridge rectifier. When both signals are equal and balanced the resultant deflection on the scale will measure 0. Unlike conventional stereo indicators having two unrelated movements, calibration of one meter against the other (channel A vs. channel B) is unnecessary. Since the two separate coils interact within a single magnetic field, the single needle movement acts upon channel A and channel B simultaneously, automatically maintaining the unit in constant calibration. Individual channels may be measured by

means of the two slide switches. An extremely stable meter action and protection from peak voltages is provided by special damping networks. Since the unit is in continuous calibration the need for individual range controls are eliminated. The single seven step range control serves for both channels and facilitates the use of the meter with all amplifier power levels. By properly positioning this control the movements may be used as VU meters when terminated across the 600-ohm load. The scales are calibrated in "Volume Units". Sensitivity is 1.2 volts, for 0 vu or 100 percent indication. The metal case is finished in a rich satin gold. Overall size is 4 1/2" L x 5 1/2" H x 4-3/16" W.  
**TM-66 Audio Analyst** .....Net 11.95

**NEW GENERAL ELECTRIC  
STEREO AMPLIFIERS**

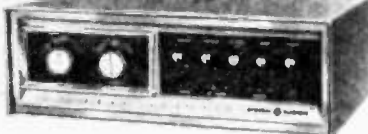

**MODEL MS-2000 "STEREO CLASSIC"  
28-WATT STEREO AMPLIFIER**

This integrated stereo amplifier combines high quality stereo performance with striking cabinet design. Consists of 2 power amplifiers and 2 preamp control units on a single chassis. Front panel controls include: input selector—stereo tape head, monaural phono, stereo phono, stereo tuner, auxiliary; Speaker mode selector—stereo, channel reverse, monaural; Volume; Contour; Balance; Bass; Treble; Rumble filter; Power on-off; Tuner level set. Inputs (with sensitivity figures): Stereo Cartridge (3.5 mv); Stereo tape head (3 mv); Monaural Cartridge (3.5 mv); Tuner (200 mv); Auxiliary (200 mv). Outputs: Dual speakers—4, 8, 16 ohms; Dual output jacks: 2 a.c. outlets, one controlled. Power Output: 28 watts total, 14 watts per channel in stereo operation. Frequency Response: 20 to 20,000 cps  $\pm$  0.5 db. Harmonic Distortion: below 1% stereo operation, at full output. Hum and noise: -55 db (phono); -73 db (high level). Channel Separation: at least 40 db between 30 and 20,000 cps. Tubes: 2-7025/12AX7; 2-12AX7; 2-6BA8A; 4-6V6GT; 1-5V4GA; 1-full wave selenium rectifier. Cabinet finished in leather grain willow gray vinyl. Front panel features a silver and willow gray color finish. Size, 15x12x5 1/4". For 110-117V, 60 cps AC. Shpg. wt., 15 lbs. Model MS-2000.....Net 137.00

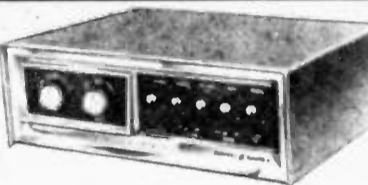

**MODEL MS-4000 "STEREO CLASSIC"  
40-WATT STEREO AMPLIFIER**

New compactly designed stereo amplifier, carefully engineered to fulfill the need for a top quality unit at a modest cost. Output power is rated at 40 watts total; 20 watts per channel in stereo operation. Frequency Response: 20 to 20,000 cps  $\pm$  0.5 db. Harmonic Distortion: below 1% at full output, stereo operation. Hum and noise: -62 db (phono); -73 db (high level). Channel Separation: better than 40 db between 30 and 20,000 cps. Front Panel Controls include: input selector—stereo tape head, monaural phono, stereo phono, stereo tuner auxiliary; Speaker mode selector—stereo, channel reverse, monaural together; Volume; Contour; Balance; Bass; Treble; Rumble filter; Power on-off; Tuner level set. Also a rear panel speaker phasing switch. Inputs (with sensitivity figures): Stereo cartridge (3.5 mv); Stereo tape head (3 mv); Monaural cartridge (3.5 mv); Tuner (200 mv); Extra (200 mv). Outputs: Dual speakers—4, 8, 16 ohms; dual output jacks; 2 AC outlets, one controlled. Tubes: 2-7025/12AX7; 2-12AX7; 2-6BA8A; 4-6V6GT; 1-GZ34/5AR4; 1-6X4; 1-selenium bridge rectifier. "Flat cabinet finished in leather grain willow gray vinyl. Panel features a silver and willow gray color pattern finish. Size, 15 x 12 x 5 1/4". For 110-117 V, 60 cps AC. Shpg. wt., 15 lbs. Model MS-4000.....Net 176.25  
Model MS-4010 Same as MS-4000 but with cabinet finished in saddle-brown vinyl and panel in brown and gold. Net 176.25



**MODEL RG-1000 "STEREO CLASSIC"  
REMOTE CONTROL UNIT**

Provides the important stereo central remote control functions of channel balance and volume control—up to 30 feet from the controlled amplifier. Ideally suited for use with the GE MS-4000 or MS-2000, or as a remote volume control with a monaural amplifier, or for volume and balance control with a pair of monaural amplifiers used for stereo. Superb styling with ebony-finish base and knobs, textured aluminum face plate, and chrome trim. 5 1/2" x 2 1/4" d x 1 3/8" h; with 30-foot output cable. Shpg. wt., 2 1/2 lbs. GE RG-1000 Remote Stereo Control.....14.36

**NEW GENERAL ELECTRIC  
FM-AM TUNER MODEL FA-12**



The new GE Model FA-12 FM-AM Tuner offers an unusual combination of excellent audio performance and trim, highly-compatible appearance design, for use with virtually any amplifier in a custom high fidelity system. This tuner features high sensitivity, precision tuning, ability to receive weak signals with minimum distortion, and an unusually low hum and noise level. Front Panel Controls: Tuning (flywheel); Selector switch with Off, AM, FM, FM (AFC) positions. Specifications: AM Sensitivity: 200  $\mu$ V per meter for 20db signal-to-noise ratio; FM: 5  $\mu$ V for 32db quieting. AM Selectivity—7kc bandwidth, 6db down; FM—200kc bandwidth, 6db down. FM Distortion—less than 1.5% harmonic at rated output—less than 2% AM. Noise—FM, 55db below 100% modulation—AM, 40db below 100% modulation. Response—FM,  $\pm$  2db of the standard de-emphasis curve; AM, 25db down at 10kc to minimize whistle interference. Audio Outputs—3 low-impedance cathode follower type; 1 high, 1 low, 1 multiplex. Antenna Inputs—FM, 300 ohm (folded dipole antenna supplied); AM, built-in ferrite rod antenna, terminal for external antenna. FM drift is negligible with AFC, and spurious radiation certified as meeting FCC requirements. Tuning Range—FM, 88 to 108mc; AM, 535 to 1620kc. Tuning Meter—dual purpose for precise FM center tuning and AM maximum signal tuning. Overall dimensions—15-1/32" W x 3 1/2" H x 10 1/2" D. Shpg. wt., 15 lbs. For use with 110-120 volts 60 cycles AC. Model FA-12 (willow gray vinyl cabinet with gray and silver faceplate).....Net 124.95  
Model FA-10 (saddle brown vinyl cabinet with brown and gold faceplate).....Net 122.95

**"COMPATIBLE"  
PHONO MUSIC SYSTEM** **STEREO and LP MONAURAL**

Plays Stereo and Monaural Records

**LAFAYETTE SUPER-VALUE HIGH FIDELITY "TWINS"**



LT-75



LA-45

**NEW! FM TUNER 47.50 WITH CAGE**  
**Ready for Stereo! ONLY 5.00 DOWN**  
**— 5.00 MONTHLY**

- MULTIPLEX OUTPUT FOR FM MULTIPLEX STEREO ● NEW EM80/6BR5 "PIN-POINT TUNING" EYE ● FULL ARMSTRONG FM CIRCUITRY ● DRIFT-FREE AUTOMATIC FREQUENCY CONTROL ● 4 $\mu$ V FM SENSITIVITY

An outstanding new FM tuner designed to receive standard FM or FM multiplex stereo with a high degree of sensitivity for "pulling in" even distant stations with excellent "quieting" and with good selectivity for separating strong local stations and weak distant stations. Most multiplex output jacks, ready for use with a multiplex decoder (when available) for FM multiplex stereo. Can be used for standard FM reception, or with your AM radio for AM/FM stereo, or 2 units can be used for FM/FM stereo (which promises to be a not-too-distant development). Features include: SENSITIVITY: 4 microvolts for 20 db quieting, 7  $\mu$ V for 30 db. FREQUENCY RESPONSE: 20-20,000 cps  $\pm$  1 db. DISTORTION: Less than 1%. AUTOMATIC FREQUENCY CONTROL (AFC): With defeat switch to permit tuning in distant stations adjacent, on the dial, to strong local stations; FM DRIFT: Maximum  $\pm$  5 kc.; HUM: 60 db below 100% modulation; OUTPUTS: Standard Audio, Multiplex, Tape Recorder; OUTPUT LEVEL: 2 1/2 volts for 100% modulation; CIRCUIT: Armstrong type, with limiter and Foster-Seely discriminator; TUNING EYE: EM80/6BR5 for pinpoint tuning of stations; BUILT-IN ANTENNA: Line cord type, with provisions for external antenna in "fringe" areas. TUBES: 6UB, 6BA6, 12AT7, 2-6AU6, 6AL5, EM80/6BR5; selenium rectifier. For 105-120 volts, 60 cps AC. Styling is modern, with gold-finished removable front panel and black metal cabinet with rubber feet. Size is 14 1/4" x 8-3/16" d x 4 1/4" h. Shpg. wt., 13 lbs. LT-75—FM Tuner, Complete with Cage Net 47.50

**NEW! LA-45 14-WATT AMPLIFIER 39.50 Only 5.00 Down!**

The Lafayette LA-45 is a complete 14-watt amplifier with built-in preamplifier-equalizer with wide range frequency response and low hum and distortion to ensure sparkling reproduction that will delight you. This undistorted power is achieved from circuitry employing the new premium quality EL84 tubes in a pentode-connected balanced output circuit. 5 inputs are provided for every type of crystal, ceramic or magnetic phono cartridge, for tuner and tape head as well as high level auxiliary input. The front panel function selector and equalization switch gives instant choice of tuner, aux., or phono with proper equalization for all types of records, and tape head. Equalization positions are RIAA (LP), POP for 78 rpm records, and NARTB tape head equalization. A "Monitor" jack and switch permit tape monitoring, provide a high level signal for tape recording, or allow plug-in use of the new stereo adapters. Other features include a 12 db per octave rumble filter, an auxiliary AC receptacle, provision for mounting in cabinet or on a console panel, attractive finish that blends harmoniously with both modern and traditional decor, and a power on-off pilot light. Its appearance matches the Lafayette LT-75 tuner. It comes complete with removable cage.

**SPECIFICATIONS**

POWER: 14 watts normal, 28 watts peak. FREQUENCY RESPONSE: 30-20,000 cps  $\pm$  1 db. IM DISTORTION: Less than 1 1/4% (60 and 7000 cps) at full output. HUM: Tuner 80 db, phono 60 db below full output. INPUTS: Crystal phono, tuner, magnetic phono, tape head, aux. OUTPUTS: Monitor, speaker (8 and 16 ohms). CONTROLS: Function selector and equalization, bass, treble, loudness with AC on-off switch, monitor on-off switch, rumble filter on-off switch. RUMBLE FILTER: 12 db per octave below 100 cps. EQUALIZATION: RIAA (LP), POP (78), TAPE HEAD (NARTB). TONE CONTROLS: 12 db cut or boost on bass or treble. INPUT SENSITIVITY: For full output: 1/2 volt for tuner, crystal or aux.; 2.7 millivolts for magnetic phono or tape head. DAMPING FACTOR: 10. TUBES: 2-12AX7, 2-EL84; E2B1 (rectifier). AC OUTPUT: Cabinet or panel. SIZE: 13 1/4" long x 6 1/4" d x 4 1/4" h including bumper feet. Knobs extend 1/4" in front of panel. SHIPPING WEIGHT: 15 lbs. LA-45—14-watt amplifier Net 39.50

**MONAURAL SYSTEM TO PLAY BOTH  
STEREO AND MONAURAL RECORDS**

**COMPONENTS**

LAFAYETTE LA-45 14-WATT COMPLETE AMPLIFIER	39.50
GARRARD RC-121 4-SPEED RECORD CHANGER	41.65
NEW GE VR-22 (.7 MIL) DIAMOND STEREO CARTRIDGE	24.45
LAFAYETTE SK-58 12" COAXIAL SPEAKER	29.50
LAFAYETTE PK-111 WOOD BASE	3.95
	<b>139.05</b>

**CONVERT TO COMPLETE STEREO LATER**



**HIGH FIDELITY PHONO SYSTEM**  
Play Stereo & Monaural Records, Monaurally, Now—  
Add Complete Stereo Later

REGULAR PRICE ~~139.05~~  
**SAVE 31.55**

**YOU PAY 107.50 ONLY**  
ONLY 10.75 DOWN—10.00 MONTHLY

An economical high fidelity system with outstanding performance features for highly-satisfying tone quality. It's all ready for stereo; conversion will involve only a few easy interconnections. Includes the new Lafayette LA-45 14-Watt amplifier, with frequency response of 30-20,000 cps. and with "Monitor" jacks for plug-in use of a stereo adapter when desired; the Garrard 4-speed automatic record changer Model RC-121/11 all set for stereo whenever you're ready; the new GE VR22 (.7 MIL) Diamond Stereo Cartridge engineered for virtually hum-free performance with a frequency response from 20 to 20,000 cycles. For both stereo and microgroove LP and 45 rpm records; the Lafayette PK-111 wood changer base, of fine, selected veneers; and the world famous Lafayette SK-58 coaxial 12" speaker with "Brilliance" high-frequency level control. The system is supplied complete with cables, connectors, and easy-to-follow installation instructions. For 105-120 volts 60 cycles AC. Shpg. wt., 55 lbs. MF-564—Complete 14-Watt Phono System with blonde, mahogany or walnut wood changer base plus choice of cartridges (please specify).....Net 107.50 MF-565—Same as MF-564 but with Lafayette CAB-16 mahogany or walnut or CAB-17 blonde resonator type speaker enclosure (please specify finishes).....Net 135.00 LAFAYETTE FM PHONO MUSIC SYSTEM ONLY 10% DOWN MF-566—Same as MF-564 above but includes new Lafayette LT-75 FM Tuner.....Net 155.00 MF-567—Same as MF-565 above but includes LT-75 FM Tuner.....Net 182.50

**SELECT YOUR OWN CARTRIDGE**

You may substitute the Shure M7D, Pickering 371-7D or the new Electro-Voice 31MD7 in any system shown with the GE VR-22 of no additional cost.

**COMPLETE HARMAN-KARDON FM-AM STEREO-PHONO SYSTEM**  
50-Watts (25 Each Channel)

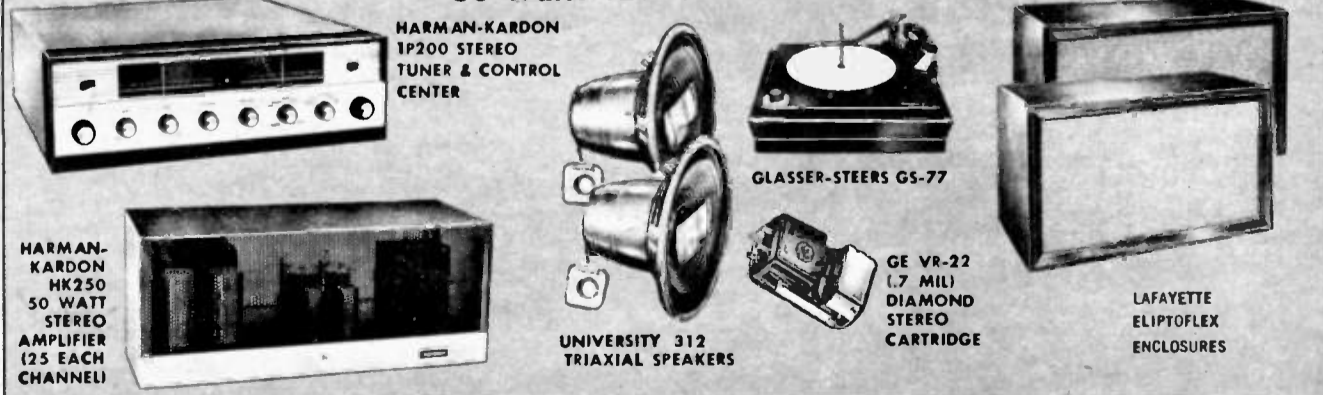

**SPECIALLY PRICED! SAVE OVER 30%**

HARMAN-KARDON TP200 STEREO TUNER & CONTROL CENTER	189.95
HARMAN-KARDON HK250 50 WATT STEREO AMPLIFIER (25 EACH CHANNEL)	99.95
GLASSER-STEERS GS-77 (less base)	59.50
GE VR-22 (.7 MIL) DIAMOND STEREO CARTRIDGE	24.45
2—UNIVERSITY 312 TRIAXIAL SPEAKERS @ 71.54	143.08
Regular Catalog Price	<del>314.95</del>

**YOU SAVE 127.43**  
**YOU PAY 389.50**  
38.95 Down  
24.00 Monthly

MF-630 Stereo system as illustrated. Shpg. wt., 85 lbs. Net 391.95  
Recommended enclosures for the MF-630 system are the Lafayette Eliptoflex series Bookshelf Enclosure or CAB-16 Series Resonator Enclosure. Set of 2 57.50 (Please specify finishes). MF-631 same as MF-630, but with 2-Lafayette SK-114 12" with 6 1/2 lb. magnet 3-way speakers and 2 Lafayette Eliptoflex Series Enclosures. Shpg. wt., 133 lbs. Net 487.95 48.79 Down 27.00 Monthly  
MODEL GSB Wood base for Glasser-Steers GS-77 in ebony with satin brass trim, or unfinished Net 9.60

# GO STEREO NOW! Super-Fidelity Extra-Low-Cost Easy Build Kits

## EICO HI-FI KITS

### NEW! EICO STEREOPHONIC DUAL PREAMP KIT

Self-powered preamp-control center offering complete switching and control facilities for any stereo program source—tapes, discs or broadcasts. Each channel provides: low-level inputs—magnetic cartridge, tape head, mike; high-level inputs—AM and FM tuners, FM multiplex, auxiliary A and B; independent level control operating separately or in clutch; 3-stage bass and treble tone controls with feedback amplifier pair driving variable crossover, feedback tone-control stage; Fletcher-Munson loudness compensation with disabling switch; function-selector switch; low-impedance output for tape recorder; hum balance control; convenience outlets. **SPECIFICATIONS** (both channels): Frequency response 5-200,000 cps  $\pm 0.3$  db; IM distortion (60 & 7000 cps) .03% @ 1 v. RMS output; Harmonic distortion (20-20,000 cps) .1% @ 3 v. RMS output; Tone-control range  $\pm 15$  db @ 50 and 10,000 cps; RIAA phono and NARTB tape head (15, 7.5, and 3.75 ips) equalization; Output-to-main amplifier impedance, 8000 ohms. Tubes: 5-12AX7/ECC83's, 1-6X4. Size: 3 1/2" high, 12" wide, 8 1/4" deep. Shpg. wt., 10 lbs. Cover supplied.

HF85K Stereo Dual Preamp Kit ..... Net 39.95  
HF85 Same, factory wired & tested ..... Net 64.95

### EICO Model HF-81K STEREOPHONIC DUAL AMPLIFIER-PREAMP

A handsome complete hi-fi stereophonic control center with 2 matched Williamson type push-pull EL84 power amplifiers, all on one chassis. Each channel has 8 inputs: low level-mag phono, tape head, and microphone. Front panel switch for choice of proper NARTB tape equalization for either 7 1/2 or 15 or 3 1/2 ips; high level—2 auxiliaries, AM, FM and FM multiplex. Front panel control to obtain stereophonically FM and AM or FM and FM Multiplex; Ganged level controls and a separate focus (balance) control; Independent, low distortion variable cross-over feedback type of bass and treble controls for each channel. Adaptable to any panel thickness for console installation. Output Power—rated 28 watts (continuous) for monaural, 14 watts for stereo. Freq. Response— $\pm 5$  db, 10 to 100 kc at 2 w out. IM Distortion (60 and 6000 cps at 4:1)—0.5% at 10 watts out. Harmonic Distortion—less than 1% from 40-10 kc at 20 w output. Sensitivity for rated output—mag phono: 4 mv; tape heads: 2 mv; mic: 6 mv; tuner and auxiliaries: 0.5 v. Hum and Noise Level (below 14W):—56 db on low level input, —75 db on high level inputs. Bass— $\pm 15$  db at 50 cps. Treble— $\pm 15$  db at 10 kc. Speaker Connections—4, 8, & 16 ohms. Tubes—4 ECC83/12AX7, 2 ECC82/12AU7, 4 EL84, 2 EZ81—Size 15 x 10 1/2 x 4 1/4". Shpg. wt., 24 lbs.

Model HF-81K. Kit complete with cover ..... Net 69.95  
Model HF-81 As above but wired ..... Net 109.95

### NEW! EICO FM TUNER HFT-90

Newly-designed, extremely sensitive, low-noise "front end" supplied in a cast housing completely pre-wired, pre-aligned, ready to use. This new front end, for the first time makes it completely practical even for a novice to build an FM tuner equal to really good professional factory-wired units. Employs the broad-band detector circuitry used in \$169 FM tuners now on the market. Temperature-compensated components and advanced circuitry completely eliminate need for AFC. Drift is less than 2 parts in 10,000 from cold start. Sensitivity is 6 times greater than other kit tuners and equals that of the most expensive wired tuners; it is 1.5 v for 20 db quieting. Radiation suppressed far below FCC standards. Also features new DM-70 traveling tuning eye. Input 300 ohms, IF bandwidth 260 kc, detector separation of 600 kc. Freq. resp. 20-20,000 cps  $\pm 1$  db. Audio output 1 v for 10 uv input with 75 kc deviation. Hum 60 db below 1 v. Cathode follower and multiplex outputs. Flywheel slide-rule tuning, AGC, stabilized low limiting threshold for excellent performance from weaker signals, broad-band ratio detector for improved capture ratio and easier tuning, full-wave rectifier and heavy filtering, very low distortion. Uses 1-ECC85/6A08, 3-6AU6, 1-6AL5, 1-6CA, 1-DM70, 1-6X4. Flexible "low silhouette" design adaptable to any panel thickness for console installation; optional cabinet. HWD: 3 1/2" x 12" x 8 1/4". Operates from 110-125 VAC. 60 cps line.

HFT 90K FM TUNER KIT (less cover) ..... Net 39.95  
HFT 90 FACTORY WIRED AND TESTED TUNER ..... Net 65.95  
E-3 Cover for above ..... Net 3.95

### EICO 12-WATT WILLIAMSON-TYPE HI-FI AMPLIFIER . . . PREAMP . . . CONTROL SECTION

Compact, attractively styled amplifier with complete front end facilities and true high fidelity performance. Direct tape head and magnetic phono inputs with NARTB (tape) and RIAA (phono) feedback equalizations. Dual triode circuit for variable turnover bass and treble feedback-type controls. Power output: 12 watts continuous, 25 watts peak. Intermodulation distortion 1.5% at 12 watts, 0.55% at 6 watts, 60 to 6000 cps. Frequency response: 12-50,000 cps  $\pm 0.5$  db at 1 watt; 25-20,000 cps  $\pm 0.5$  db at 12 watts. 4 Controls: Selector switch, level control, bass and treble controls. Speaker connections for 16, 8, and 4 ohms. Tubes: (2) ECC83/12AX7, ECC82/12AU7, (2) EL84, EZ81. Size: 3 1/2" H, 12" W, 8 1/4" D. Shpg. wt. 13 lbs. With instructions.

MF12K—Complete Kit ..... Net 34.95  
MF12—As above, factory wired ..... Net 57.95

# Lafayette



## STEREO TUNER KIT

THE STEREO-TUNER IS YEARS AHEAD

KT-500  
**74.50**  
IN KIT FORM  
LT-50  
**124.50**  
COMPLETELY WIRED AND TESTED

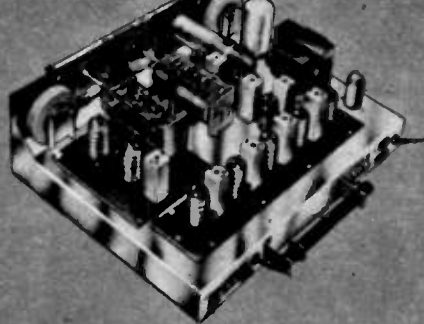

ONLY \$7.45 DOWN \$8.00 MONTHLY

### THE MOST FLEXIBLE TUNER EVER DESIGNED!

- Use it as a Stereophonic FM-AM Tuner
- Use it as separate Monaural FM & AM Tuners
- Use it as straight Monaural FM or AM Tuner

- MULTIPLEX OUTPUT FOR NEW STEREO FM
- TWO PRINTED CIRCUIT BOARDS AND IF'S PREALIGNED
- FM AFC AND AFC DEFEAT
- TUNED CASCADE FM FRONT END
- 17 TUBE PERFORMANCE—11 Tubes (4 dual-purpose) + Tuning Eye & Selenium Rectifier
- ARMSTRONG CIRCUIT WITH DUAL LIMITERS AND FOSTER-SEELEY DISCRIMINATOR
- 12 TUNED CIRCUITS AND DUAL CATHODE FOLLOWER OUTPUTS
- EXTREME SENSITIVITY AND WIDE FREQUENCY RESPONSE

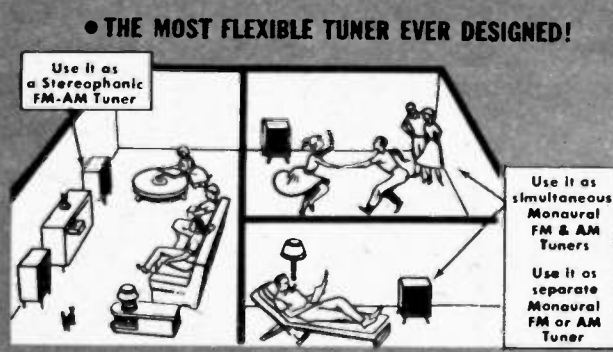

More than a year of research, planning and engineering went into the making of the Lafayette Stereophonic Tuner. Designed against obsolescence, it incorporates every practical and worthwhile feature that is considered necessary for your complete satisfaction of all present and future types of broadcasting. Already, breathtaking stereophonic programs are being transmitted via FM and AM. It will certainly become more and more the popular method of high-fidelity broadcasting. The tuner also provides an output for multiplex FM stereophonic reception, enabling you to enjoy the ultimate in high-fidelity sound reproduction. Since the FM and AM sections are completely independent of each other, this tuner can be used furthermore as a dual-monaural tuner. In this way, the music lovers are able to listen to concert programs on the FM channel in one room, while the younger set can listen to a different program on an AM in another room. In addition, on a monaural program which is broadcasted simultaneously via FM and AM, this tuner will enable you to tune in both channels and reproduce them through individual amplifier-speaker systems. The improvement of quality will be immediately noticeable because the sound source is now distributed and at the same time, the hole-in-the-wall point source effect is completely eliminated. Of course, the unit can also be used as an ordinary type of FM-AM tuner, providing you with unsurpassed quality of reception.

Apart from its unique flexibility, this is, before all else, a superior high-fidelity tuner, employing many features found only in the highest priced units. An inspection of the tubes and parts used will reveal that this tuner is engineered without compromise of any kind. With the Lafayette Stereo-Tuner you are assured of noise-free, drift-free, distortion-free performance. You will not only hear this quality, but also sense it even in the mechanical details; in the "feel" on the velvet-smooth easy flywheel tuning, in the professional appearance of the tastefully selected colors that will blend with any decor. The just-right shade of gold-brass escutcheon contrasts just enough with the dark maroon background, and is set off by matching maroon knobs with gold inserts. The design of the cabinet has the simplicity of modern styling, touched by a stroke of traditional elegance. Carefully designed for easy installation in console if desired. Deluxe features include separate FM and AM sections, each tuned with its own 3-gang tuning capacitor, and each has its individual low impedance cathode follower output. This means that long output cables can be used to connect tuner to amplifier or control center without fear of high frequency loss. Also, separate volume controls are provided for each channel so that, when used for stereophonic reception, a proper balance between channels sound would be destroyed. Without this important feature, the wonderful realism stereo to monaural use. Simplified accurate knife-edge tuning is provided by magic eye which operates independently on FM and AM. Automatic frequency control "locks in" FM signal permanently. Ferrite rod antenna with loading ring is supplied to bring in weak AM stations for quality reproduction. Designed for easy assembly, the kit is built around two printed circuit boards and prealigned IF's, making construction and wiring simple, even for such a complex unit.

**SPECIFICATIONS** RANGE: FM 88-108MC, AM 530-1650KC. FM CIRCUIT: Armstrong, low noise front end with triode grounded grid amplifier and triode mixer. Double tuned dual limiters, Foster-Seeley discriminator, AFC and AFC defeat. AM CIRCUIT: Superhet with 3 stages AVC, 10kc whistle filter, ferrite antenna. DISTORTION: Under 1% harmonic on FM; under 1% on AM for up to 80% modulation. HUM LEVEL: 60 db below 100% modulation. SENSITIVITY: FM—full limiting on signals as low as 1  $\mu$ v, 2  $\mu$ v for 30 db quieting; AM Terminal Sensitivity 5  $\mu$ v. SELECTIVITY: FM 200kc bandwidth; 6 db down, AM 8kc BW; 6 db down. FREQUENCY RESPONSE: FM 20-20,000 cps  $\pm 1/2$  db, AM 20-5,000  $\pm 3$  db. FM DRIFT:  $\pm 5$  kc Maximum. IMAGE REJECTION: FM 40 db, AM 30 db. I.F. REJECTION: FM 70 db, AM 50 db. RADIATION: MEETS FCC REQUIREMENTS. OUTPUT LEVEL: FM 250v for 100% modulation, 1V for 30%; AM average 1V. CONTROLS: 5 controls: FM VOL, AM VOL, FM Tuning, AM Tuning, and five position function selector switch. TUBES: 3-6AU6, 2-6AU6, 1 each 6BK7B, ECC85, 6AL5, 6BE6, 12AU7 and 6U5 tuning eye. Selenium rectifier. OUTPUT IMPEDANCE: Low impedances cathode follower. Output jacks for FM, AM or Stereo. ANTENNA INPUT: 300 ohms. Size, 13 1/2" W x 10 1/2" D x 4 1/4" H. Shpg. wt., 18 lbs. Kit comes complete with all parts and metal cover, a step-by-step instruction manual, schematic and pictorial diagrams.

Model KT-500WX Stereo Tuner Kit ..... Net 74.50  
LT-50WX Same as above, completely factory wired and tested ..... Net 124.50

## LAFAYETTE OFFERS THE FAMOUS KT-300 PREAMP KIT AT A SPECIAL SUMMER PRICE - OFFER EXPIRES SEPT. 15, 1959

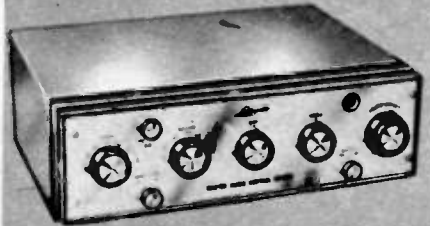

KT-300 IN KIT FORM  
**29.50**



KT-400 IN KIT FORM  
**69.50**  
ONLY 6.95 DOWN 7.00 MONTHLY

**LAFAYETTE MASTER AUDIO CONTROL CENTER**  
with BINAURAL CHANNEL AND DUAL VOLUME CONTROL

- Self-Powered
- DC On All Filaments
- 24 Positions of Equalization
- Tape Head Input, High Impedance
- Dual Cathode Follower Output Stages

This is not only the finest hi-fi preamp characterized by unmatched features, but it has been functionally designed to keep pace with the conversion of your present hi-fi system to binaural (stereophonic) sound. Incorporates an extra channel and dual volume control for binaural reproduction. Features include DC on all tube filaments, negative feedback in every stage, dual cathode follower output stages and latest printed circuit construction. Less than 0.09% IM distortion and less than 0.07 harmonic distortion at 1V. Hum and noise level better than 80 db below 3V. Uniformly flat frequency response over entire audible spectrum. 7 inputs for every type of phono, tuner or tape. Tasteful styling, brilliantly executed. Size 12 1/2" x 9 1/2" x 3 1/4". Shpg. wt., 10 1/2 lbs.

KT-300—Lafayette Master Audio Control Kit Complete with cage and detailed assembly instructions. Net 29.50  
LT-30—Same as above completely wired and tested with cage and instruction manual. Net 49.50

**DELUXE 70 WATT BASIC AMPLIFIER**

- Conservatively Rated At 70 Watts
- Inverse Feedback
- Variable Damping
- Metered Balance And Bias Adjust Controls
- Available In Kit and Wired Form

Here's ultra-stability in a 70 watt basic power amplifier employing highest quality components conservatively rated to insure performance and long life. Features matched pair KT 88's and wire range linear Chicago output transformer, variable damping control, meter for bias and balance and gold finish chassis. Frequency response 10-100,000 cps  $\pm 1$  db. Hum and noise 90 db below full output. IM distortion less than 1 1/2% at 70 watts, less than 0.3% below 30 watts. Harmonic distortion less than 2% at 70 watts from 20 to 20,000 cps  $\pm 1$  db. Output impedance 4, 8 & 16 ohms. Handsome decorative cage perforated for proper ventilation. Size 14 1/2" x 10" x 7 1/4" including cage and knobs. Shpg. wt., 40 lbs.

KT-400—Lafayette 70 watt Deluxe Basic Amplifier Kit complete with cage and detailed assembly instructions. Net 69.50  
LA-70—Same as above completely wired and tested with cage and instruction manual. Net 94.50





# LAFAYETTE SENSATIONAL VALUES in Stereo Turntables and Changers

## LAFAYETTE PROFESSIONAL TURNTABLE WITH AUTHENTIC HYSTERESIS SYNCHRONOUS MOTOR PERFECT FOR NEW STEREO & MONAURAL RECORDS

PROFESSIONAL 4-SPEED TURNTABLE WITH HYSTERESIS-SYNCHRONOUS MOTOR

The LAFAYETTE TRUE HYSTERESIS-SYNCHRONOUS MOTOR. Since many so-called "hysteresis" motors have appeared and will continue to appear on the market, it is important that you know the difference between the real thing, as provided by Lafayette, and the imitators with partial hysteresis motors.

THE LAFAYETTE TRUE HYSTERESIS SYNCHRONOUS MOTOR IS PERFECT FOR THE NEW STEREO AND MONAURAL RECORDS. THE FACT THAT THE NEW STEREO RECORDS CONTAIN VERTICAL MODULATION IMPOSES STRINGENT REQUIREMENTS ON TURNTABLES. THEY HAVE TO BE FREE FROM RUMBLE, FLUTTER, WOW AND SPEED VARIATION. THE LAFAYETTE TRUE HYSTERESIS SYNCHRONOUS MOTOR MEETS ALL THESE REQUIREMENTS WITH EFFORTLESS EASE, RESULTING IN SUPERIOR REPRODUCTION OF STEREO DISCS, AS WELL AS TREMENDOUS REDUCTION IN RECORD WEAR.

ONLY LAFAYETTE'S HYSTERESIS-SYNCHRONOUS MOTOR. In its price class, it is made to extremely fine tolerances (on the order of .0001 inches)! Only Lafayette's motor has 16 cores, a high permeability rotor magnet, ball thrust bearings, oilite sleeve bearings plus felt oil reservoir, cooling fins as an integral part of the rotor and a hollow rotor core for maximum efficiency and minimum heat. Only Lafayette's motor can be oiled from above, without disassembly, through a unique oil feed system. Only Lafayette's motor has a self-aligning armature.

ONLY LAFAYETTE CAN GIVE YOU A REALLY PROFESSIONAL TURNTABLE WITH TRUE HYSTERESIS-SYNCHRONOUS MOTOR AT SUCH AMAZINGLY LOW PRICES!

Here's THE turntable—the last word in professional high-fidelity performance! A fine precision instrument in every sense. Just look at some of these **OUTSTANDING FEATURES**:—**WOW AND FLUTTER**: Less than 0.2% • **TURNTABLE**: Heavy, diecast aluminum. Lathe-turned for perfect balance and concentricity, 12" diameter—weighs approx. 4 lbs. and provides amazingly constant speed; the extra-heavy rim acts just like a flywheel to prevent speed variations • **TRUE HYSTERESIS-SYNCHRONOUS MOTOR**: For smooth, low-noise, wow- and flutter-free operation • **RUMBLE AND NOISE**: 50 db below average recorded level • **INTEGRATED SPEED CONTROL**: For all 4 speeds—78, 45, 33 1/3 and 16 2/3 rpm • **2 OVERSIZE, HEAVY DUTY IDLERS**: Precision-ground; provide positive constant-speed rim drive • **SINGLE BALL THRUST BEARING**: Turntable rides smoothly over ball bearing floating on a thin film of oil • **FREE-FLOATING, SHOCK-MOUNTED MOTOR** • **RUBBER CUSHION SHOCKMOUNTS** • **AUTOMATIC IDLER DISENGAGEMENT** • **RUBBER MAT** • **STAINLESS STEEL PRECISION SPINDLE** • **POWER REQUIREMENTS**: For 105-130 volts, 60 cps AC; draws 16 V.A. • **ACCESSORIES SUPPLIED**: 45 RPM adapter, Strabe disc • **SIZE**: 2 1/8" above and 4" below motor board; 14 1/4" deep x 12 1/4" wide • **SHIPPING WEIGHT**: 16 lbs.

LAFAYETTE MONEY-SAVER COMBINATIONS SAVE UP TO 20%  
Save on these combinations of Lafayette turntables, arms and nationally famous compatible stereo diamond cartridges.

COMB. NO.	TURNTABLE	TONE ARM	CARTRIDGE	SPECIAL NET	COMB. NO.	TURNTABLE	TONE ARM	CARTRIDGE	SPECIAL NET
PK-301	PK-245	PK-270	Pickering 371-D	92.50	PK-305	PK-245	PK-280	Shure M7D	94.50
PK-302	PK-245	PK-270	Shure M7D	92.50	PK-306	PK-245	PK-280	GE GC-5	94.50
PK-303	PK-245	PK-270	GE GC-5	92.50	PK-307	PK-245	PK-905	Pick. 371D	88.50
PK-304	PK-245	PK-280	Pickering 371D	94.50	PK-308	PK-245	PK-905	Shure M7D	88.50
					PK-309	PK-245	PK-905	GE GC-5	88.50

PK-245 Turntable with new "Pickering Stanton" Model 196.7D Unipose Arm with integrated compatible stereo Fluxvalve Cartridge with diamond stylus PK-310. Net 104.50

VALUE ~~129.50~~ ONLY 64.50  
SAVE OVER 50%



ONLY \$6.45 DOWN \$6.00 Monthly



SPECIAL VALUE

SAVE 15.60

112.50 (Less Base)

PK-245 Turntable with PK-270 professional 12" Stereo tone arm with Shure M3D compatible stereo cartridge with diamond stylus. PK-311 112.50

## DELUXE WOODBASES AND MOUNTING BOARDS FOR TRANSCRIPTION TURNTABLES



NET 14.95

- FINEST SELECTED HARDWOOD VENEERS
- CHOICE OF FIVE CABINETMAKER FINISHES
- FREE-FLOATING FOAM RUBBER MOUNTED MOTOR BOARD
- INDIVIDUAL ADJUSTABLE FEET FOR ACCURATE LEVELING

These substantial woodbases are deluxe units made from the finest selected hardwood veneers by skilled craftsmen. All four sides are 1/4" thick and the top is 1/2". All have firmly secured mitered corners. The four bumper feet are individually adjustable for accurate leveling. The free floating mounting board is foam rubber mounted and the top has a finish matching the woodbase. Available in five attractive cabinetmaker finishes: mahogany, blonde, ebony, walnut and fruitwood; please specify when ordering. The elegant styling and finish add beauty to any high fidelity installation. Accommodates a turntable and a 12" or 16" tone arm. Size, 21 1/2" x 16 1/4" x 5 1/4". Shpg. wt., 15 lbs.

PK-265 Base and board cut for PK-245 Net 14.95  
PK-266 Base and board cut for PK-240 Net 14.95  
PK-267 Base and board uncut for mounting other makes of turntables Net 14.95

## MOUNTING BOARDS FOR LAFAYETTE TURNTABLES

Pre-cut, unfinished, smoothly sanded mounting boards for Lafayette turntables. Ready for easy finishing. Size 15 1/2" x 20 1/4" x 1/2". Shpg. wt., 3 lbs.

PK-268 Cut for PK-245 turntable Net 3.45  
PK-269 Cut for PK-240 turntable Net 3.45

## NEW! Lafayette VISCOUS-DAMPED STEREO TONE ARM — PROFESSIONAL 12" PK-905



12.50

- JEWEL BEARING SUPPORT
- INSTANT PLUG-IN CARTRIDGE CHANGE
- AUTOMATIC FLUID CONTROL
- PERFECT RECORD TRACKING
- ACCOMMODATES MOST STEREO & MONAURAL HIGH FIDELITY CARTRIDGES

This Stereo/Monaudio transcription arm assures dependable and stable operation, utilizing the floating-action principle of viscous-damping. The arm is supported at a single pivot and jewel bearing having negligible friction. Damping is accomplished by a silicone fluid occupying the gap between a ball and socket. This damping control permits high compliance and negligible tracking error and prevents damage to either record or stylus should the tone arm be accidentally dropped. Low frequency resonance, skidding and groove-jumping are likewise minimized. The tone arm accepts all records up to 12" and mized. The tone arm accepts all Stereo or Mono hi-fi cartridges, accommodates precisely engineered adapters which simplify installation and provide proper stylus pressure. The arm has a decorative glossy-black finish. Overall length is 12"; height adjustable from 1/4" to 2 1/4" above motorboard; round mounting base is 2 1/4" in diameter. Shpg. wt., 2 1/2 lbs.

PK-905—12" VISCOUS-DAMPED STEREO TONE ARM Net 12.50



PK-240 ONLY 37.50



SAVE 11.50

88.50

Less Base Only 8.85 7.00 Down Monthly

PK-240 turntable with PK-270 professional 12" stereo tone arm with Shure M3D compatible stereo cartridge with diamond stylus. PK-322 Net 88.50

## LAFAYETTE 4-SPEED PROFESSIONAL TRANSCRIPTION PLAYER WITH 3 LB. 12" ALUMINUM TURNTABLE

- IDEALLY SUITED FOR STEREO! • BETTER THAN -50 DB RUMBLE & NOISE • VIBRATIONLESS MOTOR SUSPENSION • BELOW 0.2% WOW & FLUTTER • MAGNETIC EDDY-CURRENT BRAKE
- 3 LB. 12" BALANCED & MACHINED ALUMINUM TURNTABLE • SPEED CONTROL FOR ± 7% VARIATION OF EACH SPEED

An amazing low price for the superior quality embodied in this fine instrument. Features include heavy, rim-weighted, 3 lb. machined-aluminum 12" turntable, magnetic brake with speed control for ± 7% variation of each speed; the extremely low noise and rumble figure of -50 db below average recorded level; wow and flutter (speed variations) of less than 0.2%; new-type oversize precision-ground idler with special lubrication features; positive-locking detents on 4-speed single-knob speed selector; "off" positions between all speed positions; free-floating shock-mounted motor; automatic idler disengagement in "off" positions; precision spindle turns on a single ball bearing; heavy duty 4-pole induction motor. Heavy rubber turntable mat. For 105-120 volts, 60 cps AC, draws 0.13 amperes. Size of motor plate 11" x 10" x 1 1/4"; requires 4" below motor board. 1 1/2" above. Complete with strobo disc, 45 rpm adapter, AC line cord. Shpg. wt., 14 lbs.

PK-240 12" TRANSCRIPTION TURNTABLE Net 37.50

COMB. NO.	TURNTABLE	TONE ARM	CARTRIDGE	NET	COMB. NO.	TURNTABLE	TONE ARM	CARTRIDGE	NET
PK-312	PK-240	PK-905	Pick. 371-D	65.50	PK-316	PK-240	PK-270	Shure M7D	68.50
PK-313	PK-240	PK-905	Shure-M7D	65.50	PK-317	PK-240	PK-270	GE GC-5	68.50
PK-314	PK-240	PK-905	GE GC-5	65.50	PK-318	PK-240	PK-280	Pick. 371D	70.50
PK-315	PK-240	PK-270	Pick. 371D	68.50	PK-319	PK-240	PK-280	Shure M7D	70.50
					PK-320	PK-240	PK-280	GE GC-5	70.50

New Lafayette low-rumble Model PK-240 turntable with Pickering "Stanton" Model 196.7D stereo/monaural transcription arm with Stereo-Fluxvalve magnetic cartridge and 0.7 mil diamond stylus. PK-321 84.50

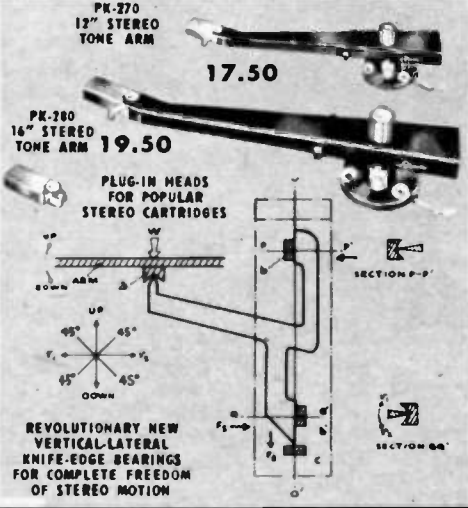

PK-270 12" STEREO TONE ARM 17.50

PK-280 16" STEREO TONE ARM 19.50

PLUG-IN HEADS FOR POPULAR STEREO CARTRIDGES

REVOLUTIONARY NEW VERTICAL-LATERAL KNIFE-EDGE BEARINGS FOR COMPLETE FREEDOM OF STEREO MOTION

## THE REVOLUTIONARY NEW LAFAYETTE VERTICAL-LATERAL KNIFE-EDGE 12" & 16" STEREO TONE ARMS!

- 4 HARDENED-STEEL KNIFE-EDGE PIVOTS & BEARINGS FOR COMPLETE, PRACTICALLY FRICTIONLESS, FREEDOM OF MOTION
- LIGHTWEIGHT, DIE-CAST ALUMINUM TONE ARM
- SELF-CONTAINED BUBBLE LEVEL FOR PERFECT, GUESS-FREE LEVELLING
- LIGHT, MOLDED PLASTIC PLUG-IN SHELLS FOR MOST POPULAR STEREO CARTRIDGES
- PRECISELY-ADJUSTABLE COUNTERBALANCE WEIGHT
- NON-RESONANT WITHIN THE AUDIBLE FREQUENCY RANGE
- PERFECT TRACKING WITH THE LIGHTEST STYLUS FORCE
- EXTREMELY EFFECTIVE FOR PERFECT REPRODUCTION WITH "45-45" STEREO DISCS

**RUGGED CONSTRUCTION — FOOLPROOF — TROUBLE FREE**

A remarkable advance in tone arm design is presented in these new Lafayette tone arms. An unusual new principle, utilizing 2 vertical and 2 lateral hardened-steel knife-edge pivots supported by hardened steel bearings, provides extremely low horizontal and vertical friction. This unusual type of bearing provides minimum waveform distortion and no undesirable motion or loose-jointed action as viewed from the stylus end. Groove tracing is smooth, with excellent tracking even with very light pickup weight, due to the absence of frictional losses. Friction in horizontal and vertical directions is low, but mechanical impedance is high at 45°, providing maximum effectiveness with 45-45 stereo cartridges. The unique knife edge bearing construction makes it possible to draw out the 2 shielded leads from the center of the support column, eliminating "stiffness friction" due to the leads. A highly-precise bubble level is provided at the top of the support column; the bubble plus 3 adjustments on the base make for perfect levelling. Height of the arm is adjustable from 1 1/8" to 2 1/4" above motorboard. Overall length of PK-270 12" arm is 12 1/4"; linear distance from support column to stylus tip is 10"; the PK-280 16" arm is 14 1/2" overall; effective length is 11 1/4".

PK-270 Lafayette 12" Tone Arm. Shpg. wt., 1 1/2 lbs. Net 17.50  
PK-280 Lafayette 16" Tone Arm. Shpg. wt., 2 lbs. Net 19.50

## LAFAYETTE COMPLETE STEREO TRANSCRIPTION PLAYER

- 5-CONTACT PLUG IN HEAD FOR ALL STEREO CARTRIDGES
- 4-SPEED, HEAVY DUTY 4-POLE TRANSCRIPTION TYPE INDUCTION MOTOR • MAGNETIC BRAKE FOR ± 7% SPEED ADJUSTMENT • STYLUS WEIGHT ADJUSTMENT SCREW ON TONE ARM • RUMBLE AND NOISE -40 DB • LESS THAN 0.3% WOW

Here is a complete hi-fi, compatible stereo pickup system, designed against obsolescence and yet priced modestly. This top quality manual player features a 5-contact plug in head to accommodate the latest stereo as well as monaural cartridges.

Equally important in contributing to the excellent performance of this system is the new 4-speed turntable assembly. It is equipped with a quiet, heavy duty 4-pole motor, with an exclusive magnetic brake for instantaneous fine adjustment of each speed. Stroboscope disc also included. Smooth operation is assured further by the 10" heavy turntable, fitted with rubber mat. Provision for easy adjustment of stylus pressure is available. Dimensions of mounting plate 12-15/16" left to right, and 10 1/2" front to rear. Requires 2 1/4" below and 3" above motor board. For 105-120V, 60 cps. Accessories included are: 45 rpm adaptor, output cable to amplifier and plug in heads. Shpg. wt., 14 lbs.

PK-1605—Complete stereo transcription player, less cartridge Net 26.95

COMB. NO.	TURNTABLE	TONE ARM	CARTRIDGE	NET
PK-323	Same as above with PICKERING 371D			39.95
PK-324	Same as above with SHURE M7D			39.95
PK-325	Same as above with GE GC-5			39.95

PK-162—Wood base for above, custom finished in either mahogany or blonde (Please Specify). Shpg. wt., 5 lbs. Net 3.95  
PK-163—Unfinished mounting board for above. Strong durable 3/4" gumwood. (Shpg. wt., 1 lb.) Net .95



26.95 (less base)

## NEW! JOBOPHONE 1301 MS SEMI-PROFESSIONAL TRANSCRIPTION TURNTABLE with Constant Speed Synchronous Motor

- LOW VERTICAL RUMBLE
- DESIGNED FOR STEREO
- IMPORTED FROM HOLLAND TO SAVE YOU MONEY!



SPECIALLY PRICED! 24.95 QUANTITY LIMITED

- COMPLETE WITH RONETTE STEREO/MONAURAL TURNOVER CARTRIDGE
- PATENTED "SONOMAT" HIGH TORQUE DRIVE ASSEMBLY • FOOLPROOF COLOR-CODED PUSHBUTTON SPEED SELECTION 1/2 OF 1% SPEED ACCURACY • LESS THAN 0.29% WOW & FLUTTER

A precision-engineered 4-speed turntable with many notable features. Only moderately-priced turntable with "gyro-action" turntable suspended on single ball bearing with deep-well brass sleeve. Record, turntable and spindle rotate as a single unit to prevent wear of record center hole and reduce the possibility of rattle, wow, and flutter. EXCLUSIVE adjustable spring counterbalance on idler. EXCLUSIVE adjustable spring counterbalance on idler. EXCLUSIVE "pick-up guide" automatically places stylus into lead-in groove of record. Thick live-rubber turntable mat with special ridged profile permits mat to float on air. Built-in muting switch; retractable mastic stop with arm-actuated on-off switch. Retractable 45-RPM spindle. Synchronous induction-type heavy-duty 22-watt motor. Large diameter rubber idler. Rim-weighted, heavy turntable, 9 1/2" diam. Wow and flutter less than 0.29%; rumble and noise better than 40 db below average recorded level. Speed accuracy 1/2 of 1%. Power: 110/120 volts or 200/240 volts, 60 cps. AC. Size: 9 1/2" d x 11 1/4" w. Clearance: 2 1/4" above and 1 1/4" below motorboard—has minimum dimensions to fit into any installation. Shpg. wt., 10 lbs.

PK-259 Turntable Net 24.95

# Lafayette

## OFFERS OUTSTANDING VALUES FOR THE AUDIOPHILE

### NEW! LAFAYETTE 12" SINGLE SPEED 33 1/3 — RPM HYSTERESIS TURNTABLE



**Sale!**

REGULAR PRICE 49.50  
**47.50**

- IDEALLY SUITED FOR STEREO
- TRUE HYSTERESIS-SYNCHRONOUS MOTOR
- RUMBLE & FLUTTER LESS THAN 0.2%
- 4 1/2 LB. RIM — WEIGHTED ALUMINUM TURNTABLE
- STURDY MOUNTING PLATE OFFERS MAXIMUM SHIELDING

Beautifully styled and modestly priced! This 33 1/3 rpm turntable offers superior performance for hi-fi and professional use. Accurate and close tolerance machining throughout insures trouble-free operation, with extremely low levels of wow, flutter and rumble. Employs superior craftsmanship throughout—all critical parts are ground to micro finish. True hysteresis synchronous motor provides absolutely constant speed regardless of line voltage variations. Motor is shock-mounted with rubber cushion. Has precision ground shaft which turns on heavy ball-thrust bearing, thereby eliminating any vertical movement—a prerequisite for stereo. The 4 1/2 lb. die-cast rim-weighted aluminum turntable is lab-tested for perfect dynamic balance. The oversize heavy duty roller wheel provides positive rim drive. The roller is disengaged in "Off" position to prevent flat spots. Sturdy mounting plate offers maximum shielding against hum pick-up. A rubber turntable mat is provided so that maximum tracking is assured. Less than 0.2% wow and flutter. Noise level is 45 db below average recording level. The turntable is attractively styled to blend with any home decor. Has "On-Off" switch and indicator light. Requires 26 watts on 105-120V., 60 cycles AC. Size: 13 3/4 x 14 1/4 x 6 1/4". Shpg. wt., 19 lbs. PK-331 Net 47.50

### NEW! LAFAYETTE PK-244 NEEDLE BALANCING GAGE

- LIFETIME ACCURACY
- PERFECT FOR LIGHTWEIGHT ARMS

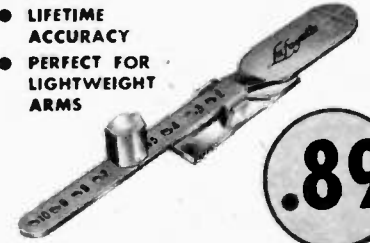

**.89**

At last a precision needle balancing gage that will never lose its accuracy. The simplicity of its design eliminates springs, interacting levers and bars that frequently require adjustment. By placing the counterweight in the corresponding index holes it is possible to correctly calibrate the tracking weight of your tone arm. PK-244 NEEDLE BALANCING GAGE Net .89

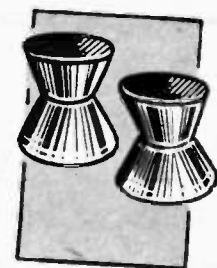

### REEL LOCKS

**59c**

Set of Two

Holds tape recorder reel in place by locking spindle to reel. Especially useful if recorder is in vertical position. Will not interfere with normal operation of reels. Easily removable. MS-564 Set of two Net .59

### NEW! Lafayette



ML-120

### LAFAYETTE PROFESSIONAL BULK TAPE ERASER AND DEMAGNETIZER

- COMPLETELY ERASES TAPE ● REDUCES NOISE LEVEL
- FOR 3", 5", 7", OR 10 1/2" REELS ● TWO ERASING COILS
- 6 1/2 AMPERES DRAIN

Regularly 49.95 Special 21.50

A carefully designed and precisely manufactured professional tape "degusser" for complete erasing of tapes. Just place the tape reel on spindle of demagnetizer, slowly rotate 2 or 3 turns, take off, and that's all—a completely clean tape. The demagnetizer removes every signal on the entire tape—even extra strong sounds too loud to be removed by the recorder's own erase head. Completely clears tape of any prior recordings. In addition, by leaving tape completely unmagnetized, it serves to reduce tape hiss to the level of new "virgin" tape. In fact, tape hiss is so low that subsequently passing it over the erase head of a recorder actually INCREASES noise by 4-6 db. To take advantage of this noise reduction, some users

prefer to permanently disconnect the recorder's erase head, and use only bulk erasure. Two completely separate coils are used for doubly effective erasure, even of large 10 1/2" reels. An extra powerful unit for heavy-duty use—draws over 6 1/2 amperes. The Lafayette Tape Demagnetizer offers all of these features, and at this special price. Can be used to demagnetize tape, magnetically striped film, plus tools and watches. This professional unit has a heavy, custom finished case, a rugged non-magnetic top, heavy duty on-off switch and power cord. Has built-in fuse. Pilot light prevents accidentally leaving it turned on. Size 6 1/2" x 7 1/2" x 3 1/2". Shpg. wt., 14 lbs. ML-120—Regularly 49.95 Net 21.50

### LAFAYETTE TAPE HEAD DEMAGNETIZER

3.95 ● REMOVABLE POLEPIECES 3.95  
● EXTRA CONVENIENT



PK-238

Unlike other demagnetizers, the Lafayette Tape Head Demagnetizer uses removable polepieces. Three complete sets are furnished: straight, 45°, and 90° (right angle), permitting quick and easy use with any tape head. Tape heads need no longer be removed from the recorder as they can be reached by the clumsy polepieces of older head demagnetizers; the Lafayette Demagnetizer's polepieces reach every head.

Far from being a luxury, a tape head demagnetizer is necessary for best tape recorder performance. Among all the possible sources of noise in tape recorders, there is only one which is common to all recorders and is a perfectly natural, common occurrence—tape hiss due to magnetized heads. Although unmagnetized when new, tape heads gradually become magnetized by sharp switching pulses occurring while switching the recorder from play

to record or vice versa. Some audio sources (especially the human voice) produce unbalanced signals containing more power peaks in one direction than in the other. This unevenness is also sufficient to cause magnetization of tape head.

The solution is to use a demagnetizer to remove this permanent magnetism from the head, thus reducing the noise level. Periodic head demagnetization is required for all tape recorders to insure optimum signal-to-noise ratio. For this reason, some professional tape recorders are demagnetized as often as several times weekly. Now, Lafayette enables anyone with even the most modest budget to perform this necessary demagnetization, with a minimum of effort. For 110 volts 60 cycles. Shpg. wt., 1 lb. PK-238—Tape Head Demagnetizer 3.95

## LAFAYETTE HIGH FIDELITY RECORDING TAPES

ALL LAFAYETTE TAPES SOLD ON MONEY-BACK GUARANTEE ● GUARANTEED FIRST QUALITY SPLICE-FREE

You Be The Judge!

### NEW! MYLAR BASE RECORDING TAPE

Lafayette's huge purchasing power makes it possible to provide you with first-quality tape at about half the price you would pay for the same tape with the manufacturer's own labels. WE GUARANTEE ABSOLUTE SATISFACTION OR YOUR MONEY BACK. These splice-free mylar base recording tapes are quality manufactured to assure uniformity of frequency response and complete absence of drop-outs. In addition, they are extremely durable and break-resistant and are capable of withstanding temperature and humidity changes. The wide frequency response characteristics combined with low noise level and long playing time opens new horizons of recording possibilities for the high fidelity enthusiasts as well as professional sound engineers. Av. Shpg. wt., 12 oz.

RT-12 1800 ft. on 1 mil Mylar base, 7" reel diameter. 2.75 Singly, Ea. 2.85  
Lots of 5, Ea. 2.75

RT-13 2400 ft. on 1/2 mil Mylar base, 7" reel diameter. 3.49 Singly, Ea. 3.69  
Lots of 5, Ea. 3.49

### ACETATE BASE RECORDING TAPE

These popular high quality tapes are coated uniformly with red oxide on plastic base with high output and uniform frequency response covering the entire audio spectrum, 40-15,000 cps, completely splice-free. Another Lafayette outstanding value for all hi-fi recordists, backed up by our Money Back Guarantee. Using 7 1/2 cps dual track, 1200 ft. reel provides 1 hr. of recording time while 1800 ft. reel provides 1 1/2 hr. of recording time.

RT-10 1200 ft. on 1 1/2 mil acetate base, 7" reel. 1.49 Singly, Ea. 1.59  
Lots of 5, Ea. 1.49

RT-11 1800 ft. on 1 mil acetate base, 7" reel. 1.88 Singly, Ea. 1.98  
Lots of 5, Ea. 1.88

1800 FT.—7" REEL—MYLAR BASE

AS LOW AS 2.75 RT-12



1200 FT.—7" REEL—ACETATE BASE

AS LOW AS 1.49 RT-10



AS LOW AS 1.88 RT-11



2400 FT.—7" REEL—MYLAR BASE

AS LOW AS 3.49 RT-13



### TELEPHONE PICKUP FOR RECORDING TELEPHONE CONVERSATIONS

Induction telephone pickup. Telephone conversations can now be picked up with no tapping of wires or special telephone circuits. Simply place the phone base, either cradle or upright type, on the pickup platform and connect the leads to the high impedance input of any medium gain audio amplifier, or directly to any tape, disc or wire recorder. Shpg. wt. 8 oz. MS-16 Net 1.95



**1.95**

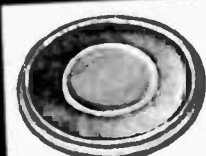

### METAL STORAGE CANS

NEW LOW PRICE .39 ea in lots of 6

Can holds 7" reel. Best protection for valuable recordings. Handsome finish of hammered enamel. Cans ribbed for stacking. Precision fit makes opening and closing easy. Shpg. wt., 8 oz. ML-61 Lots of 6, ea. .39 — Singly, ea. .41

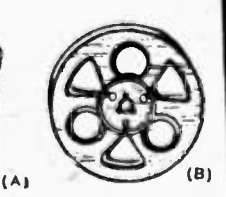

(A) METAL TAPE STORAGE CHEST STANDARD CASE: Sturdy all steel carrying case. Holds 12.7" or 5" reels and cans. Twin snap locks for positive closure; perfect portability. Guards against exposure and accidental erasure. Platinum gray hammered finish. Metal separators between reels. Includes index cards. Shpg. wt., 5 lbs. ML-60 Net 2.99

(B) 7 INCH EMPTY PLASTIC REELS Individually boxed fine plastic reels for recording tape. MS-267 In lots of 6, ea. .38. Singly, ea. .45



# DIAMOND STYLI AT LOWEST PRICES ANYWHERE

## LAFAYETTE DIAMOND and DIAMOND-SAPPHIRE STYLI MADE FOR LAFAYETTE BY THE FOREMOST AMERICAN MANUFACTURERS

### KEY TO POINT CODES HOW TO ORDER

The symbols in the column headed "PT SIZE" are explained in the table below.

LP—SINGLE 1 MIL MICROGROOVE FOR 33 1/3 AND 45 RPM  
AG—SINGLE 2 MIL ALL GROOVE FOR ALL SPEEDS  
ST—SINGLE 3 MIL STANDARD FOR 78 RPM  
COMB—DUAL 1 MIL DIAMOND AND 3 MIL SAPPHIRE  
Identify your needle by cartridge number and illustration and order by stock no. Note that all all needles listed here are for monaural cartridges.

### ALL DIAMOND STYLI ARE NOT ALIKE

Only Lafayette's Superior Diamond Styli are  
● MADE FROM WHOLE DIAMONDS ● PRECISION  
● GROUND AND POLISHED ● VERTICALLY AND  
● EDGWISE GRAIN ORIENTED  
● SHADOWGRAPHED



Each Lafayette's diamond stylus is made from individual diamond, properly oriented and ground to close tolerance; shadowgraph tested to give you last wear per play and long service life.

### FULL 1 YEAR GUARANTEE | ANY DIAMOND or DIAMOND-SAPPHIRE NEEDLE IN THIS LISTING

# 2.89



#### DIAMOND NEEDLES

STOCK NO.	SIZE PT.	FIG.	CARTRIDGE	REPLACES JENSEN NO.	STOCK NO.	SIZE PT.	FIG.	CARTRIDGE	REPLACES JENSEN NO.	STOCK NO.	SIZE PT.	FIG.	CARTRIDGE	REPLACES JENSEN NO.
<b>FOR ADMIRAL CARTRIDGES</b>														
PS-10	LP	1	409A11, 409A300, 98A54-1	JPS-30LPD	PS-35	LP	54	560176, 560180	CRA-55LPD	PS-35	LP	53	TO-200, TO-222, TO-284, TO-400 series, RA284, DT60 series.	CRA-55LPD
PS-16	COMB	6	409B21	JPS-35SD	PS-70	COMB	51	560161	5-66SD	PS-49	LP	38	TX88, A	CRA-56LPD
PS-17	LP	7	409A30	AB1LPD										
<b>FOR ASTATIC CARTRIDGES</b>														
PS-20	LP	3	AC Series, 40T, 41T, 40-1, 41-1, 42-1, 90T series, 10L-3, 11L-3	A-75LPD										
PS-23	LP	12	408	M-70LPD										
PS-25	COMB	14	GCD, 409, 55-T, 55T, 55TM	A-71SD										
PS-23	LP	12	410	M-70LPD										
PS-17	LP	7	CAC, CO, CO-1, LOD, LQD-1, QT, QT-33, 44-T, 44-1, 48-1, 166T Series	A-81LPD										
PS-35	LP	54	110, 120, 124 series, 310T, 312T, 420, 422, 424TS series, 310-1, 310-TD, TS, 312-TD, TS, 414-1	CRA-55LPD										
<b>FOR MAGNAVOX CARTRIDGES</b>														
PS-51	COMB	37	560176, 560180, 560133, 560151, 560169-1, 560170	M-50SD										
<b>FOR MAGNAVOX CARTRIDGES</b>														
PS-35	LP	54	560176, 560180	M-70LPD	PS-56	COMB	43	45-9612, 76-4449, 425-0016	PM-13SD	PS-56	COMB	43	45-0009, 425-0011, 425-0014	PM-13SD
<b>FOR PHILCO CARTRIDGES</b>														
PS-56	COMB	43	45-9612, 76-4449, 425-0016	PM-13SD										
PS-56	COMB	43	45-0009, 425-0011, 425-0014	PM-13SD										
<b>FOR PERPETUUM EBNER CARTRIDGES</b>														
PS-44	COMB	47	P12/RG	RX550SD	PS-44	COMB	47	P12/RG	RX550SD	PS-44	COMB	47	P12/RG	RX550SD
PS-45	COMB	48	PE-8, PE10	RX551SD	PS-45	COMB	48	PE-8, PE10	RX551SD	PS-45	COMB	48	PE-8, PE10	RX551SD
PS-66	LP	22	P7000 (M), (MD) (LP only)	RX552LPD	PS-66	LP	22	P7000 (M), (MD) (LP only)	RX552LPD	PS-66	LP	22	P7000 (M), (MD) (LP only)	RX552LPD
<b>FOR R.C.A. CARTRIDGES</b>														
PS-23	LP	12	74067	M-70LPD	PS-23	LP	12	74067	M-70LPD	PS-23	LP	12	74067	M-70LPD
PS-10	LP	1	55652, 76257, (988370-1), 75044	JPS-30LPD	PS-10	LP	1	55652, 76257, (988370-1), 75044	JPS-30LPD	PS-10	LP	1	55652, 76257, (988370-1), 75044	JPS-30LPD
PS-20	LP	3	76257, (988370-2)	A-75LPD	PS-20	LP	3	76257, (988370-2)	A-75LPD	PS-20	LP	3	76257, (988370-2)	A-75LPD
PS-70	COMB	51	78748, 79807, 100453	5-66SD	PS-70	COMB	51	78748, 79807, 100453	5-66SD	PS-70	COMB	51	78748, 79807, 100453	5-66SD
PS-25	COMB	14	100329	A-71SD	PS-25	COMB	14	100329	A-71SD	PS-25	COMB	14	100329	A-71SD
<b>FOR RONETTE CARTRIDGES</b>														
PS-35	LP	53	TO-200, TO-222, TO-284, TO-400 series, RA284, DT60 series.	CRA-55LPD	PS-35	LP	53	TO-200, TO-222, TO-284, TO-400 series, RA284, DT60 series.	CRA-55LPD	PS-35	LP	53	TO-200, TO-222, TO-284, TO-400 series, RA284, DT60 series.	CRA-55LPD
PS-49	LP	38	TX88, A	CRA-56LPD	PS-49	LP	38	TX88, A	CRA-56LPD	PS-49	LP	38	TX88, A	CRA-56LPD
<b>FOR SHURE CARTRIDGES</b>														
PS-16	COMB	6	WC10, WC10D, PC2 series, PC3 series, PC4 series, PC5 series, P-72, P-73, P-73R, P-75, P-76, P-77, P-80, W-21, W-21AR, W-22A, WC-24, WC-25 Series	JPS-35SD	PS-16	COMB	6	WC10, WC10D, PC2 series, PC3 series, PC4 series, PC5 series, P-72, P-73, P-73R, P-75, P-76, P-77, P-80, W-21, W-21AR, W-22A, WC-24, WC-25 Series	JPS-35SD	PS-16	COMB	6	WC10, WC10D, PC2 series, PC3 series, PC4 series, PC5 series, P-72, P-73, P-73R, P-75, P-76, P-77, P-80, W-21, W-21AR, W-22A, WC-24, WC-25 Series	JPS-35SD
PS-10	LP	1	1P-LB-1D, 2T, 2T5, 2T-SD, 2T-LB-D, 2T-LB-S, 2T-LB-SD, 9980-S, 9980-SD, 9980D, ST, ST-LB-S, ST-LB-SD	JPS-30LPD	PS-10	LP	1	1P-LB-1D, 2T, 2T5, 2T-SD, 2T-LB-D, 2T-LB-S, 2T-LB-SD, 9980-S, 9980-SD, 9980D, ST, ST-LB-S, ST-LB-SD	JPS-30LPD	PS-10	LP	1	1P-LB-1D, 2T, 2T5, 2T-SD, 2T-LB-D, 2T-LB-S, 2T-LB-SD, 9980-S, 9980-SD, 9980D, ST, ST-LB-S, ST-LB-SD	JPS-30LPD
PS-70	COMB	51	3T, 3T5, 3TD	5-66SD	PS-70	COMB	51	3T, 3T5, 3TD	5-66SD	PS-70	COMB	51	3T, 3T5, 3TD	5-66SD
PS-32	COMB	51	3T, 3T5, 3TD	5-61SD	PS-32	COMB	51	3T, 3T5, 3TD	5-61SD	PS-32	COMB	51	3T, 3T5, 3TD	5-61SD
<b>FOR WEBSTER ELECTRIC CARTRIDGES</b>														
PS-17	LP	7	BX	A-81LPD	PS-17	LP	7	BX	A-81LPD	PS-17	LP	7	BX	A-81LPD
PS-10	LP	1	F11	JPS-30LPD	PS-10	LP	1	F11	JPS-30LPD	PS-10	LP	1	F11	JPS-30LPD

### REPLACEMENT STYLI FOR GE CARTRIDGES

STOCK NO.	SIZE PT.	FIG.	CARTRIDGE	REPLACES JENSEN NO.	STOCK NO.	SIZE PT.	FIG.	CARTRIDGE	REPLACES JENSEN NO.	STOCK NO.	SIZE PT.	FIG.	CARTRIDGE	REPLACES JENSEN NO.
<b>FOR GE VR II CARTRIDGES (FIG. 35)</b>														
Direct replacements for clip-in styli in GE VR II series models 4G-050, 4G-052, 4G-053, 4G-054, 4G-055, 4G-056, 4G-057, 4G-058, 4G-059, 4G-060, 4G-061, 4G-062, 4G-063, 4G-064, 4G-065, 4G-066, 4G-067, 4G-068, 4G-069, 4G-070, 4G-071, 4G-072, 4G-073, 4G-074, 4G-075, 4G-076, 4G-077, 4G-078, 4G-079, 4G-080, 4G-081, 4G-082, 4G-083, 4G-084, 4G-085, 4G-086, 4G-087, 4G-088, 4G-089, 4G-090, 4G-091, 4G-092, 4G-093, 4G-094, 4G-095, 4G-096, 4G-097, 4G-098, 4G-099, 4G-100, 4G-101, 4G-102, 4G-103, 4G-104, 4G-105, 4G-106, 4G-107, 4G-108, 4G-109, 4G-110, 4G-111, 4G-112, 4G-113, 4G-114, 4G-115, 4G-116, 4G-117, 4G-118, 4G-119, 4G-120, 4G-121, 4G-122, 4G-123, 4G-124, 4G-125, 4G-126, 4G-127, 4G-128, 4G-129, 4G-130, 4G-131, 4G-132, 4G-133, 4G-134, 4G-135, 4G-136, 4G-137, 4G-138, 4G-139, 4G-140, 4G-141, 4G-142, 4G-143, 4G-144, 4G-145, 4G-146, 4G-147, 4G-148, 4G-149, 4G-150, 4G-151, 4G-152, 4G-153, 4G-154, 4G-155, 4G-156, 4G-157, 4G-158, 4G-159, 4G-160, 4G-161, 4G-162, 4G-163, 4G-164, 4G-165, 4G-166, 4G-167, 4G-168, 4G-169, 4G-170, 4G-171, 4G-172, 4G-173, 4G-174, 4G-175, 4G-176, 4G-177, 4G-178, 4G-179, 4G-180, 4G-181, 4G-182, 4G-183, 4G-184, 4G-185, 4G-186, 4G-187, 4G-188, 4G-189, 4G-190, 4G-191, 4G-192, 4G-193, 4G-194, 4G-195, 4G-196, 4G-197, 4G-198, 4G-199, 4G-200, 4G-201, 4G-202, 4G-203, 4G-204, 4G-205, 4G-206, 4G-207, 4G-208, 4G-209, 4G-210, 4G-211, 4G-212, 4G-213, 4G-214, 4G-215, 4G-216, 4G-217, 4G-218, 4G-219, 4G-220, 4G-221, 4G-222, 4G-223, 4G-224, 4G-225, 4G-226, 4G-227, 4G-228, 4G-229, 4G-230, 4G-231, 4G-232, 4G-233, 4G-234, 4G-235, 4G-236, 4G-237, 4G-238, 4G-239, 4G-240, 4G-241, 4G-242, 4G-243, 4G-244, 4G-245, 4G-246, 4G-247, 4G-248, 4G-249, 4G-250, 4G-251, 4G-252, 4G-253, 4G-254, 4G-255, 4G-256, 4G-257, 4G-258, 4G-259, 4G-260, 4G-261, 4G-262, 4G-263, 4G-264, 4G-265, 4G-266, 4G-267, 4G-268, 4G-269, 4G-270, 4G-271, 4G-272, 4G-273, 4G-274, 4G-275, 4G-276, 4G-277, 4G-278, 4G-279, 4G-280, 4G-281, 4G-282, 4G-283, 4G-284, 4G-285, 4G-286, 4G-287, 4G-288, 4G-289, 4G-290, 4G-291, 4G-292, 4G-293, 4G-294, 4G-295, 4G-296, 4G-297, 4G-298, 4G-299, 4G-300, 4G-301, 4G-302, 4G-303, 4G-304, 4G-305, 4G-306, 4G-307, 4G-308, 4G-309, 4G-310, 4G-311, 4G-312, 4G-313, 4G-314, 4G-315, 4G-316, 4G-317, 4G-318, 4G-319, 4G-320, 4G-321, 4G-322, 4G-323, 4G-324, 4G-325, 4G-326, 4G-327, 4G-328, 4G-329, 4G-330, 4G-331, 4G-332, 4G-333, 4G-334, 4G-335, 4G-336, 4G-337, 4G-338, 4G-339, 4G-340, 4G-341, 4G-342, 4G-343, 4G-344, 4G-345, 4G-346, 4G-347, 4G-348, 4G-349, 4G-350, 4G-351, 4G-352, 4G-353, 4G-354, 4G-355, 4G-356, 4G-357, 4G-358, 4G-359, 4G-360, 4G-361, 4G-362, 4G-363, 4G-364, 4G-365, 4G-366, 4G-367, 4G-368, 4G-369, 4G-370, 4G-371, 4G-372, 4G-373, 4G-374, 4G-375, 4G-376, 4G-377, 4G-378, 4G-379, 4G-380, 4G-381, 4G-382, 4G-383, 4G-384, 4G-385, 4G-386, 4G-387, 4G-388, 4G-389, 4G-390, 4G-391, 4G-392, 4G-393, 4G-394, 4G-395, 4G-396, 4G-397, 4G-398, 4G-399, 4G-400, 4G-401, 4G-402, 4G-403, 4G-404, 4G-405, 4G-406, 4G-407, 4G-408, 4G-409, 4G-410, 4G-411, 4G-412, 4G-413, 4G-414, 4G-415, 4G-416, 4G-417, 4G-418, 4G-419, 4G-420, 4G-421, 4G-422, 4G-423, 4G-424, 4G-425, 4G-426, 4G-427, 4G-428, 4G-429, 4G-430, 4G-431, 4G-432, 4G-433, 4G-434, 4G-435, 4G-436, 4G-437, 4G-438, 4G-439, 4G-440, 4G-441, 4G-442, 4G-443, 4G-444, 4G-445, 4G-446, 4G-447, 4G-448, 4G-449, 4G-450, 4G-451, 4G-452, 4G-453, 4G-454, 4G-455, 4G-456, 4G-457, 4G-458, 4G-459, 4G-460, 4G-461, 4G-462, 4G-463, 4G-464, 4G-465, 4G-466, 4G-467, 4G-468, 4G-469, 4G-470, 4G-471, 4G-472, 4G-473, 4G-474, 4G-475, 4G-476, 4G-477, 4G-478, 4G-479, 4G-480, 4G-481, 4G-482, 4G-483, 4G-484, 4G-485, 4G-486, 4G-487, 4G-488, 4G-489, 4G-490, 4G-491, 4G-492, 4G-493, 4G-494, 4G-495, 4G-496, 4G-497, 4G-498, 4G-499, 4G-500, 4G-501, 4G-502, 4G-503, 4G-504, 4G-505, 4G-506, 4G-507, 4G-508, 4G-509, 4G-510, 4G-511, 4G-512, 4G-513, 4G-514, 4G-515, 4G-516, 4G-517, 4G-518, 4G-519, 4G-520, 4G-521, 4G-522, 4G-523, 4G-524, 4G-525, 4G-526, 4G-527, 4G-528, 4G-529, 4G-530, 4G-531, 4G-532, 4G-533, 4G-534, 4G-535, 4G-536, 4G-537, 4G-538, 4G-539, 4G-540, 4G-541, 4G-542, 4G-543, 4G-544, 4G-545, 4G-546, 4G-547, 4G-548, 4G-549, 4G-550, 4G-551, 4G-552, 4G-553, 4G-554, 4G-555, 4G-556, 4G-557, 4G-558, 4G-559, 4G-560, 4G-561, 4G-562, 4G-563, 4G-564, 4G-565, 4G-566, 4G-567, 4G-568, 4G-569, 4G-570, 4G-571, 4G-572, 4G-573, 4G-574, 4G-575, 4G-576, 4G-577, 4G-578, 4G-579, 4G-580, 4G-581, 4G-582, 4G-583, 4G-584, 4G-585, 4G-586, 4G-587, 4G-588, 4G-589, 4G-590, 4G-591, 4G-592, 4G-593, 4G-594, 4G-595, 4G-596, 4G-597, 4G-598, 4G-599, 4G-600, 4G-601, 4G-602, 4G-603, 4G-604, 4G-605, 4G-606, 4G-607, 4G-608, 4G-609, 4G-610, 4G-611, 4G-612, 4G-613, 4G-614, 4G-615, 4G-616, 4G-617, 4G-618, 4G-619, 4G-620, 4G-621, 4G-622, 4G-623, 4G-624, 4G-625, 4G-626, 4G-627, 4G-628, 4G-629, 4G-630, 4G-631, 4G-632, 4G-633, 4G-634, 4G-635, 4G-636, 4G-637, 4G-638, 4G-639, 4G-640, 4G-641, 4G-642, 4G-643, 4G-644, 4G-645, 4G-646, 4G-647, 4G-648, 4G-649, 4G-650, 4G-651, 4G-652, 4G-653, 4G-654, 4G-655, 4G-656, 4G-657, 4G-658, 4G-659, 4G-660, 4G-661, 4G-662, 4G-663, 4G-664, 4G-665, 4G-666, 4G-667, 4G-668, 4G-669, 4G-670, 4G-671, 4G-672, 4G-673, 4G-674, 4G-675, 4G-676, 4G-677, 4G-678, 4G-679, 4G-680, 4G-681, 4G-682, 4G-683, 4G-684, 4G-685, 4G-686, 4G-687, 4G-688, 4G-689, 4G-690, 4G-691, 4G-692, 4G-693, 4G-694, 4G-695, 4G-696, 4G-697, 4G-698, 4G-699, 4G-700, 4G-701, 4G-702, 4G-703, 4G-704, 4G-705, 4G-706, 4G-707, 4G-708, 4G-709, 4G-710, 4G-711, 4G-712, 4G-713, 4G-714, 4G-715, 4G-716, 4G-717, 4G-718, 4G-719, 4G-720, 4G-721, 4G-722, 4G-723, 4G-724, 4G-725, 4G-726, 4G-727, 4G-728, 4G-729, 4G-730, 4G-731, 4G-732, 4G-733, 4G-734, 4G-735, 4G-736, 4G-737, 4G-738, 4G-739, 4G-740, 4G-741, 4G-742, 4G-743, 4G-744, 4G-745, 4G-746, 4G-747, 4G-748, 4G-749, 4G-750, 4G-751, 4G-752, 4G-753, 4G-754, 4G-755, 4G-756, 4G-757, 4G-758, 4G-759, 4G-760, 4G-761, 4G-762, 4G-763, 4G-764, 4G-765, 4G-766, 4G-767, 4G-768, 4G-769, 4G-770, 4G-771, 4G-772, 4G-773, 4G-774, 4G-775, 4G-776, 4G-777, 4G-778, 4G-779, 4G-780, 4G-781, 4G-782, 4G-783, 4G-784, 4G-785, 4G-786, 4G-787, 4G-788, 4G-789, 4G-790, 4G-791, 4G-792, 4G-793, 4G-794, 4G-795, 4G-796, 4G-797, 4G-798, 4G-799, 4G-800, 4G-801, 4G-802, 4G-803, 4G-804, 4G-805, 4G-806, 4G-807, 4G-808, 4G-809, 4G-810, 4G-811, 4G-812, 4G-813, 4G-814, 4G-815, 4G-816, 4G-817, 4G-818, 4G-819, 4G-820, 4G-														





# BUILD-YOUR-OWN LAFAYETTE SPEAKER ENCLOSURES

EASY-TO-ASSEMBLE HI-FI ENCLOSURE KITS and COMPLETE SPEAKER SYSTEMS

AT TREMENDOUS SAVINGS TO YOU!

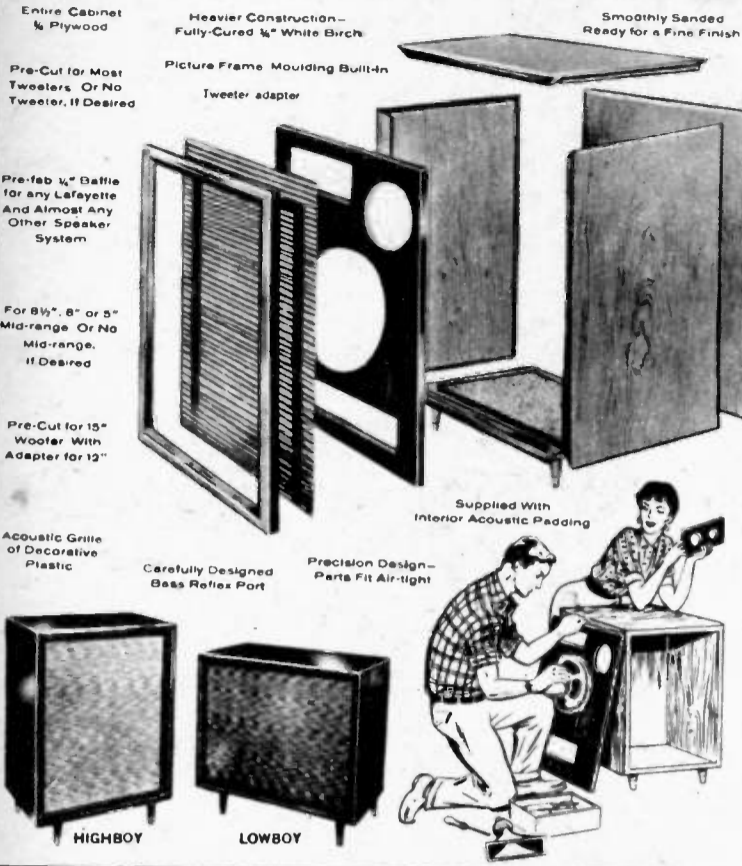

Entire Cabinet & Plywood  
Pre-Cut for Most Tweeters, Or No Tweeter, If Desired  
For 8 1/2", 8" or 5" Mid-range Or No Mid-range, If Desired  
Pre-Cut for 15" Woofer With Adapter for 12"

Heavier Construction—Fully-Cured 1/4" White Birch

Smoothly Sanded Ready for a Fine Finish

Picture Frame Moulding Built-In

Tweeter adapter

Pre-fab 1/4" Baffle for any Lafayette And Almost Any Other Speaker System

Acoustic Grille of Decorative Plastic

Carefully Designed Bass Reflex Port

Precision Design—Parts Fit Air-tight

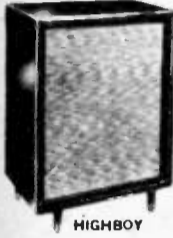

Supplied With Interior Acoustic Padding

**A LAFAYETTE BEST BUY AT ONLY 29.50**

## LAFAYETTE UNIVERSAL HI-FI BASS REFLEX ENCLOSURE KITS

• EASIEST TO ASSEMBLE — ALL YOU NEED IS A SCREWDRIVER! • 1/4" WHITE BIRCH • PRECISION-CUT — FITS TOGETHER SMOOTHLY • PERFECT FOR SINGLE WIDE RANGE, 2-WAY OR 3-WAY SPEAKER SYSTEMS • HIGHBOY OR LOWBOY STYLE

All pieces of these carefully designed bass reflex high fidelity speaker enclosures are accurately pre-cut of 3/8" veneers to fit snugly together and eliminate spurious resonances. Front panels are handsomely detailed with picture-frame moulding and covered with pleasingly decorative plastic acoustic grilles to blend with any finish and room decor. Attractively tapered offset legs are protected by good-looking brass ferrules. Acoustic lining material is provided to prevent reverberation and cabinet resonance. Cutouts are provided for 15" speaker plus adapter for 12"; 8 1/2" or 8" midrange plus adapter compression horn tweeter plus adapter for Lafayette HK-3, HW-7 or Lafayette-Goodmans SK-104 tweeters plus blank wood block if no tweeter is used. Thus, any single wide-range 12" or 15" speaker may be used, or any Lafayette 2- or 3-way speaker system, or almost any other combination of speakers. Kits are supplied unfinished, smoothly sanded and ready for finishing. The lowboy-style cabinet dimensions are (less legs) 28 3/4" w x 23 1/2" h x 16 3/4" d; legs are 7" high. Highboy has same dimensions with height and width interchanged. Instructions, all parts, hardware, and grille are included with each kit. Shpg. wt., 54 lbs.

CK-10 Unfinished Highboy Enclosure Kit ..... Net 29.50  
CK-11 Unfinished Lowboy Enclosure Kit ..... Net 29.50

### FINISHING KITS

To obtain professional-like furniture finishes. Include stain, filler, sealer, shellac, varnishes, finishing paper, brushes, and detailed instructions. Shpg. wt., 6 lbs.  
FK-10 Walnut ..... FK-20 Mahogany ..... FK-30 Fruitwood .....  
FK-40 Cherry ..... FK-50 Golden Oak ..... FK-60 Ebony ..... 5.88

### Factory-Assembled Bass Reflex Enclosures

Same as the Lafayette kits above but factory-assembled and finished in lustrous, hand-rubbed mahogany or blonde to measure up to the finest standards of high quality fine-furniture finishes. Also available assembled but unfinished. Shpg. wt., 54 lbs.  
CAB-13 Assembled, Unfinished Highboy ..... Net 39.50  
CAB-19 Highboy, Assembled, finished in Mahogany or Blonde (please specify) ..... Net 49.50  
CAB-21 Highboy Assembled, in Walnut Finish ..... Net 52.50  
CAB-14 Assembled, Unfinished Lowboy ..... Net 39.50  
CAB-20 Mahogany or Blonde Lowboy, completely assembled (please specify choice of finish) ..... Net 49.50  
CAB-22 Lowboy Assembled, in Walnut Finish ..... Net 52.50

## HIGH FREQUENCY TWEETER WITH ACOUSTIC LENS

DIRECT IMPORTATION MAKES THIS PRICE POSSIBLE!

- FREQUENCY RESPONSE FROM 2000 CPS TO BEYOND AUDIBILITY
- LOUVERED ACOUSTIC LENS FOR UNIFORM SOUND DISPERSION
- HANDLES 25 WATTS OF POWER
- PRICED EXCEPTIONALLY LOW

**14.95**

New high frequency tweeter featuring a louvered acoustic lens for uniform sound dispersion and capable of handling up to 25 watts of distortion-free power. The directional tendency of high frequency notes is overcome by the natural wide dispersion angle of the short horn and the acoustic lens which disperses and radiates the high notes smoothly throughout the entire listening area. The lens is detachable for panel mounting, with a separate base for the tweeter furnished for external mounting where desired. Aluminum voice coil has 16 ohms impedance. Size: 4 1/4" long x 3" diameter, lens extends 2 1/2". Requires a crossover network, preferably one with a level control, such as the LN-2. With full instructions. Shpg. wt., 5 lbs. Net 14.95

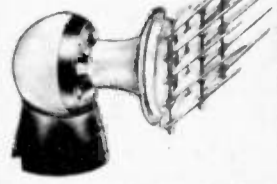

## FAMOUS LAFAYETTE HK-3 METAL-CASED CONE TYPE HI-FI TWEETER



OUTPERFORMS TWEETERS COSTING MANY TIMES THE PRICE

FREQUENCY RESPONSE 2000-16,000 CPS  
HANDLES 20 WATTS OF POWER

Highest quality cone type high frequency tweeter having a range from 2000 to 16,000 cycles. Especially efficient at higher end of audio spectrum where other cone tweeters tend to lose clarity and volume. Entirely enclosed in a metal case with a base so that it can stand by itself or be mounted on a flat surface with mounting bracket supplied. Rated to handle 20 watts of power. A crossover network is required: the Lafayette LN-2 is ideal. Voice coil impedance 8-16 ohms. Size: 3 1/2" x 2 1/2" x 3" diam. Shpg. wt., 3 lbs. Net 5.95

## NEW! METAL CASED TWEETER

SPECIAL PRICE

ONLY

**2.95**



- FREQUENCY RESPONSE 3,000-16,000 CPS
- HANDLES 20 WATTS OF POWER
- CHOICE OF 8 OR 16 OHM IMPEDANCE

The modest price of this tweeter gives no indication as to its high quality. Smooth, silky reproduction of the high frequencies along with an even sound dispersion is insured by the use of the round cone. The tweeter assembly is protected by a heavy wire mesh screen and completely enclosed in an attractive Satin Gold metal. As a result of the rear casing on the tweeter, speaker interaction between speakers has been eliminated allowing for the placement of the tweeter in the same enclosure with the woofer and mid-range speakers. Supplied with sturdy attached mounting stand and 2 1/2" ft. hook-up cord. Size 2 1/2" diam. x 2" deep. Shpg. wt., 2 1/2 lbs.  
SK-121 8 ohm Tweeter ..... Net 2.95  
SK-122 16 ohm Tweeter ..... Net 2.95

## NEW! LAFAYETTE-GOODMANS High Fidelity Speakers

FROM ONE OF ENGLAND'S LEADING SPEAKER MFR'S!

ONLY 49.50 A REAL BUY

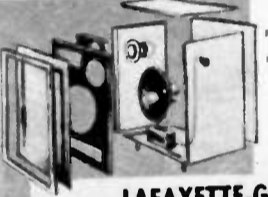

PERFECT IN LAFAYETTE BASS REFLEX CABINETS CABINET NOT INCLUDED

### LAFAYETTE-GOODMANS 3-WAY SPEAKER SYSTEM

- HANDLES 30 WATTS • FAMOUS ENGLISH GOODMANS-MADE 12" WOOFER, 8 1/2" MIDRANGE, COMPRESSION DRIVER HORN TWEETER • LAFAYETTE L/C CROSSOVER NETWORK • SYSTEM RESPONSE 30-16,000 cps

Here is an outstanding 3-way high fidelity speaker system which we are indeed proud to be able to offer. It includes a group of speakers custom-made for Lafayette by Goodmans, famous English manufacturer of some of the world's best high fidelity speakers. The system is ideal for installation in Lafayette bass reflex speaker enclosures, and provides the extremely wide range of 30 to 16,000 cps (8 db down at 20,000 cps) smoothly and without unpleasant peaks. Power handling capacity of the system is 30 watts of integrated program material. Included in the system are the Lafayette-Goodmans SK-102 12" woofer covering the range from 30 to 700 cps, the Lafayette-Goodmans SK-103 8 1/2" mid-range speaker covering 700 to 5,000 cps, and the Lafayette-Goodmans SK-104 compression-driver tweeter operating at from 5,000 cps to over 16,000 cps. Also included is the Lafayette LN-5 inductance-capacitance (L/C) crossover network with attached Brilliance (high-frequency) and Presence (mid-range) controls. System impedance is 16 ohms. This is a really great system at an unusually low price! Shpg. wt., 25 lbs.



### LAFAYETTE-GOODMANS 15" 3-WAY SYSTEM

An outstanding 3-way speaker system similar to SY-163 system above, but featuring the new SK-101 15" Lafayette-Goodmans woofer for extra high efficiency even at subaudible frequencies. System response 25 to 16,000 cps. Complete with LN-5 crossover network and SK-103 8 1/2" midrange speaker and SK-104 tweeter. A superb speaker system with wide, smooth response and a new low in distortion and tone coloration.

SY-177 Lafayette-Goodmans 3-Way 15" Speaker System Net 54.50

### Made to Lafayette's own rigid specifications LAFAYETTE-GOODMANS 15" WOOFER

An all new 15" low-frequency speaker featuring smooth, powerful reproduction down into the sub-audible frequencies. Its rigid construction and high efficiency design permit the reproduction of even the loudest low frequency transients without ringing or distortion. Response 25 to 7000 cps. Alcomax magnet with flux density of 13,000 lines and total flux of 89,500 maxwells assures the utmost linearity at full power — 30 watts of program material. Voice coil diameter 1 3/4" Impedance 16 ohms. Shpg. wt., 15 lbs.  
SK-101—15" Lafayette-Goodmans Woofer Net 28.50



### LAFAYETTE-GOODMANS 12" WOOFER

A highly-efficient low-frequency transducer for faithful reproduction of the lowest audible frequencies without tone coloration or distortion. Incorporates high flux Alcomax magnets for smooth response and good power sensitivity. Frequency response is 30-7,000 cps, with recommended crossover at 700 to 1000 cps. Total flux is 89,500 maxwells; voice coil diameter is 1 3/4". Rated at 30 watts power handling capacity for integrated program material in a multiple speaker system with an LC crossover network. Voice coil impedance 16 ohms. Size 12 1/4" diam. x 6" deep. Shpg. wt., 9 lbs.  
SK-102 12" Lafayette-Goodmans Woofer Net 23.50



### LAFAYETTE-GOODMANS 8 1/2" MIDRANGE SPEAKER

A sweet-sounding high-fidelity reproducer capable of doing full justice to the most important range of musical reproduction — the mid-frequency range from 500 to 5,000 cps. Incorporates high-efficiency Alcomax magnets, a specially-constructed cone with an "accordion fold" half-way down for smooth sound reproduction free from peaks and distortion, plus a completely sealed rear housing to prevent back radiation and interaction with other speakers. Response is 500 to 8,000 cps. Recommended crossovers are 700-1000 cps at the low end, 5,000 cps at the high end in a 3-way system. Magnet total flux is 32,900 maxwells. Voice coil diameter is 1". Power rating is 30 watts program material in a 3-way system. Voice coil is 16 ohms. Size is 8 3/4" diam. x 3 3/4" deep. Shpg. wt., 4 lbs.  
SK-103 8 1/2" Lafayette-Goodmans Midrange Net 5.95



### LAFAYETTE-GOODMANS high frequency DRIVER and HORN

A highly efficient compression-type wide-angle radiator for the higher audio frequencies. With high flux Alcomax magnets. Rigid plastic horn with circular mouth and special design acoustic chamber with phasing plug achieves smooth wide-angle distribution to extremely high frequencies. Horn diameter 2 1/2" mouth opening 1 3/4" diam. high frequencies. Overall depth 3". Frequency response 2500 to 16,000 cps; 8 db down at 20,000 cps. Incorporates 25,400 maxwells. Voice coil diameter is 1". Recommended crossover is 5,000 cps. Power rating is 30 watts program material in a 3-way system. Voice coil is 16 ohms. Shpg. wt., 3 lbs.  
SK-104 Lafayette-Goodmans Tweeter ..... Net 10.95



## Famous 3-WAY SYSTEM

with 15" WOOFER... 8" MID-RANGE SPEAKER... HORN TWEETER... CROSSOVER NETWORK

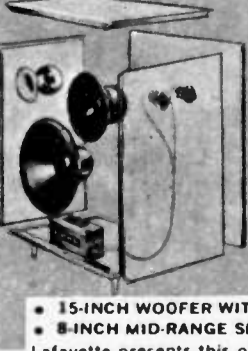
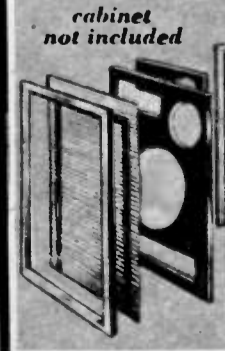

**55.50**

ONLY 5.50 DOWN \$5.00 MONTHLY

- 15-INCH WOOFER WITH 31.5 OZ. MAGNET (SK-67)
- 8-INCH MID-RANGE SPEAKER (SK-74)
- NEW HIGH-FREQUENCY ACOUSTICAL LENS TWEETER (HW-7)
- 3-WAY CROSSOVER NETWORK (LN-3)

Lafayette presents this outstanding 3-way speaker system designed for the high fidelity enthusiast who desires performance formerly possible in multi-speaker systems costing many times this price. You won't believe your ears when you hear the superb reproduction throughout the entire audio spectrum. The SK-67 15" woofer provides phenomenal bass response, the SK-74 8" speaker delivers full bodied, mid-range frequencies, and the HW-7 high frequency acoustical lens tweeter faithfully reproduces the highest audible frequencies. Crossover points at 350 and 5000 cycles are provided in the LN-5 3-way inductance-capacitance network with continuously variable presence and brilliance controls that adjust tone balance to personal taste. Shpg. wt., 25 lbs.  
SY-93—Complete System as listed above ..... Net 55.50

## NEW! 2- and 3-way L/C CROSSOVER NETWORK

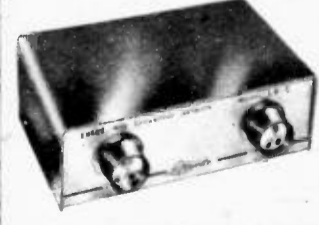

- 2- OR 3-WAY
- CHOICE OF 4 CROSSOVER FREQUENCIES
- 6 CROSSOVER COMBINATIONS
- METAL CABINET
- BUILT-IN BRILLIANCE AND PRESENCE CONTROLS

**\$14.95**

This versatile unit can be used either as a 2-way or 3-way 6 db. per octave network, simply by loosening a few screws on the rear terminal panel and shifting several wires. You can use this network for a 2-way system now, easily and quickly convert to 3-way later. Six crossover combinations are available—2-way crossover with 2000-3000 cycle or 5000 cycle crossover, and 3-way with crossover frequencies of 350 and 5000. 350 and 2000-3000, 700 and 2000-3000 or 700 and 5000 cycles — a total of four different crossover frequencies! Suitable for 8-16 ohm speakers. The network is housed in an attractive metal case, suitable for mounting inside enclosure or leaving out in the open. Two level controls—Brilliance and Presence controls—are mounted on the front panel. If desired, these level controls may be removed, along with the beautiful gleaming copper escutcheon plate, for external mounting; controls are wired with 3-foot long leads. High quality components are used for long life and top performance.  
LN-5 Lafayette L/C Crossover ..... Net 14.95



# LAFAYETTE

EXTRA  
LOW  
COST

# AUDIO & PHONO ACCESSORIES

## LAFAYETTE SPECIAL VALUES IN T PADS, FADERS AND SPEAKER SWITCHES.

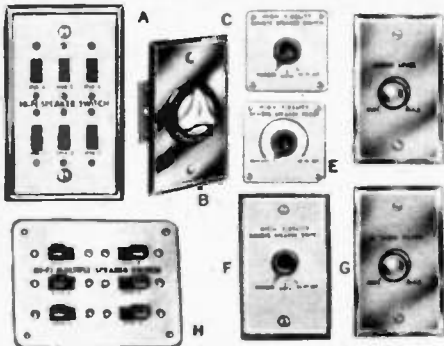

**Multiple Speaker Switch (A).** Constant impedance device for controlling any 6 remote speakers; up to 63 different combinations. Wall mounting with brass plate. Shpg. wt., 10 oz. MS-459 With instructions and hardware ..... Net 2.10

**Multiple Speaker Switch (M).** Identical to above but mounted on flat, gold-embossed plate for mounting on flat panel. 3 1/2" x 2 1/4". Shpg. wt., 10 oz. MS-544 ..... Net 1.19

**Speaker Selector Switch (B).** Selects 3 speakers in any combination, with up to 60 watts of audio power. A constant impedance device. On gold finished steel electric outlet plate., 2 1/4" x 4 1/2". MS-458 Shpg. wt., 1 lb. .... Net 1.39

**Remote Speaker Switch (C).** Connects remote speaker to any existing set. Turns both on or either speaker on or off. With gold embossed plate for front panel mounting. Shpg. wt., 6 oz. MS-469 With all parts and instructions. Net .95

**Remote Speaker Switch (F).** Same as MS-469 except for wall mounting. Shpg. wt., 6 oz. MS-470 ..... Net 1.50

**Remote Speaker Fader (E).** Provides adjustable volume level for Radio, TV, Hi-Fi and remote speaker. Gradually increases volume on one speaker while diminishing volume on the other. May also be used to adjust volume for 1 speaker. Gold plate for front panel mounting. With instructions. Shpg. wt., 6 oz. VC-53 ..... Net 1.10

**Remote Speaker Fader (G).** Same as VC-53 except for wall mounting. Shpg. wt., 6 oz. VC-54 ..... Net 1.55

**T Pads (D).** Constant impedance control to adjust speaker volume. With brass satin plate for wall mounting. With all parts and instructions. Shpg. wt., 10 oz. VC-51 8 ohm T Pad ..... Net 3.85

VC-52 16 ohm T Pad ..... Net 3.85

## NEW LAFAYETTE L PADS



New L pads for use as "brilliance" controls to vary tweeter level, or as "presence" controls to vary mid-range speaker level. Both wirewound elements are concentrically mounted within one plastic housing. With gold-finished metal escutcheon plate, mtg screws, and attractive black knob. Size: 1-9/16" dia., 7/8" deep (less shaft), 2 1/2" deep overall. Shpg. wt., 6 oz.

VC-49—L pad for 8 ohm circuits ..... Net 1.49  
VC-50—L pad for 16 ohm circuits ..... Net 1.49

## LAFAYETTE COMPLETE CABLE ASSEMBLIES FOR HI-FI AND P. A.

High quality extension cables "tailor made" for users of recorders, hi-fi equipment, etc. All plugs molded directly to various cable combinations. Shielded cable for high impedance (mike, etc.) connections; parallel wire for low impedance (speaker, etc.) connections. Average shpg. wt., 8 oz.

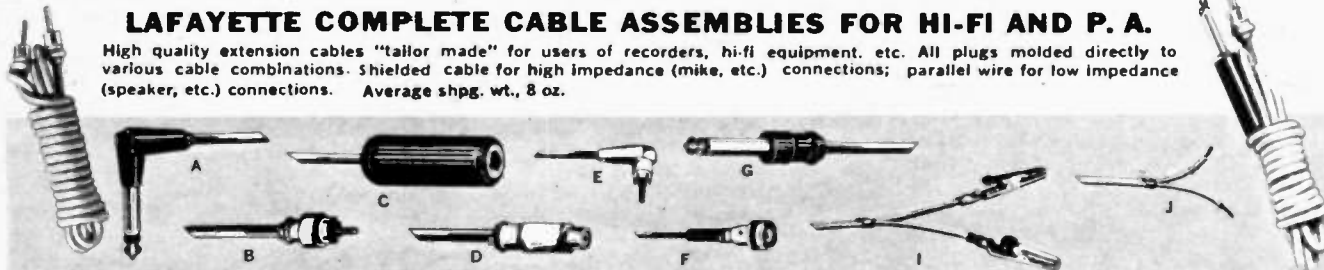

**90° PHONE PLUG (A) TO VARIOUS CONNECTIONS.** Std. 1/4" sleeve; completely shielded. All cables shielded except \* unshielded parallel cable.

Stock No.	One Termination	Cable Length	Other Termination	Net
MS-545	90° phone plug (A)	72 in.	Straight RCA phono plug (B)	.72
MS-546	90° phone plug (A)	72 in.	Straight RCA phono jack (D)	.85
MS-547	90° phone plug (A)	72 in.	Straight barrel phone jack (C)	.93
MS-548	90° phone plug (A)	72 in.	Mike connector (F)	.93
MS-549	90° phone plug (A)	120 in.	Mike connector (F)	1.26
MS-550	90° phone plug (A)	72 in.	RCA phono plug (E)	.72
MS-551*	90° phone plug (A)	72 in.	Stripped and tinned ends (I)	.51
MS-552*	90° phone plug (A)	72 in.	Alligator clips (J)	.68

**RCA TYPE PHONO PLUG (B) TO VARIOUS CONNECTIONS.** All cables shielded except \* unshielded parallel cable.

Stock No.	One Termination	Cable Length	Other Termination	Net
MS-486	Straight RCA phono plug (B)	36 in.	Straight RCA phono plug (B)	.39
MS-480	Straight RCA phono plug (B)	60 in.	Straight RCA phono plug (B)	.47
MS-481	Straight RCA phono plug (B)	72 in.	Straight RCA phono plug (B)	.69
MS-487	Straight RCA phono plug (B)	48 in.	RCA-type phono jack (D)	.54
MS-483	Straight RCA phono plug (B)	60 in.	RCA-type phono jack (D)	.59
MS-484	Straight RCA phono plug (B)	72 in.	Barrel-type phone jack (C)	.69
MS-555	Straight RCA phono plug (B)	72 in.	Mike connector (F)	.88
MS-556*	Straight RCA phono plug (B)	120 in.	Alligator clips (J)	.81

**PHONE PLUG (G) TO VARIOUS CONNECTIONS.** Std. 1/4" diam. sleeve; completely shielded. All cables shielded.

Stock No.	One Termination	Cable Length	Other Termination	Net
MS-482	Straight phone plug (G)	72 in.	RCA-type phono jack (D)	.79
MS-485	Straight phone plug (G)	72 in.	Barrel-type phone jack (C)	.79
MS-553	Straight phone plug (G)	72 in.	Mike connector (F)	.93
MS-554	Straight phone plug (G)	120 in.	Mike connector (F)	1.26

**90° RCA PHONO PLUG (E) TO VARIOUS CONNECTIONS.** All cables shielded except \* unshielded parallel cable.

Stock No.	One Termination	Cable Length	Other Termination	Net
MS-557	90° RCA phono plug (E)	72 in.	Barrel-type phone jack (C)	.72
MS-558	90° RCA phono plug (E)	72 in.	Mike connector (F)	.88
MS-559*	90° RCA phono plug (E)	36 in.	Stripped and tinned ends (I)	.32
MS-560*	90° RCA phono plug (E)	72 in.	Alligator clips (J)	.63

**SPECIAL 10 FT. JUMPER CABLE.** Unshielded parallel cable, 10 ft. long, with alligator clips (I) at both ends. MS-561 ..... Net .60

## REPLACEMENT CARTRIDGES FOR RCA 74067

- Replacement for cartridges in many thousands of RCA45 and many LP record changers.
- 1 MIL SAPPHIRE STYLUS ● 2.3V OUTPUT
- HIGH IMPEDANCE CRYSTAL ● TAKES 7-10 GMS PRESSURE ● 3/8" MTG CENTERS

PK-168 ..... Net 1.25  
PS-555—Sapphire replacement stylus for PK-168 ..... Net .99

## GOLDRING "500" MAGNETIC TURNOVER CARTRIDGE

Entirely unique, and exclusive among the 500's features is the "push-pull" coil arrangement which automatically cancels out inductive hum picked up from the radiation of changer motors, etc. This permits users of the "500" to realize the full potential of the variable reluctance principle. The "500" will fit any tone arm having standard 1/2" mounting holes to replace any cartridge without alteration of playing equipment.

PK-137—GOLDRING "500" cartridge with 2 sapphire styli ..... Net 5.75

## SONOTONE 2T-5 (Supersedes 9980-5) Turnover Ceramic Cartridge

This cartridge is used to replace Astatic AC, ACD, CAC, GC, LQD, ELECTRO-VOICE 16TT, 33, 43, 46T 96T; SHURE WC series from WC22 to WC36, W22, W26; WEBSTER ELECTRIC AX, A1, A9-1. It is to be used on VM, Columbia 360, Webster, Crescent record changers and many other types now in use. Will give rich hi-fi characteristics of extended frequency range and absence of distortion for beyond most cartridges it replaces — all with the added advantages of ceramic safety from humidity and heat. Has 1 mil stylus for LP records and 3 mil for standard — both sapphire.

PK-40—In lots of 3, ea. 3.50 ..... Singly, ea. 3.75

## HI-FI TURNOVER CARTRIDGE ● 40-14,000 CYCLES (PK-79)

Never before has a turnover cartridge of this quality been offered at such a price. Frequency response from 40-14,000 cycles ± 2 db! Has 2 sapphire styli to play all speeds and types of records. Needle pressure required is only 5 grams on LP and 12-15 grams on 78 RPM. Output is .5 volts. Comes complete with turnover mechanism and knob. Fits Webster, Garrard, VM, Callara and tone arms of other leading manufacturers of record changers and players. This is one of the outstanding Lafayette values.

PK-79—Singly, each \$2.75 ..... in lots of 3, each 2.50  
PK-84—Sapphire LP Replacement Needle ..... .69  
PK-85—Sapphire STD (78) Replacement Needle ..... .69

## PHONO CARTRIDGES 3.5 VOLT OUTPUT (PK 11)

Guaranteed high quality exact duplicates for direct replacement of all standard cartridges such as 170, 182, 192, W60B, N10, and many others. Pin plug connectors for all 78 r.p.m. PK-11 each ..... 1.29

## 3 VOLT TURNOVER CARTRIDGES

- High Output: 3 volts
- Turnover Mechanism
- Dual Sapphire Styli
- Excellent Frequency Response

STOCK NO. PK 80

Lafayette has gone all out to provide for the serviceman a replacement turnover phono cartridge of a price never before attained. Here is a crystal cartridge complete with 2 sapphire styli, turnover mechanism, mounting bracket and knob—with sufficient output to use in any record player—and yet of fine quality. All at a price that enables you to use it on any repair job. Length, (less knob) 2 1/2". Ease of mounting assured by two sets of mounting holes each set with 1/2" centers.

PK-80—Singly, each 2.50 ..... in lots of 3, each 2.25

PK-86—Sapphire LP Replacement Needle ..... .69

PK-87—Sapphire STD (78) Replacement Needle ..... .69

## RONETTE HI-FI CARTRIDGES IMPORTED FROM HOLLAND

Lafayette brings you this famous high fidelity cartridge for use in Callara, Webster, Garrard and VM changers. Turnover type equipped with 2 sapphire styli to play all speeds. Frequency response to 9,000 cycles, output .7 volt. Complete with turnover mechanism and knob; will fit most tone arms of record changers and players.

PK-62 (TO-284-OV) ..... ea. 2.95

## HIGH OUTPUT MODEL

Has less than 1% intermodulation distortion plus high output of 2.2 volts. Complete turnover with 2 sapphire styli. Popular type mounting.

PK-82 (TO-222)—In lots of 3, each 2.75; singly 2.95

## TX-88 HI-FI MODEL

This new wide range high fidelity crystal turnover cartridge has a frequency response flat from 30-24,000 cps. Output is 0.4 volts, which makes it useable without a preamp. It gives straight line response from new ortho records and so requires no equalization. Extremely high compliance stylus assembly just snaps into place. Complete with dual styli. Shpg. wt., 6 oz.

RONETTE TX-88 ..... Net 7.35

2.75



## NEW! STEREO CRYSTAL TURNOVER CARTRIDGE

- EXCELLENT FREQUENCY RESPONSE
- HIGH OUTPUT ● LOW TRACKING FORCE
- DUAL SAPPHIRE STYLI

Another instance at Lafayette special value for you: a stereo crystal turnover cartridge of such a low price. Frequency response 40-14,000 cps. Tracks with low stylus pressure and high output voltage. Excellent channel separations for stereo effect. Supplied with turnover mechanism, knob and dual sapphire styli to play records of all speeds. Completely compatible. Fits all standard arms. Shpg. wt., 6 oz.

PK-258 ..... Net 2.75

## REPLACEMENT STYLI

PK-281—Sapphire Stereo LP ..... Net .69  
PK-282—Sapphire STD (78) ..... Net .69  
PS-86—DIAMOND Stereo LP ..... Net 3.49

## NEW! 4-SPEED HI-FI TURNOVER PICKUP

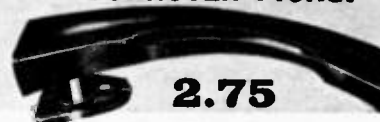

2.75

- ARM TAKES STEREO OR MONAURAL CARTRIDGES
- WITH WIDE RANGE MONAURAL CARTRIDGE ● ADJUSTABLE ARM HEIGHT AND STYLUS PRESSURE

Arm is wired for stereo, anticipating future conversion. Has a wide range turnover monaural crystal cartridge with dual sapphire styli. Output is 1 1/2 V. Easy height adjustment of base, 1 1/4" to 1-9/16". Also stylus pressure adjustment. Plastic arm 9 1/4" long overall. Base 1 1/2" w. with mounting holes in 1 1/2" centers. Shielded leads. Solin smooth light maroon finish. Shpg. wt., 2 lbs.

PK-146 ..... Net 2.75

PK-232 Pickup arm only less cartridge ..... Net 1.25

PK-158 Sapphire LP replacement Needle ..... Net .69

PK-159 Sapphire STD replacement Needle ..... Net .69

## A LAFAYETTE SPECIAL!



ONLY 6.95

## STEREO ARM WITH RONETTE STEREO TURNOVER CARTRIDGE

- DUAL SAPPHIRE CARTRIDGE ● PLAYS STEREO, MONAURAL LP, 78's

Here is a combination of a famous make crystal stereo cartridge and stereo wired arm all ready for use—at an amazingly low price for a new stereo item. Completely compatible, this unit will play either stereo or monaural records (78's, too). Output is .4 volt per channel, response 30-14,000 cps. Min. Stylus pressure 6-8 grams. Styli are dual sapphire type, .7 mil and 2.5 mil, individually replaceable.

PK-290 Stereo Tone arm with Turnover Stereo Cartridge ..... Net 6.95

## RONETTE MODEL-OV

### CRYSTAL TURNOVER STEREO CARTRIDGE

Another fabulous item for music lovers from Lafayette. We now bring you this outstanding cartridge so that you can enjoy the breathtaking realism of the latest stereo discs. Completely compatible, this cartridge plays either stereo or monaural records. Consists of 2 crystals to provide a .4 volt output per channel. Wide frequency response of 30 to 14000 cps. Vertical and lateral compliance of 3.5 x 10<sup>-4</sup> cm/dyne. Crosstalk, .24db. Supplied with turnover dual sapphire styli for microgroove records and 78 rpm records. Fits all standard tone arms. Shpg. wt., 8 oz. IREG. 12.95



SPECIAL! NET 4.45

## 4 SPEED PHONO MOTOR WITH TURNTABLE

Quiet, dependable A.C. operation assured by rubber shock-mounted friction drive motor. Speed change control through idler driving an 8" turntable. Mounting centers 4 1/2 x 3 3/4 x 2 1/2" depth below base plate. Shpg. wt., 3 1/2 lbs.

ML-24 Phono and turntable ..... Net 5.50  
PK-149 Mounting board for motor ..... Net 95c



## WIRELESS BROADCASTER

Play your phonograph through any radio anywhere in the house without connecting wires. Talk through your radio by microphone.

9.75



Lafayette's new wireless broadcaster will extend your enjoyment of your phono-player to every room that has a radio. Connect phono to wireless broadcaster, tune in any radio to the wireless broadcaster, which broadcasts on an adjustable frequency between 700KC - 1700KC. Pick your spot. Will take crystal or magnetic cartridges and also microphones for voice broadcast. Has volume control with "on-off" switch. Size 4 1/2 x 5 3/4 x 1 1/2". Completely wired and assembled with all tubes and operating instructions. 110V AC/DC operation. Shpg. wt., 4 lbs.

LA-14 Wireless broadcaster ..... Net 9.75  
PA-24 Crystal microphone ..... Net 4.25

## BOGEN 33 WATT P. A. SYSTEM 104.50

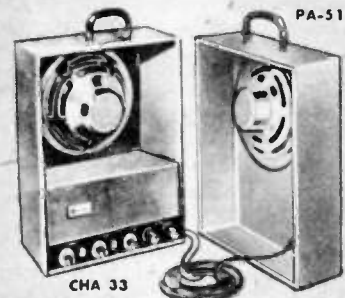

This compact 33 watt P.A. System complete with sturdy portable carrying case housing 2 high quality 12" speakers each with 35 ft. cable, microphone, floor stand and desk stand is ideal for use by schools, churches, warehouses, nightclubs—indeed any high quality P.A. application. 117 V, 60 cps. AC. Shpg. wt., 58 lbs. System consists of:  
 1—Bogen CHA 33 Amplifier.  
 1—Lafayette PA-24 crystal microphone with 5' shielded cable.  
 1—Lafayette PA-34 microphone desk stand.  
 1—Atlas MS-10C microphone floor stand.  
 2—Heavy duty 12" PA speakers.  
 1—Lafayette PA-51 portable PA case.  
 2—35' lengths speaker cable.  
 PA-180 BOGEN CHA-33 P.A. SYSTEM AS DESCRIBED. 104.50

### SPECIAL 12" & 8" P. A. SPEAKERS

- 12" FULL 15 WATTS OF POWER • 8" [FULL] 10 WATTS OF POWER
- HEAVY ALNICO 5 MAGNETS

**12" MODEL**—Fine quality throughout, these speakers were designed especially for public address work. Will handle 15 watts of power—making them ideal for use singly for medium power systems or in multiples for higher power. Rugged mechanical construction, dust-proofed and rust-resistant. Have 4.64 oz. Alnico 5 magnet, 8 ohm voice coil. Shpg. wt., 5 lbs.



12" MODEL — 4.95

**8" MODEL**—Ideal for larger scale, lower power paging systems. Same quality as 12" speaker above, but 8" diameter, rated at 10 watts, with 3.16 oz. Alnico 5 magnet, 8 ohm voice coil. Shpg. wt., 3 lbs.

8" MODEL — 3.95

12" MODEL — 4.95

## NEW! POWER MEGAPHONE Portable Sound Broadcaster

- IDEAL FOR OUTDOOR HAMFESTS
- Uses 8 Flashlight Cells • Completely Self-Contained
- Weighs only 6 1/2 lbs. with Batteries • High Efficiency
- Horn Projects Sound 1000 Ft. • Shoulder Strap for Portability and Ease of Use • Microphone Detachable On 10-Foot Cord • For Construction, Auctions, Carnivals, Fire & Police Use • Also Ideal for Marine, Railroad, Civil Defense, Sporting Events



Reg. Value 69.50  
**ONLY 29.50**

Self-Contained—Only 6 1/2 lbs. THROWS VOICE 1000 FT.

SHOULDER STRAP & DETACHABLE MIKE JUST AIM & TALK



A power megaphone with many unusual features and many applications. Basically a highly efficient sound projector horn with a built-in microphone, capable of amplifying and projecting the voice with a range of 1000 feet. The microphone is a telephone-type element, easily replaceable, and may be detached and extended up to 10 feet from the horn. The reflex-type horn is extremely light-weight, rubber-rimmed, of strong, sturdy spun aluminum construction with 2 3/4" air column and is supplied with a strap for carrying or placing on the shoulder. A press-to-talk switch on the microphone provides for economy of power use—power is used only when actually talking. No warm-up time required—amplification is instantaneous. A patented non-linear current limiting device restricts current flow to safe levels for longest battery life. Uses 8 size "D" flashlight cells in series with an approximate life of about 10 hrs. of use. Battery housing serves as base for entire assembly. Battery compartment opens easily by means of 2 thumbscrews for battery replacement. Size 17" long overall; horn mouth is 12" diam. Shpg. wt., 8 lbs. less batteries.

PA-13—Power Megaphone, Less batteries.....Net 29.50  
 BATTERIES FOR ABOVE—Burgess No. 2 or RCA VS036—8 Required.....Net each .13

### REFLEX TRUMPET DUAL WIDE ANGLE

**18.75**

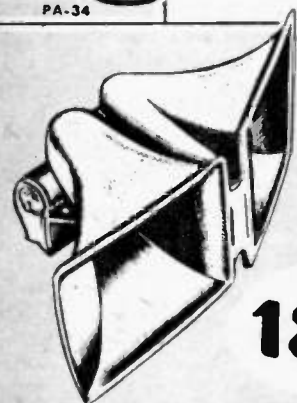

Perfect for all indoor and outdoor P.A. Applications. Essentially a pair of exponential horns having twin air columns in a single assembly providing a wide-angle dispersion of sound—120° horizontally and 60° vertically. May be used with any amplifier. Size of bell mouth, 18 1/2" x 9 1/4" Depth 10 1/4". Supplied less driver unit. PA-53 DUAL WIDE ANGLE REFLEX TRUMPET.....Net 18.75

### PAGING SPEAKER 90° DISPERSION

**15.75**

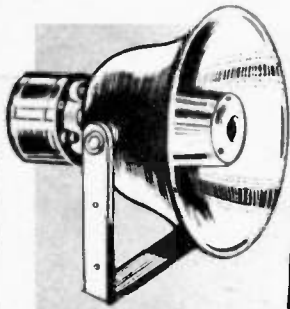

The high power handling capacity combined with maximum intelligibility make this a superior unit for paging and talk-back applications. Frequency Response 250-15,000 cps. Power capacity 30 watts. Impedance 8-ohms, 90° Dispersion. Equipped with a universal mounting bracket, weather proofed, tropicalized with hermetically sealed driver unit. 9 1/4" diam. x 8-13/16" deep the speaker lends itself to use in any P.A. situation. PA-55 90° DISPERSION PAGING SPEAKER.....Net 15.75

### BOGEN 20 WATT MOBILE P. A. SYSTEM

Completely portable in every respect, the versatility of this system allows its use from any car or truck, making the system ideal for sound truck application. System consists of:

- 1—Bogen CHA 620Y 20 watt; 6-12-117 volt amplifier with 3 speed phono top.
  - 2—Electrovoice 844 speakers, with built in 30 watt driver units.
  - 1—Lafayette PA-24 crystal microphone with 5' shielded cable.
  - 1—Lafayette PA-34 microphone desk stand.
  - 2—35' lengths speaker cable.
- Shpg. wt., of complete system 75 lbs.



PA-24



CHA 620Y

PA-181 BOGEN MOBILE 20 WATT P.A. SYSTEM

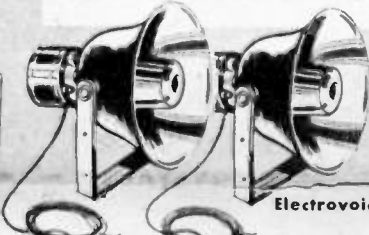

Electrovoice 844

PA-34

Net 149.95

### 25 WATT DRIVER EXCELLENT FOR ABOVE TRUMPET

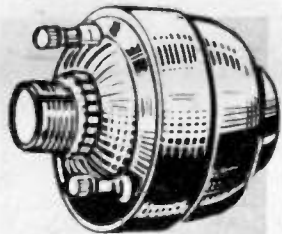

Hermetically sealed, tropicalized and weatherproofed, this rugged, high quality driver may be used with any standard 1 1/2"-18-thread horn-rated at 25 watts continuous; 50 watts peak; with heavy magnet and frequency response of 90 to 6000 cps. This unit is ideal for both speech and music. Shpg. wt., 4 lbs. PA-54 25 WATT DRIVER.....Net 13.75

### MODERN SPEAKER Baffles

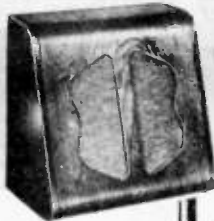

Well built plywood speaker baffles for indoor public address and paging systems, intercoms, extension speakers, etc. Frieze-design grille cloth, modern walnut finish.

NO.	DESCRIPTION	SINGLY EACH	LOTS OF 3 EACH
SB-10	For 5" or 6"	2.40	2.25
SB-11	For 8"	2.75	2.55
SB-13	For 10" or 12"	4.40	4.20

### ALL LAFAYETTE AMPLIFIERS ARE GUARANTEED FOR ONE FULL YEAR

#### LAFAYETTE MODEL PA-60 10-WATT P.A. AMPLIFIER



PA-60

24.95

ONLY 5.00 Down

**FEATURES:** Provides extensive coverage—up to 20,000 square feet when used with trumpet speakers. For store demonstrations, clubs, churches, offices, classrooms, auction sales, entertainment. Incorporates latest circuit features for improved performance. Separate volume controls permit mixing microphone and phono. 2 speaker output sockets. Cabinet is finished in baked hammerloid enamel.

**SPECIFICATIONS:** TUBES: 12AX7, 6L6GB, 6X5GT (Rectifier). **PEAK POWER:** 12 Watts. **INPUT GAIN:** Microphone 105 db 2.2 Meg., Phono 65 db 1/4 Meg. **FREQUENCY RESPONSE:** 70 to 10,000 cps ± 2 db. **tone control ATTENUATION:** Treble 15 db at 10,000 cps. **CONTROLS:** 4, mike Power, Phono or Radio, Tone. **INPUTS:** 2, 1-Microphone and 1-Phono. **OUTPUT IMPEDANCES:** 4, 8, 16 ohms and 70 volts (500 ohms). **HUM AND NOISE:** 60 db below maximum output. **POWER CONSUMPTION:** 70 Watts, 110/120 V.A.C. 60 cps. **SIZE:** 10 1/2" w x 5 1/2" d x 6" h. **SHIPPING WEIGHT:** 12 1/2 lbs.

LAFAYETTE MODEL PA-60—Complete with Tubes.....Net 24.95

#### LAFAYETTE MODEL PA-62 30-WATT P.A. AMPLIFIER



PA-62

49.50

ONLY 5.00 Down - 5.00 MONTHLY

**FEATURES:** Ideal for use in churches, schools, small theaters, lecture halls and industrial plants. Priced extremely low to give extra profits to rentals and sales. Separate bass and treble tone controls, permits adjustments to meet all acoustic requirements. Two mike inputs; optional 4-speed phono top. 70 volt constant voltage output tap. Provides coverage up to 100,000 square feet when used with trumpet type speakers. Chassis is equipped with 2-speaker plug-in output sockets. Unit is housed in sturdy steel, well-ventilated cabinet. Modern streamlined styling. Finished in baked hammerloid enamel. Removable escutcheon plate for rack and panel mounting.

**SPECIFICATIONS:** TUBES: 3-12AX7, 2-6L6GB, 5Y3GT (Rectifier). **POWER OUTPUT:** 30 Watts. **INPUT GAIN:** Microphone 125 db 3.3 Meg., Phono 82 db 1/2 Meg. **FREQUENCY RESPONSE:** 30 to 15,000 cps, ± 2 db. **tone CONTROLS:** Bass ± 15 db at 50 cps; Treble ± 15 db at 10,000 cps. **HUM LEVEL:** 70 db below rated output. **INPUTS:** 3; 2-Microphone and 1-Phono. **CONTROLS:** 6; Microphone-1, Microphone-2, on-off, Bass, Treble, Phono. **OUTPUT IMPEDANCES:** 4, 8, 16, and 250 ohms; 70 volts. **POWER CONSUMPTION:** 135 Watts, 110/120 V.A.C. 50-60 cycles. **SIZE:** 14" w x 8" d x 6" h. **SHIPPING WEIGHT:** 20 lbs.

LAFAYETTE MODEL PA-62—Complete with Tubes.....Net 49.50

#### 4-SPEED PHONO TOP

For above amplifier. Fits in place of cover. Plays all speeds—16 2/3, 33 1/3, 45 and 78 rpm. Has constant 4-speed motor, with turnover cartridge, complete with two precious metal needles. Has arm-rest and plug connection; for 110 Volt 60 cycle. Shpg. wt., 10 lbs. PA-65—4-Speed Phono Top.....Net 16.95

### DUAL-SPEAKER 30-WATT PORTABLE SYSTEMS

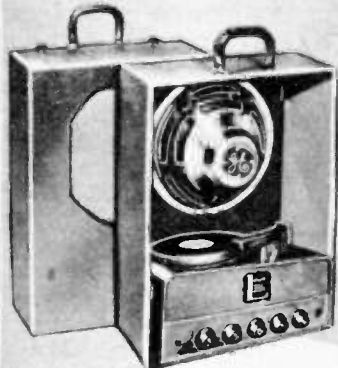

AS LOW AS 105.00 ONLY 10.50 DOWN

- CHOICE OF DELUXE DYNAMIC MIKES
- TWO GE 25-WATT SPEAKERS • MONEY-BACK GUARANTEE

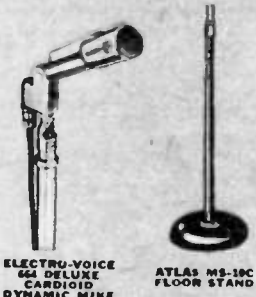

ELECTRO-VOICE 664 DELUXE CARDIOD DYNAMIC MIKE



ATLAS MS-10C FLOOR STAND



ARGONNE AR-3 DUAL IMPEDANCE DYNAMIC MIKE



ARGONNE AR-3 DUAL IMPEDANCE DYNAMIC MIKE

The 30-watt system is one of our most popular models. Large enough for the majority of sound system applications—used in thousands of school auditoriums, churches, theatres, dance halls, dance studios and lecture halls. The ideal system for rentals; these systems have been sold to many hundreds of dealers. **AND REMEMBER OUR MONEY-BACK GUARANTEE AND OUR LOW, LOW PRICE!** DUAL SPEAKER 30-WATT PORTABLE SYSTEMS INCLUDE: The outstanding feature-filled Lafayette Model PA-62 30-watt amplifier; 2-GE 25-watt PM speakers; 2-35' speaker cables and plugs; your choice of the popular Argonne AR-3 All-Purpose Dynamic dual-impedance microphone for hand-held, desk stand or floor stand use, with removable ball-joint desk stand and floor stand adapter and 8' cable; or the deluxe dual-impedance Electro-Voice 664 Cardiod dynamic for close-talking use where high-feedback problems exist, with 40-15,000 cps response, on-off switch and 18' cable; the famous Atlas MS-10C floor mike stand; and the handsomely designed split-type portable carrying case covered in high quality dark blue leatherette. Size of case 22 1/2" h x 16 1/2" w x 15" d—provides a secure place for the system components. For 110-130 volts, 60 cps AC operation. Shpg. wt., 75 lbs.

LAFAYETTE PA-142 30-watt Portable System, with Atlas MS-10C floor stand, complete as described with Argonne AR-3 dual impedance dynamic microphone.....Net 105.00  
 LAFAYETTE PA-143 Same as above, with E-V 664 dynamic microphone and MS-10C floor mike stand.....Net 124.50  
 LAFAYETTE PA-144 Same as PA-142 with 4-speed phono top.....Net 121.00  
 LAFAYETTE PA-145 Same as PA-143 with 4-speed phono top.....Net 140.50

### 10-WATT FIXED P.A. SYSTEMS

- COMPLETE PERMANENT SYSTEM
- CHOICE OF CRYSTAL OR DYNAMIC MIKE
- AMPLIFIER HAS LAFAYETTE'S MONEY-BACK GUARANTEE

High quality, low cost system engineered for smaller permanent installations. For areas up to 5500 sq. ft. For office, store, garage, small factory paging and music systems. **THE COMPLETE SYSTEMS INCLUDE:** The new Lafayette Model PA-60 10-watt amplifier complete; your choice of either the Electro-Voice 727 crystal microphone complete with detachable desk stand and 5' cable—or the new Lafayette Model PA-29 weatherproof, blast-proof slim dynamic mike complete with high or low impedance selector switch and detachable swivel-type stand adaptor; 8" heavy duty PM speaker; 35' speaker cable and plug; and attractive polished walnut speaker wall baffle. For 110-120 volts, 60 cps AC operation. Shpg. wt., 25 lbs. (Any other microphone may be substituted in all systems at additional cost. See microphones in index).

LAFAYETTE PA-140 Complete 10-watt Permanent System as described with E-V 727 Crystal Microphone.....Net 38.50  
 LAFAYETTE PA-141 Same as above, with Lafayette PA-29 dual impedance dynamic microphone.....Net 37.50

# MICROPHONES *Fine Quality Save from 50% to 75% !!!* At History Making Prices!

## HIGH QUALITY TOP NOTCH CRYSTAL MICROPHONE



COMPARE IT WITH ANY MIKE AT 2 TO 3 TIMES THE PRICE

3.95 each singly, ea.  
in lots of 3 4.25

Lafayette makes history with a high quality CRYSTAL MICROPHONE at a price that is 50% less than any comparable Crystal Microphone on the market today. Excellent for PA systems, home recorders and general applications. Frequency response 30 to 10,000 cycles. Output level—52 db. Provides ample output for use with low gain amplifiers. Uses quality moisture sealed crystal; Die cast case in rich green baked enamel finish, with chrome grill. Completely equipped with 5 feet of shielded cable. Mike may be used on any stand with 3/8"-27 thread. Grill diameter 2 1/2", depth 4 1/4", height 4 1/2". Shpg. wt. 3 1/2 lbs. PA-24—In lots of 3, each 3.95  
Singly, each 4.25

## SLIM CRYSTAL MICROPHONE



A slim crystal microphone for desk top or hand-held use that is uniquely designed for universal application, smartly styled and attractively finished. Changes in temperature and humidity do not affect its efficiency, nor does increasing the cable length increase noise or change frequency characteristics. Ingenious swivel mounting permits horizontal and vertical rotation for most convenient angle of use. Microphone easily removed from base for holding in hand. Microphone, base, grill and all fittings are chrome finished. Has a wide range smooth frequency response and an omni-directional polar pattern. Built-in locking type on-off slide switch. Microphone is only 5" long x 1" max. dia. Shpg. wt., 2 lbs. PA-45—Microphone Complete with Stand.....Net 3.95

## "WRIST WATCH" CRYSTAL MICROPHONE



- SENSITIVE
- HIGH OUTPUT
- PERFECT FOR SECRET PICKUPS
- APPEARS & IS WORN EXACTLY LIKE A REAL WATCH

\$2.95

Here is something new in microphones for use by police, private detection agencies, for recording discussions at sales conferences, and even for public address. Case is handsomely chrome plated with modern gold-finish numerals and hands and has a tan leather wrist-watch strap; looks and mounts exactly like any good wrist watch. The thin, flexible, light-colored cable is 6 1/2' long and may be run up the coat sleeve to a concealed pocket-type portable tape recorder, etc. Tiny perforations around the back of the watch case permit omnidirectional sound pickup. Sensitivity of the mike is quite high and the mike may be connected to any high impedance tape recorder or amplifier microphone input. Shpg. wt., 1/2 lb. PA-47—"Wrist-Watch" Crystal Mike.....Net 2.95

## ASTATIC M-150 RECORDER MIKE

- AMAZING PERFORMANCE AT AN AMAZINGLY LOW PRICE
- IDEAL REPLACEMENT MIKE FOR TAPE RECORDERS

\$3.82



A new high quality crystal microphone especially engineered for recorder use. Has a frequency response of 30-10,000 cps and an output level of -44 db. Housed in compact, lightweight, conveniently-held high-impact ivory plastic case having gold, rigidized metal grille. Comes with 5 ft. extra flexible, single conductor shielded cable. 2-3/16" x 2 1/4". Astatic M-150 RECORDER MIKE.....Net 3.82

## STUDIO CRYSTAL MICROPHONE



- DUAL CRYSTAL CARTRIDGES
- ALL DIRECTIONAL
- FINE QUALITY
- HIGH OUTPUT

5.75

Here is a microphone with a 360° pickup, and the added power and sensitivity of two individually shock mounted and phased crystal cartridges. This arrangement assures you of maximum pickup from all sides. Swivel mounted to give fuller flexibility. Case is chrome plated. Standard 3/8"-27 thread. Overall size 7" H x 3" W complete with 4 ft. cable. Shpg. wt. 4 lbs. PA-17.....Net 5.75

## NEW "DYNA-SLIM" MICROPHONE

- HIGH IMPEDANCE—50,000 OHMS
- ON-OFF SWITCH
- "QUICK-SLIP" ADAPTER

6.95

New dynamic, high output microphone with all the features of "mikes" costing 3 times Lafayette's price! Output level—55 db. Smooth response from 60 to 10,000 cycles. Omnidirectional head. External on-off switch. Slips on or off stand adapter in a wink. Standard 3/8"-27 adapter permits tilting mike for multi-angle use. Satin black and chrome finish. Complete with detachable cable and connector. 8" long, 1 1/4" max. dia. tapered barrel 7". Shpg. wt., 2 lbs. PA-43.....Net 6.95

## NEW! CRYSTAL THROAT MICROPHONE

ONLY 1.95

- HIGH SENSITIVITY—HIGH OUTPUT
- FOR USE WITH ANY AMPLIFIER OR TRANSMITTER WITH CRYSTAL MIKE INPUT
- IDEAL FOR AIRCRAFT, AMATEUR, INDUSTRIAL COMMUNICATIONS, AUCTIONS, PITCHMEN, CARNIVALS, SALESMEN
- COMPLETE WITH NECKSTRAP—LEAVES HANDS FREE!

A crystal throat microphone with a myriad of uses! Its high sensitivity and high output permits its use with any standard high impedance crystal microphone input. Its relatively wide frequency range provides a high degree of intelligibility for voice in public address or communications work. Requires no special power supply as do carbon-type throat mikes. Complete with flexible neckband and flexible 5 1/2' cable (less connector). Shpg. wt., 1/2 lb. PA-14.....Net 1.95

## NEW! CRYSTAL MICROPHONE WITH BUILT-IN VOLUME CONTROL



3.95

- SAVE STEPS AND EXTRA PERSONNEL BY LOCALLY CONTROLLING THE VOLUME OF A REMOTE AMPLIFIER
- EASILY REPLACEABLE MICROPHONE CARTRIDGE AND VOLUME CONTROL

A high quality crystal microphone for use with P.A. systems recorders and other applications. Permits fingertip control of the volume of a remotely located amplifier. This is a full size attractive unit with real eye appeal to complement its excellent performance—and at about one-third of the price of comparable microphones. The microphone has a frequency response of 30-10,000 cycles and output level of 52 db. Comes with 5 ft. shielded cable. Has 3/8"-27 thread fitting for mike stand. Handsome black high-impact resistance plastic case with chrome grill. Size 2 1/2" H x 4" D x 2 1/4" grill diameter. Shpg. wt., 2 lbs. PA-44—Microphone.....Net 3.95

## SLIM DYNAMIC MICROPHONE

- DUAL IMPEDANCE 50,000 AND 250 OHMS
- HIGH OUTPUT
- 50-11,000 CYCLES
- USE ON STAND OR AS HAND MIKE

The latest design in slim type microphones. A high-output dynamic mike of exceptional quality. Has very smooth response from 50-11,000 cycles. Built-in external switch gives you choice of either high impedance (50,000 ohms) or low impedance (250 ohms). Omni-directional tiltable head. Bracket has standard 3/8"-27 thread for use on stand. This bracket is inward 3/8"-27 thread for use on stand. Has costlessly removable chrome finish and acoustically correct case with satin-chrome finish and ruggedly constructed. Size: 8" long, 1 1/4" diam. barrel. Shpg. wt., 2 lbs. PA-29 In lots of 3, Each 9.25  
Single, Each 9.95

## Lafayette SPECIAL VALUES!

### MIKE STAND

Economical desk stand. Chrome plated heavy cast base finished in gray wrinkle. 4 1/2" diam., 7" h. Felt pad; 3/8"-27 thread; adjustable collar. Shpg. wt., 2 lbs. PA-34.....Net 1.29

### POPULAR MIKE CONNECTORS

Standard single contact, card mounted, nickel plated brass. knurl grips, 3/8"-27 thread. MS-467 Female connector 22¢  
MS-468 Male connector 16¢



### PORTABLE PA CASE

A sturdily constructed case for amplifier and two 12" speakers. Made of heavy plywood with reinforced metal corners. Case splits into 2 baffles, each with leather carrying handle. Strong wire mesh grilles covered with attractive cloth. Has 2 hooks in each half for carrying speaker cables and provision for mike and mike base. 4 snap locks. Inside dimensions 20 1/2" h, 15-9/16" w, 14 1/4" d. Covered in dark blue washable leatherette. Shpg. wt., 20 lbs. PA-51 CASE.....Net 14.25

## NEW! TOP QUALITY CRYSTAL MIKE



A LAFAYETTE SCOOP!

2.95

A new, attractively styled crystal microphone for all general applications such as public address and home recording—at a history making low price! Frequency response 30-10,000 cycles. Output level—52 db. Tilting head, attractive plastic case. Can be used on any stand with 3/8"-27 thread. Completely equipped with 5 ft. plastic covered shielded cable. Grill diam. 2 1/2", depth 3 1/2", height 4". Shpg. wt., 2 lbs. One of the best buys in the country! PA-42.....Net 2.95

## NEW CONTACT MICROPHONE

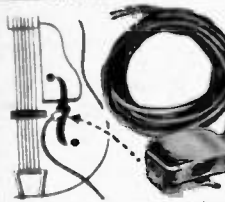

Easily Attaches to All String Instruments. This low priced, high quality contact microphone is ideal for amplification of single stringed instruments such as guitars, banjos, mandolins, cellos, ukuleles, etc. Provides rich, natural reproduction of the actual tone with sufficient amplification to be heard in a large hall. The clamp bar on the mike slides directly in the sounding board cutout to give a secure fit. Comes equipped with 8 ft. cable for connection to public address amplifiers, tape recorders or radios. Frequency response 40-9,000 cps. High impedance. Size: 1 1/2" L, 1 3/16" W, 5/16" D. Shpg. wt., 12 ozs. PA-41.....Net 1.95

## LAPEL MICROPHONE



- Full—55 db. OUTPUT LEVEL!
- IDEAL GENERAL PURPOSE MIKE

1.95

Ideal general purpose mike. Specially engineered crystal microphone. Attaches to lapel. Only 1 3/8" in diameter. Exceptional frequency response. Output level—55 db. Chrome plated case and clip for attaching to lapel. Includes 5 ft. of shielded cable. Shpg. wt. 1 lb. PA-9.....Net 1.95

## NEW DYNAMIC MICROPHONE FOR DESK-TOP, HAND HELD, OR LAVALIER USE



Reg. Value 29.50—NOW! only 6.95  
• HIGH IMPEDANCE—50,000 OHMS  
• RESPONSE—40-9,500 cps

Beautifully designed and attractively finished high impedance, light weight dynamic microphone with swivel head, tilt mechanism and vertical rotation for most convenient angle. Microphone quickly and easily released from felt-lined base clamp for holding in hand or for clamping to neck band for use as lavalier microphone. Baked enamel case with chrome finished base, grille and fittings. Ruggedly constructed to withstand plenty of handling. 3" long x 1 1/4" diam. housing with 5 ft. shielded cable. PA-48—Shipping wt., 2 lbs.....Net 6.95

## NEW STUDIO DYNAMIC MICROPHONE

IDEAL FOR HOME, OFFICE OR STUDIO USE



11.95

- FREQUENCY RESPONSE—50-11,000 cps.
- HIGH IMPEDANCE—50,000 OHMS.
- HIGH OUTPUT

A revelation in microphone value, this high quality omnidirectional dynamic microphone provides features found in microphones selling for many times the price. Employing a unique swirl ridged aluminum diaphragm completely sealed and gasketed against high humidity and temperature conditions, the PA proves itself ideal for a wide variety of applications, such as tape recording, church, choral groups and theatrical use. The 360° stirrup shaped bracket provides for mounting with any 3/8"-27 thread floor, desk stand or boom mount. Finished in an attractive gunmetal gray the microphone is supplied with 4 1/2' shielded cable. Shpg. wt., 1 lb. PA-49 STUDIO DYNAMIC MICROPHONE.....Net 11.95

REG. VALUE 49.50  
ONLY 11.95

## NEW! DUAL IMPEDANCE SLIM DYNAMIC MICROPHONE

- RUGGEDLY CONSTRUCTED
- ON-OFF SWITCH
- 600 & 50,000 OHM IMPEDANCES SELECTED BY SIMPLE ROTATION OF PLUG

Beautiful, professional-looking dynamic with solidly-cast, tapered, slim case with satin-chrome finish. Heavy duty slide-type on-off switch. Built-in transformer supplies dual unbalanced impedances—low Z is 600 ohms, high Z is 50,000 Ohms. Swivel mount fits all standard 3/8"-27 threaded stands. Blast filter eliminates unpleasant "bops" with voice use. Omnidirectional when used vertically—cardioid pattern when tilted. Engineering design and finish are of the highest quality, making this microphone excellent for any application. Complete with 5 ft. plug-in cable. Shpg. wt., 2 1/2 lbs. PA-46.....Net 11.95

## ARGONNE ALL-PURPOSE DYNAMIC MICROPHONE

- DUAL IMPEDANCE—250 & 50,000 OHMS
- USABLE RESPONSE 50-18,000 CPS
- FOR HAND-HELD, DESK OR FLOOR STAND USE
- IDEAL FOR TAPE RECORDING, PAGING, COMMUNICATIONS

Here is a flexible dynamic microphone with characteristics suitable for almost any application. Ruggedly constructed, with tapered cast-metal body and removable base for desk use. Mounts to the base by means of a 360° swivel adjustable ball joint and fitted with an adapter for standard 3/8"-27 floor stand. SPECIFICATIONS: FREQUENCY RESPONSE—Practically flat 80-10,000 cps; ± 5 db 70-13,000 cps. OUTPUT—70 db below 1 volt/microbar at 1,000 cps. DUAL IMPEDANCE: Low (250 ohms), High (50,000 ohms) unbalanced. Size 9" high (with base), 2" diam. at head, tapering down to 3/4". Base diam. 4. 13/16", 1 1/4" high. Shpg. wt., 6 lbs. AR-3—Dynamic microphone, complete with base, floor stand adapter, and 8' cable.....Net 15.95



COMPLETE WITH BALL-JOINT DESK STAND

# Save!

## 20% TO 33%

# Lafayette

## Sensational! STEREO HI-FI

### NEW! GENERAL ELECTRIC VR-22 STEREOPHONIC MAGNETIC VARIABLE RELUCTANCE HIGH FIDELITY CARTRIDGES



- **FREQUENCY RESPONSE**  
20-17,000 cps
- **UP TO 30 DB CHANNEL SEPARATION**
- **VIRTUALLY HUM-FREE**
- **HIGH COMPLIANCE**

**MODEL VR-277 with .7 mil diamond stylus.** Absolutely the finest of all G.E. cartridges. Combining new design and manufacturing techniques with proven variable reluctance excellence, this cartridge is made virtually hum-free by mu-metal shielding on top, entire front and coil assembly. Harmonic and intermodulation distortion are effectively minimized by a lack of resonant peaks in the audio range, and an essentially linear flux field. Precise tracking and optimum compliance are assured by new stylus and armature suspension system. The stylus is easily changed without the need for special tools. Output is closely balanced over entire frequency range (one db at 1000 cycles) for equal sound volume from both channels. A ground strap allows use of this cartridge with either 3-or-4-wire stereo systems; the cartridge shield may be grounded individually by a separate wire. **SPECIFICATIONS:** FREQUENCY RESPONSE: 20-17,000 cps; OUTPUT: 6 mv. per channel at stylus velocity of 5.5 cm/sec; INDUCTANCE: 420 mh. per channel; CHANNEL SEPARATION: up to 30 DB; LATERAL COMPLIANCE:  $3 \times 10^{-6}$  cm/dyne; VERTICAL COMPLIANCE:  $2 \times 10^{-6}$  cm/dyne; RECOMMENDED LOAD, EACH CHANNEL: 47,000 ohms; RECOMMENDED TRACKING FORCE: 5 to 7 gms; SHPG. WT., 6 oz. **Net 24.45**

**MODEL VR-225 with .5 mil diamond stylus.** Designed expressly for use with transcription arms and turntables. Essentially the same as VR227 except FREQUENCY RESPONSE: 20-20,000 cps; LATERAL COMPLIANCE  $4 \times 10^{-6}$  cm/dyne; RECOMMENDED TRACKING FORCE: 2 to 4 gms. SHPG. WT., 6 oz. **Net 27.39**

### GE 28-WATT MATCHED STEREO PHONO SYSTEM



- GE MS-2000 28-WATT AMPLIFIER **139.95**
- NEW COLLARO TSC-740 WITH SHIELDED MOTOR **41.65**  
(Less Base)
- NEW GE VR-22 (.7 MIL) DIAMOND STEREO CARTRIDGE **24.45**
- 2-ELECTRO-VOICE SP12B 12" SPEAKER @ 34.30 **68.60**

MF-589 Complete stereo system as listed above. Shpg. wt., 59 lbs. **Net 219.73**  
Recommended enclosures for MF-589 system are the CAB 16 Series Resonator Enclosure or Lafayette Eliptoflex Series Bookshelf Enclosure. Set of 2 **57.50** (Please specify finish).  
MF-590 Same as MF-589, but with 2 Lafayette-SK-125 3-Way Ducted Port Speaker Systems. Shpg. wt., 64 lbs. **Net 249.50**  
PK-111—Base cut for Collaro TSC-740. Specify mahogany, blonde or walnut finish. **Net 3.95**

Regular Catalog Price ~~374.65~~  
**LAFAYETTE SYSTEM PRICE**

**219.73**  
You Save **54.92**

21.97 Down  
14.00 Monthly

### HARMAN-KARDON A220 20-WATT STEREO HI-FI PHONO SYSTEM

- H-K A220 20 WATT STEREO AMPLIFIER **79.95**
- COLLARO TSC-740 WITH COMPLETELY SHIELDED MOTOR **41.65**
- NEW GE VR-22 (.7 MIL) DIAMOND STEREO CARTRIDGE **24.45**
- 2-LAFAYETTE SK-124 BOOKSHELF SPEAKER SYSTEMS @ 17.50 **35.00**

Regular Catalog Price ~~181.05~~

LAFAYETTE SYSTEM PRICE

**139.95**

You Save **41.10**

14.00 Down  
10.00 Monthly



H-K A220

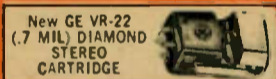

COLLARO TSC-740



LAFAYETTE SK-124 BOOKSHELF SPEAKER SYSTEMS

MF-591 Complete stereo system as listed above. Shpg. wt., 62 lbs. **Net 139.95**  
MF-592 Same as MF-591, but with 2-Lafayette Famous Free Edge SK-58 12" Coaxial speakers and 2 CAB-16 Series Resonator Enclosures. Shpg. wt., 132 lbs. **Net 179.04**  
MF-593 Same as MF-591, but with 2-Lafayette Famous Free Edge SK-58 12" Coaxial speakers and 2-Lafayette Eliptoflex Series Bookshelf Enclosures. Shpg. wt., 104 lbs. **Net 179.04**  
PK111 Base cut for Collaro TSC-740 Specify mahogany, blonde or walnut finish. **Net 3.95**

### ● SELECT YOUR OWN CARTRIDGE ●

You may substitute the Shure M7D, Pickering 371.7D or the new Electro-Voice 31MD7 in any system shown with the GE VR-22 at no additional cost. The Shure M3D may be substituted at an additional cost of \$24.00

### SCOTT 24 WATT STEREO PHONO SYSTEM



- SCOTT 222 STEREO AMPLIFIER (Less Case) **139.95**
- GARRARD RC-121/II STEREO CHANGER **41.65**
- NEW GE VR-22 (.7 MIL) DIAMOND STEREO CARTRIDGE **24.45**
- 2 STEPHENS 80 FR 8" SPEAKERS @ 33.50 **67.00**

Regular Catalog Price ~~278.05~~

LAFAYETTE SYSTEM PRICE

**218.45**

You Save **54.60**

21.84 Down  
14.00 Monthly

MF-575 Complete stereo system as listed above. Shpg. wt., 51 lbs. **Net 218.45**  
MF-576 Same as MF-575 but with 2-Lafayette Famous Free Edge SK-58 12" Coaxial speakers and 2 Lafayette Eliptoflex Series Bookshelf Enclosure. Shpg. wt., 108 lbs. **Net 264.95**  
PK-111 Wood Base cut for RC-121 specify mahogany, blonde or walnut finish. **Net 3.95**  
Scott D Case for Scott 222 Amp. **Net 9.95**

### COMPLETE FISHER STEREO PHONO SYSTEM

- FISHER TA-600 STEREO TUNER AND AMPLIFIER (Less Cabinet) **349.50**
- GARRARD RC-88 DELUXE CHANGER **58.31**
- NEW G.E. VR-22 (.7 MIL) DIAMOND STEREO CARTRIDGE **24.45**
- 2-UNIVERSITY 312 12" TRIAXIAL SPEAKERS @ 71.54 **143.08**

Regular Catalog Price ~~575.34~~

LAFAYETTE SYSTEM PRICE  
**460.28**  
You Save **115.06**

46.02 Down  
27.00 Monthly

MF-571 Complete system as listed above. Shpg. wt., 74 lbs. **Net 460.28**  
Recommended enclosures for above system are: CAB-16 Series Resonator Enclosure or Lafayette Eliptoflex Series Bookshelf Enclosure. (Please specify finish). Set of 2 **57.50**  
MF-572 Same as MF-571, but with 2 SK-114 12" 3-way speakers with 6 1/2 lb. magnets and 2 Lafayette Eliptoflex Series speaker enclosures. (Please specify finish) Shpg. wt., 170 lbs. **Net 545.54**  
PK-111 Wood base cut for RC88, specify mahogany, blonde or walnut finish. **Net 3.95**



FISHER TA-600

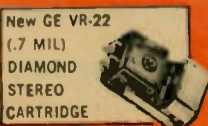

NEW GE VR-22 (.7 MIL) DIAMOND STEREO CARTRIDGE

GARRARD RC-88

UNIVERSITY 312

LAFAYETTE ELIPTOFLEX SERIES BOOKSHELF ENCLOSURE

### HARMAN-KARDON A-250 50-WATT STEREO HI-FI PHONO SYSTEM

- H-K A250 STEREO AMPLIFIER (Less Case) **179.95**
- GLASSER-STEERS GS-77 (Less Base) **59.50**
- NEW GE VR-22 (.7 MIL) DIAMOND STEREO CARTRIDGE **24.45**
- 2 UNIVERSITY 312 SPEAKERS @ 71.54 **143.08**
- 2-LAFAYETTE ELIPTOFLEX SERIES BOOKSHELF ENCLOSURES @ 32.50 **65.00**

Regular Catalog Price ~~471.98~~

LAFAYETTE SYSTEM PRICE

**377.60**

You Save **94.38**

37.76 Down  
21.00 Monthly

MF-581 Complete stereo system as listed above. Shpg. wt., 123 lbs. **Net 377.60**  
MF-582 Same as MF-581, but with 2-Lafayette SK-112 12" 3-Way speakers with 3 1/2 lb. magnets and 2 Lafayette Eliptoflex Series Bookshelf Enclosure. Shpg. wt., 152 lbs. **Net 390.00**  
Model GSB Woodbase for GS-77 in ebony with satin brass trim, or unfinished. **Net 9.60**  
H-K AC-50 Enclosure for H-K A-250 Amp. **Net 12.50**  
CAB-16 Series Resonator Enclosure may be substituted in MF-581 system at no additional cost.



H-K A250

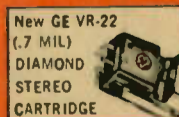

NEW GE VR-22 (.7 MIL) DIAMOND STEREO CARTRIDGE

UNIVERSITY 312

LAFAYETTE ELIPTOFLEX SERIES BOOKSHELF ENCLOSURE



GLASSER-STEERS GS-77

# SENSATIONAL SYSTEMS PRE-FALL CLEARANCE

**PILOT 240 30-WATT STEREO HI-FI PHONO SYSTEM**

PILOT 240 30 WATT STEREO AMPLIFIER 129.50  
 GARRARD RC/121/11 CHANGER (Less Base) 41.65  
 NEW GE VR-22 (.7 MIL) DIAMOND STEREO CARTRIDGE 24.45

2-ELECTRO-VOICE SP12B 12" SPEAKERS @ 34.50 68.60  
 Regular Catalog Price ~~264.20~~

**You Save 52.84**

21.13 Down  
 14.00 Monthly

HF-573 Complete stereo system as listed above. Shpg. wt., 60 lbs. Net 211.36  
 Recommended enclosures for HF-570 system are the CAB-16 Series Resonator Enclosure or Lafayette Eliptoflex Series Bookshelf Enclosure. (Please specify finish). Set of 2 57.50  
 HF-574 Same as HF-573, but with 2-Lafayette Famous Free Edge 5K-58 12" Coaxial speakers and 2 Lafayette Eliptoflex Series Bookshelf Enclosures. Shpg. wt., 106 lbs. Net 257.50  
 (Please specify finish).  
 PK-111 Wood Base cut for RC121 specify mahogany, blonde or walnut finish. Net 3.95

**LAFAYETTE SYSTEM PRICE 211.36**



**GENERAL ELECTRIC DELUXE 40-WATT STEREO PHONO MUSIC SYSTEM**

GE MS-4000 40-WATT STEREO AMPLIFIER 179.95  
 GARRARD RC-88 STEREO CHANGER (Less Base) 58.31  
 NEW GE VR-22 (.7 MIL) DIAMOND STEREO CARTRIDGE 24.45  
 2-JENSEN TR-10 TRI-ETTE SPEAKER SYSTEMS @ 114.50 229.00  
 Regular Catalog Price ~~491.77~~

HF-577 Complete GE phono system. Choice of GE 4000 Amp. Grey and Silver or GE 4010 Amp. Brown and Gold. (Please specify). Shpg. wt., 123 lbs. Net 393.37  
 HF-578 Same as HF-577 but with 2-Lafayette SK-112 12" 3-Way speakers with 3/4 lb. magnets and 2 Lafayette Eliptoflex Series Bookshelf Enclosures. Shpg. wt., 132 lbs. Net 389.64  
 PK-111 Wood base cut for RC 88 specify mahogany, blonde or walnut finish. Net 3.95

**LAFAYETTE SYSTEM PRICE 393.37**

**You Save 98.34**

39.33 Down  
 24.00 Monthly

GE MS-4000  
 GARRARD RC-88  
 JENSEN TR-10 TRI-ETTE  
 NEW GE VR-22 (.7 MIL) DIAMOND STEREO CARTRIDGE



**BOGEN 60 WATT STEREO PHONO SYSTEM**

BOGEN DB230A STEREO AMPLIFIER (Less Cabinet) 189.50  
 GLASSER-STEERS GS-77 STEREO CHANGER (Less Base) 59.50  
 NEW GE VR-22 (.7 MIL) DIAMOND STEREO CARTRIDGE 24.45  
 2-UNIVERSITY 312 SPEAKERS @ 71.54 143.08

HF-585 Complete stereo system as listed above. Shpg. wt., 74 lbs. Net 333.23  
 Recommended enclosures for HF-585 system are the CAB-16 Series Resonator Enclosure or Lafayette Eliptoflex Series Bookshelf Enclosure. Set of 2 57.50  
 HF-586 Same as HF-585, but with 2-Lafayette SK-114 12" 3-Way speakers with 3/4 lb. magnets and 2 Lafayette Eliptoflex Series Bookshelf Enclosures. Shpg. wt., 170 lbs. Net 435.00  
 (Please specify finish).  
 Model GSB Woodbase for GS-77 in ebony with satin brass trim, or unfinished. Net 9.60  
 Bogen CEG cabinet with legs for DB230 Net 8.00

Regular Catalog Price ~~416.33~~

**LAFAYETTE SYSTEM PRICE 333.23**

**You Save 83.30**

33.32 Down  
 19.00 Monthly

BOGEN DB230A  
 UNIVERSITY 312  
 NEW GE VR-22 (.7 MIL) DIAMOND STEREO CARTRIDGE  
 GLASSER-STEERS GS-77  
 LAFAYETTE ELIPTOFLEX SERIES BOOKSHELF ENCLOSURES

**BOGEN 24-WATT STEREO PHONO SYSTEM**

BOGEN DB212 24 WATT STEREO AMPLIFIER (Less Cabinet) 119.95  
 GARRARD RC121/11 STEREO CHANGER (Less Base) 41.65  
 NEW GE VR-22 (.7 MIL) DIAMOND STEREO CARTRIDGE 24.45  
 2-UNIVERSITY UXC 122 @ 34.79 69.58

Regular Catalog Price ~~255.65~~

**LAFAYETTE SYSTEM PRICE 204.51**

**You Save 51.12**

20.45 Down  
 14.00 Monthly

HF-568 Complete Bogen system as listed above. Shpg. wt., 61 lbs. Net 204.51  
 HF-569 Same as HF-568 but with 2-Lafayette SK-58 12" Coaxial speakers and 2-CAB-16 Series Resonator Enclosures. Shpg. wt., 137 lbs. Net 244.50  
 HF-570 Same as HF-568 but with 2-Lafayette SK-58 12" Coaxial speakers and 2-Lafayette Eliptoflex Series Bookshelf Enclosures. Shpg. wt., 121 lbs. Net 249.50  
 PK-111 Wood Base cut for RC-121, specify finish in mahogany, blonde or walnut. Shpg. wt., 5 lbs. Net 3.95  
 Bogen BEG cabinet with legs for DB212 Net 7.50

**• SELECT YOUR OWN CARTRIDGE •**  
 You may substitute the Shure M7D, Pickering 371.7D or the new Electro-Voice 31MD7 in any system shown with the GE VR-22 at no additional cost. The Shure M3D may be substituted at an additional cost of \$24.00

BOGEN DB212  
 UNIVERSITY UXC-122  
 NEW GE VR-22 (.7 MIL) DIAMOND STEREO CARTRIDGE  
 GARRARD RC-121  
 LAFAYETTE CAB-16 SERIES RESONATOR ENCLOSURES

**PILOT SM-245A 40 WATT STEREO HI-FI PHONO SYSTEM**

PILOT SM-245A 40 WATT STEREO AMPLIFIER 199.50  
 GLASSER-STEERS GS-77 STEREO CHANGER (Less Base) 59.50  
 NEW GE VR-22 (.7 MIL) DIAMOND STEREO CARTRIDGE 24.45  
 2-ELECTRO-VOICE 12TRXB 12" SPEAKERS @ 61.68 123.36

HF-579 Complete stereo system as listed above. Shpg. wt., 71 lbs. Net 330.35  
 Recommended enclosures for HF-579 system are the CAB-16 Series Resonator Enclosure or Lafayette Eliptoflex Series Bookshelf Enclosure. Set of 2 57.50 (Please specify finish).  
 HF-580 Same as HF-579 but with 2-Lafayette Famous Free Edge 5K-58 12" Coaxial speakers and 2 Lafayette Eliptoflex Series Bookshelf Enclosures. Shpg. wt., 113 lbs. Net 329.00  
 Model GSB Woodbase for GS-77 in ebony with satin brass trim, or unfinished. Net 9.60

Regular Catalog Price ~~412.81~~

**LAFAYETTE SYSTEM PRICE 330.35**

**You Save 82.46**

33.03 Down  
 14.00 Monthly

ELECTRO-VOICE 12TRXB  
 PILOT SM-245A  
 NEW GE VR-22 (.7 MIL) DIAMOND STEREO CARTRIDGE  
 LAFAYETTE ELIPTOFLEX SERIES BOOKSHELF ENCLOSURES  
 GLASSER-STEERS GS-77

**SCOTT 40 WATT STEREO PHONO SYSTEM**

SCOTT 299 40 WATT STEREO AMPLIFIER (Less Cage) 199.95  
 GLASSER-STEERS GS-77 STEREO CHANGER (Less Base) 59.50  
 NEW GE VR-22 (.7 MIL) DIAMOND STEREO CARTRIDGE 24.45  
 2-UNIVERSITY 312 12" TRIAXIAL SPEAKERS @ 71.54 143.08

Regular Catalog Price ~~426.98~~

**LAFAYETTE SYSTEM PRICE 341.60**

**You Save 85.38**

34.16 Down  
 21.00 Monthly

HF-587 Complete stereo system as listed above. Shpg. wt., 70 lbs. Net 341.60  
 Recommended enclosures for above system are the CAB-16 Series Resonator Enclosure or Lafayette Eliptoflex Series Bookshelf Enclosure. (Please specify finish). Set of 2 57.50  
 HF-588 Same as HF-587, but with 2-Lafayette SK-112 12" 3-Way speakers with 3/4 lb magnets and 2 Lafayette Eliptoflex Series Bookshelf Enclosures. Shpg. wt., 147 lbs. Net 406.50  
 Model GSB Woodbase for GS-77 in ebony with satin brass trim or unfinished. Net 9.60  
 Scott C cage for Scott 299 Amplifier Net 9.95

SCOTT 299  
 UNIVERSITY 312  
 NEW GE VR-22 (.7 MIL) DIAMOND STEREO CARTRIDGE  
 GLASSER-STEERS GS-77  
 LAFAYETTE CAB-16 SERIES RESONATOR ENCLOSURE

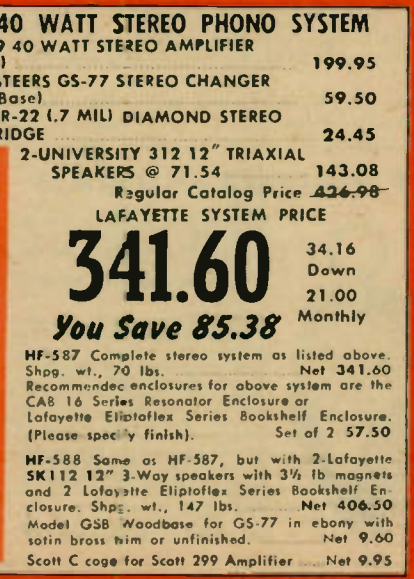

**COMPLETE HARMAN-KARDON STEREO SYSTEM**

H-K TA230 STEREO FESTIVAL (Less Cage) 259.95  
 GLASSER-STEERS GS-77 (Less Base) 59.50  
 NEW GE VR-22 (.7 MIL) DIAMOND STEREO CARTRIDGE 24.45  
 2-ELECTRO-VOICE 12TRXB 12" SPEAKERS @ 62.68 125.36

Regular Catalog Price ~~449.20~~

**LAFAYETTE SYSTEM PRICE 375.42**

**You Save 93.84**

37.54 Down  
 21.00 Monthly

HF-583 Complete stereo system as listed above. Shpg. wt., 81 lbs. Net 375.42  
 Recommended enclosure for HF-583 system are: CAB-16 Series Resonator Enclosure or Lafayette Eliptoflex Series Bookshelf Enclosure. (Please specify finish). Set of 2 57.50  
 HF-584 Same as HF-583, but with 2-Lafayette SK-112 12" 3-Way speakers with 3/4 lb magnets and 2 Lafayette Eliptoflex Series Bookshelf Enclosures. Shpg. wt., 103 lbs. Net 454.50  
 AC 30 Copper and Black metal enclosure for HK-TA230 Net 12.95  
 WW 30 Walnut or FW 30 Fruitwood hard wood enclosure. HK-TA230 Net 29.95  
 Model GSB Woodbase for GS-77 in ebony with satin brass trim, or unfinished. Net 9.60

H-K TA230  
 NEW GE VR-22 (.7 MIL) DIAMOND STEREO CARTRIDGE  
 ELECTRO-VOICE 12TRXB  
 GLASSER-STEERS GS-77  
 LAFAYETTE ELIPTOFLEX SERIES BOOKSHELF ENCLOSURE



## LAFAYETTE'S CATCH OF THE CENTURY IN RODS AND REELS



### (A) SPECIAL TUBULAR FIBREGLASS SPINNING ROD

- GENUINE TUBULAR SUPER GLASS ROD ● STANDS ROUGHEST ACTION-NEEDS MINIMUM CARE ● SOLID-COMFORTABLE-NATURAL CORK GRIP ● SINGLE WIRE NON-FOULING GUIDES

A first quality tubular (hollow) fiberglass spinning rod—plenty of power, action and eye appeal. All the features of rods selling for above Lafayette's price. Solid-comfortable-natural cork handle with anodized aluminum reel retaining rings. Holds reel solidly and securely. Extra large guides with neat, even nylon wrapping. Sealed against moisture. Long, strong extra deep jolting ferrule precisely fitted. Guides are hard-rust resistant—and properly spaced. Braced tip-top guide. Entire rod finished in hard, durable, black lacquer. Popular 2 piece, 5 foot length. Shpg., wt., 1 1/2 lbs.

Net 3.29

### (B) TUBULAR FIBREGLASS SPIN-CAST ROD

● 5 1/2 FT. MEDIUM-LIGHT ACTION ● POSITIVE LOCK REEL SEAT  
Finest 2 piece, hollow fiberglass, medium-light action spin cast rod. Five inch web, shaped cork grip on a die cast aluminum offset handle. Positive, threaded ring, locking reel seat. Designed for closed face spin cast reels. Chrome plated, stainless steel guides and braced, offset tip-top. Chromed, stainless buttplate. Extra deep, precisely fitted ferrules. Colorful, sealed, nylon wrappings. Fine action with plenty of back bone. Casts flies, streamers, bugs and poppers. Shpg. wt., 1 1/2 lbs.

Net 3.95

### (C) TUBULAR FIBREGLASS "7 SEAS" SPINNING ROD

- FOR FRESH AND SALT WATER SPINNING! ● ACTUAL WEIGHT ONLY 5 OZS. ● COMPARE TO RODS SELLING FOR TWICE AS MUCH

All the extra power you need to land the "big ones"—in fresh or salt water. Hollow glass construction for that "live" action—plus "back-bone" when you need it. 4" cork fore grips 6 1/2" cork butt with vinyl butt plate. Extra-large, non-fouling, diamond-hard guide. "Snake" design allows guides to flex with rod. Braced tip top of super-hardened, stainless steel. Fixed reel seat polished brass with chrome retaining collar and lock nut. Glossy black lacquered finish. Colorful, sealed nylon windings. 2 piece blade with extra deep ferrules. Overall length 6 1/2 ft. Superbly tapered—designed for maximum lure action—trouble free construction. Shpg. wt., 1 lb.

Net 5.95

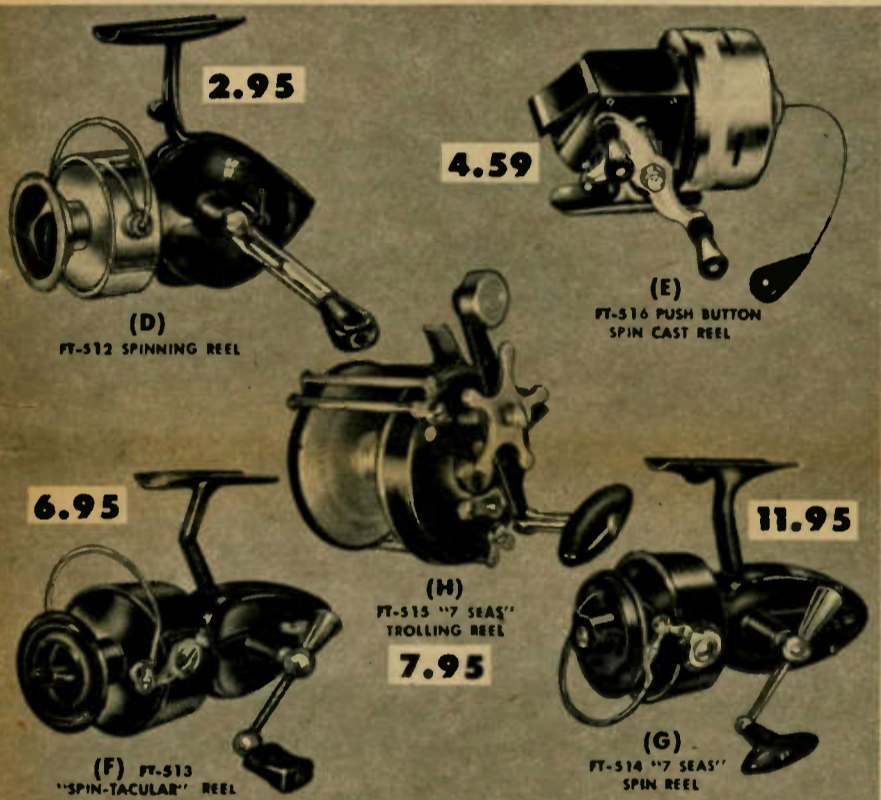

### (D) SPECIAL SPINNING REEL

● GOLD ANODIZED SPOOL ● NYLON BEVEL GEAR ● ANTI-REVERSE LOCK  
A fine, light spinning reel with all the features found in far more expensive reels. Strong-sturdy handsome appearance. Selective anti-reverse lock. Chrome plated pickup arm. Body of non-corroding, ebony finished, aluminum alloy. Housing and spool of gold anodized aluminum for maximum corrosion resistance. Noiseless, smooth running, nylon bevel gear. Handle is removable for storage. Holds 200 yds. of 4 lb. test line. Gear ratio of 3 to 1. Shpg. wt., 1 lb.

Net 2.95

### (E) PUSH BUTTON SPIN CAST REEL

Closed face—back lash free—push button action. Push button spring release—assures instantaneous line control the moment the lure hits water. Brass Gears—precision machined to assure long, trouble-free service. Finger-tip Anti-Reverse Lever—far fast action. Spring Loaded Geared Drag Adjustment—may be set for any tension. Attractively finished in triple lacquered ebony with gold-anodized spool cover. Chrome plated double handle crank. Incorporates the features and trouble-free performance of the most expensive reels. Complete with 80 yds. of 6 lb. limp monofilament line and rubber practice plug. Actual weight only 8 1/2 ozs. Shpg. wt., 1 lb.

Net 4.59

### (F) NEW! "SPIN-TACULAR" REEL

● INTERCHANGEABLE SPOOLS ● FINGER TIP ANTI-REVERSE  
Finest—fastest imported spin reel. Ultra smooth recovery, ratio about 4 to 1. Full ball, stainless pickup. Positive, smooth drag with click built into spool. Friction free line guide of diamond-hard tungsten carbide. Positive anti-reverse clutch—no manual holding when playing, netting or trolling. Metal reel with two interchangeable spools. Capacities of from 200 yds. of 10 lb. line, 340 yds. of 6 lb. line, 100 yds. of 4 lb. line, down to 200 yds. of 1/2 lb. line. "Natural-form" hook on reel handle. Handle folds back for storage. Corrosion resistant black finish. Complete with extra spool, spool case, cloth. Actual weight 9 ozs. Shpg. wt., 1 lb. 4 oz.

Net 6.95

### (G) NEW! "7 SEAS" SPIN REEL

● ALL THE FEATURES OF THE MOST EXPENSIVE REELS  
The "greatest" for surf-casting, trolling, spinning or any salt water fishing. High pressure moulded of an aluminum-magnesium alloy, surface treated and anti-corrosion coated. Eliminates need for the usual care and cleaning associated with salt water gear. Unique planetary gear system crosswinds line for greater line capacity and the smoothest, longest casts you ever made! "Back-lash" is a thing of the past. Fully adjustable, positive drag action. Built right into the spool for smooth, constant tension. Full ball pickup of chromed bronze. Line guide of super hard chromium carbide. Torpedo handle, spring loaded, folds back for storage. Positive, finger tip anti-reverse control. All the features normally found in the most expensive reels. Actual weight 19 ozs. Shpg. wt., 2 lbs.

Net 11.95

### (H) "7 SEAS" TROLLING REEL

● FINGERTIP FREE SPOOL CLUTCH ● ADJUSTABLE STAR DRAG  
Universal salt water reel. Powerful star drag, free spool, fast retrieve. All metal construction of highly corrosion resistant alloys. Aluminum-magnesium alloy spool. 3 inch diameter side plates—with satin black, triple baked, rust resistant, permanent finish. Conventional free spool lever. Hardened bronze gears. Counter weighted, torped handle. Chrome plated, hand polished frame. Self lubricating, long lasting bronze bearings. Capacity 250 yds. of 27 lb. line. Actual weight 17 ozs. Shpg. wt., 1 1/2 lbs.

Net 7.95

## SAVE NOW • Special Sports Sets

These matched sets save you even more! Specially selected top quality—latest designs. Combinations selected for ease of handling—include all necessary basic equipment—offer you more fishing fun and enjoyment at budget prices. Items sold separately cost more—you save by purchasing the complete set. Check these kits for features found only in much higher priced equipment.

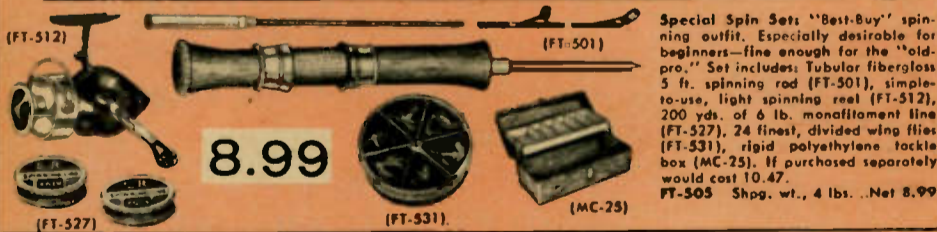

Special Spin Set "Best-Buy" spinning outfit. Especially desirable for beginners—fine enough for the "old-pro." Set includes: Tubular fiberglass 5 ft. spinning rod (FT-501), simple-to-use, light spinning reel (FT-512), 200 yds. of 6 lb. monofilament line (FT-527), 24 finest, divided wing flies (FT-531), rigid polyethylene tackle box (MC-25). If purchased separately would cost 10.47.

FT-505 Shpg. wt., 4 lbs. Net 8.99



"Push Button" Spin Cast Set: An easily handled casting set. Designed to give the fisherman complete control. Most popular outfit—contains all necessary basic equipment. Set includes: 5 1/2 ft. glass spin-cast rod (FT-503), "Push Button" spin cast reel (FT-516) pre wound with 80 yds. of 6 lb. monofilament line, practical plus, 12 selected "poppers" (FT-529), and rigid, polyethylene tackle box (MC-25). Shpg. wt., 5 lbs.

FT-506 Net 10.29

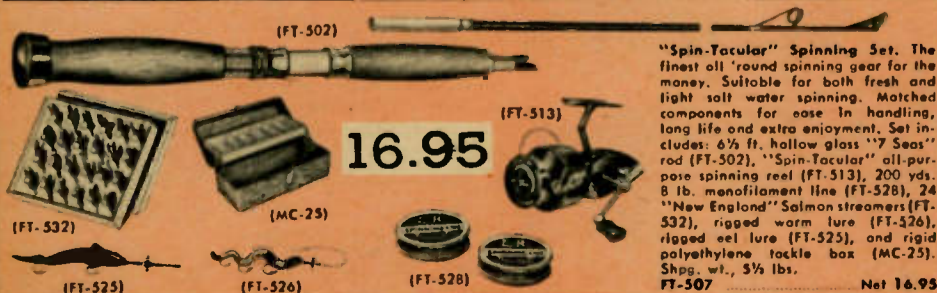

"Spin-Tacular" Spinning Set. The finest all 'round spinning gear for the money. Suitable for both fresh and light salt water spinning. Matched components for ease in handling, long life and extra enjoyment. Set includes: 6 1/2 ft. hollow glass "7 Seas" rod (FT-502), "Spin-Tacular" all-purpose spinning reel (FT-513), 200 yds. 8 lb. monofilament line (FT-528), 24 "New England" Salmon streamers (FT-532), rigged worm lure (FT-526), rigged eel lure (FT-525), and rigid polyethylene tackle box (MC-25). Shpg. wt., 5 1/2 lbs.

FT-507 Net 16.95

## NEW! MINIATURE IMPROVED HOIST 8.33

SMALL ENOUGH TO FIT YOUR POCKET!  
PRE LUBRICATED FOR LIFE!  
LIFT 1000 TO 2000 POUNDS!

The only truly miniature hoist available. Indispensable in industrial plants and workshops. Perfect for hunters-boaters-airplane owners-motorists. Great strength and tiny size permits hundreds of uses—can be a real life saver in an emergency. Made of high grade aluminum with steel axles. Pre-lubricated for life. Two lifting slings—one on top and one at bottom—with heavy, welded steel rings. Nylon cable supplied tests at 550 lbs. per strand. "Midget" hoist comes with 70 ft. of Nylon cable, has a 5 to 1 ratio—1000 lb. test—and weighs only 13 oz. "Tiny" hoist has 100 ft. of Nylon cable, a 7 to 1 ratio—2000 lbs. test—and weighs only 15 oz. Does all your lifting safely and easily.

MD-330—"Midget" shpg. wt. 1 1/2 lbs. Net 8.33  
MD-331—"Tiny" shpg. wt. 2 lbs. Net 10.83

## MAP MEASURER & COMPASS 1.59



- Not a gadget—but a real instrument.
- Measures distances on any size map.
- Measures curved or irregular shapes.

Exclusive of Lafayette! A map measurer with built-in compass! For the motorist—camper—hunter—boating enthusiast. An indispensable unit of equipment. Just trace along route on map and multiply miles—per inch factor by reading on dial. Also reads directly in inches up to 39". Built-in magnetic compass has cardinal and secondary points—full 360° markings in tenths. Accurate and dependable. Complete with leather sheath. Shpg. Wt. 8 oz.

F-47 LIST 2.75 Net 1.59

## Burgess BOAT-LITE KIT 8.20



- Easy to Install—No Extras to Buy
- Meets U.S.C.G. Requirements
- For All Class "A" and Class "1" Boats
- Running Light and Stern Light

New Burgess Boat-Lite kit full of features never before offered to small boat owners. Contains every thing needed to meet U.S. Coast Guard requirements for lights on small boats. New combination box light with optically perfect Red-Green frenal lens. Projects light over one mile. Correctly shielded-made of special corrosion-resistant aluminum alloy. New stern light-flag staff has unique plug-in feature. Quick-easy removal for safe keeping. No nails, screws or clamps just plugs in. Corrosion-resistant aluminum alloy with lamp visible for 2 miles. Kit includes heavy-duty, 6 volt, sealed-in-steel battery, all necessary hardware, mounting brackets, wire, weather proof switch and instructions. Shpg. Wt., 7 lbs.

Burgess BK-100 List 17.95 Net 8.20

## Pocket Generator Flashlight

● NO BATTERIES—EVER! ● ALWAYS READY TO OPERATE!

The perfect pocket flashlight for home car—or to carry with you. Plenty of bright light just by successive activation of generator level. No batteries to corrode or go dead. Balanced flywheel generator for ease of operation. Only 2 3/8" x 1" x 1 1/2", slips easily into pocket or purse. Never wears out. Ideal for campers—tourists—motorists. Weighs only 6 ozs. Made in Germany.

F-169 List 6.49 Shpg. wt. 1 lb. Net 3.79

# FISHING?

## SAVE you 50 to 75%!

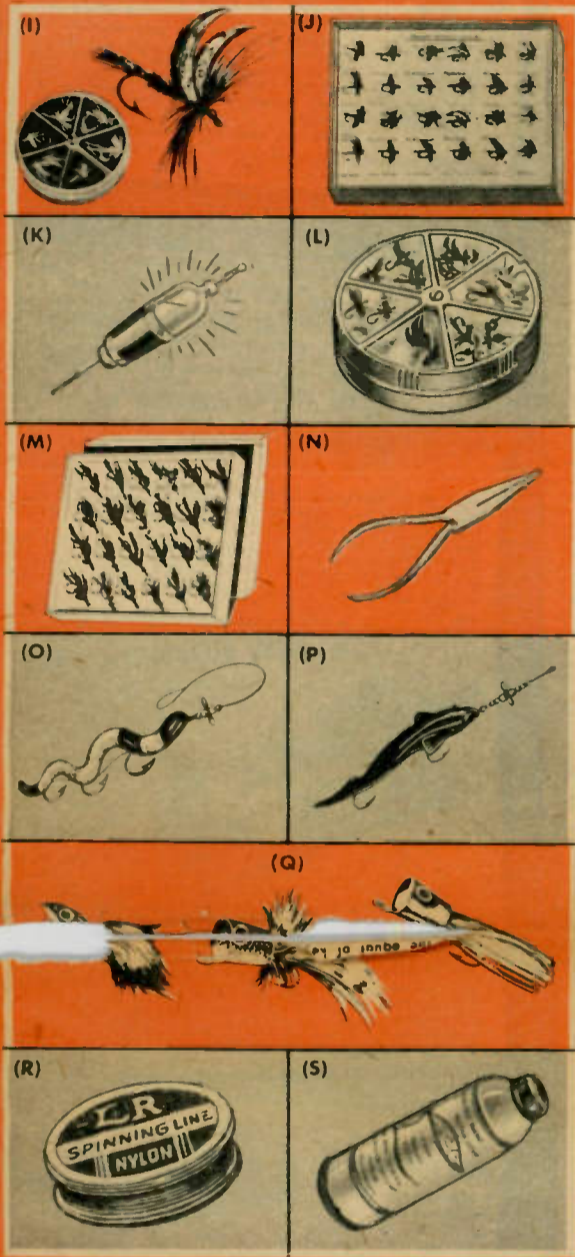

### (I) "DIAL-A-FLY" ASSORTMENT

One dozen of the most popular flies available. Expertly tied by skilled craftsmen. Packed in a round, plastic, six compartment container. Selector cover rotates for instant choice. Pocket size—handy—snag proof. Includes such favorites as Royal Coachman, Black Gnat, Silver Doctor, Parma Belle, Yellow Sally and Mosquito all tied on #10 hooks. Shpg. wt., 6 ozs. FT-530 "DIAL-A-FLY" ASSORTMENT Net .89

### (J) 24 ASSORTED WET AND DRY FLIES

24 hand tied—expertly detailed—most popular flies. The perfect kit for the beginner or old pro. All tied on #10 hooks. Includes such famous types as Royal Coachman, Black Gnat (female), Red Ibis, Silver Doctor, Quill Gordon, etc. Each fly is individually identified. Made with universally accepted fly materials. Wt., 8 oz. MD-328 24 ASSORTED WET AND DRY FLIES Net 1.05

### (K) "BITE-A-LITE" FLOAT

Flashes a nibble! Watertight Body! Adjustable Contacts! Doubles your "luck" and fun while night fishing. Excellent on cloudy days, at dawn or sunset. So sensitive even beginners do well. Flickers at a nibble—lights with a bite. Can be used as a colorful sensitive float even without the battery and light. Self-contained miniature battery and bulb are easily replaced. Long battery life. Made of corrosion-proof plastic and brass. Weighs less than 1 oz. with battery. Complete with bulb and instructions. Less battery. Shpg. wt., 4 oz. MD-344 "BITE-A-LITE" FLOAT Net .98 2 for 1.69

### (L) 24 DIVIDED WING FLIES

Finest quality, hand tied dry flies. Skillfully made with just the right amount of natural-tip hackle. Upright divided wings cocked well forward. Decorated silk bodies. Favorite patterns: Black Gnat, Silver Doctor, Royal Coachman, Yellow Sally, Parma Belle, Etc. Compare to flies selling as high as .30 each! #10 hook. Shpg. wt., 8 ozs. FT-531 24 DIVIDED WING FLIES Net 1.49

### (M) 24 ATLANTIC SALMON STREAMERS

Famous "New England" streamer flies. Resemble small, live minnows in the water. Beautifully dressed and fitted with jungle feathers tied in at the head. All dressing tight and smooth. Two dozen all time favorites tied on long shank No. 2 hook. Includes Black Ghost, Light Tiger, Aunt Ider, Gray Ghost, Parmachene Belle, Jack Scott, etc. No two alike. Regularly sell as high as .49 ea. all 24 identified on labeled card. Shpg. wt., 12 ozs. FT-532 ATLANTIC SALMON STREAMERS Net 2.39

### (N) FISHERMAN'S 8" LONG NOSE PLIERS

● HARDENED TEMPERED STEEL ● KNURLED SURE GRIP HANDLES  
A sturdy all purpose 8" Long Nose Plier especially suited for the fisherman. Made of rust resistant drop forged steel—ideal for use as leader bender, hook remover, wire cutter—literally scores of uses in the fishing boat or workshop. MD-51 8" LONG NOSE PLIER Net .89

### (O) "NITE-LIFE" WORM LURE

This life like worm lure consists of a 3-gang hook harness with 5 1/2" soft plastic worm tied to harness with 15 lb. test nylon. Fluorescent red beads with revolving nickel propeller blade and red plastic lure combine to make this excellent shallow running lure. Size 4 gold plated hooks. Actual Lure Wt., 1/2 oz. Shpg. wt., 4 oz. FT-526 "NITE-LIFE" WORM LURE Net .39

### (P) "WIGGLY-EEL" NATURAL LURE

A natural soft black plastic eel tied with 15-lb. test nylon to a 2-gang hook harness. Wire shaft directly attached to eye of front hook with revolving propeller blade located between 2 solid metal beads. Size 2 gold plated hooks. Shpg. wt., 4 oz. FT-525 "WIGGLY-EEL" NATURAL LURE Net .49

### (Q) 12 SELECTED FANCY POPPERS

A choice selection of hand painted popping bugs for blue gills, bass, trout, pan fish. All proven fish-getters. 4-cork shaped, scaled body, with hackle and tail feathers. 4-cork shaped, frog type with rubber hula skirt. 4-"open-mouthed" with feather streamer. Hooks won't pull out. All on #10 hooks. Regularly cost over 30 cents each! Shpg. wt., 8 ozs. FT-529 SELECTED FANCY POPPERS Net 1.29

### (R) MONOFILAMENT SPINNING LINE

Limp, DuPont Nylon, "Trigger Fish" monofilament spinning line. Extra strong—quick drying—small diameter. Far open or closed face spinning reels. Choose either 6 lb. or 8 lb. test. 200 yd. lengths. Shpg. wt., 8 ozs. FT-527—200 yds. 6 lb. Line Net .69  
FT-528—200 yds. 8 lb. Line Net .79

### (S) 400 YDS. NYLON LINE

400 yds. per spool—25 lb. test Shpg. wt., Net .98  
FT-534



5.95

## COMBINATION BAIT-CAST AND FLY-CAST FISHING KIT

- Fine Quality Split Bamboo Rod
- Converts from 8 ft. Fly Rod to 5'4" Casting Rod

The perfect all-around "Fisherman's-Friend." Features a split bamboo rod with interchangeable tips and reversible handle. Chrome plated, screw locking reel seat. Shaped cork handle. Chromed stainless steel guides and extra deep chromed brass ferrules. High gloss lacquered surface—colorful, sealed nylon windings. Kit contains 4 pc. Split bamboo rod, brass swivel, split-shot, line winder, float, nylon line, 12 assorted flies, 2 streamers, 6 hollow point hooks with leaders, leader cutting scissors and fitted wooden case to hold complete kit. Shpg. wt., 3 lbs.

FT-504 Regularly 9.95 Net 5.95



2.05

## Beachcomber Tackle Box

Constructed of rigid polyethylene, this rugged box will withstand warping, denting, cracking, breaking and corrosion. Solid brass hardware and nylon latch. Handy cantilever tray provides for lures and small tackle with ample room in the bottom for bait and spinning reels. Dimensions 12 1/2" long x 4 1/2" deep x 5 1/2" wide. Weighs only 1 1/2 lbs. Shpg. wt., 2 1/2 lbs. MC-25 BEACHCOMBER TACKLE BOX Net 2.05



9.95

## Golf Ranger Finder

This exciting new Range-Finder is bound to prove an invaluable addition to your Golfing Equipment. Featuring a precision 6X lens capable of measuring from 40 to 250 yards, this handy pocket size instrument enables the golfer by means of a simple focusing adjustment to easily compute the distance to the next hole. Guess work is completely eliminated and choosing the correct club is greatly simplified. Supplied with suede leather carrying case and simple instructions. Shpg. wt., 1/2 lb. F-427 GOLF RANGE FINDER Net 9.95

## HYDRAULIC PUMP OILER

- PERFECT OILER FOR 1001 USES
- LIGHTWEIGHT—HANDY—TRANSLUCENT TENITE

A new shop-home-office accessory. Gives fine, pressurized stream that lubricates hard to get at places. Seamless construction of durable tenite. Finger tip plunger. Holds 4 ozs. of oil. Lubricates all types of machinery—hand and power tools—appliances—fixtures—toys—conveyances. Removable base for easy filling. Drip proof—leak proof design. Outmodes the old fashioned oil can. Shpg. wt., 1/2 lb. MD-265



89¢

Net ea., 89¢

## IMMERSION HEATER

- Instant Heating ● Full 300 Watts
- Useful in Lab-shop-home

Hi-heat immersion coil brings water to a boil in minutes. Heats instantly to a full 300 watts. Highest efficiency in heating liquids of all types. Safe—convenient—entirely sheathed and sealed in nickel-plated brass. Specially shaped tubes provide minimum distance of heat transfer. Excellent for use in narrow containers requiring minimum displacement. Nichrome alloy heating element. Many applications in lab, shop and home. Overall length 6 1/2", immersion length 4", coil dia. 1 1/2". For 115 V. AC or DC. Shpg. wt., 8 oz. P-388



Net .98  
2 for 1.69

## AUTO-BOAT COMPASS

- Cars-Boats-Trucks-Tractors
- Illuminated and Non-Illuminated

Mounts anywhere on cars-boats-trucks-tractors-motorcycles. Non-glass, universal mounting bracket. Most easily compensated compass available. Just a twist of the bottom or top knob. Extremely accurate. Constructed to withstand all driving shocks. Important to the doily driver. Invaluable for boats and tractors. Large viewing window and figures for ease of reading. Includes mounting accessories and instructions. Illuminated model includes both 6 and 12 volt bulbs. Shpg. Wt. 1 lb. F-322 Non-Illuminated Net 3.75  
F-323 Illuminated Model Net 4.49

## HEDGE TRIMMER ATTACHMENT

Converts any 1/2" drill into an easy handling hedge-trimmer. Steel and aluminum construction. 5 1/2-in. type 10" cutting blade. Simple cam action, 1/2" stroke. Lightweight—easy handling. Shpg. wt., 3 lbs. MD-97

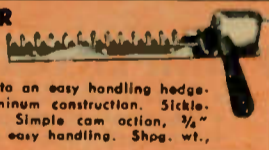

Net 8.29

## BABCO GRASS TRIMMER

- Fast Shearing actions
- Safe operation with blade guard
- Smooth, Clean Cutting

Now you can take advantage of that electric drill in your work shop to trim grass with this unit. Attaches to any 1/2" electric drill. Ideal for cutting grass grown over sidewalk, stepping stones or close to wall. Neat and fast cutting. Ten times faster than hand shears. The rotary blade is well guarded, top and sides, to insure safe operation. 5 1/2" blade can be easily re-sharpened with any kitchen knife sharpener. Shpg. wt., 1 lb. MD-399. List 3.50



Net 2.69

## "TRIG-A-MATIC" HOSE NOZZLE

- Automatic Pistol Type ● Complete—Simple One Hand Operation

Latest in garden hose nozzles. Precision built pistol type. Four spray action—automatic locks in position. Adjustment for fine variations. Trigger release button—for instant, one finger shut off. Chrome plated and highly polished. Stainless steel springs and neoprene gaskets. Gun sight permits hanging or storage. Shpg. Wt., 1 lb. MD-332 1.95 Net 1.39



1.39

## Multi-Use WRENCH SET

- 8 Precision Wrenches

Fully nickel plated—special analysis alloy tool steel. Heat treated and hardened. 16 sizes cover the most often encountered nuts in the automotive-TV-radio-appliance and hobby fields. Sizes range from 13/64" to 7/16". Set includes case with transparent cover. Shpg. wt., 8 oz. MD-405 Net 69¢



Net 69¢



## AIR CONDITIONER FILTER

- FOR ANY ROOM AIR CONDITIONER
- Made OF B.F. GOODRICH "TEXTILITE"
- PERMANENT — WASHABLE

Reg. 1.98

ONLY 99¢

Free flow design increases efficiency. Famous Goodrich "Textilite"—thousands of rubberized bustles—give optimum air flow and maximum filtration. Rigid—needs no frame. Retains shape under pressure—will not flake. Trims to fit any room air conditioner. Shpg. wt., 1/2 lb. ML-152 FREE FLOW FILTER Net .99 ea Net ea. In lots of 3 .75

## TRANSPARENT UTILITY BOXES



Attractive plastic boxes ideal for storing screws, nuts, bolts and hundreds of other small parts. With hinged cover and built-in partitions.

Stock No.	Dimensions	Compart.	Wt.	Each
MS-51	7"x3 1/2"x1-3/16"	5	5 Oz.	.41
MS-52	8 1/4"x4 1/2"x1 1/4"	6	7 Oz.	.53
MS-53	7"x3 1/2"x1-3/16"	9	5 Oz.	.41
MS-54	8 1/4"x4 1/2"x1 1/4"	12	7 Oz.	.53
MS-55	10"x6.4"x1 1/4"	18	17 Oz.	1.35

## 2 in 1 EYELET TOOL

- PUNCHES HOLE—SETS EYELET AT SAME TIME
- COMPLETE WITH 300 EYELETS

Neatly—easily—punches holes and sets eyelets in fabric—canvas—plastic—leather—paper—card board. Does a professional looking job every time. Use it on belts, shoes, sneakers, shower curtains, luggage, sports equipment, flags, banners, shower curtains. Prevents tearing of material—actually strengthens them. Hundreds of uses for everyone—everywhere. Complete with 300 assorted eyelets and instructions. Shpg. wt., 1 1/2 lbs. MD-442—EYELET TOOL Net 1.59  
MD-443 EXTRA EYELETS—Pkg. of 300 Net .39

## SWING-UP 'FLASHER-SPOTLITE' LANTERN

1.98



This powerful beam swivel head search light features a swing-up handle red blinker light which sets at any angle within a 90° arc for safety warning and emergencies. Separate blinker and beam switch operates individually or jointly. Perfect for all outdoor activities, road emergencies, home and farm. Rugged metal case in red enamel with lustrous chrome swivel head and handle. Uses 6 volt battery or 8-standard flashlight batteries. Shpg. wt., 3 lbs.

ML-153 SWING-UP HUNTING LANTERN Net 1.98  
BURGESS No. F4M or RCA V5040C 6 Volt Battery. Shpg. wt., 2 1/2 lbs. Net .79  
BURGESS 2R or RCA V5036A 1 1/2 Volt Battery. Shpg. wt., 7 oz. (8 required) Net Each .13

## MARINE COMPASS

- Jeweled Movement
- Brass Gimbals
- 2° Graduations

3.29



Imparted compass for sail or motor boats. Entirely non-magnetic and corrosion resistant. Finely made of glass-brass—and lacquered oak. Direct-reading 360° dial. Calibrated every 2°. All cardinal points are oversized. Sharp, black markings on white background. Compass is easily removed from gimbal for safekeeping. May be mounted as a permanent binnacle or used as a portable unit. Overall dimensions are 4 1/2" x 4 1/2" x 3 1/2". Compass is 74mm. Shpg. wt., 1 1/2 lbs. F-386 Net 3.29

# BUILD YOUR OWN LAFAYETTE QUALITY KIT

and  
**SAVE!**

## NEW! LAFAYETTE 15-IN-1 TRANSISTOR EXPERIMENTERS KIT

A TRULY REMARKABLE VALUE  
*Practical-Educational-Entertaining*

EXCITING PROJECTS BUILD ALL OF THESE

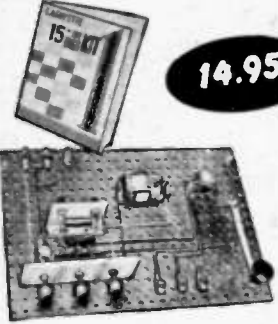

14.95

- ELECTRONIC TIMER
- BURGLAR ALARM
- 2-STAGE AUDIO AMPLIFIER
- PHOTO-ELECTRIC RELAY
- CODE PRACTICE OSCILLATOR
- AUDIO PREAMPLIFIER
- ELECTRONIC FLASHER
- TV COMMERCIAL KILLER
- RAIN ALARM
- SIGNAL INJECTOR
- INTERCOM
- 2-STAGE BROADCAST RECEIVER
- WIRELESS BROADCASTER
- WIRELESS CODE TRANSMITTER
- REGENERATIVE RADIO RECEIVER

ASSEMBLE THE BASIC COMPONENTS — THEN WIRE EACH CLEARLY EXPLAINED CIRCUIT BY SIMPLY CONNECTING THE PROPER LEADS.

AN IDEAL LABORATORY KIT WHICH HELPS TEACH YOU HOW TRANSISTORS WORK IN A PRACTICAL WAY.

### THE MOST EXTENSIVE TRANSISTOR LAB KIT IDEAL FOR STUDENT — HOBBYIST — EXPERIMENTER

Lafayette's new 15-in-1 transistor experimenters kit is the most practical introduction to the understanding of the operation of transistors — since it utilizes basic transistor principles and circuitry. Its unexcelled simplicity of construction provides a fascinating and educational program of instruction. You build practical, useful operating transistor devices that teach you transistor fundamentals and applications.

This versatile kit is supplied complete with transistors, relay, photosell, dual headphones and all necessary items including lead wire, solder. You also receive an easily understood instruction manual which explains just how each of the 15 circuits works. Battery powered, the kit is shockproof and safe — ideal for beginners. Shpg. wt., 4 lbs.

KT-134A 15-in-1 Transistor Experimenters Kit (Less batteries).....Net 14.95

BATTERIES Burgess Z or RCA VS034 (8 required).....each 8¢

## NEW!

### EXCITING "EXPLOR-AIR" RECEIVER KIT 4 BAND

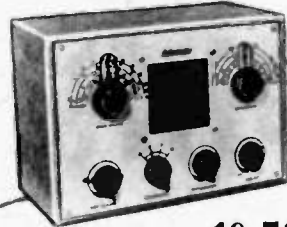

18.50

- 4 Bands for total coverage:
- 550-1600 Kc broadcast band
- 1.7-5.0 Mc., 5.0-14 Mc., 14-30 Mc. shortwave bands
- Complete bandswitching from front panel
- Built-in Big 4" PM Loud-speaker

The most sensational shortwave economy receiver kit ever offered. A complete shortwave and standard broadcast set which covers the entire region from 550 kilocycles to 30 megacycles. Four whole bands of fascinating programming unavailable elsewhere. Perfect for students of languages, radio amateurs and casual listeners.

Only a regenerative circuit can offer such amazing performance and yet be so simple to build. Building this fine kit is an absolute pleasure — it's so well designed you can't go wrong. Kit includes all the parts you need, and the detailed step-by-step instruction book with its giant pictorial drawings shows you just how to put them together.

One front panel knob does all the bandswitching at the flick of the wrist, immediately taking you from band to band. All coils are prewound for greater accuracy. This kit is so easy to build a child who can read could do it (and many already have)! The chassis is completely isolated from the circuit, so there is no shock hazard.

This precision radio kit is just full of extra features. Complete 4 band coverage of broadcast stations, international broadcast bands, amateur, maritime, fire and police services, yes, even satellite signals! Big 4" speaker and sensitive circuit with 50C5 output stage and 12AX7 regenerative detector and amplifier stages give you all the volume you want. Phone jack for privacy automatically disconnects speaker. All controls are on the front panel: On-Off Volume, Main Tuning, Band Spread, Bandswitch, Antenna Tuning, and Regeneration. 110 Volt 50-60 cycle AC-DC power supply lets you use this fine set anywhere. Size: 10" x 7" x 5". Everything needed for unexcelled reception is combined in a compact, economical package.

KT-135 "EXPLOR-AIR" RECEIVER KIT (Less Cabinet).....18.50  
ML-150 — Leatherette covered Wooden Cabinet for above.....Net 2.75

## NEW! SUPER-SENSITIVE PHOTOCELL ELECTRONIC RELAY KIT

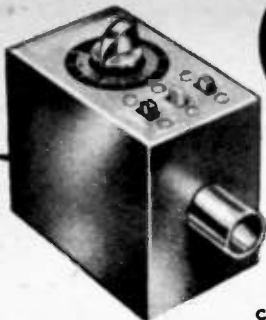

12.95

- WITH CLAIREX CADMIUM SULPHIDE PHOTOCELL
- ADJUSTABLE SUPER SENSITIVITY—WORKS WITH JUST A FLASHLIGHT AT 250 FEET!
- NEEDS NO SPECIAL HIGH-INTENSITY LIGHTS
- INSTANTANEOUS OR SUSTAINED OPERATION ON THE FLIP OF A SWITCH!

Lafayette's latest achievement in a super-sensitive photocell relay kit. Ideal for sustained operation required for burglar alarms, door buzzers, for turning on porch and home lights at night to discourage prowlers when away in the evening. Excellent for instantaneous on-off operation required for counters, packaging, door opening, motor activation and countless industrial applications. A flip of the switch converts unit from instantaneous "on-off" to sustained "on" operation. A simple push on the "RESET" switch opens the external circuit and turns off the alarm. The unit operates on 110 volts AC and incorporates the efficient 5823 cold cathode tube, permitting longer life since there are no filaments to burn out. The controlled circuit is plugged into a convenient 110V AC output socket. A simple change in wiring (in instructions), as well as convenient input terminals, enable you to supply the external circuit with any desired voltage. Relay contacts rated at 3 amps permitting up to 300 watts external load on 110 Volts AC. Complete with all parts, photocell, tube, chassis, silk-screened metal cabinet and easy-to-follow illustrated instructions. Size: 3" x 4" x 5". Shpg. wt., 3 lbs. KT-133—Kit, Complete Net 12.95

CAN BE USED AS BURGLAR ALARM



ALL LAFAYETTE KITS ARE SUPPLIED WITH EASY-TO-FOLLOW INSTRUCTIONS

## NEW! LAFAYETTE STEREO PHONO AMPLIFIER KIT

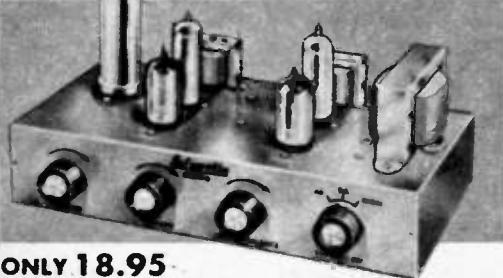

ONLY 18.95

- GANGED TONE CONTROLS
  - STEREO-MONAUROUS SWITCH
  - .04 VOLT SENSITIVITY
  - 4 WATTS STEREO OUTPUT
  - ISOLATION TRANSFORMER
  - SEPARATE VOLUME CONTROLS
- This is a complete 4-watt hi-fi stereo amplifier having 2 watts output per channel. Features separate volume control for each channel, ganged tone controls, Stereo-monaural switch to feed one channel to both speakers and to reverse the channels. Just right for any use where a small stereo amplifier is required—ideal for custom mounting in even the tightest locations; specially designed for small apartment sized stereo systems.
- An isolation transformer makes this circuit extra safe. Other circuit features for better performance include application of negative feedback to driver and output stages for wide-range response and extra low distortion. Dual-triode 12AX7 tubes function as voltage amplifier and driver, providing very high gain: 40 millivolts drives this unit to full output. This tremendous gain, plus an extremely high input impedance make this amplifier perform exceptionally well with all types of ceramic and crystal pickups, as well as tuners, tape recorders, etc. Selenium rectifier power supply has extremely good regulation. Logical layout high quality parts, plus complete instructions for assembly, make this kit a pleasure to build and use. For 3.2 or 8 ohm speakers. Tubes: 2-50C5, 2-12AX7 plus selenium rectifier. Size: 9 1/2" x 5" x 4 1/2". Complete with all parts. For 110-120 volts, 60 cycle AC. Shpg. wt., 7 lbs. KT-126—Kit, Complete Net 18.95

### COMPLETE STEREO PHONO SYSTEM KIT

- ASSEMBLE THE STEREO AMPLIFIER AND SAVE REAL MONEY
- PLAYS STEREO AND MONAUROUS RECORDS

REGULAR 76.53 ONLY 59.95

Enjoy fine stereo performance with this "easy-to-assemble" exclusive Lafayette package. The complete system consists of Lafayette KT-126 basic stereo phono amplifier kit, the renowned Collaro TSC-640 4-speed automatic record changer, the new Ronette "OV" Turnover Stereo Cartridge with dual sapphire styli for stereo and monaural records, and two Lafayette SK-109 Miniature Hi-Fi Speakers and Enclosures. The amplifier kit has many fine features including 2 watts per channel with separate volume control, "stereo-reversal-monaural operation" switch, and isolation transformer to work from either 4 or 8 ohm outputs and are supplied with 25 ft. of cable for hookup. You save 16.58 over regular catalog prices!

PK-299 Stereo Phono Kit System.....Net 59.95  
KT-126 Stereo Amplifier Kit.....Complete with all tubes, parts and instructions. Shpg. wt., 7 lbs. Net 18.95

#### COMBINATION MONEY SAVER

The KT-126 Stereo Amplifier Kit and Ronette "OV" Stereo Turnover Cartridge with dual sapphire styli. KT-136.....24.90

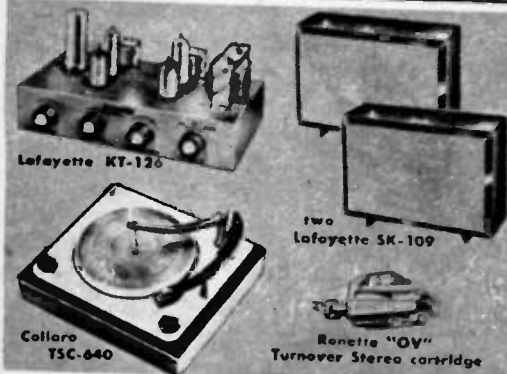

Lafayette KT-126

two Lafayette SK-109

Collaro TSC-640

Ronette "OV" Turnover Stereo cartridge

### 3 TRANSISTOR SUPERHET POCKET RADIO KIT

• A TRUE POCKET SUPERHET RECEIVER—NO EXTERNAL ANTENNA



• NO EXTERNAL GROUND

A remarkable sensitive, super-selective pocket superhet receiver with astonishing performance over the complete broadcast band. Uses 2 high-frequency and one audio transistor plus efficient diode detector and features 3 specially matched IF transformers for maximum power transfer. The components are housed in a professional looking beige plastic case. A professional looking ferrite antenna eliminates need for external antenna. A designer's dream in a true pocket superhet receiver! Complete with all parts, transistors, case, dial and easy to follow step-by-step instructions. 4 1/2" x 2 1/2" x 1-1/16".

KT-116—Complete Kit, less earphone and battery.....Net 14.95  
MS-260—Super Power Dynamic Earphone.....Net 3.95  
MS-368 Sensitive Economy Dynamic Earphone.....Net 1.44  
Battery 9 v. RCA VS309.....Net 1.13

### TRANSISTOR CODE PRACTICE OSCILLATOR KIT

For those interested in mastering the international code, an audio tone oscillator is essential. The circuit of this transistorized feedback oscillator has the simplicity of the vacuum glow, the signal strength of the vacuum tube, and requires only two pentode cells for weeks of service. It may be used for solo practice, or two may send and receive with the same unit. Kit comes complete with Transistor, Telegraph Key, Resistors, Condensers, Mosonite Board, etc., and Schematic Diagram.

KT-72 less batteries.....Net 2.99  
CANNON AM-15-1 Single Headset.....Net 1.18  
BATTERY 1 1/2 v. Burgess No. 7 (2).....Net each .08

### 1 AND 2 TRANSISTOR POCKET RADIO KITS

ONE TRANSISTOR POCKET RADIO KIT—KT-97

• IDEAL FOR STUDENTS, HOBBYISTS AND EXPERIMENTERS

PRE-PUNCHED CHASSIS FOR ADVANCEMENT TO 2 TRANSISTOR KIT

Ideal, low-cost transistor pocket radio kit. Super-selective ferrite loop antenna permits good reception up to 50 mile radius with approx. 50 ft. antenna and good ground. Provisions for advancement to 2 transistor receiver. Complete Kit with simple detailed instructions. 3 1/2" x 2 1/2" x 1 1/2". Shpg. wt., 1 lb. (less battery)

KT-97—Complete, less earphones and batteries.....Net 3.95

TWO TRANSISTOR POCKET RADIO KIT—KT-98

Contains all KT-97 components plus additional R-C coupled transistor stage for increased sensitivity and output. Complete with instructions. Shpg. wt., 1 lb.

KT-98—Complete 2 Transistor Kit, less earphone.....Net 5.45  
MS-111—Crystal earphone for KT-97 and KT-98.....Net 1.19  
MS-260—Super power dynamic earphone.....Net 3.95  
BATTERY 1 1/2 V. Burgess #7.....Net .08

### NEW! SEMI-AUTOMATIC "BUG" SUPER SPEED TELEGRAPH KEY

Fully adjustable speed and timing, so important in the right timing when using a "bug". Heavily weighted with solid steel block in base. Speed adjustable 10 wpm to as high as desired. 1/2" silver contacts, weight scale for reproducible speed settings. A real bargain for radio amateurs and professional CW operators! 6 1/2" long x 3" wide x 2 1/2" high, exclusive of knobs and feet. Shpg. wt., 3 1/2 lbs. MS-435 Semi-Automatic "Bug".....Net 9.95

Value 20.00

### NEW! LAFAYETTE "BRASS-POUNDER'S" KEY

Economical and practical code practice key and buzzer unit for learning code. Telegraph key chrome and nickel plated with both adjustable spring tension and contact clearance. The high frequency buzzer has frequency adjustment with locknut to keep tone constant. Screw type pin jack terminals for headphone connection. Works with inexpensive 1 1/2 volt battery. Heavy black molded phenolic base and buzzer housing. Base 3/4" x 2 1/2" x 1 1/2", overall length 8 1/2". Shpg. wt., 2 lbs. MS-438 Code Practice Set (less battery) 1.79

BATTERY Burgess 2......13  
MS-369 Stethoscope Headset.....1.69

### NEW! LAFAYETTE "BRASS-POUNDER'S" KEY

• With Ball-Bearing Pivots

• Solid Polished-Brass Base

A better quality precision-made key designed for hard usage. Polished brass base, spring tension and contact clearance adjustments; 3/16" silver contacts; 3/16" x 2" overall size 3" long x 2 1/2" wide x 1-1/16" high. Shpg. wt., 1 1/2 lbs. MS-428 Telegraph Key Net 1.95

### SAVE ON NEW TELEGRAPH KEY

Economical and practical code practice key. Solid, heavily chrome and nickel plated metal parts, molded phenolic base. Adjustable spring tension and adjustable contact clearance. A real buy! Base 3/4" x 2 1/2" x 1-13/16" wide. Overall length 5"; height 1 1/2". Shpg. wt., 12 oz. MS-319 Telegraph Key.....Net .69

### NEW! high frequency CODE PRACTICE BUZZER

Reg. Value 2.50

Adjustable frequency buzzer ideal for individual or group code practice. Black molded phenolic housing — Works with 1 1/2 volt battery. Screw adjustment for changing tone. 1 7/8" diam. x 1-1/16" high. Shpg. wt., 6 oz. MS-436 Buzzer.....Net .79



# LAST MINUTE RELEASES and SPECIAL VALUES

## GONSET 2-WAY RADIO DESIGNED FOR USE ON 11-METER CITIZENS' BAND **124.50**



12.45 DOWN  
No exam required...  
no code. U.S. Citizens  
required only to complete  
simple F.C.C. form

- For personal use, business or pleasure
- Simple to operate—no technical knowledge required
- Wide range radio... not confined to line-of-sight transmission
- Compact... lightweight
- rugged—can be used anywhere

A complete 2-way voice transmitter-receiver and power supply in a single compact unit operating on the 27 MC Citizens Band. Crystal controlled for highest stability—no fussy tuning—no drifting off channel frequency. Simple press-to-talk feature on microphone leaves one hand free while using set. Speaker is built into front panel—incoming calls easily heard some distance from set. Full 5-watt transmitter (maximum allowable) for maximum range. Other features include an adjustable "squelch" control for muted standby operation and tuning indicator on front panel for visual check of proper transmitter operation. Foolproof, lightweight, dependable, this new citizens radio has hundreds of uses—boating, hunting, fishing, emergency communications, construction crews, surveyors etc. Complete unit measures only 5 1/4" H x 6 3/4" W x 6 3/4" D. Shpg. Wt., lbs. Three models available: 12 Volts DC only; 6 Volts DC only; 115 Volts AC only.

**MODEL 3303.** Complete with microphone and transmitter/receiver crystals for one channel. Less antenna. For 115 Volts AC Net 124.50  
**MODEL 3304.** Same as above, but for 12 volts DC operation Net 124.50  
**MODEL 3305.** Same as above, but for 6 volts DC operation Net 124.50

### ANTENNAS FOR GONSET 2-WAY RADIO

Highest quality antennas, ruggedly built for use in varied climatic conditions. For base station or mobile service. Mobile antenna—Coil loaded whip antenna—Model 3297 Net 13.50  
Ground Plane Base Station Antenna—Complete with 50 ft. of transmission line, hardware and ready for installation—Model 3296 Net 39.95  
Beam Antenna—Directional 3-element beam. Ready for installation—Model 3302 Net 39.95

## LAFAYETTE STEREOPHONIC PHONOGRAPH

- FULLY AUTOMATIC GARRARD CHANGER
- TWO POWERFUL 10 WATT AMPLIFIERS
- SECOND SPEAKER EASILY DETACHED

**NEW!**



**89.50**



### FLEXICONE KIT



- REDUCES SPEAKER CONE RESONANCE
- IMPROVES FREQUENCY RESPONSE

Thoroughly tested and approved, Flexicone will improve your speaker sound quality and frequency response by softening the outer edges of the speaker cone thereby reducing the cone resonance from 10 to 40 cps. Easily applied in just 15 minutes. One three-bottle kit contains enough material for four 8" speakers. Complete with instructions. MS-571 Net 1.76

A complete portable and compact stereo phonograph in one convenient case. System uses the well-known Garrard RC-121/111 4-speed stereo changer which features true intermix of 12" and 10" records in any order with instant selection of either automatic or full manual operation. Uses a stereo turnover cartridge to play all your records—whether monaural or stereo. Two powerful 10 watt amplifiers provide a frequency response of 50 to 12,000 cps. Controls included: Master Volume; Remote speaker volume; Master Treble; Master Bass. Detachable front speaker cabinet houses a 6" x 9" speaker with 19 ft. extension cord. Main unit houses two speakers—one 6" x 9" woofer and one 4" tweeter. Phonograph has easy-grip handle on attractive smart-looking Pyrolyn covered case. Size: 18 1/2" long, 15 1/4" wide, 9" high. Shpg. wt., 3 1/2 lbs. PH-128 Complete Stereo phonograph with remote speaker. Net 89.50

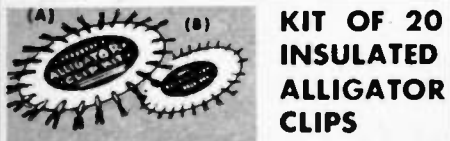

### KIT OF 20 INSULATED ALLIGATOR CLIPS

Two kits of insulated alligator clips. Kit A consists of 20 large size clips, kit B consists of 20 small size clips. All have sturdy nickel-plated jaws with strong spring and hard bite. Each kit contains 10 red and 10 black alligator clips, corded and bagged. MS-569 Kit B (small size) Net .89  
MS-570 Kit A (large size) Net 1.39

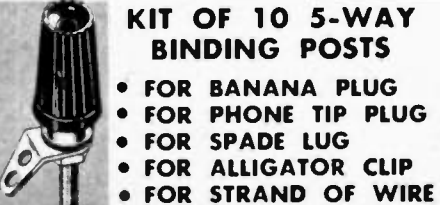

### KIT OF 10 5-WAY BINDING POSTS

- FOR BANANA PLUG
- FOR PHONE TIP PLUG
- FOR SPADE LUG
- FOR ALLIGATOR CLIP
- FOR STRAND OF WIRE

For panels 1/16" to 1/4" thick. Assortment of 10 pieces, 5 Red and 5 Black. MS-566 Binding Post Kit Net .79

### SENSITIVE MINIATURE RELAY

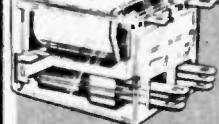

**\$2.95 ea.**  
WHILE THEY LAST

Extremely small, sensitive relay—weighs only 1/2 oz! Double-pole double-throw, with silver and silver-gold-platinum alloy contacts. Contacts handle up to 100 volts at 300 ma. (30 watts). Coil measures 5300 ohms dc resistance-rated at 4.1 ma. dc. pull-in current, 0.95 ma. dc. drop-out. Enclosed in transparent plastic dust cover; Operating time 2.8 milliseconds; release time about 1.5 msecs. Breakdown voltage ratings: coil to frame, 500V.; contacts to frame 350V. Measures 1-1/16" x 11/16" x 1/4". Ideal for model control, photocell relay, carrier-current control and dozens of other miniature applications. Shpg. wt., 4 oz.

F-332—DPDT Miniature DC Relay Net 2.95  
As above, but 4-pole double throw; pull-in current 6.3 ma. dc.; drop-out 3.3 ma. dc. Weighs 1/2 oz. 3/4" x 1 1/4" x 1 1/4". Shpg. wt., 4 oz.

F-333—4P-DT Miniature Relay Net 3.95

### TONE ARM CONTROL



An absolutely essential addition for every Hi-Fi enthusiast. Record, cartridge and needle life will be greatly extended by the use of this tone arm control. Accurately and smoothly places tone arm in record run-in groove and lifts arm off record at end of play. Ideal for "cueing." Designed to fit practically every known turntable arm as well as record changer with manual features. Unit is supplied with both wood and metal mounting screws also supplied with adhesive mounting base which eliminates drilling mounting holes. MS-572 TONE ARM CONTROL Net 4.25

### FLEXIBLE AUDIO "Y" CONNECTORS



For converting Stereo Player to Monaural. Can be used for a Tap-In-Meter Monitor connection. Also required on some Tape Recorders.

- (A) Phono Plug connected to 2 Phono Jacks by 4" shielded cable. SWITCHCRAFT 330F1 Net 1.18
- (B) Phono Jack connected to 2 Phono Plugs. SWITCHCRAFT 330F2 Net 1.18
- (C) 3 Phono Plugs connected together by 4" shielded cable. SWITCHCRAFT 330F3 Net 1.18

### SHIELDED "Y" ADAPTERS

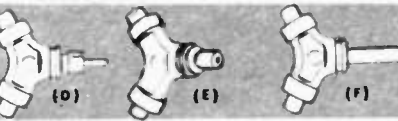

- (D) Two phono jacks in parallel to RCA type phono plug. MS-596 Net .69
- (E) Three RCA type phono jacks in parallel. MS-597 Net .69
- (F) Two RCA type phono jacks in parallel to a standard phono plug. MS-595 Net .69

### "MINI-MIX" SWITCHCRAFT AUDIO MIXER

Miniature 2-input hi-impedance mike and phono mixers. Separate gain controls for mixing. Shielded housing. Ideal for use with tape recorders, musical instruments, phonographs, microphones. Size 2-1/4" x 1-13/16" x 1-1/16".  
320—Microphone connector inputs and outputs. Net 4.67  
310—Phono jack inputs and phono plug output. Net 4.67  
8266—Cable assembly with plug and jack to use No. 310 where equipment jack is recessed. Net 2.20  
315—Phono jack inputs and microphone connector output. Net 4.67  
325—For recorders or amps using Jones connectors including recessed type in Webster Tape Recorders. Net 5.85

### SWITCHCRAFT STEREO AUDIO CABLES

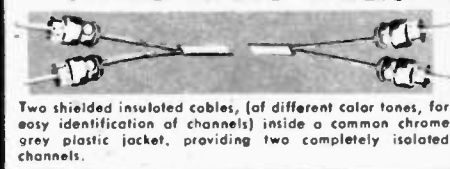

Two shielded insulated cables, (of different color tones, for easy identification of channels) inside a common chrome grey plastic jacket, providing two completely isolated channels.

TYPE	LENGTH	NET
25FF25	36"	Phono Plugs at all ends. 1.91
25FK25	6'	at all ends. 2.20
25FN25	10'	2.65
25FF84	36"	2 Phono Plugs at one end, other ends Stripped and Tinned. 1.71
25FK84	6'	1.91
25FN84	10'	2.20

### SWITCHCRAFT AUDIO CONNECTORS AND ADAPTERS

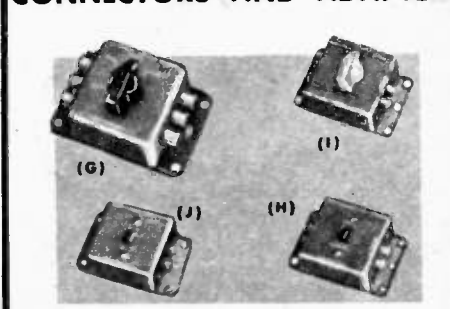

- (G) MULTIPLE SELECTOR CONTROL. Connects any one of 5 input circuits (AM, FM, PHONO, TAPE AND AUX) to one output. Attractive tan housing is completely shielded. Complete with mounting hardware. SWITCHCRAFT 664 Net 2.91
- (H) STEREO-MONAUURAL SELECTOR. Provides instant switching from monaural to Stereo. Two Phono Jack input and two Phono Jack output. Attractive tan housing is completely shielded and may be mounted on cabinet. Supplied with mounting screws. SWITCHCRAFT 661 Net 1.76
- (I) STEREO-MONAUURAL SELECTOR WITH REVERSE. Same as Switchcraft 661 but with channel reverse feature. SWITCHCRAFT 662 Net 2.06
- (J) SPEAKER PHASE CONTROL. Correct speaker phasing is essential in multiple or Stereo Speaker installations. This completely shielded control is ideal for this application. Attractively finished in tan with easy to use screw terminals. Supplied with mounting hardware. SWITCHCRAFT 665 Net 1.47

## BATTERIES



### BATTERIES FOR PORTABLE RADIO RECEIVERS

Burgess Type	RCA Type	Replaces Eveready	Volts	Shpg. wt. lbs.	Net. Ea.
1	V5035A	935	1 1/2	4 oz.	.13
2D	V5069	720	1 1/2	1/2	.69
2F	V5141	W353	1 1/2	1 1/2	.77
2R	V5036A	950	1 1/2	6 oz.	.13
4F	V5004	742	1 1/2	2	1.15
8R	V5070	960P	1 1/2	8 oz.	.46
21R	V5236	964	1 1/2	1/2	.28
37	—	—	1 1/2	1	.65
Z	V5034A	915	1 1/2	4 oz.	.08
D3	V5072	726	4 1/2	1 1/2	.76
F3	V5067	736	4 1/2	2	.82
G3	V5002	746	4 1/2	2	.85
2F4	V5010	718	6	3 1/2	2.73
4F4P1	V5009	744	6	2 1/2	1.04
Z4	V5068	724	6	1/2	.63
B5	V5129	713	7 1/2	1 1/2	1.26
C5	V5065	717	7 1/2	1 1/2	1.05

### TRANSISTOR AND HEARING AID BATTERIES

BURGESS TYPE	RCA TYPE	REPLACES EVEREADY	VOLTS	SHPG. WT. lbs.	NET EA.
NE	V5073	W468	1.5	1 oz.	.08
A4	—	—	1.5	2 oz.	.69
404	—	274	1.5	3 lbs.	3.05
2N6	V5305	246	9	1 lb.	1.30
2U6	V5323	218	9	3 oz.	.95
2X3	V5324	243	4 1/2	1/2 oz.	1.11
2Z3	—	2356	9	2 lbs.	1.10
D5	V5315	707	7 1/2	1 lb.	1.05
D6	V5306	276	9	1 1/2 lbs.	1.26
D6P1	V5301	2506	3-6-9	2 lbs.	1.58
O6S	—	2761	9	1 1/2	1.05
M6	V5322	266	9	2 1/2	1.05
P6	—	226	9	3 oz.	.77
XX9	V5304	239	9-13.5	4 oz.	.95
K10	—	417	15	4 oz.	1.16
U10	V5083	411	15	2 oz.	.81
Y10	—	504	15	2 oz.	.81
K15	—	420	22.5	4 oz.	1.23
U15	V5084	412	22.5	3 oz.	1.05
Y15	—	505	22.5	2 oz.	1.05
K20	—	430	30	6 oz.	1.51
U20	V5085	413	30	2 oz.	1.23
Y20	—	506	30	2 oz.	1.30
Y20S	—	507	30	2 oz.	1.30
—	V5313	E9	1.4	3 oz.	.51
—	V5400	E233	4	6 oz.	1.80
—	V5312	E146	9	2 oz.	1.58
P6M	V5300A	226	9	5 oz.	.95
—	V5309A	—	9	2 oz.	1.53
130	V5335	635	1 1/2	3 oz.	.16
230	V5336	A100	1 1/2	6 oz.	.16
930	V5334	1015E	1 1/2	4 oz.	.13
—	V5321	2731	4 1/2	3 lbs.	1.93

### MALLYORY MERCURY BATTERIES

FOR TRANSISTOR & RADIO APPLICATIONS

Type	Volts	Cap. MAH	Max. Std. Drain Pkg.	Shpg. Wt. Ea.	Singly	Std. Pkg.
TR152R	2.5	400	40	2	2 oz.	.79
TR132R	2.5	1000	100	2	3 oz.	.92
TR133R	4.0	1000	100	2	3 oz.	1.30
TR233R	4.0	2200	60	1	9 oz.	1.80
TR165R	6.5	500	50	2	3 oz.	1.80
TR146R	9.0	400	40	1	3 oz.	1.58
RM1R	1.34	1000	100	4	3 oz.	.42
RM12R	1.34	3600	250	2	3 oz.	.90
RM400R	1.34	80	10	5	1 oz.	.28
RM401R	1.34	800	100	2	2 oz.	.37
RM502R	1.34	2400	200	2	3 oz.	.68
RM601R	1.34	1800	150	2	3 oz.	.56
RM625R	1.34	250	20	4	1 oz.	.33
RM630R	1.34	350	20	4	1 oz.	.33
ZM9	1.5	2400	200	2	5 oz.	.56
DM-9N	1.5	2400	200	2	5 oz.	.59

### Portable "A" and "B" Packs

Type	Volts	Cap. MAH	Max. Std. Drain Pkg.	Shpg. Wt. Ea.	Singly	Std. Pkg.
2TXX40	—	W370	1 1/2-60	2	4.11	—
4TZ60	V5064	729	1 1/2-90	4 1/2	4.03	—
6TA60	V5054	W369	1 1/2-90	5 1/2	5.48	—
17GD60	V5022	759	1 1/2-90	21	7.21	—
YS250	V5050	755	6-7 1/2-75	4 1/2	4.55	—
YS250P	V5060	785	7 1/2-75	4 1/2	4.83	—
F6A60	V5019	753	7 1/2-90	7	5.43	—
G6M60	—	754	7 1/2-90	7	5.95	—
T6Z60	V5037W	756	7 1/2-90	5 1/2	4.87	—
F6A60P	V5038	757	9-90	7	5.08	—
G6B60	V5047	752	9-90	8	5.78	—
T6Z60P	V5059	727	9-90	5 1/2	4.80	—

### Flashlight & Lantern Batteries

Type	Volts	Cap. MAH	Max. Std. Drain Pkg.	Shpg. Wt. Ea.	Singly	Std. Pkg.
1	V5035A	935	1 1/2	3 oz.	.13	—
2R	V5036A	950	1 1/2	7 oz.	.13	—
4	V5006S	6 1GN	1 1/2	2	.84	—
7	V5074	912	1 1/2	1 oz.	.08	—
Z	V5073	W468	1 1/2	1 oz.	.08	—
N	V5034A	915	1 1/2	2 oz.	.08	—
4F2H	V5138	W357	3	3 1/2	1.45	—
4F4H	V5040C	509	6	2 1/2	.79	—
4F5C	—	510F	6	1 1/2	.79	—
4F4H	V5103	706	6	7 1/2	3.34	—
4F5H	V5139	715	7 1/2	8 1/2	4.32	—
4F6H	V5140	716	9	10	5.03	—

# Save 33 1/3 to 50% on MINIATURE-TRANSISTOR & R/C Equipment

## NEW! Lafayette's SUPER-TROL R/C EQUIPMENT

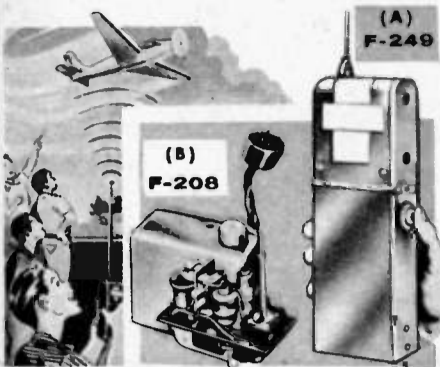

(A) **RADIO CONTROL TRANSMITTER:** Assembled-tested-guaranteed. No license examination required for operation. Crystal controlled for stability and to meet F.C.C. regulations. Uses powerful 3A5 tube for range of approximately one mile. Will operate any 27.255 mc R/C receiver. Overall dimensions only 8 1/2" x 2 3/4" x 1 1/2" — just a handful! Includes antenna — tube — crystal — and instructions. Less Batteries. Shpg. wt., 2 1/2 lbs.

**F-249** Batteries required: Burgess U30 (3 needed) 1.75 ea. Burgess #2 (1 needed) .13 ea. **Net 14.95**

(B) **RADIO CONTROL RECEIVER:** Completely wired and tested receiver — extremely sensitive and stable. Completely enclosed — ideal in boats — or case may be removed if desired. Ingeniously constructed to withstand vibration and shock. Features external fine tuning — antenna "snap" lead — plug for power and actuator connections. Ideal Companion for F-249 Transmitter and F-327 Servo shown elsewhere on this page. Requires one 1.5V battery and one 67.5 Volt battery. Size determined by use. Measures only 3" x 2 3/4" x 1 1/2". Complete with tube and instructions. Less batteries. Shpg. wt., 8 oz.

**F-208** Batteries required: Burgess UX45 (1 needed) 2.07 ea. Burgess No. 2 (1 needed) .13 ea. **Net 8.95**

### SPECIAL COMBINATION OFFER

Consists of R/C Transmitter (F-249), and R/C Receiver (F-208) **F-259** — Combination **Net 22.90**

## NEW! LAFAYETTE 27.255 MC CITIZEN BAND REMOTE CONTROL TRANSMITTER KIT KT-127

- WAY OVER 1 MILE LINE OF SIGHT TRANSMISSION!
- SUPER STABILITY FOR FOOLPROOF CONTROL OF MODEL PLANES, BOATS AND CARS.

Once again Lafayette spurs into the lead with its new amazing RC CITIZEN BAND TRANSMITTER. You'll marvel at the neatness and simplicity of its layout and at the dependability of its crystal controlled circuit. Fits comfortably in the palm of your hand — yet is so stable that it is unaffected by hand capacitance or motion. Has new attractive wide-scale meter for visually tuning transmitter for optimum foolproof performance. Has wide, non-critical tuning. Uses one B & W prewound coil — no tedious winding of coils! Tuning for maximum output and antenna loading adjustment easily performed from exterior of cabinet. Complete with approved telescoping antenna, meter, cabinet, chassis, tube, crystal, alignment tool, all parts and easy step-by-step instructions. FCC forms for exam-free permit enclosed with kit. Size 10" x 4" x 2 1/2". Shpg. wt., 5 lbs.

**KT-127**, Less Batteries. **Net 15.95**  
 1 Burgess No. 2 (RCA VS036) Battery **Net .13**  
 2 Burgess P45 (RCA VS218) Battery @ 2.17 **Net 4.34**

## "JEWEL" REMOTE CONTROL RELAY

A natural for remote control receivers, it is highly sensitive, and built to withstand severe crashes. The smallest commercial job available, it weighs less than 1/2 oz. Factory adjusted to pull in at 1.4 MA. drop out at 1.2 MA D.C. Single pole, double throw. Used in outstanding R/C receivers. 5,000 ohm coil. **IMPORTED TO SAVE YOU MONEY.**

**2.75**

**R-260** — Relay **Net 2.75**

## NEW! MULTI-PURPOSE ELECTRIC SERVO MECHANISM

- POWERFUL, MOTOR DRIVEN R/C ACTUATOR
- POSITIVE, INSTANTANEOUS ACTION
- FOR MODEL BOATS AND CARS

**4.95**

Lafayette's new, motor driven, remote control servo-mechanism. Imported by Lafayette to sell for half the price of any comparable unit! Carefully constructed for power, durability and rugged use. Operates with any single channel, remote control receiver and transmitter. When operated at the prescribed 3 volts, the action is accurate and rapid. Provides for selective steering and automatic return to neutral. Extremely efficient when used with model boats or land vehicles. Hobbyists will find uses for the servo-mechanism restricted only by their imagination. Single pulse operation — electronic neutralization. Measures only 2 1/2" x 2" x 1 1/4" overall. Includes instructions and linkage to extend actuator arm. Shpg. wt., 8 ozs.

**F-327** **Net 4.95**

## REMOTE CONTROL ESCAPEMENT

- AT THE LOWEST PRICE ANYWHERE!

A sturdy 2 arm self-neutralizing escapement. Completely wired (not a kit). Converts electrical impulses from remote control receiver to mechanical motion for varying movement of plane, boat, or car. Four 90° rotations — two by armature activation, two by neutralization. Has ratchet governor for maintaining foolproof rotating speed. Weighs only 7/8 oz. Size: 1-3/8" L x 2" W overall. Shpg. wt., 5 oz.

**F-255** **Net 2.45**

## REMOTE ENGINE CONTROL ESCAPEMENT

Lafayette's exciting new air-bleed self-neutralizing remote engine control. Varies engine speed of your model. Neutral position of one arm is low speed, neutral position of 2nd arm is high speed, and maintained activated position of either arm (armature activated) stops motor. Perfect mate for Lafayette F-256. Compact and weighs only 3/4 oz. Requires 1-1/2 volt battery. Low current drain. Size: 1-5/8" x 1" x 3/4". Shpg. wt., 5 oz.

**F-257** **Net 3.45**

## COMPOUND REMOTE CONTROL ESCAPEMENT

- LAFAYETTE'S AMAZING VALUE IN A 4-ARM SELF-NEUTRALIZING COMPOUND ESCAPEMENT!
- NO NEED TO WORRY ABOUT LOSING YOUR MODEL!

You have no sequence of operation to worry about! Simple as A B C! One pulse always gives right turn; two pulses always gives left turn. Three pulses closes the circuit for the supplementary control such as motor (F-257) or elevator, if used. The rudder always returns to neutral position after any turn as soon as transmitter keying/battery is released. With ratchet governor for foolproof operation. Sturdy construction — low current drain. Uses 1-1/2 volt battery. Weighs 1-1/8 oz. Size: 2-7/8" L x 1-9/16" overall. Shpg. wt., 6 oz.

**F-256** **Net 3.95**

## 27.255 R/C CRYSTAL



Reg. 2.95  
**1.95**

Specially manufactured for Lafayette. Designed specifically for use in R/C model planes, boats, cars, etc. Low-drift — high output — dependable frequency control. Tolerance .04%, 13/16" wide x 7/16" deep x 1 1/8" high above pins. Pins on 1/2" centers.

**MS-446** **Net ea. 1.95**

## MATCHING CRYSTAL SOCKET:

Made of special low loss phenolic. Easily mounts flush or stand-off. Small — light — rugged.

**MS-447** **Net ea. .15**

## miniature TELESCOPING ANTENNA

**.59**

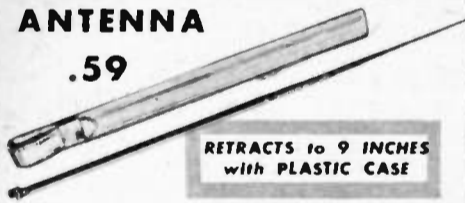

RETRACTS to 9 INCHES with PLASTIC CASE

5-section antenna of chrome-plated brass. Plugs into jack supplied. 38" fully extended and retracts to 9". Comes in a flexible plastic case with slip-under protecting flap. **F-343** Telescoping Antenna **Net 59c**

## LAFAYETTE PNP AUDIO TRANSISTOR

**SPECIAL! 59c**

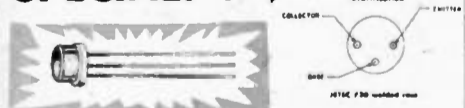

General audio type PNP transistor for experimenters and hobbyists, for code practice oscillators and similar small signal devices. In new JETC 30 welded case.

**SP-146** **Net, singly, each 59c**  
 10 for 4.50, 50 for 19.50, 100 for 37.00

## NEW! MOTOROLA POPULAR LOW COST 2N554 AUDIO POWER TRANSISTOR

**1.35**

- 40 WATT COLLECTOR DISSIPATION\*
- 2 WATT CLASS A OUTPUT\*

FREE with each 2N554 New Motorola Circuit Applications folder on HOW TO BUILD A TRANSISTORIZED AUDIO POWER AMPLIFIER, Power Control, Battery Charger, Model Power Supply, Model Train Control, Toy Electronic Organ, Geiger Counter and DC to DC Converter.  
 \* With Heat Sink

**MK-10** Power transistor mounting kit with teflon coated fiberglass insulating washer. **Net .25**

**MK-15** Same as above, but with mica insulating washer. **Net .25**

**MK-20** As above, but with oxidized aluminum insulating washer. **Net .40**

## POWER TRANSISTORS



Reg. Value 1.35

**77c**

## EACH UNIT FACTORY TESTED TO MEET SPECIFICATIONS

EQUIVALENT TO:

- CBS 2N256
- SYLVANIA 2N307
- MOTOROLA 2N554

**SP-147** Power Transistor **Net .77**

## GENERAL PURPOSE DIODES



**29c** 10 for 2.59  
 Each

## EXCELLENT DETECTOR FOR TRANSISTOR AND VACUUM TUBE RADIO RECEIVERS

EQUIVALENT TO:

- 1N34 1N34A 1N38A
- 1N48 1N56 1N69

**SP-148** General Purpose Diode **Net .29 each**  
 10 for 2.59

## NEW POWER TRANSISTOR AUDIO TRANSFORMERS

- DESIGNED FOR HIGH OUTPUT TRANSISTORS
- USED IN AUTO RADIOS — PA SYSTEMS — INTERCOMS — ETC. OUTPUT TRANSFORMER



Rated 6 watts. Frequency response 70 to 20,000 cycles ± 2 db. Primary impedance, 48 ohms center tapped. Secondary, 3.2 ohms. Primary DC resistance 1.1 ohms, secondary 0.3 ohms. Unbalanced primary current 500 ma DC. Size 1-9/16" x 1-9/16" Shpg. wt., 1 lb.

**AR-503** **Net 1.75**

### INPUT TRANSFORMER

Rated 2 watts. Frequency response 70 to 20,000 cps ± 2 db. Primary impedance 100 ohms. Secondary impedance 200 ohms CT. Primary DC resistance 1.8 ohms, secondary 2.7 ohms. Unbalanced primary current, 200 ma DC. Size 1-9/16" x 1 1/8" x 1-9/16". Shpg. wt., 1 lb.

**AR-504** **Net 1.50**

## NEW! UNIVERSAL POWER TRANSISTOR OUTPUT TRANSFORMER

- DESIGNED FOR THE EXPERIMENTER
- PRI. TAPPED AT 8-12-16-24-32 AND 48 OHMS
- RATED 10 WATTS

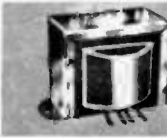

Lafayette's latest transistor circuit component. Engineered for construction projects using the increasingly popular power transistors. Will also serve as a general replacement for many transistorized auto radios. Rated at 10 watts for push-pull operation. Primary tapped at 8, 12, 16, 24, 32 and 48 ohms. Secondary tapped at 4, 8 and 16 ohms. Sizes 3-1/16" x 2 1/4" x 2-9/16". Shpg. wt., 3 lbs.

**TR-94** **Net 3.75**

## DYNAMIC EARPHONES

- FOR TRANSISTOR AND SUBMINIATURE RECEIVERS
- FOR SILENT RADIO AND TV LISTENING.

A sensitive all-purpose earphone designed with both your listening pleasure and pocketbook in mind. Extensive range and excellent tone combine, to provide excellent reproduction. Lightweight, equipped with a practically invisible ear support, that slips comfortably over either ear, from which the earphone can't slip out or fall. Ideal for use with TV and radio sets, amplifiers, miniature and transistor receivers, etc. Attractive unit with shiny chrome finish. Complete with a 3 ft. cord. A super value at this price. Shpg. wt., 5 oz.

**MS-365** 6 ohm impedance, with phone tip plugs. For silent radio or TV listening **Net .98**

**MS-367** 2000 ohm impedance, with phone tip plugs. **Net 1.15**

**MS-366** 6 ohm impedance with subminiature phone plug and matching phone jack **Net 1.19**

**MS-368** 2000 ohm impedance with subminiature phone plug and matching phone jack **Net 1.05**

## COPPER CLAD LAMINATE AT LAFAYETTE'S LOW PRICES!

Finest quality XXXP bakelite base, copper clad boards for printed circuit work.

NO.	DESCRIPTION	NET
MS-510	XXXX Copper Lam.—1 side—9"x12"	1.50
MS-511	XXXX Copper Lam.—1 side—6"x6"	
MS-512	XXXX Copper Lam.—1 side—3"x3"	
MS-513	XXXX Copper Lam.—1 side—2"x2"	
MS-514	XXXX Copper Lam.—1 side—3"x3"	
MS-515	XXXX Copper Lam.—2 sides—9"x12"	1.95
MS-516	XXXX Copper Lam.—2 sides—6"x4 1/2"	.60
MS-517	XXXX Copper Lam.—2 sides—3"x4 1/2"	.40
MS-518	XXXX Copper Lam.—2 sides—2"x4 1/2"	.30
MS-519	XXXX Copper Lam.—2 sides—3"x2 1/2"	.27

## PLASTIC CASE FOR MINIATURE EQUIPMENT

Beautiful pocket sized modern streamlined case with rounded corners and removable snap-on cover. This is an ideal case for that transistorized receiver—or other miniature or subminiature preamplifier, amplifier, oscillator or transmitter. Two pre-drilled apertures, a 2 1/2" diameter opening ideal for Poly Vari-Con tuning capacitor and a 5/16" opening ideal for volume control and switch. In addition, there are two small openings on the side for such internal leads as antenna or earphone. Experimenters, builders and hobbyists will want to stock up on several of these cases at this low bargain price. Size: 4 1/2" x 2 1/2" x 1 1/2". Shpg. wt., 6 oz.

**MS-302** **Net 95c**

## NEW! Lafayette Super-Value Sun Battery QUANTITY LIMITED!

Sensational buy enables Lafayette to offer this famous selenium photocell at a small fraction of its normal price! Approx. 8 MA current output at 100 ft. candles with 55 ohms load! .5 volts open circuit voltage in av. sunlight. 30 MW power output at 100 ft. candles with 1000 ohm load! Truly a super buy for the experimenter, kit builder, etc. With colored pigtail leads. 1 1/2" diam.

**MS-543** **Net 1.47**

## TRANSISTOR OUTPUT TRANSFORMER

Only 3/4" x 3/4" x 1-1/16". 2000 ohm primary to 10 ohm voice coil. Matches most transistor outputs. Shpg. wt., 8 ozs.

**TR-93** **Net 69c**

## SUPER MICRO-MOTORS

- HALF THE WEIGHT—TWICE THE POWER!
- HIGHER SPEED—LOWER DRAIN!
- PERMANENTLY LUBRICATED!
- DOUBLE PERMANENT FERRITE MAGNETS!

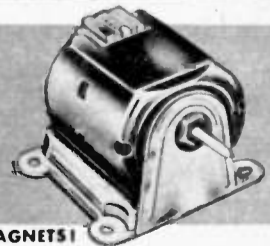

Expertly designed, miniature, D.C. permanent magnet motors. Ruggedized construction for industrial use. Highest power and speed to weight ratio of any miniature motor makes these a "natural" for models and remote control applications. Ferrite magnets preclude possibility of demagnetization and offer minimum weight. Unique, precision formed device permanently centers commutator in precise position. Utilizes phosphor-bronze brushes and brass sleeve bearings. May be mounted by means of motor mount supplied or by means of tapped hole in motor case. Avg. Shpg. wt., 4 oz. Complete with leads. Shaft diameter 3/32"

Stock No.	Volt.	Ordn. No.	RPM	H.	W.	L.	Wt.	NET EA.	LOTS 3 EA.
F-403	1.5-4.5	200-300	5000-6000	1"	1 1/2"	1 1/2"	1 1/4 oz.	.69	.62
F-404	3-6	250-300	6000-7000	1 1/4"	1 3/4"	1 3/4"	2 1/4 oz.	1.10	.98
F-405	1.2-1.6	90-140	8000-9000	1 1/4"	1 3/4"	1 3/4"	2 1/2 oz.	1.39	1.25

# SERVICEMEN AND DEALERS! LOOK AT THESE PRICES!

**LAFAYETTE COMPLETELY WIRED TEST EQUIPMENT**

**SENSATIONAL VALUES AT LESS THAN THE PRICE OF KITS!**

## TV-FM SWEEP-MARKER-ALIGNMENT GENERATOR

- SWEEP RANGE 3MC-260 MC ● MARKER RANGE 3MC-225MC
- CRYSTAL CALIBRATION OF BOTH SWEEP AND MARKER
- COMBINATION CRYSTAL AND VARIABLE MARKER—1% ACCURATE!

A precision instrument that incorporates in a single unit both TV-FM sweep and crystal marker generators with all the features required for accurate alignment of IF and RF stages of TV and FM receivers. Covers 3MC-260MC in 2 bands. Sweep width is continuously variable from 0.12MC or more. 3 volts RMS, 60 cycle sine wave horizontal sweep voltage available from front panel. The marker covers 3MC-225MC in 4 overlapping ranges. Marker calibration is accurate to better than 1%. The 4.5MC crystal supplied mounts on front panel socket and is accurate to 0.002%. RF output is over 100,000 microvolts and is controlled by the 3 step (X1, X10, X100) attenuation and the continuously variable fine adjustment control. Output impedance is 75 ohms, unbalanced. Controls are sweep width, horizontal phase, electronic retrace blanking with off position, marker amplifier, RF output 3 step multiplier, RF output fine adjustment, sweep range selector switch and marker range selector switch. Crystal socket, pilot light and external marker input are also on front panel. Other features include two 5" easy-to-read dials and vernier driven dial pointers. Sturdy gray wrinkle metal cabinet. Convenient handle. Size 9" x 13 1/2" x 6". Shpg. wt., 20 lbs. **MODEL LSG-50**



**SPECIAL PRICE**  
**69.50** *Quantity Limited*  
Completely  
Factory Wired and Tested

Net 79.50

## New! MINIATURE POCKET MULTITESTER

**ONLY 17.50**

- 20,000 Ω/v DC SENSITIVITY
- 10,000 Ω/v AC SENSITIVITY
- 1% RESISTORS
- WEIGHS ONLY 10 oz.
- 38 μA MOVEMENT
- 23 RANGES
- COMPLETELY WIRED



A terrific bargain in an all-round extra sensitive multimeter. Here is the ideal all-purpose multitester for troubleshooting anything electrical or electronic — can be used for repairing automobile wiring, checking ordinary household appliances, such as irons, heaters, and motors; troubleshooting complex electronic equipment in the home, in the shop or in the field. Ideal for TV sets, home radios, high-fidelity sets, amateur gear, commercial communications equipment — wherever a truly portable unit is required. This is a completely wired precision instrument, NOT A KIT. Uses a sensitive, rugged 38 microampere basic meter, a d'Arsonval movement with jeweled bearings providing easy, accurate read-off from its large, clear scales. 2 1/2" meter face. 1% precision resistors guarantee top-notch accuracy. This unit weighs only 10 oz., measures only 4 1/4" x 2 1/4" x 1 1/4" — fits into pocket without bulging, without weighing down. The entire front is protected by a thick, clear sheet of plastic, preventing scratching

and eradicating of switch markings, protecting your meter and preserving its appearance. Single selector switch with positive detents and clearly marked positions permits one-handed operation. Recessed, break-proof zero-ohms knob permits easy adjustment, yet cannot be broken even under rough handling.

Has 23 ranges at the unusually high sensitivities of 20,000 ohms per volt DC, 10,000 ohms per volt AC. DC Volts, 0.5-25-100-500-1000; AC Volts, 0.5-25-100-500-1000; OHMS, 0-6K-600K-6 Meg-60 Meg; DC MILLIAMPERES, 0-.05 (50 microamps) -5-50-500; DECIBELS, -20 to +64 in 5 ranges.

Truly a superb instrument for any application. Complete with 1.5 volt and 15 volt batteries, and vinyl insulated flexible test leads. Shpg. wt. 1 lb.

**AR-660 MINIATURE POCKET VOM**

Net 17.50

## 20,000 OHM PER VOLT MULTITESTER SEMI-KIT



*A New Kind of Kit*

THE DIFFICULT WORK IS ALREADY DONE

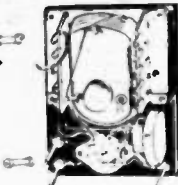

- 20,000 OHMS PER VOLT DC
- 10,000 OHMS PER VOLT AC
- 4D MICROAMPERE 3" D'ARSONVAL METER MOVEMENT

**ONLY 11.95**

The semi-kit is a new concept in test equipment kits. All the important or difficult parts are already mounted. All that remains to be done is to mount and wire in a few small parts — a job so simple you'll finish before you realize it, and best of all, you'll have one of the finest high sensitivity multitesters on the market. When used in a circuit, the high input resistance on all DC and AC ranges does away with the highly inaccurate readings

common to low resistance testers which load the circuit. Ranges: DC Volts, 0.10-50-250-500-1000; AC Volts, 0.10-50-250-500-1000; DC CURRENT, 0-500 ua, 0.10-250 ma; OHMS, 0.10K-100K-1 meg; DECIBELS, -20 to +36; PLUS 0-5000 henries and 250 mfd. to .02 mfd. Black case 5 1/4" x 3 3/4" x 1 1/4". Complete with test leads, all parts, and instructions and battery. Shpg. wt. 3 lbs. **TK-10 KIT**

Net 11.95

## HIGH SENSITIVITY MULTITESTER 20,000 OHM PER VOLT DC 10,000 OHM PER VOLT AC



LOOK AT THESE FULL SCALE RANGES!  
D.C. Volts: 0-6; 0-30; 0-120; 0-600; 0-1200; 0-6000 Volts — A.C. VOLTS: 0-6; 0-30; 0-120; 0-600; 0-1200 Volts — RESISTANCE: 0-10K; 0-100K; 0-1 Meg; 0-10 Megohms — D.C. CURRENT: 0-60 Microamp; 0-6; 0-60; 0-600 Milliamperes — DECIBELS: 20 to +37 db (0 db = -0.774V) — CAPACITY: .0001-.01; .005-15 mfd — INDUCTANCE: 20-2000 henries — OUTPUT RANGES: 0-6; 0-30; 0-120; 0-600; 0-1200 Volts

The new Lafayette high sensitivity Multitester is a complete instrument (not a kit). In addition to its unusual sensitivities of 20,000 OHMS PER VOLT DC and 10,000 OHMS PER VOLT AC, it has a scope

## EDGE-WISE PANEL METERS

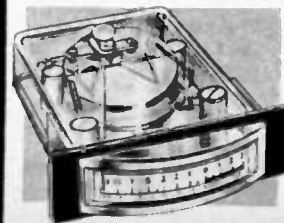

- 2% FULL SCALE ACCURACY
- PRECISION D'ARSONVAL MOVEMENTS
- FRONT PANEL AREA ONLY 3 1/4" x 1"

Precision D'Arsonval meters with 2% or better full scale accuracy. Front panel dimension is 3/4" x 1". Overall depth is 3/4" behind panel including terminals. Zero adjust screw. Shpg. wt., 1/2 lbs.

**VU METER**—Calibrated and damped in accordance with standard VU meter practice. Upper scale reads -20 to +3 VU. Lower scale reads 0-100% modulation. Accuracy from 30-15,000 cps.

Net 5.95

## A LAFAYETTE SPECIAL TUBE TESTER!

**COMPLETELY WIRED — NOT A KIT**

- MOST ADVANCED ENGINEERING TO FIT SERVICEMAN'S NEEDS



A new streamlined tube tester with a realistic approach to the problem of quickly testing the ever increasing number of tube types. It incorporates new and advanced engineering features and all at a price of about half of even the most ordinary tube tester. Read these Specifications.

**"FREE POINT" ELEMENT SELECTOR SWITCHING:** Newly designed, it reduces possibility of obsolescence to a minimum because any pin may be used as a filament pin and voltage applied between it and any other pin, or even the "top cap". Tubes with tapped filaments or with filaments terminating in more than 1 pin are truly tested.

**MULTIPURPOSE TUBES:** Special isolating circuit allow each section of multi-purpose tubes to be tested individually as if it were in a separate envelope.

**SHORTS AND LEAKAGES:** Supersensitive method checks shorts and leakages up to 5 megohm between any and ALL elements; continuity between various sections individually.

Fast simple

# LAFAYETTE is your HEADQUARTERS for TV ANTENNAS AND ACCESSORIES!

try to BEAT these ANTENNA PRICES!

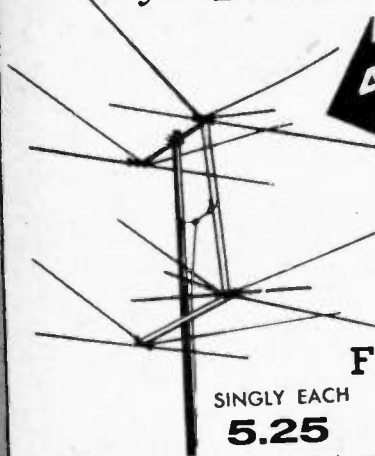

in lots of 3  
**4.95**  
EACH

REGULAR LIST **13.45**

OVER 60% OFF!

- ALL ALUMINUM
- NO LOOSE PARTS
- FASTEST INSTALLATIONS

**FULL 20 ELEMENT STACKED**  
**Snap Open Conical**

SINGLY EACH  
**5.25**

Best antenna deal yet for servicemen-dealer and installation specialists. All the most wanted features. Quickest-easiest installation possible. No loose hardware. All elements snap open and lock in without tools. Most efficient conical design for all reception areas. Two complete bays with Q bars, less mast. Shpg. wt., 8 lbs. Via Express only. **4.95**

- AN-28—Singly, ea. **5.25** Lots of 3, ea. **4.95**
- "U-INSTALL-IT" KIT With All Angle Roof Mounts. Includes AN-28 antenna and installation kit as shown with two 5 ft. masts. **Net 7.95**
- AN-32—Via Express only. Shpg. wt., 18 lbs. **Net 8.75**
- "U-INSTALL-IT" KIT With Chimney Mount. Same antenna and accessories but includes chimney mount instead of roof mount. **Net 8.75**
- AN-43—Via Express only. Shpg. wt., 18 lbs. **Net 8.75**

## FAMOUS BRAND Color 'Tenna

PRICE BREAK — Over 50% Off!

LIST **29.95**

**SALE 13.95!**

Gold Anodized

- High Gain On All VHF Channels
- Completely Factory Preassembled
- Electronic Lens Design
- Highly Directional — Yagi Performance

Lafayette is the FIRST to offer this nationally tried and proven antenna at close to 25% off the regular dealer price. This is the same fine antenna—with all its exclusive features—that sells for dollars more than our record-breaking price. Check these features: Electronic Focusing—High Gain—all VHF channel coverage—gold-anodized quality construction—easiest installation—outstanding fringe area reception—compact design dynamically balanced. All-aluminum construction—automatic hardware. Shpg. wt., 8 lbs. Via Express only.

- AN-51 List 29.95 **Net 13.95**
- Net ea. in lots of 3, **13.25**
- Complete Kit of AN-51 antenna plus AM-12 mtg. kit as shown. Shpg. wt., 15 lbs. **Net 16.30**
- AN-52 **Net 16.30**

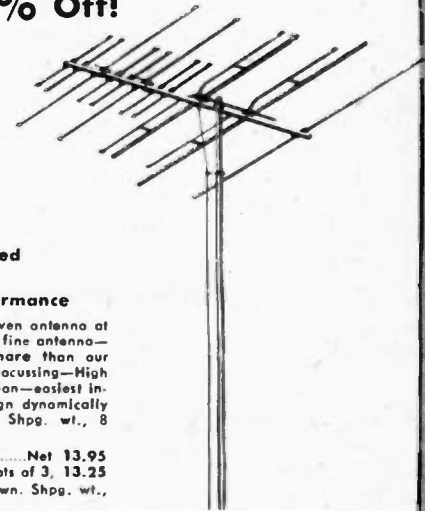

### "U-INSTALL-IT" KITS!

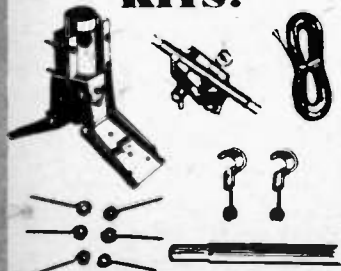

All the accessory items necessary to do a quick, easy installation from roof to receiver! You get on all angle roof mount—lightning arrester—75 feet of 300 ohm twin lead—6 insulated screw eyes—2 insulated mast standoffs and a 5 ft., 1 1/2" OD steel mast. Shpg. wt., 7 lbs.

- AM-10, ea. **2.95** Lots of 3, ea. **2.85**
- AM-11 with 2—5 ft. masts. Shpg. wt., 10 lbs. Singly, **3.55** Lots of 3, ea. **3.35**
- AM-12—Same as AM-10 but with chimney mount. Ea. **3.25** Lots of 3, ea. **3.15**
- AM-13—Same as AM-11 but with

### LAFAYETTE LEADER KITS



**2.60**

Antenna Only

- 8 Element Conical (A): All-aluminum 8 element conical. Full sized. Rugged insulator block. Designed for rapid assembly. Fan front of 6 full length elements. Real value. Shpg. wt., 4 lbs. AN-11 Singly, ea. **2.60** Lots of 3, ea. **2.40**
- "U-Install-It" Kit: Includes AN-11 and roof-mount kit as shown with one 5 ft. mast. Shpg. wt., 11 lbs. AN-33 **Net 4.95**
- "U-Install-It" Kit: With chimney-mount instead of roof-mount. Shpg. wt., 11 lbs. AN-44 **Net 5.50**
- Yee Beam (B): Popular primary area antenna. Rugged aluminum construction. Light weight—easiest to install. Sharply directional. Shpg. wt., 4 lbs. AN-21 **Net 2.29** AN-20 2 Bays stacked **Net 4.59**
- "U-Install-It" Kit: Includes AN-21 and roof-mount kit as shown. Shpg. wt., 11 lbs. AN-45 **Net 4.59**
- "U-Install-It" Kit: With chimney-mount instead of roof-mount. Shpg. wt., 11 lbs. AN-46 **Net 4.59**

**2.29**

Antenna Only

SPECIAL TUBULAR AIR-SPACE

### LEADER INDOOR ANTENNAS

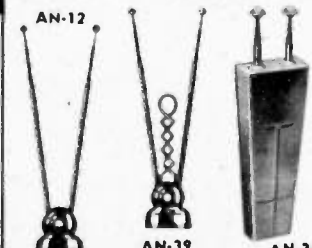

- AN-12
- AN-39
- AN-35
- 3 Section Indoor Antenna (a): Adjustable indoor antenna. 3 section aluminum staffs. Heavy, crackle finish base. Complete with 300r twin lead. Shpg. wt., 2 1/2 lbs. AN-12 Singly, ea. **1.15** In lots of 3, ea. **.99**

Switch Type Indoor Antenna (b): Indoor—6 position switch and crisscross phasing element. UHF-FM. 3 section ball

### SUPER FRINGE AREA ANTENNA

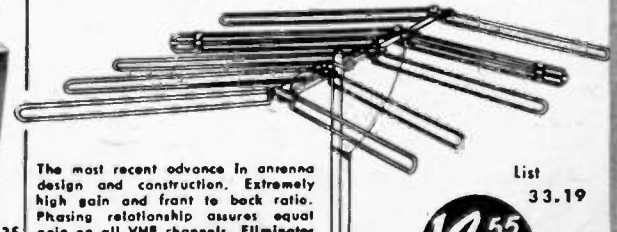

The most recent advance in antenna design and construction. Extremely high gain and front to back ratio. Phasing relationship assures equal gain on all VHF channels. Eliminates co-channel interference. Elements are double locked in high impact Styrene plastic insulators. Automatic bracket lock and secure all elements. Completely preassembled. Entire antenna snap open and locks in. Dual insulators prevent waver, slip and twist of elements. All aluminum construction. Single bay. Less mast. Shpg. wt., 12 lbs.

List **33.19**  
**14.55**  
ea.

• THE MAXIMUM ANTENNA FOR YOUR AREA.  
• MAXIMUM CONSTRUCTION

# SERVICEMEN AND DEALERS! LOOK AT THESE PRICES!

**LAFAYETTE COMPLETELY WIRED TEST EQUIPMENT**

**SENSATIONAL VALUES AT LESS THAN THE PRICE OF KITS!**

## TV-FM SWEEP-MARKER-ALIGNMENT GENERATOR

- SWEEP RANGE 3MC-260 MC
- MARKER RANGE 3MC-225MC
- CRYSTAL CALIBRATION OF BOTH SWEEP AND MARKER
- COMBINATION CRYSTAL AND VARIABLE MARKER—1% ACCURATE!

A precision instrument that incorporates in a single unit both TV-FM sweep and crystal marker generators with all the features required for accurate alignment of IF and RF stages of TV and FM receivers. Covers 3MC-260MC in 2 bands. Sweep width is continuously variable from 0.12MC or more. 3 volts RMS, 60 cycle sine wave horizontal sweep voltage available from front panel. The marker covers 3MC-225MC in 4 overlapping ranges. Marker calibration is accurate to better than 1%. The 4.5MC crystal supplied mounts on front panel socket and is accurate to 0.002%. RF output is over 100,000 microvolts and is controlled by the 3 step (X1, X10, X100) attenuation and the continuously variable fine adjustment control. Output impedance is 75 ohms, unbalanced. Controls are sweep width, horizontal phase, electronic retrace blanking with off position, marker amplifier, RF output 3 step multiplier, RF output fine adjustment, sweep range selector switch and marker range selector switch. Crystal socket, pilot light and external marker input are also on front panel. Other features include two 5" easy-to-read dials and vernier driven dial pointers. Sturdy gray wrinkle metal cabinet. Convenient handle. Size 9" x 13 1/2" x 6". Shpg. wt., 20 lbs. MODEL LSG-50



**SPECIAL PRICE**  
**69.50** Quantity Limited  
Completely Factory Wired and Tested

Net 79.50

## 20,000 OHM PER VOLT MULTITESTER SEMI-KIT



**A New Kind of Kit**

- 20,000 OHMS PER VOLT DC
- 10,000 OHMS PER VOLT AC
- 40 MICROAMPERE 3" D'ARSONVAL METER MOVEMENT

**ONLY 11.95**

The semi-kit is a new concept in test equipment kits. All the important or difficult parts are already mounted. All that remains to be done is to mount and wire in a few small parts — a job so simple you'll finish before you realize it, and best of all, you'll have one of the finest high sensitivity multitesters on the market. When used in a circuit, the high input resistance on all DC and AC ranges does away with the highly inaccurate readings

common to low resistance testers which load the circuit. Ranges: DC Volts, 0-10-50-250-500-1000; AC Volts, 0-10-50-250-500-1000; DC CURRENT, 0-500 ua, 0-10-250 ma; OHMS, 0-10K-100K-1 meg; DECIBELS, -20 to +36; PLUS 0-5000 henries and 250 mhf. to 02 mfd. Black case 5 1/4" x 3 1/4" x 1 7/8". Complete with test leads, all parts, and instructions and battery. Shpg. wt. 3 lbs. TK-10 KIT

Net 11.95



## New! MINIATURE POCKET MULTITESTER

**ONLY 17.50**

- 20,000  $\Omega/v$  DC SENSITIVITY
- 10,000  $\Omega/v$  AC SENSITIVITY
- 1% RESISTORS
- WEIGHS ONLY 10 oz.
- 38  $\mu A$  MOVEMENT
- 23 RANGES
- COMPLETELY WIRED

A terrific bargain in an all-round extra sensitive multitester. Here is the ideal all-purpose multitester for troubleshooting anything electrical or electronic — can be used for repairing automobile wiring, checking ordinary household appliances, such as irons, heaters, and motors; troubleshooting complex electronic equipment in the home, in the shop or in the field. Ideal for TV sets, home radios, high-fidelity sets, amateur gear, commercial communications equipment — wherever a truly portable unit is required. This is a completely wired precision instrument, NOT A KIT. Uses a sensitive, rugged 38 microampere basic meter, a d'Arsonval movement with jewelled bearings providing easy, accurate read-off from its large, clear scales. 2 1/2" meter face. 1% precision resistors guarantee top-notch accuracy. This unit weighs only 10 oz., measures only 4 1/2" x 2 1/2" x 1 1/4" — fits into pocket without bulging, without weighing down. The entire front is protected by a thick, clear sheet of plastic, preventing scratching

and eradicating of switch markings, protecting your meter and preserving its appearance. Single selector switch with positive detents and clearly marked positions permits one-handed operation. Recessed, break-proof zero-ohms knob permits easy adjustment, yet cannot be broken even under rough handling.

Has 23 ranges of the unusually high sensitivities of 20,000 ohms per volt DC, 10,000 ohms per volt AC; DC Volts, 0-5-25-100-500-1000; AC Volts, 0-5-25-100-500-1000; OHMS, 0-6K-600K-6 Meg-60 Meg; DC MILLIAMPERES, 0-.05 (50 microamps) -5-50-500; DECIBELS, -20 to +64 in 5 ranges.

Truly a superb instrument for any application. Complete with 1.5 volt and 15 volt batteries, and vinyl insulated flexible test leads. Shpg. wt. 1 lb. AR-660 MINIATURE POCKET VOM

Net 17.50

## HIGH SENSITIVITY MULTITESTER 20,000 OHM PER VOLT DC 10,000 OHM PER VOLT AC



**19.95**

### LOOK AT THESE FULL SCALE RANGES!

- DC Volts: 0-6; 0-30; 0-120; 0-600; 0-1200; 0-6000 Volts A.C. VOLTS: 0-6; 0-30; 0-120; 0-600; 0-1200 Volts — RESISTANCE: 0-10K; 0-100K; 0-1 Meg; 0-10 Megohms — D.C. CURRENT: 0-60 Microamps; 0-6; 0-60; 0-600 Millamps — DECIBEL: 20 to +36 db (0 db = 0.774V) — CAPACITY: 0.001-.01; .005-.15 mfd — INDUCTION: 20-2000 henries — OUTPUT RANGES: 0-6; 0-30; 0-120; 0-600; 0-1200 Volts

The new Lafayette high sensitivity Multitester is a complete instrument (not a kit). In addition to its unusual sensitivity of 20,000 OHMS PER VOLT ON D.C. AND 10,000 OHMS PER VOLT ON A.C., and the extraordinary number and range of its ranges, it is packed with features that would make it cost at least twice as much if made in this country. Uses 1% precision resistors, silver contacts on selector switch, 35 un 3" meter. Dependable, rugged and accurate. Even the test leads are heavy duty with high voltage insulation. Voltage source required for low capacity range is 120V A.C. for high range capacity and inductance range is 6V A.C. Attractive plastic front with metal bottom. Size 6 1/4" x 4 1/4" x 2 1/4". Complete with batteries and leads. Shipping weight 4 1/2 lbs. Specially. Each 19.95 In lots of 3, Each 19.25

Net 19.95

## EDGE-WISE PANEL METERS

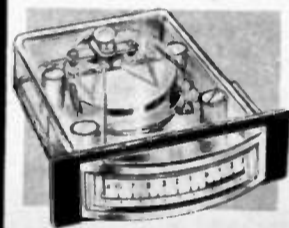

- 2% FULL SCALE ACCURACY
- PRECISION D'ARSONVAL MOVEMENTS
- FRONT PANEL AREA ONLY 3/4" x 1"

Precision D'Arsonval meters with 2% or better full scale accuracy. Front panel dimension is 3/4" x 1". Overall depth is 3/4" behind panel including terminals. Zero adjust screw. Shpg. wt., 1/4 lbs. VU METER—Calibrated and damped in accordance with standard VU meter practice. Upper scale reads -20 to +3 VU. Lower scale reads 0-100% modulation. Accuracy to  $\pm 0.5$  VU from 30-15,000 cps.

- TM-23 0-150 AC VOLT-METER—Full wave bridge rectifier type. 1000 ohms per volt. 5 volts per division, linear scale. Net 5.95
- TM-22 0.1 DC MILLIAMMETER—CALIBRATED from 0.1 to 0.02 ma. divisions. Black scale, red pointer. Net 5.69
- TM-21

Net 5.69

## A LAFAYETTE SPECIAL TUBE TESTER!

- COMPLETELY WIRED — NOT A KIT
- MOST ADVANCED ENGINEERING TO FIT SERVICEMAN'S NEEDS



**26.95**

A new streamlined tube tester with a realistic approach to the problem of quickly testing the ever increasing number of tube types. It incorporates new and advanced engineering features and all at a price of about half of even the most ordinary tube tester. Read these Specifications.

"FREE POINT" ELEMENT SELECTOR SWITCHING: Newly designed, it reduces possibility of obsolescence to a minimum because any pin may be used as a filament pin and voltage applied between it and any other pin, or even the "top cap". Tubes with tapped filaments or with filaments terminating in more than 1 pin are truly tested.

MULTIPURPOSE TUBES: Special isolating circuit allow each section of multi-purpose tubes to be tested individually as if it were in a separate envelope.

SHORTS AND LEAKAGES: Supersensitive method checks shorts and leakages up to 5 megohm between any and ALL elements; continuity between various sections of tubes indicated.

SIMPLICITY: Simple operation. The 4 position fast action snap switches are all numbered in exact accord with RMA standards. Thus when testing element terminating in pin No. 7 of a tube — you use button No. 7. You can't insert a tube in the wrong socket—there's one for each type of tube base.

TUBE TYPES: Tests all octal, octal, 7 pin miniature, 9 pin miniature as well as the new novel and Sub-Minor types. Old type sockets used for testing obsolete types—that you rarely see anymore—have been eliminated.

SIZE: A practical size to carry with you as well as for use in the shop—only 8 1/2" x 6 1/2" x 2 1/2". Shpg. Wt. 5 lbs. MODEL TD-55—complete with carrying case and instructions. Net 26.95

## SQUARE PANEL METERS

- HIGH QUALITY D'ARSONVAL MOVEMENTS
- ACCURACY 2% OF FULL SCALE
- 3/4" SQ., ONLY 1-5/16" OVERALL BEHIND PANEL
- BAKELITE CASES ● JEWELLED BEARINGS

High quality, precision built meters with better than 2% of full scale accuracy. 3/4" square, 2-5/16" x 1 1/2" dial faces, 1-11/16" overall depth, 1-5/16" behind panel including terminals. Require 2 9/16" diameter mounting hole. 1/4" screw terminals plus solder lugs. 4 threaded mounting studs in corners. Zero adjust screw. Shpg. wt., 1 lb.

- ILLUMINATED SCALE VU METER — Standard 3900 ohm "B" scale volume indicator calibrated and damped in accordance with standard VU meter practice. Upper scale reads 0-100% modulation, lower scale reads -20 to +3 VU (0 VU corresponds to 100%) Accurate to  $\pm 0.2$  VU from 35-1000 cps.  $\pm 0.5$  VU from 30-15,000 cps. With suddenly applied sine wave signal, meter will reach 99% of correct reading within 0.3 seconds; overshoot beyond correct reading is 1 to 1 1/2%. A root-mean-square instrument with full wave bridge rectifier. Includes built-in 6.8 volt bulb. Complete with instructions. Net 7.50
- TM-8D
- 0-50 DC MICROAMMETER — Highly damped, sensitive movement, calibrated in 50 one-microamp linear scale divisions. Cushioned ceramic bumpers protect pointer against overtravel and damage with moderate overloads. Red pointer. Net 7.50
- TM-70
- 0-1 DC MILLIAMETER — Sensitive, quick-acting basic movement. Linear calibrations in 0.2 ma. divisions. Black scale, red pointer. Net 3.95
- TM-60
- 0-150 AC VOLT-METER — Full wave bridge rectifier type 1000 ohms per volt. With precision carbon-film multiplier resistor. 5 volts per division, linear scale. Net 3.95
- TM-50

## METER RECTIFIER

A brand new, economical meter rectifier of exceptionally linear characteristics. This full wave rectifier is specially designed as a universal replacement for all modern multitesters, such as Lafayette's miniature V.O.M.'s. Simple to install, mounts with single screw. Long terminals facilitate easy connection. Net 4.5

RE-22

## Miniature PANEL METERS

- D'ARSONVAL MOVEMENTS
- BAKELITE CASES ● JEWELLED BEARINGS
- ONLY 1-9/16" SQ. FACES, 1/4" OVERALL BEHIND PANEL ● ACCURACY 2% OF FULL SCALE

UNUSUALLY LOW PRICED FOR SUCH EXCELLENT QUALITY! Ruggedly built miniature panel meters, with excellent accuracy. 1 1/2" dial faces, with silvered dials and black numerals and pointers. Accuracy 2% of full scale. 1-9/16" square faces, 1/4" overall front-to-back, with 1/4" behind panel including 1/4" terminals. Require 1 1/2" diameter round hole in panel. 4 corner holes for mounting, with 1/4" centers. Terminal polarity on DC models clearly marked. Screw terminals. Zero adjustment screw on front of panel. Clear optical glass fronts. Shpg. wt., 8 oz.

- VU METER — Volume level indicator, calibrated in standard -20 to +3 VU and 0-100% ranges. Uses precision carbon film multiplier resistor and full wave rectifier. Damped in accordance with standard VU meter requirements. Reference level 1 mw in 600 ohm line, 10,000 ohms internal resistance. "0" VU is 1.225 volts sine wave AC across meter connected to 600 ohm source with 600 ohm load. May be used with T-pad attenuator. 0-100% scale used to indicate percent use of transmitter output. Net 3.95
- TM-10

- "S" METER — Standard "ham" signal strength indicator. Calibrated in "S" units from 0-9, with the scale terminating in +10 and +30 db calibrations. Additional full scale calibrations of 0.5 and 0.10 in linear scale divisions. A "must" for radio amateurs for conversion of any communications receiver with AVC action to give calibrated signal strength indications. Use of "S" meter fully described in 1958 "Radio Amateur's Handbook" (Lafayette stock No. BK-1000), pages 106-107. Net 3.95
- TM-11

- DC MILLIAMMETERS
- TM-400 0.1 DC MILLIAMPERES Net 3.75
- TM-401 0.5 DC MILLIAMPERES Net 3.75
- TM-402 0.50 DC MILLIAMPERES Net 3.75
- TM-403 0.100 DC MILLIAMPERES Net 3.75
- DC MICROAMMETER
- TM-200 0.50 DC MICROAMPERES Net 4.95
- AMMETERS
- TM-510 50-0.50 DC AMPERES Net 3.95
- TM-511 0.10 DC AMPERES Net 3.95
- R. F. AMMETER
- TM-300 0.5 RF AMPERES Net 3.95

- VOLTMETERS
- TM-100 0-15 DC VOLTS Net 3.75
- TM-101 0-200 DC VOLTS Net 3.75
- TM-300 0-150 AC VOLTS Net 3.75
- TM-301 0-300 AC VOLTS Net 3.75

## FAMOUS RCA VOLTOHMYST IN KIT FORM

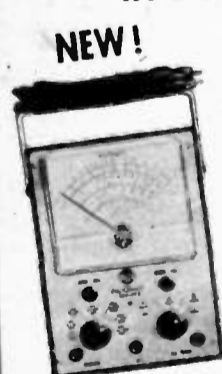

**ONLY 29.95!**  
**49.95** Wired

**ONLY 3.00 DOWN**

- BURNOUT-PROOF
- 28 RANGES
- FAMED WV-77E VOLTOHMYST VTVM
- $\pm 3\%$  ACCURACY ON DC
- RESPONSE  $\pm 5\%$ , 40 CPS to 5 MC.
- DC INPUT 11 MEG.

This new kit makes possible substantial savings in a high quality vacuum-tube voltmeter. Its 28 ranges include 7 DC voltages: 0-1.5, 5, 15, 50, 150, 500, 1500, with  $\pm 3\%$  of full scale accuracy and input resistance of 11 megohms; 7 rms AC voltages: 0-1.5, 5, 15, 50, 150, 500, 1500, with  $\pm 5\%$  of full scale accuracy; 7 peak-to-peak AC voltages: 0-4, 14, 40, 140, 400, 1400, 4000 volts, with 5% accuracy; 7 overlapping ohms ranges from 0.2 ohms to 1000 megohms with center-scale values of 10, 100, 1000, 10K, 100K, 1 meg, and 10 meg. ohms. Other important features include zero-center for discriminator alignment; frequency response of 40 cps to 5 mc. flat to within  $\pm 5\%$  on the 1.5 to 15 volt rms and 4 to 40 volt p-p ranges; 1% deposited-carbon resistors; meter electronically protected against burnout and ohms ranges fused; cables can be stored in sleeve on handle; meter scales color coded to match range switch; shielded by metal case, and etched front-panel lettering. Tubes are 6AL5 and 12AU7. Power requirement is 5 watts at 105-125 v., 50-60 cps AC and VS035 battery. Supplied complete with DC and AC/ohms probes and cables and ground leads, battery, and instruction book. Shpg. wt., 5 1/2 lbs.

RCA WV-77E(K) VoltOhmyst Kit Net 29.95  
WV-77E Some, completely wired and factory-calibrated Net 49.95

# LAFAYETTE is your HEADQUARTERS for TV ANTENNAS AND ACCESSORIES!

try to BEAT these ANTENNA PRICES!

in lots of 3  
**4.95**  
EACH

REGULAR LIST **13.45**  
OVER 60% OFF!

- ALL ALUMINUM
- NO LOOSE PARTS
- FASTEST INSTALLATIONS

FULL 20 ELEMENT STACKED  
Snap Open Conical

SINGLY EACH  
**5.25**

Best antenna deal yet for servicemen-dealer-and installation specialists. All the most wanted features. Quickest-easiest installation possible. No loose hardware. All elements snap open and lock in without tools. Most efficient conical design for all reception areas. Two complete bays with Q bars, less mast. Shpg. wt., 8 lbs. Via Express only. **4.95**  
AN-28—Singly, ea. **5.25** Lots of 3, ea. **4.95**  
"U-INSTALL-IT" KIT With All Angle Roof Mounts. Includes AN-28 antenna and installation kit as shown with two 5 ft. masts. **Net 7.95**  
AN-32—Via Express only. Shpg. wt., 18 lbs. **Net 8.75**  
"U-INSTALL-IT" KIT With Chimney Mount. Same antenna and accessories but includes chimney mount instead of roof mount. **Net 8.75**  
AN-43—Via Express only. Shpg. wt., 18 lbs. **Net 8.75**

## FAMOUS BRAND Color 'Tenna

PRICE BREAK — Over 50% Off!

LIST **29.95**

**SALE 13.95!**

Gold Anodized

- High Gain On All VHF Channels
- Completely Factory Preassembled
- Electronic Lens Design
- Highly Directional — Yagi Performance

Lafayette is the FIRST to offer this nationally tried and proven antenna at close to 25% off the regular dealer price. This is the same fine antenna—with all its exclusive features—that sells for dollars more than our record-breaking price. Check these features: Electronic Focusing—High Gain—all VHF channel coverage—gold-anodized quality construction—easiest installation—outstanding fringe area reception—compact design dynamically balanced. All-aluminum construction—automatic hardware. Shpg. wt., 8 lbs. Via Express only. **Net 13.95**  
AN-51 List **29.95** **Net 13.95**  
Complete Kit of AN-51 antenna plus AM-12 mtg. kit as shown. Shpg. wt., 15 lbs. **Net ea. in lots of 3, 13.25**  
AN-52 **Net 16.30**

### "U-INSTALL-IT" KITS!

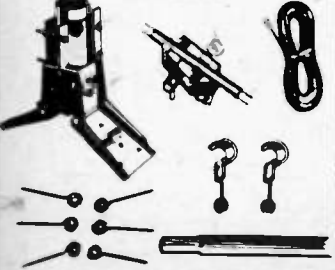

All the accessory items necessary to do a quick, easy installation from roof to receiver! You get an all angle roof mount—lightning arrester—75 feet of 300 ohm twin lead—6 insulated screw eyes—2 insulated mast standoffs and a 5 ft., 1 1/2" OD steel mast. Shpg. wt., 7 lbs.

- AM-10, ea. **2.95** Lots of 3, ea. **2.85**
- AM-11 with 2-5 ft. masts. Shpg. wt., 10 lbs. Singly, **3.55** Lots of 3, ea. **3.35**
- AM-12—Same as AM-10 but with chimney mount. Ea. **3.25** Lots of 3, ea. **3.15**
- AM-13—Same as AM-11 but with chimney mount. Ea. **3.85** Lots of 3, ea. **3.75**

### LAFAYETTE LEADER KITS



**2.60**

Antenna Only

**2.29**

Antenna Only

**COMPLETE From roof to receiver**  
8 Element Conical (A): All-aluminum 8 element conical. Full sized. Rugged insulator block. Designed for rapid assembly. Fan front of 6 full length elements. Real value. Shpg. wt., 4 lbs. AN-11...Singly, ea. **2.60** Lots of 3, ea. **2.40**  
"U-Install-It" Kit: Includes AN-11 and roof-mount kit as shown with one 5 ft. mast. Shpg. wt., 11 lbs. AN-33...Singly, ea. **4.95** Lots of 3, ea. **4.70**  
"U-Install-It" Kit: With chimney-mount instead of roof-mount. Shpg. wt., 11 lbs. AN-44...Singly, ea. **5.50** Lots of 3, ea. **5.25**  
Vee Beam (B): Popular primary area antenna. Rugged aluminum construction. Light weight—easiest to install. Sharply directional. Shpg. wt., 4 lbs. AN-21...Singly, ea. **2.29** AN-20 2 Bays stacked...Singly, ea. **4.59** Lots of 3, ea. **4.29**  
"U-Install-It" Kit: Includes AN-21 and roof-mount kit as shown with one 5 ft. mast. Shpg. wt., 11 lbs. AN-45...Singly, ea. **4.70** Lots of 3, ea. **4.45**  
"U-Install-It" Kit: With chimney-mount instead of roof-mount. Shpg. wt., 11 lbs. AN-46...Singly, ea. **5.29** Lots of 3, ea. **5.04**

### SPECIAL TUBULAR AIR-SPACED TWIN LEAD

UHF-VHF • Extreme Low Loss  
300 ohm airspaced tubular lead with copperweld conductors. Shpg. wt., 3 lbs. per 100 ft. **2.50**  
WR-46—per 100 ft. **2.50**

### LEADER INDOOR ANTENNAS

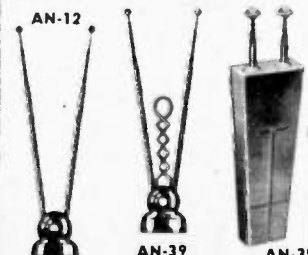

AN-12  
AN-39  
AN-35  
3 Section Indoor Antenna (a): Adjustable indoor antenna. 3 section aluminum staffs. Heavy, crackle finish base. Complete with 300r twin lead. Shpg. wt., 2 1/2 lbs. AN-12...Singly, ea. **1.15** Lots of 3, ea. **.99**  
Switch Type Indoor Antenna (b): Indoor—6 position switch and crisscross changing elements. For VHF UHF-FM. 3 section brass elements. Base housing. With 300r lead in wire. Shpg. wt., 3 lbs. AN-39...Singly, ea. **1.99** Lots of 3, ea. **1.79**  
PORTA-TENNA (c): A universal antenna for portable and stationary TV sets. When not in use dipoles disappear. Can be placed on back of any TV set. 3 section, plated, telescoping dipoles. Complete with instructions, mounting hardware and lead in. Shpg. wt., 2 lbs. AN-35...Singly, ea. **1.59** Lots of 3, ea. **1.49**

### SUPER FRINGE AREA ANTENNA

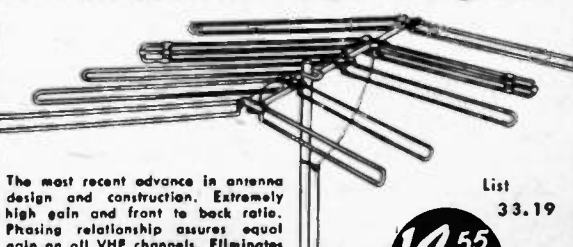

The most recent advance in antenna design and construction. Extremely high gain and front to back ratio. Phasing relationship assures equal gain on all VHF channels. Eliminates co-channel interference. Elements are double locked in high impact Styrene plastic insulators. Automatic brackets lock and secure all elements. Completely preassembled. Entire antenna snaps open and locks in. Dual insulators prevent waver, slip and twist of elements. All aluminum construction. Single bay. Less mast. Shpg. wt., 12 lbs. **List 33.19**  
**14.55** ea.

AN-37 List **33.19** **Net 14.55**  
AN-38 2 Bays stacked...**Net 29.58** **ON EACH CHANNEL**  
"U-Install-It" kit: Includes AN-37 and installation kit as shown with one 5 ft. mast. Shipping wt., 20 lbs. AN-40...**Net 16.95**  
Stacked Kit: Includes AN-38 and installation kit with two 5 ft. masts. Shipping wt., 32 lbs. AN-41...**Net 32.69**  
AN-37, 38 and 41 Shipped by Express Only!

### NEW WUERTH SURGISTOR

combines functions of RESISTOR and RELAY!

Designed to prolong tube life in TV receivers. Connect directly into the power line circuit of electronic devices. Protects tube filaments, electrolytics, rectifiers, etc. from destructive surge voltages and currents. Starting resistance, 100 ohms. Normal resistance, 0.2 ohms. Circuit power range 100-300 watts. Time delay approximately 10 seconds. Shpg. wt., 6 oz. TS-263...Each, **Net .99** Quantity of 10 or more Each, **Net .90**  
FOR COLOR TV  
Specially engineered for Color TV sets, the COLOR SURGISTOR slashes expensive Color TV tube replacement costs. Guarantees longer picture tube life too. 250-400 WATTS: 117 VOLTS, AC-DC. TS-290—List Price 1.95...**Net 1.15**

### BLONDER-TONGUE UNIVERSAL BOOSTER & COUPLER

BOOSTS SIGNAL FOR 1, 2, OR 3 TV SETS  
COUPLES 1, 2, OR 3 TV SETS WITH 1 ANTENNA  
WORKS WITH ALL TV SETS—IDEAL FOR COLOR TV  
PERFECT FOR MULTIPLE DWELLINGS  
FIXED TUNED-CHANNELS 2-13  
HANG IT ON REAR OF SET AND FORGET IT!

Made by the leading manufacturer of television amplifying equipment, this flexible combination television booster and 3-set coupler is a fine example of advanced engineering design and construction. It provides improved home TV reception without the need for tuning or adjustments. Simply make connections to convenient screw terminals, hang it on the back of the TV set, and forget it. Automatically amplifies channels 2 through 6 more than 6 db; channels 7 through 13 more than 2 db. Input for standard 300 ohm balanced antenna. Outputs for 1, 2 or 3 TV sets, 300 ohm balanced. Low noise figure—works well with all latest types of TV sets and reduces interference. Amplifies the signal on 1 or 2 TV sets, whether one or both are operating. Permits use of 1 antenna on up to 3 TV sets—outperforms all non-powered couplers by more than 2 to 1. Size 6 1/4" x 3 3/4" x 2 1/2". Uses 6BK7A or 6BK7B tube. For 117 volts. 60 cps AC. Shpg. wt., 2 lbs. BLONDER-TONGUE B-23 List Price 23.95...**Net 14.95**

STEEL GUY WIRE Six strands of No. 20 high tensiled strength galvanized steel wire. For any guy application. An excellent buy. WR-28-50 ft. roll (Shpg. wt., 1 1/2 lbs.) **Net .35**  
WR-29-100 ft. roll (Shpg. wt., 2 lbs.) **Net .59**  
WR-30-500 ft. roll (Shpg. wt., 12 lbs.) **Net 2.78**

ZUB2 1/4. All Angle Base and Roof Mount. ALL ANGLE BASE  
Most popular swivel base mount in use today. Works on any surface—flat, slant, peak or wall. Heavy gauge weather-proofed steel. Takes any mast up to 2 1/4" O.D. Complete with hardware. TS-37. List 3.05...**Net 1.79**

TRI-SET COUPLER  
Highly efficient 3 set coupler. For coupling 2 or 3 TV or FM sets to one antenna of any type. No interaction—less than 6 db insertion loss. 40 to 50 db rejection ratio. Shpg. wt., 1 lb. TS-264 **Net 2.97**

TV ANTENNA MASTS  
STEEL MASTS. New corrosion-resistant 5 ft. steel mast made to fit all antennas. One end is tapered. "Jam Fit" construction with locking key, so 2 masts fit into each other. 1 1/2" O.D.  
TL-12 5 ft. mast. (Shpg. wt., 2 1/2 lbs.)...**.69**  
TL-13 10 ft. mast. (Shpg. wt., 4 1/2 lbs.)...**1.29**  
TL-14 10 ft., 1 1/2" gauge mast. (Shpg. wt., 8 lbs.)...**1.89**  
ALUMINUM MASTS. Durable aluminum mast. 18 gauge-heavy wall-high tensile strength. Rust and corrosion proof. Swaged for stacking.  
TL-46 5 ft. mast (Shpg. wt., 1 1/2 lbs.)...**1.20**  
TL-17 10 ft. mast (Shpg. wt., 2 1/2 lbs.)...**2.30**  
10 Ft. Mast shipped via express only.

### ECONOMY MOUNT

**99¢**  
Can be erected in minutes; without special tools or drilling. Adjustable. Two-section design permits unlimited spacing between brackets for maximum support of masts 1/2" to 1 1/2" O.D. Complete with two 12-ft. lengths of 3/4" galvanized steel bands and hardware. Shpg. wt., 3 lbs. TS-82. **Net Each .99**

### 300 OHM TWIN-LEAD

1.39 COPPER CONDUCTORS  
per 100 ft. LO-LOSS POLYETHYLENE  
High quality, low-loss lead-in for all TV and FM installations. Polyethylene dielectric—standard copper leads. Shpg. wt., 2 lbs. per 100 ft.  
Stock No. WR-25—100 ft. **1.39**  
500 ft. **5.75**  
1,000 ft. **10.95**

### UNIVERSAL TV TUBE "BRITENER"

EACH **\$1.29** SINGLY  
in lots of 6 **1.39**  
Restores brightness to dim TV picture tubes. Operates on all types—magnetic or electrostatic—and in all circuits—parallel or series.  
TS-170—in lots of 6 each **1.29**  
Singly each **1.39**

### TV TUBE BRITENER

**.79** EACH in lots of 10  
Absolutely no tools or soldering needed for installing this handy inexpensive tube rejuvenator. You simply attach two-plugs as directed on the instructions. For magnetic tubes and PARALLEL CIRCUITS only. Restores brightness contrast.  
MS-12 in lots of 10, each **79¢** singly **.89**

### ALL CHANNEL'S "RIVIERA"

WORLD'S MOST POWERFUL ULTRA-FRINGE VHF—UHF—FM ANTENNA

SPECIAL UNTIL SEPT. 15th **17.95**

GUARANTEED 200 MILE VHF RECEPTION OR YOUR MONEY BACK

- Receives channel 2-83 from all directions without a rotor
- Broadband UHF-VHF and FM, motorless all direction reception
- All aluminum flip-out assembly

Field tests reception on VHF of up to 200 miles has made possible this unprecedented guarantee. Here is an antenna with one transmission line for all UHF, VHF and FM stations in all directions without the use of a rotor. The nine position selector switch connected at the set electronically rotates antenna beam instantly without physically moving the antenna. Gain on channels 2-6 comparable to 4-bay conicals; on channels 7-13 comparable to stacked 10-element single channel yagis; on 14-83 comparable to bow-tie reflector. 1 1/2" doweled aluminum elements are 60 inches long. Complete with switch, coupler, 45" stacking bars and 2 7/8" angle type mast insulators for Polymicelene line listed below. Shpg. Wt. 10 lbs. ALL CHANNEL RIVIERA LESS MAST **Net 17.95**

### ALL CHANNEL LEAD-IN WIRE FOR USE WITH RIVIERA ANTENNA

Via Express Special 4 conductors, matched impedance transmission line. Low loss, mica-filled Polymicelene copperweld conductors.  
WR-8—50 ft. length **Net 5.00** WR-18—100 ft. length **Net 8.90**  
WR-9—75 ft. length **Net 7.50** over 100 ft., per 100 ft. **Net 8.90**

### NEW! TV TUBE RESTORER

LOCATES AND CORRECTS FOR  
• OPEN CATHODE • HEATER TO CATHODE SHORT • OPEN CONTROL GRID • CONTROL GRID TO CATHODE SHORT • LOW EMISSION • COMBINATIONS OF ABOVE  
One simple unit provides the cure to any defective picture tube in any TV set. Works on electrostatic or electromagnetic focus picture tubes in series or parallel-wired filament TV sets. Corrects for dozens of picture tube faults. Shpg. wt., 1 lb. TS-268 **Net 3.23**

# COMPARE! YOU CAN'T BEAT LAFAYETTES' WHOLESALE PRICES



## 900X "MICROBE HUNTER"

- The only Microscope in its class featuring **GRADE A** optics!
- Power Range 25X, 50X, 75X, 100X, 150X, 200X, 300X, 400X, 600X, 900X
- Full Range Fine Adjustment
- Safety Stop on Coarse Adjustment

ONLY **34.50**

Made to rigid design specifications—has wide usage in schools, laboratories and law enforcement agencies. All of the most needed features for diversified micro-studies. Power range from 25X to 900X in 12 possible combinations. Gearing rack and pinion coarse focusing. Micro-motion fine focusing—12 complete revolutions. 36mm (plano/concave) mirror. Fixed square stage, 70mm x 80mm. Three Huygenian eyepieces of 5X, 10X and 15X.

Rotating 5-hole, disc diaphragm. Four achromatic objectives of 5X, 10X, 40X and 60X. Oversize base insures stability. Body perfectly balanced at any angle. Complete with upright, wooden carrying case. Shpg. wt., 8 lbs. **Net 34.50**

F-338—List 69.95



## 800X "MICRO-SEARCH" Laboratory Standard Microscope

- RECENTLY DEVELOPED DESIGN
- INFINITE MICRO-METRIC SLOW MOTION ADJUST
- HUYGENIAN EYEPIECES — ACHROMATIC OBJECTIVES
- 100X-160X-200X-320X 500X-800X

A truly fine dry system microscope, suitable for a wide range of laboratory-professional-and college use. Manocular tube of most recent, one-piece, design. Spiral rack and pinion focusing mechanism. Coaxial, dual knob, coarse adjustment. Infinite micro-metric, fine adjustment. T-shaped, dove tailed, slide, of improved design—automatic stop prevents over-rise. Square stage, 70mm X 75mm, with click stop, substage, diaphragm. 30mm plano-concave reflex mirror. Paired, Huygenian eyepieces of 10X and 16X. Three oil, horseshoe design, 50X, 100X, 150X, 200X, 300X, 400X, 500X, 600X, 700X, 800X, 900X. Gray satin finish, steel body, fitted with rubber bumper feet and carrying handle. Shpg. wt., 7 lbs.

**24.50**

PREPARED MICROSCOPE

## NEW! 30X-50X "STEREO-SCOPE"



**3D**  
WIDE FIELD VIEW

**17.95**  
NET

- STEREOSCOPIC Binocular Dissecting Microscope
- Wide Field 3-Dimension View • Two Models to Choose from

**SEMI-PRO "STEREO-SCOPE"**: An especially engineered instrument featuring the stereoscopic and wide view field needed in biology — petrography — archeology — mineralogy — criminology — industry — agriculture — etc. Indispensable for inspection of large specimens — small parts — surface features of gross objects — dissection — etc. Fixed objective lenses and interchangeable eyepieces for a choice of either 30X or 50X. Prismatic binocular head with full interpupillary adjustment. Ground glass stage 3-3/16" x 3-5/16". Oversize modified horseshoe base. Rack and pinion focusing. Automatic stop prevents over rise. Overall height 9 1/2". Complete with fitted wooden carrying case. Shpg. wt., 6 lbs.

F-337 ..... **Net 21.50**

**STUDENT "STEREO-SCOPE"**: A 30X stereoscopic binocular microscope—designed primarily for the student and serious hobbyist. Includes most of the features of our "Semi-Pro" model shown on this page. Fixed objective lenses and non-interchangeable eyepieces. All optics are achromatic. Ground glass stage measures 2 7/8" x 2-13/16". Overall height 7 3/4". Complete with fitted wooden carrying case.

F-335 ..... **Net 17.95**

**21.50**  
NET

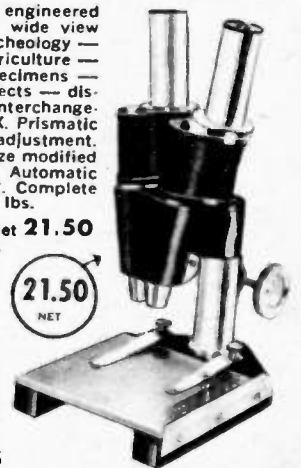

## 1200X "RESEARCHER"



**44.50**

- MAGNIFICATION RANGE 25X — 1200X
- 4 OBJECTIVES, 4 EYEPIECES,
- FULL RANGE FINE FOCUS ADJUSTMENT
- FULLY CONTROLLED, INTEGRAL MECHANICAL MOVEABLE STAGE

This superb instrument closely parallels the "Society" grade microscope in every desirable detail and yet is available at very low cost. Provides heavy, stable horseshoe base, smooth acting joint, enabling the body to turn through 60°, perfectly balanced at any angle. Tube length is 140 mm. Four Huygenian eyepieces and four achromatic objectives yield 16 combinations of power from 25X to 1200X. By means of two knurled micro-motion screws at the rear of the stage, it is possible for the operator to move the stage (and the slide) a distance of 3/16" - 1/4", in any direction, while looking through the eyepiece. Hardware is of the finest quality. Tubes are of the highest grade chrome-plated brass. All fittings are expertly machined and threaded, making this scope suitable for the most exacting work. Scope comes with a set of 5 basic dissecting instruments, made of high-grade instrument steel. 10 slides, a pack of cover slips and a tube of mounting fluid. Includes dovetailed wooden carrying case. Shipping wt., 10 lbs.

F-369

**Net 44.50**

LAFAYETTE MICRO-

- USE WITH ANY MICROSCOPE
- FURNISHES BRIGHT, EVEN LIGHT

# TOP TOOL VALUES for HOME or SHOP

## New! WEN 'SOUPED UP' SABRE SAW

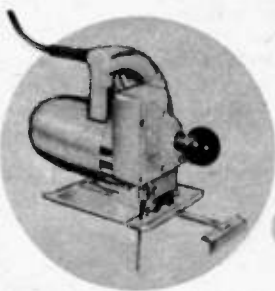

- HEAVY DUTY — full 6 Amp.
- 1/2 H.P. Motor — 1" Stroke
- LARGEST CUTTING CAPACITY
- 6" 90° Cut—4" 45° Cut

LIST PRICE 44.95

ONLY  
**29.97**

Bigger—more powerful—more versatile—faster cutting. Super-long blade easily cuts through 6" x 6" lumber. Cuts 4" x 4" at a 45° angle! Power enough to cut steel plate up to 1/2" thick—iron pipe up to 2" in diameter. Comfortable—conventional saw grip with auxiliary knob for 2 hand control. Saw tills 45°—sole plate always remains flat. Finger control trigger-switch. Hardened gears and heavy duty roller and oil to bearings. Constant air stream flows dust from line of cut. 3400 strokes per min., stroke length. Includes seven blades for cutting wood—steel—hardboard—sheet metal—pipe—leather—rubber—formica—etc. Rough cuts or fine scroll work. Equipped with rip guide and circle cutter guide, 8 ft. 3 cond cord and adaptor. 110 volts. 6 amp., AC/DC. 8" L x 7" W x 7 1/4" H. Shpg. wt., 8 1/2 lbs.  
WEN 909 List 44.95 ..... Net 29.97  
Extra Blades for WEN 909; Set of seven replacement blades. Shpg. wt., 1/2 lb. WEN 900 List 3.40 ..... Net 2.33  
Wen "All Saw" Table; Converts 909 Sabre Saw to Bench Saw. Highly versatile. Wen 972 ..... List 14.95 ..... Net 9.97

## NEW! Electrostrip OUTLET SYSTEM

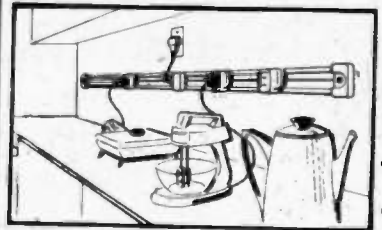

- Every Inch an Outlet!
- Mounts anywhere—quickly—easily!
- No breaking into walls!
- Add outlets—move outlets—at will!

The most notable wiring development in years. Intended for use in commercial, institutional, industrial, office and residential occupancies. Quick-easy installation anywhere. On baseboard, workbench, walls, counters—conducting or non-conducting surfaces. Hand forms to corners and irregularities. Eliminates extension cord dangers. No need for outlet planning—the outlets move as you choose. Permanent or temporary installations. Becomes a neat, attractive part of room decor—can be painted. Electrical connections where you want them—when you want them—along its entire length. Maximum safety combined with accessibility. Will not support combustion. The four ft. kit includes four ft. of strip, 3 receptacles, 2 end caps, 12" feed in cord set and mounting screws. The 15 ft. kit includes 15 ft. of strip, feed in (outlet type), 4 receptacles, 2 end caps, 2 wire connectors and mtg. screws. All are U.L. approved. 15 Amps 125 V. AC.  
EL-67 4 ft. kit—Shpg. wt., 1 1/2 lbs. .... Net 2.29  
EL-68 15 ft. kit—Shpg. wt., 3 1/2 lbs. .... Net 7.80  
EL-69 Extra receptacle. Shpg. wt., 3 ozs. .... Net .35

## NEW! TUNGSTEN-CARBIDE Lifetime Sanding Accessories

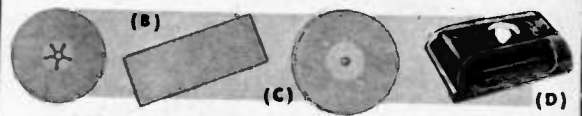

- Lifetime Sanding and Cutting Tools
- Miracle Abrasive—harder than steel
- Makes sandpaper obsolete

The amazing discovery of brazing tungsten carbide grits to steel makes possible the finest sanding equipment ever known. Each grit becomes a sanding edge that performs perfectly and stays keen and sharp indefinitely... and makes sandpaper obsolete.  
**FOR USE ON WOOD, PLASTIC, PLASTER, WALLBOARD, ALL COMPOSITION MATERIALS**  
Eliminates forever the nuisance of stopping to change torn or worn-out sandpaper. Faster—easier—saves time, effort, and money. Discs for use with all standard power drills, sheets for use with all standard oscillating and orbital sanders. Avg. Shpg. wt., for discs & sheet—6 ozs.

TYPE	Fine Grit	Med. Grit	Coarse Grit	Net ea.
	(150)	(80)	(60)	
(A) 5" Sanding Disc	HD-429	HD-430	HD-431	.87
(B) 3 1/2" x 9" Sheet	HD-432	HD-433	HD-434	1.12
(C) S-In-1 Wheel: For use with power saws. Shaves—saws—ploughs—sands—dadoes. Cuts and sands in one operation. No bind, drag or kick back. 80 grit on one side, 36 grit on edge and other side. Never needs sharpening. Shpg. wt., 1 lb. HD-35 6 1/2" Wheel, 1/2" Arbor with reducer to 3/8" ..... Net 5.21				
(D) Handy-Sander: Hand-sanding block kit. Contains sanding block, one fine grit sheet, one coarse grit sheet and felt pad. Cleans easily with solvent or wire brush. Shpg. wt., 1 lb. HD-319 ..... Net 1.69				

## THOR SPEEDWAY "20" 1/4" DRILL

- BALL THRUST BEARINGS
- GEARED CHUCK AND KEY
- HELICAL CUT GEARS
- UL APPROVED

**12.95**



Husky—Low cost 1/4" geared chuck drill rated at a full 2.5 amps. Preferred and used by professional mechanics for many years. Built for continuous production on wood or metal. Powerful, UL approved, universal motor. 1/2" capacity in steel, 3/4" in hardwood. Ball and self lubricating bronze bearings throughout. No load speed 2400 RPM. Strong, lightweight, cast aluminum alloy housing. Specially designed gear chain for greatest torque. Locking Trigger switch. Backed by Lafayette's famous Money Back Guarantee. Shpg. wt., 5 1/2 lbs.  
THOR SPEEDWAY "20"—List 18.95 ..... Net 12.95

## THOR SPEEDWAY "30" 3/8" DRILL

- HEAVY DUTY
- RATED FULL 3.1 AMPS!
- 3/8" JACOBS GEARED CHUCK
- DESIGNED FOR MAINTENANCE AND INSTALLATION.
- DRIVES HOLE SAWS UP TO 2 1/2" INCH



More power for service work—production lines—mechanics—or anyone requiring an extra heavy duty 3/8" drill. 3/8" capacity in steel—3/4" in hardwood. Sealed radial thrust ball bearing—other bearings oilite. 925 rpm no load speed, 610 rpm full load speed. Die-cast housing, steel gears, and specially reinforced construction assure long life. Trigger switch with locking pin. 6 ft. type 5L UL approved cord, universal series wound AC/DC motor. For 110-120 volts, AC/DC. Overall length 8 1/4". Shpg. wt., 6 lbs.  
THOR SPEEDWAY "30"—List 24.95 ..... Net 16.95

## THOR SPEEDWAY "14" SANDER

Here's Our Hot Sander Special



- PROFESSIONAL PERFORMANCE!
- MOTOR DRIVEN—3450 RPM!
- SANDS—SMOOTHS—BUFFS—POLISHES—RUBS!
- USE SHEET OR FREE (WET) ABRASIVES!

Get this new top quality sander for all sanding uses. Here's an orbital motion, motor driven finishing sander (no load speed... 3450 RPM) that sands, smooths, buffs, polishes, or rubs with both sheet abrasives or wet (free) abrasives. Sanding area—4 1/2" x 5 1/8". Features all sealed ball bearings; direct-connected air-cooled motor. Rugged blue hammerhead cast aluminum body. Handy switch prevents accidental starting. UL approved. Use on 110-120V 60 cycle AC only. Shpg. wt., 7 lbs.  
THOR 14—List 23.95 ..... Net 15.50  
THOR 3509—Lambwool polishing pad.....Net .85  
THOR 5-106—18 sheets assorted sandpaper.....Net .85

## THOR-SPEEDWAY SPEEDSAW



- RATED 3.1 AMPS
- 3400 STROKES PER MINUTE
- TILTS TO 45°

NEW!  
**15.98**

The most exciting tool on the market today! It replaces the handsaw for all types of sawing and takes all the hard work out of the job. Will cut wood, metal, composition; cuts straight and true and will cut bevel angles to 45° either side of the cutting line. Being a small blade, the saw can cut curves, circles, scrolls easily. Can be used for long panel cuts, ripping, cross cutting, even on 2 x 4's; and it blows away the sawdust while cutting. Will cut wood up to 2" thick and steel 1/4" thick. Its motor is meant for a lifetime—has all-steel bearings. Operates on 110/115V AC/DC, has on-off position push through slide switch, UL approved. Comes with 2 jig saw blades (wood and metal) and wrench, 6 1/2" conductor cord. Measures 6 1/4" L x 6 1/2" H. Shpg. wt., 5 lbs.  
THOR SPEEDWAY ..... Net 15.98

## NEW MODEL 4100 VERSAMATIC



- TURNS 1/4" DRILL INTO HIGH POWER TOOL
- REVERSES—INCREASES POWER—REDUCES SPEED

Sawed to one speed reduction develops tremendous torque! Hand clutch control for easy, instant stop!

## NEW Weller Dual Heat Soldering Kit



5.83

## ADEL Hand "Nibbling" Tool

- Cuts any shape or opening by hand
  - In sheet steel up to 18 gauge — in soft metals up to 1/16" thick.
- Easily operated hand "Nibbler" cuts any hole in sheet steel—any size and shape. (Cuts not add strain to work, etc.)  
In round form. Cuts in 30° angle—radius.  
● tool for cutting Shpg. wt., 8 ozs. to 71 ..... 3.60





PROFESSIONALLY PREPARED  
**• SPECIALLY SELECTED MICRO-SUBJECTS**  
**• ADD TO THE ENJOYMENT OF YOUR MICROSCOPE**  
 Specially selected slides of universal interest. Carefully prepared—cleaned, dissected, embalmed, stained, mounted and covered. Slides are professional size. Set includes 12 prepared slides and slatted, covered box for filing and storing.

F-123—Parts of Insects	Net 1.39
F-124—Spiders and Disease Carriers	Net 1.39
F-125—Tiny Creatures found around House	Net 1.39
F-126—Sea Life	Net 1.39
F-128—Structure of Blood	Net 1.15
F-130—Life cycle of Insects	Net 1.39
F-131—Bacteria	Net 1.79
F-132—Pond, Marsh and Sea Life, Plankton	Net 1.59
F-134—Micro-Animals	Net 1.29
F-135—Micro-Organisms	Net 1.29
F-136—Substance of Cells	Net .89
—Set of 6 slides	

**1.95**



8" trig slide rule of laminated, selected bamboo. Face of white plastic with engraved, permanently accurate calibrations. Exceptional dimensional stability under all atmospheric conditions. Satin-finished facing provides a high readability, virtually glare-free face. Scales are A, B, C1, C, D, and K on face — S, L, and T on reverse of slide. Table of formulae and equivalents is printed on metal back. C scale also has convenient conversion marks for changing degrees to radians, and for calculations involving areas of circles. Shpg. wt., 8 oz.  
**F-381 8" Trig Slide Rule** Net 1.95

**HUNTING WITH THE MICROSCOPE .89**



**NEW EDITION BK-1440 136 PAGES 5 1/2" x 8" Net .89**

Guide for beginners and advanced users of microscopes. How the microscope works. How to prepare and study cultures—set up a microscopic zoo and garden—grow micro organism—perform micro surgery. Profusely illustrated with photographs and drawings. 14 chapters of easy-to-read, highly informative text.

Specialty illumination. Provides a bright view. Controlled intensity, by means of adjustable condenser lens. Lamp may be raised or lowered to any desired height on its 4 1/2" stanchion. Inclination and elevation joint permit swiveling through 360° in both horizontal and vertical plane. Fully adjustable for transparent or opaque specimen, direct or indirect illumination. Invaluable where oblique light is necessary. Operate on 110-120 volt AC/DC. Lamp is easily replaced. Self contained switch, cord and plug. Lamp body is 3 1/2" long, stand is 3 1/2" high including base. Shpg. wt., 1 lb.



**\$2.95**

F-248 Net 2.95

**TECHNICAL DRAFTING SET**

- Center Wheel Adjustment
  - Professional Quality
  - German Craftsmanship
  - A \$18.00 Value
- 5.95**

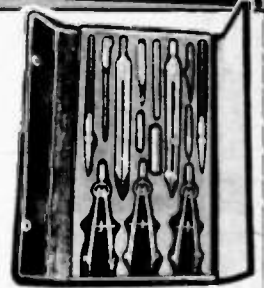

A new set of imported nickel plated brass instruments priced far below the usual price for this quality. Contains 3/4" self-centering compass, one leg buckle joint with divider, pencil, pen parts and lengthening bar; 5/16" self-centering divider; spring bow divider 4/16", center wheel adjustment with interchangeable needle points; spring bow pencil and spring bow pen, both 4/16" with center wheel adjustment and interchangeable needle point; two 5/16" ruling pens; extra handles for pen and pencil parts; adjustment tool; lead case and leads; and spare parts bit, all in velvet lined snap closing case. Shpg. Wt. 1 1/2 lbs.  
**F-48 Net 5.95**

# Lafayette IMPORTED SLIDE RULE



LIST 25.00  
**10.45**

- Machine Engraved Graduations
- Extreme Dimensional Stability
- Modern Scale Arrangements
- Smooth Slider Action
- Easily Read Graduations
- Saddle Leather Case

**F-341**

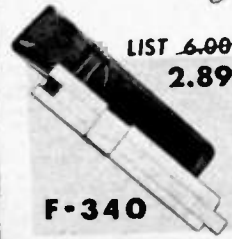

LIST 6.00  
**2.89**

**F-340**

## 10" LOG LOG DUPLEX TRIG SLIDE RULE

**10" Log Log Slide Rule:** Constructed of specially selected, laminated, non-hygroscopic bamboo. All scales are machine engraved on white plastic in permanently accurate calibrations. Adjusting screws permit varying the tension on the slide. 21 scales in all including the more frequently used C, D and CI scales on both sides of the rule. Evaluates trigonometric, algebraic and exponential problems. L10 and L100 scales refer to B scale. All other scales coordinate and refer to D scale. Scales are L, L1, DF, CF, CIF, C1, C, D, LL3, LL2, L10, L100, A, B, K, C1, C, D, S, ST and T. Scale characteristics permit multiplication, division, proportion, inverse proportion, reciprocals, cotangents, squares, square roots, cubes, cube proportion, logarithms, tangents, sines, PI factor multiplication and division, roots and roots of numbers less than 1, powers and roots of numbers greater than 1, logarithms to base "e". The most often used slide rule in all basic fields science, engineering, production and economics. Shpg. wt., 1 1/2 lbs.  
**F-341 LIST 25.00 Net 10.45**

## 5" POCKET SLIDE RULE

**5" Pocket Slide Rule:** Convenient pocket sized slide rule of specially selected and treated bamboo. Will not warp, shrink or lengthen under varying atmospheric conditions. A, B, C1, C, D and K scales engraved on white plastic surface. Reverse side of slide has standard S, L and T scales. The upper, beveled edge of the rule is graduated in mm to 13 cm. Other edge is divided into 5 inches by 32nds. Only 5-13/16" long over all. Carried easily in any pocket. Shpg. wt., 8 oz.  
**F-340 LIST 6.00 Net 2.89**

## UTILITY DRAFTING SET 2.59

- EXCEPTIONAL VALUE

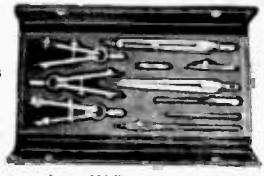

Made in Germany of hard rolled, nickel plated brass. All instruments are nested in a fitted, velvet lined case. Contains three slide wheel 3/4" bow instruments—one a divider, one a pencil and one a pen. All have reversible needle point. 5/16" compass with pen and pencil parts—and lengthening bar. 5/16" divider with straightening device. 5" ruling pen. Extra handle for use with pen and pencil parts. Capsule with extra leads. Perfect for schools, labs, industrials or wherever precision drawing sets are used.  
**F-13 Net 2.59**

## NEW JET-E-RASE ELECTRIC ERASING MACHINE

- PORTABLE — MOTOR DRIVEN!
- TIME SAVING — LIGHT WEIGHT — CONVENIENT!
- FINGER TIP CONTROL!
- 4 ERASERS — 4 COLLETS — 2 BRUSHES!



The new, exclusive, Lafayette battery operated erasing machine is the most modern eraser available. Sleek and streamlined as a rocket—erases fast as a jet. The entire unit has been designed for convenience—ease and speed in erasing. Battery operation does away with bulky A.C. motors—trailing line cords—danger of shock. Safe enough for children to use. Entire unit—including battery—weighs only 4 oz. Fits the hand as naturally as a pen or pencil. Switch precisely located for finger-tip control. Per-mog motor ensures quiet—smooth running—vibration free operation. Permanently lubricated, precision bearings assure long, trouble free life. Includes four eraser cores. One soft—two medium hard—one gritty—to cover all erasing problems. Two brushes—one soft—one stiff—for clean up, and four collets that accept both the eraser cores and brushes. Easily replaceable battery is a No. 1 or "C" cell. Supplied with battery. Shpg. wt., 1/2 lb.  
**F-416 Net 1.49**



**F-424 Kit of two each, erasers and brushes Net .24**

Power drill... Perfect for concrete or any kind of masonry drilling! Low speed and high power for hole saw attachments! A professional tool that anyone can use! Comes complete with screwdriver bit—Phillips bit— $\frac{1}{4}$ " socket set adapter—wrench pin and instruction book. Shpg. wt., 5 lbs.

HD-195 LIST 14.85 Net 11.25

### $\frac{1}{2}$ " CHUCK FOR VERSAMATIC

Geared chuck— $\frac{5}{64}$ " to  $\frac{1}{2}$ " capacity—#33 taper to fit Supreme Versomatic. Shpg. wt.,  $\frac{1}{2}$  lb.

HD-268 Net 7.38



### VINYL PLASTIC ELECTRICAL TAPE

- GUARANTEED FIRST GRADE
- 60 FT. x  $\frac{3}{4}$ "
- .008 in. THICK
- 10,900 V. BREAKDOWN

45¢  
IN  
LOTS  
OF 24

First quality, pressure sensitive polyvinyl chloride tape. Extremely high dielectric strength of 10,900V breakdown. Insulation resistance of one million megohms. Over 150% elongation at break. Excellent resistance against acids, alkalis, oils, salt water, etc. Tensile strength of 15 lbs. per in. High conformability: Forms tight, smooth protective wrap. Shpg. wt., 6 oz.

HD-216—Plastic electrical tape, 60¢ per roll; in lots of 6, 50¢ per roll; in lots of 24, 45¢ per roll.



### "VILLAGE BLACKSMITH" ANVIL

Here is workbench equipment long wanted—a rugged farm-and-home size anvil. 8" long,  $\frac{3}{4}$ " high and 3" wide at the base. Finds hundreds of uses in metal work, woodwork, leatherwork, etc. Exclusively built for the home craftsman, hobbyists and farmers. Shpg. wt., 8 lbs.

HD-404 Net 3.29

### Cordomatic HANDY LITE NEW LOW PRICE



- Portable light and power
- Locks at any length of 20 ft.
- Retracts automatically

Provides light and power up to 20 feet from installation. Swivels 180° when wall mounted—360° rotation when ceiling mounted. Detaches easily to

change location. Simply hang it up and plug it in. Eliminates the inconvenience and hazards of tangled cords. U.L. approved. Shpg. wt., 5 lbs.

EL-70 Net 6.72

**CORDOMATIC EXTENSION CABLE.** Similar to above, except terminates with a 3-way power tap instead of high fixture. Extremely versatile—use indoors or out. U.L. approved. Shpg. wt.,  $\frac{4}{5}$  lbs.

EL-71 Net 5.84

for one year. Kit includes dual heat, 90-125 watts soldering gun—solder—wire brush—soldering aid. U.L. approved. 110-120 V. AC only. Shpg. wt., 3 lbs.

Weller 8200K List 7.95 Net 5.83



HD-437

## THOR SPEEDWAY 6.5 Amp. $\frac{1}{2}$ " DRILL

- Full 6.5 Amp. Power Rating
- Two-Position Rear Handle
- Heavy Duty Sealed Thrust Ball Bearing on Spindle

This high power  $\frac{1}{2}$ " Drill in the low priced field is built to professional standards throughout and with handling ease. Features high-polished aluminum alloy die-cast housings; safety switch with push-button lock for continuous operation; and removable top handle. Includes 3-jaw geared chuck and key. The rear grip handle can be revolved to either vertical or horizontal position, and can be fastened securely in either position. It can also be removed completely for close quarters work! Specifications:  $\frac{1}{2}$ " capacity in steel; 1" capacity in wood; 6.5 amp. rating; 550 rpm no load speed; 400 rpm full load speed; sealed ball and oilite bearings  $\frac{1}{4}$ " spindle offset. Has Universal series wound AC/DC motor; standard voltage 115V, other voltages available at extra cost. Complete with 10 feet, 3-wire, type SJ, UL approved lead cord; and 3-jaw geared chuck with key. Overall length with rear handle is 14 $\frac{1}{2}$ ", less rear handle is 11 $\frac{1}{4}$ ". Shpg. wt., 14 lbs.

THOR No. 40 DRILL Net 24.95



24.95

## POWER DRILL ACCESSORIES

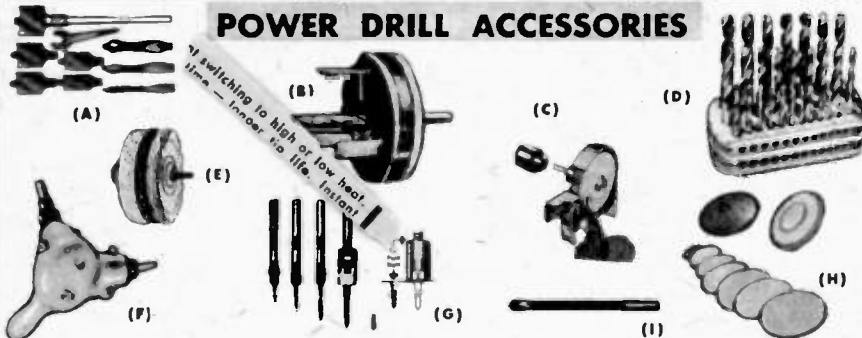

(A) 10 pc. Power Boring Set: For  $\frac{1}{2}$ " electric drill or drill press. 8 different bits plus shank and wrench. Sizes  $\frac{1}{8}$ ",  $\frac{3}{16}$ ",  $\frac{1}{4}$ ",  $\frac{5}{16}$ ",  $\frac{3}{8}$ ",  $\frac{1}{2}$ ", 1" and 1 $\frac{1}{2}$ ". Fast, clean bore at any angle. Shpg. wt., 1 lb.

HD-181 Net 1.99

(B) Adjustable Hole Saw: For  $\frac{1}{2}$ " electric drill or drill press. Drills any diameter from  $\frac{1}{8}$ " to 2 $\frac{1}{4}$ ". Max. depth of cut  $\frac{1}{2}$ ". Dial indicator sets hole size without removal from chuck. Shpg. wt., 1 $\frac{1}{2}$  lbs.

HD-257 List 6.95 Net 5.11

(C) Drill Malt Sharpener. Sharpens drills from 1-1/16" to 1 $\frac{1}{2}$ " size.  $\frac{1}{4}$ " shaft fits any electric drill. Use it also to sharpen chisels, knives, scissors, wood bits, etc. Drill holder is factory preset. Adjustable fast rest. High grade, aluminum oxide-stone grinding wheel. Shpg. wt.,  $\frac{3}{4}$  lbs.

HD-243 Net 2.21

(D) 29 pc. Drill Set: 29 chrome vanadium twist drills with indexed metal stand. Sizes 1/16" to  $\frac{1}{2}$ " by 64ths. Shpg. wt., 4 lbs.

HD-214 Net 5.40

Turned down shanks: Same as above, but with shanks turned down for  $\frac{1}{2}$ " drill.

HD-440 Net 7.29

(E) 4 pc. Utility Kit: Grinds, polishes, sharpens, cleans, finishes. Kit contains 3" grinding wheel  $\frac{1}{2}$ " thick, 3" double thick muslin buff, 3" wire wheel. Flanged arbor with  $\frac{1}{4}$ " shank. All wheels have  $\frac{1}{2}$ " bore. Shpg. wt., 1 lb.

HD-392 Net .99

(F) Right Angle Drive: Halves or doubles drill speed. Close coupled right angle drive. Fits  $\frac{1}{2}$ " chuck or may be screwed to drill spindle. Includes  $\frac{1}{4}$ " — 24 male and female adapters— $\frac{1}{2}$ " shaft adapter. Shpg. wt., 1 lb.

HD-269 Net 3.30

(G) Wood screw Countersunk set: 24 screw size and countersink combinations. Fits all drills and drill presses. Automatic stop for 3 depths. Bore for 8 most popular screw sizes from #6 x  $\frac{3}{4}$ " to #12 x 1 $\frac{1}{2}$ ". Shpg. wt.,  $\frac{1}{2}$  lb.

HD-337 Net 1.27

(H) SANDING AND POLISHING KIT Handy Sanding and polishing kit for use with drill or drill press. Kit contains flexible rubber 5" backing disc, 3" assorted sanding discs, 6" lamb's wool polishing bonnet. Shpg. wt., 1 lb.

HD-270 Net 1.43

(I) HI Speed Cope Saw Drill Bit: Drills, saws, cuts, reams. Use in any power drill or drill press. Cuts any shaped hole. Cuts wood, plastic, steel, brass, etc. Shpg. wt., 3 ozs.

HD-75 Wood bit .69

HD-74 Metal and all purpose .85

HD-439



- TURN TO ANY POSITION
- USEFUL AS AN EXTRA ARM

10.49

VERSA-VISE (D): All the features of a regular vise—plus. Locks in any position, just tighten jaws. Turns to any work position. Use standing or laid flat—turns 360° either way. Larger jaw surfaces— $3\frac{1}{2}$ " x 2 $\frac{1}{2}$ "—plus removable pipe jaws. Jaws open 5".

HD-282 Shpg. Wt., 17 lbs. Net 10.49

Right Angle Adapter: Adds belt adjustment for holding work at any angle. Shpg. Wt., 2 $\frac{1}{2}$  lbs.

HD-283 Net 2.18

## NEW Swingline #101 Stapler Gun 3.99

with 1,000 Staples

- High Compression Model
- Staples within 1/16" of corner
- 100% Jam Proof
- Open Channel Loading

Revolutionary, new staple gun with tremendous, pile driving action. Delivers as much driving power as machines twice its size and weight. Highly maneuverable—perfectly balanced—extremely lightweight. All case hardened steel construction. Rust proof, banded finish. No oiling required at any time. Uses two staple sizes—4/16" and 5/16"—with no mechanical changes. Shpg. wt., 1 $\frac{1}{2}$  lbs.

HD-322 List \$4.95 Net \$3.99

HD-323 Pkg 1000 4/16" staples Net .40

HD-324 Pkg 1000 5/16" staples Net .40



## SPRAYIT 400

- COMPLETELY PORTABLE
- NOT A FLIMSY "VIBRATOR"
- FOR ALL PAINT-SPRAYING DUTIES

Here is a precision-built complete paint-spraying outfit manufactured to the highest professional standards and yet priced for the homeowners. With integral  $\frac{1}{2}$  H.P. motor compressor unit, not a vibrator. Now it's easy to do a professional-looking paint job, 4 times faster than with a brush. Use it for other spraying or blowing duties too. Spray adjustable from a dime size to 10" wide. Features an easy-to-use two-finger trigger gun; the body is guaranteed to be unbreakable. With 6 ft. cord, plug and 8 ft. of hose. Shpg. wt., 15 lbs.

HD-415—List 39.95 Net 32.89

# Lafayette's 38<sup>th</sup> Annual Summer Tool Sale Breaking Records for Savings

### FLEXIBLE SHAFT ATTACHMENT FOR ELECTRIC DRILLS

- DRILL WHEREVER YOU WILL
- TAKES UP TO 1/8" SIZE DRILLS

## 2.39

Operates off any fixed or portable 1/4" power drill; enables you to drill at any angle anywhere. Capacity up to 1/8" size drills; 36" overall length, with chuck. Comes in box with complete instructions. Shpg. wt., 1 lb. HD-389 Net 2.39

### HANDY WARDING FILE SET

- 6 INDIVIDUAL FILES
- SPECIAL STEEL-DEEP CUT-HARDWOOD HANDLES

First quality German made file set. Perfect for shop—home—hobby work. Kit consists of flat, half round, triangular, square, round and taper files. All with individual hardwood handles. Sturdy plastic pocket case included. Shpg. wt., 1/2 lb. HD-215 Net .89

### WATCHMAKERS PRECISION SCREWDRIVER SET

Handy set of 6 precision screwdrivers with nickel-plated knurled handles, swivel heads and tempered steel blades. One each from No. 0 to 5—blade sizes: .025" to .100". In plastic kit. Shpg. wt., 3 oz. HD-444 Net .69

### Multi-Use WRENCH SET

- 8 Precision Wrenches

## 69¢

Fully nickel plated—special analysis alloy tool steel. Heat treated and hardened. 16 sizes cover the most often encountered nuts in the automotive-TV-radio-appliance and hobby fields. Sizes range from 13/64" to 7/16". Set includes case with transparent cover. Shpg. wt., 8 oz. HD-405 Net .69

### 7-PIECE SUPER NUT-DRIVER SET

Most popular socket sizes—polished, hardened steel detachable shafts. Plastic handle with precision clutch. Contains: 1—3/16" hex nut shaft, 1—1/4" hex nut shaft, 1—5/16" hex nut shaft, 1—11/32" hex nut shaft, 1—1/2" hex nut shaft, 1—7/16" hex nut shaft, 1—amber handle with chuck. HD-14—Shpg. wt., 2 lbs. Net .99

### JACOBS TYPE DRILL CHUCK

Comparable to Jacobs 18. Key type geared tooth chuck. Capacity 0-1/4", thread 3/8" x 24". Ruggedly constructed. Polished finish. Used as standard equipment on most electric drills. Made to rigid specifications. Compare our really low price. You'll find this some chuck selling for twice as much! Shpg. wt., 1 lb. HD-186 Net 2.98

### WOODWORKERS VISE

- 6 1/2" x 3 1/2" JAWS
- OPENS TO 4 1/2"

A fine, practical tool for the small shop-home-form or garage. Ruggedly built—will not loosen or slip. Guides one of finely machined cold rolled steel. Gray iron jaws—face ground and finished. 1/4" diameter screw—6 thread per inch. Saves time and labor—indispensable to the woodworker. Perfectly balanced—designed for hard use. Shpg. wt., 6 lbs. HD-182 Net 1.99

### SWIVEL CLAMP-ON BENCH VISE

Constructed of high grade cast steel. 2 1/2" machined and polished steel jaws open to 2 1/2". Twin guide rods keep jaws aligned. Easy-turn swivel base allows unit to be swung instantly to any desired position. Shpg. wt., 3 1/2 lbs. HD-107 Net 1.99

### HAND TAP SET

- AMERICAN STANDARD THREAD
- 5 MOST NEEDED SIZES
- RUGGED TAP WRENCH

Handy tap set includes most often used sizes. Consists of 6-32, 8-32, 10-32, 3/16-24, and 1/4-20 taps, rugged tap wrench with T-bar handle; all in heavy plastic pouch. All threads are American Standard. Extremely useful for repair and servicemen. Shpg. wt., 1 lb. HD-410 Net .99

### Vinyl Insulated "PROFESSIONAL" Pliers

- 10 Kilovolt Insulation
- Chrome Plated
- Tested Beyond Professional Specifications

## 1.29

Professional quality—heavy duty—forged from special heat treated, alloy steel. Chrome plated to resist rust. Insulated with filled, vinyl, non-slit handle grips—protects up to 10,000 volts. Hand honed cutting edges. Machine milled teeth. Handles shaped for easy grip and maximum leverage. Short fulcrum distance for greater gripping power. Unconditionally guaranteed by Lafayette. Average Shpg. wt., 10 oz.

HD-350 6" Diagonal cutter-wire stripper  
HD-351 6" Long nose-side cutter-wire stripper  
HD-352 6" Electronic oblique cutter-wire stripper  
HD-353 6" Long chain nose-side cutter-gripper  
HD-354 7" Linesman's side cutters-beveled nose

### 7 in 1 HOLE SAW

Fits any electric drill, drill press, motor arbor, rotary sander or lathe. Cylindrical saw blades cut holes from 1" to 2 1/2" diameter in any 3/4" stock. Hole sizes are 1", 1 1/4", 1 1/2", 1 3/4", 2", 2 1/4", 2 1/2". True size carbon steel saw blades fit into deep machined grooves in tool head and are locked into place by a full length lock screw. Cuts wood, plastics, metals, sheet-rock, wall-board, masonry, formica, etc. Has guide bit and automatic slug ejector. Shipping wt., 1 1/4 lbs. HD-225 Net 1.69

### 5 PC. SCREW EXTRACTOR SET

- FOR 1/4" TO 3/4" SCREWS

Five piece, chrome vanadium, screw extractor set. Removes broken and mutilated screws—bolts—studs, even 1/4" and 1/2" pipe. Simply drill damaged screw-twist extractor in—and back screw out. Set consists of 5 extractors in wooden case. Shpg. wt., 1 lb. HD-273 Net 1.59

### 1/2" CHUCK FOR 1/4" DRILLS

## 99¢

Converts 1/4" electric drill to 1/2" capacity. Properly machined to insure correct balance. May also be used on standard 1/2" x 24 motor arbor or shaft. Shpg. wt., 1 lb. HD-203 Net .99

### NEW! PRUNING SAW

Remarkable new blade development for all fast pruning-trimming-wood sawing. Fine Sheffield steel blade combined with heavy duty hickory frame. The ideal tool for pruning-cutting green or dried logs-rough or heavy lumber. Perfect for campers-foresters-public utilities, etc. Cuts three times faster than ordinary saws. Shpg. wt., 2 lbs. HD-454 Net 1.97

HD-453 Blade only, fits all 12" Hack saws Net .83  
HD-211 Heavy Duty Hack saw Net 1.35

### "RUBBERGRIP" SCREWDRIVER SET

- 4 Most Needed Screwdrivers
- Rubbergrip for Comfort and Torque

Rubber inlaid handles grant maximum comfort and maximum torque. Can't bite into your hands no matter how hard you grip and turn. Extra "Lift" improves balance. Blades are hardened and tempered. Plated to resist corrosion. Set contains 5" x 3/16 and 6" x 1/4 standard drivers plus 3" x 3/16 #1 and 4" x 1/4 #2 recessed drivers. Shpg. wt., 1 lb. HD-455 Net 1.65

### 5 PC. ASSORTED FILE SET

## 98.

Five files selected for utility and durability. Good quality—equal to files selling for more. Each one a different pattern—three standard shapes—two triangular. Sizes 6" to 12". Shpg. wt., 2 lbs. HD-456 Net .98

### "Tri-Y" Screwdriver Set

Two screwdrivers of unique design. Convenient—6 points on 2 tools. Utilitarian—the most often needed standard and recessed blades. "Tri-Y" grip provides extra leverage you can't get from ordinary screwdrivers. Hardened and tempered blades set in rugged, amberoid plastic. Shpg. wt., 2 lbs. HD-457 Set of 2 Net .98

### Camper's Hand Axe

Top quality, drop forged steel, one piece scout axe. Perfectly balanced. Re-curved, shock absorbing handle. Air-cushioned rubber grip. Fully polished head and shaft. 24 oz. weight, 13 1/2" overall. With nail-puller. Fine steel can be sharpened to a "shaving" edge. Shpg. wt., 2 lbs. HD-461 Net 1.95

### WIRE STRIPPER-CUTTER

- Insulated Handles

Tempered steel—handy—easy to use wire stripper. Pawl can lock sets to wire gauge. Designed to fit your grip—uses minimum pressure. Specially ground cutting edges. Cuts and strips at any point along wire. For service or light production work. Shpg. wt., 1/4 lb. HD-264 Net .59

### TUBING CUTTER

## 1.20

A quality cutter for copper, brass, or aluminum tubing. Provides up to 1" capacity. Equipped with alloy steel cutting wheel and slide-lock reamer. Ideal for light plumbing etc. Shpg. wt., 8 oz. HD-346 Net 1.20

### 13 PC. TWIST DRILL SET

## 1.29

Set of 13 high quality chrome vanadium twist drills, complete with metal index. Sizes: 1/16" to 1/2" by 1/8". Shpg. wt., 8 oz. HD-113 Net 1.29

### ROTARY RASP

## 1.66

For use with any 1/4" electric drill or drill press. Made of hardened steel, it is ideal for shaping of wood, plastic, fibre etc.—planing of floors and boards—mixing of paints, oils and other heavy liquids. Extremely handy for the home craftsman, hobbyist, handyman etc. 2 1/4" in diameter. 13/16" wide. Shpg. wt., 1/2 lb. HD-458 Net 1.66

### 3-Way Combo Hammer

## .98

Practical combination of hard and soft faced hammer. Permanent standard hammer head on one side—interchangeable, soft-face rubber and plastic heads fit other side. Metal portion is chrome plated. Smooth resilient hardwood handle. Guaranteed to become your most often-used hammer. Shpg. wt., 2 lbs. HD-459 Net .98

### NEW! GLO-BRITE KRYLON

- FLUORESCENT COLOR SPRAY!
- GLOWS IN DAYLITE!

For sure, quick attention. Makes any white surface up to 4 times brighter—easier to see. Gives neon effect under black light. For do-it-yourselfers, display men, hunters, fishermen, campers, etc. Used on fishing lures, boat markings, life preservers, targets, auto bumpers, signs, displays, bicycles, etc. Numbers 3101 and 3102 are made spec. MIL-P-21600 (AER). Used for aircraft wing tip and rudder markings. 16 oz. push button cans.

KRYLON #	COLOR
3101	Red Orange—633
3102	Yellow Orange—634
3103	Sunset Gold
3104	Lemon Yellow
3105	Cerise
3106	Green

Net 1.82

### LIGHT WEIGHT LONG NOSE PLIER

## 94¢

Ideal for all types of delicate work and for reaching into hard-to-get-at places. Spring closing—holds wires, nuts, screws etc. Handy for mechanics, assemblers, hobbyists. 8 1/2" long, with soft plastic colored handles. Shpg. wt., 4 oz. HD-462 Net .94

### LOCKING PLI-RENCH

## 1.20

Super power locking combination pliers, wrench, clamp and vise. Grips objects of any shape. Easy to use—rugged—powerful tool. Exerts over 1,000 lbs. of pressure. Heat treated, drop forged jaws. Machine milled teeth. Unlimited uses as pipe wrench—locking and adjustable wrench—clamp—vise—press—super pliers—etc. Length 10". Shpg. wt., 1 lb. HD-126 Net 1.20

### 20 PC. AUTO SOCKET SET

Ideal for auto or home. Contains 8 regular 12-point sockets—7/16", 1/2", 9/16", 5/8", 11/16", 3/4", 7/8", and 15/16"; 1/2" drive hex. L handle, 1 ratchet handle, 1 screwdriver adapter; also 7 ignition sockets—1/4", 5/16", 11/32", 3/8", 7/16", 1/2", and 5/8" internal knurled socket; 1/4" drive hex. L handle. All parts are properly heat treated and nickel-plated. Mounted in red wall bracket. Shpg. wt., 3 lbs. HD-446 Net 2.79

### 20-PIECE TAP AND DIE SET

- NATIONAL COARSE SIZES

Twenty of the most often needed taps and dies. Sizes popularly used in radio, hobby, home, shop and light industry. Contains one tap and one die in each of the following sizes: 6-32, 8-32, 10-24, 12-24, 1/4-20, 5/16-18, 3/8-16, 7/16-14, and 1/2-13. Includes die stock and adjustable tap wrench. Entire set contained in a fitted metal case. Shpg. wt., 4 lbs. HD-252 Net 5.59

### The "ULTRA" Electro-Tool Kit

- Designed with the Technician in mind
- Professional Quality Throughout
- All the most often needed tools

## 7.95

The finest-most compact carefully selected tool kit we have ever offered. Each component tool chosen to offer utility and quality. The "ULTRA" kit contains the following: 5 1/2" insulated side cutters, 5" insulated chrome-insulated chrome plated side cutters, 3 offset open-end wrenches covering from 1/4" to 1 1/2" chrome plated tweezers, shockproof chrome plated screwdriver handle, 3/32nd screw driver blade, 5/32nd screwdriver blade, #1 recessed screwdriver blade, punch-awl blades, 1/4" nut driver blade, solder and flux. Pliers insulated for 10,000 volts, hand honed cutting edges; side cutters have beveled nose, diagonals have provision for wire stripping, long nose has "wrench" grip jaws and rollers. The entire set is nested in a zippered, fitted, lined bag type carrying case with handle. Measures a scant 9" x 5" x 2". Shpg. wt., 2 1/2 lbs. HD-345 Net 7.95

### Ratchet Head SOCKETOOL

## 2.25

Amazingly versatile! Handles carriage bolts, machine bolts, lag screws, sheet metal screws, machine screws, wood screws, cap screws—any style of head—slotted, recessed, square or hex. Operates in straight or offset position—handy for hard-to-reach places. Universal ratched head works right, left or locks—speeds and simplifies any job! Contains Shelton suregrip ratchet handle; straight hex adapter; offset hex adapter; 5 hex sockets—7/16", 1/2", 11/32", 5/16", 3/8"; 3 square sockets—7/16", 1/2", 5/16"; tool steel screwdriver bit for slotted screws; tool steel screwdriver bit for recessed head (Phillips) screws. A fine small tool set, ruggedly constructed for hard usage. Complete in durable plastic case. Shpg. wt., 1 lb. HD-451 Net 2.25

### "5 in 1" BIG PAL

- Fisherman's Helper

Comprises 5 tools which compactly fold into one: "Disgorger"—backs-out hard-to-reach hooks; "Stiletto"—cleans and removes leaders from fly hook eyes; "Clipper"—cuts lines, leaders and trim ties and lures; "Screwdriver" and "Battle-and-Con opener" are also included in this rugged and versatile tool. HD-452 Net 1.59

### "Little Smith" Anvil

"Little Smith" is the perfect companion for the hobbyist-tinkerer-model maker-or just plain foolin' around. Measures only 4 1/2" x 2 1/2" x 2 1/2" overall. Rugged enough for heavy pounding-sized right for home or hobby. Makes a perfect paper weight for the craftsman's bench or desk. Shpg. wt., 2 lbs. HD-460 Net .98

### SCREW-MATIC 3.97

- SCREWDRIVER ATTACHMENT FOR ELECTRIC DRILLS

Can be fitted to any fixed or portable drill, to drive up to 1/4" diameter wood screws quickly and easily. Bit idles until pressure is applied, powerful "non-slip" industrial-type clutch disengages itself when screw is driven home. Special bit holder prevents bit from slipping out of screw slot. Includes two hardened tool steel 1/4" hex bits for No. 2 Phillips head and for No. 6 to No. 14 slotted screws. Shpg. wt., 1 1/2 lbs. HD-463 Net 3.97





# SAVE UP TO 75% ON LAFAYETTE RADIO PARTS

## PORCELAIN CASED TUBULAR CAPACITORS

New

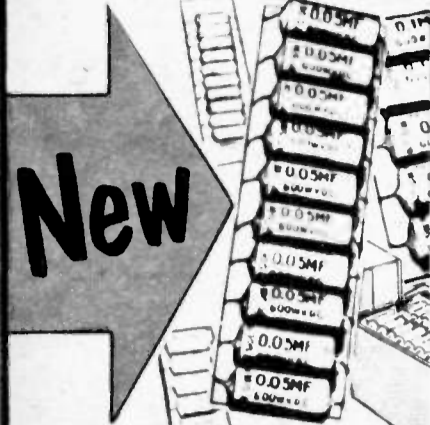

**Greatest Condenser Value Ever Offered!**

KIT OF 100 600V W V DC			KIT OF 50 600V W V DC		
QTY	Value	Net	QTY	Value	Net
10	.001	.001	5	.001	.001
10	.002	.002	5	.002	.002
10	.005	.005	5	.005	.005
10	.01	.01	5	.01	.01
10	.02	.02	5	.02	.02
10	.05	.05	5	.05	.05
10	.1	.1	5	.1	.1

KIT NO. KI-52 List Value 32.00 **4.95 SPECIAL NET**

KIT NO. KI-51 List Value 16.00 **2.75 SPECIAL NET**

They're new, they're different, and they're better! Now, at a price far less than that of ordinary plastic molded tubulars, Lafayette brings you, for every day service work, a condenser that was designed for critical industrial applications. The case is of durable gleaming porcelain, a ceramic known for its high degree of imperviousness to moisture and resistance to heat. The capacitor is of finest quality, tested at 3 times the rated voltage with much closer capacity tolerance. It maintains its characteristics under extreme conditions of heat and humidity. Its mechanical construction is excellent, the leads are firmly attached and sealed — they won't twist or break off. We've selected the most popular values and put them up in two serviceman designed kits. Each condenser is plainly marked. Each value is mounted on separate handy strips. All are conservatively rated at 600 DC working volts. See chart for contents of each kit.

KI-51... Kit of 50 **2.75**

KI-52... Kit of 100 **4.95**

## HEAVY DUTY 10 AMP DPDT MOTOR SWITCH

- MOLDED PHENOLIC CASE
- METAL FACE PLATE



Workmanship on this switch is of the best quality. Terminals are oversized, flow-free solder type which makes for neat, no-arc connections. Rated 10 Amps at 125 Volts, contacts easily take the current surges of motor starting. Size 1 3/4" x 1/2" x 1". Bushing 7/16" dia., 3/8" long, but handle 3/4" long. Shpg. wt., 6 oz.

SW-26 DPDT Toggle Switch **Net .79**  
In lots of 10, Each **.75**



## MIDGET-BAKELITE KNIFE SWITCHES

Compact switches mounted on black bakelite base with insulated knob handle of black bakelite. Plated brass contacts provide positive low-resistance connection.

**SPDT KNIFE SWITCH**  
Overall size 1 1/2" x 2 3/8". Shpg. wt., 6 oz.  
SW-23 **Net .12 ea. — 10 for .99**

**DPDT KNIFE SWITCH**  
Overall size 1 3/4" x 2 3/8". Shpg. wt., 4 oz.  
SW-24 **Net .19 ea. — 10 for 1.75**

## INSULATED ALLIGATOR CLIP



**20 for 1.17**

Sturdy nickel-plated brass jaws with plastic insulated thumb rest and insulated barrel. Strong spring with hard bite. Solder lug connection. Overall length 2 1/2". Shpg. wt., 4 oz. Supplied in Red and Black.

MS-451—Red Alligator Clip **Net Ea. .07**  
MS-452—Black Alligator Clip **20 for 1.17**

## A FABULOUS BUY! GENUINE 10% and ALLEN-BRADLEY Resistor Kit



**100 INSULATED RESISTORS with PLASTIC HINGED BOX!**

**\$4.50**

Lafayette leads the field with a genuine Allen Bradley and IEC 1/2 watt, 10% tolerance, molded resistor kit with a Transparent Plastic Utility Box (built in partitions) size: 8 1/2" x 4 1/2" x 1-3/16". The finest resistors on the market. Molded insulated composition resistors. Meet JAN-R-11 specifications, including salt water, immersion and high humidity tests.

Block No. KI-23—Total 100 molded resistors with Transparent Plastic Case. **NET 4.50 100 TOTAL**

QUANT.	OHMS
3	100
3	470
4	1,000
3	2,200
4	4,700
4	10,000
4	22,000
4	27,000
4	33,000
4	47,000
10	1 meg
4	.15 meg
4	.22 meg
10	.47 meg
10	.1 meg
4	2.2 meg
20	Other popular values

**LONG SHAFT CONTROL WITH SWITCH**  
VC-10, 1 Meg. } **AUDIO TAPER**  
VC-11, 1/2 Meg. }  
Each **.49**  
Lots of 10 Each **.39**

## LAFAYETTE METAL CASED OIL FILLED TUBULAR CAPACITORS

New!

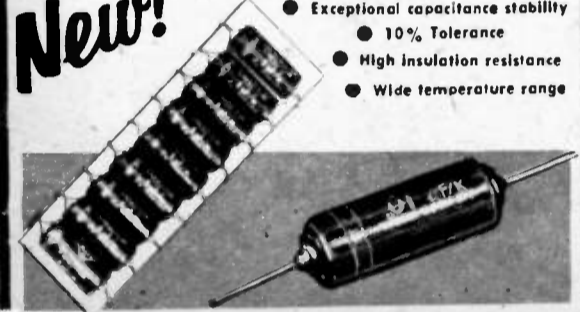

- Exceptional capacitance stability
- 10% Tolerance
- High insulation resistance
- Wide temperature range

These oil-filled and oil impregnated paper capacitors are manufactured to high standards. Features 10% tolerance. Operates efficiently from -40°C to +100°C in metal case with plastic insulating outer jacket. Low dielectric leakage, low power factor and exceptional stability. Compact, made to render long servicing life. Replacement and original applications in radio, TV and other equipment. Outside-fail is clearly printed. Doubly flinned copperweld leads are firmly attached to the case. Conservatively rated at 600 VDC. Shpg. wt., 5 oz. each.

TYPE	CAP MFD	SIZE D X L	NET EACH		
			SINGLE	Lots of 10	Lots of 100
C-800	.001	9/32 x 26/32"	.09	.81	7.00
C-801	.002	9/32 x 26/32"	.09	.81	7.00
C-802	.005	9/32 x 27/32"	.09	.81	7.00
C-803	.01	9/32 x 27/32"	.10	.90	7.90
C-804	.02	10/32 x 27/32"	.11	.99	8.50
C-805	.05	13/32 x 1"	.12	1.08	9.50
C-806	.1	15/32 x 1 1/16"	.14	1.26	11.40

## HEAVY SHIELDED PHONE PLUGS AND JACKS



(A) Sturdy, heavy brass, nickel-plated phone plug with screw terminal connections. Threaded insulated cable outlet may be removed for larger cables to pass through. Body dia. 3/8", overall length 3 3/8". Shpg. wt., 4 oz.

MS-534 Plug **Net ea. .39 10 for 5.30**

(B) Matching in-line phone jack, same construction as plug. Overall length 2".

MS-533 Jack **Net ea. .55 10 for 4.95**



## INSULATED ALLIGATOR TEST CLIPS WITH 6 FT. LEAD

Handy for quick connections. Plated brass alligator clip with insulated handles and 6 ft. of No. 22 stranded wire attached. Clip is 1 1/2" overall.

MS-536 Red **50 for 3.25 10 for .72**  
MS-537 Black **SINGLY, EACH .08**

## PHONE PLUG TO PHONO JACK ADAPTER

Brass, nickel-plated adapter. Has standard phone jack on one end to take regular phone plug, and RCA-type phono plug on other end. Has threaded bushing with nut and washer so can be panel mounted if desired. Shpg. wt., 4 oz.

MS-335 **Net .52**

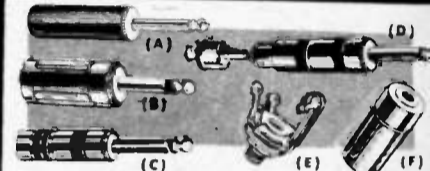

**LAFAYETTE SPECIAL 2-CONDUCTOR PHONE PLUGS**  
STANDARD 2-CONDUCTOR PHONE PLUGS  
Phone plugs for a wide variety of applications with choice of handle sizes and materials. All sleeves fit standard 1/2" phone jacks.

FIG. A. SLIM PHONE PLUG Smooth bakelite handle. Solder terminals with cable clamp. **MS-453 Net .25 ea. — 10 for 2.15**

FIG. B. BARREL PHONE PLUG Ribbed plastic barrel handle. Screw terminals. **MS-455 Net .22 ea. — 10 for 1.90**

FIG. C. SHIELDED SLIM PLUG Ribbed chromed metal handle. Solder terminal with cable clamp. **MS-443 Net .29 ea. — 10 for 2.50**

FIG. D. PHONE TO PHONO PLUG ADAPTER Adopts from standard phone plug to RCA type phono plug. Overall length 2 3/4" x 1/2" diam. **MS-444 Net .39 ea. — 10 for 3.25**

STANDARD PHONE JACKS FOR 1/4" PLUGS

FIG. E. OPEN CIRCUIT JACK Standard open circuit phone jack, 1/4" bushing, 1/2" long. Complete with mounting hardware. **MS-441 Net .19 ea. — 10 for 1.75**

FIG. E. CLOSED CIRCUIT JACK Same as above but closed circuit phone jack. **MS-454 Net .19 ea. — 10 for 1.75**

FIG. E. OPEN CIRCUIT JACK Open circuit jack for 3 conductors. **MS-318 Ea. 29¢**

FIG. F. EXTENSION CABLE JACK Fit standard 1/4" phone plug. Screw terminals. Barrel plastic handle matches MS-455 Barrel plug. **MS-442 Net .22 ea. — 10 for 1.90**



## Precision VERNIER DIALS

Precision planetary drive vernier dials with approximately 8 to 1 ratio. Mounts on panel surface and has accurately centered metal inserts for 1/4" shafts. Metal dials are brushed silver finish with deeply etched and black filled engraving to provide maximum legibility even under poor lighting conditions. Reads counter-clockwise 0 to 100 in 180°. Uses tough scratch resistant for sure grip fluted molded knob and housing. Phosphor bronze and brass utilized for internal parts. Shpg. wt., 8 oz.

F-348 36MM (1 1/2") Diameter Vernier Dial, 13/16" from front to back **Net .90**

F-347 50 MM (2") Diameter Vernier Dial, 1" from front to back **Net 1.00**

F-346 70MM (2 3/4") Diameter Vernier Dial 1 1/8" from front to back **Net 1.40**

## NEW! sub-miniature TRANSISTOR AUDIO TRANSFORMERS

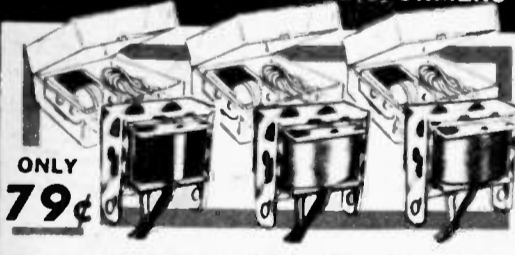

ONLY **79¢**

- Input, Output and Driver Transformers
- Only 1/2" x 1/2" x 1/2"

A new series of miniature transformers for transistor and experimental miniature circuits. Ideal for miniature radio receivers, amplifiers, hearing aids, etc., using standard transistors. Incorporate special heat-treated high permeability magnetic cores and treated to resist corrosion. Designed for improved frequency response with low distortion. 3" color-coded leads. Average shpg. wt., 4 oz.

TR-97 INPUT TRANSFORMER—Primary impedance 100,000 ohms; secondary 1000 ohms; DC resistance primary 1000 ohms; secondary 100 ohms. **Net .79**

TR-98 DRIVER TRANSFORMER—Primary impedance 10,000 ohms; secondary 2000 ohms, center-tapped. DC resistance of primary 240 ohms; secondary 60 ohms, center-tapped. **Net .79**

TR-99 OUTPUT TRANSFORMER—Primary impedance 500 ohms center-tapped; secondary 3.2 ohms. Primary DC resistance 42 ohms, center-tapped; secondary 0.7 ohms. **Net .78**

## LAFAYETTE SPECIAL BARGAINS

### BUDGET UNIVERSAL TEST LEAD KIT IN PLASTIC CASE

This kit consists of color coded 4 3/8" long x 3/8" dia. red and black plastic handle pin prods with heavy duty 37" kinkless rubber leads with 5000 v breakdown insulation terminating in coded 2" long x 3/8" dia. plastic grip banana plugs. 3 sets of interchangeable terminals are included. They all slip directly on to the banana plugs. They are spade lug terminals, phone tips and red and black insulated alligator clips. These items have their own handsome and handy compartmentalized flexible plastic case which snaps shut. Shpg. wt., 1 1/2 lbs.

F-373 **Net .77**

### TEST LEADS

Standard test leads furnished with plastic prods and pin plugs which withstands chipping or breaking. Extra flexible kinkless vinyl covered 60" red and black leads. Prods are red and black 4" long x 3/8" diameter. Supplied in pair of one red and one black.

Available with either pin or banana plugs. Shpg. wt., 8 oz.

F-344 Test Leads With Banana Plugs **Net .39**

F-345 Test Leads With Pin Plugs **Net .39**

## SINGLE POLE SINGLE THROW TOGGLE SWITCH

**22¢ • BALL HANDLE**

Ball handle S.P.S.T. toggle switch in molded bakelite case. Rated 3A-125 Volts. Supplied with chrome metal on-off indicator plate and two mounting nuts. Body size 1 1/4" x 3/4" x 1/2" behind panel. Bushing 7/16" Dia., 7/16" long. Ball handle 1/2" long. Shpg. wt., 4 oz.

SW-21 SPST Toggle Switch **Net .22**  
In lots of 10, Each **.19**

## Miniature PUSH BUTTON SWITCH

**19¢**

Momentary contact push button switch ideal for all miniaturized applications. Single pole two circuit push-to-make type. Beryllium copper leaf contacts. Overall diameter 1/2" x 1/2" dia., 3/16" long. Supplied with washer and mounting nut. Shpg. wt., 3 oz.

MS-449 Miniature Push Button Switch **.19**

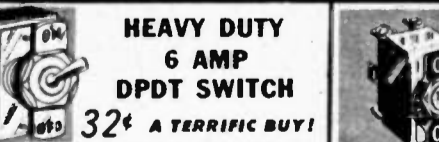

**HEAVY DUTY 6 AMP DPDT SWITCH**

**32¢ A TERRIFIC BUY!**

Heavy duty bat handle toggle switch in enclosed bakelite case — ideal for hundreds of applications. Rated 250V-3 amps or 125V-6 amps. Six solder lug terminals. Comes with chrome metal on-off indicator plate and mounting nuts. Switch body 1 1/4" x 3/4" x 1/2" behind panel, including terminals. Bushing 13/32" dia., 7/16" long. Bat handle 1/2" long. Shpg. wt., 6 oz.

SW-22 DPDT Toggle Switch **Net .32**  
In lots of 10, Each **.29**

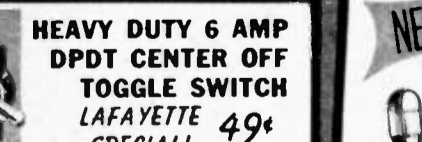

**HEAVY DUTY 6 AMP DPDT CENTER OFF TOGGLE SWITCH**

**LAFAYETTE SPECIAL! 49¢**

Heavy-duty double-pole double-throw for control of light-circuits, high power p.a. horns, electrical appliances and motors. Rated at 6 amps 125 volts AC or 3 amps 250 v. AC. Metal on-off indicator plate and mounting nuts. Switch body 1-5/16" x 1/4" x 1" behind panel, including terminals. 7/16" bushing, 7/16" diam. 1/2" bat handle. Shpg. wt., 8 oz.

SW-19 **Net .49** In lots of 10, Ea. **.45**



**HEAVY DUTY 10 AMP SPDT CENTER OFF TOGGLE**

This heavy duty switch is ideal for small size equipment. Heavy silvered lugs for low-loss connections. Rated 10 amps at 125 volts. Body size 1 1/4" x 9/16" x 1/2" depth behind panel. Bushing 1/2" dia., 7/16" long. Bat handle 1/2" long. Shpg. wt., 4 oz.

SW-27 SPDT Toggle Switch **Net .39**  
In lots of 10, Each **.35**

## RUGGED TELEPHONE TYPE 4PDT LEVER SWITCH

**ANOTHER LAFAYETTE BUY! 69¢ EA.**

Small 3-position lever action telephone type switch of rugged non-inductive construction, perfect for large industrial control panels, test equipment, model railroad control panels, communications systems, etc. Has 4 sets of single-pole, double-throw contacts. Chrome-plated actuating cam has 3 locking positions and stays put in each position. (Switching action is shown in accompanying schematic diagram.) Black insulated lever handle. Heavy insulated rollers at end of cam actuate switch contacts. All contacts easily demountable for making connections, if necessary. Mounts to panel with 2 screws (furnished), 15/16" mounting centers. Size 2 1/4" long behind panel, 1/2" wide, 1-5/16" high. Shpg. wt., 6 oz.

SW-20 3-Position Telephone-Type Switch **Net. 69 Ea.**  
Lots of 10, **.65 Ea.**

## LAFAYETTE JUMBO 5-WAY BINDING POST

**25¢**

Accepts phone tip plug, a spade lug, a banana plug, an alligator clip and a strand of wire. Head non-removable from stand. Molded plastic construction. For panels 1/16" to 1/4" thick. In either red or black color, specify. **PJ-37—Shpg. wt., 8 oz. Net Ea. 25¢**



# Lafayette

# CAMERA DIVISION



presents PHOTOGRAPHIC SYSTEM VERSATILITY at LOW COST!



## 'RANGEFINDER 35'

- 5 ELEMENT F2.8 COATED LENS!
- COUPLED RANGEFINDER

only **29.95** less case

✓ BRILLIANT COMBINED VIEW-RANGE FINDER! ✓ SINGLE STROKE RAPID FILM TRANSPORT! ✓ NINE SHUTTER SPEEDS TO 1/300! ✓ MXF SYNC-ALL SPEEDS— ALL BULBS — PLUS STROBE! ✓ F2.8 45mm COATED LENS! ✓ HI-SPEED REWIND! ✓ STANDARD PC FLASH TERMINAL! ✓ DOUBLE EXPOSURE PREVENTION! ✓ BUILT-IN SELF TIMER!

Lafayette's outstanding camera value! Precision-made to order for the camera fan who is a wise buyer. Check the features — then compare Lafayette's price with any other brand. Fast F2.8 coated anastigmat lens and extra-wide lens aperture for brilliant, sharper full color or black and white even in poor light. Sight and focus through combined range-view finder. Fully synchronized at all speeds for class F. w and electronic flash. Speeds from 1 sec to 1/300th. Rapid advance sets shutter, counts exposure and transports film. Built-in delayed action timer — automatic exposure counter and film stop. Hi-speed rewind with folding lever. Standard accessory shoe on top-film type indicator. All metal body with brushed chrome trim. Black leatherette covering. 20 or 36 exposures on black and white or color 35mm film. PC flash terminal. Shpg. wt. 3 lbs. Use series 6 accessories.

F-196 Net 29.95  
 F-197—Leather Eveready Case. Shpg. wt., ½ lb. Net 3.95  
 Three piece outfit — camera above — Eveready case — and folding BC flash gun. Shpg. wt. 4½ lbs. Net 37.50  
 F-198

Auxiliary lens pictured not included

## 35mm. PROJECTOR-VIEWER

- Projects Color Slides
- Sharp-Brilliant-F3.5 Lens
- Fast Change Slide Lever

Net Price **19.95**



- HOLDS 36 SLIDES • FAST SLIDE CHANGE LEVER

Here is a lightweight and compact 35 mm viewer that compares with models selling for more than twice the price! Precision made... simple, fool-proof construction. Use it as a table viewer with the self-contained 5½" square ground glass screen, or project your slides on a light-colored wall or projection screen and enjoy a 10 in. picture with the same sharp focus. Magazine holds 36 slides that change with the flick of a lever. Compact steel case with carrying handle measures only 10" x 7" x 3¼" deep. Supplied complete with standard 100-watt projection bulb, F3.5 lens, projection mirror, view screen, on-off switch, line cord and instructions. For 105-115 V. AC operation.

F-276 — Shpg. wt., 5 lbs. Net 19.95

## NEW-BOOSTER EXPOSURE METER 6.95 WITH BOOSTER

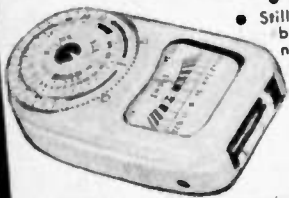

- ASA Scale—LVS Scale
- Still or Movies • Includes booster—Leather case—neck cord

Extremely versatile — extremely simple. Highly legible direct reading dial. Speeds from 4 sec. to 1/1000 sec. Lens aperture settings: from f1.1 to f32. ASA scale 6 to 800. LVS scale 1 to 18. Cine scale 8, 16, 24 and 32 frames per second. Booster cell makes possible readings at extremely low light levels. Small-rugged-lightweight. Includes booster cell, leather case, neck cord and instructions. Shpg. wt., 1 lb.

Net 6.95



25.95

INCLUDING POWER PACK AND BATTERY

## New "SPEEDLITE" Electronic Photoflash operates on 110V AC or Midget Battery Pack

- FEATHERWEIGHT • SUPER POWERED • 4 SECOND RECYCLE • 50 WATT SEC. OUTPUT • COLOR BALANCED LIGHT • BUILT IN DIFFUSER

Designed by one of the foremost electronic flash engineers. More power—more practical features than any other unit in its price class. Thousands of flashes from one lifetime tube—pays for itself in savings on flash bulbs—less than ½ cent per flash. Featherweight flash head weighs only 16 ozs. Entire unit—including battery—only 2 lbs. 4 ozs. Battery pack measures 5¼" x 3" x 1½"—fits gadget bag or pocket. Coiled cord extends 5 ft. for off-camera or bounce flash. 15 ft. AC cord gives practically unlimited movement when operating on AC. Universal bracket fits any camera with a tripod socket. Gun also mounts on side of portable pack. Light is color balanced (6500° Kelvin) for color pictures without filters. Kodachrome guide angle illumination. "Ready" light on head indicates flash is ready to fire. "Easy-off" clamp permits rapid synchronization. Complete with extension or multiple flash use. For any camera having X (zero delay) mounting bracket, clamp and instruction book. Shpg. wt., 4 lbs.

Net 25.95

Net 5.56

F-370 Battery used in F-370 portable power pack. Burgess U160—List 7.95

## FLASH GUN

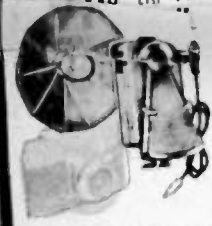

- FOLDS LIKE A... • EFFICIENT S-C OPERATION!

Flash unit or... completely... diameter metal reflector has pebbled... hot spots. B-C combination for... Heavy molded battery case with built-in test lamp — bulb... Standard shoe with pressure... adjust — extension socket. Uses standard bayonet base... adjust fits accessory clips. Uses standard bayonet base... rear of case. Complete with cord for PC fitting, ASA... adapter and condenser. Shpg. wt., 1 lb. Net 3.99  
 F-209 Complete with case. Net 1.05  
 BATTERY for above. Burgess U-15

## PAN-HEAD TRIPOD



Five section, chrome plated, brass tripod. Extends to 43" telescopes down to 12½". Weighs only 20 ozs. Tension adjust screws for each leg. Camera retaining screw on panhead rotates — makes turning camera unnecessary. Pans and tilts with a single motion. Handle is detachable. Pans 360° — tilts 145°. A "must" to take the "jiggle" out of those special shots. Shpg. wt., 2½ lbs. Net 4.49  
 F-295

## PRECISION 8mm MOVIE LENSES

FASTEST! FINEST! LOWEST PRICES!  
 • 1½" f1.4 Telephoto • 6.5mm f1.4 Wide Angle  
 • 1½" f1.9 Telephoto • 6.5mm f1.9 Wide Angle

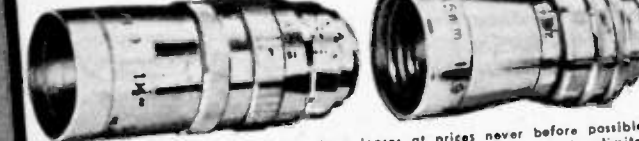

Lafayette—and only Lafayette—has these lenses at prices never before possible! Now you can add that distant scene—those exciting close ups. Add unlimited versatility to your movie camera. The finest coated optics are used throughout—fully color corrected. Fit all 8mm cameras with standard D mount such as Kodak, Keystone, Revere, DeJur, Bolex M8, etc. Satin chrome finish. Removable lens hoods. Accept standard filters. Individual lenses complete with lens caps. Kept standard presentation case. Complete with lens caps.  
 1½" f1.4 Telephoto: Fastest available lens for 8mm. Exceptional speed—extreme sharpness. Focuses 3½ ft. to infinity. Click stops f1.4 to f16. 3x magnification. 5 element lens. Focusing mount. Shpg. wt., 1 lb. Net 18.95  
 F-299—List 44.95  
 6.5mm f1.4 Wide Angle: Extreme wide angle. Covers 4x area of normal lens. Extremely fast—for poorest light conditions. Click stops f1.4 to f16. 8 element retrofocus formula. Focusing mount. Shpg. wt., 1 lb. Net 24.50  
 F-300—List 49.95  
 1½" f1.9 Telephoto: Fast, sharp, fully coated. Click stops f1.9 to f16. Focuses 3.5 ft. to infinity. 3x magnification. 5 element systems. Focusing mount. Shpg. wt., 1 lb. Net 14.95  
 F-302—List 38.95  
 6.5mm f1.9 Wide Angle: Covers 4x area of normal lens. 8 element retrofocus formula. Fixed focus for universal focusing. Click stops f1.9 to f16. Shpg. wt., 1 lb. Net 16.95  
 F-303—List 39.95  
 F1.4 Matched Set: The finest available. Both f1.4 Telephoto and f1.4 Wide Angle in a deluxe, jewel type, presentation case. Shpg. wt., 2 lbs. Net 39.50  
 F-304—List 89.95  
 F1.9 Matched Set: The "Best Buy" possible for the movie camera fan! Both f1.9 Telephoto and f1.9 Wide Angle in deluxe, jewel type presentation case. Shpg. wt., 2 lbs. Net 26.95  
 F-305—List 75.00

## NEW "mini-pro" 2" x 2" 35 MM SLIDE PROJECTOR

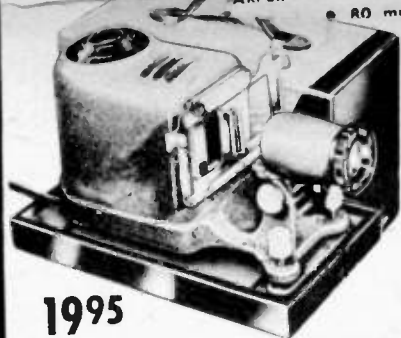

• COMPACT — ONLY 8½" x 6" x 4½" OVERALL  
 • EASIER — EVEN IN LIGHTED ROOMS  
 • 80 mm 1/3.5 COATED

A new, portable projector for showing mounted 2" x 2" 35 mm transparencies. An unusually fine, compound lens system, develops a brilliant, wide-angle image found in projectors of far higher water-tage. Projection lens is a fully coated 80 mm f/3.5 three element triplet type anastigmat. Extremely fine aspheric multi-condenser system multiplies the lamp output, giving the maximum illumination possible. Exceptionally bright-sharp images—even in lighted rooms. Highly efficient double tube venturi cooling plus hardened, heat absorbing filter. Slides will not "pop" out of focus—eliminates constant refocusing. Flat field projection eliminates the usual distortion. Projection distance ranges from 3 feet to 26 feet. Fill a 40" x 40" screen of 10 feet. At 26 feet you get a giant 8 ft. by 15 ft. picture. Elevating knobs tilt projector to desired angle. Weighs less than 3½ lbs. Includes 150 watt projection lamp, attractive, sturdy carrying case, standard two slide carrier, six foot cord and protective lens cap. Shpg. wt., 5 lbs. Net 19.95  
 F-356—List 37.50

## "35" CLIP-ON EXPOSURE METER

• Fits camera accessory shoe • ASA scale 6 to 3200  
 • Measures reflected and incident light

Exceptionally convenient exposure meter. Clips right on camera—quick easy reading. Gives better, more accurately exposed pictures with a minimum of effort. Speeds 1/1000 to 30 sec. Lens aperture f1 to f22. Light value scale (LVS) from 1 to 18. Cine settings from 8 to 64 frames per sec. Measures reflected and incident light. Mounts on camera or may be hand held. Complete with leather case and instructions. Shpg. wt., ½ lb. Net 6.95  
 F-351—Reg. 9.00

## ELECTRIC SLIDE VIEWER

• For all size slides— from 35mm to 2¼ x 2¼"

Makes slide viewing a pleasure! Versatile built in adaptor centers all slides for correct magnification. Transparencies are brilliantly illuminated and enlarged through a fine optically ground and polished lens. Electrically operated—equipped with bulb, socket, on-off switch, 6 ft. cord and plug. All steel construction—finished in platinum gray enamel. Shpg. wt. 2 lbs. Net 3.75  
 F-26

## ELEVATOR TRIPOD



REGULARLY 19.95  
 SALE PRICE 9.49

For any small camera... Professional quality steady — lightweight... legs. Lock securely in place — fold down readily. Single action tilt-pan — and swing over for taking pictures in vertical or horizontal format. Geared elevator centerpost with positive lock and folding crank. Weighs only 31 ozs. All the most wanted features in one tripod. Shpg. wt., 2½ lbs. Net 9.49  
 F-339 List 19.95

## FAMOUS "VISTAR" 2x2 VIEWER

• LARGEST PICTURE AREA OF ANY HAND VIEWER  
 • SEMI-AUTOMATIC SLIDE CARRIER  
 • 9X AREA MAGNIFICATION

The finest slide viewer available. Distortion free, oversize lenses give brilliant, uniform coverage. Largest picture area of any hand viewer for easy group viewing. Push button focusing, finger tip control. Semi-automatic slide carrier automatically activates light. Built-in tripod socket for table top use. Shpg. wt., 1 lb. Net 7.95  
 F-352

## 35 mm Slide File

HOLDS UP TO 300 SLIDES  
 Portable all steel 35mm slide file. Store 150 2x2 glass slides or 300 2x2 cardboard slides. Includes index card, and numbered strips for quick, easy identification. Metal handle and 2 snap catches. Finished in platinum gray enamel. Shpg. wt., 3 lbs. Net 1.69  
 F-161

## Polarizing Filter & Viewer

FROM 6.44

Most effective polarizing screen and view combination. You see the exact polarizations needed for your pictures. Controls reflections from surfaces such as glass, water, wood, etc. Yields spectacular sky effects. Use for fade in—fade out—lap dissolves. Threaded front and back for use with additional accessories. Supplied with pouch and complete instructions. Shpg. wt., 1 lb. Net 6.44  
 F-311 Series 4 ..... Net 6.44  
 F-312 Series 5 ..... Net 7.27  
 F-313 Series 6 ..... Net 8.06

## TILT-TOP

1.39

Precision made—all brass—neatly chrome plated. All-angle "Tilt-Top" fits German five locking action and Cameros. Positive locking action at every possible angle. Inexpensive — indispensable accessory. Shpg. wt., 8 ozs. Net 1.39  
 F-160

LAFAYETTE'S PHOTOGRAPHIC EQUIPMENT MAY BE PURCHASED ON LAFAYETTE'S EASY PAYMENT PLAN



## STEREO VU BALANCE METER

- BALANCES STEREO SYSTEMS ● TWO METERS IN ONE
- ACCURATE TAPE RECORDER LEVEL INDICATOR

Forever ends the problem of adequately balancing your stereo system. Two loudness meters provide a continuous comparison of speaker levels. The scales are calibrated in "Volume Units" and percent. 1.2 volts input sensitivity for 0 VU or 100 percent indication. Instead of continuously running back and forth between listening position and volume control, you can balance the entire system in one step. The special calibrating switch and 20 db attenuation controls permit exact matching of channels. The ideal recording level indicator for inexpensive stereo tape recorders giving accurate, reliable readings. Safeguarded against burning out by two internal DC blocking capacitors. Greater than 8,000 ohm impedance permits connecting to output circuits without loading. The entire unit is housed in an attractive plastic case 3" x 1 1/2" x 5 1/4". Shpg. wt., 2 1/2 lbs. TM-40 STEREO BALANCE METER ..... Net 8.95

**8.95**

## 5.95 **NEW!** AUDIO OUTPUT VU LEVEL METER

A level meter for manual systems, this unit is calibrated in Volume Units and percentages in accordance with standard VU meter practice. Precise damping enables quick and accurate indication of the average level of all non-sinusoidal audio signals. It has a maximum sensitivity of 1.2 volts for 0 VU indication, with a built-in 20 db attenuation control. This meter has countless uses, its 8300 ohm impedance being high enough not to load most circuits. It can be used for accurate level control of home hi-fi systems, especially where the amplifier feeds a remote loudspeaker. It is ideal as a consistently accurate recording level indicator, it indicates proper level in PA, paging and commercial music distribution systems. Housed in a compact plastic case 4" x 2-3/16" x 1-3/8". Shpg. wt., 2 lbs. TM-20-AUDIO OUTPUT LEVEL METER ..... Net 5.95



## NEW! FAMOUS BRAND 2-STATION INTERCOM

- ALL-METAL UNBREAKABLE CABINETS
- VERY SMART STYLING—FOR CHILD'S ROOM OR LIVING ROOM
- FOR 117 VOLTS AC OR DC
- SENSITIVE—PICKS UP SLIGHTEST SOUNDS AT A DISTANCE
- COMPLETE WITH 50' CABLE
- FOR HOME OR OFFICE
- IDEAL BABY SITTER—OR SICK ROOM WATCHER



Here is a FAMOUS-MAKE 2-station electronic intercom PRICED SO LOW WE DARE NOT MENTION THE MANUFACTURER'S NAME. Sensitive—picks up sounds from across the room. Beautifully styled to grace any home or office. Master station has volume control and talk-listen switch. You can talk into the Remote station from a distance—there is no switch to operate on remote. Remote is always "open", making it ideal for listening to baby, sick room, invalids, children at play—or far store to stockroom, restaurant to kitchen, etc. Alnico 5 pm speakers. Uses less power than most light bulbs—costs less than a penny a day to operate. Complete system includes Master, Remote and 50' cable. Simple to operate, easy to install—virtually foolproof. Size of each station approximately 8" x 4" x 4". Shpg. wt., 6 lbs. PA-12—2-Station Intercom System Complete ..... Net 12.50

Specially Priced At

**12.50**

COMPLETE WITH 50' CABLE

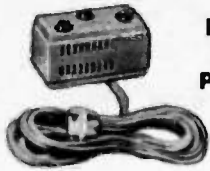

## "B" BATTERY ELIMINATOR AND CHARGER FOR PORTABLE RADIOS

**2.95**

Replaces all snap terminal 67 1/2 V. 8. batteries. When indoors you can operate set on regular 110V AC without using up your expensive "8" battery. Also rejuvenates old batteries for many extra hours of use. Complete with AC cord and plug. Fits in place of your battery. Size: 1 1/2" x 2 1/4" x 1 1/4". Shpg. wt., 1 1/2 lbs. P195 ..... Net 2.95

## NEW! LAFAYETTE'S MINIATURE HI-FI SPEAKER AND ENCLOSURE

**6.95**

**SUPER VALUE!**

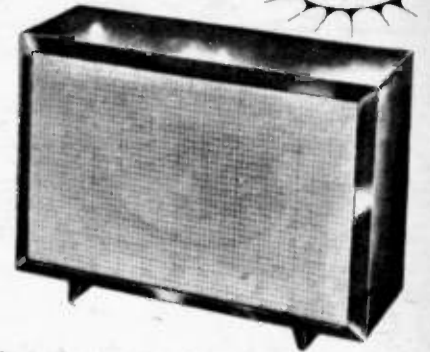

Good things come in small packages! You'll agree when you see and hear this amazing speaker system. Use it as an extension speaker, as the second unit in a stereo set-up, or in pairs for a low-power stereo installation. Housed in a beautiful mahogany-finished wood cabinet with ventilated back cover, the 5-watt 4" x 6" speaker is designed to work from either 4 or 8 ohm outputs. System is supplied with 25 feet of cable which should meet any hook-up requirement. Over-all size: 9 1/2" wide x 7 1/4" high (inc. feet) x 3 1/2" deep. Shpg. wt. 5 lbs. SK-109 Miniature Speaker System ..... Net 6.95

## KIT OF 48 SOLDER LUG STRIPS

**98c**

Handy assortment of 48 solder lug terminal strips with 8 of each type from 1 through 6 lugs. STOCK NO. KI-18 ..... Net 98c

## Deluxe Automatic Wire Stripper

- "Delayed Action Return"
- Strips solid or stranded
- 4 hole precision ground blades
- Strips sizes 12 to 20

Regular **8.25** ONLY **3.45**



Automatic — efficient — easy to use. Strips insulation from all wires, 12 to 20, neatly and quickly. Delayed return action prevents crushing fine wires. A real time saver for servicemen — electrical workers — production lines — etc. Narrow spaced handles for easy grip. Lightweight and easy action for less fatigue. No bother of changing blades or adjusting cutter for varying wire sizes. Extremely well built for years of service and uniform performance. Shpg. wt., 1 1/4 lbs. HD-349 List \$8.25 ..... Net \$3.45

HD-348 Replacement Blades for Above ..... Net .97 per pr.

USE THE LAFAYETTE EASY-PAYMENT PLAN—Requires only 10% Down! FOR YOUR CONVENIENCE, CUT ALONG DOTTED LINE

594

Name _____ Street Ad _____ Town _____ State _____		R.F.D. _____ P.O. Box _____ State _____	
Shipping PLEA NOT _____ If you wish to ship to another person or to a different address, give directions here _____ Name _____ State _____		HOW SHALL WE SHIP _____ Parcel Post _____ Express _____ Freight _____ Air Exp. _____ Best Way _____	
STOCK NO. _____ PAGE NO. _____ QUANTITY _____ REQUIRED _____ SHIPPED _____		DESCRIPTION (Show Mfr's. Name Whenever Possible) _____ PRICE _____ TOTALS _____ SHIPPING WEIGHT _____ LBS. _____ OZ. _____	
If this is an Easy Pay order _____ Check here _____ DON'T ADD SHPG. CHARGES FOR EASY PAY ORDERS. THEY ARE SENT CHARGES COLLECT		Total for Goods _____ Am't. for Sales Tax if any _____ Additional for Postage/ Shpg. Charges _____ TOTAL _____	

**LAFAYETTE RADIO CORPORATION**  
 65-08 Liberty Avenue  
 Jamaica 33, New York

(FOR EASY PAYMENT ORDERS—USE INK—SEE REVERSE SIDE) **ORDER FORM**

**Lafayette Radio**  
 165-08 LIBERTY AVENUE  
 JAMAICA 33, N. Y.  
 AXTEL 1-7000

NEW YORK 13, N. Y. BRONT 58, N. Y.  
 100 6th Ave. 542 E. Fordham Rd.  
 WORTH 6-5300 FORDHAM 7-8813

NEWARK 2, N. J. PLAINFIELD, N. J.  
 24 Central Ave. 139 W. 2nd St.  
 MARKET 2-1661 PLAINFIELD 6-4718

BOSTON 10, MASS.  
 110 Federal St.  
 HUBBARD 2-7850

© 1959 BY LRC

FOR EASY PAY PURCHASE  
USE THIS SIDE AFTER FILLING IN  
MERCHANDISE ON REVERSE SIDE.

MINIMUM ORDER \$20.00 TOTAL CASH PRICE -  
DOWN PAYMENT 10% OR MORE, MINIMUM \$5

NOTICE TO THE BUYER: 1. Do not sign this agreement before you read it or if it contains any blank space. 2. You are entitled to a completely filled in copy of this agreement. 3. Under the law, you have the right to pay off in advance the full amount due and under certain conditions to obtain a partial refund of the credit service charge.

Before filling out amounts see EASY PAY PLAN SCHEDULE and example. Figure your sums first on separate paper to avoid errors. USE INK. DO NOT ERASE OR CROSS OUT.

**RETAIL INSTALLMENT CONTRACT**  
LAFAYETTE RADIO CORPORATION (SELLER)  
165-08 LIBERTY AVE., JAMAICA 33, N. Y.

sells and buyer purchases merchandise as described on reverse side hereof to be kept in good repair and unencumbered at buyer's stated address. Seller shall retain title to and right to possession of merchandise until fully paid. Upon default of any payment or payments seller may declare entire unpaid balance due at once and may also repossess merchandise retaining previous payments as compensation for the use thereof. If proceeds of resale of merchandise are insufficient to cover buyer's obligation, buyer will pay the deficiency to seller; if proceeds result in overage, seller will pay such overage to buyer. Payments will be made to the place and/or to any party designated by the seller in writing.

LAFAYETTE RADIO CORPORATION (SELLER)

BUYER  
SIGN  
HERE

RETAIL INSTALLMENT CONTRACT

Signed \_\_\_\_\_ (L.S.) DATE \_\_\_\_\_

Buyer's Copy Mailed-Date \_\_\_\_\_

By \_\_\_\_\_

FOR OFFICE USE  
Account No. \_\_\_\_\_

(Please Print)  
Name \_\_\_\_\_  
Present Home Address \_\_\_\_\_  
City \_\_\_\_\_ Zone \_\_\_\_\_ State \_\_\_\_\_  
How Long At This Address \_\_\_\_\_ Telephone \_\_\_\_\_

To fill in spaces below correctly refer to EASY PAY PLAN Schedule on this sheet and note example.

1. Total Cash Price*	
2. Sales Tax (if any)	
3. Total (items 1+2)	
4. Down Payment (10% or more) \$5. Min.	
5. Unpaid Balance (item 3 minus item 4)	
6. Credit Service Charge (See EASY PAY Schedule)	
7. EASY PAY BALANCE (Add items 5+6)	
Total EASY PAY Price (Add items 3+6)	

**EXAMPLE**

If Item (5) Unpaid Balance  
Item (6) Credit Service Charge  
Item (7) EASY PAY Balance  
Your Monthly Payment (See Schedule)  
You will pay \$10.00 for 11 months or And your final Month payment will be \$10.00

Buyer agrees to pay \$ \_\_\_\_\_ each month beginning \_\_\_\_\_ month after shipment and a final Month payment of \$ \_\_\_\_\_

EASY PAY ORDERS SENT SHIPPING CHARGES COLLECT. DO NOT INCLUDE SHIPPING CHARGES.

"EASY PAY-PLAN" PAYMENT SCHEDULE

If Unpaid Balance Is	Credit Service Charge	Monthly Payment	If Unpaid Balance Is	Credit Service Charge	Monthly Payment	If Unpaid Balance Is	Credit Service Charge	Monthly Payment
15.00 - 25.00	2.50	5.00	100.01 - 110.00	11.00	10.00	250.01 - 275.00	27.50	27.50
25.01 - 30.00	3.00	5.00	110.01 - 120.00	12.00	10.00	275.01 - 300.00	30.00	30.00
30.01 - 35.00	3.50	5.00	120.01 - 130.00	13.00	10.00	300.01 - 350.00	35.00	35.00
35.01 - 40.00	4.00	5.00	130.01 - 140.00	14.00	11.00	350.01 - 400.00	40.00	40.00
40.01 - 50.00	5.00	5.00	140.01 - 150.00	15.00	12.00	400.01 - 450.00	45.00	45.00
50.01 - 60.00	6.00	6.00	150.01 - 160.00	16.00	12.00	450.01 - 500.00	50.00	50.00
60.01 - 70.00	7.00	7.00	160.01 - 180.00	18.00	13.00	On orders over \$500.00, send payment of 10% or more. Payments in advance will be in proportion to amounts shown on schedule.		
70.01 - 80.00	8.00	7.00	180.01 - 200.00	20.00	14.00			
80.01 - 90.00	9.00	8.00	200.01 - 225.00	22.50	15.00			
90.01 - 100.00	10.00	9.00	225.01 - 250.00	25.00	16.00			

For purpose of receiving credit for above EASY PAY PLAN purchase, the buyer makes the following representation:

With Parents  Whom Spouse  Living Alone  Landlord's Name and Address \_\_\_\_\_

Home Address \_\_\_\_\_ Permanent  Previous  (Check which)

Age (Must Be Over 21) \_\_\_\_\_ Single  Married  Divorced  Name of Spouse \_\_\_\_\_ Spouse Employed By \_\_\_\_\_ (Address) \_\_\_\_\_

How Long (Years) \_\_\_\_\_

Draft Classification \_\_\_\_\_ Reserve Status \_\_\_\_\_ Have you bought from Lafayette before? Yes  No  On Time Payment? Yes  No  If yes, please give your Lafayette Time Payment Account Number, No. \_\_\_\_\_

Real Estate Holdings—Address \_\_\_\_\_ City \_\_\_\_\_ State \_\_\_\_\_

Recorded In Name of \_\_\_\_\_ Present Value \$ \_\_\_\_\_ Mortgage \$ \_\_\_\_\_

Name Present Employer \_\_\_\_\_ If self-employed, so state \_\_\_\_\_ Position Badge No. \_\_\_\_\_ Salary \_\_\_\_\_ How Long (Years) \_\_\_\_\_ (M)

Business Address \_\_\_\_\_ Any Other Income \_\_\_\_\_ Source \_\_\_\_\_ How Long (Years) \_\_\_\_\_

Name Former Employer \_\_\_\_\_

Bank Account With \_\_\_\_\_ Savings  Checking  (Address) \_\_\_\_\_

First Trade Reference \_\_\_\_\_ (Address) \_\_\_\_\_ Highest Credit \$ \_\_\_\_\_ Still Owning \$ \_\_\_\_\_ Mon Pay \_\_\_\_\_

Second Trade Reference \_\_\_\_\_ (Name) \_\_\_\_\_ (Address) \_\_\_\_\_ (City and State) \_\_\_\_\_ Highest Credit \$ \_\_\_\_\_ Still Owning \$ \_\_\_\_\_ Mon Pay \_\_\_\_\_

Third Trade Reference \_\_\_\_\_ (Name) \_\_\_\_\_ (Address) \_\_\_\_\_ (City and State) \_\_\_\_\_ Highest Credit \$ \_\_\_\_\_ Still Owning \$ \_\_\_\_\_ Mon Pay \_\_\_\_\_

Nearest Relative \_\_\_\_\_ (Name) \_\_\_\_\_ (Address) \_\_\_\_\_ (City and State) \_\_\_\_\_ Highest Credit \$ \_\_\_\_\_ Still Owning \$ \_\_\_\_\_ Mon Pay \_\_\_\_\_

Name \_\_\_\_\_ (DO NOT LIST THOSE WITH WHOM YOU RESIDE) Address \_\_\_\_\_ Relationship \_\_\_\_\_

IMPORTANT: Please sign this form before mailing. Be sure to give age. (Must be over 21).

EASY  
PAY  
PLAN  
TERMS

EASY PAY PLAN AVAILABLE ON ALL MERCHANDISE EXCEPT ELECTRICAL APPLIANCES, PRE-RECORDED TAPE, RECORDS, TUBES AND PARTS  
MINIMUM ORDER - 20.00 - DOWN PAYMENT - 10% OR MORE, 5.00 MINIMUM: MONTHLY PAYMENTS AND CREDIT SERVICE CHARGES - SEE SCHEDULE  
CREDIT SERVICE CHARGE REFUND FOR ADVANCE PAYMENT FULL REFUND WITHIN 60 DAYS AFTER SHIPMENT, PARTIAL REFUND AFTER 60 DAYS.  
CUT ALONG DOTTED LINE

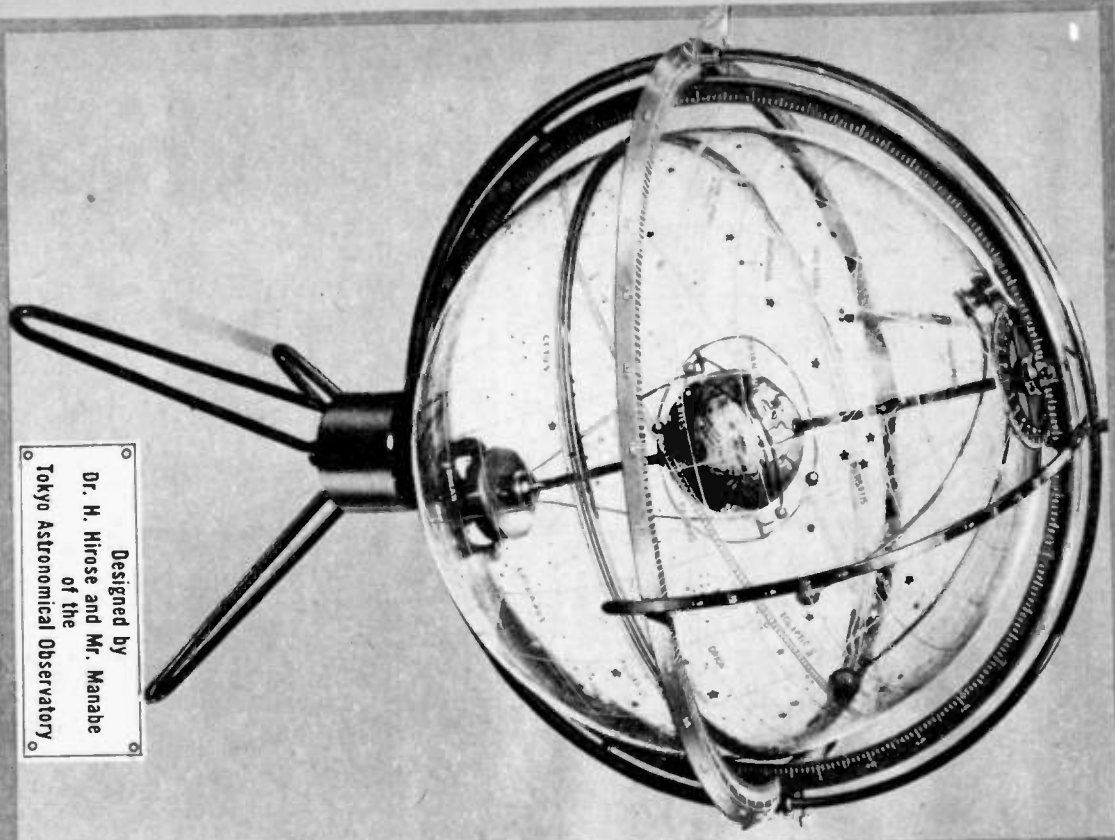

Designed by  
Dr. H. Hirose and Mr. Manabe  
of the  
Tokyo Astronomical Observatory.

- ★ Adjustable Satellite Orbits
- ★ Satellites Travel around Earth Automatically
- ★ Adjustable Sun and Moon
- ★ Adjustable Lunar orbital inclination
- ★ 80 Constellations—including all stars of 1st, 2nd, 3rd and 4th Magnitude.
- ★ Similar devices used by the Navy—Air Force—and Marines.

59.50

FIRST TIME UNDER \$100.00  
AVAILABLE ONLY THROUGH LAFAYETTE IN  
THE UNITED STATES, CANADA & MEXICO

- ★ Basic Aid for Students and Teachers of Astronomy
- ★ Navigators
- ★ Aeronautics
- ★ Astronautics.

Lafayette 14" TRANSPARENT  
CELESTIAL GLOBE

A true "mechanical universe" designed for and dedicated to those who recognize the challenge and adventure that lie on the frontiers of space. The concept of the celestial sphere is the most convenient means of illustrating and discussing the common motions of the stars and the individual motions of the members of the solar system. It offers an easily used and easily understood working model of our universe. An invaluable aid in visualizing and identifying the stars and constellations and their relationship to each other, to terrestrial positions and to times and dates. Permits comprehensive explorations in time and space beyond the earth's atmosphere. The Lafayette celestial sphere may be defined as a sphere of infinite radius with its center located at the center of the earth. All systems of geocentric coordinates, such as this equatorial, galactic, ecliptic, etc., which are based on the celestial sphere, rotate with the sphere. The apparent counter-rotation of the stars, actually due to the earth rotating about an axis is clearly demonstrated. The sphere will illustrate how the sky will appear at any hour—on any date—from any point on earth. With it you can tell time by the stars—learn to tell time by the stars—clearly illustrate and help solve navigational problems. Traces the orbits of man-made satellites and finds their overhead positions. Serves as a superb star chart. Sun and moon positioned by external controls. Artificial satellites automatically circle around the terrestrial globe. The various stars, constellations and their identifications, are permanently molded—not printed—on the celestial sphere. The celestial globe is 14" in diameter with the terrestrial globe centered within. Equipped with horizon ring—time ring—fixed meridian ring—swinging meridian ring—sun and moon pointers—fixed ecliptic—detachable "planet"—indications—universal base—and complete instructions. Ship. Wt., 36 lbs.

Net 59.50

# MORE LAFAYETTE SPECIAL VALUES!

NEW! A SCIENTIFIC INSTRUMENT FOR THE EXPERIMENTER...

## NOVATRON

- MINIATURE ATOM SMASHER
- PRODUCES 75,000 VOLTS
- ABSOLUTELY SAFE

**9.95**

COMPLETELY WIRED (NOT A KIT)



In no sense of the word a toy or gadget, the NOVATRON is a scientific instrument capable of producing 75,000 volts—makes sparks up to 2" long—yet it is absolutely safe because the current is infinitesimal. The science teacher—science lover—hobbyist can perform experiments to astound students—friends—family. Makes smoke disappear—defy gravity—turns propellers at a distance—transforms atomic energy into light—makes artificial lightning—smashes atoms—demonstrates lonic space ship drive—and many other experiments. Constructed of the finest materials. Will do exactly what you wish for instruction purposes—what generators do to teach the secrets of atomic more will do. The perfect device to teach the secrets of atomic physics and electricity. Will hold an audience spellbound as it performs tricks after amazing trick. Manual explains the "how" and "why" of every experiment. Includes an experiment kit and an illustrated experiment manual. Manual explains the "how" and "why" of every experiment. You will invent many new experiments of your own. A fine research tool that will give years of beneficial service to the institution or individual who owns one. Completely assembled, or assembled.

Net 9.95  
F-371 For 110V A-C Operation—Shpg. Wt. 3 lbs.

## LAFAYETTE PROFESSIONAL QUALITY COMMUNICATIONS RECEIVER—ENGINEERED FOR THE AMATEUR

Superheterodyne Circuit Utilizing 8 Tubes & Rectifier Tube

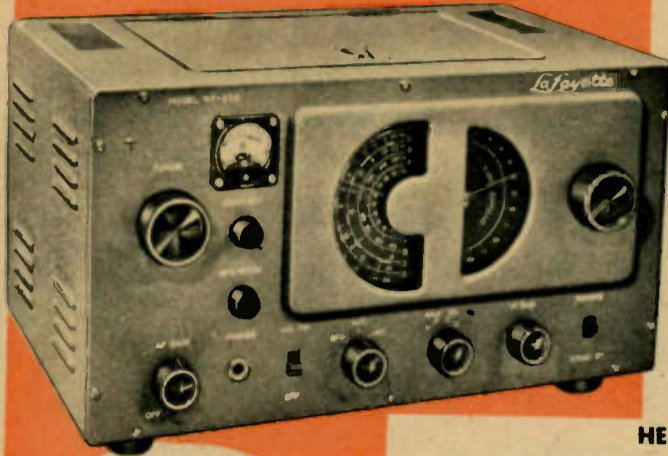

- BAND SPREAD FOR EASY TUNING
- BUILT-IN "S" METER WITH ADJUSTMENT CONTROL
- EXCELLENT SELECTIVITY
- ACCESSORY POWER SOCKET PROVIDED
- ALL TRIMMERS PRE-ALIGNED
- COVERS 455KC. to 31MC. IN FOUR BANDS
- VARIABLE AVC-BFO AND RF GAIN CONTROLS
- BUILT IN PRE-CALIBRATED "S" METER
- SWITCHABLE AUTOMATIC NOISE LIMITER

HE-10 WIRED AND TESTED **79.95** 8.00 Down

**KT-200**  
IN KIT FORM  
**64.50**

6.45 Down

High sensitivity superheterodyne circuit utilizes 8 miniature tubes plus rectifier tube and transformer input, full wave rectifier. The 80,40,20,15 and 10 meter amateur bands are clearly indicated on the illuminated dial face, and can be easily tuned with the pre-calibrated band spread. The receiver has complete band switching, thus eliminating the need for bothersome plug-in coils. Band spread is laid out on an easy-to-read 0-100 scale, and features a weighted control knob which offers smooth, precise tuning. Coverage of from 455 KC to 31 MC is obtained through the use of four switchable ranges (455-1600 KC/1.6-4.8 MC/4.8-14.5 MC/10.5-31 MC). All controls, switches and phone jack are located on the front panel, while an optional accessory socket delivering 360 volts DC and 6.3 volts AC is located in the rear of the receiver. Sensitivity is 13 microvolts (Signal to noise ratio is 20 DB at 3.5 MC) Selectivity is —60DB at 1MC, image rejection is —40DB at 3MC. Panel is grey metal with white lettering, and controls are black with aluminum trim. Hinged top makes inside of receiver readily accessible to operator. 7" H x 15" W x 9" D. Shpg. wt., 22 lbs.

KT-200 .....6.00 Down .....Net 64.50  
HE-10 Same as above, factory wired and tested .....8.00 Down .....Net 79.95

## INDUSTRIAL TIMER SWITCH

• 4000 WATT CAPACITY  
Turns equipment "on" and "off" once in 24 hours, or from one to twelve "on" and "off" operations a day. Min. can be obtained by use of extra trippers. Extra trippers can be added without removing dial. Min. on or off time 1 hr.—max. on or off time 23 hours. Can be turned on or off manually with reset.

Net 7.77

## AUTOMATIC FIRE ALARM

This inexpensive fire alarm gives constant around-the-clock protection for family, home, factories, garages, boats, and countless other applications. Installation is simple. Drive a nail or hook into wall and hang alarm by eyelets provided on back of case. Alarm is operated by a sensitive flashlight beam.

**98c**  
Battery, shpg. wt., 1 lb. Net .98  
MS-475 LIST PRICE 2.98 Net .13  
Battery for above Burgess 2R

## NEW HOPPY SPLIT IMAGE TRANSIT

\*AT LAST — AN ACCURATE LEVEL — AN INCLINE MEASURE ... AT A PRICE ANYONE CAN AFFORD —

Accurate level and incline measure. Do Any Levelling Job. A tool of a man can do a job of a man. It is precision accurate also shows how much levelling, surveying, grading, carpentry, yard grading, contour plowing and thousand other uses. Truly a handy and useful instrument for every complete brick mason and handy man. Shpg. wt., 6 lbs.  
HD-417—Unit 6.95  
HD-441—Carrying Case for Huppy Transit



## SCHAUER KAR-START

STARTS WET OR COLD ENGINES INSTANTLY



If you park your car outside in wet or wintry weather, you need Kar-Start. At instant of starting, Kar-Start sends five times the normal amount of spark from your plugs for sure-fire starts. Used for starting only. It is automatically disconnected when engine is running. Will not damage plugs or distributor. Simply, easily installed with just 3 quick connections. Save your battery, time and temper. Shipping weight 1 lb.  
A-847A for 6V cars List \$6.95 net \$4.20  
A-847B for 12V cars List \$7.95 net \$5.15

## Wollensak



REG. VALUE ~~189.50~~ **139.50**

## TAPE RECORDER

• RESPONSE 40-15,000 CPS + 3 DB AT 7.5 IPSI • DISTORTION LESS THAN 0.8% • WOW AND FLUTTER BELOW 0.3% • SIMPLIFIED KEYBOARD CONTROL • WEIGHS ONLY 18 LBS.!

MODEL T-1500 HI-FI TAPE RECORDER A really precision portable high fidelity recorder made by a famous manufacturer of precision optics. This latest model T-1500 is made available, for the FIRST TIME AT THIS PRICE, BY LAFAYETTE! Dual speed (3.75 and 7.5 inches per second), dual track—provides up to 4 hrs. of record or playback time. Utilizes miniaturized components and all-metal airplane-type construction to achieve real portability—weighs only 18 lbs., measures 6 1/2" x 10 1/2" x 1 1/2". Takes reels up to 7". Additional features of this outstanding recorder include: signal-to-noise ratio 48 db; 2 special hum balance controls; "Balanced Tone" high fidelity; exclusive high speed rewind lever; 2-level recording indicator; precision index counter. Supplied complete with ceramic wide-range microphone, 1 reel of tape, 1 empty takeup reel, radio-ty attachment cord and hi-fi cable. For 110-120 volts, 60 cycles AC. Shpg. wt., 21 lbs. Also available in 50 cycle units; specify. **WOLLENSAK T-1500 Reg. \$139.50 SALE! Net 139.50**

MODEL T-1515 STEREO HI-FI TAPE RECORDER Same features as Model T-1500 except with the addition of stereo head and a built-in second preamp. Shpg. wt., 24 lbs. **WOLLENSAK T-1500—Reg. 229.50. Net 167.50**

ACCESSORIES FOR WOLLENSAK TAPE RECORDERS  
TF-908 MIXER—3 inputs. Mixes any combination of 3 mikes, phono or radio. Net 13.50  
A196-2 MIKE EXTENSION CORD—15' with Wollensak plug and jack. Net 6.75  
A196-12 ATTACHMENT CORD—Connects radio, TV, phono or speaker to recorder. Net 2.25

## NEW LAFAYETTE'S "PRESENTATION" TRANSISTOR PORTABLE

Complete with Leather Case, Earphone & Battery

- PERFECT BACK TO SCHOOL GIFT
- EARPHONE JACK—BUILT IN—FOR PRIVATE LISTENING
- ULTRA SMALL
- PRINTED CIRCUIT
- REFLEXED FOR ADDED GAIN

A highly sensitive, super-selective true pocket transistor radio that will surprise you with its performance over the complete broadcast band. The low low Lafayette price makes this a tremendous bargain! Perfect for back to school gift, or to give to your best friends, relatives. Of course, the all-transistor portable is your perfect companion during your travels, or just for quiet listening in the house. The circuit features reflex design for extra gain. Printed circuit construction offers trouble-free performance and extra long life. Handsomely encased in a black molded case with golden grille and attractive windows for readings of volume level and tuning. Separate tuning and volume controls afford flexibility and ease of operation. Also provides a built-in PM speaker plus earphone jack, ferrite stick antenna, and special tuning condenser. Single long-life 9 volt battery for economical service. Plug-in earphone cuts out built-in speaker for completely private listening. Complete with attractive, soft, leather case, an extra battery, and a sensitive high output, crystal earphone with sanitary plastic ear-insert and 3' flexible cord. 3 transistors and diodes. Size: 3 1/2" x 2 1/2" x 1 1/2". Shpg. Wt., 1 lb.

**16<sup>95</sup>**

FS-203 .....Net 16.95

## SPECIAL SALE! ON FINEST GRADE IMPORTED BINOCULARS!

Each of these extremely precise optical instruments has a coated lens — clamped in (not just glued) prisms — lightweight alloy all-metal body — weatherproof, tear-proof outer covering. Made to our own rigid specifications. Lafayette's famous money-back guarantee applies as always! Focus: Either central focus (C.F.) by means of a single wheel and one adjustable eyepiece, or individual focus (I.F.) wherein both eye pieces are separately adjustable. Power: Is number of times image will appear 7 times larger (or closer). Second number used (i.e. "50" in 7 X 50) is the diameter, in millimeters, of the objective lens.

STOCK NO.	TYPE	SHPG. WT.	NET EACH
F-182	6 X 15 I.F.	2 lbs.	10.75
F-183	7 X 35 C.F.	3 lbs.	19.95
F-184	7 X 35 C.F.W.A.	3 1/2 lbs.	27.50
F-164	7 X 50 C.F.	3 1/2 lbs.	22.50
F-118†	16 X 50 C.F.L.W.	3 1/2 lbs.	29.50
F-185	20 X 50 C.F.	4 1/2 lbs.	32.50

Add 10% Fed. Tax to Above.

S  
A  
L  
E

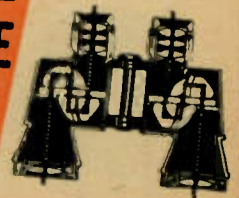

Lafayette

# MONEY SAVERS

## TINY 6-TRANSISTOR RADIO

PLENTY OF POWER IN THIS SMALL PACKAGE!!

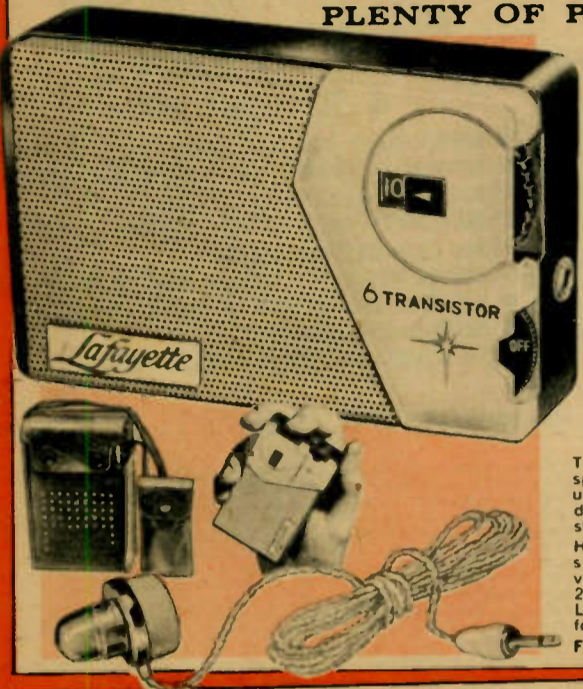

- 6 ULTRA-MODERN TRANSISTORS PLUS GERMANIUM DIODE
- PUSH-PULL AUDIO OUTPUT FOR FAITHFUL TONE QUALITY
- EARPHONE JACK—BUILT IN—FOR PRIVATE LISTENING
- FULL TONE DYNAMIC SPEAKER
- BUILT-IN FERRITE BAR ANTENNA
- TROUBLE-FREE PRINTED CIRCUIT
- SUPERHETERODYNE CIRCUIT
- HIGHLY STYLED PLASTIC CASE
- ECONOMICAL—USES ONLY ONE BATTERY

REGULAR \$48.50  
**24.95**  
INCLUDING EARPHONE BATTERY AND CARRYING CASE

True superhet circuit with push-pull audio output powers either the built-in dynamic speaker or the personal-type earphone. The trouble-free printed circuit utilizes six ultramodern transistors plus germanium diode. Built-in ferrite-rod antenna brings in distant stations like locals. Single long-life 9 volt battery for economical service. Uses standard Burgess 2U6 or RCA VS 312 replacements.

Housed in smartly designed black and white case of durable plastic with gold-toned speaker grille. Soft leather carrying case with attached earphone pouch. "On-off-volume" control plus stylized tuning dial. Coverage 530-1600 kc. Just 4 1/4" high x 2 1/4" w x 1 1/4" thick and weighing a mere 12 ounces — a true purse/pocket portable. Lafayette "Tiny" 6-Transistor Radio — including battery, carrying case, and earphone for personal listening... all at an unbelievably low price!

FS-200 "Tiny" 6-Transistor radio

Net 24.95

## NEW! SENSITIVE DYNAMIC EARPHONE SUPER VALUE

- FOR TRANSISTOR RADIOS
- ENJOY PRIVATE LISTENING
- DURABLE AND ATTRACTIVE

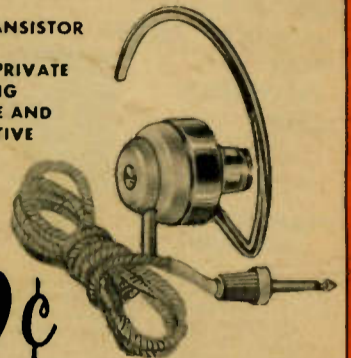

**79¢**

A sensitive fine quality earphone designed to be used for all types of transistor radios. Provides excellent listening pleasure at an unbelievably low price—clear reproduction of music as well as speech, with a pleasing tone quality. This lightweight miniature earphone is comfortable to wear. A flexible polyethylene support holds the receiver securely in place for either ear. Complete with sanitary plastic ear-insert and 3/4" flexible cord and phono plug. Impedance is 6 ohm. Shpg. wt., 6 oz. MS-591 Net .79

## 3-TRANSISTOR MINIATURIZED HEARING AID

HELP FOR THE HARD-OF-HEARING AT A PRICE TO SUIT ANY BUDGET!

Now you can enjoy radio and TV programs, chats with friends and neighbors, church, the movies — because this efficient three-transistor hearing aid amplifies and improves the intelligibility of your world of sound. A "power on/off" switch and volume control permits adjustment to meet preferences and degrees of hearing impairment. Low low price includes a miniature dynamic earphone fitted with two different sizes for individual fit and maximum volume. Different sizes for individual fit and maximum volume. Different sizes for individual fit and maximum volume. Spare battery and zippered carrying case of durable colorless plastic. F-39C 3-Transistor Hearing Aid — a \$50.00 value — now only Net 19.50 Extra battery for Above, Burgess Z or RCA VSO34 Net .08 ea.



**19.50**

## NEW! LAFAYETTE 4 TRANSISTOR INTERCOM AND ELECTRONIC BABY SITTER

**24.95**



- 4 TRANSISTORS
- PRINTED CIRCUIT BOARD • NO
- EXTRA SMALL •

Extra features... top performance... portability... long battery life... ideal for home and office. Perfect as a portable unit... for the summer cottage... backstage for once-a-year amateur theatricals... as well as permanent installation... office to office... kitchen to bedroom. This is a complete transistor intercom system, consisting of a master station and a remote station. Specialized circuitry allows each unit to call the other (remote can call the master even when it is turned off) while requiring only a 2-conductor wire for interconnection. Completely transistorized. Requires only 6 volts from built-in, easily replaceable batteries for many months of reliable operation. Elimination of all power line connections prevents all shock hazard and makes this unit safe to use everywhere. Master station has a volume control and function switch with 3 positions, Talk, for speaking to remote; listen, for monitoring the remote (baby sitting, etc.); and standby which turns off the power to conserve batteries. Zero warmup time means the unit is ready for operation. When the unit is turned off, the remote can call the master by depressing its call switch; a pleasant musical tone alerts the master that it is being called. Trouble-free long-life printed circuit board, correct amount of negative feedback, and push-pull output circuit. Big 3" speakers are used for optimum naturalness and intelligibility. Each unit is housed in an attractive two-tone case, measuring 5 x 4 1/2 x 3 1/2". Complete with cable and batteries. Shpg. wt., 6 lbs. PA-71 Net 24.95

## NEW! 4-TRANSISTOR MINIATURE HEARING AID

Reg. 75.00

**29.50**

A Lafayette Special



- LIGHTWEIGHT AND POWERFUL—A REAL BOON TO THE HARD-OF-HEARING • WEIGHS ONLY 5 OZ.—SMALLER THAN A PACK OF CIGARETTES • USES ONLY 2 SMALL LOW-COST FLASHLIGHT CELLS • QUALITY AND PRECISION BUILT FOR YEARS OF OUTSTANDING PERFORMANCE • ECONOMICAL IN COST AND UPKEEP

A completely self-contained modern hearing aid whose power and sensitivity will open up a "new world" for those with even severe hearing loss. Small enough to be carried in a breast pocket, it weighs only 5 oz. Complete with batteries. Only 2-3/16" wide x 2-13/16" long x 3/4" thick! Its 4-transistor circuit provides high amplification, good intelligibility and quiet operation. The tiny flesh-colored dynamic earphone fits snugly into the ear, and a 3-foot long thin flexible cord is supplied, with plugs at both ends. Internal electronic components are protected by a clear plastic cover which keeps the hearing aid dust and moisture free—while making inspection and service easy. A smoothly operating volume control permits easy adjustment for the various requirements of daily living. The alumite case is extremely handsome and finished in gold by a special process to prevent peeling and rusting. A good-looking gray leather zipper carrying case is also supplied. Uses only 2 pen-light battery cells, low-cost and replaceable anywhere, yet battery life is approximately 2 months with a rate of use of 4 hours per day! Shpg. wt., 1 lb. F-360—Hearing Aid Net 29.50

BATTERY FOR ABOVE

Burgess Z or RCA VSO34 (2 required).

Net each .08

## NEW LAFAYETTE "ANNOUNCECOM" 4-TRANSISTOR INTERCOM

**24.95**



PA-72. The master unit is same as above, but the remote unit is hermetically sealed so that it can be placed outdoors. A push-button buzzer alerts the master inside the house, and intercommunication can proceed as described above. Net 24.95

## LAFAYETTE RADIO

165-08 LIBERTY AVENUE, JAMAICA 33, N. Y.

BULK RATE U. S. POSTAGE PAID

New York, N. Y. Permit No. 8486

## FANTASTIC SAVINGS! 62% OFF! FAMOUS GE GC-7 DIAMOND STEREO CARTRIDGE

REGULAR CATALOG

PRICE \$23.47

**NOW 8.95**

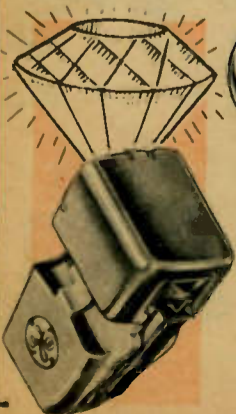

Lafayette shatters cartridge prices with this stereo buy of the year. For less than the price of the diamond needle alone you can have the famous General Electric magnetic GC7 (1.7 MIL) diamond stereo cartridge. Ideal as a replacement cartridge, for conversion to stereo—or at this low price, buy it as a spare cartridge. Frequency response is

20-17,000 cycles. Features high channel separation and excellent compliance with low record and stylus wear. These are genuine GE GC-7 diamond needle cartridges backed up by both the GE and famous Lafayette guarantees.

General Electric GC-7 (1.7 MIL) Diamond Stereo Cartridge. Shpg. wt., 1 lb. Net 8.95



JAMES M KENNEY  
2463 TIEBOUT AVE  
BRONX 58 N Y