

GraybaR

GENERAL CATALOG

NO. 105



GraybaR

GENERAL CATALOG

NO. 105



GraybaR

ELECTRIC COMPANY

CATALOG NO. 105

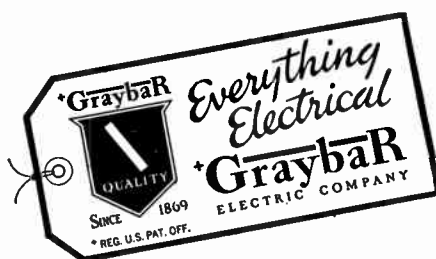

As the owner of a Graybar Catalog No. 105 you have in your possession the most complete catalog of electrical supplies and equipment yet published. We estimate that approximately 65,000 items are listed covering nearly all the commonly used products and many specialties. However, the scope of the Electrical Industry has increased so rapidly that even this book cannot be complete. If you don't find what you want listed, please call our nearest office and warehouse (see last page for location).

**PRICES IN THIS CATALOG ARE
APPROXIMATE LIST PRICES AT THE TIME OF PUBLICATION AND
SUBJECT TO CHANGE WITHOUT NOTICE.**

PRICE OF THIS CATALOG \$10.00 POSTPAID

WHAT YOU CAN EXPECT

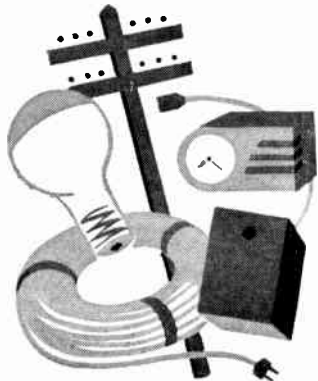

. . . all the products you need from a single source.

Graybar offers the largest variety of electrical supplies and equipment available from any single source. On standard items, even on items which are not usually stocked, we can give you the fastest possible delivery. More than 100,000 electrical products for the home, the office, industry and government, are available through Graybar to fill your electrical requirements—emergency or normal. One order, one responsibility will save you time and money.

. . . the quality and reliability you want (and get) from the nation's leading electrical manufacturers.

The Graybar tag is a symbol of quality and dependability. We have a reputation for distribution of top grade, top value supplies and equipment designed to do any kind of electrical job. Long term association with nationally known leaders in electrical manufacturing (many relationships existing for close to and, even more than, half a century) has established Graybar as THE place to come for the right products to answer your electrical needs. You can purchase with confidence, when you buy from Graybar.



. . . the specialized help you require to assist with your problems.

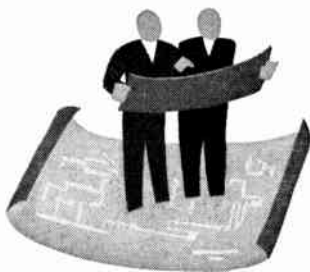

It's not enough to sell the best products—at least that's the way we feel. Graybar offers, as well, know-how in the correct use and application of these products. Our specialists in cooperation with our Suppliers' engineers and technicians are available to help you with unusual electrical problems. They have a thorough knowledge of the materials and equipment best suited to your requirements. Call Graybar first when you need special help. It's the place to get it!



**From Portland, Maine . . . to Los Angeles, California ——— From Seattle, Washington . . .
COAST TO COAST — BORDER TO BORDER**

QUICK REFERENCE INDEX

INSIDE WIRING—

Wire, Cable, Cord, Tape

1

Terminals, Connectors, Fittings

191

Conduit, Conduit Fittings, Boxes,
Condulets, Unilets

215

Metal Wiring Systems, Duct
Systems, Busways

455

Safety Switches, Knife Switches,
Service Equipment, Breakers,
Fuses, Cabinets, Panelboards

511

Wiring Devices, Lamp Guards,
Portable Lamps, Cord Sets

606

TOOLS—

Electricians', Portable Power Tools,
Line Construction Tools, Electric
and Hydraulic Power Tools,
Safety Equipment

708

OUTSIDE CONSTRUCTION EQUIPMENT—

Hot Line Tools, Trailers, Winches,
Take-Offs

883

Poles, Crossarms, Braces, Anchors
and Guying Accessories

895

Pole Line Hardware, Cable
Hangers, Brackets, Pins

923

Insulators and Insulator Fittings,
Pole Seats, Platforms, etc.

947

Transmission and Distribution
Conductors, Underground
Construction Equipment, Strand,
Armor Rod, Clamps, Splices
and Sleeves

973

Traffic Signals, Controllers,
Switches, etc., Street Lighting

1006

OUTSIDE CONSTRUCTION EQUIPMENT—Cont'd

Lighting Fixtures, Fluorescent and
Incandescent, Industrial,
Commercial and Residential,
Fluorescent Accessories, Stage,
Studio and Aviation Lighting,
Floodlights, Naval Marine
Equipment

1040

POWER APPARATUS—

Fans, Furnaces, Heaters, Base-
board Panels

1212

Hand Lamps, Lanterns, Flashlights
and Batteries, Fire Extinguishers,
Sprayers

1217

Signaling Equipment, Clocks,
Thermostats, Relays and Water
Coolers

1230

Fans, Ventilating, Blower, Propeller,
Centrifugal; Heaters and
Heating Equipment, Rectifiers,
Electric Plants

1272

Motors and Controls, Photo-
Electric Devices

1302

Industrial Transformers, Voltage
Regulators

1357

Switchgear, Circuit Breakers

1377

Distribution Transformers and
Protective Equipment, Capacitors,
Meters and Instruments

1415

Storage Batteries and Rectifiers

1501

COMMUNICATION—

Telephone Equipment, Power
Supplies, Carrier Equipment

1504

Microphones, Amplifiers,
Loudspeakers, Intercommuni-
cation Systems

1527

FROM Graybar . . .

. . . a localized service with national resources.

Graybar service can be had from coast to coast, border to border. It is a localized service with national scope and resources. In more than 130 locations established strategically throughout the country, you can get "home town" service from your local Graybar house. It's as near as your telephone—and waiting for your call. For emergency needs . . . for special help . . . for complicated orders . . . for routine purchases, call Graybar first! It's the sure, fast, convenient way and only an arm's length away.

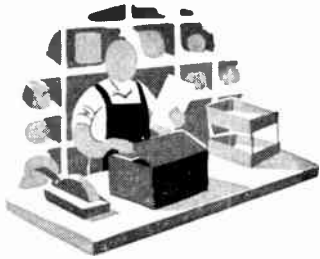

. . . service that's sure and satisfying.

The guesswork is taken out of your delivery dates when you plan your purchasing with Graybar. You get the materials you need when and where needed. Through our unique, speedy, service set-up, the materials you order are shipped from our widely diversified local warehouse stocks immediately. Out of stock items will be expedited from other of our branch warehouses or direct from our numerous, loyal sources of supply. Billing is fast, too! No long wait to learn the exact status of your account.

. . . seasoned experience backed by streamlined operation.

Graybar's experience predates much of the vast electrical industry as we know it. Yet in product lines, methods and specialized services, we endeavor to keep a step ahead of today's requirements. Founded in 1869, we have kept pace of rapid developments in the electrical and electronics fields. Actually the name Graybar is only thirty-two years old but company tradition extends back into the beginning of the Western Electric Company and the electrical industry itself, giving us eighty-nine years of electrical heritage and know-how.

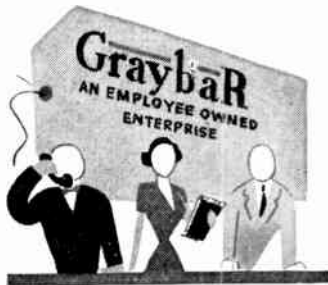
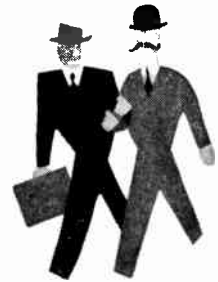

. . . a personal interest in serving you and serving you right.

Graybar people own their company. That's why they are anxious to give you the kind of service you expect. They have a personal interest in wanting to maintain customer good will, for it not only protects their jobs, it protects *their* company. Graybar employees purchased their company in 1929 from Western Electric and have made a success of it ever since because of this personalized service. Whatever your requirements, be they catalog information or quotation service, counsel on problems or delivery of an order, you get this friendly, efficient service from *every* Graybar House.

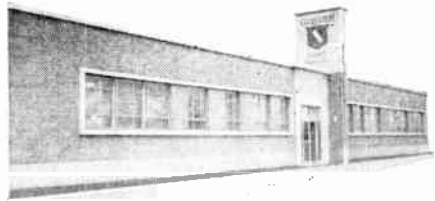

to Jacksonville, Florida ————— From Dallas, Texas . . . to Duluth, Minnesota
GRAYBAR'S SERVICE IS AS NEAR AS YOUR TELEPHONE. CALL GRAYBAR FIRST

PRICES . . .

Prices found in this catalog are revised to agree with the latest lists at the time of going to press. It is understood that they are subject to change or correction without notice and are, therefore, not offered by us as a quotation. It is contemplated that all prices are for shipment from our warehouse unless otherwise specified.

ORDERS . . .

Where possible, we have placed opposite each article a catalog number. When ordering give the catalog number and description of the article required.

You are requested to specify the routing over which you prefer shipments to be made. In the absence of specific instructions, we shall use our best judgment in selecting the route, but we are not responsible for extra trucking expenses at destination.

TERMS . . .

Our terms are 30 days net from date of invoice.

Payments may be made by check, bank draft, postal or express money order, drawn to the order of or endorsed to the order of the Graybar Electric Company, Inc.

Payments in currency through the mails even if registered are not recommended and are at sender's risk. We are not responsible for loss or miscarriage of the mails.

Receipts are not issued for remittances unless requested. Our endorsement on remittance is acknowledgment of the receipt of the funds.

We solicit new accounts on a credit basis and in order to give prompt service, request (if you are not well rated by the Commercial Agencies) that you forward bank and trade references or other information of a credit character with your order. These will be immediately acted on and the results held in strict confidence for our sole use. When reasonably satisfactory, shipment will follow with all possible dispatch.

To avoid the delay incidental to communicating with references, etc., when immediate shipment is desired, it is suggested that you send cash in advance or authorize us to ship your first order C. O. D. or sight draft bill-of-lading attached, through a local bank. This will permit us to make immediate shipment of your initial order and communicate with you as quickly as possible relative to the establishment of credit, if you desire open account facilities for future convenience.

RETURNED GOODS . . .

We can take no responsibility for any material returned without our authorization. Where we give shipping instructions for returning goods, they should be carefully followed so that credit may be issued promptly.

SHIPMENTS . . .

As experienced packers are employed, and as reasonable care is used in packing, we cannot be held responsible for breakage in packages which are delivered in "good order" by the carrier.

Shipments of glassware are made at your risk.

Goods ordered to be shipped by parcel post will be sent only at the purchaser's risk of loss or damage.

Goods are sold f. o. b. shipping point unless otherwise specifically stated.

RESPONSIBILITY . . .

All statistical information contained in this catalog, pertaining to *Strength* and *Proper Working Loads* of material, tools or machines is derived from tables compiled by the Manufacturers thereof, and is reprinted by us for the convenience of the buyer. This information is necessarily based upon *use under proper working conditions*. We assume no responsibility by this reprint, and in no way do we give you a guarantee, expressed or implied, on any material.

Phelps Dodge Building Wire and Cable

Single Conductor—600 Volts N.E.C.

**Thermoplastic Insulated
Habirdure—Type TW**



Insulated with Habirdure, a synthetic resin possessing high dielectric strength. Braided covering is not necessary because of the toughness of this insulation. Habirdure is practically non-aging, is highly resistant to moisture, oil, acids and alkalis and is easy to pull. Omission of braided covering reduces outside diameter to a minimum.

Type TW: Approved by N.E.C. for general purpose wiring and also for use in wet locations at 60° C.

Size A.W.G. or MCM	No. of Strands	Wall Thickness 64ths In.	Approx. O.D. In.	Approx. Wt. Per 1000 Feet
*18	1	2	.106	9
*18	7	2	.112	10
†18	19	2	.112	10
*16	1	2	.118	13
*16	7	2	.121	14
†16	19	2	.125	14
14	1	2	.131	20
14	7	2	.139	22
14	19	2	.140	22
12	1	2	.148	28
12	7	2	.158	31
12	19	2	.159	31
10	1	2	.169	41
10	7	2	.182	45
10	19	2	.183	45
8	1	3	.228	69
8	7	3	.244	75
8	19	3	.245	75
6	1	4	.292	110
6	7	4	.323	119
6	19	4	.323	119
6	37	4	.323	119
4	7	4	.372	176
4	19	4	.372	176
4	37	4	.372	176
2	7	4	.433	267
2	19	4	.433	267
2	37	4	.433	267
1	19	5	.508	339
1	37	5	.508	339
1	61	5	.508	339
1/0	19	5	.549	415
2/0	19	5	.595	515
3/0	19	5	.617	635
4/0	19	5	.705	785
250	37	6	.788	925
300	37	6	.843	1095
350	37	6	.895	1260
400	37	6	.942	1430
500	37	6	1.029	1760
600	61	7	1.143	2100
700	61	7	1.214	2120
750	61	7	1.219	2600
800	61	7	1.282	2740
900	61	7	1.345	3100
1000	61	7	1.404	3420
1250	91	8	1.577	4220
1500	91	8	1.702	5050
1750	127	8	1.817	5860
2000	127	8	1.922	6700

*Type TF 300 Volt fixture wire.

†300 Volt machine tool wire.

Small diameter building wire in sizes No. 14 and No. 12 A.W.G., can be supplied in the following standard colors: black, white, red, green, orange, blue, yellow and brown. Sizes No. 10 A.W.G. and larger are manufactured in a reduced number of colors. Colors are bright and fadeless and are not affected by rough handling during installation.

Prices on application.

**Rubber Insulated—Lead Sheathed
Type RHL Heat Resistant Grade Insulation**



Solid

Size A.W.G. or MCM	No. of Strands	Insulation Thick. 64ths In.	Lead Sheath Thick. 64ths In.	Diam. over Lead In.	Approx. Ship. Wt. Lbs. per 1000 Ft.
18	1	2	2	.19	115
16	1	2	2	.20	125
14	1	2	2	.21	138
12	1	2	2	.23	156
10	1	3	3	.31	285
8	1	4	3	.37	335

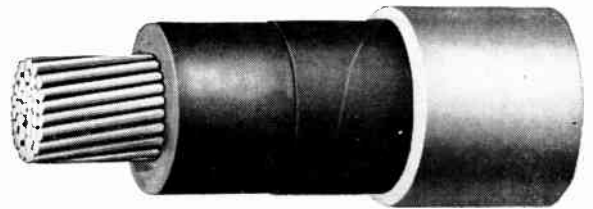

Concentric Stranded

Size A.W.G. or MCM	No. of Strands	Insulation Thick. 64ths In.	Lead Sheath Thick. 64ths In.	Diam. over Lead In.	Approx. Ship. Wt. Lbs. per 1000 Ft.
14	7	2	2	.22	141
12	7	2	2	.24	161
10	7	3	3	.34	300
8	7	4	3	.40	445
6	7	4	4	.46	575
4	7	4	4	.50	680
2	7	4	4	.56	825
1	19	5	4	.64	1015
1/0	19	5	4	.68	1120
2/0	19	5	4	.73	1270
3/0	19	5	4	.78	1440
4/0	19	5	4	.84	1645
250	37	6	5	.95	2355
300	37	6	5	1.00	2595
350	37	6	5	1.06	2950
400	37	6	5	1.10	3180
450	37	6	5	1.14	3400
500	37	6	5	1.19	3610
600	61	7	6	1.33	4665
650	61	7	6	1.36	4890
700	61	7	6	1.40	5355
750	61	7	6	1.44	5575
800	61	7	6	1.47	5785
900	61	7	6	1.53	6210
1000	61	7	6	1.59	6625
1250	91	8	7	1.79	8645
1500	91	8	7	1.91	9655
1750	127	8	7	2.02	11300
2000	127	8	7	2.13	12305

Prices on application.

Phelps Dodge Building Wire and Cable
Single Conductor—600 Volts N.E.C.
Rubber Insulated Fibrous Covered Types R, RH, RW and RHW

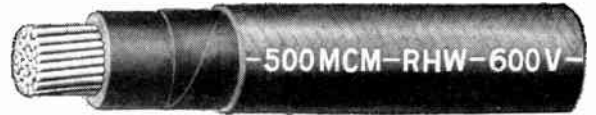

Type R: Code grade, approved by Underwriters' Laboratories for use in dry locations at temperatures not exceeding 60 C.

Type RH: Heat resisting grade, approved by Underwriters' Laboratories for use in dry locations at temperatures not exceeding 75 C.

Type RW: Moisture resisting grade, approved by Underwriters' Laboratories for use in wet locations at tempera-

tures not exceeding 60 C.

Type RHW: Heat and moisture resisting grade, approved by Underwriters' Laboratories for use in wet or dry locations at temperatures not exceeding 75 C.

Type RH-RW: RH wire except for sizes 11 and 12 AWG and all RW wire is approved and labeled as dual purpose RH-RW.

Size A.W.G. or C.M.	Stranding	Thickness of Insulation		Overall Diameter		Shipping Length Ft.	Type of Package	Shipping Weight Per Std. Package		Net Weight Per 1000 Ft.	
		R & RH	RH-RW & RHW (Inches)	R & RH	RH-RW & RHW (Inches)			R & RH	RH-RW & RHW (Pounds)	R & RH	RH-RW & RHW (Pounds)
Single Fibrous Covered											
14	Solid	$\frac{2}{64}$	$\frac{3}{64}$.15	.18	500	Carton	12	14	22	27
	7/.0212	$\frac{2}{64}$	$\frac{3}{64}$.16	.19	500	Carton	13	15	24	28
12	Solid	$\frac{2}{64}$	$\frac{3}{64}$.17	.20	500	Carton	17	19	31	36
	7/.0305	$\frac{2}{64}$	$\frac{3}{64}$.18	.21	500	Carton	18	21	34	39
10	Solid		$\frac{3}{64}$.22	500	Wrapped Coil		27		51
	7/.0385		$\frac{3}{64}$.24	500	Wrapped Coil		29		56
8	Solid		$\frac{3}{64}$.29	500	Wrapped Coil		44		84
	7/.0486		$\frac{4}{64}$.31	500	Wrapped Coil		47		90
Double Fibrous Covered											
14	Solid	$\frac{2}{64}$	$\frac{3}{64}$.17	.20	500	Carton	13	16	24	29
	7/.0212	$\frac{2}{64}$	$\frac{3}{64}$.18	.21	500	Carton	15	17	27	31
12	Solid	$\frac{2}{64}$	$\frac{3}{64}$.19	.22	500	Carton	17	20	32	38
	7/.0305	$\frac{2}{64}$	$\frac{3}{64}$.20	.23	500	Carton	19	22	36	41
10	Solid		$\frac{3}{64}$.24	500	Wrapped Coil		27		51
	7/.0385		$\frac{3}{64}$.26	500	Wrapped Coil		29		56
8	Solid		$\frac{4}{64}$.31	500	Wrapped Coil		44		83
	7/.0486		$\frac{4}{64}$.33	500	Wrapped Coil		47		90
6	Solid		$\frac{4}{64}$.34	500	Wrapped Coil		64		123
	7/.0612		$\frac{4}{64}$.37	500	Wrapped Coil		69		133
4	Solid		$\frac{4}{64}$.42	500	Wrapped Coil		99		193
	7/.0772		$\frac{4}{64}$								
2	7/.0974		$\frac{4}{64}$.48	500	Wrapped Coil		110		276
1	19/.0664		$\frac{5}{64}$.55	1000	Reel—30"		428		368
1/0	19/.0745		$\frac{5}{64}$.59	1000	Reel—30"		508		448
2/0	19/.0837		$\frac{5}{64}$.64	1000	Reel—36"		653		543
3/0	19/.0940		$\frac{5}{64}$.69	1000	Reel—36"		778		668
4/0	19/.1055		$\frac{5}{64}$.75	1000	Reel—36"		931		821
250,000	37/.0822		$\frac{6}{64}$.86	1000	Reel—42"		1278		983
300,000	37/.0900		$\frac{6}{64}$.93	1000	Reel—42"		1469		1174
350,000	37/.0973		$\frac{6}{64}$.98	1000	Reel—42"		1634		1339
400,000	37/.1040		$\frac{6}{64}$		1.03	1000	Reel—42"		1804		1509
500,000	37/.1162		$\frac{6}{64}$		1.11	1000	Reel—42"		2147		1852
600,000	61/.0992		$\frac{7}{64}$		1.23	500	Reel—42"		1408		2226
700,000	61/.1071		$\frac{7}{64}$		1.30	500	Reel—42"		1579		2567
750,000	61/.1109		$\frac{7}{64}$		1.33	500	Reel—42"		1666		2742
800,000	61/.1145		$\frac{7}{64}$		1.36	500	Reel—42"		1747		2904
900,000	61/.1215		$\frac{7}{64}$		1.43	500	Reel—42"		1917		3244
1,000,000	61/.1280		$\frac{7}{64}$		1.48	500	Reel—42"		2083		3575
1,250,000	91/.1172		$\frac{8}{64}$		1.65	500	Reel—48"		2580		4181
1,500,000	91/.1284		$\frac{8}{64}$		1.78	500	Reel—48"		3004		5327
1,750,000	127/.1174		$\frac{8}{64}$		1.87	500	Reel—60"		3645		6149
2,000,000	127/.1255		$\frac{8}{64}$		1.98	500	Reel—60"		4061		6982

Prices on application.

Phelps Dodge Building Wire and Cable

2- and 3-Conductor—600 Volts N.E.C.

Twin—Flat Braid Covered

Type RD—Code Grade Insulation



Size A.W.G.	Insulation Thick. 64ths In.	Solid		Std. Pkg. Feet	Type Pkg.	Ship. Wt., Lbs. per 1000 Ft.
		Approx. O.D. In.				
14	2	.20 x .35		500	Coil	63
12	2	.22 x .39		500	Coil	81
10	3	.26 x .49		500	Coil	125
8	4	.32 x .60		500	Coil	190
6	4	.36 x .68		1000	Reel, 30"	325

Stranded

14	2	.21 x .37		500	Coil	65
12	2	.23 x .41		500	Coil	84
10	3	.27 x .52		500	Coil	130
8	4	.33 x .64		500	Coil	200
6	4	.38 x .72		1000	Reel, 30"	310

Coils are paper wrapped.

Lead Sheathed

Type RDL—Code Grade Insulation
Type RHDL—Heat Resistant Grade Insulation



Individual conductors insulated with code grade or heat resistant grade rubber compound and enclosed in a fibrous covering. Conductors are grouped parallel (flat) as standard. Round construction, with twisted conductors, will be supplied when specified.

Solid

Size A.W.G. or MCM	No. of Strands	Insulation Thick. 64ths In.	Lead Sheath Thick. 64ths In.	Over- all Diam. In.	Approx. Ship. Wt., Lbs. per 1000 Ft.
18	1	2	2	.19 x .33	185
16	1	2	2	.20 x .35	200
14	1	2	2	.21 x .37	202
12	1	2	2	.23 x .40	253
10	1	3	3	.32 x .54	465
8	1	4	3	.38 x .67	560



Concentric Stranded

14	7	2	2	.22 x .38	210
12	7	2	2	.24 x .42	265
10	7	3	3	.33 x .57	485
8	7	4	3	.40 x .70	580
6	7	4	4	.47 x .81	955
4	7	4	4	.52 x .91	1110
2	7	4	4	.58 x 1.03	1670
1	19	5	5	.67 x 1.19	2170
1/0	19	5	5	.72 x 1.27	2550
2/0	19	5	5	.760 x 1.36	2835
3/0	19	5	5	.810 x 1.47	3185
4/0	19	5	5	.870 x 1.58	3835

Prices on application.

3-Conductor—Round

Lead Covered

Type RML—Code Grade Insulation

Individual conductors insulated with code grade rubber compound and enclosed in a fibrous covering. Conductors are twisted, filled with jute, and covered with rubber filled tape and over-all lead sheath.

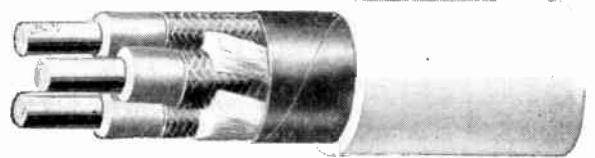

Solid

Size A.W.G.	No. of Strands	Insulation Thick. 64ths In.	Lead Sheath Thick. 64ths In.	Over- all Diam. In.	Approx. Ship. Wt., Lbs. per 1000 Ft.
18	1	2	3	.41	375
16	1	2	3	.44	405
14	1	2	3	.45	435
12	1	2	3	.49	470
10	1	3	4	.64	850
8	1	4	4	.77	1005

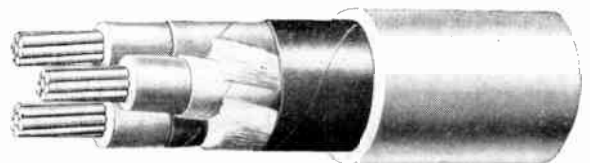

Concentric Stranded

For installations where greater flexibility is required than obtainable with solid conductors. Always recommended for larger sizes where solid conductors would make cable too stiff to handle.

Size A.W.G. or MCM	No. of Strands	Insulation Thick. 64ths In.	Lead Sheath Thick. 64ths In.	Over- all Diam. In.	Approx. Ship. Wt., Lbs. per 1000 Ft.
14	7	2	3	.47	450
12	7	2	3	.54	490
10	7	3	4	.67	890
8	7	4	4	.81	1060
6	7	4	5	.92	1595
4	7	4	5	1.03	2120
2	7	4	5	1.16	2705
1	19	5	6	1.33	3695
1/0	19	5	6	1.42	4335
2/0	19	5	6	1.52	4785
3/0	19	5	6	1.63	5805
4/0	19	5	7	1.79	6910
250	37	6	7	1.96	7710
300	37	6	7	2.08	9110
350	37	6	7	2.19	9845
400	37	6	8	2.32	11145
450	37	6	8	2.42	11860
500	37	6	8	2.50	12580

Prices on application.

Packaging on Reels

Reels, where used, will be charged separately and will be credited in full if returned in good condition, freight collect, within 12 months from date of shipment. Obtain return tags and shipping instructions from Graybar.

Phelps Dodge Service Drop and Entrance Cable

2- and 3-Conductor

Concentric bare neutral cable may be used economically for many types of installations, such as service drop cable from secondary wires at the pole to point of attachment at building, service entrance cable or combination service drop and service entrance permitting a non-splice connection between service wires at pole and service equipment.

Also has further use as a range cable and can be used for this service within the building up to range receptacle. Has a smooth moisture-resisting flame-retarding finish. Standard color for Style SD cable is black. Standard color for Styles SE-U and SE-A is neutral gray; however, other colors can be furnished upon request. The coverage of insulated conductors by the concentrically stranded bare neutral makes Phelps Dodge Service Drop and Entrance Cables virtually tamperproof.

Standard fittings are available for all types.

Type SD Service Drop Cable

Approved by Underwriters' Laboratories

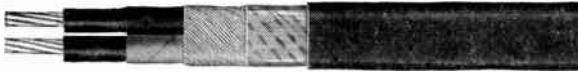

Primarily a service drop cable for use from secondary wires at the pole to point of attachment at building. May also be used as a service entrance cable if protected by conduit.

Has either one or two insulated inner conductors over which is laid a concentric bare conductor protected by paper tape and moisture and flame-resisting braid. In 3-conductor cables, insulated conductors are coded for quick identification.

No. of Conductors	Size, A.W.G.		Approx. O.D. In.	Approx. Ship. Wt. Lbs. Per 1000 Ft.
	Insulated Conductor	Bare Neutral Concentric Conductor		
2	12	12	.32	110
3	12	12	.35 x .51	190
2	10	10	.34	170
3	10	10	.36 x .52	230
2	8	8	.42	210
3	8	8	.45 x .69	310
2	6	8	.46	300
2	6	6	.48	310
3	6	8	.50 x .78	420
3	6	6	.51 x .79	460
2	4	6	.55	430
2	4	4	.57	410
3	4	6	.55 x .85	580
3	4	4	.57 x .90	640
2	2	4	.63	600
2	2	2	.65	610
3	2	4	.63 x 1.01	860
3	2	2	.66 x 1.04	960

Prices on application.

Type SE-A Service Entrance Cable

(Armored)

Approved by Underwriters' Laboratories as Type SE



Armored service entrance cable for use without conduit. Similar in construction to Type SE-U except for a flat steel armor tape applied directly over the bare neutral. Approved for the same service as Type SE-U without exception. Type SE-A cable is generally used on the exterior of a building where it may be subject to mechanical injury.

No. of Conductors	Size, A.W.G.		Approx. O.D. In.	Std. Coil Length Feet	Approx. Ship. Wt. Lbs. Per 1000 Ft.
	Insulated Conductor	Bare Neutral Concentric Conductor			
2	12	12	.35	250	120
3	12	12	.35 x .51	250	201
2	10	10	.38	250	136
3	10	10	.38 x .57	250	257
2	8	8	.46	250	260
3	8	8	.46 x .72	250	410
2	6	8	.50	250	313
2	6	6	.52	250	349
3	6	8	.50 x .79	200	498
3	6	6	.52 x .81	150	532
2	4	6	.57	200	415
2	4	4	.59	200	454
3	4	6	.57 x .91	150	695
3	4	4	.59 x .92	150	737
2	2	4	.65	150	580
2	2	2	.67	150	675
3	2	4	.65 x 1.05	100	943
3	2	2	.67 x 1.07	100	1043

Size 12 Solid—Medium hard drawn.

Size 10 Solid—Annealed.

Other Sizes—Stranded soft drawn.

Type SE-U Service Entrance Cable

(Unarmored)

Approved by Underwriters' Laboratories as Type SE



Can be installed on exterior and interior of a building without conduit.

Approved by the Underwriters for service directly to the range receptacle; may be used for the entire service or any portion of the wiring between the pole line and the electric range or service receptacle.

The use of Type SE-U cable reduces the items required for any installation to a minimum and thereby effects savings where used.

Type SE-U entrance cables have either one or two insulated inner conductors over which is laid a concentric bare conductor protected by rubberized tape and a substantial weatherproofed cotton braid, finished gray or other suitable color if desired, and forming a smooth, moisture-proof covering.

No. of Conductors	Size, A.W.G.		Approx. O.D. In.	Std. Coil Length Feet	Approx. Ship. Wt. Lbs. Per 1000 Ft.
	Insulated Conductor	Bare Neutral Concentric Conductor			
2	12	12	.33	250	87
3	12	12	.33 x .49	250	154
2	10	10	.35	250	115
3	10	10	.35 x .55	250	205
2	8	8	.44	250	189
3	8	8	.44 x .70	250	342
2	6	8	.48	250	236
2	6	6	.50	250	266
3	6	8	.48 x .70	200	432
3	6	6	.50 x .79	150	469
2	4	6	.55	200	338
2	4	4	.57	200	388
3	4	6	.55 x .89	150	624
3	4	4	.57 x .90	150	672
2	2	4	.63	150	500
2	2	2	.65	150	566
3	2	4	.63 x 1.03	100	868
3	2	2	.65 x 1.05	100	921

Prices on application.

Phelps Dodge General Purpose Type RR Cable For Direct-Burial and Duct Use—Neoprene Sheathed Habirprene



Single Conductor

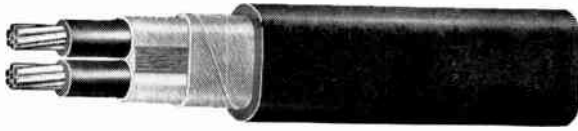

2-Conductor



3-Conductor

Designed for use in ducts or for direct underground burial. Tough Habirprene (neoprene) sheath is resistant to moisture, alkalis, acids and abrasion, assuring long service life in underground installations.

Habirduct moisture resistant insulation is supplied for 600 volt cable, and Habirite ozone resistant insulation is supplied for 5,000 volt cable.

Habirprene sheath conforms to A.S.T.M. Specification D-752, latest issue. Habirprene sheathed cables conform to the dimensional requirements of I.P.C.E.A. specifications

for rubber or thermo-setting synthetic sheaths. Heavier sheaths for unusually severe service conditions can also be furnished.

Single conductor cables are assembled with sheath directly over insulation; multiple conductor cables have single rubber-filled tapes over individual conductors, and are assembled with suitable fillers and a rubber-filled tape over the assembly.

Cables of other sizes and voltage ratings are also available. For further information contact Graybar.

600 Volts Single Conductor For Aerial Installations or Direct Burial

Conductor Size A.W.G. or MCM	Stranding	Insulation Thickness In.	For Conduit or Underground Duct Installations			For Aerial Installations or Direct Burial		
			Jacket Thickness In.	O.D. In.	Shp. Wt. Per 1000 Ft.	Jacket Thickness In.	O.D. In.	Shp. Wt. Per 1000 Ft.
14	Solid	3/64	3/64	.260	93	1/64	.203	78
14	7	3/64	3/64	.270	95	1/64	.212	80
12	Solid	3/64	3/64	.280	104	1/64	.220	89
12	7	3/64	3/64	.290	106	1/64	.231	91
10	Solid	3/64	3/64	.300	121	1/64	.241	105
10	7	3/64	3/64	.310	123	1/64	.255	107
8	Solid	4/64	3/64	.360	152	1/64	.298	132
8	7	4/64	3/64	.375	159	1/64	.316	138
6	7	4/64	3/64	.415	202	2/64	.370	189
4	7	4/64	3/64	.465	262	2/64	.420	218
2	7	4/64	3/64	.510	366	2/64	.480	350
1	19	5/64	4/64	.620	515	3/64	.580	447
1/0	19	5/64	4/64	.660	597	3/64	.620	576
2/0	19	5/64	4/64	.700	698	3/64	.670	676
3/0	19	5/64	4/64	.750	823	3/64	.720	799
4/0	19	5/64	4/64	.810	1164	3/64	.780	954
250	37	6/64	5/64	.920	1363	4/64	.890	1335
300	37	6/64	5/64	.980	1511	4/64	.940	1511
350	37	6/64	5/64	1.030	1719	4/64	.990	1687
400	37	6/64	5/64	1.070	1940	4/64	1.040	1907
500	37	6/64	5/64	1.160	2287	4/64	1.130	2251
600	61	7/64	6/64	1.310	2826	4/64	1.250	2746
750	61	7/64	6/64	1.410	3366	4/64	1.340	3280
1000	61	7/64	6/64	1.560	4180	4/64	1.500	4082

2-Conductor Flat 3-Conductor Round

Conductor Size A.W.G. or MCM	Stranding	Insulation Thickness In.	2-Conductor Flat			3-Conductor Round		
			Jacket Thickness In.	O.D. In.	Shp. Wt. Per 1000 Ft.	Jacket Thickness In.	O.D. In.	Shp. Wt. Per 1000 Ft.
14	Solid	3/64	3/64	.280x.450	140	3/64	.530	209
14	7	3/64	3/64	.295x.490	148	3/64	.549	219
12	Solid	3/64	3/64	.300x.500	163	4/64	.570	264
12	7	3/64	3/64	.310x.520	170	4/64	.598	278
10	Solid	3/64	4/64	.360x.590	223	4/64	.615	316
10	7	3/64	4/64	.370x.600	232	4/64	.645	375
8	Solid	4/64	4/64	.410x.690	296	4/64	.740	491
8	7	4/64	4/64	.430x.720	310	4/64	.778	518
6	7	4/64	4/64	.470x.800	445	5/64	.910	823
4	7	4/64	5/64	1.020	1048
2	7	4/64	5/64	1.170	1489
1	19	5/64	6/64	1.340	2023
1/0	19	5/64	6/64	1.450	2316
2/0	19	5/64	6/64	1.520	2675
3/0	19	5/64	6/64	1.630	3221
4/0	19	5/64	7/64	1.790	3829

Prices on application.

5000 Volts

Conductor Size A.W.G. or MCM	Insulation Thickness In.	Conductor Stranding	Unshielded								
			For Aerial Installations or Direct Burial			For Conduit or Underground Duct Installations					
			Jacket Thickness In.	O.D. In.	Shp. Wt. Per 1000 Ft.	Jacket Thickness In.	O.D. In.	Shp. Wt. Per 1000 Ft.			
8	10/64	7	4/64	.62	296	2/64	.52	259	4/64	.68	401
6	10/64	7	4/64	.65	334	2/64	.59	295	4/64	.79	449
4	10/64	7	4/64	.70	407	3/64	.67	386	4/64	.79	570
2	10/64	7	4/64	.76	562	3/64	.73	538	4/64	.89	678
1	10/64	19	4/64	.80	650	3/64	.77	625	5/64	.92	779
1/0	10/64	19	5/64	.90	954	3/64	.81	715	5/64	.98	882
2/0	10/64	19	5/64	.95	1064	3/64	.86	1007	5/64	1.01	1022
3/0	10/64	19	5/64	1.00	1203	3/64	.91	1139	5/64	1.06	1163
4/0	10/64	19	5/64	1.06	1366	4/64	.99	1334	5/64	1.12	1358
250	11/64	37	5/64	1.14	1589	4/64	1.08	1554	5/64	1.20	1636
300	11/64	37	5/64	1.19	1775	4/64	1.13	1746	6/64	1.28	1901
350	11/64	37	6/64	2005	4/64	1.18	1928	6/64	1.33	2085
400	11/64	37	6/64	1.32	2306	4/64	1.23	2085	6/64	1.38	2273
500	11/64	37	6/64	1.41	2692	4/64	1.31	2606	6/64	1.47	2641
750	11/64	61	6/64	1.59	3670	4/64	1.53	3482	6/64	1.65	3789
1000	11/64	61	7/64	1.78	4669	4/64	1.68	4506	7/64	1.86	4759

2-Conductor

Conductor Size A.W.G.	Insulation Thickness In.	Conductor Stranding	Unshielded				Shielded		
			Jacket Thickness In.	O.D. In.	Shp. Wt. Per 1000 Ft.	Conductor Stranding	Jacket Thickness In.	O.D. In.	Shp. Wt. Per 1000 Ft.
6	10/64	19	6/64	1.31	1471	7	6/64	1.47	1801
4	10/64	19	6/64	1.41	1688	7	6/64	1.57	1965
2	10/64	19	6/64	1.53	2102	7	7/64	1.69	2446
1	10/64	37	6/64	1.61	2310	19	7/64	1.79	2652
1/0	10/64	37	7/64	1.72	2612	19	7/64	1.88	3050
2/0	10/64	37	7/64	1.81	2909	19	7/64	1.97	3590
3/0	10/64	37	7/64	1.91	3431	19	7/64	2.07	3931
4/0	10/64	37	7/64	2.03	4121	19	7/64	2.19	4408

3-Conductor

Conductor Size A.W.G.	Insulation Thickness In.	Conductor Stranding	Unshielded				Shielded		
			Jacket Thickness In.	O.D. In.	Shp. Wt. Per 1000 Ft.	Conductor Stranding	Jacket Thickness In.	O.D. In.	Shp. Wt. Per 1000 Ft.
6	10/64	19	6/64	1.49	1629	7	6/64	1.50	1564
4	10/64	19	6/64	1.53	1904	7	6/64	1.61	2075
2	10/64	19	6/64	1.67	2403	7	6/64	1.74	2445
1	10/64	37	6/64	1.78	2670	19	7/64	1.85	2737
1/0	10/64	37	7/64	1.87	3048	19	7/64	1.94	3031
2/0	10/64	37	7/64	1.96	3597	19	7/64	2.04	3481
3/0	10/64	37	7/64	2.07	4380	19	7/64	2.15	4611
4/0	10/64	37	7/64	2.20	4918	19	7/64	2.27	5168

Prices on application.

Phelps Dodge Varnished Cloth Insulated Cable



For connecting equipment of all voltages in power stations and substations. Used in buildings instead of rubber-insulated cable where special reliability is necessary, and instead of paper insulation in lead sheathed cable subject to crystallization from vibration.

Varnished cloth tapes are helically wound over conductors with mineral base grease between wraps of the insulation.

Coverings: Varnished cloth insulated cables are covered for various applications as follows: Apparatus Cable, with saturated cotton braid or varnished braid; Station Cable, with flameproof braid; Underground Cable, lead sheath; for building mains, with saturated cotton braid on rubber-filled tape and over-all saturated cotton braid; for outdoor structures, one rubber-filled cotton tape, two galvanized steel tapes with asphalted jute over each side of armor.

Shielded Cables

Single Conductor Cables and Multiple Conductor Cables With Individually Shielded Conductors

Rated Voltage Phase to Phase Volts	Range of Sizes A.W.G. or MCM	Varnished Cambric Thickness, Mils	
		Neutral Grounded	Neutral Ungrounded
*0-600	14-8	47	47
	7-2	63	63
	1-4/0	78	78
	213-500	94	94
	501-1000	109	109
	Over 1000	125	125
*600-1000	14-2	63	63
	1-4/0	78	78
	213-500	94	94
	501-1000	109	109
	Over 1000	125	125
*1001-2000	12-2	78	78
	1-4/0	94	94
	213-500	94	94
	501-1000	109	109
	Over 1000	125	125
2001-3000 *(Incl. 2500)	10-2	94	94
	1-4/0	94	94
	213-500	109	109
	501-1000	109	109
	Over 1000	125	125
3001-4000	8-4/0	109	109
	213-500	125	125
	501-1000	125	125
	Over 1000	141	141
4001-5000 *(Incl. 4500)	8-4/0	141	141
	213-1000	156	156
	Over 1000	156	156
5001-6000	8-4/0	141	156
	213-1000	156	172
	Over 1000	156	172
6001-7000 7001-8000 *(Incl. 7500)	8 and Larger	156	172
	6 and Larger	172	188
8001-9000 9001-10000	6 and Larger	188	203
	6 and Larger	188	234
10001-11000 11001-12000 12001-13000 13001-14000	6 and Larger	203	250
	6 and Larger	219	250
	6 and Larger	234	281
	6 and Larger	234	297
	6 and Larger	250	328
*14001-15000 15001-16000 16001-17000 17001-18000	4 and Larger	266	314
	4 and Larger	281	359
	4 and Larger	297	391
	4 and Larger	313	422
18001-19000 19001-20000 20001-21000 21001-22000	2 and Larger	328	438
	2 and Larger	344	453
	2 and Larger	359	...
*22001-23000 23001-24000 24001-25000 25001-26000 26001-27000 27001-28000	2 and Larger	375	...
	2 and Larger	391	...
	2 and Larger	406	...
	2 and Larger	422	...
	2 and Larger	438	...
1 and Larger	453	...	

Belted Cables

Multiple Conductor Cables Without Individually Shielded Conductors

Rated Voltage Phase to Phase Volts	Range of Sizes A.W.G. or MCM	Varnished Cambric Thickness, Mils			
		Neutral Grounded Cond.	Belt	Neutral Ungrounded Cond.	Belt
*0-600	14-8	47	...	47	...
	7-2	63	...	63	...
	1-4/0	78	...	78	...
	213-500	94	...	94	...
	501-1000	94	31	94	31
	Over 1000	109	31	109	31
*601-1000	14-2	63	...	63	...
	1-4/0	78	...	78	...
	213-500	94	...	94	...
	501-1000	94	31	94	31
	Over 1000	109	31	109	31
1001-2000	12-2	78	...	78	...
	1-4/0	94	...	94	...
	213-500	94	...	94	...
	501-1000	94	31	94	31
	Over 1000	109	31	109	31
2001-3000 *(Incl. 2500)	10-2	78	31	78	31
	1-4/0	94	31	94	31
	213-500	94	31	94	31
	501-1000	94	47	94	47
	Over 1000	109	47	109	47
3001-4000	8-4/0	94	47	94	47
	213-500	94	47	94	47
	501-1000	94	63	94	63
	Over 1000	109	63	109	63
4001-5000 *(Incl. 4500)	8-4/0	94	63	94	63
	213-1000	109	63	109	63
	Over 1000	109	78	109	78
5001-6000	8-4/0	94	78	94	78
	213-1000	109	78	109	78
	Over 1000	109	78	109	78
6001-7000 7001-8000 *(Incl. 7500)	8 and Larger	109	78	109	94
	6 and Larger	109	94	109	109
8001-9000 9001-10000	6 and Larger	125	94	125	125
	6 and Larger	141	94	141	141
10001-11000 11001-12000 12001-13000 13001-14000	6 and Larger	156	94	156	156
	6 and Larger	156	109	156	156
	6 and Larger	172	109	172	172
	6 and Larger	188	109	188	188
	6 and Larger	203	109	203	203
*14001-15000 15001-16000 16001-17000	4 and Larger	219	109	219	219
	4 and Larger	219	109	219	219
	4 and Larger	219	109	219	219

***Preferred voltage ratings" for general apparatus, recommended by N.E.M.A.—N.E.L.A. Joint Committee on voltage standardization.

Two-conductor cables will be furnished in round construction unless flat construction is specified on orders.

All cables in accordance with I.P.C.E.A. and A.S.A. standards.

For additional information, including prices, contact Graybar.

Phelps Dodge Non-Metallic Sheathed Cable

Underwriters Approved

Perma-Dure Thermoplastic Multi-Purpose Type UF and NMC Underground Feeder and Branch Circuit Cable

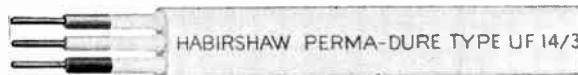

These new cables eliminate costly conduit and permit low cost installations in locations where resistance to moisture and corrosion are basic requirements.

Highly resistant to flame, moisture, rot and abrasion. Flexible, lightweight, simple to install, strip and connect.

Single Conductor—Type UF

Size A.W.G.	Approx. O. D. In.	Approx. Ship. Wt. Lbs. M-FL	FL Per Carton
14	.191	29	500
12	.208	38	500
10	.229	52	500
8	.288	83	500
6	.343	122	500
4	.391	177	500

Two and Three Conductor—Types UF and NMC

Cond. Size A.W.G.	Approximate Dimensions In.	Approx. Ship. Wt. Per M-FL		FL In. Carton
		With Ground Wire	Without Ground Wire	
14-2	.225x.405	81	75	250
12-2	.240x.440	106	97	250
10-2	.265x.490	147	120	250
14-3	.230x.630	118	112	250
12-3	.245x.670	145	136	250
10-3	.265x.740	171	151	250

PD-X Non-Metallic Sheathed Cable

Type NM—600 Volts

Inspected and Labeled by Underwriters' Laboratories, Inc.

Connections easily and quickly made. Insulation is clean and smooth. Paper armor is applied with a long twist. Quickly removed, no sticking. Barrier tape keeps finishing compounds out of the cable.

For use in new and old house wiring for all circuits beyond entrance where permitted by local code.

With Phelps Dodge Type T Thermoplastic Insulated Conductors



Size A.W.G.	No. Conductors	Type of Conductors	Overall Diameter Inches	Feet Per coil	Net Wt., Lbs. Per 1000 Feet	
					With Ground Wire	Without Ground Wire
14	2	Solid	.275x.460	*250	72	66
14	3	Solid	.510	*200	107	100
12	2	Solid	.285x.485	*200	91	88
12	3	Solid	.535	200	142	127
10	2	Solid	.320x.525	200	131	117
10	3	Solid	.575	200	197	180
8	2	7 Strand	.430x.760	125	201	183
8	3	7 Strand	.835	125	310	294
6	2	7 Strand	.510x.915	125	402	355
6	3	7 Strand	1.000	125	496	464
4	2	7 Strand	.565x1.020	125	522	465
4	3	7 Strand	1.110	125	718	667

*Packed in cartons; others in individually wrapped coils.

Phelps Dodge Flexible Cords

Type S or SO—600 Volts



Used as portable power supply cords for small electric tools and machinery. Listed by National Electrical Code as suitable for pendant or portable application in damp places for extra hard usage.

Type S has Buna-S synthetic rubber jacket; type SO jacket is neoprene.

Size A.W.G. No.	Two-Conductor		Three-Conductor		Four-Conductor	
	Approx. O.D. In.	Approx. Ship. Wt. 1000 Ft.	Approx. O.D. In.	Approx. Ship. Wt. 1000 Ft.	Approx. O.D. In.	Approx. Ship. Wt. 1000 Ft.
18	.390	80	.405	93	.435	121
16	.405	93	.430	111	.485	136
14	.530	152	.560	182	.605	229
12	.605	202	.635	245	.665	288
10	.640	246	.690	308	.745	378

Type SJ or SJO Cords—300 Volts



Similar to type S and SO; however have thinner jackets. Used for drop lights, lamps and small tools.

Size A.W.G. No.	Two-Conductor		Three-Conductor	
	Approx. O.D. In.	Approx. Ship. Wt. Lbs. Per 1000 Ft.	Approx. O.D. In.	Approx. Ship. Wt. Lbs. Per 1000 Ft.
18	.305	53	.335	66
16	.330	63	.360	82

Type SP Cord—300 Volts

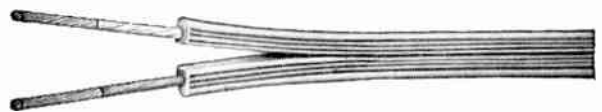

All rubber two conductor parallel rip type cord. Used for wiring lamps and other small devices. Available in two sizes, #18 A.W.G. and #16 A.W.G.

Phelps Dodge Lead Wire

For Motors, Transformers, Switchboards and Appliances



Furnished with tinned or alloy coated flexible stranded copper conductor, with paper separator.

Insulated with heat resistant rubber insulation and covered with cotton braid with heat resistant lacquer finish.

Size A.W.G.	Insulation Thick. In.	No. and Size of Strands	Coils Feet	Ship. Wt. Lbs. Per 1000 FT.
18	1/64	16 x #30	1000	12
18	1/32	16 x #30	1000	14
16	1/32	26 x #30	1000	19
14	2/64	41 x #30	1000	25
12	2/64	65 x #30	*3000	34
10	3/64	105 x #30	*2000	57
8	4/64	84 x .0142	250	130
6	4/64	84 x .0177	250	185
4	4/64	133 x .0177	250	245

*Spools.

Prices on application.

Phelps Dodge Armo-Lok Interlocked Armor Cable

Varnished Cloth Insulated



Provides industrial plant and electric utilities engineers a unit package, metal-clad line of materials to replace cables in conduit or in underground ducts or metal clad bus.

System is made up of Armo-Lok power and control cables with a fully coordinated line of terminators, straight and branch joints and junction boxes, installed on racks, or in troughs or baskets with a pleasing over-all appearance.

Cables furnished with galvanized steel, bronze or aluminum armor.

Varnished Cambric Insulated

Three Conductor 600 Volts Designation PD-3VC-A

Size A.W.G. or MCM	Insul. Thk. 64ths In.	Approx. D.D. In.	*Approx. Ship. Wgt. Lbs. Per 1000 Ft.	Std. Reel Lgth. Ft.
Galvanized Armo-Lok				
8	3	.85	618	2000
6	4	1.00	850	2000
4	4	1.18	1233	2000
2	4	1.31	1609	2000
1	5	1.16	2018	2000
0	5	1.55	2411	1500
00	5	1.65	2767	1500
000	5	1.79	3517	1000
0000	5	1.91	4158	1000
250	6	2.08	4919	1000
350	6	2.33	6376	1000
500	6	2.55	8641	1000
750	7	3.05	12994	1000

Aluminum Armo-Lok

6	4	1.05	605	2000
4	4	1.23	972	2000
2	4	1.36	1219	2000
1	5	1.51	1578	2000
0	5	1.60	2002	1500
00	5	1.70	2295	1500
000	5	1.84	2966	1000
0000	5	1.96	3574	1000
250	6	2.13	4252	1000
350	6	2.38	5676	1000
500	6	2.60	7742	1000
750	7	3.10	11880	1000

Four Conductor 600 Volts—Designation PD-4VC-A Galvanized Steel Armo-Lok

4	4	1.28	1504	2000
2	4	1.42	1981	1500
1	5	1.59	2418	1500
0	5	1.69	2867	1000
00	5	1.80	3379	1000
000	5	1.96	4064	1000
0000	5	2.10	4856	1000
250	6	2.29	5681	1000
350	6	2.57	7486	1000
500	6	2.95	10164	1000

Aluminum Armo-Lok

4	4	1.33	1166	2000
2	4	1.47	1602	1500
1	5	1.64	2018	1500
0	5	1.74	2408	1000
00	5	1.85	2888	1000
000	5	2.01	3527	1000
0000	5	2.15	4278	1000
250	6	2.34	5051	1000
350	6	2.62	6770	1000
500	6	3.00	9338	1000

*Net weight is approximately 1/6th less.

Contact Graybar for prices.

Phelps Dodge Armo-Lok Interlocked Armor Cables

Varnished Cloth Insulated with Protecto-Seal Jacket

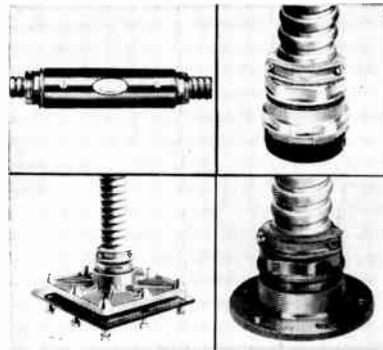

Three Conductor 0-5000 Volts Designation PD-3VC-PA-5 Galvanized Steel Armo-Lok

Size A.W.G. or MCM	Insul. Thk. 64ths In.	Jkt. Thk. 64ths In.	Approx. Diam. Over Jacket In.	Approx. D.D. In.	Approx. Ship. Wt. Lbs. Per M-Ft.	Std. Reel Lgth. Ft.
8	6	6	1.04	1.29	1240	2000
6	6	6	1.13	1.38	1450	2000
4	6	6	1.19	1.44	1759	2000
2	6	6	1.32	1.57	2178	2000
1	6	6	1.40	1.65	2502	2000
0	6	6	1.49	1.74	2838	1500
00	6	6	1.59	1.84	3339	1500
000	6	6	1.70	1.95	3900	1000
0000	6	6	1.83	2.08	4626	1000
250	7	6	1.99	2.24	5255	1000
350	7	6	2.22	2.47	7008	1000
500	7	6	2.52	2.77	8977	1000
750	7	6	2.88	3.13	12133	1000

Aluminum Armo-Lok

8	6	6	1.04	1.34	755	2000
6	6	6	1.13	1.43	1030	2000
4	6	6	1.19	1.49	1359	2000
2	6	6	1.32	1.62	1717	2000
1	6	6	1.40	1.70	2041	2000
0	6	6	1.49	1.79	2337	1500
00	6	6	1.59	1.89	2788	1500
000	6	6	1.70	2.00	3316	1000
0000	6	6	1.83	2.13	3959	1000
250	7	6	1.99	2.29	4555	1000
350	7	6	2.22	2.52	6192	1000
500	7	6	2.52	2.82	8029	1000
750	7	6	2.88	3.18	11061	1000

Bronze Armo-Lok

8	6	6	1.04	1.34	1310	2000
6	6	6	1.13	1.43	1530	2000
4	6	6	1.19	1.49	1759	2000
2	6	6	1.32	1.62	2178	2000
1	6	6	1.40	1.70	2502	2000
0	6	6	1.49	1.79	2838	1500
00	6	6	1.59	1.89	3339	1500
000	6	6	1.70	2.00	3900	1000
0000	6	6	1.83	2.13	4626	1000
250	7	6	1.99	2.29	5255	1000
350	7	6	2.22	2.52	7008	1000
500	7	6	2.52	2.82	8977	1000
750	7	6	2.88	3.18	12133	1000

Prices on application.

Phelps Dodge Armo-Lok Interlocked Armor Cables

Habirite Butyl Rubber Insulated

Size A.W.G. or MCM	Strand	Insul. Thick. 64ths In.	Approx. Diam. Under Armor In.	Approx. Diam. Over Armor Inches		Lbs. Per M-Ft. *Approx. Shipping Weight		
				Galv. Steel or Bronze Armor	Alum. Armor	Galv. Steel Armor	Alum. Armor	Bronze Armor
Three Conductor 600 Volts Designation PD-3B-A								
8	7	4	.735	.945	.998	497	365	523
6	7	4	.821	1.031	1.084	635	488	664
4	7	4	.941	1.151	1.203	848	682	881
2	7	4	1.077	1.287	1.340	1165	977	1203
<hr/>								
1	19	5	1.203	1.413	1.466	1416	1200	1460
0	19	5	1.297	1.507	1.559	1678	1447	1725
00	19	5	1.401	1.611	1.663	2006	1749	2046
000	19	5	1.516	1.729	1.831	2514	2168	2581
<hr/>								
0000	19	5	1.647	1.910	1.962	3027	2640	3086
250	37	6	1.826	2.088	2.141	3537	3123	3618
300	37	6	1.950	2.212	2.265	4101	3656	4188
350	37	6	2.065	2.328	2.380	4639	4180	4728
<hr/>								
400	37	6	2.172	2.435	2.487	5202	4709	5298
500	37	6	2.365	2.627	2.680	6285	5801	6390
600	61	7	2.616	2.878	2.931	7179	6885	7595
750	61	7	2.853	3.115	3.168	9072	8428	9198
Four Conductor 600 Volts Designation PD-4B-A								
8	7	4	.820	1.030	1.083	608	463	638
6	7	4	.916	1.126	1.178	790	625	823
4	7	4	1.050	1.260	1.313	1065	877	1103
2	7	4	1.202	1.412	1.465	1482	1266	1525
<hr/>								
1	19	5	1.344	1.554	1.607	1798	1561	1846
0	19	5	1.448	1.658	1.710	2142	1886	2194
00	19	5	1.565	1.827	1.880	2688	2331	2758
000	19	5	1.695	1.957	2.010	3217	2831	3293
<hr/>								
0000	19	5	1.842	2.104	2.157	3872	3456	3953
250	37	6	2.041	2.304	2.356	4558	4094	4649
300	37	6	2.181	2.443	2.496	5294	4798	5389
350	37	6	2.310	2.573	2.625	6028	5502	6131
<hr/>								
400	37	6	2.430	2.692	2.745	6744	6197	6851
500	37	6	2.615	2.907	2.960	8180	7578	8297
600	61	7	2.926	3.189	3.241	9745	9080	9875
750	61	7	3.192	3.455	3.507	11852	11129	11993
Three Conductor 5000 Volts Designation PD-3B-A-5								
8	7	10	1.240	1.450	1.503	1009	789	1053
6	7	10	1.325	1.535	1.588	1174	941	1221
4	7	10	1.434	1.644	1.697	1429	1176	1481
2	7	10	1.570	1.832	1.885	1913	1555	1983
<hr/>								
1	19	10	1.660	1.923	1.975	2166	1790	2239
0	19	10	1.754	2.016	2.069	2475	2078	2553
00	19	10	1.857	2.120	2.172	2844	2423	2926
000	19	10	1.973	2.235	2.288	3700	3254	3788
<hr/>								
0000	19	10	2.104	2.367	2.419	3847	3368	3940
250	37	11	2.287	2.549	2.602	4456	3938	4558
300	37	11	2.412	2.674	2.727	5088	4542	5195
350	37	11	2.527	2.790	2.842	5692	5119	5804
<hr/>								
400	37	11	2.633	2.896	2.948	6285	5690	6401
500	37	11	2.826	3.088	3.141	7463	6822	7588
600	61	11	3.007	3.270	3.322	8632	7952	8765
750	61	11	3.245	3.507	3.560	10332	9595	10475

*Net weight is approximately 1/6th less.

Prices on application.

Phelps Dodge Neoprene Arc Welding and Power Supply Cable

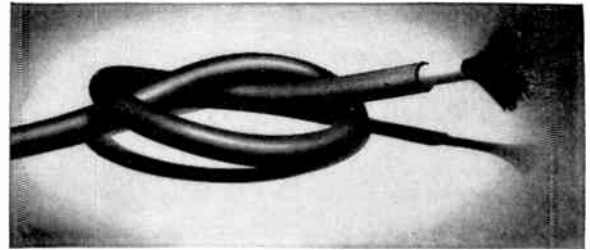

Cable is made with a super flexible conductor composed of fine, soft-drawn, bare copper wires. Has paper separator for ease in stripping and greater flexibility.

Sheathed with a tough, durable neoprene compound that resists heat, oils, acids, alkalis. Cable meets full requirements of A.S.T.M. Specifications D-752.

Arc Welding Cable

Size	Stranding	Gauge	Approx. D.O. In.	Approx. Net Wt. M-Ft.
6	672	34	.400	140
4	1071	34	.440	205
3	1344	34	.480	250
2	1680	34	.555	325
<hr/>				
1	2142	34	.600	390
0	2646	34	.670	500
00	3332	34	.725	600
000	4263	34	.795	765
0000	5344	34	.895	940

Power Supply Cable

Size	Conduc- tor Stranding	I.P.C.E.A. Amp. Rating	Insul. Thick. In.	Sheath Thick. In.	Approx. D.O. In.	Approx. Net Wt. Per M-Ft.
8-2	133 x 29	40	4/64	6/64	.782	332
8-3	133 x 29	35	4/64	6/64	.828	430
8-4	133 x 29	30	4/64	6/64	.915	510
<hr/>						
6-2	133 x 27	50	4/64	6/64	.850	417
6-3	133 x 27	50	4/64	6/64	.900	562
6-4	133 x 27	40	4/64	6/64	1.010	690

**Cable Size Selection Guide
Based On 4 Volt Drop**

Amps.	Distance In Feet From Welding Machine					
	50	75	100	125	150	175
100	4	4	2	2	1	1/0
150	4	2	1	1/0	2/0	3/0
200	2	1	1/0	2/0	3/0	4/0
250	2	1/0	2/0	3/0	4/0	...
<hr/>						
300	1	2/0	3/0	4/0
350	1/0	2/0	4/0
400	1/0	3/0	4/0
450	2/0	3/0
<hr/>						
500	2/0	4/0
550	3/0
600	3/0
Amps.	Distance In Feet From Welding Machine					
	200	225	250	300	350	400
100	1/0	2/0	2/0	3/0	4/0	4/0
150	3/0	4/0	4/0
200	4/0

Prices on application.

Phelps Dodge Bare Copper Transmission Line Conductors

Made, unless otherwise specified, to the specifications of the American Society for Testing Materials, which are the recognized American standards.



Solid

Size A.W.G.	Diam. In.	Circular Mils	Weight, Pounds		Per Std. Coil
			Per 1000 FL	Per Mile	
14	.0641	4,110	12.4	65.7	250
13	.0720	5,180	15.7	82.9	250
12	.0808	6,530	19.8	104	250
11	.0907	8,230	24.9	131	250
10	.1019	10,380	31.43	166.0	250
9	.1144	13,090	39.62	209.1	250
8	.1285	16,510	49.98	263.9	250
7	.1443	20,820	63.03	332.8	250
6	.1620	26,240	79.44	419.4	250
5	.1819	33,090	100.2	528.8	250
4	.2043	41,740	126.3	667.1	250
3	.2294	52,620	159.3	841.0	250
2	.2576	66,360	200.9	1061	250
1	.2893	83,690	253.3	1338	250

Note—Standard Wire Diameters, Weights and Cross-Sectional Areas are calculated and rounded off according to the methods prescribed in ASTM B-258.

Variations in the above weights are to be expected in commercial practice.

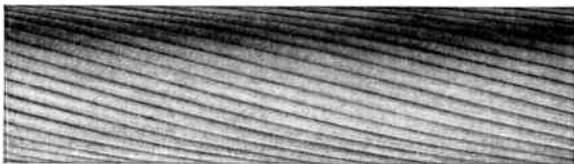

Stranded

Size A.W.G.	Circular Mils	No. of Wires	Wire Diam. Inches	Approx. Cord Diam. Inches	WL. Lbs. Per M-FL	WL. Lbs. Per Mile	Min. Breaking Strength, Lbs.		Max. Resistance @ 20° C. Dhms per 1000 Ft.	
							Hard	Medium Hard	Hard	Medium Hard
1,000,000	61	.1280	1.152	3088	16,300	45030	35100	.01100	.01094	
900,000	61	.1215	1.094	2779	14,670	40520	31590	.01222	.01216	
800,000	61	.1145	1.031	2470	13,040	36360	28270	.01375	.01368	
750,000	61	.1109	.998	2316	12,230	34090	26510	.01467	.01459	
700,000	61	.1071	.964	2161	11,410	31820	24740	.01572	.01563	
600,000	37	.1273	.891	1853	9,781	27020	21060	.01834	.01824	
500,000	37	.1182	.813	1544	8,151	22510	17550	.02200	.02189	
450,000	37	.1103	.772	1389	7,336	20450	15900	.02445	.02432	
400,000	19	.1451	.726	1235	6,521	17810	13950	.02750	.02736	
350,000	19	.1357	.679	1081	5,706	15590	12200	.03143	.03127	
300,000	19	.1257	.629	926.3	4,891	13510	10530	.03667	.03648	
250,000	19	.1147	.574	771.9	4,075	11360	8836	.04400	.04378	
1/0	19	.1055	.528	653.3	3,449	9617	7479	.05199	.05172	
2/0	19	.0940	.470	518.1	2,735	7698	5970	.06556	.06522	
3/0	167,800	7	.1548	.464	518.1	2,735	7366	.06556	.06522	
2/0	133,100	7	.1379	.414	410.9	2,170	5927	.08265	.08223	
1/0	105,600	7	.1228	.368	326.0	1,721	4755	.1042	.1036	
1	83,690	7	.1093	.328	258.4	1,364	3804	.1315	.1308	
1	83,690	3	.1670	.360	255.9	1,351	3620	.1302	.1295	
2	66,360	7	.0974	.292	204.9	1,082	3045	.1658	.1649	
2	66,360	3	.1487	.320	202.9	1,071	2913	.1641	.1633	

Note—Standard Weights, Resistances and Breaking Strengths are calculated and rounded off according to the methods prescribed in ASTM B-258 and the following formulas.

Weight, lbs. per 1000 ft. = C.M. × 0.00302699 × 1.02*
 Weight, lbs. per mile = C.M. × 0.0159825 × 1.02*

*The factor 1.02 in the above provides for the increase in weight due to stranding. Use 1.01 for conductors consisting of 3 strands.

Variations in the above weights are to be expected in commercial practice.

D.C. Resistance, ohms per 1000 ft. = $\frac{P}{C.M.} \times 11.8504 \times 1.02^{**}$

P = 910.15 ohms (mile, pound) for Hard Drawn Wire and 905.44 ohms (mile, pound) for Medium-Hard Drawn Wire.

**The factor 1.02 in the above provides for the increase in resistance due to stranding. Use 1.01 for conductors consisting of 3 strands.

The Resistance values are based on ASTM specifications; the values shown are maximum and thus higher than the average values for Commercial Cables.

Breaking Strength, lbs. = Tensile Strength, minimum psi.*** × C.M. × 0.7854 × 0.9**** × 10.6.

***Tensile Strength, minimum psi, as given in the appropriate ASTM specifications for Hard Drawn and Medium-Hard Drawn Wire for the respective diameters of the individual strands.

****The factor 0.9 provides for the decrease in tensile strength due to stranding.

Phelps Dodge Weatherproof Wire and Cable Type URC—Triple Braid

Made to conform to the requirements of ASA specifications for Weather-resistant Wire and Cable, URC Type, which are the recognized American Standard for this product.



Solid

Size A.W.G.	Weight Lbs. Per M-FL	Standard Package, FL		†Approx. Net WL, Lbs.	
		Reels	Coils	Reels	Coils
*14	25	6675	4000	167	100
*12	35	6000	3000	210	105
*10	53	5300	2650	281	140
*8	75	3333	2000	250	150
*6	112	3350	1450	375	160
*5	135	2500	1250	337	169
*4	164	2000	1000	328	164
3	199	1500	1000	299	199
2	260	4000	670	1040	174
1	316	3000	600	948	190
1/0	407	5000	500	2035	204
2/0	502	4000	500	2008	251
3/0	629	3000	500	1887	315
4/0	767	2500	400	1917	307

*Also available in package coils of 500 ft.

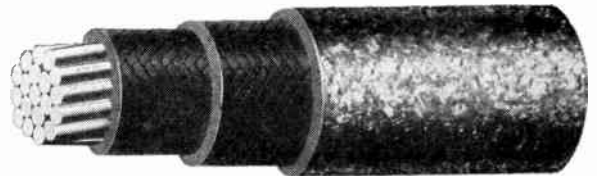

Stranded

Size A.W.G. or MCM	Weight Lbs. Per M-FL	Std. Reel FL	†Net WL, Lbs.	
			Std. Reel	Std. Reel
8	78	4000	312	312
6	115	3000	345	345
5	140	2500	350	350
4	170	2000	340	340
3	206	1500	309	309
2	270	4000	1080	1080
1	328	3100	1017	1017
1/0	424	5000	2120	2120
2/0	522	4000	2088	2088
3/0	653	3000	1959	1959
4/0	800	2500	2000	2000
250	985	2000	1970	1970
300	1174	1500	1761	1761
350	1345	1250	1681	1681
400	1553	1200	1864	1864
450	1724	1000	1724	1724
500	1894	1000	1894	1894
600	2235	1600	3576	3576
700	2650	1500	3975	3975
750	2822	1000	2822	2822
800	2992	1250	3740	3740
900	3332	1000	3332	3332
1000	3674	1000	3674	3674
1250	4508	800	3606	3606
1500	5380	700	3766	3766
1750	6193	600	3716	3716
2000	7008	500	3504	3504

†Variations in the above weights are to be expected in commercial practice.

Prices on application.

Phelps Dodge Traffic Signal Control Cable

**Habirdure Insulated—600 Volts
Solid Conductors**

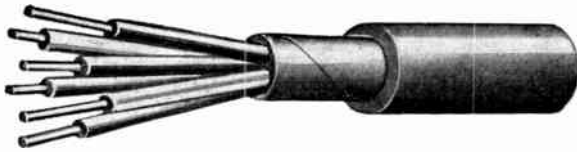

Designed for control wiring on traffic-signal circuits. It can be installed in conduit or ducts, in open air, or buried directly in the earth.

Can be easily and readily installed because color coding of the individual conductors facilitates circuit identification. The jacket of smooth Habirdure allows easy pulling into conduits and ducts. Habirdure cable is practically non-aging, is non-inflammable and is highly resistant to oils and corrosive chemicals.

Individual conductors are solid annealed bare copper insulated with 1/32-in. color coded Habirdure. The assembled conductors, with necessary fillers to make round and compact, are covered with a durable cable tape and overall is applied an extruded black Habirdure jacket.

Size A.W.G.	No. of Conductors	Sheath Thickness Inches	Overall Diameter Inches	Ship. Wt. Lbs. Per 1000 Ft.
14	4	3/64	.45	157
14	6	4/64	.56	249
14	7	4/64	.56	275
14	8	4/64	.60	301
14	12	4/64	.71	420
12	4	3/64	.49	200
12	6	4/64	.61	310
12	7	4/64	.61	341
12	8	4/64	.66	398
12	12	4/64	.78	556

Phelps Dodge Trolley Wire



Round



Grooved



Figure Eight



Figure Nine

Available in round, grooved, or in figure 8 cross-sections. Conform to the requirements of ASTM specifications.

Size A.W.G.	Diam. Round Mils	Nominal Circular Mils	Resistance, Ohms at 20 C.			Weight, Pounds Per Mile	
			Round	Per Mile Grooved	Fig. 8	Round	Grooved Fig. 8
1/0	325	105,600	0.5337	0.5337	1688 1687
2/0	365	133,100	0.4231	0.4087	0.4231	2129	2205 2127
3/0	410	167,900	0.3353	0.3369	0.3353	2687	2674 2682
4/0	460	211,600	0.2664	0.2659	0.2664	3382	3389 3382
...	548	300,000	0.1879	0.1880	4795	4792
...	...	350,000	0.1605	0.1610	5612 5597
	Nominal Circular Mils		Figure 9 Resistance Ohms at 20 C. Per Mile			Weight Lbs. Per Mile	
	350,000		0.1615			5576	
	400,000		0.1419			6347	

Prices on application.

Phelps Dodge Insulated Wires and Cables

General Information

Phelps Dodge wires and cables are insulated with rubber thermoplastic material, paper or varnished cloth.

Some of the special compounds regularly furnished by Phelps Dodge are briefly described. Complete specifications and information on these types of insulation will be furnished on request.

Code Grade Compound Underwriters' Type R

A standard compound, although designed primarily to meet minimum requirements of National Electrical Code, possesses superior electrical, mechanical and aging properties.

Habirite

Habirite is a high voltage compound of butyl rubber for use in circuits up to 30,000 volts in both single and multiple conductor constructions. It is corona-resistant and has remarkable aging qualities.

Recommended for installation at low voltages where cable is to be subjected to alternate wet and dry conditions up to 85 C. Habirite is furnished with any of the standard coverings such as lead sheath, neoprene sheath, cotton braid, asbestos braid, etc. Conforms to A.S.T.M. Specification D-1352 and I.P.C.E.A. Standard S-19-81 Appendix O ozone resistant butyl rubber insulation. The principal application is in medium voltage distribution circuits and series street lighting.

Habirdure

Insulated with a plasticized synthetic resin which is non-inflammable, highly resistant to oils and corrosive chemicals. Mechanically tough and requires no outer protective covering. Has exceptionally high dielectric strength and is highly corona-resistant. Habirdure insulation is practically non-aging as it does not oxidize. Made in a wide variety of fadeless colors. The clean, smooth, tough finish makes it easy to install. Conforms to A.S.T.M. D-734 and I.P.C.E.A. Standard S19-81.

Habirduct

Underwriters' Type RH and Type RW

A moisture and heat resistant rubber insulating compound. Conforms to requirements of Underwriters' Laboratories for Type RH and Type RW insulations and to the requirements of A.S.T.M. Specifications D-754 and D-755. It is the recommended insulation for secondary network cable and other low voltage constructions for installations requiring a heat and moisture resisting grade of insulation.

Cable is furnished with any of the standard coverings such as lead sheath, neoprene sheath, cotton braid, asbestos braid, etc. Habirduct wire and cable is suitable for operation at conductor temperatures up to 75 C.

Available also is a combination RH-RW type wire which is approved by Underwriters' Laboratories for use as Type RW at temperatures up to 60 C., and as RH up to 75 C.

Type RHW

A heat and moisture resistant rubber insulation compound incorporating the most modern development. It conforms to the requirements of Underwriters' Laboratories for Type RHW insulation and is approved by Underwriters for use in either wet or dry locations with conductor temperatures up to 75 C.

Habirprene

Habirprene is a generic term for the neoprene compounds used as wire and cable coverings. Habirprene jacket provides a tough abrasion resistant covering for many types of cables. Not affected by weather or sunlight and can be used in locations where exposed to oil, acids and alkalis, conforming to A.S.T.M. D-752 and I.P.C.E.A. Standard S-19-81 Appendix K.

For additional information contact GRAYBAR.

Phelps Dodge Slow Burning Wire and Cable

Approved by Underwriters' Laboratories

Triple Braided



Supplied with three cotton braids, each thoroughly saturated with white fireproof compound. The compound used on the outer braid provides a hard smooth finish, with no sacrifice of conductor flexibility.

Recommended for use in furnaces, boiler rooms, foundries and other installations having continuously high temperatures.

Made to conform to the requirements of ASA specifications for Slow-Burning Wire and Cable, which are the recognized American standard for this product.

Solid

Size A.W.G.	Wt., Lbs. Per 1000 Feet	Standard Package, Ft.		†Approx. Net Wt., Lbs.	
		Reels	Coils	Reels	Coils
14	40	2500	100
12	55	2000	110
10	75	1500	122
8	100	1000	100
6	160	1000	160
4	220	875	193
2	320	670	214
1	405	600	243
1/0	495	2000	500	1990	247
2/0	600	3000	500	1800	300
3/0	760	2500	400	1900	304
4/0	925	2500	400	2312	370

Stranded

8	105	1000	105
6	165	1000	165
5	195	1000	195
4	230	1000	230
3	280	800	224
2	335	670	224
1	420	600	252
1/0	510	2000	500	1020	255
2/0	625	3000	500	1875	312
3/0	785	2500	400	1963	314
4/0	960	2500	400	2810	384

*Approximate weight per bundle.

†Variations in the above weights are to be expected in commercial practice.

Phelps Dodge Copper Ground Wire

Soft bare copper ground wire on handy 25 lb. non-returnable wooden spools. Easy to handle, easy to pull wire—rolls off spool without effort. Easy to stock.

Size Solid	Stranding	Approx. Footage Per Spool	Approx. Net Weight Per M.-FL.
14	1	2000	12.43
12	1	1265	19.77
10	1	800	31.43
8	1	500	50.00
6	1	315	79.50
4	1	198	126.10
8	7	500	51.00
6	7	313	81.00
4	7	197	129.00

Spool Size: Flange 11 in. Outside traverse 1 1/4 in., drum 8 in., arbor hole 1 3/8 in. Sold in full length spools only.

Contact Graybar for prices.

Phelps Dodge Rectangular Copper Bus Bar

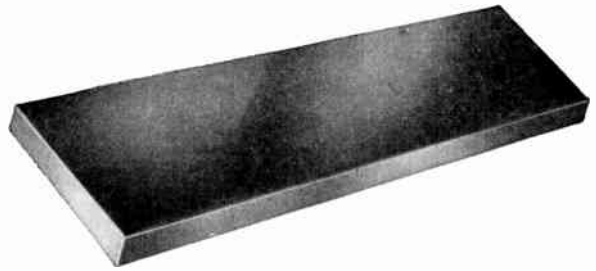

Minimum Conductivity 98%.

Made to conform to the requirements of ASTM specifications which are the recognized American standards for this product.

Processed to a uniform temper and to meet close dimensional and straightness requirements.

Special sectional shapes furnished as specified.

Bar Size, in.	Cross Section Sq. In.	*Carrying Capacity Amperes	Wt., Lbs. Per Ft.
1/8 x 2	.250	250	.969
1/8 x 2 1/2	.313	313	1.211
1/8 x 3	.375	375	1.454
1/4 x 2	.500	500	1.938
1/4 x 2 1/2	.625	625	2.423
1/4 x 3	.750	750	2.907
1/4 x 4	1.000	1000	3.88
3/8 x 3	1.125	1125	4.36
3/8 x 4	1.500	1500	5.81

*Current density 1000 amperes per square inch.

Phelps Dodge Bus Tube

Extruded and Drawn—Seamless Copper



Minimum conductivity, 98%.

Made to conform to the requirements of ASTM specifications which are the recognized American standards for this product.

Tubular bus shapes are processed to a uniform temper and to meet close dimensional and straightness requirements.

These shapes are characterized by greater mechanical rigidity per square inch of cross-section, and provided for better heat dissipation, decreased "skin effect," lower corona losses and better efficiency of transmission at power frequencies.

Tubular shapes may be easily bent or flattened for application of terminals or to meet special installation requirements.

Standard Weight

S.P.S. In.	O.D. In.	I.D. In.	Area C.M.	*Carrying Capacity Amperes	Wt., Lbs. Per Ft.
1/2	.840	.626	313,700	410	.955
3/4	1.050	.822	426,800	515	1.30
1	1.315	1.063	599,300	675	1.82
1 1/4	1.660	1.368	884,200	875	2.69
1 1/2	1.900	1.600	1,050,000	1025	3.20
2	2.375	2.063	1,384,700	1300	4.22

Extra Heavy

1/2	.840	.512	411,800	460	1.25
3/4	1.050	.736	560,800	575	1.71
1	1.315	.951	824,800	750	2.51
1 1/4	1.660	1.272	1,137,600	1000	3.46
1 1/2	1.900	1.494	1,378,000	1150	4.19
2	2.375	1.933	1,904,100	1500	5.80

*Current density, 1000 amperes per square inch.

Prices on application.

Anaconda Building Wire and Cable

Single Conductor—600 Volts

Approved by Underwriters' Laboratories, Inc.

Rubber Insulated Type RHW and Type RH-RW



Solid Conductor—Single Braid

Conductor Size A.W.G. or MCM	No. and Diam. Wires In.	Rubber Insulation Thick-ness 64th In.	D.A. Diam. In.	Std. FL Coil	Ship. WL Lbs. Std. Pkg.
14	0.0641	3	0.181	500	16
12	.0808	3*	.198	500	21
10	.1019	3	.220	500	28
8	.1285	4	.279	500	43
6 ϕ	.1620	4	.316	500	62

Solid Conductor—Double Braid

Conductor Size A.W.G. or MCM	No. and Diam. Wires In.	Rubber Insulation Thick-ness 64th In.	D.A. Diam. In.	Std. FL Coil	Ship. WL Lbs. Std. Pkg.
14	0.0641	3	0.195	500	18
12	.0808	3	.212	500	23
10	.1019	3	.235	500	30
8	.1285	4	.294	500	46
6 ϕ	.1620	4	.331	500	65

Concentric Strand—Single Braid

Conductor Size A.W.G. or MCM	No. and Diam. Wires In.	Rubber Insulation Thick-ness 64th In.	D.A. Diam. In.	Std. FL Coil	Ship. WL Lbs. Std. Pkg.
14	7x.0242	3	0.191	500	17
12	7x.0305	3	.209	500	22
10	7x.0385	3	.236	500	30
8	7x.0486	4	.297	500	47
6 ϕ	7x.0612	4	.335	500	64

Concentric Strand—Double Braid

Conductor Size A.W.G. or MCM	No. and Diam. Wires In.	Rubber Insulation Thick-ness 64th In.	D.A. Diam. In.	Std. FL Coil	Ship. WL Lbs. Std. Pkg.
14	7x.0242	3	0.205	500	19
12	7x.0305	3	.224	500	24
10	7x.0385	3	.251	500	33
8	7x.0486	4	.312	500	50
6	7x.0612	4	.355	500	67
4	7x.0772	4	.407	500	99
2	7x.0974	4	.469	500	145

Conductor Size A.W.G. or MCM	No. and Diam. Wires In.	Rubber Insulation Thick-ness 64th In.	D.A. Diam. In.	Std. FL Coil	Ship. WL Lbs. Std. Pkg.
1	19x.0664	5	.541	1000	390
1/0	19x.0745	5	.582	1000	475
2/0	19x.0837	5	.630	1000	575
3/0	19x.0940	5	.682	1000	705
4/0	19x.1055	5	.739	1000	855

Conductor Size A.W.G. or MCM	No. and Diam. Wires In.	Rubber Insulation Thick-ness 64th In.	D.A. Diam. In.	Std. FL Coil	Ship. WL Lbs. Std. Pkg.
250	37x.0822	6	.874	1000	1200
300	37x.0900	6	.930	1000	1295
350	37x.0973	6	.981	1000	1500
400	37x.1040	6	1.029	1000	1715
500	37x.1162	6	1.114	1000	2155

Conductor Size A.W.G. or MCM	No. and Diam. Wires In.	Rubber Insulation Thick-ness 64th In.	D.A. Diam. In.	Std. FL Coil	Ship. WL Lbs. Std. Pkg.
600	61x.0992	7	1.226	1000	2440
700	61x.1071	7	1.315	500	1640
750	61x.1109	7	1.332	500	1720
800	61x.1145	7	1.384	500	1815
900	61x.1215	7	1.449	500	1985

Conductor Size A.W.G. or MCM	No. and Diam. Wires In.	Rubber Insulation Thick-ness 64th In.	D.A. Diam. In.	Std. FL Coil	Ship. WL Lbs. Std. Pkg.
1000	61x.1280	7	1.488	500	2135
1250	91x.1172	8	1.699	500	3200
1500	91x.1284	8	1.799	500	3600
1750	127x.1174	8	1.943	500	4070
2000	127x.1255	8	2.053	500	4480

ϕ Not listed by Underwriters.

‡ Nonreturnable reels. All others are standard returnable.

Colors: 14-8 solid, black, white, red, blue, green, yellow; 14-4 stranded, black, white, red; 2 stranded, black, white; 1 and larger, black.

These data are approximate and subject to normal manufacturing tolerances.

Prices on application.

Densheath Insulated—Type T and TW



Solid Conductor—Standard Insulation

Conductor Size A.W.G. or MCM	No. and Diam. Wires In.	Densheath Insul.* Thick. 64th In.	D.A. Diam. In.	Net WL Lbs. Per M-FL	Std. FL Coil	Ship. WL Lbs. Std. Pkg.
14	1x.0641	2	0.13	18	500	10
12	1x.0808	2	.15	27	500	14
10	1x.1019	2	.17	40	500	21
8	1x.1285	3	.23	66	500	31

Concentric Strand—Standard Insulation

Conductor Size A.W.G. or MCM	No. and Diam. Wires In.	Densheath Insul.* Thick. 64th In.	D.A. Diam. In.	Net WL Lbs. Per M-FL	Std. FL Coil	Ship. WL Lbs. Std. Pkg.
14	7x.0242	2	0.14	19	500	11
12	7x.0305	2	.16	29	500	15
10	7x.0385	2	.18	42	500	22
8	7x.0486	3	.25	71	500	36
6	7x.0612	4	.31	115	500	58
4	7x.0772	4	.36	170	500	86
2	7x.0974	4	.42	256	500	129

Conductor Size A.W.G. or MCM	No. and Diam. Wires In.	Densheath Insul.* Thick. 64th In.	D.A. Diam. In.	Net WL Lbs. Per M-FL	Std. FL Coil	Ship. WL Lbs. Std. Pkg.
1	19x.0664	5	.50	330	1000	360
1/0	19x.0745	5	.54	405	1000	435
2/0	19x.0837	5	.58	500	1000	535
3/0	19x.0940	5	.63	615	1000	650
4/0	19x.1055	5	.69	765	1000	800
250	37x.0822	6	.77	913	1000	1025
300	37x.0900	6	.83	1075	1000	1185
350	37x.0973	6	.88	1245	1000	1357
400	37x.1040	6	.93	1410	1000	1520
500	37x.1162	6	1.01	1740	1000	1895
600	61x.0992	7	1.13	2095	500	1160
700	61x.1071	7	1.20	2420	500	1320
750	61x.1109	7	1.23	2585	500	1405
800	61x.1145	7	1.27	2755	500	1490
900	61x.1215	7	1.33	3080	500	1715
1000	61x.1280	7	1.39	3405	500	1880
1250	91x.1172	8	1.55	4250	500	2100
1500	91x.1284	8	1.68	5060	500	2805
1750	127x.1174	8	1.79	5860	500	3340
2000	127x.1255	8	1.90	6660	500	3740

Solid Conductor—Heavy Insulation

Conductor Size A.W.G. or MCM	No. and Diam. Wires In.	Densheath Insul.* Thick. 64th In.	D.A. Diam. In.	Net WL Lbs. Per M-FL	Std. FL Coil	Ship. WL Lbs. Std. Pkg.
14	1x.0641	3	0.16	23	500	12
12	1x.0808	3	.18	32	500	17
10	1x.1019	3	.20	45	500	23
8	1x.1285	4	.26	73	500	37

Concentric Strand—Heavy Insulation

Conductor Size A.W.G. or MCM	No. and Diam. Wires In.	Densheath Insul.* Thick. 64th In.	D.A. Diam. In.	Net WL Lbs. Per M-FL	Std. FL Coil	Ship. WL Lbs. Std. Pkg.
14	7x.0242	3	0.17	24	500	13
12	7x.0305	3	.19	34	500	18
10	7x.0385	3	.22	48	500	25
8	7x.0486	4	.28	78	500	40

Densheath 900 approved by U/L, sized 14 to 1/0 AWG inclusive, for use as appliance wire at 90 C. maximum in air or 60 C. maximum where exposed to mineral oil.

Colors: For types T and TW, black, white, red, blue, yellow, green, orange, brown, purple, grey. For Densheath 900; same except for brown and grey.

*Conductors insulated with a vinyl resin (Anaconda Densheath) thermoplastic compound.

Dentrol—Type TW Oil, Gasoline and Moisture Resistant—600 Volts

Conductor Size A.W.G.	No. and Diam. of Wires In.	Densheath Insulation Thick. 64th In.	Nylon Jkt. Thick. Milis	D.A. Diam. In.	FL In. Coil	Ship. WL Lbs. Std. Coil
14	7x.0242	3	5	0.18	500	14
12	7x.0305	3	5	.20	500	19
10	7x.0385	3	5	.23	500	26
8	7x.0486	3	5	.26	500	40
6	7x.0612	4	5	.33	500	59

For use in open wiring or in recognized raceways where exposed to gasoline or gasoline vapors at a maximum ambient temperature of 30 C.

These data are approximate and subject to normal manufacturing tolerances.

Prices on application.

Anaconda Building Wire and Cable

Approved by Underwriters' Laboratories, Inc.

Single Conductor—600 Volts Lead Covered—Types RHRWL and RHWL



Solid Conductor

Cond. Size A.W.G. or MCM	No. and Diam. of Wire, In.	Rubber Insul. Thick. 64th In.	Lead Thick. 64th In.	D.A. Diam. In.	Fl. In. Reel	Ship. Wt. Std. Pkg. Lbs.
**14	0.064	2	2	0.217	1000	165
**14	.064	3*	2	.217	1000	185
**12	.081	2	2	.233	1000	184
**12	.081	3*	2	.264	1000	205
**10	.102	3	3	.317	1000	302
**8	.128	4	3	.376	1000	383
†6	.162	4	4	.444	1000	575



Concentric Strand

**14	7x.0242	2	2	0.226	1000	172
**14	7x.0242	3*	2	.257	1000	192
**12	7x.0305	2	2	.244	1000	190
**12	7x.0305	3*	2	.275	1000	211
**10	7x.0385	3	3	.333	1000	319
**8	7x.0486	4	3	.394	1000	400
6	7x.0612	4	4	.463	1000	605
4	7x.0772	4	4	.515	1000	715
2	7x.0974	4	4	.577	1000	880
1	19x.0664	5	4	.649	1000	1025
1/0	19x.0745	5	4	.690	1000	1145
2/0	19x.0837	5	4	.738	1000	1300
3/0	19x.0940	5	4	.790	1000	1480
4/0	19x.1055	5	4	.847	1000	1685
250	37x.0822	6	5	.973	1000	2285
300	37x.0900	6	5	1.033	1000	2530
350	37x.0973	6	5	1.084	1000	2955
400	37x.1040	6	5	1.132	1000	3180
500	37x.1162	6	5	1.217	1000	3620
600	61x.0992	7	6	1.361	500	2613
700	61x.1071	7	6	1.450	500	2855
750	61x.1109	7	6	1.467	500	2945
800	61x.1145	7	6	1.519	500	3080
900	61x.1215	7	6	1.584	500	3290
1000	61x.1280	7	6	1.623	500	3475
1250	91x.1172	8	7	1.848	500	4685
1500	91x.1284	8	7	1.948	500	5165
1750	127x.1174	8	7	2.103	500	5770
2000	127x.1255	8	7	2.213	500	6280

*For Type RWL.

**For information only. Not made by Anaconda at present.

†Not listed by Underwriters.

These data are approximate and subject to normal manufacturing tolerances.

Prices on application.

Twin Conductor—600 Volts †Fibrous Covered—RHRWD and RHWD



Solid Conductor—Single Braid

Cond. Size A.W.G.	No. and Diam. Wire In.	Rubber Insul. Thick. 64th In.	D.A. Diam. In.	Net Wt. Lbs. Per M-Fl.	Std. Pkg. Fl. Coil	Ship. Wt. Lbs. Std. Pkg.
14	0.064	3	.216x.393	56	500	29
12	.081	3	.238x.432	74	500	39
10	.102	3	.260x.475	114	500	58
8	.128	4	.321x.595	180	500	92
6*	.162	4	.358x.669	255	500	129

Concentric Strand—Single Braid

14	7x.0242	3	.231x.418	59	500	31
12	7x.0305	3	.249x.454	79	500	41
10	7x.0385	3	.278x.509	125	500	64
8	7x.0486	4	.339x.631	193	500	98
6*	7x.0612	4	.377x.707	264	500	133

Lead Covered—Types RH/RWL and RHWL



Solid Conductor—Lead Covered

Cond. Size A.W.G.	No. and Diam. Wire In.	Rubber Insul. Thick. 64th In.	Lead Thick. 64th In.	D.A. Diam. In.	Std. Pkg. Fl. Reel	Ship. Wt. Lbs. Std. Pkg.
12	.081	3	3	.296x.490	1000	430
10	.102	3	3	.318x.536	1000	490
8	.128	4	3	.376x.652	1000	620
6	.162	4	4	.444x.757	1000	905

Concentric Strand—Lead Covered

12	7x.0305	3	3	.308x.514	1000	450
10	7x.0385	3	3	.333x.566	1000	515
8	7x.0486	4	3	.394x.688	1000	651
6	7x.0612	4	4	.463x.795	1000	955
4	7x.0772	4	4	.528x.921	1000	1190
2	7x.0974	4	4	.570x1.049	1000	1470
1	19x.0664	5	5	.693x1.224	1000	2095
1/0	19x.0745	5	5	.734x1.306	1000	2520
2/0	19x.0837	5	5	.782x1.402	1000	2815
3/0	19x.0940	5	5	.834x1.506	1000	3165
4/0	19x.1055	5	5	.891x1.620	500	1800

*Not listed by Underwriters.

†Fibrous covering may be a serve or braid.

These data are approximate and subject to normal manufacturing tolerances.

Prices on application.

Anaconda Building Wire and Cable
Silver Dutral Non-Metallic Sheathed—600 Volts



Twin-Conductor Without Ground Wire

Cond. Size A.W.G.	No. and Diam. of Wire	*Den-sheath Insul. Thick. 64th In.	Solid Ground Wire Size A.W.G.	D.A. Diam. In.	Net Wt. Lbs. M-Ft.	Fl. Coil Std. Pkg.	Ship. Wt. Lbs. Std. Pkg.
14	1x. 0641	2	..	0.22x0.41	60	250	15
14	7x. 0242	2	..	.26x .43	68	250	18
12	1x. 0808	2	..	.23x .43	80	250	20
12	7x. 0305	2	..	.26x .46	92	250	24
10	1x. 1019	2	..	.26x .49	110	250	27
10	7x. 0385	2	..	.29x .53	120	250	31
8	7x. 0486	3	..	.39x .69	213	125	28
6	7x. 0612	4	..	.46x .88	310	125	37

Three-Conductor Without Ground Wire

14	1x. 0641	2	..	0.40	96	250	24
14	7x. 0242	2	..	.42	110	250	30
12	1x. 0808	2	..	.43	121	250	32
12	7x. 0305	2	..	.46	126	250	34
10	1x. 1019	2	..	.46	164	250	41
10	7x. 0385	2	..	.49	162	250	43
8	7x. 0486	3	..	.68	302	125	34
6	7x. 0612	4	..	.83	473	125	61

Twin-Conductor With Ground Wire

14	1x. 0641	2	16	0.22x0.43	65	250	17
14	7x. 0242	2	16	.25x .44	75	250	20
12	1x. 0808	2	14	.23x .46	87	250	22
12	7x. 0305	2	14	.26x .47	105	250	27
10	1x. 1019	2	12	.26x .51	125	250	31
10	7x. 0385	2	12	.29x .54	140	250	36
8	7x. 0486	3	10	.39x .69	245	125	32
6	7x. 0612	4	8	.46x .88	356	125	44

Three-Conductor With Ground Wire

14	1x. 0641	2	16	0.40	96	250	24
14	7x. 0242	2	16	.42	110	250	30
12	1x. 0808	2	14	.43	121	250	32
12	7x. 0305	2	14	.48	126	250	34
10	1x. 1019	2	12	.46	164	250	41
10	7x. 0385	2	12	.51	162	250	43
8	7x. 0486	3	10	.68	302	125	39
6	7x. 0612	4	8	.83	473	125	61

*Thermoplastic Type TW compound, a vinyl resin.

†Ground wire is stranded, size 10 AWG and larger.

Lead Covered Types RML and RHML
3-Conductor—600 Volts

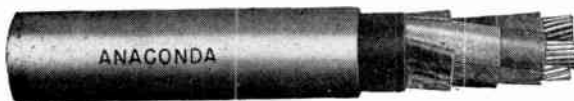

Conductor Size A.W.G. or MCM	No. and Diam. Wires In.	Insulation Thickness 64th In.*	Lead Thickness 64th In.	Overall Diam. In.	Std. Reel Length Ft.	Ship. Wt. per Std. Pkg. Lbs.
14	7x. 0242	2	3	0.468	1000	485
12	7x. 0305	2	3	.507	1000	560
10	7x. 0385	3	4	.663	1000	880
8	7x. 0486	4	4	.804	1000	1130
6	7x. 0612	4	5	.907	1000	1560
4	7x. 0772	4	5	1.046	1000	2060
2	7x. 0974	4	5	1.180	1000	2705
1	19x. 0664	5	6	1.367	500	1755
1/0	19x. 0745	5	6	1.456	500	1955
2/0	19x. 0837	5	6	1.559	500	2380
3/0	19x. 0940	5	6	1.671	500	2850
4/0	19x. 1055	5	7	1.825	500	3400
250	37x. 0822	6	7	2.002	500	3815
300	37x. 0900	6	7	2.134	500	4585
350	37x. 0973	6	7	2.243	500	4950
400	37x. 1040	6	8	2.378	500	5615
500	37x. 1162	6	8	2.561	500	6335

Conductor Size A.W.G.	No. and Diam. Wires In.	Insulation Thickness 64th In.*	Lead Thickness 64th In.	Overall Diam. In.	Std. Reel Length Ft.	Ship. Wt. per Std. Pkg. Lbs.
14	0.0641	2	3	0.448	1000	480
12	.0808	2	3	.483	1000	535
10	.1019	3	4	.630	1000	815
8	.1285	4	4	.755	1000	1070
6	.1620	4	5	.866	1000	1475

*Type RH-RW rubber insulation will be furnished.

Anaconda Machine Tool, Control and Switchboard Wire
Single Conductor—600 Volts
Densheath—Standard Insulation



Concentric Strand

Conductor Size A.W.G.	No. and Diam. Wires In.*	Insulation Thickness 64th In.	Overall Diam. In.	Std. Pkg. FL	Ship. Wt. per Std. Pkg. Lbs.
18	7x. 0152	2	0.11	1000	12
18	19x. 0092	2	.11	1000	11
16	7x. 0192	2	.12	1000	16
16	19x. 0117	2	.13	1000	15
14	7x. 0242	2	.14	500	11
14	19x. 0147	2	.14	500	11
12	7x. 0305	2	.16	500	16
12	19x. 0185	2	.16	500	16
10	7x. 0385	2	.18	500	23
10	19x. 0234	2	.18	500	23
8	7x. 0486	3	.24	500	38
8	19x. 0295	3	.25	500	37
8	37x. 0211	3	.25	500	37
6	7x. 0612	4	.31	500	61
6	19x. 0372	4	.32	500	60
6	37x. 0266	4	.32	500	60
4	7x. 0772	4	.36	500	88
4	19x. 0169	4	.37	500	87
4	61x. 0262	4	.37	500	88
2	7x. 0974	4	.42	500	132
2	19x. 0591	4	.43	500	130
2	61x. 0330	4	.43	500	129
1	19x. 0664	5	.50	1000	365
1/0	19x. 0745	5	.54	1000	445
2/0	19x. 0837	5	.58	1000	540
3/0	19x. 0940	5	.63	1000	660
4/0	19x. 1055	5	.70	1000	880

Solid Conductor

18	0.0403	2	0.11	1000	11
16	.0518	2	.12	1000	14
14	.0641	2	.13	500	11
12	.0808	2	.15	500	15
10	.1019	2	.17	500	22
8	.1285	3	.23	500	35
6	.1620	4	.29	500	56

Densheath—Heavy Insulation



Solid Conductor

14	0.0641	3	0.16	500	13
12	.0808	3	.18	500	18
10	.1019	3	.20	500	24
8	.1285	4	.26	500	39

Concentric Strand

14	7x. 0242	3	0.17	500	14
14	19x. 0117	3	.17	500	14
12	7x. 0305	3	.19	500	19
12	19x. 0185	3	.19	500	19
10	7x. 0385	3	.21	500	26
10	19x. 0234	3	.21	500	26
8	7x. 0486	4	.28	500	42
8	19x. 0295	4	.28	500	41
8	37x. 0211	4	.28	500	41

*Machine Tool and Control Wire furnished with stranded conductors; Switchboard Wire with solid conductors.

Colors: Black, white, red, light blue, dark green, yellow, orange, brown, purple. Combinations of two or more colors by means of permanent striped tracer color(s) over the base color.

These data are approximate and subject to normal manufacturing tolerances.

■ Carton ● Coil

Prices on application.

Anaconda Service Entrance Cable
Type SE—Concentric (Unarmored)



This cable approved by Underwriters' Laboratories, Inc. for use as one cable from pole to house to meter. Cable may be painted after installation without discoloration of paint.

Silvaline—300 Volts—Copper
Two Conductor—Style SC

Insul. Cond. Size A.W.G.	No. and Diam. Wire In.	Uninsulated Neutral Size A.W.G.	Rubber Insul. Thick.* 64th In.	O.A. Diam. In.	Net Wt. Lbs. M-Fl.	Std. Lgth. Ft.	Ship. Wt. Lbs. Std. Pkg.
12	1x. 0808	12	3	0.33	92	• 250	24
10	1x. 1019	10	3	.36	121	• 250	31
8	7x. 0486	8	4	.44	188	• 250	48
6	7x. 0612	6	4	.49	262	• 250	67
4	7x. 0772	4	4	.56	380	• 250	59
2	7x. 0974	2	4	.64	560	• 150	85
1	19x. 0664	1	5	.71	660	• 150	100
1/0	19x. 0745	1/0	5	.76	800	• 150	110
2/0	19x. 0837	2/0	5	.82	990	■1000	1100
3/0	19x. 0940	3/0	5	.90	1230	■1000	1340
4/0	19x. 1055	4/0	5	.97	1450	■1000	1660



Three Conductor—Style SCF (Flat)

12	1x. 0808	12	3	0.34x0.50	149	• 250	41
10	1x. 1019	10	3	.37x.55	195	• 250	51
8	7x. 0486	10	4	.45x.70	285	• 250	73
8	7x. 0486	8	4	.46x.71	305	• 250	80
6	7x. 0612	8	4	.50x.79	390	• 200	82
6	7x. 0612	6	4	.51x.80	420	• 150	67
4	7x. 0772	6	4	.55x.89	550	• 150	87
4	7x. 0772	4	4	.57x.91	600	• 150	95
3	7x. 0867	5	4	.59x.96	612	• 150	98
3	7x. 0867	3	4	.60x.98	673	• 150	107
2	7x. 0974	4	4	.61x1.03	800	• 100	83
2	7x. 0974	2	4	.63x1.05	880	• 100	91
1	19x. 0664	3	5	.69x1.22	965	■1000	1175
1	19x. 0664	1	5	.71x1.24	1065	■1000	1280
1/0	19x. 0745	2	5	.74x1.31	1175	■1000	1385
1/0	19x. 0745	1/0	5	.76x1.33	1300	■1000	1510
2/0	19x. 0837	1	5	.80x1.42	1430	■1000	1730
2/0	19x. 0837	2/0	5	.82x1.44	1590	■1000	1890
3/0	19x. 0940	1/0	5	.86x1.53	1750	■1000	2050
3/0	19x. 0940	3/0	5	.89x1.56	1955	■1000	2250
4/0	19x. 1050	2/0	5	.93x1.66	2150	■500	1490
4/0	19x. 1050	4/0	5	.96x1.69	2400	■500	1620

Silvaline—300 Volts—Aluminum

Two Conductor—Style SC

10	1x. 1019	10	3	0.36	77	• 250	20
8	7x. 0486	8	4	.44	118	• 250	30
6	7x. 0612	6	4	.49	163	• 250	44
4	7x. 0772	4	4	.56	220	• 150	36
2	7x. 0974	2	4	.64	274	• 150	44
1	19x. 0664	1	5	.71	298	• 150	48
1/0	19x. 0745	1/0	5	.76	348	• 150	56
2/0	19x. 0837	2/0	5	.82	416	■1000	526
3/0	19x. 0940	3/0	5	.90	508	■1000	618
4/0	19x. 1055	4/0	6	.97	610	■1000	820

Three Conductor—Style SCF (Flat)

10	1x. 1019	10	3	0.37x0.55	129	• 250	35
8	7x. 0486	10	4	.45x.70	194	• 250	51
8	7x. 0486	8	4	.46x.71	200	• 250	54
6	7x. 0612	8	4	.50x.79	244	• 200	53
6	7x. 0612	6	4	.51x.80	254	• 150	41
4	7x. 0772	6	4	.62x.91	286	• 150	295
4	7x. 0772	4	4	.63x.95	306	• 150	315
2	7x. 0974	4	4	.68x1.06	388	• 100	400
2	7x. 0974	2	4	.70x1.08	418	• 100	430
1	19x. 0664	3	5	.69x1.22	489	■1000	700
1	19x. 0664	1	5	.71x1.24	522	■1000	735
1/0	19x. 0745	2	5	.74x1.31	572	■1000	785
1/0	19x. 0745	1/0	5	.76x1.33	612	■1000	825

Sizes 2/0 thru 4/0 also available.
•Coil ■Reel

Anaconda Underground Service Cable
Type USE—Durasheath Jacketed
600 Volts



Approved by Underwriters for use as one cable from pole underground to house to meter.

Neoprene jacket construction furnishes a high degree of resistance to flame, sunlight, oils and soil acids and alkalis. On request, cable furnished with 60% rubber jacket instead of neoprene.

Conductor size should be adequate, particularly for buried cables, to reduce danger of mechanical trouble.

Insulation, Type RW, moisture-resistant.

Types USE and UF—600 Volts—Copper
Single Conductor

Cond. Size A.W.G.	No. and Diam. Wires In.	Rubber Insul. Thick. 64th In.	Neoprene Jkt. Thick. 64th In.	O.A. Diam. In.	Net Wt. Lbs. Per M-Fl.	Ship. Wt. Lbs. Per M-Fl.
14	1x. 0641	3	3	0.26	41	47
12	1x. 0808	3	3	.28	51	57
10	1x. 1019	3	3	.30	65	73
8	1x. 1285	4	3	.36	101	113
6	1x. 1620	4	3	.40	146	158
6	7x. 0612	4	3	.42	157	169
4	7x. 0772	4	3	.47	217	240
2	7x. 0974	4	3	.53	312	336
1	19x. 0664	5	4	.64	414	445
1/0	19x. 0745	5	4	.68	496	528
2/0	19x. 0837	5	4	.73	600	632
3/0	19x. 0940	5	4	.78	727	770
4/0	19x. 1055	5	4	.84	889	930
250	37x. 0822	6	5	.95	1082	1285
300	37x. 0900	6	5	1.01	1263	1475
350	37x. 0973	6	5	1.06	1442	1655
400	37x. 1010	6	5	1.11	1619	1832
500	37x. 1162	6	5	1.20	1972	2370
600	61x. 0992	7	6	1.35	2398	2750
750	61x. 1109	7	6	1.45	2926	3500
1000	61x. 1280	7	6	1.61	3769	4350

Twin Conductor

14	1x. 0641	3	3	0.30x0.50	99	130
12	1x. 0808	3	3	.32x.54	114	150
10	1x. 1019	3	4	.37x.61	161	200
8	1x. 1285	4	4	.43x.73	237	275
6	1x. 1620	4	4	.47x.79	315	355
6	7x. 0612	4	4	.49x.85	335	375
4	7x. 0772	4	5	.57x.97	495	540

Three Conductor

12	1x. 0808	3	4	0.60	218	253
10	1x. 1019	3	4	.65	254	280
8	1x. 1285	4	4	.78	415	440
6	1x. 1620	4	4	.85	545	640
6	7x. 0612	4	5	.93	620	660
4	7x. 0772	4	5	1.03	850	770
2	7x. 0974	4	5	1.16	1185	1585
1	19x. 0664	5	6	1.36	1550	1950
1/0	19x. 0745	5	6	1.45	1840	2120
2/0	19x. 0837	5	6	1.55	2200	2780
3/0	19x. 0940	5	6	1.67	2650	3330
4/0	19x. 1055	5	7	1.82	3250	3930

Sizes 14 to 4/0 AWG, inclusive, are shipped on nonreturnable reels.

These data are approximate and subject to normal manufacturing tolerances.

Prices on application.

Anaconda Underground Service Cable

**Types USE and UF—Durasheath
Aluminum—600 Volts**

Cable approved by U/L for use as Type USE underground service cable in one length from pole to house to meter. Limited to 60 C. copper temperature. Also approved as Type UF, size 14 through 4 AWG for 2 and 3 conductor and 14 through 4/0 AWG for 1 conductor.

Cond. Size A.W.G.	No. and Diam. Wires In.	Rubber Insul. Thick. 64th In.	Neoprene Jkt. Thick. 64th In.	O.A. Diam. In.	Net WL. Lbs. Per M-FL.	Ship. WL. Lbs. Per M-FL.
Single Conductor						
10	1x. 1019	3	3	0.30	43	55
8	1x. 1285	4	3	.36	66	85
6	1x. 1620	4	3	.40	90	109
6	7x. 0612	4	3	.42	100	119
4	7x. 0772	4	3	.47	119	186
2	7x. 0974	4	3	.53	179	218
1	19x. 0664	5	4	.64	216	285
1/0	19x. 0745	5	4	.68	281	320
2/0	19x. 0837	5	4	.73	330	370
3/0	19x. 0940	5	4	.78	385	425
4/0	19x. 1055	5	4	.84	465	505
250	37x. 0822	6	5	.96	570	680
300	37x. 0900	6	5	1.01	580	780
350	37x. 0973	6	5	1.07	720	920
400	37x. 1040	6	5	1.11	790	1000
500	37x. 1162	6	5	1.20	940	1320
600	61x. 0992	7	6	1.35	1125	1515
750	61x. 1109	7	6	1.46	1370	1770
1000	61x. 1280	7	6	1.61	1710	2175
Twin Conductor						
10	1x. 1019	3	4	0.37x0.61	117	146
8	1x. 1285	4	4	.43x.73	167	205
6	1x. 1620	4	4	.47x.79	203	243
6	7x. 0612	4	4	.49x.85	223	263
4	7x. 0772	4	5	.57x.97	320	365
Three Conductor						
0	1x. 1019	3	4	0.65	188	228
8	1x. 1285	4	4	.78	310	360
6	1x. 1620	4	4	.85	375	530
6	7x. 0612	4	5	.93	450	550
4	7x. 0772	4	5	1.03	600	655
2	7x. 0974	4	5	1.16	770	1170
1	19x. 0664	5	6	1.36	1010	1410
1/0	19x. 0745	5	6	1.45	1160	1710
2/0	19x. 0837	5	6	1.55	1340	1920
3/0	19x. 0940	5	6	1.67	1570	2250
4/0	19x. 1055	5	7	1.82	1885	2565

Shipped on non-returnable reels. 1/c Sizes 10 to 4/0, 2/c & 3/c Size 10 to 4 A.W.G.

These data are approximate and subject to normal manufacturing tolerances.

Prices on application.

**Anaconda Service Drop and Secondary Cable
Type N-SD—Neutral Supported—300 Volts**

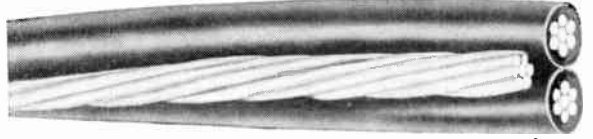

Consists of one or more aluminum or copper conductors, each insulated with black, pigmented polyethylene or neoprene and twisted around one bare conductor. The latter serves both as neutral and supporting messenger. Reels are nonreturnable.

Copper

2-Conductor—Hard Drawn Copper Messenger—Neutral Neoprene Type Insulation

Code Word	Insulated Conductor		Neutral Messenger		Net WL. Lbs. Per M-FL.	FL. In Reels
	Size A.W.G. or MCM	No. and Diam. Wire In.	Insul. Thick. 64th In.	Size A.W.G. or MCM		
Alpha	8	7x. 0186	4	8	1x. 1285	134 1000
Beta	6	7x. 0612	4	6	1x. 1690	201 1000
Gamma	6	7x. 0612	4	6	7x. 0612	202 1000

3-Conductor—Hard Drawn Copper Messenger—Neutral

Gold	8	7x. 0186	4	8	1x. 1285	218 1000
Silver	6	7x. 0612	4	6	1x. 1620	322 1000
Platinum	6	7x. 0612	4	6	7x. 0612	324 1000
Cadmium	4	7x. 0772	4	4	1x. 2043	484 1000
Iron	4	7x. 0772	4	4	7x. 0772	486 1000
Tin	2	7x. 0974	4	2	7x. 0794	740 1000

3-Conductor

Reduced Size Hard Drawn Copper Messenger—Neutral

Cobalt	6	7x. 0612	4	8	1x. 1285	293 1000
Lead	4	7x. 0772	4	6	1x. 1620	437 1000
Magnesium	4	7x. 0772	4	6	7x. 0612	439 1000
Zinc	2	7x. 0974	4	4	1x. 2043	661 1000
Steel	2	7x. 0974	4	4	7x. 0772	661 1000

2-Conductor—Hard Drawn Copper Messenger—Neutral Polyethylene Type Insulation

Iota	8	7x. 0186	3	8	1x. 1285	115 1000
Omicron	6	7x. 0612	3	6	1x. 1620	178 1000
Sigma	6	7x. 0612	3	6	7x. 0612	180 1000

3-Conductor—Hard Drawn Copper Messenger—Neutral

Bodoni	8	7x. 0186	3	8	1x. 1285	180 1000
Futura	6	7x. 0612	3	6	1x. 1620	276 1000
Gothic	6	7x. 0612	3	6	7x. 0612	278 1000
Ionic	4	7x. 0772	3	4	1x. 2043	427 1000
Caslon	4	7x. 0772	3	4	7x. 0772	430 1000
Century	2	7x. 0974	3	2	7x. 0974	672 1000

3-Conductor

Reduced Size Hard Drawn Copper Messenger—Neutral

Tudor	6	7x. 0612	3	8	1x. 1285	217 1000
Nonpareil	4	7x. 0772	3	6	1x. 1620	380 1000
Brevier	4	7x. 0772	3	6	7x. 0612	381 1000
Minion	4	7x. 0974	3	4	1x. 2043	593 1000
Primer	2	7x. 0974	3	4	7x. 0772	596 1000

Prices on application.

**Anaconda Service Drop Cable
2- and 3-Conductor—600 Volts**

Type SD—Concentric



Approved by Underwriters' for use between pole and house or as combination drop and entrance cable if in conduit from weatherhead to meter.

2-Conductor—Style C

Cond. Size A.W.G.	No. and Diameter of Wires Inches	Uninsulated Neutral Size A.W.G.	Rubber Insulation Thickness 64th In.	Over-all Diam. Inches	Reel Std. Length Feet	Ship. WL. Std. Pkg. Lbs.
12	1x. 0808	12	3	.300	1000	106
10	1x. 1019	10	3	.330	1000	134
8	7x. 0186	8	4	.415	1000	197
6	7x. 0612	6	4	.465	1000	270
4	7x. 0772	4	4	.525	1000	390
2	7x. 0974	2	4	.610	500	560

3-Conductor—Style CF (Flat)



Cond. Size A.W.G.	No. and Diameter of Wires Inches	Uninsulated Neutral Size A.W.G.	Rubber Insulation Thickness 64th In.	Over-all Diam. Inches	Reel Std. Length Feet	Ship. WL. Std. Pkg. Lbs.
12	1x. 0808	12	3	.300x.455	1000	153
10	1x. 1019	10	3	.330x.505	1000	197
8	7x. 0186	8	4	.415x.675	1000	305
6	7x. 0612	8	4	.455x.765	1000	390
6	7x. 0612	6	4	.465x.770	1000	421
4	7x. 0772	6	4	.515x.860	1000	550
4	7x. 0772	4	4	.525x.870	1000	600
2	7x. 0974	4	4	.595x1.000	1000	795
2	7x. 0974	2	4	.610x1.020	1000	870

Anaconda Service Drop and Secondary Cable

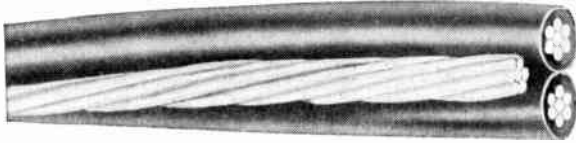

Type N-SD—Neutral Supported—300 Volts

Consists of one or more aluminum or copper conductors, each insulated with black, pigmented polyethylene or neoprene and twisted around one bare conductor. The latter serves both as neutral and supporting messenger.

Aluminum—Polyethylene Insulated

2-Conductor—All Aluminum Messenger—Neutral

Code Word	Insulated Conductor			Neutral Messenger		Net Wt. Lbs. Per M-Fl.	FL. In Reels
	Size A.W.G. or MCM	No. and Diam. Wire In.	Insul. Thick. 64th In.	Size A.W.G. or MCM	No. and Diam. Wire, In.		
Pekingese	6	1x. 1620	3	6	7x. 0612	64	2000
Collie	6	7x. 0612	3	6	7x. 0612	69	2000
Dachshund	4	1x. 2043	3	4	7x. 0772	94	2000
Spaniel	4	7x. 0772	3	4	7x. 0772	100	2000
Doberman	2	7x. 0974	3	2	7x. 0974	152	1000

3-Conductor—All Aluminum Messenger—Neutral

Haiotis	6	1x. 1620	3	6	7x. 0612	101	1000
Patella	6	7x. 0612	3	6	7x. 0612	112	1000
Fusus	4	1x. 2043	3	4	7x. 0772	118	1000
Oyster	4	7x. 0772	3	4	7x. 0772	160	1000
Clam	2	7x. 0974	3	2	7x. 0974	241	1000
Murex	1/0	7x. 1228	4	1/0	7x. 1228	388	500
Purpura	1/0	19x. 0745	4	1/0	7x. 1228	382	500
Nassa	2/0	7x. 1379	4	2/0	7x. 1379	478	500
Trophon	2/0	19x. 0837	4	2/0	7x. 1379	472	500

4-Conductor—All Aluminum Messenger—Neutral

Quarter	6	1x. 1620	3	6	7x. 0612	139	1000
Clydesdale	4	1x. 2043	3	4	7x. 0772	203	1000
Pinto	4	7x. 0772	3	4	7x. 0772	221	1000
Mustang	2	7x. 0974	3	2	7x. 0974	331	1000
Shire	1	19x. 0664	4	1	7x. 1093	428	500
Criollo	1/0	19x. 0745	4	1/0	7x. 1228	524	500
Percheron	2/0	19x. 0837	4	2/0	7x. 1379	645	*1000

2-Conductor—ACSR Messenger—Neutral

Setter	6	1x. 1610	3	6	6/1x. 0661	74	2000
Shepherd	6	7x. 0612	3	6	6/1x. 0661	79	2000
Eskimo	4	1x. 2043	3	4	6/1x. 0834	112	2000
Terrier	4	7x. 0772	3	4	6/1x. 0834	118	2000
Chow	2	7x. 0974	3	2	6/1x. 1052	181	1000

3-Conductor—ACSR Messenger—Neutral

Paludina	6	1x. 1620	3	6	6/1x. 0661	111	1000
Voluta	6	7x. 0612	3	6	6/1x. 0661	122	1000
Whelk	4	1x. 2043	3	4	6/1x. 0834	166	1000
Periwinkle	4	7x. 0772	3	4	6/1x. 0834	178	1000
Coch	2	7x. 0974	3	2	6/1x. 1052	270	1000
Neritina	1/0	7x. 1228	4	1/0	6/1x. 1327	434	500
Cenia	1/0	19x. 0745	4	1/0	6/1x. 1327	428	500
Runcina	2/0	7x. 1379	4	2/0	6/1x. 1490	536	500
Triton	2/0	19x. 0837	4	2/0	6/1x. 1490	530	500

4-Conductor—ACSR Messenger—Neutral

Morochuca	6	1x. 1620	3	6	6/1x. 0661	149	1000
Chola	8	7x. 0612	3	6	6/1x. 0661	165	1000
Morgan	4	1x. 2043	3	4	6/1x. 0834	221	1000
Hackney	4	7x. 0772	3	4	6/1x. 0834	239	1000
Palamino	2	7x. 0974	3	2	6/1x. 1052	360	1000
Albino	1	19x. 0664	4	1	6/1x. 1182	465	500
Costena	1/0	19x. 0745	4	1/0	6/1x. 1327	570	500
Grullo	2/0	19x. 0837	4	2/0	6/1x. 1490	703	*1000

3-Conductor—Reduced Size ACSR Messenger—Neutral

Scallop	4	1x. 2043	3	6	6/1x. 0661	115	1000
Strombus	4	7x. 0772	3	6	6/1x. 0661	157	1000
Cockle	2	7x. 0974	3	4	6/1x. 0834	236	1000
Janthina	1/0	7x. 1228	4	2	6/1x. 1052	380	500
Ranella	1/0	19x. 0745	4	2	6/1x. 1052	375	500
Cavolinia	2/0	7x. 1379	4	1	6/1x. 1182	468	500
Clio	2/0	19x. 0837	4	1	6/1x. 1182	462	500

Aluminum—Neoprene Insulated

2-Conductor—All Aluminum Messenger—Neutral

Code Word	Insulated Conductor			Neutral Messenger		Net Wt. Lbs. Per M-Fl.	FL. In Reels
	Size A.W.G. or MCM	No. and Diam. Wire, In.	Insul. Thick. 64th In.	Size A.W.G. or MCM	No. and Diam. Wire, In.		
Poodle	6	1x. 1620	4	6	7x. 0612	83	2000
Boxer	6	7x. 0612	4	6	7x. 0612	92	2000
Pointer	4	1x. 2043	4	4	7x. 0772	117	2000
Scotty	4	7x. 0772	4	4	7x. 0772	127	2000
Dane	2	7x. 0974	4	2	7x. 0974	186	1000

3-Conductor—All Aluminum Messenger—Neutral

Bluefish	6	1x. 1620	4	6	7x. 0612	139	1000
Salmon	6	7x. 0612	4	6	7x. 0612	158	1000
Catfish	4	1x. 2043	4	4	7x. 0772	194	1000
Trout	4	7x. 0772	4	4	7x. 0772	215	1000
Bass	2	7x. 0974	4	2	7x. 0974	309	1000
Sturgeon	1/0	7x. 1228	5	1/0	7x. 1228	489	500
Eel	1/0	19x. 0745	5	1/0	7x. 1228	480	500
Anchovy	2/0	7x. 1379	5	2/0	7x. 1379	592	500
Pompano	2/0	19x. 0837	5	2/0	7x. 1379	581	500

4-Conductor—All Aluminum Messenger—Neutral

Welch	6	1x. 1620	4	6	7x. 0612	197	1000
Durham	4	1x. 2043	4	4	7x. 0772	271	1000
Holstein	4	7x. 0772	4	4	7x. 0772	304	500
Ayrshire	2	7x. 0974	4	2	7x. 0974	433	500
Brown Swiss	1	19x. 0664	5	1	7x. 1093	562	500
Africander	1/0	19x. 0745	5	1/0	7x. 1228	671	500
Angus	2/0	19x. 0837	5	2/0	7x. 1379	810	*1000

2-Conductor—ACSR Messenger—Neutral

Samoyed	6	1x. 1620	4	6	6/1x. 0661	93	2000
Spitz	6	7x. 0612	4	6	6/1x. 0661	102	2000
St. Bernard	4	1x. 2043	4	4	6/1x. 0834	135	2000
Beagle	4	7x. 0772	4	4	6/1x. 0834	146	2000
Greyhound	2	7x. 0974	4	2	6/1x. 1052	215	1000

3-Conductor—ACSR Messenger—Neutral

Alewife	6	1x. 1620	4	6	6/1x. 0661	150	1000
Perch	6	7x. 0612	4	6	6/1x. 0661	168	1000
Argentine	4	1x. 2043	4	4	6/1x. 0834	212	1000
Carp	4	7x. 0772	4	4	6/1x. 0834	234	1000
Shad	2	7x. 0974	4	2	6/1x. 1052	338	1000
Killifish	1/0	7x. 1229	4	1/0	6/1x. 1327	536	500
Barracuda	1/0	19x. 0745	4	1/0	6/1x. 1327	527	500
Billfish	2/0	7x. 1379	5	2/0	6/1x. 1490	651	500
Sardine	2/0	19x. 0837	5	2/0	6/1x. 1490	640	500

4-Conductor—ACSR Messenger—Neutral

Brahman	6	1x. 1620	4	6	6/1x. 0661	207	1000
Galloway	6	7x. 0612	4	6	6/1x. 0661	234	1000
Red Polled	4	1x. 2043	4	4	6/1x. 0834	290	1000
Jersey	4	7x. 0772	4	4	6/1x. 0834	322	500
Hereford	2	7x. 0974	4	2	6/1x. 1052	462	500
Guernsey	1	19x. 0664	5	1	6/1x. 1182	598	500
Kerry	1/0	19x. 0745	5	1/0	6/1x. 1327	717	500
Dexter	2/0	19x. 0837	5	2/0	6/1x. 1490	868	*1000

3-Conductor—Reduced Size ACSR Messenger—Neutral

Needlefish	4	1x. 2043	4	6	6/1x. 0661	191	1000
Tuna	4	7x. 0772	4	6	6/1x. 0661	212	1000
Shark	2	7x. 0974	4	4	6/1x. 0834	304	1000
Agujon	1/0	7x. 1228	5	2	6/1x. 1052	482	500
Bonefish	1/0	19x. 0745	5	2	6/1x. 1052	473	500
Pajorito	2/0	7x. 1379	5	1	6/1x. 1182	583	500
Sailfish	2/0	19x. 0837	5	1	6/1x. 1182	572	500

*Returnable reels.

These data are approximate and subject to normal manufacturing tolerances.

Prices on application.

Anaconda Service Drop and Secondary Cable

Type N-SD—Neutral Supported—300 Volts

Consists of one or more aluminum or copper conductors, each insulated with black, pigmented polyethylene or neoprene and twisted around one bare conductor. The latter serves both as neutral and supporting messenger.

Aluminum—Copper Messenger

2-Conductor—Hard Drawn Copper Messenger Neutral

Code Word	Size A.W.G. or MCM	No. and Diam. Wire In.	Insul. Thick. 64th In.	Size A.W.G. or MCM	No. and Diam. Wire In.	Net WL Lbs. Per M-FL	FL In Reels
Neoprene Type Insulation							
Scorpio	6	1x. 1620	4	8	1x. 1285	107	1500
Draco	6	7x. 0612	4	8	1x. 1285	116	1500
Lyra	4	1x. 2013	4	6	1x. 1620	156	1500
Cygnus	4	1x. 2043	4	6	7x. 0612	158	1500
Pisces	4	7x. 0772	4	6	1x. 1620	168	1500
Aries	4	7x. 0772	4	6	7x. 0612	169	1500
Gemini	2	7x. 0974	4	4	1x. 2013	250	1000
Hydra	2	7x. 0974	4	4	7x. 0772	252	1000

3-Conductor—Hard Drawn Copper Messenger—Neutral

Cree	6	1x. 1620	4	8	1x. 1285	164	1000
Ute	6	7x. 0612	4	8	1x. 1285	182	1000
Apache	4	1x. 2013	4	6	1x. 1620	234	1000
Sioux	4	1x. 2043	4	6	7x. 0612	236	1000
Huron	4	7x. 0772	4	6	1x. 1620	256	1000
Algonquin	4	7x. 0772	4	6	7x. 0612	257	1000
Cherokee	2	7x. 0974	4	4	1x. 2013	373	1000
Comanche	2	7x. 0974	4	4	7x. 0772	376	1000
Comeanche	1/0	7x. 1228	5	2	7x. 0974	595	500
Piute	1/0	19x. 0745	5	2	7x. 0974	585	500
Seminole	2/0	7x. 1379	5	1	7x. 1093	726	500
Navajo	2/0	19x. 0837	5	1	7x. 1093	715	500

3-Conductor

Reduced Size Hard-Drawn Copper Messenger—Neutral

Arapaho	4	1x. 2043	4	8	1x. 1285	205	1000
Blackfoot	4	7x. 0772	4	8	1x. 1285	226	1000
Cheyenne	2	7x. 0974	4	6	1x. 1620	326	1000
Ojibway	2	7x. 0974	4	6	7x. 0612	328	1000
Cayuga	1/0	7x. 1228	5	4	1x. 2013	517	500
Mohawk	1/0	7x. 1228	5	4	7x. 0772	519	500
Oneida	1/0	19x. 0745	5	4	1x. 2013	508	500
Onondaga	1/0	19x. 0745	5	4	7x. 0772	510	500
Seneca	2/0	7x. 1379	5	3	7x. 0867	630	500
Choctaw	2/0	19x. 0837	5	3	7x. 0867	619	500

2-Conductor—Hard Drawn Copper Messenger—Neutral

Polyethylene Type Insulation

Andromeda	6	1x. 1620	3	8	1x. 1285	87	1500
Aquila	6	7x. 0612	3	8	1x. 1285	93	1500
Leo	4	1x. 2043	3	6	1x. 1620	134	1500
Pegasus	4	1x. 2013	3	6	7x. 0612	136	1500
Sagitta	4	7x. 0772	3	6	1x. 1620	140	1500
Ursa	4	7x. 0772	3	6	7x. 0612	141	1500
Taurus	2	7x. 0974	3	4	1x. 2043	216	1000
Canis	2	7x. 0974	3	4	7x. 0772	218	1000

3-Conductor—Hard Drawn Copper Messenger—Neutral

Ant	6	1x. 1620	3	8	1x. 1285	125	1000
Fly	6	7x. 0612	3	8	1x. 1285	136	1000
Bee	4	1x. 2043	3	6	1x. 1620	188	1000
Hornet	4	1x. 2043	3	6	7x. 0612	190	1000
Gnat	4	7x. 0772	3	6	1x. 1620	200	1000
Locust	4	7x. 0772	3	6	7x. 0612	202	1000
Cicada	2	7x. 0974	3	4	1x. 2043	305	1000
Wasp	2	7x. 0974	3	4	7x. 0772	308	1000
Spider	1/0	7x. 1228	4	2	7x. 0974	493	500
Mantis	1/0	19x. 0745	4	2	7x. 0974	488	500
Midge	2/0	7x. 1379	4	1	7x. 1093	612	500
Mosquito	2/0	19x. 0837	4	1	7x. 1093	605	500

3-Conductor

Reduced Size Hard-Drawn Copper Messenger—Neutral

Cricket	4	1x. 2043	3	8	1x. 1285	159	1000
Flea	4	7x. 0772	3	8	1x. 1285	171	1000
Beetle	2	7x. 0974	3	6	1x. 1620	258	1000
Aphid	2	7x. 0974	3	6	7x. 0612	260	1000
Centipede	1/0	7x. 1228	4	4	1x. 2013	415	500
Ladybird	1/0	7x. 1228	4	4	7x. 0772	417	500
Dragonfly	1/0	19x. 0974	4	4	1x. 2013	410	500
Humblebee	1/0	19x. 0974	4	4	7x. 0772	412	500
Thrip	2/0	7x. 1379	4	3	7x. 0867	516	500
Butterfly	2/0	19x. 0837	4	3	7x. 0867	509	500

Prices on application.

Anaconda Service Drop and Secondary Cable 2 Plus 2 Type N-SD and Type K—300 Volts



Type N-SD (2 plus 2)



Type K

2 Plus 2 Type N-SD: Insulated conductors are covered with a wall of rubber and another wall of neoprene, providing improved insulating quality and equal weathering properties.

Type K: Consists of two solid or stranded aluminum conductors; neoprene insulation on each, laid parallel, jute fillers, saturant and finish per ASA Standard C8.19, and a neutral conductor of hard-drawn aluminum ribbons applied concentrically over-all. Not approved by U/L, Inc.

Aluminum—2 Plus 2 Type N-SD

3-Conductor—All Aluminum Messenger—Neutral

Code Word	Insulated Conductor			Neutral Messenger		Net WL Lbs. Per M-FL	FL In Reels
	Size A.W.G. or MCM	No. and Diam. Wire In.	Insul. Thick. 64th In.	Size A.W.G. or MCM	No. and Diam. Wire In.		
Onion	6	1x. 1620	2	6	7x. 0612	136	1000
Leek	6	7x. 0612	2	6	7x. 0612	153	1000
Shallot	4	1x. 2043	2	4	7x. 0772	189	1000
Chive	4	7x. 0772	2	4	7x. 0772	209	1000
Beet	4	7x. 0772	3	4	7x. 0772	234	1000
Chard	2	7x. 0974	3	2	7x. 0974	331	500

3-Conductor—ACSR Messenger—Neutral

Kale	6	1x. 1620	2	6	6/1x. 0661	146	1000
Cabbage	6	7x. 0612	2	6	6/1x. 0661	163	1000
Turnip	4	1x. 2043	2	4	6/1x. 0834	207	1000
Mustard	4	7x. 0772	2	4	6/1x. 0834	228	1000
Radish	4	7x. 0772	3	4	6/1x. 0834	253	1000
Okra	2	7x. 0974	3	2	6/1x. 1052	360	500

3-Conductor

Reduced Size ACSR Messenger—Neutral

Pea	4	1x. 2043	2	6	6/1x. 0661	186	1000
Cowpea	4	7x. 0772	2	6	6/1x. 0661	206	1000
Bean	4	7x. 0772	3	6	6/1x. 0661	231	1000
Soybean	2	7x. 0974	3	4	6/1x. 0834	326	500

3-Conductor

Hard-Drawn Copper Messenger—Neutral

Asp	6	1x. 1620	2	8	1x. 1285	160	1000
Copperhead	6	7x. 0612	2	8	1x. 1285	177	1000
Rattlesnake	4	1x. 2043	2	6	1x. 1620	229	1000
Mocassin	4	7x. 0772	2	6	1x. 1620	250	1000
Cobra	4	7x. 0772	3	6	1x. 1620	275	1000
Viper	2	7x. 0974	3	4	7x. 0772	473	500

Type K

Solid

Code Word	Insulated Conductor			Uninsulated Neutral		Net WL Lbs. Per M-FL	FL In Coil
	Conductor Size A.W.G.	No. and Diam. Wires, In.	Neoprene Thick. 64th In.	Size A.W.G.	No. of Ribbons		
Granite	6	1x. 1620	4	8	8	172	500
Traprock	4	1x. 2043	4	6	8	244	500

Concentric Strand

Shale	6	7x. 0612	4	8	8	180	500
Marble	4	7x. 0772	4	6	8	264	500
Sandstone	2	7x. 0974	4	4	8	375	500
Brownstone	1	19x. 0664	5	3	8	510	500
Porphyry	1/0	19x. 0745	5	2	8	602	500

These data are approximate and subject to normal manufacturing tolerances.

All reels are nonreturnable.

Prices on application.

IPCEA Recommended Insulation Thickness
***Pole and Bracket Cable—0-10,000 Volts**
2-Conductor, Twin or Belted

Open-Circuit Voltage Volts	Conductor Size A.W.G.	Insulation Thickness (64th Inch)			Major Overall Diam. Inch	A-C Test Voltage Ozone-Resistant Insulation KV	Other Grades of Insulation KV
		Conductor	Belt	Total			
Rubber Insulation							
0- 600	10	3	0	3	0.53	4.5	3.0
	8	4	0	4	.65	6.0	3.5
	6	4	0	4	.73	6.0	3.5
601- 1000	10	4	0	4	.59	6.0	5.0
	8	4	0	4	.65	6.0	5.0
	6	5	0	5	.79	7.5	6.0
1001- 2000	10	5	0	5	.65	7.5	6.0
	8	5	0	5	.72	7.5	6.0
	6	6	0	6	.87	8.5	7.5
2001- 3000	10	6	0	6	.72	8.5	7.5
	8	6	0	6	.78	8.5	7.5
	6	7	0	7	.93	10.0	9.0
3001- 4000	10	7	0	7	.78	10.0	9.0
	10	3	4	7	.70	10.0	9.0
	8	7	0	7	.84	10.0	9.0
	8	3	4	7	.76	10.0	9.0
	6	8	0	8	.99	11.5	10.0
4001- 6000	10	4	4	8	.92	11.5	10.0
	10	9	0	9	.91	13.0	11.0
	10	3	6	9	.76	13.0	11.0
	8	9	0	9	.98	13.0	11.0
	8	3	6	9	.82	13.0	11.0
6001- 7000	10	3	7	10	.79	14.0	12.5
	8	3	7	10	.86	14.0	12.5
	6	4	6	10	.98	14.0	12.5
7001- 9000	10	3	8	11	.82	15.5	13.5
	8	3	8	11	.90	15.5	13.5
	6	4	7	11	1.01	15.5	13.5
9001-10000	10	3	9	12	.86	17.0	15.0
	8	3	9	12	.93	17.0	15.0
	6	4	8	12	1.04	17.0	15.0
	Thermoplastic Insulation						
0- 600	10	3	0	3	0.53	3.0
	8	4	0	4	.65	3.5
	6	4	0	4	.73	3.5
4001- 6000	10	3	6	9	.61	13.0	39.0
	8	3	6	9	.67	13.0	39.0
	6	4	6	10	.81	13.0	39.0
6001-10000	10	3	7	10	.64	17.0	51.0
	8	3	7	10	.70	17.0	51.0
	6	4	7	11	.84	17.0	51.0

Rubber-insulated and 600V. thermoplastic insulated cable based on IPCEA Standard S-19-81, 2nd Edition, February, 1951; 4001-10,000V. thermoplastic insulated based on recommendation in IPCEA Project 396, included in proposed Standard for Thermoplastic Insulated Wire and Cable 1st Draft, February 20th, 1956.

Anaconda Series Lighting Cable
Single Conductor—3000-8000 Volts
For Direct Burial



Thermoplastic Insulated
Thermoplastic Jacketed or NonJacketed

Conductor Size A.W.G.	Diam. of Wire In.	Voltage Rating kv	Thick. W O Protectors 64th In.	Jacket Thickness 64th In.	O.A. Diam. In.	Net WL Lbs. M-Fl.	Fl. in Reel
Polyethylene Type Insulation							
8	.1285	3	7	.	0.36	99	†2000
6	.1620	3	8	.	.43	157	†1500
8	.1285	5	10	.	.46	134	†1500
6	.1620	5	10	.	.50	184	†1500
Rubber-Insulated—Neoprene-Jacketed Insulated with Type AB (Anaconda Butyl) Ozon and Heat-Resistant Compound							
8	.1285	3	7	3	0.47	145	†2000
6	.1620	3	8	4	.56	216	†2000
8	.1285	5	10	4	.59	208	†1000
6	.1620	5	10	4	.63	255	†1000
Rubber-Insulated—Lead Covered—Jute-Armored Insulated with Type AB (Anaconda Butyl) Ozon and Heat-Resistant Compound							
8	.1285	3	7	3	0.75	178	2000
6	.1620	3	8	4	.85	730	2000
8	.1285	5	10	4	.88	750	1000
6	.1620	5	10	4	.91	835	1000
8	.1285	8	12	4	.94	850	1000
6	.1620	8	12	4	.98	935	1000

*Thermoplastic insulations, as indicated, consist of vinyl resin compound or high dielectric strength, low moisture-absorption polyethylene compound.

Based on IPCEA Standard S-19-81, 2nd Edition, February, 1951, Appendixes I and J for vinyl chloride polymer (Anaconda Densheath) insulation and jacket, respectively.

†Reels are nonreturnable.

IPCEA Recommended Insulation Thickness
Series Lighting Cable—0-15,000 Volts—Single Conductor

Rubber Insulated

Open Circuit Voltage	Insulation Thickness (64th Inch)	
	Conductor Size A.W.G.	Without Protectors
Less than 600	10	3
	8-4	4
601-1000	10-8	4
	7-4	5
1001-2000	10-8	5
	7-4	6
2001-3000	10-8	7
	7-4	8
3001-4000	10-8	9
	7-4	10
4001-5000	8-4	10
5001-6000	8-4	11
6001-7000	8-4	12
7001-8000	8-4	13
8001-9000	8-4	13

Rubber Insulated

Open Circuit Voltage	Insulation Thickness (64th Inch)	
	Conductor Size A.W.G.	Without Protectors
9001-10000	8-4	11
10001-11000	8-4	15
11001-12000	8-4	15
12001-13000	8-4	17
13001-14000	8-4	18
14001-15000	8-4	19

Thermoplastic Insulated (Vinyl Chloride)

Maximum Circuit Voltage Volts	Conductor Size A.W.G.	Insulation Thickness 64th Inch
3000	8	7
.....	6	8
500	8	10
.....	6	10

Thermoplastic (Vinyl Chloride) Insulated

Maximum Circuit Voltage Volts	Conductor Size A.W.G.	Insulation Thickness 64th Inch
3001-5000	8-4	0.110
5001-8000	8-4	.120
8001-10000	8-4	.155

*Where type of circuit is not specified, insulation thickness without protectors should be used.

Heavier thicknesses may be advisable where service conditions are unusually severe.

Based on IPCEA Standard S-19-81, 2nd Edition, February, 1951 and Appendix P, 2nd Revision, November 4, 1954, for polyethylene.

Anaconda Airport Lighting Cable 0-5000 Volts—For Direct Burial

Single, Twin and Three Conductor

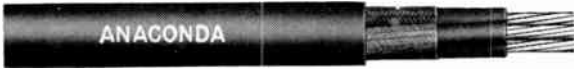

One Conductor—Type A—600 Volt

Cond. Size A.W.G.	No. and Diam. of Wires, In.	Insulation Thick. 64th In.	Neoprene Jacket Thick. 64th In.	O.A. Diam. In.	Net WL Lbs. Per M-FL	Std. Pkg. FL In Reel	Shp. Wt. Lbs. Std. Pkg.
14	1x. 0641	3	3	0.27	46	4000	284
12	1x. 0808	3	3	.29	56	4000	325
10	1x. 1019	3	3	.31	73	3000	320
8	1x. 1285	4	3	.37	110	2500	375
8	7x. 0486	4	3	.39	117	2500	395
6	7x. 0612	4	3	.42	158	2000	415
4	7x. 0772	4	3	.47	220	1500	430

Two Conductor Round—Type A—600 Volt

Cond. Size A.W.G.	No. and Diam. of Wires, In.	Insulation Thick. 64th In.	Neoprene Jacket Thick. 64th In.	O.A. Diam. In.	Net WL Lbs. Per M-FL	Std. Pkg. FL In Reel	Shp. Wt. Lbs. Std. Pkg.
14	1x. 0641	3	5	0.59	164	1000	264
12	1x. 0808	3	6	.66	209	1000	310
10	1x. 1019	3	6	.71	254	1000	355
8	1x. 1285	4	6	.83	355	1000	465
8	7x. 0486	4	6	.86	380	1000	490
6	7x. 0612	4	7	.97	510	1000	720
4	7x. 0772	4	7	1.04	705	1000	915

Three Conductor—Type A—600 Volt

Cond. Size A.W.G.	No. and Diam. of Wires, In.	Insulation Thick. 64th In.	Neoprene Jacket Thick. 64th In.	O.A. Diam. In.	Net WL Lbs. Per M-FL	Std. Pkg. FL In Reel	Shp. Wt. Lbs. Std. Pkg.
14	1x. 0641	3	6	0.66	238	1000	310
12	1x. 0808	3	6	.70	273	1000	375
10	1x. 1019	3	6	.74	340	1000	450
8	1x. 1285	4	6	.87	495	1000	605
8	7x. 0486	4	6	.91	520	1000	730
6	7x. 0612	4	7	1.03	740	1000	950
4	7x. 0772	4	7	1.09	915	1000	1125

One Conductor—Type A—3000 Volt

Cond. Size A.W.G.	No. and Diam. of Wires, In.	Insulation Thick. 64th In.	Neoprene Jacket Thick. 64th In.	O.A. Diam. In.	Net WL Lbs. Per M-FL	Std. Pkg. FL In Reel	Shp. Wt. Lbs. Std. Pkg.
10	1x. 1019	7	3	0.44	123	1000	208
8	1x. 1285	7	3	.46	151	1000	236
8	19x. 0295	7	3	.48	163	1000	248
6	19x. 0372	8	4	.58	243	1000	345
4	19x. 0469	8	4	.63	313	1000	415

Two Conductor Round—Type A—3000 Volt

Cond. Size A.W.G.	No. and Diam. of Wires, In.	Insulation Thick. 64th In.	Neoprene Jacket Thick. 64th In.	O.A. Diam. In.	Net WL Lbs. Per M-FL	Std. Pkg. FL In Reel	Shp. Wt. Lbs. Std. Pkg.
10	1x. 1019	7	7	1.00	445	1000	655
8	1x. 1285	7	7	1.02	555	1000	765
8	19x. 0295	7	7	1.06	600	1000	810
6	19x. 0372	8	7	1.20	790	1000	1190
4	19x. 0469	8	7	1.29	970	1000	1370

Three Conductor—Type A—3000 Volt							
10	1x. 1019	7	7	1.05	635	1000	845
8	1x. 1285	7	7	1.07	690	1000	900
8	19x. 0295	7	7	1.12	745	1000	1115
6	19x. 0372	8	7	1.27	1000	1000	1400
4	19x. 0469	8	8	1.40	1301	1000	1880

One Conductor—Type B—3000 Volt

Cond. Size A.W.G.	No. and Diam. of Wires, In.	Insulation Thick. 64th In.	Neoprene Jacket Thick. 64th In.	O.A. Diam. In.	Net WL Lbs. Per M-FL	Std. Pkg. FL In Reel	Shp. Wt. Lbs. Std. Pkg.
10	1x. 1019	7	3	0.44	122	1000	207
8	1x. 1285	7	3	.46	150	1000	235
8	19x. 0295	7	3	.48	162	1000	247
6	19x. 0372	8	4	.58	242	1000	340
4	19x. 0469	8	4	.63	314	1000	415

Two Conductor—Type B—3000 Volt

Cond. Size A.W.G.	No. and Diam. of Wires, In.	Insulation Thick. 64th In.	Neoprene Jacket Thick. 64th In.	O.A. Diam. In.	Net WL Lbs. Per M-FL	Std. Pkg. FL In Reel	Shp. Wt. Lbs. Std. Pkg.
10	1x. 1019	7	7	1.01	445	1000	655
8	1x. 1285	7	7	1.02	550	1000	760
8	19x. 0295	7	7	1.08	605	1000	815
6	19x. 0372	8	7	1.21	790	1000	1190
4	19x. 0469	8	7	1.32	990	1000	1390

Three Conductor—Type B—3000 Volt

Cond. Size A.W.G.	No. and Diam. of Wires, In.	Insulation Thick. 64th In.	Neoprene Jacket Thick. 64th In.	O.A. Diam. In.	Net WL Lbs. Per M-FL	Std. Pkg. FL In Reel	Shp. Wt. Lbs. Std. Pkg.
10	1x. 1019	7	7	1.07	635	1000	845
8	1x. 1285	7	7	1.09	690	1000	1090
8	19x. 0295	7	7	1.14	750	1000	1150
6	19x. 0372	8	7	1.29	1000	1000	1400
4	19x. 0469	8	8	1.44	1320	1000	1900

One Conductor—Type B—5000 Volt

Cond. Size A.W.G.	No. and Diam. of Wires, In.	Insulation Thick. 64th In.	Neoprene Jacket Thick. 64th In.	O.A. Diam. In.	Net WL Lbs. Per M-FL	Std. Pkg. FL In Reel	Shp. Wt. Lbs. Std. Pkg.
8	1x. 1285	10	4	0.60	219	1000	320
8	19x. 0295	10	4	.62	235	1000	335
6	19x. 0372	10	4	.65	283	1000	385
4	19x. 0469	10	4	.70	360	1000	460

Two Conductor—Type B—5000 Volt

Cond. Size A.W.G.	No. and Diam. of Wires, In.	Insulation Thick. 64th In.	Neoprene Jacket Thick. 64th In.	O.A. Diam. In.	Net WL Lbs. Per M-FL	Std. Pkg. FL In Reel	Shp. Wt. Lbs. Std. Pkg.
8	1x. 1285	10	7	1.22	745	1000	1145
8	19x. 0295	10	7	1.27	805	1000	1205
6	19x. 0372	10	8	1.38	985	1000	1565
4	19x. 0469	10	8	1.48	1190	1000	1770

Three Conductor—Type B—5000 Volt

Cond. Size A.W.G.	No. and Diam. of Wires, In.	Insulation Thick. 64th In.	Neoprene Jacket Thick. 64th In.	O.A. Diam. In.	Net WL Lbs. Per M-FL	Std. Pkg. FL In Reel	Shp. Wt. Lbs. Std. Pkg.
8	1x. 1285	10	7	1.30	935	1000	1335
8	19x. 0295	10	8	1.39	1045	1000	1625
6	19x. 0372	10	8	1.47	1240	1000	1820
4	19x. 0469	10	8	1.58	1515	1000	2095

All cables meet the requirements of CAA Specification L-824, Specification for Underground Electrical Cables for Airport Lighting Circuits, March 2, 1953 with amendments 1 and 2 dated June 1, 1953 and February 11, 1954 respectively.

Type A: Insulation compound is heat and moisture resistant.

Type B: Insulated with Type AB (Anaconda Butyl) Ozone and heat resistant compound.

Anaconda Railway Signal Wire (Bare and Weatherproof) Solid Conductor



Double Braid-URC Type Covering



Triple Braid-URC Type Covering

Hard-Drawn Copper

Conductor Size A.W.G.	Diam. In.	Breaking Strength Lbs.	Bare Wire		Double Braid		Duraline or Triple Braid	
			Net WL Per M-Feet	Std. Coil Length FL	Net WL Per M-Feet	Std. Coil Length FL	Net WL Per M-Feet	Std. Coil Length FL
4	0.2043	1970.0	126.4	151.0	1320	161.0	1320	
6	.1620	1280.0	79.5	100.0	1760	112.0	1760	
8	.1285	826.1	50.0	66.0	1760	75.0	1760	
9	.1144	660.9	39.6	54.5	1640	62.0	1640	
10	.1019	529.3	31.4	46.0	1640	53.0	1640	

ASTM Alloy No. 30 Bronze

Conductor Size A.W.G.	Diam. In.	Breaking Strength Lbs.	Bare Wire		Double Braid		Duraline or Triple Braid	
			Net WL Per M-Feet	Std. Coil Length FL	Net WL Per M-Feet	Std. Coil Length FL	Net WL Per M-Feet	Std. Coil Length FL
4	0.2043	2918.0	126.4	151.0	1320	164.0	1320	
6	.1620	1954.0	79.5	100.0	1760	112.0	1760	
8	.1285	1270.0	50.0	66.0	1760	75.0	1760	
9	.1144	1018.0	39.6	54.5	1640	62.0	1640	
10	.1019	816.3	31.4	46.0	1640	53.0	1640	



Duraline URC Type Covering

Made in compliance with Association of American Railroads Signal Section Specification 168 latest issue.

Conductor Size A.W.G.	Diam. In.	Breaking Strength Lbs.	Bare Wire Net WL Per M-Feet	Double Braid		Duraline or Triple Braid	
				Net WL Per M-Feet	Std. Coil Length FL	Net WL Per M-Feet	Std. Coil Length FL
30% and 40% Copperweld							
4	0.2043	3934	35.4	115.8	140.4	1320	153.4
6	.1620	2680	24.33	72.85	93.3	1760	105.3
8	.1285	1815	16.60	45.81	61.8	1760	70.8
9	.1144	1491	13.68	36.33	51.2	1640	58.7
10	.1019	1231	11.30	28.81	43.4	1640	50.4
12	.0808	769	7.85	18.12	28.3	1640	33.3

Stranded Conductor—ACSR

Conductor Size A.W.G.	No. and Diam. of Wires, In.	Breaking Strength Lbs.	Net WL Per M-Feet	Std. Coil Length FL	Net WL Per M-Feet	Std. Coil Length FL
2	6x. 1052	2790	91.3	134.8	1100	159.3
	1x. 1052†					
2	7x. 0974	3525	106.7	150.8	1100	175.3
	1x. 1299†					
4	6x. 0834	1830	57.4	84.2	1800	100.4
	1x. 0834†					
4	7x. 0772	2288	67.0	94.2	1800	110.5
	1x. 1029†					
6	6x. 0661	1170	36.1	59.2	3000	72.6
	1x. 0661†					

†Steel wire.

Anaconda Railway Signal Wire



Polene Line Wire

Polene Line Wire

Conductor Size A.W.G.	Diam. of Wire In.	Area Circular Mils	Polyethylene Covering Thick. 64th In.	Net WL Lbs. Per M-FL	Std. Coil Lgth. FL	Ship. WL Lbs. Std. Pkg.
Solid Conductor						
Soft, Medium and Hard Drawn Copper						
4	0.2043	41740	2	136	1320	181
6	.1620	26240	2	87	1760	151
8	.1285	16510	2	56	1760	100
9	.1144	13090	2	45	1640	75
10	.1019	10380	2	36.5	1640	61
12	.0808	6530	2	24	1640	40
Solid Conductor—ASTM Alloy No. 30 Bronze						
4	0.2043	41740	2	136	1320	181
6	.1620	26240	2	87	1760	154
8	.1285	16510	2	56	1760	100
9	.1144	13090	2	45	1640	75
10	.1019	10380	2	36.5	1640	61
12	.0808	6530	2	24	1640	40
Solid Conductor—30% and 40% Copperweld						
4	0.2043	41740	2	125	1320	166
6	.1620	26240	2	80.3	1760	142
8	.1285	16510	2	51.8	1760	92
9	.1144	13090	2	41.7	1640	69
10	.1019	10380	2	33.9	1640	57
12	.0808	6530	2	22.9	1640	39
Stranded Conductor—ACSR						
2	6x.1052 1x.1052†	66360	3	119	1100	132
2	7x.0974 1x.1299†	66360	3	135	1100	150
4	6x.0834 1x.0834†	41740	2	72	1800	131
4	7x.0772 1x.1029†	41740	2	82	1800	149
6	6x.0661 1x.0661†	26240	2	47.5	1900	91

Manufactured in accordance with ASA Specifications for Weather-Resistant Wire and Cable, Polyethylene Type.

Prices on application.



Neoline Line Wire

Neoline Line Wire

Conductor Size A.W.G.	Diam. of Wire In.	Area Circular Mils	Neoprene Covering Thickness 64th, In.	Net WL Lbs. Per M-FL	Std. Coil Lgth. FL	Ship. WL Lbs. Std. Pkg.
Solid Conductor						
Soft, Medium and Hard Drawn Copper						
4	0.2043	41740	3	152	1320	202
6	.1620	26240	3	101	1760	179
8	.1285	16510	3	68	1760	121
9	.1144	13090	3	56	2640	150
10	.1019	10380	2	40.6	2640	109
Solid Conductor—ASTM Alloy No. 30 Bronze						
4	0.2043	41740	3	152	1320	202
6	.1620	26240	3	101	1760	179
8	.1285	16510	3	68	1760	121
9	.1144	13090	3	56	2640	150
10	.1019	10380	2	40.6	2640	109
Solid Conductor—30% and 40% Copperweld						
4	0.2043	41740	3	141.4	1320	188
6	.1620	26240	3	94.3	1760	167
8	.1285	16510	3	63.8	1760	113
9	.1144	13090	3	52.7	2640	140
10	.1019	10380	2	38.0	2640	101
12	.0808	6530	2	25.8	2640	69
Stranded Conductor—ACSR						
2	6x.1052 1x.1052†	66360	3	139	1100	154
2	7x.0974 1x.1299†	66360	3	155	1100	172
4	6x.0834 1x.0834†	41740	3	94.5	1800	171
4	7x.0772 1x.1029†	41740	3	105	1800	190
6	6x.0661 1x.0661†	26240	3	65.0	1900	124

All copper-content conductors are in accordance with Association of American Railroads Signal Section Specification 168, latest edition.

†Steel wire.

Prices on application.

Anaconda Railway Signal Control Cable

Thermoplastic Insulated



Conductors are in accordance with ASTM Standard Specifications B3, latest edition.

†A vinyl resin thermoplastic compound.

These cable constructions are representative. Other constructions can be supplied.

These data are approximate and subject to normal manufacturing tolerances.

Prices on application.

Solid Conductors—Annealed Copper

Number of Conductors	Conductor Size A.W.G.	Diameter of Wire Inch	†Densheath Insulation Thickness 64th Inch	†Densheath Jacket Thickness 64th Inch	Approx. Overall Diam. Inch	Approx. Net Weight Lbs. per 1000 Ft.	Ship. WL Lbs. per 1000 Ft.
2	9	0.1144	3	4	0.590	200	330
3	9	.1144	3	4	.630	270	400
5	9	.1144	3	4	.740	410	550
7	9	.1144	3	4	.800	510	650
10	9	.1144	3	5	1.050	740	1040
3	14	.0641	3	3	.480	130	230
5	14	.0641	3	4	.600	220	350
7	14	.0641	3	4	.650	260	390
12	14	.0641	3	4	.830	400	540
19	14	.0641	3	5	1.000	510	810
26	14	.0641	3	5	1.160	800	1200
30	14	.0641	3	5	1.230	900	1300
37	14	.0641	3	6	1.360	1110	1660

Anaconda Control Cable



Number of Conductors	Thermoplastic Jacketed—Thermoplastic Insulated				Neoprene Jacketed—Rubber Insulated									
	19 Strands #25 A.W.G.		19 Strands #22 A.W.G.		19 Strands #25 A.W.G.		19 Strands #22 A.W.G.							
	†Insulation Thickness 64th In.	‡Jacket Thickness 64th In.	Overall Diam. In.	Ship. Wt. per M-Foot Lbs.	†Insulation Thickness 64th In.	‡Jacket Thickness 64th In.	Overall Diam. In.	Ship. Wt. per M-Foot Lbs.						
1	3	..	0.20	32	..	0.23	55	3	2	0.26	49	2	0.30	79
2	3	3	.52	127	4	.61	203	3	3	.62	188	4	.70	267
3	3	3	.53	162	4	.65	263	3	3	.66	233	4	.74	330
4	3	4	.62	205	4	.71	330	3	3	.72	288	4	.81	420
5	3	4	.66	244	4	.77	375	3	3	.78	340	4	.89	520
6	3	4	.73	288	4	.84	450	3	3	.86	395	5	1.01	610
7	3	4	.73	310	4	.84	490	3	3	.86	415	5	1.01	650
8	3	4	.79	360	5	.94	585	3	3	.96	510	5	1.09	750
9	3	4	.84	410	5	1.01	680	3	3	1.03	615	5	1.17	880
10	3	5	.94	470	5	1.10	740	3	3	1.12	640	5	1.28	945
11	3	5	.94	495	5	1.10	780	3	3	1.12	690	5	1.28	1030
12	3	5	.97	525	5	1.14	845	3	3	1.16	705	6	1.36	1105
13	3	3	1.18	770	6	1.38	1200
14	3	5	1.01	595	5	1.18	965	3	3	1.22	825	6	1.43	1285
15	3	5	1.05	640	5	1.22	1040	3	3	1.25	865	6	1.47	1345
16	3	5	1.10	690	5	1.26	1100	3	3	1.32	955	6	1.51	1425
17	3	3	1.39	1010	6	1.59	1515
18	3	5	1.13	765	6	1.35	1270	3	3	1.39	1055	6	1.59	1585
19	3	5	1.13	845	6	1.35	1330	3	3	1.39	1090	6	1.59	1645
20	3	5	1.19	910	6	1.42	1390
23	3	5	1.25	950	6	1.49	1570
24	3	6	1.35	1030	6	1.58	1670	3	3	1.63	1360	7	1.90	2100
25	3	6	1.35	1085	6	1.58	1710	3	3	1.63	1400	7	1.90	2170
27	3	6	1.38	1130	6	1.61	1820
29	3	6	1.40	1215	6	1.63	1955
30	3	6	1.43	1235	6	1.67	2005	3	3	1.73	1620	7	2.02	2545
31	3	3	1.76	1710	7	2.05	2675
33	3	6	1.48	1310	6	1.73	2195
35	3	6	1.53	1385	7	1.83	2390
37	3	6	1.53	1445	7	1.83	2480	3	3	1.90	2030	7	2.18	3095

Number of Conductors	Braid Covered—Rubber Insulated				Lead Covered—Rubber Insulated							
	19 Strands #25 A.W.G.		19 Strands #22 A.W.G.		19 Strands #25 A.W.G.		19 Strands #22 A.W.G.					
	†Insulation Thickness 64th In.	Overall Diam. In.	Ship. Wt. per M-Foot Lbs.	Overall Diam. In.	Ship. Wt. per M-Foot Lbs.	†Insulation Thickness 64th In.	Lead Thickness 64th In.	Overall Diam. In.	Ship. Wt. per M-Foot Lbs.	Lead Thickness 64th In.	Overall Diam. In.	Ship. Wt. per M-Foot Lbs.
1	3	0.24	45	0.27	66
2	3	.53	185	.61	238	3	4	0.63	740	4	0.71	885
3	3	.56	221	.65	298	3	4	.67	830	4	.75	990
4	3	.62	265	.72	380	3	4	.73	930	4	.81	1135
5	3	.69	300	.79	450	3	4	.79	1030	5	.90	1500
6	3	.75	350	.89	510	3	4	.85	1145	5	1.02	1745
7	3	.75	390	.89	565	3	4	.85	1185	5	1.02	1795
8	3	.82	435	.97	645	3	5	.97	1525	5	1.10	1975
9	3	.91	580	1.05	930	3	5	1.04	1775	5	1.18	2380
10	3	1.00	700	1.15	1155	3	5	1.13	1900	5	1.29	2540
11	3	1.00	770	1.15	1230	3	5	1.13	1975	5	1.29	2610
12	3	1.04	790	1.19	1285	3	5	1.17	2225	6	1.36	3010
13	3	1.06	835	1.22	1335	3	5	1.19	2295	6	1.37	3120
14	3	1.10	855	1.26	1400	3	5	1.23	2360	6	1.43	3430
15	3	1.13	915	1.30	1645	3	5	1.26	2460	6	1.47	3560
16	3	1.16	1140	1.34	1730	3	5	1.30	2530	6	1.51	3680
17	3	1.23	1180	1.41	1800	3	6	1.40	3160	6	1.59	3860
18	3	1.23	1230	1.41	1860	3	6	1.40	3210	6	1.59	3930
19	3	1.23	1255	1.41	1945	3	6	1.40	3240	6	1.59	4010
25	3	1.45	1735	1.67	2500	3	6	1.63	3950	7	1.91	5380
31	3	1.57	1955	1.83	2840	3	6	1.76	4340	7	2.02	5970
37	3	1.69	2320	1.95	3520	3	7	1.89	5190	7	2.06	6840

*Conductors insulated with vinyl resin thermoplastic compound.
 †Conductors insulated unless otherwise specified, with Type ANW (Heat-resistant) rubber compound. Other compounds can be supplied.
 ‡A vinyl resin thermoplastic compound.
 Based on IPCEA Standard S-19-81, 1st Edition, January 1946 with additions and corrections thereto.
 Conductor sizes listed are standard for control cables. Nonstandard sizes can be supplied to purchaser's specification.
 These conductor assemblies are representative. Others can be furnished if in quantity.
 These data are approximate and subject to normal manufacturing tolerances.
 Prices on application.

Anaconda Network Cable

Single Conductor

0-600 Volts

Neoprene Jacketed

Type ANW Rubber Insulated



Braid Covered

Type ANW Rubber Insulated

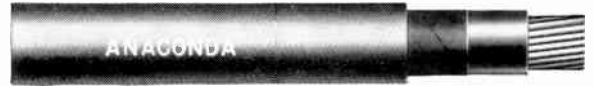

Neoprene Jacketed										Braid Covered				
Size A.W.G. or MCM	Conductor No. and Diam. of Wires Inch	Type ANW Insulation Thick- ness 64th In.*	Neoprene Jacket Thick- ness 64th In.	Overall Diameter Inches	Net Weight per M-Foot Lbs.	Standard Length Feet	†Standard Packing	Ship. WL per M-Foot Lbs.	Type Covering	Overall Diameter Inches	Net Weight per M-Foot Lbs.	Standard Length Feet	†Standard Packing	Ship. WL per M-Foot Lbs.
6	1x .1620	4	2	.37	136	• 500	500 Ft.	137	2 Braids	.40	140	• 500	500 Ft.	142
6	7x .0612	4	2	.39	146	• 500	500 Ft.	117	2 Braids	.41	155	• 500	500 Ft.	157
4	7x .0772	4	2	.44	206	• 500	500 Ft.	209	2 Braids	.47	215	• 500	500 Ft.	217
2	7x .0974	4	2	.51	299	• 500	500 Ft.	302	2 Braids	.52	310	• 500	500 Ft.	312
1	19x .0664	5	3	.61	400	■1000	36x16x12	500	2 Braids	.60	390	■1000	36x16x12	490
1/0	19x .0715	5	3	.65	480	■1000	36x16x12	580	2 Braids	.63	470	■1000	36x16x12	570
2/0	19x .0837	5	3	.70	580	■1000	36x16x12	680	2 Braids	.70	570	■1000	36x16x12	670
3/0	19x .0940	5	3	.75	705	■1000	36x16x18	815	2 Braids	.75	700	■1000	36x16x12	800
4/0	19x .1055	5	3	.81	865	■1000	36x16x18	975	2 Braids	.81	855	■1000	36x16x18	965
250	37x .0822	6	4	.93	1055	■1000	40x24x24	1165	Tp. & Bd.	.89	1005	■1000	36x16x18	1115
300	37x .0900	6	4	.98	1235	■1000	40x24x24	1410	Tp. & Bd.	.91	1170	■1000	42x24x24	1380
350	37x .0973	6	4	1.01	1410	■1000	42x24x24	1600	Tp. & Bd.	1.00	1350	■1000	42x24x24	1560
400	37x .1010	6	4	1.08	1585	■1000	42x24x24	1800	Tp. & Bd.	1.05	1545	■1000	42x24x24	1755
500	37x .1162	6	4	1.17	1930	■1000	44x24x24	2300	Tp. & Bd.	1.14	1870	■1000	42x24x24	2080
600	61x .0992	7	4	1.28	2310	■1000	46x24x24	2710						
750	61x .1109	7	4	1.38	2830	■1000	48x24x24	3410						
1000	61x .1280	7	4	1.55	3670	■1000	54x23x32	4250						

Lead Covered

Type ANW Rubber Insulated



Lead Covered									
Size A.W.G. or MCM	Conductor No. and Diam. of Wires Inch	Type ANW Insulation Thick- ness 64th In.*	Lead Thickness 64th In.	Overall Diameter Inches	Net Weight per M-Fl Lbs.	Standard Length Feet	†Standard Packing	Ship. WL per M-Foot Lbs.	
6	1x .1620	4	3	.43	395	■1000	30x16x12	480	
6	7x .0612	4	3	.45	425	■1000	30x16x12	510	
4	7x .0772	4	3	.50	520	■1000	30x16x12	605	
2	7x .0974	4	4	.59	795	■1000	36x16x12	895	
1	19x .0664	5	4	.67	945	■1000	36x16x12	1045	
1/0	19x .0715	5	4	.71	1060	■1000	36x16x12	1165	
2/0	19x .0837	5	4	.75	1205	■1000	36x16x12	1310	
3/0	19x .0940	5	4	.81	1380	■1000	36x16x18	1485	
4/0	19x .1055	5	5	.89	1805	■1000	36x16x18	1920	
250	37x .0822	6	5	.98	2060	■1000	42x24x24	2270	
300	37x .0900	6	5	1.04	2300	■1000	42x24x24	2500	
350	37x .0973	6	5	1.09	2540	■1000	42x24x24	2740	
400	37x .1010	6	5	1.13	2770	■1000	42x24x24	2970	
500	37x .1162	6	5	1.22	3210	■1000	48x24x24	3600	

*Densheath insulation.

†Reel dimensions given—flange, drum, inside traverse in inches.

Other lengths will be furnished if requested.

These data are approximate and subject to normal manufacturing tolerances.

●Coil ■Reel

Prices on application.

Anaconda All-Purpose Cable

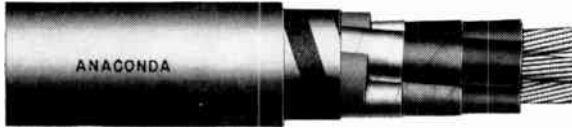

Nonshielded

Light Jacket Copper

Conductor Size A.W.G. or MCM	No. and Diam. of Wires In.	Insul. Thick. 64th In.	Neo-prene Jkt. Thick. 64th In.	D.A. Diam. In.	Net WL Lbs. Per M-Fl.	Ft. In Reel	Shp. WL Lbs. Std. Pkg.
*0-600 Volts—Grounded or Ungrounded—Nonshielded							
14	1x .0611	3	1	.21	32	4000	146
12	1x .0808	3	1	.22	41	4000	182
10	1x .1019	3	1	.25	57	3000	189
8	1x .1285	4	1	.30	88	2000	194
6	1x .1620	4	2	.37	136	2000	292
6	7x .0612	4	2	.39	146	2000	316
4	7x .0772	4	2	.44	206	1000	229
2	7x .0974	4	2	.51	299	1000	322
1	19x .0664	5	3	.61	400	1000	431
1/0	19x .0745	5	3	.65	480	1000	510
2/0	19x .0837	5	3	.70	580	1000	611
3/0	19x .0940	5	3	.75	705	1000	750
4/0	19x .1055	5	3	.81	865	1000	910
250	37x .0822	6	4	.93	1055	1000	1175
300	37x .0900	6	4	.98	1235	1000	1390
350	37x .0973	6	4	1.04	1410	1000	1560
400	37x .1040	6	4	1.08	1585	1000	1780
500	37x .1162	6	4	1.17	1930	1000	2120
600	61x .0992	7	4	1.29	2310	1000	2560
750	61x .1109	7	4	1.39	2830	1000	3115
**2001-3000 Volts—Grounded or Ungrounded							
Nonshielded							
10	1x .1019	7	2	0.41	109	1000	195
8	1x .1285	7	2	.44	135	1000	220
6	1x .1620	8	2	.51	193	1000	280
6	19x .0372	8	2	.54	205	1000	290
4	19x .0469	8	2	.59	274	1000	375
2	19x .0591	8	3	.68	395	1000	495
1	19x .0664	8	3	.73	465	1000	565
1/0	19x .0745	8	3	.77	550	1000	660
2/0	19x .0837	8	3	.82	660	1000	770
3/0	19x .0940	8	3	.87	790	1000	900
4/0	19x .1055	8	3	.94	955	1000	1165
250	37x .0822	9	4	1.05	1165	1000	1375
300	37x .0900	9	4	1.11	1345	1000	1745
350	37x .0973	9	4	1.16	1525	1000	1925
400	37x .1040	9	4	1.22	1715	1000	2115
500	37x .1162	9	4	1.31	2070	1000	2470
600	61x .0992	9	4	1.38	2420	1000	3000
**4001-5000 Volts—Grounded or Ungrounded							
Nonshielded							
8	1x .1285	10	2	0.54	183	1000	270
6	1x .1620	10	2	.58	229	1000	330
6	19x .0372	10	2	.60	243	1000	345
4	19x .0469	10	3	.69	335	1000	435
2	19x .0591	10	3	.75	445	1000	555
1	19x .0664	10	3	.79	515	1000	625
1/0	19x .0745	10	3	.84	605	1000	715
2/0	19x .0837	10	3	.88	710	1000	820
3/0	19x .0940	10	3	.94	850	1000	1060
4/0	19x .1055	10	4	1.03	1045	1000	1255
250	37x .0822	11	4	1.12	1230	1000	1630
300	37x .0900	11	4	1.17	1415	1000	1815
350	37x .0973	11	4	1.23	1610	1000	2010
400	37x .1040	11	4	1.28	1795	1000	2200
500	37x .1162	11	4	1.37	2150	1000	2550
600	61x .0992	11	4	1.46	2520	1000	3100
750	61x .1109	11	4	1.57	3060	1000	3640

*Insulated with rubber compound.

**Insulated with Type AB (Anaconda Butyl) ozone and heat-resistant compound.

Durasheath cable with light jacket is recommended by IPCEA for use in conduit and underground ducts; with heavy jacket for aerial and direct burial.

Durasheath—Nonmetallic Sheathed Cable
Single Conductor—0-5000 Volts

Heavy Jacket Copper

Conductor Size A.W.G. or MCM	No. and Diam. of Wires In.	Insul. Thick. 64th In.	Neo-prene Jkt. Thick. 64th In.	D.A. Diam. In.	Net WL Lbs. Per M-Fl.	Ft. In Reel	Shp. WL Lbs. Std. Pkg.
*0-600 Volts—Grounded or Ungrounded—Nonshielded							
14	1x .0611	3	3	.23	41	4000	188
12	1x .0808	3	3	.28	51	4000	228
10	1x .1019	3	3	.30	65	3000	218
8	1x .1285	4	3	.36	101	2000	226
6	1x .1620	4	3	.40	146	2000	316
6	7x .0612	4	3	.42	157	2000	238
4	7x .0772	4	3	.47	217	1000	240
2	7x .0974	4	3	.53	312	1000	336
1	19x .0664	5	4	.64	414	1000	445
1/0	19x .0745	5	4	.68	496	1000	528
2/0	19x .0837	5	4	.73	600	1000	632
3/0	19x .0940	5	4	.78	727	1000	772
4/0	19x .1055	5	4	.84	889	1000	935
250	37x .0822	6	5	.96	1082	1000	1280
300	37x .0900	6	5	1.01	1263	1000	1360
350	37x .0973	6	5	1.06	1442	1000	1640
400	37x .1040	6	5	1.11	1619	1000	1815
500	37x .1162	6	5	1.20	1972	1000	2275
600	61x .0992	7	6	1.35	2398	1000	2680
750	61x .1109	7	6	1.45	2926	1000	3375
**2001-3000 Volts—Grounded or Ungrounded							
Nonshielded							
10	1x .1019	7	3	.44	117	1000	200
8	1x .1285	7	3	.47	144	1000	225
6	1x .1620	8	4	.56	217	1000	310
6	19x .0372	8	4	.59	232	1000	320
4	19x .0469	8	4	.64	300	1000	400
2	19x .0591	8	4	.71	405	1000	505
1	19x .0664	8	4	.76	480	1000	590
1/0	19x .0745	8	4	.80	565	1000	675
2/0	19x .0837	8	4	.85	675	1000	780
3/0	19x .0940	8	5	.94	825	1000	935
4/0	19x .1055	8	5	1.00	990	1000	1200
250	37x .0822	9	5	1.10	1180	1000	1580
300	37x .0900	9	5	1.16	1360	1000	1760
350	37x .0973	9	5	1.21	1545	1000	1945
400	37x .1040	9	5	1.26	1730	1000	2130
500	37x .1162	9	6	1.38	2120	1000	2700
600	61x .0992	9	6	1.47	2430	1000	3260
750	61x .1109	9	6	1.58	3010	1000	3690
**4001-5000 Volts—Grounded or Ungrounded							
Nonshielded							
8	1x .1285	10	4	.60	209	1000	310
6	1x .1620	10	4	.63	256	1000	355
6	19x .0372	10	4	.66	270	1000	370
4	19x .0469	10	4	.71	340	1000	440
2	19x .0591	10	4	.77	450	1000	560
1	19x .0664	10	4	.83	525	1000	635
1/0	19x .0745	10	5	.90	530	1000	690
2/0	19x .0837	10	5	.95	750	1000	860
3/0	19x .0940	10	5	1.00	885	1000	1090
4/0	19x .1055	10	5	1.06	1050	1000	1450
250	37x .0822	11	5	1.17	1245	1000	1645
300	37x .0900	11	5	1.23	1435	1000	1835
350	37x .0973	11	6	1.31	1660	1000	2240
400	37x .1040	11	6	1.36	1850	1000	2430
500	37x .1162	11	6	1.45	2210	1000	2870
600	61x .0992	11	6	1.54	2570	1000	3250
750	61x .1109	11	6	1.65	3110	1000	3790

Anaconda All-Purpose Cable

**Durasheath—Nonmetallic Sheathed Cable
Three Conductor—0-5000 Volts**

Con-ductor Size A.W.G. or MCM	No. and Diam. of Wires In.	Insul. Thick. 64th In.	Neo-prene Jkt. Thick. 64th In.	O.A. Diam. In.	Net Wt. Lbs. Per M-Ft.	Ft. In Reel	Shp. Wt. In Lbs. Std. Pkg.
*0-600 Volts—Grounded or Ungrounded—Nonshielded							
14	1x. 0611	3	3	.54	155	1000	193
12	1x. 0808	3	4	.60	215	1000	253
10	1x. 1019	3	4	.65	240	1000	280
8	1x. 1285	4	4	.78	390	1000	410
6	1x. 1620	4	4	.85	510	1000	600
6	7x. 0612	4	5	.93	590	1000	640
4	7x. 0772	4	5	1.03	715	1000	770
2	7x. 0974	4	5	1.16	1185	1000	1585
1	19x. 0664	5	6	1.36	1550	1000	1950
1/0	19x. 0715	5	6	1.45	1810	1000	2120
2/0	19x. 0837	5	6	1.55	2200	1000	2780
3/0	19x. 0940	5	6	1.67	2650	1000	3330
4/0	19x. 1055	5	7	1.82	3250	1000	3930
250	37x. 0822	6	7	2.00	3880	1000	4845
300	37x. 0900	6	7	2.13	4510	1000	5475
350	37x. 0973	6	7	2.24	5130	1000	6305
400	37x. 1040	6	8	2.37	5800	1000	6975
500	37x. 1162	6	8	2.58	7080	1000	8650
**2001-3000 Volts—Grounded or Ungrounded Nonshielded							
10	1x. 1019	7	5	0.97	570	1000	780
8	1x. 1285	7	5	1.02	670	1000	880
6	1x. 1620	8	5	1.17	905	1000	1305
6	19x. 0732	8	5	1.22	965	1000	1365
4	19x. 0169	8	6	1.38	1280	1000	1860
2	19x. 0591	8	6	1.51	1665	1000	2245
1	19x. 0664	8	6	1.60	1910	1000	2590
1/0	19x. 0745	8	6	1.69	2230	1000	2910
2/0	19x. 0837	8	7	1.83	2670	1000	3350
3/0	19x. 0940	8	7	1.94	3140	1000	3820
4/0	19x. 1055	8	7	2.09	3760	1000	4725
250	37x. 0822	9	7	2.26	4450	1000	5620
300	37x. 0900	9	8	2.42	5170	1000	6340
350	37x. 0973	9	8	2.52	5790	1000	6960
400	37x. 1040	9	8	2.66	6500	1000	8070
500	37x. 1162	9	8	2.84	7740	1000	9310
**4001-5000 Volts—Grounded or Ungrounded Nonshielded							
8	1x. 1019	10	5	1.24	850	1000	1250
6	1x. 1620	10	6	1.35	1070	1000	1650
6	19x. 0372	10	6	1.41	1140	1000	1720
4	19x. 0169	10	6	1.51	1410	1000	1990
2	19x. 0591	10	6	1.66	1815	1000	2500
1	19x. 0664	10	6	1.74	2080	1000	2760
1/0	19x. 0745	10	7	1.87	2470	1000	3150
2/0	19x. 0837	10	7	1.97	2870	1000	3835
3/0	19x. 0940	10	7	2.10	3380	1000	4345
4/0	19x. 1055	10	7	2.22	3970	1000	5140
250	37x. 0822	11	8	2.43	4730	1000	5900
300	37x. 0900	11	8	2.55	5390	1000	6960
350	37x. 0973	11	8	2.69	6110	1000	7680
400	37x. 1040	11	8	2.79	6750	1000	8320
500	37x. 1162	11	8	2.97	8030	1000	9600

*Insulated with Anaconda Type ANW rubber compound.

**Insulated with Type AB (Anaconda Butyl) ozone and heat-resistant compound.

Based on IPCEA Standard S-19-81 2nd Edition, February, 1951.

Durasheath cables, insulated with type RH-RW compound, approved by Underwriters' Laboratories, Inc. for use as Type USE Underground Service Cable.

These data are approximate and subject to normal manufacturing tolerances.

**Durasheath—Nonmetallic Sheathed Cable
Three Conductor—4001-15000 Volts**

Con-ductor Size A.W.G. or MCM	No. and Diam. of Wires In.	Insul. Thick. 64th In.	Neo-prene Jkt. Thick. 64th In.	D.A. Diam. In.	Net Wt. Lbs. Per M-Ft.	Ft. In Reel	Shp. Wt. In Lbs. Std. Pkg.
**4001-5000 Volts—Grounded or Ungrounded Shielded							
8	1x. 1285	10	6	1.37	1190	1000	1850
6	19x. 0372	10	6	1.53	1505	1000	2165
4	19x. 0169	10	6	1.64	1800	1000	2480
2	19x. 0591	10	7	1.81	2270	1000	2950
1	19x. 0664	10	8	1.89	2560	1000	3240
1/0	19x. 0745	10	7	2.00	2935	1000	3615
2/0	19x. 0837	10	7	2.10	3365	1000	4305
3/0	19x. 0940	10	7	2.21	3860	1000	4800
4/0	19x. 1055	10	8	2.37	4570	1000	6010
250	37x. 0822	11	8	2.61	5575	1000	7745
300	37x. 0900	11	8	2.74	6305	1000	8170
350	37x. 0973	11	8	2.85	7010	1000	8880
400	37x. 1040	11	8	2.96	7695	1000	10500
500	37x. 1162	11	8	3.15	8990	1000	11800
**7001-8000 Volts—Grounded Neutral—Shielded							
6	19x. 0372	12	6	1.68	1745	1000	2525
4	19x. 0169	12	7	1.82	2110	1000	2890
2	19x. 0591	12	7	1.92	2565	1000	3345
1	37x. 0476	12	7	2.05	2875	1000	3815
1/0	37x. 0534	12	7	2.14	3235	1000	4175
2/0	37x. 0600	12	7	2.24	3670	1000	5110
3/0	37x. 0673	12	8	2.39	4270	1000	5710
4/0	37x. 0756	12	8	2.52	4950	1000	6390
250	61x. 0640	12	8	2.68	5770	1000	7640
300	61x. 0701	12	8	2.81	6500	1000	8370
350	61x. 0757	12	8	2.92	7200	1000	9070
400	61x. 0810	12	8	3.03	7905	1000	10710
500	61x. 0905	12	8	3.23	9275	1000	12080
**11001-12000 Volts—Grounded Neutral—Shielded							
6	19x. 0372	16	7	2.00	2345	1000	3285
4	19x. 0469	16	7	2.11	2690	1000	3630
2	19x. 0591	16	7	2.25	3185	1000	4125
1	37x. 0476	16	8	2.36	3580	1000	5020
1/0	37x. 0534	16	8	2.43	3940	1000	5380
2/0	37x. 0600	16	8	2.56	4445	1000	5885
3/0	37x. 0673	16	8	2.67	5000	1000	6870
4/0	37x. 0756	16	8	2.81	5690	1000	7560
250	61x. 0640	16	8	2.97	6605	1000	9110
300	61x. 0701	16	8	3.09	7365	1000	10170
350	61x. 0757	16	8	3.21	8100	1000	10910
400	61x. 0810	16	8	3.31	8825	1000	11630
500	61x. 0905	16	9	3.54	10405	1000	13210
**14001-15000 Volts—Grounded Neutral—Shielded							
2	19x. 0591	19	8	2.51	3965	1000	5405
1	37x. 0476	19	8	2.60	4315	1000	5755
1/0	37x. 0534	19	8	2.69	4730	1000	6000
2/0	37x. 0600	19	8	2.79	5230	1000	7100
3/0	37x. 0673	19	8	2.91	5830	1000	7540
4/0	37x. 0756	19	8	3.04	6560	1000	9365
250	61x. 0640	19	8	3.18	7275	1000	10080
300	61x. 0701	19	8	3.31	8055	1000	10860
350	61x. 0757	19	9	3.45	8925	1000	11730
400	61x. 0810	19	9	3.56	9685	750	12490
500	61x. 0905	19	9	3.76	11155	750	13705

**Insulated with Type AB (Anaconda Butyl) ozone and heat-resistant compound.

Based on IPCEA Standard S-19-81, 2nd Edition, February, 1951.

Heavier jacket thickness may be advisable where service conditions are unusually severe.

These data are approximate and subject to normal manufacturing tolerances.

Anaconda All-Purpose Cable

**Durasheath—Nonmetallic Sheathed Cable
Single Conductor—0-600 Volts—Nonshielded**



Conductor Size A.W.G. or MCM	No. and Diam. of Wires In.	Insul. Thick. 64th In.	Neo-prene Jkt. Thick. 64th In.	O.A. Diam. In.	Net WL Lbs. Per M-Fl	Fl. In Reel	Shp. WL Lbs. Std. Pkg.
0-600 Volts *†Light Jacket—Grounded or Ungrounded Nonshielded							
6	7x. 0612	4	2	0.39	91	\$2000	206
4	7x. 0772	4	2	.44	120	\$1000	143
2	7x. 0974	4	2	.51	162	\$1000	185
1	19x. 0664	5	3	.61	228	\$1000	259
1/0	19x. 0745	5	3	.65	262	\$1000	293
2/0	19x. 0837	5	3	.70	305	\$1000	336
3/0	19x. 0910	5	3	.75	360	\$1000	405
4/0	19x. 1055	5	3	.81	425	\$1000	470
250	37x. 0822	6	4	.93	540	1000	750
300	37x. 0900	6	4	.98	615	1000	825
350	37x. 0973	6	4	1.04	690	1000	900
400	37x. 1040	6	4	1.08	755	1000	965
500	37x. 1162	6	4	1.17	900	1000	1300
600	61x. 0992	7	4	1.29	1075	1000	1475
750	61x. 1109	7	4	1.39	1280	1000	1860
1000	61x. 1280	7	4	1.55	1610	1000	2190

Conductor Size A.W.G. or MCM	No. and Diam. of Wires In.	Insul. Thick. 64th In.	Neo-prene Jkt. Thick. 64th In.	O.A. Diam. In.	Net WL Lbs. Per M-Fl	Fl. In Reel	Shp. WL Lbs. Std. Pkg.
0-600 Volts *†Heavy Jacket—Grounded or Ungrounded Nonshielded							
6	7x. 0612	4	3	0.42	100	\$2000	232
4	7x. 0772	4	3	.47	149	\$1000	186
2	7x. 0974	4	3	.53	179	\$1000	218
1	19x. 0664	5	4	.64	246	\$1000	285
1/0	19x. 0745	5	4	.68	281	\$1000	320
2/0	19x. 0837	5	4	.73	330	\$1000	370
3/0	19x. 0940	5	4	.78	385	\$1000	425
4/0	19x. 1055	5	4	.84	465	\$1000	505
250	37x. 0822	6	5	.96	570	1000	780
300	37x. 0900	6	5	1.01	580	1000	790
350	37x. 0973	6	5	1.07	720	1000	920
400	37x. 1040	6	5	1.11	790	1000	1000
500	37x. 1162	6	5	1.20	940	1000	1320
600	61x. 0992	7	6	1.35	1125	1000	1515
750	61x. 1109	7	6	1.46	1370	1000	1770
1000	61x. 1280	7	6	1.61	1710	1000	2290

*Insulated with Type RH-RW (Anaconda Type ANW) rubber compound.

†Durasheath cable with light jacket is recommended by IPCEA for use in conduit and underground ducts; with heavy jacket for aerial and direct burial.

‡Based on IPCEA Standard S-19-81, 2nd Edition, February, 1951.

§Durasheath cable with heavy jacket approved by Underwriters' Laboratories, Inc. for use as follows: insulated with Type RHW compound, as Type USE underground service entrance cable at 75C; with Type RH-RW compound as Type USE or Type UF at 60C; recommended by IPCEA for aerial and direct-burial installation.

¶Nonreturnable reels. All others are standard returnable. These data are approximate and subject to normal manufacturing tolerances.

Call Graybar FIRST For . . .

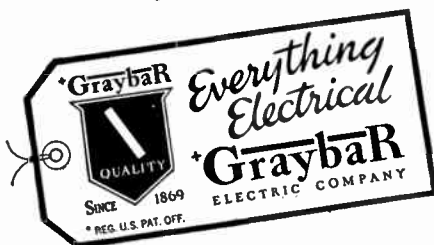

**Durasheath—Nonmetallic Sheathed Cable
Single Conductor—4001-15000 Volts**

Conductor Size A.W.G. or MCM	No. and Diam. of Wires In.	Insul. Thick. 64th In.	Neo-prene Jkt. Thick. 64th In.	O.A. Diam. In.	Net WL Lbs. Per M-Fl	Fl. In Reel	Shp. WL Lbs. Std. Pkg.
*4001-5000 Volts—Grounded or Ungrounded—Shielded							
8	1x. 1285	10	4	.66	272	1000	385
6	19x. 0372	10	4	.74	345	1000	460
4	19x. 0469	10	4	.79	425	1000	535
2	19x. 0591	10	4	.86	535	1000	725
1	19x. 0664	10	5	.92	635	1000	900
1/0	19x. 0745	10	5	.97	735	1000	1000
2/0	19x. 0837	10	5	1.02	855	1000	1120
3/0	19x. 0910	10	5	1.07	990	1000	1315
4/0	19x. 1055	10	5	1.14	1165	1000	1480
250	37x. 0822	11	5	1.24	1370	1000	1685
300	37x. 0900	11	6	1.33	1605	1000	2035
350	37x. 0973	11	6	1.38	1800	1000	2460
400	37x. 1040	11	6	1.43	1995	1000	2655
500	37x. 1162	11	6	1.52	2345	1000	3005
*7001-8000 Volts—Grounded—Shielded							
6	19x. 0372	12	4	.81	385	1000	575
4	19x. 0469	12	4	.86	490	1000	680
2	19x. 0591	12	5	.96	605	1000	870
1	37x. 0476	12	5	.99	685	1000	950
1/0	37x. 0534	12	5	1.04	780	1000	1045
2/0	37x. 0600	12	5	1.09	895	1000	1160
3/0	37x. 0673	12	5	1.14	1040	1000	1355
4/0	37x. 0756	12	5	1.20	1220	1000	1535
250	61x. 0640	12	6	1.30	1420	1000	1810
300	61x. 0701	12	6	1.36	1620	1000	2280
350	61x. 0757	12	6	1.42	1810	1000	2470
400	61x. 0810	12	6	1.47	2005	1000	2665
500	61x. 0905	12	6	1.56	2370	1000	3150
*11001-12000 Volts—Grounded—Shielded							
6	19x. 0372	16	5	.97	545	1000	810
4	19x. 0469	16	5	1.02	630	1000	895
2	19x. 0591	16	5	1.09	760	1000	1085
1	37x. 0476	16	5	1.13	840	1000	1155
1/0	37x. 0534	16	5	1.17	945	1000	1260
2/0	37x. 0600	16	5	1.22	1070	1000	1385
3/0	37x. 0673	16	6	1.30	1260	1000	1695
4/0	37x. 0756	16	6	1.37	1450	1000	2110
250	61x. 0640	16	6	1.44	1625	1000	2285
300	61x. 0701	16	6	1.50	1830	1000	2490
350	61x. 0757	16	6	1.55	2030	1000	2690
400	61x. 0810	16	6	1.60	2235	1000	3015
500	61x. 0905	16	6	1.69	2615	1000	3395
*14001-15000 Volts—Grounded—Shielded							
4	19x. 0469	19	5	1.13	735	1000	1050
2	19x. 0591	19	5	1.19	870	1000	1185
1	37x. 0476	19	5	1.23	955	1000	1390
1/0	37x. 0534	19	6	1.31	1105	1000	1540
2/0	37x. 0600	19	6	1.35	1235	1000	1670
3/0	37x. 0673	19	6	1.41	1390	1000	2050
4/0	37x. 0756	19	6	1.47	1585	1000	2245
250	61x. 0640	19	6	1.54	1770	1000	2550
300	61x. 0701	19	6	1.60	1980	1000	2760
350	61x. 0757	19	6	1.65	2185	1000	2965
400	61x. 0810	19	6	1.70	2390	1000	3170
500	61x. 0905	19	7	1.82	2835	1000	3615

*Insulated with Type AB (Anaconda Butyl) ozone and heat-resistant compound.

Based on IPCEA Standard S-19-81, 2nd Edition, February, 1951.

Heavier jacket thicknesses may be advisable where service conditions are unusually severe.

These data are approximate and subject to normal manufacturing tolerances.

Anaconda Thermoplastic Power Cable
Polyethylene Insulated
0-600 Volts



Conductor Size* A.W.G. or MCM	No. and Diam. of Wires In.	Polyethylene Insul. Thick. In.	Con-sheath JkL Thick. † 64th In.	O.A. Diam. In.	Net WL Lbs. Per M FL	Std. Length Feet	Ship. WL Lbs. Std. Pkg.
One Conductor—Light Jacket							
14	1x. 0641	.030	1	0.19	20	500*	11
12	1x. 0808	.030	1	.20	29	500*	16
10	1x. 1019	.030	1	.22	42	500*	22
8	1x. 1285	.030	1	.25	63	500*	33
6	1x. 1620	.045	2	.34	110	500*	56
6	7x. 0612	.045	2	.37	116	500*	59
4	7x. 0772	.045	2	.41	171	500*	87
2	7x. 0974	.045	2	.47	254	500*	128
1	19x. 0664	.055	3	.58	334	‡1000	370
1/0	19x. 0745	.055	3	.62	409	‡1000	440
2/0	19x. 0837	.055	3	.66	503	‡1000	510
3/0	19x. 0940	.055	3	.70	619	‡1000	655
4/0	19x. 1055	.055	3	.77	767	‡1000	810
250	37x. 0822	.065	4	.87	927	1000	1045
300	37x. 0900	.065	4	.93	1094	1000	1295
350	37x. 0973	.065	4	.98	1261	1000	1460
400	37x. 1040	.065	4	1.02	1427	1000	1625
500	37x. 1162	.065	4	1.12	1756	1000	2045

Conductor Size* A.W.G. or MCM	No. and Diam. of Wires In.	Polyethylene Insul. Thick. In.	Con-sheath JkL Thick. † 64th In.	O.A. Diam. In.	Net WL Lbs. Per M FL	Std. Length Feet	Ship. WL Lbs. Std. Pkg.
One Conductor—Heavy Jacket							
14	1x. 0641	.030	3	0.25	32	500*	17
12	1x. 0808	.030	3	.26	42	500*	22
10	1x. 1019	.030	3	.29	56	500*	29
8	1x. 1285	.030	3	.31	79	500*	41
6	1x. 1620	.045	3	.38	120	500*	61
6	7x. 0612	.045	3	.40	126	500*	64
4	7x. 0772	.045	3	.45	185	500*	93
2	7x. 0974	.045	3	.51	272	500*	137
1	19x. 0664	.055	4	.61	355	‡1000	390
1/0	19x. 0745	.055	4	.65	435	‡1000	470
2/0	19x. 0837	.055	4	.69	530	‡1000	570
3/0	19x. 0940	.055	4	.75	650	‡1000	690
4/0	19x. 1055	.055	4	.80	800	‡1000	845
250	37x. 0822	.065	5	.90	955	1000	1080
300	37x. 0900	.065	5	.96	1130	1000	1330
350	37x. 0973	.065	5	1.01	1300	1000	1500
400	37x. 1040	.065	5	1.06	1465	1000	1670
500	37x. 1162	.065	5	1.15	1790	1000	2080

Conductor Size* A.W.G. or MCM	No. and Diam. of Wires In.	Polyethylene Insul. Thick. In.	Con-sheath JkL Thick. † 64th In.	O.A. Diam. In.	Net WL Lbs. Per M FL	Std. Length Feet	Ship. WL Lbs. Std. Pkg.
Twin Conductor (Flat)—600 Volts							
14	1x. 0641	.030	3	.24x. 38	57	500*	30
12	1x. 0808	.030	3	.26x. 42	76	500*	39
10	1x. 1019	.030	3	.28x. 46	105	1000	143
8	1x. 1285	.045	4	.37x. 61	177	1000	257
6	7x. 0612	.045	4	.43x. 73	281	1000	390

Conductor Size* A.W.G. or MCM	No. and Diam. of Wires In.	Polyethylene Insul. Thick. In.	Con-sheath JkL Thick. † 64th In.	O.A. Diam. In.	Net WL Lbs. Per M FL	Std. Length Feet	Ship. WL Lbs. Std. Pkg.
Three Conductor—600 Volts							
12	1x. 0808	.030	3	0.45	117	500*	60
10	1x. 1019	.030	3	.50	166	1000	246
8	1x. 1285	.045	4	.67	275	1000	385
6	7x. 0612	.045	4	.79	375	1000	495
4	7x. 0772	.045	5	.93	630	1000	825
2	7x. 0974	.045	5	1.06	900	1000	1095

Based on IPCEA Standard S-19-81, 2nd Edition, February, 1951, Appendixes I and J for vinyl chloride polymer insulation and jacket respectively, and Appendix P, 2nd Revision, Nov. 4th, 1954 for polyethylene insulation.

*Conductor size should be adequate, particularly for buried cables, to reduce danger of mechanical trouble. No. 8 AWG minimum is suggested.

† A vinyl resin thermoplastic compound.

‡ Nonreturnable reels. All others are standard returnable.

These data are approximate and subject to normal manufacturing tolerances.

Anaconda Thermoplastic Insulated Power Cable
Vinyl Resin Insulated Densheath
0-600 Volts

Conductor Size* A.W.G. or MCM	No. and Diam. of Wires In.	Vinyl Resin Densheath Insul. Thick. 64th In.	Densheath Jacket Thick. 64th In.	O.A. Diam. In.	Net WL Lbs. Per M FL	Std. Length Feet	Ship. WL Lbs. Std. Pkg.
-------------------------------	----------------------------	--	----------------------------------	----------------	----------------------	------------------	-------------------------

Single Conductor—600 Volts							
14	1x. 0641	4	...	0.19	27	500*	15
12	1x. 0808	421	36	500*	20
10	1x. 1019	423	50	500*	27
8	1x. 1285	529	79	500*	43
6	1x. 1620	532	113	500*	60
6	7x. 0612	534	122	500*	62
4	7x. 0772	539	180	500*	90
2	7x. 0974	545	266	500*	133
1	19x. 0664	652	336	‡1000	365
1/0	19x. 0745	657	417	‡1000	450
2/0	19x. 0837	661	512	‡1000	545
3/0	19x. 0940	666	630	‡1000	690
4/0	19x. 1055	672	779	‡1000	820
250	37x. 0822	780	926	1000	1025
300	37x. 0900	786	1094	1000	1190
350	37x. 0973	791	1262	1000	1440
400	37x. 1040	796	1428	1000	1605
500	37x. 1162	7	...	1.04	1759	1000	1930

Twin Conductor (Flat)—600 Volts							
14	1x. 0641	3	3	.25x. 41	75	500*	42
12	1x. 0808	3	3	.27x. 45	96	500*	52
10	1x. 1019	3	3	.30x. 48	127	1000	206
8	1x. 1285	4	4	.38x. 64	210	1000	290
6	7x. 0612	4	4	.44x. 75	308	1000	385

Three Conductor—600 Volts							
12	1x. 0808	3	3	0.49	136	500*	78
10	1x. 1019	3	4	.56	235	1000	320
8	1x. 1285	4	4	.69	297	1000	430
6	7x. 0612	4	4	.81	429	1000	565
4	7x. 0772	4	5	.95	657	1000	900
2	7x. 0974	4	5	1.08	927	1000	1200

Based on IPCEA Standard S-19-81, 2nd Edition, February, 1951, Appendixes I and J for vinyl chloride polymer (Anaconda Densheath) insulation and jacket respectively.

*Conductor size should be adequate, particularly for buried cables, to reduce danger of mechanical trouble.

† Nonreturnable reels. All others are standard returnable.

These data are approximate and subject to normal manufacturing tolerances.

Anaconda Powerduct Bus Drop Cable
0-600 Volts—Thermoplastic Insulated
Three Conductor With Ground Wire



Ground wire is of the same stranding as for the insulated conductors. The standard size is 2 AWG sizes smaller than the insulated conductors. Standard colors are black, white and red. Approved by U/L. Reels are nonreturnable. Vinyl Resin (Densheath) insulation and jacket covering.

Conductor Size A.W.G.	No. and Diam. of Wires In.	Insul. Thick. 64th In.	Vinyl Resin JkL Thick. 64th In.	O.A. Diam. In.	Net WL Lbs. Per M FL	FL In. Reel	Ship. WL Lbs. Std. Pkg.
-----------------------	----------------------------	------------------------	---------------------------------	----------------	----------------------	-------------	-------------------------

Thermoplastic Insulated—Thermoplastic Jacket							
14	7x. 0242	2	3	0.42	110	1000	139
12	7x. 0305	2	3	.47	146	1000	175
10	7x. 0385	2	3	.52	315	1000	350
8	7x. 0486	3	4	.69	370	1000	410
6	7x. 0612	4	4	.83	540	1000	585
4	7x. 0772	4	5	.97	800	1000	850

These data are approximate and subject to normal manufacturing tolerances.

*Coil

‡Reel

**Anaconda Borehole Cable
0-15000 Volts**

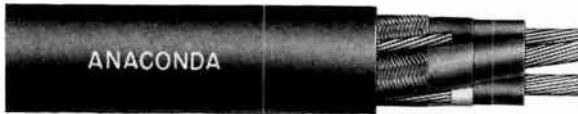

High Strength Copper Conductor Size A.W.G. or MCM	No. and Diam. of Wires, In.	Rubber Insulation Thick. 64th In.	Neoprene Jkt. Thick. 64th In.	O.A. Diam. In.	Wt. With Grounding *Cond. Lbs. Per M FL.	Max. Full Load Current Q Amps.
One Conductor—Nonshielded—600 Volts						
†Heat Resistant Conductor						
500	37x. 1162	6	5	1.20	1960	496
750	61x. 1109	7	6	1.45	2890	634
Three Conductor—Shielded—5000 Volts						
‡Ozone Resistant Conductors						
4	19x. 0469	10	8	1.61	1710	104
2	19x. 0591	10	8	1.75	2160	138
1	37x. 0476	10	8	1.85	2317	158
1/0	37x. 0534	10	9	2.06	2665	184
2/0	37x. 0600	10	9	2.13	3645	215
3/0	37x. 0673	10	9	2.25	4080	241
4/0	37x. 0756	10	9	2.31	4620	278
350	61x. 0757	11	10	2.89	7720	379
500	61x. 0905	11	10	3.19	10220	469
Three Conductor—Shielded—7500 Volts						
Suitable for 8-kv Operation						
‡Ozone Resistant Conductors						
4	19x. 0469	12	8	1.82	2125	110
2	19x. 0591	12	9	1.99	2685	142
1	37x. 0476	12	9	2.08	3030	161
1/0	37x. 0534	12	9	2.17	3425	189
2/0	37x. 0600	12	9	2.27	3930	220
3/0	37x. 0673	12	9	2.39	4560	248
4/0	37x. 0756	12	10	2.55	5385	285
350	61x. 0757	12	10	2.95	7910	390
500	61x. 0905	12	10	3.26	10450	486
Three Conductor—Shielded—15000 Volts						
‡Ozone Resistant Conductors						
2	19x. 0591	19	10	2.54	4015	146
1	37x. 0471	19	10	2.63	4420	167
1/0	37x. 0534	19	10	2.72	4910	193
2/0	37x. 0600	19	10	2.82	5565	223
3/0	37x. 0673	19	10	2.94	6150	253
4/0	37x. 0756	19	10	3.07	6980	291
350	61x. 0757	19	10	3.45	9525	388
500	61x. 0905	19	11	3.79	12310	480

*For 3 conductor cables. They are recommended to have both grounding conductor and individually shielded insulated conductors and so furnished unless otherwise specified by the purchaser. Conductor temper is furnished medium hard drawn.

†Conductors are insulated with a heat-resistant rubber compound meeting requirements of ASTM Specification D754-54T.

‡Conductors are insulated with an ozone-resistant butyl-rubber compound meeting the requirements of IPCEA Standard S-19-81, February, 1951, Appendix O, amended rated at 85C. maximum conductor temperature.

Q Current ratings based on cables installed in ventilated boreholes having a mean ambient temperature of 40C. with single conductor cables carrying alternating current, one cable per borehole.

Call Graybar FIRST For . . .

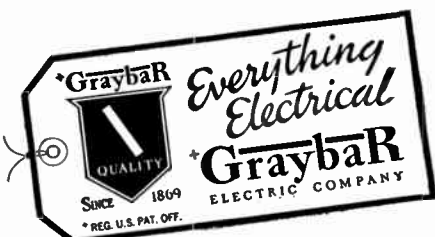

**Anaconda Durall-T Type UF Nonmetallic Sheathed Cable
600 Volts**



Solid



Stranded

Conductor Size A.W.G.	No. and Diam. of Wires In.	Den- sheath Insul. Thick. 64th In.	Den- sheath Insul. Thick. 64th In.	Solid Ground Wire Size A.W.G.	Net Wt. Lbs. Per M FL.	Std. Lgth. FL.
One-Conductor						
14	1x. 0641	4	28	Carton 500
12	1x. 0808	4	37	500
10	1x. 1019	4	52	500
8	7x. 0486	5	87	500
6	7x. 0612	5	125	500
4	7x. 0772	5	182	500
2	7x. 0974	5	268	500
1	19x. 0664	6	345	1000
1/0	19x. 0745	6	420	1000
2/0	19x. 0837	6	515	1000
3/0	19x. 0917	6	635	1000
4/0	19x. 1055	6	780	1000
Twin-Conductor Without Ground Wire						
14	1x. 0641	2	2	..	68	Coil 250
12	1x. 0808	2	2	..	95	250
10	1x. 1019	2	2	..	121	250
Three Conductor Without Ground Wire						
14	1x. 0641	2	2	..	105	250
12	1x. 0808	2	2	..	151	250
10	1x. 1019	2	2	..	176	250
Twin-Conductor With Ground Wire						
14	1x. 0641	2	2	16	81	250
12	1x. 0808	2	2	14	105	250
10	1x. 1019	2	2	12	150	250
Three Conductor With Ground Wire						
14	1x. 0641	2	2	16	130	250
12	1x. 0808	2	2	14	162	250
10	1x. 1019	2	2	12	241	250

Approved by U/L as Type UF underground feeder and branch circuit cable, including direct burial, when provided with over current protection, also for interior wiring and other purposes. Also approved as Types NM and NMC.

Reels are nonreturnable.

These data are approximate and subject to normal manufacturing tolerances.

**Mine Power and Borehole Cable
Grounding Conductor Construction
Concentric Strand—Coated**

Insulated Power Conductors Size A.W.G.	Area Circular Mils	Total Area of Grounding Conductor Cir. Mil	Grounding Conductor	
			No. of Section Inter- stices	No. and Size of Wires In.
4	41740	39270	3	9 7x. 0432
2	66360	62460	3	7 7x. 0545
1	83690	78720	3	6 7x. 0612
1/0	105600	99270	3	5 7x. 0688
2/0	133100	125220	3	4 7x. 0772
3/0	167800	157860	3	3 7x. 0867
4/0	211600	199080	3	2 7x. 0974
350	350000	316800	3	1/0 19x. 0745
500	500000	503400	3	3/0 19x. 0940

The grounding conductor is constructed under the same specifications as the insulated conductors. The three bare, stranded sections forming the grounding conductor are placed in the interstices of the insulated cable assembly.

These data are approximate and subject to normal manufacturing tolerances.

Anaconda Rubber Insulated Power Cable

Single Conductor—Lead Covered

Nonshielded—0-8000 Volts



0-600 Volts (Grounded or Ungrounded)

Conductor Size A.W.G. or MCM	No. and Diam. of Wires Inch	Insulation Thickness 64th In.	†Lead Thickness 64th In.	Over-all Diam. In.	Std. Reel Length Feet	Ship. Wt. Std. Pkg. Lbs.
6	1x. 1620	4	3	.43	1000	480
6	7x. 0612	4	3	.45	1000	510
4	7x. 0772	4	3	.50	1000	605
2	7x. 0974	4	4	.59	1000	880
1	19x. 0664	5	4	.67	1000	1045
<hr/>						
1/0	19x. 0745	5	4	.71	1000	1160
2/0	19x. 0837	5	4	.75	1000	1305
3/0	19x. 0940	5	4	.81	1000	1490
4/0	19x. 1055	5	5	.90	1000	1915
<hr/>						
250	37x. 0822	6	5	.98	1000	2270
300	37x. 0900	6	5	1.04	1000	2510
350	37x. 0973	6	5	1.09	1000	2750
400	37x. 1040	6	5	1.11	1000	2980
500	37x. 1162	6	5	1.22	1000	3610
<hr/>						
600	61x. 0992	7	6	1.36	500	2235
750	61x. 1109	7	6	1.47	500	2565
1000	61x. 1280	7	6	1.63	500	3465
1500	91x. 1284	8	7	1.95	500	4780
2000	127x. 1255	8	7	2.19	500	5780

4001-5000 Volts (Grounded or Ungrounded)

8	1x. 1285	10	4	0.62	1000	805
6	1x. 1620	10	4	.66	1000	885
6	19x. 0372	10	4	.69	1000	920
<hr/>						
4	19x. 0469	10	4	.73	1000	1035
2	19x. 0591	10	4	.80	1000	1200
1	19x. 0664	10	4	.81	1000	1315
<hr/>						
1/0	19x. 0745	10	5	.91	1000	1665
2/0	19x. 0837	10	5	.96	1000	1825
3/0	19x. 0940	10	5	1.01	1000	2125
4/0	19x. 1055	10	5	1.07	1000	2360
<hr/>						
250	37x. 0822	11	5	1.16	1000	2820
300	37x. 0900	11	5	1.21	1000	3060
350	37x. 0973	11	6	1.30	1000	3640
400	37x. 1040	11	6	1.35	1000	3890
500	37x. 1162	11	6	1.44	1000	4540
<hr/>						
600	61x. 0892	11	6	1.52	500	2800
750	61x. 1109	11	6	1.63	500	3140
1000	61x. 1280	11	7	1.82	500	3905
1500	91x. 1284	12	7	2.13	500	5030
2000	127x. 1255	12	8	2.36	500	6180

§11001-12000 Volts (Grounded Neutral)

6	19x. 0372	16	5	1.01	1000	2155
4	19x. 0469	16	5	1.07	1000	2330
2	19x. 0591	16	5	1.13	1000	2540
1	37x. 0476	16	5	1.17	1000	2690
<hr/>						
1/0	37x. 0534	16	5	1.21	1000	3050
2/0	37x. 0600	16	5	1.29	1000	3560
3/0	37x. 0673	16	5	1.35	1000	3820
4/0	37x. 0756	16	6	1.41	1000	4110
<hr/>						
250	61x. 0640	16	6	1.45	1000	4530
300	61x. 0701	16	6	1.51	1000	4830
350	61x. 0757	16	6	1.56	1000	5150
400	61x. 0810	16	6	1.61	1000	5420
500	61x. 0905	16	6	1.70	1000	5950

*Tape or braid over conductor insulation.

Shielded—11,001-15,000 Volts



2,001-3,000 Volts (Grounded or Ungrounded)

Conductor Size A.W.G. or MCM	No. and Diam. of Wires Inch	Insulation Thickness 64th In.	†Lead Thickness 64th In.	Over-all Diam. In.	Std. Reel Length Feet	Ship. Wt. Std. Pkg. Lbs.
10	1x. 1019	7	3	0.47	1000	480
8	1x. 1285	8	3	.49	1000	525
6	1x. 1620	8	4	.60	1000	775
<hr/>						
6	19x. 0372	8	4	.62	1000	820
4	19x. 0469	8	4	.67	1000	940
2	19x. 0591	8	4	.73	1000	1095
1	19x. 0664	8	4	.77	1000	1200
<hr/>						
1/0	19x. 0745	8	4	.81	1000	1335
2/0	19x. 0837	8	4	.86	1000	1485
3/0	19x. 0940	8	5	.95	1000	1890
4/0	19x. 1055	8	5	1.01	1000	2230
<hr/>						
250	37x. 0822	9	5	1.09	1000	2490
300	37x. 0900	9	5	1.15	1000	2740
350	37x. 0973	9	5	1.20	1000	3160
400	37x. 1040	9	5	1.25	1000	3410
500	37x. 1162	9	6	1.37	1000	4200
<hr/>						
600	61x. 0992	9	6	1.45	500	2705
750	61x. 1109	9	6	1.56	500	3075
1000	61x. 1280	9	6	1.72	500	3590
1500	91x. 1284	10	7	2.07	500	4925
2000	127x. 1255	10	7	2.29	500	6050

§7001-8000 Volts (Grounded Neutral)

6	19x. 0372	12	4	0.84	1000	1480
4	19x. 0469	12	4	.89	1000	1620
2	19x. 0591	12	5	.99	1000	2160
1	37x. 0476	12	5	1.03	1000	2300
<hr/>						
1/0	37x. 0534	12	5	1.07	1000	2470
2/0	37x. 0600	12	5	1.12	1000	2650
3/0	37x. 0673	12	5	1.18	1000	3070
4/0	37x. 0756	12	5	1.25	1000	3650
<hr/>						
250	61x. 0640	12	5	1.32	1000	3880
300	61x. 0701	12	6	1.37	1000	4190
350	61x. 0757	12	6	1.42	1000	4470
400	61x. 0810	12	6	1.47	1000	4920
500	61x. 0905	12	6	1.57	1000	5460

§14001-15000 Volts (Grounded Neutral)

2	19x. 0591	19	5	1.26	1000	3000
1	37x. 0476	19	5	1.30	1000	3460
<hr/>						
1/0	37x. 0534	19	5	1.34	1000	3640
2/0	37x. 0600	19	6	1.39	1000	3870
3/0	37x. 0673	19	6	1.44	1000	4300
4/0	37x. 0756	19	6	1.50	1000	4590
<hr/>						
250	61x. 0640	19	6	1.55	1000	4840
300	61x. 0701	19	6	1.61	1000	5160
350	61x. 0757	19	6	1.66	1000	5450
400	61x. 0810	19	6	1.71	1000	5740
500	61x. 0905	19	6	1.83	1000	6850

§Ozone Resistant insulating compound. (Anaconda Butyl.) Based on IPCEA Standard S-19-81, 1st Edition, January 1946 with additions and corrections thereto.

These data are approximate and subject to normal manufacturing tolerances.

†Lead thickness will differ in some sizes if the requirements of the Underwriters' Laboratories, Inc. are followed.

Prices on application.

Anaconda Rubber Insulated Power Cable

Twin Conductor—Nonshielded 0-5000 Volts

Lead Covered



0-600 Volts (Grounded or Ungrounded)

Size A.W.G. or MCM	Conductor No. and Diam. of Wires Inch	*Insulation Thickness 64th In.	§Lead Thickness 64th In.	Overall Diam. In.	Std. Lgth. Feet	Ship. Wt. Std. Pkg. Lbs.
14	.0641	‡3	3	0.27x0.17	1000	285
12	.0808	‡3	3	.32x.53	1000	435
10	.1019	3	3	.34x.58	1000	510
8	.1285	4	3	.39x.69	1000	645
6	.1620	4	4	.46x.79	1000	930
6	7x.0612	4	4	.48x.83	1000	985
4	7x.0772	4	4	.53x.93	1000	1295
2	7x.0974	4	4	.59x1.05	1000	1570
1	19x.0664	5	5	.70x1.23	1000	2095
1/0	19x.0745	5	5	.74x1.31	1000	2530
2/0	19x.0837	5	5	.78x1.40	1000	2830
3/0	19x.0910	5	5	.81x1.51	1000	3180
4/0	19x.1055	5	5	.88x1.62	500	1815
250	37x.0822	6	6	1.01x1.82	500	2210
300	37x.0900	6	6	1.07x1.93	500	2850
350	37x.0973	6	6	1.12x2.05	500	3090
400	37x.1040	6	6	1.17x2.14	500	3315
500	37x.1162	6	6	1.25x2.31	500	3760

2001-3000 Volts (Grounded or Ungrounded)

10	1x.1019	7	5	0.54x0.90	1000	1140
8	1x.1285	7	5	.56x.95	1000	1230
6	1x.1620	8	5	.63x1.09	1000	1480
6	19x.0372	8	5	.65x1.12	1000	1650
4	19x.0469	8	5	.70x1.14	1000	1890
2	19x.0591	8	6	.80x1.39	1000	2690
1	19x.0664	8	6	.84x1.48	1000	2920
1/0	19x.0745	8	6	.88x1.56	1000	3360
2/0	19x.0837	8	6	.93x1.67	1000	3690
3/0	19x.0910	8	6	.98x1.76	1000	4070
4/0	19x.1055	8	7	1.07x1.91	500	2580
250	37x.0822	9	7	1.16x2.09	500	3010
300	37x.0900	9	7	1.21x2.20	500	3300
350	37x.0973	9	7	1.26x2.34	500	3545
400	37x.1040	9	8	1.35x2.44	500	4055
500	37x.1162	9	8	2.64	500	5325

4001-5000 Volts (Grounded or Ungrounded)

8	1x.1019	10	5	.66x1.15	1000	1860
6	1x.1620	10	5	.70x1.22	1000	2040
6	19x.0372	10	6	.75x1.30	1000	2125
4	19x.0469	10	6	.80x1.40	1000	2560
2	19x.0591	10	6	.86x1.53	1000	3250
1	19x.0664	10	6	.90x1.60	1000	3490
1/0	19x.0745	10	6	.94x1.69	1000	3970
2/0	19x.0837	10	7	1.02x1.81	1000	4300
3/0	19x.0910	10	7	1.08x1.92	1000	4820
4/0	19x.1055	10	7	1.14x2.05	500	2710
250	37x.0822	11	7	1.22x2.22	500	3410
300	37x.0900	11	8	1.31x2.36	500	3690
350	37x.0973	11	8	1.36x2.47	500	3955
400	37x.1040	11	8	2.60	500	5460
500	37x.1162	11	8	2.77	500	6350

3-Conductor—Nonshielded 0-5000 Volts

Lead Covered

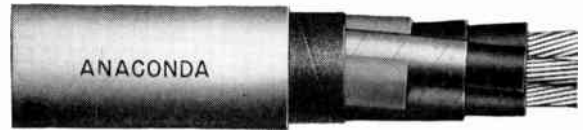

0-600 Volts (Grounded or Ungrounded)

Size A.W.G. or MCM	Conductor No. and Diam. of Wires Inch	*Insulation Thickness 64th In.	§Lead Thickness 64th In.	Overall Diam. In.	Std. Length Reel Feet	Ship. Wt. Std. Pkg. Lbs.
14	.0641	‡3	4	0.59	1000	715
12	.0808	‡3	4	.63	1000	795
10	.1019	3	4	.67	1000	870
8	.1285	4	4	.79	1000	1035
6	.1620	4	5	.70	1000	1545
6	7x.0612	4	5	.94	1000	1655
4	7x.0772	4	5	1.05	1000	2080
2	7x.0974	4	5	1.18	1000	2720
1	19x.0664	5	6	1.37	500	1770
1/0	19x.0745	5	6	1.46	500	1960
2/0	19x.0837	5	6	1.56	500	2390
3/0	19x.0910	5	6	1.67	500	2675
4/0	19x.1055	5	7	1.83	500	3420
250	37x.0822	6	7	2.01	500	3810
300	37x.0900	6	7	2.14	500	4220
350	37x.0973	6	7	2.25	500	4695
400	37x.1040	6	8	2.38	500	5365
500	37x.1162	6	8	2.57	500	6380

2001-3000 Volts (Grounded or Ungrounded)

10	1x.1019	7	5	0.98	1000	0.98
8	1x.1285	7	5	1.03	1000	1.03
6	1x.1620	8	5	1.18	1000	1.18
6	19x.0372	8	5	1.23	1000	1.23
4	19x.0469	8	6	1.37	1000	1.37
2	19x.0591	8	6	1.50	1000	1.50
1	19x.0664	8	6	1.59	500	1.59
1/0	19x.0745	8	6	1.68	500	1.68
2/0	19x.0837	8	7	1.82	500	1.82
3/0	19x.0910	8	7	1.93	500	1.93
4/0	19x.1055	8	7	2.06	500	2.06
250	37x.0822	9	7	2.24	500	2.24
300	37x.0900	9	8	2.39	500	2.39
350	37x.0973	9	8	2.50	500	2.50
400	37x.1040	9	8	2.61	500	2.61
500	37x.1162	9	8	2.80	500	2.80

4001-5000 Volts (Grounded or Ungrounded)

8	1x.1019	10	5	1.27	1000	2455
6	1x.1620	10	6	1.36	1000	3050
6	19x.0372	10	6	1.42	1000	3170
4	19x.0469	10	6	1.52	1000	3730
2	19x.0591	10	6	1.66	1000	4380
1	19x.0664	10	6	1.74	500	2425
1/0	19x.0745	10	7	1.87	500	3055
2/0	19x.0837	10	7	1.97	500	3310
3/0	19x.0910	10	7	2.10	500	3630
4/0	19x.1055	10	7	2.22	500	3995
250	37x.0822	11	8	2.43	500	4855
300	37x.0900	11	8	2.55	500	5260
350	37x.0973	11	8	2.67	500	5985
400	37x.1040	11	8	2.77	500	6370
500	37x.1162	11	8	2.96	500	7360

*Tape or braid over individual conductor insulation.

†Three conductor, rubber power cable can be supplied, shielded up to 15,000 Volts.

‡For building wire, N.E.C. permits the use of a 3/64-inch wall of Types R and RH insulations on sizes No. 14 and 12 A.W.G. for 600-volt service.

§Lead thickness will differ in some sizes if underwriters' requirements are followed.

Based on IPCEA Standard S-19-81, 1st Edition, January, 1946 with additions and corrections thereto.

These data are approximate and subject to normal manufacturing tolerances.

Prices on application.

Anaconda Varnished Cambric Insulated Wire and Cable

600 to 3000 Volts

Fibrous Covered



Single Conductor—Non-Shielded

Solid

Conductor Size A.W.G. or MCM	Diam. Mils	D-C Resistance at 25°C (77°F.) Ohms per M Feet	Braid Thickness (Mils)			
			600 Volts Grounded or Ungrounded Neutral	1 KV Grounded or Ungrounded Neutral	2 KV Grounded or Ungrounded Neutral	3 KV Grounded or Ungrounded Neutral
14	64.1	2.525	26	26
12	80.8	1.588	26	27	27	..
10	101.9	.9989	26	27	27	27
8	128.5	.6282	27	27	27	27
Concentric—Class B						
6	184	0.410	27	27	27	30
4	232	.259	30	30	30	30
2	292	.162	30	30	30	30
1	332	.129	30	30	30	30
1/0	373	.102	30	30	30	30
2/0	419	.0811	30	30	30	30
3/0	470	.0642	30	30	30	30
4/0	528	.0509	30	30	30	30
250	575	.0431	30	30	30	30
300	630	.0360	35	35	35	35
350	681	.0308	35	35	35	35
400	728	.0270	35	35	35	35
450	772	.0240	35	35	35	35
500	813	.0216	36	36	36	36
550	855	.0196	36	36	36	36
600	893	.0180	36	36	36	36
650	929	.0166	36	36	36	36
700	964	.0154	36	36	36	36
750	998	.0144	36	36	36	36
800	1031	.0135	36	36	36	36
900	1094	.0120	36	36	36	36
1000	1152	.0108	36	36	36	36

3-Conductor—Belted

Solid

14	64.1	2.525	30	30
12	80.8	1.588	30	30	30	..
10	101.9	.9989	30	30	30	30
8	128.5	.6282	30	30	30	30

Concentric—Class B

6	184	0.410	30	30	30	30
4	232	.259	30	30	35	35
2	292	.162	35	35	35	36
1	332	.129	36	36	36	36
1/0	373	.102	36	36	36	36
2/0	419	.0811	36	36	36	36
3/0	470	.0642	36	36	36	36
4/0	528	.0509	36	36	42	42
250	575	.0431	42	42	42	42
300	630	.0360	42	42	42	42
350	681	.0308	42	42	42	42
400	728	.0270	42	42	42	42
450	772	.0240	42	42	42	42
500	813	.0216	42	42	42	42
550	855	.0196	42	42	42	42
600	893	.0180	42	42	42	42
650	929	.0166	42	42	42	42
700	964	.0154	42	42	42	42
750	998	.0144	42	42	42	42

Lead Covered

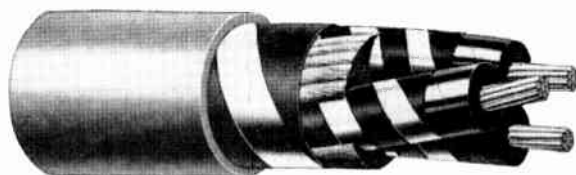

Single Conductor—Non-Shielded

Solid

Conductor Size A.W.G. or MCM	Diam. Mils	D-C Resistance at 25°C (77°F.) Ohms per M Feet	Lead Sheath Thickness (Mils)			
			600 Volts Grounded or Ungrounded Neutral	1 KV Grounded or Ungrounded Neutral	2 KV Grounded or Ungrounded Neutral	3 KV Grounded or Ungrounded Neutral
14	64.1	2.525	47	47
12	80.8	1.588	47	47	47	..
10	101.9	.9989	47	47	47	47
8	128.5	.6282	47	47	47	47
Concentric—Class B						
6	184	0.410	47	47	47	47
4	232	.259	47	47	47	47
2	292	.162	47	47	63	63
1	332	.129	63	63	63	63
1/0	373	.102	63	63	63	63
2/0	419	.0811	63	63	63	63
3/0	470	.0642	63	63	63	63
4/0	528	.0509	63	63	78	78
250	575	.0431	78	78	78	78
300	630	.0360	78	78	78	78
350	681	.0308	78	78	78	78
400	728	.0270	78	78	78	78
450	772	.0240	78	78	78	78
500	813	.0216	78	78	78	78
550	855	.0196	94	94	94	94
600	893	.0180	94	94	94	94
650	929	.0166	94	94	94	94
700	964	.0154	94	94	94	94
750	998	.0144	94	94	94	94
800	1031	.0135	94	94	94	94
900	1094	.0120	94	94	94	94
1000	1152	.0108	94	94	94	94

3-Conductor—Belted

Solid

14	64.1	2.525	47	47
12	80.8	1.588	47	63	63	..
10	101.9	.9989	63	63	63	63
8	128.5	.6282	63	63	63	63

Concentric—Class B

6	184	0.410	63	63	78	78
4	232	.259	78	78	78	78
2	292	.162	78	78	78	78
1	332	.129	94	94	94	94
1/0	373	.102	94	94	94	94
2/0	419	.0811	94	94	94	94
3/0	470	.0642	94	94	94	94
4/0	528	.0509	109	109	109	109
250	575	.0431	109	109	109	109
300	630	.0360	109	109	109	109
350	681	.0308	109	125	125	109
400	728	.0270	125	125	125	125
450	772	.0240	125	125	125	125
500	813	.0216	125	125	125	125
550	855	.0196	125	125	125	125
600	893	.0180	125	125	125	125
650	929	.0166	125	125	125	125
700	964	.0154	125	125	125	125
750	998	.0144	125	125	125	125

Based on IPCEA "Specifications for Varnished-Cambric Insulated Cables," 5th Edition, 1946. These data are approximate and subject to normal manufacturing tolerances.

Prices on application.

Anaconda Non-Metallic Armored Cable

Durasheath

Twin-Conductor—0-3000 Volts

***0-600 Volts (Grounded or Ungrounded)**

Size A.W.G.	Conductor Number and Diameter of Wires	Insulation Thickness 64th In.	Neoprene Jacket Thickness 64th In.	Overall Diameter Inch	Ship. Wt. Per M.Ft. Lbs.
12	1x.0808	3	3	.32x .54	150†
10	1x.1219	3	4	.37x .61	200†
8	1x.1285	4	4	.43x .73	275†
6	1x.1620	4	4	.47x .79	355†
6	7x.0612	4	4	.49x .85	375†
4	7x.0772	4	5	.57x .97	540†
2	7x.0974	4	5	.63x1.09	730†

†2001-3000 Volts (Grounded or Ungrounded)

10	1x.1019	7	5	.54x .92	450
8	1x.1285	7	5	.56x .96	510
6	1x.1620	8	5	.64x1.11	655
6	19x.0372	8	5	.67x1.15	795
4	19x.0169	8	5	.72x1.26	960
2	19x.0591	8	6	.81x1.41	1430

*Insulated with Type RH-RW rubber compound; approved by Underwriters' Laboratories, Inc., for use as Type USE Underground Service Cable.

†Insulated with Type AB ozone- and heat-resistant compound.

‡Non-returnable Reels.

Based on IPCEA Standard S-19-81, 2nd Edition, February, 1951 with additions and corrections thereto.

Heavier jacket thicknesses may be advisable where service conditions are unusually severe.

Prices on application.

Anaconda Railway Signal Cable

Thermoplastic Insulated

Conductors are in accordance with ASTM Standard Specifications B3 and B8, latest editions.

Single Conductor—Solid

Conductor Size A.W.G.	No. and Diameter of Wires Inch	†Densheath Insulation Thickness 64th Inch	Overall Diam. Inch	Net Wt. Per 1000 Ft. Lbs.	Std. Coil Length Feet	Ship. Wt. Std. Pkg. Lbs.
16	1 x .0508	3	0.149	17.5	1000	18.5
14	1 x .0640	3	.164	23.4	500	12.7
12	1 x .0808	3	.181	32.6	500	17.3
9	1 x .1144	3	.215	55.8	500	28.9
9	1 x .1144	5	.277	72.0	500	37.0
6	1 x .1620	4	.297	109.7	500	55.9
6	1 x .1620	6	.360	132.3	500	67.2

Single Conductor—Concentric Strand

16	19 x .0117	2	0.128	14.3	1000	15.3
16	19 x .0117	3	.159	19.0	500	10.5
14	19 x .0147	2	.143	20.3	500	11.2
14	19 x .0147	3	.174	25.2	500	13.6

†A vinyl resin thermoplastic compound.

Prices on application.

IPCEA Recommended Insulation Thickness For Portable Cables

Single and 2-Conductor

Types W and G, 3- and 4-Conductor

0-5000 Volts

Nearest Conductor Size A.W.G.	No. and Size of Wires A.W.G.	*Insulation Thickness (Inches)					
		0-600 Volts	601-1000 Volts	1001-2000 Volts	2001-3000 Volts	3001-4000 Volts	4001-5000 Volts
8	49 x 25	0.063	0.063	0.078	0.109
6	49 x 23	.063	.078	.094	.125	0.141	0.156
6	133 x 27	.063	.078	.094	.125	.141	.156
4	49 x 21	.063	.078	.094	.125	.141	.156
4	133 x 25	.063	.078	.094	.125	.141	.156
3	49 x 20	.063	.078	.094	.125	.141	.156
3	133 x 24	.063	.078	.094	.125	.141	.156
2	133 x 23	.063	.078	.094	.125	.141	.156
2	259 x 26	.063	.078	.094	.125	.141	.156
1	133 x 22	.078	.094	.109	.125	.141	.156
1	259 x 25	.078	.094	.109	.125	.141	.156
1/0	133 x 21	.078	.094	.109	.125	.141	.156
1/0	259 x 24	.078	.094	.109	.125	.141	.156
2/0	133 x 20	.078	.094	.109	.125	.141	.156
2/0	259 x 23	.078	.094	.109	.125	.141	.156
3/0	259 x 22	.078	.094	.109	.125	.141	.156
3/0	427 x 24	.078	.094	.109	.125	.141	.156
4/0	259 x 21	.078	.094	.109	.125	.141	.156
4/0	427 x 23	.078	.094	.109	.125	.141	.156
250	259 x 20	.094	.109	.125	.141	.156	.172
250	427 x 22	.094	.109	.125	.141	.156	.172
350	259 x 19	.094	.109	.125	.141	.156	.172
350	427 x 21	.094	.109	.125	.141	.156	.172
500	259 x 17	.094	.109	.125	.141	.156	.172
500	427 x 19	.094	.109	.125	.141	.156	.172

Type SH, 3- and 4-Conductor

2001-7000 Volts

Nearest Conductor Size A.W.G.	No. and Size of Wires A.W.G.	*Insulation Thickness (Inches)					
		2001-3000 Volts	3001-4000 Volts	4001-5000 Volts	5001-6000 Volts	6001-7000 Volts	7001-8000 Volts
8	49 x 25	0.125
6	49 x 23	.141	0.156	.172	.187	.203	.219
6	133 x 27	.141	.156	.172	.187	.203	.219
4	49 x 21	.141	.156	.172	.187	.203	.219
4	133 x 25	.141	.156	.172	.187	.203	.219
3	49 x 20	.141	.156	.172	.187	.203	.219
3	133 x 24	.141	.156	.172	.187	.203	.219
2	133 x 23	.141	.156	.172	.187	.203	.219
2	259 x 26	.141	.156	.172	.187	.203	.219
1	133 x 22	.141	.156	.172	.187	.203	.219
1	259 x 25	.141	.156	.172	.187	.203	.219
1/0	133 x 21	.141	.156	.172	.187	.203	.219
1/0	259 x 24	.141	.156	.172	.187	.203	.219
2/0	133 x 20	.141	.156	.172	.187	.203	.219
2/0	259 x 23	.141	.156	.172	.187	.203	.219
3/0	259 x 22	.141	.156	.172	.187	.203	.219
3/0	427 x 24	.141	.156	.172	.187	.203	.219
4/0	259 x 21	.141	.156	.172	.187	.203	.219
4/0	427 x 23	.141	.156	.172	.187	.203	.219

Conductors insulated, unless otherwise specified, with Type RH (heat-resistant) rubber compound. Other compounds can be supplied.

*Recommended insulation thicknesses apply to single-conductor and individual insulated conductors of multi-conductor cables.

Cables rated 2001 to 7000 volts are insulated with an ozone-resistant and heat-resistant compound, (Anaconda Butyl).

For two-conductor 600-volt concentric mining machine cable, 1/4 inch greater insulation thickness than shown above is recommended.

Anaconda Portable Power Cable
Securityflex 0-600 Volts
Single Conductor



Conductors are insulated, unless otherwise specified, with Type RH (heat-resistant) rubber compound. Other compounds can be supplied.

Steel wires not to exceed 10% of the area of the conductor may be substituted for copper when greater tensile strength is required.

Conductor Size A.W.G.	No. and Size of Wires A.W.G.	Current-Carrying Capacity Amperes	Overall Diam. In.	†Net WL per 1000 Ft. Lbs.	†Ship. WL per 1000 Ft. Lbs.
8	49x#95	55	0.44	155	175
6	49x#23	70	.51	230	260
6	133x#27	70	.51	230	260
4	49x#21	100	.57	285	315
4	133x#25	100	.57	285	315
2	133x#23	130	.66	370	400
2	259x#26	130	.66	370	400
1	133x#22	155	.74	480	510
1	259x#25	155	.74	480	510
1/0	133x#21	180	.77	520	630
1/0	259x#24	180	.77	520	630
2/0	133x#20	210	.82	600	710
2/0	259x#23	210	.82	600	710
3/0	259x#22	245	.87	810	920
3/0	427x#24	245	.87	810	920
4/0	259x#21	280	.93	865	1075
4/0	427x#23	280	.93	865	1075
250	259x#20	330	1.03	1100	1300
250	427x#22	330	1.03	1100	1300
350	259x#19	415	1.15	1500	1700
350	427x#21	415	1.15	1500	1700
500	259x#17	510	1.31	2140	2350
500	427x#19	510	1.31	2140	2350

Anaconda Gathering Locomotive Cable
Securityflex—0-600 Volts
Single Conductor



Conductor Size A.W.G.	No. and Size of Wires A.W.G.	Current-Carrying Capacity Amperes	Overall Diam. In.	†Net WL per 1000 Ft. Lbs.	†Ship. WL per 1000 Ft. Lbs.
8	49x#25	55	0.44	155	175
6	49x#23	70	.51	230	260
6	133x#27	70	.51	230	260
4	49x#21	100	.57	285	315
4	133x#25	100	.57	285	315
3	49x#20	115	.63	315	345
3	133x#24	115	.63	315	345
2	133x#23	130	.66	370	400
2	259x#26	130	.66	370	400
1	133x#22	155	.74	480	510
1	259x#25	155	.74	480	510
1/0	133x#21	180	.77	520	630
1/0	259x#24	180	.77	520	630
2/0	133x#20	210	.82	600	710
2/0	259x#23	210	.82	600	710
3/0	259x#22	245	.87	810	920
3/0	427x#24	245	.87	810	920
4/0	259x#21	280	.93	865	1075
4/0	427x#23	280	.93	865	1075

†Based on 1000 foot lengths. Longer lengths can be furnished to purchaser's specifications.

All types and sizes of portable cables for mine use branded with the designation 102 BM by authorization of Underwriters' Laboratories, Inc.

These data are approximate and subject to normal manufacturing tolerances.

Prices on application.

Anaconda Mining Machine Cable
Securityflex—600 Volts
Flat Twin



With Grounding Conductor

Conductor Size A.W.G.	No. and Sizes of Wires Conductor A.W.G.	Flat Ground Wire A.W.G.	Current-Carrying Capacity Amperes	Overall Diam. In.	†Net WL per 1000 Ft. Lbs.	†Ship. WL per 1000 Ft. Lbs.
6	19x#23	24x 7x#30	60	.56x1.02	490	700
6	133x#27	24x 7x#30	60	.56x1.02	490	700
4	49x#21	24x 11x#30	85	.61x1.15	625	950
4	133x#25	24x 11x#30	85	.61x1.15	625	950
3	49x#20	24x 14x#30	95	.68x1.26	850	1050
3	133x#24	24x 14x#30	95	.68x1.26	850	1050
2	133x#23	24x 18x#30	115	.73x1.35	1000	1250
2	259x#26	24x 18x#30	115	.73x1.35	1000	1250
1	133x#22	8x 66x#30	130	.81x1.55	1260	1680
1	259x#25	8x 66x#30	130	.81x1.55	1260	1680
1/0	133x#21	8x 83x#30	155	.93x1.67	1500	1900
1/0	259x#24	8x 83x#30	155	.93x1.67	1500	1900
2/0	133x#20	8x104x#30	180	.99x1.85	1800	2160
2/0	259x#23	8x104x#30	180	.99x1.85	1800	2160
3/0	259x#22	8x 83x#28	210	1.03x2.00	2160	2520
3/0	427x#24	8x 83x#28	210	1.03x2.00	2160	2520
4/0	259x#21	8x104x#28	240	1.10x2.10	2775	3220
4/0	427x#23	8x104x#28	240	1.10x2.10	2775	3220

Without Grounding Conductor

8	49x#25	50	.51x .84	400	500
6	49x#33	60	.56x .93	425	550
6	133x#27	60	.56x .93	425	550
4	49x#21	85	.61x1.05	550	770
4	133x#25	85	.61x1.05	550	770
3	49x#20	95	.68x1.14	690	910
3	133x#24	95	.68x1.14	690	910
2	133x#23	115	.73x1.24	875	1070
2	259x#26	115	.73x1.24	875	1070
1	133x#22	130	.81x1.40	1100	1440
1	259x#25	130	.81x1.40	1100	1440
1/0	133x#21	155	.93x1.51	1530	1910
1/0	259x#24	155	.93x1.51	1530	1910
2/0	133x#20	180	.99x1.63	1675	2255
2/0	259x#23	180	.99x1.63	1675	2255
3/0	259x#22	210	1.03x1.77	1925	2605
3/0	427x#24	210	1.03x1.77	1925	2605
4/0	259x#21	240	1.10x1.89	2370	2950
4/0	427x#23	240	1.10x1.89	2370	2950

Call Graybar FIRST For . . .



Anaconda Portable Power Cable

0-600 Volts

Conductors are insulated, unless otherwise specified, with Type RH (heat-resistant) rubber compound. Other compounds can be supplied.

Type W—Securityflex

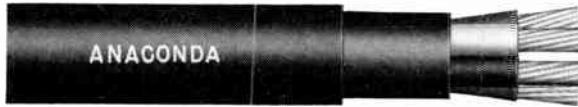

2-Conductor

Conductor Size A.W.G.	No. and Size of Wires A.W.G.	Current-Carrying Capacity Amperes	Overall Diameter Inches	Net Wt. Per 1000 Ft. Lbs.	†Ship. Wt. Per 1000 Ft. Lbs.
8	49 x #25	50	0.81	410	550
6	49 x #23	60	.93	505	715
6	133 x #27	60	.93	505	715
4	49 x #21	85	1.08	720	1120
4	133 x #25	85	1.08	720	1120
2	133 x #23	115	1.27	1120	1520
2	259 x #26	115	1.27	1120	1520
1	133 x #22	130	1.44	1460	2040
1	259 x #25	130	1.44	1460	2040
1/0	133 x #21	155	1.52	1720	2300
1/0	259 x #21	155	1.52	1720	2300
2/0	133 x #20	180	1.65	2245	2925
2/0	259 x #23	180	1.65	2245	2925
3/0	259 x #22	210	1.77	2410	3090
3/0	427 x #24	210	1.77	2410	3090
4/0	259 x #21	240	1.92	3065	4030
4/0	427 x #23	240	1.92	3065	4030

5-Conductor

Nearest Conductor Size A.W.G.	No. and Size of Wires A.W.G.	Current-Carrying Capacity Amperes	Overall Diameter Inches	†Net Wt. Per 1000 Ft. Lbs.	†Ship. Wt. Per 1000 Ft. Lbs.
8	49 x #25	35	1.07	780	1180
6	49 x #23	50	1.21	1110	1510
6	133 x #27	50	1.21	1110	1510
4	49 x #21	65	1.40	1515	2100
4	133 x #25	65	1.40	1515	2100
2	133 x #23	85	1.61	2155	2840
2	259 x #26	85	1.61	2155	2840
1	133 x #22	100	1.88	2790	3470
1	259 x #25	100	1.88	2790	3470

6-Conductor

8	49 x #25	35	1.18	960	1360
6	49 x #23	45	1.31	1270	1670
6	133 x #27	45	1.31	1270	1670
4	49 x #21	60	1.52	1850	2430
4	133 x #25	60	1.52	1850	2430
2	133 x #23	80	1.75	2605	3300
2	259 x #26	80	1.75	2605	3300
1	133 x #22	95	2.05	3375	4350
1	259 x #25	95	2.05	3375	4350

Types W and G—Securityflex



3-Conductor

Nearest Conductor Size A.W.G.	No. and Size of Wires A.W.G.	Current-Carrying Capacity Types W & G Amps.	3 Grounding Wires Size Each Wire A.W.G.	No. and Size of Wires Each Wire A.W.G.	Over-all Diam. In.	Type W per 1000 Ft. Lbs.	Type G per 1000 Ft. Lbs.
8	49x#25	40	12	84x#31	0.91	675	715
6	49x#23	60	12	84x#31	1.01	940	1000
6	133x#27	60	12	84x#31	1.01	940	1000
4	49x#21	80	10	84x#29	1.17	1375	1475
4	133x#25	80	10	84x#29	1.17	1375	1475
3	49x#20	90	9	84x#28	1.24	1615	1820
3	133x#24	90	9	84x#28	1.24	1615	1820
2	133x#23	110	8	84x#27	1.34	2150	2305
2	259x#26	110	8	84x#27	1.34	2150	2305
1	133x#22	120	7	84x#26	1.51	2480	2680
1	259x#25	120	7	84x#26	1.51	2480	2680
1/0	133x#21	145	6	84x#25	1.65	3100	3250
1/0	259x#24	145	6	84x#25	1.65	3100	3250
2/0	133x#20	160	5	84x#24	1.75	3480	3650
2/0	259x#23	160	5	84x#24	1.75	3480	3650
3/0	259x#22	185	4	84x#23	1.89	4410	4600
3/0	427x#24	185	4	84x#23	1.89	4410	4600
4/0	259x#21	215	3	84x#22	2.04	4640	5135
4/0	427x#23	215	3	84x#22	2.04	4640	5135

4-Conductor

8	49x#25	35	12	84x#31	0.99	845	880
6	49x#23	50	12	84x#31	1.10	1065	1115
6	133x#27	50	12	84x#31	1.10	1065	1115
4	49x#21	65	10	84x#29	1.27	1590	1680
4	133x#25	65	10	84x#29	1.27	1590	1680
3	49x#20	75	10	84x#29	1.34	2060	2180
3	133x#24	75	10	84x#29	1.34	2060	2180
2	133x#23	90	8	84x#27	1.48	2370	2520
2	259x#26	90	8	84x#27	1.48	2370	2520
1	133x#22	100	7	84x#27	1.68	3055	3245
1	259x#25	100	7	84x#27	1.68	3055	3245
1/0	133x#21	120	6	84x#26	1.79	3410	3650
1/0	259x#24	120	6	84x#26	1.79	3410	3650
2/0	133x#20	135	5	84x#25	1.93	4460	4810
2/0	259x#23	135	5	84x#25	1.93	4460	4810
3/0	259x#22	155	4	84x#24	2.07	5030	5630
3/0	427x#24	155	4	84x#24	2.07	5030	5630
4/0	259x#21	180	3	84x#23	2.26	5860	6490
4/0	427x#23	180	3	84x#23	2.26	5860	6490

†Based on 1000 foot lengths. Longer lengths can be furnished to purchaser's specifications.

All types and sizes of portable cables for mine use branded with the designation 102 BM, by authorization of Underwriters' Laboratories, Inc.

Instead of standard neoprene fillers, Type W cables will be manufactured to order with jute fillers for winding on very small diameter reels.

4-conductor Types W and G cables, 2001-5000 volts, can be supplied.

Special cables and cables with other numbers of conductors can be furnished.

These data are approximate and subject to normal manufacturing tolerances.

Prices on application.

Anaconda Portable Power Cable

Type SH—2001-7000 Volts

3-Conductor—Securityflex

Complies with U. S. Bureau of Mines and Pennsylvania Department of Mines Specifications

Manufactured in accordance with IPCEA Standard S-19-81, Second Edition February, 1951. Securityflex Neoprene Jacket highly resistant to abrasion, particularly to mechanical cutting. Also resistant to flame, moisture, oils and grease, acids and alkalis.

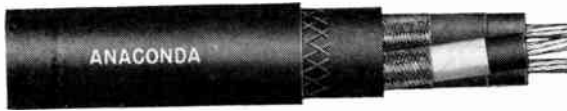

Type SH-A
Shield over Individual Conductors

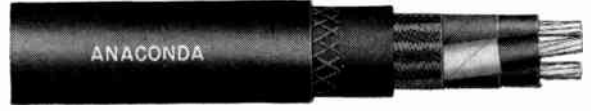

Type SH-B
Shield over Assembled Conductors

Nearest Size A.W.G.	Conductor No. and Size of Wires A.W.G.	Current-carrying Capacity Amperes	Type SH-A				Type SH-B											
			2001-3000 Volts		3001-4000 Volts		4001-5000 Volts		6001-7000 Volts		2001-3000 Volts		3001-4000 Volts		4001-5000 Volts		6001-7000 Volts	
			Over-all Diam. In.	Ship. WT. per M-FL Lbs.	Over-all Diam. In.	Ship. WT. per M-FL Lbs.	Over-all Diam. In.	Ship. WT. per M-FL Lbs.	Over-all Diam. In.	Ship. WT. per M-FL Lbs.	Over-all Diam. In.	Ship. WT. per M-FL Lbs.	Over-all Diam. In.	Ship. WT. per M-FL Lbs.	Over-all Diam. In.	Ship. WT. per M-FL Lbs.	Over-all Diam. In.	Ship. WT. per M-FL Lbs.
8	49x#25	40	1.45	1.45	1500
6	49x#23	60	1.67	1970	1.74	2030	1.85	2270	1.67	1900	1.74	1950	1.85	2190
6	133x#27	60	1.67	1970	1.74	2030	1.85	2270	1.67	1900	1.74	1950	1.85	2190
4	49x#21	80	1.83	2340	1.89	2490	1.98	2850	2.15	4010	1.83	2290	1.89	2390	1.98	2830	2.15	4025
4	133x#25	80	1.83	2340	1.89	2490	1.98	2850	2.15	4010	1.83	2290	1.89	2390	1.98	2830	2.15	4025
2	133x#23	110	1.99	2835	2.10	3030	2.18	3555	2.32	4395	1.99	2755	2.10	2965	2.18	3405	2.32	4375
2	259x#26	110	1.99	2835	2.10	3030	2.18	3555	2.32	4395	1.99	2755	2.10	2965	2.18	3405	2.32	4375
1	133x#22	120	2.12	3485	2.20	3685	2.27	4550	2.45	4965	2.12	3325	2.20	3655	2.27	4255	2.45	4855
1	259x#25	120	2.12	3485	2.20	3685	2.27	4550	2.45	4965	2.12	3325	2.20	3655	2.27	4255	2.45	4855
1/0	133x#21	145	2.23	4555	2.30	4765	2.41	4965	2.56	5410	2.23	4440	2.30	4490	2.41	4550	2.56	5290
1/0	259x#24	145	2.23	4555	2.30	4765	2.41	4965	2.56	5410	2.23	4440	2.30	4490	2.41	4550	2.56	5290
2/0	133x#20	160	2.36	5025	2.47	5275	2.53	5410	2.72	5895	2.36	4935	2.47	4985	2.53	5075	2.72	5800
2/0	259x#23	160	2.36	5025	2.47	5275	2.53	5410	2.72	5895	2.36	4935	2.47	4985	2.53	5075	2.72	5800
3/0	259x#22	185	2.54	5460	2.61	5760	2.72	6050	2.87	6650	2.54	5405	2.61	5535	2.72	5750	2.87	6405
3/0	427x#24	185	2.54	5460	2.61	5760	2.72	6050	2.87	6650	2.54	5405	2.61	5535	2.72	5750	2.87	6405
4/0	259x#21	215	2.73	6220	2.80	6490	2.88	6770	3.05	7235	2.73	6075	2.80	6125	2.88	6290	3.05	6945
4/0	427x#23	215	2.73	6220	2.80	6490	2.88	6770	3.05	7235	2.73	6075	2.80	6125	2.88	6290	3.05	6945

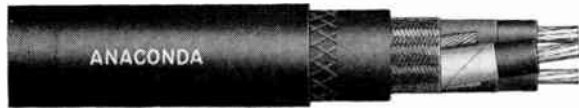

Type SH-C
Shield over Assembled Conductors with Grounding Conductor

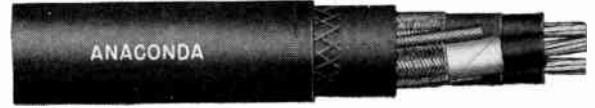

Type SH-D
Shield over Individual Conductors with Grounding Conductor

Nearest Size A.W.G.	Conductor No. and Size of Wires A.W.G.	Current-carrying Capacity Amperes	Type SH-C				Type SH-D											
			2001-3000 Volts		3001-4000 Volts		4001-5000 Volts		6001-7000 Volts		2001-3000 Volts		3001-4000 Volts		4001-5000 Volts		6001-7000 Volts	
			Over-all Diam. In.	Ship. WT. per M-FL Lbs.	Over-all Diam. In.	Ship. WT. per M-FL Lbs.	Over-all Diam. In.	Ship. WT. per M-FL Lbs.	Over-all Diam. In.	Ship. WT. per M-FL Lbs.	Over-all Diam. In.	Ship. WT. per M-FL Lbs.	Over-all Diam. In.	Ship. WT. per M-FL Lbs.	Over-all Diam. In.	Ship. WT. per M-FL Lbs.	Over-all Diam. In.	Ship. WT. per M-FL Lbs.
8	49x#25	40	1.45	1510	1.45	1600
6	49x#23	60	1.67	1960	1.74	2110	1.85	2250	1.67	2030	1.74	2100	1.85	2320
6	133x#27	60	1.67	1960	1.74	2110	1.85	2250	1.67	2030	1.74	2100	1.85	2320
4	49x#21	80	1.83	2390	1.89	2590	1.98	2930	2.15	4125	1.83	2360	1.89	2730	1.98	3040	2.15	4210
4	133x#25	80	1.83	2390	1.89	2590	1.98	2930	2.15	4125	1.83	2360	1.89	2730	1.98	3040	2.15	4210
2	133x#23	110	1.99	2910	2.10	3220	2.18	3700	2.32	4530	1.99	2990	2.10	3450	2.18	4360	2.32	4750
2	259x#26	110	1.99	2910	2.10	3220	2.18	3700	2.32	4530	1.99	2990	2.10	3450	2.18	4360	2.32	4750
1	133x#22	120	2.12	3520	2.20	3750	2.27	4150	2.45	5050	2.12	3600	2.20	3820	2.27	4510	2.45	5160
1	259x#25	120	2.12	3520	2.20	3750	2.27	4150	2.45	5050	2.12	3600	2.20	3820	2.27	4510	2.45	5160
1/0	133x#21	145	2.23	4690	2.30	4740	2.41	4800	2.56	5540	2.23	4770	2.30	4960	2.41	5140	2.56	5660
1/0	259x#24	145	2.23	4690	2.30	4740	2.41	4800	2.56	5540	2.23	4770	2.30	4960	2.41	5140	2.56	5660
2/0	133x#20	160	2.36	5250	2.47	5300	2.53	5390	2.72	6115	2.36	5340	2.47	5550	2.53	5670	2.72	6210
2/0	259x#23	160	2.36	5250	2.47	5300	2.53	5390	2.72	6115	2.36	5340	2.47	5550	2.53	5670	2.72	6210
3/0	259x#22	185	2.54	5800	2.61	5930	2.72	6150	2.87	6800	2.54	5890	2.61	6090	2.72	6390	2.87	7045
3/0	427x#24	185	2.54	5800	2.61	5930	2.72	6150	2.87	6800	2.54	5890	2.61	6090	2.72	6390	2.87	7045
4/0	259x#21	215	2.73	6570	2.80	6620	2.88	6785	3.05	7450	2.73	6670	2.80	6880	2.88	7400	3.05	7730
4/0	427x#23	215	2.73	6570	2.80	6620	2.88	6785	3.05	7450	2.73	6670	2.80	6880	2.88	7400	3.05	7730

†Based on 1000-foot lengths. Longer lengths can be furnished to purchaser's specifications.

Special cables and cables with other numbers of conductors can be furnished.

Cables rated 2001 to 7000 volts are insulated with Type AB (Anaconda Butyl) ozone-resistant and heat-resistant compound.

4-conductor Type SH-A, SH-B, SH-C and SH-D cables will be furnished on request. They are of the same general construction as 3-conductor. For information consult Graybar.

These data are approximate and subject to normal manufacturing tolerances.

Prices on application.

Anaconda Portable Power Cable

Types W and G—2001-5000 Volts
3-Conductor—Securityflex

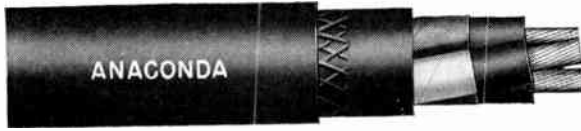

2001-3000 Volts

Nearest Conductor Size A.W.G.	No. and Size of Wires A.W.G.	Current-Carrying Capacity Amperes	Overall Diameter Inches	†Shipping Weight Per 1000 Ft. Lbs.	
				Type W	Type G
8	49 x #25	40	1.21	1120	1160
6	49 x #23	60	1.39	1415	1475
6	133 x #27	60	1.39	1415	1475
4	49 x #21	80	1.54	1700	1800
4	133 x #25	80	1.54	1700	1800
2	133 x #23	110	1.72	2160	2315
2	259 x #26	110	1.72	2160	2315
1	133 x #22	120	1.81	2600	2795
1	259 x #25	120	1.81	2600	2795
1/0	133 x #21	145	1.91	3150	3400
1/0	259 x #24	145	1.91	3150	3400
2/0	133 x #20	160	2.05	3585	3900
2/0	259 x #23	160	2.05	3585	3900
3/0	259 x #22	185	2.18	4400	4795
3/0	427 x #24	185	2.18	4400	4795
4/0	259 x #21	215	2.34	5140	5635
4/0	427 x #23	215	2.37	5140	5635

3001-4000 Volts

8	49 x #25
6	49 x #23	60	1.48	1700	1760
6	133 x #27	60	1.48	1700	1760
4	49 x #21	80	1.59	1970	2070
4	133 x #25	80	1.59	1970	2070
2	133 x #23	110	1.79	2340	2495
2	259 x #26	110	1.79	2340	2495
1	133 x #22	120	1.87	2720	2915
1	259 x #25	120	1.87	2720	2915
1/0	133 x #21	145	2.01	3330	3580
1/0	259 x #24	145	2.01	3330	3580
2/0	133 x #20	160	2.12	4290	4605
2/0	259 x #23	160	2.12	4290	4605
3/0	259 x #22	185	2.29	4780	5175
3/0	427 x #24	185	2.29	4780	5175
4/0	259 x #21	215	2.43	5400	5895
2/0	427 x #23	215	2.43	5400	5895

4001-5000 Volts

6	49 x #23	60	1.55	1730	1790
6	133 x #27	60	1.55	1730	1790
4	49 x #21	80	1.67	2210	2310
4	133 x #25	80	1.67	2210	2310
2	133 x #23	110	1.86	2490	2645
2	259 x #26	110	1.86	2490	2645
1	133 x #22	120	1.97	2900	3095
1	259 x #25	120	1.97	2900	3095
1/0	133 x #21	145	2.08	3460	3710
1/0	259 x #24	145	2.08	3460	3710
2/0	133 x #20	160	2.19	4530	4845
2/0	259 x #23	160	2.19	4530	4845
3/0	259 x #22	185	2.36	4960	5355
3/0	427 x #24	185	2.36	4960	5355
4/0	259 x #21	215	2.50	5510	6005
4/0	427 x #23	215	2.50	5510	6005

†Based on 1000 foot lengths. Longer lengths can be furnished to purchaser's specifications.

Cables rated 2001 to 7000 volts are insulated with Type AB (Anaconda Butyl) ozone-resistant and heat-resistant compound.

Instead of standard neoprene fillers, Type W cables will be manufactured to order with jute fillers for winding on very small diameter reels.

All types and sizes of portable cables for mine use branded with the designation 102 BM, by authorization of Underwriters' Laboratories, Inc.

Ground wire construction is the same as shown for 600-volt cables.

Special cables with other numbers of conductors can be furnished.

These data are approximate and subject to normal manufacturing tolerances.

Prices on application.

Anaconda Arc Welding Cable

Securityflex—Single Conductor



Conductor Size A.W.G. or MCM	No. of #34 A.W.G. Wires	Current-Carrying Capacity Amperes	Overall Diameter Inches	Net Wt. Per 1000 Ft. Lbs.	†Ship. Wt. Per 1000 Ft. Lbs.
8	420	60	0.390	116	134
6	665	90	.400	140	158
4	1,064	120	.495	220	250
2	1,666	240	.560	300	330
1	2,107	300	.625	380	380
1/0	2,646	360	.675	465	510
2/0	3,332	450	.750	600	646
3/0	4,263	540	.815	710	755
4/0	5,320	640	.900	885	1040
250	6,384	710	.950	990	1186
300	7,581	780	1.030	1190	1386
350	8,806	860	1.080	1330	1526
400	10,101	940	1.150	1550	1835
500	12,691	1090	1.250	2015	2300
750	18,788	1400	1.490	2990	3440
1000	25,193	1630	1.680	3770	4315

*Based on an ambient temperature of 40°C. Yield load factors of from about 32% for No. 2 A.W.G. to 23% for No. 3/0 A.W.G. and larger. Since ambient generally is below 40°C, load factor may then be much higher than indicated without overheating cable.

Based on IPCEA standard S-19-81, 2nd Edition Feb., 1951.

†Non-returnable Reels.

Anaconda Remote Control

and
Heavy Duty Drill Cord



Conductor Size A.W.G.	No. and Size of Wires A.W.G.	Current-Carrying Capacity Amperes	Overall Diameter Inches	Net Wt. Per 1000 Ft. Lbs.	†Ship. Wt. Per 1000 Ft. Lbs.
§2-Conductor					
14	104 x #34	15	0.64	368	370
12	65 x #30	20	.68	408	410
10	104 x #30	25	.37	458	460
3-Conductor					
14	104 x #34	15	0.67	398	400
12	65 x #30	20	.72	458	460
10	104 x #30	25	.80	548	550
4-Conductor					
14	104 x #34	12	0.71	438	440
12	65 x #30	16	.76	508	510
10	104 x #30	20	.84	608	610

Conform to U. S. Bureau of Mines standards.

†Based on 1000-foot lengths. Longer lengths can be furnished to purchaser's requirements.

§Not included in U. S. Bureau of Mines standards since the Bureau does not approve operation of drills or remote control stations without grounding wire. All types and sizes of portable cables for mine use branded with the designation 102 BM, by authorization of Underwriters' Laboratories, Inc.

These data are approximate and subject to normal manufacturing tolerances.

Prices on application.

Anaconda Portable Cords

Approved by Underwriters' Laboratories, Inc.

**Securityflex—Type SJO
Light Duty—300 Volts**



Designed for hard usage, pendant or portable in either moist or dry places.

Conductors insulated, unless otherwise specified, with Type RH (heat-resistant) compound.

2-Conductor

Size A.W.G.	Conductor No. and Diam.	Current-Carrying Capacity Amperes	Overall Diam. In.	Net Wt. Per 1000 Foot Pounds	Std. Ctn. Ft.	Ship. Std. Pkg. Pounds
18	41 x #34	7	.325	58	250	15
16	65 x #34	10	.350	80	250	20
*14	104 x #34	15	.460	115	250	30

3-Conductor

18	41 x #34	7	.354	78	250	20
16	65 x #34	10	.379	106	250	26
*14	104 x #34	15	.490	150	250	38

4-Conductor

18	41 x #34	5.6	.379	90	250	22
16	65 x #34	8	.409	110	250	28

**Securityflex—Type SO
Heavy Duty 600 Volts**



For extra-hard service, pendant or portable, moist or dry installations.

1-Conductor

18	41 x #34	7	.195	20	500	10
16	65 x #34	10	.205	30	500	15
14	104 x #34	15	.257	45	500	23
12	65 x #30	20	.277	55	500	28
10	104 x #30	25	.308	75	500	38

2-Conductor

18	41 x #34	7	.399	90	250	23
16	65 x #34	10	.414	105	250	26
14	104 x #34	15	.540	160	250	40
12	65 x #30	20	.616	205	250	50
10	104 x #30	25	.666	245	250	60

3-Conductor

18	41 x #34	7	.414	102	250	26
16	65 x #34	10	.440	127	250	32
14	104 x #34	15	.571	186	250	48
12	65 x #30	20	.646	250	250	65
10	104 x #30	25	.702	315	250	80

†4-Conductor †5-Conductor †6-Conductor

Size A.W.G.	Conductor No. and Diam.	Current-Carrying Capacity Amperes	†4-Conductor		†5-Conductor		†6-Conductor	
			Overall Diam. In.	Ship. Std. Pkg. Lbs.	Overall Diam. In.	Ship. Std. Pkg. Lbs.	Overall Diam. In.	Ship. Std. Pkg. Lbs.
18	41 x #34	5.6	.435	30	.480	34	.530	40
16	65 x #34	8	.485	38	.520	42	.560	45
14	104 x #34	12	.605	60	.675	60	.745	76
12	65 x #30	16	.665	72	.745	77	.790	90
10	104 x #30	20	.715	95	.815	99	.865	134

*Underwriters' labels not available for this size.
†Standard pkg.: 250 feet. Cartons in size 18 through 16 A.W.G. Reels in size 14 through 10 A.W.G.

Based on Code Grade or 30% rubber compound and max. copper temperature of 60°C. Labels for Type SJO furnished on request, marked for 75°C max.

Underwriters' labels not available for single-conductor. Types S and SJ furnished on request in same construction and so labeled. These data are approximate and subject to normal manufacturing tolerances.

Prices on application.

Anaconda Fixture Wire

Single Conductor

Densheath Insulated—Types TF and TFF—600 Volts



Concentric Strand—Type TF

Size A.W.G.	Conductor †No. and Diam. Wires In.	Insulation Thickness In.	Overall Diam. In.	Std. Coil Ft.	Ship. Wt. Std. Pkg. Lbs.
18	7 x .0152	2	.111	1000	12
16	7 x .0192	2	.124	1000	16

Solid—Type TF

18	.0403	2	.105	1000	11
16	.0518	2	.116	1000	15

Bunched Strand—Type TFF

18	16 x .010	2	.113	1000	12
16	26 x .010	2	.126	1000	16

†Conductors, bare annealed, per ASTM B 3, B 8 and B 174. Standard colors, black, white, red, yellow, green, orange, brown.

Anaconda Office Wire

**Dampproof Office Wire
Densheath Insulated**



Single Conductor—Solid

Size A.W.G.	†Conductor Diam. Inch	Insulation Thickness Inch	Overall Braid Saturant	Overall Diameter Inch	Std. Pkg.	Ship. Wt. Std. Pkg. Lbs.
22	0.0254	0.010	no braid	0.0454	■25 Lbs.	26
20	.0320	.010	no braid	.0520	■25 Lbs.	26
18	.0403	.010	no braid	.0603	■25 Lbs.	26
16	.0508	.010	no braid	.0708	■25 Lbs.	26

†Double Cotton Covered



Twin Wire—Solid

Dampproof office wire individual conductor insulation is asphaltic-compound saturated; furnished also in 3-, 4- and 5-conductor cables, braid overall on 5 to 7 lb. spools or specified lengths on reels.

22	0.0254	0.016	paraffin	.073x.146	●1000 Ft.*	8.5
20	.0320	.016	paraffin	.080x.160	●1000 Ft.*	11.5
18	.0403	.016	paraffin	.089x.178	●1000 Ft.*	16.0
16	.0508	.016	paraffin	.099x.198	●1000 Ft.*	23.0

Single Conductor—Solid

22	0.0254	0.016	paraffin	0.073	●1000 Ft.*	5.2
20	.0320	.016	paraffin	.080	●1000 Ft.*	6.5
18	.0403	.016	paraffin	.090	●1000 Ft.*	8.7
16	.0508	.016	paraffin	.100	●1000 Ft.*	12.0

*Or 500 ft. carton.

†Office wire individual conductor insulation is paraffin-saturated.

†Conductors are bare annealed in accordance with ASTM Standard Specification B3, latest edition.

Colors:

Office Wire Double-Cotton covered: blue and white braid.

Dampproof Office Wire Colors: Densheath insulated; black, white, red, green; Double-Cotton covered: green and white braid.

●Coil

■Carton

Anaconda Annunciator Wire
Densheath Insulated

Single Conductor—Solid

Size A.W.G.	Conductor Diam. In.	Insulation Thickness In.	Overall Diam. In.	Net WL M-FL Lbs.	Standard Length	Ship. WL Std. Pkg. Lbs.
24	.0201	.010	.0401	2	½ lb. Coil	26
22	.0253	.010	.0454	3		or
20	.0320	.010	.0520	4	1 lb. Coil	26
18	.0403	.010	.0603	6		or
16	.0508	.010	.0708	9	5 lb. Spool	26

2-Conductor (Flat)—Solid

18	.0403	†.025	.083 x .170	16	500' Coil	9
----	-------	-------	-------------	----	-----------	---

Double-Cotton Covered and Weatherproof



Single Conductor—Solid

Size A.W.G.	Conductor Diam. In.	Insulation Thickness In.	Overall Diam. In.	Net WL M-FL Lbs.	Standard Length	Ship. WL Std. Pkg. Lbs.
22	.0253	.016	.057	3.0	§5 to 7 lb. Spool	55
20	.0320	.016	.064	4.3		55
18	.0403	.016	.073	6.4		55
16	.0508	.016	.083	9.5		55

Twisted Pair—Solid

Size A.W.G.	Conductor Diam. In.	Insulation Thickness In.	Overall Diam. In.	Net WL M-FL Lbs.	Standard Length	Ship. WL Std. Pkg. Lbs.
22	.0253	.016	.114	6.1	§5 to 7 lb. Spool	55
20	.0320	.016	.128	8.7		55
18	.0403	.016	.146	12.8		55
16	.0508	.016	.166	19.2		55

Conductors, bare annealed per ASTM Specification B 3. †Minimum thickness, 0.015 inch. ‡Also in cartons of 50 1-lb. spools or coils; or ½-lb. coils. Shipping weight, 55 lbs.

Annunciator cables with double-cotton on individual conductors, made up with any desired number of conductors, colors and shipping lengths, on specification. These data are approximate and subject to normal manufacturing tolerances.

Anaconda Nylon-Insulated Wire

Approved by Underwriters' Laboratories for Use as Appliance Wire

Single Conductor—Solid

†Conductor Size A.W.G.	Conductor Diam. In.	Insulation Thickness In.	Overall Diam. In.	Std. Length Feet	Standard Package	Ship. WL Standard Package Lbs.
22	.0253	.0065	.039	50.000	‡16 x 6 x 8	128
20	.0320	.0075	.047	30.000	‡16 x 6 x 8	126
18	.0403	.0085	.057	20.000	‡16 x 6 x 8	128

***Twisted Pair—Solid**

Size A.W.G.	Conductor Diam. In.	Insulation Thickness In.	Overall Diam. In.	Std. Length Feet	Standard Package	Ship. WL Std. Pkg. Lbs.
22	.0250	.0065	.078	500' Coil	Carton	3.0
20	.0320	.0075	.094	500' Coil	Carton	4.5
18	.0403	.0085	.114	500' Coil	Carton	7.0

3-Conductor (Twisted)—Solid

Size A.W.G.	Conductor Diam. In.	Insulation Thickness In.	Overall Diam. In.	Std. Length Feet	Standard Package	Ship. WL Std. Pkg. Lbs.
22	.0250	.0065	.084	500' Coil	Carton	4.5
20	.0320	.0075	1.01	500' Coil	Carton	6.5
18	.0403	.0085	1.23	500' Coil	Carton	9.5

†Conductors, bare or tinned annealed (depending on intended use) per ASTM Specifications B 3 or B 33.

‡Bobbin dimensions given: flange, drum, traverse (inches). *Twisted pair and 3-conductor twisted also furnished in lengths and packages required by purchaser.

These data are approximate and subject to normal manufacturing tolerances.

Prices on application.

Anaconda Thermostat Control Cable
*Densheath Insulated



3-Conductor (Flat)

Size A.W.G.	Conductor Diam. In.	Insulation Thickness In.	Overall Braid Saturant	Overa Diam. In.	Std. Pkg. FL	Ship. WL Std. Pkg. Lbs.
18	.0403	†.025	No Braid	.083 x .255	500	8

2-Conductor (Flat)

18	.0403	†.025	No Braid	.083 x .170	500	10
----	-------	-------	----------	-------------	-----	----

‡Double-Cotton Covered



2-Conductor (Twisted)

Size A.W.G.	Conductor Diam. In.	Insulation Thickness In.	Overall Braid Saturant	Overa Diam. In.	Std. Pkg. FL	Ship. WL Std. Pkg. Lbs.
22	.0253	.016	Paraffin	.146	1000	8
20	.0320	.016	Paraffin	.160	1000	11
18	.0403	.016	Paraffin	.178	1000	16
16	.0508	.016	Paraffin	.198	1000	23

‡Double-Cotton Covered—Armored Two-Conductor (Twisted)

Size A.W.G.	Conductor Diam. In.	Insulation Thickness In.	Overall Braid Saturant	Overa Diam. In.	Std. Pkg. FL	Ship. WL Std. Pkg. Lbs.
20	.0320	.016	None	.184	500	14
18	.0403	.016	None	.202	500	17
16	.0508	.016	None	.222	500	21

Conductors, bare annealed per ASTM Specification B 3. *One outside wire coated, or with ridged insulation for identification.

†Minimum thickness, 0.012 inch.

‡Individual conductor insulation paraffin-saturated.

‡D-shaped steel armor overall.

Furnished also in 3-, 4- and 5- conductor cables in 500-ft. lengths; other lengths available.

These data are approximate and subject to normal manufacturing tolerances.

Anaconda Gas-Tube-Sign and Oil Burner Ignition Cable

GTO-10—10,000 Volts
GTO-15—15,000 Volts



Single Conductor—Concentric Strand

Conductor Size A.W.G.	No. and Diam. Wires In.	Polyethylene Insulation Thickness (Ins.)	Densheath Jacket Thickness (Ins.)	Overall Diam. (In.)	Std. Coil FL	Ship. WL Std. Coil Lbs.
14	19 x .0147	.030	.050	.028	GTO-10 GTO-15	260 500
						15 17

†Conductors, tinned annealed per ASTM Specification B 33. Standard Color, black.

Anaconda Loop Antenna Wire
Polyethylene Insulated



Solid Conductor

Conductor Size A.W.G. or MCM	Diam. of Wire Inch	Insulation Thickness Mils	Overall Diameter Inch	Standard Length Feet	Ship. WL Std. Pkg. Lbs.
24	0.020	0.010	0.040	10,000	10

Conductor is bare annealed in accordance with ASTM Standard Specification B33.

Color: Brown.

These data are approximate and subject to normal manufacturing tolerances.

Prices on application.

Anaconda Copper Bus Conductors

Flat Bars—Tubes—Channels—Square Tubes—Bare Cable
Commercially Hard Drawn

Copper conductors, because of their low resistance, low losses, high thermal conductivity and excellent resistance to corrosion, are particularly suited for use in bus systems.

Supplied in several forms to provide mechanical and electrical characteristics required for the best and most economical performance of a particular bus system design.



Flat Bars

Shape provides maximum surface for heat dissipation. Capable of unlimited direct-current capacity in properly designed multibar busses.

Usually limited to 3000 amps on a-c systems. Available in a wide range of sizes.

For information, contact Graybar.

BARS

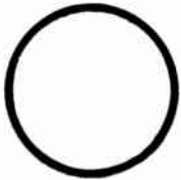

ROUND TUBES

Round Tubes

Provides relatively large cross-sectional area in minimum space. Rigid, suitable for bending and the long spans in outdoor switch yards.

Offers lowest impedance to a-c current; minimum corona discharge at high voltage.

May be internally cooled by oil or water.

Channel Busses

Arranged to form a hollow square tube with longitudinal ventilating slots vertically one above the other.

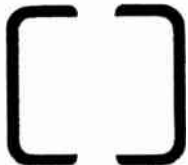

CHANNELS

Provide:

1. Greater rigidity than round tube, permitting longer span.
2. Good current distribution.
3. Large surface area for dissipation of heat.
4. Simplicity of arrangement for minimum installation expense. Available in lengths to 25 feet.

Round Solid Bars and Wire

Used for light loads, special types of construction, plug-in ducts.



Round Solid

Square Tubes

Stronger and more rigid than round tubes. Have the advantage of flat surfaces for joints.

Obtainable in ventilated or unventilated designs, in lengths to 25 ft., 3-in. to 8-in. square. Larger sizes furnished to meet special requirements. For additional information, contact Graybar.

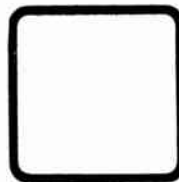

SQUARE TUBES

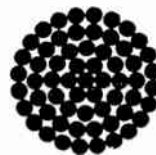

CABLES

Cable Conductors

Particularly useful for extremely heavy currents in a confined space.

Provides flexibility. Frequently used in high capacity arc furnaces for connections from main bus runs to electrodes. For specifications, consult Graybar.

Anaconda Copper Bus Channels

High-Conductivity—Hard Drawn

Sect. No.	Flange Web or Leg			Corner Radii			Cross Sect. Area of Copper Sq. In.	Nom. Wt. Per Ft. Lb.	Moment of Inertia In. ⁴	With Respect to X-X Axis			With Respect to Y-Y Axis			Channel Square Bus		
	Hgt. In.	Wdth. In.	Thick-ness In.	A	B	C				Section Modulus In. ³	Radius of Gyration In.	Dist. From Back of Channel In.	Moment of Inertia In. ⁴	Section Modulus In. ³	Radius of Gyration In.	D-C Resistance Per Ft. at 20C (68F) (a)	Skin Effect Ratio (b)	60-Cycle Current Rating Amperes (c)
1-A	3	1 1/16	0.165	0.409	0.244	0.0625	0.8258	3.18	1.028	0.6856	1.116	0.3844	0.1281	0.1380	0.3939	5.01	1.03	2200
2-A	3	1 1/16	0.216	0.409	0.193	0.0625	1.064	4.10	1.284	0.8558	1.098	0.4016	0.1598	0.1754	0.3875	3.89	1.07	2500
3-A	3	1 1/16	0.284	0.409	0.125	0.0625	1.369	5.28	1.583	1.055	1.075	0.4240	0.1972	0.2220	0.3795	3.02	1.11	2800
4-A	4	1 3/4	0.200	0.463	0.263	0.0625	1.356	5.22	3.059	1.529	1.502	0.5013	0.3788	0.3033	0.5285	3.05	1.07	3200
5-A	4	1 3/4	0.240	0.463	0.223	0.0625	1.612	6.21	3.569	1.785	1.488	0.5148	0.4414	0.3574	0.5232	2.57	1.10	3500
6-A	4	1 3/4	0.338	0.463	0.125	0.0625	2.220	8.55	4.691	2.346	1.454	0.5474	0.5795	0.4819	0.5110	1.86	1.22	4000
7-A	5	2 3/16	0.260	0.464	0.204	0.0625	2.226	8.57	7.888	3.155	1.882	0.6234	0.9675	0.6186	0.6593	1.86	1.15	4500
8-A-T	5	2 3/16	0.339	0.464	0.125	0.0625	2.861	11.02	9.839	3.936	1.854	0.6501	1.204	0.7832	0.6488	1.45	1.25	5000
9-T	6	2 11/16	0.276	0.615	0.339	0.0635	2.872	11.06	14.88	4.960	2.276	0.7629	1.927	1.001	0.8190	1.44	1.19	5600
10-T	6	2 11/16	0.384	0.615	0.231	0.0625	3.932	15.15	19.69	6.562	2.238	0.7992	2.544	1.317	0.8013	1.05	1.34	6300
11-T	6	2 11/16	0.490	0.615	0.125	0.0625	4.936	19.01	23.90	7.968	2.201	0.8343	3.086	1.665	0.7907	0.84	1.63	6800
12-T	7	3 3/16	0.375	0.695	0.320	0.0625	4.569	17.60	31.96	9.130	2.615	0.9261	4.271	1.889	0.9668	0.91	1.36	7300
13-T	7	3 3/16	0.325	0.615	0.320	0.0625	3.999	15.41	28.42	8.120	2.666	0.9061	3.790	1.661	0.9735	1.03	1.36	7000
14-T	8	3 11/16	0.470	0.595	0.125	0.0625	6.638	25.57	60.76	15.19	3.026	1.077	8.233	3.154	1.114	0.62	1.51	8900
15-T	9	4 3/8	0.500	0.625	0.125	0.0625	7.962	30.67	92.81	20.62	3.414	1.191	12.41	4.229	1.248	0.52	1.70	10000

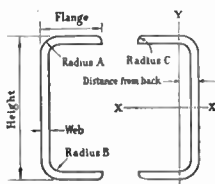

Channel-Square Bus Conductor

Notes: Variations from these values must be expected in practice.

ASTM Specification B 187, Copper Bus Bar, Rod and Shapes, controls dimensional tolerances, tensile and electrical properties, tests and inspection.

- (a) D-C resistance for hard-temper channels corresponding to a conductivity of 98.4% IACS minimum, at 20 C.
- (b) The skin-effect ratios are approximate and

were derived from the curves for square tubes, Electrical Coils and Conductors, H. B. Dwight, McGraw-Hill Book Co., 1945, page 223.

- (c) 60-cycle current-carrying-capacity ratings were computed for 30 C temperature rise over 40 C ambient, bright mill surface finish, the conductor horizontal, in still air, and free from all external magnetic influences, conductivity 98.4% IACS minimum.

Anaconda Copper Bus Tubes

High Conductivity—Hard Drawn Standard Pipe Sizes, Regular

Pipe Size In.	Nominal Dimensions, In.				Nom. Wt. Per Ft. Lbs.	Cross Sectional Area of Copper		Moment of Inertia In. ⁴	Section Modulus, In. ³	Radius of Gyration, In.	D-C Resistance Microhms per Foot at 20C. (68 F) (a)	Skin Effect Ratio (b)	60-Cycle Rating Indoor	Current Amps. (c) Outdoor
	Outside Diam.	Inside Diam.	Wall Thick.	t/D		Sq. In.	Thousand Cir. Mils.							
1/2	0.840	0.626	0.107	0.127	0.955	0.2464	313.7	0.01690	0.04024	0.2619	34.22	1.00	410	550
3/4	1.050	0.822	0.114	0.109	1.30	0.3352	426.8	0.03726	0.7096	0.3334	25.15	1.00	515	680
1	1.315	1.063	0.126	0.0958	1.82	0.4707	599.3	0.08411	0.1279	0.4227	17.91	1.00	675	860
1 1/4	1.660	1.368	0.146	0.0880	2.69	0.6944	884.2	0.2008	0.2420	0.5378	12.14	1.00	875	1130
1 1/2	1.900	1.600	0.150	0.0789	3.20	0.8247	1050.	0.3180	0.3347	0.6210	10.22	1.00	1025	1285
2	2.375	2.063	0.156	0.0657	4.22	1.088	1385.	0.6727	0.5665	0.7865	7.75	1.01	1300	1585
2 1/2	2.875	2.501	0.187	0.0650	6.12	1.579	2011.	1.433	0.9970	0.9526	5.34	1.01	1700	2010
3	3.500	3.062	0.219	0.0626	8.75	2.257	2874.	3.051	1.743	1.163	3.73	1.02	2175	2560
3 1/2	4.000	3.500	0.250	0.0625	11.4	2.945	3750.	5.200	2.600	1.329	2.86	1.02	2525	3040
4	4.500	4.000	0.250	0.0556	12.9	3.338	4250.	7.563	3.361	1.505	2.51	1.02	2850	3400
5	5.562	5.062	0.250	0.0449	16.2	4.172	5312.	14.75	5.303	1.880	2.00	1.02	3425	4100
6	6.625	6.125	0.250	0.0377	19.4	5.007	6375.	25.47	7.690	2.256	1.67	1.03	4150	4750

Type K Sizes

1/2	0.625	0.527	0.049	.0784	0.344	0.08867	112.9	0.003704	0.01185	0.2044	95.08	1.00	240
3/4	0.875	0.745	0.065	.0783	0.641	0.1654	210.6	0.01365	0.03121	0.2873	50.97	1.00	340
1	1.125	0.995	0.065	.0578	0.839	0.2165	275.6	0.03052	0.05425	0.3755	38.64	1.00	460
1 1/4	1.375	1.245	0.065	.0473	1.04	0.2675	340.6	0.05753	0.08367	0.4637	31.26	1.00	510
1 1/2	1.625	1.481	0.072	.0443	1.36	0.3513	447.3	0.1061	0.1306	0.5497	23.81	1.00	620
2	2.125	1.959	0.083	.0391	2.06	0.5325	677.9	0.2780	0.2616	0.7226	15.71	1.00	900
2 1/2	2.625	2.435	0.095	.0362	2.93	0.7551	961.4	0.6050	0.4610	0.8951	11.08	1.00	1150
3	3.125	2.907	0.109	.0349	4.00	1.033	1315.	1.176	0.7525	1.067	8.10	1.00	1350
3 1/2	3.625	3.385	0.120	.0331	5.12	1.321	1682.	2.031	1.121	1.240	6.33	1.00	1650
4	4.125	3.857	0.134	.0325	6.51	1.680	2139.	3.349	1.624	1.412	4.98	1.00	1900

Type L Sizes

1/2	0.625	0.545	0.040	.0640	0.285	0.07351	93.60	0.003159	0.01011	0.2073	114.68	1.00	200
3/4	0.875	0.785	0.045	.0510	0.455	0.1173	149.4	0.01013	0.02316	0.2939	71.85	1.00	300
1	1.125	1.025	0.050	.0444	0.655	0.1689	215.0	0.02445	0.04346	0.3805	49.52	1.00	400
1 1/4	1.375	1.265	0.055	.0400	0.884	0.2281	290.4	0.04976	0.07238	0.4671	36.67	1.00	500
1 1/2	1.625	1.505	0.060	.0369	1.14	0.2950	375.6	0.09045	0.1113	0.5537	28.35	1.00	600
2	2.125	1.985	0.070	.0329	1.75	0.4519	575.4	0.2388	0.2248	0.7270	18.51	1.00	825
2 1/2	2.625	2.465	0.080	.0305	2.48	0.6396	814.4	0.5184	0.3950	0.9002	13.07	1.00	1050
3	3.125	2.945	0.090	.0288	3.33	0.8581	1093.	0.9889	0.6329	1.074	9.75	1.00	1300
3 1/2	3.625	3.425	0.100	.0276	4.29	1.107	1410.	1.721	0.9497	1.247	7.55	1.00	1550
4	4.125	3.905	0.110	.0267	5.38	1.387	1767.	2.798	1.357	1.420	6.03	1.00	1800

Threadless Pipe Sizes

1/2	0.840	0.710	0.065	0.0774	0.613	0.1583	201.5	0.01197	0.02849	0.2750	53.27	1.00	330	440
3/4	1.050	0.920	0.065	0.0619	0.780	0.2011	256.1	0.02450	0.04667	0.3490	41.58	1.00	390	520
1	1.315	1.185	0.065	0.0494	0.989	0.2553	325.0	0.04999	0.07603	0.4425	32.76	1.00	500	630
1 1/4	1.660	1.530	0.065	0.0392	1.262	0.3257	414.7	0.1037	0.1250	0.5644	25.68	1.00	590	770
1 1/2	1.900	1.770	0.065	0.0342	1.452	0.3747	477.1	0.1579	0.1662	0.6492	22.32	1.00	680	800
2	2.375	2.245	0.065	0.0274	1.828	0.4717	600.6	0.3149	0.2652	0.8170	17.73	1.00	850	1000
2 1/2	2.875	2.745	0.065	0.0226	2.22	0.5738	730.6	0.5667	0.3942	0.9938	14.57	1.00	1000	1250
3	3.500	3.334	0.083	0.0237	3.45	0.8910	1134.	1.301	0.7435	1.208	9.39	1.00	1375	1600
3 1/2	4.000	3.810	0.095	0.0238	4.52	1.165	1484.	2.223	1.111	1.381	7.18	1.00	1600	1925
4	4.500	4.286	0.107	0.0238	5.72	1.477	1880.	3.564	1.584	1.554	5.66	1.00	1900	2300
5	5.562	5.298	0.132	0.0237	8.73	2.252	2867.	8.304	2.986	1.920	3.71	1.00	2500	3000
6	6.625	6.309	0.158	0.0238	12.44	3.210	4087.	16.79	5.069	2.287	2.61	1.00	3300	3800

NOTES: Sizes above and below those listed available. Variations from these values must be expected in practice. Tabular weights and resistances based on Density of 0.323 lbs. per cu. in.

- (a) D-C resistance for hard-drawn temper:
 - Diameters up to 1-in. inclusive, conductivity 96.60% IACS minimum.
 - Diameters over 1-in., conductivity 97.40% IACS minimum.

- (b) Skin-effect ratio at 60 cycles per second.

Prices on application.

- (c) For sizes up to and including 6-in. diameter, bare, the 60-cycle indoor current ratings are based on 30 C temperature rise above a 40 C ambient for copper pipe having conductivity of 98 per cent IACS. The nominal outdoor ratings take advantage of favorable conditions such as air currents, weathering of copper, etc. Both ratings in this table are from National Electrical Manufacturers Association Standards for Power Switching Equipment, Publication No. SG6-1954, Part 8, and other NEMA publications.

Anaconda Copper Square Bus Tubes

High-Conductivity—Hard Drawn

Nom. Size In.	Outside Dimensions, In.			Wall Thickness In.	Nom. Wt. Per Ft. Lb.	Cross-Sectional Area of Copper		Moment of Inertia In. ⁴	Section Modulus In. ³	Radius of Gyration In.	D-C Resistance, Microhms per Ft. (a) at 20 C (68F)	Skin Effect Ratio (b)	60-Cycle Current Rating, Amperes (c)
	Square	Diagonal	Corner Radius			Sq. In.	Thousand Cir. Mills						
3x ¹ / ₈	3.00	3.932	0.375	0.125	5.31	1.370	1745.	1.835	1.223	1.157	6.10	1.02	1660
3x ³ / ₁₆	3.00	3.932	0.375	0.1875	7.83	2.019	2570.	2.599	1.733	1.135	4.14	1.04	1990
3x ¹ / ₄	3.00	3.932	0.375	0.250	10.24	2.643	3365.	3.272	2.181	1.113	3.15	1.07	2250
3x ⁵ / ₁₆	3.00	3.828	0.500	0.3125	12.31	3.175	4042.	3.723	2.482	1.083	2.62	1.12	2420
3x ³ / ₈	3.00	3.828	0.500	0.375	14.48	3.736	4757.	4.215	2.810	1.062	2.23	1.19	2540
3x ¹ / ₂	3.00	3.621	0.750	0.500	17.72	4.571	5820.	4.598	3.065	1.003	1.82	1.38	2640
4x ¹ / ₈	4.00	5.243	0.500	0.125	7.15	1.844	2347.	4.475	2.237	1.558	4.54	1.03	2140
4x ³ / ₁₆	4.00	5.243	0.500	0.1875	10.58	2.729	3474.	6.431	3.216	1.535	3.06	1.05	2570
4x ¹ / ₄	4.00	5.243	0.500	0.250	13.91	3.589	4570.	8.215	4.108	1.513	2.32	1.09	2900
4x ⁵ / ₁₆	4.00	5.243	0.500	0.3125	17.15	4.425	5634.	9.836	4.918	1.491	1.88	1.15	3140
4x ³ / ₈	4.00	5.243	0.500	0.375	20.30	5.236	6667.	11.30	5.652	1.469	1.59	1.23	3300
4x ¹ / ₂	4.00	5.036	0.750	0.500	25.47	6.571	8366.	13.06	6.532	1.410	1.27	1.46	3420
5x ¹ / ₈	5.00	6.450	0.750	0.125	8.88	2.290	2916.	8.705	3.482	1.950	3.65	1.03	2610
5x ³ / ₁₆	5.00	6.450	0.750	0.1875	13.17	3.398	4327.	12.62	5.048	1.927	2.46	1.07	3130
5x ¹ / ₄	5.00	6.450	0.750	0.250	17.37	4.482	5706.	16.26	6.503	1.905	1.86	1.11	3520
5x ⁵ / ₁₆	5.00	6.450	0.750	0.3125	21.48	5.541	7055.	19.64	7.854	1.882	1.50	1.17	3810
5x ³ / ₈	5.00	6.450	0.750	0.375	25.49	6.575	8372.	22.76	9.105	1.861	1.27	1.25	4010
5x ¹ / ₂	5.00	6.450	0.750	0.500	33.22	8.571	10910.	28.32	11.33	1.818	0.97	1.51	4180
6x ¹ / ₈	6.00	7.864	0.750	0.125	10.81	2.790	3552.	15.54	5.179	2.360	3.00	1.05	3070
6x ³ / ₁₆	6.00	7.864	0.750	0.1875	16.08	4.148	5282.	22.65	7.551	2.337	2.02	1.08	3670
6x ¹ / ₄	6.00	7.864	0.750	0.250	21.25	5.482	6980.	29.36	9.786	2.314	1.52	1.12	4160
6x ⁵ / ₁₆	6.00	7.864	0.750	0.3125	26.32	6.791	8646.	35.66	11.89	2.292	1.23	1.20	4480
6x ³ / ₈	6.00	7.864	0.750	0.375	31.30	8.075	10280.	41.59	13.86	2.269	1.03	1.28	4720
6x ¹ / ₂	6.00	7.864	0.750	0.500	40.97	10.57	13460.	52.35	17.45	2.225	0.79	1.54	4930
7x ³ / ₁₆	7.00	9.278	0.750	0.1875	18.99	4.898	6236.	36.94	10.55	2.746	1.69	1.10	4230
7x ¹ / ₄	7.00	9.278	0.750	0.250	25.12	6.482	8253.	48.07	13.73	2.723	1.28	1.15	4760
7x ⁵ / ₁₆	7.00	9.278	0.750	0.3125	31.17	8.041	10240.	58.64	16.76	2.701	1.03	1.22	5140
7x ³ / ₈	7.00	9.278	0.750	0.375	37.11	9.575	12190.	68.67	19.62	2.678	0.86	1.31	5420
7x ¹ / ₂	7.00	9.278	0.750	0.500	48.72	12.57	16010.	87.18	24.91	2.633	0.66	1.57	5680
8x ³ / ₁₆	8.00	10.69	0.750	0.1875	21.89	5.648	7191.	56.23	14.06	3.155	1.47	1.11	4760
8x ¹ / ₄	8.00	10.69	0.750	0.250	29.00	7.482	9526.	73.40	18.35	3.132	1.11	1.17	5350
8x ⁵ / ₁₆	8.00	10.69	0.750	0.3125	36.01	9.291	11830.	89.82	22.46	3.109	0.89	1.24	5790
8x ³ / ₈	8.00	10.69	0.750	0.375	42.93	11.08	14100.	105.5	27.38	3.087	0.75	1.33	6110
8x ¹ / ₂	8.00	10.69	0.750	0.500	56.48	14.57	18550.	134.8	33.70	3.041	0.57	1.59	6400

NOTES:

Variations from these values must be expected in practice. ASTM Specification B 188, Seamless Copper Bus Pipe and Tube, Controls the tensile properties, conductivity, tests and inspection. Dimensional tolerances are agreed between manufacturer and purchaser at the time of placing an order.

(a) D-C resistivity. The resistances are based on the ASTM Specification B 188. The conductivities of square tubes according to size are:

Up to 6-in. outside diameter and up to ³/₁₆-in. wall thickness, conductivity 97.40% IACS minimum.

Up to 6-in. outside diameter and over ³/₁₆-in. wall thickness, conductivity 97.80% IACS minimum.

All sizes over 6-in. outside diameter, conductivity 98.40% IACS minimum.

(b) Skin-effect ratio at 60 cycles per second.

(c) 60-cycle current-carrying-capacity ratings have been computed for 30 C temperature rise in still air at 40 C, conductor with new, bright, mill finish, horizontal and free from all outside magnetic influences.

Prices On Application.

Anaconda Copper and Bronze Trolley Wire

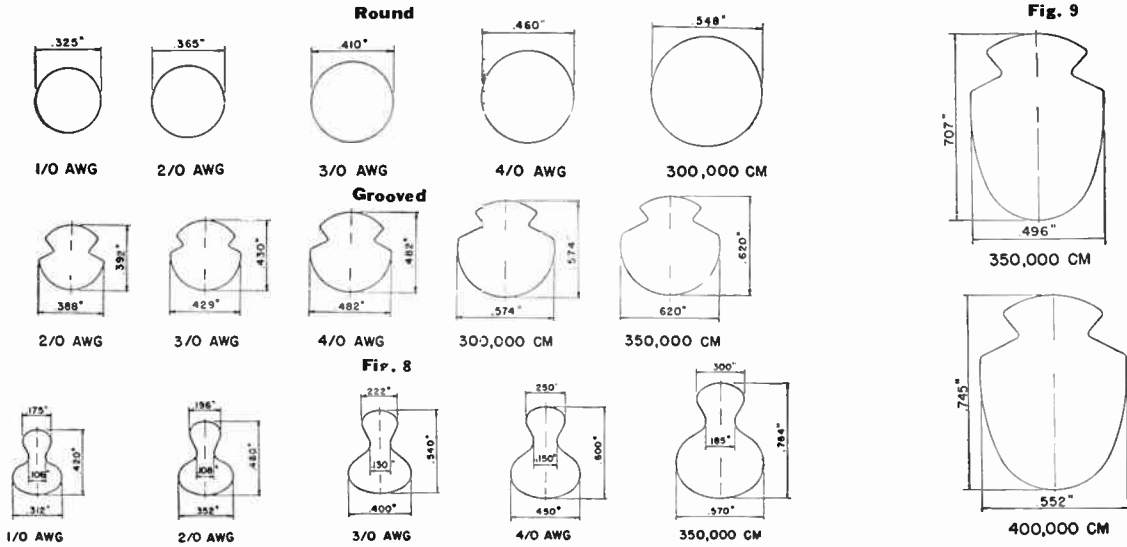

Hard-Drawn Copper—97.16% Conductivity

Nominal Size A.W.G. or MCM	Nominal Cross-Sectional Area MCM	%Min. Conductivity % IACS	Actual Cross-Sectional Area		Weight Lbs. per 1000 FL	D-C Resistance or Volts Drop per Ampere (20°C.)		Min. Tensile Strength Lbs. per Sq. In.	Elongation in 10" per cent	Actual Cross-Sectional Area		Weight Lbs. per 1000 FL	D-C Resistance or Volts Drop per Ampere (20°C.)		Min. Tensile Strength Lbs. per Sq. In.	Elongation in 10" per cent				
			MCM	Sq. In.		Ohms or Volts per 1000 FL	Ohms or Volts per 1000 FL			MCM	Sq. In.		Ohms or Volts per 1000 FL	Ohms or Volts per 1000 FL						
1/0	105.6	97.16	105.6	0.0829	319.5	0.1011	54500	2.40	105.6	0.08296	319.5	0.1011	51800	2.40	46600	4.50				
2/0	133.1	97.16	133.1	0.1045	402.8	0.08012	52800	2.80	133.1	0.1045	402.8	0.08023	50200	2.80	48500	3.25				
3/0	167.8	97.16	167.8	0.1318	507.8	0.06362	51000	3.25	167.8	0.1318	508.0	0.06361	48500	3.25	46600	4.50				
4/0	211.6	97.16	211.6	0.1662	640.5	0.05045	49000	3.75	211.6	0.1662	640.5	0.05044	46600	3.75	42800	4.50				
300	300.0	97.16	300.0	0.2356	908.0	0.03558	46400	4.50	300.0	0.2356	908.0	0.03558	42800	4.50	350.1	0.2750	1060.0	0.03049	42800	4.50
350	350.0	97.16	350.1	0.2750	1060.0	0.03049	42800	4.50				

Hard-Drawn Copper—97.16% Conductivity (continued)

Nominal Size A.W.G. or MCM	Nominal Cross-Sectional Area MCM	%Min. Conductivity % IACS	Actual Cross-Sectional Area		Weight Lbs. per 1000 FL	D-C Resistance or Volts Drop per Ampere (20°C.)		Min. Tensile Strength Lbs. per Sq. In.	Elongation in 10" per cent	Actual Cross-Sectional Area		Weight Lbs. per 1000 FL	D-C Resistance or Volts Drop per Ampere (20°C.)		Min. Tensile Strength Lbs. per Sq. In.	Elongation in 10" per cent				
			MCM	Sq. In.		Ohms or Volts per 1000 FL	Ohms or Volts per 1000 FL			MCM	Sq. In.		Ohms or Volts per 1000 FL	Ohms or Volts per 1000 FL						
2/0	133.1	97.16	137.9	0.1083	417.6	0.07741	50200	2.80				
3/0	167.8	97.16	167.3	0.1314	506.4	0.06380	48500	3.25				
4/0	211.6	97.16	212.0	0.1665	641.9	0.05035	46600	3.75				
300	300.0	97.16	299.8	0.2355	907.6	0.03560	41200	4.50				
350	350.0	97.16	351.2	0.2758	1063.0	0.03040	42800	4.50	348.9	0.2740	1056.0	0.03060	42800	4.50	397.2	0.3120	1202.0	0.02687	41300	4.50
400	400.0	97.16				

Hitensho A Bronze—85% Conductivity—ASTM Class B

Nominal Size A.W.G. or MCM	Nominal Cross-Sectional Area MCM	%Min. Conductivity % IACS	Actual Cross-Sectional Area		Weight Lbs. per 1000 FL	D-C Resistance or Volts Drop per Ampere (20°C.)		Min. Tensile Strength Lbs. per Sq. In.	Elongation in 10" per cent	Actual Cross-Sectional Area		Weight Lbs. per 1000 FL	D-C Resistance or Volts Drop per Ampere (20°C.)		Min. Tensile Strength Lbs. per Sq. In.	Elongation in 10" per cent
			MCM	Sq. In.		Ohms or Volts per 1000 FL	Ohms or Volts per 1000 FL			MCM	Sq. In.		Ohms or Volts per 1000 FL	Ohms or Volts per 1000 FL		
1/0	105.6	85	105.6	0.0829	319.5	0.1156	68000	2.40
2/0	133.1	85	133.1	0.1045	402.8	0.09172	66000	2.75	137.9	0.1083	417.6	0.08849	66000	2.25	64000	2.25
3/0	167.8	85	167.8	0.1318	507.8	0.07275	64000	3.25	167.3	0.1314	506.4	0.07293	64000	2.75	61500	3.25
4/0	211.6	85	211.6	0.1662	640.5	0.05768	61500	3.75	212.0	0.1665	641.9	0.05756	61500	3.25	58300	4.00
300	300.0	85	300.0	0.2356	908.0	0.04609	58300	4.50	299.8	0.2355	907.6	0.04609	58300	4.00	57000	4.00
350	350.0	85	351.2	0.2758	1063.0	0.03475	57000	4.00

Hitensho BB Bronze—80% Conductivity—ASTM Class C

Nominal Size A.W.G. or MCM	Nominal Cross-Sectional Area MCM	%Min. Conductivity % IACS	Actual Cross-Sectional Area		Weight Lbs. per 1000 FL	D-C Resistance or Volts Drop per Ampere (20°C.)		Min. Tensile Strength Lbs. per Sq. In.	Elongation in 10" per cent	Actual Cross-Sectional Area		Weight Lbs. per 1000 FL	D-C Resistance or Volts Drop per Ampere (20°C.)		Min. Tensile Strength Lbs. per Sq. In.	Elongation in 10" per cent
			MCM	Sq. In.		Ohms or Volts per 1000 FL	Ohms or Volts per 1000 FL			MCM	Sq. In.		Ohms or Volts per 1000 FL	Ohms or Volts per 1000 FL		
1/0	105.6	80	105.6	0.0829	319.5	0.1228	72000	2.40
2/0	133.1	80	133.1	0.1045	402.8	0.09742	69000	2.75	137.9	0.1083	417.6	0.09402	69000	2.25	67000	2.75
3/0	167.8	80	167.8	0.1318	507.8	0.07727	67000	3.25	167.3	0.1314	506.4	0.07749	67000	2.75	65000	3.25
4/0	211.6	80	211.6	0.1662	640.5	0.06127	65000	3.75	212.0	0.1665	641.9	0.06115	65000	3.25	61500	4.00
300	300.0	80	300.0	0.2356	908.0	0.04322	61500	4.50	299.8	0.2355	907.6	0.04324	61500	4.00	59500	4.00
350	350.0	80	351.2	0.2758	1063.0	0.03692	59500	4.00

Trolley Bronze "65"—65% Conductivity—ASTM Class B

Nominal Size A.W.G. or MCM	Nominal Cross-Sectional Area MCM	%Min. Conductivity % IACS	Actual Cross-Sectional Area		Weight Lbs. per 1000 FL	D-C Resistance or Volts Drop per Ampere (20°C.)		Min. Tensile Strength Lbs. per Sq. In.	Elongation in 10" per cent	Actual Cross-Sectional Area		Weight Lbs. per 1000 FL	D-C Resistance or Volts Drop per Ampere (20°C.)		Min. Tensile Strength Lbs. per Sq. In.	Elongation in 10" per cent
			MCM	Sq. In.		Ohms or Volts per 1000 FL	Ohms or Volts per 1000 FL			MCM	Sq. In.		Ohms or Volts per 1000 FL	Ohms or Volts per 1000 FL		
1/0	105.6	65	105.6	0.0829	319.5	0.1511	68000	2.40
2/0	133.1	65	133.1	0.1045	402.8	0.1199	65000	2.75	137.9	0.1083	417.6	0.1157	65000	2.25	63000	2.75
3/0	167.8	65	167.8	0.1318	507.8	0.09507	63000	3.25	167.3	0.1314	506.4	0.09537	63000	2.75	61000	3.25
4/0	211.6	65	211.6	0.1662	640.5	0.07538	61000	3.75	212.0	0.1665	641.9	0.07526	61000	3.25	57800	4.00
300	300.0	65	300.0	0.2356	908.0	0.05317	57800	4.50	299.8	0.2355	907.6	0.05321	57800	4.00	56200	4.00
350	350.0	65	351.2	0.2758	1063.0	0.04544	56200	4.00

Hitensho C Bronze—55% Conductivity—ASTM Class A

Nominal Size A.W.G. or MCM	Nominal Cross-Sectional Area MCM	%Min. Conductivity % IACS	Actual Cross-Sectional Area		Weight Lbs. per 1000 FL	D-C Resistance or Volts Drop per Ampere (20°C.)		Min. Tensile Strength Lbs. per Sq. In.	Elongation in 10" per cent	Actual Cross-Sectional Area		Weight Lbs. per 1000 FL	D-C Resistance or Volts Drop per Ampere (20°C.)		Min. Tensile Strength Lbs. per Sq. In.	Elongation in 10" per cent
			MCM	Sq. In.		Ohms or Volts per 1000 FL	Ohms or Volts per 1000 FL			MCM	Sq. In.		Ohms or Volts per 1000 FL	Ohms or Volts per 1000 FL		
1/0	105.6	61	105.6	0.0829	319.5	0.1786	76000	2.40
2/0	133.1	61	133.1	0.1045	402.8	0.1417	73000	2.75	137.9	0.1083	417.6	0.1368	73000	2.25	71000	2.75
3/0	167.8	61	167.8	0.1318	507.8	0.1124	71000	3.25	167.3	0.1314	506.4	0.1127	71000	2.75	69000	3.25
4/0	211.6	61	211.6	0.1662	640.5	0.08910	69000	3.75	212.0	0.1665	641.9	0.08895	69000	3.25	64800	4.00
300	300.0	61	300.0	0.2356	908.0	0.06285	64800	4.50	299.8	0.2355	907.6	0.06289	64800	4.00	62500	4.00
350	350.0	61	351.2	0.2758	1063.0	0.05370	62500	4.00

Electric Bronze—40% Conductivity—ASTM Class A

Nominal Size A.W.G. or MCM	Nominal Cross-Sectional Area MCM	%Min. Conductivity % IACS	Actual Cross-Sectional Area		Weight Lbs. per 1000 FL	D-C Resistance or Volts Drop per Ampere (20°C.)		Min. Tensile Strength Lbs. per Sq. In.	Elongation in 10" per cent	Actual Cross-Sectional Area		Weight Lbs. per 1000 FL	D-C Resistance or Volts Drop per Ampere (20°C.)		Min. Tensile Strength Lbs. per Sq. In.	Elongation in 10" per cent
			MCM	Sq. In.		Ohms or Volts per 1000 FL	Ohms or Volts per 1000 FL			MCM	Sq. In.		Ohms or Volts per 1000 FL	Ohms or Volts per 1000 FL		
1/0	105.6	40	105.6	0.0829	319.5	0.2456	76000	2.40
2/0	133.1	40	133.1	0.1045	402.8	0.1948	73000	2.75	137.9	0.1083	417.6	0.1880	73000	2.25	71000	2.75
3/0	167.8	40	167.8	0.1318	507.8	0.1545	71000	3.25	167.3	0.1314	506.4	0.1550	71000	2.75	69000	3.25
4/0	211.6	40	211.6	0.1662	640.5	0.1225	69000	3.75	212.0	0.1665	641.9	0.1223	69000	3.25	64800	4.00
300	300.0	40	300.0	0.2356	908.0	0.08644	64800	4.50	299.8	0.2355	907.6	0.08647	64800	4.00	62500	4.00
350	350.0	40	351.2	0.2758	1063.0	0.07384	62500	4.00

*These are ASTM minimum values of conductivity and usually are exceeded. Bronze trolley wire is manufactured in accordance with ASTM Specification B9, latest edition. Trolley wire is layer-wound on ATA standard or other reels as required by the purchaser. These data are approximate and subject to normal manufacturing tolerances.

Prices on application.

Anaconda Weatherproof Wire and Cable

URC Type

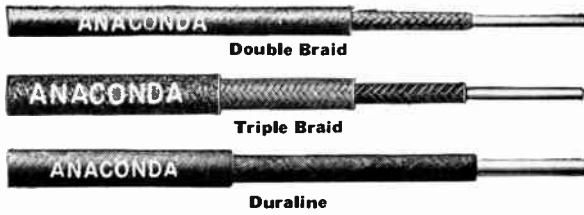

Soft, Medium, Hard Drawn Copper and Hard Bronze

Conductor Size A.W.G. or MCM	No. Wires	Double Braid			Duraline or Triple Braid			
		*Wt. per M-Ft Lbs.	Std. Reel Ft.	Std. Coil Lbs.	†Indoor Current Rating \$Amps.	*Wt. per M-Ft Lbs.	Std. Reel Ft.	Std. Coil Lbs.
10	1	46	4800	110	55	53	4800	125
9	1	51.5	4000	110	60	62	4000	125
8	1	66	4000	130	70	75	4000	150
6	1	100	3000	135	100	112	2660	150
4	1	151	2000	150	130	164	1830	150
3	1	185	2000	185	150	199	1510	150
2	1	239	1000	180	175	260	1000	195
1	1	294	1000	190	205	316	1000	205
1/0	1	377	4000	265	235	407	4000	285
2/0	1	467	3000	280	275	502	3000	300
3/0	1	587	3000	295	320	629	3000	315
4/0	1	723	2000	290	370	767	2000	305

Solid—30% and 40% Copperweld

12	1	28.3	On Request	107	...	33.4	On Request	125
10	1	43.4		141	...	50.4		164
9	1	51.2		140	...	58.7		160
8	1	61.8		135	...	70.8		155
6	1	93.4		129	...	105.4		146
4	1	140.4	122	...	153.4	134		

Concentric—Class A, Soft, Medium, Hard-Drawn Copper and Hard Bronze

8	7	68	4000	155	70	78	4000	115
6	7	103	3000	155	100	115	3000	115
4	7	155	2000	155	130	170	2000	170
3	7	190	2000	190	150	206	1850	205
2	7	246	1000	245	175	270	1000	270
1	7	303	1000	210	205	328	1000	230
1/0	7	388	4000	195	235	424	4000	210
2/0	7	482	3000	240	275	522	3000	260
3/0	7	604	2000	300	320	653	2000	325
4/0	7	745	2000	300	370	800	2000	320
250	19	907	2000	...	410	985	2000	...
300	19	1083	2000	...	460	1174	2000	...
350	19	1248	2000	...	510	1345	2000	...
400	19	1436	1000	...	555	1553	1000	...
450	37	1601	1000	...	595	1724	1000	...
500	37	1765	1000	...	630	1894	1000	...
600	37	2093	1000	...	710	2235	1000	...
700	61	2471	1000	...	780	2650	1000	...
750	61	2635	1000	...	810	2822	1000	...
800	61	2799	1000	...	845	2992	1000	...
900	61	3127	1000	...	905	3332	1000	...
1000	61	3456	1000	...	965	3674	1000	...
1250	61	4264	500	...	1085	4508	500	...
1500	61	5098	500	...	1215	5380	500	...
1750	91	5894	500	...	1315	6193	500	...
2000	91	6690	500	...	1405	7008	500	...

*Subject to tolerance of ASA Specification.
 †Slightly less for double-braid weatherproof.
 ‡For approximate outdoor current ratings, in horizontal cross-wind at 2 ft. per sec., multiply by 1.35 for sizes 250 MCM and smaller; 1.25 for sizes 350 MCM and larger.
 §Current ratings apply to copper conductors only.
 Anaconda Hy-Therm copper furnished when specified, instead of other commercial brands, for hard and medium hard drawn.

These data are approximate and subject to normal manufacturing tolerances.

Prices on application.

Anaconda Copperweld-Copper Composite Cable

Extra-High Strength



Types A & C



Type D

Weights and Dimensions

*Hard Drawn Copper Equivalent Area A.W.G. or MCM	No. and Diameter of Wires	Actual Area			Min. Ultimate Strength Lbs.	Wt. per M-FL Lbs.
		E.H.S. 30% Conductivity Copperweld In.	Hard Drawn Copper In.	Circular Mills		
8	C .179 †1x.0808 2x.0834	20.430	.01604	1362	60.67	
8	A .199 1x.1127 2x.0797	25.100	.01995	2233	71.27	
8	D .219 2x.1016 1x.1016	30.970	.02432	3256	89.21	
6	A .230 1x.1068 2x.1068	34.220	.02688	2585	101.6	
4	A .290 1x.1347 2x.1347	51.430	.04275	3938	161.5	
2	A .366 1x.1699 2x.1699	86.600	.06801	5876	256.8	

Electrical Characteristics

*Hard Drawn Copper Equivalent Area A.W.G. or MCM	Type	Geometric Mean Radius at 60 cps Feet	Approximate Current Rating at 60 cps Amps.	Resistance per Conductor Mile at 25°C. (77°F.)		Reactance per Conductor / Mile at 60 cps (1-Ft. Space.)		\$Nominal Std. Reel Feet
				D-C Ohms	60 cps Ohms	Inductive Xl Ohms	Capacitive Xc Megohms	
8	C	.00373	100	3.49	3.51	.679	.1453	8200
8	A	.00394	100	3.49	3.51	.672	.1422	5400
8	D	.00356	110	3.49	3.51	.684	.1393	6700
6	A	.00479	140	2.20	2.21	.648	.1379	6000
4	A	.00604	180	1.382	1.395	.620	.1310	3800
2	A	.00763	240	.869	.882	.592	.1241	2400

Manufactured in accordance with ASTM Specification B 229, latest edition.

*Hard drawn copper cable, 97.5% conductivity, IACS, having same D-C resistance as that of composite cable after allowing for increases in resistance due to stranding, based on Table II, ASTM, B229-48T.

†High strength Copperweld, 40% Conductivity.

‡90% of the reels in any shipment shall have an average length of conductor not less than values shown, with no lengths more than 10% below value given. The remaining 10% of the reels (or one reel where the total number of reels is less than 10) may be in random lengths, but no such lengths shall be less than 50% of table value.

§Longer lengths can be furnished in some sizes. Information on request.

Anaconda Hy-Therm copper will be furnished when specified, instead of other commercial brands, for hard and medium hard-drawn.

These data are approximate and subject to normal manufacturing tolerances.

Prices on application.

Anaconda Bare Copper Wire
Hard, Medium Hard and Annealed



Based on ASTM Specifications B 1, B 2 and B 3, latest editions.

Size A.W.G.	Wire Diam. Inch	Cross-Sectional Area		Weight	
		Circular Mils	Sq. In.	Lbs. per M Feet	Lbs. per Mile
44	.0020	4.00	.00000314	.0121	.0639
43	.0020	4.84	.00000380	.0147	.0774
42	.0025	6.25	.00000491	.0189	.0999
41	.0028	7.84	.00000616	.0237	.125
40	.0031	9.61	.00000755	.0291	.154
39	.0035	12.2	.00000962	.0371	.196
38	.0040	16.0	.0000126	.0484	.256
37	.0045	20.2	.0000159	.0613	.324
36	.0050	25.0	.0000196	.0757	.400
35	.0056	31.4	.0000246	.0949	.501
34	.0063	39.7	.0000312	.120	.634
33	.0071	50.4	.0000396	.153	.806
32	.0080	64.0	.0000503	.194	1.02
31	.0089	79.2	.0000622	.240	1.27
30	.0100	100	.0000785	.303	1.60
29	.0113	128	.000100	.387	2.04
28	.0126	159	.000125	.481	2.54
27	.0142	202	.000158	.610	3.22
26	.0159	253	.000199	.765	4.04
25	.0179	320	.000252	.970	5.12
24	.0201	404	.000317	1.22	6.46
23	.0226	511	.000401	1.55	8.16
22	.0253	640	.000503	1.94	10.2
21	.0285	812	.000638	2.46	13.0
20	.0320	1020	.000804	3.10	16.4
19	.0359	1290	.00101	3.90	20.6
18	.0403	1620	.00128	4.92	26.0
17	.0453	2050	.00161	6.21	32.8
16	.0508	2580	.00203	7.81	41.2
15	.0571	3260	.00256	9.87	52.1
14	.0641	4110	.00323	12.4	65.7
13	.0720	5180	.00407	15.7	82.9
12	.0808	6530	.00513	19.8	104
11	.0907	8230	.00646	24.9	131
10	.1019	10380	.008155	31.43	165.9
9	.1144	13090	.01028	39.63	209.3
8	.1285	16510	.01297	49.97	263.9
7	.1443	20820	.01635	63.02	332.7
6	.1620	26250	.02062	79.46	419.6
5	.1819	33100	.02600	100.2	529.1
4	.2043	41740	.03278	126.4	667.1
3	.2294	52630	.04134	159.3	841.2
2	.2576	66370	.05213	200.9	1061
1	.2893	83690	.06573	253.3	1338
1 0	.3249	105500	.08289	319.5	1687
2 0	.3648	133100	.1045	402.8	2127
3 0	.4096	167800	.1318	507.9	2682
4 0	.4600	211600	.1662	640.5	3382

Anaconda Bare Copper Cable
Hard, Medium Hard and Annealed



Concentric Strand

Conductor Size		Stranding Class	Total No. of Wires	Wire Diam. Inches	Cable Diam. Inches	Cross Sectional Area Sq. In.	Weight	
MCM	A.W.G.						Per M-FL Lbs.	Per Mile Lbs.
10	38 10	B	7	.0385	.116	.008155	32.06	169.3
13	09 9	B	7	.0432	.130	.01028	40.42	213.4
16	51 8	B	7	.0486	.146	.01297	50.97	269.1
20	82 7	B	7	.0545	.164	.01635	64.28	339.4
26	25 6	B	7	.0612	.184	.02062	81.05	427.9
33	10 5	B	7	.0688	.206	.02600	102.2	539.6
41	74 4	AA	3	.1180	.254	.03278	127.6	673.8
41	74 4	B&A	7	.0772	.232	.03278	128.9	680.5
52	63 3	AA	3	.1325	.286	.04134	160.9	849.6
52	63 3	B&A	7	.0867	.260	.04134	162.5	858.0
66	37 2	AA	3	.1487	.320	.05213	202.9	1071
66	37 2	B&A	7	.0974	.292	.05213	204.9	1082
83	69 1	AA	3	.1670	.360	.06573	255.9	1351
83	69 1	A	7	.1093	.328	.06573	258.4	1364
83	69 1	B	19	.0664	.332	.06573	258.4	1364
105	5 1 0	A&AA	7	.1228	.368	.08289	325.8	1720
105	5 1 0	—	*12	.0938	.390	.08289	325.8	1720
105	5 1 0	B	19	.0745	.372	.08289	325.8	1720
133	1 2 0	A&AA	7	.1379	.414	.1045	410.9	2169
133	1 2 0	—	*12	.1053	.438	.1045	410.9	2169
133	1 2 0	B	19	.0837	.419	.1045	410.9	2169
167	8 3 0	A&AA	7	.1548	.464	.1318	518.1	2736
167	8 3 0	—	*12	.1183	.492	.1318	518.1	2736
167	8 3 0	B	19	.0940	.470	.1318	518.1	2736
211	6 4 0	A&AA	7	.1739	.522	.1662	653.3	3450
211	6 4 0	—	*12	.1328	.552	.1662	653.3	3450
211	6 4 0	B	19	.1055	.528	.1662	653.3	3450
250		AA	12	.1443	.600	.1963	771.9	4076
250		A	19	.1147	.574	.1963	771.9	4076
250		B	37	.0822	.575	.1963	771.9	4076
300		AA	12	.1581	.657	.2356	926.3	4891
300		A	19	.1257	.628	.2356	926.3	4891
300		B	37	.0900	.630	.2356	926.3	4891
350		AA	12	.1708	.710	.2749	1081	5706
350		A	19	.1357	.678	.2749	1081	5706
350		B	37	.0973	.681	.2749	1081	5706
400		A&AA	19	.1451	.726	.3142	1235	6521
400		B	37	.1040	.728	.3142	1235	6521
450		AA	19	.1539	.770	.3534	1389	7336
450		B&A	37	.1103	.772	.3534	1389	7336
500		AA	19	.1622	.811	.3927	1544	8151
500		B&A	37	.1162	.813	.3927	1544	8151
550		A&AA	37	.1219	.853	.4320	1698	8966
550		B	61	.0950	.855	.4320	1698	8966
600		A&AA	37	.1273	.891	.4712	1853	9781
600		B	61	.0992	.893	.4712	1853	9781
650		AA	37	.1325	.928	.5105	2007	10600
650		B&A	61	.1032	.929	.5105	2007	10600
700		AA	37	.1375	.962	.5498	2161	11410
700		B&A	61	.1071	.964	.5498	2161	11410
750		AA	37	.1424	.997	.5890	2316	12230
750		B&A	61	.1109	.998	.5890	2316	12230
800		AA	37	.1470	1.029	.6283	2470	13040
800		B&A	61	.1145	1.031	.6283	2470	13040
850		—	*37	.1516	1.061	.6676	2624	13860
850		—	*61	.1180	1.062	.6676	2624	13860
900		AA	37	.1560	1.092	.7069	2779	14670
900		B&A	61	.1215	1.094	.7069	2779	14670
1000		AA	37	.1644	1.151	.7854	3088	16300
1000		B&A	61	.1280	1.152	.7854	3088	16300

Based on ASTM Specification B8-56, classes of stranding in accordance therewith.

*These sizes not included in ASTM B8-56.

These data are approximate and subject to normal manufacturing tolerances.

Prices on application.

These data are approximate and subject to normal manufacturing tolerances.

Prices on application.

Call Graybar FIRST for ...

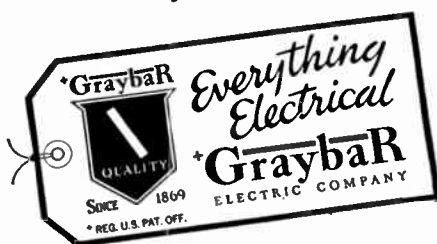

Anaconda Hard Drawn Copper Overhead Conductors

97.5% Conductivity—IACS

*Hy-Therm and Other Commercial Grades

Solid Conductor



Conductor		Operating Temperature, Degrees C										Resistance at 20°C (68°F.)				Self Geometric Mean Radius Feet	Reactance per Conductor per Mile at 60 cps	
Size A.W.G. or MCM	No. of Wires	Diam. In.	25	35	45	50	55	65	75	D-C Ohms Per 1000 Feet	A-C 60 cps Ohms Per Mile	D-C Ohms Per Mile	A-C 60 cps Ohms Per Mile	Inductive Xc Ohms	Capacitive Xc Megohms			
10	1	0.1019	50	59	66	68	71	76	80	1.0215	1.0215	5.4094	5.4094	0.00331	0.6930	0.1620		
8	1	.1285	68	79	88	92	96	105	110	.6443	.6443	3.402	3.402	.00117	.6649	.1552		
6	1	.1620	91	105	120	125	130	140	145	.4052	.4052	2.140	2.140	.00526	.6368	.1483		
4	1	.2043	120	140	160	165	175	185	195	.2548	.2548	1.346	1.346	.00663	.6087	.1414		
3	12021	.2021	1.067	1.067	.00745	.5945	.1380		
2	1	.2576	165	190	215	225	235	250	265	.1603	.1604	.8464	.8468	.00836	.5810	.1345		
1	1	.2893	190	220	250	260	270	290	310	.1271	.1272	.6710	.6714	.00939	.5664	.1311		
1/0	1	.3249	220	260	290	300	315	335	360	.1008	.1009	.5322	.5328	.01054	.5525	.1276		
2/0	1	.3648	255	300	335	350	365	390	415	.0799	.0801	.4220	.4228	.01184	.5383	.1242		
3/0	1	.4096	295	345	390	405	425	455	480	.0631	.0636	.3347	.3357	.01329	.5243	.1208		
4/0	1	.4600	345	400	450	470	490	530	560	.05027	.0505	.2654	.2666	.01493	.5102	.1173		
Concentric Strand—Classes A and AA																		
4	7	0.232	125	115	165	170	180	190	200	0.2599	0.2599	1.372	1.372	0.00702	0.6017	0.1376		
4	2	.254	130	150	170	175	185	195	210	.2574	.2574	1.359	1.359	.00718	.5990	.1349		
3	72062	.2062	1.088	1.089	.00786	.5880	.1342		
3	32041	.2042	1.078	1.078	.00808	.5847	.1314		
2	7	.292	170	195	220	230	240	255	270	.1635	.1635	.8632	.8635	.00883	.5739	.1308		
2	3	.320	175	200	225	240	245	265	280	.1619	.1619	.8547	.8550	.00904	.5710	.1281		
1	7	.328	195	230	255	265	280	300	315	.1296	.1297	.6845	.6849	.00992	.5598	.1274		
1	3	.360	200	235	265	275	285	310	325	.1284	.1284	.6778	.6782	.0102	.5564	.1246		
1/0	191028	.1030	.5430	.5436	.0117	.5397	.1236		
1/0	121028	.1030	.5430	.5436	.0124	.5327	.1222		
1/0	7	.368	225	265	295	310	320	345	365	.1028	.1030	.5430	.5436	.0111	.5461	.1239		
2/0	1208152	.08166	.4304	.4311	.0139	.5188	.1188		
2/0	7	.414	260	305	345	360	375	400	422	.08152	.08166	.4304	.4311	.0125	.5317	.1204		
3/0	1206466	.06483	.3444	.3423	.0156	.5048	.1153		
3/0	7	.464	310	355	400	415	435	465	495	.06466	.06483	.3444	.3423	.0140	.5180	.1171		
4/0	1905128	.05149	.2707	.2719	.0167	.4966	.1132		
4/0	1205128	.05149	.2707	.2719	.0175	.4909	.1119		
4/0	7	.522	355	410	460	485	505	540	575	.05128	.05149	.2707	.2719	.0158	.5033	.1136		
250	19	.571	395	460	515	540	565	605	645	.04310	.04365	.2291	.2305	.0181	.4868	.1107		
250	12	.600	400	465	525	550	570	615	650	.04310	.04365	.2291	.2305	.0190	.4809	.1094		
300	19	.628	415	515	580	605	635	680	725	.03617	.03647	.1910	.1925	.0198	.4759	.1081		
300	12	.657	450	525	590	615	640	690	735	.03617	.03647	.1910	.1925	.0208	.4699	.1067		
350	19	.678	490	570	640	670	700	750	800	.03100	.03128	.1637	.1651	.0214	.4665	.1058		
350	12	.710	495	580	650	680	710	760	810	.03100	.03128	.1637	.1651	.0225	.4604	.1044		
400	19	.726	530	620	700	730	760	820	870	.02712	.02753	.1432	.1453	.0229	.4583	.1038		
450	3702411	.02456	.1273	.1297	.0247	.4491	.1020		
450	19	.770	575	670	750	785	820	880	940	.02411	.02456	.1273	.1297	.0243	.4511	.1021		
500	3702170	.02220	.1146	.1172	.0260	.4429	.1004		
500	19	.811	615	715	805	840	880	945	1005	.02170	.02220	.1146	.1172	.0256	.4447	.1005		
550	37	.853	650	760	855	895	935	1005	1070	.01973	.02027	.1042	.1070	.0273	.4369	.09900		
600	37	.891	690	805	900	945	985	1060	1130	.01808	.01867	.09548	.09860	.0285	.4317	.09771		
650	37	.928	725	845	955	995	1040	1115	1190	.01669	.01733	.08813	.09151	.0297	.4267	.09650		
700	6101550	.01619	.08184	.08546	.0310	.4215	.09537		
700	37	.962	755	885	1000	1040	1085	1170	1245	.01550	.01619	.08184	.08546	.0308	.4223	.09543		
750	6101447	.01520	.07638	.08024	.0321	.4173	.09434		
750	37	.997	790	925	1040	1090	1135	1220	1300	.01447	.01520	.07638	.08024	.0319	.4180	.09437		
800	6101356	.01434	.07161	.07570	.0332	.4132	.09338		
800	37	1.029	825	960	1080	1135	1180	1275	1355	.01356	.01434	.07161	.07570	.0329	.4143	.09343		
850	37	1.061	855	1000	1120	1175	1225	1320	1405	.01276	.01358	.06740	.07172	.0340	.4103	.09253		
900	6101206	.01292	.06365	.06820	.0352	.4061	.09162		
900	37	1.092	885	1035	1160	1220	1270	1365	1455	.01206	.01292	.06365	.06820	.0349	.4071	.09167		
1000	6101085	.01179	.05729	.06227	.0371	.3997	.09008		
1000	37	1.151	910	1100	1235	1295	1355	1455	1555	.01085	.01179	.05729	.06227	.0368	.4007	.09011		
1250	61	1.288	1075	1255	1410	1475	1540	1670	1780	.008924	.009834	.04712	.05192	.0444	.3864	.08678		
1500	61	1.411	1180	1385	1560	1635	1715	1845	1975	.007436	.008492	.03926	.04484	.0454	.3753	.08406		
1750	91	1.526	1280	1505	1695	1780	1860	2015	2150	.006374	.007553	.03365	.03988	.0492	.3655	.08176		
2000	91	1.630	1385	1620	1820	1910	2000	2160	2310	.005578	.006877	.02945	.03631	.0526	.3574	.07979		

†Current rating is for average tarnished surfaces, ambient temperature 25°C., conductivity 97.5% IACS, frequency 60 cycles. Values of current rounded off to nearest ampere 100 and below, nearest 5 amperes above 100.
 ‡Recommended maximum operating temperatures: Hy-Therm, 100°C.; other commercial grades, 75°C.
 §Resistance values are for nominal sizes based on 97.5% conductivity, IACS; increased 2% to allow for stranding except for 3-wire cables where the allowance is 1%.
 ¶Inductive and capacitive reactance calculated for an equivalent spacing of 1 foot.
 *These data are approximate and subject to normal manufacturing tolerances.
 **Trade Mark.

Prices on application.

Anaconda Bare Aluminum-Steel Cable (ACSR)

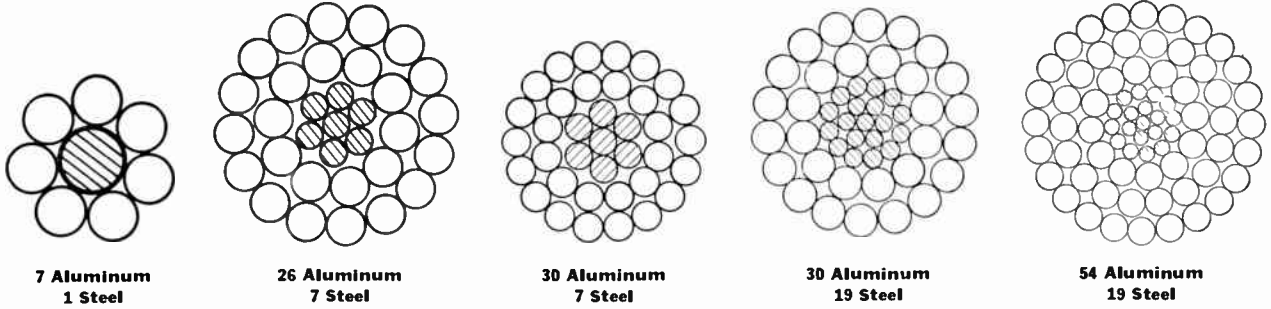

*Conductor Size A.W.G. or MCM	Copper Equivalent Based Upon Equal D-C Res. Copper 97% Aluminum 61%	No. and Diameter of Wires		Over- all Diam. In.	**Ultimate Strength Lbs.	D-C Resistance at ††20° C (68° F) Ohms per M-FL	Total WL. of Cable		No. of Pieces	‡Nominal Standard Packing		
		Aluminum In.	Steel In.				Lbs. Per 1000 FL	Lbs. Per Mile		Reels Length Each Piece FL	Total Weight Lbs.	Coils Weight Lbs.
6	8	6x.0661	1x.0661	0.198	1170	0.6577	36.1	190	2	17,210†	1216	623
5	7	6x.0743	1x.0743	.223	1160	.5216	45.5	240	2	13,700†	1217	624
4	6	6x.0834	1x.0834	.250	1830	.4134	57.4	303	2	10,870†	1218	624
4	6	7x.0772	1x.1029	.257	2288	.4134	67.0	354	2	7,120†	957	479
3	5	6x.0937	1x.0937	.281	2250	.3280	72.4	383	2	8,620†	1248	624
2	4	6x.1052	1x.1052	.316	2790	.2601	91.3	482	2	6,825†	1216	623
2	4	7x.0974	1x.1299	.325	3525	.2601	106.7	563	1	8,950†	955	478
1	3	6x.1182	1x.1182	.355	3480	.2062	115.2	608	2	5,405†	1245	623
1/0	2	6x.1327	1x.1327	.398	4280	.1634	145.2	766	1	6,410†	935	623
2/0	1	6x.1490	1x.1190	.417	5345	.1297	183.1	966	1	5,100†	934	623
3/0	1/0	6x.1672	1x.1672	.502	6675	.1028	230.8	1219	1	5,400†	1246	623
4/0	2/0	6x.1878	1x.1878	.563	8420	.08155	291.1	1537	1	4,285†	1217	624
266.8	3/0	6x.2109	7x.0703	.633	9615	.06500	342.3	1807	1	4,475	1417	...
266.8	3/0	26x.1013	7x.0708	.642	11250	.06532	367.3	1939	1	5,345	1961	...
300.0	188.7	26x.1074	7x.0835	.680	12650	.05809	412.8	2179	1	4,751	1961	...
336.4	4/0	26x.1138	7x.0885	.721	14050	.05180	463.0	2416	1	8,475	3922	...
336.4	4/0	30x.1059	7x.1059	.741	17040	.05193	527.1	2783	1	6,565	3460	...
397.5	250	26x.1236	7x.0961	.783	16190	.04384	546.9	2888	1	7,180	3927	...
397.5	250	30x.1151	7x.1151	.806	19980	.04395	622.8	3288	1	5,555	3459	...
477.0	300	26x.1355	7x.1054	.858	19430	.03653	656.8	3468	1	5,980	3924	...
477.0	300	30x.1261	7x.1261	.883	23300	.03662	747.4	3916	1	4,630	3462	...
556.5	350	26x.1463	7x.1138	.927	22400	.03132	766.1	4015	1	5,125	3926	...
556.5	350	30x.1362	7x.1362	.953	27200	.03139	872.0	4604	1	3,970	3457	...
605.0	380.5	54x.1059	7x.1059	.953	22500	.02881	779.3	4114	1	6,580	5126	...
605.0	380.5	26x.1525	7x.1186	.966	24100	.02881	832.6	4395	1	4,715	3928	...
605.0	380.5	30x.1420	19x.0852	.994	30000	.02888	939.7	4962	1	5,070	4766	...
636.0	400	54x.1085	7x.1085	.977	23600	.02740	819.0	4324	1	6,260	5127	...
636.0	400	26x.1561	7x.1216	.990	25000	.02740	875.3	4621	1	4,490	3929	...
636.0	400	30x.1456	19x.0874	1.019	31500	.02747	988.2	5218	1	4,815	4752	...
666.6	419	54x.1111	7x.1111	1.000	24500	.02614	858.6	4532	1	5,975	5127	...

*Aluminum wires only.

**Ultimate strength is calculated as the sum of the minimum average ultimate strength of the aluminum wires plus the stress developed in the steel wires at one percent elongation in 10 inches.

††D-c resistance based on 17.011 ohms (mil, foot) at 20 C (68 F) for the nominal aluminum area of the conductors, with standard increments for stranding. ASTM B232-55T.

A-c resistance of ACSR having a single layer of aluminum wires is considerably higher than d-c resistance.

‡The allowable tolerance shall be plus or minus 5 percent for all sizes larger than No. 1. For No. 1 and smaller shall be plus or minus 10 percent.

†Nonreturnable Reels.

These data are approximate and subject to normal manufacturing tolerances.

Pricing on application.

Anaconda Cathodic Protection Cable



Polyethylene-Densheath Construction

Conductor Size* A.W.G. or MCM	No. and Diam. of Wires In.	Polyethylene Insul. Thick. 64th In.	Copper Red Densheath Jacket* Thick. 64th In.	O.A. Diam. In.	Net WL Lbs. Per M-FL	FL In Reels
8	7x. 0486	1	3	0.37	100	1000
6	7x. 0612	1	3	.41	138	1000
4	7x. 0772	1	3	.46	195	1000
2	7x. 0972	4	3	.52	284	1000
1	19x. 0664	5	3	.59	355	1000
1/0	19x. 0745	5	3	.63	432	1000
2/0	19x. 0837	5	3	.68	530	1000
3/0	19x. 0940	5	3	.74	648	1000
4/0	19x. 1055	5	3	.79	797	1000

Reels are nonreturnable.

*Conductors are soft or annealed in accordance with ASTM B 3, latest edition.

A vinyl resin thermoplastic compound.

All Polyethylene Construction



Conductor Size* A.W.G. or MCM	No. and Diam. of Wires In.	Polyethylene Insul. † Thick. 64th In.	O.A. Diam. In.	Net WL Lbs. Per M-FL	Shp. WL Lbs. Per M-FL	FL In Reels
8	7x. 0486	7	0.37	89	120	1000
6	7x. 0612	7	.41	129	161	1000
4	7x. 0772	7	.46	182	217	1000
2	7x. 0974	7	.52	268	306	1000
1	19x. 0664	8	.59	337	380	1000
1/0	19x. 0745	8	.63	412	453	1000
2/0	19x. 0837	8	.68	508	549	1000
3/0	19x. 0940	8	.74	628	671	1000
4/0	19x. 1055	8	.79	772	819	1000

†Conductors are soft or annealed in accordance with ASTM B 3, latest edition.

‡High-molecular weight, black pigmented polyethylene.

Nonreturnable reels.

Call Graybar **FIRST** For . . .

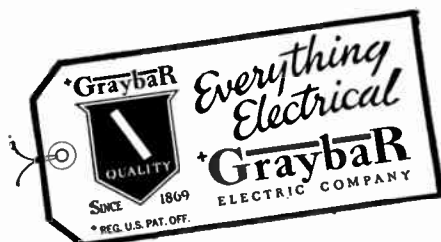

Anaconda Direct Burial Telephone Cables

**And Special Aerial and Duct Installations
Type ATC-DB**



Outer Polyethylene Jacket. Aluminum shield and armor (.013 inches). Inner Polyethylene Jacket. Binder Tape. Polyethylene insulated conductors (.015 inches). Bare, Soft-Drawn copper conductors.

Electrical Data

Average mutual capacitance at 1KC, mf/mile. 0.090

Loop resistance, ohms/mile

19AWG 92 24AWG 290

22AWG 184

Insulation resistance, megohms-mile. 1000

Dielectric Strength

Conductor-to-conductor, volts. 3500

Conductor-to-shield, volts. 3500

Color-Coding

In Cable ranging in pairs from 6 to 76 inclusive, one tracer pair is red and orange—all other pairs being red and natural.

101, 202, 303 and 404-pair cables are assembled in groups of pairs. Each group contains one red and orange tracer pair. All other pairs in the group are either red and natural, red and blue or blue and natural.

Cond. Size AWG	No. of Pairs	Jacket Thickness Inner In.	Jacket Thickness Outer In.	O. A. Diam. In.	Shp. WL Lbs. Per M. FL	Reel Lgth. FL
24	6	.050	.050	.54	175	5000
24	11	.050	.050	.61	216	5000
24	16	.050	.060	.68	259	5000
24	26	.050	.060	.77	331	5000
24	51	.050	.070	.96	551	2500
24	76	.050	.080	1.14	707	2500
24	101	.060	.080	1.32	919	2500
24	152	.060	.090	1.55	1337	1000
24	202	.060	.090	1.73	1581	1000
24	303	.070	.100	2.30	2343	1000
24	404	.070	.100	2.40	2811	1000
22	6	.050	.050	.57	183	5000
22	11	.050	.060	.66	251	5000
22	16	.050	.060	.75	297	5000
22	26	.050	.060	.85	388	5000
22	51	.050	.070	1.04	655	2500
22	76	.050	.080	1.26	905	2500
22	101	.060	.080	1.42	1131	2500
22	152	.060	.090	1.63	1586	1000
22	202	.060	.100	1.83	2101	1000
22	303	.070	.100	2.39	2894	1000
19	6	.050	.060	.61	240	5000
19	11	.050	.060	.75	309	5000
19	16	.050	.060	.83	400	5000
19	26	.050	.070	.98	605	2500
19	51	.050	.080	1.23	982	2500
19	76	.060	.090	1.48	1347	2500
19	101	.060	.090	1.69	1686	2500
19	152	.060	.100	1.90	2504	1000
19	202	.070	.100	2.40	3161	1000

Anaconda Aerial and Duct Telephone Cable

Type ATC-AD



Polyethylene jacket. Aluminum shield (.001 inches). Polyethylene binder tape. Polyethylene insulated conductors (.015 inches). Bare, soft-drawn copper conductors.

Electrical Data

Average mutual capacitance at 1KC, mf/mile..... 0.090
 Loop resistance, ohms/mile
 19 AWG..... 92 24 AWG..... 290
 22 AWG..... 181
 Insulation resistance, megohms-mile..... 1000
 Dielectric strength
 Conductor-to-conductor, volts..... 3500
 Conductor-to-shield, volts..... 3500

Color-Coding

In cable ranging in pairs from 6 to 76 inclusive, one tracer pair is red and orange—all other pairs being red and natural.

101, 202, 303 and 401-pair cables are assembled in groups of pairs. Each group contains one red and orange tracer pair. All other pairs in the group are either red and natural, red and blue or blue and natural.

Alpeth*



Polyethylene jacket. Longitudinal aluminum shield (.008 inches). Non-hygroscopic binder tape. Polyethylene insulated conductors (.015 in.). Bare, soft-drawn copper construction.

Cond. Size AWG	No. of Pairs	Jacket Thick. In.	O. A. Diam. In.	Ship. Wt. Lbs. Per M. FL.	Reel Lgth. Ft.
24	6	0.050	0.41	72	5000
24	11	.050	.48	103	5000
24	16	.050	.55	163	5000
24	26	.060	.66	227	5000
24	51	.060	.84	385	2500
24	76	.070	1.02	550	2500
24	101	.080	1.18	710	2500
24	152	.080	1.35	1089	1000
24	202	.090	1.63	1365	1000
24	303	.100	1.91	2016	1000
24	401	.100	2.28	2151	1000
22	6	.050	.42	85	5000
22	11	.050	.50	152	5000
22	16	.050	.59	191	5000
22	26	.060	.70	271	5000
22	51	.070	.93	509	2500
22	76	.070	1.10	693	2500
22	101	.080	1.28	927	2500
22	152	.090	1.50	1377	1000
22	202	.100	1.71	1753	1000
22	303	.100	2.21	2589	1000
22	401	.100	2.55	3690	500
19	6	.050	.49	120	5000
19	11	.050	.59	212	5000
19	16	.060	.70	290	5000
19	26	.060	.83	411	5000
19	51	.070	1.08	788	2500
19	76	.080	1.35	1117	2500
19	101	.090	1.53	1465	2000
19	152	.100	1.77	2161	1000
19	202	.100	2.01	2881	1000
19	303	.100	2.61	4470	500
19	401	.100	2.95	5550	500

*Manufactured in same sizes and construction as Type ATC-AD. Aluminum shield is corrugated except on smaller diameter construction.

Anaconda Self-Supporting Aerial Telephone Cable
Type ATC-SS



Polyethylene jacket. Aluminum shield (.001 inches). Polyethylene binder tape. Polyethylene insulated conductors (.015 inches). Bare, hard-drawn copper conductors.

Cond. Size AWG	No. of Pairs	Jacket Thick. In.	O. A. Diam. In.	Ship. Wt. Lbs. Per M. FL.	Reel Lgth. Ft.
19	6	0.050	0.49	120	5000
19	11	.050	.59	212	5000
19	16	.060	.70	290	5000
19	26	.060	.83	411	5000

Note: Construction and data identical to ATC-AD except conductors are hard-drawn high tensile copper. No messenger needed.

For
NATIONAL ELECTRIC CODE
CURRENT CARRYING CAPACITIES
on
THESE AND OTHER WIRES
AND CABLES
See
TABLES OF USEFUL INFORMATION
Preceding Index

General Cable *Guardian Building Wire and Cable

Single Conductor—Rubber Insulated—600 Volts

Fibrous Covered



Code Grade Type R, dual rated Type RH RW and Type RHW: Approved by Underwriters' Laboratories as follows: Type R for use in dry locations up to 60° C; Type RH/RW for use as RH up to 75° C; as RW up to 60° C; Type RHW for use in wet or dry locations up to 75° C.

Solid Conductor, Single Braid

Size A.W.G. or MCM	Conductors No. of Strands	Diam. Indiv. Strands In.	Diam. In.	Insulation Thickness In.	Overall Diam. In.	Net Wt. Lbs. Per M-Ft.
14	1	Solid	.0641	$\frac{2}{64}$.15	.23
12	1	Solid	.0808	$\frac{2}{64}$.17	.32
10	1	Solid	.1019	$\frac{3}{64}$.22	.51
8	1	Solid	.1285	$\frac{4}{64}$.28	.85

Stranded Conductor, Single Fibrous Cover

14	7		.0242	.0726	$\frac{2}{64}$.16	.25
12	7		.0305	.0915	$\frac{2}{64}$.18	.35
10	7		.0385	.116	$\frac{3}{64}$.24	.56
8	7		.0486	.146	$\frac{4}{64}$.30	.89

Solid Conductor, Double Fibrous Cover

14	1	Solid	.0641	$\frac{2}{64}$.17	.27
12	1	Solid	.0808	$\frac{2}{64}$.19	.37
10	1	Solid	.1019	$\frac{3}{64}$.24	.58
8	1	Solid	.1285	$\frac{4}{64}$.30	.90
†6	1	Solid	.1620	$\frac{4}{64}$.34	1.27

Stranded Conductor, Double Fibrous Cover



14	7		.0242	.0726	$\frac{2}{64}$.18	.29
12	7		.0305	.0915	$\frac{2}{64}$.20	.39
10	7		.0385	.116	$\frac{3}{64}$.25	.62
8	7		.0486	.146	$\frac{4}{64}$.31	.97
6	7		.0612	.184	$\frac{4}{64}$.37	1.10
4	7		.0772	.232	$\frac{4}{64}$.43	1.95
2	7		.0974	.292	$\frac{4}{64}$.49	2.90
1	19		.0664	.332	$\frac{5}{64}$.57	3.60
1/0	19		.0745	.373	$\frac{5}{64}$.61	4.10
2/0	19		.0837	.419	$\frac{5}{64}$.66	5.35
3/0	19		.0940	.470	$\frac{5}{64}$.71	6.60
4/0	19		.1055	.528	$\frac{5}{64}$.77	8.10
250	37		.0822	.575	$\frac{6}{64}$.85	9.60
300	37		.0900	.630	$\frac{6}{64}$.92	11.10
350	37		.0973	.681	$\frac{6}{64}$.96	13.10
400	37		.1040	.728	$\frac{6}{64}$	1.01	14.80
500	37		.1162	.813	$\frac{6}{64}$	1.09	18.20
600	37		.1273	.891	$\frac{7}{64}$	1.21	21.90
700	61		.1071	.964	$\frac{7}{64}$	1.27	25.20
750	61		.1109	.998	$\frac{7}{64}$	1.31	26.90
800	61		.1115	1.031	$\frac{7}{64}$	1.35	28.50
900	61		.1215	1.094	$\frac{7}{64}$	1.41	31.80
1,000	61		.1280	1.152	$\frac{7}{64}$	1.47	35.20
1,250	91		.1172	1.289	$\frac{8}{64}$	1.65	44.20
1,500	91		.1284	1.412	$\frac{8}{64}$	1.78	52.50
1,750	127		.1174	1.526	$\frac{8}{64}$	1.89	60.70
2,000	127		.1255	1.632	$\frac{8}{64}$	2.00	68.90

Lead Covered



Lead Sheathed Code Grade Type RL, Lead Sheathed Heat Resisting Grade Type RHL: Approved by Underwriters' Laboratories as follows: Type RL for use in wet locations up to 60° C; Type RHL for use in wet locations up to 75° C.

Solid Conductors

Size A.W.G. or MCM	Conductors No. of Strands	Diam. Indiv. Strands In.	Diam. In.	Insulation Thickness In.	Sheath Thickness In.	Overall Diam. In.	Net Wt. Lbs. Per M-Ft.
14	1	Solid	.0641	$\frac{2}{64}$	$\frac{2}{64}$.23	115
12	1	Solid	.0808	$\frac{2}{64}$	$\frac{2}{64}$.25	130
10	1	Solid	.1019	$\frac{3}{64}$	$\frac{3}{64}$.33	250
8	1	Solid	.1285	$\frac{4}{64}$	$\frac{3}{64}$.38	320
†6	1	Solid	.1620	$\frac{4}{64}$	$\frac{4}{64}$.45	490
†4	1	Solid	.2043	$\frac{4}{64}$	$\frac{4}{64}$.47	590

Stranded Conductors



14	7		.0242	.0726	$\frac{2}{64}$	$\frac{2}{64}$.24	120
12	7		.0305	.0915	$\frac{2}{64}$	$\frac{2}{64}$.25	140
10	7		.0385	.116	$\frac{3}{64}$	$\frac{3}{64}$.34	265
8	7		.0486	.146	$\frac{4}{64}$	$\frac{3}{64}$.40	340
6	7		.0612	.184	$\frac{4}{64}$	$\frac{4}{64}$.47	515
4	7		.0772	.232	$\frac{4}{64}$	$\frac{4}{64}$.53	620
2	7		.0974	.292	$\frac{4}{64}$	$\frac{4}{64}$.58	770
1	19		.0664	.332	$\frac{5}{64}$	$\frac{4}{64}$.66	910
1/0	19		.0745	.373	$\frac{5}{64}$	$\frac{4}{64}$.70	1030
2/0	19		.0837	.419	$\frac{5}{64}$	$\frac{4}{64}$.75	1170
3/0	19		.0940	.470	$\frac{5}{64}$	$\frac{4}{64}$.80	1340
4/0	19		.1055	.528	$\frac{5}{64}$	$\frac{4}{64}$.86	1540
250	37		.0822	.575	$\frac{6}{64}$	$\frac{5}{64}$.97	2000
300	37		.0900	.630	$\frac{6}{64}$	$\frac{5}{64}$	1.02	2230
350	37		.0973	.681	$\frac{6}{64}$	$\frac{5}{64}$	1.07	2460
400	37		.1040	.728	$\frac{6}{64}$	$\frac{5}{64}$	1.12	2690
500	37		.1162	.813	$\frac{6}{64}$	$\frac{5}{64}$	1.20	3120
600	37		.1273	.891	$\frac{7}{64}$	$\frac{6}{64}$	1.35	3960
700	61		.1071	.964	$\frac{7}{64}$	$\frac{6}{64}$	1.42	4390
750	61		.1109	.998	$\frac{7}{64}$	$\frac{6}{64}$	1.44	4600
800	61		.1115	1.031	$\frac{7}{64}$	$\frac{6}{64}$	1.48	4820
900	61		.1215	1.094	$\frac{7}{64}$	$\frac{6}{64}$	1.55	5240
1000	61		.1280	1.152	$\frac{7}{64}$	$\frac{6}{64}$	1.61	5660
1250	91		.1172	1.289	$\frac{8}{64}$	$\frac{7}{64}$	1.80	7180
1500	91		.1284	1.412	$\frac{8}{64}$	$\frac{7}{64}$	1.92	8820
1750	127		.1174	1.526	$\frac{8}{64}$	$\frac{7}{64}$	2.04	9210
2000	127		.1255	1.632	$\frac{8}{64}$	$\frac{7}{64}$	2.15	10220

*Trade Mark.

†Not permitted by N.E.C. for installation in raceways.

§Sizes 14 and 12 with $\frac{3}{64}$ -in. wall approved as Types R and RHL. If type RW is specified, these sizes will be supplied with $\frac{3}{64}$ -in. insulation and labeled accordingly. Weights and dimensions shown are for Types R and RH only on sizes 14 and 12.

Current Carrying Capacity: N.E.C. 1956.

The above data are approximate and subject to normal manufacturing tolerances.

Prices on application.

General Cable *Guardian Building Wire and Cable
Rubber Insulated — 600 Volts
Lead Sheathed



Lead Sheathed Code Grade Type RDL. Lead Sheathed Heat Resisting Grade Type RHDL. Approved by Underwriters' Laboratories as follows: Type RDL for use in wet locations up to 60° C; Type RHDL for use in wet locations up to 75° C.

Solid Conductors

Size A.W.G. or MCM	No. of Strands	Diam. Indiv. Strands In.	Diam. In.	Insulation Thickness In.	Sheath Thickness In.	Overall Diam. In.	Net Wt. Lbs. Per M-Ft.
14	1	Solid	.0641	2/64	2/64	.37 x .22	185
12	1	Solid	.0808	2/64	2/64	.41 x .24	215
10	1	Solid	.1019	3/64	3/64	.51 x .32	405
8	1	Solid	.1285	1/4	3/64	.67 x .38	535
†6	1	Solid	.1620	1/4	1/4	.77 x .45	810

Stranded Conductors

14	7	.0242	.0726	2/64	2/64	.40 x .24	190
12	7	.0305	.0915	2/64	2/64	.44 x .26	225
10	7	.0385	.116	3/64	3/64	.58 x .34	425
8	7	.0486	.146	1/4	3/64	.70 x .40	565
6	7	.0612	.184	1/4	1/4	.82 x .48	850
4	7	.0772	.232	1/4	1/4	.91 x .52	1070
2	7	.0974	.292	1/4	1/4	1.04 x .58	1310
1	19	.0664	.332	1/4	1/4	1.21 x .69	1810
1/0	19	.0745	.373	5/64	5/64	1.30 x .72	2050
2/0	19	.0837	.419	5/64	5/64	1.38 x .77	2340
3/0	19	.0940	.470	5/64	5/64	1.48 x .82	2700
4/0	19	.1055	.528	5/64	5/64	1.60 x .88	3100

3-Conductor Lead Sheathed

Lead Sheathed Code Grade Type RML. Lead Sheathed Heat Resisting Grade Type RHML. Approved by Underwriters' Laboratories as follows: Type RML for use in wet locations up to 60° C; Type RHML for use in wet locations up to 75° C.

Solid Conductors

Size A.W.G. or MCM	No. of Strands	Diam. Indiv. Strands In.	Diam. In.	Insulation Thickness In.	Sheath Thickness In.	Overall Diam. In.	Net Wt. Lbs. Per M-Ft.
14	1	Solid	.0641	2/64	3/64	.47	380
12	1	Solid	.0808	2/64	3/64	.50	440
10	1	Solid	.1019	3/64	3/64	.65	740
8	1	Solid	.1285	1/4	1/4	.78	980
†6	1	Solid	.1620	1/4	1/4	.88	1380

Stranded Conductors



14	7	.0242	.0726	2/64	3/64	.48	100
12	7	.0305	.0915	2/64	3/64	.56	595
10	7	.0385	.116	3/64	3/64	.67	800
8	7	.0486	.146	1/4	1/4	.82	1010
6	7	.0612	.184	1/4	1/4	.93	1160
4	7	.0772	.232	1/4	1/4	1.04	1780
2	7	.0974	.292	1/4	1/4	1.17	2230
1	19	.0664	.332	1/4	1/4	1.35	2990
1/0	19	.0745	.373	5/64	5/64	1.44	3370
2/0	19	.0837	.419	5/64	5/64	1.54	3820
3/0	19	.0940	.470	5/64	5/64	1.65	4370
4/0	19	.1055	.528	5/64	5/64	1.80	5460

CM sizes available.

General Cable *Guardian Building Wire and Cable

Synthetic Rubber Insulated

***Gencaseal Type TW Small Diameter — 600 Volts**

Approved by Underwriters' Laboratories for Use in Wet Locations



Solid Conductors

Size A.W.G. or MCM	No. of Strands	Diam. Indiv. Strands In.	Diam. In.	Insulation Thickness In.	Overall Diam. In.	Net Wt. Lbs. Per M-Ft.
14	1	Solid	.0641	2/64	.13	19
12	1	Solid	.0808	2/64	.15	27
10	1	Solid	.1019	2/64	.17	40
8	1	Solid	.1285	3/64	.23	66

Stranded Conductors

14	7	.0242	.0726	2/64	.14	20
12	7	.0305	.0915	2/64	.16	29
10	7	.0385	.116	2/64	.19	43
8	7	.0486	.146	3/64	.25	71
6	7	.0612	.184	4/64	.32	115
4	7	.0772	.232	4/64	.37	170
2	7	.0974	.292	4/64	.43	255
1	19	.0664	.332	5/64	.50	330
1/0	19	.0745	.373	5/64	.54	405
2/0	19	.0837	.419	5/64	.59	495
3/0	19	.0940	.470	5/64	.64	620
4/0	19	.1055	.528	5/64	.69	760
250	37	.0822	.575	6/64	.77	910
300	37	.0900	.630	6/64	.83	1080
350	37	.0973	.681	6/64	.88	1240
400	37	.1040	.728	6/64	.93	1410
500	37	.1162	.813	6/64	1.01	1740
600	37	.1273	.891	7/64	1.12	2090
700	61	.1071	.964	7/64	1.19	2420
750	61	.1109	.998	7/64	1.23	2590
800	61	.1145	1.031	7/64	1.26	2750
900	61	.1215	1.094	7/64	1.32	3080
1000	61	.1280	1.152	7/64	1.38	3410
1250	91	.1172	1.289	8/64	1.56	4250
1500	91	.1284	1.412	8/64	1.68	5060
1750	127	.1174	1.526	8/64	1.80	5860
2000	127	.1255	1.632	8/64	1.90	6680

General Cable *Guardian Fixture Wires

Rubber Insulated

Code Grade Underwriters' Type RF

1/64-inch Insulation — 300 Volts
 3/64-inch Insulation — 600 Volts

Supplied in solid or 7-strand tinned annealed copper. Covered with weatherproof finished cotton braid; also available with lacquer finish or glazed cotton braid.

Size A.W.G.	Insulation Thickness Ins.	Overall Diameter In.	Weight Per 1000 Ft. Lbs.
18	1/64	.11	10
18	3/64	.14	14
16	3/64	.15	17

*Trade Mark.

†Not permitted by N.E.C. for installation in raceways.

Current Carrying Capacity: N.E.C. 1956.

The above data are approximate and subject to normal manufacturing tolerances.

Prices on application.

General Cable Non-Metallic Sheathed

***Romex (Type NM) Cable
600 Volts**



For concealed or open work in locations that are reasonably dry. Inspected and labeled by Underwriters' Laboratories.

Romex (NM) has very high insulation value, both between conductors and to ground. There is no metal covering to become accidentally grounded or opened.

Insulated with thermoplastic compound, colored for polarity identification. Covered with a protective paper armor.

Overall covering of fibrous braid, finished with a flame and moisture-resistant compound, surface marked for identification.

Insulated Conductor Size A.W.G.	No. of Conductors	Type Conductor	Overall Dimensions In.	Standard Pkg. Ft.	Shipping Wt. Per Pkg.	
					With Ground Wire (Lbs.)	Without Ground Wire (Lbs.)
14	2	Sol.	.26 x .45	●250	22	20
14	3	Sol.	.48	●250	32	30
12	2	Sol.	.27 x .50	●250	26	23
12	3	Sol.	.52	●250	41	39
10	2	Sol.	.30 x .54	●250	36	32
10	3	Sol.	.58	●250	55	51
8	2	7 Str.	.41 x .76	■125	32	30
8	3	7 Str.	.80	■125	53	50
6	2	7 Str.	.49 x .92	■125	44	42
6	3	7 Str.	.97	■125	70	66
4	2	7 Str.	.54 x 1.02	■125	61	56
4	3	7 Str.	1.08	■125	96	91

● Individual carton.

■ Wrapped coil.

General Cable Non-Metallic Sheathed

***Romex (Type NMC) Cable
Fungus Resistant**

N.E.C.S. to 600 Volts Approved by Underwriters' Laboratories



Particularly suitable for installation where heat, corrosion, moisture, cold and fungus are encountered; complies with all performance standards for non-metallic sheathed cable. Packed in individual cartons and available with or without ground wire. Standard package, 250 feet.

Insulated Conductors Size A.W.G.	No. of Conductors	Type Conductor	Ground Wires Size A.W.G.	Type Conductor	Overall Dimensions In.	Net Wt. Per 1000 Ft.		Ship. Wt. Per Package	
						With Ground Wire (Lbs.)	Without Ground Wire (Lbs.)	With Ground Wire (Lbs.)	Without Ground Wire (Lbs.)
14	2	Sol.	16	Sol.	.26 x .45	90	98	24	26
14	3	Sol.	16	Sol.	.51	170	178	44	46
12	2	Sol.	14	Sol.	.27 x .48	112	124	29	32
12	3	Sol.	14	Sol.	.54	212	224	54	57
10	2	Sol.	12	Sol.	.32 x .58	160	180	41	46
10	3	Sol.	12	Sol.	.59	270	290	69	74

***Gencatrol Cable**

Thermoplastic Insulated — Nylon Jacketed

Gencatrol is an oil and gasoline resistant thermoplastic insulated, nylon jacketed wire designed for use on all applications where exposed to oil, gasoline or gasoline vapors.

Underwriters' Laboratories approved.

Size A.W.G.	Strands	Insulation Thickness In.	Approx. O. D. In.	Ft. Per Ctn.	Ship. Wt. Lbs. Per M Ft.
14	7	3/64	.19	500	30
12	7	3/64	.21	500	30
10	7	3/64	.23	500	55
8	7	3/64	.26	500	76
				Coil	
6	7	3/64	.33	500	122

*Trade Mark.

General Cable Service Entrance Cable

Type SE (Style U)—208 Volts



Does not require conduit protection where extending along exterior or entering building.

2-Conductor (Concentric)

Insulated Conductor Size A.W.G.	No.	Insulation Thickness In.	Uninsulated Neutral Coverage		Std. Coil Ft.	With Solid Insulated Cond.		With Stranded Insulated Cond.	
			Size A.W.G.	†Per Cent		Overall Diam. In.	Ship. Wt. Lbs. Per Coil	Overall Diam. In.	Ship. Wt. Lbs. Per Coil
12	1	3/64	12	85	250	.33	21	.34	23
10	1	3/64	10	85	250	.36	28	.38	31
8	1	3/64	8	85	250	.41	43	.45	46
*6	1	3/64	8	85	250	.46	49	.48	56
*6	1	1/4	6	85	250	.48	57	.51	66
4	1	1/4	6	85	20055	65
4	1	1/4	4	85	20058	75
2	1	1/4	4	85	15064	73
2	1	1/4	2	85	15067	84

3-Conductor (Flat)

12	2	3/64	12	65	250	.33x .52	36	.34x .54	37
10	2	3/64	10	65	250	.36x .56	47	.38x .60	51
8	2	3/64	8	65	250	.43x .69	72	.44x .72	76
*6	2	1/4	8	50	200	.45x .74	67	.49x .80	77
*6	2	3/64	6	65	150	.46x .75	54	.51x .84	63
4	2	1/4	6	50	15057x .93	81
4	2	3/64	4	65	15058x .94	89
2	2	1/4	4	50	10064x 1.07	78
2	2	3/64	2	65	10065x 1.07	87

Type SE (Style A)—208 Volts



Light steel armor applied over concentric neutral.

2-Conductor (Concentric)

Insulated Conductor Size A.W.G.	No.	Insulation Thickness In.	Uninsulated Neutral Coverage		Std. Coil Ft.	With Solid Insulated Cond.		With Stranded Insulated Cond.	
			Size A.W.G.	†Per Cent		Overall Diam. In.	Ship. Wt. Lbs. Per Coil	Overall Diam. In.	Ship. Wt. Lbs. Per Coil
12	1	3/64	12	85	250	.35	27	.36	28
10	1	3/64	10	85	250	.38	36	.40	38
8	1	3/64	8	85	250	.45	52	.47	55
*6	1	1/4	8	85	250	.48	58	.51	66
*6	1	3/64	6	85	250	.50	67	.53	76
4	1	1/4	6	86	20057	74
4	1	3/64	4	85	20060	85
2	1	3/64	4	85	15066	81
2	1	1/4	2	85	15069	93

3-Conductor (Flat)

12	2	3/64	12	65	250	.35x .53	44	.36x .55	47
10	2	3/64	10	65	250	.38x .57	58	.40x .61	62
8	2	3/64	8	65	250	.45x .70	86	.46x .73	89
*6	2	1/4	8	50	200	.48x .75	79	.52x .81	89
*6	2	3/64	6	65	150	.48x .76	63	.53x .85	72
4	2	1/4	6	50	15060x .94	92
4	2	3/64	4	65	15061x .95	99
2	2	1/4	4	50	10066x 1.07	86
2	2	3/64	2	65	10067x 1.08	95

*Solid conductors not permitted by N.E.C. for installation in raceways. †No. 12 A.W.G. insulated conductors medium hard drawn copper. Sizes larger than No. 12 are annealed.

†Percentage of the surface of the underlying core which is covered by the concentric uninsulated neutral conductor subject to a tolerance of plus or minus 5%.

Can be furnished, if desired, on reels as specified for Type S.D. Cable. The above data are approximate and subject to normal manufacturing tolerances.

Prices on application.

General Cable Messenger Type Service Drop and Secondary Cable

600 Volts

A self-supporting aerial cable suitable for service drop and secondary distribution application. Cable consists normally of one or two neoprene or polyethylene insulated conductors twisted around a straight messenger. The messenger offers mechanical support for cable and serves as neutral conductor. Advantages of this type of cable include economy of installation, excellent weather resistance, relief from strain on the insulated conductors and neat appearance.

Cables normally supplied with either copper or E.C. Grade aluminum power conductors and have either a hard drawn copper or copper covered steel neutral conductor; cables having aluminum power conductors are in addition available with E.C. Grade hard drawn aluminum or A.C.S.R. neutral conductor.

Typical Construction Details

Power Conductors: Copper conductors shall be uncoated annealed copper solid or stranded as indicated in the tables which follow, and conforming to A.S.T.M. Specifications B3 and B8. The aluminum conductors shall be uncoated E.C. Grade aluminum, solid or stranded as specified in tables which follow.

Neutral Conductors: Copper neutral conductors shall be hard drawn bare copper solid or stranded and conforming to A.S.T.M. Specifications B1 and B8 as may be applicable. The aluminum neutral conductors shall be "E.C." grade, hard drawn aluminum solid or stranded as indicated and conforming to A.S.T.M. Specifications B230 and B231 as may be applicable. The copper covered steel neutral conductor shall be stranded composite copper and copper covered steel conforming to applicable requirements of A.S.T.M. Specification B229. The aluminum conductor steel reinforced neutral conductor shall be composed of six aluminum strands around one steel strand conforming in all respects to A.S.T.M. Specification B232.

Insulation: Neoprene, a special weather resistant compound applied in the wall thicknesses specified in following tables. The Neoprene insulation conforming to requirements set forth by I.P.C.E.A. for this type of service. Polyethylene, an insulating compound having a high resistance to exposure to direct sunlight and the effects of weathering. Compound colored black and applied in the wall thicknesses specified in following tables. The polyethylene insulation shall conform to the I.P.C.E.A. requirements for service on this type of cable.

Assembly: One or more insulated conductors are twisted around the neutral conductor without fillers, and with a suitable lay.

Aluminum Power Conductors Only

Insulated Power Conductors Aluminum Conductors				Hard Drawn Aluminum Messenger			
A.W.G. Size	No. of Strands	Insul. Thickness Inches		A.W.G. Size	No. of Strands	Finished Cable Wgt. Lbs. Per 1000 Ft.	
		Neoprene	Polyethylene			Neoprene	Polyethylene
Two Conductor Cables							
6	Solid*	4/64	3/64	6	7	80	60
4	7	4/64	3/64	4	7	125	100
4	7	4/64	3/64
2	7	4/64	3/64	2	7	185	150
2	7	4/64	3/64
1/0	19	5/64	4/64	1/0	7	290	240
1/0	19	5/64	4/64
2/0	19	5/64	4/64	2/0	7	350	295
2/0	19	5/64	4/64
3/0	19	5/64	4/64	3/0	19	430	370
3/0	19	5/64	4/65
4/0	19	5/64	4/64	4/0	19	525	460
4/0	19	5/64	4/64
Three Conductor Cables							
6	Solid*	4/64	3/64	6	7	140	100
4	7	4/64	3/64	4	7	215	160
4	7	4/64	3/64
2	7	4/64	3/64	2	7	310	240
2	7	4/64	3/64
1/0	19	5/64	4/64	1/0	7	480	380
1/0	19	5/64	4/64
2/0	19	5/64	4/64	2/0	7	580	470
2/0	19	5/64	4/64
3/0	19	5/64	4/64	3/0	19	700	580
3/0	19	5/64	4/64
4/0	19	5/64	4/64	4/0	19	850	715
4/0	19	5/64	4/64
Four Conductor Cables							
6	Solid*	4/64	3/64	6	7	195	135
4	7	4/64	3/64	4	7	300	220
4	7	4/64	3/64
2	7	4/64	3/64	2	7	430	330
2	7	4/64	3/64
1/0	19	5/64	4/64	1/0	7	670	520
1/0	19	5/64	4/64
2/0	19	5/64	4/64	2/0	7	805	640
2/0	19	5/64	4/64
3/0	19	5/64	4/64	3/0	19	970	790
3/0	19	5/64	4/64
4/0	19	5/64	4/64	4/0	19	1180	975
4/0	19	5/64	4/64

*These conductor sizes may be stranded when so requested. The above data are approximate and subject to normal manufacturing tolerances.

Aluminum Power Conductors Only

Aluminum Conductor Steel Reinforced Messenger				Aluminum Conductor Steel Reinforced Messenger				Aluminum Conductor Steel Reinforced Messenger			
A.W.G. Size	Messenger No. of Strands	Finished Cable Weight Lbs. Per 1000 Ft.		A.W.G. Size	Messenger No. of Strands	Finished Cable Weight Lbs. Per 1000 Ft.		A.W.G. Size	Messenger No. of Strands	Finished Cable Weight Lbs. Per 1000 Ft.	
		Neoprene	Polyethylene			Neoprene	Polyethylene			Neoprene	Polyethylene
Two Conductor Cables											
6	7	95	75	6	7	150	110	6	7	205	145
4	7	145	115	4	7	230	175	4	7	320	240
6	7	125	95	6	7	210	155	6	7	300	215
2	7	215	180	2	7	340	270	2	7	460	360
4	7	180	145	4	7	305	235	4	7	425	325
1/0	7	335	285	1/0	7	525	425	1/0	7	715	565
2	7	280	230	2	7	470	370	2	7	660	515
2/0	7	410	355	2/0	7	635	525	2/0	7	860	700
1	7	340	285	1	7	565	460	1	7	795	630
3/0	7	500	440	3/0	7	775	655	3/0	7	1040	865
1/0	7	415	355	1/0	7	685	565	1/0	7	960	780
4/0	7	615	550	4/0	7	945	810	4/0	7	1270	1070
2/0	7	510	440	2/0	7	835	700	2/0	7	1160	960

General Cable Messenger Type Service Drop and Secondary Cable

600 Volts

Neoprene Insulated and Polyethylene Insulated (Copper or Aluminum Power Conductors)



Insulated Power Conductors				Hard Drawn Copper Messenger				Composite Copper—Copper Covered—Steel Messenger					
Copper Conductors		Aluminum Conductors		Finished Cable				Copper		Aluminum			
A.W.G. Size	No. of Strands	Neoprene Insulation Thickness In.	Polyethylene Insulation Thickness In.	Messenger A.W.G. Size	No. of Strands	Wt. Lbs. Per M. Ft. Neoprene	Wt. Lbs. Per M. Ft. Polyethylene	Messenger A.W.G. Size	Wt. Lbs. Per M. Ft. Neoprene	Wt. Lbs. Per M. Ft. Polyethylene	Messenger A.W.G. Size	Wt. Lbs. Per M. Ft. Neoprene	Wt. Lbs. Per M. Ft. Polyethylene
8	Solid*	4/64	3/64	8	Solid*	130	110	8C	140	120	115	100	
6	7	4/64	3/64	6	Solid*	200	175	6C	215	195	185	160	
6	7	4/64	3/64	6	Solid*	170	150	6C	180	160	150	120	
4	7	4/64	3/64	4	7	305	280	4A	340	315	285	250	
4	7	4/64	3/64	4	Solid*	255	230	6C	275	250	220	185	
2	7	4/64	3/64	2	7	470	435	2F	490	455	415	365	
2	7	4/64	3/64	1/0	19	395	360	4A	430	395	350	305	
1	19	5/64	4/64	2/0	19	595	555	1F	620	575	505	455	
1	19	5/64	4/64	2/0	19	500	460	3A	515	500	430	375	
1/0	19	5/64	4/64	3/0	19	745	695	1/0F	770	720	625	565	
1/0	19	5/64	4/64	3/0	19	625	575	2F	610	590	495	435	
2/0	19	5/64	4/64	4/0	19	925	870	2/0F	960	905	775	705	
2/0	19	5/64	4/64	4/0	19	770	715	1F	795	740	605	540	
8	Solid*	4/64	3/64	8	Solid*	205	170	8C	215	185	175	135	
6	7	4/64	3/64	6	Solid*	320	275	6C	310	295	270	215	
6	7	4/64	3/64	4	7	290	245	8C	300	255	235	180	
4	7	4/64	3/64	4	7	485	430	4A	515	465	410	340	
4	7	4/64	3/64	2	7	435	380	6C	450	400	345	275	
2	7	4/64	3/64	2	7	735	670	2F	755	685	605	505	
2	7	4/64	3/64	1/0	19	660	595	4A	695	625	540	445	
1	19	5/64	4/64	2/0	19	935	850	1F	960	875	735	625	
1	19	5/64	4/64	2/0	19	810	755	3A	885	795	655	545	
1/0	19	5/64	4/64	3/0	19	1160	1060	1/0F	1130	1090	895	775	
1/0	19	5/64	4/64	3/0	19	1010	910	2F	1060	960	765	645	
2/0	19	5/64	4/64	4/0	19	1410	1330	2/0F	1470	1370	1100	965	
2/0	19	5/64	4/64	4/0	19	1280	1180	1F	1310	1200	935	800	
8	Solid*	4/64	3/64	8	Solid*	285	235	8C	295	245	230	175	
6	7	4/64	3/64	6	Solid*	440	375	6C	460	390	360	280	
6	7	4/64	3/64	4	7	410	345	8C	420	355	325	240	
4	7	4/64	3/64	2	7	660	580	4A	695	615	530	430	
4	7	4/64	3/64	2	7	610	530	6C	630	550	465	365	
2	7	4/64	3/64	1/0	19	1000	900	2F	1020	920	790	645	
2	7	4/64	3/64	1/0	19	925	825	4A	960	860	730	585	
1	19	5/64	4/64	2/0	19	1280	1150	1F	1300	1170	960	795	
1	19	5/64	4/64	2/0	19	1180	1050	3A	1220	1090	880	720	
1/0	19	5/64	4/64	3/0	19	1580	1410	1/0F	1610	1460	1170	985	
1/0	19	5/64	4/64	3/0	19	1460	1310	2F	1480	1330	1040	855	
2/0	19	5/64	4/64	4/0	19	1950	1790	2/0F	1990	1820	1430	1220	
2/0	19	5/64	4/64	4/0	19	1800	1630	1F	1820	1660	1260	1060	

*These conductor sizes may be stranded when so requested.

The above data are approximate and subject to normal manufacturing tolerances.

General Cable Tree Wire

**Neoprene Jacketed
Thermax-W***



Tree wire is usually supported on insulators in same manner as ordinary weatherproof wires. Wire manufactured with a tough abrasion, ozone, and weather resistant neoprene jacket.

Tree wire mainly used by utilities for aerial urban or suburban primary feeders (occasionally for secondaries) and series street lighting circuits where bad tree conditions exist. Standard wall insulation thicknesses are recommended for use on secondary type wires, thin wall insulation is recommended for normal primary tree wire applications and is indicated in tables that follow.

Conductors: Medium hard drawn copper, tin or lead alloy coated, or hard drawn uncoated aluminum. No. 4 AWG and smaller solid; larger sizes stranded. Aluminum conductors will be supplied in sizes 8-1/0 AWG only.

For Power Circuits—Supported on Insulators

Rated Voltage, 0-600, Phase-to-Phase (Gnd. or Ungnd.)

Size AWG	Conductor Solid or Concentric Stranded	Diam. In.	Insulation Thickness In.	Jacket Thickness In.	D.A. Diam. In.	Weight Lbs. Per M Ft. Copper Cond.	Alum. Cond.
10	Solid	.1019	3/64	3/64	.30	70	...
8	Solid	.1285	1/2	3/64	.36	107	72
6	Solid	.1620	5/64	3/64	.39	113	88
4	Solid	.2013	3/64	3/64	.43	200	112
2	7	.292	1/2	3/64	.52	301	158
1	19	.332	5/64	1/2	.62	403	224
1/0	19	.373	5/64	1/2	.66	484	257
2/0	19	.418	5/64	1/2	.71	583	297
3/0	19	.470	5/64	1/2	.76	706	346
4/0	19	.528	5/64	1/2	.82	858	404

Rated Voltage, 1001-5000, Phase-In-Phase (Gnd. or Ungd.)

8	Solid	.1285	5/64	3/64	.39	119	84
6	Solid	.1620	5/64	3/64	.41	158	103
4	Solid	.2013	5/64	3/64	.45	216	128
2	7	.246	5/64	3/64	.51	338	195
1	19	.332	5/64	1/2	.62	403	224
1/0	19	.373	5/64	1/2	.66	484	257
2/0	19	.418	5/64	1/2	.71	583	297
3/0	19	.470	5/64	1/2	.76	706	346
4/0	19	.528	5/64	1/2	.82	858	404

Standard Package: 1000 feet on reels unless otherwise specified. The above data are approximate and subject to normal manufacturing tolerances.

Series Street Lighting Circuits—Supported on Insulators

Open Circuit Voltage—1,001-5,000

Size AWG	Solid Condrs. Diam. In.	Insulation† Thick. In.	Jacket Thick-ness In.	O.A. Diam. In.	Weight Lbs. Per M. Ft. Copper Cond.	Alum. Cond.
8	.1285	5/64	3/64	.39	119	84
6	.1620	5/64	3/64	.42	158	103

Open Circuit Voltage, 5,001-6,000

8	.1285	6/64	3/64	.42	134	99
6	.1620	6/64	3/64	.45	173	118

Open Circuit Voltage 7,001-8,000

8	.1285	8/64	3/64	.48	161	129
6	.1620	8/64	3/64	.52	207	152

*Trade Mark.

†Insulation thickness based on use "without protectors."

Standard packages: 1000 feet on reels unless otherwise specified.

The above data are approximate and subject to normal manufacturing tolerances.

**General Cable
Rubber-Insulated Power Cables**

These cables fall into three broad classifications—

1. Neoprene Jacketed Cables
2. Lead Sheathed Cables
3. Braid Covered Cables

The first group of cables has by far the widest field of application. Cables offer important advantages such as light weight, flexibility, ease of splicing and installation. Cables are not subject to rust, rotting, crystallization, induced sheath losses or trouble from stray currents. Rubber insulated neoprene jacketed cables available for operation at potentials up to 15000 volts and are designated as SUPERSHEATH* cables by General Cable Corporation.

Supersheath Cables

These cables are suitable for installation in conduit and underground ducts, for direct earth burial and may also be used aerially. Primarily these cables are designed for use in moist or wet locations; therefore, the principal requirements for this type of cable are:

1. An insulation of the moisture resistant type having stable physical and electrical properties, as, when the cable is installed in a wet location, moisture will in time find its way through the cable coverings and come in contact with the insulated conductors. To meet this requirement, SUPERSHEATH* Cables are supplied with any one of the following outstanding types of moisture resistant insulations THERMAX-W*, AQUASEAL*, GENCORONE* OR BUTARONE*. The latter two insulations are of particular importance where resistance to ozone is an additional essential requirement.

2. A tough, durable outer protective covering with strong resistance to rot or deterioration when in contact with moisture, earth acids, alkalis, or other earth chemicals. To meet this requirement, a tough heavy duty neoprene jacket having a suitable wall thickness for the service involved is provided on all SUPERSHEATH* Cables.

Lead Sheath Cables

Where the need for a completely impervious sheath outweighs the advantages of the non-metallic sheathed type, Graybar can supply a complete line of lead sheathed cables suitable for conduit, underground duct or aerial use and direct earth burial if suitably protected by outer coverings.

The grade of insulation employed on lead sheathed cables is dependent upon the operating temperatures and voltages involved. All grades of insulation are available.

Braid Covered Cables

Braid covered cables are suitable for conduit, underground duct, or aerial use. All grades of insulation are available on braid covered cables.

Detailed specifications follow. Engineering data and packaging information are available upon application. Contact GRAYBAR for all your requirements.

*Trade Mark

For
**NATIONAL ELECTRIC CODE
CURRENT CARRYING CAPACITIES
ON THESE AND OTHER WIRES
AND CABLES**

*See Tables of Useful Information
Preceding Index*

**General Cable Thermax-W* (RH-RW)
Insulated Neoprene Jacketed Power Cable**

Type Designation: Supersheath*—Thermax-W* (Heat and moisture-resistant insulation).

Operating Voltages: 600 to 3000 volts.

Conductors: Conductors are solid or stranded lead alloy coated annealed copper or uncoated E.C. grade aluminum. Coated copper conductors conforming to A.S.T.M. Specifications B189 and B8, solid uncoated aluminum conductors to A.S.T.M. Specifications B230 or B262, stranded to A.S.T.M. Specifications B231.

Strand Shielding: All cables having stranded conductors and rated over 1000 volts are to have a semi-conducting strand shielding tape applied directly over the conductor.

Insulation: Thermax-W*, suitable for operation in wet or dry locations at a maximum conductor temperature of 75°C. This insulation compound meets the requirements of A.S.T.M. and I.P.C.E.A. for Performance and Heat Resistant rubber insulation and further complies with I.P.C.E.A. Appendix N requirements when tested by Methods GM and EM-60 for moisture absorption and electrical stability.

Insulation Thickness: Insulation wall thickness is based upon conductor size and voltage rating in accordance with I.P.C.E.A. Standard S-19-81.

Polarity Identification: For two or three conductor cables colored fibrous coverings over the individual insulated conductors may be used, two conductor black and white, three conductor black, white and red. Single conductor cable may be supplied with colored jacket.

Cabling: Two conductor shall be twin flat or round construction, three conductor cables shall be round construction.

Jacket: Heavy duty neoprene meeting the requirements of I.P.C.E.A. Standard S-19-81 Appendix K. On single conductor unshielded cable a heavy wall jacket is normally supplied for direct burial or a light wall jacket for conduit or underground duct use.

Physical Properties—

Original: Tensile strength p.s.i. 1800 min.
Tensile strength 200% Elongation p.s.i. 500 min.
Elongation at Rupture % 300 min.
Set in 2 in. gage length, inches 3/8 max.

Aged:

After 168 hrs. Air Oven 70° C.
Tensile strength p.s.i. 1600 min.
Elongation % 250 min.

After 96 hrs. Oxygen Bomb 70° C.
Tensile strength p.s.i. 1600 min.
Elongation % 250 min.

Oil Resistance

After 18 hrs. in Oil 250° F.
Tensile strength % of original 60 min.
Elongation % of original 60 min.

Ozone Resistance**

After 3 hrs. exposure in concentration of .015% at 25° C. No effect

Corona Resistance**

After 48 hr. at voltage stress of 100 volts/mil when bent in U shape around a mandrel as specified below. No effect

Conductor Size AWG or MCM	Mandrel Diameter
14-6	5 x O.D.
5-2	6 x O.D.
1/0-4/0	8 x O.D.
250 and over	15 x O.D.

*Trade Mark

**These tests apply to single conductor unshielded cables rated at 2 KV and higher.

Jacket Thickness: Jacket wall thickness is based upon I.P.C.E.A. Standard S-19-81.

**General Cable Aquaseal* (Low SIC)
Insulated Neoprene Jacketed Power Cable**

Type Designation: Supersheath*—Aquaseal* (Low SIC, heat and moisture-resistant insulation).

Operating Voltage: 600 to 3000 volts.

Conductors: Conductors are solid or stranded lead alloy coated annealed copper or uncoated E.C. grade aluminum. Coated copper conductors conforming to A.S.T.M. Spec. B189 and B8, solid uncoated aluminum conductors to A.S.T.M. Specifications B230 or B262, stranded to A.S.T.M. specification B231.

Strand Shielding: All cables having stranded conductors and rated over 1000 volts are to have a semi-conducting strand shielding tape applied directly over the conductor.

Insulation: Aquaseal* insulation compound is suitable for operation in wet or dry locations at a maximum conductor temperature of 75° C. Meets A.S.T.M. and I.P.C.E.A. requirements for Performance and Heat Resistant rubber insulation and complies with I.P.C.E.A. Appendix N requirements when tested by Methods GM and EM-60 for moisture absorption and electrical stability.

Insulation Thickness: Insulation wall thickness is based upon conductor size and voltage rating in accordance with I.P.C.E.A. Standard S-19-81.

Polarity Identification: For two or three conductor cables colored fibrous coverings over the individual insulated conductors may be used, two conductor black and white, three conductor black, white and red. Single conductor cable may be supplied with colored jacket.

Cabling: Two conductor shall be twin flat or round construction, three conductor cables shall be round construction.

Jacket: Heavy duty neoprene meeting the requirements of I.P.C.E.A. Standard S-19-81 Appendix K. On single conductor unshielded cable a heavy wall jacket is normally supplied for direct burial or a light wall jacket for conduit or underground duct use.

Physical Properties—

Original: Tensile strength p.s.i. 1800 min.
Tensile strength 200% elongation p.s.i. 500 min.
Elongation at Rupture % 300 min.
Set in 2 in. gage length, inches 3/8 max.

Aged:

After 168 hrs. Air Oven 70° C.
Tensile strength p.s.i. 1600 min.
Elongation % 250 min.

After 96 hrs. Oxygen Bomb 70° C.
Tensile strength, p.s.i. 1600 min.
Elongation % 250 min.

Oil Resistance

After 18 hr. in Oil 250° F.
Tensile strength % of original 60 min.
Elongation % of original 60 min.

Ozone Resistance**

After 3 hrs. exposure in a concentration of .015% at 25° C. No effect

Corona Resistance**

After 48 hrs. at voltage stress of 100 volts/mil when bent in U shape around a mandrel as specified below. No effect

Conductor Size AWG or MCM	Mandrel Diameter
14-6	5 x O.D.
5-2	6 x O.D.
1/0-4/0	8 x O.D.
250 and over	15 x O.D.

*Trade Mark

**These tests apply to single conductor unshielded cables rated at 2 KV and higher.

Jacket Thickness: Jacket wall thickness is based upon I.P.C.E.A. Standard S-19-81.

**General Cable Gencorone* (Oil Base)
Insulated Neoprene Jacketed Power Cable**

Type Designation: Supersheath*, Gencorone* (Oil Base, Ozone Resistant Insulation).

Operating Voltages: 600 to 15000 volts.

Conductors: Conductors are solid or stranded lead alloy coated annealed copper or uncoated E.C. grade aluminum. Coated copper conductors conforming to A.S.T.M. Specifications B189 and B8, solid uncoated aluminum conductors to A.S.T.M. Specifications B230 or B262, stranded to A.S.T.M. Specification B231.

Strand Shielding: All cables having stranded conductors and rated over 1000 volts are to have a semi-conducting strand shielding tape applied directly over the conductor.

Insulation: Gencorone*, suitable for operation in wet or dry locations at a maximum conductor temperature of 75° C. for voltages 8 KV and less than 70° C. for higher voltages. This insulation compound meets requirements of A.S.T.M. and I.P.C.E.A. for Ozone Resistant Grade Insulation and further complies with I.P.C.E.A. Appendix N requirements when tested by Method EM-60 for moisture absorption and electrical stability.

Insulation Thickness: Insulation wall thickness is based upon conductor size and voltage rating in accordance with I.P.C.E.A. Standard S-19-81.

Shielding: For all single and multiple conductor cables rated over 3 KV grounded or ungrounded neutral the conductor insulation shall be shielded by means of a tinned copper shielding tape applied in suitable manner and conforming to the requirements of I.P.C.E.A. Standard S-19-81, Part 5.

Note: Cables intended for aerial use bound by a metallic binder to a messenger will be of unshielded construction up to and including 5 KV grounded neutral.

Polarity Identification: Color coding for polarity identification may be accomplished by use of colored tapes or by means of colored neoprene jackets. Standard coding for two conductor cables is black and white; for three conductor cables black, white and red.

Cabling: Two conductor shall be twin flat or round construction, three conductor cables shall be round construction.

Jacket: Heavy duty neoprene meeting requirements of I.P.C.E.A. Standard S-19-81 Appendix K.

On single conductor unshielded cable a heavy wall jacket is normally supplied for direct earth burial or a light wall jacket for conduit or underground duct use.

Physical Properties—

Original
Tensile strength p.s.i. 1800 min.
Tensile strength 200% Elongation p.s.i. 500 min.
Elongation at Rupture % 300 min.
Set in 2 in. gage length, inches 3/8 max.

Aged
After 168 hrs. Air Oven 70° C.
Tensile strength p.s.i. 1600 min.
Elongation % 250 min.
After 96 hrs. Oxygen Bomb 70° C.
Tensile strength p.s.i. 1600 min.
Elongation % 250 min.

Oil Resistance
After 18 hrs. in Oil 250° F.
Tensile strength % of original 60 min.
Elongation % of original 60 min.

Ozone Resistance**
After 3 hrs. exposure in a concentration of .015% at 25° C. No effect

Corona Resistance**
After 48 hrs. at voltage stress of 100 volts/mil when bent in U shape around mandrel as specified below No effect

Cond. Size AWG or MCM	Mandrel Diameter	Cond. Size AWG or MCM	Mandrel Diameter
14-6	5 x O.D.	1/0-1/0	8 x O.D.
5-2	6 x O.D.	250 and over	15 x O.D.

*Trade Mark
**Tests apply to single conductor unshielded cables rated at 2 KV and higher.

**General Cable Butarone* (Butyl Rubber)
Insulated Neoprene Jacketed Power Cable**

Type Designation: Supersheath*—Butarone* (Butyl Rubber Ozone Resistant Insulation).

Operating Voltage: 600 to 15,000 volts.

Conductors: Conductors are solid or stranded lead alloy coated annealed copper or uncoated E.C. grade aluminum. Coated copper conductors conforming to A.S.T.M. Specifications B189 and B8, solid uncoated aluminum conductors to ASTM Specifications B230 or B262, stranded to A.S.T.M. Specification B231.

Strand Shielding: All cables having stranded conductors and rated over 1000 volts are to have a semi-conducting strand shielding tape applied directly over the conductor.

Insulation: Butarone* suitable for operation at maximum conductor temperature of 90° C up to 5000 volts and 85° C for higher voltages. Exceeds I.P.C.E.A. Standard S-19-81 Second Edition, Appendix O, and A.S.T.M. D-574 and D-1352 requirements for ozone resistant insulation.

Insulation Thickness: Insulation wall thickness is based upon conductor size and voltage rating in accordance with I.P.C.E.A. Standard S-19-81.

Shielding: For all single and multiple conductor cables rated over 3 KV grounded or ungrounded neutral the conductor insulation shall be shielded by means of a tinned copper shielding tape applied in suitable manner and conforming to requirements of I.P.C.E.A. Standard S-19-81, Part 5.

Note: Cables intended for aerial use bound by a metallic binder to a messenger will be of unshielded construction up to and including 5 KV grounded neutral.

Polarity Identification: Color coding for polarity identification may be accomplished by the use of colored tapes or by means of colored neoprene jackets. Standard coding for two conductor cables is black and white, for three conductor cables black, white and red.

Cabling: Two conductor shall be twin flat or round construction, three conductor cables shall be round construction.

Jacket: Heavy duty neoprene meeting the requirements of I.P.C.E.A. Standard S-19-81 Appendix K. On single conductor unshielded cable a heavy wall jacket is normally supplied for direct earth burial or a light wall jacket for conduit or underground duct use.

Physical Properties—

Original
Tensile strength p.s.i. 1800 min.
Tensile strength 200% Elongation p.s.i. 500 min.
Elongation at Rupture % 300 min.
Set in 2 in. gage length, inches 3/8 max.

Aged
After 168 hrs. Air Oven 70° C.
Tensile strength p.s.i. 1600 min.
Elongation % 250 min.
After 96 hr. Oxygen Bomb 70° C.
Tensile strength p.s.i. 1600 min.
Elongation % 250 min.

Oil Resistance
After 18 hrs. in Oil 250° F.
Tensile strength % of original 60 min.
Elongation % of original 60 min.

Ozone Resistance**
After 3 hrs. exposure in a concentration of .015% at 25° C. No effect

*Trade Mark

**This test applies to single conductor unshielded cables rated at 2 KV and higher.

Jacket Thickness: Jacket wall thickness is based upon I.P.C.E.A. Standard S-19-81.

General Cable Series Street Lighting Cables

Engineering data and other information on the following products will be supplied upon application.



Rubber Insulated, Lead Sheathed



Rubber Insulated, Neoprene Jacketed



Gencaseal* Insulated



Polyethylene Insulated

General Cable Traffic Control Fire Alarm and Signal Cable

Engineering data and other information on the following products will be supplied upon application.



Rubber Insulated, Lead Sheathed Multiple Conductor Cable for General Use in Underground Ducts, Or For Aerial Use with Messenger



Rubber Insulated, Braid Covered Multi-Conductor Cable for Installation in Buildings and Stations



Rubber Insulated, Neoprene Jacketed Multi-Conductor Cable for General Use in Underground Ducts, Aerial Use With Messenger or for Installation in Buildings or Stations



Gencaseal* Insulated—Gencaseal* Jacketed

General Cable Power Cables

600 Volts—Bus Drop



Bus drop cables designed to provide flexible and extensible connecting circuits between overhead open or enclosed fixed bus structures and electrically-driven machinery and equipment in factories, mills, machine shops, etc.

Experience shows that bus drop cable installations are dependable, time-saving and economical because:

1. Conduits are not required.
2. Standard fittings are used.
3. Installations and connections are simply and rapidly made.
4. Cost of completed installation is low.
5. Cable adjustments are made quickly and with little expense when equipment is moved.

Bus drop cable in actual practice is usually connected directly to the overhead bus at upper end, and to a manual starter mounted on or near the motor or machine to be served at other end. A loop of several turns ordinarily held in place near the bus end of circuit provides desired reserve length in the bus drop connection and makes it unnecessary to cut cable if machine is moved.

Rubber Insulated Neoprene Jacketed Type RMN

Conductors: Conductors and ground wires are stranded lead alloy coated, annealed copper meeting requirements of A.S.T.M. Specification B189 and B8.

Insulation: Code Type R rubber insulation with color coded Guardian fibrous coverings.

Cabling: The insulated conductors are cabled with three ground wires arranged one in each interstice. Suitable fillers are employed to provide a rounded core and a core tape applied overall.

Jacket: Tough oil and flame resistant neoprene jacket meeting all requirements of A.S.T.M. Specification D752 and I.P.C.E.A. Standard S-19-81 Appendix K.

Gencaseal* Insulated and Jacketed—Type TMG

Conductors: Conductors and ground wires are stranded uncoated annealed copper, meeting requirements of A.S.T.M. Specifications B3 and B8.

Insulation: Gencaseal* insulation meeting all requirements for UL Type T, color coded for polarity identification.

Cabling: The insulated conductors are cabled with three ground wires one in each interstice. Suitable fillers are employed to provide a rounded core and core tape applied overall.

Jacket: Oil and flame resistant Gencaseal* jacket meeting all requirements of I.P.C.E.A. Standard S-19-81 Appendix J. Note: Regular coding colors for bus drop cables are black, white, red and will be furnished unless otherwise specified.

Type RMN and Type TMG Bus Drop Cables With Three Insulated Conductors and Three Bare Ground Wires

Conductor Size AWG	No. Str.	Ground Wire		Insulation Thick., In.		Jacket Thick., In.		Net Wt. Lbs. Per M Ft.	
		Size AWG	No. Str.	Type RMN	Type TMG	Type RMN	Type TMG	Type RMN	Type TMG
14	7	18	7	2/64	2/64	3/64	3/64	124	144
12	7	18	7	2/64	2/64	3/64	3/64	158	181
10	7	18	7	3/64	2/64	4/64	3/64	257	197
8	7	16	7	4/64	3/64	4/64	4/64	384	331
6	7	14	7	4/64	4/64	5/64	4/64	566	507
4	7	12	7	4/64	4/64	5/64	5/64	783	751
2	7	10	7	4/64	4/64	5/64	5/64	1110	1080
1	19	9	7	5/64	5/64	6/64	6/64	1440	1100
1/0	19	8	7	5/64	5/64	6/64	6/64	1730	1690
2/0	19	7	7	5/64	5/64	6/64	6/64	2080	2050

The above data are approximate and subject to normal manufacturing tolerances.

*Trade Mark

Note: Additional information upon request, contact GRAYBAR.

General Cable Parkway Steel Armored Cable

**0-5000 Volts
2-Conductor**

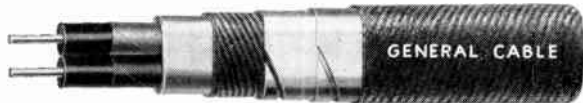

Twin Flat Construction, Double Flat Steel Tape Armor



Round Construction, Interlocking Steel Tape Armor

Construction data for cables of other sizes, types and voltage ratings will be supplied on request.

Rated Voltage, 0-600, Phase to Phase

(Grounded or Ungrounded)

Conductors (Solid or Concentric Stranded) Size A.W.G.	Type	Insulation Thickness In.	Lead Sheath Thickness In.	Twin Flat Const. Double Flat Steel Tape Armor Wt. Per M. Ft. Neoprene Jacket		Round Const. Interlocking Steel Tape Armor Wt. Per M. Ft. Neoprene Jacket	
				Copper Cond.	Alum. Cond.	Copper Cond.	Alum. Cond.
14	Sol.	3/64	3/64	358	311	453	436
12	Sol.	3/64	3/64	395	365	491	463
10	Sol.	3/64	4/64	488	446	607	577
8	Sol.	3/64	3/64	625	558	788	718
6	Sol.	4/64	4/64	721	610	931	821
6	7	3/64	3/64	780	672	974	864
4	7	4/64	5/64	1000	818	1200	1020
2	7	5/64	3/64	1460	1180	1590	1310
1	19	5/64	5/64	1750	1390	1910	1550
1/0	19	5/64	6/64	2040	1590	2370	1920
2/0	19	5/64	6/64	2390	1820	2690	2120
3/0	19	5/64	6/64	2640	1920	3110	2400
4/0	19	5/64	6/64	3040	2130	3590	2680

Rated Voltage, 2001-3000, Phase to Phase

(Grounded or Ungrounded)

Conductors (Solid or Concentric Stranded) Size A.W.G.	Type	Insulation Thickness In.	Lead Sheath Thickness In.	Copper Cond.	Alum. Cond.	Copper Cond.	Alum. Cond.
10	Sol.	7/64	5/64	785	745	982	942
8	Sol.	7/64	5/64	858	788	1070	1000
6	Sol.	8/64	5/64	1240	1130	1340	1230
6	7	8/64	5/64	1270	1160	1360	1250
4	7	8/64	5/64	1500	1320	1650	1470
2	7	8/64	6/64	1870	1580	2170	1890
1	19	8/64	6/64	2070	1710	2430	2070
1/0	19	8/64	6/64	2320	1860	2710	2260
2/0	19	8/64	6/64	2580	2010	3030	2460
3/0	19	8/64	6/64	2930	2210	3440	2730
4/0	19	8/64	7/64	3440	2530	4040	3130

Rated Voltage, 4001-5000, Phase to Phase

(Grounded or Ungrounded)

Conductors (Solid or Concentric Stranded) Size A.W.G.	Type	Insulation Thickness In.	Lead Sheath Thickness In.	Copper Cond.	Alum. Cond.	Copper Cond.	Alum. Cond.
8	Sol.	10/64	5/64	1280	1210	1370	1340
6	Sol.	10/64	5/64	1440	1320	1540	1430
6	7	10/64	6/64	1530	1420	1770	1660
4	7	10/64	6/64	1760	1580	1980	1800
2	7	10/64	6/64	2070	1790	2410	2130
1	19	10/64	6/64	2280	1920	2650	2290
1/0	19	10/64	6/64	2520	2070	2950	2500
2/0	19	10/64	7/64	2870	2300	3380	2810
3/0	19	10/64	7/64	3250	2530	3780	3070
4/0	19	10/64	7/64	3680	2740	4320	3410

The above data are approximate and subject to normal manufacturing tolerances.

Prices on application.

3-Conductor

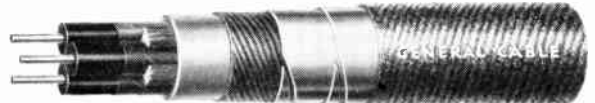

Double Flat Steel Tape Armor



Interlocking Steel Tape Armor

Construction data for cables of other sizes and types will be supplied on request.

Rated Voltage, 0-600, Phase to Phase

(Grounded or Ungrounded Neutral)

Conductors (Solid or Concentric Stranded) Size A.W.G. or MCM	Type	Insulation Thickness In.	Lead Sheath Thickness In.	Double Flat Steel Tape Armor Wt. Lbs. Per M. Ft. Neoprene Jacket		Interlocking Steel Tape Armor Wt. Lbs. Per M. Ft. Neoprene Jacket	
				Copper Cond.	Alum. Cond.	Copper Cond.	Alum. Cond.
14	Sol.	3/64	3/64	640	600	599	579
12	Sol.	3/64	3/64	700	660	651	611
10	Sol.	3/64	4/64	789	719	749	679
8	Sol.	4/64	4/64	990	890	960	860
6	Sol.	4/64	5/64	1210	1080	1200	1040
6	7	4/64	5/64	1310	1140	1280	1110
4	7	4/64	5/64	1870	1610	1560	1300
2	7	4/64	5/64	2300	1870	1980	1550
1	19	5/64	6/64	2770	2230	2570	2030
1/0	19	5/64	6/64	3160	2480	2960	2280
2/0	19	5/64	6/64	2590	2710	3350	2490
3/0	19	5/64	6/64	4140	3070	3870	2800
4/0	19	5/64	7/64	4920	3560	4660	3300
250	37	6/64	7/64	5630	4040	5260	3650
350	37	6/64	7/64	6940	4680	6620	4360
500	37	6/64	8/64	9030	5800	8680	5450

Rated Voltage, 2001-3000, Phase to Phase

(Grounded or Ungrounded Neutral)

Conductors (Solid or Concentric Stranded) Size A.W.G.	Type	Insulation Thickness In.	Lead Sheath Thickness In.	Copper Cond.	Alum. Cond.	Copper Cond.	Alum. Cond.
10	Sol.	7/64	5/64	1230	1170	1220	1160
8	Sol.	7/64	5/64	1370	1270	1370	1270
6	Sol.	8/64	5/64	1950	1780	1670	1500
6	7	8/64	5/64	2040	1870	1710	1540
4	7	8/64	6/64	2450	2180	2260	1990
2	7	8/64	6/64	2830	2100	2720	2290
1	19	8/64	6/64	3220	2680	3000	2460
1/0	19	8/64	6/64	3600	2920	3380	2700
2/0	19	8/64	7/64	4110	3250	3860	3000
3/0	19	8/64	7/64	4670	3600	4430	3360
4/0	19	8/64	7/64	5320	3960	4950	3590
250	37	9/64	7/64	6060	4450	5760	4050
350	37	9/64	8/64	7640	5380	7310	5050
500	37	9/64	8/64	9670	6450	9300	6080

Rated Voltage, 4001-5000, Phase to Phase

(Grounded or Ungrounded Neutral)

Conductors (Solid or Concentric Stranded) Size A.W.G.	Type	Insulation Thickness In.	Lead Sheath Thickness In.	Copper Cond.	Alum. Cond.	Copper Cond.	Alum. Cond.
8	Sol.	10/64	5/64	2020	1920	1800	1700
6	Sol.	10/64	5/64	2310	2140	2140	1970
6	7	10/64	6/64	2390	2220	2190	2020
4	7	10/64	6/64	2740	2470	2520	2250
2	7	10/64	6/64	3220	2790	2990	2560
1	19	10/64	6/64	3530	2990	3280	2710
1/0	19	10/64	7/64	3600	2920	3780	3100
2/0	19	10/64	7/64	4110	3250	4210	3350
3/0	19	10/64	7/64	4670	3600	4760	3690
4/0	19	10/64	7/64	5320	3960	5400	4040
250	37	11/64	8/64	6060	4450	6280	4670
350	37	11/64	8/64	7640	5380	7730	5470
500	37	11/64	8/64	9670	6450	9730	6510

The above data are approximate and subject to normal manufacturing tolerances.

Prices on application.

General Cable

Ornamental Pole and Bracket Cables



Rubber Insulated—Twin Type



Plastic Insulated—Belted Type

Construction data on these and other available types will be supplied upon request.

General Cable Staneon* Neon Sign and Oil Burner Ignition Cables

NEC Type GTO-15 Rated 15 KV Max.



Gencaseal* Jacketed Type

Size A.W.G.	Insulation Thickness Mils	Flame Retardant Polyethylene Jacket Thickness Mils	Overall Diam. In.	Net Wgt. Lbs. Per 1000 Ft.
14	50	50	.26	35
12	50	50	.28	45
10	50	50	.31	60
14	63	31	.26	39
12	63	31	.28	49
10	63	31	.31	64

Conductors have Class C stranding. The above data are approximate and subject to normal manufacturing tolerances.

General Cable

Wire Armored Semi-Portable Cables



**Dredge Cables
3000 to 15,000 Volts**

These cables are furnished in three conductor form in a complete range of voltages up to 15 KV.

Data on construction and other information will be supplied upon request. Contact GRAYBAR.

*Trade Mark

General Cable Drive-In Theater Cables

600 Volts



Designed for direct installation in the earth under outdoor motion picture theater lots to serve for sound distribution networks from the projection booth to speaker posts installed adjacent to the designated automobile parking station.

Two types of cable are available (1) Rubber insulated and neoprene jacket cable, (2) Gencaseal* uni-insulation and jacket cable.

Construction Data on Rubber Insulated and Neoprene Jacketed Type Cables

Conductors: Solid or A.S.T.M. Class B stranded coated annealed copper conductors, or when so specified may be A.S.T.M. Class K flexible bunch stranded.

Insulation: 3/64 in. wall of RW 755 performance grade moisture resistant compound.

Assembly: The two insulated conductors are laid parallel and bound with a suitable open braid or serve. Over the assembly so formed is applied a tough heavy duty neoprene jacket in a wall thickness of 3/64 in. and which complies with all the requirements of I.P.C.E.A. Standard S-19-81, Appendix K.

Circuit identification is obtained by means of two ridge tracers approximately 90 degrees apart on one edge (minor face) of the jacket.

Cond. Size A.W.G.	No. of Cond.	No. of Strand	Overall Dimen. In.	Net Wt. Lbs. Per M. Ft.	Std. Pkg. Ft. In. Reel	Ship. Wt. Package Lbs.
14	2	Solid	.28x .44	83	1000	91
14	2	7	.29x .46	89	1000	97
12	2	Solid	.30x .47	107	1000	115
12	2	7	.31x .50	112	1000	120

The above data are approximate and subject to normal manufacturing tolerances.

General Cable Varnished Cambric Insulated Wire and Cable



Two Conductor Round Braided



Three Conductor Varnished Cambric Lead Sheathed



Three Conductor Individually Braided Interlocking Tape Armor

Available upon request is information covering a complete line of varnished cambric insulated wires and cables for building wiring for general power purposes and for special applications where varnished cambric insulation is the most suitable type to employ.

All the requirements are in compliance with the specifications of the Insulated Power Cable Engineers Association or the National Electrical Code.

**General Cable *Super Service
Type SO Cord**

Extra Tough Neoprene Jacket—600 Volts



2-Conductor



3-Conductor



4-Conductor

All General Cable Super Service products feature an extra heavy duty flame resistant mold-cured neoprene jacket with cord reinforcement, trademarked SUPERTUF.

Designed specifically for use where the toughest cable obtainable is required. Exceeds in every specification the requirements of N.E.C. for hard-service cords.

Meets all requirements of Pennsylvania Dept. of Mines and U. S. Bureau of Mines for flame-resistance.

Flexible or extra-flexible rope or bunch-stranded conductors of annealed copper, tinned or fibre-separated from vulcanized synthetic rubber insulation.

Cabled together with jute or cotton fillers, covered with cotton or glass reinforcement and jacketed in neoprene sheath. Identification by colored insulation.

For uses requiring shielding, Type SO cord is supplied with a flexible metallic shielding braid. Also available with un-insulated or insulated grounding conductor.

Single Conductor

Size A.W.G.	Conductors Construction	Current Carrying Capacity Amps.	Insulation Thickness In.	Overall Diameter In.	Net Weight		Standard Packages		Ship. Weight Lbs.
					per 1000 Ft.	Total Feet	Type of Package		
18	41/#34	7	2/64	.180	52	250	Carton	14	
16	65/#34	10	2/64	.190	54	250	Carton	15	
14	41/#30	15	3/64	.245	58	250	Wrapped Coil	16	
12	65/#30	20	3/64	.265	64	250	Wrapped Coil	17	
10	104/#30	25	3/64	.285	74	250	Wrapped Coil	19	

2-Conductor

18	41/#34	7	2/64	.390	81	250	Carton	21
16	65/#34	10	2/64	.405	91	250	Carton	23
14	41/#30	15	3/64	.530	150	250	Carton	37
12	65/#30	20	3/64	.600	198	250	Carton	50
10	104/#30	25	3/64	.640	235	250	Carton	59

3-Conductor

18	41/#34	7	2/64	.405	95	250	Carton	24
16	65/#34	10	2/64	.430	111	250	Carton	29
14	41/#30	15	3/64	.560	181	250	Carton	46
12	65/#30	20	3/64	.635	244	250	Carton	62
10	104/#30	25	3/64	.690	304	250	Carton	77

4-Conductor

18	41/#34	5.6	2/64	.435	109	250	Carton	28
16	65/#34	8	2/64	.485	142	250	Carton	37
14	41/#30	12	3/64	.605	216	250	Wrapped Coil	55
12	65/#30	16	3/64	.665	277	250	Wrapped Coil	70
10	104/#30	20	3/64	.745	367	250	Wrapped Coil	92

*Trade Mark.

Current Carrying Capacities—N.E.C., 1956.

Color Coding: Insulation colors black; black and white; black, white and green; or black, white, green and red for single, two, three or four-conductor cords respectively.

Cords with more than four conductors not recognized by Underwriters' Laboratories for labeling.

The above data are approximate and subject to normal manufacturing tolerances.

Prices on application.

**General Cable *Super Service
Type SJO Cord**

Extra Tough Neoprene Jacket—300 Volts



Exceeds in every way the requirements of N.E.C. for junior hard-service cords. Oil and flame resistant.

Construction features identical to Type SO Cord.

Size A.W.G.	Conductors No.	Construction	Current Carrying Capacity Amps.	Insulation Thickness In.	Over-all Diameter In.	Net Weight per 1000 Ft. Lbs.	Ft. Per Spool	Standard Packages		Gross Wt. Lbs.
								Spools Per Ctn.		
18	2	41/#34	7	2/64	.305	50	250	4		23
16	2	65/#34	10	2/64	.330	61	250	4		25
18	3	41/#34	7	2/64	.335	66	250	4		27
16	3	65/#34	10	2/64	.360	83	250	4		32
18	4	41/#34	5.6	2/64	.360	79	250	4		31
16	4	65/#34	8	2/64	.390	98	250	4		36

Also available in 500 or 1,000 ft. lengths on reels.

*Trade Mark.

Current Carrying Capacities N.E.C., 1956.

Color Coding: Insulation colors black and white; or black, white and green; or black, white, green and red for two, three or four conductor cords respectively.

Cords with more than four conductors not recognized by Underwriters' Laboratories for labeling.

The above data are approximate and subject to normal manufacturing tolerances.

General Cable *Super Service Cable

Single Conductor 600 Volts



For general portable power supply service where a heavy duty flexible cable is required. Particularly adapted to use in gathering reel locomotives in mines.

A.W.G. or M.C.M.	Current Carrying Capacity Amperes	Insulation Thick. In.	Jacket Thick. In.	O.A. Diam. In.	Net Wt. Lbs. Per M. Ft.	Gross Wt. Lbs. Per M. Ft.
8	45	0.063	0.44	147	206
6	60	0.063	0.51	210	269
4	85	0.063	0.57	281	346
3	95	0.063	0.63	354	450
2	110	0.063	0.66	410	506
1	130	0.078	0.74	519	615
1/0	150	0.078	0.77	600	696
2/0	175	0.078	0.82	712	826
3/0	205	0.078	0.87	813	957
4/0	235	0.078	0.93	1020	1134
250	275	0.094	0.094	1.03	1190	1373
300	305	0.094	0.094	1.09	1370	1553
350	345	0.094	0.094	1.15	1570	1753
400	375	0.094	0.094	1.20	1750	1954
450	400	0.094	0.094	1.26	1940	2144
500	425	0.094	0.094	1.31	2130	2334

Conductors can be furnished with flexible or extra-flexible stranding.

The above data are approximate and subject to normal manufacturing tolerances.

*Trade Mark.

prices on application.

General Cable *Super Service Welding Cable

All General Cable Super Service products feature an extra heavy duty flame resistant mold-cured neoprene jacket with cord reinforcement, trademarked SUPERTUF.



Extremely flexible, light weight, tough and durable; for damp or dry locations. Construction data and other information covering a complete line of welding cables and welder power supply cables are available upon request.

Size AWG or MCM	Conductors		Min. O.A. Diam. In.	Approx. Net Wt. Lbs. Per M. Ft.	Approx. Shipping Wt. Lbs.		Current(1) Carrying Cap. Amps.	Voltage Drop Per 100 Ft. at 60° C. Volts
	Nomina No. of #34 AWG Wires				Coils	Reels		
8	420	0.39	1.21	31	160	50	3.71	
6	665	0.40	1.18	38	192	75	3.58	
4	1064	0.50	2.31	59	290	100	3.18	
3	1330	0.50	2.57	65	316	150	3.70	
2	1672	0.56	3.22	82	387	200	3.92	
1	2109	0.63	4.06	103	502	250	3.88	
1/0	2660	0.68	4.91	124	587	300	3.72	
2/0	3325	0.75	6.03	152	699	375	3.68	
3/0	4256	0.82	7.51	189	817	450	3.51	
4/0	5320	0.90	9.19	231	1033	550	3.41	
250	6384	0.95	10.70	269	1184	600	3.12	
300	7581	1.03	12.60	316	1374	650	2.80	
350	8820	1.08	14.30	...	1613	700	2.47	
400	10108	1.15	16.30	...	1813	775	2.40	
450	11438	1.20	18.10	...	2014	825	2.28	
500	12635	1.25	19.90	...	2191	900	2.24	
600	15162	1.37	23.80	...	2584	1000	2.09	
700	17689	1.46	27.30	...	3107	1100	1.99	
750	18886	1.49	28.90	...	3267	1150	1.95	
800	20216	1.53	30.70	...	3447	1200	1.92	
900	22743	1.61	34.30	...	3807	1300	1.87	
1000	25270	1.68	37.80	...	4265	1400	1.82	

The above data are approximate and subject to normal manufacturing tolerances.

The sizes of cable recommended by the Machine Group of the NEMA Electric Welding Section for standard hand welding equipment based on lengths up to 90 ft. that is, 45 ft. of welding cable and 45 ft. of return cable, are as follows:

100 Amp. Welder	4 AWG	400 Amp. Welder	2/0 AWG
150 Amp. Welder	3 AWG	500 Amp. Welder	2/0 AWG
200 Amp. Welder	2 AWG	600 Amp. Welder	3/0 AWG
300 Amp. Welder	1/0 AWG		

(1) The above values for current carrying capacity are based on a copper temperature of 60° C. and an ambient temperature of 40° C. and yield load factors of from approximately 32 per cent of the No. 2 AWG cable to approximately 23 per cent for the No. 3/0 AWG cable and higher for the smaller sizes. The IPCEA Standards cover only sizes 8-300 MCM, inclusive. The sizes of cables generally used range from No. 2 AWG to No. 3/10 AWG. In actual service the load factor may be much higher than indicated without overheating the cable as the ambient temperature will generally be substantially lower than 40° C.

Note: Size 8 to 300 MCM available in 250 ft. coils and 1000 ft. reels.

*Trade mark.

General Cable *Super Service Mining Machine Cable



Used principally in mines on cutting machines, gathering locomotives, shuttle cars, and other mine equipment, and are designed to have a maximum flexibility for this type of cable. Used also for general portable power cable use where size and weight are important considerations.

Two Conductor—Concentric Type 600 and 1,000 Volts

Size AWG	Current Carrying Cap. Amp.	Inner Insul. Thick.	Inner Insul. Thick.	Outer Insul. Thick.	Outer Insul. Thick.	Jacket Thick.	O.A. Diam.	O.A. Diam.
		In. 600 Volt	In. 1000 Volt	In. 600 Volt	In. 1000 Volt	In. 1000 Volt	In. 600 Volt	In. 1000 Volt
8	10	0.078	0.094	0.063	0.078	0.109	0.65	0.83
6	50	0.078	0.094	0.063	0.078	0.109	0.77	0.87
4	65	0.078	0.094	0.063	0.078	0.109	0.84	0.94
3	75	0.078	0.094	0.063	0.078	0.109	0.89	0.99
2	90	0.078	0.094	0.063	0.078	0.109	0.91	1.03
1	100	0.094	0.109	0.078	0.094	0.109	1.05	1.15
1/0	120	0.094	0.109	0.078	0.094	0.109	1.10	1.21
2/0	135	0.094	0.109	0.078	0.094	0.109	1.18	1.28
3/0	160	0.094	0.109	0.078	0.094	0.109	1.21	1.31
4/0	180	0.094	0.109	0.078	0.094	0.109	1.33	1.42

2 Conductor Parallel Duplex Type W and Type G



Type W



Type G

Type W—600 and 1,000 Volts Without Grounding Conductor

Size AWG	Current Carrying Cap. Amp.	Insulation Thick. In. 600 Volt	Insulation Thick. In. 1000 Volt	Jacket Thick. In. 1000 Volt	Nominal Diameters			
					O.A. Minor Axis In. 600 Volt	O.A. Minor Axis In. 1000 Volt	O.A. Major Axis In. 600 Volt	O.A. Major Axis In. 1000 Volt
8	10	0.063	0.063	0.125	0.51	0.60	0.84	0.92
6	50	0.063	0.078	0.125	0.56	0.68	0.93	1.08
4	70	0.063	0.078	0.141	0.61	0.77	1.05	1.22
3	80	0.063	0.078	0.141	0.68	0.80	1.14	1.29
2	95	0.063	0.078	0.141	0.73	0.84	1.24	1.36
1	110	0.078	0.094	0.156	0.81	0.94	1.40	1.54
1/0	130	0.078	0.094	0.156	0.93	0.99	1.51	1.64
2/0	150	0.078	0.094	0.156	0.99	1.05	1.63	1.75
3/0	175	0.078	0.094	0.172	1.03	1.14	1.77	1.91
4/0	200	0.078	0.094	0.172	1.10	1.21	1.89	2.04

Type G—600 Volts With Grounding Conductor

Size AWG	Current Carrying Capacity Amperes	Insulation Thickness In.	Nom. Diameters		Net Wt. Lbs. Per 1000 Ft.
			O.A. Minor Axis In.	O.A. Major Axis In.	
6	50	0.063	0.56	1.02	180
4	70	0.063	0.61	1.15	635
3	80	0.063	0.68	1.26	790
2	95	0.063	0.73	1.35	940
1	110	0.078	0.81	1.55	1230
1/0	130	0.078	0.93	1.67	1440
2/0	150	0.078	0.99	1.85	1820
3/0	175	0.078	1.03	2.00	2200
4/0	200	0.078	1.10	2.10	2475

The above data are approximate and subject to normal manufacturing tolerances.

General Cable *Super Service Cable

Two conductor round, Type W and Type G, 600 and 1000 volts, used in mines for cutting machines, loaders, cranes and conveyor mining systems; recommended for general power supply purposes and various single phase portable machinery.

1000 volts, used for general power supply purposes: heavy portable tools and appliances, large portable lights, flexible jumpers and portable construction equipment; also in mines for cutting machines, drilling units, loaders and other mining machinery. Flexible, resilient and non-kinking.

Multi-conductor round type, Type W and Type G, 600 and

Types W and G—600 and 1000 Volts Two Conductor Round

Size AWG Or MCM	Current Carrying Cap. Amp.	Insulation Thick. In. 600 Volt	Insulation Thick. In. 1000 Volt	Jacket Thick. In. 600 Volt	Jacket Thick. In. 1000 Volt	O.A. Diam. In. 600 Volt	O.A. Diam. In. 1000 Volt	Std. Pkg. Ft. In 600 And 1000 Volt	Type W				Type G			
									Without Grounding Conductors				With Grounding Conductors			
									Net Wt. Lbs. Per 600 V.	Net Wt. Lbs. Per 1000 V.	Gr. Wt. Lbs. Per 600 V.	Gr. Wt. Lbs. Per 1000 V.	Net Wt. Lbs. Per 600 V.	Net Wt. Lbs. Per 1000 V.	Gr. Wt. Lbs. Per 600 V.	Gr. Wt. Lbs. Per 1000 V.
8	40	0.063	0.063	0.141	0.81	0.92	1000	461	580	557	694	501	620	597	734
6	50	0.063	0.078	0.141	0.93	1.08	1000	624	825	738	1008	674	875	788	1058
4	70	0.063	0.078	0.156	1.08	1.23	1000	870	1090	1053	1294	950	1160	1133	1364
3	80	0.063	0.078	0.156	1.17	1.30	1000	1030	1230	1234	1434	1140	1340	1344	1544
2	95	0.063	0.078	0.156	1.27	1.37	1000	1260	1360	1464	1737	1380	1490	1584	1867
1	110	0.078	0.094	0.172	1.44	1.55	1000	1520	1780	1897	2157	1720	1940	2097	2317
1/0	130	0.078	0.094	0.172	1.52	1.64	1000	1820	2000	2197	2485	2020	2200	2397	2685
2/0	150	0.078	0.094	0.187	1.65	1.78	1000	2190	2390	2675	2875	2440	2640	2925	3125
3/0	175	0.078	0.094	0.187	1.77	1.91	1000	2600	2800	3085	3285	2920	3120	3405	3605
4/0	200	0.078	0.094	0.203	1.92	2.07	500	2980	3400	3465	3852	3340	3800	3825	4252
250	220	0.094	0.109	0.203	0.203	2.16	2.22	500	3950	4010	4402	4462	4450	4510	4902	4962
300	240	0.094	0.109	0.219	0.219	2.32	2.38	500	4570	4680	5055	5165	5070	5180	5552	5665
350	260	0.094	0.109	0.219	0.219	2.43	2.49	500	5000	5140	5485	5625	5620	5760	6105	6245
400	280	0.094	0.109	0.234	0.234	2.57	2.63	500	5630	5840	6115	6340	6160	6670	6945	7170
450	300	0.094	0.109	0.234	0.234	2.67	2.73	500	6086	6360	6838	7112	6920	7190	7672	7942
500	320	0.094	0.109	0.234	0.250	2.76	2.85	500	6700	7010	7452	7762	7740	8050	8492	8802

Types W and G—600 Volts and 1000 Volts Three Conductor

Size AWG Or MCM	Current Carrying Cap. Amp.	Insulation Thick. In. 600 Volt	Insulation Thick. In. 1000 Volt	Jacket Thick. In. 1000 Volt	O.A. Diam. In. 600 Volt	O.A. Diam. In. 1000 Volt	Std. Pkg. Ft. In 600 And 1000 Volt	Type W				Type G			
								Without Grounding Conductors				With Grounding Conductors			
								Net Wt. Lbs. Per 600 V.	Net Wt. Lbs. Per 1000 V.	Gr. Wt. Lbs. Per 600 V.	Gr. Wt. Lbs. Per 1000 V.	Net Wt. Lbs. Per 600 V.	Net Wt. Lbs. Per 1000 V.	Gr. Wt. Lbs. Per 600 V.	Gr. Wt. Lbs. Per 1000 V.
8	35	0.063	0.063	0.141	0.91	0.97	1000	581	679	695	793	616	714	730	828
6	50	0.063	0.078	0.141	1.01	1.15	1000	736	995	850	1178	781	1040	895	1223
4	65	0.063	0.078	0.156	1.17	1.32	1000	1080	1340	1263	1544	1150	1420	1333	1624
3	75	0.063	0.078	0.156	1.24	1.38	1000	1240	1470	1444	1847	1340	1570	1544	1947
2	90	0.063	0.078	0.172	1.34	1.49	1000	1500	1760	1704	2137	1620	1880	1824	2257
1	100	0.078	0.094	0.172	1.51	1.64	1000	1900	2180	2277	2665	2050	2340	2427	2825
1/0	120	0.078	0.094	0.187	1.65	1.78	1000	2310	2620	2795	3105	2500	2810	2985	3295
2/0	135	0.078	0.094	0.187	1.75	1.89	1000	2670	3000	3155	3485	2910	3240	3395	3725
3/0	155	0.078	0.094	0.203	1.89	2.06	1000	3330	3600	3815	4057	3630	3900	4082	4352
4/0	180	0.078	0.094	0.203	2.04	2.20	500	3950	4110	4327	4562	4330	4500	4707	4952
250	200	0.094	0.109	0.219	2.39	2.39	500	5310	4950	5795	5435	5780	5420	6265	5905
300	220	0.094	0.109	0.234	2.56	2.56	500	6150	5820	6650	6305	6740	6420	7240	6905
350	235	0.094	0.109	0.234	2.68	2.68	500	6670	6450	7422	7202	7260	7040	8012	7792
400	250	0.094	0.109	0.250	2.82	2.82	500	7370	7360	8122	8112	8120	8110	8872	8862

Types W and G—600 and 1000 Volts Four Conductor

8	30	0.063	0.063	0.141	0.99	1.06	1000	707	820	821	1003	747	855	862	1038
6	40	0.063	0.078	0.156	1.10	1.29	1000	1050	1240	1233	1447	1100	1290	1283	1497
4	55	0.063	0.078	0.156	1.27	1.42	1000	1290	1520	1494	1897	1370	1600	1574	1977
3	65	0.063	0.078	0.172	1.34	1.53	1000	1520	1780	1724	2157	1620	1880	1824	2257
2	75	0.063	0.078	0.172	1.48	1.62	1000	1890	2010	2267	2387	2020	2140	2397	2517
1	85	0.078	0.094	0.187	1.68	1.83	1000	2370	2700	2855	3185	2530	2860	3015	3345
1/0	100	0.078	0.094	0.203	1.79	2.01	1000	2860	3300	3345	3677	3060	3510	3545	3887
2/0	115	0.078	0.094	0.203	1.93	2.10	1000	3420	3600	3905	4052	3680	3860	4165	4312
3/0	130	0.078	0.094	0.219	2.07	2.29	500	4050	4360	4502	4845	4300	4680	4752	5165
4/0	150	0.078	0.094	0.219	2.26	2.45	500	4980	5080	5465	5565	5380	5480	5865	5965
250	160	0.094	0.109	0.234	2.66	2.66	500	6600	6220	7352	6972	7110	6730	7862	7482
300	175	0.094	0.109	0.250	2.84	2.84	500	7550	7340	8302	8092	8060	7850	8812	8602

Type W—600 Volts Five and Six Conductor

Size AWG	Current Carrying Capacity Amperes 5 Cond.	Current Carrying Capacity Amperes 6 Cond.	Insulation Thick. In.	Cable O.A. Diam. 5 Cond.	Cable O.A. Diam. 6 Cond.	Net Wt. Lbs. Per M. Ft. 5 Cond.	Net Wt. Lbs. Per M. Ft. 6 Cond.	Shipping Weights			
								500 Ft. Reel Lbs. 5 Cond.	500 Ft. Reel Lbs. 6 Cond.	1000 Ft. Reel Lbs. 5 Cond.	1000 Ft. Reel Lbs. 6 Cond.
8	25	20	0.063	1.07	1.18	854	1030	1037	1234
6	35	30	0.063	1.21	1.31	1120	1290	1324	1494
4	45	35	0.063	1.40	1.52	1540	1780	1917	2157
3	55	45	0.063	1.48	1.61	1740	2040	2117	2417
2	65	55	0.063	1.61	1.75	2110	2440	2487	2925
1	75	65	0.078	1.88	2.05	3010	3590	2170	3495
1/0	85	70	0.078	1.96	2.13	3350	3890	2050	2400
2/0	95	75	0.078	2.13	2.32	4127	4740	2520	2860
3/0	110	85	0.078	2.26	2.49	4720	5750	2850	3360
4/0	125	100	0.078	2.46	2.71	6000	7230	3490	4370

The above data are approximate and subject to normal manufacturing tolerances.

*Trade Mark.

General Cable *Super Service High Voltage Cable

All General Cable SUPER SERVICE products feature an extra heavy duty flame resistant mold-cured neoprene jacket with cord reinforcement, trademarked SUPERTUF.

Service high voltage portable power cables — Supertuf jacketed designed for wide variety of purposes. In general their use covers transmission of power from the supply to the mobile electrical equipment — shovels, dredges, cranes and draglines. Used also as a temporary line during construction or repair work in generating stations and substations. Can be used to advantage in power distribution work to by-pass a faulty section of buried cable while repairs are being made. Super Service portable power cables are selected where arduous service and safety must combine for uninterrupted production and long cable life. Available for operating voltages up to and including 15,000 volts, in single and multi-conductor form, and in a wide range of conductor sizes.

There are three general types of Super Service high voltage cables:

Type W Cables — Without grounding conductors.

Type G Cables — With grounding conductors.

Type SH (Shielded) — With or without grounding conductors.

Super Service Type W — Supertuf: Jacketed, portable cables consist of rubber insulated flexible stranded conductors with neither shielding nor ground wires. Type W not recommended for service exceeding 3000 volts, although it can be furnished for voltage ratings up to 5000 volts. Where maximum safety is desired on voltages above 2000 volts, Type SH-D is recommended.

Super Service Type G Supertuf: Jacketed, portable cables are of same construction as Type W except they have flexible grounding conductors in each filler space. While cables operating above 2000 volts should preferably be shielded, the grounding conductors in Type G cables in effect provide some shielding and afford a certain degree of protection to operators when the grounding conductors are grounded at both ends of the cable length. In many instances Type G cables have proved satisfactory at 5000 volts, which is the maximum recommended rating. Where maximum safety is desired on voltages above 2000 volts, Type SH-D is recommended.

Super Service Type SH Shielded — Supertuf: Jacketed, portable cables are similar to Types W and G except for the addition of shielding braids and are recommended for operating voltages above 2000 volts to 15,000 volts. These cables are classified in four groups depending on the way in which the shielding is applied and whether or not grounding conductors are included.

It is considered good practice to employ grounding conductors in all shielded high-voltage portable cables. These grounding conductors are normally uninsulated to permit electrical contact with the shielding braids.

For operating voltages up to 6000 volts, a shield over the assembled conductors with the use of grounding conductors (Type SH-C) is sometimes used. For voltages from 7000 to 15,000 volts, shielding over the individual conductors with the use of grounding conductors (Type SH-D) is strongly recommended and is generally used.

*Trade Mark.



**Three Conductor 2,000 to 5,000 Volts
Type W Without Grounding Conductors**



**Three Conductor 2,000 to 5,000 Volts
Type G With Grounding Conductors**



**Type SH-A Shielding on Each Conductor
Without Grounding Conductors**



**Type SH-B Shielding Over Cabled Conductors
Without Grounding Conductors**



**Type SH-C Shielding Over Cabled Conductors
With Grounding Conductors**



**Type SH-D Shielding on Each Conductor
With Grounding Conductors**

3000 Volts Three Conductor—Types W and G

Size AWG Or MCM	Current Carrying Cap. Amps.	Insula- tion Thick. In.	Jac- ket Thick. In.	C.A. Diam. In.	Std. Pkg. Ft.	Net Wt. Lbs. Per 1000 Ft.	
						Without Ground. Type W	With Ground. Type G
8	35	0.109	0.156	1.21	1000	818	853
6	50	0.125	0.156	1.39	1000	1351	1400
4	65	0.125	0.172	1.51	1000	1710	1780
3	75	0.125	0.172	1.61	1000	1880	1980
2	90	0.125	0.187	1.72	1000	2230	2350
1	100	0.125	0.187	1.81	1000	2500	2660
1/0	120	0.125	0.187	1.91	1000	2870	3160
2/0	135	0.125	0.203	2.05	500	3300	3540
3/0	155	0.125	0.203	2.18	500	3760	4060
4/0	180	0.125	0.219	2.37	500	4530	4915
250	200	0.141	0.234	2.56	500	5480	5955
300	220	0.141	0.234	2.69	500	6130	6720
350	235	0.141	0.250	2.85	500	7070	7660

Where maximum safety is desired for circuit voltages in excess of 2000 volts, the recommended type is SH-D with grounding conductors. The above data are approximate and subject to normal manufacturing tolerances.

**General Cable
*Super Service High Voltage Cable**

5000 Volts Three Conductor—Types W and G

Size A.W.G. Or MCM	Cur. Carrying Cap. Amp.	Insulation Thick. In.	Jacket Thick. In.	D.A. Diam. In.	Std. Pkg. Ft.	Net Wt. Lbs. Per 1000 Ft.	
						Without Ground. Type W	With Ground. Type G
†6	50	0.156	0.172	1.55	1000	1560	1605
†4	65	0.156	0.172	1.67	1000	1870	1945
†3	75	0.156	0.187	1.78	1000	2200	2300
†2	90	0.156	0.187	1.86	1000	2430	2550
†1	100	0.156	0.203	1.97	500	2820	2950
†1/0	120	0.156	0.203	2.08	500	3250	3410
†2/0	135	0.156	0.203	2.19	500	3610	3860
†3/0	155	0.156	0.219	2.36	500	4230	4510
†4/0	180	0.156	0.219	2.50	500	4900	5280
†250	200	0.172	0.234	2.69	500	5850	6320
†300	220	0.172	0.250	2.86	500	6840	7410

****3000 Volts Grounded Neutral Three Conductor**

Size AWG	Cur. Carrying Cap. Amp.	Jacket Thick. In.	D.A. Diam. In.	Net Wt. Per M Feet			
				Type SH-A	Type SH-B	Type SH-C	Type SH-D
Insulation Thickness 0.125 In.							
†8	35	0.156	1.39	1210	1210	1230	1230
Insulation Thickness 0.141 In.							
†6	50	0.172	1.59	1580	1520	1620	1620
†4	65	0.187	1.74	2060	2060	2120	2120
†3	75	0.187	1.82	2280	2280	2370	2370
†2	90	0.187	1.89	2590	2590	2700	2700
†1	100	0.203	2.01	2920	2920	3060	3060
†1/0	120	0.203	2.11	3330	3330	3500	3500
†2/0	135	0.203	2.23	3810	3810	4050	4050
†3/0	155	0.219	2.40	4330	4330	4640	4640
†4/0	180	0.234	2.57	4920	4920	5280	5280

****5000 Volts Grounded Neutral Three Conductor**

Insulation Thickness 0.172 In.							
†6	50	0.187	1.76	1800	1800	1840	1840
†4	65	0.187	1.88	2360	2360	2430	2430
†3	75	0.187	1.95	2600	2600	2690	2690
†2	90	0.203	2.06	2940	2940	3050	3050
†1	100	0.203	2.15	3290	3290	3410	3410
†1/0	120	0.219	2.28	3730	3730	3900	3900
†2/0	135	0.219	2.39	4240	4240	4470	4470
†3/0	155	0.234	2.56	4810	4810	5110	5110
†4/0	180	0.234	2.71	5480	5480	5830	5830

****8000 Volts Grounded Neutral Three Conductor**

Insulation Thickness 0.219 In.							
†4	65	0.203	2.11	2510	2510	2590	2590
†3	75	0.203	2.18	2750	2750	2850	2850
†2	90	0.219	2.30	3070	3070	3190	3190
†1	100	0.219	2.38	3410	3410	3560	3560
†1/0	120	0.219	2.48	3850	3850	4130	4130
†2/0	135	0.234	2.63	4380	4380	4630	4630
†3/0	155	0.234	2.77	4960	4960	4950	4950

****15,000 Volts Grounded Neutral Three Conductor**

Size AWG	Current Carrying Cap. Amp.	Insulation Thick. In.	Jacket Thick. In.	D.A. Diam. In.	Std. Pkg. Ft.	Net Weight Per 1000 Ft.	
						Type SH-A	Type SH-D
4	65	0.328	0.234	2.64	500	3700	3780
3	75	0.328	0.234	2.72	500	4010	4100
2	90	0.328	0.250	2.83	500	4370	4490
1	100	0.328	0.250	2.92	500	4760	4900

*Trade Mark.

**Recommendations and constructional data for ungrounded neutral ratings will be furnished upon request.

Where maximum safety is desired for circuit voltages in excess of 2000 volts, the recommended type is SH-D with grounding conductors.

The above data are approximate and subject to normal manufacturing tolerances.

†Standard package 1,000 ft. ‡Standard package 500 ft.

General Cable Flat-Twin TV and FM Transmission Lines

Polyethylene Insulated—300 Ohms



Low-loss, high frequency cable for service as a transmission line (antenna lead-in) between antenna and television or FM receivers. Useful for forming folded dipole antennas in attics, apartments, or wholly within receiver cabinets.

May be used for intra-receiver high frequency connections. Velocity of wave propagation, approximately 84%.

Supplied with dark brown insulation unless otherwise specified. Also available in natural translucent or frosty white polyethylene.

Size A.W.G.	Conductors		Diam. In.	Insulation Thick. On Edge In.	Major Axis	Minor Axis	Separation of Conductor Centers
	Construction						
22	7 x	.010	0.030	0.008	0.302	0.052	0.250
20	7 x	.0126	0.038	0.010	0.353	0.062	0.293

Size A.W.G.	Net Wt. Per 1000 Ft. Lbs.	Actual Characteristic Impedance Ohms	Capacitance MMF/Ft.	Attenuation Ob/100 Ft.	
				100 Mc	200 Mc
22	10.0	285	4.3	1.08	1.57
20	14.5	285	4.3	0.83	1.22

Standard packages, 1000 ft. on spools; 5000 ft. on reels.

Longer lengths available on special order.

Also supplied with flame-resistant polyethylene when specified.

The above data are approximate and subject to normal manufacturing tolerances.

General Cable Standard Coaxial Cable



Polyethylene insulated conductor surrounded by braided return conductor which is provided with an overall covering. Widely used for carrying r-f power, up to 5000 watts at 100 Mc., between a transmitter and receiver and an antenna. For i-f and video transmission and applications where radiation or pickup must be reduced.

Engineering data and all other information available upon request. Contact GRAYBAR.

**General Cable Hinge Cable
Type TA—600 Volts**



Single Conductor—Extra Flexible Stranded

Recommended for swinging panel jumpers and connections and other applications where extra flexible construction is required.

Insulation: Wall of Gencaseal compound and a wall of felted asbestos saturated with flame heat and moisture-resisting compound; covered with a cotton braid finished with a flame and heat-resisting compound. Not recommended for use in temperatures lower than -10°C.

Size A.W.G.	Conductor Construction	Diam. In.	Insulation Thickness		Cotton Braid Thickness Mils	Overall Diam. In.	Net Weight per 1000 Ft. Lbs.	Std. Coil Feet
			Gencaseal Mils	Asbestos Mils				
*18	16x#30	.045	20	20	16	.165	17	1000
*16	26x#30	.059	20	20	16	.180	22	1000
14	41x#30	.075	20	20	16	.195	29	500
12	65x#30	.095	20	20	16	.215	39	500
10	104x#30	.120	20	20	16	.240	58	500
8	168x#30	.157	20	20	17	.280	84	500

*Not listed in 1956 National Electrical Code.

The above data are approximate and subject to normal manufacturing tolerances.

Prices on application.

General Cable Power and Rheostat Wire
Type AIA—Rated 600 Volts, 125°C
Single Conductor—Solid or Stranded

Recommended for higher voltage rated installations where moisture resistance is required. Similar to Type AA except for lowered temperature rating due to use of moisture resistant impregnant.

Conductors, untinned annealed copper; insulated with wall of felted asbestos saturated with flame, heat and moisture-resistant compound.

Saturated asbestos braid outer covering: Standard color, black.



All-Asbestos Power Cable

Size A.W.G. or MCM	Construction	Diameter In.	Insulation Thickness Mils	Braid Thickness Mils	Overall Diameter In.	Net Weight per 1000 Ft. Lbs.	Std. Pkg. Ft.
*18	7 x .0152"	.045	30	40	.185	24	●1000
*16	7 x .0192"	.058	30	40	.200	30	●1000
14	7 x .0242"	.073	30	40	.215	36	●1000
12	7 x .0305"	.092	40	10	.255	52	●1000
10	7 x .0385"	.116	40	40	.280	70	●500
8	7 x .0486"	.146	40	40	.310	94	●500
6	7 x .0612"	.184	60	45	.395	150	■1000
5	7 x .0688"	.206	60	45	.420	170	■1000
4	7 x .0772"	.232	60	45	.445	210	■1000
3	7 x .0867"	.260	60	45	.470	240	■1000
2	7 x .0974"	.292	60	45	.505	300	■1000
1	19 x .0664"	.332	75	45	.575	380	■1000
1/0	19 x .0745"	.373	75	45	.615	460	■1000
2/0	19 x .0837"	.419	75	45	.660	560	■1000
3/0	19 x .0940"	.470	75	45	.710	680	■1000
4/0	19 x .1055"	.528	75	45	.770	830	■1000
250	37 x .0822"	.575	90	45	.845	990	■500
300	37 x .0900"	.630	90	45	.900	1160	■500
350	37 x .0973"	.681	90	45	.955	1330	■500
400	37 x .1040"	.728	90	45	1.000	1580	■500
450	37 x .1103"	.772	90	45	1.045	1680	■500
500	37 x .1162"	.813	90	45	1.085	1850	■500
550	61 x .0950"	.855	105	45	1.155	2020	■500
600	61 x .0992"	.893	105	45	1.195	2210	■500
650	61 x .1032"	.929	105	45	1.230	2400	■500
700	61 x .1071"	.964	105	45	1.265	2560	■500
750	61 x .1109"	.998	105	45	1.300	2720	■500
800	61 x .1145"	1.031	105	45	1.335	2890	■500
900	61 x .1215"	1.094	105	45	1.395	3230	■500
1000	61 x .1280"	1.152	105	45	1.455	3560	■500



All-Asbestos Rheostat Wire

*18	Solid	.040	30	40	.180	24	●1000
*16	Solid	.051	30	40	.195	28	●1000
14	Solid	.064	30	40	.205	35	●1000
12	Solid	.081	30	10	.225	45	●1000
10	Solid	.102	30	40	.245	60	●1000
8	Solid	.128	30	40	.270	84	●500
6	Solid	.162	40	40	.325	125	●500
5	Solid	.182	40	45	.355	150	●500
4	Solid	.204	40	45	.375	180	■1000
3	Solid	.229	40	45	.400	200	■1000
2	Solid	.258	40	45	.430	270	■1000
1	Solid	.280	60	45	.500	350	■1000
1/0	Solid	.325	60	45	.535	420	■500
2/0	Solid	.365	60	45	.575	520	■500
3/0	Solid	.410	60	45	.620	630	■500
4/0	Solid	.460	60	45	.670	780	■500

*Not listed in 1956 National Electrical Code.

●Coil. ■Reel.

The above data are approximate and subject to normal manufacturing tolerances.

Prices on application.

General Cable Apparatus Cable
Type AIA—Rated 600 Volts, 125°C



Single Conductor—Flexible Stranded

For open wiring of apparatus in power plants, steel mills, foundries and other locations where moisture is slight.

Insulation: Wall of asbestos saturated with flame, heat and moisture resisting compound. Outer Covering: Asbestos braid saturated and finished with flame, heat and moisture-resisting compound. Standard color, black.

Size A.W.G. or MCM	Construction	Diam. In.	Insulation Thickness Mils	Braid Thickness Mils	Overall Diam. In.	Net Weight per 1000 Ft. Lbs.	Standard Package Feet
*18	16 x #30	.015	30	40	.185	24	●1000
*16	26 x #30	.059	30	10	.200	29	●1000
14	41 x #30	.075	30	40	.215	36	●1000
12	65 x #30	.095	40	40	.255	53	●1000
10	104 x #30	.120	40	40	.280	70	●500
8	133 x .0111"	.168	40	40	.330	98	●500
6	133 x .0140"	.212	60	15	.425	150	■1000
5	133 x .0158"	.237	60	15	.450	180	■1000
4	133 x .0177"	.266	60	15	.480	220	■1000
3	133 x .0199"	.299	60	15	.510	260	■1000
2	133 x .0223"	.336	60	15	.550	310	■1000
1	259 x .0180"	.378	75	15	.620	360	■1000
1/0	259 x .0202"	.421	75	15	.665	480	■1000
2/0	259 x .0227"	.477	75	15	.720	580	■1000
3/0	259 x .0255"	.536	75	15	.780	610	■1000
4/0	259 x .0286"	.600	75	15	.810	870	■1000
250	427 x .0242"	.653	90	15	.925	1030	■500
300	427 x .0265"	.716	90	15	.990	1210	■500
350	427 x .0286"	.772	90	15	1.045	1390	■500
400	427 x .0306"	.826	90	15	1.100	1570	■500
450	427 x .0325"	.878	90	15	1.150	1750	■500
500	427 x .0342"	.923	90	15	1.195	1930	■500

General Cable Stove and Appliance Lead Wire
Type AIA—Rated 600 Volts, 125°C
Single Conductor—Solid or Stranded



For wiring electrically heated apparatus. May be used where moderate moisture hazards exist.

Solid Conductors

Size A.W.G. or MCM	Construction	Diam. In.	Insulation Thickness Mils	Braid Thickness Mils	Overall Diam. In.	Net Weight per 1000 Ft. Lbs.	Standard Package Feet
*18	Solid	.040	30	40	.180	24	●500
*16	Solid	.051	30	40	.195	30	●500
14	Solid	.064	30	40	.205	36	●500
12	Solid	.081	30	40	.225	45	●500
10	Solid	.102	30	40	.245	60	●500
8	Solid	.128	30	40	.270	84	●500
6	Solid	.162	40	40	.325	120	■500
5	Solid	.182	40	45	.355	150	■500
4	Solid	.204	40	45	.375	170	■500

Stranded Conductors

*18	7 x .0152"	.045	30	10	.185	24	●1000
*16	7 x .0192"	.058	30	40	.200	30	●1000
14	7 x .0242"	.073	30	40	.215	36	●1000
12	7 x .0305"	.092	40	40	.255	52	●1000
10	7 x .0385"	.116	40	40	.280	70	●500
8	7 x .0486"	.146	40	40	.310	94	●500
6	7 x .0612"	.184	60	45	.365	150	■1000
5	7 x .0688"	.206	60	45	.420	170	■1000
4	7 x .0772"	.232	60	45	.445	210	■1000

*Not listed in 1956 National Electrical Code.

●Coil. ■Reel.

The above data are approximate and subject to normal manufacturing tolerances.

Prices on application.

General Cable Boiler Room Wire
Type AVA—Rated 600 Volts, 110° C



Single Conductor Solid

For general lighting and control circuits, either open circuits or in conduit. Also for switchboard wire where overall asbestos braid is required. Particularly adapted to locations subject to heat, flame, oil, grease or corrosive vapors.

Insulation: Saturated asbestos wall, varnished cambric tape, and saturated asbestos. Asbestos braid covering, finished with flame, heat and moisture-resisting compound (standard color—black).

Size A.W.G. or MCM	Conductors		1st Asbestos Mils	Var-nished Cambric Mils	2nd Asbestos Mils	Braid Thick-ness Mils	Over-all Diam. In.	Net WL. per 1000 FL Lbs.	Std. Pkg. FL
	Construc-tion	Diam. In.							
*18	Solid	.040	0	30	20	40	.220	32	●1000
*16	Solid	.051	0	30	20	40	.235	36	●1000
14	Solid	.064	0	30	20	40	.245	44	●1000
12	Solid	.081	0	30	20	40	.265	54	●1000
10	Solid	.102	0	30	20	40	.285	83	●1000
8	Solid	.128	0	30	20	40	.310	96	●500
6	Solid	.162	15	30	20	45	.385	150	■1000
5	Solid	.182	15	30	20	45	.405	170	■1000
4	Solid	.204	15	30	20	45	.425	200	■1000
3	Solid	.229	15	30	20	45	.450	230	■1000
2	Solid	.258	15	30	20	45	.480	290	■1000
1	Solid	.289	20	30	30	45	.510	370	■1000
1/0	Solid	.325	20	30	30	45	.575	430	■500
2/0	Solid	.365	20	30	30	45	.615	560	■500
3/0	Solid	.410	20	30	30	45	.660	650	■500
4/0	Solid	.460	20	30	30	45	.710	800	■500

●Coil.

■Reel.

Type AVL—Rated 600 Volts, 110° C

Lead sheathed for installations subject to heat and moisture. Insulation, saturated felted asbestos over varnished cambric tape.

Size A.W.G.	Conductors	Diam. In.	Insulation Thickness		Lead Sheath Thick-ness In.	Over-all Diam. Mils	Net Weight per 1000 Ft. Lbs.	Std. Pkg. FL
			Var-nished Cambric Mils	Asbes-tos** Mils				
*18	Solid	0.010	30	25	3/64	.24	154	1000
*16	Solid	0.051	30	25	3/64	.26	166	1000
14	Solid	0.064	30	25	3/64	.27	181	1000
12	Solid	0.081	30	25	3/64	.29	199	1000
10	Solid	0.102	30	25	3/64	.31	229	1000
8	Solid	0.128	30	25	3/64	.33	270	1000

General Cable Headlight Wire

Type AVB—Rated 600 Volts, 90° C



Single Conductor—Flexible Stranded

Recommended for cab and gauge wiring on locomotives.

Size A.W.G.	Conductors	Diam. In.	Insulation Thickness		Cotton Braid Thick-ness Mils	Over-all Diam. In.	Net WL. per M-FL Lbs.	Std. Pkg. Feet per Coil	Ship. WL. per M-FL Lbs.
			Var-nished Cambric Mils	Feltd Asbes-tos Mils					
16	19 x	.0117	.059	30	20	.195	24	1000	27
14	19 x	.0147	.074	30	20	.210	33	1000	36
12	19 x	.0185	.093	30	20	.225	42	1000	45

*Not listed in 1956 National Electrical Code.

**On sizes #18 to 8 A.W.G. (inclusive) 600 V, the thickness given may include, at the manufacturer's option, a barrier tape not over 10 mils thick.

The above data are approximate and subject to normal manufacturing tolerances.

Prices on application.

General Cable Apparatus and Motor Lead Cable

Type AVA—Rated 600 Volts, 110° C



Single Conductor—Extra Flexible Stranded

Recommended where flexibility is an important requirement. Used for motor leads, coil connections, transformer leads and internal wiring of mining machinery, etc.

Size A.W.G. or MCM	Conductors	Diam. In.	Insulation Thickness			Over-all In.	Net WL. per 1000 FL Lbs.	Std. Pkg. FL
			1st Asbestos Mils	Var-nished Cambric Mils	2nd Asbestos Mils			
*18	16x#30	.045	10	30	15	.235	36	●1000
*16	26x#30	.059	10	30	15	.250	42	●1000
14	41x#30	.075	10	30	15	.265	50	●1000
12	65x#30	.095	10	30	15	.285	62	●1000
10	104x#30	.120	10	30	15	.310	79	●500
8	133x .0111"	.168	10	30	15	.370	112	●500
6	133x .0140"	.212	15	30	20	.435	160	■1000
5	133x .0158"	.237	15	30	20	.460	180	■1000
4	133x .0177"	.266	15	30	20	.490	230	■1000
3	133x .0199"	.299	15	30	20	.520	270	■1000
2	133x .0223"	.336	15	30	20	.560	320	■1000
1	259x .0180"	.378	20	30	30	.630	400	■1000
1/0	259x .0202"	.424	20	30	30	.675	490	■1000
2/0	259x .0227"	.477	20	30	30	.730	590	■1000
3/0	259x .0255"	.536	20	30	30	.790	720	■1000
4/0	259x .0286"	.600	20	30	30	.850	880	■1000
250	427x .0242"	.653	25	40	40	.955	1060	■500
300	427x .0265"	.716	25	40	40	1.020	1240	■500
350	427x .0286"	.772	25	40	40	1.075	1410	■500
400	427x .0306"	.826	25	40	40	1.130	1590	■500
450	427x .0325"	.878	25	40	40	1.180	1770	■500
500	427x .0342"	.923	25	40	40	1.225	1950	■500
550	427x .0359"	.969	30	40	40	1.280	2140	■500
600	427x .0375"	1.027	30	40	40	1.340	2320	■500
650	427x .0390"	1.053	30	40	40	1.365	2490	■500
700	427x .0405"	1.088	30	40	40	1.400	2670	■500
750	427x .0419"	1.134	30	40	40	1.445	2940	■500
800	427x .0433"	1.153	30	40	40	1.465	3010	■500
900	427x .0459"	1.222	30	40	40	1.535	3360	■500
1000	427x .0484"	1.295	30	40	40	1.605	3790	■500

●Coil

■Reel

*Not listed in 1956 National Electrical Code.

General Cable Hinge Cable

Type AVB—Rated 600 Volts-90° C



Single Conductor—Flexible Stranded

Specially tested cable, recommended for swinging panel connections or other uses requiring extra flexibility.

Size A.W.G. or MCM	Conductors	Diam. In.	Insulation Thickness			Cotton Braid Thick-ness Mils	Over-all Diam. In.	Net Weight per 1000 Ft. Lbs.	Std. Pkg. Ft. per Coil
			1st Asbestos Mils	Var-nished Cambric Mils	2nd Asbestos Mils				
*18	16x#30	.045	10	30	15	16	.190	20	1000
*16	26x#30	.059	10	30	15	16	.205	28	1000
14	41x#30	.075	10	30	15	16	.220	35	500
12	65x#30	.095	10	30	15	17	.245	47	500
10	104x#30	.120	10	30	15	17	.270	62	500
8	168x#30	.157	10	30	15	17	.305	90	500

*Not listed in 1956 National Electrical Code.

The above data are approximate and subject to normal manufacturing tolerances.

Prices on application.

General Cable Asbestos-Varnished Cambric Insulated Power Cable

Single Conductor—Stranded

0-1000 Volts

Type AVA-Asbestos Braided

Type AVL-Lead Sheathed



Rated 600 Volts—110°C.

Size A.W.G. or MCM	Conductors		Insulation Thickness (Mils)				Braid Thickness Mils	Type AVA		Std. Pkg. FL	Lead Sheath Thickness In.	Type AVL		
	Construction	Diam. In.	1st Asbestos	Varnished Cambric	*2nd Asbestos Type AVA	Type AVL		Over-all Diam. In.	Net Wt. per 1000 Ft. Lbs.			Overall Diam. In.	Net Wt. per 1000 Ft. Lbs.	Std. Reel Feet
14	7 x .0242"	.073	10	30	15	25	40	.265	48	●1000	3/64	.300	215	1000
12	7 x .0305"	.092	10	30	15	25	40	.285	60	●1000	3/64	.320	240	1000
10	7 x .0385"	.116	10	30	15	25	40	.310	78	●1000	3/64	.340	270	1000
8	7 x .0486"	.146	10	30	15	25	45	.350	110	● 500	3/64	.370	310	1000
6	7 x .0612"	.184	15	30	20	25	45	.405	150	■1000	3/64	.420	390	1000
5	7 x .0688"	.206	15	30	20	25	45	.430	172	■1000	3/64	.440	460	1000
4	7 x .0772"	.232	15	30	20	25	45	.455	220	■1000	3/64	.470	480	1000
3	7 x .0867"	.260	15	30	20	25	45	.480	260	■1000	3/64	.495	550	1000
2	7 x .0974"	.292	15	30	20	25	45	.515	310	■1000	4/64	.560	740	1000
1	19 x .0664"	.332	20	30	30	30	45	.585	380	■1000	4/64	.620	880	1000
1/0	19 x .0745"	.373	20	30	30	30	45	.625	460	■1000	4/64	.660	990	1000
2/0	19 x .0837"	.419	20	30	30	30	45	.670	560	■1000	4/64	.705	1130	1000
3/0	19 x .0940"	.470	20	30	30	30	45	.720	680	■1000	4/64	.760	1300	1000
4/0	19 x .1055"	.528	20	30	30	30	45	.780	840	■1000	4/64	.815	1500	1000
250	37 x .0822"	.575	25	40	40	40	45	.875	1000	■ 500	5/64	.945	1980	500
300	37 x .0900"	.630	25	40	40	40	45	.930	1180	■ 500	5/64	1.000	2220	500
350	37 x .0973"	.681	25	40	40	40	45	.985	1360	■ 500	5/64	1.050	2450	500
400	37 x .1040"	.728	25	40	40	40	45	1.030	1530	■ 500	5/64	1.095	2680	500
450	37 x .1103"	.772	25	40	40	40	45	1.075	1700	■ 500	5/64	1.140	2900	500
500	37 x .1162"	.813	25	40	40	40	45	1.115	1870	■ 500	5/64	1.180	3110	500
550	61 x .0950"	.855	30	40	40	40	45	1.165	2090	■ 500	6/64	1.265	3650	500
600	61 x .0992"	.893	30	40	40	40	45	1.205	2220	■ 500	6/64	1.305	3880	500
650	61 x .1032"	.929	30	40	40	40	45	1.240	2400	■ 500	6/64	1.340	4110	500
700	61 x .1071"	.964	30	40	40	40	45	1.275	2560	■ 500	6/64	1.375	4310	500
750	61 x .1109"	.998	30	40	40	40	45	1.310	2720	■ 500	6/64	1.410	4530	500
800	61 x .1145"	1.031	30	40	40	40	45	1.345	2790	■ 500	6/64	1.440	4740	500
900	61 x .1215"	1.094	30	40	40	40	45	1.405	3120	■ 500	6/64	1.505	5160	500
1000	61 x .1280"	1.152	30	40	40	40	45	1.465	3560	■ 500	6/64	1.560	5570	500

Rated 1000 Volts—110°C.

14	7 x .0242"	.073	15	45	25	25	40	.325	70	●1000	3/64	.340	250	1000
12	7 x .0305"	.092	15	45	25	25	45	.355	80	●1000	3/64	.360	260	1000
10	7 x .0385"	.116	15	45	25	25	45	.380	90	●1000	3/64	.380	310	1000
8	7 x .0486"	.146	15	45	25	25	45	.410	110	● 500	3/64	.410	360	1000
6	7 x .0612"	.184	15	45	25	25	45	.445	170	■1000	3/64	.450	420	1000
5	7 x .0688"	.206	15	45	25	25	45	.470	195	■1000	3/64	.470	460	1000
4	7 x .0772"	.232	15	45	25	25	45	.495	230	■1000	3/64	.500	510	1000
3	7 x .0867"	.260	15	45	25	25	45	.520	270	■1000	4/64	.560	710	1000
2	7 x .0974"	.292	15	45	25	25	45	.555	330	■1000	1/64	.590	810	1000
1	19 x .0664"	.332	20	45	30	30	45	.615	400	■1000	1/64	.650	920	1000
1/0	19 x .0745"	.373	20	45	30	30	45	.655	490	■1000	4/64	.690	1030	1000
2/0	19 x .0837"	.419	20	45	30	30	45	.700	590	■1000	4/64	.735	1190	1000
3/0	19 x .0940"	.470	20	45	30	30	45	.750	710	■1000	4/64	.790	1310	1000
4/0	19 x .1055"	.528	20	45	30	30	45	.810	870	■1000	5/64	.875	1760	1000
250	37 x .0822"	.575	25	45	40	40	45	.885	1070	■ 500	5/64	.955	2000	500
300	37 x .0900"	.630	25	45	40	40	45	.940	1200	■ 500	5/64	1.010	2240	500
350	37 x .0973"	.681	25	45	40	40	45	.995	1370	■ 500	5/64	1.060	2470	500
400	37 x .1040"	.728	25	45	40	40	45	1.040	1540	■ 500	5/64	1.105	2690	500
450	37 x .1103"	.772	25	45	40	40	45	1.085	1710	■ 500	5/64	1.150	2910	500
500	37 x .1162"	.813	25	45	40	40	45	1.125	1890	■ 500	5/64	1.190	3130	500
550	61 x .0950"	.855	30	45	40	40	45	1.175	2040	■ 500	6/64	1.275	3680	500
600	61 x .0992"	.893	30	45	40	40	45	1.215	2240	■ 500	6/64	1.315	3900	500
650	61 x .1032"	.929	30	45	40	40	45	1.250	2400	■ 500	6/64	1.350	4120	500
700	61 x .1071"	.964	30	45	40	40	45	1.285	2580	■ 500	6/64	1.385	4230	500
750	61 x .1109"	.998	30	45	40	40	45	1.320	2744	■ 500	6/64	1.420	4550	500
800	61 x .1145"	1.031	30	45	40	40	45	1.355	2930	■ 500	6/64	1.450	4770	500
900	61 x .1215"	1.094	30	45	40	40	45	1.415	3250	■ 500	6/64	1.515	5120	500
1000	61 x .1280"	1.152	30	45	40	40	45	1.475	3590	■ 500	6/64	1.570	5600	500

●Coil ■Reel.

*For Type AVL Cable on sizes #14 through #2 A.W.G., 600 Volt, the thickness given may include, at the manufacturer's option, a barrier tape not over 10 mils thick.

The above data are approximate and subject to normal manufacturing tolerances.

Prices on application.

General Cable Asbestos—Varnished Cambric Insulated Power Cable

Single Conductor—Stranded 2000—5000 Volts

2000 Volts—103°C

3000 Volts—106°C

Size A.W.G. or MCM	Conductors		Insulation Thickness (Mils)				Type AVA Asbestos Braided			Type AVL Lead Sheathed			Type AVA Asbestos Braided			Type AVL Lead Sheathed			Std. Reel FT.
							Braid Thick- ness Mils	Over- all Diam. In.	Net Wt. per 1000 Ft. Lbs.	Lead Sheath Thick- ness In.	Over- all Diam. In.	Net Wt. per 1000 Ft. Lbs.	Braid Thick- ness Mils	Over- all Diam. In.	Net Wt. per 1000 Ft. Lbs.	Lead Sheath Thick- ness In.	Over- all Diam. In.	Net Wt. per 1000 Ft. Lbs.	
14	7 x .0242"	.073	15	60	80	25	45	.365	78	3/64	.370	290	45	.405	92	3/64	.410	320	1000
12	7 x .0305"	.092	15	60	80	25	45	.385	91	3/64	.390	310	45	.425	110	3/64	.430	350	1000
10	7 x .0385"	.116	15	60	80	25	45	.410	110	3/64	.410	310	45	.456	130	3/64	.450	390	1000
8	7 x .0486"	.146	15	60	80	25	45	.440	138	3/64	.440	390	45	.480	160	3/64	.480	430	1000
6	7 x .0612"	.184	15	60	80	25	45	.475	180	3/64	.480	450	45	.515	200	3/64	.520	500	1000
5	7 x .0688"	.206	15	60	80	25	45	.500	210	3/64	.500	490	45	.540	230	4/64	.575	680	1000
4	7 x .0772"	.232	15	60	80	25	45	.525	250	4/64	.560	680	45	.565	270	4/64	.600	740	1000
3	7 x .0867"	.260	15	60	80	25	45	.550	290	4/64	.590	740	45	.590	310	4/64	.630	800	1000
2	7 x .0974"	.292	15	60	80	25	45	.585	340	4/64	.620	810	45	.625	350	4/64	.660	890	1000
1	19 x .0664"	.332	20	60	80	30	45	.645	420	4/64	.680	960	45	.685	470	4/64	.720	1020	1000
1/0	19 x .0745"	.373	20	60	80	30	45	.685	500	4/64	.720	1080	45	.725	530	4/64	.760	1140	1000
2/0	19 x .0837"	.419	20	60	80	30	45	.730	610	4/64	.765	1220	45	.770	630	4/64	.805	1280	1000
3/0	19 x .0940"	.470	20	60	80	30	45	.780	730	4/64	.820	1390	45	.820	760	5/64	.890	1670	1000
4/0	19 x .1055"	.528	20	60	80	30	45	.840	890	5/64	.905	1820	45	.880	920	5/64	.945	1890	1000
250	37 x .0822"	.575	25	60	80	40	45	.915	1050	5/64	.985	2060	45	.955	1080	5/64	1.025	2140	500
300	37 x .0900"	.630	25	60	80	40	45	.970	1220	5/64	1.040	2300	45	1.010	1260	5/64	1.080	2380	500
350	37 x .0973"	.681	25	60	80	40	45	1.025	1410	5/64	1.090	2530	45	1.065	1440	5/64	1.130	2610	500
400	37 x .1040"	.728	25	60	80	40	45	1.070	1580	5/64	1.135	2760	45	1.110	1590	5/64	1.175	2830	500
450	37 x .1103"	.772	25	60	80	40	45	1.115	1750	5/64	1.180	2950	45	1.115	1790	6/64	1.250	3370	500
500	37 x .1162"	.813	25	60	80	40	45	1.155	1920	6/64	1.255	3500	45	1.195	1960	6/64	1.295	3600	500
550	61 x .0950"	.855	30	60	80	40	45	1.205	2100	6/64	1.305	3750	45	1.245	2150	6/64	1.315	3850	500
600	61 x .0992"	.893	30	60	80	40	45	1.245	2270	6/64	1.345	3980	45	1.285	2310	6/64	1.385	4080	500
650	61 x .1032"	.929	30	60	80	40	45	1.280	2440	6/64	1.380	4200	45	1.320	2480	6/64	1.420	4300	500
700	61 x .1071"	.964	30	60	80	40	45	1.315	2610	6/64	1.415	4420	45	1.355	2660	6/64	1.455	4510	500
750	61 x .1109"	.998	30	60	80	40	45	1.350	2780	6/64	1.450	4630	45	1.390	2830	6/64	1.490	4730	500
800	61 x .1145"	1.031	30	60	80	40	45	1.385	2950	6/64	1.510	4850	45	1.425	3000	6/64	1.520	4950	500
900	61 x .1215"	1.094	30	60	80	40	45	1.445	3290	6/64	1.575	5360	45	1.485	3340	6/64	1.585	5380	500
1000	61 x .1280"	1.152	30	60	80	40	45	1.505	3630	6/64	1.630	5760	45	1.545	3680	6/64	1.640	5380	500

4000 Volts—103°C

5000 Volts—100°C

Size A.W.G. or MCM	Conductors		Insulation Thickness (Mils)				Type AVA			Type AVL			Type AVA			Type AVL			Std. Reel FT.
							Braid Thick- ness Mils	Over- all Diam. In.	Net Wt. per 1000 Ft. Lbs.	Lead Sheath Thick- ness In.	Over- all Diam. In.	Net Wt. per 1000 Ft. Lbs.	Braid Thick- ness Mils	Over- all Diam. In.	Net Wt. per 1000 Ft. Lbs.	Lead Sheath Thick- ness In.	Over- all Diam. In.	Net Wt. per 1000 Ft. Lbs.	
14	7 x .0242"	.073	15	100	120	25	45	.445	110	3/64	.450	350	45	.485	130	3/64	.490	400	1000
12	7 x .0305"	.092	15	100	120	25	45	.465	120	3/64	.470	390	45	.505	140	3/64	.510	430	1000
10	7 x .0385"	.116	15	100	120	25	45	.490	140	3/64	.490	430	45	.530	160	4/64	.565	600	1000
8	7 x .0486"	.146	15	100	120	25	45	.520	170	4/64	.555	610	45	.560	190	4/64	.595	660	1000
6	7 x .0612"	.184	15	100	120	25	45	.555	220	4/64	.590	680	45	.595	210	4/64	.630	740	1000
5	7 x .0688"	.206	15	100	120	25	45	.580	250	4/64	.615	730	45	.620	240	4/64	.655	790	1000
4	7 x .0772"	.232	15	100	120	25	45	.605	290	4/64	.640	790	45	.645	310	4/64	.680	850	1000
3	7 x .0867"	.260	15	100	120	25	45	.630	330	4/64	.670	860	45	.670	360	4/64	.710	920	1000
2	7 x .0974"	.292	15	100	120	25	45	.665	390	4/64	.700	960	45	.705	410	4/64	.740	1000	1000
1	19 x .0664"	.332	20	100	120	30	45	.725	470	4/64	.760	1080	45	.765	500	4/64	.800	1140	1000
1/0	19 x .0745"	.373	20	100	120	30	45	.765	560	4/64	.800	1200	45	.805	590	5/64	.870	1470	1000
2/0	19 x .0837"	.419	20	100	120	30	45	.810	660	5/64	.875	1560	45	.850	690	5/64	.915	1630	1000
3/0	19 x .0940"	.470	20	100	120	30	45	.860	790	5/64	.930	1740	45	.900	820	5/64	.970	1820	1000
4/0	19 x .1055"	.528	20	100	120	30	45	.920	950	5/64	.985	1970	45	.960	990	5/64	1.025	2050	1000
250	37 x .0822"	.575	25	100	120	40	45	.995	1120	5/64	1.065	2220	45	1.035	1150	5/64	1.105	2300	500
300	37 x .0900"	.630	25	100	120	40	45	1.050	1300	5/64	1.120	2460	45	1.090	1330	5/64	1.160	2540	500
350	37 x .0973"	.681	25	100	120	40	45	1.105	1480	5/64	1.170	2700	45	1.145	1530	6/64	1.240	3080	500
400	37 x .1040"	.728	25	100	120	40	45	1.150	1630	6/64	1.250	3230	45	1.190	1670	6/64	1.290	3320	500
450	37 x .1103"	.772	25	100	120	40	45	1.195	1830	6/64	1.290	3460	45	1.235	1870	6/64	1.330	3600	500
500	37 x .1162"	.813	25	100	120	40	45	1.235	2000	6/64	1.335	3690	45	1.275	2050	6/64	1.375	3790	500
550	61 x .0950"	.855	30	100	120	40	45	1.285	2180	6/64	1.385	3950	45	1.325	2330	6/64	1.425	4050	500
600	61 x .0992"	.893	30	100	120	40	45	1.325	2360	6/64	1.425	4180	45	1.365	2410	6/64	1.465	4280	500
650	61 x .1032"	.929	30	100	120	40	45	1.360	2540	6/64	1.460	4400	45	1.400	2590	6/64	1.500	4500	500
700	61 x .1071"	.964	30	100	120	40	45	1.395	2710	6/64	1.495	4620	45	1.435	2750	6/64	1.535	4720	500
750	61 x .1109"	.998	30	100	120	40	45	1.430	2880	6/64	1.530	4840	45	1.470	2830	6/64	1.570	4940	500
800	61 x .1145"	1.031	30	100	120	40	45	1.465	3050	6/64	1.560	5050	45	1.505	3100	6/64	1.600	5160	500
900	61 x .1215"	1.094	30	100	120	40	45	1.525	3390	6/64	1.625	5490	45	1.565	3460	6/64	1.665	5600	500
1000	61 x .1280"	1.152	30	100	120	40	45	1.585	3740	6/64									

General Cable Asbestos—Varnished Cambric Insulated Power Cable

3-Conductor Stranded—0-2000 Volts

Type AVMA—Asbestos Braided

Type AVML—Lead Sheathed

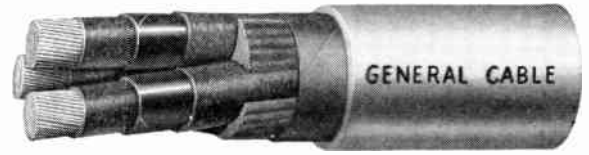

Rated 600 Volts—110°C.

Size A.W.G. or MCM	Conductors		Insulation Thickness (Mils) Type AVMA					Over- all Diam. In.	Net Wt. per 1000 Ft. Lbs.	Insulation Thickness Type AVML					Net Wt. per 1000 Ft. Lbs.	Std. Reel Ft.	
	Construction	Diam. In.	1st Asbestos	Varnished Cambric	2nd Asbestos	Braid Thick- ness Mils	1st Asbestos			Varnished Cambric	2nd Asbestos	Lead Sheath Thickness In.	Overall Diam. In.	Net Wt. per 1000 Ft. Lbs.			Std. Reel Ft.
14	7 x .0242"	.073	10	30	15	45	.515	170	10	30	25	4/64	.595	580	1000		
12	7 x .0305"	.092	10	30	15	45	.555	200	10	30	25	4/64	.635	670	1000		
10	7 x .0385"	.116	10	30	15	45	.610	250	10	30	25	4/64	.690	760	1000		
8	7 x .0486"	.146	10	30	15	45	.675	310	10	30	25	4/64	.750	910	1000		
6	7 x .0612"	.184	15	30	20	45	.800	490	15	30	25	5/64	.885	1380	1000		
5	7 x .0688"	.206	15	30	20	45	.815	580	15	30	25	5/64	.935	1520	1000		
4	7 x .0772"	.232	15	30	20	45	9.00	700	15	30	25	5/64	.990	1700	1000		
3	7 x .0867"	.260	15	30	20	45	9.60	830	15	30	25	5/64	1.050	1900	1000		
2	7 x .0971"	.292	15	30	20	45	1.030	990	15	30	25	5/64	1.120	2140	1000		
1	19 x .0664"	.332	20	30	30	45	1.180	1250	20	30	30	6/64	1.280	2880	1000		
1/0	19 x .0745"	.373	20	30	30	45	1.270	1510	20	30	30	6/64	1.370	3270	1000		
2/0	19 x .0837"	.419	20	30	30	45	1.370	1830	20	30	30	6/64	1.470	3720	1000		
3/0	19 x .0910"	.470	20	30	30	45	1.480	2210	20	30	30	6/64	1.580	4210	500		
4/0	19 x .1055"	.528	20	30	30	45	1.605	2720	20	30	30	7/64	1.730	5350	500		
250	37 x .0822"	.575	25	40	40	45	1.815	3280	25	40	40	7/64	1.940	6250	500		
300	37 x .0900"	.630	25	40	40	45	1.930	3860	25	40	40	7/64	2.060	7020	500		
350	37 x .0973"	.681	25	40	40	45	2.045	4410	25	40	40	7/64	2.170	7750	500		
400	37 x .1010"	.728	25	40	40	45	2.145	4960	25	40	40	8/64	2.305	9050	500		
450	37 x .1103"	.772	25	40	40	45	2.240	5510	25	40	40	8/64	2.400	9860	500		
500	37 x .1162"	.813	25	40	40	45	2.330	6100	25	40	40	8/64	2.490	10510	500		

Rated 1000 Volts—110°C.

14	7 x .0242"	.073	10	30	15	45	.645	200	15	45	25	4/64	.680	740	1000
12	7 x .0305"	.092	15	45	25	45	.685	250	15	45	25	4/64	.720	840	1000
10	7 x .0385"	.116	15	45	25	45	.740	320	15	45	25	4/64	.775	940	1000
8	7 x .0486"	.146	15	45	25	45	.800	400	15	45	25	5/64	.870	1300	1000
6	7 x .0612"	.184	15	45	25	45	.885	510	15	45	25	5/64	.950	1530	1000
5	7 x .0688"	.206	15	45	25	45	.930	630	15	45	25	5/64	1.000	1670	1000
4	7 x .0772"	.232	15	45	25	45	.990	740	15	45	25	5/64	1.055	1850	1000
3	7 x .0867"	.260	15	45	25	45	1.050	880	15	45	25	5/64	1.115	2060	1000
2	7 x .0971"	.292	15	45	25	45	1.115	1050	15	45	25	5/64	1.185	2300	1000
1	19 x .0664"	.332	20	45	30	45	1.215	1300	20	45	30	6/64	1.315	3030	1000
1/0	19 x .0745"	.373	20	45	30	45	1.335	1570	20	45	30	6/64	1.435	3410	1000
2/0	19 x .0837"	.419	20	45	30	45	1.435	1900	20	45	30	6/64	1.530	3910	1000
3/0	19 x .0910"	.470	20	45	30	45	1.515	2260	20	45	30	6/64	1.640	4300	500
4/0	19 x .1055"	.528	20	45	30	45	1.670	2810	20	45	30	7/64	1.800	5550	500
250	37 x .0822"	.575	25	45	40	45	1.835	3320	25	45	40	7/64	1.965	6330	500
300	37 x .0900"	.630	25	45	40	45	1.955	3880	25	45	40	7/64	2.080	7080	500
350	37 x .0973"	.681	25	45	40	45	2.065	4410	25	45	40	7/64	2.190	7820	500
400	37 x .1010"	.728	25	45	40	45	2.165	5000	25	45	40	8/64	2.325	9120	500
450	37 x .1103"	.772	25	45	40	45	2.260	5550	25	45	40	8/64	2.420	9840	500
500	37 x .1162"	.813	25	45	40	45	2.350	6110	25	45	40	8/64	2.510	10540	500

Rated 2000 Volts—109°C.

14	7 x .0242"	.073	15	60	25	45	.710	250	15	60	25	4/64	.745	800	1000
12	7 x .0305"	.092	15	60	25	45	.750	300	15	60	25	4/64	.785	900	1000
10	7 x .0385"	.116	15	60	25	45	.800	350	15	60	25	5/64	.870	1250	1000
8	7 x .0486"	.146	15	60	25	45	.865	460	15	60	25	5/64	.935	1420	1000
6	7 x .0612"	.184	15	60	25	45	.950	580	15	60	25	5/64	1.015	1620	1000
5	7 x .0688"	.206	15	60	25	45	.995	680	15	60	25	5/64	1.060	1790	1000
4	7 x .0772"	.232	15	60	25	45	1.050	790	15	60	25	5/64	1.120	2000	1000
3	7 x .0867"	.260	15	60	25	45	1.115	900	15	60	25	5/64	1.180	2150	1000
2	7 x .0971"	.292	15	60	25	45	1.180	1080	15	60	25	6/64	1.280	2660	1000
1	19 x .0664"	.332	20	60	30	45	1.310	1370	20	60	30	6/64	1.410	2880	1000
1/0	19 x .0745"	.373	20	60	30	45	1.400	1630	20	60	30	6/64	1.495	3560	1000
2/0	19 x .0837"	.419	20	60	30	45	1.500	1970	20	60	30	6/64	1.595	4040	1000
3/0	19 x .0910"	.470	20	60	30	45	1.610	2380	20	60	30	7/64	1.735	5020	500
4/0	19 x .1055"	.528	20	60	30	45	1.735	2860	20	60	30	7/64	1.860	5710	500
250	37 x .0822"	.575	25	60	40	45	1.900	3400	25	60	40	7/64	2.030	6510	500
300	37 x .0900"	.630	25	60	40	45	2.020	3970	25	60	40	7/64	2.150	7280	500
350	37 x .0973"	.681	25	60	40	45	2.130	4530	25	60	40	8/64	2.255	7860	500
400	37 x .1010"	.728	25	60	40	45	2.230	5100	25	60	40	8/64	2.390	9340	500
450	37 x .1103"	.772	25	60	40	45	2.325	5670	25	60	40	8/64	2.485	10090	500
500	37 x .1162"	.813	25	60	40	45	2.420	6210	25	60	40	8/64	2.580	10790	500

The above data are approximate and subject to normal manufacturing tolerances.

Prices on application.

General Cable Asbestos-Varnished Cambric Insulated Power Cable

3-Conductor Stranded—3000-5000 Volts

Rated 3000 Volts—106°C.

Size A.W.G. or MCM	Type AVMA—Asbestos Braided			Type AVML—Lead Sheathed											
	Conductors	Diam. In.	Insulation Thickness (Mils)			Braid Thick- ness Mils	Over- all Diam. In.	Net Wt. per 1000 Ft. Lbs.	Insulation Thickness			Lead Sheath Thick- ness In.	Over- all Diam. In.	Net Wt. per 1000 Ft. Lbs.	Std. Reel Ft.
			1st Asbestos	Varnished Cambric	2nd Asbestos				1st Asbestos	Varnished Cambric	2nd Asbestos				
14	7 x .0242"	.073	15	80	25	45	.800	300	15	80	25	5/64	.865	1150	1000
12	7 x .0305"	.092	15	80	25	45	.835	350	15	80	25	5/64	.905	1280	1000
10	7 x .0385"	.116	15	80	25	45	.890	420	15	80	25	5/64	.950	1410	1000
8	7 x .0486"	.146	15	80	25	45	.955	510	15	80	25	5/64	1.020	1580	1000
6	7 x .0612"	.184	15	80	25	45	1.035	660	15	80	25	5/64	1.100	1820	1000
5	7 x .0688"	.206	15	80	25	45	1.085	750	15	80	25	5/64	1.150	1960	1000
4	7 x .0772"	.232	15	80	25	45	1.140	870	15	80	25	6/64	1.235	2410	1000
3	7 x .0867"	.260	15	80	25	45	1.200	1000	15	80	25	6/64	1.295	2660	1000
2	7 x .0974"	.292	15	80	25	45	1.270	1200	15	80	25	6/64	1.365	2950	1000
1	19 x .0644"	.332	20	80	30	45	1.395	1460	20	80	30	6/64	1.495	3390	1000
1/0	19 x .0745"	.373	20	80	30	45	1.485	1740	20	80	30	6/64	1.585	3790	1000
2/0	19 x .0837"	.419	20	80	30	45	1.585	2080	20	80	30	6/64	1.685	4260	1000
3/0	19 x .0940"	.470	20	80	30	45	1.695	2480	20	80	30	7/64	1.825	5260	500
4/0	19 x .1055"	.528	20	80	30	45	1.820	2990	20	80	30	7/64	1.950	5970	500
250	37 x .0822"	.575	25	80	40	45	1.985	3540	25	80	40	7/64	2.115	6790	500
300	37 x .0900"	.630	25	80	40	45	2.105	4100	25	80	40	8/64	2.265	8110	500
350	37 x .0973"	.681	25	80	40	45	2.215	4690	25	80	40	8/64	2.375	8880	500
400	37 x .1040"	.728	25	80	40	45	2.315	5290	25	80	40	8/64	2.475	9700	500
450	37 x .1103"	.772	25	80	40	45	2.410	5820	25	80	40	8/64	2.570	10400	500
500	37 x .1162"	.813	25	80	40	45	2.500	6370	25	80	40	8/64	2.660	11110	500

Rated 4000 Volts—103°C.

14	7 x .0242"	.073	15	100	25	45	.885	340	15	100	25	5/64	.950	1310	1000
12	7 x .0305"	.092	15	100	25	45	.925	410	15	100	25	5/64	.990	1440	1000
10	7 x .0385"	.116	15	100	25	45	.975	480	15	100	25	5/64	1.040	1560	1000
8	7 x .0486"	.146	15	100	25	45	1.040	580	15	100	25	5/64	1.105	1750	1000
6	7 x .0612"	.184	15	100	25	45	1.120	730	15	100	25	5/64	1.185	1980	1000
5	7 x .0688"	.206	15	100	25	45	1.170	830	15	100	25	6/64	1.265	2150	1000
4	7 x .0772"	.232	15	100	25	45	1.225	940	15	100	25	6/64	1.325	2640	1000
3	7 x .0867"	.260	15	100	25	45	1.285	1100	15	100	25	6/64	1.385	2880	1000
2	7 x .0974"	.292	15	100	25	45	1.353	1190	15	100	25	6/64	1.450	3200	1000
1	19 x .0664"	.332	20	100	30	45	1.485	1540	20	100	30	6/64	1.580	3490	1000
1/0	19 x .0745"	.373	20	100	30	45	1.570	1810	20	100	30	6/64	1.670	4010	1000
2/0	19 x .0837"	.419	20	100	30	45	1.670	2180	20	100	30	7/64	1.800	4930	1000
3/0	19 x .0940"	.470	20	100	30	45	1.780	2600	20	100	30	7/64	1.910	5520	500
4/0	19 x .1055"	.528	20	100	30	45	1.905	3120	20	100	30	7/64	2.035	6250	500
250	37 x .0822"	.575	25	100	40	45	2.070	3670	25	100	40	7/64	2.200	7060	500
300	37 x .0900"	.630	25	100	40	45	2.190	4260	25	100	40	8/64	2.350	8130	500
350	37 x .0973"	.681	25	100	40	45	2.300	4830	25	100	40	8/64	2.465	9210	500
400	37 x .1040"	.728	25	100	40	45	2.400	5390	25	100	40	8/64	2.565	9960	500
450	37 x .1103"	.772	25	100	40	45	2.500	5970	25	100	40	8/64	2.660	10710	500
500	37 x .1162"	.813	25	100	40	45	2.585	6530	25	100	40	8/64	2.750	11430	500

Rated 5000 Volts—100°C.

14	7 x .0242"	.073	15	120	25	45	.970	420	15	120	25	5/64	1.035	1490	1000
12	7 x .0305"	.092	15	120	25	45	1.010	470	15	120	25	5/64	1.075	1610	1000
10	7 x .0385"	.116	15	120	25	45	1.060	550	15	120	25	5/64	1.125	1730	1000
8	7 x .0486"	.146	15	120	25	45	1.125	660	15	120	25	5/64	1.190	1920	1000
6	7 x .0612"	.184	15	120	25	45	1.210	800	15	120	25	6/64	1.305	2180	1000
5	7 x .0688"	.206	15	120	25	45	1.255	900	15	120	25	6/64	1.355	2640	1000
4	7 x .0772"	.232	15	120	25	45	1.310	1050	15	120	25	6/64	1.410	2860	1000
3	7 x .0867"	.260	15	120	25	45	1.370	1200	15	120	25	6/64	1.470	3100	1000
2	7 x .0974"	.292	15	120	25	45	1.440	1410	15	120	25	6/64	1.540	3400	1000
1	19 x .0664"	.332	20	120	30	45	1.570	1680	20	120	30	6/64	1.670	3810	1000
1/0	19 x .0745"	.373	20	120	30	45	1.660	1970	20	120	30	7/64	1.785	4700	1000
2/0	19 x .0837"	.419	20	120	30	45	1.755	2330	20	120	30	7/64	1.885	5200	1000
3/0	19 x .0940"	.470	20	120	30	45	1.865	2750	20	120	30	7/64	1.995	5800	500
4/0	19 x .1055"	.528	20	120	30	45	1.990	3330	20	120	30	7/64	2.120	6600	500
250	37 x .0822"	.575	25	120	40	45	2.160	3810	25	120	40	8/64	2.320	7920	500
300	37 x .0900"	.630	25	120	40	45	2.280	4380	25	120	40	8/64	2.440	8720	500
350	37 x .0973"	.681	25	120	40	45	2.390	4990	25	120	40	8/64	2.550	9520	500
400	37 x .1040"	.728	25	120	40	45	2.490	5440	25	120	40	8/64	2.650	10370	500
450	37 x .1103"	.772	25	120	40	45	2.585	6190	25	120	40	8/64	2.745	11160	500
500	37 x .1162"	.813	25	120	40	45	2.675	7070	25	120	40	8/64	2.835	11770	500

The above data are approximate and subject to normal manufacturing tolerances.

Prices on application.

General Cable Asbestos-Varnished Cambric Insulated Control Cable

Single or Multi Conductor—Flexible Stranded

600 Volts—110°C



Type AVMA-Asbestos Braided



Type AVML-Lead Sheathed

Type AVMA				Type AVML															
Size A.W.G.	Number	Conductors		*Type Thickness Mils	Insulation Thickness (Mils)			Cotton Braid Thickness Mils	Asbestos Braid Thickness Mils	Over-all Diam. In.	Net WL per 1000 Ft. Lbs.	Insulation Thickness (Mils)			Cotton Braid Thickness Mils	Lead Sheath Thickness Mils	Over-all Diam. In.	Net WL per 1000 Ft. Lbs.	Std. Reel Ft.
		Construction	Diam. In.		1st Asbestos	Var-nished Cambric	2nd Asbestos					1st Asbestos	Var-nished Cambric	2nd Asbestos					
12	1	19 x #25	.090	..	10	30	15	..	40	.280	50	10	30	25	..	3/64	.315	230	500
12	2	19 x #25	.090	15	10	30	15	15	45	.585	175	10	30	25	17	4/64	.665	700	500
12	3	19 x #25	.090	15	10	30	15	15	45	.620	210	10	30	25	17	4/64	.705	780	500
12	4	19 x #25	.090	15	10	30	15	15	45	.685	270	10	30	25	17	4/64	.775	880	500
12	5	19 x #25	.090	15	10	30	15	15	45	.750	320	10	30	25	17	5/64	.880	1210	500
12	6	19 x #25	.090	15	10	30	15	15	45	.825	380	10	30	25	17	5/64	.955	1360	500
12	7	19 x #25	.090	15	10	30	15	15	45	.825	420	10	30	25	17	5/64	.955	1410	500
12	8	19 x #25	.090	15	10	30	15	15	45	.895	480	10	30	25	17	5/64	1.035	1560	500
12	9	19 x #25	.090	15	10	30	15	15	45	.970	540	10	30	25	17	5/64	1.115	1830	500
12	10	19 x #25	.090	15	10	30	15	15	45	1.050	590	10	30	25	17	6/64	1.205	2150	500
12	11	19 x #25	.090	15	10	30	15	15	45	1.050	630	10	30	25	17	6/64	1.205	2200	500
12	12	19 x #25	.090	15	10	30	15	15	45	1.085	680	10	30	25	17	6/64	1.275	2300	500
12	13	19 x #25	.090	15	10	30	15	15	45	1.115	730	10	30	25	17	6/64	1.310	2400	500
12	14	19 x #25	.090	15	10	30	15	15	45	1.150	770	10	30	25	17	6/64	1.345	2500	500
12	15	19 x #25	.090	15	10	30	15	15	45	1.190	830	10	30	25	17	6/64	1.390	2600	500
12	16	19 x #25	.090	15	10	30	15	15	45	1.215	870	10	30	25	17	6/64	1.420	2700	500
12	17	19 x #25	.090	15	10	30	15	15	45	1.265	920	10	30	25	17	6/64	1.475	2820	500
12	18	19 x #25	.090	15	10	30	15	15	45	1.290	970	10	30	25	17	6/64	1.500	2900	500
12	19	19 x #25	.090	15	10	30	15	15	45	1.290	1010	10	30	25	17	6/64	1.500	2950	500
9	1	19 x #22	.127	..	10	30	15	..	40	.320	90	10	30	25	..	3/64	.350	280	500
9	2	19 x #22	.127	15	10	30	15	17	45	.665	260	10	30	25	17	4/64	.740	840	500
9	3	19 x #22	.127	15	10	30	15	17	45	.705	330	10	30	25	17	4/64	.785	940	500
9	4	19 x #22	.127	15	10	30	15	17	45	.780	410	10	30	25	17	5/64	.895	1300	500
9	5	19 x #22	.127	15	10	30	15	17	45	.860	500	10	30	25	17	5/64	.980	1480	500
9	6	19 x #22	.127	15	10	30	15	17	45	.940	590	10	30	25	17	5/64	1.070	1660	500
9	7	19 x #22	.127	15	10	30	15	17	45	.940	660	10	30	25	17	5/64	1.070	1730	500
9	8	19 x #22	.127	15	10	30	15	17	45	1.025	750	10	30	25	17	5/64	1.160	1920	500
9	9	19 x #22	.127	15	10	30	15	17	45	1.115	840	10	30	25	17	6/64	1.285	2110	500
9	10	19 x #22	.127	15	10	30	15	17	45	1.205	930	10	30	25	17	6/64	1.385	2650	500
9	11	19 x #22	.127	15	10	30	15	17	45	1.205	1000	10	30	25	17	6/64	1.385	2730	500
9	12	19 x #22	.127	15	10	30	15	17	45	1.250	1090	10	30	25	17	6/64	1.430	2850	500
9	13	19 x #22	.127	15	10	30	15	17	45	1.285	1170	10	30	25	17	6/64	1.470	2970	500
9	14	19 x #22	.127	15	10	30	15	17	45	1.320	1250	10	30	25	17	6/64	1.510	3100	500
9	15	19 x #22	.127	15	10	30	15	17	45	1.370	1350	10	30	25	17	6/64	1.560	3270	500
9	16	19 x #22	.127	15	10	30	15	17	45	1.400	1430	10	30	25	17	6/64	1.595	3390	500
9	17	19 x #22	.127	15	10	30	15	17	45	1.460	1520	10	30	25	17	6/64	1.660	3570	500
9	18	19 x #22	.127	15	10	30	15	17	45	1.485	1600	10	30	25	17	6/64	1.685	3680	500
9	19	19 x #22	.127	15	10	30	15	17	45	1.485	1690	10	30	25	17	6/64	1.685	3770	500

*This tape is applied over conductors and fillers after cabling.

The above data are approximate and subject to normal manufacturing tolerances.

I. P. C. E. A. Color Code for Control Cables

Conductor Number	Base Braid	Tracer	Conductor Number	Base Braid	Tracer	Conductor Number	Base Braid	Tracer	Conductor Number	Base Braid	Tracer
1	Black	None	6	Blue	None	11	Blue	Black	16	Black	Red
2	White	None	7	White	Black	12	Black	White	17	White	Red
3	Red	None	8	Red	Black	13	Red	White	18	Orange	Red
4	Green	None	9	Green	Black	14	Green	White	19	Blue	Red
5	Orange	None	10	Orange	Black	15	Blue	White			

Prices on application.

General Cable Switchboard Wire
Type TA—Rated 600 Volts, 90°C



Single Conductor, Solid

Impervious to moisture, oil, acid and similar solutions.

Size A.W.G.	Conductors Construction	Insulation Thickness				Cotton Braid Thickness Mils	Over-all Diam. In.	Net Weight per 1000 Ft. Lbs.	Std. Pkg. Ft.
		Diam. In.	Genca-seal Mils	Var-nish-ed Cam-bric Mils	Asbes-tos Mils				
*18	Solid	.040	20	..	20	16	.160	16	●1000
*16	Solid	.051	20	..	20	16	.170	20	●1000
14	Solid	.064	20	..	20	16	.180	28	●500
12	Solid	.081	20	..	20	16	.200	37	●500
10	Solid	.102	20	..	20	16	.220	52	●500
8	Solid	.128	20	..	20	17	.250	74	●500
6	Solid	.162	30	..	25	17	.315	120	●500
5	Solid	.182	30	..	25	17	.335	110	●500
4	Solid	.204	30	..	25	17	.355	170	■500
3	Solid	.229	30	..	25	17	.380	210	■500
2	Solid	.258	30	..	25	20	.415	260	■500
1	Solid	.289	40	..	30	20	.480	330	■500
1/0	Solid	.325	40	..	30	20	.515	400	■500
2/0	Solid	.365	40	..	30	20	.555	450	■500
3/0	Solid	.410	40	..	30	20	.600	610	■500
4/0	Solid	.460	40	..	30	20	.650	760	■500

Single Conductor, Stranded

*18	7 x .0152"	.045	20	..	20	16	.165	17	●1000
*16	7 x .0192"	.058	20	..	20	16	.175	22	●1000
14	7 x .0242"	.073	20	..	20	16	.190	28	●500
12	7 x .0305"	.092	20	..	20	16	.210	38	●500
10	7 x .0385"	.116	20	..	20	16	.235	53	●500
8	7 x .0486"	.146	20	..	20	17	.265	79	●500
6	7 x .0612"	.181	30	..	25	17	.335	120	●500
5	7 x .0688"	.206	30	..	25	17	.360	150	●500
4	7 x .0772"	.232	30	..	25	17	.385	180	■500
3	7 x .0867"	.260	30	..	25	20	.420	220	■500
2	7 x .0974"	.292	30	..	25	20	.450	270	■500
1	19 x .0664"	.332	40	..	30	20	.520	310	■500
1/0	19 x .0745"	.373	40	..	30	20	.565	420	■500
2/0	19 x .0837"	.419	40	..	30	20	.610	520	■500
3/0	19 x .0940"	.470	40	..	30	20	.660	630	■500
4/0	19 x .1055"	.528	40	..	30	20	.720	780	■500

Type AVB



Single Conductor, Solid

18	solid	.040	..	30	20	16	.175	19	●1000
16	solid	.051	..	30	20	16	.185	20	●1000
14	solid	.064	..	30	20	16	.200	31	●500
12	solid	.081	..	30	20	16	.215	40	●500
10	solid	.102	..	30	20	17	.240	60	●500
8	solid	.128	..	30	20	17	.265	80	●500
6	solid	.162	..	40	30	17	.340	120	■1000
5	solid	.182	..	40	30	17	.360	150	■1000
4	solid	.204	..	40	30	17	.380	180	■1000
3	solid	.229	..	40	30	20	.410	220	■1000
2	solid	.258	..	40	30	20	.440	270	■1000
1	solid	.289	..	40	40	20	.490	340	■1000
1/0	solid	.325	..	40	40	20	.525	410	■500
2/0	solid	.365	..	40	40	20	.565	500	■500
3/0	solid	.410	..	40	40	20	.610	620	■500
4/0	solid	.460	..	40	40	20	.660	770	■500

Single Conductor, Stranded

18	7x.0152"	.045	..	30	20	16	.180	20	●1000
16	7x.0192"	.058	..	30	20	16	.190	25	●1000
14	7x.0242"	.073	..	30	20	16	.205	32	●500
12	7x.0305"	.092	..	30	20	16	.225	43	●500
10	7x.0385"	.116	..	30	20	17	.255	60	●500
8	7x.0486"	.146	..	30	20	17	.285	82	●500
6	7x.0612"	.181	..	40	30	17	.360	130	■1000
5	7x.0688"	.206	..	40	30	17	.385	160	■1000
4	7x.0772"	.232	..	40	30	20	.415	190	■1000
3	7x.0867"	.260	..	40	30	20	.440	230	■1000
2	7x.0974"	.292	..	40	30	20	.475	280	■1000
1	19x.0664"	.332	..	40	40	20	.535	350	■1000
1/0	19x.0745"	.373	..	40	40	20	.575	430	■500
2/0	19x.0837"	.419	..	40	40	20	.620	520	■500
3/0	19x.0940"	.470	..	40	40	20	.670	640	■500
4/0	19x.1055"	.528	..	40	40	20	.730	750	■500

●Coil ■Reel

*Not listed in 1956 National Electrical Code.
The above data are approximate and subject to normal manufacturing tolerances.

Prices on application.

General Cable Switchboard Bus Cable
Type AVB—Rated 600 Volts 90°C



Single Conductor, Stranded

Recommended for wiring switchboards and all other types of control apparatus where the conductor temperatures are high as a result of high current loading.

Size A.W.G. or MCM	Conductors Construction	Insulation Thickness			Cotton Braid Mils	Over-all Diam. In.	Net Weight per 1000 Ft. Lbs.	Std. Pkg. Ft.	
		Diam-eter In.	1st As- bes- tos Mils	Var- nish- ed Cam- bric Mils					2nd As- bes- tos Mils
*18	7 x .0152"	.045	10	30	15	16	.190	23	●1000
*16	7 x .0192"	.058	10	30	15	16	.200	28	●1000
14	7 x .0242"	.073	10	30	15	16	.215	34	●1000
12	7 x .0305"	.092	10	30	15	17	.240	43	●1000
10	7 x .0385"	.116	10	30	15	17	.265	62	●500
8	7 x .0486"	.146	10	30	15	17	.295	86	●500
6	7 x .0612"	.181	15	30	20	17	.350	130	●500
5	7 x .0688"	.206	15	30	20	17	.375	150	■1000
4	7 x .0772"	.232	15	30	20	20	.405	190	■1000
3	7 x .0867"	.260	15	30	20	20	.430	230	■1000
2	7 x .0974"	.292	15	30	20	20	.465	280	■1000
1	19 x .0664"	.332	20	30	30	20	.535	350	■1000
1/0	19 x .0745"	.373	20	30	30	20	.575	430	■1000
2/0	19 x .0837"	.419	20	30	30	20	.620	530	■1000
3/0	19 x .0940"	.470	20	30	30	20	.670	640	■1000
4/0	19 x .1055"	.528	20	30	30	20	.730	800	■1000
250	37 x .0822"	.575	25	40	40	20	.825	960	■500
300	37 x .0900"	.630	25	40	40	25	.895	1150	■500
350	37 x .0973"	.681	25	40	40	25	.945	1220	■500
400	37 x .1010"	.728	25	40	40	25	.990	1490	■500
450	37 x .1103"	.772	25	40	40	25	1.035	1660	■500
500	37 x .1162"	.813	25	40	40	25	1.075	1830	■500
550	61 x .0950"	.855	30	40	40	25	1.130	2010	■500
600	61 x .0992"	.893	30	40	40	25	1.165	2170	■500
650	61 x .1032"	.929	30	40	40	25	1.205	2340	■500
700	61 x .1071"	.964	30	40	40	25	1.240	2510	■500
750	61 x .1109"	.998	30	40	40	25	1.270	2670	■500
800	61 x .1145"	1.031	30	40	40	25	1.305	2840	■500
900	61 x .1215"	1.091	30	40	40	25	1.370	3160	■500
1000	61 x .1280"	1.152	30	40	40	25	1.425	3500	■500

Sizes over 1000 MCM to 2000 MCM listed in 1956 National Electrical Code.

*Not listed in 1956 National Electrical Code.

The above data are approximate and subject to normal manufacturing tolerances.

General Cable Aircraft Wire

Mil-W-5086
Gencaseal* Insulated—Nylon Jacketed

General Cable can supply Types AN-22 through AN-12 with qualification approval; max. temp. 60°C.

Cable Designation	No. and Size of Strands, In.	Ship. Wt. Lbs. Per 1000 Ft.	Lgth. Ft.	Std. Package Spool Size, In.
AN-22	19/.0063	6	5000	12
AN-20	19/.0079	8	5000	12
AN-18	19/.0100	11	10000	18
AN-16	19/.0113	14	10000	18
AN-14	19/.0142	22	5000	18
AN-12	19/.0179	30	5000	18

Prices on application.

The above data are approximate and subject to normal manufacturing tolerances.

*Trade Mark

General Cable *Gencaseal Appliance Wiring Material 600 Volts

For machine tool, appliance and switchboard wiring. Underwriters' approved for operation at various temperatures and at 60° C. under all conditions. Machine tool and switchboard wire is rated at 90° C.; available in 18 to 4/0 A.W.G. Appliance wire rated at 105° C., sizes 18 to 8 A.W.G.; 90° C., sizes 18 to 4/0 A.W.G. and 80° C. for sizes larger than 4/0 A.W.G. Available with spiral stripe identification.

Standard Insulation

Size A.W.G.	Conductor	No. Strands	Insulation Thick. In.	O.D. In.	Net Wt. Lbs. Per M. Ft.	Spool Total Feet	Ship. Wt. Lbs. Per M. Ft.
18**	Solid	2	6/64	.10	9	1000	9
18**		7	2/64	.11	10	1000	10
18**		19	2/64	.11	10	1000	10
16**	Solid	2	6/64	.11	13	1000	13
16**		7	2/64	.12	14	1000	14
16**		19	2/64	.12	14	1000	14
14	Solid	2	6/64	.13	19	500	19
14		7	2/64	.14	20	500	20
14		19	2/64	.14	20	500	20
12	Solid	2	6/64	.15	27	500	27
12		7	2/64	.16	29	500	29
12		19	2/64	.16	29	500	29
10	Solid	2	6/64	.17	40	500	40
10		7	2/64	.18	43	500	43
10		19	2/64	.18	43	500	43
8	Solid	3	6/64	.23	66	500	66
8		7	3/64	.25	71	500	71
8		19	3/64	.25	71	500	71
Paper Wrapped Coil							
6		7	4/64	.31	115	500	117
6		19	4/64	.32	114	500	116
4		7	4/64	.36	169	500	171
4		19	4/64	.37	169	500	171
2		7	4/64	.42	257	500	259
2		19	4/64	.43	257	500	259
Reel							
1		19	5/64	.50	328	1000	400
1/0		19	5/64	.54	404	1000	475
2/0		19	5/64	.58	498	1000	580
3/0		19	5/64	.63	615	1000	740
4/0		19	5/64	.69	762	1000	880
†250MCM		37	6/64	.77	910	1000	1030
†300MCM		37	6/64	.82	1080	1000	1200
†350MCM		37	6/64	.88	1240	1000	1360
†400MCM		37	6/64	.92	1110	1000	1530
†500MCM		37	6/64	1.01	1740	1000	1960
†600MCM		61	7/64	1.12	2100	1000	2360
†700MCM		61	7/64	1.19	2420	1000	2670
†750MCM		61	7/64	1.22	2590	1000	2840
†800MCM		61	7/64	1.26	2750	1000	3000
†900MCM		61	7/64	1.32	3080	1000	3330
†1000MCM		61	7/64	1.38	3400	1000	3660

Heavy Insulation

Size A.W.G.	Conductor	No. Strands	Insulation Thick. In.	O.D. In.	Net Wt. Lbs. Per M. Ft.	Spool Total Feet	Ship. Wt. Lbs. Per M. Ft.
16	Solid	3	3/64	.15	17	500	17
16		7	3/64	.15	18	500	18
16		19	3/64	.15	18	500	18
14	Solid	3	3/64	.16	23	500	24
14		7	3/64	.17	24	500	25
14		19	3/64	.17	24	500	25
12	Solid	3	3/64	.18	32	500	33
12		7	3/64	.19	34	500	35
12		19	3/64	.19	34	500	35
10	Solid	3	3/64	.20	45	500	46
10		7	3/64	.21	48	500	49
10		19	3/64	.21	48	500	49
8	Solid	4	4/64	.25	74	500	75
8		7	4/64	.27	79	500	80
8		19	4/64	.27	79	500	80

*Trade Mark.

**Sizes 16 and 18 AWG also supplied with 16 strands.

†Approved by Underwriters' for 60° C. operation under oil conditions and 80° C. in air—600 volts.

Standard Colors: #18 to #10 Black, White, Red, Blue, Green, Yellow and Orange. #8—and larger, Black, White and Red.

General Cable Square and Rectangular Bare Copper Wire

Soft or Annealed (A.S.T.M. Specification B 48-55)

GENERAL CABLE

Round corners, freedom from surface imperfections and control of bending characteristics during fabrication make this wire particularly suitable for use in the construction of transformers and other electrical apparatus.

Manufactured to customer specifications and to A.S.T.M. (Types A and B). When ordering, state type or use to which wire will be put.

Tensile Properties

Specified Thickness Inches	Elongation in 10 Inches Minimum Per Cent	
	Maximum Tensile Strength Per Square Inch	Minimum Per Cent
0.290 and Over.....	36,000	35
0.289 to 0.051.....	37,000	32
0.050 to 0.021.....	38,000	30
0.020 to 0.011.....	40,000	25
0.010 and Under.....	20

Permissible Variations in Dimensions

Specified Thickness Inches	Tolerances, Plus or Minus	
	1.000 to 0.501 In. in Width	0.500 In. and Under in Width
0.501 and Over.....	1 Per Cent
0.500 to 0.301.....	1 Per Cent	0.003 In.
0.300 to 0.101.....	1 Per Cent	1 Per Cent
0.100 and Under.....	0.001 In.	0.001 In.

Specified Thickness Inches	Tolerances, Plus or Minus	
	1 Per Cent but Not to Exceed 0.016 In.	
0.501 and Over.....	1 Per Cent	0.003 In.
0.500 to 0.301.....	1 Per Cent	0.001 In.
0.300 to 0.101.....	1 Per Cent	0.001 In.
0.100 and Under.....	1 Per Cent	0.001 In.

Radius of Corners

Specified Thickness Inches	Specified Width, Inches	
	0.189 to 0.750 Incl.	Up to 0.188 Incl.
0.689 and Over.....	3/16	..
0.688 to 0.439 Incl.....	3/32	..
0.438 to 0.226 Incl.....	1/16	..
0.225 to 0.166 Incl.....	3/64	3/64
0.165 to 0.126 Incl.....	1/32	1/32
0.125 to 0.073 Incl.....	1/32	1/64
*0.072 to 0.051 Incl.	Rounded Edge
0.050 and Under	Rounded Edge	Rounded Edge

*Square wire, 0.072 inches and under, shall have a corner radius of 0.012 inches, plus or minus 25%.

A rounded edge is produced by rolling round wire to the size specified either with or without edging rolls.

Density

For calculating weights, cross-sections, etc., the density of copper shall be taken as 8.89 grams per cubic cm. (0.32117 lbs. per cu. in.) at 20°C. (68°F.).

Resistivity

Resistivity is used in place of percentage conductivity. The value of 0.15328 ohm (meter, gram) at 20° C. (68°F.) is the international standard for the resistivity of annealed copper equal to 100% conductivity. This term means that a wire 1 mile in length and weighing 1 gram would have a resistance of 0.15328 ohms. This is equivalent to a resistivity of 875.20 ohms (mile, pound), which signifies the resistance of a wire 1 mile in length weighing 1 pound. It is also equivalent to 1.7241 microhms per cm. of length of a bar 1 square centimeter in cross-section.

Conductivity at 20°C. (68°F.), Per Cent.....	100.00
Ohms (Mile, Pound).....	875.20
Ohms (Meter, Gram).....	0.15328
Ohms (Mil, Foot).....	10.371
Ohms (Meter, Square Centimeter).....	0.017241
Microhm-Inch.....	0.67879
Microhm-Centimeter.....	1.7241

Prices on application.

General Cable Concentric Stranded Cable
Bare and Tinned or Coated Copper—Soft or Annealed

Medium Hard and Hard Drawn
 ASTM Standard B 8-56



Class AA: Used for bare cable.

Class A: For weather-resistant (weatherproof), for a slow-burning and for weather-resistant slow-burning cable. For bare cable where flexibility greater than that of Class AA is required.

Class B: For cable insulated with various materials, such as rubber, paper, varnished cloth, etc. and for cable indicated under Class A where greater flexibility is required.

Class C and Class D: For cable requiring greater flexibility than that afforded by Class B cable.

AWG	Cir. Mils	Class AA No. of Strands	Class A No. of Strands	Class B No. of Strands	Class C No. of Strands	Class D No. of Strands
...	5000000	...	169	217	271	271
...	4500000	...	169	217	271	271
...	4000000	...	169	217	271	271
...	3500000	...	127	169	217	271
...	3000000	...	127	169	217	271
...	2500000	...	91	127	169	217
...	2000000	...	91	127	169	217
...	1900000	...	91	127	169	217
...	1800000	...	91	127	169	217
...	1750000	...	91	127	169	217
...	1700000	...	91	127	169	217
...	1600000	...	91	127	169	217
...	1500000	...	61	91	127	169
...	1400000	...	61	91	127	169
...	1300000	...	61	91	127	169
...	1250000	...	61	91	127	169
...	1200000	...	61	91	127	169
...	1100000	...	61	91	127	169
...	1000000	37	61	61	91	127
...	900000	37	61	61	91	127
...	800000	37	61	61	91	127
...	750000	37	61	61	91	127
...	700000	37	61	61	91	127
...	650000	37	61	61	91	127
...	600000	37	37	61	91	127
...	550000	37	37	61	91	127
...	500000	19	37	37	61	91
...	450000	19	37	37	61	91
...	400000	19	19	37	61	91
...	350000	12	19	37	61	91
...	300000	12	19	37	61	91
...	250000	12	19	37	61	91
4/0	211600	7	7	19	37	61
3/0	167800	7	7	19	37	61
2/0	133100	7	7	19	37	61
1/0	105600	7	7	19	37	61
1	83690	3	7	19	37	61
2	66360	3	7	7	19	37
3	52620	3	7	7	19	37
4	41740	3	7	7	19	37
5	33090	7	19	37
6	26240	7	19	37
7	20820	7	19	37
8	16510	7	19	37
9	13090	7	19	37
10	10380	7	19	37
12	6530	7	19	37
14	4110	7	19	37
16	2580	7	19	...
18	1620	7	19	...
20	1020

Prices on application.

General Cable
Tinned or Lead Alloy Coated Solid Wire
Soft or Annealed Copper



A.S.T.M. Standards
 Tinned Wires: B33-56T—Lead Alloy Coated: B189-56T

Tinned copper wires are also available in hard drawn and medium hard drawn tempers in accordance with ASTM Standard B246-51T.

Size A.W.G.	Diam. Mils	Diam. Range Mils		Max. Break-ing Stgth. Lbs.	Soft or Annealed Nominal Resist. Ohms Per M. Ft. (20° C.)		Net Wgt. Lbs. Per M. Ft.	Feet In Reel
		Min.	Max.		68° F.	68° F.		
2	257.6	255.0	265.3	1928	.1609	200.9	1240	
3	229.4	227.1	236.3	1529	.2028	159.3	1570	
4	204.3	202.3	210.4	1213	.2557	126.3	1980	
5	181.9	180.1	187.4	961.5	.3226	100.2	2500	
6	162.0	160.4	166.9	762.6	.4067	79.44	3150	
7	144.3	142.9	148.6	605.1	.5126	63.03	3970	
8	128.5	127.2	132.4	479.8	.6465	49.98	5010	
9	114.4	113.3	117.8	380.3	.8156	39.61	6320	
10	101.9	100.9	105.0	314.0	1.039	31.43	7960	
11	90.7	89.8	93.4	249	1.31	24.9	10000	
12	80.8	80.0	83.2	197	1.65	19.8	12600	
13	72.0	71.3	74.2	157	2.08	15.7	15900	
14	64.1	63.5	66.0	124	2.63	12.4	20200	
15	57.1	56.5	58.8	98.6	3.31	9.87	12200	
16	50.8	50.3	52.3	78.0	4.18	7.81	15100	
17	45.3	44.8	46.6	62.1	5.26	6.21	19300	
18	40.3	39.9	41.5	49.1	6.64	4.92	24100	
19	35.9	35.5	37.0	39.0	8.37	3.90	30800	
20	32.0	31.7	33.0	31.0	10.5	3.10	25800	
21	28.5	28.2	29.4	24.6	13.3	2.46	10200	
22	25.3	25.0	26.1	19.4	16.9	1.94	
23	22.6	22.4	23.3	15.4	21.1	1.55	
24	20.1	19.9	20.7	26.7	1.22	
25	17.9	17.7	18.4	34.4	.970	
26	15.9	15.7	16.4	43.6	.765	
27	14.2	14.1	14.6	54.6	.610	
28	12.6	12.5	13.0	69.4	.481	
29	11.3	11.2	11.6	86.3	.387	
30	10.0	9.9	10.3	111	.303	
31	8.9	8.8	9.2	141	.240	
32	8.0	7.9	8.3	174	.194	
33	7.1	7.0	7.4	221	.153	
34	6.3	6.2	6.6	281	.120	
35	5.6	5.5	5.9	355	.0949	
36	5.0	4.9	5.3	445	.0757	
37	4.5	4.4	4.8	550	.0613	
38	4.0	3.9	4.3	696	.0484	
39	3.5	3.4	3.8	909	.0371	
40	3.1	3.0	3.4	1160	.0291	

Breaking Strength: Based on nominal wire diameters. No. ASTM tensile requirements for wire sizes smaller than .0226 in. Size No. 23 A.W.G.

Resistance: Based on nominal wire diameters. Resistivities as follows:

Diameter Inches	A.S.T.M. Resistivity At 68° F. (20° C.) Ohms (Mile, Pound)	I.A.C.S. Conductivity Percentage
.460 — .290	896.15	97.66
Under .290 — .103	900.77	97.16
Under .103 — .0201	910.15	96.16
Under .0201 — .0111	929.52	94.16
Under .0111 — .0030	939.51	93.15

Tolerances in Wire Diameters: Wire .010 in. and larger plus 3%, minus 1%. Wires under .010 in. plus .0003 in. (.03 mil) minus .0001 in. (.01 mil).

Above data approximate, subject to normal manufacturing tolerances.

General Cable Bare Solid Copper Wire

A.S.T.M. Standards: Hard Drawn B 1-56; Medium Hard Drawn B 2-52; Soft or Annealed B-3-56; Diameters and Areas B 258-51T

Size AWG	Dia. Mils	Circular Area Mils	Area Sq. In.	Soft or Annealed			Medium Hard			Hard Drawn			Standard Packages		
				Max. Break. Str. Lbs.	Max. Tens. Str. P.S.I.	Break. Str. Lbs.	Min. Lbs.	Max. Tens. Str. P.S.I.	Min. P.S.I.	Min. Break. Str. Lbs.	Min. Tens. Str. P.S.I.	Net Wt. Per M-FL Lbs.	On Reels or Spools Ft.	Net Wt. Lbs.	In Coils Net Wt. Lbs.
4/0	160.0	211,600	.1662	5983	36,000	8143	6980	49,000	42,000	8143	49,000	640.5	2640	1691	250
3/0	149.6	167,800	.1318	4744	36,000	6588	5666	50,000	43,000	6720	51,000	507.8	2640	1341	250
2/0	134.8	133,100	.1015	3763	36,000	5330	4599	51,000	44,000	5519	52,800	402.8	5280	2130	250
1/0	124.9	105,600	.08291	2986	36,000	4311	3731	52,000	45,000	4518	54,500	319.5	5280	1690	250
1	119.3	83,690	.06573	2432	37,000	3484	3024	53,000	46,000	3688	56,100	253.3	5280	1340	250
2	111.6	66,360	.05212	1928	37,000	2814	2450	54,000	47,000	3002	57,600	200.9	4980	1000	220
3	104.4	52,620	.04133	1529	37,000	2273	1984	55,000	48,000	2439	59,000	159.3	6280	1000	220
4	97.3	41,740	.03278	1213	37,000	1814	1584	55,330	48,330	1970	60,100	126.3	7920	1000	220
5	90.7	33,090	.02599	961.5	37,000	1446	1265	55,660	48,660	1590	61,200	100.2	9980	1000	220
6	84.5	26,240	.02061	762.6	37,000	1154	1010	56,000	49,000	1280	62,100	79.44	12590	1000	220
7	78.7	20,820	.01635	605.1	37,000	921.2	806.7	56,330	49,330	1030	63,000	63.03	1000	220
8	73.4	16,510	.01297	479.8	37,000	734.8	644.0	56,660	49,660	826.1	63,700	49.98	1000	220
9	68.3	13,090	.01028	380.3	37,000	585.9	513.9	57,000	50,000	660.9	64,300	39.61	1000	220
10	63.5	10,380	.008155	314.0	38,500	467.5	410.5	57,330	50,330	529.3	64,900	31.43	1000	220
11	59.0	8,230	.00646	249	38,500	373	327	57,660	50,660	423	65,400	24.9	250	220
12	54.8	6,530	.00513	197	38,500	297	262	58,000	51,000	337	65,700	19.8	250	220
13	50.8	5,180	.00407	157	38,500	237	209	58,330	51,330	268	65,900	15.7	250	220
14	47.0	4,110	.00323	124	38,500	189	167	58,660	51,660	214	66,200	12.4	250	220
15	43.4	3,260	.00256	98.6	38,500	151	133	59,000	52,000	170	66,400	9.87	250	125
16	40.0	2,580	.00203	78.0	38,500	120	106	59,330	52,330	135	66,600	7.81	250	125
17	36.8	2,050	.00161	62.1	38,500	96.2	84.9	59,660	52,660	108	66,800	6.21	250	125
18	33.8	1,620	.00128	49.1	38,500	76.5	67.6	60,000	53,000	85.5	67,000	4.92	70	125
19	31.0	1,290	.00101	39.0	38,500	61.0	54.0	60,300	53,300	68.0	67,200	3.90	70	125
20	28.5	1,020	.000804	31.0	38,500	48.8	43.2	60,700	53,700	54.2	67,400	3.10	70	125
21	26.0	812	.000638	24.6	38,500	38.9	34.4	61,000	54,000	43.2	67,700	2.46	70	50
22	23.8	640	.000503	19.4	38,500	30.8	27.3	61,300	54,300	34.1	67,900	1.94	70	50
23	21.8	511	.000401	15.4	38,500	24.7	21.9	61,600	54,600	27.3	68,100	1.55	70	50
24	19.9	404	.000317	12.7	40,000	19.7	17.5	62,000	55,000	21.7	68,300	1.22	70	50
25	18.2	320	.000252	10.1	40,000	15.7	13.9	62,300	55,300	17.3	68,600	.970	70	50
26	16.7	253	.000199	7.94	40,000	12.4	11.1	62,700	55,700	13.7	68,800	.765	10	50
27	15.3	202	.000158	6.33	40,000	9.98	8.87	63,000	56,000	10.9	69,000	.610	10	..
28	14.0	159	.000125	4.99	40,000	7.89	7.02	63,300	56,300	8.64	69,300	.481	10	..
29	12.8	128	.000100	4.01	40,000	6.39	5.69	63,700	56,700	6.96	69,400	.387	10	..
30	11.8	100	.0000785	3.14	40,000	5.03	4.48	64,000	57,000	5.47	69,700	.303	10	..
31	10.9	79.2	.0000622	2.49	40,000	4.00	3.56	64,300	57,300	4.35	69,900	.240	7	..
32	10.0	64.0	.0000503	2.01	40,000	3.25	2.90	64,600	57,600	3.53	70,200	.194	7	..
33	9.2	50.4	.0000396	1.58	40,000	2.57	2.30	65,000	58,000	2.79	70,400	.153	7	..
34	8.5	39.7	.0000312	1.25	40,000	2.04	1.82	65,300	58,300	2.20	70,600	.120	7	..
35	7.8	31.4	.0000246	.985	40,000	1.62	1.44	65,600	58,600	1.75	70,900	.0949	7	..
36	7.2	25.0	.0000196	.785	40,000	1.30	1.16	66,000	59,000	1.40	71,100	.0757	7	..
37	6.6	20.2	.0000159	.636	40,000	1.05	.943	66,300	59,300	1.13	71,300	.0613	7	..
38	6.0	16.0	.0000126	.503	40,000	.838	.750	66,700	59,700	.898	71,500	.0484	7	..
39	5.5	12.2	.00000962	.385	40,000	.645	.577	67,000	60,000	.691	71,800	.0371	7	..
40	5.0	9.61	.00000755	.302	40,000	.508	.455	67,300	60,300	.543	72,000	.0291	7	..
41	4.5	7.84	.00000616	.246	40,000	.414	.371	67,300	60,300	.443	72,000	.0237	2	..
42	4.0	6.25	.00000491	.196	40,000	.330	.296	67,300	60,300	.353	72,000	.0189	2	..
43	3.6	4.84	.00000380	.152	40,000	.256	.229	67,300	60,300	.274	72,000	.0147	2	..
44	3.2	4.00	.00000314	.126	40,000	.211	.189	67,300	60,300	.226	72,000	.0121	2	..
45	2.8	3.24	.00000254	.102	40,000	.171	.153	67,300	60,300	.183	72,000	.00981	2	..
46	2.5	2.56	.00000201	.0804	40,000	.136	.121	67,300	60,300	.145	72,000	.00775	2	..

Breaking Strengths: Based on nominal wire diameters. No A.S.T.M. tensile requirements for hard drawn or medium hard drawn wire for sizes smaller than size 18 A.W.G. (.0403-in.), and no A.S.T.M. tensile requirement for soft or annealed wire for sizes smaller than size 23 A.W.G. (.0226-in.).

Tolerances: Conform to tolerances in wire diameters (area).

Weights: Based on nominal wire diameters. Tolerances in weight conform to tolerances in diameter (area).

Tolerances:

Diameter:

Hard Drawn: A.S.T.M. B 1-56

Medium Hard Drawn A.S.T.M. B 2-52

Wires .4600-in. Diameter to .0403-in. Diameter ±1%

No A.S.T.M. requirements for hard drawn or medium hard drawn wire, for wires smaller than size 18 A.W.G. (.0403-in.).

Soft or annealed A.S.T.M. B 3-56.

Wires .0100-in. diameter and larger ±1%

Wires under .0100-in. diameter ±.0001-in.

No A.S.T.M. requirements for soft or annealed wire, for wires smaller than size 40 A.W.G. (.0031-in.).

The above data are approximate and subject to normal manufacturing tolerances.

General Cable Bare Concentric Stranded Cable

Soft or Annealed Copper

A.S.T.M. Standards B 8-56 and B3-56



Size AWG	Circular Mills	Area Sq. In.	Class A		Class B		Class C		Class D		Nom. Wt. Per M-Ft. Lbs.	Nominal Resist. at 68° F. (20° C.) Ohms Per M-Ft.	Standard Packages		
			Over-all Dia. In.	Max. Break. Str. Lbs.	Over-all Dia. In.	Max. Break. Str. Lbs.	Over-all Dia. In.	Max. Break. Str. Lbs.	Over-all Dia. In.	Max. Break. Str. Lbs.			On Reels Ft.	Lbs.	In Coils Lbs.
5,000,000	3,927	2.580	145,300	2,581	145,300	2,580	145,300	2,580	145,300	15,890	.002178	As Specified	
4,500,000	3,534	2,418	130,800	2,418	130,800	2,449	130,800	2,449	130,800	14,300	.002420	As Specified	
4,000,000	3,142	2,307	116,200	2,309	116,200	2,309	116,200	2,309	116,200	12,590	.002697	As Specified	
3,500,000	2,749	2,158	101,700	2,159	101,700	2,159	101,700	2,159	101,700	11,020	.003082	As Specified	
3,000,000	2,356	1,998	87,180	1,998	87,180	1,999	87,180	1,999	87,180	9,353	.003561	As Specified	
2,500,000	1,963	1,823	72,650	1,824	72,650	1,824	72,650	1,824	72,650	7,791	.004273	As Specified	
2,000,000	1,571	1,630	58,120	1,632	58,120	1,632	60,480	1,632	60,480	6,175	.005289	650	4,020	...	
1,900,000	1,492	1,590	55,210	1,590	55,210	1,590	57,450	1,591	57,450	5,866	.005568	700	4,100	...	
1,800,000	1,414	1,547	52,310	1,548	52,310	1,548	54,430	1,549	54,430	5,558	.005877	725	4,030	...	
1,750,000	1,374	1,526	50,850	1,526	50,850	1,527	52,920	1,527	52,920	5,403	.006045	750	4,060	...	
1,700,000	1,335	1,504	49,400	1,504	49,400	1,505	51,400	1,505	51,400	5,249	.006223	775	4,070	...	
1,600,000	1,257	1,459	46,500	1,459	48,380	1,460	48,380	1,460	48,380	4,940	.006612	800	3,950	...	
1,500,000	1,178	1,411	43,590	1,412	43,590	1,413	45,360	1,413	45,360	4,631	.007052	900	4,170	...	
1,400,000	1,100	1,364	40,680	1,364	40,680	1,365	42,330	1,365	42,330	4,323	.007556	950	4,130	...	
1,300,000	1,021	1,314	37,780	1,315	37,780	1,316	39,310	1,316	39,310	4,014	.008137	1,000	4,014	...	
1,250,000	.9817	1,288	36,320	1,289	36,320	1,290	37,800	1,290	37,800	3,859	.008463	1,000	3,860	...	
1,200,000	.9425	1,263	34,870	1,263	34,870	1,264	36,290	1,265	36,290	3,705	.008816	1,100	4,080	...	
1,100,000	.8639	1,209	31,970	1,209	33,260	1,210	33,260	1,211	33,260	3,396	.009617	1,200	4,080	...	
1,000,000	.7854	1,152	29,060	1,152	29,060	1,153	30,240	1,153	30,240	3,088	.01058	1,300	4,020	...	
900,000	.7069	1,094	26,150	1,094	26,150	1,093	27,210	1,095	27,210	2,779	.01175	1,500	4,170	...	
800,000	.6283	1,031	23,250	1,031	23,250	1,032	24,190	1,032	24,190	2,470	.01322	1,600	3,950	...	
750,000	.5890	.998	22,680	.998	22,680	.999	22,680	.998	22,680	2,316	.01410	1,700	3,940	...	
700,000	.5498	.964	21,170	.964	21,170	.965	21,170	.965	21,170	2,161	.01511	1,850	4,000	...	
650,000	.5105	.929	19,650	.929	19,650	.930	19,650	.930	19,650	2,007	.01627	2,000	4,010	...	
600,000	.4712	.891	17,410	.893	18,140	.893	18,140	.893	18,140	1,853	.01763	2,100	3,900	...	
550,000	.4320	.853	15,980	.855	16,630	.855	16,630	.855	16,630	1,698	.01923	2,400	4,080	...	
500,000	.3927	.813	14,530	.813	14,530	.815	15,120	.815	15,120	1,544	.02116	2,600	4,020	...	
450,000	.3534	.772	13,610	.772	13,610	.773	13,610	.773	13,610	1,389	.02351	2,900	4,030	...	
400,000	.3142	.726	11,620	.728	12,100	.729	12,100	.729	12,100	1,235	.02645	3,200	3,950	...	
350,000	.2749	.679	10,170	.681	10,580	.681	10,580	.682	10,580	1,081	.03022	3,700	4,000	...	
300,000	.2356	.629	8,718	.630	9,071	.631	9,071	.631	9,071	926.3	.03526	4,300	3,980	...	
250,000	.1963	.574	7,265	.575	7,559	.576	7,559	.576	7,559	771.9	.04231	5,200	4,020	...	
211,600	.1662	.522	6,149	.528	6,398	.529	6,398	.530	6,398	653.3	.04999	6,000	3,920	250	
167,800	.1318	.464	4,876	.470	5,074	.471	5,074	.472	5,074	518.1	.06304	8,000	4,150	250	
133,100	.1045	.414	3,868	.419	4,025	.420	4,025	.420	4,025	411.0	.07948	10,000	4,110	250	
105,600	.08294	.368	3,069	.373	3,193	.374	3,193	.374	3,193	326.0	.1002	12,000	3,910	250	
83,690	.06573	.328	2,531	.332	2,531	.333	2,531	.333	2,531	258.4	.1264	15,000	3,860	250	
66,360	.05212	.292	2,007	.292	2,007	.296	2,007	.297	2,007	204.9	.1594	5,700	1,170	250	
52,620	.04133	.260	1,591	.260	1,591	.263	1,591	.264	1,591	162.5	.2010	5,380	875	250	
41,740	.03278	.232	1,262	.232	1,262	.235	1,262	.235	1,262	128.9	.2534	6,800	875	250	
5	33,090	.02599206	1,001	.209	1,001	.209	1,001	102.2	.3197	4,900	500	250	
6	26,240	.02061184	793.4	.186	793.4	.186	793.4	81.02	.4031	6,170	500	250	
7	20,820	.01635164	629.6	.166	629.6	.166	629.6	64.28	.5081	7,700	500	125	
8	16,510	.01297146	499.2	.148	499.2	.148	499.2	50.98	.6407	9,800	500	125	
9	13,090	.01028130	395.8	.131	395.8	.132	395.8	41.2	.8081	500	
10	10,380	.008152116	313.9	.117	313.9	.117	313.9	32.05	1.019	500	
12	6,530	.0051290915	197.5	.0925	205.1	.0931	205.1	20.16	1.620	500	
14	4,110	.0032280726	124.3	.0735	129.1	.0735	129.1	12.69	2.574	500	
16	2,580	.0020260576	81.05	.0585	81.05	7.966	4.100	As Specified	
18	1,620	.0012720456	50.89	.0460	50.89	5.002	6.530	As Specified	
20	1,020	.00080110363	32.04	.0365	32.04	3.149	10.37	As Specified	

For Class AA stranding and data for hard drawn and medium hard drawn and standard packages for overhead line conductors information available upon request.

Breaking Strengths: Based on nominal wire diameters and shall not exceed the total of the specified maximum tensile strengths of the component wires by more than 5 per cent.

Resistances and weights: Based on nominal wire diameters. Resistivity at 68°F. (20°C), 875.20 ohms (mile, pound), 100% I.A.C.S. Conductivity.

Increments for stranding for weights and resistances:

2,000,000 C.M. and less	2%
Over 2,000,000 C.M. including 3,000,000	3%
Over 3,000,000 C.M. including 4,000,000	4%
Over 4,000,000 C.M. including 5,000,000	5%

Tolerances: Conform to tolerances in wire diameters. Total area of conductor shall be not less than 98% of the nominal listed area.

The above data are approximate and subject to normal manufacturing tolerances.

Prices on application.

General Cable Overhead Line Conductors

Bare Copper—Hard Drawn and Medium Hard Drawn

A.S.T.M. Standards B 1-56; B 2-56 and B 8-56

A complete series of bare overhead line conductors, covering the entire range of electrical and physical requirements necessary for all designs of transmission, distribution, signal and communications systems, is supplied by General Cable.

Copper conductors are available in a variety of tempers to provide the best combination of tensile strength and flexibility for a particular application. The conductivity of copper is higher than that of any other commercial metal.

Long, dependable service life, re-usability and high salvage value are characteristics of these conductors, maintained by copper's high degree of resistance to corrosion, fatigue and abrasion.

Size AWG Or Cir. Mils	Over- all Dia. In.	Area		No. Strands	Nom. Wt. Per M-Ft. Lbs.	Nom. Wt. Per Mile Lbs.	Hard Drawn		Medium Hard			Std. Pkgs. On Reels Ft.	Net Wt. Lbs.
		Circular Mils	Sq. In.				Min. Break. Str. Lbs.	Nom. Resist. Ohms Per M-Ft. 68° F. (20° C.)	Break. Min. Lbs.	Str. Max. Lbs.	Nom. Resist. Ohms Per M-Ft. 68° F. (20° C.)		
Solid Conductors													
4/0	.4600	211,600	.1662	640.5	3,382	8,143	.05045	6,980	8,143	.05019	2,640	1690
3/0	.4096	167,800	.1318	507.8	2,681	6,720	.06362	5,666	6,588	.06330	2,640	1340
2/0	.3648	133,100	.1045	402.8	2,127	5,519	.08021	4,599	5,330	.07980	5,280	2130
1/0	.3249	105,600	.08291	319.5	1,687	4,518	.1011	3,731	4,311	.1006	5,280	1690
1	.2893	83,690	.06573	253.3	1,338	3,688	.1289	3,024	3,484	.1282	5,280	1340
2	.2576	66,360	.05212	200.9	1,061	3,002	.1625	2,454	2,814	.1617	5,280	1060
3	.2294	52,620	.04133	159.3	811.1	2,439	.2050	1,984	2,273	.2039	5,280	841
4	.2043	41,740	.03278	126.3	667.1	1,970	.2584	1,584	1,814	.2571	5,280	667
5	.1819	33,090	.02599	100.2	528.8	1,590	.3260	1,265	1,446	.3243	7,920	794
6	.1620	26,240	.02061	79.44	419.4	1,280	.4110	1,010	1,154	.4088	7,920	629
7	.1443	20,820	.01635	63.03	332.8	1,030	.5180	806.7	921.2	.5153
8	.1285	16,510	.01297	49.98	263.9	826.1	.6532	644.0	734.8	.6498
9	.1144	13,090	.01028	39.61	209.2	660.9	.8241	513.9	589.9	.8199
10	.1019	10,380	.008155	31.43	166.0	529.3	1.039	410.5	467.5	1.033
11	.0907	8,230	.00646	24.9	131	423	1.31	327	373	1.30
12	.0808	6,530	.00513	19.8	104	337	1.65	262	297	1.64
13	.0720	5,180	.00407	15.7	82.9	268	2.08	209	237	2.07
14	.0641	4,110	.00323	12.4	65.7	214	2.63	167	189	2.61
Stranded Conductors													
1,000,000	1.151	1,000,000	.7854	AA-37	3088	16,300	43,830	.01100	34,400	43,720	.01094	1,300	4020
900,000	1.092	900,000	.7069	AA-37	2779	14,670	39,510	.01222	31,170	39,580	.01216	1,500	4170
800,000	1.029	800,000	.6283	AA-37	2470	13,040	35,120	.01375	27,710	35,190	.01368	1,600	3950
750,000	.997	750,000	.5890	AA-37	2316	12,230	33,400	.01467	26,150	33,180	.01459	1,700	3940
700,000	.963	700,000	.5498	AA-37	2161	11,410	31,170	.01572	24,410	30,970	.01563	1,850	4000
600,000	.891	600,000	.4712	(AA-A)-37	1853	9,781	27,020	.01834	21,060	26,700	.01824	2,100	3900
500,000	.813	500,000	.3927	A-37	1544	8,151	22,510	.02200	17,550	22,250	.02189	2,600	4020
500,000	.811	500,000	.3927	AA-19	1544	8,151	21,950	.02200	17,320	21,990	.02189	2,600	4020
450,000	.770	450,000	.3534	AA-19	1389	7,336	19,750	.02445	15,590	19,790	.02432	2,900	4030
400,000	.726	400,000	.3142	(AA-A)-19	1235	6,521	17,810	.02750	13,950	17,700	.02736	3,200	3950
350,000	.679	350,000	.2749	A-19	1081	5,706	15,590	.03143	12,200	15,480	.03127	3,700	4000
350,000	.710	350,000	.2749	AA-12	1081	5,706	15,140	.03143	12,040	15,300	.03127	2,770	3000
300,000	.629	300,000	.2356	A-19	926.3	4,891	13,510	.03667	10,530	13,350	.03648	4,300	3980
300,000	.657	300,000	.2356	AA-12	926.3	4,891	13,170	.03667	10,390	13,190	.03648	3,240	3000
250,000	.574	250,000	.1963	A-19	771.9	4,076	11,360	.04400	8,836	11,190	.04378	5,280	4080
250,000	.600	250,000	.1963	AA-12	771.9	4,076	11,130	.04400	8,717	11,060	.04378	3,890	3000
4/0	.528	211,600	.1662	B-19	653.3	3,450	9,617	.05199	7,479	9,473	.05172	6,000	3920
4/0	.522	211,600	.1662	(AA-A)-7	653.3	3,450	9,154	.05199	7,278	9,250	.05172	5,350	3500
3/0	.464	167,800	.1318	(AA-A)-7	518.1	2,736	7,366	.06556	5,812	7,380	.06522	6,750	3500
2/0	.414	133,100	.1045	(AA-A)-7	411.0	2,170	5,927	.08265	4,641	5,889	.08222	8,530	3500
1/0	.368	105,600	.08291	(AA-A)-7	326.0	1,722	4,755	.1042	3,707	4,699	.1036	10,750	3500
1	.328	83,690	.06573	A-7	258.4	1,364	3,804	.1315	2,958	3,747	.1308	6,680	1725
2	.292	66,360	.05212	A-7	204.9	1,082	3,044	.1658	2,361	2,988	.1649	5,700	1165
2	.320	66,360	.05212	AA-3	202.9	1,071	2,913	.1642	2,298	2,919	.1633	7,400	1500
3	.285	52,620	.04133	AA-3	160.9	819.4	2,358	.2070	1,835	2,328	.2059	9,330	1500
4	.254	41,740	.03278	AA-3	127.6	673.8	1,879	.2610	1,465	1,857	.2596	11,800	1500
4	.226	33,090	.02599	3*	101.2	534.1	1,504	.3292	1,169	1,481	.3275	As Specified
6	.201	26,240	.02061	3*	80.22	423.6	1,204	.4151	933.5	1,182	.4130	As Specified

Modulus of Elasticity: (Lbs. per Sq. In.)

	Initial	Final
Hard Drawn:		
Solid wire.....	14,500,000	17,000,000
Stranded Conductor		
3 wire.....	14,000,000	17,000,000
7 and 19 wire.....	14,500,000	17,000,000
12 wire.....	14,000,000	17,000,000
37 wire.....	14,000,000	16,500,000
Coefficient of Linear Expansion per degree F. —	.0000094.	

Breaking Strength: Based on nominal wire diameters.

Weights and Resistances: Based on nominal wire diameters.

Increments for stranding:

3 wire cable.....	1%
7 to 37 wire cable, inclusive.....	2%

Tolerances: Conform to tolerances in wire diameters.

Total area of stranded conductors shall be not less than 98% of the nominal listed area.

The above data are approximate and subject to normal manufacturing tolerances.

Resistance: Based on the following A.S.T.M. resistivities at 68°F (20°C):

Hard Drawn:	Ohms (Milo Lb.)	I.A.C.S. Conductivity%
Diameters: .160-in. — .325-in. (Size 4/0 to 1/0 AWG).....	900.77	97.16
Under .325-in. — .0403-in. (Size 1 to 18 AWG).....	910.15	96.16
Medium Hard Drawn:		
Diameters .160-in. — .325-in. (Size 4/0 to 1/0 AWG).....	896.15	97.66
Under .325-in. — .0403-in. (Size 1 to 18 AWG).....	905.44	96.66

*Not listed in A.S.T.M.

Letters preceding the number of strands refer to A.S.T.M. class designation BB.

When lengths are not specified, random lengths will be included.

When lengths are specifically agreed upon for any item, ninety per cent of the reels shall have the specified length subject to a variation of 10% plus or minus; the remainder of the item may be shipped in random lengths of not less than 50% of the specified length.

General Cable Overhead Line Conductors

Bare Copper—Hard Drawn

A.S.T.M. Standards B 1-56 and B 8-56

Size AWG Or Cir. Mils	Area Cir. Mils	No. Strands	Over- all Dia. In.	Resistances D-C - A-C												Phase to Neutral Reactance at One-Foot Separation					
				Resistance Ohms Per Mile-77° F. (25° C.)						Resistance Ohms Per Mile-122° F. (50° C.)						Inductive Reactance Ohms Per Mile			Capacitive Reactance Megohms Per Mile		
				D.C.	25	50	60	D.C.	25	50	60	25	50	60	25	50	60				
Solid Conductors																					
2	66,360	Solid	.2576	.8744	.8745	.8746	.8748	.9555	.9555	.9557	.9558	.2419	.4838	.5806	.3229	.1614	.1345				
3	52,620	Solid	.2294	1.103	1.103	1.103	1.103	1.205	1.205	1.205	1.205	.2478	.4955	.5946	.3311	.1656	.1380				
4	41,740	Solid	.2043	1.390	1.390	1.390	1.390	1.519	1.519	1.519	1.519	.2536	.5072	.6087	.3394	.1697	.1414				
5	33,090	Solid	.1819	1.754	1.754	1.754	1.754	1.916	1.916	1.916	1.916	.2595	.5190	.6288	.3476	.1738	.1449				
6	26,240	Solid	.1620	2.211	2.211	2.211	2.211	2.416	2.416	2.416	2.416	.2653	.5307	.6368	.3559	.1779	.1483				
7	20,820	Solid	.1443	2.787	2.787	2.787	2.787	3.045	3.045	3.045	3.045	.2712	.5424	.6509	.3641	.1821	.1517				
8	16,510	Solid	.1285	3.514	3.514	3.514	3.514	3.840	3.840	3.840	3.840	.2771	.5541	.6649	.3724	.1862	.1552				
Stranded Conductors																					
750	750,000	37	.997	.07891	.07958	.08154	.08266	.08623	.08684	.08864	.08968	.1742	.3484	.4180	.2265	.1133	.09438				
700	700,000	37	.963	.08455	.08517	.08701	.08806	.09239	.09296	.09465	.09562	.1759	.3519	.4223	.2290	.1145	.09541				
600	600,000	37	.891	.09864	.09918	.1008	.1017	.1078	.1083	.1097	.1104	.1799	.3597	.4317	.2345	.1173	.09771				
500	500,000	37	.813	.1184	.1188	.1201	.1209	.1293	.1298	.1310	.1317	.1845	.3690	.4428	.2410	.1205	.1004				
500	500,000	19	.811	.1184	.1188	.1201	.1209	.1293	.1298	.1310	.1317	.1853	.3706	.4447	.2412	.1206	.1005				
450	450,000	19	.770	.1315	.1319	.1331	.1338	.1437	.1441	.1452	.1458	.1879	.3759	.4510	.2419	.1225	.1020				
400	400,000	19	.726	.1480	.1483	.1494	.1500	.1617	.1620	.1630	.1636	.1909	.3818	.4582	.2491	.1245	.1038				
350	350,000	19	.679	.1691	.1694	.1704	.1709	.1848	.1851	.1859	.1864	.1943	.3886	.4663	.2539	.1269	.1058				
350	350,000	12	.710	.1691	.1694	.1704	.1709	.1848	.1851	.1859	.1864	.1918	.3836	.4604	.2507	.1253	.1044				
300	300,000	19	.629	.1973	.1975	.1984	.1988	.2156	.2156	.2166	.2170	.1982	.3963	.4756	.2593	.1297	.1080				
300	300,000	12	.657	.1973	.1975	.1984	.1988	.2156	.2156	.2166	.2170	.1957	.3915	.4698	.2562	.1281	.1068				
250	250,000	19	.574	.2367	.2370	.2376	.2380	.2587	.2587	.2595	.2599	.2028	.4056	.4867	.2658	.1329	.1108				
250	250,000	12	.600	.2367	.2370	.2376	.2380	.2587	.2587	.2595	.2599	.2003	.4006	.4808	.2627	.1313	.1094				
4/0	211,600	19	.528	.2797	.2799	.2805	.2808	.3056	.3058	.3063	.3066	.2070	.4140	.4968	.2718	.1359	.1132				
4/0	211,600	7	.522	.2797	.2799	.2805	.2808	.3056	.3058	.3063	.3066	.2098	.4195	.5034	.2726	.1363	.1136				
3/0	167,800	7	.464	.3527	.3529	.3533	.3536	.3854	.3855	.3860	.3862	.2137	.4314	.5177	.2810	.1405	.1171				
2/0	133,100	7	.414	.4447	.4448	.4451	.4453	.4859	.4860	.4863	.4865	.2215	.4429	.5315	.2891	.1445	.1205				
1/0	105,600	7	.368	.5604	.5605	.5608	.5610	.6124	.6125	.6128	.6129	.2274	.4549	.5458	.2975	.1487	.1239				
1	83,690	7	.328	.7072	.7072	.7075	.7076	.7727	.7728	.7730	.7731	.2332	.4665	.5598	.3057	.1528	.1274				
2	66,360	7	.292	.8918	.8919	.8921	.8922	.9745	.9746	.9748	.9749	.2391	.4783	.5739	.3139	.1570	.1308				
2	66,360	3	.320	.8831	.8832	.8834	.8835	.9650	.9650	.9652	.9653	.2380	.4759	.5711	.3074	.1537	.1281				
3	52,620	3	.286	1.114	1.114	1.114	1.114	1.217	1.217	1.217	1.217	.2438	.4877	.5852	.3157	.1578	.1315				
4	41,740	3	.254	1.404	1.404	1.404	1.404	1.534	1.534	1.534	1.534	.2496	.4993	.5991	.3239	.1619	.1349				
5	33,090	3	.226	1.771	1.771	1.771	1.771	1.935	1.935	1.935	1.935	.2555	.5111	.6133	.3322	.1661	.1384				
6	26,240	3	.202	2.233	2.233	2.233	2.233	2.440	2.440	2.440	2.441	.2615	.5229	.6275	.3405	.1703	.1419				

D-C Resistances: Based on nominal wire diameters and following A.S.T.M. resistivity at 68°F (20°C): 910.15 ohms (mile pound)—I.A.C.S. conductivity—96.5%.

Increments for stranding: 3 wire strand 1%, 7 to 37 wire strand, inclusive 2%.

Information regarding separations greater than one foot will be supplied upon request.

General Cable Copper Trolley Wire Hard Drawn—Round, Grooved, Fig. 8 and Fig. 9, Deep Section

Shape of Conductor	Size C.M.	Overall Diameter† In.	Area		Weight		Minimum Tensile Strength P.S.I.	Minimum Breaking Strength Lbs.	Nom. Resist. Ohms Per M-Ft. 68° F. (20° C.)	Std. Pkgs. On Reels Feet	Net Wt. Lbs.
			Circular Mils	Square In.	Lbs. Per M-Ft.	Lbs. Per Mile					
Round ASTM B 47-55	300,000	.548	300,000	.2356	908.1	4795	46,400	10,930	.03558	2640	2400
	211,600	.460	211,600	.1662	640.5	3382	49,000	8,143	.05045	5280	3380
	168,100	.410	168,100	.1320	508.9	2687	51,000	6,733	.06350	5280	2690
	133,200	.365	133,200	.1016	403.2	2129	52,800	5,524	.08014	5280	2130
	105,600	.325	105,600	.08294	319.7	1688	51,500	4,520	.1011	5280	1690
Grooved ASTM B 47-55	350,000	.620	351,200	.2758	1063	5612	42,800	11,810	.03039	1250	1330
	300,000	.574	299,800	.2355	907.6	4792	44,200	10,410	.03560	2640	2400
	211,600	.482	212,000	.1665	641.9	3389	46,600	7,759	.05035	5280	3390
	168,100	.430	167,300	.1314	506.4	2674	48,500	6,373	.06380	5280	2670
	133,200	.392	137,900	.1083	417.6	2205	50,200	5,437	.07741	5280	2210
Figure Eight ASTM B 116-55	350,000	.754 x .570	350,100	.2750	1060	5597	42,800	11,770	.03049	2640	2800
	211,600	.600 x .450	211,600	.1662	610.5	3382	46,600	7,744	.05045	5280	3380
	168,100	.540 x .400	167,800	.1318	508.0	2682	48,500	6,392	.06361	5280	2680
	133,200	.480 x .352	133,200	.1045	402.8	2127	50,200	5,252	.08014	5280	2130
	105,600	.420 x .312	105,600	.0829	319.5	1687	51,800	4,296	.1011	5280	1690
Figure Nine Deep Sect. ASTM B 116-55	400,000	.745 x .552	397,200	.3120	1202	6347	41,300	12,880	.02687	1000	1200
	350,000	.707 x .496	348,900	.2740	1056	5576	42,800	11,730	.03059	1000	1060

†For Figure 8 and Figure 9 wire, dimensions given are nominal height of entire section and width of lower lobe.

Size 6/0 A.W.G. (336,200 C.M.) Grooved or Figure 8 will regularly be furnished in 350,000 C.M.

Weights: Based on nominal dimensions.

Tolerances: Round-Wire — Diameter $\pm 1\%$. Grooved Wire — Dimensions, see Diagrams page 32. Weight $\pm 4\%$ of values listed. Figure 8 Wire-Dimensions, see Diagrams page 33. Weight $\pm 5\%$ of values listed. Figure 9 Wire-Dimensions, see Diagrams page 33. Weight $\pm 5\%$ of values listed.

Breaking Strengths: Based on nominal dimensions.

Resistances: Based on nominal dimensions, and on the following resistivity: 900.77 ohms (mile, pound) at 68° F. (20° C.) — 97.16% I.A.C.S. conductivity.

The above data are approximate and subject to normal manufacturing tolerances.

General Cable Copper Trolley Wire

A full range of copper trolley contact wires are available. In the manufacture of these wires special care is taken in rolling and drawing to obtain a surface free from imperfections and wire continuously true in shape. This produces a contact wire giving maximum life and freedom from operating trouble.

Wire manufactured in accordance with A.S.T.M. Specification B47, A.S.A. C7.6 and American Transit Association Specification D2. These specifications were prepared jointly by these associations in collaboration with the Association of American Railroads and are identical.

Round and Grooved

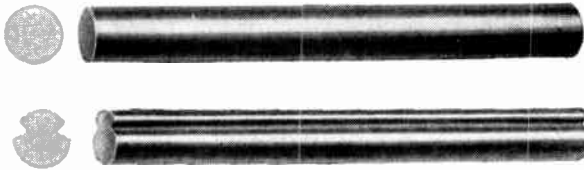

A.S.T.M. Standard B47-55
A.T.A. Engineering Manual Specification D2

Figure Eight and Figure Nine (Deep Section)

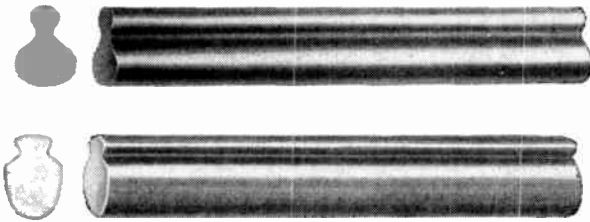

A.S.T.M. Standard B116-55

General Cable Copper Alloy Conductors

A.S.T.M. Standard B105-55

Bronze wires are copper alloyed with small amounts of tin and/or cadmium to provide high strength and electrical conductivity. They are highly corrosion resistant under atmospheric conditions and are, therefore, useful as line wires, guy and messenger strands, overhead ground wires or in combination with copper as composite conductors.

Nominal Modulus of Elasticity: Solid 16 x 10⁶. Stranded 10 x 10⁶.

Coefficient of Linear Expansion per Degree F: .0000094.

Alloy Conductivity I.A.C.S.	Density at 20° C.		Minimum Tensile Strength 6 A.W.G. (1620") HD-Wire Lbs. Per Sq. In.	Max. Resistivity at 66° F. (20° C.)	
	Grams Per Cu. Cm.	Lbs. Per Circ. Mil M. Ft.		Ohms (Mile Lb.)	Ohms (Mile Ft.)
Copper Tin Alloy					
30	8.89	.003027	94,800	2917	34.57
40	8.89	.003027	80,400	2188	25.93
65	8.89	.003027	72,000	1346	15.96
Copper Tin Cadmium Alloy					
55	8.89	.003027	84,000	1591	18.86
80	8.89	.003027	78,600	1094	12.96
85	8.89	.003027	74,700	1030	12.20

Characteristics:

Copper alloy characteristics compared to copper indicates:

- (1) **Weight:** Corresponds to copper.
- (2) **Strength:** 53% to 16% greater than Hard Drawn Copper.
- (3) **Conductivity:** 30% to 85% that of Annealed Copper.
- (4) **Modulus of Elasticity:** Approximately that of Hard Drawn Copper.
- (5) **Coefficient of Linear Expansion:** Corresponds to Hard Drawn Copper.

Note: Solid and stranded hard drawn copper alloy conductors and wires are available according to ASTM Standard B105-53 and information regarding these may be obtained upon request.

Prices on Application.

General Cable Bare All-Aluminum and ACSR Wires and Cables

Bare Solid All-Aluminum Hard Drawn ASTM Standard B230-55T

Size AWG	Diam. In.	Area Circ. Mills	Hard Drawn Copper Equivalent Size AWG	Breaking Strength Lbs.	Average Tensile Strength Lbs. Per Sq. In.	Nom. D-C Resist. Ohms Per M. Ft. 68° F. (20° C.)	*Reel 30 In. Flange Lgh. Ft.
8	0.1285	16,510	10	324.2	25000	1.030	23025
7	0.1413	20,820	9	400.7	24500	0.8165	18260
6	0.1620	26,240	8	494.7	24000	0.6478	14490
5	0.1819	33,090	7	623.7	24000	0.5138	11490
4	0.2043	41,740	6	786.8	24000	0.4073	9110
3	0.2294	52,620	5	971.3	23500	0.3231	7230
2	0.2576	66,360	4	1225	23500	0.2562	5730

*Additional lengths on 40-in. reels available upon request to a maximum of 1216 pounds. 200 pound packages also available on 22 in. reels. 27 in. I.D. coils also available.

Weights and breaking strength based on nominal wire diameters.

Resistances based on nominal wire diameters and ASTM Resistivity of 17,002 ohms (mil-foot) at 20C (equivalent conductivity 61% IACS).

Nominal shipping lengths shown are subject to a variation of ±10%. Ten per cent of the reels or coils may be shipped in random lengths of not less than 50% of the indicated nominal length.

The above data are approximate and subject to normal manufacturing tolerances.

General Cable Weatherproof Wires and Cables

Types and Size Range of Conductors

The standard conductor size ranges of the various types of weatherproof are as follows:

"OK-URC" Double and Triple Braided "Peerless-URC" Double and Triple Braid Weights

Material	Construction	Sizes
Copper	Solid	14 A.W.G.—4/0 A.W.G.
Copper	Stranded	8 A.W.G.—2,000,000 C.M.
Aluminum	Solid	8 A.W.G.—2 A.W.G. (10 A.W.G.—4 A.W.G. copper equivalent)
Aluminum	Stranded	4 A.W.G.—1,600,000 C.M. (6 A.W.G.—100600 C.M. Copper Equiv.)
ACSR	Stranded	6 A.W.G.—336,100 C.M. (8 A.W.G.—4/0 Copper Equivalent).
Bronze	Solid	14 A.W.G.—4 A.W.G.
Copperweld	Solid	12 A.W.G.—4 A.W.G.

"Tip-Top" Weatherproof Wires and Cables

Copper	Solid	12 A.W.G.—1 A.W.G.
Copper	Stranded	8 A.W.G.—500,000 C.M.
Aluminum	Solid	8 A.W.G.—2 A.W.G. (10 A.W.G.—4 A.W.G. copper Equivalent).
Aluminum	Stranded	6 A.W.G.—500,000 C.M. (8 A.W.G.—315,000 C.M. Copper Equiv.)
ACSR	Stranded	6 A.W.G.—4/0 A.W.G. (8 A.W.G.—2/0 A.W.G. Copper Equivalent).
Bronze	Solid	14 A.W.G.—4 A.W.G.
Copperweld	Solid	12 A.W.G.—4 A.W.G.

Polyethylene Weatherproof Wires and Cables

Copper	Solid	12 A.W.G.—1 A.W.G.
Copper	Stranded	8 A.W.G.—500,000 C.M.
Aluminum	Solid	8 A.W.G.—2 A.W.G. (10 A.W.G.—4 A.W.G. Copper Equivalent).
Aluminum	Stranded	6 A.W.G.—500,000 C.M. (8 A.W.G.—315,000 C.M. Copper Equiv.)
ACSR	Stranded	6 A.W.G.—4/0 A.W.G. (8 A.W.G.—2/0 A.W.G. Copper Equivalent).
Bronze	Solid	14 A.W.G.—4 A.W.G.
Copperweld	Solid	12 A.W.G.—4 A.W.G.

General Cable Bare All-Aluminum and ACSR Wires and Cables

Bare Stranded All-Aluminum Hard Drawn ASTM Standard B 231-55T

Dimensions—Weights—Breaking Strengths

Size WG Or Cir. Mils	Over- all Diam. In.	Cir. Mils	Area Sq. In.	Hd. Drawn Copper Equiv. AWG Or Cir. Mils	No. Strands	Dia. of Indiv. Strands In.	Net Wt. Per M-FL Lbs.	Break. Str. Lbs.	Nom. Resist. Ohms Per M-FL 68° F. (20° C.)	Standard Packages			
										Reels*	Coils		
										Lgth. Fl.	Net Wt. Per Reel Lbs.	Lgth. Fl.	Net Wt. Per Coil Lbs.
6	0.184	26,240	0.02061	8	A-7	0.612	21.63	529	0.6609	28,425	700	7,110	175
5	0.206	33,090	0.02599	7	A-7	0.688	31.06	667	0.5241	22,525	700	5,635	175
4	0.232	41,740	0.03278	6	A-7	0.772	39.18	826	0.4155	17,860	700	4,465	175
3	0.260	52,620	0.04133	5	A-7	0.867	49.40	1,023	0.3296	14,170	700	3,510	175
2	0.292	66,360	0.05212	4	AA-A-7	0.974	62.30	1,266	0.2613	11,230	700	2,810	175
1	0.328	83,690	0.06573	3	AA-A-7	0.1093	78.56	1,538	0.2052	8,910	700	2,225	175
1/0	0.368	105,600	0.08294	2	AA-A-7	0.1228	99.13	1,866	0.1612	7,060	700	1,765	175
2/0	0.414	133,100	0.1015	1	AA-A-7	0.1379	124.9	2,352	0.1303	5,605	700	1,400	175
3/0	0.461	167,800	0.1318	1/0	AA-A-7	0.1548	157.5	2,847	0.1033	4,445	700	1,110	175
4/0	0.522	211,600	0.1662	2/0	AA-A-7	0.1739	198.6	3,590	0.08196	3,525	700	880	175
<hr/>													
250,000	0.600	250,000	0.1964	157,200	AA-12	0.1443	231.7	4,330	0.06937	5,112	1,200		
500,000	0.574	250,000	0.1964	157,200	A-19	0.1447	231.7	4,506	0.06937	8,100	1,900		
266,800	0.619	266,800	0.2095	3/0	AA-12	0.1491	250.5	4,620	0.06500	4,790	1,200		
266,800	0.593	266,800	0.2095	3/0	A-19	0.1485	250.5	4,809	0.06500	7,535	1,900		
300,000	0.657	300,000	0.2356	188,700	AA-12	0.1581	281.6	5,089	0.05781	4,260	1,200		
300,000	0.629	300,000	0.2356	188,700	A-19	0.1257	281.6	5,301	0.05781	6,747	1,900		
336,400	0.695	336,400	0.2642	4/0	AA-12	0.1674	315.8	5,707	0.05155	3,800	1,200		
336,400	0.666	336,400	0.2642	4/0	A-19	0.1331	315.8	5,945	0.05155	6,015	1,900		
350,000	0.710	350,000	0.2749	220,000	AA-12	0.1708	328.6	5,938	0.04955	3,650	1,200		
350,000	0.679	350,000	0.2749	220,000	A-19	0.1357	328.6	6,185	0.04955	5,780	1,900		
<hr/>													
400,000	0.726	400,000	0.3142	252,000	AA-A-19	0.1151	375.5	6,927	0.04336	5,060	1,900		
450,000	0.770	450,000	0.3534	283,000	AA-19	0.1539	422.4	7,634	0.03854	4,500	1,900		
450,000	0.772	450,000	0.3534	283,000	A-37	0.1103	422.4	8,111	0.03854	8,760	3,700		
477,000	0.792	477,000	0.3746	300,000	AA-19	0.1584	447.8	8,092	0.03636	4,245	1,900		
477,000	0.795	477,000	0.3746	300,000	A-37	0.1135	447.8	8,598	0.03636	8,260	3,700		
500,000	0.811	500,000	0.3927	311,000	AA-19	0.1622	469.4	8,482	0.03468	4,050	1,900		
500,000	0.813	500,000	0.3927	311,000	A-37	0.1162	469.4	9,012	0.03468	7,880	3,700		
550,000	0.853	550,000	0.4320	316,000	AA-A-37	0.1219	516.3	9,719	0.03153	7,165	3,700		
600,000	0.891	600,000	0.4712	377,000	AA-A-37	0.1273	563.3	10,600	0.02890	6,570	3,700		
636,000	0.918	636,000	0.4995	400,000	AA-A-37	0.1311	597.0	11,240	0.02727	6,200	3,700		
<hr/>													
650,000	0.928	650,000	0.5105	409,000	AA-37	0.1325	610.2	11,490	0.02668	6,065	3,700		
650,000	0.929	650,000	0.5105	409,000	A-61	0.1032	610.2	11,950	0.02668	6,600	4,066		
700,000	0.963	700,000	0.5498	440,000	AA-37	0.1375	657.1	12,370	0.02477	5,630	3,700		
700,000	0.964	700,000	0.5498	440,000	A-61	0.1071	657.1	12,860	0.02477	6,180	4,066		
750,000	0.997	750,000	0.5891	472,000	AA-37	0.1424	704.1	12,990	0.02312	5,250	3,700		
750,000	0.998	750,000	0.5891	472,000	A-61	0.1109	704.1	13,520	0.02312	5,775	4,066		
800,000	1.029	800,000	0.6283	503,000	AA-37	0.1470	751.0	13,850	0.02618	4,925	3,700		
800,000	1.031	800,000	0.6283	503,000	A-61	0.1145	751.0	14,420	0.02168	5,415	4,066		
900,000	1.092	900,000	0.7069	566,000	AA-37	0.1560	811.9	15,270	0.01927	4,380	3,700		
900,000	1.094	900,000	0.7069	566,000	A-61	0.1215	811.9	15,900	0.01927	4,810	4,066		
<hr/>													
1,000,000	1.151	1,000,000	0.7854	629,000	AA-37	0.1644	938.8	16,960	0.01734	3,940	3,700		
1,000,000	1.152	1,000,000	0.7854	629,000	A-61	0.1280	938.8	17,670	0.01734	4,330	4,066		
1,110,000	1.209	1,100,000	0.8639	692,000	AA-A-61	0.1343	1033	19,440	0.01577	3,935	4,066		
1,200,000	1.263	1,200,000	0.9425	755,000	AA-A-61	0.1403	1127	20,780	0.01445	3,607	4,066		
1,250,000	1.288	1,250,000	0.9818	786,000	AA-A-61	0.1431	1173	21,650	0.01387	3,465	4,066		
1,300,000	1.314	1,300,000	1.021	818,000	AA-A-61	0.1460	1220	22,550	0.01334	3,330	4,066		
1,400,000	1.364	1,400,000	1.100	880,000	AA-A-61	0.1515	1314	23,750	0.01239	3,095	4,066		
1,500,000	1.411	1,500,000	1.178	943,000	AA-A-61	0.1568	1408	25,450	0.01156	2,885	4,066		
1,600,000	1.458	1,600,000	1.257	1,006,000	A-61	0.1620	1502	27,140	0.01084	2,700	4,066		
1,600,000	1.459	1,600,000	1.257	1,006,000	A-91	0.1326	1502	27,270	0.01084	3,029	4,550		
<hr/>													
1,700,000	1.502	1,700,000	1.335	1,069,000	AA-61	0.1669	1596	28,840	0.01020	2,515	4,066		
1,700,000	1.504	1,700,000	1.335	1,069,000	A-91	0.1367	1596	30,040	0.01020	2,850	4,550		
1,750,000	1.525	1,750,000	1.374	1,101,000	AA-61	0.1694	1613	29,690	0.009910	2,475	4,066		
1,750,000	1.526	1,750,000	1.374	1,101,000	A-91	0.1387	1613	30,930	0.009910	2,760	4,550		
1,800,000	1.547	1,800,000	1.414	1,132,000	A-91	0.1406	1690	31,170	0.009634	2,690	4,550		
1,900,000	1.590	1,900,000	1.492	1,195,000	A-91	0.1445	1784	32,900	0.009127	2,550	4,550		
2,000,000	1.630	2,000,000	1.571	1,260,000	A-91	0.1482	1878	34,640	0.008671	2,420	4,550		

Weights, breaking strengths and resistances based on nominal wire diameters.

Resistances based on ASTM B230 resistivity of 17.002 ohms (mil-foot) at 20 C.

Increment of weight and resistance for stranding: 2%.

Tolerances: Wire diameter: Wires 100 miles and larger ±1%

Wires 99 miles and smaller ±1 mil

Area: Not less than 98% of nominal area.

Tolerances in other quantities conform to tolerances in wire diameters.

Letters preceding the number of component wires refer to stranding class designations of ASTM B 231-55T.

Nominal shipping lengths shown are subject to a variation of ±10%.

Ten per cent of the reels or coils may be shipped in random lengths of not less than 50% of the indicated nominal length.

*Sizes 6 through 4/0 standard lengths shipped on non-returnable reels.

The above data are approximate and subject to normal manufacturing tolerances.

General Cable Bare All-Aluminum and ACSR Wires and Cables



Bare ACSR—ASTM Standard B 232-55T

Dimensions—Breaking Strengths—Weights

ACSR Size and Area		Alum. and Steel Sq. In.	Hd. Drawn Copper Equivalent AWG Or Cir. Mils	Stranding No. and Dia. of Indiv. Strands-In.		Dia. In.		Wt. Per M-Ft. Total	Standard Packages		Coils			
Size AWG Or Cir. Mils	Sq. In.			Aluminum	Steel	Complete Cable	Steel Core		Break. Str. Lbs.	Lgth. Ea. Pc. Ft.	No. Pcs. Per Reel	Net Wt. Per Reel Lbs.	Lgth. Ea. Pc. Ft.	Net Wt. Per Coil Lbs.
6	0.02061	0.02404	8	6x0.0661	1x0.0661	0.198	0.0661	1,170	36.1	17,240	2	1,246	5,745	208
5	0.02599	0.03032	7	6x0.0743	1x0.0743	0.223	0.0743	1,460	45.5	13,700	2	1,246	4,565	208
4	0.03278	0.03825	6	6x0.0834	1x0.0834	0.250	0.0834	1,830	57.4	10,870	2	1,246	3,620	208
4	0.03278	0.04111	6	7x0.0772	1x0.1029	0.257	0.103	2,290	67.1	7,145	2	957	3,570	239
3	0.04133	0.04822	5	6x0.0937	1x0.0937	0.281	0.0937	2,250	72.4	8,620	2	1,246	2,870	208
2	0.05212	0.06081	4	6x0.1052	1x0.1052	0.316	0.105	2,790	91.3	6,825	2	1,246	2,275	208
2	0.05212	0.06536	4	7x0.0974	1x0.1299	0.325	0.118	3,525	106.6	8,950	1	957	2,235	240
1	0.06573	0.07669	3	6x0.1182	1x0.1492	0.355	0.118	3,480	115.1	5,405	2	1,246	1,800	208
1	0.08294	0.09676	2	6x0.1327	1x0.1327	0.398	0.133	4,280	145.2	6,440	1	934	1,610	234
2/0	0.1045	0.1220	1	6x0.1490	1x0.1490	0.447	0.149	5,345	183.1	5,100	1	934		
3/0	0.1318	0.1538	1/0	6x0.1672	1x0.1672	0.502	0.167	6,675	230.9	5,400	1	1,246		
4/0	0.1662	0.1939	2/0	6x0.1878	1x0.1878	0.563	0.188	8,420	291.1	4,285	1	1,246		
266,800	0.2095	0.2212	3/0	18x0.1217	1x0.1217	0.609	0.122	6,835	289.8	5,100	1	1,480		
266,800	0.2095	0.2367	3/0	6x0.2109	7x0.0703	0.633	0.211	9,540	342.4	4,975	1	1,700		
266,800	0.2095	0.2437	3/0	26x0.1013	7x0.0788	0.612	0.236	11,250	367.3	5,340	1	1,960		
336,400	0.2642	0.2789	4/0	18x0.1367	1x0.1367	0.684	0.137	8,620	365.3	8,080	1	2,950		
336,400	0.2642	0.3072	4/0	26x0.1138	7x0.0885	0.721	0.206	14,050	463.0	8,470	1	3,922		
336,400	0.2642	0.3259	4/0	30x0.1059	7x0.1059	0.741	0.318	17,040	527.1	6,565	1	3,460		
397,500	0.3122	0.3295	250,000	18x0.1486	1x0.1486	0.743	0.149	10,040	431.7	6,800	1	2,936		
397,500	0.3122	0.3630	250,000	26x0.1236	7x0.0961	0.783	0.288	16,190	547.2	7,180	1	3,925		
397,500	0.3122	0.3850	250,000	30x0.1151	7x0.1151	0.806	0.345	19,980	622.8	5,555	1	3,461	Sizes larger than shipped on reels only.	1/0 only.
477,000	0.3746	0.3954	300,000	18x0.1628	1x0.1628	0.814	0.163	11,870	518.0	5,700	1	2,950		
477,000	0.3746	0.4232	300,000	24x0.1110	7x0.0940	0.846	0.282	17,190	614.5	8,340	1	5,129		
477,000	0.3746	0.4357	300,000	26x0.1355	7x0.1054	0.858	0.316	19,430	656.6	5,975	1	3,926		
477,000	0.3746	0.4620	300,000	30x0.1261	7x0.1261	0.883	0.378	23,350	747.4	4,635	1	3,462		
556,500	0.4371	0.4937	350,000	24x0.1523	7x0.1015	0.914	0.305	19,840	716.9	7,150	1	5,127		
556,500	0.4371	0.5083	350,000	26x0.1463	7x0.1138	0.927	0.341	22,450	766.1	5,125	1	3,926		
556,500	0.4371	0.5391	350,000	30x0.1362	7x0.1362	0.953	0.409	27,240	872.0	3,965	1	3,457		
636,000	0.4995	0.5643	400,000	24x0.1628	7x0.1085	0.977	0.326	22,670	819.3	6,260	1	5,127		
636,000	0.4995	0.5809	400,000	26x0.1564	7x0.1216	0.990	0.365	25,010	875.5	4,490	1	3,929		
636,000	0.4995	0.6134	400,000	30x0.1456	19x0.0874	1.019	0.437	31,600	987.8	4,810	1	4,752		
715,500	0.5620	0.6348	450,000	54x0.1151	7x0.1151	1.036	0.345	26,350	921.4	5,575	1	5,135		
715,500	0.5620	0.6535	450,000	26x0.1659	7x0.1290	1.051	0.387	28,130	984.9	3,985	1	3,925		
715,500	0.5620	0.6901	450,000	30x0.1514	19x0.0926	1.081	0.463	34,630	1111	4,290	1	4,762		
795,000	0.6244	0.7053	500,000	54x0.1214	7x0.1214	1.093	0.364	28,560	1024	5,010	1	5,130		
795,000	0.6244	0.7261	500,000	26x0.1749	7x0.1360	1.108	0.408	31,260	1094	3,590	1	3,927		
795,000	0.6244	0.7668	500,000	30x0.1628	19x0.0977	1.140	0.489	38,480	1235	3,855	1	4,761		
874,500	0.6868	0.7759	550,000	54x0.1273	7x0.1273	1.146	0.382	31,420	1126	4,551	1	5,129		
954,000	0.7493	0.8464	600,000	54x0.1329	7x0.1329	1.196	0.399	34,270	1229	4,170	1	5,125		
1,033,500	0.8117	0.9169	650,000	54x0.1384	7x0.1384	1.246	0.445	37,130	1331	3,855	1	5,131		
1,113,000	0.8741	0.9849	700,000	54x0.1436	19x0.0862	1.292	0.431	40,240	1431	3,300	1	4,722		
1,192,500	0.9366	1.055	750,000	54x0.1486	19x0.0892	1.337	0.446	43,110	1533	3,080	1	4,722		
1,272,000	0.9990	1.126	800,000	54x0.1535	19x0.0921	1.382	0.461	44,860	1635	2,885	1	5,131		
1,351,500	1.061	1.196	850,000	54x0.1582	19x0.0949	1.424	0.475	47,660	1737	2,720	1	4,725		
1,431,000	1.124	1.266	900,000	54x0.1628	19x0.0977	1.465	0.489	50,460	1840	2,570	1	4,729		
1,510,500	1.186	1.337	950,000	54x0.1673	19x0.1004	1.506	0.502	53,270	1942	2,435	1	4,729		
1,590,000	1.249	1.407	1,000,000	54x0.1716	19x0.1030	1.544	0.515	56,070	2044	2,310	1	4,722		

Breaking strengths and weights based on nominal wire diameters:

Breaking strength is the sum of the minimum average breaking strengths of the individual aluminum wires as specified in ASTM B 230, taking 95 per cent of the total aluminum wire strength for the 18/1 constructions and 100 per cent for all other constructions, in accordance with ASTM B 232, plus the sum of the breaking strengths of the individual steel wires, based on the stress at 1 per cent extension as specified in ASTM B 232.

Weights are calculated using the following (ASTM B 232) increments for stranding.

ACSR Constructions	Increment, Per Cent	
	Aluminum	Steel
6/1 and 7/1	1.5	0
18/1	2.0	0
6/7	2.0	0.3
24/7 and 26/7	2.5	0.4
30/7	2.75	0.5
54/7	2.5	0.3
30/19	2.75	0.6
54/19	3.0	0.6

All conductors subject to dimensional tolerances of ASTM B 230, B 232, and B 245.

Nominal shipping lengths shown are subject to a variation of ±10% for conductors 1 Awg and smaller, and ±5% for conductors larger than 1 Awg. Ten per cent of the reels or coils may be shipped in random lengths of not less than 50% of the indicated nominal length.

*Sizes 6 through 4/0 standard lengths shipped on non-returnable reels.

The above data are approximate and subject to normal manufacturing tolerances.

General Cable URC Weatherproof Wires and Cables

“OK” and “Peerless” With Copper Conductors



AWG	Size Circular Mils	Area Sq. In.	Copper Conductor Data			Resistance*			Breaking Strength - Lbs.†			Weights—Standard Packages			
			Cond. Dia. in.	No. Strands	Dia. Indiv. Strands In.	Ohms Per M-Ft.—20° C. (68° F.)			(After Weatherproofing)			Wt. Per M-Ft. Lbs.	Std. Pkgs. Reel Lgth. Ft.	Wt. Per M-Ft. Lbs.	Std. Pkgs. Reel Lgth. Ft.
						Hard Drawn	Medium Hard	Annealed	Hard Drawn	Medium Hard	Annealed				
Stranded Copper Conductors															
...	2,000,000	1.571	1.630	91	.1182	.005501	.005172	.005289	83,100	65,810	61,030	7,008	500	6,690	500
...	1,750,000	1.374	1.526	91	.1387	.006286	.006254	.006015	71,030	57,970	53,400	6,193	600	5,894	600
...	1,500,000	1.178	1.411	61	.1568	.007334	.007296	.007052	62,550	49,360	45,770	5,380	700	5,098	700
...	1,250,000	.9817	1.288	61	.1431	.008801	.008755	.008463	52,880	41,110	38,140	4,508	800	4,264	800
...	1,000,000	.7851	1.152	61	.1280	.01100	.01094	.01058	42,780	33,350	30,510	3,674	900	3,456	900
...	900,000	.7069	1.094	61	.1215	.01222	.01216	.01175	38,500	30,040	27,460	3,332	1,000	3,127	1,000
...	800,000	.6283	1.031	61	.1145	.01375	.01368	.01322	34,540	26,860	24,410	2,992	1,000	2,799	1,000
...	750,000	.5890	.998	61	.1109	.01467	.01459	.01410	32,380	25,180	22,880	2,822	1,100	2,635	1,100
...	700,000	.5498	.964	61	.1074	.01572	.01563	.01511	30,220	23,500	21,360	2,650	1,200	2,471	1,200
...	600,000	.4712	.891	37	.1273	.01834	.01824	.01763	25,670	20,010	18,310	2,235	1,500	2,093	1,500
...	500,000	.3927	.813	37	.1162	.02200	.02189	.02116	21,390	16,670	15,260	1,894	2,000	1,765	2,000
...	450,000	.3534	.752	37	.1103	.02445	.02432	.02351	19,430	15,110	13,730	1,724	2,000	1,601	2,000
...	400,000	.3142	.726	19	.1454	.02750	.02736	.02645	16,920	13,250	12,200	1,553	2,000	1,436	2,000
...	350,000	.2749	.679	19	.1357	.03143	.03127	.03022	14,810	11,590	10,680	1,315	2,000	1,248	2,000
...	300,000	.2356	.629	19	.1257	.03667	.03648	.03526	12,830	10,000	9,154	1,174	2,000	1,083	2,000
...	250,000	.1964	.574	19	.1147	.04400	.04378	.04231	10,790	8,394	7,628	985	2,500	907	2,500
...	211,600	.1662	.522	7	.1739	.05199	.05172	.04999	8,696	6,914	6,157	800	2,500	745	2,500
...	167,800	.1318	.464	7	.1518	.06557	.06523	.06304	6,996	5,520	5,119	653	3,000	604	3,000
2/0	133,100	.1045	.414	7	.1379	.08267	.08224	.07948	5,630	4,408	4,061	522	3,500	482	3,500
1/0	105,600	.08291	.368	7	.1228	.1012	.1037	.1002	4,515	3,520	3,221	424	4,000	388	4,000
1	83,690	.06573	.328	7	.1093	.1314	.1308	.1264	3,614	2,810	2,554	328	2,500	303	2,500
2	66,360	.05212	.292	7	.0971	.1658	.1619	.1594	2,892	2,243	2,107	270	3,750	246	3,750
3	52,620	.04133	.260	7	.0867	.2091	.2080	.2010	2,311	1,790	1,671	206	4,250	190	4,250
4	41,740	.03278	.232	7	.0772	.2636	.2622	.2534	1,811	1,429	1,325	170	5,000	155	5,000
5	33,090	.02599	.206	7	.0688	.3325	.3308	.3197	1,464	1,144	1,051	140	6,500	126	6,500
6	26,240	.02061	.184	7	.0612	.4192	.4170	.4031	1,167	910.1	833.2	115	8,000	103	8,000
8	16,510	.01297	.116	7	.0486	.6663	.6628	.6407	738.5	580.2	524.3	78	6,250	68	6,250
Solid Copper Conductors															
4/0	211,600	.1662	.460005045	.05019	.04901	7,736	6,631	6,282	767	2,500	723	2,500
3/0	167,800	.1318	.409606362	.06330	.06182	6,384	5,383	4,981	629	3,000	587	3,000
2/0	133,100	.1045	.364808021	.07980	.07793	5,243	4,369	3,951	502	3,500	467	3,500
1/0	105,600	.08291	.32491011	.1006	.09825	4,293	3,514	3,139	407	4,000	377	4,000
1	83,690	.06573	.28931289	.1282	.1239	3,593	2,873	2,554	316	2,500	294	2,500
2	66,360	.05212	.25761625	.1617	.1563	2,852	2,327	2,025	260	3,100	239	3,100
3	52,620	.04133	.22942050	.2039	.1971	2,317	1,885	1,606	199	4,000	185	4,000
4	41,740	.03278	.20432584	.2571	.2485	1,872	1,505	1,274	164	5,000	151	5,000
5	33,090	.02599	.18193260	.3243	.3133	1,511	1,201	1,010	135	6,500	122	6,500
6	26,240	.02061	.16204110	.4088	.3952	1,216	959.4	800.8	112	8,000	100	8,000
8	16,510	.01297	.12856532	.6498	.6284	784.8	611.8	503.8	75	6,250	66	6,250
9	13,090	.01028	.11448211	.8199	.7925	627.9	488.2	399.3	62	6,300	54	6,300
10	10,380	.008155	.1019	1.039	1.033	.9988	502.8	389.9	329.7	53	8,000	46	8,000
12	6,530	.00513	.0808	1.65	1.64	1.59	320.0	248.4	207.3	35	...	30	...
14	4,110	.00323	.0611	2.63	2.61	2.52	202.9	158.4	130.5	25	...	20	...

*Resistances are nominal values corresponding to the requirements of A.S.T.M. B1-56, B2-52, B3-56 and B8-56.

†Breaking strengths represent minimum values for hard and medium hard drawn conductors and maximum values for soft drawn conductors corresponding to the requirements of A.S.T.M. B1-56, B2-52, B3-56, and B8-56 for bare conductors, adjusted in accordance with the provisions of the proposed revision of A.S.A. C8.18.

All weights are net and subject to A.S.A. specification tolerances.

Standard lengths are subject to a manufacturing tolerance of plus or minus 10%. Not more than 10% of the total quantity of wire on any given order may be shipped in random lengths not shorter than 50% of the listed standard lengths.

Sizes 8 to 14 A.W.G. inclusive also supplied in 100 lb. bundles of four coils, each weighing approximately 25 lbs.

Sizes 8 to 14 A.W.G. inclusive also supplied in 500 ft. cartons and Sizes 1 to 6 A.W.G. inclusive also supplied in 500 ft. coils.

The above data are approximate and subject to normal manufacturing tolerances.

General Cable URC Weatherproof Wires and Cables

“OK” and “Peerless” With Aluminum Conductors

Hard Drawn Aluminum and ACSR URC Weatherproof “O.K.” and Peerless Braided Types

Proposed ASA Specification C8.18, 5/18/56 Revision



Solid Aluminum Conductors

Size AWG	Hd. Drawn Copper Equiv. AWG	Conductor Area Sq. In.	Conductor Diameter In.	Break. Str. Lbs. (After Weather- proof)	Resist. (D-C) Ohms Per M-Fl. 68° F. (20° C.)	Triple Braided			Double Braided				
						Net Wt. Per M-Fl. Lbs.	Reel Lgth. Fl.	Net Wt. Per Reel Lbs.	Reel No.	Net Wt. Per M-Fl. Lbs.	Reel Length Fl.	Net Wt. Per Reel Lbs.	Reel No.
8	10	0.01297	0.1285	276	1.030	40.2	6,250	250	271812	31.2	9,000	280	271812
6	8	0.02061	0.1620	420	0.6478	56.7	8,000	456	322216	44.7	7,000	312	322216
4	6	0.03278	0.2043	669	0.4073	76.0	5,000	380	301812	63.0	5,000	315	271812
2	4	0.05212	0.2576	1041	0.2562	120	3,100	372	301812	99.2	3,000	298	271812

Stranded Aluminum Conductors

Size AWG Or Circ. Mils	Hd. Drawn Copper Equiv. AWG Or Circ. Mils	Cond. Area Sq. In.	Cond. Dia. In.	No. Strands	Dia. of Indiv. Strands In.	Break. Str. Lbs. (After Weather- proof)	Resist. (D-C) Ohms Per M-Fl. 68° F. (20° C.)	Triple Braided			Double Braided				
								Net Wt. Per M-Fl. Lbs.	Reel Lgth. Fl.	Net Wt. Per Reel Lbs.	Reel No.	Net Wt. Per M-Fl. Lbs.	Reel Length Fl.	Net Wt. Per Reel Lbs.	Reel No.
4	6	0.03278	0.232	7	0.0772	702	0.4155	80.3	5,000	400	322216	65.3	8,000	522	322216
3	5	0.04133	0.260	7	0.0867	870	0.3296	92.9	4,250	395	322216	76.9	7,000	538	322216
2	4	0.05212	0.292	7	0.0974	1,076	0.2613	127	3,750	476	322216	103	4,450	458	322216
1	3	0.06573	0.328	7	0.1093	1,307	0.2072	148	2,500	370	322216	123	3,560	438	322216
1/0	2	0.08294	0.368	7	0.1228	1,586	0.1642	197	4,000	788	382618	161	4,000	614	362218
2/0	1	0.1045	0.414	7	0.1379	1,999	0.1303	236	3,500	826	382618	196	3,500	686	362218
3/0	1/0	0.1318	0.464	7	0.1548	2,420	0.1033	292	3,000	876	382618	243	3,000	729	362218
4/0	2/0	0.1662	0.522	7	0.1739	3,052	0.08196	345	2,500	863	443024	290	3,500	1,115	443024
250,000	157,200	0.1964	0.574	19	0.1147	3,830	0.06937	448	2,500	1,120	443024	370	3,225	1,192	443024
266,800	3/0	0.2095	0.593	19	0.1185	4,088	0.06500	480	2,250	1,080	443034	395	2,800	1,106	443024
300,000	188,700	0.2356	0.629	19	0.1257	4,506	0.05781	529	2,000	1,058	443024	438	2,600	1,139	443024
336,400	4/0	0.2642	0.666	19	0.1331	5,053	0.05155	577	2,000	1,154	443024	482	2,000	964	443024
350,000	220,000	0.2749	0.679	19	0.1357	5,257	0.04955	593	2,000	1,186	443024	496	2,000	992	443024
400,000	252,000	0.3142	0.726	19	0.1451	5,888	0.04336	694	2,000	1,388	443024	577	2,000	1,152	443024
450,000	283,000	0.3534	0.772	37	0.1103	6,894	0.03854	757	2,000	1,514	443024	634	2,000	1,268	443024
477,000	300,000	0.3746	0.795	37	0.1135	7,308	0.03636	794	2,000	1,588	443024	666	2,000	1,372	443024
500,000	314,000	0.3927	0.813	37	0.1162	7,660	0.03468	819	2,000	1,638	443024	690	2,000	1,380	443024
550,000	346,000	0.4320	0.853	37	0.1219	8,261	0.03153	884	1,500	1,326	443024	746	1,500	1,120	443024
600,000	377,000	0.4712	0.891	37	0.1273	9,010	0.02890	945	1,500	1,418	443024	803	1,500	1,205	443024
636,000	400,000	0.4995	0.918	37	0.1311	9,554	0.02727	989	1,350	1,397	443024	843	1,350	1,179	443024
650,000	409,000	0.5105	0.929	61	0.1032	10,160	0.02668	1006	1,350	1,358	443024	859	1,350	1,160	443024
700,000	440,000	0.5498	0.964	61	0.1071	10,930	0.02477	1146	1,200	1,375	443024	967	1,200	1,160	443024
750,000	472,000	0.5891	1.008	61	0.1109	11,490	0.02312	1210	1,100	1,331	443024	1023	1,100	1,125	443024
800,000	503,000	0.6283	1.031	61	0.1145	12,560	0.02168	1273	1,000	1,273	443024	1080	1,000	1,080	443024
900,000	566,000	0.7069	1.094	61	0.1215	13,520	0.01927	1398	1,000	1,398	443024	1193	1,000	1,193	443024
1,000,000	629,000	0.7854	1.152	61	0.1280	15,020	0.01734	1525	900	1,373	443024	1307	900	1,177	443024
1,100,000	692,000	0.8639	1.209	61	0.1343	16,520	0.01577	1645	900	1,480	443024	1414	900	1,272	443024
1,200,000	755,000	0.9425	1.263	61	0.1403	17,660	0.01445	1765	900	1,589	443024	1525	900	1,372	443024
1,250,000	786,000	0.9818	1.288	61	0.1431	18,400	0.01387	1822	800	1,456	443024	1578	800	1,262	443024
1,300,000	818,000	1.021	1.314	61	0.1460	19,130	0.01334	1888	800	1,510	443024	1636	800	1,308	443024
1,400,000	880,000	1.100	1.364	61	0.1515	20,190	0.01239	2009	700	1,406	443024	1745	700	1,221	443024
1,500,000	943,000	1.178	1.411	61	0.1568	21,630	0.01156	2157	700	1,510	443024	1875	700	1,313	443024
1,600,000	1,006,000	1.257	1.459	91	0.1326	23,180	0.01084	2267	650	1,473	443024	1979	650	1,298	443024

ACSR

Size AWG Or Circ. Mils	Hd. Drawn Copper Equiv. AWG	Cond. Area Sq. In.		Cond. Dia. In.	Stranding No. and Dia. of Indiv. Wires - In.		Break. Str. Lbs. (After Weather- proof)	Resist. (D-C) Ohms Per M-Fl. 68° F. (20° C.)	Strand- ing	Triple Braided Std. Pkgs.			Double Braided Std. Pkgs.				
		Aluminum	Total		Aluminum	Steel				Net Wt. Per M-Fl. Lbs.	Lgth. Fl.	Net Wt. Per Reel Lbs.	Reel No.	Net Wt. Per M-Fl. Lbs.	Lgth. Fl.	Net Wt. Per Reel Lbs.	Reel No.
6	8	0.02061	0.02404	0.198	6x0.0661	1x0.0661	1053	0.6577	6/1	72.6	5745	420	322216	59.2	5747	339	322216
5	7	0.02599	0.03032	0.223	6x0.0743	1x0.0743	1314	0.5215	6/1	85.5	4567	393	322216	71.0	4567	324	322216
4	6	0.03278	0.03825	0.250	6x0.0834	1x0.0834	1647	0.4134	7/1	100.4	3623	362	322216	84.2	3623	304	322216
4	6	0.03278	0.04111	0.257	7x0.0772	1x0.1029	2061	0.4134	6/1	110.5	3573	397	322216	94.2	3573	336	322216
3	5	0.04133	0.04822	0.281	6x0.0937	1x0.0937	2025	0.3280	6/1	136.4	4310	586	322216	112.4	4310	483	322216
2	4	0.05212	0.06081	0.316	6x0.1052	1x0.1052	2511	0.2061	7/1	159.3	3413	543	322216	134.8	3413	461	322216
2	4	0.05212	0.06536	0.325	7x0.0974	1x0.1299	3173	0.2061	6/1	175.3	4475	783	362218	150.8	4475	676	362218
1	3	0.06573	0.07669	0.355	6x0.1182	1x0.1182	3132	0.2062	6/1	209.6	2703	568	362218	174.8	2703	473	362218
1/0	2	0.08294	0.09676	0.398	6x0.1327	1x0.1327	3852	0.1634	6/1	252.2	3220	811	362218	213.4	3220	686	362218
2/0	1	0.1045	0.1220	0.447	6x0.1490	1x0.1490	4810	0.1297	6/1	311.2	2550	801	362218	267.0	2550	681	362218
3/0	1/0	0.1318	0.1538	0.502	6x0.1672	1x0.1672	6007	0.1028	6/1	373.3	2007	1007	382618	320.3	2700	864	362218
4/0	2/0	0.1662	0.1939	0.563	6x0.1878	1x0.1878	7578	0.08155	6/1	446.2	2143	956	382618	386.7	2143	829	362218
266,800	3/0	0.2095	0.2212	0.609	18x0.1217	1x0.1217	6155	0.06500	18/1	561.0	1700	954	382618	475.0	1700	808	362218
336,400	4/0	0.2642	0.2789	0.684	18x0.1367	1x0.1367	7761	0.05155	18/1	681.1	1513	1030	382618	584.1	1513	884	362218

The above data are approximate and subject to normal manufacturing tolerances.

**General Cable "Tip-Top"
Weatherproof Wires and Cables**

**General Cable "Tip-Top"
Weatherproof Wires and Cables**

With Copper Conductors						
Size C.M. or A.W.G.	Conductor Construction	Cond. Diam. In.	Neoprene Thick. In.	Approx. O.A. Diam. In.	Net Wt. Lbs. Per M. Ft.	Fl. On Reels
Stranded Copper Conductors						
500000	37X	.1162	.813	1.00	1759	1000
450000	37X	.1103	.772	.96	1593	1000
400000	19X	.1451	.726	.91	1438	1000
350000	19X	.1357	.679	.84	1240	1000
300000	19X	.1257	.629	.79	1073	1500
250000	19X	.1147	.574	.73	905	1500
4 0	7X	.1739	.522	.65	761	3300
3 0	7X	.1548	.464	.59	612	3800
2 0	7X	.1379	.414	.54	494	4600
1 0	7X	.1228	.368	.49	398	4700
1	7X	.1093	.328	.45	323	4300
						Coils
2	7X	.0974	.292	.39	248	800
3	7X	.0867	.260	.35	200	1000
4	7X	.0772	.232	.33	163	1200
5	7X	.0688	.205	.30	132	1400
6	7X	.0612	.184	.28	108	1800
8	7X	.0486	.146	.24	72.3	2600
Solid Copper Conductors						
1	Solid	.2893	3/64	.41	301	600
2	Solid	.2576	3/64	.35	232	800
3	Solid	.2294	3/64	.32	188	1100
4	Solid	.2043	3/64	.30	152	1300
6	Solid	.1620	3/64	.26	101	2000
8	Solid	.1285	3/64	.22	68	2900
9	Solid	.1144	3/64	.21	56	3000
10	Solid	.1019	3/64	.16	40.6	3600
12	Solid	.0808	3/64	.14	27.5	5500

With Aluminum Conductors							
Size A.W.G. or C.M.	Hard Drawn Copper Equip. AWG Or C.M.	No. of Strands	Cond. Diam. In.	Neoprene Thick. 3/64 In.	Approx. O.A. Diam. In.	Net Wt. Lbs. Per M. Ft.	Lgth. Ft. Coils
Solid Aluminum Conductors							
8	10	Solid	0.1285	3	0.222	33.2	3600
6	8	Solid	0.1620	3	0.256	45.7	2900
4	6	Solid	0.2043	3	0.289	61.0	2000
2	4	Solid	0.2576	3	0.351	92.2	1300
Stranded Aluminum Conductors							
6	8	7	0.184	3	0.278	51.5	2600
4	6	7	0.232	3	0.326	73.3	1800
2	4	7	0.292	3	0.386	105	1200
						Reel	
1	3	7	0.328	4	0.453	143	4150
1 0	2	7	0.368	4	0.493	171	3530
2 0	1	7	0.414	4	0.539	208	2800
3 0	1/0	7	0.464	4	0.589	251	2200
4 0	2/0	7	0.522	4	0.647	306	1760
250000	157200	19	0.574	5	0.730	368	2025
266800	3 0	19	0.593	5	0.749	388	2525
300000	188700	19	0.629	5	0.785	428	2250
336400	4 0	19	0.666	5	0.822	472	2000
350000	220000	19	0.679	5	0.835	488	2000
400000	252000	19	0.726	6	0.914	579	1685
450000	283000	37	0.772	6	0.960	626	2190
477000	300000	37	0.795	6	0.983	659	2065
500000	314000	37	0.813	6	1.00	684	1970

**General Cable Polyethylene
Weatherproof Wires and Cables**

**General Cable Polyethylene
Weatherproof Wires and Cables**

With Copper Conductors						
Size C.M. or A.W.G.	Conductor Construction	Cond. Diam. In.	Poly-ethylene Thick. In.	Approx. O.A. Diam. In.	Net Wt. Lbs. Per M. Ft.	Fl. On Reels
Stranded Copper Conductors						
500000	37X	.1162	.813	.97	1618	2000
450000	37X	.1103	.772	.93	1487	2000
400000	19X	.1451	.726	.88	1334	2000
350000	19X	.1357	.679	.80	1157	2500
300000	19X	.1257	.629	.75	996	2500
250000	19X	.1147	.574	.70	834	2500
4 0	7X	.1739	.522	.65	715	3300
3 0	7X	.1548	.464	.59	572	3800
2 0	7X	.1379	.414	.54	458	4600
1 0	7X	.1228	.368	.49	367	4700
1	7X	.1093	.318	.42	287	4300
						Coil
2	7X	.0974	.292	.39	230	800
3	7X	.0867	.260	.35	185	1000
4	7X	.0772	.232	.29	143	1200
5	7X	.0688	.206	.27	114	1500
6	7X	.0612	.184	.25	91.5	1800
8	7X	.0486	.146	.21	59.3	2600
Solid Copper Conductors						
1	Solid	.2893	3/64	.38	273	600
2	Solid	.2576	3/64	.35	219	800
3	Solid	.2294	3/64	.32	176	1000
4	Solid	.2043	3/64	.27	136	1300
6	Solid	.1629	3/64	.22	87	2000
8	Solid	.1285	3/64	.19	56	2900
9	Solid	.1144	3/64	.18	45	3000
10	Solid	.1019	3/64	.16	36.5	3600
12	Solid	.0808	3/64	.14	24	5500

With Aluminum Conductors							
Size A.W.G. or C.M.	Hard Drawn Copper Equip. AWG Or C.M.	No. of Strands	Cond. Diam. In.	Poly-ethylene Thick. 3/64 In.	Approx. O.A. Diam. In.	Net Wt. Lbs. Per M. Ft.	Lgth. Ft. Coils
Solid Aluminum Conductors							
8	10	Solid	0.1285	2	0.191	21.2	3600
6	8	Solid	0.1620	2	0.225	31.7	2900
4	6	Solid	0.2043	2	0.267	48.0	2000
2	4	Solid	0.2576	3	0.351	79.2	1300
Stranded Aluminum Conductors							
6	8	7	0.184	2	0.247	35.0	2600
4	6	7	0.232	2	0.295	53.3	1800
2	4	7	0.292	3	0.386	87.4	1200
						Reels	
1	3	7	0.328	3	0.422	107	4150
1 0	2	7	0.368	4	0.493	140	3530
2 0	1	7	0.414	4	0.539	172	2800
3 0	1/0	7	0.464	4	0.589	211	2220
4 0	2 0	7	0.522	4	0.647	260	1760
250000	157200	19	0.574	4	0.699	297	2025
266800	3 0	19	0.593	4	0.718	315	2525
300000	188700	19	0.629	4	0.751	351	2250
336400	4 0	19	0.666	4	0.791	390	2000
350000	220000	19	0.679	4	0.804	405	2000
400000	252000	19	0.726	5	0.882	475	1685
450000	283000	37	0.772	5	0.928	520	2190
477000	300000	37	0.795	5	0.951	550	2065
500000	314000	37	0.813	5	0.969	573	1970

Standard lengths are subject to a manufacturing tolerance of plus or minus 10%. Not more than 10% of the total quantity of wire on any given order may be shipped in random lengths not shorter than 50% of listed standard lengths.

Weights based on nominal wire diameters. All conductors subject to dimensional tolerances of ASTM B230, B231, B232 and B245. All weights subject to ASTM and ASA specification tolerances.

The above data are approximate and subject to normal manufacturing tolerances.

Note: All reels for Aluminum Tip-Top or Polyethylene are non-returnable.

The above data are approximate and subject to normal manufacturing tolerances.

**General Cable "Tip-Top"
Weatherproof Wires and Cables**

With ACSR Conductors

Size AWG	Hard Drawn Copper Equiv. AWG	Stranding No. and Diam. Of Individual Strands—In.		Cond. Diam. In.	Neo- prene Thick. 1/64 In.	Appr. O.A. Diam. In.	Lgth. Ft. Reel	Net Wt. Lbs. Per Reel
		Aluminum	Steel					
6	8	6X0.0661	1X0.0661	0.198	3	0.292	8620	560
5	7	6X0.0743	1X0.0743	0.223	3	0.317	6850	538
4	6	6X0.0834	1X0.0834	0.250	3	0.341	5435	514
4	6	7X0.0772	1X0.1029	0.257	3	0.351	7145	750
3	5	6X0.0937	1X0.0937	0.281	3	0.375	4310	491
2	4	6X0.1052	1X0.1052	0.316	3	0.410	3410	471
2	4	7X0.0974	1X0.1299	0.325	3	0.419	4475	694
1	3	6X0.1182	1X0.1182	0.355	4	0.480	2700	500
1/0	2	6X0.1327	1X0.1327	0.398	4	0.523	3220	721
2/0	1	6X0.1490	1X0.1490	0.447	4	0.572	2550	696
3/0	1/0	6X0.1672	1X0.1672	0.502	4	0.627	2700	902
4/0	2/0	6X0.1878	1X0.1878	0.563	4	0.688	2140	875

**General Cable Polyethylene
Weatherproof Wires and Cables**

With ACSR Conductors

Size AWG	Hard Drawn Copper Equiv. AWG	Stranding No. and Diam. Of Individual Strands—In.		Cond. Diam. In.	Poly- ethylene Thick. 1/64 In.	Appr. D.A. Diam. In.	Lgth. Ft. Reel	Net Wt. Lbs. Per Reel
		Aluminum	Steel					
6	8	6X0.0661	1X0.0661	0.198	2	0.261	8620	409
5	7	6X0.0743	1X0.0743	0.223	2	0.286	6850	401
4	6	6X0.0834	1X0.0834	0.250	2	0.313	5435	391
4	6	7X0.0772	1X0.1029	0.257	2	0.320	7145	586
3	5	6X0.0937	1X0.0937	0.281	3	0.375	4310	416
2	4	6X0.1052	1X0.1052	0.316	3	0.410	3410	406
2	4	7X0.0974	1X0.1299	0.325	3	0.419	4475	604
1	3	6X0.1182	1X0.1182	0.355	3	0.449	2700	394
1/0	2	6X0.1327	1X0.1327	0.398	4	0.523	3220	615
2/0	1	6X0.1490	1X0.1490	0.447	4	0.572	2550	599
3/0	1/0	6X0.1672	1X0.1672	0.502	4	0.627	2700	783
4/0	2/0	6X0.1878	1X0.1878	0.563	4	0.688	2140	768

Weights based on nominal wire diameters.

All conductors subject to dimensional tolerances of ASTM B230, B231, B232 and B245.

All reels for ACSR Tip-Top and Polyethylene Weatherproof are non-returnable.

The above data are approximate and subject to normal manufacturing tolerances.

Note: Size #6 to #1 also available in coils.

Call Graybar FIRST For . . .



Graybartel Telephone Wire

Station Wire (For Inside-Outside Use)

Neoprene Jacketed—Brown

Cat. No.	Size A.W.G. and No. Cond.	Construction	Outside Diam., In.	Lbs. Per M. Ft.	Ft. In Coil
222NC876	22-2	Neoprene Insulation	.190	22	1000
322NC876	22-3	Neoprene Insulation	.200	26	1000
422NC876	22-4	Neoprene Insulation	.225	33	1000

2—Conductor Coded Red and Green.
3—Conductor Coded Red, Green and Ivory.
4—Conductor Coded Red, Green, Ivory and Black.



Bridle Wire

For bridling open wire lines or ring wiring. Tinned soft copper conductors, rubber insulated and neoprene jacketed.

**Soft Tinned Copper—Neoprene Jacketed—Rubber
Insulated**

Cat. No.	Size A.W.G. and No. Cond.	Construction	Outside Diam., In.	Lbs. Per M. Ft.	Ft. In Coil
214BC666	14-2	Twisted Pair	.225	81	1000
218BC666	18-2	Twisted Pair	.140	34	1000
220BC666	20-2	Twisted Pair	.130	28	1000
318BC666	18-3	Triplex	.140	50	1000
320BC666	20-3	Triplex	.130	40	1000

Black, conductors ridged for polarity.

Ground Wire

For use in ground connections, pole or protectors to ground. Polyvinylchloride moisture and heat resistant insulation.



Vinyl Plastic Insulation

Cat. No.	Size A.W.G. and No. Cond.	Construction	Outside Diam., In.	Lbs. Per M. Ft.	Ft. In Coil
114GC585	14-1	Solid Soft Copper	.130	19	500
112GC585	12-1	Solid Soft Copper	.150	28	500
110GC585	10-1	Solid Soft Copper	.168	41	500

Available in Black, White or Brown. Soft Bright Copper.

Tree Wire

No. 12 Copperweld—Neoprene Jacketed

Cat. No.	Size A.W.G. and No. Cond.	Construction	Outside Diam., In.	Lbs. Per M. Ft.	Ft. In Coil
112TW566	12-1	Rubber Insulation	.250	50	1000

Jumper and Duct Wire

For use on distributing frames and cross connecting racks. Insulated with a high dielectric strength, semi-rigid polyvinylchloride insulation.



Tinned Soft Copper—Vinyl Plastic Insulated

Cat. No.	Size A.W.G. and No. Cond.	Construction	Outside Diam., In.	Lbs. Per M. Ft.	Ft. In Coil
222YC685	22-2	Twisted	.061	8	1000
322YC685	22-3	Twisted	.061	11	1000
422YC685	22-4	Twisted	.061	15	1000

2—Conductor Coded Red and White or Red and Black.
3—Conductor Coded Red, White and Yellow or Red, Black and Yellow.
4—Conductor Coded Red, Green, Yellow and Black.

Graybartel Wire

GRAYBARTEL Telephone Wires are constructed to specifications tried and proven in the independent telephone industry over many years. Combining the finest materials and

manufacturing experience, GRAYBARTEL assures the industry of a high quality, long lasting, dependable product, the leader in its field.

Drop Wire

Used to extend telephone circuit from open wire or distributing cable terminal on pole to subscribers' stations.

Furnished in parallel and twisted pair types with Copperweld or signal bronze conductors, high quality insulation, and a tough, abrasion and weather resistant neoprene jacket over insulation. Tinned conductor.

Reinforced types have a strong textile open braid or serve between insulation and jacket, adding desired strength without sacrifice of jacket to insulation adhesion. 1000 ft. in coil.



Twisted Pair—Neoprene



Parallel Reinforced—Neoprene



Parallel—Neoprene



Parallel Dumbbell—Neoprene

No. 18 Copperweld—Neoprene Jacketed—Rubber Insulated

Cat. No.	Size A.W.G. and No. Cond.	Construction	Diam., In.	Wt. Lbs. Per M. Ft.
2181D/W666	18-2	Twisted Pair	.155	37
2181D/W866	18-2	Parallel (Non-Reinf.)	.170 x .275	35
2181D/W766	18-2	Parallel Reinforced	.190 x .295	40
2181D/W966	18-2	Parallel Dumbbell	.145 x .290	29

No. 17 Signal Bronze—Neoprene Jacketed—Rubber Insulated

2171D/666	17-2	Twisted Pair	.160	42
2171D/866	17-2	Parallel (Non-Reinf.)	.175 x .285	43
2171D/766	17-2	Parallel Reinforced	.195 x .305	46
2171D/966	17-2	Parallel Dumbbell	.150 x .300	34

Hard Drawn Copper—Neoprene Jacketed—Outside Distrib. Wire

2161D/11666	16-2	Twisted Pair	.185	55
2141D/11666	14-2	Twisted Pair	.225	81

Underground Burial Wire—Hard Copper



*216U/11666	16-2	Twisted Pair	.205	62
*214U/11666	14-2	Twisted Pair	.240	76
*212U/11666	12-2	Twisted Pair	.265	96

*750 ft. in coil.

For use either overhead or direct underground burial. Can be used even in locations where moisture is encountered. Low moisture absorption, low transmission losses at telephone frequencies in wet locations.



Interior Wire

Used inside buildings for extending circuits from arrestors or other terminating fixtures of outside lines to station sets. Furnished in plastic insulated soft copper conductors in twisted or twisted overall jacket types. With insulation and jacket of tough, abrasion resistant synthetic resin, this wire lends itself to fast, economical stapling gun installation. Packed 1,000 ft. in coil.

Vinyl Plastic Insulated Interior Wire

Cat. No.	Size A.W.G. and No. Cond.	Construction	Cond. Diam., In.	Wt. Lbs. Per 1000 Ft.
222XC685-B	22-2	Twisted Pair	.075	10
222XC685-I	22-2	Twisted Pair	.075	10
322XC685-B	22-3	Triplex	.075	14
322XC685-I	22-3	Triplex	.075	14
219XC685-B	19-2	Twisted Pair	.085	14
219XC685-I	19-2	Twisted Pair	.085	14
319XC685-B	19-3	Triplex	.085	21
319XC685-I	19-3	Triplex	.085	21

Available in Brown or Ivory Conductors ridged for polarity.

Vinyl Plastic Insulated Parallel Interior Wire

222NC984-B	22-2	Parallel	.074 x .160	10
222NC984-I	22-2	Parallel	.074 x .160	10
322NC984-B	22-3	Parallel	.074 x .205	13
322NC984-I	22-3	Parallel	.074 x .205	13

Vinyl Plastic Insulated Duct Wire

219XC685-D	19-2	Twisted Pair	.085	14
319XC685-D	19-3	Triplex	.085	21

2—Conductor Coded Red and Green.
3—Conductor Coded Red, Green and Yellow.

Cotton Braided Interior Wire

219XC668	19-2	Twisted Pair	.125	20
319XC668	19-3	Triplex	.125	30

Available in green only. Rubber Insulated over tinned soft copper.

Vinyl Plastic Jacketed Interior Wire



Cat. No.	Size A.W.G. and No. of Cond.	Construction	Outside Diam., In.	Wt. Lbs. Per M. Ft.
222NC484-B	22-2	Vinyl Insulation	.165	17
222NC484-I	22-2	Vinyl Insulation	.165	17
322NC484-B	22-3	Vinyl Insulation	.170	20
322NC484-I	22-3	Vinyl Insulation	.170	20
422NC484-B	22-4	Vinyl Insulation	.185	25
422NC484-I	22-4	Vinyl Insulation	.185	25

2—Conductor Coded Red and Green.

3—Conductor Coded Red, Green, and Ivory.

4—Conductor Coded Red, Green, Ivory and Black.

Available Jacket Colors—Brown or Ivory.

Diamond Wire Portable Cords

Types S, SJ and SV—Rubber Insulated, Rubber Jacketed
Types SO, SJO and SV Neoprene—Rubber Insulated, Neoprene Jacketed
Approved by Underwriters' Laboratories, Inc.

Heavy Duty Cord—Type S

Diamond Red-D Type S rubber jacketed cords, with rubber insulation, designed for hard, extra duty service. Though soft and pliable, the rugged, wear-resistant sheath protects against alkalis and acids as well as moisture. Very flexible construction prevents kinking in service.



Listed by Underwriters' Laboratories. Type S Rubber Jacketed Cord—60° C. Service. Canadian Standards Assn. Approved. 250 ft. coils (*250 ft. spools).

Two Conductor—600 Volts

Cat. No.	Size A.W.G. and No. Conds.	Stranding	Insulation Wall, In.	Jacket Wall, In.	Cap., Amps.	Diam., In.	Lbs. Per 1000 Ft.
J101	18-2	41 x 34	3/64	1/64	7	.390	82
J102	16-2	65 x 34	3/64	1/64	10	.405	92
J103	14-2	41 x 30	3/64	1/64	15	.530	115
J104	12-2	65 x 30	3/64	1/64	20	.600	190
J105	10-2	105 x 30	3/64	1/64	25	.640	234

Three Conductor—600 Volts

J106	18-3	41 x 34	3/64	1/64	7	.405	90
J107	16-3	65 x 34	3/64	1/64	10	.430	110
J108	14-3	41 x 30	3/64	1/64	15	.560	180
J109	12-3	65 x 30	3/64	1/64	20	.635	230
J110	10-3	105 x 30	3/64	1/64	25	.690	300

Four Conductor—600 Volts

J111	18-4	41 x 34	3/64	1/64	5.6	.435	100
J112	16-4	65 x 34	3/64	1/64	8	.485	135
J113	14-4	41 x 30	3/64	1/64	12	.605	220
J114	12-4	65 x 30	3/64	1/64	16	.665	280
J115	10-4	105 x 30	3/64	1/64	20	.745	360

Light Duty Cord—Type SV



Diamond Red-D Types SV and SV-Neoprene are very flexible, small diameter, light weight cords with tough jackets overall. Intended for light duty service where frequent flexing occurs, and where ease of handling is especially desired. Type SV Neoprene recommended where there is possibility of exposure to oil, heat, sunlight or chemicals. Listed by U/L. For light duty appliances, vacuum cleaners, office machines, etc.

Type SV—300 Volts

J170	18-2	41 x 34	1/64	2/64	7	.245	36
------	------	---------	------	------	---	------	----

Type SV—Neoprene Jacket

N170	18-2	41 x 34	1/64	2/64	7	.245	38
------	------	---------	------	------	---	------	----

Medium Oil Resistant Cord—Type SJO



Diamond Red-D Type SJO is similar to Diamond Red-D Type SJ. Construction features such as durability, abrasion resistance and flexibility are similar. Outstanding for use where exposed to oil and greases, sunlight, ozone, most chemicals, solvents and acids. Listed by U/L 60 and 75°.

Two Conductor—Constant Service—300 Volts

Cat. No.	Size A.W.G. and No. Conds.	Stranding	Insulation Wall, In.	Jacket Wall, In.	Cap., Amps.	Diam., In.	Per 1000 Ft.
N160	18-2	41 x 34	3/64	2/64	7	.305	52
N161	16-2	65 x 34	3/64	2/64	10	.330	67

Two Conductor—Stationary Service—300 Volts

N150	18-2	16 x 30	3/64	2/64	7	.305	52
N151	16-2	26 x 30	3/64	2/64	10	.330	67

Note: 3 and 4 conductor also available.

Heavy Duty Oil Resistant Cord—Type SO



Diamond Red-D Type SO is a companion cord to Type S. Construction features such as durability, abrasion resistance and flexibility are similar. Outstanding for use when exposed to oil and grease, sunlight, ozone, most chemicals, solvents and acids. Tough neoprene jacket is practically unaffected by these enemies of natural rubber and general purpose synthetic rubbers. In addition, Neoprene has superior age-resisting qualities, is flame-retardant and heat-resistant. Listed by Underwriters' Laboratories. Type SO Neoprene Jacketed Cord—60° C. Service. Canadian Standards Ass'n. Approved. 250 ft. coils.

Two Conductor 600 Volts

Cat. No.	Size A.W.G. and No. Conds.	Stranding	Insulation Wall, In.	Jacket Wall, In.	Cap., Amps.	Diam., In.	Lbs. Per 1000 Ft.
*N101	18-2	41 x 34	2/64	1/64	7	.390	90
*N102	16-2	65 x 34	2/64	1/64	10	.405	100
N103	14-2	41 x 30	2/64	1/64	15	.530	155
N104	12-2	65 x 30	2/64	1/64	20	.600	200
N105	10-2	105 x 30	2/64	1/64	25	.640	240

Three Conductor 600 Volts

N106	18-3	41 x 34	2/64	1/64	7	.405	100
N107	16-3	65 x 34	2/64	1/64	10	.430	120
N108	14-3	41 x 30	2/64	1/64	15	.560	190
N109	12-3	65 x 30	2/64	1/64	20	.635	250
N110	10-3	105 x 30	2/64	1/64	25	.690	320

Four Conductor—600 Volts

N111	18-4	41 x 34	2/64	1/64	5.6	.435	110
N112	16-4	65 x 34	2/64	1/64	8	.485	145
N113	14-4	41 x 30	2/64	1/64	12	.605	230
N114	12-4	65 x 30	2/64	1/64	16	.665	290
N115	10-4	105 x 30	2/64	1/64	20	.745	370

Medium Duty Cord—Type SJ



Red-D Type SJ is a flexible, light weight rubber sheathed cord, resistant to moisture, alkalis and acids. Intended for medium duty uses. Extra flexible or Constant Service type recommended if much movement is apt to be encountered. Stationary Service type where less movement in use is expected.

Used as extension power cords, extension lights, household appliances, lawn mowers, office equipment, etc.

Two Conductor—300 Volts—250 Ft. Spools Constant Service

Cat. No.	Size A.W.G. and No. Conds.	Stranding	Insulation Wall, In.	Jacket Wall, In.	Cap., Amps.	Diam., In.	Lbs Per 1000 Ft.
J160	18-2	41 x 34	2/64	2/64	7	.305	50
J161	16-2	65 x 34	2/64	2/64	10	.330	64

Stationary Service

J150	18-2	16 x 30	2/64	2/64	7	.305	50
J151	16-2	26 x 30	2/64	2/64	10	.330	64
*X102	14-2	41 x 30	2/64	2/64	15	.440	104

Three Conductors—300 Volts—250 Ft. Spools Constant Service

J162	18-3	41 x 34	2/64	2/64	7	.335	65
J163	16-3	65 x 34	2/64	2/64	10	.360	80

Stationary Service

J152	18-3	16 x 30	2/64	2/64	7	.335	65
J153	16-3	26 x 30	2/64	2/64	10	.360	80
*X103	14-3	41 x 30	2/64	2/64	15	.480	148

Four Conductor—300 Volts—250 Ft. Coils Constant Service

J164	18-4	41 x 34	2/64	2/64	5.6	.360	80
J165	16-4	65 x 34	2/64	2/64	8	.390	100

*Not U/L approved.

Diamond Red-D-Prene Cords

Type MD—(Mill Duty)



**Rubber Insulation
Red Neoprene Jacket**

The most advanced design in portable cord for heavy duty use throughout mill and plant installation both indoors and outdoors.

Constructed with a fine soft textile center, insuring a maximum uniform flexibility and moisture and abrasion resistance. Type MD is outstanding for use when exposed to oil and grease, sunlight, ozone, most chemicals, solvents and acids. Type MD Red Neoprene jacket has superior age-resisting qualities, and is flame-retardant and heat-resistant.

This cord was especially designed and created for fabricators, automotive industry, oil refineries, steel mills, chemical industries, food and meat packers, and textile plants.

Listed by Underwriters' Laboratories Type MD Neoprene Jacketed Cord—60° C. Service. Canadian Standards Ass'n. Approved.

Two Conductor—600 Volt—250 Ft. Coils

Cat. No.	Size A.W.G. and No. Conds.	Stranding	Insulation Wall, In.	Jacket Wall, In.	Cap. Amps.	Diam., In.	Lbs. Per 1000 Ft.
*R101	18-2	41 x 34	2/64	3/64	7	.390	90
*R102	16-2	65 x 34	2/64	3/64	10	.405	100
R103	14-2	41 x 30	3/64	3/64	15	.530	155
R104	12-2	65 x 30	3/64	6/64	20	.600	200
R105	10-2	105 x 30	5/64	6/64	25	.610	210
R116	8-2	133 x 29	3/64	6/64	40	.782	338
R117	6-2	133 x 27	3/64	6/64	50	.850	417

Three Conductor—600 Volt—250 Ft. Coils

R106	18-3	41 x 34	2/64	3/64	7	.405	100
R107	16-3	65 x 34	2/64	3/64	10	.430	120
R108	14-3	41 x 30	3/64	3/64	15	.560	190
R109	12-3	65 x 30	3/64	6/64	20	.635	250
R110	10-3	105 x 30	3/64	6/64	25	.690	320
R118	8-3	133 x 29	3/64	6/64	35	.828	426
R119	6-3	133 x 27	3/64	6/64	50	.900	562

Four Conductor—600 Volt—250 Ft. Coils

R111	18-4	41 x 34	2/64	3/64	5.6	.435	110
R112	16-4	65 x 34	2/64	3/64	8	.485	115
R113	14-4	41 x 30	3/64	5/64	12	.605	230
R114	12-4	65 x 30	3/64	6/64	16	.665	290
R115	10-4	105 x 30	3/64	6/64	20	.715	370
R120	8-4	133 x 29	3/64	6/64	30	.915	540
R121	6-4	133 x 27	3/64	6/64	40	1.010	699

*250 ft. spools.

Call Graybar FIRST For . . .

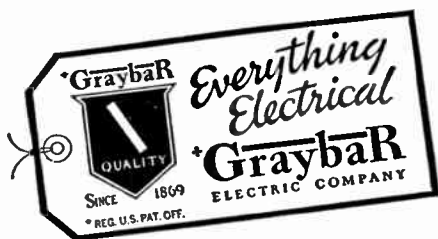

Diamond Coiled Cords

The manufacture of spring type cords has a history of many years. However, it was in the middle and latter 1930's that the chemistry of rubber, neoprene and similar insulating and protective materials permitted the first commercial application of the coiled cords of the type most commonly used.



Retracted—3 Ft. Long



Extended—15 Ft. Long

The first applications of the concept of molding the jacket and insulating materials of a piece of wire into a helical construction, formed by winding the wire around a mandrel, resulted in the production of an expandible dog leash.

The first commercial applications of current-carrying coiled cords occurred after laboratory and development engineering work using the facilities of the Diamond Wire & Cable Company in the Chicago Heights plant, Chicago Heights, Illinois.

Thus, from the first commercial recognition of the coiled cord, the Diamond Wire & Cable Co. has been knowledgeable and has had experience in the field. In recent years, Diamond Wire Co. has been a major supplier of coiled cords to the telephone industry. It is participating in basic research on rubber, neoprene, and plastic insulations and jackets and methods of construction, that are resulting in the finest, most serviceable Retractable Cords made.

Coiled cords are engineered for specific application. Special oil, acid, and moisture resistant properties of the jackets, and the largest standard molding facilities for plug and conductor termination are available to customers. Contact GRAYBAR. Your quotation requests will receive immediate attention.

Diamond Display Racks

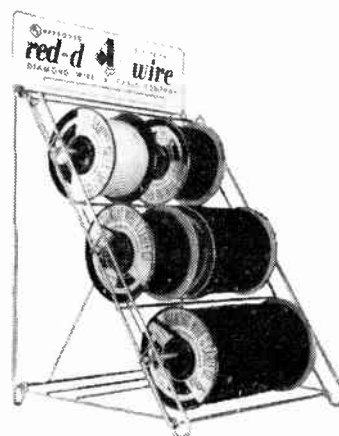

Assortment No. 1

Wire display merchandiser 16 in. deep, 17 in. wide and 27 inches high. Popular wire assortment all in one package. Complete shipping weight 53 lbs. Self-service measuring marker.

Consist of one plated wire merchandiser display stand; 250 ft. No. 18-2 SV Service Cord; 250 ft. No. 16-2 SJ Service Cord; 250 Ft. No. 18-2 SPT-1 (POT) Brown plastic Lamp Cord; 250 Ft. No. 18-2 SPT-1 (POT) Ivory Plastic Lamp Cord; 250 ft. No. 18-2 SP-1 (POSJ) Brown Rubber Lamp Cord.

Diamond Lamp Cord



**Type SP
Parallel Integral Construction**

Flexible cord with rib along one edge for polarity identification. Listed by U/L 60° C. Service. 250 Ft. Spools. Standard colors, brown and black.

Cat. No.	Type	Stranding	Insulation Wall, In.	Amps. Cap.	Diameter, In.	Lbs. Per 1000 Ft.
*†P100	X	26 x 34	2/64	—	.105 x .195	20
†P101	SP-1	41 x 34	2/64	7	.114 x .208	25
†P103	SP-2	41 x 34	3/64	7	.116 x .271	35
†P105	SP-2	65 x 34	3/64	10	.160 x .299	45
**P102	SP-1	41 x 34	2/64	7	.120 x .315	37
**P104	SP-2	41 x 34	3/64	7	.150 x .410	30
**P106	SP-2	65 x 34	3/64	10	.165 x .455	37

**Plastic Rip Cord—Type SPT
Parallel Integral Construction**

Flexible cord with permanent coloring. Fine ribbing along one conductor provides polarity identification. Standard colors are brown, black and ivory.

Cord used for cash registers, clocks, electric blankets, fans, floor lamps, fixtures, floodlights, portable lamps, projectors, radios, scales, signs, table lamps, television and toys. Listed by U/L 60° C. Service. 250 ft. spools.

Cat. No.	Type	Stranding	Insulation Wall, In.	Amps. Cap.	Diameter, In.	Lbs. Per 1000 Ft.
*†P110	XT	26 x 34	2/64	—	.105 x .195	18
†P111	SPT-1	41 x 34	2/64	7	.114 x .208	23
†P113	SPT-2	41 x 34	3/64	7	.116 x .271	30
†P115	SPT-2	65 x 34	3/64	10	.160 x .300	40
†P116	SPT-3	41 x 34	4/64	7	.177 x .333	45
†P117	SPT-3	65 x 34	4/64	10	.190 x .355	50
**P107	SPT-1	41 x 34	2/64	7	.120 x .315	53
**P108	SPT-2	41 x 34	3/64	7	.116 x .395	72
**P109	SPT-2	65 x 34	3/64	10	.165 x .455	60

Type CB Brewery Cord



Similar to Type C, except braid has been saturated for moisture and weather resistance, enabling it to be used more safely where moisture is apt to be encountered. Weather-proofed braid. Listed by U/L. 250 ft. spools.

Cat. No.	Size A.W.G. and No. Cond.	Stranding	Insulation Wall, In.	Voltage	Cap. Amp.	Diam., In.	Lbs. Per 1000 Ft.
C111	18-2	16 x 30	1/32	300	5	.335	32
C112	16-2	26 x 30	1/32	300	7	.370	40
C113	14-2	41 x 30	3/64	600	15	.430	70
†C114	12-2	65 x 30	3/64	600	20	.460	90
†C115	10-2	105 x 30	3/64	600	25	.540	136

Type CBN Brewery

Insulated with weather, sunlight and oil-resistant Neoprene compound. Good for temporary outdoor usage for construction purposes. Christmas lighting, etc. 250 ft. spool.

Cat. No.	Size A.W.G. and No. Cond.	Stranding	Insulation Wall, In.	Voltage	Cap. Amp.	Diam., In.	Lbs. Per 1000 Ft.
C121	18-2	16 x 30	1/32	300	5	.250	25
C122	16-2	26 x 30	1/32	300	7	.270	35
C123	14-2	41 x 30	3/64	600	15	.360	60
†C124	12-2	65 x 30	3/64	600	20	.400	80
†C125	10-2	105 x 30	3/64	600	25	.450	110

Type C Cord

Green and yellow twisted lamp cord. Rubber insulated and cotton braided. For general purpose extensions, pendant services, etc. U/L approved. 250 ft. spools.

Cat. No.	Size A.W.G. and No. Cond.	Stranding	Insul. Wall, In.	Voltage	Cap. Amp.	Diam., In.	Wt. Lbs. Per M Ft.
C101	18-2	16 x 30	1/32	300	5	.290	30
C102	16-2	26 x 30	1/32	300	7	.325	36
C103	14-2	41 x 30	3/64	600	15	.415	66
†C104	12-2	65 x 30	3/64	600	20	.435	83

*Approved for Clocks and Christmas Tree Wiring.

**Approved for Wireless Record Players.

†Canadian Standards Assn. Approved.

‡250 ft. spools.

**Diamond Heater Cords
Type HSJ and HS**



Red-D type HSJ heater cords have flexible, non-kinking construction features similar to Type HPD braided heater cords. Cord totally enclosed in tough rubber, moisture-proof sheath. Recommended for complete safety protection whenever moisture is likely to be encountered. Available in neoprene jacket. U/L approved. 250 ft. spools.

Type HSJ—3,000 Cycle

90° C. Core Service—60 Jacket Service

Cat. No.	Size A.W.G. No. Cond.	Stranding	Voltage	Cap. Amps.	Diam., In.	Wt. Lbs. Per M Ft.
††1190	18-2	41 x 34	300	10	.300	50
††1191	16-2	65 x 34	300	15	.330	60

Type HS

90° C. Core Service—75 C. Jacket Service

Cat. No.	Size A.W.G. No. Cond.	Stranding	Voltage	Cap. Amps.	Diam., In.	Wt. Lbs. Per M Ft.
††1192††	14-2	105 x 34	300	20	.500	118
††1193††	12-2	165 x 34	300	25	.540	160

Type HPD



Red-D Type HPD braided heater cord designed for long, trouble-free service. Flexibility and freedom from kinking are combined with durable braided coverings. Used for flatirons, grills, heaters, portable, heating pads, ironing machines, toasters and waffle irons.

Standard grade, 3,000 cycle: Made with individual copper strands, .0063-in. and is capable of withstanding over 3,000 severe flexings on U/L flex-testing machine. Attractively braided with soft cotton and contrasting colored rayon tracers.

Premium grade 10,000 cycle: Made with individual copper strands of .005 in. for even greater flexibility and longer life in service. Available with glazed cotton braid.

Type HPD—3,000 Cycle

Soft Cotton Braid—90° C. Service

Cat. No.	Size A.W.G. No. Cond.	Stranding	Voltage	Cap. Amps.	Diam., In.	Wt. Lbs. Per M Ft.
††1180	18-2	41 x 34	300	10	.265	32
††1181	16-2	65 x 34	300	15	.300	40
††1182	14-2	105 x 34	300	20	.310	55
††1183	12-2	165 x 34	300	—	.360	70
††1185	18-3	41 x 34	300	10	.300	44
††1186	16-3	65 x 34	300	15	.310	55
††1187	14-3	105 x 34	300	20	.400	75

Type HPD—10,000 Cycle

Glazed Cotton Braid—90° C. Service

Cat. No.	Size A.W.G. No. Cond.	Stranding	Voltage	Cap. Amps.	Diam., In.	Wt. Lbs. Per M Ft.
††1188	18-2	65 x 36	300	10	.280	35
††1189	16-2	105 x 36	300	15	.315	44
††1184	14-2	165 x 36	300	20	.355	60

Type HPN Cord



Red-D Type HPN all neoprene heater cord is non-fraying, specialized heating appliance cord. Neoprene covering available in colors. Covering absolutely impervious to oil, grease, liquids and may be quickly wiped clean and dry. Used for toasters, roasters, fryers, heating pads, flatirons, and coffee makers. Listed by U/L. 90° C. Service. 250 ft. spool.

Type HPN—3,000 Cycle

Cat. No.	Size A.W.G. No. Cond.	Insul. In.	Stranding	Voltage	Cap. Amps.	Diam., In.	Lbs. Per M Ft.
††1194	18-2	3/64	41 x 34	300	10	.154 x .292	33
††1194	16-2	3/64	65 x 34	300	15	.168 x .320	43

‡250 ft. coils.

Triangle Building Wire and Cable 600 Volts

Rubber Insulated—Glazon Covered Single Conductor

Maximum Copper Operating Temperature
Type R—60C Dry, Type RH-RW—75C Moist, 60C Dry
Type RHW—75C Wet or Dry



Glazon protective outer covering is smooth and flexible for ease of installation. Braid is made of continuous filament glass yarn which cannot rot, burn, absorb moisture, or deteriorate with age. Saturant, developed especially for this braid, bonds permanently to the individual fibers. Cannot chip, flake, or peel.

Solid Conductor

Size A.W.G. or MCM	No. of Strands	Type R		Types RH/RW and RHW		
		Insul. Thick-ness 64th In.	Nominal D.D. In.	Insul. Thick-ness 64th In.	Nominal D.D. In.	Approx. Weight Per M-FL. Lbs.
14	Sol.	2	.152	20	.183	25
12	Sol.	2	.169	28	.200	34
10	Sol.	3	.221	49	.221	49
8	Sol.	4	.279	79	.279	79
6	Sol.	4	.337	110	.337	110

Stranded Conductor

14	7	2	.160	23	.191	29
12	7	2	.180	32	.211	38
10	7	3	.235	53	.235	54
8	7	4	.296	84	.296	85
6	7	4	.359	122	.359	129

Rubber Insulated

Tape and Braid or Double Braid Covered
Single Conductor



Code Grade—Type R
60SC (140°F)

Type RH-RW (Dual Rated)
Wet: 60°C (140°F)
Dry: 75°C (167°F)

Type RHW Wet or Dry:
75°C (167°F)

Size A.W.G. or MCM	No. of Strands	Code Grade—Type R 60SC (140°F)		Type RH-RW (Dual Rated)		
		Insul. Thick-ness 64th In.	Nominal D.D. In.	Insul. Thick-ness 64th In.	Nominal D.D. In.	Approx. Weight Per M-FL. Lbs.
4	7	4	.417	190	.417	190
2	7	4	.478	278	.478	278
1	19	5	.563	361	.563	361
1/0	19	5	.603	443	.603	443
2/0	19	5	.649	540	.649	540
3/0	19	5	.701	663	.701	663
4/0	19	5	.759	814	.759	814
250	37	6	.838	962	.838	962
300	37	6	.903	1139	.903	1139
350	37	6	.954	1300	.954	1300
400	37	6	1.01	1473	1.01	1473
500	37	6	1.09	1815	1.09	1815
600	61	7	1.21	2177	1.21	2177
700	61	7	1.27	2512	1.27	2512
750	61	7	1.30	2673	1.30	2673
800	61	7	1.33	2848	1.33	2848
900	61	7	1.40	3194	1.40	3194
1000	61	7	1.46	3530	1.46	3530

Also available with neoprene jacket instead of braid covering.

Triangle building wire is identified by the purple thread under the braid.

Prices on application.

Rubber Insulated—Lead Covered Types RL, RDL, RML (60 C.) RHL, RHD, RHNL (75 C.)



Single Conductor

Size A.W.G. or MCM	No. of Strands	Insulation Thickness 64th In.	Lead Thickness 64th In.	Nom. D.D. In.	Approx. Wt. Per 1000 Ft. Pounds
14	Solid	2	*2	.22	109
12	Solid	2	*2	.24	126
10	Solid	3	3	.32	260
8	Solid	4	3	.38	320
6	Solid	4	**4	.45	520
4	Solid	4	**4	.49	620
14	7	2	*2	.23	109
12	7	2	*2	.25	126
10	7	3	3	.34	260
8	7	4	3	.40	320
6	7	4	**4	.47	520
4	7	4	**4	.52	620
2	7	4	4	.58	770
1	19	5	4	.65	930
1/0	19	5	4	.68	1060
2/0	19	5	4	.73	1210
3/0	19	5	4	.78	1370
4/0	19	5	*4	.85	1570
250	37	6	5	.95	2030
300	37	6	5	1.00	2270
350	37	6	5	1.06	2490
400	37	6	5	1.10	2720
500	37	6	5	1.19	3160
600	61	7	6	1.33	3980
700	61	7	6	1.40	4420
750	61	7	6	1.44	4620
800	61	7	6	1.47	4850
900	61	7	6	1.53	5265
1000	61	7	6	1.59	5690

2-Conductor (Twin Parallel)

14	Solid	2	*2	27 x .38	178
12	Solid	2	*2	24 x .42	222
10	Solid	3	*3	32 x .55	410
8	Solid	4	*3	38 x .66	540
6	Solid	4	4	45 x .77	852
14	7	2	*2	23 x .40	178
12	7	2	*2	25 x .44	222
10	7	3	*3	34 x .58	410
8	7	4	*3	40 x .71	540
6	7	4	4	47 x .81	852
4	7	4	*4	52 x .92	1045
2	7	4	*4	58 x 1.04	1310
1	19	5	5	68 x 1.20	1860
1/0	19	5	*5	72 x 1.29	2120
2/0	19	5	*5	77 x 1.39	2395
3/0	19	5	*5	82 x 1.49	2730
4/0	19	5	*5	88 x 1.61	3120

3-Conductor

14	Solid	2	3	.47	495
12	Solid	2	3	.51	556
10	Solid	3	4	.66	770
8	Solid	4	4	.79	960
6	Solid	4	5	.90	1470
14	7	2	3	.49	495
12	7	2	3	.57	556
10	7	3	4	.69	770
8	7	4	4	.80	960
6	7	4	5	.95	1470
4	7	4	5	1.05	1780
2	7	4	5	1.16	2240
1	19	5	6	1.33	2980
1/0	19	5	6	1.42	3340
2/0	19	5	6	1.52	3830
3/0	19	5	6	1.63	4370
4/0	19	5	7	1.79	5430
250	37	6	7	1.96	6320
300	37	6	7	2.08	7100
350	37	6	7	2.19	7830
400	37	6	8	2.32	9130
500	37	6	8	2.50	10550

*I.P.C.E.A. and A.S.T.M. Specifications require 1/8-inch thicker lead sheath.

**I.P.C.E.A. and A.S.T.M. Specifications permit 1/8-inch thinner lead sheath.

Purple thread under the fibrous covering or lead sheath identifies TRIANGLE lead covered cable.

Prices on application.

Triangle Building Wire and Cable
600 Volts
Type TW
Trioseal (polyvinylchloride) Insulated
Single Conductor—Wet or Dry Locations



Size A.W.G. or MCM	No. of Strands	Insul. Thickness 64th In.	Nominal O.D. In.	Approx. Weight Per M-Ft. Lbs.
Solid Conductor				
14	Solid	2	.131	20
12	Solid	2	.148	28
10	Solid	2	.169	41
8	Solid	3	.229	69
6	Solid	4	.292	110
4	Solid	4	.331	165
Stranded Conductor				
14	7	2	.140	22
14	19	2	.110	20
12	7	2	.158	30
12	19	2	.159	28
10	7	2	.182	41
10	19	2	.183	51
8	7	3	.246	75
8	19	3	.247	80
6	7	4	.315	119
6	19	4	.317	124
4	7	4	.363	176
4	19	4	.376	188
2	7	4	.423	263
2	19	4	.436	276
1	19	5	.496	339
1/0	19	5	.537	416
2/0	19	5	.583	514
3/0	19	5	.631	633
4/0	19	5	.692	787
250	37	6	.76	914
300	37	6	.82	1084
350	37	6	.87	1267
400	37	6	.92	1415
500	37	6	1.00	1751
600	61	7	1.11	2098
700	61	7	1.18	2429
750	61	7	1.22	2590
800	61	7	1.25	2760
900	61	7	1.31	3084
1000	61	7	1.37	3414

Triangle Duplex Cable
600 Volts

Rubber Insulated—Tape and Braid Covered
Maximum Copper Operating Temperature
Type RD 60° C. Dry
Type RHD/RWD 75° C. Dry, 60° C. Wet
Type RHWD 75° C. Dry or Wet
Tape and Braid Covered



Parallel conductors of tinned (alloy coated) copper, rubber insulation of each conductor wrapped with fibrous covering, saturated and finished. Over-all covering is cotton braid, paint and wax finished for ease of handling.

Size A.W.G.	No. of Strands	Type RD		Types RHD/RWD and RHWD		Approx. Weight Per M-Ft. Lbs.
		Insul. Thickness 64th In.	Nominal O.D. In.	Insul. Thickness 64th In.	Nominal O.D. In.	
14	Solid	2	.35 x .20	3	.41 x .22	50
12	Solid	2	.39 x .22	3	.45 x .24	65
10	Solid	3	.49 x .26	3	.49 x .26	114
8	Solid	4	.60 x .32	4	.60 x .32	174
6	Solid	4	.68 x .36	4	.68 x .36	285
Stranded Conductor						
14	7	2	.37 x .21	3	.42 x .23	52
12	7	2	.41 x .23	3	.47 x .25	67
10	7	3	.52 x .27	3	.52 x .27	124
8	7	4	.64 x .33	4	.64 x .33	186
6	7	4	.72 x .38	4	.72 x .38	295

Triangle Armored Cable
600 Volts
Listed by Underwriters' Laboratories, Inc.
Type ACT



Interlocking flexible steel armor, hot dip galvanized. Bushed and bonded. Thermoplastic (polyvinylchloride) insulated conductors.

Single Conductor—Solid

Size A.W.G.	Nominal O.D. In.	Approx. Weight Per M-Ft. Lbs.	Coil Length Ft.	No. of Bushings in Bag Per Coil
8	.425	263	250	35
6	.480	314	250	35
2-Conductor—Solid				
14	.476	198	250*	35
12	.514	228	250*	35
10	.560	274	250	35
8	.730	595	150	20
6	.874	714	100	16

2-Conductor—Stranded

14	.495	202	250*	35
12	.538	233	250*	35
10	.590	280	250	35
8	.770	595	150	20
6	.992	686	100	16
4	1.026	833	100	16
2	1.160	1098	100	16

3-Conductor—Solid

14	.497	232	250*	35
12	.538	274	250	35
10	.588	325	200	35
8	.768	567	150	20
6	.922	788	100	16

3-Conductor—Stranded

14	.518	237	250*	35
12	.564	279	250	35
10	.620	331	200	35
8	.810	578	150	20
6	.975	804	100	16
4	1.088	1128	100	16
2	1.231	1421	100	16

4-Conductor—Solid

14	.532	275	250	35
12	.576	325	250	35
10	.635	600	150	20
8	.830	690	100	16
6	1.000	1097	100	16

4-Conductor—Stranded

14	.554	288	250	35
10	.670	931	150	20
8	.874	1029	100	16

*Also available in coil lengths at 100, 50, 25 and 15 ft. with 16, 8, 4 and 4 bushings respectively in bag per coil.

Triangle Armored Bare Ground Wire

Single Conductor
Solid or Stranded



Solid

Size A.W.G.	Approx. O.D. In.	Approx. Wt. Per 1000 Ft. Lbs.	Coil Length Feet
8	.225	136	250
6	.260	168	250
4	.378	241	250

Stranded

6	.260	168	250
4	.378	241	250

Prices on application.

Triangle Non-Metallic Sheathed Cable
Type NM—Glazon Covered
Trioseal (polyvinylchloride) Insulated
2 and 3 Conductors—600 Volts



2-Conductor—Solid

Size A.W.G.	No. of Strands	Insul. Thickness 64th In.	With Grounding Wire		Without Grounding Wire	
			Nom. O.D. In.	Approx. Weight Per M-Fl. Lbs.	Non. O.D. In.	Approx. Weight Per M-Fl. Lbs.
14	Solid	2	.475 x .234	70	.424 x .234	62
12	Solid	2	.525 x .252	96	.460 x .252	82
10	Solid	2	.583 x .273	126	.502 x .273	102

2-Conductor—Stranded

8	7	3	.840 x .384	250	.724 x .384	214
6	7	4	.983 x .456	330	.868 x .456	293
4	7	4	1.108 x .503	490	.962 x .503	428

3-Conductor—Solid

14	Solid	2	.507	114	.456	104
12	Solid	2	.557	148	.492	134
10	Solid	2	.619	200	.538	174

3-Conductor—Stranded

8	7	3	.893	380	.777	354
6	7	4	1.048	540	.932	500
4	7	4	1.180	955	1.034	890

Triangle non-metallic sheathed cable is identified by the purple thread under the braid.
 Available with or without ground wire.

Type UF and NMC/UF
Trioseal (polyvinylchloride) Insulated
Trioseal Sheathed
1, 2 and 3 Conductors—600 Volts



Single Conductor

Size A.W.G.	No. of Strands	Insul. Thickness 64th In.	Sheath Thickness 64th In.	Nom. O.D. In.	With Gr. App. Wt. Per M-Fl. Lbs.	Without Gr. App. Wt. Per M-Fl. Lbs.
14	Solid	4	.	.195	...	29
12	Solid	4	.	.212	...	38
10	Solid	4	.	.233	...	52
8	Solid	5	.	.292	...	83
6	7	5	.	.347	...	122
4	7	5	.	.395	...	177

2-Conductor

14	Solid	2	2	.214 x .411	79	73
12	Solid	2	2	.230 x .445	104	95
10	Solid	2	2	.251 x .488	145	125

3-Conductor

14	Solid	2	2	.214 x .611	116	110
12	Solid	2	2	.230 x .658	164	134
10	Solid	2	2	.251 x .721	192	149

Call Graybar FIRST For . . .

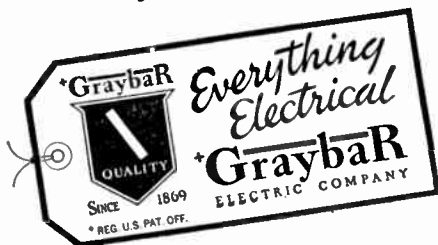

Triangle Armored Lead Sheathed Cable
Type ACL
Rubber Insulated—Lead Covered
2 and 3 Conductor—600 Volts



2-Conductor

Size A.W.G.	No. of Strands	Insul. Thickness 64th In.	Lead Thickness 64th In.	Approx. O.D. In.	Approx. Weight Per M-Fl. Lbs.	Length Per Coil Ft.
14	Solid	2	2	.577	447	150
12	Solid	2	2	.612	480	150
10	Solid	3	2	.758	670	100
8	7	4	3	.954	1020	100
6	7	4	3	1.033	1240	100

3-Conductor

14	Solid	2	2	.603	507	150
12	Solid	2	2	.640	520	150
10	Solid	3	2	.795	810	100
8	7	4	3	1.002	1360	100
6	7	4	3	1.088	1480	100
4	7	4	4	1.241	2740	100

Triangle Series Street Lighting Cable
Rubber, Trioseal (polyvinylchloride) or Triolene (polyethylene) Insulated, Trioprene (neoprene), Trioseal, Triolene or Lead Covered
Single Conductor—3000-5000 Volts



Trioseal Insulated—3000 Volts

Size A.W.G.	Insulation Thickness Without Protectors 64th In.	Mils	Jacket Thickness 64th In.	Nominal O.D. In.	Approx. Wt. Per 1000 Ft. Lbs.
8	7*356	96
6	8*425	151

Triolene Insulated—3000 Volts

8	..	75*	.	.285	78
6	..	90*	.	.350	90
8	..	75*	3	.385	102
6	..	90*	3	.450	116

Rubber Insulated—Trioprene Jacketed—3000 Volts

8	7	...	3	.460	137
6	8	...	4	.555	193

Rubber Insulated—Lead Jacketed—3000 Volts

8	7	...	3	.485	420
6	8	...	3	.550	648

Trioseal Insulated—5000 Volts

8	10*452	132
6	10*485	179

Triolene Insulated—5000 Volts

8	..	110*	.	.355	90
6	..	110*	.	.380	103
8	..	110*	3	.455	117
6	..	110*	3	.488	152

Rubber Insulated—Trioprene Jacketed—5000 Volts

8	10	...	4	.585	158
6	10	...	4	.622	200

Rubber Insulated—Lead Jacketed—5000 Volts

8	10	...	4	.612	665
6	10	...	4	.645	735

*Insulation thickness same with protectors.

†Also available with one or two jute servings, or jute-double steel armor-jute, over lead sheath.

‡Insulation thickness includes jacket except where extra thickness is required for severe service, direct burial, etc.

Triangle Service Entrance Cable

300 Volts to Ground

Type SE-UBN—75° C. (167° F.)



Has bare neutral. Also available with all conductors insulated, and in two, three, four, five or six conductor construction.

Size A.W.G.	Conc. Uninsul. Neutral Cond. A.W.G.	Two Conductor			Three Conductor		
		Nom. D.D. In.	Approx. Wt. Per 1000 Ft. Pounds	Std. Coil Lgth. Feet	Nom. D.D. In.	Approx. Wt. Per 1000 Ft. Pounds	Std. Coil Lgth. Feet
10	Sol. 10	.34	170	250	.37x .55	230	250
8	Str. 8	.44	182	250	.44x .72	290	250
6	8	.50	230	250	.50x .83	380	200
6	6	.51	265	250	.51x .85	420	150
4	6	.56	330	200	.56x .94	540	150
4	4	.57	385	200	.57x .96	595	150
2	4	.63	495	200	.63x1.08	790	100
2	2	.66	570	200	.66x1.10	895	100

Type SE-ABN (Armored)—75° C. (167° F.)



Has bare neutral. Also available with all conductors insulated, and in two, three, four, five or six conductor construction.

Size A.W.G.	Conc. Uninsul. Neutral Cond. A.W.G.	Two Conductor			Three Conductor		
		Nom. D.D. In.	Approx. Wt. Per 1000 Ft. Pounds	Std. Coil Lgth. Feet	Nom. D.D. In.	Approx. Wt. Per 1000 Ft. Pounds	Std. Coil Lgth. Feet
10	Sol. 10	.42	136	250	.46x .60	257	250
8	Str. 8	.46	246	250	.46x .71	390	250
6	8	.52	305	250	.52x .85	490	200
6	6	.53	340	250	.53x .87	530	150
4	6	.58	410	200	.58x .96	660	150
4	4	.59	465	200	.58x .98	725	150
2	4	.65	580	200	.65x1.10	920	100
2	2	.68	655	200	.68x1.12	1035	100

Triangle Service Drop Cable

Type SD-SDC—60° C. (140° F.)

300 Volts to Ground



Has bare neutral. Also available with all conductors insulated, and in two, three, four, five or six conductor construction.

Size A.W.G.	Conc. Uninsul. Neutral Cond. A.W.G.	Two Conductor			Three Conductor		
		Nom. D.D. In.	Approx. Wt. Per 1000 Ft. Pounds	Std. Coil Lgth. Feet	Nom. D.D. In.	Approx. Wt. Per 1000 Ft. Pounds	Std. Coil Lgth. Feet
10	10	.33	106	250	.38x .58	174	250
8	8	.41	170	250	.46x .69	285	250
6	8	.45	223	250	.50x .77	375	200
6	6	.47	255	250	.52x .78	415	150
4	6	.52	320	200	.57x .89	535	150
4	4	.54	370	200	.58x .90	590	150
2	4	.60	475	200	.64x1.01	780	100
2	2	.62	550	200	.66x1.04	885	100

Prices on application.

Triangle Service Drop Cable

Self Supporting

Trioprene (neoprene)—Triolene (polyethylene) Insulated
Copper Conductor—Copper Messenger
2 and 3 Conductors—600 Volts



Bare neutral supports cable weight leaving conductors free of tension so that installation and splicing operations can be accomplished easily. Available with either polyethylene or neoprene covering, both of which offer great resistance to sunlight and exposure to the elements.

Neoprene—Two Conductors

A.W.G. Size Insulated Conductor	No. of Strands	Insul. Thick. In.	A.W.G. Size Bare Neutral Messenger	Approx. Net Wgt. Lbs. Per M Ft.
8	7	3/64	10 Solid	154
8	7	3/64	8 Solid	172
8	7	3/64	8 Strand	215
6	7	3/64	8 Solid	251
6	7	3/64	6 Solid	281
6	7	3/64	6 Strand	281

Neoprene—Three Conductors

8	7	3/64	10 Solid	304
8	7	3/64	8 Solid	322
8	7	3/64	8 Strand	323
6	7	3/64	8 Solid	398
6	7	3/64	6 Solid	427
6	7	3/64	6 Strand	429
4	7	3/64	6 Solid	554
4	7	3/64	4 Solid	600
4	7	3/64	4 Strand	603
2	7	3/64	4 Solid	780
2	7	3/64	4 Strand	781
2	7	3/64	2 Strand	857

Polyethylene—Two Conductors

6	7	3/64	6 Strand	66
4	7	3/64	4 Strand	100
2	7	3/64	2 Strand	150

Polyethylene—Three Conductors

6	7	3/64	6 Strand	107
4	7	3/64	4 Strand	161
2	7	3/64	2 Strand	240

Triangle Tree Wire
Neutral Grounded and Ungrounded
0-600 Volts



Size A.W.G.		Insul. Thick-ness 64th In.	Jacket Thick-ness 64th In.	Approx. D.D. In.	Weight Per M-Ft. Lbs.
10	Solid	4	2	.302	70
8	Solid	5	2	.360	107
6	Solid	5	2	.392	143
4	Solid	5	2	.431	200
2	Str.	5	2	.423	301
1	Str.	5	3	.594	340
1/0	Str.	5	3	.635	425
2/0	Str.	5	3	.680	520
3/0	Str.	5	3	.732	640
4/0	Str.	5	3	.790	790
601-3000 Volts					
8	Solid	5	3	.393	119
6	Solid	5	3	.425	158
4	Solid	5	3	.467	216
2	Str.	5	3	.557	321
1	Str.	5	3	.594	310
1/0	Str.	5	3	.635	425
2/0	Str.	5	3	.680	520
3/0	Str.	5	3	.732	640
4/0	Str.	5	3	.790	790

Note: 3001-5000 available—contact GRAYBAR.

Triangle Parkway Cable

Rubber Insulated*—Lead Sheathed—IPCEA Type RLJFJ*
1, 2 and 3 Conductors—0-5000 Volts



Also available in 600-4000, 1001-2000 and 2001-3000 voltage ratings and in sizes up to 1,000,000 C.M. For information contact Graybar.

0-600 Volts

Single Conductor—Solid

Size A.W.G. or 1000 C.M.	Insulation Thickness 64th In.	Lead Thickness 64th In.	Armor Tape Thickness In.	Nominal O.D. In.	Approx. Ship. WL Per M-FL Lbs.
14	3	3	.020	.63	516
12	3	3	.020	.65	556
10	3	3	.020	.67	608
8	4	3	.020	.72	732
6	4	3	.020	.76	835

Single Conductor—Stranded

6	4	3	.020	.78	884
4	4	3	.020	.83	1036
3	4	4	.020	.89	1320
2	4	4	.020	.92	1416
1	5	4	.020	.99	1680
0	5	4	.020	1.03	1851
00	5	4	.020	1.07	2058
000	5	4	.020	1.15	2298
0000	5	5	.020	1.24	2886
250	6	5	.020	1.32	3258
300	6	5	.030	1.41	3830
350	6	5	.030	1.47	4206
400	6	5	.030	1.51	4516
500	6	5	.030	1.60	5178
600	7	6	.030	1.74	6386
700	7	6	.030	1.81	7012
750	7	6	.030	1.85	7271
800	7	6	.030	1.88	7528
900	7	6	.030	1.94	8143
1000	7	6	.030	2.00	8645

2-Conductor (Flat Parallel)—Solid

Size A.W.G. or 1000 C.M.	Insulation Thickness 64th In.	Lead Thickness 64th In.	Armor Tape Thickness In.	Nominal O.D. In.	Approx. Ship. WL Per M-FL Lbs.
14	3	3	.020	.84 x .65	683
12	3	3	.020	.87 x .67	750
10	3	4	.020	.95 x .72	1002
8	4	4	.020	1.06 x .78	1264
6	4	4	.020	1.13 x .81	1432

2-Conductor (Flat Parallel)—Stranded

6	4	4	.020	1.17 x .83	1531
4	4	5	.020	1.30 x .91	2062
3	4	5	.030	1.36 x .95	2270
2	4	5	.030	1.48 x 1.03	2718
1	5	5	.030	1.62 x 1.10	3206
0	5	6	.030	1.74 x 1.18	3894
00	5	6	.030	1.83 x 1.22	4326
000	5	6	.030	1.93 x 1.27	4813
0000	5	6	.030	2.05 x 1.33	5460
250	6	7	.030	2.24 x 1.44	6650
300	6	7	.030	2.35 x 1.50	7325
350	6	7	.030	2.45 x 1.55	7984
400	6	7	.030	2.54 x 1.60	8620
500	6	8	.030	2.75 x 1.71	10492

3-Conductor—Solid

14	3	4	.020	.93	1218
12	3	4	.020	.97	1334
10	3	4	.020	1.01	1471
8	4	4	.020	1.13	1850
6	4	5	.020	1.24	2418

0-600 Volts (Cont'd)

3-Conductor—Stranded

Size A.W.G. or 1000 C.M.	Insulation Thickness 64th In.	Lead Thickness 64th In.	Armor Tape Thickness In.	Nominal O.D. In.	Approx. Ship. WL Per M-FL Lbs.
6	4	5	.020	1.29	2552
4	4	5	.030	1.46	3360
3	4	5	.030	1.53	3672
2	4	5	.030	1.58	4044
1	5	6	.030	1.76	5118
0	5	6	.030	1.85	5712
00	5	6	.030	1.95	6360
000	5	6	.030	2.06	7176
0000	5	7	.030	2.21	8640
250	6	7	.030	2.38	9780
300	6	7	.030	2.50	10824
350	6	7	.030	2.61	11832
400	6	8	.030	2.74	13500
500	6	8	.030	2.93	15444

601 to 1000 Volts

Single Conductor—Solid

14	4	3	.020	.663	580
12	4	3	.020	.680	620
10	4	3	.020	.701	673
8	4	3	.020	.727	732
6	5	3	.020	.792	902

Single Conductor—Stranded

6	5	3	.020	.814	954
4	5	3	.020	.862	1106
3	5	4	.020	.921	1406
2	5	4	.020	.953	1531
1	6	4	.020	1.025	1764
0	6	4	.020	1.067	1912
00	6	4	.020	1.136	2150
000	6	4	.020	1.187	2378
0000	6	5	.020	1.277	2990
250	7	5	.020	1.364	3356
300	7	5	.030	1.450	3962
350	7	5	.030	1.501	4340
400	7	5	.030	1.548	4670
500	7	6	.030	1.666	5673

2-Conductor (Flat Parallel)—Solid

14	4	4	.020	.93 x .719	934
12	4	4	.020	.97 x .736	1016
10	4	4	.020	1.01 x .757	1118
8	4	4	.020	1.06 x .783	1264
6	5	4	.020	1.19 x .848	1565

2-Conductor (Flat Parallel)—Stranded

6	5	4	.020	1.24 x .870	1656
4	5	5	.020	1.36 x .949	2212
3	5	5	.030	1.48 x 1.037	2630
2	5	5	.030	1.54 x 1.069	2892
1	6	6	.030	1.72 x 1.172	3714
0	6	6	.030	1.80 x 1.213	4090
00	6	6	.030	1.89 x 1.258	4516
000	6	6	.030	1.99 x 1.310	5040
0000	6	6	.030	2.11 x 1.369	5668
250	7	7	.030	2.30 x 1.478	6876
300	7	7	.030	2.41 x 1.533	7560
350	7	7	.030	2.51 x 1.584	8214
400	7	7	.030	2.60 x 1.631	8862
500	7	8	.030	2.81 x 1.748	10721

3-Conductor—Solid

14	4	4	.020	1.001	1393
12	4	4	.020	1.037	1507
10	4	4	.020	1.083	1648
8	4	4	.020	1.138	1850
6	5	5	.020	1.309	2630

*Also available with Trioprene (neoprene) sheath IPCEA Type RNJFJ.

Triangle Parkway Cable
Rubber Insulated*—Lead Sheathed—IPCEA Type RLJFJ*
1, 2 and 3 Conductors—0-5000 Volts

601 to 1000 Volts (Cont'd)

Size A.W.G. or 1000 C.M.	Insulation Thickness 64th In.	Lead Thickness 64th In.	Armor Tape Thickness In.	Nominal O.D. In.	Approx. Ship. Wt. Per M-FL. Lbs.
3-Conductor—Stranded					
6	5	5	.020	1.357	2778
4	5	5	.030	1.520	3600
3	5	5	.030	1.580	3888
2	5	6	.030	1.680	4680
1	6	6	.030	1.836	5424
0	6	6	.030	1.924	6000
00	6	6	.030	2.020	6648
000	6	7	.030	2.163	7980
0000	6	7	.030	2.288	8952
250	7	7	.030	2.456	10104
300	7	7	.030	2.574	11148
350	7	8	.030	2.715	12876
400	7	8	.030	2.816	13884
500	7	8	.030	3.000	15840

2001 to 3000 Volts
Single Conductor—Solid

Size A.W.G. or 1000 C.M.	Insulation Thickness 64th In.	Lead Thickness 64th In.	Armor Tape Thickness In.	Nominal O.D. In.	Approx. Ship. Wt. Per M-FL. Lbs.
10	7	3	.020	.795	869
8	7	3	.020	.821	936
6	8	4	.020	.917	1286

Single Conductor—Stranded

6	8	4	.020	.939	1357
4	8	4	.020	.987	1532
3	8	4	.020	1.015	1664
2	8	4	.020	1.047	1790
1	8	4	.020	1.087	1940
0	8	4	.020	1.153	2118
00	8	4	.020	1.198	2320
000	8	5	.020	1.281	2864
0000	8	5	.020	1.339	3202
250	9	5	.030	1.457	3806
300	9	5	.030	1.512	4229
350	9	5	.030	1.563	4597
400	9	5	.030	1.610	4920
500	9	6	.030	1.728	5960

2-Conductor (Flat Parallel)—Solid

10	7	5	.020	1.23 x .882	1714
8	7	5	.020	1.28 x .908	1860
6	8	5	.030	1.48 x 1.033	2442

2-Conductor (Flat Parallel)—Stranded

6	8	5	.030	1.52 x 1.055	2573
4	8	5	.030	1.62 x 1.103	2924
3	8	6	.030	1.70 x 1.162	3482
2	8	6	.030	1.77 x 1.194	3757
1	8	6	.030	1.85 x 1.234	4094
0	8	6	.030	1.93 x 1.275	4471
00	8	6	.030	2.02 x 1.320	4900
000	8	6	.030	2.12 x 1.372	5438
0000	8	7	.030	2.27 x 1.462	6517
250	9	7	.030	2.42 x 1.541	7328
300	9	7	.030	2.53 x 1.596	8024
350	9	7	.030	2.63 x 1.647	8682
400	9	8	.030	2.76 x 1.725	9962
500	9	8	.030	2.93 x 1.811	11178

3-Conductor—Solid

10	7	5	.020	1.316	2498
8	7	5	.020	1.372	2728
66	8	5	.020	1.571	3589

2001 to 3000 Volts (Cont'd)

Size A.W.G. or 1000 C.M.	Insulation Thickness 64th In.	Lead Thickness 64th In.	Armor Tape Thickness In.	Nominal O.D. In.	Approx. Ship. Wt. Per M-FL. Lbs.
3-Conductor—Stranded					
6	8	5	.030	1.619	3805
4	8	6	.030	1.754	4740
3	8	6	.030	1.816	5088
2	8	.	.030	1.883	5388
1	8	6	.030	1.969	5988
0	8	6	.030	2.057	6564
00	8	7	.030	2.181	7764
000	8	7	.030	2.297	8628
0000	8	7	.030	2.421	9624
250	9	7	.030	2.589	10788
300	9	8	.030	2.738	12552
350	9	8	.030	2.848	13668
400	9	8	.030	2.949	14688
500	9	8	.030	3.134	16656

4001 to 5000 Volts

Single Conductor—Solid

8	10	4	.020	.946	1342
6	10	4	.020	.980	1464

Single Conductor—Stranded

6	10	4	.020	1.001	1554
4	10	4	.020	1.050	1710
3	10	4	.020	1.078	1836
2	10	4	.020	1.135	1956
1	10	4	.020	1.175	2118
0	10	5	.020	1.247	2570
00	10	5	.020	1.292	2807
000	10	5	.020	1.344	3084
0000	10	5	.030	1.443	3610
250	11	5	.030	1.521	4080
300	11	5	.030	1.575	4493
350	11	6	.030	1.658	5216
400	11	6	.030	1.705	5568
500	11	6	.030	1.791	6246

2-Conductor (Flat Parallel)—Solid

8	10	5	.030	1.53 x 1.062	2544
6	10	5	.030	1.60 x 1.096	2796

2-Conductor (Flat Parallel)—Stranded

6	10	6	.030	1.67 x 1.148	3250
4	10	6	.030	1.77 x 1.197	3622
3	10	6	.030	1.83 x 1.225	3858
2	10	6	.030	1.88 x 1.257	4134
1	10	6	.030	1.97 x 1.297	4474
0	10	6	.030	2.05 x 1.338	4856
00	10	7	.030	2.18 x 1.415	5744
000	10	7	.030	2.28 x 1.436	6336
0000	10	7	.030	2.40 x 1.525	6996
250	11	7	.030	2.55 x 1.603	7780
300	11	8	.030	2.69 x 1.690	9016
350	11	8	.030	2.79 x 1.740	9732
400	11	8	.030	2.88 x 1.787	10418
500	11	8	.030	3.06 x 1.873	11630

3-Conductor—Solid

8	10	5	.030	1.634	3758
6	10	6	.030	1.738	4494

3-Conductor—Stranded

6	10	6	.030	1.784	4722
4	10	6	.030	1.889	5292
3	10	6	.030	1.949	5640
2	10	6	.030	2.018	6060
1	10	6	.030	2.104	6564
0	10	7	.030	2.223	7716
00	10	7	.030	2.320	8424
000	10	7	.030	2.432	9288
0000	10	7	.030	2.557	10296
250	11	8	.030	2.755	12228
300	11	8	.030	2.874	13344
350	11	8	.030	2.983	14460
400	11	8	.030	3.084	15480
500	11	8	.030	3.269	17460

*Also available with Triprene (neoprene) sheath IPCEA Type RNJFJ.

Prices on application.

Triangle Weather Resistant Line Wire
Triprene or Polyethylene Insulated
Copper or Aluminum Conductor—0-600 Volts



Size A.W.G. or MCM	No. of Strands *	Neoprene			Polyethylene		
		Cover Thickness 64th In.	Nominal O.D. In.	Approx. Weight Per M-FL Lbs.-COPPER	Cover Thickness 64th In.	Nominal O.D. In.	
14	Solid	2	.128	20	2	.128	
12	Solid	2	.147	27	2	.147	
10	Solid	2	.168	40	2	.168	
9	Solid	3	.214	56	2	.178	
8	Solid	3	.228	66	2	.192	
6	Solid	3	.262	99	2	.225	
4	Solid	3	.304	150	2	.270	
4	7	3	.332	164	2	.295	
3	Solid	3	.329	178	3	.329	
3	7	3	.360	181	
2	Solid	3	.357	232	3	.357	
2	7	3	.392	248	3	.392	
1	7	4	.464	325	3	.430	
1/0	7	5	.538	400	4	.505	
2/0	7	5	.583	519	4	.550	
3/0	7	5	.635	608	4	.602	
4/0	7	5	.693	753	4	.660	
250	19	5	.790	846	4	.710	
300	19	5	.795	1006	4	.760	
350	19	5	.846	1167	4	.810	
400	19	6	.927	1344	5	.890	
450	37	6	.971	1507	5	.935	
500	37	6	1.013	1668	5	.975	

Concentric—Lay—Stranded Hard Drawn
Aluminum Conductors Steel—Reinforced
(ACSR)

Size A.W.G.	No. of Strands	Cover Thickness 64th In.	Nominal O.D. In.	Approx. Weight Per M-FL Lbs.-COPPER	Cover Thickness 64th In.	Nominal O.D. In.
6	6/1	3	.284	65	2	.252
4	6/1	3	.332	94	2	.295
4	7/1	3	.332	104	2	.295
2	6/1	3	.392	139	3	.392
2	7/1	3	.392	154	3	.392
1	6/1	4	.464	185	3	.430
1/0	6/1	4	.505	264	4	.505
2/0	6/1	4	.550	273	4	.550
3/0	6/1	4	.602	333	4	.602
4/0	6/1	4	.660	409	4	.660

*Class "A" stranding. Also available in class AA and class B.

Call Graybar **FIRST** For . . .

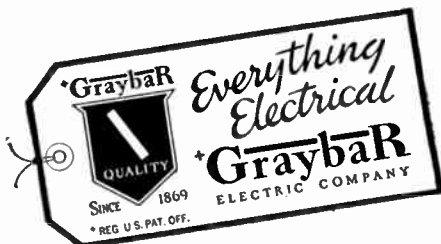

Triangle Varnished Cambric-Interlocked
Armor Cable



0-1000 Volts

Size A.W.G. or MCM	V.C. Thick- ness 64th In.	2-Conductor		3-Conductor		4-Conductor	
		Nominal O.D. In.	Shp. WL Per M-FL Lbs.	Nominal O.D. In.	Shp. WL Per M-FL Lbs.	Nominal O.D. In.	Shp. WL Per M-FL Lbs.
6	4	1.161	819	1.225	950	1.326	1268
4	4	1.257	1029	1.329	1233	1.442	1504
2	4	1.377	1310	1.459	1609	1.586	1981
1	5	1.505	1570	1.597	2018	1.740	2448
0	5	1.587	1803	1.685	2441	1.840	2867
00	5	1.679	2092	1.785	2767	1.950	3379
000	5	1.781	2424	1.895	3517	2.073	4064
0000	5	1.897	2850	2.020	4158	2.213	4856
250	6	2.067	3303	2.203	4919	2.418	5684
300	6	2.177	3818	2.323	5648	2.550	6585
350	6	2.279	4282	2.433	6376	2.673	7486
400	6	2.373	4748	2.534	7320	2.786	8669
500	6	2.540	6042	2.718	8611	2.997	10164

2001-3000 Volts (Including 2500 Volts)

6	6	1.257	960	1.330	1187	1.442	1439
4	6	1.353	1147	1.432	1447	1.558	1774
2	6	1.473	1412	1.562	1860	1.702	2309
1	6	1.553	1633	1.651	2128	1.798	2652
0	6	1.635	1873	1.737	2467	1.898	3096
00	6	1.727	2165	1.836	2881	2.008	3635
000	6	1.829	2489	1.947	3343	2.131	4236
0000	6	1.955	2918	2.072	3958	2.270	5039
250	7	2.167	3416	2.307	4692	2.534	5990
300	7	2.277	3943	2.426	5411	2.666	6932
350	7	2.379	4409	2.537	6084	2.789	7815
400	7	2.473	4881	2.638	6664	2.902	8717
500	7	2.643	5853	2.822	8186

4001-5000 Volts (Including 4500 Volts)

6	9	1.449	1169	1.538	1457	1.674	1773
4	9	1.515	1378	1.640	1747	1.790	2148
2	9	1.665	1654	1.770	2131	1.934	2642
1	9	1.745	1883	1.859	2413	2.030	3005
0	9	1.827	2112	1.945	2778	2.130	3484
00	9	1.920	2394	2.044	3178	2.240	4003
000	9	2.020	2754	2.155	3695	2.363	4678
0000	9	2.157	3213	2.301	4348	2.526	5530
250	10	2.311	3721	2.463	5069	2.708	6472
300	10	2.421	4225	2.582	5799
350	10	2.519	4715	2.693	6522
400	10	2.617	5230	2.794	7256
500	10	2.787	6187	2.993	8671

For
NATIONAL ELECTRIC CODE
CURRENT CARRYING CAPACITIES
 on
THESE AND OTHER WIRES
AND CABLES
 See
TABLES OF USEFUL INFORMATION
 Preceding Index

Triangle Asbestos Varnished Cambric Interlocked Armor Cable 0-5000 Volts

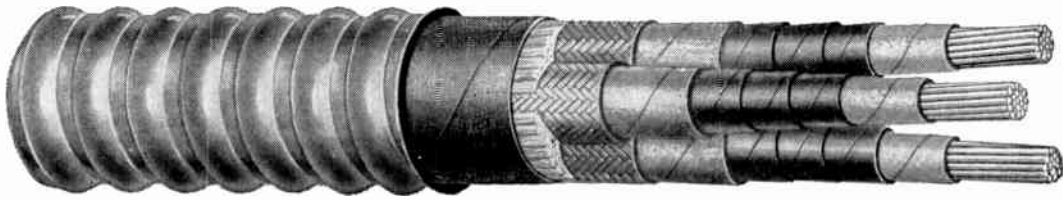

0-600 Volts

Size A.W.G. or MCM	No. of Strands	Inner Asbestos Mils	Varnished Cambric Mils	Outer Asbestos Mils	Nom. Dia. Under Armor In.	Nom. Dia. Over Armor In.	Approx. Wt. Per M-FL Lbs.
4	7	15	30	20	.474	.794	551
2	7	15	30	20	.534	.854	706
1	19	20	30	30	.594	.914	821
1/0	19	20	30	30	.635	.955	941
2/0	19	20	30	30	.681	1.001	1083
3/0	19	20	30	30	.732	1.052	1268
4/0	19	20	30	30	.790	1.110	1487
250	37	25	40	40	.905	1.225	1752
300	37	25	40	40	.960	1.280	1996
350	37	25	40	40	1.011	1.331	2234
400	37	25	40	40	1.058	1.378	2463
450	37	25	40	40	1.102	1.422	2702
500	37	25	40	40	1.143	1.463	2928
550	61	30	40	40	1.185	1.505	3174
600	61	30	40	40	1.223	1.543	3424
700	61	30	40	40	1.294	1.614	3882
750	61	30	40	40	1.328	1.648	4111
1000	61	30	40	40	1.482	1.802	5205

Single Conductor

Size A.W.G. or MCM	No. of Strands	Inner Asbestos Mils	Varnished Cambric Mils	Outer Asbestos Mils	Nom. Dia. Under Armor In.	Nom. Dia. Over Armor In.	Approx. Wt. Per M-FL Lbs.
4	7	15	80	25	.590	.910	689
2	7	15	80	25	.650	.970	832
1	19	20	80	30	.690	1.010	957
1/0	19	20	80	30	.731	1.051	1077
2/0	19	20	80	30	.777	1.097	1225
3/0	19	20	80	30	.828	1.148	1415
4/0	19	20	80	30	.886	1.206	1638
250	37	25	80	40	.977	1.297	1882
300	37	25	80	40	1.032	1.352	2128
350	37	25	80	40	1.083	1.403	2376
400	37	25	80	40	1.130	1.450	2611
450	37	25	80	40	1.174	1.494	2845
500	37	25	80	40	1.215	1.535	3077
550	61	30	80	40	1.257	1.577	3301
600	61	30	80	40	1.295	1.615	3482
700	61	30	80	40	1.366	1.686	3857
750	61	30	80	40	1.400	1.720	4074
1000	61	30	80	40	1.554	1.874	5060

2001-3000 Volts

601-1000 Volts

4001-5000 Volts

Two Conductor

0-600 Volts							
Size A.W.G. or MCM	No. of Strands	Inner Asbestos Mils	Varnished Cambric Mils	Outer Asbestos Mils	Nom. Dia. Under Armor In.	Nom. Dia. Over Armor In.	Approx. Wt. Per M-FL Lbs.
4	7	15	30	20	.983	1.303	1070
2	7	15	30	20	1.103	1.423	1351
1	19	20	30	30	1.223	1.543	1627
1/0	19	20	30	30	1.305	1.625	1867
2/0	19	20	30	30	1.397	1.717	2156
3/0	19	20	30	30	1.499	1.819	2507
4/0	19	20	30	30	1.615	1.935	2938
250	37	25	40	40	1.845	2.165	3477
300	37	25	40	40	1.955	2.275	3966
350	37	25	40	40	2.055	2.375	4411
400	37	25	40	40	2.150	2.470	4901
450	37	25	40	40	2.240	2.560	5382

2001-3000 Volts							
Size A.W.G. or MCM	No. of Strands	Inner Asbestos Mils	Varnished Cambric Mils	Outer Asbestos Mils	Nom. Dia. Under Armor In.	Nom. Dia. Over Armor In.	Approx. Wt. Per M-FL Lbs.
4	7	15	80	25	1.215	1.535	1307
2	7	15	80	25	1.335	1.655	1593
1	19	20	80	30	1.415	1.735	1844
1/0	19	20	80	30	1.497	1.817	2085
2/0	19	20	80	30	1.589	1.909	2390
3/0	19	20	80	30	1.691	2.011	2753
4/0	19	20	80	30	1.807	2.127	3197
250	37	25	80	40	1.990	2.310	3702
300	37	25	80	40	2.100	2.420	4190
350	37	25	80	40	2.200	2.520	4686
400	37	25	80	40	2.295	2.615	5160
450	37	25	80	40	2.383	2.703	5638

601-1000 Volts

4001-5000 Volts

601-1000 Volts							
Size A.W.G. or MCM	No. of Strands	Inner Asbestos Mils	Varnished Cambric Mils	Outer Asbestos Mils	Nom. Dia. Under Armor In.	Nom. Dia. Over Armor In.	Approx. Wt. Per M-FL Lbs.
4	7	15	45	25	1.070	1.390	1141
2	7	15	45	25	1.190	1.510	1434
1	19	20	45	30	1.270	1.590	1666
1/0	19	20	45	30	1.353	1.673	1920
2/0	19	20	45	30	1.445	1.765	2208
3/0	19	20	45	30	1.547	1.867	2570
4/0	19	20	45	30	1.665	1.985	2990
250	37	25	45	40	1.845	2.165	3500
300	37	25	45	40	1.955	2.275	3980
350	37	25	45	40	2.055	2.375	4450
400	37	25	45	40	2.150	2.470	4930
450	37	25	45	40	2.240	2.560	5405

4001-5000 Volts							
Size A.W.G. or MCM	No. of Strands	Inner Asbestos Mils	Varnished Cambric Mils	Outer Asbestos Mils	Nom. Dia. Under Armor In.	Nom. Dia. Over Armor In.	Approx. Wt. Per M-FL Lbs.
4	7	15	120	25	1.360	1.680	1490
2	7	15	120	25	1.480	1.800	1910
1	19	20	120	30	1.560	1.880	2087
1/0	19	20	120	30	1.641	1.961	2279
2/0	19	20	120	30	1.733	2.053	2622
3/0	19	20	120	30	1.835	2.155	2990
4/0	19	20	120	30	1.951	2.271	3458
250	37	25	120	40	2.133	2.453	3957
300	37	25	120	40	2.243	2.563	4471
350	37	25	120	40	2.345	2.665	4981
400	37	25	120	40	2.440	2.760	5478
450	37

Triangle Asbestos Varnished Cambric Interlocked Armor Cable
0-5000 Volts
Three Conductor

0-600 Volts								2001-3000 Volts							
Size A.W.G. or MCM	No. of Strands	Inner Asbestos Mils	Varnished Cambric Mils	Outer Asbestos Mils	Nom. Dia. Under Armor In.	Nom. Dia. Over Armor In.	Approx. Wt. Per M-FL Lbs.	Size A.W.G. or MCM	No. of Strands	Inner Asbestos Mils	Varnished Cambric Mils	Outer Asbestos Mils	Nom. Dia. Under Armor In.	Nom. Dia. Over Armor In.	Approx. Wt. Per M-FL Lbs.
4	7	15	30	20	1.058	1.378	1388	4	7	15	80	25	1.309	1.629	1666
2	7	15	30	20	1.188	1.508	1875	2	7	15	80	25	1.439	1.759	2070
1	19	20	30	30	1.318	1.638	2216	1	19	20	80	30	1.525	1.845	2130
1/0	19	20	30	30	1.406	1.726	2621	1/0	19	20	80	30	1.614	1.934	2774
2/0	19	20	30	30	1.505	1.825	3017	2/0	19	20	80	30	1.713	2.033	3208
3/0	19	20	30	30	1.616	1.936	3563	3/0	19	20	80	30	1.823	2.143	3740
4/0	19	20	30	30	1.741	2.061	4185	4/0	19	20	80	30	1.948	2.268	4385
250	37	25	40	40	1.990	2.310	4951	250	37	25	80	40	2.145	2.465	5082
300	37	25	40	40	2.108	2.428	5729	300	37	25	80	40	2.264	2.584	5808
350	37	25	40	40	2.218	2.538	6427	350	37	25	80	40	2.374	2.694	6498
400	37	25	40	40	2.320	2.640	7131	400	37	25	80	40	2.475	2.795	7218
450	37	25	40	40	2.415	2.735	7883	450	37
500	37	500	37
601-1000 Volts								4001-5000 Volts							
4	7	15	45	25	1.154	1.474	1459	4	7	15	100	25	1.413	1.733	1920
2	7	15	45	25	1.283	1.603	1861	2	7	15	100	25	1.512	1.862	2259
1	19	20	45	30	1.370	1.690	2186	1	19	20	100	30	1.629	1.949	2759
1/0	19	20	45	30	1.458	1.778	2517	1/0	19	20	100	30	1.717	2.037	3056
2/0	19	20	45	30	1.557	1.877	2963	2/0	19	20	100	30	1.817	2.137	3537
3/0	19	20	45	30	1.667	1.987	3486	3/0	19	20	100	30	1.927	2.247	4060
4/0	19	20	45	30	1.793	2.113	4092	4/0	19	20	100	30	2.052	2.372	4722
250	37	25	45	40	1.990	2.310	4817	250	37	25	100	40	2.249	2.569	5450
300	37	25	45	40	2.108	2.428	5197	300	37	25	100	40	2.367	2.687	6195
350	37	25	45	40	2.218	2.538	6198	350	37	25	100	40	2.477	2.797	6925
400	37	25	45	40	2.320	2.640	6898	400	37
450	37	25	45	40	2.415	2.735	7582	450	37
500	37	500	37

Triangle Asbestos—Varnished Cambric Insulated Power Cable
0-5000 Volts
Single Conductor—Braid Covered

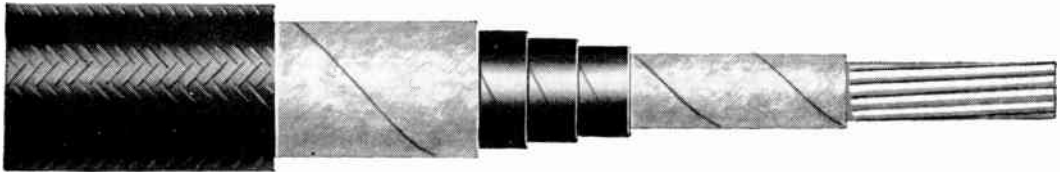

0-600 Volts							2001-3000 Volts						
Size A.W.G. or MCM	No. of Strands	Inner Asbestos Mils	Varnished Cambric Mils	Outer Asbestos Mils	Nominal D.O. In.	Approx. Wt. Per M-FL Lbs.	Size A.W.G. or MCM	No. of Strands	Inner Asbestos Mils	Varnished Cambric Mils	Outer Asbestos Mils	Nominal D.O. In.	Approx. Wt. Per M-FL Lbs.
4	7	15	30	20	.474	250	4	7	15	80	25	.590	312
2	7	15	30	20	.534	356	2	7	15	80	25	.650	425
1	19	20	30	30	.591	462	1	19	20	80	30	.690	531
1/0	19	20	30	30	.635	562	1/0	19	20	80	30	.731	631
2/0	19	20	30	30	.681	681	2/0	19	20	80	30	.777	756
3/0	19	20	30	30	.732	831	3/0	19	20	80	30	.828	912
4/0	19	20	30	30	.790	1018	4/0	19	20	80	30	.886	1106
250	37	25	40	40	.905	1231	250	37	25	80	40	.977	1306
300	37	25	40	40	.960	1443	300	37	25	80	40	1.032	1525
400	37	25	40	40	1.058	1862	400	37	25	80	40	1.130	1956
500	37	25	40	40	1.143	2281	500	37	25	80	40	1.215	2381
600	61	30	40	40	1.223	2718	600	61	30	80	40	1.295	2741
750	61	30	40	40	1.328	3343	750	61	30	80	40	1.400	3261
1000	61	30	40	40	1.482	4362	1000	61	30	80	40	1.554	4172
601-1000 Volts							4001-5000 Volts						
4	7	15	45	25	.518	268	4	7	15	120	25	.662	368
2	7	15	45	25	.578	381	2	7	15	120	25	.722	493
1	19	20	45	30	.618	475	1	19	20	120	30	.762	612
1/0	19	20	45	30	.659	581	1/0	19	20	120	30	.803	693
2/0	19	20	45	30	.705	700	2/0	19	20	120	30	.849	837
3/0	19	20	45	30	.756	856	3/0	19	20	120	30	.900	993
4/0	19	20	45	30	.814	1037	4/0	19	20	120	30	.958	1193
250	37	25	45	40	.905	1243	250	37	25	120	40	1.049	1400
300	37	25	45	40	.960	1450	300	37	25	120	40	1.104	1625
400	37	25	45	40	1.058	1875	400	37	25	120	40	1.202	2075
500	37	25	45	40	1.143	2293	500	37	25	120	40	1.287	2512
600	61	30	45	40	1.223	2731	600	61	30	120	40	1.367	2860
750	61	30	45	40	1.328	3350	750	61	30	120	40	1.472	3284
1000	61	30	45	40	1.482	4375	1000	61	30	120	40	1.626	4310

Triangle Control Cable

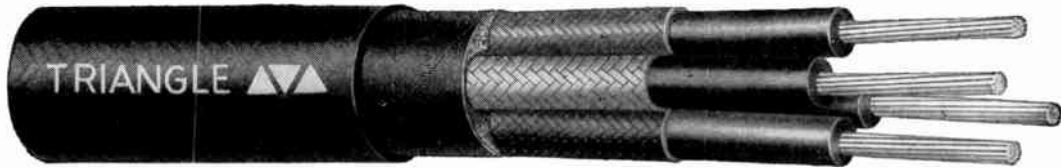

Rubber Insulated—Braid Covered

Rubber Insulated—Lead Covered

No. of Cond.	(19x25)		Approx.		(19x22)		(19x25)		Lead Thick. 64th In.	Approx.		(19x22)		Approx.	
	Insul. Thick. 64th In.	In.	Ship. W/L Per M-FL Lbs.	D.O.	Ship. W/L Per M-FL Lbs.	Insul. Thick. 64th In.	In.	D.O.		Ship. W/L Per M-FL Lbs.	Lead Thick. 64th In.	D.O.	Ship. W/L Per M-FL Lbs.	D.O.	Ship. W/L Per M-FL Lbs.
1	3	.215	50	.253	70	3	3	.310	256	3	.350	315			
2 Flat	3	.295x.515	215	.336x.600	180	3	4	.360x.580	650	4	.400x.660	890			
2	3	.515	275	.600	310	3	4	.580	720	4	.660	990			
3	3	.537	335	.620	375	3	4	.632	805	4	.705	1190			
4	3	.592	360	.690	450	3	4	.678	905	4	.770	1540			
5	3	.653	426	.755	515	3	4	.738	1065	5	.870	1870			
6	3	.718	440	.840	705	3	4	.805	1165	5	.915	1915			
7	3	.718	495	.840	750	3	4	.805	1205	5	.915	2100			
8	3	.783	660	.920	850	3	5	.900	1600	5	1.020	2410			
9	3	.860	720	1.000	1035	3	5	.962	1830	5	1.100	2600			
10	3	.916	760	1.100	1105	3	5	1.050	1885	6	1.230	2970			
11	3	.746	880	1.100	1175	3	5	1.050	2025	6	1.230	3060			
12	3	.980	935	1.135	1210	3	5	1.082	2210	6	1.268	3117			
13	3	1.033	965	1.200	1340	3	5	1.140	2240	6	1.330	3530			
14	3	1.033	995	1.200	1370	3	5	1.140	2320	6	1.330	3640			
15	3	1.100	1045	1.270	1815	3	6	1.230	2406	6	1.405	3750			
16	3	1.100	1100	1.270	1745	3	6	1.230	2450	6	1.405	3850			
17	3	1.162	1130	1.315	1960	3	6	1.295	3170	6	1.480	4010			
18	3	1.162	1155	1.315	1990	3	6	1.295	3200	6	1.480	4045			
19	3	1.162	1205	1.315	2030	3	6	1.295	3230	6	1.480	4225			
20	3	1.227	1255	1.420	2110	3	6	1.358	3295	6	1.555	4405			
21	3	1.242	1305	1.445	2190	3	6	1.380	3360	6	1.580	4585			
22	3	1.292	1355	1.500	2270	3	6	1.422	3425	6	1.630	4770			
23	3	1.307	1405	1.518	2350	3	6	1.443	3490	6	1.654	4955			
24	3	1.382	1455	1.610	2430	3	6	1.507	3560	7	1.760	5140			
25	3	1.382	1505	1.610	2515	3	6	1.507	3626	7	1.760	5324			
26	3	1.382	1565	1.610	2585	3	6	1.507	3720	7	1.760	5485			
27	3	1.415	1625	1.657	2655	3	6	1.550	3815	7	1.810	5645			
28	3	1.460	1685	1.700	2725	3	6	1.595	3910	7	1.855	5805			
29	3	1.460	1745	1.700	2795	3	6	1.595	4005	7	1.855	5960			
30	3	1.460	1805	1.700	2865	3	6	1.595	4100	7	1.855	6120			
31	3	1.530	1865	1.782	2940	3	6	1.657	4195	7	1.910	6279			
32	3	1.530	1925	1.782	3055	3	6	1.657	4330	7	1.910	6340			
33	3	1.530	1985	1.782	3170	3	6	1.657	4465	7	1.910	6400			
34	3	1.606	2040	1.857	3285	3	7	1.752	4600	7	2.010	6680			
35	3	1.606	2100	1.857	3400	3	7	1.752	4735	7	2.010	6760			
36	3	1.606	2160	1.857	3515	3	7	1.752	4870	7	2.010	6820			
37	3	1.606	2200	1.857	3640	3	7	1.752	5010	7	2.010	6880			

Thermoplastic Insulated—Thermoplastic Jacketed

Rubber Insulated—Neoprene Jacketed

No. of Cond.	(19x25)		Approx.		(19x22)		(19x25)		Neoprene Thick. 64th In.	Approx.		(19x22)		Approx.	
	Insul. Thick. 64th In.	Sheath Thick. 64th In.	D.O.	Ship. W/L Per M-FL Lbs.	Sheath Thick. 64th In.	D.O.	Insul. Thick. 64th In.	D.O.		Ship. W/L Per M-FL Lbs.	Neoprene Thick. 64th In.	D.O.	Ship. W/L Per M-FL Lbs.	D.O.	Ship. W/L Per M-FL Lbs.
1	3	*	.221	35	*	.260	58	3	3	320	55	4	.400	85	
2 Flat	3	3	.300x.490	200	4	.370x.600	310	3	3	.320x.535	255	4	.400x.660	320	
2	3	3	.501	227	4	.608	350	3	4	.570	285	4	.690	360	
3	3	3	.562	261	4	.644	395	3	4	.637	325	4	.705	425	
4	3	4	.610	335	4	.702	475	3	4	.692	370	4	.770	510	
5	3	4	.662	395	4	.765	540	3	4	.738	415	5	.870	605	
6	3	4	.721	425	4	.832	605	3	4	.805	485	5	.945	805	
7	3	4	.721	445	4	.832	665	3	4	.805	515	5	.945	870	
8	3	4	.777	515	5	.932	900	3	5	.900	590	5	1.020	950	
9	3	4	.865	550	5	.999	985	3	5	.962	760	5	1.100	1150	
10	3	5	.940	790	5	1.088	1155	3	5	1.050	815	6	1.230	1210	
11	3	5	.940	815	5	1.088	1200	3	5	1.050	860	6	1.230	1330	
12	3	5	.970	845	5	1.124	1250	3	5	1.082	980	6	1.268	1365	
13	3	5	1.016	880	5	1.180	1310	3	5	1.140	1040	6	1.330	1520	
14	3	5	1.016	920	5	1.180	1375	3	5	1.140	1070	6	1.330	1885	
15	3	5	1.070	955	6	1.276	1480	3	5	1.230	1110	6	1.405	1955	
16	3	5	1.070	1015	6	1.276	1590	3	6	1.230	1150	6	1.405	2015	
17	3	5	1.127	1105	6	1.343	1710	3	6	1.295	1610	6	1.480	2110	
18	3	5	1.127	1195	6	1.343	1835	3	6	1.295	1640	6	1.480	2170	
19	3	5	1.127	1210	6	1.343	1870	3	6	1.295	1670	6	1.480	2200	
20	3	5	1.184	1280	6	1.410	1965	3	6	1.358	1695	6	1.555	2295	
21	3	5	1.232	1310	6	1.432	2030	3	6	1.380	1715	6	1.580	2390	
22	3	6	1.270	1345	6	1.478	2095	3	6	1.422	1740	6	1.630	2485	
23	3	6	1.292	1380	6	1.502	2160	3	6	1.443	1760	6	1.654	2580	
24	3	6	1.346	1495	6	1.568	2300	3	6	1.507	1785	7	1.760	2675	
25	3	6	1.346	1610	6	1.568	2445	3	6	1.507	1810	7	1.760	2765	
26	3	6	1.346	1635	6	1.568	2500	3	6	1.507	1860	7	1.760	2885	
27	3	6	1.346	1660	6	1.612	2560	3	6	1.550	1910	7	1.810	3005	
28	3	6	1.421	1705	3	6	1.595	1960	7	1.855	3125	

Also Available in 29,30,31, 32, 33, 34, 35 and 37 conductors

*4/64 inch integral insulation sheath.

Triangle Varnished Cambric Insulated Power Cable



**Braid, Lead or Polyvinylchloride
Thermoplastic Sheathed**

0-5000 Volts

Single Conductor

0-600 Volts

Size A.W.G. or MCM	No. of Strands	Braid Covered			Lead Covered			Thermoplastic		
		Insul. Thick- ness 64th In.	Nominal O.D.	Approx. WL Per M-FL Lbs.	Sheath Thick- ness 64th In.	Nominal O.D.	Approx. WL Per M-FL Lbs.	Sheath Thick- ness 64th In.	Nominal O.D.	Approx. WL Per M-FL Lbs.
14	Solid	3	.191	30	3	.252	215	3	.295	45
12	Solid	3	.208	47	3	.269	251	3	.312	56
10	Solid	3	.230	65	3	.290	276	3	.333	72
8	Solid	3	.282	89	3	.316	323	3	.360	109
6	Solid	4	.365	144	3	.381	430	3	.441	192
6	7	4	.373	156	3	.405	453	3	.463	204
4	7	4	.422	216	3	.453	562	3	.511	278
2	7	4	.482	318	3	.515	864	1	.603	369
1	19	5	.553	408	4	.613	1051	4	.667	503
1/0	19	5	.594	498	4	.654	1168	4	.708	589
2/0	19	5	.640	610	4	.700	1339	4	.754	691
3/0	19	5	.691	741	4	.751	1548	4	.805	813
4/0	19	5	.749	918	4	.809	2028	5	.896	985
250	37	6	.828	1090	5	.919	2311	5	.967	1217
300	37	6	.903	1308	5	.974	2604	5	1.022	1419
350	37	6	.955	1512	5	1.026	2863	5	1.073	1601
400	37	6	1.000	1704	5	1.072	3131	5	1.120	1874
500	37	6	1.117	2131	5	1.158	3648	5	1.205	2299
600	61	7	1.266	2778	6	1.300	4620	6	1.368	2759
750	61	7	1.333	3186	6	1.406	5280	6	1.473	3369
1000	61	7	1.486	4150	6	1.559	6622	6	1.627	4429

2001-3000 Volts

10	Solid	6	.355	94	3	.384	386	3	.429	95
8	Solid	6	.381	121	3	.410	434	3	.456	120
6	Solid	6	.415	168	3	.444	506	3	.489	158
6	7	6	.436	181	3	.468	534	3	.511	164
4	7	6	.485	216	3	.515	724	4	.591	240
2	7	6	.545	355	4	.609	977	4	.651	332
1	19	6	.585	425	4	.646	1097	4	.691	396
1/0	19	6	.626	518	4	.687	1235	4	.732	475
2/0	19	6	.672	634	4	.733	1402	4	.778	572
3/0	19	6	.723	762	4	.784	1606	4	.829	693
4/0	19	6	.781	937	5	.872	2100	5	.920	869
250	37	7	.858	1130	5	.950	2382	5	1.015	1029
300	37	7	.933	1340	5	1.005	2671	5	1.070	1212
350	37	7	.985	1537	5	1.057	2940	5	1.121	1384
400	37	7	1.031	1740	5	1.103	3203	5	1.168	1556
500	37	7	1.147	2164	5	1.190	3896	6	1.288	1933
600	37	7	1.222	2646	6	1.300	4620	6	1.368	2271
750	61	7	1.333	3186	6	1.406	5280	6	1.473	2770
1000	61	7	1.486	4150	6	1.559	6622	6	1.627	3600

4001-5000 Volts

8	Solid	9	.474	163	3	.503	547	4	.584	173
6	Solid	9	.508	210	4	.568	792	4	.617	214
6	7	9	.530	229	4	.592	832	4	.639	223
4	7	9	.579	304	4	.610	964	4	.687	286
2	7	9	.639	403	4	.702	1141	4	.747	383
1	19	9	.679	478	4	.738	1265	4	.787	450
1/0	19	9	.720	580	4	.779	1486	4	.828	532
2/0	19	9	.766	690	5	.857	1670	5	.907	659
3/0	19	9	.817	836	5	.908	2041	5	.958	785
4/0	19	9	.895	1020	5	.966	2302	5	1.016	945
250	37	10	.972	1223	5	1.015	2604	5	1.087	1101
300	37	10	1.027	1436	5	1.100	2894	5	1.142	1268
350	37	10	1.079	1616	5	1.152	3170	5	1.193	1443
400	37	10	1.155	1868	5	1.195	3617	6	1.275	1653
500	37	10	1.241	2285	6	1.315	4354	6	1.360	2006
600	61	10	1.320	2707	6	1.394	4907	6	1.440	2348
750	61	10	1.426	3305	6	1.500	5690	6	1.545	2854
1000	61	10	1.579	4292	6	1.653	6924	6

Triangle Varnished Cambric Insulated Power Cable

Two Conductor

0-600 Volts

Braid Covered

Lead Sheathed

Size A.W.G. or MCM	No. of Strands	Insul. Thick. 64th In.	Nominal O.D.	Approx. Wt. Lbs. Per M-Fl.	Sheath Thick. 64th In.	Nominal O.D.	Approx. Wt. Lbs. Per M-Fl.
14	Solid	3	.396	98	3	.425	398
12	Solid	3	.430	126	3	.459	454
10	Solid	3	.472	180	3	.501	533
8	Solid	3	.524	247	4	.584	804
6	Solid	4	.656	379	4	.717	1087
6	7	4	.698	396	4	.759	1151
4	7	4	.796	574	5	.887	1674
2	7	4	.936	863	5	1.007	2118
1	19	5	1.076	1126	5	1.147	2562
1/0	19	5	1.188	1384	6	1.261	3266
2/0	19	5	1.280	1687	6	1.353	3734
3/0	19	5	1.382	2060	6	1.455	4288
4/0	19	5	1.498	2524	6	1.571	4966
250	37	6	1.656	3023	7	1.759	6209
300	37	6	1.766	3559	7	1.869	6984
350	37	6	1.870	4087	7	1.973	7735
400	37	6	1.962	4604	7	2.065	8455
500	37	6	2.149	5680	8	2.284	10498
600	61	7	2.526	7584	8	2.490	12218
750	61	7	2.660	8659	8	2.702	14342
1000	61	7	2.966	11261	8	3.008	17696

2001-3000 Volts

10	Solid	5 x 2	.644	258	4	.704	943
8	Solid	5 x 2	.696	330	4	.756	1080
6	Solid	5 x 2	.764	418	4	.825	1265
6	7	5 x 2	.806	467	5	.897	1573
4	7	5 x 2	.924	678	5	.995	1902
2	7	5 x 2	1.044	986	5	1.115	2359
1	19	6 x 2	1.218	1270	6	1.291	3174
1/0	19	6 x 2	1.300	1514	6	1.373	3564
2/0	19	6 x 2	1.392	1831	6	1.465	4043
3/0	19	6 x 2	1.494	2219	6	1.567	4608
4/0	19	6 x 2	1.610	2707	6	1.683	5296
250	37	6 x 2	1.704	3118	7	1.807	6373
300	37	6 x 2	1.814	3661	7	1.917	7153
350	37	6 x 2	1.918	4193	7	2.021	7910
400	37	6 x 2	2.010	4744	7	2.113	8681
500	37	6 x 2	2.197	5822	8	2.332	10751
600	61	6 x 3	2.464	7459	8	2.521	12341
750	61	6 x 3	2.598	8527	8	2.733	14470
1000	61	6 x 3	2.904	11093	8	3.039	17832

4001-5000 Volts

Braid Covered

Lead Covered

Size A.W.G. or MCM	No. of Strand	Insul. Thick. 64th In.	Nominal O.D.	Sheath Thick. 64th In.	Nominal O.D.
14	Solid913
12	Solid
10	Solid
8	Solid	6 x 4	.822	5	.913
6	Solid	6 x 4	.910	5	.981
6	7	6 x 4	.952	5	1.023
4	7	6 x 4	1.050	5	1.121
2	7	6 x 4	1.200	6	1.273
1	19	6 x 4	1.280	6	1.353
1/0	19	6 x 4	1.362	6	1.435
2/0	19	6 x 4	1.454	6	1.527
3/0	19	6 x 4	1.556	6	1.629
4/0	19	6 x 4	1.672	7	1.775
250	37	7 x 4	1.828	7	1.931
300	37	7 x 4	1.938	7	2.041
350	37	7 x 4	2.042	7	2.145
400	37	7 x 4	2.149	8	2.284
500	37	7 x 4	2.321	8	2.456
600	61	7 x 4	2.479	8	2.614
750	61	7 x 4	2.691	8	2.826
1000	61	7 x 4	2.998	8	3.132

Three Conductor

0-600 Volts

Braid Covered

Lead Covered

Size A.W.G. or MCM	No. of Strands	Insul. Thick-ness 64th In.	Nominal O.D.	Approx. Wt. Per M-Fl. Lbs.	Sheath Thick-ness 64th In.	Nominal O.D.	Approx. Wt. Per M-Fl. Lbs.
14	Solid	3	.420	124	3	.449	468
12	Solid	3	.456	157	3	.485	534
10	Solid	3	.501	224	4	.562	796
8	Solid	3	.557	308	4	.618	946
6	Solid	4	.697	474	4	.757	1279
6	7	4	.742	494	4	.803	1354
4	7	4	.818	717	5	.939	1969
2	7	4	.997	1079	5	1.068	2491
1	19	5	1.164	1406	6	1.252	3390
1/0	19	5	1.252	1729	6	1.340	3842
2/0	19	5	1.351	2107	6	1.439	4393
3/0	19	5	1.461	2575	6	1.549	5045
4/0	19	5	1.586	3156	6	1.674	5842
250	37	6	1.755	3779	7	1.873	7304
300	37	6	1.874	4450	7	1.992	8216
350	37	6	1.986	5110	7	2.104	9101
400	37	6	2.084	5755	7	2.202	9947
500	37	6	2.284	7099	8	2.419	12350
600	61	8	2.652	14375
650	61	6 x 2	2.601	9248
750	61	6 x 2	2.745	10580	8	2.880	16873
1000	61	6 x 2	3.074	13774	8	3.209	20819

2001-3000 Volts

10	Solid	5 x 2	.683	323	4	.743	1110
8	Solid	5 x 2	.739	413	4	.800	1270
6	Solid	5 x 2	.812	559	5	.903	1759
6	7	5 x 2	.857	583	5	.948	1850
4	7	5 x 2	.982	847	5	1.053	2238
2	7	5 x 2	1.141	1232	5	1.182	2776
1	19	6 x 2	1.296	1586	6	1.369	3734
1/0	19	6 x 2	1.384	1894	6	1.457	4193
2/0	19	6 x 2	1.483	2290	6	1.556	4756
3/0	19	6 x 2	1.593	2773	6	1.666	5422
4/0	19	6 x 2	1.717	3384	7	1.820	6776
250	37	6 x 2	1.818	3898	7	1.922	7498
300	37	6 x 2	1.937	4577	7	2.040	8416
350	37	6 x 2	2.049	5242	7	2.152	9306
400	37	6 x 2	2.162	5929	8	2.297	10901
500	37	6 x 2	2.347	7278	8	2.482	12648
600	61	6 x 3	2.632	9324	8	2.683	14519
750	61	6 x 3	2.776	10660	8	2.911	17020
1000	61	6 x 3	3.105	13866	8	3.240	20980

4001-5000 Volts

8	Solid	6 x 4	.889	530	5	.960	1800
6	Solid	6 x 4	.962	690	5	1.034	2050
6	7	6 x 4	1.008	724	5	1.080	2161
4	7	6 x 4	1.143	991	5	1.185	2552
2	7	6 x 4	1.272	1405	6	1.346	3504
1	19	6 x 4	1.358	1662	6	1.432	3922
1/0	19	6 x 4	1.446	1978	6	1.520	4392
2/0	19	6 x 4	1.545	2380	6	1.619	4950
3/0	19	6 x 4	1.655	2872	7	1.759	6150
4/0	19	6 x 4	1.779	3480	7	1.883	7008
250	37	7 x 4	1.947	4116	7	2.040	7984
300	37	7 x 4	2.065	4786	7	2.167	8886
350	37	7 x 4	2.192	5533	8	2.326	10572
400	37	7 x 4	2.291	6204	8	2.426	11460
500	37	7 x 4	2.476	7536	8	2.611	13244
600	61	7 x 4	2.646	8904	8	2.781	15000
750	61	7 x 4	2.874	10913	8	3.009	17502
1000	61	7 x 4	3.203	14170	8	3.369	22496

Triangle Rubber Insulated Power Cable
Single Conductor 0-5000 Volts
Braid Covered, Lead Sheathed, and Neoprene Sheathed

0-600 Volts

Size A.W.G. or MCM	No. of Strands	Insul. Thick-ness 64th In.	Nominal O.D.	Approx. Wt. Per M-FL Lbs.	Sheath Thick-ness 64th In.	Nominal O.O.	Approx. Wt. Per M-FL Lbs.	Sheath Thick-ness 64th In.	Nominal O.O.	Approx. Wt. Per M-FL Lbs.	Sheath Thick-ness 64th In.	Nominal O.O.	Approx. Wt. Per M-FL Lbs.	Sheath Thick-ness 64th In.
14	Solid	3	.183	25	3	.280	109	.020"	.202	28	3	.260	46	14
12	Solid	3	.200	34	3	.300	126	.020"	.219	39	3	.276	57	12
10	Solid	3	.221	49	3	.320	260	.020"	.240	55	3	.296	73	10
8	Solid	4	.279	79	3	.380	320	.020"	.300	96	3	.353	110	8
14	7	3	.191	29	3	.280	109	.020"	.211	32	3	.267	48	14
12	7	3	.211	38	3	.300	126	.020"	.230	41	3	.286	59	12
10	7	3	.235	54	3	.320	260	.020"	.254	61	3	.310	79	10
8	7	4	.296	85	3	.380	320	.020"	.317	102	3	.372	116	8
6	7	4	.359	129	3	.440	520	2	.381	180	3	.414	193	6
4	7	4	.438	190	3	.490	620	2	.430	265	3	.462	279	4
2	7	4	.498	278	4	.580	770	2	.491	355	3	.522	370	2
1	19	5	.570	364	4	.640	930	3	.594	488	4	.626	504	1
1/0	19	5	.610	443	4	.680	1060	3	.635	570	4	.667	590	1/0
2/0	19	5	.655	540	4	.730	1210	3	.680	670	4	.712	692	2/0
3/0	19	5	.707	663	4	.780	1370	3	.732	790	4	.764	811	3/0
4/0	19	5	.766	814	5	.870	1570	3	.790	960	4	.822	986	4/0
250	37	6	.816	962	5	.950	2030	4	.903	1190	5	.936	1218	250
300	37	6	.911	1139	5	1.000	2270	4	.959	1390	5	.992	1420	300
350	37	6	.962	1300	5	1.060	2490	4	1.009	1570	5	1.042	1602	350
400	37	6	1.009	1473	5	1.100	2720	4	1.056	1840	5	1.089	1875	400
500	37	6	1.094	1815	5	1.190	3160	4	1.141	2260	5	1.174	2300	500
600	61	7	1.205	2177	6	1.330	3980	4	1.250	2746	6	1.318	2760	600
750	61	7	1.311	2673	6	1.440	4620	4	1.355	3280	6	1.423	3370	750
1000	61	7	1.464	3530	6	1.590	5690	4	1.510	4082	6	1.577	4430	1000

601-1000 Volts

For Conduit and Duct Direct Burial or Aerial

Size A.W.G.	No. of Strands	Insulation Thick. 64th In.	Braid Covered Nominal O.O.	Approx. Ship. Wt. Per M-FL Lbs.	Lead Sheath Thick. 64th In.	Nominal O.O.	Approx. Ship. Wt. Per M-FL Lbs.	Neoprene Sheath Thick. 64th In.	Nominal O.O.	Approx. Ship. Wt. Per M-FL Lbs.	Neoprene Sheath Thick. 64th In.	Nominal O.O.	Ship. Wt. Per M-FL Lbs.
14	1	4	* .25	46	3	.31	275	2	.26	35	3	.31	51
12	1	4	* .27	59	3	.33	302	2	.28	46	3	.33	72
10	1	4	.30	91	3	.35	338	2	.30	63	3	.35	82
8	1	4	.33	120	3	.38	378	2	.34	83	3	.37	105
6	1	5	.41	181	3	.44	492
6	7	5	.45	194	3	.47	523	2	.41	143	3	.46	162
4	7	5	.48	271	3	.52	637	2	.46	202	3	.51	223
2	7	5	.55	389	4	.61	981	2	.52	287	4	.61	330
1	19	6	.62	492	4	.68	1158	3	.63	385	4	.68	414
1/0	19	6	.67	592	4	.72	1302	3	.68	475	4	.72	495
2/0	19	6	.72	718	4	.76	1471	3	.71	564	4	.76	587
3/0	19	6	.77	875	4	.81	1654	3	.77	691	4	.82	720
4/0	19	6	.83	1092	5	.90	2190	3	.82	837	5	.91	883
250	37	7	.92	1296	5	.98	2493	4	.84	1021	5	.99	1066
300	37	7	.96	1517	5	1.04	2780	4	.99	5	1.04
350	37	7	1.02	1738	5	1.09	3061	4	1.04	5	1.09
400	37	7	1.06	1955	5	1.13	3336	4	1.09	5	1.14
500	37	7	1.16	2387	6	1.25	4229	4	1.17	1882	5	1.22	1921
550	4	1.25	6	1.31
600	61	8	1.27	2862	6	1.36	4868	4	1.28	6	1.37
650	4	1.32	6	1.39
700	61	8	1.34	3291	6	1.43	5401	4	1.35	6	1.44
750	61	8	1.37	3504	6	1.47	5660	4	1.39	6	1.48
800	61	8	1.41	3716	6	1.50	5920	4	1.42	6	1.51
900	61	8	1.47	4140	6	1.56	6430	4	1.49	6	1.57
1000	61	8	1.54	4562	6	1.62	6923	4	1.54	3575	6	1.63	3685

*Single braid only.

Triangle Rubber Insulated Power Cables
Single Conductor—Braid Covered, Neoprene Sheath, Lead Sheath
2001-3000 Volts

Size A. W. G.	No. of Strands	Insulation Thick. 64th In.	Braid Covered Nominal O.D.	Approx. Ship. Wt. Per M-FL Lbs.	Lead Sheath Thick. 64th In.	Nominal O.D.	For Conduit and Duct			Direct Burial or Aerial			
							Approx. Ship. Wt. Per M-FL Lbs.	Neoprene Sheath Thick. 64th In.	Nominal O.D.	Approx. Ship. Wt. Per M-FL Lbs.	Neoprene Sheath Thick. 64th In.	Nominal O.D.	Ship. Wt. Per M-FL Lbs.
10	1	7	.45	116	3	.45	449	2	.39	105	3	.42	119
8	1	7	.48	180	3	.47	503	2	.43	122	3	.48	148
6	1	8	.54	237	4	.57	793
6	7	8	.60	253	4	.59	833	2	.53	194	4	.60	235
4	7	8	.63	336	4	.64	966	2	.58	256	4	.67	305
2	7	8	.69	462	4	.70	1154	3	.67	372	4	.73	415
1	19	8	.74	552	4	.74	1285	3	.71	453	4	.77	480
1/0	19	8	.77	650	4	.78	1424	3	.75	514	4	.81	557
2/0	19	8	.82	779	5	.88	1598	3	.80	614	4	.85	660
3/0	19	8	.88	964	5	.91	2071	3	.85	748	5	.94	820
4/0	19	8	.96	1165	5	.96	2345	3	.91	895	5	1.00	973
250	37	9	1.05	1376	5	1.04	2655	4	1.02	1098	5	1.08	1150
300	37	9	1.10	1601	5	1.10	2948	4	1.07	5	1.12
350	37	9	1.15	1827	5	1.15	3233	4	1.13	5	1.18
400	37	9	1.21	2048	6	1.26	3499	4	1.18	5	1.23
500	37	9	1.29	2488	6	1.31	4431	4	1.26	1970	6	1.31	2070
550	4	1.28	6	1.35
600	61	9	1.36	2917	6	1.39	4974	4	1.33	6	1.40
650	4	1.36	6	1.43
700	61	9	1.44	3349	6	1.46	5508	4	1.41	6	1.47
750	61	9	1.47	3563	6	1.50	5770	4	1.44	6	1.51
800	61	9	1.52	3777	6	1.53	6031	4	1.48	6	1.53
900	61	9	1.57	4204	6	1.59	6533	4	1.54	6	1.60
1000	61	9	1.63	4629	6	1.65	7040	4	1.60	3630	6	1.66	4027

Note: Internal (Strand) Shielding is used also on unshielded cable.

Unshielded braided cables of above 2000 volts rating are recommended only for installation in permanently dry locations or on full voltage insulators.

Single Conductor
Shielded and Unshielded

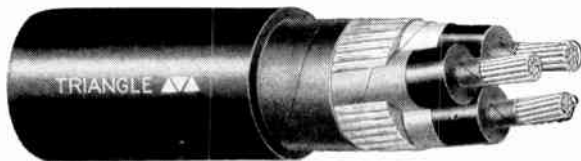

For All Purposes,
Conduit and Duct, Aerial and Direct Burial
Neoprene Sheathed

4001-5000 Volts

Size A. W. G. or MCM	No. of Strands *	Insul. Thick- ness 64th In.	Unshielded Braid Covered		Lead Sheathed		Unshielded Neoprene Conduit & Duct		Unshielded Neoprene Aerial & Direct Burial		Shielded Neoprene					
			Nominal O.D.	Approx. Wt. Per M-FL Lbs.	Sheath Thick- ness 64th In.	Nominal O.D.	Approx. Wt. Per M-FL Lbs.	Sheath Thick- ness 64th In.	Nominal O.D.	Approx. Wt. Per M-FL Lbs.	Sheath Thick- ness 64th In.	Nominal O.D.	Approx. Wt. Per M-FL Lbs.			
8	Solid	10	.570	242	4	.600	815	2	.520	220	4	.610	257	4	.700	401
6	Solid	10	.580	281	4	.630	905	2	.560	260	4	.630	297	4	.760	449
6	7	10	.600	299	4	.650	946	2	.590	274	4	.670	313	4	.830	570
4	7	10	.670	387	4	.700	1086	3	.670	411	4	.730	434	5	.890	678
2	7	10	.740	517	4	.760	1277	3	.730	514	4	.790	538	5	.960	779
1	19	10	.780	604	4	.800	1405	3	.750	586	4	.830	610	5	1.000	882
1/0	19	10	.820	735	5	.870	1805	3	.770	683	5	.910	736	5	1.050	1022
2/0	19	10	.860	869	5	.920	1997	3	.810	790	5	.950	846	5	1.100	1163
3/0	19	10	.920	1037	5	.970	2230	3	.860	915	5	1.000	974	5	1.150	1358
4/0	19	10	.980	1243	5	1.030	2507	4	.980	1136	5	1.060	1167	5	1.230	1636
250	37	11	1.060	1461	5	1.110	2823	4	1.070	1407	5	1.140	1441	6	1.290	1901
300	37	11	1.120	1691	5	1.160	3120	4	1.110	1589	5	1.200	1624	6	1.370	2085
350	37	11	1.160	1921	6	1.240	3768	4	1.170	1772	6	1.280	1849	6	1.420	2273
400	37	11	1.220	2146	6	1.290	4064	4	1.220	1955	6	1.330	2035	6	1.500	2641
500	37	11	1.310	2594	6	1.380	4637	4	1.300	2313	6	1.410	2400	6	1.590	3251
600	61	11	1.380	3030	6	1.460	5188	4	1.380	2890	6	1.490	2982	6	1.660
700	61	11	1.450	3468	6	1.530	5726	4	1.450	6	1.560	6	1.690	3789
750	61	11	1.490	3686	6	1.560	5993	4	1.490	3413	6	1.600	3511	6	1.730
800	61	11	1.530	3902	6	1.590	6246	4	1.520	6	1.630	7	1.820
900	61	11	1.580	4334	6	1.670	6763	4	1.580	6	1.700	7	1.870	4759
1000	61	11	1.650	4764	7	1.750	7790	4	1.640	4268	7	1.790	4431

*Class "C" stranding may be furnished if more flexible strand is required.

Triangle Rubber Insulated Neoprene Sheathed Power Cable

**Two Conductor
0-600 Volts**

Size A.W.G. or MCM	No. of Strands	Insul. Thickness 64th In.	Jacket Thickness 64th In.	Nominal O.D.
14	Solid	3	3	.290 x .480
12	Solid	3	3	.309 x .514
10	Solid	3	4	.363 x .589
8	Solid	4	4	.425 x .713
14	7	3	3	.300 x .496
12	7	3	3	.319 x .534
10	7	3	4	.381 x .625
8	7	4	4	.418 x .759
6	7	4	4	.486 x .835
4	7	4	5	.575 x .978
2	4	4	5	.635 x 1.098
1	19	5	5	.700 x 1.240
1/0	19	5	6	1.381
2/0	19	5	6	1.475
3/0	19	5	6	1.577
4/0	19	5	6	1.693
250	37	6	7	1.887
300	37	6	7	1.997
350	37	6	7	2.100
400	37	6	7	2.193
500	37	6	8	2.398
550	61	7	8	2.542

**2001-3000 Volts
Unshielded**

Size A.W.G. or MCM	No. of Strands	Insul. Thickness 64th In.	Jacket Thickness 64th In.	Nominal O.D.
10	Solid	7	5	.540 x .890
8	Solid	7	5	.560 x .940
6	Solid	8	5	.630 x 1.070
6	7	8	5	.650 x 1.110
4	7	8	6	.730 x 1.240
2	7	8	6	1.453
1	19	8	6	1.533
1/0	19	8	6	1.613
2/0	19	8	6	1.707
3/0	19	8	7	1.813
4/0	19	8	7	1.960
250	37	9	7	2.117
300	37	9	7	2.227
350	37	9	8	2.364
400	37	9	8	2.458

**4001-5000 Volts
Shielded**

Size A.W.G. or MCM	No. of Strands	Insul. Thickness 64th In.	Jacket Thickness 64th In.	Nominal O.D.
6	7	10	6	1.445
4	7	10	6	1.550
2	7	10	6	1.671
1	19	10	7	1.785
1/0	19	10	7	1.865
2/0	19	10	7	1.960
3/0	19	10	7	2.061
4/0	19	10	7	2.177
250	37	11	8	2.370
300	37	11	8	2.480

**Three Conductor
0-600 Volts**

Size A.W.G. or MCM	No. of Strands	Insul. Thickness 64th In.	Jacket Thickness 64th In.	Nominal O.D.
14	Solid	3	3	.578
12	Solid	3	4	.615
10	Solid	3	4	.660
8	Solid	4	4	.780
14	7	3	4	.595
12	7	3	4	.637
10	7	3	4	.690
8	7	4	4	.802
6	7	4	5	.960
4	7	4	5	1.053
2	7	4	5	1.187
1	19	5	6	1.391
1/0	19	5	6	1.461
2/0	19	5	6	1.560
3/0	19	5	6	1.670
4/0	19	5	7	1.820
250	37	6	7	2.000
300	37	6	7	2.120
350	37	6	7	2.230
400	37	6	8	2.380
500	37	6	8	2.580

**Three Conductor
2001-3000 Volts
Unshielded**

Size A.W.G. or MCM	No. of Strands	Insul. Thickness 64th In.	Jacket Thickness 64th In.	Nominal O.D.
10	Solid	7	5	.940
8	Solid	7	5	1.000
6	Solid	8	5	1.140
6	7	8	5	1.190
4	7	8	6	1.330
2	7	8	6	1.450
1	19	8	6	1.540
1/0	19	8	6	1.630
2/0	19	8	7	1.760
3/0	19	8	7	1.870
4/0	19	8	7	1.990
250	37	9	7	2.160
300	37	9	8	2.420
350	37	9	8	2.530

**4001-5000 Volts
Shielded**

Size A.W.G. or MCM	No. of Strands	Insul. Thickness 64th In.	Jacket Thickness 64th In.	Nominal O.D.
8	Solid	10	6	1.390
6	7	10	6	1.520
4	7	10	6	1.621
2	7	10	7	1.790
1	19	10	7	1.840
1/0	19	10	7	1.940
2/0	19	10	7	2.050
3/0	19	10	7	2.170
4/0	19	10	7	2.250
250	37	11	8	2.460
300	37	11	8	2.580

**Four Conductor
0-600 Volts**

Size A.W.G. or MCM	No. of Strands	Insul. Thickness 64th In.	Jacket Thickness 64th In.	Nominal O.D.
14	Solid	3	4	.627
12	Solid	3	4	.668
10	Solid	3	4	.719
8	Solid	4	5	.904
14	7	3	4	.646
12	7	3	4	.692
10	7	3	4	.762
8	7	4	5	.958
6	7	4	5	1.056
4	7	4	5	1.170
2	7	4	6	1.333
1	19	5	6	1.521
1/0	19	5	6	1.621
2/0	19	5	7	1.765
3/0	19	5	7	1.890
4/0	19	5	7	1.935
250	37	6	7	2.225
300	37	6	8	2.388
350	37	6	8	2.512

2001-3000 Volts

Size A.W.G. or MCM	No. of Strands	Insul. Thickness 64th In.	Jacket Thickness 64th In.	Nominal O.D.
10	Solid	7	5	1.100
8	Solid	7	5	1.170
6	Solid	8	6	1.350
6	7	8	6	1.460
4	7	8	6	1.600
2	7	8	7	1.750
1	19	8	7	1.850
1/0	19	8	7	1.970
2/0	19	8	7	2.060
3/0	19	8	7	2.180
4/0	19	8	8	2.242
250	37	9	8	2.296

4001-5000 Volts

Size A.W.G. or MCM	No. of Strands	Insul. Thickness 64th In.	Jacket Thickness 64th In.	Nominal O.D.
8	Solid	10	6	1.500
6	7	10	6	1.631
4	7	10	7	1.746
2	7	10	7	1.931
1	19	10	7	2.021
1/0	19	10	7	2.121
2/0	19	10	7	2.231
3/0	19	10	8	2.380

Triangle Rubber Insulated Power Cable

Two Conductor—Flat Parallel
601-1000 Volts
Solid

Size A.W.G. or MCM	Lead Covered			Braid		
	Insul. Thick. 64th In.	Nominal O.D. Inches	Ship. Wt. Lbs. M-FL	Insul. Thick. 64th In.	Nominal O.D. Inches	Ship. Wt. Lbs. M-FL
14	4	.56x .314	576
12	4	.59x .361	632
10	4	.63x .382	709	7	.83x .451	284
8	4	.69x .408	814	7	.91x .537	385
6	5	.82x .473	1052	8	.99x .552	523
Stranded						
6	5	.89x .526	1333	7	1.03x .574	559
4	5	.99x .574	1603	7	1.13x .622	732
2	5	1.11x .634	1972	8	1.25x .682	992
1	6	1.28x .737	2651	8	1.33x .722	1178
0	6	1.30x .778	2960	8	1.41x .768	1380
00	6	1.45x .823	3328	8	1.50x .808	1645
000	6	1.56x .875	3779	8	1.61x .860	1979
0000	6	1.68x .934	4316	8	1.72x .918	2387
250	7	1.86x1.043	5383	9	1.88x .996	2818
300	7	1.97x1.098	5987	9	1.99x1.051	3277
350	7	2.07x1.149	6578	9	2.09x1.102	3733

2001-3000 Volts
Solid

10	7	.85x .507	1175	7	.83x .451	284
8	7	.91x .533	1296	7	.91x .537	385
6	8	1.04x .598	1594	8	.99x .552	523
Stranded						
6	8	1.08x .620	1676	8	1.03x .574	559
4	8	1.18x .668	1949	8	1.13x .622	732
2	8	1.33x .759	2656	8	1.25x .682	992
1	8	1.41x .799	2944	8	1.33x .722	1178
0	8	1.49x .840	3246	8	1.41x .768	1380
00	8	1.58x .885	3623	8	1.50x .808	1645
000	8	1.68x .938	4084	8	1.61x .860	1979
0000	8	1.83x1.027	5080	8	1.72x .918	2387
250	9	1.99x1.105	5742	9	1.88x .996	2818
300	9	2.10x1.160	6355	9	1.99x1.051	3277
350	9	2.20x1.211	6958	9	2.09x1.102	3733

4001-5000 Volts
Solid

8	10	1.09x .62	1640	10	.99x .523	544
6	10	1.16x .66	1826	10	1.06x .556	620
Stranded						
6	10	1.23x .713	2212	10	1.16x .636	659
4	10	1.33x .762	2520	10	1.26x .685	843
2	10	1.45x .822	2940	10	1.38x .745	1113
1	10	1.53x .862	3222	10	1.46x .785	1293
0	10	1.61x .903	3546	10	1.54x .826	1516
00	10	1.74x .980	4356	10	1.63x .871	1799
000	10	1.84x1.032	4819	10	1.73x .923	2132
0000	10	1.96x1.090	5436	10	1.85x .981	2551
250	11	2.11x1.168	6113	11	2.00x1.059	2998
300	11	2.25x1.254	7276	11	2.11x1.114	3466
350	11	2.35x1.304	7880	11	2.22x1.165	3932

Three Conductor
601-1000 Volts
Solid

14	4	.626	816	4	.556	194
12	4	.662	900	4	.602	237
10	4	.708	1014	4	.648	304
8	4	.763	1169	4	.703	401
6	5	.934	1793	5	.858	634
Stranded						
6	5	.982	1909	5	.906	684
4	5	1.085	2293	5	1.009	937
2	5	1.245	3205	5	1.138	1329
1	6	1.401	3797	6	1.293	1676
0	6	1.489	4266	6	1.381	2011
00	6	1.585	4820	6	1.477	2422
000	6	1.728	6001	6	1.589	2936
0000	6	1.853	6859	6	1.714	3572
250	7	2.021	7835	7	1.882	4247
300	7	2.139	8756	7	2.000	4966
350	7	2.280	10315	7	2.110	5675

Three Conductor
2001-3000 Volts
Solid

Size A.W.G. or MCM	Lead Covered			Braid		
	Insul. Thick. 64th In.	Nominal O.D. Inches	Ship. Wt. Lbs. M-FL	Insul. Thick. 64th In.	Nominal O.D. Inches	Ship. Wt. Lbs. M-FL
10	7	.941	1664	7	.865	489
8	7	.997	1848	7	.921	600
6	8	1.136	2271	8	1.060	841
Stranded						
6	8	1.184	2395	8	1.108	902
4	8	1.319	3185	8	1.211	1181
2	8	1.448	3804	8	1.340	1600
1	8	1.534	4231	8	1.426	1896
0	8	1.622	4691	8	1.514	2224
00	8	1.750	5770	8	1.611	2649
000	8	1.862	6497	8	1.723	3179
0000	8	1.986	7373	8	1.847	3839
250	9	2.154	8370	9	2.015	4534
300	9	2.303	9976	9	2.133	5267
350	9	2.413	10915	9	2.243	5991

4001-5000 Volts
Solid

8	10	1.199	2339	10	1.123	821
6	10	1.303	2989	10	1.196	1004
Stranded						
6	10	1.349	3130	10	1.241	1070
4	10	1.454	3593	10	1.346	1370
2	10	1.583	4226	10	1.475	1807
1	10	1.669	4646	10	1.561	2095
0	10	1.788	5656	10	1.649	2454
00	10	1.885	6272	10	1.746	2896
000	10	1.997	7018	10	1.858	3445
0000	10	2.122	7909	10	1.983	4119
250	11	2.320	9604	11	2.150	4837
300	11	2.444	10589	11	2.269	5587
350	11	2.548	11542	11	2.378	6329

Four Conductor
601-1000 Volts
Solid

14	4	.684	936	4	.624	249
12	4	.725	1037	4	.665	308
10	4	.776	1176	4	.716	394
8	4	.870	1615	4	.794	539
6	5	1.028	2100	5	.952	819
Stranded						
6	5	1.081	2234	5	1.005	884
4	5	1.196	2718	5	1.120	1221
2	5	1.373	3786	5	1.265	1713
1	6	1.545	4538	6	1.437	2199
0	6	1.644	5120	6	1.536	2631
00	6	1.783	6337	6	1.644	3174
000	6	1.909	7128	6	1.770	3740
0000	6	2.049	8318	6	1.910	4694
250	7	2.269	10201	7	2.099	5581
300	7	2.402	11412	7	2.232	6529
350	7	2.525	12590	7	2.355	7468

2001-3000 Volts
Solid

10	7	1.034	1925	7	.958	626
8	7	1.097	2149	7	1.021	773
6	8	1.286	3036	8	1.178	1083
Stranded						
6	8	1.339	3204	8	1.231	1166
4	8	1.455	3749	8	1.347	1533
2	8	1.600	4520	8	1.492	2085
1	8	1.727	5557	8	1.588	2475
0	8	1.825	6162	8	1.687	2903
00	8	1.934	6917	8	1.795	3470
000	8	2.060	7832	8	1.921	4165
0000	8	2.200	8941	8	2.061	5035
250	9	2.420	10895	9	2.250	5950
300	9	2.553	12128	9	2.383	6921
350	9	2.672	13326	9	2.506	7880

Simplex-Anhydrex Power Cables Neoprene Jacketed



Type RR-600 Volts W.P.

Single Conductor—Solid					2-Conductor—Round								
Size A.W.G. or MCM	No. of Strands	Insulation Thickness In.	Jacket Thickness In.	Approx. O.D. In.	Approx. Ship. Wt. per M-Ft. Lbs.	Size A.W.G. or MCM	No. of Strands	Insulation Thickness In.	Jacket Thickness In.	Approx. O.D. In.	Approx. Ship. Wt. per M-Ft. Lbs.		
14	Solid	.047	.047	.25	50	16	Solid	.047	.047	.45	110		
12	Solid	.047	.047	.27	60	14	Solid	.047	.078	.54	180		
10	Solid	.047	.047	.29	80	12	Solid	.047	.078	.57	210		
8	Solid	.063	.047	.35	120	10	Solid	.047	.094	.65	280		
6	Solid	.063	.047	.38	160	8	Solid	.063	.094	.76	390		
6	7	.063	.047	.41	180	6	7	.063	.094	.87	510		
4	7	.063	.047	.45	240	4	7	.063	.109	1.00	810		
2	7	.063	.047	.51	350	2	7	.063	.109	1.12	990		
1	19	.078	.063	.62	470	1	19	.078	.109	1.26	1240		
1 0	19	.078	.063	.66	590	1 0	19	.078	.125	1.37	1510		
2 0	19	.078	.063	.71	650	2 0	19	.078	.125	1.47	1820		
3 0	19	.078	.063	.76	850	3 0	19	.078	.125	1.57	2180		
4 0	19	.078	.063	.81	1010	4 0	19	.078	.125	1.69	2570		
250	37	.094	.078	.96	1260	3-Conductor							
300	37	.094	.078	1.01	1470								
350	37	.094	.078	1.06	1680	14	Solid	.047	.078	.57	210		
400	37	.094	.078	1.11	1900	12	Solid	.047	.094	.64	280		
500	37	.094	.078	1.19	2300	10	Solid	.047	.094	.68	350		
600	61	.109	.094	1.34	2720	8	Solid	.063	.094	.81	490		
750	61	.109	.094	1.44	3370	6	7	.063	.109	.95	710		
1000	61	.109	.094	1.60	4430	4	7	.063	.109	1.05	970		
2-Conductor—Twin Flat						2	7	.063	.109	1.19	1320		
						1	19	.078	.078	.61 x 1.08	820	1	19
16	Solid	.047	.047	.27 x .45	90	1 0	19	.078	.125	1.16	2030		
14	Solid	.047	.047	.29 x .48	110	2 0	19	.078	.125	1.56	2490		
12	Solid	.047	.047	.30 x .51	140	3 0	19	.078	.125	1.67	2980		
10	Solid	.047	.0625	.35 x .58	180	4 0	19	.078	.141	1.83	3600		
8	Solid	.063	.0625	.41 x .70	290	250	37	.094	.141	2.00	4250		
6	Solid	.063	.0625	.44 x .76	380	300	37	.094	.141	2.11	4970		
4	7	.063	.0625	.47 x .81	400	350	37	.094	.141	2.23	5650		
6	7	.063	.078	.55 x .93	580	400	37	.094	.156	2.36	6420		
2	7	.063	.078	.61 x 1.08	820	500	37	.094	.156	2.54	7760		
1	19	.078	.078	.68 x 1.23	1030	Mine Telephone—Solid (300 Volts Maximum)							
1 0	19	.078	.094	.75 x 1.34	1240								
2 0	19	.078	.094	.80 x 1.45	1520	16	Twin	.031	.047	.24 x .39	80		
3000 Volts W.P. (Nonshielded)†						16	2-Cond.	.031	.047	.39	80		
						Single Conductor						2-Conductor Round	
Size A.W.G. or MCM	No. of Strands	Insulation Thickness In.	Jacket Thickness In.	Approx. O.D. In.	Approx. Ship. Wt. per M-Ft. Lbs.								
10	Solid	.109	.047	.42	130	.109	.109	.92	.480	.109	.109	.97	590
8	Solid	.109	.047	.44	160	.109	.109	.97	.570	.109	.109	1.03	700
6	Solid	.125	.063	.54	230	.125	.109	1.10	.720	.125	.109	1.17	950
6	7	.125	.063	.56	260	.125	.109	1.15	.780	.125	.109	1.22	980
4	7	.125	.063	.61	330	.125	.109	1.25	1000	.125	.125	1.36	1320
2	7	.125	.063	.67	450	.125	.125	1.40	1320	.125	.125	1.49	1730
1	19	.125	.063	.71	510	.125	.125	1.48	1530	.125	.125	1.57	2010
1 0	19	.125	.063	.75	680	.125	.125	1.56	1770	.125	.125	1.66	2340
2 0	19	.125	.063	.80	750	.125	.125	1.66	2100	.125	.141	1.79	2890
3 0	19	.125	.078	.88	940	.125	.141	1.79	2560	.125	.141	1.91	3400
4 0	19	.125	.078	.94	1150	.125	.141	1.91	2950	.125	.141	2.03	3970
250	37	.141	.078	1.05	1440141	.141	2.20	4760
300	37	.141	.078	1.10	1540141	.156	2.35	5590
350	37	.141	.078	1.15	1800141	.156	2.46	6240
400	37	.141	.078	1.20	2060141	.156	2.56	6960
500	37	.141	.094	1.32	2500141	.156	2.74	8370
600	61	.141	.094	1.41	2860
750	61	.141	.094	1.50	3500
1000	61	.141	.094	1.66	4570
5000 Volts W.P. (Nonshielded)†						3-Conductor							
												Single Conductor	
Size A.W.G. or MCM	No. of Strands	Insulation Thickness In.	Jacket Thickness In.	Approx. O.D. In.	Approx. Ship. Wt. per M-Ft. Lbs.	Insulation Thickness In.	Jacket Thickness In.	Approx. O.D. In.	Approx. Ship. Wt. per M-Ft. Lbs.				
8	Solid	.156	.063	.57	220	.156	.078	1.11	580	.156	.109	1.23	940
6	Solid	.156	.063	.60	280	.156	.078	1.18	680	.156	.125	1.34	1140
4	7	.156	.063	.64	300	.156	.094	1.29	760	.156	.125	1.43	1230
4	7	.156	.063	.69	390	.156	.094	1.38	940	.156	.125	1.53	1500
2	7	.156	.063	.75	500	.156	.094	1.50	1260	.156	.125	1.67	1920
1	19	.156	.063	.79	590	.156	.094	1.58	1410	.156	.125	1.78	2210
1 0	19	.156	.078	.87	770	.156	.094	1.67	1630	.156	.141	1.90	2630
2 0	19	.156	.078	.91	830	.156	.109	1.79	1910	.156	.141	1.97	3120
3 0	19	.156	.078	.96	1040	.156	.109	1.89	2290	.156	.141	2.08	3650
4 0	19	.156	.078	1.02	1210	.156	.109	2.01	2730	.156	.141	2.21	4220
250	37	.172	.078	1.13	1560172	.156	2.41	5130
300	37	.172	.078	1.19	1800172	.156	2.53	5880
350	37	.172	.094	1.27	2080172	.156	2.64	6600
400	37	.172	.094	1.32	2300172	.156	2.74	7210
500	37	.172	.094	1.40	2570172	.156	2.92	8690
600	61	.172	.094	1.49	3000
750	61	.172	.094	1.58	3640
1000	61	.172	.109	1.77	4740

†Shielded constructions available up through 15,000 Volts.
Prices on application.

Simplex Anhydrex XX Cables
Anhydrex XX Insulation—Neoprene Jacket
For Power Circuits
Overhead, in Ducts, or Buried in the Ground



‡5,000 Volts, Nonshielded
Three Conductors

Construction Features:

Coated copper conductors.
 Simplex special strand shielding except over solid conductors.
 Simplex-Anhydrex XX heat-resistant, ozone-resistant, low water-absorptive rubber insulating compound.
 Cabled conductors protected by a specially compounded neoprene jacket.
 3-conductor cables have colored tapes for coding.
 Simplex Neoprene Jacket is resistant to abrasion, soil acids and alkalis, oils, sunlight and weather hazards.
‡Note: I.P.C.E.A. specifies a shield in cables operating over 3,000 volts.

5,000 Volts, Shielded
Three Conductors

Construction Features:

Coated copper conductors.
 Simplex special strand shielding except over solid conductors.
 Simplex-Anhydrex XX heat-resistant, ozone-resistant, low water-absorptive rubber insulating compound.
 Simplex Semiconducting Tape printed "SIMPLEX CONDUCTING TAPE—REMOVE WHEN SPLICING OR TERMINATING." Semiconducting tape is printed in different colors for coding.
 Tinned copper shielding tape over insulated conductor.
 Cabled conductors protected by a specially compounded neoprene jacket.
 Simplex Neoprene Jacket is resistant to abrasion, soil acids and alkalis, oils, sunlight and weather hazards.

Size A.W.G. or M.C.M.	Strands	Thickness Insulation	64ths-Inch Jacket	Approx. D.D. In.	Approx. Gross Lbs. Per M. Ft.	No.
8	1	10	5	1.21	1005	37767
6	1	10	6	1.31	1170	37768
8†	7	10	6	1.31	1096	37792
8	19	10	6	1.31	1096	37793
6†	7	10	6	1.39	1225	37769
6	19	10	6	1.40	1225	38148
4†	7	10	6	1.49	1737	37770
4	19	10	6	1.51	1737	38149
2†	7	10	6	1.64	2097	37771
2	19	10	6	1.64	2097	38150
1†	19	10	7	1.75	2335	37772
1	37	10	7	1.77	2335	38151
*1/0†	19	10	7	1.84	2693	37773
1/0	37	10	7	1.86	2693	38152
*2/0†	19	10	7	1.95	3052	37774
2/0	37	10	7	1.97	3052	38153
3/0†	19	10	7	2.06	4182	37775
3/0	37	10	7	2.07	4182	38154
*4/0†	19	10	7	2.19	4729	37776
4/0	37	10	7	2.20	4729	38155
250†	37	11	8	2.42	5453	37777
250	61	11	8	2.42	5453	37794
300†	37	11	8	2.53	6057	37778
300	61	11	8	2.55	6057	37795
350†	37	11	8	2.65	6671	37779
350	61	11	8	2.66	6671	37824
400†	37	11	8	2.75	7510	37780
400	61	11	8	2.77	7510	37825
500†	37	11	8	2.95	8712	37781
500	61	11	8	2.95	8712	37826

Size A.W.G. or M.C.M.	Strands	Thickness Insulation	64ths-Inch Jacket	Approx. D.D. In.	Approx. Gross Lbs. Per M. Ft.	No.
8	1	10	6	1.23	1293	37836
6	1	10	6	1.30	1509	37837
6†	7	10	6	1.39	1564	38000
6	19	10	6	1.39	1564	38140
4†	7	10	6	1.50	2075	38001
4	19	10	6	1.50	2075	38141
2†	7	10	6	1.63	2545	38002
2	19	10	6	1.63	2545	38142
1†	19	10	7	1.76	2737	38003
1	37	10	7	1.76	2737	38143
1/0†	19	10	7	1.84	3031	38004
1/0	37	10	7	1.84	3031	38144
2/0†	19	10	7	1.95	3481	38005
2/0	37	10	7	1.95	3481	38145
3/0†	19	10	7	2.06	4611	38006
3/0	37	10	7	2.06	4611	38146
4/0†	19	10	7	2.19	5168	38007
4/0	37	10	7	2.19	5168	38147
250†	37	11	8	2.41	5875	38008
250	61	11	8	2.41	5875	37838
300†	37	11	8	2.54	6589	38009
300	61	11	8	2.54	6589	37839
350†	37	11	8	2.65	7202	38010
350	61	11	8	2.65	7202	37840
400†	37	11	8	2.75	8041	38011
400	61	11	8	2.75	8041	37841
500†	37	11	8	2.93	9244	38012
500	61	11	8	2.93	9244	37842

*Stock Items.

†Our Standard. Class B stranding.

Prices on application.

Simplex Anhydrex XX Cables
Anhydrex XX Insulation—Neoprene Jacket
For Power Circuits
Overhead, in Ducts, or Buried in the Ground

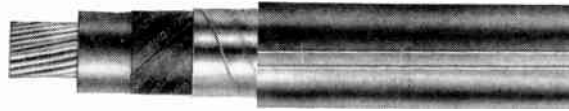

‡5,000 Volts, Nonshielded

Single Conductor

Construction Features:

Coated copper conductors.
 Simplex special strand shielding except over solid conductors.
 Simplex-Anhydrex XX heat-resistant, ozone-resistant, low water-absorptive rubber insulating compound.
 Specially compounded neoprene jacket protects insulated conductors.
 Simplex Neoprene Jacket is resistant to abrasion, soil acids and alkalis, oils, sunlight and weather hazards.

†Note: I.P.C.E.A. specifies a shield in cables operating over 3,000 volts.

Size A.W.G. or M.C.M.	Strands	Thickness Insulation	64ths-Inch Jacket	Approx. O.D. In.	Approx. Gross Lbs. Per M. Ft.	No.
*8	1	10	4	.59	257	37739
6	1	10	4	.62	297	37740
8†	7	10	4	.62	269	37782
8	19	10	4	.62	269	37783
*6†	7	10	4	.66	313	37741
6	19	10	4	.66	313	38132
*4†	7	10	4	.70	434	37742
4	19	10	4	.70	434	38133
*2†	7	10	4	.77	538	37743
2	19	10	4	.77	538	38134
1†	19	10	4	.81	610	37744
1	37	10	4	.81	610	38135
*1/0†	19	10	5	.89	736	37745
1/0	37	10	5	.89	736	38136
*2/0†	19	10	5	.93	816	37746
2/0	37	10	5	.93	816	38137
3/0†	19	10	5	.99	974	37747
3/0	37	10	5	.99	974	38138
*4/0†	19	10	5	1.04	1167	37748
4/0	37	10	5	1.04	1167	38139
*250†	37	11	5	1.16	1441	37749
250	61	11	5	1.16	1441	37784
400†	37	11	5	1.23	1624	37750
300	61	11	5	1.23	1624	37785
*300†	37	11	6	1.31	1819	37751
350	61	11	6	1.31	1819	37786
400†	37	11	6	1.36	2035	37752
400	61	11	6	1.36	2035	37787
*500†	37	11	6	1.44	2400	37753
500	61	11	6	1.44	2400	37788
600†	61	11	6	1.53	2982	37754
600	91	11	6	1.53	2982	37789
750	61	11	6	1.63	3511	37755
750†	91	11	6	1.63	3511	37790
1000†	61	11	7	1.82	4431	37756
1000	91	11	7	1.82	4431	37791

5,000 Volts, Shielded

Single Conductor

Construction Features:

Coated copper conductors.
 Simplex special strand shielding.
 Simplex-Anhydrex XX heat-resistant, ozone-resistant, low water-absorptive rubber insulating compound.
 Simplex Semiconducting Tape printed "SIMPLEX CONDUCTING TAPE—REMOVE WHEN SPLICING OR TERMINATING."
 Tinned copper shielding tape over each conductor.
 Specially compounded neoprene jacket protects insulated conductors.
 Simplex Neoprene Jacket is resistant to abrasion, soil acids, alkalis, oils, sunlight and weather hazards.

Made with Interlocked (Condex) Armor or Armor Wire coverings.

Size A.W.G. or M.C.M.	Strands	Thickness Insulation	64ths-Inch Jacket	Approx. O.D. In.	Approx. Gross Lbs. Per M. Ft.	No.
8†	7	10	4	.64	401	37983
8	19	10	4	.64	401	37827
*6†	7	10	4	.68	449	37984
6	19	10	4	.68	449	38124
*4†	7	10	4	.73	570	37985
4	19	10	4	.73	570	38125
*2†	7	10	4	.80	678	37986
2	19	10	4	.80	678	38126
1†	19	10	5	.87	779	37987
1	37	10	5	.87	779	38127
*1/0†	19	10	5	.92	882	37988
1/0	37	10	5	.92	882	38128
*2/0†	19	10	5	.96	1022	37989
2/0	37	10	5	.96	1022	38129
3/0†	19	10	5	1.01	1163	37990
3/0	37	10	5	1.01	1163	38130
*4/0†	19	10	5	1.08	1358	37991
4/0	37	10	5	1.08	1358	38131
250†	37	11	5	1.16	1636	37992
250	61	11	5	1.16	1636	37828
300†	37	11	6	1.25	1901	37993
300	61	11	6	1.25	1901	37829
350†	37	11	6	1.31	2085	37994
350	61	11	6	1.31	2085	37830
400†	37	11	6	1.36	2273	37995
400	61	11	6	1.36	2273	37831
500†	37	11	6	1.44	2641	37996
500	61	11	6	1.44	2641	37832
600†	61	11	6	1.53	3251	37997
600	91	11	6	1.53	3251	37833
750†	61	11	6	1.64	3789	37998
750	91	11	6	1.64	3789	37834
1000†	61	11	7	1.82	4759	37999
1000	91	11	7	1.82	4759	37835

*Stock Item.

†Our standard. Class B stranding.

Prices on application.

Simplex Anhydrex XX Cables

Anhydrex XX Insulation—Neoprene Jacket—(Con't.)

For Power Circuits

Overhead, in Ducts, or Buried in the Ground

15,000 Volts, Ungrounded Neutral Service
Single Conductor, Shielded

Size A.W.G. or M.C.M.	Strands	Thickness Insulation	64ths-Inch Jacket	Approx. O.D. In.	Approx. Gross Lbs. Per M. Ft.	No.
6†	7	27	6	1.29	1280	37288
6	19	27	6	1.29	1280	37289
4†	7	27	6	1.35	1377	38034
4	19	27	6	1.35	1377	38187
2†	7	27	6	1.41	1521	38035
2	19	27	6	1.41	1521	38188
1†	19	27	6	1.45	1615	38036
1	37	27	6	1.45	1615	38189
1/0†	19	27	6	1.49	1992	38037
1/0	37	27	6	1.49	1992	38190
2/0†	19	27	6	1.54	2124	38038
2/0	37	27	6	1.54	2124	38191
3/0†	19	27	6	1.58	2291	38039
3/0	37	27	6	1.58	2291	38192
4/0†	19	27	6	1.65	2497	38040
4 0	37	27	6	1.65	2497	38193
250†	37	27	7	1.74	2823	38041
250	61	27	7	1.74	2823	37290
300†	37	27	7	1.80	2972	38042
300	61	27	7	1.80	2972	37291
350†	37	27	7	1.84	3137	38043
350	61	27	7	1.84	3137	37292
500†	37	27	7	1.98	3807	38044
500	61	27	7	1.98	3807	37293
600	61	27	7	2.07	4906	38045
600	91	27	7	2.07	4906	37294
750†	61	27	7	2.18	5494	38046
750	91	27	7	2.18	5494	37295

15,000 Volts, Grounded Neutral Service
Single Conductor, Shielded

*6†	7	19	5	1.01	800	37883
6	19	19	5	1.01	800	37884
*4†	7	19	5	1.06	911	38021
4	19	19	5	1.06	911	38180
*2†	7	19	5	1.12	1036	38022
2	19	19	5	1.12	1036	38181
1†	19	19	5	1.16	1224	38023
1	37	19	5	1.16	1224	38182
1/0†	19	19	6	1.24	1401	38024
1/0	37	19	6	1.24	1401	38183
2/0†	19	19	6	1.29	1530	38025
2/0	37	19	6	1.29	1530	38184
3/0†	19	19	6	1.33	1683	38026
3/0	37	19	6	1.33	1683	38185
4/0†	19	19	6	1.40	1872	38027
4/0	37	19	6	1.40	1872	38186
250†	37	19	6	1.45	2025	38028
250	61	19	6	1.45	2025	37885
300†	37	19	6	1.51	2487	38029
300	61	19	6	1.51	2487	37886
350†	37	19	6	1.56	2690	38030
350	61	19	6	1.56	2690	37284
500†	37	19	7	1.73	3336	38031
500	61	19	7	1.73	3336	37285
600†	61	19	7	1.82	3741	38032
600	91	19	7	1.82	3741	37286
750†	61	19	7	1.93	4297	38033
750	91	19	7	1.93	4297	37287

*Stock Item.

†Our standard. Class B stranding.

Prices on application.

Simplex-Tirex Portable Cables

3-Conductor—Type SH-D†
4001 5000 V.W.P.

Selenium Neoprene Armored—Cured in Lead

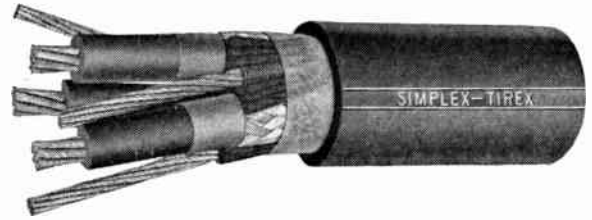

Individual conductors shielded. Instead of, or in addition to, the three braided ground wires shown, one bare ground wire of suitable size may be used in the center of Type SH-D Cable, in direct contact with the conductor shields.

Size A.W.G.	No. of Strands	*Gross Lbs. per 1,000-Foot	*O.D. Inches	Product Number
6	49	2280	1.81	T-31691
6	133	2280	1.82	T-31697
6	259	2280	1.82	T-31698
4	49	2650	2.00	T-31709
4	133	2640	1.97	T-31700
4	259	3000	1.98	T-31703
3	49	3240	2.02	T-31704
3	133	3230	2.05	T-31705
3	259	3280	2.05	T-31706
2	49	4110	2.12	T-31700
2	133	4160	2.13	T-31731
2	259	4100	2.12	T-31722
2	427	4100	2.12	T-31711
1	133	4460	2.22	T-31727
1	259	4430	2.21	T-31724
1	427	4430	2.21	T-31710
1/0	133	4960	2.35	T-31710
1/0	259	4920	2.34	T-31715
1 0	427	4910	2.34	T-31710
2 0	133	5450	2.46	T-31711
2 0	259	5100	2.46	T-31716
2 0	427	5100	2.46	T-31878
3 0	259	5980	2.61	T-31177
3 0	427	6060	2.63	T-31972
4 0	259	6680	2.76	T-31790
4 0	427	7120	2.78	T-31721

†Also available in Types SH-A, SH-B and SH-C.

*Approximate values.

Prices on application.

For
NATIONAL ELECTRIC CODE
CURRENT CARRYING CAPACITIES

on
THESE AND OTHER WIRES
AND CABLES

See
TABLES OF USEFUL INFORMATION

Preceding Index

Simplex-Tirex Portable Cables

2-Conductor 600 Volts W.P.

Selenium Neoprene Armored - Cured in Lead

These cables bear approval P-101 of Pennsylvania Department of Mines. Also listed by U. S. Bureau of Mines.

Type W Cable (without Grounding Conductor)

Twin: Specially designed for shuttle car operation. Conductors are "ribbed" or "gear-shaped," providing greater adhesion between jacket and conductor insulation. Complies with U. S. Bureau of Mines Schedule 2-E.

Round: Recommended for mining machines, cranes, loaders and other mobile equipment. Suitable for d-c motors and single phase portable machines.

Type G Cable (with Grounding Conductor)

Twin: "Ribbed" conductor construction. Complies with U. S. Bureau of Mines Schedule 2-E.

Round: Twisted conductors. Grounding conductor, divided in two parts, in interstices. Conforms to new Federal Mine Safety Code.

2-Conductor Round

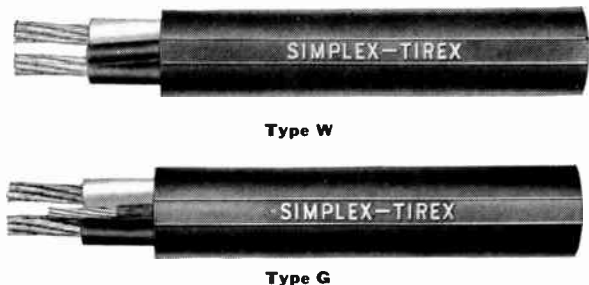

Shuttle Car Cable

2-Conductor (Twin)—Types W and G



Type W					Type G				
Size A.W.G.	No. of Strands	*Gross Wt. per M-Ft. Lbs.	*O.D. In.	Product Number	*Ground Conductor Size	*Gross Wt. per M-Ft. Lbs.	*O.D. In.	Product Number	
8	49	510	.81	T-30146	8	2 x #11	510	.81	T-32885
8	133	510	.81	T-30147	8	2 x #11	510	.81	T-32886
6	49	770	.93	T-30148	7	2 x #10	770	.93	T-32887
6	133	770	.93	T-30149	7	2 x #10	770	.93	T-32888
6	259	770	.93	T-30150	7	2 x #10	770	.93	T-32889
5	49	880	1.01	T-30151	6	2 x #9	880	1.01	T-32890
5	133	880	1.01	T-30152	6	2 x #9	880	1.01	T-32891
4	49	1000	1.08	T-30153	5	2 x #8	1020	1.08	T-32892
4	133	1000	1.08	T-30154	5	2 x #8	1020	1.08	T-32893
4	259	1000	1.08	T-30155	5	2 x #8	1020	1.08	T-32894
3	49	1160	1.17	T-30156	4	2 x #7	1310	1.17	T-32895
3	133	1160	1.17	T-30157	4	2 x #7	1310	1.17	T-32896
3	259	1160	1.17	T-30158	4	2 x #7	1310	1.17	T-32897
2	49	1450	1.27	T-30159	3	2 x #6	1450	1.27	T-32898
2	133	1450	1.27	T-30160	3	2 x #6	1450	1.27	T-32899
2	259	1450	1.27	T-30161	3	2 x #6	1450	1.27	T-32900
2	427	1450	1.27	T-30162	3	2 x #6	1450	1.27	T-32901
1	133	1880	1.44	T-30163	2	2 x #5	1930	1.44	T-32902
1	259	1880	1.44	T-30164	2	2 x #5	1930	1.44	T-32903
1	427	1880	1.44	T-30165	2	2 x #5	1930	1.44	T-32904
1/0	133	2130	1.52	T-30166	1	2 x #4	2200	1.52	T-32905
1/0	259	2130	1.52	T-30167	1	2 x #4	2200	1.52	T-32906
1/0	427	2130	1.52	T-30168	1	2 x #4	2200	1.52	T-32907
2/0	133	2780	1.65	T-30169	1/0	2 x #3	2870	1.65	T-32908
2/0	259	2780	1.65	T-30170	1/0	2 x #3	2870	1.65	T-32909
2/0	427	2780	1.65	T-30171	1/0	2 x #3	2870	1.65	T-32910
3/0	259	2940	1.77	T-30172	2/0	2 x #2	3130	1.77	T-32911
3/0	427	2940	1.77	T-30173	2/0	2 x #2	3130	1.77	T-32912
4/0	259	3870	1.92	T-30174	3/0	2 x #1	4120	1.92	T-32913
4/0	427	3870	1.92	T-30175	3/0	2 x #1	4120	1.92	T-32914

Type W					Type G				
Size A.W.G.	No. of Strands	*Gross Wt. per M-Ft. Lbs.	*O.D. In.	Product Number	*Ground Conductor Size	*Gross Wt. per M-Ft. Lbs.	*O.D. In.	Product Number	
8	49	410	.51 x .84	T-32997	8	580	.51 x .92	T-33027	
8	133	410	.51 x .84	T-32998	8	580	.51 x .92	T-33028	
6	49	620	.56 x .93	T-32999	6	680	.56 x 1.02	T-33029	
6	133	620	.56 x .93	T-33000	6	680	.56 x 1.02	T-33030	
6	259	620	.56 x .93	T-33001	6	680	.56 x 1.02	T-33031	
5	49	700	.58 x .99	T-33002	8	760	.58 x 1.08	T-33032	
5	133	700	.58 x .99	T-33003	8	760	.58 x 1.08	T-33033	
4	49	780	.61 x 1.05	T-33004	7	880	.61 x 1.15	T-33034	
4	133	780	.61 x 1.05	T-33005	7	880	.61 x 1.15	T-33035	
4	259	780	.61 x 1.05	T-33006	7	880	.61 x 1.15	T-33036	
3	49	880	.68 x 1.14	T-33007	6	1010	.68 x 1.26	T-33037	
3	133	880	.68 x 1.14	T-33008	6	1010	.68 x 1.26	T-33038	
3	259	880	.68 x 1.14	T-33009	6	1010	.68 x 1.26	T-33039	
2	49	1000	.73 x 1.24	T-33010	5	1130	.73 x 1.35	T-33040	
2	133	1000	.73 x 1.24	T-33011	5	1130	.73 x 1.35	T-33041	
2	259	1000	.73 x 1.24	T-33012	5	1130	.73 x 1.35	T-33042	
2	427	1000	.73 x 1.24	T-33013	5	1130	.73 x 1.35	T-33043	
1	133	1310	.81 x 1.40	T-33014	4	1480	.81 x 1.55	T-33044	
1	259	1310	.81 x 1.40	T-33015	4	1480	.81 x 1.55	T-33045	
1	427	1310	.81 x 1.40	T-33016	4	1480	.81 x 1.55	T-33046	
1/0	133	1490	.93 x 1.51	T-33017	3	1690	.93 x 1.67	T-33047	
1/0	259	1490	.93 x 1.51	T-33018	3	1690	.93 x 1.67	T-33048	
1/0	427	1490	.93 x 1.51	T-33019	3	1690	.93 x 1.67	T-33049	
2/0	133	1870	.99 x 1.63	T-33020	2	2120	.99 x 1.85	T-33050	
2/0	259	1870	.99 x 1.63	T-33021	2	2120	.99 x 1.85	T-33051	
2/0	427	1870	.99 x 1.63	T-33022	2	2120	.99 x 1.85	T-33052	
3/0	259	2150	1.03 x 1.77	T-33023	1	2470	1.03 x 2.00	T-33053	
3/0	427	2150	1.03 x 1.77	T-33024	1	2470	1.03 x 2.00	T-33054	
4/0	259	2470	1.10 x 1.89	T-33025	1/0	2870	1.10 x 2.10	T-33055	
4/0	427	2470	1.10 x 1.89	T-33026	1/0	2870	1.10 x 2.10	T-33056	

*Approximate values.

Grounding conductor is divided into two equal parts to avoid increasing diameter of cable. Total circular mil area of the two parts is that of the size listed.

To enable the workman to identify the size and type of wire, Simplex-Tirex Cables are provided with molded markings on the jacket. Being raised characters, these markings are provided at no sacrifice of jacket thickness. These molded characters will not rub off or separate from the jacket.

Prices on application.

Simplex-Anhydroprene Cables

Single Conductor—600 Volts W.P.

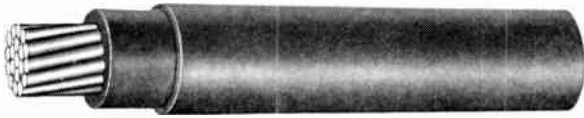

For power circuits in conduits or ducts, or as open wire in buildings. The same cable used underground in ducts may be extended up walls and overhead in buildings.

Designed primarily to replace braided or taped cables. Simplex-Anhydroprene cables in many instances have proved to be more dependable than metallic sheathed types.

Construction

Conductors: Solid or stranded, tin or alloy coated copper.

Insulation: Low-water-absorption Anhydrex rubber. Possesses high dielectric strength and low specific inductive capacity. Suitable for use at operating temperatures as high as 75° C. (167°F).

Jacket: Neoprene, resistant to sunlight, oil, acids, fungus growth, mildew, heat and flame. Not subject to corrosion. Smooth finish facilitates pulling through ducts.

Solid Conductors

Size A.W.G. or MCM	Strands	Insulation Thickness 64th In.	Jacket Thickness 64th In.	Approx. O.D. In.	Approx. Net Wt. per M-Ft. Lbs.	Approx. Ship. Wt. per M-Ft. Lbs.	Product Number
16	Solid	3	1	.19	20	25	37532
14	Solid	3	1	.20	30	35	37500
12	Solid	3	1	.22	40	45	37502
10	Solid	3	1	.24	50	60	37504
9	Solid	3	1	.25	60	70	37525
8	Solid	4	1	.31	90	110	37506
6	Solid	4	2	.35	120	140	37508

Stranded Conductors

16	7	3	1	.19	25	30	37533
16	19	3	1	.20	25	30	37527
14	7	3	1	.21	30	35	37501
14	19	3	1	.21	30	35	37528
12	7	3	1	.23	45	50	37503
12	19	3	1	.23	40	45	37631
10	7	3	1	.25	60	70	37505
10	19	3	1	.25	60	70	37530
9	7	3	1	.27	60	70	37526
9	19	3	1	.26	60	70	37531
8	7	4	1	.33	100	120	37507
6	7	4	2	.37	130	160	37509
4	7	4	2	.42	190	230	37510
2	7	4	2	.50	290	340	37511
1	19	5	3	.59	370	440	37512
1/0	19	5	3	.63	470	570	37513
2/0	19	5	3	.67	520	630	37514
3/0	19	5	3	.73	680	820	37515
4/0	19	5	3	.78	820	980	37516
250	37	6	4	.93	1020	1230	37517
300	37	6	4	.98	1200	1440	37518
350	37	6	4	1.03	1370	1650	37519
400	37	6	4	1.08	1550	1860	37520
500	37	6	4	1.16	1880	2260	37521
600	61	7	4	1.28	2180	2620	37522
750	61	7	4	1.38	2710	3260	37523
1000	61	7	4	1.53	3590	4300	37524

†Simplex-Anhydroprene cables are also available for voltages up to 17,000 volts. For Specification data, including weights and diameters, contact Graybar.

Prices on application.

Simplex-Tirex Portable Cables

Designed for portable service under extreme service conditions.

Conductors, flexible or extra flexible stranded and insulated with high-dielectric rubber.

Jackets of Selenium-Neoprene, cured in lead for maximum toughness, resistance to oil, moisture, abrasion, acids, alkalis and sunlight.

Motor Lead Cable

Single Conductor—600 Volts W.P.



For interior wiring of motors, mine locomotives and other installations requiring a flexible cable.

Size A.W.G.	Strands	Approx. Gross Wt. per M-Ft. Lbs.	Approx. Outside Diam. In.	Size A.W.G.	Strands	Approx. Gross Wt. per M-Ft. Lbs.	Approx. Outside Diam. In.
8	133	180	.44	1	259	570	.74
6	133	250	.51	1/0	133	630	.77
5	49	280	.52	1/0	259	630	.77
5	133	280	.52	2/0	133	750	.82
4	49	330	.57	2/0	259	750	.82
4	133	330	.57	3/0	259	950	.87
3	49	390	.63	3/0	427	950	.87
3	133	390	.63	4/0	259	1110	.93
2	133	470	.66	4/0	427	1110	.93
2	259	470	.66

**2-Conductor—Concentric
600 Volts W.P.**



Recommended for mining machines. Has approval No. P-101, Pennsylvania Department of Mines; also U. S. Bureau of Mines listing.

Size A.W.G.	Strands	Approx. Gross Wt. per M-Ft. Lbs.	Approx. Outside Diam. In.	Size A.W.G.	Strands	Approx. Gross Wt. per M-Ft. Lbs.	Approx. Outside Diam. In.
8	49	360	.65	1	259	1250	1.05
6	49	510	.77	1/0	133	1440	1.10
6	133	510	.77	1/0	259	1440	1.10
5	49	570	.80	2/0	133	1660	1.18
4	49	750	.84	2/0	259	1660	1.18
4	133	750	.84	3/0	259	2020	1.24
3	49	870	.89	3/0	427	2020	1.24
3	133	870	.89	4/0	259	2340	1.33
2	133	970	.94	4/0	427	2340	1.33
2	259	970	.94

Welding Cable

Single Conductor—125 Volts



Extra flexible, clean stripping. Safe for operator and public. Jacket will not support combustion.

Size A.W.G.	Strands	Approx. Gross Wt. per M-Ft. Lbs.	Approx. Outside Diam. In.
2	1715	350	.56
1	2156	450	.63
1/0	2695	530	.68
2/0	3381	640	.75
3/0	4263	770	.82
4/0	5341	950	.90

Prices on application.

Simplex-Tirex Portable Cables

3-, 4- and 5-Conductor 600 Volts, W. P.

Selenium Neoprene Armored—Cured-in-Lead

Approved by Pennsylvania Department of Mines (P-101); also U. S. Bureau of Mines' listing.

3-Conductor Cable Types W & G

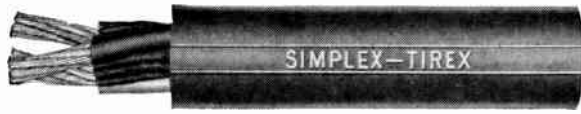

Type W Without Ground Wires				Type G With Ground Wires			
Conductor Size A.W.G. or MCM	No. of Strands	*O.D. In.	Product Number	Conductor Size A.W.G. or MCM	No. of Strands	Ground Conductor Size	*O.D. In. Product Number
8	49	.91	T-30176	8	49	8 3x#12	.91 T-30248
8	133	.91	T-30177	8	133	8 3x#12	.91 T-30249
6	49	1.01	T-30178	6	49	8 3x#12	1.01 T-30250
6	133	1.01	T-30179	6	133	8 3x#12	1.01 T-30251
6	259	1.01	T-30180	6	259	8 3x#12	1.01 T-30252
5	49	1.10	T-30181	4	49
5	133	1.10	T-30182	4	133
4	49	1.17	T-30183	4	259	5 3x#10	1.17 T-30253
4	133	1.17	T-30184	3	49	5 3x#10	1.17 T-30254
4	259	1.17	T-30185	3	133	5 3x#10	1.17 T-30255
3	49	1.24	T-30186	3	259	4 3x#9	1.24 T-30256
3	133	1.24	T-30187	2	49	4 3x#9	1.24 T-30257
3	259	1.24	T-30188	2	133	4 3x#9	1.24 T-30258
2	49	1.34	T-30189	2	259	3 3x#8	1.34 T-30259
2	133	1.34	T-30190	2	127	3 3x#8	1.34 T-30260
2	259	1.34	T-30191	1	133	3 3x#8	1.34 T-30261
2	427	1.34	T-30192	1	259	3 3x#8	1.34 T-30262
1	133	1.51	T-30193	1	427	2 3x#7	1.51 T-30263
1	259	1.51	T-30194	1/0	133	2 3x#7	1.51 T-30264
1	427	1.51	T-30195	1/0	259	2 3x#7	1.51 T-30265
1/0	133	1.65	T-30196	1/0	427	1 3x#6	1.65 T-30266
1/0	259	1.65	T-30197	2/0	133	1 3x#6	1.65 T-30267
1/0	427	1.65	T-30198	2/0	259	1 3x#6	1.65 T-30268
2/0	133	1.75	T-30199	2/0	427	1/0 3x#5	1.75 T-30269
2/0	259	1.75	T-30200	3/0	259	1/0 3x#5	1.75 T-30270
2/0	427	1.75	T-30201	3/0	127	1/0 3x#5	1.75 T-30271
3/0	259	1.89	T-30202	4/0	259	2/0 3x#4	1.89 T-30272
3/0	427	1.89	T-30203	4/0	127	2/0 3x#4	1.89 T-30273
4/0	259	2.04	T-30204	250	259	3/0 3x#3	2.04 T-30274
4/0	427	2.04	T-30205	250	127	3/0 3x#3	2.04 T-30275
250	259	2.39	T-30206	300	259	4/0 3x#2	2.39 T-30276
250	427	2.39	T-30207	300	127	4/0 3x#2	2.39 T-30277
300	259	2.56	T-30208	350	259	1/0 3x#2	2.56 T-30278
300	427	2.56	T-30209	350	127	4/0 3x#2	2.56 T-30279
350	259	2.68	T-30210	400	259	250 3x#1	2.68 T-30280
350	427	2.68	T-30211	400	427	250 3x#1	2.68 T-30281
400	259	2.82	T-30212	450	259	300 3x#1/0	2.82 T-30282
400	427	2.82	T-30213	450	127	300 3x#1/0	2.82 T-30283
450	259	2.94	T-30214	500	259	300 3x#1/0	2.94 T-30284
450	427	2.94	T-30215	500	427	300 3x#1/0	2.94 T-30285
500	259	3.03	T-30216			400 3x#2/0	3.03 T-30286
500	427	3.03	T-30217			400 3x#2/0	3.03 T-30287

4-Conductor Cable Types W & G



Type W Without Ground Wires				Type G With Ground Wires			
Conductor Size A.W.G. or MCM	No. of Strands	*O.D. In.	Product Number	Conductor Size A.W.G. or MCM	No. of Strands	Ground Conductor Size	*O.D. In. Product Number
8	49	.99	T-30218	8	49	7 4x#13	.99 T-30288
8	133	.99	T-30219	8	133	7 4x#13	.99 T-30289
6	49	1.10	T-30220	6	49	7 4x#13	1.10 T-30290
6	133	1.10	T-30221	6	133	7 4x#13	1.10 T-30291
6	259	1.10	T-30222	6	259	7 4x#13	1.10 T-30292
5	49	1.19	T-30223
5	133	1.19	T-30224
4	49	1.27	T-30225	4	49	5 4x#11	1.27 T-30293
4	133	1.27	T-30226	4	133	5 4x#11	1.27 T-30294
4	259	1.27	T-30227	4	259	5 4x#11	1.27 T-30295
3	49	1.34	T-30228	3	49	4 4x#10	1.34 T-30296
3	133	1.34	T-30229	3	133	4 4x#10	1.34 T-30297
3	259	1.34	T-30230	3	259	4 4x#10	1.34 T-30298
2	49	1.48	T-30231	2	49	3 4x#9	1.48 T-30299
2	133	1.48	T-30232	2	133	3 4x#9	1.48 T-30300
2	259	1.48	T-30233	2	259	3 4x#9	1.48 T-30301
2	427	1.48	T-30234	2	217	3 4x#9	1.48 T-30302
1	133	1.68	T-30235	1	133	2 4x#8	1.68 T-30303
1	259	1.68	T-30236	1	259	2 4x#8	1.68 T-30304
1	427	1.68	T-30237	1	427	2 4x#8	1.68 T-30305
1/0	133	1.79	T-30238	1/0	133	1 4x#7	1.79 T-30306
1/0	259	1.79	T-30239	1/0	259	1 4x#7	1.79 T-30307
1/0	427	1.79	T-30240	1/0	427	1 4x#7	1.79 T-30308
2/0	133	1.93	T-30241	2/0	133	1/0 4x#6	1.93 T-30309
2/0	259	1.93	T-30242	2/0	259	1/0 4x#6	1.93 T-30310
2/0	427	1.93	T-30243	2/0	427	1/0 4x#6	1.93 T-30311
3/0	259	2.07	T-30244	3/0	259	2/0 4x#5	2.07 T-30312
3/0	427	2.07	T-30245	3/0	427	2/0 4x#5	2.07 T-30313
4/0	259	2.26	T-30246	4/0	259	3/0 4x#4	2.26 T-30314
4/0	427	2.26	T-30247	4/0	427	3/0 4x#4	2.26 T-30315

5-Conductor Cable

Type W

Size A.W.G.	Conductor No. of Strands	*Gross Wt per M-FL Lbs.	*O.D. In.	Product Number	Size A.W.G.	Conductor No. of Strands	*Gross Wt per M-FL Lbs.	*O.D. In.	Product Number
8	49	940	1.07	T-32563	4	49	1800	1.40	T-32569
8	133	940	1.07	T-32564	4	133	1800	1.40	T-32570
6	49	1300	1.21	T-32565	3	49	2110	1.48	T-32571
6	133	1300	1.21	T-32566	3	133	2100	1.48	T-32572
5	49	1560	1.29	T-32567	2	133	2590	1.61	T-32573
5	133	1560	1.29	T-32568	2	259	2590	1.61	T-32574

*Approximate values.

To enable the workman to identify the size and type of wire, Simplex-Tirex cables are provided with molded markings on the jacket. Being raised characters, these markings are provided at no sacrifice of jacket thickness. These molded characters will not rub off or separate from the jacket.

Prices on application.

Simplex-Tirex Portable Cords

Selenium Neoprene Armored—Cured-in-Lead

Non-kinking, flexible, portable cord. Copper conductors stranded to provide extra flexibility and ease of handling. Individual conductor insulation is high-grade rubber compound, color-coded for identification and polarity marking.

Type SO: Heavy duty, designed for long-life, trouble-free performance under continuous rough usage. Used on portable tools wherever working conditions call for unusual stamina and endurance. Conductors protected from me-

chanical injury by heavy, tough Selenium Neoprene Armor.

Type SJO: Lighter and smaller in diameter than Type SO. Clean, non-fraying, smooth outer covering. Suitable for use in offices or in residences where a small, flexible conductor is required.

Hospital Silent Call Cord: Flexible stranded conductors. Two conductors with color-coded insulation for identification. Brown, smooth rubber sheath.

*Current Carrying Capacities—Tirex Cords

Size	(Amperes)	
	Up to 3 Conductors	4 to 6 Conductors
18	7	5.6
16	10	8
14	15	12
12	20	16
10	25	20

*From 1947 N.E.C.

Standard Packages—Tirex Cords

Following standard stock sizes, 250 ft., cutout carton.

Type SO	Type SJO
#18-2, 3, and 4-Conductor	#18-2, 3 and 4-Conductor
#16-2, 3 and 4-Conductor	#16-2, 3 and 4-Conductor
#14-2-Conductor	

Maximum, two lengths per carton. Minimum length, 50 ft. Each length under 100 feet in carton will be 5 feet more than marked. All other sizes in coils or on reels.

Color-Coding—Type SO and SJO Cords

No. of Conductors	No. 1	No. 2	No. 3	Colors and Sequence		No. 5	No. 6	No. 7	No. 8
				No. 4					
Two	Black	White
Three	Black	White	Green
Four	Black	White	Red	Green
Five	Black	White	Red	Orange	Green
Six	Black	White	Red	Orange	Blue	Green
Seven	Black	White	Red	Orange	Blue	Yellow	Green
Eight	Black	White	Red	Orange	Blue	Yellow	Brown	Green

Type SO Cord—600 Volts



†Single Conductor

*2-Conductor

Size	Approx. O.D. In.	Approx. Gross Wt. per M-FL. Lbs.	Product Number	Size	Approx. O.D. In.	Approx. Gross Wt. per M-FL. Lbs.	Product Number
18	.18	25	T-32182	18	.39	80	T-32187
16	.19	25	T-32183	16	.41	90	T-32188
14	.25	40	T-32184	14	.53	160	T-32189
12	.26	50	T-32185	12	.61	320	T-32190
10	.29	70	T-32186	10	.64	360	T-32191

*3-Conductor

*4-Conductor

18	.41	90	T-32192	18	.44	110	T-32197
16	.43	110	T-32193	16	.49	140	T-32198
14	.56	300	T-32194	14	.61	340	T-32199
12	.64	360	T-32195	12	.67	400	T-32200
10	.69	420	T-32196	10	.75	490	T-32201

5-Conductor

6-Conductor

18	.48	200	T-32202	18	.52	230	T-32207
16	.52	230	T-32203	16	.55	260	T-32208
14	.68	400	T-32204	14	.73	450	T-32209
12	.75	470	T-32205	12	.79	510	T-32210
10	.82	570	T-32206	10	.86	670	T-32211

7-Conductor

8-Conductor

18	.56	230	T-32212	18	.59	340	T-32217
16	.59	260	T-32213	16	.67	380	T-32218
14	.78	460	T-32214	14	.84	590	T-32219
12	.85	530	T-32215	12	.91	670	T-32220
10	.93	700	T-32216	10	1.00	840	T-32221

†Approved by Underwriters for car wiring only.

*Approved by Underwriters.

No N.E.C. Standards for cords having more than four conductors.

Prices on application.

Type SJO Cord—300 Volts



2-Conductor

Size	Approx. O.D. In.	Approx. Gross Wt. per M-FL. Lbs.	Product Number
18	.31	60	T-32222
16	.33	70	T-32223
14	.43	120	T-32224

3-Conductor

18	.34	80	T-32227
16	.36	100	T-32228
14	.47	150	T-32229

4-Conductor

18	.36	90	T-32230
16	.39	110	T-32231

Type SJO Cords in sizes 18 and 16 meet N.E.C. Standards. No N.E.C. standards for size 14.

Hospital Silent Call Cord—50 Volts Max.

4-Conductor

Size	Approx. O.D. In.	Approx. Gross Wt. per M-FL. Lbs.	Product Number
18	.32	70	T-32265

5-Conductor

18	.32	80	T-32266
----	-----	----	---------

National Electric Building Wire and Cable

600 Volts

Type RH-RW Style RR—600 Volts
For Power Circuits In Ducts or Conduits

Listed by Underwriters' Laboratories, Inc.



Tinned soft copper drawn conductors. Thermo-Seal rubber insulation with a Neoprene sheath.

Single Conductor—Solid

AWG Size	Stranding In.	Thickness Insulation	64ths In. Jacket	Approx. O.D., In.	Approx. Net Wgt. Pounds Per M Feet	Feet Per Package
14	1/.064	3/64	1/64	.189	31	500
12	1/.081	3/64	1/64	.206	41	500
10	1/.102	3/64	1/64	.227	55	500
8	1/.128	3/64	1/64	.289	87	500

Single Conductor—Stranded

14	7/.0242	3/64	1/64	.197	33	500
12	7/.0305	3/64	1/64	.216	43	500
10	7/.0385	3/64	1/64	.240	58	500
8	7/.0486	3/64	1/64	.301	92	500
6	7/.0612	1/2	2/64	.371	143	500
4	7/.0772	1/2	2/64	.420	200	500
2	7/.0974	1/2	2/64	.481	289	1000
1	19/.0664	1/2	3/64	.582	390	1000
1/0	19/.0745	5/64	3/64	.622	467	1000
2/0	19/.0837	5/64	3/64	.668	576	1000
3/0	19/.0940	5/64	3/64	.720	687	1000
4/0	19/.1055	5/64	3/64	.778	840	1000
250 MCM	37/.0822	5/64	4/64	.888	1044	1000
300 MCM	37/.0900	5/64	4/64	.943	1214	1000
350 MCM	37/.0973	5/64	4/64	1.004	1379	1000
400 MCM	37/.1040	5/64	4/64	1.041	1546	1000
500 MCM	37/.1162	5/64	4/64	1.128	1892	1000
600 MCM	61/.0992	1/2	4/64	1.236	2266	1000
750 MCM	61/.1109	1/2	4/64	1.344	2880	1000
1000 MCM	61/.1280	1/2	4/64	1.496	3598	1000

Conductors comply with ASTM Standard B-33.

Insulation complies with U/L Type RII-RW, ASTM Standard D-754, Federal Specification J-C-103 and IPCEA Specification Appendix C.

Sheath complies with ASTM Standard D-752 and IPCEA Specification Appendix K and Underwriters' Laboratories Standards.

Call Graybar FIRST For . . .

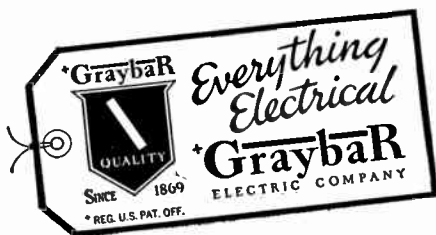

Type TW—Nepronol Thermoplastic

Listed by Underwriters' Laboratories, Inc.



For use in unusually moist or humid locations.

Possesses high resistance to moisture, acids, alkalis, oil and grease.

Available in a wide range of permanent colors, marked and measured.

Solid

Size A.W.G. or MCM	No. of Strands	Insulation 64ths In.	Approx. O.D. In.	Approx. Net Wt. Per M-Ft.
14	1	2	.131	20
12	1	2	.148	28
10	1	2	.160	41
8	1	3	.224	69

Standard Strand

14	7	2	.110	22
12	7	2	.158	30
10	7	2	.185	44
8	7	3	.243	75
6	7	4	.323	119
4	7	4	.372	176
3	7	4	.405	220
2	7	4	.433	263
1	19	5	.504	339
1/0	19	5	.545	416
2/0	19	5	.590	514
3/0	19	5	.640	633
4/0	19	5	.700	787
250	37	6	.771	923
300	37	6	.827	1085
350	37	6	.878	1253
400	37	6	.924	1415
500	37	6	1.012	1746
600	61	7	1.122	2106
700	61	7	1.194	2430
750	61	7	1.217	2590
800	61	7	1.260	2757
900	61	7	1.324	3083
1000	61	7	1.381	3417

Thermoplastic Non-Metallic Sheathed Cable

Listed by Underwriters' Laboratories, Inc.



A multi-purpose cable which can be used for: Direct earth burial in branch or feeder circuits; interior wiring in wet, damp or corrosive locations; embedded in plaster or masonry block walls, and installed in dry locations.

Without Ground Wire			With Ground Wire		
Size	Approx. Ft. Per Coil	Wt. Lbs. Per M Ft.	Size	Approx. Ft. Per Coil	Wt. Lbs. Per Coil
14/2	250	73	14/2	250	79
12/2	250	94	12/2	250	104
10/2	250	129	10/2	250	141
14/3	250	109	14/3	250	115
12/3	250	139	12/3	250	149
10/3	250	154	10/3	250	169

National Electric 600 Volt Motor Lead or Apparatus Cable All-Asbestos—Type AIA



Flexible coated copper conductor, .045 in. black asbestos braid which is flame-heat-and moisture resistant impregnated. Dielectric test voltage kv 1.5.

Recommended particularly for motor connections, crane and engine compartment wiring, electric furnace leads and other open wired high temperature installations where moisture is not a factor. Can be operated at temperatures up to 125° C (257° F).

Cond. Size AWG or MCM	No. and Size of Strands (Coated) In.	Thick. of Felted Asbestos In.	*Nom. Over-all Diam. In.	Approx. Net Wt. Lbs. Per M. Ft.	Feet In Reel
14	41 x .010	.030	.225	35	±500
12	65 x .010	.040	.265	50	±500
10	104 x .010	.040	.290	67	±500
8	133 x .0111	.040	.310	96	±500
6	133 x .0110	.060	.425	142	1000
4	133 x .0177	.060	.480	200	1000
2	133 x .0223	.060	.550	305	1000
1	259 x .0180	.075	.620	386	1000
1/0	259 x .0202	.075	.665	460	1000
2/0	259 x .0227	.075	.720	576	1000
3/0	259 x .0255	.075	.780	704	1000
4/0	259 x .0286	.075	.840	857	1000
250	427 x .0242	.090	.925	1015	500
300	427 x .0265	.090	.990	1191	500
350	427 x .0286	.090	1.045	1359	500
400	427 x .0306	.090	1.100	1539	500
500	427 x .0342	.090	1.195	1882	500

±ft. in coil.

National Electric Switchboard Wire 600 Volt—Asbestos-Varnished Cambric Type AVB



Recommended for wiring panel boards, switchboards and control equipment; also suitable for general purpose wiring in dry locations. Can be operated at temperatures up to 90° C (194° F).

Solid coated copper conductor; gray flame-and heat resisting finish cotton braid. Standard package 500 feet.

Varnished cambric thicknesses: Sizes Nos. 14 to 8, .030 in.; Nos. 6 to 4/0, .040 in. Size Nos. 14 to 8 subjected to 3 kv, and Nos. 6 to 4/0 4 kv, dielectric test voltage.

Cond. Size AWG	No. and Size of Strands (Coated) In.	Thick. of Felted Asbestos In.	Thick. of Cotton Braid In.	*Nom. Over-all Diam. In.	Approx. Net Wt. Lbs. Per M. Ft.
14	Solid	.020	.016	.200	33
12	Solid	.020	.016	.220	43
10	Solid	.020	.017	.245	59
8	Solid	.020	.017	.270	82
6	Solid	.030	.017	.345	129
4	Solid	.030	.017	.385	185
Stranded					
14	7 x .0242	.020	.016	.210	35
12	7 x .0305	.020	.016	.230	45
10	7 x .0385	.020	.017	.260	62
8	7 x .0486	.020	.017	.290	85
6	7 x .0612	.030	.017	.365	135
4	7 x .0772	.030	.020	.420	197
2	7 x .0974	.030	.020	.480	285
1	19 x .0664	.040	.020	.540	361
1/0	19 x .0745	.040	.020	.580	438
2/0	19 x .0837	.040	.020	.625	531
3/0	19 x .0940	.040	.020	.675	651
4/0	19 x .1055	.040	.020	.735	804

*Subject to plus or minus 5% tolerance due to variations in manufacturing processes.

National Electric Braided Power Cable 5000 Volts—Asbestos-Varnished Cambric Type AVA-50



Recommended for wiring in the open or in conduit where subject to heat, oil and grease, fire hazard and corrosive fumes in boiler rooms, steel mills, power plants, factories etc. Permitted for operating temperatures as high as 100° C (212° F).

Stranded copper conductor. Black asbestos braid is flame-heat-and moisture resistant impregnated. Varnished cambric thickness .120 in., asbestos braid thickness .045 in. Dielectric test voltage kv. 12.5.

Cond. Size AWG or MCM	No. and Size of Strands In.	Thick. of First Felted Asbestos Wall, In.	*Nom. Over-all Diam. In.	Approx. Net Wt. Lbs. Per M. Ft.	Std. Ft. In Reel
14	7 x .0242	.015	.485	113	1000
12	7 x .0305	.015	.505	128	1000
10	7 x .0385	.015	.530	147	1000
8	7 x .0486	.015	.560	176	1000
6	7 x .0612	.015	.595	237	1000
4	7 x .0772	.015	.645	301	1000
2	7 x .0974	.015	.705	414	1000
1	19 x .0664	.020	.765	497	1000
1/0	19 x .0745	.020	.805	581	1000
2/0	19 x .0837	.020	.850	684	1000
3/0	19 x .0940	.020	.900	811	1000
4/0	19 x .1055	.020	.960	969	1000
250	37 x .0822	.025	1.035	1137	500
300	37 x .0900	.025	1.090	1314	500
350	37 x .0973	.025	1.145	1484	500
400	37 x .1040	.025	1.190	1664	500
500	37 x .1162	.025	1.275	2007	500
600	61 x .0992	.030	1.365	2366	500
700	61 x .1071	.030	1.435	2701	500
750	61 x .1190	.030	1.470	2876	500
800	61 x .1115	.030	1.505	3040	500
900	61 x .1215	.030	1.565	3379	500
1000	61 x .1280	.030	1.625	3742	500

National Electric Switchboard Wire 600 Volt—Asbestos-Thermoplastic Type TA



Recommended for wiring switchboards and other types of control apparatus. Can be operated at temperatures up to 90° C (194° F).

Solid coated copper conductor; thermoplastic compound. Gray flame-and heat resisting finish cotton braid. Thickness of thermoplastic insulation .020 in., thickness of felted asbestos insulation .020 in.

Cond. Size AWG	No. and Size of Strands In.	Min. Cotton Braid Thick. In.	*Nom. Over-all Diam. In.	Approx. Net Wt. Lbs. Per M. Ft.	Dielectric Test Voltage KV
14	Solid	.016	.185	30	3.0
12	Solid	.016	.200	39	3.0
10	Solid	.016	.225	54	3.0
8	Solid	.017	.255	77	3.0
Stranded					
14	7 x .0242	.016	.195	32	3.0
12	7 x .0305	.016	.215	42	3.0
10	7 x .0385	.017	.235	58	3.0
8	7 x .0486	.017	.270	83	3.0

*Subject to plus or minus 5% tolerance due to variations in manufacturing processes.

Note: Colors other than standard dark gray may be furnished on special order.

National Electric Power and Rheostat Cable
600 Volt—All-Asbestos
Type AIA



Recommended for wiring rheostats, ranges, hot-plates and general open wiring where exposed to heat, fumes, grease, etc. Will withstand operating temperatures up to 125° C (257° F). It is not recommended for use in raceways except as leads to or within apparatus.

Uncoated stranded copper conductors; .045-in. flame-heat-and-moisture resistant impregnated black asbestos braid. Subjected to 1.5 kv dielectric test voltage.

Cond. Size AWG or MCM	No. and Size of Strands In.	Thick. of Felted Asbestos In.	*Nom. Overall Diam. In.	Approx. Net Wt. Lbs. Per M. Ft.	Feet In Reel
14	7 x .0242	.030	.225	35	±500
12	7 x .0305	.040	.265	48	±500
10	7 x .0385	.040	.290	64	±500
8	7 x .0486	.040	.320	87	±500
6	7 x .0612	.060	.395	134	1000
4	7 x .0772	.060	.445	189	1000
2	7 x .0974	.060	.505	275	1000
1	19 x .0664	.075	.575	363	1000
1/0	19 x .0745	.075	.615	440	1000
2/0	19 x .0837	.075	.660	534	1000
3/0	19 x .0940	.075	.710	667	1000
4/0	19 x .1055	.075	.770	814	1000

Circular Mil Sizes

250	37 x .0822	.090	.845	962	500
300	37 x .090	.090	.900	1131	500
350	37 x .0973	.090	.955	1297	500
400	37 x .1040	.090	1.000	1462	500
500	37 x .1162	.090	1.085	1739	500
600	61 x .0992	.105	1.195	2147	500
700	61 x .1071	.105	1.265	2473	500
750	61 x .1109	.105	1.300	2638	500
800	61 x .1145	.105	1.335	2800	500
900	61 x .1215	.105	1.395	3124	500
1000	61 x .1280	.105	1.455	3448	500

†Supplied in coils.

Note: Can be furnished with white flame-and-heat resisting saturant and finish for 300 volt service and operating temperatures as high as 200°C (329°F) in definitely dry locations.

National Electric Rheostat Wire
600 Volt—All-Asbestos
Type AIA



Recommended for wiring rheostats, ranges, hot-plates and general open wiring where exposed to heat, fumes, grease, etc. Will withstand operating temperatures up to 125° C (257° F). It is not recommended for use in raceways except as leads to or within apparatus.

Solid copper conductor uncoated. .045 in. black flame-heat-and-moisture resistant impregnated asbestos braid. Subjected to 1.5 kv dielectric test voltage.

Cond. Size AWG	Type	Thick. of Felted Asbestos In.	*Nom. Overall Diam. In.	Approx. Net Wt. Lbs. Per M. Ft.	Feet In Coil
14	Solid	.030	.215	33	500
12	Solid	.030	.235	42	500
10	Solid	.030	.255	56	500
8	Solid	.030	.280	78	500
6	Solid	.040	.335	119	±500
4	Solid	.040	.375	169	±00

†Supplied on reels.

*Subject to plus or minus 5% tolerance due to variations in manufacturing processes.

Note: Can be furnished with white flame-and-heat resisting saturant and finish, for 300 volt service and operating temperatures as high as 200° C (392° F) in definitely dry locations.

National Electric Braided Power Cable
600 Volts—Asbestos-Varnished Cambric
Type AVA

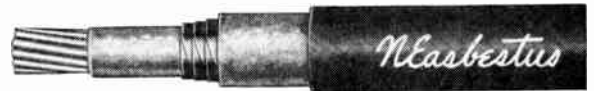

Stranded copper conductor; black asbestos braid which is flame-heat-and-moisture resistant impregnated.

Recommended for power wiring in the open, in conduit or raceways where subject to heat, oil and grease, fire hazard and corrosive fumes in boiler rooms, steel mills, power plants, factories, etc. Permitted for operating temperatures as high as 110° C (230° F).

Thickness of asbestos braid .045 in. Thickness of varnished cambric .030 in. on sizes #11 thru 4/0 and .040 in. on circular mil sizes.

Cond. Size AWG or MCM	No. and Size of Strands In.	Thick. of First Felted Asbestos Wall, In.	*Nom. Overall Diam. In.	Approx. Net Wt. Lbs. Per M. Ft.	Std. Feet In Reel
14	7 x .0212	.010	.275	45	±500
12	7 x .0305	.010	.295	55	±500
10	7 x .0385	.010	.320	73	±500
8	7 x .0486	.010	.350	98	±500
6	7 x .0612	.015	.405	142	1000
4	7 x .0772	.015	.455	199	1000
2	7 x .0974	.015	.515	286	1000
1	19 x .0664	.020	.585	380	1000
1/0	19 x .0745	.020	.625	458	1000
2/0	19 x .0837	.020	.670	553	1000
3/0	19 x .0940	.020	.720	688	1000
4/0	19 x .1055	.020	.780	837	1000
250	37 x .0822	.025	.875	1007	500
300	37 x .0900	.025	.930	1177	500
350	37 x .0973	.025	.985	1346	500
400	37 x .1040	.025	1.030	1515	500
500	37 x .1162	.025	1.115	1816	500
600	61 x .0992	.030	1.205	2193	500
700	61 x .1071	.030	1.275	2522	500
750	61 x .1109	.030	1.310	2689	500
800	61 x .1145	.030	1.345	2852	500
900	61 x .1215	.030	1.405	3179	500
1000	61 x .1280	.030	1.465	3507	500

†Feet in coils.

National Electric Braided Boiler Room Cable
Asbestos-Varnished Cambric—Type AVA



Recommended for lighting and control circuits in boiler rooms, chemical and processing plants, steel mills, locomotives, furnaces, in the open, in conduit raceways, where exposed to heat, corrosive fumes, oil, grease, etc.

Can be operated at temperatures up to 110° C (230° F). Solid copper conductors. .030 in. thickness of varnished cambric; .045 in. thickness of asbestos braid; .020 in. thickness of second asbestos wall. 500 feet in standard package.

Cond. Size AWG	No. and Size of Strand	Thick. of First Felted Asbestos Wall, In.	*Nom. Overall Diam. In.	Dielectric Test Voltage KV	Approx. Net Wt. Lbs. Per M. Ft.
14	Solid215	3.0	39
12	Solid265	3.0	48
10	Solid285	3.0	63
8	Solid310	3.0	85
6	Solid	.015	.385	3.0	134
4	Solid	.015	.425	3.0	90
14	7/.0212254	3.0	41
12	7/.0305276	3.0	49
10	7/.0385299	3.0	65
8	7/.0486328	3.0	88

*Subject to plus or minus 5% tolerance due to variations in manufacturing processes.

National Electric 600 Volt Motor Lead or Apparatus Cable

Asbestos-Varnished Cambric—Type AVA

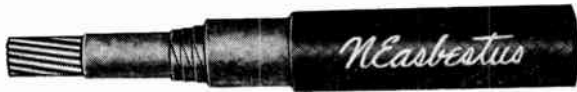

Flexible coated copper conductor. Black asbestos braid is flame-heat-and-moisture resistant impregnated.

Recommended for coil connections, transformers, resistors, traction and mill motors, diesel and electric locomotives, etc. Can be operated at temperatures up to 110° C (230° F).

Thickness of asbestos braid .015 in. Thickness of varnished cambric .030 in. on sizes #14 thru 4/0 and .040 in. on circular mil sizes.

Cond. Size AWG or MCM	No. and Size of Strands In.	Thick. of First Felted Asbestos Wall, In.	*Nom. Overall Diam. In.	Approx. Net Wt. Lbs. Per M. Ft.	Std. Feet In Reel
14	41 x .010	.010	.275	45	†500
12	65 x .010	.010	.295	57	†500
10	104 x .010	.010	.320	76	†500
8	133 x .0111	.010	.370	105	†500
6	133 x .0140	.015	.435	151	1000
4	133 x .0177	.015	.490	210	1000
2	133 x .0223	.015	.560	319	1000
1	259 x .0180	.020	.630	403	1000
1/0	259 x .0202	.020	.675	479	1000
2/0	259 x .0227	.020	.730	597	1000
3/0	259 x .0255	.020	.785	728	1000
4/0	259 x .0286	.020	.850	882	1000

Circular Mil Sizes

250	427 x .0242	.025	.955	1066	500
300	427 x .0265	.025	1.020	1247	500
350	427 x .0286	.025	1.075	1418	500
400	427 x .0306	.025	1.130	1601	500
500	427 x .0342	.025	1.225	1949	500
600	427 x .0380	.030	1.340	2398	500
700	427 x .0403	.030	1.400	2663	500
750	427 x .0420	.030	1.445	2829	500
800	427 x .0427	.030	1.465	2926	500
900	427 x .0453	.030	1.535	3294	500
1000	427 x .0480	.030	1.605	3695	500

†Feet in coils.

*Subject to plus or minus 5% tolerance due to variations in manufacturing processes.

National Electric Fixture Wire 300 Volt—Heat-Resisting—Type AF



Plain



Braided

Recommended for wiring lighting fixtures, radio apparatus and as small motor leads. Suitable for operating temperatures up to 150° C (302° F). Standard colors, plain type—black or white. Braided type—brown, old brass, or black with or without tracer in cotton or rayon.

Cond. Size AWG	No. and Size of Strands In.	Felted Asbestos Wall In.	Nom. Overall Diam. In.	Approx. Net Wt. Lbs. Per M. Ft.	Std. Pkg. Ft. In Spool
Plain (No Braid)					
18	16 x 30	.031	.113	11	500
16	26 x 30	.031	.127	15	500
14	41 x 30	.031	.144	21	500
12	65 x 30	.047	.199	36	†500
10	104 x 30	.047	.225	51	†500
18	Solid	.031	.113	11	500
16	Solid	.031	.127	15	500
14	Solid	.031	.144	21	500
12	Solid	.047	.199	35	†500
10	Solid	.047	.225	51	†500
Glazed Cotton					
18	16 x 30	.031	.143	13	500
16	26 x 30	.031	.157	17	500
14	41 x 30	.031	.174	23	500
12	65 x 30	.047	.229	39	†500
10	104 x 30	.047	.255	54	†500
18	Solid	.031	.143	13	500
16	Solid	.031	.157	17	500
14	Solid	.031	.174	23	500
12	Solid	.047	.229	39	†500
10	Solid	.047	.255	54	†500
Rayon					
18	16 x 30	.031	.128	12	500
16	26 x 30	.031	.142	16	500
14	41 x 30	.031	.159	22	500
12	65 x 30	.047	.214	38	†500
10	104 x 30	.047	.240	53	†500
18	Solid	.031	.128	12	500
16	Solid	.031	.142	16	500
14	Solid	.031	.159	22	500
12	Solid	.047	.214	38	†500
10	Solid	.047	.240	53	†500

†Coils std. pkg.

National Electric Motion Picture Cable

300 Volt—All-Asbestos—Type AA



Rope lay stranded plain copper conductor. .045 in. white asbestos braid which is flame and heat resisting. Subjected to 1.0 kv dielectric test voltage.

Recommended for motion picture projectors, arc lamps, spot lights and industrial applications. Can be operated at temperatures up to 200° C (392° F).

Cond. Size AWG	No. and Size of Strands In.	Thick. of Felted Asbestos In.	Nom. Overall Diam. In.	Approx. Net Wt. Lbs. Per M. Ft.	Feet In Reel
Flexible Strand					
14**	41 x .010	.030	.230	28	†500
12**	65 x .010	.030	.250	40	†500
10**	104 x .010	.030	.270	54	†500
8	133 x .0112	.030	.315	73	†500
6	133 x .0111	.040	.385	106	500
4	133 x .0177	.040	.410	178	500
2	133 x .0224	.040	.510	275	500
1	259 x .0180	.060	.590	338	500
1/0	259 x .0202	.060	.635	391	500
2/0	259 x .0227	.060	.690	485	500
3/0	259 x .0255	.060	.750	588	500
4/0	259 x .0286	.060	.810	732	500

Cond. Size AWG	No. and Size of Strands In.	Thick. of Felted Asbestos In.	Nom. Overall Diam. In.	Approx. Net Wt. Lbs. Per M. Ft.	Feet In Reel
**14	104 x .0063	.030	.230	30	†500
12	259 x .005	.030	.255	40	†500
10	413 x .005	.300	.280	56	†500
8	661 x .005	.030	.315	79	†500
6	1050 x .005	.040	.385	122	500
4	1666 x .005	.040	.450	178	500
2	2646 x .005	.040	.535	276	500
1	3332 x .005	.060	.635	360	500
1/0	4214 x .005	.060	.680	436	500
2/0	5292 x .005	.060	.760	533	500
3/0	6713 x .005	.060	.810	652	500
4/0	8464 x .005	.060	.885	802	500

**Bunched Strands.

†Feet in coil.

National Electric Power Cables

**"Nepco-Sil" Silicone Rubber Insulated
0 to 1000 Volts**

Maximum Operating Temperature—125° C (257° F)

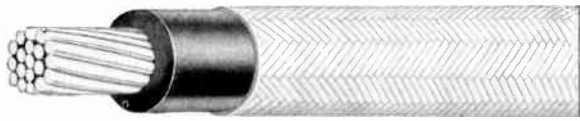

Stranded tinned copper conductor, Silicone rubber insulation, and white glass (silicone impregnated) braid.

AWG Size	Strands No.	Size In.	Insulation Thickness 64th-In.	Nominal Over-all Diam., In.	Approx. Wt. Lbs. Per M-Ft.	Current Carrying Capacity*
0 - 600 Volts						
14	7	.0242	3	.246	42	27
12	7	.0305	3	.265	53	35
10	7	.0385	3	.289	68	48
8	7	.0486	4	.350	102	62
6	7	.0612	4	.388	139	82
4	7	.0772	4	.437	197	110
2	7	.0974	4	.498	284	146
1	19	.0664	5	.568	363	166
1 0	19	.0715	5	.608	439	192
2 0	19	.0837	5	.654	534	249
3 0	19	.0910	5	.706	653	252
4 0	19	.1055	5	.764	802	293

AWG Size	Strands No.	Size In.	Insulation Thickness 64th-In.	Nominal Over-all Diam., In.	Approx. Wt. Lbs. Per M-Ft.	Current Carrying Capacity*
601 to 1000 Volts						
14	7	.0242	4	.277	50	27
12	7	.0305	4	.296	61	35
10	7	.0385	4	.320	77	48
8	7	.0486	4	.350	102	62
6	7	.0612	5	.419	151	82
4	7	.0772	5	.468	210	110
2	7	.0974	5	.529	293	146
1	19	.0664	6	.600	380	166
1 0	19	.0715	6	.640	456	192
2 0	19	.0837	6	.686	551	249
3 0	19	.0910	6	.738	674	252
4 0	19	.1055	6	.796	825	293

*Based on 3 cables in conduit 40° C ambient. Ratings determined by IPCFA methods.

Note: Also available with two glass braids or an asbestos braid covering, also with multi-conductors.

National Electric Control Cables

**"Nepco-Sil" Silicone Rubber Insulated
600 Volts**

Maximum Operating Temperature—125° C (257° F)

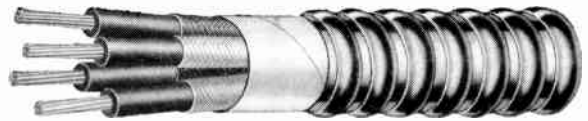

Flexible tinned copper conductor. Silicone rubber insulation. Color coded glass braid. Asbestos tape. All encased in a galvanized steel interlocked armor sheath.

Single Conductor

AWG Size	Strands No.	Size In.	Insulation Thickness 64th-In.	Thickness Glass Braid In.	Nominal Diameter In.
12	19	.018	3	.007	.202
9	19	.025	3	.007	.236

Cabled Conductors

No. of Cond.	Nominal Over-all Diam., In.	Approx. St. Lbs. Per M Ft.	No. of Cond.	Nominal Over-all Diam., In.	Approx. Wt. Lbs. Per M Ft.
No. 12 AWG			No. 9 AWG		
2	.59	265	2	.72	440
3	.68	411	3	.76	519
4	.73	473	4	.81	611
5	.79	535	5	.89	709
6	.85	600	6	.95	777
7	.85	634	7	.95	811
8	.91	700	8	1.03	932
9	.98	767	9	1.10	1026
10	1.05	842	10	1.19	1070
11	1.05	888	11	1.19	1125
12	1.08	946	12	1.22	1266
13	1.14	979	13	1.29	1353
14	1.14	1012	14	1.29	1409
15	1.20	1081	15	1.36	1505
16	1.20	1117	16	1.36	1560
17	1.48	1306	17	1.43	1650
18	1.48	1339	18	1.43	1711
19	1.48	1371	19	1.43	1746

Note: Sizes other than those shown can be supplied if the quantity involved warrants special production.

National Electric Station Control Cables

Type RR—Rubber Insulated—Neoprene Sheathed



For use in control circuits rated at 600 volts and less. Solid conductors can be furnished but flexible conductors are most desirable as they provide for a more flexible, easier to handle assembly, and also provide for greater flexibility on the individual conductors.

Specify National Thermo-Seal rubber insulation if moisture, high temperatures or other critical conditions are to be encountered.

Conductors are cabled round with fibrous fillers where

necessary and bound together with a rubber filled cable tape. Over this assembly is applied National's tough Neoprene sheath. This sheath provides resistance to oil, grease, moisture, heat, flame, acids, alkalis, oxidation, and abrasion to mention a few.

No. 12 AWG, 19 / 25 Tinned Copper Conductors

No. of Cond.	Over-all Sheath Thick. 64th-In.	Insulation Thickness In.	Color Coded Neoprene Cond. Sheath Thickness, In.	Approx. O.D. In.	Approx. Wt. Lbs. Per M Ft.
2	4	3/64	1/64	.550	135
3	4	3/64	1/64	.623	215
4	4	3/64	1/64	.680	270
5	4	3/64	1/64	.756	315
6	4	3/64	1/64	.809	385
7	4	3/64	1/64	.809	415
8	5	3/64	1/64	.906	505
9	5	3/64	1/64	.972	555
10	5	3/64	1/64	1.058	615
11	5	3/64	1/64	1.058	655
12	5	3/64	1/64	1.090	695

Only the most popular sizes are listed here. For a complete range of available sizes contact Graybar.

National Electric Nepcozone Flexlay Cable

**Type RR—5000 Volt—Non-Shielded
For Duct Installation**



Conductors of tinned soft drawn copper complying with ASTM Standard B-33, Class C stranding. Strand shielding of semi-conducting non-metallic tape. Insulation is Nepcozone butyl or oil base compound complying with ASTM Standard D-1352 or D-574 and LPCEA Standard S-19-81 Appendix O or D. Also Federal Spec. J-C-121.

Neoprene sheath complies with ASTM Standard D-752 and IPCEA Standard S-19-81 Appendix K.

AWG Size	Stranding No.	Size In.	Thickness, 64th-In. Insulation	64th-In. Jacket	Approx. O.D. In.	Wt. Lbs. Per M Ft.
Single Conductor						
8 Sol.	1	.128	10	2	.523	179
8	19	.0295	10	2	.511	188
6	19	.0372	10	3	.610	250
4	19	.0169	10	3	.659	311
2	19	.0591	10	3	.720	425
1	37	.0176	10	3	.759	497
1/0	37	.0534	10	3	.811	588
2/0	37	.060	10	3	.858	692
3/0	37	.0673	10	3	.908	821
4/0	37	.0756	10	4	.998	1013
250MCM	61	.064	11	4	1.075	1187
350MCM	61	.0757	11	4	1.181	1533
500MCM	61	.0905	11	4	1.314	2082
750MCM	91	.0908	11	4	1.499	2948
1000MCM	91	.1048	11	4	1.653	3795
Three Conductor						
8 Sol.	1	.1285	10	5	1.201	781
6	19	.0372	10	6	1.384	992
4	19	.0169	10	6	1.488	1321
2	19	.0591	10	6	1.621	1656
1	37	.0176	10	6	1.703	1931
1/0	37	.0545	10	7	1.816	2283
2/0	37	.060	10	7	1.907	2597
3/0	37	.0673	10	7	2.025	3100
4/0	37	.0756	10	7	2.156	3598
250MCM	61	.064	11	8	2.350	4107
350MCM	61	.0757	11	8	2.579	5468

Type RR—5000 Volt—Shielded—All Uses



Same as above but has a strand shielding of semi-conducting non-metallic tape and a shielding of tinned copper tape or braid. Meets all of the above specifications.

AWG Size	Stranding No.	Size In.	Thickness, 64th-In. Insulation	64th-In. Jacket	Approx. O.D. In.	Wt. Lbs. Per M Ft.
Single Conductor						
8	1	.1285	10	4	.686	286
8	19	.0295	10	4	.703	302
6	19	.0372	10	4	.742	352
4	19	.0169	10	4	.790	430
2	19	.0591	10	5	.852	540
1	37	.0176	10	5	.921	644
1/0	37	.0534	10	5	.961	734
2/0	37	.060	10	5	1.007	849
3/0	37	.0673	10	5	1.058	984
4/0	37	.0756	10	5	1.117	1156
250MCM	61	.064	11	5	1.194	1345
350MCM	61	.0757	11	6	1.331	1758
500MCM	61	.0905	11	6	1.473	2319
750MCM	91	.0908	11	6	1.662	3212
1000MCM	91	.1048	11	7	1.846	4139

Type RR—5000 Volt—Shielded—All Uses

AWG Size	Stranding No.	Size In.	Thickness, 64th-In. Insulation	64th-In. Jacket	Approx. O.D. In.	Wt. Lbs. Per M Ft.
Three Conductor						
8 Sol.	1	.1285	10	6	1.348	619
6	19	.0372	10	6	1.494	741
4	19	.0169	10	6	1.60	883
2	19	.0591	10	7	1.762	1131
1	37	.0176	10	7	1.846	1248
1/0	37	.0534	10	7	1.932	1359
2/0	37	.060	10	7	2.031	1573
3/0	37	.0673	10	7	2.112	1731
4/0	37	.0756	10	8	2.289	1979
250MCM	61	.064	11	8	2.466	2341
350MCM	61	.0757	11	8	2.585	2768

**Type RR—14,001 to 15,000 Volts—Shielded
Grounded Neutral**



AWG Size	Stranding No.	Size In.	Thickness, 64th-In. Insulation	64th-In. Jacket	Approx. O.D. In.	Wt. Lbs. Per M Ft.
Single Conductor						
6	19	.0372	19	5	1.054	633
4	19	.0169	19	5	1.102	717
2	19	.0591	19	5	1.164	846
1	37	.0176	19	5	1.202	934
1/0	37	.0534	19	6	1.274	1071
2/0	37	.060	19	6	1.320	1198
3/0	37	.0673	19	6	1.371	1351
4/0	37	.0756	19	6	1.430	1536
250MCM	61	.064	19	6	1.476	1696
350MCM	61	.0757	19	6	1.759	2960
500MCM	61	.0905	19	7	1.943	3677
1000MCM	91	.0908	19	7	2.096	4560
Three Conductor						
6	19	.0372	19	7	2.104	1366
4	19	.0169	19	7	2.207	1464
2	19	.0591	19	8	2.371	1738
1	37	.0176	19	8	2.453	1911
1/0	37	.0534	19	8	2.539	2056
2/0	37	.060	19	8	2.635	2202
3/0	37	.0673	19	8	2.745	2371
4/0	37	.0756	19	8	2.874	2576
250MCM	61	.064	19	8	2.973	2784
350MCM	61	.0757	19	8	3.117	6673

**Type RR—14,001 to 15,000 Volts—Shielded
Ungrounded Neutral**



AWG Size	Stranding No.	Size In.	Thickness, 64th-In. Insulation	64th-In. Jacket	Approx. O.D. In.	Wt. Lbs. Per M Ft.
Single Conductor						
6	19	.0372	27	6	1.336	878
4	19	.0169	27	6	1.384	1015
2	19	.0591	27	6	1.446	1200
1	37	.0176	27	6	1.485	1297
1/0	37	.0534	27	6	1.524	1408
2/0	37	.060	27	6	1.570	1546
3/0	37	.0673	27	6	1.636	1713
4/0	37	.0756	27	6	1.680	1919
250MCM	61	.064	27	7	1.757	2133
350MCM	61	.0757	27	7	1.862	2539
500MCM	61	.0905	27	7	1.996	3161
750MCM	91	.0908	27	7	2.113	4152
1000MCM	91	.1048	27	8	2.375	5159
Three Conductor						
6	19	.0372	27	8	2.672	1884
4	19	.0169	27	8	2.775	2068
2	19	.0591	27	8	2.909	2246
1	37	.0176	27	8	2.985	2385
1/0	37	.0534	27	8	3.076	2615
2/0	37	.060	27	8	3.091	5030

National Electric Nepco-Lok Power Cables

**Type NE-1
Three Conductor**

**5,000 Volt Varnished Cambric Insulated
Neponol-Jacketed Interlocked Armor Cable**



For 0 to 5,000 volt power circuits in industrial plants, sub-stations, and similar installations. The Neponol thermoplastic sheath provides a water-seal making the cable suitable for outdoor installations.

Consists of untinned copper conductors, varnished Cambric tape insulation, color coded tape on each conductor, conductors cabled with jute fillers, cable tape, a Neponol thermoplastic-sheath and single strip interlocked galvanized steel armor. Aluminum or bronze armor can also be furnished.

Size	Strands		Insulation Thickness 64th-In.	Sheath Thickness 64th-In.	Armor Thick. In.	Approx. O.D. In.	Wt. Lbs. Per M Ft.
	No.	Size In.					
8	1	.128	6	6	.110	1.173	1211
6	7	.0612	6	6	.110	1.295	1382
4	7	.0772	6	6	.110	1.399	1648
2	7	.0974	6	6	.110	1.530	2062
1	19	.0664	6	6	.110	1.616	2324
1/0	19	.0745	6	6	.110	1.700	2643
2/0	19	.0837	6	6	.110	1.798	3048
3/0	19	.0940	6	6	.110	1.910	3535
4/0	19	.1055	6	6	.125	2.065	4437
250MCM	37	.0822	7	6	.125	2.233	5140
350MCM	37	.0973	7	6	.125	2.468	6359
500MCM	37	.1162	7	6	.125	2.748	8230

Type NE-2

**15,000 Volt Varnished Cambric Insulated, Shielded
Neponol-Jacketed, Interlocked Armor Cable**



For 15,000 volt grounded neutral service for industrial and other power applications. Shielded to provide the protection necessary at such voltages. The Neponol thermoplastic sheath serves as an adequate water seal which is recommended for installation in outdoor or damp locations.

Constructed with untinned copper conductors, varnished Cambric tape insulation, rubber filled tape on each conductor, tinned copper shielding tape, jute fillers, tinned copper shielding binder tape, Neponol thermoplastic-sheath, and a single strip interlocked galvanized steel armor. Aluminum or bronze armor can be furnished.

6	7	.0612	16	6	.110	1.968	2704
4	7	.0772	16	6	.125	2.093	3319
2	7	.0974	16	6	.125	2.244	3887
1	19	.0664	16	6	.125	2.348	4182
1/0	19	.0745	16	6	.125	2.004	4520
2/0	19	.0837	16	6	.125	2.503	4935
3/0	19	.0940	16	6	.125	2.613	5617
4/0	19	.1055	16	6	.125	2.724	6198
250MCM	37	.0822	16	6	.125	2.841	6779

*Can also be furnished in 1, 2, or 4 conductor cables.

National Electric Nepco-Lok Power Cables

**Type NE-3
*Three Conductor**

**600 Volt Varnished Cambric Insulation
Braided, Interlocked Armored Cable**



The most economical cable of the Nepco-lok line. Designed for 600 volt maximum service in indoor and dry locations. Does not have the overall protection of a Neponol jacket and is not recommended for outdoor or installation in damp locations.

Constructed with untinned copper conductors, varnished Cambric tape insulation, color coded cotton braid or rubber filled tape on each conductor, cabled conductors are covered with asphalt impregnated fibertex tapes, all encased in a single strip interlocked galvanized steel armor. Aluminum or bronze can also be furnished.

Size	Strands		Insulation Thickness 64th-In.	Armor Thick. In.	Approx. O.O. In.	Wt. Lbs. Per M Ft.
	No.	Size				
8	1	.128	3	.110	.828	618
6	7	.0612	4	.110	1.017	861
4	7	.0772	4	.110	1.134	1081
2	7	.0974	4	.110	1.260	1423
1	19	.0664	5	.110	1.415	1738
1/0	19	.0745	5	.110	1.500	1986
2/0	19	.0837	5	.110	1.595	2349
3/0	19	.0940	5	.110	1.710	2768
4/0	19	.1055	5	.110	1.835	3285
250MCM	37	.0822	6	.110	2.000	3833
350MCM	37	.0973	6	.125	2.280	5322
500MCM	37	.1162	6	.125	2.633	6967

National Electric Silicone Lead Cable

"Nepco-Sil" Silicone Rubber Insulated



Flexible tinned copper conductor. Silicone rubber insulation. White glass (silicone impregnated) braid.

600 Volt. Maximum operating temperature—200°C (392°F).

18	16	.010	2	.123	10
16	26	.010	2	.136	14
14	41	.010	3	.182	25
12	65	.010	3	.200	34
10	104	.010	3	.224	49
8	133	.011	4	.307	82
6	133	.014	4	.350	114
4	133	.0177	4	.406	171
2	133	.0223	4	.475	243
1	259	.0180	5	.519	334
1/0	259	.0202	5	.595	411
2/0	259	.0227	5	.648	505
3/0	259	.0255	5	.707	625
4/0	259	.0286	5	.772	772

Note: Other strandings available if sufficient quantity warrants special production. Also available with 2 glass braids.

National Electric Canvas-Back Loom Wire

Listed by Underwriters' Laboratories, Inc.

Non-Metallic Sheathed—Frosty-Finish



For all types of wiring conditions in homes and farm buildings. Maximum moisture resistance. Clean stripping; free from tackiness. Pulls from the carton freely in temperatures as high as 125°F.—does not stick to your hands.

With Type TW Conductors

Size	Approx. Feet Per Coil	Without Ground Wire Weight, Lbs. Per 1000 Ft.	With Ground Wire Weight, Lbs. Per 1000 Ft.
14/2	250	74	82
12/2	250	92	104
10/2	250	129	149
8/2	125	176	196
<hr/>			
6/2	125	268	300
4/2	125	372	422
14/3	250	104	112
12/3	250	131	144
<hr/>			
10/3	250	190	210
8/3	125	273	293
6/3	125	416	448
4/3	125	599	699

Canvas-Back Loom Wire Fittings

Clips



No. 9000

For open wiring of 14/2 and 12/2 cable.

No.	Unit Pkg.	Std. Pkg. Wt. Lbs.	Std. Pkg. Wt. Lbs.	Unit Pkg. Per 100
9000	50	500	10 1/2	\$2.65

Straps



No. 9011

For concealed wiring. Packed 50 to a unit package; 1000 to a standard package.

No.	For Wire Sizes	Std. Pkg. Wt. Lbs.	Unit Pkg. Per 100
9011	14/2, 12/2	7	\$0.80
9012	14/3, 12/3	7 3/4	.80

Connectors



No. 9050-EZ

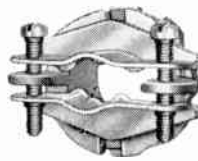

No. 708-N

No.	Description	Unit Pkg.	Std. Pkg.	Wt. Lbs. Per 1000	Unit Pkg. Per 100
9050-EZ	For 14/2, 12/2, 14/3 and 12/3 Wire.....	..	1000	68	\$ 8.50
708-N	For 14/4, 14/3, 12/4, 12/3, 10/4, 10/3 & 8/2 Cable: Fits 3/4-in. KO.....	25	100	†18 1/4	25.00
709-N	For 8/4, 8/3, 6/3, 6/2 and 4/2 Cable: Fits 1-in. KO.....	10	20	†5	35.75

†Weight per 100.

Quantity prices on request.

National Electric Underground Service Entrance Cable

Listed by Underwriters' Laboratories, Inc.

Type USE—Style RR—Flexlay



Has unlimited application in the residential, commercial and industrial wiring field.

Can be buried directly in earth, installed in ducts or conduit, or in the open air for wet or dry conditions.

Ideally suited where both underground and overhead installations are required on the same line.

Neoprene sheath affords protection against the destructive forces encountered below the earth's surface and also gives outstanding protection when exposed to the sun and the weather.

Single Conductor—Solid

Size A.W.G. or MCM	Insulation Thickness	64th Inch Sheath	Approx. O. D. In.	Approx. Net Wt. Per M-Foot
*14	3	3	.255	42
12	3	3	.272	53
10	3	3	.293	68
8	4	3	.354	103

Single Conductor—Stranded

Size	Insulation Thickness	64th Inch Sheath	Approx. O. D. In.	Approx. Net Wt. Per M-Foot
8	4	3	.374	109
6	4	3	.412	148
4	4	3	.461	206
2	4	3	.523	297
<hr/>				
1	5	4	.648	406
1/0	5	4	.688	484
2/0	5	4	.735	583
3/0	5	4	.785	704
4/0	5	4	.848	859
<hr/>				
250	6	5	.954	1059
300	6	5	1.009	1229
350	6	5	1.060	1395
500	6	5	1.193	1910
750	7	5	1.433	2834

2-Conductor (Flat)—Solid

Size	Insulation Thickness	64th Inch Sheath	Approx. O. D. In.	Approx. Net Wt. Per M-Foot
*14	3	3	.280x .466	88
12	3	3	.297x .500	118
10	3	3	.319x .573	156
8	4	4	.415x .705	235

2-Conductor (Flat)—Stranded

Size	Insulation Thickness	64th Inch Sheath	Approx. O. D. In.	Approx. Net Wt. Per M-Foot
6	4	4	.498x .846	340

3-Conductor—Solid

Size	Insulation Thickness	64th Inch Sheath	Approx. O. D. In.	Approx. Net Wt. Per M-Foot
*14	3	4	.550	156
12	3	4	.587	188
10	3	4	.632	254
8	4	4	.774	355

3-Conductor—Stranded

Size	Insulation Thickness	64th Inch Sheath	Approx. O. D. In.	Approx. Net Wt. Per M-Foot
6	4	5	.929	548
4	4	5	1.024	746
2	4	5	1.155	1056
1	5	6	1.340	1362
<hr/>				
1/0	5	6	1.426	1615
2/0	5	6	1.527	1945
3/0	5	6	1.635	2364
4/0	5	7	1.792	2859

*For use between buildings only.

National Electric Ovalflex Flat A.B.C. Armored Bushed Cable

Listed by Underwriters' Laboratories, Inc.



Size B&S Gage	No. of Bushings to Bag Per Std. Coil	Feet Per Coil	Wt. Lbs. Per 1000 Ft.
14/2	35	250	272
12/2	35	250	296
10/2	20	125	345
14/3	20	125	344
12/3	20	125	376

For Open or Concealed Surface Wiring

Flat shape permits laying directly on walls or ceilings of tile, concrete or brick.

When necessary, Ovalflex may be covered with an ordinary thickness of plaster.

Bends easily, edgewise or flatwise, for snug fitting into corners around machinery, beams or offsets.

Furnished with anti-short bushings for dependable, safe bushing of cut ends of cable.

Regularly supplied with N.E.C. insulation and solid conductors; other insulation types and stranded conductors upon specification.

Fittings for Ovalflex Flat A.B.C. Armored Bushed Cable

Connectors

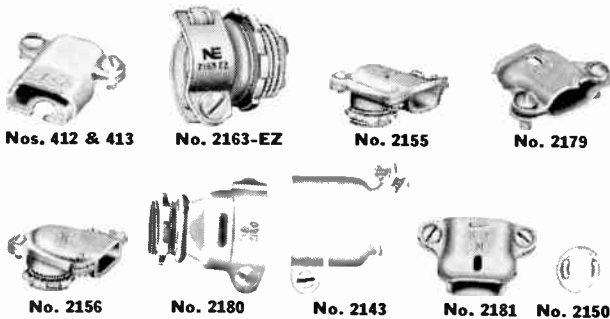

No.	Description	Std. Pkg.	Unit Pkg. Per 100
412	For 14/2, 12/2 and 12/2 Ovalflex to Metal Molding Devices	100	\$17.50
413	For 14/3 and 12/3 Ovalflex to Metal Molding Devices	100	16.90
2143	Pitcher Lip Type; For 14/3 Ovalflex or Ovalduct to Oval K.O.'s	100	25.25
2155	90° Box Connector with removable back. Takes 14/2 and 12/2 Ovalflex into 1/2-in. Conduit K. O.	100	61.50
2156	90° Box Connector. Takes 14/3, 10/3 and 10/2 Ovalflex or Ovalduct into Conduit or 1/2-in. K.O.	100	62.75
2163-EZ	For 14/2 and 12/2 Ovalflex	1000	10.40
2179	For 14/2, 12/2 and 10/2 Ovalflex into Oval K.O.'s	100	18.70
2181	For 14/3 and 12/3 Ovalflex and Ovalduct	100	20.00
2150	Adapter Bushing for use with Nos. 2179 and 2181 Connectors in 1/2-in. Conduit K.O.'s	1000	1.50
2180	Box Connector with 1/2-in. Bondnut. Takes Ovalduct or 14/3 and 12/3 Ovalflex into Conduit or 1/2-in. K.O.'s	100	27.30

Straps and Fasteners



No.	Description	Std. Pkg.	Unit Pkg. Per 100
2157	Special Folding Strap; one Screw Type. For 14/2, 12/2 and 10/2 Ovalflex	1000	1.55
2159	Wire Toggle Fastener with Wire Loop for Supporting Ovalflex on Hollow Tile, Plaster Board, Wire Lath, etc.	500	4.40
2160	Strap Fastener. For 14/2 and 12/2 Ovalflex	1000	1.10
2161	Strap Fastener. For 14/3 and 12/3 Ovalflex and Ovalduct	1000	1.10

Extension Box Covers

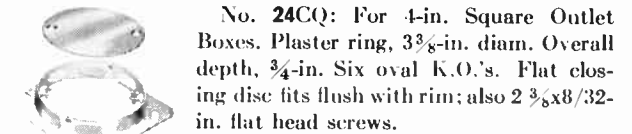

No. 24CQ: For 4-in. Square Outlet Boxes. Plaster ring, 3 3/8-in. diam. Overall depth, 3/4-in. Six oval K.O.'s. Flat closing disc fits flush with rim; also 2 3/8x8/32-in. flat head screws.

Standard package, 50.

No. 24CQ..... Unit Pkg. per 100 \$99.75

No. 26CQ: For 4-in. Octagon Outlet Boxes. Plaster ring, 4-in. diam. Overall depth, 3/4-in. Six oval K.O.'s. Flat closing disc fits flush with rim. For connecting Ovalduct in boxes buried in walls and ceilings. 2 3/8x8/32-in. flat head screws.

Standard package, 50.

No. 26CQ..... Unit Pkg. per 100 \$99.75

Outlet Boxes and Extension Rings



No.	Description	Std. Pkg.	Unit Pkg. Per 100
2862	Outlet Box 3 1/4 x 3 1/4-in. Outside; Four Oval K.O.'s in Side; One 1/2-in. Conduit K. O. in Bottom	50	\$37.40
2865	Outlet Box. Same as No. 2862 with Addition of 3/8-in. Fixture Stud	50	51.55
2662	Outlet Box 4 x 3 1/4-in. Outside; Six Oval K.O.'s in Side; Five 1/2-in. Conduit K.O.'s in Bottom	50	37.75
2665	Outlet Box. Same as No. 2662 with Addition of 3/8-in. Fixture Stud	50	50.00
2663	Extension or Plaster Ring; Fits Nos. 2662 and 2665 or any 4-in. Round or Octagonal Box; 4 x 3 1/4-in. Outside; Six Oval K.O.'s in Side	50	38.90

Sectional Switch Box

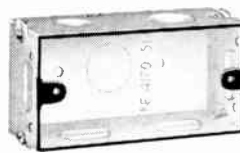

Dimensions: 4x2x1 1/2-in. deep.

Has one oval K.O. each and two oval K.O.'s one side, one 1/2-in. and one 1 1/4-in. K.O. on opposite side.

No.	Description	Std. Pkg.	Unit Pkg. Per 100
4170S1	Sectional Switch Box	50	\$35.60
4172S1	Spacer for No. 4170S1 (Box less Sides)	50	31.60

Quantity prices available on request.

National Electric A.C.T. Armored Bushed Cable

Listed by Underwriters' Laboratories, Inc.



Easily handled, quickly installed metal-clad wiring system. Wires and raceway are installed together; no waste, no threading, no couplings required. With TW thermoplastic conductors.

Installed without special tools.

Single Conductor

Size A.W.G.	Solid Wires			Stranded Wires			
	No. of Bushings Per Std. Coil	Feet Per Coil	WL Lbs. Per M-FL	Size A.W.G.	No. of Bushings Per Std. Coil	Feet Per Coil	WL Lbs. Per M-FL
8	35	250	268
6	35	250	320
2-Conductor							
14	35	250	218	8	20	150	607
12	35	250	252	6	16	100	700
10	35	250	340	4	16	100	850
8	20	150	607	2	16	100	1120
3-Conductor							
14	35	250	252	8	20	150	732
12	35	250	294	6	16	100	850
10	35	250	416	4	16	100	1150
8	20	150	720	2	16	100	1450
4-Conductor							
14	35	250	288	8	16	100	950
12	35	250	343	6	16	100	1050
10	20	150	600	4	16	100	1430

National Electric Armored Leaded Cable

2-Conductor — Rubber Insulated

Size A.W.G.	Solid Wires			Stranded Wires		
	Feet Per Coil	WL Lbs. Per M-FL	Size A.W.G.	Feet Per Coil	WL Lbs. Per M-FL	
14	150	380	8	100	1020	
12	150	427	6	100	1240	
10	100	670	
3-Conductor						
14	150	466	8	100	1360	
12	150	526	6	100	1480	
10	100	810	4	100	2210	

National Electric Bare Armored Ground Wire

Single Conductor—Solid

Size A.W.G.	No. of Bushings Per Std. Coil	Feet Per Coil	WL Lbs. Per 1000-FL
8	..	250	136
6	..	250	168
4	..	250	241

National Electric Anti-Short Bushings



Each coil of cable has sufficient bag of anti-shorts attached for average requirements.

For Use with A.T.C., A.B.C. Cable

No.	A.C.T.	Flexsteel In.	Anti-Short Per Bags
1	14/4, 12/3, 12/4, 10/2, 10/3	3/8	35
2	10/4, 8/2, 8/3	..	20

Prices on application.

Kaiser Grizzly® Power Cables



Rubber-insulated, neoprene-jacketed Grizzly Power Cables are used for general power distribution. May be installed in conduit, underground ducts, or buried directly in the ground. When supported by a suitable messenger they may be installed aerially.

Cables conform to all applicable IPCEA and NEMA specifications. They have conductor shielding for operating voltages above 2,000 and are externally shielded for voltages above 3,000. Either annealed copper or three-quarter hard aluminum is available as the conductor.

Aluminum cables mean less weight and should be considered for use where weight is important, such as for aerial cable.

All insulations used on these constructions are resistant to heat, allowing the conductor to be operated at the maximum temperature permitted for rubber and rubber-like insulation. For cables used in duct installations and for direct burial, the insulations are resistant to both heat and moisture. Laytex insulation is available on the smaller sizes of 600 volt cables, resulting in cables with smaller diameters and less weight than can be obtained with the conventional extruded insulations. Ozone-resistant insulations of the oil base or Butyl type are available for all voltages. Both insulations, especially the Butyl type, show remarkable electrical stability and outstanding resistance to ozone, heat and moisture.

The neoprene jacket used on cables for operation at 2,000 volts and less conforms to A.S.T.M. Specification D-752. The jacket used on cables for operation at higher voltages conforms to this specification and, in addition, possesses ozone resistance which compares favorably with the requirements for oil base insulation.

Kaiser Service Entrance Cables

Aluminum Conductors

Concentric Uninsulated Neutral

Underwriters' Type SE, Style U

Rated for 75° C. Operation



Braided

Consists of two or three conductors, one of which is uninsulated. Conductors are aluminum insulated with RIHW compound and covered with a color coded tape.

In the two conductor cable, the taped conductor is covered with an aluminum conductor in the form of a concentric wrap. Over the uninsulated conductor, a moisture seal is applied and then protected by a moisture resistant, flame-retardant braid with a gray finish.

The three conductor cable is constructed as above with the exception that two taped conductors are laid parallel before application of the concentric. Conductors 8 AWG and larger are stranded.

Neoprene Jacketed

Same as above except the completed construction is covered with a neoprene jacket, rather than braid.

Kaiser Service Entrance Cables

Aluminum Conductors
Concentric Uninsulated Neutral, Braided
Underwriters' Type SE, Style U
Rated for 75°C. Operation

Insulated Conductor AWG Size and Stranding	Uninsulated Conductor AWG Size and Stranding	Insulation Wall 64th In.	Approx. O.D. In.	Amperage Rating	Std. Pkg.
Two Conductors					
6-7	6-26	4	.50	50	250-ft. Coil
4-7	4-26	4	.57	65	200-ft. Coil
2-7	2-26	4	.64	100	200-ft. Coil
Three Conductors					
10-7	10-26	3	.36x .55	25	250-ft. Coil
8-7	8-26	4	.47x .32	40	250-ft. Coil
6-7	6-26	4	.56x .87	50	250-ft. Coil
4-7	4-26	4	.59x .94	65	200-ft. Coil
3-7	3-26	4	.63x1.00	75	200-ft. Coil
2-7	2-26	4	.69x1.08	100	200-ft. Coil
1-19	1-33	5	.78x1.24	110	150-ft. Coil
1/0-19	1/0-33	5	.84x1.35	125	500-ft. Reel
2/0-19	2/0-33	5	.93x1.46	150	500-ft. Reel
3/0-19	3/0-33	5	1.00x1.57	170	500-ft. Reel
4/0-19	4/0-33	5	1.07x1.70	200	500-ft. Reel
Reduced Neutral					
6-7	8-26	4	.51x .82	50	250-ft. Coil
4-7	6-26	4	.57x .92	65	200-ft. Coil
3-7	5-26	4	.62x .98	75	200-ft. Coil
2-7	4-26	4	.67x1.06	100	200-ft. Coil
1/0-19	2-26	5	.77x1.27	125	500-ft. Reel
2/0-19	1-33	5	.81x1.36	150	500-ft. Reel
3/0-19	1/0-33	5	.86x1.46	170	500-ft. Reel
4/0-19	2/0-33	5	.92x1.58	200	500-ft. Reel

Kaiser Service Entrance Cables

Aluminum Conductors
Concentric Uninsulated Neutral, Neoprene Jacketed
Underwriters' Type SE, Style U
Rated for 75°C. Operation

Insulated Conductor AWG Size and Stranding	Uninsulated Conductor AWG Size and Stranding	Insulation Wall 64th In.	Jacket In. 64th In.	Amperage Rating	Approx. O.D. In.	Std. Pkg.
Two Conductors						
6-7	6-26	4	3	50	.49	250-ft. Coil
4-7	4-26	4	4	65	.57	200-ft. Coil
2-7	2-26	4	4	100	.65	200-ft. Coil
Three Conductors						
10-7	10-26	3	3	25	.38x .60	250-ft. Coil
8-7	8-26	4	3	40	.45x .72	250-ft. Coil
6-7	6-26	4	3	50	.49x .80	250-ft. Coil
4-7	4-26	4	4	65	.60x .94	200-ft. Coil
2-7	2-26	4	4	100	.68x1.07	200-ft. Coil
1-19	1-33	5	4	110	.75x1.22	150-ft. Coil
1/0-19	1/0-33	5	4	125	.86x1.36	500-ft. Reel
2/0-19	2/0-33	5	4	150	.92x1.46	500-ft. Reel
3/0-19	3/0-33	5	4	170	.99x1.57	500-ft. Reel
4/0-19	4/0-33	5	5	200	1.10x1.73	500-ft. Reel
Reduced Neutral						
6-7	8-26	4	3	50	.49x .80	250-ft. Coil
4-7	6-26	4	4	65	.57x .93	200-ft. Coil
2-7	4-26	4	4	100	.66x1.06	200-ft. Coil
1-19	3-26	5	4	110	.73x1.21	150-ft. Coil
1/0-19	2-26	5	4	125	.84x1.33	500-ft. Reel
2/0-19	1-33	5	4	150	.90x1.43	500-ft. Reel
3/0-19	1/0-33	5	4	170	.96x1.54	500-ft. Reel
4/0-19	2/0-33	5	5	200	1.07x1.70	500-ft. Reel

Kaiser Service Entrance Cable

Copper Conductors
Concentric Uninsulated Neutral, Without Metal Armor
Underwriters' Type SE, Style U
Rated for 75°C. Operation
Specification 828

Consists of two or three conductors, one of which is uninsulated. Conductors are annealed coated copper insulated with RIHW compound and covered with a color coded tape. In the two conductor cable, the taped conductor is covered with an annealed coated copper conductor in the form of a concentric wrap. Over the uninsulated conductor, a moisture seal is applied and then protected by a moisture resistant, flame-retardant braid with a gray finish. The three conductor cable is constructed as above with the exception that two taped conductors are laid parallel before the application of the concentric. Conductors 8 Awg and larger are stranded.

Insulated Conductor AWG Size and Stranding	Uninsulated Conductor AWG Size and Stranding	Insulation Wall 64th In.	Approx. O.D. In.	Amperage Rating	Std. Pkg.
Two Conductors					
12-1	12-26	3	.32	20	250-ft. Coil
10-1	10-26	3	.35	30	250-ft. Coil
8-7	8-26	4	.42	45	250-ft. Coil
6-7	6-26	4	.50	65	250-ft. Coil
4-7	4-26	4	.57	85	200-ft. Coil
2-7	2-31	4	.64	115	150-ft. Coil
Three Conductors					
12	12-26	3	.33x .51	20	250-ft. Coil
10	10-26	3	.36x .55	30	250-ft. Coil
8-7	8-26	4	.47x .32	45	250-ft. Coil
6-7	8-31	4	.51x .82	65	250-ft. Coil
6-7	6-31	4	.56x .87	65	250-ft. Coil
4-7	6-31	4	.57x .92	85	150-ft. Coil
4-7	4-31	4	.59x .94	85	150-ft. Coil
3-7	5-31	4	.62x .98	100	150-ft. Coil
3-7	3-31	4	.63x1.00	100	150-ft. Coil
2-7	4-31	4	.67x1.06	115	100-ft. Coil
2-7	2-31	4	.69x1.08	115	100-ft. Coil
1-19	1-33	5	.78x1.24	130	1000-ft. Reel
1/0-19	1/0-33	5	.84x1.35	150	1000-ft. Reel

Laytex Insulated
Specification 950—Braided

Consists of two or three stranded conductors, one of which is uninsulated. Conductors are annealed coated copper insulated with type RUH 90% unmilled grainless rubber insulation and covered with a color coded weatherproofed cotton braid. In three conductor cables two insulated conductors, one red and the other black, are laid parallel and covered with a treated paper tape. Over this assembly the uninsulated annealed coated copper conductor is applied in the form of a concentric wrap. Over the uninsulated conductor a moisture seal is applied and the whole assembly is protected by a moisture resistant, flame-retardant braid finished gray. In two conductor cables a single insulated conductor, colored black, is used.

Insulated Conductor AWG Size and Stranding	Uninsulated Conductor AWG Size and Stranding	Thickness Insulation In.	Approx. O.D. In.	Approx. Net Wt. Per M-FL. Lbs.	Std. Pkg.
Two Conductors					
8-7	8-26	.025	.42	160	250-ft. Coil
6-7	6-31	.025	.47	250	250-ft. Coil
Three Conductors					
8-7	8-26	.025	.43x.63	235	250-ft. Coil
6-7	8-31	.025	.48x.72	320	250-ft. Coil
6-7	6-31	.025	.50x.74	350	250-ft. Coil

Specification 952—Neoprene Jacket

Same as above except tape on individual conductors. On the three conductor construction, a paper tape is applied over the neutral (open wrap). On the two conductor construction, the jacket is applied over the concentric.

Laytex Kaiser Master Portable Cords and Cables

The Kaiser Master's rugged, lead-cured jacket of 60% neoprene assures highest protection against sunlight, heat, oil, acid, alkalies, etc. Fine strands of tinned copper are helically wound around a fibrous core for maximum resistance

to flexing, impact, abrasion and cord breakage. Patented Laytex® 90% natural rubber insulation guarantees unbeatable physical, aging and electrical properties.

Laytex Kaiser Master Portable Cords
Fibrous Core Conductors—60% Neoprene Jacket—
Cured in Lead
Type SO—Specification 920
Heavy Duty—600 Volts—60° C.



A 3-mil wall of neoprene laytex over the insulation affords added protection. Insulated conductors are twisted with rayon tire cord fillers, then spirally wrapped with cotton and jacketed with neoprene.

Laytex Kaiser Master Cords conform with all industry practices concerning jacket thickness and over-all diameter. Listed and labeled by Underwriters' Laboratories, Inc. Patent applied for.

AWG Size Stranding	Approx. D.D. in.	Approx. Net Wt. Per M.-Fl. Lbs.	Std. Pkg.	Allowable Capacity Amperes
Type SO—1 Conductor				
18- 41	.18	20	500-ft. Coil	7
16- 65	.19	25	500-ft. Coil	10
14-104	.24	39	250-ft. Coil	15
12-165	.26	50	250-ft. Coil	20
10-104	.28	65	250-ft. Coil	25
Type SO—2 Conductor				
18- 41	.39	75	250-ft. Coil	7
16- 65	.41	86	250-ft. Coil	10
14-104	.53	150	250-ft. Coil	15
12-165	.61	210	250-ft. Coil	20
10-104	.64	260	250-ft. Coil	25
Type SO—3 Conductor				
18- 41	.41	89	250-ft. Coil	7
16- 65	.44	105	250-ft. Coil	10
14-104	.56	180	250-ft. Coil	15
12-165	.64	250	250-ft. Coil	20
10-104	.69	315	250-ft. Coil	25
Type SO—4 Conductor				
18- 41	.44	105	250-ft. Coil	5.6
16- 65	.49	135	250-ft. Coil	8
14-104	.61	215	500-ft. 30-in. Reel	12
12-165	.67	305	500-ft. 30-in. Reel	16
10-104	.75	375	500-ft. 30-in. Reel	20
Type SO—5 Conductor				
18- 41	.48	140	500-ft. 24-in. Reel	5.6
16- 65	.52	170	500-ft. 30-in. Reel	8
14-104	.68	295	500-ft. 30-in. Reel	12
12-165	.75	365	500-ft. 30-in. Reel	16
10-104	.82	480	500-ft. 36-in. Reel	20
Type SO—6 Conductor				
18- 41	.52	160	500-ft. 24-in. Reel	5.6
16- 65	.55	200	500-ft. 24-in. Reel	8
14-104	.73	310	500-ft. 30-in. Reel	12
12-165	.79	420	500-ft. 36-in. Reel	16
10-104	.86	540	500-ft. 36-in. Reel	20
Type SO—7 Conductor				
18- 41	.56	195	500-ft. 30-in. Reel	4.9
16- 65	.59	235	500-ft. 30-in. Reel	7
14-104	.78	390	500-ft. 36-in. Reel	10.5
12-165	.85	485	500-ft. 36-in. Reel	14
10-104	.93	645	500-ft. 36-in. Reel	17.5
Type SO—8 Conductor				
18- 41	.59	210	500-ft. 30-in. Reel	4.9
16- 65	.67	285	500-ft. 30-in. Reel	7
14-104	.84	455	500-ft. 36-in. Reel	10.5
12-165	.91	605	500-ft. 36-in. Reel	14
10-104	1.00	740	500-ft. 36-in. Reel	17.5

Note: Color coding of the seven conductors will have a repetition of Black. The eight conductors will have a repetition of Black and Red. Nine conductors and over will be all black conductors with one conductor of a different color in each layer for identification.

Laytex Kaiser Master Portable Cords
Fibrous Core Conductors—60% Neoprene Jacket—
Cured in Lead
Type SJO—Specification 921
Light Duty—300 Volts—60° C.

AWG Size Stranding	Approx. D.D. in.	Approx. Net Wt. Per M.-Fl. Lbs.	Std. Pkg.	Allowable Capacity Amperes
Type SJO—2 Conductor				
18- 41	.31	48	250-ft. Spool	7
16- 65	.33	59	250-ft. Spool	10
Type SJO—3 Conductor				
18- 41	.34	63	250-ft. Spool	7
16- 65	.36	78	250-ft. Spool	10
Type SJO—4 Conductor				
18- 41	.36	76	250-ft. Coil	5.6
16- 65	.39	97	250-ft. Coil	8

Note: Multi-Conductor SO Cords 14 AWG and larger have approval No. P-103 and sizes 14 through 10.3 and 4-conductor cables, have approval No. P-103BM of Pennsylvania Department of Mines.

Laytex Kaiser Master Portable Cables
600 Volts—2-Conductors Parallel—60° C.
Neoprene Jacketed—Cured in Lead



Designed for service demanding greater current-carrying capacity than permissible with portable cords. Standard constructions are: 2-conductor parallel cable, Types W and G; 2, 3 and 4 conductor round cable, Types W and G.

Sizes 8 through 1 give 600 volt service. Rubber fillers are used in all 3 and 4-conductor round Laytex Kaiser Master Cables. For the 2, 3 and 4-conductor round cables, the neoprene jacket is applied in two layers with an intermediate reinforcing fibrous braid.

Type W—Specification 976

AWG Size	Strand-Ing	Approx. D.D. in.	Approx. Net Wt. Per M.-Fl. Lbs.	Std. Pkg.	Allowable Capacity Amperes
8	132	.51 x .84	335	1000-ft. 36-in. Reel	40
6	132	.56 x .93	410	1000-ft. 36-in. Reel	50
6	258	.56 x .93	410	1000-ft. 36-in. Reel	50
4	132	.61 x 1.05	565	1000-ft. 42-in. Reel	70
4	258	.61 x 1.05	565	1000-ft. 42-in. Reel	70
3	132	.68 x 1.14	690	1000-ft. 42-in. Reel	80
3	258	.68 x 1.14	690	1000-ft. 42-in. Reel	80
2	132	.73 x 1.24	825	1000-ft. 42-in. Reel	95
2	258	.73 x 1.24	825	1000-ft. 42-in. Reel	95
1	132	.81 x 1.40	1040	1000-ft. 48-in. Reel	110
1	258	.81 x 1.40	1040	1000-ft. 48-in. Reel	110
1	426	.81 x 1.40	1040	1000-ft. 48-in. Reel	110

Type G—Specification 977

Insulated Conductors AWG Size	Strand-Ing	Ground Wire Approx. AWG Size	Approx. D.D. in.	Approx. Net Wt. Per M.-Fl. Lbs.	Std. Pkg.	Allowable Capacity Amperes
8	132	8	.51 x .92	365	1000-ft. 36-in. Reel	40
6	132	8	.56 x 1.02	475	1000-ft. 36-in. Reel	50
6	258	8	.56 x 1.02	475	1000-ft. 36-in. Reel	50
4	132	7	.61 x 1.15	640	1000-ft. 36-in. Reel	70
4	258	7	.61 x 1.15	640	1000-ft. 36-in. Reel	70
3	132	6	.68 x 1.26	790	1000-ft. 42-in. Reel	80
3	258	6	.68 x 1.26	790	1000-ft. 42-in. Reel	80
2	132	5	.73 x 1.35	975	1000-ft. 42-in. Reel	95
2	258	5	.73 x 1.35	975	1000-ft. 42-in. Reel	95
1	132	4	.81 x 1.55	1210	1000-ft. 48-in. Reel	110
1	258	4	.81 x 1.55	1210	1000-ft. 48-in. Reel	110
1	426	4	.81 x 1.55	1210	1000-ft. 48-in. Reel	110

Note: Cables approved by Pennsylvania Dept. of Mines.

Laytex Kaiser Master Portable Cables
600 Volts—2 Conductors Round—60° C.
Neoprene Jacketed—Cured in Lead
Type W—Specification 978

AWG Size	Strand- ing	Approx. O.D. In.	Approx. Net WL Per M-FL Lbs.	Std. Pkg.	Allowable Capacity Amperes
8	132	.81	395	1000-ft. 36-in. Reel	40
6	132	.93	550	1000-ft. 42-in. Reel	50
6	258	.93	550	1000-ft. 42-in. Reel	50
4	132	1.05	770	500-ft. 36-in. Reel	70
4	258	1.05	770	500-ft. 36-in. Reel	70
3	132	1.14	925	500-ft. 36-in. Reel	80
3	258	1.14	925	500-ft. 36-in. Reel	80
2	132	1.25	1120	500-ft. 42-in. Reel	95
2	258	1.25	1120	500-ft. 42-in. Reel	95
1	132	1.34	1390	500-ft. 42-in. Reel	110
1	258	1.34	1390	500-ft. 42-in. Reel	110
1	426	1.34	1390	500-ft. 42-in. Reel	110

Type G—Specification 979

AWG Size	Insulated Conductors Strand- ing	Ground Wire* Approx. AWG Size	Approx. O.D. In.	Approx. Net WL Per M-FL Lbs.	Std. Pkg.	Allowable Capacity Amperes
8	132	8 (2x#11)	.81	410	1000-ft. 36-in. Reel	40
6	132	7 (2x#10)	.93	585	1000-ft. 42-in. Reel	50
6	258	7 (2x#10)	.93	585	1000-ft. 42-in. Reel	50
4	132	5 (2x#8)	1.05	855	500-ft. 36-in. Reel	70
4	258	5 (2x#8)	1.05	855	500-ft. 36-in. Reel	70
3	132	4 (2x#7)	1.14	1030	500-ft. 36-in. Reel	80
3	258	4 (2x#7)	1.14	1030	500-ft. 36-in. Reel	80
2	132	3 (2x#6)	1.25	1245	500-ft. 42-in. Reel	95
2	258	3 (2x#6)	1.25	1245	500-ft. 42-in. Reel	95
1	132	2 (2x#5)	1.34	1550	500-ft. 42-in. Reel	110
1	258	2 (2x#5)	1.34	1550	500-ft. 42-in. Reel	110
1	426	2 (2x#5)	1.34	1550	500-ft. 42-in. Reel	110

*The grounding conductor is divided into two equal parts. Together the two parts have the approximate circular mil area of the ground conductor size listed.

Note: Cables approved by Pennsylvania Dept. of Mines.

600 Volts—3 Conductors—60° C.
Neoprene Jacketed—Cured in Lead
Type W—Specification 978

AWG Size	Strand- ing	Approx. O.D. In.	Approx. Net WL Per M-FL Lbs.	Std. Pkg.	Allowable Capacity Amperes
8	132	.86	540	1000-ft. 42-in. Reel	35
6	132	.98	705	1000-ft. 42-in. Reel	50
6	258	.98	705	1000-ft. 42-in. Reel	50
4	132	1.11	1005	500-ft. 36-in. Reel	65
4	258	1.11	1005	500-ft. 36-in. Reel	65
3	132	1.23	1160	500-ft. 42-in. Reel	75
3	258	1.23	1160	500-ft. 42-in. Reel	75
2	132	1.33	1395	500-ft. 42-in. Reel	90
2	258	1.33	1395	500-ft. 42-in. Reel	90
1	132	1.45	1755	500-ft. 48-in. Reel	100
1	258	1.45	1755	500-ft. 48-in. Reel	100
1	426	1.45	1755	500-ft. 48-in. Reel	100

Type G—Specification 979

AWG Size	Insulated Conductors Strand- ing	Ground Wire* Approx. AWG Size	Approx. O.D. In.	Approx. Net WL Per M-FL Lbs.	Std. Pkg.	Allowable Capacity Amperes
8	132	8 (3x#13)	.86	575	1000-ft. 42-in. Reel	35
6	132	8 (3x#12)	.98	755	1000-ft. 42-in. Reel	50
6	258	8 (3x#12)	.98	755	1000-ft. 42-in. Reel	50
4	132	5 (3x#10)	1.11	1070	500-ft. 36-in. Reel	65
4	258	5 (3x#10)	1.11	1070	500-ft. 36-in. Reel	65
3	132	4 (3x#9)	1.23	1240	500-ft. 42-in. Reel	75
3	258	4 (3x#9)	1.23	1240	500-ft. 42-in. Reel	75
2	132	3 (3x#8)	1.33	1500	500-ft. 42-in. Reel	90
2	258	3 (3x#8)	1.33	1500	500-ft. 42-in. Reel	90
1	132	2 (3x#7)	1.45	1915	500-ft. 48-in. Reel	100
1	258	2 (3x#7)	1.45	1915	500-ft. 48-in. Reel	100
1	426	2 (3x#7)	1.45	1915	500-ft. 48-in. Reel	100

*The grounding conductor is divided into three equal parts. Together the three parts have the approximate circular mil area of the ground conductor size listed.

Note: Cables approved by Pennsylvania Dept. of Mines.

Laytex Kaiser Master Portable Cables
600 Volts—4 Conductors—60° C.
Neoprene Jacketed—Cured in Lead
Type W—Specification 978

AWG Size	Strand- ing	Approx. O.D. In.	Approx. Net WL Per M-FL Lbs.	Std. Pkg.	Allowable Capacity Amperes
8	132	.96	665	1000-ft. 42-in. Reel	30
6	132	1.10	875	1000-ft. 42-in. Reel	40
6	258	1.10	875	1000-ft. 42-in. Reel	40
4	132	1.24	1235	500-ft. 42-in. Reel	55
4	258	1.24	1235	500-ft. 42-in. Reel	55
3	132	1.34	1535	500-ft. 42-in. Reel	65
3	258	1.34	1535	500-ft. 42-in. Reel	65
2	132	1.48	1765	500-ft. 42-in. Reel	75
2	258	1.48	1765	500-ft. 42-in. Reel	75
1	132	1.58	2300	500-ft. 48-in. Reel	85
1	258	1.58	2300	500-ft. 48-in. Reel	85
1	426	1.58	2300	500-ft. 48-in. Reel	85

Type G—Specification 979

AWG Size	Insulated Conductors Strand- ing	Ground Wire* Approx. AWG Size	Approx. O.D. In.	Approx. Net WL Per M-FL Lbs.	Std. Pkg.	Allowable Capacity Amperes
8	132	8 (4x#14)	.96	695	1000-ft. 42-in. Reel	30
6	132	7 (4x#13)	1.10	925	1000-ft. 42-in. Reel	40
6	258	7 (4x#13)	1.10	925	1000-ft. 42-in. Reel	40
4	132	5 (4x#11)	1.24	1315	500-ft. 42-in. Reel	55
4	258	5 (4x#11)	1.24	1315	500-ft. 42-in. Reel	55
3	132	4 (4x#10)	1.34	1540	500-ft. 42-in. Reel	65
3	258	4 (4x#10)	1.34	1540	500-ft. 42-in. Reel	65
2	132	3 (4x#9)	1.48	1905	500-ft. 42-in. Reel	75
2	258	3 (4x#9)	1.48	1905	500-ft. 42-in. Reel	75
1	132	2 (4x#8)	1.58	2515	500-ft. 48-in. Reel	85
1	258	2 (4x#8)	1.58	2515	500-ft. 48-in. Reel	85
1	426	2 (4x#8)	1.58	2515	500-ft. 48-in. Reel	85

*The grounding conductor is divided into four equal parts. Together the four parts have the approximate circular mil area of the ground conductor size listed.

Note: Cables approved by Pennsylvania Dept. of Mines.

Kaiser Master Laytex® Resin Utility Control Cables



Composed of 19-strand annealed copper conductors individually insulated with Laytex, an unmilled natural rubber compound protected by a three-mil colored synthetic resin coating, applied by the dip process, and firmly bonded to the insulation. The required number of conductors (2-18) is cabled together with suitable treated fillers, as necessary, and covered with a rubber-filled tape. The core thus formed is covered with a neoprene jacket.

Suitable for 600-volt service on the control circuits of the electrical systems of industrial plants, utility generating stations and similar installations. May be installed in conduits, ducts or trays, as aerial cable on a suitable messenger or buried in the ground. Specification No. 935.

Kaiser Master Laytex® Resin Supervisory Control Cables

Used in systems for the selective control and automatic indication of remotely controlled units, such as in municipal fire alarm, police signal and traffic control applications. Composed of solid annealed coated copper conductors individually insulated with 90% unmilled grainless rubber compound and protected by a three-mil colored synthetic resin coating firmly bonded to the insulation.

Required number of conductors (2 to 20) are cabled together with suitable treated filler, as necessary, and covered with compound-filled tape. Each layer of more than 8 conductors is covered with rubber-filled tape. The core thus formed is covered either with a neoprene jacket, a lead-alloy sheath, a lead sheath with armor or a rubber jacket.

Suitable for 600-volt service. Specification No. 933.

Kaiser Fluted Gold Welding Cable
Extra Flexible 60° C.



An entirely new and superior conception in the design of welding cable. Its rugged fluted jacket of yellow, 60% rubber is molded with fluting to increase ease of handling and over-all flexibility, to aid in dissipation of heat from the conductor. The yellow jacket provides an excellent contrasting color to black where two cables are required on a welding machine. Fluted Gold is easier to see and cooler to handle. Cable is lightweight and flexible, facilitating welding in cramped quarters.

Base of cable made of fine strands of bare copper, which are combined into a rope-stranded conductor and covered with a wrap of high-grade insulating paper tape. Special insulation of 60% rubber is applied over the paper tape. Heavy reinforcing braid is applied over the insulation, and the cable is completed with a rugged jacket of yellow 60% natural rubber, molded and cured in lead to produce a jacket of permanent smoothness and maximum ruggedness.

Designed for use on electrode holders. Available with aluminum conductor. Specification No. 751.

AWG or CM Size	Strand-ing	Approx. O.D. In.	Approx. Net Wt. Per M-Ft. Lbs.	Std. Pkg.	Voltage Drop Per C-Fl. Max. Current	Allowable Capacity Amperes†
6	672	.53	160	1000-ft. 30-in. Reel	3.58	75
4	1071	.59	223	1000-ft. 30-in. Reel	3.18	100
3	1365	.63	269	1000-ft. 36-in. Reel	3.70	150
2	1701	.67	321	1000-ft. 36-in. Reel	3.92	200
1	2156	.71	387	1000-ft. 36-in. Reel	3.88	250
1/0	2695	.76	469	500-ft. 36-in. Reel	3.72	300
2/0	3381	.82	573	500-ft. 36-in. Reel	3.68	375
3/0	4263	.89	710	500-ft. 36-in. Reel	3.51	450
4/0	5341	1.01	917	500-ft. 36-in. Reel	3.41	550
250,000	6384	1.10	1070	500-ft. 36-in. Reel	3.12	600
300,000	7581	1.18	1245	500-ft. 36-in. Reel	2.80	650
350,000	8806	1.25	1424	500-ft. 36-in. Reel	2.47	700
400,000	10101	1.30	1569	500-ft. 42-in. Reel	2.40	775
450,000	11396	1.36	1750	500-ft. 42-in. Reel	2.28	825
500,000	12691	1.45	2024	500-ft. 42-in. Reel	2.24	900

†The above values of allowable current carrying capacity are based on copper temperature of 60° C. and an ambient temperature of 40° C. yielding load factors of approximately 32 percent for No. 2 AWG cable to approximately 23 percent for No. 3/0 AWG cable, and higher for smaller sizes. The sizes of cables generally used range from No. 2 AWG to No. 3/0 AWG. In actual service, the load factor may be much higher than indicated without overheating the cable as ambient temperature will ordinarily be substantially lower than 40° C.

Note: The sizes of cable recommended by the Machine Group of NEMA Electric Welding Section for standard hand-welding equipment based on maximum length of 90 ft., that is, 45 ft. of welding cable and 45 feet of return cable, are as follows: 100 ampere welder—No. 2 cable; 200 ampere welder—No. 2 cable; 300 ampere welder—No. 1/0 cable; 400 ampere welder—No. 2/0 cable; 600 ampere welder—No. 3/0 cable.

Kaiser Master Welding Cable
Extra Flexible 60° C.



Rope-stranded conductor of fine strands of bare copper forms the base of this construction. Conductor is wrapped with a high-grade insulating paper tape and insulated with Performance compound. Heavy reinforcing braid is applied over the insulation, and the assembly is completed with a jacket of 60% neoprene, cured in lead for maximum toughness and continuously embossed for identification.

Designed for use on electrode holders. Its extra-flexible construction increases ease of handling. Available with aluminum conductor. Specification No. 752.

AWG or CM Size	Strand-ing	Approx. O.D. In.	Approx. Net Wt. Per M-Ft. Lbs.	Std. Pkg.	Voltage Drop Per C-Fl. Max. Current	Allowable Capacity Amperes†
6	672	.47	165	1000-ft. 30-in. Reel	3.58	75
4	1071	.53	325	1000-ft. 30-in. Reel	3.18	100
3	1365	.56	280	1000-ft. 30-in. Reel	3.70	150
2	1701	.60	310	1000-ft. 36-in. Reel	3.92	200
1	2156	.64	405	1000-ft. 36-in. Reel	3.88	250
1/0	2695	.69	490	500-ft. 30-in. Reel	3.72	300
2/0	3381	.75	600	500-ft. 30-in. Reel	3.68	375
3/0	4263	.83	740	500-ft. 36-in. Reel	3.51	450
4/0	5341	.96	960	500-ft. 36-in. Reel	3.41	550
250,000	6384	1.01	1100	500-ft. 36-in. Reel	3.12	600
300,000	7581	1.08	1285	500-ft. 36-in. Reel	2.80	650
350,000	8806	1.15	1470	500-ft. 36-in. Reel	2.47	700
400,000	10101	1.21	1650	500-ft. 42-in. Reel	2.40	775
450,000	11396	1.26	1840	500-ft. 42-in. Reel	2.28	825
500,000	12691	1.35	2125	500-ft. 42-in. Reel	2.24	900

Kaiser Intercommunication Cables
Thermoplastic Insulation and Jacket



Cables are made with bare annealed copper conductors insulated with .015-in. of colored thermoplastic compound. Pairs and single conductors as required are cabled and a treated crepe paper tape applied over the conductor assembly. A jacket of brown thermoplastic compound .040-in. thick is applied overall. Finished cable is flameproof throughout. Specification No. 228.

Cable Type No.	Construction	Approx. O.D. In.	Approx. Net Wt. Per M-Ft. Lbs.	Std. Pkg.
I	3 cdrs. #22 Awg	.31	46	1000-ft. 24-in. Reel
II	12 cdrs. #22 Awg	.32	59	1000-ft. 24-in. Reel
III	8 prs. #22 Awg	.52	120	1000-ft. 30-in. Reel
	2 prs. #18 Awg	.52	120	1000-ft. 30-in. Reel
	2 cdrs. #22 Awg	.52	120	1000-ft. 30-in. Reel

Cable Type No.	Construction	Approx. O.D. In.	Approx. Net Wt. Per M-Ft. Lbs.	Std. Pkg.
IV	14 prs. #22 Awg	.56	160	1000-ft. 30-in. Reel
	2 prs. #18 Awg	.56	160	1000-ft. 30-in. Reel
	2 cdrs. #22 Awg	.56	160	1000-ft. 30-in. Reel
V	18 prs. #22 Awg	.66	195	1000-ft. 36-in. Reel
	2 prs. #18 Awg	.66	195	1000-ft. 36-in. Reel
	2 cdrs. #22 Awg	.66	195	1000-ft. 36-in. Reel
VI	26 prs. #22 Awg	.71	215	1000-ft. 36-in. Reel
	2 prs. #18 Awg	.71	245	1000-ft. 36-in. Reel
	2 cdrs. #22 Awg	.71	245	1000-ft. 36-in. Reel
VII	4 prs. #22 Awg	.33	51	1000-ft. 24-in. Reel
VIII	6 prs. #22 Awg	.36	68	1000-ft. 24-in. Reel
IX	11 prs. #22 Awg	.45	110	1000-ft. 30-in. Reel
X	12 prs. #22 Awg	.46	115	1000-ft. 30-in. Reel
XI	16 prs. #22 Awg	.53	150	1000-ft. 30-in. Reel
XII	21 prs. #22 Awg	.59	194	1000-ft. 30-in. Reel
XIII	26 prs. #22 Awg	.63	225	1000-ft. 36-in. Reel
XIV	13 prs. #22 Awg	.51	115	1000-ft. 30-in. Reel
XV	28 prs. #22 Awg	.67	225	1000-ft. 36-in. Reel

Whitney Blake Dynaprene®

Approved by Underwriters' Laboratories, Inc.



Neoprene is a tough synthetic rubber. For all-around service, neoprene compounds provide the most dependable jackets available for flexible cords, because of their exceptionally good resistance to oil, aging, sunlight, chemical vapors and abrasion. Whitney Blakes' Dynaprene neoprene-jacketed cord is recommended where the exposure conditions or application demand a long-wearing, oil-resisting cord. Factories and garages where oil and grease are constant hazards to rubber jacketed cords are localities where neoprene-jacketed cord should be used. Sanders, portable tools, and food mixers which come into contact with oils and cleaning compounds in normal use are just a few of the products which require neoprene-jacketed cord if early replacement is to be avoided.

Construction: Annealed copper conductors stranded for flexibility; wound cotton separator over conductor to protect insulation from corrosive effects of copper; high dielectric strength natural or synthetic rubber insulation, color-coded for polarity; fillers for roundness and strength; textile covering for firmness and reinforcement; tough, abrasion, oil and flame-resistant, tire-tread type neoprene jacket — for rugged performance.

Type SO 600 Volts

No.	Size A.W.G.	No. and Size of Strands	Current Carrying Capacity Amperes	Approx. O.D. In.	Approx. Wt. Per 1000 Ft. Pounds
Single Conductor					
5360	18	41x#34	7	.188	26
5361	16	65x#34	10	.201	31
5362	14	41x#30	15	.250	50
5363	12	65x#30	20	.270	60
5364	10	105x#30	25	.297	79
Two Conductor					
5720	18	41x#34	7	.390	87
5723	16	65x#34	10	.405	100
5726	14	41x#30	15	.530	163
5729	12	65x#30	20	.605	213
5732	10	105x#30	25	.640	258
Three Conductor					
5721	18	41x#34	7	.405	100
5724	16	65x#34	10	.430	123
5727	14	41x#30	15	.560	203
5730	12	65x#30	20	.635	266
5733	10	105x#30	25	.690	350
Four Conductor					
5722	18	41x#34	5.6	.435	119
5725	16	65x#34	8	.485	158
5728	14	41x#30	12	.605	249
5731	12	65x#30	16	.678	321
5734	10	105x#30	20	.745	461

Type SJO—300 Volts

No.	Size A.W.G.	No. and Size of Strands	Current Carrying Capacity Amperes	Approx. O.D. In.	Approx. Wt. Per 1000 Ft. Pounds
Two Conductor					
5340	18	41x#34	7	.300	52
5344	16	65x#34	10	.330	67
Three Conductor					
5341	18	41x#34	7	.330	70
5345	16	65x#34	10	.360	91
Four Conductor					
5342	18	41x#34	5.6	.360	85
5346	16	65x#34	8	.390	109

Type SV—Neoprene—300 Volts

No.	Size A.W.G.	No. and Size of Strands	Current Carrying Capacity Amperes	Approx. O.D. In.	Approx. Wt. Per 1000 Ft. Pounds
Two Conductor					
5350	18	41x#34	7	.250	42

Prices on application.

Whitney Blake Rubber Jacketed Portable Cords

Approved by Underwriters' Laboratories, Inc.



Natural or synthetic rubber, Buna type, provides a sturdy jacket for cords which are not used in greasy, oily locations or where they might be exposed to chemical fumes. Whitney Blake rubber-jacketed cords are of the finest quality, the jacket being carefully compounded for abrasion resistance and tear resistance.

Construction: Annealed copper conductor stranded for flexibility; separator over conductor to protect insulation from corrosive effects of copper; high dielectric strength natural or synthetic rubber insulation; fillers for roundness and strength; textile covering for firmness and reinforcement; tough, durable natural or synthetic rubber jacket for rugged performance.

Type S—600 Volts

No.	Size A.W.G.	No. and Size of Strands	Current Carrying Capacity Amperes	Approx. O.D. In.	Approx. Wt. Per 1000 Ft. Pounds
Two Conductor					
5700	18	41x#34	7	.390	76
5703	16	65x#34	10	.405	92
5706	14	41x#30	15	.530	153
5708	12	65x#30	20	.605	192
5710	10	105x#30	25	.640	237
Three Conductor					
5701	18	41x#34	7	.405	92
5704	16	65x#34	10	.430	110
5707	14	41x#30	15	.560	190
5709	12	65x#30	20	.635	246
5712	10	105x#30	25	.690	350
Four Conductor					
5702	18	41x#34	5.6	.435	109
5705	16	65x#34	8	.485	149
5713	14	41x#30	12	.605	235
5711	12	65x#30	16	.678	300
5714	10	105x#30	20	.745	465

Type SJ—300 Volts (Stationary Service)

No.	Size A.W.G.	No. and Size of Strands	Current Carrying Capacity Amperes	Approx. O.D. In.	Approx. Wt. Per 1000 Ft. Pounds
Two Conductor					
5333	18	16x#30	7	.300	49
5322	16	26x#30	10	.330	61
*5336	14	41x#30	15	.365	85
Three Conductor					
5334	18	16x#30	7	.330	69
5323	16	26x#30	10	.360	76
*5337	14	41x#30	15	.390	109

*Not listed by Underwriters' Laboratories.

Type SV—300 Volts

No.	Size A.W.G.	No. and Size of Strands	Current Carrying Capacity Amperes	Approx. O.D. In.	Approx. Wt. Per 1000 Ft. Pounds
Two Conductor					
5300	18	41x#34	7	.250	40

Prices on application.

Whitney Blake Tru-Rip Cords

Approved by Underwriters' Laboratories, Inc.



Construction: Annealed #34 bare copper conductors stranded for flexibility. Plastite integral insulation and jacket applied over parallel conductors; ridges on one edge of cord provide polarity identification.

Type SPT-1 (Formerly POT-64) 300 Volts

No.	Color	Size A.W.G.	No. and Size of Strands	Insul. Thick. 64th In.	Current Carrying Capacity Amperes	Approx. O.D. In.	Wt. Per 1000 Ft. Gross Lbs.
5210	Black	18	41x#34	2	7	.115x.215	25
5211	Brown	18	41x#34	2	7	.115x.215	25
5212	Ivory	18	41x#34	2	7	.115x.215	25

Type SPT-2 (Formerly POT-32) 300 Volts

5213	Black	18	41x#34	3	7	.148x.273	33
5214	Brown	18	41x#34	3	7	.148x.273	33
5215	Ivory	18	41x#34	3	7	.148x.273	33



Approved by Underwriters' Laboratories, Inc.

Construction: Annealed No. 34 bare copper conductors stranded for flexibility; separator to protect rubber from copper; tough natural or synthetic rubber integral insulation and jacket with two ridged tracers on one edge of cord to provide conductor identification.

Type SP-1 (Formerly POSJ-64) 300 Volts

No.	Color	Size A.W.G.	No. and Size of Strands	Insul. Thick. 64th In.	Current Carrying Capacity Amperes	Approx. O.D. In.	Wt. Per 1000 Ft. Gross Lbs.
5370	Black	18	41x#34	2	7	.119x.219	26
5371	Brown	18	41x#34	2	7	.119x.219	26
5372	Ivory	18	41x#34	2	7	.119x.219	26

Type SP-2 (Formerly POSJ-32) 300 Volts

5373	Black	18	41x#34	3	7	.150x.280	35
5374	Brown	18	41x#34	3	7	.150x.280	35
5375	Ivory	18	41x#34	3	7	.150x.280	35
5365	Black	16	65x#34	3	10	.160x.300	43
5366	Brown	16	65x#34	3	10	.160x.300	43

Whitney Blake Lamp Cords

Approved by Underwriters' Laboratories, Inc.



Construction: Annealed No. 30 bare copper conductors covered with protective separator, natural or synthetic rubber insulation; soft cotton braid with colored tracers indicating polarity; braided legs twisted together.

Type C—300 Volts

No.	Size A.W.G.	Outer Covering	No. and Size of Strands	Current Carrying Capacity Amperes	Max. Rating Volts	Approx. Wt. 1000 Ft. Gross Lbs.
Green and Yellow Braid—2 Conductor						
6360	18	Soft Cotton	16x#30	5	300	31
6350	16	Soft Cotton	26x#30	7	300	39
6340	14	Soft Cotton	41x#30	15	600	65

Prices on application.

Whitney Blake Heater Cords

Approved by Underwriters' Laboratories, Inc.



Construction: Annealed copper conductors stranded for flexibility; special cotton wrap; natural or synthetic rubber insulation; asbestos roving applied and conductors twisted together; cotton wind over twist; tough natural or synthetic rubber jacket.

Type HSJ—300 Volts

No.	Size A.W.G.	Outer Covering Jacket	No. and Size of Strands	Current Carrying Capacity Amperes	Approx. O.D. In.	Approx. Wt. 1000 Ft. Gross Lbs.
5507	18	Rubber	41x#34	10	.285	43
5508	16	Rubber	65x#34	15	.295	55



Approved by Underwriters' Laboratories, Inc.

Construction: Flexible annealed copper conductors; special cotton wrap to increase flex resistance; natural or synthetic rubber insulation; asbestos roving applied and conductors twisted together; overall braid of soft cotton, glazed cotton.

Type HPD—300 Volts

No.	Size A.W.G.	Outer Covering Jacket	No. and Size of Strands	Current Carrying Capacity Amperes	Approx. O.D. In.	Approx. Wt. 1000 Ft. Gross Lbs.
5509	18	Soft Cotton	41x#34	10	.280	33
5500	18	Glazed Cotton	41x#34	10	.280	33
5510	16	Soft Cotton	65x#34	15	.300	42
5502	16	Glazed Cotton	65x#34	15	.300	42
5511	14	Soft Cotton	104x#34	20	.345	58
5504	14	Glazed Cotton	104x#34	20	.345	58

Prices on application.

Whitney Blake Teleprene®

Neoprene Jacketed Outside Telephone Wires

TELEPRENE telephone wires are designed to give long, dependable service. Conductors have Teleplate coating—lead to resist corrosion with an electroplated brass coating over the lead to provide enduring adhesion of the insulation to the conductor. Teleplate coating meets the Ammonium Persulphate Test for continuity of coating, in accordance with A.S.T.M. Spec. B-189. Insulation is high quality Buna rubber selected for its long life and excellent electrical characteristics. Jacket is a tire-tread type neoprene compound which provides excellent resistance to sunlight, abrasion, oils, acid fumes, alkalis and other corrosive chemicals.

Samples exposed to natural weathering for twelve years remain substantially unchanged in appearance and tests indicate that many more years of service can be expected;

Whitney Blake Teleprene®

Neoprene Jacketed Outside Telephone Wires

Type designations below indicate the size, conductor material and construction. The initial number indicates gauge size. Numerical suffix indicates number of conductors. When none is used, wire has two conductors. The following symbols are used:

- T Teleprene HC Hard Copper R Reinforced
 B Bronze BC Bridle Copper T Twin Parallel
 CW Copperweld P Parallel

Drop Wire

Used to extend telephone circuits from open wire or distributing cable terminals on poles to subscribers' stations. Furnished in parallel, twin parallel and twisted pair with either signal bronze or Copperweld conductors. Reinforced types have a tough textile wind between the insulation and jacket. Polarity identification is provided by double ridged tracer.

Parallel—Regular and Reinforced Types
 1000 Ft. Coils



No.	Type	Max. Cond. Resis. @ 68° F. Ohms Per M.-Fl.	Min. Cond. Breaking Strength Lbs.	Nominal Overall Dimen. In.	Coil Eye In.	Approx. Wt. Per M.-Fl. Lbs.
567	18TCWP	24.2	200	.170x.286	16	35
*559	18TCWP-R	24.2	200	.190x.296	16	39
552	17TBP	16	170	.175x.296	16	40
*553	17TBP-R	16	170	.195x.306	16	44

*Approved by R.E.A.

Twin Parallel Types
 1500 Ft. Coils

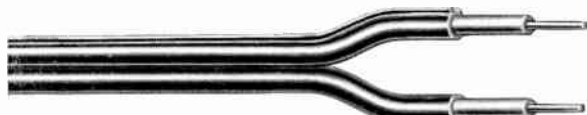

577	18TICWP	24.2	200	.140x.280	16	30
566	17TIBP	16	170	.145x.290	16	34

Twisted Pair Type
 1000 Ft. Coils



565	18TCW2	24.2	200	.150	16	35
550	17TB2	16	170	.155	16	40
561	17TCW2	20	240	.155	16	39
551	17TB2-R	16	170	.175	16	45

All of the above drop wires conform to Section 8021, paragraph C-1 of the 1953 National Electric Code and may be used without insulating hardware under certain conditions as provided in Section 8021, paragraphs C-3 and C-4 of the Code.

Bridle Wire
 500 Ft. Coils



Used in ring wiring and in bridling open wire lines. Double and triple ridge tracers on neoprene jacket identify conductors in twisted pair and triple types.

1TTBC2 similar to 1TTHC2 except it has soft copper conductors. Used for making connections between open wire lines and wire terminals or lightning arrestors and as leads on various types of apparatus.

732	20TBC2	12130	..	25
733	20TBC3	12130	..	38
730	18TBC2	7.5140	..	31
731	18TBC3	7.5140	..	47
*740	14TBC2	2.65220	..	82

*Approved by Rural Electrification Administration.

Whitney Blake Distributing Wire



For use in drops extending the telephone circuit from open wire leads or distributing cable terminals to subscribers' stations. Hard copper conductors with Teleplate coating insulated with high dielectric strength Buna rubber and jacketed with tough, abrasion resistance neoprene.

No.	Type	Max. Cond. Resis. @ 68° F. Ohms Per M.-Fl.	Min. Cond. Breaking Strength Lbs.	Nominal Overall Dimen. In.	Coil Eye In.	Approx. Wt. Per M.-Fl. Lbs.
562	14TTHC1	3	190	.220	16	38
554	14TTHC2	3	190	.220	16	78
576	14TTHC3	3	190	.220	16	116
572	16TTHC1	4.55	125	.185	16	26
556	16TTHC2	4.55	125	.185	16	52
575	16TTHC3	4.55	125	.185	16	78

Whitney Blake Teleseal® Wire



Teleseal was developed for long service in wet locations and for direct burial underground. Its low loss transmission characteristics and stability in wet weather guarantee dependable, trouble-free service even under severe conditions. Teleseal is used extensively by railroads where dependability is essential.

Construction: Hard copper conductor with Teleplate coating of lead to resist corrosion and brass to provide enduring adhesion of the insulation to the conductor. Insulation is specially developed low moisture absorbing compound equivalent in moisture absorption and electrical stability to submarine cable insulation. Jacket is tough weather resistant and abrasion resistant neoprene. It is resistant to sunlight, ozone, and flame. It provides lasting protection against the harmful effects of oils and grease as well as the destructive action of corrosive materials such as acid from cinders.

No.	Type	Max. Cond. Resis. @ 68° F. Ohms Per M.-Fl.	Min. Cond. Breaking Strength Lbs.	Nominal Overall Dimen. In.	Coil Eye In.	Approx. Wt. Per M.-Fl. Lbs.
1351	16TSC2	4.55	125	.203	16	59
1352	14TSC1	3	190	.238	16	41
1350	14TSC2	3	190	.238	16	82
1359	12TSC1	1.75	300	.265	16	56
1358	12TSC2	1.75	300	.265	20	112

Whitney Blake Armored Teleseal®



Designed and built for direct burial without supplementary protection. Available in either polyethylene insulated, polyethylene jacketed or rubber insulated neoprene jacketed. Both constructions are one pair parallel No. 16 Awg. soft copper conductors protected with a served armor of flat steel wires.

Withstands the abrasive action of cinders and certain types of soils and also of moisture and other destructive forces underground. Particularly effective in areas infested with rodents and termites. Shipped on nonreturnable reels.

Standard package 5000 Ft.

No.	Type	Description	Nom. O.D. n.	Approx. Ship. Wt. Lbs. Per M.-Fl.
1370	16TSCP-A	Rubber-Neoprene	.335x.465	119
1650	16PSCP-A	All Polyethylene	.245x.355	72

Whitney Blake Parallel Distribution Wires



Designed for use in rural areas in place of open wire. Its tough jacket protects the conductors from the many conditions that harm open wire. Parallel Distribution Wire is economical because it can be installed with minimum labor, the need for cross arms is eliminated. It may be used to extend runs of rural distribution wire where only one, two or three pairs are required. In locations where atmospheric conditions are detrimental to open wires, such as the sea coast, insulated Parallel Distribution Wire is unaffected.

Construction: Extra high strength 30% conductivity Copperweld conductors. High molecular weight polyethylene insulation and jacket. Ridged one side for polarity identification.

No.	Type	Nom. O.D., In.	Approx. Net WL Lbs. Per M-FL	Approx. Ship. WL Lbs. Per M-FL	FL in Std. Pkg.
210	14CWP	.154x.318	38	45	5000
211	12CWP	.170x.310	49	60	5000
212	.083" SP	.160x.315	51	59	5000

Tree Wire



Used on open wire lines which are near trees to avoid danger of interference in wet weather. 1000 Ft. Coils.

No.	Type	Max. Cond. Resis. @ 68° F. Ohms Per M-FL	Min. Cond. Breaking Strength Pounds	Nom. O.D. In.	Coil Eye In.	Approx. Gr. WL Per M-FL Lbs.
591	12TCW1	4.05	710	.245	20	49

Teleground®



A polyvinyl chloride insulated No. 14 copper wire designed specifically for ground connections from station protector to ground. 500 Ft. Coils.

No.	Type	Max. Cond. Resis. @ 68° F. Ohms Per M-FL	Nom. O.D. In.	Approx. Gr. WL Per M-FL Lbs.
1460	14-1 Ivory	2.65	.130	19
1461	14-1 Brown	2.65	.130	19
*1462	14-1 Black	2.65	.130	19

*Approved by Rural Electrification Administration.

Prices on application.

Microphone Cable Copper Shield



Construction: Tinned soft copper conductors insulated with high quality rubber and shielded with braided tinned copper. Cotton covered with oil resistant neoprene jacket.

No.	Type	Cond. Size A.W.G.	Nom. Capacitance FL *Mutual **Grounded	Nom. O.D. In.	Gr. WL Lbs. Per M-FL
3310	N-18J-1	18 (16/.010")	100	.171	25
3311	N-18J-2	18 (11/.0063")	41 68	.280	55
3312	N-18J2†	18 (11/.0063")	30 50	.355	80
3320	N-20J-2	20 (10/.010")	37 65	.245	42
3322	N-20J-3	20 (10/.010")	35 60	.285	57

*One conductor to other conductors connected to shield.

**Any pair with third leg and shield grounded.

†Modified for heavy duty. Can be used for direct burial.

**Whitney Blake Multi-Pair Distribution Wire
Polyethylene Insulation—Polyvinyl Chloride Covering Over Each Conductor**

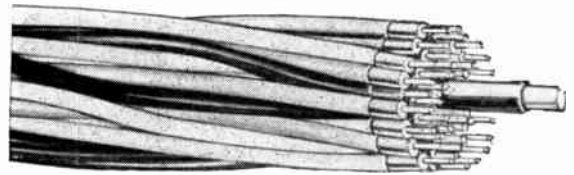

Used primarily for extending service economically in rapidly growing rural and suburban residential areas. Made with high conductivity No. 19 AWG., No. 22 Awg. and No. 24 Awg. annealed copper conductors.

No. 19 Awg. and No. 22 Awg. are made with paired conductors, twisted with varying lays to minimize cross talk, are insulated with high dielectric strength, weather resistant polyethylene. Color coded with polyvinyl chloride plastite jacket. Pairs are cabled around a core of polyethylene-covered 109E galvanized steel.

No. 24 Awg. is made in the same manner as other two sizes except it is insulated with color coded polyvinyl chloride and has an over-all binder. Shipped on nonreturnable reels.

No.	No. Pairs	A.W.G. Con-ductors	Nom. O.D. In.	Approx. Net WL Lbs. Per M-FL	Approx. Ship. WL Lbs. Per M-FL	Feet in Reel
*1296	2	19	.350	66	85	2000
1295	3	19	.450	81	99	2000
*1298	4	19	.500	97	117	2000
*1292	6	19	.500	130	150	2000
1294	11	19	.610	209	257	2000
1293	16	19	.720	273	323	2000
*1602	11	22	.500	135	170	2000
*1603	16	22	.610	180	217	2000
1612	16	24	.525	144	181	2000

*Also available in 4000 ft. reels.

Note: Contact GRAYBAR for color coding.

Whitney Blake Telecable (Inside)



Construction: Solid bare soft copper conductors in No. 21 and No. 22 AWG insulated with tough semi-rigid polyvinyl chloride to a nominal wall of .014 in. Color coded for polarity and pair identification. Pairs are twisted with systematically varied lays to minimize crosstalk. Pairs are cabled without fillers into a round core. Free-stripping jacket is brown or ivory polyvinyl chloride with a nominal wall of .040 in. for all except 51 and 76 pair which have .050 in. nominal wall. Steel rip wire under jacket for easy removal of plastic covering.

No.	A.W.G.	No. Pairs	Nom. O.D. In.	Net WL Lbs. Per M-FL	Approx. Gr. WL Lbs. Per M FL
1001	24	6	.305	50	59
1002	24	11	.370	76	93
1003	24	12	.380	81	98
1004	24	16	.430	105	122
1009	24	21	.480	128	152
1005	24	26	.520	154	183
1008	24	32	.570	183	216
1006	24	51	.710	299	358
1007	24	76	.840	414	482
1026	22	6	.325	61	70
1027	22	11	.400	99	116
1028	22	12	.410	106	123
1029	22	16	.470	136	156
1030	22	26	.570	208	237
1032	22	32	.645	260	308
1031	22	51	.775	414	464

Whitney Blake Telecable® (Outside)
Exchange Area Cable for Aerial and Duct Use



Totally new design using only copper, polyethylene and an aluminum shield. Polyethylene used for conductor insulation because of its low capacitance, high dielectric strength and generally excellent stability. Black polyethylene, properly compounded to withstand sunlight oxidation, is used for the jacket. RFA approved per Specifications PE-14.

Construction: Each conductor is bare annealed copper with a nominal insulation wall of .010 on 24 AWG; .012 on 22 AWG; and .016 on 19 AWG. Its high dielectric strength insures satisfactory operation of cable even if sheath becomes damaged. Up to and including 76 Pair Cable, one pair of each cable has one red leg and one orange leg for use as tracer pair. All other pairs have one red leg and one natural leg.

101 Pair Cable has a center core of 50 pairs, 49 pairs with one leg red and one leg natural and one marker pair with one leg red and one leg orange. Around this core are cabled 51 pairs, 50 pairs with one leg blue, one leg natural and one marker pair with one leg red and one leg orange.

152 Pair Cable has center core of 52 pairs, 51 pairs with one leg red and one leg natural and one marker pair with one leg red and one leg orange. Around this core are cabled 62 pairs, 61 pairs with one leg blue and one leg natural and one marker pair with one leg red and one leg orange. Outside layer has 38 pairs, 37 pairs with one leg red and one leg natural and one marker pair with one leg red and one leg orange.

202 Pair Cable has a center core of 52 pairs, 51 pairs with one leg red and one leg natural and one marker pair with one leg red and one leg orange. Around this core are cabled 62 pairs, 61 pairs with one leg blue and one leg natural, and one marker pair with one leg red and one leg orange. The next layer has 41 pairs, 40 pairs with one leg red and one leg natural, and one marker pair with one leg red and one leg orange. The outside layer has 47 pairs, 46 pairs with one leg blue, one leg natural and one marker pair with one leg red, one leg orange.

303 Pair Cable assembled into 50 and 51 pair units, each having a red-orange pair in the outer layer. Five units—3 with blue-white pairs and 2 with red-natural pairs are cabled around one unit with red-natural pairs. Each unit is provided with an open spiral multiple and textile binder.

No.	Total	No. Pairs Guaranteed	Nom. Wall Jkt. In.	Nom. O.D. In.	Approx. Net Wt. Lbs. Per M-FL	Approx. Ship. Wt. Lbs. Per M-FL	Feet Per Reel
No. 26 AWG Conductor							
1221	11	11	.050	.310	46	57	5000
1222	16	15	.050	.345	59	73	5000
1223	26	25	.050	.410	86	100	5000
1224	51	50	.050	.540	151	179	2500
1225	76	75	.060	.645	220	271	2500
1226	101	100	.060	.735	281	333	2500
1227	152	150	.060	.855	399	467	2500
1228	202	200	.070	.985	526	656	1000
1229	303	300	.080	1.200	809	909	1000
1230	404	400	.080	1.370	1049	1399	1000

No.	Total	No. Pairs Guaranteed	Nom. Wall Jkt. In.	Nom. O.D. In.	Approx. Net Wt. Lbs. Per M-FL	Approx. Ship. Wt. Lbs. Per M-FL	Feet Per Reel
No. 24 AWG Conductor							
1201	11	11	.050	.380	70	87	5000
1202	16	15	.050	.430	91	109	5000
1203	26	25	.050	.515	133	153	5000
1204	51	50	.060	.705	244	284	2500
1205	76	75	.060	.815	312	393	2500
1206	101	100	.070	.945	450	515	2500
1207	152	150	.070	1.110	645	748	2500
1208	202	200	.080	1.295	855	1117	1000
1209	303	300	.090	1.650	1248	1548	1000
1210	404	400	.100	1.850	1405	2070	1000

No.	Total	No. Pairs Guaranteed	Nom. Wall Jkt. In.	Nom. O.D. In.	Approx. Net Wt. Lbs. Per M-FL	Approx. Ship. Wt. Lbs. Per M-FL	Feet Per Reel
No. 22 AWG Conductor							
1231	11	11	.050	.435	97	113	5000
1232	16	15	.050	.500	131	151	5000
1233	26	25	.050	.600	202	235	5000
1234	51	50	.060	.815	364	399	2500
1235	76	75	.070	.995	530	645	2500
1236	101	100	.070	1.125	685	801	2500
1237	152	150	.080	1.365	1005	1237	2500
1238	202	200	.090	1.565	1312	1662	1000
1239	303	300	.110	2.202	2049	2714	1000
1240	404	400	.120	2.220	2885	3550	1000

No.	Total	No. Pairs Guaranteed	Nom. Wall Jkt. In.	Nom. O.D. In.	Approx. Net Wt. Lbs. Per M-FL	Approx. Ship. Wt. Lbs. Per M-FL	Feet Per Reel
No. 19 AWG Conductor							
1261	11	11	.050	.560	161	186	5000
1262	16	15	.060	.660	230	266	5000
1263	26	25	.060	.810	351	407	5000
1264	51	50	.070	1.095	657	751	2500
1265	76	75	.080	1.300	985	1109	2500
1266	101	100	.090	1.520	1307	1462	2500
1267	152	150	.100	1.820	1927	2325	1000
1268	202	200	.110	2.040	2375	2776	1000

Whitney Blake Telecable Exchange Area Cable for Direct Burial



Construction of this cable is similar to Telecable Exchange Area Cable for aerial and duct use with the addition of a double layer of heavy gage aluminum armor applied spirally over the polyethylene belt. A sheath of black weather-resistant polyethylene is applied over the armor.

No.	Total	No. Pairs Guaranteed	Nom. O.D. In.	Approx. Net Wt. Lbs. Per M-FL	Approx. Ship. Wt. Lbs. Per M-FL	Feet Per Reel
No. 24 AWG Conductor						
1211	11	11	.530	138	158	5000
1212	16	15	.580	167	192	5000
1213	26	25	.665	222	254	5000
1214	51	50	.875	375	438	2500
1215	76	75	.985	490	591	2500
1216	101	100	1.135	642	743	2500
1217	152	150	1.300	871	1052	2500
1218	202	200	1.505	1133	1484	1000
1219	303	300	1.880	1647	2198	1000
1220	404	400	2.100	2101	2767	1000

No.	Total	No. Pairs Guaranteed	Nom. O.D. In.	Approx. Net Wt. Lbs. Per M-FL	Approx. Ship. Wt. Lbs. Per M-FL	Feet Per Reel
No. 22 AWG Conductor						
1241	11	11	.585	173	198	5000
1242	16	15	.650	217	249	5000
1243	26	25	.750	303	354	5000
1244	51	50	.985	517	618	2500
1245	76	75	1.185	699	880	2500
1246	101	100	1.315	898	1079	2500
1247	152	150	1.575	1287	1548	2500
1248	202	200	1.795	1655	2206	1000
1249	303	300	2.290	2530	3196	1000
1250	404	400	2.490	3306	4637	500

No.	Total	No. Pairs Guaranteed	Nom. O.D. In.	Approx. Net Wt. Lbs. Per M-FL	Approx. Ship. Wt. Lbs. Per M-FL	Feet Per Reel
No. 19 AWG Conductor						
1271	11	11	.710	260	311	5000
1272	16	15	.830	356	447	5000
1273	26	25	.980	501	592	5000
1274	51	50	1.285	886	1067	2500
1275	76	75	1.510	1240	1453	2500
1276	101	100	1.750	1622	2073	1000
1277	152	150	2.070	2335	3001	1000
1278	202	200	2.310	2982	3648	1000

**Whitney Blake Teleduct®
Inside Telephone Wires**

Teleduct is the family name for Whitney Blake inside telephone wire and without jacket. Plastite and neoprene types are available. Teleduct is used inside buildings for extending circuits from arrestors or other terminating fixtures of outside lines to station sets. 500 Ft. Coils.



Construction: Soft copper conductors insulated with smooth Plastite polyvinyl chloride that has high dielectric strength and is tough, flameproof and highly resistant to abrasion, water, oil, alkali and most solvents. Colored rayon threads permit easy identification for polarity. Standard colors, ivory and brown.

No.	Type	Max. Cond. Resis. @ 68° F. Ohms Per M-FL	Nom. Wall Insul. In.	Nom. O.D. In. Single	Appr. Gr. Wt. Lbs. Per M-FL
*1412	22-2 Br.	17.7	.021	.074	9
*1413	22-2 Iv.	17.7	.021	.074	9
*1414	22-3 Br.	17.7	.021	.074	14
*1415	22-3 Iv.	17.7	.021	.074	14
1420	22-4 Br.	17.7	.021	.074	18
1421	22-4 Iv.	17.7	.021	.074	18
1416	19-2 Br.	9	.025	.086	15
1417	19-2 Iv.	9	.025	.086	15
1418	19-3 Br.	9	.025	.086	23
1419	19-3 Iv.	9	.025	.086	23
1422	19-4 Br.	9	.025	.086	30

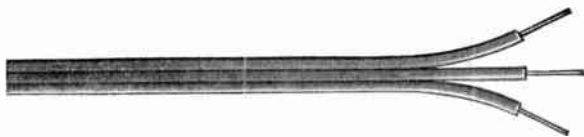

Construction: Soft copper conductors, one tinned for instant polarity identification. High dielectric strength Plastite insulation. Web type construction for easy separation of insulated conductors. Wire requires less space than twisted pair type. Available in brown and ivory. Designed for low cost speedy installation by modified Bostitch type stapling gun. Lies flat for exceptionally neat and unobtrusive installation.

No.	Type	Max. Cond. Resis. @ 68° F. Ohms Per M-FL	Nom. Wall Insul. In.	Nom. O.D. Inches Overall	Appr. Gr. Wt. Lbs. Per M-FL
*1475	22PL2 Br.	17.7	.024	.074x.160	10
*1476	22PL2 Iv.	17.7	.024	.074x.160	10
*1477	22PL3 Br.	17.7	.024	.074x.205	13
*1478	22PL3 Iv.	17.7	.024	.074x.205	13



Soft copper conductors insulated with ree stripping, high dielectric strength polyethylene insulation. Over-all plastite jacket. Pair has one leg red, one leg green; triple has yellow third leg; quad has black fourth leg. Used in all types of building ducts.

No.	Type	Color	Max. Cond. Resis. @ 68° F. Ohms Per M-FL	Nom. O. D. In. Overall	Approx. Ship. Wt. Lbs. Per M-FL
*1431	22PN2J	Brown	17.7	.167	17
*1432	22PN2J	Ivory	17.7	.167	17
1437	22PN2J	Beige	17.7	.167	17
*1433	22PN3J	Brown	17.7	.167	18
*1434	22PN3J	Ivory	17.7	.167	18
1438	22PN3J	Beige	17.7	.167	18
1435	22PN4J	Brown	17.7	.182	23
1436	22PN4J	Ivory	17.7	.182	23
1439	22PN4J	Beige	17.7	.182	23

*Approved by Rural Electrification Administration.

**Whitney Blake Teleduct®
Inside Telephone Wires**

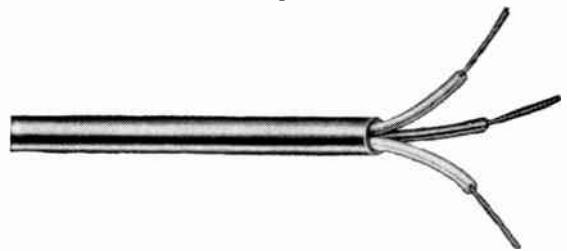

Construction: Tinned soft copper conductors, color coded neoprene insulation, over-all brown neoprene jacket. Nominal wall of insulation is .022 in. Nominal wall of jacket is .028 in. Tough neoprene jacket is highly resistant to sunlight, heat, moisture, abrasion and compression loads. This wire can be used directly from the outside station protector to the telephone with complete safety.

No.	Type	Max. Cond. Resis. @ 68° F. Ohms Per M-FL	Nom. O.D. In. Overall	Appr. Gr. Wt. Lbs. Per M-FL
*950	22NE2-J RG	17.7	.196	28
*951	22NE3-J RGY	17.7	.207	32
*952	22NE4-J RGYB	17.7	.225	38

*Approved by Rural Electrification Administration.

Whitney Blake Telecord Replacement Sets

Telecord has excellent flexibility and is neat, clean and attractive. The neoprene jacket is highly resistant to abrasion, perspiration, humidity, oil and grease.

Has cadmium bronze tinsel conductors for improved conductivity and flex endurance, a protective separator and an essentially sulphur-free rubber insulation to eliminate the risk of tarnish. Conductors are parallel and paper wrapped.



Made from Telecord described above, the following standard cord sets are completely trimmed and equipped with solderless terminals and strain reliefs, ready for attachment to the equipment indicated.

Whitney Blake Replace. No.	Cord No.	Cord Type	Whitney Blake Replace. No.	Cord No.	Cord Type
Automatic Electric			Leich Electric		
T3031H	AH27	Handset	T3061H	34	Handset
T3051H	AH11	Handset	T3081H	52	Handset
T3121H	Type 80	Handset	T4011H	56	Handset
T4021D	AD13	Line	T3081D	57	Line
T3211D	AD73	Line	T3111D	36	Line
T3181D	Type 80	Line	T4061D	33	Line
Kellogg Electric			T3161D	58	Line
T3041H	F673G	Handset	North Electric		
T3131H	3000	Handset	T3011H	F1202	Handset
T3131H	770MFP	Handset	T3011D	F1205	Line
T2011R	F644TR	Receiver	Stromberg-Carlson		
T2011D	F665D	Line	T3071H	WC-3-F	Handset
T3021D	F641D	Line	T3091H	WC-N-3J	Handset
T3171D	3004	Line	T4031H	WC-4-J	Handset
T3171D	769MFP	Line	T3041D	WD-N-3J	Line
T4051D	F666D	Line	T3091D	WD-3-F	Line

Whitney Blake Shielded Sound System Wires—Plastic Types

These wires have solid or stranded conductors, as indicated, tough semi-rigid Plastite insulation for high resistance to crushing. Conductors are twisted together and covered with a braided copper shield. A ground wire is used on types which show "G" in type designation. Over-all braid, where used, is gray cotton. Jacket, where used, is black plastite.

These wires have excellent insulation resistance and electrical stability under high humidity conditions. Semi-rigid plastite insulation is tough, abrasion resistant and flame resistant.

Nominal insulation thickness is .015 in. for No. 22 and No. 20 AWG, .018 in. for No. 18 AWG with solid conductors; .021 in. for No. 18 AWG with stranded conductors and for No. 16 AWG. Nominal jacket thickness is .025 in. for No. 22, 20 and 18 AWG and .030 in. for No. 16 AWG.

Symbols Used in Type Designations

- SR—Semi-rigid plastite insulation
- B—Bare copper shield
- T—Tinned copper shield
- C—Over-all gray cotton braid
- J—Over-all plastite jacket
- F—Flexible stranded conductor (otherwise solid conductor)
- G—Ground wire

No.	Type	Cond. Size A.W.G.	Shield	Outer Covering	Nom. O.D. In.	Gr. Wt. Lbs. Per M-Ft.
3230	SR-22B-2	22	Bare Cu.	None	.130	13
3245	SR-20B-2	20	Bare Cu.	None	.144	17
3248	SR-18B-2	18	Bare Cu.	None	.172	25
3240	SR-22TC-2G	22	Tinned Cu.	Braid	.180	23
3242	SR-22FTC-2G	22	Tinned Cu.	Braid	.198	26
3241	SR-22TJ-2G	22	Tinned Cu.	Plastite	.200	29
3243	SR-22FTJ-2G	22	Tinned Cu.	Plastite	.216	31
3244	SR-16FTJ-2G	16	Tinned Cu.	Plastite	.308	66
3246	SR-20TJ-2	20	Tinned Cu.	Plastite	.194	25
3249	SR-18TJ-2	18	Tinned Cu.	Plastite	.222	35
3247	SR-20FTJ-2	20	Tinned Cu.	Plastite	.210	29
3250	SR-18FTJ-2	18	Tinned Cu.	Plastite	.254	42

Whitney Blake Shielded Sound System Wires—Enamel Textile Types

No. 22 gage has tinned soft solid copper conductors, enamel coated with two reversed cellulose acetate wraps, a color-coded lacquered cotton wind, copper shield over twisted conductors, and an over-all cotton braid on types indicated.

No.	Type	Cond. Size In.	Copper Shield	Over-all Braid	Nom. O.D. In.	Gr. Wt. Lbs. Per M-Ft.
3512	C-22SB-2	22	Bare	No	.125	11
3525	C-22ST-2	22	Tinned	No	.125	11
3510	C-20SB-2	20	Bare	No	.165	21
3520	C-20ST-2	20	Tinned	No	.165	21
3514	C-18SB-2	18	Bare	No	.185	28
3513	C-22SBC-2	22	Bare	Yes	.145	15
3526	C-22STC-2	22	Tinned	Yes	.145	15
3511	C-20SBC-2	20	Bare	Yes	.185	23
3521	C-20STC-2	20	Tinned	Yes	.185	23

3527 C-22STC-2G 22 Tinned Yes .175 20

Cat. No. 3527 is similar to Cat. No. 3513 but has a No. 22 AWG solid tinned copper ground wire run laterally under a tinned copper shield, a lateral paper tape and an over-all gray cotton braid.

Whitney Blake Shielded Wires and Cables Microphone Cable Semi-Conducting Textile Shield

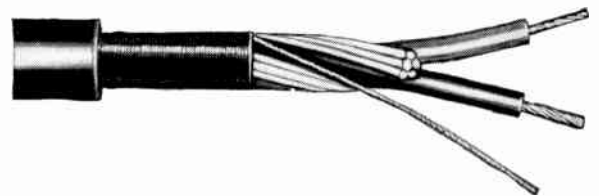

Construction: This is a completely new cable design in which a close semi-conducting textile wrap and a stranded flexible drain wire replaced the conventional braided copper shield. Conductors are cadmium copper for improved flex life and insulated with high quality rubber. This cable is not subject to damage by twisting and by the pressure of heavy equipment running over it. There is no danger of the shield breaking as a result of continued flexing. The cord has a tough brown neoprene jacket which will resist abrasion, oil, grease, perspiration, sunlight and acid fumes. The cord is lightweight, handles easily and can be coiled easily without kinking. The use of the textile shield removes the objectionable stiffness inherent in copper shielded construction. Noisy circuits caused by intermittent opens with movement of the cable are non-existent in this new construction. Because of this construction this cord has longer service life.

No.	Type	Cond. Size A.W.G.	Nom. Capacitance Mutual Ft.	Nom. Capacitance Grounded Ft.	Nom. O.D. In.	Gr. Wt. Lbs. Per M-Ft.
3340	SCN-18J-2	18 (65/.005")	41	70	.290	62
3341	SCN-20J-3	20 (41/.005")	31	58	.290	64

Whitney Blake Telecable Self Supporting Exchange Area Cable

Available in 6, 11, 16 and 26 pair No. 19 AWG high strength 40% conductivity copperweld conductors with high molecular weight polyethylene insulation.

Insulated conductors are twisted into pairs with the lays varied to eliminate cross talk. Each cable has a tracer pair with one red leg and one orange leg. All other pairs have one red leg and one natural leg.

Cable core wrapped spirally with a non-hygroscopic tape and then covered with an aluminum shield. Jacket is black weather-resistant polyethylene.

Measured Electrical Characteristics

Mutual Capacitance: At 1000 cps. Average—.085 microfarads per mile.

Conductor Resistance: At 68° F. Maximum—117 ohms per mile of cable.

Insulation Resistance: Conductor to other conductors and shield—Minimum 1000 megohms 1 mile.

Dielectric Strength: Conductor to other conductors and shield—10,000 volts rms.

Attenuation: At 1000 cps. Nominal—2.01 db/Mile.

Transmission Distance: Non-loaded, based on 30 db loss Nominal—15 miles.

No.	No. Pairs		Nom. Wall Jkt. In.	Nom. O.D. In.	Approx. Net Wgt. Lbs. Per M-FL	Approx. Ship. Wt. Lbs. Per M-FL	Feet Per Reel
	Total	Guaranteed					
1285	6	6	.050	.485	107	127	5000
1286	11	11	.050	.590	170	202	5000
1287	16	15	.060	.685	238	371	5000
1288	26	25	.060	.820	355	395	2500

Whitney Blake Telecable Multiple Drop Cable



Provides a simple, fast method of installing multiple drops. Made with No. 19 AWG bare, medium hard copper, polyethylene insulated conductors twisted into pairs with length of lay systematically varied to provide minimum cross talk levels.

Color-coded pairs are cabled around a center filler core, then wrapped with separator tape over which is applied an aluminum shield.

Over-all black polyethylene jacket provides protection under all weather conditions. Shipped on nonreturnable reels.

No.	No. Pairs		Nom. Wall Jkt. In.	Nom. O.D. In.	Approx. Net Wt. Lbs. Per M-FL	Approx. Ship. Wt. Lbs. Per M-FL	Feet Per Reel
	Total	Guaranteed					
1281	6	6	.050	.470	102	135	5000

Whitney Blake Telecable Underground Service Wire



Used as direct burial from pole to subscriber's premises. Four No. 20 AWG 40% copperweld conductors, polyethylene insulated, color coded, quaded, inner jacket polyvinyl chloride. Aluminum shield, black polyvinyl chloride jacket. Shipped on nonreturnable reels.

No.	Type	Nom. Wall Jkt. In.	Nom. O.D. In.	Feet Per Reel
1660	20BSW4	.248	.41	5000

Whitney Blake Teleframe® Distributing Frame, Jumper and Duct Wires

Teleframe is the family name for Whitney Blake distributing frame and jumper wires made with enamel and textile insulation, with Plastite insulation and with Plastite insulation and nylon jacket. 1000 Ft. Metal Spools.



Construction: Soft copper conductors, tinned for easy soldering. Insulated with high dielectric strength semi-rigid Plastite. Nominal wall of .015 in. Toughness and high resistance to crushing of semi-rigid Plastite permits small diameter. Semi-rigid Plastite is tough, abrasion resistant and flame resistant. Used on distributing frames and cross connecting racks and in ducts.

No.	Type	Max. Cond. Resis. @ 68° F. Ohms Per M-FL	Nom. O.D. In. Single	Coll Eye In.	Appr. Gr. Wt. Lbs. Per M-FL
1401	22S2 BW	17.7	.055	5	7
1402	22S2 RW	17.7	.055	5	7
1406	22S2 RB	17.7	.055	5	7
1403	22S3 RBW	17.7	.055	7	11
1404	22S4 RBWG	17.7	.055	7	14

Construction: Same as 22S with the following exceptions. Nominal wall of insulation is .010 in. For extra protection a jacket of transparent nylon, which resists cuffing and pulls easily through rings or bunches of other wires, is added. Nominal wall of jacket is .005 in. Used on distributing frames and cross connecting racks and in ducts.



No.	Type	Max. Cond. Res. @ 68° F. Ohms Per M-FL	Nom. O.D. In. Single	Appr. Gr. Wt. Lbs. Per M-FL
2110	22DFN2 BW	17.7	.056	7
2111	22DFN2 RW	17.7	.056	7
2112	22DFN3 BWR	17.7	.056	11
2113	22DFN4 BWRG	17.7	.056	14

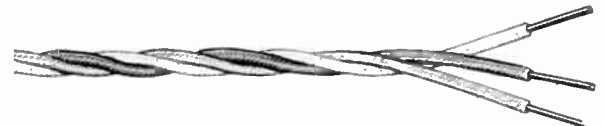

Construction: Enamel tinned soft copper conductors covered with two cellulose acetate wraps and one cotton wrap to provide insulation and mechanical protection. Lacquered for flame and moisture resistance and to prevent fraying.

2100	22DF2 BW	17.7	.050	6
2102	22DF2 RW	17.7	.050	6
2101	22DF3 BWR	17.7	.050	9

Call Graybar FIRST For . . .

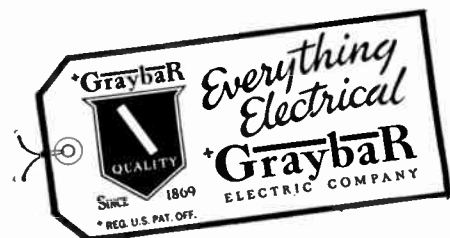

Plastic Wire and Cable Flexible Cords

U/L Listed and Labeled

PWC Standard Cord — Black Jacket

Extra flexible and capable of withstanding severe abuses in general purpose applications. Color black with number of conductors, size and type imprinted on jacket surface.

Type SJT — 300 Volts



Product Number	AWG Size	Strand	D.D. In.	Gr. Wt. Lbs. Per M Ft.
Two Conductor				
251-820	18	41x34	.300	52
251-620	16	65x34	.325	60
251-420*	14	41x30	.460	112
Three Conductor				
251-830	18	41x34	.330	67
251-630	16	65x34	.355	75
251-430*	14	41x30	.480	125
Four Conductor				
251-840	18	41x34	.355	77
251-640	16	65x34	.385	102
251-440*	14	41x30	.530	159

Type ST — 600 Volts



Product Number	AWG Size	Strand	D.D. In.	Gr. Wt. Lbs. Per M Ft.
Two Conductor				
252-820	18	41x34	.385	73
252-620	16	65x34	.400	85
252-420†	14	41x30	.525	139
252-220†	12	65x30	.595	194
252-020†	10	105x30	.635	251
Three Conductor				
252-830	18	41x34	.400	92
252-630	16	65x34	.425	112
252-430†	14	41x30	.555	165
252-230†	12	65x30	.630	244
252-030†	10	105x30	.685	298
Four Conductor				
252-840	18	41x34	.430	103
252-640	16	65x34	.480	134
252-440†	14	41x30	.600	206
252-240†	12	65x30	.660	268
252-040†	10	105x30	.740	352

†Listed as Flame Resistant by Penn. Dept. of Mines and U. S. Bureau of Mines. Listing No. P-124-BM.

Type SVT — 300 Volts



Product Number	AWG Size	Strand	D.D. In.	Gr. Wt. Lbs. Per M Ft.
250-820	18	41x34	.25	39

*Not U/L Listed.

These data are approximate and subject to normal manufacturing tolerances.

Prices on application.

PWC Oil Proof Cord — Gray Jacket

Designed for hard and extra hard usage in all applications especially where exposure to oil and grease is prevalent. Recognized by U/L for application as severe as those involving actual immersion in oil.

Number of conductors, size and type imprinted on jacket surface.

Type SJT — 300 Volts



Product Number	AWG Size	Strand	O.D. In.	Gr. Wt. Lbs. Per M Ft.
Two Conductor				
253-820	18	41x34	.300	52
253-620	16	65x34	.325	60
253-420*	14	41x30	.460	112
Three Conductor				
253-830	18	41x34	.330	67
253-630	16	65x34	.355	75
253-430*	14	41x30	.480	125
Four Conductor				
253-840	18	41x34	.355	77
253-640	16	65x34	.385	102
253-440*	14	41x30	.530	159

Type ST — 600 Volts



Product Number	AWG Size	Strand	O.D. In.	Gr. Wt. Lbs. Per M Ft.
Two Conductor				
254-820	18	41x34	.385	73
254-620	16	65x34	.400	85
254-420†	14	41x30	.525	139
254-220†	12	65x30	.595	194
254-020†	10	105x30	.635	251
Three Conductor				
254-830	18	41x34	.400	92
254-630	16	65x34	.425	112
254-430†	14	41x30	.555	165
254-230†	12	65x30	.630	244
254-030†	10	105x30	.685	298

Product Number	AWG Size	Strand	O.D. In.	Gr. Wt. Lbs. Per M Ft.
Four Conductor				
254-840	18	41x34	.430	103
254-640	16	65x34	.480	134
254-440†	14	41x30	.600	206
254-240†	12	65x30	.660	268
254-040†	10	105x30	.740	352

†Listed as Flame Resistant by Penn. Dept. of Mines and U. S. Bureau of Mines. Listing No. P-124-BM.

*Not U/L Listed.

These data are approximate and subject to normal manufacturing tolerances.

Prices on application.

Plastic Wire and Cable Flexible Cords

**PWC Yankee Safety Cord
(Chrome Yellow Jacket)**

Designed for extra hard service in industrial, municipal and utility organizations where safety is important. Insulation and jacket are oil and moisture resistant. Will not support combustion.

On quantity orders personalized jacket printing available according to special PWC policy.

Type SJT — 300 Volts



Product Number	AWG Size	Strand	O.D. In.	Gr. Wt. Lbs. Per M Ft.
Two Conductor				
255-820	18	41 x 34	.300	52
255-620	16	65 x 34	.325	60
255-420*	14	41 x 30	.460	112
Three Conductor				
255-830	18	41 x 34	.330	67
255-630	16	65 x 34	.355	75
255-430*	14	41 x 30	.480	125
Four Conductor				
255-840	18	41 x 34	.355	77
255-640	16	65 x 34	.385	102
255-440*	14	41 x 30	.530	159

Type ST — 600 Volts



Product Number	AWG Size	Strand	O.D. In.	Gr. Wt. Lbs. Per M Ft.
Two Conductor				
256-820	18	41 x 34	.38	73
256-620	16	65 x 34	.39	85
256-420†	14	41 x 30	.52	139
256-220†	12	65 x 30	.59	194
256-020†	10	105 x 30	.64	251
Three Conductor				
256-830	18	41 x 34	.39	92
256-630	16	65 x 34	.42	112
256-430†	14	41 x 30	.55	165
256-230†	12	65 x 30	.63	244
256-030†	10	105 x 30	.68	298
Four Conductor				
256-840	18	41 x 34	.42	103
256-640	16	65 x 34	.47	134
256-440†	14	41 x 30	.59	206
256-240†	12	65 x 30	.67	268
256-040†	10	105 x 30	.74	352

†Listed as Flame Resistant by Penn. Dept. of Mines and U. S. Bureau of Mines. Listing No. P-124-BM.
*Not U/L Listed.

**PWC Motor Plant Cord
(Maroon Jacket)**

Designed for extra hard usage in industrial plants where exposure to oil and grease is prevalent. A special composite stranding in the conductors assures extraordinary flexural endurance and increased breaking strength. It has excellent abrasion resistance.

Rated for 600 volts.

Product Number	AWG Size	Conductor Insulation 64th In.	O.D. In.	Gr. Wt. Lbs. Per M Ft.
Two Conductor				
257-820	18	2	.37	73
257-620	16	2	.39	85
257-420	14	3	.52	145
257-220	12	3	.60	194
257-020	10	3	.64	251
Three Conductor				
257-830	18	2	.38	92
257-630	16	2	.41	112
257-430	14	3	.55	165
257-230	12	3	.63	244
257-030	10	3	.68	298
Four Conductor				
257-840	18	2	.42	103
257-640	16	2	.45	134
257-440	14	3	.60	206
257-240	12	3	.68	268
257-040	10	3	.74	352

**PWC Super Safety Tool Cord
(Clear Vinyl Jacket)**

Designed for hard usage on high cycle and standard electric tools requiring three circuit conductors and a grounding conductor.

This is a safety cord with four additional uninsulated grounding conductors laid into the interstices of the insulated conductors.

A transparent vinyl jacket covers the cable assembly to allow visual inspection of the core and grounding conductors at all times.

Rated for 600 volts.

Product No.	AWG Size	Ground Wire Size	O.D. In.	Gr. Wt. Lbs. Per M Ft.
Four Conductor				
258-184	18	20	.43	104
258-164	16	18	.48	145
258-144	14	18	.60	210
258-124	12	18	.67	273
258-104	10	18	.74	351

**PWC Multi-Conductor Flexible Control Cable
Rated 600 Volts**



A cable design, available in sizes #18 to #10 AWG with extra flexible stranding. The conductors are insulated with a high dielectric strength polyvinyl chloride and are fully color coded. Cabled for maximum flexibility.

A polyvinyl, hard service jacket offers ample protection from severe usage. Will not support combustion. Is abrasion and impact resistant.

No. of Conds.	#18 AWG 41 x 34			#16 AWG 65 x 34			#14 AWG 41 x 30			#12 AWG 65 x 30			#10 AWG 105 x 30		
	Insul. Wall	Jkt. Wall	Approx. Diam. In.	Insul. Wall	Jkt. Wall	Approx. Diam. In.	Insul. Wall	Jkt. Wall	Approx. Diam. In.	Insul. Wall	Jkt. Wall	Approx. Diam. In.	Insul. Wall	Jkt. Wall	Approx. Diam. In.
5	2/64	5/64	.475	2/64	5/64	.510	3/64	6/64	.630	3/64	6/64	.720	3/64	3/64	.790
7	2/64	5/64	.505	2/64	5/64	.540	3/64	6/64	.720	3/64	6/64	.770	3/64	6/64	.850
9	2/64	5/64	.580	2/64	6/64	.620	3/64	6/64	.820	3/64	6/64	.890	3/64	7/64	1.010
10	2/64	6/64	.620	2/64	6/64	.700	3/64	6/64	.890	3/64	7/64	.990	3/64	7/64	1.100
12	2/64	6/64	.640	2/64	6/64	.720	3/64	7/64	.910	3/64	7/64	1.020	3/64	7/64	1.130
15	2/64	6/64	.730	2/64	6/64	.790	3/64	7/64	1.040	3/64	7/64	1.130	3/64	7/64	1.290
17	2/64	6/64	.760	2/64	6/64	.820	3/64	7/64	1.090	3/64	7/64	1.180	3/64	8/64	1.350
18	2/64	6/64	.760	2/64	6/64	.820	3/64	7/64	1.090	3/64	7/64	1.180	3/64	8/64	1.350
19	2/64	6/64	.760	2/64	6/64	.820	3/64	7/64	1.090	3/64	7/64	1.180	3/64	8/64	1.350

**Plastic Wire and Cable
Bus Drop Cable**

Thermoplastic Insulated and Jacketed
U/L Listed As Oil and Moisture Resistant

Designed to provide branch circuit runs between overhead bus feeders to machine control boxes. Eliminates necessity for rigid conduit.

PWC Bus Drop Cable is resistant to cutting oils, acids, impact, and abrasion.



**3 Insulated Conductors and 3 Uninsulated
Grounding Conductors**

Product Number	AWG Size	Ins. Cond. Stranding	Grd. Wires Total AWG	Insul. Wall 64th	Jkt. Wall 64th	Approx. Diam. In.	Approx. Gr. Wt. Lbs. Per M Ft.
870-144	14	7x 0242	14	2	3	.400	125
870-124	12	7x 0305	12	2	3	.447	155
870-104	10	7x 0385	10	2	3	.503	227
870-084	8	7x 0486	8	3	4	.678	374
870-064	6	7x 0612	6	4	4	.803	549
870-044	4	7x 0772	4	4	5	.940	826
870-024	2	7x 0974	2	4	5	1.075	1193

**Plastic Wire and Cable
Flexible Power Cable**
600 Volts

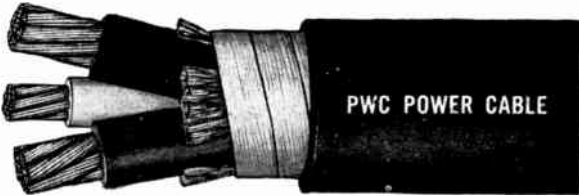

Heavy Duty Flexible Power Cable

Product Number	AWG Size	Strand-ing	Insul. Wall 64ths	Jkt. Wall In.	Approx. Diam. In.	Approx. Gr. Wt. Lbs. Per M Ft.
Two Conductor						
262-802	8	168 #30	4	7	.804	348
262-602	6	266 #30	4	8	.945	488
262-402	4	420 #30	4	9	1.100	685
Three Conductor						
262-803	8	168 #30	4	7	.846	428
262-603	6	266 #30	4	8	.997	609
262-403	4	420 #30	4	10	1.190	891
Four Conductor						
262-804	8	168 #30	4	8	.955	559
262-604	6	266 #30	4	10	1.147	817
262-404	4	420 #30	4	10	1.295	1093

Prices on application.

**Plastic Wire and Cable
Station Control Cables**

Rated 600 Volts



Station Control cables are made in conformance with IPCEA specifications. Insulated with polyvinyl chloride and fully color coded.

Sheathed with a tough vinyl sheath having temperature range from -40° C. to 80° C. Alternate constructions can be furnished on request.

#12 AWG—19 Strands

Product Number	No. Conds.	Insulation 64th In.	O.D. In.	Gr. Wt. Lbs. Per M Ft.
800-433	2	3	.485	128
800-435	3	3	.510	174
800-443	4	3	.600	255
800-445	5	3	.650	290
800-450	6	3	.710	326
800-457	7	3	.710	344
800-463	8	3	.770	395
800-467	9	3	.830	433
800-473	10	3	.930	506
800-475	11	3	.930	532
800-483	12	3	.960	560
800-486	13	3	1.010	592
800-490	14	3	1.010	708
800-492	15	3	1.070	740
800-498	16	3	1.070	773
800-502	17	3	1.120	807
800-507	18	3	1.120	841
800-510	19	3	1.120	859

9 AWG—19 Strands

Product Number	No. Conds.	Insulation 64th In.	O.O. In.	Gr. Wt. Lbs. Per M Ft.
800-727	2	3	.590	200
800-730	3	3	.620	290
800-733	4	3	.680	345
800-736	5	3	.750	414
800-739	6	3	.810	463
800-742	7	3	.810	512
800-745	8	3	.910	620
800-748	9	3	.980	645
800-751	10	3	1.070	720
800-754	11	3	1.070	800
800-756	12	3	1.100	846
800-760	13	3	1.160	900
800-763	14	3	1.160	960
800-765	15	3	1.260	1062
800-770	16	3	1.260	1122
800-774	17	3	1.320	1290
800-778	18	3	1.320	1350
800-780	19	3	1.320	1410

Prices on application.

Plastic Wire and Cable Neon Sign and Oil Burner Cable

Type GTO — 5 — 10 — 15

U/L Listed And Labeled



Small diameter. Easy to install. Highly resistant to ozone and oxidation at high voltages. Excellent resistance to acids, oils, water, gasoline and alkalis. For indoor or outdoor use.

One universal type for gas tube sign or oil burner ignition applications.

Product No.	AWG Size	Strand	Type	Diam. In.	Approx. Gr. Wt. Lbs. Per M Ft.	Ft. In Coil
900-145	14	19x.0147	GTO-15	.254	36	500

Prices on application.

**Plastic Wire and Cable
IMSA Control Cables
Rated 600 Volts**



ISMA cables as listed below conform to ISMA specs. 19-1951 and 20-1951. Also available are constructions made to ISMA 19-1956 and ISMA 20-1956.

Cables are for use in signal systems in underground conduit, as messenger supported aerial cable or direct earth burial. Alternate constructions can be furnished on request.

**IMSA 19 — 1951
Polyethylene Insulated**

Product No.	No. Conds.	Insul. Thick. In.	O.D. In.	Gr. Wt. Lbs. Per M Ft.
#14 AWG Solid				
830-228	3	.025	.430	105
830-233	4	.025	.455	127
830-239	5	.025	.485	150
830-262	6	.025	.520	169
830-268	7	.025	.530	180
#12 AWG Solid				
830-436	3	.030	.490	145
830-440	4	.030	.520	180
830-445	5	.030	.560	210
830-450	6	.030	.630	266
830-455	7	.030	.630	287
830-457	8	.030	.670	327
830-465	9	.030	.720	359
830-470	10	.030	.780	400
830-480	12	.030	.800	452

**IMSA 20 — 1951
Polyvinyl Chloride Insulated**

Product No.	No. Conds.	Insul. Thick. In.	O.D. In.	Gr. Wt. Lbs. Per M Ft.
#14 AWG Solid				
832-244	3	.025	.430	109
832-251	4	.025	.455	131
832-258	5	.025	.485	155
832-265	6	.025	.520	175
832-272	7	.025	.520	186
#12 AWG Solid				
832-430	3	.030	.490	150
832-437	4	.030	.520	186
832-444	5	.030	.560	217
832-451	6	.030	.630	275
832-458	7	.030	.630	297
832-465	8	.030	.670	338
832-472	9	.030	.720	372
832-479	10	.030	.780	414
832-493	12	.030	.800	468

These data are approximate and subject to normal manufacturing tolerances.

Prices on application.

**Plastic Wire and Cable
Range and Dryer Cord Sets
U/L Listed And Labeled**



Dryer Cord Set



Range Cord Set

Range and Dryer Cords are made with high dielectric thermoplastic compound. They are resistant to water, grease, acids, and alkalis. The non-breakable, molded on, thermoplastic cap has rolled finished blades.

Each blade is soldered to the conductors. Conductors, jacket and grounding blade are marked for positive identification.

Range Cord Sets

Product No.	No. Conds. And Size AWG	Lgth. In.	Amp. Rat ng.	Std. Pkg. Units	Ship. Wt. Lbs. Ctn.
C-88203	3 #6	36	50	24	46
C-88303	2 #6 & 1 #8	36	50	24	34
C-88304	2 #6 & 1 #8	48	50	24	46
C-88305	2 #6 & 1 #8	60	50	24	58
C-88306	2 #6 & 1 #8	72	50	24	70
C-88103	2 #8 & 1 #10	36	40	24	28
C-88104	2 #8 & 1 #10	48	40	24	37
C-88105	2 #8 & 1 #10	60	40	24	47
C-88106	2 #8 & 1 #10	72	40	24	56

Dryer Cord Sets

C-78303	3 #10	36	30	24	22
C-78404	3 #10	48	30	24	29
C-78405	3 #10	60	30	24	37
C-78406	3 #10	72	30	24	46

**Plastic Wire and Cable
Parallel Portable Tool Cords
(Chrome Yellow)**



Portable Cord Set



Cordset With Grounding Conductor

Designed as an all purpose extension cord for outdoor use. Has excellent resistance to weather, oil, soil acids and alkalis. Will not sun crank or change color.

Unbreakable molded-on plug and receptacle are furnished in either the two conductor systle or three conductor with new U/L grounding pin.

Two Conductor

Product No.	Size & Strand-ing	Lgth. Ft.	Grd. Cond. Size	Units Per Box	Units Per Case
C-32625	#16	25	...	2	24
C-32650	65 x 34	50	...	1	12
C-33025	#14	25	...	2	24
C-33050	#14	50	...	1	12
C-33000	41 x 30	100	...	1	6
C-33425	#12	25	...	2	24
C-33450	65 x 30	50	...	1	12

Two Conductor Plus Grounding Conductor

C-32725	#16	25	#16	2	24
C-32750	65 x 34	50	...	1	12
C-33125	#14	25	...	2	24
C-33150	#14	50	#14	1	12
C-33100	41 x 30	100	...	1	6
C-33525	#12	25	#12	1	12
C-33550	65 x 30	50	...	1	12

Price on application.

**Plastic Wire and Cable
A - Z Non Metallic Sheathed Cable**

**Type UF—600 Volts
U/L Listed And Labeled**



Single conductor underground feeder cable for duct or direct burial installations. Highly resistant to soil acids or alkalis.

Single Conductor

Product No.	Size AWG	Strand	Insul. Wall In.	Diam. In.	Net Wt. Lbs. Per M Ft.
120-141	14	Solid	4/64	.195	28
120-121	12	Solid	4/64	.210	37
120-101	10	Solid	4/64	.230	51
120-081	8	Solid	5/64	.290	80
120-067	6	7	5/64	.350	124
120-047	4	7	5/64	.395	182
120-027	2	7	5/64	.455	262
120-019	1	19	6/64	.525	356
120-108	1/0	19	6/64	.566	432
120-209	2/0	19	6/64	.612	524
120-309	3/0	19	6/64	.663	644
120-409	4/0	19	6/64	.721	804

Note: Standard package 250 ft. coils or 1000 ft. reels.
Prices on application.

Plastic Wire and Cable Thermostat Wires

Polyvinyl chloride insulated conductors for standard thermostat wiring applications. Fully color coded. Easy stripping.



Parallel Figure 8 With Colored Tracer

Product No.	Size Conds.	Approx. Dimensions In.	Net Wt. Lbs. Per M Ft.	Ft. In Std. Carton
300-820	18-2	.067 x .143	14	4000
300-830	18-3	.069 x .225	21	2000



Twisted (No outer Braid or Jacket)

310-820	18-2	.140	13	4000
310-830	18-3	.145	19	2000
310-840	18-4	.165	25	1000
310-850	18-5	.185	32	1000



Braided and Waxed

320-820	18-2	.160	15	4000
320-830	18-3	.170	22	2000
320-840	18-4	.185	28	1000
320-850	18-5	.205	36	1000



Plastic Jacketed

330-820	18-2	.175	16	2000
330-830	18-3	.183	23	2000
330-840	18-4	.200	29	1000
330-850	18-5	.224	36	1000

PWC Bell Wire

340-810	*18-1	.070	7	1000
340-820	18-2	.140	13	500

*Available in Black, Red, White, Blue, Green and Orange.
Prices on application.

**Plastic Wire and Cable
A - Z Non Metallic Sheathed Cable**

**Types NMC and Type UF — 600 Volts
Multi Conductor
U/L Listed And Labeled**



Ideal for all applications where nonmetallic sheathed cables and underground feeder systems are specified. Recommended for use where corrosive or moisture conditions might exist.

Product No.	Cond. Size AWG	Insul. Wall 64th	Grd. Cond. Size	Jkt. Wall 64ths	Approx. Dimensions	Net Wt. Lbs. Per M Ft.
Two Conductor						
121-421	14	2	..	2	.210 x .405	65
121-221	12	2	..	2	.235 x .465	85
121-021	10	2	..	2	.260 x .505	120
Three Conductor						
121-431	14	2	..	2	.215 x .630	100
121-231	12	2	..	2	.230 x .670	130
121-031	10	2	..	2	.248 x .730	145
Two Conductor Plus Grounding Conductor						
122-421	14	2	16	2	.205 x .400	70
122-221	12	2	16	2	.240 x .460	95
122-021	10	2	14	2	.243 x .500	135
Three Conductor Plus Grounding Conductor						
122-431	14	2	16	2	.205 x .595	118
122-231	12	2	16	2	.223 x .654	145
122-031	10	2	14	2	.243 x .734	205

Note: Standard package 250 ft. coils or 1000 ft. reels.
Prices on application.

**Plastic Wire and Cable
Silv-A-Flex Cable**

**Type NM — 600 Volts
U/L Listed and Labeled**



2 Cond. Silv-A-Flex



3 Cond. Silv-A-Flex

Nonmetallic sheathed cable, silver finish. Clean pulling and stripping. Moisture resistant. For all types of farm and home wiring. TW insulation.

Product No.	Size AWG	Strand	Approx. Diam. In.	Grd. Cond. Size	Approx. Gr. WL Lbs. Per M Ft.
Two Conductor					
123-421	14	Solid	.215 x .430	..	65
123-221	12	Solid	.260 x .465	..	85
123-021	10	Solid	.275 x .505	..	122
Three Conductor					
123-431	14	Solid	.475	..	110
123-231	12	Solid	.510	..	139
123-031	10	Solid	.556	..	181
Two Conductor Plus Grounding Conductor					
124-421	14	Solid	.245 x .485	16	73
124-221	12	Solid	.260 x .530	16	97
124-021	10	Solid	.275 x .570	14	142
Three Conductor Plus Grounding Conductor					
124-431	14	Solid	.475	16	118
124-231	12	Solid	.510	16	152
124-031	10	Solid	.556	14	200

Standard package 250 ft. coils.
Prices on application.

**Plastic Wire and Cable Building Wire
60° C Type TW—600 Volts**

U/L Listed and Labeled



A thermoplastic insulated building wire designed for moist and wet locations. Excellent resistance to acids, alkalis, oils and grease. Available in wide color range.

Product No.	AWG Size	Strand	Insul. Wall In.	Diam. In.	Fl. In. Std. Pkg.	Net Wt. Lbs. Per M Ft.
100-205	14	Solid	2/64	.131	500	20
100-220	12	Solid	2/64	.148	500	28
100-235	10	Solid	2/64	.169	500	41
100-350	8	Solid	3/64	.229	500	69

Stranded Conductors

100-210	14	7	2/64	.140	500	22
100-225	12	7	2/64	.158	500	30
100-240	10	7	2/64	.182	500	44
100-355	8	7	3/64	.246	500	75
100-465	6	7	3/64	.315	500	119

100-470	4	7	3/64	.363	500	176
100-475	2	7	3/64	.423	500	263
100-501	1	19	3/64	.494	1000	339
100-510	1/0	19	3/64	.537	1000	416
100-520	2/0	19	3/64	.583	1000	514
100-530	3/0	19	5/64	.634	1000	633
100-540	4/0	19	5/64	.692	1000	787
100-625	250	37	6/64	.763	1000	914
100-630	300	37	6/64	.819	1000	1084
100-635	350	37	6/64	.870	1000	1267
100-640	400	37	6/64	.916	1000	1415
100-650	500	37	6/64	1.002	1000	1751

Heavy Insulation Solid Conductors

100-305	14	Solid	3/64	.161	500	23
100-320	12	Solid	3/64	.178	500	32
100-335	10	Solid	3/64	.199	500	45
100-450	8	Solid	3/64	.258	500	74

Stranded Conductors

100-310	14	7	3/64	.173	500	25
100-325	12	7	3/64	.193	500	33
100-340	10	7	3/64	.218	500	48
100-455	8	7	3/64	.283	500	79

Note: #14 to #10 available in 8 stock colors. Size #8 to #2 available in black, white, red. Size #1 and larger black.

Plastic Wire and Cable Fixture Wires



Type TF Wire



Type TFF Wire

Type TF

Product No.	AWG Size	Strand	Insul. Wall In.	Diam. In.	Fl. In. Std. Pkg.	Net Wt. Lbs. Per M Ft.
102-281	18	Solid	2/64	.103	500	9
102-287	18	7	2/64	.114	500	10
102-261	16	Solid	2/64	.110	500	12
102-267	16	7	2/64	.122	500	13

Type TFF

102-286	18	16	2/64	.110	500	10
102-266	16	26	2/64	.122	500	13

Note: Standard colors—15 stock colors.

Prices on application.

**Plastic Wire and Cable
90° Machine Tool Wire**

600 Volts

U/L Listed and Labeled



Insulated with a highly oil resistant thermoplastic compound. Conforms with National Machine Tool Builders Association Standards.

Sizes #18 to #4 0-600 volts at 90° C. in Air 80° C. in oil.

Product No.	AWG Size	Strand	Insul. Wall In.	Diam. In.	Fl. In. Std. Pkg.	Net Wt. Lbs. Per M Ft.
111-228	18	Solid	2/64	.103	9	
111-231	18	7	2/64	.110	10	
111-234	18	16	2/64	.110	10	
111-243	16	Solid	2/64	.114	13	
111-246	16	7	2/64	.123	14	
111-249	16	26	2/64	.122	14	
111-255	14	Solid	2/64	.131	20	
111-258	14	7	2/64	.140	22	
111-261	14	19	2/64	.140	22	
111-267	12	Solid	2/64	.148	28	
111-270	12	7	2/64	.158	29	
111-273	12	19	2/64	.159	29	
111-282	10	Solid	2/64	.169	41	
111-288	10	19	2/64	.180	43	
111-371	8	19	3/64	.246	72	
111-436	6	19	3/64	.316	117	
111-451	4	19	3/64	.365	172	
111-464	2	19	3/64	.426	258	
111-570	1	19	3/64	.494	339	
111-575	1/0	19	3/64	.537	416	
111-578	2/0	19	3/64	.583	514	
111-584	3/0	19	3/64	.634	633	
111-587	4/0	19	3/64	.692	787	

Heavy Insulation

111-330	14	Solid	3/64	.161	23	
111-333	14	7	3/64	.168	25	
111-336	14	19	3/64	.169	25	
111-342	12	Solid	3/64	.178	32	
111-345	12	7	3/64	.184	35	
111-348	12	19	3/64	.184	35	
111-353	10	Solid	3/64	.199	45	
111-356	10	7	3/64	.222	50	
111-359	10	19	3/64	.222	49	
111-416	8	Solid	3/64	.258	74	
111-418	8	7	3/64	.278	81	
111-422	8	19	3/64	.278	80	

Colors: Sizes #18 and #16 available in 15 stock colors. Sizes #14 to #10 available in 8 stock colors. Sizes #8 and larger, black or per special color order.

Packaging: Sizes #18 to #8 available on 500 ft. spools. Sizes #6 to #2 available in 500 ft. coils. Sizes #1 and larger on 1000 ft. reels.

These data are approximate and subject to normal manufacturing tolerances.

Prices on application.

**Plastic Wire and Cable
105° C Appliance Wire**

U/L Listed and Labeled



Appliance wire is available in all of the above sizes, strandings, insulation walls and colors.

Prices on application.

**Plastic Wire and Cable
Audio Speaker Cable
Shielded and Jacketed**

Recommended for low loss intercom wiring for schools, factories and commercial buildings.

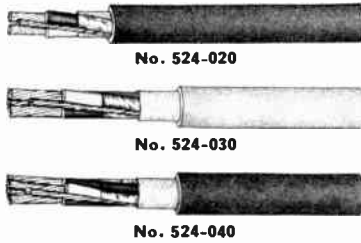

Product No. 524-020: 2 conductor #20 intercom cable. Conductor #20-10X#30, tinned copper .016 in. vinyl insulation, black, red. Conductors twisted, aluminum foil shield. #22-7X#30 tinned copper ground wire cabled around shielded pair. .020 in. black vinyl jacket.

Product No. 524-030: 3 conductor #20 intercom cable. Conductor #20-10X#30 tinned copper .016 in. vinyl insulation, black, white, red. Black-red conductors twisted, aluminum foil shield. White conductor and #20-10X#30 tinned ground wire cabled around shielded pair. .015 in. gray vinyl jacket.

Product No. 524-040: 4 conductor #20 intercom cable. Conductor #20-10X#30 tinned copper .016 in. vinyl insulation, colored black, white, red, green. Black and red conductors aluminum foil shield. White and green conductors with #20-10X#30 tinned ground conductor cabled around shielded pair. .020 in. gray vinyl jacket.

Product No.	Conductor	O.D. In.	Net Wt. Lbs. Per M Ft.	Ft. In Spool
524-020	2	.185	22	1000
524-030	3	.200	27	1000
524-040	4	.225	33	1000

Prices on application.

**Plastic Wire and Cable Rur-A-Line
Polyethylene Insulated Telephone Line Wires
No. 214, No. 212, No. 083S**



A two conductor parallel line wire insulated with a tough, high-molecular weight polyethylene. Extra high strength copperweld or steel conductors allow span lengths up to 600 feet in light storm loading districts. Special preformed hardware has been designed for Rur-A-Line. Sag, construction and transmission data can be furnished upon request.

Recommended for rural telephone lines; railroad communications; forest telephone lines; yard communication systems and sea coast and corrosive locations.

Standard package 5000 ft. reels.

Rur-A Line No.	Product No.	Cond.	Cond. Diam. In.	O.A. Oimen. In.	Total Break-ing Stgh. Lbs.	O.C. Res. Ohms Loop Mile	Net Wt. Lbs. Per M Ft.
083S	655-832	Grade 155 Steel	.083	.160x.315	1600	126	52
212	655-220	30% Cond. E.H.S. CW*	.080	.160x.315	1800	58	51
214	655-420	30% Cond. E.H.S. CW*	.064	.145x.280	1100	91	34

*Copperweld.

Prices on application.

**Plastic Wire and Cable
Microphone Cord — Shielded**



Tinned conductors, polyethylene insulation, tinned copper braid shield, 80% minimum coverage. Black vinyl jacket overall. Recommended for microphone trailing and hard usage.

Moisture and oil resistant. High insulation resistance and low attenuation at audio frequencies.

Product No.	No. Conds.	Size	Stranding	Insul. Wall In.	Jkt. Wall In.	Approx. O.O. In.
510-420	2	24	16 #36	.027	.025	.247
510-220	2	22	16 #34	.016	.034	.230
510-020	2	20	26 #34	.020	.025	.247
510-820	2	18	41 #34	.032	.032	.328
510-412	1	24	16 #36	.028	.023	.150

**Plastic Wire and Cable
Multi-Pair Audio Cable — Shielded**



Tinned copper conductors, vinyl insulation, full color code. Each pair shielded with tinned copper braid. Cable jacketed with vinyl jacket compound.

Recommended for commercial and municipal sound systems of permanent installation.

Product No.	Size	Strand	No. of Pairs	Insul. Wall In.	Jkt. Wall In.	O.D. In.
526-180	18	41 x 34	5	.015	.047	.560
526-200	20	26 x 34	18	.015	.063	.634

Note: Also available in other sizes and construction.

**Plastic Wire and Cable
Twisted Pair Audio Wire—Shielded**



Tinned copper conductors, vinyl insulation, paired and shielded with tinned copper braid. Packaged 1000 ft. spools.

No Cover Over Shield

Product No.	Pairs	AWG Size	Strand	Insul. Wall In.	O.D. In.
520-200	1	20	Solid	.015	.155
520-205	1	20	10 x #30	.015	.165
520-180	1	18	Solid	.015	.175
520-185	1	18	16 x #30	.015	.185
520-220	1	22	Solid	.015	.140
520-225	1	22	16 x #34	.015	.150

Cotton Braid Over Shield

Product No.	Pairs	AWG Size	Strand	Insul. Wall In.	O.D. In.
521-200	1	20	Solid	.015	.185
521-205	1	20	10 x #30	.015	.195
521-180	1	18	Solid	.015	.205
521-185	1	18	16 x #30	.015	.215
521-220	1	22	Solid	.015	.175
521-225	1	22	16 x #34	.015	.185

Vinyl Jacket Over Shield

Product No.	Pairs	AWG Size	Strand	Insul. Wall In.	O.D. In.
522-200	1	20	Solid	.015	.180
522-205	1	20	10 x #30	.015	.190
522-180	1	18	Solid	.015	.200
522-185	1	18	16 x #30	.015	.210
522-220	1	22	Solid	.015	.170
522-225	1	22	16 x #34	.015	.180

Prices on application.

Plastic Wire and Cable Multi-Pair Inside Telephone and Intercommunication Cable Unshielded



Type 122 cables are manufactured in sizes #21, #22 and #19 AWG. The conductor insulation is a tough heat resistant vinyl compound. Twisted pairs have a systematically varying lay to minimize cross talk.

The cable assembly is bound with nylon binder tape. A special nylon rip thread is placed longitudinally under the jacket to facilitate easy jacket removal. A special vinyl jacket provides excellent protection against all types of installation conditions.

Conductor sizes 24 and 22 are insulated with a .012 in. wall of vinyl, and size 19 with a .015 in. wall of vinyl.

Recommended for inside telephone, switchboard, intercommunication and sound systems.

Packaged in 500 ft. coils or 1000, 1500 or 2500 ft. lengths on reels.

#24 AWG Solid				#22 AWG Solid			
No. Of Pairs	Product No.	Diam. In.	Gr. Wt. Lbs. Per M Ft.	Product No.	Diam. In.	Gr. Wt. Lbs. Per M Ft.	
4	600-404	.237	48	600-204	.257	51	
6	600-406	.267	50	600-206	.289	72	
7	600-407	.281	55	600-207	.315	76	
11	600-411	.355	98	600-211	.385	120	
12	600-412	.367	107	600-212	.419	133	
16	600-416	.467	134	600-216	.462	166	
21	600-421	.375	170	600-221	.527	207	
26	600-426	.528	202	600-226	.584	248	
31	600-431	.605	224	600-231	.669	287	
51	600-451	.722	388	600-251	.798	490	
76	600-476	.894	590	600-276	.976	724	
101	600-480	1.050	785	600-280	1.150	980	

#19 AWG Solid							
No. Of Pairs	Product No.	Diam. In.	Gr. Wt. Lbs. Per M Ft.	No. Of Pairs	Product No.	Diam. In.	Gr. Wt. Lbs. Per M Ft.
4	600-904	.332	82	21	600-921	.690	336
6	600-906	.376	109	26	600-926	.752	405
7	600-907	.407	131	31	600-931	.862	478
11	600-911	.521	202	51	600-951	1.010	778
12	600-912	.538	216	76	600-976	1.260	1122
16	600-916	.606	273	101	600-980	1.500	1473

Note: Other sizes and numbers of conductors are available.

Plastic Wire and Cable Gasoline and Oil Resistant Wire U/L Listed and Labeled Nylon Jacketed—600 Volts



For electrical and control wiring where exposure to gasoline or oil is prevalent. TW insulation with nylon jacket.

Listed as Type TW 60° C. at 600 volts. Oil Resistant for use in open wiring or approved metal raceways where exposed to gasoline, gasoline vapors or mineral oil.

Sizes 14 to 12: Black, white, red, green, orange.

Sizes 10 to 6: Black, white, red.

Product No.	Size AWG	No. Of Strands	Insul. Wall 64th In.	Diam. In.	Net Wt. Lbs. Per M Ft.
105-147	14	7	3	.19	30
105-127	12	7	3	.21	40
105-107	10	7	3	.23	55
105-087	8	7	3	.26	76
105-067	6	7	4	.33	122

Standard package 500 ft. coils.

Prices on application.

Plastic Wire and Cable Mining Machine and Shuttle Car Cables

Listed by U. S. Bureau of Mines and Dept. of Mines Pennsylvania as Flame Resistant and damage resistant. Listing No. P-124-BM.

These mining cables are the first of thermoplastic construction to be listed by the U. S. Bureau of Mines and the Dept. of Mines Commonwealth of Pennsylvania. In addition to meeting the flame resistance tests, these cables also meet the severe Damage Resistance Tests of U. S. Bureau of Mines.

Twin Type W Cable—600 Volts (Small Diameter) Color Orange



"Small Diameter" is explained by the fact that cable with a given conductor size has the same overall dimensions as the next smaller size in a conventional Type W construction. (i.e. a #2 AWG Small Diameter Type W Cable has the same diameter as a #1 AWG conventional Type W Cable.) This factor has two distinct advantages.

1. Using the same conductor size, at least 20% more cable can be reeled.
2. Using the same cable diameter, the next larger conductor size can be used, allowing greater strength, less voltage drop and reduced heating.

Integral insulation and jacket of special "PWC-DR" polyvinyl chloride compound. High dielectric strength, excellent flame, moisture, abrasion, crushing, and impact resistance. This compound is also resistant to oils, greases, acids and alkalis. Service temperature range, 0° F. to 180° F.

No.	AWG Size	Stranding No. Size	Minor In.	Major In.	Net Wt. Lbs. Per 1000 Ft.	Ft. In Reel
280-062	#6	266X#30	.510	.810	375	500
280-042	#4	420X#30	.560	.930	500	500
280-022*	#2	655X#30	.610	1.050	647	500

Twin Type G Cable — 600 Volts — Color Orange



Type G cable is constructed with extra flexible stranding and the newly developed "PWC-DR" Compound. The integral insulation-jacket design gives greater service life and performance; will not crack or come apart under the most severe service conditions.

Insulated Conductors: Bare soft annealed copper in AWG sizes #6, #4 and #2 only. Type K, extra flexible stranding per ASTM-B-172 except one conductor with reverse lay. Individual strands are #30 AWG size conforming to ASTM B-3.

Ground Conductor: Bare soft annealed copper conductors of Type K stranding. Size equals 50% minimum of the power conductor size.

Insulation: Integral insulation and sheath of special PWC polyvinyl chloride compound. High dielectric strength, excellent flame, moisture, abrasion, crushing and impact resistance. Compound is highly resistant to oil, grease, acids and alkalis. Service temperature range from 0° F. to 180° F. Standard feet on reel 1000 feet.

No.	Cond. Size AWG	Stranding	Ground Cond. Size	Minor In.	Major In.	Net Wt. Lbs. Per M. Ft.	
281-062	#6	266X#30	#8	.168	.560	1.020	472
281-042	#4	420X#30	#7	.210	.610	1.180	672
281-022*	#2	655X#30	#5	.336	.730	1.350	921

*Modified Type K stranding.

**Plastic Wire & Cable
Premium Aerial and Duct Cable**



PWC Type 150

Premium grade cable designed for aerial or duct installation. Manufactured in Nos. 19, 22 and 24 gauge sizes. The conductors are insulated with polyethylene. Pairs are semi-color coded and twisted with varying lays. Cable assembly bound with non-hygroscopic tape and shielded with .002-in. copper tape.

A long-aging, durable dark gray polyvinyl chloride jacket protects cable from moisture and weather.

No. 19 AWG Cable

No. Pairs	Jacket Wall In.	Approx. O.O. In.	Approx. Ship. Wt. Lbs.	Standard Reel Ft.
6	.50	.46	172	5000
11	.50	.56	248	5000
16	.60	.63	323	5000
22	.60	.83	495	5000
51	.70	1.09	890	2500
76	.80	1.32	1260	2000
101	.90	1.42	1547	2000

No. 22 AWG Cable

6	.050	.41	120	5000
11	.050	.50	172	5000
16	.050	.56	228	5000
22	.060	.68	325	5000
51	.070	1.02	595	3000
76	.070	1.20	855	2000
101	.080	1.32	1090	2000

No. 24 AWG Cable

6	.050	.39	102	5000
11	.050	.47	135	5000
16	.050	.52	185	5000
22	.060	.64	281	5000
51	.060	.94	502	3000
76	.070	1.08	730	2000
101	.080	1.22	928	2000

Note—Available up to and including 404 pairs.

**Plastic Wire & Cable
Rural Distribution Wire
REA Listed**



PWC Type 177 Wire

A self-supporting rural distribution wire designed for medium length spans. Offers an economical construction for rural extension runs. The pairs are fully color coded and assembled around an 1800 pound breaking strength polyethylene insulated steel messenger.

Conductors are insulated with polyethylene and individually jacketed with polyvinyl chloride. Stringing sag data for Rural Distribution Wire will be furnished upon request.

#19 AWG Wire

Insul. Wall .020" Jkt. Wall .010"

No. Pairs	Approx. O.D., In.	Approx. Wt., Lbs. M Feet
2	.355	64
4	.545	93
6	.545	120
11	.800	195
16	.800	270

#22 AWG Wire

Insul. Wall .015" Jkt. Wall .010"

No. Pairs	Approx. O.D., In.	Approx. Wt., Lbs. M Feet
2
4
6
11	.640	140
16	.640	173

Standard Shipping Lengths: All constructions of Type 177 Rural Distribution Cable can be furnished in either 2000 or 4000 ft. lengths on reels.

**Plastic Wire & Cable
Exchange Cables**



PWC Type 190 Cable

Designed for aerial and duct installation.

Electromagnetic and electrostatic shielding is achieved with a helically applied aluminum tape. A black polyethylene sheath provides excellent mechanical protection and weathering resistance. REA listed and conforms to REA spec. PE14.

No. 19 AWG Solid

No. Pairs	Jacket Wall Ins.	Approx. D.D. In.	Ship. Wt. Lbs.	Reel Ft.
6	.050	.480	103	5000
11	.050	.580	186	5000
16	.060	.670	266	5000
26	.060	.825	407	5000
51	.070	1.080	751	2500
76	.080	1.300	1109	2000
101	.090	1.500	1463	2000
152	.110	1.850	2210	1000
202	.125	2.250	2633	1000
303	.125	2.630	4800	1000
404	.130	3.100	6950	1000

No. 22 AWG Solid

6	.050	.420	71	5000
11	.050	.520	128	5000
16	.050	.570	164	5000
26	.060	.700	253	5000
51	.060	.830	459	3000
76	.070	1.100	673	2000
101	.080	1.300	915	2000
152	.110	1.600	1382	1000
202	.110	1.830	1647	1000
303	.125	2.210	3500	1000
404	.130	2.600	4160	1000

No. 24 AWG Solid

6	.050	.395	60	5000
11	.050	.480	96	5000
16	.050	.530	132	5000
26	.060	.650	194	5000
51	.060	.850	350	3000
76	.070	.980	523	2000
101	.080	1.100	721	2000
152	.110	1.500	1045	1000
202	.110	1.675	1243	1000
303	.125	2.100	3170	1000
404	.125	2.350	3700	1000

**Plastic Wire & Cable
Long Span Rural Distribution Wire**



PWC Type 180

A self-supporting rural distribution wire designed for long span installations. Particularly adaptable for joint use on long span power lines. Each conductor insulated with polyethylene and jacketed with highly moisture and weather resistant polyvinyl chloride compound.

The pairs are fully color coded and assembled around a polyethylene insulated .142-in. high strength steel messenger. (Breaking strength 3000 lbs.) Stringing sag data available upon request.

#19 AWG Wire

No. of Pairs	O.D., In.	Net Wt. Lbs. Per M Feet	Cond. Insul. Wall, In.	Jkt. Wall, In.	Ship. Lgth., Feet
7	.580	150	.020	.010	3500

#22 AWG Wire

16	.650	200	.015	.020	3500
26	.760	290	.015	.020	3500

**Plastic Wire & Cable
Urban Distribution Wire**



PWC Type 183

A 16 pair No. 24 AWG self-supporting wire for urban distribution use. Offers an economical construction where a group of subscribers are to be served a short distance from the main pole line.

Conductors insulated with a .025-in. wall of polyvinyl chloride that is weather and abrasion resistant. The pairs are fully color coded and assembled around a 109E polyethylene insulated steel messenger.

Stringing sag data is available upon request.

No. of Pairs	Size AWG	Insul. Wall, in.	Approx. O. D., in.	Net WL Lbs. Per M Feet	Diam. Steel Mess., in.	Ship. Reel Lgth., Feet
16	24	.025	.650	140	.109	5000

**Plastic Wire & Cable
Direct Burial Telephone Cables**



PWC Type 166 Cable

Hard service double sheathed cable designed for direct earth burial. Manufactured in No. 24, No. 22 and No. 19 AWG sizes. Conductors are insulated with polyethylene. They are twisted into pairs with variable lays to prevent crosstalk. A polyethylene inner jacket provides additional mechanical protection necessary for direct burial as well as maximum dielectric protection from lightning surges.

A low resistance copper tape is applied over the inner jacket providing protection from induced power line noise. The outer jacket is polyvinyl-chloride; mechanically tough and resistant to moisture and earth acids.

No. 24 AWG Cable

No. Pairs	Inner Jkt. Wall 64ths	Outer Jkt. Wall 64ths	O. D. in.	Wgt. Lbs. Per M Feet	Ship. Reel Lgth. Feet
6	3	3	.44	132	5000
11	3	3	.52	206	5000
16	3	4	.57	280	5000
26	3	4	.70	412	5000

No. 22 AWG Cable

No. Pairs	Inner Jkt. Wall 64ths	Outer Jkt. Wall 64ths	O. D. in.	Wgt. Lbs. Per M Feet	Ship. Reel Lgth. Feet
6	3	3	.46	146	5000
11	3	4	.55	224	5000
16	3	4	.61	330	5000
26	3	4	.75	456	5000
51	4	5	1.12	735	2500
76	4	6	1.28	1040	1500
101	5	6	1.50	1270	1000

No. 19 AWG Cable

No. Pairs	Inner Jkt. Wall 64ths	Outer Jkt. Wall 64ths	O. D. in.	Wgt. Lbs. Per M Feet	Ship. Reel Lgth. Feet
6	3	3	.51	206	5000
11	3	4	.61	320	5000
16	3	4	.70	466	5000
26	3	5	.90	625	3500
51	4	5	1.20	1016	2500
76	4	6	1.46	1475	2500
101	5	7	1.56	1845	1000

Available up to and including 404 pairs.

**Plastic Wire & Cable
Buried Telephone Wire**

Types 163 and 164 designed for direct earth burial in rural areas by means of a cable plow. A single circuit wire that can be installed with total cost comparable to open line wire installation.



Type 163 Buried Telephone Wire—Unarmored

PWC Type 163 is a parallel line wire designed for direct burial. The conductors are No. 17 AWG special relief annealed, hard drawn copper individually insulated with polyethylene, one blue and one white. The conductors are jacketed in parallel with a .030-in. wall of tough, moisture resistant polyvinyl chloride, bright red in color.

Type	AWG Size	Insul. Wall, in.	Jkt. Wall, in.	Approx. Diam., in.	WL, Lbs. M Ft.	Break. Strg., Lbs.	Ship. Reel Lgth. Ft.
163	17	.035	.030	.180 x .300	36	225	5000



Type 164 Buried Telephone Wire—Armored

Constructed with No. 17 AWG special relief-annealed hard drawn copper conductors. The conductors are insulated in parallel with black polyethylene. A ridged tracer provides tip and ring identification. A .005-in. bronze armor tape is applied longitudinally for both shielding protection and against rodent or insect damage. A special jacket of chrome yellow polyvinyl chloride gives a protective covering against water, oil, and earth alkalis.

Type	AWG Size	Insul. Wall, in.	Jkt. Wall, in.	Approx. Diam., in.	WL, Lbs. M Ft.	Break. Strg., Lbs.	Ship. Reel Lgth., Ft.
164	17	.035	.030	.195 x .310	47	300	5000

**Plastic Wire & Cable
Self-Supporting Telephone Cables**



**PWC Types 130 and 132 with Polyethylene Jacket
PWC Types 160 and 162 with Polyvinyl Chloride Jacket**

Self-Supporting Telephone Cables designed for use in aerial spans without messenger support. Types 130 and 160 feature #19 gauge copperweld conductors for high tensile strength. Types 132 and 162 are made with #19 hard drawn copper conductors. In all types the conductors are partially color coded with a .015-in. wall of polyethylene.

Types 130 and 132 are jacketed with black hard service polyethylene compound. Types 160 and 162 feature a durable hard service polyvinyl chloride jacket.

Full sag and tension data will be furnished upon request.

No. Pairs	Approx. Diam. in.	Breaking Strength Lbs. Types		Ship. Wgt. Lbs. P. 1000 Ft. Types		Std. Ship. Reel Lgth. Ft.
		130 160	132 162	130 160	132 162	
6	.480	1500	815	107	121	5000
11	.600	2770	1495	188	203	5000
16	.700	4030	2175	230	252	5000
26	.860	6550	3535	358	388	5000

Gavitt General Purpose Internal Wires
For Meters, Panels, Electrical and Electronic Equipment



Excellent resistance to moisture and solvents. Maximum temperature rating 100° C. Government specifications MIL-W-16878B.

Type B—No. G15U—600 Volts (rms)

A.W.G.	No. of Strands	Conductor Strand Diam. In.	Lgth. of Lay	Diam. Over Cond. Nom. In.	Diameter Over Plastic Insulation	
					Min. In.	Max. In.
30	7	.0040	.25	.012	.028	.034
28	7	.0050	.25	.015	.031	.037
26	7	.0063	.25	.019	.035	.041
26	19	.0040	.25	.020	.035	.041
24	7	.0080	.33	.024	.040	.047
24	19	.0050	.33	.025	.040	.047
22	7	.0100	.33	.030	.046	.053
22	19	.0063	.33	.032	.046	.053
20	7	.0126	.50	.038	.054	.061
20	19	.0080	.50	.040	.054	.061
18	7	.0159	.65	.048	.064	.071
18	19	.0100	.65	.050	.064	.071
16	19	.0113	.80	.057	.073	.081
16	26	.0100	.80	.059	.073	.081

Type C—No. G16U—1000 Volts (rms)

24	7	.0080	.33	.024	.054	.062
24	19	.0050	.33	.025	.054	.062
22	7	.0100	.33	.030	.060	.068
22	19	.0063	.33	.032	.060	.068
20	7	.0126	.50	.038	.068	.076
20	19	.0080	.50	.040	.068	.076
18	7	.0159	.65	.048	.078	.086
18	19	.0100	.65	.050	.078	.086
16	19	.0113	.80	.057	.087	.095
16	26	.0100	.80	.059	.087	.095
14	19	.0142	1.20	.071	.101	.109
14	41	.0100	1.20	.074	.101	.109

Type D—No. G17U—3000 Volts (rms)

24	7	.0080	.33	.024	.075	.090
24	19	.0050	.33	.025	.075	.090
22	7	.0100	.33	.030	.081	.096
22	19	.0063	.33	.032	.081	.096
20	7	.0126	.50	.038	.089	.104
20	19	.0080	.50	.040	.089	.104
18	7	.0159	.65	.048	.099	.114
18	19	.0100	.65	.050	.099	.114
16	19	.0113	.80	.057	.108	.123
16	26	.0100	.80	.059	.108	.123
14	19	.0142	1.20	.071	.122	.137
14	41	.0100	1.20	.074	.122	.137

Prices on application.

Gavitt General Purpose Wire

Government Specification JAN-C-76
Amendment 4



Graybar Type	Stranded Conductor	A.W.G.	Solid Conductor	Volts (rms)	Equivalent Types MIL-W-76A
Type SRIR					
G10U	24-16		24-18	1000	Type MW
Type SRHV					
G11U	24-16		24-18	2500	Type HW
Type WL (Braided)					
G12L	24-14		24-18	600
Type WL (Nylon Jacket)					
G13N	24-14		24-18	600

Prices on application.

Gavitt General Purpose Wire

For Internal Wiring of
Electrical and Electronic Equipment

Government Spec. MIL-W-76A



Maximum Temperature Rating 80° C.

Type MW: Equivalent to SRIR (JAN-C-76) and may be used for direct replacement. Wider variety of constructions than SRIR, including nylon jacket, braids, shield and combinations. Insulation wall thickness (PVC) Nom. .016; Min. .013.

Type HW: Equivalent to SRHV (JAN-C-76) and may be used for direct replacement. Wider variety of constructions than SRHV, including nylon jacket, braids, shield and combinations. Insulation wall thickness (PVC) Nom. .031; Min. .028.

Type LW: Primarily intended for use in miniature equipment. Not covered by JAN-C-76. Insulation wall thickness (PVC) Nom. .010; Min. .008.

Type MW—No. G110U—1000 Volts (rms)

A.W.G.	No. of Strands	Conductor Strand Diam. In.	Lgth. of Lay, In.	Diam. Over Cond. Max. In.	Diam. Over Insulation Max. In.
24	7	.0080	.33	.025	.062
24	19	.0050	.33	.025	.062
22	1	.0254062
22	7	.0100	.33	.033	.070
22	19	.0063	.33	.033	.070
22	26	.0050	.33	.033	.070
20	1	.0320069
20	10	.0100	.50	.041	.078
20	26	.0063	.50	.041	.078
20	41	.0050	.50	.041	.078
18	1	.0403077
18	16	.0100	.65	.052	.089
18	41	.0063	.65	.052	.089
16	1	.0508088
16	19	.0113	.80	.065	.102
16	26	.0100	.80	.065	.102
14	19	.0142	1.20	.078	.115

Type HW—No. G111U—2500 Volts (rms)

22	1	.0254098
22	7	.0100	.33	.033	.106
22	19	.0063	.33	.033	.106
22	26	.0050	.33	.033	.106
20	1	.0320105
20	10	.0100	.50	.041	.114
20	26	.0063	.50	.041	.114
20	41	.0050	.50	.041	.114
18	1	.0403113
18	16	.0100	.65	.052	.125
18	41	.0063	.65	.052	.125
16	19	.0113	.80	.065	.138
16	26	.0100	.80	.065	.138

Type LW—No. G112U—300 Volts (rms)

30	1	.0100033
30	7	.0040	.25	.014	.037
28	1	.0126037
28	7	.0050	.25	.016	.039
26	1	.0159040
26	7	.0063	.25	.020	.043
24	1	.0201044
24	7	.0080	.33	.025	.049
24	19	.0050	.33	.025	.049
22	1	.0254049
22	7	.0100	.33	.033	.057
22	19	.0063	.33	.033	.057
22	26	.0050	.33	.033	.057
20	1	.0320056
20	10	.0100	.50	.041	.065
20	26	.0063	.50	.041	.065
20	41	.0050	.50	.041	.065

Prices on application.

Gavitt General Purpose Wire
For Internal Wiring Of
Electrical And Electronic Equipment
 Government Spec. MIL-W-76A

Maximum temperature rating 90° C. For use primarily in Army Ordnance Corps applications. Supersedes Frankford Arsenal Specification FXS-1063.
 Insulation wall thickness (PVC). Sizes 30 to 26 Nom. .010; Min. .008; Sizes 24 to 16 Nom. .016; Min. .013

Type FX—No. G113N—500 Volts (rms)

A.W.G.	No. of Strands	Conductor Strand Diam., In.	Lgth. of Lay, In.	Diam. Over Cond. Nom. In.	Diam. Over Nylon Jkt. Max. In.
30	1	.0100011
30	7	.0040	.25	.014	.045
28	1	.0126015
28	7	.0050	.25	.016	.047
26	1	.0159048
26	7	.0063	.25	.020	.053
24	1	.0201073
24	7	.0080	.33	.025	.078
24	19	.0050	.33	.025	.078
22	1	.0254078
22	7	.0100	.33	.033	.086
22	19	.0063	.33	.033	.086
22	26	.0050	.33	.033	.086
20	1	.0320085
20	10	.0100	.50	.041	.096
20	26	.0063	.50	.041	.096
20	41	.0050	.50	.041	.096
18	1	.0403095
18	16	.0100	.65	.052	.107
18	41	.0063	.65	.052	.107
16	19	.0113	.80	.065	.120
16	26	.0100	.80	.065	.120

Prices on application.

Gavitt Extra Flexible Miniature Cable
Multi-Conductor Jacketed
 Government Specifications MIL-C-10392A



Designed primarily for communication equipment, but can be used for voltages up to 300 (rms).

Tinned copper conductors, Buna S insulation, twisted around staycord, with outer jacket of smooth, dense Buna.

Type MC: Stranding—41/40; Circular Mills (nom.) 404; Insulation min. wall .010 in., insulation max. o.d. .059 in.

Type MC Maximum Voltage 300 V. (rms)

Graybar Type	Govt. Type	Total No.	Conductors No. Each	AWG Size	Cable Diam. +.010 - .005
GMC-2A	WD-27/U	2	2	24	0.146
GMC-3	WT-15/U	3	3	24	0.212
GMC-4	WF-11/U	4	4	24	0.212
GMC-5	WM-59/U	5	5	24	0.212
GMC-6	WM-60/U	6	6	24	0.252
GMC-7	WM-61/U	7	7	24	0.252
GMC-8	WM-62/U	8	8	24	0.262
GMC-9	WM-63/U	9	9	24	0.280
GMC-10	WM-64/U	10	10	24	0.297

Type FC Maximum Voltage 300 V. (rms)

Total No. Each	Conductor Size	AWG Size	Stranding	Circular Mills (Nom.)	Insulation Min. Wall	Max. O.D.	Cable Diam. +.010 - .005
6	Graybar Type GFC-24A—Govt. Type WM-69 A/U	2	18	168/40T	1620	.010	.097
6		4	24	41/10T	404	.010	.059
8	Graybar Type GFC-26A—Govt. Type WM-70 A/U	2	18	168/40T	1620	.010	.097
8		6	24	41/40T	404	.010	.059
7	Graybar Type GFC-25A—Govt. Type WM-111/U	2	18	168/40T	1620	.010	.097
7		5	24	41/40T	404	.010	.059

Price on application.

Gavitt Appliance Wire
 U/L Approved



No. G20L Plastic Insulation & Fabric Braid



No. G22N—Plastic Insulation & Nylon Jacket



No. G30U—Plastic Insulation No Outer Covering

No.	Temperature	Volt. Electric Use Only	Thermo-Plastic Insul. Wall In.	Dielectric Strength (1 min.) (rms)	Break-down Volt. In Excess of	Outer Covering
G20L	90°C	600	1/64	5000 V	10 KV	Syn. Yarn or Cotton
G22N	90°C	600	1/64	5000 V	10 KV	Ext. Nylon
G30U	80°C	*300	1/64	3000 V	10 KV	Non

*Also recommended up to 600 (rms).

AWG	No. of Strands	Conductor Strand Diam.	Lgth. of Lay	G20L O.D. ±.004		G22N O.D. ±.004	G30U O.D. ±.004
				Synth. Yarn	Cotton		
26	1	.0159066	.083	.055	.051
26	7	.0063	.25	.069	.086	.058	.054
24	1	.0201070	.087	.059	.055
24	7	.0080	.33	.074	.091	.063	.059
24	16	.0050	.33	.074	.091	.063	.059
22	1	.0251075	.092	.064	.060
22	7	.0100	.33	.080	.097	.069	.065
22	26	.0050	.33	.080	.097	.069	.065
20	1	.0320082	.099	.073	.067
20	10	.0100	.50	.087	.101	.079	.073
20	26	.0063	.50	.087	.101	.079	.073
18	1	.0403090	.107	.083	.075
18	16	.0100	.65	.097	.114	.091	.083
18	41	.0063	.65	.097	.114	.091	.083
16	1	.0508086
16	26	.0100	.80	.108	1.25	.102	.094

Contact GRAYBAR for prices and additional types of Appliance wire.

Gavitt Miniature Instrument Wire



Features good high-voltage breakdown; high insulation resistance; low moisture absorption.

Temperature 40° C. to 105° C.; voltage 300 V. (rms), insulation extruded PVC—.008 in.—.010 in. wall, dielectric strength (1 min.) 1500 V. (rms), breakdown voltage in excess 5 kV (rms).

Graybar Type G52U

A.W.G.	No. of Strands	Strand Diam., In.	Length of Lay	O.D. Max.
28	1	.0126037
28	7	.0050	.25	.039
26	1	.0159040
26	7	.0063	.25	.043
24	1	.0201044
24	7	.0080	.33	.049
24	16	.0050	.33	.049
22	1	.0254049
22	7	.0100	.33	.054
22	16	.0063	.33	.054
22	26	.0050	.33	.054
20	1	.0320056
20	10	.0100	.50	.062
20	26	.0063	.50	.062
20	41	.0050	.50	.062

Note: A nylon outer covering can be added to produce high abrasion resistance.

Gavitt Spiral Shielded Jacketed Cable

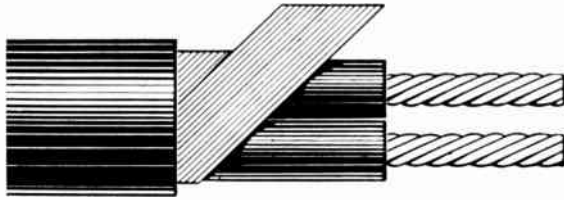

No. 44

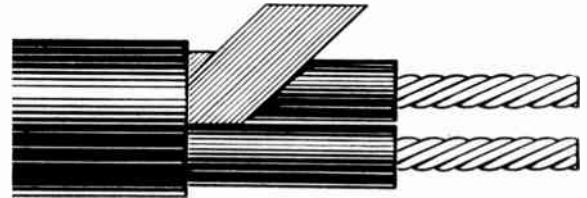

No. 43

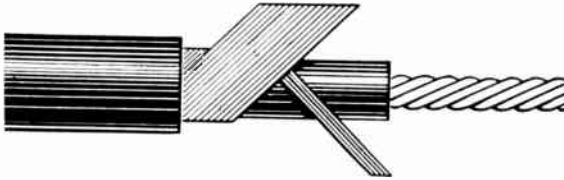

No. 41

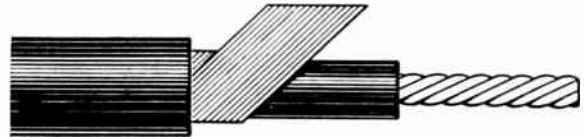

No. 42

Cable can be supplied in long lengths on spools or reels, or cut to specified lead lengths, with jacket and insulation stripped, with shield tails prepared to customers' specifications.

Although spiral shielding is preferred by many, because of the ease in preparing the shield tails for ground connections, there are many applications where a braided shield is desired.

No.	Constr. OWG.	Size	No. Conds.	Primary Insulation Material	Primary Insulation Thickness	Approx. O.D.	Spiral Shield		Outer Jacket		Outside Diam.		U.L. Approved
							One Way	Reverse	Matl.	Wall	Nom.	+ & -	
G100A	41	7/010	1	Rubber	.025	.085	32/34T	4/34T	PVC	.015	.135	.005	No
G100A-1	42	7/010	1	Rubber	.025	.085	32/34T	None	PVC	.015	.135	.005	No
G100 32A	41	7/010	1	Rubber	.030	.100	32/34T	4/34T	PVC	.015	.148	.005	Yes—75° C.
G100C	41	7/010	1	Rubber	.030	.100	32/34T	4/34T	PVC	.030	.180	.005	Yes—75° C.
G100D	41	10/010	1	Rubber	.030	.108	32/34T	4/34T	PVC	.030	.188	.005	Yes—75° C.
G100SWB	41	7/010	1	Rubber	.025	.085	32/34T	4/34T	PVC(105°)	.020	.135	.005	No
G100 16	41	7/010	1	PVC	.025	.085	32/34T	4/34T	PVC	.010	.125	.005	No
G100L	42	7/010	1	PVC	.030	.100	32/34T	None	PVC	.030	.175	.005	Yes—80° C.
G100P	42	7/010	1	Polyeth.	.030	.100	32/34T	None	PVC	.030	.175	.005	Yes—60° C.
G100 P64	41	7/010	1	Polyeth.	.030	.100	32/34T	4/34T	PVC	.020	.148	.005	No
G100 K-1*	43	7/010	2	PVC	.030	.100	32/34T	None	PVC	.030	175x270	.005	Yes—80° C.
G100 K-2**	44	7/010	2	PVC	.030	.100	32/34T	None	PVC	.030	175x270	.005	Yes—80° C.

Gavitt Harness and Cable Assemblies

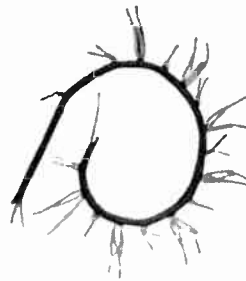
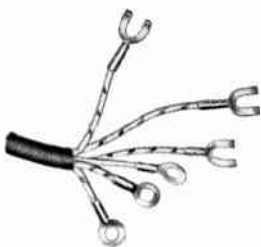

Harness and cable assemblies are available from the smallest simple single lead to the most complicated assembly with a multiplicity of various wires, branch-outs, terminals and connectors.

Can be furnished from any standard wire constructions, or wire can be made to meet your own specifications.

Graybar can incorporate all standard terminals, plugs, sockets, connectors and wiring terminals in a harness or assembly; also can supply assemblies twisted in multiple conductor form or laid out in harness form... laced, taped, shielded, braided or molded.

Contact GRAYBAR for prices and additional information.

Gavitt Ribbonized Wire

Multi-Conductor Flat Cable

Ribbonized wire required minimum space; PVC insulated only with excellent adhering qualities and rip features.

Available in gage size No. 14 thru No. 28. Concentric insulation regardless of number of conductors. Any number of conductors up to 35 depending on gage, insulation and practical packaging.

Can combine any of the following 15 solid colors in any sequence: Brown, tan, red, pink, orange, yellow, dark green, light green, dark blue, light blue, purple, violet, grey, white and black.

Contact GRAYBAR for price and other information.

Times Extruded Teflon® Hook-Up Wires



Manufactured to the MIL-W-16878B specifications with a rating of -90° to +250° C., are available in 14 solid colors, and/or spiral striping. Conductor of silver plated copper. Solid Colors: Black, Yellow, Brown, Green, White, Tan, Pink, Red, Orange, Blue, Light Blue, Gray (Slate), Violet (Purple), Light Green.

Type E—600 V, Wall Thickness .010-In. Nom.

No.	Dia. Over Insul. (Max.) In.	Conductor—Silver Plated Copper		
		AWG	Stranding	Circular Mils (Nom.)
T-30	.036	30	7/38	110
T-28	.039	28	7/36	175
T-26	.043	26	7/34	278
T-24	.048	24	7/32	442
T-24A	.048	24	19/36	475
T-22	.054	22	7/30	700
T-22A	.054	22	19/34	755
T-20	.062	20	7/28	1120
T-20A	.062	20	19/32	1201
T-18	.074	18	19/30	1900
T-16	.087	16	19/29	2400
T-14	.101	14	19/27	3830
T-12	.120	12	19/25	6090
T-10	.157	10	133/31	10600

Type EE—1000 V, Wall Thickness .015-In. Nom.

TT-30	.046	30	7/38	110
TT-28	.049	28	7/36	175
TT-26	.053	26	7/34	278
TT-24	.058	24	7/32	442
TT-24A	.058	24	19/36	475
TT-22	.064	22	7/30	700
TT-22A	.064	22	19/34	755
TT-20	.072	20	7/28	1120
TT-20A	.072	20	19/32	1201
TT-18	.084	18	19/30	1900
TT-16	.095	16	19/29	2400
TT-14	.113	14	19/27	3830
TT-12	.132	12	19/25	6090
TT-10	.169	10	133/31	10600

All above hook-up wires can be shielded to customers specifications. Solid wire or other strandings are available on request.

® Du Pont.

Times Fused Teflon® Jacketed Wire



Fused Teflon® Jackets over shielded Teflon insulated Silver Plated Copper conductors for applications requiring both high dielectric and high operating temperatures (up to 250° C.). Nylon braids and Teflon jackets available in 10 standard colors.

No.	Cable		Shield Coverage (90% Min.) Wire Size AWG	Conductor Insul. Wall Thick. .010-In. Min.	
	Dia. Over Jacket (Max.) In.	Capacitance (Nom.) mmfd/ft.		AWG	Stranding
TSJ-30	.089	25	38	30	7/38
TSJ-28	.092	30	38	28	7/36
TSJ-26	.095	32	38	26	10/36
TSJ-24	.111	38	36	24	16/36
TSJ-22	.116	42	36	22	27/36
TSJ-20	.120	50	36	20	41/36

Multi-conductor cables also available on request.

® Du Pont.

Times Spirally Wrapped Teflon® Hook-Up Wires



Manufactured to the MIL-W-16878B specifications for temperatures up to 250° C. Available in 14 solid colors and feature a free stripping, extra flexible construction.

Type E 600 Volts

No.	Unshielded Construction Wall Thick. .010-In. Nom. Dia. Over Insul. (Max.) In.	Shielded Construction % Coverage (90% Min.)		Wire AWG	Conductor Silver Plated Copper		
		No.	Dia. Over Shield (Max.) In.		AWG	Stranding	Circular Mils (Nominal)
AT-32	.033	ATS-32	.053	38	32	7/40	69
AT-30	.036	ATS-30	.056	38	30	7/38	110
AT-28	.039	ATS-28	.059	38	28	7/36	175
AT-26	.043	ATS-26	.063	38	26	7/34	278
AT-24	.048	ATS-24	.073	36	24	7/32	442
AT-22	.054	ATS-22	.079	36	22	7/30	700
AT-20	.062	ATS-20	.087	36	20	7/28	1120

Type EE—1000 Volts

No.	Unshielded Construction Wall Thick. .015-In. Nom.	Shielded Construction % Coverage (90% Min.)		Wire AWG	Conductor Silver Plated Copper		
		No.	Dia. Over Shield (Max.) In.		AWG	Stranding	Circular Mils (Nominal)
ATT-32	.043	ATTTS-32	.063	38	32	7/40	69
ATT-30	.046	ATTTS-30	.066	38	30	7/38	110
ATT-28	.049	ATTTS-28	.069	38	28	7/36	175
ATT-26	.053	ATTTS-26	.073	38	26	7/34	278
ATT-24	.058	ATTTS-24	.083	36	24	7/32	442
ATT-22	.064	ATTTS-22	.089	36	22	7/30	700
ATT-20	.072	ATTTS-20	.097	36	20	7/28	1120

Twisted multi-conductor cables and lacquered braids or Teflon jackets are available on request.

® Du Pont.

Times Miniature Coaxial Cables



Conductor: 29 AWG Solid, O.D. .011, Silver Plated Copperweld.

Shield: Wire Size 38 AWG, 90% Minimum Coverage.

No.	Nominal Impedance Ohms	Extruded Teflon Insul. (Max. O.D.) In.	Teflon Jacket O.D. In.	Electrical Characteristics*			
				1	2	3	4
TM-295	50	.038	.082	50 Ohms	28	73	29
TM-297	70	.058	.102	70 Ohms	21	73	21
TM-299	93	.097	.141	93 Ohms	15	75	17

Conductor: 30 AWG Stranded, 7/38 Stranding, O.D. .012-In., Silver Plated Cadmium Bronze.

Shield: Wire Size 38 AWG, 90% Minimum Coverage.

TM-305	50	.039	.083	50 Ohms	28	73	29
TM-307	70	.059	.103	70 Ohms	21	73	21
TM-309	93	.107	.151	93 Ohms	15	75	17

*Electrical Characteristics:

1. Characteristic Impedance (Nominal) Ohms.
2. Capacitance (Nominal) mmfd.
3. Velocity of Propagation (Nominal) percent.
4. Attenuation at 400 MC db/100-ft. (Nominal).
5. Dielectric Strength in all of the above cables is 1000.

Alcoa Self-Supporting Secondary and Service Drop Cables



Composed of one or more insulated conductors and one bare neutral conductor serving as the supporting member ("Multi-plex" cables), is recommended for use on circuits not exceeding 300 volts to ground.

Polyethylene Duplex Type

Code Word	Phase Conductors		Insulation Thickness 64ths in.	Bare Neutral Messenger		Complete Cable			Standard Package				
	Size AWG	Stranding		Size AWG	Stranding	Breaking Strength Lb.	Nominal Wt. Lb. Per 1000 Ft. Al	Total	Diam. of Circumscribed Circle	Reels Lgth. Ft.	Lb. on Reel	Coils* Lgth. Ft.	Lb. on Coil
All-Aluminum Neutral Messenger													
Pekingese	6	1x0.1620	3	6	7x0.0612	528	49	63	0.410	2500	158	1000	63
Collie	6	7x0.0612	3	6	7x0.0612	528	49	66	0.462	2000 2500	126 165	1000	66
Dachshund	4	1x0.2043	3	4	7x0.0772	826	78	95	0.530	2000 1800 2000	132 171 190	1000	95
Spaniel	4	7x0.0772	3	4	7x0.0772	826	78	100	0.558	1800 2000	180 200	1000	100
Doberman	2	7x0.0974	3	2	7x0.0974	1266	125	152	0.678	1100 2000	167 304	500	76
Malmut	1/0	19x0.0745	4	1/0	7x0.1228	1865	198	244	0.866	1000 2000	244 488
ACSR Neutral Messenger													
Setter	6	1x0.1620	3	6	6/1x0.0661	1170	49	75	0.454	2500 2000	188 150	1000	75
Shepherd	6	7x0.0612	3	6	6/1x0.0661	1170	49	78	0.476	2500 2000	195 156	1000	78
Eskimo	4	1x0.2043	3	4	6/1x0.0834	1830	77	114	0.548	1800 2000	205 228	1000	114
Terrier	4	7x0.0772	3	4	6/1x0.0834	1830	78	118	0.576	1800 2000	213 236	1000	118
Chow	2	7x0.0974	3	2	6/1x0.1052	2790	124	181	0.702	1100 2000	199 362	500	92
Bull	1/0	19x0.0745	4	1/0	6/1x0.1327	4280	198	289	0.896	1000 2000	289 578

Neoprene Duplex Type

All Aluminum Neutral Messenger													
Poodle	6	1x0.1620	4	6	7x0.0612	528	49	81	0.471	2500 2000	203 162	1000	81
Boxer	6	7x0.0612	4	6	7x0.0612	528	49	88	0.493	2500 2000	220 176	1000	88
Pointer	4	1x0.2043	4	4	7x0.0772	826	78	119	0.561	1800 2000	214 238	1000	119
Scotty	4	7x0.0772	4	4	7x0.0772	826	78	127	0.589	1800 2000	229 254	1000	127
Dane	2	7x0.0974	4	2	7x0.0974	1266	125	185	0.709	1100 2000	204 370	500	93
Hound	1/0	19x0.0745	5	1/0	7x0.0228	1865	198	290	0.897	1000 2000	290 580
ACSR Neutral Messenger													
Samoyed	6	1x0.1620	4	6	6/1x0.0661	1170	49	93	0.485	2500 2000	233 186	1000	93
Spitz	6	7x0.0612	4	6	6/1x0.0661	1170	49	100	0.507	2500 2000	250 200	1000	100
St. Bernard	4	1x0.2043	4	4	6/1x0.0834	1830	77	137	0.579	1800 2000	247 274	1000	137
Beagle	4	7x0.0772	4	4	6/1x0.0834	1830	78	145	0.607	1800 2000	261 290	1000	145
Greyhound	2	7x0.0974	4	2	6/1x0.1052	2790	124	214	0.733	1100 2000	235 428	500	107
Chesapeake	1/0	19x0.0745	5	1/0	6/1x0.1327	4280	198	336	0.927	1000 2000	336 672

*Sizes No. 6 and No. 4 can be supplied in 500-ft. coils.

The standard lengths are subject to a manufacturing tolerance of ±10 percent. An amount not exceeding 10 percent of the total length of any one order may be shipped in random lengths with no piece less than 25 percent nor longer than 110 percent of the standard length. Reels will be marked to show length of each piece, and, in the case of reels containing random lengths, the number of pieces, footage of each piece and position on reel.

Shipments to each destination will be made to the nearest package specified on each item ordered.

Weights of covered conductors are approximate and subject to normal manufacturing tolerance.

Alcoa Self-Supporting Secondary and Service Drop Cables

Polyethylene Triplex Type

Code Word	Phase Conductors			Bare Neutral Messenger			Complete Cable		Reels			
	Size AWG	Stranding	Insulation Thickness 64th In.	Size AWG	Stranding	Breaking Strength Lbs.	Nominal Wt. Lbs. Per 1000 Ft. Al	Total	Diam. of Circumscribed Circle	Non-returnable Lgh. Ft.	Wood Returnable Lgh. Ft.	Coils Lgh. Ft.
All-Aluminum Neutral Messenger												
Fusus	4	1x0 2013	3	4	7x0 0772	826	116	151	0.60	1500	500
Oyster	4	7x0 0772	3	4	7x0 0772	826	118	161	0.65	1500	500
Clam	2	7x0 0974	3	2	7x0 0974	1266	187	240	0.78	1000	1000	500
Murex	1/0	7x0 1228	4	1/0	7x0 1228	1865	297	395	0.99	1000	1000	...
Purpura	1/0	19x0 0745	4	1/0	7x0 1228	1865	297	390	1.00	1000	1000	...
Nassa	2/0	7x0 1379	4	2/0	7x0 1379	2350	375	486	1.08	1000	1000	...
Trophon	2/0	19x0 0837	4	2/0	7x0 1379	2350	375	478	1.09	1000	1000	...
ACSR Neutral Messenger												
Paludina	6	1x0 1620	3	6	6/1x0 0661	1170	73	112	0.51	1700	500
Voluta	6	7x0 0612	3	6	6/1x0 0661	1170	74	120	0.56	1700	500
Whelk	4	1x0 2043	3	4	6/1x0 0834	1830	116	170	0.60	1500	500
Periwinkle	4	7x0 0772	3	4	6/1x0 0834	1830	118	180	0.65	1500	500
Conch	2	7x0 0974	3	2	6/1x0 1052	2790	187	270	0.78	1000	1000	500
Neritina	1/0	7x0 1228	4	1/0	6/1x0 1327	4280	297	431	0.99	1000	1000	...
Cenia	1/0	19x0 0745	4	1/0	6/1x0 1327	4280	297	426	1.00	1000	1000	...
Runcina	2/0	7x0 1379	4	2/0	6/1x0 1490	5345	374	514	1.08	1000	1000	...
Triton	2/0	19x0 0837	4	2/0	6/1x0 1490	5345	374	536	1.09	1000	1000	...
ACSR Reduced Size Messenger												
Scallop	4	1x0 2043	3	6	6/1x0 0661	1170	101	148	0.60	1500	500
Strombus	4	7x0 0772	3	6	6/1x0 0661	1170	103	158	0.65	1500	500
Cockle	2	7x0 0974	3	4	6/1x0 0834	1830	161	235	0.78	1000	1000	500
Janthina	1/0	7x0 1228	4	2	6/1x0 1052	2790	260	387	0.99	1000	1000	...
Ranella	1/0	19x0 0745	4	2	6/1x0 1052	2790	260	382	1.00	1000	1000	...
Cavolinia	2/0	7x0 1379	4	1	6/1x0 1182	3480	328	476	1.08	1000	1000	...
Clio	2/0	19x0 0837	4	1	6/1x0 1182	3480	328	468	1.09	1000	1000	...
Neoprene Triplex Type												
All-Aluminum Neutral Messenger												
Catfish	4	1x0 2043	4	4	7x0 0772	826	116	194	0.66	1500	500
Trout	4	7x0 0772	4	4	7x0 0772	826	118	215	0.71	1500	500
Bass	2	7x0 0974	4	2	7x0 0974	1266	187	308	0.84	1000	1000	500
Sturgeon	1/0	7x0 1228	5	1/0	7x0 1228	1865	297	489	1.05	1000	1000	...
Eel	1/0	19x0 0745	5	1/0	7x0 1228	1865	297	480	1.06	1000	1000	...
Anchovy	2/0	7x0 1379	5	2/0	7x0 1379	2350	375	592	1.14	1000	1000	...
Pompano	2/0	19x0 0837	5	2/0	7x0 1379	2350	375	580	1.15	1000	1000	...
ACSR Neutral Messenger												
Alewife	6	1x0 1620	4	6	6/1x0 0661	1170	73	150	0.57	1700	500
Perch	6	7x0 0612	4	6	6/1x0 0661	1170	74	164	0.62	1700	500
Argentine	4	1x0 2043	4	4	6/1x0 0834	1830	116	212	0.66	1500	500
Carp	4	7x0 0772	4	4	6/1x0 0834	1830	118	233	0.71	1500	500
Shad	2	7x0 0974	4	2	6/1x0 1052	2790	187	337	0.84	1000	1000	500
Killifish	1/0	7x0 1228	5	1/0	6/1x0 1327	4280	297	535	1.05	1000	1000	...
Barracuda	1/0	19x0 0745	5	1/0	6/1x0 1327	4280	297	526	1.06	1000	1000	...
Billfish	2/0	7x0 1379	5	2/0	6/1x0 1490	5345	374	650	1.14	1000	1000	...
Sardine	2/0	19x0 0837	5	2/0	6/1x0 1490	5345	374	638	1.15	1000	1000	...
ACSR Reduced Size Neutral Messenger												
Needlefish	4	1x0 2043	4	6	6/1x0 0661	1170	101	205	0.66	1500	500
Tuna	4	7x0 0772	4	6	6/1x0 0661	1170	103	212	0.71	1500	500
Shark	2	7x0 0974	4	4	6/1x0 0834	1830	164	303	0.84	1000	1000	500
Agujon	1/0	7x0 1228	5	2	6/1x0 1052	2790	260	479	1.05	1000	1000	...
Bonefish	1/0	19x0 0745	5	2	6/1x0 1052	2790	260	472	1.06	1000	1000	...
Pajarito	2/0	7x0 1379	5	1	6/1x0 1182	3480	328	582	1.14	1000	1000	...
Saifish	2/0	19x0 0837	5	1	6/1x0 1182	3480	328	570	1.15	1000	1000	...

The standard lengths are subject to a manufacturing tolerance of ± 10 per cent. An amount not exceeding 10 per cent of the total length of any one order may be shipped in random lengths with no piece less than 25 per cent nor longer than 110 per cent of the standard length. Reels will be marked to show length of each piece, and, in the case of reels containing random lengths, the number of pieces, footage of each piece and position on reel.

Shipments to each destination will be made to the nearest package specified on each item ordered.

Weights of covered conductors are approximate and subject to normal manufacturing tolerance.

Alcoa Self-Supporting Secondary and Service Drop Cables

Rubber Insulated—Neoprene-Jacketed Triplex

Code Word	Phase Conductors				Bare Neutral Messenger			Complete Cable			Standard Packages				
	Size AWG	Stranding	Insulation Thickness 64th In.	Jacket Thickness 64th In.	Size AWG	Stranding	Break. Strength Lb.	Nom. Wt. Lbs. Per M-Ft. Al	Nom. Wt. Lbs. Per M-Ft. Total	Dia. of Circumscribed Circle	Lgth. Ft.	Lbs. on Reel	Dia. Reel In. **	Lgth. Ft.	Lbs. on Coil
All-Aluminum Neutral Messenger															
Shallot	4	1x0.2043	2	2	4	7x0.0772	826	116	192	0.66	1,500	288	30	500	96
Chive	4	7x0.0772	2	2	4	7x0.0772	826	118	213	0.71	1,500	320	30	500	107
Beet	4	7x0.0772	3	2	4	7x0.0772	826	118	237	0.78	1,500	356	30	500	119
Chard	2	7x0.0974	3	2	2	7x0.0974	1,266	187	336	0.90	1,000	336	30	500	163
ACSR Neutral Messenger															
Kale	6	1x0.1620	2	2	6	6/1x0.0661	1,170	73	148	0.57	1,500	222	30	500	74
Cabbage	6	7x0.0612	2	2	6	6/1x0.0661	1,170	74	163	0.62	1,500	245	30	500	82
Broccoli	6	7x0.0612	3	2	6	6/1x0.0661	1,170	74	182	0.68	1,500	273	30	500	91
Turnip	4	1x0.2043	2	2	4	6/1x0.0834	1,830	116	210	0.66	1,500	315	30	500	105
Mustard	4	7x0.0772	2	2	4	6/1x0.0834	1,830	118	231	0.71	1,500	347	30	500	116
Radish	4	7x0.0772	3	2	4	6/1x0.0834	1,830	118	255	0.78	1,500	383	30	500	128
Okra	2	7x0.0974	3	2	2	6/1x0.1052	2,790	187	366	0.90	1,000	366	30	500	183
ACSR Reduced Size Neutral Messenger															
Pea	4	1x0.2043	2	2	6	6/1x0.0661	1,170	101	189	0.66	1,500	284	30	500	95
Cowpea	4	7x0.0772	2	2	6	6/1x0.0661	1,170	103	210	0.71	1,500	315	30	500	105
Bean	4	7x0.0772	3	2	6	6/1x0.0661	1,170	103	234	0.78	1,500	351	30	500	117
Soybean	2	7x0.0974	3	2	4	6/1x0.0834	1,830	164	332	0.90	1,000	332	30	500	166

Polyethylene Quadruplex Type*

Code Word	Phase Conductors				Bare Neutral Messenger			Complete Cable			Standard Packages					
	Size AWG	Stranding	Insulation Thickness 64th In.	Jacket Thickness 64th In.	Size AWG	Stranding	Break. Strength Lb.	Nom. Wt. Lbs. Per M-Ft. Al	Nom. Wt. Lbs. Per M-Ft. Total	Dia. of Circumscribed Circle	Nonreturnable		Wood Returnable			
											Lgth. Ft.	Lbs. on Reel	Dia. Reel In.	Lgth. Ft.	Lbs. on Reel	Dia. Reel In.
All-Aluminum Neutral Messenger																
Clydesdale	4	1x0.2043	3	4		7x0.0772	826	154	207	0.75	900	186	30	1,000	207	36
Pinto	4	7x0.0772	3	4		7x0.0772	826	157	220	0.79	900	198	30	1,000	220	36
Mustang	2	7x0.0974	3	2		7x0.0974	1,266	249	330	0.95	700	231	30	1,000	330	40
Criollo	1/0	19x0.0745	4	1/0		7x0.1228	1,865	396	535	1.22	900	382	36‡	800	428	44
Percheron	2/0	19x0.0837	4	2/0		7x0.1379	2,350	500	655	1.34	800	524	36‡	800	524	44
ACSR Neutral Messenger																
Morochouca	6	1x0.1620	3	6		6/1x0.0661	1,170	97	151	0.64	1,200	181	30	1,000	151	32
Chola	6	7x0.0612	3	6		6/1x0.0661	1,170	98	163	0.67	1,200	196	30	1,000	163	32
Morgan	4	1x0.2043	3	4		6/1x0.0834	1,830	154	225	0.76	900	203	30	1,000	225	36
Hackney	4	7x0.0772	3	4		6/1x0.0834	1,830	157	245	0.81	900	221	30	1,000	245	36
Palomino	2	7x0.0974	3	2		6/1x0.1052	2,790	249	370	0.98	700	259	30	1,000	370	40
Costena	1/0	19x0.0745	4	1/0		6/1x0.1327	4,280	396	580	1.25	900	522	36‡	800	464	44
Grullo	2/0	19x0.0837	4	2/0		6/1x0.1490	5,345	499	715	1.38	800	572	36‡	800	572	44
Neoprene Quadruplex Type*																
All-Aluminum Neutral Messenger																
Durham	4	1x0.2043	4	4		7x0.0772	826	154	277	0.80	900	249	30	1,000	277	40
Holstein	4	7x0.0772	4	4		7x0.0772	826	157	300	0.84	900	270	30	1,000	300	40
Ayrshire	2	7x0.0974	4	2		7x0.0974	1,266	249	430	1.00	700	301	30	1,000	430	40
Africander	1/0	19x0.0745	5	1/0		7x0.1228	1,865	396	670	1.27	900	603	36‡	800	536	44
Angus	2/0	19x0.0837	5	2/0		7x0.1379	2,350	500	808	1.39	800	646	36‡	800	646	44
ACSR Neutral Messenger																
Braham	6	1x0.1620	4	6		6/1x0.0661	1,170	97	206	0.69	1,200	247	30	1,000	206	32
Galloway	6	7x0.0612	4	6		6/1x0.0661	1,170	98	227	0.72	1,200	272	30	1,000	227	32
Red Polled	4	1x0.2043	4	4		6/1x0.0834	1,830	154	295	0.81	900	266	30	1,000	295	40
Jersey	4	7x0.0772	4	4		6/1x0.0834	1,830	157	318	0.86	900	286	30	1,000	318	40
Hereford	2	7x0.0974	4	2		6/1x0.1052	2,790	249	460	1.03	700	322	30	1,000	460	40
Kerry	1/0	19x0.0745	5	1/0		6/1x0.1327	4,280	396	710	1.30	900	639	36‡	800	568	44
Dexter	2/0	19x0.0837	5	2/0		6/1x0.1490	5,345	499	860	1.43	800	688	36‡	800	688	44

**Nonreturnable reels.

*One phase wire identified by ribbing.

‡Quadruplex sizes No. 6, No. 4 and No. 2 can be supplied in 500-foot coils.

‡15-inch drum.

The standard lengths are subject to a manufacturing tolerance of ± 10 per cent. An amount not exceeding 10 per cent of the total length of any one order may be shipped in random lengths with no piece less than 25 per cent nor longer than 110 per cent of the standard length. Reels will be marked to show length of each piece, and, in the case of reels containing random lengths, the number of pieces, footage of each piece and position on reel.

Shipments to each destination will be made to the nearest package specified on each item ordered.

Weights of covered conductors are approximate and subject to normal manufacturing tolerances.

Alcoa Accessory Catalog Numbers

No. 4 ACSR to 397,500 CM ACSR and Ground Wires

Code Word	ACSR				Tubular Compression Accessories										Swage Type Repair Sleeves, Swages and Dies			
	C.M. or AWG	Size	Stranding	Conductor Diameter In.	Bolted Dead Ends				Twisting Joint		Dead-End Assembly		Jumper Terminal Straight	Jumper Connector		Terminal Connectors		
					Snubbing	Loop	Thimble	Straight	Single Tongue	Double Tongue	Aluminum Body	Steel Clevis End						
Swan	4	6	1	0.250	402	411	782	...	544	544	372.1	...	435	
Swanate	4	7	1	0.257	402	411	782	...	544	544	372.1	...	435	
Sparrow	2	6	1	0.316	402	412	782	...	542	542	373.1	...	436	
Sparate	2	7	1	0.325	402	412	782	...	542	542	373.1	...	436	
Grouse	80,000	8	1	0.367	782	...	551.2	551	B1874.3	B1674.3	102.17	1974.1	374.1	...	437	
Raven	1/0	6	1	0.398	402	412	782	...	540	540	B1874.1	B1674.1	100.14	1974.1	374.1	674	438	
Quail	2/0	6	1	0.447	402	413	783	...	529	529	B1874.2	B1674.2	100.16	1974.2	374.2	674	439	
Pigeon	3/0	6	1	0.502	403	...	783	...	528	528	B1875.1	B1675.1	102.17	1975.1	375.1	675	440	
Penguin	1/0	6	1	0.563	404	...	783	...	527	527	B1875.2	B1675.2	102.20	1975.2	375.2	675	441	
Waxwing	266,800	18	1	0.609	404	...	783	B1876.4	B1676.4	101.13	1976.4	376.4	676	442	
Owl	266,800	6	7	0.633	783	B1876.1	B1676.1	103.22	1976.1	376.2	676	442	
Partridge	266,800	26	7	0.642	783	B1876.1	B1676.1	103.25	1976.1	376.2	676	442	
Merlin	336,400	18	1	0.684	783	B1876.5	B1676.5	101.14	1976.5	376.5	676	...	
Linnnet	336,400	26	7	0.721	783	B1676.3	B1676.3	103.28	1976.3	376.3	676	...	
Chickadee	397,500	18	1	0.743	B1676.3	B1676.3	101.16	1976.3	376.3	676	...	
	5/8 S. GW.	...	7 or 3	0.312
	3/4 S. GW.	...	7 or 3	0.360

Code Word	C.M. or AWG	Size	Stranding	Conductor Diameter In.	Armor Rods and Accessories										Swage Type Repair Sleeves, Swages and Dies			
					Model "B" Dies		Model 12A Dies		Tie Wire Size AWG	Straight		Tapered		Armor Rod Clamp		Armor Rod Wrench		
					For AL	For Steel	For AL	For Steel		Rods For Single Support	Rods For Double Support	Rods For Single Support	Rods For Double Support					
Swan	4	6	1	72A	72S	B72AH	B72SH	6	1124	1154	1103	4203	
Swanate	4	7	1	72A	72S	B72AH	B72SH	6	1124	1154	1103	4203	
Sparrow	2	6	1	73A	73S	B73AH	B73SH	6	1126	1156	1103	4205	
Sparate	2	7	1	73A	73S	B73AH	B73SH	6	1126	1156	1103	4205	
Grouse	80,000	8	1	74A	74S	B74AH	B74SH	4	1185.1	1195	1105	4207	
Raven	1/0	6	1	74A	74S	B74AH	B74SH	6	1129.1	1158.1	1105	4207	
Quail	2/0	6	1	74A	74S	B74AH	B74SH	4	1129	1159	1105	4225	1241	1291	1104	1312.0	4315	
Pigeon	3/0	6	1	75A	75S	B75AH	B75SH	4	1130	1160	1106	4225	1245	1295	1105	1312.1	4315	
Penguin	1/0	6	1	75A	75S	B75AH	B75SH	4	1131	1161	1107	4225	1249	1299	1105	1312.4	4315	
Waxwing	266,800	18	1	76A	76S	B76AH	B76SH	4	1174	1194	1108	4225	1251	...	1106	1312.6	4315	
Owl	266,800	6	7	76A	76S	B76AH	B76SH	4	1253	...	1106	1312.7	4315	
Partridge	266,800	26	7	76A	76S	B76AH	B76SH	4	1253	...	1106	1312.7	4315	
Merlin	336,400	18	1	76A	76S	B76AH	B76SH	4	1175	1195	1108	4226	1256	...	1107	1313.2	4316	
Linnnet	336,400	26	7	76A	76S	B76AH	B76SH	4	1258	...	1107	1313.3	4316	
Chickadee	397,500	18	1	76A	76S	B76AH	B76SH	4	1176	1196	1108	4227	1258	...	1108	1313.4	4316	
	5/8 S. GW.	...	7 or 3	76A	76S	B76AH	B76SH
	3/4 S. GW.	...	7 or 3	76A	76S	B76AH	B76SH

Alcoa Accessory Catalog Numbers

No. 6 Stranded Aluminum to 397,500 CM Stranded Aluminum

Code Word	Stranded Aluminum Conductor				Tubular Compression Accessories										Swage Type Repair Sleeves, Swages and Dies		
	Cm or AWG	Size	Stranding	Conductor Diameter In.	Bolted Dead Ends				Twisting Joint		Dead-End Assembly		Straight Jumper Terminal	Jumper Connector		Terminal Connectors	
					Snubbing	Loop	Thimble	Straight	Single Tongue	Double Tongue	Aluminum Body	Steel Clevis End					
Peachbell	6	7	0.184	...	411	545.1	545	1371.1	371.1
Rose	4	7	0.232	...	411	782	545.1	545	1371.2	371.2
Lily	3	7	0.260	...	402	411	782	435
Iris	2	7	0.292	...	402	412	782	...	543.1	543	1372.2	372.2	...	436
Pansy	1	7	0.328	...	402	412	782	436
Poppy	1/0	7	0.368	...	402	412	782	...	551	551	1373.2	373.2	...	437
Aster	2/0	7	0.414	...	402	413	783	...	552	552	B1874.1	B1674.1	A100X	1974.1	374.1	674	438
Phlox	3/0	7	0.464	...	402	413	783	...	553	553	B1874.2	B1674.2	A100X	1974.2	374.2	674	439
Oxlip	4/0	7	0.522	...	403	...	783	...	554	554	B1875.1	B1675.1	A102X	1975.1	375.1	675	440
Daisy	266,800	7	0.586	...	404	...	783	...	555	555	B1875.2	B1675.2	A102X	1975.2	375.2	675	441
Laurel	266,800	19	0.593	...	404	...	783	...	555	555	B1875.2	B1675.2	A102X	1975.3	375.2	675	441
Tulip	336,400	19	0.666	...	404	...	783	...	557	557	B1876.1	B1676.1	A103X	1976.1	376.1	676	...
Canna	397,500	19	0.724	783	...	558	558	B1876.2	B1676.2	A103X	1976.2	376.3	676	...
Code Word	Stranded Aluminum Conductors				Armor Rods and Accessories										Swage Type Repair Sleeves, Swages and Dies		
	Cm or AWG	Size	Stranding	Conductor Diameter In.	Tie Wire Size AWG	Straight		Tapered		Armor Rod Clamp	Armor Rod Wrench	Wrench Die	Come-Alongs				
						Rods For Single Support	Rods For Double Support	Rods For Single Support	Rods For Double Support								
Peachbell	6	7	6				
Rose	4	7	6				
Lily	3	7	6				
Iris	2	7	6	1125	1155	1103	C or D	4205				
Pansy	1	7	6				
Poppy	1/0	7	6	1185.1	1195.1	1105	C or D	4207				
Aster	2/0	7	6	1171.1	1191.1	1106	C or D	4207				
Phlox	3/0	7	4	1172	1192	1106	C	4225	1242	1104	1312.0	4315	4208	4050	
Oxlip	4/0	7	4	1173	1193	1107	C	4225	1246	1105	1312.2	4315	4209	4053	
Daisy	266,800	7	4	1174	1194	1108	C	4225	1250	1106	1312.5	4315	4210	4056	
Laurel	266,800	19	4	1174	1194	1108	C	4225	1250	1106	1312.5	4315	4210	4056	
Tulip	336,400	19	4	1175	1195	1108	B	4226	1254	1107	1313.1	4316	4210	4060	
Canna	397,500	19	4	1176	1196	1108	B	4227	1258	1107	1313.3	4316	4211	4062	

Alcoa Accessory Catalog Numbers

4/0 ACSR to 1,590,000 CM ACSR and Ground Wires

Code Word	ACSR				Compression Accessories									
	Size Cir. Mills or AWG	Strands		Conductor Diameter In.	Dead End Assembly			Jumper Terminal			Joint Assembly			Jumper Con- nector
		AL	S.		Aluminum Body	Steel Clevis	30°	Straight	AL Sleeve	Steel Sleeve	Tap	Repair Sleeve		
Penguin	4/0	6	1	0.563	A1080.0	A1090.0	771.0	A761.0	A1761.0	1061.1	1025.0	691.1	591.1	360
Waxwing	266,800	18	1	0.609	A1080.3	A1090.3	771.8	A761.3	A1761.3	1061.4	1024.4	691.2	591.2	360
Owl	266,800	6	7	0.633	A1080.1	A1090.1	771.1	A761.1	A1761.1	1061.0	1025.1	691.2	591.2	360
Partridge	266,800	26	7	0.642	A1080.1	A1090.1	771.2	A761.1	A1761.1	1061.0	1025.2	691.2	591.2	360
Ostrich	300,000	26	7	0.680	A1080.2	A1090.2	771.3	A761.2	A1761.2	1061.2	1025.3	691.2	591.2	360
Merlin	336,400	18	1	0.684	A1080.2	A1090.2	771.4	A761.2	A1761.2	1061.2	1024.2	691.2	591.2	360
Linnet	336,400	26	7	0.721	A1081.0	A1091.0	772.0	A763.0	A1763.0	1062.1	1026.0	692.2	592.2	361
Oriole	336,400	30	7	0.741	A1081.1	A1091.1	772.3	A763.1	A1763.1	1062.0	1026.4	692.2	592.2	361
Chickadee	397,500	18	1	0.743	A1081.1	A1091.1	772.5	A763.1	A1763.1	1062.01	1024.3	692.2	592.2	361
Ibis	397,500	26	7	0.783	A1081.2	A1091.2	772.1	A763.2	A1763.2	1062.2	1026.1	692.2	592.2	361
Lark	397,500	30	7	0.806	A1082.0	A1092.0	773.3	A765.0	A1765.0	1063.4	1027.4	693.3	593.3	362
Pelican	477,000	18	1	0.814	A1082.0	A1092.0	773.7	A765.0	A1765.0	1063.41	1024.0	693.3	593.3	362
Flicker	477,000	24	7	0.816	A1082.1	A1092.1	773.8	A765.1	A1765.1	1063.2	1027.7	693.3	593.3	362
Hawk	477,000	26	7	0.858	A1082.1	A1092.1	773.0	A765.1	A1765.1	1063.2	1027.0	693.3	593.3	362
Hen	477,000	30	7	0.883	A1082.2	A1092.2	773.5	A765.2	A1765.2	1063.3	1027.6	693.3	593.3	362
Parakeet	556,500	24	7	0.914	A1082.3	A1092.3	773.9	A765.3	A1765.3	1063.1	1027.8	693.4	593.4	362
Dove	556,500	26	7	0.927	A1082.3	A1092.3	773.3	A765.3	A1765.3	1063.1	1027.4	693.4	593.4	362
Eagle	556,500	30	7	0.953	A1083.1	A1093.1	774.3	A765.10	A1765.10	1063.01	1028.4	693.4	593.4	362
Peacock	605,000	24	7	0.953	A1082.5	A1092.5	773.0	A765.10	A1765.10	1063.5	1027.0	693.4	593.4	362
Squab	605,000	26	7	0.966	A1082.4	A1092.4	773.4	A765.4	A1765.4	1063.0	1027.5	693.4	593.4	362
Teal	605,000	30	19	0.994	A1085.8	A1095.8	774.7	A768.8	A1768.8	1065.8	1028.7	695.1	595.1	364
Rook	636,000	24	7	0.977	A1084.3	A1094.3	773.1	A767.3	A1767.3	1064.3	1027.1	694.1	594.1	363
Grosbeak	636,000	26	7	0.990	A1084.0	A1094.0	773.4	A767.0	A1767.0	1064.2	1027.5	694.1	594.1	363
Egret	636,000	30	19	1.019	A1085.5	A1095.5	774.6	A768.5	A1768.5	1065.5	1028.6	695.1	595.1	364
Flamingo	666,600	24	7	1.000	A1084.0	A1094.0	773.2	A767.0	A1767.0	1064.2	1027.3	694.1	594.1	363
Crow	715,500	54	7	1.036	A1084.1	A1094.1	773.3	A767.1	A1767.1	1064.0	1027.4	694.2	594.2	363
Starling	715,500	26	7	1.051	A1085.4	A1095.4	774.1	A768.4	A1768.4	1065.4	1028.1	695.1	595.1	364
Redwing	715,500	30	19	1.081	A1085.4	A1095.4	774.9	A768.4	A1768.4	1065.4	1028.9	695.1	595.1	364
Condor	795,000	54	7	1.093	A1084.2	A1094.2	773.4	A767.2	A1767.2	1064.1	1027.5	694.2	594.2	363
Drake	795,000	26	7	1.108	A1085.6	A1095.6	774.3	A768.6	A1768.6	1065.6	1028.4	695.2	595.2	364
Mallard	795,000	30	19	1.110	A1085.7	A1095.7	775.1	A768.0	A1768.0	1065.2	1029.1	695.2	595.2	364
Crane	874,500	54	7	1.146	A1085.0	A1095.0	774.0	A768.0	A1768.0	1065.2	1028.0	695.2	595.2	364
Canary	900,000	54	7	1.162	A1085.1	A1095.1	774.1	A768.1	A1768.1	1065.3	1028.1	695.2	595.2	364
Cardinal	954,000	54	7	1.196	A1085.2	A1095.2	774.2	A768.2	A1768.2	1065.0	1028.2	695.3	595.3	364
Curlew	1,033,500	54	7	1.246	A1085.3	A1095.3	774.3	A768.3	A1768.3	1065.1	1028.4	695.3	595.3	364
Finch	1,113,000	54	19	1.293	A1086.0	A1096.0	774.7	A769.0	A1769.0	1066.0	1028.7	696.1	596.1	365
Grackle	1,192,500	54	19	1.338	A1086.1	A1096.1	774.8	A769.1	A1769.1	1066.1	1028.8	696.1	596.1	365
Pheasant	1,272,000	54	19	1.382	A1087.4	A1097.4	774.9	A770.4	A1770.4	1067.4	1028.9	697.1	597.1	366
Martin	1,351,500	54	19	1.424	A1087.0	A1097.0	775.2	A770.0	A1770.0	1067.0	1029.4	697.1	597.1	366
Plover	1,431,000	54	19	1.465	A1087.1	A1097.1	775.1	A770.1	A1770.1	1067.1	1029.1	697.2	597.2	366
Parrot	1,510,500	54	19	1.506	A1087.2	A1097.2	775.0	A770.2	A1770.2	1067.2	1029.0	697.2	597.2	366
Falcon	1,590,000	54	19	1.545	A1087.3	A1097.3	775.3	A770.3	A1770.3	1067.3	1029.3	697.2	597.2	366
Petrel	101,800	12	7	0.461	A915	A991.0	772.6	A763.4	A1763.4	815	1026.6	692.1	592.1	361
Minorea	110,800	12	7	0.481	A915	A991.0	772.1	A763.4	A1763.4	815	1026.1	692.1	592.1	361
Leghorn	134,600	12	7	0.530	A917	A991.2	772.3	A763.5	A1763.5	817	1026.4	692.1	592.1	361
Guinea	159,000	12	7	0.576	A925	A992.0	773.3	A765.5	A1765.5	825	1027.4	693.1	593.1	362
Dotterel	176,900	12	7	0.607	A926	A992.1	773.4	A765.6	A1765.6	826	1027.5	693.1	593.1	362
Dorking	190,800	12	7	0.631	A927	A992.2	773.5	A765.7	A1765.7	827	1027.6	693.1	593.1	362
Brahma	203,200	16	19	0.714	A945	A993.1	775.1	A765.9	A1765.9	845	1029.1	693.2	593.2	362
Cochin	211,300	12	7	0.663	A935	A993.0	774.2	A765.8	A1765.8	835	1028.2	693.2	593.2	362
5/16 S. GW.		7 or 3	0	0.312	...904	complete.....				804	complete			
5/16 S. GW.		7 or 3	0	0.312	...905	complete.....				805	complete			
3/8 S. GW.		7 or 3	0	0.360	...906	complete.....				806	complete			
3/8 S. GW.		7 or 3	0	0.360	...907	complete.....				807	complete			
7/16 S. GW.		7	0	0.435	...908	complete.....				808	complete			
1/2 S. GW.		7	0	0.495	...909.1	complete.....				809.1	complete			

Alcoa Accessory Catalog Numbers
4/0 ACSR to 1,590,000 CM ACSR and Ground Wires (Con't)

Code Word	ACSR			Conductor Diameter In.	Dies For Models F-1 and H Compressors		Tapered Armor Rods	Armor Rods and Accessories					
	Size C.M. or AWG	AL Strands	S.		For AL	For Steel		Armor Rod Clip	Armor Rod Clamp	Wrench Frame Size	Armor Rod Dies	Armor Rod Clamp Wrench	Come-alongs
Penguin	4/0	6	1	0.563	4424	4418	1249	1105	1312.4	C	4209	4315	4055
Waxwing	266,800	18	1	0.609	4424	1251	1106	1312.6	C	4210	4315	4057
Owl	266,800	6	7	0.633	4424	4418	1253	1106	1312.7	C	4210	4315	4058
Partridge	266,800	26	7	0.642	4424	4418	1253	1106	1312.7	C	4210	4315	4060
Ostrich	300,000	26	7	0.680	4424	4418	1255	1107	1313.2	B	4211	4316	4061
Merlin	336,400	18	1	0.684	4424	1256	1107	1313.2	B	4211	4316	4061
Linnet	336,400	26	7	0.721	4426	4419	1258	1107	1313.3	B	4211	4316	4062
Oriole	336,400	30	7	0.741	4426	4419	1258	1107	1313.4	B	4211	4316	4063
Chickadee	397,500	18	1	0.743	4426	1258	1108	1313.4	B	4211	4316	4063
Ibis	397,500	26	7	0.783	4426	4419	1260	1108	1314.0	B	4212	4317	4064
Lark	397,500	30	7	0.806	4428	4420	1261	1108	1314.1	B	4212	4317	4065
Pelican	477,000	18	1	0.814	4428	1262	1108	1314.1	B	4212	4317	4065
Flicker	477,000	24	7	0.846	4428	4420	1263	1108	1314.3	B	4212	4317	4070
Hawk	477,000	26	7	0.858	4428	4420	1264	1109	1314.3	BA	4212	4317	4071
Hen	477,000	30	7	0.883	4428	4420	1265	1109	1314.4	BA	4213	4317	4072
Parakeet	556,500	24	7	0.914	4428	4420	1266	1109	1314.6	BA	4213	4317	4073
Dove	556,500	26	7	0.927	4428	4420	1266	1109	1314.6	BA	4213	4317	4073
Eagle	556,500	30	7	0.953	4428	4421	1267	1109	1315.1	BA	4213	4317	4074
Peacock	605,000	24	7	0.953	4428	4420	1267	1109	1315.1	BA	4213	4317	4074
Squab	605,000	26	7	0.966	4428	4420	1268	1110	1315.2	BA	4213	4317	4074
Teal	605,000	30	19	0.994	4431	4421	1269	1110	1315.3	BA	4213	4317	4075
Rook	636,000	24	7	0.977	4430	4420	1268	1110	1315.2	BA	4213	4317	4075
Grosbeak	636,000	26	7	0.990	4430	4420	1269	1110	1315.3	BA	4213	4317	4075
Egret	636,000	30	19	1.019	4431	4421	1270	1110	1315.4	A or AA	4214	4317	4080
Flamingo	666,600	24	7	1.000	4430	4420	1269	1110	1315.3	BA	4213	4317	4075
Crow	715,500	54	7	1.036	4430	4420	1270	1110	1315.5	A or AA	4214	4317	4081
Starling	715,500	26	7	1.051	4431	4421	1271	1110	1315.5	A or AA	4214	4317	4081
Redwing	715,500	30	19	1.081	4431	4421	1272	1110	1315.6	A or AA	4214	4317	4082
Condor	795,000	54	7	1.093	4430	4420	1272	1110	1315.7	A or AA	4214	4317	4083
Drake	795,000	26	7	1.108	4431	4421	1272	1111	1315.8	A or AA	4214	4317	4083
Mallard	795,000	30	19	1.140	4431	4422	1274	1111	1316.1	A or AA	4214	4318	4084
Crane	874,500	54	7	1.146	4431	4421	1274	1111	1316.1	A or AA	4214	4318	4084
Canary	900,000	54	7	1.162	4431	4421	1274	1111	1316.2	A or AA	4214	4318	4085
Cardinal	954,000	54	7	1.196	4431	4421	1275	1111	1316.3	A or AA	4215	4318	4090
Curlew	1,033,500	54	7	1.246	4431	4421	1277	1112	1316.5	A or AA	4215	4318	4092
Finch	1,113,000	54	19	1.293	4432	4421	1278	1112	1316.6	A or AA	4215	4318	4093
Grackle	1,192,500	54	19	1.338	4432	4421	1280	1112	1316.6	A or AA	4216	4318	4095
Pheasant	1,272,000	54	19	1.382	4433	4421	1281	1112	1317.1	A or AA	4216	4318	4096
Martin	1,351,500	54	19	1.424	4433	4422
Plover	1,431,000	54	19	1.465	4433	4422
Parrot	1,510,500	54	19	1.506	4433	4422
Falcon	1,590,000	54	19	1.545	4433	4422
Petrel	101,800	12	7	0.461	4426	4419	1242	1104	1312.0	C	4208	4315	4050
Minorca	110,800	12	7	0.481	4426	4419	1243	1104	1312.1	C	4208	4315	4051
Leghorn	134,600	12	7	0.530	4426	4419	1247	1105	1312.2	C	4209	4315	4053
Guinea	159,000	12	7	0.576	4428	4420	1250	1106	1312.4	C	4210	4315	4055
Dotterel	176,900	12	7	0.607	4428	4420	1251	1106	1312.6	C	4210	4315	4057
Dorking	190,800	12	7	0.631	4428	4420	1253	1106	1312.7	C	4210	4315	4058
Brahma	203,200	16	19	0.714	4428	4422	1257	1107	1313.3	B	4411	4316	4062
Cochin	211,300	12	7	0.663	4428	4421	1255	1107	1313.1	B	4211	4316	4060
5/16 S. GW.	7 or 3	0.312	4424	4419
5/16 S. GW.	7 or 3	0.312	4426	4419
3/8 S. GW.	7 or 3	0.360	4424	4420
3/8 S. GW.	7 or 3	0.360	4426	4420
7/16 S. GW.	7	0.435	4426	4421
1/2 S. GW.	7	0.495	4428	4422

Alcoa Aluminum Bus Conductors

Aluminum bus conductors are available in alloys with a range of electrical and mechanical properties which meet the requirements for all bus conductor applications.

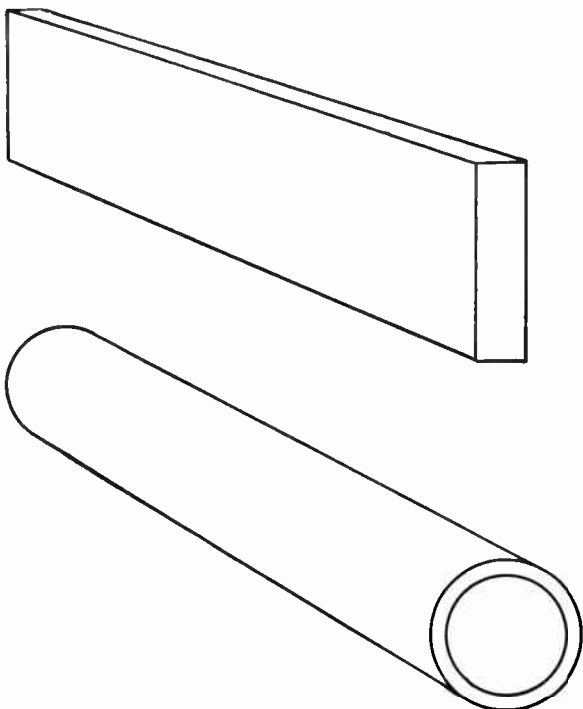

Mechanical Properties

Alloy and Temper	Strength, Pounds Per Sq. In.			
	Minimum Values		Typical Values	
	Tensile	Yield (Offset=0.2%)	Tensile	Yield (Offset=0.2%)
EC-H112	12,000	8,000	15,000	12,000
EC-H113	14,000	12,000	17,000	16,000
EC-H117	17,000	15,000	20,000	19,000
EC-H111	9,000	4,000
EC-H141	15,000	13,000
EC-H112
0.250-0.500-in.	12,000	7,000
0.501-1.000-in.	11,000	5,000
1.001-1.500-in.	10,000	4,000
No. 2EC-T61
.125-.749-in.	20,000	15,000
.750-1.499-in.	18,000	11,000
1.500-2.000-in.	15,000	8,000
No. 2EC-T62	27,000	22,000
No. 2EC-T6	29,000	25,000
6061-T6 (extruded)	38,000	35,000	43,000	40,000
6063-T6	30,000	25,000	35,000	31,000

Physical Properties

	EC Grade		No. 2 EC-T6		Alloy and Temper No. 2 EC-T61		No. 2 EC-T62		6063-T6	6061-T6
	Minimum	Typical	Minimum	Typical	Minimum	Typical	Minimum	Typical	Typical	Typical
Wt. Lbs. per cu. in.	0.098	0.098	0.098	0.098	0.098	0.098
Specific gravity	2.70	2.70	2.70	2.70	2.70	2.70
Coefficient of linear expansion per degree C.	0.000023	0.000023	0.000023	0.000023	0.000023	0.000023
Thermal conductivity at 20° C, watts/sq. in./in./°C.	5.9	6.0	5.3	5.4	5.5	5.6	5.4	5.5	5.1	3.9
Electrical conductivity at 20° C, per cent IACS	61	62	55	56	57	58	56	57	53	40
Electrical resistance at 20° C, microhms/sq.-in./ft.	13.35*	13.14	14.81*	14.55	14.29*	14.04	14.55*	14.29	15.37	20.36
Temperature coefficient of electrical resistance at 20° C per degree C.	0.00403	0.00409	0.00363	0.00370	0.00376	0.00383	0.00370	0.00376	0.00350	0.00264
Modulus of elasticity, Lbs. per Sq. In.	10 x 10 ⁶	10 x 10 ⁶	10 x 10 ⁶	10 x 10 ⁶	10 x 10 ⁶	10 x 10 ⁶

*Maximum value of resistance corresponding to minimum value of conductivity.

Nominal Dimensions and Weights, Rectangular Bus Conductors

Size In.	Square Corners		Rounded Corners		Full-rounded Edge		Size In.	Area Sq. In.	Wt. Lbs. Per Ft.	Area Sq. In.	Wt. Lbs. Per Ft.	Area Sq. In.	Wt. Lbs. Per Ft.
	Area Sq. In.	Wt. Lbs. Per Ft.	Area Sq. In.	Wt. Lbs. Per Ft.	Area Sq. In.	Wt. Lbs. Per Ft.							
1/4 x 1	0.2500	0.294	0.2466	0.290	0.2366	0.278	5/8 x 5	1.4063	1.654	1.4029	1.650	1.3893	1.634
1 1/4	0.3125	0.368	0.3091	0.364	0.2991	0.352	6	1.6875	1.985	1.6841	1.981	1.6705	1.965
1 1/2	0.3750	0.411	0.3716	0.437	0.3616	0.425	3/8 x 1 1/2	0.5625	0.662	0.5591	0.658	0.5323	0.626
1 3/4	0.4375	0.515	0.4341	0.511	0.4241	0.499	2	0.7500	0.882	0.7466	0.878	0.7198	0.847
2	0.5000	0.588	0.4966	0.584	0.4866	0.572	2 1/2	0.9375	1.103	0.9341	1.099	0.9073	1.066
2 1/4	0.5625	0.662	0.5591	0.658	0.5491	0.616	3	1.1250	1.323	1.1216	1.319	1.0948	1.288
2 1/2	0.6250	0.735	0.6216	0.731	0.6116	0.719	4	1.5000	1.764	1.4966	1.760	1.4698	1.729
2 3/4	0.6875	0.809	0.6841	0.805	0.6741	0.793	5	1.8750	2.205	1.8716	2.201	1.8448	2.170
3	0.7500	0.882	0.7466	0.878	0.7366	0.866	6	2.2500	2.646	2.2466	2.642	2.2198	2.611
3 1/2	0.8750	1.029	0.8716	1.025	0.8616	1.013	8	3.0000	3.528	2.9966	3.524	2.9698	3.493
4	1.0000	1.176	0.9966	1.172	0.9866	1.160	10	3.7500	4.410
5	1.2500	1.470	1.2466	1.466	1.2366	1.454	1/2 x 2	1.0000	1.176	0.9966	1.172	0.9464	1.113
6	1.5000	1.764	1.4966	1.760	1.4866	1.748	2 1/2	1.2500	1.470	1.2466	1.466	1.1964	1.407
8	2.0000	2.352	1.9966	2.348	1.9866	2.336	3	1.5000	1.764	1.4966	1.760	1.4464	1.701
10	2.5000	2.940	4	2.0000	2.352	1.9966	2.348	1.9464	2.289
9/32 x 1	0.2813	0.331	0.2779	0.327	0.2643	0.311	5	2.5000	2.940	2.4966	2.936	2.4464	2.877
1 1/2	0.1219	0.496	0.4185	0.492	0.4019	0.476	6	3.0000	3.528	2.9966	3.524	2.9464	3.465
2	0.5625	0.662	0.5591	0.658	0.5455	0.642	8	4.0000	4.704	3.9966	4.700	3.9464	4.641
2 1/2	0.7031	0.827	0.6998	0.823	0.6862	0.807	10	5.0000	5.880
3	0.8438	0.992	0.8404	0.988	0.8268	0.972	5/8 x 4	2.5000	2.940	2.4966	2.936	2.4162	2.841
4	1.1250	1.323	1.1216	1.319	1.1080	1.303	5	3.1250	3.675	3.1216	3.671	3.0412	3.576
							6	3.7500	4.410	3.7466	4.406	3.6662	4.311
							8	5.0000	5.880
							10	6.2500	7.350

Note—Unless otherwise specified, bars shall be finished with commercially square corners. When specified, bars shall be finished with corners rounded to a quarter circle, or with substantially uniform round edges.

Alcoa Aluminum Bus Conductors

**Structural-Shaped Bus Conductors
Standard Sizes**

Nominal Dimensions and Weights

Channels									
Depth In.	Web Thick. In.	Flange Width In.	Section Area Sq. In.	Weight Lbs. Per Ft.	Max. Length Ft.	EC-H12	No. 2 EC-T61	No. 2 EC-T6	
3	0.170	1.410	1.21	1.42	50	X	X	X	
	0.258	1.498	1.47	1.73	50	X	X	X	
	0.356	1.596	1.76	2.07	50	X	X	X	
4	0.180	1.580	1.57	1.85	50	X	X	X	
	0.247	1.647	1.84	2.16	50	X	X	X	
	0.320	1.720	2.13	2.50	50	X	X	X	
5	0.190	1.750	1.97	2.32	50	X	X	X	
	0.325	1.885	2.64	3.11	50	X	X	X	
	0.472	2.032	3.38	3.97	50	X	X	X	
6	0.225	1.945	2.55	3.00	85	X	X	X	
	0.314	2.034	3.09	3.63	85	X	X	X	
	0.437	2.157	3.82	4.48	85	X	X	X	
7	0.314	2.194	3.60	4.23	85	X	X	X	
	0.419	2.299	4.33	5.10	85	X	X	X	
	0.524	2.404	5.07	5.96	85	X	X	X	
8	0.303	2.343	4.04	4.75	85	X	X	X	
	0.395	2.435	4.78	5.62	85	X	X	X	
	0.520	2.560	5.78	6.80	85	X	X	X	
10	0.375	3.500	7.30	8.58	85	X	X	X	
	0.438	3.563	7.93	9.32	85	X	X	X	
	0.500	3.625	8.55	10.05	85	X	X	X	
12	0.387	3.047	7.35	8.64	85	X	X	X	
	0.510	3.170	8.82	10.37	85	X	X	X	
	0.632	3.292	10.29	12.10	85	X	X	X	

Angles

Size In.	Flange Thick. In.	Section Area Sq. In.	Weight Lbs. Per Ft.	Max. Length Ft.	EC-H12	No. 2 EC-T61	No. 2 EC-T6
2 1/2 x 2	1/4	1.07	1.26	50	X	X	X
	3/8	1.55	1.83	50	X	X	X
2 1/2 x 2 1/2	1/4	1.19	1.40	50	X	X	X
	3/8	1.74	2.05	50	X	X	X
3 x 3	1/4	1.43	1.68	50	X	X	X
	3/8	2.10	2.47	50	X	X	X
	1/2	2.74	3.23	50	X	X	X
	1/2	2.91	3.42	50	X	X	X
4 x 3	1/4	1.69	1.99	85	X	X	X
	3/8	2.49	2.93	85	X	X	X
	1/2	3.25	3.83	85	X	X	X
	5/8	3.99	4.69	85	X	X	X
4 x 4	1/4	1.94	2.28	85	X	X	X
	3/8	2.86	3.38	85	X	X	X
	1/2	3.75	4.41	85	X	X	X
	5/8	4.61	5.42	85	X	X	X
5 x 3 1/2	3/8	3.05	3.58	85	X	X	X
	1/2	4.00	4.70	85	X	X	X
	5/8	4.92	5.79	85	X	X	X
6 x 4	3/8	3.60	4.24	85	X	X	X
	1/2	4.74	5.58	85	X	X	X
	5/8	5.85	6.88	85	X	X	X

†Extruded Angle.

‡Rolled angle—Nominal size of 3 3/32-in. x 3 3/32-in.

Notes:

1. Area computations were based on nominal dimensions. Weights were calculated using an aluminum weight of 0.098 pounds per cubic inch.

2. Sizes and lengths other than listed are subject to inquiry.

3. For current-carrying capacity and other data, see booklet "Alcoa Aluminum Bus Conductors."

**Tubular Bus Conductors Standard Pipe Sizes
Nominal Dimensions and Weights**

Nom. Pipe Size In.	Diameter, In.		Wall Thick. In.	Area Sq. In.	Weight Per Ft. Lbs.	6063-T6	6061-T6
	Outside	Inside					
ASA Schedule 40 Pipe (Standard Pipe Size)							
1/2	0.840	0.622	0.109	0.250	0.294	X	X
3/4	1.050	0.824	0.113	0.333	0.391	X	X
1	1.315	1.019	0.133	0.494	0.581	X	X
1 1/4	1.660	1.380	0.140	0.668	0.786	X	X
1 1/2	1.900	1.610	0.145	0.800	0.940	X	X
2	2.375	2.067	0.154	1.075	1.264	X	X
2 1/2	2.875	2.469	0.203	1.704	2.004	X	X
3	3.500	3.068	0.216	2.228	2.621	X	X
3 1/2	4.000	3.518	0.226	2.680	3.151	X	X
4	4.500	4.026	0.237	3.174	3.733	X	X
5	5.563	5.047	0.258	4.300	5.057	X	X
ASA Schedule 80 Pipe (Extra-Heavy Pipe Size)							
1/2	0.810	0.546	0.117	0.320	0.376	X	X
3/4	1.050	0.742	0.154	0.434	0.510	X	X
1	1.315	0.957	0.179	0.639	0.751	X	X
1 1/4	1.660	1.278	0.191	0.881	1.037	X	X
1 1/2	1.900	1.500	0.200	1.068	1.256	X	X
2	2.375	1.939	0.218	1.477	1.737	X	X
2 1/2	2.875	2.323	0.276	2.254	2.650	X	X
3	3.500	2.900	0.300	3.016	3.547	X	X
3 1/2	4.000	3.364	0.318	3.678	4.326	X	X
4	4.500	3.826	0.337	4.407	5.183	X	X
5	5.563	4.813	0.375	6.112	7.188	X	X

Notes:

1. Area computations based on nominal dimensions. Weights computed using an aluminum weight of 0.098 pounds per cubic inch.

2. Tubular conductors in this range of diameters can also be furnished with dimensions in terms of outside or inside diameters and specific wall thickness.

3. If tolerances closer than pipe tolerances are desired, tubular conductors can be supplied to extruded tube tolerances.

4. Sizes, alloys and tempers other than listed are subject to inquiry.

5. For current-carrying capacity and other data, see booklet "Alcoa Aluminum Bus Conductors."

**Standard Tube Sizes
Nominal Dimensions and Weights
Square Tube**

Square Side In.	Wall Thick. In.	Area, Sq. In.		Wt. Per Ft. Lbs.		No. 2 EC-T61 Extruded	EC-H141 Drawn
		No. 2 EC-T61	EC-H141	No. 2 EC-T61	EC-H141		
3	1/4	2.643	2.589	3.108	3.045	X	X
	3/8	3.736	3.575	4.394	4.204	X	X
	1/2	4.571	4.375	5.375	5.175	X	X
4	1/4	3.589	3.589	4.221	4.221	X	X
	3/8	5.236	5.057	6.158	5.947	X	X
	1/2	6.571	6.356	7.728	7.475	X	X
5	1/4	4.482	4.589	5.271	5.397	X	X
	3/8	6.575	6.575	7.732	7.732	X	X
	1/2	8.571	8.356	10.08	9.827	X	X
6	1/4	5.482	5.589	6.447	6.573	X	X
	3/8	8.075	8.075	9.496	9.496	X	X
	1/2	10.57	10.36	12.43	12.18	X	X

Notes:

1. Area computations based on nominal dimensions. Weights computed using an aluminum weight of 0.098 pounds per cubic inch.

2. Sizes, alloys and tempers other than shown in tables are subject to inquiry.

**Alcoa Heavy Series Aluminum Alloy Bolts, Nuts and Washers
For Bus Bar Stock Items**

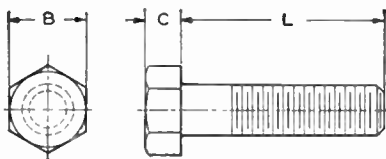

Bolt Size	F (Head), In.	Dimensions	
		L (Length), In.	
1/2-13	7/8	1 1/4, 1 1/2, 1 3/4, 2, 2 1/4	2 1/2, 2 3/4, 3, 3 1/2
5/8-11	1 1/16	1 1/4, 1 1/2, 1 3/4, 2, 2 1/2	3, 3 1/2, 4
3/4-10	1 1/4	1 1/2, 2, 2 1/2, 3, 3 1/2, 4	

Alcoa Aluminum Conductors Steel-Reinforced (ACSR) Bare

Code Word	ACSR Cross Section			Copper Equivalent Based Upon Equal D-C Resistance Cu 97% Al 61%	Stranding No. and Dia. of Strands In.		Dia., In.		D-C Resistance at 20°C Ohms Per M-Ft. (71%)	Ult. Strength Lbs. *	Total Wt. Per M-Ft. Lbs.	Std. Ship. on Reel
	Aluminum		Total Sq. In.		Aluminum	Steel	Complete Cable	Steel Core				
	Cir. Mils or AWG	Sq. In.										
Turkey	6	0.0206	0.0240	8	6x0.0661	1x0.0661	0.198	0.0661	0.6573	1170	36.1	1246
Thrush	5	0.0260	0.0303	7	6x0.0743	1x0.0743	0.223	0.0743	0.5213	1460	45.5	1246
Swan	4	0.0328	0.0383	6	6x0.0834	1x0.0834	0.250	0.0834	0.4134	1830	57.4	1246
Swanate	4	0.0328	0.0411	6	7x0.0772	1x0.1029	0.257	0.1029	0.4134	2288	67.1	955
Swallow	3	0.0413	0.0482	5	6x0.0937	1x0.0937	0.281	0.0937	0.3279	2250	72.4	1246
Sparrow	2	0.0521	0.0608	4	6x0.1052	1x0.1052	0.316	0.1052	0.2600	2790	91.3	1246
Sparate	2	0.0521	0.0653	4	7x0.0974	1x0.1299	0.325	0.1299	0.2600	3525	106.7	955
Robin	1	0.0657	0.0767	3	6x0.1182	1x0.1182	0.355	0.1182	0.2062	3480	115.2	1246
Raven	1/0	0.0829	0.0967	2	6x0.1327	1x0.1327	0.398	0.1327	0.1635	4280	145.2	934
Quail	2/0	0.1045	0.1219	1	6x0.1190	1x0.1190	0.447	0.1190	0.1297	5345	183.1	1246
Pigeon	3/0	0.1318	0.1538	1/0	6x0.1672	1x0.1672	0.502	0.1672	0.1028	6675	230.9	1246
Penguin	4/0	0.1662	0.1939	2/0	6x0.1878	1x0.1878	0.563	0.1878	0.08155	8420	291.1	1246
Waxwing	266800	0.2095	0.2211	3/0	18x0.1217	1x0.1217	0.609	0.1217	0.06500	7100	289.7	1480
Owl	266800	0.2095	0.2367	3/0	6x0.2109	7x0.0703	0.633	0.2109	0.06500	9645	343.3	1530
Partridge	266800	0.2095	0.2436	3/0	26x0.1013	7x0.0788	0.612	0.2364	0.06531	11250	367.3	3920
Ostrich	300000	0.2356	0.2740	188700	26x0.1074	7x0.0835	0.680	0.2505	0.05809	12650	412.9	3920
Merlin	336400	0.2642	0.2789	4/0	18x0.1367	1x0.1367	0.684	0.1367	0.05155	8950	365.3	2210
Linnet	336400	0.2642	0.3072	4/0	26x0.1138	7x0.0885	0.721	0.2655	0.05181	11050	463.0	3920
Oriole	336400	0.2642	0.3259	4/0	30x0.1059	7x0.1059	0.741	0.3177	0.05193	17040	527.1	3460
Chickadee	397500	0.3122	0.3295	250000	18x0.1486	1x0.1486	0.743	0.1486	0.04363	10400	431.0	2940
Ibis	397500	0.3122	0.3630	250000	26x0.1236	7x0.0961	0.783	0.2883	0.04384	16190	547.2	3920
Lark	397500	0.3122	0.3850	250000	30x0.1151	7x0.1151	0.806	0.3453	0.04395	19980	622.8	3460
Pelican	477000	0.3746	0.3954	300000	18x0.1628	1x0.1628	0.814	0.1628	0.03636	12300	518.0	2940
Flicker	477000	0.3746	0.4231	300000	24x0.1410	7x0.0940	0.846	0.2820	0.03653	17200	614.5	5150
Hawk	477000	0.3746	0.4356	300000	26x0.1355	7x0.1054	0.858	0.3162	0.03653	19430	656.6	3920
Hen	477000	0.3746	0.4620	300000	30x0.1261	7x0.1261	0.883	0.3783	0.03662	23300	747.3	3460
Osprey	556500	0.4371	0.4614	350000	18x0.1758	1x0.1758	0.879	0.1758	0.03116	14300	604.	2940
Parakeet	556500	0.4371	0.4938	350000	24x0.1523	7x0.1015	0.914	0.3045	0.03132	19850	717.	5150
Dove	556500	0.4371	0.5083	350000	26x0.1463	7x0.1138	0.927	0.341	0.03132	22400	766.	3920
Eagle	556500	0.4371	0.5391	350000	30x0.1362	7x0.1362	0.953	0.409	0.03139	27200	872.	3460
Peacock	605000	0.4752	0.5368	380500	24x0.1588	7x0.1059	0.953	0.318	0.02880	21500	779.	5150
Squab	605000	0.4752	0.5526	380500	26x0.1525	7x0.1186	0.966	0.356	0.02880	24100	833.	3920
Teal	605000	0.4752	0.5835	380500	30x0.1420	19x0.0852	0.994	0.426	0.02888	30000	939.	4760
Rook	636000	0.4995	0.5643	400000	24x0.1628	7x0.1085	0.977	0.326	0.02740	22600	819.	5150
Grosbeak	636000	0.4995	0.5809	400000	26x0.1564	7x0.1216	0.990	0.365	0.02740	25000	875.	3920
Egret	636000	0.4995	0.6134	400000	30x0.1456	19x0.0874	1.019	0.437	0.02747	31500	988.	4760
Flamingo	666600	0.5235	0.5914	419000	24x0.1667	7x0.1111	1.000	0.333	0.02614	23700	859.	5150
Crow	715500	0.5620	0.6348	450000	54x0.1151	7x0.1151	1.036	0.345	0.02436	26300	921.	5130
Starling	715500	0.5620	0.6535	450000	26x0.1659	7x0.1290	1.051	0.387	0.02436	28100	985.	3920
Redwing	715500	0.5620	0.6901	450000	30x0.1544	19x0.0926	1.081	0.463	0.02441	34600	1111.	4760
Tern	795000	0.6244	0.6676	500000	45x0.1329	7x0.0886	1.063	0.266	0.02192	22900	896.	4230
Condor	795000	0.6244	0.7053	500000	54x0.1214	7x0.1214	1.093	0.364	0.02192	28500	1024.	5130
Drake	795000	0.6244	0.7261	500000	26x0.1749	7x0.1360	1.108	0.408	0.02192	31200	1094.	3920
Mallard	795000	0.6244	0.7668	500000	30x0.1628	19x0.0977	1.140	0.489	0.02197	38400	1235.	4760
†Grouse	80000	0.0628	0.0847	50310	8x0.1000	1x0.1670	0.367	0.1670	0.2168	5200	149.0	805
†Petrel	101800	0.0800	0.1266	64160	12x0.0921	7x0.0921	0.461	0.2763	0.1712	9860	254.1	2205
†Minoreca	110800	0.0870	0.1378	69700	12x0.0961	7x0.0961	0.481	0.2883	0.1573	10730	276.6	1985
†Leghorn	134600	0.1057	0.1674	84600	12x0.1059	7x0.1059	0.530	0.3177	0.1295	12920	336.0	2205
†Guinea	159000	0.1249	0.1977	100000	12x0.1151	7x0.1151	0.576	0.3453	0.1096	15200	396.8	2205
†Dotterel	176900	0.1389	0.2200	111200	12x0.1214	7x0.1214	0.607	0.3642	0.09851	16440	441.5	2205
†Dorking	190800	0.1499	0.2373	120000	12x0.1261	7x0.1261	0.631	0.3783	0.09134	17730	476.3	2205
†Cochin	211300	0.1660	0.2628	132900	12x0.1327	7x0.1327	0.663	0.3981	0.08248	19640	527.5	3310
†Bahama	203200	0.1596	0.3020	127800	16x0.1127	19x0.0977	0.714	0.4885	0.08576	27500	676.7	5195

*Based on standard weight zinc-coated steel core wire.

†Have a high ratio of mechanical strength to current-carrying capacity. Used largely for overhead ground wires and for special construction such as river crossing spans.

Notes:

1. An amount not exceeding 10 per cent of the total weight of any one order may be shipped in random lengths, but no piece shorter than 50 per cent of the standard length will be shipped. No random length will be wound on the same reel with a standard length, and all reels will be marked showing number of pieces, length of piece.

2. The actual weight of cable will be held within a tolerance of plus or minus two per cent (2%) of the weights listed. Invoicing will be based on actual weight.

**Alcoa Weather Resistant-Line Wires
Polyethylene Type**

Code Word	AWG	Conductor Size		Cover Thickness 64ths In.	Stranding Number and Diam. of Strands, In.		Nominal Diam. In.	Covered Conductor	Copper Equivalent Based on Equal D-C Resistance, Copper 97% Aluminum 61%	D-C Resistance Ohms Per 1000 Ft. at 20° C (61%)	Breaking Strength Lbs.	Reel Length Ft.
		Circular Mils	Square In.		Aluminum	Steel						
Solid Aluminum Conductor												
Apple	6	26,250	0.0206	2	1x0.1620	0.1620	0.225	8	0.6477	450	7,200
Pear	4	41,740	0.0328	2	1x0.2043	0.2043	0.267	6	0.4073	716	8,500
Cherry	2	66,370	0.0521	3	1x0.2576	0.2576	0.352	4	0.2562	1,110	5,600
Stranded Aluminum Conductor												
Plum	6	26,250	0.0206	2	7x0.0612	0.184	0.247	8	0.6606	501	9,500
Apricot	4	41,740	0.0328	2	7x0.0772	0.232	0.295	6	0.4155	785	6,000
Peach	2	66,370	0.0521	3	7x0.0974	0.292	0.386	4	0.2613	1,200	4,000
Nectarine	1	83,690	0.0657	3	7x0.1094	0.328	0.422	3	0.2072	1,460	4,100
Quince	1 0	105,500	0.0829	4	7x0.1228	0.368	0.493	2	0.1643	1,770	4,800
Orange	2 0	133,100	0.1045	4	7x0.1379	0.414	0.539	1	0.1303	2,230	3,700
Fig	3 0	167,800	0.1318	4	7x0.1548	0.464	0.589	1 0	0.1033	2,700	2,900
Olive	1 0	211,600	0.1662	4	7x0.1739	0.522	0.647	2 0	0.08195	3,410	2,300
Pomegranate	4 0	211,600	0.1662	4	19x0.1055	0.528	0.653	2 0	0.08195	3,695	2,400
Mulberry	...	266,800	0.2095	4	19x0.1185	0.593	0.718	3 0	0.06500	4,560	2,500
Anona	...	336,400	0.2642	4	19x0.1331	0.666	0.791	4 0	0.05153	5,640	2,000
Crabapple	...	336,400	0.2642	5	19x0.1331	0.666	0.822	4 0	0.05153	5,640	2,000
Molles	...	397,500	0.3122	5	19x0.1447	0.724	0.880	250,000	0.04363	6,510	1,725
Huckleberry	...	477,000	0.3746	5	37x0.1135	0.795	0.951	300,000	0.03636	8,170	1,700
Paw Paw	...	556,500	0.4371	5	37x0.1226	0.858	1.014	350,000	0.03116	9,340	1,175
Breadfruit	...	636,000	0.4995	6	61x0.1021	0.918	1.106	400,000	0.02727	10,680	1,225
Persimmon	...	795,000	0.6244	6	61x0.1142	1.028	1.216	500,000	0.02181	13,610	1,150
Grapefruit	...	1,033,500	0.8117	6	61x0.1302	1.172	1.360	650,000	0.01678	17,350	1,050
ACSR												
Walnut	6	26,250	0.0240	2	6x0.0661	1x0.0661	0.198	0.261	8	0.6573	1,110	8,500
Butternut	4	41,740	0.0383	2	6x0.0834	1x0.0834	0.250	0.313	6	0.4134	1,740	5,500
Hickory	4	41,740	0.0411	2	7x0.0772	1x0.1029	0.257	0.320	6	0.4134	2,170	3,500
Pignut	2	66,370	0.0608	3	6x0.1052	1x0.1052	0.316	0.410	4	0.2600	2,650	3,400
Beech	2	66,370	0.0653	3	7x0.0974	1x0.1299	0.325	0.419	4	0.2600	3,350	4,500
Chestnut	1	83,690	0.0767	3	6x0.1182	1x0.1182	0.355	0.449	3	0.2062	3,300	5,400
Almond	1/0	105,500	0.0967	4	6x0.1327	1x0.1327	0.398	0.523	2	0.1635	4,070	2,800
Pecan	2/0	133,100	0.1219	4	6x0.1490	1x0.1490	0.447	0.572	1	0.1297	5,080	2,300
Filbert	3/0	167,800	0.1538	4	6x0.1672	1x0.1672	0.502	0.627	1 0	0.1028	6,340	2,700
Buckeye	4/0	211,600	0.1939	4	6x0.1878	1x0.1878	0.563	0.688	2 0	0.08155	8,000	2,100
Hackberry	...	266,800	0.2211	4	18x0.1217	1x0.1217	0.609	0.734	3 0	0.06500	6,745	2,400
Neoprene Type												
Solid Aluminum Conductor												
Pine	6	26,250	0.0206	3	1x0.1620	0.1620	0.256	8	0.6477	427	7,200
Larch	4	41,740	0.0328	3	1x0.2043	0.2043	0.298	6	0.4073	678	8,500
Tamarack	2	66,370	0.0521	3	1x0.2576	0.2576	0.352	4	0.2562	1,060	5,600
Stranded Aluminum Conductor												
Spruce	6	26,250	0.0206	3	7x0.0612	0.184	0.278	8	0.6606	475	9,500
Hemlock	4	41,740	0.0328	3	7x0.0772	0.232	0.326	6	0.4155	743	6,000
Fir	2	66,370	0.0521	3	7x0.0974	0.292	0.386	4	0.2613	1,140	4,000
Cypress	1	83,690	0.0657	4	7x0.1094	0.328	0.453	3	0.2072	1,380	4,400
Sequoia	1/0	105,500	0.0829	4	7x0.1228	0.368	0.493	2	0.1643	1,680	4,800
Cedar	2/0	133,100	0.1045	4	7x0.1379	0.414	0.539	1	0.1303	2,120	3,700
Holly	3/0	167,800	0.1318	4	7x0.1548	0.464	0.589	1 0	0.1033	2,560	2,900
Pieris	4/0	211,600	0.1662	4	7x0.1739	0.522	0.647	2 0	0.08195	3,230	2,300
Azalea	...	266,800	0.2095	5	19x0.1185	0.593	0.749	3 0	0.06500	4,320	2,500
Box	...	336,400	0.2642	5	19x0.1331	0.666	0.822	4 0	0.05155	5,340	2,000
Yucca	...	397,500	0.3122	6	19x0.1447	0.724	0.912	250,000	0.04363	6,190	1,725
ACSR												
Abies	6	26,250	0.0240	3	6x0.0661	1x0.0661	0.198	0.292	8	0.6573	1,110	8,500
Buxux	4	41,740	0.0383	3	6x0.0834	1x0.0834	0.250	0.344	6	0.4134	1,740	5,500
Kalmia	4	41,740	0.0411	3	7x0.0772	1x0.1029	0.257	0.351	6	0.4134	2,170	3,500
Biota	2	66,370	0.0608	3	6x0.1052	1x0.1052	0.316	0.410	4	0.2600	2,650	3,400
Hex	2	66,370	0.0653	3	7x0.0974	1x0.1299	0.325	0.419	4	0.2600	3,350	4,500
Thuja	1	83,690	0.0767	4	6x0.1182	1x0.1182	0.355	0.480	3	0.2062	3,300	5,400
Jackpine	1/0	105,500	0.0967	4	6x0.1327	1x0.1327	0.398	0.523	2	0.1635	4,070	2,800
Araucaria	2/0	133,100	0.1219	4	6x0.1490	1x0.1490	0.447	0.572	1	0.1297	5,080	2,300
Tsuga	3/0	167,800	0.1538	4	6x0.1672	1x0.1672	0.502	0.627	1 0	0.1028	6,340	2,700
Retinospora	4/0	211,600	0.1939	4	6x0.1878	1x0.1878	0.563	0.688	2 0	0.08155	8,000	2,100
Redfir	...	266,800	0.2211	5	18x0.1217	1x0.1217	0.609	0.765	3 0	0.06500	6,745	2,400

Note: The standard lengths are subject to a manufacturing tolerance of ± 10 percent. An amount not exceeding 10 percent of the total length of any one order may be shipped in random lengths with no piece less than 25 percent nor longer than 110 percent of the standard length. Reels will be marked to show length of each piece, and, in the case of reels containing random lengths, the number of pieces, footage of each piece and position on reel. Shipments to each destination will be made to the nearest package specified on each item ordered. Weights of covered conductors are approximate and subject to normal manufacturing tolerances. For further information contact Graybar.

Alcoa Parallel Groove Clamps

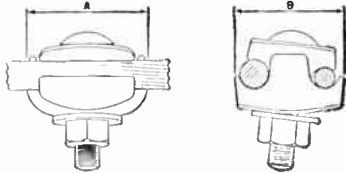

Universal—190 Series



Cap Screw Type—480 Series

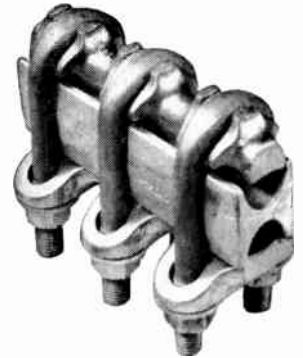

U-Bolt Type—580 Series

Universal Parallel Groove Clamps will accommodate a range of conductor sizes in each groove. They are recommended for this convenience and for light-duty service. Not recommended for main circuit connections.

Heavy Duty Parallel Groove Clamps are recommended for main line connections and heavy duty service. These clamps offer maximum electrical efficiency. The groove contour and the aluminum hardware combine to make them the best parallel groove clamps for use where the current load is large or operating conditions are severe.

Clamp Catalog No.	Nominal Wt. Lbs.	Diam.	Bolt	Dimensions in Inches		
				Length	A	B
190	0.53	1/2		2 3/8	2 3/8	2 1/8
191	0.58	1/2		2 3/8	2 3/8	2 1/8
R192	0.25	3/8		1 3/4	1 7/8	1 21/32
R193	0.27	3/8		1 1/2	1 7/8	1 21/32
R194	0.12	5/16		1 7/16	1 7/16	1 7/32
195	0.13	5/16		1 7/16	1 7/16	1 7/32
R196	0.53	1/2		2 3/8	2 3/8	2 3/16
R197	0.56	1/2		2 3/8	2 3/8	2 3/16
198	0.26	3/8		1 3/4	1 7/8	1 3/4
199	0.27	3/8		1 3/4	1 7/8	1 3/4
200	1.0	5/8		3	3	2 5/8
201	1.1	5/8		3	3	2 5/8

Heavy Duty Parallel Groove Clamps

480 and 580 Series

The following clamps are cataloged by a decimal system which denotes the groove sizes:

Example: ^(A) ^(B) A 481.2 Clamp

(A) has a Number 1 groove shown in the units figure (Range 0.292 — 0.502),

(B) has a Number 2 groove shown in the tenths figure (Range 0.464 — 0.743)

Number	Diam. Range		Min.	ACSR	Max.	Min.	Stranded Conductor	
	Min.	Max.					Min.	Max.
1	0.292	0.502	2 6/1		3/0 6/1	2	3/0	
2	0.464	0.743	3/0 6/1		397.5 MCM 18/1	3/0	400 MCM	
3	0.743	1.060	397.5 MCM 18/1		715.5 MCM 26/7	450 MCM	800 MCM	

Available Clamps

U-Bolt Type					Cap Screw Type				
No.	Nominal Wt.	No.	Bolts	Size	No.	Nominal Wt.	No.	Bolts	Size
581.1	0.30	1		3/8	481.1	0.26	2		3/8
582.1	0.63	1		1/2	482.1	0.61	2		1/2
582.2	1.20	2		1/2	482.2	1.09	3		1/2
583.1	1.30	1		5/8	483.2	1.75	2		5/8
583.2	2.60	2		5/8					
583.3	3.90	3		5/8					

*Extensive field experience and exposure tests show that if a suitable grease type joint compound is liberally applied over and around the contact area, copper-to-aluminum electric connections can be made satisfactorily with aluminum clamps without copper bushings.

Copper bushings are available for all universal grooves—subject to inquiry.

In choosing a parallel groove clamp for connecting two different sizes of conductor, determine the groove and clamp required for the size of conductor.

Alcoa Parallel Groove Clamps

Conductor Diameters For Use In Selecting Parallel Groove Clamps

Size	ACSR Stranding		Diam. In.	Stranded Aluminum Conductor		Round Aluminum Wire		Stranded Copper Conductors		Round Copper Wire	
	AL	S.		Size	Diam. In.	Size	Diam. In.	Size	Diam. In.	Size	Diam. In.
6	6	1	0.198	6	0.184	10	0.101	8	0.146	10	0.101
5	6	1	0.223	4	0.232	9	0.114	7	0.164	9	0.114
4	6	1	0.250	3	0.260	8	0.128	6	0.184	8	0.128
4	7	1	0.257	2	0.292	7	0.144	5	0.206	7	0.144
3	6	1	0.281	1	0.328	6	0.162	4	0.232	6	0.162
2	6	1	0.316	1/0	0.368	5	0.181	*4	0.254	5	0.181
2	7	1	0.325	2/0	0.414	4	0.204	3	0.260	4	0.204
1	6	1	0.355	3/0	0.464	3	0.229	*3	0.286	3	0.229
1/0	6	1	0.398	4/0	0.522	2	0.257	2	0.292	2	0.257
2/0	6	1	0.447	250,000	0.575	1	0.289	*2	0.320	1	0.289
3/0	6	1	0.502	266,800	0.593	1/0	0.324	1	0.328	1/0	0.324
4/0	6	1	0.563	300,000	0.629	2/0	0.364	*1	0.360	2/0	0.364
266,800	18	1	0.609	336,400	0.666	1/0	0.368	3/0	0.409
266,800	6	7	0.633	350,000	0.681	†1/0	0.390	4/0	0.460
266,800	26	7	0.642	397,500	0.724	2/0	0.414
300,000	26	7	0.680	400,000	0.728	†2/0	0.438
336,400	18	1	0.684	450,000	0.772	3/0	0.464
336,400	26	7	0.721	477,000	0.795	†3/0	0.492
336,400	30	7	0.741	500,000	0.813	4/0	0.522
397,500	18	1	0.743	556,500	0.858	†4/0	0.552
397,500	26	7	0.783	600,000	0.893	250,000	0.575
397,500	30	7	0.806	636,000	0.918	†250,000	0.600
477,000	18	1	0.814	650,000	0.929	300,000	0.630
477,000	24	7	0.846	700,000	0.964	†300,000	0.657
477,000	26	7	0.858	715,500	0.975	350,000	0.681
477,000	30	7	0.883	750,000	0.998	†350,000	0.710
556,500	24	7	0.914	795,000	1.028	400,000	0.728
556,500	26	7	0.927	800,000	1.031	450,000	0.772
556,500	30	7	0.953	874,500	1.078	500,000	0.813
605,000	24	7	0.953	900,000	1.094	550,000	0.855
605,000	26	7	0.996	954,000	1.126	600,000	0.893
605,000	30	19	0.994	1,000,000	1.152	650,000	0.929
636,000	36	1	0.930	1,033,500	1.170	700,000	0.964
636,000	24	7	0.966	1,100,000	1.209	750,000	0.998
636,000	26	7	0.990	1,113,000	1.216	800,000	1.031
636,000	30	19	1.019	1,200,000	1.263	850,000	1.062
666,600	24	7	1.000	1,250,000	1.289	900,000	1.094
715,500	54	7	1.036	1,272,000	1.300	950,000	1.123
715,500	26	7	1.051	1,300,000	1.315	1,000,000	1.152
715,500	30	19	1.081	1,400,000	1.364	1,250,000	1.289
795,000	36	1	1.040	1,431,000	1.379	1,500,000	1.412
795,000	54	7	1.093	1,500,000	1.412	1,750,000	1.536
795,000	26	7	1.108	1,590,000	1.454
795,000	30	19	1.140	1,600,000	1.459
874,500	54	7	1.146
900,000	54	7	1.162
954,000	54	7	1.196
1,033,500	54	7	1.246
1,113,000	54	19	1.293
1,192,500	54	19	1.338
1,272,000	54	19	1.382
1,351,500	54	19	1.424
1,431,000	54	19	1.465
1,510,500	54	19	1.506
1,590,000	54	19	1.545

*Strand.
†12 Strand.

Globetray Interchangeable Trays

For Cable Wiring and Tubing Support

Ladder Type



Cable-Strut Basket Type



Both Types Joined By Splice Plate

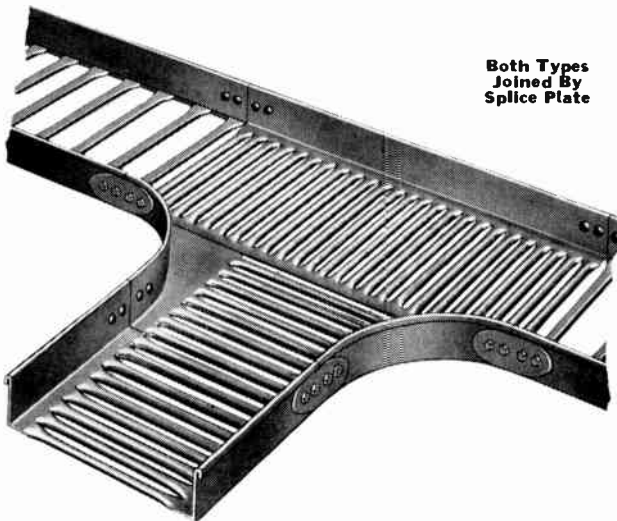

Interchangeability

These illustrations show the advantages of using Globetray (ladder type tray) in conjunction with Cable-Strut (basket type).

The cross channel design of Globetray provides natural drop out openings wherever needed. Globetray and Cable-Strut can be joined with the Universal Splice Plate at any point. They match perfectly, provide lower cost installation and are completely compatible. All straight sections and fittings are completely interchangeable.

These two trays were engineered for uniform and easy installation. There is complete interchangeability at any given location between the two types.

The Globetray (ladder type) is intended for use where festooning of cables is not a problem, while the Cable-Strut (basket type) is used for the support of communication wire, instrument tubing and control cables in automation applications. Both types available in steel or aluminum, with complete accessories for speedier installation and with offset locking channels to eliminate sharp edges and to add strength and rigidity.

Fittings:

All Globetray and Cable-Strut fittings are engineered to have the same load capacity as the straight sections.

All parts are produced and inspected to assure perfect alignment for faster installation.

Accessories:

This system carries a complete line of accessories in both types to speed installation and keep field manpower down to a minimum.

Load Charts:

Load charts for both types have been prepared by Pittsburgh Testing Laboratory and are to be found at the end of this section.

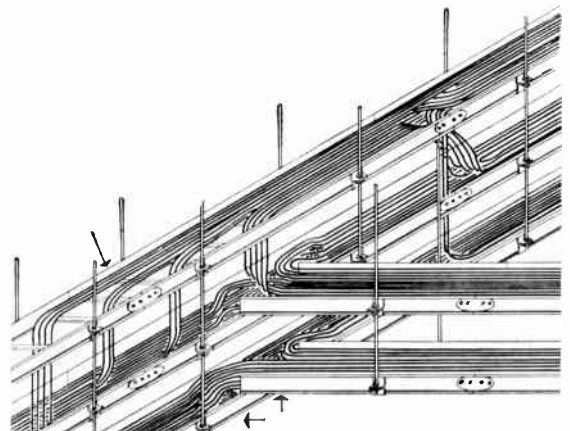

For complete information and prices contact your nearest Graybar office.

Globetray and Cable-Strut Fittings

Engineered to carry the same loads as the straight sections. All radii start at the ends of the fitting, therefore in critical locations a small amount of space is required to change elevations and make quick turns. This is accomplished by

furnishing straight, half curve and full curve splice plates.

Divider strips are available for all straight sections and fittings.

**All Fittings Shown Are Globetray Ladder Type
Also Available in Cable-Strut Type**

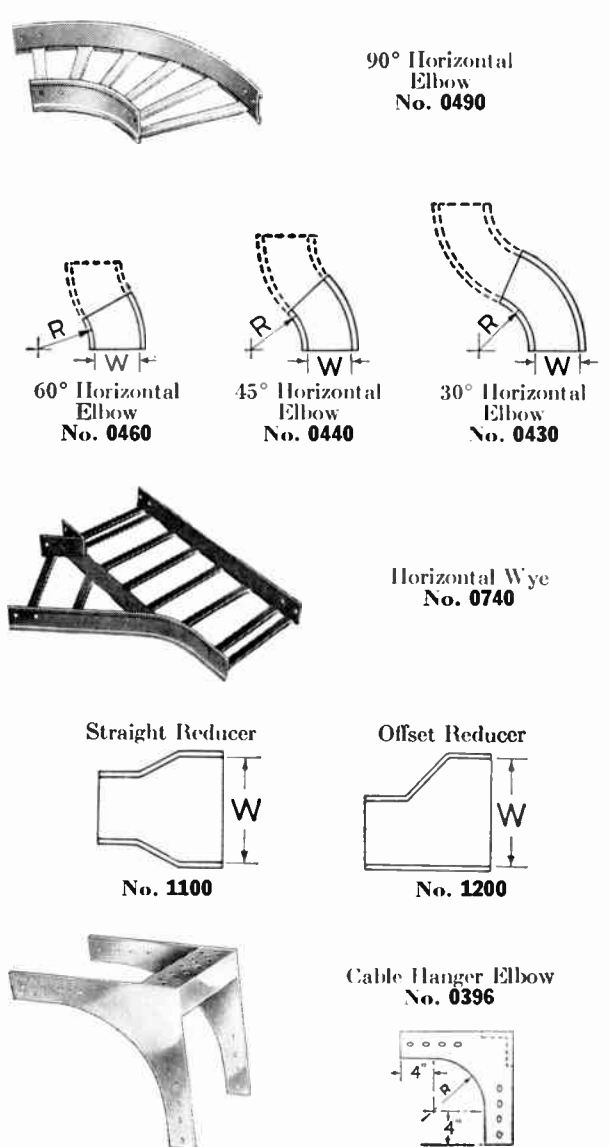
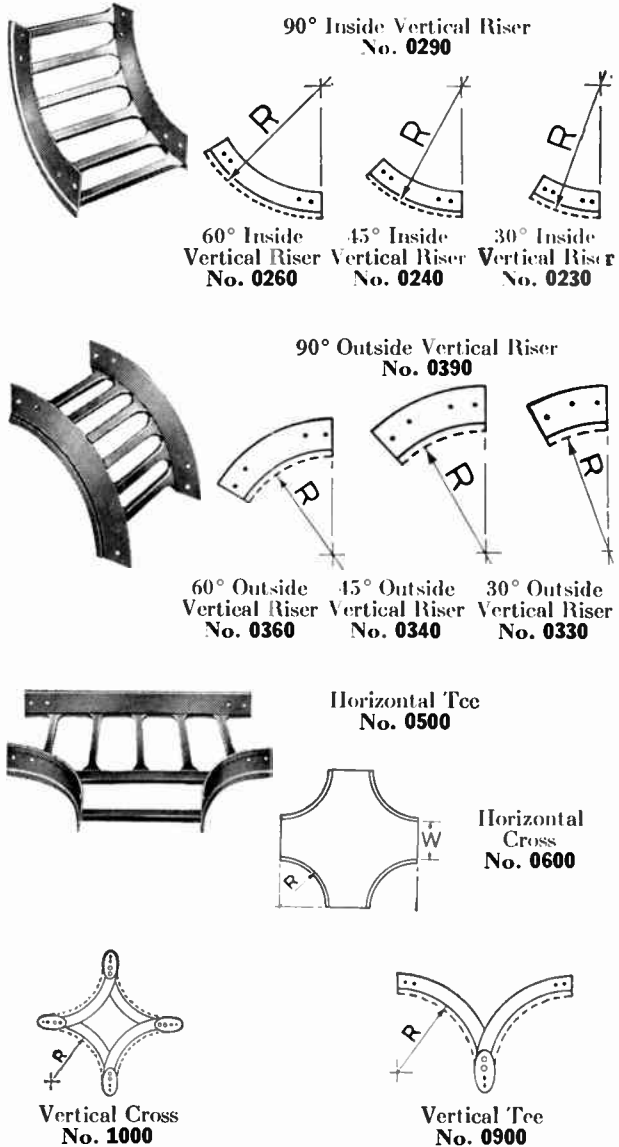

Splice Plates



Standard Type

Universal splice plates are made of No. 10 gauge steel, hot dip galvanized, or of 1/8-in. alloy 5052-H134 aluminum and come complete with four square shank button head bolts, washers and hex nuts (all hot dip galvanized). This splice plate can be installed as quickly as any hammer type connector or gimmick type connector—in many cases much faster. It is the strongest type connector made.

Note: Splice plates are ordered as a separate item.

Hinge Type Connector

Available where this type connector is desired; but no hinge type connector can carry the loads specified on load chart.

For complete information and prices contact your nearest Graybar office.

Globetray and Cable-Strut Accessories

Interchangeable on Both Trays

Globetray and Cable-Strut accessories are designed to speed installation and eliminate holes in cross channels to produce a smooth cable surface. Their use will eliminate

field labor almost entirely. The accessories on this page are available in either style tray.

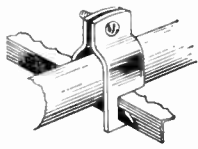

Cable Clamps

Made from aluminum alloy 5052-50 (.50-in.) complete with cadmium plated No. 10-24 screws, washers and nuts. Supplied straight and easily bent in the field to cable curve.

Conduit Clamp Brackets

Holds conduit or cable when it is necessary for them to run over side of tray.

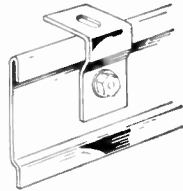

Divider Strip For Horizontal Elbow

Supplied in 6-ft. lengths and can easily be bent to any radius. It follows curve of the cable.

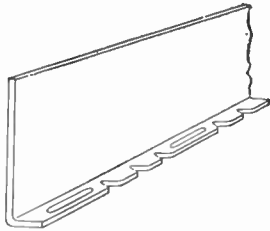

Wall Brackets

To support Globetray and Cable-Strut from walls, columns and available makes of channel framing.



Hold Down Clamps

Locks securely to side channels and can be bolted to most available makes of channel framing.

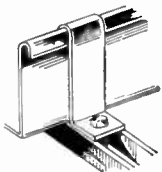

Globetray Cable Pulleys

Two sizes—for any bend larger than 45° the No. 144-24 permits curvature of the cable to a minimum radius of 24-in., while the No. 144-32 permits curves to a minimum of 32-in. radius.

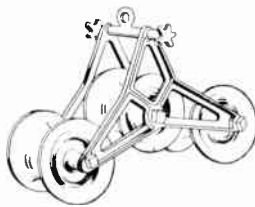

Globetray Cable Rollers

For pulling cable into straight sections of tray. Reduces drag.

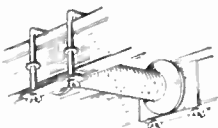

For complete information and prices contact your nearest Graybar office.



Side Channel Clamps

For fastening down tray when it is to be mounted flush with wall.

Drill Jigs

When sections are required to be cut in the field, this jig eliminates the necessity of laying out holes. Locks securely in position, guides drill perfectly.

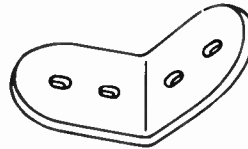
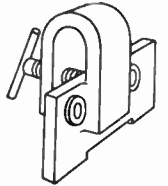

Tray To Box Connector

Use 90° splice plate. Frame type connectors also available.

Divider Strip Cable Protector

Used where cables cross over divider strip. Made of rubber. Slips over top edge of divider strip.

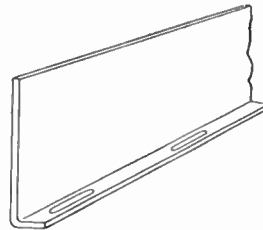
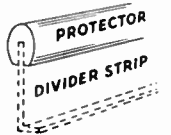

Straight Section Divider Strip

Quick, easy to install. Divider Strip Clamp includes bolts, nuts and washers cadmium plated.

Cover Clamps

Securely fastens cover on horizontal or vertical runs. Complete with (2) bolts, nuts and washers.

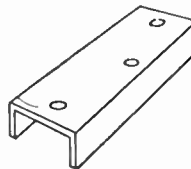
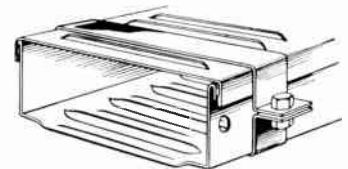

Cable-Strut Hanger Channels

Will carry the full loads as shown on load charts. Punched with 9/16-in. diam. holes for 1/2-in. diam. rods. Hot dip galvanized or aluminum.

Cable-Strut Single Hangers

Will support tray so cable can be installed from side. For 3-in. and 4-in. Cable-Strut only. Galvanized.

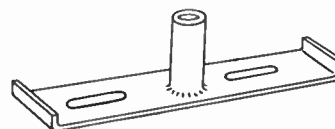
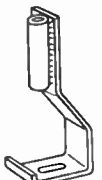

Cable-Strut Double Hangers

Will support two trays. Cables can be installed from the side. For 3-in. and 4-in. Cable-Strut only.

Safe Uniform Loads for Globetray and Cable-Strut

(Pounds Per Lineal Foot)—Deflection (Inches)

Tested as a free beam. When tray is used as a continuous beam, deflection will be (two fifths) of that shown.

These load charts have been prepared by the Pittsburgh Testing Laboratory and are based on tests performed by them in their laboratory.

Globetray Steel Load Chart

Unsupported Span	Cross Channel Spacing	4' 0"		6' 0"		8' 0"		10' 0"		12' 0"	
		Load Lbs.	Defl. In.	Load Lbs.	Defl. In.	Load Lbs.	Defl. In.	Load Lbs.	Defl. In.	Load Lbs.	Defl. In.
Globetray 6" wide	6	500	.125	270	.300	155	.400	80	.506	52	.683
	9	400	.104	270	.300	155	.400	80	.506	52	.683
	12	*300	.080	270	.300	155	.400	80	.506	52	.683
	18	*200	.058	*200	.225	155	.400	80	.506	52	.683
Globetray 9" wide	6	*390	.102	270	.300	155	.400	80	.506	52	.683
	9	*260	.071	*260	.290	155	.400	80	.506	52	.683
	12	*195	.057	*195	.215	155	.400	80	.506	52	.683
	18	*130	.041	*130	.145	*130	.325	80	.506	52	.683
Globetray 12" wide	6	*300	.080	270	.300	155	.400	80	.506	52	.683
	9	*200	.058	*200	.225	155	.400	80	.506	52	.683
	12	*150	.048	*150	.170	*150	.382	80	.506	52	.683
	18	*100	.033	*100	.110	*100	.254	80	.506	52	.683
Globetray 18" wide	6	*195	.057	*195	.215	155	.400	80	.506	52	.683
	9	*130	.041	*130	.145	*130	.400	80	.506	52	.683
	12	* 98	.032	* 98	.108	* 98	.249	80	.506	52	.683
	18	* 65	.022	* 65	.075	* 65	.173	*65	.416	52	.683
Globetray 20" wide	6	*180	.054	*180	.200	155	.400	80	.506	52	.683
	9	*117	.038	*117	.130	*117	.298	80	.506	52	.683
	12	* 88	.030	* 88	.100	* 88	.226	80	.506	52	.683
Globetray 24" wide	6	*150	.048	*150	.170	*150	.382	80	.506	52	.683
	9	*100	.033	*100	.110	*100	.254	80	.506	52	.683
	12	* 75	.026	* 75	.085	* 75	.196	*75	.476	52	.683

Note: 18 in. cross channel spacing is not recommended in 20 in. and 24 in. widths on steel tray.

*Limited by cross channel strength.

Globetray Aluminum Load Chart

Unsupported Span	Cross Channel Spacing, In.	4' 0"		6' 0"		8' 0"		10' 0"		4' 0"		6' 0"		8' 0"		10' 0"	
		Load Lbs.	Defl. In.	Load Lbs.	Defl. In.	Load Lbs.	Defl. In.	Load Lbs.	Defl. In.	Load Lbs.	Defl. In.	Load Lbs.	Defl. In.	Load Lbs.	Defl. In.	Load Lbs.	Defl. In.
Globetray (Aluminum) 6-In. Wide																	
6	200	.240	110	.365	60	.490	32	.575	*150	.117	110	.365	60	.490	32	.575	
9	200	.240	110	.365	60	.490	32	.575	*100	.100	*100	.332	60	.490	32	.575	
12	200	.240	110	.365	60	.490	32	.575	* 75	.075	* 75	.225	60	.490	32	.575	
Globetray (Aluminum) 9-In. Wide																	
6	200	.240	110	.365	60	.490	32	.575	*136	.135	110	.365	60	.490	32	.575	
9	200	.240	110	.365	60	.490	32	.575	* 91	.091	* 91	.302	60	.490	32	.575	
12	*150	.147	110	.365	60	.490	32	.575	* 68	.068	* 68	.263	60	.490	32	.575	
Globetray (Aluminum) 12-In. Wide																	
6	200	.240	110	.365	60	.490	32	.575	112	.111	110	.365	60	.490	32	.575	
9	*150	.147	110	.365	60	.490	32	.575	* 75	.075	* 75	.225	60	.490	32	.575	
12	*113	.112	110	.365	60	.490	32	.575	* 56	.056	* 56	.188	*56	.155	32	.575	
Globetray (Aluminum) 18-In. Wide																	
Globetray (Aluminum) 20-In. Wide																	
Globetray (Aluminum) 24-In. Wide																	

Note: 12 foot spans are not recommended in aluminum tray.

18-in. cross channel spacing is not recommended in aluminum tray.

For complete information and prices contact your nearest Graybar office.

Cable-Strut Load Chart

Material	Unsupported Span Width, In.	4' 0"		6' 0"		8' 0"		10' 0"	
		Load Lbs.	Defl. In.	Load Lbs.	Defl. In.	Load Lbs.	Defl. In.	Load Lbs.	Defl. In.
16 ga. steel	6-9-12	350	.200	175	.353	100	.471	50	.580
14 ga. steel	18-20-24	380	.220	225	.390	130	.517	70	.654
Aluminum (.081")	6-9-12-18-20-24	300	.390	155	.598	90	.850	50	1.275

Tested as a free beam. When cable-strut is used as a continuous beam, deflection will be 2/5 (two-fifths) of that shown.

Koiled Kords

Retractable Cords of a Thousand Uses



Retracted—4-Ft. Long



Extended—25 Ft. Long

Eliminate trailing wires; always retract to their original length. Reduce cord replacements; Koiled Kords are not subject to the twisting or tangling of straight cords.

Neoprene jacketed; permanently coiled into a spring-like shape. Available with one to seven conductors. Supplied in mandrel lengths, cut and used like ordinary straight cord, or furnished according to specifications in combinations of coiled and straight lengths, with or without terminals.

Standard Types

Stock items consist of a full line of 48-in. mandrel lengths and a limited number of prepared coil sets. Where quantity is sufficient, cords will be furnished for shielded applications. Shielding is provided by a special tinsel. Facilities for specialty items are available.

In forwarding inquiries on cord sets, enclose either specifications indicating design and construction, or a drawing.

Communication Cords

No.	No. of Conductors	Size A.W.G.	O.D. In.	No.	No. of Conductors	Size A.W.G.	O.D. In.
4010	2	23	.215	4040	6	23	.305
4001	3	23	.220	4050	7	23	.305
4020	4	23	.250	4221	4	2/23	.270
4030	5	23	.285				

Power Cords

No.	No. of Conductors	Size A.W.G.	U.L. Type	O.D. In.	No.	No. of Conductors	Size A.W.G.	U.L. Type	O.D. In.
8001	2	18	SVO	.260	8032	2	14	SO	.510
8011	2	18	SJO	.320	8033	3	14	SO	.560
8013	3	18	SJO	.350	8034	4	14	SO	.605
8014	4	18	SJO	.385	8042	2	12	SO	.605
8022	2	16	SJO	.360	8043	3	12	SO	.635
8023	3	16	SJO	.390	8044	4	12	SO	.665
8024	4	16	SJO	.425	8094	4	16	SO	.500
Heater Cord					Test Leads				
7007	2	18	HSJ	.335	9000	1	20	..	.165

Furnished in 24" lengths.

Prepared Cords

Carried in stock.

23 Gage Radio Replacement Cords

- No. 4001-23: 3-Cond.; 6-ft. extended, 12-in. retracted. One end stripped and tinned.
- No. 4020-25: 4-Cond.; 6-ft. extended, 12-in. retracted. Ends stripped and tinned.
- No. 4030-6: 5-Cond.; 5-ft. extended, 12-in. retracted. Ends stripped and tinned.

Heater Cords—2-Conductor

- No. 7007-8: 18 gage; with male plug and heater jack.
- No. 7007-9: 18 gage; male plug only.

Appleton Portable Reelites

Schedule RE

7P Series

Newly designed 7P Series has all the features of the 7S Series.

Consists of a universal type mounting bracket which gives unlimited flexibility.

Adaptable for ceiling or wall installation. Rated 7 Amps. 250 v.



No.	Cord Lgth. Ft.	Cord Type	Each
7P2	28	18-2 SJO	\$17.95
7P2G	25	18-3 SJO	21.00

Vaporproof Type

Extra safety features are incorporated in this model.

Furnished complete with handlamp attached.

Rated 7 Amp., 250 volt. Has three conductor cord with one conductor being grounded.

Ideal for wet steamy areas. Equipped with heavy plastic handle, wire guard and vapor-proof globe.

Takes lamps up to 75 watts.

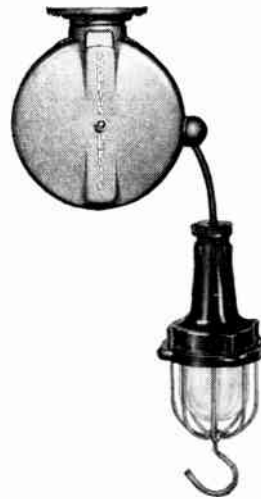

No.	Cord Lgth. Ft.	Cord Type	Each
7SV2	20	18-3 SJO	\$30.00

Appleton Air-Fluid Reels

Spring-Driven Lift Reels for Air and Fluid Hose

Types CA and CF—Light Duty

For light duty pneumatic tool, paint spray and blow-gun applications to keep hose free of kinks and out of the way.

Compact design makes this reel unit particularly valuable in places where head room is at a premium.

Furnished with 25-ft. of durable two-braid hose. Hose outlet is adjustable and should be set so that hose does not drag around rollers when mounted on wall or ceiling.

Reel diameter, 13½ inches.



Type CA

Maximum Pressure: Air—150 lbs., Fluid—125 lbs.

No.	Service	Hose Size, I.D.	Reel O.D.	Ship. Wt., Lbs.	*Each
CA11A	Air	¼	9/16	27	\$72.00
CA22A	Air	3/8	47/64	32	80.00
CF22A	†Fluid Paint	3/8	1/16	32	76.00

†Hose has proper O.D. for DeVilbiss fittings. Paint-fluid hose is not recommended for air service as this use is usually severe on the specially compounded rubber necessary for paints and oil solvents.

*For ratchet device add \$3.00 to above prices. Ratchet designed for use where constant tension is unnecessary. For ceiling installations only.

Appleton Portable Reelites and Accessories

Automatic Reeling Devices for Extension Cords

Continuous Swivel Reelites

Furnish light—or flexible power source for electrical devices when and where you want it, while keeping cord neatly reeled up and out of the way. Continuous swiveling action reduces accident hazards and increases cord life by preventing kinks or other damage. Positive stop action holds cord at any desired length, yet a flick of the wrist lets the reel take up cord when the job is done.

Hanger plates fit neatly over any 4-in. octagonal outlet box; installation is quick and easy.

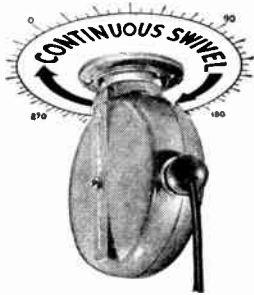

No. 7S2

7S Series

Double silver-alloy contact brushes permit free rotation of entire reel without power interruption or tangling of cord.

Totally enclosed steel construction keeps dust from moving parts. Furnished with durable, attractive baked hammertone finish. Reel Diameter, 7-in.



No. 7SV2

No. 7S2: Rated 10 amps., 250 volts. Maximum accessory weight, 20 oz.

No. 7S2G: Rated 7 amps., 250 volts. Maximum accessory weight, 20 oz.

No. 7SV2: Furnished complete with handlamp, as shown, with heavy plastic handle, heavy-duty wire guard and vapor-proof globe. Ideal for wet, steamy areas. Takes lamps up to 75 watts. Type SJO Cord, size 18 A.W.G., 3-conductor, has one conductor grounded to reel frame for added safety. Rated 7 amps., 250 volts. Maximum accessory weight, 30 oz.

No.	Cord Lgth. Feet	Cord Type	Each
7S2	25	16-2 SJO	\$19.75
7S2G	25	18-3 SJO	21.00
7SV2	20	18-3 SJO	30.00

All "G" Reelites come equipped with three conductor cord. Extra conductor serves as ground and not as a power source.

Call Graybar **FIRST** For . . .

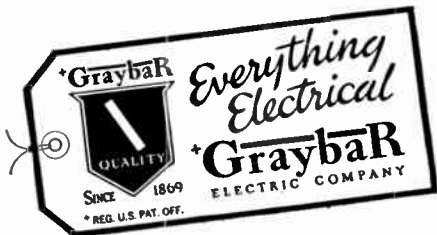

1500 Series Reelites

Available in 5½- or 10-in. sizes. Provide most of the features of the 7S Series except continuous swiveling action.

Rated 660 Watts, 250 Volts.
Finished in durable baked enamel.



No.	Cord Lgth. Feet	Cord Type	Reel Diam. In.	Max. Accessory Wt. Oz.	Each
1532	12	16-2SJO	5½	32	\$14.25
1532G	12	18-3SJO	5½	30	15.25
†1511	50	18-2	10	..	27.25
1519	40	16-2SJO	10	16	26.90
1519G	40	18-3SJO	10	14	29.25
1520	50	18-2SJO	10	‡	29.25
1520G	50	18-3SJO	10	‡	31.25

‡For cloth cutting machine use.
‡Will not support weight of hand-lamp.

All "G" Reelites come equipped with three conductor cord. Extra conductor serves as ground and not as a power source.

Handlamps for Portable Reelites

Maximum Lamp Wattage, 100 Watts



No. RE-H3SR-H3SRG



No. H2S



No. H4S

No. H2S: Rubber handle, with switch, half reflector and guard. Cam lock-guard lock.

No. H3SR: Plastic handle, with switch and receptacle, half reflector, guard and cam lock. Has a ground.

No. H4S: Lighter and smaller than standard units. Rubber handle, with switch and half reflector.

No. H3SRG: Rubber handle, with half reflector, 3 prong ground outlet and cam lock.

No.	Wt. Oz.	Each
H2S	19	\$3.10
H3SR	18	4.10
H4S	15	1.70

Accessories



No. CB1: Machine Tool Receptacle Connector Body. Weight, 4 oz.

Each **\$1.35**

Appleton Constant Duty Reelites

Spring-Driven Cable Lift Reels

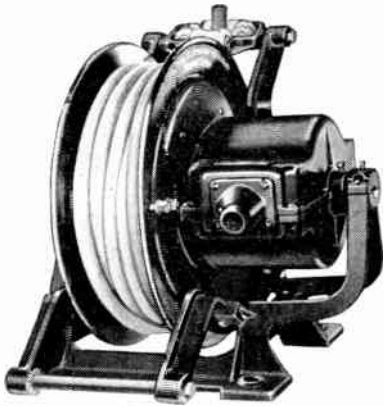

Left: Constant Duty Reelite equipped with guide roller cable outlet.

Right: Type EG Constant Duty Reelite equipped with special 4-roller cable outlet.

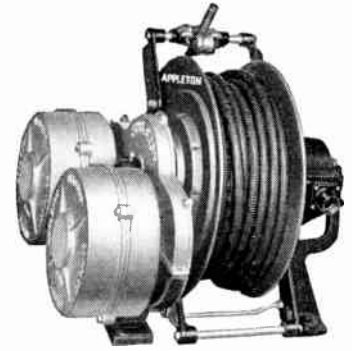

Made of cast aluminum and steel, black enamel finish. Use of ball bearings throughout eliminates wear and provides long-life, trouble-free reeling.

Type EG Constant Duty Reelite is furnished with guide roller type cable outlet only. Other Reelites are furnished as standard with guide roller type outlets, but may be fur-

nished, at extra charge, with swivel or large roller type outlets. See Roller Cable Outlets on following page for descriptions and prices.

To Order

Specify catalog number, length, gage and number of conductors of cable. Order special cable outlets separately.

Reelites for Type "S" Cords

35 Amp.—600 Volts

Type "BS"

No.	Wt., Lbs. Reelite Only	No. of Conductors	Max. Cap. in Ft. of Various Sizes and Conductors of Cable					Each
			No. 18	No. 16	No. 14	No. 12	No. 10	
BS22	124	2	60	60	55	\$198.00
BS32	126	3	60	60	55	209.00
BS42	128	4	...	65	60	50	50	220.00
BS52	154	5	65	65	55	50	45	238.00
BS62	156	6	65	65	55	50	40	249.00
BS72	158	7	65	65	55	50	40	260.00
BS82	160	8	60	55	40	35	30	271.00

Type "CS"

CS24	154	2	110	110	105	90	85	\$252.00
CS34	156	3	110	110	100	85	70	264.00
CS44	158	4	110	110	90	75	60	275.00
CS54	184	5	110	100	75	65	55	292.00
CS64	186	6	100	100	65	55	45	303.00
CS74	188	7	100	100	65	55	45	314.00
CS84	190	8	85	80	45	40	35	353.00

Type "DS"

DS32	214	3	80	\$328.00
DS42	216	4	80	75	339.00
DS52	210	5	80	75	70	356.00
DS62	242	6	80	75	65	368.00
DS72	244	7	75	70	65	379.00
DS82	246	8	65	65	50	389.00

Type "ES"

ES24	272	2	150	150	140	135	130	\$384.00
ES34	274	3	150	150	140	135	125	387.00
ES44	276	4	150	150	130	130	105	396.00
ES54	300	5	150	150	130	110	90	405.00
ES64	302	6	150	140	110	95	80	416.00
ES74	304	7	150	140	110	90	70	427.00
ES84	306	8	130	130	85	70	55	438.00

Reelites for Type "W" Cables

110 Amp.—600 Volts

Type "EG"

No.	Wt., Lbs. Reelite Only	No. of Conductors	Max. Cap. in Ft. of Various Sizes and Conductors of Cable					Each	
			No. 8	No. 6	No. 4	No. 3	No. 2		
EG22	358	2	...	75	60	55	50	45	\$619.00
EG32	360	3	75	65	55	50	45	40	690.00
EG42	362	4	70	60	50	45	40	35	686.00
EG14	370	1	130	130	120	110	674.00
EG24	372	2	110	105	90	70	65	50	690.00
EG34	374	3	105	100	75	65	60	45	745.00
EG44	376	4	100	85	60	55	45	...	762.00

Type "BW"

BW12	122	1	60	60	55	\$206.00
BW22	124	2	45	35	20	220.00
BW32	126	3	40	30	20	235.00
BW42	128	4	30	25	15	250.00

Type "CW"

CW14	152	1	100	100	85	\$260.00
CW24	154	2	55	40	25	272.00

Type "DW"

DW12	210	1	75	65	60	\$309.00
DW22	212	2	75	65	45	35	30	25	324.00
DW32	214	3	65	50	35	30	25	20	339.00
DW42	216	4	50	40	25	20	20	15	354.00

Type "EW"

EW14	270	1	140	135	120	110	100	75	\$358.00
EW24	272	2	90	70	373.00
EW34	274	3	70	55	397.00
EW44	276	4	55	45	409.00

Type "EWM"

EWM15	285	1	140	135	120	110	100	75	\$418.00
EWM25	287	2	90	70	433.00
EWM35	289	3	70	55	448.00
EWM45	291	4	55	45	462.00

For installations where constant tension is not desired, a gravity-type ratchet is available; each, \$7.80. Orders must specify mounting position of Reelite Base.

Appleton Constant Duty Reelites
Spring-Driven Cable Lift Reel



Type A
35 Amps.—440 Volts

Cast ferrous construction.
Black enamel finish.
Available with gravity-type ratchet for installations where constant tension is not desired—to order, add \$4.00 to prices below and specify mounting position of Reelite base.

3-Spring

No.	Wt. Lbs. Reelite Only	No. of Conductors	Max. Capacity, in Feet of Various Sizes and Conductors of Cable				Each
			No. 18	No. 16	No. 14	No. 12	
A23	36	2	55	55	50	35	\$121.00
A33	37	3	55	55	45	35	130.00
A43	38	4	55	55	35	30	139.00
A53	43	5	50	50	30	20	150.00
A63	44	6	45	40	20	20	158.00

5-Spring

A25	40	2	100	90	55	..	152.00
A35	41	3	90	75	50	..	161.00
A45	42	4	75	60	169.00
A55	47	5	60	55	184.00
A65	48	6	50	50	193.00

Type SR
20 Amps.—300 Volts



For use with Type SJ Cords. Roller outlet permits either ceiling, wall or base mounting.
Cord capacity, 25 feet of size 18 or 16 A.W.G.
For gravity-type ratchet, add \$4.00 to prices below and specify mounting position of Reelite base.

No.	No. of Cond.	Wt. Lbs. Reelite Only	Each
SR21	2	12	\$68.00
SR31	3	12	74.00

Appleton Type YS Reelites
Portable Power for Electric Hoists

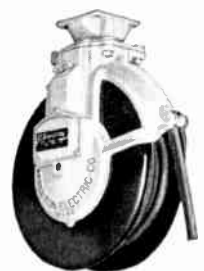

Designed principally for automatic cord takeup on electric hoists operating on straight or curved tracks. Cord may be fed in any direction. Swivel range of 335° provides full track coverage with half cord length.
Enclosed current collectors, elimination of hazards from tangled cords and provisions for adequate grounding prevent electrical mishaps.
Grounding shunt furnished as standard.

Long-life power spring and self-lubricating bearings keep maintenance at a minimum. Supplied with swivel

base and Type S rubber-covered cord. Reel diameter, 12½ in.; overall height, 16¼ in. Finished in two tone baked enamel.

For 10 Amp., 550 Volt A-C or 250 Volt D-C Service

No.	Conductors		Cord Lgth., Ft.	Net Wt., Pounds	Each
	Size A.W.G.	No.			
YS162-45	16	2	45	23	\$73.00
YS163-45	16	3	45	24	80.00
YS164-40	16	4	40	25	87.00

For 15 Amp., 550 Volt A-C or 250 Volt D-C Service

YS142-40	14	2	40	25	\$77.00
YS143-35	14	3	35	25	83.00
YS144-25	14	4	25	25	89.00

Appleton Roller Cable Outlets
For Use with Constant Duty Reelites

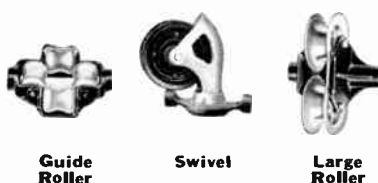

Guide Roller Type: General purpose outlet for use where cable is drawn tangent to drum. Cable must not be drawn around rollers.
Swivel Type: Recommended where cable is drawn at right angle to drum. Swivel range, 225 degrees or less.
Large Roller Type: For straight track operation where current source is at midpoint of runway.

Guide Roller Type

No.	Reelite Types	*Cable Diam. In.	Each
CO1R	SR, R.....	.625	\$4.00
CO1SN	SN.....	.812	6.00
CO1	A.....	.812	7.00
CO11	BS, CS, BW, CW, DS, ES, DW, EW, EWM.....	1.750	10.00
CO111	EG.....	1.750	15.00

Swivel Type

CO2R	R.....	.625	10.00
CO2SN	SN.....	.625	15.00
CO2	A.....	.625	11.00
CO22	BS, CS, BW, CW, DS, ES, DW, EW, EWM.....	1.125	14.00
CO22A	BW, CW, DW, EW, EWM.....	2.000	48.00
CO2S	AF, AFB.....	.625	12.00

Large Roller Type

CO3	A.....	.625	13.00
CO33	BS, CS, DS, ES, BW, CW, DW, EW, EWM.....	1.125	15.00
CO333	EG.....	1.625	50.00

*Largest recommended diameter.

Appleton Retract-O-Reel

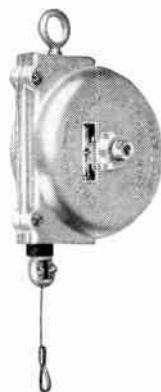

A convenient spring-operated balance reel for supporting tools directly over work. Recommended for portable tools, air and electrical devices weighing up to 10 lbs.

Adjustable cable clamp holds tools in exact position for easy reach and use. Wedge-type wire grip stopper maintains a positive grip without danger of damage to wire rope. No set screws used.

Spring tension adjustable through balance point; set at factory according to weight of tool to be used.

Furnished complete with 6-ft. of pre-formed wire rope, rubber bumper, cable clamps and eye loop with swaged-in thimble for quick, easy connection of tools.

Made of light-weight cast aluminum. Ball bearings are all of self-lubricating type. Net weight, 6 lbs.

Retract-O-Reel

No.	Wt., Lbs., of Tool to be Balanced		Active Rope Max. Working Range, Ft.	Inactive Rope Min. Lgth. Outside Reel Drum, Ft.	Each
	Min.	Max.			
B21-010	0	10	6	0	\$24.30

Retract-O-Reel Handwheel

Provides safe, quick spring tension adjustment for proper balance, particularly after reel servicing. Net weight, 8 oz.

No. A1-B21..... Each \$1.65



Benjamin Grounding Reels For Static Discharge

Available for use in connection with the generation of static charges on fuel servicing equipment during the transfer of combustible fuels.

The use of a Grounding Reel is an added precaution in

eliminating the possibility of fire or explosion because of discharge of sparks in the vicinity of inflammable fuels or vapors. The Reel keeps the grounding cable off the ground where there is always the possibility of damaging or entangling it and making it useless.

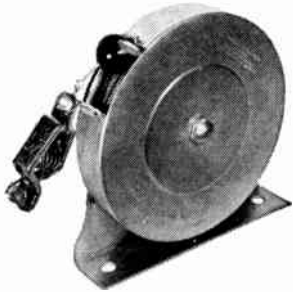

600-40-GOR

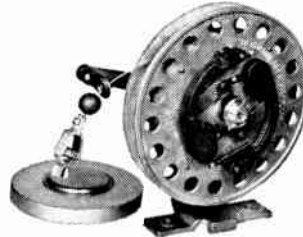

3000AG-50-GOR-15Y-E

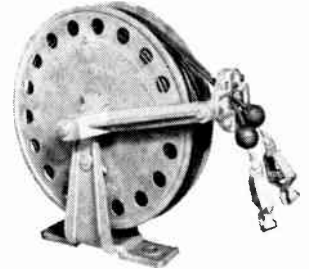

3000R-80-GOR-15Y-R



200-20-GOR

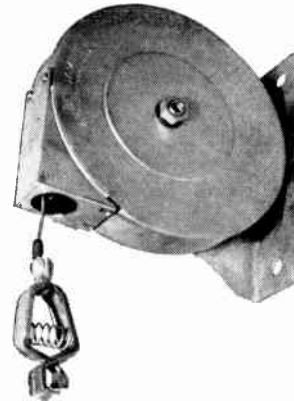

700-40-GOR

Series 200 Grounding Reels

Model	Type	Cable Length, Ft.	Ratchet Latching	Diam. In.	Overall Width, In.	Wt. Lbs.	Each
200-20-GO	Overhead	20	Without	6	1 1/2	4	\$16.50
200-20-GOR	Overhead	20	With	6	1 1/2	4	17.50
200-20-GS	Stake	20	Without	6	1 1/2	5	18.50
200-20-GSR	Stake	20	With	6	1 1/2	5	19.50

Series 600 and 700, Grounding Reels

Model	Aircord Steel Cable Length, Ft.	Ratchet Latching	Clip	Diam. In.	Width In.	Wt. Lbs.	Each
600-40-GO	40	Less	100 Amp.	8	2 1/8	6	\$21.40
600-40-GOR	40	With	100 Amp.	8	2 1/8	6	21.90
600-50-GO	50	Less	100 Amp.	8	2 1/8	6 1/2	21.70
600-50-GOR	50	With	100 Amp.	8	2 1/8	6 1/2	22.20
700-40-GO	40	Less	100 Amp.	8	2 1/8	7	31.50
700-40-GOR	40	With	100 Amp.	8	2 1/8	7	32.00

Series 3000 Grounding Reels for Static Discharge

Model	Aircord Steel Cable 1/2" Dia.	No. 12 Rubber Covered Cable	Speedometer Cable	Governor Control	Length Cable Ft.	Latching	Length of Y, Ft.	Eyelet Guide	Roller Guide	Amp. Clip	Size, In.	Wt. Lbs.	Each
3000A-50-GO-15Y-E	x		x		50	Less	15	x		100	6 x 17	20	\$59.00
3000A-50-GOR-15Y-E	x		x		50	With	15	x		100	6 x 17	20	60.00
3000AG-50-GO-15Y-E	x		x	x	50	Less	15	x		100	6 x 17	25	74.00
3000AG-50-GOR-15Y-E	x		x	x	50	With	15	x		100	6 x 17	25	75.00
3000R-80-GO-15Y-R	x	x			80	Less	15		x	50	7 x 17	32	69.00
3000R-80-GOR-15Y-R	x	x			80	With	15		x	50	7 x 17	32	70.00
3000RG-80-GO-15Y-R	x	x		x	80	Less	15		x	50	7 x 17	37	84.00
3000RG-80-GOR-15Y-R	x	x		x	80	With	15		x	50	7 x 17	37	85.00

When ordering specify preference in cable.

Benjamin Electric Extension Cord Reels

Supplied with two or three conductor electric cord and with or without a grounding wire and with various types of mounting arrangements.

The length of cord, that can be accommodated in the Cord Reel, depends on the number and gauge of the conductors and diameter of the electric wire.



995-20-ML

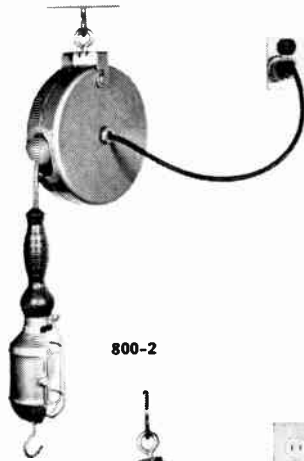

800-2



700JB-20-SJ

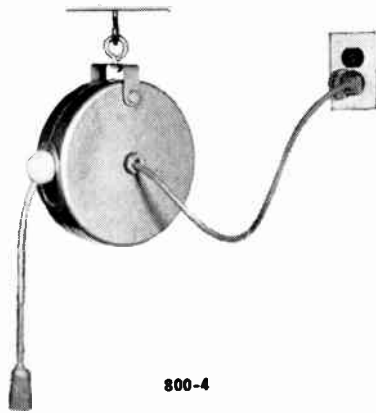

800-4



995

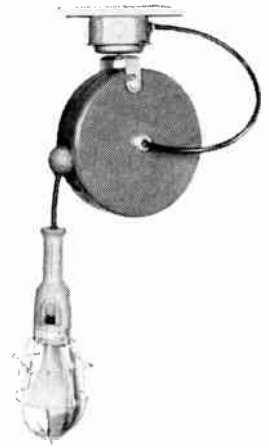

800JB-3

Model	Length & Type of Cord Set	No. & Gauge of Conductors	Trouble Light	Ground Wire	Female Connector	Amperes Rating	Size In.	Wt. Lbs.	Each
995	20-SVO	18/2	-TL			6	1 7/8 x 7 5/8	5	\$ 9.95
995JB	20-SVO	18/2	-TL			6	1 7/8 x 7 5/8	5	10.95
995-T	20-SVO	18/2	-TL			6	1 7/8 x 7 5/8	5	10.45
995JB-T	20-SVO	18/2	-TL			6	1 7/8 x 7 5/8	5	11.45
995-20-ML	20-SVO	18/2	-TL			6	6 1/2 x 10	7	16.50*
700-20-SJ	20-SJO	18/2	-TL			6	1 7/8 x 7 5/8	7	18.50
700JB-20-SJ	20-SJO	18/2	-TL			6	1 7/8 x 7 5/8	7	19.50
700-20-SJT	20-SJO	18/2	-TL			6	1 7/8 x 7 5/8	7	20.50
700JB-20-SJT	20-SJO	18/2	-TL			6	1 7/8 x 7 5/8	7	20.50
700-25-SV	25-SVO	18/2			-F	6	1 7/8 x 7 5/8	7	16.00**
700JB-25-SV	25-SVO	18/2			-F	6	1 7/8 x 7 5/8	7	17.00**
700-20-ML	20-SVO	18/2	-TL			6	7 3/4 x 10	9	19.00*
800-1	50-SVO	18/2			-F	6	2 1/2 x 8 3/4	10	19.75
800JB-1	50-SVO	18/2			-F	6	2 1/2 x 8 3/4	10	20.75
800-2	40-SJO	18/2	-TL			6	2 1/2 x 8 3/4	10	21.75
800JB-2	40-SJO	18/2	-TL			6	2 1/2 x 8 3/4	10	22.75
800-3	30-SJO	18/3	-TL	-G		6	2 1/2 x 8 3/4	10	24.75
800JB-3	30-SJO	18/3	-TL	-G		6	2 1/2 x 8 3/4	10	25.75
800-4	25-SJO	16/3		-G	-F	10	2 1/2 x 8 3/4	10	20.00**
800JB-4	25-SJO	16/3		-G	-F	10	2 1/2 x 8 3/4	10	21.00**
800-5	30-SJO	16/2			-F	10	2 1/2 x 8 3/4	10	17.50
800JB-5	30-SJO	16/2			-F	10	2 1/2 x 8 3/4	10	18.50

*Deduct \$3.00 if furnished less Par 38 Lamp.

**For use with cloth cutting machines and with hand power tools.

Letters "JB" after model number indicates that Cord Reel is equipped with arrangement with cover plate for mounting Reel on any overhead 4-in. octagonal outlet box.

Letter "T" after model number indicates that handle is equipped with a tool tap.

Series 700 Cord Reels have the exclusive and unique level-winder feature.

Benjamin Electric Extension Cord Reels are available for Service Stations, Garages and Industry—Also available for original equipment purposes on Wringer Type Washing Machines, Floor Lamps, Ironers, Vacuum Cleaners, Projectors, Tape Recorders, Portable Television and Portable Radios, etc. Dual Action-Reels are also available for pull-up-and-down electric lighting fixtures.

Appleton Industrial Type Aireels

Spring Driven Lift Reels for Air Hose Lines

Types CWT and CTL

Automatically wind and maintain constant tension on air hose lines of portable air-driven tools.

Open type reel with adjustable outlet support arm to assure minimum friction when air hose is drawn through rollers. Can be mounted on wall or ceiling.

Furnished with positive, self-adjusting swivel air joint. Strong, closely braided air hose has ample strength to withstand high pressures and pulsation loads.

Reel diameters: Type CWT—19½ in.; Type CTL—30¾ in.
Max. Air Pressure—150 lbs.

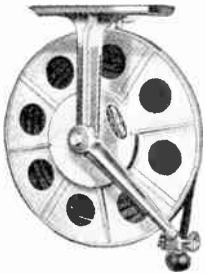

Type CWT

No.	Hose Size, In.		Hose Lgth. Feet	Ship. Wt. Lbs.	\$Each
	I.D.	O.D.			
CWT11A	1/4	3/4	25	70	\$109 00
CWT21A	3/8	47/64	25	75	113 00
CWT31A	1/2	29/32	25	75	128 00
CTL31B	1/2	29/32	50	100	210 00
CTL41B	3/4	113/64	50	110	222 00

†Only 20-ft. of hose wound on reel drum; 5-ft. remain outside.

‡For ratchet device, specify on order and add \$4.00 for Type CWT Reels or \$9.00 for Type CTL Reels. Ratchets designed for use where constant tension is unnecessary.

Ericson Extension Cord Reels

10 Amp.—120 Volt

Designed for hard usage, where the cord will be pulled in and out many times a day.

Reels do not have any ratchets, pawls, or dogs to wear out or get out of order. Equipped with exclusive Scroll-Type Lock and extra heavy spring motor.

Carton Qty. 1. Std. Pkg. 4.



No. 2001

No.	Description	Pkg. Wt. Lbs.	Each
2001	25-ft. w/o wiring device	38	\$32 96
4001	45-ft. w/o wiring device	48	48 94

Note: Above reels are without wiring device but portable lamp guard can be installed.

Equipped with 16-2.SJO Type Cord.

Hykon Portable Extension Cord Reels

Provides Both Light and Power Up to 250 Feet Away

Portable, lightweight reels for extension cord service on all types power tools, lighting and wiring installation, commercial and home workshop applications.

Manual rewind, no springs. Cord won't twist, tangle or break off.

Models 15XC and 18XC equipped with 30 amp. 110 volt enclosed collector and 10 ft. 12-2 cord. Model 9XC has 8 feet 16-2 plug-in cord and enclosed collector.

Rated at 10 amps.



No.	Capacity	Each
15XC	400 Feet 16-2 Cord	\$32 50
15XC	200 Feet 11-2 Cord	32 50
15XC	150 Feet 12-2 Cord	32 50
18XC	300 Feet 11-2 Cord	34 75
18XC	250 Feet 12-2 Cord	34 75
9XC	125 Feet 16-2 Cord	19 95
9XC	150 Feet 18-2 Cord	19 95

Hykon Wiring Reels

Keep wire free from kinks and snarls; maintain correct tension. Save time, effort and wire on any wiring job. Wire may be reeled off top or bottom from any angle. Adjustable to different sizes of wire rolls. Furnished with holes, in edge of face plate, into which free wire end may be anchored. Turns easily, but will not coast. Available in gang units, or individually.

Finished in durable black enamel.

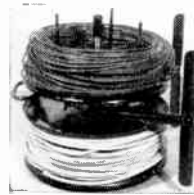

Showing simple method of loading Hykon reels.

Reel Specification

Hykon 15-inch reels take wire up to No. 8 A.W.G.; 18-inch takes larger diameter coils, such as loom wire, heavy wire and light cable.

	15-Inch Reel	18-Inch Reel
Disc Diameter (In.)	15	18¾
Coil Eye Adjustment (In.)	4½ to 12½	4½ to 13¾
*Coil Width (In.)	Up to 5½	Up to 6

*Coil width can be increased if desired.

In addition to standard sizes, larger sizes made up to meet special requirements.

Individual Reels

Fastens on any framework, on service trucks or in the storeroom.

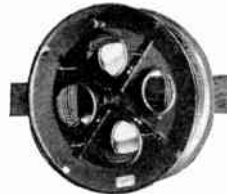

Reel Size, In.	Ship. Wt., Lbs.	Each
15	11	\$11 50
18	13	13 50
25	..	24 25
30	..	34 00

Single Unit Reels

Handles unwieldy metallic cable or non-metallic cable. Cable comes off reel without a twist, ready to be laid.

Framework takes up little space, will take the heaviest roll of wire.



Reel Size, In.	Ship. Wt., Lbs.	Each
15	16	\$18 25
18	19	22 25
25	33	42 50
30	40	53 50

Double Unit Reels

Reels work independently of each other.

Can be used on all wiring jobs.

Easily carried by a convenient handle.

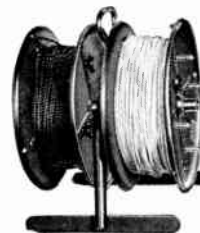

Reel Size, In.	Ship. Wt., Lbs.	Each
15	25	\$25 00
18	30	29 00

Gang Reels

Particularly valuable on jobs where a number of wires are pulled into conduit. Handles at ends provide easy holds for carrying.

Furnished in 4-gang and 6-gang units.

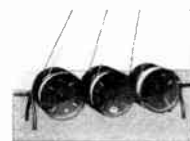

Reel Size, In.	4-Gang Unit		6-Gang Unit	
	Ship. Wt., Lbs.	Each	Ship. Wt., Lbs.	Each
15	46	\$45 75	72	\$66 00
18	58	54 50	90	79 25

Hykon Dispensing Reels



Keep broken coils compact and ready for immediate dispensing. Save time, money and material.

Wire is easily pulled off without kinks or tangles.

Takes up no more space than coils themselves. Can be used with Hykon Wire Meter as either pay-out or take-up reel.

Available only in 15-inch size, for coils of No. 8 and smaller wire. Adjustable for various size coils.

No. Reels	Shp. Weight, Lbs.	Each
1	44	\$45.75
6	68	66.00

Hykon Reelifts



A timesaving, easy way to handle bulky, heavy cable reels. A simple lift on the Reelift handles sets reel up, ready for unrolling the cable.

To load Reelift, insert axle through reel; slip fitting on the axle. Tilting the base lets handles be slipped through axle fittings to proper height. A lift on the handles sets up reel, ready to pull wire. One man can easily set up over 1,000 lbs., two men can raise over 2,000 lbs. Safe—will not tip.

Reel revolves on axle, broken flanges or other damaged reels, cause no trouble.

No.	Max. Reel Dimensions (In.) Width	Diam.	Weight, Lbs.	Each
R1.25	25	36	60	\$42.00
R1.31	31	48	85	50.00

Hykon Wire Meter

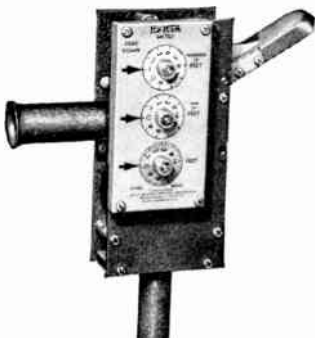

Accurately measures wire, loom, etc. Will handle flexible material up to 1 inch in diameter and registers up to 1000 feet.

Dials are instantly reset to zero and are easy to read. By using this wire meter, errors and guesswork is eliminated.

Meter is well built for long life. Sold separately or with Store Room Reel.

Floor stand also available.

No.	Description	Each
WM	Meter 8 3/4-in. x 4-in.	\$27.50
MS	Floor Stand 21-in. high	4.75

Hykon Wire Measuring Equipment

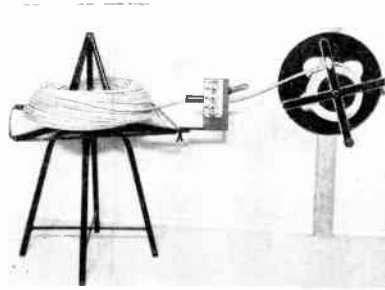

Unit, consisting of storeroom reel, wire meter and take-up reel, facilitates measuring and recoiling of wire, in the storeroom or in the field. Portable, easily handled by one man.

Wire Meter: For wire, loom, etc., up to 1-inch diameter. Registers up to 1000 feet. Easy to read dials. Instantly reset to zero. Eliminates errors and guesswork.

Storeroom Reel: Takes any size wire or cable without adjustment. Will not tip, but easily moved. Wire pulls off without kinks or tangles. Welded construction. Available with or without wire meters.

Take-up Reel: Unwinds wire from storeroom reel through meter, making a neat, compact coil. Outer disc slides off for easy removal of measured coil.

No.	Description	Shp. Wt., Lbs.	Each
SRM-18	Complete Unit, Incl. Wire Meter, Take-up Reel and Storeroom Reel.	59	\$91.50
WM	Wire Meter, less Stand 8 3/4 in. x 4 in.	6	27.50
WMS	Wire Meter Stand, 21 in. high.	3	4.75
SRR	Storeroom Reel, 39 in. high, 33 in. wide.	40	50.50
TU	Take-up Reel, 18 in.	13	13.50
TUS	Take-up Reel Floor Stand, 20 in. high.	6	5.50

Hykon "Tums" Wire Measuring Units

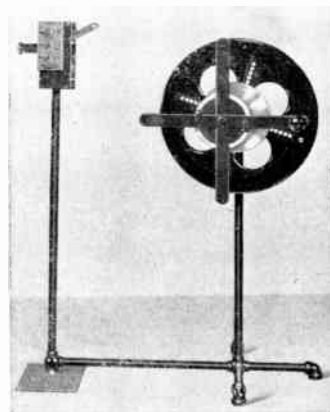

Consists of meter and take-up reel mounted on a light weight but sturdy steel framework. Takes wire, rope and other flexible material up to 1-in. diameter. Accurate measurement guaranteed. Registers up to 1,000 feet. Instantly reset to zero.

Take-up reel has tapered cone for easy removal. Reel dimensions, 18 3/4-in. diameter, 7-in. wide. Capacity 1,500 feet of No. 11 wire. Other sizes accordingly.

No.	Description	Each
TU MS	Wire Measuring Unit	\$52.25

Brady Perma-Code Wire Markers

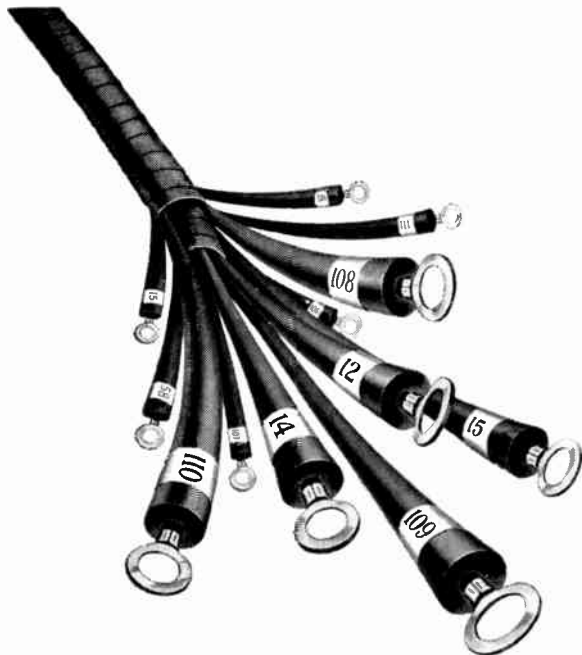

For marking wires, harnesses, circuits, coils, panels, assemblies, terminals. Self-sticking. Apply to any wire. Permanent "around-the-wire" identification. Select from over 3000 different stock markers. Conform to NEMA and NMTBA specifications for a standardized wire identification system. Markers are Silicone Plastic Coated for maximum resistance to dirt, grease, moisture and abrasion. Markers come mounted on handy, catch-free Blue Streak® Dispenser Cards. Exclusive Brady Zip-Strip permits instant removal of one or all markers from dispenser card for quick permanent identification.

Brady Wire Markers come in a size for every wire, a marker for every purpose. Two different sizes in stock to fit your needs:

Order 1½-in. long markers for wire ¼ in. o.d. and over.
 Order ¾-in. long markers for wires under ¼-in. o.d.
 (Specify ¾-in. when ordering). ¾-in. markers give you twice as many markers at no extra cost.

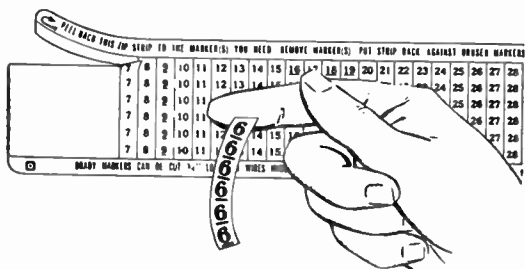

1½-in. long markers on this consecutive Number Card are for wires over ¼ in. O.D.

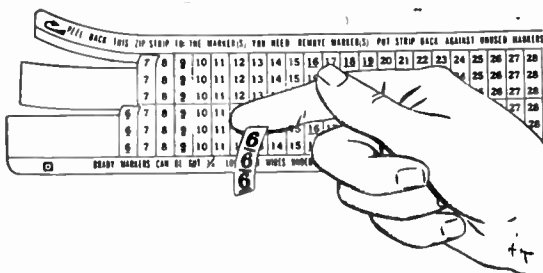

Use ¾ in. long markers for wires under ¼ in. O.D. ¾ in. long markers furnished at no extra charge.

All-Temperature Vinyl-Cloth Wire Markers

These general purpose markers have black legends on white background. Withstand -300° F. to +300° F. Pulling thru conduit won't loosen markers.

All-Temperature Color-Code Wire Markers

Gives you two-way identification—both color and number. Numbers on all standard NEMA color backgrounds in stock.

Flame-Proof Aluminum Foil Wire Markers

Self-sticking 3 mil super-thin markers hug wires tightly in oil surroundings, elevated temperatures; won't discolor.

Solid Number Cards

(All Markers on each Card are the same.)

Vinyl-Cloth Stock No.	Aluminum Foil Stock No.	Legend on Each Marker	Markers Per Card ¼ In.	1½ In.
0	AF-0	0	72	36
1	AF-1	1	72	36
2	AF-2	2	72	36
and so on thru				
99	AF-99	99	72	36
100	AF-100	100	50	25
and so on thru				
600	600	50	25

Solid Symbol Cards

(Same symbol on all markers.)

Vinyl-Cloth Stock No.	Aluminum Foil Stock No.	Symbols on Each Card	Markers Per Card ¼ In.	1½ In.
A1 thru A5	AF-A1 thru AF-A5	A1 thru A5	72	36
L1 thru L5	AF-L1 thru AF-L3	L1 thru L5	72	36
S1 thru S5	AF-S1 thru AF-S4	S1 thru S5	72	36
T0 thru T10	AF-T0 thru AF-T10	T0 thru T10	72	36
AC		AC	72	36
DC		DC	72	36
POS		POS	50	25
NEG		NEG	50	25
GND		GND	50	25

Solid Letter Cards

(All Markers on each card are the same.)

Vinyl-Cloth Stock No.	Aluminum Foil Stock No.	Printing On Each Marker	No. of Markers On Each Card ¼ In.	1½ In.
A Cap	AF-A	A	72	36
B Cap	AF-B	B	72	36
and so on thru				
Z Cap	AF-Z	Z	72	36
A Sml.		a	72	36
B Sml.		b	72	36
and so on thru				
Z Sml.		z	72	36

Color-Code Markers

Solid numbers on NEMA color backgrounds. All markers on each card are the same. Come in seven different NEMA background colors.

Red No.	Yellow No.	Orange No.	Blue No.	Green No.	Brown No.	Black No.	Print. on Each Marker	No. of Markers Per Card ¼ In.	1½ In.
1-RD	1-YL	1-OR	1-BL	1-GR	1-BR	1-BK	1	72	36
2-RD	2-YL	2-OR	2-BL	2-GR	2-BR	2-BK	2	72	36
and so on thru									
50-RD	50-YL	50-OR	50-BL	50-GR	50-BR	50-BK	50	72	36

Brady Perma-Code Wire Markers

Consecutive Numbers

Markers on each card are different and follow numerical sequence.

Vinyl-Cloth Stock No.	Aluminum Foil Stock No.	Printing on Each Marker	No. of Markers of Each Number On Each Card	
			¼ In.	½ In.
1-33	AF-1-33	1-33	2	1
34-66	AF-34-66	34-66	2	1
67-99	AF-67-99	67-99	2	1
100-124	AF-100-124	100-124	2	1
125-149	AF-125-149	125-149	2	1
1975-1999	..	1975-1999	2	1

and so on thru 1975-1999

Consecutive Letters

Markers on each card are different and follow alphabetical sequence.

Vinyl-Cloth Stock No.	Aluminum Foil Stock No.	Printing On Each Marker	No. of Markers of Each Letter On Each Card	
			¼ In.	½ In.
A-Z (Cap)	AF-A-Z (cap)	A thru Z (Cap letters)	2	1
A-Z (small)	..	a thru z (small letters)	2	1

Consecutive Numbers Repeated

Markers in each sequence are different, sequences are repeated.

Vinyl-Cloth Stock No.	Aluminum Foil Stock No.	Printing On Each Marker	No. of Sequences of Markers On Each Card	
			¼ In.	½ In.
1-3	AF-1-3	1-3	24	12
1-4	AF-1-4	1-4	18	9
1-5	AF-1-5	1-5	14	7
1-6	AF-1-6	1-6	12	6
1-8	..	1-8	8	4
1-9	AF-1-9	1-9	8	4
0-9	..	0-9	6	3
1-10	AF-1-10	1-10	6	3
0-10	..	0-10	6	3
1-12	AF-1-12	1-12	6	3
1-16	AF-1-16	1-16	4	2
17-32	AF-17-32	17-32	4	2
1-18	AF-1-18	1-18	4	2
19-36	..	19-36	4	2

PRICES

No. of Cards	B-500 Vinyl-Cloth Tape	B-184 Aluminum Foil Tape
	B-500 Color-Code Per 100	Per 100
25-99	\$17.50	\$19.50
100-249	14.00	15.60
250-499	12.25	13.65
500-999	11.38	12.68
1000-2499	10.94	12.19
2500-4999	10.68	11.90

Ask your GRAYBAR salesman for samples and complete list of 3,000 different Wire Markers in Brady Bulletin #130.

Brady All-Purpose Numbers and Letters

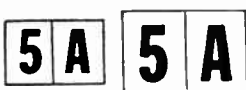

For fast economical marking of areas, bays, columns, tote boxes, machinery, shelves, stock bins, parts, plant and office equipment. Positive, at-a-glance identification. Self-Sticking, no special skill or tools required. Come mounted on handy, portable dispenser cards. Just peel from card, and press in place. Permanent. Cost as little as ¼ cent per Marker.

Five stock sizes from ½ to 5-in. Stock Markers come printed in bold black letters on bright Yellow background; specials made to your order.

Contact GRAYBAR for prices, samples and Bulletin #165.

Brady Self-Sticking Miniature Markers

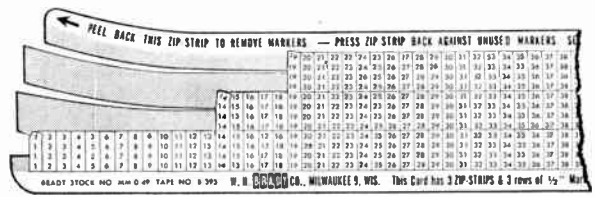

Designed and "job-tested" for identifying small diameter wire under 5/32 in. O.D., miniature electronic components and sub-miniature circuits.

At-a-glance identification from any angle. Four bold legends per marker. White background with black letters and numerals.

150 individual markers (3/16 in. x 1/2 in.) mounted on Blue Streak ® Dispenser Card. Over 100 numbers and letters in stock.

Blank Miniature "Write-On" labels for on-the-spot marking of small parts and assemblies. Use pencil or ball point. Stock labels come mounted on Dispenser Cards in three sizes: 3/16 x 1/2 in.; 1/4 x 1/2 in.; 1/2 x 1/2 in.

Special Miniature Markers made to your order—any color, any size—any printing.

Contact GRAYBAR for prices, samples and Bulletin #130-2.

Brady Pre-Cut Quik-Masks

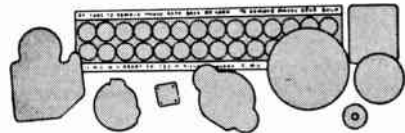

Pre-cut, self-sticking Quik-Masks. Protect nameplates, dials, plated or polished surfaces, holes, threads, etc. from paint spray, plating, machining, tumbling or from damage during shipment.

Reduce your masking costs, increase production and save inspection, re-work and clean up time. Quik-Masks are ready-to-use precision pre-cut pieces of self-sticking masking tape. Come mounted on handy Blue Streak ® Dispenser Cards or Zip-Off liners. Stock circles 1/4 in. O.D. to 5 in. O.D. ready for immediate shipment. Special Brady Pre-Cut Masks made in any size, any shape to your specifications. Select from over 300 different tapes.

Ask your GRAYBAR salesman for prices, samples and Bulletin #160.

Brady Card Holders

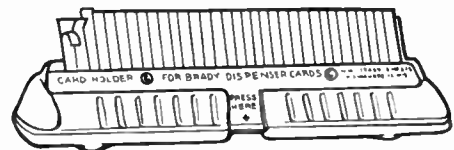

New, time-saving Card Holder reduces labor costs, speeds productions, saves motions. Use with card-mounted Brady Wire Markers, Special Quik-Labels, Pre-Cut Quik-Masks and Brady Printed Circuit Tapes and Shapes.

Card Holder eliminates all non-productive motions of picking up and putting down card each time a Marker or Mask is used. Worker uses both hands for speedy production.

No parts to wear out or replace. Ask your GRAYBAR salesman for demonstration, prices and Brady Bulletin #147.

Brady "Quik-Label"® Special Markers
Made to Order

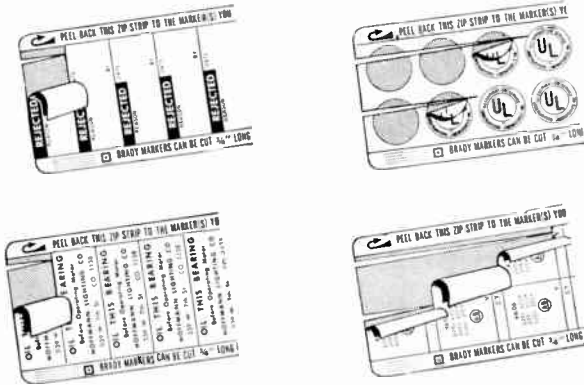

Use Brady Self-Sticking Special Markers to instruct, inspect, identify and improve your product. Economical to buy and inexpensive to apply. Stick to any clean, dry surface without moistening. Silicone Plastic overcoating resists dust, dirt, grease and abrasion.

New write-on surface permits coding, dating, calibrating during assembly or installation.

You can get Special Brady Quik-Labels with any wording, trade mark, number or symbol . . . in any color, size, shape or material you specify.

Ask your GRAYBAR salesman for samples, case history file, prices and Bulletin #132.

Brady Quik-Plates

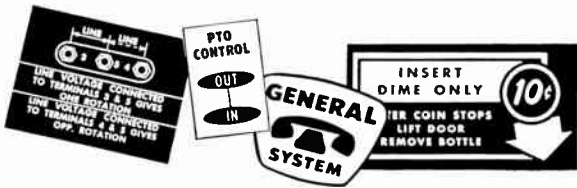

Self-Bonding Nameplates—.003-in. aluminum. Won't peel, chip or crack. Low cost. Any size, any shape, "all-over anodized."* Stick to flat, curved or crinkled surfaces. Fast to apply. No holes to drill, no fasteners required.

Four different self-bonding types meet MIL specifications. Trademarks, instructions, gauges, dials and diagrams made to your specifications. Ask your GRAYBAR salesman for prices, samples and Bulletin #177.

*Patent pending.

Brady Printed Circuit Tapes and Shapes
Self-Sticking

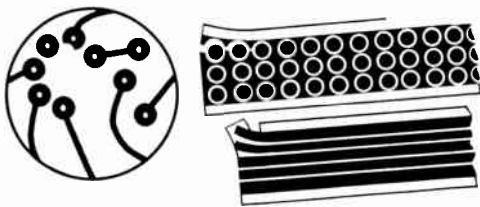

Save engineering and drafting time. Make accurate and detailed inkless layouts with Brady precision-slit black, photographic, self-sticking tape.

Stock Terminal Circles, Connector Strips, Fillets, etc. come mounted on Blue Streak® Dispenser Cards.

Stock Brady Connector Strips are furnished on Dispenser Cards in 9-in. lengths or in 18 yard rolls—all precision slit to exact dimensions for accurate reproduction.

Contact GRAYBAR for prices, samples and Bulletin #163.

Brady Self-Sticking Pipe Markers

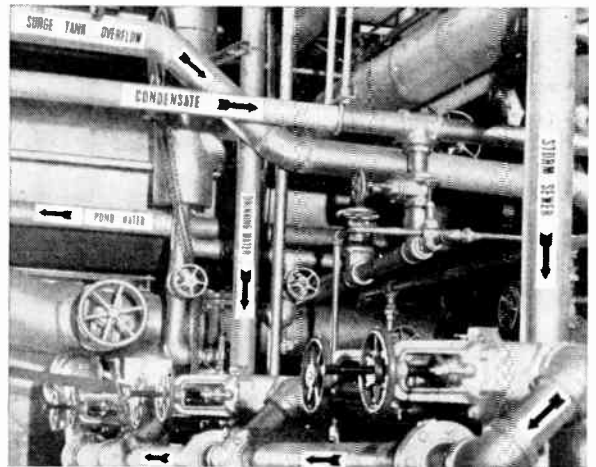

The standardized method of identifying pipe contents and direction of flow. Low cost Perma-Code Pipe Markers conform to American Standards Assn. Standard #A-13, "Identification of Piping Systems". Pipe contents are clearly marked in large, bold letters on bright fade-proof backgrounds. Quick, positive identification for productive maintenance. Anyone who can read can identify pipe contents at-a-glance.

Use this "job-tested" Pipe Identification system to make repairs fast, reduce costly mistakes and guesswork. Save valuable production time in emergencies.

All standard A.S.A. legends and Directional Arrows in stock. Special Pipe Markers made to order.

Contact GRAYBAR for Pipe Marker Planning Kit, prices, samples and Brady Bulletin #135.

Brady All-Vinyl Aisle Markers
Outlast Painted Lines
5 to 1

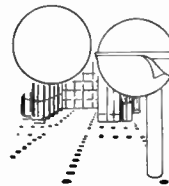

Brady Dotted Line marked aisles save time, labor. Simple to apply, aisles are marked without interrupting traffic or material flow. Bright, all-vinyl Yellow.

Self-sticking all-vinyl Aisle Markers withstand severe truck, pedestrian traffic. Unaffected by oil, grease, acids, salts, moisture and many solvents.

Stick and stay stuck to any clean, dry surface.

Four stock diameters: 2, 3, 4 and 5 inch. Matching Yellow Directional Arrows also in stock for 2 to 5 inch sizes.

Contact GRAYBAR for prices, free testing samples and Brady Bulletin #111.

Brady Accident Prevention Signs
Self-Sticking



Lower your accident rate by using low cost, longer lasting, easy-to-apply Self-Sticking Accident Prevention Signs. Stocked in over 100 different signs made to A.S.A. Standard Z 35.1 and National Safety Council Specifications.

Self-Sticking Signs stick to smooth or rough, curved or flat surfaces. No screws, tags, moistening or tools needed for application.

You can apply signs in seconds right at the point of hazard. Make up your own combination signs for caution, danger and plant housekeeping.

Contact GRAYBAR for prices, samples and Bulletin #145.

Sticka Black Friction Tapes



High quality friction tape, non-ravelling and suitable for all application where friction tape is indicated. Strong, abrasion-resisting, and very adhesive.

Free from pinholes, will not dry out. Rolls packed in moisture-proof wrapping.

Roll Size No.	Min. Ft. Per Roll	Rolls Per Case	*Per 100 Rolls
4	30	200	\$20.00
8	60	100	38.00
†8	60	100	38.00

*Prices are for 3/4-in. wide tape in moisture-proof wrapping in a carton. For rolls in moisture-proof wrapping only, deduct \$1.00 per 100 rolls.

†Shop package. The convenient container has 10 rolls of tape, each heat sealed in moisture-proof wrapping.

Prices on widths other than 3/4-in. available on request.

Amazon ASTM Friction Tapes



High quality friction tape guaranteed to meet and exceed all ASTM and U. S. Government specifications.

Extremely abrasion resisting. Has excellent tensile and adhesive qualities. Long lasting, will not dry out, non-ravelling. Protected by moisture-proof wrapping in sturdy cardboard carton.

Roll Size No.	Min. Ft. Per Roll	Rolls Per Case	*Per 100 Rolls
4	41 1/4	200	\$25.50
8	82 1/2	100	49.00

*Prices are for 3/4-in. wide tape in moisture-proof wrapping, in a carton. For tape in moisture-proof wrapping only, deduct \$1.00 per 100 rolls.

Prices on width other than 3/4-in. available on request.

Victor Black Friction Tapes



An all-purpose friction tape of highest quality. Alike to Sticka Tape in all instances, except footage per roll.

Roll Size No.	Min. Ft. Per Roll	Rolls Per Case	*Per 100 Rolls
4	34	200	\$21.00
8	68	100	40.00

*Prices are for 3/4-in. wide tape in moisture-proof wrapping in a carton. For tape in moisture-proof wrapping only, deduct \$1.00 per 100 rolls.

Prices on widths other than 3/4-in. available on request.

Manson Friction Tape



Made only with new, naturally-tacky rubber which thoroughly impregnates and coats the strong, closely-woven cotton fabric.

Unequaled in true adhesiveness and in aging and weathering qualities. Provides lasting protection for joint.

Tape, 3/4-in. wide, containing an average of 82 ft. packed 1/2-lb. in white cans.

Per Lb. \$1.50

Amazon ASTM Splicing Compounds

Rubber Tape



Manufactured from a higher grade rubber compound.

Will meet and exceed requirements of all U. S. Government and ASTM specifications. Self-vulcanizing, will conform to all splices so as to give complete insulation. Strong in tensile and extremely flexible.

Dielectric strength: 350 volts per mil. of thickness.

Roll Size No.	Min. Ft. Per Roll	Rolls Per Case	*Per 100 Rolls
4	15	200	\$27.50
8	30	100	53.00

*Prices are for 3/4-in. wide tape in moisture-proof wrapping in a carton. For tape in moisture-proof wrapping only, deduct \$1.00 per 100 rolls.

Prices for width other than 3/4-in. on request.

Victor Splicing Compounds

Rubber Tape



An excellent quality Splicing Compound designed for use on all regular circuits.

Extremely strong and elastic. Seals splices against all moisture and dirt.

Dielectric strength: 300 volts per mil. of thickness.

Roll Size No.	Min. Ft. Per Roll	Rolls Per Case	*Per 100 Rolls
4	10 1/2	200	\$23.00
8	21	100	44.00

*Prices are for 3/4-in. wide tape in moisture-proof wrapping in a carton. For tape in moisture-proof wrapping only, deduct \$1.00 per 100 rolls.

Prices on widths other than 3/4-in. on request.

Okonite Rubber Tape



Compounded only from new, Up-River Fine Para rubber. When wrapped on the joint, fuses into a homogeneous wall of tough insulation, impervious to moisture, that stays elastic and resilient.

Insures highest electrical strength and permanence.

Roll, 3/4-in. wide, packed 1/2 lb. in yellow cans.

Per Lb. \$1.70

Ruberoid Insulating Tape



Waterproof, both sides adhesive. For use both above and below ground. High tensile strength; resist abrasion; acid and alkali proof. Will not dry, crack or harden. May be stored without deterioration.

Furnished in 1/2-lb. rolls, 3/4-inch wide. Other widths available.

Per Lb. \$0.85

"Scotch" Brand Electrical Insulating Tapes

Listed by Underwriters' Laboratories, Inc.

No. 33

Plastic Electrical Tape—.007 In. Thick



Has a stretchy, rubber-like plastic backing enabling it to do the work of two ordinary tapes. Goes on in one operation.

Stretchability and resistance to oil and moisture provide a wide range of uses in electrical construction and repair. Thinness is advantageous in eliminating "overstuffed" junction boxes. Has a dielectric strength of 9,500 volts.

Backed with the same synthetic resin used on Type T synthetic insulated wire. Provides complete electrical and mechanical protection.



Width, In.	Per Roll, Ft.	Packing Type	Shp. Wt. Per Ctn.	Per Roll
3/4	66	1/Can	50 1/2	\$1.50
3/4	20	12/Tube	14 1/4	.55
3/8	20	12/Tube	7 1/2	.35

All sizes packed 144 to carton.

No. 22

Plastic Electrical Tape—.010 In. Thick



Made in six standard widths, its extra mechanical strength and abrasion resistance make it a popular insulating tool for industrial construction and maintenance.

Used extensively for insulating large cable splices, transformers, circuit breaker connections, bus bars, etc.

Packed 1/Box and 12 to a carton except 1 1/2 and 2-in — 6/carton.

Width, In.	Per Roll, Yds.	Shp. Wt. Per Ctn.	Per Roll
1 1/2	36	5	\$1.95
3/4	36	7	2.40
1	36	8 3/4	3.00
2	36	17	6.00

No. 27

Glass Cloth Backing with Thermosetting Adhesive



Will stand up under high operating temperatures. Thermosetting adhesive sets at high temperatures forming a permanent bond of great strength.

An ideal insulation on pig tails of Hi-Heat wire, splices in enclosed fixtures and appliances, etc.

Dependable insulation in foundries, steel mills and other industrial locations where high heat is normal.

Width, In.	Per Roll, Ft.	Type	Packing Carton	Shp. Wt. Per Ctn.	Per Roll
1/2	66	1/Can	48	12	\$1.75

Elkhart Hydro-Proof Tape

Waterproof tape having an average dielectric strength per layer of 1850 volts.

Width, 3/4 inch.

Packed 21 yards per 8-ounce roll.

Per Pound..... \$1.02

"Scotch" Brand Electrical Tape

No. 49

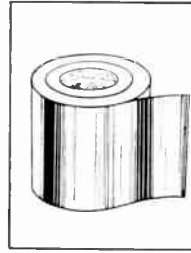

A pressure-sensitive aluminum foil tape designed for use as a moisture vapor barrier on communication cable splices, also for shielding applications on cable splices.

Approved for use in REA Cable Splicing Specification TC-2 and TC-3.

Width, In.	Per Roll, Ft.	Packing	Boxes Per Ctn.	Per Roll
2	20	1/Box	24	\$1.75

Bishop Bi-Seal Self-Bonding Electrical Tapes

For Sealing, Splicing, Insulating



A permanent moisture sealing polyethylene base tape. Ideal for communication and power distribution wire and cable splicing; moisture proofing bi-metal connections; insulating high frequency electronic circuits.

All rolls 30-ft. by .020 thick. 1/2-in. rolls packed two per box. All others individually boxed.

Type 1. (Clear) — Type 2A, (Black) — Type 4. (Ivory).

Width In.	Rolls Per Case	Approx. Ship. Wt.	Per Roll	Width In.	Rolls Per Case	Approx. Ship. Wt.	Per Roll
1 1/2	72	18	\$0.97	1 1/2	20	15	\$2.70
3/4	36	14	1.41	2	20	20	3.59
1	36	18	1.81				

Bishop High Voltage Splicing Tapes

No. 30



Use this butyl rubber base tape for splicing high voltage cable operating at 2 kv. to 17 kv.

Exceptional resistance to corona and ozone plus outstanding aging properties insures a lasting splice that will equal or better the original cable insulation.

Recommended for operating temperatures of 90° C up to 5 kv., and 85° C up to 17 kv.

Rolls are 30-ft. by .030 thick. One cellophane wrapped roll per container.

Width In.	Rolls Per Case	Approx. Ship. Wt.	Per Roll	Width In.	Rolls Per Case	Approx. Ship. Wt.	Per Roll
3/4	100	67	\$.90	1 1/2	40	54	\$1.80
1	80	64	1.20	2	40	64	2.40

Bishop Electrical Filler Tapes

No. 125



Synthetic rubber base. Good for cable splice build-up, cable end sealing, etc. Can be molded by hand to fit odd shapes.

Rolls 1 1/2-in. wide by 5-ft. long by 1/8-in. thick. 24 individually boxed rolls per case.

Per Roll..... \$1.17

Note: Special Case and Quantity prices available on request.

Bishop Bi-Prene Electrical Jacketing Tapes

Types C and H

A neoprene base jacketing tape excellent for splicing neoprene sheathed cables. Fuses into a solid mass to form a permanent weatherproof outer sheath. Protects against ozone, heat, moisture, and sunlight. Tape is flame resistant.



All rolls 30-ft. long by .030 thick.
1/2-in. widths packed two per box.
All others one per box.

Width In.	Rolls Per Case	Approx. Ship. Wt.	Type C	Per Roll	Type H*
1/2	160	62	\$0.60		\$0.70
3/4	80	52	.90		1.00
1	80	62	1.20		1.40
2	40	62	2.40		2.80

*Type H is designed for use with vulcanizing equipment.
Note: For red or yellow add 10% to Type H prices above.

Okolite High Voltage Tape



Specially designed for splicing cables insulated with ozone-resistant rubber compounds, particularly those operating at over 2000 volts between phases.

High electric strength, low power factor. Fuses into moisture-proof wall of insulation.

Tape, 3/4-in. wide, containing 30 ft. packed 1/2 lb. in red cans.

Per Lb. \$1.80

Okoprene Weather-Resistant Tape



Made with neoprene, provides permanent, non-fibrous protection for splices, in neoprene-sheathed cable.

Particularly designed for protecting splices in neoprene-sheathed cables. Eliminates need for friction tape and paint while adding electrical values.

Tape, 3/4-in. wide, containing 30 ft. packed 1/2 lb. in blue cans.

Per Lb. \$1.80

Permacel Electrical Tapes

All Permacel electrical tapes are both pressure sensitive and heat curing.

Permacel 21 Glass Cloth Electrical Tape

A glass cloth backed tape for applications requiring great mechanical strength and heat resistance such as taping coils in large motors and generators. Acceptable for NEMA Class B insulation. 60 yd. rolls. Tensile strength 150 lbs. per in.

Width Inches	Rolls Per Bulk Case	Per Roll	Width Inches	Rolls Per Bulk Case	Per Roll
1/4	144	\$2.09	3/4	48	\$6.27
3/8	96	3.14	7/8	44	7.32
1/2	72	4.18	1	36	8.36
5/8	60	5.23			

Permacel 201 Cotton Cloth Electrical Tape

For armature winding, transformer coils and anchoring heavy leads. Permacel 201 possesses low stretch features, excellent varnish-penetration properties and good conformability to irregular surfaces. 60 yd. rolls. Tensile strength 50 lbs. per in.

Permacel Electrical Tapes

Permacel 202 Sized Cotton Cloth Electrical Tape

Permacel 202 has a special non-corrosive adhesive, high tensile strength and excellent wear resistance. Suitable for anchoring heavy leads, coil wrapping and taping motor leads. Easy unwind permits quick hand or machine dispensing. 60 yd. rolls. Tensile strength 50 lbs. per in.

Permacel 201 and 202*

Width Inches	Rolls Per Bulk Case	Per Roll	Width Inches	Rolls Per Bulk Case	Per Roll
1/4	144	\$0.79	5/8	60	\$1.98
3/8	96	1.19	3/4	48	2.37
1/2	72	1.58	7/8	44	2.77
			1	36	3.16

*Bulk only.

Permacel 241

Acetate Film Cloth Electrical Tape

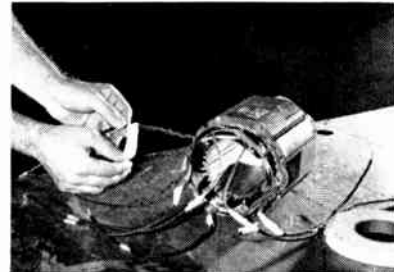

Permacel 241 used in fine wire applications

Recommended for fine wire applications, where maximum corrosion resistance and dielectric strength is required. Made of electrical grade acetate cloth with a 0.88 film-laminated together and coated with a non-corrosive adhesive. 72 yd. rolls. Tensile strength 45 lbs. per in.

Width Inches	Rolls Per Bulk Case	Per Roll	Width Inches	Rolls Per Bulk Case	Per Roll
1/4	144	\$1.66	3/4	48	\$4.98
3/8	96	2.49	7/8	44	5.81
1/2	72	3.32	1	36	6.64
5/8	60	4.15			

Permacel 24

White Acetate Cloth Electrical Tape

Excellent electrical properties and a high-hold, heat-curing adhesive make Permacel 24 especially suitable for fine wire applications. Its strength also permits its use in medium to heavy wire applications. Excellent coil wrapping tape. 60 yd. rolls. Tensile strength 45 lbs. per in.

Permacel 242

Colored Acetate Cloth Electrical Tape

Particularly suitable for outside wraps on transformers coils and solenoids. Same as P24 except for color. Available in black and brown. 72 yd. rolls. Tensile strength 45 lbs. per in.

Permacel 24 and 242

Width Inches	Rolls Per Bulk Case	Per Roll	Width Inches	Rolls Per Bulk Case	Per Roll
1/4	144	\$1.17	3/4	48	\$3.51
3/8	96	1.76	7/8	44	4.10
1/2	72	2.34	1	36	4.68
5/8	60	2.93			

Permacel 245

Acetate Fibre Electrical Tape

Has high hold value for lasting adhesion. Its principal uses are for insulation applications requiring high purity, good dielectric properties and great tear strength. Constructed of a cellulose acetate film, laminated to a 4 mil rope paper and coated with a pressure sensitive heat-curing adhesive. 72 yd. rolls. Tensile strength 50 lbs. per in.

Width Inches	Rolls Per Bulk Case	Per Roll	Width Inches	Rolls Per Bulk Case	Per Roll
1/4	144	\$1.06	3/4	48	\$3.18
3/8	96	1.59	7/8	44	3.71
1/2	72	2.12	1	36	4.24
5/8	60	2.65			

Permacel Electrical Tapes

Permacel 246

Rayon Reinforced Film Electrical Tape

A pressure sensitive heat curing acetate film reinforced with rayon strands. Meets Class A electrical insulation requirements. Excellent for anchoring heavy gauge electrical wiring and banding armature coils prior to forming. 72 yd. rolls. Tensile strength 225 lbs. per in. Impact strength 150 lbs. per in.

Width Inches	Rolls Per Bulk Case	Per Roll	Width Inches	Rolls Per Bulk Case	Per Roll
1/4	144	\$0.96	3/4	48	\$2.88
3/8	96	1.44	7/8	44	3.36
1/2	72	1.92	1	36	3.84
5/8	60	2.40			

Permacel 25

Clear Acetate Film Electrical Tape

Extremely thin with high dielectric strength and insulation resistance, Permacel 25 is ideal for holding and insulating fine wires in transformers and coil construction where a very limited space is required. 72 yd. rolls. Tensile strength 25 lbs. per in.

Permacel 251

Orange-Yellow Acetate Film Electrical Tape

The exceptionally high dielectric strength and thinness of Permacel 251 make it ideal for fine wire holding and insulating where maximum resistance to electrolytic corrosion at high humidities is required. The distinctive orange-yellow color makes Permacel 251 suitable for marking and anchoring the start and finish of wires in coil winding operations.

Width Inches	Rolls Per Bulk Case	Per Roll	Width Inches	Rolls Per Bulk Case	Per Roll
1/4	144	\$0.88	5/8	60	\$2.20
3/8	96	1.32	3/4	48	2.64
1/2	72	1.76	1	36	3.52

Permacel 22

Black Crepe Paper Electrical Tape

Permacel 22 is a purified kraft paper backed tape impregnated with an electrical grade saturating solution for uniformity and better electrical properties and a non-corrosive heat-curing adhesive. Features maximum stretch and "quick stick." 60 yd. rolls. Tensile strength 22 lbs. per in.

Permacel 23

Black Flatback Paper Electrical Tape

A paper tape with purified 100% rope paper impregnated with an electrical grade saturating solution. Recommended for all jobs that require an extra-strong tape. Has superior hold-value, excellent heat stability and maximum "quick stick." 60 yd. rolls. Tensile strength 50 lbs. per in. of width.

Permacel 27

Yellow Flatback Paper Electrical Tape

Constructed from an impregnated 4 mil rope paper coated with a heat curing pressure sensitive adhesive. Excellent for applications which require an easy handling tape with high tear and tensile strength. 60 yd. rolls. Tensile strength 50 lbs. per in.

Permacel 28

Yellow Crepe Paper Electrical Tape

Recommended for application to irregular shaped surfaces. Excellent for protective jobs requiring a flexible electrical tape and applications where the tape must withstand pre-bake cycles at elevated temperatures without softening and must have improved solvent resistance and higher adhesion after baking. 60 yd. rolls. Tensile strength 22 lbs. per in.

Permacel 22, 23, 27 and 28

Width Inches	Rolls Per Bulk Case	Per Roll	Width Inches	Rolls Per Bulk Case	Per Roll
1/4	144	\$0.58	5/8	60	\$1.45
3/8	96	.87	3/4	48	1.74
1/2	72	1.16	1	36	2.32

Permacel Electrical Tapes

Permacel 252

Orange-Yellow Polyester "Mylar" Film Electrical Tape

An orange-yellow film tape made with a 1 mil electrical grade "Mylar" film and a heat curing non-corrosive adhesive. An ideal insulating tape in small construction where space is an important factor. High heat stability is provided together with a thermosetting adhesive. Particularly suited for units operating at high temperatures. 72 yd. rolls. Tensile strength 20 lbs. per in. of width.

Permacel 253

Clear Polyester "Mylar" Film (1 mil) Electrical Tape

A "Mylar" film backed tape with a heat curing adhesive, free of corrosive agents. Excellent resistance to the attack of varnish and paint solvents. The high insulation resistance and complete lack of corrosibility make Permacel 253 ideal for holding and insulating applications where the finest gauge wires are used. 72 yd. rolls. Tensile strength 20 lbs. per in. of width.

*Du Pont's registered trade-mark.

Permacel 252 and 253

Width Inches	Rolls Per Bulk Case	Per Roll	Width Inches	Rolls Per Bulk Case	Per Roll
1/4	144	\$1.27	5/8	60	\$3.18
3/8	96	1.91	3/4	48	3.81
1/2	72	2.54	1	36	5.08

Permacel 254

Orange-Yellow Polyester "Mylar" Film (2 mil) Electrical Tape

Through its combination of superlative physical, mechanical, chemical, electrical and adhesive properties, Permacel 254 finds broad application throughout the entire electrical and electronic manufacturing field. 72 yd. rolls. Tensile strength 50 lbs. per in. of width.

Permacel 255

Clear Polyester "Mylar" Film (2 mil) Electrical Tape

A polyester "Mylar" film backed tape with a heat curing adhesive, with outstanding physical and mechanical properties. It has high tensile and tear strength, and affords maximum dielectric strength per unit thickness. 72 yd. rolls. Tensile strength 50 lbs. per in.

*Du Pont's registered trade-mark.

Permacel 254 and 255

Width Inches	Rolls Per Bulk Case	Per Roll	Width Inches	Rolls Per Bulk Case	Per Roll
1/4	144	\$2.04	5/8	60	\$5.10
3/8	96	3.06	3/4	48	6.12
1/2	72	4.08	1	36	8.16

Permacel Metal Foil Tapes

Permacel 12

Sound Damping Tape

An aluminum foil backed tape laminated to unbleached cotton cloth. An effective sound-damping medium on metal panels, aircraft, automobile bodies, truck bodies and railway cars. Can be used wherever protection against moisture, heat, humidity and sunlight is required. 60 yd. rolls. Tensile strength 45 lbs. per in.

Width, Inches	Per Roll	Width, Inches	Per Roll
1	\$ 6.50	6	\$ 39.02
3	19.51	36	234.09

Permacel 11

Aluminum Foil Tape

An excellent industrial tape designed to take advantage of the many desirable and unusual properties of aluminum foil. Good adhesion to work surfaces made possible by high strength adhesive. Aging is almost non-existent. 60 yd. rolls. Tensile strength 28 lbs. per in. of width.

Width Inches	Rolls Per Case	Per Roll
1/2	72	\$2.12
3/4	48	2.61
1	36	3.26

Permacel Paper Tapes

**Permacel 71
All Purpose Crepe Masking Tape**

A crepe paper backed masking tape for masking near-white and pastel finishes. Treated to minimize the possibility of staining or discoloring surfaces to which it is applied. 60 yd. rolls. Tensile strength 18 lbs. per in. of width.

**Permacel 718
All Purpose Flexible Flatback Masking Tape**

Specially processed flatback masking tape with high flexibility, internal stretch and solvent and moisture resistance. Adheres well under forced oven drying conditions. Stain resistant on white or pastel finishes. 60 yd. rolls. Tensile strength 20 lbs. per in. of width.

**Permacel 73
Hi-Temperature Crepe Masking Tape**

A crepe paper backed masking tape especially developed for use in masking operations that require a baked finish at temperatures of 250° F. or over. Good adhesion and flexibility allows conformability to curved and irregular surfaces. 60 yd. rolls. Tensile strength 17 lbs. per in. of width.

**Permacel 77
Crepe Paper Masking Tape**

A general-purpose tape used widely for masking in spray painting. Specially treated backing unaffected by solvents in paints, varnishes, and enamels. Extreme thinness and good flexibility. 60 yd. rolls. Tensile strength 18 lbs. per in. of width.



Permacel 71, 718*, 73*, and 77

Width Inches	Rolls Per Bulk Case	Per Bulk Roll	Per Indiv. Roll	Width Inches	Rolls Per Bulk Case	Per Bulk Roll	Per Indiv. Roll
1/4	144	\$0.57	\$0.77	1 1/4	30	\$1.45	\$1.94
3/8	96	.68	.89	1 1/2	24	1.74	2.33
1/2	72	.75	1.02	1 3/4	24	2.03	2.71
5/8	60	.84	1.13	2	18	2.32	3.10
3/4	48	.90	1.21	2 1/4	16	2.61	3.49
7/8	42	1.06	1.41	2 1/2	12	2.90	3.88
1	36	1.16	1.55	2 3/4	12	3.19	4.26
				3	12	3.48	4.65

*Bulk only.

**Permacel 717
Black Crepe Paper Masking Tape**

A lightly-creped, black paper tape with transparent firm adhesive, for use in all plant work. Heat resistant to hold at normal or forced drying oven temperatures. 60 yd. rolls. Tensile strength 21 lbs. per in. of width.

**Permacel 72
Stain Resistant Flatback Masking Tape**

A rope fibre paper backed tape treated to resist moisture and common solvents. Principally used in straight line and stencil painting to produce sharp, clear edges. Stain resistant, extra-high adhesion and tensile strength. 60 yd. rolls. Tensile strength 55 lbs. per in. of width.

**Permacel 721
Low Tack Flatback Masking Tape**

A rope fibre paper backed tape, with good heat and stain resistant qualities. Permacel 721 is printable, and easily removed from the job. 60 yd. rolls. Tensile strength 55 lbs. per in. of width.

**Permacel 728
Hi-Strength Flatback Masking Tape**

Specially processed rope paper backed masking tape, with high tear resistance, thinness, and stain resistant qualities. High adhesion to a wide variety of surfaces. 60 yd. rolls. Tensile strength 45 lbs. per in. of width.

**Permacel 75
Solvent-Resistant Crepe Masking Tape**

Specially developed crepe paper backed tape for masking operations in the plastics industry. Specially treated backing highly resistant to solvents in cement, paints and lacquers. 60 yd. rolls. Tensile strength 27 lbs. per in.

**Permacel Paper Tapes
Permacel 717*, 72*, 721*, 728*, 75***

Width Inches	Rolls Per Bulk Case	Per Bulk Roll	Per Indiv. Boxed Roll	Width Inches	Rolls Per Bulk Case	Per Bulk Roll	Per Indiv. Boxed Roll
1/4	144	\$0.60	\$0.82	1 1/4	30	\$1.50	\$2.05
3/8	96	.68	.94	1 1/2	24	1.80	2.46
1/2	72	.78	1.07	1 3/4	24	2.10	2.87
5/8	60	.88	1.20	2	18	2.40	3.28
3/4	48	.96	1.30	2 1/4	16	2.70	3.69
7/8	42	1.08	1.48	2 1/2	12	3.00	4.10
1	36	1.20	1.64	2 3/4	12	3.30	4.51
				3	12	3.60	4.92

*Bulk only.

**Permacel 02
Double Faced Paper Tape**

A strong thin paper tape coated on both sides with a pressure sensitive adhesive mass and a heavy crepe paper interliner on one side. Easier and better to use than liquid adhesives. For permanent and temporary splicing of webs or strips of material and for joining two objects together. 36 yd. rolls. Tensile strength 30 lbs. per in. of width.

Width Inches	Rolls Per Bulk Case	Per Bulk Roll	Per Indiv. Boxed Roll	Width Inches	Rolls Per Bulk Case	Per Bulk Roll	Per Indiv. Boxed Roll
1/4	144	\$0.82	\$1.09	3/4	48	\$1.64	\$2.18
3/8	96	1.03	1.37	7/8	42	1.84	2.45
1/2	72	1.22	1.63	1	36	2.04	2.72
5/8	60	1.43	1.91	2	20	4.08	5.44

**Permacel 01
All Purpose Protective Paper Tape**

A strong thin paper tape with a pressure-sensitive adhesive designed for protecting various types of polished surfaces. Adheres well to polished surfaces, yet will come off with minimum pull. Maximum protection during forming, bending, fabrication and shipment. 100 yd. rolls.

Width, in.	36 1/2	48 1/2
Per Roll.....	\$58.47	\$77.62

Permacel Reinforced Tapes

**Permacel 15
Strapping Tape**

A creped paper tape with glass reinforcement. Strong, flexible and self-sticking, will not chafe packing materials and provides all round reinforcement for strapped objects. Excellent for bundling, packaging, palletizing and sealing. 60 yd. rolls. Tensile strength 240 lbs. per in. of width.

Width Inches	Rolls Per Case	Per Roll	Width Inches	Rolls Per Case	Per Roll
1/4	144	\$1.00	7/8	44	\$2.27
3/8	96	1.26	1	36	2.52
1/2	72	1.51	1 1/2	24	3.78
5/8	60	1.76	2	20	5.04
3/4	48	2.03			

**Permacel 16
Hi-Tack Strapping Tape**

A cellulose acetate self-sticking tape reinforced with rayon strands providing excellent shock and abrasion resistance. Highly water resistant—assuring package bonds under adverse climatic conditions. Available in seven different colors. 60 yd. rolls. Tensile strength 210 lbs. per in.

Width Inches	Rolls Per Case	Per Roll Transparent	Per Roll Colored	Width Inches	Rolls Per Case	Per Roll Transparent	Per Roll Colored
1/4	144	\$1.07	\$1.18	3/4	48	\$2.14	\$2.36
3/8	96	1.34	1.47	7/8	44	2.40	2.65
1/2	72	1.61	1.76	1	36	2.67	2.94
5/8	60	1.87	2.06				

Permaccel Plastic Tapes



Permaccel 29 used as insulation in a wire splicing application.

Permaccel 29 Plastic Electrical Tape

A specially formulated vinyl plastic backing, with a pressure-sensitive adhesive, free from corrosive agents. Carefully balanced adhesion and easy stretch. Flame resistant for greater safety as an electrical insulating material. 20 and 66 ft. rolls. Tensile strength 20 lbs. per in. of width.

Permaccel 291 Plastic Electroplating Tape—Yellow

A clear vinyl plastic backed tape specially compounded for electrical properties. Elongation and conformability with ease of handling are assured by carefully controlled formulation. Moisture proof and resists acid, oil, gasoline and salt water. 36 yd. rolls. Tensile strength 22 lbs. per in.

Permaccel 30 Heavy Duty (Electrical Grade) Plastic Tape (Black, Grey)

A vinyl film tape with a vinyl film backing and a high-hold non-corrosive adhesive. Extremely high dielectric strength and maximum insulation resistance. Other features include exceptional strength and elongation, high adhesive firmness. 36 yd. rolls. Tensile strength 30 lbs. per in. of width.

Permaccel 29, 291 and 30

Width Inches	Rolls Per Canister	Per Roll	Width Inches	Rolls Per Canister	Per Roll
1/4	24	\$1.50	3/4	8	\$2.40
3/8	16	1.72	7/8	6	2.70
1/2	12	1.95	1	6	3.00
5/8	8	2.18			

Permaccel 32 Colored Plastic Tape

A colored vinyl tape with high resistance to abrasion for marking safety aisles, work or danger areas. Waterproof and washable, it is more durable than paint. Resists grease, oil and solvents, and adheres firmly to clear, dry floor surfaces. 36 yd. rolls. Tensile strength 18 lbs. per in. of width.

Width Inches	Rolls Per Canister	Per Roll	Width Inches	Rolls Per Canister	Per Roll
1/2	12	\$1.95	1	6	\$3.00
5/8	8	2.18	2	3	6.00
3/4	8	2.40	3	2	9.00
7/8	6	2.70			

Permaccel 29 A Display

A colorful display box containing 12 rolls 1/2 in. by 150 in. black plastic electrical tape. Each roll is cellophane wrapped to insure clean, fresh stock. A handy size for minor electrical repairs and numerous other applications.

Per Roll.....\$0.39

Permaccel 29 C Display

Contains 12 rolls of 3/4 in. by 20 ft. plastic electrical tape in a sturdy, eye-catching display box, cellophane protected from dust and handling. It is a job size roll ideal for antenna wiring, repairing frayed cords, electrical splicing, etc.

Per Roll.....\$0.55

Permaccel Plastic Tapes

Permaccel 29 D Display

Each display contains 12 rolls 3/4 in. by 66 ft. plastic electrical tape. Each roll is packed in a metal can for maximum protection. A free plastic cutter bar is included with each roll. Permaccel 29 D is the ideal shop and service kit size tape roll, for insulating splices, harness wrapping, protecting tool handles, splicing in junction boxes, etc.

Per Roll.....\$1.50

Permaccel 306 Heavy Duty (Pipewrap) Plastic Tape

A vinyl film non-electrical tape made specifically for use where high chemical and abrasion resistance, strength and conformability are needed. 100 ft. rolls. Tensile strength 30 lbs. per in. of width.

Per 100 Sq. Ft.....\$23.33

Permaccel 307 Extra Heavy Duty (Pipewrap) Plastic Tape

A vinyl film tape with a superior aging high-hold adhesive. Maximum abrasion resistance and good conformance is obtained with this flexible tape. Has a nonconductive fungi, bacteria resistant backing and adhesive. 100 ft. rolls. Tensile strength 40 lbs. per in. of width.

Per 100 Sq. Ft.....\$37.33

Permaccel Acetate Fibre and Film Tapes

Permaccel 97 Tru-Color Acetate Fibre Tape

A moisture-resistant colored tape especially designed for use in packaging. Will provide a moisture-resistant and colorful closure. Printable to serve as a message-carrying closure. Available in white, yellow, light blue, cream, light gray, silver, gold, red, orange, green, blue, black, orange-yellow and brown. 72 yd. rolls. Tensile strength 35 lbs. per in. of width.

Permaccel 98 Moisture-Tight Colored Acetate Fibre Tape

An opaque moisture-tight acetate fibre tape whose colors are derived from pigments in the laminating adhesive. Backing is cellulose acetate film combined with a strong but thin rope-fibre paper. Has strong adhesive qualities. 72 yd. rolls. Tensile strength 34 lbs. per in. of width.

Width Inches	Rolls Per Case	Per Roll	Width Inches	Rolls Per Case	Per Roll
1/4	144	\$1.11	3/4	48	\$2.20
3/8	96	1.38	1	36	2.76
1/2	72	1.65			

Permaccel 90 Clear Acetate Film Tape

A transparent acetate film backed tape with excellent aging properties. It is more water resistant than cellophane. Has excellent ultra-violet transmission properties, both backing and adhesive being resistant to ultra-violet effect on aging qualities. 72 yd. rolls. Tensile strength 25 lbs. per in. of width.

Permaccel 99 Moisture-Tight Transparent Acetate Fibre Tape

A cellulose acetate film and thin rope-fibre paper backed tape which is semi-transparent, and highly moisture-resistant. Laminated backing gives high tensile strength and tear-resistance. 72 yd. rolls. Tensile strength 38 lbs. per in. of width.

Permaccel 991 Low M. V. T. Transparent Acetate Fibre Tape

A thin semi-transparent highly moisture-resistant tape especially designed for packing and packaging under Government specifications. 72 yd. rolls. Tensile strength 38 lbs. per in. of width.

Width Inches	Rolls Per Case	Per Roll	Width Inches	Rolls Per Case	Per Roll
1/4	144	\$0.93	1	36	\$2.28
3/8	96	1.14	1 1/2	24	3.42
1/2	72	1.36	2	20	4.56
3/4	48	1.82			

Permaccel Cotton Cloth Tapes

Permaccel 66 Extra Strength Tape

An ideal general-purpose cloth tape, with high flexibility, great tensile strength and comparative thinness. 60 yd. rolls. Tensile strength 50 lbs. per in. of width.

Permaccel 663 Heat-Resistant Extra Strength Tape

A cotton cloth backed tape suitable for general industrial applications requiring conformability and strength, combined with resistance to moderately high temperatures. Has good stain resistance. 60 yd. rolls. Tensile strength 50 lbs. per in. of width.

Permaccel 66 and 663

Width Inches	Rolls Per Case	Per Roll	Width Inches	Rolls Per Case	Per Roll
1/4	96	\$0.70	7/8	52	\$1.26
3/8	96	.81	1	48	1.40
1/2	96	.91	2	24	2.80
5/8	76	1.02	3	16	4.20
3/4	64	1.12	4	12	5.60

Permaccel 67 Extra Strength Tape

An extra strong cotton cloth tape with high tensile strength, thinness and flexibility. 60 yd. rolls. Tensile strength 50 lbs. per in. of width. Available in black and other colors.

Permaccel 63 Stain-Resistant Extra Strength Tape

A sturdy, flexible cloth backed tape with tensile strength combined with thinness and flexibility. Will not tend to stain, tarnish or discolor white or pastel shades of synthetic lacquers or enamels under normal conditions. 60 yd. rolls. Tensile strength 50 lbs. per in. of width.

Permaccel 67 and 63

Width Inches	Rolls Per Case	Per Roll	Width Inches	Rolls Per Case	Per Roll
1/4	96	\$0.73	7/8	52	\$1.31
3/8	96	.84	1	48	1.46
1/2	96	.95	2	24	2.92
5/8	76	1.06	3	16	4.38
3/4	64	1.17	4	12	5.84

Permaccel 64 Production Grade Tape

A lightweight cloth tape for moderately priced, general purpose applications. Flexibility allows conformance to curved and irregular surfaces. 60 yd. rolls. Tensile strength 40 lbs. per in. of width. Conforms to Federal specifications.

Width Inches	Rolls Per Case	Per Roll	Width Inches	Rolls Per Case	Per Roll
1/4	96	\$0.58	7/8	52	\$1.04
3/8	96	.66	1	48	1.15
1/2	96	.75	2	24	2.30
5/8	76	.83	3	16	3.45
3/4	64	.92	4	12	4.60

Permaccel 641 Production Grade Sized Tape

A sized cotton cloth backed, natural colored tape ideal for all applications requiring greater strength. Thin and stiff, with great tensile strength. 60 yd. rolls. Tensile strength 42 lbs. per in. of width.

Width Inches	Rolls Per Case	Per Roll	Width Inches	Rolls Per Case	Per Roll
1/4	96	\$0.60	7/8	52	\$1.08
3/8	96	.69	1	48	1.20
1/2	96	.78	2	24	2.40
5/8	76	.87	3	16	3.60
3/4	64	.96	4	12	4.80

Permaccel 50 Double Faced Tape

A high grade cotton sheeting backed tape with a back sized calendered cloth interliner. Adheres easily and quickly to almost any surface. Heavy adhesive coating holds firmly, providing a cushion between brittle or breakable materials. 25 yd. rolls. Tensile strength 40 lbs. per in. of width.

Width Inches	Rolls Per Case	Per Roll	Width Inches	Rolls Per Case	Per Roll
1/2	48	\$1.41	2	16	\$4.34
3/4	32	1.74	3	12	6.51
1	24	2.17	4	8	8.68

Permaccel 68

Extra Strength Colored Waterproof Tape

A cotton cloth tape waterproofed with a plastic coating which permits the use of an adhesive with maximum "quick-stick" for ease of application and "high hold" value for lasting adhesion. 60 yd. rolls. Tensile strength 60 lbs. per in. of width

Permaccel 681

Extra Strength White Waterproof Tape

A white cloth tape waterproofed with a plastic coating. Ideal for those applications requiring printing of tape. Use of plastic coated backing permits use of tackier adhesive and results in high "quick stick," better conformance to irregular shapes. 60 yd. rolls. Tensile strength 60 lbs. per in. of width.

Permaccel 68 and 681

Width Inches	Rolls Per Case	Per Roll	Width Inches	Rolls Per Case	Per Roll
1/4	96	\$1.03	7/8	52	\$1.85
3/8	96	1.18	1	48	2.05
1/2	96	1.33	2	24	4.10
5/8	76	1.49	3	16	6.15
3/4	64	1.64	4	12	8.20

Permaccel 69

Low M. V. T. Colored Waterproof Tape

A cotton cloth tape treated with a waterproof plastic coating, with a very low moisture vapor transmission rate. Backing almost completely impervious to moisture, with a special adhesive for extra "high hold" value. 60 yd. rolls. Tensile strength 60 lbs. per in. of width.

Width Inches	Rolls Per Case	Per Roll	Width Inches	Rolls Per Case	Per Roll
1/4	96	\$1.30	7/8	52	\$2.33
3/8	96	1.49	1	48	2.59
1/2	96	1.68	2	24	5.18
5/8	76	1.88	3	16	7.77
3/4	64	2.07	4	12	10.36

Permaccel 691

Production Grade Colored Waterproof Tape

A waterproof cloth tape developed for packaging, sealing and waterproofing operations. Plastic-coated backing minimizes lint pick-up. Meets Government specifications. 60 yd. rolls. Tensile strength 55 lbs. per in.

Width Inches	Rolls Per Case	Per Roll	Width Inches	Rolls Per Case	Per Roll
1/4	96	\$0.92	7/8	52	\$1.65
3/8	96	1.05	1	48	1.83
1/2	96	1.19	2	24	3.66
5/8	76	1.33	3	16	5.49
3/4	64	1.46	4	12	7.32

Permaccel 672

Utility Waterproof Tape (Colored)

A plastic coated cotton cloth tape for general industrial and utility applications. Has high adhesion to work, good resistance to abrasion, solvents, oil, water and moisture. 60 yd. rolls. Tensile strength 45 lbs. per in. of width.

Width Inches	Rolls Per Case	Per Roll	Width Inches	Rolls Per Case	Per Roll
1/4	96	\$0.79	7/8	52	\$1.42
3/8	96	.91	1	48	1.58
1/2	96	1.03	2	24	3.16
5/8	76	1.15	3	16	4.74
3/4	64	1.26	4	12	6.32

Permacel "Texcel" Cellophane Tapes

Texcel 44

Clear Cellophane Tape

A clear cellophane backed tape with high adhesive qualities. Is extremely thin, and break-resistant to a high degree. Resistant to grease, oil and solvents. 1296 in. and 2592 in. rolls. Tensile strength 27 lbs. per in. of width.

2592-Inch Lengths

Width, In....	1/4	3/8	1/2	5/8	3/4	1	1 1/2	2
Per Roll	\$0.53	\$0.67	\$0.92	\$1.18	\$1.34	\$1.76	\$2.64	\$3.52

1296-Inch Lengths

Width, In....	3/8	1/2	3/4
Per Roll	\$0.56	\$0.68	\$0.90

Texcel 45

Tru-Color Cellophane Tape

A clear cellophane tape coated with a pigmented opaque adhesive mass. Is extremely thin, has high adhesive qualities, and possesses greater tensile strength than many paper tapes. Available in red, white, black, green, light green, yellow, orange-yellow, light blue, blue, gold, silver and orange. 1296 in. and 2592 in. rolls. Tensile strength 27 lbs. per in. of width.

2592-Inch Lengths

Width, In.....	1/4	3/8	1/2	3/4	1
Per Roll.....	\$0.85	\$1.04	\$1.42	\$1.99	\$2.60

Permacel "Texcel" Cellophane Tapes

Texcel 46

Hi-Tack Cellophane Tape

A cellophane tape designed for industrial uses involving rough surfaces where an extra adhesive cushion is required. Also ideally suited for sealing and holding applications. 2592 in. rolls. Tensile strength 27 lbs. per in. of width.

Width, In....	1/4	3/8	1/2	5/8	3/4	1	1 1/2	2
Per Roll.	\$0.53	\$0.67	\$0.92	\$1.18	\$1.34	\$1.76	\$2.64	\$3.52

Permacel Texcel Dispensers

Texcel 5 A

Desk Dispenser

For both office and home use, is available in black, satin-wood, blue spruce and mahogany and holds tape up to 1 in. wide and 2 3/4 in. in diameter.

Per Dispenser.....\$1.98

Texcel 5 B

Counter Dispenser

For storeroom, shipping room or sales counter use, is available in French Grey and Sea Spray. A heavy duty, all purpose dispenser, it holds tape up to 1 1/4 in. in width and 6 1/4 in. in diameter.

Per Dispenser.....\$3.95

Texcel 5 C

Industrial Dispenser

For production line, and shipping room is available in Gummatal. The roll width capacity of 2 1/4 in. and roll diameter of 7 3/4 in. makes this the ideal dispenser for high speed production work.

Per Dispenser.....\$6.10

Call Graybar FIRST For . . .

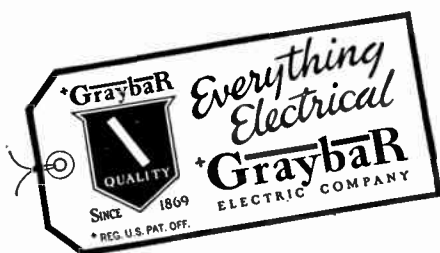

Kester Acid Core Solder

For General Soldering



Quickly forms permanently strong joints. Acid flux flows evenly, in right amount.

No paste or additional flux necessary.

Standard size, 1/8-inch. Approximately 25 feet per pound.

Pkg.....	1-Lb. Spool	5-Lb. Spool	20-Lb. Spool
Prices on application.			

Kester Plastic Rosin Core Solder

For Electrical and Radio Work



Non-corrosive plastic rosin flux, flows evenly in correct amount.

Forms perfect solder joints.

No pastes or additional flux necessary.

Standard solder size 3/32-inch.

Approximately 50 ft. per pound.

Spool Size in Pounds.....	1	5	20
Prices on application.			

Dunton Solders

Gem Rosin Core

For Electrical and Radio Work

Made of virgin tin and lead—no scrap metals used. Rosin flux.

Approximate size of solder, .093 inch standard gage.

Supplied in spools of 1, 5, and 20 pounds each.



Ideal Acid Core

Made of virgin tin and lead—no scrap metals used.

Superior acid soldering flux. Approximate size of solder, No. 8 standard gage.

Supplied in spools only of 1, 5, and 20 pounds each.

Nokorode Core

For General Soldering

For all kinds of soldering. Replaces acids or rosin core solder. Ready for instant use.

Quick-working; forms permanently strong joints.

Metals, virgin tin and lead. Core completely and uniformly filled with solid flux. Flux will not run out on heating; no waste. Supplied in 1, 5, and 20-lb. spools.

Prices on application.

Allen Aluminum Solder



Complete, solder and flux combined. Requires only heat to permanently join aluminum to itself or other metals.

Supplied in 1/8-inch (11 gauge) square wire, or triangular 1/4 and 1-lb. bars.

Prices on application.

Kester Bar Solder



Tin-lead alloy solder. Bar form particularly convenient for heavier soldering jobs.

Prices on application.

Allen Stainless Steel Solder



Hi-Luster. Supplied in wire form, provides close-matching, non-dulling joints. Particularly desirable on decorative work.

Prices on application.

Extra-Strong



Fornis joints of unusual strength. Designed for general stainless steel soldering. Bar forms only.

Darkens slowly with age, but does not lose strength.

Prices on application.

Allen Soldering Paste

Approved by Underwriters' Laboratories, Inc.



Standard Formula

Convenient, corrosion-free, soft form of flux.

Fast working; adheres to surface during soldering.

Makes solder self-fluxing.

Size Can.....	2 oz.	4 oz.	1/2-lb.	1-lb.	5-lb.
No. in Carton.....	24	24	12	6	1
Each Can.....	\$0.13	\$0.20	\$0.50	\$0.70	\$2.75



Ezy-Flow Torch Formula

Special soldering paste for torch and "sweat joint" soldering. Also works well with soldering iron.

Size Can.....	2 oz.	4 oz.	1/2-lb.	1-lb.	5-lb.
No. in Carton.....	24	24	12	6	1
Each Can....	\$0.13	\$0.25	\$0.50	\$0.70	\$2.75

Burnley Soldering Paste



Size Can	Per Pound	Size Can	Per Pound
2 oz.	*\$1.80	5 lb.	\$0.60
4 oz.	*2.70	50 lb.	.50
1/2 lb.	.80	500 lb.	.40
1 lb.	.75

*Per dozen cans

Nokorode Soldering Paste



Will flux all metals except aluminum.

Takes the place of acid in all soldering jobs. Non-corrosive; safe as resin, rapid as acid. Not affected by heat; will not splatter.

This solder will not turn dark after using.

2-Oz. Cans

Supplied in cartons of 12; 144 cans to a shipping case.

2 Oz. Can..... Per Gross \$20.00

By Pound		
Size Can (Lbs.)	Standard Package	Per Pound
1	6 to Carton.....	\$.85
10	Individual Carton.....	.70
25	Individual Carton.....	.65
50	Individual Carton.....	.60
100	Drum.....	.55

Allen Soldering Sticks



Acidless non-corrosive flux. Fuses solder rapidly; just a touch to the hot metal does the work.

Made to "Samson" formula, or to superior "Allen" formula. Sticks per carton, 24.

Formula	Size, In.	Each
Samson	1x5	\$.15
Allen	1x5 1/4	.30

Brach Solderall



Combined Metal Solder and Flux. Not a cold solder.

Small quantity applied to joints to be soldered will, when heated, flow and unite the parts the same as wire and bar solder.

Solderall is available in tubes or cans.

No.	Description	Each
SL2	No. 2 Size Tube	\$0.69
SL2	1-lb. Can	2.94

Dunton Electro Soldering Flux



Prepared especially for the Electronic, Radio, Television and other branches of the Electrical Industry. Has been certified for Army, Navy, Air Force and Signal Corps Specification MIL-S-6872, and is both non-corrosive and non-conductive.

Free from acid and safe as Rosin. Especially effective on cable and wire having cloth or plastic coverings.

Available as Electro Plastic Core Solder.

Size Container, Gals.	Standard Package	Approx. Net Wt.	Per Gal.
1	1 jug per case.....	12	\$5.00
5	1 can per case.....	40	4.90

Dunton Rosin "X" Flux



Completely non-corrosive and electrically non-conductive. An activated flux which has been certified for Army-Navy and Air Force Specification MIL - S - 6872. Especially adapted for the Electronics, Radio, Television and Electrical Industries. Free from acid reaction, safe as rosin, fast as acid.

Available in cored solders.

Size Container Gals.	Standard Package	Per Gal.
1	1 jug per case.....	\$5.00
5	1 can per case.....	4.90

Dunton Neutro-14 Flux



Contains no zinc or ammonium chloride nor strong acids. Has no rosins or other synthetic resins or waxes. Non-fuming and non-toxic.

Residues are non-corrosive, non-conductive and non-hygroscopic. Readily water soluble. Contains special wetting agent to give maximum wetting properties to the flux.

Not designed for use on Inconel, tarnished stainless steel, aluminum nor zinc.

Size Container Gals.	Standard Package	Approx. Net Wt.	Per Gal.
1	1 jug per case.....	13	\$8.00
5	1 jug per case.....	65	7.00

Allen Soldering Flux



"All-Sol" Stainless Steel

Fast flux which makes soldering of stainless steel as easy as soldering tin plate.

Works with all solders. Available in a special odorless formula where less strength is required.

Size	No. Per Ctn.	Each
Pint	6	\$1.60

Allen Silver-Brazing Flux



Rapid working product that enables operator to fuse silver with itself or with other metals. Strong, ductile and will not discolor silver in any way. This flux meets Army, Navy and Military specifications.

Size	No. Per Ctn.	Each
1 Lb.	6	\$1.35

Allen Neutral Rosin Liquid Flux



Absolutely safe for electric motor, telephone, radio, commutator and instrument work, or on fine wires.

Will not corrode, even if spilled on work and allowed to stand.

Neutral, moisture-free flux, non-conductive to electric current.

Size Can	1 Qt.	1 Gal.
No. per Carton.....	3	1
Each Can.....	\$1.00	\$3.50

Allen Soldering Salts



Non-acid flux in convenient powder form. Takes a quick bite and makes solder hold on. Solders all metals but aluminum.

For old metals, use 3 parts water to 1 part salt; for new metals, 5 parts water to 1 part salts.

In bottles or metal container.

Size	1/2 Lb.	1-Lb.	5-Lb.
No. in Carton.....	12	6	1
Each.....	\$.40	\$.59	\$ 2.50

Burnley Soldering Salts



For all metals. Made of pure chemicals.

Size Lbs.	Standard Package	Per Pound
1/2	25 or 50 Cans.....	\$0.95
1	25 or 50 Cans.....	.85
5	Cans, any quantity.....	.70
50	Pail.....	.60

Nokorode Soldering Salts

Eliminates the use of soldering acids.

Highly economical.

Has no disagreeable fumes while under heat; will not burn operators skin or clothing.

Size Can (Lbs.)	Standard Package	Per Pound
1	6 to Carton.....	\$.75
5	Individual Carton.....	.65
25	Individual Carton.....	.60
50	Individual Carton.....	.55
100	Drum.....	.50

Allen Solid Sal Ammoniac



Speedily cleans and brightens the soldering copper. Lasts longer than fibrous lump.

Does not crumble or corrode.

Supplied in solid, convenient, six-sided form.

Size Lbs.	Number Per Carton	Each
1/4	24	\$.20
1/2	12	.35
1	6	.60

Nokorode Soldering Fluid



Ready for instant use.

Size Container Gals.	Standard Package	Approx. Net Wt. Lbs.	Per Gal.
1	1 Jug Per Case	10½	\$3.00
5	1 Can Per Case	54½	2.75
55	Drum	580	Price on request

Allen Soldering Liquid



For all-around work, for all metals except aluminum and stainless steel. 17,000 lbs. to the square inch with no gumming, fumes or corrosion.

Double strength, non-evaporating. Adaptable to hand or machine soldering. Ideal for tinning the soldering copper.

Size	No. Per Ctn.	Each
2 oz.	24	\$0.13
4 oz.	12	.20
1 quart	4	.80
1 gallon	1	2.00

Burnley Soldering Solution

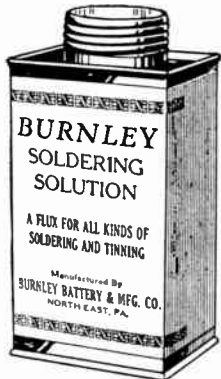

A flux for all kinds of soldering and tinning.

Size Can	Per Can
1 Pint	\$0.50
1 Gallon	2.30

Allen Stainless Steel Polish



Cleans, polishes, removes heat burns and fabrication marks from stainless steel. Supplied in either powder form for all-around use, or cake form for buffing-wheel use. High finish formula available, when specified, for mirror-finish work.

Size Pkg. Lbs.	Number Per Carton	Per Lb.
1	1	\$1.35
5	6	.90

Unique Joint Wiping Cloths

Finishing and catch cloths have smooth, slick wiping surface to which solder will not stick. Made of finest ticking.

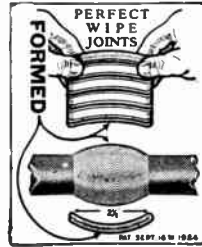

Formed Flexible Finishing Cloth

Permanent curve of cloth forms neat, narrow uniform joints.

Ready to use; no breaking in necessary.

Contains no stiffening; can be massaged to any desired flexibility without losing curvature.

Formed, Finishing Cloth

Size, Inches	2x2	2½x2½	3x3	3½x3½	4x4
Ticking, Each	\$.48	\$.50	\$.60	\$.60	\$.70

Flat, Catch Cloth

Size, Inches	5x5	6x6	6x7	7x8	8x8
Ticking, Each	\$.90	\$ 1.00	\$ 1.12	\$ 1.33	\$ 1.45

Upright Joint Wiping Cloth



Make perfect upright wipe joints.

Smooth wiping surface; solder will not stick.

O. D., Inches	9	11	12	14	17
Hole, Inches	1	1¼	2¼	3¼	6
Each	\$1.78	\$2.43	\$2.97	\$3.25	\$4.80

Reliable Testing Clips

For temporary connections to insulated wires. Made of heavy bronze with hard sharp insulation puncturing points and perfectly registering teeth.

No. 1

Fitted with screw, nut, spike, and washer for attaching to instrument cord.

No. 1.....each \$0.26

Nos. 2 and 3

Same as No. 1 with exceptions as noted. Preferred where connection to cord is to be soldered.

No. 2 No screw, nut or washer.....each \$0.24

No. 3 Without spike.....each 0.24



No. 5

A light, sturdy clip with a strong spring. Convenient for temporary connections in radio, telephone and signal work.

Particularly good for congested telephone equipment. Ample space for soldering flat cord terminals.

No. 5.....each \$0.14

No. 5T Fitted with Tip.....each .22



Quantity prices on request.

Mueller Universal Test Clips and Insulators



No. 24-A Clip Only



No. 45 Clip with No. 47 Insulator

For electrical work requiring quick temporary connections. A complete line of test clips and flexible insulators.

Clips are packaged in standard quantities of 10 and 100. Sizes 21-A, 21-A, and 11A are packed half marked plus, half plain to indicate polarity.

Flexible insulators provide convenient protection against electric shock, and prevent clips from shorting against each other. Color coding offers quick identification of different leads. Packaged in standard quantities of 10 and 100 in red and black, half of each color.

All Mueller products may be assorted to obtain quantity prices.

Screw Connection

No.	Description	Spread of Jaws, In.	Wt., Lbs Per 100	Net Price Each
45	Pee-Wee clip, cadmium plated..	5/16	1 1/4	\$0.07
45-C	Pee-Wee clip, solid copper.....	1/4	1 1/4	.13
47	Flexible Insulator for clips 15, 15-C.....		1	.07
48-B	Test clip, cadmium plated.....	3/16	2	.10
48-C	Test clip, 10 amp., solid copper..	3/16	2	.14
49	Flexible Insulator for clips 48-B, 48-C.....		2	.10
27	Test clip, 20 amp., cadmium plated.....	5/8	3 1/4	.12
27-C	Test clip, 40 amp., solid copper..	5/8	3 1/2	.20
29	Flexible insulator for clips 27, 27-C.....		4	.16
24-A	Test clip, 25 amp., lead plated..	3/4	6 1/4	.20
24-C	Test clip, 50 amp., solid copper..	7/8	7	.34
26	Flexible insulator for clips 24-A, 24-C.....		7	.24
21-A	Heavy duty clip, 50 amp., lead plated.....	1 1/8	15	.36

Lug Connection

21-C	Heavy duty clip, 100 amp., solid copper.....	1 1/8	18	.88
23	Flexible insulator for clips 21-A, 21-C.....		8	.48
11-A	Heavy duty clip, 100 amp., lead plated.....	1 3/4	38	1.00
11-C	Heavy duty clip, 200 amp., solid copper.....	1 3/4	11	1.70
13	Flexible insulator for clips, 11-A, 11-C.....		23	.77

Mueller Alligator Clips 60 Series



No. 60-S



No. 60-HS

Small, slim-nosed clips, popular, with many uses. Fine meshing teeth, round thumb grip, and barrel connection for banana plug. All these clips have jaw opening of 5/16 in., weight approx. 1 1/4 lb. per 100.

No.	Description	Lenh., In.	Net Price Each
60	Solder connection, cadmium plated...	2	\$0.07
60S	Screw connection, cadmium plated....	2	.08
60CS	Screw connection, solid copper.....	2	.12
60HS	Screw connection, cadmium plated, red or black insulating sleeves on end...	2 1/32	.14
60HIS	Screw connection, solid copper, red or black insulating sleeves on end.....	2 1/32	.16

Mueller Insulation for Alligator Clips



No. 60-S Clip with No. 62 Insulator



No. 63

No.	Description	Net Price Each
62	Separate flex. insulator for 60, 60S, 60CS clips..	\$0.07
63	Clip 60S equipped with tough, close-fitting, flexible insulation (red or black).....	.28
63C	Same as No. 63 except solid copper (60CS)....	.30

Mueller Miniature Clips



No. 30 Clip with No. 32 Insulator



No. 88 Clip with No. 93 Insulator

No.	Description	Spread of Jaw, In.	Wt., Lbs. Per 100	Net Price Each
30	The smallest alligator clip ever made. Only 1 1/16-in. long. Ideal for test work in close quarters. Solder connection. Cadmium plated.....	3/16	1/4	\$0.07
30-C	Same as No. 30 except solid copper	3/16	1/4	.08
32	Thin-walled flexible insulator for clips 30, 30-C. Special tip slot permits full jaw opening without exposing teeth.....		1/4	.11
88	Slim flat jaws, phosphor bronze, entirely non-ferrous. Ideal for coils and high frequency test work. Length 1 1/16-in.....	5/32	3/4	.22
93	Flexible insulator for clip No. 88..		1/4	.10

Crocodile Clips, Needle Clip



No. 85 Clip with No. 87 Insulator



No. 50-C Needle Clip

No.	Description	Spread of Jaws, In.	Wt., Lbs. Per 100	Net Price Each
85	Long thin nose provides for tests in deep recesses. Teeth mesh entire length of jaw. Cadmium plated.....	5/16	1 1/2	\$0.08
85-C	Same as No. 85 except solid copper	5/16	1 3/4	.16
85-T	Same as No. 85 except equipped with standard phone tip on one jaw.....	5/16	1 1/2	.21
87	Flexible insulator for clips 85, 85C, 85-T.....		1	.07
50-C	A rugged solid copper clip equipped with needle in one jaw. Ideal for making quick connection through insulation of wire. For telephone men, connecting truck trailer lights, and many other applications. Length 2 1/4 in....	1/2	2 1/2	.25
51-C	Same as No. 50-C except without needle.....	1/2	2 1/2	.17
49	Flexible insulator for clips 50-C, 51-C.....		2	.10

Ideal "Wire-Nuts"

Solderless-Tapeless Wire Connectors

Approved by Underwriters' Laboratories.

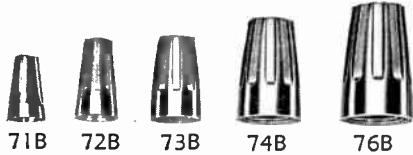

1. Strip Wire. 2. Screw-on—that's all. "Wire Nut" threads on to wire just like a nut on a bolt. The coil shaped spring insert presses (does not cut) clean threads into the stripped wires as the Connector is applied. Wires are tightly compressed and automatically twisted together by powerful grip. Molded composition shell completely protects against shorts, grounds and corrosion such as develop in loose solder and tape connections. Solid or stranded.

No.	Size	Description	Per 100	Per 1000
30-015	71B	No. 16 and No. 18 up to 3 No. 18; 1 No. 16 and 1 No. 18.....	\$	\$6.45
30-016	72B	No. 14, 16 and 18 AWG up to 1 No. 14 and 1 No. 16-2, 3, or 4 No. 18.....	1.10	9.75
30-017	73B	No. 14, 16 and 18 AWG up to 2 No. 14 and 1 No. 18 or 5 No. 18.....	1.25	10.80
30-018	74B	No. 12, 14, 16 and 18 AWG up to 2 No. 12 and 1 No. 18; 4 No. 14 and 1 No. 18.....	1.45	13.10
30-019	76B	No. 10, 12, 14, 16 and 18 AWG up to 3 No. 10 with 1 No. 18; 4 No. 12 with 2 No. 18; 6 No. 14 with 2 No. 18.....	2.75	24.55

Ideal Set Screw Wire Connectors



Underwriters' Laboratories approved for 600 volts, and as pressure cable connectors.

No.	Size	Description	Per 100	Per 1000
30-210	10	2 No. 14, 4 No. 16, 5 No. 18 or combinations.....	\$4.95	\$45.75
30-211	11	2 No. 12, 3 No. 14.....	4.65	42.00
30-222	22	2 No. 10, 3 No. 12, 6 No. 14 or combinations.....	6.50	59.00

"Scotchlok" Pre-Insulated Wire Connectors



Have the same positive holding power as "SCOTCHLOK" Electrical Spring Connectors.

Constructed with tough spring steel, rugged vinyl cover plus metal armor cap which prevents fracture or crushing in a crowded junction box.

Have "live" reserve strength and ability to absorb stress of electrical loads.

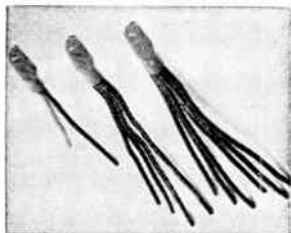

WIRE RANGES: Solid Stranded

Type Y	#12 to #18 AWG
Type R	#10 to #16 AWG
Type B	#6 to #12 AWG

Type	Conn. Per Box	Ship. Wt. Per Ctn.	Per Box
Y	100	6	\$2.65
R	100	9	3.50
B	50	16	5.25

Ideal Crimp Connectors

With "Wrap Cap" Insulator

Underwriters' Laboratories Approved



Made of steel for maximum strength, cadmium plated for corrosion resistance. Gives greater holding power than any other crimp connector used for pigtail splices.

Handles all wire combinations from No. 14 through No. 10. Compact, strong, vibration-proof.

No.	Per 100	Per 1000
30-410.....	\$1.00	\$9.00

"Wrap-Cap" Insulator

Assures perfect insulation on every connection. Deep skirt insures greater safety, even when wires are not evenly stripped.

Made of the same vinyl insulating material used in TW wire, providing excellent ageing characteristics and resistance to corrosive atmospheres, sunlight, water, alcohol and even gasoline.

Listed for maximum temperature of 165° F., easily workable at 10° F.

No.	Per 100	Per 1000
30-415.....	\$1.80	\$16.00

Sherman Fixture Connectors

Listed by Underwriters' Laboratories, Inc.



Bronze, "No-Torch" type. Divided wall, wedge lock.

For fixture connectors, motors, neon signs, etc.

One group of wires can be disconnected without disturbing others. Can be cut through center, making two small compact connectors. Connects all wires up to No. 12 either end.

No.	Car- ton	Std. Pkg.	WL, Lbs. Per 1000	Per 100
501	100	500	25	\$13.11

Sherman Set-Screw Connectors



No. 74

Made from solid brass rod; all dimensions held to accurate size and proportions, other sizes available.

Screws heavily rust-proofed. Neatly boxed and plainly labeled.

For Stranded Cable (With Ovoiding Wall)

No.	Max. Wire Size B & S (AWG)		Screws	Oiam. Hole In.	Out Oiam. In.	Lgth. In.	WL Lbs. Per 1000	Per 100
	Solid	Strd.						
60	10	12	2	.110	1/4	1 1/4	20	\$14.60
62	9	10	4	.110	5/16	1 1/2	35	17.80
64	7	8	4	.160	3/8	1 1/2	33	19.40
66	4	6	4	.218	7/16	1 1/2	46	21.00
68	3	4	4	.265	7/16	1 7/8	70	22.60
70	1	2	4	.312	1/2	1 7/8	90	27.50
71	00	0	4	.390	9/16	2 1/4	110	36.40
72	000	00	4	.437	5/8	2 1/2	150	37.20
73	0000	000	4	.500	3/4	2 7/8	260	69.50
74	0000	4	.562	7/8	2 7/8	370	85.70



Sherman Midget Connector

Has positive acting screw for securing wires. Fine pitch threads will not shake loose.

No. 504	Car- ton	Wt. Lbs., Per 1000	Per 100
504	500	5	\$6.24

Sherman Solderless Wedge-Grip Connectors



No. SC-6X

For service entrance and all small wire connections.

The oval point, hexagon head, bronze screw wedges wires between V-shaped corrugations.



No. SC-4X

Pure copper body is hard drawn with highest conductivity; needs no taping.

No.	B. and S. Wire Gage Max. Min.	No. in Carton	Weight Pounds per 1000	Per 100
SC-12X	*2-12 2-20	100	10	\$11.53
SC-6	2-6 2-12	100	25	13.46
SC-6X	2-6 2-12	100	25	15.17
SC-6X549	2-6 2-10	100	25	15.17
SC-4X	2-4 2-8	100	38	18.93
SC-2X	2-2 2-4	50	47	23.65

*Solid.

T&B Lock-Tite Two-Way Connectors

Approved by Underwriters' Laboratories



Seven connectors splice all cables #4 to 1,000 MCM. Each connector takes a wide range of cable sizes and all types of conductors. Quickly installed with key wrench.

No.	Cable Size (Each End)	Unit Quan.	Per 100
32503	14 Sol. to 8 Sol.	10	\$163.00
32505	8 to 6 Sol. or Str.	5	176.00
32507	8 Sol. to 4 Str.	5	186.00
32509	1 Sol. to 2/0	5	277.00
32511	2/0 to 4/0	2	403.00
32513	4/0 to 300	2	565.00
32515	300 to 500	1	960.00
32517	500 to 750	1	1560.00
32519	750 to 1000 MCM	1	1824.00

O. Z. Two-Way Connectors

Type XW—Combination



For joining two cables end to end, either of the same or varying sizes within the range of the fitting.

Copper alloy. The high clamping pressure exerted by pressure plate insures high conductivity. Complete with wrench for socket set screws.

No.	Conductor Range Either End		Std. Pkg.	Wt. Ea. Lbs.	Each
	Min.	Max.			
XW0101	No. 4 Sol.	No. 1 Str.	25	.15	\$ 0.80
XW2222	1 Str.	2/0 Str.	25	.21	1.20
XW2424	2/0 Str.	4/0 Str.	25	.41	1.75
XW3030	4/0 Str.	300 MCM	10	.50	2.40
XW5050	300 MCM	500 MCM	10	.93	4.15
XW7575	500 MCM	750 MCM	5	1.4	6.40
XW9292	750 MCM	1000 MCM	5	2.1	8.00

O. Z. Parallel Cable Clamps



Type PC

For connecting parallel cable.
Copper alloy, with Everdur hexagon head bolts.

No.	Size Main Tap	Wt. Ea. Lbs.	Each	No.	Size Main Tap	Wt. Ea. Lbs.	Each
PC0404	4 4	.25	\$ 1.35	PC5021	*500 1/0	2.1	\$5.60
PC0204	2 4	.50	1.65	PC5022	2/0	2.1	5.60
PC0202	2 .50	1.65	1.65	PC5023	3/0	2.1	5.60
PC0104	1 4	.63	1.70	PC5024	4/0	2.1	5.60
PC0102	2 .63	1.70	1.70	PC5025	*250 2.5	5.60	5.60
PC0101	1 .63	1.70	1.70	PC5030	*300 2.5	5.60	5.60
PC2104	1/0 4	.81	1.85	PC5035	*350 2.5	5.60	5.60
PC2102	2 1.0	1.85	1.85	PC5040	*400 2.5	5.60	5.60
PC2101	1 1.0	1.85	1.85	PC5050	*500 2.5	5.60	5.60
PC2121	1/0 1.0	1.85	1.85	PC6021	*600 1/0	2.5	7.00
PC2204	2/0 4	.88	1.85	PC6022	2/0	2.5	7.00
PC2202	2 1.0	1.85	1.85	PC6023	3/0	2.5	7.00
PC2201	1 1.0	1.85	1.85	PC6024	4/0	2.5	7.00
PC2221	1/0 1.0	1.85	1.85	PC6025	*250 4.4	7.00	7.00
PC2222	2/0 1.1	1.85	1.85	PC6030	*300 4.4	7.00	7.00
PC2304	3/0 4	1.0	3.05	PC6035	*350 4.4	7.00	7.00
PC2302	2 1.3	3.05	3.05	PC6040	*400 4.4	7.00	7.00
PC2301	1 1.3	3.05	3.05	PC6050	*500 4.4	7.00	7.00
PC2321	1/0 1.3	3.05	3.05	PC6060	*600 4.4	7.00	7.00
PC2322	2/0 1.4	3.05	3.05	PC7021	*700 1/0	2.5	7.75
PC2323	3/0 1.4	3.05	3.05	PC7022	2/0	2.5	7.75
PC2404	4/0 4	1.0	3.05	PC7023	3/0	2.5	7.75
PC2402	2 1.3	3.05	3.05	PC7024	4/0	2.5	7.75
PC2401	1 1.3	3.05	3.05	PC7025	*250 4.4	7.75	7.75
PC2421	1/0 1.3	3.05	3.05	PC7030	*300 4.4	7.75	7.75
PC2422	2/0 1.4	3.05	3.05	PC7035	*350 4.4	7.75	7.75
PC2423	3/0 1.4	3.05	3.05	PC7040	*400 4.4	7.75	7.75
PC2424	4/0 2.0	3.05	3.05	PC7050	*500 4.4	7.75	7.75
PC2504	*250 4	1.3	3.95	PC7060	*600 4.4	7.75	7.75
PC2502	2 1.3	3.95	3.95	PC7070	*700 4.4	7.75	7.75
PC2501	1 1.3	3.95	3.95	PC7521	*750 1/0	2.6	8.45
PC2521	1/0 1.3	3.95	3.95	PC7522	2/0	2.6	8.45
PC2522	2.0 1.3	3.95	3.95	PC7523	3/0	2.6	8.45
PC2523	3/0 1.5	3.95	3.95	PC7524	4/0	2.6	8.45
PC2524	4/0 1.8	3.95	3.95	PC7525	*250 3.5	8.45	8.45
PC2525	*250 1.8	3.95	3.95	PC7530	*300 3.5	8.45	8.45
PC3004	*300 4	1.5	3.95	PC7535	*350 3.5	8.45	8.45
PC3002	2 1.5	3.95	3.95	PC7540	*400 3.5	8.45	8.45
PC3001	1 1.5	3.95	3.95	PC7550	*500 4.5	8.45	8.45
PC3021	1/0 1.8	3.95	3.95	PC7560	*600 4.5	8.45	8.45
PC3022	2/0 1.8	3.95	3.95	PC7570	*700 4.5	8.45	8.45
PC3023	3/0 1.8	3.95	3.95	PC7575	*750 4.5	8.45	8.45
PC3024	4/0 1.9	3.95	3.95	PC9224	*1000 4/0	3.3	10.40
PC3025	*250 1.9	3.95	3.95	PC9225	*250 3.3	10.40	10.40
PC3030	*300 1.9	3.95	3.95	PC9230	*300 3.3	10.40	10.40
PC3521	*350 1/0	2.3	5.60	PC9235	*350 4.0	10.40	10.40
PC3522	2/0	2.3	5.60	PC9240	*400 4.0	10.40	10.40
PC3523	3/0	2.3	5.60	PC9250	*500 4.0	10.40	10.40
PC3524	4/0	2.3	5.60	PC9260	*600 4.0	10.40	10.40
PC3525	*250 2.6	5.60	5.60	PC9270	*700 5.3	10.40	10.40
PC3530	*300 2.6	5.60	5.60	PC9275	*750 5.3	10.40	10.40
PC3535	*350 2.6	5.60	5.60	PC9280	*800 5.3	10.40	10.40
PC4021	*400 1/0	2.1	5.60	PC9290	*900 5.3	10.40	10.40
PC4022	2/0	2.1	5.60	PC9292	*1000 5.3	10.40	10.40
PC4023	3/0	2.1	5.60				
PC4024	4/0	2.1	5.60				
PC4025	*250 2.9	5.60	5.60				
PC4030	*300 2.9	5.60	5.60				
PC4035	*350 2.9	5.60	5.60				
PC4040	*400 2.9	5.60	5.60				

O.Z. Solderless Connectors

Combination Lugs

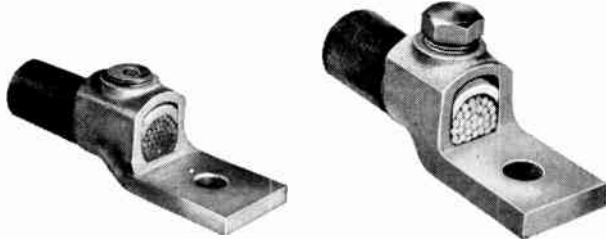

Type XL

Type XLH

These copper alloy fittings are so designed that high clamping pressure is exerted by the pressure plate to insure high conductivity. (Type XL furnished with wrench for socket set screws.)

Numbers		Conductor Range		No. Holes	Std. Pkg.	Wt. Ea. Lbs.	Each
Type XL	Type XLH	Min.	Max.				
XL041	XLH1041	No. 8 Sol.	No. 4 Str.	1	100	.05	\$.40
XL011	XLH1011	4 Sol.	1 Str.	1	100	.12	.55
XL012	XLH1012	4 Sol.	1 Str.	2	100	.14	.75
XL221	XLH1221	1 Str.	2/0 Str.	1	50	.19	.90
XL222	XLH1222	1 Str.	2/0 Str.	2	50	.23	1.05
XL241	XLH1241	2/0 Str.	4/0 Str.	1	50	.33	1.20
XL242	XLH1242	2/0 Str.	4/0 Str.	2	50	.38	1.35
XL301	XLH1301	4/0 Str.	300MCM	1	20	.44	1.55
XL302	XLH1302	4/0 Str.	300MCM	2	20	.51	1.70
XL501	XLH1501	300MCM	500MCM	1	10	.70	2.35
XL502	XLH1502	300MCM	500MCM	2	10	.75	2.65
XL751	XLH1751	500MCM	750MCM	1	10	1.3	4.00
XL752	XLH1752	500MCM	750MCM	2	10	1.4	4.00
XL921	XLH1921	750MCM	1000MCM	1	10	1.7	4.65
XL922	XLH1922	750MCM	1000MCM	2	10	1.8	5.15

Combination "T" and Parallel Taps



As a "T" Tap

As a Parallel Tap

Type XTP

Can be used either as "T" or Parallel Tap, taking a range of wire sizes on main or tap as below.

One piece copper alloy with socket set screws. Complete with wrench.

No.	Conductor Range		Std. Pkg.	Wt. Ea. Lbs.	Each
	Main	Tap			
XTP2104	No. 4 to 1/0	No. 8 to 4	12	.27	\$1.20
XTP2121		4 to 1/0	12	.25	1.45
XTP2404	1/0 to 4/0	8 to 4	12	.45	1.30
XTP2421		4 to 1/0	12	.43	1.55
XTP2424		1/0 to 1/0	12	.56	1.95
XTP3004	4/0 to 300MCM	8 to 4	12	.51	1.45
XTP3021		4 to 1/0	12	.46	1.75
XTP3024		1/0 to 1/0	12	.61	2.15
XTP3030		4/0 to 300MCM	12	.73	2.40
XTP5004	300 to 500MCM	No. 8 to 4	12	.61	2.40
XTP5021		4 to 1/0	12	.61	2.75
XTP5024		1/0 to 4/0	12	.75	3.15
XTP5030		4/0 to 300	6	.95	3.35
XTP5050		300 to 500MCM	6	1.1	4.15
XTP7521	500 to 750MCM	4 to 1/0	6	.77	4.00
XTP7524		1/0 to 4/0	6	.96	4.40
XTP7530		4/0 to 300MCM	3	1.4	4.65
XTP7550		300 to 500MCM	3	1.6	5.60
XTP7575		500 to 750MCM	3	1.9	6.90
XTP9221		750 to 1000MCM	4 to 1/0	6	1.1
XTP9224	1/0 to 4/0		6	1.2	5.20
XTP9230	4/0 to 300MCM		3	1.5	5.60
XTP9250	300 to 500MCM		3	1.7	6.75
XTP9275	500 to 750MCM		3	2.5	8.80
XTP9292	750 to 1000MCM		3	3.0	9.60

Two-Wire Lugs



Type LM

Copper alloy, machined on one side only. With socket set screws. Complete with wrench.

No.	Cable Size A.W.G. or MCM	Contact Width	Contact Dimen., In. Length	Wt. Ea. Lbs.	Each
LM10100	1	1 1/8	1 1/2	.38	\$1.45
LM10122	1	2	2 5/8	.75	1.75
LM12100	1/0	1 7/8	2	.63	1.75
LM12122	1/0	2	2 5/8	.75	2.10
LM12200	2/0	1 7/8	2	.63	2.10
LM12222	2/0	2	2 5/8	.75	2.50
LM12232	2/0	2	3 5/8	.88	2.75
LM12300	3/0	2 1/8	2	.88	2.75
LM12322	3/0	2	2 5/8	1.0	3.30
LM12332	3/0	2	3 5/8	1.1	3.55
LM12301	3/0	3	3	1.4	3.85
LM12400	4/0	2 1/8	2	.88	2.75
LM12422	4/0	2	2 5/8	1.0	3.30
LM12432	4/0	2	3 5/8	1.1	3.55
LM12401	4/0	3	3	1.4	3.85
LM12500	250	2 3/8	2 1/2	1.3	3.35
LM12523	250	3	2 5/8	1.4	4.10
LM12533	250	3	3 3/4	1.6	4.40
LM13000	300	2 3/8	2 1/2	1.3	3.35
LM13023	300	3	2 5/8	1.4	4.10
LM13033	300	3	3 3/4	1.6	4.40
LM13500	350	2 1/2	2 1/2	1.6	4.50
LM13523	350	3	2 5/8	1.8	5.40
LM13533	350	3	3 3/4	1.9	5.85
LM13543	350	3	4 3/4	2.1	6.35
LM14000	400	2 3/4	2 3/4	1.8	4.50
LM14023	400	3	2 5/8	1.8	5.40
LM14033	400	3	3 3/4	1.8	5.85
LM14043	400	3	4 3/4	2.1	6.35
LM15000	500	3	3	2.0	5.30
LM15023	500	3	2 5/8	1.9	6.35
LM15033	500	3	3 3/4	2.3	6.90
LM15043	500	3	4 3/4	2.5	7.45
LM15001	500	4	4	2.8	7.45
LM15044	500	4	4 3/4	3.1	8.00
LM16000	600	3 1/4	3 1/4	2.5	6.40
LM16023	600	3	2 5/8	2.4	7.70
LM16033	600	3	3 3/4	2.8	8.35
LM16043	600	3	4 3/4	2.9	8.95
LM16001	600	4	4	3.0	8.95
LM16044	600	4	4 3/4	3.4	9.60
LM17000	700	3 3/8	3 3/8	3.8	8.00
LM17024	700	4	2 5/8	3.5	9.60
LM17034	700	4	3 3/4	3.9	10.40
LM17044	700	4	4 3/4	4.9	11.20
LM17500	750	3 3/4	3 3/4	3.8	8.00
LM17524	750	4	2 5/8	3.5	9.60
LM17534	750	4	3 3/4	3.9	10.40
LM17544	750	4	4 3/4	4.9	11.20
LM18000	800	3 3/4	3 3/4	3.9	8.00
LM18024	800	4	2 5/8	3.5	9.60
LM18034	800	4	3 3/4	4.0	10.40
LM18044	800	4	4 3/4	4.9	11.20
LM19200	1000	4	4	5.5	10.25
LM19234	1000	4	3 3/4	5.4	12.35
LM19244	1000	4	4 3/4	5.8	13.30
LM19254	1000	4	5 3/4	6.3	14.35

Sherman Soldering Lugs



Seamless all around. Solder cannot leak out at closed end. Round end lugs in small sizes are recommended.

Approved by Underwriters' Laboratories

Round End

Size Inches	Amp. Cap. N.E.C. Std.	Maximum Stranded Wire	Car-ton	Weight Pounds per 1000	Per 100
* 3/16	25	10 A.W.G.	250	4	\$ 2.96
1/4	35	8 A.W.G.	200	6	3.48
5/16	50	6 A.W.G.	200	11	5.36
3/8	70	4 A.W.G.	125	17	6.00
7/16	90	2 A.W.G.	100	21	8.20
1/2	125	0 A.W.G.	100	35	10.62
5/8	150	00 A.W.G.	100	46	13.66
3/4	175	000 A.W.G.	100	60	18.88
7/8	225	0000 A.W.G.	50	80	23.60
1 1/8	250	250,000 C.M.	25	120	46.48

***Square End**

1 5/16	325	400,000 C.M.	25	225	69.00
1 1/8	362	450,000 C.M.	25	285	87.00
1 1/16	400	500,000 C.M.	25	380	108.30
1 1/8	450	600,000 C.M.	5	420	114.60
1 1/16	550	800,000 C.M.	5	705	181.50
1 7/16	650	1,000,000 C.M.	5	788	203.40
1 3/4	850	1,500,000 C.M.	5	1170	354.30
2 1/16	1050	2,000,000 C.M.	5	2765	573.60
2 7/8	1200	3,500,000 C.M.	5	7200	1480.00

Approximate Dimensions, Inches

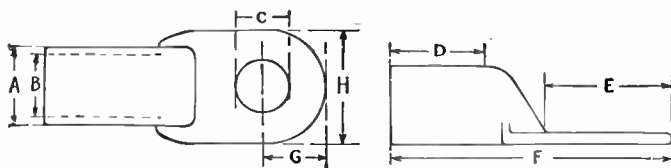

Round End

A	E	C	E	F	G	H
3/16	.136	1 1/4	1 5/8	1 5/8	7/8	1 7/8
1/4	.186	1 3/4	1 7/8	1 7/8	1 1/8	1 9/8
5/16	.232	1 3/4	1 9/8	1 7/8	1 1/8	1 7/8
3/8	.286	1 3/4	1 1 1/8	1 7/8	1 1/8	1 7/8
7/16	.336	1 3/4	1 1 3/8	1 7/8	1 1/8	1 7/8
1/2	.407	1 3/4	1 1 5/8	1 7/8	1 1/8	1 7/8
5/8	.461	1 3/4	1 1 7/8	1 7/8	1 1/8	1 7/8
3/4	.511	1 3/4	1 1 9/8	1 7/8	1 1/8	1 7/8
7/8	.559	1 3/4	1 1 11/8	1 7/8	1 1/8	1 7/8
1 1/8	.688	1 3/4	1 1 13/8	1 7/8	1 1/8	1 7/8

Square End

1 5/16	.776	1 3/4	1 5/8	3 3/8	3/4	1 1 3/8
1 1/8	.820	1 3/4	1 3/4	3 1/8	3/4	1 1 1/2
1 1/16	.880	1 3/4	2 1/8	4 1/8	1 1/8	1 1 1/8
1 1/8	.913	1 3/4	2 1/4	4 1/8	1 1/8	1 1 1/8
1 5/16	1.084	1 3/4	2 1/2	5 1/8	1 1/8	1 1 5/8
1 7/16	1.210	1 3/4	2 3/8	5 3/8	1 1/8	2 1/8
1 3/4	1.460	1 3/4	3 1/8	6 3/8	1 1/8	2 5/8
2 1/16	1.660	1 3/4	3 5/8	7 1/2	1 5/8	3 1/8
2 7/8	2.500	1 3/4	4 1/4	10 3/4	1 3/4	4 1/2

To select terminals according to the N.E.C. ratings governing knife switches, use the following equivalents:

Capacity... amperes 30 60 100 200 400 500 800 1000
Size Lug... inches 1/4 3/8 1/2 1 1/8 1 1/16 1 7/16 1 3/4 2 1/16

*Furnished square end unless specified round. Not made seamless.

†Furnished with 3/8 or 1 1/8-inch stud hole at no extra charge. Standard lugs furnished blank (without stud hole) at no extra charge.

Lugs which are to be bent should be specified "Annealed," 10% extra plus set-up charge.

Quantity prices on request.

Sherman Heavy Duty Soldering Lugs

N.E.L.A. Standard

Best quality seamless copper tubing. Blank lugs furnished when specified; otherwise regular bolt holes as listed. Special drilling may be had at extra cost. Straight lugs regularly furnished. Angle lugs 45 and 90-degree when specified at extra price. Plain finish unless otherwise specified.

Special finishes as follows at added prices: Rosin dipped, cadmium plated, and tinned all over. Special dimensions may be made to order with dimension E other than regular or special drilling of stud holes, at added cost.

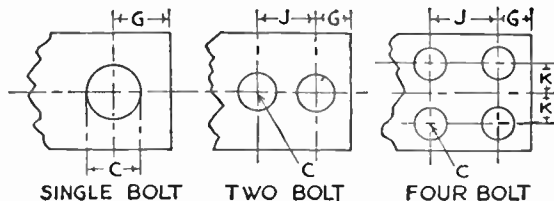
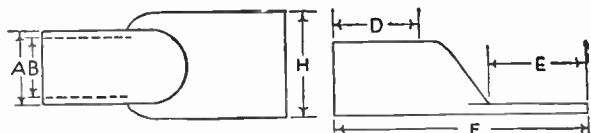

Max. Size Conductor Inches	Amp. Rate N.E.C.	Single Bolt Lug No.	Wt. Lbs. per 1000	2-Bolt Lug No.	Wt. Lbs. per 1000	4-Bolt Lug No.	Wt. Lbs. per 1000
19/22	35	1	8	1A	12
6, B. & S.	50	2	18	2A	25
2	90	3	80	3A	105
00	150	4	155	4A	210
250,000 C.M.	250	5	275	5A	330
350,000 C.M.	300	6	540	6A	650
500,000	400	7	1350
750,000*	525	8	2000	8A	2000
1,000,000	650	9	3200	9A	2800
1,500,000	850	10	5000
2,000,000	1050	11	8300

Single Bolt Tongue

Lug No.	Approximate Dimensions, Inches							Per 100		
	A	B	H	E	F	G	J	K	C	
1	.25	.187	.39	.50	1 1/2	3/16	7/32	\$ 5.77
2	.313	.232	.47	.75	1 1/2	3/8	7/32	8.75
3	.510	.375	.71	.87	2	3/8	9/32	19.40
4	.675	.491	.97	1.25	2 3/4	1/2	1 1/32	36.90
5	.810	.625	1.22	1.50	3 1/4	3/4	1 1/32	60.50
6	1.050	.822	1.50	2.25	4 1/4	1	1 1/32	102.30

Two-Bolt Tongue

1-A	.25	.187	.39	1.00	1 1/2	3/16	1/2	...	7/32	7.65
2-A	.313	.232	.47	1.25	2	1/4	5/8	...	7/32	11.25
3-A	.510	.375	.71	1.50	2 5/8	3/8	5/8	...	9/32	27.80
4-A	.675	.491	.97	2.25	3 3/4	1/2	1	...	1 1/32	50.30
5-A	.810	.625	1.22	2.25	4	1/2	1	...	1 1/32	82.50
6-A	1.050	.822	1.50	3.25	5 3/4	3/4	1 1/2	...	1 1/32	176.50
7	1.315	.951	1.87	3.25	6 1/4	3/4	1 1/2	...	1 1/32	250.50
8	1.660	1.272	2.11	3.25	6 7/8	3/4	1 1/2	...	1 1/32	396.00
9	1.900	1.190	2.74	4.25	8 7/8	1	2	...	1 1/32	528.00

Four-Bolt Tongue

8-A	1.660	1.272	2.11	3.25	6 7/8	3/4	1 1/4	5/8	1 1/32	396.00
9-A	1.900	1.190	2.74	3.25	7 7/8	3/4	1 1/2	3/4	1 1/32	462.00
10	2.370	1.930	3.50	4.25	10	1	2	1	1 1/32	802.50
11	2.870	2.315	4.25	4.25	11	1	2	1	1 1/32	1308.00

Note—Dimensions E in larger sizes will be found slightly larger than specified to allow for bending in the field.

Quantity prices on request.

Sherman Heavy Duty Soldering Lugs

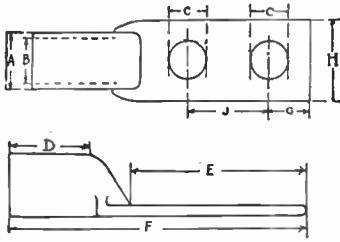

2-Hole

Two-hole lugs are made of seamless tubing and furnished square end, unless otherwise specified.

Flat portion (E) may be made to order either longer or shorter but tubular portion (D) cannot be changed.

Size Inches	Amp. Cap. N.E.C. Std.	C	E	Approx. Dimen., In.			Per 100	Price
				F	G	J		
3/16	25	5/32	3/4	1 7/32	5/32	3/8	\$	4.44
1/4	35	1/8	7/8	1 1/32	3/16	7/8		5.22
5/16	50	3/32	1 1/16	1 3/4	1/2	1 1/2		8.04
3/8	70	1/4	1 1/4	1 29/32	5/16	5/8		9.00
7/16	90	9/32	1 3/8	2 1/8	5/16	1 1/8		12.30
1/2	125	11/32	1 11/16	2 5/8	3/8	1 1/8		15.94
9/16	150	1/2	2	3 1/16	7/16	1		20.50
5/8	175	13/32	2	3 1/8	7/16	1		28.32
11/16	225	1/2	2 1/8	3 1/4	1/2	1		35.40
13/16	250	11/16	2 5/8	4	5/8	1 1/4		69.72
15/16	325	1 1/16	2 3/4	4 1/2	1 1/8	1 1/4		103.50
1	362	1 1/8	3	4 29/32	3/4	1 1/2		130.50
1 1/16	400	1 1/4	3 1/4	5 3/8	13/16	1 1/2		162.46
1 1/8	450	1 1/2	3 3/8	5 9/16	7/8	1 3/2		171.90
1 1/4	550	1 5/8	3 11/16	7 1/16	1	1 13/16		272.26
1 3/8	650	1 7/8	4 1/8	7 1/4	1 1/8	2		305.10
1 1/2	850	2	4 3/8	8 1/8	1 3/8	2 1/4		531.40
1 5/8	1050	2 1/8	5 3/8	9 1/4	1 1/2	2 1/4		860.40

Dimensions, except as noted are same as standard lugs.

Sherman Solderless Lugs



Type SS

Low silhouette design, ideal for installing in close quarters. Corrosion-resistant copper alloy.

Open end in barrel insures proper insertion depth. Only six sizes required for No. 14 through 1,000,000 CM cable.

No.	Max. Wire Range	Min.	Wt., Lbs. Per 100	Ctn., Qty.	Price Per 100
SS-35	8Str.	14Sol.	2	100	\$ 11.84
SS-70	4Str.	14Sol.	4	100	15.88
SS-125	1/0Str.	4Sol.	11	50	35.77
SS-225	4/0Str.	1/0Str.	21	25	72.86
SS-400	500MCM	4/0Str.	69	10	171.86
SS-650	1000MCM	500MCM	155	5	463.98

Sherman Solderless Lugs

Listed by Underwriters' Laboratories, Inc.

No special wrenches. No separation of wire strands is necessary. Pure Copper.

Type SO



No.	Wire Size Max. Min.	Ctn. Qty.	Per 100
SO-8	8-14	200	\$12.35
SO-4	4-14	100	19.59
SO-1/0	0-3	50	30.25
SO-4/0	0000-0	25	68.91
SO-500	500-250 MCM	5	158.14

For all Sherman items conforming to Military standards—be sure to see GRAYBAR first.

T&B Compression Connectors

Color Keyed—U. L. Approved



One-Hole Lugs

No.	Cable Size	Unit Qty.	Std. Pkg.	Wt. Lbs. Per 100	Per 100
54104*	8	50	500	1	\$13.00
54105*	6	50	500	2	13.50
54106*	4	50	500	2	18.50
54107*	2	25	250	3	35.00
54108*	1	20	200	7	37.50
54109*	1/0	10	100	9	39.00
54110*	2/0	10	100	11	46.50
54111*	3/0	10	100	13	54.50
54112*	4/0	10	100	16	62.50
54113*	250	10	100	19	73.00
54114	300	10	100	29	84.00
54115	350	10	100	33	88.00
54116	400	6	60	38	103.00
54118	500	6	60	47	126.00
54120	600	6	60	65	234.00
54122	700	6	60	67	237.00
54123	750	6	60	80	245.00
54124	800	3	30	90	395.00
54126	900	3	30	102	422.00
54128	1000	3	30	113	505.00

Two Hole Lugs

54204*	8	50	500	2	\$29.00
54205*	6	50	500	3	37.50
54206*	4	50	500	5	40.00
54207*	2	25	250	6	47.00
54208*	1	20	200	10	52.00
54209*	1/0	10	100	14	58.50
54210*	2/0	10	100	16	61.00
54211*	3/0	10	100	18	76.00
54212*	4/0	10	100	20	81.50
54213*	250	10	100	25	92.00
54214	300	10	100	32	114.00
54215	350	10	100	40	118.00
54216	400	6	60	53	139.00
54218	500	6	60	65	171.00
54220	600	6	60	72	245.00
54222	700	6	60	80	250.00
54223	750	6	60	90	258.00
54224	800	3	30	102	414.00
54226	900	3	30	115	462.00
54228	1000	3	30	133	535.00

Two Way Connectors

54504*	8	50	500	1	\$18.50
54505*	6	50	500	1	31.00
54506*	4	50	500	2	37.00
54507*	2	25	250	3	45.00
54508*	1	20	200	4	53.50
54509*	1/0	10	100	5	58.50
54510*	2/0	10	100	6	62.50
54511*	3/0	10	100	7	72.00
54512*	4/0	10	100	8	78.50
54513*	250	10	100	10	87.00
54514	300	10	100	14	98.50
54515	350	10	100	18	102.00
54516	400	6	60	23	125.00
54518	500	6	60	31	155.00
54520	600	6	60	31	222.00
54522	700	6	60	42	240.00
54523	750	6	60	50	258.00
54524	800	3	30	59	349.00
54526	900	3	30	70	349.00
54528	1000	3	30	76	349.00

*Color-Keyed.

T&B Lock-Tite® Lugs

Approved by Underwriters' Laboratories

One Bolt Hole Tongue

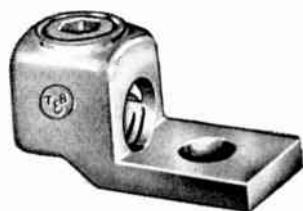

One-piece design lugs. Uniform pressure all-around provides direct contact and high conductivity.

For all types of conductors-stranded, solid, flexible, etc., from No. 4 A.W.G. to 1000 MCM.

Proven in tests to make up tight, stay tight and to run cooler than cable.

No.	Description	Use Key Wrench No.	Unit Quan.	Per 100
31003	14 Sol. to 8 Sol.		20	\$ 71.50
31005	8 Sol to 4 Str.		10	91.00
31007	4 Sol. to 1 Str.	30	10	123.00
31009	1 Sol. to 2/0	30	5	194.00
31011	2/0 to 4/0	30	5	277.00
31013	4/0 to 300 MCM	50	2	344.00
31015	300 to 500 MCM	50	2	530.00
31017	500 to 750 MCM	50	1	904.00
31019	750 to 1,000 MCM	50	1	1056.00



Two Bolt Hole Tongue

Bolt holes and spacings listed are standard, but lugs with blank tongues will be furnished, if specified, without extra charge.

No.	Description	Use Key Wrench No.	Unit Quan.	Per 100
32003	14 Sol. to 8 Sol.		10	\$141.00
32005	8 Sol to 4 Str.		10	147.00
32007	4 Sol. to 1 Str.	30	10	162.00
32009	1 Sol. to 2/0	30	5	227.00
32011	2/0 to 4/0	30	5	302.00
32013	4/0 to 300 MCM	50	2	403.00
32015	300 to 500 MCM	50	2	595.00
32017	500 to 750 MCM	50	1	904.00
32019	750 to 1,000 MCM	50	1	1160.00

For Hex-head screw, prefix above numbers with "H."
Prices are same for both types.
Special connectors can be supplied. Prices and information on request.



Key Wrenches For Lock-Tite Lugs

No.	Std. Pkg.	WL Per 100	Per 100
30	1	9	\$16.00
50	1	30	24.00

T&B Lug-It®

Approved by Underwriters' Laboratories



For solid or stranded wire. Double thickness at thread gives double thread strength and locking action. Serrated copper tongue for high conductivity. Bronze body provides strength.

No.	Wire Range	Bolt Size	Unit Quan.	Std. Pkg.	WL, Lbs. Per 100	Per 100
35301	14 to 6	1/4	100	500	2 1/2	\$15.10
35401	8 to 2	1/4	50	250	6	20.20
35501	4 to 2/0	1/4	20	100	13	43.50
35601	1/0 to 4/0	3/8	10	50	28	90.50

T&B Sta-Kon® Pressure Terminals

Approved by Underwriters' Laboratories



Provide solderless, high conductivity connections, mechanically as strong as the wire itself.

Copper tongue comes into direct contact with wire, and secure mechanical grip is produced by the staking, which runs parallel to the strands. Complete terminal is hot-tinned. Staking pressure may be applied by hand or power operated tools. Available in many forms for wires from No. 18 A.W.G. to 250 MCM.

Standard Series—For Use with Stock Tool No. WT-111M

Cat. No.	Wire Size (Com'l AWG)	Std. Pkg.	Unit Quan.	Bolt Size	Price Per 100
A18-6	#22 to #18	1000	100	#6, #4	\$4.80
A18-8	#22 to #18	500	100	#8	4.80
A18-10	#22 to #18	1000	100	#10	4.80
A18-14	#22 to #18	500	100	1/4	4.80
B14-6	#20, #14	2000	100	#6, #4	4.80
B14-8	#20, #14	2000	100	#8	4.80
B14-10	#20, #14	2000	100	#10	4.80
B14-14	#20, #14	2000	100	1/4	4.80
C10-6	#16, #10	500	50	#6, #4	6.00
C10-8	#16, #10	500	50	#8	6.00
C10-10	#16, #10	1000	50	#10	6.00
C10-14	#16, #10	1000	50	1/4	6.00
C10-516	#16, #10	1000	50	5/16	6.00
C10-38	#16, #10	500	50	3/8	6.00

Standard Series—For Use with Stock Tool No. WT-115

D8-10	#9, #8, #7	500	25	#10, #8	12.40
D8-14	#9, #8, #7	500	25	1/4	12.40
D8-516	#9, #8, #7	500	25	5/16	12.40
D8-38	#9, #8, #7	500	25	3/8	12.40
E6-10	#6, #5	200	20	#10, #8	13.20
E6-14	#6, #5	200	20	1/4	13.20
E6-516	#6, #5	200	20	5/16	13.20
E6-38	#6, #5	200	20	3/8	13.20
F4-10	#4, #3	200	20	#10, #8	18.40
F4-14	#4, #3	200	20	1/4	18.40
F4-516	#4, #3	200	20	5/16	18.40
F4-38	#4, #3	200	20	3/8	18.40
G1-14	#1	100	10	1/4	35.20
G1-516	#1	100	10	5/16	35.20
G1-38	#1	100	10	3/8	35.20
G2-14	#2	100	10	1/4	35.20
G2-516	#2	100	10	5/16	35.20
G2-38	#2	100	10	3/8	35.20

Standard Series for Larger Wires—For Use with No. WT-127 and Power Tools

H10-14	1/0	100	10	1/4	40.00
J20-38	2/0	100	10	3/8	46.00
K30-38	3/0	50	5	3/8	54.40
L40-38	4/0	50	5	3/8	62.40
M250-38	250 MCM	50	5	3/8	72.00

T&B Sta-Kon® Terminal Assortment Kits



Handy kits provide an easier and better way to hook up wires No. 20 through No. 10.

No. 20 Assortment Kit: Consists of 100 pieces of A18-10, 100 pieces of B14-10, 50 pieces No. C-10-10 and 1 No. WT111M Stakon-Terminal installing tool.

No. 20WJ Assortment Kit: Consists of 200 pieces No. PT-70, 100 pieces No. B14-10, 50 pieces C10-10 and 1 No. WT111M Stakon-Terminal installing tool.

No.	Description	Each
20	Sta-Kon terminal assortment kit	\$10.40
20WJ	Sta-Kon terminal assortment kit	12.80

T&B Sta-Kon® Terminals

Approved by Underwriters' Laboratories

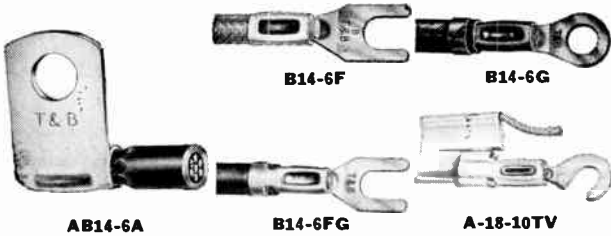

Flag Type—Use WT-119 Tool

No.	Cable Size Max.	Unit Quan.	Std. Quan.	Wt. Lbs. Per 1000	Per 100
AB14-6A	#22-#14	100	500	2 1/2	\$4.80
AB14-8A	#22-#14	100	500	2 1/2	4.80
AB14-10A	#22-#14	100	500	2 1/2	4.80
C10 -6A	#16-#10	50	500	3	8.80
C10 -8A	#16-#10	50	500	5	8.80
C10 -10A	#16-#10	50	500	5	8.80

***Spade Tongue—Use WT-111 M Tool**

No.	Cable Size Max.	Unit Quan.	Std. Quan.	Wt. Lbs. Per 1000	Per 100
B14 -6F	#20-#14	100	2000	3	4.80
B14 -10F	#20-#14	100	2000	3	4.80
C10 -10F	#16-#10	50	1000	6	6.00
C10 -14F	#16-#10	50	1000	7	6.00

***Ring Tongue—Insulation Grip**
Use WT-110M Tool

No.	Cable Size Max.	Unit Quan.	Std. Quan.	Wt. Lbs. Per 1000	Per 100
B14 -6G	#20-#14	100	500	2 1/2	4.80
B14 -10G	#20-#14	100	500	2 1/2	4.80
B14 -14G	#20-#14	100	500	4	4.80

***Spade Tongue—Insulation Grip**
Use WT-110M Tool

No.	Cable Size Max.	Unit Quan.	Std. Quan.	Wt. Lbs. Per 1000	Per 100
B14 -6FG	#20-#14	100	500	3	4.80
B14 -10FG	#20-#14	100	500	3 1/2	4.80

Television Hook Type

For Dual-Conductor Plastic Ribbon Lead-In

Use WT-16S Tool

No.	Cable Size	Unit Quan.	Std. Quan.	Wt. Lbs. Per 1000	Per 100
A18 -6TV	.025"-.046"	100	500	3	5.60
A18 -10TV	.025"-.046"	100	500	3	5.60

Sta-Kons® For The Production Line

Additional tongue sizes, bolt sizes, and a wide variety of special shapes and designs of Sta-Kon Terminals and Connectors are available. Full information is available on request from Graybar.

Where large quantities are required, Sta-Kons can be supplied packed in bulk for direct shipment at lower prices than the standard stock packing shown above. Specific inquiries are invited.

For high-speed production installation there is a broad line of power tools available, hydraulic or air actuated. They make consistently uniform installations at speeds up to one thousand per hour. Complete details will be furnished on request.



T&B One Piece Insulated Wire Joints

Approved by Underwriters' Laboratories

For use with WT181 Tool.

No.	Wire Size	Std. Pkg.	Unit Quan.	Wt. Lbs. Per 1000	Per 100
RB-44	Max. 2 #16 or 3 #18, etc.	1000	100	2	\$4.80
RC-55	Max. 3 #14 or 4 #16, etc.	500	50	3	5.60

T&B Sta-Kon® Wire Joints

Approved by Underwriters' Laboratories

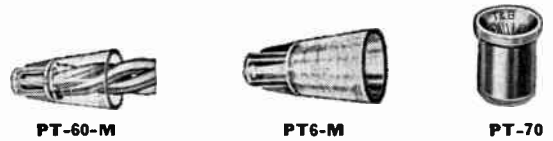

Maximum capacity 3 No. 12 wires, solid or stranded. Approved by U/L for circuit and fixture splices. Installs with standard WT-161 Sta-Kon hand tool.

No.	Description	Unit Qty.	Std. Pkg.	Wgt. Lbs. Per 1000	Per 100
PT66M	Complete Joint	100	1000	4 1/2	\$3.85
PT60M	Connector only	100	1000	2 1/2	1.92
PT6M	Insulator only	100	1000	2	1.92

Without Ears For Use With Tape

No.	Description	Unit Qty.	Std. Pkg.	Wgt. Lbs. Per 1000	Per 100
PT70	Connector only	200	2000	2 1/2	\$2.70

T&B Sta-Kon Two-Way Connectors

Uninsulated

Approved by Underwriters' Laboratories

For use with stock tools WT-111M and WT-115.



No.	Wire Size (Com'l AWG)	Std. Pkg.	Unit Quan.	Wt. Lbs. Per 1000	Per 100
2A-18	#20, #18, #16, #14	1000	100	2 1/2	\$ 6.00
2B-14	#20, #18, #16, #14	1000	100	2 1/2	6.00
2C-10	#16, #14, #12, #10	500	50	7	10.40
2D- 8	#9, #8, #7	250	25	18	18.40
2E- 6	#6, #5	200	20	25	31.60
2F- 4	#4, #3	150	15	30	36.80

Insulated

For use with WT-105M Tool.



No.	Wire Size	Std. Pkg.	Unit Quan.	Wt. Lbs. Per 1000	Per 100
2B-16	2 #16	1000	100	2	\$6.40
2C-12	2 #12	1000	100	4	9.20

T&B Sta-Kon Four-Way Connectors

For Use with Stock Tools WT-111M



For use with Standard (A.W.G.) Code Wire. Will also fit any type or size of wire that will go in the barrel.

For Three-Way Connectors remove one branch with cutting pliers.

No.	Wire Size (Com'l AWG)	Std. Pkg.	Unit Quan.	Wt. Lbs. Per 1000	Per 100
4A-18	#22 & #18	500	50	3	\$16.80
4B-14	#20 & #14	500	50	10	16.80
4C-10	#16 & #10	250	25	16	20.40

T&B Sta-Kon® Hand Tools

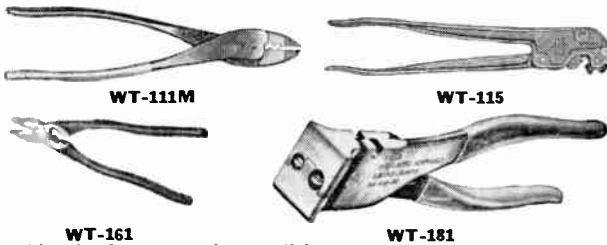

WT-161
Simple, fast operating, well balanced.
Drop forged steel head.

No.	Installs Terminals For Wire Sizes	Color of Handle	Std. Pkg.	Wt. Lbs. Each	Each
WT-110M	#22 to #10	Green	1	1	\$5.60
WT-111M	#22 to #10	Red	1	1	4.80
WT-115	#8 to #1	Black	1	4	28.80
WT-116	Bench adapter for WT-115		1	3	3.20
WT-105M	For 2B-16, 2C-12 Splices	White	1	1	7.20
WT-161	#22 to #8 and PT60M, PT70	Blue	1	1	7.20
WT-165	TV Terminals	1 Black	1	1	6.40
WT-181	Installs RB, RC, Insulated wire joints	White	1	1	9.60

Shure-Stake Tool
Toggle-type, with pawl.
Work cannot be removed until stake is properly completed. Cushion-grip handles.



WT-130 #22-#10 Red 1 1 1/2 \$19.20

Ratchet Tool
With one nest. Strong, but light aluminum tool with quadrant gear. Very powerful toggle action.



WT-127G	#2-#1	1	12	\$80.00
WT-127H	1/0	1	12	80.00
WT-127J	2/0	1	12	80.00
WT-127K	3/0	1	12	80.00
WT-127L	4/0	1	12	80.00
WT-127M	250MCM	1	12	80.00
WT-127	Tool Only	1	10	72.00

T&B Wedge-On® Lugs
Approved by Underwriters' Laboratories

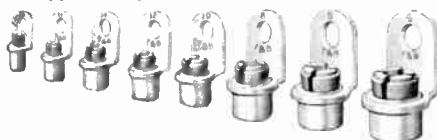

No.	Wire Size	Carton	Std. Pkg.	Wt. Lbs. Per 1000	Per 100
181.100	#22 to #18	100	200	10	\$16.00
161.100	#16	100	200	7	16.00
141.100	#14	100	200	10	16.00
121.100	#12	100	200	11	17.60
101.100	#10	100	200	20	20.00
91.101	#9	100	200	40	23.20
81.100	#8	50	200	20	25.60
61.100	#6 Stranded	50	200	32	28.80
6S1.100	#6 Solid	50	200	32	28.80
41.100	4 Stranded	50	200	34	32.00
4S1.100	4 Solid	50	200	34	32.00

Terminals of special sizes and shapes can be furnished.

T&B Wedge-On Wire Splicers

Approved by Underwriters' Laboratories



High conductivity, high tensile strength bronze.

No.	Size Wire	Wt. Lbs. Per 1000	Per 100	No.	Size Wire	Wt. Lbs. Per 1000	Per 100
16C	16	20	\$28.75	9C	9	22	\$33.75
14C	14	20	28.75	8C	8	40	45.63
12C	12	30	33.75	6C	6	80	55.00
10C	10	21	33.75	4C	4	80	55.00

T&B Wedge-On® Tool



For use in installing T&B Wedge-On Lugs; Splicers.

No.	For Terminal Sizes	Std. Pkg.	Wt. Lbs. Each	Each
21000	8 to 16, Incl.	1	1 1/2	\$8.00
21001	8, 6 and 4	1	1 1/2	8.00
21004	22, 18, 16, and 14	1	1 1/2	8.00

T&B Lock-Tite® Tee-Parallel Taps

Approved by Underwriters' Laboratories, Inc.



For use as a tee or parallel tap two-way connector, or elbow. The one-piece design — no detachable parts—allows easy assembly to main and branch.

No.	†Main Cable Sizes	‡Branch Cable Sizes	Unit Quan.	Per 100
35003	1/0 to 4/0	2 Sol. & Str. to 1	2	\$310.00
35005	1/0 to 4/0	1/0 to 4/0	2	403.00
35007	4/0 to 300 MCM	2 Sol. & Str. to 1/0	2	403.00
35009	4/0 to 300 MCM	2/0 to 300 MCM	2	540.00
35011	300 to 500 MCM	2 Sol. & Str. to 3/0	2	630.00
35013	300 to 500 MCM	4/0 to 500 MCM	1	816.00
35015	500 to 750 MCM	2 Sol. & Str. to 3/0	1	960.00
35017	500 to 750 MCM	4/0 to 500 MCM	1	1224.00
*35019	500 to 750 MCM	500 to 750 MCM	1	1496.00
35021	750 to 1000 MCM	2 Sol. & Str. to 3/0	1	1008.00
25023	750 to 1000 MCM	4/0 to 500 MCM	1	1192.00
*35025	750 to 1000 MCM	500 to 750 MCM	1	1360.00
*35027	750 to 1000 MCM	750 to 1000 MCM	1	1480.00

*These sizes supplied with two clamping screws instead of as illustrated.

†Main indicates the size of cable running through the tap.
‡Branch indicates the size of cable to be connected to the main.

Hinjon® Junior

For Mains No. 8 to 1000 MCM—For Small Wire Branches No. 14 to No. 1



Compact, small and easy to tape. Twelve fittings take the entire range of sizes shown above.

Self-adjusting jaws grip main and branch cable all around, providing a perfect electrical and mechanical connection.

To make a tee tap, just bend the branch. Quickly installed with screw driver or pliers.

No.	Main Cable Sizes	Branch Cable Sizes	Unit Quan.	Per 100
35107	8 to 4	14 to 8	5	\$176.00
35108	8 to 4	8 to 4	5	186.00
35109	4 to 1/0	14 to 4	5	210.00
35110	4 to 1/0	4 to 1	5	243.00
35111	1/0 to 4/0	11 to 4	2	302.00
35112	1/0 to 1/0	8 to 1	2	320.00
35113	4/0 to 300 MCM	14 to 4	2	344.00
35114	4/0 to 300 MCM	8 to 1	2	370.00
35115	300 to 500 MCM	14 to 4	2	462.00
35116	300 to 500 MCM	8 to 1	2	555.00
35118	500 to 750 MCM	14 to 1	1	713.60
35120	750 to 1000 MCM	14 to 1	1	976.00

Burndy Hydent Connectors

Hydent connectors are of one-piece, pure copper construction. They are indented onto conductors with simple and easy-to-use Hytools and Hypresses as listed on following pages. Due to the one-piece construction and uniform barrel thickness of Hydent connectors, the indent can be placed anywhere on the circumference of the barrel.

**Solderless and Secure
Electrically Efficient
Electro-Tinned
Easily Inspected.**

Hydent connector sizes include the smallest used on wiring harnesses, electronic equipment, etc., to the largest

required for industrial applications. Those listed below and on the following pages are the most commonly used types and sizes carried in stock. Applying the Hydent method to the many wiring needs can effect economies of both time and expense. Standard Hydent connectors meet the requirements of:

**Underwriters' Laboratories, Inc.
Canadian Standards Association.
U. S. Air Force.
Army Signal Corps.
Ordnance Department.
U. S. Navy.—
Bureau of Ships
Bureau of Aeronautics
Bureau of Ordnance
Civil Aeronautics Authority.**



Hydent Cross-Section. Note how the cable strands have been formed into one solid mass.

Burndy Hylugs

Listed by Underwriters' Laboratories, Inc.

For No. 22 Through No. 8 Commercial and Aircraft Conductors

For Cable to Flat

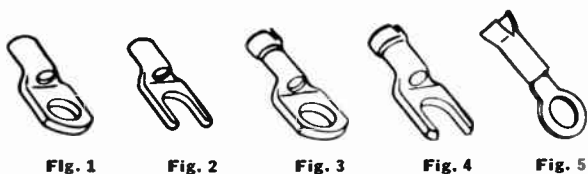

No.	Fig. No.	Cond. Sizes Coml. AWG & Aircraft AN	Solid Wire AWG	For Use on Screw Sizes	Unit Qty.	Wt. Per 1000, Lbs.	Per 100, (Unit Qty.)
YAV18-T4	1			4		1.5	\$2.30
YAV18-T5	1			4,5,6		2.3	2.30
YAV18-T19F	2	22-18	22-18	4,5,6	200	2.9	2.30
YAV18-T1	1			6,7,8		2.0	2.30
YAV18	1			8,9,10		2.0	2.30
YAV18-T21F	2			8,9,10		2.8	2.30
YAD18-H17	5			1		2.5	2.40
YAD18-G43	5			4,5,6		2.0	2.40
YAD18-H16	5	22-18	22-18	4,5,6	200	2.4	2.40
YAD18-H	5			8,9,10		2.5	2.40
YAD18-H15	5			3/8 In.		1.4	2.40
YAV18-H4	3			1		2.0	2.40
YAV18-H15	3			4,5,6		2.8	2.40
YAV18-H19F	4	22-18	22-18	4,5,6	200	3.5	2.40
YAV18-H11	3			6,7,8		2.5	2.40
YAV18-H	3			8,9,10		2.5	2.40
YAV18-H121F	4			8,9,10		3.4	2.40
YAV14-L33	1			4,5,6		2.3	2.50
YAV14-T5	1			4,5,6		2.8	2.50
YAV14-T32F	2			4,5,6		3.9	2.50
YAV14-T1	1			6,7,8		2.6	2.50
YAV14	1	20-14	20-12	8,9,10	200	2.8	2.50
YAV14-T34F	2			8,9,10		3.9	2.50
YAV14-T2	1			1/4 In.		3.3	2.50
YAV14-T3	1			5/16 In.		2.9	2.50
YAV14-T4	1			3/8 In.		3.2	2.50
YAD14-G43	5			4,5,6		2.3	2.60
YAD14-H15	5	20-14	20-12	4,5,6	200	3.1	2.60
YAD14-H152	5			4,5,6		3.0	2.60
YAD14-H	5			8,9,10		3.0	2.60

No.	Fig. No.	Cond. Sizes Coml. AWG & Aircraft AN	Solid Wire AWG	For Use on Screw Sizes	Unit Qty.	Wt. Per 1000, Lbs.	Per 100, (Unit Qty.)
YAD14-H12	5			1/4 In.		3.8	\$2.60
YAD14-H13	5	20-14	20-12	5/16 In.	200	3.5	2.60
YAD14-H4	5			3/8 In.		4.8	2.60
YAV14-H133	3			4,5,6		2.8	2.60
YAV14-H15	3			4,5,6		3.5	2.60
YAV14-H132F	4			4,5,6		4.5	2.60
YAV14-H11	3			6,7,8		3.5	2.60
YAV14-H	3	20-14	20-12	8,9,10	200	3.5	2.60
YAV14-H134F	4			8,9,10		4.5	2.60
YAV14-H12	3			1/4 In.		4.0	2.60
YAV14-H13	3			5/16 In.		3.6	2.60
YAV14-H4	3			3/8 In.		3.9	2.60
YAV10-T5	1			4,5,6		5.8	3.50
YAV10	1			8,9,10		5.2	3.50
YAV10-T21F	2			8,9,10		7.1	3.50
YAV10-T3	1	12-10	11-9	1/4 In.	100	6.0	3.50
YAV10-T23F	2			1/4 In.		8.0	3.50
YAV10-T2	1			5/16 In.		5.8	3.50
YAV10-T4	1			3/8 In.		5.6	3.50
YAV10-H	3			8,9,10		7.0	3.90
YAV10-H13	3	12-10	11-9	1/4 In.	100	6.7	3.90
YAV10-H12	3			5/16 In.		7.5	3.90
YAV10-H4	3			3/8 In.		7.3	3.90
YAV9C-L36	1			8,9,10		5.3	4.70
YAV9C-T12	1	*9	8-7	1/4 In.	100	7.0	5.60
YAV9C-T4	1			5/16 In.		7.1	5.60
YAV8C-L	1			8,9,10		9.3	7.50
YAV8C-L1	1	8	6	1/4 In.	100	9.1	7.50
YAV8C-L2	1			5/16 In.		10.0	7.50
YAV8C-L3	1			3/8 In.		11.0	7.50

*Commercial AWG only.

Available in new flip-top box for sizes from No. 22 through No. 8
In sturdy corrugated boxes through 2000 MCM.

Burndy Double Indent Connectors



Type YS



Type YA

On large conductors, particularly from 300 MCM through 2000 MCM, multiple indents are sometimes desirable for severe operating conditions. Long barrel Hydent connectors are especially designed for this purpose.

For complete information, contact Graybar.

Burndy Flag-Type Hylugs

Listed by Underwriters' Laboratories, Inc.

Type YBV

For No. 20 through No. 9 Commercial and Aircraft Conductors
For Cable to Flat



Fig. 1

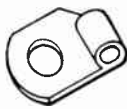

Fig. 2



Fig. 3

These flag or side entrance type terminals are of pure copper, one-piece construction. Electro-tinned surfaces minimize corrosion. Provide dependable and rapidly made connections. Installed onto conductor with Hytools and Hypresses.

No.	Fig. No.	Cond. Sizes		For Use on Screw Sizes	Unit Qty.	Wt. Per 1000, Lbs.	Per 100 (Unit Qty.)
		Com. A.W.G. & Aircraft AN	Solid Wire, A.W.G.				
YBV14-T1	2	20-14	20-12	4,5,6	200	2.6	\$3.80
YBV14-T3	2	20-14	20-12	6,7,8	200	2.5	3.80
YBV14	2	20-14	20-12	8,9,10	200	2.4	3.80
YBV14-T5	3	20-14	20-12	1/4 In.	200	3.4	3.80
YBV10	1	12-10	11-9	8,9,10	100	3.7	4.70
YBV10-T2	3	12-10	11-9	1/4 In.	100	5.0	4.70

Available in new flip top box for sizes from No. 22 through No. 8

Burndy Clasps and Clasp Lugs

Listed by Underwriters' Laboratories, Inc.

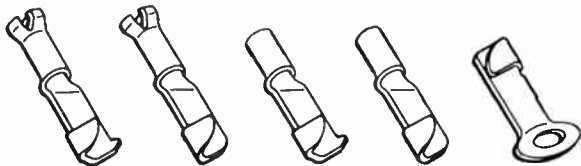

Type YZ-H Type YZ-H1 Type YZ Type YZ-1 Type YZA



The Burndy Clasp is a quick disconnect composed of two identical halves for joining commercial or aircraft cable sizes from No. 22 through No. 9. Cannot be separated by direct tensile stress. Clasps can be supplied with insulation grips as well as locking tabs that lock the connection against accidental loosening. Terminal connection is made by Burndy Clasp Lug which connects to the clasp.

Clasps and Clasp Lugs are installed onto conductors with standard Hytools and Hypresses.

For complete information and prices, contact Graybar.

Burndy Belled Hydent Connectors



Type YS-LB



Type YA-LB

These belled entrance connectors are available for efficient insertion of flexible, extra-flexible, and welding cables. Deep Hypress indentations made during installation provide low-resistance, high-strength connections.

For complete information and prices, contact Graybar.

Burndy Hyseal Connectors



Hysealplug Type YE-LH



Hysealug Type YA-LH



Hysealink Type YS-LH

For preventing electrical faults that arise from the admission of water, moisture or acid vapors into the conductor strands or under the insulation. Made of pure copper, one-piece, and fit a variety of cable sizes and insulations.

Typical Applications of Burndy Hyseal Connectors

Hysealugs: For battery jumpers that seal cable against acid vapors. Also used in mines.

Hysealinks: Provide moisture-proof end-to-end connections.

Hysealplugs: For primary metering connections that prevent seepage of water at the connection and through the cable strands into the meter boxes.

These connectors are installed with Hypresses. The connector barrel is indented onto the bare conductor providing an excellent mechanical and electrical connection. The skirt or shroud provides a watertight connection by firmly gripping the cable insulation (synthetic or natural rubber compounds). Hyseal joints resist water pressures in excess of 50 psi.

For complete information and prices, contact Graybar.

Burndy Shielded Cable Terminations

Type YIC and YOC

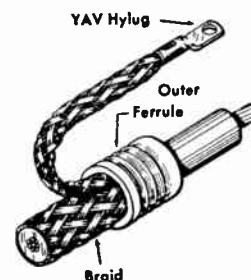

A single or double ferrule is used for tapping braid on shielded cable. This connector can also be used to anchor the braid ending, thereby preventing it from slipping or fraying.

For complete information and prices, contact Graybar.

Burndy Solderless Terminals

Listed by Underwriters' Laboratories, Inc.

Hylugs—Type YA-L

For Commercial Stranded Cable No. 6 Through 2000 MCM
For Cable to Flat

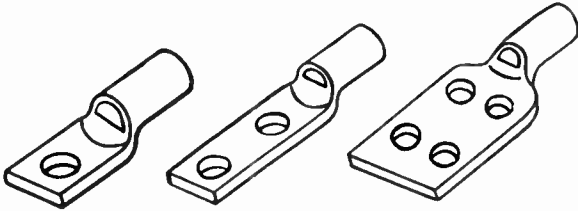

Fig. 1

Fig. 2

Fig. 3

Short barrel, one-piece, pure copper, seamless terminals ideal for industrial applications where space is limited. Stud holes other than those listed below can be supplied on request.

No.	Fig. No.	Cond. Size, Coml. A.W.G.	For Use on Screw Sizes, In.	Unit Qty.	Wt. Per 1000, Lbs.	Per 100 (Unit Qty.)
YA6C-L1	1	6 Str.	1/4	50	16	\$7.80
YA6C-L*	1	6 Str.	5/16	50	16	7.80
YA6C-L3*	2	6 Str.	1/4	50	16	25.60
YA4C-L1	1	4 Str.	1/4	50	20	11.30
YA4C-L*	1	4 Str.	3/8	50	20	11.30
YA4C-L4*	2	4 Str.	1/4	50	20	27.10
YA2C-L2*	1	2 Str.	1/4	25	33	22.70
YA2C-L*	1	2 Str.	5/16	25	33	22.70
YA2C-L4*	1	2 Str.	3/8	25	33	22.70
YA1C-L*	1	1 Str.	5/16	10	37	25.10
YA25-L*	1	1/0 Str.	5/16	10	47	26.00
YA25-L4*	1	1/0 Str.	3/8	10	47	26.00
YA25-2L	2	1/0 Str.	5/16	10	67	39.40
YA26-L*	1	2/0 Str.	3/8	10	59	30.30
YA26-2LN	2	2/0 Str.	5/16	10	79	40.90
YA27-L4*	1	3/0 Str.	3/8	10	73	36.30
YA27-L	1	3/0 Str.	1/2	10	73	36.30
YA27-2LN	2	3/0 Str.	3/8	10	100	51.60
YA28-L4*	1	4/0 Str.	3/8	10	93	40.90
YA28-L	1	4/0 Str.	1/2	10	93	40.90
YA28-2LN	2	4/0 Str.	3/8	10	130	55.30
YA29-L*	1	*250	1/2	10	130	46.20
YA29-2LN	2	*250	3/8	10	160	62.40
YA30-L	1	*300	1/2	10	150	56.70
YA30-2LN	2	*300	3/8	10	190	76.70
YA31-L	1	*350	1/2	10	180	59.40
YA31-2LN	2	*350	3/8	10	240	80.20
YA32-L	1	*400	5/8	10	240	70.00
YA32-2LN	2	*400	3/8	10	290	94.50
YA34-L	1	*500	5/8	10	350	85.80
YA34-2LN	2	*500	3/8	10	410	115.80
YA36-L	1	*600	5/8	6	500	157.60
YA36-2LN	2	*600	3/8	6	550	165.50
YA39-L	1	*750	5/8	6	650	165.50
YA39-2LN	2	*750	3/8	6	700	173.40
YA40-L	1	*800	5/8	6	750	266.40
YA40-2LN	2	*800	3/8	6	800	280.60
YA44-L	1	*1000	5/8	6	1100	342.10
YA44-2LN	2	*1000	1/2	6	1100	359.40
YA44-4L	3	*1000	3/8	6	1000	375.20
YA46-L	1	*1500	3/4	3	1600	614.80
YA46-2LN	2	*1500	1/2	3	1800	646.40
YA46-4L	3	*1500	1/2	3	1700	674.70
YA48-L	1	*2000	3/4	3	2500	796.10
YA48-2LN	2	*2000	1/2	3	2600	835.50
YA48-4L	3	*2000	1/2	3	2600	875.00

*Sizes supplied only in unit quantities or multiples of unit quantity. Other sizes the unit quantity is the minimum ordering quantity.

Burndy Hylinks

Listed by Underwriters' Laboratories, Inc.

Type YSV

For No. 22 through No. 6 Commercial and Aircraft Conductors
For Cable End-to-End

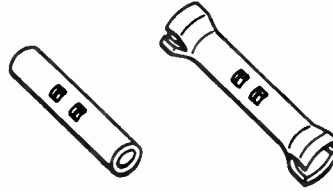

Fig. 1

Fig. 2

For making end-to-end solderless electrical connections. Electro-tinned to minimize corrosion. Sight holes and cable stops insure proper insertion of cable ends. Also available with insulation grips.

No.	Fig. No.	Cond. Sizes Coml. AWG & Aircraft AN	Solid Wire AWG	Unit Qty.	Wt. Per 1000, Lbs.	Per 100 (Unit Qty.)
YSV18	1	22-18	22-18	200	1.8	\$2.20
YSV18-H	2	22-18	22-18	200	2.3	3.40
YSV14	1	20-14	20-12	200	2.7	2.60
YSV14-H	2	20-14	20-12	200	3.5	3.80
YSV10	1	12-10	11-9	200	5.3	5.30
YSV10-H	2	12-10	11-9	200	7.5	9.50
YSV9C-L	1	†9	8-7	100	5.5	7.50
YSV8C-L	1	8	6	100	9.1	11.00

Available in new flip top box for sizes from No. 22 through No. 8.

Type YS-L

For Commercial Stranded Cable No. 6 through 2000 MCM
For Cable End-to-End



Seamless, one-piece, pure copper, electro-tinned connectors for making End-to-End connections. Cable stops insure proper insertion of cable. Short barrels require only one indent per end with Hytools or Hypresses.

No.	Conductor Sizes, Coml. A.W.G.	Unit Quantity	Wt. Per 1000, Lbs.	Per 100 (Unit Qty.)
YS6C-L	6 Str.	50	17	\$18.20
YS4C-L	4 Str.	50	26	21.20
YS2C-L	2 Str.	25	40	30.30
YS1C-L	1 Str.	10	52	36.30
YS25-L	1/0	10	57	39.40
YS26-L	2/0	10	65	42.50
YS27-L	3/0	10	94	48.50
YS28-L	4/0	10	94	53.10
YS29-L	*250	6	120	59.30
†YS30-L	*300	6	110	66.50
†YS31-L	*350	6	170	69.60
†YS32-L	*400	6	210	84.90
†YS34-L	*500	6	310	105.10
YS36-L	*600	6	410	149.70
YS39-L	*750	6	540	173.40
YS40-L	*800	6	610	224.50
YS44-L	*1000	6	860	236.40
YS46-L	*1500	3	1400	362.60
YS48-L	*2000	3	2100	488.70

*MCM.

†These sizes supplied in bulk only.

†Commercial AWG only.

Call Graybar FIRST for . . .



Burndy Hydent Installation Tools

Electrical connectors are only as dependable as the tools which install them. Here is a wide variety of practical, tested, well-designed tools whose uniform performance assures dependable electrical connections.

These tools are made for manual, pneumatic or hydraulic operation. For small connectors, where quantity high-speed production is not required, Hytools in the form of hand pliers are employed. For quantity production, both manually-operated Hytools and power-actuated Hypresses are available.

Each tool has been designed to insure: Simple operation by unskilled personnel, rapid low-cost-unit installation—as many as 1000 small-wire connections per hour can be made with a pneumatic Hypress; Uniformity of installation—the release valve feature of Hypresses and the close tolerances built into all Burndy tools control the depth of indentation.

Burndy Hytools

Type Y10M

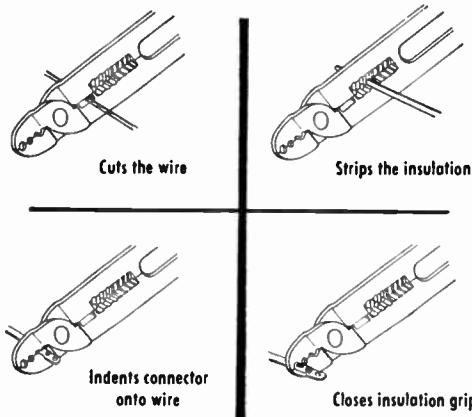
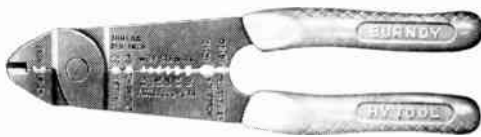

This popular all-purpose hand plier cuts the wire, strips the insulation and installs Hydent Connectors on conductor sizes No. 22 through No. 10. A single indenting die installs connectors on this entire conductor range. Other features are wire strippers, bolt cutter, thread chasers, and dies for closing insulation grips.

Type Y10M—Weight each 3/4 Lbs. Ea. **\$3.95**

Type MY29



A simple hand-operated Hytool that installs Hydent Connectors on conductor sizes No. 8 Stranded through 250 MCM without requiring the removal of dies. Unique indenter and nest which is adjustable to cable size scale on side of the Hytool gives this extensive range.

Type MY29—Weight each 6 1/2 Lbs. Ea. **\$36.00**

Burndy Hylugger

Type Y8ND



A light weight, compact, fast acting pneumatic tool.

Air pressure of 90 psi. is augmented by internal cam action to provide more than 3000 lb. crimping force. The built-in full cycle valve assures ram cannot return until it has completed its full forward motion. Thus crimping is uniform.

Convenient trigger location. Uses same dies as the M8ND. Dies must be ordered separately.

Head dimensions: 1 1/2-in. wide, 3/8 in. thick, 3/4-in. from terminal to end. Overall length 9 1/2-in. complete with hose.

No.	Weight 2 3/4 lbs. Description	Each
Type Y8ND	Hylugger, without dies	\$183.00

Burndy Pneumatic Hypress

Type Y10NCP

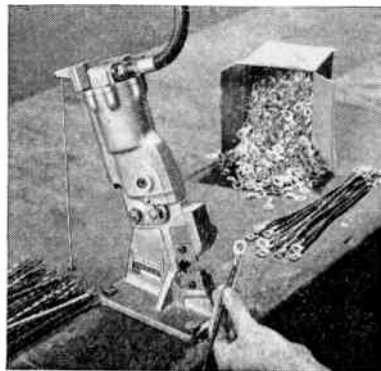

A high-speed, bench-mounted, foot-actuated Hypress, furnished with pneumatic pressure unit, foot-pedal and body. Installs Hydent Connectors on stranded cable sizes No. 22 through No. 8, and on solid wire sizes No. 22 through No. 6. Dies are extra. Tool angle and adequate jaw spacing,

plus foot-actuated pneumatic operation permit fast feed of assemblies into the die.

An air-line pressure of 90 psi., developing over 2000 lbs. total force is required for operation of this Hypress over its entire range. For smaller connectors lower pressures will be satisfactory.

Type Y10NCP—Without Dies; wt. ea., 10 1/2 Lbs. Ea. **\$270.00**

Burndy Hydent Installation Tools

Burndy Manual Hydraulic Hypress Type Y34A

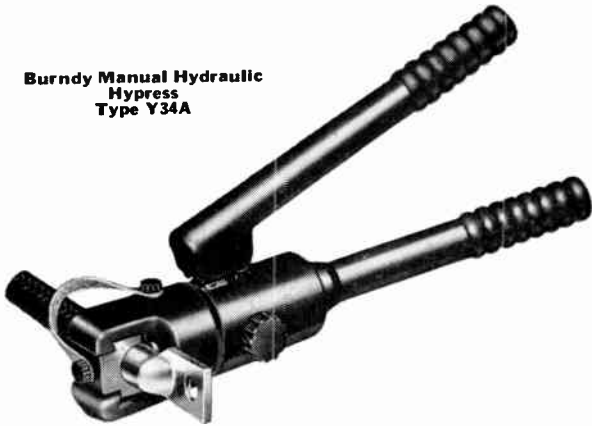

A manual Hypress weighing 9 lbs. that delivers a 9-ton force. Ideal for close-quarter operation; head rotates 90°. Installs Hydent Connectors on cable sizes No. 6 to 500 MCM. Tool is neoprene covered. Dies are quickly placed into the head—all dies must be ordered separately. Pumping the handle operates the Hypress. An overload valve controls the depth of indent on each size connector and its operation is indicated by an audible click and a drop in force when the indent is correctly completed. The indenter is returned to starting position by opening a release valve. Complete with metal carrying case.

Type Y34A—Without Dies; Weight each, 9 lbs., Each **\$155.00**

Burndy Foot-Operated Hydraulic Hypresses Type Y-B

Made in five types as illustrated. Includes foot-pump, 8-ft. flexible hose, Hypress head, and metal carrying case. All dies must be ordered separately. Flexible hose and swivel joint permit use of head at any angle, making the Hypress suitable for both bench and field installation. An overload valve controls the depth of indent on each connector size, and its operation is indicated by an audible click and a drop in force when the indent is correctly completed.

Air and electric units are also available to replace foot-pump units. Graybar invites your inquiries.

Type Y34B—For Cable Sizes No. 6 through 500 MCM.....Each **\$275.00**



Type Y34B (Neoprene-Covered Head)



Type Y29B—For Cable Sizes No. 9 through 250 MCM.....Each **\$228.00**



Type Y44B—For Cable Sizes No. 1/0 through 1000 MCM.....Each **\$366.00**

For Overhead Line Work



Type Y35—For Cable Sizes No. 6 Through 400 MCM.....Each **\$195.00**

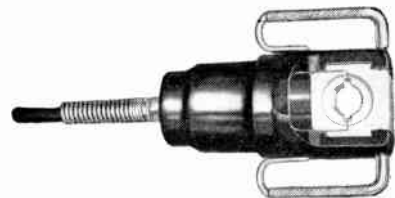

Type Y48B—For Cable Sizes No. 4/0 through 2000 MCM.....Each **\$492.00**

Burndy Hylug Kit

This kit contains assorted Hydent Connectors for No. 20 through No. 10 wire, packaged in new flip-top boxes. One Burndy Hytool No. Y10M for cutting wire, stripping insulation and for installing the connectors.

Designed for electrical contractors, automotive, radio, industrial maintenance, motor and appliance men.

No. 11—Wt. ea., 3 Lbs.....Ea. **\$6.50**



For additional information on any of the products listed on preceding pages the following Burndy catalogs are available:

- General Catalog No. 50**
- Industrial Catalog No. 52**
- Hydent Catalog No. Y58**
- Hysplice Catalog No. O1157**
- Underground Catalog No. Z47**
- Grounding Catalog No. G47**

Graybar Invites Your Inquiries.

Burndy Cable Terminals
Qiklug Type Q2A and Type Q3A

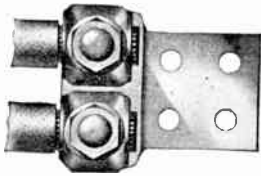

Type Q2A



Type Q3A

Type Q2A: A compact clamp type connector with two clamping elements for joining two cables to bar or flat pad. Connection is quickly made by inserting cables into Qiklug cable eyes and tightening nuts. Qiklugs can be used.

Type Q3A: A Qik connector for terminating three cables to bar or flat pad. Cables are securely held in place, forcing a high pressure contact with terminal, by merely tightening nuts on clamping elements.

No.	Copper Conductor Range		Ship. Wt. Lbs. Per 100	Std. Pkg.	Per 100
	Min.	Max.			
Q2A26-2	1/0 Str.	2/0 Str.	61	24	\$ 450.30
Q2A26-2N	1/0 Str.	2/0 Str.	73	24	450.30
Q2A26-4	1/0 Str.	2/0 Str.	62	24	450.30
Q2A28-2N	3/0 Str.	4/0 Str.	86	24	589.60
Q2A28-4	3/0 Str.	4/0 Str.	68	24	589.60
Q2A28-4N	3/0 Str.	4/0 Str.	110	24	589.60

Q2A31-2N	250 Mem.	350 Mem.	150	12	970.70
Q2A31-4	250 Mem.	350 Mem.	140	12	970.70
Q2A31-4N	250 Mem.	350 Mem.	170	12	970.70
Q2A34-2N	400 Mem.	500 Mem.	210	12	1143.80
Q2A34-4	400 Mem.	500 Mem.	190	12	1143.80
Q2A34-4N	400 Mem.	500 Mem.	220	12	1143.80

Q3A26-2N	1/0 Str.	2/0 Str.	97	24	\$ 700.50
Q3A26-4	1/0 Str.	2/0 Str.	85	24	700.50
Q3A28-2N	3/0 Str.	4/0 Str.	110	24	917.30
Q3A28-4	3/0 Str.	4/0 Str.	92	24	917.30
Q3A28-2N	3/0 Str.	4/0 Str.	130	24	917.30
Q3A31-2N	250 Mem.	350 Mem.	200	12	1510.00

Q3A31-4	250 Mem.	350 Mem.	190	12	1510.00
Q3A31-4N	250 Mem.	350 Mem.	210	12	1510.00
Q3A34-2N	400 Mem.	500 Mem.	280	12	1779.40
Q3A34-4	400 Mem.	500 Mem.	260	12	1779.40
Q3A34-4N	400 Mem.	500 Mem.	290	12	1779.40

Qiklink Type QR

Join cables end-to-end with this rapidly installed link. Provides good electrical conductivity, high mechanical strength. No parts to separate; just insert cable, tighten 2 nuts. Each size takes convenient range of conductors.

No.	Copper Conductor Range		Ship. Wt. Lbs. Per 100	Std. Pkg.	Per 100
	Min.	Max.			
QR8C	14 Sol.	8 Str.	13	100	\$ 123.20
QR4C	6 Sol.	4 Str.	13	100	123.20
QR1C	4 Str.	1 Str.	20	100	154.00
QR26	1/0 Str.	2/0 Str.	37	48	231.10

QR28	3/0 Str.	4/0 Str.	39	36	349.40
QR31	250 Mem.	350 Mem.	76	24	539.30
QR34	400 Mem.	500 Mem.	120	24	801.30
QR40	600 Mem.	800 Mem.	200	12	1309.70

QR44	850 Mem.	1000 Mem.	220	12	1540.70
QR46	1100 Mem.	1500 Mem.	390	12	2157.10
QR48	1600 Mem.	2000 Mem.	560	12	2773.30

Burndy Cable Terminals

Listed by Underwriters' Laboratories, Inc.

Qiklugs—Type QA-B

For Range of Cable to Flat



A high-copper alloy, heavy duty terminal for rapid termination of cables. Quickly installed with an ordinary wrench. Accommodates a range of cable sizes and is supplied with, one, two or more holes in the terminal pad. They maintain their full salvage value.

No.	Conductor Range		Holes in Tongue	Quan. In Ctn.	Std. Pkg.	Wt. Per 100 Lbs.	‡Per 100
	Min.	Max.					
QA8C-B	14 Sol.	8 Str.	1	25	100	8	\$53.30
QA8C-2B	14 Sol.	8 Str.	2	25	100	10	80.20
QA4C-B	8 Str.	4 Str.	1	25	100	9	66.60
QA4C-2B	8 Str.	4 Str.	2	25	100	10	93.60

QA1C-B	4 Str.	1 Str.	1	25	100	13	93.60
QA1C-2B	4 Str.	1 Str.	2	25	100	16	120.10
QA26-B	1/0 Str.	2/0 Str.	1	12	48	23	146.90
QA26-2B	1/0 Str.	2/0 Str.	2	12	48	28	173.50

QA28-B	3/0 Str.	4/0 Str.	1	9	36	28	200.30
QA28-2B	3/0 Str.	4/0 Str.	2	9	36	34	227.10
QA31-B	*250	*350	1	6	24	53	320.40
QA31-2B	*250	*350	2	6	24	60	373.90

QA34-B	*400	*500	1	6	24	82	387.30
QA34-2B	*400	*500	2	6	24	84	440.60
QA34-4B	*400	*500	4	6	24	93	574.10
QA40-B	*600	*800	1	6	24	130	655.00

QA40-2B	*600	*800	2	6	24	140	655.00
QA40-4B	*600	*800	4	6	24	140	774.40
QA44-B	*850	*1000	1	6	24	170	774.40
QA44-2B	*850	*1000	2	6	24	170	842.00

QA44-4B	*850	*1000	4	6	24	180	934.60
QA46-B	*1100	*1500	1	6	24	270	1468.80
QA46-2B	*1100	*1500	2	6	24	290	1468.80
QA46-4B	*1100	*1500	4	6	24	290	1495.50

QA48-B	*1600	*2000	1	3	12	400	1976.20
QA48-2B	*1600	*2000	2	3	12	420	1976.20
QA48-4B	*1600	*2000	4	3	12	410	2002.90

*MCM.

‡By carton quantities.

Scrulugs—Type KPA

For Range of Cable to Flat



A low-cost compact terminal especially suited for light duty industrial installation. Unexcelled for terminating cable in confined space — at safety switches, relays, electric control equipment, test blocks, etc.

Each size takes a convenient range of conductors.

No.	Conductor Range		‡1947 N.E.C. Conduc. Rating	Quan. In Ctn.	Wt. Per 100 Lbs.	‡Per 100
	Min.	Max.				
KPA8C	14 Sol.	8 Str.	55A	100	2.3	\$10.00
KPA4C	14 Sol.	4 Str.	105A	100	3.5	13.20
KPA25	4 Str.	1/0 Str.	195A	100	8	27.30
KPA28	1/0 Str.	4/0 Str.	300A	25	25	61.20
KPA34	4/0 Str.	*500	515A	18	50	157.00

*MCM

‡Type R insulation—single conductor in free air.

§For 1-4 carton quantities.

Burndy Cable Terminals

Kalug Type KA



A low cost lug of high conductivity copper alloy, compactly designed with Allen Head screw, for easy terminating at service switch, terminal block, etc. where space and cost are the important factors. Each lug takes a convenient range of conductors.

One hole tongue. For copper conductors, cable to flat.

No.	Copper Conductor Range		Approx. Ship. Wt. Lbs. Per 100	Ctn. Qty.	Per 100
	Minimum	Maximum			
KA8C	14 Sol.	8 Str.	2.1	100	\$ 12.11
KA4C	14 Sol.	4 Str.	1.3	100	16.29
KA25	4 Str.	1/0 Str.	14.5	50	36.60
KA28	1 Str.	4/0 Str.	23.5	25	76.12
KA34	4/0 Str.	500 Mcm.	64	18	176.08

Burndy Aluminum Hylinks



Type YS-A

For Aluminum Cable End-To-End

Aluminum Hylinks for making end-to-end connections of aluminum cable from #12 str. to 2000 Mcm. Supplied factory filled with Penetrox A and capped so that there is no need to apply this corrosion inhibiting and oxide penetrating compound as a separate operation.

The staked plug which forms cable stop in center of hylink provides maximum insertion of the conductor and proper distribution of Penetrox A through the strands.

To make installation, insert aluminum cable in each end and crimp with recommended installation tool and die.

Contact GRAYBAR for price and further information.

Burndy Aluminum Hylugs



Type YA-A-TN

For joining aluminum cable to flat. Tin-plated aluminum Hylugs recommended wherever it is necessary to terminate aluminum cable to a copper or aluminum surface.

Supplied factory-filled with Penetrox A, a corrosion inhibiting and oxide penetrating compound.

Easy to install, simply insert the aluminum conductor and crimp with recommended installation tool and dies. U.S. standard flat washers recommended for use under the heads of the clamping bolts when installing these Hylugs.

Contact GRAYBAR for price and further information.

Call Graybar FIRST For . . .



Burndy Cable Connectors

Listed by Underwriters' Laboratories, Inc.

Versitaps—Type QPX

For Range of Copper Conductors



An all-purpose connector used to make parallel taps, T-connections or end-to-end connections.

Made of high strength, high conductivity copper alloy, it consolidates the functions of a number of connector types into one low-priced device.

Variety of QPX Connections

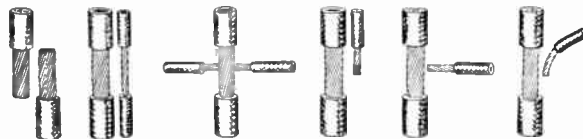

No.	Conductor Range				Tap	Quan. In Ctn.	Wt. Per 100 Lbs.	Per 100 (By Ctn.)
	Min.	Run	Max.	Min.				
QPX2C2C	6 Str.	2 Str.	6 Str.	2 Str.	12	33	\$203.20	
QPX282C	1 Str.	4/0 Str.	6 Str.	2 Str.	12	37	232.40	
QPX2828	1 Str.	4/0 Str.	1 Str.	4/0 Str.	9	70	290.50	
QPX342C	*250	*500	6 Str.	2 Str.	6	60	435.80	
QPX3428	*250	*500	1 Str.	4/0 Str.	6	88	479.30	
QPX3434	*250	*500	*250	*500	6	140	610.00	
QPX442C	*500	*1000	6 Str.	2 Str.	3	90	755.30	
QPX4428	*500	*1000	1 Str.	4/0 Str.	3	130	755.30	
QPX4434	*500	*1000	*250	*500	3	170	915.10	
QPX4444	*500	*1000	*500	*1000	3	240	1104.00	

*MCM

Oklips—Type KVS

For Copper Conductors



A husky connector for heavy duty copper to copper service connections. Takes a wide range of conductors.

Made of high strength, high conductivity alloy, its compact construction permits quick and easy taping. No loose hardware.—rubber-like rings capture bolts, thus preventing their loss.

No.	Conductor Range				Tap	Quan. In Ctn.	Wt. Per 100 Lbs.	Per 100 (Ctn. to 99)
	Min.	Run	Max.	Min.				
KVS26	2 Str.	2/0 Str.	10 Str.	2/0 Str.	25	44	\$79.40	
KVS28	1/0 Str.	4/0 Str.	10 Str.	4/0 Str.	25	66	128.20	
KVS31	*250	*350	10 Str.	*350	12	110	250.90	
KVS34	*400	*500	10 Str.	*500	12	130	292.70	
KVS40	*400	*800	3/0 Str.	*800	6	220	414.70	
KVS44	*500	*1000	3/0 Str.	*1000	6	330	585.60	

*MCM.

Burndy Flat Bar and Tubular Bus Fittings

Illustrated on this and following pages are typical Burndy bus connectors available through Graybar. Connectors for flat, square, angle or tubular bus, for cable and for connections between the various conductor types can be furnished to meet your particular installation requirements. For complete information on these and other types, contact your nearest Graybar office or warehouse.

Flat Bar Fittings

Bar clamps distribute pressure over a wide area. Available for flat bars, or for flat bar to cable, tube or special shapes. Connectors for taps from multiple bars also available.

Either the 4-bolt and cap, or special clamping eye and cap elements are recommended for joining cables to flat bar. Contact Graybar.

Connectors

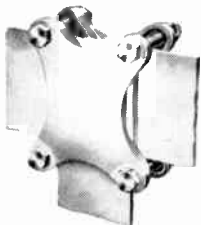

Type H Clamp

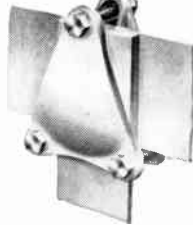

Type A Clamp



Type B Flexible Joint



Type FD (Stud Connector)

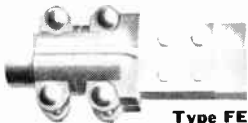

Type FE

Bartaps



Type FEH

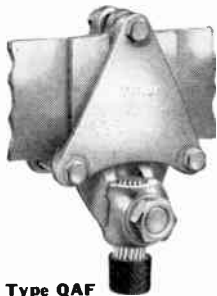

Type QAF

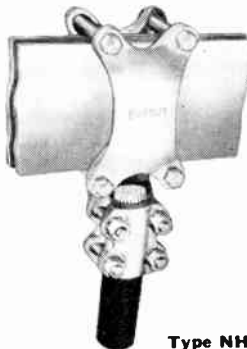

Type NHF

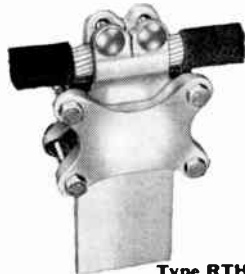

Type RTH

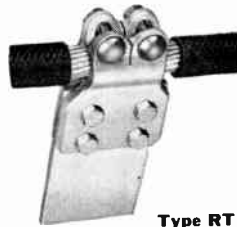

Type RT

Bus Support Clamps



Type HHH

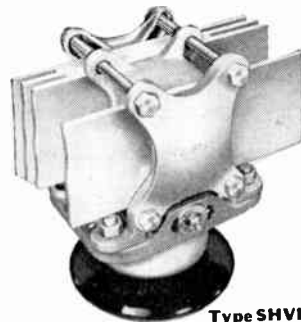

Type SHVH

Tubular Bus Fittings

Connectors



Type NT T-Connector



Type NL Elbow



Type NS Coupler

Terminals



Type CB Corona Bell



Type NA Terminal



Type XA Terminal

Stud Connectors



Type XD



Type XDU



Type ND

Bus Support Clamps



Type UH

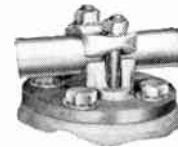

Type LH



Type UHR



Type CHP Suspension Clamp



Type XHP



Type SSH

Burndy Cable and Tube-to-Cable Fittings

**Cable Fittings
Terminals**

Shown here are a few of the many variations of Burndy terminals. Compactness and positive clamping action are outstanding features. These terminals can be designed with tongue set at an angle to meet special installation requirements. Many of these terminals accommodate a convenient range of conductors.



Type NA



Type KPA



Type QA-B



Type Q3A



Type VA



Type QB

Bar Taps



Type YA-L



Type VF



Type QGF

T-Connectors



Type NT



Type VT



Type QT

Couplers

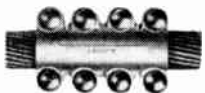

Type NS



Type QR



Type YSV



Type VR



Type ER



Type YS-L

Bus Support Clamps



Type RHB



Type LH



Type UHR

**Cable Fittings
Range Taking Stud Connectors
Type NDR**

**For Cable, Tubing or Flat Bar to
Threaded Stud**



Constructed of high copper alloy. Has reversible cap that permits full cable, flat bar, or tubular bus range to be taken either in line with the stud or at right angles to it.

12 sizes of NDR line replace the over 100 designs previously used and permit prompt shipment of all sizes.

Only one wrench is required for installation.

Parallel Tap Connectors



Type QPX



Type KVS



Type KVSU

Parallel Clamps



Type CP



Type VP



Type UC

Strain Clamps



Type DUW



Type BC



Type M
Thimble

**Tube-To-Cable Fittings
T-Connectors**



Type NT



Type NVT



Type NVTT

End Connector

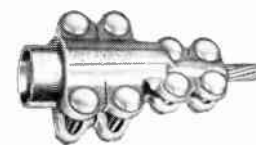

Type NE

Slots between clamping bolts on many of the connectors shown here cause multiple areas of high-pressure contact, thus assuring minimum contact resistance and minimum heat losses.

**O. Z. Bus Bar Clamps
For Copper Bus Bar**

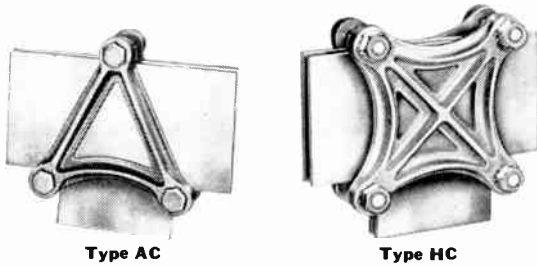

Both halves are bronze, with bolts of Everdur alloy.
Bolts furnished will accommodate total bar thickness up to 1 in. Longer bolts can be furnished if specified at slight additional charge.

Type AC			Type HC			For Bars, In.		Overall Lgth., In.
No.	Wt., Ea. Lbs.	Each	No.	Wt., Ea. Lbs.	Each	Main Wdth.	Tap Wdth.	
AC22	1.0	\$ 3.10	HC22	1.4	\$ 4.05	2	2	3 1/4
AC32	1.4	3.40	HC32	1.9	4.35	3	2	4 5/16
AC33	1.7	3.60	HC33	3.0	4.50	3	3	4 1/2
AC42	1.8	4.35	HC42	2.1	5.45	4	2	5 5/16
AC43	2.1	4.65	HC43	3.9	5.90	4	3	5 1/2
AC44	2.9	4.80	HC44	5.3	6.05	4	4	5 11/16
AC52	3.0	6.20	HC52	3.5	8.10	5	2	6 1/2
AC53	3.4	6.70	HC53	5.8	8.55	5	3	6 1/2
AC54	4.6	7.00	HC54	7.8	8.85	5	4	6 11/16
AC55	5.9	7.30	HC55	8.5	9.15	5	5	6 11/16
AC62	4.0	10.55	HC62	4.8	13.65	6	2	7 1/2
AC63	4.5	11.20	HC63	6.5	14.30	6	3	7 1/2
AC64	5.1	11.50	HC64	8.8	14.60	6	4	7 11/16
AC65	6.5	11.80	HC65	12.0	14.90	6	5	7 11/16
AC66	10.0	12.10	HC66	14.0	15.20	6	6	8 1/8

Burndy Connectors for Special Bus Shapes

A complete line of heavy-duty connectors is available for channel, angle and square tube bus. High-pressure contact areas are set up by the clamping bolts, providing these connectors with excellent electrical characteristics and the ability to withstand the large short-circuit forces encountered in high-current buses.

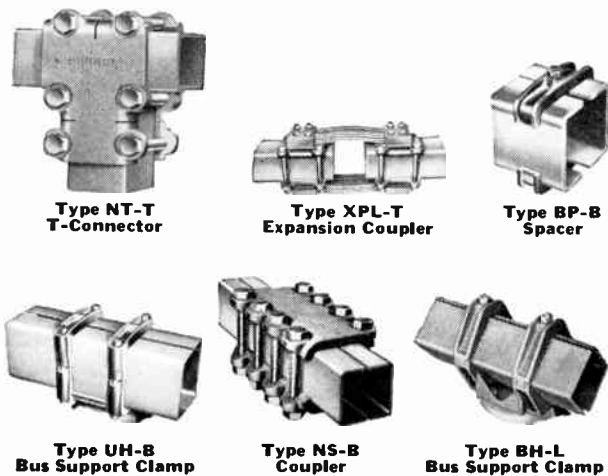

Burndy Connectors for Underground and Industrial Systems

Provide compact, secure, insulated connections with full cable insulation protection at low installation cost.
Another feature of this equipment is its flexibility in providing for future additional loads which can be installed rapidly and inexpensively.

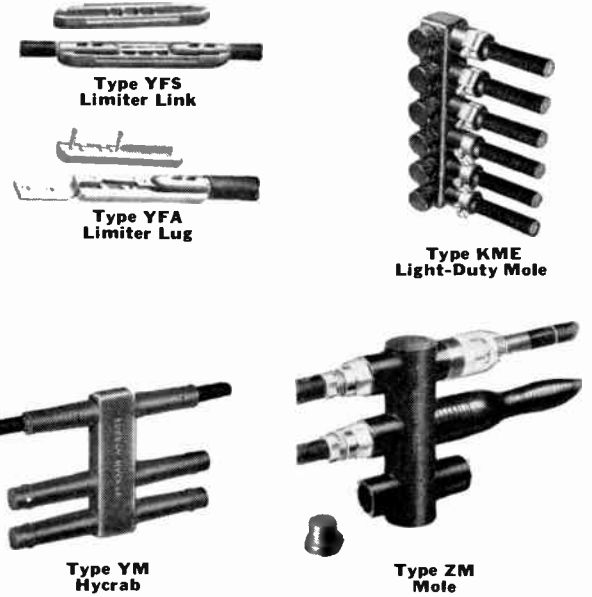

Efficiency Non-Adjustable Supports

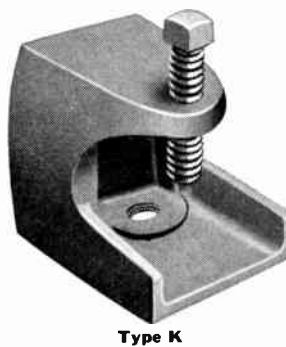

Type K
Malleable iron. Case hardened set screw. Designed for supporting porcelain and glass insulators to beams and angles in open steel construction of all kinds. Made in four sizes for standard insulators. Has numerous applications. Does not require burning or drilling holes.

Complete information and prices on request.



Type X
Malleable iron, extra heavy head. Case hardened cup point set screw and nut. Set screw tightens on nut, if thread is stripped, replacement can be made with common steel nut.

Designed for use where no more than two insulators or fittings are required, and where these fittings may be placed in either an upright or horizontal position. Adaptable to mount various designs of cable racks.

No drilling or burning holes in beam is required. A great variety of uses can be found for this support.

Complete information and prices on request.

Steel City Universal Insulator Supports

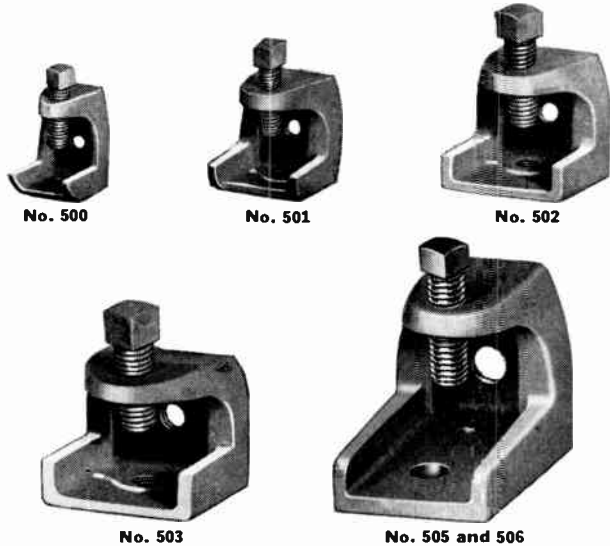

Malleable iron, electro-galvanized. Case hardened cup pointed set screw.

For securing porcelain or glass insulators, knobs, cleats, brackets, or pipe in any open construction.

Easily attached to I-beams, angles, channels, etc., or to round, square or flat bars, edges of tanks, pipes, etc.

One set screw design, providing a three-point contact that holds the support securely and rigidly to the steel framework. Vibration will not loosen set screw.

Screw holes for fastening insulator to Universal Insulator Supports are tapped standard as indicated.

Special tapping can be specified when required, at no extra cost.

Machine screws for fastening porcelain insulators to Universal Insulator Supports are furnished only when specified and at additional cost.

No.	In.	Jaw Opening Inch	*Standard Tapping	Std. Pkg.	Wt. Lbs. Per 100	Std. Pkg. Per 100
500	1	3/4	1/4-20	100	20	\$22.05
509	1	3/4	10-24	100	20	22.05
501	1 1/2	3/4	5/8-18	100	50	33.85
502	2	7/8	3/8-16	50	86	53.75
503	2 1/2	7/8	1/2-13	50	150	82.00
505	1 1/2	3/4	10-24 & 3/8" Clear	100	75	50.65
506	2	1	10-24	100	117	66.10
507	2 1/2	1 1/4	1/2-13	50	150	95.85
508	2 1/2	2	1/2-13	50	188	107.30

*All supports can be tapped as specified without extra charge.

Call Graybar **FIRST** For . . .



Steel City Marchand Clamps and Plugs

For Stranded Wire Cable



Assembled view showing "dead-ending" Clevis Clamp attached to strain insulator and clamp end of 1,000,000 CM stranded copper conductor.

Safest and most efficient wire clamp on the market.

Simple in design. Saves labor and material. Easily and quickly installed. The only Single Clamp that can be used for maximum strain. Does not crush the strand—each wire of strand gripped separately and carries equal load. Standard designs meet all conditions of construction. Only one clamp required for each connection. Sherardized finish.

Clamps and plugs only. Insulator not included.

For Stranded Conductors

No.	Spreader Plug No.	Description	Wt. Lbs. Per 100	Per 100
1645	2003	1/0-7 Strand	130	\$ 75.00
1646	2054	2/0-7 Strand	215	88.00
1647	2052	3/0-7 Strand	215	88.00
1648	2055	4/0-7 Strand	215	88.00
1649	2056	1/0-19 Strand	215	88.00
1650	2059	2/0-19 Strand	215	180.00
1651	2057	3/0-19 Strand	215	180.00
1660	2060	4/0-19 Strand	215	180.00
1661	2058	2/0-37 Strand	215	180.00
1665	2065	250,000 CM 37 Strand	215	180.00
1670	2070	300,000 CM 37 Strand	215	180.00
1672	2072	350,000 CM 37 Strand	215	365.00
1675	2075	400,000 CM 37 Strand	215	365.00
1680	2082	450,000 CM 37 Strand	220	365.00
1700	2101	500,000 CM 37 Strand	220	365.00
1701	2102	600,000 CM 61 Strand	220	365.00
1702	2104	650,000 CM 61 Strand	220	365.00
1703	2103	700,000 CM 61 Strand	220	365.00
1750	2151	750,000 CM 61 Strand	240	425.00
1751	2152	800,000 CM 61 Strand	240	425.00
1752	2105	900,000 CM 37 Strand	240	425.00
1753	2106	900,000 CM 61 Strand	240	425.00
1754	2153	1,000,000 CM 61 Strand	240	425.00
1755	2061	1,100,000 CM 91 Strand	240	425.00
1756	2062	1,200,000 CM 91 Strand	240	425.00
1775	2154	1,250,000 CM 91 Strand	300	575.00
1780	2155	1,500,000 CM 91 Strand	350	1125.00
1781	2063	1,590,000 CM 61 Strand	350	1125.00
1790	2156	2,000,000 CM 127 Strand	470	1750.00



No. 1425

One-fourth size sectional view of Clevis Clamp attached to Anchor Rod

No.	Spreader Plug No.	Description	Wt. Lbs. Per 100	Per 100
1425	2001	1/4" For use with	130	\$75.00
1426	2002	3/8" For use with	130	75.00
1450	2051	5/8" 7-Wire Guy Strand	215	88.00
1451	2052	7/8" 7-Wire Guy Strand	215	88.00
1452	2053	1 1/2" 7-Wire Guy Strand	215	88.00

Efficiency Time Saver Cleats

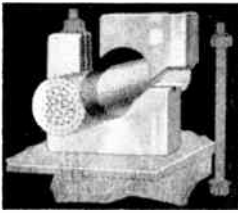

Unique design. Base is mounted permanently with one bolt, and forms a solid support or shelf for the wire or cable. Cap is bolted as a separate operation. Wire groove diameters $\frac{3}{8}$ -inch to $1\frac{1}{8}$ -inch. Also available with mounting for lag screw, machine bolt, toggle bolt or expansion plug.

Complete information and prices on request.

Efficiency Cleat Racks

For Time Saver Cleats

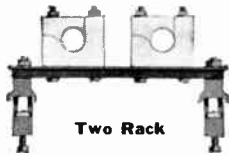

Two Rack

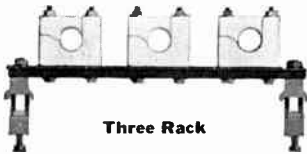

Three Rack

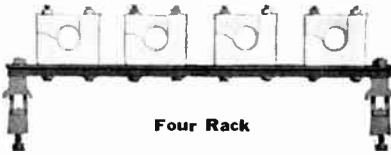

Four Rack

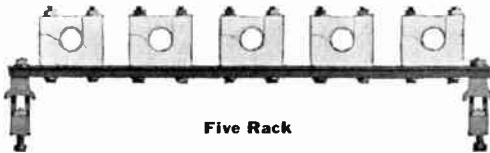

Five Rack

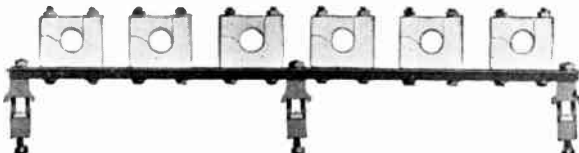

Six Rack

Made in 2, 3, 4, 5 and 6 cleat types and 3 phase cleat rack. Wire size $\frac{3}{8}$ -inch and $1\frac{1}{8}$ -inch. Base of Time Saver cleat is mounted permanently with one bolt and forms a solid support or shelf for the wire or cable. Cap is bolted as a separate operation. Furnished with or without adjustable beam supports. When ordering give outside diameter of wire or cable over insulation.

Complete information and prices on request.

Efficiency Bushing Supports

Type V



Type VG



Type VB

Malleable Iron. Independent mountings for cable and wires. Type VB requires only one bolt to be tightened to hold porcelain bushing and clamp to base. In both supports the bushing is completely surrounded by metal. Mounted with one bolt; the circular base is adjustable to any angle. For a-c service, a brass half is furnished to prevent induction. For wire sizes $\frac{1}{8}$ -inch to $2\frac{3}{8}$ -inch. When ordering give outside diameter of wire or cable over insulation. Complete information and prices on request.

Type G

Adaptable for mounting on Steel, Wood, Concrete, Tile, Brick or Stone.



On Wood Screw



Type G

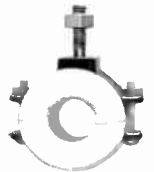

On Machine Bolt

Malleable Iron. For a-c service a brass half is furnished to prevent induction. For wire sizes $\frac{5}{16}$ -inch to $2\frac{3}{8}$ -inch. When ordering give outside diameter of wire or cable over insulation. Toggle or machine bolts, lag screw or expansion plug are extra.

Complete information and prices on request.

Efficiency Bushing Messenger Supports

Type GM

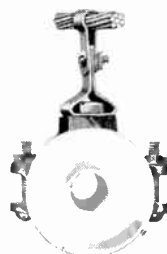

Designed to suspend wire or cable from messengers where beam mounting is not possible. A combination of Type G Bushing Support with strip steel messenger attachment. Furnished complete as illustrated. For wire sizes $\frac{5}{16}$ -inch to $2\frac{3}{8}$ -inch. For a-c or d-c service.

When ordering give outside diameter of wire or cable over insulation. Also size of messenger.

Complete information and prices on request.

Efficiency Conductor Racks

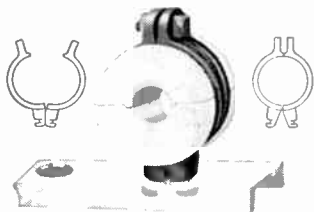

U.S. Patent No. 1,837,259

A patented cable support of fundamental and extremely simple design. Tightening one bolt clamps porcelain bushing firmly and fulcrum surfaces transmit the pressure to the flanged foot which engages the sides of the hole in the rack. Engagement is positive and will not loosen by

vibration or shock. For a-c or d-c service. Wire sizes from $\frac{5}{16}$ -inch to $2\frac{3}{8}$ -inch. Complete prices and information on request.

Nested Conductor Rack—Type U

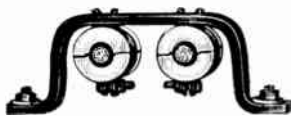

Two Conductor Rack

Relieves impedance. Compact and scientifically designed to carry conductor equidistant from center to center.

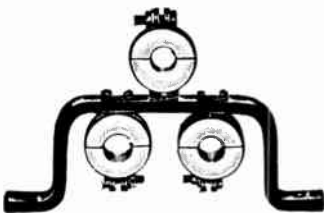

Three Conductor Rack

One bolt supports the bushing and clamps the bushing support to the rack.

Each fitting is a separate unit and permits installation of each cable line independently.

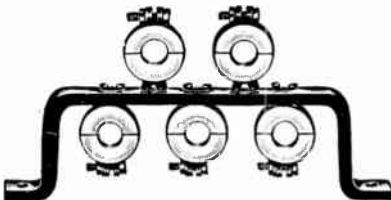

Five Conductor Rack

Rack is standard rolled steel channel.

Bushing supports are malleable iron.

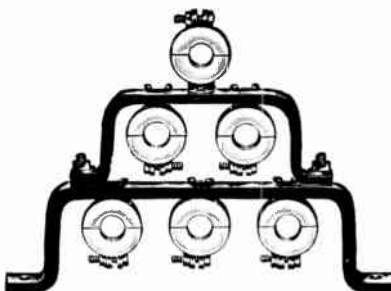

Six Conductor Rack

For a-c or d-c service. For a-c service a brass half is furnished to prevent induction. For wire sizes $\frac{5}{16}$ -inch to $2\frac{3}{8}$ -inch.

Complete information and prices on request.

Efficiency Hangers

2 or 3 Wire Cleat Mounting

This fitting is furnished complete with No. 150 Adjustable Support, malleable iron cleat fitting, 2 or 3 wire glazed porcelain cleats and all bolts. Wire sizes from 2 to 14. Also available without adjustable support.

Complete information and prices on request.

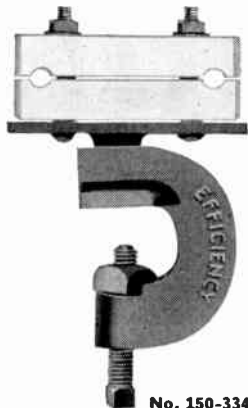

No. 150-334

Efficiency Bushing Racks

Type B Adjustable

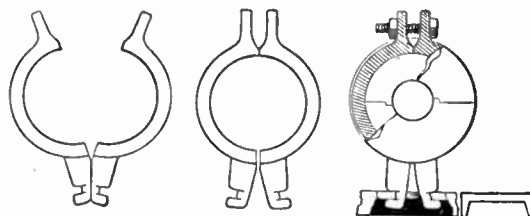

Only one bolt required to support the bushing and clamp the bushing support to the rack. Each fitting is a separate unit and permits the installation of each line of cable independently.

Rack is standard rolled steel channel, sizes $1\frac{1}{2} \times 1\frac{1}{2} \times \frac{1}{8}$ -inches and $2 \times 1\frac{1}{2} \times \frac{1}{8}$ -inches, varying according to size of bushings and number of mountings to each rack. Bushing supports are malleable iron. Bushings are glazed porcelain, extra large and heavy, and designed to allow a minimum of leakage.

These racks can be furnished with any required number of bushing mountings.

The bare rack can be attached permanently to the structure and mountings can be added later as required.

B-700S to and including **B-702S** are spaced 4 inches center to center of bushing.

B-703S to and including **B-705S** are spaced 5 inches center to center of bushing.

B-706S to and including **B-710S** are spaced 6 inches center to center of bushing.

Any desired spacing of bushings, from center to center, other than above specified, can be furnished.

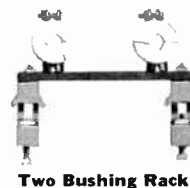

Two Bushing Rack

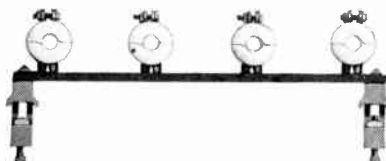

Four Bushing Rack

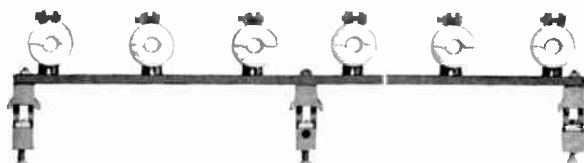

Six Bushing Rack

Made in 2, 3, 4, 5, and 6 bushing racks. For a-c or d-c service, wire diameters from $\frac{5}{16}$ -inch to $2\frac{3}{8}$ -inch. For a-c service a brass half is furnished to prevent induction.

Available with or without single or double adjustable beam supports. Complete information and prices on request.

Efficiency Adjustable Insulator Supports

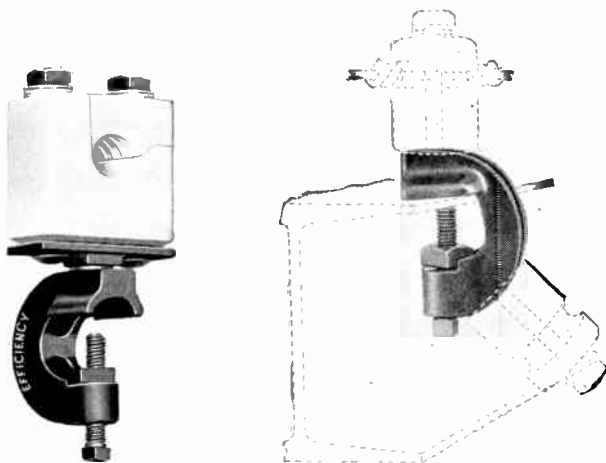

With Time Saver Cleat

Showing How Wires May Be Run Above Or Under The I-Beam, or Carried At The Side Parallel With The Beam

Designed to carry insulator and fittings at any angle, either above or below the beam. Permits the mounting of several conductors on one support, or any combination of wires or cables by the addition of various fittings. Slot permits movement of 120° from vertical position. Support clamps tightly to beams or angles without drilling or burning holes.

Malleable iron frame with case hardened cup point set screw.
Complete information and prices on request.

Porcelain Products Cleats

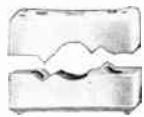

Style A

Style R (Regular) cleats have wire grooves 1/2 in. from surface of both cap and base.

Style A wire grooves are 1 in. from surface of base and 1/2 in. from surface of cap.

Style B wire grooves are 1 in. from surface of both cap and base.

Regular (R)

No.	Length Inches	Groove Inches	Takes Wire Size	Lbs. Per 1M Pairs
1	2	1/8-3/8	14-8	200
1 1/2	2 1/4	1/4-1/2	6-4	230
2	2 1/4	3/8-5/8	4-2	320
2 1/2	2 13/16	7/16-5/8	2-0	580
3	3 1/8	7/16-3/4	0-00	700

Style "A"

1	2	1/8-3/8	14-8	255
1 1/2	2 1/4	1/4-1/2	6-4	310
2	2 1/4	3/8-5/8	4-2	395
2 1/2	2 13/16	7/16-5/8	2-0	680
3	3 1/8	7/16-3/4	0-00	840

Style "B"

1	2	1/8-3/8	14-8	305
1 1/2	2 1/4	1/4-1/2	6-4	390
2	2 1/4	3/8-5/8	4-2	510
2 1/2	2 13/16	7/16-5/8	2-0	760
3	3 1/8	7/16-3/4	0-00	880

3 1/4	3 1/4	3/4-1 1/4	10 Duplex Par'l	1080
3 1/2	3 3/16	3/4-1	00-0000	890
4	3 3/4	1-1 3/8	500M-1MM	1180
4 1/4	5	1 3/8-1 5/8	800M-1 1/4MM	2840
4 1/2	5 7/16	1 3/4-1 7/8	1MM-2MM	3080

Knox One-Wire Glazed Cleats

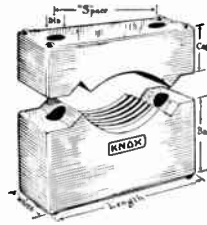

Style A

Style "Regular" light cap and light base.

Style A light cap and heavy base.

Style B heavy cap and heavy base.

Regular (R)

No.	Length Inches	Groove Inches	Takes Wire Sizes	Wt. Lbs. per 1M Pairs	Per 1000
1-R	1 15/16	1/8-3/8	14-8	170	\$ 86.10
1 1/2-R	2 1/4	1/4-1/2	6-4	260	117.00
2-R	2 1/4	3/8-5/8	4-2	310	125.50
2 1/2-R	2 11/16	7/16-5/8	2-0	500	165.30
3-R	3 1/8	7/16-3/4	0-00	560	222.10

Style "A"

1-A	1 15/16	1/8-3/8	14-8	220	97.20
1 1/2-A	2 1/4	1/4-1/2	6-4	340	120.70
2-A	2 1/4	3/8-5/8	4-2	395	141.10
2 1/2-A	2 11/16	7/16-5/8	2-0	575	181.80
3-A	3 1/8	7/16-3/4	0-00	650	239.20

Style "B"

1-B	1 15/16	1/8-3/8	14-8	270	110.90
1 1/2-B	2 1/4	1/4-1/2	6-4	420	123.90
2-B	2 1/4	3/8-5/8	4-2	480	156.60
2 1/2-B	2 11/16	7/16-5/8	2-0	650	197.80
3-B	3 1/8	7/16-3/4	0-00	740	255.80

3 1/4-B	3 1/4	1 1/16-1 5/16	00-0000	900	338.20
3 1/2-B	3 3/16	3/4-1	250-100MCM	1000	358.30
4-B	3 3/4	1-1 3/8	100-800MCM	1400	412.80
4 1/4-B	5	1 3/8-1 5/8	800-1250MCM	2300	688.40
4 1/2-B	5 7/16	1 3/4-1 7/8	1250-1750MCM	2700	812.40

**Knox Nail Assembled Split Knobs
Glazed or Unglazed**



Glazed or unglazed. Cap, base, 16d nail assembled. Has two grooves. Wire sizes 12 to 14.

No.	5 1/2 Nailnob
Diameter, inches	1 1/8
Height, inches	1 3/4
No. per Barrel	3300
Weight per 1000, pounds	160
Glazed per 1000	\$54.60
Unglazed per 1000	48.30

Knox Split Knobs for Screw Assembly

Consists of base and cap. No. 5 1/2 Nailnob and Detroit have 2 grooves, and take wire sizes 12 to 14. Nos. 9419 and 9420, 4 grooves, take wire sizes 8 to 10 and 4 to 6 respectively.

No.	5 1/2 Nailnob	Detroit	9419	9420
Diameter inches	1 1/8	1 1/4	1 1/2	2
Height inches	1 3/4	1 3/4	1 7/8	2 1/8
No. per Barrel	3300	2800	1800	1000
Wt. per 1000 lb.	160	160	287	750
Per 1000	\$72.90	\$76.00	\$123.30	\$241.90

Knox Standard 2-Wire Porcelain Cleats

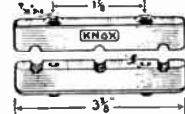

No.	334
Width inches	5/8
Length inches	3 3/8
Size Wire	12 to 14
Std. Pkg pairs	2000
Wt. per 1000 pair ... pounds	200
Glazed ... per 1000	\$109.10
Unglazed ... per 1000	\$56.50

Porcelain Products Porcelain Cleats



Standard two- and three-wire glazed or unglazed cleats. Unglazed furnished unless glazed is specified.

Any of the two- or three-wire cleats shown can be shipped with nails or screws assembled as illustrated.

For No. 12 and No. 14 Wire

No. 2-Wire	No. 3-Wire	Width In.	Lgth. In.	WL Per 100 Pr.
334	337	1 1/16	3 1/2	220
334A	337A	1 1/16	3 1/2	340
335	336	3/4	3 7/16	288
335A	336A	3/4	3 7/16	540

For No. 8 and No. 10 Wire

350	351	3/4	3 5/8	333
-----	-----	-----	-------	-----

Porcelain Products Split Knobs

Alligator Nail Assembled



Provide an insulating support in interior wiring, both open and concealed.

Made of hard vitrified porcelain, either glazed or unglazed.

Assembled with 12d wire nails, held in position by a steel washer and cushioned with a leather washer. Size of wire, 12-14.

Height, 1 3/4 In. Diameter, 1 1/8 In.

Packed in cartons of 100 and 500.

Weight per 1,000, 160 lbs.

Porcelain Products Two-Groove Split Knobs

White Glazed



No.	5 1/2
Height, inches.....	1 3/4
Diameter, inches.....	1 1/8
Size of Wire.....	12-14
Shipping Weight per 1,000 Pairs, Lbs.....	135

Porcelain Products Telephone Knobs

Split

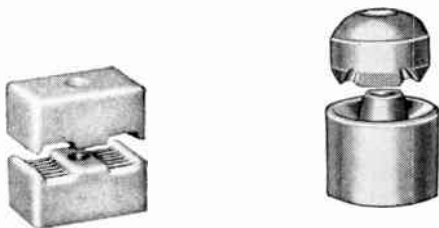

No. 6066 Type C

Paragon Knob, Self Tying

Height	1 1/4 In.	Height	2 1/4 In.
Width	3/4 In. x 1 3/16 In.	Diameter	2 In.
Hole Diameter	7/16 In.	Hole Diameter	1/4 In.
Standard Carton		Standard Carton	
Quantity	500	Quantity	100
Weight per M	96 Lbs.	Weight per M	485 Lbs.

Porcelain Products Telephone Knobs

Solid

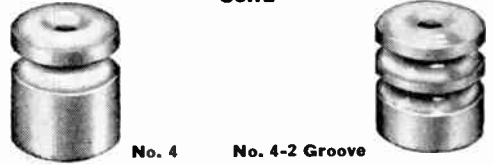

Height	1 1/16 In.	Height	1 1/16 In.
Diameter	1 1/2 In.	Diameter	1 1/2 In.
Hole Diameter	3/8 In.	Hole Diameter	3/8 In.
Wire Groove	3/8 In.	Wire Groove	5/16 In.
Standard Carton		Standard Carton	
Quantity	250	Quantity	250
Weight per M	230 Lbs.	Weight per M	225 Lbs.

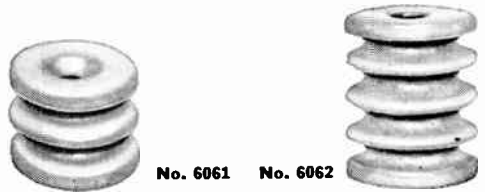

Height	1 1/16 In.	Height	2 1/4 In.
Diameter	1 5/8 In.	Diameter	1 3/4 In.
Hole Diameter	3/8 In.	Hole Diameter	7/16 In.
Wire Groove	3/16 In.	Wire Groove	5/16 In.
Standard Carton		Standard Carton	
Quantity	250	Quantity	125
Weight per M	200 Lbs.	Weight per M	368 Lbs.

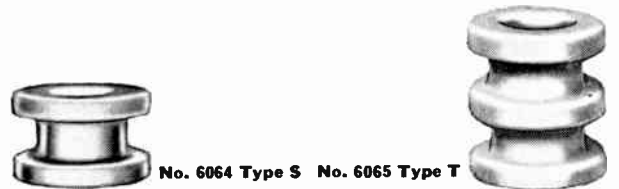

Height	1 1/16 In.	Height	1 3/16 In.
Diameter	1 5/8 In.	Diameter	1 5/8 In.
Hole Diameter	3/8 In.	Hole Diameter	7/16 In.
Wire Groove	7/16 In.	Wire Groove	7/16 In.
Standard Carton		Standard Carton	
Quantity	500	Quantity	200
Weight per M	140 Lbs.	Weight per M	245 Lbs.

Porcelain Products Porcelain Tubes

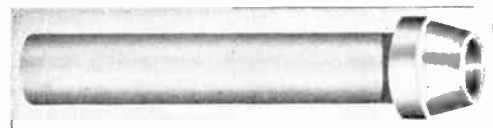

Tube Length	Std. Pkg. Quantity	WL Lb. Per M	Tube Length	Std. Pkg. Quantity	WL Lb. Per M
3/8-In. ID x 3/16-In. OD Tubes			3/8-In. ID x 1/16-In. OD Tubes		
3	1000	65	3	500	130
4	1000	80	4	100	150
5	500	102	5	100	169
6	500	110	6	100	204
8	100	55	8	150	300
10	100	194	10	150	350
12			12	100	400
14			14	100	450
3/8-In. ID x 1/16-In. OD Tubes			3/8-In. ID x 1/16-In. OD Tubes		
3	100	107	3	100	375
4	200	135	4	100	400
5	100	142	5	100	425
6	100	190	6	100	450
8	100	250	8	50	444
10	100	280	10	50	840
12	100	340	12	50	1100
14	100	400	14	50	1200
16	100	450			
18	100	500			

Knox Porcelain Telephone Knobs

No. 6062

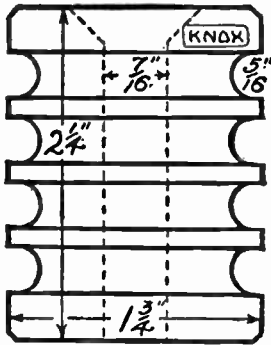

4 groove. Packed 500 in a standard package. Weight, standard package, 192 pounds.
Per 1000..... **\$128.20**

No. 4

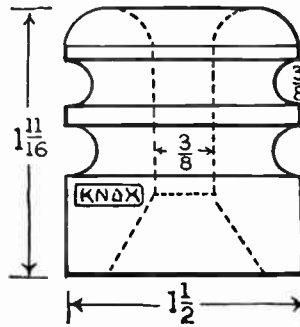

2 groove. Standard package 500. Weight, standard package, 115 pounds.
Per 1000..... **\$65.20**

No. 7139-T

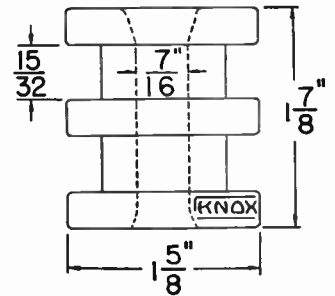

2 groove. Standard package 500. Weight, standard package, 120 pounds.
Per 1000..... **\$88.80**

No. 7138-S

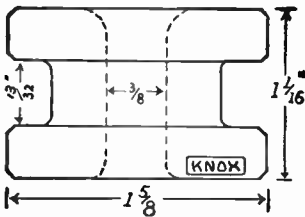

1 groove. Standard package 500. Weight, standard package, 75 pounds.
Per 1000..... **\$59.80**

No. 6572

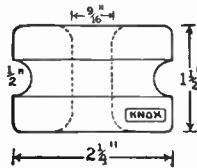

Single groove. Standard package 500. Weight, standard package, 180 pounds.
Per 1000..... **\$234.40**

No. 6061

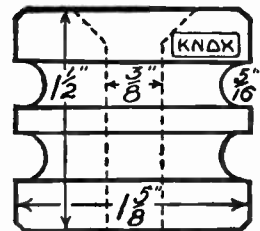

2 groove. Standard package, 500. Weight, standard package, 105 pounds.
Per 1000..... **\$82.00**

Porcelain Telephone Cleats

**No. 333, Top
No. 333 1/2, Base**

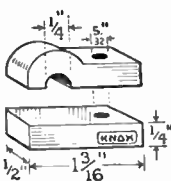

No.....	333	333 1/2
Std. Pkg.....	1000	1000
Std. Pkg. Wt., Lbs..	26	22
Per 1000.....	\$39.20	\$34.10

**No. 314, Top
No. 315, Base**

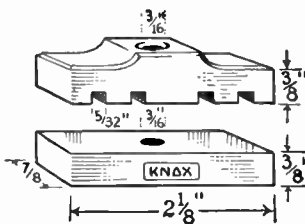

No.....	314	315
Std. Pkg.....	1000	1000
Std. Pkg. Wt., Lbs..	35	35
Per 1000.....	\$75.30	\$72.90

No. 7137-C

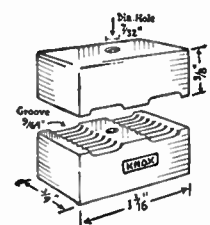

Western Electric "C". Standard package, 1000. Weight, standard package, 72 pounds.
Per 1000..... **\$47.10**

Knox Porcelain Standard Tubes



Length Under Head Inches	5/16-Inch Hole 3/16-Inch O.D.			3/8-Inch Hole 11/16-Inch O.D.			1/2-Inch Hole 13/16-Inch O.D.		
	Tubes per Barrel	Wt. Lb. Barrel	Per 1000	Tubes per Barrel	Wt. Lb. Barrel	Per 1000	Tubes per Barrel	Wt. Lb. Barrel	Per 1000
1/2	1800	380	\$18.50	1000	390	\$23.10	7000	400	\$
1	1100	370	19.60	7500	380	24.30	6000	375	31.20
1 1/2	950	380	20.80	6500	370	25.40	4200	345	32.30
2	700	310	5000	355	27.70	3400	335	34.60
2 1/2	550	310	4000	305	2200	275	38.10
3	450	290	3100	280	2000	280	42.70
4	360	285	2300	270	1400	275	55.40
5	290	285	1900	270	1200	295	69.30
6	200	235	1400	280	1000	285	83.20
8	1500	210	104.00	1200	250	121.00	800	300	150.00
10	1500	280	193.00	1000	265	215.00	600	265	248.00
12	1000	260	281.00	850	235	309.00	525	225	346.00
14	700	215	371.00	550	205	402.00	400	205	445.00
16	550	215	460.00	435	190	496.00	325	200	543.00
18	425	195	548.00	325	170	589.00	280	195	640.00
20	360	185	637.00	225	155	682.00	200	160	739.00
24	350	200	816.00	225	175	869.00	200	180	936.00

Length Under Head Inches	5/8-Inch Hole 15/16-Inch O.D.			3/4-Inch Hole 13/16-Inch O.D.			1-Inch Hole 1 1/16-Inch O.D.		
	Tubes per Barrel	Wt. Lb. Barrel	Per 1000	Tubes per Barrel	Wt. Lb. Barrel	Per 1000	Tubes per Barrel	Wt. Lb. Barrel	Per 1000
1	4500	380	\$46.20	3700	330	\$69.30	1900	380	\$115.00
1 1/2	3200	375	53.10	2500	320	80.80	1500	360	129.00
2	2500	355	60.10	1800	310	92.40	1100	315	144.00
2 1/2	2000	325	67.00	1500	295	104.00	900	330	160.00
3	1800	210	75.10	1100	285	115.00	800	315	173.00
4	1200	265	92.40	850	250	134.00	600	300	194.00
5	1100	225	109.00	650	255	152.00	500	290	215.00
6	900	255	127.00	525	255	171.00	400	280	236.00
8	700	255	162.00	400	245	208.00	325	290	278.00
10	500	255	289.00	350	240	335.00	245	270	434.00
12	375	220	393.00	300	240	450.00	190	255	577.00
14	310	215	497.00	250	230	568.00	150	230	722.00
16	250	205	601.00	185	205	686.00	140	230	866.00
18	200	205	705.00	160	200	804.00	110	210	1011.00
20	160	175	808.00	125	180	922.00	85	195	1155.00
24	160	195	1016.00	125	210	1155.00	85	215	1444.00

Length Under Head Inches	1 1/4-Inch Hole 1 1/16-Inch O.D.			1 1/2-Inch Hole 2 1/16-Inch O.D.			1 3/4-Inch Hole 2 1/8-Inch O.D.		
	Tubes per Barrel	Wt. Lb. Barrel	Per 1000	Tubes per Barrel	Wt. Lb. Barrel	Per 1000	Tubes per Barrel	Wt. Lb. Barrel	Per 1000
1 1/2	650	310	\$173.00	450	345	\$243.00
2	600	330	196.00	400	335	266.00	275	300	358.00
2 1/2	525	320	219.00	355	325	295.00	250	380	393.00
3	425	310	243.00	300	315	323.00	225	370	427.00
4	360	310	277.00	250	305	370.00	200	360	514.00
5	325	305	314.00	220	305	416.00	175	340	601.00
6	250	300	354.00	180	305	468.00	150	320	693.00
8	180	290	435.00	140	300	566.00	145	300	866.00
10	140	265	520.00	110	300	670.00	140	290	1039.00
12	120	265	808.00	90	280	1186.00	120	280	1848.00
14	100	255	1005.00	75	275	1428.00	90	260	2194.00
16	85	175	1207.00	65	265	1669.00	60	255	2541.00
18	70	235	1396.00	55	250	1921.00	50	250	2887.00
20	55	215	1596.00	50	220	2163.00	50	210	3234.00
24	55	210	1995.00	50	250	2656.00	50	250	3927.00

Knox Standard 2-Wire Porcelain Cleats

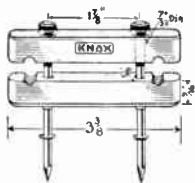

No. 336 Assembled on nails.
 No. 337 Assembled on screws.
 Width inches 3/16
 Length inches 3 3/8
 Size Wire 12 to 14
 Wt. per 1000 pair lb. 225

No. 336 . . . per 1000 **\$81.70** No. 337 . . . per 1000 **\$100.80**

Republic Rigid Threaded Conduit, Couplings and Elbows

Easy-bending steel raceway, produced by "continuous weld" process. Uniform; free from "burnt" or hard spots which might cause cutting, threading or bending problems. Welds will not open even under severe abuse. Cuts free-running threads easily and cleanly. Inside surface is smooth and free of burrs and rough spots.



ENAMELITE® Finish

Red Label: Protected inside and outside with a heavy, baked-on coating of tough, wear-resisting black enamel. Coating is highly resistant to acid types of corrosion, particularly where sulphuric fumes are present.



GALVITE® Finish

Blue Label: Hot-dip galvanized inside and outside, with a special coating of baked-on lacquer applied inside and outside to further insure high corrosion-resisting properties.

Size In.	Wt. Lbs. Per Ft.		O.D. In.	I.D. In.	Thickness Inches	Threads Per In.
	Galvite	Enamelite				
1/4	.416	.429	.510	.361	.088	18
3/8	.595	.570	.675	.493	.091	18
1/2	.844	.806	.840	.622	.109	14
3/4	1.106	1.053	1.050	.821	.113	14
1	1.608	1.517	1.315	1.019	.133	11 1/2
1 1/4	2.110	2.011	1.660	1.380	.140	11 1/2
1 1/2	2.559	2.490	1.900	1.610	.145	11 1/2
2	3.585	3.437	2.375	2.067	.154	11 1/2
2 1/2	5.474	5.270	2.875	2.469	.203	8
3	7.121	7.003	3.500	3.068	.216	8
3 1/2	9.039	8.685	4.000	3.548	.226	8
4	10.412	10.572	4.500	4.026	.237	8
5	15.158	14.925	5.563	5.047	.258	8
6	20.037	19.800	6.625	6.065	.280	8

Conduit

All dimensions shown above are nominal. Conduit is furnished in accordance with American Standards Association specifications C80.1 or C80.2 and Federal Specifications WW-C-581 or WW-C-571, latest revision.

Conduit is furnished in 10-foot lengths, threaded both ends, with coupling screwed on one end and thread protector on the other.

Conduit is always designated by its nominal inside diameter.

Couplings and Elbows

Size In.	Couplings Weight Each Pounds	90° Elbows			Thread Length Inches	Weight Each Pounds
		Radius Inches	Tangent Inches	Offset Inches		
1/4	.060410
3/8	.095550
1/2	.124	4	2 3/4	6 3/4	.75	.881
3/4	.187	4 1/2	2 3/4	7 3/4	.76	1.262
1	.314	5 3/4	2 3/4	8 1/2	.91	1.937
1 1/4	.393	7 1/4	3 1/4	10 1/2	.97	2.931
1 1/2	.539	8 1/4	3 1/4	11 1/2	.98	4.156
2	.904	9 1/2	4	13 1/2	1.12	6.877
2 1/2	1.730	10 1/2	4 1/4	14 3/4	1.51	11.322
3	2.897	13	4 1/4	17 1/4	1.57	19.869
3 1/2	3.621	15	4 3/4	19 3/4	1.62	28.081
4	3.966	16	5	21	1.67	32.637
5	7.784	24	6 1/8	30 1/8	1.78	66.000
6	10.031	30	6 1/2	36 1/2	1.89	96.450

Prices on application.

Triangle Rigid Steel Conduit, Couplings and Elbows

Hot-Dipped Galvanized or Black Enameled Finish

Conforming to Federal Specifications WWC 581A (Galvanized) and WWC 571 (Enameled)



Hot-Dipped Galvanized

In hot-dip galvanizing each length of Triangle conduit is immersed in a bath of molten virgin zinc (99.85% pure), thoroughly galvanizing the interior as well as the exterior surfaces.

Intimate contact of the surfaces of the tube with the molten zinc results in an alloying action which thoroughly bonds the pure zinc coating to the pipe.

Further protection against corrosion is provided by submerging the conduit in a bath of specially prepared linseed oil base lacquer. A thorough baking of the lacquer produces a smooth, even, continuous finish.



Black Enameled

Finished with high quality, tough, elastic black enamel. Thoroughly baked to produce a durable black luster.

Conduit

Size in.	Weight Per Ft. Pounds	O. D. In.	I. D. In.	Thick-ness In.	Threads Per In.
1/2	.852	.840	.622	.109	14
3/4	1.134	1.050	.824	.113	14
1	1.684	1.315	1.049	.133	11 1/2
1 1/4	2.281	1.660	1.380	.140	11 1/2
1 1/2	2.731	1.900	1.610	.145	11 1/2
2	3.678	2.375	2.067	.154	11 1/2
2 1/2	5.819	2.875	2.469	.203	8
3	7.616	3.500	3.068	.216	8
3 1/2	9.202	4.000	3.548	.226	8
4	10.889	4.500	4.026	.237	8
5	14.810	5.563	5.047	.258	8
6	19.185	6.625	6.065	.280	8

Conduit furnished in 10-ft. lengths, threaded both ends, with one coupling. Conduit pipe is known and spoken of by its nominal inside diameter.

Couplings and Elbows

Size in.	Couplings Weight Per 100 Pieces, Pounds	90° Elbows		
		Weight Per 100 Pieces, Pounds	Radius Inches	Offset Inches
1/2	11.6	82	4.000	6.500
3/4	20.9	109	4.500	7.250
1	34.3	201	5.750	8.625
1 1/4	53.5	313	7.250	10.000
1 1/2	74.3	441	8.250	11.000
2	120.8	707	9.500	13.625
2 1/2	172.0	1411	10.500	15.687
3	249.8	1850	13.000	17.750
3 1/2	424.1	2979	15.000	20.000
4	474.1	3528	16.000	21.312
5	700.0	6575	24.000	29.000
6	750.0	9645	30.000	36.500

Prices on application.

Triangle Plastic Conduit—Semi-Rigid



Size in.	Weight Pounds Per Ft.	O.D.	I.D.
1/2	.040	.600	.500
3/4	.062	.855	.750
1	.109	1.140	1.000
1 1/4	.166	1.420	1.250
1 1/2	.271	1.730	1.500
2	.388	2.250	2.000
*2 1/2	.446	2.570	2.320
3	.636	3.250	2.978
4	.956	4.100	3.758
*6	2.261	6.220	5.700

Dimensions of 90° Elbows

Size, in.	Radius to Center of Tube in.	Straight Length at Each End, in.
1/2	4	1 1/2
3/4	4 1/2	1 1/2
1	5 3/4	1 7/8
1 1/4	7 1/4	2
1 1/2	8 1/4	2
2	9 1/2	2
*2 1/2	10 1/2	3
3	13	3 1/8
4	16	3 3/8
*6	30	3 3/4

Conduit furnished 20-ft. lengths, 1 coupling cemented per length.

All dimensions given above are nominal.

*Sizes manufactured on special order.

Smooth inner walls facilitate fishing wire. Lightweight—easy to install.

Triangle Plastic Conduit—Rigid Standard Wall

Size in.	Weight Pounds Per Ft.	O.D.	I.D.
1/2	.12	.840	.622
3/4	.16	1.050	.844
1	.23	1.315	1.049
1 1/4	.31	1.660	1.380
1 1/2	.37	1.900	1.610
2	.50	2.375	2.067
3	1.04	3.500	3.068
4	1.50	4.500	4.026
6	2.64	6.625	6.065

Dimensions of 90° Elbows

Size, in.	Radius to Center of Tube in.	Straight Length at Each End, in.
1/2	4	1 1/2
3/4	4 1/2	1 1/2
1	5 3/4	1 7/8
1 1/4	7 1/4	2
1 1/2	8 1/4	2
2	9 1/2	2
*2 1/2	10 1/2	3
3	13	3 1/8
4	16	3 3/8
*6	30	3 3/4

Furnished 20 or 10-ft. lengths, plain ends.

All dimensions given above are nominal.

Lightweight, easily suspended. Particularly useful as overhead conduit in corrosive atmospheres.

*Sizes manufactured on special order.

National Electric Rigid Steel Conduit Couplings and Elbows

"Sherarduct"



A high grade, rigid steel conduit that has been galvanized by a dry process of galvanizing known as Sherardizing. The steel conduit and commercially pure zinc dust are heated together at a very high temperature. In this process, the zinc combines with the steel to form zinc-steel alloys which become a part of the steel wall. Being an intergal part of the steel conduit wall, the galvanized coating cannot flake or scale; even the threads are Sherardized.

Additional interior, exterior protection is provided by National Electric's new MVC-1 enamel. This enamel coating is composed of a modified vinyl copolymer and is plasticized and pigmented. MVC-1 vinyl enamel is highly impervious to all chemical attacks; it also withstands extreme mechanical abuse without fracture or skimming of the coating. MVC-1 enamel has elasticity that allows bends and general working of conduit without damage to the interior bonded coating of enamel.

Sherarduct with its new MVC-1 enamel coating guarantees double corrosion protection.

"Superduct"



Completely new, Superduct was specially designed to answer a definite need for a protective electrical conduit for locations where corrosion is both severe and costly. Like Sherarduct, this conduit is made of high quality steel, rigid, with threads, couplings and conduit zinc-coated by the sherardizing process of galvanizing.

After the galvanizing process, Superduct is then coated, inside and out, with a special vinyl chloride-acetate copolymer, pigmented and plasticized enamel finish. The vinyl enamel resists the corrosive and deteriorating action of practically all chemicals, greases, oils, moisture, salt water and severe weather conditions.

"Xduct"



The improved Xduct rigid threaded steel conduit now has a new interior finish which is a baked-on-coating of aluminum enamel. The outside surface is also new; a heavy and uniform coating of electrolytically pure zinc is deposited on the outside surfaces of the conduit by an exclusive end-suspension technique. This insures a zinc coating which adheres to the basic steel and has exceptional resistance to both corrosion and to flaking during bending operations.

A special brightening agent, applied over the pure zinc electrogalvanizing, gives Xduct conduits a highly-polished appearance and makes it ideal for exposed-to-view installations.

Twice as easy to start pull, and 66% easier to continue pulling wires, as proved by actual test results.



Economy Enameled Conduit

Made of homogeneous, fine-grain steel.

Tough, flexible, enamel applied by immersing conduit.

Clean, scale-free surfaces prepared before immersion eliminate any possible cracking off of enamel. Threads are kept clean by protectors during enameling.

Threaded on both ends and shipped in lengths of 10-feet, including coupling.

Sherarduct, Superduct, Xduct, Economy Rigid Conduits

Size In.	Approx. O.D. In.	Approx. I.D. In.	Approx. Wall Thickness In.	Threads Per In.	Approx. Wgt. Lbs. Per M. Ft.
1/2	.810	.622	.109	14	820
3/4	1.050	.824	.113	14	1120
1	1.315	1.049	.133	11 1/2	1600
1 1/4	1.660	1.380	.140	11 1/2	2160
1 1/2	1.900	1.610	.145	11 1/2	2680
2	2.375	2.067	.154	11 1/2	3500
2 1/2	2.875	2.469	.203	8	5600
3	3.500	3.068	.216	8	7120
3 1/2	4.000	3.548	.226	8	8520
4	4.500	4.026	.237	8	10300
5	5.563	5.047	.258	8	13910
6	6.625	6.065	.280	8	18500

Conduit Elbows

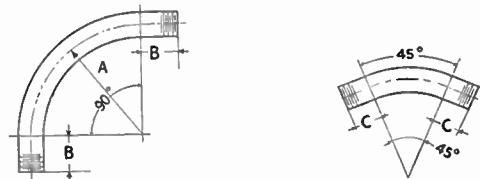

Trade Size In.	90° Elbows				45° Elbows		
	Approx. O.D. In.	Approx. I.D. In.	Dimensions Inches		Weight Pounds Per 100	Weight Pounds Per 100	
1/2	.810	.622	4	2 3/4	80	4 1/4	80
3/4	1.050	.824	4 1/2	2 3/8	105	4 1/8	105
1	1.315	1.049	5 3/4	2 7/8	191	3 5/8	152
1 1/4	1.660	1.380	7 1/4	2 3/4	300	4 1/2	260
1 1/2	1.900	1.610	8 1/4	3 1/2	441	4 5/8	347
2	2.375	2.067	9 1/2	4 1/4	692	4 3/4	472
2 1/2	2.875	2.469	10 1/2	5 1/2	1230	8 3/8	1118
3	3.500	3.068	13	5 3/4	1850	7 7/8	1510
3 1/2	4.000	3.548	15	7	2700	8 7/8	2120
4	4.500	4.026	16	7 1/8	3528	8 1/2	2650
5	5.563	5.047	24	6 1/8	6575	6 1/8	4076
6	6.625	6.065	30	6 1/2	9645	8 3/4	6590

Couplings

Trade Size In.	O.D. In.	Length In.	Approx. Wt. Pounds Per 100	Trade Size In.	O.D. In.	Length In.	Approx. Wt. Pounds Per 100
1/2	1.010	1 9/16	14	2 1/2	3.250	3 1/8	180
3/4	1.250	1 5/8	24	3	4.000	3 1/4	300
1	1.525	2	39	3 1/2	4.500	3 3/8	390
1 1/4	1.869	2 1/16	47	4	5.000	3 1/2	400
1 1/2	2.155	2 1/16	66	5	6.296	3 3/4	760
2	2.730	2 1/8	105	6	7.390	4	1075

Prices on application.

Anaconda Everdur Electrical Conduit

High-strength, corrosion-resistant conduit, composed of non-magnetic copper-silicon alloy. Possesses high strength, exceptional ductility and fatigue-resistance.

Suitable for use in installations where unusually corrosive conditions are encountered.

Seamless Rigid Conduit

Listed by the Underwriters' Laboratories, Inc.



Supplied in nominal sizes from 1/4 to 4 inches. As ordinarily supplied, the 10-foot lengths are threaded both ends with one Everdur coupling attached.

Nom. Size In.	Outside Diameter In.	Inside Diameter In.	Wall Thickness In.	Wt. Per Foot Lbs.
1/4	.540	.382	.079	.431
3/8	.675	.503	.086	.600
1/2	.840	.636	.102	.893
3/4	1.050	.834	.108	1.21
1	1.315	1.075	.120	1.70
1 1/4	1.660	1.382	.139	2.51
1 1/2	1.900	1.614	.143	2.99
2	2.375	2.077	.149	3.94
2 1/2	2.875	2.519	.178	5.71
3	3.500	3.084	.208	8.14
3 1/2	4.000	3.548	.226	10.1
4	4.500	4.026	.237	12.0

Seamless EMT Conduit

Listed by the Underwriters' Laboratories, Inc.



Everdur Electric Metallic Tubing is a thin-wall conduit made of Everdur metal. Available, in sizes 3/8 to 2 inches in diameter, in standard 10-foot lengths, for assembly with threadless fittings to facilitate installation or dismantling.

Nom. Size In.	Outside Diameter In.	Inside Diameter In.	Wall Thickness In.	Wt. per Foot Lbs.
3/8	.577	.493	.042	.2677
1/2	.706	.622	.042	.3322
3/4	.922	.824	.049	.5096
1	1.163	1.049	.057	.751
1 1/4	1.510	1.380	.065	1.119
1 1/2	1.740	1.610	.065	1.297
2	2.197	2.067	.065	1.651

Seamless Raceways

Special sizes are available up to 4" nominal, with wall thicknesses comparable to Everdur Electrical Metallic Tubing, in random lengths of 10 to 14 feet. Not listed by Underwriters', but are specified as Everdur Seamless Raceways.

Nom. Size In.	Outside Diameter In.	Inside Diameter In.	Wall Thickness In.	Approx. Wt. per Foot Lbs.
2 1/2	2.605	2.469	.068	2.055
2 3/4	2.875	2.739	.068	2.274
3	3.210	3.068	.071	2.655
3 1/4	3.500	3.358	.071	2.900
3 1/2	3.696	3.548	.074	3.193
3 3/4	4.000	3.852	.074	3.461
4	4.182	4.026	.078	3.813

Prices on application.

Seamless Couplings

For Rigid Conduit—With Tapered Threads

All Everdur couplings have tapered threads which provide the stronger and tighter joints essential for installations in hazardous locations.

Nom. Size In.	Outside Diameter In.	Minimum Length In.	Wgt. Lbs. Per 100 Pieces
1/4	.719	1 3/16	8
3/8	.840	1 1/8	10
1/2	1.063	1 9/16	11
1/2	1.063	1 9/16	20
3/4	1.313	1 5/8	30
1	1.576	2	50
1 1/4	1.950	2 1/16	70
1 1/2	2.220	2 1/16	80
2	2.750	2 1/8	120
2 1/2	3.280	3 1/8	250
3	4.000	3 1/4	370
3 1/2	4.500	3 3/8	450
4	5.000	3 1/2	500

Seamless Rigid Conduit Elbows

Threaded Both Ends—Without Coupling

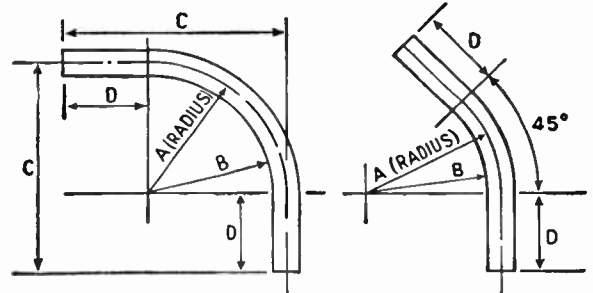

Listed under Factory Inspection and Label Service Procedure by the Underwriters' Laboratories, Inc.

Approximate Dimensions, Inches

Nom. Size In.	A (Radius)	B	C Offset 90° Elbow	D Tangent 90° Elbow & 45° Elbow
1/2	4	3 9/16	6 3/4	2 3/4
3/4	4 1/2	4	7 1/2	3
1	5 3/4	5 1/16	8 3/4	3
1 1/4	7 1/4	6 7/16	10 1/4	3
1 1/2	8 1/4	7 9/16	12	3 3/4
2	9 1/2	8 9/16	14 1/2	5
2 1/2	10 1/2	9 1/16	15 1/2	5
3	13	11 1/4	19 3/4	6 3/4
3 1/2	15	13	22	7
4	16	13 3/4	23	7

Seamless EMT Conduit Elbows

Everdur (Not Threaded)

Nom. Size In.	A	B	C	D
1/2	4	3 3/8	6 3/4	2 3/4
3/4	4 1/2	4 1/16	7 1/2	3
1	5 3/4	5 1/8	8 3/4	3
1 1/4	7 1/4	6 1/2	10 1/4	3
1 1/2	8 1/4	7 3/8	12	3 3/4
2	9 1/2	8 3/8	14 1/2	5

Alcoa Aluminum Rigid Conduit, Couplings and Elbows

Approved by Underwriters' Laboratories, Inc.



Lightweight, corrosion-resistant aluminum conduit for longer service life, easier handling during installation and more efficient performance of electrical systems.

The lower reactance of aluminum conduit systems results in a lower voltage drop than that of systems using magnetic conduit. Conductors of a single or polyphase system may be enclosed, regardless of the electrical load, each in a separate aluminum conduit.

Aluminum conduit cannot discolor or stain adjacent surfaces. Painting is not necessary except under severest service conditions.

Furnished in 10-ft. lengths, one end fitted with a coupling.

For use with standard threading fittings, of aluminum or galvanized or cadmium-plated iron or steel.

Easily bent with rigid conduit bending tool for sizes 1-in. and larger and with thin-wall conduit bending tool for size 3/4-in. and smaller.

Trade Size In.	O.D. In.	I.D. In.	Length without Couplings		Min. WL 10 Lgths.—10 ft. L. w/Couplings Lbs.
			Ft.	In.	
1/4	0.510	0.361	9	11 1/2	13.3
3/8	0.675	0.493	9	11 1/2	17.8
1/2	0.810	0.622	9	11 1/4	27.4
3/4	1.050	0.824	9	11 1/4	36.4
1	1.315	1.049	9	11	53.0
1 1/4	1.660	1.380	9	11	69.6
1 1/2	1.900	1.610	9	11	86.2
2	2.375	2.067	9	11	115.7
2 1/2	2.875	2.469	9	10 1/2	182.5
3	3.500	3.068	9	10 1/2	238.9
3 1/2	4.000	3.518	9	10 1/4	287.7
4	4.500	4.026	9	10 1/4	340.0

Aluminum Conduit Elbows and Couplings

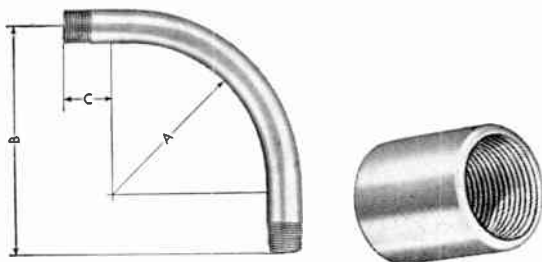

Trade Size In.	A	B	C	Approx. WL 90° Elbows	Each, Lbs. Couplings
1/4	3 49/64	6 3/4	3	0.15	0.034
3/8	3 25/32	6 3/4	3	0.20	0.039
1/2	4	6 11/16	2 11/16	0.29	0.061
3/4	4 1/2	7 13/32	2 29/32	0.13	0.091
1	5 3/4	8 27/64	2 43/64	0.71	0.125
1 1/4	7 1/4	9 7/8	2 5/8	1.10	0.189
1 1/2	8 1/4	11 1/2	3 1/4	1.53	0.233
2	9 1/2	13 25/32	4 19/32	2.49	0.346
2 1/2	10 1/2	15 1/4	4 3/4	4.37	0.683
3	13	20 3/8	7 3/8	7.67	0.914
3 1/2	15	22 13/16	7 13/16	10.36	1.08
4	16	23	7	12.28	1.42

Prices on application.

Alcoa Aluminum E.M.T.

Approved by Underwriters' Laboratories, Inc.



Lightweight, easily handled aluminum tubing. Highly corrosion-resistant for long life, indoors or out.

Cannot discolor or stain adjacent surfaces.

Furnished in 10-ft. lengths, not threaded.

Trade Size In.	O.D. In.	I.D. In.	Length Ft.	WL Per 100 Ft. Lbs.
3/8	0.577	0.493	10	8.5
1/2	0.706	0.622	10	10.3
3/4	0.922	0.824	10	15.8
1	1.163	1.049	10	23.8
1 1/4	1.510	1.380	10	34.8
1 1/2	1.740	1.610	10	40.2
2	2.197	2.067	10	51.2

Prices on application.

Triangle E.M.T. Conduit and Elbows

Conforming to Federal Specification WWT-806A

Electro-Galvanized



Produced from flat cold-rolled steel, oxy-acetylene welded to form a perfectly true tube of uniform thickness and strength.

Tubing, which is threadless and much lighter in weight than heavy wall conduit, is first thoroughly pickled and cleaned to remove all scale and foreign substances adhering to its surfaces and is then immersed in a bath of molten virgin zinc (99.85% pure.)

Tubing sizes up through 2-inches are approved by N.E.C. for use on circuits where the conductor size does not exceed No. 1/0 and where the voltage does not exceed 600 volts.

Conduit furnished in 10-ft. lengths.

Conduit

Size In.	I. D. In.	O. D. In.	FL Per Bundle	WL Per 1000 Ft. Pounds
1/2	.622	.706	100	321
3/4	.824	.922	100	488
1	1.049	1.163	100	711
1 1/4	1.380	1.508	50	1000
1 1/2	1.610	1.738	50	1180
2	2.067	2.195	50	1500

90° Elbows Without Couplings

Size, Inches	1	1 1/4	1 1/2	2
Weight, per 100 lbs.	100	144	180	277

Also available in 45° elbows. Elbows are of same high-grade material as tubing, and are protected against corrosion by the same process of cleaning and coating.

Call Graybar FIRST For . . .

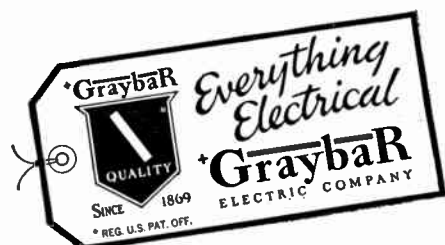

Republic Electrunite® E.M.T. and Elbows
Lightweight Rigid Steel Raceway—Threadless

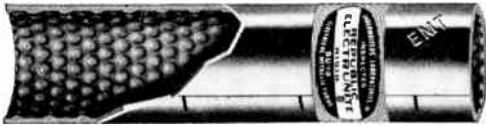

High-strength, ductile E.M.T. for protection of electrical conductors.

Requires no thread cutting. Galvanized, vibration-proof compression fittings slip over tube without disturbing the corrosion-resisting zinc coating.

Easily bent and formed; “Inch-Marked” and “Guide-Lined” for convenience. Knurled inner surfaces make wire pulling as much as 30% easier.

Approved by N.E.C. for exposed, concealed or concrete slab construction. Particularly suited for use in close quarters, such as narrow spaces between pans in concrete work.

ELECTRUNITE E.M.T. is furnished in galvanized finish in accordance with American Standards Association Specification C80.3. Federal Specification WW-T-806 and Underwriters’ Laboratories Standards.

Conduit

Trade Size Inches	O.D. In.	Nom. I.O. In.	Nom. Wall Thickness Inches	Min. Wt. Per 100 Ft. Pounds	Ft. Per Bundle
3/8	0.577	0.493	0.042	23	200
1/2	0.706	0.622	0.042	28.5	100
3/4	0.922	0.824	0.049	43.5	100
1	1.163	1.049	0.057	68	100
1 1/4	1.510	1.380	0.065	95	50
1 1/2	1.740	1.610	0.065	110	50
2	2.197	2.067	0.065	140	30

†Furnished with knurled inside finish, “Inch-Marked” and “Guide-Lined”. All sizes furnished in 10-foot lengths.
 ††“Inch-Marked” and “Guide-Lined.”

45° Elbows

Size In.	Min. Radius to C.L. of Tubing Inches	Nominal Offset Inches	Min. Straight Length—Ls at Each End Inches	Wt. Per 100 Pcs. Pounds	Std. Pkg.
1	5.000	6.3125	5.250	87.5	25
1 1/4	5.500	6.8175	5.500	124	25
1 1/2	6.875	6.9375	5.125	147	20
2	8.000	7.4375	6.000	226	10

90° Elbows

Size In.	Min. Radius to C.L. of Tubing Inches	Nominal Offset Inches	Min. Straight Length—Ls at Each End Inches	Wt. Per 100 Pcs. Pounds	Std. Pkg.
1	5.750	7.812	2.062	76	25
1 1/4	7.370	9.375	2.000	104	25
1 1/2	8.625	10.625	2.000	195	20
2	9.500	12.375	2.875	290	10

Prices on application.

Republic *Electrunite®
“Dekoron-Coated” E.M.T.

Polyethylene Coated Rigid Steel Raceway

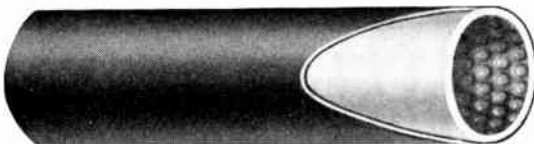

“Dekoron-Coated” E.M.T., standard galvanized electrical metallic tubing protected by an extruded covering of polyethylene, provides an economical means of eliminating corrosion damage to electrical raceway systems. The chemical-resistant polyethylene coating protects E.M.T. against unusual corrosive conditions, that exist in chemical plants, meat-packing plants or sewerage disposal plants.

“Dekoron-Coated” E.M.T. needs no special tools for installation. Standard E.M.T. fittings or, by the use of a connector, threaded conduit fittings are used.

Standard chemical-resistant tapes available permit completely corrosion-resistant systems to be provided by forming atmosphere-tight wrapping over fittings and couplings.

In addition to the excellent chemical resistance of polyethylene, it possesses toughness, good weathering characteristics, insensitivity to moisture, flexibility and dimensional stability over a wide temperature range.

For further information, prices and technical data, contact Graybar.

® Trade Mark.

National Electric Xduct Junior E.M.T. and Elbows

Electro-Galvanized



Uniform unbroken zinc coating produced by electro-galvanizing.

Inside surfaces furnished additional protection by a complete covering of aluminum enamel. Enamel will not crack or break down even under severe baking and bending. Not affected by weather. Provides permanent protection against abrasion, moisture and corrosion.

E.M.T.

Size In.	Internal Diameter, In.	External Diameter, In.	Feet Per Bundle	Min. Wt. Lbs. Per M-Feet
1/2	.622	.706	100	285
3/4	.824	.922	100	435
1	1.049	1.163	100	640
1 1/4	1.380	1.510	50	950
1 1/2	1.610	1.740	50	1100
2	2.067	2.197	30	1400

American Brass Sealtite* Flexible, Liquid-Tight Conduit



Flexible, liquid-tight conduit for protecting electrical conduit from moisture, oil, grease, dirt, chemicals, corrosive fumes, abrasion, etc., in both indoor and outdoor connection. Reduces burnouts, downtime. Construction: Flexible galvanized steel core over which is extruded a polyvinyl chloride cover. Supplied in corrugated cartons on non-returnable reels; can be cut and assembled on the job. Takes standard liquid-tight connectors.

Three general types: U.A. (Underwriters’ Laboratories Approved) C.S.A. (Approved by Canadian Standards Association) E.F. (Meets J.I.C. (Joint Industry Conference requirements). Colors: Black, gray. (Black only on C.S.A. type).

Specifications—Type U.A. And Type C.S.A.

Trade Size In.	Outside Diameter		Appr. Inside Bend Diam.	Appr. Wt. Lbs. Per 100 Ft.	Ft. Per Std. Coil
	Min.	Max.			
3/8	.690	.710	8	30.0	200
1/2	.820	.840	10	36.6	200
3/4	1.030	1.050	15	48.2	150
1	1.290	1.315	18	87.7	100
1 1/4	1.630	1.660	21	116.5	50

Specifications—Type E.F.

Trade Size In.	Outside Diameter	Inside Bend Diam.	Appr. Wt. Lbs. Per 100 Ft.	Ft. Per Std. Coil
3/8	.690	.710	5	24.0
1/2	.820	.840	5	29.0
3/4	1.030	1.050	6	38.5
1	1.290	1.315	8	67.5
1 1/4	1.630	1.655	10	87.0
1 1/2	1.875	1.900	12	117.0
2	2.350	2.375	15	155.0
2 1/2	2.850	2.875	20	198.0
3	3.470	3.500	26	282.0
4	4.465	4.500	34	414.5

*Trade Mark

Triangle Plastic Conduit—Flexible



Lightweight, easy to handle, corrosion resistant. Particularly useful protecting wires on poles.

Size, In.	Wt. Lbs. Per 100 Ft.	O.D.	I.D.	Reel or Coil Length in Feet
1/2†	7.1	.782	.622	600 or 100
3/4†	11.7	1.024	.824	500 or 100
1†	18.6	1.300	1.050	500-300-100
1 1/4	26.7	1.660	1.380	300 or 100
1 1/2	31.8	1.900	1.610	250 or 100
2	45.0	2.375	2.067	200 or 100
3	90.0	3.500	3.068	100 or 20*
4	125.0	4.500	4.026	20*
6	233.0	6.625	6.065	20*

All dimensions shown above are nominal.

*Straight lengths.

†75-psi Pressure Rated type—all other sizes are Standard Wall.

Triangle Flexible Steel Conduit

Conforming to Federal Specification WWC-566

Hot-Dipped Galvanized



Interlocking convolutions permit short radius bends without danger of accidental opening. Interior surface cannot snag wires.

Trade Size in Inches	Nominal Inside Diam., Inches	Approx. Ft. Per Std. Coil	Wt. Lbs. Per 1000 Feet
5/16	5/16	250	150
3/8	3/8	250	255
1/2	5/8	100	470
3/4	13/16	50	575
1	1	50	1020
1 1/4	1 1/4	50	1250
1 1/2	1 1/2	25	1620
2	2	25	2125
2 1/2	2 1/2	25	2630
3	3	25	3130

National Flexsteel Flexible Metallic Conduit



Rounded channel-iron shape provides strength and makes fishing easy over the roller-bearing surfaces.

Spring action of the cold-rolled steel holds a true circular cross section under any bend.

Size In.	Ft. per Std. Coil	Approx. Wt. Per M-FL Pounds
5/16	250	150
3/8	250	255
1/2	100	470
3/4	50	575
1	50	1020
1 1/4	50	1250
1 1/2	25	1620
2	25	2125
2 1/2	25	2630
3	25	3130

Conduit Pipe Products

Conduit Pipe Couplings



Hot-Dip Galvanized or Black Enameled

For user's convenience sizes 1/2-in. to 2-in., inclusive. Cartoned in standard packages.

Pipe Size, In.	Approx. Wt., Lbs. Per 100	Approx. Wt., Lbs. Per Ctn.	Qty. Per Ctn.	Per 100
1/2	13	13	100	\$11.00
3/4	19	9	50	16.00
1	31	10	30	23.00
1 1/4	42	10	25	28.00
1 1/2	59	15	25	38.00
2	97	19	20	59.00
2 1/2	184	—	—	137.00
3	300	—	—	199.00
3 1/2	372	—	—	288.00
4	424	—	—	317.00
4 1/2	520	—	—	598.00
5	700	—	—	598.00
6	1080	—	—	814.00

Conduit 90 Degree Elbows

Hot-Dip Galvanized

Underwriters' Labeled

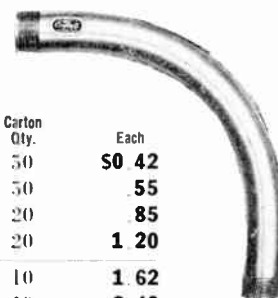

Pipe Size, In.	Std. Radius to C/L Pipe, In.	Approx. Wt., Lbs. Per 100	Carton Qty.	Each
1/2	4	76	50	\$0.42
3/4	4 1/2	110	50	.55
1	5 3/4	205	20	.85
1 1/4	7 1/4	325	20	1.20
1 1/2	8 1/4	450	10	1.62
2	9 1/2	720	10	2.48
2 1/2	10 1/2	1300	—	4.64
3	13	2000	—	7.45
3 1/2	15	2800	—	13.50
4	16	3500	—	15.70
5	21	7500	—	42.00
6	30	11500	—	57.00

The 1/2-in. to 2-in. size elbows are cartoned in standard packages. Other sizes furnished with thread protectors.

Standard Radius 45 degree elbows available but furnished with same prices as shown above.

E.M.T. Conduit 90 Degree Elbows

Galvanized

Underwriters' Labeled

Pipe Size, In.	Std. Radius to C. L. Pipe, In.	Approx. Wt., Lbs. Per 100	Approx. Wt., Lbs. Per Carton	Carton Qty.	Each
1	5 3/4	95	19	20	\$0.45
1 1/4	7 1/4	116	30	20	.66
1 1/2	8 1/4	200	20	10	.86
2	9 1/2	294	29	10	1.56

Fabricated in accordance with specifications of the Underwriters' Laboratories.

Fittings For American Brass Sealtite Flexible Metallic Conduit Appleton—Series "ST"

Schedule ST
For Electrical Wiring on Machinery—Oil and Moisture Tight

Specifically designed to meet UL and JIC Electrical Standards for wiring of machinery by excluding oil, water, acid fumes, chemicals, grease and dirt. Cadmium plated.

"ST" Connectors with Locknut

For use with Outlet or Junction Boxes
Complete with Gasket Assembly and Locknut



Straight



45° Elbow



90° Elbow

*Straight

No.	Nominal Cable Size In.	Hub Size In.	Ctn. Qty.	Std. Pkg.	Wt. Lbs. Per 100	Per 100
ST-38	3/8	1/2	25	100	16	\$ 62 50
ST-50	1/2	1/2	25	100	16	62 50
ST-75	3/4	3/4	25	50	20	89 30
ST-100	1	1	5	25	38	125 00

*45° Elbow

ST-4538	3/8	1/2	25	50	21	\$ 98 30
ST-4550	1/2	1/2	25	50	21	98 30
ST-4575	3/4	3/4	25	50	30	143 00
ST-45100	1	1	5	25	60	286 00

*90° Elbow

ST-9038	3/8	1/2	25	50	25	\$ 98 30
ST-9050	1/2	1/2	25	50	25	98 30
ST-9075	3/4	3/4	10	50	36	143 00
ST-90100	1	1	5	25	78	286 00

*Sizes 1 1/4, 1 1/2, 2, 2 1/2, 3 and 4-in. available.

Connectors



Straight "STJ"



Straight "ST"



Brass "ST"

Straight "STJ" Connectors with Extra-Long Threaded Hub, with Locknut

No.	Nominal Cable Size In.	Hub Size In.	Ctn. Qty.	Std. Pkg.	Wt. Lbs. Per 100	Per 100
STJ-50	1/2	1/2	25	100	18	\$ 68 80
STJ-75	3/4	3/4	25	50	22	96 00
STJ-100	1	1	5	25	40	131 00

Straight "ST" Connectors with Female Threaded Hub

ST-38F	3/8	1/2	25	100	16	\$ 68 80
ST-50F	1/2	1/2	25	100	16	68 80
ST-75F	3/4	3/4	25	60	20	98 40
ST-100F	1	1	5	50	38	137 60

Brass "ST" Connectors without Locknut

ST-38B	3/8	1/2	25	100	18	\$160 00
ST-50B	1/2	1/2	25	100	18	160 00
ST-75B	3/4	3/4	25	50	23	240 00
ST-100B	1	1	5	25	42	360 00

Note: The new "STN" and "STB" Series Sealtite Connectors—sizes 3/8, 1/2, 3/4, 1, 1 1/4, 1 1/2 and 2-in. available.

Accessories for Above:

Gaskets Assemblies

Consists of Neoprene "O" Ring and Steel Reinforcing Ring



No.	K.O. Size In.	Ctn. Qty.	Std. Pkg.	Wt. Lbs. Per 100	Per 100
STG-50	1/2	50	100	1	\$14 40
STG-75	3/4	50	100	1	16 00
STG-100	1	25	50	1	23 20

Note: Sizes 1 1/4, 1 1/2, 2, 2 1/2, 3 and 4-in. available.

Ferrule Assemblies

For use with "ST" Series Connectors



No.	Nominal Cable Size In.	Hub Size In.	Std. Pkg.	Wt. Lbs. Per 100	Per 100
STF-38	3/8	1/2	100	1.2	\$ 9 60
STF-50	1/2	1/2	100	1.5	9 60
STF-75	3/4	3/4	50	2.5	16 00
STF-100	1	1	50	3.5	24 00

Note: Sizes 1 1/4, 1 1/2, 2, 2 1/2, 3 and 4-in. available.

Installation



Screw Ferrule and Sleeve Assembly (A) on end of Liquid-Tight Flexible Conduit. Insert Flexible Conduit with Ferrule attached into connector body.



Tighten nut onto connector body. (Important—nut must be tightened as far as possible to complete compression action which assures liquid-tight seal.)

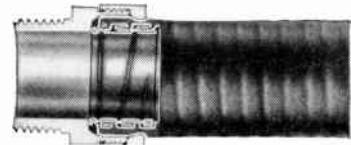

Cross section of completed connection shows how tapered end of nut performs compression action on Ferrule wall, and gives positive ground between flexible conduit and connector.



Ferrule Assembly as seen when nut is loosened and end of Liquid-Tight Flexible Conduit with Ferrule attached is withdrawn from connector body.

Pyle-National CT Series Connectors

**For Use with LIQUID-TIGHT Flexible Conduit
(Sealtite or Equivalent Products)**

"CT" Series connectors can be installed assembled . . . no parts to lose . . . no wasted time. Available in straight, 45 degree and 90 degree types for 3/8" to 2" liquid-tight flexible conduit. Meet U/L and J.I.C. standards.

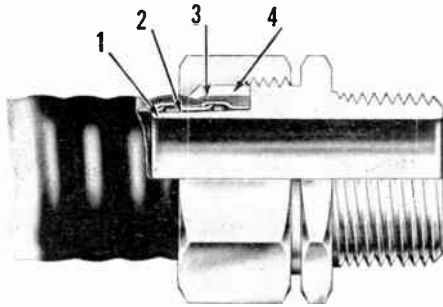

1. Displaced Bending Action

Tapered grounding shank elongated to extend beyond gland nut, thus avoiding short radius bends which shorten life of the conduit sheath and more important the permanency of the joint.

2. Highly Efficient Ground

Less than 10 millivolt drop.
Tapered grounding shank, integral with connector body, makes a firmly wedged contact with the flexible metal conduit.

3. Extra Strong Grip

Compression force is supported—not by the conduit alone—but also by the body shank, making a vise-like clamp. Gripping is well behind end of flexible conduit for firm anchorage against creeping loose.

Pliable seamless sleeve makes a plastic-to-plastic grip with the conduit sheath . . . thereby avoids cutting and abrasion common to metal sleeves.

High safety factor of compression range more than compensates for tolerance in the outside diameter of the flexible conduit.

4. Permanent Seal

Plastic sleeve and conduit sheath have equivalent physical characteristics therefore the seal will last the life of the conduit, unimpaired by temperature variations within the limits of the conduit.

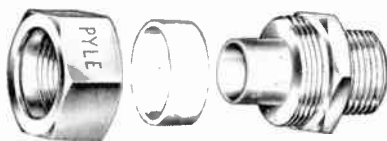

Straight Type—Exploded View

See Complete Listings at Right.

**For Use with LIQUID-TIGHT Flexible Conduit
(Sealtite or Equivalent Products)**

**Protects Wiring from Oil, Grease, Water and Dirt
Designed to Meet Underwriters' Laboratories and
J.I.C. Standards**

Seamless, oil-proof, highly pliable plastic ring provides positive gripping and sealing. Tapered inner wedge integral with body assures positive grounding and supports clamping pressure of plastic ring or gland.

Gland nut has tapered seat on wedging flange resulting in a clamping action against tapered grounding wedge of the body well beyond the termination of the resilient conduit sheath.



Straight Male

45° Male

90° Male

Nominal † Flexible Conduit Size	Hub Size	Cat. No.	Std. Pkg.	List Per 100
Straight				
3/8"	1/2"	CT-38101	100	\$ 58.30
1/2"	1/2"	CT-1101	100	58.30
3/4"	3/4"	CT-2101	50	83.30
1"	1"	CT-3101	25	116.60
1 1/4"	1 1/4"	CT-4101	25	200.00
1 1/2"	1 1/2"	CT-5101	10	283.30
2"	2"	CT-6101	5	525.00
45 Degree				
3/8"	1/2"	CT-38201	50	91.60
1/2"	1/2"	CT-1201	50	91.60
3/4"	3/4"	CT-2201	50	133.30
1"	1"	CT-3201	25	266.60
1 1/4"	1 1/4"	CT-4201	25	408.30
1 1/2"	1 1/2"	CT-5201	10	500.00
2"	2"	CT-6201	5	733.30
90 Degree				
3/8"	1/2"	CT-38301	50	91.60
1/2"	1/2"	CT-1301	50	91.60
3/4"	3/4"	CT-2301	50	133.30
1"	1"	CT-3301	25	266.60
1 1/4"	1 1/4"	CT-4301	25	408.30
1 1/2"	1 1/2"	CT-5301	10	500.00
2"	2"	CT-6301	5	733.30

†Dimensions of liquid-tight flexible conduit as prescribed by Underwriters' Laboratories, Inc.

Nominal I.D.	ACTUAL					
	—Inside Dia.—		—Outside Dia.—		—Wall Thickness—	
	Min.	Max.	Min.	Max.	Min.	Max.
3/8	.484	.505	.690	.710	.087	.118
1/2	.620	.642	.820	.840	.083	.116
3/4	.815	.840	1.030	1.050	.088	.124
1	1.030	1.066	1.290	1.315	.105	.149
1 1/4	1.370	1.410	1.630	1.660	.100	.152
1 1/2	1.575	1.600	1.875	1.900	.122	.177
2	2.020	2.045	2.350	2.375	.137	.192

Pyle-National Portable Cord and Cable Grips

Complete with aluminum body, plain aluminum compression nut and single hole rubber grommet.

Male Thread



Complete Assembly



Compression Nut



Grommet



Body

(Exploded View)

Female Thread

Male			Size Cord or Cable		Female		
No.	Each	Size Conduit			No.	Each	
DB44316	\$0.80	1/4	.125 to .187		DBF-4316	\$0.80	
DB44516	.80	3/8	.250 to .312		DBF-4516	.80	
DB-4316	.80	3/8	.125 to .187		DBF-438	.80	
DB-4516	.80	3/8	.250 to .312		DBF-4	.80	
DB-438	.80	3/8	.312 to .375				
DB-4	.80	3/8	.375 to .437				
DB-938	1.00	3/8	.375 to .500				
DB-1038	1.00	3/8	.500 to .625*				
DB-3316	.80	1/2	.125 to .187		DBF-3316	.80	
DB-3516	.80	1/2	.250 to .312		DBF-3516	.80	
DB-338	.80	1/2	.312 to .375		DBF-338	.80	
DB-3	.80	1/2	.375 to .437		DBF-3	.80	
DB-9	1.00	1/2	.375 to .500		DBF-9	1.30	
DB-10	1.00	1/2	.500 to .625		DBF-10	1.30	
DB-934	2.00	1/2	.687 to .750*				
DB-614	1.00	3/4	.125 to .250		DBF-614	1.30	
DB-638	1.00	3/4	.250 to .375		DBF-638	1.30	
DB-6716	1.00	3/4	.312 to .437		DBF-6716	1.30	
DB-612	1.00	3/4	.375 to .500		DBF-612	1.30	
DB-6916	1.00	3/4	.437 to .562		DBF-6916	1.30	
DB-6	1.00	3/4	.500 to .625		DBF-6	1.30	
DB-11	2.00	3/4	.687 to .750		DBF-11	2.00	
DB-111316	2.00	3/4	.750 to .812		DBF-1178	2.60	
DB-1178	2.00	3/4	.812 to .875*				
DB-3312	2.00	1	.437 to .500				
DB-3358	2.00	1	.562 to .625				
DB-331116	2.00	1	.625 to .687		DBF-1234	2.60	
DB-33	2.00	1	.687 to .750				
DB-12	2.00	1	.750 to .812		DBF-121316	2.60	
DB-14	2.80	1	.812 to .875		DBF-12	2.60	
DB-14118	3.80	1	.937 to 1.000		DBF-14	3.10	
			1.062 to 1.125*		DBF-14118	3.80	
DB-1378	3.80	1 1/4	.812 to .875		DBF-1378	3.80	
DB-131516	3.80	1 1/4	.875 to .937		DBF-131516	3.80	
DB-131	3.80	1 1/4	.937 to 1.000		DBF-131	3.80	
DB-13	3.80	1 1/4	1.062 to 1.125		DBF-13	3.80	
DB-15	3.80	1 1/4	1.125 to 1.250		DBF-15	3.80	
DB-13112	5.50	1 1/4	1.375 to 1.500*				
DB-1678	3.80	1 1/2	.812 to .875		DBF-1678	4.30	
DB-161516	3.80	1 1/2	.875 to .937		DBF-161516	4.30	
DB-161	3.80	1 1/2	.937 to 1.000		DBF-161	4.30	
DB-16118	3.80	1 1/2	1.062 to 1.125		DBF-16118	4.30	
DB-16114	3.80	1 1/2	1.187 to 1.250		DBF-16114	4.30	
DB-16	3.80	1 1/2	1.312 to 1.375		DBF-16	5.50	
DB-16112	5.50	1 1/2	1.375 to 1.500				
DB-16158	5.50	1 1/2	1.500 to 1.625				
DB-178	5.50	2	.875 to 1.000		DBF-178	6.50	
DB-17118	5.50	2	1.000 to 1.125		DBF-17118	6.50	
DB-17114	5.50	2	1.125 to 1.250		DBF-17114	6.50	
DB-17138	5.50	2	1.250 to 1.375		DBF-17138	6.50	
DB-17	5.50	2	1.375 to 1.500		DBF-17	6.50	
DB-18	5.50	2	1.500 to 1.625		DBF-18	6.50	
DB-19	5.50	2	1.625 to 1.750		DBF-19	6.50	
DB-20†	8.70	2 1/2	1.625 to 1.750				
DB-21†	8.70	2 1/2	1.750 to 1.875				
DB-22†	8.70	2 1/2	1.875 to 2.000				
DB-26178	9.90	3	1.750 to 1.875				
DB-26	9.90	3	2.156 to 2.281				
DB-26238	9.90	3	2.250 to 2.375				

†Has Phenolic compression nut and rustproofed steel body.

*Maximum size cord will not pass through body without removing outer covering.

Male Thread

Complete with rustproofed ferrous alloy body, plain aluminum compression nut and single hole rubber grommet.



45-Degree Angle



90-Degree Angle

45 Degree Angle Type Male Thread

No.	Size Conduit	Size Cord or Cable	Bore of Body	Each
DB-745	1/2	.125 to .250	5/8	1.60
DB-845	1/2	.250 to .375	5/8	1.60
DB-945	1/2	.375 to .500	5/8	1.60
DB-1045	1/2	.500 to .625*	5/8	1.60
DB-1171645	3/4	.375 to .437	3/4	2.60
DB-111245	3/4	.437 to .500	3/4	2.60
DB-1191645	3/4	.500 to .562	3/4	2.60
DB-115845	3/4	.562 to .625	3/4	2.60
DB-1145	3/4	.687 to .750*	3/4	2.60
DB-123445	1	.687 to .750	7/8	2.60
DB-12131645	1	.750 to .812	7/8	2.60
DB-1245	1	.812 to .875*	7/8	2.60
DB-1445	1	.937 to 1.000	1 1/2	4.50
DB-137845	1 1/4	.812 to .875	1 1/4	4.50
DB-13151645	1 1/4	.875 to .937	1 1/4	4.50
DB-13145	1 1/4	.937 to 1.000	1 1/4	4.50
DB-1345	1 1/4	1.062 to 1.125	1 1/4	4.50
DB-1545	1 1/4	1.187 to 1.250*	1 1/4	4.50
DB-1513845	1 1/4	1.312 to 1.375*	1 1/4	5.30

90 Degree Angle Type Male Thread

DB-431690	3/8	.125 to .187	7/16	\$1.75
DB-451690	3/8	.250 to .312	7/16	1.75
DB-43890	3/8	.312 to .375	7/16	1.75
DB-490	3/8	.375 to .437*	7/16	1.75
DB-790	1/2	.125 to .250	5/8	1.60
DB-890	1/2	.250 to .375	5/8	1.60
DB-990	1/2	.375 to .500	5/8	1.60
DB-1090	1/2	.500 to .625*	5/8	1.60
DB-1171690	3/4	.375 to .437	3/4	2.60
DB-111290	3/4	.437 to .500	3/4	2.60
DB-1191690	3/4	.500 to .562	3/4	2.60
DB-115890	3/4	.562 to .625	3/4	2.60
DB-1190	3/4	.687 to .750*	3/4	2.60
DB-123490	1	.687 to .750	7/8	2.60
DB-12131690	1	.750 to .812	7/8	2.60
DB-1290	1	.812 to .875*	7/8	2.60
DB-1490	1	.937 to 1.000	1 1/2	4.50
DB-137890	1 1/4	.812 to .875	1 1/4	4.50
DB-13151690	1 1/4	.875 to .937	1 1/4	4.50
DB-13190	1 1/4	.937 to 1.000	1 1/4	4.50
DB-1390	1 1/4	1.062 to 1.125	1 1/4	4.50
DB-1590	1 1/4	1.187 to 1.250*	1 1/4	4.50

*Cord or cable will not pass through body without removing outer covering.

Conduit Pipe Products
Special Large Radius Elbows

Hot-Dip Galvanized

The approximate weights shown are for 90° Elbows. To arrive at weight of 60°, 45° and 30° Elbows, deduct the same percentage from the weight as for arriving at the price.

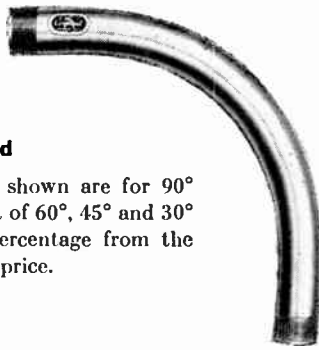

Size, In.	12-Inch Radius Each	Lb.	15-Inch Radius Each	Lb.	18-Inch Radius Each	Lb.	24-Inch Radius Each	Lb.
1	\$4.00	4	\$4.70	5	\$5.80	6	\$7.00	8
1 1/4	4.60	6	5.50	7	6.90	8	8.20	11
1 1/2	5.80	7	6.70	8	8.20	10	9.70	13
2	7.10	9	8.50	11	10.10	13	12.40	17
2 1/2	9.70	15	11.50	18	13.90	21	16.80	27
3	—	—	15.20	23	17.50	25	22.10	35
3 1/2	—	—	—	—	26.60	34	31.30	40
4	—	—	—	—	29.10	38	34.30	45

Size, In.	30-Inch Radius Each	Lb.	36-Inch Radius Each	Lb.	42-Inch Radius Each	Lb.	48-Inch Radius Each	Lb.
1	\$7.80	9	\$9.20	11	\$10.40	12	\$11.60	14
1 1/4	9.40	13	11.20	15	12.30	16	14.00	18
1 1/2	11.30	15	13.20	18	14.50	19	16.60	22
2	14.40	20	16.80	24	18.50	26	21.10	29
2 1/2	19.60	32	22.90	38	25.40	41	28.80	46
3	25.70	42	30.20	49	33.20	53	37.80	61
3 1/2	36.00	50	42.10	58	46.90	63	53.00	72
4	39.50	55	46.10	65	56.50	70	64.10	80
5	62.20	77	73.00	91	81.20	98	92.00	112
6	Std.	—	76.30	123	84.80	133	95.90	152

Special Large Radius 90° Elbows

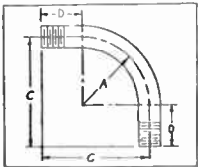

Conduit of Columbus now supplies all needed sizes of special large radius elbows as shown below.

Radius "A" In.	Offset "C" Ft. In.	Straight End "D," In.	Length Unbent Ft. In.	Pipe Size, In. nc.
12	1 9	9	3 0	1-2 1/2
15	2 0	9	3 6	1-3
18	2 4	10	4 0	1-3 1/2
24	2 11	11	4 11	1-4
30	3 5	11	5 9	1-5
36	3 11	11	6 6	1-6
42	4 6	12	7 6	1-6
48	6 0	12	8 4	1-6

Fairmount Cast Iron Caps

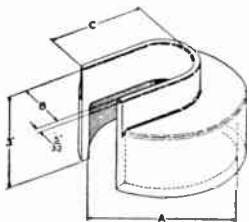

Used for making connections between U-cable guards and iron pipe bends or conduit couplings where they emerge from ground adjacent to pole or wall surface.

Size Cap.	Dimension In.			Wt., Lbs.
	A	B	C	
2-2	2 5/8	1 3/4	2 1/8	1.1
2-3 1/2	4 1/8	1 3/4	2 1/8	2.7
3-3 1/2	4 1/8	2 3/4	2 1/8	2.1

Fairmount Conduit Couplings

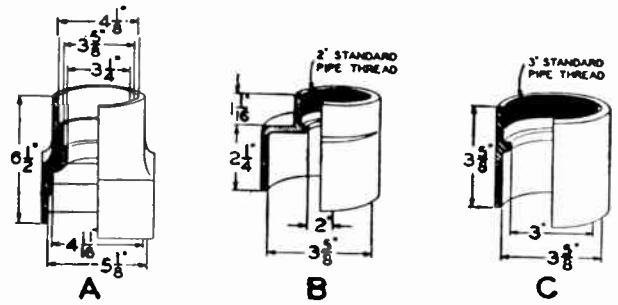

Iron couplings used for making connections between conduit, pipe and bends. Various types and sizes available.

Prices on request.

Fairmount Cast Iron Bends

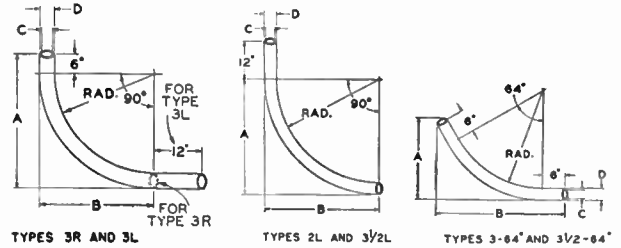

Six types of iron bends available for making turns in subsidiary ducts of underground conduit construction.

No.	Radius	Dimensions-In.				Wt. Lbs.
		A	B	C	D	
2L	24	26 5/8	26 5/8	2	2 1/2	27
3R	24	33 3/4	27 3/4	3	3 1/2	41
3L	30	39 3/4	33 3/4	3	3 1/2	58
3-64°	24	22 5/8	33 1/2	3	3 1/2	38
3 1/2-64°	24	23 3/16	34	3 1/2	4	44
3 1/2-L	30	34 1/4	34 1/4	3 1/2	4	66

Conduit Running Thread Pipe

3-Foot Lengths



A real convenience to the contractor where indefinite dimensions are encountered.

Can be cut to length to meet different installations.

Type A: Raw Black; threads raw black.
Type B: Raw Black; threads electro-galvanized.
Type C: Hot-dip galvanized; threads electro-galvanized.
When ordering, specify Type desired.

Pipe Size In.	Approx. Wt. Per 100 Ft.	Per Ft.	Pipe Size In.	Approx. Wt. Per 100 Ft.	Per Ft.
1/8	15	\$0.39	1 1/2	200	\$ 1.70
1/4	25	.42	2	260	2.40
3/8	35	.50	2 1/2	430	3.75
1/2	61	.55	3	550	5.15
3/4	76	.80	3 1/2	640	6.20
1	110	1.25	4	830	7.20
1 1/4	160	1.55	5	1080	13.00
			6	1440	15.00

Conduit Pipe Products Nipples

Hot Dip Galvanized

Underwriters' Labeled



Provide fast, easy assembly.

Make tight, weather-and corrosion-proof assemblies.

Clean, accurately cut threads.

Starting threads correctly chamfered.

Close Nipples

Pipe Size, In.	Lgth., In.	Ctn. Qty.	Wt., Lbs. Per 100 Pieces	Each	Pipe Size, In.	Lgth., In.	Ctn. Qty.	Wt., Lbs. Per 100 Pieces	Each
1/2	1 1/8	100	6	\$0.10	2 1/2	2 1/2	*	84	\$0.90
3/4	1 3/8	100	9	.14	3	2 5/8	*	118	1.20
1	1 1/2	50	16	.20	3 1/2	2 3/4	*	160	1.60
1 1/4	1 5/8	25	22	.26	4	2 7/8	*	180	1.90
1 1/2	1 3/4	25	28	.34	5	3	*	240	3.10
2	2	20	44	.40	6	3 1/8	*	350	4.40

1/2-In. Length Nipples

Pipe Size, In.	Ctn. Qty.	Wt., Lbs. Per 100 Pieces	Each
1/2	100	8	\$0.12

3-In. Length Nipples

Pipe Size, In.	Ctn. Qty.	Wt., Lbs. Per 100 Pieces	Each
1/2	100	19	\$0.16
3/4	50	24	.19
1	50	36	.26
1 1/4	25	47	.32
1 1/2	25	56	.40
2	20	72	.52
2 1/2	*	100	1.00
3	*	130	1.30

2-In. Length Nipples

Pipe Size, In.	Ctn. Qty.	Wt., Lbs. Per 100 Pieces	Each
1/2	100	12	.14
3/4	100	14	.16
1	50	22	.22
1 1/4	25	28	.28
1 1/2	25	34	.36

3 1/2-In. Length Nipples

Pipe Size, In.	Ctn. Qty.	Wt., Lbs. Per 100 Pieces	Each
1/2	50	22	.17
3/4	50	28	.20
1	25	43	.28
1 1/4	25	55	.34
1 1/2	25	68	.44
2	20	88	.56
2 1/2	*	120	1.20
3	*	157	1.45

2 1/2-In. Length Nipples

Pipe Size, In.	Ctn. Qty.	Wt., Lbs. Per 100 Pieces	Each
1/2	100	15	.15
3/4	50	19	.18
1	50	28	.24
1 1/4	25	37	.30
1 1/2	25	44	.38
2	20	59	.46

4-In. Length Nipples

Pipe Size, In.	Ctn. Qty.	Wt., Lbs. Per 100 Pieces	Each
1/2	50	26	\$0.18
3/4	50	34	.22
1	25	49	.30
1 1/4	25	66	.36
1 1/2	25	80	.46
2	20	103	.60
2 1/2	*	150	1.25
3	*	200	1.60
3 1/2	*	240	2.00
4	*	285	2.15
5
6

5-In. Length Nipples

Ctn. Qty.	Wt., Lbs. Per 100 Pieces	Each
50	33	\$0.20
50	43	.24
25	64	.32
25	84	.40
25	103	.50
15	132	.70
*	197	1.50
*	260	1.70
*	320	2.30
*	380	2.50
*	480	5.00
*	660	6.00

6-In. Length Nipples

Ctn. Qty.	Wt., Lbs. Per 100 Pieces	Each
50	40	\$0.24
50	52	.28
25	78	.36
25	100	.50
20	122	.60
15	160	.80
*	240	1.70
*	300	2.00
*	373	2.65
*	440	3.00
*	600	5.30
*	820	6.40

***8-In. Length Nipples**

Pipe Size, In.	Wt., Lbs. Per 100 Pieces	Each
1/2	54	\$0.32
3/4	73	.36
1	109	.50
1 1/4	136	.66
1 1/2	170	.80
2	220	1.05
2 1/2	329	2.30
3	411	2.70
3 1/2	510	3.20
4	600	3.60
5	825	6.00
6	1125	7.20

***10-In. Length Nipples**

Pipe Size, In.	Wt., Lbs. Per 100 Pieces	Each
1/2	68	\$0.40
3/4	89	.44
1	138	.62
1 1/4	176	.84
1 1/2	216	1.00
2	285	1.30
2 1/2	422	2.60
3	528	3.10
3 1/2	655	3.85
4	775	4.45
5	1055	6.80
6	1440	9.00

***12-In. Length Nipples**

Pipe Size, In.	Wt., Lbs. Per 100 Pieces	Each
1/2	82	\$0.48
3/4	109	.52
1	166	.76
1 1/4	216	1.00
1 1/2	260	1.20
2	335	1.50
2 1/2	505	3.10
3	630	3.95
3 1/2	785	4.50
4	925	5.30
5	1260	8.00
6	1720	10.00

*Supplied in bulk packaging, order in any quantities desired. For lengths not listed above, take price of next longer length.

National Electric Large Radius Rigid Conduit Elbows

Zinc-Sherardized, Electro Galvanized or Black Enameled

Dimensions

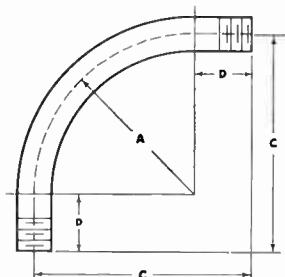

Radius (A) In.	Offset (C) In.	Straight End (D) In.	Length Unbent In.
12	1' 9"	9	3' 0"
15	2' 0"	9	3' 6"
18	2' 4"	10	4' 0"
24	2' 11"	11	4' 11"
30	3' 5"	11	5' 9"
36	3' 11"	11	6' 6"
42	4' 6"	12	7' 6"
48	5' 0"	12	8' 5"

Weights shown below are approximate values for 90° elbows. To obtain weights of 60° deduct 10%, for 45° deduct 15% and for 30° deduct 20%.

Weights in Pounds

Size In.	12-in. Radius	15-in. Radius	18-in. Radius	24-in. Radius	30-in. Radius	36-in. Radius	42-in. Radius	48-in. Radius
1	4	5	6	8	9	11	12	14
1 1/4	6	7	8	11	13	15	16	18
1 1/2	7	8	10	13	15	18	19	22
2	9	11	13	17	20	24	26	29
2 1/2	15	18	21	27	32	38	41	46
3	..	23	25	35	42	49	53	61
3 1/2	34	40	50	58	63	72
4	38	45	55	65	70	80
5	77	91	98	112
6	123	133	152

Prices on these and special sizes, bends and lengths available on application to Graybar.

Steel City Conduit Coupling

Three-Piece

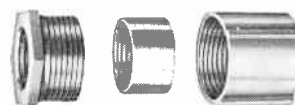

Malleable iron, galvanized. No running threads. Permits open run of conduit at any desired point. Makes a strong connection at any point in the run.

No.	Size Inches	Unit Pkg.	Std. Pkg.	Wt., Lbs. Per 100	Std. Pkg. Per 100
750	1/2	50	100	28	\$ 32.25
751	3/4	25	50	33	42.50
752	1	5	25	54	75.50
753	1 1/4	5	25	90	145.00
754	1 1/2	5	25	100	183.00
755	2	5	20	135	371.00
756	2 1/2	5	10	210	645.00
757	3	5	10	250	970.00
758	3 1/2	2	5	320	1560.00
759	4	2	5	340	1770.00



Steel City Combination Couplings

Flexible to Threaded Conduit

Malleable Iron, Galvanized

No.	Size Inches	Unit Pkg.	Std. Pkg.	Wt., Lbs. Per 100	Std. Pkg. Per 100
960	1/2	10	50	26	\$33.50
961	3/4	10	50	30	45.00

Appleton Rigid Conduit Nipples

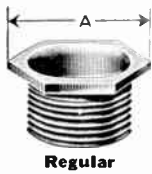

Regular

Schedule CF
Cadmium Finish

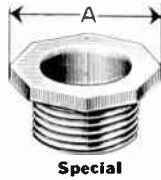

Special

Regular Conduit Nipples

No.	Size In.	Dimen. "A", In.	Ctn. Qty.	Std. Pkg.	Std. Pkg. Wt., Lbs.	Per 100
7200	3/8	13/16	50	100	3	\$ 20.80
7201	1/2	1	50	500	4	8.00
7202	3/4	1 1/8	50	500	8	11.20
7203	1	1 1/4	25	100	15	19.20
7115	1 1/4	2 1/8	25	200	25	30.40
7116	1 1/2	2 5/16	25	200	30	40.00
7117	2	2 7/8	10	100	50	64.00
7118	2 1/2	3 1/2	5	25	65	104.00
7119	3	4 3/8	5	25	100	152.00
7120	3 1/2	4 5/8	1	5	125	320.00
7121	4	5 7/16	1	25	150	528.00
7123	5	6 3/16	1	5	210	1398.40

Appleton Male and Female Unions



Male Union

Schedule CF
For Use in Non-Hazardous Locations



Female Union

Male Unions

No.	Size In.	Dimen. Lgth.	Diam. In.	Ctn. Qty.	Std. Pkg.	Std. Pkg. Wt., Lbs.	Per 100
37460	1/2	2 1/8	1 9/16	10	50	50	\$ 86.40
37461†	3/4 to 1/2	2 1/8	1 9/16	10	50	54	124.80
37462	3/4	2 1/8	1 9/16	10	50	60	124.80
37463	1	2 7/16	1 7/8	5	25	68	216.00
UCM-125	1 1/4	3	2 5/16	5	25	105	336.00
UCM-150	1 1/2	3 3/8	2 11/16	5	25	148	432.00
UCM-200	2	3 3/4	3 1/8	2	10	260	552.00
UCM-250	2 1/2	3 7/8	4 5/16	2	10	350	872.00
UCM-300	3	4 3/16	5	1	5	380	1188.80

Female Unions

UCF-50	1/2	1 3/4	1 9/16	10	100	42	\$ 78.40
37471†	3/4 to 1/2	1 3/4	1 9/16	10	50	46	112.00
UCF-75	3/4	1 3/4	1 9/16	10	100	44	112.00
UCF-100	1	1 7/8	1 7/8	5	25	56	200.00
UCF-125	1 1/4	2 3/16	2 5/16	5	25	64	320.00
UCF-150	1 1/2	2 5/16	2 11/16	5	25	130	416.00
UCF-200	2	2 5/8	3 1/8	2	10	180	513.60
UCF-250	2 1/2	2 7/8	4 5/16	2	10	320	708.80
UCF-300	3	3 3/16	5	1	5	320	1024.00

†End at right in illustration is for 3/4-inch conduit.

Appleton Conduit Male Enlargers

Schedule CF



When screwed into the hub of any conduit fitting having 1/2, 3/4 or 1-inch female hubs, respectively, will enlarge the hub to the next size, namely, 3/4, 1 and 1 1/4 inches according to the number selected.

No.	Female Size, In.	Male Size, In.	Ctn. Qty.	Std. Pkg.	Std. Pkg. Wt., Lbs.	Per 100
9407	3/4	1/2	50	500	70	\$ 31.00
9408	1	3/4	50	500	80	57.50
9409	1 1/4	1	20	200	40	133.00

Appleton Rigid Conduit Couplings

Schedule CF

Cadmium Finish
Economical Couplings



No.	Size In.	Carton Qty.	Std. Pkg.	Wt., Lbs. Per 100	Per 100
18801	1/2	10	100	24	\$ 47.70
18802	3/4	10	100	31	63.04
18803	1	5	25	52	112.00
18804	1 1/4	5	25	92	214.40
18805	1 1/2	5	25	116	272.00
18806	2	5	25	195	549.00
18807	2 1/2	2	10	380	960.00
18808	3	1	10	420	1440.00
18809	3 1/2	1	5	520	2309.00
18810	4	5	5	620	2620.00
18812	5	2	2	900	5564.80

No-Thread Couplings



1/2- to 2-Inch



2 1/2 to 4-Inch

No.	Size In.	Carton Qty.	Std. Pkg.	Wt., Lbs. Std. Pkg.	Per 100
82N80	1/2	25	100	23	\$ 65.60
82N81	3/4	25	100	14	96.00
82N82	1	5	25	13	152.00
82N83	1 1/4	5	25	20	230.40
82N84	1 1/2	5	25	15	288.00
82N96	2	1	10	15	659.20
82N90	2 1/2	1	10	21	1496.00
82N91	3	1	10	26	2000.00
82N92	3 1/2	1	5	31	2560.00
82N93	4	5	5	36	3280.00

Appleton Rigid Conduit Connectors

Schedule CF

Type L No-Thread



1/2- to 2-Inch



2 1/2- to 4-Inch

No.	Size In.	Carton Qty.	Std. Pkg.	Wt., Lbs. Std. Pkg.	Per 100
80N95	1/2	50	200	15	\$ 48.20
80N96	3/4	25	200	10	70.40
80N97	1	5	25	8	92.80
80N98	1 1/4	5	50	13	168.00
80N99	1 1/2	2	10	10	233.60
80N90	2	1	5	9	459.20
80N91	2 1/2	1	10	13	1200.00
80N92	3	1	10	16	1440.00
80N93	3 1/2	1	10	24	1760.00
80N94	4	1	5	33	2160.00

O. Z. Insulating Couplings



Threaded, with substantial center shoulder to prevent butting of conduit and to break metallic path.

Type ICC

Laminated Canvas Bakelite

No.	For Cond. In.	O.D. In.	Dimensions, In. Lgth.	Shldr.	Pkg.	Wt. Lbs.	Each
ICC 50	1/2	1 1/4	1 3/4	3/8	25	.05	\$1.08
ICC 75	3/4	1 1/2	1 3/4	3/8	25	.06	1.32
ICC100	1	1 1/2	2 3/8	3/8	25	.12	1.86
ICC125	1 1/4	2 3/8	2 3/8	1/2	10	.18	2.22
ICC150	1 1/2	2 7/8	2 7/8	1/2	10	.20	2.64
ICC200	2	2 15/8	2 7/8	1/2	10	.25	3.36
ICC250	2 1/2	3 1/8	3 3/4	3/4	5	.40	6.00
ICC300	3	4 1/8	3 15/8	3/4	5	.75	7.80
ICC350	3 1/2	4 5/8	4	3/4	1	.80	8.00
ICC400	4	5 1/4	4 5/8	1	1	1.20	10.00

Type ICP

Laminated Paper Bakelite

No.	For Cond. In.	O.D. In.	Dimensions, In. Lgth.	Shldr.	Pkg.	Wt. Lbs.	Each
ICP 50	1/2	1 1/4	1 3/4	3/8	25	.05	\$0.53
ICP 75	3/4	1 1/2	1 3/4	3/8	25	.06	.66
ICP100	1	1 13/8	2 3/8	3/8	25	.12	.92
ICP125	1 1/4	2 3/8	2 3/8	1/2	10	.18	1.12
ICP150	1 1/2	2 7/8	2 7/8	1/2	10	.20	1.32
ICP200	2	2 15/8	2 7/8	1/2	10	.25	1.85
ICP250	2 1/2	3 1/8	3 3/4	3/4	5	.40	3.96
ICP300	3	4 1/8	3 15/8	3/4	5	.75	5.02
ICP350	3 1/2	4 5/8	4	3/4	1	.80	5.06
ICP400	4	5 1/4	4 5/8	1	1	1.20	6.60

Steel City Conduit Enlarger

1/2 to 3/4-Inch



Unit package 25, standard package 100. Weight per 100, 9 pounds.

No. 1326.....Std. Pkg., Per 100 **\$19.40**

Steel City Chase Nipples

Malleable iron, galvanized. Use with couplings to connect conduit to boxes. Permits box to be removed without disturbing conduit.



No.	Size Inches	Unit Pkg.	Std. Pkg.	Wt. Lbs. Per 100	Std. Pkg. Per 100
151	3/8	100	500	3	\$ 14.00
152	1/2	100	500	5	5.40
153	3/4	50	200	9	7.55
154	1	25	100	13	12.90
155	1 1/4	25	100	26	20.00
156	1 1/2	10	50	32	27.25
157	2	5	50	50	43.00
158	2 1/2	5	20	65	69.00
159	3	2	10	110	101.00
160	3 1/2	2	5	150	215.00
161	4	2	5	190	355.00

Appleton Tiger-Grip Bondnuts

Schedule LB

Galvanized Finish Only



1/2- and 3/4-Inch

Provide a lock-tight spring action between threads and the surface of the box. Sharp, beveled teeth cut into the outlet or switch box, insuring positive metal-to-metal grounding.

Bondnuts lock with a firm, permanent grip; will not slip or loosen through vibration.

Shoulders permit tightening from all angles, with fingers, pliers or wrench.

Thorough cadmium plating eliminates rusting.

No.	Size Inches	Ctn. Qty.	Std. Pkg.	Std. Pkg. Wt., Lbs.	Per 100
BL38	3/8	100	1000	14	\$ 4.50
BL50	1/2	100	2500	30	3.20
BL75	3/4	100	1000	21	4.50
BL100	1	50	500	21	7.35
BL125	1 1/4	50	200	12	9.60
BL150	1 1/2	50	100	7	11.85
BL200	2	20	40	5	20.80
BL250	2 1/2	10	40	5	32.00
BL300	3	10	40	13	41.60
BL350	3 1/2	5	20	7	96.00
BL400	4	5	20	8	120.00
BL500	5	2	10	9	248.00
BL600	6	2	10	14	438.00

T&B Insuliner® Sleeves

Approved by Underwriters' Laboratories



Can be used in any raceway outlet.

Overlapping ends automatically adjust "Insuliner" to normal variations to conduit diameters—either standard heavywall, or thinwall conduit (E.M.T.).

The smoothly rounded mouth covers the bushing and long skirt shields end of conduit.

No.	Conduit Size In.	Unit Pkg.	Std. Pkg.	Wt. Lbs. Per 100	Per 100
422	1/2	25	100	1	\$14.40
423	3/4	25	100	1	21.12
424	1	25	100	2	24.00
425	1 1/4	20	40	2 1/2	30.40
426	1 1/2	20	40	2 1/2	35.20
427	2	15	30	3 1/2	40.00
428	2 1/2	5	10	6 1/2	70.40
429	3	5	10	8	94.40
430	3 1/2	1	5	12	128.00
431	4	1	5	15	160.00
433	5	1	2	20	384.00
434	6	1	2	40	640.00

National Electric EZ Conduit Couplings



EZ Hinged Strap Type. Rigid to flexible. For one-inch conduit. Rustproofed finish.

Open I.D., 1 1/4-inches; closed I.D., 1 1/8-inches.

Packed 25 in standard package; 5 in carton. Weight per std. pkg., 9 pounds.

No. 2192-EZ...per 100 **\$102.00**

T&B Erickson® Couplings

Approved by Underwriters' Laboratories



Does away with running threads. Malleable iron, Tabolited. Permits conduit run to be opened at any desired point.

No.	Size In.	Std. Pkg.	Wt. Lbs. Per 100	Per 100
674	3/8	100	12	\$ 87.36
675	1/2	100	21	47.68
676	3/4	50	32	63.04
677	1	25	52	112.00
678	1 1/4	25	92	214.40
679	1 1/2	25	112	272.00
680	2	20	175	548.80
681	2 1/2	10	360	960.00
682	3	10	380	1440.00
683	3 1/2	5	500	2308.80
684	4	5	580	2620.80
686	5	2	1000	5564.80

T&B Couplings

Approved by Underwriters' Laboratories



With T&B Couplings you can use 3/4-inch knockouts on the whole job. Use No. 1410 Coupling for 1/2-in. conduit in 3/4-in. hole. For 3/4-in. conduit in 3/4-in. hole, use No. 1420.

No.	Size	Unit Quan.	Std. Pkg.	Wt. Lbs. Per 100	Per 100
1410	1/2"	25	100	9	\$42.75
1420	3/4"	25	100	16	69.00

T&B Insulated Chase® Nipples

Insulated Male Bushing



Provides complete protection. The long insulator lines the entire throat. Provides protection against all metal surfaces.

No.	Size In.	Unit Pkg.	Std. Pkg.	Wgt. Lbs. Per 100	Per 100
1942	1/2	25	100	4	\$ 25.60
1943	3/4	25	100	7	31.20
1944	1	25	100	13	42.40
1945	1 1/4	10	50	21	73.60
1946	1 1/2	10	50	29	95.20
1947	2	10	50	52	147.20
1948	2 1/2	5	20	83	262.40
1949	3	5	20	125	283.20

T&B Chase® Nipples

Approved by Underwriters' Laboratories



When Chase nipples and couplings are used, box can be removed without disturbing the conduit. Chase nipples are Tabolited.

No.	Size In.	Std. Pkg.	Per 100	No.	Size In.	Std. Pkg.	Per 100
840	1/4	1000	\$20.80	847	2	50	\$ 64.00
841	3/8	1000	20.80	848	2 1/2	20	104.00
842	1/2	500	8.00	849	3	10	152.00
843	3/4	200	11.20	850	3 1/2	5	320.00
844	1	100	19.20	851	4	5	528.00
845	1 1/4	100	30.40	853	5	5	1398.00
846	1 1/2	50	40.00				

T&B E.M.T. Connectors

Insulated Throat—Raintight



Completely self insulated. Blue insulating liner covers area inside connector throat and provides a rounded, burr-free passage for wiring. A lip protrudes slightly beyond connector body forming a bright blue ring providing visual assurance for an inspector that connection is insulated.

No.	Size In.	Unit Pkg.	Std. Pkg.	Wgt. Lbs. Per 100	Per 100
5123	1/2	50	500	10	\$23.25
5223	3/4	25	250	14	33.50
5323	1	25	100	23	52.00
5423	1 1/4	5	25	46	93.00
5523	1 1/2	2	10	59	136.00
5623	2	2	5	80	203.00

T&B Locknuts

Approved by Underwriter's Laboratories



Sizes 3/8 to 2-inch inclusive are made of steel and are notched.

Sizes 2 1/2 to 6-inches inclusive are made of malleable iron, extra heavy not notched, but ribbed.

No.	Size In.	Std. Pkg.	Per 100
140	3/8	500	\$ 4.48
141	1/2	2500	3.20
142	3/4	1000	4.48
143	1	500	7.36
144	1 1/4	200	9.60
145	1 1/2	100	11.84
146	2	50	20.80
147	2 1/2	30	32.00
148	3	25	41.60
149	3 1/2	10	96.00
150	4	10	120.00
152	5	4	248.00
153	6	4	438.40

O. Z. Expansion Fittings

Type AX



Designed to compensate for expansion and contraction in a line of conduit. Complete with insulating bushing. Allows a maximum movement of 4 in. in conduit. Malleable iron, hot dip galvanized.

No.	For Cond. In.	Max. O.D. In.	Overall Lgth. In.	Wt. Lbs. Ea.	Each
AX 50	1/2	1 7/8	6 1/4	1 3/8	\$ 2.95
AX 75	3/4	2 1/4	6 3/8	2	3.50
AX100	1	2 5/8	6 5/8	2 1/2	4.40
AX125	1 1/4	3	6 5/8	3 3/4	5.50
AX150	1 1/2	3 1/2	6 5/8	5	7.70
AX200	2	4	7 1/8	7	11.00
AX250	2 1/2	4 1/2	7 1/2	9	16.15
AX300	3	5 3/8	8 1/8	12	22.00
AX350	3 1/2	6	8 1/2	15	30.00
AX400	4	6 5/8	8 5/8	18	40.00

Appleton Electrical Metallic Tubing Fittings

For Use with Threadless Thin-Wall Conduit

Schedule TW

Couplings and Connectors Indenter Type



Coupling

Connector

Size In.	Car- ton Qty.	Std. Pkg.	Couplings No.	Std. Pkg. Wt. Lbs.	Per 100	Connector No.	Std. Pkg. Wt. Lbs.	Per 100
1/2	50	500	971050	5	\$10.25	981050	6	\$12.50
3/4	25	250	971075	8	13.45	981075	11	21.70
1	25	200	971100	13	21.70	981100	21	31.60

Note: Also available with Insulated Throat.

Compression Type Approved Raintight—Cadmium Finish



Coupling

Connector

No.	Size Inches	Carton Qty.	Std. Pkg.	Wt., Lbs. Per 100	Per 100
951050	1/2	50	500	13	\$23.00
951075	3/4	50	250	15	32.00
951100	1	25	200	20	49.60
951125	1 1/4	5	25	50	83.20
951150	1 1/2	10	10	80	118.40
951200	2	5	5	140	163.20

No.	Size Inches	Carton Qty.	Std. Pkg.	Wt., Lbs. Per 100	Per 100
961050	1/2	50	500	11	\$19.20
961075	3/4	25	250	13	26.55
961100	1	25	200	20	41.60
961125	1 1/4	5	25	50	75.20
961150	1 1/2	10	10	60	111.00
961200	2	25	25	100	160.00

†Designed to take 3/8-inch Electrical Metallic Tubing, with other end threaded and furnished with locknut to fit in regular 1/2-inch Knockout.

Note: Also available with Insulated Throat.



Combination Coupling No-Thread

For connecting flexible steel conduit to E.M.T.

No.	Size In.	Designed to Hold	Max. Hole Diam.	Car- ton Qty.	Std. Pkg.	Std. Pkg. Wt., Lbs.	Per 100
18854	1/2	3/8" Flex.	...	100	40	7	\$26.65
18855	1/2	1/2" Flex.	15/16	100	40	8	50.65
18856	3/4	3/4" Flex.	1 1/8	100	40	11	68.00
18857	1	1" Flex.	1 13/32	20	20	7	166.65

Economy 2-Piece Connector

For new or old work. Only one wrench needed to install. Leaves extra wiring room inside box.

Knurling on chamfered connector body eliminates need for locknut—bites into K.O. rim and prevents slippage. Approved for all inside work or for imbedding in concrete.

Install by cutting conduit to extend 1/16-in. inside box for 1/2-in. conduit; 3/32-in. inside for 3/4-in. conduit and 5/32-in. inside with 1-in. conduit.

No.	Size In.	Ctn. Qty.	Std. Pkg.	Wt., Lbs. Per 100	Per 100
921050	1/2	50	200	5.4	\$17.30
921075	3/4	25	250	8.5	24.00
921100	1	25	200	13	37.45

Economy 2-Piece Connectors With Insulated Throat



Concrete Tight

No.	Size In.	Std. Pkg.	Ctn. Qty.	Wt. Lbs. Per 100	Per 100
821050	1/2	200	50	5.4	\$19.70
821075	3/4	250	25	8.5	28.80
821100	1	200	25	13	44.65

Adapters

Cadmium Finish

For Use with Threaded Unilets



Adapter



Adapter Installed in Type C Rectangular Threaded Unilet for Use with E. M. T.

Adapts any Appleton threaded Unilet or similar fittings of other manufacturers, to take E.M.T. Adapter screws into the hub of any 3/8- to 2-inch threaded fitting, gripping the conduit securely, and forming a no-thread fitting. No other special parts needed.

No.	Size In.	Carton Qty.	Std. Pkg.	Wt., Lbs. Per 100	Per 100
80159	3/8	50	200	1 1/2	\$10.40
80160	1/2	50	200	1 1/2	9.05
80161	3/4	25	100	5	12.65
80162	1	10	100	6	18.80
80163	1 1/4	10	100	10	37.85
80164	1 1/2	5	10	15	43.30
80165	2	1	5	20	84.00

For Use with Standard No-Thread Unilets

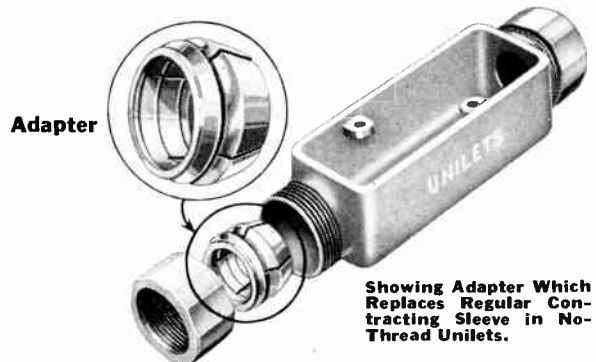

Showing Adapter Which Replaces Regular Contracting Sleeve in No-Thread Unilets.

Designed for use in the hubs of 1/2- to 2-inch No-Thread Unilets for heavy wall conduit. By removing contracting sleeve normally furnished with No-Thread Unilets and inserting Adapter, fitting is adapted for use with E.M.T. Knurled nut screws down to hold E.M.T. firmly.

No.	Size In.	Carton Qty.	Std. Pkg.	Wt., Lbs. Per 100	Per 100
80130	1/2	50	200	3 1/2	\$19.05
80131	3/4	25	100	6 1/4	26.40
80132	1	10	40	9 1/2	38.10
80133	1 1/4	10	20	13 1/2	61.60
80134	1 1/2	5	20	21	148.65
80135	2	1	5	33 1/2	236.40

**T&B Threadless Couplings and Connectors
For Heavy Wall Conduit**

Approved by Underwriters' Laboratories



Coupling



Connector

For standard rigid conduit. Easy to tighten; made ready with fingers—then a turn with a wrench and the connection is permanent. Made of malleable iron and steel.

Couplings

No.	Size In.	Unit Pkg.	Std. Pkg.	Wt., Lbs. Per 100	Per 100
8120	1/2	50	100	22	\$ 65.60
8220	3/4	25	50	30	96.00
8320	1	5	25	52	152.00
8420	1 1/4	5	25	112	230.40
8520	1 1/2	2	10	140	288.00
8620	2	1	5	202	659.20
8720	2 1/2	1	5	480	1496.00
8820	3	1	5	700	2000.00
8850	3 1/2	1	5	800	2560.00
8970	4	1	5	900	3280.00

Connectors

No.	Size In.	Unit Pkg.	Std. Pkg.	Wt., Lbs. Per 100	Per 100
8121	1/2	25	100	17	\$ 48.20
8221	3/4	25	50	26	70.40
8321	1	5	25	44	92.80
8421	1 1/4	5	25	88	168.00
8521	1 1/2	2	10	110	233.60
8621	2	1	5	180	459.20
8721	2 1/2	1	5	360	1200.00
8821	3	1	5	500	1440.00
8851	3 1/2	1	5	600	1760.00
8971	4	1	5	630	2160.00

**T&B Couplings and Box Connectors
For Electrical Metallic Tubing**

Formed steel ribbed glands, with opposite faces parallel. Easily tightened with wrench or pliers.

Raintight



Size Inches	Unit Pkg.	Std. Pkg.	Couplings		Connectors	
			No.	Per 100	No.	Per 100
3/8	50	200	5118	\$32.64	5119	\$27.20
*1/2	50	500	5120	23.04	5121	19.20
*3/4	25	250	5220	32.00	5221	26.56
1	25	100	5320	49.60	5321	41.60
1 1/4	5	25	5420	83.20	5421	75.20
1 1/2	2	10	5520	118.40	5521	111.04
2	2	5	5620	163.20	5621	160.00

*Case-hardened locknut; will not slip.

Non-Watertight Couplings and Connectors

1/2	50	500	4270	\$22.40	4271	\$19.20
-----	----	-----	------	---------	------	---------

T&B Tite-Bite® Combination Couplings

Approved by Underwriters' Laboratories



To connect flexible conduit and standard threaded rigid conduit.

Tite-Bite saddle holds flexible conduit securely with a double grip.

With a Chase Nipple this fitting will connect flexible conduit to outlet boxes, allowing more wiring space in the box than the usual connector.

No.	Size In.	Unit Quan.	Std. Pkg.	Wt., Lbs. Per 100	Per 100
440	1/2	10	50	24	\$ 49.60
441	3/4	10	50	30	67.20
442	1	5	25	52	96.00
443	1 1/4	5	25	72	163.20
444	1 1/2	5	25	112	240.00
445	2	5	10	150	344.00
446	2 1/2	5	10	280	820.00
447	3	2	5	360	1120.00

T&B Socks® Couplings

For Thinwall Conduit (E.M.T.)

Approved by Underwriters' Laboratories



No.	Size	Unit Quan.	Std. Pkg.	Wt., Lbs. Per 100	Per 100
5180	1/2	50	250	8 1/2	\$27.50
5280	3/4	25	100	11	36.75
5380	1	25	50	18	51.00

T&B Socks® Connectors

For Thinwall Conduit (E.M.T.)

Approved by Underwriters' Laboratories



No.	Size	Unit Quan.	Std. Pkg.	Wt., Lbs. Per 100	Per 100
5181	1/2	200	1000	3	\$13.60
5281	3/4	100	500	4	18.40
5381	1	25	50	10	28.00

O. Z. Split Couplings

Type SP

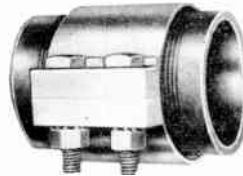

A union for joining conduit in indoor installations where conduit cannot be turned or where space is limited.

It can be slipped over the conduit when in the open position to permit butting of ends of conduit.

Malleable Iron, Cadmium Plated

No.	Size Cond. In.	Std. Pkg.	Wt., Lbs. Ea.	Each	No.	Size Cond. In.	Std. Pkg.	Wt., Lbs. Ea.	Each
SP 50	1/2	6	.50	\$1.45	SP250	2 1/2	2	3.3	\$ 4.05
SP 75	3/4	6	.79	1.60	SP300	3	1	3.6	5.50
SP100	1	6	.88	1.75	SP350	3 1/2	1	4.8	7.35
SP125	1 1/4	4	1.2	2.00	SP400	4	1	5.9	9.55
SP150	1 1/2	4	1.3	2.20	SP450	4 1/2	1	7.8	14.65
SP200	2	2	2.1	2.70	SP500	5	1	8.6	22.00

T & B Insulated Threadless Connectors



No.	Size In.	Std. Pkg.	Unit Pkg.	Wt. Lbs. Per 100	Per 100
8123	1/2	25	100	17	\$ 80.00
8223	3/4	25	50	26	125.00
8323	1	5	25	14	167.00
8423	1 1/4	5	25	88	296.00
8523	1 1/2	2	10	110	412.00
8623	2	1	5	180	1010.00
8723	2 1/2	1	5	360	2575.00
8823	3	1	5	500	2970.00
8853	3 1/2	1	5	600	3770.00
8973	4	1	5	630	4625.00

T&B Panel Connector Extensions



Approved by Underwriters' Laboratories

To make a panel connector from any fitting with a female thread. Male thread 1-inch long. Made from malleable iron.

No.	Size In.	Unit Quan.	Std. Pkg.	Wt. Lbs. Per 100	Per 100
1440	1/2	25	50	14	\$ 56.00
1441	3/4	25	50	18	79.00
1442	1	10	25	28	122.00
1443	1 1/4	10	25	36	232.00
1444	1 1/2	10	25	44	328.00
1445	2	5	10	70	416.00
1446	2 1/2	5	10	90	670.00

T & B Connectors

For Liquid-Tight Flexible Conduit
Insulated Straight Connectors



No.	Size In.	Std. Pkg.	Unit Pkg.	Wt. Lbs. Per 100	Per 100
5331	3/8	100	25	13	\$100.00
5332	1/2	100	25	17	100.00
5333	3/4	50	25	24	150.00
5334	1	25	5	41	220.00
5335	1 1/4	25	5	84	350.00
5336	1 1/2	10	2	105	500.00
5337	2	5	1	160	915.00
5338	2 1/2	5	1	312	4370.00
5339	3	5	1	375	4850.00
5340	4	5	1	612	5662.00

Straight Connectors



No.	Size In.	Std. Pkg.	Unit Pkg.	Wt. Lbs. Per 100	Per 100
5231	3/8	100	25	13	\$ 96.00
5232	1/2	100	25	17	96.00
5233	3/4	50	25	24	140.00
5234	1	25	5	41	195.00
5235	1 1/4	25	5	84	335.00
5236	1 1/2	10	2	105	460.00
5237	2	5	1	160	880.00
5238	2 1/2	5	1	312	3900.00
5239	3	5	1	375	4370.00
5240	4	5	1	612	5000.00

Insulated 45° Angle Connectors



No.	Size In.	Std. Pkg.	Unit Pkg.	Wt. Lbs. Per 100	Per 100
5341	3/8	50	25	18	\$175.00
5342	1/2	50	25	28	175.00
5343	3/4	50	25	40	250.00
5344	1	25	5	68	470.00
5345	1 1/4	25	5	100	685.00
5346	1 1/2	10	2	160	850.00
5347	2	5	1	230	1260.00
5348	2 1/2	5	1	600	5452.00
5349	3	5	1	875	6562.00
5350	4	5	1	1225	7312.00

45° Angle Connectors



No.	Size In.	Std. Pkg.	Unit Pkg.	Wt. Lbs. Per 100	Per 100
5241	3/8	50	25	18	\$153.25
5242	1/2	50	25	28	153.25
5243	3/4	50	25	40	223.70
5244	1	25	5	68	447.00
5245	1 1/4	25	5	100	640.00
5246	1 1/2	10	2	160	830.00
5247	2	5	1	230	1225.00
5248	2 1/2	5	1	600	4725.00
5249	3	5	1	875	5870.00
5250	4	5	1	1225	6500.00

T & B Connectors
For Liquid-Tight Flexible Conduit
Insulated 90° Angle Connectors



No.	Size In.	Std. Pkg.	Unit Pkg.	Wt. Lbs. Per 100	Per 100
5351	3/8	50	25	18	\$ 175.00
5352	1/2	50	25	28	175.00
5353	3/4	50	25	40	250.00
5354	1	25	5	68	470.00
5355	1 1/4	25	5	100	685.00
5356	1 1/2	10	2	160	850.00
5357	2	5	1	230	1260.00
5358	2 1/2	5	1	862	5452.00
5359	3	5	1	1287	6562.00
5360	4	5	1	2181	7312.00

90° Angle Connectors



No.	Size In.	Std. Pkg.	Unit Pkg.	Wt. Lbs. Per 100	Per 100
5251	3/8	50	25	18	\$ 153.25
5252	1/2	50	25	28	153.25
5253	3/4	50	25	40	223.70
5254	1	25	5	68	447.00
5255	1 1/4	25	5	100	640.00
5256	1 1/2	10	2	160	830.00
5257	2	5	1	230	1225.00
5258	2 1/2	5	1	862	4725.00
5259	3	5	1	1287	5870.00
5260	4	5	1	2181	6500.00

Female Hub Connectors



No.	Size In.	Std. Pkg.	Unit Pkg.	Wt. Lbs. Per 100	Per 100
5271	3/8	50	10	16	\$ 107.00
5272	1/2	50	10	22	107.00
5273	3/4	25	5	32	153.00
5274	1	15	5	42	215.00
5275	1 1/4	15	5	72	350.00

Appleton Combination Couplings

Schedule CF

Threaded

For connecting flexible steel conduit or armored bushed cable to rigid conduit.



No.	Size In.	Designed to Hold	Max. Hole Diam. In.	Ctn. Qty.	Std. Pkg.	Wt. Lbs. Per 100	Per 100
18839	1/2	3/8" BX	11/16	10	40	15	\$ 43.70
18840	1/2	1/2" Flex.	15/16	10	100	17	49.60
18841	3/4	3/4" Flex.	1 1/8	10	100	21	67.20
18842	1	1" Flex.	1 3/32	5	25	35	96.00
18843	1 1/4	1 1/4" Flex.	1 11/16	5	25	40	163.20
18844	1 1/2	1 1/2" Flex.	2	5	25	75	240.00
18845	2	2" Flex.	2 15/32	5	10	90	344.00

No-Thread

For connecting steel conduit or armored bushed cable to rigid conduit.



18849	1/2	3/8" BX	11/16	10	50	20	\$ 96.00
18850	1/2	1/2" Flex.	15/16	10	50	23	113.60
18851	3/4	3/4" Flex.	1 1/8	10	40	30	133.60

Appleton Rigid Conduit Elbows

Schedule CP

Cadmium Finish



90-Degree Bushed—Short

No.	Size In.	Ctn. Qty.	Std. Pkg.	Std. Pkg. Wt., Lbs.	Per 100
7495	1/2	25	100	16	\$40.65
7496	3/4	25	100	26	56.30
7497	1	10	40	37	86.40



90-Degree Bushed—Long

No.	Size In.	Ctn. Qty.	Std. Pkg.	Std. Pkg. Wt., Lbs.	Per 100
7490	1/2	25	100	30	\$54.10
7491	3/4	25	100	50	75.50
7492	1	5	25	80	161.60
7493	1 1/4	5	20	130	243.20
7494	1 1/2	5	10	240	344.00
7494-A	2	1	10	380	595.00



90-Degree Angle Connector Extension

No.	Size In.	Ctn. Qty.	Std. Pkg.	Std. Pkg. Wt., Lbs.	Per 100
27495	1/2	10	100	16	\$40.65
27496	3/4	25	100	26	56.30
27497	1	10	40	37	86.40



Pulling Elbow Type PEL—Threaded

No.	Size In.	Ctn. Qty.	Std. Pkg.	Std. Pkg. Wt., Lbs.	Per 100
37450	1/2	10	100	52	\$77.05
37451	3/4	5	50	80	90.65
37452	1	5	20	135	117.30

45- and 90-Degree Elbows



45-Degree Female



90-Degree Female



90-Degree Elbows No-Thread

45-Degree Elbows—Female

No.	Size In.	Ctn. Qty.	Std. Pkg.	Std. Pkg. Wt., Lbs.	Per 100
8285	1/2	10	200	56	\$44.00
8286	3/4	10	100	..	73.30
8287	1	5	50	..	120.00

90-Degree Elbows—Female

No.	Size In.	Ctn. Qty.	Std. Pkg.	Std. Pkg. Wt., Lbs.	Per 100
8270	1/2	10	100	38	\$40.00
8271	3/4	10	100	58	53.30

90-Degree Elbows—No-Thread

No.	Size In.	Ctn. Qty.	Std. Pkg.	Std. Pkg. Wt., Lbs.	Per 100
82N70	1/2	5	100	37	\$120.00
82N71	3/4	5	50	70	160.00

Appleton Meter Connector

Schedule CP



No.	Size In.	Ctn. Qty.	Std. Pkg.	Std. Pkg. Wt., Lbs.	Per 100
18860	1 1/4	5	25	13	\$88.00

T&B Bushed Elbows

Approved by Underwriters' Laboratories



Bushed Elbows are installed at the end of each underfloor conduit run, in such a manner that the floor coupling will be flush with the floor surface.

Made of malleable iron, heavily plated with Tabolite.

No.	Size	Radius In.	Offset In.	Unit Pkg.	Std. Pkg.	Wt. Lbs. Per 100	Per 100
460	1/2	1 1/8	1 1/8	10	50	30	\$54.08
461	3/4	1 1/2	1 1/2	10	50	44	75.52
462	1	1 13/16	1 13/16	5	25	84	161.60
463	1 1/4	2 1/4	2 1/4	5	10	150	243.20

T & B Insulated Bushed Elbows



No.	Size In.	Std. Pkg.	Unit Pkg.	Wt. Lbs. Per 100	Per 100
470	1/2	10	50	30	\$64.00
471	3/4	10	50	44	100.00
472	1	5	25	84	224.00
473	1 1/4	5	10	150	312.00

T&B Threaded Tubelet Reducers

Approved by Underwriters' Laboratories



Smoothly bushed to reduce the opening in Tubelet hubs or any female threaded fitting.

No.	Conduit Sizes, In.	Unit Quan.	Std. Pkg.	Wt., Lbs. Per 100	Per 100
600	1/2 to 3/8	50	100	3	\$25.28
601	3/4 to 1/2	50	100	4	14.40
602	1 to 1/2	25	50	12	22.40
603	1 to 3/4	25	50	8	22.40
604	1 1/4 to 1/2	25	50	30	37.12
605	1 1/4 to 3/4	25	50	28	37.12
606	1 1/4 to 1	25	50	16	37.12
607	1 1/2 to 1/2	25	50	38	57.60
608	1 1/2 to 3/4	25	50	38	57.60
609	1 1/2 to 1	25	50	28	57.60
610	1 1/2 to 1 1/4	25	50	12	57.60
611	2 to 1/2	10	25	88	121.60
612	2 to 3/4	10	25	72	121.60
613	2 to 1	10	25	64	100.80
614	2 to 1 1/4	10	25	52	100.80
615	2 to 1 1/2	10	25	40	100.80

T&B Insulated Metallic Bushings

Approved by Underwriters' Laboratories



Eliminates skinning wire when pulled. Practical for protecting motor leads entering a motor Code Requirements on insulating fully covered.

No.	Size	Std. Pkg.	Unit Quan.	Per 100
1222	1/2	100	50	\$22.40
1223	3/4	50	25	40.00
1224	1	40	10	51.20
1225	1 1/4	20	5	72.00
1226	1 1/2	20	5	96.00
1227	2	10	5	128.00
1228	2 1/2	10	5	184.00
1229	3	5	1	272.00
1230	3 1/2	5	1	352.00
1231	4	5	1	448.00
586	5	1	—	864.00
587	6	1	—	1240.00

T&B Short Elbows
For Standard Rigid Conduit
Approved by Underwriters' Laboratories

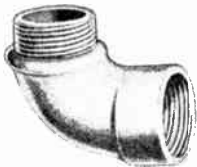

Threaded

T&B Short Elbows (90° Angle Adapters) are well bushed, with clean machine-cut threads. Malleable iron, Tabolite galvanized inside and out.

Conduit sizes: 1/2-inch to 2-inches.

Short Elbows (90° Adapters)

No.	Size In.	Unit Pkg.	Std. Pkg.	Wt. Lbs. Per 100	Per 100
4250	1/2	25	50	20	\$ 40.64
4251	3/4	25	50	30	56.32
4252	1	10	25	56	86.40
4253	1 1/4	10	25	92	173.00
4254	1 1/2	10	25	120	258.00
4255	2	5	10	180	432.00



Threadless

Malleable iron body with patented T&B split steel gripping ring. Tabolite finish.

Conduit Sizes: 1/2-inch to 2-inches.

No.	Size In.	Unit Quan.	Std. Pkg.	Wt. Lbs. Per 100	Per 100
8030	1/2	25	50	36	\$ 68.80
8031	3/4	25	50	34	110.40
8032	1	5	25	68	243.20
8033	1 1/4	2	10	120	400.00
8034	1 1/2	2	10	160	472.00
8035	2	2	10	230	720.00

T&B Male Conduit Enlargers
Approved by Underwriters' Laboratories

For adapting an outlet to the next larger size of conduit.



No.	Size In.	Std. Pkg.	Wt. Lbs. Per 100	Per 100
1245	1/2-3/4	100	9	\$ 31.00
1246	3/4-1	50	16	57.50
1244	1-1 1/4	50	28	133.00
1247	1 1/4-1 1/2	25	36	310.00

T&B Female Conduit Reducers
Approved by Underwriters' Laboratories

Designed to adapt an outlet to the next smaller size of conduit.



No.	Size In.	Unit Quan.	Std. Pkg.	Wt. Lbs. Per 100	Per 100
1250	3/4 to 1/2	50	100	9	\$ 34.50
1261	1 to 1/2	25	100	15	48.00
1251	1 to 3/4	25	100	14	48.00
1262	1 1/4 to 1/2	25	50	31	110.00
1263	1 1/4 to 3/4	25	50	28	110.00
1252	1 1/4 to 1	25	50	22	110.00
1253	1 1/2 to 1 1/4	25	50	22	155.00
1254	2 to 1 1/2	10	25	60	283.00
1255	2 1/2 to 2	10	25	76	520.00
1256	3 to 2 1/2	10	25	140	705.00
1257	3 1/2 to 3	5	10	140	1140.00
1258	4 to 3 1/2	5	10	200	1420.00

T&B Knockout Adapter
Approved by Underwriters' Laboratories

Locknut and collar for using a 3/8-inch thread size in a 1/2-inch knockout hole.

Standard Package, 100; in lots of 1000.

No.	Unit Quan.	Wt. Lbs. Per 100	Per 100
400	50	3	\$29.50



T&B Reducing Washers

Approved by Underwriters' Laboratories



T&B Reducing Washers are designed to reduce the size of knock-outs in outlet boxes.

Made of steel and galvanized.

No.	K.O.	Size, Inches Conduit	Unit Pkg.	Std. Pkg.	Wt. Lbs. Per 1000	Per 100
3700						
3701	3/4	to 3/8	250	500	1 1/2	\$3.05
3702	3/4	to 1/2	250	500	1 1/2	2.55
3703	1	to 3/8	125	250	1 1/2	5.60
3704	1	to 1/2	125	250	2	4.50
3705	1	to 3/4	125	250	2	4.50
3706	1 1/4	to 3/8	125	250	3 1/2	8.50
3707	1 1/4	to 1/2	125	250	2 1/2	8.50
3707	1 1/4	to 3/4	125	250	3	7.20
3708	1 1/4	to 1	125	250	6	7.20
3709	1 1/2	to 3/8	50	100	6	10.20
3710	1 1/2	to 1/2	50	100	5	10.20
3711	1 1/2	to 3/4	50	100	6	10.20
3712	1 1/2	to 1	50	100	5	8.50
3713	1 1/2	to 1 1/4	50	100	4	8.50
3714	2	to 1/2	50	100	8	13.30
3715	2	to 3/4	50	100	8	13.30
3716	2	to 1	50	100	6	10.90
3717	2	to 1 1/4	50	100	7	10.90
3718	2	to 1 1/2	50	100	5	10.90

T&B Pennies

Approved by Underwriters' Laboratories



Slip inside bushing and, when the job is done, unscrew the bushing and penny drops out. The best way to keep plaster, cement, nails, dirt, etc., out of conduit system while job is in construction.

No.	For Size Conduit In.	Std. Pkg.	Wt. Lbs. Per 100	Per 100
815	1/2	1000	1/2	\$3.05
816	3/4	500	1/2	3.45
817	1	250	1	6.00
818	1 1/4	250	1 1/2	12.10
819	1 1/2	100	2 1/2	15.50
820	2	100	4	17.30
821	2 1/2	100	5	25.75
822	3	100	9	31.75
824	3 1/2	100	13	43.25
823	4	100	9	57.00

T&B Push-Pennies

Economically protects electrical raceways against grout, water and dirt.

Polyethylene push-pennies are designed to fit all fittings and conduit that meet U/L dimensional standards.

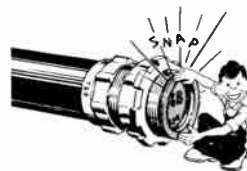

No.	Size In.	Std. Pkg.	Ctn. Qty.	Per 100
1570	1/2	2500	100	\$3.52
1571	3/4	1000	100	4.00
1572	1	500	50	5.12
1573	1 1/4	200	50	8.00
1574	1 1/2	100	25	15.20
1575	2	100	25	20.32

Steel City Locknuts and Bushings

Schedule CF
Galvanized



Locknut



Bushings



Capped Bushing

Locknuts

Bonding Type

No.	Size Inches	Unit Pkg.	Std. Pkg.	Wt., Lbs. Per 100	Std. Pkg. Per 100
301	1/2	100	1000	1 1/2	\$ 2.20
302	3/4	100	1000	2	3.00
303	1	50	500	3 1/2	4.90
304	1 1/4	50	200	6	6.40
305	1 1/2	50	100	7	7.90
306	2	25	50	10	13.90

Notched Type

300	3/8	100	1000	1 1/4	\$ 2.90
307	2 1/2	10	30	15	21.50
308	3	5	25	34	28.00
309	3 1/2	5	25	46	64.50
310	4	5	25	68	80.50
312	5	2	10	135	167.00
313	6	2	10	190	296.00

Bushings — Malleable Iron

101	1/2	100	1000	3	\$ 3.20
102	3/4	100	1000	4	4.55
103	1	50	500	7	7.55
104	1 1/4	50	200	12	10.20
105	1 1/2	50	100	16	14.90
106	2	25	50	19	23.75
107	2 1/2	10	30	28	43.00
108	3	5	25	52	54.00
109	3 1/2	5	25	70	108.00
110	4	5	25	81	129.00
112	5	2	10	190	269.00
113	6	2	10	250	484.00

Capped Bushings — Malleable Iron

115	1/2	100	1000	3	\$ 5.65
116	3/4	100	1000	4	7.20
117	1	50	500	8	9.70
118	1 1/4	50	200	13	16.70
119	1 1/2	50	100	17	18.80
120	2	25	50	21	32.25

T&B Capped Elbows

For Threaded Rigid Conduit

Approved by Underwriters' Laboratories



Eliminate fishing of wires through sharp bends. They are smooth on the interior, all openings bushed to prevent abrasion. Made of cast iron, plated with Tabolite to resist corrosion.

No.	Size Inches	Unit Pkg.	Std. Pkg.	Wt. Lbs. Per 100	Per 100
1480	1/2	10	50	48	\$76.80
1481	3/4	5	50	62	92.80
1482	1	5	25	112	131.20
1483	1 1/4	5	10	200	363.20
1484	1 1/2	2	5	280	532.80

Steel City Capped Elbows



Malleable iron, galvanized weather-proof right angle fittings. Liberal wiring space, rounded edges and smooth run-ways.

No.	Size Inches	Unit Pkg.	Std. Pkg.	Wt., Lbs. Per 100	Std. Pkg. Per 100
280	1/2	10	50	52	\$ 51.50
281	3/4	5	50	59	62.50
282	1	5	25	108	89.00
283	1 1/4	5	10	200	245.00

Steel City Reducers



Malleable iron, galvanized.

To enable small conduit to be run into large conduit holes.

No.	Size Inches	Unit Pkg.	Std. Pkg.	Wt., Lbs. Per 100	Std. Pkg. Per 100
1325	3/4 to 1/2	50	100	6	\$21.50
1327	1 to 3/4	25	50	9	30.00

Appleton Rigid Conduit Reducers

Cadmium Finish

Schedule CF



Used to reduce conduit fittings from larger to smaller sizes.

No.	Size Inches	Ctn. Qty.	Std. Pkg.	Wt., Lbs. Per 100	Per 100
RB50-38	1/2 to 3/8	50	100	4	\$25.30
RB75-50	3/4 to 1/2	50	500	5	14.40
RB100-50	1 to 1/2	25	250	12	22.40
RB100-75	1 1/4 to 1/2	25	100	33	22.40
RB125-50	1 1/2 to 1/2	25	100	40	37.10
RB125-75	2 to 1/2	25	100	65	37.10
RB125-100	1 to 3/4	25	100	9	37.10
RB150-50	1 1/4 to 3/4	25	50	24	57.60
RB150-75	1 1/2 to 3/4	25	50	36	57.60
RB150-100	2 to 3/4	25	100	70	57.60
RB150-125	1 1/4 to 1	25	100	11	57.60
RB200-50	1 1/2 to 1	5	25	29	121.60
RB200-75	2 to 1	5	25	52	121.60
RB200-100	1 1/2 to 1 1/4	5	50	15	100.80
RB200-125	2 to 1 1/4	5	50	50	100.80
RB200-150	2 to 1 1/2	5	50	38	100.00
RB250-150	2 1/2 to 1 1/2	5	25	87	151.00
RB250-200	3 to 1 1/2	5	25	125	151.00
RB300-150	2 1/2 to 2	5	25	53	202.00
RB300-200	3 to 2	5	25	130	202.00
RB300-250	3 to 2 1/2	5	25	100	202.00
RB350-250	3 1/2 to 2 1/2	5	10	200	335.00
RB350-300	4 to 2 1/2	5	10	263	335.00
RB400-250	3 1/2 to 3	2	10	93	440.00
RB400-300	4 to 3	2	10	250	440.00
RB400-350	4 to 3 1/2	2	10	200	440.00

Steel City Reducing Bushings and Washers



Bushings used to reduce a tapped conduit hole.

Washers used to reduce knockouts in outlet boxes, cabinets, etc.



Bushings

No.	Size Inches	Unit Pkg.	Std. Pkg.	Wt., Lbs. Per 100	Std. Pkg. Per 100
17100	3/4 to 1/2	50	100	4	\$ 9.60
17101	1 to 1/2	25	50	22	15.00
17102	1 to 3/4	25	50	7	15.00
17103	1 1/4 to 1/2	25	50	29	25.00
17104	1 1/4 to 3/4	25	50	20	25.00
17105	1 1/2 to 1	25	50	11	25.00
17106	1 1/2 to 1/2	25	50	12	39.00
17107	1 1/2 to 3/4	25	50	36	39.00
17108	1 1/2 to 1	25	50	27	39.00
17109	1 1/2 to 1 1/4	25	50	12	39.00
17110	2 to 1/2	10	25	74	81.60
17111	2 to 3/4	10	25	70	81.60
17112	2 to 1	10	25	60	68.40
17113	2 to 1 1/4	10	25	42	68.40
17114	2 to 1 1/2	10	25	30	68.40
17115	2 1/2 to 1/2	10	25	156	94.60
17116	2 1/2 to 3/4	10	25	135	94.60
17117	2 1/2 to 1	10	25	130	94.60
17118	2 1/2 to 1 1/4	10	25	120	94.60
17119	2 1/2 to 1 1/2	10	25	80	94.60
17120	2 1/2 to 2	10	25	18	94.60
17121	3 to 1/2	10	25	130	126.50
17122	3 to 3/4	10	25	127	126.50
17123	3 to 1	10	25	118	126.50
17124	3 to 1 1/4	10	25	112	126.50
17125	3 to 1 1/2	10	25	105	126.50
17126	3 to 2	10	25	100	126.50
17127	3 to 2 1/2	10	25	90	126.50

Washers

No.	Size Inches	Unit Pkg.	Std. Pkg.	Wt., Lbs. Per 100	Std. Pkg. Per 100
15020	1/2 to 3/8	250	500	3/4	\$ 1.90
15021	3/4 to 1/2	250	500	1	1.60
15022	1 to 1/2	125	250	3	2.80
15023	1 to 3/4	125	250	2	2.80
15024	1 1/4 to 1/2	125	250	2	5.30
15025	1 1/4 to 3/4	125	250	2	4.50
15026	1 1/4 to 1	125	250	2	4.50
15027	1 1/2 to 1/2	50	100	4 1/2	6.40
15028	1 1/2 to 3/4	50	100	5	6.40
15029	1 1/2 to 1	50	100	4	5.30
15030	1 1/2 to 1 1/4	50	100	3	5.30
15031	2 to 1/2	50	100	9	8.30
15032	2 to 3/4	50	100	8	8.30
15033	2 to 1	50	100	7	6.80
15034	2 to 1 1/4	50	100	7	6.80
15035	2 to 1 1/2	50	100	5	6.80
15036	2 1/2 to 1/2	25	100	10	11.20
15037	2 1/2 to 3/4	25	100	9	11.20
15038	2 1/2 to 1	25	100	9	11.20
15039	2 1/2 to 1 1/4	25	100	7	11.20
15040	2 1/2 to 1 1/2	25	100	9	11.20
15041	2 1/2 to 2	25	100	4	11.20
15042	3 to 1/2	25	100	22	16.30
15043	3 to 3/4	25	100	22	16.30
15044	3 to 1	25	100	23	16.30
15045	3 to 1 1/4	25	100	20	16.30
15046	3 to 1 1/2	25	100	15	16.30
15047	3 to 2	25	100	11	16.30
15048	3 to 2 1/2	25	100	14	16.30

Appleton Cupped Reducing Washers

Galvanized Finish
Schedule CF



For reducing knockouts in outlet boxes, cabinets, etc.

No.	Size Inches	Ctn. Qty.	Std. Pkg.	Wt., Lbs. Per 100	Per 100
7336	3/4 to 1/2	250	1000	2	\$ 2.55
7337	1 to 3/4	125	1000	3	4.50
7338	1 to 1/2	125	1000	4	4.50
7339	1 1/4 to 1	125	1000	5	7.20
7340	1 1/4 to 3/4	125	500	6	7.20
7341	1 1/4 to 1/2	125	500	7	8.50
7342	1 1/2 to 1 1/4	50	500	7	8.50
7343	1 1/2 to 1	50	500	8	8.50
7344	1 1/2 to 3/4	50	500	9	10.20
7345	1 1/2 to 1/2	50	500	10	10.20
7346	2 to 1 1/2	50	500	5	10.90
7347	2 to 1 1/4	50	100	6	10.90
7348	2 to 1	50	100	7	10.90
7349	2 to 3/4	50	100	8	13.30
7350	2 to 1/2	50	100	9	13.30

T&B Conduit Bushings

Approved by Underwriters' Laboratories



Smooth round shoulder covers end of conduit, covers k.o. hole. High ribs make tightening easy with fingers or wrench.

Packed in neat, strong boxes, marked to show contents.

No.	Size In.	Std. Pkg.	Per 100
121	3/8	500	\$ 8.32
122	1/2	2500	4.80
123	3/4	1000	6.72
124	1	500	11.20
125	1 1/4	200	15.04
126	1 1/2	100	22.08
127	2	50	35.20
128	2 1/2	30	64.00
129	3	25	80.00
130	3 1/2	10	160.00
131	4	10	192.00
133	5	4	400.00
134	6	4	720.00

T&B Insulating Bushings

For Standard Rigid Conduit



Meet NEC requirements for protection against damage to cable sheath or wire insulation from burred or unevenly cut conduit. Takes minimum space in a cabinet or pull box.

Bushings constructed wholly of cellulose acetate butyrate. Provide a smoothly rounded surface where wiring emerges from conduit.

No.	Size In.	Unit Quan.	Std. Pkg.	Wt., Lbs. Per 100	Per 100
222	1/2	100	400	1	\$4.00
223	3/4	100	400	1	6.10
224	1	50	200	2	9.60
225	1 1/4	25	100	3	14.10
226	1 1/2	25	100	3	18.60
227	2	25	50	5	33.60
228	2 1/2	10	20	8	58.25
229	3	10	20	10	64.00
230	3 1/2	5	10	13	80.00
231	4	5	10	15	96.00
233	5	...	2	21	208.00
234	6	...	2	25	400.00



Appleton Conduit Bushings

Schedule LB

No.	Size Inches	Ctn. Qty.	Std. Pkg.	Std. Pkg. Wt., Lbs.	Per 100
BU 38	3/8	100	1000	55	\$ 8.30
BU 50	1/2	100	2500	79	4.80
BU 75	3/4	100	1000	42	6.70
BU 100	1	50	500	32	11.20
BU 125	1 1/4	50	200	20	15.00
BU 150	1 1/2	50	200	23	22.10
BU 200	2	25	100	20	35.20
BU 250	2 1/2	10	50	19	64.00
BU 300	3	10	50	23	80.00
BU 350	3 1/2	5	20	18	160.00
BU 400	4	5	20	21	192.00
BU 500	5	10	10	15	400.00
BU 600	6	10	10	21	720.00



Appleton Capped Bushings

Schedule LB

No.	Size Inches	Ctn. Qty.	Std. Pkg.	Std. Pkg. Wt., Lbs.	Per 100
BUC 50	1/2	100	1000	27	\$ 8.30
BUC 75	3/4	100	1000	42	10.95
BUC 100	1	50	500	36	14.40
BUC 125	1 1/4	25	200	24	24.65
BUC 150	1 1/2	10	100	18	27.85
BUC 200	2	10	50	8	48.00
BUC 250	2 1/2	5	30	22	117.00
BUC 300	3	5	20	16	157.00
BUC 350	3 1/2	5	20	17	239.00
BUC 400	4	5	20	22	329.00



T&B Capped Bushings

Approved by Underwriters' Laboratories

Make a workmanlike seal against dirt and mischief. Cap is quickly removable with a screw driver.

No.	Size In.	Unit Quan.	Std. Pkg.	Wt., Lbs. Per 100	Per 100
1460	1/2	100	500	2 1/2	\$8.32
1461	3/4	100	200	4	10.56
1462	1	50	200	9 1/2	14.40
1463	1 1/4	25	100	12 1/2	24.64
1464	1 1/2	10	50	16	27.84
1465	2	10	50	20	48.00

National Electric Bushcaps Malleable Iron Bushings—Tin Caps



Full strength, National Malleable Iron Bushings closed by tin caps. Caps are pressed in tightly and will stay put. They can be easily removed when desired.

A National Bushcap placed on an open end, when conduit is installed, will keep it clean and clear until the wires are drawn in.

Size In.	1/2	3/4	1	1 1/4	1 1/2	2
Standard Package	2500	1000	500	200	100	50
Weight per Std. Pkg. Lbs.	68	38	39	25	12 1/2	9
Carton Qty. Per 100	\$7.05	\$8.05	\$12.10	\$21.00	\$23.50	\$40.25

Union Insulated Conduit-End Bushings

Schedule C



Molded of impact resistant bakelite. Sizes 1/2-in. and 1-in. from paper impregnated material. 1 1/2 in. from canvas impregnated bakelite.

Molded Non-Metallic

No.	Pipe Size Inch	Car-ton	Std. Pkg.	Wt. Lbs. Per 100	Std. Pkg. Per 100
24-12	1/2	100	500	1	\$2.50
24-34	3/4	50	500	1 1/2	3.80
24-1	1	25	250	3	6.00
24-114	1 1/4	25	100	6	8.80
24-112	1 1/2	25	100	7	11.60
24-2	2	25	50	9	21.00
24-212	2 1/2	10	20	15	36.40
24-3	3	10	20	17 1/2	40.00
24-312	3 1/2	5	20	23	50.00
24-4	4	5	10	25	60.00
24-5	5	2	2	41	130.00
24-6	6	2	2	50	250.00

Insulated Metallic

Schedule C



Extra wide insulated lip provides substantial bearing surface for heavy cables.

Deeply knurled galvanized collar for convenient tightening.

No.	Pipe Size Inch	Car-ton	Std. Pkg.	Wt. Lbs. Per 100	Per 100
97-12	1/2	25	25	5	\$14.00
97-34	3/4	20	20	8	25.00
97-1	1	10	20	11	32.00
97-114	1 1/4	10	20	16	45.00
97-112	1 1/2	10	20	22	60.00
97-2	2	5	10	26	80.00
97-212	2 1/2	2	4	50	115.00
97-3	3	2	4	66	170.00
97-312	3 1/2	2	2	84	220.00
97-4	4	2	2	90	280.00

Insulated Grounding

Schedule C



Large lug connecting screw assures good ground and lug takes wide variety of wire sizes.

No.	Pipe Size Inch	Lug Capacity	Car-ton	Std. Pkg.	Wt. Lbs. Per 100	Per 100
96-12	1/2	#6-14	25	25	7 1/2	\$40.75
96-34	3/4	#6-14	20	20	9	53.50
96-1	1	#4-14	10	20	15	63.00
96-114	1 1/4	#4-14	10	20	20	78.00
96-112	1 1/2	#4-14	10	20	26	87.00
96-2	2	#4-14	5	10	30	110.00
96-212	2 1/2	#4-1/0	2	4	62	150.00
96-3	3	#4-1/0	2	4	75	200.00
96-312	3 1/2	#2-1/0	2	2	114	250.00
96-4	4	#2-1/0	2	2	125	300.00

National Conduit Locknuts



Size In.	Std. Pkg.	Wt. Lb. Std. Pkg.	Carton Qty. Per 100
2 1/2	30	8	\$ 27.00
3	25	10 1/2	33.75
3 1/2	25	15	80.50
4	25	20	101.00
5	10	13	209.00
6	10	19	370.00

Steel City Insulating Bushings

		Male Type		
No.	Size Inches	Std. Pkg.	Wt. Lbs. Per 100	Per 100
IB-499	3/8	50	1	\$ 16.00
IB-500	1/2	25	1 1/2	17.00
IB-501	3/4	25	2	21.00
IB-502	1	25	3	28.00
IB-503	1 1/4	10	6	34.00
IB-504	1 1/2	10	7	43.00
IB-505	2	10	8	52.00
IB-506	2 1/2	5	20	90.00
IB-507	3	5	25	131.00
IB-508	3 1/2	1	30	143.00
IB-509	4	1	40	204.00

National Electric Conduit Bushings

Size In.	Std. Pkg.	Wt. Lbs. Std. Pkg.	Carton Quantity Per 100
Steel Formed			
1/2	2500	55	\$ 3.70
3/4	1000	37	5.70
Malleable Iron			
1	500	37	9.45
1 1/4	200	20	12.80
1 1/2	100	11	15.50
2	50	8	29.75
2 1/2	30	10	54.00
3	25	10 1/2	67.50
3 1/2	25	15 1/2	135.00
4	25	24 1/2	161.00
5	10	15	6.00
6	10	23	605.00



Galvanized Finish

Standard package is strong wooden case.

Appleton Cable End Fittings

Schedule EF

Type FCE

For use with armored cable or non-metallic sheathed cable.

Have 3-hole composition cover.



No.	Size In.	Ctn. Qty.	Std. Pkg.	Wt. Lbs. Per 100	Per 100
1755	3/8	25	200	14	\$28.15

T&B Straight Insulets

Approved by Underwriters' Laboratories

For use at motor outlets or at the end of any conduit run where wires emerge. Insulator has three wire holes with one hole plugged. Can also be used with T&B Chase Nipples where wires emerge from an outlet box knockout.



No.	Size In.	Unit Pkg.	Std. Pkg.	Wt. Lbs. Per 100	Per 100
1610	1/2	25	100	18	\$ 25.92
1611	3/4	25	100	22	35.52
1612	1	5	50	42	52.48
1613	1 1/4	5	25	92	227.00

T&B Round Type Insulet

Approved by Underwriters' Laboratories

Plated with Tabolite; insulator has three wire holes with one hole plugged. Where it is desirable to bring two or three wires out of 1/2, 3/4 or 1-inch knockout use the Insulet and T&B Chase Nipple.



No.	Description	Unit Pkg.	Std. Pkg.	Wt. Lbs. Per 100	Per 100
1660	1/2" Round Type	25	100	10	\$24.32

O. Z. Insulating Bushings

Molded Canvas Bakelite—Threaded



Type "A"
For insulating end of stand-
ing conduit.



Type "BB"
Male bushing for insulat-
ing cables passing through
metal boxes or troughs.

Cond. Size, In.	No.	Std. Ctn.	Type "A" Wt., 100, Lbs.	Per 100	No.	Type "BB" Std. Pkg.	Wt., 100, Lbs.	Per 100
1/2	A 50	100	1.3	\$ 3.75	BB 50	100	1.2	\$16.00
3/4	A 75	100	1.8	5.70	BB 75	100	2.2	20.00
1	A100	50	3.5	9.00	BB100	100	3.1	26.00
1 1/4	A125	25	6.0	13.20	BB125	50	5.3	32.00
1 1/2	A150	25	7.0	17.40	BB150	50	7.0	40.00
2	A200	20	10.5	31.50	BB200	50	11.0	49.00
2 1/2	A250	20	11.4	54.60	BB250	20	19.0	84.00
3	A300	10	19.0	60.00	BB300	20	23.0	123.00
3 1/2	A350	10	25.0	75.00	BB350	10	27.0	134.00
4	A400	10	28.0	90.00	BB400	10	30.0	191.00
5	A500	5	48.0	195.00	BB500	5	35.0	321.00
6	A600	2	63.0	375.00	BB600	5	45.0	351.00

O. Z. Conduit End Fittings

Type E



A compact fitting for use where space is limited and a neat appearance plus strength are required.

Spaces and individually insulates cables at end of conduit.

High grade malleable iron, cadmium plated. Covers are molded canvas bakelite.

Furnished complete with covers.

No.	Cond. Size, In.	Diam. In.	Ht. In.	Std. Pkg.	Wt., Ea. Lbs.	Blank	With Covers 1 to 4 Holes*	5 to 9 Holes*
E 50	1/2	13/16	7/8	5	.13	\$ 0.60	\$ 0.60	\$ 0.70
E 75	3/4	1 1/8	7/8	5	.18	.80	.80	.90
E100	1	1 11/16	1 1/8	5	.20	1.05	1.05	1.25
E125	1 1/4	2	1	5	.28	1.35	1.35	1.65
E150	1 1/2	2 1/4	1	5	.33	2.00	2.00	2.35
E200	2	2 7/8	1 1/8	1	.63	3.05	3.05	3.45
E250	2 1/2	3 7/16	1 1/4	1	1.0	5.20	5.20	6.00
E300	3	4 3/8	1 1/4	1	1.4	6.90	6.90	7.80
E350	3 1/2	4 3/4	1 1/2	1	2.1	9.10	9.10	10.00
E400	4	5 3/8	1 9/16	1	2.6	12.15	12.15	13.05
E450	4 1/2	5 7/8	1 9/16	1	2.9	15.60	15.60	16.60
E500	5	6 3/8	1 9/16	1	3.5	20.80	20.80	21.80
E600	6	7 3/8	1 9/8	1	4.5	26.00	26.00	27.00

*Holes accommodate maximum size cable according to code.

Note—Set screw type fittings for threadless conduit can be furnished. Can be supplied for thin wall conduit (E.M.T.) and fibre conduit on request at additional charge.

Holes other than standard can be drilled according to specification.

For hot dipped galvanized finish add 25% to price.

O. Z. Insulated Bushings



Threaded Type



Set Screw Type



Type SBT

These bushings, using bakelite as an insulator, will prevent disastrous grounds. The insulating material is molded and locked into the casting of high grade malleable iron. All are

capped. In set screw type, the bushing is securely fastened to conduit by case-hardened cup-point set screws.

Threaded Type—For Heavy Wall Conduit

Conduit Size, In.	Std. Pkg.	Type B Cadmium Plated			Type HB Hot Dip Galvanized			Type RB Bronze		
		No.	Approx. Wt., Lbs.	Per 100	No.	Approx. Wt., Lbs.	Per 100	No.	Approx. Wt., Lbs.	Per 100
1/2	100	B50	.04	\$ 22.80	HB50	.04	\$ 30.80	RB50	.04	\$ 45.60
3/4	50	B75	.06	43.20	HB75	.06	51.20	RB75	.07	76.00
1	25	B100	.11	65.20	HB100	.11	77.20	RB100	.12	98.80
1 1/4	20	B125	.15	87.00	HB125	.15	99.04	RB125	.16	136.80
1 1/2	20	B150	.18	109.00	HB150	.18	121.04	RB150	.20	167.20
2	10	B200	.30	152.00	HB200	.30	168.00	RB200	.33	304.00
2 1/2	10	B250	.48	208.00	HB250	.48	228.00	RB250	.53	334.40
3	5	B300	.80	288.00	HB300	.80	312.00	RB300	.88	448.40
3 1/2	5	B350	.98	368.00	HB350	.98	400.00	RB350	1.1	592.00
4	5	B400	1.3	464.00	HB400	1.3	496.00	RB400	1.4	760.00
4 1/2	1	B450	1.5	680.00	HB450	1.5	744.00	RB450	1.9	1096.00
5	1	B500	2.3	960.00	HB500	2.3	1064.00	RB500	2.5	1504.00
6	1	B600	3.0	1480.00	HB600	3.0	1640.00	RB600	3.3	2336.00

Set Screw Type—For Heavy Wall Conduit (Unthreaded)

Conduit Size, In.	Std. Pkg.	Type SB			Type HSB			Type RSB		
		No.	Approx. Wt., Lbs.	Per 100	No.	Approx. Wt., Lbs.	Per 100	No.	Approx. Wt., Lbs.	Per 100
1/2	100	SB50	.04	42.40	HSB50	.04	50.40	RSB50	.04	68.40
3/4	50	SB75	.06	63.20	HSB75	.06	71.20	RSB75	.06	98.80
1	25	SB100	.10	92.40	HSB100	.10	104.40	RSB100	.11	136.80
1 1/4	20	SB125	.13	114.40	HSB125	.13	126.40	RSB125	.14	167.20
1 1/2	20	SB150	.16	136.40	HSB150	.16	148.40	RSB150	.18	197.60
2	10	SB200	.26	180.00	HSB200	.26	196.00	RSB200	.29	334.40
2 1/2	10	SB250	.40	243.00	HSB250	.40	263.20	RSB250	.48	380.00
3	5	SB300	.70	323.20	HSB300	.70	347.20	RSB300	.78	494.00
3 1/2	5	SB350	.83	408.00	HSB350	.83	440.00	RSB350	.90	638.40
4	5	SB400	1.1	504.00	HSB400	1.1	536.00	RSB400	1.2	805.60
4 1/2	1	SB450	1.6	744.00	HSB450	1.6	808.00	RSB450	1.8	1144.00
5	1	SB500	2.0	1024.00	HSB500	2.0	1088.00	RSB500	2.3	1552.00
6	1	SB600	2.8	1560.00	HSB600	2.8	1640.00	RSB600	3.0	2392.00

Type SBT—For Thin Wall Conduit (E.M.T.) (Unthreaded)

No.	Conduit Size, In.	Std. Pkg.	Approx. Wt., Lbs.	Per 100	No.	Conduit Size, In.	Std. Pkg.	Approx. Wt., Lbs.	Per 100
SBT50	1/2	100	.04	\$42.40	SBT125	1 1/4	20	.16	\$114.40
SBT75	3/4	50	.07	63.20	SBT150	1 1/2	20	.20	136.40
SBT100	1	25	.12	92.40	SBT200	2	10	.31	180.00

Snap-In Blanks and Bushings

For closing up knockouts in outlet and service boxes, meter loops, drop cord covers, electric sign letters, etc. Snap in like a glove fastener. Neat, one-piece design; occupy little space in box. Thoroughly rust-proof.

Bushings: 1/2-inch size takes single-braid rubber covered wire up to No. 8; 3/4-inch size takes double-braid up to No. 4.

Steel City Blanks



No.	Size Inches	Wt., Lbs. Per 1000	Per 1000
15000	1/2	12	\$3.25
15100	3/4	17	3.85
15200	1	26	7.55
15300	1 1/4	36	9.70
15400	1 1/2	41	14.00
15500	2	54	18.80

Steel City Bushings



No.	Size Inches	Wt., Lbs. Per 1000	Per 1000
15000I	1/2	13	\$2.70
15100I	3/4	17	3.35

Appleton Blanks



No.	Size In.	Wt., Lbs. Per 1000	Per 1000
S 50	1/2	17	\$ 5.05
S 75	3/4	20	6.10
S100	1	30	10.95
S125	1 1/4	40	14.30
S150		43	21.00
S200	2	65	27.80

Appleton Bushings



No.	Size In.	Wt., Lbs. Per 1000	Per 1000
SU 50	1/2	15	\$ 5.05
SU 75	3/4	20	6.10

Steel City Fixture Stud and Strap Combination

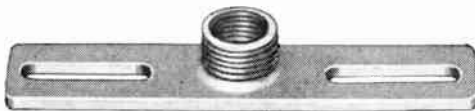

Malleable iron, galvanized. Mounts on ears of outlet box. Allows ample room in box for easy wiring. Slots 1 3/8" x 3/16" inch provide adjustments to any size box. Length, 4 inches. Width, 3/4"-inch. Stud has combination 1/8"- and 1/4"-inch female thread and 3/8"-inch male thread.

No.	Unit Pkg.	Std. Pkg.	Wt., Lbs. Per 100	Std. Pkg. Per 100
8500	50	100	11	\$15.05

T&B Clinching Clips For Knockout Plugs

Approved by Underwriters' Laboratories

Quick Action Clips now give sure protection, Assemble plugs, insert the clip and tighten with pliers.



No.	Conduit Size, In.	Std. Pkg.	Wt. Lbs. Per 100	Per 100
1451	1/2	1000	2	\$7.50
1452	3/4	1000	2 1/2	9.00
1453	1	1000	...	16.25
1454	1 1/4	500	...	21.25
1455	1 1/2	500	...	31.25
1456	2	500	...	41.25

Steel City Bushing Closers

Schedule CF



Used with regular bushings for closing end of conduit. Closers for 5 and 6-inch can be furnished.

No.	Size Inches	Unit Pkg.	Std. Pkg.	Wt., Lbs. Per 100	Std. Pkg. Per 100
9101	1/2	500	1000	1/2	\$1.90
9102	3/4	250	500	1/2	2.15
9103	1	125	250	1	3.75
9104	1 1/4	125	250	1	7.55
9105	1 1/2	50	100	2 1/2	9.70
9106	2	50	100	4	10.80
9107	2 1/2	50	100	5	16.10
9108	3	50	100	8	19.90
9109	3 1/2	50	100	10	27.00
9110	4	25	100	13	35.50

Steel City Fixture Extensions

Malleable iron, galvanized.

For attaching to 3/8"-inch fixture studs to lengthen connection so fixture can be mounted quickly.



No.	Size Inches	Unit Pkg.	Std. Pkg.	Wt., Lbs. Per 100	Std. Pkg. Per 100
725					
725	1	500	1000	6	\$5.40
726	1 3/8	500	1000	7	6.90
727	1 1/16	500	1000	4	5.10

T&B Fixture Extension

Approved by Underwriters' Laboratories



Made of steel with ribs for a good finger grip. Clean-out threads for easy installation.

Three sizes: 1, 1 3/8, 1 1/16 inches long; 3/8"-inch thread. Unit quantity, 500.

No.	Length In.	Std. Pkg.	Wt., Lbs. Per 100	Per 100
1590	1	1000	4	\$8.65
1591	1 3/8	1000	6	11.00
1592	1 1/16	1000	3	8.15

Appleton Fixture Extension Pieces

Schedule CF

3/8"-Inch Male by 3/8"-Inch Female



No.	Length Inches	Ctn. Qty.	*Std. Pkg.	Std. Pkg. Wt., Lbs.	Per 100
18830	1	100	1000	52	\$ 8.65
18831	1 3/8	100	1000	70	11.00

*May be assorted with combination extension pieces to make up standard package quantities.

Appleton Combination Hickey and Swivel Fixture Joint

Schedule CF



In addition to the swivel fixture joint feature, it also has the added feature of being a hickey and eliminates the use of the ordinary hickey.

No.	Size Inches	Ctn. Qty.	Std. Pkg.	Std. Pkg. Wt., Lbs.	Per 100
7221	3/8-1/2	25	50	14	\$112.00

Steel City Fixture Hangers



1355

Galvanized

Standard package 250; unit package 50.

Female Type—Open

No.	Description	Wt., Lbs. Per 100	Std. Pkg. Per 100
1360	3/8" x 1/8" Female.....	5	\$11.25
1361	3/8" x 1/4" Female.....	5	11.25
1362	3/8" x 3/8" Female.....	5	11.25

Combination Male and Female Open

1363	3/8" Male x 1/8" Female.....	4	11.25
1365	1/4" Male x 3/8" Female.....	8	11.25

Appleton Swivel Fixture Hangers

**Cadmium Finish
Schedule CF**



No. 7161



No. 7166

Carton quantity, 10. Standard Package, 50.

Ball Without Cushion

No.	Fixture Stem Size, In.	Male Hub	Fixture Wt., Lbs.	Std. Pkg. Wt., Lbs.	Per 100
7161	1/2	1/2	...	34	\$112.00
7163	3/4	3/4	...	36	120.00

Ball With Cushion

7166	1/2	1/2	3 to 6	41	152.00
7168	3/4	3/4	3 to 6	43	160.00

Appleton Fixture Stems

**Cadmium Finish
Schedule CF**



Boltless Type

Made of malleable iron. Carton quantity, 100.

No.	Size In.	Std. Pkg.	Std. Pkg. Wt., Lbs.	Per 100
8056	3/8	1000	72	15.90
8070	3/8M—1/8F	1000	80	16.00

Hickey Type

Open style, without bolts.
Available in malleable iron or steel.
Carton quantity, 100.



Malleable

8050	3/8	1000	76	\$11.20
------	-----	------	----	---------

Steel

8091	3/8M—1/8F	1000	75	11.70
------	-----------	------	----	-------

Steel City Fixture Studs

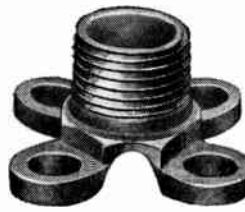

Bolt Type



No Bolt Type

Malleable iron, galvanized. Have all features consistent with practical design. Prices do not include bolts and nuts.

Bolt Type

No.	Size Inches	Unit Pkg.	Std. Pkg.	Wt., Lbs. Per 100	Std. Pkg Per 100
1300	3/8 Solid.....	50	250	12	\$ 7.00
1301	1/2 Solid.....	25	100	13	14.00
1302	1/8 F x 3/8 M.....	50	250	7	7.50
1303	1/4 F x 3/8 M.....	50	250	10	7.50
1305	3/8 Hollow.....	50	250	8	6.00
1306	1/2 Hollow.....	25	100	12	14.00

No Bolt Type—Complete with Locknut

1309	3/8 M x 1/8 F.....	100	500	7	9.70
1310	3/8 M Solid.....	100	500	8	10.75

T&B Hickey Fixture Studs

Approved by Underwriters' Laboratories



This stud is of malleable iron, and is Tabolite galvanized.

All four prongs have extra long slots to allow adjustments.

With this stud no hickey are required on straight electrical work.

No.	Stud Size In.	Unit Pkg.	Std. Pkg.	Wt., Lbs. Per 100	Per 100
16	3/8	100	1000	8	\$11.20

Steel City Entrance Caps And Eils



Caps

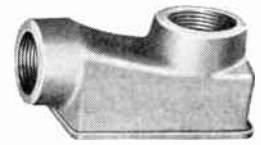

Eils

Aluminum Caps

No.	Size Inches	Unit Pkg.	Std. Pkg.	Wt., Lbs. Per 100	Std. Pkg. Per 100
2609	1/2	5	50	35	\$ 36.00
2619	3/4	5	50	37	48.00
2629	1	2	25	58	66.00
2639	1 1/4	2	20	85	87.00
2649	1 1/2	1	5	120	150.00
2659	2	1	5	280	305.00
2669	2 1/2	..	1	600	915.00
2679	3	..	1	975	1335.00
2689	3 1/2	..	1	1050	1775.00
2699	4	..	1	1125	2220.00

Aluminum Eils

2709	1/2	5	50	31	\$ 54.00
2719	3/4	5	50	42	65.00
2729	1	5	25	64	97.00
2739	1 1/4	5	10	100	170.00

Steel City End Fittings



For Conduit and Armored Cable

Malleable iron, galvanized. Composition insulators.

No.	Size Inches	Unit Pkg.	Std. Pkg.	Wt. Lbs. Per 100	Std. Pkg. Per 100
1850	1/2 Cond.	25	100	10	\$16.50
1860	3/8 Cable	25	100	13	19.00

T&B Entrance Ells

For Electrical Metallic Tubing

Approved by Underwriters' Laboratories



Furnished with a blank steel cover and gasket.

Weather-proof, made of tough malleable iron with Tabolite superior galvanizing.

No.	Size In.	Unit Pkg.	Std. Pkg.	Per 100
5490	1/2	5	60	\$ 129.60
5491	3/4	5	20	169.60
5492	1	5	10	236.80
5493	1 1/4	1	10	520.00
5494	1 1/2	1	5	1072.00
5495	2	1	5	1344.00

T&B Raintight Short Elbows

For Electrical Metallic Tubing—90°

Approved by Underwriters' Laboratories



Accurate, machine cut threads and carefully bushed edges, malleable iron; plated inside and out with Tabolite.

No.	Size In.	Radius In.	Offset In.	Std. Pkg.	Unit Quan.	Per 100
4230	1/2	9/16	1 1/8	50	25	\$51.84
4231	3/4	1 1/8	1 3/8	50	25	81.28
4232	1	1 3/8	1 5/8	25	5	122.88
4233	1 1/4	1 5/8	1 7/8	10	2	360.00
4234	1 1/2	1 7/8	1 3/2	10	2	515.00
4235	2	1 3/2	1 5/8	10	2	785.00

T & B Insulated Raintight Short Elbows



No.	Size In.	Std. Pkg.	Unit Pkg.	Wt. Lbs. Per 100	Per 100
4240	1/2	20	10	20	\$ 90.00
4241	3/4	20	10	32	143.00
4242	1	15	5	56	217.00
4243	1 1/4	4	2	80	615.00
4244	1 1/2	4	2	160	870.00
4245	2	4	2	230	1347.00

T & B Insulated Short Elbows



No.	Size In.	Std. Pkg.	Unit Pkg.	Wt. Lbs. Per 100	Per 100
4290	1/2	20	50	20	\$ 70.00
4291	3/4	25	50	30	100.50
4292	1	10	25	56	160.00
4293	1 1/4	10	25	92	300.00
4294	1 1/2	10	25	120	450.00
4295	2	5	10	180	725.00

T&B Insulated Short Elbows

Threadless



No.	Size In.	Std. Pkg.	Unit Pkg.	Wt. Lbs. Per 100	Per 100
8130	1/2	25	50	36	\$120.00
8131	3/4	25	50	34	190.00
8132	1	5	25	68	375.00
8133	1 1/4	2	10	120	625.00
8134	1 1/2	2	10	160	700.50
8135	2	2	10	230	975.50

T&B Entrance Caps

For Service Entrance Cable

Approved by Underwriters' Laboratories

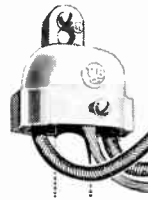

Has only two parts, weather-proof aluminum cap and phenolic insulator.

One clamping screw holds cable and insulator, and grounds cap to the bare neutral.

Deep hood shields end of the cable from all weather. One screw mounting.

One-piece molded composition insulator eliminates threading of conductors.

No.	Max. Cable Sizes	Unit Pkg.	Std. Pkg.	Wt. Lbs. Per 100	Per 100
5549	2-#8	5	50	16	\$72.00
5550	3-#6 or 3-#8	5	50	25	72.00
5551	3-#4 or 3-#8	5	50	30	80.00
5552	3-#2 or 3-#3	2	10	46	128.00

Appleton Rigid Conduit Entrance Fittings

Cadmium Finish

Schedule EF

Type FEBS

Threaded



No. F50: has combination 2, 3 and 4-wire Bakelite cover; 2 holes plugged.

Nos. F75, F100 and F125: have combination 2, 3, 4 and 5-wire Bakelite covers; 2 holes plugged.

No. F125S: has combination 4, 5, 6 and 7-wire composition cover; 3 holes plugged.

Nos. F150 and F200: have combination 2, 3, 4, 5 and 6-wire Bakelite covers, 4 holes plugged.

No.	Size In.	No. and Size of Holes	Car-ton Qty.	Std. Pkg.	Wt. Lbs. Per 100	Per 100
F50	1/2	1-5/16	10	50	55	\$ 53.45
F75	3/4	3-13/32, 2-3/8	10	50	63	71.50
F100	1	3-1, 2-13/32	5	25	105	97.60
F125	1 1/4	3-5/8, 2-13/32	1	10	145	100.50
F125S	1 1/4	5-11/16, 2-9/16	1	10	145	100.50
F150	1 1/2	3-25/32, 2-9/16, 1-3/8	1	5	260	173.70
F200	2	3-1, 2-3/4, 1-1 1/32	1	5	520	352.50

Type FEBR—Reversible

Threaded



Reversible type for outside installation. Have combination 2, 3, 4, 5 and 6-wire composition covers.

Have 6 holes in cover.

Number in carton, 1; standard pack-age, 1.

No.	Size In.	Size of K.O.	Wt. Lbs. Each	Per 100
F250	2 1/2	3-1 3/4, 3-1 1/8	11 1/5	\$ 847.00
F300	3	3-1 3/4, 3-1 1/8	12 1/5	1235.00
F350	3 1/2	3-1 3/4, 3-1 1/8	13 1/4	1650.00
F400	4	3-1 3/4, 3-1 1/8	13 1/2	2050.00

Appleton Rigid Conduit Entrance Fittings

Cadmium Finish

Schedule EF

Type FEB Threaded



Furnished as standard with 3-wire porcelain covers. Available with 4, 5, 6, 7 or 8-wire covers when specified on order.

No.	Size In.	Carton Qty.	Std. Pkg.	Wt., Lbs. Per 100	Per 100
F500	5	1	1	62	\$5600.00
F600	6	1	1	78	\$800.00

Type FC

Threaded



Furnished with combination 2, 3 and 4-wire composition covers.

No.	Size In.	Carton Qty.	Std. Pkg.	Wt., Lbs. Per 100	Per 100
1723	1/2	25	100	17	\$25.90
1733	3/4	25	100	17	\$35.50
1743	1	5	50	44	\$52.50

Type REA Entrance Fittings

Flange Type



Combination entrance cap and flange for outbuilding service entrances meet REA specifications. Aluminum, cannot rust. Insulator has four holes, two plugged. Hub in back tapped for 1/2-inch conduit. Furnished with hot-galvanized wood screws. Standard package, 21; carton, 1.

No.	Description	Wt., Lbs. Std. Pkg.	Carton Quantity
REA-25	Without DuxSeal Compound	20	\$74.50
REA-26	With DuxSeal Compound...	21	\$77.00

Conduit End Fittings

Type FCC

Threaded



Furnished with 3-hole composition cover.

No.	Size In.	Carton Qty.	Std. Pkg.	Wt., Lbs. Per 100	Per 100
1756	1/2	25	100	10	\$24.30

Type AY Angle Fittings

With two threaded female hubs.



No.	Size In.	Ctn. Qty.	Std. Pkg.	Wt., Lbs. Per 100	Per 100
1950	1/2	10	50	84	\$ 76.80
1951	3/4	10	50	100	92.80
1952	1	5	25	108	131.20
1953	1 1/4	5	10	135	363.20
1954	1 1/2	1	10	340	532.20

Type SLAY

†Threaded—With Gasket



For service entrances and outside conduit installations.

Can be installed close to buildings.

No.	Size In.	Ctn. Qty.	Std. Pkg.	Wt., Lbs. Per 100	Per 100
31790	1/2	5	50	66	\$ 75.20
31791	3/4	5	50	84	91.20
31792	1	5	25	136	140.80
31793	1 1/4	5	10	260	192.00

Appleton Entrance Fittings

Schedule EF

For Rigid Conduit (Heavy Wall)

Cadmium Finish

Type LAY—Threaded

For Service Entrances and Outside Conduit Installations



Waterproof; no gasket required.

Cover is held in place by the flange and securely fastened by a screw.

Can be installed close to building.

No.	Size In.	Ctn. Qty.	Std. Pkg.	Wt., Lbs. Per 100	Per 100
1790	1/2	5	50	90	\$ 80.00
1791	3/4	5	50	94	96.00
1792	1	5	25	156	144.00
1793	1 1/4	5	10	330	192.00

1794	1 1/2	1	5	400	312.50
1795	2	1	1	500	380.00
LAY250	2 1/2	1	1	1850	2072.00
LAY300	3	1	1	1950	2145.60

LAY350	3 1/2	1	1	4300	4464.00
LAY400	4	1	1	3850	4992.00

For Driven Grounds



For services that are grounded outside of building.

Hub in bottom of fitting takes 1/2-in. conduit.

11791	3/4 x 1/4 x 1/2	5	50	100	\$140.80
11792	1 x 1/4 x 1/2	5	50	151	201.60
11793	1 1/4 x 1/4 x 1/2	5	10	210	272.00

Appleton Sill Plates

Schedule OF

For Service Entrance Cable



Provides metallic protection at the point where the service entrance cable enters the building.

Eliminates unsightly bends, making a neater, safer installation.

Made of aluminum and furnished with two hot dip galvanized screws.

Can be furnished with DuxSeal weatherproof compound for filling and sealing the entrance hole. Compound is compressed around cable, and fills up the hole when the sill plate is screwed down. Permits hole to be drilled on a downward angle and allows longer sweep bends to be made in cable.

With DuxSeal Weatherproof Compound

No.	Fits Cable	Ctn. Qty.	Std. Pkg.	Pkg. Wt., Lbs.	Per 100
25235	All Sizes to 3 Cond. No. 4	10	100	13	\$32.00
25236	3 Cond. to No. 2	10	100	15	57.00

DuxSeal Weatherproof Compound

No.	Description	Each
25250	1 lb. Package	\$0.70
25251	5 lb. Package	2.75

Appleton Entrance Cable Fittings

Entrance Fittings

Schedule OF

For Underwriters' Types SEA or SEU (Oval) Cable



OF-1

For use with oval bare neutral concentric service entrance cable and for oval armored service entrance cable.

Combine greater convenience with increased weather protection. One-piece cast bodies eliminate need for fastening a separate cover on top of entrance head; eliminate danger of losing covers.

Clamping plate secures cable, locks insulating covers in place, and provides slot for passage of ground wire.

Only two screws are loosened and retightened in making installation.



OF-2

No.	Cable Opening Diam. In.		Ctn. Qty.	Std. Pkg.	Per 100
	Min.	Max.			
OF-1	5/16 x 3/4	11/16 x 3/4	10	40	\$72.00
OF-2	7/16 x 1 3/32	3/4 x 1 3/32	10	40	80.00

Cable Sizes

No. OF-1		No. OF-2	
Insulated Conductor	Bare Neutral	Insulated Conductor	Bare Neutral
2-10	1-10	2-4	1-4
2-8	1-8	2-2	1-2
2-6	1-6

For Underwriters' Cable Type SE

Accommodates following cable sizes:

Insul. Cond. 2-4 2-2 1-4 1-2
Bare Neutral 1-4 1-2 1-4 1-2

Diameter of cable opening, 5/8 x 7/8 in. min., 13/16 x 1 1/8-in. max.

Carton quantity, 5; std. pkg., 50.



No. 15202 Per 100 \$160.00

For Underwriters' Cable Type ASE



No. 15205

No. 15206

No. 8

No.	Cable Opening Diam., In.		Ctn. Qty.	Std. Pkg.	Per 100
	Min.	Max.			
15205	19/32	7/8	5	50	\$160.00
15206	19/32	1 3/32	2	5	168.00
8	3/4 x 1 1/8	1 3/16 x 1 3/8

Cable Sizes

No. 15205		No. 15206		No. 8	
Insulated Conductor	Bare Neutral	Insulated Conductor	Bare Neutral	Insulated Conductor	Bare Neutral
2-12	1-12	2-6	1-8	2-2	1-2
2-10	1-12	2-6	1-6	2-1	1-1
2-10	1-10	2-4	1-6	2-1/0	1-1/0
2-8	1-8	2-4	1-4		
		2-2	1-2		

Cable Clamps

Schedule OF

Universal Clamps

Malleable Iron



No. OF-15275

No. 15275: Fits service entrance cable — 2 No. 12, 2 No. 10, 2 No. 8, 2 No. 6, 1 No. 8 and 1 No. 10, 1 No. 6 and 1 No. 8, 3 No. 12.



Nos. OF-15276 and OF-15277

No. 15276: Fits service entrance cable — 2 No. 4, 1 No. 4 and 1 No. 6, 3 No. 10, 2 No. 10 and 1 No. 12, 3 No. 8, 2 No. 8 and 1 No. 10, 3 No. 6, 2 No. 6 and 1 No. 8.

No. 15277: Fits service entrance cable — 2 No. 2, 1 No. 2 and 1 No. 4, 3 No. 4, 2 No. 4 and 1 No. 6, 3 No. 2, 2 No. 2 and 1 No. 4.

No.	Ctn. Qty.	Std. Pkg.	Wt. Lbs. Per 100	Per 100
15275	100	100	3	\$5.10
15276	100	100	4 1/2	5.45
15277	100	100	6	6.10

One-Screw Clamps

Schedule OF

Malleable Iron-Cadmium Finish



For Round Cable



For Oval Cable

Carton quantity, 100; standard package, 100.

For Round Cable

No.	For Type SE Cable	For Type SD Cable	Wt. Lbs. Per 100	Per 100
15290	{ 2 No. 12, 2 No. 10, 1 No. 10, 1 No. 12 }	2 No. 10, 2 No. 8	2 1/2	\$2.00
15291	{ 2 No. 8, 1 No. 8, 1 No. 10, 1 No. 6, 1 No. 8, 2 No. 6 }	2 No. 6, 2 No. 4	3	3.75

For Oval Cable

15240	{ 3 No. 8, 2 No. 8, 1 No. 10 }	{ 3 No. 6, 2 No. 6 and 1 No. 8 }	3	\$4.05
15241	{ 3 No. 6, 3 No. 4, 2 No. 6, 1 No. 8 }	2 No. 4, 1 No. 6	3	4.40
15295	3 No. 2	3 No. 2	7	5.00

Call Graybar FIRST For . . .

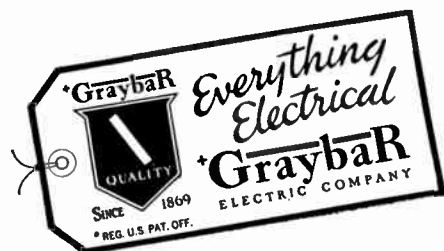

Crouse-Hinds Condulets

**Service Entrance Conduit Fittings
For Threaded Heavy Wall Conduit**



***Type F Caps
Form 8**

Furnished with composition cover with knockouts to accommodate 5 to 7 wires. Can be furnished with 2 or 3-wire porcelain covers in 1/2, 3/4 and 1" at same prices; add suffix PH.

No.	Size In.	Each
F186	1/2	\$0.60
F285	3/4	.80
F385	1	1.10
F487	1 1/4	1.45
F586	1 1/2	2.50
F686	2	5.10



***Type F Caps
Form 6**

Furnished with composition cover for 2 or 3-wire service. Four-wire covers can be furnished at the same list price.

No.	Size In.	Each
F766	2 1/2	\$15.30
F866	3	22.25
F966	3 1/2	26.95
F1066	4	37.05
F01263	5	85.25
F01463	6	88.95



Type FEE Caps

Caps for Type SE 3-conductor oval or 2-conductor round service entrance cable (with or without steel serving) with bare neutral.

Cast aluminum.

No.	Max. Dimen. of Cable, In.	Each	No.	Size of Cable	Each
FEE8	.625x.750	.625	FED284	#10	\$1.85
FEE4	.750x.940	.750	FED384	#6	2.05
FEE2	.844x1.188	.844			



Type FED Caps

Elbows and Tees

Form 6



Type LB

Furnished with gasket and blank sheet steel cover having end wedgenuts.†

No.	Size In.	Each
LB16	1/2	\$0.95
LB26	3/4	1.05
LB36	1	1.65
LB46	1 1/4	2.80
LB56	1 1/2	4.05
LB666	2	6.95
LB76	2 1/2	13.90



Type LBC

For driven grounds. Furnished with blank cast Feraloy cover and break neck locking screw. Hub at left in illustration is 1/2 inch.

No.	Size In.	Each
LBC216	3/4	\$1.45
LBC316	1	2.15
LBC416	1 1/4	2.95

**Service Entrance Conduit Fittings
For Thick-Wall and Thin-Wall Conduit
Type FBM**



Type FBM

Size In.	Without Sealing Compound		With Sealing Compound	
	No.	Each	No.	Each
1/2	FBM145	\$0.95	FBM146	\$1.00
1/2	FBM145-MT	\$1.50	FBM146-MT	\$1.65

**For Threaded Heavy Wall Conduit
Type FBA End Fittings**

Furnished with composition cover for 2, 3, or 4-wire service.



Type FBA

No.	Size In.	Each
FBA1	1/2	\$0.60
FBA2	3/4	.70
FBA3	1	.95
FBA4	1 1/4	2.05

Type FBB End Fittings

Furnished with composition cover for 2, 3, or 4-wire service.



Type FBB

No.	Size In.	Each
FBB1	1/2	\$0.80
FBB2	3/4	.85
FBB3	1	1.15
FBB4	1 1/4	2.60

Type LBY Elbows

Furnished with cast screw cover.



Type LBY

No.	Size In.	Each
LBY1	1/2	\$0.80
LBY2	3/4	1.00
LBY3	1	1.35
LBY4	1 1/4	3.75
LBY5	1 1/2	5.50

**Type CGY Service Entrance Connectors
2-Screw Compression Clamp Type**

Meets the requirements of watertightness and resistance to corrosion, the two most important requirements of a service entrance cable connector. Screws are reversible, making heads accessible under all conditions of installation.

Non-ferrous metal, corrosion-resistant alloy, and heavily-plated steel clamping screws.

Round Cable—Single Conductor

Types SE (with or without steel serving) and SD, Bare Neutral.



No.	Each	Size Insulated	Size Bare	Size Thrd. Nipple, In.	No. of Cap
CGY2292	\$.60	10	10	3/4	FEE8
CGY3292	.70	10	10	1	FEE8
CGY2282†	.60	8	8†	3/4	FEE8
CGY3412†	.70	8	8†	1	FEE8
CGY2282	.60	6	8	3/4	FEE8
CGY3412	.70	6	8	1	FEE8
CGY2272	.60	6	6	3/4	FEE8
CGY3422	.70	6	6	1	FEE8
CGY2242	.60	4	6	3/4	FEE4
CGY2242	.60	4	4	3/4	FEE4

Oval Cable—2 Conductor

No.	Each	Size Insulated	Size Bare	Size Thrd. Nipple, In.	No. of Cap
CGY2412	\$.60	12	12	3/4	FEE8
CGY2352	.60	8 or 10	8 or 10	3/4	FEE8
CGY3402	.70	8	8	1	FEE8
CGY3352	.70	6	6 or 8	1	FEE4
CGY3232	.70	4	4 or 6	1	FEE2

†For two No. 8 round cable without internal steel tape armor CGY2292 or CGY3292 will, with some makes of cable, produce a better fit.

Appleton Service Entrance Connectors



2-Screw Type

Round



Oval

Schedule OF Watertight



Round

Nut Type



Oval

2-Screw Type: Made of non-ferrous metal; will not rust.

Nut Type: Made of malleable iron; cadmium finish.

2-Screw—Round

No.	Hub Size In.	Bushings Size		Cable Size	Std. Pkg.	Ctn. Qty.	Each
		Max. Diam. In.	Min. Diam. In.				
SER-1075S	3/4	.375	.312	2-12, 2-10	100	10	\$48.00
SER-1100S	1	.375	.312	2-12, 2-10	100	10	59.85
SER-2075S	3/4	.437	.375	2-12, 2-10	100	10	48.00
SER-2100S	1	.437	.375	2-12, 2-10	100	10	59.85
SER-3075S	3/4	.500	.437	2-12, 2-10	100	10	48.00
SER-3100S	1	.500	.437	2-12, 2-10	100	10	59.85
SER-4075S	3/4	.562	.500	2-8, 2-6	100	10	48.00
SER-4100S	1	.562	.500	2-8, 2-6	100	10	59.85
SER-5075S	3/4	.625	.562	2-6, 2-4	100	10	48.00
SER-5100S	1	.625	.562	2-6, 2-4	100	10	59.85
SER-6075S	3/4	.687	.625	2-4, 2-2	100	10	48.00
SER-6100S	1	.687	.625	2-4, 2-2	100	10	59.85
SER-7075S	3/4	.750	.687	2-2	100	10	48.00
SER-7100S	1	.750	.687	2-2	100	10	59.85

2-Screw—Oval

No.	Hub Size In.	Bushings Size		Cable Size	Std. Pkg.	Ctn. Qty.	Each
		Max. Diam. In.	Min. Diam. In.				
SEO-1075S	3/4	.343x.500	.265x.421	3-12	100	10	\$48.00
SEO-1100S	1	.343x.500	.265x.421	3-12	100	10	59.85
SEO-2075S	3/4	.406x.578	.328x.500	3-12, 3-10	100	10	48.00
SEO-2100S	1	.406x.578	.328x.500	3-12, 3-10	100	10	59.85
SEO-3075S	3/4	.468x.609	.390x.531	3-12, 3-10	100	10	48.00
SEO-3100S	1	.468x.609	.390x.531	3-12, 3-10	100	10	59.85
SEO-4075S	3/4	.515x.750	.437x.671	3-8	100	10	48.00
SEO-4100S	1	.515x.750	.437x.671	3-8	100	10	59.85
SEO-5075S	3/4	.516x.828	.468x.750	3-8, 3-6	100	10	48.00
SEO-5100S	1	.516x.828	.468x.750	3-8, 3-6	100	10	59.85
SEO-6100S	1	.578x.921	.500x.813	3-6, 3-4	100	10	59.85
SEO-7100S	1	.690x.937	.531x.859	3-4	100	10	59.85
SEO-8100S	1	.656x1.00	.578x.921	3-4	100	10	59.85

Nut Type—Round

No.	Hub Size In.	Bushings Size		Cable Size	Std. Pkg.	Ctn. Qty.	Each
		Max. Diam. In.	Min. Diam. In.				
SER-1075	3/4	.375	.312	2-12, 2-10	100	10	\$48.00
SER-1100	1	.375	.312	2-12, 2-10	100	10	59.85
SER-2075	3/4	.437	.375	2-12, 2-10	100	10	48.00
SER-2100	1	.437	.375	2-12, 2-10	100	10	59.85
SER-3075	3/4	.500	.437	2-12, 2-10	100	10	48.00
SER-3100	1	.500	.437	2-12, 2-10	100	10	59.85
SER-4075	3/4	.562	.500	2-8, 2-6	100	10	48.00
SER-4100	1	.562	.500	2-8, 2-6	100	10	59.85
SER-5075	3/4	.625	.562	2-6, 2-4	100	10	48.00
SER-5100	1	.625	.562	2-6, 2-4	100	10	59.85
SER-6075	3/4	.687	.625	2-4, 2-2	100	10	48.00
SER-6100	1	.687	.625	2-4, 2-2	100	10	59.85
SER-7075	3/4	.750	.687	2-2	100	10	48.00
SER-7100	1	.750	.687	2-2	100	10	59.85

Nut Type—Oval

No.	Hub Size In.	Bushings Size		Cable Size	Std. Pkg.	Ctn. Qty.	Each
		Max. Diam. In.	Min. Diam. In.				
SEO-1075	3/4	.343x.500	.265x.421	3-12	100	10	\$48.00
SEO-1100	1	.343x.500	.265x.421	3-12	100	10	59.85
SEO-2075	3/4	.406x.578	.328x.500	3-12, 3-10	100	10	48.00
SEO-2100	1	.406x.578	.328x.500	3-12, 3-10	100	10	59.85
SEO-3075	3/4	.468x.609	.390x.531	3-12, 3-10	100	10	48.00
SEO-3100	1	.468x.609	.390x.531	3-12, 3-10	100	10	59.85
SEO-4075	3/4	.515x.750	.437x.671	3-8	100	10	48.00
SEO-4100	1	.515x.750	.437x.671	3-8	100	10	59.85
SEO-5075	3/4	.516x.828	.468x.750	3-8, 3-6	100	10	48.00
SEO-5100	1	.516x.828	.468x.750	3-8, 3-6	100	10	59.85
SEO-6100	1	.578x.921	.500x.813	3-6, 3-4	100	10	59.85
SEO-7100	1	.690x.937	.531x.859	3-4	100	10	59.85
SEO-8100	1	.656x1.00	.578x.921	3-4	100	10	59.85
SEO-9125	1 1/4	.671x1.078	.593x1.00	3-2	50	5	128.00
SEO-10125	1 1/4	.734x1.140	.656x1.062	3-2	50	5	128.00
SEO-11150	1 1/2	.875x1.375	.812x1.281	3-1/0			128.00

T&B Service Entrance Cable Connectors

Approved by Underwriters' Laboratories

Strain Relief Bushings—Watertight



Bushing forms snug, watertight fit against cable.

Die cast bodies. Tabolite finished.

Popular sizes have color coded bushings.

For 2-Conductor (Round) Cable

Cable Size	Cable Type	Hex Nut Type Nos.		2-Screw Type Nos.	
		1/2-in.	3/4-in.	1-in.	1 1/4-in.
2-#12 or 2-#10	ASE, SE	2196	2229	2429	
	SD	2195	2228	2428	
2-#8 or 1-#8 & #10	ASE, SE,	2196	2229	2429	2504 2604
	SD				
2-#6 or 1-#6 & #8	ASE, SE,	2196	2229	2429	2504 2604
	SD				

For 3-Conductor (Oval) Cable

Cable Size	Cable Type	Hex Nut Type Nos.			2-Screw Type Nos.	
		1/2-in.	3/4-in.	1-in.	3/4-in.	1-in.
3-#12	ASE		2232	2432		
	SE, SD	2111	2232	2432		
3-#10 or 2-#10 & 1-#12	ASE		2233	2433		
	SE		2232	2432		
	SD	2111	2232	2432		
3-#8 or 2-#8 & 1-#10	ASE, SE,		2233	2433	2514	2514
	SD					
3-#6 or 2-#6 & 1-#8	ASE, SE			2438		2625
	SD		2233	2433	2514	2614
3-#4 or 2-#4 & 1-#6	ASE, SE			2439		2627
	SD			2438		2625
3-#2 or 2-#2 & 1-#4	ASE, SE,					
	SD			2446 (1 1/4" thread)		

Prices and Packages

Applying to Service Entrance Cable Connectors

Connector	Std. Pkg.	Unit Quan.	Wt., Lbs. Per 100	Per 100
All 1/2"	100	10	20	\$48.00
All 3/4"	100	10	18	48.00
All 1"	100	10	22	59.84
All 1 1/4"	50	5	62	128.00

T&B Angle Insulets®

Approved by Underwriters' Laboratories

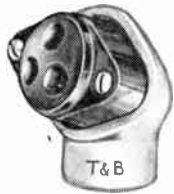

Can be used as a service entrance on horizontal conduit, or as an inside installation.

Insulator has three wire holes, with one hole plugged.

No.	Size Inches	Unit Pkg.	Std. Pkg.	Wt., Lbs. Per 100	Per 100
1640	1/2	5	50	22	\$ 74.50
1641	3/4	5	50	52	79.00
1642	1	6	30	97	114.00
1643	1 1/4	5	25	120	250.00

T&B Insulets® For Armored Cable

Approved by Underwriters' Laboratories



Has a "Tite-Bite" grip made to hold all 3/8-inch sizes of armored cable, as well as non-metallic cable.

Insulator has three wire holes, with one hole plugged.

No.	Size Inches	Unit Pkg.	Std. Pkg.	Std. Pkg. Wt., Lbs.	Per 100
1665	3/8	25	100	16	\$30.50

T&B Entrance Caps

For Threaded Rigid Conduit

Approved by Underwriters' Laboratories

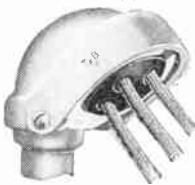

May be used in both vertical and horizontal positions with entrance holes always 45° from the weather.

Insulator is of heavy composition, moulded to sit in the frame. Cap is hot galvanized; frame Tabolited.

No.	Size In.	Holes in Insul.	Unit Pkg.	Std. Pkg.	Wt., Lbs.	Per 100
1525	1/2	4	10	50	82	\$ 53.44
1521	3/4	5	5	50	104	71.04
1522	1	5	5	25	136	97.60
1523	1 1/4	5	1	10	220	126.40
1524	1 1/4	7	1	10	230	126.40
1529	1 1/2	6	1	5	240	222.40
1530	2	6	1	5	600	451.20
1531	2 1/2	4	1	1	1600	1355.20
1532	3	6	1	1	2800	1976.00
1533	3 1/2	6	1	1	2500	2640.00
1534	4	6	1	1	2600	3280.00

T&B Aluminum Wall Plate

Approved by Underwriters' Laboratories

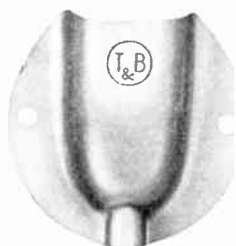

Made of solid formed aluminum. Accommodates a maximum of 3 #4 wires in the service cable and a maximum of 1 #4 for ground connection.

Furnished with non-drying Dux Seal caulking compound.

Complete with 2 #8 screws.

No.	Max. Service Cable Size	Unit Pkg.	Std. Pkg.	Wt., Lbs. Per 100	Per 100
5546	3W4	10	100	21	\$32.00

*Wall plate with Dux Seal.

Appleton E.M.T. Entrance Fittings

Cadmium Finish

Schedule TW

Type FEBS

No. FT 50: has combination 2, 3 and 4-wire bakelite cover, two holes plugged.

Nos. FT 75, FT 100 and FT 125: have combination 2, 3, 4 and 5-wire Bakelite cover, two holes plugged.

No. FT 125S: has combination 4, 5, 6 and 7-wire composition cover, three holes plugged.

Nos. FT 150 and FT 200: have combination 2, 3, 4, 5 and 6-wire Bakelite covers, four holes plugged.



No.	Size In.	No. and Size of Holes	Ctn. Qty.	Std. Pkg.	Wt., Lbs. Per 100	Per 100
FT 50	1/2	4 3/16	10	40	55	\$ 85.75
FT 75	3/4	3 13/16, 2 3/8	10	40	63	94.70
FT 100	1	3 1/2, 2 13/16	2	20	105	133.10
FT 125	1 1/4	3 3/8, 2 13/32	1	10	115	208.75
FT 125S	1 1/4	5 11/16, 2 9/16	1	10	21	208.75
FT 150	1 1/2	3 25/32, 2 9/16, 1 3/8	1	5	260	307.85
FT 200	2	3-1, 2 3/4, 1 11/32	1	5	520	502.20

Type SLAY

Approved Raintight.

With flanged cover and gasket. Will be supplied with sealing screws, when specified, at no additional charge.



No.	Size In.	Ctn. Qty.	Std. Pkg.	Std. Pkg. Wt., Lbs.	Per 100
317T90	1/2	10	40	30 1/2	\$129.60
317T91	3/4	10	20	42	169.60
317T92	1	5	10	35	236.80
317T93	1 1/4	1	10	30	406.25

Special Entrance Ell

Type FEL



No.	Size In.	Ctn. Qty.	Std. Pkg.	Std. Pkg. Wt., Lbs.	Per 100
37T90	1/2	25	100	30	\$ 63.36
37T91	3/4	10	40	21	95.04
37T92	1	5	20	20	145.73
37T93	1 1/4	5	20	27	205.92

90-Degree Short Elbow



No.	Size In.	Ctn. Qty.	Std. Pkg.	Std. Pkg. Wt., Lbs.	Per 100
73T90	1/2	10	40	9	\$ 51.85
73T91	3/4	10	40	11	81.30
73T92	1	5	20	13	122.90

T&B Entrance Caps for E.M.T.

Approved by Underwriters' Laboratories



Same as standard T&B Entrance Cap for heavywall conduit, except with a thinwall conduit connector at the base.

Furnished with a heavy composition insulator. Made of heavy cast-iron, plated with Tabolite superior galvanizing.

No.	Size In.	Unit Pkg.	Std. Pkg.	Wt., Lbs. Per 100	Per 100
5525	1/2	10	50	90	\$ 85.76
5526	3/4	5	50	124	94.72
5527	1	5	25	160	133.12
5528	1 1/4	1	10	270	265.20

T&B Entrance Ells

Approved by Underwriters' Laboratories



Designed for straight pull in either direction. Mounts flush on wall, eliminating any need for bending conduit.

Has no sharp edges; carefully bushed to protect the cable. Cover is held in place with one screw which does not come out. A turn of the screw and the cover slips out. Made of heavy cast iron, plated with Tabolite.

No.	Size In.	Unit Pkg.	Std. Pkg.	Wt., Lbs. Per 100	Per 100
1490	1/2	5	50	72	\$ 80.00
1491	3/4	5	50	86	96.00
1492	1	5	25	132	144.00
1493	1 1/4	5	10	260	252.80
1494	1 1/2	1	5	340	400.00
1495	2	1	1	520	608.00
1496	2 1/2	1	1	900	2072.00
1497	3	1	1	1200	2145.60

Steel City Pipe Strap



Malleable iron; for heavy weight conduit. Galvanized.

No.	Size Inches	Unit Pkg.	Std. Pkg.	Wt., Lbs. Per 100	*Std. Pkg. Per 100
175	3/8	100	500	4 1/2	\$ 4.75
176	1/2	100	500	5	4.15
177	3/4	50	500	9 1/2	5.70
178	1	50	100	12 1/2	8.35
179	1 1/4	25	100	17	13.60
180	1 1/2	25	50	26	16.95
181	2	10	25	41	30.05
182	2 1/2	10	25	98	52.40
183	3	10	25	114	73.70
184	3 1/2	5	10	245	104.75
185	4	5	10	315	234.75
187	5	2	5	430	630.50

*Prices slightly higher in Western and Southeastern States.

T&B One-Hole Pipe Straps For Thinwall Conduit (E.M.T.)



Malleable

Made of tough malleable iron, designed specially for a snug fit on E.M.T. 3/8-inch size made of steel.

No.	Size Inches	Std. Pkg.	Pkg. Wt., Lbs.	Per 100
4175	3/8	500	3	\$ 8.96
4176	1/2	500	4 1/2	6.72
4177	3/4	500	6	8.96
4178	1	100	11	12.80
4179	1 1/4	100	19	20.80
4180	1 1/2	50	30	25.60
4181	2	25	52	48.00

Steel



No.	Size Inches	Unit Quan.	Std. Pkg.	Wt., Lbs. Per 100	Per 100
4159	1/2	100	500	7	\$ 4.80
4160	3/4	50	500	10	7.36
4161	1	50	100	14	10.88

T&B One-Hole Conduit Straps For Standard Rigid Conduit

Approved by Underwriters' Laboratories



Malleable Strap

Hot-dip galvanized malleable iron. Has reinforced ribs. Designed to prevent conduit sag.

No.	Size Inches	Unit Quan.	Std. Pkg.	Wt., Lbs. Per 100	Per 100
1275	3/8	100	500	5	\$ 7.36
1276	1/2	100	500	6	6.40
1277	3/4	50	500	9	8.64
1278	1	50	100	16	12.80
1279	1 1/4	25	100	24	20.80
1280	1 1/2	25	50	30	25.60
1281	2	10	25	64	46.40
1282	2 1/2	10	25	112	80.00
1283	3	5	10	150	112.00
1284	3 1/2	5	10	240	160.00
1285	4	5	10	280	360.00
1287	5	2	5	440	1040.00

Steel Strap

Prevent slipping of conduit or conductor after the strap is in place. No. 65 has projection on inside to fit the groove in armored cable.



No.	Size Inches	Std. Pkg.	Wt., Lbs. Per 100	Per 100
65	1/4	500	3	\$ 4.00
1210	3/8	500	7	6.40
1211	1/2	500	10	6.24
1212	3/4	500	14	8.32
1213	1	100	21	12.80

T&B Cable Straps



Designed to take the entire range of service entrance cable sizes.

Do the work formerly covered by eleven old style straps.

Malleable iron.

No.	Cable Size	Unit Pkg.	Std. Pkg.	Pkg. Wt. Lbs.	Per 100
1341	2W12, 2W10, 2W8, 2W6, 3W12	50	100	3	\$5.12
1344	2W4, 3W10, 3W8, 3W6	50	100	5	5.44
1345	2W2, 3W4, 3W2	50	100	6 1/2	6.08

Appleton Cable Straps

Schedule CF

For Use with Non-Metallic Sheathed Cable



1-Hole



2-Hole

Fit rubber insulated or thermo-plastic insulated conductors 14-2, 12-2 and 10-2.

For Rubber Insulated Conductors

Package	1-Hole			2-Hole		
	No.	Avg. No. Per Lb.	Per 100	No.	Avg. No. Per Lb.	Per 100
10# carton	7146-10	118	\$26.90	8067-10	80	\$26.90
25# carton	7146-25	118	25.80	8067-25	80	25.80
Bulk 50# bag	7146-50	118	25.80	8067-50	80	25.80

For Thermoplastic Insulated Conductors

10# carton	7147-10	124	\$24.80	8068-10	92	\$24.80
25# carton	7147-25	124	23.10	8068-25	92	23.10
Bulk 50# bag	7147-50	124	23.10	8068-50	92	23.10

Appleton 1-Screw Clamps

Schedule TW
Cadmium Finish

For Use with Electrical Metallic Tubing
(Threadless Thin-Wall Conduit)



Malleable



Steel

Require only one screw to fasten the clamp, holding conduit securely.

Malleable

No.	Size In.	Ctn. Qty.	Std. Pkg.	Wt., Lbs. Per 100	Per 100
171T49	3/8	200	2000	3	\$ 8.95
171T50	1/2	100	1000	3 3/4	6.70
171T51	3/4	100	1000	5 1/2	8.95
171T52	1	100	500	7	12.80
171T53	1 1/4	100	500	11	20.80
171T54	1 1/2	50	250	15	25.60
171T55	2	50	250	17	48.00

Steel

No.	Size In.	Ctn. Qty.	Std. Pkg.	Wt., Lbs. Per 100	Per 100
172T50	1/2	100	1000	5 1/2	\$4.80
172T51	3/4	100	1000	6 5/8	7.35

Appleton 1-Screw Clamp

Schedule CF

For 1/4-In. Pipe and 3/8-In. Armored Conductor



No.	Size In.	Std. Pkg.	Std. Pkg. Wt., Lbs.	Per 1000
7145	1/4	500	9	\$11.90

Diamond 1-Hole Clamps

Malleable Iron



Two designs available for use with standard rigid conduit or with thin-wall (E.M.T.).

Straps are annealed twice before galvanizing to assure ductility. Will not crack during installation. Hot dip galvanizing after annealing.

For Standard Rigid Conduit

No.	Pipe Size In.	Cable Size In.	Std. Pkg.	Approx. Ship. Wt. Lbs. Per 100
MC-25	1/4	.50	100	3
MC-38	3/8	.67	100	4
MC-50	1/2	.81	100	5 1/2
MC-75	3/4	1.05	100	6
MC-100	1	1.31	100	11
MC-125	1 1/4	1.66	50	17
MC-150	1 1/2	1.90	50	25
MC-200	2	2.37	50	46
MC-250	2 1/2	2.87	50	100
MC-300	3	3.50	35	157
MC-350	3 1/2	4.00	25	158
MC-400	4	4.50	25	201

For Thin-Wall Conduit (E.M.T.)

No.	Size In.	Cable Size In.	Std. Pkg.	Approx. Ship. Wt. Lbs. Per 100
MC-50S	1/2 s	.706	100	5
MC-75S	3/4 s	.922	100	6
MC-100S	1 s	1.163	100	10
MC-125S	1 1/4 s	1.508	50	16
MC-150S	1 1/2 s	1.738	50	23
MC-200S	2 s	2.195	50	42

Diamond 1-Hole Clamps

Made of cold rolled mild steel. Annealed and hot dip galvanized after forming. In standard or offset designs.

Standard

For use with cable, standard rigid conduit or threadless thinwall conduit (E.M.T.).



No.	Cable Size In.	Pipe Size In.	Thinwall Size In.	Size Stock In.	Std. Pkg.	Approx. Ship. Wt. Lbs. Per 100
L-3	3/16	1/2x.072	500	1
L-4	1/4	1/2x.062	500	1
L-5	5/8	1/2x.062	500	1
L-6	3/8	1/8	...	1/2x.048	500	1
L-7	7/16	1/2x.048	500	1.1
L-8	1/2	1/4	3/8	1/2x.048	500	1.2
L-9	5/8	1/2x.048	500	1.2
L-10	3/4	1/2x.048	500	1.3
L-11	11/16	3/8	1/2	5/8x.062	500	4
L-12	7/8	1/2	...	1 1/4x.062	500	4.5
L-14	7/8	...	3/4	1 1/8x.062	500	5.0
L-16	1	3/4	...	3/4x.080	250	7.0
L-18	1 1/8	...	1	3/4x.080	250	7.5
L-20	1 1/4	1	...	7/8x.115	100	15
L-24	1 1/2	...	1 1/4	7/8x.115	100	16
L-26	1 5/8	1 1/4	...	7/8x.115	100	17
L-28	1 3/4	...	1 1/2	7/8x.115	100	19
L-30	1 7/8	1 1/2	...	7/8x.115	100	20

Offset Type

Accommodate wider range of cable or conduit sizes than do comparable sizes of standard type clamp, starting in offset position down to position where the tail is flat on surface.



No.	Cable Size, Inches	Pipe Size In.	Size Stock In.	Approx. Ship. Wt. Per 100
403	3/32	...	5/16x.048	.4
405	1/4	...	5/16x.048	.5
406	5/16	...	1/2x.048	1
407	3/8	1/8	1/2x.048	1.1
408	1/2	1/4	1/2x.048	1.2
409	5/8	...	3/4x.060	2.5
411	11/16	3/8	3/4x.060	2.87
413	3/4	1/2	3/4x.078	4.12
417	1	3/4	3/4x.078	5.31
421	1 1/8	1	3/4x.115	9.75
425	1 1/2	1 1/4	3/4x.115	10.62
430	1 3/4	1 1/2	3/4x.115	12.43
435	2 1/8	2	3/4x.130	16
442	2 1/2	2 1/2	3/4x.130	18.43

Prices on application.

Minerallac 2-Hole Straps



Zinc-Plated Steel, or Everdur Alloy.

Designed for use on loads too heavy to be supported by the one-hole Jiffy Clip.

No.	Fits	Std. Pkg.	Wt., Lbs. Std. Pkg.	Steel Per 100	Everdur Per 100
225	1/4" Rigid Conduit—BX	500	7	\$1.45	\$ 3.95
228	3/8" Rigid Conduit.....	100	3	1.60	6.20
230	1/2" EMT.....	100	3	1.70	6.30
240	1/2" Rigid.....	100	3 1/2	1.85	7.95
245	3/4" EMT.....	100	4	2.30	9.10
250	3/4" Rigid.....	100	4	2.65	10.15
255	1" EMT.....	100	4 1/2	3.20	13.70
260	1" Rigid.....	100	5	3.90	17.00

For Broken Package Quantities Add 15%.

Appleton 1-Screw Clamps

Schedule CF

For Rigid Conduit (Heavy Wall)



Malleable



Steel

Only one screw is required to fasten strap and secure conduit.

Size In.	Malleable			Steel		
	No.	Std. Pkg. Wt., Lbs.	Per 100	No.	Std. Pkg. Qty.	Per 100
1/4	17148	3	\$ 7.84	7148	3	\$3 85
3/8	17149	2	7.84	7149	3	3 20
1/2	17150	11	6.88	7150	5	5 10
3/4	17151	13	9.44	7151	8	5 30
1	17152	21	13.76	7152	9	5 45
1 1/4	17153	14	22.40	7153	17	10 10
1 1/2	17154	16	28.00	10	100
2	17155	14	49.60	50	50
2 1/2	17156	25	86.40	50	50
3	17157	36	121.60	25	25
3 1/2	17158	24	172.80	25	25
4	17159	29	387.20	10	10



Heavy Stamped Steel Clamp

No.	Size In.	Ctn. Qty.	Std. Pkg.	Std. Pkg. Wt., Lbs.	Per 100
17248	1/4	100	100	9	\$ 4.00
17249	3/8	100	100	9	6.40
17250	1/2	100	100	11	6.25
17251	3/4	100	100	12	8.30
17252	1	25	100	23	12.80
17253	1 1/4	25	100	14	17.60
17254	1 1/2	25	100	20	20.00
17255	2	5	25	16	43.20
17256	2 1/2	5	25	16	48.00
17257	3	5	10	14	72.00
17258	3 1/2	5	10	18	96.00
17259	4	5	10	22	112.00

Appleton 1-Screw Clamp Backs

Schedule CF

Cadmium Finish

For Rigid Conduit or E.M.T.

Used under 1-screw pipe clamps to raise the conduit from the surface to prevent moisture accumulation around the pipe. Also allow conduits to run in a straight line into hubs and knockout boxes.



No.	Size In.	Ctn. Qty.	Std. Pkg.	Std. Pkg. Wt., Lbs.	Per 100
27148	3/8	100	100	6	\$ 9.45
27150	1/2	100	100	10	9.45
27151	3/4	100	100	10	10.80
27152	1	100	100	15	17.20
27153	1 1/4	25	100	10	25.60
27154	1 1/2	100	100	12	32.80
27155	2	10	100	8	53.60
27156	2 1/2	10	100	8	84.00
27157	3	5	50	16	132.80
27158	3 1/2	5	25	..	177.60
27159	5	5	10	..	187.20

Diamond 2-Hole Conduit and Cable Straps

Steel—Hot Galvanized



Standard Type



Offset Type

Designed to withstand heavy strains and vibrations.

High strength design permits a fewer number of straps to be used in cable runs.

Available in standard, extra heavy, or offset types.

Standard Type

No.	Cable Size In.	Pipe Size In.	Stock Size In.	Approx. Ship. Wt. Lbs. Per 100
T7	7/16	1/8	1/2 x .048	1.5
T10	5/8	1/4	1/2 x .048	2
T11	1 1/8	3/8	5/8 x .062	3.2
T12	3/4	..	1 1/8 x .062	4.1
T14	7/8	1/2	1 1/8 x .062	4.4
T16	1	..	3/4 x .080	6.9
T18	1 1/4	3/4	3/4 x .080	7.3
T20	1 1/2	1	7/8 x 1/8	13.5
T24	1 1/2	..	7/8 x 1/8	15.25
T26	1 5/8	1 1/4	7/8 x 1/8	16.5
T28	1 3/4	..	7/8 x 1/8	17
T30	1 7/8	1 1/2	7/8 x 1/8	19
T40	2 1/2	2	1 1/8 x 1	26
T46	2 7/8	2 1/2	1 1/8 x 1	31
T56	3 1/2	3	1 1/8 x 1	35

Extra Heavy Type

N1	7/16	1/8	1 1/16	4.5
N2	5/8	1/4	1 1/16	5.5
N3	1 1/8	3/8	1 1/16	6.7
N4	3/4	..	1 1/16	7.1
N5	7/8	1/2	1 1/16	7.7
N6	1	..	1 1/16	8.3
N7	1 1/8	3/4	1 1/8	17.9
N8	1 1/4	1	1 1/8	19.2
N9	1 1/2	..	1 1/8	21.5
N10	1 3/4	..	1 1/4	23.5
N11	1 7/8	..	1 1/8	24.7
N12	2	..	1 1/8	26.0
N13	2 1/8	..	1 1/8	27.2
N14	2 1/4	..	1 1/8	28.5

Offset Type

709	9/16	..	5/8 x .048	1.6
711	1 1/16	..	5/8 x .048	2.1
713	1 1/8	..	3/4 x .048	2.75
716	1	..	3/4 x .068	5.0
720	1 1/4	..	3/4 x .068	6.5
724	1 1/2	1	3/4 x .068	7.1
730	1 7/8	1 1/4	7/8 x .068	9.8
736	2 1/4	..	7/8 x .083	13.6
742	2 5/8	2	7/8 x .083	15.5
756	3 1/2	..	1 x .083	22.25
764	4	3	1 x .083	25.5

Prices on application.

Minerallac Fittings

Jiffy Clips

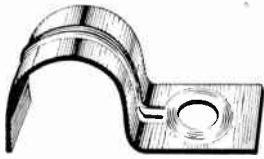

A substantial clamp for hanging pipe, conduit, tubing and lead covered cable. Made in Everdur and zinc-plated steel. Only one screw or bolt is required to hold the clip firmly in place. A round boss which serves the purpose of a lock washer is raised on the edge of the bolt hole.

No.	Copper Tube	Fits, Inches		Std. Pkg.	Approx. Std. Pkg. Wt., Lbs.	Price Per 100	
		Rigid	EMT			Steel	Everdur
102	1/8	500	2 3/4	\$0.80	\$ 2.65
103	3/16	500	3	.85	2.75
105	1/4	500	3 1/2	.90	2.80
110	3/16	500	3 1/2	1.00	2.90
115	3/8	500	6 3/4	1.15	3.00
120	...	1/8	...	500	7	1.25	3.25
▲125	1/2	1/4	...	500	8 1/4	1.40	3.80
130	5/8	3/8	1/2	200	6 1/2	1.65	6.00
135	3/4	100	3 1/2	1.70	6.60
140	...	1/2	...	100	4 1/4	1.75	7.55
145	3/4	100	1 1/2	2.20	8.70
150	1	3/4	...	100	5	2.50	9.80
155	1	100	5 1/4	3.05	13.10
160	...	1	...	100	9	3.70	16.30
165	1 1/2	...	1 1/4	100	11	4.25	19.00
170	...	1 1/4	1 1/2	100	13 1/2	4.90	21.75

▲ Fits BX.

**Duplex Jiffy Clips
Pipe Clamp, with One Hole**



Zinc-Plated steel, or Everdur alloy. For fastening parallel runs of conduit or cable. Clip is held in place by one screw or bolt.

No.	Size Cable or Tube, In.	Std. Pkg.	Steel Per 100 Pcs.	Everdur Per 100 Pcs.
300	1/4 x 1/4	500	\$1.15	\$3.45
300A	1/8 x 1/8	500	1.00	3.00
301	3/8 x 3/8	500	1.50	4.40
302	1/4 x 3/8	500	1.60	4.80
303	1/4 x 1/2	500	1.75	5.25
303A	1 3/32 x 1 3/32	500	1.75	5.25
304	3/8 x 5/8	500	1.95	5.80
305	1/2 x 1/2	500	2.10	6.30
306	5/8 x 5/8	500	2.20	6.60

**Messenger Straps
For Conduit Boxes**

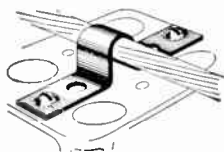

Made of zinc-plated steel or Everdur alloy. Fits all standard outlet boxes and 3/8-inch messenger cable. To be used in conjunction with the Minerallac messenger hanger for messenger cable installations.

Recommended stove bolt size, 1/4 x 1/2 inches.
Standard package, 100.

Size Cable.....inches 3/8
Approximate Weight per Standard Package.....pounds 3 1/4

*Steel.....per std. pkg. \$ 3.50
*Everdur.....per std. pkg. 10.50

*Prices do not include stove bolts.

Messenger Hangers

For Messenger Cable Installations

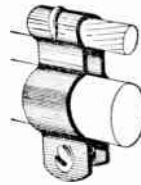

Strong, durable hangers made of zinc-plated steel or Everdur metal. Quickly and easily installed. Design and construction saves time, material and installation costs.

Standard package, 100.

No.	Messenger Size	Conduit Size		Wt., Lb. Std. Pkg.		Price Per 100	
		Rigid	Thin Wall	Steel	Everdur	Plated Steel	Everdur
M-0	3/8	3/8	1/2	5 1/2	6	\$4.70	\$14.10
M-1	3/8	1/2	3/4	7 1/4	8	5.15	15.45
M-2	3/8	3/4	1	9 1/4	10	6.90	20.70

Cable and Conduit Hangers

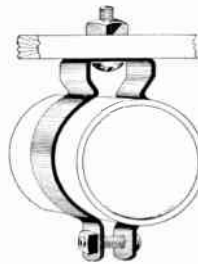

Made of zinc-plated steel or Everdur alloy.

Quickly and easily put in place.

Open wiring, conduit and cable may be run rapidly and arranged compactly.

For voltages above 550 volts, the hanger should be used with insulating bushings.

No.	Conduit Size		O.D. Conduit		Opening Inches		Price Per 100	
	Rigid	Thin Wall	Rigid	Thin Wall	Min.	Max.	Steel	Everdur
0	3/8, 1/2	1/2	{.675 .810}	.706	5/8	27/32	\$ 4.50	\$13.50
1	3/4	3/4	1.050	.922	1 3/16	1 1/16	5.00	15.00
2	1	1	1.315	1.163	1 1/16	1 11/32	6.65	19.95
2 1/2	...	1 1/4	...	1.503	1 9/32	1 1/2	7.00	21.00
3	1 1/4	1 1/2	1.660	1.738	1 1/2	1 11/16	7.25	21.75
4	1 1/2	...	1.900	...	1 11/16	1 31/32	8.95	31.50
5	2	2	2.375	2.195	27/32	2 15/32	9.65	40.00
6	2 1/2	...	2.875	...	2 11/16	3	10.70	47.15
7	3	...	3.50	...	3 1/4	3 3/4	11.95	51.00
8	3 1/2	...	4.000	...	4	4 1/2	14.00	56.00

Porcelain Bushings

For Cable Hangers

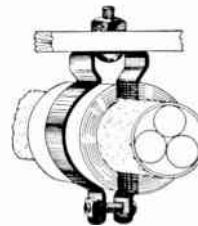

For high voltage work. Porcelain bushings are for use with hangers of the same catalog number. Properly designed for necessary dielectric and mechanical strength.

No.	Opening Inches		Wt., Lbs. Std. Pkg.	Per 100
	Min.	Max.		
1	5/16	1/2	8	\$14.60
2	5/8	27/32	9 1/2	18.00
3	7/8	1 1/16	15	21.00
4	1 1/8	1 13/32	22	23.65
5	1 11/32	1 9/32	49	29.50
6	1 3/16	2 1/8	60	32.50

Beam Clamps



For use with hangers, gang straps, etc. Made of heavy gage pressed steel zinc plated. Complete with case hardened set screw. Fits up to 1/2-inch thick Beam Flange, 1/4-20 tapped holes.

No.	Std. Pkg.	Std. Pkg. Wt., Lbs.	Per 100
600	50	6 1/2	\$17.60

Diamond 1-Hole Di-Stamp Clamps

Steel

Hot dip galvanized for long life. Arched cross section provides strength with minimum weight.



No.	Pipe Size In.	Std. Pkg.	Approx. Ship. Wt. Lbs. Per 100
DC-25*	1/4	100	3
DC-38*	3/8	100	3
DC-50	1/2	100	5
DC-75	3/4	100	8
DC-100	1	100	9
DC-125	1 1/4	100	20
DC-150	1 1/2	50	36

*Made of flat stock.

Prices on application.

Korns Conduit Supports

Galvanized or Black Enamel Finish

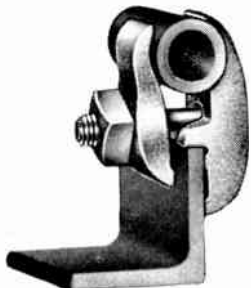

Parallel Type



Right Angle Type

For attaching conduit easily and securely to steel framework without drilling holes.

Eliminates the necessity of designing special rigging for either permanent or temporary work.

Made of malleable iron with a piece of tool steel inserted into one end. Edge of tool steel bites into structural steel member to which it is attached, providing a non-slip grip.

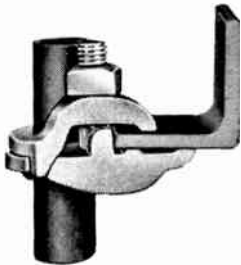

Edge Type

To Order
Specify Parallel, Right Angle or Edge Type and Finish Desired

Std. Pipe Size, In.	Parallel Type		Right Angle Type		Edge Type	
	Ship. Wt. Lbs. Per 100	List Price Per 100	Ship. Wt. Lbs. Per 100	List Price Per 100	Ship. Wt. Lbs. Per 100	List Price Per 100
3/8	31	\$27.00	26	\$24.00	*	*
1/2	58	30.00	40	25.15	67	\$43.00
3/4	64	32.00	43	26.20	71	45.00
1	70	35.00	48	29.00	85	48.00
1 1/4	72	41.00	53	32.00	91	59.00
1 1/2	93	47.00	58	36.40	115	68.00
2	128	58.00	85	48.00	135	80.00
2 1/2	135	74.00	106	62.00	183	103.00
3	155	90.00	110	70.00	230	126.00
3 1/2	190	110.00	128	85.00	*	*
4	205	124.00	140	93.25	*	*

*Not made in this size.

Prices slightly higher in Western and Southern States.

Call Graybar FIRST For . . .



Appleton Sta-Tite Pipe Hangers

Cadmium Finish

Schedule CP

For Use with Rigid Conduit or E.M.T.



Type PHS with single conduit parallel with structural shape.

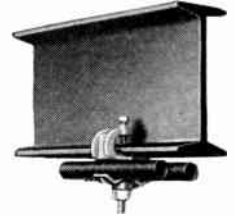

Type PHD with two conduits parallel with structural shape.

Designed to accommodate 1/2, 3/4 and 1-inch rigid conduit (heavy wall) or 1/2, 3/4, 1, 1 1/4 and 1 1/2-inch threadless thin-wall conduit.

Type PHS

For Single Line Conduit

Permits conduits to be run parallel with beam, cross-wise, or at any horizontal angle.



No.	For Rigid Conduit Size, In.	For E.M.T. Size, In.	Car-ton Qty.	Std. Pkg.	Std. Pkg. Wt., Lbs.	Per 100
2330	1/2, 3/4	1/2, 3/4, 1	25	25	80	\$112.00
2331	1	1 1/4, 1 1/2	50	50	120	128.00

Type PHD

For Two Lines of Conduit

Permits conduit to be run parallel with beam, cross-wise, or at any horizontal angle.



2335	1/2, 3/4	1/2, 3/4, 1	50	50	85	\$120.00
2336	1	1 1/4, 1 1/2	10	50	50	144.00



Type PH Hanger



Single Pipe Accessory

Type PH and Accessories

Designed for hanging either single line or two lines of conduit by use of desired accessory.



Double Pipe Accessory

Type PH Hanger

No.	Ctn. Qty.	Std. Pkg.	Std. Pkg. Wt., Lbs.	Per 100
2342	50	50	65	\$96.00

Single Pipe Accessories

No.	For Rigid Conduit Size, In.	For E.M.T. Size, In.	Car-ton Qty.	Std. Pkg.	Std. Pkg. Wt., Lbs.	Per 100
2345	1/2, 3/4	1/2, 3/4, 1	10	100	18	\$16.00
2346	1	1 1/4, 1 1/2	10	100	18	32.00

Double Pipe Accessories

2350	1/2, 3/4	1/2, 3/4, 1	10	100	20	\$24.00
2351	1	1 1/4, 1 1/2	10	100	20	48.00

Kindorf Hangers and Supports

Ceiling Flange



For suspending hanger rods from ceiling. For 3/8-in. and 1/2-in. hanger rods. Hanger rods and nuts extra.

No.	Hanger Rod, Inches	Wt., Lbs. Per 100	Per 100
E-243-3/8	3/8	18	\$21.15
E-243-1/2	1/2	28	23.90

Side Beam Connector



Holes are 7/16-in. diameter. Order Hanger Rod and Nuts separately.

No.	Wt., Lbs. Per 100	Per 100
E-244	18	\$13.80

Swing Connector



Through bolt furnished with patented lock nut. Order Hanger Rod and Nuts separately.

No.	Wt., Lbs. Per 100	Per 100
E-245	18	\$34.40

Spot Type Concrete Insert with Knockout



Ready to install—knockout is removed after pouring concrete. Hanger Rod sizes 1/4-in. through 7/8-in. Use B-913. Specify nut size when ordering.

No.	Wt., Lbs. Per 100	Per 100
D-255	52	\$21.30

Continuous Slot Concrete Insert

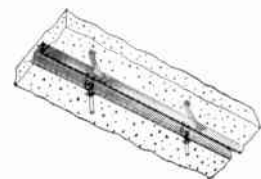

1 1/2-in. x 1 1/2-in. x 12 ga. channel with welded anchors.

Available in lengths from 1 to 20 feet.

No.	Length, Feet	Wt., Lbs. Per Ft.	Per 100 Ft.
D-980-2	2	4.0	\$195.95
D-980-4	4	7.6	353.00
D-980-6	6	11.2	508.95
D-980-8	8	14.8	688.65
D-980-10	10	18.4	839.20

Anchor End Cap

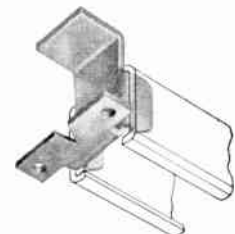

For capping ends of D-980 insert channel.

No.	Wt., Lbs. Per 100	Per 100
D-982	19	\$9.90

Channel, With or Without Holes



No. B-905



No. B-907

For Building Racks, Frames, and Trapeze

Holes are 17/32-in. on 1 1/2-in. centers. Standard lengths are 10 and 20 feet.

Cross-Section, Inches	No.	With Holes		Without Holes	
		Wt., Lbs. Per Ft.	Per 100 Ft.	No.	Wt., Lbs. Per Ft.
1 1/2 x 1 1/2	B-905	1.6	\$62.00	B-900	1.68
1 1/2 x 3/4	B-907	.82	35.50	B-906	.88

Hardened Steel Nuts



No. B-910



No. B-911



No. B-912

Without Spring

Size, Inches	No.	Use with	Wt., Lbs. Per 100	Per 100
3/8	B-910-3/8	Any Channel	8.0	\$9.55
1/2	B-910-1/2	Any Channel	8.5	10.10

With Spring

3/8	B-911-3/8	B-900, B-905	9.0	13.60
	B-912-3/8	B-906, B-907	8.7	13.10
1/2	B-911-1/2	B-900, B-905	9.5	14.15
	B-912-1/2	B-906, B-907	9.2	14.10

Angle Connectors



No. B-915



No. B-916



No. B-917

No.	Design	Wt., Lbs. Per 100	Per 100
B-915	2-Hole	37	\$18.60
B-916	3-Hole	53	26.20
B-917	5-Hole	63	32.30

Zee Support



No. B-926

Wt., Lbs. Per 100	Per 100
42	\$23.25

Three-Hole Plate Connector



No. B-935

Wt., Lbs. Per 100	Per 100
40	\$18.85

U Support

No. B-927

Wt., Lbs. Per 100	Per 100
65	\$41.00

Kindorf Hangers and Supports For Suspending Single Runs of Conduit

Steel Conduit Clamps



No. C-248

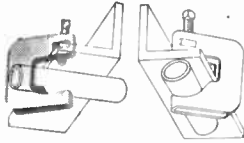

No. C-247

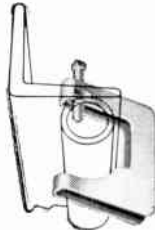

No. C-249

Clamps conduit snugly, either parallel to or at right angle to support.

No.	Conduit Size, Inches	Beam Flange Thickness, Inches	Wt., Lbs. Per 100	Per 100
C-247	1/2 3/4	up to 5/8 up to 7/16	30	\$22.00
C-248	1/2 3/4 1	up to 1 up to 3/4 up to 1/2	38	28.55
C-249	3/4 1 1 1/4 1 1/2	up to 1 1/2 up to 1 1/4 up to 1 up to 5/8	56	38.70

Edge-Type Conduit Clamp

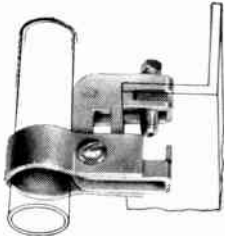

Assembly consists of one E-231-3/8 beam clamp and conduit strap of proper size with bolt and nut.

Used to install conduit across edge of I-beams, channels, angles of columns.

No.	Conduit Size, Inches	Wt., Lbs. Per 100	Per 100
C-246-1/2	1/2	51	\$40.35
C-246-3/4	3/4	52	42.45
C-246-1	1	54	43.60
C-246-1-1/4	1 1/4	58	45.85
C-246-1-1/2	1 1/2	75	54.95
C-246-2	2	83	58.00
C-246-2-1/2	2 1/2	91	62.05
C-246-3	3	101	78.70
C-246-3-1/2	3 1/2	109	81.25
C-246-4	4	127	95.40

Adjustable Conduit Hangers

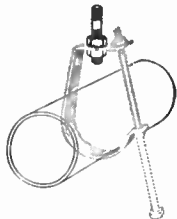

Size 1/2-in. through 2-in. require 3/8-in. hanger rod. 2 1/2-in. through 5-in. require 1/2-in. hanger rod.

No.	Conduit, Inches	Hanger Rod, Inches	Wt., Lbs. Per 100	Per 100
C-149-1/2	1/2	3/8	19	\$20.15
C-149-3/4	3/4	3/8	20	21.15
C-149-1	1	3/8	22	22.45
C-149-1-1/4	1 1/4	3/8	26	24.85
C-149-1-1/2	1 1/2	3/8	29	25.00
C-149-2	2	3/8	31	27.25
C-149-2-1/2	2 1/2	1/2	96	58.80
C-149-3	3	1/2	106	64.35
C-149-3-1/2	3 1/2	1/2	125	70.75

Conduit Beam Clamp



Fits any American Standard Beam up to 6 inch flange width.

No.	Conduit, Inches	Wt., Lbs. Per 100	Per 100
C-147-1/2	1/2	120	\$120.70
C-147-3/4	3/4	123	121.70
C-147-1	1	125	123.80
C-147-1-1/4	1 1/4	130	124.80
C-147-1-1/2	1 1/2	140	127.80
C-147-2	2	148	129.90
C-147-2-1/2	2 1/2	170	138.00
C-147-3	3	190	148.10
C-147-3-1/2	3 1/2	200	155.20
C-147-4	4	260	181.60

Structural Steel Clamps

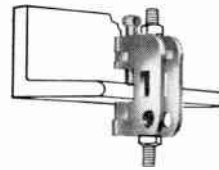

No. E-231



No. E-233

For Fastening to Structures

Hanger Rod, Inches	Without Swing Connectors			With Swing Connectors		
	No.	Wt., Lbs. Per 100	Per 100	No.	Wt., Lbs. Per 100	Per 100
3/8	E-231-3/8	30	\$24.00	E-232-3/8	46	\$42.60
1/2	E-231-1/2	67	39.40	E-232-1/2	83	60.40

Anchor Clips

For E-231 and E-232 beam clamps subject to excessive vibration.

Hanger Rod, Inches	For 6-In. Beam			For 10-In. Beam		
	No.	Wt., Lbs. Per 100	Per 100	No.	Wt., Lbs. Per 100	Per 100
3/8	E-233-3/8-6	20	\$9.30	E-233-3/8-10	33	\$13.20
1/2	E-233-1/2-6	21	9.30	E-233-1/2-10	35	13.30

Adjustable Beam Clamps For 1/4-In. Hanger Rod

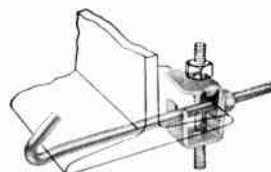

Clamps to I-Beams. Available in three sizes to fit beam flange widths up to 6-, 9- or 12-in. widths.

For Beam Flange Width, Inches	Without Swing Connector			With Swing Connector		
	No.	Wt., Lbs. Per 100	Per 100	No.	Wt., Lbs. Per 100	Per 100
2 1/2 to 6	E-160-6	110	\$65.70	E-165-6	210	\$134.30
5 1/2 to 9	E-160-9	123	69.70	E-165-9	223	139.30
8 1/2 to 12	E-160-12	136	74.80	E-165-12	236	145.40

Kindorf Hangers and Supports

For Building Racks, Frames and Trapeze



No.	Description	Wt., Lbs. Per 100	Per 100
B-936	Angle Plate Connector.....	53	\$37.00
B-937	"T" Plate Connector.....	70	47.80
B-938	Open Angle Connector.....	40	22.10

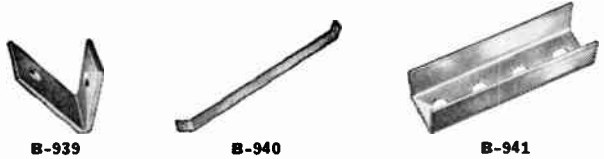

No.	Description	Wt., Lbs. Per 100	Per 100
B-939	Closed Angle Connector.....	50	\$23.80
B-940-1	Corner Brace.....	114	50.90
B-941	Joiner.....	73	59.95

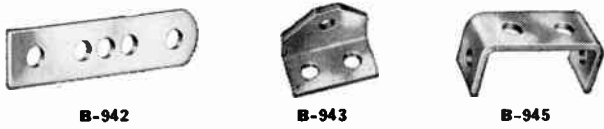

No.	Description	Wt., Lbs. Per 100	Per 100
B-942	Swivel Plate.....	54	\$38.15
B-943	Brace Connector.....	61	42.90
B-945	Rod Connector.....	58	30.85



Rigid Conduit Straps

Available also for E.M.T. Order C-106 and specify size.

No.	Conduit, Inches	Wt., Lbs. Per 100	Per 100
C-105-3/8	3/8	19	\$13.25
C-105-1/2	1/2	21	15.40
C-105-3/4	3/4	23	17.55
C-105-1	1	27	18.75
C-105-1-1/4	1 1/4	29	20.95
C-105-1-1/2	1 1/2	33	23.20
C-105-2	2	37	24.40
C-105-2-1/2	2 1/2	43	26.85
C-105-3	3	50	30.30
C-105-3-1/2	3 1/2	58	33.85

Larger sizes available.

Hanger Rod, Continuous Thread

Threads are continuous throughout the standard six-foot length. Cuts to any desired length.

No.	Diameter, Inches	Wt., Lbs. Per 100	Per 100
H-191	3/8	226	\$128.00
H-192	1/2	400	174.00

Steel Rod Coupling

For coupling hanger rod.

No.	Rod, Inches	Wt., Lbs. Per 100	Per 100
H-195-A	3/8	14	\$23.85
H-195-B	1/2	28	34.70

For Building Racks, Frames, and Trapeze "U" Bolt

Standard "U" Bolt. Galv-Krom finish. Furnished with two hex nuts. Made of 3/16-in. steel rod, through 2-in., 2 1/2-in. and 3-in.

No.	Conduit, Inches	Wt., Lbs. Per 100	Per 100
H-286-1/2	1/2	25	\$8.65
H-286-3/4	3/4	30	10.60
H-286-1	1	32	11.75
H-286-1-1/4	1 1/4	35	12.80
H-286-1-1/2	1 1/2	37	13.95
H-286-2	2	41	18.80
H-286-2-1/2	2 1/2	84	21.80
H-286-3	3	93	24.45

Square Washer 1 1/2-in. x 1 1/2-in.

No.	Bolt, Inches	Wt., Lbs. Per 100	Per 100
H-119-C	3/8	11.50	\$7.30
H-119-D	1/2	14.36	8.50

Heavy Hex Nut

No.	Bolt, Inches	Wt., Lbs. Per 100	Per 100
H-114-C	3/8	3.2	2.30
H-114-D	1/2	4.84	4.40

Hex Head Capscrew (Less nut)

No.	Size, Inches	Wt., Lbs. Per 100	Per 100
H-113-A	1/2 x 3/4	6.75	6.50
H-113-B	1/2 x 1	9.09	7.00

For Hanging Fluorescent Fixtures Approved by Underwriters' Laboratories, Inc.

Fixture Hanging Channel

1 1/2-in. x 1 1/2-in. cross-section. Channel has 1/2-in. knock-outs spaced on 6-in. centers. Standard 10 and 20 foot lengths.

No.	Wt., Lbs. Per Ft.	Per 100 Ft.
G-975	1.8	\$62.00

Closure Strip

Snap-locks into the slot side of the channel to complete the enclosure. 10-ft. standard lengths.

No.	Wt., Lbs. Per Ft.	Per 100 Ft.
G-969	.21	\$17.60

Swing Connector

Connects conduit to G-975 channel with provision for expansion and contraction.



No.	Wt., Lbs. Per 100	Per 100
G-977	130	\$133.00

Channel Hanger

Standard with 1 1/2-in. hole for 1/2-in. hanger rod. Other size holes available if specified.

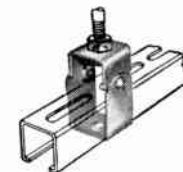

No.	Wt., Lbs. Per 100	Per 100
G-962	90	\$42.65

Channel Joiner

For joining together two pieces of G-975 channel.

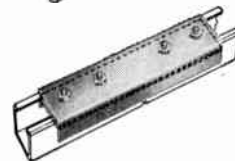

No.	Wt., Lbs. Per 100	Per 100
G-978	110	\$89.90

Stud Nut

For fastening fixture to channel.



No.	Size, Inches	Wt., Lbs. Per 100	Per 100
G-974-1/2	1/4 x 1/2	8	\$12.45
G-974-1	1/4 x 1	9	12.50

End Caps



No.	Description	Wt., Lbs. Per 100	Per 100
G-967	Drive-in end cap.....	10	\$9.30
G-979	End cap with 1/2-in. knockout.....	20	24.65

Minerallac Perforated Strapping

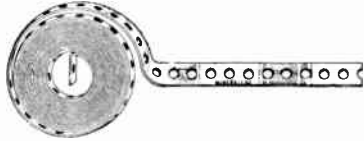

10 ft. coils — 10 coils per box.

No.	Weight, Lbs. Per 100 Feet	Per 100 Feet
410C 3/4" x .035" electro galvanized steel . . .	8	\$2.70
478 7/8" x .050" electro galvanized steel . . .	12	3.60



Perforated Strapping Counter Display

Excellent counter item for Dealer's walk-in trade.

24—10-ft. coils per display carton.

No.	3/4" x .035 Gage Electro galv. steel . . .	Per Display Carton	Suggested Retail Price
410D		\$6.95	\$0.48 per coil

O. Z. U-Bolts

Type U



For clamping conduit to a structure up to 3/8-in. thick.

Made of steel can be supplied with flat washers and lock washers at additional cost. Longer bolts can be furnished at additional cost.

Conduit Size In.	Stock Dia. In.	Cadmium Plated		Hot Dip Galvanized	
		No.	Per 100	No.	Per 100
1/2	1/4	MU054	\$19.20	HU054	\$27.20
3/4	3/8	MU074	20.00	HU074	28.00
3/4	5/16	MU075	23.20	HU075	32.80
3/4	3/8	MU076	27.20	HU076	40.00
1	1/4	MU114	20.80	HU114	28.80
1	5/16	MU115	24.00	HU115	33.60
1	3/8	MU116	28.80	HU116	41.60
1 1/4	1/4	MU124	22.40	HU124	30.40
1 1/4	5/16	MU125	25.60	HU125	35.20
1 1/4	3/8	MU126	30.40	HU126	43.20
1 1/2	1/4	MU154	24.00	HU154	32.00
1 1/2	5/16	MU155	27.20	HU155	36.80
1 1/2	3/8	MU156	32.00	HU156	44.80
2	5/16	MU205	28.80	HU205	38.40
2	3/8	MU206	33.60	HU206	46.40
2 1/2	3/8	MU266	36.80	HU266	49.60
2 1/2	1/2	MU268	52.80	HU268	68.80
3	3/8	MU316	40.00	HU316	52.80
3	1/2	MU318	56.00	HU318	72.00
3 1/2	3/8	MU366	43.20	HU366	56.00
3 1/2	1/2	MU368	59.20	HU368	75.20
4	3/8	MU416	48.00	HU416	60.80
4	1/2	MU418	64.00	HU418	80.00
4 1/2	3/8	MU466	52.80	HU466	65.60
4 1/2	1/2	MU468	68.80	HU468	84.80
5	3/8	MU516	57.60	HU516	76.40
5	1/2	MU518	73.60	HU518	89.60
6	3/8	MU616	80.00	HU616	92.80
6	1/2	MU618	96.00	HU618	112.00

T&B Conduit Supports

Approved by Underwriters' Laboratories

Malleable



Will fit any beam flange up to 5/6 inch thick. Pointed set screw bites into the beam, insuring permanent tightness and a good electrical ground.

Tough, malleable iron body holds standard rigid conduit or E.M.T.

No.	Conduit Size	Unit Pkg.	Std. Pkg.	Wt., Lbs. Per 100	Per 100
690	1/2	10	100	42	\$112.00
691	3/4	10	100	46	125.00
692	1	10	50	54	133.00
693	1 1/4	10	50	62	184.00

T&B Adjustable Conduit Hangers

Approved by Underwriters' Laboratories

Will fit any flange from 2 3/4 to 12 inches. They are universal in the range of beam flanges they fit, the number of pipes they accommodate, and the various angles at which the pipe may be run.

Adjustable for varying plaster lines, and will support any number of conduits, from one to eight.

Beam Clamps



No. 700—Fits flanges from 2 3/4 to 7 3/8 inches. Including bolts; standard package, 100. Weight per 100, 31 pounds.

Per 100..... \$150.40

No. 701—Fits flanges from 7 to 12 ins. Including bolts; standard package, 100; weight 58 pounds.

Per 100..... \$240.00

No. 703—Bolt and 3 Nuts, Standard Package 100, Weight per 100—6 pounds.

Per 100..... \$26.40

T&B Steel Conduit Supports

For Use with Beam Clamps

No.	No.	Conduit Size, In.	Std. Pkg.	Wt., Lbs. Per 100	Per 100
733	1	1/2	100	21	\$ 43.20
734	1	3/4	100	23	52.00
735	1	1	50	24	86.40
736	1	1 1/4	50	24	96.00
737	1	1 1/2	25	28	104.00
738	1	2	25	32	176.00
739	1	2 1/2	25	36	192.00
740	1	3	25	40	224.00

T&B Malleable Iron Conduit Supports

For Use with Beam Clamps

741	2	1/2	100	27	\$ 86.40
743	2	3/4	50	36	104.00
745	2	1	25	44	176.00
746	2	1 1/4	25	56	224.00
747	2	1 1/2	25	64	248.00
742	4	1/2	100	44	147.20
744	4	3/4	50	54	208.00

T&B Disconnect Hangers

Approved by Underwriters' Laboratories



Provides a safety disconnect for light and power circuits. Designed primarily for mercury vapor lighting units. Can be used equally well with other types of industrial lighting fixtures.

Each hanger consists of a locking hook with 10-amp., 250-volt polarized receptacle and a bushed loop.

Made of tough malleable iron, they support the fixture or pendant outlet and cannot be unhooked until the plug is out and the fixture "dead." The plug closes the hook so the loop cannot be removed while the plug is in place.

No.	Description	Std. Pkg.	Wt. Lbs. Per 100	Each
6140	Complete Assembly	10	120	\$9.60

Parts for Making Up Other Sizes of Disconnect Hanger Assemblies

Hooks

For use with Loops listed Below. Standard package, 10. Furnished with plug.



No.	Description	Wt. Lbs. Per 100	Each
6150	1/2" thr., 2-W Recept.	90	\$ 9.60
6151	3/4" thr., 2-W Recept.	95	10.40
6152	1/2" thr., 3-W Recept.	115	20.00
6153	3/4" thr., 3-W Recept.	120	20.80

Loops

For use with Hooks listed above. Standard package, 10.



No.	Description	Wt. Lbs. Per 100	Each
785	1/2" thread, non-cushion	20	\$ 1.02
786	3/4" thread, non-cushion	26	1.92
805	1/2" thread, 3-6 lbs. cushion	45	6.88
806	1/2" thread, 6-12 lbs. cushion	45	7.84
807	1/2" thread, 12-24 lbs. cushion	45	8.16

T&B Grounding Wedge

Approved by Underwriters' Laboratories

Used with regular conduit bushings. Does away with all jumper wires.

Each grounding wedge is marked "T&B" and size of conduit with which it is to be used.



No.	Size In.	Unit Pkg.	Std. Pkg.	Per 100
3650	1/2	50	100	\$ 22.88
3651	3/4	50	100	26.40
3652	1	25	50	35.20
3653	1 1/4	25	50	44.80
3654	1 1/2	25	50	65.60
3655	2	10	25	96.00
3656	2 1/2	5	10	179.20
3657	3	5	10	228.80
3658	3 1/2	2	5	400.00
3659	4	2	5	464.00
3661	5	2	2	840.00
3662	6	2	2	1040.00

O. Z. Grounding Bushings

Type GB—For Grounding Conduit



Corrosion-resistant bronze, with a mechanical connection for joining a ground wire to conduit. For use with metallic protected cables and other grounding purposes. Adaptable for grounding a bank of conduits in a manhole, pullbox or at switchboard positions.

For Solid or Stranded Wire

For 1/2 In. Cond.—Ht. 5/8 In.				For 3 In. Cond.—Ht. 7/8 In.			
No.	Wire Size	Wt. Lbs. Ea.	Each	No.	Wire Size	Wt. Lbs. Ea.	Each
GB0508	8	.19	\$ 0.85	GB3108	8	.75	\$ 2.35
GB0506	6	.19	.85	GB3106	6	.75	2.35
				GB3104	4	.75	2.35
				GB3102	2	.75	2.35
				GB3101	1	.75	2.35
For 3/4 In. Cond.—Ht. 1 In.				For 3 1/2 In. Cond.—Ht. 1 In.			
No.	Wire Size	Wt. Lbs. Ea.	Each	No.	Wire Size	Wt. Lbs. Ea.	Each
GB0708	8	.25	.85	GB1108	8	.38	1.00
GB0706	6	.25	.85	GB1106	6	.38	1.00
				GB1104	4	.38	1.00
				GB1102	2	.38	1.00
				GB1101	1	.38	1.00
For 1 In. Cond.—Ht. 7/8 In.				For 3 1/2 In. Cond.—Ht. 1 In.			
No.	Wire Size	Wt. Lbs. Ea.	Each	No.	Wire Size	Wt. Lbs. Ea.	Each
GB1208	8	.38	1.15	GB3608	8	1.0	2.90
GB1206	6	.38	1.15	GB3606	6	1.0	2.90
GB1204	4	.38	1.15	GB3604	4	1.0	2.90
GB1202	2	.38	1.15	GB3602	2	1.0	2.90
GB1201	1	.38	1.15	GB3601	1	1.0	2.90
For 1 1/4 In. Cond.—Ht. 7/8 In.				For 4 In. Cond.—Ht. 1 1/4 In.			
No.	Wire Size	Wt. Lbs. Ea.	Each	No.	Wire Size	Wt. Lbs. Ea.	Each
GB1508	8	.50	1.35	GB4108	8	1.4	3.50
GB1506	6	.50	1.35	GB4106	6	1.4	3.50
GB1504	4	.50	1.35	GB4104	4	1.4	3.50
GB1502	2	.50	1.35	GB4102	2	1.4	3.50
GB1501	1	.50	1.35	GB4101	1	1.4	3.50
For 1 1/2 In. Cond.—Ht. 7/8 In.				For 4 1/2 In. Cond.—Ht. 1 1/2 In.			
No.	Wire Size	Wt. Lbs. Ea.	Each	No.	Wire Size	Wt. Lbs. Ea.	Each
GB2008	8	.50	1.55	GB5108	8	1.6	5.85
GB2006	6	.50	1.55	GB5106	6	1.6	5.85
GB2004	4	.50	1.55	GB5104	4	1.6	5.85
GB2002	2	.50	1.55	GB5102	2	1.6	5.85
GB2001	1	.50	1.55	GB5101	1	1.6	5.85
For 2 In. Cond.—Ht. 7/8 In.				For 5 In. Cond.—Ht. 1 1/2 In.			
No.	Wire Size	Wt. Lbs. Ea.	Each	No.	Wire Size	Wt. Lbs. Ea.	Each
GB2608	8	.63	1.95	GB6108	8	2.3	8.55
GB2606	6	.63	1.95	GB6106	6	2.3	8.55
GB2604	4	.63	1.95	GB6104	4	2.3	8.55
GB2602	2	.63	1.95	GB6102	2	2.3	8.55
GB2601	1	.63	1.95	GB6101	1	2.3	8.55

Sherman Heavy Duty Cast Ground Clamps

Listed by Underwriters' Laboratories, Inc.

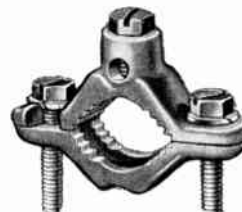

No. GF13B

For copper water pipe connections. Fits 1/4 to 3/4-inch pipe and 1/2 to 1-inch ground rods of any shape or material. Body of cast copper alloy, no loose parts to handle.

No.	GF13B
Carton	10
Standard Package	100
Weight per 1000	pounds 260
Per 100	\$36.11

O. Z. Insulated Bushings

Grounded Type BL



These are standard insulated bushings equipped with combination lug, and can be used for through type ground connections as well as for end use.

They afford the protection of insulated bushings and provide a means of making quick, positive ground connections. The insulating material is molded and locked into the casting of high grade malleable iron. A cup point set screw locks the casting in any desired position. Cadmium plated.

No.	Conduit Size, In.	Grd. Wire Min.	Size Max.	Std. Pkg.	Approx. Wt., Lbs.	Per 100
BL0508	1/2	14 Sol.	8 Str.	100	.07	\$ 65.20
BL0708	3/4	14 Sol.	8 Str.	50	.09	85.60
BL0704	3/4	14 Sol.	4 Str.	50	.11	88.80
BL1108	1	14 Sol.	8 Str.	25	.14	105.36
BL1104	1	14 Sol.	4 Str.	25	.16	108.56
BL1208	1 1/4	14 Sol.	8 Str.	20	.18	126.80
BL1204	1 1/4	14 Sol.	4 Str.	20	.20	130.00
BL1508	1 1/2	14 Sol.	8 Str.	20	.21	148.80
BL1504	1 1/2	14 Sol.	4 Str.	20	.23	152.00
BL2008	2	14 Sol.	8 Str.	10	.33	185.36
BL2004	2	14 Sol.	4 Str.	10	.35	188.56
BL2604	2 1/2	14 Sol.	4 Str.	10	.51	251.20
BL2621	2 1/2	6 Sol.	1/0 Str.	10	.58	275.20
BL3104	3	14 Sol.	4 Str.	5	.85	331.20
BL3121	3	6 Sol.	1/0 Str.	5	.90	355.20
BL3604	3 1/2	14 Sol.	4 Str.	5	1.0	411.20
BL3621	3 1/2	6 Sol.	1/0 Str.	5	1.1	435.20
BL3624	3 1/2	1/0 Str.	4/0 Str.	5	1.3	475.20
BL4104	4	14 Sol.	4 Str.	5	1.3	507.20
BL4121	4	6 Sol.	1/0 Str.	5	1.4	531.20
BL4124	4	1/0 Str.	4/0 Str.	5	1.6	571.20
BL4604	4 1/2	14 Sol.	4 Str.	1	1.6	723.20
BL4621	4 1/2	6 Sol.	1/0 Str.	1	1.6	747.20
BL4624	4 1/2	1/0 Str.	4/0 Str.	1	1.8	787.20
BL5104	5	14 Sol.	4 Str.	1	2.4	1003.20
BL5121	5	6 Sol.	1/0 Str.	1	2.4	1027.20
BL5124	5	1/0 Str.	4/0 Str.	1	2.6	1067.20
BL6104	6	14 Sol.	4 Str.	1	3.1	1523.20
BL6121	6	6 Sol.	1/0 Str.	1	3.1	1547.20
BL6124	6	1/0 Str.	4/0 Str.	1	3.3	1587.20

NOTE: Set screw type and thin wall conduit ground bushings can be furnished. Prices on application.

T&B Ground Clamps



Wrap-around type of ground clamp, made of copper. Has four adjustment holes and knurled clamp for quick secure hold on ground wire.

No.	Size In.	Unit Pkg.	Std. Pkg.	Wt., Lbs. Per 100	Per 100
961	3/8 to 1	100	1000	9	\$29.50
962	3/8 to 2	100	1000	13	40.00
963	3/8 to 3	100	1000	17	60.00

Call Graybar FIRST For . . .

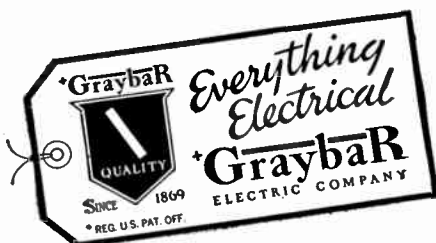

Federal Porcelain Standard Bushings

Schedule E



No. A-1



No. B-1

One-piece vitrified porcelain. Clamping rings are metal, threaded to fit the porcelain threads.

No.	Conduit K.O. Size In.	I.O. In.	O.O. In.	Length Under Head In.	Approx. Max. Size S.R.C. Wire	Std. Pkg.	Ship. Lbs. Std. Pkg.	Per 100
A-1	1/4	5/16	41/64	5/8	No. 10	500	15	\$11.50
A-1 1/2	1/2	5/8	13/16	9/16	No. 10	250	14	12.00
†A-1 1/2 LS	1/2	5/8	13/16	3/4	No. 10	250	16	14.00
A-2	1/2	3/2	15/16	13/16	No. 8	250	12	12.00
A-2 LS	1/2	27/32	13/16	3/4	No. 8	250	11	15.00
A-2 1/2	1/2	63/64	13/16	9/16	No. 4*	250	11	14.00
A-3	3/4	1	1	1 1/8	No. 3	250	22	17.00
A-4	1	3/4	1 5/16	1 1/8	No. 00	125	18	22.00
A-4L	1	7/8	1 5/16	1 1/8	No. 1/0	125	17	24.00
A-5	1 1/4	1 1/8	1 5/8	1 1/8	150000 CM	125	25	32.00
A-6	2	1 5/8	2 5/16	1 1/8	1000000 CM	60	21	65.00
B-1	1/4	9/32	41/64	11/4	No. 10	250	11	22.00

*For 1/2-inch Neon sign cable.

†LS—Long shank.

‡Loom.

§Rubber covered.

Federal Porcelain Spring Clamp Bushings

Schedule E

An especially short shank bushing using a spring clamp instead of ferrule. Carton, 100. Standard package, 500. Shipping weight, standard package, 15 pounds.



No. C-1

No. C-2

No.	I.O. In.	O.O. In.	Lgth. Under Head, In.	Per 100
C-1	11/32	9/16	3/8	\$7.75
C-2	1/2	11/16	3/8	9.50

Federal Porcelain Pipe Thread Bushings

Schedule E



Made to fit standard pipe couplings.

Pipe Size In.	Hole Diam. In.	Under-head Lgth., In.	Ctn. Qty.	Std. Pkg.	Without Lock Nut		With Lock Nut		Per 100
					No.	Per 100	No.	Per 100	
3/8	13/32	1 1/2	100	50	F-1	\$7.75	F-1L	\$11.00	
3/8	13/32	1 1/2	50	250	F-1 1/2	7.75	F-1 1/2 L	11.00	
1/2	1 1/2	1 3/2	50	250	F-2	7.75	F-2L	11.00	

Mueller Ground Clamp



CLAMPPIPE™

The exclusive patented feature of a U-shaped cross section in combination with a U-shaped clamp gives rigidity and effectiveness to the ClampPipe.

The ClampPipe will not bend or lop over when applied to a pipe. The point of the large case hardened screw, cuts through rust, paint or corrosion into clean, fresh metal, insuring a good contact. The Clamp may be installed on a pipe lying flush against a wall. Will not spread open. Applicable to pipe 3/8" to 1 3/8" outside diameter.

Packed 10 in a box.

No. 58..... Each \$0.20

Appleton Ground Fittings

Schedule GF

For Grounding Service Wire and Conduit Systems

Cadmium Finish

Type GCH

For No. 8 or No. 6 Bare Armored Ground Conductor



Made with adjustable top clamp to accommodate No. 8 or No. 6 bare armored ground conductor, and for grounding to 1/2, 3/4 or 1-inch water pipe or 1-inch ground rod.

No.	Size Bare Armored Ground Wire	Size of Water Pipe Inches	Ctn. Qty.	Std. Pkg.	Std. Pkg. Wt., Lbs.	Per 100
9445	8 or 6	1/2, 3/4, 1	5	25	10	\$56.65

Type GCWC



Has deck with a hole drilled to accommodate ground wire. The screw, when tightened, wedges the wire into a cup in the center of fitting, making a good bond and positive grip. Adapted for No. 8, 6 or 4 bare or insulated copper wire.

No.	Water Pipe Size, In.	Ground Rod Size Inches	Ctn. Qty.	Std. Pkg.	Std. Pkg. Wt., Lbs.	Per 100
9489	1/2, 3/4, 1	1	5	25	11	\$56.00

Type GCAR

Swivel Type—Adjustable



Adapted for No. 8, 6 or 4 B&S armored ground wire.

No.	Water Pipe Size, In.	Ground Rod Size Inches	Ctn. Qty.	Std. Pkg.	Std. Pkg. Wt., Lbs.	Per 100
9448	1/2, 3/4, 1	1	5	25	15	\$61.60

Type GCP



Takes wires No. 8, 6 or 4 either solid or stranded. The wire fastening device consists of a 3/8-inch bolt with a 1/4-inch hole through it. In connecting the wire, put the end of the wire through the hole in the bolt, then tighten the nut, clamping the wire with the bolt. Made of malleable iron.

No.	Water Pipe Size, In.	Ground Rod Size Inches	Ctn. Qty.	Std. Pkg.	Std. Pkg. Wt., Lbs.	Per 100
9491	1/2, 3/4, 1	1	5	25	8	\$38.55

Type GCNS

Non-Swivel



Furnished with "V" shaped clamp. Fits Nos. 8, 6 or 4 B&S Armored Ground Wire and takes 1/2 to 1-inch Water Pipe or 1-inch Ground Rod. May also be used with Nos. 8, 6 or 4 bare or insulated copper wire.

No.	Water Pipe Size, In.	Ground Rod Size Inches	Ctn. Qty.	Std. Pkg.	Std. Pkg. Wt., Lbs.	Per 100
9493	1/2, 3/4, 1	1	5	25	7 1/2	\$60.00

Type GCIC

With Tite-Grip Contacts



For 8, 6 or 4 bare or insulated copper wire and armored wire. Furnished with Tite-grip contacts; will not injure the copper ground wire. Has a heavy screw through the center of clamping member that forms a contact when tightened.

No.	Water Pipe Size, In.	Ground Rod Size Inches	Ctn. Qty.	Std. Pkg.	Std. Pkg. Wt., Lbs.	Per 100
9446	1/2, 3/4, 1	1	5	25	13	\$56.00

Type GCRC

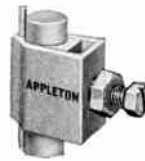

For bare or insulated copper wire. Especially designed for ground rods. Make a very neat, secure ground installation.

Ground wire is wedged against the rod by tightening the screw and is permanently set by running down the locknut.

No.	Fits Ground Rod Size Inches	Takes Bare or Insulated Copper Wire Sizes, B&S	Ctn. Qty.	Std. Pkg.	Std. Pkg. Wt., Lbs.	Per 100
9447	1/2, 3/8	8, 6 or 4	5	25	3 1/2	\$39.20

Type GCH

For Rigid Conduit



Equipped with flat, brass washer. Rigid clamp jaws hold securely to water pipe.

Adapted for No. 8, 6 or 1 B&S bare or insulated copper wire.

No.	Size Conduit Gnd., In.	Water Pipe Size, In.	Ground Rod Size Inches	Ctn. Qty.	Std. Pkg.	Std. Pkg. Wt., Lbs.	Per 100
9402	1/2	1/2, 3/4, 1	1	5	25	10	\$104.00

Type FGF

Flexible



Has an 8-inch flexible copper strip that can be bent, twisted or turned into any position. Particularly useful where water pipe or ground rod is not easily accessible. If the ground conduit should by chance be a little too long or too short, the flexible strap can be formed to meet the conduit. Furnished with vise-grip clamp.

No.	Size Conduit Gnd., In.	Water Pipe Size, In.	Ctn. Qty.	Std. Pkg.	Std. Pkg. Wt., Lbs.	Per 100
9481	1/2	1/2, 3/4, 1	5	25	18	\$144.00

Type GCGF

Flexible



Solderless, adjustable type, furnished with "V" shaped clamp.

Fits any 1/2-inch ground conduit and takes 1/2 to 1-inch ground rod.

Can be bent, twisted or turned into any position.

No.	Size Conduit Gnd., In.	Water Pipe Size, In.	Ctn. Qty.	Std. Pkg.	Std. Pkg. Wt., Lbs.	Per 100
9494	1/2	1/2, 3/4, 1	5	25	22	\$144.00

Appleton Ground Fittings

Cadmium Finish

For Grounding Service Wire and Conduit Systems

Schedule GF

Type GCVG

For Rigid Conduit



Vice-grip clamp enables fitting to be clamped to pipe that is closely secured to a surface; an attachment not possible with other type clamps.

Adapted for Nos. 8, 6 or 4 B&S bare or insulated copper wire.

No.	Size Conduit Gnd., In.	Water Pipe Size, In.	Ground Rod Size Inches	Ctn. Qty.	Std. Pkg.	Std. Pkg. Wt., Lbs.	Per 100
9492	1/2	1/2, 3/4, 1	1	5	25	19	\$92.00

Type LGC

For Large Size Water Pipe Adjustable



The deck of these large size clamps has a heavy brass washer. By placing ground wire under the lug a positive bond is formed.

Adapted for No. 8, 6, or 4 B&S bare or insulated copper wire.

No.	Size Conduit Gnd., In.	Water Pipe Size, In.	Ctn. Qty.	Std. Pkg.	Std. Pkg. Wt., Lbs.	Per 100
9482	1/2	1 1/4, 1 1/2, 2	5	25	20	\$149.00
9483	1/2	2 1/2, 3	5	10	15	480.00
9484	1/2	3 1/2, 4	2	5	9	544.00

Type LGCH

For Large Size Water Pipe V-Shaped Clamp



Furnished with a hole through the deck to take No. 8, 6 or 4 bare or insulated copper wire. Ground wire is held in place by the center screw.

No.	Water Pipe Size, In.	Ctn. Qty.	Std. Pkg.	Std. Pkg. Wt., Lbs.	Per 100
9497	1 1/4, 1 1/2, 2	5	10	5	\$ 96.00
9498	2 1/2, 3	5	10	11	400.00
9499	3 1/2, 4	5	10	15	455.00

Grounding Water Meter Shunt



Consists of two grounding fittings with screws connected to a 24-inch length of flexible copper strap.

Takes water pipe sizes 1/2, 3/4 and 1-inch or, ground rod sizes 1/2 to 1-inch.

No.	Ctn. Qty.	Std. Pkg.	Std. Pkg. Wt., Lbs.	Per 100
9486	5	25	25	\$160.00

Call Graybar FIRST for . . .

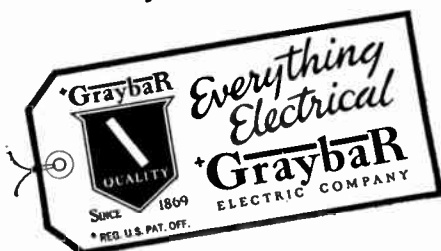

Grounding Bushings



Locking Type
1/2" to 2"



Non-Locking Type
2 1/2" to 4"

Locking Type—*Malleable

No.	Size Inches	Ctn. Qty.	Std. Pkg.	Std. Pkg. Wt., Lbs.	Per 100
GB50	1/2	50	250	5	\$ 24.30
GB75	3/4	50	250	7	30.40
GB100	1	25	250	5	40.65
GB125	1 1/4	25	25	6 1/4	56.30
GB150	1 1/2	25	25	7 3/4	93.10
GB200	2	5	25	6	155.15

Non-Locking Type—*Malleable

No.	Size Inches	Ctn. Qty.	Std. Pkg.	Std. Pkg. Wt., Lbs.	Per 100
GB250	2 1/2	5	10	4 1/4	\$248.00
GB300	3	5	10	6 1/2	312.00
GB350	3 1/2	1	5	4 1/2	563.20
GB400	4	1	5	6	832.00

*Cadmium finish only.

Grounding Locknuts



Eliminates the use of grounding bushing and jumper wire. Used in place of ordinary locknut.

The set screw wedges its way between the knockout and conduit, cutting into the steel and forming a perfect bond. Cadmium finish only.

No.	Size Inches	Ctn. Qty.	Std. Pkg.	Std. Pkg. Wt., Lbs.	Per 100
GI50	1/2	1000	1000	3 1/2	\$ 11.75
GI75	3/4	500	500	4	14.75
GI100	1	500	500	3	21.50
GI125	1 1/4	500	500	3	26.90
GI150	1 1/2	500	500	4	34.90
GI200	2	250	250	4	47.20
GI250	2 1/2	100	100	2	80.50
GI300	3	100	100	4	100.00
GI350	3 1/2	50	50	2 1/2	165.00
GI400	4	50	50	2 1/2	215.00

Bonding Meter Ring

Type GR



Designed for grounding the meter box to a driven or artificial ground, when a water pipe or other grounding electrode is not available in the building.

Meter ring is placed between the watertight connector and the meter box, after which the ground wire is placed through either the vertical or horizontal hole and the screw is then tightened. This makes a good tight connection and a positive bond; requires no soldering.

No.	Size Inches	Ctn. Qty.	Std. Pkg.	Std. Pkg. Wt., Lbs.	Per 100
9415	3/4	50	100	8	\$26.40
9416	1	50	100	8 1/4	35.20
9417	1 1/4	10	50	9	44.80

Crouse-Hinds Groundulet Safety Circuit Equipment

Type GCH

For use where conduit is employed to protect the grounding conductor. Grounding conductor is connected to conduit-hub part by swivel bolt. Conduit can be brought in from any angle. Malleable.

For Threaded Heavy Wall Conduit With Swivel Feature

No.	Conduit	Size, Inches Water Pipe	D. O. Grounding Electrode	Each
GCH1	1/2	1/2-1	1/2-1	\$1.80

Type GCH for Threaded Heavy Wall Conduit Without Swivel Features

No.	Water Pipe	Size, Inches D. O. Grounding Electrode	Each
GCH 13	1/2 to 1	1/2 to 1	\$1.80

Type GCH with Clamp Connection for Ground Conductor

For Nos. 8, 6 or 4 Armored or Unarmored Ground Conductor.

In this type the grounding conductor passes through the bolt and is clamped between the under side of bolthead and upper face of square cavity. A set screw holds armor in place and effectively grounds it to clamp. Malleable.

No.	Water Pipe	Size, Inches D. O. Grounding Electrode	Each
GCH08	1/2 to 1	1/2 to 1	\$1.80
GCH086	1 to 2	1 to 2	3.10

For Nos. 8, 6, or 4 Unarmored Ground Conductor and No. 2 Solid Copper Wire.

GCH91	1/2 to 1	1/2 to 1	\$1.60
-------	----------	----------	--------

Type GCE Strap Clamp Terminals

No.	Water Pipe	Size, Inches Grounding Electrode	Each
GCE012	1/2 to 2	5/8 to 1	\$1.95
GCE014	1/2 to 4	5/8 to 1	1.70
GCE016	1/2 to 6	5/8 to 1	1.90

Type GC Strap Clamps

For bonding and grounding equipment in wiring systems.

No.	Material	Each
GC101	Steel	\$0.45
GC102	Brass	1.00

Type GC Grounding Straps

For bonding and grounding equipment in wiring systems. Flexible Copper.



No. GC100	1 to 10 Coils of 50 Ft.	Each...per Coil	\$44.75
No. GC100	11 to 25 Coils of 50 Ft.	Each...per Coil	40.60
No. GC100	26 to 50 Coils of 50 Ft.	Each...per Coil	38.50
No. GC100	51 or More Coils of 50 Ft.	Each...per Coil	37.50

T&B Ground Fittings Hub Type

Approved by Underwriters' Laboratories

Complete fittings, consisting of hub and waterpipe clamp. Available with hub for grounding standard rigid conduit, or with hub for use with armored ground wire. Each size waterpipe clamp makes positive ground connections quickly and neatly on a range of pipe sizes.

For Standard Rigid Conduit Fixed-Length Hub



Solderless grip takes ground wires from No. 8 to No. 2 A.W.G.

Tongue of ground wire clamp extends into hub, protecting ground wire against mechanical damage.

For 1/2-Inch Conduit

No.	Water Pipe Size In.	Unit Quan.	Std. Pkg.	WL. Lbs. Per 100	Price Per 100
3932	1/2, 3/4 or 1	5	25	68	\$ 104.00
3933	1 1/4, 1 1/2 or 2	5	10	90	149.00
3934	2 1/2, 3 or 3 1/2	2	4	150	545.00
3935	4, 4 1/2 or 5	2	4	250	815.00
3936	6	..	1	300	1184.00

For 3/4-Inch Conduit

3942	1/2, 3/4 or 1	5	25	64	\$ 210.00
3943	1 1/4, 1 1/2 or 2	5	10	90	256.00
3944	2 1/2, 3 or 3 1/2	2	4	150	655.00
3945	4, 4 1/2 or 5	2	4	200	910.00
3946	6	..	1	240	1296.00

For 1-Inch Conduit

3952	1/2, 3/4 or 1	5	10	80	\$ 368.00
3953	1 1/4, 1 1/2 or 2	5	10	110	400.00
3954	2 1/2, 3 or 3 1/2	2	4	175	800.00
3955	4, 4 1/2 or 5	2	4	250	1055.00
3956	6	..	1	400	1440.00

Adjustable-Length Hub

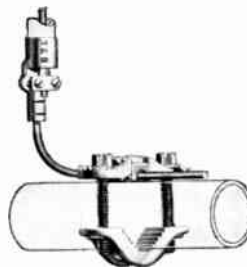

Hub has 8-inch length of No. 4 wire, forming a flexible connection of variable length, between end of conduit and waterpipe.

Wire, fastened to waterpipe clamp with a solderless grip, can be bent to position or varied in length to meet installation conditions.

No.	Water Pipe Size In.	Unit Quan.	Std. Pkg.	WL. Lbs. Per 100	Price Per 100
3972	1/2, 3/4 or 1	5	25	76	\$ 176.00
3973	1 1/4, 1 1/2 or 2	5	10	80	208.00
3974	2 1/2, 3 or 3 1/2	2	4	175	610.00
3975	4, 4 1/2 or 5	2	4	200	865.00
3976	6	..	1	240	1248.00

For Armored Wire



Tite-Bite connector grips cable armor securely without danger of damage to the sheath. Takes ground wire from No. 2 to No. 8.

No.	Water Pipe Size In.	Unit Quan.	Std. Pkg.	WL. Lbs. Per 100	Price Per 100
3962	1/2, 3/4 or 1	5	25	60	\$ 232.00
3963	1 1/4, 1 1/2 or 2	5	10	90	280.00
3964	2 1/2, 3 or 3 1/2	2	4	160	690.00
3965	4, 4 1/2 or 5	2	4	250	930.00
3966	6	..	1	300	1312.00

T&B Ground Fitting Parts

Approved by Underwriters' Laboratories

The interchangeable hubs and waterpipe clamps listed below will assemble to do any type of grounding job required; for conduit, armored wire or unarmored wire ground connections.

Waterpipe clamps are complete ground fittings for unarmored wire.

Conduit Hubs



No.	Size	Unit Quan.	Std. Pkg.	Wt., Lbs. Per 100	Per 100
3930	1/2" Conduit	5	25	21	\$ 40.00
3940	3/4" Conduit	5	20	25	136.00
3950	1" Conduit	5	10	40	272.00
3970	1/2" Adj.	5	25	40	96.00
3960	Arm'd. Wire	5	25	24	157.00

Waterpipe Clamps



No.	Size	Unit	Std.	Wt.,	Per
2	1/2, 3/4 or 1 -In.	5	25	40	\$ 56.00
3	1 1/4, 1 1/2 or 2 -In.	5	10	70	96.00
4	2 1/2, 3 or 3 1/2 -In.	2	4	125	456.00
5	4, 4 1/2 or 5 -In.	2	4	200	690.00
6	6-In.	1	1	300	1040.00

T&B General Purpose Ground Clamp

Approved by Underwriters' Laboratories

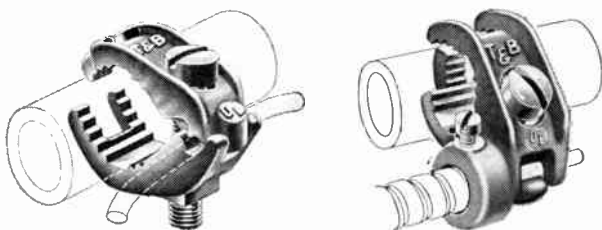

No. 3846

No. 3847

Cast from enduring bronze or malleable iron. No loose parts and only one screw to tighten.

Easy to install in dark corners.

Powerful jaws make a positive ground, yet cannot crush copper tubing.

Fits 1/2 to 3/4-inch copper tubing or waterpipe; 1/2 to 1-inch ground rod.

For Unarmored Wire—No. 6, No. 4.

No.	Water Pipe Size	Std. Pkg.	Unit Quan.	Wt., Lbs. Per 100	Price Per 100
3826	1/2", 3/4" M.I.	50	5	20	\$34.50
3846	1/2", 3/4" Bronze	50	5	20	41.50

For Armored Wire—No. 8, No. 6, No. 4

No.	Water Pipe Size	Std. Pkg.	Unit Quan.	Wt., Lbs. Per 100	Price Per 100
3827	1/2", 3/4" M.I.	50	5	22	48.00
3847	1/2", 3/4" Bronze	50	5	22	61.00

Burndy Grounding Connectors

Listed by Underwriters' Laboratories, Inc.

Burndy Groundem

Type GH

For Cable to Driven Rod or Pipe



An economical, non-corrosive ground clamp for driven rod or pipe. Can be slipped over the top of the rod as a one-piece assembly, or from the side when the head of the rod has been mushroomed from driving.

No.	Electrode Size Rod, In.	I.P.S., In.	Conductor Range Min. Max.	Quant. In Ctn.	Wt. Per 100, Lbs.	Per 100 (1 to 4 Ctns.)
GI163	1/2	1/4	8 Sol. 2 Str.	50	15
GI1635	5/8	3/8	8 Sol. 2/0 Str.	50	19
GI164	3/4	1/2	8 Sol. 2 Str.	50	28
GI165	1	3/4	8 Sol. 2 Str.	25	30

Type GAR

Parallel or 90° cable connection to rod or pipe with the same connector.

Easily installed—the connection is completed by merely tightening the two nuts on the U-bolt. High copper alloy cast body with silicon bronze U-bolts, nuts and lock washers permit entire connection to be buried in the ground without danger of corrosion.



As Parallel Connector



As Cross Connector

No.	Electrode Size Rod, In.	I.P.S., In.	Conductor Range Min. Max.	Wt. Each, Lbs.	Each
GAR114C	1/2	1/4	8 Sol. 4 Str.	.50	\$2.55
GAR1126	1/2	1/4	4 Sol. 2/0 Str.	.75	2.70
GAR1129	1/2	1/4	2/0 Sol. *250	.75	2.85
GAR644C	5/8 or 3/4	3/8	8 Sol. 4 Str.	.50	2.55
GAR6426	5/8 or 3/4	3/8	4 Sol. 2/0 Str.	.75	2.70
GAR6429	5/8 or 3/4	3/8	2/0 Sol. *250	1.0	2.85
GAR6434	5/8 or 3/4	3/8	*300 *500	1.8	4.35
GAR6439	5/8 or 3/4	3/8	*550 *750	2.2	5.10
GAR144C	3/8 or 1/2	1/2 or 3/4	8 Sol. 4 Str.	.50	3.60
GAR1426	3/8 or 1/2	1/2 or 3/4	4 Sol. 2/0 Str.	.75	3.75
GAR1429	3/8 or 1/2	1/2 or 3/4	2/0 Sol. *250	1.0	4.05
GAR1434	3/8 or 1/2	1/2 or 3/4	*300 *500	2.0	6.00
GAR1439	3/8 or 1/2	1/2 or 3/4	*550 *750	2.3	6.75
GAR154C	1 1/8 to 1 1/2	1	8 Sol. 4 Str.	.75	3.75
GAR1526	1 1/8 to 1 1/2	1	4 Sol. 2/0 Str.	.75	3.90
GAR1529	1 1/8 to 1 1/2	1	2/0 Sol. *250	1.0	4.05
GAR1534	1 1/8 to 1 1/2	1	*300 *500	2.0	6.30
GAR1539	1 1/8 to 1 1/2	1	*550 *750	2.5	6.90
GAR164C	1 3/8 to 1 3/4	1 1/4	8 Sol. 4 Str.	.75	3.75
GAR1626	1 3/8 to 1 3/4	1 1/4	4 Sol. 2/0 Str.	1.0	4.05
GAR1629	1 3/8 to 1 3/4	1 1/4	2/0 Sol. *250	1.3	4.20
GAR1634	1 3/8 to 1 3/4	1 1/4	*300 *500	2.3	7.20
GAR1639	1 3/8 to 1 3/4	1 1/4	*550 *750	2.8	7.35
GAR174C	1 5/8 to 1 7/8	1 1/2	8 Sol. 4 Str.	1.0	4.05
GAR1726	1 5/8 to 1 7/8	1 1/2	4 Sol. 2/0 Str.	1.0	4.20
GAR1729	1 5/8 to 1 7/8	1 1/2	2/0 Sol. *250	1.3	4.50
GAR1734	1 5/8 to 1 7/8	1 1/2	*300 *500	2.5	7.20
GAR1739	1 5/8 to 1 7/8	1 1/2	*550 *750	2.8	7.65
GAR184C	2 to 2 3/8	2	8 Sol. 4 Str.	1.0	4.65
GAR1826	2 to 2 3/8	2	4 Sol. 2/0 Str.	1.3	5.25
GAR1829	2 to 2 3/8	2	2/0 Sol. *250	1.5	5.85
GAR1834	2 to 2 3/8	2	*300 *500	2.8	8.10
GAR1839	2 to 2 3/8	2	*550 *750	3.3	8.70

*MCM.

Burndy Grounding Connectors

This wide variety of connectors for grounding are designed and manufactured as accurately as those which are called upon to carry current continuously. They are cast of high copper alloy and assembled with durium hardware. High strength and corrosion resistance are combined to provide permanently tight connections which may be buried as required. The all-bronze non-magnetic construction is also advantageous in the safe conduction of high frequency oscillatory lightning discharges.

The reliability and convenience of using these connectors for grounding is witnessed by the fact that they are specified in grounding standards of leading utilities and consulting engineers in the refining, mining and chemical industries.

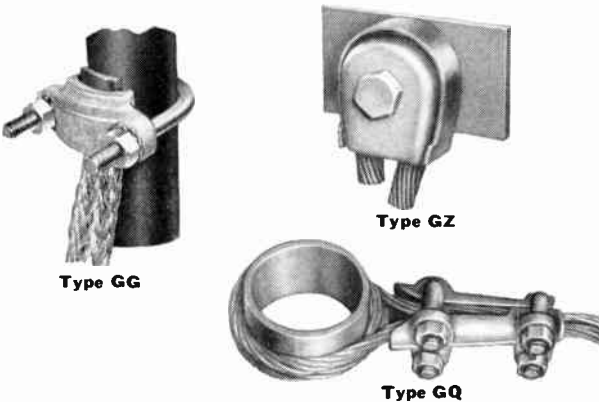
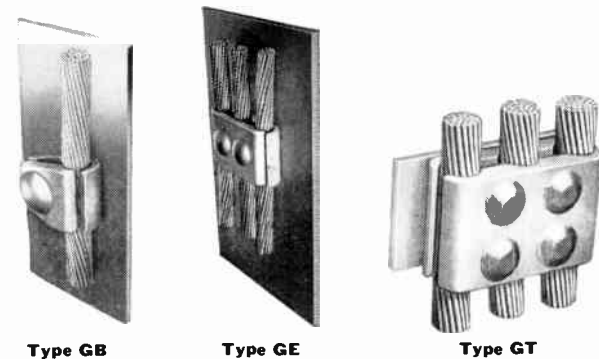
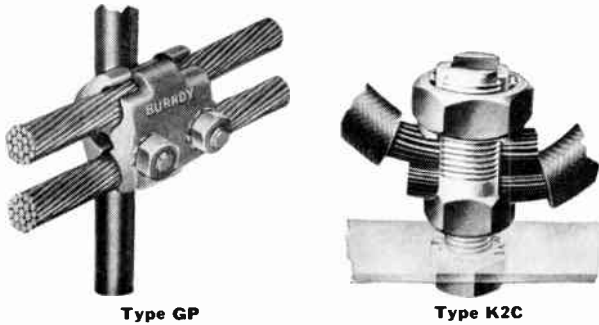
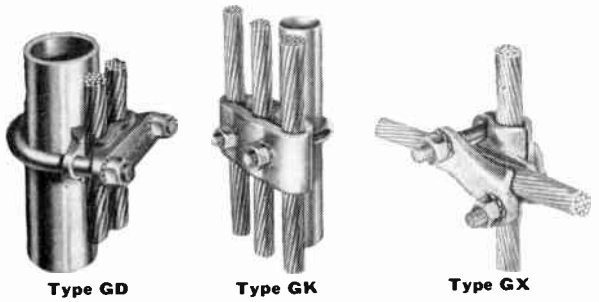

Burndy Ground Connectors

Type GB

For Cable To Flat Bar



For clamping ground lead cable to supporting flat metal surface or equipment casing. Head of bolt has oval shank to prevent turning. Only one wrench required for installation.

Cast copper alloy body accommodates a range of cable sizes. Bolts, nuts and washers made of high strength, corrosion resistant silicon bronze.

A standard silicon bronze bolt will grip 1/4-in. bar. For heavier bar longer bolts will be supplied on request.

No.	Min.	Conductor Range	Max.	Approx. Ship. Wt. Lbs. Each	Price Each
GB4C	8 Sol.		4 Str.	.25	\$1.50
GB26	4 Sol.		2/0 Str.	.40	1.65
GB29	2/0 Sol.		250 Mem.	.50	3.30
GB34	300 Mem.		500 Mem.	1.2	4.65
GB39	550 Mem.		750 Mem.	2.0	6.90
GB44	800 Mem.		1000 Mem.	2.3	8.10

O. Z. Ground Connectors

Type "ABG"

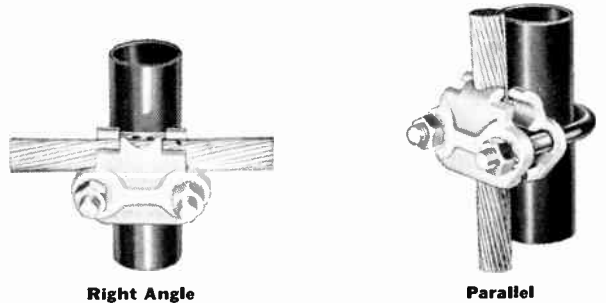

A high strength copper alloy ground connector connecting a ground wire either parallel or at right angles to a ground rod or pipe. A positive ground is assured by the clamping pressure that can be applied by the high strength silicon bronze U-bolt, nuts and lock washers.

No.	Rod In.	L. P. S. In.	Conductor Min.	Range Max.	Approx. Wt. Lbs. Each	Price Each
ABG0204	1/2	1/4	8 Sol.	4 Str.	.50	\$1.35
ABG0222	1/2	1/4	4 Sol.	2/0 Str.	.60	1.40
ABG0304	5/8 or 3/4	3/8	8 Sol.	4 Str.	.55	1.35
ABG0322	5/8 or 3/4	3/8	4 Sol.	2/0 Str.	.65	1.40
ABG0325	5/8 or 3/4	3/8	2/0 Sol.	250 Mem.	.80	1.50
ABG0350	5/8 or 3/4	3/8	300 Mem.	500 Mem.	1.5	3.75
ABG0704	1	1/2 or 3/4	8 Sol.	4 Str.	.60	1.85
ABG0722	1	1/2 or 3/4	4 Sol.	2/0 Str.	.70	1.95
ABG0725	1	1/2 or 3/4	2/0 Sol.	250 Mem.	.90	2.10
ABG0750	1	1/2 or 3/4	300 Mem.	500 Mem.	1.7	3.10
ABG1104	...	1	8 Sol.	4 Str.	.65	1.95
ABG1122	...	1	4 Sol.	2/0 Str.	.75	2.00
ABG1125	...	1	2/0 Sol.	250 Mem.	1.0	2.10
ABG1150	...	1	300 Mem.	500 Mem.	1.8	3.25
ABG1204	...	1 1/4	8 Sol.	4 Str.	.80	1.95
ABG1222	...	1 1/4	4 Sol.	2/0 Str.	.90	2.10
ABG1225	...	1 1/4	2/0 Sol.	250 Mem.	1.2	2.20
ABG1250	...	1 1/4	300 Mem.	500 Mem.	2.0	3.75
ABG1504	...	1 1/2	8 Sol.	4 Str.	.80	2.10
ABG1522	...	1 1/2	4 Sol.	2/0 Str.	1.1	2.20
ABG1525	...	1 1/2	2/0 Sol.	250 Mem.	1.3	2.35
ABG1550	...	1 1/2	300 Mem.	500 Mem.	2.1	3.75

O. Z. Ground Connectors

Type CG



For grounding cable to pipe, either parallel or at 90°.

Has a reversible plate which permits ground wire to be connected either at right angles or parallel to ground pipe.

Everdur U-bolt, nuts and lock washers. Makes a positive, strong and corrosion-proof ground.

No.	I.P.S. In.	Conductor Range		Wt., Ea. Lbs.	Each
		Min.	Max.		
CG2004	2	#8 Sol.	#4 Str.	.63	\$2.40
CG2022	2	4 Sol.	2/0 Str.	.69	2.70
CG2025	2	2/0 Sol.	*250	1.0	3.05
CG2050	2	*300	*500	1.8	4.20
CG2604	2 1/2	8 Sol.	4 Str.	.69	2.95
CG2622	2 1/2	4 Sol.	2/0 Str.	.88	3.25
CG2625	2 1/2	2/0 Sol.	*250	1.1	3.40
CG2650	2 1/2	*300	*500	1.8	4.65
CG3104	3	8 Sol.	4 Str.	.81	3.60
CG3122	3	4 Sol.	2/0 Str.	1.0	4.05
CG3125	3	2/0 Sol.	*250	1.3	4.35
CG3150	3	*300	*500	2.4	5.60
CG3604	3 1/2	8 Sol.	4 Str.	.88	4.05
CG3622	3 1/2	4 Sol.	2/0 Str.	1.1	4.50
CG3625	3 1/2	2/0 Sol.	*250	1.3	4.80
CG3650	3 1/2	*300	*500	2.4	6.15
CG4104	4	8 Sol.	4 Str.	1.0	4.65
CG4122	4	4 Sol.	2/0 Str.	1.3	5.30
CG4125	4	2/0 Sol.	*250	1.5	5.75
CG4150	4	*300	*500	2.6	7.25
CG4622	4 1/2	4 Sol.	2/0 Str.	1.4	5.85
CG4625	4 1/2	2/0 Sol.	*250	1.8	6.30
CG4650	4 1/2	*300	*500	2.9	7.85
CG5122	5	4 Sol.	2/0 Str.	1.5	6.60
CG5125	5	2/0 Sol.	*250	2.0	7.25
CG5150	5	*300	*500	3.1	8.95
CG6122	6	4 Sol.	2/0 Str.	1.8	7.95
CG6125	6	2/0 Sol.	*250	2.0	8.10
CG6150	6	*300	*500	3.4	10.65
CG8125	8	2/0 Sol.	*250	2.5	11.50
CG8150	8	*300	*500	4.4	14.05

Type DG



For grounding two parallel cables at 90° to pipe or rod.

Everdur U-bolt, nuts and washers. Makes a positive strong and corrosion proof ground.

No.	Rod, In.	I.P.S. In.	Conductor Range		Wt., Ea. Lbs.	Each
			Min.	Max.		
DG0204	1/2	1/4	8 Sol.	4 Str.	.25	\$1.35
DG0222	1/2	1/4	4 Sol.	2/0 Str.	.44	1.40
DG0304	5/8 or 3/4	3/8	8 Sol.	4 Str.	.31	1.35
DG0322	5/8 or 3/4	3/8	4 Sol.	2/0 Str.	.63	1.40
DG0325	5/8 or 3/4	3/8	2/0 Sol.	*250	.75	1.55
DG0350	5/8 or 3/4	3/8	*300	*500	1.3	2.50
DG0704	1	1/2 or 3/4	8 Sol.	4 Str.	.44	1.80
DG0722	1	1/2 or 3/4	4 Sol.	2/0 Str.	.63	2.00
DG0725	1	1/2 to 3/4	2/0 Sol.	*250	.88	2.25
DG0750	1	1/2 or 3/4	*300	*500	1.8	3.90
DG1104	...	1	8 Sol.	4 Str.	.50	2.00
DG1122	...	1	4 Sol.	2/0 Str.	.81	2.25
DG1125	...	1	2/0 Sol.	*250	1.0	2.40
DG1150	...	1	*300	*500	2.0	4.30
DG1204	...	1 1/4	8 Sol.	4 Str.	.55	2.20
DG1222	...	1 1/4	4 Sol.	2/0 Str.	.88	2.40
DG1225	...	1 1/4	2/0 Sol.	*250	1.1	2.65
DG1250	...	1 1/4	*300	*500	2.2	4.90

*MCM.

O. Z. Ground Connectors

Type KG



For grounding cable to flat bar. Bolts furnished will fasten connector to plate 1/4-in. thick. Longer bolts will be furnished when necessary if plate thickness is specified.

Everdur bolt and nut. Strong and corrosion-proof.

No.	Conductor Range		Wt., Ea. Lbs.	Each
	Min.	Max.		
KG04	#8 Sol.	#4 Str.	.25	\$0.80
KG22	4 Sol.	2/0 Str.	.38	.85
KG25	2/0 Sol.	*250	.50	1.70
KG50	*300	*500	.88	2.40
KG75	*550	*750	1.5	3.60
KG92	*800	*1000	2.3	4.20

*MCM.

Steel City Grounding Bushings

Malleable iron, galvanized.



No. 390

Completely assembled with 2 screws. Smaller pointed screw acts as a bond. Heavy screw secures ground wire in slotted shoulder.

Grounding Bushings

No.	Size Inches	Unit Pkg.	Std. Pkg.	Wt., Lbs. Per 100	Std. Pkg. Per 100
390	1/2	50	100	7	\$16.50
391	3/4	50	100	8	20.50
392	1	25	50	13	27.50
393	1 1/4	25	50	15	38.00
394	1 1/2	25	50	17	63.00
395	2	10	25	20	105.00
396	2 1/2	5	10	35	168.00
397	3	5	10	60	210.00
398	3 1/2	1	5	70	380.00
399	4	1	5	95	560.00

T&B Grounding Bushings

Approved by Underwriters' Laboratories



No. 3860

No. 3860 Series: Approved for use with or without jumper wire. The wedge, when screwed into place, cuts into the box, thereby insuring a perfect ground between conduit and box.

Size In.	Unit Quan.	Std. Pkg.	Wt., Lbs. Per 100	No. 3860 Series	
				No.	Per 100
1/2	50	100	11	3860	\$ 24.32
3/4	50	100	11	3861	30.40
1	25	50	14	3862	40.64
1 1/4	25	50	16	3863	56.32
1 1/2	25	50	20	3864	93.12
2	10	25	28	3865	155.52
2 1/2	5	10	40	3866	248.00
3	5	10	50	3867	312.00
3 1/2	1	5	100	3868	563.20
4	1	5	100	3869	832.80

T & B Insulated Grounding Bushings



No.	Size In.	Std. Pkg.	Unit Pkg.	Wt. Lbs. Per 100	Per 100
3802	1/2	100	50	11	\$ 46.50
3803	3/4	100	50	11	60.00
3804	1	50	25	14	82.00
3805	1 1/4	50	25	16	115.00
3806	1 1/2	50	25	20	183.25
3807	2	25	10	28	310.00
3808	2 1/2	10	5	40	500.00
3809	3	10	5	50	617.00
3810	3 1/2	5	1	100	1055.00
3811	4	5	1	100	1525.00

T&B Single-Bolt Ground Clamps

Approved by Underwriters' Laboratories

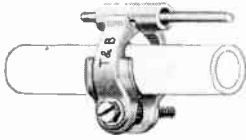

Tough, malleable iron ground clamps, Tabolite galvanized. Fits 1/2, 3/4 and 1-inch water-pipe.

Unit Package, 5; Standard Package, 25.

For Armored Ground Wires

Take Nos. 8 and 6 Bare Armored Ground Wire

No.	Description	Wt., Lbs. Per 100	Per 100
3841	With Set Screw for Armor.....	32	\$61.00
3843	With Adapter for Ground Rod from 1/2-inch up.....	36	61.00

For Unarmored Ground Wires

Take Nos. 8, 6 and 4 B&S Bare or Insulated Copper Wire

3840	For Use with Waterpipe.....	32	\$48.00
3842	With Adapter for Ground Rods from 1/2-inch up.....	36	48.00

Sherman Copper Ground Clamps

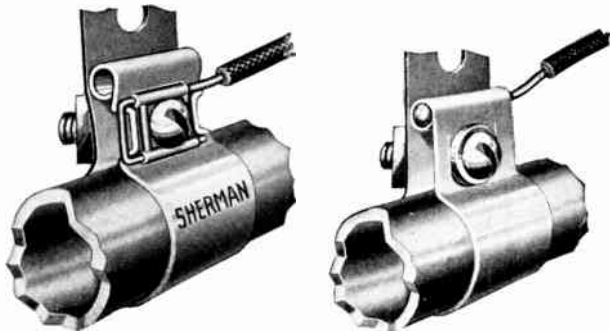

S.L. Type Approved Solderless Type

Original Type Solder Type

For general grounding or bonding of electrical conductors. Heavy copper strap is easy to apply.

Solderless No.....	1SL	2SL	3SL	4SL
Solder No.....	1	2	3	4
Pipe Size, inches.....	3/8-1	3/8-2	3/8-3	3/8-4
Carton Quantity.....	100	500	50	25
Standard Package.....	1000	1000	500	250
Weight per 100, pounds..	80	130	170	200
Per 100—Solderless Type..	\$20.31	\$27.42	\$44.11	\$57.56
Per 100—Solder Type.....	18.11	26.27	40.62	55.63

Sherman Solderless Clamps

GF23 For Rigid Conduit

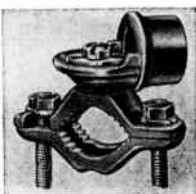

Efficient solderless fitting for 1/2-in. conduit. Swivel conduit hub adjustable to any position. Bronze alloy construction.

Accommodates up to No. 4 stranded AWG wire. Fits 1/2 to 1-in. pipe as well as 1/2 to 1-in. diameter ground rods. Reversible bottom clamp for small rods.

No.	Conduit Size, In.	Pipe Size, In.	Wt., Lbs. Per M	Ctn. Qty.	Price Per 100
GF23	1/2	1/2-1	460	10	\$77.68

National Electric Connector

With EZ Hinged Strap



Galvanized finish. Positive holding action by steel bondnut. For 14-2 and 12-2 Ovalflex. Also fits 14-2, 14-3, 14-4, 12-2, 12-3, 12-4, 10-2, 8-1, 6-1, 2-1, 4-1 armored cable; 14-1, 12-1, 10-1, 8-1, 6-1, 4-1 armored lead cable; 14-2, 14-3 lampcord, 5/16-inch, 3/8-inch flexible conduit; 14-2, 14-3, 12-2, 12-3, 10-2 loom wire; 6-1 and 4-1 bare armored ground wire.

No.....	2163-EZ
I. D. Open.....	inches 2 1/2
I. D. Closed.....	inches 1 1/2
Wire Throat.....	inches 2 3/4
Size of K. O.....	inches 1/2
Std. Pkg. Wt.....	pounds 68
Per 100.....	\$10.40

Quantity prices on request.

Steel City Duplex Box Connectors

Malleable Iron — Galvanized

Squeeze Type

For Armored Cable: 14-2, 14-3, 14-4, 12-2, 12-3, 10-1, 8-1, 6-1, 4-1.

For Armored Lamp Cord: 18-2, 18-3, 16-2, 16-3.

For Armored Lead Cable: 14-2, 10-1, 8-1.

For Armored Ground Wire: 4-1, (Str. and Sol.)

For Non-Metallic Sheathed Cable: Type R — 14-2, 14-3, 12-2, 12-3; Type T — 14-2, 14-3, 12-2, 12-3, 10-2, 10-3.



No. 515

No.	Trade Size In.	K. O. Size In.	Clamp Diam., Inches		Wire Throat Diam., In.	Wt., Lbs. Per 100	Std. Pkg. Per 100
			Open	Closed			
515	3/8	1/2	.605	.250	.600	19	\$20.00

Unit package, 25; Standard package, 100.

Steel City Box Connectors

Malleable Iron — Galvanized

2-Screw



No. 550



No. 570

90° Angle Type

For Armored Cable: 14-2, 14-3, 14-4, 12-2, 12-3, 12-4, 10-1, 8-1, 6-1, 4-1.

For Armored Lead Cable: 14-2, 14-3, 12-2, 10-1, 8-1, 6-1.

No. 550: For Flexible Steel Conduit 3/8-In.

No. 570: For Flexible Steel Conduit 5/16 and 3/8-In.

No.	Trade Size In.	K. O. Size In.	Clamp Diam., Inches		Wire Throat Diam., In.	Wt., Lbs. Per 100	Std. Pkg. Per 100
			Open	Closed			
550	3/8	1/2	.630	.400	.375	14	\$17.50
570	3/8	1/2	.630	.258	.375	20	17.50

Unit package, 50; Standard package, 100.

Steel City Box Connectors

Malleable Iron — Galvanized

Squeeze Type

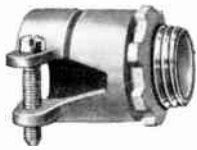

Straight Squeeze Type

For Armored Cable: 10-2, 10-3.
For Armored Lead Cable: 12-3, 12-4, 10-2, 4-1.

No.	Trade Size In.	K. O. Size In.	Clamp Diam., Inches		Wire Throat Diam., In.	Wt. Lbs. Per 100	Std. Pkg. Per 100
			Open	Closed			
526	$\frac{3}{4}$ A	$\frac{1}{2}$.805	.550	.546	13	\$16.50

Unit package, 50; Standard package, 100.

For Armored Cable: 10-4, 8-2.
For Armored Lead Cable: 10-3, 10-4, 8-2.
For Flexible Steel Tubing: $\frac{1}{2}$ -In.

527	$\frac{1}{2}$	$\frac{1}{2}$.922	.725	.637	13	\$16.50
------------	---------------	---------------	------	------	------	----	----------------

Unit package, 50; Standard package, 100.

For Armored Cable: 8-2.

528S	$\frac{3}{4}$ S	$\frac{3}{4}$.875	.750	.660	18	\$19.00
-------------	-----------------	---------------	------	------	------	----	----------------

Unit package, 25; Standard package, 100.

For Armored Cable: 8-3, 8-4, 6-2, 6-3, 4-2.
For Armored Lead Cable: 8-2, 8-3, 8-4, 6-2, 6-3.
For Flexible Steel Tubing: $\frac{3}{4}$ -In.

528	$\frac{3}{4}$	$\frac{3}{4}$	1.140	.840	.790	18	\$19.00
------------	---------------	---------------	-------	------	------	----	----------------

Unit package, 25; Standard package, 100.

For Armored Cable: 6-4, 4-2, 4-3.
For Armored Lead Cable: 8-4, 6-3, 4-2.
For Flexible Steel Tubing: $\frac{3}{4}$ -In.

529S	1S	1	1.220	.969	.935	25	\$30.00
-------------	----	---	-------	------	------	----	----------------

Unit package, 25; Standard package, 100.

For Flexible Steel Conduit: 1-In.

529	1	1	1.385	1.105	1.000	30	\$30.00
------------	---	---	-------	-------	-------	----	----------------

Unit package, 25; Standard package, 100.

For Flexible Steel Tubing: $1\frac{1}{4}$ -In.

530	$1\frac{1}{4}$	$1\frac{1}{4}$	1.610	1.310	1.250	37	\$48.50
------------	----------------	----------------	-------	-------	-------	----	----------------

Unit package, 5; Standard package, 10.

For Flexible Steel Tubing: $1\frac{1}{2}$ -In.

532	$1\frac{1}{2}$	$1\frac{1}{2}$	1.955	1.585	1.500	65	\$89.00
------------	----------------	----------------	-------	-------	-------	----	----------------

Unit package, 5; Standard package, 10.

For Flexible Steel Tubing: 2-In.

534	2	2	2.445	2.140	2.000	105	\$130.00
------------	---	---	-------	-------	-------	-----	-----------------

Unit package, 5; Standard package, 10.

For Flexible Steel Tubing: $2\frac{1}{2}$ -In.

535	$2\frac{1}{2}$	$2\frac{1}{2}$	3.018	2.685	2.500	130	\$210.00
------------	----------------	----------------	-------	-------	-------	-----	-----------------

Unit package, 2; Standard package, 5.

For Flexible Steel Tubing, 3-In.

536	3	3	3.510	3.060	3.135	190	\$295.00
------------	---	---	-------	-------	-------	-----	-----------------

Unit package, 2; Standard package, 5.

Quantity prices on request.



90° Angle Squeeze Type

For Armored Cable: 10-4.
For Armored Lead Cable: 10-2, 10-3.

No.	Trade Size In.	K. O. Size In.	Clamp Diam., Inches		Wire Throat Diam., In.	Wt. Lbs. Per 100	Std. Pkg. Per 100
			Open	Closed			
552S	$\frac{1}{2}$ S	$\frac{1}{2}$.800	.695	.595	25	\$30.00

Unit package, 25; Standard package, 100.

For Armored Cable: 8-2, 8-3.
For Armored Lead Cable: 10-4, 8-2.
For Flexible Steel Conduit: $\frac{1}{2}$ -In.

552	$\frac{1}{2}$	$\frac{1}{2}$.930	.780	.595	22	\$30.00
------------	---------------	---------------	------	------	------	----	----------------

Unit package, 25; Standard package, 100.

For Armored Cable: 8-4, 6-3.
For Armored Lead Cable: 8-3, 8-4.
For Flexible Steel Conduit: $\frac{3}{4}$ -In.

553	$\frac{3}{4}$	$\frac{3}{4}$	1.062	.885	.764	30	\$42.50
------------	---------------	---------------	-------	------	------	----	----------------

Unit package, 25; Standard package, 50.

For Flexible Steel Conduit: 1-In.

554	1	1	1.458	1.305	1.000	60	\$70.00
------------	---	---	-------	-------	-------	----	----------------

Unit package, 10; Standard package, 25.

For Flexible Steel Conduit: $1\frac{1}{4}$ -In.

555	$1\frac{1}{4}$	$1\frac{1}{4}$	1.633	1.385	1.250	90	\$130.00
------------	----------------	----------------	-------	-------	-------	----	-----------------

Unit package, 5; Standard package, 10.

For Flexible Steel Conduit: $1\frac{1}{2}$ -In.

556	$1\frac{1}{2}$	$1\frac{1}{2}$	2.000	1.780	1.500	205	\$225.00
------------	----------------	----------------	-------	-------	-------	-----	-----------------

Unit package, 5; Standard package, 10.

For Flexible Steel Conduit: 2-In.

557	2	2	2.490	2.250	2.000	310	\$295.00
------------	---	---	-------	-------	-------	-----	-----------------

Unit package, 2; Standard package, 5.

45° Angle Squeeze Type

For Armored Cable: 8-1, 6-1, 4-1, 14-2, 14-3, 14-4, 12-2, 12-3.

For Armored Lead Cable: 14-2, 14-3, 10-1, 8-1.

For Flexible Steel Conduit: $\frac{3}{8}$ -In.

No.	Trade Size In.	K. O. Size In.	Clamp Diam., Inches		Wire Throat Diam., In.	Wt. Lbs. Per 100	Std. Pkg. Per 100
			Open	Closed			
540	$\frac{3}{8}$	$\frac{1}{2}$.602	.465	.595	14	\$19.00

Unit package, 25; Standard package, 100.

For Armored Cable: 8-2.

For Armored Lead Cable: 10-4, 8-2.

For Flexible Steel Conduit: $\frac{1}{2}$ -In.

542	$\frac{1}{2}$	$\frac{1}{2}$.937	.795	.625	21	\$32.50
------------	---------------	---------------	------	------	------	----	----------------

Unit package, 25; Standard package, 100.

For Armored Cable: 8-4, 6-3, 6-2.

For Armored Lead Cable: 8-2, 8-3, 8-4.

543	$\frac{3}{4}$	$\frac{3}{4}$	1.065	.815	.775	27	\$46.00
------------	---------------	---------------	-------	------	------	----	----------------

Unit package, 25; Standard package, 50.

Steel City Box Connectors

Malleable Iron — Galvanized

3/8-Inch Connectors



No. 571
Hinged Type



No. 574
2-Screw Type

For Non-Metallic Sheathed Cable: Type T — 14-2, 14-3, 14-4, 12-2, 12-3, 12-4, 10-2, 10-3; Type R — 14-2, 14-3, 12-2, 12-3.

For Service Drop Cable: Type SD — 12-2, 12-3, 10-2, (10-2 & 12-1), 10-3, (8-1 & 10-1), 8-2, (6-1 & 8-1), 6-2, (4-1 & 6-1), 4-2.

For Rubber Jacketed Portable Cord: Type S & SO — 18-2, 18-3, 18-4, 16-2, 16-3, 16-4, 14-2, 14-3, 14-4, 12-2.

For Service Entrance Cable: Type SE, Style A — 12-2, 12-3 (10-2 & 12-1), 10-2, (8-1 & 10-1), 8-2 (6-1 & 8-1), 6-2.

For Service Entrance Cable: Type SE, Style U — 12-2, 12-3, 10-2, (10-2 & 12-1), 10-3, (8-1 & 10-1), 8-2, (6-1 & 8-1), 6-2, (4-1 & 6-1), 4-2.

No.	Trade Size In.	K.D. Size In.	Type	Clamp Diam., Inches	Wire Throat Diam., In.	Wt., Lbs. Per 100	Std. Pkg. Per 100
571	3/8	1/2	Hinged	.600 .250	.600	8	\$6.80
574	3/8	1/2	2-Screw	.600 .150	.600	8	6.80

Unit package, 100; Standard package, 500.

Connectors for Armored Cable



No. 521
Set Screw Type

No. 521 — Set Screw Type

For Armored Cable: 14-2, 14-3, 12-2, 8-1 and 6-1.

For Armored Lead Cable: 14-2, 10-1 and 8-1.

No. 522 — Hinged Type

For Armored Cable: 14-2, 14-3, 14-4, 12-2, 12-3, 10-1, 8-1, 6-1, 4-1.

For Armored Lead Cable: 14-2, 14-3, 12-2, 8-1 and 6-1.

For Armored Lamp Cord: 18-2, 18-3, 16-2 and 16-3.

For Armored Ground Wire: (Solid and Stranded) 8-1, 6-1 and 4-1.

No. 523 — 2-Screw Type

For Armored Cable: 14-2, 14-3, 14-4, 12-2, 12-3, 6-1 and 4-1.

For Armored Lead Cable: 14-2, 14-3, 12-2, 10-1, 8-1 and 6-1.

For Armored Lamp Cord: 18-2, 18-3, 16-2 and 16-3.

No.	Trade Size In.	K.D. Size In.	Type	Clamp Diam., Inches	Wire Throat Diam., In.	Wt., Lbs. Per 100	Std. Pkg. Per 100
521	3/8	1/2	Set-Screw	.562 .425	.545	7	\$5.50
522	3/8	1/2	Hinged	.618 .150	.600	8	6.50
523	3/8	1/2	2-Screw	.620 .445	.600	8	6.80

Unit package, 100; Standard package, 500.

Quantity prices on request.

2-Screw Connectors

Straight Type

No. 577

For Non-Metallic Sheathed Cable: Type R — 14-3, 14-4, 12-3, 12-4, 10-2, 10-3, 10-4. Type T — 14-3, 14-4, 12-3, 12-4, 10-3, 10-1, 8-2.

For Service Entrance Cable: Style A 10-3, 8-2, (8-2 & 10-1), 8-3, (6-1 & 8-1), 6-2, (4-1 & 6-1), 4-2, (2-1 & 4-1), 2-2.

Style U 10-3, (8-2 & 10-1), 8-3, (6-1 & 8-1), 6-2, (4-1 & 6-1), 4-2, (2-1 & 4-1), 2-2.

For Service Drop Cable: Type SD: (8-2 & 10-1), 8-3, (4-1 & 6-1), 4-2, (2-1 & 4-1), 2-2.



No. 577

No.	Trade Size In.	K. D. Size In.	Clamp Diam., Inches	Wire Throat Diam., In.	Wt., Lbs. Per 100	Std. Pkg. Per 100
577	3/4	3/4	.805 .437	.805	20	\$20.00

Unit package, 25; Standard package, 100.

No. 578

For Non-Metallic Sheathed Cable: Type R — 14-3, 14-4, 12-3, 12-4, 10-3, 10-4. Type T — 14-3, 14-4, 12-3, 12-4, 10-3, 10-1, 8-2, 8-3.

For Service Entrance Cable: Style A: 10-3, 8-2, (8-2 & 10-1), 8-3, (6-1 & 8-1), 6-2, (6-2 & 8-1), 6-3, (4-1 & 6-1), 4-2, (4-2 & 6-1), 4-3, (2-1 & 4-1), 2-2. Style U: 10-3, (8-2 & 10-1), 8-3, (6-1 & 8-1), 6-2, (6-2 & 8-1), 6-3, (4-1 & 6-1), 4-2, (4-2 & 6-1), 4-3, (2-1 & 4-1), 2-2.

For Service Drop Cable: (8-2 & 10-1), 8-3, (6-2 & 8-1), 6-3, (4-1 & 6-1), 4-2, (4-2 & 6-1), 4-3, (2-2 & 4-1).

578	1	1	.895 .437	1.050	25	\$28.50
-----	---	---	-----------	-------	----	---------

Unit package, 10; Standard package, 50.

No. 573

For Non-Metallic Sheathed Cable: Type R — 12-3, 12-4, 10-3, 10-4. Type T — 12-4, 10-4.

For Service Entrance Cable: Style A (6-1 & 8-1), (8-2 & 10-1), 8-3, 6-2, (4-1 & 6-1), 4-2. Style U: (6-1 & 8-1), (8-2 & 10-1), 8-3, 6-2, (4-1 & 6-1).

For Rubber Jacketed Portable Cord — Styles S & O: 14-2, 14-3.

573	1/2	1/2	.878 .489	.595	17	\$16.50
-----	-----	-----	-----------	------	----	---------

Unit package, 25; Standard package, 100.

No. 573S

For Non-Metallic Sheathed Cable: Type R — 10-3, 10-4. Type T — 10-4, 8-3.

For Service Entrance Cable: Style A — (4-1 & 6-1), 4-2, (8-2 & 10-1), 8-3, (2-1 & 4-1) 2-2. Style U: 4-2, (2-1 & 4-1), 2-2.

For Service Drop Cable: (2-1 & 4-1), 2-2.

573S	1/2	3/4	.906 .530	.765	23	\$20.35
------	-----	-----	-----------	------	----	---------

Unit package, 25; Standard package, 100.

No. 572

For Non-Metallic Sheathed Cable: Type R — 8-2.

For Service Entrance Cable, Style A — 4-3.

572	3/4	3/4	1.075 .920	.795	22	\$20.35
-----	-----	-----	------------	------	----	---------

Unit package, 25; Standard package, 100.

Appleton Box Connectors

For Non-Metallic Sheathed Cable and Non-Metallic Flexible Tubing

Schedule BC



No. 7316

Take non-metallic sheathed cable sizes 14-2, 14-3, 12-2, 12-3 and 10-2.

Standard Package, 500.

No.	Size In.	K.D. Size In.	Approx. Opening In.	Approx. Closed In.	Wire Throat In.	Ctn. Qty.	Std. Pkg. Wt., Lbs.	Per 100
7316	3/8	1/2	.625	.310	5/8	50	7 1/2	\$10.25

For Larger Sizes of Non-Metallic Sheathed Cable and Service Entrance Cable



No. BC-15233

Made of Malleable iron, cadmium finish.

May be used as non-watertight connector for service entrance cable.

No.	K.D. Size In.	Approx. Opening In.	Approx. Closed In.	Wire Throat In.	Ctn. Qty.	Std. Pkg. Wt., Lbs.	Per 100
15233	3/4	.780	2 5/8	3/4	25	100 20	\$29.75
15234	1	1.000	.500	1	10	100 30	42.25
15235	1 1/4	1.375	.750	1 3/8	5	50 27	64.00

Appleton Cord and Bare Armored Ground Wire Connector



No. BC-7286

Specially designed to take rubber jacketed portable cords. Will take any type of cable having an outside diameter from 1/8 to 1/2-inch. Makes an ideal connector for use with bare armored ground wire. Can be screwed into any 1/2-inch conduit ground fitting by removing locknut.

No.	K.D. Size In.	Approx. Opening In.	Approx. Closed In.	Ctn. Qty.	Std. Pkg. Wt., Lbs.	Per 100
7286	1/2	.500	.187	50	500 8 1/2	\$10.00

Appleton Angle Box Connectors

For Armored Cable and Flexible Steel Conduit
Schedule BC

Clamp Type

45° Connectors

90° Connectors



No. 7245V



No. 7246V and No. 7247V



No. 7380V

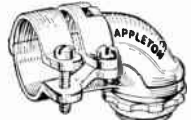

No. 7381V to No. 7386

45-Degree Angle Box Connector

For Armored Cable Sizes—14-2, 14-3, 14-4, 12-2, 12-3, 12-4, 10-2, 14-2L, 14-3L and 12-2L; Flexible Steel Conduit sizes, 5/8 to 3/8-inch.

No.	Size In.	K.D. Size In.	Approx. Opening In.	Approx. Closed In.	Diam. In. Bushed Hole	Ctn. Qty.	Std. Pkg. Wt., Lbs.	Per 100
7245V	3/8	1/2	.656	.375	1 1/2	50 100	16	\$28.15

For Armored Cable Sizes—8-2, 8-3 and 8-2L; Flexible Steel Conduit, 1/2-inch.

7246V	1/2	1/2	.937	.812	9/16	25 100	24	48.00
-------	-----	-----	------	------	------	--------	----	-------

For Armored Cable Sizes—6-2, 6-3, 4-2, 6-3L and 8-3L; Flexible Steel Conduit, 3/4-inch.

7247V	3/4	3/4	1.125	1.000	1 1/8	10 50	18	68.15
-------	-----	-----	-------	-------	-------	-------	----	-------

90-Degree Angle Box Connectors

For Armored Cable Sizes—14-2, 14-3, 14-4, 12-2, 12-3, 12-4, 10-2, 14-2L, 14-3L and 12-2L; Flexible Steel Conduit Sizes, 5/8- to 3/8-inch.

No.	Size In.	K.D. Size In.	Approx. Opening In.	Approx. Closed In.	Diam. In. Bushed Hole	Ctn. Qty.	Std. Pkg. Wt., Lbs.	Per 100
7380V	3/8	1/2	.656	.406	1 1/2	25 100	16	25.90

For Armored Cable Sizes—8-2, 8-3 and 8-2L; Flexible Steel Conduit, 1/2-inch.

7381V	1/2	1/2	.937	.812	9/16	25 100	26	44.80
-------	-----	-----	------	------	------	--------	----	-------

For Armored Cable Sizes—6-2, 6-3, 4-2, 6-3L and 8-3L; Flexible Steel Conduit, 3/4-inch.

7382V	3/4	3/4	1.125	1.000	1 1/8	10 100	26	63.00
-------	-----	-----	-------	-------	-------	--------	----	-------

For Flexible Steel Conduit, 1-inch.

7383	1	1	1.406	1.250	1	5 20	20	104.00
------	---	---	-------	-------	---	------	----	--------

For Flexible Steel Conduit, 1 1/4-inch.

7384	1 1/4	1 1/4	1.687	1.500	1 1/8	5 25	11	192.00
------	-------	-------	-------	-------	-------	------	----	--------

For Flexible Steel Conduit, 1 1/2-inch.

7385	1 1/2	1 1/2	1.875	1.688	1 1/8	5 10	17	333.00
------	-------	-------	-------	-------	-------	------	----	--------

For Flexible Steel Conduit, 2-inch.

7386	2	2	2.500	2.313	2	1 10	15	437.00
------	---	---	-------	-------	---	------	----	--------

Quantity prices on request.

Call Graybar FIRST For . . .



Appleton Straight Box Connectors

For Armored Cable and Flexible Steel Conduit
Schedule BC



No. 7285V



No. 7315V



No. 7226V

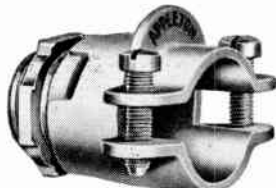

No. 7287V

For Armored Cable Sizes—11-2, 11-3, 11-4, 12-2, 12-3, 12-1, 10-2, 11-2L, 12-2L; Flexible Steel Conduit Sizes— $\frac{5}{16}$ -inch to $\frac{3}{8}$ -inch.

No.	Size In.	K-O Size In.	Approx. Opening In.	Approx. Closed In.	Diam. Bushed Hole, In.	Std. Pkg.	Ctn. Qty.	Lbs. per 100	Per 100
7285V	$\frac{3}{8}$	$\frac{1}{2}$.625	.250	$\frac{13}{32}$	500	50	7 $\frac{1}{2}$	\$10 25

For Armored Cable Sizes—11-2, 11-3 and 12-2; Flexible Steel Conduit Sizes— $\frac{5}{16}$ -inch.

7315V	$\frac{3}{8}$	$\frac{1}{2}$.531	.250	$\frac{13}{32}$	500	50	8 $\frac{3}{4}$	10 25
-------	---------------	---------------	------	------	-----------------	-----	----	-----------------	-------

For Armored Cable Sizes—11-4, 12-3, 12-1 and 10-2; Flexible Steel Conduit Size— $\frac{3}{8}$ -inch.

7226V	$\frac{3}{8}$	$\frac{1}{2}$.625	.437	$\frac{1}{16}$	100	25	7 $\frac{3}{4}$	8 30
-------	---------------	---------------	------	------	----------------	-----	----	-----------------	------

For Armored Cable Sizes—10-3, 10-4, 8-2, 8-3, 12-3L, 10-2L and 10-3L; Flexible Steel Conduit Size— $\frac{1}{2}$ -inch.

7287V	$\frac{1}{2}$	$\frac{1}{2}$.937	.625	$\frac{9}{16}$	100	25	16	24 00
7288V	$\frac{1}{2}$ S	$\frac{3}{4}$.937	.500	$\frac{3}{4}$	100	25	20	28 80

For Armored Cable Sizes—8-3, 8-1, 6-2, 6-3, 1-2, 8-2L, 8-3L, 6-2L and 6-3L. Flexible Steel Conduit Size— $\frac{3}{4}$ -inch.

7289V	$\frac{3}{4}$	$\frac{3}{4}$	1.125	.875	$\frac{3}{4}$	500	50	22	28 80
-------	---------------	---------------	-------	------	---------------	-----	----	----	-------

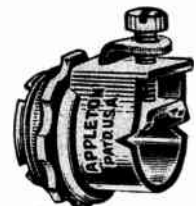

7230V

Connectors with Clamp

Furnished with locknut.

Provides a secure grip on armored cable or flexible steel conduit.

For Armored Cable Sizes—11-2, 11-3, 11-4, 12-2, 12-3, 12-1, 10-2, 10-3, 11-2L and 12-2L; Flexible Steel Conduit Sizes— $\frac{5}{16}$ to $\frac{3}{8}$ -inch.

No.	Size In.	K-O Size In.	Approx. Opening In.	Approx. Closed In.	Diam. Bushed Hole, In.	Std. Pkg.	Ctn. Qty.	Lbs. per 100	Per 100
7230V	$\frac{3}{8}$	$\frac{1}{2}$.656	.375	$\frac{13}{32}$	500	5	8 $\frac{3}{4}$	\$10 25

Squeeze Type Cadmium Finish

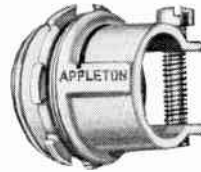

No. 7265V

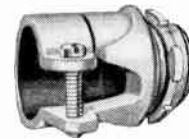

Nos. 7480V to 7483
With One Screw



Nos. 7485 to 7488
With Two Screws

Made of heavy malleable iron. Available in sizes from $\frac{3}{8}$ -inch up to 3 inches, to take all sizes of armored cable, flexible metallic conduit and armored service entrance cable.

Sizes $\frac{1}{2}$ to 3 inches are furnished with two screws, providing a double grip on the cable and eliminating any danger of the cable slipping out on short bends.

Furnished with E-Z-On Locknuts.

For Armored Cable Sizes—14-2, 11-3, 14-4, 12-2, 12-3, 14-2L; Flexible Steel Conduit Sizes— $\frac{5}{16}$ -inch to $\frac{3}{8}$ -inch.

No.	Size In.	K-O Size In.	Approx. Opening In.	Approx. Closed In.	Diam. Bushed Hole, In.	Std. Pkg.	Ctn. Qty.	Std. Pkg. WL, Lbs.	Per 100
7265V	$\frac{3}{8}$	$\frac{1}{2}$.600	.375	$\frac{13}{32}$	500	50	8 $\frac{1}{2}$	\$9 60

For Armored Cable Sizes—12-4, 10-2, 10-3, 10-4, 11-3L, 12-2L, 12-3L, 10-2L and 10-3L; Flexible Steel Conduit Size— $\frac{3}{8}$ -inch.

7480V	$\frac{3}{8}$	$\frac{1}{2}$.812	.562	$\frac{1}{32}$	100	25	11	24 50
-------	---------------	---------------	------	------	----------------	-----	----	----	-------

For Armored Cable Sizes—8-2, 8-3, 8-2L; Flexible Steel Conduit Size— $\frac{1}{2}$ -inch.

*7481V	$\frac{1}{2}$	$\frac{1}{2}$.937	.812	$\frac{9}{16}$	100	25	15	24 50
--------	---------------	---------------	------	------	----------------	-----	----	----	-------

For Armored Cable Sizes—6-2, 6-3, 1-2, 8-3L, 6-3L; Flexible Steel Conduit Size— $\frac{3}{4}$ -inch.

*7482V	$\frac{3}{4}$	$\frac{3}{4}$	1.125	1.000	$\frac{3}{4}$	100	25	21	28 15
--------	---------------	---------------	-------	-------	---------------	-----	----	----	-------

For Flexible Steel Conduit—1-inch.

7483	1	1	1.406	1.250	1	25	5	35	44 80
------	---	---	-------	-------	---	----	---	----	-------

For Flexible Steel Conduit—1 $\frac{1}{4}$ -inch.

7484	1 $\frac{1}{4}$	1 $\frac{1}{4}$	1.656	1.500	1 $\frac{1}{4}$	25	5	50	72 00
------	-----------------	-----------------	-------	-------	-----------------	----	---	----	-------

For Flexible Steel Conduit—1 $\frac{1}{2}$ -inch.

7485	1 $\frac{1}{2}$	1 $\frac{1}{2}$	1.875	1.688	1 $\frac{1}{2}$	25	5	70	132 80
------	-----------------	-----------------	-------	-------	-----------------	----	---	----	--------

For Flexible Steel Conduit—2 inches.

7486	2	2	2.500	2.313	2	10	5	110	192 00
------	---	---	-------	-------	---	----	---	-----	--------

For Flexible Steel Conduit—2 $\frac{1}{2}$ inches.

7487	2 $\frac{1}{2}$	2 $\frac{1}{2}$	3.000	2.813	2 $\frac{1}{2}$	5	1	180	312 00
------	-----------------	-----------------	-------	-------	-----------------	---	---	-----	--------

For Flexible Steel Conduit—3 inches.

7488	3	3	3.563	3.313	3	10	1	220	437 00
------	---	---	-------	-------	---	----	---	-----	--------

*Have peck-holes for anti-short bushing.

Duplex Connector With Clamps

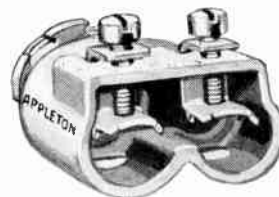

No.	Size In.	K-O Size In.	Approx. Opening In.	Approx. Closed In.	Diam. Bushed Hole, In.	Std. Pkg.	Ctn. Qty.	Std. Pkg. WL, Lbs.	Per 100
7240V	$\frac{3}{8}$	$\frac{1}{2}$.625	.375	$\frac{13}{32}$	200	25	19	\$29 75

For Armored Cable Sizes—11-2, 11-3, 11-4, 12-2, 12-3, 12-4, 10-2, 11-2L and 12-2L. For Flexible Steel Conduit Sizes— $\frac{5}{16}$ to $\frac{3}{8}$ -inch.

Quantity prices on request.

T & B Armored Cable Connectors

Approved by Underwriters' Laboratories



Fig. 1



Fig. 2



Fig. 3



Fig. 4



Fig. 5

Tite-Bite Straight Connectors (Fig. 1)

No.	Trade Size In.	Size K.O. In.	Conductor Sizes	Throat Bushed Diam. In.	Std. Pkg.	Wt. Lbs. Per 100	Per 100
300	3/8	1/2	14-2, 14-3, 14-4, 12-2, 12-3, 12-4, 10-2, 4-1, 6-1, 1-8; Lead 14-2, 14-3, 6-1; Flex. Cond. 3/8"; and others.....	1/2	1000	7	\$ 10.24
301	3/8A	1/2	10-2, 10-3; Lead 12-3, 10-2.....	19/32	100	14	24.64
302	1/2	1/2	10-4, 8-2; Lead 10-2; Flex. Cond. 1/2"; and others.....	19/32	100	14	24.64
303	3/4S	3/4	8-2, 8-3, 6-2; Lead 8-2, 8-3; and others.....	49/64	100	21	28.80
304	3/4	3/4	6-2, 6-3, 4-2; Lead 6-2, 6-3; Flex. Cond. 3/4"; others.....	49/64	100	22	28.80
305	1S	1	2-2, 4-3; Lead 4-3; and others.....	7/8	25	32	46.40
306	1	1	2-2; Lead 4-3; Flex. Cond. 1"; and others.....	1	25	40	46.40
308	1 1/4	1 1/4	Flexible Conduit 1 1/4".....	1 1/4	10	60	75.20
310	1 1/2	1 1/2	Flexible Conduit 1 1/2".....	1 1/2	10	100	136.00
312	2	2	Flexible Conduit 2".....	2	10	120	200.00
314	2 1/2	2 1/2	Flexible Conduit 2 1/2".....	2 1/2	5	200	340.80
316	3	3	Flexible Conduit 3".....	3	5	260	464.00

Tite-Bite Angle Connectors (Fig. 2)

321	3/8 90°	1/2	14-2, 14-3, 14-4, 12-2, 12-3, 10-2, 4-1, 6-1; Lead 14-2, 14-3, 12-2; Flex. Cond. 3/8"; and others.....	1/2	100	13	27.52
322	3/8A 90°	1/2	10-3; Lead 12-3, 10-2.....	17/32	100	25	46.72
323	1/2 90°	1/2	10-4, 8-2; Lead 10-3; Flex. Cond. 1/2"; and others.....	19/32	100	27	46.72
323V 8	1/2 90°	1/2	10-4, 8-2, 8-3; Lead 10-3; Flex. Cond. 1/2"; others.....	21/32	100	25	46.72
324	3/4S 90°	3/4	8-2, 8-3, 6-2; Lead 8-2, 8-3, 6-2; and others.....	49/64	50	32	66.56
325	3/4 90°	3/4	6-2, 6-3, 4-2; Lead 6-2, 6-3; Flex. Cond. 3/4"; others.....	49/64	50	34	66.56
326S	1S 90°	1	6-2, 6-3, 4-2; Lead 6-2, 8-3; and others.....	7/8	25	64	108.16
326	1 90°	1	2-2; Lead 4-3; Flex. Cond. 1"; and others.....	1	25	60	108.16
327	1 1/4 90°	1 1/4	Flexible Conduit 1 1/4".....	1 1/4	10	110	200.00
328	1 1/2 90°	1 1/2	Flexible Conduit 1 1/2".....	1 1/2	10	170	355.20
329	2 90°	2	Flexible Conduit 2".....	2	5	280	464.00
330	2 1/2 90°	2 1/2	Flexible Conduit 2 1/2".....	2 1/2	5	500	1380.00
331	3 90°	3	Flexible Conduit 3".....	3	5	800	1940.00

T & B Squeeze Straight Connectors (Fig. 3)

253	3/8	1/2	14-2, 14-3, 12-2; Lead 14-2; Flex. Cond. 3/8"; others.....	7/16	1000	6	9.60
250	1/4	3/8	Small armored wire or flexible cord.....	5/16	100	6	36.80
252	5/16	3/8	Flexible Cond. 5/16"; flexible cord; small armored wire.....	5/16	100	5	36.80
250A	1/4	1/2	Small armored wire or Flexible cord.....	1 3/8	100	7	40.00
252A	5/16	1/2	Flexible Cond. 5/16"; flexible cord; and small armored wire.....	3/8	100	7	40.00
260	3/8A	1/2	10-3; Lead 10-2, 10-3; and others.....	9/16	100	13	24.48
254	1/2	1 1/2	8-2; Lead 8-2; Flex. Cond. 1/2"; and others.....	19/32	100	13	24.48
278	3/4S	3/4	8-3, 6-2; Lead 8-2, 8-3; and others.....	3/4	100	17	28.16
255	3/4	3/4	6-3, 4-2; Lead 8-3, 6-2, 6-3; Flex. Cond. 3/4"; others.....	3/4	100	19	28.16
264	1S	1	2-2, 4-3; Lead 4-3; and others.....	1	25	24	44.80
256	1	1	Flexible Conduit 1".....	1	25	32	44.80
257	1 1/4	1 1/4	Flexible Conduit 1 1/4".....	1 5/16	10	40	72.00
258	1 1/2	1 1/2	Flexible Conduit 1 1/2".....	1 1/2	10	70	132.80
259	2	2	Flexible Conduit 2".....	2	10	100	192.00
249	2 1/2	2 1/2	Flexible Conduit 2 1/2".....	2 1/2	5	180	312.00
277	3	3	Flexible Conduit 3".....	3	5	200	436.80

T & B Squeeze Angle Connectors (Fig. 4)

266	3/8 90°	1/2	14-2, 14-3, 14-4, 12-2, 12-3, 12-4, 8-1; Lead 14-2, 14-3; Flex. Cond. 3/8".....	9/16	100	15	25.92
272	3/8A 90°	1/2	10-3; Lead 10-2, 10-3.....	9/16	100	23	44.80
268	1/2 90°	1 1/2	8-2; Lead 8-2; Flex. Cond. 1/2".....	9/16	100	21	44.80
279	3/4S 90°	3/4	8-2, 8-3, 6-2; Lead 8-2, 8-3; and others.....	3/4	50	32	63.04
270	3/4 90°	3/4	6-3, 4-2, 4-3; Lead 6-3.....	25/32	50	28	63.04
273	1 90°	1	Flexible Conduit 1".....	1	25	52	104.00
274	1 1/4 90°	1 1/4	Flexible Conduit 1 1/4".....	1 1/4	10	100	192.00
275	1 1/2 90°	1 1/2	Flexible Conduit 1 1/2".....	1 1/2	10	180	332.80
276	2 90°	2	Flexible Conduit 2".....	2	5	300	436.80

T & B Two-Screw Connector (Fig. 5)

3301	3/8	1/2	14-2, 14-3, 14-4, 12-2, 12-3, 10-2, 8-1 (Insul.) 6-1, 4-1; Lead 14-2, 14-3, 12-2; Flex. Cond. 3/8"; and others.....	7/16	1000	6	10.90
------	-----	-----	---	------	------	---	-------

T & B 45° Angle Squeeze Connectors

Approved by Underwriters' Laboratories



For armored conductors and flexible steel conduit. Steel. Unit quantity, 25.

No.	Size In.	Std. Pkg.	Wt. Lbs. Per 100	Per 100
265	3/8	100	16	\$28.16
267	1/2	100	21	48.00
269	3/4	50	26	68.16

T & B Inclined Set Screw Connector

Approved by Underwriters' Laboratories



Screw is on the right hand side making it easy to tighten. Lock-nuts furnished without charge.

No. 240: For 14W3, 12W2, 12W3, 12W4, 14W2L, 14W3L; 3/8-inch flexible steel Conduit.

No. 241: For 8W2, 10W3L; 1/2-inch flexible steel.

No.	Trade Size In.	K.O. In.	Unit Pkg.	Std. Pkg.	Wt. Lbs. Per 100	Per 100
240	3/8	1/2	100	1000	5 1/2	\$8.32
241	1/2	1/2	50	100	12	21.44

T&B Duplex Clamp Connectors

Approved by Underwriters' Laboratories



Designed to accommodate two armored cables in the same knock-out—saving labor, time and materials.

Fitting has a single opening. Both cables securely clamped by a single screw.

Made of malleable iron, Tabolite galvanized.

Holds, 14W2, 14W3, 12W2.

No.	Trade Size In.	K.O. Size	Unit Pkg.	Std. Pkg.	Wt. Lbs. Per 100	Per 100
291	3/8	1/2	25	100	15	\$29.76

T&B Insulated Tite-Bite® Connectors



Straight Connectors

No.	Size In.	Std. Pkg.	Ctn. Qty.	Wgt. Lbs. Per 100	Per 100
3110	3/8	500	50	7	\$14.20
3112	1/2	100	25	15	30.00
3115	3/4	50	10	23	36.00
3117	1	25	5	45	57.50
3118	1 1/4	10	5	62	92.00
3119	1 1/2	10	5	102	160.00
3120	2	5	1	130	240.00
3121	2 1/2	5	1	230	400.00
3122	3	5	1	270	544.00

90° Angle Connectors

No.	Size In.	Std. Pkg.	Ctn. Qty.	Wgt. Lbs. Per 100	Per 100
3130	3/8	100	25	15	\$31.75
3132	1/2	100	25	25	52.00
3135	3/4	50	10	41	74.50
3137	1	25	5	62	122.00
3138	1 1/4	10	5	135	221.00
3139	1 1/2	10	5	205	384.00
3140	2	5	1	280	512.00
3141	2 1/2	5	1	430	1456.00
3142	3	5	1	580	2032.00

T & B Tite-Bite 90° Angle Connectors

Listed by Underwriters' Laboratories, Inc.



An exclusive design that holds the armor with a double grip, tightened with one screw, the saddle grips tighter under strain.

No.	Trade	Size, In.	K. O.	Std. Pkg.	Unit Pkg.	Wt. Lbs. Per 100	Per 100
321	3/8	1/2	1/2	100	50	13	\$ 37.50
322	3/8A	1/2	1/2	100	50	25	68.75
323	1/2	1/2	1/2	100	25	27	68.75
323V8	1/2	1/2	1/2	100	25	25	68.75
324	3/4S	3/4	3/4	50	25	32	105.00
325	3/4	3/4	3/4	50	25	31	105.00
326S	1S	1	1	25	10	64	157.50
326	1	1	1	25	10	60	157.50
327	1 1/4	1 1/4	1 1/4	10	5	110	287.50
328	1 1/2	1 1/2	1 1/2	10	5	170	500.00
329	2	2	2	5	2	280	725.00
330	2 1/2	2 1/2	2 1/2	5	2	500	2000.00
331	3	3	3	5	2	800	2812.50

**T & B Armored Cable Fittings
Tite-Bite® Straight Connectors**

Listed by Underwriters' Laboratories, Inc.



Holds armored cables, leaded cables, and flexible conduit in all sizes from small armored cable to large flexible steel conduit. Reusable. Sizes 3/8-in. and 1/2-in. are of steel. Larger sizes of malleable iron.

Has bright Tabolite plated finish.

No.	Trade	Size, In.	K. O.	Std. Pkg.	Unit Pkg.	Wt. Lbs. Per 100	Per 100
300	3/8	1/2	1/2	1000	100	7	\$ 17.00
301	3/8A	1/2	1/2	100	50	14	35.50
302	1/2	1/2	1/2	100	50	14	35.50
303	3/4S	3/4	3/4	100	50	21	40.75
304	3/4	3/4	3/4	100	25	22	40.75
305	1S	1	1	25	10	32	66.25
306	1	1	1	25	10	40	66.25
308	1 1/4	1 1/4	1 1/4	10	5	60	112.50
310	1 1/2	1 1/2	1 1/2	10	5	100	197.50
312	2	2	2	10	5	120	287.50
314	2 1/2	2 1/2	2 1/2	5	2	200	460.00
316	3	3	3	5	2	260	725.00

National Electric Box Connectors

With EZ Hinged Strap



Galvanized finish.

Furnished with bondnut.

EZ Strap is wide, strong and clamps cable securely and strongly without twisting or squeezing. Opens enough to let cable in or out easily.

No.	Open I.O. In.	Closed I.O. In.	Wire Throat In.	K.O. Size In.	Std. Pkg.	Car-ton	Wt. Lb. Pkg.	Unit Pkg. Per 100
2165-EZ	7/8	1 1/2	9/16	1/2	100	25	11	\$20.75
Fits 10-2, 10-3, 10-4, 8-2, 2-1 armored cable; 14-4, 12-2, 12-3, 12-4, 10-2, 10-3 armored lead cable.								
2166-EZ	1 5/16	1 9/16	1 1/16	1/2	100	25	11	\$17.20
Fits 10-4, 8-2, 8-3, 8-4, 6-2 armored lead cable; 1/2-inch flexible conduit; 10-2, 10-3, 10-4, 8-2, 8-3, armored lead cable.								
2167-EZ	1 1/8	1 7/8	2 1/4	3/4	100	25	19 1/2	\$23.75
Fits 14-10, 6-3, 6-4, 4-2, 4-3 armored cable; 14-4, 12-3, 12-4, 10-2, 10-3, 10-4, 8-2, 8-3 armored lead cable; 3/4-inch flexible conduit.								
2169-EZ	1 1 1/2	1 3/8	1	1	25	5	10	\$37.50
Fits 1-inch flexible conduit.								

Quantity prices on request.

**T & B Connectors
for Non-Metallic Sheathed Cable**
Approved by Underwriters' Laboratories



Two-Screw Connectors

Precision made. All edges rounded; no sharp burrs to harm conductors.

The screws thread into the saddle, not the body. Made of steel, Tabolite galvanized.

No. 3302: Fits non-metallic sheathed cables. Non-Met. Cable—14-2, 14-3, 12-2, 12-3, 10-2. Serv. Ent. Cable—12-2, 12-3, 10-2, 8-2, 6-2, 4-2. Or any non-metallic cable .250" to .650" diam.

No. 3303: Fits non-metallic sheathed cables. Non-Met. Cable—14-3, 12-3, 10-3, 8-2. Serv. Ent. Cable—10-3, 8-3, 6-2, 6-3, 4-2, 2-2. Or any non-metallic cable .450" to .720" diam.

No. 3304: Fits non-metallic sheathed cables. Non-Met. Cable—8-3, 6-2, 4-2. Serv. Ent. Cable—8-3, 6-3, 4-3, 2-2, or any non-metallic cable .530" to .950" diam.

No.	Trade Size In.	Inside Open	Diam., In. Closed	K. D. Size, In.	Std. Pkg.	Per 100
3302	3/8	.650	.310	1/2	1000	\$10.24
3303	3/4	.720	.450	3/4	100	29.76
3304	1	.950	.530	1	50	42.24
3305	1 1/4	1.375	.750	1 1/4	10	64.00

No. 2020 Connector

For non-metallic sheathed cable, 14W2, 14W3, 12W2, 12W3, 10W2, 10W3, also 3/2, 1/4 and 3/8-inch flexible fibre tubing. Unit package, 100; Standard package, 1000.



No.	Size In.	Size K. D.	Wt., Lbs. Per 100	Per 100
2020	3/8	1/2	3 1/2	\$8.00

Squeeze Type Connector



Connector



Insert

Provided with insert to hold cable in center of connector, preventing sharp bends in conductor when strap is tightened.

Insert cannot be accidentally displaced, yet is easily removed. Insert has long bearing surface. Connector has threaded end; supplied with locknut.

No.	Size K. D. In.	Made to Hold With Insert	Made to Hold Insert Removed	Unit Pkg.	Std. Pkg.	Wt., Lbs. Per 100	Per 100
2005	1/2	{ 14W2 12W2 }	{ 14W3 12W3 }	100	1000	7	\$34.50
2006	1/2	10W2	10W3	50	100	13	44.75
2007	3/4	10W2	10W3	25	50	14	65.00
2008	3/4	8W2	8W3	25	50	12	65.00
2009	1	6W2	6W3	10	20	25	86.50

T & B Tite-Bite® Connector

For Non-Metallic Sheathed Cable



A strong steel connector which may be used again and again. Set screw cannot touch cable. Equipped with T & B case-hardened locknut.

Takes 14W2, 14W3, 12W2, 10W2. Unit package, 100. Standard package, 1000.

No.	Size In.	Wt., Lbs. Per 100	Per 100
3100	3/8	7	\$12.30

**T & B Tite-Bite Connectors
For Armored and Non-Metallic Sheathed Cable**
Approved by Underwriters' Laboratories

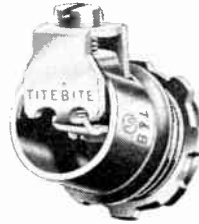

Corrugated grip holds non-metallic sheathed cable without danger of cutting fabric.

Takes up to 1 No. 4 armored cable, 3/8-inch flexible conduit, and non-metallic sheathed cable from 0.188 in. to 0.495 in. diam.

Standard package, 1000.

No.	Trade Size In.	Approx. Open In.	Approx. Closed In.	Unit Pkg.	Wt. Lbs. Per 100	Per 100
3101	3/8	.495	.188	100	7	\$12.30

**National Electric Connector
Duplex Type**



Galvanized finish. With bondnut.

For armored cable, non-metallic cable and loom. Fits 14-2, 14-3, 12-2, 4-1 armored cable; 3/8-inch flexible conduit. For taking two cables into one 1/2-inch knockout. Tightening a screw holds the cables firmly in place.

No.	Open I.D. In.	Closed I.D. In.	Wire Throat In.	K.D. Size In.	Std. Pkg.	Car-ton	Wt. Lb. Std. Pkg.	Unit Pkg. Per 100
2175	9/16	1/8	5/8	1/2	100	20	17	\$25.00

**National Electric
Angle Box Connectors**

90° Open Back Type

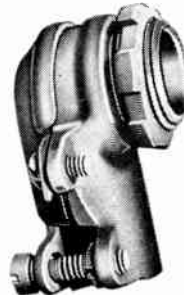

For Armored Cable Lampeord and Flexible Conduit

Rustproofed finish.

Galvanized. Furnished with bondnut and hinged strap fitting.

No.	Open I.D. In.	Closed I.D. In.	Wire Throat In.	Knock-out In.	Car-ton	Std. Pkg.	Wt. Lb. Std. Pkg.	Unit Pkg. Per 100
2210-EZ	4 1/64	1/2	15/32	1/2	20	100	17 1/2	\$37.50
Fits 14-2, 14-3, 12-2, 4-1 armored cable; 6-1 armored lead cable; 14-2, 14-3 plain lamp cord; 3/8-inch flexible conduit.								
2211-EZ	15/16	4 7/64	4 1/64	1/2	20	100	24	\$37.50
Fits 8-3 armored cable; 12-4, 10-3, 10-4, 8-2 armored lead cable; 1/2-inch flexible conduit.								
2214-EZ	1 1/8	7/8	2 7/32	3/4	10	50	16	\$53.00
Fits 6-3, 6-4, 4-2, 4-3 armored cable; 8-4, 6-2, 6-3 armored lead cable; 3/4-inch flexible conduit.								
2216-EZ	1 17/32	1 1/4	1	1	20	20	12	\$87.50
Fits 2-3 armored cable; 4-4 armored lead cable; 1-inch flexible conduit.								
2218-EZ	1 23/32	1 7/16	1 17/32	1 1/4	10	10	12	\$163.00
Fits 1 1/4-inch flexible conduit.								
2234-EZ	2 7/64	1 3/4	1 1/2	1 1/2	10	10	17	\$281.00
Fits 1 1/2-inch flexible conduit.								

45° Open Back Type

Rustproofed finish. Furnished with bondnut and hinged strap fitting.

Fits 14-2, 14-3, 12-2, 4-1 armored cable; 6-1 armored lead cable; 14-2, 14-3 plain lamp cord; 3/8-inch flexible conduit.



No.	Open I.D. In.	Closed I.D. In.	Wire Throat In.	K.D. Size In.	Std. Pkg.	Car-ton	Wt. Lb. Std. Pkg.	Unit Pkg. Per 100
2208-EZ	4 1/64	1/2	15/32	1/2	100	20	14	\$23.75

T & B 90° Set-Screw Connectors

Approved by Underwriters' Laboratories



For small armored wire. Recommended on machines and appliances where space is limited and appearance is important. One-piece malleable iron, brightly plated.

No.	Trade Size In.	K.O. Size	Opening Max.	Opening Min.	Std. Pkg.	Wt. Lbs. Per 100	Per 100
285	5/16	3/8	.437	.312	100	13	\$65.00
*285A	5/16	1/2	.437	.312	100	14	69.00

*Supplied with No. 400 1/2-inch KO Adapter.

Appleton Cable Clamps

Schedule CF

For Exposed Industrial Wiring



No. 18990



No. 18993



No. 18997



No. 18992

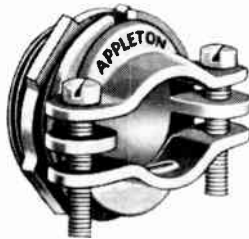

Connector No. 15233

Provide secure support for power cable branch feeder circuits from main distribution systems. Flexibility of arrangement and mounting particularly suited for mass machinery installations in modern industrial plants.

Quarter-bend cable clamp provides proper bending radius without injury to cable. Mooring clamp anchors cable at supply and output ends, without stress to cable.

Quarter-Bend Clamps

No.	Clamping Cable Range Diam. In.	Std. Pkg.	Ctn. Qty.	Wt. Lbs. Per 100	Per 100
18990	.437 to 1.187	50	25	50	\$93.35
18992	.437 to 1.187	50	25	65	113.35
18993	.437 to 1.187	50	25	103	226.70

Mooring Cable Clamps

No.	Clamping Cable Range Diam. In.	Std. Pkg.	Ctn. Qty.	Wt. Lbs. Per 100	Per 100
18997	.875 to 1.187	50	25	50	\$101.35

Cable Connectors

No.	Clamping Cable Range Diam. In.	Fits K.O. Size In.	Std. Pkg.	Ctn. Qty.	Per 100
15233	.437 to .687	3/4	40	20	\$29.75

Appleton Guy Wire Conduit Clamps and Box Supports

For Rigid Conduit (Heavy Wall) and E.M.T.

Schedule OB



Outlet Box with 17210 Outlet Box Support and 17200 Clamp

For use in industrial plants having irregular or high ceiling construction making it necessary to suspend the conduit system at a practical level. Box supports are equipped with 3/8-in. fixture studs. Galvanized finish.

Guy Wire Conduit Clamps

Standard package, 100.

For Rigid Conduit (Heavy Wall)

No.	Conduit Size, In.	Wt. Lbs. Per 100	Per 100
17200	1/2	14	\$27.70
17201	3/4	15	30.35

For Electrical Metallic Tubing

No.	Conduit Size, In.	Wt. Lbs. Per 100	Per 100
171'200	1/2	15	\$27.70
171'201	3/4	16	30.35

Guy Wire Box Support

Left: For use in bottom knockouts of outlet boxes.

Furnished with two screws.

Right: For use in side knockouts of handy boxes.



No.	Std. Pkg.	Wt. Lbs. Per 100	Per 100
17210	100	11	\$71.30
17211	100	15	55.45

Appleton 90° Knockout Box Connectors

Schedule CF

Cadmium Finish

For Rigid Conduit (Heavy Wall)

Threaded Type

No.	Size In.	Ctn. Qty.	Std. Pkg.	Std. Pkg. Wt. Lbs.	Per 100
7390	1/2	25	100	17	\$36.00
7391	3/4	25	100	26	53.30

No-Thread Type

No.	Size In.	Ctn. Qty.	Std. Pkg.	Std. Pkg. Wt. Lbs.	Per 100
73N90	1/2	25	100	20	\$68.80
73N91	3/4	10	50	32	110.40



O. Z. Cable Supports

Type S

For Two or More Wires

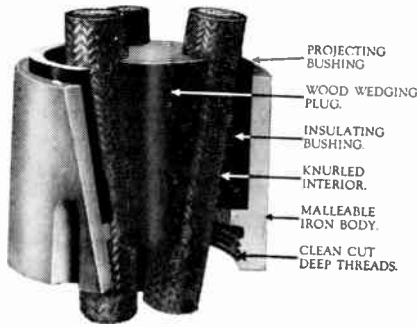

For supporting electrical cables in vertical conduit risers.

Use with standard rubber, synthetic, plastic, varnished cambric or lead covered cables. (For soft synthetic rubber covered cables use Type "R" below.)

No.	Cond. In.	Body Only Each	2 to 4 Same Size Wires		5 or More or Different Size Wires		Wt. Ea. Lbs.
			Plug Only Each	Complete Each	Plug Only Each	Complete Each	
S 500	1/2	\$ 2.10	\$0.50	\$ 2.60	\$0.95	\$ 3.05	.25
S 750	3/4	2.10	.50	2.60	.95	3.05	.33
S1000	1	2.35	.70	3.05	1.30	3.65	.50
S1250	1 1/4	2.45	.70	3.15	1.30	3.75	.75
S1500	1 1/2	2.95	.85	3.80	1.55	4.50	.88
S2000	2	4.70	.95	5.65	1.70	6.40	1.5
S2500	2 1/2	5.30	1.05	6.35	1.85	7.15	2.5
S3000	3	6.95	1.40	8.35	2.30	9.25	4.0
S3500	3 1/2	9.55	1.75	11.30	2.65	12.20	5.3
S4000	4	11.45	2.00	14.05	3.50	14.95	6.5
S4500	4 1/2	16.90	3.00	20.80	4.80	21.70	8.7
S5000	5	20.80	5.20	26.00	6.10	26.90	13.3
S6000	6	34.65	8.65	43.30	9.55	44.20	19.0

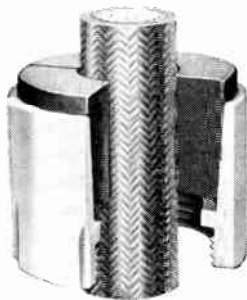

For One Wire

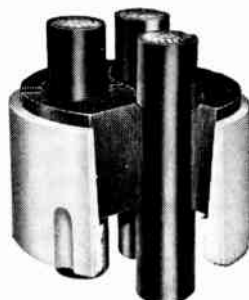

For Two or More Wires

Type R

Recommended for supporting soft synthetic rubber covered cables. One wire support takes all types of cables.

No.	Cond. In.	Body Only Each	One Wire		2 to 4 Same Size Wires		5 or More, or Diff. Size Wires		Wt. Ea. Lbs.
			Plug Only Each	Complete Each	Plug Only Each	Complete Each	Plug Only Each	Complete Each	
R 501	1/2	\$ 1.55	\$ 1.05	\$ 2.60	\$ 1.90	\$ 3.45	\$ 2.35	\$ 3.90	.25
R 751	3/4	1.55	1.05	2.60	1.90	3.45	2.35	3.90	.38
R1001	1	1.65	1.40	3.05	2.50	4.15	3.10	4.75	.63
R1251	1 1/4	1.75	1.40	3.15	2.50	4.25	3.10	4.85	.75
R1501	1 1/2	2.10	1.70	3.80	3.10	5.20	3.80	5.90	1.3
R2001	2	3.75	1.90	5.65	3.45	7.20	4.20	7.95	1.6
R2501	2 1/2	4.25	2.10	6.35	3.75	8.00	4.55	8.80	2.5
R3001	3	5.55	2.80	8.35	4.50	10.05	5.40	10.95	3.8
R3501	3 1/2	7.80	3.50	11.30	5.20	13.00	6.05	13.85	5.1
R4001	4	8.85	5.20	14.05	6.95	15.80	7.80	16.65	6.5
R4501	4 1/2	13.85	6.95	20.80	8.65	22.50	9.55	23.40	8.5
R5001	5	17.35	8.65	26.00	10.40	27.75	11.30	28.65	13.0
R6001	6	30.30	13.00	43.30	14.75	45.05	15.60	45.90	18.0

Finish—Malleable iron, cadmium plated. For hot dipped galvanized add 25% to price.

Can be furnished for thin wall conduit (E.M.T.) and fibre conduit on request at additional charge.

When ordering, specify type of conductor, number of conductors in conduit and outside diameter of each.

Split Type D



For use where the cables are already installed in the conduit.

Use with two or more standard rubber, synthetic, plastic, varnished cambric or lead covered cables.

When ordering, specify type of conductor, number of conductors and outside diameter of each.

No.	Conduit, In.	2 to 4 Same Size Wires Each		5 or More, or Different Size Wires Each		Wt. Ea. Lbs.
D 502	1/2	\$ 2.60	\$ 3.05			.13
D 752	3/4	2.60	3.05			.19
D1002	1	3.05	3.65			.25
D1252	1 1/4	3.15	3.75			.44
D1502	1 1/2	3.80	4.50			.63
D2002	2	5.65	6.40			.81
D2502	2 1/2	6.35	7.15			1.1
D3002	3	8.35	9.25			1.4
D3502	3 1/2	11.30	12.20			2.6
D4002	4	14.05	14.95			3.3
D4502	4 1/2	20.80	21.70			3.4
D5002	5	26.00	26.90			3.6
D6002	6	43.30	44.20			5.3

Lock Type K

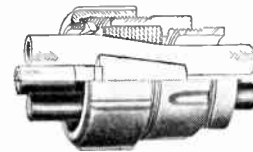

Can be installed in horizontal or vertical position.

When ordering, specify type of conductor, number of conductors in conduit and outside diameter of each.

No.	Conduit, In.	2 to 4 Same Size Wires Each		5 or More, or Different Size Wires Each		Wt. Ea. Lbs.
K 503	1/2	\$ 5.20	\$ 6.10			.50
K 753	3/4	5.20	6.10			.63
K1003	1	6.10	7.30			.75
K1253	1 1/4	6.30	7.50			.88
K1503	1 1/2	7.60	9.00			1.4
K2003	2	11.30	12.80			2.3
K2503	2 1/2	12.70	14.30			3.3
K3003	3	16.70	18.50			4.8
K3503	3 1/2	22.60	24.40			6.1
K4003	4	28.10	29.90			8.1
K4503	4 1/2	41.60	43.40			10.0
K5003	5	52.00	53.80			17.0
K6003	6	86.60	88.40			25.0

Compound Type C



For supporting all types of cables and seal end of conduit.

When ordering, specify type of conductor, number of conductors in conduit, and outside diameter of each.

Can be furnished for thin wall conduit (E.M.T.) and fibre conduit on request at additional charge.

No.	Conduit In.	One Wire Each	2 to 4 Same Size Wires Each		5 or More, or Different Size Wires Each		Wt. Ea. Lbs.
C 504	1/2	\$ 4.40	\$ 5.25	\$ 5.70		.38	
C 754	3/4	4.40	5.25	5.70		.50	
C1004	1	5.15	6.25	6.85		.63	
C1254	1 1/4	5.55	6.45	7.05		1.0	
C1504	1 1/2	6.50	7.85	8.55		1.5	
C2004	2	9.45	11.00	11.75		2.0	
C2504	2 1/2	10.15	11.80	12.60		3.5	
C3004	3	13.96	15.65	16.55		4.8	
C3504	3 1/2	18.75	20.50	21.35		6.0	
C4004	4	23.55	25.30	26.15		7.5	
C4504	4 1/2	34.00	35.70	36.60		9.0	
C5004	5	41.95	43.70	44.60		11.0	
C6004	6	68.45	70.20	71.05		14.0	

Finish—Malleable iron, cadmium plated. For hot dipped galvanized add 25% to price.

O. Z. Cable Supports

Ventilated Compound Type V

All Bakelite

For supporting all types of cables, seal top, and ventilate conduit allowing cables to "breathe".

When ordering, specify type of conductor, number of conductors in conduit and outside diameter of each.

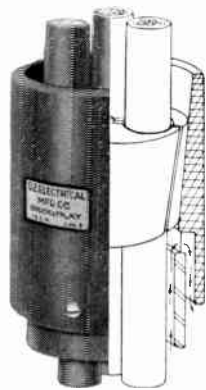

No.	Conduit, In.	One Wire, Each	2 to 4 Same Size Wires Each	5 or More, or Diff. Size Wires Each	Wt. Ea. Lbs.	Each
V1005	1	\$ 7.65	\$ 8.75	\$ 9.35	.07	
V1255	1 1/4	8.50	9.35	10.20	.13	
V1505	1 1/2	9.85	11.20	11.90	.30	
V2005	2	11.35	12.90	13.65	.63	
V2505	2 1/2	14.05	15.70	16.50	1.0	
V3005	3	18.75	20.45	21.35	1.4	
V3505	3 1/2	24.35	26.10	26.95	1.6	
V4005	4	30.35	32.10	33.05	2.4	
V4505	4 1/2	39.45	41.15	42.05	2.8	
V5005	5	46.80	48.55	49.45	3.4	

O. Z. Sealing Bushings

Type KL*

For Lead Covered Cable

To be used with a multiple or a single conductor cable.

Malleable iron bodies, cadmium plated. For hot-dipped galvanized add 25% to prices.

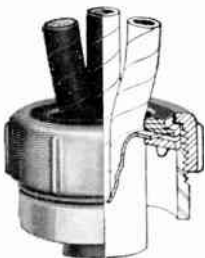

No.	Conduit, In.	Max. Cable Diam., In.	Wt. Ea. Lbs.	Each
KL 75	3/4	.56	.13	\$ 1.45
KL100	1	.78	.25	1.80
KL125	1 1/4	1.02	.38	2.20
KL150	1 1/2	1.20	.50	2.70
KL200	2	1.53	.75	3.40
KL250	2 1/2	1.83	1.0	4.30
KL300	3	2.28	1.8	5.55
KL350	3 1/2	2.65	2.0	6.95
KL400	4	3.00	2.6	8.65
KL450	4 1/2	3.35	3.8	10.60
KL500	5	3.75	4.3	12.80

Type GRK*

For Rubber Covered and Braided Cables in Conduit Entering Cabinets

To be used with one or more cables. Complete with locknuts.

Malleable iron bodies, cadmium plated. For hot-dipped galvanized add 25% to prices.

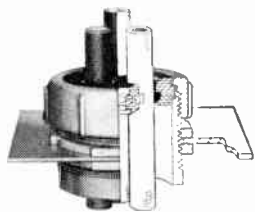

No.	Conduit, In.	Max. Cable Diam., Inches				Wt. Ea. Lbs.	Each
		1 Wire	2 Wires	3 Wires	4 Wires		
GRK 75	3/4	.61	.29	.26	.22	.13	\$ 1.90
GRK100	1	.78	.38	.34	.31	.25	2.40
GRK125	1 1/4	1.02	.55	.50	.44	.50	2.85
GRK150	1 1/2	1.20	.63	.59	.51	.63	3.65
GRK200	2	1.53	.81	.78	.65	.75	4.50
GRK250	2 1/2	1.83	.97	.93	.78	1.1	5.95
GRK300	3	2.28	1.21	1.16	.97	1.8	7.65
GRK350	3 1/2	2.65	1.40	1.34	1.12	2.5	9.75
GRK400	4	3.00	1.58	1.52	1.27	3.1	11.95
GRK450	4 1/2	3.35	1.77	1.71	1.43	4.3	15.85
GRK500	5	3.75	1.99	1.91	1.60	5.5	19.00

*When ordering, specify size of conduit, number of cables, outside diameter of cables.

O. Z. Compound Bushings

Type FR

For Rubber Covered and Braided Cables

Can be used with one or more cables, a-c or d-c.

Also available for lead covered cables. Contact Graybar.

Filling Compound not included.

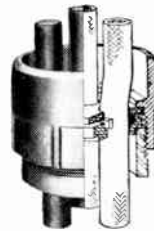

No.	Conduit, In.	Max. Cable Diam., In.				Wt. Ea. Lbs.	Each
		1 Wire	2 Wires	3 Wires	4 Wires		
FR 75	3/4	.61	.28	.26	.22	.25	\$ 2.20
FR100	1	.78	.38	.34	.31	.38	2.65
FR125	1 1/4	1.02	.55	.50	.44	.50	3.25
FR150	1 1/2	1.20	.63	.59	.51	.63	3.95
FR200	2	1.53	.81	.78	.65	1.0	5.00
FR250	2 1/2	1.83	.97	.93	.78	1.8	6.20
FR300	3	2.28	1.21	1.16	.97	2.6	7.65
FR350	3 1/2	2.65	1.40	1.34	1.12	2.9	9.30
FR400	4	3.00	1.58	1.52	1.27	3.8	11.30
FR450	4 1/2	3.35	1.77	1.71	1.43	4.3	13.50
FR500	5	3.75	1.99	1.91	1.60	8.1	15.90

Malleable iron, cadmium plated. For hot-dipped galvanized add 25% to prices.

When ordering, specify size of conduit, number of cables and outside diameter of cables.

Type HLK

For Lead Covered Cables In Conduits Entering Cabinets

To be used with a multiple or a single conductor cable.

Filling Compound not included.

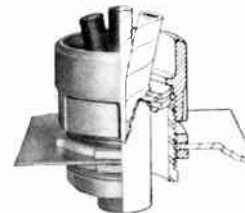

No.	Conduit, In.	Max. Cable Diam., In.	Wt. Ea. Lbs.	Each
HLK 75	3/4	.56	.38	\$ 1.80
HLK100	1	.78	.50	2.20
HLK125	1 1/4	1.02	.75	2.65
HLK150	1 1/2	1.20	1.0	3.30
HLK200	2	1.53	1.5	4.10
HLK250	2 1/2	1.83	2.4	5.35
HLK300	3	2.28	3.8	6.80
HLK350	3 1/2	2.65	4.4	8.65
HLK400	4	3.00	6.0	10.55
HLK450	4 1/2	3.35	7.3	14.10
HLK500	5	3.75	12.0	16.85

Malleable iron, cadmium plated. For hot-dipped galvanized add 25% to prices.

When ordering, specify size of conduit and outside diameter of cable.

Type GRE*

For Exposed Rubber Covered and Braided Cables Entering Cabinets

To be used with one or more cables.

Fittings furnished will be for standard 1/4-in. thick cabinets.

Malleable iron bodies, cadmium plated. For hot-dipped galvanized add 25% to prices.

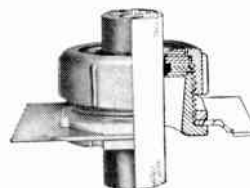

No.	Knockout, In.	Max. Cable Diam., Inches				Wt. Ea. Lbs.	Each
		1 Wire	2 Wires	3 Wires	4 Wires		
GRE100	1	.78	.38	.34	.31	.50	\$ 3.45
GRE125	1 1/4	1.02	.55	.50	.44	.75	4.15
GRE150	1 1/2	1.20	.63	.59	.51	.88	5.20
GRE200	2	1.53	.81	.78	.65	1.3	6.45
GRE250	2 1/2	1.83	.97	.93	.78	2.0	8.15
GRE300	3	2.28	1.21	1.16	.97	3.0	10.15
GRE350	3 1/2	2.65	1.40	1.34	1.12	3.6	12.55
GRE400	4	3.00	1.58	1.52	1.27	4.9	15.35
GRE450	4 1/2	3.35	1.77	1.71	1.43	6.8	19.15
GRE500	5	3.75	1.99	1.91	1.60	8.6	22.85

*When ordering, specify knockout size, number of cables and outside diameter of cables.

O. Z. Cable Terminators

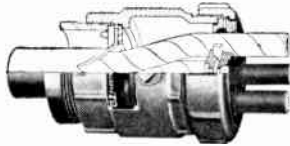

Horizontal Type CLH*

For Lead Covered Cables

For use with a multiple or a single conductor cable. Filling Compound not included.

No.	Cond. In.	Max. Cable Diam. In.	Diam. In.	Overall Ht. In.	Wt. Ea. Lbs.	Each
CLH100	1	.78	2 1/8	3 3/8	1.4	\$ 7.50
CLH125	1 1/4	1.02	2 3/8	3 3/8	1.7	8.75
CLH150	1 1/2	1.20	2 5/8	3 1/2	1.9	10.55
CLH200	2	1.53	3 1/2	4 1/8	2.7	12.65
CLH250	2 1/2	1.83	4	5 1/8	4.3	15.45
CLH300	3	2.28	4 1/2	5 1/8	6.1	18.55
CLH350	3 1/2	2.65	5 1/8	5 5/8	8.3	22.70
CLH400	4	3.00	5 7/8	6 3/8	12.0	27.30
CLH450	4 1/2	3.35	6 1/2	6 5/8	15.0	32.60
CLH500	5	3.75	7	6 7/8	16.0	41.25
CLH600	6	4.50	8	7 3/8	21.0	54.95

O. Z. Cable Terminators
Types CUC,* CAC,* CUN,* and CAN*

For Lead Covered Cables

For use with two or more single conductor cables.

Types "CUC" and "CUN" are used where the wires installed in a conduit are small enough to allow sufficient space for bellowing purposes in a pot-head the same size as the conduit.

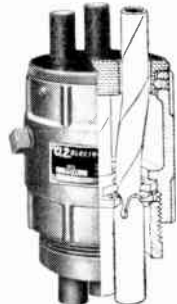

Type "CUC" With Top Cover

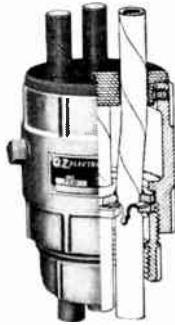

Type "CAC" With Top Cover and Adapter

Types "CAC" and "CAN" are used where larger wires are installed in the same size conduit according to standard code requirements.

Fittings available with taping cones. Filling compound not included.

Types "CUC" & "CAC" With Cover		Types "CUN" & "CAN" No Cover		Conduit In.	Max. Cable Diam.			Wt. Each, Lbs.
No.	Each	No.	Each		2 Wires	3 Wires	4 Wires	
CUC 75	\$ 4.65	CUN 75	\$ 3.80	3/4	.24	.24	.25	1.84
CAC 75	6.70	CAN 75	5.70	3/4	.32	.30	.25	1.4
CUC100	5.40	CUN100	4.40	1	.32	.30	.25	1.2
CAC100	7.80	CAN100	6.60	1	.41	.38	.32	1.9
CUC125	6.25	CUN125	5.05	1 1/4	.41	.38	.32	1.5
CAC125	9.05	CAN125	7.70	1 1/4	.54	.44	.43	2.2
CUC150	7.20	CUN150	5.85	1 1/2	.54	.44	.43	1.7
CAC150	10.85	CAN150	9.15	1 1/2	.62	.59	.50	3.3
CUC200	8.65	CUN200	6.95	2	.68	.66	.50	2.8
CAC200	13.10	CAN200	11.00	2	.80	.75	.64	4.7
CUC250	10.40	CUN250	8.30	2 1/2	.80	.75	.68	3.8
CAC250	15.85	CAN250	13.30	2 1/2	.96	.90	.76	7.2
CUC300	12.55	CUN300	10.00	3	1.00	.96	.81	5.6
CAC300	19.20	CAN300	16.25	3	1.19	1.12	.94	9.7
CUC350	15.15	CUN350	12.20	3 1/2	1.25	1.18	1.00	7.7
CAC350	23.45	CAN350	19.65	3 1/2	1.38	1.30	1.10	14.0
CUC400	18.55	CUN400	14.75	4	1.43	1.38	1.18	11.0
CAC400	28.10	CAN400	23.45	4	1.56	1.47	1.24	16.0
CUC450	22.25	CUN450	17.60	4 1/2	1.56	1.47	1.31	13.0
CAC450	33.40	CAN450	27.70	4 1/2	1.75	1.65	1.39	18.0
CUC500	26.55	CUN500	20.85	5	1.75	1.65	1.39	15.0
CAC500	43.60	CAN500	36.25	5	1.95	1.84	1.56	26.0
CUC600	35.65	CUN600	28.30	6	1.95	1.84	1.56	20.0

Types CUN and CAN are same as types CUC and CAC except with conduit threads in top of body for the extension of conduit or greenfield connector.

*Finish—Malleable iron bodies, cadmium finish. For hot dipped galvanized add 25% to prices.

When ordering, specify size of conduit, number of conductors, diameter over lead sheath and diameter over insulation under sheath.

O. Z. Cable Terminators

Types CLC and CLN

For Lead Covered Cable

For use with a multiple or a single conductor cable.

This fitting seals the cable and grounds the lead sheath. The body of fitting screws directly on the conduit, clamping the lead sheath to a bronze bell ring which has been previously set into the end of the conduit. Fittings available with taping cones; filling compound not included.



No. CLC

Type "CLC" With Cover		Type "CLN" No Cover		Cond. In.	Max. Cable Diam. In.	Diam. In.	Overall Ht. In.	Wt. Ea. Lbs.
No.	Each	No.	Each					
CLC 50	\$ 4.50	CLN 50	\$ 3.65	1/2	.46	1 1/2	2 5/8	.78
CLC 75	4.50	CLN 75	3.65	3/4	.56	1 1/2	2 5/8	.78
CLC100	5.15	CLN100	4.15	1	.78	1 3/4	3	1.1
CLC125	5.90	CLN125	4.70	1 1/4	1.02	2 1/4	3 1/8	1.4
CLC150	6.80	CLN150	5.45	1 1/2	1.20	2 3/8	3 1/4	1.6
CLC200	8.15	CLN200	6.45	2	1.53	3	3 3/8	2.4
CLC250	9.80	CLN250	7.70	2 1/2	1.83	3 1/2	4 1/4	3.5
CLC300	11.80	CLN300	9.25	3	2.28	4 1/4	4 3/4	5.3
CLC350	14.25	CLN350	11.30	3 1/2	2.65	4 3/4	5 1/4	7.1
CLC400	17.45	CLN400	13.65	4	3.00	5 3/8	5 7/8	10.0
CLC450	21.00	CLN450	16.35	4 1/2	3.35	5 7/8	6 1/4	12.0
CLC500	25.10	CLN500	19.40	5	3.75	6 1/2	6 1/2	14.0
CLC600	33.85	CLN600	26.50	6	4.50	7 3/8	6 3/4	19.0

Note—Type CLN is same as Type CLC, except with conduit threads in top of body for the extension of conduit or greenfield connector.

Finish—Malleable iron, cadmium plated. For hot dipped galvanized add 25% to prices.

When ordering, specify size of conduit, diameter over lead sheath, number of conductors and diameter over insulation of individual conductors.

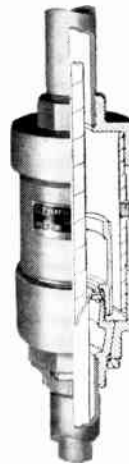

Type J

For Lead or Rubber Covered Cables (as below)

This compact device permits termination of the cables and the sealing of both conduit and cables outside of cabinets without disturbing the installed conduit.

Can be used as a terminating and sealing fitting or a pulling and splicing chamber.

Filling compound not included.

For a Multiple or a Single Lead Covered Cable		For 2 or More Single Conductor Lead Cables		For 1 or More Rubber Covered Cables		Conduit In.	Wt. Ea. Lbs.
No.	Each	No.	Each	No.	Each		
JL100	\$19.65	JU100	\$20.00	JR100	\$20.40	1	9.0
JL125	23.40	JU125	23.80	JR125	24.30	1 1/4	11.0
JL150	29.00	JU150	29.55	JR150	30.20	1 1/2	13.0
JL200	36.75	JU200	37.30	JR200	38.15	2	19.0
JL250	47.75	JU250	48.50	JR250	49.50	2 1/2	28.0
JL300	58.80	JU300	59.75	JR300	60.90	3	34.0
JL350	70.15	JU350	71.25	JR350	72.60	3 1/2	46.0
JL400	84.75	JU400	86.05	JR400	87.55	4	56.0
JL500	124.00	JU500	125.80	JR500	127.65	5	97.0

Finish—Hot-dipped galvanized.

When ordering, specify size of conduit, number of cables and outside diameter of cables.

O. Z. Cable Terminators

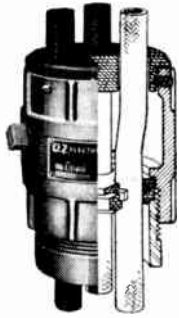

Types CRC and CRN

For rubber covered and other braided cable.

Fittings available with taping cones.

Conductors are sealed by neoprene rings placed over cables, set into canvas bakelite seating disc and compressed by a pressure disc.

Filling compound not included.

Type "CRC" With Cover		Type "CRN" No Cover		Conduit, In.	Max. Cable Diam., In.				Wt. Ea. Lbs.
No.	Each	No.	Each		1 Wire	2 Wire	3 Wire	4 Wire	
CRC 50	\$ 5.00	CRN 50	\$ 4.15	1/2	.4672
CRC 75	5.00	CRN 75	4.15	3/4	.61	.29	.26	.22	.72
CRC100	5.75	CRN100	4.75	1	.78	.38	.34	.31	1.1
CRC125	6.65	CRN125	5.45	1 1/4	1.02	.55	.50	.44	1.3
CRC150	7.70	CRN150	6.35	1 1/2	1.20	.63	.59	.51	1.5
CRC200	9.30	CRN200	7.60	2	1.53	.81	.78	.65	2.3
CRC250	11.25	CRN250	9.15	2 1/2	1.83	.97	.93	.78	3.4
CRC300	13.60	CRN300	11.05	3	2.28	.21	1.16	.97	5.1
CRC350	16.35	CRN350	13.40	3 1/2	2.65	1.40	1.34	1.12	6.9
CRC400	19.90	CRN400	16.10	4	3.00	1.58	1.52	1.27	9.7
CRC450	23.80	CRN450	19.15	4 1/2	3.35	1.77	1.71	1.43	11.0
CRC500	28.20	CRN500	22.50	5	3.75	1.99	1.91	1.60	13.0
CRC600	37.50	CRN600	30.15	6	4.50	2.39	2.30	1.92	17.0

Note—"CRN" has conduit threads in top of body to provide for extension of conduit or greenfield connector.

When ordering—Give number and specify size of conduit, number of cables and outside diameter of cables.

Type HUE

For Lead Covered Exposed Cables Entering Cabinets

To be used with two or more single conductor cables.

Fittings furnished will be for standard 1/4-in. thick cabinets.

Filling Compound not included.

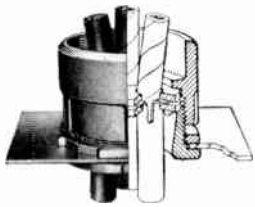

No.	Knockout, In.	Max. Cable Diam., Inches			Wt. Each, Lbs.	Each
		2 Wires	3 Wires	4 Wires		
HUE100	1	.32	.30	.25	.75	\$ 3.50
HUE125	1 1/4	.41	.38	.32	1.0	4.30
HUE150	1 1/2	.54	.44	.43	1.3	5.25
HUE200	2	.68	.66	.50	2.0	6.55
HUE250	2 1/2	.80	.75	.68	3.1	8.15
HUE300	3	1.00	.96	.81	4.9	10.05
HUE350	3 1/2	1.25	1.18	1.00	5.6	12.35
HUE400	4	1.43	1.38	1.18	7.5	15.05
HUE450	4 1/2	1.56	1.47	1.31	9.5	18.65
HUE500	5	1.75	1.65	1.39	15.0	22.15

Malleable iron, cadmium plated. For hot-dipped galvanized add 25% to prices.

When ordering, specify knockout size, number of cables and outside diameter of cables.

Call Graybar **FIRST** For . . .

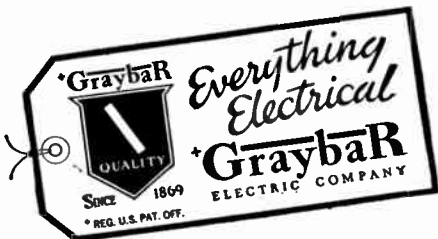

O. Z. Interlocked Armor Cable Terminators

Type "PK"

The "PK" is used to terminate and ground interlocked armor cable. Can be used with cable entering at bottom, top or side of cabinet. Can be installed in a standard I.P.S. knockout, siphole or drilled and tapped entrance.

A complete line of interlocked armor cable terminators and splicing fittings are also available.



No.	Diam. Over Armor, Inches		I.P.S. In.	Approx. Wt., Lbs.	Each
	Min.	Max.			
PK 62-07	.45	.62	3/4	.35	\$ 2.65
PK 80-10	.63	.80	1	.40	3.55
PK 99-12	.81	.99	1 1/4	.55	4.40
PK 118-12	1.00	1.18	1 1/2	.55	4.40
PK 134-12	*1.19	1.34	1 1/4	.55	4.40
PK 134-15	*1.19	1.34	1 1/2	.65	6.25
PK 156-15	*1.35	1.56	1 1/2	.65	6.25
PK 156-20	*1.35	1.56	2	.90	7.05
PK 178-20	1.57	1.78	2	.90	7.05
PK 200-20	*1.79	2.00	2	.90	7.05
PK 200-25	*1.79	2.00	2 1/2	1.3	8.80
PK 220-25	2.01	2.20	2 1/2	1.3	8.80
PK 240-25	*2.21	2.40	2 1/2	1.3	8.80
PK 240-30	*2.21	2.40	3	1.8	10.55
PK 258-30	2.41	2.58	3	1.8	10.55
PK 278-30	2.59	2.78	3	1.8	10.55
PK 298-30	*2.79	2.98	3	1.8	10.55
PK 298-35	*2.79	2.98	3 1/2	2.5	13.30
PK 320-35	2.99	3.20	3 1/2	2.5	13.30
PK 344-35	*3.21	3.44	3 1/2	2.5	13.30
PK 344-40	*3.21	3.44	4	3.0	18.55
PK 367-40	3.45	3.67	4	3.0	18.55
PK 391-40	3.68	3.91	4	3.0	18.55
PK 414-50	3.92	4.14	5	5.0	28.70
PK 428-50	4.15	4.28	5	5.0	28.70

*Fittings in these cable ranges are available in two K.O. sizes.

T&B Cable Clips



For Armored Cable

Made of galvanized round steel wire. Needle sharp points will stick even in hard wood when pushed in with the fingers. Will hold 14-2, 14-3, 14-4, 12-2, 12-3, 12-4, 10-2, 8-1, 6-1, 4-1; Lead 14-2, 14-3, 12-2.

No.	Size	Std. Pkg.	Wt., Lbs. Per 100	Per 100
90	3/8	10,000	1 1/4	\$0.59

For Non-Metallic Sheathed Cable

All inside surfaces are rounded to prevent damage to cable. Shorter than Cat. No. 90, this clip suits the smaller diameter of unarmored cable. Will hold 2 #14, 3 #14, 2 #12, 3 #12, 2 #10, or 3 #10.

91	3/8	10,000	1 1/4	\$0.59
----	-----	--------	-------	--------



Appleton E-Z-In Cable Staples

Cadmium Finish

Schedule CF

For Use With Armored Cable

Fits sizes 11-2, 11-3, 12-2, 12-3, 10-2 and 10-3.

No.	Case Qty.	Length Inches	Wt., Lbs. Per 5000	Per 1000
8065- 5	500	1 3/8	65	\$4.10
8065-25	2500	1 3/8	65	3.70
8065-50	5000	1 3/8	65	3.55

Quantity Lots: 30,000, 10,000, 5,000, 2,000, 500.



For Use with Armored or Non-Metallic Sheathed Cable with Rubber Insulated Conductors

Fits sizes 14-2, 14-3, 12-2, 12-3, 10-2, 10-3.

No.	Case Qty.	Length Inches	Wt., Lbs. Per 5000	Per 1000
8064- 5	500	1 1/8	54	\$3.90
8064-25	2500	1 1/8	54	3.55
8064-50	5000	1 1/8	54	3.40

Quantity Lots: 30,000, 10,000, 5,000, 2,500, 500.



For Use with Non-Metallic Sheathed Cable with Thermoplastic Insulated Conductors

Fits Sizes 14-2, 12-2, 10-2.

No.	Case Qty.	Length Inches	Wt., Lbs. Per 5000	Per 1000
8063- 5	500	7/8	43	\$2.95
8063-25	2500	7/8	43	2.60
8063-50	5000	7/8	43	2.40

Quantity Lots: 30,000, 10,000, 5,000, 2,500, 500.

Quantity prices on request.

Steel City Cable Clips

Schedule CF

Weight, 10 Lbs. Per 1000.

Rust resisting Terne plate steel. Will not damage cable. Indents conform to convolutions of the cable and securely lock it. For BX, non-metallic sheathed cable, armored cable, or flexible steel conduit.

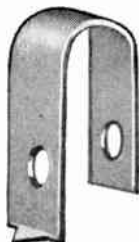

No. **11000**.....Per 1000 **\$4.30**

Appleton Cable Clips

Schedule CF

For Armored Cable, Non-Metallic Sheathed Cable and "CNX" Cable

Made of rust-resistant terne plate steel.

Impressions hold the cable firmly in place without injury, and the spur anchors the clip in place.

Hole in clip for fastening screw or nail is 3/16-inch diameter. Fits cable 14W2, 12W2, 10W2, 14W3 and 12W3. Average 110 Clips to a pound.



No.	Carton Quantity	Standard Package	Wt., Lbs. Per 1000	Per 1000
8066	500	1000	9	\$4.95

Emerson Insulated Staples

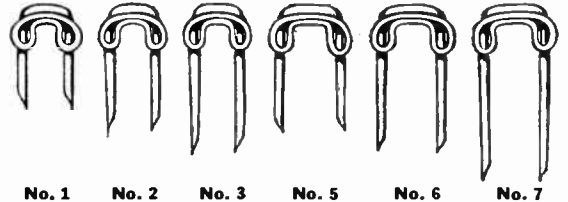

For general wiring. Plain fibre insulation with copper-coated staple. Regular packing for all sizes unptd., 100 to box; 10 boxes, 1000 pcs. to carton. Nos. 1, 2, 3 and 5 unptd., also packed 50 to box; 20 boxes, 1000 pcs., to carton. Nos. 2 and 5 can be had in brown, buff or white when specified, packed 10 to the box; 25 boxes, 1000 pcs. to carton; 10,000 to case or 25,000 to case.

All prices quoted below on basis of 1 to 9-M. For 50's add \$0.10 per M to prices.

No.	Size	Per 1000	No.	Size	Per 1000
1	3/16 x 1/2	\$2.19	6	1/4 x 3/4	\$2.30
*2	3/16 x 5/8	2.19	7	1/4 x 7/8	2.30
3	3/16 x 3/4	2.19	10	3/4 x 7/8	3.45
*5	1/4 x 5/8	2.19	12	1/2 x 7/8	3.74

*Specify Color: Brown, Buff, or White; otherwise plain will be furnished. Prices, Painted, \$2.76 per M.

Morse Brass Cleats



Style	For Wire O.D., In.	Style	For Wire O.D., In.
221	3/16	226	1/2
222	1/4	227	9/16
223	5/16	228	5/8
224	3/8	229	11/16
225	7/16		

Excellent for Marine Wiring.—Do not rust. Sizes up to 3/8-inch Plain. 3/8-inch and over with Ribbed Back for additional strength. Standard package, 1,000.

Prices on application.

Appleton 3 1/4-Inch Octagonal Outlet Boxes and Covers

Schedule OB
Galvanized

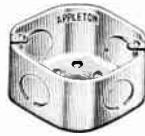

No. 30
Box

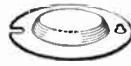

No. 8301
Cover



No. 8301A
Cover



No. 8302A
Cover



No. 8320
Cover



No. 8311
Cover

No.	Universal Key Number	Inside Depth Inches	Description	Boxes	Std. Pkg.	Wt., Lbs. Per 100	Per 100
30 1/2	24151	1 1/2	4 1/2-In. K.O. in Sides, 1 in Bottom.....		50	51	\$15.35

No.	Universal Key Number	Description	Covers	Std. Pkg.	Wt., Lbs. Per 100	Per 100
8301	24C2	Raised, Closed.....		100	24	\$ 6.60
8301A	24C1	Flat, Blank.....		100	23	5.15
8302A	24C12	Raised, with 3/8-In. Steel Bushing.....		100	24	7.20
8311	24C35, 24C36	Raised 1 1/2-In. Hole for Sign Receptacles.....		100	18	6.95
8320	24C6	Flat, with 1/2-In. K.O. in Center.....		100	20	6.20

Appleton 4-Inch Octagonal Outlet Boxes and Covers

Schedule OB
Galvanized



No. 40
Box



No. 8400
Cover



No. 8401
Cover



No. 8409
Cover

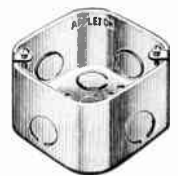

No. 40D
Box

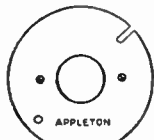

No. 8419LR
Cover



No. 8424
Cover



No. 8434
Cover



No. 8441
Cover

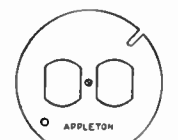

No. 8420LR
Cover

No.	Universal Key Number	Inside Depth Inches	Description	Boxes	Std. Pkg.	Wt., Lbs. Per 100	Per 100
40 1/2	54151	1 1/2	4 1/2-In. K.O. in Sides, 5 1/2-In. K.O. in Bottom.....		50	66	\$17.70
40 3/4	54151	3/4	1 3/4-In. K.O. in Each Side, 3 1/2-In. and 2 3/4-In. K.O. in Bottom.....		50	66	17.70
40 Spec.	54151	Spec.	2 1/2-In. and 2 3/4-In. K.O. in Sides, 3 1/2-In. and 2 3/4-In. K.O. in Bottom.....		50	66	17.70
40D 1/2	54171	1 1/2	4 1/2-In. K.O. in Sides, 5 1/2-In. K.O. in Bottom.....		50	84	23.70
40D 3/4	54171	3/4	1 3/4-In. K.O. in Sides, 3 1/2-In. and 2 3/4-In. K.O. in Bottom.....		50	84	23.70
40D1	54171	1	1-In. K.O. in Sides, 3 1/2-In. and 2 3/4-In. K.O. in Bottom.....		50	84	23.70
40D Spec.	54171	Spec.	2 1/2-In. and 2 3/4-In. K.O. in Sides, 3 1/2-In. and 2 3/4-In. K.O. in Bottom.....		50	84	23.70

No.	Universal Key Number	Description	Covers	Std. Pkg.	Wt., Lbs. Per 100	Per 100
8401	54C2	Raised 5/8-In., Closed.....		100	32	\$ 8.95
8402A	54C12	Raised, with 3/8-In. Steel Bushing.....		100	37	9.75
8403	54C1	Flat, Blank.....		100	29	7.00
8409	54C3	Raised 5/8-In., Open with Ears, 2 23/32-In. Center to Center.....		100	26	10.85
8409D	Raised 1 1/4-In., Open with Ears, 2 23/32-In. Center to Center.....		100	44	35.45
8413	54C6	Flat with 1/2-In. K.O. in Center.....		100	26	7.05
8414	54C7	Raised, with 1/2-In. K.O. in Center.....		100	37	9.75
8424	54C35, 54C36	Raised, with 1 1/2-In. Hole for Sign Receptacles.....		100	28	10.60
8434	54C14	Raised, for Single Flush Device.....		100	27	12.85
8419LR	With Opening for Single Receptacle.....		100	27	10.60
8420LR	With Openings for Duplex Receptacle.....		100	21	10.60

Quantity prices on request.

Steel City 3/4-Inch Octagonal Outlet Boxes and Covers

Galvanized—Furnished with Holes in Bottom for Fixture Studs and Nails



No. 24151



No. 24-C-1



No. 24-C-2



No. 24-C-6



No. 24-C-12



No. 24-C-35

Boxes

No.	Inside Depth Inches	Number and Size of Knockouts in Bottom	Number and Size of Knockouts in Sides	Wiring Capacity Cu. In.	Std. Pkg.	Wt., Lbs. Per 100	*Std. Pkg. Per 100
24151 1/2	1 1/2	1-1/2-in.	4-1/2-in.	10.6	100	50	\$16.05
24151 3/4	1 1/2	1-1/2-in.	4-3/4-in.	10.6	100	50	16.05
24151 1/2 & 3/4	1 1/2	1-1/2-in.	2-1/2-in., 2-3/4-in.	10.6	100	50	16.05

Covers—3/2-Inch Diameter

For Use with 3/4- and 3/2-Inch Round and Octagonal Boxes

No.	Description	Std. Pkg.	Wt., Lbs. Per 100	*Std. Pkg. Per 100
24-C-1	Flat; Blank.....	100	19	\$5.40
24-C-2	Raised 3/8-in.; Blank.....	100	20	6.40
24-C-6	Flat; With 1/2-in. K.O. in Center.....	100	19	6.00
24-C-7	Raised 3/8-in. with 1/2-in. K.O. in Center.....	100	20	8.15
24-C-12	Raised 3/8-in.; Drop Cord Type with Bushed Hole.....	100	20	7.10
24-C-35	Raised 3/8-in.; With 1 1/2-inch Notched Opening for Sign Receptacles.....	100	16	6.95
2401-LR	Flat, for Single Receptacle.....	100	15	8.55
2402-LR	Flat, for Duplex Receptacle.....	100	14	8.55

Steel City 4-Inch Octagonal Outlet Boxes and Covers

Galvanized—Furnished with Holes in Bottom for Fixture Studs and Nails



No. 54151



No. 54-C-1



No. 54-C-2



No. 54-C-3



No. 54-C-7



No. 5401-LR



No. 54171



No. 54-C-12



No. 54-C-14



No. 54-C-48



No. 54-C-35



No. 5402-LR

Boxes

No.	Inside Depth Inches	Number and Size of Knockouts in Bottom	Number and Size of Knockouts in Sides	Wiring Capacity Cu. In.	Std. Pkg.	Wt., Lbs. Per 100	*Std. Pkg. Per 100
54151 1/2	1 1/2	5-1/2-in.	4-1/2-in.	16.5	50	56	\$18.50
54151 3/4	1 1/2	3-1/2-in., 2-3/4-in.	4-3/4-in.	16.5	50	56	18.50
54151 1/2 & 3/4	1 1/2	3-1/2-in., 2-3/4-in.	2-1/2-in., 2-3/4-in.	16.5	50	56	18.50
54171 1/2	2 1/8	5-1/2-in.	4-1/2-in.	23.0	50	70	24.80
54171 3/4	2 1/8	3-1/2-in., 2-3/4-in.	4-3/4-in.	23.0	50	70	24.80
54171 1/2 & 3/4	2 1/8	3-1/2-in., 2-3/4-in.	2-1/2-in., 2-3/4-in.	23.0	50	70	24.80
54171-1	2 1/8	3-1/2-in., 2-3/4-in.	4-1-in.	23.0	50	70	24.80

Covers—4 1/4-Inch Diameter

For Use with 4-Inch Octagonal Boxes

No.	Description	Std. Pkg.	Wt., Lbs. Per 100	*Std. Pkg. Per 100
54-C-1	Flat, Blank.....	100	27	\$ 6.95
54-C-2	Raised 5/8-in.; Blank.....	100	34	8.55
54-C-3	Raised 5/8-in.; Open with Ears; Tapped on 2 3/32-in. Centers to take 3 1/4-in. Receptacle or Steel Cover.....	50	23	11.35
54-C-6	Flat; 1/2-in. K.O. in Center.....	100	27	7.35
54-C-7	Raised 5/8-in.; 1/2-in. K.O. in Center.....	100	33	9.35
54-C-12	Drop Cord Type with 3/8-in. Bushed Hole.....	100	35	9.35
54-C-14	Raised 5/8-in. for Single Rectangular Switch or Receptacle.....	100	24	12.70
54-C-35	Raised 5/8-in. with 1 1/2-in. Notched Opening for Sign Receptacles.....	100	30	10.50
54-C-48	Raised 5/8-in. with 2 3/4-in. Diameter Open Canopy.....	100	22	9.25
5401-LR	Flat, for Single Receptacle.....	100	21	10.65
5402-LR	Flat, for Duplex Receptacle.....	100	22	10.65

*Prices slightly higher in Western and Southeastern States.

Quantity prices on request.

Appleton 4-Inch Square Outlet Boxes and Covers

Schedule OB

Galvanized



No. 4S
Box



No. 8461
Cover



No. 8461D
Cover



No. 8462
Cover



No. 8465
Cover



No. 4S
Special Box



No. 8468
Cover



No. 8468A
Cover



No. 8470
Cover



No. 8475
Cover



No. 8472
Cover



No. 8474
Cover

Boxes

No.	Universal Key Number	Inside Depth Inches	Description	Std. Pkg.	Wt. Lbs. Per 100	Per 100
4S $\frac{1}{2}$	52151- $\frac{1}{2}$	1 $\frac{1}{2}$	10- $\frac{1}{2}$ -In. K. O. in Sides, 5 in Bottom.....	50	88	\$24.05
4S $\frac{3}{4}$	52151- $\frac{3}{4}$	1 $\frac{1}{2}$	2- $\frac{3}{4}$ -In. K.O. in Each Side; 3- $\frac{1}{2}$ -In. and 2- $\frac{3}{4}$ -In. K.O. in Bottom.....	50	88	24.05
4S Spec.	52151 Spec.	1 $\frac{1}{2}$	2- $\frac{1}{2}$ -In. and 1- $\frac{3}{4}$ -In. K.O. in Each Side; 3- $\frac{1}{2}$ -In. and 2- $\frac{3}{4}$ -In. K.O. in Bottom.....	50	88	24.05
4SL $\frac{1}{2}$	52141 $\frac{1}{2}$	1 $\frac{1}{4}$	10- $\frac{1}{2}$ -In. K.O. in Sides, 5 in Bottom.....	50	78	24.05
4SD $\frac{1}{2}$	52171 $\frac{1}{2}$	2 $\frac{1}{8}$	With 10- $\frac{1}{2}$ -In. K.O. in Sides, 5 in Bottom.....	50	102	43.05
4SD $\frac{3}{4}$	52171 $\frac{3}{4}$	2 $\frac{1}{8}$	With 8- $\frac{3}{4}$ -In. K.O. in Sides, 2- $\frac{3}{4}$ -In. and 3- $\frac{1}{2}$ -In. in Bottom.....	50	102	43.05
4SD1	52171-1	2 $\frac{1}{8}$	With 8-1-In. K.O. in Sides and 3- $\frac{1}{2}$ -In. and 2- $\frac{3}{4}$ -In. in Bottom.....	50	102	43.05
4SD Spec.	2 $\frac{1}{8}$	2- $\frac{1}{2}$ In. and 1- $\frac{3}{4}$ -In. K.O. in Each Side; 3- $\frac{1}{2}$ -In. and 2- $\frac{3}{4}$ -In. in Bottom.....	50	102	43.05

Covers

No.	Universal Key Number	Description	Std. Pkg.	Wt. Lbs. Per 100	Per 100
8461	52C3	Raised $\frac{5}{8}$ -In., Open, Ears, 2 $\frac{3}{32}$ -In. Center to Center.....	100	35	\$12.15
8461D	Raised 1 $\frac{1}{4}$ -In., Open, Ears, 2 $\frac{3}{32}$ -In. Center to Center.....	50	58	46.50
8462	52C2	Raised $\frac{5}{8}$ -In., Closed.....	100	46	11.10
8465	52C1	Flat, Blank.....	100	39	8.45
8466	52C16	Raised 1 $\frac{1}{4}$ -In., for Single Flush Device.....	100	49	19.15
8466A	52C15	Raised 1-In., for Single Flush Device.....	100	45	17.75
8468	52C14	Raised $\frac{3}{4}$ -In., for Single Flush Device.....	100	36	13.15
8468C	52C14- $\frac{5}{8}$ -In.	Raised $\frac{5}{8}$ -In., for Single Flush Device.....	100	34	19.35
8468A	52C13	Raised $\frac{1}{2}$ -In., for Single Flush Device.....	100	31	11.85
8468B	52C62	Raised $\frac{1}{4}$ -In., for Single Flush Device.....	100	27	9.90
8468F	Flat, for One Single Flush Device.....	100	27	12.40
8469	52C21	Raised 1 $\frac{1}{4}$ -In., for Two Flush Devices.....	100	45	24.80
8469A	52C19	Raised 1-In., for Two Flush Devices.....	100	39	24.80
8470	52C18	Raised $\frac{3}{4}$ -In., for Two Flush Devices.....	100	30	18.85
8470A	52C17	Raised $\frac{1}{2}$ -In., for Two Flush Devices.....	100	21	18.30
8470B	52C20	Raised $\frac{1}{4}$ -In., for Two Flush Devices.....	100	17	15.30
8470F	Flat, for Two Flush Devices.....	100	14	13.35
8475	52C10	Raised $\frac{1}{4}$ -In., Offset for Single Flush Device at One Side, Other Gang Blank.....	100	27	14.55
8474	52C6	Flat, with $\frac{1}{2}$ -In. K.O. in Center.....	100	38	9.60

Quantity prices on request.

Steel City 4-Inch Square Outlet Boxes and Covers
Galvanized

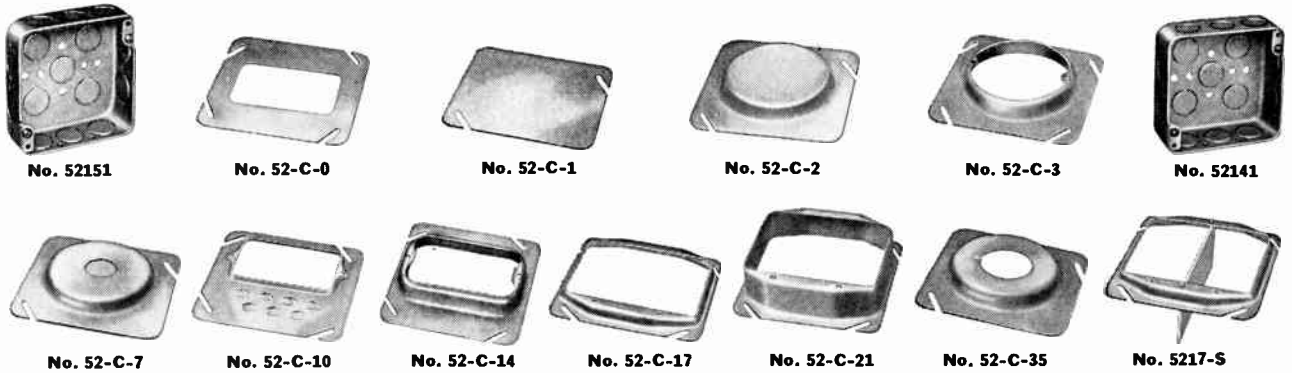

***Boxes—Without Mounting Brackets**

No.	Depth Inches	Number of Knockouts in Sides	Number of Knockouts in Bottom	Wiring Capacity Cu. In.	Std. Pkg.	Wt. Lbs. Per 100	*Std. Pkg. Per 100
52151 $\frac{1}{2}$	1 $\frac{1}{2}$	10- $\frac{1}{2}$ -in.	5- $\frac{1}{2}$ -in.	21.1	50	72	\$25.20
52151 $\frac{3}{4}$	1 $\frac{1}{2}$	8- $\frac{3}{4}$ -in.	2- $\frac{3}{4}$ -in., 3- $\frac{1}{2}$ -in.	21.1	50	72	25.20
52151 $\frac{1}{2}$ & $\frac{3}{4}$	1 $\frac{1}{2}$	8- $\frac{1}{2}$ -in., 4- $\frac{3}{4}$ -in.	3- $\frac{1}{2}$ -in., 2- $\frac{3}{4}$ -in.	21.1	50	72	25.20
†52141 $\frac{1}{2}$	1 $\frac{1}{4}$	10- $\frac{1}{2}$ -in.	5- $\frac{1}{2}$ -in.	17.6	50	62	24.15
†52141-1 $\frac{1}{2}$	1 $\frac{1}{4}$	10- $\frac{1}{2}$ -in.	5- $\frac{1}{2}$ -in.	17.6	50	68	27.55
52171 $\frac{1}{2}$	2 $\frac{1}{8}$	10- $\frac{1}{2}$ -in.	3- $\frac{1}{2}$ -in., 2- $\frac{3}{4}$ -in.	29.9	50	90	43.75
52171 $\frac{3}{4}$	2 $\frac{1}{8}$	8- $\frac{3}{4}$ -in.	3- $\frac{1}{2}$ -in., 2- $\frac{3}{4}$ -in.	29.9	50	90	43.75
52171 $\frac{1}{2}$ & $\frac{3}{4}$	2 $\frac{1}{8}$	8- $\frac{1}{2}$ -in., 4- $\frac{3}{4}$ -in.	3- $\frac{1}{2}$ -in., 2- $\frac{3}{4}$ -in.	29.9	50	90	43.75
52171-1	2 $\frac{1}{8}$	8-1-in.	3- $\frac{1}{2}$ -in., 2- $\frac{3}{4}$ -in.	29.9	50	90	43.75
52171-1 $\frac{1}{4}$	2 $\frac{1}{8}$	6-1 $\frac{1}{4}$ -in.	3- $\frac{1}{2}$ -in., 2- $\frac{3}{4}$ -in.	29.9	50	90	

*Furnished with double lugs for reversing covers. For boxes installed with single lugs, double lugs and additional screws can be furnished, free of charge.

†Has slip holes in 2 sides for mounting on No. 7502 or No. 7503 footed box supports.

‡Has tapped holes in one side for mounting on No. 7502 or No. 7503 footed box supports. Two screws are assembled in tapped side.

Covers—For 4-In. Square Boxes

No.	Description	Std. Pkg.	Wt. Lbs. Per 100	*Std. Pkg. Per 100
52-C-0	For Single Rectangular Switch or Receptacle; Flat	50	24	\$12.40
52-C-1	Flat; Blank	100	33	7.90
52-C-2	Raised $\frac{5}{8}$ -in.; Blank	100	41	10.80
52-C-3	Raised $\frac{5}{8}$ -in.; Open with Ears Drilled and Tapped 2 $\frac{3}{4}$ -in. on Centers to Take 3 $\frac{1}{4}$ -in. Covers or Receptacles.	50	29	12.75
52-C-6	Flat; with $\frac{1}{2}$ -in. K.O. in Center	100	33	9.25
52-C-7	Raised $\frac{5}{8}$ -in. with $\frac{1}{2}$ -in. K.O. in Center	100	41	11.95
52-C-10	Offset; Raised $\frac{1}{4}$ -in.; Keyed for Plaster; for Single Switch or Receptacle	50	24	14.90
52-C-12	Drop Cord Type; Raised $\frac{5}{8}$ -in.; with $\frac{3}{8}$ -in. Bushed Hole	50	41	12.15
52-C-62	For Single Rectangular Base Switch or Receptacle; Raised $\frac{1}{4}$ -in.	50	23	10.35
52-C-13	For Single Rectangular Base Switch or Receptacle; Raised $\frac{1}{2}$ -in.	50	29	12.40
52-C-14	For Single Rectangular Base Switch or Receptacle; Raised $\frac{3}{4}$ -in.	50	34	13.75
52-C-15	For Single Rectangular Base Switch or Receptacle; Raised 1-in.	25	36	17.90
52-C-16	For Single Rectangular Base Switch or Receptacle; Raised 1 $\frac{1}{4}$ -in.	25	42	19.25
52-C-00	For Two Rectangular Base Switches or Receptacles; Square, Flat	50	14	13.75
52-C-20	For Two Rectangular Base Switches or Receptacles; Raised $\frac{1}{4}$ -in.	50	14	16.00
52-C-17	For Two Rectangular Base Switches or Receptacles; Raised $\frac{1}{2}$ -in.	50	19	19.15
52-C-18	For Two Rectangular Base Switches or Receptacles; Raised $\frac{3}{4}$ -in.	50	26	19.35
52-C-19	For Two Rectangular Base Switches or Receptacles; Raised 1-in.	25	32	25.95
52-C-21	For Two Rectangular Base Switches or Receptacles; Raised 1 $\frac{1}{4}$ -in.	25	40	25.95
52-C-35	For Sign Receptacles; Raised $\frac{5}{8}$ -in., 1 $\frac{1}{2}$ -in. Notched Opening for Sign Receptacles.	50	38	14.90
52-C-48	Raised $\frac{5}{8}$ -in.; with 2 $\frac{3}{4}$ -in. Open Canopy	100	29	12.05

Partition Covers

For Two Rectangular Base Switches or Receptacles

For Use With 52151 Boxes		For Use With 52141 Boxes		For Use With 52171 Boxes		Description
No.	Std. Pkg. Per 100	No.	Std. Pkg. Per 100	No.	Std. Pkg. Per 100	
5217S	\$27.70	5217SS	\$27.70	5217D	\$27.70	Raised $\frac{1}{2}$ -in.
5218S	27.70	5218SS	27.70	5218D	27.70	Raised $\frac{3}{4}$ -in.
5219S	27.70	5219SS	27.70	5219D	27.70	Raised 1 -in.
5220S	27.70	5220SS	27.70	5220D	27.70	Raised $\frac{1}{4}$ -in.
5221S	27.70	5221SS	27.70	5221D	27.70	Raised 1 $\frac{1}{4}$ -in.

*Prices slightly higher in Western and Southeastern States.

Quantity prices on request.

Appleton 4-Inch Square Boxes

Schedule OB

With Brackets—No Lath Supports

Galvanized

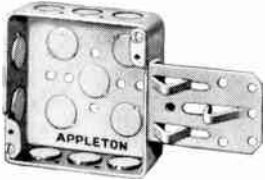

No. 4SB $\frac{1}{2}$: Has three $\frac{1}{2}$ -K.O.'s in each of two opposite sides, two in side opposite bracket, and five $\frac{1}{2}$ -in. K.O.'s in bottom.

No. 4SB-Spl.: has combination of two $\frac{1}{2}$ -in. and one $\frac{3}{4}$ -in. K.O.'s in each of three sides, (none in bracket side) and two $\frac{3}{4}$ -in. K.O.'s in bottom.

No.	Universal No.	Depth In.	Std. Pkg.	Wt. Lbs. Per 100	Per 100
4SB- $\frac{1}{2}$	52151-B- $\frac{1}{2}$	1 $\frac{1}{2}$	50	93	\$30.70
4SB-Spl.	52151-B-Spl.	1 $\frac{1}{2}$	50	93	30.70

Steel City 4-Inch Square Boxes

Schedule OB

With Brackets

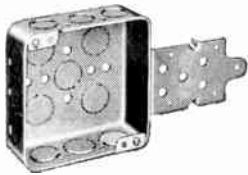

No. 52151-B- $\frac{1}{2}$



No. 52151-V- $\frac{1}{2}$

Without Clamps

Bracket boxes have no knockouts in bracket side. Wiring capacity, 21.1 cubic inches. Depth, 1 $\frac{1}{2}$ in. Standard package, 50.

No.	No. and Size Sides	Knockouts Bottom	Wt. Lbs. Per 100	*Std. Pkg. Per 100
52151-B- $\frac{1}{2}$	8- $\frac{1}{2}$ -In.	5- $\frac{1}{2}$ -In.	85	\$30.80
52151-B- $\frac{3}{4}$	6- $\frac{3}{4}$ -In.	{ 3- $\frac{1}{2}$ -In. } { 2- $\frac{3}{4}$ -In. }	85	30.80
52151-B- $\frac{1}{2}$ & $\frac{3}{4}$	{ 6- $\frac{1}{2}$ -In. } { 3- $\frac{3}{4}$ -In. }	{ 3- $\frac{1}{2}$ -In. } { 2- $\frac{3}{4}$ -In. }	85	30.80
52151-V- $\frac{1}{2}$	8- $\frac{1}{2}$ -In.	5- $\frac{1}{2}$ -In.	78	30.80
52151-V- $\frac{3}{4}$	6- $\frac{3}{4}$ -In.	{ 3- $\frac{1}{2}$ -In. } { 2- $\frac{3}{4}$ -In. }	78	30.80
52151-V- $\frac{1}{2}$ & $\frac{3}{4}$	{ 6- $\frac{1}{2}$ -In. } { 3- $\frac{3}{4}$ -In. }	{ 3- $\frac{1}{2}$ -In. } { 2- $\frac{3}{4}$ -In. }	78	30.80

With Clamps



No. 52151-BX



No. 52151-BN

Have knockouts for $\frac{1}{2}$ -inch conduit, 2 in one side and 1 in bottom.

Furnished with two $\frac{3}{4}$ -inch pri-outs in each clamp side. Standard package, 50.

No. 52151-BX: For armored cable. Has type C-3 clamps.

No. 52151-BN: For non-metallic sheathed cable. Type C-5 clamps.

No.	Wiring Capacity Cu. In.	Wt. Lbs. Per 100	*Std. Pkg. Per 100
52151-BX	21.1	95	\$40.10
52151-BN	21.1	95	40.10

*Prices slightly higher in Western and Southeastern States. Quantity prices on request.

Steel City Convenience Wall Boxes

Schedule OB

4-Inch Square

Takes the place of two 4-in. square boxes. May be used with No. 52-C-10 covers (not furnished), allowing switches or receptacles to be installed in same box on both sides of the wall. Primarily for thin partition installations. Furnished with holes for mounting on footed box support.

No. X-1- $\frac{1}{4}$: Has knockouts for $\frac{1}{2}$ -inch conduit.

No. XR-1- $\frac{1}{4}$: Has knockouts for $\frac{1}{2}$ -in. conduit.

Holes for box support are tapped and two screws are assembled in one side.

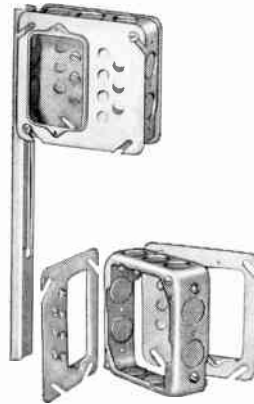

No. X-1- $\frac{1}{2}$: Has knockouts for $\frac{1}{2}$, $\frac{3}{4}$ -inch or combination $\frac{1}{2}$ and $\frac{3}{4}$ -inch.

No.	Depth In.	Wiring Capacity Cu. In.	Std. Pkg.	Wt. Lbs. Per 100	*Std. Pkg. Per 100
X-1- $\frac{1}{4}$	1 $\frac{1}{4}$	17.6	50	44	\$30.90
XR-1- $\frac{1}{4}$	1 $\frac{1}{4}$	17.6	50	46	34.35
X-1- $\frac{1}{2}$	1 $\frac{1}{2}$	21.1	50	52	30.90

Steel City Box Supports

Schedule OB

Footed

For use with convenience wall boxes and other boxes having mounting holes on sides.

Slotted riser permits mounting box at desired height. Keyhole at bottom of slot allows box to be installed on riser without removing screws. Slot, 8 inches long, extends to $\frac{1}{2}$ -inch from top riser. Made of sturdy channelled steel, galvanized.



No.	Length In.	Width In.	Std. Pkg.	Approx. Wt. Per 100, Pounds	*Std. Pkg. Per 100
7502	20	$\frac{1}{2}$	50	62	\$21.55
7503	31	$\frac{1}{2}$	50	82	30.30

*Prices slightly higher in Western and Southeastern States.

Appleton Double Opening Wall Rings

Schedule OB

4-Inch Square

For Use with Rigid Conduit (Heavy Wall)

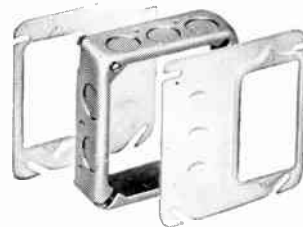

Double-opening ring accommodates two No. 8475 4-in. square switch or receptacle covers as required when used for outlets on opposite sides of partition.

Covers are not included.

No. 4SLES: Has ten $\frac{1}{2}$ -in. knockouts in sides.

No. 4SES: Has six $\frac{1}{2}$ -in. and four $\frac{3}{4}$ -in. knockouts in sides.

No.	Depth In.	Std. Pkg.	Wt. Lbs. Per 100	Per 100
4SLES	1 $\frac{1}{4}$	50	54	\$30.25
4SES	1 $\frac{1}{2}$	50	63	30.25

Quantity prices on request.

National Electric "Redege" Boxes

Combination Available In Outlet Boxes

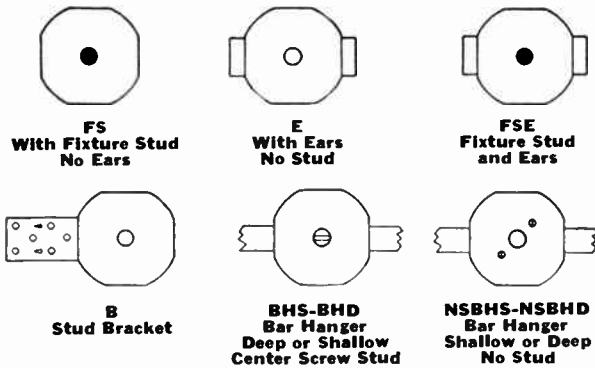

National Electric "Redege" Outlet Boxes

3 1/4-Inch Octagon—1 1/2 Inch Deep

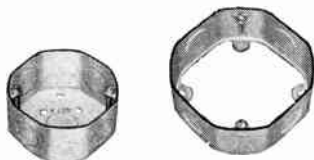

Galvanized

3 1/4 in. octagon conduit boxes and extension rings. Four bottom holes for fixture stud and nailing.

No.	Universal No.	Knockouts Side In.	Bottom In.	Std. Pkg.	Std. Pkg. Per 100
2900	24151-1/2	1 1/2"	1 1/2"	50	\$16.05
2901	24151-3/4	1 3/4"	1 1/2"	50	16.05

Boxes Mounted On 18 Inch Hangers

2900BHS	24151-1/2BHHS	1 1/2"	...	25	39.25
2901BHS	24151-3/4BHHS	1 3/4"	...	25	39.25
2900NSBHS	24151-1/2NSBHHS	1 1/2"	1 1/2"	25	32.60
2901NSBHS	24151-3/4NSBHHS	1 3/4"	1 1/2"	25	32.60

Extension Rings

2904	25151-1/2	1 1/2"	...	50	20.60
------	-----------	--------	-----	----	-------

National Electric Outlet Box Covers

For 3 1/4-Inch Octagon and Round Boxes Galvanized

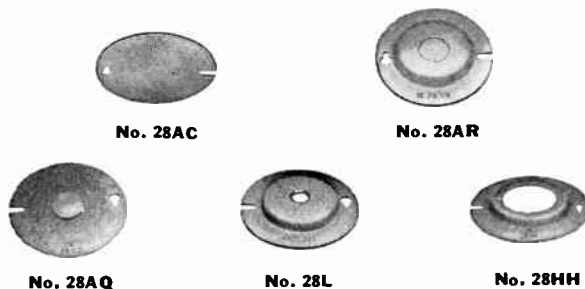

All covers keyholed and slotted. Actual outside diameter 3 3/8-in. Packed 100 in standard package.

No.	Universal No.	Description	Std. Pkg. Per 100
28AC	24C1	Flat Blank	\$5.40
28AR	24C7	Raised 3/8-1/2 in. k.o.	8.15
28AQ	24C6	Flat 1/2 in. k.o.	6.00
28HH	24C36	Raised 3/4", 1 1/2" opening. Bent tongue	6.95
28L	24C12	Raised 3/8" metal bushing 3/8"	7.10

†Eastern Zone Price: Prices Higher in Western and Southern Zones.

National Cable Boxes

For Non-Metallic Sheathed Cable—Flexible Tubing

3 1/4-Inch Octagon—1 1/2 In. Deep

Galvanized

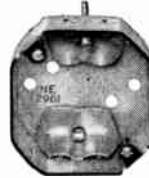

Clamps are indestructible. 4 1/2-in. side and bottom entry pri-outs. Four bottom holes for fixture stud and nailing.

Cable pri-outs take 14-2, 14-3, 12-2, and 12-3. Equipped with two loom wire clamps.

No.	Universal No.	1/2 In. Stud	1/2 In. K.O. Side	Bottom	Std. Pkg. Per 100
Without Ears					
2961	24151L	No	2	1	\$25.30
2961FS	24151LS	Yes	2	..	34.00
With Ears					
2961E	24151LE	No	2	1	32.10
With Ears and Stud					
2961FSE	24151LSE	Yes	2	..	40.75
Boxes Mounted on 18-In. Bar Hangers					
2961BHS	24151LB	No	2	..	48.50
2961NSEHS	24151LBHS	Yes	2	..	41.85

For Armored Cable

3 1/4-In. Octagon—1 1/2 In. Deep

Galvanized

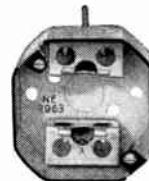

Clamps are indestructible. 4 1/2-in. side and bottom pri-outs. Four bottom holes for fixture stud and nailing. Cable pri-outs take 14-2, 14-3, 12-2, and 12-3 armored cable.

Equipped with two armored cable clamps.

No.	Universal No.	1/2 In. Stud	1/2 In. K.O. Side	Bottom	Std. Pkg. Per 100
Without Ears					
2963	24151A	No	2	1	\$25.30
2963FS	24151AS	Yes	2	..	34.00
With Ears					
2963E	24151AE	No	2	1	32.10
With Ears and Stud					
2963FSE	24151ASE	Yes	2	..	40.75
Boxes Mounted On 18-In. Bar					
2963BHS	24151ABHHS	Yes	2	..	48.50
2963NSBHHS	24151NSHHS	No	2	..	41.85

* Eastern Zone Price: Prices higher in Western and Southern Zones.

National Electric Spigots



Utility outlet for 14/2 and 12/2 armored cable or loom wire. For inside use. Complete with 10-ampere, 250-volt or 15-ampere, 125-volt receptacle and cable clamp. Complete assembly. Box fits into hole and wide flange covers work marks or irregular edges of hole.

Packed 50 in standard package.

Weight per standard package, 25 pounds.
No. 60.....Per 100 \$140.25

National Electric "Redege" Outlet Boxes, Rings, Covers

Listed by Underwriters' Laboratories, Inc.

Outlet Boxes 4-Inch Octagon



No. 2700

Galvanized finish.
Packed 50 in a standard package.



No. 2714

National No.	Universal No.	Depth Inside Inches	Knockouts	Wt. Lb. Std. Pkg.	Std. Pkg. Per 100
2700	54151	1 1/2	Back 5-1/2"	32	\$18.50
2701	54151	1 1/2	Sides 4-1/2"	32	18.50
2702	54151	1 1/2	2-3/4"	32	18.50
2714	54171	2 1/8	2-3/4"	41	24.80
2715	54171	2 1/8	5-1/2"	41	24.80
2790	54171	2 1/8	3-1/2"	41	24.80

Extension Rings 4-Inch Octagon



No. 2704..... Std. Pkg. per 100 \$22.35

Galvanized finish.

Universal No. 55151. Depth inside 1 1/2 inches; four 1/2-inch knockouts. Packed 50 in a standard package. Weight per standard package, 22 pounds.

Outlet Box Covers For 4-Inch Octagon and Round Boxes

Galvanized finish.
Outside diameter, 4 7/8 inches.
Packed 100 in a standard package.



No. 26AC

Flat, closed.



No. 26L

Raised 5/8 inch high, with 2 3/4-inch metal eyelet for drop cord.

National No.	Universal No.	Wt. Lb. Std. Pkg.	Std. Pkg. Per 100	National No.	Universal No.	Wt. Lb. Std. Pkg.	Std. Pkg. Per 100
26AC	54C1	30	\$6.95	26L	54C12	35	\$9.35



No. 26AQ

Flat, with 1/2-inch knockout in center.



No. 26Q

Raised 5/8 inch high, 2 3/4-inch opening. Lugs tapped 8-32 on 2 3/4-inch centers.

National No.	Universal No.	Wt. Lb. Std. Pkg.	Std. Pkg. Per 100	National No.	Universal No.	Wt. Lb. Std. Pkg.	Std. Pkg. Per 100
26AQ	54C6	30	\$7.40	26Q	54C3	26	\$11.35



No. 26AR

Raised 5/8-inch high with 1/2-inch knockout in center.

National No.	Universal No.	Wt. Lb. Std. Pkg.	Std. Pkg. Per 100
26AR	54C7	35	\$9.35

Quantity prices on request.

†Eastern Zone Price: Prices Higher in Western and Southern Zones.

Outlet Boxes 4-Inch Square—1 1/2-Inch Deep



No. 2410

Double riveted. No. 14 gage steel. Recessed cover lugs puts head of screw below box top. 1/2-inch screws. Conforms with Federal specification, No. W-0-821a.

Galvanized.

National No.	Universal No.	Back	Sides	Std. Pkg.	Wt. Lb. Std. Pkg.	Std. Pkg. Per 100
2400	52151	5-1/2"	10-1/2"	50	42	\$25.20
2401	52151	3-1/2"	8-3/4"	50	42	25.20
2410	52151	2-3/4"	8-1/2"	50	42	25.20



2404 53151 10-1/2" 50 30 \$26.95

Extension Rings 4-Inch Square—1 1/2-Inch Deep

Two tapped lugs at top, two untapped lugs at back.

Galvanized.

Outlet Box Cover For 4-Inch Square Boxes

Galvanized. Dimensions, 4 3/16-inches square. Packed 100 in a standard package.



No. 24AC



No. 24AQ



No. 24AR



No. 24Q

No.	Universal No.	Description	Std. Pkg. Per 100
24AC	52C1	Flat blank.....	\$ 7.90
24AR	52C7	Raised 5/8" with 1/2" k.o.....	11.95
24AQ	52C6	Flat 1/2 in. k.o.....	9.25
24Q	52C3	Raised 5/8 in., 2 3/4 in. opening, lugs tapped 2 3/4 in. center.....	12.75

Flush Device Covers For 4-Inch Square Boxes



Nos. 24HZ, HY, H, HK, HL



Nos. 24KZ, KY, K, KK, KL

Either vertical or horizontal mounting on 4-inch square boxes is permitted by extra slots and screw holes.

Galvanized.

Outside dimensions, 4 3/16-inches square.

National No.	Universal No.	Depth In.	No. of Devices	Std. Pkg.	Std. Pkg. Per 100
24HZ	52C62	1/4	1	100	\$10.35
24HY	52C13	1/2	1	50	12.40
24H	52C14	3/4	1	50	13.15
24HK	52C15	1	1	25	17.90
24HL	52C16	1 1/4	1	25	19.25
24KZ	52C20	1 1/4	2	100	16.00
24KY	52C17	1 1/4	2	50	19.15
24K	52C18	3/4	2	50	19.35
24KK	52C19	1	2	25	25.95
24KL	52C21	1 1/4	2	25	25.95

†Eastern Zone Price: Prices Higher in Western and Southern Zones.

Appleton 4¹/₁₆-Inch Square Outlet Boxes and Covers

Schedule OB

Galvanized



No. 4SJ 1/2 Box



No. 8480 Cover



No. 8485 Cover



No. 8486 Cover



No. 8487 Cover



No. 8488 Cover



No. 8489 Cover



No. 8489A Cover



No. 4SJD 1/2 Box

Boxes

No.	Universal Key Number	Inside Depth Inches	Sides	Number of Knockouts	Bottom	Std. Pkg.	Wt. Lbs. Per 100	Per 100
4SJ 1/2	72151 1/2	1 1/2	10-1/2-in.	3-1/2-in., 2-3/4-in.	3-1/2-in., 2-3/4-in.	50	110	\$ 43.00
4SJ 3/4	72151 3/4	1 1/2	4-1/2-in., 6-3/4-in.	3-1/2-in., 2-3/4-in.	3-1/2-in., 2-3/4-in.	50	110	43.00
4SJD 1/2	72171 1/2	2 1/8	8-1/2-in., 2-3/4-in.	3-1/2-in., 2-3/4-in.	3-1/2-in., 2-3/4-in.	50	128	50.50
4SJD 3/4	72171 3/4	2 1/8	4-1/2-in., 6-3/4-in.	3-1/2-in., 2-3/4-in.	3-1/2-in., 2-3/4-in.	50	128	50.50
4SJD 1	72171-1	2 1/8	8-1-in.	3-1/2-in., 2-3/4-in.	3-1/2-in., 2-3/4-in.	50	128	50.50

Covers

No.	Universal Key Number	Description	Std. Pkg.	Wt. Lbs. Per 100	Per 100
8480	72C2	Raised, Closed.....	50	51	\$24.70
8485	72C14	Raised 3/4-in., for Single Device.....	50	50	26.95
8485A	Raised 1/2-in., for Single Device.....	50	46	26.95
8485B	Raised 1/4-in., for Single Device.....	50	40	26.70
8486	72C18	Raised 3/4-in., for Two Flush Devices.....	50	44	28.90
8487	72C1	Flat, Blank.....	50	50	17.95
8488	72C3	Raised, Open, Ears 2 ²³ / ₃₂ Center to Center.....	50	44	20.60
8489	72C7	Raised, with 1/2-in. Knockout in Center.....	50	56	20.60
8489A	Raised, for Hubbell 4-Wire Receptacles Nos. 7294 and 7301.....	50	56	39.30

Appleton Universal Conduit Boxes and Covers

Schedule OB



No. 181 Box



No. 180A Cover



No. 180T Cover



No. 180X Cover



No. 180Y Cover



No. 180W Cover



No. 180Z Cover

Boxes

Length 4 1/8-In., Width 2 3/8-In.

No.	Inside Depth Inches	Sides	Number of Knockouts	Bottom	Std. Pkg.	Wt. Lbs. Per 100	Per 50
180 1/2	1 13/16	3-1/2-in.	1-1/2-in.	3-1/2-in.	50	66	\$20.15
181 1/2	2 13/16	3-1/2-in.	1-1/2-in.	3-1/2-in.	50	70	23.75
181 3/4	2 13/16	2-3/4-in.	1-3/4-in.	1-3/4-in.	50	70	23.75
185 1/2	1 13/16	3-1/2-in.	1-1/2-in.	1-1/2-in.	50	66	21.80

*Furnished with two stud holes on 1 1/2-in. center, and two nail holes, on 2 3/4-in. centers, in bottom of box.

Covers

No.	Description	Std. Pkg.	Wt. Lbs. Per 100	Per 100
180A	Raised, Blank.....	100	16	\$ 7.50
180T	Raised, for Tumbler or Toggle Switches and Square Handle.....	100	15	9.15
180W	Raised, for Standard Duplex Receptacles.....	100	11	9.15
180X	Raised, for Flush Plug Receptacles.....	100	13	9.15
180Y	Raised, with One-Hole Strap for &PS Despard, Bryant II or Hubbell LS Wiring Devices.....	100	22	21.15
180Z	Raised, with Three-Hole Strap for P&S, Despard, Bryant II or Hubbell LS Wiring Devices.....	100	20	22.10

Quantity prices on request.

Steel City 4 1/16-Inch Square Outlet Boxes and Covers Galvanized



No.	Inside Depth Inches	Number and Size of Knockouts in Sides	Number and Size of Knockouts in Bottom	Wiring Capacity Cu. In.	Std. Pkg.	Wt., Lbs. Per 100	*Std. Pkg. Per 100
72151 1/2	1 1/2	10-1/2-in.	3-1/2-in., 2-3/4-in.	30.0	25	88	\$43.75
72151 3/4	1 1/2	8-3/4-in.	3-1/2-in., 2-3/4-in.	30.0	25	88	43.75
72151 1/2 & 3/4	1 1/2	8-1/2-in., 1-3/4-in.	3-1/2-in., 2-3/4-in.	30.0	25	88	43.75
72171 1/2	2 1/8	10-1/2-in.	3-1/2-in., 2-3/4-in.	42.0	25	118	52.50
72171 3/4	2 1/8	8-3/4-in.	3-1/2-in., 2-3/4-in.	42.0	25	118	52.50
72171 1/2 & 3/4	2 1/8	8-1/2-in., 1-3/4-in.	3-1/2-in., 2-3/4-in.	42.0	25	118	52.50
72171-1	2 1/8	8-1-in.	3-1/2-in., 2-3/4-in.	42.0	25	118	52.50
72171-1 1/4	2 1/8	6-1 1/4-in.	3-1/2-in., 2-3/4-in.	42.0	25	118	52.50

Boxes

With Holes in Bottom for Fixture Stud and Nails

Covers—4 1/16-Inches

No.	Description	Std. Pkg.	Wt., Lbs. Per 100	*Std. Pkg. Per 100
72-C-1	Flat; Blank	25	45	\$18.75
72-C-2	Raised 5/8-inch; Blank	25	54	25.00
72-C-3	Raised 5/8-inch; Open with Ears Tapped 2 3/32 inches on Centers to Take 3 1/4 inches Receptacles or Covers	25	40	25.00
72-C-6	Flat; With 1/2-inch Knockout in Center	25	44	20.00
72-C-7	Raised 5/8-inch; With 1/2-inch Knockout in Center	25	52	25.00
72-C-12	Raised 5/8-inch; Drop Cord Type; With 3/8-inch Bushed Hole	25	50	25.00
72-C-14	Raised 3/4-inch; For Single Rectangular Base Switch or Receptacle	25	48	27.50
72-C-15	Raised 1 inch; For Single Rectangular Base Switch or Receptacle	25	52	27.50
72-C-17	Raised 1/2-inch; For Two Rectangular Base Switches or Receptacles	25	32	30.00
72-C-18	Raised 3/4-inch; For Two Rectangular Base Switches or Receptacles	25	40	30.00
72-C-48	Raised 5/8-inch; With 2 3/4-inch Diameter Open Canopy	25	40	27.50

Steel City Utility Boxes and Covers

Galvanized



Holes in ears, 3 5/8 inches on centers, accommodate all standard receptacles, switches, etc. Furnished with holes in bottom for fixture studs and nails. Boxes are 2 1/8 inches wide, 4 inches long; standard package, 50.

Boxes—Without Brackets

Boxes—With Brackets†

No.	Depth In.	Size In.	Side	Each End	Bottom	Wt., Lbs. Per 100	*Std. Pkg. Per 100	No.	Depth In.	Size In.	One Side	Each End	Bottom	Wt., Lbs. Per 100	*Std. Pkg. Per 100
58351 1/2	1 1/2	1 1/2	3	1	3	49	\$19.50	58361-B	1 7/8	1 1/2	3	1	3	70	\$26.25
58361 1/2	1 7/8	1 1/2	3	1	3	55	20.30	58361-V	1 7/8	1 1/2	3	1	3	65	26.25
58361 3/4	1 7/8	3/4	2	1	2	55	20.30	58361-T	1 7/8	1 1/2	3	1	3	73	26.25
58371 1/2	2 1/8	1 1/2	3	1	3	60	20.85	58371-T	2 1/8	1 1/2	3	1	3	75	26.80
58371 3/4	2 1/8	3/4	2	1	2	60	20.85								

†Without Lath Support.

Covers—Raised 1/8-Inch

No.	Description	Std. Pkg.	Wt., Lbs. Per 100	*Std. Pkg. Per 100
58-C-1	Blank	100	15	\$ 6.60
58-C-5	For Single Receptacle	20	13	8.50
58-C-6	With 1/2-in. Knockout	100	15	8.50
58-C-7	For Duplex Receptacle	100	11	8.50
58-C-11	With 3/8-in. Bushed Hole in Center	20	15	8.50
58-C-30	For Toggle Switch	100	15	8.50
58-C-40	With 3-hole Strap for "Despard" Type Wiring Devices; 3 K.O.'s	20	20	20.00

*Prices slightly higher in Western and Southeastern States.

Quantity prices on request.

Appleton Handy Boxes and Covers

Schedule OB



No. 4SS Box



No. 2555 Cover



No. 2540 Cover



No. 2539 Cover



No. 4SSL Box



No. 2520 Cover



No. 2510 Cover



No. 2594 Cover



No. 2598 Cover



No. 2599 Cover

Boxes

No.	Lgth.	Dimensions, In.		Depth	Number and Size of Knockouts			Std. Pkg.	Wt., Lbs. Per 100	Per 100
		Width			Each Side	Each End	Bottom			
4SS	3 ³ / ₄	1 ¹ / ₂	1 ¹ / ₂	1 ¹ / ₂	3-1 ¹ / ₂ -in.	1-1 ¹ / ₂ -in.	2-1 ¹ / ₂ -in.	100	43	\$ 20.70
4CS ¹ / ₂	4	2 ¹ / ₈	1 ⁷ / ₈	1 ⁷ / ₈	3-1 ¹ / ₂ -in.	1-1 ¹ / ₂ -in.	3-1 ¹ / ₂ -in.	50	59	19.35
4CS ³ / ₄	4	2 ¹ / ₈	1 ⁷ / ₈	1 ⁷ / ₈	2-3 ³ / ₄ -in.	1-3 ³ / ₄ -in.	2-3 ³ / ₄ -in.	50	59	19.35
4SSL ¹ / ₂	4	2 ¹ / ₈	2 ¹ / ₈	2 ¹ / ₈	3-1 ¹ / ₂ -in.	1-1 ¹ / ₂ -in.	3-1 ¹ / ₂ -in.	50	68	21.10
4SSL ³ / ₄	4	2 ¹ / ₈	2 ¹ / ₈	2 ¹ / ₈	2-3 ³ / ₄ -in.	1-3 ³ / ₄ -in.	2-3 ³ / ₄ -in.	50	68	21.10
4SSL	4	2 ¹ / ₈	2 ¹ / ₈	2 ¹ / ₈	2-1-in.	1-1-in.	1-1-in.	50	68	21.10
4SSLD ¹ / ₂	4	2 ¹ / ₈	2 ¹ / ₂	2 ¹ / ₂	3-1 ¹ / ₂ -in.	1-1 ¹ / ₂ -in.	3-1 ¹ / ₂ -in.	50	80	69.85
4SSLD ³ / ₄	4	2 ¹ / ₈	2 ¹ / ₂	2 ¹ / ₂	2-3 ³ / ₄ -in.	1-3 ³ / ₄ -in.	2-3 ³ / ₄ -in.	50	80	69.85
4SSLD ¹ / ₂	4	2 ¹ / ₈	1 ¹ / ₂	1 ¹ / ₂	3-1 ¹ / ₂ -in.	1-1 ¹ / ₂ -in.	3-1 ¹ / ₂ -in.	50	66	18.65

Covers

For No. 4SS Box

No.	Description	Std. Pkg.	Wt., Lbs. Per 100	Per 100
2520	Flat.....	200	17 ¹ / ₂	\$ 7.40

For Handy Boxes 4-In. Long x 2¹/₈-In. Wide

2540	Raised, Blank.....	100	15	6.30
2555	With one 1/2-inch Knockout in Center.....	100	23	8.30
2539	Raised, for Flush Plug Receptacles (without Lift Cover).....	100	11	8.10
2510	Raised, for Standard Duplex Receptacles.....	100	11	8.10
2594	Raised, for Tumbler or Toggle Switches with Square Handle.....	100	14	8.10
2598	Raised, with One-hole Strap for P&S Despard, Bryant II or Hubbard LS Wiring Devices.....	100	21	18.25
2599	Raised with Three-Hole Strap for P&S Despard, Bryant II or Hubbard LS Wiring Devices.....	100	16	19.15

*Has three knockouts so that one, two or three devices may be used in a single-gang cover by removing knockouts to be utilized.

Appleton Special Outlet Boxes and Covers

Schedule OB



No. 6SLD Box

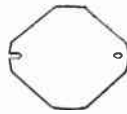

No. 8596 Cover

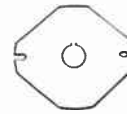

No. 8596A Cover

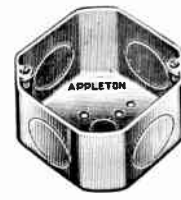

No. 50D Box

Boxes

No.	Dimensions, In.	Each Side	Number and Size of Knockouts	Bottom	Std. Pkg.	Wt., Lbs. Per 100	Per 100
6SLD	5 ³ / ₄ Long, 3 ¹ / ₄ Wide, 3 Deep	2-1 ¹ / ₄ -in.	1-1 ¹ / ₄ -in.	2-1 ¹ / ₄ -in.	25	98	\$239.25
50D	4 ¹ / ₈ Octagonal, 2 ¹ / ₁₆ Deep	1-1 ¹ / ₄ -in.	1-1 ¹ / ₂ -in.	25	65	128.25

Covers

For No. 6SLD Box

No.	Description	Std. Pkg.	Wt., Lbs. Per 100	Per 100
8594	Flat, Blank.....	25	25	\$78.65

For No. 50D Box

8596	Flat, Blank.....	25	20	39.70
8596A	Flat, Blank, with 1/2-in. Knockout in Center.....	25	21	44.90

Quantity prices on request.

Appleton Extension Rings

Schedule OB

For 3/4- and 4-Inch Octagonal Boxes, 4- and 4 1/16-Inch Square Boxes and Handy Boxes

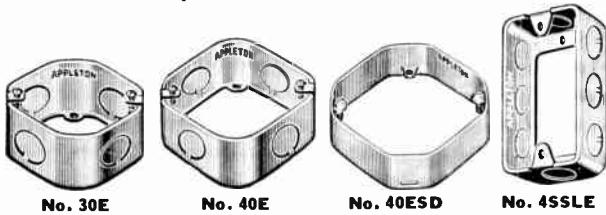

No. 30E No. 40E No. 40ESD No. 4SSLE

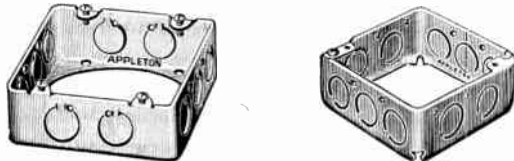

No. 4SJE No. 4SE

For 3/4-In. Octagonal Boxes

Rings 1 1/2-In. Deep

No.	Universal Key Number	Knockouts	Std. Pkg.	Wt., Lbs. Per 100	Per 1000
30E1/2	251511/2	4-1/2-in.	50	.43	\$15.35

For 4-In. Octagonal Boxes

Rings 1 1/2-In. Deep

40E1/2	551511/2	4-1/2-in.	50	.48	21.35
40E3/4	551513/4	4-3/4-in.	50	.48	21.35
40ESpt.	2-1/2" & 2-3/4"	50	.48	21.35

Rings 2 1/8-In. Deep

40ED1/2	551711/2	4-1/2-in.	50	.59	29.85
---------	----------	-----------	----	-----	-------

Rings 5/8-In. Deep

40ES	57111	None	50	.20	26.55
------	-------	------	----	-----	-------

Rings 1-In. Deep

40ESD	None	50	.32	47.65
-------	-------	------	----	-----	-------

For 4-In. Square Boxes

Rings 1 1/2-In. Deep

4SE1/2	531511/2	10-1/2-in.	50	.60	25.75
4SE3/4	531513/4	8-3/4-in.	50	.60	25.75

For 4 1/16-In. Square Boxes

Rings 1 1/2-In. Deep

4SJE1/2	731511/2	10-1/2-in.	50	.82	47.90
4SJE3/4	731513/4	2-3/4" in Two Sides 2-1/2" & 1-3/4" in 2 Opposite Sides	50	.82	47.90

Rings 2 1/8-In. Deep

4SJDE1/2	731711/2	2-1/2" in Two Sides 2-1/2" & 1-3/4" in 2 Opposite Sides	25	130	56.55
4SJDE3/4	731713/4	2-3/4" in Two Sides 2-1/2" & 1-3/4" in 2 Opposite Sides	25	130	56.55
4SJDE1	73171-1	8-1-in.	25	130	56.55

For Handy Boxes

4-In. x 2 1/8-In. x 1 1/2-In. Deep

4SSLE1/2	8-1/2-in.	100	.40	24.25
----------	-------	-----------	-----	-----	-------

Quantity prices on request.

Steel City Extension Rings

For 3/4- and 4-Inch Octagonal Boxes; 4- and 4 1/16-Inch Square Boxes and Utility Boxes



No. 25151 No. 55151 No. 53151 No. 53171



No. 73151 No. 73171 No. 59361

For 3/4-In. Octagonal Boxes

No.	Depth In.	*Number and Size of Knockouts Available				Wiring Cap. Cu. In.	Std. Pkg.	Wt., Lbs. Per 100	*Std. Pkg. Per 100
		1/2-In.	3/4-In.	1/2 & 3/4-In.	1-In.				
25151	1 1/2	4	4	2, 2	..	10.6	50	30	\$20.60

For 4-In. Octagonal Boxes

55151	1 1/2	4	4	2, 2	..	16.5	50	41	22.35
55171	2 1/8	4	4	2, 2	4	23.0	50	60	30.30

For 4-In. Square Boxes

53151	1 1/2	10	8	8, 4	..	21.1	50	51	26.95
53171	2 1/8	10	8	8, 4	8	29.9	50	71	49.40

For 4 1/16-In. Square Boxes

73151	1 1/2	10	8	8, 4	..	30.0	25	76	49.40
73171	2 1/8	10	8	8, 4	8	12.0	25	96	58.15

For Utility Boxes 4-In. x 2 1/8-In.

59361	1 7/8	8	14.0	50	44	25.35
-------	-------	---	----	----	----	------	----	----	-------

*In ordering, specify knockouts desired.

*Prices slightly higher in Western and Southeastern States.

Steel City 4-Inch Square Surface Covers Galvanized

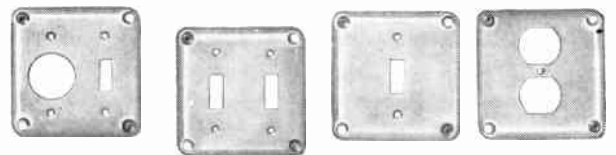

No. RS-1 No. RS-5 No. RS-9 No. RS-12

For exposed work. Turned down all around edges; fit flush with top of box.

Stamped steel, 1/2-inch deep. Standard package, 50.

No.	Description	Wt., Lbs. Per 100	*Std. Pkg. Per 100
RS-1	For 1 Toggle Sw. & 1 Single Flush Receptacle.....	35	\$19.95
RS-2	For 1 Toggle Sw. & 1 Duplex Flush Receptacle.....	32	19.95
RS-5	For 2 Toggle Switches.....	37	19.95
RS-8	For Duplex Flush Receptacles.....	28	19.95
RS-9	For 1 Toggle Switch.....	38	18.80
RS-11	For 1 Single Flush Receptacle.....	35	18.80
RS-12	For 1 Duplex Flush Receptacle.....	33	18.80

*Prices slightly higher in Western and Southeastern States.

Quantity prices on request.

National Electric "Redege" Boxes and Extension Rings

4 1/16-Inch Square

No. 2500 Line—For Conduit



Galvanized

Four lug mounting. Boxes have three 1/2 inch and two 3/4 inch knockouts in bottom.

Weight per 100: 1 1/2 in. deep 96 lbs., 2 1/8 in. deep 128 lbs.

Packed 25 in standard package.

No.	Universal No.	Knockouts In Sides			*Std. Pkg. Per 100
		1/2 In.	3/4 In.	1 In.	
1 1/2 Inch Deep					
2500	72151-1/2	10	\$43.75
2501	72151-3/4	..	8	..	43.75
2510	72151-1/2-3/4	6	4	..	33.75
2 1/8 Inch Deep					
2514	72171-1/2	10	\$52.50
2515	72171-3/4	..	8	..	52.50
2519	72171-1/2-3/4	6	4	..	52.50
2590	72171-1	8	52.50

Extension Rings

2504	73151-1/2	10	\$49.40
2505	73151-3/4	..	8	..	49.40

*Eastern Zone Price: Prices Higher in Western and Southern Zones.

Steel City Concrete Box Rings and Plates

Galvanized

4-Inch Octagonal Rings

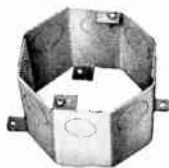

No. 54551 Box

Furnished standard with four 1/2-in. and four 3/4-in. K.O.'s. Can be furnished with combination 3/4 and 1-in. K.O.'s if desired.

Knockouts fit snugly around conduit and are properly spaced for locknuts and bushings—eliminating any possibility of concrete entering the box.

Knockouts are so arranged that any combination for 1/2 or 3/4-in. conduit easily obtained merely by setting box in the desired position, eliminating necessity and expense of reaming or reducing knockouts.

Furnished with punched lugs for fastening to wood forms.

No.	Depth In.	Wiring Capacity Cu. In.	Std. Pkg.	Approx. Wt. Lbs. Per 100	*Std. Pkg. Per 100
54531	2	25.0	50	64	\$29.80
54541	2 1/2	31.0	50	77	32.75
54551	3	37.0	25	88	35.70
54561	3 1/2	43.0	20	110	38.70
54571	4	49.0	20	123	52.02
54581	5	62.0	20	150	66.95
54591	6	74.0	20	170	74.35

Plates for Concrete Boxes



No. CBP: has three 1/2-in. and two 3/4-in. K.O.'s.

Nos. CBP-3/8 and CBP-1/2: have two 1/2-in. and two 3/4-in. K.O.'s.

No.	Stud Size Inches	Std. Pkg.	Approx. Wt. Lbs. Per 100	*Std. Pkg. Per 100
CBP	none	50	33	\$12.30
CBP-3/8	3/8	50	37	17.35
CBP-1/2	1/2	50	48	22.75

*Prices slightly higher in Western and Southeastern States.

National Electric "Redege" Concrete Boxes

4-Inch Octagon Rings and Back Plates



Galvanized

Ring and back plate furnished separately.

No.	Universal No.	Depth In.	Knockouts			*Std. Pkg. Per 100
			1/2 In.	3/4 In.	1 In.	
3202	54531	2	4	4	..	\$29.80
3202-1/2	54541	2 1/2	4	4	..	32.75
3202	54551	3	4	4	..	35.70
3304	54551	3	2	4	2	35.70
3402	54561	3 1/2	4	4	..	38.70
3404	54561	3 1/2	2	4	2	38.70
3502	54571	4	4	4	..	52.05
3504	54571	4	2	4	2	52.05

Back Plates

No.	Description	Knockout		Each
		1/2 In.	3/4 In.	
3100	No Stud	3	2	\$12.30
3101	3/8 in. Stud	2	2	17.35

Appleton Concrete Rings and Plates

Schedule OB

Octagonal—4 3/8-In. Diameter



No. OCR 3 1/2 Ring

Bottom plates and lugs made so that concrete will not seep through into box during pouring.

Rings are of two-piece design; have two inside lugs at both ends, drilled and tapped to take OCP plates or any standard type of 4-in. round box cover.



No. OCR 3 1/2 Ring with Plate

Outside ears have holes for nailing box to concrete form.

Concrete Rings

With 4-1/2-In. and 4-3/4-In. K.Os. In Sides

No.	Universal Key Number	Ring Depth In.	Wt. Lbs. Per 100	Std. Pkg.	Per 100
OCR1 1/2	54521	1 1/2	54	100	\$29.75
OCR2	54531	2	70	50	29.75
OCR2 1/2	54541	2 1/2	82	50	32.95
OCR3	54551	3	100	50	36.15
OCR3 1/2	54561	3 1/2	110	50	39.35
OCR4	54571	4	132	25	52.05

With 4-3/4-In. and 4-1-In. K.Os.

OCRS3	3	102	50	\$36.15
OCRS3 1/2	3 1/2	114	25	39.35
OCRS4	4	128	25	52.05

Concrete Plates



No. OCP Plate



No. OCP 3/8 Plate

Have 3-1/2-in. and 2-3/4-in. Knockouts.

No.	Fixture Stud	Wt. Lbs. Per 100	Std. Pkg.	Per 100
OCP	None	34	50	\$12.50
OCP 3/8	3/8-in.	36	50	17.25

Appleton 4-Inch Square Surface Covers

Schedule OB

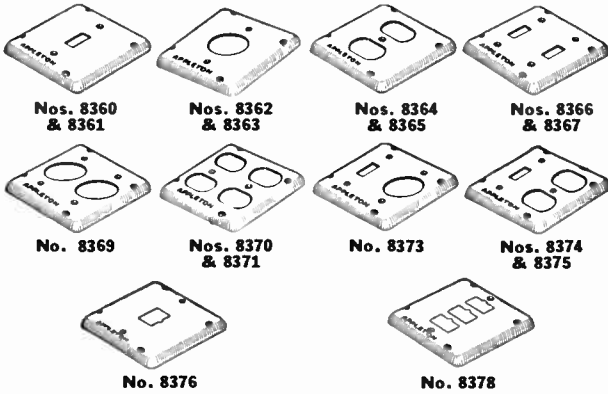

Eliminates the use of regular switch covers and other plates, providing neater assemblies and minimizing installation time. Regularly supplied with four knockouts to take fastening screws. Standard package, 50.

Covers 1/8-Inch Deep

No.	Description	Wt. Lbs. Per 100	Per 100
8360	For 1 Toggle Switch	25	\$18.55
8362	For 1 Single Flush Receptacle	27	18.55
8364	For 1 Duplex Flush Receptacle	25	18.55
8366	For 2 Toggle Switches	42	19.55
8370	For 2 Duplex Flush Receptacles	20	19.55
8374	For 1 Toggle Sw. & 1 Duplex Flush Receptacle	21	19.55
8378	With 3-Hole Strap for P&S Despard, Bryant II or Hubbell LS Wiring Devices	30	29.35

Covers 1/2-Inch Deep

8361	For 1 Toggle Switch	50	\$18.55
8363	For 1 Single Flush Receptacle	48	18.55
8365	For 1 Duplex Flush Receptacle	45	18.55
8367	For 2 Toggle Switches	44	19.55
8369	For 2 Single Flush Receptacles	44	19.55
8371	For 2 Duplex Flush Receptacles	39	19.55
8373	For 1 Toggle Sw. & 1 Single Flush Receptacle	49	19.55
8375	For 1 Toggle Sw. & 1 Duplex Flush Receptacle	47	19.55

National Electric Steel Covers for Flush Device Boxes

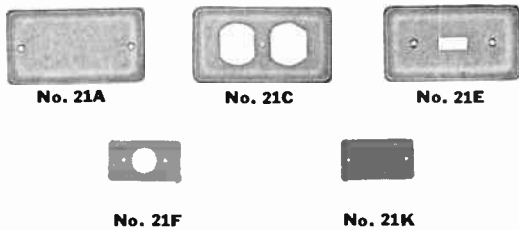

Galvanized. Packed 20 in standard package. No. 21 Series Covers are specially designed and constructed to assure a perfect fitting cover with the No. 2020 Series Conduit Device Boxes. These covers are flanged and rounded on the corners.

No.	Description	Wt. Lbs. Per 100	Std. Pkg. Per 100
21A	Blank	11	\$ 6.60
21C	Standard Duplex Receptacle	10	8.50
21E	Square Handle Toggle Switch	10	8.50
21F	Single Receptacle	10	8.50
21K	KO's for Despard or Bryant Devices Furnished with P&S Mounting Strap	20	20.00

* Eastern Zone Price: Prices Higher in Western and Southern Zones.

Quantity prices on request.

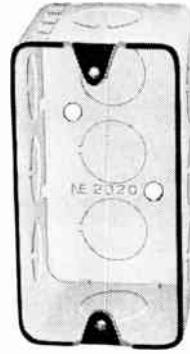

National Electric "Redege" Flush Device Boxes

4 1/8 Inches Long—2 1/8 Inches Wide

Lugs are tapped on 3 3/8-inch centers for all standard makes of push button and rectangular rotary switches and flush convenience outlets.

Two nail holes in back for nailing or fixture stud. Packed 50 in standard package.

National	Nos. Universal	Depth In.	Type	Wt. Lbs. Per 100	Std. Pkg. Per 100
(2018-20 Series—1/2-in. KO's—3 Ea. Side & Bottom, 1 Ea. End)					
2018	58351-1/2	1 1/2	Straight Sides	58	\$19.50
2018B	58351-1/2	1 1/2	B Bracket	84	25.35
2018L.B	58351-1/2	1 1/2	L Bracket	84	25.35
2018SS	58351-1/2	1 1/2	Strap Bracket	84	25.35
2020	58361-1/2	1 7/8	Straight Sides	64	20.30
2020B	58361-1/2	1 7/8	B Bracket	90	26.25
2020L.B	58361-1/2	1 7/8	L Bracket	90	26.25
2020SS	58361-1/2	1 7/8	Strap Bracket	90	26.25

(2021 Series—3/4-in. KO's—2 Ea. Side & Bottom, 1 Ea. End)

2021	58361-3/4	1 7/8	Straight Sides	55	20.30
2021B	58361-3/4	1 7/8	B Bracket	70	26.25
2021L.B	58361-3/4	1 7/8	Angle Bracket	73	26.25
2021SS	58361-3/4	1 7/8	Strap Bracket	70	26.25

(2022 Series—1/2-in. KO's—3 Ea. Side & Bottom, 1 Ea. End)

2022	58371-1/2	2 1/8	Straight Sides	60	20.85
2022B	58371-1/2	2 1/8	B Bracket	75	26.80
2022L.B	58371-1/2	2 1/8	Angle Bracket	78	26.80
2022SS	58371-1/2	2 1/8	Strap Bracket	75	26.80

(2023 Series—3/4-in. KO's—2 Ea. Side & Bottom, 1 Ea. End)

2023	58371-3/4	2 1/8	Straight Sides	60	20.85
2023B	58371-3/4	2 1/8	B Bracket	75	26.80
2023L.B	58371-3/4	2 1/8	Angle Bracket	78	26.80
2023SS	58371-3/4	2 1/8	Strap Bracket	75	26.80

* Eastern Zone Price: Prices Higher in Western and Southern Zones.

Call Graybar FIRST For . . .

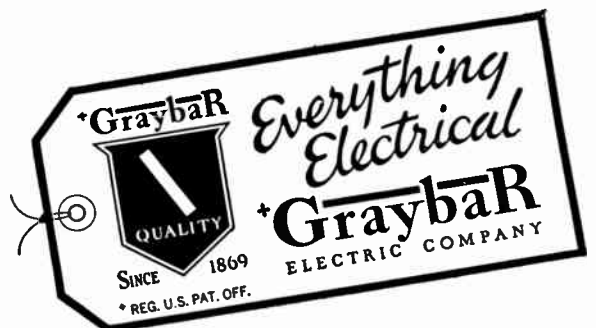

Appleton Safety Swivel Hangers

Schedule OB

Type SSH

For Use with 1½- to 4-In. Deep Concrete Boxes and 4-In. Octagonal Boxes 1½- or 2¼-In. Deep

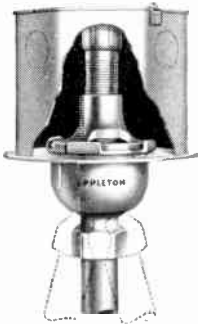

Hanger Installed in Concrete Box

Assures safe suspension of extra heavy fixtures, such as those used in industrial lighting installations.

Furnished with ½ hub for a 3⁄8-inch fixture stud.

Entire weight of the suspended fixture is borne by the stud instead of relying on the screws and screw ears of the box or ring for support.

Steel plate furnished to serve as a cover for 1-in. octagonal boxes and concrete ring. Properly installed when notches in the cover engage the ribs on the swivel ball.

For Use with 4-In. Octagonal Boxes and Concrete Rings 1½-In. and 2-In. Deep



No. 11355: for octagonal boxes 1½-in. deep having a 3⁄8-in. fixture stud in bottom of box.

No.	Hub Size Inches	Standard Package	Weight, Lbs. Per 100	Per 50
11355	½	50	50	\$197 45

For Use with Concrete Rings 2½- to 4-In. Deep



Designed for concrete rings having Appleton No. OCF3⁄8 stud bottom plate.

Standard package, 50.

No.	Stud Size Inches	Wt., Lbs. Per 100	Per 50
11360	½	50	\$259 60

Appleton Ball Type Swivel Hanger Covers

Schedule OB

Provide a free-swing of 30 degrees in all directions from plumb. Furnished in two styles, with and without cushion, for use with 3¼ or 1-in. octagonal boxes, for 1-in. square boxes or for concrete rings.

Cushion type cover particularly designed to increase bulb life in installations subject to vibration.



No. 8438R



No. 8458R



No. 8448R

Without Cushion

For 3¼- and 4-In. Octagonal Outlet Boxes

No.	Hub Size In.	Fixture Wt., Lbs.	Std. Pkg.	Wt., Lbs. Per 100	Per 100
8438R	½	50	63	\$78.10
8436R	¾	50	86	78.10

For 4-In. Square Outlet Boxes

8458R	½	50	67	80.85
-------	---	------	----	----	-------

For 4½-In. Diam. Concrete Rings

8448R	½	50	66	80.85
-------	---	------	----	----	-------



No. 8438C



No. 8458C

With Cushion

For 3¼- and 4-In. Octagonal Outlet Boxes

8438C	½	3 to 6	50	65	\$129.80
-------	---	--------	----	----	----------

For 4-In. Square Outlet Boxes

8458C	½	3 to 6	50	72	\$133.85
-------	---	--------	----	----	----------

Appleton Fluorescent Fixture Hangers

Schedule OB

For Use with 4-Inch Octagonal Outlet Boxes

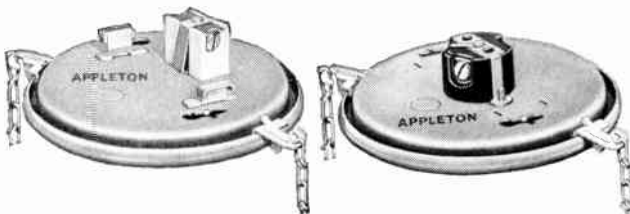

No. 11440 -No. 11450

No. 11440G -No. 11450G

Has exclusive safety brackets (available on hangers 11450 and 11450G) which give positive added protection against falling should outlet box screws vibrate loose or corrode through.

Two non-slip hooks accommodate chains for fixture suspension. Special rim construction allows hooks to slide freely a full 360° for effortless positioning of fixture. Alignment is instantaneous at any angle.

Complete with 2-Wire, Snap-in Receptacle 15 Amp.—25 Volt, 10 Amp.—250 Volt

No.	Description	Wt. Lbs. Per 100	Std. Pkg.	Per 100
11440	Without Safety Brackets	100	10	\$143 00
11450	With Safety Brackets	120	10	162 00

Complete With Hubbell Receptacle No. 7733G 2 and 3 Wire, Grounded, 15 Amp.—125 Volt, 10 Amp.—250 Volt

No.	Description	Wt. Lbs. Per 100	Std. Pkg.	Per 100
11440G	Without Safety Brackets	110	10	\$246 00
11450G	With Safety Brackets	120	10	246 00

All hangers listed are furnished with two 5-ft. chains, hooks and cord clips.

Steel City Gang Boxes and Raised Covers

Galvanized

Boxes from 2 through 5 gangs are supplied in standard packages of five; from 5 through 9 gang, one per standard package.



No. 6-G

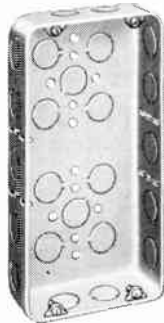

No. 3-G

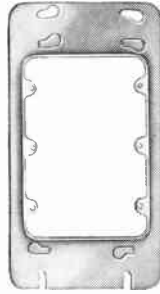

No. 3-GC

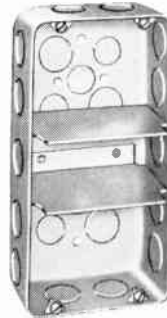

H-3BD
With Two DGP
Partitions Installed

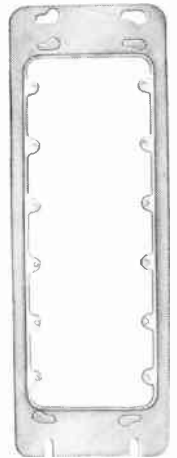

No. 6-GC

Regular Boxes

Depth, 1 5/8-in.; width, 4 1/2-in. Furnished with 1/2, 3/4 or combination 1/2 and 3/4-in. K.O.'s.

Outside Lgth. 6 13/16-In.—Wiring Capacity 50 Cu. In.

No.	No. and Size of Knockouts						Approx. Wt. Lbs. Per 100	*Std. Pkg. Per 100
	Sides 1/2	3/4	1	Bottom 1/2	3/4	1		
2-G-1/2	8	..	4	..	3	2	136	\$ 96.25
2-G-3/4	..	8	..	4	3	2	136	96.25
2-G-1/2 & 3/4	4	4	2	2	3	2	136	96.25

Outside Lgth. 8 5/8-In.—Wiring Capacity 62 Cu. In.

3-G-1/2	10	..	4	..	6	4	161	\$130.65
3-G-3/4	..	10	..	4	6	4	161	130.65
3-G-1/2 & 3/4	6	4	2	2	6	4	161	130.65

Outside Lgth. 10 7/16-In.—Wiring Capacity 74 Cu. In.

4-G-1/2	12	..	4	..	6	4	190	\$165.00
4-G-3/4	..	12	..	4	6	4	190	165.00
4-G-1/2 & 3/4	6	6	2	2	6	4	190	165.00

Outside Lgth. 12 1/4-In.—Wiring Capacity 86 Cu. In.

5-G-1/2	14	..	4	..	6	4	220	\$226.90
5-G-3/4	..	14	..	4	6	4	220	226.90
5-G-1/2 & 3/4	8	6	2	2	6	4	220	226.90

Outside Lgth. 14 1/16-In.—Wiring Capacity 98 Cu. In.

6-G-1/2	16	..	4	..	6	4	210	\$412.50
6-G-3/4	..	16	..	4	6	4	210	412.50
6-G-1/2 & 3/4	8	8	2	2	6	4	210	412.50

Outside Lgth. 15 7/8-In.—Wiring Capacity 110 Cu. In.

7-G-1/2	18	..	4	..	6	4	300	\$618.75
7-G-3/4	..	18	..	4	6	4	300	618.75
7-G-1/2 & 3/4	10	8	2	2	6	4	300	618.75

Outside Lgth. 17 1/16-In.—Wiring Capacity 110 Cu. In.

8-G-1/2	20	..	4	..	6	4	350	\$687.50
8-G-3/4	..	20	..	4	6	4	350	687.50
8-G-1/2 & 3/4	10	10	2	2	6	4	350	687.50

Outside Lgth. 19 1/2-In.—Wiring Capacity 134 Cu. In.

9-G-1/2	22	..	4	..	6	4	395	\$825.00
9-G-3/4	..	22	..	4	6	4	395	825.00
9-G-1/2 & 3/4	12	10	2	2	6	4	395	825.00

Raised Covers

Raised 1 1/8-in.; 4 1/8-in wide. Holes in ears spaced 3 3/8-in. on centers to accommodate all standard receptacles and switches.

No.	Length In.	Wiring Capacity Cu. In.	Std. Pkg.	Wt. Lbs. Per 100	*Std. Pkg. Per 100
2-GC	7	9.0	5	56	\$ 37.15
3-GC	8 13/16	14.0	5	64	55.00
4-GC	10 5/8	19.0	5	70	75.65
5-GC	12 7/16	21.0	5	80	103.15
6-GC	14 1/4	29.0	1	90	171.90

*Prices slightly higher in Western and Southeastern States. Quantity prices on request.

Deep Boxes

Depth, 2 1/2-in.; width, 4 1/2-in. Furnished with 1/2, 3/4, 1 or combination 1/2, 3/4 and 1-in. K.O.'s.

Outside Lgth. 6 13/16-In.—Wiring Capacity 71.4 Cu. In.

No.	No. and Size of Knockouts						Approx. Wt. Lbs. Per 100	*Std. Pkg. Per 100
	Sides 1/2	3/4	1	Bottom 1/2	3/4	1		
II-2-BD-1/2	8	..	4	..	3	2	156	\$121.70
II-2-BD-3/4	..	8	..	4	3	2	156	121.70
II-2-BD-1/2 & 3/4	4	4	..	2	2	3	156	121.70
II-2-BD-1	4	..	4	3	156	121.70

Outside Lgth. 8 5/8-In.—Wiring Capacity 88.5 Cu. In.

II-3-BD-1/2	10	..	4	..	6	4	195	\$171.90
II-3-BD-3/4	..	10	..	4	6	4	195	171.90
II-3-BD-1/2 & 3/4	6	4	..	2	2	6	195	171.90
II-3-BD-1	6	..	4	6	195	171.90

Outside Lgth. 10 7/16-In.—Wiring Capacity 105.7 Cu. In.

II-4-BD-1/2	12	..	4	..	6	4	230	\$206.25
II-4-BD-3/4	..	12	..	4	6	4	230	206.25
II-4-BD-1/2 & 3/4	6	6	..	2	2	6	230	206.25
II-4-BD-1	8	..	4	6	230	206.25

Outside Lgth. 12 1/4-In.—Wiring Capacity 122.8 Cu. In.

II-5-BD-1/2	14	..	4	..	6	4	280	\$268.15
II-5-BD-3/4	..	14	..	4	6	4	280	268.15
II-5-BD-1/2 & 3/4	8	6	..	2	2	6	280	268.15
II-5-BD-1	10	..	4	6	280	268.15

Outside Lgth. 14 1/16-In.—Wiring Capacity 140.0 Cu. In.

II-6-BD-1/2	16	..	4	..	6	4	300	\$481.25
II-6-BD-3/4	..	16	..	4	6	4	300	481.25
II-6-BD-1/2 & 3/4	8	8	..	2	2	6	300	481.25
II-6-BD-1	12	..	4	6	300	481.25

Between gangs, holes in ears are spaced 1 13/16-in. on centers. Curved slots permit perfect adjustment without removing screws. Furnished with extra slotted screw holes, plugged and so situated to fit the next smaller box.

No.	Length In.	Wiring Capacity Cu. In.	Std. Pkg.	Wt. Lbs. Per 100	*Std. Pkg. Per 100
7-GC	16 1/8	31.0	1	111	\$275.00
8-GC	18 7/8	39.0	1	136	343.75
9-GC	19 11/16	41.0	1	148	412.50
10-GC	19 15/16	49.0	1	148	481.25
.....

National Electric "Redege" Gang Boxes

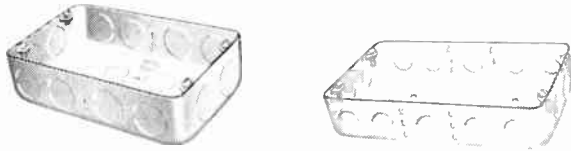

Galvanized finish.

4 1/2 inches wide, 1 5/8 inches deep. Holes in bottom for fixture studs and nails.

Boxes are made with slots for installing partitions (barriers) for low and high potential wiring. Boxes furnished with partitions installed if desired.

Three 1/2 In. and Two 3/4 In. K.O.'s in Back

No.	Gangs	Length In.	Knockouts		Std. Pkg.	Wt. Std. Pkg. Lbs.	Std. Pkg. Per 100
			Ea. End No. Size In.	Ea. Side No. Size In.			
3002	2	6 7/8	2 1/2	1 1/2	5	8	\$ 96 25
3012	2	6 7/8	2 3/4	1 3/4	5	8	96 25

Six 1/2 In. and Four 3/4 In. K.O.'s in Back

3003	3	8 5/8	2 1/2	5 1/2	5	9	130 65
3013	3	8 5/8	2 3/4	5 3/4	5	9	130 65
3004	4	10 1/2	2 1/2	6 1/2	5	12	165 00
3014	4	10 1/2	2 3/4	6 3/4	5	12	165 00
3005	5	12 1/4	2 1/2	7 1/2	5	13	226 90
3015	5	12 1/4	2 3/4	7 3/4	5	13	226 90
3006	6	14	2 1/2	8 1/2	1	18	412 50
3016	6	14	2 3/4	8 3/4	1	18	412 50
3007	7	16	2 1/2	9 1/2	1	18	618 75
3017	7	16	2 3/4	9 3/4	1	18	618 75
3008	8	17 3/4	2 1/2	10 1/2	1	19	687 50
3018	8	17 3/4	2 3/4	10 3/4	1	19	687 50
3009	9	19 1/2	2 1/2	11 1/2	1	20	825 00
3019	9	19 1/2	2 3/4	11 3/4	1	20	825 00

* Eastern Zone Price: Price Higher in Western and Southern Zones.

National Electric Gang Box Covers



Galvanized finish. 1 5/16 inch deep. Inside can be knocked out.

No.	Gangs	Designed For Box Nos.	Extra KO Screw Holes Permit Use with Box Nos.	Std. Pkg.	Wt. Lbs. Std. Pkg.	Std. Pkg. Per 100
30C2	2	3002, 3012		5	3	\$ 37 15
30C3	3	3003, 3013	3002, 3012	5	3	55 00
30C4	4	3004, 3014	3003, 3013	5	4	75 65
30C5	5	3005, 3015	3004, 3014	5	5	103 15
30C6	6	3006, 3016	3005, 3015	1	1	171 90
30C7	7	3007, 3017	3006, 3016	1	1	275 00
30C8	8	3008, 3018	3007, 3017	1	1	343 75
30C9	9	3009, 3019	3008, 3018	1	2	412 50
30C10	10		3009, 3019	1	2	481 25

* Eastern Zone Price: Prices Higher in Western and Southern Zones.

Steel City Gang Box Partitions



No. SGP

No. DGP

No.	Description	Wt. Lbs. Per 100	Std. Pkg. Per 100
SGP	For 1 5/8-in. Deep Boxes	20	\$ 9.65
DGP	For 2 1/2-in. Deep Boxes	25	11.45

* Prices slightly higher in Western and Southeastern States.

Appleton Solid Conduit Gang Switch Boxes and Covers

Schedule OB

Galvanized

Boxes can be furnished with either 1/2 or 3/4-in. K.O.'s. All orders must specify which size is wanted.

In addition to one K.O. for each gang, two additional K.O.'s are provided in each side of the 2-gang to 8-gang boxes. For example, a 2-gang box has four K.O.'s in each side, and a 3-gang box has five K.O.'s in each side.

Deep Type—Form 1

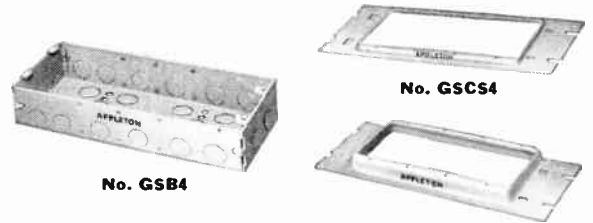

No. GSB4

No. GSC4

No. GSC4

All 2-in. deep two and three-gang have five 1/2-in. K.O.'s in center of bottom. All 2-in. deep four to ten-gang boxes inclusive, have two sets of five 1/2-in. K.O.'s in bottom.

Form 1—2-Inch Deep Boxes (Without Covers)

No.	No. of Gangs	Dimensions, In. Width	Length	Std. Pkg.	Wt. Lbs. Per 100	Per 100
GSB2	2	4	6 7/8	5	150	\$ 93 30
GSB3	3	4	8 1 1/16	5	181	125 95
GSB4	4	4	10 1 1/2	5	213	159 30
GSB5	5	4	12 5/16	5	256	216 95
GSB6	6	4	14 1 1/8	1	263	389 50

Form 1 Covers

No. of Gangs	3/4-Inch Deep Covers		1/2-Inch Deep Covers		Std. Pkg.	Per 100
	No.	Wt. Lbs. Per 100	No.	Wt. Lbs. Per 100		
2	GSC2	58	GSCS2	45	5	\$ 36 10
3	GSC3	63	GSCS3	48	5	52 95
4	GSC4	70	GSCS4	56	5	72 20
5	GSC5	102	GSCS5	67	5	98 00
6	GSC6	101	GSCS6	68	1	102 00

Appleton Solid Gang Switch Boxes

Schedule SB

Galvanized Finish Only With Square Corners for Rigid Conduit

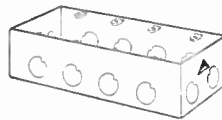

Boxes are solid and ears permit mounting any standard push button or rectangular base switch and also receptacles. Regularly used for concealed work, but can be furnished for open work and flush covers if desired.

2-Gang

No.	No. of Gangs	Depth Inches	Size K.O.	Std. Pkg.	Wt. Lbs. Per 100	Per 100
19010	2	2 1/4	1/2	25	124	\$305 00
19025	2	2 3/4	3/4	25	124	305 00

3-Gang

19015	3	2 1/4	1/2	25	154	402 00
19030	3	2 3/4	3/4	25	154	402 00

4-Gang

19020	4	2 1/4	1/2	10	200	485 00
19035	4	2 3/4	3/4	10	200	485 00

5-Gang

19070	5	2 1/4	1/2	10	250	594 00
19075	5	2 3/4	3/4	10	250	594 00

Switch boxes are furnished galvanized only.











Quantity prices on request.

Appleton Switch Box Covers
For Solid Gang Boxes
Schedule SB
Galvanized finish only.

Instructions for Ordering:

To describe combination give designating letters from left to right in order of arrangement desired. State whether 2, 3, 4, 5 or 6-gang. Example: An order for 50 three-gang covers for flush mounting, for push-button switch, pilot lamp and round flush receptacle, arranged right to left in the order given, should read, "50 flush covers, combination "FRK" for three-gang solid switch boxes."

The price of any combination cover is the sum of the prices of the component covers listed on this page, plus a flat charge of **\$0.07** net per gang.

Symbol	Description	Each
 F	For Double Push Button Switches.....	\$0.30
 J	For Round Flush Plug Receptacles (Without Lift Cover)....	.30
 K	For Round Flush Plug Receptacles (With Lift Cover).....	.50
 O	For Standard Duplex Flush Receptacles.....	.30
 PS1	For P&S Despard, Bryant "IL" and Hubbell Interchangeable line (With Strap for One Device).....	.40
 PS3	For P&S Despard, Bryant "IL" and Hubbell Interchangeable line (With Strap for 2 or 3 Devices).....	.50
 Q	For Sign Receptacles with Removable Ring 1 1/2-inch Hole....	.30
 R	For Pilot Lamp Receptacle. Furnished with Ruby Jewel....	1.50
 S	For Arrow, Bryant, Connecticut and General Electric Square Handle Toggle Switches.....	.30
 X	Blank Metal.....	.20

Appleton Laundry Fittings
Schedule SB
With Single or Duplex Receptacle
Galvanized

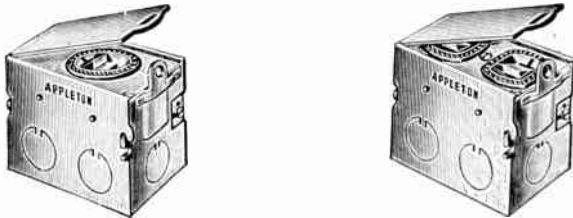

Furnished in single gang. Sectional style can be built into any number of gangs necessary. Each section provided with a hinged door and lugs for an ordinary small padlock. (Padlock not furnished.)

No.	L.	Size, Inches		Size K.O.	Std. Pkg.	Wt., Lbs. Per 100	Per 100
		W.	D.				
1460	3	2	2 3/4	1/2"	20	120	\$276.00
1463	3	2	2 3/4	1/2"	20	120	426.00
With Duplex Receptacle							
1462	3	2	2 3/4	1/2"	20	144	306.00
1464	3	2	2 3/4	1/2"	20	144	606.00

Quantity prices on request.

Steel City Gang Box Covers
Flat Toggle Switch and Receptacle Covers
Galvanized

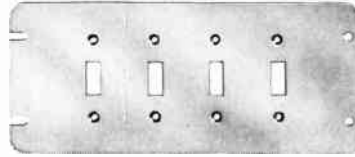

No. 4-GCS

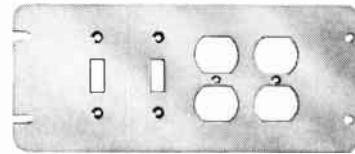

Special No. 4-GCS

Will be furnished for toggle switch unless otherwise specified.

Can be furnished for any combination of receptacles, switches, etc.

No.	No. of Gangs	Std. Pkg.	Wt., Lbs. Per 100	*Std. Pkg. Per 100
2-GCS	2	5	70	\$ 44.55
3-GCS	3	5	90	66.00
4-GCS	4	5	100	90.75
5-GCS	5	1	130	123.75
6-GCS	6	1	140	206.25
7-GCS	7	1	155	330.00
8-GCS	8	1	170	412.50
9-GCS	9	1	195	495.00
10-GCS	10	1	210	577.50

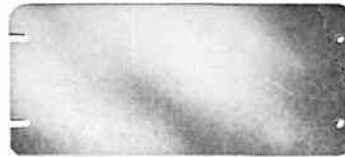

Blank Covers

Available for gang boxes from two through six gangs.

No.	No. of Gangs	Std. Pkg.	Wt., Lbs. Per 100	*Std. Pkg. Per 100
2-GCB	2	5	70	\$ 37.15
3-GCB	3	5	90	55.00
4-GCB	4	5	100	75.65
5-GCB	5	1	130	103.15
6-GCB	6	1	140	171.90

Steel City Hung Ceiling Boxes
4-Inch Octagon

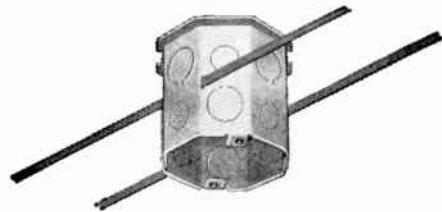

No. **II-54561**: has two rows of 1/2 and 3/4-inch K.O.'s. Supporting bars between upper and lower rows.

No. **II-54561-3/4**: has two rows of all 3/4-in. K.O.'s. Supporting bars between upper and lower rows.

Galvanized finish only. Standard package, 20.

Furnished with two flat bars 1/8x3/8-in., standard 18-in. long.

No.	Depth In.	Stud Size In.	Wiring Capacity Cu. In.	Approx. Wt., Lbs. Per 100	*Std. Pkg. Per 100
H-54561	3 1/2	3/8	43.0	175	\$74.35**
H-54561 3/4	3 1/2	3/8	43.0	175	74.35**

*Prices slightly higher in Western and Southeastern States.

For 24-in. bars, add **\$6.05 per 100 to above prices; for 30-in. bars, add **\$12.10** per 100 to above prices.

Quantity prices on request.

Steel City Combination Boxes

Galvanized

For Armored Cable

3 1/4-Inch Round



No. 36125-XS

No. **36125-X**: With four 3/8-in. pri-outs and K.O. for 1/2-in. conduit. Has C-9 clamps with bushing plates.

No. **36125-XS**: Same as No. 36125-X with addition of 3/8-in. stud in bottom.

No.	Depth In.	Wiring Capacity Cu. In.	Std. Pkg.	Wt., Lbs. Per 100	*Std. Pkg. Per 100
36125-X	3/4	5.7	50	38	\$21.65
36125-XS	3/4	5.7	50	40	30.30



No. 24151-X

3 1/2-Inch Octagonal

With C-12 Clamp

No. **24151-X**: With 3/8-in. pri-outs, 4 in sides and 4 in bottom at clamps. Has K.O.'s for 1/2-in. conduit, 1 in two sides and 1 in bottom.



No. 24151-XSE

No. **24151-XE**: Same as No. 24151-X with addition of mounting ears.

No. **24151-XS**: Same as 24151-X except with 3/8-in. stud in bottom.

No. **24151-XSE**: Same as No. 24151-XS with addition of mounting ears.

No.	Depth In.	Wiring Capacity Cu. In.	Std. Pkg.	Wt., Lbs. Per 100	*Std. Pkg. Per 100
24151-X	1 1/2	12.2	50	55	\$25.30
24151-XE	1 1/2	12.2	50	54	32.10
24151-XS	1 1/2	12.2	50	58	34.00
24151-XSE	1 1/2	12.2	50	62	40.75

4-Inch Octagonal

With CA-1 Clamps



No. 54151-A



No. 54151-AE



No. 54151-AS

No. **54151-A**: With 3/8-in. pri-outs, 4 in sides and 1 in bottom at clamps. Has K.O.'s for 1/2-in. conduit, 1 in two sides and 1 in bottom.

No. **54151-AE**: Same as No. 54151-A with addition of mounting ears.

No. **54151-AS**: Same as 54151-A except with 3/8-in. stud in bottom.

No. **54151-ASE**: Same as No. 54151-AS with addition of mounting ears.

No.	Depth In.	Wiring Capacity Cu. In.	Std. Pkg.	Wt., Lbs. Per 100	*Std. Pkg. Per 100
54151-A	1 1/2	16.5	50	63	\$27.70
54151-AE	1 1/2	16.5	50	70	34.45
54151-AS	1 1/2	16.5	50	67	36.35
54151-ASE	1 1/2	16.5	50	72	43.00

*Prices slightly higher in Western and Southeastern States.

Quantity prices on request.

Steel City Combination Box and Bar Sets

Galvanized

For Armored Cable, Non-Metallic Sheathed Cable or Loom, and Rigid Conduit



No. 24151-XSB



No. 24151-NSB

3 1/2-In. Octagon Boxes—1 1/2-In. Deep—18-In. Bars

All bar sets listed below are assembled on bar with 3/8-in. malleable iron stud with wing-nut.

For Armored Cable

No.	Clamps	Type Offset	Wiring Capacity, Cu. In.	Wt., Lbs. Per 100	*Std. Pkg. Per 100
24151-XSB	C-12	Shallow	12.2	112	\$48.50
24151-NSB	CN-1	Shallow	12.2	104	49.95
24151-XSDB	C-12	Deep	12.2	116	49.95

For Rigid Conduit

†24151-SB	None	Shallow	10.6	98	\$39.25
-----------	------	---------	------	----	---------

†Regular 24151 conduit box.



No. 54151-ASB



No. 54151-NSB



No. 54151-SB

4-In. Octagon Boxes—1 1/2-In. Deep—18-In. Bars

Bars of clamp boxes are assembled through the 3/8-in. malleable iron stud and two straps formed from the bottom of the box. Stud has no wing-nut; set-screw through center of stud is used only to hold box in position on bar.

Clamp boxes have four 3/8-in. pri-outs in sides and bottom at clamps, permitting entrance from either sides or bottom of box. One K.O. for 1/2-in. conduit in each of two opposite sides.

For Armored Cable

No.	Clamps	Type Offset	Wiring Capacity, Cu. In.	Wt., Lbs. Per 100	*Std. Pkg. Per 100
54151-ASB	CA-1	Shallow	16.5	124	\$50.90
54151-ASDB	CA-1	Deep	16.5	128	52.25

For Non-Metallic Sheathed Cable or Loom

54151-NSB	CN-1	Shallow	16.5	120	\$52.45
54151-NSDB	CN-1	Deep	16.5	128	53.90

For Rigid Conduit

**54151-SB	None	Shallow	16.5	110	\$41.65
------------	------	---------	------	-----	---------

**These are regular 54151 conduit boxes and are assembled on bar with 3/8-in. malleable iron stud with wing-nut.

All bar sets can be furnished on longer bars, if so desired, at additional cost.

*Prices slightly higher in Western and Southeastern States.

Quantity prices on request.

Steel City Combination Boxes

Galvanized

For Non-Metallic Flexible Tubing (Loom)
1½-Inches Deep



No. 24155

Have two ½-in. K.O.'s in opposite sides; two round pri-outs for loom locks in each of other two sides. One ½-in. K.O. and 4 round pri-outs in bottom.

Furnished in 3½ or 4-in. octagonal types, with or without clamps.

3½-In. Octagonal

No.	Type Clamps	Wiring Capacity Cu. In.	Std. Pkg.	Wt., Lbs. Per 100	*Std. Pkg. Per 100
24155	None	12.2	50	45	\$22.60

4-In. Octagonal

54155	None	16.5	50	57	\$22.65
-------	------	------	----	----	---------

For Non-Metallic Sheathed Cable or Loom
3¼-Inch Round



No. 36125-DS

No. 36125-D: Has four ¾-in. pri-outs and K.O. for ½-in. conduit. With C-10 clamps.

No. 36125-DS: Same as No. 36125-D with addition of ⅜-in. stud in bottom.

No.	Depth In.	Wiring Capacity Cu. In.	Std. Pkg.	Wt., Lbs. Per 100	*Std. Pkg. Per 100
36125-D	¾	5.7	50	34	\$21.65
36125-DS	¾	5.7	50	37	30.30

4-Inch Octagonal



No. 54151-N



No. 54151-NE



No. 54151-NS

No. 54151-N: With ¾-in. pri-outs, 4 in sides and 4 in bottom at clamps. K.O.'s for ½-in. conduit, 1 in two sides and 1 in bottom.

No. 54151-NE: Same as No. 54151-N with addition of mounting ears.

No. 54151-NS: Same as 54151-N except with ⅜-in. stud in bottom.

No. 54151-NSE: Same as No. 54151-NS with addition of mounting ears.

No.	Depth In.	Wiring Capacity Cu. In.	Std. Pkg.	Wt., Lbs. Per 100	*Std. Pkg. Per 100
54151-N	1½	16.5	50	61	\$27.70
54151-NE	1½	16.5	50	65	34.45
54151-NS	1½	16.5	50	64	36.45
54151-NSE	1½	16.5	50	67	43.00

*Prices slightly higher in Western and Southeastern States. Quantity prices on request.

Steel City Bar Hangers
Straight Type with Wing Nut



No.	Bar In.	Offset		Std. Pkg.	Wt., Lbs. Per 100	*Std. Pkg. Per 100
		Length In.	Depth In.			
6000	18	50	55	\$19.40
6000-A	26	50	64	22.15

Shallow Offset Type with Wing Nut



6001	18	9	15/16	50	61	\$20.80
6001-A	26	13	15/16	50	66	23.60

Steel City Bar Hangers

Deep Offset Type with Wing Nut



6002	18	9	1 1/16	50	63	\$22.15
6002-A	26	13	1 1/16	50	68	24.95

Straight Type—For Old Work



6003	12	100	43	\$32.30
------	----	----	----	-----	----	---------

Offset Cleat Type



6005	21	4	1 1/16	50	56	\$17.40
------	----	---	--------	----	----	---------

Offset Cleat Type—Continuous Slot



6008	21	7	1 5/8	50	46	\$17.40
------	----	---	-------	----	----	---------

Steel City Ceiling Boxes and Plates

Round—Galvanized



No. 36115-C



No. 36125-C



No. 56111



No. 56121



No. 56712

3¼-Inch Diam. Boxes

For Non-Metallic Flexible Cable (Loom)

With lugs. Have 1 K.O. for ½-in. conduit and 4 K.O.'s for loom.

No.	Depth In.	Clamp Type	Wiring Capacity Cu. In.	Std. Pkg.	Wt., Lbs. Per 100	*Std. Pkg. Per 100
36115	1½	None	4.1	100	26	\$17.65
36115-C	1½	C-8	4.1	100	29	20.55
36125	¾	None	5.7	100	31	18.75
36125-C	¾	C-8	5.7	100	34	21.65

4-Inch Diam. Boxes

With lugs. Have 5 K.O.'s for ½-in. conduit and holes for fixture stud and nails.

No.	Depth In.	Wiring Capacity Cu. In.	Std. Pkg.	Wt., Lbs. Per 100	*Std. Pkg. Per 100
56111	1½	5.7	100	37	\$17.90
56121	¾	8.6	100	44	27.05

4½-Inch Diam. Flat Plates

56712	100	27	\$10.80
-------	----	----	-----	----	---------

*Prices slightly higher in Western and Southeastern States. Quantity prices on request.

National Electric Box Hangers



No. 2263 Straight

For shallow boxes in new work, or for holding boxes to concrete forms. With 1/2-inch deep boxes where bar is nailed to joists or studding, edge of box will be flush with ordinary plaster. Will fit any box having 1/2-inch knockout.

No.	Length Bar, In.	Std. Pkg.	Wt., Lb. Std. Pkg.	Std. Pkg. Per 100
2263	18	50	26	\$19.40
2263L	26	50	35	22.15



No. 2265 Shallow Offset

For 1 1/2-inch deep boxes without switch covers or plaster rings, offset brings box edge flush with plaster. Will fit any box having 1/2-inch knockout. Offset, 1 5/16-inches deep from face of studding.

2265	18	50	32	\$20.80
2265L	26	50	45	23.60



No. 2266 Deep Offset

For 1 1/2-inch deep boxes with switch covers or plaster rings, offset brings covers 5/8-inch high, flush with plaster. Will fit any box having 1/2-inch knockout. Offset, 1 11/16-inches deep from face of studding.

2266	18	50	33	\$22.15
2266L	26	50	50	24.95



No. 2268 Box Cleat

For 1 1/2-inch deep boxes with covers and integral studs, or without studs. Offset has slots for stove bolts to hold box, and is right depth to bring 5/8-inch covers flush with plaster. Offset, 1 11/16 inches deep.

2268	21	50	27	\$17.40
------	----	----	----	---------

Quantity prices on request.

†Eastern Zone Price: Prices Higher in Western and Southern Zones.

**National Electric "Redege" Boxes
Shallow Round Ceiling Cable Boxes**



No. 2365



No. 2368



No. 2835-L2

For armored cable, non-metallic sheathed cable, loom and conduit. 1/2 in. k.o.'s in bottom for bar hanger mounting or fixture stud. Cable pri-outs take 14-2, 14-3, 12-2, 12-3. Boxes equipped with two clamps. No side pri-outs. Packed 50 in standard package.

No.	Universal No.	3/8 In. Stud	2 1/2 In. Pri-Outs Bottom	1/2 In. K.O.	Wt. Lbs. Per 100	Std. Pkg. Per 100
3 1/4 In. Diameter—3/4 In. Deep						
2365	36125S	Yes	4	No	44	\$30.30
2368	36125	No	4	1	40	21.65
3 1/2 In. Diameter—1/2 In. Deep						
2835L2S	36115S	Yes	8	No	40	29.20
2835L2	36115	No	8	1	34	20.55
4 In. Diameter—1/2 In. Deep						
*2630	56111	No	No	5	38	17.90

*No clamps.

National Electric "Redege" Boxes

**4 Inch Outlet Boxes
1 1/2 In. Deep—Galvanized**



For non-metallic sheathed cable and non-metallic flexible tubing. Equipped with indestructible clamps; four bottom holes for fixture stud and nailing.

Accommodates 14-2, 14-3, 12-2 and 12-3 cable. Four 2 1/2 in. side and bottom cable pri-outs.

No.	Universal No.	3/8 In. Stud	1/2" K.O. Side	Bot- tom	Std. Pkg.	Wt. Lbs. Per 100	Std. Pkg. Per 100
Without Ears							
2761	54151L	No	2	1	50	72	\$27.70
2761FS	54151LS	Yes	2	..	50	74	36.45
With Ears							
2761E	54151LE	No	2	1	50	76	34.45
With Ears and Stud							
2761FSE	54151LSE	Yes	2	..	50	78	43.00
With Bracket							
2761B	54151LB	No	2	1	25	86	33.25
Box Mounted On 18 In. Bar Hanger							
2761BHIS	54151LBHIS	Yes	2	..	25	136	50.90
2761BHID	54151LBHID	Yes	2	..	25	138	52.25
2761NSBHIS	54151LNSBHIS	No	2	..	25	132	44.25
2761NSBHID	54151LNSBHID	No	2	..	25	134	45.60

**4 Inch Outlet Boxes
1 1/2 In. Deep—Galvanized**

For Armored Cable



No. 2763

Accommodates 14-2, 14-3, 12-2, and 12-3 cable. Equipped with two armored cable clamps; four bottom holes for fixture stud and nailing.

Four 2 1/2 in. side and bottom pri-outs.

No.	Universal No.	3/8 In. Stud	1/2" K.O. Side	Bot- tom	Std. Pkg.	Wt. Lbs. Per 100	Std. Pkg. Per 100
Without Ears							
2763	54151A	No	2	1	50	72	\$27.70
2763FS	54151AS	Yes	2	..	50	74	36.45
With Ears							
2763E	54151E	No	2	1	50	76	34.45
With Ears and Stud							
2763FSE	54151ASE	Yes	2	..	50	78	43.00
With Bracket							
2763B	54151AB	No	2	1	25	86	33.25
Boxes Mounted On 18-In. Bar Hangers							
2763BHIS	54151ABHIS	Yes	2	..	25	136	50.90
2763BHID	54151ABHID	Yes	2	..	25	138	52.25
2763NSBHIS	54151ANSBHIS	No	2	..	25	132	44.25
2763NSBHID	54151ANSBHID	No	2	..	25	134	45.60

†Eastern Zone Price: Prices Higher in Western and Southern Zones.

Appleton 4-Inch Ceiling Boxes

Schedule OB

With Knockouts for 1/2-Inch Rigid Conduit

Boxes are 4-in. diameter, 1/2-in. deep.

Without clamps.

Standard Package, 100.

No. 4CL: With ears.



No. 4CL

No.	Universal Key No.	Wt. Lbs. Per 100	Per 100
4CL	56111	41	\$17.90

Quantity prices on request.

Appleton Combination Boxes

Galvanized
Schedule OB

Clamp Types

Used in Appleton Combination Boxes for Flexible Steel Conduit and Armored Cable, for Non-Metallic Sheathed Cable and Non-Metallic Flexible Tubing.

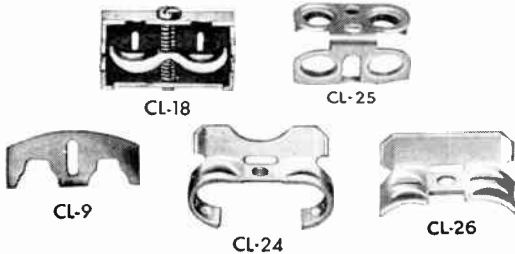

Clamps used with the various Appleton Combination Boxes are listed below:

Box No.	Clamp No.	Box No.	Clamp No.
510CL	CL-9	560LXE	CL-26
511CL	CL-9	561L	CL-26
521CL	CL-9	561LXE	CL-26
550L	CL-25	536L	CL-24
551L	CL-25	564L	CL-24
		571L	CL-18

Combination Boxes

For Flexible Steel Conduit and Armored Cable

Galvanized—With Ears

With Two CL-6 Clamps

No. 532L: Diameter, 3½-in.; depth, ¾-in. Has ears and ⅜-in. fixture stud.

Standard Package, 50.



No. 532L

No.	No. of K.O.'s in Bottom	21/32-In. Conduit	¾-In. Conduit	Wt., Lbs. Per 100	Per 100
532L	4	47	\$29.20

With Two CL-25 Two-Way Knockout Closing Clamps

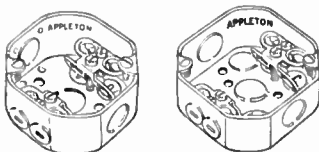

No. 550L

No. 551L

One screw of clamps may be used for bonding. Furnished with ears tapped 8/32-in. on 2¾-in. centers and with nail holes. Without fixture stud.

No.	Diam. In.	Depth In.	No. of K.O.'s in Bottom	21/32-In. Conduit	¾-In. Conduit	Wt., Lbs. Per 100	Per 100
550L	3½	1½	4	4	1	62	\$24.15
551L	4	1½	4	3	3	70	26.45

Quantity prices on request.

Combination Boxes

For Flexible Steel Conduit and Armored Cable



No. 571L

Have clamps on the outside, providing more room for wiring and for splicing and reducing the danger of any injury to wires.

Clamps are riveted to boxes, insuring a positive ground. Screws in clamps are staked to prevent removal or falling out in transit. Furnished with ears.

With Two CL-18 Outside Clamps

No.	Diam. In.	Depth In.	Std. Pkg.	Wt., Lbs. Per 100	Per 100
571L	4	1½	50	82	\$44.00

Combination Boxes

With Side Mounting Ears

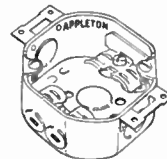

No. 560LXE

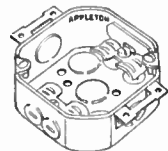

No. 561LXE

Boxes with side mounting ears meet the requirements of many territories where the installation of outlet and combination boxes require furring strips at each ceiling outlet to support cut ends of laths.

As furring strips afford an ideal support for outlet boxes, the mounting ears permit boxes to be attached directly to the strips and eliminate the additional expense of bar hangers.

Boxes with mounting ears will not tip or rock after installation, avoiding the hazard of cracked plaster.

All boxes are 1½-in. deep.

For Non-Metallic Sheathed Cable and Non-Metallic Flexible Tubing

No.	Diam. In.	Depth In.	No. of K.O.'s in Bottom	21/32-In. Conduit	¾-In. Conduit	Clamp Types	Wt., Lbs. Per 100	Per 100
560LXE	3½	1½	4	4	1	CL-26	57	\$30.95
561LXE	4	1½	4	4	3	CL-26	65	33.60

Quantity prices on request.

Appleton Combination Boxes

Galvanized
Schedule OB

For Non-Metallic Sheathed Cable and Non-Metallic Flexible Tubing

3 1/2-In. Diam.—With Ears



Nos. **510LC** and **511LC**: Have 2 1/2-in. K.O.'s in bottom for loom and 3 K.O.'s in bottom for 1/2-in. conduit.

Have two CL-9 clamps.

No.	Universal Key No.	Depth In.	Std. Pkg.	Wt., Lbs. Per 100	Per 100
510LC	36115-C	1/2	50	36	\$19.80
511LC	36125-C	3/4	50	15	21.20



No. **521LC**: Has 3 2/32-in. K.O.'s in bottom for loom and 1 K.O. in bottom for 1/2-in. conduit.

Has two CL-9 clamps.

No.	Universal Key No.	Depth In.	Std. Pkg.	Wt., Lbs. Per 100	Per 100
521LC	56113-C	1/2	50	36	\$19.80

Boxes Below Furnished with Clamps Permitting Insertion of Cable without Removal of Outer Braid



No. **560L**



No. **561L**

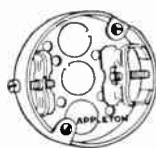

No. **563L**

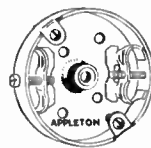

No. **564L**

Have two clamps which hold cable securely without injury to the outer covering.

Boxes 1 1/2-in. deep have two 2 1/32-in. K.O.'s in each of two opposite sides and one K.O. for 1/2-in. conduit in each of the other two opposite sides.

All boxes furnished with ears.

No.	Diam. In.	Depth In.	Clamp Type	Std. Pkg.	Wt., Lbs. Per 100	Per 100
560L	3 1/2	1 1/2	CL-26	50	58	\$24.15
561L	4	1 1/2	CL-26	50	70	26.45
563L	3 1/2	3/4	CL-24	50	45	21.20
*564L	3 1/2	3/4	CL-24	50	47	29.20

*Have 3/8-in. fixture stud.

Quantity prices on request.

Appleton Bar Hangers and Bar Sets

"Expandable"

Approved by Underwriters' Laboratories

Easily installed. Simply fasten outlet box to bar hanger with 2-piece Hanger Stud. Slip the bar stud through box knockout and engage box stud. Two-piece stud travels length of bar hanger enabling box to be tightened in correct position.

Concealed "nail" prongs eliminate possibility of injury, grab studding quickly and hold firmly until Bar Hanger is positioned.

Bar Hangers



No. **SX-115**



No. **SX-160**

Used between Joists with Centers of: 14-in.; 16-in.; 18-in.; 20-in.

No.	Length of Hanger		Std. Pkg.	Wt. Lbs. Per 100	Per 100
	Min.	Max.			
SX-115	11 1/2	18 1/2	50	41	\$21.35

Used between Joists with Centers of: 18-in.; 20-in.; 22-in.; 24-in.; 26-in.

SX-160	16	26 1/2	50	52	\$24.15
---------------	----	--------	----	----	----------------

Bar Sets



No. **SX-115-40 1/2**



No. **SX-115-560L**



No. **SX-115-561L**



No. **SX-115-551L**



No. **SX-115-571L**

Used between Joists with Centers of: 14-in.; 16-in.; 18-in.; 20-in.

No.	Std. Pkg.	Wt. Lbs. Per 100	Per 100
SX-115-40 1/2	25	93	\$42.15
SX-115-560L	25	95	48.75
SX-115-561L	25	102	48.75
SX-115-551L	25	111	48.75
SX-115-571L	25	115	67.75

Appleton Bar Sets and Bar Hangers

Schedule OB

Galvanized

Bar Sets

For Non-Metallic Sheathed Cable and Non-Metallic Flexible Tubing



No. BHS560L

No.	Catalog Numbers of Components Used to Make Bar Set		Std. Pkg.	Wt., Lbs. Per 100	Per 100
	Box	Bar			
BHS560L	560L	S23	25	122	\$48.65

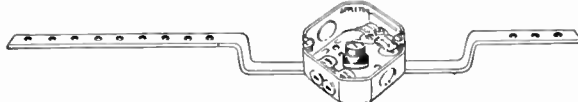

No. BHD561L

No.	Catalog Numbers of Components Used to Make Bar Set		Std. Pkg.	Wt., Lbs. Per 100	Per 100
	Box	Bar			
BHS561L	561L	S23	25	132	\$48.65
BHD561L	561L	S24	25	148	\$2.05

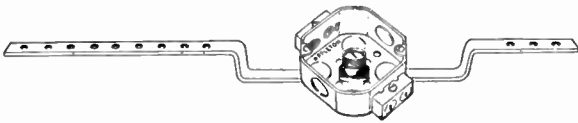

No. BHS70L

No.	Catalog Numbers of Components Used to Make Bar Set		Std. Pkg.	Wt., Lbs. Per 100	Per 100
	Box	Bar			
BHS71L	571L	S23	25	144	\$67.55
BHD71L	571L	S24	25	159	\$8.85

For 1/2-Inch Rigid Conduit (Heavy Wall)

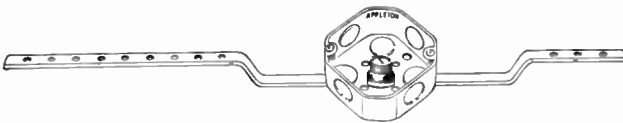

No. BHS40

No.	Catalog Numbers of Components Used to Make Bar Sets		Std. Pkg.	Wt., Lbs. Per 100	Per 100
	Box	Bar			
BHS40	40	S23	25	94	\$42.15

Quantity prices on request.

Bar Sets

For Flexible Steel Conduit and Armored Cable



No. BHS550L

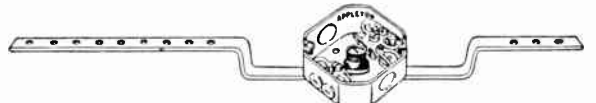

No. BHD551L

No.	Catalog Numbers of Components Used to Make Bar Set		Std. Pkg.	Wt., Lbs. Per 100	Per 100
	Box	Bar			
BHS550L	550-L	S-23	25	133	\$48.65
BHS551L	551-L	S-23	25	130	\$8.65
BHD551L	551-L	S-24	25	148	\$2.05

Bar Hangers

With 3/8-Inch Set-Screw Stud

Straight



No. S21

No.	Length Inches	Depth Inches	Std. Pkg.	Wt., Lbs. Per 100	Per 100
S21	18	...	50	51	\$19.65
S22	26	...	50	70	\$22.80

Shallow Offset



No. S23

No.	Length Inches	Depth Inches	Std. Pkg.	Wt., Lbs. Per 100	Per 100
S23	19 1/2	15/16	50	58	\$21.15
S25	24	15/16	50	72	\$22.45

Deep Offset



No. S24

No.	Length Inches	Depth Inches	Std. Pkg.	Wt., Lbs. Per 100	Per 100
S24	19 1/2	19/16	50	63	\$23.90
S26	24	19/16	50	76	\$23.25

Straight—For Old Work



BHOW 3/8"	12	...	50	39	\$31.40
-----------	----	-----	----	----	---------

Box Cleat



CBH	21	1 1/16	50	56	\$17.70
-----	----	--------	----	----	---------

Quantity prices on request.

Appleton Switch Boxes

Schedule SB

Galvanized Finish

For Flexible Steel Conduit and Armored Cable

2 Holes Each Side For 20-Penny Nails in Addition to Regular Nail Holes

With Leveling Ridges—Without Plaster Ears

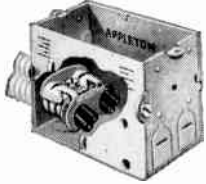

Two 3/4-inch knockouts in ends. Two 3/4-inch knockouts in sides. Four 3/4-inch and one 1/2-inch knockout in bottom.

No.	Dimen., Inches			Type of Clamps	Std. Pkg.	Wt., Lbs. Per 100	Per 100
	L	W.	D.				
173LE	3	2	2 1/2	CL-13	50	72	\$22.70

With Leveling Ridges—With Plaster Ears

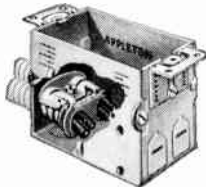

Two 3/4-inch knockouts in ends. Two 3/4-inch knockouts in sides. Four 3/4-inch and one 1/2-inch knockout in bottom.

No.	Dimen., Inches			Type of Clamps	Std. Pkg.	Wt., Lbs. Per 100	Per 100
	L	W.	D.				
173LR	3	2	2 1/2	CL-13	50	72	\$24.35

Without Leveling Ridges—With Plaster Ears

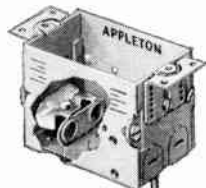

Two 3/4-inch knockouts in ends. Two 3/4-inch knockouts in sides. Four 3/4-inch and one 1/2-inch knockout in bottom.

No.	Dimen., Inches			Type of Clamps	Std. Pkg.	Wt., Lbs. Per 100	Per 100
	L	W.	D.				
171F	3	2	2	CL-13	50	61	\$20.05
173F	3	2	2 1/2	CL-13	50	72	20.30

With Mounting Bracket—Without Lath Support

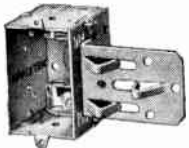

Two 3/4-inch knockouts in ends. Two 3/4-inch knockouts in sides. Four 3/4-inch and one 1/2-inch knockout in bottom.

No.	Dimen., Inches			Type of Clamps	Std. Pkg.	Wt., Lbs. Per 100	Per 100
	L	W.	D.				
171FNL	3	2	2	CL-13	50	78	\$21.90
173FNL	3	2	2 1/2	CL-13	50	86	22.25

"VB" Bracket Switch Boxes—No Lath Support

Used in wall board, beaver board, veneer board and plaster board construction.

Knockouts, two 3/4-inch in ends, two 3/4-inch in sides; four 3/4-inch and one 1/2-inch in bottom.

No.	Dimen., Inches			Type of Clamps	Std. Pkg.	Wt., Lbs. Per 100	Per 100
	L	W.	D.				
171FVB	3	2	2	CL-13	50	76	\$21.90
173FVB	3	2	2 1/2	CL-13	50	80	22.25

Quantity prices on request.

Appleton Switch Boxes

Schedule SB

For Non-Metallic Sheathed Cable and Non-Metallic Flexible Tubing

Galvanized Finish

2 Holes Each Side For 20-Penny Nails

Side Leveling Ridges—Less Plaster Ears

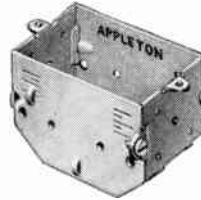

Two 3/4-inch knockouts in each end. Two 3/4-inch knockouts in each side. One 1/2-inch knockout for conduit in bottom.

No.	Dimen., Inches			Type of Clamp	Std. Pkg.	Wt., Lbs. Per 100	Per 100
	L	W.	D.				
33LE*	3	2	2 1/4	None	50	59	\$17.30

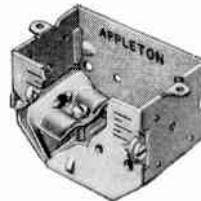

Two 3/4-inch knockouts in each end. Two 3/4-inch knockouts in each side. One 1/2-inch knockout for conduit in bottom.

No.	Dimen., Inches			Type of Clamp	Std. Pkg.	Wt., Lbs. Per 100	Per 100
	L	W.	D.				
44LE*	3	2	2 1/4	CL-5	50	63	\$21.20

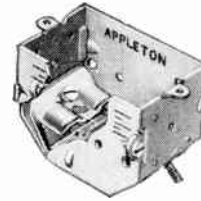

Two 3/4-inch knockouts in each end. Two 3/4-inch knockouts in each side. One 1/2-inch knockout in bottom for conduit.

No.	Dimen., Inches			Type of Clamp	Std. Pkg.	Wt., Lbs. Per 100	Per 100
	L	W.	D.				
388LE*	3	2	2 1/4	CL-17	50	66	\$21.20

Without Leveling Ridges—With Plaster Ears

2 Holes Each Side For 20-Penny Nails In Addition to Regular Nail Holes

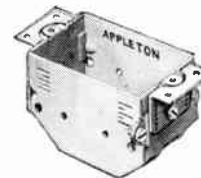

Two 3/4-inch knockouts in each end. Two 3/4-inch knockouts in each side. One 1/2-inch knockout in bottom for conduit.

No.	Dimen., Inches			Type of Clamp	Std. Pkg.	Wt., Lbs. Per 100	Per 100
	L	W.	D.				
33*	3	2	2 1/4	None	50	59	\$21.15

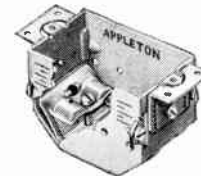

Two 3/4-inch knockouts in each end. Two 3/4-inch knockouts in each side. One 1/2-inch knockout in bottom for conduit.

No.	Dimen., Inches			Type of Clamp	Std. Pkg.	Wt., Lbs. Per 100	Per 100
	L	W.	D.				
44*	3	2	2 1/4	CL-5	50	63	\$22.10

*Available with two 10-32 tapped grounding screw holes in bottom. When required add suffix "GR" to the catalog number.

Quantity prices on request.

Appleton Switch Boxes

Schedule SB

For Non-Metallic Sheathed Cable and Non-Metallic Flexible Tubing

Galvanized Finish

Without Leveling Ridges—With Plaster Ears



Two 3/4-inch knockouts in each end. Two 3/4-inch knockouts in each side. One 1/2-inch knockout in bottom for conduit.

No.	Dimen., Inches			Type of Clamp	Std. Pkg.	Wt., Lbs. Per 100	Per 100
	L	W.	D.				
188*	3	2	2 1/4	CL-17	50	60	\$22.10

Side Leveling Ridges—With Plaster Ears

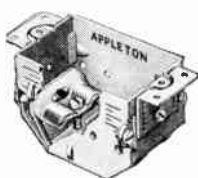

Two 3/4-inch knockouts in each end. Two 3/4-inch knockouts in each side. One 1/2-inch knockout in bottom for conduit.

No.	Dimen., Inches			Type of Clamp	Std. Pkg.	Wt., Lbs. Per 100	Per 100
	L	W.	D.				
14LR*	3	2	2 1/4	CL-5	50	63	\$22.10

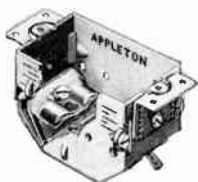

Two 3/4-inch knockouts in each end. Two 3/4-inch knockouts in each side. One 1/2-inch knockout in bottom for conduit.

No.	Dimen., Inches			Type of Clamp	Std. Pkg.	Wt., Lbs. Per 100	Per 100
	L	W.	D.				
188LR*	3	2	2 1/4	CL-17	50	66	\$22.10

Quantity prices on request.

Switch Box Extension



Designed to fit snugly inside the box and allow ample room for switch and wiring. Screws furnished are 1-inch long. Fit all single-gang switch boxes.

No.	No. of Gangs	Depth Inches	Std. Pkg.	Wt., Lbs. Per 100	Per 100
L490	Single	7/8	100	19	\$35.30

Quantity prices on request.

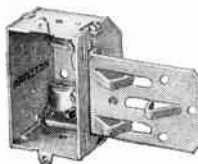

Two 3/4-inch knockouts in ends. Two 3/4-inch knockouts in sides. One 1/2-inch knockout in bottom.

No. 95NL has two 2 1/2-inch knockouts in end corners.

No.	Dimen., Inches	Type of Clamp	Std. Pkg.	Wt., Lbs. Per 100	Per 100		
	L	W.	D.				
44NL	3	2	2 1/4	CL-5	50	76	\$25.40
95NL	3	2	1 1/2	CL-26	50	85	24.35

*Available with two 10-32 tapped grounding screw holes in bottom. When required add suffix "GR" to the catalog number.

Appleton Switch Boxes

Schedule SB

For Non-Metallic Sheathed Cable and Non-Metallic Flexible Tubing

Galvanized Finish

Without Leveling Ridges—With Plaster Ears

2 Holes Each Side For 20-Penny Nails In Addition to Regular Nail Holes

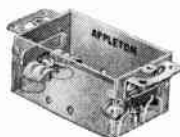

Two 3/4-inch knockouts in end corners.

No.	Dimen., Inches			Type of Clamp	Std. Pkg.	Wt., Lbs. Per 100	Per 100
	L	W.	D.				
95*	3	2	1 1/2	CL-26	50	68	\$22.55

VB Bracket Switch Boxes—No Lath Support



No. 95VB



No. 44VB



No. 383VB

Simplifies the electrician's work in installations using wall board or veneer board. The flat type "VB" Bracket spot-welded onto the long side of a Standard Switch Box, provides an easy means of solidly mounting the switch box to the wide side of a two-by-four, eliminating the need for channeling out the wall board or the studding. The "VB" Bracket Switch Box is easily fixed into place so that the edges of the switch box come perfectly flush with the outer surface of the board.

May be used under 3/4-inch Celotex or boards having a thickness up to 7/8-inch.

44VB boxes have two 2 1/2-inch knockouts in ends and sides; one 1/2-inch knockout in bottom for conduit.

95VB box has two 2 1/2-inch knockouts in end corners.

383VB box has two 2 1/2-inch knockouts in ends, two 2 1/2-inch knockouts in sides, and four 2 1/2-inch and one 1/2-inch knockout in bottom.

No.	Dimen., Inches			Type of Clamps	Std. Pkg.	Wt., Lbs. Per 100	Per 100
	L	W.	D.				
44VB*	3	2	2 1/4	CL-5	50	68	\$25.40
95VB*	3	2	1 1/2	CL-26	50	80	24.35
383VB*	3	2	2	CL-26	50	77	26.25

Appleton Switch Box Clamps

Schedule SB

For Non-Metallic Sheathed Cable, Non-Metallic Flexible Tubing, and Flexible Steel Conduit and Armored Cable

Along with the listing of all Appleton Switch Boxes having clamps, we specify the number of the clamp furnished. These clamp numbers correspond with those listed below and illustrate more clearly the clamps furnished with each box.



CL-24



CL-25

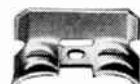

CL-26

Appleton Switch Boxes

Schedule SB

For 1/2-Inch Rigid Conduit (Heavy Wall)

4 Holes Each Side For 20-Penny Nails in Addition to Regular Nail Holes

With Leveling Ridges—Without Plaster Ears

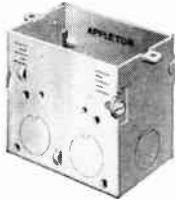

One 1/2-inch knockout in ends. Two 1/2-inch knockouts in sides. One 1/2-inch knockout in bottom, all for 1/2-inch conduit.

No.	Dimen., Inches			Std. Pkg.	Wt., Lbs. Per 100	Per 100
	L.	W.	D.			
3331.E	3	2	2 3/4	50	76	\$21.20

With Leveling Ridges—With Plaster Ears



One 1/2-inch knockout in ends. Two 1/2-inch knockouts in sides. One 1/2-inch knockout in bottom, all for 1/2-inch conduit.

No.	Dimen., Inches			Std. Pkg.	Wt., Lbs. Per 100	Per 100
	L.	W.	D.			
3331.R	3	2	2 3/4	50	76	\$24.60

Without Leveling Ridges—Less Plaster Ears

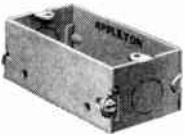

One 1/2-inch knockout in ends, none in sides and one 1/2-inch in bottom. Has two holes in each side for 20-penny nails.

No.	Dimen., Inches			Std. Pkg.	Wt., Lbs. Per 100	Per 100
	L.	W.	D.			
778	3 3/4	2	1 1/2	100	80	\$23.15

Without Leveling Ridges—With Plaster Ears



One 1/2-inch knockout in ends. Two 1/2-inch knockouts in sides. One 1/2-inch in bottom.

No.	Dimen., Inches			Std. Pkg.	Wt., Lbs. Per 100	Per 100
	L.	W.	D.			
111	3	2	2	50	58	\$20.50



No. 222 box has one 1/2-inch knockout in ends, two 1/2-inch knockouts in sides, and one 1/2-inch in bottom.

225 box has one 3/4-inch knockout in ends, two 3/4-inch knockouts in sides, and one 1/2-inch knockout in bottom.

No.	Dimen., Inches			Std. Pkg.	Wt., Lbs. Per 100	Per 100
	L.	W.	D.			
222	3	2	2 1/2	50	70	\$21.30
225	3	2	2 1/2	50	70	21.30

Quantity prices on request.

For 1/2-Inch Rigid Conduit (Heavy-Wall)

4 Holes Each Side For 20-Penny Nails in Addition to Regular Nail Holes

Without Leveling Ridges—With Plaster Ears



333 and 333D boxes have one 1/2-inch K.O. in ends, two 1/2-inch K.O. in sides, and one 1/2-inch K.O. in bottom.

335 and 336 boxes have one 3/4-inch K.O. in ends, two 3/4-inch K.O. in sides, one 1/2-inch K.O. in bottom.

No.	Dimen., Inches			Std. Pkg.	Wt., Lbs. Per 100	Per 100
	L.	W.	D.			
333	3	2	2 3/4	50	76	\$23.15
333D	3	2	3 1/2	50	98	35.75
335	3	2	2 3/4	50	77	23.15
336	3	2	3 1/2	50	91	35.75

With Mounting Bracket Less Lath Support

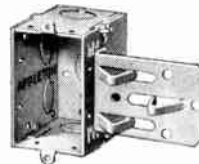

These boxes have one 1/2-inch knockout in ends, two 1/2-inch knockouts in sides, and one 1/2-inch knockout in bottom.

No.	Dimen., Inches			Std. Pkg.	Wt., Lbs. Per 100	Per 100
	L.	W.	D.			
111NL	3	2	2	50	72	\$22.50
222NL	3	2	2 1/2	50	82	24.15
333NL	3	2	2 3/4	50	88	25.40

"VB" Bracket Switch Boxes



All 1/2-inch knockouts are for 1/2-inch rigid conduit. One 1/2-inch in ends, two 1/2-inch in sides and one 1/2-inch in bottom.

No clamps furnished with these boxes. No lath support.

No.	Dimen., Inches			Std. Pkg.	Wt., Lbs. Per 100	Per 100
	L.	W.	D.			
111VB	3	2	2	50	78	\$22.50
222VB	3	2	2 1/2	50	82	24.15
333VB	3	2	2 3/4	50	86	25.40



Solid Switch Box With Mounting Bracket

Knockouts for 1/2-inch conduit, one in ends, three in side opposite bracket, and three in bottom.

No clamps furnished with these boxes.

No.	Dimen., Inches			Std. Pkg.	Wt., Lbs. Per 100	Per 100
	L.	W.	D.			
4SSLX	4	2 1/8	2 1/8	50	86	\$25.60

Quantity prices on request.

**Appleton Bracket Switch Boxes—
No Lath Support**

Schedule SB

Non-Changeable

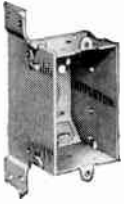

Two 2¹/₂-in. knockouts in each end. One 1/2-in. knockout in bottom for 1/2-in. conduit.

No.	Length	Dimen. In. Width	Depth	Type of Clamp	Per 100
33PC*	3	2	2 ¹ / ₄	None	\$18.30



Two 2¹/₂-in. knockouts in each end. One 1/2-in. knockout in bottom for 1/2-in. conduit.

No.	Length	Dimen. In. Width	Depth	Type of Clamp	Std. Pkg.	Wt. Lbs. Per 100	Per 100
44PC*	3	2	2 ¹ / ₄	CL-17	50	70	\$22.20



Two 2¹/₂-in. knockouts in each end. One 1/2-in. knockout in bottom for 1/2-in. conduit.

No.	Length	Dimen. In. Width	Depth	Type of Clamp	Per 100
388PC*	3	2	2 ¹ / ₄	CL-17	\$22.20

*Available with two 10-32 tapped grounding screw holes in bottom. When required add suffix "GR" to the catalog number.

Appleton Door Switch Boxes

7010. For Perkins Door Switches.



One 5/8-inch knockout in one end and bottom for flexible Non-Metallic Sheathed Cable 1917 N.E.C. Code and one knockout in opposite end for 1/2-inch rigid conduit. Screw centers 3 3/4 inches.



7011. Same as above only has 3/32-inch knockout for flexible Steel Conduit and is furnished with clamp.

No.	Std. Pkg.	Wt. Lbs. Per 100	Per 100
7010	25	68	\$75.60
7011	25	76	87.60

Quantity prices on request.

Appleton Switch Box Supports

"Loxbox"



For mounting switch boxes in beaverboard, sheetrock and other types of "dry wall" installations.

Easily snapped into position. Pre-determined tension prevents slipping or sliding during installation.

No.	Std. Pkg.	Wt. Lbs. Per 100	Per 100
892	500	2	\$6.30

Appleton Switch Box Supports

Original "Kruise" Switch Box Supports

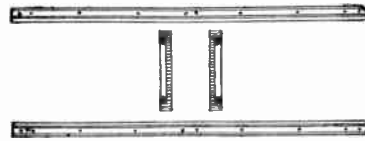

For any standard switch work. For new work.

No.	Description	Std. Pkg.	Wt. Lbs. Per 100	Per 100
897	Two 16 1/2-inch Strips and Lath Support	500 Sets	40	\$21.40
897LLS	Two 16 1/2-inch Strips. No Lath Supports	500 Sets	35	21.30
898	Two 18 1/2-inch Strips and Lath Support	500 Sets	50	22.20
898LLS	Two 18 1/2-inch Strips. No Lath Supports	500 Sets	45	22.10

Appleton E-Z-In Switch Box Supports

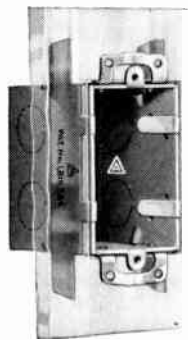

For mounting switch boxes to beaverboard, sheetrock, metal laths, etc. or old house wiring using lath and plaster. Will take standard switch boxes of any number of gangs.

Cut opening in wall just large enough for switch box, insert E-Z-In Switch Box Support, one on each side of opening for switch box and bend over the two projections against the wall on the outside which serve to fasten the Switch Box Support temporarily until the box is inserted.

Insert Box in wall in the usual manner, press ears of box firmly against the wall, then while still pressing against box, bend the projections of the Switch Box Supports down over the sides into the box, securely anchoring the box in the wall constructed of any material. It is unnecessary to countersink the ears of the box and no screws are required. The switch or receptacle plate will lie flat on the surface of walls.

No.	Std. Pkg.	Wt. Lbs. Per 1000	Per 100
896	1000	43 1/2	\$4.02

Quantity prices on request.

Steel City Sectional Switch Boxes

Made of 14-Gauge Steel—Galvanized Finish

For Non-Metallic Flexible Tubing or Non-Metallic Sheathed Cable

For all standard flush switches and receptacles. Removable sides; no obstructing partitions between the sections. Nail holes each side.

Switch Boxes Using C-1 and C-13 Clamps



C-1 Clamp
With Clamp Screws Through Beveled Corners



C-13 Clamp
With Clamp Screws Through Bottom of Box

Switch boxes with C-1 and C-13 clamps will take Types T and R non-metallic sheathed cable, sizes 14-2, 14-3, 12-2 and 12-3.



No. LC

No.	Clamps	L	Size, Inches W. D.	Std. Pkg.	Wt., Lbs. Per 100	*Std. Pkg. Per 100
LC	C-1	3	2 2 1/4	50	61	\$24.40
LO	No	3	2 2 1/4	50	56	21.00
LCN	C-13	3	2 2 1/4	50	61	24.40

Two 3/4-inch pri-outs each beveled end. 1/2-inch knockout in bottom.

Nail holes in each side permits mounting with two 10-penny nails.

Leveling bumps on sides.



No. LCV

No.	Clamps	L	Size, Inches W. D.	Std. Pkg.	Wt., Lbs. Per 100	*Std. Pkg. Per 100
LCV	C-1	3	2 2 1/4	50	60	\$25.45
LOV	No	3	2 2 1/4	50	59	22.05

"V" Type Bracket.

Two 3/4-inch pri-outs in each beveled end. One 1/2-inch knockout in bottom. Clamp screws through beveled corners.

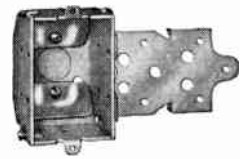

No. 802SN

No.	Clamps	L	Size, Inches W. D.	Std. Pkg.	Wt., Lbs. Per 100	*Std. Pkg. Per 100
800-S	No	3	2 2 1/4	50	67	\$19.95
802-S	C-1	3	2 2 1/4	50	71	25.45
802-SN	C-13	3	2 2 1/4	50	76	25.45

With Mounting Bracket Without Lath Supports

Two 3/4-inch pri-outs in each beveled end. One 1/2-inch knockout in bottom. With "S" type bracket.



No. LCLE

No.	Clamps	L	Size, Inches W. D.	Std. Pkg.	Wt., Lbs. Per 100	*Std. Pkg. Per 100
LCLE	C-1	3	2 2 1/4	50	55	\$21.20
LOLE	No	3	2 2 1/4	50	51	16.95

Two 3/4-inch pri-outs in each beveled end, one knockout in bottom. C-1 clamps screws through beveled corners. No mounting ears. Nail holes each side. Bumps for leveling.

*Prices slightly higher in Western and Southeastern States. Quantity prices on request.



No. LCNV

No.	Clamps	L	Size, Inches W. D.	Std. Pkg.	Wt., Lbs. Per 100	*Std. Pkg. Per 100
LCNV	C-13	3	2 2 1/4	50	68	\$25.45

"V" Type bracket.

Two 3/4-inch pri-outs in each beveled end. One 1/2-inch knockout in bottom. C-13 clamps screws through bottom of box.

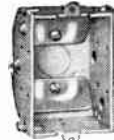

No. LCNLE

No.	Clamps	L	Size, Inches W. D.	Std. Pkg.	Wt., Lbs. Per 100	*Std. Pkg. Per 100
LCNLE	C-13	3	2 2 1/4	50	57	\$21.20

Two 3/4-inch pri-outs in each beveled end. One 1/2-inch knockout in bottom. Clamp screws through bottom of box. No mounting ears. Nail holes each side. Bumps for leveling.



No. C-5 Clamp
With Clamp Screws Through Bottom of Box.

Switch Boxes Using C-5 Clamp

This clamp will take 14-2, 14-3, 12-2 and 12-3 Type T and Type R non-metallic sheathed cable.



No. LXMW

No.	Clamps	L	Size, Inches W. D.	Std. Pkg.	Wt., Lbs. Per 100	*Std. Pkg. Per 100
LXW	C-5	3	2 2 1/2	50	68	\$25.50
LXMW	C-5	3	2 2	50	59	25.15

Two 3/4-inch pri-outs in each end and each side. One 1/2-inch knockout in bottom. Nail holes each side. LXMW has two screw mounting ears.



No. SWB

No.	Clamps	L	Size, Inches W. D.	Std. Pkg.	Wt., Lbs. Per 100	*Std. Pkg. Per 100
SWB**	C-5	3	2 1 1/2	50	50	\$23.60
SSB**	No	3	2 1	100	35	20.10

No. SWB has two 3/4-inch pri-outs in each end.

No. SSB has two 3/4-inch pri-outs in each side.



No. LXWV

No.	Clamps	L	Size, Inches W. D.	Std. Pkg.	Wt., Lbs. Per 100	*Std. Pkg. Per 100
LXWV	C-5	3	2 2 1/2	50	73	\$26.60
LXMWV	C-5	3	2 2	50	63	26.30

"V" Type bracket, no mounting ears.

Two 3/4-inch pri-outs in each end and each side. One 1/2-inch knockout in bottom.

*Prices slightly higher in Western and Southeastern States. Quantity prices on request.

Steel City Sectional Switch Boxes

Made of 14-Gauge Steel, Galvanized Finish

For Non-Metallic Flexible Tubing or Non-Metallic Sheathed Cable

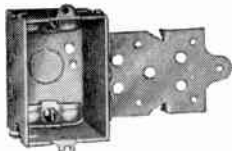

Two $\frac{3}{4}$ -inch pri-outs in each end and one side. One $\frac{1}{2}$ -inch knockout in bottom. "S" type bracket.

No. 806-SW

No.	Clamps	L	Size, Inches W. D.	Std. Pkg.	Wt., Lbs. Per 100	*Std. Pkg. Per 100
806-SW	C-5	3	2 2 1/2	50	80	\$26.60
807-SW	C-5	3	2 2 2	50	71	26.30



Two $\frac{3}{4}$ -inch pri-outs in each end and each side. One $\frac{1}{2}$ -inch knockout in bottom. No mounting ears. Nail holes each side.

No. LXWLE

No.	Clamps	L	Size, Inches W. D.	Std. Pkg.	Wt., Lbs. Per 100	*Std. Pkg. Per 100
LXWLE	C-5	3	2 2 1/2	50	66	\$22.20
LXMWLE	C-5	3	2 2 2	50	56	21.55

For Flexible Metallic Conduit and Armored Cable



Clamps For Switch Boxes

Switch boxes with C-3 clamps will take Type R Armored cable.

No. C-3



Pri-outs are $2\frac{1}{2}$ -inch, knockouts are for $\frac{1}{2}$ -inch conduit.

Two pri-outs in each end and side. Knockout in bottom. C-3 clamps. Nail holes in each side.

No. LX

No.	Clamps	L	Size, Inches W. D.	Wiring Cu. In. Cap.	Std. Pkg.	Wt., Lbs. Per 100	*Std. Pkg. Per 100
LX	C-3	3	2 2 1/2	12.8	50	69	\$25.50
LXM	C-3	3	2 2 2	12.0	50	60	25.15

Units only or boxes without sides can be furnished, less than prices of corresponding box.



"V" Type Bracket.

For use where wall veneer or other boards are used. An easy means for solidly mounting the switch box to a 2 x 4.

No. LXV

No.	Clamps	L	Size, Inches W. D.	Std. Pkg.	Wt., Lbs. Per 100	*Std. Pkg. Per 100
LXV	C-3	3	2 2 1/2	50	74	\$26.60
LXMV	C-3	3	2 2 2	50	66	26.30

*Prices slightly higher in Western and Southeastern States. Quantity prices on request.

For Flexible Metallic Conduit and Armored Cable

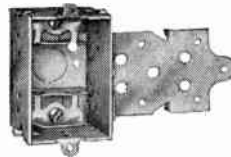

With Mounting Bracket.

Two $\frac{3}{4}$ -inch pri-outs in each end and one side. One $\frac{1}{2}$ -inch knockout in bottom. C-3 clamps.

No. 806-S

No.	Clamps	L	Size, Inches W. D.	Std. Pkg.	Wt., Lbs. Per 100	*Std. Pkg. Per 100
806-S	C-3	3	2 2 1/2	50	81	\$26.60
807-S	C-3	3	2 2 2	50	72	26.30



Two $\frac{3}{4}$ -inch pri-outs in each end, and each side. One $\frac{1}{2}$ -inch conduit knockout in bottom. No mounting ears. Nail holes in each side. C-3 clamps.

No. LXLE

No.	Clamps	L	Size, Inches W. D.	Std. Pkg.	Wt., Lbs. Per 100	*Std. Pkg. Per 100
LXLE	C-3	3	2 2 1/2	50	67 1/2	\$22.20
LXMLE	C-3	3	2 2 2	50	55	21.55

For Rigid Metallic Conduit

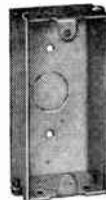

One $\frac{1}{2}$ -inch conduit knockout in each end and bottom.

No. CB

No.	Clamps	L	Size, Inches W. D.	Std. Pkg.	Wt., Lbs. Per 100	*Std. Pkg. Per 100
CB	No	4	2 1 1/2	50	49	\$23.50

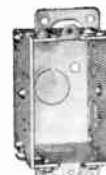

Two $\frac{1}{2}$ -inch knockouts in each side, 1 each end, 2 in bottom.

Knockouts for $\frac{3}{4}$ -inch can be furnished if desired, at extra cost.

No. CL

No.	Clamps	L	Size, Inches W. D.	Std. Pkg.	Wt., Lbs. Per 100	*Std. Pkg. Per 100
CL	No	3	2 2	50	52	\$21.45
CD	No	3	2 2 1/2	50	62	22.30
+CW	No	3	2 2 3/4	50	67	24.25
†CY	No	3	2 3 1/2	50	80	37.45



"V" Type Bracket.

One $\frac{1}{2}$ -inch knockout in each end, two in one side, two in bottom.

No. CLV

No.	Clamps	L	Size, Inches W. D.	Std. Pkg.	Wt., Lbs. Per 100	*Std. Pkg. Per 100
CLV	No	3	2 2	50	57	\$22.50
CDV	No	3	2 2 1/2	50	66	23.45
†CWV	No	3	2 2 3/4	50	69	25.40

*Prices slightly higher in Western and Southeastern States. †One knockout in bottom.

Quantity prices on request.

National Electric "Redege" Device Boxes

No Clamp Sectional Switch Boxes

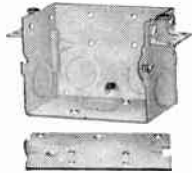

For 1/2-in. rigid conduit, armored cable with standard connectors.

Have thru nail holes for anchorage. Two bottom holes for fixture stud and nailing.

1/2-in. knockout on each end and bottom; two 1/2-in. knockouts in bottom.

Packed 50 in standard package.

No. 13

2-In. Deep—2-In. Wide—3-In. Long

No.	Type	Sides	Wt. Lbs. Per 100	Std. Pkg. Per 100
8	Ears	Stay Aligners	60	\$21.45
8NE	No Ears	Stay Aligners	56	17.80
8S	Ears	Straight Sides	60	21.45
8NES	No Ears	Straight Sides	56	17.80
8B	Bracket	Straight Sides	74	22.50
8SS	Strap Brac.	Straight Sides	70	22.50

2 1/2-In. Deep—2-In. Wide—3-In. Long

13	Ears	Stay Aligners	72	22.30
13NE	No Ears	Stay Aligners	68	18.65
13S	Ears	Straight Sides	72	22.30
13NES	No Ears	Straight Sides	68	18.65
13B	Bracket	Straight Sides	86	23.45
13SS	Strap Brac.	Straight Sides	82	23.45

2 3/4-In. Deep—2-In. Wide—3-In. Long

14	Ears	Stay Aligners	74	24.25
14NE	No Ears	Stay Aligners	70	20.60
14S	Ears	Straight Sides	74	24.25
14NES	No Ears	Straight Sides	70	20.60
14B	Bracket	Straight Sides	88	25.40
14SS	Strap Brac.	Straight Sides	84	25.40

Sectional Switch Boxes—Bevelled Corners

One 1/2-in. k.o. in bottom of box and two 3/32-in. cable pri-out in each beveled corner. One screw, adjustable ears.

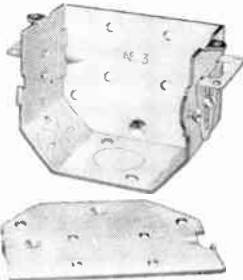

No. 3

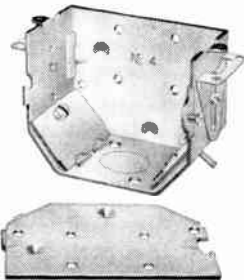

No. 4

No. 3 Series: For conduit, non-metallic sheathed cable and non-metallic flexible tubing when using connectors. Nail holes provided; two holes in bottom for fixture stud and nailing. Galvanized steel. Standard package 50.

No. 4 Series: For non-metallic sheathed cable and non-metallic tubing. Two holes in bottom for fixture stud and nailing. Galvanized steel. Standard package 50.

2 In. Wide, 2 1/4-In. Deep and 3-In. Long Without Clamps

No.	Type	Sides	Wt. Lbs. Per 100	Std. Pkg. Per 100
3	Adjustable Ears	Stay Aligners	58	\$21.00
3NE	No Ears	Stay Aligners	51	16.95
3S	Adjustable Ears	Straight Side	58	21.00
3NES	No Ears	Straight Side	51	16.95
3B	Bracket	Straight Side	72	22.05
3SS	Strap Brac.	Straight Side	68	22.05

With Two Loomwire Clamps

4	Adjustable Ears	Stay Aligners	62	24.40
4NE	No Ears	Stay Aligners	58	21.20
4S	Adjustable Ears	Straight Side	62	24.40
4NES	No Ears	Straight Side	58	21.20
4B	Bracket	Straight Side	76	25.45
4SS	Strap Brac.	Straight Side	68	25.45

*Eastern Zone Price: Prices Higher in Western and Southern Zones.

Sectional Switch Boxes—Square Corners



No. 6



No. 7

No. 6 and No. 11 series: For Non-Metallic sheathed cable and non-metallic flexible tubing.

No. 7 and No. 12 series: For Armored cable and flexible steel conduit. Take armored cable sizes 14/2, 14/3, 12/2 and 12/3. 3/8-in. flexible conduit.

All have 2 clamps for either loomwire or armored cable, depending on the type, thru nail holes, two holes in bottom for fixture stud and nailing. Made of 14 gauge electro-galvanized steel.

Have 1/2-in. KO in bottom of box, and two, 2 1/2-in. cable Pri-Outs in each end and each side.

Packed 50 in a standard package.

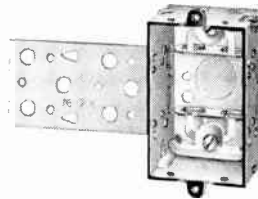

No. 12-B

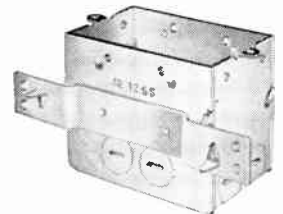

No. 12-SS

2-In. Deep—2-In. Wide—3-In. Long

No.	Type	Sides	Wt. Lbs. Per 100	Std. Pkg. Per 100
6	Ears	Stay Aligners	64	\$25.15
6NE	No Ears	Stay Aligners	60	21.55
6S	Ears	Straight Sides	64	25.15
6NES	No Ears	Straight Sides	60	21.55
6B	Bracket	Straight Sides	78	26.30
6SS	Strap Brac.	Straight Sides	74	26.30

2 1/2-In. Deep—2-In. Wide—3-In. Long

11	Ears	Stay Aligners	74	\$25.50
11NE	No Ears	Stay Aligners	70	22.20
11S	Ears	Straight Sides	74	25.50
11NES	No Ears	Straight Sides	70	22.20
11B	Bracket	Straight Sides	88	26.60
11SS	Strap Brac.	Straight Sides	84	26.60

2-In. Deep—2-In. Wide—3-In. Long

7	Ears	Stay Aligners	64	\$25.15
7NE	No Ears	Stay Aligners	60	21.55
7S	Ears	Straight Sides	64	25.15
7NES	No Ears	Straight Sides	60	21.55
7B	Bracket	Straight Sides	78	26.30
7SS	Strap Brac.	Straight Sides	74	26.30

2 1/2-In. Deep—2-In. Wide—3-In. Long

12	Ears	Stay Aligners	74	\$25.50
12NE	No Ears	Stay Aligners	70	22.20
12S	Ears	Straight Sides	74	25.50
12NES	No Ears	Straight Sides	70	22.20
12B	Bracket	Straight Sides	88	26.60
12SS	Strap Brac.	Straight Sides	84	26.60

No. 5 Switch Box

Solid switch box, non-hanging, with ears.

Has nail holes, two 2 1/2-in. end bottom Pri-Outs in each end and two C5 loomwire clamps.

1 1/2-in. Deep—2-in. Wide—3-in. Long.

Standard package—50.

Wt. Per 100—50 Lbs.

No. 5 Std. Pkg. per 100 \$23.60

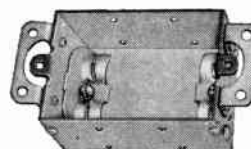

*Eastern Zone Price: Prices Higher in Western and Southern Zones.

Steel City Sectional Switch Boxes
Made of 14-Gauge Steel—Galvanized Finish

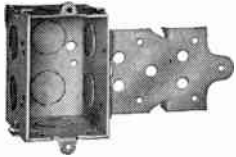

With Mounting Bracket.
 For Rigid Metallic Conduit.
 All knockouts are for 1/2-inch conduit.
 Two knockouts in side, one each end, two in bottom.

No. 804-S		Size, Inches			Std. Pkg.	Wt. Lbs. Per 100	*Std. Pkg. Per 100
No.	Clamps	L.	W.	D.			
805-S	No	3	2	2	50	64	\$22.50
804-S	No	3	2	2 1/2	50	74	23.45
*803-S	No	3	2	2 3/4	50	80	25.40

*One knockout in bottom.

Steel City Door Switches



For new or old work. Consists of galvanized steel box, cover, striking plate, switch and necessary screws.

Type DS-25 and DS-30 for new work.

Type DS-25-V and DS-30-V are furnished with metal plate, 4-inches long, 1 1/2 inches wide, for old work. Switch, with wire leads: 6 amp., 125 volts; 3 amps., 250 volts.

Light On When Door Is Open

No.	Description	O.D. Inches	Std. Pkg.	Wt. Lbs. Per 100	*Std. Pkg. Per 100
DS-25	New Work	1 1/2 x 1 3/8 x 2 11/16	10	55	\$205.35
DS-25-V	Old Work	1 1/2 x 1 3/8 x 2 11/16	10	70	223.05

Light On When Door Is Closed

DS-30	New Work	1 1/2 x 1 3/8 x 2 11/16	10	55	205.35
DS-30-V	Old Work	1 1/2 x 1 3/8 x 2 11/16	10	70	223.05

Knockouts: For 1/2-inch conduit, 1 in one end, and 1 in bottom. *Prices higher in Western and Southeastern States.

Union Fixed Ear Shallow Boxes
For Trailers and Pre-Fabs



No. 7030

No. 7060

These boxes are 1/4-in. wider than standard for extra wiring space, but can easily be covered by a standard plate.

1 3/4-in. high, 2 1/4-in. wide, length box 3 1/16-in., 4 1/8-in. overall. Two 9/16-in. dia. k.o.'s in each end.

No.	Clamps	Std. Pkg.	Std. Pkg. Wt. Lbs.	Eastern Price Per 100
7030	Two	100	22	\$18.00
7060	None	100	15	10.65

Steel City Wall Boxes
Solid Flush Type



No. GW-235

For Tile or Marble Walls. These boxes have no ears and are square cornered. This simplifies installation in tile or marble.

Standard 1 1/16-inch device spacing.

Knockouts are 3/4-inch.

Two on each end for each gang, i.e., four gang box has eight K.O.'s in each end.

No.	Description	L.	Size, Inches W.	D.	*Per 100
GW-135	Single Gang	3 11/16	2 1/4	3 1/2	\$80.00
GW-235	Two Gang	3 11/16	3 3/16	3 1/2	125.00
GW-335	Three Gang	3 11/16	5 5/8	3 1/2	155.00
GW-435	Four Gang	3 11/16	7 1/16	3 1/2	180.00

Union's Insulated New Work Boxes

Schedule C

Switch Boxes

Sharpened tips on bracket permit temporary positioning before nailing. 2 1/8 in. high; 2 in. wide; 3 5/16 in. long. Two 2 1/2-in. dia. concentric k.o.'s in ends. Supplied with plaster seals.

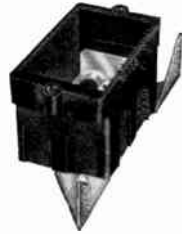

No. 7050-2

*No clamps.

No.	Std. Pkg.	Std. Pkg. Wt. Lbs.	Eastern Price Per 100
7050-2	100	31	\$16.60
*7050-202	100	26	14.15
Same as Above 2 5/8-in. High			
7070-2	100	34	\$18.70
*7070-202	100	31	16.25

2 gang, 2 1/8 in. high; 4 in. wide; 3 5/16 in. long. 4 21/32 in. dia. concentric k.o.'s in ends. Supplied with plaster seals.

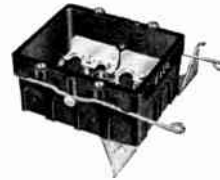

No. 7052-2

Available in 3 and 4 gang construction.

*No clamps.

No.	Std. Pkg.	Std. Pkg. Wt. Lbs.	Eastern Price Per 100
7052-2	50	26	\$40.00
*7052-202	50	22	35.00
Same as Above 2 5/8-in. High			
7072-2	50	27	\$44.00
*7072-202	50	23	39.00

Outlet Boxes

Much more easily and economically installed than bar hanger assemblies.

4-in. diameter, 1 1/2 in. deep. Two 2 1/2-in. dia. concentric k.o.'s in each side.



No. 4060-3

*No clamps.

Note: Prices slightly higher in Central and Western zones.

No.	Std. Pkg.	Std. Pkg. Wt. Lbs.	Eastern Price Per 100
4060-3	100	48	\$28.75
*4060-302	100	44	26.25

Union Old Work Snap-In Bracket Outlet and Switch Boxes

Convenient snap-in bracket sharply cuts installation time. Ears permanently fixed for perfect depth alignment. Plates fit snugly every time. No awkward metal strips needed.



No. 3080-9

3 1/2-in. Dia., 2-in. Deep. Two 2 1/2-in. dia. concentric k.o.'s on each side. Two clamps.

No.	Std. Pkg.	Std. Pkg. Wt. Lbs.	Eastern Price Per 100
3080-9	50	23	\$30.00



No. 7020-8

2 1/4-in. high, 2 1/8-in. wide, 3 3/4-in. long.

Two 2 1/2-in. dia. concentric k.o.'s in each end. Two clamps.

No.	Std. Pkg.	Std. Pkg. Wt. Lbs.	Eastern Price Per 100
7020-8	50	19	\$22.00

Prices slightly higher in Central and Western zones.

Union Insulated Surface Wiring Boxes and Covers

Schedule C

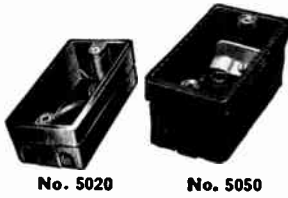

Boxes molded of general purpose phenolic compound. Working parts protected from dust and moisture by two insulating housings.

For use with No. 12 and No. 14 non-metallic sheathed cable.

No.	Description	Clamps	Std. Pkg.	Std. Pkg. Wt. Lbs.	Eastern Prices Per 100
5020	Box, Shallow, brown, 1 3/8-in. deep.....	None	100	16	\$13.80
5050	Box, black, 2-in. deep..	Two	50	12	19.95
5050-02	Box, black 2-in. deep..	None	50	10	17.45

Handy Box Covers—Brown Fit Steel or Insulated Boxes



No.	Description	Std. Pkg.	Std. Pkg. Wt. Lbs.	Eastern Prices Per 100
5051	Blank or knockout.....	100	6	\$11.00
5051-1	Knockout with strap....	100	11	19.25
5052	Blank or pendent.....	100	8	9.40
5053	Duplex receptacle.....	100	5	9.40
5054	Single plug receptacle..	100	6	11.45
5055	Toggle switch.....	100	6	9.40
5059	Keyless lampholder.....	50	8	25.00
5071-1	Pull chain lampholder..	50	10	45.50

Note: Prices slightly higher in Central and Western zones.

Union 4-Inch Square Boxes and Covers

Schedule C



Built-in clamps save time and eliminate connectors.

No.	Depth In.	Clamps	Std. Pkg.	Std. Pkg. Wt. Lbs.	Eastern Price Per 100
4040-64	1 1/2	Four	50	28	\$36.25
4040-602	1 1/2	None	50	24	31.25

Covers For 4-Inch Square Boxes

Description	Std. Pkg.	Std. Pkg. Wt. Lbs.	Eastern Price Per 100
4041 Flat Blank.....	50	6	\$ 7.50
4042-12 1/2-in. deep.....	50	5	10.65

Plaster Ring With Ears For 3 1/4-In. Receptacle

4043 1/2-in. deep.....	50	5	10.65
------------------------	----	---	-------

Prices slightly higher in Central and Western zones.

Union Insulated Outlet Box Covers

Schedule C



Will fit all standard insulated and steel boxes.

No.	Description	Std. Pkg.	Std. Pkg. Wt. Lbs.	Eastern Prices Per 100
4051	3 1/4-4-in. blank or pendent provided with 25/64-in. dia. k.o....	100	10	\$11.65
4061	4-in. plaster ring 5/8-in. deep offset 1/2-in. with plaster seal. Takes standard fixture or lampholder.....	100	7	8.90

Prices slightly higher in Central and Western zones.

T&B Cast Iron Junction Boxes and Covers

Flanged and Unflanged Types

Approved by Underwriters' Laboratories

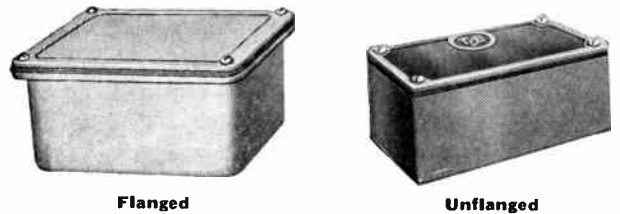

Heavy walled boxes designed to meet the most rigid requirements of subway, industrial, marine, underground work, etc. Watertight and weather-proof when gasketed.

Thinner walled boxes may be furnished, if desired, at less cost.

Standard finish, black enamel. Hot dip galvanized finish can be furnished. Drilling and tapping extra—to order.

Flanged Type

No.	Width	Size, Inches Length	Depth	Wt., Lbs. Complete	Gasket Each	Box Only Each	Box and Cover Each
10897	6	6	3	10	\$1.92	\$10.40	\$15.60
10898	6	6	4	10	1.92	12.40	17.60
10915	6	6	6	16	1.92	16.80	22.00
10900	6	8	3	13	2.24	16.00	21.60
10902	6	8	4	15	2.24	16.80	22.40
10916	6	8	6	18	2.24	24.00	29.60
10906	6	12	3	16	3.20	24.00	30.40
10908	6	12	4	19	3.20	24.80	31.20
10910	6	12	6	40	3.20	41.60	48.00
10904	8	8	6	22	2.88	24.80	32.00
10764	8	12	6	39	3.68	44.80	57.60
10911	12	12	6	56	3.68	60.00	76.00
10771	12	18	12	104	8.00	182.40	208.00
10785	12	24	12	139	9.60	206.40	238.40

Unflanged Type

10861	4	4	2	3.5	\$.72	\$3.52	\$5.04
10862	4	4	3	5	.72	4.96	6.48
10703	4	6	4	7	.96	9.28	11.04
10962	6	6	3	9	1.52	8.72	12.08
10868	6	6	4	9	1.52	10.48	13.84
10964	6	6	6	12.5	1.52	19.04	22.40
10871	6	8	3	10.5	1.92	10.40	14.40
10872	6	8	4	12.5	1.92	12.80	16.80
10874	6	8	6	15	1.92	19.20	23.20
10880	6	12	3	19	3.20	17.60	25.60
10968	6	12	4	13	3.20	19.20	27.20
10882	6	12	6	23.5	3.20	23.20	31.20
10718	8	12	6	34	3.68	35.68	42.08
10969	12	12	6	41	4.96	52.64	65.44

T&B Cast Iron Junction Boxes and Covers
Flanged and Unflanged Types

Approved by Underwriters' Laboratories

Weatherproof

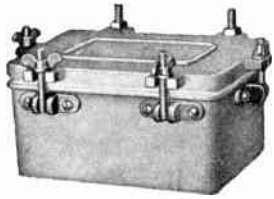

Built for rugged service. Hinged covers, supplied with thumb nuts on three sides. Provides watertight weather-proof job when tightened. Furnished with gaskets as standard equipment.

No.	Width	Size, Inches Length	Depth	Wgt., Lbs. Each	Each
10503	6	8	4	15	\$42.40
10511	8	8	6	24	58.40
10538	8	12	6	34	80.00
10539	12	12	6	57	104.00
10535	12	16	8	80	147.20
10547	18	18	8	17	200.00

Appleton Pull Boxes

Threaded—With Blank Covers

Schedule PB

For Pulling a Number of Heavy Wires and Cables
Cadmium Finish

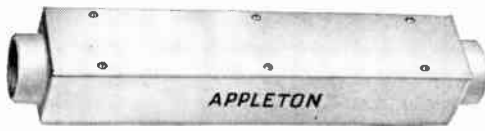

Type PTC

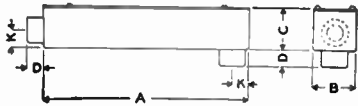

Type PTB

Bodies are made from sheet steel; hubs are malleable iron and brazed into body.

Dimensions in Inches

Hub Size In.	A As Selected According to Catalog No.	B	C	D	K
1	12 to 36 incl.	2 ³ / ₁₆	2 ¹ / ₈	2 ⁷ / ₃₂	1 ⁵ / ₁₆
1 ¹ / ₄	12 to 36 incl.	2 ¹ / ₂	2 ⁷ / ₁₆	1 ¹ / ₁₆	1 ³ / ₃₂
1 ¹ / ₂	12 to 36 incl.	2 ¹ / ₂	2 ⁷ / ₁₆	1 ¹ / ₁₆	1 ³ / ₈
2	12 to 72 incl.	3 ¹¹ / ₃₂	3 ⁵ / ₁₆	1 ⁵ / ₁₆	1 ¹¹ / ₁₆
2 ¹ / ₂	12 to 72 incl.	4 ¹³ / ₁₆	4 ³ / ₄	1 ¹⁹ / ₃₂	1 ¹³ / ₁₆
3	12 to 72 incl.	4 ¹³ / ₁₆	4 ³ / ₄	1 ²¹ / ₃₂	2 ¹ / ₁₆
3 ¹ / ₂	12 to 72 incl.	6 ⁵ / ₁₆	6 ⁵ / ₁₆	1 ²³ / ₃₂	2 ³ / ₈
4	12 to 72 incl.	6 ⁵ / ₁₆	6 ⁵ / ₁₆	1 ²³ / ₃₂	2 ²¹ / ₃₂
5	12 to 72 incl.	7 ⁵ / ₁₆	7 ⁵ / ₁₆	2 ⁹ / ₃₂	3 ¹ / ₄
6	12 to 72 incl.	8 ⁵ / ₁₆	8 ⁵ / ₁₆	2 ⁹ / ₁₆	3 ¹³ / ₁₆

1-Inch Hub

Length Inches	Type PTC No.	Type PTB No.	Each
12	1200	1250	\$6.20
18	1210	1260	6.60
24	1220	1270	7.00
30	1230	1280	7.70
36	1240	1290	8.10

Appleton Pull Boxes

Schedule PB (cont.)

1¹/₄-Inch Hub

Length Inches	Type PTC No.	Type PTB No.	Each
12	1201	1251	\$ 6.70
18	1211	1261	7.20
24	1221	1271	8.10
30	1231	1281	9.25
36	1241	1291	10.30

1¹/₂-Inch Hub

Length Inches	Type PTC No.	Type PTB No.	Each
12	1202	1252	\$ 7.50
18	1212	1262	8.60
24	1222	1272	9.70
30	1232	1282	10.90
36	1242	1292	12.10

2-Inch Hub

Length Inches	Type PTC No.	Type PTB No.	Each
12	1203	1253	\$ 9.50
18	1213	1263	11.10
24	1223	1273	12.75
30	1233	1283	14.20
36	1243	1293	15.90
42	1800	1850	22.70
48	1810	1860	28.50
54	1820	1870	40.00
60	1830	1880	41.40
66	1840	1890	47.00
72	1550	1540	54.70

2¹/₂-Inch Hub

Length Inches	Type PTC No.	Type PTB No.	Each
12	1204	1254	\$13.90
18	1214	1264	15.75
24	1224	1274	17.90
30	1234	1284	20.80
36	1244	1294	23.00
42	1801	1851	32.00
48	1811	1861	37.65
54	1821	1871	44.65
60	1831	1881	51.50
66	1841	1891	56.20
72	1551	1541	65.30

3-Inch Hub

Length Inches	Type PTC No.	Type PTB No.	Each
12	1205	1255	\$14.90
18	1215	1265	18.30
24	1225	1275	21.75
30	1235	1285	24.10
36	1245	1295	27.60
42	1802	1852	35.45
48	1812	1862	40.00
54	1822	1872	49.40
60	1832	1882	55.30
66	1842	1892	61.00
72	1552	1542	72.50

3¹/₂-Inch Hub

Length Inches	Type PTC No.	Type PTB No.	Each
12	1206	1256	\$19.40
18	1216	1266	22.90
24	1226	1276	25.20
30	1236	1286	29.90
36	1246	1296	34.50
42	1803	1853	59.20
48	1813	1863	64.75
54	1823	1873	70.80
60	1833	1883	77.00
66	1843	1893	82.70
72	1553	1543	90.80

4-Inch Hub

Length Inches	Type PTC No.	Type PTB No.	Each
12	1207	1257	\$22.80
18	1217	1267	25.30
24	1227	1277	30.90
30	1237	1287	34.60
36	1247	1297	39.10
42	1804	1854	61.50
48	1814	1864	68.25
54	1824	1874	75.50
60	1834	1884	81.80
66	1844	1894	87.50
72	1554	1544	95.70

Hope Cast Iron Boxes
Underwriters' Laboratories Approved

Unflanged Junction Boxes Type H2200
Weatherproof Surface Mounting NEMA III, IV, V

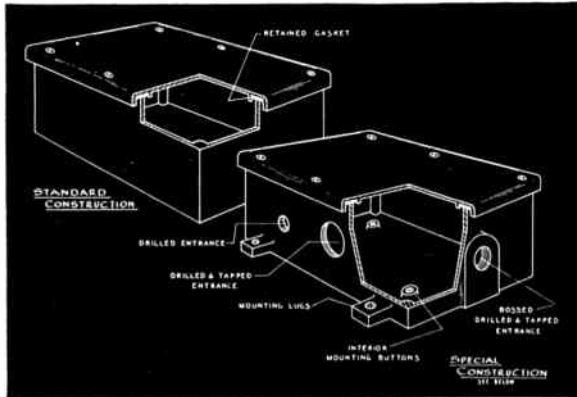

Standard Construction: Cast Iron Box and Cover; Hot Dip Galvanized finish; Rubber gasket; Brass Machine screws.

Special Construction: Drilling; Tapping; Bosses for five threads; Mounting lugs; Interior buttons; Special gaskets; Panels.

Type H2200 boxes are equipped with overlap cover and retained gasket. Specify bossed conduit entrances to ensure raintight and dust-tight engagement. Mounting lugs add to ease of installation. Interior mounting buttons, tapped blind to specified centers, required for installation of panels or apparatus.

No.	Length	Inside Dimen., In. Width	Depth	Approx. Wall Thick., In.	Each. Stand. Construction
I12201	4	4	3	3/16	\$ 5.20
I12203	5	5	3	3/16	7.80
I12206	6	4	4	1/4	9.40
I12208	6	6	4	1/4	12.10
I12212	8	4	4	1/4	10.70
I12214	8	6	4	1/4	13.50
I12216	8	6	6	9/32	22.00
I12218	8	8	4	1/4	19.00
I12220	8	8	6	9/32	26.90
I12224	10	6	4	1/4	20.00
I12229	10	8	4	1/4	25.90
I12231	10	8	6	9/32	32.40
I12236	10	10	6	9/32	35.30
I12239	12	6	6	1/4	30.50
I12241	12	8	6	1/4	40.20
I12249	12	12	6	9/32	48.80
I12250	12	12	8	5/16	55.10
I12254	14	8	4	1/4	33.60
I12255	14	8	6	9/32	40.30
I12258	14	14	6	1/4	75.20
I12259	14	14	8	5/16	81.40
I12260	14	14	10	3/8	114.40
I12270	16	12	6	1/4	71.60
I12271	16	12	8	9/32	77.30
I12272	16	16	6	1/4	99.80
I12279	18	12	6	9/32	77.00
I12280	18	12	8	5/16	96.70
I12282	18	12	12	3/8	158.80
I12289	18	18	8	11/32	129.00
I12291	18	18	12	7/16	200.20
I12305	24	12	6	9/32	98.70
I12307	24	12	12	3/8	163.60
I12312	24	18	8	5/16	180.50
I12314	24	18	12	3/8	218.60
I12317	24	24	8	9/32	228.40
I12319	24	24	12	1/2	324.30
I12320	30	8	6	1/4	96.70
I12323	30	18	12	7/16	328.50
I12326	30	24	12	7/16	379.30
I12327	30	24	17	9/16	606.00
I12328	36	12	8	3/8	266.50
I12330	36	18	8	5/16	300.30
I12332	36	24	12	7/16	514.60
I12334	36	36	12	9/16	676.00

Hinged Cover Junction Boxes Type H3200
Weatherproof Surface Mounting NEMA III, IV, V

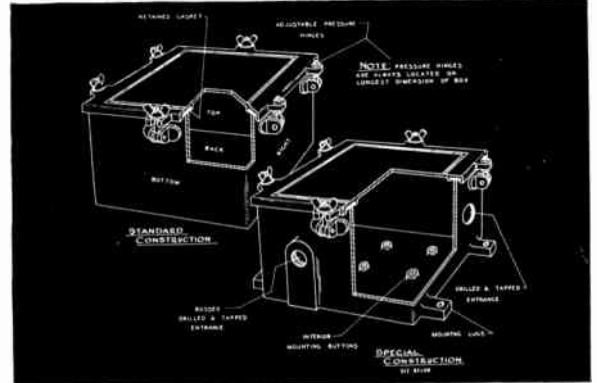

Standard Construction: Cast Iron Box and Cover; Hot Dip Galvanized finish; Retained rubber gasket; Brass with bronze hardware.

Special Construction: Drilling; Tapping; Bosses for five threads; Mounting lugs; Interior buttons; Special gaskets; Hasp.

Retained rubber gasket, adequate pressure hinges and brass wingnut provide thorough weathertight and dust-tight closure. Bossed and tapped conduit entrances recommended. Mounting lugs for ease of installation. Ideal for enclosing panels, transformers, relays and many diverse types of electrical equipment.

No.	Length	Inside Dimen., In. Width	Depth	Approx. Wall Thick., In.	Each. Stand. Construction
I13207	5	5	3	1/4	\$ 21.30
I13208	6	4	3	1/4	20.70
I13209	6	4	4	1/4	22.60
I13211	6	6	4	1/4	27.40
I13215	8	4	4	1/4	23.70
I13216	8	6	4	1/4	33.40
I13217	8	6	6	9/32	42.60
I13219	8	8	4	1/4	38.00
I13220	8	8	6	9/32	46.50
I13222	10	6	4	1/4	38.80
I13223	10	8	4	1/4	44.30
I13249	10	8	6	9/32	55.00
I13253	10	10	6	9/32	60.60
I13226	12	6	6	1/4	49.40
I13227	12	8	6	1/4	63.50
I13230	12	12	6	9/32	74.00
I13231	12	12	8	5/16	87.40
I13233	14	8	4	1/4	57.80
I13275	14	8	6	9/32	66.80
I13277	14	14	6	1/4	108.90
I13278	14	14	8	5/16	115.50
I13279	14	14	10	3/8	151.90
I13288	16	12	6	9/32	108.70
I13289	16	12	8	5/16	115.60
I13294	18	8	6	9/32	88.00
I13238	18	12	6	9/32	127.60
I13296	18	12	8	5/16	156.50
I13298	18	12	12	7/16	197.40
I13241	18	18	8	11/32	182.90
I13302	18	18	12	3/8	274.00
I13252	24	12	6	9/32	167.60
I13315	24	12	12	3/8	228.00
I13256	24	18	8	5/16	242.50
I13317	24	18	12	3/8	301.40
I13377	24	24	8	9/32	349.70
I13319	24	24	12	7/16	434.30
I13380	30	8	6	1/4	174.80
I13324	30	18	12	7/16	431.50
I13382	30	24	12	7/16	521.70
I13386	30	24	17	9/16	789.60
I13330	36	12	8	3/8	349.70
I13332	36	18	8	5/16	401.90
I13333	36	24	12	7/16	637.30
I13336	36	36	12	9/16	747.30

Hope Cast Iron Boxes
Underwriters' Laboratories Approved

Sidewalk Boxes Type H5800

Weatherproof Flush Mounting NEMA III, IV, V

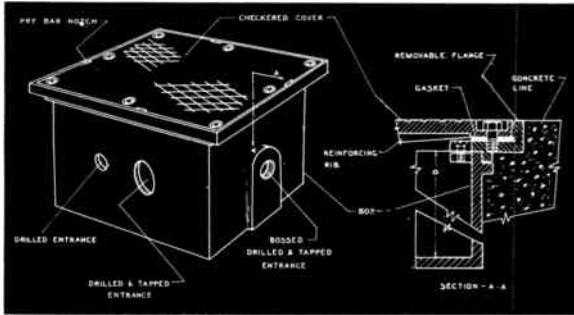

Standard Construction: Box, Flange and Cover of cast iron; Hot Dip Galvanized finish; Rubber gasket; Monel hardware.

Special Construction: Drillings; Tappings; Bosses for five threads; Special gaskets.

H5800 type boxes widely installed in sidewalks and walkways of bridges, dams, tunnels, approaches and airports. The checkered non-slip cover, flush with finished concrete, is cross-ribbed for heavy pedestrian traffic. Flanges and covers are replaceable without disturbing box and conduits when heavy vehicle damages installation. Monel cap screws, set down in counter-bore, assure weathertight closure.

No.	Length	Inside Dimen., In. Width	Depth	Approx. Wall Thick., In.	Each, Stand. Construction
115847	6	6	4	5/16	\$ 32.90
115848	8	6	4	5/16	37.10
115849	8	8	4	5/16	45.10
115850	8	8	6	5/16	51.60
115804	8	8	8	3/8	58.00
115805	12	8	5	3/16	62.90
115851	12	8	6	5/16	67.70
115806	12	12	4	3/16	88.70
115807	12	12	6	3/16	108.00
115808	12	12	8	3/8	130.00
115809	12	12	12	3/8	156.00
115810	12	12	8	3/8	249.60
115813	14	14	6	5/16	129.00
115814	14	14	8	5/16	145.00
115815	14	14	10	5/16	158.00
115816	18	6	6	3/8	101.00
115817	18	12	4	3/8	129.00
115818	18	12	6	3/8	137.00
115819	18	12	8	3/8	149.50
115820	18	12	10	3/8	161.20
115821	18	12	12	3/8	180.50
115854	18	12	18	3/8	297.50
115822	18	18	8	3/8	197.20
115823	18	18	12	3/8	219.50
115824	19	14	10	3/8	193.20
115857	24	10	10	3/8	205.00
115825	24	12	6	3/8	174.40
115826	24	12	8	3/8	192.50
115828	24	12	12	3/8	216.00
115829	24	12	14	3/8	264.40
115830	24	14	10	3/8	248.00
115831	24	14	14	3/8	282.00
115855	24	18	8	3/8	235.40
115832	24	18	12	3/8	295.00
115833	24	24	10	1/2	315.00
115856	24	24	30	1/2	736.00
115836	30	12	12	3/8	260.00
115838	30	14	12	3/8	280.00
115839	30	14	14	3/8	300.00
115840	30	14	22	9/16	498.00
115842	30	18	12	3/8	389.50
115843	36	12	14	3/8	413.10
115844	36	14	14	3/8	386.30
115845	36	24	12	5/16	566.80
115846	36	24	14	3/8	659.90

Floor and Sidewall Boxes Type H7000

Weatherproof Flush Mounting NEMA III, IV, V

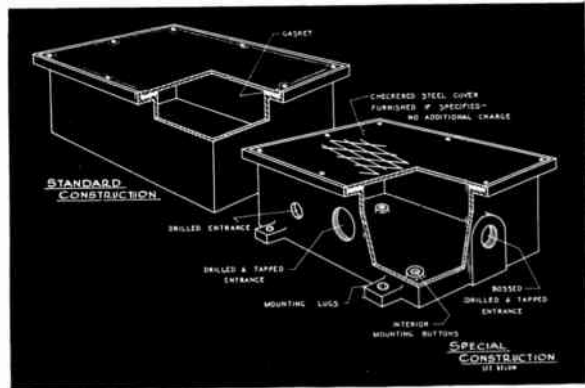

Standard Construction: Box and plain cover of cast iron; Hot Dip Galvanized finish; Rubber gasket; Galvanized checkered steel cover if specified on order.

Special Construction: Drillings; Tappings; Bosses for five threads; Mounting lugs; Special gaskets; Plain brass or checkered bronze covers.

Intended for flush mounting in side walls or parapets, or in concrete floors where light pedestrian traffic is encountered. For industrial floors, checkered galvanized steel covers should be specified to carry moderate hand-truck traffic. Non-adjustable.

No.	Length	Inside Dimen., In. Width	Depth	Approx. Wall Thick., In.	Each, Stand. Construction
117001	4	4	3	3/16	\$ 8.50
117002	4	4	4	3/16	9.20
117004	6	4	4	1/4	12.60
117005	6	6	3	1/4	14.90
117006	6	6	4	1/4	16.10
117007	6	6	6	1/4	21.00
117009	8	4	4	1/4	16.90
117011	8	6	4	1/4	21.50
117012	8	6	6	1/4	25.20
117013	8	8	4	1/4	28.10
117014	8	8	6	1/4	32.60
117015	8	8	8	1/4	52.50
117016	10	6	4	1/4	27.50
117017	10	6	6	1/4	32.90
117018	10	10	4	1/4	46.30
117019	10	10	6	1/4	50.30
117043	10	10	8	9/32	59.60
117021	12	6	4	1/4	32.60
117022	12	6	6	1/4	39.50
117023	12	8	4	1/4	38.40
117024	12	8	6	1/4	44.80
117025	12	8	8	1/4	56.10
117026	12	10	4	1/4	49.40
117027	12	10	6	1/4	56.00
117028	12	10	8	1/4	60.10
117057	12	10	10	9/32	67.00
117029	12	12	4	1/4	59.60
117030	12	12	6	9/32	66.00
117044	12	12	8	9/32	73.70
117045	12	12	10	9/32	88.80
117046	12	12	12	9/16	102.00
117047	16	12	4	9/32	69.00
117048	16	12	6	9/32	82.80
117049	16	12	8	9/32	99.20
117037	18	6	6	3/32	63.50
117039	18	12	6	3/32	105.80
117040	18	12	8	3/16	117.20
117050	18	12	10	3/16	126.00
117041	18	12	12	3/8	166.00
117042	18	18	8	3/16	213.30
117051	18	18	10	3/8	232.70
117052	18	18	12	3/8	280.60
117053	24	12	6	9/32	167.50
117054	24	12	8	5/16	192.60
117055	24	12	12	3/8	249.00

Hope Cast Iron Boxes

Explosion Resisting Housings Type H6000
Class I Group D Surface Mounting NEMA VII

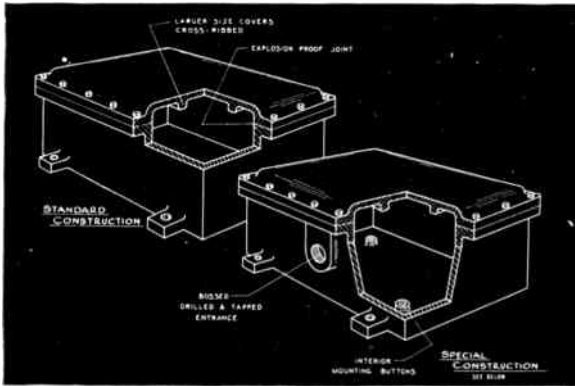

Standard Construction: Box and cover of cast iron; Hot Dip Galvanized finish; Retained rubber gasket; Mounting lugs each long side.

Special Construction: Five thread tapping; Bosses with five threads; Interior mounting buttons; Bronze hinges.

Manufactured to the standards of the Underwriters' Laboratories but not tested by that agency. Specifying engineers recognize the rugged construction with bolt-on type covers as wholly adequate for installation in Class I hazardous locations of explosive vapors in refineries, chemical and powder plants, paint, varnish and solvent manufacture.

No.	Length	Inside Dimen., In. Width	Depth	Min. Wall Thick., In.	Each, Stand. Construction
116003	5	5	3	1/16	\$ 38.30
116006	6	4	4	1/16	39.70
116008	6	6	4	1/16	51.00
116010	6	6	6	1/16	69.60
116012	8	4	4	1/16	47.50
116014	8	6	4	1/16	55.00
116015	8	6	6	1/16	65.00
116017	8	8	4	1/16	70.00
116018	8	8	6	1/16	80.00
116020	10	6	4	1/16	63.00
116022	10	8	4	1/16	80.00
116023	10	8	6	1/16	91.00
116026	10	10	6	1/16	106.00
116027	12	6	4	1/16	70.00
116028	12	6	6	1/16	83.00
116029	12	8	6	1/16	113.00
116032	12	12	6	1/16	130.00
116033	12	12	8	5/8	148.00
116034	12	12	12	1/16	175.00
116039	14	14	6	1/16	168.00
116040	14	14	8	1/16	193.00
116043	16	10	6	1/16	140.00
116044	16	12	6	1/16	165.00
116082	16	12	8	5/8	200.00
116046	18	6	6	1/16	119.00
116048	18	12	6	1/16	188.00
116049	18	12	8	1/16	213.00
116051	18	12	12	1/16	270.00
116053	18	18	6	1/16	275.00
116054	18	18	8	1/16	300.00
116064	24	12	8	1/16	270.00
116066	24	12	12	1/16	350.00
116071	24	18	8	1/16	345.00
116072	24	18	12	5/8	395.00
116074	24	24	8	1/16	415.00
116085	24	24	10	1/16	460.00
116089	30	12	6	1/16	300.00
116090	30	12	8	1/16	358.00
116092	30	18	8	1/2	525.00
116093	30	18	12	1/2	585.00
116094	30	24	8	1/2	624.00
116091	30	24	12	1/2	700.00
116075	36	24	8	1/2	846.00
116097	36	24	12	5/8	1000.00
116099	36	30	10	5/8	1100.00

Hope Cast Iron Boxes

Terminal Cabinets Type H3200-T
Weatherproof-Dust-tight Surface Mounting
NEMA III, IV, V

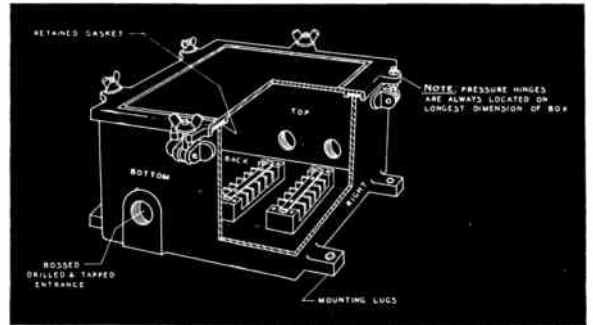

Standard Construction: Box and cover of cast iron; Hot Dip Galvanized finish; Retained rubber gasket; Mounting lugs; Brass with bronze hardware; Terminal blocks mounted on buttons.

Special Construction: Drilling; Tapping; Bosses for five threads; Special gaskets; Hasp.

Hinged terminal cabinets enclosing rugged terminal blocks in a variety of sizes to meet differing wiring conditions. The blocks, rated at 30 amps, 750 volts, are mounted on blind tapped buttons raised above back of box to provide air gap; each has white target strip for marking circuits. Ample wiring gutters. Ideal for thermocouple and telephone circuits; instrumentation.

No.	No. of Terminals	Inside Dimen., In. Length	Width	Depth	Each, Stand. Construction
113207-T2	2	5	5	3	\$ 39.00
113207-T4	4	5	5	3	42.50
113216-T6	6	8	6	4	54.00
113222-T8	8	10	6	4	60.00
113225-T12	12	12	6	4	65.00
113229-2T12	12	12	12	4	91.00
113229-2T16	16	12	12	4	97.00
113229-2T24	24	12	12	4	100.00
113237-T36	36	18	12	5	150.00
113237-T40	40	18	12	5	155.00
113313-T56	56	24	12	4 1/2	216.00
113378-T64	64	28	12	6	268.00
113374-T72	72	20	20	4	276.00
113320-T96	96	27	21	4 1/2	400.00
113329-T120	120	34	30	5 3/4	612.00
113329-T144	144	34	30	5 3/4	632.00
113329-T180	180	34	30	5 3/4	662.00

Underwriters' Laboratories approved.
 Specially designed or sized boxes available on request.

Call Graybar **FIRST** For . . .



R & S Watertight Floor Boxes

Non-Adjustable—Round Type—Type FB



No. 2580

For wood flooring or where adjustable type is not required. Furnished complete with box and cover, with or without convenience receptacle as listed.

†Outlets—Box tapped 1/2-inch straight through on sides and two 1/2-inch on bottom, three outlets plugged. Specify size and location of outlets when ordering. See note.

No.	Complete With	Floor Plate Dia.	Box Hght.	Max. Out-let	Each
‡2580	2-W., 2-P. Receptacle	3 1/2	3 1/4	1/2	\$4.75
‡2580G	2-W., 3-P. Grounding Type Receptacle	3 1/2	3 1/4	1/2	6.00
‡2581	3-W., 3-P. Receptacle	3 1/2	3 1/4	1/2	6.50
‡2590	1/2-inch flush cap	3 1/2	3 1/4	1/2	3.50
466	1/2-inch flush cap	4 1/8	3 5/8	3/4	7.00
366	1/2-inch flush cap	5	3 7/8	3/4	9.00
367	1/2-inch flush cap	6 3/4	4 5/8	2	18.00

For special 3/4, 1 or 2 1/8-inch flush caps, suffix A, B, or C respectively to catalog numbers. Suffix A—no extra charge, suffixes B and C—prices on request.

Adjustable—Round Type

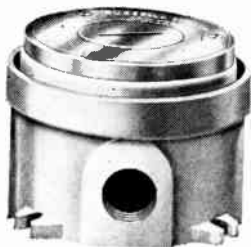

No. 2503

Regularly furnished complete with box and cover. Boxes accommodate Midget Ever-Lok and all standard 15 ampere, 125 volt convenience receptacles.

Outlets—Regularly furnished tapped two 1/2-inch and two 3/4-inch outlets straight through at right angles; all plugged except one 1/2-inch outlet. Unless otherwise specified.

Maximum conduit as listed, four-way. Types H and HD can

also be tapped for two 1/2-inch or 3/4-inch conduits in each side. Specify size and location of special outlets when ordering. See note.

No.	Complete With	Box Dia.	Flg. Dia.	Min. Hght.	Max. Out-let	Each
2502	1/2-in. flush cap	5	4 1/4	3 3/4	1	\$ 8.00
2503	2 1/8-in. flush cap	5	4 1/4	3 3/4	1	8.00
2502H	1/2-in. flush cap	4 3/4	4 1/4	3 5/8	1	8.50
2503H	2 1/8-in. flush cap	4 3/4	4 1/4	3 5/8	1	8.50
2502HD	1/2-in. flush cap	5	4 3/4	4 1/4	1 1/2	10.00
2503HD	2 1/8-in. flush cap	5	4 3/4	4 1/4	1 1/2	10.00

Shallow Type



No. 2505

Regularly furnished complete with box and cover, less receptacle, except as noted.

Outlets—Regularly tapped 1/2-inch four way. Three outlets plugged See note.

Cat. No.	Complete With	Box Dia.	Flg. Dia.	Min. Hght.	Max. Outlet	List Each
2504	"T" slot receptacle and 2 1/8-in. flush cap	3 1/4	3 3/8	2 3/4	1 1/2	\$8.00
2505	1/2-in. flush cap	3 1/4	3 3/8	2 3/4	1 1/2	7.50
2509	"T" slot receptacle only for 2504					1.00

Adjustment—Ample angular. Vertical—Nos. 2504 and 2505 3/8-inch; others 5/8-inch.

Note—1/2-inch and 3/4-inch drilled and tapped and plugged outlets as listed—no charge. Additional and/or larger outlets are extra. Plugs for 1-inch outlets and larger are extra.

Enclosures—Boxes: cast iron, corrosion resisting finish. Covers and flanges, brass.

R & S Watertight Floor Boxes

Adjustable—Round Shallow Type—Type FB

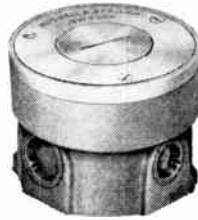

No. 2519C

Accommodates Midget Ever-Lok and all standard 15 ampere, 125 volt convenience receptacles. Regularly furnished complete with box and cover.

Outlets—Regularly furnished tapped two 1/2-inch and two 3/4-inch outlets straight through at right angles, on sides; and two 3/4-inch on bottom; all plugged except one 1/2-inch outlet on side. Unless otherwise specified.

Maximum conduit—3/4-inch four way on sides; two 3/4-inch or one 1-inch outlets on bottom. See note.

No.	Flush Cap Size	Box Dia.	Flg. Dia.	Min. Hght.	Max. Out-let	Each
2519	1/2-inch	4 1/4	4 1/4	3	3/4	\$7.90
2519A	3/4-inch	4 1/4	4 1/4	3	3/4	7.90
2519C	2 1/8-inch	4 1/4	4 1/4	3	3/4	7.90

Adjustable—Rectangular Types

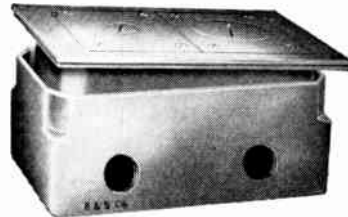

No. 2512 with 2537 and 2538 Covers

These boxes accommodate Midget Ever-Lok and all standard 15 ampere, 125 volt convenience receptacles. Furnished complete with No. 2537 (1/2-inch cap) covers, or No. 2538 (2 1/8-inch flush cap) covers, as desired. Specify when ordering.

No.	No. of Gangs	Box Size	Flange Size	Min. Hght.	Max. Outlet	Each
2511	1	5 Dia.	4 3/4 x 5 5/16	3 3/4	1	\$ 9.60
*2511H	1	4 1/2 x 4 1/2	4 3/4 x 5 5/16	4	3/4	10.10
*2511HD	1	5 Dia.	4 3/4 x 5 5/16	4 3/4	1 1/2	11.60
2512	2	7 1/2 x 5	7 3/4 x 5 5/16	3 7/8	1	18.00
2513	3	10 3/4 x 5 5/16	10 3/4 x 5 5/16	3 7/8	1	27.00
2514	4	13 5/8 x 5 5/16	13 3/4 x 5 5/16	3 7/8	1	35.00
2515	5	16 1/2 x 5 5/16	16 3/4 x 5 5/16	3 7/8	1	45.00

Single Gang

Outlets—Single Gang. Tapped two 1/2-inch and two 3/4-inch outlets straight through at right angles; all plugged except one 1/2-inch outlet; unless otherwise specified. Types H and HD can also be tapped for two 1/2-inch or 3/4-inch conduits in each side. On No. 2511H, center line is displaced for two outlets per side, information on request. See note.

Two to Five Gang

Tapped two 3/4-inch outlets straight through per gang, one plugged; unless otherwise specified. See note.

*Furnished undrilled unless otherwise specified.

Note—1/2-inch and 3/4-inch drilled and tapped and plugged outlets as listed—no charge. Additional and/or larger outlets are extra. Plugs for 1-inch outlets and larger are extra. Specify size and location of special outlets when ordering.

Adjustment—Ample angular and 5/8-inch vertical.

Enclosures—Boxes: cast iron, corrosion resisting finish. Covers and flanges, brass.

Brass Cone Nozzle



No. 2558 Threaded for 2 1/8-inch diameter floor plate, list each \$1.50.

R & S Junction Boxes
Class I, Groups C and D
Explosion-Proof and Dust-Tight



No. 4201BC

Type BC Complete Box and Cover

No.	L. In.	W. In.	Over-all D. In.	Max. Outlet	Each
4201BC	3 1/2	3 1/2	2 3/4	3/4	\$6.00
4202BC	4 3/4	4 3/4	2 3/4	3/4	7.50
4203BC	4 3/4	4 3/4	3 3/4	1 1/4	8.50
4205BC	5 1/2	4 3/4	3 3/4	1 1/2	12.00

Outlets—Unless otherwise specified, furnished with one 3/4-inch outlet. Additional or larger outlets charged extra. Maximum conduit size as listed, four way. Specify size and location.

Blank Covers

No.	For Boxes	Each
4201BCP	No. 4201BC	\$2.25
4202BCP	{ No. 4202BC No. 4203BC }	2.75



No. 4201BCP

Can also be furnished with 1/2-inch outlet in center.

Canopy Covers



No. 4201BCC

For Suspending Lighting Fixtures

No.	For Boxes	Each
Cond. Hub Sizes: 1/2, 3/4, 1, 1 1/4		
4201BCC	4201BC	\$7.00
4202BCC	{ 4202BC 4203BC }	8.50
Cond. Hub Sizes: 1/2, 3/4, 1		
*4201FBCC	4201BC	10.50
*4202FBCC	{ 4202BC 4203BC }	12.00

*Overhang canopy for flush mounting.

Outlets—Unless otherwise specified, furnished with 3/4-inch outlet. Larger outlets charged extra. Maximum conduit size as listed. Specify size required.

R & S Sealing Fittings—Type ES



No. 4430V

Can be furnished with 1 male hub at same cost. Suffix "M" to catalog number. Material—Cast iron, corrosion resisting baked enamel finish.



No. 4430H

Conduit Size, In.	For Vertical Run		For Horizontal Run	
	No.	Each	No.	Each
1/2	4430V	\$2.25	4430H	\$2.25
3/4	4431V	2.75	4431H	2.75
1	4432V	3.50	4432H	3.50
1 1/4	4433V	4.25	4433H	4.25
1 1/2	4434V	6.50	4434H	6.50
2	4435V	8.00	4435H	8.00
2 1/2	4436VH	12.00	4436VH	12.00
3	4437VH	18.00	4437VH	18.00
2 1/2	4438VH	25.00	4438VH	25.00
4	4439VH	30.00	4439VH	30.00

Compound Only

No.	Size	Each
A-69	1 lb.	\$1.25
A-69	5 lb.	3.00
A-69	10 lb.	5.50

Packing Only

No.	Size	Each
P-69	4 oz.	\$2.50
P-69	8 oz.	4.25
P-69	1 lb.	7.50

R & S Waterproof Junction Boxes
Heavy Wall—With External Lugs—Type WJB

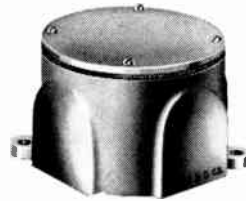

No. 1442

Round Type

Boxes with blank cover are furnished complete with gasket and screws. Boxes only, without cover, gasket or screws. Also available in cast aluminum alloy.

Outlets—Unless otherwise specified, furnished with one 3/4-inch outlet.

Additional or larger outlets extra; can also be furnished undrilled. Maximum conduit size as listed, four way. Specify size and location.

Complete, with Plain Cover

Size	Dimensions, Inches			Cast Iron		Cast Brass	
	D.S. Dia.	Depth Inside	Max. Size Conduit	No.	Each	No.	Each
3	3 3/8	1 1/2	3/4	1481	\$2.00	481	\$5.00
4	4 1/2	1 5/16	3/4	1432	2.50	432	6.25
4	4 1/2	1 3/4	1	2400	3.00	2402	7.50
4	4 1/2	2	1	1459	3.00	1460	7.50
4	4 1/2	2 7/8	1	1442	3.50	1446	8.75
4	4 1/2	2 3/16	1 1/2	1442II	4.00	1446II	11.00
Boxes Only							
3	3 3/8	1 1/2	3/4	382	\$1.25	381	\$3.25
4	4 1/2	1 5/16	3/4	333	1.50	332	3.75
4	4 1/2	1 3/4	1	2401	2.00	2403	5.00
4	4 1/2	2	1	1461	2.00	1462	5.00
4	4 1/2	2 7/8	1	1441	2.50	1445	6.25
4	4 1/2	2 3/16	1 1/2	1441II	3.00	1445II	7.50

R & S 4-Inch Junction Box Extension Collars
With Gaskets and Screws



Overall Depth	Max. Conduit	Cast Iron		Cast Brass	
		No.	Each	No.	Each
1 1/16	None	321	\$2.00	325	\$4.50
1 1/2	3/4	322	3.75	326	8.50
3	3/4	323	5.50	327	12.50

Outlets—Maximum conduit sizes as listed, four way. All outlets charged extra. Specify size and location, otherwise extension collars will be furnished undrilled.

R & S Adapter Plates



No.	Type of Mounting	Each
406	4" Steel O.B.	\$1.50
407	3" Junc. Box	1.50
408	SE Condulets	1.50

Cast Brass

416	4" Steel O. B.	\$2.50
417	3" Junc. Box	2.50
418	SE Condulets	2.50

R & S 4-Inch Junction Box Pendant Covers
Cast Iron



No.	Outlet	D.S. Diam.	Each
868	1/2	4 1/2	\$2.00
836	3/4	4 1/2	2.00

Cast Brass—Natural Finish

869	1/2	4 1/2	\$4.00
630	3/4	4 1/2	4.00

R & S Waterproof Ball Aligner



No.	For Stem	Each
410	1/2-inch	\$4.00
4110	3/4-inch	4.00

Cast Brass

412	1/2-inch	\$6.75
4112	3/4-inch	6.75

Finish—Cast iron, corrosion resisting baked enamel finish. Cast brass, natural finish.

R & S Combination Floor Extension Sets

Type FB

2 Wire, 2 Pole T-Slot: 10 Amp., 250 Volts, 15 Amp., 125 Volts, A.C. or D.C.

2 Wire, 3 Pole Grounding Type: 15 Amp., 125 Volts, A.C. or D.C.

3 Wire, 3 Pole: 10 Amp., 250 Volts, 15 Amp., 125 Volts, A.C. or D.C.



No. 3000G

These extensions are suitable for banks, offices, libraries, etc., for connection of desk lamps, dictaphones, adding machines, telephones, etc. Can be used with any floor duct system having 1/2 or 3/4-inch I.P.S. outlets.

Molded composition interiors, mounted in brass casing tapped for 1/2-inch or 3/4-inch extensions, as specified.



No. 3008

Standard height of complete unit 6-inches overall. Also available in other heights upon request. Extension sets supplied complete or in parts. Regularly furnished complete with duplex head, extension and locking flange.

Complete Duplex Combination Set†

No.	Description	Each
3000	With 2 wire, 2 pole T-slot receptacles for 1/2-inch floor outlet	\$8.25
3001	Same for 3/4-inch floor outlet	9.75
3000G	With 2 wire, 3 pole grounding type receptacles for 1/2-inch floor outlet	9.75
3001G	Same for 3/4-inch floor outlet	11.25
3020	*Style L with 3-wire, 3 pole receptacles for 1/2-inch floor outlet	13.25
3021	*Same for 3/4-inch floor outlet	14.75

Duplex Extension Head Only††

2696	With 2 wire, 2 pole T-slot receptacles for 1/2-inch floor outlet	5.25
2697	Same for 3/4-inch floor outlet	5.75
2696G	With 2 wire, 3 pole grounding type receptacles for 1/2-inch floor outlet	6.75
2697G	Same for 3/4-inch floor outlet	7.25
2570	*Style L with 3-wire, 3 pole receptacles for 1/2-inch floor outlet	10.50
2569	*Same for 3/4-inch floor outlet	11.00

Replacement Duplex Receptacle Interiors Only

2688G	2 wire, 3 pole duplex grounding type for 1/2-inch or 3/4-inch outlet	3.25
-------	--	------

Low Tension

3008	Complete low tension combination set for 1/2-inch floor outlet	7.00
3009	Same for 3/4-inch floor outlet	8.75
2686	Low Tension head only for 1/2-inch floor outlet	4.25
2687	Same for 3/4-inch floor outlet	4.75

Parts

1921	3 1/2-inch Extension, 1/2-inch I.P.S., threaded for flange	1.50
1956	Same for 3/4-inch I.P.S.	2.00
2619	Locking flange for 1/2-inch I.P.S.	1.75
2620	Same for 3/4-inch I.P.S.	2.25

†Threaded for floor outlets, I.P.S. sizes as listed.

††Tapped for extensions, I.P.S. sizes as listed.

Fittings — Brass, standard finish brush brass. Other finishes furnished at extra cost.

*Extension heads are of standard size except style "L" which are slightly larger.

T & B Watertight Floor Boxes

Approved by Underwriters' Laboratories

Non-Adjustable—1700 Series



Cover plate is smooth, polished, lacquered heavy bronze.

Nos. 1700 and 1701 furnished with receptacle (rating: 10-amp., 250-volts; or 15-amp., 125 volts), and blank cover disc.

No. 1703 supplied with flat cover disc drilled and tapped for 1/2-inch, complete with plug; has no receptacle.

Standard conduit drilling: two 1/2-in. and two 3/4-in. tapped holes in sides and two 1/2-in. tapped holes in bottom; all holes plugged.

Dimensions: Height 3 3/16 inches; diameter of cover plate 3 3/4 inches. Unit quantity, 1.

No.	Description	Std. Pkg.	Wt., Lbs. Each	Each
*1700	Two-Wire Box	12	2	\$ 6.40
1701	Three-Wire Box	10	2 1/4	10.40
1703	Telephone or Signal Box	10	2	4.80
1729	NEMA Grounded Receptacle	10	2	10.40

*Attachment Plug furnished only when specified—extra charge.

Adjustable—Shallow Series



Have a 5/8-inch vertical and 10° angular adjustment. Covers metallically grounded to box.

Nos. 1760 and 1761 furnished with receptacle (rating: 10 amp., 250 volts or 15 amp., 125 volts) and blank cover disc.

No. 1763 supplied with a flat cover disc drilled and tapped for 1/2-inch conduit, complete with plug; has no receptacle.

Standard conduit drilling is two 1/2-in. and two 3/4-in. tapped holes; all holes plugged.

When specified, 3/4-inch will be supplied at no extra charge. Standard package: \$120.00 list value.

No.	Description	Unit Pkg.	Wt., Lbs. Each	Each
1763	Telephone or Signal	1	3 1/2	\$10.40
1760	Two-Wire	1	3 1/2	11.20
1761	Three-Wire	1	3 1/2	14.40
1779	NEMA Grounded Receptacle	1	4	14.40

Steel City Round Floor Outlets
Original Fullman Type
Adjustable
Schedule S

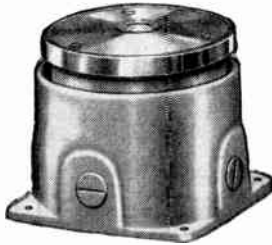

Nos. 400 and 420

4 1/4-inch Diameter—1/2-in. Plug in Cover

No. 400, Complete Outlet consisting of: No. 402 Standard Box Body; *No. 105 Standard Combination Adjusting Ring and Bronze Flange Ring; No. 409 Cover Plate with No. 471 1/2-inch Plug; No. 411 Cork Gasket and No. 476 Sealing Cement. No. 400D, Same as No. 400 except has No. 404 Deep Box Body. No. 400S, Same as No. 400 except has No. 402S Shallow Box Body and 405S Shallow Adjusting Ring.

No.	Min. HL. In.	Max. HL. In.	Approx. Wt. Lbs. Each	Each
400	3 3/4	4 3/8	5 1/2	\$ 6.60
400D	4 1/2	5 1/4	8	10.00
400S	3 3/8	3 3/4	5 1/2	6.60

5-in. Diameter—1/2-in. Plug in Cover

No. 420, Complete Outlet consisting of: No. 422 Box Body; *No. 431 Standard Combination Adjusting Ring and Bronze Flange Ring; No. 435 Cover Plate with No. 471 1/2-inch plug; No. 438 Rubber Gasket and No. 476 Sealing Cement. No. 420S, same as No. 420 except has No. 422S Box Body and 431S Shallow Adjusting Ring.

No.	Min. HL. In.	Max. HL. In.	Approx. Wt. Lbs. Each	Each
420	3 13/16	4 3/8	7	\$9.50
420S	2 13/16	3 1/8	7	9.50

*Special adjustment rings for higher adjustment are available at additional cost, as follows: Nos. 406, 407 and 408 for Outlet Nos. 400, 400D, 400S; Nos. 432, 433 and 434 for Outlet Nos. 420 and 420S.

Regular tapping, all boxes, is 1/2, 3/4, or 1/2 and 3/4, with all but one hole of each size plugged. There are additional charges for larger tappings and plugs.

Maximum tapping is 1-in. except No. 400D which can be tapped 1 1/2-in. with bushing and 2-in. without bushing.

Steel City Service X-IT



Diameter of box body, 1 5/8-inches; diameter brass cover plate 2 1/2-inches; height (bottom of box body to top of cover plate) 1 1/2-inches; connector adds 5/8-inch to height.

Box body galvanized. Cover plate finished in brush brass.

Consists of three parts — box body, receptacle and brass cover plate.

Body equipped with clamp No. 494 Service X-IT for holding armored cable — clamp cannot become loose. Furnished standard in 180 degree type. Also available in 90 degree type.

Easily and quickly installed — simply drill a hole in the floor, etc., insert X-IT in the hole and secure the flanged cover plate by two flat head screws provided for the purpose.

No.	Description	Std. Pkg.	Wt. Oz. Each	Each
494	Service X-IT fitted with 10 amp. 115-volt bakelite receptacle and with straight connector for 3/8" armored cable.....	50	10	\$1.25
494AC	Same as No. 494 except fitted with 45° connector.....	50	11	1.75

Quantity prices on request.

Steel City Round Floor Outlets
Original Fullman Type
Adjustable
4 1/4-in. Diameter—2-in Plug



Nos. 401 and 421

These boxes will take standard 2 or 3 wire, 10 amp. or 20 amp. receptacles. Receptacles optional and cost extra.

No. 401, Complete Outlet consisting of: No. 402 Standard Box Body; *No. 405 Standard Combination Adjusting Ring and Bronze Flange Ring No. 410 Cover Plate with No. 472 2-inch Plug; No. 411 Cork Gasket; No. 414 Steel Plate as a Seat for 2-in. Plug and No. 476 Sealing Cement. No. 410D, same as No. 401 except has No. 404 Deep Box Body. No. 401S, same as No. 401 except has No. 402S Shallow Box Body and No. 405S Shallow Adjusting Ring.

No.	Min. HL. In.	Max. HL. In.	Approx. Wt. Lbs. Each	Each
401	3 3/4	4 3/8	5 1/2	\$ 6.60
401D	4 1/2	5 1/4	8	10.00
401S	3 3/8	3 3/4	5 1/2	6.60

5-in. Diameter—2-in Plug

No. 421, Complete Outlet consisting of: No. 422 Box Body; *No. 431 Standard Combination Adjusting Ring and Bronze Flange Ring; No. 436 Cover Plate with No. 472 2-inch plug; No. 438 Rubber Gasket; No. 437 Steel Plate as a Seal for 2-inch Plug and No. 476 Sealing Cement. No. 421S, same as No. 421 except has No. 422S Box Body and No. 431S Shallow Adjusting Box.

No.	Min. HL. In.	Max. HL. In.	Approx. Wt. Lbs. Each	Each
421	3 13/16	4 3/8	7	\$9.50
421S	2 13/16	3 1/8	6 1/2	9.50

*Special adjustment rings for higher adjustment are available at additional cost, as follows: Nos. 406, 407 and 408 for Outlet Nos. 401, 401D and 401S; Nos. 432, 433 and 434 for Outlet Nos. 421 and 421S.

Regular tapping, all boxes, is 1/2, 3/4 or 1/2 and 3/4, with all but one hole of each size plugged. There are additional charges for larger tappings and plugs. Maximum tapping is 1-in. except No. 401D which can be tapped 1 1/2-in. with bushing and 2-in. without bushing.

Call Graybar FIRST For . . .

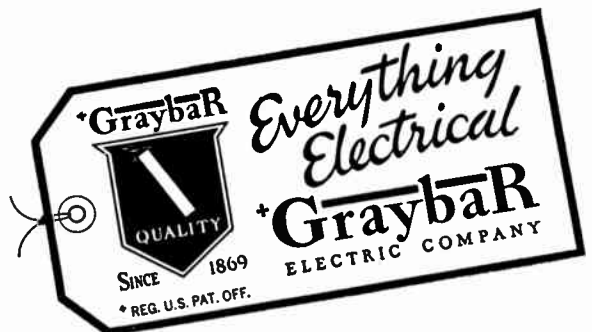

Steel City Non-Adjustable Floor Outlets

Round and Rectangular Fullman Types



No. 475 Duplex Outlet Complete



477 Outlet Showing Receptacle Mounted on Steel Ring

*Complete Assembly for No. 477 is No. 481 Box Body. No. 478, 10-amp. 2-wire bakelite receptacle mounted on flat steel ring which also serves as a seat for the bell nozzle or flush brass plug. No. 483 Brass Cover Plate with 2-in. tapped hole. No. 480 Flush Brass Plug in cover plate. No. 484 Cork Gasket. No. 479 Bell Nozzle.

Nos. 477, 493 and 491, dimensions $3\frac{1}{16}$ inches high, $3\frac{1}{2}$ inches diameter.

No.	Description	Wt. Lbs. Each	Each
475	Duplex Type of No. 477	5	\$8.50
*477	Complete assembly as listed	2	4.00
*493	Complete assembly with 493R, 10-amp. 3-wire receptacle and plug	2	5.75
*491	Complete assembly with No. 491-R 20-amp. 2-wire polarized receptacle and plug, and No. 466 Nozzle	2 $\frac{3}{4}$	6.50



No. 497

Four $\frac{1}{2}$ -inch tapped holes in body. One 2-inch tapped hole in center of cover. Size, $4\frac{3}{8}$ x $4\frac{3}{8}$ x $3\frac{15}{16}$ inches deep. Cover plate, $5\frac{1}{2}$ inches square.

No.	Description	Wt. Lbs. Each	Each
496	Rectangular floor outlet same as above with 10-amp. receptacle, on steel plate with attachment plug	6 $\frac{3}{4}$	\$ 7.75
497	Rectangular floor box with $3\frac{1}{4}$ -in. flush plug in cover plate. Also furnished with bell nozzle and 2-wire 30 amp., 250 Volt receptacle, on steel plate, with attachment plug	7 $\frac{1}{2}$	20.00

Quantity prices on request.



498 Outlet Complete



490 Outlet Complete

No.	Description	Std. Pkg.	Wt. Lbs. Each	Each
498	Round Fullman, type outlet. Same as No. 477 except has Flange Ring ($3\frac{1}{4}$ -in. high)	10	3	\$ 6.00*
490	Round outlet Fullman type. No. 481 Box Body No. 482 Brass Cover Plate, with $\frac{1}{2}$ -in. tapped hole. Brass plug in No. 487 cover plate. No. 484 Cork Gasket ($3\frac{1}{16}$ -in. high, $3\frac{1}{2}$ -in. diam.)	25	1 $\frac{3}{4}$	3.00*
490LB	Large Non-adjustable Floor Box, similar to No. 490. Takes conduit up to $1\frac{1}{4}$ -in. in all 4 sides. 5-in. cover ($3\frac{5}{16}$ -in. high overall; inside diam. 4-in., inside height $3\frac{1}{2}$ -in.)	5	5 $\frac{1}{2}$	8.00
490ELB	Extra Large Non-adjustable Box. Takes conduit up to $1\frac{1}{2}$ -in. in all 4 sides. $\frac{1}{4}$ -in. bronze cover $6\frac{3}{4}$ -in. diam. (high $4\frac{1}{2}$ -in. overall; inside diam. $5\frac{7}{16}$ -in., inside height $4\frac{1}{4}$ -in.)	2	11	20.00

*Maximum tapping $\frac{3}{4}$ -in.

Parts

No.	Description	Wt. Oz. Each	Each
481	Box Body only; $\frac{1}{2}$ -in. conduit holes tapped one in each of 2 sides and 1 in bottom; 2 of which are plugged with iron plugs	20	\$1.30
484	Cork Gasket	1	.20
482	Brass Cover Plate ($3\frac{1}{2}$ -in. diam.) with $\frac{1}{2}$ -in. convex plug	6	1.75
483	Brass Cover Plate ($3\frac{1}{2}$ -in. diam.) with 2-in. flush plug	4	1.75
487	Convex Brass Plug for No. 482 cover; $\frac{1}{2}$ -in. diameter	1	.75
480	Flush Brass Plug for No. 483 cover; 2-in. diameter	2	1.00
479	Brass Bell Nozzle; threaded 2-in. at bottom	2	1.00
478	10-amp. 2-wire Bakelite Receptacle mounted on flat steel ring	7	.95
475-R	Two 10 amp., 2-wire receptacles mounted on flat steel ring	6	2.00
493-R	10-amp. 3-wire Receptacle and Plug mounted on flat steel ring	10	2.25
491-R	20-amp. 2-wire Receptacle and Plug mounted on steel strap	12	3.16

Quantity prices on request.

Steel City Adjustable Floor Outlets

Round Box—Fullman Screw Adjustment Type

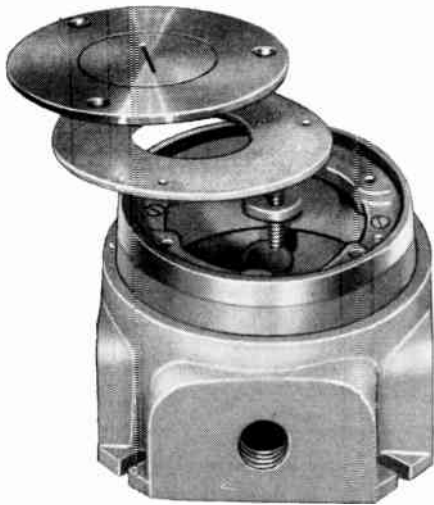

No. 6501

Three adjusting screws extend through the adjusting frame into three lugs, cast on the inside of the box body. Minimum height of box 3½ inches, maximum height 11⅝ inches with ½-inch of the adjusting frame still seated in ring of the box today. Maximum adjustment ⅝-inch.

Covers, gaskets and seating plates used on No. 400 and 401 are interchangeable with this box.

Each of four bosses is large enough to allow drilling and tapping of one 1-inch hole with room for bushing or 1¼-inch hole without bushing. Two ½-inch or two ¾-inch holes, can also be drilled and tapped in each boss.

No.	Description	Wt., Lbs. Each	Each
6500	4¼-inch diam. cover with ½-in. plug...	6	\$10 50
6501	4¼-inch diam. cover with 2-in. plug...	6	10 50

**3½-inch Diameter Outlet
High Tension Outlet—2-in. Plug**



No. 403-R

No.	Description	Wt., Lbs. Each	Approx. Wt., Lbs. Each	Each
403R	Complete Outlet consisting of: Box Body; Adjusting Ring; Cover Plate with 2-in. Flush Plug; Cork Gasket; Sealing Cement and Flat Steel Plate..	2¾		\$6 00

Low Tension Telephone Outlet—½-in. Plug

403T	Complete Outlet consisting of: Box Body; Adjusting Ring; Cover Plate with ½-in. Convex Plug; Cork Gasket and Sealing Cement.....	2¾		\$6 00
------	--	----	--	--------

Diameter of complete outlet at top, 3½ inches. Height overall 3-inches. Can be adjusted to a maximum height of 3⅜ inches.

Standard Tapping—one ½-inch hole in each of three sides, two of which are plugged. Can be tapped special to take ½-inch and ¾-inch conduit. Maximum tapping ¾-in.

Quantity prices on request.

Original Fullman Type

Parts

In addition to the parts listed below, a complete line of nozzles for cover plates are listed on pages 252 and 253.



Nos. 402 and 422



No. 404

Box Bodies

No.	Description	Approx. Wt., Lbs. Each	Each
402	Standard Box Body for Outlets Nos. 100 and 101; height overall 3⅛ inches; diameter of center opening in top 3¼ inches; depth of groove, 1 inch.....	3½	\$3.00
	Standard tapping—four ½-in. holes (1 in each side), three of which are closed with plugs. Can be tapped special to meet requirements.		
	Maximum tapping is 1 inch.		
402S	Special Shallow Box Body for outlets Nos. 100S and 101S; height overall, 2⅝ inches; diameter of center opening in top, 3¼ inches; depth of groove, ½-in....	3½	3.00
	Standard tapping, same as in No. 102.		
404	Special Deep Box Body for Outlets Nos. 400D and 101D; height overall, 3¾ inches; diameter of center opening in top, 3 inches; depth of groove, 1 inch.....	6¼	6.50
	Standard tapping, same as No. 102.		
	Can be tapped on special order for conduit up to 1½ inches with room for bushing or for 2-inch conduit without room for bushing.		
	Boss is large enough to allow room for two ½-inch or two ¾-inch conduits side by side.		
422	Standard Box Body for Outlets Nos. 120 and 121; height overall, 3⅛ inches; diameter of center opening in top, 3¾ inches; depth of groove, 1 inch.....	5	3.75
	Standard tapping, same as No. 402.		
422S	Standard Shallow Box Body for Outlets Nos. 120S and 121S; height overall, 2¼ inches; diameter of center opening 3¾ inches; depth of groove, ½-inch.....	3½	3.75
	Standard tapping, same as No. 402.		



Nos. 411 and 438

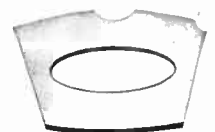

Nos. 414 and 437

Gaskets

411	For Nos. 100, 400D, 400S, 101, 101D, or 101S Outlets.....	¼	.24
438	For Nos. 420, 420S, 121 or 121S Outlets.....	½	.24

Steel Plates for Forming Seats Under 2-inch Plugs No. 472

414	For Nos. 101, 101D or 101S Outlets....	1	.24
437	For Nos. 421 or 121S Outlets.....	2	.24

Quantity prices on request.

Steel City Adjustable Floor Outlets

Parts



Nos. 405 and 431

Combination Adjusting Rings and Bronze Flange Rings

No.	Description	Height Overall Inches	WL Lbs. Each	Each
For Outlets Nos. 400, 400D, 400S, 401, 401D or 401S				
405	Standard Ring	1 1/2	1	\$1 50
405S	Special Ring	1 3/8	1	1 50
406	Special Ring	2 1/8	1 1/4	1 60
407	Special Ring	2 3/4	1 1/2	1 75
408	Special Ring	3 7/8	1 3/4	1 90

For Outlets Nos. 420, 420S, 421 or 421S

431	Standard Ring	1 1/2	1 1/4	2 70
431S	Special Ring	1	1	2 70
432	Special Ring	2 1/8	1 1/2	3 25



Nos. 409 and 435



Nos. 410 and 436

Bronze Cover Plates

No.	Four Outlets Nos.	*Diam. In.	With Plug No. 1/2-inch	2-inch	Wt. Oz. Each	Each
409	400, 400D, 400S	4	471	...	8	\$1 90
410	401, 401D, 401S	4	...	472	8	1 90
435	420, 420S	4 3/4	471	...	12	2 40
436	421, 421S	4 3/4	...	472	12	2 40

*The flange rings are 1/8-inch thick, therefore the total top diameter of the complete outlets is 1 1/4 inches in outlets Nos. 400, 400D, 400S, 401, 401D and 401S, and 5 inches in outlets Nos. 420, 420S, 421 and 421S. All cover plates are 9/64-inch thick and set flush with tops of flange ring.



No. 471



No. 472

Bronze Plugs for Cover Plates

No.	Description	Wt. Oz. Each	Each
471	Convex plug, 1/2-in., to fit 409 and 435 cover plate	1/2	\$0.75
472	Flush plug, 2-in., to fit 410 and 436 cover plate	1	1.00
472S	Combination 2-in. plug with 1/2-in. plug in center, to fit 410 and 436 cover plates	2	1.25

Sealing Cement for All Outlets

Carton of sealing cement for one outlet. Weight, 1 oz. each.

No. 476.....each \$0.25



Quantity prices on request.

Steel City Combination Cover Plates and Duplex Bell Nozzles

For Use With All Types of Floor Outlets



No. 415



No. 460

No. 415—For use with floor outlets Nos. 400, 400S, 400D, 401, 401S, 401D. 4-inch diameter. Approximate weight, 16 ounces.....Each \$2.75

No. 460—For use with all adjustable gang type floor outlets. Size 3x4 inches. Approximate weight, 12 oz.....Each \$2.75

Standpipe Nozzles



Length, 3 inches.

No.	Threaded Inches	Approx. Wt., Oz.	Each
416	1/2	7	\$1.25
416-A	3/4	9	1.50

Special sizes can be furnished. Price on request.

Round Type High Tension Nozzles



Complete with 10 ampere, 250 volt receptacle. Head diameter, 2 7/8 inches. Length overall, 4 3/4 inches.

No.	Stem Threaded, In.	Approx. Wt., Oz.	Each
417	1/2	16	\$6.50
417-A	3/4	16	6.75
417-D	1/2	16	9.00

No. 417-D has a receptacle on each side.

Round Type Low Tension Nozzles



Head diameter, 2 7/8 inches. Length overall, 4 3/4 inches. Complete with two 5/8-inch inside diameter fiber bushings, one on each side.

No.	Stem Threaded, In.	Approx. Wt., Oz.	Each
417-B	1/2	16	\$5.00
417-C	3/4	16	5.25

Bronze Bell Nozzles



2 inches diameter at bottom. For use with cover plates with 2-inch openings. Approximate weight, 3 ounces.

No. 466.....\$1.00

Bronze Stem Nozzles



Diameter 1/2-inch. Threaded 1/2-inch to fit all cover plates or bases with 1/2-inch female opening. Approximate weight, 3 ounces.

No. 467.....Each \$1.00

Prices of nozzles do not include cover plates or bases.

Quantity prices on request.

National Electric Floor Boxes

No. "800"

"800" Floor Boxes

Conform with Federal Specification No. W-B-616



No. 800

A modernized outlet box for floor placement. Features simplicity.

An integral gasket makes the box water and moisture-proof.

Adjusts simply to meet the floor surface.

Rubber collar locks in adjustment position. Wire holes for tying down to concrete forms. Standard 4-in. octagon box. Electro-galvanized finish.

All Nos. have 2, 1/2-in. and 2, 3/4-in. bottom KO's. Nos. 800 thru 801-3/4 have 2, 1/2-in. and 2, 3/4-in. side KO's. Nos. 802 thru 802-3/4 have 1-in. side KO's. Standard package 12.

No.	Junction Box Depth In.	Floor Opening	Abandon Plugs Diam., In.	Overall Ht. Max. In.	Min. In.	Wt. Std. Pkg.	Lbs.	Each
800	2 1/8	Service Fitting						
		1 3/8-in. Opening	1 3/8	3 5/8	3 1/4	25		\$6.55
800-1/2	2 1/8	1/2-in. Pipe Tapping	1/2	3 5/8	3 1/4	25		6.55
800-3/4	2 1/8	3/4-in. Pipe Tapping	3/4	3 5/8	3 1/4	25		6.55
801	1 1/2	Service Fitting						
		1 3/8-in. Opening	1 3/8	3	2 5/8	24		6.25
801-1/2	1 1/2	1/2-in. Pipe Tapping	1/2	3	2 5/8	24		6.25
801-3/4	1 1/2	3/4-in. Pipe Tapping	3/4	3	2 5/8	24		6.25
802	2 1/8	Service Fitting						
		1 3/8-in. Opening	1 3/8	3 5/8	3 1/4	25		6.55
802-1/2	2 1/8	1/2-in. Pipe Tapping	1/2	3 5/8	3 1/4	25		6.55
802-3/4	2 1/8	3/4-in. Pipe Tapping	3/4	3 5/8	3 1/4	25		6.55

Component Parts for "800" Floor Boxes



No. 800A

No. 800C

No. 800D

No.	Description	Std. Pkg. Wt. Lbs.	Each
Abandon Plugs			
800A	1 3/8-in. Diameter	1	\$1.80
800A-1/2	1/2-in. Pipe Thread Plug	1	1.80
800A-3/4	3/4-in. Pipe Thread Plug	1	1.80
Floor Plates			
800C	1 3/8 For Service Fitting	3	2.60
800C-1/2	1/2-in. Pipe Thread Tapping	3	2.60
800C-3/4	3/4-in. Pipe Thread Tapping	3	2.60
Adjusting Ring			
800D	Permits 3/8-in. Adjustment	3	3.45



No. 800E

No. 800F

No. 800H

No.	Description	Std. Pkg. Wt. Lbs.	Each
800E	4-in. Gal. Threaded Cover	3	\$1.15
800F	4-in. Gal. Boxes. 3 screw legs for adjusting and leveling. See above for Dimen.	12	2.25
801F		10	1.50
802F		12	2.25
800H	Rubber Sealing Collar	1/2

Except for No. 800H, above packed 10 in a standard pkg. No. 800H packed 5 in a standard package.

Component Parts For "800" Floor Boxes



No. 820

No. 820G

No. 821

No. 821G

No. 831

Plugs and Receptacles

No.	No. Poles	Amps.	Volts	Wt. Std. Pkg.	Each
Receptacles					
820	2	15	125	1 1/2	\$1.80
820G	3	15	125	2	3.10
Plugs					
821	2	15	125	1 1/2	2.60
821G	3	15	125	2	2.90
Plug and Receptacle					
830	#820 Receptacle and #821 Plug			2 1/2	4.20
830G	#820G Receptacle and #821G Plug			2 3/4	6.00
831	Sheath & Slip Ring, for 3 twisted Pr.			2	1.95

All above packed 10 in a standard package.



No. 7900P

No. 7952

No. 805

No.	Description	Wt. Std. Pkg.	Each
7900P	1-in. Adapter. 2 3/8-in. Diam.		
	1-in. Internal Pipe Thread	5	\$1.55
7952	Universal Level	2	6.65
805	Terminal Block Only	1	1.45

No. 7952 packed 1 in., all others 10 in a std. pkg.

Service Fittings—With 1-Inch Nipple Horizontal-Cast Design

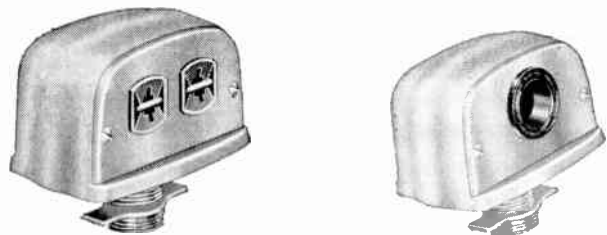

No. 803C

No. 804C

Cast aluminum satin finish with a protective coating of clear enamel.

Dimensions, Inches: Length (Base)—4 7/8; Height—2 15/16; Base Width—2 7/8; Top Width—2 1/2.

Packed 12 in a standard package.

No.	Amps.	Volts	Receptacle	Std. Pkg. Wt. Lbs.	Each
803C	1-15	125	2-wire Duplex	18	\$12.25
803DC	2-15	125	2-wire Duplex	20	13.40
803GC	1-15	125	3-wire Duplex	18	13.75
803SC	20	250	2-wire Tw. Lock	18	13.40
803STC	{ 20	{ 250	{ 3-wire Tw. Lock	{ 18	{ 15.50
	{ 10	{ 575			
804C	One 1-in. Bushed Telephone Outlet			18	11.20
804BC	One 1-in. Bushed Buzzer Outlet			18	14.20
804DC	Two 1-in. Bushed Telephone Outlet			18	12.20
807C	30	250	3-wire "L" Slot	20	20.10
808C	50	250	3-wire Str. Slots	20	22.35
809C	{ 15	{ 125	{ 1-3-wire Duplex	{ 18	{ 15.50
	{ 10	{ 250			

National Electric Service Fittings
Monumental Design With 1-Inch Nipple



Brushed brass or satin aluminum with a protective coating of clear enamel. Brushed brass furnished unless otherwise specified.

Dimensions, Inches; Base Diam. — 3 $\frac{3}{8}$; Height — 4 $\frac{1}{8}$;

Top Length — 2 $\frac{9}{64}$; Top Width — 2 $\frac{1}{8}$.

Packed 12 in a standard package.

No.	Amps.	Volts	Receptacle	Std. Pkg. Wt. Lbs.	Each
803	1-15	125	2-wire Duplex	22	\$12 25
803D	2-15	125	2-wire Duplex	24	13 40
803G	1-15	125	3-wire Duplex	22	13 75
803S	20	250	2-wire Tw. Lock	22	13 40
803ST	(20 10)	(250 575)	3-wire Tw. Lock	22	15 50
804	One 1-in. Bushed Telephone Outlet			22	11 20
804B	One 1-in. Bushed Buzzer Outlet			22	14 20
804D	Two 1-in. Bushed Telephone Outlets			22	12 20
809	(15 10)	(125 250)	1-3-wire Duplex	22	15 50

Steel City Cast Bronze Nozzles

For Use With All Types of Floor Outlets



No. 468-H

Threaded $\frac{1}{2}$ inch to fit all cover plates or bases with $\frac{1}{2}$ -inch female opening. Can also be furnished with $\frac{3}{4}$ -inch stem at no extra cost. Specify when ordering. Available in horizontal or vertical type. Add suffix "H" for horizontal type, "V" for vertical type.

- No. 468 with duplex receptacle, approximate weight, 16 ounces..... Each \$ 7.50
- No. 468-A with single receptacle, approximate weight, 16 ounces..... Each \$ 7.00
- No. 468-B with two duplex receptacles, allowing four connections, approximate weight, 14 ounces.. Each \$10.50

Steel City Telephone Pull-Box Nozzles

For All Types of Floor Outlets



No. 469 Nozzle
No. 461 Base



No. 470 Nozzle
No. 461-A Base



No. 474 Nozzle
No. 473-A Base

Steel City pull-boxes and nozzles for telephone work are designed for use in all types of floor boxes, underfloor duct systems, and telephone ells and tees. Especially suited for low potential wiring and will serve from 1 to 15 telephones at an individual desk. The $\frac{1}{2}$ -inch size takes 5-pair braided cable; the $\frac{3}{4}$ -inch size takes from 5 to 20-pair braided cable for inter-telephone or annunciator service.

For all pipe fittings up to and including 2 inches. Removable top permits snaking and pulling wires with ease, eliminates twisting and breaking of wires after installation.

- Telephone nozzles furnished with or without bases.
- No. 469 — threaded $\frac{1}{2}$ -inch. Takes 5-pair braided cable. Approximate weight, 10 ounces..... Each \$5.00
- No. 470 — threaded $\frac{3}{4}$ -inch. Takes from 5 to 20-pair braided cable. Approximate weight, 14 ounces. Each \$5.25
- No. 474 — Low tension nozzle, threaded for attachment to any $\frac{3}{4}$ -inch opening. Height, 3 $\frac{1}{4}$ -inches. Approximate weight, 14 ounces..... Each \$2.75

Prices of nozzles do not include cover plates or bases.

Bronze Bases for Nozzles Listed on this Page and Page 321

No.	Base, Inches		Diam. In.	Each
	Drilled & Tapped	Threaded For Opening		
461	$\frac{1}{2}$	$\frac{3}{4}$	2 $\frac{1}{8}$	\$1 50
461-A	$\frac{3}{4}$	$\frac{3}{4}$	2 $\frac{1}{8}$	1 50
461-B	$\frac{1}{2}$	$\frac{1}{2}$	2 $\frac{1}{8}$	1 50
462	$\frac{1}{2}$	1	2 $\frac{1}{8}$	1 50
462-A	$\frac{3}{4}$	1	2 $\frac{1}{8}$	1 50
463	$\frac{1}{2}$	2	2 $\frac{1}{8}$	1 50
463-A	$\frac{3}{4}$	2	2 $\frac{1}{8}$	1 50
463-B	1	2	2 $\frac{1}{8}$	1 50
473	$\frac{1}{2}$	*	3	1 75
473-A	$\frac{3}{4}$	*	3	1 75

*No male thread on bottom of 473 and 473-A.

T & B Rectangular Gang Floor Boxes

Adjustable and Watertight Boxes for Light, Power and Communications

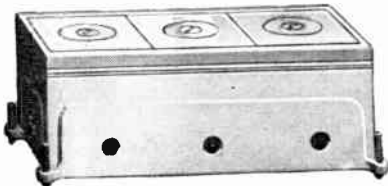

Boxes have double mechanical adjustment: floor form adjustment by adjusting screw in ear at each corner of box; floor level adjustment by adjusting screws in cover frames. Covers have no unsightly screws. Cover is metallicly grounded to the box. Boxes are heavily gasketed.

Standard equipment of these boxes is a combination $\frac{1}{2}$ -inch and 2-inch cover plate with each gang. Receptacles, nozzles and other accessories extra. Underwriters' Laboratories Approved.

Adjustment: $\frac{5}{8}$ -inch vertical; 10° angular. Minimum height overall 3 $\frac{3}{8}$ inches; width 4 $\frac{1}{16}$ inches.

No.	Description	Length In.	Std. Pkg.	Wt., Lbs.	Each
1810	One-Gang	4 $\frac{5}{16}$	\$100	9	\$12 80
1820	Two-Gang	8 $\frac{3}{8}$	list	15	24 80
1830	Three-Gang	12 $\frac{7}{8}$	value	21	36 80

No.	Description	Each
1706	Cover.....	\$1 76
1707	Disc.....	1 36
1728	Insulated Bushed Nozzle.....	1 04
1709	Disc with $\frac{1}{2}$ -in. Hole and Plug.....	1 76
1711	Large Rubber Gasket.....	.24
1712	Small Rubber Gasket.....	.24
1666	Two-Wire Recp. with 2 Screws.....	1 76
1673	Three-Wire Recp. with 2 Screws.....	3 04
1739	Bushed Triple Nozzle.....	2 24
1741	Tin Box Protector.....	.88
1746	$\frac{3}{4}$ -inch Plug with Screwdriver Slot.....	.24
1747	Extension Piece, $\frac{1}{2}$ -in. size, 4-in. long.....	2 24
1748	$\frac{1}{2}$ -in. Plug with Screwdriver Slot.....	.16
1749	1-inch Plug with Screwdriver Slot.....	.32
1816	Square Cover.....	5 28

T & B Receptacles

No.	Description	Each
1666	T Slot—2-wire.....	\$2.85
1667	"Twist-Lock®"—2-wire.....	4.60
1669	Three wire—20 amp.....	5.25
1670	"Twist-Lock®"—3-wire.....	5.00
1671	Three wire—grounded 20 amp. .	5.25
1672	"Twist-Lock®"—3-wire.....	5.00
1673	Three wire.....	4.60
1674	Three wire—grounded polarized.	4.60
1675	NEMA—grounded.....	4.60

Steel City Special Types and Sizes of Floor Outlets With Blank Bronze Covers



No. 423 Adjustable Floor Outlet

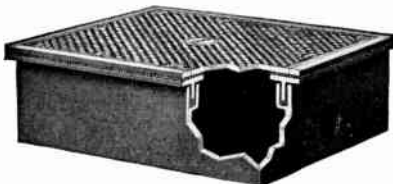

No. 426 Adjustable Floor Outlet

*No.	Description	Wt., Lbs.	Each
423	6¼x8¼x1⅜-in. Deep Adjustable Floor	16	\$15.00
424	6¼x8¼x6-in. Deep Adjustable Floor	20	17.50
425	10x12x1⅜-in. Deep Adjustable Floor. .	28	35.00
426	10x12x1⅜-in. Deep Adjustable Floor	28	35.00

*Outlet with ¼-in. thick Cover Plate.

Conform to U. S. Government Drawing 311

Non-Adjustable Floor Outlet 6 inches square, Cover Plate 7 inches square with inside checkered cover 5 inches square.

429	6x6x3⅝ inches.....	12	\$15.00
430	6x6x1⅜ inches.....	13	15.00

All covers for above boxes furnished blank.

Tapped holes in cover plates and plugs to fit can be furnished at extra cost. Please specify size. Prices on inquiry.

Box bodies can be tapped with ½-inch or ¾-inch holes, plugged, at no additional cost. Larger tappings and plugs at additional cost. Prices upon request.

Quantity prices on request.

Steel City Adjustable Gang Floor Outlets Original Fullman Type

Watertight rectangular gang floor boxes designed to meet the need where a variety of services such as light, power, telephone, buzzer, etc., are required at one point.

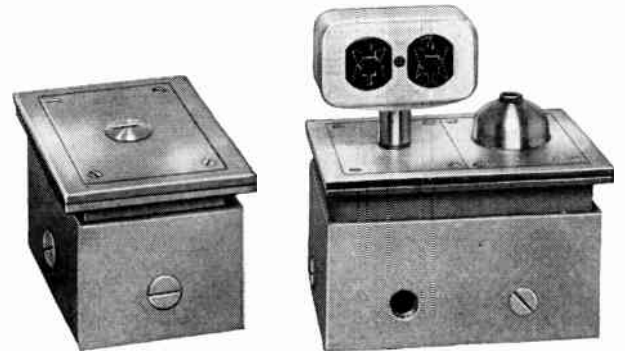

No. 441-A Adjustable Floor Outlet with No. 458 Cover Plate No. 442-C Adjustable Floor Outlet with 468H and 466 Nozzles

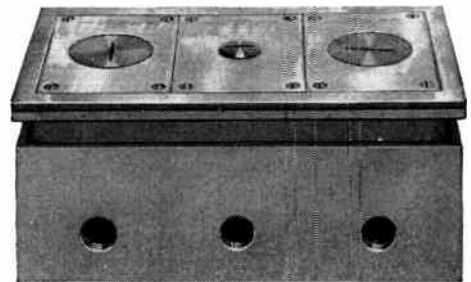

No. 443-B Adjustable Outlet with One No. 458 and Two No. 459 Cover Plates

Complete Outlets

Receptacles optional and cost extra. Any standard 2 or 3 wire, 10 amp. or 20 amp. receptacle will fit these boxes. All boxes can be furnished with either 458 or 459 cover plates, or combination of both. Please specify.

No. 458 No. 459

Complete Box No.	Box Body	Adjusting Ring	Cover With ½" Plug No. 471	Cover With 2" Plug No. 472	No. 439 Seating Plate	No. 464 Gasket	No. 476 Sealing Cement	Each
3⅝-in. Min. Hgt., 3½-in. Max. Hgt., 4-in. Long, 5½-in. Wide								
441A	447	488	1	—	—	1	1	\$10.00
441B	447	488	—	1	1	1	1	10.00
4½-in. Min. Hgt., 4¼-in. Max. Hgt. 7-in. Long, 5½-in. Wide								
442A	448	453	2	—	—	2	2	\$15.50
442B	448	453	—	2	2	2	2	15.50
442C	448	453	1	1	1	2	2	15.50
442LA	448L	453	2	—	—	2	2	15.50
442LB	448L	453	—	2	2	2	2	15.50
442LC	448L	453	1	1	1	2	2	15.50
3-in. Min. Hgt., 3-in. Max. Hgt., 7-in. Long, 5½-in. Wide								
442SA	448L	453S	2	—	—	2	2	15.50
442SB	448L	453S	—	2	2	2	2	15.50
442SC	448L	453S	1	1	1	2	2	15.50
3½-in. Min. Hgt., 4½-in. Max. Hgt., 10 in. Long, 5½-in. Wide								
443A	449	454	3	—	—	3	3	23.00
443B	449	454	—	3	3	3	3	23.00
443C	449	454	2	1	1	3	3	23.00
443D	449	454	1	2	2	3	3	23.00
4¼-in. Min. Hgt., 4½-in. Max. Hgt. 13-in. Long, 5½-in. wide								
444*	450	456	—	—	—	4	4	29.00
4½-in. Min. Hgt., 4¾-in. Max. Hgt., 16-in. Long, 9½-in. Wide								
445**	451	456	—	—	—	5	5	36.00
4-in. Min. Hgt., 4½-in. Max. Hgt. 19-in. Long, 5½-in. Wide								
446**	452	457	—	—	—	6	6	41.00

*No. 458 or No. 459 as required.

**One No. 439 Seating Plate furnished for each No. 459 plate.

Steel City Adjustable Gang Floor Outlets

**Rectangular Box—Fullman Type
Screw Adjustment**

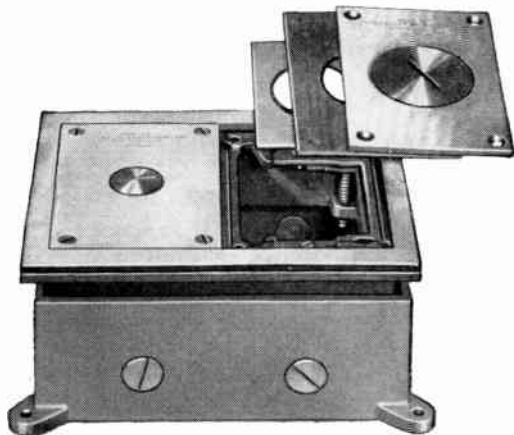

No. 6542

Two-gang floor outlet similar to No. 412. Four adjusting screws, one in each corner. Minimum height of box 3 1/2 inches; maximum height 1 inches with 1/2-inch of the adjusting frame still seated in the ring of box body. Can be tapped for 1-inch conduit with room for bushing or for 1 1/4-inch conduit without bushing.

No.	Description	Wt., Lbs. Each	Each
6542	Overall dimensions, 5 1/2 in. wide, 7 in. long.....	12 1/2	\$19.50

Parts

Box Bodies

Made of gray iron; sherardized. Lugs are provided on each adjusting frame for mounting receptacles, etc.

End sections have three holes tapped for 1/2-inch conduit; intermediate sections have two holes tapped for 1/2-inch conduit. All boxes can be tapped for 3/4-in. and 1-in. conduit with room for bushing. All boxes except 412S and 412L can be tapped for 1 1/4 in. conduit without room for bushing.

No.	Description	Ht. In.	Approx. Wt., Lbs. Each	Each
447	1-Gang Box.....	2 3/4	4	\$4.50
448	2-Gang Box.....	3 1/8	7	6.50
449	3-Gang Box.....	3 1/8	11	9.25
450	4-Gang Box.....	3 1/8	14	12.65
451	5-Gang Box.....	3 1/8	16	14.52
452	6-Gang Box.....	3 1/8	19	17.43
448L	2-Gang Box.....	2 5/8	7	6.50

Adjusting Frames with Rubber Gaskets and Edge Frame

Adjusting frame is grey iron casting, sherardized. Bronze edge frame has statutory bronze finish.

The edge frame extends all around the cover plates, thus preventing chipping of floor when cover plates are removed.

No.	Description	Height Overall Inches	Approx. Wt., Lbs. Each	Each
488	Adjusting Frame for 1-Gang Box Body.....	1 1/4	2	\$3.50
453	Adjusting Frame for 2-Gang Box Body.....	1 3/4	3	4.50
454	Adjusting Frame for 3-Gang Box Body.....	1 5/8	4	6.75
455	Adjusting Frame for 4-Gang Box Body.....	1 5/16	6	8.80
456	Adjusting Frame for 5-Gang Box Body.....	1 3/4	9	10.37
457	Adjusting Frame for 6-Gang Box Body.....	1 5/16	9	12.47
453S	Adjusting Frame for 442-S.....	1 1/16	3	4.50

Quantity prices on request.

**Steel City Adjustable Gang Floor Outlets
Parts**

No.	Description	Approx. Wt., Oz. Each	Each
458	Cover Plate with 1/2-in. Flush Plug, for one section of Gang Outlet.....	7	\$1.90
459	Cover Plate, with 2-in. Flush Plug, for one section of Gang Outlet.....	7	1.90
471	1/2-inch Plug for Cover Plate (convex).....	1	.75
472	2-in. Plug for Cover Plate (flush).....	2	1.00
472S	Plug for Cover with 1/2-in. convex plug in center (2-in. diam.).....	2	1.25
439	Steel Plate for Seating 2-in. Flush Plug.....	2	.24
464	Rubber Gasket for No. 458 or No. 459 Cover Plates.....	1	.24
476	Sealing Cement for One Section.....	3	.25

**Dimensions of Complete Steel City
Gang Floor Outlets**

No. of Gangs	1	2	3	4	5	6
Min. height to top of Cover Plate, In.....	3 1/2	4 1/16	3 7/8	4 1/4	4 1/8	4
Length overall, In.....	4	7	10	13	16	19
Width overall, In.....	5 1/2	5 1/2	5 1/2	5 1/2	5 1/2	5 1/2
Max. height overall, In.....	3 13/16	4 3/4	4 1/2	4 7/8	4 3/4	4 5/8

Appleton Unilets

Malleable Iron, Cadmium Finish

Series "GS"

For use with Rigid Conduit (Heavy Wall)

Will take covers, fixtures, vaporproof fixtures, plug receptacle housings, etc. Complete with strap and screws for wiring devices.

Type GS with Lugs

Form 5 and 10

No.	Size In.	Std. Pkg.	Wt. Lbs. Std. Pkg.	Each
16051	1/2	25	42	\$1.80
16071	3/4	25	41	2.10
Form 20				
16061	1/2	25	75	\$3.00
16081	3/4	25	100	3.30
16091	1	10	30	3.70

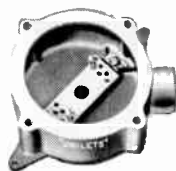

Type GSA with Lugs

Form 5 and 10

No.	Size In.	Std. Pkg.	Wt. Lbs. Std. Pkg.	Each
16056	1/2	25	50	\$1.80
16076	3/4	25	56	2.10
Form 20				
16066	1/2	25	97	\$3.00
16086	3/4	25	80	3.30
16096	1	10	32	3.70



Type GSC with Lugs

Form 5 and 10

No.	Size In.	Std. Pkg.	Wt. Lbs. Std. Pkg.	Each
16052	1/2	25	64	\$2.00
16072	3/4	25	42	2.30
Form 20				
16062	1/2	25	102	\$3.20
16082	3/4	25	105	3.50
16092	1	10	50	3.90

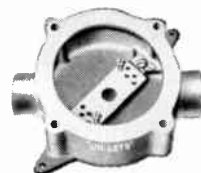

Type GSS with Lugs

**(Form 5 and 10 not made)
Form 20**

No.	Size In.	Std. Pkg.	Wt. Lbs. Std. Pkg.	Each
16020	1/2	25	102	\$3.20
16050	3/4	25	105	3.50
16070	1	10	50	3.90



Note—Form 5 and 10, also 20 indicate sizes of Unilets which take covers and wiring devices correspondingly classified.

Appleton Unilets

**Malleable Iron, Cadmium Finish
For "GS" Series Unilet Bodies
Complete with Gaskets and Screws**

Vaportight Hub Covers

No.	Form	Hub Size, In.	Std. Pkg.	Wt., Lbs. Std. Pkg.	Each
18062	5 & 10	3/8	25	16	\$1.20
18063	5 & 10	1/2	25	17	1.20
18064	20	3/8	25	35	2.00
18065	20	1/2	25	38	2.00



Vaportight Blank Covers

18066	5 & 10	..	25	26	\$1.00
18067	20	..	25	36	1.80



Lock Switch Covers

For Form 5 and 10 Unilet Bodies where the use of a key is desirable when used with lock switch attachment.



No.	Std. Pkg.	Wt., Lbs. Std. Pkg.	Each
18068	25	13	\$1.20

Midget Guard Fixtures

For Form 5 and 10 Unilet Bodies.

Complete fixture consists of cover, receptacle, guard, gaskets and screws. (Vapor-proof Glass Globes cannot be furnished for these fixtures).



Fixture Complete

For Lamps, Watts	Complete Fixture No.	Each	Cover Only No.	Each	Guard Only No.	Lgth. In.	Each
15-25	18069†	\$5.60	18073†	\$1.60	18075	4 1/4	\$2.50
40-50-60	18070†	5.60	18074†	1.60			
50-60	18071†	6.10	18073†	1.60			
75-100	18072†	6.10	18074†	1.60			

†Cover with receptacle outside.

‡Cover with receptacle inside.

Plug Receptacle Covers

For Form 5 and 10 Unilet Bodies. Will take Benjamin watertight plug receptacles. Quantity prices on request.

Vaportight Lamp Receptacle Covers

Complete with receptacle with screw shell, gaskets and screws. Plain type.



No. 18082



No. 18088

No.	Form	Std. Pkg.	Wt., Lbs. Std. Pkg.	Each
18082†	5 & 10	25	35	\$3.00
18088†	20	25	33	3.67

†When specified on order above lamp receptacles will be furnished with lamp grip at an advance in price.

Appleton Vaportight Adapters

No. 18092 permits the use of Form 100 and 200 vapor-tight fixtures.

No. 18093 permits the use of Form 5 and 10 covers and accessories.

For Unilet Bodies

No.	Form	Std. Pkg.	Wt., Lbs. Std. Pkg.	Each
18092	5 and 10	25	25	\$1.50
18093	20	25	27	1.50



R & S Conduit Boxes

Type FS and FD—One to Six Gang

Accommodate All R & S Type FS and FD Fittings

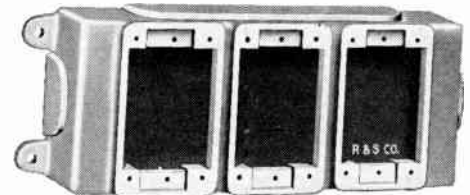

Type FS—Three Gang

Maximum conduit — 1-inch; one per gang top and bottom and one each side.

*Dimensions: Type FS single gang 4 1/8 x 2 5/8 x 2 1/4 inches. Type FD single gang 4 1/8 x 2 5/8 x 2 7/8 inches. Dimensions of gang boxes on request.



Type FS Single Gang

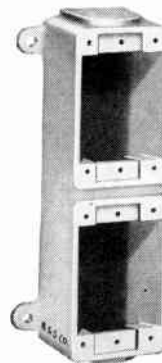

Type FS Tandem

Type	No.	Each	Cast Brass No.	Each
Single Gang				
FS	3701	\$2.00	3721	\$6.00
FD	3711	2.50	3731	7.50
Two Gang				
FS	3702	4.00	3722	12.00
FD	3712	5.00	3732	15.00
Three Gang				
FS	3703	6.00	3723	18.00
FD	3713	7.50	3733	22.50
Four Gang				
FS	3704	8.00	3724	24.00
FD	3714	10.00	3734	30.00
Six Gang				
FD	3700	15.00	3719	45.00
Tandem				
FS	3715	4.00	3735	12.00

Type DSFD

Single Gang Only

Will accommodate same devices as FS and FD boxes.

Maximum conduit: One 1 1/2-inch or two 1/2-inch top and bottom.

*Dimensions: 4 1/8 x 3 5/8 x 4 1/8 inches.

Type	No.	Each	Cast Brass No.	Each
DSFD	3781	\$4.00	3782	\$12.00



Type DSFD

Finish — Cast iron, corrosion resisting baked enamel finish. Cast brass, natural finish.

Outlets — Unless otherwise specified, furnished with one 3/4-inch outlet per gang, top or bottom. Additional or larger outlets charged extra. Specify size and location.

*Dimensions are overall exclusive of conduit pads and mounting lugs.

Appleton Unilets
Malleable Iron, Cadmium Finish

Series "GR"

Explosion-Proof and Dust-Tight
With Regular Threaded Hubs
Furnished with External Threaded Surface Covers

Type GRE



No.	Size In.	Wt. Lbs. Per 5 Pcs.	Each
GRE-50	1/2	11	\$ 3.60
GRE-75	3/4	12	3.70
GRE-100	1	13	3.80
GRE-125	1 1/4	15	6.30
GRE-150	1 1/2	37	13.75

Type GRC



No.	Size In.	Wt. Lbs. Per 5 Pcs.	Each
GRC-50	1/2	12	\$ 3.80
GRC-75	3/4	13	4.00
GRC-100	1	14	4.20
GRC-125	1 1/4	16	6.80
GRC-150	1 1/2	38	14.20

Type GRLB



No.	Size In.	Wt. Lbs. Per 5 Pcs.	Each
GRLB-50	1/2	12	\$ 3.80
GRLB-75	3/4	12	4.00
GRLB-100	1	13	4.20
GRLB-125	1 1/4	16	6.80
GRLB-150	1 1/2	38	14.20

Type GRCA



No.	Size In.	Wt. Lbs. Per 5 Pcs.	Each
GRCA-50	1/2	13	\$ 4.00
GRCA-75	3/4	14	4.30

Type GRL



No.	Size In.	Wt. Lbs. Per 5 Pcs.	Each
GRL-50	1/2	11	\$ 3.80
GRL-75	3/4	12	4.00
GRL-100	1	13	4.20
GRL-125	1 1/4	16	6.80
GRL-150	1 1/2	38	14.20

Type GRLA



No.	Size In.	Wt. Lbs. Per 5 Pcs.	Each
GRLA-50	1/2	13	\$ 4.00
GRLA-75	3/4	14	4.30

Type GRT



No.	Size In.	Wt. Lbs. Per 5 Pcs.	Each
GRT-50	1/2	13	\$ 4.00
GRT-75	3/4	14	4.30
GRT-100	1	15	4.50
GRT-125	1 1/4	18	7.30
GRT-150	1 1/2	40	14.90

Type GRTA



No.	Size In.	Wt. Lbs. Per 5 Pcs.	Each
GRTA-50	1/2	14	\$ 4.20
GRTA-75	3/4	15	4.60

Type GRX



No.	Size In.	Wt. Lbs. Per 5 Pcs.	Each
GRX-50	1/2	12	\$ 4.20
GRX-75	3/4	13	4.60
GRX-100	1	13	4.90
GRX-125	1 1/4	23	7.80
GRX-150	1 1/2	45	15.40

If any of these Unilet Bodies are wanted without covers for use in fixture canopies, specify number of fitting and indicate "Less Cover."

Quantity prices on request.

Appleton Unilets
Malleable Iron, Cadmium Finish
Series "GRJ"

Explosion-Proof and Dust-Tight Fittings
With Threaded Hubs
Dotted lines in bottom indicate Hubs



Type GRJX Unilet with Blank Cover

This series has been designed to meet the demand for a very small, yet substantial explosion-proof unilet for use as a junction box. It is especially suited for use inside of gasoline pumps where the space is limited. Have threaded screw cover.

Complete with Blank Cover

The body is 2 1/4-in. in diameter and 1 15/16-in. deep.

Type GRJC

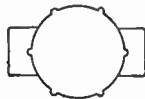

No.	Size In.	Wt. Lbs. Per 25 pcs.	Each
40002	1/2	40	\$3.10
40022	3/4	38	3.30

Type GRJCA



No.	Size In.	Wt. Lbs. Per 25 pcs.	Each
40008	1/2	44	\$3.30
40028	3/4	42	3.60

Type GRJEA

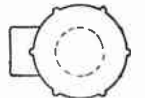

No.	Size In.	Wt. Lbs. Per 25 pcs.	Each
40007	1/2	40	\$3.10
40027	3/4	38	3.30

Type GRJL

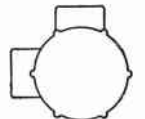

No.	Size In.	Wt. Lbs. Per 25 pcs.	Each
40005	1/2	41	\$3.10
40025	3/4	36	3.30

Type GRJT



No.	Size In.	Wt. Lbs. Per 25 pcs.	Each
40003	1/2	45	\$3.30
40023	3/4	42	3.60

Type GRJTA

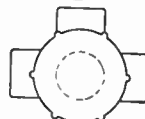

No.	Size In.	Wt. Lbs. Per 25 pcs.	Each
40009	1/2	45	\$3.50
40029	3/4	42	3.90

Type GRJX

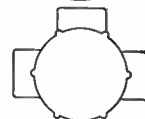

No.	Size In.	Wt. Lbs. Per 25 pcs.	Each
40004	1/2	46	\$3.50
40024	3/4	45	3.90

Type GRJXA

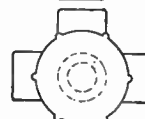

No.	Size In.	Wt. Lbs. Per 25 pcs.	Each
40010	1/2	54	\$3.70
40020	3/4	47	4.20

Type GRJN

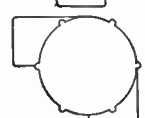

No.	Size In.	Wt. Lbs. Per 25 Pcs.	Each
40006	1/2	40	\$3.10
40026	3/4	38	3.30

Type GRJS
With Blank Cover.

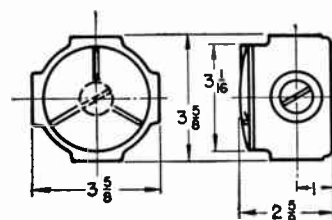

A small, compact junction fitting 3 5/8-in. diameter, 2 3/8-in. high, with cover having external threads. Has five threaded hubs, one in each of four sides and in bottom. Four hubs have close-up plugs and one hub open.

No.	Size In.	Wt. Lbs. Per 25 Pcs.	Each
40094	1/2	19	\$3.75
40095	3/4	19	3.75

Quantity prices on request.

Appleton Unilets
Malleable Iron, Cadmium Finish
Series "GRUJ" — Universal
Explosion-Proof and Dust-Tight Fittings

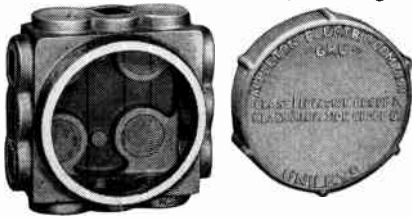

Type GRUJ-2
With Cover Removed Showing
Close-Up Plugs In Certain Threaded Openings

This is a Universal Fitting and can be used as a junction box because practically any combination of outlets can be made with the use of close-up plugs, reducers and connectors.

The GRUJ-2 and GRUJ-4 have 4 conduit hubs on back which are on the same centers as the knockouts in a 4-in. square outlet box No. OB-4S, commonly known as the 1900 box. As many old gasoline pump wiring installations are made with conduits entering through the back knockouts of the 4-in. square outlet box, changing over to an explosion-proof installation is comparatively easy. It is only necessary to remove the old outlet box, attach union connectors to the existing conduits and make connections to the unilet. Requires no cutting or bending of conduits to meet the openings in the unilet.

With Threaded Hubs and Close-Up Plugs
Close-Up Plugs Furnished In All But Three Hubs

No.	Type	Number of Hubs and Size In.				Wt., Lbs. Per 5 Pcs.	Each
		Each Side	Top End	Bot. End	Back		
8650	GRUJ-1	2-3/4	1-3/4	2-3/4	None	22 1/2	\$5.40
8651	GRUJ-2	2-3/4	1-3/4	2-3/4	4-3/4	22 1/2	5.80
8652	GRUJ-5	2-3/4	1-3/4	2-3/4	4-1	22 1/2	6.40

With Threaded Hubs—Without Close-Up Plugs

8655	GRUJ-3	2-3/4	1-3/4	2-3/4	None	20	\$5.17
8656	GRUJ-4	2-3/4	1-3/4	2-3/4	4-3/4	20	5.50
8657	GRUJ-6	2-3/4	1-3/4	2-3/4	4-3/4	22 1/2	5.85

Accessories For GRUJ Series Unilets

Threaded Reducers

No.	Size, In.	Wt., Lbs. Per 1000 Pcs.	Each
18201	3/4 to 1/2	51	\$0.16
18213	1 to 3/4	55	.25

Quantity prices on request.

Appleton Unilets
The "35" Line

Appleton Unilet Receptacles

For Form 35 Threaded and No-Thread Unilet Bodies
Complete with Fastening Screws



Two-Piece Lamp Receptacles
660 Watts, 600 Volts

Porcelain Top and Composition Base.

No.	Size In.	Std. Pkg.	Wt., Lbs. Std. Pkg.	Each
35100	1/2	100	52	\$1.00
35101	3/4	100	60	1.10
35102	1	50	40	1.60



One-Piece Lamp Receptacles

660 Watts, 600 Volts

Porcelain

35110	1/2	100	60	\$1.00
35111	3/4	100	65	1.10
35112	1	50	40	1.60

Appleton Unilets
The "35" Line (Cont.)

Attachment Plug Receptacles Two-Pole



With double T-slots. 15 amp., 125 volts; 10 amp., 250 volts

Composition

No.	Single		Duplex		Size In.	Std. Pkg.
	Wt. Lbs. Std. Pkg.	Each	No.	Wt. Lbs. Std. Pkg.		
35120	45	\$1.20	35125	35	\$1.80	1/2 100
35121	50	1.40	35126	38	2.00	3/4 100
35122	35	1.80	35127	30	2.50	1 50

Polarity Plug Receptacles Three Pole



Take Hubbell Plug Caps No. 7055 and 9750. Composition

Rating: 15 amp., 125 volts; 10 amp., 250 volts

Grounded

35151	55	\$1.65	35156	57	\$1.85	3/4 100
35152	38	1.75	35157	40	2.00	1 50

†Plug Caps are not included. Lamp Receptacles with lamp grip will be furnished if specified at an advance in price.

Appleton Unilet Body Covers

For Form 35 Threaded and No-Thread Unilet Bodies
With Fastening Screws and Fibre Retaining Washers

Composition — With Wire Holes



One-Wire Standard

No.	Diam. Hole, In.	Size In.	*Std. Pkg.	Wt. Lbs. Std. Pkg.	Each
35201	13/32	1/2	200	25	\$0.30

*Unit Packing: 1/2 to 1 in., 20; 1 1/4 and 1 1/2 in., 10; 2 to 4 in., 5.



Two-Wire



Three-Wire

2-Wire			3-Wire			Size, In.	*Std. Pkg.	Wt., Lbs. Std. Pkg.
No.	Dia. Hole, In.	Each	No.	Dia. Hole, In.	Each			
35202	3/8	\$0.30	35203	5/16	\$0.30	1/2	200	25
35222	3/8	.40	35223	3/8	.40	3/4	100	15
35242	19/32	.60	35243	19/32	.60	1	50	14
35262	19/16	.80	35263	13/16	.80	1 1/4, 1 1/2	20	12
35282	1	1.20	35283	1	1.20	2	5	8
35402	1 1/16	3.20	35403	1 1/16	3.20	2 1/2, 3	5	16
35422	1 1/16	5.00	35423	1 1/16	5.00	3 1/2, 4	5	25
4-Wire			5-Wire					
35204	5/16	\$0.30	1/2	200	25
35224	5/16	.40	3/4	100	15
35244	13/32	.60	35245	13/32	.50	1	50	14
35264	19/32	.80	1 1/4, 1 1/2	20	12
35284	1	1.20	35285	13/16	1.20	2	5	8
35404	1 1/16	3.20	35405	1 1/16	3.20	2 1/2, 3	5	16
35424	1 1/16	5.00	35425	1 1/2	5.00	3 1/2, 4	5	25
36054	...	8.00	36055	...	8.00	5	1	7
36064	...	8.00	36065	...	8.00	6	1	9

		Blank			
35200	...	\$0.30	1/2 200 25
3522040	3/4 100 15
3524060	1 50 14
35260	...	1.00	1 1/4, 1 1/2 20 12
35280	...	1.20	2 5 8
35400	...	3.20	2 1/2, 3 5 16
35420	...	5.00	3 1/2, 4 5 25

*Unit Packing: 1/2 to 1 in., 20; 1 1/4 and 1 1/2 in., 10; 2 to 4 in., 5; 5 and 6 in., 1.

†Standard and Special 1-wire covers differ only in the diameter of wire hole. Standard 1-wire covers will be furnished unless otherwise specified.

Appleton Unilets

The "35" Line

Unbreakable malleable iron castings, clean-cut in every detail, smooth and free from scars, holes and blemishes. Cadmium finish insures positive resistance to rust and corrosion.

Have no cover ear lugs and can be used where specifications require fittings without ear lugs. Wide, flat cover surfaces, drilled and tapped at each end for cover screws.

Conduit hub edges are chamfered assuring straight and accurate tapping—no sharp or rough edges.

Blank metal covers are reinforced and slightly raised.

Porcelain and composition covers are perfectly flat and smooth.

Moulded receptacles are specially designed for convenient and easy wiring.

Threaded types listed below; for information and prices on No-Thread types, contact Graybar.



Threaded type in all popular styles. Sizes 1/2 to 6 inches.



No-Thread type in all popular styles. Sizes 1/2 to 6 inches. For complete information, contact Graybar.

Appleton Unilet Bodies

Form 35—Threaded

For use with Rigid Conduit (Heavy Wall)



Type C



Type E

No.	Size, In.	Std. Pkg.	Wt. Pkg. Lbs.	Each	No.	Size, In.	Std. Pkg.	Wt. Pkg. Lbs.	Each
C351	1/2	100	80	\$.80	E351	1/2	100	70	\$.70
C352	3/4	50	60	.95	E352	3/4	50	45	.80
C353	1	20	36	1.45	E353	1	20	30	1.10
C354	1 1/4	20	57	2.30	E354	1 1/4	20	54	1.70
C355	1 1/2	10	34	3.00	E355	1 1/2	10	30	2.40
C356	2	5	33	5.00	E356	2	5	32	4.40
C357	2 1/2	5	50	10.50	E357	2 1/2	5	45	9.00
C358	3	5	60	14.00	E358	3	5	55	11.00
C359	3 1/2	5	75	23.00	E359	3 1/2	5	65	16.00
C360	4	5	95	26.00	E360	4	5	80	19.00



Type LB



Type LL

LB351	1/2	100	80	\$.80	LL351	1/2	100	80	\$.80
LB352	3/4	50	60	.95	LL352	3/4	50	60	.95
LB353	1	20	36	1.45	LL353	1	20	36	1.45
LB354	1 1/4	20	57	2.30	LL354	1 1/4	20	57	2.30
LB355	1 1/2	10	34	3.00	LL355	1 1/2	10	51	3.00
LB356	2	5	33	5.00	LL356	2	5	33	5.00
LB357	2 1/2	5	50	10.50	LL357	2 1/2	5	50	10.50
LB358	3	5	60	14.00	LL358	3	5	60	14.00
LB359	3 1/2	5	75	23.00	LL359	3 1/2	5	75	23.00
LB360	4	5	95	26.00	LL360	4	5	95	26.00
LB362	5	1	38	38.35					
LB363	6	1	61	60.00					



Type LR



Type LRL

LR351	1/2	100	80	\$.80	LRL351	1/2	100	85	\$.90
LR352	3/4	50	60	.95	LRL352	3/4	50	65	1.10
LR353	1	20	36	1.45	LRL353	1	20	40	1.50
LR354	1 1/4	20	57	2.30	LRL354	1 1/4	20	60	3.20
LR355	1 1/2	15	51	3.00	LRL355	1 1/2	10	38	4.40
LR356	2	5	33	5.00	LRL356	2	5	35	6.30
LR357	2 1/2	5	50	10.50	LRL357	2 1/2	5	55	12.00
LR358	3	5	60	14.00	LRL358	3	5	65	15.00
LR359	3 1/2	5	75	23.00	LRL359	3 1/2	5	80	25.00
LR360	4	5	95	26.00	LRL360	4	5	100	28.00

Quantity prices on request.

Appleton Unilet Bodies

Form 35—Threaded

For use with Rigid Conduit (Heavy Wall)



Type T—Regular

No.	Size, In.	Std. Pkg.	Wt. Pkg. Lbs.	Each	No.	Size, In.	Std. Pkg.	Wt. Pkg. Lbs.	Each
T351	1/2	100	95	\$1.00	T356	2	5	34	\$5.60
T352	3/4	50	70	1.20	T357	2 1/2	5	60	11.00
T353	1	20	42	1.80	T358	3	5	70	16.00
T354	1 1/4	20	60	2.70	T359	3 1/2	5	90	25.00
T355	1 1/2	10	38	3.60	T360	4	5	110	28.00

Appleton Unilet Body Covers

For Form 35 Threaded and No-Thread Unilet Bodies

With Fastening Screws and Fibre Retaining Washers



Blank
Cadmium Finish

Steel				Malleable				Size, In.	Std. Pkg.	Unit Pkg.
No.	Wt. Std. Pkg. Lbs.	Each	No.	Wt. Std. Pkg. Lbs.	Each					
35000	30	\$.15	35010	50	\$.35	1/2	200	50		
35020	20	.20	35030	35	.45	3/4	100	50		
35040	12	.35	35050	20	.70	1	50	25		
35060	14	.50	35070	18	1.00	1 1/4, 1 1/2	20	20		
35080	10	.85	35090	15	1.40	2	5	5		
36000	15	1.30	36010	28	1.70	2 1/2, 3	5	5		
36020	21	1.60	36030	35	2.50	3 1/2, 4	5	5		
36050	11	3.00				5	1	1		
36060	13	5.00				6	1	1		

Call Graybar FIRST For . . .



Appleton Unilet Bodies

For use with Rigid Conduit
(Heavy Wall)

Series FS

Malleable Iron, Cadmium Finish

Will take covers and shallow flush rectangular wiring devices, or plug receptacle housings. Wiring device screws are not included.

Overall size, exclusive of hubs: Length $4\frac{9}{16}$ in., Width $2\frac{3}{16}$ in.; Depth 2 in.

Type FS

No.	Size In.	Std. Pkg.	Wt., Lbs. Std. Pkg.	Each
 7901	$\frac{1}{2}$	25	44	\$1.45
7921	$\frac{3}{4}$	25	47	1.55
7941	1	15	26	1.70

Type FSC

No.	Size In.	Std. Pkg.	Wt., Lbs. Std. Pkg.	Each
 7902	$\frac{1}{2}$	25	47	\$1.65
7922	$\frac{3}{4}$	25	51	1.80
7942	1	15	29	2.20

Type FSL

No.	Size In.	Std. Pkg.	Wt., Lbs. Std. Pkg.	Each
 7905L	$\frac{1}{2}$	25	46	\$1.65
7925L	$\frac{3}{4}$	25	51	1.80
7945L	1	15	29	2.20

Type FSR

No.	Size In.	Std. Pkg.	Wt., Lbs. Std. Pkg.	Each
 7905R	$\frac{1}{2}$	25	46	\$1.65
7925R	$\frac{3}{4}$	25	51	1.80
7945R	1	15	29	2.20

Type FSCC

No.	Size In.	Std. Pkg.	Wt., Lbs. Std. Pkg.	Each
 7911	$\frac{1}{2}$	25	46	\$2.00
7931†	$\frac{3}{4}$	25	49	2.50
7951†	1	15	32	2.90
7971†	$\frac{3}{4}$	25	53	2.90

Type FSCT

No.	Size In.	Std. Pkg.	Wt., Lbs. Std. Pkg.	Each
 7909	$\frac{1}{2}$	25	49	\$2.00
7929	$\frac{3}{4}$	25	50	2.50
7949	1	15	33	2.90

Type FSX

No.	Size In.	Std. Pkg.	Wt., Lbs. Std. Pkg.	Each
 7904	$\frac{1}{2}$	25	49	\$2.40
7924	$\frac{3}{4}$	25	52	3.00
7944	1	15	35	3.40

†Hubs at right are $\frac{1}{2}$ -in.

‡All Hubs are $\frac{3}{4}$ -in.

Quantity prices on request.

Series FS and FD — Threaded

Malleable Iron, Cadmium Finish

Will take covers and deep or shallow flush rectangular wiring devices respectively. Wiring device screws not included.

Two-Gang

Overall size, exclusive of hubs: $4\frac{1}{8}$ in. wide, $4\frac{9}{16}$ in. high; Depth—shallow type 2 in.; deep type $2\frac{1}{4}$ in.

Type FS — Shallow

No.	Size In.	Std. Pkg.	Wt., Lbs. Std. Pkg.	Each
 6625	$\frac{1}{2}$	25	57	\$2.65
6630	$\frac{3}{4}$	15	36	2.75
6635	1	5	13	2.90

Type FD — Deep

16625	$\frac{1}{2}$	25	67	\$3.05
16630	$\frac{3}{4}$	15	44	3.15
16635	1	5	16	3.30

Type FSC — Shallow

6626	$\frac{1}{2}$	25	59	\$2.85
6631	$\frac{3}{4}$	15	37	3.00
6636	1	5	14	3.40

Type FDC — Deep

16626	$\frac{1}{2}$	25	69	\$3.25
16631	$\frac{3}{4}$	15	45	3.40
16636	1	5	17	3.80

Type FSD — Shallow

6627	$\frac{1}{2}$	25	62	\$3.10
6632	$\frac{3}{4}$ - $\frac{1}{2}$ †	15	34	3.30
6637	1- $\frac{1}{2}$ †	5	15	3.50

Type FDD — Deep

16627	$\frac{1}{2}$	25	70	\$3.50
16632	$\frac{3}{4}$ - $\frac{1}{2}$ †	15	45	3.70
16637	1- $\frac{1}{2}$ †	5	17	3.90

†The hubs at top in illustration are $\frac{1}{2}$ in.

Three-Gang — Unilet Bodies

Overall size, exclusive of hubs: $6\frac{1}{8}$ in. long, $4\frac{9}{16}$ in. high. Depth—shallow type 2 in.; deep type $2\frac{1}{4}$ in.

Type FS — Shallow

No.	Size In.	Std. Pkg.	Wt., Lbs. Std. Pkg.	Each
 6640	$\frac{1}{2}$	10	36	\$3.90
6645	$\frac{3}{4}$	10	35	4.00
6650	1	5	19	4.15

Type FD — Deep

16640	$\frac{1}{2}$	10	37	\$4.50
16645	$\frac{3}{4}$	10	38	4.60
16650	1	5	20	4.75

Type FSC — Shallow

6641	$\frac{1}{2}$	10	39	\$4.05
6646	$\frac{3}{4}$	10	37	4.25
6651	1	5	20	4.40

Type FDC — Deep

16641	$\frac{1}{2}$	10	38	\$4.70
16646	$\frac{3}{4}$	10	39	4.85
16651	1	5	21	5.00

Type FSD — Shallow

6642	$\frac{1}{2}$	10	38	\$4.50
6647	$\frac{3}{4}$ - $\frac{1}{2}$ †	10	40	4.60
6652	1- $\frac{1}{2}$ †	5	22	4.75

Type FDD — Deep

16642	$\frac{1}{2}$	10	39	\$5.10
16647	$\frac{3}{4}$ - $\frac{1}{2}$ †	10	40	5.20
16652	1- $\frac{1}{2}$ †	5	21	5.20

†Hubs at top in illustration are $\frac{1}{2}$ in.

Quantity prices on request.

Appleton Unilet Covers

For FS and FD Series Threaded and No-Thread Unilet Bodies
Cadmium Finish
Complete with Fastening Screws

Single-Gang Covers

Steel Covers



For double push button switches, double push button momentary contact and double push lock switches.

For square handle tumbler and toggle flush switches.

No.	Std. Pkg.	Wt., Lbs. Std. Pkg.	Each
7960	50	12	\$0.30

No.	Std. Pkg.	Wt., Lbs. Std. Pkg.	Each
7963	50	12	\$0.30



For one P & S-Despard, Bryant "IL" and Hubbell interchangeable wiring devices. With single opening strap.

For 2 or 3 P & S-Despard, Bryant "IL" and Hubbell interchangeable wiring devices. With 3-opening strap.

7965	50	13	\$0.50
------	----	----	--------

7965A	50	13	\$0.50
-------	----	----	--------



For Round flush receptacles.

For standard 2- or 3- wire duplex receptacles.

7969	50	12	\$0.30
------	----	----	--------

7976	50	11	\$0.30
------	----	----	--------

Cast Covers



For square handle toggle switches

For square handle toggle switches, with protecting guard.

7990	50	28	\$0.60
------	----	----	--------

7990A	50	31	\$0.70
-------	----	----	--------

With Receptacle for Standard Attachment Plug Cap
15 Amp., 125 Volts; 10 Amp., 250 Volts
With Spring Door and Gasket



No.	Description	Std. Pkg.	Wt., Lbs. Std. Pkg.	Each
7993	2-Wire, 2-Pole	25	30	\$3.50
7993A	2-Wire, 3-Pole*	25	31	5.00
7993B	3-Wire, 3-Pole	25	32	5.50

Without Door



7994	2-Wire, 2-Pole	25	19	\$2.00
7994A	2-Wire, 3-Pole*	25	20	3.50
7994B	3-Wire, 3-Pole	25	21	4.00

With Brass Cap — With Gasket



7992	2-Wire, 2-Pole	25	42	\$4.00
7992A	2-Wire, 3-Pole*	25	43	5.50
7992B	3-Wire, 3-Pole	25	44	6.00

*Third pole grounded.

Cast Vaportight Covers

With Gaskets



For square handle tumbler and toggle flush switches.

For square handle tumbler and toggle flush switches (with guards).

No.	Std. Pkg.	Wt., Lbs. Std. Pkg.	Each
8144	25	16	\$3.50

No.	Std. Pkg.	Wt., Lbs. Std. Pkg.	Each
8144B	25	16	\$3.50

Blank Metal



No.	Std. Pkg.	Wt., Lbs. Std. Pkg.	Each
7986	50	13	\$0.20

For round flush receptacles, with spring door, with gasket.

7988	50	44	\$2.50
------	----	----	--------



For Duplex Flush Receptacles, with spring door, with gasket.

7988D	50	44	\$3.00
-------	----	----	--------

Quantity prices on request.

Two-Gang Covers

Steel Covers



No. 14090 No. 14058 No. 14075 No. 14076 No. 14089

Cadmium finish. For square handle tumbler and toggle flush switches.

No.	Std. Pkg.	Wt., Lbs. St. Pkg.	Each
14090	25	10	\$0.60

For standard duplex flush receptacles.

14058	25	8	\$0.60
-------	----	---	--------

For toggle flush switches and round flush receptacles (without lift cover).

14075	25	10	\$1.00
-------	----	----	--------

For toggle flush switches and standard duplex flush receptacles.

14076	25	10	\$1.00
-------	----	----	--------

Blank Metal

14089	25	11	\$0.40
-------	----	----	--------

Malleable Covers — Without Gasket



For square handle toggle switches. (With protecting guard).

No.	Std. Pkg.	Wt., Lbs. Std. Pkg.	Each
8167	15	13	\$1.30

Malleable Vaportight Covers

With Gaskets



No. 8164

No. 8165

No.	For Switches	Std. Pkg.	Wt., Lbs. Std. Pkg.	Each
8164	Sq. Idle. Tumbler and Toggle Flush		15 26	\$6.00
8165	Blank		15 13	1.00

Three-Gang Covers

For FS and FD Series Threaded and No-Thread Unilet Bodies

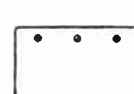
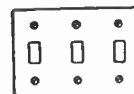

No. 15013

No. 15011-S

No. 15013-C

Steel covers. For square handle tumbler and toggle flush switches.

No.	Std. Pkg.	Wt., Lbs. Std. Pkg.	Each
15013	10	14	\$0.90

Blank Steel

15011-S	10	15	\$0.80
---------	----	----	--------

Cast Covers. For external operation of tumbler and toggle switches with square handle.

15013-C	10	51	\$8.50
---------	----	----	--------

Quantity prices on request.

Appleton Explosion-Proof Expansion Unions

**For Class I, Groups C and D;
Class II, Groups E, F, and G**
Listed by Underwriters' Laboratories, Inc.

"UNY" Series

These completely new Expansion Unions are more compact, are safer and easier to install than conventional union fittings.

Union is shipped as one assembled unit, and is never taken apart, either during installation, or while performing maintenance after initial installation.

The reduced external diameters permit easy installation in places where you might ordinarily encounter difficulty.

The union remains completely explosion-proof at all times, regardless of its position (full retraction to maximum extension, or any point between).

The close tolerances to which these unions are manufactured and a specially designed phosphor-bronze spring insure positive grounding at all times.

Type UNY—Male Type



No. UNY50



No. UNYL50

No.	Size In.	Dimensions, In. Diam.	Length	Std. Pkg.	Wt. Lbs. Per 100	Each
Type "UNY" Standard						
UNY50	1/2	1 3/16	2 7/8	50	39	\$1.00
UNY75	3/4	1 7/16	3 1/16	50	54	1.45
UNY100	1	1 3/4	3 3/8	25	82	2.50

Type "UNYL" Long

UNYL50	1/2	1 3/16	3 7/8	25	47	\$1.50
UNYL75	3/4	1 7/16	4 1/16	25	62	2.15
UNYL100	1	1 3/4	4 1/16	10	107	3.75

Type UNF—Female Type



No. UNF50



No. UNFL50

No.	Size In.	Dimensions, In. Diam.	Length	Std. Pkg.	Wt. Lbs. Per 100	Each
Type "UNF" Standard						
UNF50	1/2	1 3/16	2 5/16	50	41	\$1.00
UNF75	3/4	1 7/16	3 1/16	50	56	1.45
UNF100	1	1 3/4	3 3/8	25	84	2.50

Type "UNFL" Long

UNFL50	1/2	1 3/16	3 5/16	25	64	\$1.50
UNFL75	3/4	1 7/16	4 1/8	25	94	2.15
UNFL100	1	1 3/4	4 3/4	10	109	3.75

Note: For further information please contact Graybar.

Type UNL 90° Angle Unions

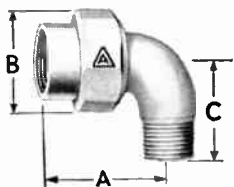

For connecting a conduit to a Unilet. (Not made in Long Type.)

Male end size given first, threaded to fit hubs of Series GRUO and GRUJ Unilets.

No.	Size, In.	Dimensions, Inches			Std. Pkg.	Wt. Per 5 Pcs.	Each
		A	B	C			
UNL84	1/2 to 1/2	2 11/16	1 7/8	1 13/16	25	3	\$2.80
UNL85-R	1/2 to 3/4	2 11/16	1 7/8	1 9/16	25	3	2.80
UNL86-R	3/4 to 1/2	2 1/8	1 7/8	1 13/16	25	3	2.80
UNL86	3/4 to 3/4	2 1/8	1 7/8	1 9/16	25	3	2.80

*Male end size given first, threaded to fit hubs of Series GRUO and GRUJ Unilets.

†End at right in illustration is for 3/4-in. conduit.

Quantity prices on request.

**Crouse-Hinds Condulet Equipment
For REA Rural Electrification Wiring**



Lamp Watts	No.	Each	Lamp Watts	No.	Each
25-100	VRA110	\$4.25	25-100	VR0410	\$4.75
25-100	VRB110	6.45	VR10	1.65

**FS Series
Switch and Plug Receptacle Condulets**



Type FS			Rating	Type FSC	
No.	Each			No.	Each
FS1311	\$5.05	1-Pole	10 T.-125 V. 5 A.-250 V.	FSC1311	\$5.20
FS1312	5.50	2-Pole	10 T.-125 V. 10 A.-250 V.	FSC1312	5.65
FS1313	5.80	3-Way	10 T.-125 V. 5 A.-250 V.	FSC1313	5.95
FS1314	9.00	4-Way	5 T.-125 V. 2 A.-250 V.	FSC1314	9.15

FS Series Plug Receptacles with Spring Door



Type FS		Type FSC		
No.	Each	Description	No.	Each
Receptacle—15 Amp.—125 V.—10 Amp.—250 V.				
FS1514	\$5.35	2-Wire, 2-Pole*	FSC1514	\$5.50
FS1515	6.80	2-Wire, 3-Pole†	FSC1515	6.95
FS1516	6.80	3-Wire, 3-Pole‡	FSC1516	6.95

FS Series Plug Receptacles With Threaded Cap and Chain



Type FS		Type FSC		
No.	Each	Description	No.	Each
Receptacle—15 Amp.—125 V.—10 Amp.—250 V.				
FS1614	\$5.00	2-Wire, 2-Pole*	FSC1614	\$5.15
FS1615	6.45	2-Wire, 3-Pole†	FSC1615	6.60
FS1616	6.45	3-Wire, 3-Pole‡	FSC1616	6.60

*Double T Slots.

†Polarized. ‡Third pole grounded.

‡Polarized.

Appleton REA Conduit Fittings
Schedule CF
For Rural Electrification Wiring—Weathertight

Special "REA" Conduit Fittings (Weatherproof) designed expressly to meet the needs for inexpensive, well-made Lighting Fixtures, Wall Receptacles and Switches (all weathertight) for use in R.E.A. wiring.

For lighting basements, woodsheds, garages, poultry houses, cow-stables, milk houses, shops, pumphouses and numerous other places about the modern, up-to-the-minute farm buildings and yards.

Lightweight Lighting Fixtures
With Clear Globe—No Guard

Type RVA



No. REA1

Hub at top tapped for 1/2-inch rigid conduit (heavy wall). Watts, 100. Packed 1 to a carton; weight, 3 lb.
 Each.....\$2.65

Type ROB



No. REA2

With 4-inch square plate for 4-inch square or 3 1/4 and 4-inch octagonal outlet boxes. Watts, 100. Packed 1 to a carton; weight, 3 lb.
 Each.....\$2.95



No. REA20

Type RBVA

With bracket for mounting on 3 1/4 or 4-inch octagonal outlet boxes. Screw holes for 4-inch octagonal box and fastening strap for 3 1/4-inch octagonal box.

Watts, 100. Packed 1 to a carton; weight, 4 lb.

No. REA20..... Each \$4.00

Globe Only



No. REA33

For types RVA, RBVA, and ROB lighting fixtures. Watts, 100. Packed 1 to a carton; weight, 1 1/4 lb.
 Each.....\$0.90

Wire Guard Only



No. REA3

For types RVA, RBVA, and ROB lighting fixtures. Watts, 100. Packed 1 to a carton; weight 3 oz.
 Each.....\$1.00

Outdoor Receptacle Fittings
Complete with Receptacle Cap and Chain



Type E



Type C

Take standard attachment plug caps, 15 amperes, 125 volt or 10 amperes, 250 volt. Packed 1 to a carton.

Type E—One 1/2-Inch Hub

No.	Style	Amperes		Wt. Ea. Lb.	Each
		125 V.	250 V.		
REA-4	2-Wire, 2-Pole	15	10	2 11/16	\$3.10

Type C—Two 1/2-Inch Hubs

REA-7	2-Wire, 2-Pole	15	10	2 3/4	\$3.20
-------	----------------	----	----	-------	--------

Outdoor Receptacle Fittings
Complete with Receptacle and Lift Cover



Type E



Type C

Take standard attachment plug caps, 15 amperes, 125 volt or 10 amperes, 250 volt. Packed 1 to a carton.

Type E—One 1/2-Inch Hub

No.	Style	Amperes		Wt. Ea. Lb.	Each
		125 V.	250 V.		
REA-44	2-Wire, 2-Pole	15	10	2 13/16	\$3.30
REA-45	2-Wire, 3-Pole	15	10	2 15/16	4.20
REA-46	3-Wire, 3-Pole	15	10	2 15/16	4.20

Type C—Two 1/2-Inch Hubs

REA-47	2-Wire, 2-Pole	15	10	3	\$3.40
REA-48	2-Wire, 3-Pole	15	10	3	4.30
REA-49	3-Wire, 3-Pole	15	10	3	4.30

Outdoor Switch Fittings

Complete With Switches

All Switches Except Double Pole are "T" Rated



Type E



Type C

Packed 1 to a carton.

Type E—One 1/2-Inch Hub

No.	Style	Amperes		Wt. Ea. Lb.	Each
		125 V.	250 V.		
REA-10	Single Pole	10	5	1 1/8	\$3.10
REA-11	Double Pole	..	10	1 1/8	3.40
REA-12	Three Way	10	5	1 1/8	3.60

Type C—Two 1/2-Inch Hubs

REA-14	Single Pole	10	5	1 3/16	\$3.20
REA-15	Double Pole	..	10	1 3/16	3.50
REA-16	Three Way	10	5	1 3/16	3.70

Appleton Explosion-Proof Lighting Fixtures

AA51 Series — Vented Type

With Reflectors

A new explosion-proof design, featuring improved vented design, safer and easier installation and maintenance, increased light output and cooler operating temperature.

Canopies are standardized; interchangeable for any size fixture in the line, 100- to 500-watt, without rewiring.

No wiring in canopies; collector ring method of energizing permits instant removal of entire fixture.

Canopy has five full threads engaged whenever contact is made or broken . . . confining any arcs in approved explosion proof method, even if fixture were accidentally left energized during maintenance.

Entire lower edge of hood serves as a continuous louver, and interiors are of porous metal, providing even heat distribution and lower operating temperatures. Gives longer bulb life.

Malleable iron, cadmium finish on Ceiling Unilets; aluminum, satin finish on Canopy, Globe Holder and Guard. Hood is steel. Type AAC has explosion-proof junction fitting, with four threaded hubs for 1/2 and 3/4-in. conduit—three of which have close-up plugs.

Reflectors are porcelain enameled, green outside, white inside.

Listed by Underwriters' Laboratories, Inc., for Class I, Groups C and D Hazardous Locations

Pendant Type

Complete with Guard



No. AAP-1050STG



No. AAP-1050DBG

Lamp Size, Watts	Hub Size, In.	With Standard Dome Reflector		With Deep Bowl Reflector	
		No.	Wt. Each Lbs.	No.	Wt. Each Lbs.
60-100	1/2	AAP1050STG	10	AAP1050DBG	9 3/4
	3/4	AAP1075STG	10	AAP1075DBG	9 3/4
150	1/2	AAP1550STG	10 3/8	AAP1550DBG	9 3/4
	3/4	AAP1575STG	10 3/8	AAP1575DBG	9 3/4
200	1/2	AAP2050STG	15 1/4	AAP2050DBG	14 7/8
	3/4	AAP2075STG	15 1/4	AAP2075DBG	14 7/8
or 300*	3/4	AAP5075STG	24	AAP5075DBG	23 1/2

Without Guard

60-100	1/2	AAP1050ST	9 1/2	AAP1050DB	9 1/4
	3/4	AAP1075ST	9 1/2	AAP1075DB	9 1/4
150	1/2	AAP1550ST	9 7/8	AAP1550DB	9 1/4
	3/4	AAP1575ST	9 7/8	AAP1575DB	9 1/4
200	1/2	AAP2050ST	14 1/2	AAP2050DB	14 1/8
	3/4	AAP2075ST	14 1/2	AAP2075DB	14 1/8
or 300*	3/4	AAP5075ST	22 5/8	AAP5075DB	22 1/8

Complete with Guard



No. AAP-1050SHG



No. AAP-1050ANG

Lamp Size, Watts	Hub Size, In.	With Shallow Dome Reflector		With 30° Angle Reflector	
		No.	Wt. Each Lbs.	No.	Wt. Each Lbs.
60-100	1/2	AAP1050SHG	9 1/2	AAP1050ANG	9 3/4
	3/4	AAP1075SHG	9 1/2	AAP1075ANG	9 3/4
150	1/2	AAP1550SHG	9 3/4	AAP1550ANG	9 3/4
	3/4	AAP1575SHG	9 3/4	AAP1575ANG	9 3/4
200	1/2	AAP2050SHG	14 1/2	AAP2050ANG	14 7/8
	3/4	AAP2075SHG	14 1/2	AAP2075ANG	14 7/8
or 300*	3/4	AAP5075SHG	22 1/2	AAP5075ANG	23 1/2

Without Guard

60-100	1/2	AAP1050SH	9	AAP1050AN	9 1/4
	3/4	AAP1075SH	9	AAP1075AN	9 1/4
150	1/2	AAP1550SH	9 1/4	AAP1550AN	9 1/4
	3/4	AAP1575SH	9 1/4	AAP1575AN	9 1/4
200	1/2	AAP2050SH	13 3/4	AAP2050AN	14
	3/4	AAP2075SH	13 3/4	AAP2075AN	14
or 300*	3/4	AAP5075SH	21 1/8	AAP5075AN	22 1/8

*Only when 300 watt Type PS-30 medium base lamp is used. In this case, fixture is also approved for Class I, Group C and D, Hazardous locations.

Prices on application.

Ceiling Type

Complete with Guard



No. AAC-1050STG



No. AAC-1050DBG

Lamp Size, Watts	Hub Size, In.	With Standard Dome Reflector		With Deep Bowl Reflector	
		No.	Wt. Each Lbs.	No.	Wt. Each Lbs.
60-100	1/2	AAC1050STG	13 1/4	AAC1050DBG	13
	3/4	AAC1075STG	13 1/4	AAC1075DBG	13
150	1/2	AAC1550STG	13 5/8	AAC1550DBG	13
	3/4	AAC1575STG	13 5/8	AAC1575DBG	13
200	1/2	AAC2050STG	18 1/2	AAC2050DBG	18 1/8
	3/4	AAC2075STG	18 1/2	AAC2075DBG	18 1/8
or 300*	3/4	AAC5050STG	27 1/4	AAC5050DBG	26 3/4
300-500	3/4	AAC5075STG	27 1/4	AAC5075DBG	26 3/4

Without Guard

60-100	1/2	AAC1050ST	12 3/4	AAC1050DB	12 1/2
	3/4	AAC1075ST	12 3/4	AAC1075DB	12 1/2
150	1/2	AAC1550ST	13 1/8	AAC1550DB	12 1/2
	3/4	AAC1575ST	13 1/8	AAC1575DB	12 1/2
200	1/2	AAC2050ST	17 3/4	AAC2050DB	17 3/8
	3/4	AAC2075ST	17 3/4	AAC2075DB	17 3/8
or 300*	3/4	AAC5050ST	25 7/8	AAC5050DB	25 3/8
300-500	3/4	AAC5075ST	25 7/8	AAC5075DB	25 3/8

Complete with Guard



No. AAC-1050SHG



No. AAC-1050ANG

Lamp Size, Watts	Hub Size, In.	With Shallow Dome Reflector		With 30° Angle Reflector	
		No.	Wt. Each Lbs.	No.	Wt. Each Lbs.
60-100	1/2	AAC1050SHG	12 3/4	AAC1050ANG	13
	3/4	AAC1075SHG	12 3/4	AAC1075ANG	13
150	1/2	AAC1550SHG	13	AAC1550ANG	13
	3/4	AAC1575SHG	13	AAC1575ANG	13
200	1/2	AAC2050SHG	17 3/4	AAC2050ANG	18 1/8
	3/4	AAC2075SHG	17 3/4	AAC2075ANG	18 1/8
or 300*	3/4	AAC5050SHG	25 3/4	AAC5050ANG	26 3/4
300-500	3/4	AAC5075SHG	25 3/4	AAC5075ANG	26 3/4

Without Guard

60-100	1/2	AAC1050SH	12 1/4	AAC1050AN	12 1/2
	3/4	AAC1075SH	12 1/4	AAC1075AN	12 1/2
150	1/2	AAC1550SH	12 1/2	AAC1550AN	12 1/2
	3/4	AAC1575SH	12 1/2	AAC1575AN	12 1/2
200	1/2	AAC2050SH	17	AAC2050AN	17 1/4
	3/4	AAC2075SH	17	AAC2075AN	17 1/4
or 300*	3/4	AAC5050SH	24 3/8	AAC5050AN	25 3/8
300-500	3/4	AAC5075SH	24 3/8	AAC5075AN	25 3/8

Appleton Explosion-Proof Lighting Fixtures

AA-51 Series—Vented Type

Listed by Underwriters' Laboratories, Inc., for Class I, Groups C and D Hazardous Locations

Malleable Iron, Cadmium Finish on Ceiling Unilets and Brackets; Aluminum, Satin Finish on Canopy, Globe Holder and Guard. Hood is steel. Types AAC and AALB have an explosion-proof junction fitting, with four threaded hubs for 1/2 or 3/4 in. conduit—three of which have close-up plugs. 200 watt types AALB and AASB Fixtures take deep bowl and 30° angle reflectors only.

Pendant and Ceiling Types

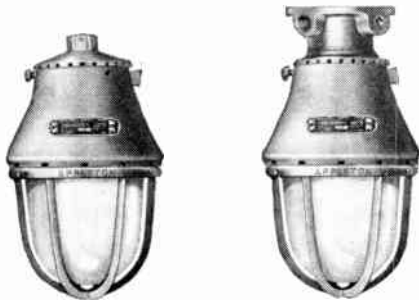

No. AAP1050G

No. AAC1050G

Bracket Types

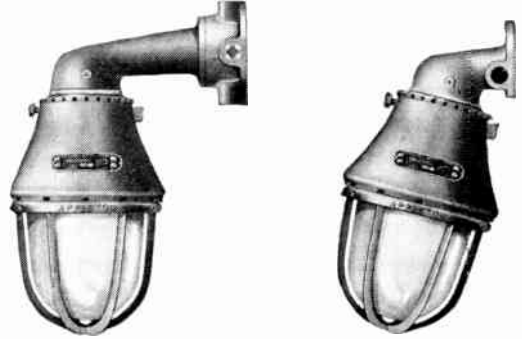

No. AALB1050G

No. AASB1050G

Complete with Guard

Lamp Size, Watts	Hub Size, in.	AAP Pendant Type		AAC Ceiling Type	
		No.	Wt. Each Lbs.	No.	Wt. Each Lbs.
60-100	1/2	AAP1050G	8 3/4	AAC1050G	11 1/2
	3/4	AAP1075G	8 3/4	AAC1075G	11 1/2
150	1/2	AAP1550G	8 3/4	AAC1550G	11 1/2
	3/4	AAP1575G	8 3/4	AAC1575G	11 1/2
200	1/2	AAP2050G	12 3/4	AAC2050G	16
	3/4	AAP2075G	12 3/4	AAC2075G	16
or 300*	1/2	AAC5050G	22 3/4
	3/4	AAP5075G	19 1/2	AAC5075G	22 3/4

Without Guard

Lamp Size, Watts	Hub Size, in.	AAP		AAC	
		No.	Wt. Each Lbs.	No.	Wt. Each Lbs.
60-100	1/2	AAP1050	7 3/4	AAC1050	11
	3/4	AAP1075	7 3/4	AAC1075	11
150	1/2	AAP1550	7 3/4	AAC1550	11
	3/4	AAP1575	7 3/4	AAC1575	11
200	1/2	AAP2050	12	AAC2050	15 1/4
	3/4	AAP2075	12	AAC2075	15 1/4
or 300*	1/2	AAC5050	21 3/8
	3/4	AAP5075	18 1/8	AAC5075	21 3/8

Complete with Guard

Lamp Size, Watts	Hub Size, in.	AALB Bracket Type		AASB Bracket Type	
		No.	Wt. Each Lbs.	No.	Wt. Each Lbs.
60-100	1/2	AALB1050G	16	AASB1050G	12
	3/4	AALB1075G	16	AASB1075G	12
150	1/2	AALB1550G	16	AASB1550G	12
	3/4	AALB1575G	16	AASB1575G	12
200	1/2	AALB2050G	20 1/2	AASB2050G	16 1/2
	3/4	AALB2075G	20 1/2	AASB2075G	16 1/2
or 300*	1/2	AALB5050G	27 1/4
	3/4	AALB5075G	27 1/4

Without Guard

Lamp Size, Watts	Hub Size, in.	AALB		AASB	
		No.	Wt. Each Lbs.	No.	Wt. Each Lbs.
60-100	1/2	AALB1050	15 1/2	AASB1050	11 1/2
	3/4	AALB1075	15 1/2	AASB1075	11 1/2
150	1/2	AALB1550	15 1/2	AASB1550	11 1/2
	3/4	AALB1575	15 1/2	AASB1575	11 1/2
200	1/2	AALB2050	19 3/4	AASB2050	15 3/4
	3/4	AALB2075	19 3/4	AASB2075	15 3/4
or 300*	1/2	AALB5050	25 7/8
	3/4	AALB5075	25 7/8

Lighting Fixture Accessories

For Explosion-Proof Lighting Fixtures

AA-51 Series—Vented Type

Reflectors are Porcelain Enameled Steel, Green Outside, White Inside



Lamp Size, Watts	Dome			Bowl			Shallow Dome			30° Angle	Globe		Guard			
	No.	Diam. In.	Wt. Lbs.	No.	Diam. In.	Wt. Lbs.	No.	Diam. In.	Wt. Lbs.		No.	Wt. Lbs.	No.	Wt. Lbs.		
60-100	AARE1ST	12	1 3/4	AARE1DB	10	1 1/2	AARE1SH	12	1 1/4	AARE1AN	10	1 1/2	AAG1.1	1 1/8	AAGU1	1 1/2
	150 AARE15ST	14	2 1/8	AARE15DB	10	1 1/2	AARE15SH	14	1 1/2	AARE15AN	10	1 1/2	AAG1.2	3 3/8	AAGU2	3/4
200 or 300*	AARE2ST	16	2 1/2	AARE2DB	12	2 1/8	AARE2SH	16	1 3/4	AARE2AN	12	2	AAG1.5	5 3/4	AAGU5	1 3/8
	300-500 AARE5ST	20	4 1/2	AARE5DB	18	4	AARE5SH	18	3	AARE5AN	18	4

Note: If specified on the order, 60 to 200 watt inclusive "AA-51" series Lighting Fixtures can be furnished equipped with aluminum half shades having etched Alzak finish at an advance in price. Add suffix AHS to the catalog number when ordering.

*Only when 300 watt Type PS-30 medium base lamp is used. In this case, fixture is also approved for Class I, Group C and D, Hazardous Locations.

Prices on application.

Appleton Unilets

Series "GR"—Flanged

Malleable Iron, Cadmium Finish

Explosion-Proof and Dust-Tight

With Regular Threaded Hubs



Type "GRFC" Unilet with Inside Cover Threads and No. 26894 Fixture Canopy Attached.

Furnished standard with blank cover and regular threaded hubs, also fastening plate provided with four screw holes for attaching Unilet body to ceiling. Used principally with fixture canopies in connection with AA-51 Series Pendant Lighting Fixtures.

*Furnished with External Threaded Surface Cover.



Type GRFC

No.	Size, In.	Wt. Per 5 Pcs.	Each
GRFC-50	1/2	22 1/2	\$4.60
GRFC-75	3/4	22 1/2	4.80
GRFC-100	1	22 1/2	5.20



Type GRFL

No.	Size, In.	Wt. Per 5 Pcs.	Each
GRFL-50	1/2	22 1/2	\$4.60
GRFL-75	3/4	22 1/2	4.80
GRFL-100	1	22 1/2	5.20



Type GRFT

No.	Size, In.	Wt. Per 5 Pcs.	Each
GRFT-50	1/2	22 1/2	\$5.00
GRFT-75	3/4	22 1/2	5.20
GRFT-100	1	22 1/2	5.60



Type GRFX

No.	Size, In.	Wt. Per 5 Pcs.	Each
GRFX-50	1/2	24	\$5.40
GRFX-75	3/4	24	5.60
GRFX-100	1	24	6.00

*When any of the above Unilets are to be used with fixture canopies listed below, specify "Less Cover" at a reduction in price.

Appleton Fixture Canopies

For use in suspending Lighting Fixtures from "GRU" Series Unilets



*No.	Hub Size, In.	Wt. Lbs. 5 Pcs.	Each
26894	1/2	14	\$7.00
26895	3/4	15 1/2	7.00
26896	1	17	6.90
26897	1 1/4	18	7.00

*For suspending AA-51 series from GRU series Unilet bodies having internal threads for cover.

Quantity prices on request.

Appleton Vaportight Lighting Fixtures

Series "V-51" Convertible

For use with Rigid Conduit (Heavy Wall)

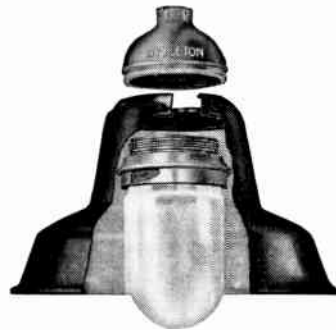

These fixtures have been re-engineered throughout and incorporate advantages to the user beyond all previous designs.

Relamping is simple, and removing or replacing reflectors is a matter of seconds — no clamps or set screws, no tools required.

Malleable Iron Unilets — 1/2 or 3/4 in. hubs in pendant, ceiling or bracket types. Has vaportight gasket; connecting block with line wire terminals and spring leaf contacts for globe adapter. Takes either 100 watt or 150-200 watt adapters.

Globe Adapter — Die cast aluminum; 100 watt and 150-200 watt

sizes; complete with shock-absorbing socket; collector ring assembly; vaportight gasket. Threaded for Navy standard globes; two cavities to receive snap-type guard.

Reflector — Steel, with green porcelain enamel exterior and white interior. Standard dome, shallow dome, deep bowl or angle types.

Neoprene Rubber Ring — Attaches reflector to Unilet with slight twisting pressure... cushions against vibration.

Guard — Die cast aluminum, with two sealed ball plunger units that snap securely into cavities in globe adapter. When turned counter-clockwise, the guard acts as a tool for easy removal of adapter and globe assembly.

100 Watt or 150-200 Watt Units



Type V



Type VA



Type VC

With Globe and Guard

Watts	Hub Size, In.	Type V		Type VA		Type VC	
		No.	Each	No.	Each	No.	Each
100	1/2	V1050G	\$10.85	VA1050G	\$10.85	VC1050G	\$11.00
100	3/4	V1075G	10.95	VA1075G	10.95	VC1075G	11.10
		Wt. ea: 4 lbs. 4 oz.		Wt. ea: 3 lbs. 14 oz.		Wt. ea: 4 lbs. 7 oz.	
150-200	1/2	V2050G	\$13.40	VA2050G	\$13.40	VC2050G	\$13.55
	3/4	V2075G	13.50	VA2075G	13.50	VC2075G	13.65
		Wt. ea: 6 lbs. 6 oz.		Wt. ea: 6 lbs.		Wt. ea: 6 lbs. 9 oz.	

Without Globe and Guard

Watts	Hub Size, In.	Type V		Type VA		Type VC	
		No.	Each	No.	Each	No.	Each
100	1/2	V1050	\$6.65	VA1050	\$6.65	VC1050	\$6.80
100	3/4	V1075	6.75	VA1075	6.75	VC1075	6.90
		Wt. ea: 2 lbs. 14 oz.		Wt. ea: 2 lbs. 8 oz.		Wt. ea: 3 lbs. 1 oz.	
150-200	1/2	V2050	\$8.00	VA2050	\$8.00	VC2050	\$8.15
	3/4	V2075	8.10	VA2075	8.10	VC2075	8.25
		Wt. ea: 3 lbs. 6 oz.		Wt. ea: 3 lbs.		Wt. ea: 3 lbs. 9 oz.	

*All 200 watt fixtures can use 300 watt medium base type PS-30 lamps.

Quantity prices on request.

Appleton Vaportight Lighting Fixtures

Series "V-51" Convertible

For use with Rigid Conduit
(Heavy Wall)

Vaportight Fixture Bodies

Complete with Connecting Block No. VPT-7 and Gasket No. VPT-4.
Will take either 100 Watt or 150-200 Watt Adapters.
Malleable Iron, Cadmium Finish.

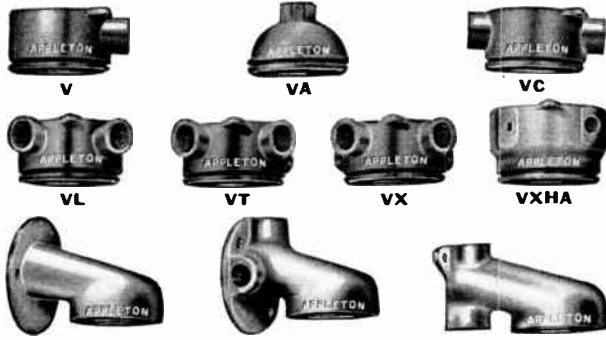

Hub Size, In.	No.	Type	WL Lbs.	Each	Hub Size, In.	No.	Type	WL Lbs.	Each
1/2	V50	V	2 1/4	\$3.50	1/2	VX50	VX	2 1/4	\$4.00
3/4	V75	V	2 1/4	3.60	3/4	VX75	VX	2 1/4	4.10
1	VA50	VA	1 3/4	3.50	1	VXHA50	VXHA	3 1/2	4.40
1 1/4	VA75	VA	1 3/4	3.60	1 1/4	VXHA75	VXHA	3 1/2	4.50
1 1/2	VC50	VC	2 1/4	3.65	1 1/2	VGA50	VGA	3 3/4	4.75
1 3/4	VC75	VC	2 1/4	3.75	1 3/4	VGA75	VGA	3 3/4	4.85
2	VL50	VL	2 1/4	3.65	2	VGAT50	VGAT	3 3/4	5.00
2 1/4	VL75	VL	2 1/4	3.75	2 1/4	VGAT75	VGAT	3 3/4	5.15
2 1/2	VT50	VT	2 1/4	3.85	2 1/2	VD50	VD	3 1/2	4.85
2 3/4	VT75	VT	2 1/4	3.95	2 3/4	VD75	VD	3 1/2	5.00

*All types except VGA, VGAT and VD are grooved for neoprene rubber ring attachment of 100, 150 or 200 watt reflectors. Bracket types not designed for reflectors.

Vaportight Fixture Mounting Units

Complete with Connecting Block No. VPT-7 and Gasket No. VPT-4.
To fit JB and GS Unilets; also 3 1/4 and 4 in. octagonal outlet boxes.
Will take either 100 watt or 150-200 Watt Adapters.



No.	Style	Mounts on	WL Lbs.	Each
JB-1*	Straight	JB Unilet	1 3/4	\$3.75
GS-1*	Straight	GS Unilet Form 5-10	1 1/2	3.75

*With groove for neoprene rubber ring attachment of 100, 150 or 200 watt reflectors. Bracket type not designed for reflector.

Vaportight Fixture Parts

Unit Assembly Complete

Consists of adapter, globe and guard.
Complete with socket, socket gasket and globe gasket.



No.	Watts	WL Lbs.	Each
VU-100	100	2 1/8	\$7.53
VU-200	150-200*	4 1/4	9.90

Globe and Guard Adapter Bodies

Complete with socket, socket gasket and globe gasket. Can be used on all "V-51" Series Vaporlight Fixtures.



No.	Watts	WL Lbs.	Each
VAD-1	100	3/4	\$3.15
VAD-2	150-200*	1 1/4	4.50

*Can use 300 watt medium base type PS-30 lamp.

Quantity prices on request.

Vaportight Globes



Globe	No.	100 Watt		150-200 Watt	
		Each	No.	Each	No.
Clear	VGL-1CL	\$1.40	VGL-2CL	\$1.60	
Opal	VGL-1OP	1.60	VGL-2OP	2.75	
Green	VGL-1GR	2.35	VGL-2GR	5.45	
Blue	VGL-1BL	2.35	VGL-2BL	5.45	
Orange	VGL-1OR	2.35	VGL-2OR	5.45	
Ruby	VGL-1RU	2.35	VGL-2RU	5.45	
Amber	VGL-1AM	2.35	VGL-2AM	5.45	
H. R.*	VGL-1HR	1.95	VGL-2HR	3.35	

Weight Each; 100 watt, 1 lb.; 150-200 Watt, 2 lbs.
*Heat Resisting.

Vaportight Fixture Lamp Guards



No.	Watts	WL Lbs.	Each
VGU-1	100	3/8	\$2.75
VGU-2	150-200	1	3.85

Vaportight Fixture Reflectors

Standard Dome



No.	Lamp Size, Watts	Diam. In.	WL Lbs.	Each
VRE-1ST	100	12	2	\$5.15
VRE-15ST	150	14	2 1/4	6.10
VRE-2ST	200	16	2 1/2	7.10

Shallow Dome



VRE-1SH	100	12	2	\$4.25
VRE-15SH	150	14	2 1/4	5.15
VRE-2SH	200	16	2 1/2	6.10

Deep Bowl



VRE-1DB	100	10	2	\$5.15
VRE-15DB	150	12	2 1/4	6.10
VRE-2DB	200	12	2 1/2	7.10

30° Angle



VRE-1AN	100	10	2	\$3.75
VRE-15AN	150	12	2 1/2	6.60
VRE-2AN	200	12	2 1/2	7.10

Heavy steel, green baked porcelain enamel outside, white enamel inside.

Quantity prices on request.

Appleton Type EFUX Explosion-Proof X-Ray Film Illuminator With Explosion-Proof Switch

Class I, Group C and D

**To Take Two 15 Watt T-12 Fluorescent Lamps
Furnished with 110-125 Volt 60 Cycle Ballast**

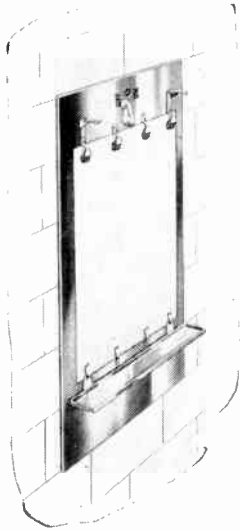

Type "EFUX" Explosion-proof X-Ray Film Illuminator, flush mounting in tile wall

The Type "EFUX" Explosion-proof X-Ray Film Illuminator is designed for flush mounting in Hospital Operating Rooms.

The fixture is compact and includes an Explosion-proof switch which eliminates the need of an additional switch Unit. The handle of the Explosion-proof switch extends through the panel within convenient reach of the operator. Glass cover panel. Four chrome plated roller clips at top of glass to hold the X-Ray film. Two extended hinge clips support the wet film holder. A drip tray can be easily adapted to two of the four lower clips which hold the panel.

A threaded hub for 3/4-inch rigid conduit is provided in cabinet. Two cabinet styles, one shallow and one deep, are available as illustrated in dimensional drawings below.

shallow and one deep, are available as illustrated in dimensional drawings below.

When installing, the metal cabinet should first be mounted in the wall. The fixture is mounted in cabinet with the use of a union (which is furnished). Line wires are connected to the connection block located under screw cover in lower housing. All other wiring and sealing is completed at the factory.

To relamp, remove switch handle, loosen one cover screw and remove plastic glass panel cover. Tip fixture out of the cabinet by releasing tension of spring clip (no tool is necessary for this operation) then remove screw cover and pull out lamp.

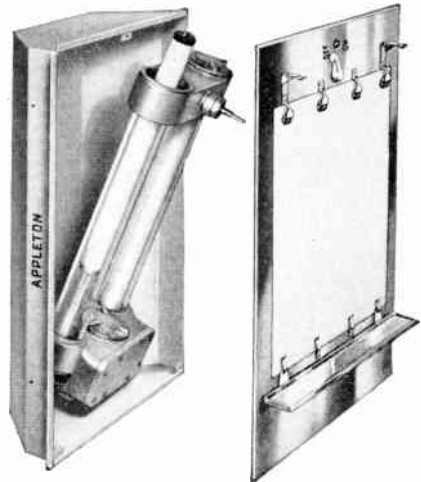

Type "EFUX" Explosion-proof X-Ray Film Illuminator with cover removed

The Type "EFUX" Explosion-proof X-Ray Film Illuminator is designed for bottom entrance of conduit, however the complete unit can be inverted when mounted in the wall to allow for conduit entrance at the top. When cabinet is mounted with hub at top, the switch handle will be at the bottom. If a drip tray is to be used on inverted installation, specify and a handle with an extension is included. This handle is located under the drip tray for easy elbow operation.

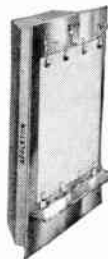

Flush Mounting For 6-inch Walls or Larger With Opal Plastic Glass

Hub Size	Drip Tray	Wt., Lbs. Each	No.
3/4"	No	40	A182-A
3/4"	Yes	40	A182-D

With 1 3/4-inch Flanged Cover For 4-inch Walls With Opal Plastic Glass

Hub Size	Drip Tray	Wt., Lbs. Each	No.
3/4"	No	40	A182-E
3/4"	Yes	40	A182-F



No. A182-B Drip Tray



No. A182-C Utility Handle



To be used if unit is inverted and Drip Tray is used.

Finish; Cover — Stainless Steel, Satin Finish. Housing — Protective Coating Outside, White Enamel Inside. Drip Tray — Stainless Steel. Fluorescent Lamps not included.

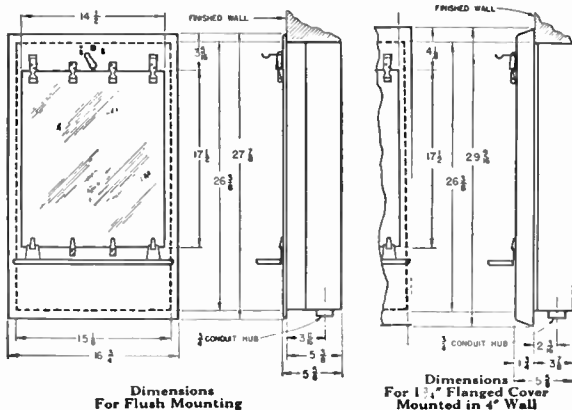

Dimensions For Flush Mounting

Dimensions For 1 3/4" Flanged Cover Mounted in 4" Wall

Appleton Type EFUX Explosion-Proof Duplex X-Ray Film Illuminator With Explosion-Proof Switch

Class I, Groups C and D

To take four 15 Watt T-12 Fluorescent Lamps

Furnished with 110-125 Volts 60 Cycle Ballast

Type "EFUX" Appleton Explosion-proof Duplex X-Ray Film Illuminator is similar in construction to the regular type "EFUX", except that the cabinet and cover are wider to accommodate two units, each to take two 15 Watt T-12 fluorescent lamps.

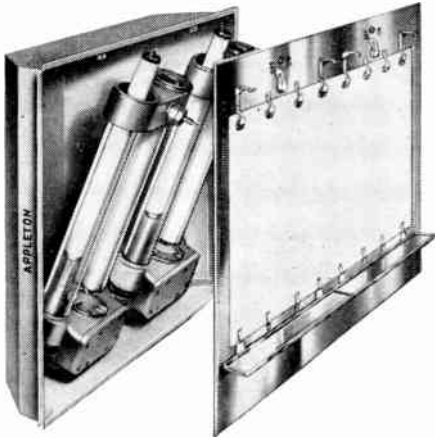

Type "EFUX" Explosion-proof Duplex X-Ray Illuminator with cover removed

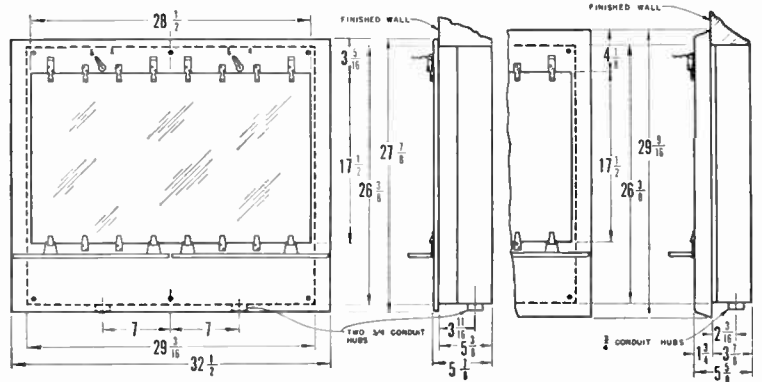

Dimensions for Flush Mounting

Dimensions for 1 3/4" Flanged Cover Mounted in 4" Wall

Duplex X-Ray Film Illuminators

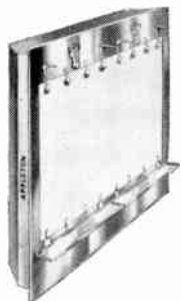

Type EFUX

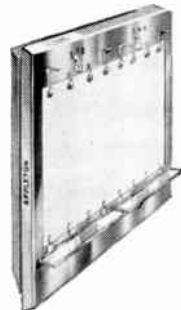

Type EFUX

No.	Hub Size	Construction	Wt., Lbs. Each
A-182-O	Two 3/4"	Flush mounting for walls 6" or greater With Opal Plastic Glass Without Drip Trays	76
A-182-P	Two 3/4"	Flush mounting for walls 6" or greater With Opal Plastic Glass With Drip Trays	78
A-182-V	Two 3/4"	With 1 3/4" Flanged Cover for 4" Walls With Opal Plastic Glass Without Drip Trays	76
A-182-W	Two 3/4"	With 1 3/4" Flanged Cover for 4" Walls With Opal Plastic Glass With Drip Trays	78

Drip Trays

No. A-182-R*	Wt., Lbs. Each, 1
--------------	-------------------

Finish — Cover Stainless Steel, Satin Finish — Housing, Protective Coating Outside, White Enamel Inside.

Drip Tray — Stainless Steel. Fluorescent Lamps not included. *Consists of 2 Trays.

Utility Handle, to be used if unit is inverted and Drip Trays are used, is listed on the preceding page.

Prices on application.

Appleton Fluorescent Lighting Fixtures

Type EFU — Explosion-Proof

Class I, Groups C and D

Class II, Groups E, F and G

Made in Two Sizes: For use with Two 40-Watt, 48 in., T12; also for Two 100-Watt, 60 in., T17 Fluorescent Lamps.

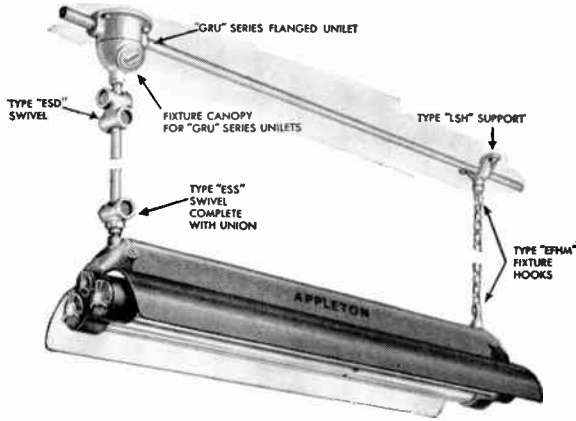

Type "EFU"

Explosion-Proof Fluorescent Lighting Fixture suspended more than 12 inches from fixture canopy, with "GRU" Flanged Unilet, Fixture Canopy and Type "ESD" and "ESS" Swivels

Modern fluorescent lighting for hazardous locations.

Hospital operating rooms, volatile fuel and chemical refineries, powder manufacture and shell loading, flour and grain mills are a few of the many locations where fluorescent lighting can now be safely applied.

The advantages of fluorescent lighting include new working comfort due to low brightness and lack of glare: high efficiency when compared with incandescent lamps of equal wattage and the ever important safety of operation in explosive atmosphere due to cooler operating temperature.

They are designed to be suspended horizontally or at 45 degrees. No external seals are necessary as all seals and internal wiring are completed in manufacture. Line connections are made to terminal block in junction chamber.

Are easily relamped by lowering at chain end (if an extra 3 in. of chain is provided when fixtures are installed). Relamping from either end is possible by swinging fixture out of line with the use of a Type "ESS" Swivel.

The National Electrical Code, Article 500, calls for flexibility in the form of a fitting or flexible connector to be used when lighting fixtures are suspended more than 12 in. from fixture canopy. Types "ESS" and "ESD" Swivels shown in illustration above will give the fixture this flexibility.

Standard equipment of all Appleton Fluorescent Lighting Fixtures includes the following:

High power factor two-lamp ballast.

Necessary auxiliary equipment.

Two-piece reflector, with high-reflector factor; Inside white, outside gray.



Reflectors — B/F Steel; White Inside, Gray Outside

Ballast Size: One Two-Lamp of 95% Power Factor

LAMPS ARE NOT INCLUDED

For Two 40-Watt, 48-in. T-12 Lamps

No.	Hub Size, In.	Circuit Voltage	Normal Voltage	Cycle	WL	Each
A-174	1/2	110-125	118	60	73	\$268.00
A-176	3/4	220-250	236	60	73	268.00

For Two 100-Watt, 60-in. T-17 Lamps

A-178	3/4	110-125	118	60	126	380.00
A-180	3/4	220-250	236	60	126	380.00

For Two T-12 Instant Starting Lamps

No.	Lgth.	Dimensions, Inches:			Mounting Centers
		Overall Size Wdth.	Hgt.	Tube Centers	
A-174 & A-176	52 1/16	15	8 3/4	5	46 5/8
A-178 & A-180	65 1/16	16	10 1/2	6	59

Accessories

Malleable Iron, Cadmium Finish

Type "ESD" Swivels

No.	Size, In.	Wt. Per 25 Pcs.	Each
ESD-50	1/2	86	\$13.50
ESD-75	3/4	86	13.50

Type "ESS" Swivels

No.	Size, In.	Wt. Per 10 Pcs.	Each
ESS-50	1/2	23	\$11.00
ESS-75	3/4	22	11.00

Type "LSH"

Rigid Support for Dummy Side of Fixture

No.	Size, In.	Wt. Lbs.	Each
52910	1/2 & 3/4	1/2	\$1.00

Hook for Dummy Side of Fixture

No.	Male Size, In.	Each	No.	Female Size, In.	Each
EFHM-50	1/2	\$0.70	EFHF-50	1/2	\$0.70
EFHM-75	3/4	.80	EFHF-75	3/4	.80

Type "UNY" Union Connectors

Length 2 1/8 in.; Diameter 1 7/8 in.

No.	Size, In.	Std. Pkg.	Wt. Per 5 Pcs.	Each
UNY84	1/2	50	3	\$1.00
UNY85	3/4	50	3	1.45

Quantity prices on request.

Appleton Unilets

Malleable Iron, Cadmium Finish

Series "AL" — Flexible Fixture Hangers

For Pendant Fixtures

(Threaded Stem takes 1/2 in. or 3/4 in. Rigid Conduit)

Designed in two styles — Ball and Cushion — and provide a flexible suspension for electric fixtures.

The suspension is from a universal joint which permits the fixture to swivel to an angle of 20 degrees in any direction from the perpendicular and assures the fixture hanging plumb at all times. This also prevents breaking of fixture stem at point of suspension caused by unusual strain, accidental or otherwise.

Type ALA

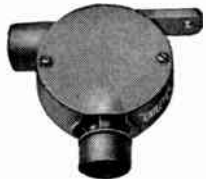

Ball Type

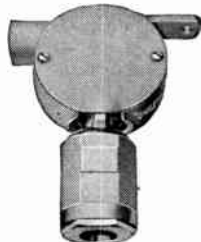

Cushion Type

ALA Ball Type

Threaded		No-Thread				Size, In.		Std. Pkg.
No.	Heavy Wall Each	No.	Heavy Wall Each	No.	Thin Wall Each	Fix. Stem	Conduit	
1300	\$2.00	13N00	\$2.20	13T00	\$2.20	1/2	1/2	25
1301	2.20	13N01	2.40	13T01	2.40	1/2	3/4	25
1302	2.40	13N02	2.60	13T02	2.60	3/4	3/4	25

ALA Cushion Type

For Fixtures weighing 3 to 6 lbs.

1305	4.20	13N05	4.40	13T05	4.40	1/2	1/2	25
1306	4.60	13N06	4.80	13T06	4.80	1/2	3/4	25
1307	4.80	13N07	5.00	13T07	5.00	3/4	3/4	25

For Fixtures weighing 6 to 12 lbs.

1310	4.20	13N10	4.40	13T10	4.40	1/2	1/2	25
1311	4.60	13N11	4.80	13T11	4.80	1/2	3/4	25
1312	4.80	13N12	5.00	13T12	5.00	3/4	3/4	25

For Fixtures weighing 12 to 24 lbs.

1315	4.20	13N15	4.40	13T15	4.40	1/2	1/2	25
1316	4.60	13N16	4.80	13T16	4.80	1/2	3/4	25
1317	4.80	13N17	5.00	13T17	5.00	3/4	3/4	25

For Fixtures weighing 24 to 48 lbs.

1560	4.20	15N60	4.40	15T60	4.40	1/2	1/2	25
1561	4.60	15N61	4.80	15T61	4.80	1/2	3/4	25
1562	4.80	15N62	5.00	15T62	5.00	3/4	3/4	25

For Fixtures weighing 48 to 64 lbs.

1565	4.20	15N65	4.40	15T65	4.40	1/2	1/2	25
1566	4.60	16N66	4.80	15T66	4.80	1/2	3/4	25
1567	4.80	15N67	5.00	15T67	5.00	3/4	3/4	25

Quantity prices on request.

Type ALC



Ball Type

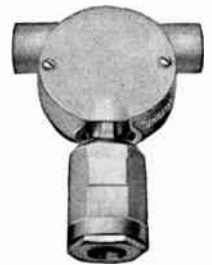

Cushion Type

ALC Ball Type

Threaded		No-Thread				Size, In.		Std. Pkg.
No.	Heavy Wall Each	No.	Heavy Wall Each	No.	Thin Wall Each	Fix. Stem	Conduit	
1320	\$2.20	13N20	\$2.60	13T20	\$2.60	1/2	1/2	25
1321	2.40	13N21	2.80	13T21	2.80	1/2	3/4	25
1322	2.60	13N22	3.20	13T22	3.20	1/2	1	10
1323	2.60	13N23	3.00	13T23	3.00	3/4	3/4	25
1324	2.90	13N24	3.50	13T24	3.50	3/4	1	10

ALC Cushion Type

For Fixtures weighing 3 to 6 lbs.

1325	4.40	13N25	4.80	13T25	4.80	1/2	1/2	25
1326	4.60	13N26	5.00	13T26	5.00	1/2	3/4	25
1327	4.80	13N27	5.40	13T27	5.40	1/2	1	10
1328	4.80	13N28	5.20	13T28	5.20	3/4	3/4	25
1329	5.00	13N29	5.60	13T29	5.60	3/4	1	10

For Fixtures weighing 6 to 12 lbs.

1330	4.40	13N30	4.80	13T30	4.80	1/2	1/2	25
1331	4.60	13N31	5.00	13T31	5.00	1/2	3/4	25
1332	4.80	13N32	5.40	13T32	5.40	1/2	1	10
1333	5.20	13N33	5.60	13T33	5.60	3/4	3/4	25
1334	5.00	13N34	5.60	13T34	5.60	3/4	1	10

For Fixtures weighing 12 to 24 lbs.

1335	4.40	13N35	4.80	13T35	4.80	1/2	1/2	25
1336	4.60	13N36	5.00	13T36	5.00	1/2	3/4	25
1337	4.80	13N37	5.40	13T37	5.40	1/2	1	10
1338	4.80	13N38	5.20	13T38	5.20	3/4	3/4	25
1339	5.00	13N39	5.60	13T39	5.60	3/4	1	10

For Fixtures weighing 24 to 48 lbs.

1570	4.40	15N70	4.80	15T70	4.80	1/2	1/2	25
1571	4.60	15N71	5.00	15T71	5.00	1/2	3/4	25
1572	4.80	15N72	5.40	15T72	5.40	1/2	1	10
1573	4.80	15N73	5.20	15T73	5.20	3/4	3/4	25
1574	5.00	15N74	5.60	15T74	5.60	3/4	1	10

For Fixtures weighing 48 to 64 lbs.

1575	4.40	15N75	4.80	15T75	4.80	1/2	1/2	25
1576	4.60	15N76	5.00	15T76	5.00	1/2	3/4	25
1577	4.80	15N77	5.40	15T77	5.40	1/2	1	10
1578	4.80	15N78	5.20	15T78	5.20	3/4	3/4	25
1579	5.00	15N79	5.60	15T79	5.60	3/4	1	10

Quantity prices on request.

Appleton Unilets
Malleable Iron, Cadmium Finish
Series "AL" — Flexible Fixture Hangers
For Pendant Fixtures

(Threaded Stem takes 1/2-in. or 3/4-in. Rigid Conduit)

By removing the cover of the Unilet the entire fixture can be removed as a unit, so that it is only necessary to disconnect the fixture wires and slide the supporting nipple completely out of the groove in the Unilet.

Cushion type fixture hangers differ from the ball type in that they are equipped with a spring which gives according to weight of the fixture, thereby absorbing any shocks due to vibration.

Type ALL

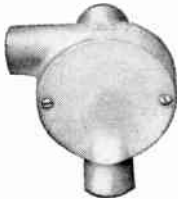

Ball Type

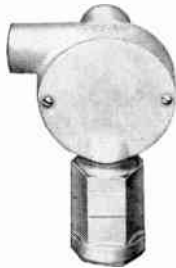

Cushion Type

ALL Ball Type

Threaded		No-Thread				Size, In. Fix. Stem	Con- duit	Std. Pkg.
No.	Heavy Wall Each	No.	Heavy Wall Each	No.	Thin Wall Each			
1340	\$2.20	13N40	\$2.60	13T40	\$2.60	1/2	1/2	25
1341	2.40	13N41	2.80	13T41	2.80	1/2	3/4	25
1342	2.60	13N42	3.00	13T42	3.00	3/4	3/4	25

ALL Cushion Type

For Fixtures weighing 3 to 6 lbs.								
1345	4.40	13N45	4.80	13T45	4.80	1/2	1/2	25
1346	4.60	13N46	5.00	13T46	5.00	1/2	3/4	25
1347	4.80	13N47	5.20	13T47	5.20	3/4	3/4	25
For Fixtures weighing 6 to 12 lbs.								
1350	4.40	13N50	4.80	13T50	4.80	1/2	1/2	25
1351	4.60	13N51	5.00	13T51	5.00	1/2	3/4	25
1352	4.80	13N52	5.20	13T52	5.20	3/4	3/4	25
For Fixtures weighing 12 to 24 lbs.								
1355	4.40	13N55	4.80	13T55	4.80	1/2	1/2	25
1356	4.60	13N56	5.00	13T56	5.00	1/2	3/4	25
1357	4.80	13N57	5.20	13T57	5.20	3/4	3/4	25
For Fixtures weighing 24 to 48 lbs.								
1580	4.40	15N80	4.80	15T80	4.80	1/2	1/2	25
1581	4.60	15N81	5.00	15T81	5.00	1/2	3/4	25
1582	4.80	15N82	5.20	15T82	5.20	3/4	3/4	25
For Fixtures weighing 48 to 64 lbs.								
1585	4.40	15N85	4.80	15T85	4.80	1/2	1/2	25
1586	4.60	15N86	5.00	15T86	5.00	1/2	3/4	25
1587	4.80	15N87	5.20	15T87	5.20	3/4	3/4	25

Quantity prices on request.

Type ALT

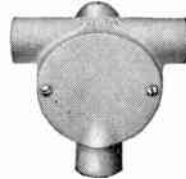

Ball Type

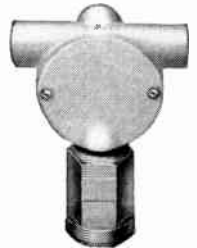

Cushion Type

ALT Ball Type

Threaded		No-Thread				Size, In. Fix. Stem	Con- duit	Std. Pkg.
No.	Heavy Wall Each	No.	Heavy Wall Each	No.	Thin Wall Each			
1360	\$2.30	13N60	\$2.90	13T60	\$2.90	1/2	1/2	25
1361	2.50	13N61	3.10	13T61	3.10	1/2	3/4	25
1362	2.70	13N62	3.30	13T62	3.30	1/2	1	10
1363	2.70	13N63	3.30	13T63	3.30	3/4	3/4	25
1364	3.00	13N64	3.60	13T64	3.60	3/4	1	10

ALT Cushion Type

For Fixtures weighing 3 to 6 lbs.								
1365	4.50	13N65	5.10	13T65	5.10	1/2	1/2	25
1366	4.70	13N66	5.30	13T66	5.30	1/2	3/4	25
1367	4.90	13N67	5.50	13T67	5.50	1/2	1	10
1368	4.90	13N68	5.50	13T68	5.50	3/4	3/4	25
1369	5.10	13N69	5.80	13T69	5.80	3/4	1	10
For Fixtures weighing 6 to 12 lbs.								
1370	4.50	13N70	5.10	13T70	5.10	1/2	1/2	25
1371	4.70	13N71	5.30	13T71	5.30	1/2	3/4	25
1372	4.90	13N72	5.50	13T72	5.50	1/2	1	10
1373	4.90	13N73	5.50	13T73	5.50	3/4	3/4	25
1374	5.10	13N74	5.80	13T74	5.80	3/4	1	10
For Fixtures weighing 12 to 24 lbs.								
1375	4.50	13N75	5.10	13T75	5.10	1/2	1/2	25
1376	4.70	13N76	5.30	13T76	5.30	1/2	3/4	25
1377	4.90	13N77	5.50	13T77	5.50	1/2	1	10
1378	4.90	13N78	5.50	13T78	5.50	3/4	3/4	25
1379	5.10	13N79	5.80	13T79	5.80	3/4	1	10
For Fixtures weighing 24 to 48 lbs.								
1590	4.50	15N90	5.10	15T90	5.10	1/2	1/2	25
1591	4.70	15N91	5.30	15T91	5.30	1/2	3/4	25
1592	4.90	15N92	5.50	15T92	5.50	1/2	1	10
1593	4.90	15N93	5.50	15T93	5.50	3/4	3/4	25
1594	5.10	15N94	5.80	15T94	5.80	3/4	1	10
For Fixtures weighing 48 to 64 lbs.								
1595	4.50	15N95	5.10	15T95	5.10	1/2	1/2	25
1596	4.70	15N96	5.30	15T96	5.30	1/2	3/4	25
1597	4.90	15N97	5.50	15T97	5.50	1/2	1	10
1598	4.90	15N98	5.50	15T98	5.50	3/4	3/4	25
1599	5.10	15N99	5.80	15T99	5.80	3/4	1	10

Quantity prices on request.

Appleton Flexible Couplings

Series "EX"

Explosion-Proof, Dust-Tight and Weatherproof

Class I, Groups C and D, and Classes II, III and IV



Type EXK



Type EXL

Type EXK With Male Nipple at One End, and Female Union on the other		Type EXL With Female Nipple at One End, and Female Union at the other		Size In.	Flex. Lgth. In.	Overall Lgth. In.
No.	Each	No.	Each			
EXK14	\$ 10.30	EXL14	\$ 10.30	1/2	4	8 1/4
EXK24	12.20	EXL24	12.20	3/4	4	8 1/4
EXK16	11.30	EXL16	11.30	1/2	6	10 1/4
EXK26	13.60	EXL26	13.60	3/4	6	10 1/4
EXK36	25.00	EXL36	25.00	1	6	11
EXK18	12.30	EXL18	12.30	1/2	8	12 1/4
EXK28	15.00	EXL28	15.00	3/4	8	12 1/4
EXK38	27.00	EXL38	27.00	1	8	13
EXK110	13.30	EXL110	13.30	1/2	10	14 1/4
EXK210	16.40	EXL210	16.40	3/4	10	14 1/4
EXK310	29.00	EXL310	29.00	1	10	15
EXK112	14.30	EXL112	14.30	1/2	12	16 1/4
EXK212	17.80	EXL212	17.80	3/4	12	16 1/4
EXK312	31.00	EXL312	31.00	1	12	17
EXK412	46.00	EXL412	46.00	1 1/4	12	17 15/16
EXK512	62.50	EXL512	62.50	1 1/2	12	18 5/16
EXK612	83.00	EXL612	83.00	2	12	18 5/8
EXK115	15.80	EXL115	15.80	1/2	15	19 1/4
EXK215	19.90	EXL215	19.90	3/4	15	19 1/4
EXK315	34.00	EXL315	34.00	1	15	20
EXK415	49.90	EXL415	49.90	1 1/4	15	20 15/16
EXK515	67.30	EXL515	67.30	1 1/2	15	21 5/16
EXK615	89.00	EXL615	89.00	2	15	21 5/8
EXK118	17.30	EXL118	17.30	1/2	18	22 1/4
EXK218	22.00	EXL218	22.00	3/4	18	22 1/4
EXK318	37.00	EXL318	37.00	1	18	23
EXK418	53.80	EXL418	53.80	1 1/4	18	23 15/16
EXK518	72.10	EXL518	72.10	1 1/2	18	24 5/16
EXK618	95.00	EXL618	95.00	2	18	24 5/8
EXK121	18.80	EXL121	18.80	1/2	21	25 1/4
EXK221	22.00	EXL221	22.00	3/4	21	25 1/4
EXK321	37.00	EXL321	37.00	1	21	26
EXK421	53.80	EXL421	53.80	1 1/4	21	26 15/16
EXK521	72.10	EXL521	72.10	1 1/2	21	27 5/16
EXK621	95.00	EXL621	95.00	2	21	27 5/8
EXK124	20.30	EXL124	20.30	1/2	24	28 1/4
EXK224	26.20	EXL224	26.20	3/4	24	28 1/4
EXK324	43.00	EXL324	43.00	1	24	29
EXK424	61.60	EXL424	61.60	1 1/4	24	29 15/16
EXK524	81.70	EXL524	81.70	1 1/2	24	30 5/16
EXK624	107.00	EXL624	107.00	2	24	30 5/8
EXK127	21.80	EXL127	21.80	1/2	27	31 1/4
EXK227	28.30	EXL227	28.30	3/4	27	31 1/4
EXK327	46.00	EXL327	46.00	1	27	32
EXK427	65.50	EXL427	65.50	1 1/4	27	32 15/16
EXK527	86.50	EXL527	86.50	1 1/2	27	33 5/16
EXK627	113.00	EXL627	113.00	2	27	33 5/8
EXK130	23.30	EXL130	23.30	1/2	30	34 1/4
EXK230	30.40	EXL230	30.40	3/4	30	34 1/4
EXK330	49.00	EXL330	49.00	1	30	35
EXK430	69.40	EXL430	69.40	1 1/4	30	35 15/16
EXK530	91.30	EXL530	91.30	1 1/2	30	36 5/16
EXK630	119.00	EXL630	119.00	2	30	36 5/8

Note—Any of the above couplings can be furnished in longer flexible lengths when desired. Contact Graybar.

Quantity prices on request.

Series "EX"

Explosion-Proof, Dust-Tight and Weatherproof

Class I, Groups C D, and Classes II, III and IV



Type EXJ



Type EXH



Type "EXG"

Type EXJ		Type EXH		Type EXG		Size In.	Flex. Lgth. In.	Overall Lgth. In.
With Female Nipples at Both Ends No.	Each	With Male Nipples at Both Ends No.	Each	With Male Nipple at One End, and Female Nipple at the other No.	Each			
EXJ14	\$9.50	EXH14	\$9.50	EXG14	\$9.50	1/2	4	7
EXJ24	11.40	EXH24	11.40	EXG24	11.40	3/4	4	7
EXJ16	10.50	EXH16	10.50	EXG16	10.50	1/2	6	9
EXJ26	12.80	EXH26	12.80	EXG26	12.80	3/4	6	9
EXJ36	23.00	EXH36	23.00	EXG36	23.00	1	6	9 1/2
EXJ18	11.50	EXH18	11.50	EXG18	11.50	1/2	8	11
EXJ28	14.20	EXH28	14.20	EXG28	14.20	3/4	8	11
EXJ38	25.00	EXH38	25.00	EXG38	25.00	1	8	11 1/2
EXJ110	12.50	EXH110	12.50	EXG110	12.50	1/2	10	13
EXJ210	15.60	EXH210	15.60	EXG210	15.60	3/4	10	13
EXJ310	27.00	EXH310	27.00	EXG310	27.00	1	10	13 1/2
EXJ112	13.50	EXH112	13.50	EXG112	13.50	1/2	12	15
EXJ212	17.00	EXH212	17.00	EXG212	17.00	3/4	12	15
EXJ312	29.00	EXH312	29.00	EXG312	29.00	1	12	15 1/2
EXJ412	43.00	EXH412	43.00	EXG412	43.00	1 1/4	12	16 1/2
EXJ512	59.00	EXH512	59.00	EXG512	59.00	1 1/2	12	16 1/2
EXJ612	76.00	EXH612	76.00	EXG612	76.00	2	12	17 1/2
EXJ115	15.00	EXH115	15.00	EXG115	15.00	1/2	15	18
EXJ215	19.10	EXH215	19.10	EXG215	19.10	3/4	15	18
EXJ315	32.00	EXH315	32.00	EXG315	32.00	1	15	18 1/2
EXJ415	46.90	EXH415	46.90	EXG415	46.90	1 1/4	15	19 1/2
EXJ515	63.80	EXH515	63.80	EXG515	63.80	1 1/2	15	19 1/2
EXJ615	82.00	EXH615	82.00	EXG615	82.00	2	15	20 1/2
EXJ118	16.50	EXH118	16.50	EXG118	16.50	1/2	18	21
EXJ218	21.20	EXH218	21.20	EXG218	21.20	3/4	18	21
EXJ318	35.00	EXH318	35.00	EXG318	35.00	1	18	21 1/2
EXJ418	50.80	EXH418	50.80	EXG418	50.80	1 1/4	18	22 1/2
EXJ518	68.80	EXH518	68.80	EXG518	68.80	1 1/2	18	22 1/2
EXJ618	88.00	EXH618	88.00	EXG618	88.00	2	18	23 1/2
EXJ121	18.00	EXH121	18.00	EXG121	18.00	1/2	21	24
EXJ221	23.30	EXH221	23.30	EXG221	23.30	3/4	21	24
EXJ321	38.00	EXH321	38.00	EXG321	38.00	1	21	24 1/2
EXJ421	54.70	EXH421	54.70	EXG421	54.70	1 1/4	21	25 1/2
EXJ521	73.40	EXH521	73.40	EXG521	73.40	1 1/2	21	25 1/2
EXJ621	94.00	EXH621	94.00	EXG621	94.00	2	21	26 1/2
EXJ124	19.50	EXH124	19.50	EXG124	19.50	1/2	24	27
EXJ224	25.40	EXH224	25.40	EXG224	25.40	3/4	24	27
EXJ324	41.00	EXH324	41.00	EXG324	41.00	1	24	27 1/2
EXJ424	58.60	EXH424	58.60	EXG424	58.60	1 1/4	24	28 1/2
EXJ524	78.20	EXH524	78.20	EXG524	78.20	1 1/2	24	28 1/2
EXJ624	100.00	EXH624	100.00	EXG624	100.00	2	24	29 1/2
EXJ127	21.00	EXH127	21.00	EXG127	21.00	1/2	27	30
EXJ227	27.50	EXH227	27.50	EXG227	27.50	3/4	27	30
EXJ327	44.00	EXH327	44.00	EXG327	44.00	1	27	30 1/2
EXJ427	62.50	EXH427	62.50	EXG427	62.50	1 1/4	27	31 1/2
EXJ527	83.00	EXH527	83.00	EXG527	83.00	1 1/2	27	31 1/2
EXJ627	106.00	EXH627	106.00	EXG627	106.00	2	27	32 1/2
EXJ130	22.50	EXH130	22.50	EXG130	22.50	1/2	30	33
EXJ230	29.60	EXH230	29.00	EXG230	29.60	3/4	30	33
EXJ330	47.00	EXH330	47.00	EXG330	47.00	1	30	33 1/2
EXJ430	66.40	EXH430	66.40	EXG430	66.40	1 1/4	30	34 1/2
EXJ530	87.80	EXH530	87.80	EXG530	87.80	1 1/2	30	34 1/2
EXJ630	112.00	EXH630	112.00	EXG630	112.00	2	30	35 1/2

Overall length of items () are 1/16 in. less on Type EXG Only.

Note—Any of the above couplings can be furnished in longer flexible lengths when desired. Contact Graybar.

Quantity prices on request.

Appleton Unilets

Series "ER"
Malleable Iron, Cadmium Finish
With Threaded Hubs

(Dotted lines in bottom of illustrations indicate hubs)

Explosion-Proof and Dust-Tight Fittings

Designed in the rectangular shape to provide as narrow a fitting as practical with ample wiring space. For use as a junction box in all hazardous locations. Cover and Unilet body have a ground surface where the two parts join each other. Covers attached by screws, which are fixed in place to prevent loss when installing. Hubs threaded standard for conduit.

Form 1



Type "ERC" — Form 1

Length exclusive of Hubs 5 1/2 in.

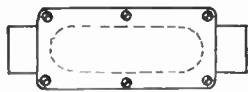

Type ERC			
No.	Size, In.	Wt. Lbs. Per 10 Pcs.	Each
41102	1/2	43	\$4.10
41122	3/4	42	4.35

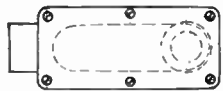

Type ERLB			
No.	Size, In.	Wt. Lbs. Per 10 Pcs.	Each
41108	1/2	43	\$4.10
41128	3/4	43	4.35

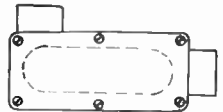

Type ERLB			
No.	Size, In.	Wt. Lbs. Per 10 Pcs.	Each
41108	1/2	43	\$4.10
41128	3/4	43	4.35

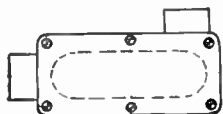

Type ERLB			
No.	Size, In.	Wt. Lbs. Per 10 Pcs.	Each
41105-L	1/2	43	\$4.10
41125-L	3/4	43	4.35

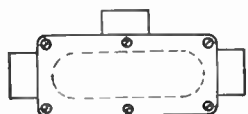

Type ERLB			
No.	Size, In.	Wt. Lbs. Per 10 Pcs.	Each
41105-R	1/2	43	\$4.10
41125-R	3/4	43	4.35



Type ERLB			
No.	Size, In.	Wt. Lbs. Per 10 Pcs.	Each
41103	1/2	46	\$4.25
41123	3/4	44	4.50

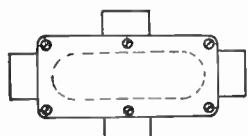

Type ERLB			
No.	Size, In.	Wt. Lbs. Per 10 Pcs.	Each
41109	1/2	43	\$4.25
41129	3/4	44	4.50

Quantity prices on request.

Form 2



Type "ERC" — Form 2

Length exclusive of Hubs: 1/2-inch size 3 11/16 inches, 3/4-inch size 4-inches.



Type ERC			
No.	Size, In.	Wt. Lbs. Per 5 Pcs.	Each
41150	1/2	9	\$3.00
41151	3/4	9	3.50



Type ERLB			
No.	Size, In.	Wt. Lbs. Per 5 Pcs.	Each
41155	1/2	8	\$3.00
41156	3/4	8	3.50

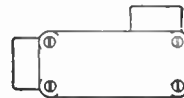

Type ERLB			
No.	Size, In.	Wt. Lbs. Per 5 Pcs.	Each
41160	1/2	8	\$3.00
41161	3/4	8	3.50



Type ERLB			
No.	Size, In.	Wt. Lbs. Per 5 Pcs.	Each
41165	1/2	7	\$3.00
41166	3/4	7	3.50

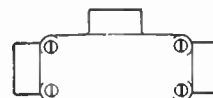

Type ERLB			
No.	Size, In.	Wt. Lbs. Per 5 Pcs.	Each
41170	1/2	7	\$3.20
41171	3/4	7	3.80



Type ERLB			
No.	Size, In.	Wt. Lbs. Per 5 Pcs.	Each
41175	1/2	7	\$3.20
41176	3/4	7	3.80

Quantity prices on request.

Appleton Panelboards

For Class I, Groups C and D;
Class II, Groups E, F and G; and
Class III, Hazardous Locations

Type "ELP"
Explosion-Proof and Dust-Tight

Complete with Connection Block and
Thermotype Circuit Breakers
15, 20 and 30 Ampere Ratings

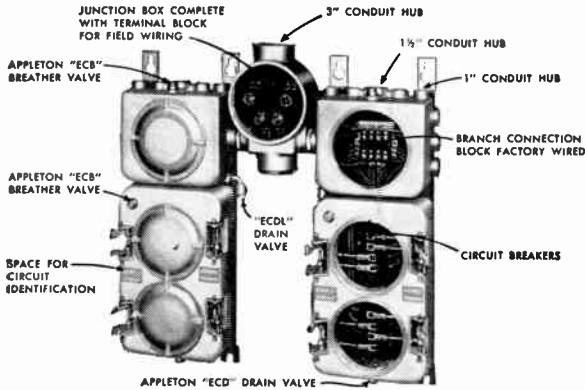

Designed as a convenient control and distribution center for lighting circuits or single phase motor circuits. Has many improvements, such as lighter weight, simplified wiring installation, easier access for inspection or maintenance, new locking switch handles, provision for identifying circuits, etc. Wired complete—factory wiring terminates in a connection block located for field connections.

The 4 to 8 circuit panelboards have a 1 1/2 in. main center hub, a 1 1/2 in. side hub, and seven 1 in. hubs for branch circuits; for installations requiring bottom or straight-thru feed a Special Junction Box Unilet can be furnished.

The 10 to 16 circuit panelboards are furnished complete with Center Junction Unilet having two 3-in. hubs allowing for top or bottom entrance or straight-thru feed; one 3-in. close-up plug furnished for unused conduit opening.

*14 to 16 Circuits, Single Pole; 8 Circuits Double Pole

Wiring System

Mains—2 Wire
125 V, A-C or D-C
Branches—2 Wire
125 V, A-C or D-C
Breakers—Dble. Pole

Mains—3 Wire
125-250 V, A-C or D-C
Branches—2 Wire
125 V, A-C or D-C
Breakers—Dble. Pole

Mains—3 Wire
125-250 V, A-C or D-C
Branches—3 Wire
125-250 V, A-C or D-C
Solid Neutral
Breakers—Dble. Pole

Mains—3 Wire
125-250 V, A-C or D-C
Branches—2 Wire
125 V, A-C or D-C
Solid Neutral
Breakers—Sgle. Pole

Mains—4 Wire
120-208 V, 3-Phase
Branches—2 Wire
120 V, 1-Phase
Solid Neutral
Breakers—Sgle. Pole

No. Cir- cuits	Amp. Rat- ing	No.	Each	No.	Each	No.	Each	No.	Each	No.	Each
2	15	ELP222-215	\$210.00	ELP322-215	\$210.00	ELP332-215	\$210.00
	20	ELP222-220	210.00	ELP322-220	210.00	ELP332-220	210.00
	30	ELP222-230	210.00	ELP322-230	210.00	ELP332-230	210.00
4	15	ELP222-415	518.60	ELP322-415	518.60	ELP332-415	518.60	ELP321-415	\$200.00	ELP421-415	\$200.00
	20	ELP222-420	518.60	ELP322-420	518.60	ELP332-420	518.60	ELP321-420	200.00	ELP421-420	200.00
	30	ELP222-430	518.60	ELP322-430	518.60	ELP332-430	518.60	ELP321-430	200.00	ELP421-430	200.00
6	15	ELP222-615	651.60	ELP322-615	651.60	ELP332-615	651.60	ELP321-615	439.60	ELP421-615	439.60
	20	ELP222-620	651.60	ELP322-620	651.60	ELP332-620	651.60	ELP321-620	439.60	ELP421-620	439.60
	30	ELP222-630	651.60	ELP322-630	651.60	ELP332-630	651.60	ELP321-630	439.60	ELP421-630	439.60
8	15	ELP222-815	848.60	ELP322-815	848.60	ELP332-815	848.60	ELP321-815	509.60	ELP421-815	509.60
	20	ELP222-820	848.60	ELP322-820	848.60	ELP332-820	848.60	ELP321-820	509.60	ELP421-820	509.60
	30	ELP222-830	848.60	ELP322-830	848.60	ELP332-830	848.60	ELP321-830	509.60	ELP421-830	509.60
10	15	ELP321-1015	580.60	ELP421-1015	580.60
	20	ELP321-1020	580.60	ELP421-1020	580.60
	30	ELP321-1030	580.60	ELP421-1030	580.60
12	15	ELP321-1215	650.60	ELP421-1215	650.60
	20	ELP321-1220	650.60	ELP421-1220	650.60
	30	ELP321-1230	650.60	ELP421-1230	650.60
14	15	ELP321-1415	780.60	ELP421-1415	780.60
	20	ELP321-1420	780.60	ELP421-1420	780.60
	30	ELP321-1430	780.60	ELP421-1430	780.60
16	15	ELP321-1615	851.60	ELP421-1615	851.60
	20	ELP321-1620	851.60	ELP421-1620	851.60
	30	ELP321-1630	851.60	ELP421-1630	851.60

Special Junction Box Outlets

For use with
Type "ELP"
Explosion-Proof
and Dust-Tight
Panelboards

2 to 4 Circuits,
Double Pole—

4 to 8 Circuits,
Single Pole

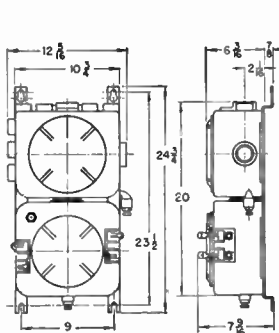

4 Circuits, Single Pole
2 Circuits, Double Pole

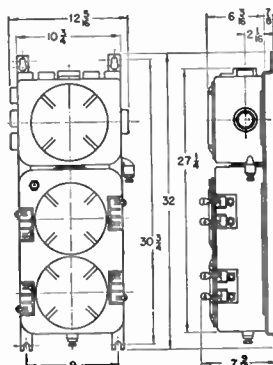

6 to 8 Circuits, Single Pole
4 Circuits, Double Pole

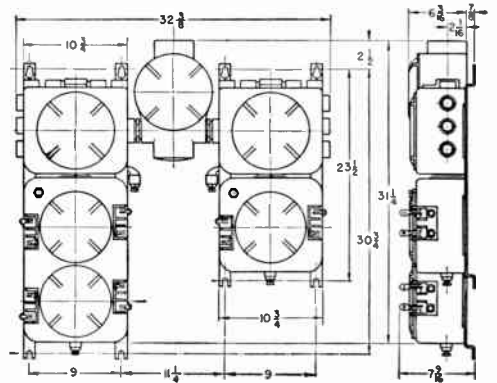

*10 to 12 Circuits, Single Pole
6 Circuits, Double Pole

Hub Sizes: 2 in. top and
bottom; 1 1/2 in. right and
left.

No. ELPJ-2 . . . Ea. \$15.00

*When BOTTOM entrance to Center Junction Unilet is wanted, add
suffix "B" to catalog number — as "ELP321-1015B", etc.

Appleton Unilets

Malleable Iron, Cadmium Finish

Series "EFS"

Explosion-Proof and Dust-Tight Switches

With Operating Handle and Tumbler Switches



Type EFS Single-Gang



Type EFSC Two-Gang

Type EFS Single-Gang

Switch	Size, In.	No.	Ratings Amperes		Hp.	Each	No.	Ratings Amp. Hp.		Each
			125V	250V				250 V	230 V. A-C	
S.P.	1/2	61501	20	10	..	\$12.20	\$.....
	3/4	61511	20	10	..	12.30	61711	30	2	15.30
D.P.	3/4	61531	..	20	2	12.80	*61731	30	2	17.20
3-Way	1/2	61541	20	10	..	13.00
	3/4	61551	20	10	..	13.10
4-Way	1/2	61561	10	5	..	17.20
	3/4	61571	10	5	..	17.30

Type EFSC Single-Gang

Switch	Size, In.	No.	Ratings Amperes		Hp.	Each	No.	Ratings Amp. Hp.		Each
			125V	250V				250 V	230 V. A-C	
S.P.	1/2	61502	20	10	..	12.40	61702	30	2	15.60
	3/4	61512	20	10	..	12.60	61712	30	2	15.80
D.P.	1/2	61522	..	20	2	12.90
	3/4	61532	..	20	2	13.10	*61732	30	2	17.70
3-Way	1/2	61542	20	10	..	13.20
	3/4	61552	20	10	..	13.40
4-Way	1/2	61562	10	5	..	17.40
	3/4	61572	10	5	..	17.60

Type EFS Two-Gang

Switch	Size, In.	No.	Ratings Amperes		Hp.	Each	No.	Ratings Amp. Hp.		Each
			125V	250V				250 V	230 V. A-C	
S.P.	1/2	61601	20	10	..	24.40
	3/4	61611	20	10	..	24.50	61811	30	2	30.30
D.P.	1	61631	..	20	2	25.70	*61831	30	2	34.10
3-Way	1	61651	20	10	..	26.30
4-Way	1	61671	10	5	..	37.70

Type EFSC Two-Gang

Switch	Size, In.	No.	Ratings Amperes		Hp.	Each	No.	Ratings Amp. Hp.		Each
			125V	250V				250 V	230 V. A-C	
S.P.	1/2	61602	20	10	..	24.60
	3/4	61612	20	10	..	24.80	61812	30	2	30.80
D.P.	1/2	61622	..	20	2	25.60
	3/4	61632	..	20	2	25.80	*61832	30	2	34.60
3-Way	1/2	61642	20	10	..	26.20
	3/4	61652	20	10	..	26.40
4-Way	1/2	61662	10	5	..	34.60
	3/4	61672	10	5	..	34.80

Overall Dimensions: exclusive of hubs: Single Gang — 4 5/8 in. long, 3 in. wide, 4 1/8 in. deep, over handle. Two-gang — 4 5/8 in. long, 6 3/16 in. wide, 4 1/8 in. deep over handle.

*Approved for 1 hp. 440 volts a-c., 2 hp. 220 volts a-c.

Quantity prices on request.

With Push-Pull Rod and Tumbler Switches



Type EFS Single-Gang



Type EFSC Two-Gang

Type EFS Single-Gang

Switch	Size, In.	No.	Ratings Amperes		Hp.	Each	No.	Ratings Amp. Hp.		Each
			125V	250V				250 V	230 V. A-C	
S.P.	1/2	51501	20	10	..	\$13.40	\$.....
	3/4	51511	20	10	..	13.50	51711	30	2	15.50
D.P.	3/4	51531	..	20	2	13.80	*51731	30	2	17.20
3-Way	1/2	51541	20	10	..	13.90
	3/4	51551	20	10	..	14.00
4-Way	1/2	51561	10	5	..	18.90
	3/4	51571	10	5	..	19.00

Type EFSC Single-Gang

Switch	Size, In.	No.	Ratings Amperes		Hp.	Each	No.	Ratings Amp. Hp.		Each
			125V	250V				250 V	230 V. A-C	
S.P.	1/2	51502	20	10	..	13.60	51702	30	2	15.60
	3/4	51512	20	10	..	13.80	51712	30	2	15.80
D.P.	1/2	51522	..	20	2	13.90
	3/4	51532	..	20	2	14.10	*51732	30	2	17.70
3-Way	1/2	51542	20	10	..	14.10
	3/4	51552	20	10	..	14.30
4-Way	1/2	51562	10	5	..	19.10
	3/4	51572	10	5	..	19.30

Type EFS Two-Gang

Switch	Size, In.	No.	Ratings Amperes		Hp.	Each	No.	Ratings Amp. Hp.		Each
			125V	250V				250 V	230 V. A-C	
S.P.	1/2	51601	20	10	..	26.80
	3/4	51611	20	10	..	26.90	51811	30	2	30.30
D.P.	1	51631	..	20	2	27.70	*51831	30	2	34.10
3-Way	1	51651	20	10	..	27.90
4-Way	1	51671	10	5	..	38.10

Type EFSC Two-Gang

Switch	Size, In.	No.	Ratings Amperes		Hp.	Each	No.	Ratings Amp. Hp.		Each
			125V	250V				250 V	230 V. A-C	
S.P.	1/2	51602	20	10	..	27.00
	3/4	51612	20	10	..	27.20	51812	30	2	30.80
D.P.	1/2	51622	..	20	2	27.60
	3/4	51632	..	20	2	27.80	*51832	30	2	34.60
3-Way	1/2	51642	20	10	..	28.10
	3/4	51652	20	10	..	28.20
4-Way	1/2	51662	10	5	..	38.00
	3/4	51672	10	5	..	38.20

Overall Dimensions: exclusive of hubs: Single-Gang — 4 5/8 in. long, 3 in. wide, 3 3/4 in. high. Two-Gang — 4 5/8 in. long, 6 3/16 in. wide, 3 3/4 in. high.

*Approved for 1 hp. 440 volts a-c., 2 hp. 220 volts a-c.

Quantity prices on request.

Appleton Unilets
Series "EFS"
Motor Control Push Button Stations
Explosion-Proof and Dust-Tight



Type EFS



Type EFSC

Complete with Momentary Contact "Start-Stop" Switches. With Threaded Hubs.

Two-Button Start-Stop Switch — 5 Amp. 600 Volts A-C Maximum

Circuit — 1 Normally open — 1 Normally Closed

Unilet Malleable Iron, Cadmium Finish. Size, exclusive of hubs: 4 1/8 in. long, 3 in. wide, 4 1/8 in. high.

Type EFS				Type EFSC			
No.	Size, In.	Wt. Lbs.	Each	No.	Size, In.	Wt. Lbs.	Each
50041	1/2	6	\$18.70	50042	1/2	6	\$18.90
50051	3/4	6	18.80	50052	3/4	6	19.10

Appleton Lighting Fixture Swivels
Type "ESD" — Explosion-Proof



Class I, Groups C and D
Class II, Groups F and G

Designed to introduce flexibility for suspension lighting fixtures in hazardous locations.

The National Electrical Code, Article 500, calls for flexibility in the form of a fitting or flexible connector to be used when lighting fixtures are suspended more than 12 in. from fixture canopy.

This light weight, smooth fitting will give the fixture the flexibility to meet those requirements.

Gray Iron, Cadmium Finish.

Dimensions: 3 1/8 in. high, 2 7/8 in. wide.

No.	Size In.	Wt. Lbs. Per 25 Pcs.	Each
ESD-50	1/2	86	\$13.50
ESD-75	3/4	86	13.50

Appleton Sealing Units
Series EYS — Explosion-Proof
With Pipe Plugs*
Malleable Iron, Cadmium Finish



Type EYSF



Type EYSMA



Type EYSMB

Size, In.	EYSF Female Hub Top and Bottom		EYSMA Male Hub Top and Female Hub Bottom		EYSMB Female Hub Top and Male Hub Bottom		Sealing Cement Req. Ozs.
	No.	Each	No.	Each	No.	Each	
1/2	38670	\$1.30	48670	\$1.30	58670	\$1.30	2
3/4	38671	1.60	48671	1.60	58671	1.60	3
1	38672	2.10	48672	2.10	58672	2.10	4
1 1/4	38673	2.60	48673	2.60	58673	2.60	8
1 1/2	38674	3.90	48674	3.90	58674	3.90	12
2	38675	5.10	48675	5.10	58675	5.10	18
2 1/2	38676	8.00	48676	8.00	58676	8.00	30
3	38677	10.00	48677	10.00	58677	10.00	90

*All sealing unilets of the "EYS" series must be filled with "Apelco" Sealing Cement in order to comply with requirements of Underwriters' Laboratories.

Quantity prices on request.

Appleton Unilets

Malleable Iron, Cadmium Finish

Series "CPSI" — Explosion-Proof

Dead-End Receptacles and Plugs
For Industrial Plants

15 Amp. or 1 Hp., 115 or 230 Volts, 60 Cycles A-C



Type "CPSIC" Unilet Complete with Lift Cover (Closed)

For use in industrial plants where hazardous fumes and explosive atmosphere exist. The dead-end receptacle isolates the exposed, outer contacts from the live, inner contacts and affords a safety measure which proves indispensable in hazardous locations.

An extra ground is furnished to carry off any accumulated charges in either plug or receptacle. Should always be installed with cover hinge in downward position.

2-Wire, 3-Pole

Form 5 and 10 — O.S. Diameter 3 3/8 in. Depth over all 4 1/8 in.

Type CPSIC

No.	Size In.	Wt. Per 5 Pcs.	Each
28052	1/2	16 1/2	\$26.10
28062	3/4	16 1/2	26.50

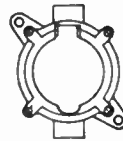

Type CPSIE

No.	Size In.	Wt. Per 5 Pcs.	Each
28051	1/2	15 1/2	\$25.80
28061	3/4	15 1/2	26.10

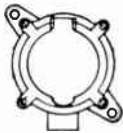

Type CPSIL

No.	Size In.	Wt. Per 5 Pcs.	Each
28055	1/2	16 1/2	\$26.10
28065	3/4	16 1/2	26.50

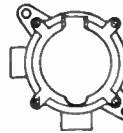

Type CPSIT

No.	Size In.	Wt. Per 5 Pcs.	Each
28053	1/2	17	\$26.40
28063	3/4	17	26.90

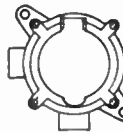

Type CPSIX

No.	Size In.	Wt. Per 5 Pcs.	Each
28054	1/2	18	\$26.70
28064	3/4	18	27.30

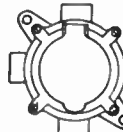

Type CPSIA — Angle Style
2-Wire — 3-Pole

Form 5 and 10 — Height 6 1/4 in.

Width 4 3/4 in.

No.	Size In.	Wt. Per 5 Pcs.	Each
28056	1/2	20	\$25.80
28066	3/4	20	26.10



Note—Type CPP Plugs will fit this series of CPSI Unilets.

Quantity prices on request.

Appleton Unilets

Malleable Iron, Cadmium Finish

Series "AE"

Type AERH



Hub Size In.	Form B 30 Amp. No.	Each	Hub Size In.	Form C 60 Amp. No.	Each
1/2	AERH13	\$1.80	1	AERH36	\$3.00
3/4	AERH23	2.00	1 1/4	AERH46	3.20
1	AERH33	2.20	1 1/2	AERH56	3.40

Type AERC



1/2	AERC13	2.00	1	AERC36	2.40
3/4	AERC23	2.20	1 1/4	AERC46	3.20
1	AERC33	2.40	1 1/2	AERC56	3.40

Type AEE



1/2	AEE13	2.00	1	AEE36	3.30
3/4	AEE23	2.20	1 1/4	AEE46	3.50
1	AEE33	2.40	1 1/2	AEE56	3.70

Type AEDF



1/2	AEDF13	2.30	1	AEDF36	3.60
3/4	AEDF23	2.50	1 1/4	AEDF46	3.80
1	AEDF33	2.70	1 1/2	AEDF56	4.00

Type AEJ

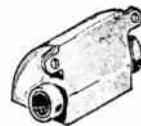

1/2	AEJ13	2.60	1	AEJ36	3.90
3/4	AEJ23	2.80	1 1/4	AEJ46	4.10
1	AEJ33	3.00	1 1/2	AEJ56	4.30

Type AED



Hub Size In.	Form B 30 Amp. No.	Each	Hub Size In.	Form C 60 Amp. No.	Each
1/2	AED13	\$2.90	1	AED36	\$4.20
3/4	AED23	3.10	1 1/4	AED46	4.40
1	AED33	3.30	1 1/2	AED56	4.60

Type AEJG

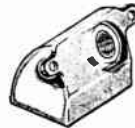

1/2	AEJG13	2.40	1	AEJG36	3.80
3/4	AEJG23	2.60	1 1/4	AEJG46	4.00
1	AEJG33	2.80	1 1/2	AEJG56	4.20

Type AEJK

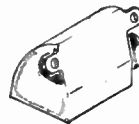

1/2	AEJK13	2.00	1	AEJK36	3.30
3/4	AEJK23	2.20	1 1/4	AEJK46	3.50
1	AEJK33	2.40	1 1/2	AEJK56	3.70

Type AEJP

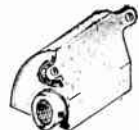

1/2	AEJP13	2.00	1	AEJP36	3.30
3/4	AEJP23	2.20	1 1/4	AEJP46	3.50
1	AEJP33	2.40	1 1/2	AEJP56	3.70

Type AERA



1/2	AERA13	1.80	1	AERA36	3.00
3/4	AERA23	2.00	1 1/4	AERA46	3.20
1	AERA33	2.20	1 1/2	AERA56	3.40

Series "AJ"

For 60 and 100 Ampere Receptacles

Straight Type "AJS"

For 60 Ampere Receptacles

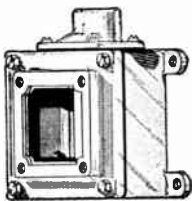

No.	Hub Size, In.	Each
AJS36	1	\$14.10
AJS46	1 1/4	14.20
AJS56	1 1/2	14.30
AJS66	2	14.40

For 100 Ampere Receptacles

AJS310	1	14.90
AJS410	1 1/4	15.00
AJS510	1 1/2	15.10
AJS610	2	15.20

Angle Type "AJA"

For 60 and 100 Ampere Receptacles

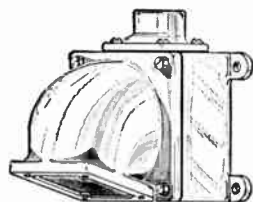

No.	Hub Size, In.	Each
AJA310	1	\$15.40
AJA410	1 1/4	15.50
AJA510	1 1/2	15.60
AJA610	2	15.70

Quantity prices on request.

Straight Type "AJSC"

For 60 Ampere Receptacles

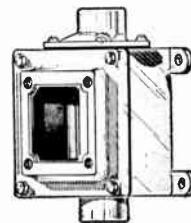

No.	Hub Size, In.	Each
AJSC36	1	\$14.50
AJSC46	1 1/4	14.70
AJSC56	1 1/2	14.90
AJSC66	2	15.10

For 100 Ampere Receptacles

AJSC310	1	15.30
AJSC410	1 1/4	15.50
AJSC510	1 1/2	15.70
AJSC610	2	15.90

Angle Type "AJAC"

For 60 and 100 Ampere Receptacles

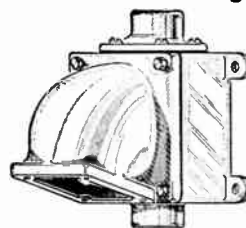

No.	Hub Size, In.	Each
AJAC310	1	\$15.80
AJAC410	1 1/4	16.00
AJAC510	1 1/2	16.20
AJAC610	2	16.40

Quantity prices on request.

Appleton Receptacles And Plugs

Complete with Interiors.
Unilets Malleable Iron,
Cadmium Finish.

Series "AE"
60 to 100 Amperes
250 Volts D-C — 600 Volts A-C

Receptacle and Plug Housing
are made in Aluminum.

Type "AEEA"—With Unilet Bodies

Type "AE"—Less Unilet Bodies

Type "AEP"—Plug

Style 1
Grounded
Through
Shell

Style 2
Grounded
Through Extra
Pole Only

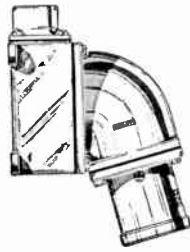
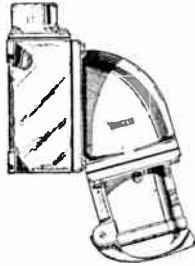

For use with Receptacle of corresponding rating listed on this page.

Description	Hub Size In.	With Lift Cover Each		Plain (No Cover) Each		With Lift Cover Each		Plain (No Cover) Each		No.	Cable Diam. In.		Each
		No.	Each	No.	Each	No.	Each	No.	Each		Min.	Max.	
60 Amp. Style 1	2-Wire 1	AEEA6213	\$35.40	AEEA6233	\$23.70	AE621	\$20.00	AE623	\$17.50	AEP6212	.750	1.375	\$17.50
	2-Pole 1/4	AEEA6214	35.50	AEEA6234	23.90								
	3-Wire 1	AEEA6313	37.40	AEEA6333	34.90	AE631	22.00	AE633	19.50	AEP6312	.750	1.375	19.00
	3-Pole 1/4	AEEA6314	37.50	AEEA6334	35.00								
60 Amp. Style 2	4-Wire 1/4	AEEA6414	41.50	AEEA6434	39.00	AE641	26.00	AE643	23.50	AEP6412	.750	1.375	21.00
	4-Pole 1/2	AEEA6415	41.60	AEEA6435	39.10								
	2-Wire 1	AEEA6323	39.90	AEEA6343	37.40	AE632	24.50	AE634	22.00	AEP6322	.750	1.375	21.50
	3-Pole 1/4	AEEA6324	40.00	AEEA6344	37.50								
100 Amp. Style 1	2-Wire 1/4	AEEA10214	41.50	AEEA10234	38.50	AE1021	26.00	AE1023	23.00	AEP10213	1.375	1.750	28.00
	2-Pole 1/2	AEEA10215	41.60	AEEA10235	38.60								
	3-Wire 1/4	AEEA10314	43.50	AEEA10334	40.50	AE1031	28.00	AE1033	25.00	AEP10313	1.375	1.750	30.00
	3-Pole 1/2	AEEA10315	43.60	AEEA10335	40.60								
100 Amp. Style 2	4-Wire 1/2	AEEA10415	47.60	AEEA10435	44.60	AE1041	32.00	AE1043	29.00	AEP10413	1.375	1.750	34.00
	4-Pole 2	AEEA10416	47.70	AEEA10436	44.70								
	2-Wire 1/4	AEEA10324	46.50	AEEA10344	43.50	AE1032	31.00	AE1034	28.00	AEP10323	1.375	1.750	33.00
	3-Pole 1/2	AEEA10325	46.60	AEEA10345	43.60								
100 Amp. Style 2	3-Wire 1/2	AEEA10425	50.60	AEEA10445	47.60	AE1042	35.00	AE1044	32.00	AEP10423	1.375	1.750	37.00
	4-Pole 2	AEEA10426	50.70	AEEA10446	47.70								

Style 1
Grounded
Through Shell

Style 2
Grounded
Through Extra
Pole Only

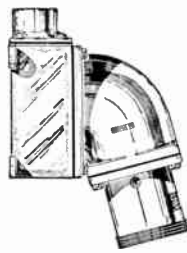
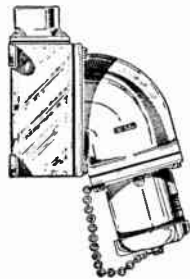

For use with receptacle of corresponding rating listed on this page.

Description	Hub Size In.	Threaded With Cap Each		Threaded No Cap Each		Threaded With Cap Each		Threaded No Cap Each		No.	Plug Cable Diam. In.		Each
		No.	Each	No.	Each	No.	Each	No.	Each		Min.	Max.	
60 Amp. Style 1	2-Wire 1	AEEA6273	\$35.80	AEEA6253	\$33.60	AE627	\$20.40	AE625	\$18.20	AEP6252	.750	1.375	\$19.50
	2-Pole 1/4	AEEA6274	35.90	AEEA6254	33.70								
	3-Wire 1	AEEA6373	37.80	AEEA6353	35.60	AE637	22.40	AE635	20.20	AEP6352	.750	1.375	21.00
	3-Pole 1/4	AEEA6374	37.90	AEEA6354	35.70								
60 Amp. Style 2	4-Wire 1/4	AEEA6474	41.90	AEEA6454	39.70	AE647	26.40	AE645	24.20	AEP6452	.750	1.375	23.00
	4-Pole 1/2	AEEA6475	42.00	AEEA6455	39.80								
	2-Wire 1	AEEA6383	40.30	AEEA6363	38.10	AE638	24.90	AE636	22.70	AEP6362	.750	1.375	23.52
	3-Pole 1/4	AEEA6384	40.40	AEEA6364	38.20								
100 Amp. Style 1	3-Wire 1/4	AEEA6484	44.40	AEEA6464	42.20	AE648	28.90	AE646	26.70	AEP6462	.750	1.375	25.50
	4-Pole 1/2	AEEA6485	44.50	AEEA6465	42.30								
	2-Wire 1/4	AEEA10274	43.50	AEEA10254	39.50	AE1027	28.00	AE1025	24.00	AEP10253	1.375	1.750	31.00
	2-Pole 1/2	AEEA10275	43.60	AEEA10255	39.60								
100 Amp. Style 2	3-Wire 1/4	AEEA10374	45.50	AEEA10354	41.50	AE1037	30.00	AE1035	26.00	AEP10353	1.375	1.750	33.00
	3-Pole 1/2	AEEA10375	45.60	AEEA10355	41.60								
	4-Wire 1/2	AEEA10475	49.60	AEEA10455	45.60	AE1047	34.00	AE1045	30.00	AEP10453	1.375	1.750	37.00
	4-Pole 2	AEEA10476	49.70	AEEA10456	45.70								
100 Amp. Style 2	2-Wire 1/4	AEEA10384	48.50	AEEA10364	44.50	AE1038	33.00	AE1036	29.00	AEP10363	1.375	1.750	36.00
	3-Pole 1/2	AEEA10385	48.60	AEEA10365	44.60								
	3-Wire 1/2	AEEA10485	52.60	AEEA10465	48.60	AE1048	37.00	AE1046	33.00	AEP10463	1.375	1.750	40.00
	4-Pole 2	AEEA10486	52.70	AEEA10466	48.70								

Quantity prices on request.

Appleton Receptacles and Plugs

Unilets Malleable Iron, Cadmium Finish.

Receptacle and plug housings are made in aluminum.

Form "B" and "C" Unilets may be used with this receptacle equipment.

Series "AE"

Complete with Interiors

30 and 60 Amperes

250 Volts O-C — 600 Volts A-C

If specified on order, 30 amp. receptacles can be furnished for use with old style "QE" Unilet installation. Add suffix "QE" to number at an advance in price. The suffix is not necessary for 60 amp. receptacles.

Type "AEE"—With Unilet Bodies Type "AE"—Less Unilet Bodies

Type "AEP"—Plug

Style 1
Grounded Through Shell

Style 2
Grounded Through Extra Pole Only



For use with Receptacle of corresponding rating listed on this page.

Description	Hub Size In.	With Lift Cover Each		Plain (No Cover) Each		With Lift Cover Each		Plain (No Cover) Each		No.	Cable Diam. In.		Each	
		No.	Price	No.	Price	No.	Price	No.	Price		Min.	Max.		
30 Amp. Style 1 Form B Unilet	2-Wire	1/2	AEE3211	\$14.50	AEE3231	\$13.10	AE321	\$12.50	AE323	\$11.10	AEP3211	500	.750	\$12.30
	2-Pole	3/4	AEE3212	14.70	AEE3232	13.30								
	3-Wire	3/4	AEE3312	15.70	AEE3332	14.30	AE331	13.50	AE333	12.10	AEP3311	500	.750	13.60
	3-Pole	1	AEE3313	15.90	AEE3333	14.50								
30 Amp. Style 2 Form B Unilet	4-Wire	3/4	AEE3412	17.30	AEE3432	15.90	AE341	15.10	AE343	13.70	AEP3411	500	.750	15.20
	4-Pole	1	AEE3413	17.50	AEE3433	16.10								
	2-Wire	3/4	AEE3322	17.70	AEE3342	16.30	AE332	15.50	AE334	14.10	AEP3321	500	.750	15.60
	3-Pole	1	AEE3323	17.90	AEE3343	16.50								
60 Amp. Style 1 Form C Unilet	3-Wire	3/4	AEE3422	19.30	AEE3442	17.90	AE342	17.10	AE344	15.70	AEP3421	500	.750	17.20
	4-Pole	1	AEE3423	19.50	AEE3443	18.10								
	2-Wire	1	AEE6213	35.40	AEE6233	20.80	AE621	20.00	AE623	17.50	AEP6212	.750	1.375	17.50
	2-Pole	1 1/4	AEE6214	35.50	AEE6234	21.00								
60 Amp. Style 2 Form C Unilet	3-Wire	1	AEE6313	41.50	AEE6333	34.90	AE631	22.00	AE633	19.50	AEP6312	.750	1.375	19.00
	3-Pole	1 1/4	AEE6314	41.60	AEE6334	35.00								
	4-Wire	1 1/4	AEE6414	27.80	AEE6434	39.00	AE641	26.00	AE643	23.50	AEP6412	.750	1.375	21.00
	4-Pole	1 1/2	AEE6415	28.00	AEE6435	39.10								
60 Amp. Style 2 Form C Unilet	2-Wire	1	AEE6323	39.90	AEE6343	37.40	AE632	24.50	AE634	22.00	AEP6322	.750	1.375	21.50
	3-Pole	1 1/4	AEE6324	40.00	AEE6344	37.50								
	3-Wire	1 1/4	AEE6424	44.00	AEE6444	41.50	AE642	28.50	AE644	26.00	AEP6422	.750	1.375	23.50
	4-Pole	1 1/2	AEE6425	44.10	AEE6445	41.60								

Style 1
Grounded Through Shell

Style 2
Grounded Through Extra Pole Only

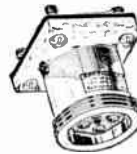
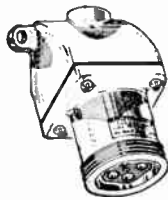
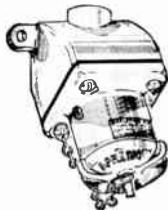

For use with Receptacle of corresponding rating listed on this page.

Description	Hub Size In.	Threaded With Cap Each		Threaded No Cap Each		Threaded With Cap Each		Threaded No Cap Each		No.	Cable Diam. In.		Each	
		No.	Price	No.	Price	No.	Price	No.	Price		Min.	Max.		
30 Amp. Style 1 Form B Unilet	2-Wire	1/2	AEE3271	\$15.20	AEE3251	\$13.60	AE327	\$13.20	AE325	\$11.60	AEP3251	500	.750	\$13.50
	2-Pole	3/4	AEE3272	15.40	AEE3252	13.80								
	3-Wire	3/4	AEE3372	16.40	AEE3352	14.80	AE337	14.20	AE335	12.60	AEP3351	500	.750	14.80
	3-Pole	1	AEE3373	16.60	AEE3353	15.00								
30 Amp. Style 2 Form B Unilet	4-Wire	3/4	AEE3472	18.00	AEE3452	16.40	AE347	15.80	AE345	14.20	AEP3451	500	.750	16.40
	4-Pole	1	AEE3473	18.20	AEE3453	16.60								
	2-Wire	3/4	AEE3382	18.40	AEE3362	16.80	AE338	16.20	AE336	14.60	AEP3361	500	.750	16.80
	3-Pole	1	AEE3383	18.60	AEE3363	17.00								
60 Amp. Style 1 Form C Unilet	3-Wire	3/4	AEE3482	20.00	AEE3462	18.40	AE348	17.80	AE346	16.20	AEP3461	500	.750	18.40
	4-Pole	1	AEE3483	20.20	AEE3463	18.60								
	2-Wire	1	AEE6273	23.70	AEE6253	21.50	AE627	20.40	AE625	18.20	AEP6252	.750	1.375	19.50
	2-Pole	1 1/4	AEE6274	23.90	AEE6254	21.70								
60 Amp. Style 2 Form C Unilet	3-Wire	1	AEE6373	25.70	AEE6353	23.50	AE637	22.40	AE635	20.20	AEP6352	.750	1.375	21.00
	3-Pole	1 1/4	AEE6374	25.90	AEE6354	23.70								
	4-Wire	1 1/4	AEE6474	29.90	AEE6454	27.70	AE647	26.40	AE645	24.20	AEP6452	.750	1.375	23.00
	4-Pole	1 1/2	AEE6475	30.10	AEE6455	27.90								
60 Amp. Style 2 Form C Unilet	2-Wire	1	AEE6383	40.30	AEE6363	26.00	AE638	24.90	AE636	22.70	AEP6362	.750	1.375	23.50
	3-Pole	1 1/4	AEE6384	40.40	AEE6364	26.20								
	3-Wire	1 1/4	AEE6484	44.40	AEE6464	30.20	AE648	28.90	AE646	26.70	AEP6462	.750	1.375	25.50
	4-Pole	1 1/2	AEE6485	44.50	AEE6465	30.40								

Quantity prices on request.

Appleton Extension Cable Connectors

Series APC

Aluminum Finish

30, 60 and 100 Amperes

250 Volts D-C, 600 Volts A-C

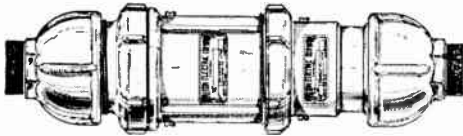

These connectors are for use in conjunction with AE Series Receptacles and Plugs, particularly for breaking up extra long extensions when used with portable machinery.

Style 1 — Grounded through shell.

Style 2 — Grounded through extra pole only.

30 Amp., for Cable .500 to .750 in. Diameter

Style 1		
No.	Description	Each
APC3251	2-Wire, 2-Pole	\$29.00
APC3351	3-Wire, 3-Pole	31.40
APC3451	4-Wire, 4-Pole	34.60

Style 2		
No.	Description	Each
APC3361	2-Wire, 3-Pole	35.40
APC3461	3-Wire, 4-Pole	38.60

60 Amp., for Cable .750 to 1.375 in. Diameter

Style 1		
No.	Description	Each
APC6252	2-Wire, 2-Pole	45.70
APC6352	3-Wire, 3-Pole	49.20
APC6452	4-Wire, 4-Pole	55.20

Style 2		
No.	Description	Each
APC6362	2-Wire, 3-Pole	54.20
APC6462	3-Wire, 4-Pole	60.20

100 Amp., for Cable 1.375 to 1.750 in. Diameter

Style 1		
No.	Description	Each
APC10253	2-Wire, 2-Pole	70.00
APC10353	3-Wire, 3-Pole	74.00
APC10453	4-Wire, 4-Pole	82.00

Style 2		
No.	Description	Each
APC10363	2-Wire, 3-Pole	80.00
APC10463	3-Wire, 4-Pole	88.00

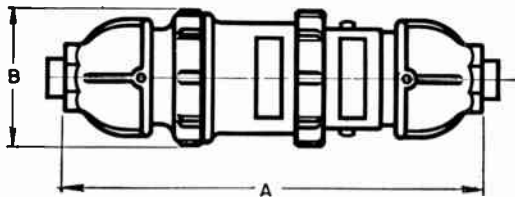

Dimensions in Inches

Amp.	A	B
30	9 1/4	2 15/16
60	12	3 11/16
100	14	4 1/8

Quantity prices on request,

Appleton Interiors for Receptacles and Plugs

Series AE

250 Volts D-C — 600 Volts A-C

Interiors for Receptacles
Style 2

Complete with Ground Strap

Amps.	2-Wire, 3-Pole		3-Wire, 4-Pole	
	No.	Each	No.	Each
30	AEI-332	\$8.25	AEI-342	\$9.35
60	AEI-632	11.95	AEI-642	14.20
100	AEI-1032	16.85	AEI-1042	18.95

Complete with Ground Clip

Amps.	2-Wire, 2-Pole		3-Wire, 3-Pole		4-Wire, 4-Pole	
	No.	Each	No.	Each	No.	Each
30	AEI-321	\$7.10	AEI-331	\$8.25	AEI-341	\$9.35
60	AEI-621	10.85	AEI-631	11.95	AEI-641	14.20
100	AEI-1021	14.20	AEI-1031	16.85	AEI-1041	18.95

Interiors for Plugs

Style 2

Amps.	2-Wire, 3-Pole		3-Wire, 4-Pole	
	No.	Each	No.	Each
30	AEPI-332	\$7.58	AEPI-342	\$8.17
60	AEPI-632	9.33	AEPI-642	11.50
100	AEPI-1032	13.00	AEPI-1042	15.17

Style 1

Complete with Ground Clip

Amps.	2-Wire, 2-Pole		3-Wire, 3-Pole		4-Wire, 4-Pole	
	No.	Each	No.	Each	No.	Each
30	AEPI-321	\$6.58	AEPI-331	\$7.58	AEPI-341	\$8.17
60	AEPI-621	8.25	AEPI-631	9.33	AEPI-641	11.50
100	AEPI-1021	11.92	AEPI-1031	13.00	AEPI-1041	15.17

Appleton Adapters for Receptacles and Plugs

Cadmium Finish

Adapter for Receptacles



For use in installing new 30-amp. AE Series receptacles in old Appleton QE Series unilets.

No.	Description	Each
64900	For 30-Amp. Receptacle Only	\$1.70

Series AEPA Plug Adapter

Aluminum Finish



For adapting new AEP Series Plugs to old Appleton Series QE receptacles.

Plugs with or without clamping ring can be used with this adapter.

Description	30-Ampere		60-Ampere	
	No.	Each	No.	Each
2-Wire, 2-Pole	AEPA-3211	\$8.67	AEPA-6212	\$12.92
3-Wire, 3-Pole	AEPA-3311	9.33	AEPA-6312	14.50
4-Wire, 4-Pole	AEPA-3411	11.00	AEPA-6412	16.67

Style 2

Description	30-Ampere		60-Ampere	
	No.	Each	No.	Each
2-Wire, 3-Pole	AEPA-3321	\$9.83	AEPA-6322	\$14.08
3-Wire, 4-Pole	AEPA-3421	11.00	AEPA-6422	16.67

Appleton Explosion-Proof Dead-End Plugs

Type CPP



For use with CPS, CPSI and CPSH Series Unilets. Brass plugs, buffed and lacquered with chromium-plated cord grip.

For 60 Cycles A-C

No.	For use with Form	Max. Amp.	Volts	Diam. Cable, In.	Wt. Lbs.	Each
						Each
28040	1	15	230	.250-.375	3/4	\$10.00
28041			230	.375-.500	3/4	10.00
28042			115	.500-.625	3/4	10.00
2-Wire — 3-Pole						
28070	2	30	230	.500-.625	1	22.00
28071			230	.625-.750	1	22.00
28072			115	.750-.875	1	22.00
3-Wire — 4-Pole						
28075	2	30	230	.500-.625	1	23.50
28076			230	.625-.750	1	23.50
28077			115	.750-.875	1	23.50

Quantity prices on request.

Appleton Unilets

Series "CES" — Explosion-Proof
Malleable Iron, Cadmium Finish



Dead-End Receptacles and Plugs

For use mainly in commercial and industrial plants where a receptacle must comply with the safety requirements as prescribed for fittings to be installed in explosive atmospheres.

Added safety was introduced in the development of the dead-end receptacle. That is, an intermediate, current carrying receptacle normally isolated from the line until the plug is inserted, turned to the right and seated fully; actual re-establishment of the circuit does not take place until the plug is pushed in as far as it will go.

The Unilet body upon which the "CES" receptacle is fastened, is designed for wall mounting with a 15 degree tilt to the plug outlet. Both the plug and receptacle are ruggedly constructed of materials to stand up under wear and strain consistent with its usage. All sliding members are made of metal. Unilets have three hubs, two of which have removable close-up plugs.

Type "CEST" Receptacle Complete

*Style 2 — 60 Cycles A-C

Includes Unilet, Receptacle and Receptacle Housing

Single-Phase — 2-Wire, 3-Pole

No.	Max. Amps.	Volts	Max. Hp.	Hub Size In.	WL Lbs. Each	Each
9501	15	230	1 1/2	3/4	6 1/2	\$47.00
	30	115	1 1/2	3/4		
Three-Phase — 3-Wire, 4-Pole						
9502	15	460	1 1/2	3/4	7	50.00
	15	230	3	3/4		
	30	115	3	3/4		
Single-Phase — 2-Wire, 3-Pole						
9505	30	230	3	1 1/4	15	59.00
	60	115	3	1 1/4		
Three-Phase — 3-Wire, 4-Pole						
9506	30	460	3	1 1/4	15 1/4	66.00
	30	230	5	1 1/4		
	60	230	5	1 1/4		

*Grounded through shell and extra pole.

Appleton Dead-End Plugs

Type CPH — Cast Aluminum

For Use with Type CEST Receptacles



15 Amp., 230 Volts,
30 Amp., 115 Volts,
60 Cycles A-C.

Single Phase — 2-Wire, 3-Pole

No.	Amp.	Volts	Hp.	Diam. Cable In.	WL Lbs. Per 5 Pcs.	Each
9510	15	230	1 1/2	.500 to .625	5	\$22.00
9511				.625 to .750	5	22.00
9512	30	115	1 1/2	.750 to .875	5	22.00
9520				.500 to .625	11	26.00
9521	30	230	3	.625 to .750	11	26.00
9522				.750 to .875	11	26.00
9523	60	115	3	.875 to 1.000	11	26.00
9524				1.000 to 1.188	11	26.00

Three Phase — 3 Wire, 4-Pole

9515	15	460	1 1/2	.500 to .625	6	\$23.50
9516				.625 to .750	6	23.50
9517	30	115	3	.750 to .875	6	23.50
9525				.500 to .625	11 1/2	28.00
9526	30	460	3	.625 to .750	11 1/2	28.00
9527				.750 to .875	11 1/2	28.00
9528	60	230	5	.875 to 1.000	11 1/2	28.00
9529				1.000 to 1.188	11 1/2	28.00

Quantity prices on request.

Appleton Unilets

Malleable Iron, Cadmium Finish

Type "FSQX"

Explosion-Proof and Dust-Tight
Interlocking Safety Switch
and Plug Receptacle

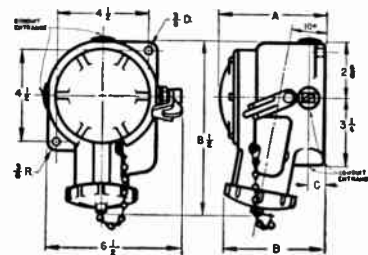
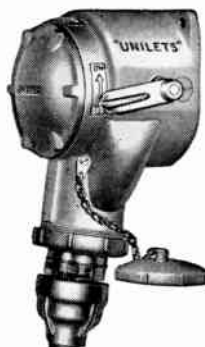

Hub Size, In.	A	B	C
3/4	4 15/16	4 5/8	1 11/16
1	5 5/16	5	1 7/8

Type "FSQX" Unilet with Type "FP" Plug

This Unilet comprises an Interlocking Safety Switch and Plug Receptacle mounted in a malleable iron body, cadmium finish, with threaded type cover. The receptacle and switch are interlocked so that the plug cannot be inserted or withdrawn unless the switch is in the "off" position. Likewise, the switch cannot be operated until the plug is fully inserted. The receptacle, as well as the "FP" plug, is polarized and the contacts are self-aligning. Each 2-Wire and 3-Wire receptacle and "FP" plug is provided with an additional terminal which is expressly designed for grounding only. These ground terminals are also connected with the shell of the plug and receptacle, making an effective ground throughout the entire conduit system.

Furnished complete with two fastening lugs for attaching to a wall, machine, etc. Two types are available: one having four outlets for 3/4-in. conduit, and one having four outlets for 1-in. conduit. Three of the outlets are equipped with removable close-up plugs.

Type "FSQX" Unilets are furnished with Interlocking Switch and Receptacle Housing — Without Plug. Will take Type "FP" Plugs.



2-Wire — 3-Pole
30 Amp., 250 Volts 2 Hp., 230 Volts; A-C
1 Hp., 460 Volts A-C

No.	Hubs, In.	WL Lbs.	Each
FSQX-23	3/4	12	\$46.00
FSQX-25	1	12	46.40

3-Wire — 4-Pole
30 Amp., 250 Volts A-C. A-C or D-C,
20 Amp., 2 Hp. 460 Volts A-C

FSQX-24	3/4	12	\$52.00
FSQX-26	1	13	52.40

Can be furnished with hub at back at no additional charge if specified on order.

Safety Switch Plugs

For "FSQX" Unilets

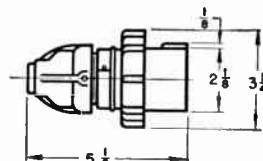

With cable grip and rubber bushing. Grounded through extra pole and shell. Cast aluminum.

Type "FP" — Cable Diameter .500 to .875 in.

No.	Circuit	WL Lbs.	Each
FP-323	2-Wire, 3-Pole	2	\$12.00
FP-334	3-Wire, 4-Pole	2	14.00

Quantity prices on request.

Crouse-Hinds Arktite Circuit Breaking Plugs and Receptacles

Weather Resistant (Raintight)*

20, 30, and 60-Ampere—250 Volts D-C, 600 Volts A-C

Type ARE Receptacle Equipment†

Type APJ Plugs

Type AR Receptacle Housings



Receptacles will take any of the plugs grouped in the bracket opposite the receptacle listings.



***20-Ampere**

For AR Series, Form B

Style 1—Grounded Through Shell

Description	Hub Size In.	Spring Door		Plain		‡With Mechanical Cable Grip and Rubber Bushing		Spring Door		Plain		
		No.	Each	No.	Each	Diam. Cable, Inches	No.	Each	No.	Each		
2-Wire, 2-Pole*	1/2	ARE2211	\$12.90	ARE2231	\$11.50	{ .250 to .500	APJ2251	\$11.00	AR221	\$10.90	AR223	\$9.50
	3/4	ARE2212	13.10	ARE2232	11.70		{ .500 to .875	APJ2253				

30-Ampere

For AR Series, Form B

Style 1—Grounded Through Shell

2-Wire, 2-Pole }	1/2	ARE3211	\$14.50	ARE3231	\$13.10	{ .500 to .875	APJ3253	\$12.30	AR321	\$12.50	AR323	\$11.10
	3/4	ARE3212	14.70	ARE3232	13.30		{ .875 to 1.375	APJ3255				
3-Wire, 3-Pole }	3/4	ARE3312	15.70	ARE3332	14.30	{ .500 to .875	APJ3353	13.60	AR331	13.50	AR333	12.10
	1	ARE3313	15.90	ARE3333	14.50		{ .875 to 1.375	APJ3355				
4-Wire, 4-Pole }	3/4	ARE3412	17.30	ARE3432	15.90	{ .500 to .875	APJ3453	15.20	AR341	15.10	AR343	13.70
	1	ARE3413	17.50	ARE3433	16.10		{ .875 to 1.375	APJ3455				
5-Wire, 5-Pole }	1	ARE3513	19.90	ARE3533	18.50	{ .500 to .875	APJ3553	17.70	AR351	17.50	AR353	16.10

30-Ampere

For AR Series, Form B

Style 2—Grounded Through Extra Pole and Shell

2-Wire, 3-Pole }	3/4	ARE3322	\$17.70	ARE3342	\$16.30	{ .500 to .875	APJ3363	\$15.60	AR332	\$15.50	AR334	\$14.10
	1	ARE3323	17.90	ARE3343	16.50		{ .875 to 1.375	APJ3365				
3-Wire, 4-Pole }	3/4	ARE3422	19.30	ARE3442	17.90	{ .500 to .875	APJ3463	17.20	AR342	17.10	AR344	15.70
	1	ARE3423	19.50	ARE3443	18.10		{ .875 to 1.375	APJ3465				
4-Wire, 5-Pole }	1	ARE3523	23.00	ARE3543	21.60	{ .500 to .875	APJ3563	21.00	AR352	20.60	AR354	19.20

60-Ampere

For AR and AJ Series, Form C

Style 1—Grounded Through Shell

2-Wire, 2-Pole }	1	ARE6213	\$23.30	ARE6233	\$20.80	{ .500 to .875	APJ6253	\$17.50	AR621	\$20.00	AR623	\$17.50
	1 1/4	ARE6214	23.50	ARE6234	21.00		{ .875 to 1.375	APJ6255				
3-Wire, 3-Pole }	1	ARE6313	25.30	ARE6333	22.80	{ .500 to .875	APJ6353	19.00	AR631	22.00	AR633	19.50
	1 1/4	ARE6314	25.50	ARE6334	23.00		{ .875 to 1.375	APJ6355				
4-Wire, 4-Pole }	1 1/4	ARE6414	29.50	ARE6434	27.00	{ .500 to .875	APJ6453	21.00	AR641	26.00	AR643	23.50
	1 1/2	ARE6415	29.70	ARE6435	27.20		{ .875 to 1.375	APJ6455				

60-Ampere

For AR and AJ Series, Form C

Style 2—Grounded Through Extra Pole and Shell

2-Wire, 3-Pole }	1	ARE6323	\$27.80	ARE6343	\$25.30	{ .500 to .875	APJ6363	\$21.50	AR632	\$24.50	AR634	\$22.00
	1 1/4	ARE6324	28.00	ARE6344	25.50		{ .875 to 1.375	APJ6365				
3-Wire, 4-Pole }	1 1/4	ARE6424	32.00	ARE6444	29.50	{ .500 to .875	APJ6463	23.50	AR642	28.50	AR644	26.00
	1 1/2	ARE6425	32.20	ARE6445	29.70		{ .875 to 1.375	APJ6465				

*20-ampere, 2-pole plugs and receptacles have binding screw terminals. All others have soldering terminals for line conductors and a pressure type terminal for the grounding conductor.

†Where other hub arrangements are desired, type AR receptacle housings can be used with types AR and AJ Condulet bodies listed on another page.

‡Where non-watertight plugs are required, add Suffix NB to the above catalog numbers. The set of rubber bushings will then be omitted at the following reductions in list prices: 20-A., \$.60; 30-A., \$1.00; 60-A., \$1.00.

*Spring door housing only, when downwardly inclined.

Crouse-Hinds Arktite Plugs and Receptacles

Weather Resistant (Raintight) *

20, 30, and 60-Ampere—250 Volts D-C, 600 Volts A-C

Type ARE Receptacle Equipment†

Type APJ Plugs

Type AR Receptacle Housings‡

Receptacles will take any of the plugs grouped in the bracket opposite the receptacle listings.

With Fastening Ring

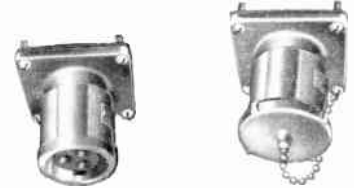
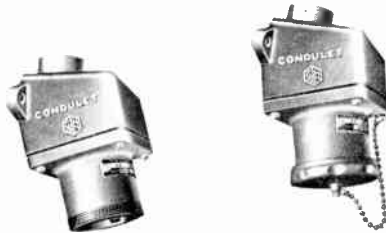

**20-Ampere
For AR Series, Form B
Style 1*—Grounded Through Shell**

Description	Hub Size In.	Threaded		With Cap		‡With Mechanical Cable Grip and Rubber Bushing Diam. Cable	No.	Each	No.	Each	Threaded		With Cap	
		No.	Each	No.	Each						No.	Each	No.	Each
2-Wire, 2-Pole	1 1/2	ARE2251	\$12 00	ARE2271	\$13 60	{.250 to .500 .500 to .875	APJ2271	\$12 20	AR225	\$10 00	AR227	\$11 60		
	3/4	ARE2252	12 20	ARE2272	13 80									

**30-Ampere
For AR Series, Form B
Style 1—Grounded Through Shell**

2-Wire, 2-Pole	1 1/2	ARE3251	\$13 60	ARE3271	\$15 20	{.500 to .875 .875 to 1.375	APJ3273	\$13 50	AR325	\$11 60	AR327	\$13 20		
	3/4	ARE3252	13 80	ARE3272	15 40									
3-Wire, 3-Pole	3/4	ARE3352	14 80	ARE3372	16 40	{.500 to .875 .875 to 1.375	APJ3373	14 80	AR335	12 60	AR337	14 20		
	1	ARE3353	15 00	ARE3373	16 60									
4-Wire, 1-Pole	3/4	ARE3452	16 40	ARE3472	18 00	{.500 to .875 .875 to 1.375	APJ3473	16 40	AR345	14 20	AR347	15 80		
	1	ARE3453	16 60	ARE3473	18 20									
5-Wire, 5-Pole	1	ARE3553	19 00	ARE3573	20 60	.500 to .875	APJ3573	18 90	AR355	16 60	AR357	18 20		

**30-Ampere
For AR Series, Form B
Style 2—Grounded Through Extra Pole and Shell**

2-Wire, 3-Pole	3/4	ARE3362	\$16 80	ARE3382	\$18 40	{.500 to .875 .875 to 1.375	APJ3383	\$16 80	AR336	\$14 60	AR338	\$16 20		
	1	ARE3363	17 00	ARE3383	18 60									
3-Wire, 4-Pole	3/4	ARE3462	18 40	ARE3482	20 00	{.500 to .875 .875 to 1.375	APJ3483	18 40	AR346	16 20	AR348	17 80		
	1	ARE3463	18 60	ARE3483	20 20									
4-Wire, 5-Pole	1	ARE3563	21 90	ARE3583	23 50	.500 to .875	APJ3583	22 20	AR356	19 50	AR358	21 10		

**60-Ampere
For AR and AJ Series, Form C
Style 1—Grounded Through Shell**

2-Wire, 2-Pole	1	ARE6253	\$21 50	ARE6273	\$23 70	{.500 to .875 .875 to 1.375	APJ6273	\$19 50	AR625	\$18 20	AR627	\$20 40		
	1 1/4	ARE6254	21 70	ARE6274	23 90									
3-Wire, 3-Pole	1	ARE6353	23 50	ARE6373	25 70	{.500 to .875 .875 to 1.375	APJ6373	21 00	AR635	20 20	AR637	22 40		
	1 1/4	ARE6354	23 70	ARE6374	25 90									
4-Wire, 4-Pole	1 1/4	ARE6454	27 70	ARE6474	29 90	{.500 to .875 .875 to 1.375	APJ6473	23 00	AR645	24 20	AR647	26 40		
	1 1/2	ARE6455	27 90	ARE6475	30 10									

**60-Ampere
For AR and AJ Series, Form C
Style 2—Grounded Through Extra Pole and Shell**

2-Wire, 3-Pole	1	ARE6363	\$26 00	ARE6383	\$28 20	{.500 to .875 .875 to 1.375	APJ6383	\$23 50	AR636	\$22 70	AR638	\$24 90		
	1 1/4	ARE6364	26 20	ARE6384	28 40									
3-Wire, 4-Pole	1 1/4	ARE6464	30 20	ARE6484	32 40	{.500 to .875 .875 to 1.375	APJ6483	25 50	AR646	26 70	AR648	28 90		
	1 1/2	ARE6465	30 40	ARE6485	32 60									

*20-Ampere, 2-pole plugs and receptacles have binding screw terminals. All others have soldering terminals for line conductors and a pressure type terminal for the grounding conductor.

†Where other hub arrangements are desired, type AR receptacle housings can be used with Condulet bodies of AR and AJ series listed on another page.

‡Where non-watertight plugs are required, add Suffix NB to the above catalog numbers. The set of rubber bushings will then be omitted at the following reductions in list prices: 20-A., \$0.60; 30-A., \$1.00; 60-A., \$1.00.

★Housing with threaded cap only.

Crouse-Hinds Arktite Plugs and Receptacles

Weather Resistant (Raintight)*

60 and 100-Amperes—250 Volts D-C, 600 Volts A-C

Type AREA Receptacle Equipment†

Type APJ Plugs

Type AR Receptacle Housings



Receptacles will take any of the plugs grouped in the bracket opposite the receptacle listings.



60-Ampere

For AR and AJ Series, Form C

Style 1—Grounded Through Shell

Description	Hub Size In.	Spring Door		Plain		With Mechanical Cable Grip and Rubber Bushing‡		Spring Door		Plain		
		No.	Each	No.	Each	Diam. Cable	No.	No.	Each	No.	Each	
2-Wire, 2-Pole	1	AREA6213	\$35.40	AREA6233	\$32.90	.500 to .875	APJ6253	\$17.50	AR621	\$20.00	AR623	\$17.50
	1¼	AREA6214	35.50	AREA6234	33.00	.875 to 1.375	APJ6255	17.50				
3-Wire, 3-Pole	1	AREA6313	37.40	AREA6333	34.90	.500 to .875	APJ6353	19.00	AR631	22.00	AR633	19.50
	1½	AREA6314	37.50	AREA6334	35.00	.875 to 1.375	APJ6355	19.00				
4-Wire, 4-Pole	1¼	AREA6414	41.50	AREA6434	39.00	.500 to .875	APJ6453	21.00	AR641	26.00	AR643	23.50
	1½	AREA6415	41.60	AREA6435	39.10	.875 to 1.375	APJ6455	21.00				

60-Ampere

For AR and AJ Series, Form C

Style 2—Grounded Through Extra Pole and Shell

2-Wire, 2-Pole	1	AREA6323	\$39.90	AREA6343	\$37.40	.500 to .875	APJ6363	\$21.50	AR632	\$24.50	AR634	\$22.00
	1¼	AREA6324	40.00	AREA6344	37.50	.875 to 1.375	APJ6365	21.50				
3-Wire, 3-Pole	1¼	AREA6424	44.00	AREA6444	41.50	.500 to .875	APJ6463	23.50	AR642	28.50	AR644	26.00
	1½	AREA6425	44.10	AREA6445	41.60	.875 to 1.375	APJ6465	23.50				

100-Ampere

For AJ Series, Form D

Style 1—Grounded Through Shell

2-Wire, 2-Pole	1¼	AREA10214	\$41.50	AREA10234	\$38.50	.875 to 1.375	APJ10255	\$28.00	AR1021	\$26.00	AR1023	\$23.00
	1½	AREA10215	41.60	AREA10235	38.60	1.375 to 1.875	APJ10257	28.00				
3-Wire, 3-Pole	1¼	AREA10314	43.50	AREA10334	40.50	.875 to 1.375	APJ10355	30.00	AR1031	28.00	AR1033	25.00
	1½	AREA10315	43.60	AREA10335	40.60	1.375 to 1.875	APJ10357	30.00				
4-Wire, 4-Pole	1½	AREA10415	47.60	AREA10435	44.60	.875 to 1.375	APJ10455	34.00	AR1041	32.00	AR1043	29.00
	2	AREA10416	47.70	AREA10436	44.70	1.375 to 1.875	APJ10457	34.00				

100-Ampere

For AJ Series, Form D

Style 2—Grounded Through Extra Pole and Shell

2-Wire, 3-Pole	1¼	AREA10324	\$46.50	AREA10344	\$43.50	.875 to 1.375	APJ10365	\$33.00	AR1032	\$31.00	AR1034	\$28.00
	1½	AREA10325	46.60	AREA10345	43.60	1.375 to 1.875	APJ10367	33.00				
3-Wire, 4-Pole	1½	AREA10425	50.60	AREA10445	47.60	.875 to 1.375	APJ10465	37.00	AR1042	35.00	AR1044	32.00
	2	AREA10426	50.70	AREA10446	47.70	1.375 to 1.875	APJ10467	37.00				

†Type AREA Condulets are square, and can therefore be mounted with the hub at top, bottom, right or left. When through-feed hubs or other adapters are desired, type AR receptacle housings can be used with Condulet bodies of AR and AJ series listed on another page.

‡Where non-watertight plugs are required, add Suffix NB to the above catalog numbers. The set of rubber bushings will then be omitted at the following reductions in list prices: 60-A., \$1.00; 100-A., \$1.40.

*Spring door housing only, when downwardly inclined.

Crouse-Hinds Arktite Plugs and Receptacles

Weather Resistant (Raintight)*

60 and 100-Ampere—250 Volts D-C, 600 Volts A-C

Type AREA Receptacle Equipment†

Type APJ Plugs

Type AR Receptacle Housings

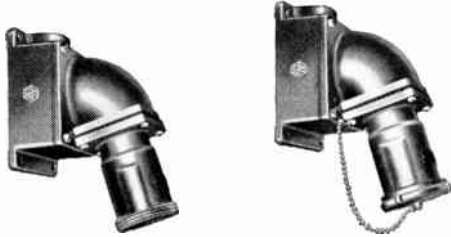

Receptacles will take any of the plugs grouped in the bracket opposite the receptacle listings.

With Fastening Ring



60-Ampere

For AR and AJ Series, Form C

Style 1—Grounded Through Shell

Description	Hub Size In.	Threaded		With Cap		With Mechanical Cable Grip and Rubber Bushing‡		Threaded		With Cap		
		No.	Each	No.	Each	Diam. Cable	No.	No.	Each	No.	Each	
2-Wire,	1	AREA6253	\$33.60	AREA6273	\$35.80	.500 to .875	APJ6273	\$19.50	AR625	\$18.20	AR627	\$20.40
2-Pole,	1¼	AREA6254	33.70	AREA6274	35.90		.875 to 1.375	APJ6275	19.50			
3-Wire,	1	AREA6353	35.60	AREA6373	37.80	.500 to .875	APJ6373	21.00	AR635	20.20	AR637	22.40
3-Pole,	1¼	AREA6354	35.70	AREA6374	37.90		.875 to 1.375	APJ6375	21.00			
4-Wire,	1¼	AREA6454	39.70	AREA6474	41.90	.500 to .875	APJ6473	23.00	AR645	24.20	AR647	26.40
4-Pole,	1½	AREA6455	39.80	AREA6475	42.00		.875 to 1.375	APJ6475	23.00			

60-Ampere

For AR and AJ Series, Form C

Style 2—Grounded Through Extra Pole and Shell

2-Wire,	1	AREA6363	\$38.10	AREA6383	\$40.30	.500 to .875	APJ6383	\$23.50	AR636	\$22.70	AR638	\$24.90
3-Pole,	1¼	AREA6364	38.20	AREA6384	40.40		.875 to 1.375	APJ6385	23.50			
3-Wire,	1¼	AREA6464	42.20	AREA6484	44.40	.500 to .875	APJ6483	25.50	AR646	26.70	AR648	28.90
4-Pole,	1½	AREA6465	42.30	AREA6485	44.50		.875 to 1.375	APJ6485	25.50			

100-Ampere

For AJ Series, Form D

Style 1—Grounded Through Shell

2-Wire,	1¼	AREA10254	\$39.50	AREA10274	\$43.50	.875 to 1.375	APJ10275	\$31.00	AR1025	\$24.00	AR1027	\$28.00
2-Pole,	1½	AREA10255	39.60	AREA10275	43.60		1.375 to 1.875	APJ10277	31.00			
3-Wire,	1¼	AREA10354	41.50	AREA10374	45.50	.875 to 1.375	APJ10375	33.00	AR1035	26.00	AR1037	30.00
3-Pole,	1½	AREA10355	41.60	AREA10375	45.60		1.375 to 1.875	APJ10377	33.00			
4-Wire,	1½	AREA10455	45.60	AREA10475	49.60	.875 to 1.375	APJ10475	37.00	AR1045	30.00	AR1047	34.00
4-Pole,	2	AREA10456	45.70	AREA10476	49.70		1.375 to 1.875	APJ10477	37.00			

100-Ampere

For AJ Series, Form D

Style 2—Grounded Through Extra Pole and Shell

2-Wire,	1¼	AREA10364	\$44.50	AREA10384	\$48.50	.875 to 1.375	APJ10385	\$36.00	AR1036	\$29.00	AR1038	\$33.00
3-Pole,	1½	AREA10365	44.60	AREA10385	48.60		1.375 to 1.875	APJ10387	36.00			
3-Wire,	1½	AREA10465	48.60	AREA10485	52.60	.875 to 1.375	APJ10485	40.00	AR1046	33.00	AR1048	37.00
4-Pole,	2	AREA10466	48.70	AREA10486	52.70		1.375 to 1.875	APJ10487	40.00			

†Type AREA Condulets are square, and can therefore be mounted with the hub at top, bottom, right or left. When through-feed hubs or other adapters are desired, type AR receptacle housings can be used with Condulet bodies of AR and AJ series listed on another page.

‡Where non-watertight plugs are required, add Suffix NB to the above catalog numbers. The set of rubber bushings will then be omitted at the following reductions in list prices: 60-A., \$1.00; 100-A., \$1.40.

*Housing with threaded cap only.

Crouse-Hinds Arktite Plugs and Receptacles

Weather Resistant (Raintight)

400-Ampere—250 Volts D-C, 600 Volts A-C

**Type AREX
Receptacle Equipment†**

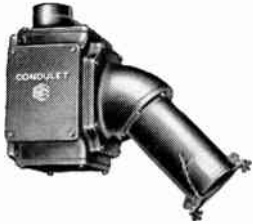

Type AP Plugs

Receptacles will take any of the plugs grouped in the bracket opposite the receptacle listings.

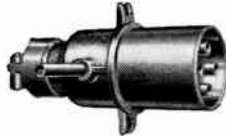

**Type AR
Receptacle Housings**



**400 Ampere—Soldering recess takes .84" maximum conductor size‡
For AJ Series and AJX with angle adapter, Form F
Style 1—Grounded Through Shell**

Description	Hub Size In.	Clamp Cover No.	Each	With Mechanical Cable Grip and Rubber Bushing			Clamp Cover No.	Each
				Diam. Cable	No.	Each		
2-Wire, } 2-Pole }	2	AREX40216	\$203.80	{ 1.375 to 1.875 1.875 to 2.500	AP40257 AP40258	\$100.00 100.00	AR4021	\$120.00
	2½	AREX40217	204.30					
3-Wire, } 3-Pole }	2½	AREX40317	212.30	{ 1.375 to 1.875 1.875 to 2.500	AP40357 AP40358	108.00 108.00	AR4031	128.00
	3	AREX40318	212.80					
4-Wire, } 4-Pole }	2½	AREX40417	240.30	{ 1.375 to 1.875 1.875 to 2.500	AP40457 AP40458	126.00 126.00	AR4041	156.00
	3	AREX40418	240.80					

**400-Ampere—Soldering recess takes .84" maximum conductor size‡
For AJ Series and AJX with angle adapter, Form F
Style 2—Grounded Through Extra Pole and Shell**

2-Wire, } 3-Pole }	2	AREX40326	\$221.80	{ 1.375 to 1.875 1.875 to 2.500	AP40367 AP40368	\$118.00 118.00	AR4032	\$138.00
	2½	AREX40327	222.30					
3-Wire, } 4-Pole }	2½	AREX40427	250.30	{ 1.375 to 1.875 1.875 to 2.500	AP40467 AP40468	136.00 136.00	AR4042	166.00
	3	AREX40428	250.80					

**400-Ampere—Soldering recess takes 1.25" maximum conductor size‡
For AJ Series and AJX with angle adapter, Form F
Style 1—Grounded Through Shell**

2-Wire, } 2-Pole }	3	AREX402128	\$228.80	{ 2.500 to 3.000 3.000 to 3.500	AP402510 AP402512	\$150.00 150.00	AR40212	\$144.00
	3½	AREX402129	229.30					
3-Wire, } 3-Pole }	4	AREX403128	254.80	{ 2.500 to 3.000 3.000 to 3.500	AP403510 AP403512	176.00 176.00	AR40312	170.00
	4	AREX403129	255.30					
4-Wire, } 4-Pole }	4	AREX4041210	299.80	{ 2.500 to 3.000 3.000 to 3.500	AP404510 AP404512	220.00 220.00	AR40412	214.00
	4½	AREX4041211	300.30					
	5	AREX4041212	300.80					

**400-Ampere—Soldering recess takes 1.25" maximum conductor size‡
For AJ Series and AJX with angle adapter, Form F
Style 2—Grounded Through Extra Pole and Shell**

2-Wire, } 3-Pole }	3	AREX403228	\$268.80	{ 2.500 to 3.000 3.000 to 3.500	AP403610 AP403612	\$190.00 190.00	AR40322	\$184.00
	3½	AREX403229	269.30					
3-Wire, } 4-Pole }	4	AREX4042210	313.80	{ 2.500 to 3.000 3.000 to 3.500	AP404610 AP404612	234.00 234.00	AR40422	228.00
	4½	AREX4042211	314.30					
	5	AREX4042212	314.80					

†Type AREX Condulet is a type AJX body with three blank plates and a one-hub plate. Other styles and sizes of conduit hub plates of the YYP9 series can be substituted at the difference in the list prices.

‡The wire and soldering recess sizes will determine the catalog numbers of the plug and of the receptacle to be used.

Complete information on request.

Crouse-Hinds Arktite Plugs and Receptacles

Weather Resistant (Raintight)

200-Ampere—250 Volts D-C, 600 Volts A-C

**Type AREA
Receptacle Equipment†**

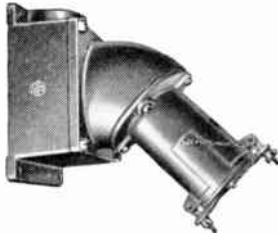

Type AP Plugs

Receptacles will take any of the plugs grouped in the bracket opposite the receptacle listings.



**Type AR
Receptacle Housings**



200-Ampere

For AJ Series, Form E

Style 1—Grounded Through Shell

Description	Hub Size In.	No.	Clamp Cover	Each	With Mechanical Cable Grip and Rubber Bushing		Clamp Cover	Each
					Diam. Cable	No.		
2-Wire, } 2-Pole }	1 1/2	AREA20215		587 90	.875 to 1.375	AP20255	AR2021	560 00
		AREA20216				AP20257		
						AP20258		
3-Wire, } 3-Pole }	1 1/2	AREA20315		89 90	.875 to 1.375	AP20355	AR2031	62 00
		AREA20316				AP20357		
		AREA20317				AP20358		
4-Wire, } 4-Pole }	2 1/2	AREA20416		96 10	.875 to 1.375	AP20455	AR2041	68 00
		AREA20417				AP20457		
						AP20458		

Style 2—Grounded Through Extra Pole and Shell

Description	Hub Size In.	No.	Clamp Cover	Each	With Mechanical Cable Grip and Rubber Bushing		Clamp Cover	Each
					Diam. Cable	No.		
2-Wire, } 3-Pole }	1 1/2	AREA20325		593 90	.875 to 1.375	AP20365	AR2032	566 00
		AREA20326				AP20367		
		AREA20327				AP20368		
3-Wire, } 4-Pole }	1 1/2	AREA20425		99 90	.875 to 1.375	AP20465	AR2042	72 00
		AREA20426				AP20467		
		AREA20427				AP20468		

†Type AREA Condulets are square and can therefore be mounted with the hub at top, bottom, right or left.

**Type BRME 30° Angle Plug†
Receptacle Condulets**

30 Amperes, 250 Volts, A.C.*



Size In.	No. Poles	Spring Door		Without Spring Door		Threaded Cap†			
		No.	Each	No.	Each	No.	Each		
1/2	2	BRME-	1302	7 50	1302	5 00	81302	7 30	
		61302							81302
		62302							82302
3/4	2	BRME-	2302	7 70	2302	5 20	82302	7 50	
		62303							82303
		63303							83303
1	3	BRME-	2303	8 90	2303	6 40	82303	9 60	
		63303							83303
		62304							82304
3/4	4	BRME-	3303	9 10	3303	6 60	83303	9 80	
		62304							82304
		63304							83304
1	4	BRME-	3304	12 50	3304	8 00	83304	11 70	
		62304							82304
		63304							83304

*Can be used on 25-ampere, 125-volt D.C. circuits; or on 30-ampere, 250-volt D.C. circuits if circuit is broken before plug is withdrawn.

The 2-pole Condulets are furnished with 30-ampere, 250-volt receptacle BR2302; 3-pole Condulets are furnished with 30-ampere, 250-volt receptacle BR2303; 4-pole Condulets are furnished with 30-ampere, 250-volt receptacle BR2304.

††Furnished with Gaskets.

†Take type BP plugs.

Type BRP Plug Receptacle Housings†

For Outlet Boxes—Surface or Flush Mounting

25 Amperes, 125 Volts, D.C.; 30 Amperes, 250 Volts, A.C.*



For Outlet Boxes, Sizes	Poles	Without Spring Door		Spring Door		Threaded Cap†			
		No.	Each	No.	Each	No.	Each		
3 1/2	2	BRP-	3023	5 00	63023	58 20	83023	57 30	
		3023							83023
		3033							83033
3 1/2	3	BRP-	3033	6 50	63033	10 10	83033	9 70	
		3033							83033
		3043							83043
3 1/2	4	BRP-	3043	7 80	63043	11 80	83043	11 90	
		3043							83043
		3024							83024
4	2	BRP-	3024	5 30	63024	8 50	83024	7 60	
		3024							83024
		3034							83034
4	3	BRP-	3034	6 80	63034	10 40	83034	10 00	
		3034							83034
		3044							83044
1	4	BRP-	3044	8 10	63044	12 10	83044	12 20	
		3044							83044
		3044							83044

*Can be used on 25-ampere, 125-volt D.C. circuits; or on 30-ampere, 250-volt D.C. circuits if circuit is broken before plug is withdrawn.

The 2-pole Condulets are furnished with 30-ampere, 250-volt receptacle BR2302; 3-pole Condulets are furnished with 30-ampere, 250-volt receptacle BR2303; 4-pole Condulets are furnished with 30-ampere, 250-volt receptacle BR2304.

††Furnished with Gaskets.

†Take type BP plugs.

Crouse-Hinds Plugs and Receptacles

**Type BP Plugs
For Flexible Cable**

For use with types BRD, BRG, BRME, BRP, BRY, and plug receptacle housings. The 30-ampere plugs are arranged for soldered terminals. The 20-ampere plugs are equipped with binding screw terminals. Plugs so equipped with binding screw will not take wires larger than No. 12; consequently, these plugs are rated at 20 amperes. Otherwise, the 20 and 30-ampere plugs are exactly alike.

Grounding—Provision is made on these plugs for an extra grounding conductor in the cable for grounding the frame of the portable device to the shell of the plug.

The grounding or safety circuit is completed through the shell of the plug, the detent spring, the receptacle housing, and the conduit system. The detent spring in the receptacle has three branches, two of which make contact before and break contact after the main circuit contacts. This method of grounding is N.E.C. standard.

With Cable Clamp—Without Clamping Nut

Furnished with cable clamp. With composition handle (non-watertight).



*20 Amperes, 250 Volts A.C.			
Diam. Opening in Cable Clamp, In.	No.	2-Pole	Each
†.500 to .814	BP22		\$7.20
†30 Amperes, 250 Volts A.C.			
†.500 to .814	BP32		7.20



**With Gland Nut
Without Clamping Nut**

Furnished with tapered rubber bushing and cast aluminum handles.

*20 Amperes, 250 Volts A.C.							
Diam. Opening in Cable Clamp, In.	2-Pole No.	Each	3-Pole No.	Each	4-Pole No.	Each	
.375 to .500	BP6422	\$6.80	BP6423	\$8.30	BP6424	\$9.80	
.500 to .625	BP6522	7.20	BP6523	8.70	BP6524	10.20	
.635 to .750	BP6622	7.60	BP6623	9.10	BP6624	10.60	
.750 to .875	BP6722	8.00	BP6723	9.50	BP6724	11.00	
.875 to 1.000			BP6823	9.90	BP6824	11.40	

†30 Amperes, 250 Volts A.C.							
Diam. Opening in Cable Clamp, In.	2-Pole No.	Each	3-Pole No.	Each	4-Pole No.	Each	
.375 to .500	BP6432	\$6.80	BP6433	\$8.30	BP6434	\$9.80	
.500 to .625	BP6532	7.20	BP6533	8.70	BP6534	10.20	
.625 to .750	BP6632	7.60	BP6633	9.10	BP6634	10.60	
.750 to .875	BP6732	8.00	BP6733	9.50	BP6734	11.00	
.875 to 1.000			BP6833	9.90	BP6834	11.40	



**With Gland Nut
With Clamping Nut**

Furnished with tapered rubber bushing and cast aluminum handles.

*20 Amperes, 250 Volts A.C.							
Diam. Opening in Cable Clamp, In.	2-Pole No.	Each	3-Pole No.	Each	4-Pole No.	Each	
.375 to .500	BP8422	\$7.80	BP8423	\$9.80	BP8424	\$11.80	
.500 to .625	BP8522	8.20	BP8523	10.20	BP8524	12.20	
.625 to .750	BP8622	8.60	BP8623	10.60	BP8624	12.60	
.750 to .875	BP8722	9.00	BP8723	11.00	BP8724	13.00	
.875 to 1.000			BP8823	11.40	BP8824	13.40	

†30 Amperes, 250 Volts A.C.							
Diam. Opening in Cable Clamp, In.	2-Pole No.	Each	3-Pole No.	Each	4-Pole No.	Each	
.375 to .500	BP8432	\$7.80	BP8433	\$9.80	BP8434	\$11.80	
.500 to .625	BP8532	8.20	BP8533	10.20	BP8534	12.20	
.625 to .750	BP8632	8.60	BP8633	10.60	BP8634	12.60	
.750 to .875	BP8732	9.00	BP8733	11.00	BP8734	13.00	
.875 to 1.000			BP8833	11.40	BP8834	13.40	

*Can be used on 20-ampere, 125-volt D.C. circuits; or on 20-ampere, 250-volt D.C. circuits if circuit is broken before plug is withdrawn.

†Clamp opening 1/2 to 2 1/2 inch takes most of the 2-wire and 3-wire rubber sheathed, fabric sheathed, and deck cables No. 14 to No. 8.

‡Can be used on 25-ampere, 125-volt D.C. circuits; or on 30-ampere, 250-volt D.C. circuits if circuit is broken before plug is withdrawn.

**Type BRC Extension Cable Connectors
With Rubber Bushing (Watertight)—Cast Aluminum
*30 Amperes, 250 Volts, A.C.**



Diameter Cable, In.	2-Pole		3-Pole		4-Pole	
	Complete No.	Each	Receptacle Only No.	Each	Plug Only No.	Each
.375-.500	BRC-8432	\$14.80	BRM-70432	\$7.00	BP-8432	\$7.80
.500-.625	8532	15.30	70532	7.10	8532	8.20
.625-.750	8632	16.10	70632	7.50	8632	8.60
.750-.875	8732	16.90	70732	7.90	8732	9.00
3-Pole						
.375-.500	8433	\$17.70	70433	\$7.90	8433	\$9.80
.500-.625	8533	18.20	70533	8.00	8533	10.20
.625-.750	8633	19.00	70633	8.40	8633	10.60
.750-.875	8733	19.80	70733	8.80	8733	11.00
.875-1.000	8833	20.60	70833	9.20	8833	11.40
4-Pole						
.375-.500	8434	\$20.60	70434	\$8.80	8434	\$11.80
.500-.625	8534	21.10	70534	8.90	8534	12.20
.625-.750	8634	21.90	70634	9.30	8634	12.60
.750-.875	8734	22.70	70734	9.70	8734	13.00
.875-1.000	8834	23.50	70834	10.10	8834	13.40

*Can be used on 25-ampere, 125-volt d.c. circuits; or on 10-ampere, 250-volt d.c. circuits if circuit is broken before plug is withdrawn. The 2-pole Condulets are furnished with 30-ampere, 250-volt receptacle BR2302; 3-pole Condulets are furnished with 30-ampere, 250-volt receptacle BR2303; 4-pole Condulets are furnished with 30-ampere, 250-volt receptacle BR2304.

**Non-Adjustable Type CPS Delayed Action
Arktite Plug Receptacle Condulets**
Explosion-Proof Class I, Groups C and D**



Receptacle Unit includes receptacle sealed housing and spring door. Takes Type CPP Plugs.

**15-A, 1 Hp.—115 or 230-V., A-C, 2-Wire, 3-Pole
Chromium-Plated**

Size Hub	Condulet with Receptacle Unit No.	Each	Receptacle Unit** No.	Each
3/4	CPS212	\$40.00	CPS212-R	\$35.00
		Plain		
3/4	CPS2162	28.00	CPS2162-R	23.00

Replacement Plug Receptacle Units**

For Replacement of Non-Explosion-Proof Plug Receptacles. Replacement Unit includes Receptacle with Sealed Housing and Spring Door. Takes Type CPP Plugs.



15-A, 1 Hp.—115 or 230-V., A-C, 2-Wire, 3-Pole

	No.	Each
Chromium Plated	CPS212-S33	\$37.00
Plain	CPS2162-S33	25.00

For mounting on single gang switch boxes and switch box covers.

**Non-interchangeable CPS receptacles and CPP plugs can be furnished. Information on request to GRAYBAR.

Crouse-Hinds Type CPS Delayed Action Arktite Plug Receptacle Equipment

Explosion-Proof

Class I, Groups C and D

Includes Condulet and Receptacle—Takes Type CPP Plugs

2-Wire, 3-Pole—15-Ampere or 1 Hp., 115 or 230-Volt, 60-Cycle A-C



Dead End Through Feed "L"

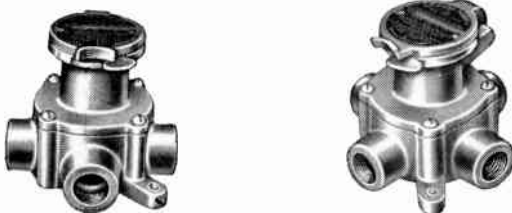

"T" "X"

Hub Arrangement	Size Hub	Complete		Body Only	
		No.	Each	No.	Each
Dead End	1/2	CPS14-120	\$25.90	CPS120	\$2.50
	3/4	CPS14-20	26.00	CPS20	2.60
	1	CPS14-20	26.00	CPS20	2.60
Through Feed	1/2	CPS14-121	26.10	CPS121	2.70
	3/4	CPS14-21	26.30	CPS21	2.90
	1	CPS14-21	26.30	CPS21	2.90
"L"	1/2	CPS14-122	26.10	CPS122	2.70
	3/4	CPS14-22	26.30	CPS22	2.90
	1	CPS14-22	26.30	CPS22	2.90
"T"	1/2	CPS14-123	26.30	CPS123	2.90
	3/4	CPS14-23	26.60	CPS23	3.20
	1	CPS14-23	26.60	CPS23	3.20
"X"	1/2	CPS14-124	26.50	CPS124	3.10
	3/4	CPS14-24	26.90	CPS24	3.50
	1	CPS14-24	26.90	CPS24	3.50

Crouse-Hinds Type CPP Plugs

**For Type CPS Receptacle Units
Furnished with Cable Grip and Rubber Bushing**



With Molded Composition Handle

With Aluminum Handle

No.	Each	15-Ampere or 1-Hp.	Diameter Cable	No.	Each
CPP312	\$10.00	115 or 230-V.	.250-.375	CPP316	\$10.00
CPP412	10.00	60-Cycle A-C	.375-.500	CPP416	10.00
CPP512	10.00	2-Wire, 3-Pole	.500-.625	CPP516	10.00

Call Graybar FIRST For

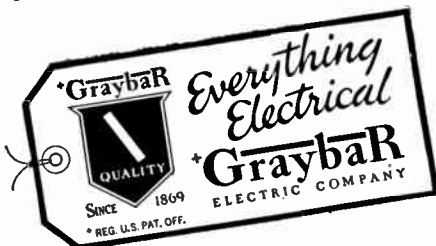

Crouse-Hinds Plugs and Receptacles

Types CES and CESD Delayed Action Arktite Plug Receptacle Condulets

Explosion-Proof Class 1, Group D*

Includes Condulet, Receptacle, and Receptacle Housing—Takes Type CPH Plugs

Style 2—Grounded Through Extra Pole and Shell

Interchangeability: Types AP and APJ Arktite circuit-breaking plugs cannot be used with types CES and CESD delayed action Arktite receptacles. Type CPH delayed action Arktite plugs can be used with regular style 2 receptacles of the same rating and pole arrangement. This fact may be utilized in a plant having hazardous and non-hazardous locations as follows: Types CES or CESD delayed action receptacle Condulets can be installed in the hazardous areas.

Regular Style 2 Arktite receptacles rated 30 or 60 amperes, 2-wire, 3-pole or 3-wire, 4-pole can be installed in non-hazardous areas.

Portable equipment suitable for use in the hazardous areas may be equipped with type CPH delayed action plugs. Such equipment may then be used anywhere in the plant, including the non-hazardous areas.

Portable equipment not suitable for use in such areas may be equipped with regular types AP and APJ Arktite plugs and such equipment can then be used in any non-hazardous location in the plant, but there is complete assurance that it cannot be connected to a receptacle in the hazardous areas.



Type CES Condulets have three hubs, one on each side and one at the top, and two threaded pipe plugs. Type CESD Condulets have vertical through feed hubs and one threaded pipe plug. There is a threaded opening in the top with a cover which may be removed to facilitate pulling wires.



Size Hubs	Circuit	Phases	Max. Hp.	Max. Amps.	Volts at 60 Cy. A-C	No.	Each
3/4	{2-Wire 3-Pole}	1	{1/2 1 1/2}	7 30	115 to 460 230	CES2213	\$47.00
						CESD2213	47.00
3/4	{3-Wire 4-Pole}	3	{1 3}	30 30	115 to 230 460	CES2214	50.00
						CESD2214	50.00
1 1/4	{2-Wire 3-Pole}	1	3	60 60	115 to 230 460	CES4233	59.00
						CESD4233	59.00
1 1/4	{3-Wire 4-Pole}	3	5	60 60	115 to 230 460	CES4234	66.00
						CESD4234	66.00

Type CPH Plugs

For Types CES and CESD Receptacle Equipment

Furnished with Mechanical Cable Grip and Rubber Bushing.



Circuit	Ph.	Max. Hp.	Max. Amps.	Volts at 60 Cy. A-C	Diameter Cable	No.	Each
2-W.	1	{1/2 1 1/2}	7 30	115-230	.375-.875	CPH7713	\$22.00
						CPH7913	22.00
3-W.	3	{1 3}	7 30	460	.375-.875	CPH7714	23.50
						CPH7914	23.50
4-P.	3	30	115-230	.875-1.375	.500-.875	CPH7733	26.00
						CPH7933	26.00
2-W.	1	{3 60}	460	115-230	.875-1.375	CPH7734	26.00
						CPH7934	26.00
3-P.	3	5	{30 60}	460	.500-.875	CPH7733	26.00
						CPH7933	26.00
3-W.	3	5	{30 60}	460	.500-.875	CPH7734	26.00
						CPH7934	26.00

*Type CES receptacle Condulets and type CPH plugs are also suitable for Class 1, Group C locations.

Pyle-National Triploc Plugs and Receptacles

Listed by Underwriters' Laboratories, Inc.

Interchangeability: The universal construction of the Triploc line permits thousands of plug and receptacle assembly combinations. The wide variety of styles and sizes allows meeting individual requirements for any portable electrical equipment rated within the capacity of the line.

Triploc contact units (1 to 12 poles) are all of one standard size and shape to fit in the same plug shells and receptacle housings. The line includes receptacle housings for standard conduit fittings and sheet metal boxes. Because of the many possible assembly combinations, all plug shells and receptacle housings are listed less contact units which must be ordered separately.

Reversibility: Either male (fuseless) or female contact units can be assembled in the plug shell or receptacle housing, depending upon which is the live side when the plug is withdrawn.

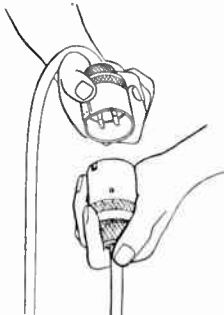

Automatic Locking: Fuseless and fusible plug shells are provided with a bayonet lock which automatically engages a lock post on the receptacle housing.

Manual Release Type: Positive locking. A slight turn of the outer sleeve releases the lock.

Automatic and Manual Release Type: Same as manual release type except lock releases with heavy strain on portable cord.

Triploc Plug Shells—Fuseless

Less Contact Units

Fit Types AR and XR Receptacle Housings. Contact Units must be ordered separately. Use only grounded contact units when equipment ground wire is required. Take only Type AP Fuseless Male and Type AR Female Contact Units. Pressed steel, galvanized.



Type APD With Cord Grip



Type APC Tapped for Conduit

Cord Diam., Inches	Manual Release		Automatic and Manual Release	
	No.	Each	No.	Each
.250-.375	APD-2003	\$2.65	APD-2003-L	\$2.95
.375-.500	APD-2004	2.65	APD-2004-L	2.95
.500-.625	APD-2005	2.65	APD-2005-L	2.95
.625-.750	APD-2006	2.65	APD-2006-L	2.95
.750-.875	APD-2007	3.65	APD-2007-L	4.05
.875-1.000	APD-2008	3.65	APD-2008-L	4.05

Tapped for Conduit

Size	No.	Each
1/2	APC-2001	\$1.80
3/4	APC-2002	2.00

Triploc Fuseless Contact Units

With no Provision for Grounding

Material is moulded Phenolic with renewable, self-aligning bronze contacts. Female contact unit can be mounted in plug or receptacle to be on line side when plug is withdrawn.

1 Wire, Single Pole



Male



Female

No.	Male		125V. D-C	Ampere Rating		600V. D-C
	No.	Each		250V. D-C	460V. A-C	
AP-160	\$4.80	AR-160	30	25	30	0.2

Triploc Fuseless Contact Units

With no Provision for Grounding

Material is moulded Bakelite with renewable, self-aligning bronze contacts. Female contact unit can be mounted in plug or receptacle to be on line side when plug is withdrawn.

2 Wire, 2 Pole



Male



Female

No.	Male		125V. D-C	Ampere Rating		600V. D-C
	No.	Each		250V. D-C	460V. A-C	
AP-221	\$2.40	AR-221	20	20	20	0.2

3 Wire, 3 Pole



Male



Female

No.	Male		125V. D-C	Ampere Rating		600V. D-C
	No.	Each		250V. D-C	460V. A-C	
AP-320	\$2.60	AR-320	20	20	20	0.2

4 Wire, 4 Pole



Male



Female

No.	Male		125V. D-C	Ampere Rating		600V. D-C
	No.	Each		250V. D-C	460V. A-C	
AP-420	\$2.80	AR-420	20	20	20	0.2

6 Wire, 6 Pole



Male



Female

No.	Male		125V. D-C	Ampere Rating		600V. D-C
	No.	Each		250V. D-C	460V. A-C	
†AP-610	\$4.20	†AR-610	5	1.5	*15	0.2

8 Wire, 8 Pole



Male



Female

No.	Male		125V. D-C	Ampere Rating		600V. D-C
	No.	Each		250V. D-C	460V. A-C	
†AP-810	\$5.20	†AR-810	5	1.5	*15	0.2

12 Wire, 12 Pole

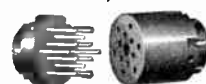

Male



Female

No.	Male		125V. D-C	Ampere Rating		600V. D-C
	No.	Each		250V. D-C	460V. A-C	
†AP-1210	\$8.55	†AR-1210	5	1.5	*15	0.2

With One Pole Grounded

2 Wire, 3 Pole



Male



Female

No.	Male		125V. D-C	Ampere Rating		600V. D-C
	No.	Each		250V. D-C	460V. A-C	
AP-320G	\$2.80	AR-320G	20	20	20	0.2

*Any one pole can be used as a common return provided that the total current through the remaining poles does not exceed 20 Amperes.

†Solder terminals, silver plated contacts.

Pyle-National Triploc Plugs and Receptacles

Triploc Fuseless Contact Units

With One Pole Grounded
(Continued)

Material is moulded Phenolic with renewable, self-aligning bronze contacts. Female contact unit can be mounted in plug or receptacle to be on line side when plug is withdrawn.

3 Wire, 4 Pole



Male



Female

Male		Female		Ampere Rating			
No.	Each	No.	Each	125V. D-C	250V. D-C	460V. A-C	600V. D-C
AP-420-G	\$3.00	AR-420-G	\$3.20	20	20	20	0.2

5 Wire, 6 Pole



Male



Female

Male		Female		Ampere Rating			
No.	Each	No.	Each	125V. D-C	250V. D-C	460V. A-C	600V. D-C
†AP-610G	\$4.40	†AR-610G	\$4.60	5	1.5	*15	0.2

7 Wire, 8 Pole



Male



Female

Male		Female		Ampere Rating			
No.	Each	No.	Each	125V. D-C	250V. D-C	460V. A-C	600V. D-C
†AP-810G	\$5.40	†AR-810G	\$5.60	5	1.5	*15	0.2

11 Wire, 12 Pole

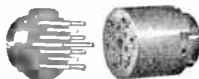

Male		Female		Ampere Rating			
No.	Each	No.	Each	125V. D-C	250V. D-C	460V. A-C	600V. D-C
†AP-1210-G	\$8.75	†AR-1210-G	\$8.95	5	1.5	*15	0.2

*Any one pole can be used as a common return provided that the total current through the remaining poles does not exceed 20 Amperes.

†Solder terminals, silver plated contacts.

Triploc Plug Shells—Fusible

Less Contact Units

Fit Types AR and NR Receptacle Housings. Contact Units must be ordered separately. Use only grounded contact units when equipment ground wire is required. Take only Type APF Fusible Male Contact Units. Pressed steel, rust-proofed.



Type APFD With Cord Grip

Plain Compression Nut, Rubber Bushing Cord Grip

Size, Inches	Manual Release No.	Each
.250-.375	APFD-2003	\$4.60
.375-.500	APFD-2004	4.60
.500-.625	APFD-2005	4.60
.625-.750	APFD-2006	4.60

Triploc Fusible Contact Units

With One Pole Grounded

For mounting only in Type APF Fusible Plug Shells. Type APF Plug Shells equipped with Fusible Contact Units fit any Type AR and NR Receptacle Housings equipped with Type AR Female Contact Units of the same circuit description. Easy replacement of fuses is made possible by ejectors which force the fuses out of the Plug Shell along with the front portion of the Contact Unit.

Take 250-volt cartridge fuses or Fusotrons. (National Electrical Code Standard.)

2-Wire, 3-Pole (2 Poles Fusible)



Male

No.	125V. D-C	Ampere Rating 250V. D-C	250V. A-C	Each
APF-320-GR	20	20	20	\$9.00

3 Wire, 4 Pole (2 or 3 Poles Fusible)



Male

No.	125V. D-C	Ampere Rating 250V. D-C	250V. A-C	Each
APF-420-GR	20	20	20	\$9.40

3-Wire, 4-Pole (2 Poles Fusible)

APF-420-GR	20	20	20	\$9.40
------------	----	----	----	--------

3-Wire, 4-Pole (3 Poles Fusible)

APF-3420-GR	20	20	20	\$11.00
-------------	----	----	----	---------

Pendant or Cord Connector Receptacle Housing

Less contact units. Pressed steel, rust-proofed.



Type ARD



Type ARDC

No.	Description	Size	Each
ARD-2003	Plain, compression nut.	.250 to .375	\$2.65
ARD-2004	rubber bushing	.375 to .500	2.65
ARD-2005	cord grip.	.500 to .625	2.65
ARD-2006		.625 to .750	2.65
ARD-2007		.750 to .875	3.65
ARD-2008		.875 to 1.000	3.65
ARDC-2001	Tapped for conduit.	1 1/2	1.80
ARDC-2002		3/4	2.00

Midget Triploc Receptacles

For FS and FD Series Pylets

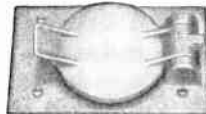

Type RXF Hinged Spring Door Housing with Gasket



Type RAW Plain Housing Without Gasket

Style "H"—With No Provision for Grounding

Cat. No.	List Each	Poles	Cat. No.	List Each
RXF-25221	\$4.90	2	RAW-25221	\$3.70
RXF-25321	5.10	3	RAW-25321	3.90
RXF-25421	5.40	4	RAW-25421	4.20

Style "J"—With One Pole Grounded

RXF-25321-G	5.40	3	RAW-25321-G	\$4.20
RXF-25421-G	5.70	4	RAW-25421-G	4.50

Pyle-National Triploc Plugs and Receptacles

Triploc Receptacle Housings

Less Contact Units

Take Triploc Plug Shells. Contact Units must be ordered separately.

For 3/4-inch and 1-inch outlet boxes. Plain housings are pressed steel, rust-proofed. Hinged spring door housings are cast iron with pressed steel sleeves, rust-proofed.



Type ARP—Surface		No.	Housing	Size Box	Each
		ARP-2030	Plain	3/4	\$2.70
		ARP-2040	Plain	1	2.70



Type XRP—Surface		No.	Housing	Size Box	Each
		XRP-2030	Hinged	3/4	\$3.20
		XRP-2040	Spring Door	1	3.20



Type ARPF—Flush		No.	Housing	Size Box	Each
		ARPF-2040	Plain	1	\$3.00

Triploc Receptacle Housings

Less Contact Units

Take Triploc Plug Shells. Contact Units must be ordered separately.

Plain housings are pressed steel—galvanized. Hinged spring door housings are cast iron with pressed steel sleeves—rust-proofed.

Flush Type Receptacles

For FS and FD Series Single and Two-Gang Tandem Pylets.



No.	Housing	Each
*ARF-2000	Plain	\$2.50
*XRF-2000	Hinged Spring Door	3.00



Surface Type Receptacles



No.	Housing	Each
ARR-2000	Plain	\$2.50
XRR-2000	Hinged Spring Door	3.00



*For FD Deep Series Pylets.



Type XRR—Surface		No.	Housing	Each
	45° Angle	XRR-2045	Spring Door	\$5.00

Type XRR—45°

Midget

10 Amp., 250 Volts; 15 Amp., 125 Volts

Type Rapf Midget Triploc Receptacles



For 3/4-inch and 1-inch outlet boxes, also Types BODS and BODN Pylets.

Housings are of rustproofed pressed steel. Insulation, moulded phenolic.

Type RAPF

Style "H"—With No Provision for Grounding

Poles	For 3/4-Inch Outlet Box		For 1-Inch Outlet Box	
	Cat. No.	List Each	Cat. No.	List Each
2	RAPF-325221	\$4.90	RAPF-425221	\$4.90
3	RAPF-325321	5.10	RAPF-425321	5.10
4	RAPF-325421	5.40	RAPF-425421	5.40

Style "J"—With One Pole Grounded

3	RAPF-325321-G	\$5.40	RAPF-425321-G	\$5.40
4	RAPF-325421-G	5.70	RAPF-425421-G	5.70

Midget Triploc Connectors and Male Plugs

With Rubber Bushing Cord Grip



Type RAD Connector

Type PAD Male Plug

Style "H"—With No Provision for Grounding

No.	Each	Poles	No.	Each
Cord Size: 1/4" to 5/16"				
RAD-2125221	\$4.85	2	PAD-2125221	\$4.55
RAD-2125321	5.05	3	PAD-2125321	4.75
RAD-2125421	5.35	4	PAD-2125421	5.05
Cord Size: 5/16" to 3/8"				
RAD-325221	4.85	2	PAD-325221	4.55
RAD-325321	5.05	3	PAD-325321	4.75
RAD-325421	5.35	4	PAD-325421	5.05
Cord Size: 3/8" to 7/16"				
RAD-3125221	4.85	2	PAD-3125221	4.55
RAD-3125321	5.05	3	PAD-3125321	4.75
RAD-3125421	5.35	4	PAD-3125421	5.05
Cord Size: 7/16" to 1/2"				
RAD-425221	5.05	2	PAD-425221	4.75
RAD-425321	5.25	3	PAD-425321	4.95
RAD-425421	5.55	4	PAD-425421	5.25
Cord Size: 1/2" to 5/8"				
RAD-525221	5.05	2	PAD-525221	4.75
RAD-525321	5.25	3	PAD-525321	4.95
RAD-525421	5.55	4	PAD-525421	5.25

Style "J"—With One Pole Grounded

Cord Size: 1/4" to 5/16"				
RAD-2125321-G	\$5.35	3	PAD-2125321-G	\$5.05
RAD-2125421-G	5.65	4	PAD-2125421-G	5.35
Cord Size: 5/16" to 3/8"				
RAD-325321-G	5.35	3	PAD-325321-G	5.05
RAD-325421-G	5.65	4	PAD-325421-G	5.35
Cord Size: 3/8" to 7/16"				
RAD-3125321-G	5.35	3	PAD-3125321-G	5.05
RAD-3125421-G	5.65	4	PAD-3125421-G	5.35
Cord Size: 7/16" to 1/2"				
RAD-425321-G	5.55	3	PAD-425321-G	5.25
RAD-425421-G	5.85	4	PAD-425421-G	5.55
Cord Size: 1/2" to 5/8"				
RAD-525321-G	5.55	3	PAD-525321-G	5.25
RAD-525421-G	5.85	4	PAD-525421-G	5.55

Pyle-National Triploc Plugs and Receptacles

Types XRP and ARP Triploc Receptacles For 3¼-Inch and 4-Inch Outlet Boxes

Take Type APD Triploc Plugs



Type XRP—Surface Hinged Spring Door Ferrous Alloy



Type ARP—Surface Plain Housing Pressed Steel

Style "H"—With No Provision for Grounding

No.	Each	Poles	No.	Each
20 Ampere, 460 Volts A-C; 250 Volts D-C For 3¼-Inch Outlet Box				
XRP-321221	\$5.80	2*	ARP-321221	\$5.30
XRP-320221	5.80	2†	ARP-320221	5.30
XRP-320321	6.00	3	ARP-320321	5.50
XRP-320421	6.20	4	ARP-320421	5.70
For 4-Inch Outlet Box				
XRP-421221	\$5.80	2*	ARP-421221	\$5.30
XRP-420221	5.80	2†	ARP-420221	5.30
XRP-420321	6.00	3	ARP-420321	5.50
XRP-420421	6.20	4	ARP-420421	5.70
15A., 460V., A-C; 5A., 125V., D-C; 1.5A., 250V., D-C For 3¼-Inch Outlet Box				
XRP-310621	\$7.60	6	ARP-310621	\$7.10
XRP-310821	8.60	8	ARP-310821	8.10
XRP-3101221	11.95	12	ARP-3101221	11.45
For 4-Inch Outlet Box				
XRP-410621	\$7.60	6	ARP-410621	\$7.10
XRP-410821	8.60	8	ARP-410821	8.10
XRP-4101221	11.95	12	ARP-4101221	11.45

Style "J"—With One Pole Grounded

No.	Each	Poles	No.	Each
20 Ampere, 460 Volts A-C; 250 Volts D-C For 3¼-Inch Outlet Box				
XRP-320321-G	\$6.20	3	ARP-320321-G	\$5.70
XRP-320421-G	6.40	4	ARP-320421-G	5.90
For 4-Inch Outlet Box				
XRP-420321-G	\$6.20	3	ARP-420321-G	\$5.70
XRP-420421-G	6.40	4	ARP-420421-G	5.90
15A., 460V., A-C; 5A., 125V., D-C; 1.5A., 250V., D-C For 3¼-Inch Outlet Box				
XRP-310621-G	\$7.80	6	ARP-310621-G	\$7.30
XRP-310821-G	8.80	8	ARP-310821-G	8.30
XRP-3101221G	12.15	12	ARP-3101221G	11.65
For 4-Inch Outlet Box				
XRP-410621-G	\$7.80	6	ARP-410621-G	\$7.30
XRP-410821-G	8.80	8	ARP-410821-G	8.30
XRP-4101221G	12.15	12	ARP-4101221G	11.65

Type ARPF Triploc Receptacles

For 4-Inch Outlet Boxes



Type ARPF Flush—Plain Pressed Steel

Fit only outlet boxes having a minimum inside depth of 2½ inches.

Type ARPF Triploc Receptacles take Type APD Triploc Plugs.

Style "H"—With No Provision for Grounding

No.	Poles	Amperes			Each
		460V. A-C	125V. D-C	250V. D-C	
ARPF-421221	2*	20	20	20	\$5.60
ARPF-420221	2†	20	20	20	5.60
ARPF-420321	3	20	20	20	5.80
ARPF-420421	4	20	20	20	6.00
ARPF-410621	6	15	5	1.5	7.40
ARPF-410821	8	15	5	1.5	8.40
ARPF-4101221	12	15	5	1.5	11.75

Type ARPF Receptacles (Cont.) Style "J"—With One Pole Grounded

No.	Poles	Amperes			Each
		460V. A-C	125V. D-C	250V. D-C	
ARPF-420321-G	3	20	20	20	\$6.00
ARPF-420421-G	4	20	20	20	6.20
ARPF-410621-G	6	15	4	1.5	7.60
ARPF-410821-G	8	15	5	1.5	8.60
ARPF-4101221-G	12	15	5	1.5	11.95

†Old Style. *New Style. Caution: Use new style to avoid interchangeability with 4-pole types. Old and new style have unmatched contact spacing.

Type Bods Round Pylets

For Types ARP and XRP Triploc plug receptacles. O.D. at top 4½ inches; outside height 1⅞ inches; inside depth 1¼ inches.

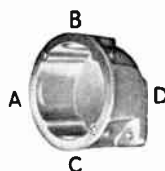

Type BODSF-1

No.	Mounting Lugs	Each
BODS-1	None	\$1.55
BODSF-1	Two	1.75

Watertight Triploc Receptacle Housings

Less Contact Units



Type RNLR



Type RNER

For FS and FD Series Single and Two-Gang Tandem Pylets. Take only the Type PNLD Watertight Plugs. Housing is cast iron, rust-proofed. Threaded cap is brass, natural finish.

No.	Style	Each
RNLR-2000*	Threaded Housing	\$3.20
RNER-2000	Threaded Cap Housing	4.80

*Water-tight only when plug is engaged.

Watertight Triploc Plug Shells

Less Contact Units

For Types AP and AR Triploc Contact Units. Contact Units must be ordered separately. Fit only Types RNLR and RNER Watertight Receptacle Housings. Cast aluminum alloy.

Type PNLD

With threaded clamping nut and rubber bushing cable grip.



No.	Cable Diam. Inches	Each
PNLD-2003	.250 to .375	\$4.50
PNLD-2004	.375 to .500	4.50
PNLD-2005	.500 to .625	4.50
PNLD-2006	.625 to .750	4.50
PNLD-2007	.750 to .875	6.20
PNLD-2008	.875 to 1.000	6.20

Pyle-National Environmental Neptune Series

Electrical Connectors 7 to 100 Poles



Service "A" Rating
 (MIL-C-5015-B operating voltage limits at sea level: 700 volts DC-500 volts AC rms)

An entirely new line of electrical connectors for universal application in military and industrial use, with extraordinary new characteristics of construction and performance never before combined in compact, light, standardized connectors.

Designed to meet and exceed Class A, B, C and E of military specifications MIL-C-5015C also NEC requirements, these connectors will provide design engineers with new possibilities for power, lighting, control, telemetering and coaxial connector systems.

These connectors have been thoroughly tested for satisfactory performance under Neptune Class W conditions listed below. Being of far more rugged construction they are not interchangeable with military connectors of the AN type.

Environmental Limits

Temperature: -80° F. to 225° F. Consult factory for higher limits.

Pressure: 300 PSI External—200 PSI Internal.

Chemical Resistance: Oil, most acids and alkalis.

Corrosion Resistance: Salt spray: 300 days, no failure.

Dust Resistance: Exceeds requirements of Mil C 5015 C. Also suitable for NEC Class 11, Groups E, F and G Hazardous Locations.

Shock Resistance: 50 G Minimum. Consult factory for higher limits.

Vibration: Exceeds 20 G to Method II of Mil-C-5015 C.
Humidity and Moisture Resistance: Exceeds Class E Spec of Mil-C-5015 C.

Air Leakage: Meets Class E Spec of Mil-C-5015 C.

Male Skirt Barrels with Contact Inserts



Male skirt with pin (P—Male) or socket (S—Female) contact insert as listed.

With Male Pin Insert

No.	Poles*	Wire Size	Overall Diam.
Form 12			
ZZM-WO-1012-11P	7	12 1.956	
ZZM-WO-1012-17P	10	16 1.956	
Form 16			
ZZM-WO-1016-12P	19	12 2.488	
ZZM-WO-1016-14P	37	16 2.488	
Form 20			
ZZM-WO-1020-13P	68	16 3.030	
Form 24			
ZZM-WO-1024-13P	100	16 3.560	

With Female Socket Insert

No.	Poles*	Wire Size	Overall Diam.
Form 12			
ZZM-WO-1012-11S	7	12 1.956	
ZZM-WO-1012-17S	10	16 1.956	
Form 16			
ZZM-WO-1016-12S	19	12 2.488	
ZZM-WO-1016-14S	37	16 2.488	
Form 20			
ZZM-WO-1020-13S	68	16 3.030	
Form 24			
ZZM-WO-1024-13S	100	16 3.560	

Female Skirt Barrels with Contact Inserts

Female skirt with socket (S—Female) or pin (P—Male) contact insert as listed.



With Female Socket Insert

No.	Poles*	Wire Size	Overall Diam.
Form 12			
ZZM-WO-1512-11S	7	12 1.956	
ZZM-WO-1512-17S	10	16 1.956	
Form 16			
ZZM-WO-1516-12S	19	12 2.488	
ZZM-WO-1516-14S	37	16 2.488	
Form 20			
ZZM-WO-1520-13S	68	16 3.030	
Form 24			
ZZM-WO-1524-13S	100	16 3.560	

With Male Pin Insert

No.	Poles*	Wire Size	Overall Diam.
Form 12			
ZZM-WO-1512-11P	7	12 1.956	
ZZM-WO-1512-17P	10	16 1.956	
Form 16			
ZZM-WO-1516-12P	19	12 2.488	
ZZM-WO-1516-14P	37	16 2.488	
Form 20			
ZZM-WO-1520-13P	68	16 3.030	
Form 24			
ZZM-WO-1524-13P	100	16 3.560	

*Information on other pole arrangements and wire sizes furnished on request. Prices on request.

Dust Covers

For Male Skirt Barrels



No.	Form No.
ZZM-W-5512	12
ZZM-W-5516	16
ZZM-W-5520	20
ZZM-W-5524	24

For Female Skirt Barrels



No.	Form No.
ZZM-W-5612	12
ZZM-W-5616	16
ZZM-W-5620	20
ZZM-W-5624	24

Panelboard Adapters

For Male Skirt or Female Skirt Connector Barrels.



No.	Form No.
ZZM-W-2112	12
ZZM-W-2116	16
ZZM-W-2120	20
ZZM-W-2124	24

Bulkhead Mounting Kit

For Female Skirt Barrels Only.



No. (3 Parts)	Form No.
ZZM-W-2212	12
ZZM-W-2216	16
ZZM-W-2220	20
ZZM-W-2224	24

Cable Housings

With Oil-Resistant Rubber Grommets.



For Male Skirt or Female Skirt Connector Barrels.

*No.	Barrel Size Form	Cable Diam. Min.	Cable Diam. Max.	*No.	Barrel Size Form	Cable Diam. Min.	Cable Diam. Max.
ZZM-W-2012-0400	12	1/8	3/4	ZZM-W-2020-2000	20	1 1/8	1 1/4
ZZM-W-2012-0600	12	3/8	3/8	ZZM-W-2020-2200	20	1 1/4	1 3/8
ZZM-W-2012-0800	12	3/8	3/8	ZZM-W-2020-2400	20	1 3/8	1 1/2
ZZM-W-2012-1000	12	3/8	3/8	ZZM-W-2020-2600	20	1 1/2	1 5/8
ZZM-W-2012-1200	12	5/8	3/4	ZZM-W-2020-2800	20	1 5/8	1 3/4
ZZM-W-2012-1400	12	5/8	3/4	ZZM-W-2020-3000	20	1 3/4	1 3/8
ZZM-W-2012-1500	12	7/8	15/16	ZZM-W-2020-3100	20	1 3/8	1 11/16
ZZM-W-2016-1200	16	5/8	3/4	ZZM-W-2024-2800	24	1 5/8	1 3/4
ZZM-W-2016-1400	16	5/8	3/4	ZZM-W-2024-3000	24	1 3/4	1 3/8
ZZM-W-2016-1600	16	3/4	1	ZZM-W-2024-3200	24	1 3/8	2
ZZM-W-2016-1800	16	1	1 1/8	ZZM-W-2024-3400	24	2	2 1/8
ZZM-W-2016-2000	16	1 1/8	1 1/4	ZZM-W-2024-3600	24	2 1/8	2 1/4
ZZM-W-2016-2200	16	1 1/4	1 3/8	ZZM-W-2024-3800	24	2 1/4	2 3/8
ZZM-W-2016-2400	16	1 3/8	1 5/8	ZZM-W-2024-3900	24	2 3/8	2 3/4

*Information on other types furnished on request. Prices on request.

Basketweave Grips



For above cable housings.

Information furnished on request.

R & S Delayed Action Receptacles, Plugs and Connectors

**Type EFS—For Surface Mounting
Explosion-Proof—Class I, Groups C and D
15 Amp., 125 or 250 Volts A.C.**

Two and Three Wire with One Pole for Grounding Polarized

**Maximum Horsepower Ratings:
Two Wire, Three Pole—1 Hp., 1-Phase, 125 or 250 Volts, A.C.
Three Wire, Four Pole—1½ Hp., 3-Phase,
125 or 250 Volts, A.C.**



No. 4462



No. 4464

Factory Sealed

The delayed action feature requires the turning of plug shell on withdrawal to allow time for extinction of the arc and cooling. Equipment grounding is provided by means of a separate pole which makes contact before and breaks contact after the circuit poles.

**Receptacles With Enclosures—
Less Plugs**

Description	Single Gang		Two Gang		Takes Plug No.
	No.	Each	No.	Each	
With Straight Cover					
2 wire, 3 pole	4462	\$18.00	4450	\$36.00	4466
3 wire, 4 pole	4463	19.00	4451	38.00	4467
With Angle Cover with Flap*					
2 wire, 3 pole	4464	20.00	4460	40.00	4466
3 wire, 4 pole	4465	21.00	4461	42.00	4467

Plugs and Connectors



No. 4466



No. 4804

15 Amp., 125 or 250 Volts A.C.—Polarized

Plugs and connectors are furnished with aluminum alloy cable clamp and neoprene cable bushing.

Description	Plugs		Connectors		Cable Bushing Dia., In.
	No.	Each	No.	Each	
2 wire, 3 pole	4466	\$7.50	4803	\$25.00	9/16
3 wire, 4 pole	4467	8.50	4804	26.00	19/32

*Can be furnished with screw cap. Price on application.

Receptacle Enclosures — Cast iron, corrosion resisting baked enamel finish. Available in three or four gang or tandem units and in combination with other R & S type EFS devices.

Plugs — Steel, cadmium plated.

Connectors — Cast aluminum alloy, natural finish.

Outlets — Unless otherwise specified, furnished with one 3/4-inch outlet per gang, top or bottom. Additional or larger outlets charged extra. Maximum conduit 1-inch: single gang — top and bottom only, two gang — one per gang top and bottom and one each side. Specify size and location.

*Cable bushing regularly furnished. Other hole sizes available if specified on order — 1/8 to 5/8-inch diameter.

R & S Delayed Action Receptacles and Plugs

**Type DA—For Surface Mounting
Explosion-Proof and Dust-Tight
Class I, Groups C and D**

30 and 60 Amp., 440 Volts, A.C.

Two and Three Wire with One Pole for Grounding Polarized

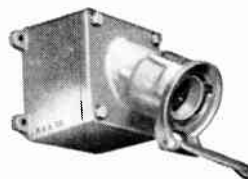

No. 4233BC

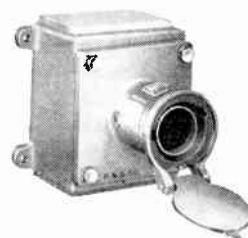

No. RA4233BC

Factory Sealed

The delayed action feature requires the turning of plug shell on withdrawal to allow time for extinction of the arc and cooling. Equipment grounding is provided by means of a separate pole which makes contact before and breaks contact after the circuit poles.

**Receptacles With Enclosures—
Less Plugs**

No.	With Angle Cover		With Straight Cover		Takes Plug No.
	No.	Each	No.	Each	
30 Amperes 2 Wire, 3 Pole					
4233BC	\$42.50	RA4233BC	\$42.50	4237BC	
3 Wire, 4 Pole					
4234BC	47.50	RA4234BC	47.50	4238BC	
60 Amperes 2 Wire, 3 Pole					
4263BC	50.00	RA4263BC	50.00	4267BC	
3 Wire, 4 Pole					
4264BC	57.50	RA4264BC	57.50	4268BC	

Plugs

Furnished with aluminum alloy cable clamp and neoprene cable bushing. Cable bushings of other hole sizes available for 30 ampere only: 3/16 to 1 1/8-inch diameter.

Material — 30 ampere: cast iron, cadmium plated. 60 ampere: cast aluminum alloy, natural finish.

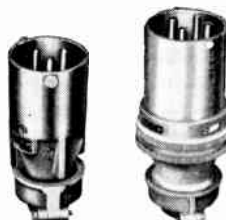

No. 4237BC

No. 4268BC

No.	30 Ampere Cable Bushing, Dia., In.		No.	60 Ampere Cable Bushing, Dia., In.	
	Each	Each		Each	Each
2 Wire, 3 Pole					
4237BC	21/32	\$20.00	4267BC	1 1/32	\$25.00
3 Wire, 4 Pole					
4238BC	23/32	22.00	4268BC	1 1/32	28.00

Receptacle Enclosures — Cast iron, corrosion resisting baked enamel finish.

Outlets — Unless otherwise specified, furnished with one outlet top or bottom as follows: 30 amp. 3/4-inch; 60 amp. 1 1/4-inch. Additional or larger outlets charged extra. Maximum conduit 1 1/2-inch for 30 amp. receptacles with angle cover; all others 2-inch. Specify size and location.

R & S Midget Ever-Lok® Receptacles

**Automatic Locking
Type M Receptacles**
10 Amp., 250 Volts, A.C. or D.C.
20 Amp., 125 Volts, A.C.—15 Amp., 125 Volts, D.C.
Two, Three and Four Pole—Polarized
Maximum Horsepower Ratings:
½ Hp., 1-Phase—1 Hp. 3-Phase, 115 Volts, 230 Volts, A.C.
For FS and Similar Conduit Fittings



No. 8703

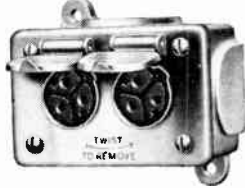

No. 8773

Description	With Spring Hinged Flap		Without Flap		Takes Plug No.
	No.	Each	No.	Each	
Single Receptacle with Cover					
2 wire, 2 pole	8702	\$3.80	8802	\$3.30	8712
2 wire, 3 pole	8703	3.90	8803	3.40	8713
3 wire, 4 pole	8704	4.00	8804	3.50	8714

Description	With Spring Hinged Flap		Without Flap		Takes Plug No.
	No.	Each	No.	Each	
Duplex Receptacle with Cover					
2 wire, 2 pole	8732	5.60	8832	4.60	8712
2 wire, 3 pole	8733	5.80	8833	4.80	8713
3 wire, 4 pole	8734	6.00	8834	5.00	8714

Furnished with 6-32 mounting screws. Can be furnished with 10-24 screws at same price, if specified on order.

With Single Gang FS Box*

Description	Single Receptacle with Cover		Takes Plug No.
	No.	Each	
2 wire, 2 pole	8752	\$5.80	8712
2 wire, 3 pole	8753	5.90	8713
3 wire, 4 pole	8754	6.00	8714

Description	Duplex Receptacle with Cover		Takes Plug No.
	No.	Each	
2 wire, 2 pole	8772	7.60	8712
2 wire, 3 pole	8773	7.80	8713
3 wire, 4 pole	8774	8.00	8714

For Metal Raceways



No. MD3



No. MDDF3
With NEP1710RS deep body assembly on No. 1700 duct.

Description	Single Receptacle with Cover		Takes Plug No.
	No.	Each	
2 wire, 2 pole	MDF2	POA	8712
2 wire, 3 pole	MDF3	8713
3 wire, 4 pole	MDF4	8714

Description	Duplex Receptacle with Cover		Takes Plug No.
	No.	Each	
2 wire, 2 pole	MDDF2	8712
2 wire, 3 pole	MDDF3	8713
3 wire, 4 pole	MDDF4	8714

Covers — Heavy gage steel, cadmium plated.
***Boxes** — Cast iron, corrosion resisting baked enamel finish. Can be furnished in gang or tandem units and in combination with other R & S Type FS and FD devices.

Outlets — Unless otherwise specified, furnished with a ¼-inch outlet one end. Additional or larger outlets charged extra. Maximum conduit 1-inch, four way. Specify size and location.

For Reverse Service add suffix "R" to above catalog numbers. Prices on application.

All Type M, Midget Ever-Lok plugs fit the above receptacles.

POA — Price on application.

R & S Midget Ever-Lok® Receptacles

**Automatic Locking
Type M Receptacles**
10 Amp., 250 Volts, A.C. or D.C.
20 Amp., 125 Volts, A.C.—15 Amp., 125 Volts, D.C.
Two, Three and Four Pole—Polarized
Maximum Horsepower Ratings:
½ Hp., 1-Phase—1 Hp., 3-Phase, 115 Volts, 230 Volts, A.C.

Flush Receptacles
For 4-Inch Stamped Steel Outlet Boxes with Raised Covers



No. 8743



No. 8763

Description	With Hinged Flush Flap		Without Flap		Takes Plug No.
	No.	Each	No.	Each	
Single Receptacle with Flush Plate					
2 wire, 2 pole	8742	\$4.40	8842	\$3.80	8712
2 wire, 3 pole	8743	4.50	8843	3.90	8713
3 wire, 4 pole	8744	4.60	8844	4.00	8714

Description	Duplex Receptacle with Flush Plate		Takes Plug No.
	No.	Each	
2 wire, 2 pole	8762	7.60	8712
2 wire, 3 pole	8763	7.80	8713
3 wire, 4 pole	8764	8.00	8714

Flush Plates — Brass, brush brass finish. Can also be furnished in special finishes. Price on application.

Gang Types — Can be furnished in gang units and for combination with standard toggle switches.

Surface Receptacles



No. 8993



No. 8793

Description	With Spring Hinged Flap		Without Flap		Takes Plug No.
	No.	Each	No.	Each	
For Gang or Panel Mounting					
2 wire, 2 pole	8992	\$5.70	9092	\$3.70	8712
2 wire, 3 pole	8993	5.80	9093	3.80	8713
3 wire, 4 pole	8994	5.90	9094	3.90	8714

Description	On Midget Conduit Box*		Takes Plug No.
	No.	Each	
2 wire, 2 pole	8792	7.70	8712
2 wire, 3 pole	8793	7.80	8713
3 wire, 4 pole	8794	7.90	8714

Covers and Box — Cast aluminum alloy, natural finish. Conduit box can also be furnished with external mounting feet. Price on application.

*Outlets — Regularly tapped for ½-inch conduit.

For Reverse Service add suffix "R" to above catalog numbers. Prices on application.

All Type M, Midget Ever-Lok plugs fit the above receptacles.

R & S Midget Ever-Lok® Receptacles

**Automatic Locking
Type M Receptacles**
10 Amp., 250 Volts, A.C. or D.C.
20 Amp., 125 Volts, A.C.—15 Amp., 125 Volts, D.C.
Two, Three and Four Pole—Polarized

Maximum Horsepower Ratings:
½ Hp., 1-Phase—1 Hp., 3-Phase, 115 Volts, 230 Volts, A.C.
Surface Receptacles



No. 8783



No. 8903

Description	With Spring Hinged Flap		Without Flap		Takes Plug No.
	No.	Each	No.	Each	

For 3¼-Inch Stamped Steel Outlet Boxes

Description	With R & S No. 382 Box		Takes Plug No.
	No.	Each	
2 wire, 2 pole	8782	\$6.30	8712
2 wire, 3 pole	8783	6.40	8713
3 wire, 4 pole	8784	6.50	8714

Description	With R & S No. 382 Box		Takes Plug No.
	No.	Each	
2 wire, 2 pole	8902	7.80	8712
2 wire, 3 pole	8903	7.90	8713
3 wire, 4 pole	8904	8.00	8714

Covers — Cast aluminum alloy, natural finish.

Boxes — Cast iron, corrosion resisting baked enamel finish.

Outlets — Unless otherwise specified, furnished with one ¾-inch outlet. Additional outlets charged extra. Maximum conduit ¾-inch, four way. Specify size and location.

Pedestal Receptacles



No. 9053

For business machines, laboratory tables, floor outlets, etc.

***Duplex Receptacles**

Description	Horizontal Type		Tandem Type		Takes Plug No.
	No.	Each	No.	Each	
Threaded for ½-Inch Outlet					
2 wire, 2 pole	9052	\$14.60	9072	\$14.60	8712
2 wire, 3 pole	9053	14.80	9073	14.80	8713
3 wire, 4 pole	9054	15.00	9074	15.00	8714

Description	Horizontal Type		Tandem Type		Takes Plug No.
	No.	Each	No.	Each	
Threaded for ¾-Inch Outlet					
2 wire, 2 pole	9062	14.60	9082	14.60	8712
2 wire, 3 pole	9063	14.80	9083	14.80	8713
3 wire, 4 pole	9064	15.00	9084	15.00	8714

Double Duplex Receptacles

Description	Horizontal Type		Tandem Type		Takes Plug No.
	No.	Each	No.	Each	
Threaded for ¾-Inch Outlet					
2 wire, 2 pole	9562	18.20	9582	18.20	8712
2 wire, 3 pole	9563	18.60	9583	18.60	8713
3 wire, 4 pole	9564	19.00	9584	19.00	8714

*Duplex receptacles can also be furnished with female tapped hubs at same price. When so required add suffix "F" to catalog numbers.

Enclosures — Heavy gage brass, brush brass finish. Can be furnished in special finishes. Price on application.

For Reverse Service add suffix "R" to above catalog numbers. Prices on application.

All Type M, Midget Ever-Lok plugs fit the above receptacles.

R & S Midget Ever-Lok® Plugs and Connectors

**Automatic Locking
Type M Plugs and Connectors**
10 Amp., 250 Volts, A.C. or D.C.
20 Amp., 125 Volts, A.C.—15 Amp., 125 Volts, D.C.
Two, Three and Four Pole—Polarized

Maximum Horsepower Ratings:
½ Hp., 1-Phase—1 Hp., 3-Phase, 115 Volts, 230 Volts, A.C.

Clamp Type



No. 8713



No. 8723

Description	Plugs Male End		Connectors Female End		Cable Dia., In.
	No.	Each	No.	Each	
2 wire, 2 pole	8712	\$3.10	8722	\$3.80	½
2 wire, 3 pole	8713	3.20	8723	3.90	½
3 wire, 4 pole	8714	3.30	8724	4.00	½

Bushing Type



No. 8813

Description	Plugs Male End		Connectors Female End		Cable Dia., In.
	No.	Each	No.	Each	
2 wire, 2 pole	8812	\$4.10	8822	\$4.80	•½
2 wire, 3 pole	8813	4.20	8823	4.90	•½
3 wire, 4 pole	8814	4.30	8824	5.00	•½

Hub Type

Tapped for ½-Inch Conduit*



No. 8923

Description	Plugs Male End		Connectors Female End		Cable Dia., In.
	No.	Each	No.	Each	
2 wire, 2 pole	8912	\$3.60	8922	\$4.30
2 wire, 3 pole	8913	3.70	8923	4.40
3 wire, 4 pole	8914	3.80	8924	4.50

Housing — Steel, cadmium plated.

*Accommodate rigid conduit or standard connectors for armored and non-metallic cable or flexible conduit. Can be furnished tapped for ⅜-inch conduit. Information on application.

*Cable bushing regularly furnished. Other hole sizes available if specified on order — ⅛ to ⅝-inch diameter.

For Reverse Service add suffix "R" to above catalog numbers. Prices on application.

R & S Midget Ever-Lok® Receptacles and Plugs

Type M Automatic Locking

10 Amp., 250 Volts, A.C. or D.C.

20 Amp., 125 Volts, A.C.—15 Amp., 125 Volts, C.D.

Two, Three and Four Pole—Polarized

Maximum Horsepower Ratings:

½ Hp., 1-Phase—1 Hp., 3-Phase, 115 Volts, 230 Volts, A.C.

Panel Mounting Receptacles With Metal Housing and Flange



No. 8944



No. 8944R

Open Type

Description Wires Poles	With Female Interior For Standard Service			Takes Plug No.	With Male Interior For Reverse Service		
	No.	Each	No.		No.	Each	Takes Plug No.
2 2	8942	\$2.80	8712	8942R	\$2.60	8712R	
2 3	8943	2.90	8713	8943R	2.70	8713R	
3 4	8944	3.00	8714	8944R	2.80	8714R	



No. 8934



No. 8934R

Enclosed Type

Tapped for ½-Inch Conduit*

2 2	8932	\$4.50	8912	8932R	\$4.30	8912R
2 3	8933	4.60	8913	8933R	4.40	8913R
3 4	8934	4.70	8914	8934R	4.50	8914R

With Cable Clamp—for ½-Inch Max. Cable

2 2	8952	4.00	8712	8952R	3.80	8712R
2 3	8953	4.10	8713	8953R	3.90	8713R
3 4	8954	4.20	8714	8954R	4.00	8714R

Panel Mounting Plugs With Metal Housing and Flange



No. 9033



No. 9033R

Description Wires Poles	With Male Interior			Takes Connector No.	With Female Interior		
	No.	Each	No.		No.	Each	Takes Connector No.
Clamp Type—For ½-Inch Max. Cable							
2 2	9032	\$3.30	8722	9032R	\$3.50	8722R	
2 3	9033	3.40	8723	9033R	3.60	8723R	
3 4	9034	3.50	8724	9034R	3.70	8724R	

Hub Type—Tapped for ½-Inch Conduit*

2 2	9592	3.80	8922	9592R	4.00	8922R
2 3	9593	3.90	8923	9593R	4.10	8923R
3 4	9594	4.00	8924	9594R	4.20	8924R

Housing — Steel, cadmium plated.

*Accommodate rigid conduit or standard connectors for armored and non-metallic cable or flexible conduit. Can be furnished tapped for ¾-inch conduit.

All Type M, Midget Ever-Lok plugs and connectors fit the above receptacles and plugs.

R & S Ever-Lok® Conduit Box Receptacles

Automatic Locking

Type S

Two, Three and Four Pole—Polarized



No. 8004

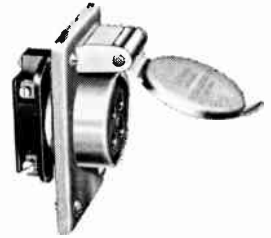

No. 8304

Receptacle With Cover

With Spring Hinged Flap

Without Flap

Description	No.	Each	No.	Each	Takes Plug No.
10 Amp., 600 Volts, A. C., 250 Volts, D. C. 20 Amp., 125 Volts, A. C. or D. C.					
2 wire, 2 pole	8002	\$3.90	8133	\$3.60	8012
2 wire, 3 pole	8003	4.00	8134	3.70	8013
3 wire, 4 pole	8008	4.10	8135	3.80	8018

20 Amp., 600 Volts, A. C.— 30 Amp., 250 Volts, A. C. or D. C.					
2 wire, 2 pole	8006	4.65	8136	4.35	8016
2 wire, 3 pole	8005	4.75	8137	4.45	8015
3 wire, 4 pole	8004	4.85	8138	4.55	8014
30 Amp., 600 Volts, A. C., 250 Volts, D. C.					
*3 wire, 4 pole	8304	6.00	8307	5.70	8314S

*30 ampere devices require type FD boxes.

Reverse Service—for FD and Similar Conduit Fittings



No. 8143



No. 8374

Male Receptacle with Cover

With Spring Hinged Flap

Without Flap

Description	No.	Each	No.	Each	Takes Female Plug No.
10 Amp., 600 Volts, A. C., 250 Volts, D. C. 20 Amp., 125 Volts, A. C. or D. C.					
2 wire, 2 pole	8142	\$6.90	8085	\$6.60	8022
2 wire, 3 pole	8143	7.00	8086	6.70	8023
3 wire, 4 pole	8144	7.10	8087	6.80	8028
20 Amp., 600 Volts, A. C.— 30 Amp., 250 Volts, A. C. or D. C.					
2 wire, 2 pole	8145	7.65	8088	7.35	8026
2 wire, 3 pole	8146	7.75	8089	7.45	8025
3 wire, 4 pole	8147	7.85	8090	7.55	8024
30 Amp., 600 Volts, A. C., 250 Volts, D. C.					
3 wire, 4 pole	8374	12.00	8377	11.70	8324S

Covers — Heavy gage steel, cadmium plated. Furnished with 6-32 mounting screws. Can be furnished with 10-24 screws at same price, if specified on order.

Hub and bushing type S plugs also fit the above receptacles.

R & S Ever-Lok® Plugs and Cord Connectors

Automatic Locking
Two, Three and Four Pole—Polarized
Type S Plugs—Male End



No. 8014



No. 8153

Clamp Type

Bushing Type

Description Wires Poles	No.	Each	Max. Cable Dia., In.	Cable Bushing Dia., In.			
				No.	Each		
10 Amp., 600 Volts, A. C., 250 Volts, D. C.							
20 Amp., 125 Volts, A. C. or D. C.							
2	2	8012	\$3.20	1/2	8152	\$4.20	9/16
2	3	8013	3.30	1/2	8153	4.30	5/8
3	4	8018	3.40	1/2	8158	4.40	11/16
20 Amp., 600 Volts, A. C.							
30 Amp., 250 Volts, A. C. or D. C.							
2	2	8016	3.95	5/8	8156	4.95	5/8
2	3	8015	4.05	5/8	8155	5.05	5/8
3	4	8014	4.15	5/8	8154	5.15	3/4
30 Amp., 600 Volts, A. C., 250 Volts, D. C.							
3	4	8314S	5.00	3/4	8354	6.00	1
3	4	8314	5.00	1 1/8	†8354J	7.50	1

†Fitted with molded Duro Neoprene jacket for waterproof assembly with No. 8304 receptacle only.

Type S Connectors—Female End



No. 8024



No. 8093

Clamp Type

Bushing Type

Description Wires Poles	No.	Each	Max. Cable Dia., In.	Cable Bushing Dia., In.			
				No.	Each		
10 Amp., 600 Volts, A. C., 250 Volts, D. C.							
20 Amp., 125 Volts, A. C. or D. C.							
2	2	8022	\$3.90	1/2	8092	\$4.90	9/16
2	3	8023	4.00	1/2	8093	5.00	5/8
3	4	8028	4.10	1/2	8098	5.10	11/16
20 Amp., 600 Volts, A. C.							
30 Amp., 250 Volts, A. C. or D. C.							
2	2	8026	4.65	5/8	8096	5.65	5/8
2	3	8025	4.75	5/8	8095	5.75	5/8
3	4	8024	4.85	5/8	8094	5.85	3/4
30 Amp., 600 Volts, A. C., 250 Volts, D. C.							
3	4	8324S	8.00	3/4	8394	9.00	1
3	4	8324	8.00	1 1/8

Housings — Steel, cadmium plated.

*Cable bushing regularly furnished. Other hole sizes available if specified on order — 10 ampere: 1/8 to 7/32-inch diameter — 20 and 30 ampere: 3/8 to 1-inch diameter.

R & S Ever-Lok® Receptacles

Automatic Locking

Two, Three and Four Pole—Polarized

Type S Receptacles—with FS Boxes



No. 8083

Boxes — Cast iron, corrosion resisting baked enamel finish. Can be furnished in multiple gang or tandem units and in combination with other R&S type FS and FD devices.

Covers — Heavy gage steel, cadmium plated.

Outlets — Unless otherwise specified, furnished with one 3/4-inch outlet per gang, top or bottom. Additional or larger outlets charged extra. Maximum conduit 1-inch; one per gang top and bottom and one each side. Specify size and location.

Receptacles with Box and Covers with Spring Hinged Flap

Single Gang

Two Gang

Description	No.	Each	No.	Each	Takes Plug No.
20 Amp., 125 Volts, A. C. or D. C.					
2 wire, 2 pole	8082	\$5.90	8127	\$11.80	8012
2 wire, 3 pole	8083	6.00	8128	12.00	8013
3 wire, 4 pole	8084	6.10	8129	12.20	8018
20 Amp., 600 Volts, A. C.					
30 Amp., 250 Volts, A. C. or D. C.					
2 wire, 2 pole	8029	6.65	8130	13.30	8016
2 wire, 3 pole	8030	6.75	8131	13.50	8015
3 wire, 4 pole	8031	6.85	8132	13.70	8014
30 Amp., 600 Volts, A. C., 250 Volts, D. C.					
*3 wire, 4 pole	8331	8.00	8334	16.00	8314S

*30 ampere devices are on FD boxes.

Type S Flush Receptacles for Stamped Steel Outlet Boxes

For Combination With Toggle Switch

Requires two-gang outlet box with two-gang 3/4-inch raised covers.

Flush Plates — Brass, brush brass finish. Can also be furnished with special finishes. Prices on application.

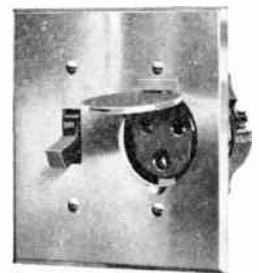

No. 8053

Receptacle with Flush Plate Switch Not Included

With Double Hinged Flush Flap

Without Flap

Description	No.	Each	No.	Each	Takes Plug No.
20 Amp., 125 Volts, A. C. or D. C.					
2 wire, 2 pole	8052	\$9.05	8112	\$7.05	8012
2 wire, 3 pole	8053	9.15	8113	7.15	8013
3 wire, 4 pole	8054	9.25	8114	7.25	8018
20 Amp., 600 Volts, A. C.					
30 Amp., 250 Volts, A. C. or D. C.					
2 wire, 2 pole	8106	9.80	8109	7.80	8016
2 wire, 3 pole	8107	9.90	8110	7.90	8015
3 wire, 4 pole	8108	10.00	8111	8.00	8014

Hub and bushing type S plugs also fit the above receptacles.

R & S Ever-Lok® Receptacles

Automatic Locking

Two, Three and Four Pole—Polarized

Type S Flush Receptacles for Stamped Steel Outlet Boxes



No. 8043

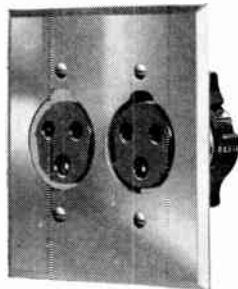

No. 8063

Require standard outlet boxes with 3/4-inch raised covers as noted.

Flush Plates — Brass, brush brass finish. Can also be furnished in special finishes. Prices on application.

Receptacles with Flush Plate

With Double Hinged Flush Flap

Without Flap

Description	No.	Each	No.	Each	Takes Plug No.
10 Amp., 600 Volts, A. C., 250 Volts, D. C.					
20 Amp., 125 Volts, A. C. or D. C.					
Single Gang—Requires 4" Square Box with Single Gang Cover					
2 wire, 2 pole	8042	\$5 90	8069	\$3 90	8012
2 wire, 3 pole	8043	6 00	8070	4 00	8013
3 wire, 4 pole	8044	6 10	8071	4 10	8018
Two Gang—Requires 2-Gang Box with 2-Gang Cover					
2 wire, 2 pole	8066	11 80	8062	7 80	8012
2 wire, 3 pole	8067	12 00	8063	8 00	8013
3 wire, 4 pole	8068	12 20	8064	8 20	8018

20 Amp., 600 Volts, A. C.

30 Amp., 250 Volts, A. C. or D. C.

Single Gang—Requires 4" Square Box with Single Gang Cover

2 wire, 2 pole	8048	6 65	8019	4 65	8016
2 wire, 3 pole	8049	6 75	8020	4 75	8015
3 wire, 4 pole	8050	6 85	8021	4 85	8014

Two Gang—Requires 2-Gang Box with 3-Gang Cover

2 wire, 2 pole	8102	13 30	8055	9 30	8016
2 wire, 3 pole	8103	13 50	8056	9 50	8015
3 wire, 4 pole	8104	13 70	8057	9 70	8014

30 Amp., 600 Volts, A. C., 250 Volts, D. C.

Single Gang

3 wire, 4 pole	*8344	10 00	*8347	8 00	8314S
----------------	-------	-------	-------	------	-------

*Furnished with special two gang 3/4-inch raised cover. Requires 4-inch square outlet box 2 1/8-inches deep.

Hub and bushing type S plugs also fit the above receptacles.

R & S Ever-Lok® Fusible Plugs and Connectors

Type S—Three and Four Pole—Polarized

For protection of branch circuit extensions or for motor overload protection of small motors.

Plugs—Automatic Locking with Safety Composition Holder for Fuses

For Standard N.E.C. Fuses or Fusetrans



No. 9114

30 Amp., 250 Volts, A.C. or D.C.
(Fit Type S devices rated 20 A., 600 V., A.C., 30 A., 250 V., A.C. or D.C.)

No.	Each	Max. Cable Dia. In.	Clamp Type		Bushing Type		Hub Type		Cond. Size, In.
			No.	Each	No.	Each	No.	Each	
3 Fused and 1 Grounded Pole									
9114	\$14 00	5/8	9134	\$15 00	3/4	9164	\$14 50	1/2	

For Midget Fuses or Midget Fusetrans



No. 9144

30 Amp., 250 Volts, A.C. or D.C.
(Fit Type S devices rated 20A., 600 V., A.C., 30 A., 250 V., A.C. or D.C.)

No.	Each	Max. Cable Dia. In.	Clamp Type		Bushing Type		Hub Type		Cond. Size, In.
			No.	Each	No.	Each	No.	Each	
2 Fused and 1 Grounded Pole									
9143	\$10 00	5/8	9173	\$11 00	5/8	9193	\$10 50	1/2	
3 Fused and 1 Grounded Pole									
9144	10 00	5/8	9174	11 00	3/4	9194	10 50	1/2	

(Fit Type S devices rated 30 A., 600 V., A.C., 250 V., D.C.)
3 Fused and 1 Grounded Pole
 9344S 10 00 3/4 9374 11 00 1 9394 10 50 3/4
 9344 10 00 1 1/8 †9374J 12 50 1 †9394J 12 00 3/4
 †Fitted with molded Duro Neoprene jacket for waterproof assembly with No. 8304 receptacle only.

Connectors—With Safety Composition Holder for Fuses

For Standard N.E.C. Fuses or Fusetrans

For installation in series with switches and not for opening or closing circuits under load.



No. 9124

30 Amp., 250 Volts, A.C. or D.C.
(Fit Type S devices rated 20 A., 600 V., A.C., 30 A., 250 V., A.C. or D.C.)

No.	Each	Max. Cable Dia. In.	Clamp Type		Bushing Type		Hub Type		Cond. Size, In.
			No.	Each	No.	Each	No.	Each	
3 Fused and 1 Grounded Pole									
9124	\$13 00	5/8	9154	\$14 00	3/4	9184	\$13 50	1/2	

Housings — Steel, cadmium plated.
 *Accommodate rigid conduit or standard connectors for armored and non-metallic cable or flexible conduit. All sizes can be furnished tapped for 1/2- or 3/4-inch conduit.
 •Cable bushing regularly furnished. Other hole sizes available if specified on order — 3/8 to 1-inch diameter.
 Fuses not included.

R & S Ever-Lok® Receptacles, Plugs and Connectors

Automatic Locking Type SE— For Automatic Press and Tool Control Applications

5 A., 250 V., A. C. or D. C.—Two to Twelve Pole—Polarized



No. SE9

Receptacles with Cover

Covers — Heavy gage steel, cadmium plated. Furnished with 6-32 mounting screws. Can be furnished with 10-24 screws, at same price, if specified.

Boxes — Use type FD cast boxes. Can be furnished with single gang cast iron conduit box No. 3711 at additional cost. When so required, add final suffix "D"

to catalog number.

Interiors — Contacts are removable and have crimp type terminals for No. 12 wire. Regularly furnished with housings ungrounded. When required with one pole grounded to housing add prime suffix "G" to catalog number. Same price.

With Female Receptacle

With Spring Hinged Flap

Without Flap

No. Poles	No.	Each	No.	Each	Takes Plug No.
2	SE2	\$8.00	SE302	\$7.70	PSE2
2	SE3	8.30	SE303	8.00	PSE3
4	SE4	8.60	SE304	8.30	PSE4
5	SE5	8.90	SE305	8.60	PSE5
6	SE6	9.20	SE306	8.90	PSE6
7	SE7	9.50	SE307	9.20	PSE7
8	SE8	9.80	SE308	9.50	PSE8
9	SE9	10.10	SE309	9.80	PSE9
10	SE10	10.40	SE310	10.10	PSE10
11	SE11	10.70	SE311	10.40	PSE11
12	SE12	11.00	SE312	10.70	PSE12

Reverse Service—With Male Receptacle

2	SE802	11.00	SE902	10.70	CSE2
3	SE803	11.30	SE903	11.00	CSE3
4	SE804	11.60	SE904	11.30	CSE4
5	SE805	11.90	SE905	11.60	CSE5
6	SE806	12.20	SE906	11.90	CSE6
7	SE807	12.50	SE907	12.20	CSE7
8	SE808	12.80	SE908	12.50	CSE8
9	SE809	13.10	SE909	12.80	CSE9
10	SE810	13.40	SE910	13.10	CSE10
11	SE811	13.70	SE911	13.40	CSE11
12	SE812	14.00	SE912	13.70	CSE12

Plugs and Connectors



No. PSE9



No. CSE9
Connectors
Female End

No. Poles	Plugs—Male End		Connectors Female End		Cable Bushing Dia. ^ø
	No.	Each	No.	Each	
2	PSE2	\$10.70	CSE2	\$13.90	5/8
3	PSE3	11.00	CSE3	14.20	5/8
4	PSE4	11.30	CSE4	14.50	5/8
5	PSE5	11.60	CSE5	14.80	3/4
6	PSE6	11.90	CSE6	15.10	3/4
7	PSE7	12.20	CSE7	15.40	3/4
8	PSE8	12.50	CSE8	15.70	7/8
9	PSE9	12.80	CSE9	16.00	7/8
10	PSE10	13.10	CSE10	16.30	1
11	PSE11	13.40	CSE11	16.60	1
12	PSE12	13.70	CSE12	16.90	1

Housings — Steel, cadmium plated with cast aluminum alloy cable clamp and neoprene cable bushing.

*Cable bushing regularly furnished. Other hole sizes available—3/8 to 1-inch diameter.

R & S Ever-Lok® Receptacles, Plugs and Cable Connectors

Automatic Locking

Two, Three and Four Pole—Polarized 30 to 200 Amp., 480 Volts, A. C.—250 Volts, D. C.

Type HS Heavy Service Weathertight Receptacles



Type HSA
45° Angle Type

Enclosures — Cast iron, corrosion resisting baked enamel finish.

Outlets — Unless otherwise specified, furnished with one outlet top or bottom: 30 amp. 3/4-inch; 60 amp. 1 1/4-inch; 100 amp. 1 1/2-inch; 200 amp. 2-inch. Additional or larger outlets charged extra. Maximum conduit size as listed, four way. Specify size and location.

Type HSA

With Box For Surface Mtg.

Description Wires	Poles	†No.	Each	Max. Cond. In.	No.	Each	Takes Plug No.
30 Amperes							
*2	2	8402	\$13.00	1 1/4	HSB8402	\$11.50	8406
2	3	8403	14.00	1 1/4	HSB8403	12.50	8407
3	4	8404	15.00	1 1/4	HSB8404	13.50	8408
60 Amperes							
*2	2	8412	21.50	1 1/2	HSB8412	19.00	8416
2	3	8413	23.50	1 1/2	HSB8413	21.00	8417
3	4	8414	25.50	1 1/2	HSB8414	23.00	8418
100 Amperes							
*2	2	8422	36.00	2	HSB8422	26.00	8426
2	3	8423	38.00	2	HSB8423	28.00	8427
3	4	8424	40.00	2	HSB8424	30.00	8428
200 Amperes							
*2	2	8432	115.00	3	HSB8432	95.00	8436
2	3	8433	120.00	3	HSB8433	100.00	8437
3	4	8434	125.00	3	HSB8434	105.00	8438

***Type HSB**

Less Box For Box Wall or Panel Mtg.

†Cat. Nos. shown for 45° Angle Type Receptacles. For Straight Type, prefix "HSR" to Cat. No. Gang units available. Weathertight to Waterproof

*Have small size flanges.

Plugs and Cable Connectors



Plug



Connector

Plugs Male End Only

Connectors Female End Only

Description	No.	Each	No.	Each	Max. Cable Dia., In.
30 Amperes					
*2 wire, 2 pole	8406	\$16.00	8442	\$17.00	1
2 wire, 3 pole	8407	17.00	8443	18.00	1
3 wire, 4 pole	8408	18.00	8444	19.00	1
60 Amperes					
*2 wire, 2 pole	8416	23.50	8452	24.50	1 1/2
2 wire, 3 pole	8417	25.50	8453	26.50	1 1/2
3 wire, 4 pole	8418	27.50	8454	28.50	1 1/2
100 Amperes					
*2 wire, 2 pole	8426	31.00	8462	36.00	1 1/2
2 wire, 3 pole	8427	33.00	8463	38.00	1 1/2
3 wire, 4 pole	8428	35.00	8464	40.00	1 1/2
200 Amperes					
2 wire, 2 pole	8436	100.00	8472	90.00	2 1/4
2 wire, 3 pole	8437	105.00	8473	95.00	2 1/4
3 wire, 4 pole	8438	110.00	8474	100.00	2 1/4

Housings — Cast aluminum alloy, natural finish.

*Have no provision for equipment grounding; all others have equipment ground through separate pole.

For Reverse Service add suffix "R" to above catalog numbers. Prices on application.

**R & S Angle Type Receptacles
Type FC—Weathertight**

With Flap Cover
15 to 200 Amperes
Two, Three and Four Wire—Polarized
480 Volts, A. C.—250 Volts, D. C.

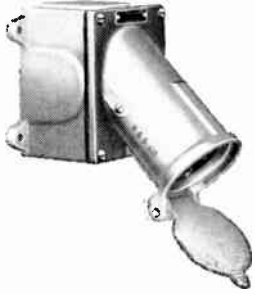

Type FCA
45° Angle Type

Type FCB
Panel Mounting Type

Type FCA
With Box
For Surface
Mtg.

Type FCB
Less Box
For Box Wall
or Panel Mtg.

Description	Wires	Poles	†No.	Each	Max. Cond. In.	No.	Each	Takes Plug No.
15 Amperes								
*2	2		3102	\$10.50	1 1/4	FCB3102	\$ 9.00	3106
2	3		3103	11.75	1 1/4	FCB3103	10.25	3107
*3	3		3103W	11.75	1 1/4	FCB3103W	10.25	3107W
3	4		3104	13.00	1 1/4	FCB3104	11.50	3108
*4	4		3104W	13.00	1 1/4	FCB3104W	11.50	3108W
30 Amperes								
*2	2		3112	11.00	1 1/4	FCB3112	9.50	3116
2	3		3113	12.25	1 1/4	FCB3113	10.75	3117
*3	3		3113W	12.25	1 1/4	FCB3113W	10.75	3117W
3	4		3114	13.50	1 1/4	FCB3114	12.00	3118
*4	4		3114W	13.50	1 1/4	FCB3114W	12.00	3118W
60 Amperes								
*2	2		3122	19.00	1 1/2	FCB3122	16.50	3126
2	3		3123	21.50	1 1/2	FCB3123	19.00	3127
*3	3		3123W	21.50	1 1/2	FCB3123W	19.00	3127W
3	4		3124	24.00	1 1/2	FCB3124	21.50	3128
*4	4		3124W	24.00	1 1/2	FCB3124W	21.50	3128W
100 Amperes								
*2	2		3132	33.00	2	FCB3132	23.00	3136
2	3		3133	35.50	2	FCB3133	25.50	3137
*3	3		3133W	35.50	2	FCB3133W	25.50	3137W
3	4		3134	38.00	2	FCB3134	28.00	3138
*4	4		3134W	38.00	2	FCB3134W	28.00	3138W
200 Amperes								
*2	2		3142	62.50	3	FCB3142	42.50	3146
2	3		3143	67.50	3	FCB3143	47.50	3147
*3	3		3143W	67.50	3	FCB3143W	47.50	3147W
3	4		3144	72.50	3	FCB3144	52.50	3148
*4	4		3144W	72.50	3	FCB3144W	52.50	3148W

†Catalog numbers listed are for 45° Angle Type Receptacles. For Straight Type, prefix "FCR" to catalog number. Price is the same.

Enclosures — Cast iron, corrosion resisting baked enamel finish.

Gang Units — Can be furnished in gang units. Prices on application.

•Have small size flanges.

Outlets — Unless otherwise specified, furnished with one outlet top or bottom as follows: 15 and 30 amp. 3/4-inch; 60 amp. 1 1/4-inch; 100 amp. 1 1/2-inch; 200 amp. 2-inch. Additional or larger outlets charged extra. Maximum conduit size as listed, four way. Specify size and location.

*Have provision for equipment grounding through enclosure only; all others have equipment ground through separate pole.

For Reverse Service add suffix "R" to above catalog numbers. Prices on application.

**R & S Plugs and Cable Connectors
Type FC—Weathertight**

15 to 200 Amperes
Two, Three and Four Wire—Polarized
480 Volts, A. C.—250 Volts, D. C.



Connector

Plug

**Plugs
Male End
Only**

**Connectors
Female End
Only**

**Complete
Male & Female**

Description Wires Poles No. Each No. Each No. Each Cable Bushing Dia., In

15 Amperes

*2	2		3106	\$ 9.00	3206	\$10.50	3202	\$19.50	5/8
2	3		3107	10.25	3207	11.75	3203	22.00	5/8
*3	3		3107W	10.25	3207W	11.75	3203W	22.00	5/8
3	4		3108	11.50	3208	13.00	3204	24.50	5/8
*4	4		3108W	11.50	3208W	13.00	3204W	24.50	5/8

30 Amperes

*2	2		3116	9.50	3216	11.00	3212	20.50	7/8
2	3		3117	10.75	3217	12.25	3213	23.00	7/8
*3	3		3117W	10.75	3217W	12.25	3213W	23.00	7/8
3	4		3118	12.00	3218	13.50	3214	25.50	7/8
*4	4		3118W	12.00	3218W	13.50	3214W	25.50	7/8

60 Amperes

*2	2		3126	11.50	3226	19.00	3222	30.50	1 3/16
2	3		3127	14.00	3227	21.50	3223	35.50	1 3/16
*3	3		3127W	14.00	3227W	21.50	3223W	35.50	1 3/16
3	4		3128	16.50	3228	24.00	3224	40.50	1 3/16
*4	4		3128W	16.50	3228W	24.00	3224W	40.50	1 3/16

100 Amperes

*2	2		3136	21.00	3236	33.00	3232	54.00	1 1/2
2	3		3137	23.50	3237	35.50	3233	59.00	1 1/2
*3	3		3137W	23.50	3237W	35.50	3233W	59.00	1 1/2
3	4		3138	26.00	3238	38.00	3234	64.00	1 1/2
*4	4		3138W	26.00	3238W	38.00	3234W	64.00	1 1/2

200 Amperes

*2	2		3146	35.50	3246	62.50	3242	98.00	2
3	3		3147	40.50	3247	67.50	3243	108.00	2
*3	3		3147W	40.50	3247W	67.50	3243W	108.00	2
3	4		3148	45.50	3248	72.50	3244	118.00	2
*4	4		3148W	45.50	3248W	72.50	3244W	118.00	2

Housings — Plugs: Steel, cadmium plated.

Connectors: Cast aluminum alloy, natural finish.

*Have provision for equipment grounding through housing only; all others have equipment ground through separate pole.

For Reverse Service add suffix "R" to above catalog numbers. Prices on application.

600 Volt Service

Type FC units rated

600 Volts, A-C.—250 Volts, D-C.

Can be furnished in sizes from 15 to 200 amperes. Prices and information on application.

**R & S Angle Type Receptacles
Type SC—Waterproof—With Screw Cap**

15 to 200 Amperes
Two, Three and Four Pole—Polarized



Type SCA
45° Angle Type



Type SCR
Straight Type

Type SCA

With Box for
Surface Mtg.

***Type SCB—Less Box**

For Box Wall
or Panel Mtg.

Description Wires Poles	No.	Each	Max. Cond. In.	No.	Each	Takes Plug No.
480 Volts, A. C.—250 Volts, D. C.						
15 Amperes						
*2	2	3302	\$11 50	1 1/4	SCB3302	\$10 00 3306
2	3	3303	12 75	1 1/4	SCB3303	11 25 3307
3	4	3304	14 00	1 1/4	SCB3304	12 50 3308
30 Amperes						
*2	2	3312	12 00	1 1/4	SCB3312	10 50 3316
2	3	3313	13 25	1 1/4	SCB3313	11 75 3317
3	4	3314	14 50	1 1/4	SCB3314	13 00 3318
60 Amperes						
*2	2	3322	20 00	1 1/2	SCB3322	17 50 3326
2	3	3323	22 50	1 1/2	SCB3323	20 00 3327
3	4	3324	25 00	1 1/2	SCB3324	22 50 3328
100 Amperes						
*2	2	3332	34 00	2	SCB3332	24 00 3336
2	3	3333	36 50	2	SCB3333	26 50 3337
3	4	3334	39 00	2	SCB3334	29 00 3338
200 Amperes						
*2	2	3342	65 00	3	SCB3342	45 00 3346
2	3	3343	70 00	3	SCB3343	50 00 3347
3	4	3344	75 00	3	SCB3344	55 00 3348
600 Volts, A. C.—250 Volts, D. C.						
15 Amperes						
*2	2	7302	12 50	1 1/4	SCB7302	11 00 7306
2	3	7303	13 75	1 1/4	SCB7303	12 25 7307
3	4	7304	15 00	1 1/4	SCB7304	13 50 7308
30 Amperes						
*2	2	7312	13 00	1 1/4	SCB7312	11 50 7316
2	3	7313	14 25	1 1/4	SCB7313	12 75 7317
3	4	7314	15 50	1 1/4	SCB7314	14 00 7318
60 Amperes						
*2	2	7322	21 00	1 1/2	SCB7322	18 50 7326
2	3	7323	23 50	1 1/2	SCB7323	21 00 7327
3	4	7324	26 00	1 1/2	SCB7324	23 50 7328
100 Amperes						
*2	2	7332	36 00	2	SCB7332	26 00 7336
2	3	7333	38 50	2	SCB7333	28 50 7337
3	4	7334	41 00	2	SCB7334	31 00 7338
200 Amperes						
*2	2	7342	67 50	3	SCB7342	47 50 7346
2	3	7343	72 50	3	SCB7343	52 50 7347
3	4	7344	77 50	3	SCB7344	57 50 7348

†Catalog numbers listed are for 45° Angle Type Receptacles. For Straight Type Receptacles, prefix "SCR" to catalog number. Price is the same.

Enclosures — Cast iron, corrosion resisting baked enamel finish.

Gang Units — Can be furnished in gang units. Prices on application.

*Have small size flanges.

Outlets — Unless otherwise specified, furnished with one outlet top or bottom as follows: 15 and 30 amp. 3/4-inch; 60 amp. 1 1/4-inch; 100 amp. 1 1/2-inch; 200 amp. 2-inch. Additional or larger outlets charged extra. Maximum conduit size as listed, four way. Specify size and location.

*Have no provision for equipment grounding; all others have equipment ground through separate pole.

For Reverse Service add suffix "R" to above catalog numbers. Prices on application.

**R & S Plugs and Cable Connectors
Type SC—Waterproof**

15 to 200 Amperes
Two, Three and Four Pole—Polarized



Connector



Plug

Plugs
Male End
Only

Connectors
Female End
Only

Complete
Male & Female

Description Wires Poles	No.	Each	No.	Each	No.	Each	Cable Bushing Dia., In.
480 Volts, A. C.—250 Volts, D. C.							
15 Amperes							
*2	2	3306	\$10 00	3406	\$11 50	3402	\$21 50 5/8
2	3	3307	11 25	3407	12 75	3403	24 00 5/8
3	4	3308	12 50	3408	14 00	3404	26 00 5/8
30 Amperes							
*2	2	3316	10 50	3416	12 00	3412	22 50 7/8
2	3	3317	11 75	3417	13 25	3413	25 00 7/8
3	4	3318	13 00	3418	14 50	3414	27 50 7/8
60 Amperes							
*2	2	3326	12 50	3426	20 00	3422	32 50 1 3/16
2	3	3327	15 00	3427	22 50	3423	37 50 1 3/16
3	4	3328	17 50	3428	25 00	3424	42 50 1 3/16
100 Amperes							
*2	2	3336	22 00	3436	34 00	3432	56 00 1 1/2
2	3	3337	24 50	3437	36 50	3433	61 00 1 1/2
3	4	3338	27 00	3438	39 00	3434	66 00 1 1/2
200 Amperes							
*2	2	3346	38 00	3446	65 00	3442	103 00 2
2	3	3347	43 00	3447	70 00	3443	113 00 2
3	4	3348	48 00	3448	75 00	3444	123 00 2
600 Volts, A. C.—250 Volts, D. C.							
15 Amperes							
*2	2	7306	11 00	7406	12 50	7402	23 50 5/8
2	3	7307	12 25	7407	13 75	7403	26 00 5/8
3	4	7308	13 50	7408	15 00	7404	28 50 5/8
30 Amperes							
*2	2	7316	11 50	7416	13 00	7412	24 50 7/8
2	3	7317	12 75	7417	14 25	7413	27 00 7/8
3	4	7318	14 00	7418	15 50	7414	29 50 7/8
60 Amperes							
*2	2	7326	13 50	7426	21 00	7422	34 50 1 3/16
2	3	7327	16 00	7427	23 50	7423	39 50 1 3/16
3	4	7328	18 50	7428	26 00	7424	44 50 1 3/16
100 Amperes							
*2	2	7336	24 00	7436	36 00	7432	60 00 1 1/2
2	3	7337	26 50	7437	38 50	7433	65 00 1 1/2
3	4	7338	29 00	7438	41 00	7434	70 00 1 1/2
200 Amperes							
*2	2	7346	40 50	7446	67 50	7442	108 00 2
2	3	7347	45 50	7447	72 50	7443	118 00 2
3	4	7348	50 50	7448	77 50	7444	128 00 2

Housings — Plugs: Steel, cadmium plated. Connectors: Cast aluminum alloy, natural finish. Can be furnished with retained screw cap at extra cost.

*Have no provision for equipment grounding; all others have equipment ground through separate pole.

For Reverse Service add suffix "R" to above catalog numbers. Prices on application.

R & S Receptacles and Plugs
Types FS and FD Weathertight and Waterproof
Two, Three and Four Pole—Polarized

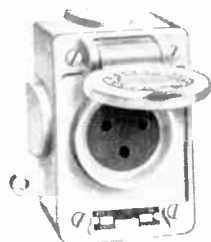

No. 3746



No. 3743



No. 3819

Weathertight—With Flap Cover
Receptacle
Less Plug

Plug Only

Description Wires Poles No. Each No. Each Plug Cable Bushing Dia., In. ●

Cast Iron With Box 3701

Cast Alum. Alloy Plug

10 Amp., 600 Volts, A. C., 250 Volts, D. C.
 20 Amp., 125 Volts, A. C. or D. C.

2	2	3745	\$ 7 50	3818	\$ 4 00	9/16
2	3	3746	8 00	3819	4 50	5/8
3	4	3747	8 50	3820	5 00	11/16

20 Amp., 600 Volts, A. C.—30 Amp., 250 Volts, A. C. or D. C.

2	2	3755	7 50	3828	4 50	5/8
2	3	3756	8 50	3829	5 50	5/8
3	4	3757	9 50	3830	6 50	3/4

Cast Brass With Box 3721

Cast Brass Plug

10 Amp., 600 Volts, A. C., 250 Volts, D. C.
 20 Amp., 125 Volts, A. C. or D. C.

2	2	3765	11 75	3818B	5 00	9/16
2	3	3766	12 25	3819B	5 50	5/8
3	4	3767	12 75	3820B	6 00	11/16

20 Amp., 600 Volts, A. C.—30 Amp., 250 Volts, A. C. or D. C.

2	2	3768	12 25	3828B	5 50	5/8
2	3	3769	13 25	3829B	6 50	5/8
3	4	3770	14 25	3830B	7 50	3/4

Waterproof—With Screw Cap

Receptacle
Less Plug

Plug Only

Description Wires Poles No. Each No. Each Plug Cable Bushing Dia., In. ●

Cast Iron With Box 3701

Cast Alum. Alloy Plug

10 Amp., 600 Volts, A. C., 250 Volts, D. C.
 20 Amp., 125 Volts, A. C. or D. C.

2	2	3742	\$ 7 50	3710	\$ 4 50	9/16
2	3	3743	8 00	3720	5 00	5/8
3	4	3744	8 50	3730	5 50	11/16

20 Amp., 600 Volts, A. C.—30 Amp., 250 Volts, A. C. or D. C.

2	2	3752	7 50	3740	5 00	5/8
2	3	3753	8 50	3750	6 00	5/8
3	4	3754	9 50	3760	7 00	3/4

Cast Brass With Box 3721

Cast Brass Plug

10 Amp., 600 Volts, A. C., 250 Volts, D. C.
 20 Amp., 125 Volts, A. C. or D. C.

2	2	3762	11 75	3710B	5 50	9/16
2	3	3763	12 25	3720B	6 00	5/8
3	4	3764	12 75	3730B	6 50	11/16

20 Amp., 600 Volts, A. C.—30 Amp., 250 Volts, A. C. or D. C.

2	2	3772	12 25	3740B	6 00	5/8
2	3	3773	13 25	3750B	7 00	5/8
3	4	3774	14 25	3760B	8 00	3/4

Finish — Cast iron, corrosion resisting baked enamel finish. Cast brass and aluminum, natural finish.

Gang Types — Can be furnished in gang or tandem units and in combination with other R&S type FS and FD devices.

Outlets — Unless otherwise specified, furnished with one 3/4-inch outlet top or bottom. Additional or larger outlets charged extra. Maximum conduit 1-inch, four way. Specify size and location.

●Other hole sizes available if specified on order — 10 amp.: 1/8 to 29/32-inch diameter — 20 amp.: 3/8 to 1-inch diameter.

R & S Convenience Receptacles
Types FS and FD

15 Amp., 125 Volts, A. C. or D. C.
 Two and Three Wire

Single Receptacle with Box and Cast Cover—Less Plug



No. 3908



No. 3910

Cast Iron With Box
No. 3701

Cast Brass With Box
No. 3721

Description No. Each No. Each

Weathertight—With Flap Cover

2 wire	3908	\$7 00	3918	\$12 25
2 wire, 3 pole	3908G	8 00	3918G	13 25
3 wire	3909	8 00	3919	13 25

Waterproof—With Screw Cover

2 wire	3910	7 00	3920	12 25
2 wire, 3 pole	3910G	8 00	3920G	13 25
3 wire	3911	8 00	3921	13 25

Finish — Cast iron, corrosion resisting baked enamel finish. Cast brass, natural finish.

Gang Types — Can be furnished in gang or tandem units and in combination with other R&S type FS and FD devices.

Outlets — Unless otherwise specified, furnished with one 3/4-inch outlet one end. Additional or larger outlets charged extra. Maximum conduit 1-inch, four way. Specify size and location.

Accommodate convenient type plugs.

R & S Cord Connectors and Plugs
Type FS—Waterproof

Two, Three and Four Pole—Polarized



No. 3720
 Male End



No. 3913
 Female End

Housings — Cast aluminum alloy, natural finish. Can be furnished in cast brass at \$1.00 each additional. When so required add suffix "B" to catalog number.

Finish — Cast brass and aluminum, natural finish.

		Complete Male & Female		Plug Male End Only		Connector Female End Only		
Description Wires Poles	No.	Each	No.	Each	No.	Each	No.	Each

10 Amp., 600 Volts, A. C., 250 Volts, D. C.
 20 Amp., 125 Volts, A. C. or D. C.

2	2	3902	\$11 00	3710	\$4 50	3912	\$6 50	9/16
2	3	3903	12 00	3720	5 00	3913	7 00	5/8
3	4	3904	13 00	3730	5 50	3914	7 50	11/16

20 Amp., 600 Volts, A. C. —
 30 Amp., 250 Volts, A. C. or D. C.

2	2	3922	12 00	3740	5 00	3932	7 00	5/8
2	3	3923	14 00	3750	6 00	3933	8 00	5/8
3	4	3924	16 00	3760	7 00	3934	9 00	3/4

●Cable bushing regularly furnished. Other hole sizes available if specified on order — 10 ampere: 1/8 to 29/32-inch diameter — 20 ampere: 3/8 to 1-inch diameter.

R & S Saf-T-Arc® Receptacles

Type J—Circuit Breaking
30 to 200 Amperes

Two, Three and Four Wire—Polarized
600 Volts, A-C—250 Volts, A-C or D-C



Style JRF Weathertight With Flap Cover

Complete circuit breaking safety. Quick conversion from Weathertight to Waterproof styles or Reverse Service. Basic receptacle accommodates screw cap or flap cover which may be rotated and locked in any position. Waterproof and weathertight plugs may be used interchangeably. Non-interchangeable polarization for different electrical systems available.

JRFA

Receptacles Complete—Less Plug

Style	Wires	Poles	†No.	Max. Cond.	Takes Plug No.	Each
	2*	2	JRFA322K	...	JP322K	\$12.00
	2	3	JRFA323H	...	JP323H	12.50
	3*	3	JRFA333F	...	JP333F	13.00
	3	4	JRFA334H	...	JP334H	13.50
4*	4	JRFA344F	...	JP344F	14.00	
JRFA Above have flap. Component or panel mounting.						
	2*	2	JRFA322K	1¼	JP322K	16.50
	2	3	JRFA323H	1¼	JP323H	17.00
	3*	3	JRFA333F	1¼	JP333F	17.50
	3	4	JRFA334H	1¼	JP334H	18.00
4*	4	JRFA344F	1¼	JP344F	18.50	
JRFA Above have flap, angle adapter and box.						
	2*	2	#JRFE322K	1	JP322K	14.00
	2	3	#JRFE323H	1	JP323H	14.50
	3*	3	#JRFE333F	1	JP333F	15.00
	3	4	#JRFE334H	1	JP334H	15.50
4*	4	#JRFE344F	1	JP344F	16.00	
JRFE Above have flap and angle enclosure.						
	2*	2	JRFB322K	1¼	JP322K	16.50
	2	3	JRFB323H	1¼	JP323H	17.00
	3*	3	JRFB333F	1¼	JP333F	17.50
	3	4	JRFB334H	1¼	JP334H	18.00
4*	4	JRFB344F	1¼	JP344F	18.50	
JRFB Above have flap, angle adapter and hor. box.						
	2*	2	JRFR322K	1¼	JP322K	14.00
	2	3	JRFR323H	1¼	JP323H	14.50
	3*	3	JRFR333F	1¼	JP333F	15.00
	3	4	JRFR334H	1¼	JP334H	15.50
4*	4	JRFR344F	1¼	JP344F	16.00	
JRFR Above have flap, straight adapter and box.						

†Nos. listed above are for 30A units. For other sizes, change first digit 3 to 6 for 60A, to 10 for 100A, to 20 for 200A.

*Available in 30A size only.

#Available in 30A and 60A sizes only.

Housings—Cast aluminum alloy. Natural finish. Gang units can be furnished. Prices on request.

Outlets—Unless otherwise specified, furnished with one outlet as follows: 30A—¾-in., 60A—1¼-in., 100A—1½-in., 200A—2-in. Extra charge for change. Max. Conduit: 60A & 100A 2-in., except JRFE—1½-in., 200A—3-in. Specify size and location.

*Grounds through enclosure. Others through separate pole. For Reverse Service add final suffix "R" to number. Prices on request.

R & S Saf-T-Arc® Plugs and Cable Connectors

Type J—Circuit Breaking
30 to 200 Amperes

Two, Three and Four Wire—Polarized
600 Volts, A-C—250 Volts, A-C or D-C

Weathertight With Flap Cover on Connector



Style JCF Connector



Style JP Plug

Wires	Poles	Plugs Male End Only		Connectors Female End Only		Cable Bushing Hole Diam. In. #
		No.	Each	No.	Each	
30 Amperes						
*2	2	JP322K	\$12.50	JCF322K	\$14.00	7/8
2	3	JP323H	13.00	JCF323H	14.50	7/8
*3	3	JP333F	13.50	JCF333F	15.00	7/8
3	4	JP334H	14.00	JCF334H	15.50	7/8
*4	4	JP344F	14.50	JCF344F	16.00	7/8
60 Amperes						
*2	2	JP622K	16.00	JCF622K	23.00	1 1/16
2	3	JP623H	17.00	JCF623H	24.00	1 1/16
*3	3	JP633F	18.00	JCF633F	25.00	1 1/16
3	4	JP634H	19.00	JCF634H	26.00	1 1/16
*4	4	JP644F	20.00	JCF644F	27.00	1 1/16
100 Amperes						
*2	2	JP1022K	24.00	JCF1022K	31.00	1 1/2
2	3	JP1023H	25.00	JCF1023H	32.00	1 1/2
*3	3	JP1033F	26.00	JCF1033F	33.00	1 1/2
3	4	JP1034H	27.00	JCF1034H	34.00	1 1/2
*4	4	JP1044F	28.00	JCF1044F	35.00	1 1/2
200 Amperes						
*2	2	JP2022K	POA	JCF2022K	POA	2
2	3	JP2023H	POA	JCF2023H	POA	2
*3	3	JP2033F	POA	JCF2033F	POA	2
3	4	JP2034H	POA	JCF2034H	POA	2
*4	4	JP2044F	POA	JCF2044F	POA	2

Housings—Cast aluminum alloy. Natural finish. Plugs also fit type J Waterproof receptacles and connectors.

#Cable bushing regularly furnished with hole size as listed. Other sizes available as per table below at no extra cost, if specified on order. Specify hole size desired.

Hole Diam. Range, In....	Ampere Rating of Plug or Connector			
	30	60	100	200
3/8-1	5/8-1 3/8	3/4-1 1/8	1-2 1/2	

*Have provision for equipment grounding through enclosure only; all others have equipment ground through separate pole.

For Reverse Service add final suffix "R" to number. POA—Prices on Application.

R & S Saf-T-Arc® Receptacles
Type J—Circuit Breaking
30 to 200 Amperes

Two, Three and Four Wire—Polarized
 600 Volts, A-C—250 Volts, A-C or D-C

Style JRS Waterproof With Screw Cap

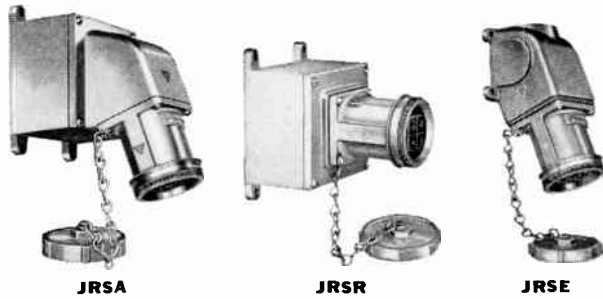

For description see listings of Style JRF.

Receptacles Complete—Less Plug

Style	Wires	Poles	†No.	Max. Cond.	Takes Plug No.	Each
	2*	2	JRS322K	...	JPS322K	\$11.00
	2	3	JRS323H	...	JPS323H	11.50
	3*	3	JRS333F	...	JPS333F	12.00
	3	4	JRS334H	...	JPS334H	12.50
4*	4	JRS344F	...	JPS344F	13.00	
JRS	Have screw cap. Component or panel-mounting.					
	2*	2	JRSA322K	1¼	JPS322K	15.50
	2	3	JRSA323H	1¼	JPS323H	16.00
	3*	3	JRSA333F	1¼	JPS333F	16.50
	3	4	JRSA334H	1¼	JPS334H	17.00
4*	4	JRSA344F	1¼	JPS344F	17.50	
JRSA	Above have screw cap, angle adapter and box.					
	2*	2	#JRSE322K	1	JPS322K	13.00
	2	3	#JRSE323H	1	JPS323H	13.50
	3*	3	#JRSE333F	1	JPS333F	14.00
	3	4	#JRSE334H	1	JPS334H	14.50
4*	4	#JRSE344F	1	JPS344F	15.00	
JRSE	Above have screw cap and angle enclosure.					
	2*	2	:JRSH322K	1¼	JPS322K	15.50
	2	3	:JRSH323H	1¼	JPS323H	16.00
	3*	3	:JRSH333F	1¼	JPS333F	16.50
	3	4	:JRSH334H	1¼	JPS334H	17.00
4*	4	:JRSH344F	1¼	JPS334F	17.50	
JRSH	Have screw cap, angle adapter and hor. box.					
	2*	2	JRSR322K	1¼	JPS322K	13.00
	2	3	JRSR323H	1¼	JPS323H	13.50
	3*	3	JRSR333F	1¼	JPS333F	14.00
	3	4	JRSR334H	1¼	JPS334H	14.50
4*	4	JRSR344F	1¼	JPS344F	15.00	
JRSR	Have screw cap, straight adapter and box.					

†Nos. listed are for 30A units. For other sizes change first digit 3 to 6 for 60A, to 10 for 100A, to 20 for 200A.
 *Available in 30A size only.
 #Available in 30A and 60A sizes only.
Housings—Cast aluminum alloy. Natural finish.
Outlets—Unless otherwise specified, furnished with one outlet as follows: 30A—¾-in., 60A—1¼-in., 100A—1½-in., 200A—2-in. Extra charge for change. Max. conduit: 60A and 100A—2-in., except type JRSE 1½-in.; 200A—3-in. Specify size and location.
 *Have provision for equipment grounding through enclosure only; all others through separate pole.
 For Reverse Service add final suffix "R" to number. Gang units can be furnished. Prices on application.

R & S Saf-T-Arc® Plugs
and Cable Connectors

Type J—Circuit Breaking
30 to 200 Amperes

Two, Three and Four Wire—Polarized
 600 Volts, A-C—250 Volts, A-C or D-C

Waterproof
With Screw Cap On Connector

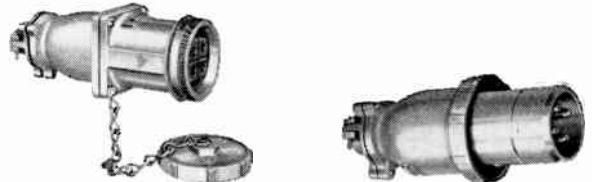

Wires	Poles	Plugs—Male End Only		Connectors—Female End Only		Cable Bushing Hole Diam. In. #
		No.	Each	No.	Each	
*2	2	JPS322K	\$13.50	JCS322K	\$13.00	7/8
2	3	JPS323H	14.00	JCS323H	13.50	7/8
*3	3	JPS333F	14.50	JCS333F	14.00	7/8
3	4	JPS334H	15.00	JCS334H	14.50	7/8
*4	4	JPS344F	15.50	JCS344F	15.00	7/8

60 Ampere

*2	2	JPS622K	18.00	JCS622K	22.50	1 3/16
2	3	JPS623H	19.00	JCS623H	23.50	1 3/16
*3	3	JPS633F	20.00	JCS633F	24.50	1 3/16
3	4	JPS634H	21.00	JCS634H	25.50	1 3/16
*4	4	JPS644F	22.00	JCS644F	26.50	1 3/16

100 Amperes

*2	2	JPS1022K	26.50	JCS1022K	30.50	1 1/2
2	3	JPS1023H	27.50	JCS1023H	31.50	1 1/2
*3	3	JPS1033F	28.50	JCS1033F	32.50	1 1/2
3	4	JPS1034H	29.50	JCS1034H	33.50	1 1/2
*4	4	JPS1044F	30.50	JCS1044F	34.50	1 1/2

200 Amperes

*2	2	JPS2022K	POA	JCS2022K	POA	2
2	3	JPS2023H	POA	JCS2023H	POA	2
*3	3	JPS2033F	POA	JCS2033F	POA	2
3	4	JPS2034H	POA	JCS2034H	POA	2
*4	4	JPS2044F	POA	JCS2044F	POA	2

Housing—Cast Aluminum alloy. Natural Finish.

Plugs also fit Type "J" Weathertight receptacles and connectors.

#Cable bushing regularly furnished with hole size as listed. Other sizes available as per table below at no extra cost, if specified on order. Specify hole size required.

Hole Diam. Range, In..	Ampere Rating of Plug or Connector			
	30	60	100	200
	3/8-1	5/8-1 3/8	3/4-1 7/8	1-2 1/2

*Have provision for equipment grounding through enclosure only; all others have equipment ground through separate pole.

For Reverse Service add final suffix "R" to number.

POA—Prices on application.

Crouse-Hinds Condulets



Graybar distributes the complete line of Crouse-Hinds Condulets. The extensive listing on the following pages is sufficiently complete for most applications. When more complete information on Condulets is needed, ask your Graybar representative or refer to Crouse-Hinds Catalogs 3000 or 3100.



Discount Schedule: Unless otherwise specified, Condulets carry Crouse-Hinds CD Schedule of terms and discounts.

Finish: Unless otherwise indicated, the standard finish is cadmium-galvanized.

Material: Unless otherwise indicated, all Condulets are made of Feraloy, a special Crouse-Hinds alloy. Crouse-Hinds "complete line" is more than just a range of sizes—there is a Condulet for every need and purpose.

Feraloy is a special alloy having the desirable characteristics of both cast steel and gray iron. It is the result of many years of study and development. Feraloy possesses high tensile strength and unusual resistance to corrosion.

Condulets will be found to stand up under the trying conditions of installation and subsequent use.

(Condulets are made only by Crouse-Hinds)

AR Series Condulets

AR Series Condulets take Arktite receptacle housings.

Type ARRH

Size In.	Form B Condulets Take 20 and 30 Amp. Housings		Form C Condulets Take 60-Amp. Housings	
	No.	Each	No.	Each
1/2	ARRH13	\$1.80	ARRH16	\$2.60
3/4	ARRH23	2.00	ARRH26	2.80
1	ARRH33	2.20	ARRH36	3.00
1 1/4	ARRH46	3.20	
1 1/2	ARRH56	3.40	



Type ARRC

1/2	ARRC13	\$2.00	ARRC16	\$2.80
3/4	ARRC23	2.20	ARRC26	3.00
1	ARRC33	2.40	ARRC36	3.20
1 1/4	ARRC46	3.40	
1 1/2	ARRC56	3.60	



Type ARE

1/2	ARE13	\$2.00	ARE16	\$2.90
3/4	ARE23	2.20	ARE26	3.10
1	ARE33	2.40	ARE36	3.30
1 1/4	ARE46	3.50	
1 1/2	ARE56	3.70	



Type ARDF

1/2	ARDF13	\$2.30	ARDF16	\$3.20
3/4	ARDF23	2.50	ARDF26	3.40
1	ARDF33	2.70	ARDF36	3.60
1 1/4	ARDF46	3.80	
1 1/2	ARDF56	4.00	



Type ARJ

1/2	ARJ13	\$2.60	ARJ16	\$3.50
3/4	ARJ23	2.80	ARJ26	3.70
1	ARJ33	3.00	ARJ36	3.90
1 1/4	ARJ46	4.10	
1 1/2	ARJ56	4.30	



Type ARD

1/2	ARD13	\$2.90	ARD16	\$3.80
3/4	ARD23	3.10	ARD26	4.00
1	ARD33	3.30	ARD36	4.20
1 1/4	ARD46	4.40	
1 1/2	ARD56	4.60	



AR Series Condulets

AR Series Condulets take Arktite receptacle housings.

Type ARJG

Size In.	Form B Condulets Take 20 and 30 Amp. Housings		Form C Condulets Take 60-Amp. Housings	
	No.	Each	No.	Each
1/2	ARJG13	\$2.40	ARJG16	\$3.40
3/4	ARJG23	2.60	ARJG26	3.60
1	ARJG33	2.80	ARJG36	3.80
1 1/4	ARJG46	4.00	
1 1/2	ARJG56	4.20	



Type ARJK

1/2	ARJK13	\$2.00	ARJK16	\$2.90
3/4	ARJK23	2.20	ARJK26	3.10
1	ARJK33	2.40	ARJK36	3.30
1 1/4	ARJK46	3.50	
1 1/2	ARJK56	3.70	



Type ARJP

1/2	ARJP13	\$2.00	ARJP16	\$2.90
3/4	ARJP23	2.20	ARJP26	3.10
1	ARJP33	2.40	ARJP36	3.30
1 1/4	ARJP46	3.50	
1 1/2	ARJP56	3.70	



Type ARRA

1/2	ARRA13	\$1.80	ARRA16	\$2.60
3/4	ARRA23	2.00	ARRA26	2.80
1	ARRA33	2.20	ARRA36	3.00
1 1/4	ARRA46	3.20	
1 1/2	ARRA56	3.40	



15° Angle Adapters

For types ARRA, ARRC, and ARRH Condulets. Adapters listed below are furnished with gaskets and take Arktite receptacle housings.

AR30	\$3.00	AR60	\$4.00
------	--------	------	--------



AJ Series Condulets

Type AJ With 60-Ampere Straight Adapter, Form C

No.	Size, In.	Each
AJ23	3/4	\$14.00
AJ33	1	14.10
AJ43	1 1/4	14.20
AJ53	1 1/2	14.30
AJ63	2	14.40



Type AJC With 60-Ampere Straight Adapter, Form C

AJC23	3/4	\$14.30
AJC33	1	14.50
AJC43	1 1/4	14.70
AJC53	1 1/2	14.90
AJC63	2	15.10



Type AJ With 100-Ampere Straight Adapter, Form D

AJ24	3/4	\$14.80
AJ34	1	14.90
AJ44	1 1/4	15.00
AJ54	1 1/2	15.10
AJ64	2	15.20



Crouse-Hinds Condulets

AJ Series Condulets and Conduit Hub Plates

Type AJC With 100-Ampere Straight Adapter, Form D



No.	Size In.	Each
AJC24	3/4	\$15.10
AJC34	1	15.30
AJC44	1 1/4	15.50
AJC54	1 1/2	15.70
AJC64	2	15.90

Type AJ With 60 and 100-Ampere Angle Adapter, Forms C and D

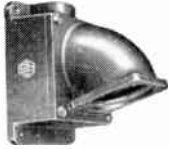

No.	Size In.	Each
AJ27	3/4	\$15.30
AJ37	1	15.40
AJ47	1 1/4	15.50
AJ57	1 1/2	15.60
AJ67	2	15.70

Type AJC With 60 and 100-Ampere Angle Adapter, Forms C and D



No.	Size In.	Each
AJC27	3/4	\$15.60
AJC37	1	15.80
AJC47	1 1/4	16.00
AJC57	1 1/2	16.20
AJC67	2	16.40

Type AJ With 200-Ampere Angle Adapter, Form E

No.	Size, In.	Each
AJ58	1 1/2	\$27.90
AJ68	2	28.10
AJ78	2 1/2	28.30

Type AJ With 400-Ampere Angle Adapter, Form F

No.	Size, In.	Each
AJ69	2	\$63.10
AJ79	2 1/2	63.30
AJ89	3	63.50

Type AJX

Furnished with Gaskets for Hub Plates
Takes Four Hub Plates



No.	Condulet	Each	Rating	Series	No.	Adapter	Each
AJX88		\$19.10	200 Amp.	YYP8	AJ45		\$12.10
AJX99		37.90	400 Amp.	YYP9	AJ245		22.40



Hub Size	No.	YYP8 Series Each	No.	YYP9 Series Each	Each
2 1/2	YYP87	\$2.30	YYP800		\$0.80
2 1/2	YYP97	7.50	YYP900		5.50
3	YYP98	8.00		

Call Graybar FIRST For

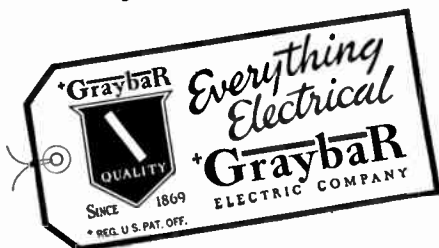

Oround Series Condulets

Oround Condulets of the same size take the same covers and wiring devices.

Threaded for Rigid Conduit (Thick Wall)

Type A



No.	Each	Size In.
A17	\$0.70	1/2
A27	.80	3/4
A37	1.10	1
A47	1.80	1 1/4
A57	2.50	1 1/2
A67	4.50	2
A77	9.00	2 1/2
A87	11.00	3
A97	16.00	3 1/2
A107	20.00	4

Type B*



No.	Each
B17	\$0.70
B27	.80
B37	1.50
B47	2.50
B57	3.00
B67	5.20
B77	17.00
B87	18.00
B97	30.50
B107	34.00

Type C



No.	Each	Size In.
C17	\$0.80	1/2
C27	.95	3/4
C37	1.45	1
C47	2.30	1 1/4
C57	3.00	1 1/2
C67	5.00	2
C77	10.50	2 1/2
C87	14.00	3
C97	23.00	3 1/2
C107	26.00	4

Type E



No.	Each
E17	\$0.70
E27	.80
E37	1.10
E47	1.70
E57	2.40
E67	4.40
E77	9.00
E87	11.00
E97	16.00
E107	19.00

*One-piece body, 1/2 to 1 inch; two-piece body, 1 1/4 to 4 inch.

Type T‡

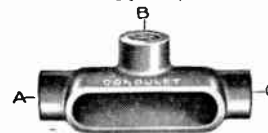

Type TB‡

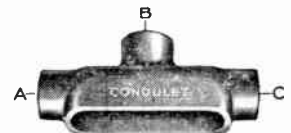

No.	Each	Size In. A.B.C.	No.	Each
T17	\$1.00	1/2-1/2-1/2	TB17	\$1.10
T127	1.20	1/2-3/4-1 1/2	
T217	1.30	3/4-1-3/4	
T27	1.20	3/4-3/4-3/4	TB27	1.30
T237	1.40	3/4-1-3/4	
T317	1.90	1-1-1	
T327	1.90	1-3/4-1	
T37	1.80	1-1-1	TB37	1.90
T417	2.90	1 1/4-1 1/2-1 1/4	
T427	2.90	1 1/4-3/4-1 1/4	
T437	2.90	1 1/4-1-1 1/4	
T47	2.70	1 1/4-1 1/4-1 1/4	TB47	2.90
T517	3.80	1 1/2-1-1 1/2	
T527	3.80	1 1/2-3/4-1 1/2	
T537	3.80	1 1/2-1-1 1/2	
T547	3.80	1 1/2-1 1/4-1 1/2	
T57	3.60	1 1/2-1 1/2-1 1/2	TB57	3.80
T647	5.80	2-1 1/4-2	
T657	5.80	2-1 1/4-2	
T67	5.60	2-2-2	TB67	6.00
T77	11.00	2 1/2-2 1/2-2 1/2	TB77	12.00
T87	16.00	3-3-3	TB87	17.00
T97	25.00	3 1/2-3 1/2-3 1/2	TB97	27.00
T107	28.00	4-4-4	TB107	29.00

‡The size of the cover or wiring device is the same size of hubs at ends of cover opening.

Crouse-Hinds Condulets

Obround Series

Threaded for Rigid Conduit (Thick Wall)

Type L†



No.	Each	Size In.
L.17	\$0.90	1/2
L.27	1.10	3/4
L.37	1.50	1
L.47	3.20	1 1/4
L.57	4.40	1 1/2
L.67	6.30	2

Type TA



No.	Each
TA17	\$1.40
TA27	1.80
TA37	2.40
TA47	3.40
TA57	4.60
TA67	8.00

Type LB



No.	Each	Size In.
LB17	\$0.80	1/2
LB27	.95	3/4
LB37	1.45	1
LB47	2.30	1 1/4
LB57	3.00	1 1/2
LB67	5.00	2
LB777	10.50	2 1/2
LB87	14.00	3
LB97	23.00	3 1/2
LB107	26.00	4

Type LR



No.	Each
LR17	\$0.80
LR27	.95
LR37	1.45
LR47	2.30
LR57	3.00
LR67	5.00
LR777	10.50
LR87	14.00
LR97	23.00
LR107	26.00

Type LL



No.	Each	Size In.
LL17	\$0.80	1/2
LL27	.95	3/4
LL37	1.45	1
LL47	2.30	1 1/4
LL57	3.00	1 1/2
LL67	5.00	2
LL777	10.50	2 1/2
LL87	14.00	3
LL97	21.20	3 1/2
LL107	26.00	4

Type LF



No.	Each
LF17	\$.90
LF27	1.10
LF37	1.50
LF47	3.20
LF57	4.40
LF67	6.30
LF777	12.00
LF87	15.00
LF97	25.00
LF107	28.00

Type COV



No.	Each	Size Pipe Crossed In.
COV147	\$1.00	1 1/4
COV247	1.30	1 3/4
COV347	1.60	1 3/4
COV457	2.60	1 1/2
COV567	3.40	2
COV677	6.50	2 1/2

Type CUB



No.	Each	Size Pipe Crossed In.
CUB127	\$1.50	3/4
CUB147	1.70	1 1/4
CUB247	1.90	1 1/4
CUB347	2.80	1 1/4
CUB457	3.80	1 1/2
CUB567	4.80	2
CUB677	9.60	2 1/2

Obround Series

Threaded for Rigid Conduit (Thick Wall)

Type F



No.	Each	Size In.
F17	\$1.40	1/2
F27	2.00	3/4
F37	2.90	1
F47	5.60	1 1/4
F57	7.00	1 1/2
F67	10.00	2
F77	19.00	2 1/2
F87	21.00	3
F97	39.00	3 1/2
F107	50.00	4
FO117	90.00	4 1/2
FO127	95.00	5
FO147	100.00	6

Type CO



No.	Each
CO17	\$1.00
CO27	1.30
CO37	1.60
CO47	2.60
CO57	3.40
CO67	6.50
CO777	11.50
CO87	16.00
CO97	26.00
CO107	32.00

Type U



No.	Each	Size In.
U17	\$1.00	1/2
U27	1.20	3/4
U37	1.80	1
U47	2.70	1 1/4
U57	3.60	1 1/2
U67	6.00	2
U777	12.00	2 1/2
U87	16.00	3
U97	27.00	3 1/2
...	4

Type UB



No.	Each
UB17	\$1.00
UB27	1.20
UB37	1.80
UB47	2.70
UB57	3.60
UB67	6.00
UB777	12.00
UB87	16.00
UB97	27.00
UB107	30.00

Type X†

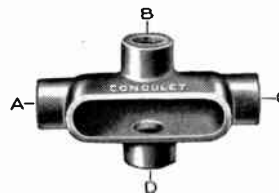

No.	Each	Size, In. A-B-C-D
X17	\$1.30	1/2-1/2-1/2-1/2
X217	1.80	3/4-1/2-3/4-1/2
X27	1.60	3/4-3/4-3/4-3/4
X317	2.50	1-1/2-1-1/2
X327	2.50	1-3/4-1-3/4
X37	2.20	1-1-1-1
X417	3.50	1 1/4-1/2-1 1/4-1/2
X427	3.50	1 1/4-3/4-1 1/4-3/4
X47	3.40	1 1/4-1 1/4-1 1/4-1 1/4
X527	5.00	1 1/2-3/4-1 1/2-3/4
X57	4.00	1 1/2-1 1/2-1 1/2-1 1/2
X67	7.00	2-2-2-2
X77	13.00	2 1/2-2 1/2-2 1/2-2 1/2
X87	20.00	3-3-3-3

Type XA



No.	Each
XA17	\$2.00
XA27	2.30
XA37	2.90

†Type L Condulets have two openings, with one blank sheet steel cover. Can be used for either an LL or LR.

†The size of the cover or wiring device is the same size of hubs at ends of cover opening.

Crouse-Hinds Condulets

Obround Series

Threadless



For EMT (Thin Wall)

Illustrations shown above listings are for Rigid Conduit (Thick Wall).

Type A



Thick Wall No.	Each	Thin Wall No.	Each	Size In.
A197	\$0.90	A17-MT	\$0.90	1/2
A297	1.15	A27-MT	1.10	3/4
A397	1.55	A37-MT	1.50	1
A497	3.05	1 1/4
A597	4.00	1 1/2
A697	7.00	2

Type B*



Thick Wall No.	Each	Thin Wall No.	Each
B197	\$0.90	B17-MT	\$0.90
B297	1.15	B27-MT	1.10
B397	1.55	B37-MT	1.50
B497	3.75
B597	4.50
B697	7.70

Type C



Thick Wall No.	Each	Thin Wall No.	Each	Size In.
C197	\$1.20	C17-MT	\$1.20	1/2
C297	1.65	C27-MT	1.55	3/4
C397	2.35	C37-MT	2.25	1
C497	4.80	C47-MT	3.70	1 1/4
C597	6.00	C57-MT	5.00	1 1/2
C697	10.00	C67-MT	8.00	2
.....	2 1/2
.....	3

Type E



Thick Wall No.	Each	Thin Wall No.	Each
E197	\$0.90	E17-MT	\$0.90
E297	1.15	E27-MT	1.10
E397	1.55	E37-MT	1.50
E497	2.95
E597	3.90
E697	6.90
E797	18.00
E897	21.00

Type LR



Thick Wall No.	Each	Thin Wall No.	Each	Size In.
LR197	\$1.20	LR17-MT	\$1.20	1/2
LR297	1.65	LR27-MT	1.55	3/4
LR397	2.35	LR37-MT	2.25	1
LR497	4.80	LR47-MT	3.70	1 1/4
LR597	6.00	LR57-MT	5.00	1 1/2
LR697	10.00	LR67-MT	8.00	2
LR797	28.50	2 1/2
LR897	34.00	3
.....	3 1/2
.....	4

Type T



Thick Wall No.	Each	Thin Wall No.	Each
T197	\$1.60	T17-MT	\$1.60
T297	2.25	T27-MT	2.10
T397	3.15	T37-MT	3.00
T497	6.45	T47-MT	4.80
T597	8.10	T57-MT	6.60
T697	13.10	T67-MT	10.10
T797	38.00
T897	46.00
T997	64.00
T10097	73.00

*One-piece body, 1/2 to 1 inch; two-piece body, 1 1/4 to 4 inch.

†Size of hubs for T127-MT: 1/2, 3/4, 1/2.

Obround Series

Threadless

Type LB



Type LL



Thick Wall No.	Each	Thin Wall No.	Each	Size In.	Thick Wall No.	Each	Thin Wall No.	Each
LB197	\$1.20	LB17-MT	\$1.20	1/2	LL197	\$1.20	LL17-MT	\$1.20
LB297	1.65	LB27-MT	1.55	3/4	LL297	1.65	LL27-MT	1.55
LB397	2.35	LB37-MT	2.25	1	LL397	2.35	LL37-MT	2.25
LB497	4.80	LB47-MT	3.70	1 1/4	LL497	4.80	LL47-MT	3.70
LB597	6.00	LB57-MT	5.00	1 1/2	LL597	6.00	LL57-MT	5.00
LB697	10.00	LB67-MT	8.00	2	LL697	10.00	LL67-MT	8.00
LB797	28.50	2 1/2	LL797	28.50
LB897	34.00	3	LL897	34.00
LB997	49.00	3 1/2
LB1097	56.00	4

Type X



Type L††



Thick Wall No.	Each	Thin Wall No.	Each	Size In.	Thick Wall No.	Each	Thin Wall No.	Each
X197	\$2.10	X17-MT	\$2.10	1/2	L197	\$1.30	L17-MT	\$1.30
X297	3.00	X27-MT	2.80	3/4	L297	1.80	L27-MT	1.70
X397	4.00	X37-MT	3.80	1	L397	2.40	L37-MT	2.30
X497	8.10	X47-MT	5.90	1 1/4	L497	4.97	L47-MT	4.60
X597	10.00	X57-MT	8.00	1 1/2	L597	7.40	L57-MT	6.40
X697	17.00	X67-MT	13.00	2	L697	11.30	L67-MT	9.30

Gaskets

Solid Type



For use with blank sheet steel and cast Feraloy covers.

Size In.	Rubber	Cork	Vellumoid	Each
1/2	Gask 571	Gask 671	Gask 771	\$.20
3/4	Gask 572	Gask 672	Gask 772	.20
1	Gask 573	Gask 673	Gask 773	.30
1 1/4	Gask 574	Gask 674	Gask 774	.40
1 1/2	Gask 575	Gask 675	Gask 775	.40
2	Gask 576	Gask 676	Gask 776	.50
2 1/2 or 3	Gask 578	Gask 678	Gask 778	.80
3 1/2 or 4	Gask 579	Gask 679	Gask 779	1.00

Open Type



For use with blank composition covers, wire-hole covers, and wiring devices.

Size In.	Rubber	Cork	Vellumoid	Each
1/2	Gask 471	Gask 371	\$.20
3/4	Gask 472	Gask 37220
1	Gask 473	Gask 37330
1 1/4	Gask 474	Gask 37440
1 1/2	Gask 475	Gask 37540
2	Gask 476	Gask 37650
2 1/2 or 3	Gask 478	Gask 37880
3 1/2 or 4	Gask 479	Gask 379	1.00

††Type L Condulets have two openings, with one blank sheet steel cover. Can be used for either an LL or an LR.

Crouse-Hinds Condulets

Covers for Obround Series Condulets

Blank Covers

Special drilling at additional charge: Up to 1" diam., \$0.30 per hole; 1" and larger, \$0.50 per hole.



Sheet Steel		Cast Feraloy		Composition	
Size	No. Each	No. Each	No. Each	No. Each	No. Each
1/2	170 \$.15	170F \$.35	1770 \$.30		
3/4	270 .20	270F .45	2770 .40		
1	370 .35	370F .70	3770 .60		
1 1/4	470 .50	470F 1.00	4770 1.00		
1 1/2	570 .50	570F 1.00	5770 1.00		
2	670 .85	670F 1.40	6770 1.20		
2 1/2 or 3	870 1.30	870F 1.70	8770 3.20		
3 1/2 or 4	970 1.60	970F 2.50	9770 5.00		
4 1/2, 5 or 6	14770 8.00		

**Knockout Covers*
Composition**

1, 2 or 3-Wire

Size	Diam. Knockouts	No.	Each
1/2	1-1/16	1773	\$.30
	2-5/16		
3/4	3-1/16	2773	.40
1	3-1/2	3773	.60

2, 3, 4 or 5-Wire

1 1/4	5-9/16	4775	\$.80
1 1/2	5-11/16	5775	.80
2	2-11/16	6775	1.20
	3-7/8		

Wire Hole Covers*

Porcelain and Composition



1-Wire†

1-Wire Special†

Size	Dia. Holes	Porcelain		Composition	
		No.	Each	No.	Each
1/2	5/8	1771S	\$.30
3/4	25/32	2771S	.40
1	1	3771S	.60
1 1/4	1 1/8	4771S	1.00

1-Wire Standard†

1 1/2	1 3/8	571	\$.80	5771	\$1 00
2	1 3/4	6771	1.20
2 1/2 or 3	2 5/16	871	2.50	8771	3.20
3 1/2 or 4	3 1/4	971	4.00	9771	5.00
4 1/2, 5 or 6	3 3/4	14771	8.00

*For special drilling use blank composition covers.

†Use knockout covers for sizes not shown.

Covers for Obround Series Condulets

Wire Hole Covers*

Porcelain and Composition



2-Wire†

Size	Diam. Holes	Porcelain		Composition	
		No.	Each	No.	Each
2 1/2 or 3	1 7/16	872	\$2.50	8772	\$3.20
3 1/2 or 4	1 15/16	972	4.00	9772	5.00
4 1/2, 5 or 6	2 1/4	14772	8.00



3-Wire†

2 1/2 or 3	1 7/16	873	\$2.50	8773	\$3.20
3 1/2 or 4	1 15/16	973	4.00	9773	5.00
4 1/2, 5 or 6	2 1/4	14773	8.00



4-Wire†

1/2	5/16	1774	\$.30
3/4	5/16	2774	.40
1	13/32	3774	.60
2 1/2 or 3	1 7/16	874	\$2.50	8774	3.20
3 1/2 or 4	1 15/16	974	4.00	9774	5.00
4 1/2, 5 or 6	1 7/8	14774	8.00



5-Wire†

3/4	5/16	2775	\$.30
1	13/32	3775	.50
2 1/2 or 3	1 7/16	875	\$2.50	8775	3.20
3 1/2 or 4	1 15/16	9775	5.00
4 1/2, 5 or 6	1 9/16	14775	8.00



6-Wire

3/4	5/16	2776	\$.30
1	3/8	3776	.50
1 1/4	1 1/2	476	\$.80	4776	1.00
1 1/2	1 7/32	576	.80	5776	1.00
2	5/4	6776	1.20
2 1/2 or 3	7/8	8776	3.20
3 1/2 or 4	1 3/16	9776	5.00
4 1/2, 5 or 6	1 9/16	14776	8.00

*For special drilling use blank composition covers.

†Use knockout covers for sizes not shown.

Sheet Steel Covers with Cord Clamps

Provided with cord clamp and bushed hole which safeguards the drop cord. Takes cord 1/4 to 3/8-inch diameter.



Size In.	No.	Each
1/2	1972	\$.70
3/4	2972	.80

Crouse-Hinds Condulets

Wiring Devices for Obround Series

Condulets

2-Pole Attachment Plug Receptacles

15 Amp., 125V., or 10 Amp., 250V.

Single with Double T Slots

Size In.	Composition		Porcelain	
	No.	Each	No.	Each
1/2	1715	\$1.20	1705	\$1.35
3/4	2715	1.40	2705	1.55
1	3715	1.80	3705	2.00

Composition

Size In.	Composition		Porcelain	
	No.	Each	No.	Each
1/2	1748	\$1.35
3/4	2748	1.55
1	3748	2.00

Composition

Duplex, with Parallel Slots

Size In.	Composition		Porcelain	
	No.	Each	No.	Each
1/2	1725	\$1.80
3/4	2725	2.00
1	3725	2.50

Composition

Duplex, with Double T Slots

2-Pole Polarity Plug Receptacles

15 Amp., 125V. or 10 Amp., 250V.

*1728	\$1.20	*1708	\$1.35
*2728	1.40	*2708	1.55
*3728	1.80	*3708	2.00

20 Amperes, 250 Volts

1738	\$1.45	1718	\$1.45
2738	1.65	2718	1.65
3738	2.15	3718	2.15

Composition

Attachment Plug Receptacles 3-Wire, 3-Pole

15 Amp., 125V. or 10 Amp., 250V.

.....	1709	\$1.65
.....	2709	1.75

20 Amperes, 250 Volts

.....	1719	\$2.00
.....	2719	2.20

Porcelain 3-Wire

2-Wire, 3-Pole Extra Pole Grounded

15 Amp., 125V. or 10 Amp., 250 V.

.....	1729	\$1.85
.....	2729	2.00

20 Amperes, 250 Volts

.....	1739	\$2.20
.....	2739	2.40

Lamp Receptacles

660 Watts, 600 Volts

With Shade Holder Groove

1726	\$1.00	1706	\$1.00
2726	1.10	2706	1.10
3726	1.60	3706	1.60

Composition, With Groove

Cord Rosettes

660 Watts, 250 Volts

1720	\$1.90	1700	\$1.35
2720	2.10	2700	1.60
3720	2.50	3700	2.00

Composition

*Takes Hubbell No. 5567 polarized plug.

Prices for receptacles listed above do not include attachment plugs.

If specified on the order, lamp receptacle with lamp grip will be furnished at an advance in price of 20 cents.

Cast Aluminum Covers

Take P&S-Despard, Bryant, Hubbell, Arrow-H&H and GE Interchangeable wiring devices. Mounting bridge furnished.

Without Guard

Size In.	No.	Each
1/2	1755	\$0.60
3/4	2755	.80

With Guard—For Switches Only

Size In.	No.	Each
1/2	1785	\$0.70

Vaportight Switch Covers

With gasket and mounting strap for switches. Take P&S-Despard, Bryant, Hubbell, Arrow-H&H, and G-E Interchangeable switches.

Size In.	No.	Each
1/2	1766	\$2.80
3/4	2766	3.00
1	3766	3.20

Cast Feraloy Covers with Nipples



With Male Nipple

With Female Nipple

With 3/8-Inch Nipple

Size In.	No.	Each	Size In.	No.	Each
1/2	1723	\$0.75	1/2	1733	\$0.65
3/4	2723	.90	3/4	2733	.80

With 1/2-Inch Nipple

1/2	1724	\$0.80	1/2	1734	\$0.70
3/4	2724	.90	3/4	2734	.80
1	3724	1.20	1	3734	1.00
1 1/4	4724	1.50	1 1/4	4734	1.25
1 1/2	5724	1.50	1 1/2	5734	1.25

Adapters for Obround Series Condulets

Size In.	No.	Each
1	731	\$0.70
1 1/4	741	1.00
1 1/2	751	1.40
2	761	1.80

Type LBD Condulets

For use when it is necessary to make a 90° bend in the conduit system. Arrangement of cover opening allows condulets to be pulled straight through either hub. Furnished with blank cast Feraloy cover.

Size In.	No.	Each
1/2	LBD1100	\$1.30
3/4	LBD2200	1.60
1	LBD3300	2.40
1 1/4	LBD4400	6.50
1 1/2	LBD5500	11.50
2	LBD6600	12.50
2 1/2	LBD7700	23.50
3	LBD8800	28.50
3 1/2	LBD9900	46.50
4	LBD10900	52.00
4 1/2	LBD011	70.00
5	LBD012	80.00
6	LBD014	150.00

Gaskets for LBD Condulets

Size In.	No.	Each	Size In.	No.	Each
1/2	Gask 680R	\$.20	2 1/2 or 3	Gask 685R	\$3.00
3/4	Gask 681R	.30	3 1/2 or 4	Gask 686R	3.50
1	Gask 682R	.40	4 1/2 or 5	Gask 687R	7.00
1 1/4	Gask 683R	.60	6	Gask 688R	10.00
1 1/2 or 2	Gask 684R	1.20

Crouse-Hinds Condulets

Mogul Series Condulets

Type BC



Size In.	No.	Each
1	BC3	\$3.80
1 1/4	BC4	4.30
1 1/2	BC5	8.30
2	BC6	10.00
2 1/2	BC7	15.20
3	BC8	20.40
3 1/2	BC9	32.70
4	BC10	40.00

Type BT



Size In.	No.	Each
1	BT3	\$4.50
1 1/4	BT4	5.00
1 1/2	BT5	9.30
2	BT6	11.20
2 1/2	BT7	15.60
3	BT8	22.40
3 1/2	BT9	33.70
4	BT10	42.00

Type BEE



Size In.	No.	Each
1	BEE3	\$3.40
1 1/4	BEE4	3.80
1 1/2	BEE5	7.40
2	BEE6	9.00
2 1/2	BEE7	13.60
3	BEE8	17.40
3 1/2	BEE9	28.00
4	BEE10	34.00

Type BTB



Size In.	No.	Each
1 1/4	BTB3	\$4.50
1 1/2	BTB4	5.00
1 1/2	BTB5	9.30
2	BTB6	11.20
2 1/2	BTB7	15.60
3	BTB8	22.40
3 1/2	BTB9	33.70
4	BTB10	42.00

Type BLB



Size In.	No.	Each
1	BLB3	\$3.80
1 1/4	BLB4	4.30
1 1/2	BLB5	8.30
2	BLB6	10.00
2 1/2	BLB7	15.20
3	BLB8	20.40
3 1/2	BLB9	32.70
4	BLB10	40.00

Type BX



Size In.	No.	Each
1	BX3	\$5.00
1 1/4	BX4	5.50
1 1/2	BX5	10.30
2	BX6	12.50
2 1/2	BX7	19.00
3	BX8	25.00
3 1/2	BX9	42.00
4	BX10	52.00

Type BUB



Size In.	No.	Each
1 1/2	BUB5	\$8.30
2	BUB6	10.00
2 1/2	BUB7	15.20
3	BUB8	20.40
3 1/2	BUB9	32.70
4	BUB10	40.00

Covers for Mogul Series Condulets
Blank



Bakelite



Cast Feraloy

Size In.	Bakelite		Cast Feraloy	
	No.	Each	Without Gasket	With Gasket
1 or 1 1/4	CF534	\$3.20	BG47	\$2.20
1 1/2 or 2	CF536	6.00	BG67	3.50
2 1/2 or 3	CF538	8.00	BG87	7.50
3 1/2 or 4	CF539	12.00	BG97	13.50
			BG48	\$3.00
			BG68	4.80
			BG88	12.50
			BG98	17.50

Gaskets for Mogul Series Condulets

For use between Condulets and covers; except No. BG48, BG68, BG88 and BG98 covers, which have round gaskets.

Size In.	No.	Each
1 or 1 1/4	Gask 271	\$0.50
1 1/2 or 2	Gask 272	.70
2 1/2 or 3	Gask 273	1.50
3 1/2 or 4	Gask 274	2.00

Type FS and FD Multiple Gang Condulets—Without Hubs

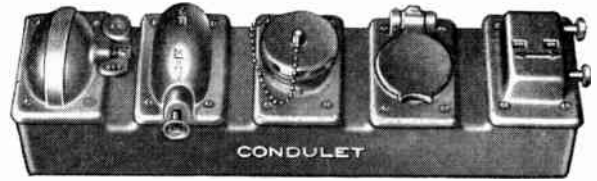

Type FS, Five Gang

With Push Button and Tumbler Switch Covers, and Threaded Cap and Spring Door Housings



Type FS, Two-Gang Tandem



Type FS, Three-Gang

Listed without hubs. Can be furnished with brazed conduit hubs complete with integral bushings or can be drilled on the job and used with locknut and bushing. Take all individual covers to make up combination of several devices in one Condulet.

No. of Gangs	Type FS		Type FD	
	No.	Each	No.	Each
Single	FS01	\$1.00	FD01	\$1.20
Two-Gang Tandem	FS07	2.50	FD07	2.90
Two-Gang	FS02	2.50	FD02	2.90
Three-Gang	FS03	4.00	FD03	4.60
Four-Gang	FS04	5.50	FD04	6.30
Five-Gang	FS05	7.00	FD05	8.00

When ordering with brazed hubs specify type (threaded, union, threadless thin wall or threadless thick wall), size, and location of each hub. Furnish description or sketch of hub layout desired.

Prices of Brazed Hubs

Size In.	Threaded		Union		Threadless Thick Wall or Thin Wall
	Each	Each	Each	Each	
1/2	\$1.10		\$1.80		\$1.50
3/4	1.20		1.80		1.70
1	1.40		2.20*		2.00*
1 1/4*	1.70		3.20		2.40
1 1/2*	2.00	

*For FD Series only.

Type FS Condulets—With Bosses for Tapping



Type FS

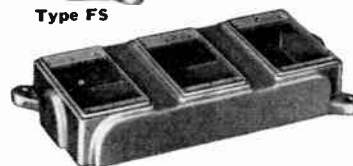
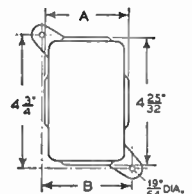

Type FS Three-Gang

No.	Condulet	Dimensions Inches		Depth	Each
		A	B		
FS019	Single	3 1/4	3 1/4	1 31/32	\$1.50
FS029	Two-Gang	7	7	1 31/32	3.00
FS039	Three-Gang	10 3/4	10 3/4	1 31/32	4.50

Drilling and Tapping Information

These Condulets can be drilled and tapped on the job or if specified will be drilled and tapped at the factory for the following prices per opening: 1/2 or 3/4 inch, \$0.10; 1 inch, \$0.20.

Crouse-Hinds Condulets

FS and FD Series Condulets

Take covers and accessories or plug receptacle housings. Overall dimensions, exclusive of hubs: FS—Length, 4⁵/₁₆" ; width, 2³/₄" ; depth, 1⁷/₈". FD—Length, 4⁵/₁₆" ; width, 2³/₄" ; depth, 2¹/₁₆". FS Condulets can be furnished with flat face (4¹/₂"x2¹³/₁₆"x2¹/₁₆" inches) to take standard wall plates at the same list prices; add suffix S24 to catalog number.

FS Series take devices 1⁵/₈" deep or less. FD Series take devices 2³/₈" deep or less.

Threaded for Rigid Conduit (Thick Wall)

Type FS or FD



Type FSA or FDA



No.	Each	Size	No.	Each
FS1	\$1.45	1/2	FSA1	\$1.45
FS2	1.55	3/4	FSA2	1.55
FS3	1.70	1	FSA3	1.70
FD1	1.75	1/2	FDA1	1.75
FD2	1.85	3/4	FDA2	1.85
FD3	2.00	1	FDA3	2.00

Type FSC or FDC



Type FSL or FDL



No.	Each	Size	No.	Each
FSC1	\$1.65	1/2	FSL1	\$1.65
FSC2	1.80	3/4	FSL2	1.80
FSC3	2.20	1	FSL3	2.20
FDC1	1.95	1/2	FDL1	1.95
FDC2	2.10	3/4	FDL2	2.10
FDC3	2.50	1	FDL3	2.50

Type FSR or FDR



Type FSS or FDD



No.	Each	Size	No.	Each
FSR1	\$1.65	1/2	FSS1	\$1.65
FSR2	1.80	3/4	FSS2	1.80
FSR3	2.20	1	FSS3	2.20
FDR1	1.95	1/2	FDD1	1.95
FDR2	2.10	3/4	FDD2	2.10
FDR3	2.50	1	FDD3	2.50

Type FSCA or FDCA



Type FSCC or FDCC



No.	Each	Size	No.	Each
FSCA1	\$2.00	1/2	FSCC1	\$2.00
FSCA2	2.50	★ 3/4	FSCC21	2.50
FSCA3	2.90	★ 1	FSCC31	2.90
FDCA1	2.30	1/2	FDCC1	2.30
FDCA2	2.80	★ 3/4	FDCC21	2.80
FDCA3	3.20	★ 1	FDCC31	3.20

★The hubs at the right in the illustration are 1/2 inch on types FSCC and FDCC.

FS and FD Series Condulets

FS Series take devices 1⁵/₈" deep or less. FD Series take devices 2³/₈" deep or less.

Threaded for Rigid Conduit (Thick Wall)

Type FSCT or FDCT



Type FST or FDI

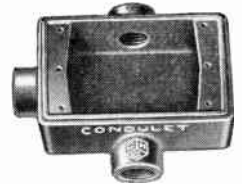

No.	Each	Size In.	No.	Each
FSCT1	\$2.00	1/2	FST1	\$2.00
FSCT2	2.50	3/4	FST2	2.50
FSCT3	2.90	1	FST3	2.90
FDCT1	2.30	1/2	FDT1	2.30
FDCT2	2.80	3/4	FDT2	2.80
FDCT3	3.20	1	FDT3	3.20

Type FSX or FDX



No.	Each
FSX1	\$2.40
FSX2	3.00
FSX3	3.40
FDX1	2.60
FDX2	3.20
FDX3	3.60

Type FS —Double Face— Type FSC



No.	Each	Size	No.	Each
FS152	\$2.30	1/2	FSC152	\$2.50
FS252	2.50	3/4	FSC252	2.90

Threadless for Thick Wall or EMT (Thin Wall)

Type FS or FD



Type FSC or FDC



Illustrations shown above are for Rigid Conduit (Thick Wall).

Thick Wall No.	Size In.	Each	Thin Wall No.	Size In.	Each
FS191	1/2	\$1.65	FS1-MT	1/2	\$1.65
FS291	3/4	1.90	FS2-MT	3/4	1.85
FS391	1	2.15	FS3-MT	1	2.10
FD191	1/2	1.95	FD1-MT	1/2	1.95
FD291	3/4	2.20	FD2-MT	3/4	2.15
FD391	1	2.45	FD3-MT	1	2.40
FSC191	1/2	2.05	FSC1-MT	1/2	2.05
FSC291	3/4	2.50	FSC2-MT	3/4	2.40
FSC391	1	3.10	FSC3-MT	1	3.00
FDC191	1/2	2.35	FDC1-MT	1/2	2.35
FDC291	3/4	2.80	FDC2-MT	3/4	2.70
FDC391	1	3.40	FDC3-MT	1	3.30

Crouse-Hinds Condulets

FS and FD Series 2-Gang Condulets

FS Series Condulets take Covers and Shallow Flush Rectangular Wiring Devices.

FD Series Condulets take Covers and Deep or Shallow Flush Rectangular Wiring Devices.

Overall dimensions, exclusive of hubs: FS-Length, 4⁵/₁₆" ; width, 4⁵/₈" ; depth, 1⁷/₈" ; FD-Length, 4⁵/₁₆" ; width, 4⁵/₈" ; depth, 2¹¹/₁₆" .

FS Condulets can be furnished with flat face (4¹/₂x4⁵/₈x2¹/₁₆ inches) to take standard wall plates at the same list prices; add Suffix S24 to catalog number.

FS Series take devices 1⁵/₈" deep or less.

FD Series take devices 2³/₈" deep or less.

Threaded for Rigid Conduit (Thick Wall)

Type FS or FD



No.	Each	Size
FS12	\$2.65	1/2
FS22	2.75	3/4
FS32	2.90	1
FD12	3.05	1/2
FD22	3.15	3/4
FD32	3.30	1

Type FSA or FDA



No.	Each
FSA12	\$2.65
FSA22	2.75
FSA32	2.90
FDA12	3.05
FDA22	3.15
FDA32	3.30

Type FSE or FDE



No.	Each	Size
FSE12	\$2.70	1/2
.....	3/4
.....	1
FDE12	3.25	1/2
.....	3/4
.....	1

Type FSC or FDC



No.	Each
FSC12	\$2.85
FSC22	3.00
FSC32	3.40
FDC12	3.25
FDC22	3.40
FDC32	3.80

Type FSS or FDS



No.	Each	Size
FSS222	\$3.00	1/2
.....	★3/4
.....	★1
FDS222	3.40	1/2
.....	★3/4
.....	★1

Type FSD or FDB



No.	Each
FSD12	\$3.10
FSD212	3.30
FSD312	3.50
FDB12	3.50
FDB212	3.70
FDB312	3.90

★The hubs at the top in the illustration are 1/2 inch.

FS and FD Series 2-Gang Condulets

Threadless for Thick Wall or EMT (Thin Wall)



For EMT (Thin Wall)

Type FS or FD



Type FSC or FDC



Illustrations shown above are for Rigid Conduit (Thick Wall)

Type FS or FD

Size	Thick Wall		Thin Wall	
	No.	Each	No.	Each
1/2	FS192	\$2.85	FS12-MT	\$2.65
	FS292	3.10	FS22-MT	3.05
	FS392	3.35	FS32-MT	3.30
3/4	FD192	FD12-MT	2.90
	FD292	FD22-MT	3.20
	FD392	FD32-MT	3.50

Type FCS or FDC

Size	Thick Wall		Thin Wall	
	No.	Each	No.	Each
1/2	FSC192	\$3.25	FSC12-MT	\$3.25
	FSC292	3.70	FSC22-MT	3.60
	FSC392	4.30	FSC32-MT	4.20
3/4	FDC192	3.65	FDC12-MT	3.65
	FDC292	4.10	FDC22-MT	4.00
	FDC392	4.70	FDC32-MT	4.60

FS Series Condulets, Two-Gang Tandem

Take Single-Gang Covers and Receptacle Housings.

Threaded for Rigid Conduit (Thick Wall)

Type FS, 2-Gang Tandem Type FSC, 2-Gang Tandem



No.	Each	Size	No.	Each
FS17	\$3.30	1/2	FSC17	\$3.50
FS27	3.50		FSC27	3.70
FS37	3.70		FSC37	3.90

Type ExF Two-Gang Extensions



Depth of Extension	No.	Each
1	ExF12	\$2.10
4 ⁵ / ₈	ExF42	5.70

ExF12

ExF42

Covers for "Standard" Duplex Flush Receptacles, and for Pilot Lamp Flush Receptacles

Furnished with red jewel.



Sheet Steel	Surface	Flush	Each
S23242	\$2.50
SS23242	2.50

Blank Metal Covers



Sheet Steel	Surface	Flush	Each
S1002	\$0.40
SS100240

Cast Feraloy—With Gasket

Surface	Flush	Each
S1002G	\$1.00
SS1002G	1.00

Crouse-Hinds Condulets

Condulet Covers

For Condulets FS and FD Series, Single-Gang, FS Series 2-Gang Tandem, and Type ExF Extensions.

**For Round Flush Receptacles
Sheet Steel—Spring Hinge Lid**

Diameter Opening, 1 5/8 Inches		No.	Type	Each
	DS10	Surface	\$1.20	
	DSS10	Flush	1.20	

**Cast Feraloy—With Spring Door
With Gaskets**

Diameter Opening, 1 1/16 Inches		No.	Type	Each
	DS10G	Surface	\$2.50	
	DSS10G	Flush	2.50	

Sheet Steel

Diameter Opening, 1 13/32 Inches		No.	Type	Each
	DS21	Surface	\$0.30	
	DSS21	Flush	.30	

For Standard Duplex Flush Receptacles.

For Duplex Tumbler Switches.		No.	Type	Each
	DS23	Surface	\$0.30	
	DSS23	Flush	.30	

For Duplex Tumbler Switches.

For Triple Tumbler Switches.		No.	Type	Each
	DS63	Surface	\$0.30	
	DSS63	Flush	.30	

For Triple Tumbler Switches.

For Despard, Bryant, Hubbell, Arrow-H&H, and G-E Wiring Devices.		No.	Type	Each
	DS65	Surface	\$0.30	
	DSS65	Flush	.30	

Furnished with Mounting Bridge.

With 1 Opening—Sheet Steel

For Despard, Bryant, Hubbell, Arrow-H&H, and G-E Wiring Devices.		No.	Type	Each
	DS71	Surface	\$0.50	
	DSS71	Flush	.50	

With 2 Openings—Sheet Steel

For G-E, 30-Ampere Flush Plug Receptacles.		No.	Type	Each
	DS72	Surface	\$0.50	
	DSS72	Flush	.50	

With 3 Opening—Sheet Steel

Diameter Cover Opening, 1 5/8 Inches.		No.	Type	Each
	DS73	Surface	\$0.50	
	DSS73	Flush	.50	

For G-E, 30-Ampere Flush Plug Receptacles. Diameter Cover Opening, 1 5/8 Inches.

Sheet Steel

Diameter Cover Opening, 1 5/8 Inches.		No.	Type	Each
	DS35	Surface	\$0.30	
	DSS35	Flush	.30	

**With Female Brass Nipple
Sheet Steel—3/8-Inch Nipple**

Diameter Cover Opening, 1 5/8 Inches.		No.	Type	Each
	DS18	Surface	\$0.80	

Sheet Steel—1/2-Inch Nipple

Diameter Cover Opening, 1 5/8 Inches.		No.	Type	Each
	DS116	Surface	\$0.90	

Blank Covers

Diameter Cover Opening, 1 5/8 Inches.		No.	Type	Each
	DS100	Surface	\$0.20	
	DSS100	Flush	.20	

Cast Feraloy—With Gasket

Diameter Cover Opening, 1 5/8 Inches.		No.	Type	Each
	DS100G	Surface	\$0.50	
	DS100G	Flush	.50	

FS and FD Series Condulets

Threadless

Type FSCT or FDCT



Size	Thick Wall No.	Each	Thin Wall No.	Each
1/2	FSCT191	\$2.60	FSCT1-MT	\$2.60
	FSCT291	3.55	FSCT2-MT	3.40
	FSCT391	4.25	FSCT3-MT	4.10
3/4	FDCT191	2.90	FDCT1-MT	2.90
	FDCT291	3.85	FDCT2-MT	3.70
	FDCT391	4.55	FDCT3-MT	4.40

Type FSX or FDY



Size	No.	Each
1/2	FSX191	\$3.20
	FSX291	4.40
	FSX391	5.20
3/4	FDX191	3.50
	FDX291	4.70
	FDX391	5.50

Type EXF Extensions

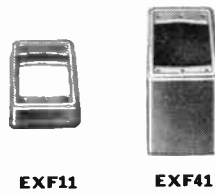

For FS and FD Series Condulets, Single-Gang.

Depth of Extension	No.	Each
1	EXF11	\$1.00
2 1/2	EXF21	3.50
4 5/8	EXF41	4.00

Condulet Covers

For Condulets FS and FD Series, Single-Gang, FS Series 2-Gang Tandem, and Type ExF Extensions.

For Double Push Button, Double Push Button Momentary Contact, and Double Push Lock Switches.

Sheet Steel

No.	Style	Each
DS8	Surface	\$0.30
DSS8	Flush	.30

Cast Feraloy—Guarded

No.	Style	Each
DS8G	Surface	\$0.70
DS8G	Flush	.70

For G-E, Arrow-H&H, Bryant, and Hubbell Tumbler Flush Switches with Square Handles.

Sheet Steel

No.	Style	Each
DS32	Surface	\$0.30
DSS32	Flush	.30

Cast Feraloy—Guarded

No.	Style	Each
DS32G	Surface	\$0.70
DS32G	Flush	.70

Crouse-Hinds Condulets

Condulet Covers

For Condulets FS and FD Series, Single-Gang, FS Series 2-Gang Tandem, and Type ExF Extensions.

Vaportight And Weatherproof Covers

With Switch Operating Mechanism.
Surface or flush. Furnished with gasket.

For External Operation of Double Push Button Furnished With Handle

No.	Material	Each
 DS108	Cast Feraloy	\$3.50

For Momentary Contact Switches

Furnished with Handle		
No.	Material	Each
 DS107	Cast Feraloy	\$3.50

For External Operation of Tumbler Switches

For Standard Operation, On or Off

No.	Material	Each
 DS128	Cast Feraloy	\$3.50

For Momentary Contact Operation

Normally On		Normally Off		Material
No.	Each	No.	Each	
DS126	\$3.50	DS127	\$3.50	Cast Feraloy

For Standard Operation "On" or "Off"			
No.	Material	Each	
 DS181	Cast Feraloy	\$3.50	

For Momentary Contact Switches			
No.	Material	Each	
 DS183	Cast Feraloy	\$3.50	

For Standard Operation "On" or "Off"



Furnished with Switch Mounting Bridge.

No.	Material	Arrangement	Each
DS101	Cast Feraloy	1 Switch	\$3.50
DS102	Cast Feraloy	2 Switches	5.00
DS103	Cast Feraloy	3 Switches	6.50



Furnished with Buttons for Operating Motor Control Push Button and "Standard" Push Button Switches.

For Motor Control Push Button Switches

No.	Description	Switch Markings	Each
DS171F	1 Button (Normally Open)	Start	\$3.50
DS171G	1 Button (Normally Closed)	Stop	3.50
DS171	2 Buttons (1 Normally Open, 1 Normally Closed)	Start, Stop	3.50

For "Standard" Flush Push Button Switches.

DS171C	2 Buttons (On and Off)	On, Off	\$3.50
--------	------------------------	---------	--------

Condulet Covers

For Condulets FS and FD Series, Single-Gang, FS Series 2-Gang Tandem, and Type ExF Extensions.



For Pilot Lamp Flush Receptacles



Jewel	Surface		Sheet Steel		Cast Feraloy Surface or Flush Vaportight	
	No.	Each	No.	Each	No.	Each
Red	DS24	2.00	DSS24	\$2.00	DS24G	\$2.50
Green	DS41	2.00	DSS41	2.00	DS41G	2.50
Amber	DS44	2.00	DSS44	2.00	DS44G	2.50
Opal	DS47	2.00	DSS47	2.00	DS47G	2.50
Clear	DS48	2.00	DSS48	2.00	DS48G	2.50
Blue	DS49	2.00	DSS49	2.00	DS49G	2.50

Type DS Plug Receptacle Housings With Receptacle

For Condulets FS and FD Series, Single-Gang, FS Series, 2-Gang Tandem, and Type ExF Extensions.

Take Standard Attachment Plugs



Plain Housing With Receptacle



Spring Door Housing With Receptacle



Threaded Cap Housing With Receptacle

Receptacle Poles	Plain		With Spring Door		With Receptacle With Threaded Cap	
	No.	Each	No.	Each	No.	Each
15 Amperes, 125 Volts; 10 Amperes, 250 Volts						
Hole in Cover, 1 1/16" Dia.						

Double T

2-W., 2-P.	DS325	\$2.00	DS332	\$3.50	DS339	\$4.00
------------	-------	--------	-------	--------	-------	--------

Polarized

2-W., 2-P.	DS326*	2.80	DS333*	4.30	DS340*	4.80
2-W., 3-P.*	DS327	3.50	DS334	5.00	DS341	5.50
3-W., 3-P.	DS328	4.00	DS335	5.50	DS342	6.00

Twistlock

2-W., 2-P.	DS329	2.60	DS336	4.10	DS343	4.60
2-W., 3-P.*	DS330	3.80	DS337	5.30	DS344	5.80
3-W., 3-P.	DS331	4.30	DS338	5.80	DS345	6.30

20 Amperes, 125 or 250 Volts

Hole in Cover, 1 1/16" Diameter.

Polarized

2-W., 2-P.	DS346*	3.60	DS354*	5.10	DS362*	5.60
2-W., 3-P.*	DS347	4.20	DS355	5.70	DS135	8.00
3-W., 3-P.	DS348	4.20	DS356	5.70	DS139	8.00
3-W., 4-P.*	DS349	5.00	DS357	6.50
4-W., 4-P.	DS350	5.00	DS358	6.50

Twistlock

2-W., 2-P.	DS351	2.90	DS359	4.40	DS365	4.90
------------	-------	------	-------	------	-------	------

20 Amperes, 125 or 250 Volts; 10 Amperes, 575 Volts A.C.

Hole in Cover, 1 1/16" Diameter.

2-W., 3-P.*	DS352	4.60	DS360	6.10	DS138†	8.00
3-W., 3-P.	DS353	4.60	DS361	6.10	DS137‡	8.00

Hole in Cover, 1 5/8" Diameter.

3-W., 4-P.*	DS366	5.80	DS368	7.30
4-W., 4-P.	DS367	5.80	DS369	7.30

*Extra pole grounded.

†For use only with Hubbell No. 9965 rubber plug.

‡Cannot be used with type WP plugs.

*Takes Hubbell #6918 or similar plugs with right angle blades.

Crouse-Hinds Condulets

Type DS Plug Receptacle Housings

For Condulets FS and FD Series, Single-Gang, FS Series, 2-Gang Tandem, and Type ExF Extensions.
Take Standard Attachment Plugs.
Threaded Housings take Type WP Plugs.
Surface or flush.

15 Amperes, 125 Volts; 10 Amperes, 250 Volts



With Spring Door

No.	Style	Each
DS83	2-Wire, 2-Pole	\$5.15
DS84	★2-Wire, 3-Pole	7.15
DS91	3-Wire, 3-Pole	7.15

With Threaded Cap†

Without Threaded Cap



No.	Each	Style	No.	Each
DS81	\$4.30	2-Wire, 2-Pole	DS87	\$3.00
DS82	6.30	★2-Wire, 3-Pole	DS88	5.00
DS90	6.30	3-Wire, 3-Pole	DS93	5.00

Type FAR Arktite Receptacle Housings

For Condulets FS and FD Series, Single-Gang, FS Series, 2-Gang Tandem, and Type ENF Extensions.
Take Type APJ Plugs.

30 Amperes, 250 Volts D.C., 600 Volts A.C.



With Spring Door

Description
Style 1—Grounded Through Shell.
Style 2—Grounded Through Extra Pole and Shell.



Without Spring Door

No.	Each	Style	No.	Each
FAR321	\$13.60	1 2-W., 2-P.	FAR323	\$12.00
FAR331	14.70	1 3-W., 3-P.	FAR333	13.10
FAR341	16.40	1 4-W., 4-P.	FAR343	14.90
FAR351	19.00	1 5-W., 5-P.	FAR353	17.50
FAR332	16.80	2 2-W., 3-P.	FAR334	15.30
FAR342	18.60	2 3-W., 4-P.	FAR344	17.10
FAR352	22.20	2 4-W., 5-P.	FAR354	20.80



Style 1—Grounded Through Shell.
Style 2—Grounded Through Extra Pole and Shell.



Without Threaded Cap

With Threaded Cap

No.	Each	Style	No.	Each
FAR325	\$13.60	1 2-W., 2-P.	FAR327	\$14.30
FAR335	13.70	1 3-W., 3-P.	FAR337	15.50
FAR345	15.40	1 4-W., 4-P.	FAR347	17.20
FAR355	18.00	1 5-W., 5-P.	FAR357	19.80
FAR336	15.90	2 2-W., 3-P.	FAR338	17.60
FAR346	17.60	2 3-W., 4-P.	FAR348	19.30
FAR356	21.20	2 4-W., 5-P.	FAR358	22.90

†Furnished with Gaskets. ★Extra pole grounded.

Type WP Watertight Plugs

15 Amperes, 125 Volts, or 10 Amperes, 250 Volts

For use with Type DS and Type GS Threaded Receptacle Housings.



Style	Size Cord	No.	Each
2-Pole Tandem Blade	.375 to .500	WP721	\$3.00
	.500 to .625	WP821	3.00
2-Pole Parallel Blade	.375 to .500	WP722	3.00
	.500 to .625	WP822	3.00
3-Pole	.375 to .500	WP731	3.50
	.500 to .625	WP831	3.50

Type BRD Plug Receptacle Housings

For Condulets FS and FD Series, Single-Gang, FS Series, 2-Gang Tandem and Type ExF Extensions.

*30 Amperes, 250 Volts A.C.

Can be used on Condulets mounted either on the surface of or flush with the wall. Take Type BP plugs. Two-pole housings are furnished with 30-ampere, 250-volt receptacle BR302; 3-pole housings with 30-ampere, 250-volt receptacle BR303; 4-pole with 30-ampere, 250-volt receptacle BR304.



With Spring Door



Without Spring Door

No.	Each	Style	No.	Each
BRD6302	\$8.40	2-Pole	BRD302	\$5.20
BRD6303	9.80	3-Pole	BRD303	6.20
BRD6304	11.20	4-Pole	BRD304	7.20



With Threaded Cap



Without Threaded Cap

Furnished with gaskets.

No.	Each	Style	No.	Each
BRD8302	\$7.50	2-Pole	BRD7302	\$5.60
BRD8303	9.40	3-Pole	BRD7303	6.70
BRD8304	11.30	4-Pole	BRD7304	7.80

*Can be used on 25-ampere, 125-volt D.C. circuits; or on 30-ampere, 250-volt D.C. circuits if circuit is broken before plug is withdrawn.

Gaskets for FS and FD Series Condulets

For Use Between Condulets and Covers.
(Not recommended as watertight.)

No. of Gangs	Rubber	No.	Vellumoid	Each
1	Gask 91	Gask 412	\$0.40	
2	Gask 145	Gask 343	.50	
3	Gask 13560	
4	Gask 14680	

For Use Between Condulets and Vaportight Covers

No.	Each
1 Gask 425 \$0.40
2 Gask 43450
3 Gask 46060
4 Gask 46180

For Use in Threaded Cap for Type BRD Plug Receptacle Housings

No. of Poles	Rubber	No.	Each
2	Gask 173	\$0.20	
3	Gask 144	.20	
4	Gask 144	.20	

Crouse-Hinds Condulets

2-Gang Condulet Covers

For Condulets FS and FD Series, 2-Gang, and Type EXF 2-Gang Extensions

For Tumbler Flush Switches with Square Handles

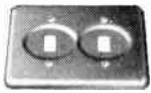

No.	Sheet Steel Style	Each
S322	Surface	\$0 60
SS322	Flush	.60



No.	Cast Feraloy—Guarded	Each
S322G	Surface	\$1 30
SS322G	Flush	1 30

For "Standard" Duplex Flush Receptacles

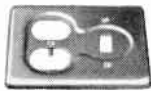

No.	Sheet Steel	Each
S32232	Surface	\$1 00
SS32232	Flush	1 00

For Round Plug Flush Receptacles



No.	Sheet Steel	Each
S32212	Surface	\$1 00
SS32212	Flush	1 00

For Pilot Lamp Flush Receptacles Furnished With Red Jewel



No.	Sheet Steel	Each
S32242	Surface	\$2 40
SS32242	Flush	2 40

For Round Flush Receptacles and Pilot Lamp Flush Receptacles



No.	Sheet Steel—Furnished with Red Jewel	Each
S21242	Surface	\$2 50
SS21242	Flush	2 50

Take P & S-Despard, Bryant, Hubbell, Arrow-H.&H., and General Electric Interchangeable Wiring Devices

Sheet Steel

Furnished with mounting bridge.

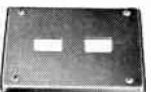

No.	Style	Each
S712	Surface	\$1 00
SS712	Flush	1 00



No.	Style	Each
S722	Surface	\$1 00
SS722	Flush	1 00



No.	Style	Each
S732	Surface	\$1 00
SS732	Flush	1 00

For Round Flush Receptacles



No.	Style	Each
S212	Surface	\$0 60
SS212	Flush	.60

For "Standard" Duplex Flush Receptacles



No.	Style	Each
S232	Surface	\$0 60
SS232	Flush	.60

For Round Flush Receptacles and "Standard" Duplex Flush Receptacles

No.	Style	Each
S21232	Surface	\$1 00
SS21232	Flush	1 00

2-Gang Vaportight and Weatherproof Covers

For Condulets FS and FD Series, 2 Gang, and Type EXF

2-Gang Extensions

With Switch Operating Mechanism

Surface or flush. Furnished with gasket.

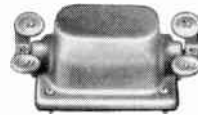

No.	Material	Each
DS1812	Feraloy	\$6 00

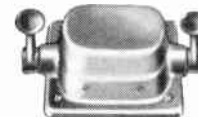

No.	Material	Each
DS1832	Feraloy	\$6 00



No.	Material	Each
DS1282	Feraloy	\$6 00

No.	Material	Each
DS1262	Feraloy	\$6 00

No.	Material	Each
DS1272	Feraloy	\$6 00

For Standard Operation On or Off

Take P&S-Despard, Bryant, Hubbell, Arrow-H.&H., and G-E Interchangeable Switches. Furnished with Switch Mounting Bridges.



No.	Description	Material	Each
DS1012	For 2 Switches	Feraloy	\$6 00
DS1022	For 4 Switches	Feraloy	9 00
DS1032	For 6 Switches	Feraloy	12 00

For External Operation of Double Push Button Switches

Furnished with Handle



No.	Material	Each
DS1082	Feraloy	\$6 00



No.	Material	Each
DS1072	Feraloy	\$6 00



For Double Push Button or Momentary Contact Switches

Furnished with Key§

No.	Material	Each
DS1062	Feraloy	\$6 00

§Extra keys for Vaportight Cover, Cat. No. Key 1—List Price, \$0.40.

Crouse-Hinds Condulets

FS and FD Series 3-Gang Condulets

FS Series Condulets take Covers and Shallow Flush Rectangular Wiring Devices.

FD Series Condulets take Covers and Deep or Shallow Flush Rectangular Wiring Devices.

Overall Dimensions, exclusive of hubs; FS—Length, 4⁵/₁₆" ; width, 6¹/₂" ; depth, 1⁷/₈" ; FD—Length, 4⁵/₁₆" ; width, 6¹/₂" ; depth 2¹/₁₆" . FS Condulets can be furnished with flat face (4¹/₂x6¹/₂x2¹/₁₆ inches) to take standard wall plates at the same list prices; add Suffix S24 to catalog number.

FS Series take devices 1⁵/₈" deep or less.
FD Series take devices 2³/₈" deep or less.

Threaded for Rigid Conduit (Thick Wall)
Type FS or FD Type FSA or FDA

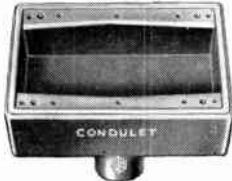
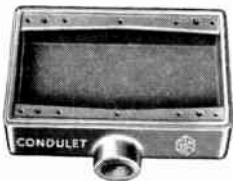

No.	Each	Size In.	No.	Each
FS23	\$4.00	3/4	FSA23	\$4.00
FS33	4.15	1	FSA33	4.15
FD23	4.60	3/4	FDA23	4.60
FD33	4.75	1	FDA33	4.75

Type FSC or FDC Type FSS or FDS

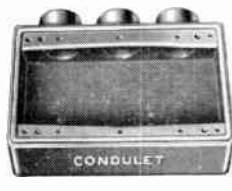

FSC23	\$4.85	3/4	FSS23	\$4.50
FSC333	4.40	1
FDC23	4.85	3/4	FDS223	5.10
FDC333	5.00	1
FDC43	7.00	1 1/4

Threadless

Type FS or FD Type FSC or FDC

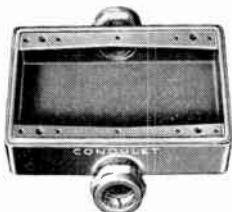
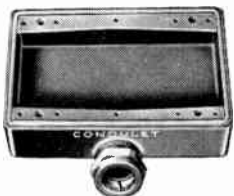

Thick Wall No.	Size In.	Each	Thin Wall No.	Size In.	Each
FS293	3/4	\$4.35	FS23-MT	3/4	\$4.30
FS393	1	4.60	FS33-MT	1	4.55
FD293	3/4	4.95	FD23-MT	3/4	4.90
FD393	1	5.20	FD33-MT	1	5.20
FSC293	3/4	4.95	FSC23-MT	3/4	4.85
FSC393	1	5.30	FSC333-MT	1	5.20
FDC293	3/4	5.55	FDC23-MT	3/4	5.45
FDC393	1	5.90	FDC333-MT	1	5.80
			FDC43-MT	1 1/4	8.40

3-Gang Condulet Covers

For Condulets FS and FD Series, 3-Gang and Type EXF

3-Gang Extensions

For Double Push Button, Double Push Button Momentary Contact, and Double Push Lock Switches



No.	Sheet Steel Style	Each
S83	Surface	\$0.90
SS83	Flush	.90



No.	Cast Feraloy—Guarded Style	Each
S83G	Surface or Flush	\$2.00

For Tumbler Flush Switches with Square Handles

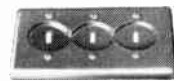

No.	Sheet Steel Style	Each
S323	Surface	\$0.90
SS323	Flush	.90



No.	Sheet Steel—Guarded Style	Each
S523	Surface	\$1.50
SS523	Flush	1.50



No.	Cast Feraloy—Guarded Style	Each
S323G	Surface	\$2.00

Blank Metal Covers



No.	Sheet Steel Style	Each
S1003	Surface	\$0.80
SS1003	Flush	.80

No.	Cast Feraloy with Gasket Style	Each
S1003G	Surface	\$1.50

3-Gang Vaportight Covers

For Condulets FS and FD Series, 3-Gang and Type EXF Extensions, 3-Gang

With Switch Operating Mechanism

For External Operation of Tumbler Switches



Surface or flush; furnished with gasket.

Cast Feraloy

No.	For Standard Operation "On" and "Off" Each	No.	For Momentary Contact Operation	Each
DS1283	\$8.50	DS1263	Normally "On"	\$8.50
		DS1273	"Off"	8.50

Type EXF Three-Gang Extensions
For FS and FD Series Condulets, 3-Gang

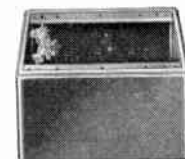

No.	Depth Ext. In.	Each
EXF13	1	\$2.90
EXF43	4 ⁵ / ₈	7.50

EXF13

EXF43

Crouse-Hinds Condulets

FS and FD Series 4-Gang Condulets

FS Series Condulets, Four-Gang, take covers and shallow flush rectangular wiring devices.

FD Series Condulets, Four-Gang, take covers and deep or shallow flush rectangular wiring devices.

Overall Dimensions, exclusive of hubs: FS—Length, 4⁵/₁₆" ; width, 8³/₈" ; depth, 1⁷/₈" ; FD—Length, 4⁵/₁₆" ; width, 8³/₈" ; depth, 2¹/₁₆" .

FS Condulets can be furnished with flat face (4¹/₂ x 8⁵/₁₆ x 2¹/₁₆ inches) to take standard wall plates at the same list prices: add suffix S24 to catalog number.

FS Series take devices 1⁵/₈" deep or less.

FD Series take devices 2³/₈" deep or less.

Threaded for Rigid Conduit (Thick Wall)

Type FS or FD



No.	Each	Size In.
FS24	\$4.80	3/4
FS34	4.95	1
FD24	5.60	3/4
FD34	5.75	1

Type FSA or FDA



No.	Each
FSA24	\$4.80
FSA34	4.95
FDA24	5.60
FDA34	5.75

Type FSC or FDC

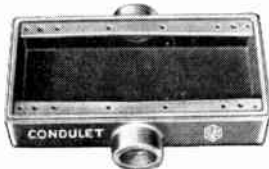

No.	Each	Size In.
FSC24	\$5.00	1/2
FSC34	5.20	3/4
FDC24	5.80	1
FDC34	6.00	1 1/2

Type FSD or FDB



No.	Each
FSD14	\$6.00
*FSD214	6.10
*FSD314	6.25
FDB14	6.80
*FDB214	6.90
*FDB314	7.05

Threadless

Type FS or FD



Thick Wall No.	Size In.	Each
FS294	3/4	\$5.15
FS394	1	5.40
FD294	3/4	5.95
FD394	1	6.20
FSC294	3/4	5.70
FSC394	1	6.10
FDC294	3/4	6.50
FDC394	1	6.90

Type FSC or FDC



Thin Wall No.	Size In.	Each
FS24-MT	3/4	\$5.10
FS34-MT	1	5.35
FD24-MT	3/4	5.90
FD34-MT	1	6.15
FSC24-MT	3/4	5.60
FSC34-MT	1	6.00
FDC24-MT	3/4	6.40
FDC34-MT	1	6.80

*The hubs at the top in the illustration are 1/2 inch on Types FSD and FDB.

4-Gang Condulet Covers

For Condulets FS and FD Series, 4-Gang and Type ExF 4-Gang Extensions

For Double Push Button, Double Push Button Momentary Contact, and Double Push Lock Switches



No.	Sheet Steel Style	Each
S84	Surface	\$1.20
SS84	Flush	1.20



No.	Cast Ferrelloy—Guarded Surface or Flush	Each
S84G		\$2.80

For Tumbler Flush Switches with Square Handles



No.	Sheet Steel Style	Each
S324	Surface	\$1.20
SS324	Flush	1.20



No.	Sheet Steel—Guarded Surface or Flush	Each
S524	Surface	\$2.80
SS524	Flush	2.80



No.	Cast Ferrelloy—Guarded Surface or Flush	Each
S324G	Surface	\$2.80
S324G	Flush	2.80

Blank Metal Covers



No.	Sheet Steel Style	Each
S1004	Surface	\$1.20
SS1004	Flush	1.20



No.	Cast Ferrelloy—With Gasket Surface or Flush	Each
S1004G	Surface	\$2.00
S1004G	Flush	2.00

4-Gang Vaportight Covers

With Switch Operating Mechanism



Surface or flush—furnished with gasket.

For External Operation of Tumbler Switches

Cast Ferrelloy

For Standard Operation "On" and "Off"		For Momentary Contact Operation		Normally
No.	Each	No.	Each	
DS1284	\$10.00	DS1264	\$10.00	"On"
.....	DS1274	10.00	"Off"

Type EXF 4-Gang Extensions

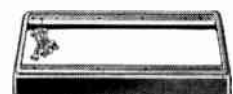
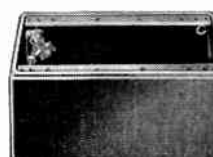

No.	Depth Ext. In.	No.	Each
EXF44	1	EXF14	\$3.30
	4 ⁵ / ₈	EXF44	9.00

Crouse-Hinds Condulets

**Form 8 Series Condulets
Threaded for Thick Wall Conduit**

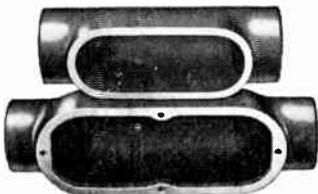

**Relative Sizes of 2-Inch Type C,
Obround and Form 8 Condulets**

Form 8 Series Condulets are for use where sizes of conductors, number of splices or tapping and pulling requirements necessitate more room than provided in the Obround series.

Type C

Type LR



Size In.	No.	Each	Size In.	No.	Each
1/2	C18	\$ 0.80	1/2	LR18	\$ 0.80
3/4	C28	.95	3/4	LR28	.95
1	C38	1.45	1	LR38	1.45
1 1/4	C448	2.80	1 1/4	LR448	2.80
1 1/2	C58	3.00	1 1/2	LR58	3.00
2	C68	5.00	2	LR68	5.00
2 1/2	C78	10.50	2 1/2	LR78	10.50
3	C88	14.00	3	LR888	14.00
3 1/2	C98	23.00	3 1/2	LR98	23.00
4	C108	26.00	4	LR108	26.00

Type E

Type T



Size In.	No.	Each	Size In.	No.	Each
1/2	Use Obround Condulets	\$ 2.30	1/2	T18	\$ 1.00
3/4			3/4	T28	1.20
1	E448	2.40	1	T38	1.80
1 1/4	E58	2.40	1 1/4	T448	3.30
1 1/2	E68	4.40	1 1/2	T58	3.60
2	E78	9.00	2	T68	5.60
2 1/2	E88	11.00	2 1/2	T78	11.00
3	E98	16.00	3	T88	16.00
3 1/2	E108	19.00	3 1/2	T98	25.00
4			4	T108	28.00

Type LB

Type TB



Size In.	No.	Each	Size In.	No.	Each
1/2	LB18	\$ 0.80	1/2	TB18	\$ 1.10
3/4	LB28	.95	3/4	TB28	1.30
1	LB38	1.45	1	TB38	1.90
1 1/4	LB448	2.80	1 1/4	TB448	3.50
1 1/2	LB58	3.00	1 1/2	TB58	3.80
2	LB68	5.00	2	TB68	6.00
2 1/2	LB78	10.50	2 1/2	TB78	12.00
3	LB888	14.00	3	TB88	17.00
3 1/2	LB98	23.00	3 1/2	TB98	27.00
4	LB108	26.00	4	TB108	29.00

**Form 8 Series Condulets
Threaded for Thick Wall Conduit
Type LL**

Type X



Size In.	No.	Each	Size In.	No.	Each
1/2	LL18	\$ 0.80	1/2	X18	\$ 1.30
3/4	LL28	.95	3/4	X28	1.60
1	LL38	1.45	1	X38	2.20
1 1/4	LL48	2.80	1 1/4	X48	3.70
1 1/2	LL58	3.00	1 1/2	X58	4.00
2	LL68	5.00	2	X68	7.00
2 1/2	LL78	10.50	2 1/2	X78	13.00
3	LL888	14.00	3	X88	20.00
3 1/2	LL98	23.00	3 1/2	X98	29.00
4	LL108	26.00	4	X108	35.00

**Covers for Form 8 Series Condulets
Blank**

Sheet Steel

Size In.	No.	Each
1 1/4 or 1 1/2	580	\$0.50
2	680	.85
2 1/2 or 3	880	1.30
3 1/2 or 4	980	1.60

Cast Feraloy

Size In.	No.	Each
1 1/4 or 1 1/2	580F	\$1.00
2	680F	1.40
2 1/2 or 3	880F	1.70
3 1/2 or 4	980F	2.50

Bakelite

Size In.	No.	Each
1 1/4 or 1 1/2	5870	\$2.00
2	6870	2.40
2 1/2 or 3	8870	3.20
3 1/2 or 4	9870	5.00

If specified on order, blank bakelite cover will be furnished with special drilling at an advance in list price as follows: Up to 1 inch diameter, 30 cents list per hole; 1 inch and over, 50 cents list per hole.

**2, 3, 4, or 5-Wire
Bakelite**

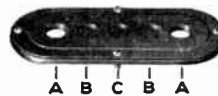

Size In.	Diameter, Inches			No.	Each
	Holes A	Knockouts B	C		
1 1/4 or 1 1/2	13/16	5/8	13/16	5875	\$2.00
2	1	1	1	6875	2.40
2 1/2 or 3	1 7/16	1 3/16	1 1/16	8875	3.20
3 1/2 or 4	1 13/16	1 9/16	1 13/16	9875	5.00

Gaskets for Form 8 Series



For use between Condulets and metal covers.

Size In.	Rubber	No. Cork	Vellumoid	Each
1 1/4 or 1 1/2	Gask 805R	Gask 805C	Gask 805V	\$0.40
2	Gask 806R	Gask 806C	Gask 806V	.50
2 1/2 or 3	Gask 808R	Gask 808C	Gask 808V	.80
3 1/2 or 4	Gask 809R	Gask 809C	Gask 809V	1.00

Crouse-Hinds Condulets

SK Series Condulets

For Concealed Installations in Concrete

Take covers, vaportight fixtures, or 3/4-inch outlet box round base wiring devices with 2 3/4-inch screw centers.

A gasket is made for use with blank covers, so that when used with SK Series Condulets, an excellent vaportight junction box is provided.



Type SK



Type SKC



Type SKL



Type SKT



Type SKX

Type SK

Size In.	2-Inch Depth		3-Inch Depth	
	No.	Each	No.	Each
1/2	SK12	\$2.00	SK13	\$2.30
3/4	SK22	2.20	SK23	2.50
1	SK32	2.40	SK33	2.70

Type SKC

1/2	SKC12	\$2.20	SKC13	\$2.50
3/4	SKC22	2.40	SKC23	2.70
1	SKC32	2.60	SKC33	2.90

Type SKL

1/2	SKL12	\$2.20	SKL13	\$2.50
3/4	SKL22	2.40	SKL23	2.70
1	SKL32	2.60	SKL33	2.90

Type SKT

1/2	SKT12	\$2.40	SKT13	\$2.70
3/4	SKT22	2.60	SKT23	2.90
1	SKT32	2.80	SKT33	3.10

Type SKX

1/2	SKX12	\$2.60	SKX13	\$2.90
3/4	SKX22	2.80	SKX23	3.10
1	SKX32	3.00	SKX33	3.30

Covers and Gaskets

For SK Series Condulets

Blank Cover



No.	Material	Size Hub, In.	Each
SK 8C9	Cast Feraloy	..	\$0.60

Hub Covers



SK 83	Cast Feraloy	3/8	\$1.30
SK 84	Cast Feraloy	1/2	1.30
SK 86	Cast Feraloy	3/4	1.50

Gasket



For use between Condulets and wiring devices or covers.

Gask 208	\$0.50
----------	-------	--------

GRF Series Condulets



Body Only With Lugs



Body Only Without Lugs

GRF Series Condulets take Flush or Surface Covers, Vapor-tight Lighting Fixtures, Fixture Hangers and Receptacles with Housings.

Bodies Only—Without Tapping

Cast Feraloy

Inside Depth In.	No.	Without Lugs		With Lugs	
		Each	No.	Each	
1 1/2	GRF1	\$1.55	GRF19	\$1.75	
2 3/4	GRF2	2.00	GRF29	2.20	
3	GRF3	2.30	GRF39	2.50	

Covers for GRF Series Condulets



Blank Metal Covers

No.	Surface	Each	Size	Material	No. Flush	Each
GRF10	..	\$0.55	..	Feraloy	GRF50	\$0.90

Hub Covers

GRF11	1.10	1/2	Feraloy	GRF51	1.20
GRF12	1.30	3/4	Feraloy	GRF52	1.40

Gaskets

Gask 643	.20	..	Rubber	Gask 690	.15
----------	-----	----	--------	----------	-----

GS Series Condulets

Without Fastening Straps

Take covers, fixtures, round base snap switches, vaportight fixtures, receptacles with housings, or connection blocks.



Type GS



Type GSA



Type GSC

Form 5

Size In.	No.	Each	No.	Each	No.	Each
1/2	GS15	\$1.80	GSA15	\$1.80	GSC15	\$2.00
3/4	GS25	2.10	GSA25	2.10	GSC25	2.30
1	GS35	2.50	GSA35	2.50	GSC35	2.70

Form 10

1/2	GS110	\$1.80	GSA110	\$1.80	GSC110	\$2.00
3/4	GS210	2.10	GSA210	2.10	GSC210	2.30
1	GS310	2.50	GSA310	2.50	GSC310	2.70

Form 20

1/2	GS120	\$3.00	GSA120	\$3.00	GSC120	\$3.20
3/4	GS220	3.30	GSA220	3.30	GSC220	3.50
1	GS320	3.70	GSA320	3.70	GSC320	3.90

Crouse-Hinds Condulets

GS Series Condulets

Without Fastening Strap

Take covers, fixtures, round base snap switches, vapor-tight fixtures, receptacles with housings, or connection blocks.

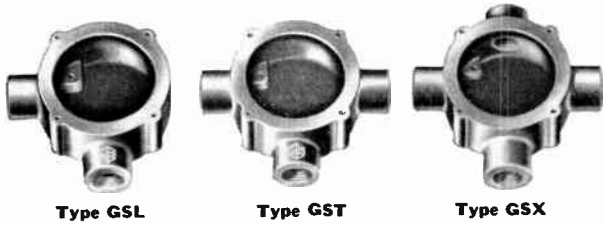

	Type GSL		Type GST		Type GSX	
		Form 5				
1/2	GSL15	\$2.00	GST15	\$2.40	GSX15	\$2.70
3/4	GSL25	2.30	GST25	2.70	GSX25	3.00
1	GSL35	2.70	GST35	3.10	GSX35	3.60
		Form 10				
1/2	GSL110	\$2.00	GST110	\$2.40	GSX110	\$2.70
3/4	GSL210	2.30	GST210	2.70	GSX210	3.00
1	GSL310	2.70	GST310	3.10	GSX310	3.60
		Form 20				
1/2	GSL120	\$3.20	GST120	\$3.60	GSX120	\$3.90
3/4	GSL220	3.50	GST220	4.00	GSX220	4.40
1	GSL320	3.90	GST320	4.60	GSX320	5.40

Connection Blocks for GS Series Condulets

Composition

5-Wire—20 Amperes, 125 Volts



No.	Form	Each
CF210	10 and 20	\$1.30
CF209	20	1.70



2-Wire—30 Amperes, 250 Volts

5-Wire

2-Wire

Fuse Block

Composition

Main Line, 2-Pole
30 Amperes, 250 Volts



No.	Form	Each
GS34	20	\$1.50

Fastening Straps for GS Series Condulets



No.	Size	Each
Strap 11	Form 5	\$0.30
Strap 12	Form 10	.40
Strap 13	Form 20	.60

Call Graybar **FIRST** For . . .

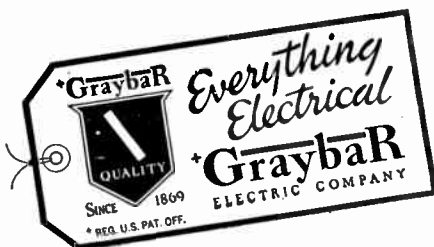

GS Series 2-Gang Condulets With Lugs

Take covers, fixtures, round base snap switches, vapor-tight fixtures, plug receptacle housings, or connection blocks.



Type GSE 2-Gang			Type GSC 2-Gang		
Size Inches	No.	Each		No.	Each
1/2 3/4 1	GSE1529	\$4.20	Form 5	GSC1529	\$4.60
	GSE2529	4.80		GSC2529	5.20
	GSE3529	5.60		GSC3529	6.00
1/2 3/4 1	GSE1129	4.20	Form 10	GSC1129	4.60
	GSE2129	4.80		GSC2129	5.20
	GSE3129	5.60		GSC3129	6.00
1/2 3/4 1	GSE1229	6.60	Form 20	GSC1229	7.00
	GSE2229	7.20		GSC2229	7.60
	GSE3229	8.00		GSC3229	8.40

Forms 5, 10, and 20 indicate sizes of Condulets which take covers and wiring devices correspondingly classified. If specified on order, GS Series Condulets will be furnished with lugs, 30 cents extra. Also available in GS 3-Gang Series.

Type GS Vaportight Fixtures

For GS Series Form 20 Condulets

Screw Type Guard



Pendant Type



Bracket Type

Form 100 is furnished with No. V75 globe and No. V911 guard, and takes 50, 60, 75, or 100-watt lamps. Form 200 is furnished with No. V200 globe and No. V912 guard, and takes 150 or 200-watt lamps.

Form	No.	With Globe and Guard		Without Globe and Guard	
		Type	Each	No.	Each
100	GS675	Pendant	\$ 9.50	GS6	\$4.30
200	GS8200	Pendant	11.00	GS8	4.90
100	GS775	Bracket	9.50	GS7	4.30
200	GS9200	Bracket	11.00	GS9	4.90

Forms, 5, 10, and 20 indicate sizes of Condulets which take covers and wiring devices correspondingly classified.

Lamp Receptacles

Keyless—Composition

660 Watts, 600 Volts

No.	Form	Without Lamp Grip Each	With Lamp Grip Each
GS59	5	\$1.00
GS569	5	\$1.20



Key Receptacle—Armored

With Lamp Grip

250 Watts, 250 Volts



No.	Form	Each
GS549	5	\$4.00

Crouse-Hinds GUA Series Junction Condulets

Explosion-Proof, Dust-Tight, and Weather-Resistant (Raintight) Class I, Groups C and D; Class II, Groups E, F, and G; and Class III



Type GUA



Type GUAC



Type GUAB



With Threaded Hubs

Furnished with surface covers, but can be furnished without covers or with flush, sealing or nipple covers, or fixture canopies.



With Union Hubs

Prices for combinations of threaded and union hubs upon request.

With Threaded Hubs		Size Hub In.	Nom. Diam. Cover Open., In.	Outside Dimen. of Body, In.		With Union Hubs	
No.	Each			Diam.	Depth	No.	Each
Type GUA							
GUA14	\$2.90	1/2	2	2 1/2	2 1/4		
GUA24	3.00	3/4	2	2 1/2	2 1/2	GUA645	\$3.60
GUA16	3.60	1/2	3	3 1/2	2	GUA745	3.60
GUA26	3.70	3/4	3	3 1/2	2	GUA765	4.30
GUA36	3.80	1	3	3 1/2	2 5/16	GUA865	4.80
GUA47	6.30	1 1/4	3 5/8	4 1/4	2 11/16		
Type GUAC							
GUAC14	\$3.10	1/2	2	2 1/2	2 1/4		
GUAC24	3.30	3/4	2	2 1/2	2 1/2	GUAC645	\$4.50
GUAC16	3.80	1/2	3	3 1/2	2	GUAC745	4.50
GUAC26	4.00	3/4	3	3 1/2	2	GUAC765	5.20
GUAC36	4.20	1	3	3 1/2	2 5/16	GUAC865	6.20
GUAC47	6.80	1 1/4	3 5/8	4 1/4	2 11/16		
GUAC59	14.20	1 1/2	5	5 3/4	3 3/4		
Type GUAB							
GUAB14	\$3.10	1/2	2	2 1/2	2 1/4		
GUAB24	3.30	3/4	2	2 1/2	2	GUAB645	\$4.50
GUAB16	3.80	1/2	3	3 1/2	2	GUAB745	4.50
GUAB26	4.00	3/4	3	3 1/2	2	GUAB665	5.20
GUAB36	4.20	1	3	3 1/2	2 5/16	GUAB765	5.20
GUAB47	6.80	1 1/4	3 5/8	4 1/4	2 11/16		
GUAB59	14.20	1 1/2	5	5 3/4	3 3/4		
Type GUAD							
GUAD14	\$3.30	1/2	2	2 1/2	2 1/4		
GUAD24	3.60	3/4	2	2 1/2	2 1/2	GUAD645	\$5.40
GUAD16	4.00	1/2	3	3 1/2	2	GUAD745	5.40
GUAD26	4.30	3/4	3	3 1/2	2	GUAD665	6.10
GUAD36	4.50	1	3	3 1/2	2 5/16	GUAD765	6.10
Type GUAL							
GUAL14	\$3.10	1/2	2	2 1/2	2 1/4		
GUAL24	3.30	3/4	2	2 1/2	2 1/2	GUAL645	\$4.50
GUAL16	3.80	1/2	3	3 1/2	2	GUAL745	4.50
GUAL26	4.00	3/4	3	3 1/2	2		
GUAL36	4.20	1	3	3 1/2	2 5/16	GUAL865	6.20
GUAL47	6.80	1 1/4	3 5/8	4 1/4	2 11/16		
GUAL59	14.20	1 1/2	5	5 3/4	3 3/4		

Explosion-Proof, Dust-Tight, and Weather-Resistant (Raintight) Class I, Groups C and D; Class II, Groups E, F, and G; and Class III

Outside dimensions of body: length, 3 3/4 inches; depth, 1 15/16 inches at corners, 3 1/8 inches over covers; nominal diameter of cover opening, 3 inches. Width, type GUAQ, 5 5/8 inches; other types, 3 3/4 inches.



Type GUAG



Type GUAH

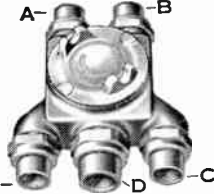

Type GUAP

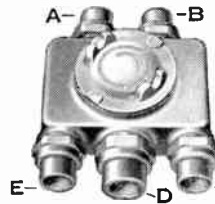

Type GUAQ

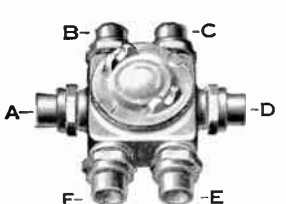

Type GUAF

Hub Sizes, Inches			Without Nuts and Sleeves★		With Nuts and Sleeves			
A	B	C	No.	Each	No.	Each		
1/2	1/2	1/2			GUAG6665	\$7.00		
3/4	3/4	3/4			GUAG7775	7.00		
1/2	3/4	3/4	GUAG706	\$5.50	GUAG6775	7.00		
3/4	1/2	1/2	(Use 3/4" nuts)				GUAG7665	7.00
1/2	3/4	1/2			GUAG6765	7.00		
Type GUAH								
1/2	1/2	1/2			GUAH66665	7.90		
3/4	3/4	3/4			GUAH77775	7.90		
1/2	3/4	3/4	GUAH706	\$5.90	GUAH66775	7.90		
3/4	1/2	1/2	(Use 3/4" nuts)				GUAH66765	7.90
Type GUAP								
1/2	1/2	1/2			GUAP666765	8.80		
3/4	3/4	3/4			GUAP666865	8.80		
1/2	3/4	3/4	*GUAP706	\$6.30	GUAP667775	8.80		
3/4	1/2	1/2	(Use 3/4" nut except "D" hub★)				GUAP667875	8.80
1/2	3/4	3/4			GUAP777775	8.80		
3/4	1/2	1/2			GUAP777875	8.80		
1/2	1/2	1/2	†GUAP7806	6.70	GUAP668885	9.80		
3/4	3/4	1/2	(Use 3/4" nut except for "C", "D" and "E" hubs†)				GUAP778885	9.80
Type GUAQ								
1/2	1/2	1/2			GUAQ666765	9.90		
3/4	3/4	3/4			GUAQ666865	9.90		
1/2	3/4	3/4			GUAQ667775	9.90		
3/4	1/2	1/2	*GUAQ706	\$7.40	GUAQ667875	9.90		
1/2	3/4	3/4	(Use 3/4" nut except "D" hub★)				GUAQ777775	9.90
3/4	1/2	1/2			GUAQ777875	9.90		
Type GUAF								
1/2	1/2	1/2			GUAF6666665	10.80		
3/4	3/4	3/4			GUAF6776775	10.80		
1/2	3/4	3/4			GUAF6666775	10.80		
3/4	1/2	1/2	GUAF706	\$7.80	GUAF7777775	10.80		
1/2	3/4	3/4	(Use 3/4" nuts)				GUAF7667665	10.80
3/4	1/2	1/2			GUAF7667775	10.80		

*The D hub requires the use of a 1-inch nut for 1/2, 3/4 and 1-inch sleeve. †The C, D, and E hubs require the use of a 1-inch nut for 1/2, 3/4 and 1-inch sleeve.
★See page 329. 3/4" nuts take 1/2" and 3/4" sleeves. 1" nuts take 1/2", 3/4" and 1" sleeves.

Crouse-Hinds Condulets

GUJ Series Junction Condulets

Explosion-Proof, Dust-Tight, and Weather-Resistant (Raintight) Class I, Groups C and D; Class II, Groups E, F, and G; and Class III



Type GUJ

Hub Size In.	No.	Each
1/2	GUJ16	\$3.60
3/4	GUJ26	3.70
1	GUJ36	3.80



Type GUJC

Hub Size In.	No.	Each
1/2	GUJC16	\$3.80
3/4	GUJC26	4.00
1	GUJC36	4.20



Type GUJL

Hub Size In.	No.	Each
1/2	GUJL16	\$3.80
3/4	GUJL26	4.00
1	GUJL36	4.20



Type GUJB

Hub Size In.	No.	Each
1/2	GUJB16	\$3.80
3/4	GUJB26	4.00
1	GUJB36	4.20



Type GUJT

Hub Size In.	No.	Each
1/2	GUJT16	\$4.00
3/4	GUJT26	4.30
1	GUJT36	4.60



Type GUJX

Hub Size In.	No.	Each
1/2	GUJX16	\$4.20
3/4	GUJX26	4.60
1	GUJX36	5.00

Threaded Covers



Flat Cover



Dome Cover



Fixture Cover Union Hub Type

No.	Each	No.	Depth In.	Each	No.	Fix. Stem, In.	Each
GUJ06	\$1.50	GUJ0611	1	\$1.80	GUJ0686	1/2	\$5.50
		GUJ0612	2	2.20	GUJ0687	3/4	5.50

Type EJH Junction Condulets

For Pulling In or Splicing Conductors Explosion-Proof and Dust-Tight

The Condulet body has four bosses located 90° apart around the sides and one boss in the center back. These bosses can be drilled and tapped for 1/2 inch or 3/4 inch conduit.

When ordering include sketch showing location of holes to be drilled and tapped and size desired.

Price of Condulet includes drilling and tapping.

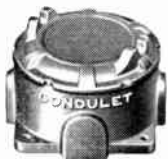

With Flat Cover

Inside Depth In.	No.	Each
2 5/32	EJH150	\$16.00



With 1 1/4-Inch Dome Cover

Inside Depth In.	No.	Each
3 7/16	EJH151	\$16.80

Inside Depth In.	No.	Each
4 3/8	EJH152	17.60

Inside Depth In.	No.	Each
5 7/16	EJH153	18.50

Inside Depth In.	No.	Each
7 3/16	EJH155	19.80

Threaded Covers and Canopies

For GUA and GUF Series Condulets

Used interchangeably on Condulets of GUA and GUF series.



Surface Covers



Flush Covers



Sealing Covers

Diam. Open. In.	No.	Each	No.	Each	No.	Each
2	GUA04	\$1.30	GUA049	\$1.30	GUA041	\$1.60
3	GUA06	1.50	GUA069	1.50	GUA062	2.00
3 5/8	GUA07	2.20	GUA079	2.20	GUA072	2.60
5	GUA09	6.70	GUA099	6.70	GUA092	7.50



Fixture Canopies



Fixture Covers Union Hub Type

Diam. Open. In.	Fix. Stem In.	No.	Each	No.	Each
3	1/2	GUA0618	\$7.00	GUA0686	\$5.50
3	3/4	GUA068	7.00	GUA0687	5.50
3	1 1/4	GUA0684	7.00
5	1 1/4	GUA098	15.00



Nipple Covers

Diam. Open. In.	Fix. Stem In.	No.	Each	Diam. Open. In.	Adapters No.	Each
2	1/2	GUA0471	\$2.40			
3	1/2	GUA0671	3.10	3 5/8 to 3	GUA0760	\$5.00
3	3/4	GUA0672	3.50			



Adapters

Type GUA Extension

For flush mounted GUA and GUF series with 3-inch cover opening to make one or more exposed extensions. Furnished with 3 pipe plugs.



Size In.	No.	Each
1/2	GUAX166	\$5.40
3/4	GUAX266	5.40

Type EKC Condulets

Explosion-Proof and Dust-Tight

Class I, Group D; Class II, Groups E, F, and G; and Class III EKC30, 40, 50, and 60 are also suitable for Class I, Group C locations.



No.	Size Hub In.	Each
EKC30	1	\$15.40
EKC40	1 1/4	16.00
EKC50	1 1/2	23.00
EKC60	2	24.00
EKC70	2 1/2	50.00
EKC80	3	51.20

Crouse-Hinds Condulets

CPS Series Junction Condulets

Explosion-Proof and Dust-Tight
Class I, Groups C and D; Class II, Groups E, F, and G; and Class III

Furnished With Hub Cover

Dead End

Size Hub Condulet In.	Cover	Form 10		Form 20	
		No.	Each	No.	Each
1/2	1/2	CPS10181	\$4.00	CPS10281	\$6.20
3/4	1/2	CPS20181	4.10	CPS20281	6.30
3/4	3/4	CPS20182	4.20	CPS20282	6.40
1	1/2	CPS30181	4.20	CPS30281	6.40
1	3/4	CPS30182	4.30	CPS30282	6.50

Through Feed

1/2	1/2	CPS11181	\$4.20	CPS11281	6.40
3/4	1/2	CPS21181	4.40	CPS21281	6.60
3/4	3/4	CPS21182	4.50	CPS21282	6.70
1	1/2	CPS31181	4.60	CPS31281	6.80
1	3/4	CPS31182	4.70	CPS31282	6.90

Type L

1/2	1/2	CPS12181	\$4.20	CPS12281	6.40
3/4	1/2	CPS22181	4.40	CPS22281	6.60
3/4	3/4	CPS22182	4.50	CPS22282	6.70
1	1/2	CPS32181	4.60	CPS32281	6.80
1	3/4	CPS32182	4.70	CPS32282	6.90

Type T

1/2	1/2	CPS13181	\$4.40	CPS13281	6.60
3/4	1/2	CPS23181	4.70	CPS23281	6.90
3/4	3/4	CPS23182	4.80	CPS23282	7.00
1	1/2	CPS33181	5.00	CPS33281	6.80
1	3/4	CPS33182	5.10	CPS33282	7.30

Type X

1/2	1/2	CPS14181	\$4.60	CPS14281	6.80
3/4	1/2	CPS24181	5.00	CPS24281	7.20
3/4	3/4	CPS24182	5.10	CPS24282	7.30
1	1/2	CPS34181	5.40	CPS34281	7.60
1	3/4	CPS34182	5.50	CPS34282	7.70

Furnished with Blank Covers
Dead End

Size Hub In.	Form 10		Form 20	
	No.	Each	No.	Each
1/2	CPS10185	\$3.50	CPS10286	\$5.70
3/4	CPS20185	3.60	CPS20286	5.80
1	CPS30185	3.70	CPS30286	5.90

Through Feed

1/2	CPS11185	\$3.70	CPS11286	5.90
3/4	CPS21185	3.90	CPS21286	6.10
1	CPS31185	4.10	CPS31286	6.30

Type L

1/2	CPS12185	\$3.70	CPS12286	5.90
3/4	CPS22185	3.90	CPS22286	6.10
1	CPS32185	4.10	CPS32286	6.30

Type T

1/2	CPS13185	\$3.90	CPS13286	6.10
3/4	CPS23185	4.20	CPS23286	6.40
1	CPS33185	4.50	CPS33286	6.70

Type X

1/2	CPS14185	\$4.10	CPS14286	6.30
3/4	CPS24185	4.50	CPS24286	6.70
1	CPS34185	4.90	CPS34286	7.10

If specified on the order, CPS series Condulets will be furnished with fastening lugs at an advance of \$0.20 in the list prices.

Outside dimensions of body, exclusive of hubs:
Diameter—Form 10, 3 1/2 inches. Form 20, 4 5/8 inches.
Depth—Form 10, 2 1/2 inches; Form 20, 2 11/16 inches.

Universal Junction Condulets

Explosion-Proof and Dust-Tight
Types GU, GUE, and GUB

These Condulets can be equipped with threaded or union hubs located as required. When ordering refer to information tables below and furnish a sketch showing the size, location and type of hubs required on each Condulet. Add price of hubs selected to price of Condulet. GU and GUE Condulets take CB1124, four-wire connection block.

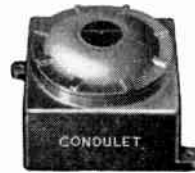

Type GUB01

Type GU

No.	Overall Dimensions in Inches of Body Including Cover			Diam. Cover Opening Inches	Each
	Width	Height	Depth		
GU	4 1/8	4 1/8	3 3/16	3 5/8	\$4.00
GUE	4 5/8	4 5/8	5 5/8	3 5/8	5.50
GUB01	6 1/2	7	5 5/8	5 1/2	20.00
GUB02	8	10	5 5/8	7	37.00
GUB06	8 1/2	10	6 5/8	7	46.00
GUB03	11	12	9 5/16	9 5/8	90.00

Symbol Numbers and Letters for Maximum Size Hubs That Can Be Used

No.	Type of Hub	Number of Hubs			
		On Top and Bottom		On Back	
GU	Threaded	4	4	1	4
	Union	Y	Y	R	Y
GUE	Threaded	6	5	2	4
	Union	T	Y	W	R
GUB01	Threaded	7	6	4	10
	Union	U	S	Y	V
GUB02	Threaded	7	7	5	10
	Union	U	T	Y	V
GUB06	Threaded	8	7	5	10
	Union	V	T	Y	V
GUB03	Threaded	10	9	6	10
	Union	XD	V	S	XD

Threaded and Union Hubs

Inches	Threaded		Union	
	Symbol	Each	Symbol	Each
1/2	1	\$1.90	W	\$2.70
3/4	2	2.00	X	2.70
1	3	2.30	Y	3.20
1 1/4	4	2.70	R	4.40
1 1/2	5	3.40	S	7.10
2	6	4.30	T	9.30
2 1/2	7	6.50	U	13.00
3	8	9.70	V	17.20
3 1/2	9	13.20	WD	22.20
4	10	17.20	XD	27.20

Type GUB Dome Covers

In ordering dome covers for GUB Condulets deduct cost of the flat cover shown in listing below, from cost of complete Condulet selected from listing above—then add cost of the dome cover selected from listing below.

Body No.	No.	Flat Cover		Nominal Depth, In.	Dome Cover	
		Each	Each		No.	Each
GUB01	GUB0101	\$6.40	13.00	2	GUB712	\$11.80
				4	GUB714	13.40
				10	GUB7110	18.20
				3	GUB723	18.30
GUB02	GUB0102	13.00	13.00	6	GUB726	22.80
				9	GUB729	27.30
				12	GUB7212	31.80
				17	GUB7217	39.30
GUB06	GUB0103	18.60	13.00	4	GUB734	22.80
				10	GUB738	33.00
				12	GUB7311	36.40
				14	GUB7313	39.80
GUB04	GUB0103	18.60	13.00	17	GUB7316	44.90
				17	GUB7316	44.90

Crouse-Hinds Condulets

Types EJB and GUB Junction Condulets With Terminal Blocks Explosion-Proof and Dust-Tight

Class I, Group D; Class II, Groups E, F, and G; and Class III

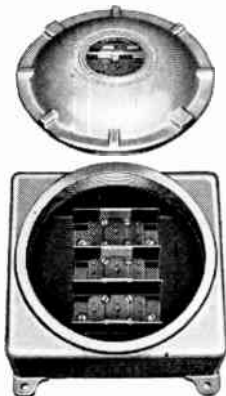

**GUB036 and GUB039 Without Hubs
Cover Removed Showing Terminal Block**

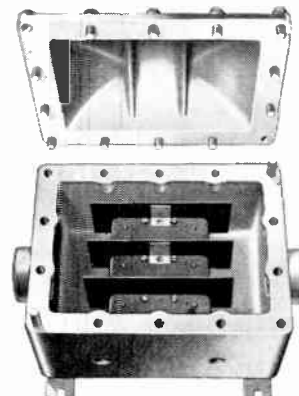

**EJB1184 and EJB1185 with Main Hubs and Branch Tapping
Cover Removed Showing Terminal Block**

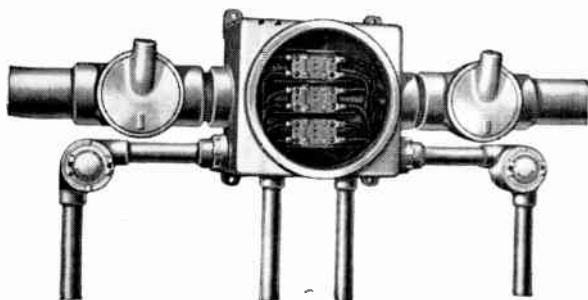

**GUB036 With Main and Branch Conduits and Wires in Place
for Motor Control Panel Assembly
(Motor Controls not Shown)**

Use: The EJB and GUB explosion-proof and dust-tight junction Condulets with terminal blocks provide convenient means for making taps of branch circuits for main feeders.

They are exceptionally useful in making up explosion-proof bus assemblies for groups of motor starters, branch circuit breakers, or combination starters and breakers. One such junction Condulet provides a means of tapping the main feeders to accommodate up to ten branch circuits.

One compact EJB or GUB junction Condulet with terminal block takes the place of one or more large junction boxes at as little as one-third the cost.

Design: These Condulets are standard types EJB and GUB, listed elsewhere in this section, except that they are provided with terminal blocks.

The blocks are equipped with heavy duty cast copper alloy pressure connectors for the main feeders. They are so arranged that the main cables may be pulled through unbroken and need only be skinned where they are clamped between halves of the pressure connectors.

The upper half or top clamp of each main pressure connector is arranged for attachment of standard branch circuit wire lugs.

3-Wire

Basic Condulet	Range of Main Pressure Terminals	Maximum Number per Terminal and Range of Branch Lugs*	Condulet Without Hubs With Terminal Block† Each		Terminal Block Only Each	
			No.	Price	No.	Price
GUB06	#4 to #0 #00 to 250 MCM	Four #4 stranded to #0 or Ten #14 to #4 stranded	GUB061	\$91.00	CB220	\$35.00
			GUB062	91.00	CB221	35.00
GUB03	#0 to #0000 250 to 500 MCM	Two #0 to #0000 or Four #4 stranded to #0 or Ten #14 solid to #4 stranded	GUB039	150.00	CB84	50.00
			GUB036	150.00	CB86	50.00
EJB12168	#0 to #0000 250 to 500 MCM 500 to 900 MCM 100 to 1250 MCM	Two #0 to #0000 or Four #4 stranded to #0 or Ten #14 solid to #4 stranded Four #0 to #0000 or Six #4 stranded to #0 or Ten #14 solid to #4 stranded	EJB287	250.00	CB84	50.00
			EJB286	250.00	CB86	50.00
			EJB1185	320.00	CB343	100.00
			EJB1184	320.00	CB344	100.00

4-Wire

EJB12168	#0 to #0000 250 to 500 MCM	Two #0 to #0000 or Four #4 stranded to #0 or Ten #14 solid to #4 stranded	EJB290	280.00	CB81	80.00
			EJB289	280.00	CB87	80.00

*Standard solder or solderless lugs can be used but these are not included in the list prices of the Condulets. They can be supplied and prices will be quoted on request.

†Sketch showing conduit arrangement required with order. Refer to pages 332 and 334 for prices.

Crouse-Hinds Condulets

Type ESC Pull Condulets
For Pulling or Splicing Conductors
Explosion-Proof and Dust-Tight
Class I, Group D; and Classes II and III

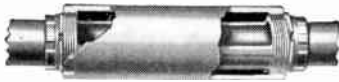

For use in hazardous locations, and designed to afford a convenient opening in the conduit system for pulling or splicing conductors.

The body is cylindrical with a long and wide opening in the front between the threaded end portions.

No.	Overall Length, In.		Size Hub In.	Each
	Condulet Pulled Open	Opening Only		
ESC1	15 ⁷ / ₈	6	1/2	\$12.50
ESC2	15 ⁷ / ₈	6	3/4	12.50
ESC3	23 ³ / ₄	10	1	21.00
ESC4	23 ³ / ₄	10	1 1/4	21.00
ESC5	37 ¹ / ₈	16	1 1/2	43.00
ESC6	37 ¹ / ₈	16	2	43.00
ESC7	53 ¹ / ₁₆	24	2 1/2	78.00
ESC8	53 ¹ / ₁₆	24	3	78.00
ESC9	84 ¹ / ₈	38	3 1/2	200.00
ESC10	84 ¹ / ₈	38	4	200.00

Type LBH Condulets
For Pulling Cables
Explosion-Proof and Dust-Tight



Particularly well suited for pulling large conductors or conductors that are still because of their lead sheathing. Especially useful at motor locations. Covers are domed, which provides room for an easy bend in the conductor, thus avoiding undue strain upon the insulation or lead sheath.

Particularly well suited for pulling large conductors or conductors that are still because of their lead sheathing. Especially useful at motor locations. Covers are domed, which provides room for an easy bend in the conductor, thus avoiding undue strain upon the insulation or lead sheath.

No.	Overall Length Inches	Overall Width Inches	Size Hub In.	Each
LBH10	6 1/16	2 3/4	1/2	\$5.60
LBH120	6 1/16	2 3/4	3/4	6.00
LBH130	9 3/8	4	1	15.40
LBH140	9 3/8	4	1 1/4	16.00
LBH150	12 1/2	5	1 1/2	23.00
LBH160	12 1/2	5	2	24.00
LBH170	17 3/8	6 5/8	2 1/2	50.00
LBH180	17 3/8	6 5/8	3	51.20

Type ECD Drain and Breather Valves
Explosion-Proof—Class I, Groups C and D



ECD Drain



ECD Breather

The ECD breather valve is similar to the ECD drain but is designed to be installed in the top of explosion-proof housings, allowing air to pass in or out as conditions vary. The labyrinth handle is a rotating cap to prevent dirt from interfering with the action of the valve.

For Water Only No.	For Water Under Oil No.	For Air Only No.	Size Pipe Thread In.	Each
ECD281	ECD282	ECD283	1/4	\$3.30
ECD381	ECD382	ECD383	3/8	3.30
ECD11	ECD12	ECD13	1/2	3.30
Universal Breather-Drain				
	ECD385		3/8	\$3.30
	ECD15		1/2	3.30

Type EJB Junction Condulets

Explosion-Proof, Dust-Tight, and Weather Resistant (Raintight)

Class 1, Group D; Class II, Groups E, F, and G; and Class III



Type EJB886

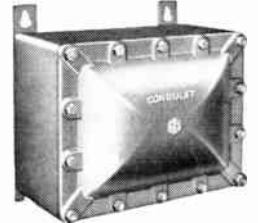

Type EJB12168 and EJB8138



Type EJB4164

No.	Width In.	Size Inside Length In.	Depth In.	Net Weight With Cover	Each Without Hubs or Tapping
EJB886	8	8	6	82	\$70.00
EJB4164	4	16	4	68	68.00
EJB8138	8	13	8	170	135.00
EJB12168	12	16	8	230	190.00
EJB9166	9	16	6	140	155.00
EJB12236	12	23	6	220	200.00

Conduit Connection Information

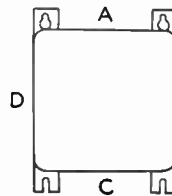

With mounting straps in vertical position, specify the number, size and location of tapped holes or hubs required in each wall, starting with wall A and continuing clockwise with walls B, C, and D. Tapped holes or brazed hubs will be furnished at the following list prices:

Size Conduit In.	Tapped Holes \$	Brazed Hubs \$	Brazed Union Hubs \$
1/2	1.00	1.90	2.70
3/4	1.30	2.00	2.70
1	1.60	2.30	3.40
1 1/4	2.00	2.70	4.40
1 1/2	2.50	3.40	7.10
2	3.50	4.30	9.30
2 1/2	4.50*	6.50	13.00
3	6.00*	9.70	17.20
3 1/2	9.00*	13.20	22.20
4	12.00*	17.20	27.20

*Drilled and tapped openings of these sizes can be furnished only on 8 x 8 ends of the EJB8138.

RS Series Junction Condulets



Take conduit hub plates. Furnished with cast Feraloy cover, screws and gaskets for cover and hub plates.

No.	Type	Approx. Inside Dimen. Inches	Each
RS1	RS	8 1/2 x 8 1/2 x 4	\$18.50
RSM1	RSM	8 1/2 x 4 1/2 x 4	15.70
RSS1	RSS	4 1/2 x 4 1/2 x 4	13.50

Crouse-Hinds Condulets

**RSP Series Conduit Hub Plates
For RS Series Condulets**

For 8 1/2 x 4-inch sides of Types RS and RSM Condulets. Approximate outside dimensions, 8 1/16 x 3 1/2 inches. Cap screws and gaskets furnished with Condulet.



With One Hub

With Two Hubs

No.	*Size Inches	Each
RSP1	1 1/2	\$2.00
RSP2	3/4	2.10
RSP3	1	2.20
RSP4	1 1/4	2.30
RSP5	1 1/2	2.40
RSP6	2	2.50
RSP7	2 1/2	2.80
RSP8	3	3.30
RSP9	3 1/2	3.80

No.	*Size Inches	Each
RSP11	1 1/2-1 1/2	\$2.20
RSP22	3/4-3/4	2.40
RSP31	1-1 1/2	2.60
RSP33	1-1	2.60
RSP42	1 1/4-3/4	2.80
RSP43	1 1/4-1	3.00
RSP44	1 1/4-1 1/4	2.80
RSP52	1 1/2-3/4	3.10
RSP53	1 1/2-1	3.10
RSP54	1 1/2-1 1/4	3.10
RSP55	1 1/2-1 1/2	3.10
RSP62	2-3/4	3.50
RSP63	2-1	3.50
RSP64	2-1 1/4	3.50
RSP65	2-1 1/2	3.50
RSP66	2-2	3.50
RSP73	2 1/2-1	3.90



With Three Hubs

RSP111	1 1/2-1 1/2-1 1/2	\$2.40
RSP222	3/4-3/4-3/4	2.70
RSP331	1-1-1 1/2	3.00
RSP333	1-1-1	3.00
RSP442	1 1/4-1 1/4-3/4	3.30
RSP444	1 1/4-1 1/4-1 1/4	3.30
RSP553	1 1/2-1 1/2-1	3.80
RSP555	1 1/2-1 1/2-1 1/2	3.80



Blank

RSPO \$1.90

*Sizes are given from left to right in illustrations.

RSPM Series Conduit Hub Plates

For 1 1/2 x 4-inch Sides of Types RSM and RSS Condulets. Approximate outside dimensions, 3 1/2 x 3 1/2 inches. Cap screws and gaskets furnished with Condulet.

With One Hub



No.	Hub Size In.	Each
RSMP1	1/2	\$1.00
RSMP2	3/4	1.10
RSMP3	1	1.20



RSMP4	1 1/4	1.30
RSMP5	1 1/2	1.40
RSMP6	2	1.50
RSMP7	2 1/2	1.80

With Two Hubs

RSMP11	1 1/2-1 1/2	\$1.20
RSMP22	3/4-3/4	3.40



Blank

RSMP0 \$0.90

Condulet Expansion Unions

Explosion-Proof & Dust-Tight

Type UNY—Male

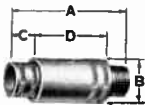

No.	Size In.	Each
UNY17	1/2	\$1.00
UNY27	3/4	1.45
UNY37	1	2.50

Type UNYL—Male

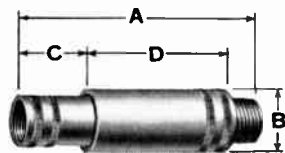

UNYL17	1/2	1.50
UNYL27	3/4	2.15
UNYL37	1	3.75

Unions, Plugs, Explosion-Proof and Dust-Tight

Type UNY—Male

For connecting conduit to a Condulet.



No.	Size Inches	Dimensions, Inches		Each
		Length	diam.	
UNY105	3/8	2 1/16	1 1/2	\$1.00
UNY215	*3/4 to 1/2	2 1/8	1 3/4	1.45
UNY205	3/4	2 1/8	1 3/4	1.45
UNY305	1	2 1/8	2 1/16	2.50
UNY405	1 1/4	2 1/16	2 1/16	3.90
UNY505	1 1/2	3 1/8	3 1/8	5.00
UNY605	2	3 1/4	3 1/16	6.40
UNY705	2 1/2	3 3/8	3 1/16	10.10
UNY805	3	4 1/16	5	13.75
UNY905	3 1/2	5	5 1/2	22.40
UNY1005	4	5 1/2	6 3/16	25.60
UNY012	5	5 3/8	8 3/16	35.65
UNY014	6	5 3/8	9 3/16	42.25

Type UNF—Female

For connecting conduit to conduit.



No.	Size Inches	Dimensions, Inches		Each
		A	B	
UNF105	1/2	1 3/4	1 1/2	\$0.90
UNF215	*3/4 to 1/2	1 3/4	1 3/4	1.25
UNF205	3/4	1 3/4	1 3/4	1.25
UNF305	1	1 15/16	2 1/16	2.30
UNF405	1 1/4	2	2 1/16	3.50
UNF505	1 1/2	2 1/16	3 1/8	4.55
UNF605	2	2 1/16	3 1/16	5.95
UNF705	2 1/2	2 7/8	4 1/16	8.20
UNF805	3	3 3/16	5	11.85
UNF905	3 1/2	4	5 1/2	18.75
UNF1005	4	5	6 3/16	21.95
UNF012	5	5 1/2	8 3/16	29.70
UNF014	6	5 3/8	9 3/16	35.60

Type UNL 90° Angle Unions

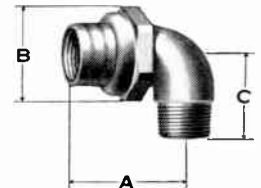

For connecting conduit to a Condulet.

No.	Size, Inches	Dimensions, Inches			Each
		A	B	C	
UNL125	*1/2 to 3/4	2 3/16	1 3/4	1 7/16	\$2.80
UNL215	*3/4 to 1 1/2	2 5/16	1 3/4	1 5/8	2.80
UNL205	3/4 to 3/4	2 5/16	1 3/4	1 5/8	2.80

*Size of right end is given first.

Type UNA Connectors and Unions

A convenient coupling or union for conduit joints made at angles from 90° to 180°.

Box Connectors—Male

For use only if adjacent to a Condulet. Explosion-proof and dust-tight.



No.	Size In.	Dimensions, Inches		Each
		Length	Width	
UNA16	1 1/2	4	2 11/32	\$4.20
UNA26	3 1/4	4 1/2	2 27/32	4.50
UNA36	1	5 1/4	3 15/32	4.80

Universal Unions—Female



UNA1	1/2	3 3/8	2 11/32	\$3.90
UNA2	3/4	3 7/8	2 27/32	4.40
UNA3	1	4 3/8	3 15/32	4.80

Type PLG Pipe Plugs



No.	Each	For Pipe Size In.	No.	Each
PLG1	\$0.16	1/2	PLG15	\$0.16
PLG2	.20	3/4	PLG25	.20
PLG3	.24	1	PLG35	.24
PLG4	.30	1 1/4	PLG45	.30
PLG5	.40	1 1/2	PLG55	.40
PLG6	.76	2	PLG65	.76
PLG7	1.20	2 1/2	PLG75	1.20
PLG8	1.80	3	PLG85	1.80
.....	3 1/2	PLG95	2.40
.....	4	PLG105	3.20

Crouse-Hinds Type EC Flexible Couplings

Explosion-Proof, Dust-Tight and Watertight Class I, Group D; and Classes II and III

For use in hazardous locations where it is necessary to employ flexible fittings, as at motor terminals. Provide a safe means of making connections. They are made to withstand explosion pressures and to provide ample mechanical and electrical protection.

Also watertight, and are, therefore, suitable for use in damp locations or under water, such as connections to underwater floodlights and fountain lights.

Type ECJ

Type ECG

Type ECH



Two Female Nipples

One Female Nipple, One Male Nipple

Two Male Nipples

4 Inches

Size In.	No.	Overall Length In.	No.	Overall Length In.	No.	Overall Length In.	Each
1/2	ECJ114	7	ECG114	7	ECH114	7	59.50
3/4	ECJ24	7	ECG24	7	ECH24	7	11.40

10 Inches

1/2	ECJ110	13	ECG110	13	ECH110	13	12.50
3/4	ECJ210	13	ECG210	13	ECH210	13	15.60
1	ECJ310	14 1/8	ECG310	14 1/16	ECH310	14 1/2	27.00

18 Inches

1/2	ECJ118	21	ECG118	21	ECH118	21	16.50
3/4	ECJ218	21	ECG218	21	ECH218	21	21.20
1	ECJ318	22 7/8	ECG318	22 11/16	ECH318	22 1/2	35.00
1 1/4	ECJ418	23 1/2	ECG418	23 5/16	ECH418	23 3/8	50.80
1 1/2	ECJ518	23 7/8	ECG518	23 5/8	ECH518	23 3/8	68.60
2	ECJ618	22 7/8	ECG618	22 5/8	ECH618	22 3/8	88.00

Type ECJ

Type ECG

Type ECH

27 Inches

1/2	ECJ127	30	ECG127	30	ECH127	30	521.00
3/4	ECJ227	30	ECG227	30	ECH227	30	27.50
1	ECJ327	31 7/8	ECG327	31 11/16	ECH327	31 1/2	44.00
1 1/4	ECJ427	32 1/2	ECG427	32 5/16	ECH427	32 1/8	62.50
1 1/2	ECJ527	32 7/8	ECG527	32 5/8	ECH527	32 3/8	83.00
2	ECJ627	31 7/8	ECG627	31 5/8	ECH627	31 3/8	106.00

36 Inches

1/2	ECJ136	39	ECG136	39	ECH136	39	25.50
3/4	ECJ236	39	ECG236	39	ECH236	39	33.80
1	ECJ336	40 7/8	ECG336	40 11/16	ECH336	40 1/2	53.00
1 1/4	ECJ436	41 1/2	ECG436	41 5/16	ECH436	41 1/8	74.20
1 1/2	ECJ536	41 7/8	ECG536	41 5/8	ECH536	41 3/8	97.40
2	ECJ636	40 7/8	ECG636	40 5/8	ECH636	40 3/8	124.00

Type ECL

Type ECK



One Female Union, One Female Nipple



One Female Union, One Male Nipple

4 Inches

Size In.	No.	Overall Length In.	No.	Overall Length In.	Each
1/2	ECL14	7 21/32	ECK14	7 21/32	510.30
3/4	ECL24	7 3/4	ECK24	7 3/4	12.20

10 Inches

1/2	ECL110	13 21/32	ECK110	13 21/32	13.30
3/4	ECL210	13 3/4	ECK210	13 3/4	16.40
1	ECL310	15 1/8	ECK310	14 15/16	29.00

Crouse-Hinds Type EC Flexible Couplings—Continued

Type ECL

Type ECK

18 Inches

Size In.	No.	Overall Length In.	No.	Overall Length In.	Each
1/2	ECL118	21 21/32	ECK118	21 21/32	17.30
3/4	ECL218	21 3/4	ECK218	21 3/4	22.00
1	ECL318	23 1/8	ECK318	22 15/16	37.00
1 1/4	ECL418	23 7/8	ECK418	23 7/8	53.80
1 1/2	ECL518	24 9/16	ECK518	24 1/4	72.10
2	ECL618	24 1/8	ECK618	23 19/16	95.00

27 Inches

1/2	ECL127	30 21/32	ECK127	30 21/32	21.80
3/4	ECL227	30 3/4	ECK227	30 3/4	28.30
1	ECL327	32 1/8	ECK327	31 15/16	46.00
1 1/4	ECL427	32 7/8	ECK427	32 7/8	65.50
1 1/2	ECL527	33 9/16	ECK527	33 1/4	86.50
2	ECL627	33 1/8	ECK627	32 19/16	113.00

36 Inches

1/2	ECL136	39 21/32	ECK136	39 21/32	26.30
3/4	ECL236	39 3/4	ECK236	39 3/4	34.60
1	ECL336	41 1/8	ECK336	40 15/16	55.00
1 1/4	ECL436	41 7/8	ECK436	41 7/8	77.20
1 1/2	ECL536	42 9/16	ECK536	42 1/4	100.90
2	ECL636	42 1/8	ECK636	41 19/16	131.00

Crouse-Hinds Type CGE Connectors

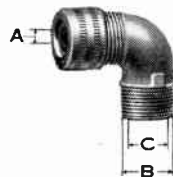

90° Angle—Male Thread With Tapered Rubber Bushing

The smaller sizes of connectors are made of steel; larger sizes of cast Feraloy.

***Schedule 1**

For connecting round flexible cord or cable to Condulets, outlet boxes, plug handles, or rigid conduit. Cord or cable will pass entirely through the connector without removing outer covering.

No.	Dimensions, Inches	Each
CGE192	.125 to .250	1/2
CGE292	.125 to .250	3/4
CGE193	.250 to .375	1/2
CGE293	.250 to .375	3/4
CGE194	.375 to .438	1/2
CGE294	.375 to .500	3/4
CGE295	.500 to .625	3/4
CGE395	.500 to .625	1
CGE396	.625 to .750	1
CGE397	.750 to .813	1
CGE498	.875 to 1.000	1 1/4

***Schedule 2**

For connecting round flexible cord or cable to Condulets, outlet boxes, or rigid conduit. Cord or cable will not pass through the connector without removing outer covering.

CGE195	.500 to .625	1/2	1/2	51.60
CGE196	.625 to .750	1/2	1/2	2.60
CGE296	.625 to .750	3/4	1 1/16	2.60
CGE197	.750 to .875	1/2	1/2	2.60
CGE297	.750 to .875	3/4	1 1/16	2.60
CGE397	.813 to .875	1	2 9/32	2.60
CGE398	.875 to 1.000	1	2 9/32	4.50

*Use schedule numbers for identification of connectors, when consulting Underwriters' Laboratories' list of inspected electrical appliances.

†A—Inside diameter in inches of rubber bushing which takes round flexible cord or cable.

§B—Size in inches of Condulet hub with which connectors can be used.

||C—Inside diameter of hole through nipple of connectors.

Crouse-Hinds Type CGB Connectors

Straight—Male Thread



The smaller sizes of connectors are made of steel; larger sizes, of cast Feroyal.

With Tapered Rubber Bushing

**Schedule 1*

For connecting round flexible cord or cable to Condulets, outlet boxes, plug handles, or rigid conduit. Cord or cable will pass entirely through the connector without removing outer covering.

No.	†A	Dimensions, Inches		Each
		§B	¶C	
CGB3892	.125 to .250	3/8	15/32	\$1.00
CGB192	.125 to .250	1/2	19/32	1.00
CGB292	.125 to .250	3/4	11/16	1.00
CGB3893	.250 to .375	3/8	15/32	1.00
CGB193	.250 to .375	1/2	19/32	1.00
CGB293	.250 to .375	3/4	11/16	1.00
CGB194	.375 to .500	1/2	19/32	1.00
CGB294	.375 to .500	3/4	11/16	1.00
CGB295	.500 to .625	3/4	11/16	1.00
CGB395	.500 to .625	1	15/16	2.00
CGB396	.625 to .750	1	15/16	2.00

**Schedule 2*

For connecting round flexible cord or cable to condulets, outlet boxes, or rigid conduit. Cord or cable will not pass through the connector without removing outer covering.

CGB195	.500 to .625	1/2	1/2	\$1.00
CGB196	.625 to .750	1/2	1/2	2.00
CGB296	.625 to .750	3/4	11/16	2.00
CGB297	.750 to .875	3/4	11/16	2.00
CGB398	.875 to 1.000	1	29/32	3.80

With Tapered Split Lead Sleeves

Schedule 3

For connecting armored cable or flexible conduit to Condulets, outlet boxes, plug handles, or rigid conduit. Armored cable or flexible conduit will pass entirely through the connector.

No.	†A	Dimensions, Inches		Each
		§B	¶C	
CGB184	.375 to .500	1/2	19/32	\$1.20
CGB185	.500 to .563	1/2	19/32	1.20
CGB285	.500 to .625	3/4	11/16	1.20
CGB386	.625 to .781	1	15/16	2.25
CGB387	.781 to .938	1	15/16	2.25
CGB489	.938 to 1.156	1 1/4	1 1/2	4.30
CGB589	.938 to 1.156	1 1/2	1 7/16	4.30

Schedule 4

For connecting armored cable or flexible conduit to Condulets, outlet boxes, plug handles, or rigid conduit. Armored cable or flexible conduit will not pass through the connector without removing outer covering.

CGB186	.625 to .781	1/2	1/2	\$2.25
CGB286	.625 to .781	3/4	11/16	2.25
CGB187	.781 to .938	1/2	1/2	2.25
CGB287	.781 to .938	3/4	11/16	2.25
CGB289	.938 to 1.156	3/4	11/16	4.30
CGB389	.938 to 1.156	1	29/32	4.30

*Use schedule numbers for identification of connectors when consulting Underwriters' Laboratories' list of inspected electrical appliances.

†A—Inside diameter in inches of rubber bushing which takes round flexible cord or cable.

†A—Inside diameter in inches of split lead sleeve which takes armored cable or flexible conduit.

§B—Size in inches of Condulet hub with which connectors can be used.

¶C—Inside diameter of hole through nipple of connectors.

Crouse-Hinds Threaded Condulet Reducers



Used to reduce Condulets from larger to smaller sizes.

Size In.	No.	Per 100	Size In.	No.	Per 100
1/4 - 1/8	RE2818	\$30.00	3 - 1/2	RE81	\$250.00
3/8 - 1/8	RE3818	30.00	3 - 3/4	RE82	250.00
3/8 - 1/4	RE3828	30.00	3 - 1	RE83	250.00
1/2 - 1/8	RE1108	30.00	3 - 1 1/4	RE84	210.00
1/2 - 1/4	RE1208	30.00	3 - 1 1/2	RE85	210.00
1/2 - 3/8	RE1308	26.00	3 - 2	RE86	210.00
3/4 - 1/2	RE21	16.00	3 - 2 1/2	RE87	210.00
1 - 1/2	RE31	25.00	3 1/2 - 1/2	RE91	390.00
1 - 3/4	RE32	25.00	3 1/2 - 3/4	RE92	390.00
1 1/4 - 1/2	RE41	42.00	3 1/2 - 1	RE93	390.00
1 1/4 - 3/4	RE42	42.00	3 1/2 - 1 1/4	RE94	390.00
1 1/4 - 1	RE43	42.00	3 1/2 - 1 1/2	RE95	390.00
1 1/2 - 1/2	RE51	65.00	3 1/2 - 2	RE96	390.00
1 1/2 - 3/4	RE52	65.00	3 1/2 - 2 1/2	RE97	350.00
1 1/2 - 1	RE53	65.00	3 1/2 - 3	RE98	350.00
1 1/2 - 1 1/4	RE54	65.00	4 - 1/2	RE101	560.00
2 - 1/2	RE61	136.00	4 - 3/4	RE102	560.00
2 - 3/4	RE62	136.00	4 - 1	RE103	560.00
2 - 1	RE63	114.00	4 - 1 1/4	RE104	560.00
2 - 1 1/4	RE64	114.00	4 - 1 1/2	RE105	560.00
2 - 1 1/2	RE65	114.00	4 - 2	RE106	560.00
2 1/2 - 1/2	RE71	180.00	4 - 2 1/2	RE107	460.00
2 1/2 - 3/4	RE72	180.00	4 - 3	RE108	460.00
2 1/2 - 1	RE73	180.00	1 - 3 1/2	RE109	460.00
2 1/2 - 1 1/4	RE74	180.00	5 - 1	RE1210	1300.00
2 1/2 - 1 1/2	RE75	175.00	6 - 5	RE1412	1600.00
2 1/2 - 2	RE76	157.00			

Crouse-Hinds Threadless Condulet Reducers



For Threadless Condulets

Size Inches	Thick Wall		Thin Wall EMT*	
	No.	Per 100	No.	Per 100
3/4 - 1/2	RE291	\$58.00	RE251	\$58.00
1 - 1/2	RE391	76.00	RE351	76.00
1 - 3/4	RE392	86.00	RE352	86.00
1 1/4 - 1/2	RE491	102.00	RE451	102.00
1 1/4 - 3/4	RE492	108.00	RE452	108.00
1 1/4 - 1	RE493	116.00	RE453	116.00
1 1/2 - 1/2	RE591	114.00	RE551	114.00
1 1/2 - 3/4	RE592	128.00	RE552	128.00
1 1/2 - 1	RE593	134.00	RE553	134.00
1 1/2 - 1 1/4	RE594	162.00	RE554	162.00
2 - 1/2	RE691	150.00	RE651	150.00
2 - 3/4	RE692	170.00	RE652	170.00
2 - 1	RE693	184.00	RE653	184.00
2 - 1 1/4	RE694	204.00	RE654	204.00
2 - 1 1/2	RE695	216.00	RE655	216.00

*External threaded portion has a fine thread to fit EMT Condulets only.

Certain sizes of thin wall reducers for old style Condulets with external clamping nut can be furnished. Information on request to Graybar.

Call Graybar FIRST For . . .



Crouse-Hinds Condulets

Type EL Condulet Elbows
Explosion-Proof and Dust-Tight

45° Female

No.	Size In.	Dimension A In.	Each
EL1	1/2	1 3/16	\$0.40
EL2	3/4	1 5/16	.50
EL3	1	1 7/16	.70
EL4	1 1/4	1 11/16	1.30
EL5	1 1/2	2	1.50
EL6	2	2 1/4	2.40
EL7	2 1/2	2 3/4	6.30
EL8	3	3	7.00
EL9	3 1/2	3 9/16	9.90
EL10	4	3 3/4	11.10

90° Male

EL195	1/2	1 1/2	\$1.20
EL295	3/4	1 5/8	1.40
EL395	1	1 7/8	1.70
EL495	1 1/4	2 1/8	2.00

90° Female

EL19	1/2	1 7/16	\$0.50
EL29	3/4	1 9/16	.70
EL39	1	1 11/16	.90
EL49	1 1/4	2 1/16	1.50
EL59	1 1/2	2	3.00
EL69	2	5	5.00
EL79	2 1/2	6 7/16	9.50

90° Male and Female

EL196	1/2	1 1/2	\$1.20
EL296	3/4	1 5/8	1.40
EL396	1	1 7/8	1.70
EL496	1 1/4	2 1/8	2.00

Type EYS Sealing Condulets

Explosion-Proof
For Sealing Vertical Runs of Conduit

Female Hub Top and Bottom

No.	Size In.	Length In.	Turning Rad. In.	App. Int. Vol. Cu. In.	Each
EYS1	1/2	3 9/32	1 5/8	1	\$1.30
EYS2	3/4	3 11/16	1 29/32	1 1/4	1.60
EYS3	1	4 1/16	2 3/8	4	2.10
EYS4	1 1/4	5 1/16	1 23/32	6 1/2	2.60
EYS5	1 1/2	5 1/2	2 1/16	8 1/2	3.90
EYS6	2	6 1/4	2 5/16	18	5.10
EYS7	2 1/2	7 1/2	2 11/16	30	8.00
EYS8	3	8 1/2	3 5/16	64	10.00

Male and Female Hub†

EYS16	1/2	3 9/32	1 5/8	1	\$1.30
EYS26	3/4	3 11/16	1 29/32	1 3/4	1.60
EYS36	1	4 1/16	2 3/8	4	2.10
EYS46	1 1/4	5 1/16	1 23/32	6 1/2	2.60
EYS56	1 1/2	5 1/2	2 1/16	8 1/2	3.90
EYS66	2	6 1/4	2 5/16	18	5.10
EYS76	2 1/2	7 1/2	2 11/16	30	8.00
EYS86	3	8 1/2	3 5/16	64	10.00

†See footnote, preceding column.

Type EZD Inspection and Drain Sealing Condulets
Explosion-Proof

For Sealing Vertical Runs of Conduit

The National Electrical Code requires that conduit systems in Class I Hazardous Locations be provided with means by which the systems can be drained of water, if there is a likelihood of water accumulation. Type EZD Drain Seals and EZD Inspection Seals listed below make compliance with this rule simple and inexpensive.

Inspection Seal Condulets

No.	Size In.	Length In.	Turning Radius† In.	Internal Volume	Each
EZD1C	1/2	4 3/16	2 1/16	5	\$2.70
EZD20	3/4	4 3/16	2 3/16	6	3.40
EZD30	1	4 11/16	2 7/16	10	4.40
EZD40	1 1/4	4 15/16	2 9/16	11	5.50
EZD50	1 1/2	5 3/16	2 11/16	13	8.20
EZD60	2	7 1/8	3 11/16	40	10.80
EZD70	2 1/2	8	3 7/8	50	13.00

Drain Seal Condulets

EZD111	1/2	4 3/16	2 1/16	5	\$5.70
EZD211	3/4	4 3/16	2 3/16	6	6.40
EZD311	1	4 11/16	2 7/16	10	7.40
EZD411	1 1/4	4 15/16	2 9/16	11	8.50
EZD511	1 1/2	5 3/16	2 11/16	13	11.20
EZD611	2	7 1/8	3 11/16	40	13.80
EZD711	2 1/2	8	3 7/8	50	16.00

†With cover removed.

Chico A Sealing Compound

Not affected by gasoline, alcohol, acetone, etc.

Put up in air-tight and moisture-proof packages.

No.	A2	A3	A4	A23	A24	A05	A5
*Vol. cu. In.	13	23	23	46	46	115	230
Package No.	2	3	4	23	24	05	5
Weight, Lbs.	9 oz.	1	▲1	2	§2	5	10

Each \$0.80 \$1.30 \$2.00 \$2.20 \$3.80 \$3.60 \$7.20

*Number of cubic inches volume this amount fills when set.

▲With 3/4-ounce Chico X Fiber. §With 2-oz. Chico X Fiber.

Chico X Fiber

No.	X1	X2	X3	X4	X5	X6	X7
Package No.	1	2	3	4	5	6	7
Weight, oz.	3/8	3/4	1	2	4	8	16

Approximate amount of fiber required per Condulet hub:

Size Hub, inches	1/2	3/4	1	1 1/4	1 1/2	2	2 1/2	3
Oz. Required	1/32	1/16	1/8	1/4	1/2	1	1 1/2	2
Per Package	\$0.50	\$0.80	\$1.00	\$1.80	\$3.40	\$5.80	\$9.60	

Type EZS Sealing Condulets

Explosion-Proof

For Sealing Vertical or Horizontal Runs of Conduit Condulets have round cover openings and provide ample room for placing dams around and between conductors, preparatory to sealing.

Female Hub Top and Bottom

No.	Size In.	Length In.	Turning Rad.▲ In.	App. Int. Vol. Cu. In.	Each
EZS1	1/2	4 3/16	1 3/4	5 1/2	\$2.30
EZS2	3/4	4 3/16	1 3/4	6	2.90
EZS3	1	4 15/16	2 1/16	9	3.70
EZS4	1 1/4	5 1/16	2 3/16	12 1/2	4.70
EZS5	1 1/2	5 3/16	2 1/4	14	7.00
EZS6	2	7 1/16	3 3/16	46	9.20
EZS7	2 1/2	7 15/16	3 3/8	55	14.80
EZS8	3	8 5/8	3 3/4	88	21.40

Male and Female Hub†

EZS16	1/2	4 3/16	1 3/4	5 1/2	\$2.30
EZS26	3/4	4 3/16	1 3/4	6	2.90
EZS36	1	4 15/16	2 1/16	9	3.70
EZS46	1 1/4	5 1/16	2 3/16	12 1/2	4.70
EZS56	1 1/2	5 3/16	2 1/4	14	7.00
EZS66	2	7 1/16	3 3/16	46	9.20
EZS76	2 1/2	7 15/16	3 3/8	55	14.80
EZS86	3	8 5/8	3 3/4	88	21.40

†The male and female hub listings include a close conduit nipple which may be used interchangeably in either top or bottom hub.

▲With cover removed.

Crouse-Hinds Wedgtite Hangers and Wire Supports

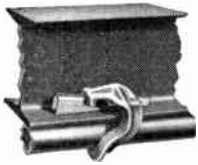

Wedgtite hangers are for attaching conduits or wire hangers to structural steel members. They can be installed without drilling or in any way preparing the member. A few blows of the hammer makes the attachment secure.

Type CHRP Installed Pipe Parallel With a Structural Support

Type CHRP

For pipe running parallel or at right angle to support.



No. For Flange		Conduit Size In.	Each
1/8"-1/2"	CHRP1	1/2	\$0.80
1/4"-3/8"	CHRP2	3/4	.90
	CHRP3	1	1.00
	CHRP4	1 1/4	1.10
	CHRP5	1 1/2	1.20
	CHRP6	2	1.30



Type PED Condulet Pedestals

Rigid support for Condulets mounted on conduit that projects through the floor.



Ht. In.	Threaded		Each	Size In.	Ht. In.	Not Threaded		Each
	No.	No.				No.	No.	
3	Ped13	\$1.90	1/2	6	Ped16	\$3.50	
3	Ped223	Ped23	2.40	3/4	6	Ped26	4.00	
3	Ped333	Ped33	2.90	1	6	Ped36	4.50	
3	Ped443	Ped43	3.40	1 1/4	6	Ped46	5.00	
3	Ped53	3.90	1 1/2	6	Ped56	5.50	
3	Ped63	4.40	2	6	Ped66	6.00	
3	Ped73	4.90	2 1/2	6	Ped76	6.50	

Crouse-Hinds Industrial Lighting Fixtures

Type EVA

Explosion-Proof and Weather Resistant—Raintight
Class I, Groups A, B, C, and D



No. EVA295



No. EVA2951



No. EVA2953

Without Reflector

Guard	150 or 200 Watt		200 or 300 Watt	
	No.	Each	No.	Each
With	EVA295	\$62.00	EVA292	\$80.00
Without	EVA285	60.30	EVA282	77.60

With Dome Reflector

With	EVA2951	67.20	EVA2921	86.30
Without	EVA2851	65.50	EVA2821	83.90

With Deep Bowl Reflector

With	EVA2953	67.30	EVA2923	86.40
Without	EVA2853	65.60	EVA2823	84.00

With Shallow Bowl Reflector

With	EVA2955	67.20	EVA2925	86.00
Without	EVA2855	65.50	EVA2825	83.60

With 30° Angle Reflector

With	EVA2957	67.70	EVA2927	87.00
Without	EVA2857	66.00	EVA2827	84.60

Crouse-Hinds Lighting Fixtures
EV Series

Explosion-Proof
Class I, Groups C and D

Hoods are cast aluminum with etched Alzak aluminum inner reflectors. Globe holder assembly consists of clear, heat-resisting, impact-resisting, glass globe, equipped with sheet aluminum gasket and cast aluminum mounting and retaining rings. Cast aluminum guards are held to globe mounting rings by machine screws. Furnished without reflectors.

Type EVA—Pendent Type

Complete with a Condulet body for pendent mounting on a conduit stem. A set screw in hub may be tightened against unthreaded part of conduit to prevent unscrewing from conduit when relamping. May be suspended by a conduit stem from GUA or GUF series Condulets with three-inch cover opening and GUA fixture covers or canopies.



Watts	Size In.	With Guard		Without Guard	
		No.	Each	No.	Each
75	1/2	EVA140	\$26.00	EVA104	\$24.80
	3/4	EVA240	26.20	EVA204	25.00
	1	EVA110	32.50	EVA101	30.80
†100	1/2	EVA210	32.70	EVA201	31.00
	3/4	EVA115	32.50	EVA105	30.80
	1	EVA215	32.70	EVA205	31.00
150	1/2	EVA120	46.50	EVA102	44.10
	3/4	EVA220	46.70	EVA202	44.30
	1	EVA230	70.00	EVA203	65.40
300	1 1/4	EVA450	151.50	EVA406	144.50

Type EVCX—Ceiling Type

Has four threaded hubs, three of which are furnished with pipe plugs.



75	1/2	EVCX140	\$33.30	EVCX104	\$32.10
	3/4	EVCX240	33.80	EVCX204	32.60
	1	EVCX110	39.80	EVCX101	38.10
†100	1/2	EVCX210	40.30	EVCX201	38.60
	3/4	EVCX115	39.80	EVCX105	38.10
	1	EVCX215	40.30	EVCX205	38.60
150	1/2	EVCX120	53.80	EVCX102	51.40
	3/4	EVCX220	54.30	EVCX202	51.90
	1	EVCX136	76.80	EVCX163	72.20
300	1 1/4	EVCX236	77.30	EVCX263	72.70
	1/2	EVCX150	157.80	EVCX106	150.80
	3/4	EVCX250	158.30	EVCX206	151.30

Type EVBX—Bracket Type

Four hubs tapped for rigid conduit are provided, three of which are equipped with threaded pipe plugs.



75	1/2	EBX140	\$36.70	EBX104	\$35.50
	3/4	EBX240	37.20	EBX204	36.00
	1	EBX110	43.20	EBX101	41.50
†100	1/2	EBX210	43.70	EBX201	42.00
	3/4	EBX115	43.20	EBX105	41.50
	1	EBX215	43.70	EBX205	42.00
150	1/2	EBX120	57.20	EBX102	54.80
	3/4	EBX220	57.70	EBX202	55.30

†300-watt type PS30 lamp only. Fixtures equipped with deep bowl or 30° angle reflectors are listed for Class I, Group D locations only.

*Take deep bowl and 30° angle reflectors only.

†These lighting units are designed for the A-21 standard lamp and cannot be used with 100-watt A-23 lamp. Should there be a requirement for the A-23 100-watt lamp, add Suffix S261 to catalog number. There will be no extra charge for the lighting fixture arranged in this manner. Also available in polished aluminum finish for hospital use. Prices on request.

Crouse-Hinds Lighting Fixtures

Reflectors for EV Series Lighting Fixtures

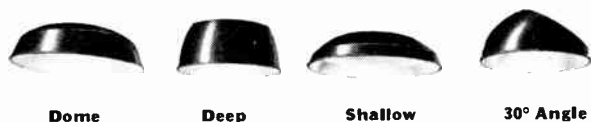

Reflectors are porcelain enameled steel, green outside and white inside. Also available in all white enamel for hospital use.

Fixture Watts	Diam. In.	No.	Each	Style	Fixture Watts	Diam. In.	No.	Each
75	10 1/4	EV481	\$4.30	Dome	150	13 3/4	EV581	\$5.20
	8 3/4	EV483	4.40	Deep		10 1/4	EV583	5.30
	10 1/4	EV485	4.30	Shallow		13 3/4	EV585	5.20
	8 1/4	EV487	4.80	30° Angle		12 1/8	EV587	5.70
100	12 1/8	EV181	4.50	Dome	200/300	16 1/16	EV281	6.30
	9 1/4	EV183	4.60	Deep		12 1/8	EV283	6.40
	12 1/4	EV185	4.50	Shallow		16 1/16	EV285	6.00
	10 1/4	EV187	5.00	30° Angle		13 3/4	EV287	7.00
300	20 7/16	EV381	10.50	Dome	500	20 1/2	EV681	10.50
	16 1/16	EV383	10.30	Deep				
	20 1/2	EV385	10.50	Shallow				
	16 1/16	EV387	8.50	30° Angle				

Type EVF Industrial Lighting Fixture For Fluorescent Lamps Explosion-Proof and Dust-Tight

Class I, Groups C and D; Class II, Groups E, F, and G; and Class III.

Furnished with Enameled Reflector, Standard Ballast, and Starter.

For 40-Watt, T-12 Fluorescent Lamps

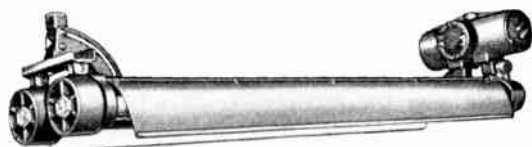

Number	Lamps	Volts at 60 Cycles	Size Hub In.	No.	Each
1		110-125	1/2 †	EVF114	\$209.00
				EVF214	209.00
2		110-125	1/2 †	EVF124	268.00
				EVF224	268.00
3		110-125	1/2 †	EVF134	401.00
				EVF234	401.00
4		110-125	1/2 †	EVF144	518.00
				EVF244	518.00

Type EVF Accessories



Ceiling Saddle for Conduit Support

Ceiling Saddle for Support Hook

Support Hook for Conduit

Size In.	No.	Each	No.	Each	Size In.	No.	Each
3/4	EVF20	\$1.10	EVF021	\$1.10	3/4	EVF21	\$.80

†1/2-inch hub at ballast end only. 3/4-inch hub at relamping end.

‡Lamps are not included in the list price.

Type EVH Hand Lamps

Explosion-Proof and Weather Resistant (Raintight) Class I, Groups C and D



Globe with Holder

Guard

Furnished with lamp receptacle, globe and guard. Designed and constructed to provide the utmost safety, durability and ease of wiring.

Non-sparking metals are used. Laminated bakelite handle is firmly secured to the cast aluminum body, in which is mounted a keyless, composition lamp receptacle.

Diameter of cord, .375 to .625 inch.

75-Watt, Takes 25, 40, 60 or 75-Watt A19 Lamps

No.	Description	Each
EVH140§	EVH Hand Lamp.....	\$42.00
EVH14	Clear Globe with Holder.....	16.00
	Cost of New Globe Installed in Customer's Holder†.....	7.20
EVH084	Guard.....	4.20

100-Watt, †† Takes 75 or 100 Watt A21 or 100-Watt A23 Lamps

EVH110	EVH Hand Lamp.....	54.70
EVH14	Clear Globe with Holder.....	16.00
	Cost of New Globe Installed in Customer's Holder†.....	7.20
EVH084	Guard.....	4.20

Type EVS—Portable Lamps Explosive-Proof and Weather Resistant (Raintight) Class I, Groups C and D

Furnished with lamp receptacle, globe and guard. Same construction as the type EVA fixtures, with a handle assembly added.

Handle assembly includes a hook and cable clamp. A Third terminal is provided in Type EVS for connection to a third wire in the portable cord for grounding the non-current-carrying metal parts of the unit. Diameter of Cable, .250 to .625 inch.

100-watt takes 75 or 100-watt A21 lamps;

150-watt takes 150-watt lamps; 200-watt takes 150 or 200-watt lamps.

No. of Watts	Portable Lamps		†Globes and Holders Replacement		Cost †
	No.	Each	No.	Each	
100	EVS80	\$55.20	EV710	\$23.00	\$ 9.20
150	EVS81	55.20	EV715	23.00	9.20
200	EVS82	60.20	EV720	37.00	16.70

†Globes must be assembled in the threaded holder at the factory. Used holder assemblies, when sent to the factory accompanied by a repair and return order, will be fitted with new globes at the list prices indicated above. The holder must not be damaged to such an extent that an explosion-proof assembly cannot be made.

††The EVH100, formerly listed on this page, can still be furnished where required by government specifications or where needed for match-up and replacement.

Price on application to GRAYBAR.

§The EVH140 is also suitable for Class II, Group G locations when used with 25 or 40-watt lamps.

Crouse-Hinds Lighting Fixtures

DL Series Lighting Fixtures

Dust-Tight and Weather Resistant (Raintight) Class II, Groups E, F, and G; and Class III

Bodies and hoods of cast aluminum.
Type DLA pendent type fixtures may be suspended from CPS series Condulets with hub covers.
Type DLC ceiling type is made to mount directly on CPS series Condulets.



Type DLA Pendent Type

With Shock-Absorbing Lamp Receptacle V46 and Globe
100-Watt Lamps

Size In.	No.	Each	No.	Each
1/2	DLA101	\$15.50	DLC50F	\$15.50
3/4	DLA201	15.50		

150 and 200-Watt Lamps

1/2	DLA121	\$19.00	DLC20F	\$19.00
3/4	DLA221	19.00		

With Porcelain Enamelled Steel Reflector

Reflector is green porcelain enamel outside and white porcelain enamel inside.



Type DLA (Dome) Pendent Type

100-Watt Lamps

No.	Each	Reflector Diam. In.
DLA1020	\$20.20	DL23 12
DLA2020	20.20	DL23 12

150 or 200-Watt Lamps

DLA1022	\$26.00	DL24 18
DLA2022	26.00	DL24 18



Type DLC (Dome) Ceiling Type

100-Watt Lamps

No.	Each	Reflector Diam. In.
DLC720F	\$20.20	DL23 12
		DL23 12

150 or 200-Watt Lamps

DLC722F	\$26.00	DL24 18
		DL24 18

Type DLA

Dust-Tight and Weather Resistant (Raintight) Class II, Groups E, F, and G; and Class III

For use in Class II hazardous locations where a simple yet sturdy fixture without reflector is required. Also suitable where a raintight unit is needed.

Form 100 takes 60, 75, and 100-W. lamps. Furnished with V105 globe.

Form 200 takes 150 and 200-W. lamps. Furnished with V205 globe.

Fixtures with heat-resisting globes can be furnished. Prices on application to GRAYBAR.



Conduit with Globe



Conduit with Globe and Guard



Guard

Form	No.	Each	No.	Each	No.	Each
100	DLA110	\$5.00	DLA119	\$ 6.70	DL103	\$1.70
200	DLA120	7.30	DLA129	10.00	DL222	2.70

CPS Series Junction Condulets
Dust-Tight and Weather Resistant (Raintight)* Class II, Groups E, F, and G; and Class III



Dead End



Through Feed

Size Hub In.
1/2
3/4
1

Form 20—Without Mounting Feet†

No.	Each	No.	Each
CPS1028	\$3.70	CPS1128	\$3.90
CPS2028	3.80	CPS2128	4.10
CPS3028	3.90	CPS3128	4.30

Type L

Type X



1/2
3/4
1

CPS1228	\$3.90
CPS2228	4.10
CPS3228	4.30



CPS1428	\$4.30
CPS2428	4.70
CPS3428	5.10

Covers

For CPS Series Condulets—Form 20▲



Size Hub In.
1/2
3/4

No.	Each
DL1	\$2.50
DL2	2.60

†CPS series Condulets will be furnished with mounting feet at an advance of \$.20 in the list price.

*When assembled with DLC series lighting fixtures or hub covers.

▲Form 20 indicates size of Condulet which takes covers correspondingly classified.

Type LG Gauge Lamps

Take 10-watt S14 bulb or 15-watt A15 or A17 bulb lamps. Cast aluminum. Furnished with lamp receptacle with lamp grip.

Also obtainable for round flexible cable and flexible conduit or armored cable (as shown in the illustrations) at the same prices; information on request to GRAYBAR.

Water Glass Lamps

Lubricator Lamps

No.	Vertical Slot Each	Size Rigid Conduit	No.	13-Inch Slott Each
LG21	\$10.00	1/2	LG31	\$10.00

Multiple Steam and Air Gauge Lamps

Rectangular opening.

No.	Size Rigid Conduit	Each
LG61	1/2	\$8.50



No. LG31

Single Steam and Air Gauge Lamps

Round opening.

No.	Size Rigid Conduit	Each
LG11	1/2	\$7.00



†25-watt type T8 lamp can be used.

Crouse-Hinds Vaportight Industrial Lighting Fixtures

V Series—Screw Guard Type

Class III

Form 100 is furnished with No. V75 globe and No. V911 guard, and takes 50, 60, 75, or 100-watt lamps.

Form 200 furnished with No. V200 globe and No. V912 guard, takes 150 or 200-watt lamps, cast aluminum guards; Cast Feraloy Fixtures.



Type V

Size In.	Type V Form 100		Type V Form 200	
	With Globe and Guard No.	Each	Without Globe and Guard No.	Each
1/2	V1759	\$9.00	V175	\$3.80
3/4	V2759	9.10	V275	3.90
1	V3759	9.20	V375	4.00

Size In.	Type V Form 100		Type V Form 200	
	With Globe and Guard No.	Each	Without Globe and Guard No.	Each
1/2	V12009	\$10.80	V1200	\$4.70
3/4	V22009	10.90	V2200	4.80
1	V32009	11.00	V3200	4.90



Type VC

Size In.	Type VC Form 100		Type VC Form 200	
	With Globe and Guard No.	Each	Without Globe and Guard No.	Each
1/2	VC1759	\$9.20	VC175	\$4.00
3/4	VC2759	9.40	VC275	4.20
1	VC3759	9.60	VC375	4.40

Size In.	Type VC Form 100		Type VC Form 200	
	With Globe and Guard No.	Each	Without Globe and Guard No.	Each
1/2	VC12009	\$11.00	VC1200	\$4.90
3/4	VC22009	11.20	VC2200	5.10
1	VC32009	11.30	VC3200	5.20



Type VL

Size In.	Type VL Form 100		Type VL Form 200	
	With Globe and Guard No.	Each	Without Globe and Guard No.	Each
1/2	VL1759	\$9.20	VL175	\$4.00
3/4	VL2759	9.40	VL275	4.20
1	VL3759	9.60	VL375	4.40

Size In.	Type VL Form 100		Type VL Form 200	
	With Globe and Guard No.	Each	Without Globe and Guard No.	Each
1/2	VL12009	\$11.00	VL1200	\$4.90
3/4	VL22009	11.20	VL2200	5.10
1	VL32009	11.30	VL3200	5.20



Type VT

Size In.	Type VT Form 100		Type VT Form 200	
	With Globe and Guard No.	Each	Without Globe and Guard No.	Each
1/2	VT1759	\$9.50	VT175	\$4.30
3/4	VT2759	9.70	VT275	4.50
1	VT3759	10.10	VT375	4.90

Size In.	Type VT Form 100		Type VT Form 200	
	With Globe and Guard No.	Each	Without Globe and Guard No.	Each
1/2	VT12009	\$11.20	VT1200	\$5.10
3/4	VT22009	11.50	VT2200	5.40
1	VT32009	11.70	VT3200	5.60



Type VX

Size In.	Type VX Form 100		Type VX Form 200	
	With Globe and Guard No.	Each	Without Globe and Guard No.	Each
1/2	VX1759	\$9.70	VX175	\$4.50
3/4	VX2759	10.10	VX275	4.90
1	VX3759	10.40	VX375	5.20

Size In.	Type VX Form 100		Type VX Form 200	
	With Globe and Guard No.	Each	Without Globe and Guard No.	Each
1/2	VX12009	\$11.40	VX1200	\$5.30
3/4	VX22009	11.80	VX2200	5.70
1	VX32009	12.10	VX3200	6.00

Forms 100 and 200 indicate sizes of fixtures.

Accessories and parts are correspondingly classified.

If specified on the order, lamp receptacle with lamp grip will be furnished at an advance of 20 cents in the list price.

If specified on the order, pigtail receptacle will be furnished at an advance of 90 cents in the list price.

These fixtures can be equipped with externally operated switch at an advance of \$2.00 in the list price.

V Series—Screw Guard Type

Type VDA Form 100



Type VDA

Size In.	Type VDA Form 100		Type VDA Form 200	
	With Globe and Guard No.	Each	Without Globe and Guard No.	Each
1/2	VDA1759	\$9.00	VDA175	\$3.80
3/4	VDA2759	9.10	VDA275	3.90
1	VDA3759	9.20	VDA375	4.00

Size In.	Type VDA Form 100		Type VDA Form 200	
	With Globe and Guard No.	Each	Without Globe and Guard No.	Each
1/2	VDA12009	\$10.80	VDA1200	\$4.70
3/4	VDA22009	10.90	VDA2200	4.80
1	VDA32009	11.00	VDA3200	4.90



Type VJ

Size In.	Type VJ Form 100		Type VJ Form 200	
	With Globe and Guard No.	Each	Without Globe and Guard No.	Each
1/2	VJ1759	\$10.30	VJ175	\$5.10
3/4	VJ2759	10.50	VJ275	5.30
1	VJ3759	10.70	VJ375	5.50

Size In.	Type VJ Form 100		Type VJ Form 200	
	With Globe and Guard No.	Each	Without Globe and Guard No.	Each
1/2	VJ12009	\$11.80	VJ1200	\$5.70
3/4	VJ22009	12.00	VJ2200	5.90
1	VJ32009	12.20	VJ3200	6.10



Type VG

Size In.	Type VG Form 100		Type VG Form 200	
	With Globe and Guard No.	Each	Without Globe and Guard No.	Each
1/2	VG1759	\$9.50	VG175	\$4.30
3/4	VG2759	9.70	VG275	4.50

Size In.	Type VG Form 100		Type VG Form 200	
	With Globe and Guard No.	Each	Without Globe and Guard No.	Each
1/2	VG12009	\$11.00	VG1200	\$4.90
3/4	VG22009	11.20	VG2200	5.10



Type VE

Size In.	Type VE Form 100		Type VE Form 200	
	With Globe and Guard No.	Each	Without Globe and Guard No.	Each
1/2	VE1759	\$9.50	VE175	\$4.30
3/4	VE2759	9.70	VE275	4.50

Size In.	Type VE Form 100		Type VE Form 200	
	With Globe and Guard No.	Each	Without Globe and Guard No.	Each
1/2	VE12009	\$11.00	VE1200	\$4.90
3/4	VE22009	11.20	VE2200	5.10

For Surface or Flush Mounted GRF Series Condulets



Pendent Type

Screw Guard Type Form 100 is furnished with Globe V75 and Guard V911, and takes 50, 60, 75, or 100-Watt Lamps.



Bracket Type

Form 200 is furnished with Globe V200 and Guard V912, and takes 150 or 200-watt Lamps.

Form	Style	Pendent Type		Bracket Type	
		With Globe and Guard No.	Each	No.	Each
100	Surface	GRV34	\$9.10	VGR1139	\$10.50
100	Flush	GRV1493	9.10	VGR1129	10.50
200	Surface	GRV32	10.20	VGR1239	12.00
200	Flush	GRV2493	10.20	VGR1229	12.00

Feraloy lighting fixtures are regularly furnished with cast aluminum guards.

Crouse-Hinds Vaportight Industrial Lighting Fixtures

V and VH Series—Clamp Guard Type

Class III

Cast aluminum guards. Cast Feraloy Fixtures. Form 100 is furnished with No. V75 globe and No. V97 guard, and takes 50, 60, 75, or 100-watt lamps. Form 200 is furnished with No. V200 globe and No. VII99 guard, and takes 150 or 200-watt lamps.



Type V Form 100				
Size In.	With Globe and Guard No.	Each	Without Globe and Guard No.	Each
1/2	V189	\$9 00	V1	\$3 80
3/4	V289	9 10	V2	3 90
1	V389	9 20	V3	4 00

Type V and VH

Type VH Form 200				
Size In.	With Globe and Guard No.	Each	Without Globe and Guard No.	Each
1/2	VII189	\$10 80	VH1	\$4 70
3/4	VII289	10 90	VH2	4 80
1	VII389	11 00	VH3	4 90



Type VC Form 100				
Size In.	With Globe and Guard No.	Each	Without Globe and Guard No.	Each
1/2	VC1189	\$9 20	VC11	\$4 00
3/4	VC2289	9 40	VC22	4 20
1	VC3389	9 60	VC33	4 40

Type VC and VHC

Type VHC Form 200				
Size In.	With Globe and Guard No.	Each	Without Globe and Guard No.	Each
1/2	VHC1189	\$11 00	VHC11	\$4 90
3/4	VHC2289	11 20	VHC22	5 10
1	VHC3389	11 30	VHC33	5 20



Type VL Form 100				
Size In.	With Globe and Guard No.	Each	Without Globe and Guard No.	Each
1/2	VL1189	\$9 20	VL11	\$4 00
3/4	VL2289	9 40	VL22	4 20
1	VL3389	9 60	VL33	4 40

Type VL and VHL

Type VHL Form 200				
Size In.	With Globe and Guard No.	Each	Without Globe and Guard No.	Each
1/2	VHL1189	\$11 00	VHL11	\$4 90
3/4	VHL2289	11 20	VHL22	5 10
1	VHL3389	11 30	VHL33	5 20



Type VT Form 100				
Size In.	With Globe and Guard No.	Each	Without Globe and Guard No.	Each
1/2	VT1189	\$9 50	VT111	\$4 30
3/4	VT2289	9 70	VT222	4 50
1	VT3389	10 10	VT333	4 90

Type VT and VHT

Type VHT Form 200				
Size In.	With Globe and Guard No.	Each	Without Globe and Guard No.	Each
1/2	VHT11189	\$11 20	VHT111	\$5 10
3/4	VHT22289	11 50	VHT222	5 40
1	VHT33389	11 70	VHT333	5 60



Type VDA Form 100				
Size In.	With Globe and Guard No.	Each	Without Globe and Guard No.	Each
1/2	VDA189	\$9 00	VDA1	\$3 80
3/4	VDA289	9 10	VDA2	3 90
1	VDA389	9 20	VDA3	4 00

Type VDA and VHDA

Type VHDA Form 200				
Size In.	With Globe and Guard No.	Each	Without Globe and Guard No.	Each
1/2	VHDA189	\$10 80	VHDA1	\$4 70
3/4	VHDA289	10 90	VHDA2	4 80
1	VHDA389	11 00	VHDA3	4 90

Forms 100 and 200 indicate sizes of fixtures. Accessories and parts are correspondingly classified. If specified on the order, lamp receptacle with lamp grip will be furnished at an advance of 20 cents in the list price.

If specified on the order, pigtail receptacle will be furnished at an advance of 90 cents in the list price.

These fixtures can be equipped with externally operated switch at an advance of \$2.00 in the list price.

V and VH Series—Clamp Guard Type



Type VJ Form 100				
Size In.	With Globe and Guard No.	Each	Without Globe and Guard No.	Each
1/2	VJ1189	\$10 30	VJ11	\$5 10
3/4	VJ2289	10 50	VJ22	5 30
1	VJ3389	10 70	VJ33	5 50

Type VJ and VHJ

Type VHJ Form 200				
Size In.	With Globe and Guard No.	Each	Without Globe and Guard No.	Each
1/2	VHJ1189	\$11 80	VHJ11	\$5 70
3/4	VHJ2289	12 00	VHJ22	5 90
1	VHJ3389	12 20	VHJ33	6 10



Type VG Form 100				
Size In.	With Globe and Guard No.	Each	Without Globe and Guard No.	Each
1/2	VG189	\$9 50	VG1	\$4 30
3/4	VG289	9 70	VG2	4 50

Type VG and VHJ

Type VHJ Form 200				
Size In.	With Globe and Guard No.	Each	Without Globe and Guard No.	Each
1/2	VHG189	\$11 00	VHG1	\$4 90
3/4	VHG289	11 20	VHG2	5 10



Type VE Form 100				
Size In.	With Globe and Guard No.	Each	Without Globe and Guard No.	Each
1/2	VE189	\$9 50	VE1	\$4 30
3/4	VE289	9 70	VE2	4 50
1	VE389	9 90	VE3	4 70

Type VE and VHE

Type VHE Form 200				
Size In.	With Globe and Guard No.	Each	Without Globe and Guard No.	Each
1/2	VHE189	\$11 00	VHE1	\$4 90
3/4	VHE289	11 20	VHE2	5 10
1	VHE389	11 40	VHE3	5 30

Types ARB and VGR

Class III

For flush mounted SE, SEH and SK series Condulets or 3/4 or 4-inch octagonal outlet boxes.*

Clamp Guard Type

Form 100 is furnished with Globe V75 and Guard V97, and takes 50, 60, 75, or 100-Watt Lamps.

Form 200 is furnished with Globe V200 and Guard VH99, and takes 150 or 200-Watt Lamps.



Ceiling Type Form 100				
	With Globe and Guard No.	Each	Without Globe and Guard No.	Each
	ARB43	\$9 10	ARB44	\$3 90



Form 200				
	With Globe and Guard No.	Each	Without Globe and Guard No.	Each
	ARB41	10 20	ARB42	4 10

Bracket Type*

Form 100				
	With Globe and Guard No.	Each	Without Globe and Guard No.	Each
	VGR126	10 50	VGR120	5 30

Form 200				
	With Globe and Guard No.	Each	Without Globe and Guard No.	Each
	VGR226	12 00	VGR220	5 90

*Type VGR bracket fixtures can be furnished without over-hang for surface mounting on SE, SEH, or SK series Condulets at no additional charge. Catalog numbers on request to Graybar.

Crouse-Hinds Vaportight Industrial Lighting Fixtures

**Types ARB and VGR
Class III**

For flush mounted SE, SEII, and SK series Condulets or 3/4 or 4-inch octagonal outlet boxes.*

Screw Guard Type

Form 100 is furnished with Globe V75 and Guard V911, and takes 50, 60, 75, or 100-Watt Lamps.

Form 200 is furnished with Globe V200 and Guard V912, and takes 150 or 200-Watt Lamps.



**Ceiling Type
Form 100**

With Globe and Guard No.	Each	Without Globe and Guard No.	Each
ARB31	\$9.10	ARB32	\$3.90

Form 200

ARB33	10.20	ARB34	4.10
-------	-------	-------	------

**Bracket Type*
Form 100**

VGR116	10.50	VGR110	5.30
--------	-------	--------	------

Form 200

VGR216	12.00	VGR210	5.90
--------	-------	--------	------



**Type VXHA
Screw Guard Type**

Has five hubs flush with the surface of the body. The hubs have integral bushings. Four of the hubs are spaced 90° apart around the side of the Condulet, while the fifth hub is placed in the center of the top of the Condulet. Condulet is furnished with four flush type threaded pipe plugs.

Form 100 is furnished with Globe V75 and Guard V911, and takes 50, 60, 75, or 100-Watt Lamps.

Form 200 is furnished with Globe V200 and Guard V912, and takes 150 or 200-Watt Lamps.

Cast aluminum guards. Cast Feraloy Condulets.

Form 100

Size In.	With Globe and Guard		Without Globe and Guard	
	No.	Each	No.	Each
1/2	VXHA1199	\$10.20	VXHA119	\$5.00
3/4	VXHA2199	10.60	VXHA219	5.40
1	VXHA3199	10.90	VXHA319	5.70

Form 200

1/2	VXHA1299	\$11.90	VXHA129	\$5.80
3/4	VXHA2299	12.30	VXHA299	6.20
1	VXHA3299	12.60	VXHA329	6.50

Forms 100 and 200 indicate sizes of vaportight fixtures. Accessories and parts are correspondingly classified.

If specified, lamp receptacle with lamp grip will be furnished at an advance of 20 cents in list price. If specified, pigtail receptacle will be furnished at an advance of 90 cents in list price.

*Type VGR bracket fixtures can be furnished without over-hang for surface mounting on SE, SEII, or SK series Condulets at no additional charge. Catalog numbers on request to Graybar.

**Type VXHA
Clamp Guard Type**

Has five hubs flush with the surface of the body. The hubs have integral bushings. Four of the hubs are spaced 90° apart around the side of the Condulet, while the fifth hub is placed in the center of the top of the Condulet. Condulet is furnished with four flush type threaded pipe plugs.

Form 100 furnished with V75 globe, and takes 50, 60, 75, or 100-watt lamps. Clamp guard type has V97 guard.

Form 200 furnished with V200 globe and takes 150- or 200-watt lamps. Clamp guard type has V1199 guard.

Cast aluminum guards. Cast Feraloy Condulets.



Form 100

Size In.	With Globe and Guard		Without Globe and Guard	
	No.	Each	No.	Each
1/2	VXHA112	\$10.20	VXHA11	\$5.00
3/4	VXHA212	10.60	VXHA21	5.40
1	VXHA312	10.90	VXHA31	5.70

Form 200

1/2	VXHA152	\$11.90	VXHA151	\$5.80
3/4	VXHA252	12.30	VXHA251	6.20
1	VXHA352	12.60	VXHA351	6.50

Forms 100 and 200 indicate sizes of vaportight fixtures. Accessories and parts are correspondingly classified.

If specified on the order, lamp receptacle with lamp grip will be furnished at an advance of \$.20 in the list price.

If specified on the order, pigtail receptacle will be furnished at an advance of \$.90 in the list price.

Type VLG Gauge Lighting Fixtures

Take T8 Lumiline or T8 Fluorescent lamps, 110-125 volts. Hub sizes: 3/4". Cast Aluminum.



Type VLG260



Type VLG280



Type VLG215

No.	Each	Lamp	Size
VLG260	\$36.00	1 Lumiline	60-Watt—18"
VLG280	55.00	2 Lumiline	40-Watt—12"
VLG215	54.00	1 Fluorescent With Starter and Ballast for 110-125 Volts A-C 60 Cycles	15-Watt—18"

Crouse-Hinds Vaportight Industrial Lighting Fixtures

Accessories and Parts

For V Series Fixtures, Screw Guard Type

Guards



Guards



Guards with Reflector Holders



Guards for Use with Pear-Shaped Globes

Cast Aluminum

For Globe In.	No.	Each	No.	Each	Form	No.	Each
5 5/8	V910	\$3.60			100		
6 3/4	V911	3.60	V911	\$3.60	100	V946	\$6.00
9 1/4	V912	4.50	V912	4.50	200	V947	7.00

Steel, Tinned Finish

Reflector Holders



Cast Aluminum.

No.	For Guard No.	Each
V623	V911	\$1.00
V624	V912	1.30

Half Shades



Sheet Aluminum.

No.	For Guard No.	Each
V916	V910	\$1.00
V918	V911	1.00
V919	V912	2.00

For V Series Fixtures, Screw Guard Type
For V and VH Series Fixtures, Clamp Guard Type

Globes



Form 100

Form 200

Globe	5 5/8 In. Long		6 3/4 In. Long		9 1/4 In. Long	
	No.	Each	No.	Each	No.	Each
Clear	V18	\$1.60	V75	\$1.60	V200	\$1.60
Opal	VN81	3.40	VN71	3.40	V201	4.70
Green	VN82	3.40	VN72	3.40	V202	4.70
Blue	VN83	3.40	VN73	3.40	V203	4.70
Red	VN85	3.40	VN75	3.40	V205	4.70
Amber	VN86	3.40	VN76	3.40	V206	4.70

Prismatic Diffusing Globes

Clear			V103	1.60		
-------	--	--	------	------	--	--

Heat-Resisting Globes

Clear	V183	\$2.50	V63	\$2.50	V93	\$4.00
-------	------	--------	-----	--------	-----	--------

Pear-Shaped Globes

Clear globes. Cannot be used with straight guards.



No.	Lamp Size Watts	Each
V105	50, 60, 75, 100	\$1.60
V205	150	1.60
V205	200	1.60

†For clamping reflector to Condulet when guard is not used.

Accessories and Parts

For V and VH Series Condulets, Clamp Guard Type

Guards



Guards



Guards with Reflector Holders



Guards for Use with Pear-Shaped Globes

Cast Aluminum

For Globe In.	No.	Each	No.	Each	Form	No.	Each
5 5/8	V95	\$3.60			100		
6 3/4	V97	3.60	V913	\$3.60	100	V948	\$6.00
9 1/4	V1199	4.50	V11914	4.50	200	V11949	7.00

Steel, Tinned Finish

Reflector Holders



Cast Aluminum.

No.	For Guard No.	Each
V625	V97	\$1.00
V11626	V1199	1.30

Half Shades



Sheet Aluminum.

No.	For Guard No.	Each
SI17	V95	\$1.00
SI11	V97	1.00
SI12	V1199	2.00

Reflectors



Dome Reflectors



Shallow Bowl Reflectors

Form 100

No.	Each	Lamp Size Watts	Diam. In.	Depth In.	No.	Each	Diam. In.	Depth In.
SI127	\$5.50	50, 60, 75, 100	12	4 1/4	SI157	\$4.50	12	2 7/8

Form 200

SI128	\$6.50	150	14	5 7/8	SI158	\$5.50	14	4 1/4
SI129	7.50	200	16	7	SI159	6.50	16	5 3/8



Deep Bowl Reflectors



30° Angle Reflectors

Form 100

SI147	\$5.50	50, 60, 75, 100	8	4 5/8	*SI167	\$4.00	10	7 3/8
-------	--------	-----------------	---	-------	--------	--------	----	-------

Form 200

SI148	\$6.50	150	10	6 5/8	†SI168	\$7.00	12	9 3/4
SI149	7.50	200	10	7 3/8	†SI168	7.00	12	9 3/4



Receptacles
660 Watts, 600 Volts
Forms 100 and 200



No.	Each	Material	Shock-Absorbing No.	Each
V46	\$1.30	Porcelain		
GS126M2	1.30	Composition	V56	\$2.50

V56 for use with Pear-Shaped Globes V105 and V205 only.
†For clamping reflector to Condulet when guard is not used.
*Center line of Condulet must be located 1 5/8 inches from the wall for mounting angle reflector.
†Center line of Condulet must be located 4 7/8 inches from the wall for mounting angle reflector.
Reflectors are green porcelain enamel outside and white porcelain enamel inside.

Crouse-Hinds Vaportight Industrial Lighting Fixtures

**Type VDB Fixtures With Reflectors
Class III**

Type VDB is an industrial fixture of the vaportight type, designed to meet the need for a simple, effective, and inexpensive vaportight industrial lighting fixture. Furnished with a clear, plain pear-shaped globe, and a porcelain enameled reflector. The reflector is held to the body by four screws.

Form 3 furnished with No. VDB3 globe, reflector, and medium base lamp receptacle.

Form 5 furnished with No. VDB5 globe, reflector, and mogul base lamp receptacle.

With Dome Reflector

No.	Form	Size In.	Lamp Watts	Each
VDB138	3	1 1/2	150	\$12.00
VDB238	3	3/4	150	12.00
VDB139	3	1 1/2	200/300	14.85
VDB239	3	3/4	200/300	14.85
VDB15	5	1 1/2	300/500	18.90
VDB25	5	3/4	300/500	18.90



Reflectors Only

VDB28	3	14	150	\$4.00
VDB29	3	16	200/300	6.85
VDB115	5	18	300/500	8.20

With Deep Bowl Reflectors

VDB137	5	1 1/2	300/500	\$16.00
VDB237	5	3/4	300/500	16.00



Reflector Only

VDB225	5	12	300/500	\$5.30
--------	---	----	---------	--------

With Shallow Bowl Reflectors

VDB13	3	1 1/2	150	\$12.50
VDB23	3	3/4	150	12.50
VDB17	3	1 1/2	200/300	14.85
VDB27	3	3/4	200/300	14.85
VDB16	5	1 1/2	300/500	18.90
VDB26	5	3/4	300/500	18.90



Reflectors Only

VDB113	3	14	150	\$4.50
VDB117	3	16	200/300	6.85
VDB19	5	18	300/500	8.20

With 30° Angle Reflectors*

VDB143	3	1 1/2	150/200/300	\$13.20
VDB243	3	3/4	150/200/300	13.20
VDB145	5	1 1/2	300/500	18.00
VDB245	5	3/4	300/500	18.00



Reflectors Only

VDB213	3	12	150/200/300	\$5.20
VDB215	5	14	300/500	7.30

*Center line of fixture must be located 5 inches from the wall for mounting.

Pear-Shaped Globes

Clear Form 3

Lamp Size Watts	No.	Plain	Each	Heat-Resisting No.	Each
150, 200, 300	VDB3	\$1.60		VDB6	\$4.40



Form 5

300/500	VDB5	\$3.30		VDB8	\$6.30
---------	------	--------	--	------	--------

Basket Wire Guards



Steel, tinned finish. For use with reflectors listed above; also with reflectors for V and VH series Condulets.

Number.....	V932	V934	V936	V938
For Size Reflector, In.....	12	14	16	18
Each.....	\$3.65	4.20	4.75	5.30

Type VS Vaportight Portable Hand Lamps

Clamp Guard Type

Made of cast aluminum, with molded rubber handle.

Furnished with globe, guard, receptacle and three rubber bushings. Lamp receptacle has additional binding screw terminal for grounding. Cable, .250 to .625.



No.	Size Lamp Watts	Size Globe Inches	Each
VS20	60, 100 A21	5 5/8	\$12.80
VS30	100 A23*	6 3/4	12.80

Clamp Guard Type

Made of cast aluminum, with hard wood handle.

Furnished with globe, guard, receptacle and three rubber bushings. Lamp receptacle has additional binding screw terminal for grounding. Cable, .250 to .625.



No.	Size Lamp Watts	Size Globe Inches	Each
VS91	60, 100 A21	5 5/8	\$12.80
VS92	100 A23*	6 3/4	12.80

Guards for Type VS Vaportight Portable Hand Lamps

Clamp Guard Type

Made of steel wire.



Clamp Guard

No.	For Globe Inches	Each
VS95	5 5/8	\$4.00
VS97	6 3/4	4.00

Globes for Type VS Vaportight Portable Hand Lamps

Clear

Size In.	No.	Plain	Each	Heat-Resisting No.	Each
5 5/8	V18	\$1.60		V183	\$2.50
*6 3/4	V75	1.60		V63	2.50



Safety Hand Lamps

Types LPG and LPH

Take 15 to 100-watt lamps. Seasoned maple handle, black enameled.

Aluminum alloy guard and half shade.

No.	Each
LPG24, with Guard.....	\$6.00
LPH24, with Guard and Half Shade.....	6.30



Type LPG24



Type LPH24

*Will take lamps with maximum dimensions of 6 1/2 inches long and 2 3/8 inches diameter.

Crouse-Hinds VM Series Vapormaster® Vaportight Lighting Fixtures



VM Series VaporMaster lighting fixtures provide the user with greatest convenience in installing and maintaining a vaportight lighting system. A variety of Condulet bodies in pendant, ceiling, and bracket types are available. Any style or size VM VaporMaster fixture can be assembled in a few seconds. All fixtures can be made up from a stock of only 33 items.

Unit construction simplifies relamping, changing reflectors, and changing from one lamp size to another; reducing maintenance time to a minimum. VM VaporMaster fixtures offer a choice of relamping methods—replacing the lamp only, or replacing the whole assembly of lamp, globe, and adapter. Any Condulet body will take either a Form 100 or Form 200 adapter without disturbing wiring. Form 100 VM Series fixtures take up to 150-watt, A-23 lamps; Form 200 up to 300-watt, medium base PS30 lamps.

Features of the VM Series include: aluminum adapter-guard assembly fitting all Condulet bodies; guard is part of adapter and is not removed for relamping. Stainless steel retaining spring holds reflector. Gaskets make vaportight seal between globe and adapter, reflector and body, adapter and reflector. Pear-shaped globe adds to effectiveness of shock-absorbing receptacle—lamp cannot strike side of globe. Globe clamping spring opens for relamping. Condulet body equipped with receptacle base has set screw in hub to lock on conduit. Shock-absorbing receptacle has "universal" action—absorbs shock from any direction. Porcelain enameled steel reflector.

Type VM



Size	With Globe & Guard No.	Each	With Globe Only No.	Each
*Form 100				
1/2	VM1759	\$10.85	VM1757	\$8.05
3/4	VM2759	10.95	VM2757	8.15
**Form 200				
1/2	VM12009	13.40	VM12007	9.60
3/4	VM22009	13.50	VM22007	9.70

Form 100 with Globe and Guard

Type VMA



Size	With Globe & Guard No.	Each	With Globe Only No.	Each
*Form 100				
1/2	VMA1759	10.85	VMA1757	8.05
3/4	VMA2759	10.95	VMA2757	8.15
**Form 200				
1/2	VMA12009	13.40	VMA12007	9.60
3/4	VMA22009	13.50	VMA22007	9.70

Form 100 with Globe and Guard

Clear Globe Only



No.	Form	Each
V105	*100	\$1.60
V205	**200	1.60

V108 and V208 heat-resistant, V151 and V251 opalescent pear-shaped globes, and VN82, etc., and V0202 etc., straight sided colored globes are available.

*Form 100 with globe and guard is furnished with pear-shaped globe V105, adapter-guard VM946. Form 100 with globe only is furnished with pear-shaped globe V105, adapter VM10.

**Form 200 with globe and guard is furnished with pear-shaped globe V205, adapter-guard VM947. Form 200 with globe only is furnished with pear-shaped globe V205, adapter VM120.

Fixtures complete with reflectors are also available.

Type VMC



Size	With Globe & Guard No.	Each	With Globe Only No.	Each
*Form 100				
1/2	VMC1759	\$11.00	VMC1757	\$ 8.20
3/4	VMC2759	11.10	VMC2757	8.30
**Form 200				
1/2	VMC12009	13.55	VMC12007	9.75
3/4	VMC22009	13.65	VMC22007	9.85

Form 100 with Globe and Guard

Type VMG†



Size	With Globe & Guard No.	Each	With Globe Only No.	Each
*Form 100				
1/2	VMG1759	12.10	VMG1757	9.30
3/4	VMG2759	12.20	VMG2757	9.40
**Form 200				
1/2	VMG12009	14.65	VMG12007	10.85
3/4	VMG22009	14.75	VMG22007	10.95

Form 100 with Globe and Guard

Type VMXHA



Size	With Globe & Guard No.	Each	With Globe Only No.	Each
*Form 100				
1/2	VMXHA1199	\$11.75	VMXHA1197	\$ 8.95
3/4	VMXHA2199	11.85	VMXHA2197	9.05
**Form 200				
1/2	VMXHA1299	14.30	VMXHA1297	10.50
3/4	VMXHA2299	14.40	VMXHA2297	10.60

Form 100 with Globe and Guard

†Bracket fixtures are not designed for reflectors.

Crouse-Hinds VM Series VaporMaster® Vaportight Lighting Fixtures

Condulet Bodies* for VM Series VaporMaster Lighting Fixtures



Type VM Condulet Bodies		
No.	Size, In.	Each
VM1	1/2	\$3.50
VM2	3/4	3.60



Type VMA Condulet Bodies		
No.	Size, In.	Each
VMA1	1/2	\$3.50
VMA2	3/4	3.60



Type VMC Condulet Bodies		
No.	Size, In.	Each
VMC1	1/2	\$3.65
VMC2	3/4	3.75



Type VMG Condulet Bodies†
One hub in center of flange.

No.	Size, In.	Each
VMG1	1/2	\$4.75
VMG2	3/4	4.85



Type VMXHA Condulet Bodies
With 4 tapped openings in sides, 1 in top, 4 pipe plugs.

No.	Size, In.	Each
VMXHA1	1/2	\$4.40
VMXHA2	3/4	4.50



Type VMRB Condulet Bodies
For SE, SEH, and SK Series Condulets or 3/4" and 4" Octagonal Outlet Boxes.

No. VMRB5	Each	\$3.75
For GRF Series		
No. VMRB6	Each	\$3.75

**Type VMGR Condulet Bodies*†
For Surface Mounting**

For SE Series and 3 1/4" Outlet Boxes.

No. VMGR5	Each	\$4.50
-----------	------	--------



For GRF Series

No. VMGR6	Each	\$4.50
-----------	------	--------

For SEH Series & 4" Octgl. Outl. Box

No. VMGR8	Each	\$4.50
-----------	------	--------

For SK Series

No. VMGR9	Each	\$4.50
-----------	------	--------

For Flush Mounting



For GRF, SE, SEH, and SK, or 3 1/4" and 4" Octagonal Outlet Boxes.

No. VMGR7	Each	\$5.00
-----------	------	--------

*Includes V155 receptacle base.

†Bracket fixtures are not designed for reflectors.

Complete Adapter-Guard Assembly



No.	Form	Each
VM946	100	\$5.75
MV947	200	8.30

Adapter Only

Includes Gask 861, lamp receptacle V154, and globe gasket, Gask 213 (Form 100) or Gask 441 (Form 200).



No.	Form	Each
VM10	100	\$2.95
VM20	200	4.50

Reflectors for VM Series VaporMaster® Lighting Fixtures

Dome Reflectors Complete with Gasket



No.	Size, In.	Each
Form 100—100-Watt		
SH327	12	\$5.10
Form 200—150-Watt		
SH328	14	6.10
Form 200—200-300-Watt		
SH329	16	7.10

Deep Bowl Reflectors Complete with Gasket



No.	Size, In.	Each
Form 100—100 Watt		
SH347	10	\$5.15
Form 200—200, 300-Watt		
SH349	12	7.10

Shallow Bowl Reflector Complete with Gasket



No.	Size, In.	Each
Form 100—100-Watt		
SH357	12	\$4.25
Form 200—150-Watt		
SH358	14	5.15
Form 200—200, 300-Watt		
SH359	16	6.10

30° Angle Reflector Complete with Gasket



No.	Size, In.	Each
Form 100—100-Watt		
SH367	10	\$3.75
Form 200—200-300-Watt		
SH368	12	7.10

Crouse-Hinds Type ELG Gauge Lighting Fixtures

Explosion-Proof and Weather Resistant (Raintight) For Medium Screw Base, Lumiline, and Fluorescent Lamps

Class I, Group D

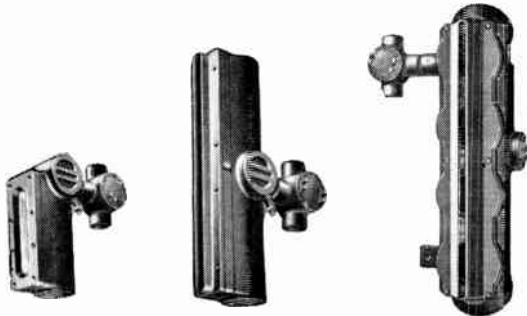

Style 1 One-Light, Less Hood Style 1 Two-Light with Hood Style 2 and Style 3 with Hood

Takes Medium Screw Base Incandescent Lamps 25-Watt, T10-Bulb

Style	No. of Lamps†	Hub Size In.	Less Hood		With Hood	
			No.	Each	No.	Each
1	1	1/2	ELG1250	\$33.50	ELG125	\$35.50
1	1	3/4	ELG2250	33.70	ELG225	35.70
1	2	1/2	ELG1500	55.50	ELG150	59.50
1	2	3/4	ELG2500	55.70	ELG250	59.70

Takes 18-Inch Incandescent Lumiline Lamp 60-Watt, T8-Bulb

2	1	1/2	ELG1060	\$73.50	ELG106	\$79.00
2	1	3/4	ELG2060	73.70	ELG206	79.20

Takes 18-Inch Fluorescent Lamp—15 Watt, T8-Bulb Complete with Ballast and Starter

3	1	1/2	ELG1150	\$86.50	ELG115	\$92.00
3	1	3/4	ELG2150	86.70	ELG215	92.20

†Lamps are not included in the list price.

Crouse-Hinds Fixture Hangers Type EFHC

For EVA, EVF, and DLA Pendant Fixtures Explosion-Proof, Dust-Tight, and Weather Resistant (Raintight)

Class I, Groups C and D; Class II, Groups E, F, and G; and Class III



Size Hub In.	Size Fixture Stem In.	No.	Each
3/4	1/2	EFHC2601	\$7.20
	3/4	EFHC2602	7.20
	1	EFHC3601	7.50
1	1/2	EFHC3602	7.50
	3/4		

Accessories for Type EFHC



No.	Description	Each
CB308	2-Wire 20-A., 125-V.	\$0.70

Suspension attachment for type EFHC Condulets can be furnished for 3/8" max. diam. supporting rod or span wires. Add suffix S1 to cat. no. and \$.40 to list price.

Crouse-Hinds AL Series Flexible Fixture Hanger Condulets

For Pendant Fixtures

AL series Condulets provide a flexible suspension for electrical fixtures. The fixtures are suspended from a universal joint which assures that the fixture will hang plumb.

This universal joint permits the fixture to swing through an angle of about 20 degrees in any direction from the perpendicular.

Threaded for Thick Wall Conduit

Type ALA Ball Hangers



No.	Weight Fixture, Pounds	Size, In. Fixture Stem	Conduit	Each
ALA1	...	1/2	1/2	\$2.00
ALA21	...	1/2	3/4	2.20
ALA22	...	3/4	3/4	2.40

Type ALA Ball

Type ALA Cushion Hangers



ALA14	3	1/2	1/2	\$4.20
ALA214	to	1/2	3/4	4.60
ALA224	6	3/4	3/4	4.80
ALA18	6	1/2	1/2	4.20
ALA218	to	1/2	3/4	4.60
ALA228	12	3/4	3/4	4.80
ALA116	12	1/2	1/2	4.20
ALA2116	to	1/2	3/4	4.60
ALA2216	24	3/4	3/4	4.80

Type ALA Cushion

Type ALC Ball Hangers



ALC1	...	1/2	1/2	\$2.20
ALC21	...	1/2	3/4	2.40
ALC31	...	1/2	1	2.60
ALC22	...	3/4	3/4	2.60
ALC32	...	3/4	1	2.90

Type ALC Ball

Type ALC Cushion Hangers



ALC14	...	1/2	1/2	\$4.40
ALC214	3	1/2	3/4	4.60
ALC314	to	1/2	1	4.80
ALC224	6	3/4	3/4	4.80
ALC324	...	3/4	1	5.00
ALC18	...	1/2	1/2	4.40
ALC218	6	1/2	3/4	4.60
ALC318	to	1/2	1	4.80
ALC228	12	3/4	3/4	4.80
ALC328	...	3/4	1	5.00
ALC116	...	1/2	1/2	4.40
ALC2116	12	1/2	3/4	4.60
ALC3116	to	1/2	1	4.80
ALC2216	24	3/4	3/4	4.80
ALC3216	...	3/4	1	5.00

Type ALC Cushion

Connection Block

For AL Series Fixture Hanger Condulets 20 Amperes, 125 Volts



No.	Description	Material	Each
CB308	2-Wire	Porcelain	\$0.70

Type GS Flexible Fixture Hangers

For GS Series Condulets—For Pendant Fixtures



No.	Weight Fixture, Lbs.	Size, In. Fixture Stem	No.	Each
GS1302	\$3.50	2 to 4	1/2	GS1064 \$2.30
GS1303	3.50	4 to 8	1/2	GS1066 2.30
GS1304	3.50	8 to 16	1/2	GS1067 2.30
GS1311	3.50	16 to 30	1/2	GS1068 2.30

Crouse-Hinds Fixture Hangers

For Pendent Fixtures

**EC Series Flexible Lighting Fixture Supports
Explosion-Proof, Dust-Tight, and Watertight
Class I, Group D; Class II, Groups E, F, and G;
and Class III**

The National Electrical Code requires the use of a flexible member for fixture stems longer than 12 inches. This flexible member must not be more than 12 inches from the point of attachment to the supporting Condulet. (Section 5019 N.E.C.)

1/2-inch EC series flexible fixture supports are also suitable for Class I, Group C locations. 3/4-inch supports, suitable for Class I, Group C locations, can be supplied and are made up using heavier flexible tubing. Add suffix DB to the catalog numbers and \$.60 per inch of flexible length.

Permit fixtures to assume vertical positions by gravity, thus protecting the conduit and connections from lateral stresses caused by fixture sway.

Type ECJF



Flexible Nipple Length†	Size Nipple In.	Two Female Nipples	
		No.	Each
1"	1/2"	ECJF14	\$11.50
1"	3/4"	ECJF24	\$14.40
6"	1/2"	ECJF16	\$12.50
6"	3/4"	ECJF26	\$15.80
8"	1/2"	ECJF18	\$13.50
8"	3/4"	ECJF28	\$17.20

Type ECHF



Flexible Nipple Length†	Size Nipple In.	Two Male Nipples	
		No.	Each
1"	1/2"	ECHF14	\$10.90
1"	3/4"	ECHF24	\$13.40
6"	1/2"	ECHF16	\$11.90
6"	3/4"	ECHF26	\$14.80
8"	1/2"	ECHF18	\$12.90
8"	3/4"	ECHF28	\$16.20

Type ECGF



Flexible Nipple Length†	Size Nipple In.	One Female Nipple, One Male Nipple	
		No.	Each
4"	1/2"	ECGF14	\$11.20
4"	3/4"	ECGF24	\$13.90
6"	1/2"	ECGF16	\$12.20
6"	3/4"	ECGF26	\$15.30
8"	1/2"	ECGF18	\$13.20
8"	3/4"	ECGF28	\$16.70

Type ECKF



Flexible Nipple Length†	Size Nipple In.	One Female Union, One Male Nipple	
		No.	Each
4"	1/2"	ECKF14	\$11.20
4"	3/4"	ECKF24	\$14.70
6"	1/2"	ECKF16	\$12.20
6"	3/4"	ECKF26	\$16.10
8"	1/2"	ECKF18	\$13.20
8"	3/4"	ECKF28	\$17.50

Type ECF

For use with pendent lighting fixtures having 1 1/4-inch hubs. Has two male nipples; flexible body is 3/4" size.



6"	1 1/4"	ECF44	12"	20.00
----	--------	-------	-----	-------

†EC series flexible fixture supports can be furnished with longer flexible lengths. Prices and catalog numbers on application to GRAYBAR.

Crouse-Hinds AL Series Flexible Fixture Hanger Suspension Attachment

For Horizontal Span Wire or Vertical Support Rod



**S1
Suspension
Attachment**

AL series flexible fixture hanger Condulets can be furnished with a malleable iron loop fastened to the top of the Condulet body to provide means for suspending fixtures from vertical support rods or horizontal span wires. The loop will take a wire or cable with a maximum diameter of 3/8 of an inch. The boss on

the top of the loop is tapped 3/8-16, for a threaded rod. When this suspension attachment is required, add suffix S1 to the AL series catalog number and \$.60 to the list price.

Cushion Hangers for fixtures weighing up to 64 lbs. can be furnished. Information on request to Graybar.

Crouse-Hinds Fixture Hangers

For Pendent Fixtures

**Type AHG Vaportight Flexible Cushion
Fixture Hangers**



**Type AHG
Cushion**

No.	Weight Fixture Lbs.	Size, In. Fixture Stem	Male Nipple	Each
AHG11102	2 to 4	1/2"	1/2"	\$4.40
AHG21102	2 to 4	1/2"	3/4"	4.50
AHG11103	4 to 8	1/2"	1/2"	4.40
AHG21103	4 to 8	1/2"	3/4"	4.50
AHG11104	8 to 16	1/2"	1/2"	4.40
AHG21104	8 to 16	1/2"	3/4"	4.50
AHG11111	16 to 30	1/2"	1/2"	4.40
AHG21111	16 to 30	1/2"	3/4"	4.50

Types UNJ and UNJC

For supporting pendent fixtures so that they will always hang plumb, even though supported from an inclined surface. They will allow the fixture to swing through an angle of 20° in any direction from the perpendicular.



**Type UNJ
Ball**

Type UNJ Ball Hangers

No.	Stem In.	Hub In.	Each
UNJ1308	3/8"	1/2"	\$1.80
UNJ1	1/2"	1/2"	1.80
UNJ2308	3/8"	3/4"	2.10
UNJ21	1/2"	3/4"	2.10
UNJ2	3/4"	3/4"	2.10

Type UNJC Cushion Hangers

Provided with spring which carries the weight of the fixture and absorbs any shocks due to vibration or other causes.



**Type UNJC
Cushion**

No.	Stem In.	Hub In.	Fixture Weight, Pounds	Each
UNJC12	1/2"	1/2"	1 1/2-3	\$3.50
UNJC22	3/4"	3/4"	1 1/2-3	4.00
UNJC14	1/2"	1/2"	3-6	3.50
UNJC24	3/4"	3/4"	3-6	4.00
UNJC18	1/2"	1/2"	6-12	3.50
UNJC28	3/4"	3/4"	6-12	4.00
UNJC116	1/2"	1/2"	12-24	3.50
UNJC216	3/4"	3/4"	12-24	4.00
UNJC132	1/2"	1/2"	24-48	3.70
UNJC232	3/4"	3/4"	24-48	4.20

Type ARB Flexible Fixture Hangers

For use on concealed conduit systems. Provide flexible suspension for pendent fixtures with 1/2-inch conduit stem.

Fastening screws spaced 3 1/2 inches center to center are provided for use on standard 4-inch outlet boxes.



**Type ARB
Cushion
Hanger**

Cushion Hangers

Wt. Fixture, Lbs.	No. Surface	Flush	
		Each	Each
2 to 4	ARB142	\$1.50	ARB144 \$1.70
4 to 8	ARB82	1.50	ARB84 1.70
8 to 16	ARB102	1.50	ARB104 1.70
16 to 30	ARB122	1.50	ARB124 1.70



**Type ARB
Cushion**

No.	Fixture Weight, Pounds	Each
ARB14	2-4	\$1.90
ARB8	4-8	1.90
ARB10	8-16	1.90
ARB12	16-30	1.90



Type ARB Ball

Ball Hanger

No.	Size In.	Each
ARB6	1/2"	\$1.40

Crouse-Hinds Fixture Hanger Condulets
Type UNH Rigid Hangers

Size Fix. Stem, In.	Male		Female	
	No.	Each	No.	Each
1/2	UNH16	\$0.80	UNH11	\$0.70
3/4	UNH26	.90	UNH12	.80

Male  Female 

Type UNHC Cushion Hangers

No.	WL Fixture, Lbs.	Size Fixture Stem In.	Each
UNHC12	1 1/2 to 3	1/2	\$2.20
UNHC22	1 1/2 to 3	3/4	2.80
UNHC14	3 to 6	1/2	2.20
UNHC24	3 to 6	3/4	2.80
UNHC18	6 to 12	1/2	2.20
UNHC28	6 to 12	3/4	2.80
UNHC116	12 to 24	1/2	2.20
UNHC216	12 to 24	3/4	2.80
UNHC132	24 to 48	1/2	2.20
UNHC232	24 to 48	3/4	2.80
UNHC164	48 to 64	1/2	2.20
UNHC264	48 to 64	3/4	2.80



Type UNE Fixture Loops

Size Fix. Stem, In.	Male		Female	
	No.	Each	No.	Each
1/2	UNE16	\$0.80	UNE1	\$0.70
3/4	UNE26	.90	UNE2	.80



Male Female

Type FOH Fixture Hanger Equipment
For Fluorescent Lighting Fixtures

Used to suspend a fluorescent lighting fixture from a regular threaded conduit hub of an Obround, FS or other Condulet in an overhead conduit line. A receptacle cover on the Condulet and a flexible cord with attachment plug on the fixture provide a convenient means for quickly connecting or disconnecting the fixture.



Size of Conduit Hub and Connector In.	Yoke, Connector, Two Chains, Hooks and Cord Clips		Yoke, Connector and Cord Clips without Chains and Hooks*	
	No.	Each	No.	Each
1/2	FOH122	\$3.00	FOH120	\$2.20
3/4	FOH222	3.10	FOH220	2.30
1	FOH322	3.22	FOH320	2.40

Type OSA Suspension Hangers

No.	Size Condulet In.	Max. Diam. Span Wire In.	Support Rod Tap In.	Each
OSA3	1/2	3/8	3/8-16	\$1.10
OSA3	3/4	3/8	3/8-16	1.10
OSA3	1	3/8	3/8-16	1.10
OSA4	1 1/4	3/8	3/8-16	1.30



Type CHS Suspension Clamps

No.	Size Conduit In.	Max. Diam. Span Wire In.	Each
CHS143	1/2	3/8	\$0.45
CHS243	3/4	3/8	.60
CHS343	1	3/8	.75



*1/8 inch diameter rods with hooks formed on the ends to engage yoke and fixture may be used in place of chains, if desired.

Crouse-Hinds Condulets
FSQ Series Interlocked Plug
Receptacle and Switch Condulet
Explosion-Proof and Dust-Tight

Class I, Groups C and D; Class II, Group G; and Class III
2-Wire, 3-Pole, 30-Ampere, 250-V., A.C. or D.C.
2-Hp., 230-V., 1-Hp., 460-V. A.C.
3-Wire, 4-Pole, 30-Ampere, 250-V. or 20-Amp.,
600-V. A.C. or D.C.
2-Hp., 115-575 Volts A.C.



Type FSQC, with Threaded Housing



Type FSQC, with Spring Door

Furnished with tumbler type switch and receptacle, either with threaded housing or spring door housing.

Take FP and BP plugs.



Type FSQ



Type FSQC

With Threaded Housing

Size Hub In.	No. of Poles	*Form	Type FSQ No.	Each	Type FSQC No.	Each
3/4	2-Wire, 3-Pole	E	FSQ232	\$46.00	FSQC232	\$46.00
			FSQ332	46.40	FSQC332	46.40
1	3-Wire, 4-Pole	F	FSQ233	52.00	FSQC233	52.00
			FSQ333	52.40	FSQC333	52.40

With Spring Door Housing

3/4	2-Wire, 3-Pole	B	FSQ230	46.00	FSQC230	46.00
			FSQ330	46.40	FSQC330	46.40

*Order by number.

Plugs for FSQ Series Condulets



Type FP



Type BP

Furnished with cable grip and rubber bushing. Gounded through extra pole and shell. Cast aluminum. Will not fit FSQ223 10 amp. receptacle.

Type FP—For Threaded Housings

No.	No. of Poles	Diam. Cable, In.	Each
FP233	2-Wire, 3-Pole	.500 to .875	\$12.00
FP334	3-Wire, 4-Pole	.500 to .875	14.00

Type BP—For Spring Door Housings

BP49	2-Wire, 3-Pole	.375 to .500	12.00
BP59	2-Wire, 3-Pole	.500 to .625	12.00
BP69	2-Wire, 3-Pole	.625 to .750	12.00
BP79	2-Wire, 3-Pole	.750 to .875	12.00

Furnished with 2-Pole Switch.



10-Amp., 250-V., A.C. or D.C.
2-Wire, 3-Pole Receptacle

No.	Size In.	Each
FSQ223	3/4	\$36.00

Crouse-Hinds Condulets

Type FP Plug

For Type FSQ Condulet

Furnished with cable grip and rubber bushing. Grounded through extra pole and shell.

**10-Amp., 250-V., A-C or D-C
2-Wire, 3-Pole**



No.	Diam. Cable In.	Each
FP23	.375 to .500	\$8.00

Type DBR Circuit Breaker Condulet

**With Interlocking Arktite Plug Receptacle
Dust-Tight and Weather-Resistant (Raintight)
Class II, Group G, and Class III (NEMA Types IX, V,
and III) Take Type APJ Arktite Plugs**

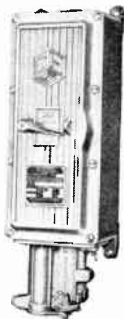

For use wherever power outlets combined with over-current protection are required. They may be employed for supplying motor-operated portable appliances up to the maximum horsepower for which the circuit breakers are suitable.

The receptacle is so interlocked with the circuit breaker that the plug cannot be withdrawn unless the breaker is open; and the breaker cannot be closed unless the plug is fully inserted.

**60-Ampere, 3-Wire, 4-Pole
Style 2**

Plug Receptacle with Spring Door Housing 100-Ampere Frame Size Circuit Breaker with Non-Interchangeable Thermal Trip and Non-Adjustable Magnetic Trip.

Condulet Without Circuit Breaker

No.	Circuit Breaker Poles and Volts	Size Hub†	Each
DBR56342	{ 3-Pole, 250-V., A-C } or { 125-250-V., D-C }	1½	\$145.00
DBR56742	3-Pole, 600-V., A-C	1½	145.00

Condulet With Circuit Breaker

250-V., A-C or 125-250-V., D-C—3-Pole

Size Hub† In.	Amps.	No. Westinghouse	No. Trumbull	Each
1½	15	DBR56342-WT15-3	DBR56342-TT15-3	\$205.50
	20	DBR56342-WT20-3	DBR56342-TT20-3	205.50
	30	DBR56342-WT30-3	DBR56342-TT30-3	205.50
	40	DBR56342-WT40-3	DBR56342-TT40-3	205.50
	50	DBR56342-WT50-3	DBR56342-TT50-3	205.50
	70	DBR56342-WT70-3	DBR56342-TT70-3	219.00
	90	DBR56342-WT90-3	DBR56342-TT90-3	219.00
	100	DBR56342-WT100-3	DBR56342-TT100-3	219.00

600-V., A-C—3-Pole

Size Hub† In.	Amps.	No. Westinghouse	No. Trumbull	Each
1½	15	DBR56742-WT15-3	DBR56742-TT15-3	\$205.50
	20	DBR56742-WT20-3	DBR56742-TT20-3	205.50
	30	DBR56742-WT30-3	DBR56742-TT30-3	205.50
	40	DBR56742-WT40-3	DBR56742-TT40-3	205.50
	50	DBR56742-WT50-3	DBR56742-TT50-3	205.50
	70	DBR56742-WT70-3	DBR56742-TT70-3	219.00
	90	DBR56742-WT90-3	DBR56742-TT90-3	219.00
	100	DBR56742-WT100-3	DBR56742-TT100-3	219.00

†Furnished with one drilled and tapped conduit opening at the top equipped with threaded-in bushing. Removal of the bushing permits the use of the opening for the next larger size conduit. Other sizes or arrangements of conduit openings can be furnished. Prices on application to Graybar.

Type EPC Plug Receptacles With Interlocked Circuit Breaker

Explosion-Proof, Dust-Tight, and Weather Resistant (Raintight)

Class I, Group D (NEMA Type VII); Class II, Group G; and Class III (NEMA Types IX, V, and III)



Take Type APJ Arktite Plugs.

For use wherever power outlets combined with over-current protection are required. They may be employed for supplying motor-operated portable appliances up to the maximum horsepower for which the circuit breakers are suitable.

The receptacle is so interlocked with the circuit breaker that the plug cannot be withdrawn unless the breaker is open; and the breaker cannot be closed unless the plug is fully inserted.

60-Ampere, 3-Wire, 4-Pole

Style 2 Plug Receptacle with Spring Door Housing 100-Ampere Frame Size Circuit Breaker with Non-Interchangeable Thermal Trip and Non-Adjustable Magnetic Trip

Condulet Without Circuit Breaker

No.	Size Hub In.	Volts	Amps.	Each
EPC46242	1¼	250	{ 50	\$190.00
EPC66342	2		{ 70*—100	220.00
EPC46642	1¼	600	{ 50	190.00
EPC66742	2		{ 70*—100	220.00

Condulet With Circuit Breaker

250-V., A.C. or 125-250-V., D.C.—3-Pole

Size Hub In.	Amps.	No. Westinghouse	No. Trumbull	Each
1¼	50	EPC46242-WT50-3	EPC46242-TT50-3	\$250.50
	*70	EPC66342-WT70-3	EPC66342-TT70-3	294.00
2	90	EPC66342-WT90-3	EPC66342-TT90-3	294.00
	100	EPC66342-WT100-3	EPC66342-TT100-3	294.00

600-V., A.C.—3-Pole

Size Hub In.	Amps.	No. Westinghouse	No. Trumbull	Each
1¼	50	EPC46642-WT50-3	EPC46642-TT50-3	\$250.50
	*70	EPC66742-WT70-3	EPC66742-TT70-3	294.00
2	90	EPC66742-WT90-3	EPC66742-TT90-3	294.00
	100	EPC66742-WT100-3	EPC66742-TT100-3	294.00

Type APJ Arktite Plug

With Mechanical Cable Grip and Rubber Bushing

**60-Ampere, 3-Wire, 4-Pole
250-V., D.C. or 600-V., A.C.**

No.	Style	Diam. Cable In.	Each
APJ6463	2	.500 to .875	\$23.50
APJ6465	2	.875 to 1.375	23.50

*Can be furnished in smaller Condulet with 1¼" hubs, prices upon application to Graybar.

Crouse-Hinds Condulets

Type WMKS Enclosed Safety Switch Condulet



With Interlocking Plug Receptacle

**Weather Resistant (Raintight)
NEMA Types III and V
Take Type DP Plugs**

Furnished with fusible motor circuit switch and receptacle with spring door housing. The receptacle is so interlocked with the switch that the plug cannot be withdrawn unless the switch is open; and the switch cannot be closed unless the plug is fully inserted.

**230 Volts A-C, 250 Volts D-C
2-Pole Fusible Switch with
2-Wire, 2-Pole, Style 1
Receptacle****

No.	Amps.	Hub Size† In.	230-V. A-C	Hp. Rating 250-V. D-C	Each
WMKS16332	30	3/4	2	5	\$ 89.70
WMKS1662	60	1 1/4	5	10	102.50
WMKS16102	100	1 1/2	10	15	216.00
WMKS16202	200	2	15	30	317.00

**2-Pole Fusible Switch with 2-Wire, 3-Pole,
Style 2 Receptacle****

WMKS16333	30	3/4	2	5	\$ 91.50
WMKS16623	60	1 1/4	5	10	104.50
WMKS16103	100	1 1/2	10	15	218.00
WMKS16203	200	2	15	30	326.00

**3-Pole Fusible Switch with 3-Wire, 3-Pole,
Style 1 Receptacle****

WMKS1633	30	1	3	\$ 98.80
WMKS1663	60	1 1/4	7 1/2	115.50
WMKS16103	100	1 1/2	15	236.00
WMKS16203	200	2 1/2	30	344.00

**3-Pole Fusible Switch with 3-Wire, 4-Pole,
Style 2 Receptacle****

WMKS16334	30	1	3	\$102.50
WMKS16634	60	1 1/4	7 1/2	119.00
WMKS161034	100	1 1/2	15	240.00

575 Volts A-C, 600 Volts D-C

No.	Amps.	Hub Size† In.	575-V. A-C††	Hp. Rating 600-V. D-C	Each
WMKS163235	30	3/4	5	7 1/2	\$106.20
WMKS166235	60	1 1/4	10	15	121.00
WMKS1610235	100	1 1/2	15	25	231.00
WMKS1620235	200	2	30	50	337.00

**3-Pole Fusible Switch with 3-Wire, 3-Pole,
Style 1 Receptacle****

WMKS16335	30	1	7 1/2	\$113.50
WMKS16635	60	1 1/4	20	128.00
WMKS161035	100	1 1/2	30	245.00
WMKS162035	200	2 1/2	50	350.00

**3-Pole Fusible Switch with 3-Wire, 4-Pole,
Style 2 Receptacle****

WMKS163345	30	1	7 1/2	\$117.20
WMKS166345	60	1 1/4	20	133.50
WMKS1610345	100	1 1/2	30	249.00

†Furnished with one drilled and tapped conduit opening at the top equipped with threaded-in bushing. Removal of the bushing permits the use of the opening for the next larger size conduit. Other sizes or arrangements of conduit openings can be furnished. Prices on application.

**Style 1—Grounded through shell. Style 2—Grounded through extra pole and shell.

††575-volt A-C horsepower rating also applies for 440-480-volt A-C service.

Type DP Interlocking Plugs

For Use with Type WMKS Safety Switch and Interlocking Receptacle Condulets

Furnished with clamp for cord, cable, flexible conduit, or armored conductor



**Type DP Plug
30 to 100-Ampere**



**Type DP Plug
200-Ampere**

Style 1*

Rating Amps.	Max. Volts	Outside Diam. of Cable, Flexible Conduit or Armored Cable In.	2-Wire, 2-Pole		3-Wire, 3-Pole	
			No.	Each	No.	Each
30	250	.500— .875	DP132	\$13.00	DP133	\$ 14.00
		.750—1.188	DP332	13.00	DP333	14.00
30 & 60	600†	.750—1.188	DP162	15.00	DP163	16.00
		1.188—1.400	DP362	15.00	DP363	16.00
100	600†	.938—1.469	DP1102	28.00	DP1103	30.00
		1.469—1.800	DP3102	28.00	DP3103	30.00
200	600†	1.188—1.813	DP1202	80.00	DP1203	86.00
		1.750—2.563	DP3202	80.00	DP3203	86.00

Style 2*

Rating Amps.	Max. Volts	Outside Diam. of Cable, Flexible Conduit or Armored Cable In.	2-Wire, 3-Pole		3-Wire, 4-Pole	
			No.	Each	No.	Each
30	250	.500— .875	Use 600-Volt plugs listed directly below			
		.750—1.188				
30 & 60	600†	.750—1.188	DP1623	\$18.50
		1.188—1.400	DP3623	18.50
60	600†	.500— .875	DP164	\$ 23.00
		.875—1.400	DP364	23.00
100	600†	.938—1.469	DP11023	33.00
		1.469—1.800	DP31023	33.00
200	600†	1.000—1.500	DP1104	37.00
		1.500—1.800	DP3104	37.00
200	600†	1.188—1.813	DP12023	96.00
		1.750—2.563	DP32023	96.00

Type FSQ Safety Switch and Interlocking Receptacle Condulet

Type FSQ Condulet is furnished with Tumbler Switch, Vaportight Cover, Hubbell 3-Pole Twist Lock Receptacle, and Hubbell 3-Pole Twist Lock Plug

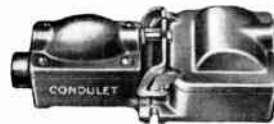

No. FSQ28 Size 3/4 Each \$24.00

*Style 1—Grounded through shell. Style 2—Grounded through extra pole and shell.

†Use with 250-volt receptacles.

Call Graybar FIRST For . . .

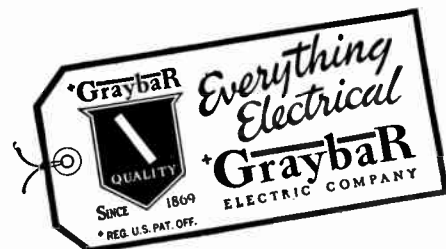

Crouse-Hinds Condulets

Type WMK Enclosed Safety Switch Condulets
Watertight
NEMA Types III, IV, and V



Type WMK Condulets are furnished with switches and are especially suited to locations where a strong, durable case and switch mechanism are required. May be used indoors or outdoors, and in all places except hazardous locations. An interlock is provided which prevents the opening of the enclosure except when the switch is in the "off" position. These Condulets are furnished with one drilled and tapped conduit opening at the top and one at the bottom equipped with threaded-in bushings. Removal of the bushing permits the use of the next larger size conduit. Other arrangements or sizes available. Information on Request.

230 Volts A-C, 250 Volts D-C
2-Pole—No Fuse

No.	230-V. A-C	Hp. Rating 250-V. D-C	Amps.	Hub Size In.	Each
WMK 30254-1-22	3	5	30	3/4	\$ 75.50
WMK 60254-1-44	7 1/2	10	60	1 1/4	80.20
WMK 10254-1-55	15	15	100	1 1/2	207.00
WMK 20254-1-66	25	30	200	2	287.00

3-Pole—No Fuse

WMK 30354-1-33	5	..	30	1	83.00
WMK 60354-1-44	10	..	60	1 1/4	88.70
WMK 10354-1-55	20	..	100	1 1/2	221.00
WMK 20354-1-77	40	..	200	2 1/2	301.00

2-Pole—Fusible*

WMK 302-1-22	2	5	30	3/4	74.50
WMK 602-1-44	5	10	60	1 1/4	78.20
WMK 1002-1-55	10	15	100	1 1/2	205.00
WMK 2002-1-66	15	30	200	2	301.00

3-Wire, Solid Neutral (2 Blades, 2 Fuses)*

WMK 307-1-33	3	..	30	1	82.00
WMK 607-1-44	7 1/2	..	60	1 1/4	88.70
WMK 1007-1-55	15	..	100	1 1/2	220.00
WMK 2007-1-77	30	..	200	2 1/2	317.00

3-Wire, Switched Neutral (3 Blades, 2 Fuses)*

WMK 308-1-33	3	..	30	1	83.00
WMK 608-1-44	7 1/2	..	60	1 1/4	91.50
WMK 1008-1-55	15	..	100	1 1/2	225.00
WMK 2008-1-77	30	..	200	2 1/2	323.00

3-Pole—Fusible*

WMK 303-1-33	3	..	30	1	83.00
WMK 603-1-44	7 1/2	..	60	1 1/4	91.50
WMK 1003-1-55	15	..	100	1 1/2	225.00
WMK 2003-1-77	30	..	200	2 1/2	323.00

575-Volts, A-C—600-Volts, D-C
2-Pole—No Fuse

No.	575-V. A-C†	Hp. Rating 600-V. D-C	Amps.	Hub Size In.	Each
WMK 30254-1-22	7 1/2	7 1/2	30	3/4	\$ 75.50
WMK 60254-1-44	15	15	60	1 1/4	80.20
WMK 10254-1-55	25	25	100	1 1/2	207.00
WMK 20254-1-66	50	50	200	2	287.00

3-Pole—No Fuse

WMK 30354-1-33	10	..	30	1	83.00
WMK 60354-1-44	25	..	60	1 1/4	88.70
WMK 10354-1-55	40	..	100	1 1/2	221.00
WMK 20354-1-77	50	..	200	2 1/2	301.00

*Cartridge fuses are not included in the catalog number or price.

†575-volt a-c horsepower rating also applies for 440-480-volt a-c service.

Type WMK Enclosed Safety Switch Condulets
(Continued)

575-Volts, A-C—600 Volts, D-C

2-Pole—Fusible*

No.	575-V. A-C†	Hp. Rating 600-V. D-C	Amps.	Hub Size In.	Each
WMK 3025-1-22	5	7 1/2	30	3/4	\$ 92.30
WMK 6025-1-44	10	15	60	1 1/4	99.00
WMK 10025-1-55	15	25	100	1 1/2	220.00
WMK 20025-1-66	30	50	200	2	317.00

3-Pole—Fusible*

WMK 3035-1-33	7 1/2	..	30	1	101.00
WMK 6035-1-44	20	..	60	1 1/4	109.50
WMK 10035-1-55	30	..	100	1 1/2	237.00
WMK 20035-1-77	50	..	200	2 1/2	331.00

†575-volt A-C horsepower rating also applies for 440-480-volt A-C service.

*Cartridge fuses not included in catalog number or list price.

Type EMS Mercury Limit Switch Condulet
Parts



Type EMS Condulet



Connection Block



Glass Tube Switch



Switch Carrier

Condulet Housing With Operating Mechanism Only
Direct Action

No.	Size 1	Each	No.	Size 2	Each
EMS33-M2		\$22.00	EMS34-M2		\$25.00

Snap Action

EMS330-M2	34.00	EMS340-M2	37.00
-----------	-------	-----------	-------

Spring Return Clockwise
(Facing Cover)

EMS332	27.00	EMS342	30.00
--------	-------	--------	-------

Spring Return Counter-Clockwise
(Facing Cover)

EMS335	27.00	EMS345	30.00
--------	-------	--------	-------

Spring Return to Center of Travel

EMS333	27.00
--------	-------	-------	-------

Connection Block

No. of Terminals		No.	Each
3 for #14-#10 Wire	Molded Bakelite	CB641	\$2.20

Mercury Switches and Carriers
Glass Tube Switches

Nom. Size of Switch, Amps.†	(Non-Inductive) Ratings, Amps.			Max. Hp. 175 V. or 250 A-C V. \$	No.	Each	No.	Each
	115 V.	230 V.	440 V.					
4	4	2	1	1/6	SWM241	\$3.20	EMS4-M2★	\$2.40
10	10	5	3	1	SWM210	5.70	EMS10-M2	2.40
25	25	12 1/2	6	2	SWM225	11.50	EMS25	3.70
4	4	2	1	1/6	SWM242▲	6.00	EMS-M2★	2.40

Metal Clad Switches††

10	10†	8†	5†	1/3	SWM110	\$3.20	EMS5-M2★	\$2.40
20	20†	16†	10†	3/4	SWM120	4.30	EMS5-M2★	2.40

★With vernier adjustment.

▲Double-throw. All other switches are single-throw.

†D-C ampere rating approximately 50% less on these metal clad switches.

††35-Ampere metal clad switches can be furnished. Prices on application.

§Repulsion induction motors.

Crouse-Hinds Condulets

Y Series Condulets

**For Cutouts
NEMA Type I**



Take main line fuse cutouts. Furnished with sheet steel door and cutout fastening plate.



Type Y

Type YC

Type Y — 30 Amperes, 250 Volts

Size In.	2-Wire		3-Wire	
	No.	Each	No.	Each
1/2	Y1302	\$8.50
3/4	Y2302	8.70	Y2303	\$9.85

Type YC — 30 Amperes, 250 Volts

Size In.	2-Wire		3-Wire	
	No.	Each	No.	Each
1/2	YC1302	\$8.80	YC1303	\$ 9.95
3/4	YC2302	9.00	YC2303	9.00
1	YC3302	9.20	YC3303	10.35
1 1/4	YC4302	9.40	YC4303	10.55

Type YC — 60 Amperes, 250 Volts

Size In.	2-Wire		3-Wire	
	No.	Each	No.	Each
3/4	YC2602	\$12.95	YC2603	\$15.75
1	YC3602	13.15
1 1/4	YC4603	16.15

Type YAC Condulets

**Watertight
NEMA Types III, IV, and V**

2-Wire, 30 Amperes, 250 Volts



Take main line fuse cutouts. Cast Feraloy door.

No.	Size In.	Each
YAC2302	3/4	\$10.50

Type YYC Condulets with Hub Plates

**For Cutouts
NEMA Type I**

Take main line fuse cutouts. Furnished with cast Feraloy door, removable conduit hub plates, cutout fastening plate.

**30 Amperes, 205 Volts
2 Wire**



No.	Size In.	Each
YYC1302	1/2	\$13.35
YYC2302	3/4	13.75
3-Wire		
YYC2303	3/4	15.45
YYC3303	1	15.85

Type YWC with Hub Plates

**For Cutouts
Watertight
NEMA Types III, IV, and V**

Take main line fuse cutouts. Furnished with cast Feraloy door, removable conduit hub plates, gaskets and cutout fastening plate.

30 Amperes, 250 Volts



2-Wire		
No.	Size In.	Each
YWC1302	1/2	\$15.10
YWC2302	3/4	15.50
3-Wire		
YWC2303	3/4	16.70
YWC3303	1	17.10

Type FLS General Use Switch Condulets

Explosion-Proof, Dust-Tight and Weather Resistant (Raintight)



**Class I, Group D (NEMA Type VII);
Class II, Groups E, F, and G; and
Class III (NEMA Types IX, V,
and III)**

Furnished with No Fuse Switch

Type FLS Condulets with single throw and double throw fuseless switches with no "off" position, rated in amperes, are general use enclosed tumbler switches for hazardous locations. Double throw and motor reversing fuseless switches with "off" position, rated in horsepower, are for use as motor circuit switches in hazardous locations.

General use switches are quick-make and quick-break. Motor circuit switches are slow-make and quick-break. Slow-make permits proper control of handle for jogging.

Single Throw—Tumbler

**30 Amperes, 250 Volts 30 Amperes, 250 Volts
5 Amperes, 600 Volts 20 Amperes, 600 Volts, A-C
5 Amperes, 600 Volts, D-C**

Size Hub In.	30 Amperes, 250 Volts		30 Amperes, 250 Volts	
	No.	Each	No.	Each
1/2	FLS102-11	\$44.00	FLS103-11	\$60.00
3/4	FLS102-22	44.00	FLS103-22	60.00
1	FLS102-33	44.00	FLS103-33	60.00
1 1/4	FLS102-44	44.00	FLS103-44	60.00

Double Throw—Tumbler—No "Off" Position

30 Amperes, 250 Volts 5 Amperes, 600 Volts

Size In.	30 Amperes, 250 Volts		5 Amperes, 600 Volts	
	No.	Each	No.	Each
1/2	FLS101-11	\$60.00
3/4	FLS101-22	60.00
1	FLS101-33	60.00
1 1/4	FLS101-44	60.00

Double Throw—With "Off" Position*

Size In.	30 Amperes, 250 Volts		5 Amperes, 600 Volts	
	No.	Each	No.	Each
1/2	FLS112-11	\$72.00	FLS113-11	\$76.00
3/4	FLS112-22	72.00	FLS113-22	76.00
1	FLS112-33	72.00	FLS113-33	76.00

Motor Reversing—With "Off" Position*

Size In.	30 Amperes, 250 Volts		5 Amperes, 600 Volts	
	No.	Each	No.	Each
1/2	FLS110-11	\$76.00	FLS111-11	\$80.00
3/4	FLS110-22	76.00	FLS111-22	80.00
1	FLS110-33	76.00	FLS111-33	80.00

*For ratings of these switches, see table immediately below.

Description	110-V.	Hp. Ratings at 20 Amperes A-C		
		208/220-V.	440/600-V.	
3-Pole, 2 or 3-Phase.....	3	5	7 1/2	
2-Pole, 1-Phase.....	1 1/2	3	5	

Type FLS Motor Circuit Switch Condulets

Explosion-Proof, Dust-Tight and Weather Resistant (Raintight)



**Class I, Group D (NEMA Type VII);
Class II, Groups E, F, and G; and
Class III (NEMA Types IX, V,
and III)**

Furnished With Switch—Not Fusible

Type FLS Motor Circuit Switches are for motor disconnects to comply with code requirements for installation of disconnect switch within sight of motor.

The fuseless switch is the sliding action quick-make quick-break type with double break positive pressure contacts.

No.	Amps.	Poles	Hp. Rating		Size Hub In.	Each
			230-V. A-C	250-V. D-C		
FLS30254-1-22	30	2	5	5	3/4	\$126.00
FLS30354-1-33	30	3	7 1/2	..	1	136.50
FLS60254-1-44	60	2	10	10	1 1/4	136.50
FLS60354-1-44	60	3	20	..	1 1/4	147.00
FLS10254-1-55	100	2	10	20	1 1/2	360.00
FLS10354-1-55	100	3	30	..	1 1/2	370.00
FLS20254-1-66	200	2	25	30	2	375.00
FLS20354-1-77	200	3	50	..	2 1/2	385.00

Crouse-Hinds Condulets

Type ESW Tumbler Switch Condulets

Explosion-Proof and Dust-Tight
Class I, Groups C and D (NEMA Type VII); Class II,
Groups E, F, and G; and Class III
(NEMA Types IX and V)

Non-Adjustable—Factory Sealed
Switch Unit Includes Tumbler Switch with
Sealed Housing and Cover

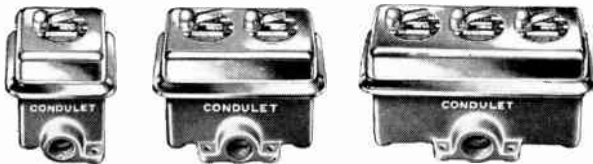

Single-Gang

3/4" Through—Feed Hubs—Horizontal or Vertical
For Flush Mounting—Chromium Plated Cover

No.	Style	125 V.	250 V.	Amperes	Each
ESW2113	1-Pole	10T	5		††
ESW2123	2-Pole	10T	10		\$26.40
ESW2133	3-Way	10T	5		26.60
ESW2143	4-Way	5T	2		26.90
ESW2153	1-Pole, M.O.†	10	5		28.60
ESW2163	1-Pole, M.C.‡	10	5		28.60

For Surface Mounting—Plain Finish Cover

ESW2112	1-Pole	10T	5		\$18.00
ESW2122	2-Pole	10T	10		18.40
ESW2132	3-Way	10T	5		18.60
ESW2142	4-Way	5T	2		21.60
ESW2152	1-Pole, M.O.†	10	5		20.60
ESW2162	1-Pole, M.C.‡	10	5		20.60

Two-Gang†

Two 3/4" Hubs at Top and One 3/4" Hub at Bottom—
Reversible

For Flush Mounting—Chromium Plated Cover

ESW2213	1-Pole	10T	5		††
ESW2223	2-Pole	10T	10		\$43.30
ESW2233	3-Way	10T	5		43.70
ESW2243	4-Way	5T	2		49.70
ESW2253	1-Pole, M.O.†	10	5		47.70
ESW2263	1-Pole, M.C.‡	10	5		47.70

For Surfaced Mounting—Plain Finish Cover

ESW2212	1-Pole	10T	5		\$32.50
ESW2222	2-Pole	10T	10		33.30
ESW2232	3-Way	10T	5		33.70
ESW2242	4-Way	5T	2		39.70
ESW2252	1-Pole, M.O.†	10	5		37.70
ESW2262	1-Pole, M.C.‡	10	5		37.70

Three Gang†

Two 3/4" and One 1" Hubs at Top, and One 1" at
Bottom—Reversible

For Flush Mounting—Chromium Plated Cover

ESW3313	1-Pole	10T	5		††
ESW3323	2-Pole	10T	10		\$66.20
ESW3333	3-Way	10T	5		66.80
ESW3343	4-Way	5T	2		75.80
ESW3353	1-Pole, M.O.†	10	5		72.80
ESW3363	1-Pole, M.C.‡	10	5		72.80

For Surfaced Mounting—Plain Finish Cover

ESW3312	1-Pole	10T	5		\$50.00
ESW3322	2-Pole	10T	10		51.20
ESW3332	3-Way	10T	5		51.80
ESW3342	4-Way	5T	2		60.80
ESW3352	1-Pole, M.O.†	10	5		57.80
ESW3362	1-Pole, M.C.‡	10	5		57.80

†Combinations of switches can be furnished. Prices on application. ‡Momentary contact; M.O.—normally open; M.C.—normally closed.

††Prices on request.

Type ERS Replacement Switch Units

For Replacement of Non-Explosion-Proof Flush
Mounted Switches in Hazardous Locations
Includes tumbler switch with sealed housing and cover

In existing buildings it is frequently impractical to remove, in their entirety, non-explosion-proof switch outlets and replace them with full explosion-proof types. In such instances, a considerable degree of safety can be had by enclosing switches in explosion-proof chambers. Type ERS replacement units provide such explosion-proof chambers, but will not bring an electrical installation into full conformity with the National Electrical Code.



Single-Gang—Chromium Plated Cover

No.	Style	125-V.	250-V.	Amperes	Each
ERS41	1-Pole	10T	5		††
ERS42	2-Pole	10T	10		\$23.30
ERS43	3-Way	10T	5		23.50
ERS44	4-Way	5T	2		26.50
ERS45	1-Pole, M.O.†	10	5		24.70
ERS46	1-Pole, M.C.‡	10	5		24.70

†Two-Gang—Chromium Plated Cover

ERS412	1-Pole	10T	5		††
ERS422	2-Pole	10T	10		\$34.60
ERS432	3-Way	10T	5		35.00
ERS442	4-Way	5T	2		41.00
ERS452	1-Pole, M.O.†	10	5		37.40
ERS462	1-Pole, M.C.‡	10	5		37.40

†Three-Gang—Chromium Plated Cover

ERS413	1-Pole	10T	5		††
ERS423	2-Pole	10T	10		\$46.40
ERS433	3-Way	10T	5		47.00
ERS453	1-Pole, M.O.†	10	5		50.60
ERS463	1-Pole, M.C.‡	10	5		50.60

Type GUSC Condulets

Explosion-Proof, Dust-Tight, and Weather
Resistant (Raintight)

Class I, Groups C and D (NEMA Type VII); Class II,
Groups E, F, and G; and Class III
(NEMA Types IX, V, and III)



Type GUSC switch Condulets have a rectangular body with a round, threaded opening in the front equipped with a threaded cover. They are furnished with through feed hubs for threaded conduit, and external mounting lugs with fastening holes, and tumbler switches.

No.	Style	Rating	Size Hub In.	Each
GUSC1061-AH	1-Pole	30-Ampere, 250-Volt	1/2	\$20.40
GUSC2061-AH			3/4	20.70
GUSC1052-AH	2-Pole	30-Ampere, 250-Volt; 2 Hp., 115-230-Volt A-C;	1/2	20.40
GUSC2052-AH		1 Hp., 160-Volt A-C	3/4	20.70
GUSC2013-AH	3-Pole	30-Ampere, 250-Volt; 20-Ampere, 600-Volt A-C	3/4	27.50
GUSC2024-AH	4-Pole	30-Ampere, 250-Volt; 20-Ampere, 600-Volt A-C;	3/4	42.50
GUSC2073-AH	3-Way	2 Hp., 230-575-Volt A-C 30-Ampere, 250-Volt; 2 Hp., 220-Volt A-C	3/4	30.50
		1 Hp., 440-Volt A-C		

†Combinations of switches can be furnished. Prices on application. ‡Momentary contact; M.O.—normally open; M.C.—normally closed.

Crouse-Hinds Condulets

EFS and EFD Series Tumbler Switch Condulets

Explosion-Proof and Dust-Tight

Class I, Groups C and D (NEMA Type VII); Class II, Groups E, F, and G; and Class III (NEMA Types IX, V)

Used to enclose tumbler and push button switches, motor control push button stations, pilot lights, manual motor starters, and circuit breakers.

Furnished with tumbler switches.

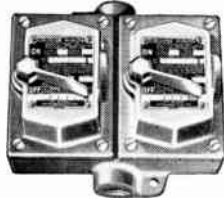

Type EFS† (Single-Gang) Dead End

Type EFSC (Two-Gang) Through Feed

Dead End—Single-Gang

No.	Style	Amperes		Max. Hp.	Size Hub In.	Each
		125-V.	250-V.			
EFSC1129	1-Pole	20T	10	\$12.20
EFSC118	2-Pole	20T	20	2	12.70
EFSC1130	3-Way	15T	10	1/2	13.00
EFSC1140	4-Way	10T	5	17.20
EFSC2129	1-Pole	20T	10	12.30
EFSC218	2-Pole	20T	20	2	12.80
EFSC2123	3-Pole	10	5	1/2 A-C	3/4	26.50
EFSC2130	3-Way	15T	10	13.10
EFSC2140	4-Way	10T	5	17.30

Through Feed—Single-Gang

No.	Style	Amperes		Max. Hp.	Size Hub In.	Each
		125-V.	250-V.			
EFSC1129	1-Pole	20T	10	\$12.40
EFSC118	2-Pole	20T	20	2	12.90
EFSC1130	3-Way	15T	10	1/2	13.20
EFSC1140	4-Way	10T	5	17.40
EFSC2129	1-Pole	20T	10	12.60
EFSC218	2-Pole	20T	20	2	13.10
EFSC2123	3-Pole	10	5	1/2 A-C	3/4	18.90
EFSC2130	3-Way	15T	10	13.40
EFSC2140	4-Way	10T	5	17.60

Dead End—Two-Gang†

No.	Style	Amperes		Max. Hp.	Size Hub In.	Each
		125-V.	250-V.			
EFSC1229	1-Pole	20T	10	1/2	\$24.40
EFSC2229	1-Pole	20T	10	3/4	24.50
EFSC2230	3-Way	15T	10	26.10
EFSC3229	1-Pole	20T	10	28.10
EFD3691	1-Pole	30T	30	1	30.30
EFSC328	2-Pole	20T	20	2	25.70
EFSC3230	3-Way	15T	10	26.30
EFD3694	3-Way	30T	30	35.70
EFSC3240	4-Way	10T	5	1	34.70
EFD3690	4-Way	20T	10	44.50

Through Feed—Two Gang†

No.	Style	Amperes		Max. Hp.	Size Hub In.	Each
		125-V.	250-V.			
EFSC1229	1-Pole	20T	10	\$24.60
EFSC128	2-Pole	20T	20	2	25.60
EFSC1230	3-Way	15T	10	1/2	26.20
EFSC1240	4-Way	10T	5	34.60
EFSC2229	1-Pole	20T	10	24.80
EFSC228	2-Pole	20T	20	2	25.80
EFSC2223	3-Pole	10	5	1/2 A-C	3/4	37.40
EFSC2230	3-Way	15T	10	26.40
EFSC2240	4-Way	10T	5	34.80
EFSC3229	1-Pole	20T	10	25.20
EFD3691	1-Pole	30T	30	30.80
EFSC328	2-Pole	20T	20	2	26.20
EFD3693	2-Pole	30T	30†	2	34.60
EFSC3223	3-Pole	10	5	1/2 A-C	1	37.80
EFSC3230	3-Way	15T	10	26.80
EFD3694	3-Way	30T	30	36.20
EFSC3240	4-Way	10T	5	35.20
EFD3690	4-Way	20T	10	45.00

†Combinations of switches can be furnished. Prices on application to GRAY BAR. ‡Also rated at 20 amperes, 600 volts.

EFS Series Tumbler Switch Condulets

Explosion-Proof and Dust-Tight

Class I, Groups C and D (NEMA Type VII); Class II, Groups E, F, and G; and Class III (NEMA Types IX, V)

Used to enclose tumbler and push button switches, motor control push button stations, pilot lights, manual motor starters, and circuit breakers.

Furnished with tumbler switches.



Type EFS (Single) Dead End

For Surface Mounting Plain Finish*



Type EFSC (Triple) Through Feed

Type EFS Single

No.	Style	Amperes		Size Hub In.	Each
		125-V.	250-V.		
EFSC1101	1-Pole	10T	5	\$12.20
EFSC1100	2-Pole	10T	10	12.60
EFSC1107	3-Way	10T	5	1/2	12.80
EFSC1108	4-Way	5T	2	15.80
EFSC2101	1-Pole	10T	5	12.10
EFSC2100	2-Pole	10T	10	12.50
EFSC2107	3-Way	10T	5	3/4	12.70
EFSC2108	4-Way	5T	2	15.70

Type EFSC—Single

No.	Style	Amperes		Size Hub In.	Each
		125-V.	250-V.		
EFSC1101	1-Pole	10T	5	\$12.20
EFSC1100	2-Pole	10T	10	12.60
EFSC1107	3-Way	10T	5	1/2	12.80
EFSC1108	4-Way	5T	2	15.80
EFSC2101	1-Pole	10T	5	12.40
EFSC2100	2-Pole	10T	10	12.80
EFSC2107	3-Way	10T	5	3/4	13.00
EFSC2108	4-Way	5T	2	16.00

Type EFS—Duplex†

No.	Style	Amperes		Size Hub In.	Each
		125-V.	250-V.		
EFSC1109	1-Pole	10T	5	1/2	\$15.20
EFSC2109	1-Pole	10T	5	15.30
EFSC2110	2-Pole	10T	10	3/4	16.10
EFSC2113	3-Way	10T	5	16.50
EFSC3114	4-Way	5T	2	1	22.70

Type EFSC—Duplex†

No.	Style	Amperes		Size Hub In.	Each
		125-V.	250-V.		
EFSC1109	1-Pole	10T	5	\$15.40
EFSC1110	2-Pole	10T	10	16.20
EFSC1113	3-Way	10T	5	1/2	16.60
EFSC1114	4-Way	5T	2	22.60
EFSC2109	1-Pole	10T	5	15.60
EFSC2110	3-Pole	10T	10	16.40
EFSC2113	4-Way	10T	5	3/4	16.80
EFSC2114	2-Way	5T	2	22.80

Type EFS—Triple†

No.	Style	Amperes		Size Hub In.	Each
		125-V.	250-V.		
EFSC1115	1-Pole	10T	5	1/2	\$18.30
EFSC2115	1-Pole	10T	5	3/4	18.40
EFSC3116	2-Pole	10T	10	19.80
EFSC3117	3-Way	10T	5	1	20.40

Type EFSC—Triple†

No.	Style	Amperes		Size Hub In.	Each
		125-V.	250-V.		
EFSC1115	1-Pole	10T	5	\$18.50
EFSC1116	2-Pole	10T	10	1/2	19.70
EFSC2115	1-Pole	10T	5	18.70
EFSC2116	2-Pole	10T	10	19.90
EFSC2117	3-Way	10T	5	3/4	20.50
EFSC2118	4-Way	5T	2	29.50

*Plain flush covers are available and can be specified by addition of suffix S173 to catalog number of surface mounting plain cover type at an additional charge of \$.60 list, each.

†Combinations of switches can be furnished. Prices on application.

Crouse-Hinds Condulets

EFS Series Push Button Station Condulets

Explosion-Proof and Dust-Tight

Class I, Groups C and D (NEMA Type VII); Class II, Groups E, F, and G; and Class III (NEMA Types IXA, IX, and V)

EFS series push button station Condulets with front operated push buttons are furnished with individual indicating plates, one under each button. The standard markings available are as follows:

START RUN TEST FORWARD UP RAISE
STOP JOG HAND REVERSE DOWN LOWER
ON RESET AUTO OPEN IN LGT. ON
OFF TRIP EMER. CLOSE OUT

Furnished with Motor Control Push Button Stations Front Operated



EFS Single-Gang Dead End

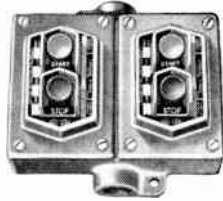

EFSC Two-Gang Through Feed

Single-Gang—D120 Series Standard Duty

Push Button Station Information‡ 600 Volts A-C Maximum		Size Hub In.	With Push Button Station		Form ★
Normal Positions	Plate Marking		No.† EFS-	Each EFSC-	
1 Circuit Open—A	Start	1/2	111 \$15.90	111 \$16.10	1
		3/4	211 16.00	211 16.30	
1 Circuit Closed—A	Stop	1/2	1102 15.90	1102 16.10	2
		3/4	212 16.00	212 16.30	
2 Circuits 1 Open—A	Start	1/2	115 18.70	115 18.90	5
1 Closed—B	Stop	3/4	215 18.80	215 19.10	
2 Circuits 1 Open—A-B	Start	1/2	1103 18.70	1103 18.90	3
	Stop	3/4	213 18.80	213 19.10	
2 Circuits 1 Open—A-B	Start	1/2	1105 18.70	1105 18.90	0.5
	Stop	3/4	2105 18.80	2105 19.10	
1 Circuit Universal	Must be Specified*	1/2	1184 16.80	1184 17.00	184
		3/4	2184 16.90	2184 17.20	
2 Circuits Universal	Must be Specified*	1/2	1190 20.40	1190 20.50	190
		3/4	2190 20.40	2190 20.70	

Two-Gang—D120 Series Standard Duty

1 Circuit Open—A	Start	1/2	121 \$31.80	121 \$32.00	1
		3/4	221 31.90	221 32.20	
1 Circuit Closed—A	Stop	1/2	122 31.80	122 32.00	2
		3/4	2202 31.90	2202 32.20	
2 Circuits 1 Open—A	Start	1/2	125 37.60	125 37.80	5
1 Closed—B	Stop	3/4	225 37.50	225 37.80	
2 Circuits 1 Open—A-B	Start	1/2	123 37.60	123 37.80	3
	Stop	3/4	2203 37.50	2203 37.80	
2 Circuits 1 Open—A-B	Start	1/2	1205 37.60	1205 37.80	0.5
	Stop	3/4	2205 37.50	2205 37.80	
1 Circuit Universal	Must be Specified*	1/2	1284 33.80	1284 34.00	184
		3/4	2284 33.70	2284 34.00	
2 Circuits Universal	Must be Specified*	1/2	1290 40.80	1290 41.00	190
		3/4	2290 40.70	2290 41.00	

†When ordering prefix **EFS** or **EFSC** to number.

★Order by catalog number. Use type and form number for identification of Condulets for hazardous locations when consulting Underwriters' Laboratories, Inc., List of Inspected Electrical Equipment.

‡Two-circuit push button stations are provided with a removable jumper for common line connection. It can be quickly removed for independent connections.

*Indicating plate markings must be specified.

†Combinations of push button stations can be furnished, prices on application.

EFS Series Push Button Station Condulets

Explosion-Proof and Dust-Tight

Class I, Groups C and D (NEMA Type VII); Class II, Groups E, F, and G; and Class III (NEMA Types IXA, IX, and V)

The indicating plate marking for each of the units must be specified. Two styles of indicating plates are available: one for a single marking and one for two markings. Either one or two markings, selected from the list below, will be supplied at no additional charge. Markings other than those shown will be supplied at \$1.00 per word list additional.

START RUN TEST FORWARD UP RAISE
STOP JOG HAND REVERSE DOWN LOWER
ON RESET AUTO OPEN IN LGT. ON
OFF TRIP EMER. CLOSE OUT

Furnished with Motor Control Push Button Stations Front Operated

Single Button Operates Both Buttons of the Push Button Station Simultaneously



Type EFS Dead End

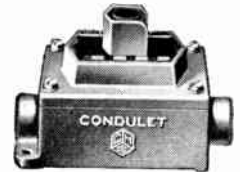

Type EFSC Through Feed

Type EFS Single-Gang—D120 Series Standard Duty

Push Button Station Information‡ 600 Volts A-C Maximum		Size Hub In.	With Push Button Station		Form ★
Normal Positions	Plate Marking		No.	Each	
2 Circuits 1 Open—A		1/2	EFS1155 \$18.70	55	
1 Closed—B		3/4	EFS2155 18.80		
		1	EFS3155 19.00	55B	
2 Circuits 1 Open—A-B		1/2	EFS1155B 18.70		
		3/4	EFS2155B 18.80	55D	
		1	EFS3155B 19.00		
2 Circuits 1 Open—A-B		1/2	EFS1155D 18.70	192	
		3/4	EFS2155D 18.80		
		1	EFS3155D 19.00	192	
2 Circuits 1 Open—A-B		1/2	EFS2192 20.40		
		3/4	EFS3192 20.60		

Type EFSC Single-Gang—D120 Series Standard Duty

2 Circuits 1 Open—A		1/2	EFSC1155 \$18.90	55
1 Closed—B		3/4	EFSC2155 19.10	
		1	EFSC3155 19.50	55B
2 Circuits 1 Open—A-B		1/2	EFSC1155B 18.90	
		3/4	EFSC2155B 19.10	55D
		1	EFSC3155B 19.50	
2 Circuits 1 Open—A-B		1/2	EFSC1155D 18.90	192
		3/4	EFSC2155D 19.10	
		1	EFSC3155D 19.50	192
2 Circuits 1 Open—A-B		1/2	EFSC1192 20.50	
		3/4	EFSC2192 20.70	
		1	EFSC3192 21.10	

★Order by catalog number. Use type and form number for identification of Condulets for hazardous locations when consulting Underwriters' Laboratories, Inc., List of Inspected Electrical Equipment.

‡Two-circuit push button stations are provided with a removable jumper for common line connection. It can be quickly removed for independent connections.

Crouse-Hinds Condulets

EFS Series Push Button Station Condulets
Explosion-Proof and Dust-Tight

Class I, Groups C and D (NEMA Type VII); Class II, Groups E, F, and G; and Class III (NEMA Types IXA, IX, and V)

EFS series push button station Condulets with rocker type operating handle are furnished with name plates. The standard markings available are as follows:

START RUN TEST FORWARD UP RAISE
STOP JOG HAND REVERSE DOWN LOWER
ON RESET AUTO OPEN IN LGT. ON
OFF TRIP EMER. CLOSE OUT

**Furnished with Motor Control Push Button Stations
Rocker Type Operating Handle**



**EFS Single-Gang
Dead End**

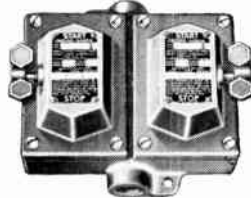

**EFSC Two-Gang
Through Feed**

Single-Gang—D120 Series Standard Duty

Push Button Switch Information;
600 Volts A-C Maximum

With Push Button Station

Normal Positions	Plate Marking	Size Hub In.	EFS-		EFSC-		Form ★
			No.††	Each	No.††	Each	
1 Circuit Open—A	Start	1/2	1174	\$15.90	1174	\$16.10	74
		3/4	2174	16.00	2174	16.30	
1 Circuit Closed—A	Stop	1/2	1177	15.90	1177	16.10	77
		3/4	2177	16.00	2177	16.30	
2 Circuits							
1 Open—A	Start	1/2	1162	18.70	1162	18.90	62
		3/4	2162	18.80	2162	19.10	
1 Closed—B	Stop	1/2	1165	18.70	1165	18.90	65
		3/4	2165	18.80	2165	19.10	
2 Circuits Open—A-B	Start	1/2	1168	18.70	1168	18.90	68
		3/4	2168	18.80	2168	19.10	
2 Circuits Closed—A-B	Stop	1/2	1168	18.70	1168	18.90	68
		3/4	2168	18.80	2168	19.10	
1 Circuit Universal	Must be Specified*	1/2	1596	16.80	1596	17.00	596
		3/4	2596	16.90	2596	17.20	
2 Circuits Universal	Must be Specified*	1/2	2194	20.40	2194	20.50	194
		3/4	2194	20.40	2194	20.70	

Two-Gang—D120 Series Standard Duty

Normal Positions	Plate Marking	Size Hub In.	EFS-		EFSC-		Form ★
			No.††	Each	No.††	Each	
1 Circuit Open—A	Start	1/2	1274	\$31.80	1274	\$32.00	74
		3/4	2274	31.90	2274	32.00	
1 Circuit Closed—A	Stop	1/2	1277	31.80	1277	32.00	77
		3/4	2277	31.90	2277	32.20	
2 Circuits							
1 Open—A	Start	1/2	1262	37.60	62
		3/4	2262	35.70	2262	37.80	
1 Closed—B	Stop	1/2	1265	37.60	65
		3/4	2265	37.50	2265	37.80	
2 Circuits Open—A-B	Start	1/2	1268	37.60	68
		3/4	2268	37.50	2268	37.80	
2 Circuits Closed—A-B	Stop	1/2	1268	37.60	68
		3/4	2268	37.50	2268	37.80	
1 Circuit Universal	Must be Specified*	1/2	1696	33.80	596
		3/4	2696	33.70	2696	34.00	
2 Circuits Universal	Must be Specified*	1/2	1294	40.80	194
		3/4	2294	40.70	2294	41.00	

★Order by catalog number. Use type and form number for identification of Condulets for hazardous locations when consulting Underwriters' Laboratories, Inc., List of Inspected Electrical Equipment.

††Two-circuit push button stations are provided with a removable jumper for common line connection. It can be quickly removed for independent connections.

*Name plate markings must be specified.

†Combinations of push button stations can be furnished, prices on application.

††When ordering, prefix **EFS** or **EFSC** to number.

EFD Series Push Button Station Condulets
Factory Sealed

Explosion-Proof and Dust-Tight

Class I, Groups C and D (NEMA Type VII); Class II, Groups E, F, and G; and Class III (NEMA Types IXA, IX, and V)

EFD series Condulets utilize heavy duty, 600-volt A-C, factory sealed, single button universal push button stations. Each push button station may be connected for one circuit normally closed, one circuit normally open or two circuits, one normally closed and one normally open. One unit may be used for jogging service or two may be used to make up a "Start-Stop" push button station.

The name plate marking for each push button station must be specified.

Certain standard markings are available at no extra charge. Special markings will be furnished at \$1.00 per word list additional. The standard markings available are as follows:

START RUN TEST FORWARD UP RAISE
STOP JOG HAND REVERSE DOWN LOWER
ON RESET AUTO OPEN IN LGT. ON
OFF TRIP EMER. CLOSE OUT

**Push Button Station Rating—Heavy Duty,
600 Volts, A-C Max.**

Single-Gang



**Type EFD—Dead End
With One Push Button
Station**



**Type EFDC—Through
Feed
With Two Push Button
Stations**

No.	Each	No. of P. B. Stations	Size Hub In.	No.	Each
EFD1437†	\$21.40	1	1/2	EFDC1437†	\$21.60
EFD2437†	21.50		3/4	EFDC2437†	21.80
EFD3437†	21.70		1	EFDC3437†	22.20
EFD1438†	32.80	2	1/2	EFDC1438†	33.00
EFD2438†	32.90		3/4	EFDC2438†	33.20
EFD3438†	33.10		1	EFDC3438†	33.60

Three-Device

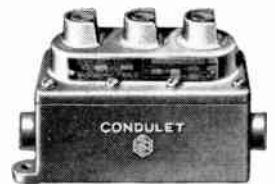

EFD1453†	\$49.50	3	1/2	EFDC1453†	\$49.70
EFD2453†	49.60		3/4	EFDC2453†	49.90
EFD3453†	49.80		1	EFDC3453†	50.30

Two-Gang Tandem



EFD2454†	\$65.70	4	3/4	EFDC2454†	\$66.00
EFD3454†	65.90		1	EFDC3454†	66.40

†Specify indicating plate markings for each push button station. Refer to table above listing.

Crouse-Hinds Condulets

EFS and EFD Series Selector Switch Condulets§

Explosion-Proof and Dust-Tight

Class I, Group C and D (NEMA Type VII); Class II, Groups E, F, and G; and Class III (NEMA Types IXA, IX, and V)

EFS and EFD series selector switch Condulets are provided with rotary type, maintained contact selector switches. Both two and three-position, two-circuit switches are used. These are especially useful in conjunction with motor control equipment. The name plate marking for each selector switch must be specified. Standard markings are available at no extra charge. Special markings will be provided at \$1.00 list additional per five letter word or abbreviation. The standard markings are as follows:

Two-Position

RUN, JOG
AUTO, HAND
FORW., REV.
FAST, SLOW
OPEN, CLOSE
UP, DOWN
OFF, ON

Three-Position

RUN, OFF, JOG
AUTO, OFF, HAND
FORW., OFF, REV.
1, OFF, 2
OPEN, OFF, CLOSE
UP, OFF, DOWN
FAST, OFF, SLOW

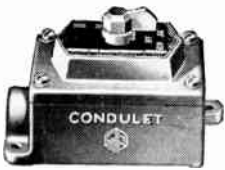

**Type EFS
Standard Duty**



**Type EFD
Heavy Duty**

**Switch Information
Two-Position, Two-Circuit**

No.	Each	600-V. A-C Max. Circuit	Size Hub In.	No.	Each
EFS11001	\$19.40	1-2	1/2	{ EFD11008	\$30.40
EFS21001	19.50			{ EFD21008	30.50
EFS31001	19.70			{ EFD31008	30.70
EFS11002	19.40	Off-1&2	1/2	{ EFD11009	30.40
EFS21002	19.50			{ EFD21009	30.50
EFS31002	19.70			{ EFD31009	30.70

Three-Position, Two-Circuit

EFS11003	\$19.40	1-Off-2	1/2	{ EFD11010	\$30.40
EFS21003	19.50			{ EFD21010	30.50
EFS31003	19.70			{ EFD31010	30.70
EFS11004	19.40	Off-1-2	1/2
EFS21004	19.50		
EFS31004	19.70		
EFS11005	19.40	Off-1&2-1	1/2
EFS21005	19.50		
EFS31005	19.70		
EFS11006	19.40	1-1&2-2	1/2	{ EFD11011	30.40
EFS21006	19.50			{ EFD21011	30.50
EFS31006	19.70			{ EFD31011	30.70
.....	1&2-1-Off	1/2	{ EFD11012	30.40
.....			{ EFD21012	30.50
.....			{ EFD31012	30.70

§Combinations of selector switches or selector switches and pilot lights, push button stations, etc. can be furnished in multiple gang Condulets; prices on application.

**EFS and EFD Series Pilot Light Condulets
Factory Sealed**

Explosion-Proof and Dust-Tight

Class I, Groups C and D (NEMA Type VII); Class II, Groups E, F, and G; and Class III (NEMA Types IXA, IX, and V)

Equipped with candelabra base lamp receptacles, 125-volt, 6-watt type S-6 clear bulb lamps, for use on 110-125 volt circuits; and colored or clear glass jewels.

Single-Gang



**Dead End
With Single Pilot Light**



**Through Feed
With Double Pilot Lights**

With Single Pilot Light

No.	Each	Size Hub In.	No.	Each
EFS1524-*	\$17.30	1/2	EFSC1524-*	\$17.50
EFS2524-*	17.40	3/4	EFSC2524-*	17.70
EFS3524-*	17.60	1	EFSC3524-*	18.10

With Double Pilot Lights

EFS1561-*	\$25.40	1/2	EFSC1561-*	\$25.60
EFS2561-*	25.50	3/4	EFSC2561-*	25.80
EFS3561-*	25.70	1	EFSC3561-*	26.20

Three-Device†

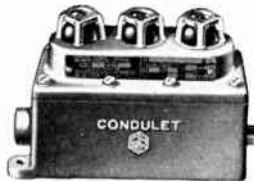

**Dead End
With Three Pilot Lights**



**Through Feed
With Three Pilot Lights**

With Three Pilot Lights

EFD1476-*	\$39.60	1/2	EFDC1476-*	\$39.80
EFD2476-*	39.70	3/4	EFDC2476-*	40.00
EFD3476-*	39.90	1	EFDC3476-*	40.40

Two-Gang Tandem



With Double Pilot Lights

.....	1/2	EFDC1477-*	\$52.60
EFD2477-*	\$52.50	3/4	EFDC2477-*	52.80
EFD3477-*	52.70	1	EFDC3477-*	53.20

†Three-device and two-gang tandem Condulets are made only in the EFD deep type.

*Insert symbol for jewel colors.

Pilot light Condulets listed above are furnished with jewel guards. Condulets without jewel guards will be supplied at the same list prices. Add suffix S308 to the catalog number.

Symbols for Jewel Colors

Color.....	Red	Green	Amber	Opal	Clear	Blue
Symbol.....	J1	J3	J6	J8	J10	J11

Crouse-Hinds Condulets

EFS Series Combination Push Button Station and Pilot Light Condulets

Explosion-Proof and Dust-Tight

Class I, Groups C and D (NEMA Type VII); Class II, Groups E, F, and G; and Class III (NEMA Types IXA, IX, and V)

Furnished with motor control push button stations, both standard and heavy duty, in combination with pilot lights. Push button stations are rated 600-volts A-C maximum. Pilot lights are equipped with candelabra base lamp receptacles and 125-volt, 6-watt type S6 clear bulb lamps, for use on 110-125-volt circuits.

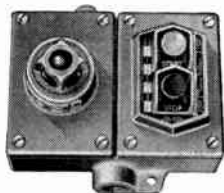

Type EFS Two-Gang Dead End

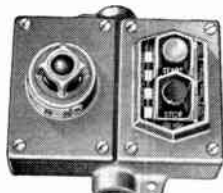

Type EFSC Two-Gang Through Feed

Type EFS Two-Gang—D120 Series Standard Duty

No.	Normal Positions	Plate Marking	Size Hub In.	Each	Form *
EFSC121-J1*			1/2	\$33.20	
EFSC221-J1*	1 Circuit	Start	3/4	33.30	1J
EFSC321-J1*	Open—A		1	33.50	
EFSC122-J1*			1/2	33.20	
EFSC2202-J1*	1 Circuit	Stop	3/4	33.30	2J
EFSC322-J1*	Closed—A		1	33.50	
EFSC125-J1*	2 Circuits		1/2	36.00	
EFSC225-J1*	1 Open—A	Start	3/4	36.10	5J
EFSC325-J1*	1 Closed—B	Stop	1	36.30	
EFSC123-J1*			1/2	36.00	
EFSC2203-J1*	2 Circuits	Start	3/4	36.10	3J
EFSC323-J1*	Open—A-B	Start	1	36.30	
EFSC1205-J1*			1/2	36.00	
EFSC2205-J1*	2 Circuits	Stop	3/4	36.10	05J
EFSC3205-J1*	Closed—A-B	Stop	1	36.30	
EFSC2858-J1*	2 Circuits	Must be	3/4	37.70	
EFSC3858-J1*	Universal	Specified†	1	37.90	458J

Type EFSC Two-Gang—D120 Series Standard Duty

EFSC121-J1*			1/2	\$33.40	
EFSC221-J1*	1 Circuit	Start	3/4	33.60	1J
EFSC321-J1*	Open—A		1	34.00	
EFSC122-J1*			1/2	33.40	
EFSC2202-J1*	1 Circuit	Stop	3/4	33.60	2J
EFSC322-J1*	Closed—A		1	34.00	
EFSC125-J1*	2 Circuits		1/2	36.20	
EFSC225-J1*	1 Open—A	Start	3/4	36.40	5J
EFSC325-J1*	1 Closed—B	Stop	1	36.40	
EFSC123-J1*			1/2	36.20	
EFSC2203-J1*	2 Circuits	Start	3/4	36.40	3J
EFSC323-J1*	Open—A-B	Start	1	36.80	
EFSC1205-J1*			1/2	36.20	
EFSC2205-J1*	2 Circuits	Stop	3/4	36.40	05J
EFSC3205-J1*	Closed—A-B	Stop	1	36.80	
EFSC1858-J1*			1/2	37.80	
EFSC2858-J1*	2 Circuits	Must be	3/4	38.00	458J
EFSC3858-J1*	Universal	Specified†	1	38.40	

*Order by catalog number. Use type and form number for identification of Condulets for hazardous locations when consulting Underwriters' Laboratories, Inc., List of Inspected Electrical Equipment.

†Two-circuit push button stations are provided with a removable jumper for common line connection. It can be quickly removed for independent connections.

‡Indicating plate marking must be specified.

*Catalog numbers listed above include red pilot light jewel (J1) in all cases. Where a different color is required substitute the proper color symbol. Example EFSC225-J1 with amber jewel is EFSC225-J6.

Type EGP Condulets

Explosion-Proof, Dust-Tight—For Panel Mounting
Factory-Sealed

Class I, Groups C and D (NEMA Type VII); Class II, Groups E, F, and G;
and Class III (NEMA)Types IXA, IX and V)



Furnished with 1-inch through-feed hubs. Pilot Light: Pilot light Condulets are equipped with candelabra base lamp receptacles, 125-volt, 6-watt, type S-6 clear bulb lamps, for use on 110-125 volt circuits; and colored or clear glass jewel.

Push Button Stations: Heavy duty, 600-volt A-C, factory-sealed, single button universal push button stations are used. Each push button station may be connected for one circuit normally closed, one circuit

normally open, or two circuits, one normally closed and one normally open. One unit may be used for jogging service or two may be used to make up a "Start-Stop" push button station.



Single-Gang—Style 1

No.	No. of Push Button Stations	No. of Pilot Lights	Each
EGP311-*	...	1	\$16.00
EGP3011-†	1	...	19.00

Two-Gang—Style 1

EGP312-*	...	2	32.00
EGP3012-†	2	...	38.00
EGP3117-†	1	1	35.00

Three-Gang—Style 1

EGP313-†	...	3	48.00
EGP3013-†	3	...	57.00
EGP3127-†	1	2	51.00
EGP3217-†	2	1	54.00

Four-Gang—Style 1

EGP3115-*	...	4	64.00
EGP3014-†	4	...	76.00
EGP3137-†	1	3	67.00
EGP3227-†	2	2	70.00
EGP3317-†	3	1	73.00

Type EGP Push Button Switch Condulets



The Type EGP Condulets listed below are equipped with standard maintained contact push button switches.

No.	Style	125 Volts	250 Volts	H.P.	Plate Marking	Each
EGP3141	1-Pole	20TA.	10-A.	..	On-Off	\$32.10
EGP3142	2-Pole	20TA.	20-A.	2	On-Off	32.30
EGP3143	3-Way	15TA.	10-A.	32.90
EGP3144	4-Way	5TA.	2-A.	38.70

*To catalog number add suffix -J1 for red; -J3 for green; -J6 for amber; -J8 for opal; -J10 for clear; and -J11 for blue.

†Specify indicating plate marking for each push button station.

Crouse-Hinds Condulets

EFD Series Combination Push Button Station and Pilot Light Condulets

Factory Sealed
Explosion-Proof and Dust-Tight

Class I, Groups C and D (NEMA Type VII); Class II, Groups E, F, and G; and Class III (NEMA Types IXA, IX, and V)

Ratings: Push Button Stations—Heavy Duty, 600 Volts A-C Max.

Push buttons have both normally open and normally closed contact.

Pilot Lights—6 Watts, 125 Volts, Candelabra Base Dead End Through Feed

Single-Gang

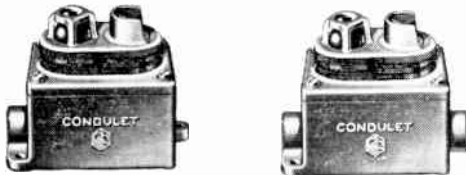

1 Push Button Station and 1 Pilot Light

No.	Each	Hub Size In.	No.	Each
EFD1473—*†	\$29.50	1/2	EFDC1473—*†	\$29.70
EFD2473—*†	29.60	3/4	EFDC2473—*†	29.90
EFD3473—*†	29.80	1	EFDC3473—*†	30.30

Three-Device

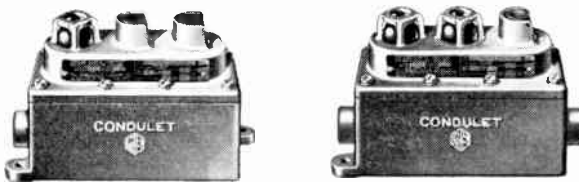

1 Push Button Station and 2 Pilot Lights

EFD1474—*†	\$42.90	1/2	EFDC1474—*†	\$43.10
EFD2474—*†	43.00	3/4	EFDC2474—*†	43.30
EFD3474—*†	43.20	1	EFDC3474—*†	43.70

2 Push Button Stations and 1 Pilot Light

EFD1475—*†	\$46.20	1/2	EFDC1475—*†	\$46.40
EFD2475—*†	46.30	3/4	EFDC2475—*†	46.60
EFD3475—*†	46.50	1	EFDC3475—*†	47.00

Two-Gang Tandem

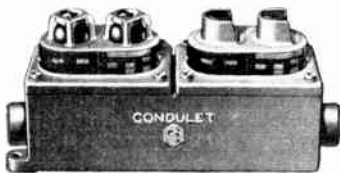

2 Push Button Stations and 2 Pilot Lights

EFD2472—*†	\$59.10	3/4	EFDC2472—*†	\$59.40
EFD3472—*†	59.30	1	EFDC3472—*†	59.80

Table of Jewel Symbols

Color	Symbol	Color	Symbol
Red	J1	Opal	J8
Green	J3	Clear	J10
Amber	J6	Blue	J11

*Insert color symbol for pilot light jewels. Give symbol for each jewel where more than one is supplied.

†Specify indicating plate marking for each push button station.

FS Series Push Button Station Condulets
Furnished with Motor Control Push Button Stations
Front Operated

Weather Resistant (Raintight)

NEMA Types III and V

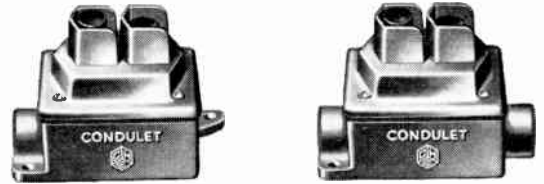

Type FS—Dead End

Type FSC—Through Feed

Type FS-D120 Series Standard Duty

No.	Push Button Switch Information* 600 Volts A.C. Maximum		Size Hub In.	Each
	Normal Positions	Plate Marking		
FS1910F	1 Circuit	Start	1/2	\$10.60
FS2910F	Open-A		3/4	10.80
FS1910G	1 Circuit	Stop	1/2	10.60
FS2910G	Closed-A		3/4	10.80
FS1910	2 Circuits		1/2	12.60
FS2910	1 Open-A	Start		
FS1910U	1 Closed-B	Stop	3/4	12.80
FS1910U	2 Circuits	Must Be	1/2	14.10
FS2910U	Universal	Specified	3/4	14.30

Type FS-D113 Series Heavy Duty

FS1913F	1 Circuit	Start	1/2	16.10
FS2913F	Open-A		3/4	16.30
FS1913G	1 Circuit	Stop	1/2	16.10
FS2913G	Closed-A		3/4	16.30
FS1913	2 Circuits		1/2	18.10
FS2913	1 Open-A	Start		
FS1913U	1 Closed-B	Stop	3/4	18.30
FS1913U	2 Circuits	Must be	1/2	19.60
FS2913U	Universal	Specified	3/4	19.80

Type FSC-D120 Series Standard Duty

FSC1910F	1 Circuit	Start	1/2	10.80
FSC2910F	Open-A		3/4	11.10
FSC1910G	1 Circuit	Stop	1/2	10.80
FSC2910G	Closed-A		3/4	11.10
FSC1910	2 Circuits		1/2	12.80
FSC2910	1 Open-A	Start		
FSC1910U	1 Closed-B	Stop	3/4	13.10
FSC1910U	2 Circuits	Must be	1/2	14.30
FSC2910U	Universal	Specified	3/4	14.60

Type FSC-D113 Series Heavy Duty

FSC1913F	1 Circuit	Start	1/2	16.30
FSC2913F	Open-A		3/4	16.60
FSC1913G	1 Circuit	Stop	1/2	16.30
FSC2913G	Closed-A		3/4	16.60
FSC1913	2 Circuits		1/2	18.30
FSC2913	1 Open-A	Start		
FSC1913U	1 Closed-B	Stop	3/4	18.60
FSC1913U	2 Circuits	Must be	1/2	19.80
FSC2913U	Universal	Specified	3/4	20.10

*Two-circuit push button stations are furnished with a jumper for common line connections. It can be quickly removed for independent connections. Other push button stations can be furnished. Prices on application.

Other hub arrangements or hub sizes can be furnished by using Condulet bodies of the FS series, with special tapping for larger cover screws. Prices on application.

Overall Dimensions, exclusive of hubs: Length, 4 3/8 inches; width, 2 3/4 inches; depth, 4 inches.

Crouse-Hinds Condulets

EFD and EFS Series Manual Motor Starting Switch Condulets Explosion-Proof and Dust-Tight

Class I, Groups C and D (NEMA Type VII); Class II, Groups E, F, and G; and Class III (NEMA Types IXA, IX, and V)

EFD Series

Furnished with either General Electric or Trumbull manual motor starting switches. Heaters are interchangeable and therefore may be used with either switch.

Maximum Horsepower Ratings: G.E. and Trumbull

Poles	115-230 Volts A-C	32 Volts D-C	115 Volts D-C	230 Volts D-C
1	1 Hp.	1/4 Hp.	3/4 Hp.	1 1/2 Hp.
2	1 Hp.	1/4 Hp.	1 Hp.	1 Hp.

Single-Gang

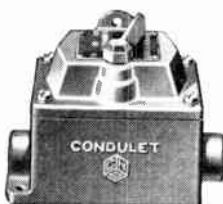

Dead End

Through Feed

No.	Each	Poles	Size Hub In.	Form ★	No.	Each
EFD1181*	\$18.80	1	1/2	81	EFDC1181*	\$19.00
EFD2181*	18.90	1	3/4	81	EFDC2181*	19.20
EFD3181*	19.10	1	1	81	EFDC3181*	19.60
EFD1182*	19.80	2	1/2	82	EFDC1182*	20.00
EFD2182*	19.90	2	3/4	82	EFDC2182*	20.20
EFD3182*	20.10	1	1	82	EFDC3182*	20.60

EFS Series

Furnished with Allen-Bradley Bulletin 600 manual motor starting switches.

Maximum Horsepower Ratings:	Poles	110-220 Volts A-C	115-230 Volts D-C
	1	1 Hp.	1 1/2 Hp.
	2	1 Hp.	3/4 Hp.

Single-Gang



Dead End

Through Feed

No.	Each	Poles	Size Hub	No.	Each
EFS1199*	\$17.00	1	1/2	EFSC1199*	\$17.20
EFS2199*	17.10	1	3/4	EFSC2199*	17.40
EFS3199*	17.30	1	1	EFSC3199*	17.70
EFS11100*	18.00	2	1/2	EFSC11100*	18.20
EFS21100*	18.10	2	3/4	EFSC21100*	18.40
EFS31100*	18.30	1	1	EFSC31100*	18.70

*List price includes switch with one interchangeable heater. Specify voltage and horsepower or Full Load Motor Current when ordering.

EFD Series Manual Motor Starting Switch Condulets—Without Overload Protection

Explosion-Proof and Dust-Tight

Class I, Groups C and D (NEMA Type VII); Class II, Groups E, F, and G; and Class III (NEMA Types IXA, IX, and V)

EFD Series

Furnished with Trumbull manual motor starting switches. These switches are without overload protection and do not take heater units.

Poles	Switch Ratings	Poles	Switch Ratings
2	{ 30A., 250 V., 2 Hp. 5A., 600 V. A-C, 2 Hp. 5A., 250 V. D-C, 1 Hp.	3	{ 30A., 250 V., 2 Hp. 20A., 600 V., 2 Hp.

Single-Gang

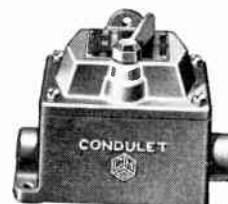

Dead End

Through Feed

No.	Each	Poles	Size Hub In.	Form ★	No.	Each
EFDC118-T8	\$15.30	2	1/2	8T8	EFDC118-T8	\$15.50
EFDC218-T8	15.40	2	3/4	8T8	EFDC218-T8	15.70
EFDC318-T8	15.60	1	1	8T8	EFDC318-T8	16.10
EFDC1419	24.80	2	1/2	19	EFDC1419	25.00
EFDC2419	24.90	3	3/4	19	EFDC2419	25.20
EFDC3419	25.10	1	1	19	EFDC3419	25.60

★Order by catalog number. Use type and form number for identification of Condulets for hazardous locations when consulting Underwriters' Laboratories, Inc. List of Inspected Electrical Equipment.

Type GUSC Line Starter Condulets

Explosion-Proof, Dust-Tight, and Weather Resistant (Raintight)

Class I, Groups C and D (NEMA Type VII); Class II, Groups E, F, and G; and Class III (NEMA Types IXA, IX, V, and III)



Furnished with across-the-line manual motor starting switches for starting D-C or single and polyphase A-C motors.

They provide thermal relay time limit overload protection but do not provide undervoltage or short circuit protection.

They are furnished with 3/4" through-feed hubs for threaded conduit, and external mounting lugs with fastening holes.

Motor Starting Switch Information

Horse Power Ratings

No.	Size	Poles	Phase	110 V. 220 V.	A-C	115 V. 230 V.	D-C	Each
GUSC2092-AII-†	0	2	1	1	1 1/2	1	1 1/2	\$49.50
GUSC2123-AII-†	0	3	3 and 2	1 1/2	2	53.00
GUSC2124-AII-†	0	4	2	1 1/2	2	70.00

†List prices include necessary heaters.

Specify voltage and h.p. or Full Load Motor Current when ordering.

Crouse-Hinds Condulets

EFD Series Motor Sentinel Condulets

Explosion-Proof and Dust-Tight

Class I, Groups C and D (NEMA Type VII); Class II, Groups E, F, and G; and Class III (NEMA Types IXA, IX, and V)

Furnished with either Bryant or Westinghouse Motor Sentinels.

Heaters are interchangeable and, therefore, may be used with either Motor Sentinel.

Maximum Horsepower Ratings: Bryant or Westinghouse

Poles	115-230 Volts A-C	32 Volts D-C	125 Volts D-C	250 Volts D-C
1	1 Hp.	¼ Hp.	1 Hp.	¼ Hp.
2	1 Hp.	¼ Hp.	1 Hp.	1 Hp.

Single-Gang



Dead End

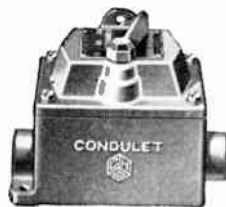

Through Feed

No.	Each	Poles	Size Hub In.	No.	Each
EFD11101-*	\$18.80	1	½	EFDC11101-*	\$19.20
EFD21101-*	18.90	1	¾	EFDC21101-*	19.60
EFD31101-*	19.10	1	1	EFDC31101-*	19.60
EFD11102-*	19.80	2	½	EFDC11102-*	20.00
EFD21102-*	19.90	2	¾	EFDC21102-*	20.20
EFD31102-*	20.10	1	1	EFDC31102-*	20.60

*List price includes Motor Sentinel with one interchangeable heater. Specify voltage and hp. or Full Load Motor Current when ordering.

Type FSPC Tumbler Switch Condulets

Explosion-Proof, Dust-Tight and Weather Resistant—Raintight

Class I, Groups C and D; Class II, Groups E, F, and G; and Class III (NEMA Types 3, 3R, 5, 7CD, 9EFG)



Furnished with tumbler switch, threaded cover, through feed threaded hubs, and mounting feet.

Hub size on all models is ¾ in.

No.	Pole	Amperes	Max. H. P.	Each
FSPC21	1	20T 10	\$14.00
FSPC22	2	20T 20	2	14.20
FSPC230	3	10 5	½A.C.	16.60
FSPC23	3-Way	15T 10	14.80
FSPC24	4-Way	5T 2	18.60
FSPC222	DP DT	10 5	19.10

no "off"

Type FLF Line Starter Condulets

Explosion-Proof, Dust-Tight, and Weather Resistant (Raintight)

Class I, Group D (NEMA Type VII); Class II, Groups E, F, and G; and Class III (NEMA Types IXA, IX, V, and III)

Manual Across-the-Line Motor Starters—Sizes 0 and 1



Type FLF Condulet for Square D

The type FLF Condulets listed have two 1" through-feed conduit hubs. The 1" size as listed is standard and will be supplied unless otherwise specified. Other hub arrangements can be furnished; prices on application to Graybar.

Square D Starters—Class 2510

Size	Poles	Max. Hp.		Condulet with Starter		Condulet without Starter	
		110 V.	220 V.	No.	Each	No.	Each
0 2(1 Ph.)	1	1½	1½	FLF103-D21	\$63.50	FLF103	\$40.00
0 3(3 Ph.)	1½	2	2	FLF103-D33	71.00	FLF103	40.00
0 2(D-C)	1	1	1	FLF103-D20	63.50	FLF103	40.00
1 2(1 Ph.)	1½	3	5	FLF189-D21	75.00	FLF189	44.00
1 3(3 Ph.)	3	5	7½	FLF189-D33	80.00	FLF189	44.00
1 2(D-C)	1½	2	2	FLF189-D20	75.00	FLF189	44.00

Type GUB Line Starter Condulets

Magnetic Across-The-Line Motor Starters



Type GUB Condulet Remote Control

Furnished with external push button for operating manual reset over-load relays.

Starters are opened and closed by push button "start-stop" stations located at convenient points. Types EFD, EFS, and EGP series air break push button stations and type OFC oil immersed push button stations are recommended for this service.

¾" threaded hubs with integral bushing, two on the bottom and one on the top, are supplied. Other sizes, arrangements or union hubs can be furnished if specified. Prices on application to Graybar.

Square D Starters—Class 8536—3-Phase, 60-Cycle

Size	Poles	Max. Hp.		Condulet with Starter		Condulet without Starter	
		208-220 V.**	440-480 V.**	No.	Each	No.	Each
0 2 2	2	GUB182-D6230	GUB182-D6430	\$124.50	GUB182	\$75.00	
1 5 7½	2	GUB182-D6231	GUB182-D6431	130.00	GUB182	75.00	

Types FLF and GUB Condulets are also available with General Electric, Westinghouse, Allen-Bradley, Arrow-II.&II., and Trumbull starting switches; information on request to Graybar.

**Also available for 110 and 550 volts at the same prices. †For larger starters and Combination Starters refer to listings of Type EPC Condulets.

Ordering Information: When ordering complete type FLF or GUB Line Starter Condulets, give complete catalog number and specify hp., voltage, frequency, number of phases, r.p.m. type, and full load ampere rating of motor. If complete motor data is not available, specify ampere rating of heater required.

Heaters: Two-pole motor starters are furnished with one heater; three-pole and four-pole starters are furnished with two heaters.

Crouse-Hinds Condulets

FS Series Push Station Condulets

Furnished with Motor Control Push Button Stations
Rocker Type Operating Handle

Watertight
NEMA Types III, IV, V



Type FS—Dead End



Type FSC—Through Feed

Type FS-D120 Series Standard Duty

No.	Normal Positions	Push Button Switch Information* 600 Volts A-C Maximum Plate Marking	Size Hub In.	Each
FS1810F	1 Circuit	Start	1/2	\$10.60
FS2810F	Open-A		3/4	10.80
FS1810G	1 Circuit	Stop	1/2	10.60
FS2810G	Closed-A		3/4	10.80
FS1810	2 Circuits	Start	1/2	12.60
FS2810	1 Open -A 1 Closed-B	Stop	3/4	12.80
FS1810U	2 Circuits	Must be	1/2	14.10
FS2810U	Universal	Specified	3/4	14.30

Type FS-D113 Series Heavy Duty

FS1813F	1 Circuit	Start	1/2	16.10
FS2813F	Open-A		3/4	16.30
FS1813G	1 Circuit	Stop	1/2	16.10
FS2813G	Closed-A		3/4	16.30
FS1813	2 Circuits	Start	1/2	18.10
FS2813	1 Open-A 1 Closed-B	Stop	3/4	18.30
FS1813U	2 Circuits	Must be	1/2	19.60
FS2813U	Universal	Specified	3/4	19.80

Type FSC-D120 Series Standard Duty

FSC1810F	1 Circuit	Start	1/2	10.80
FSC2810F	Open-A		3/4	11.10
FSC1810G	1 Circuit	Stop	1/2	10.80
FSC2810G	Closed-A		3/4	11.10
FSC1810	2 Circuits	Start	1/2	12.80
FSC2810	1 Open-A 1 Closed-B	Stop	3/4	13.10
FSC1810U	2 Circuits	Must be	1/2	14.30
FSC2810U	Universal	Specified	3/4	14.60

Type FSC-D113 Series Heavy Duty

FSC1813F	1 Circuit	Start	1/2	16.30
FSC2813F	Open-A		3/4	16.60
FSC1813G	1 Circuit	Stop	1/2	16.30
FSC2813G	Closed-A		3/4	16.60
FSC1813	2 Circuits	Start	1/2	18.30
FSC2813	1 Open-A 1 Closed-B	Stop	3/4	18.60
FSC1813U	2 Circuits	Must be	1/2	19.80
FSC2813U	Universal	Specified	3/4	20.10

*Two circuit push button stations are furnished with a jumper for common line connection. It can be quickly removed for independent connections. Other push button stations can be furnished.

Other hub arrangements or hub sizes can be furnished by using Condulet bodies of the FS series, with special tapping for larger cover screws. Prices on application to Graybar.

Overall Dimensions, exclusive of hubs: Length, 4 9/32 inches; width, 2 3/4 inches; depth, 4 inches.

FS and FD Series Pilot Light Condulets and Combination Push Button Station and Pilot Light Condulets

Weather Resistant (Raintight)
NEMA Types III and V
With Cast Feraloy Covers



Single Pilot Light

Single Pilot Light Condulets

Furnished with jewel cover, candelabra type lamp receptacle, 120-v., 6-w., S-6 clear lamp, and 50-60 cycle transformer for circuit voltage above 110.

Type FS		Type FSC			
Size Hub In.	Circuit Voltage	No.	Each	No.	Each
1/2	110	FS180*	\$6.65	FSC180*	\$ 6.85
3/4	110	FS280*	6.25	FSC280*	7.00

Type FD		Type FDC			
Size Hub In.	Circuit Voltage	No.	Each	No.	Each
1/2	220	FD181*	\$12.95	FDC181*	\$13.15
3/4	220	FD281*	13.05	FDC281*	13.30
1/2	410	FD182*	12.95	FDC182*	13.15
3/4	410	FD282*	13.05	FDC282*	13.30
1/2	550	FD183*	12.90	FDC183*	13.15
3/4	550	FD283*	13.05	FDC283*	13.30



Two-Gang Combination

Two-Gang Combination Push Button Station and Pilot Light Condulets

Furnished with D120 standard duty, 600-v. A-C maximum, start-stop push button station with front operated push button cover; pilot light receptacle with jewel cover, candelabra type lamp receptacle, 120-v., 6-w., S-6 clear lamp, and 50-60 cycle transformer for circuit voltage above 110.

Type FS		Type FSC			
Size Hub In.	Circuit Voltage	No.	Each	No.	Each
1/2	110	FS1635*	\$19.80	FSC1635*	\$20.90
3/4	110	FS2635*	19.90	FSC2635*	21.10

Type FD		Type FDC			
Size Hub In.	Circuit Voltage	No.	Each	No.	Each
1/2	220	FD1637*	26.20	FDC1637*	27.30
3/4	220	FD2637*	26.30	FDC2637*	27.50
1/2	410	FD1638*	26.20	FDC1638*	27.30
3/4	410	FD2638*	26.30	FDC2638*	27.50
1/2	550	FD1639*	26.20	FDC1639*	27.30
3/4	550	FD2639*	26.30	FDC2639*	27.50

*To catalog number add suffix for jewel color: -J1 for Red, -J3 for Green, -J6 for Amber, -J8 for Opal, -J10 for Clear, -J11 for Blue.

Crouse-Hinds Condulets

Type EMP

Explosion-Proof and Dust-Tight—Panel Mounting

Class I, Groups C and D (NEMA Type VII);
Class II, Groups E, F, and G;
and Class III (NEMA Types IXA, IX, and V)

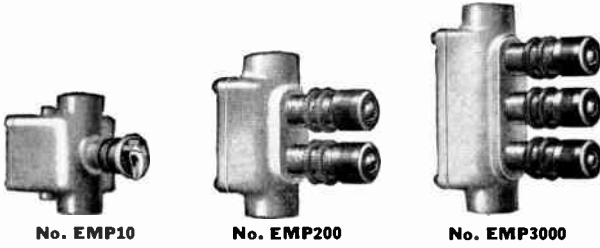

Type EMP Condulets are designed for mounting on panelboards so that pilot lights, push buttons, and switch handles are flush with the front of the panel, and bodies are in back of the panel. Threaded necks of EMP Condulets are provided with locking nuts to firmly clamp the Condulets in place. This permits easy alignment with conduit and other Condulets on the panel.

EMP Condulets are compactly designed to require the absolute minimum panel space consistent with explosion-proof construction. For this reason they are ideally suited for flow chart panels.

Condulet bodies have through-feed 1" conduit hubs. They are fitted with flat ground joint covers fastened with heavy screws. Large covers give maximum accessibility to interior.

EMP Condulets are furnished in two styles: Style 1 for 125-volt pilot lights only—Factory Sealed; Style 2 for push button stations, selector switches and pilot lights with transformers, or combinations of these—Not Factory Sealed.

Condulet parts extending beyond the face of the panel have dull black instrument finish. External seals are required when push button stations and/or selector switches are used.

Single-Gang 1" Hubs

No.	No. of Push Button Stations	No. of Pilot Lights	No. of Selector Switches	Circuit	Body Style	Each
EMP10*	..	1	1	\$16.00
EMP61†	1	2	21.00
EMP62§	1	1-2	2	25.00
EMP63§	1	1 & 2-Off	2	25.00
EMP64§	1	1-Off-2	2	25.00
EMP65§	1	2-1-Off	2	25.00
EMP66§	1	1-1 & 2-Off	2	25.00
EMP67§	1	1-1 & 2-2	2	25.00
EMP68†	1 Double	2	28.00
EMP60-T4*	..	1 (440V)	2	24.00

Two-Gang 1" Hubs

EMP200*	..	2	1	28.00
EMP711†	2	2	36.00
EMP701*†	1	1	2	33.00
EMP704*§	..	1	1	1-Off-2	2	37.00
EMP714†§	1	..	1	1-Off-2	2	40.00
EMP708*†	1 Double	1	2	40.00
EMP700-T4*	..	2 (440V)	2	42.00

Three-Gang 1" Hubs

EMP3000*	..	3	1	40.00
EMP8111†	3	2	51.00
EMP8011†	2	1	2	40.00
EMP8001*†	1	2	2	45.00
EMP8004*§	..	2	1	1-Off-2	2	49.00
EMP8014*†§	1	1	1	1-Off-2	2	52.00
EMP8114†§	2	..	1	1-Off-2	2	55.00
EMP8008*†	1 Double	2	2	52.00
EMP8101*†	2	1	2	55.00
EMP8000-T4*	..	3 (440V)	2	60.00

*To catalog number add suffix -J1 for red; -J3 for green; -J6 for amber; -J8 for opal; -J10 for clear; and -J11 for blue.

†Specify indicating plate marking for each push button.

§Specify indicating plate marking for each selector switch.

Type OFC

For Oil Immersed or Air Break Devices
Explosion-Proof, Dust-Tight, and Watertight
Class I, Group D (NEMA Types VII and VIII); Class II, Groups E, F, and G; and Class III (NEMA Types IXA, IX, V, IV, and III)



Furnished with Motor Control Push Button Station.

Push button station may be air break or oil immersed.

Single Operating Handle

No.	Normal Positions	Handle Marking	Size Hub In.	Each
OFC2101	1 Circuit	..	3/4	\$27.00
OFC3101	Open—A	Start	1	27.40
OFC2102	1 Circuit	..	3/4	27.00
OFC3102	Closed—A	Stop	1	27.40

Double Operating Handle

No.	Normal Positions	Handle Marking	Size Hub In.	Each
OFC2103	2 Circuits	..	3/4	\$29.00
OFC3103	1 Open—A	Start	1	29.40
OFC2104	1 Closed—B	Stop	1	29.40
OFC3104	Open—A-B	Start	1	29.40
OFC2105	2 Circuits	..	3/4	29.00
OFC3105	Stop	Stop	1	29.40
OFC2133	2 Circuits	Must be Specified	3/4	30.50
OFC3133	Universal	..	1	30.90

**Single Operating Handle—
Operating Both Buttons Together**

OFC2131	2 Circuits	..	3/4	\$29.00
OFC3131	Open—A-B	Start	1	29.40
OFC2132	2 Circuits	..	3/4	29.00
OFC3132	Closed—A-B	Stop	1	29.40
OFC2139	2 Circuits	Must be Specified	3/4	30.50
OFC3139	Universal	..	1	30.90

†Two-circuit push button stations are provided with a jumper for common line connection. It can be quickly removed for independent connections.

**Type GUSC Auxiliary Circuit
Breaker Condulets**

Explosion-Proof, Dust-Tight, and Weather Resistant (Raintight)



Class I, Groups C and D (NEMA Type VII); Class II, Groups E, F, and G; and Class III (NEMA Types IX, V, and III)

Furnished with Heinemann #0131 Electro-Magnetic Auxiliary Breaker

Auxiliary Breaker Information—Condulet with Breaker

Condulet with Breaker No.	Poles	Auxiliary Breaker Information Volts	1 Hp. A-C Max.	Size In.	Each
GUSC2041-11-†	1	115 A-C	1/4 to 1-A.	3/4	\$32.50
GUSC2041-13-†			1 to 35-A.		
GUSC2041-31-†			1/4 to 1-A.		
GUSC2041-33-†	1	230 A-C	1 to 35-A.	3/4	\$30.50
GUSC2041-51-†			1/4 to 1-A.		
GUSC2041-53-†			1 to 35-A.		

†Insert ampere rating required (Any rating within limits shown in listing above). Example: Cat. No. GUSC2041-13-2 covers a Condulet with auxiliary breaker for 115 volts a-c and with 2 ampere rating.

Crouse-Hinds Panelboards With Circuit Breakers

Type EDP Explosion-Proof, Dust-Tight, and Weather Resistant (Raintight)

Class I, Group D (NEMA Type VII); Class II, Groups E, F, and G; and Class III (NEMA Types IX, V, and III)

Furnished with Thermal Branch Circuit Breakers, Main Lugs, and Terminal Connection Blocks.

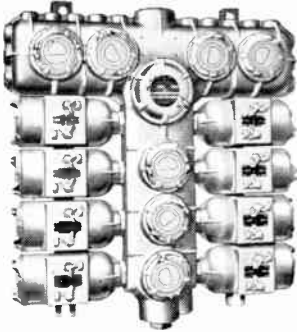

Type EDP panelboards are especially designed for use in hazardous locations. They may also be used in non-hazardous locations where corrosive vapors, non-combustible dusts, or moisture are present.

All EDP panels are wired complete. Connections between terminal blocks and circuit breakers are made at the factory. Each circuit breaker compartment is sealed from the "T" section.

All EDP panelboards are provided with 3" through feed main hubs. Size 1 panelboards have 12 1" branch hubs while Size 2 panelboards have 16 1" branch hubs.

*15-Ampere Branch Circuit Breakers (E Frame)

Mains—3-W., 125-250-V., A.C. or D.C.
Branches—2-W., 125-V. A.C. or D.C. Solid Neutral

Mains—4-W., 120-208-V., 3-Ph.
Branches—2-W., 120-V., 1-Ph. Solid Neutral

Breakers—Single-Pole

No. Breakers	No.	Each	No.	Panel Size
6	EDP406-15	\$409.00	EDP506-15	1
8	EDP408-15	471.00	EDP508-15	1
10	EDP410-15	534.00	EDP510-15	1
12	EDP412-15	596.00	EDP512-15	1
14	EDP414-15	718.00	EDP514-15	2
16	EDP416-15	781.00	EDP516-15	2

Mains—3-W., 125-250-V. A.C. or D.C.
Branches—2-W., 125-V. A.C. or D.C.

Mains—3-W., 125-250-V. A.C. or D.C.
Branches—3-W., 125-250-V. A.C. or D.C. Solid Neutral

Breakers—Two-Pole

4	EDP204-15	\$480.00	EDP304-15	1
6	EDP206-15	597.00	EDP306-15	1
8	EDP208-15	778.00	EDP308-15	2

Mains—2-W., 125-V. A.C. or D.C.
Branches—2-W., 125-V. A.C. or D.C.

Mains—4-W., 120-208-V., 3-Ph.
Branches—3-W., 120-208-V., 1-Ph. Solid Neutral

Breakers—Two-Pole

4	EDP104-15	\$480.00	EDP804-15	1
6	EDP106-15	597.00	EDP806-15	1
8	EDP108-15	778.00	EDP808-15	2

Mains—3-W., 125-250-V. A.C. or D.C.
Branches—3-W., 125-250-V. A.C. or D.C.

Mains—4-W., 120-208-V., 3-Ph.
Branches—4-W., 120-208-V., 3-Ph. Solid Neutral

Breakers—Three-Pole

4	EDP604-15	\$594.00	EDP1104-15	1
6	EDP606-15	825.00	EDP1106-15	2

Type EQP Explosion-Proof and Dust-Tight

Class I, Groups C and D (NEMA Type 7CD)

Furnished with Thermal-Magnetic Branch Circuit Breakers Main Lugs, Terminal Connection Blocks and Breathers and Drains.

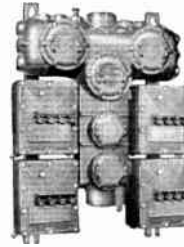

Type EQP Condulet is similar to type EDP panelboards except that circuit breaker housing covers are of bolted, flanged joint construction permitting complete accessibility from the front.

All EQP panelboards are wired complete. Connections between terminal blocks and circuit breakers are made at the factory. Each circuit breaker compartment is sealed from the "T" section.

All are provided with 3" through-feed main hubs.

15-Ampere Branch Circuit Breakers

Mains—3-W., 125-250V A.C. or D.C.
Branches—2-W., 125V A.C. or D.C. Solid Neutral

Mains—4-W., 120-208V, 3-Ph.
Branches—2-W., 120V, 1-Ph. Solid Neutral

Breakers—Single Pole

No. Breakers	No.	Each	No.	Panel Size
8	EQP408-15	\$471.00	EQP508-15	1
12	EQP412-15	596.00	EQP512-15	1
16	EQP416-15	781.00	EQP516-15	1
20	EQP420-15	950.00	EQP520-15	2
24	EQP424-15	1059.00	EQP524-15	2

Mains—3-W., 125-250V A.C. or D.C.
Branches—2-W., 125V A.C. or D.C.

Mains—3-W., 125-250V A.C. or D.C.
Branches—3-W., 125-250V A.C. or D.C. Solid Neutral

Breakers—Two Pole

4	EQP204-15	480.00	EQP304-15	1
6	EQP205-15	597.00	EQP306-15	1
8	EQP205-15	778.00	EQP308-00	1

Crouse-Hinds Circuit Breaker Load Center Condulets

Explosion-Proof, Dust-Tight, and Weather Resistant (Raintight)

Class I, Group D (NEMA Type VII); Class II, Groups E, F, and G; and Class III (NEMA Types IX, V, and III) *

Furnished with Type MO Multi-breakers.

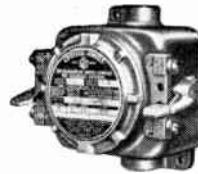

Type GUSC Single-Gang

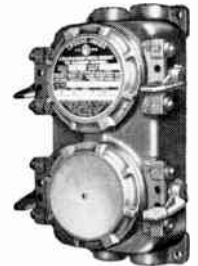

Type GUSC Two-Gang

Type GUSC Single-Gang

No. Breakers	Poles	Ampere Rating †	Size Hub In.	Condulet with Circuit Breaker. Neutral Connection Block		Each
				Grounded No.	Ungrounded No.	
1	1	15	3/4	GUSC2251	GUSC2252	\$35.00
2	1	15	3/4	GUSC2281	GUSC2282	44.00
1	2	15	3/4	GUSC2331	GUSC2332	38.00

Type GUSC Two-Gang

3	1	15	3/4	GUSC2361	GUSC2362	75.00
4	1	15	3/4	GUSC2471	GUSC2472	84.00
2	2	15	3/4	GUSC2571	GUSC2572	72.00

*Panelboards with all 20 or 30-ampere breakers can be furnished at the same list prices. 40 or 50-ampere breakers, or combinations of 15 through 50-ampere breakers, can be furnished. Prices on application to Graybar.

†Condulets with 20 or 30-ampere breakers can be furnished at the same list prices.

★Single-Gang GUSC Condulets are also suitable for Class I, Group C locations.

‡These panelboards may be used on 250-volts A-C. They are labeled for 125-volts as this is the highest voltage available at Underwriters' Laboratories, Inc., for short circuit tests of these breakers in explosion-proof enclosures.

Crouse-Hinds Condulets

Type GUSC Circuit Breaker Load Center Condulets—Continued

Furnished with Thermal Magnetic "Quicklag" Circuit Breakers, 125-250 Volts A-C.

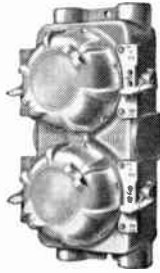

Type GUSC Single-Gang

Type GUSC Two-Gang

No. Breakers	Circuit Breaker Information			Conduit With Circuit Breaker		Neutral Connection Block		Each
	Poles	Ampere Rating	Size Hub In.	Grounded No.	Ungrounded No.			
Type GUSC Single-Gang *								
1	1	10	1	GUSC3110-10	GUSC3111-10			\$35.00
1	1	15	1	GUSC3110-15	GUSC3111-15			35.00
2	1	10	1	GUSC3210-10	GUSC3211-10			44.00
2	1	15	1	GUSC3210-15	GUSC3211-15			44.00
1	2	10	1	GUSC3120-10	GUSC3121-10			38.00
1	2	15	1	GUSC3120-15	GUSC3121-15			38.00
Type GUSC Two-Gang								
3	1	10	1	GUSC3310-10	GUSC3311-10			75.00
3	1	15	1	GUSC3310-15	GUSC3311-15			75.00
4	1	10	1	GUSC3410-10	GUSC3411-10			84.00
4	1	15	1	GUSC3410-15	GUSC3411-15			84.00
2	2	10	1	GUSC3220-10	GUSC3221-10			72.00
2	2	15	1	GUSC3220-15	GUSC3221-15			72.00

Type DVSP Panelboards With Circuit Breakers

Dust-Tight and Weather Resistant (Raintight)
Class II, Groups E, F, and G; and Class III (NEMA Types IX, V, and III)

Furnished with Thermal Branch Circuit Breakers, Pressure Type Main Lugs, Neutral Terminal Connection Block, and Conduit Openings.

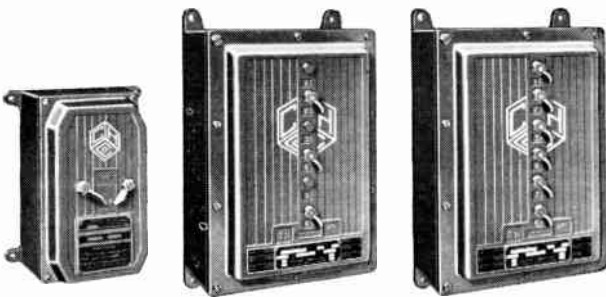

Form A With Two Single-Pole Circuit Breakers **Form B With Three Double Pole Circuit Breakers** **Form B With Six Single-Pole Circuit Breakers**

*15-Amp. Single Pole Branch Circuit Breakers (E Frame).

Mains—3-W., 125-250-V. A.C. or D.C. Mains—4-W., 120-208-V., 3-Ph.
Branches—2-W., 125-V. A.C. or D.C. Solid Neutral Branches—2-W., 120-V., 1-Ph. Solid Neutral

No. Breakers	No.	Each	No.	Form
2	DVSP402-15	\$ 74.00		A
3	DVSP403-15	144.00	DVSP503-15	B
4	DVSP404-15	157.00	DVSP504-15	B
5	DVSP405-15	170.00	DVSP505-15	B
6	DVSP406-15	183.00	DVSP506-15	B

*Panelboards with all 20 or 30-ampere breakers can be furnished at the same list prices. 40 or 50-ampere breakers, or combinations of 15 through 50-ampere breakers, can be furnished. Prices on application.

†Single-gang Condulets with 20, 30, or 40-ampere breakers and two-gang Condulets with 20 or 30-ampere breakers can be furnished at the same list prices. ★Single-gang GUSC Condulets are also suitable for Class I, Group C locations.

Type DLP Panelboards With Circuit Breakers
Dust-Tight and Weather Resistant (Raintight)
Class II, Groups E, F, and G; and Class III (NEMA Types IX, V, and III)

Furnished with Thermal-Magnetic (Quicklag) Branch Circuit Breakers, Pressure Type Main Lugs, Neutral Terminal Connection Block, and Conduit Openings.

Cast Aluminum Housings

Prices of DLP panelboards include a maximum of one conduit opening for each branch circuit and one for main conduit. Tapped conduit openings with threaded-in bushings will be provided. Orders should be accompanied by a sketch showing the number, size, and location of openings desired.

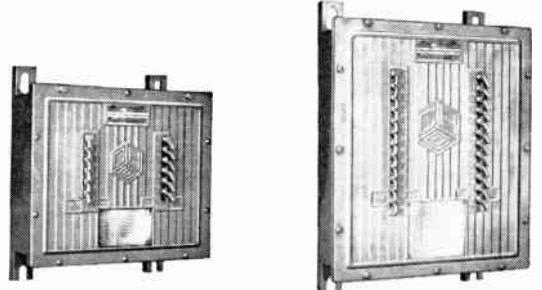

Type DLP Panelboard—Form A **Type DLP Panelboard—Form B**

***15-Amp., Single Pole Branch Circuit Breakers**

Mains—3-W., 125-250-V. A.C.
Branches—2-W., 125-V. A.C.
Solid Neutral

Mains—4-W., 120-208-V., 3-Ph.
Branches—2-W., 120-V., 1-Ph.
Solid Neutral

No. Breakers	No.	Each	No.	Form
6	DLP406-15	\$264.00	DLP506-15	A
8	DLP408-15	280.00	DLP508-15	A
10	DLP410-15	296.00	DLP510-15	A
12	DLP412-15	312.00	DLP512-15	A
14	DLP414-15	404.00	DLP514-15	B
16	DLP416-15	420.00	DLP516-15	B
18	DLP418-15	436.00	DLP518-15	B
20	DLP420-15	452.00	DLP520-15	B
22	DLP422-15	468.00	DLP522-15	B
24	DLP424-15	484.00	DLP524-15	B

Type YSW Circuit Breaker Load Center Condulets Without Hub Plates

Weather Resistant (Raintight)
NEMA Types III and V

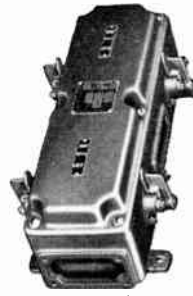

Form 3



Form 1

Take YYP7 Series Removable Conduit Hub Plates.

Furnished with Connection Block, Gaskets for Hub Plates, and Thermal Branch Circuit Breakers.

1 Circuit Breaker

Amps.	Single Pole		Two-Pole	
	No.	Each	No.	Each
15	YSW1115	\$33.40	YSW1215	\$49.80
20	YSW1120	33.40	YSW1220	49.80
30	YSW1130	33.40	YSW1230	49.80
40	YSW1140	35.40	YSW1240	49.80

2 Circuit Breakers

15	YSW2115	\$50.80
20	YSW2120	50.80
30	YSW2130	50.80

YSW Form 3

15	YSW4115	\$109.60	YSW2215	\$107.60
20	YSW4120	109.60	YSW2220	107.60
30	YSW4130	109.60	YSW2230	107.60
40	YSW4140	117.60	YSW2240	107.60

Crouse-Hinds Condulets

FD Series Motor Sentinel Condulets
Watertight
NEMA Types III, IV, and V

Furnished with either Bryant or Westinghouse Motor Sentinels. Unless a preference is stated on the order, the make of switch supplied will depend on its availability at the time of assembly.

Max. Hp. Ratings: Bryant and Westinghouse

Poles	115-230 Volts A-C	32 Volts D-C	125 Volts D-C	250 Volts D-C
1	1 Hp.	¼ Hp.	1 Hp.	¼ Hp.
2	1 Hp.	¼ Hp.	1 Hp.	1 Hp.

Single-Gang

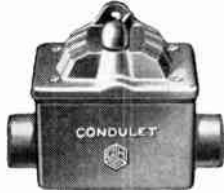

Dead End

No.	Each	Poles	Size Hub In.
FD1211*	\$12.25	1	½
FD2211*	12.35	1	¾
FD3211*	12.50	1	1
FD1212*	13.25	2	½
FD2212*	13.35	2	¾
FD3212*	13.50	2	1

Through Feed

No.	Each
FDC1211*	\$12.45
FDC2211*	12.60
FDC3211*	13.00
FDC1212*	13.45
FDC2212*	12.60
FDC3212*	13.00

Table 3—Bryant and Westinghouse Interchangeable Heater Units for EFD and FD Series Condulets

Full Load Motor Current	Heater Rating	C-H Symbol Number	Full Load Motor Current	Heater Rating	C-H Symbol Number
0.40—0.45	0.50	BW 1	2.40—2.70	3.00	BW14
0.46—0.52	0.57	BW 2	2.80—3.10	3.50	BW15
0.53—0.60	0.66	BW 3	3.20—3.60	4.00	BW16
0.61—0.69	0.76	BW 4	3.70—4.20	4.60	BW17
0.70—0.79	0.87	BW 5	4.30—4.90	5.30	BW18
0.80—0.91	1.00	BW 6	5.00—5.60	6.20	BW19
0.92—1.03	1.10	BW 7	5.70—6.50	7.10	BW20
1.04—1.20	1.30	BW 8	6.60—7.50	8.20	BW21
1.21—1.38	1.50	BW 9	7.60—8.50	9.40	BW22
1.39—1.55	1.70	BW10	8.60—9.90	10.70	BW23
1.60—1.80	2.00	BW11	10.00—11.30	12.50	BW24
1.90—2.00	2.30	BW12	11.40—13.00	14.30	BW25
2.10—2.30	2.60	BW13			

*List prices include Motor Sentinel with one interchangeable heater.

Select heater from Table 3 above and use the heater symbol for the second section of the catalog number. Example: FD1211-BW5.

Other hub arrangements or hub sizes can be furnished by using Condulet bodies of the FD series, with special tapping for larger cover screws.

Type EPC Circuit Breaker Condulets

100-Ampere Frame Size with Non-Interchangeable Thermal Trip and Non-Adjustable Magnetic Trip
Condulet Without Circuit Breaker

Square D

No.	Poles	Voltage Rating	Amps.	Size Hub In.	Each
EPC437	2	250-V. A.C. or 125-250-V. D.C.	70*/100	2	\$120.00
		EPC427	2	600-V. A.C. or 250-V. D.C.	70*/100
600-V. A.C.					

Type EPC Condulets are available with ITE, Westinghouse, and Trumbull circuit breakers; information on request to Graybar.

*Available in \$100.00 Condulet with 1¼" hubs.

Type EPC Circuit Breaker Condulets

Air Break Circuit Breakers
Explosion-Proof, Dust-Tight, and Weather Resistant (Raintight)

Class I, Group D (NEMA Type VII); Class II, Groups E, F, and G; Class III (NEMA Types, IX, V, and III).



These Condulets with air break circuit breakers are suitable for service entrance, feeder, or branch circuit protection, for lighting, appliance, and motor circuit conductors. For manual closing, opening, or resetting, an external handle is provided. Four threaded hubs are provided, two at the top and two at the bottom.

50-Ampere Frame Size with Non-Interchangeable Thermal Trip and Non-Adjustable Magnetic Trip

Condulet Without Circuit Breaker

Square D

No.	Poles	Voltage Rating	Amps.	Size Hubs	Each
EPC434	1	125-V. A.C. or D.C.	15-50	1	\$ 80.00
EPC434	2	250-V. A.C. or 125-250-V. D.C.		1	80.00
EPC435	3	125-250-V. D.C.		1¼	100.00
EPC441	2	600-V. A.C. or 250-V. D.C.	15-50	1¼	100.00
		600-V. A.C.			

Condulet With Breaker

Square D

125-V. A-C or D-C—Single Pole

No.	Amps.	Size Hub In.	Each
EPC434-DT15-1	15	1	\$89.00
EPC434-DT20-1	20	1	89.00
EPC434-DT30-1	30	1	89.00
EPC434-DT40-1	40	1	89.00
EPC434-DT50-1	50	1	89.00

250-V. A-C or 125-250-V. D-C—Two Pole

EPC434-DT15-2	15	1	102.00
EPC434-DT20-2	20	1	102.00
EPC434-DT30-2	30	1	102.00
EPC434-DT40-2	40	1	102.00
EPC434-DT50-2	50	1	102.00

250-V. A-C or 125-250-V. D-C—Three Pole

EPC435-DT15-3	15	1¼	133.00
EPC435-DT20-3	20	1¼	133.00
EPC435-DT30-3	30	1¼	133.00
EPC435-DT40-3	40	1¼	133.00
EPC435-DT50-3	50	1¼	133.00

600-V. A-C or 250-V. D-C—Two Pole

EPC441-DT15-2	15	1¼	148.00
EPC441-DT20-2	20	1¼	148.00
EPC441-DT30-2	30	1¼	148.00
EPC441-DT40-2	40	1¼	148.00
EPC441-DT50-2	50	1¼	148.00

600-V. A-C—Three Pole

EPC441-DT15-3	15	1¼	160.50
EPC441-DT20-3	20	1¼	160.50
EPC441-DT30-3	30	1¼	160.50
EPC441-DT40-3	40	1¼	160.50
EPC441-DT50-3	50	1¼	160.50

Crouse-Hinds Condulets

Type EPC Line Starter Condulets Magnetic Across-The-Line Motor Starters

Explosion-Proof, Dust-Tight, and Weather Resistant (Raintight)

Class I, Group D (NEMA Type VII); Class II, Groups E, F, and G; and Class III (NEMA Types IXA, IX, V, and III)



**Type EPC
Line Starter Condulet
Air Break**



Oil Immersed

Listed for both air break and oil immersed starters. Oil immersion is especially useful in corrosive locations. Type EPC Condulets arranged for oil immersed starters are explosion-proof regardless of whether or not the oil level is properly maintained.

Air break starters have thermal overload relays arranged for manual reset. For this purpose, a reset push button is mounted upon the front of the body.

Oil immersed starters have thermal induction overload relays arranged for automatic resetting; therefore, no external reset buttons are furnished.

The starters are opened and closed by push button "start-stop" stations located at convenient points. Types EFD, EFS, and EGP series air break push button stations and type OFC oil immersed push button stations are recommended for this service. Push button stations are not included.

Square D Starters

Air Break—Class 8536—3 Phase, 60 Cycle

208-220 Volts**

Size	Max. H.P.	Size Hub In.	Condulet With Starter No.	Each	Condulet Without Starter No.	Each
0	2	1 1/4	EPC615-D623	\$149.50	EPC615	\$100.00
1	5	1 1/4	EPC615-D623	155.00	EPC615	100.00
2	15	1 1/2	EPC616-D623	250.00	EPC616	150.00
3	30	2 1/2	EPC617-D623	370.00	EPC617	210.00
4	50	2 1/2	EPC627-D623	580.00	EPC627	270.00

440-480 Volts**

0	2	1 1/4	EPC615-D643	149.50	EPC615	100.00
1	7 1/2	1 1/4	EPC615-D643	155.00	EPC615	100.00
2	25	1 1/2	EPC616-D643	250.00	EPC616	150.00
3	50	2 1/2	EPC617-D643	370.00	EPC617	210.00
4	100	2 1/2	EPC627-D643	580.00	EPC627	270.00

Catalog numbers of oil immersed starters do not include oil.

*Two-speed starters are also available for 550 volts at the same prices.

**Also available for 110 and 550 volts at the same prices.

Heaters: Air break motor starters are furnished with two heaters; oil immersed starters are furnished with two induction temperature overload relays with relay coils. Reversing starters are furnished with two heaters; two-speed starters are furnished with four heaters.

*Maximum horsepower ratings shown for two-speed starters are at the high motor speed.

Type EPC Condulets are also available with General-Electric, Westinghouse, Allen-Bradley, Arrow-H.&H., and Trumbull starting switches; information on request to GRAYBAR.

Square D Reversing Starters

Air Break—Class 8736—3-Phase, 60-Cycle

208-220 Volts**

Size	Max. H.P.	Size Hub In.	Condulet With Starter No.	Each	Condulet Without Starter No.	Each
0	2	1 1/4	EPC640-D623	\$230.00	EPC640	\$120.00
1	5	1 1/4	EPC620-D623	241.00	EPC620	120.00
2	15	1 1/2	EPC621-D623	420.00	EPC621	200.00
3	30	2 1/2	EPC622-D623	703.00	EPC622	340.00

440-480 Volts**

0	2	1 1/4	EPC640-D643	230.00	EPC640	120.00
1	7 1/2	1 1/4	EPC620-D643	241.00	EPC620	120.00
2	25	1 1/2	EPC621-D643	420.00	EPC621	200.00
3	50	2 1/2	EPC622-D643	703.00	EPC622	340.00

Square D Two-Speed Starters*

For Two-Winding, Constant or Variable Torque, Star Connected Motors Only

For use only with two-winding, constant or variable torque, star connected motors. Starters for constant horsepower applications or open delta connections can be supplied. Information on request accompanied by complete details. Write GRAYBAR.

Compelling or accelerating relays can be supplied but require larger Condulets. Prices on application.

Air Break—Class 8810—3-Phase, 60-Cycle

208-220 Volts

1	5	1 1/4	EPC668-D623	\$317.00	EPC668	\$135.00
2	15	1 1/2	EPC662-D623	507.00	EPC662	210.00
3	30	2 1/2	EPC669-D623	796.00	EPC669	350.00

440-480 Volts§

1	7 1/2	1 1/4	EPC668-D643	317.00	EPC668	135.00
2	25	1 1/2	EPC662-D643	507.00	EPC662	210.00
3	50	2 1/2	EPC669-D643	796.00	EPC669	350.00

Square D Two-Speed Starters*

For Single Winding, Consequent Pole, Constant or Variable Torque Motors

For use with single winding, consequent pole, constant or variable torque motors. Starters for constant horsepower applications can be supplied. Information on request accompanied by complete details.

Compelling or accelerating relays can be supplied but require larger Condulets. Prices on application.

Air Break—Class 8810—3-Phase, 60-Cycle

208-220 Volts

1	5	1 1/4	EPC663-D623	\$372.00	EPC663	\$135.00
2	15	2 1/2	EPC655-D623	676.00	EPC655	280.00
3	30	2 1/2	EPC664-D623	1013.00	EPC664	430.00

440-480 Volts§

1	7 1/2	1 1/4	EPC663-D643	372.00	EPC663	135.00
2	25	2 1/2	EPC655-D643	676.00	EPC655	280.00
3	50	2 1/2	EPC664-D643	1013.00	EPC664	430.00

Ordering Information: When ordering complete type EPC Line Starter Condulets, give complete catalog number and specify Hp., voltage, frequency, number of phases, R.P.M., type and full-load ampere rating of motor. For two-speed motors, give full load ampere rating at each speed. If complete motor data is not available, specify ampere rating of heaters required.

Crouse-Hinds Condulets

Type EPC Combination Line Starter Condulets

Explosion-Proof, Dust-Tight, and Weather Resistant (Raintight)

Class I, Group D (NEMA Type VII); Class II, Groups E, F, and G; and Class III (NEMA Types IXA, IX, V, and III)

Square D Magnetic Across-The-Line Starters and Air Break Circuit Breakers

Air Break—208-220 Volts**

Size	Max. H.P. Amp.*	Size Hub In.	Condulet With Starter and Circuit Breaker No.	Each	Condulet Without Starter and Circuit Breaker No.	Each
0	2 15	1 1/4	EPC10148-DT15-D623	\$247.50	EPC10148	\$165.00
1	5 30	1 1/2	EPC10148-DT30-D623	253.00	EPC10148	165.00
2	10 50	1 3/4	EPC10149-DT50-D623	343.00	EPC10149	210.00
2	15 70	1 3/4	EPC10162-DT70-D623	358.00	EPC10162	210.00
3	30 100	2 1/2	EPC10163-DT100-D623	573.00	EPC10163	365.00
3	30 125	2 1/2	EPC10146-DT125-D623	713.00	EPC10146	385.00
4	50 225	2 1/2	EPC10147-DT225-D623	918.00	EPC10147	440.00

Air Break—440-480 Volts**

Size	Max. H.P. Amp.*	Size Hub In.	Condulet With Starter and Circuit Breaker No.	Each	Condulet Without Starter and Circuit Breaker No.	Each
0	2 15	1 1/4	EPC10161-DT15-D643	275.00	EPC10161	165.00
1	3 15	1 1/4	EPC10161-DT15-D643	280.50	EPC10161	165.00
1	7 1/2 30	1 1/2	EPC10161-DT30-D643	280.50	EPC10161	165.00
2	10 30	1 1/2	EPC10162-DT30-D643	370.50	EPC10162	210.00
2	25 50	1 1/2	EPC10162-DT50-D643	370.50	EPC10162	210.00
2	25 70	1 1/2	EPC10134-DT70-D643	384.00	EPC10314	210.00
3	50 100	2 1/2	EPC10135-DT100-D643	599.00	EPC10135	365.00
3	50 125	2 1/2	EPC10146-DT125-D643	713.00	EPC10146	385.00
4	75 150	2 1/2	EPC10147-DT150-D643	918.00	EPC10147	440.00
4	100 200	2 1/2	EPC10147-DT200-D643	918.00	EPC10147	440.00

Oil Immersed—208-220 Volts**

Size	Max. H.P. Amp.*	Size Hub In.	Condulet With Starter and Circuit Breaker No.	Each	Condulet Without Starter and Circuit Breaker No.	Each
1	5 30	1 1/4	EPC11148-DT30-D623	398.00	EPC11148	253.00
2	10 50	1 1/2	EPC11149-DT50-D623	489.00	EPC11149	290.00
2	15 70	1 1/2	EPC11162-DT70-D623	504.00	EPC11162	290.00
3	30 100	2 1/2	EPC11163-DT100-D623	745.00	EPC11163	455.00
3	30 125	2 1/2	EPC11146-DT125-D623	839.00	EPC11146	455.00
4	50 225	2 1/2	EPC11147-DT225-D623	1027.00	EPC11147	510.00

Oil Immersed—440-480 Volts**

Size	Max. H.P. Amp.*	Size Hub In.	Condulet With Starter and Circuit Breaker No.	Each	Condulet Without Starter and Circuit Breaker No.	Each
1	3 15	1 1/4	EPC11161-DT15-D643	425.50	EPC11161	235.00
1	7 1/2 30	1 1/2	EPC11161-DT30-D643	425.50	EPC11161	235.00
2	10 30	1 1/2	EPC11162-DT30-D643	516.50	EPC11162	290.00
2	25 50	1 1/2	EPC11162-DT50-D643	516.50	EPC11162	290.00
2	25 70	1 1/2	EPC11134-DT70-D643	530.00	EPC11134	290.00
3	50 100	2 1/2	EPC11135-DT100-D643	745.00	EPC11135	455.00
3	50 125	2 1/2	EPC11146-DT125-D643	839.00	EPC11146	455.00
4	75 150	2 1/2	EPC11147-DT150-D643	1027.00	EPC11147	510.00
4	100 200	2 1/2	EPC11147-DT200-D643	1027.00	EPC11147	510.00

Square D Magnetic Across-The-Line Air Break Starters and Westinghouse Air Break Circuit Breakers

Reversing Starters—208-220 Volts**

Size	Max. H.P. Amp.*	Size Hub In.	Condulet With Starter and Circuit Breaker No.	Each	Condulet Without Starter and Circuit Breaker No.	Each
0	2 15	1 1/4	EPC10136-WT15-D623	\$370.50	EPC10136	\$200.00
1	2 15	1 1/4	EPC1049-WT15-D623	381.50	EPC1049	200.00
1	5 30	1 1/2	EPC1049-WT30-D623	381.50	EPC1049	200.00
2	10 50	1 1/2	EPC1050-WT50-D623	555.00	EPC1050	275.00
2	15 70	1 1/2	EPC1050-WT70-D623	569.00	EPC1050	275.00
3	30 100	2 1/2	EPC10156-WT100-D623	932.00	EPC10156	495.00

Ordering Information: When ordering, select complete Cat. No. above and specify I.P., voltage, frequency, R.P.M., type, and full-load ampere rating of motor. For two-speed motors, give full load ampere rating at each speed. If complete motor data is not available, specify ampere rating of heaters.

Heaters: Air break starters are furnished with two heaters; oil immersed starters are furnished with two induction temperature over-load relays with relays coils. Reversing starters are furnished with two heaters; two-speed starters are furnished with four heaters.

Square D Magnetic Across-The-Line Air Break Starters and Westinghouse Air Break Circuit Breakers

Reversing Starters—440-480 Volts**

Size	Max. H.P. Amp.*	Size Hub In.	Condulet With Starter and Circuit Breaker No.	Each	Condulet Without Starter and Circuit Breaker No.	Each
0	2 15	1 1/4	EPC10136-WT15-D643	\$370.50	EPC10136	\$200.00
1	3 15	1 1/4	EPC1049-WT15-D643	381.50	EPC1049	200.00
1	7 1/2 30	1 1/2	EPC1049-WT30-D643	381.50	EPC1049	200.00
2	20 50	1 1/2	EPC1050-WT50-D643	555.00	EPC1050	275.00
2	25 70	1 1/2	EPC1050-WT70-D643	569.00	EPC1050	275.00
3	50 100	2 1/2	EPC10156-WT100-D643	932.00	EPC10156	495.00

Two-Speed Starters†

For Two-Winding, Constant or Variable Torque, Star Connected Motors Only

For use only with two-winding, constant or variable torque, star connected motors. Combinations for constant horsepower applications or open delta connections can be supplied. Information on request accompanied by complete details. Write GRAYBAR.

Compelling or accelerating relays can be supplied but require larger Condulets. Prices on application.

208-220 Volts

1	1 1/2 15	1 1/4	EPC10165-WT15-D623	\$442.50	EPC10165	\$200.00
1	5 30	1 1/4	EPC10165-WT30-D623	442.50	EPC10165	200.00
2	10 50	1 1/2	EPC10150-WT50-D623	632.50	EPC10150	275.00
2	15 70	1 1/2	EPC10150-WT70-D623	646.00	EPC10150	275.00
3	30 100	2 1/2	EPC10166-WT100-D623	1015.00	EPC10166	495.00

440-480 Volts§

1	3 15	1 1/4	EPC10165-WT15-D643	442.50	EPC10165	200.00
1	7 1/2 30	1 1/2	EPC10165-WT30-D643	442.50	EPC10165	200.00
2	20 50	1 1/2	EPC10150-WT50-D643	632.50	EPC10150	275.00
2	25 70	1 1/2	EPC10150-WT70-D643	646.00	EPC10150	275.00
3	50 100	2 1/2	EPC10166-WT100-D643	1015.00	EPC10166	495.00

Two-Speed Starters†

For Single Winding, Consequent Pole, Constant or Variable Torque Motors

For use with single winding, consequent pole, constant or variable torque motors. Combinations for constant horsepower applications can be supplied. Information on request accompanied by complete details. Write GRAYBAR.

Compelling or accelerating relays can be supplied but require larger Condulets. Prices on application.

208-220 Volts

1	1 1/2 15	1 1/4	EPC10159-WT15-D623	\$497.50	EPC10159	\$200.00
1	5 30	1 1/4	EPC10159-WT30-D623	497.50	EPC10159	200.00
2	10 50	2 1/2	EPC10141-WT50-D623	896.50	EPC10141	440.00
2	15 70	2 1/2	EPC10141-WT70-D623	910.00	EPC10141	440.00
3	30 100	2 1/2	EPC10142-WT100-D623	1317.00	EPC10142	660.00

440-480 Volts§

1	3 15	1 1/4	EPC10159-WT15-D643	497.50	EPC10159	200.00
1	7 1/2 30	1 1/2	EPC10159-WT30-D643	497.50	EPC10159	200.00
2	20 50	2 1/2	EPC10141-WT50-D643	896.50	EPC10141	440.00
2	25 70	2 1/2	EPC10141-WT70-D643	910.00	EPC10141	440.00
3	50 100	2 1/2	EPC10142-WT100-D643	1317.00	EPC10142	660.00

*Circuit breakers are selected for average motors.

**Also available for 110 and 550 volts. Information on request to GRAYBAR.

Push button stations are not included. Types EFD, EFS, EGP, and OFC are recommended.

Catalog numbers of oil immersed starters do not include oil.

†Maximum horsepower ratings shown for two-speed motors are at the high motor speed.

§Two speed starters are also available for 550 volts. Information on request to GRAYBAR.

Type EPC Condulets are available with General Electric, Westinghouse, Allen-Bradley, Arrow-H.&H., and Trumbull starting switches and ITE, Westinghouse, and Trumbull circuit breakers; information on request to GRAYBAR.

Square D Spin Top Enclosures Class 990 For Hazardous Locations

Class 990 NEMA 7 and NEMA 9, (Class I Groups C and D, Class II Groups E, F, and G) Spin Top threaded joint explosion proof enclosure consist of a collar section, mounting frame, long or short tanks, and miscellaneous hardware. They are available in three forms:

(1) Complete unit with starter and circuit breaker (if used) in the enclosure ready for installation.

(2) Completely assembled enclosure only for customer mounting of starter and circuit breaker (if used).

(3) Individual component parts for versatility of stock. For a comprehensive list of complete devices, complete enclosures only, and component parts refer to nearest field office.

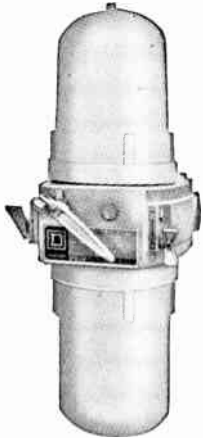

Complete Enclosure for Size 0 or 1 Reversing Combination Starter



Complete Enclosure for Size 0 or 1 Combination Starter



Collar Section with Circuit Breaker Operating Mechanism



Short Tank

For Devices with Melting Alloy Overload Relays

Device	For NEMA Size	Enclosure Size In.	For Starter with Main Breaker		Type	For Starter Only	
			Type	Each		Type	Each
Single Speed	0	7	CR-1	\$140.00	CR-10	\$ 85.00	
Non-Reversing	1	7	CR-2	140.00	CR-11	85.00	
Starters	2	9	DR-1	178.00	DR-7	128.00	
Two-Speed	0	7	CR-3	170.00	CR-12	115.00	
Separate Winding	1	7	CR-4	170.00	CR-13	115.00	
(Two Winding)	2	9	DR-3	234.00	DR-9	178.00	
Two Speed	0	9	CR-5	170.00	CR-14	115.00	
Consequent Pole	1	9	CR-6	170.00	CR-15	115.00	
Single Speed	0	7	CR-7	170.00	CR-16	102.00	
Reversing	1	7	CR-8	170.00	CR-17	102.00	
	2	9	DR-5	234.00	DR-11	170.00	
Circuit Breaker	...	7	CR-9	85.00	
Only ML & ML-1							

For Devices with Bimetal Overload Relays

Device	For NEMA Size	Enclosure Size In.	For Starter with Main Breaker		Type	For Starter Only	
			Type	Each		Type	Each
Single Speed	0	7	CR-1	\$140.00	CR-10	\$ 85.00	
Non-Reversing	1	7	CR-2	140.00	CR-11	85.00	
Starters	2	9	DR-2	178.00	DR-8	128.00	
Two-Speed	0	7	CR-3	170.00	CR-12	115.00	
Separate Winding	1	7	CR-4	170.00	CR-13	115.00	
(Two Winding)	2	9	DR-4	234.00	DR-10	178.00	
Two Speed	0	9	CR-5	170.00	CR-14	115.00	
Consequent Pole	1	9	CR-6	170.00	CR-15	115.00	
Single Speed	0	7	CR-7	170.00	CR-16	102.00	
Reversing	1	7	CR-8	170.00	CR-17	102.00	
	2	9	DR-6	234.00	DR-12	170.00	

Accessory Kits

Description	Ordering Abbrev.	Each	Description	Each
"Start-Stop" Push Button	A	\$15.00	Drain (Part No. 9904W47)	\$3.00
"Hand-Off-Auto" Selector Switch	C	13.00	Breather (Part No. 9904W49)	3.00
"For Rev.-Stop" Push Button or "High-Low-Stop" Push Button	A1	25.00		

R & S Interlocked Switch Receptacles and Plugs

Type ERI—Explosion-Proof and Dust-tight

Class I, Group D

30 Amp., 250 V., A-C—20 Amp., 575 V., A-C

Two and Three Wire

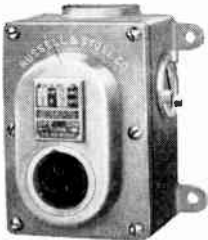

No. 4240C

For use in chemical plants, oil refineries, distilleries, solvent areas, etc., under Class I locations. Plug interlocks with switch and cannot be withdrawn or inserted under load. Rotating member of plug throws switch to "on" or "off" position. Separate ground pole which "makes" first and "breaks" last.

Receptacle Enclosures—Cast iron, corrosion resisting baked enamel finish.

Plugs—Steel, cadmium plated. Furnished with aluminum alloy cable clamp and neoprene cable bushing.

Type C—Without Flap—Receptacle Less Plug

Description	Single Gang		Two Gang	
	No.	Each	No.	Each
2 wire, 3 pole	4240C	\$42.50	4240C2	\$85.00
3 wire, 4 pole	4242C	43.50	4242C2	87.00

Type FC—With Flap—Receptacle Less Plug

2 wire, 3 pole	4240FC	45.00	4240FC2	90.00
3 wire, 4 pole	4242FC	46.00	4242FC2	92.00

Type SC—With Screw Cap—Receptacle Less Plug

2 wire, 3 pole	4240SC	45.00	4240SC2	90.00
3 wire, 4 pole	4242SC	46.00	4242SC2	92.00

Plugs for Type C, FC or SC Receptacles

Description	No.	Each	Cable Bushing
			Dia. In.
2 wire, 3 pole	4241	\$9.00	21/32
3 wire, 4 pole	4243	11.00	23/32

Outlets—Unless otherwise specified, furnished with one 3/4-inch outlet per gang on top. Additional or larger outlets charged extra. Maximum conduit 1-inch; one per gang top and bottom and one each side. Specify size and location.

*Cable bushing regularly furnished. Other hole sizes available if specified on order — 3/16 to 1 1/8-inch diameter.

Call Graybar FIRST For . . .

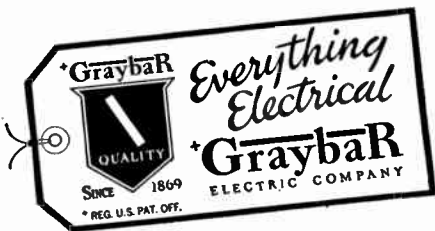

**R & S Tumbler Switches
Explosion-Proof and Dust-Tight
Class I, Groups C and D
Types EFS—Surface Mounting—Heavy Duty Type**

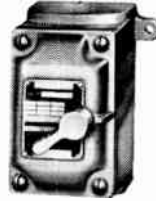

Single Gang

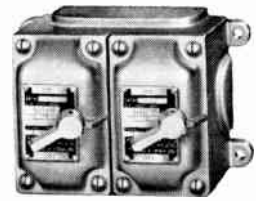

Double Gang

Switch	Amperes		Single Gang		Double Gang	
	125 V.	250 V.	No.	Each	No.	Each
*1 pole	10T	5	4411	\$9.00	4421	\$18.00
*1 pole	20T	20	4411S2	9.50	4421S2	19.00
*1 pole	30T	30	4411S3	11.75	4421S3	23.50
*2 pole	10T	30	4412	9.25	4422	18.50
*2 pole	20T	20	4412D2	9.75	4422D2	19.50
*2 pole	30T	30	4412D3	13.00	4422D3	26.00
*3 way	10T	5	4414	9.50	4424	19.00
*3 way	20T	20	4414T2	10.00	4424T2	20.00
*3 way	30T	30	4414T3	13.25	4424T3	26.50
*4 way	10T	5	4415	16.00	4425	32.00
*4 way	20T	10	4415T2	17.00	4425T2	34.00
*3 pole	20	20	4413	13.50	4423	27.00
*3 pole	30	30	*4413T3	19.00	*4423T3	38.00

Nurses' Call—less Buzzer 10 5 4416N4 POA 4426N4 POA
Nurses' Call—with Buzzer 4416N5 POA 4426N5 POA

Ratings—*Switches rated 15 amp. 277 volts, A.C. can be furnished. Prices on application.

*Rating—20 amperes, 600 Volts A-C. *A-C. only.

3 and 4 gang or tandem units available. Prices on application.

Single gang units available for flush mounting when specified, at \$1.00 list each, additional.

POA—Prices on application.

Light Duty Switches



With Three Switches

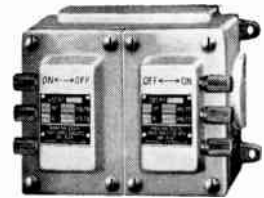

With Six Switches

Switch	Amperes		One Switch Per Gang		Double Gang	
	125 V.	250 V.	No.	Each	No.	Each
1 pole	10T	5	4300S1	\$10.00	4350S1	\$20.00
2 pole	10	10	4300S2	10.25	4350S2	20.50
3 way	10T	5	4300S3	11.25	4350S3	22.50
4 way	5T	2	4300S4	15.25	4350S4	30.50
Two Like Switches Per Gang						
1 pole	10T	5	4300D1	14.00	4350D1	28.00
2 pole	10	10	4300D2	14.50	4350D2	29.00
3 way	10T	5	4300D3	16.00	4350D3	32.00
4 way	5T	2	4300D4	25.00	4350D4	50.00
Three Like Switches Per Gang						
1 pole	10T	5	4300T1	18.00	4350T1	36.00
2 pole	10	10	4300T2	18.75	4350T2	37.50
3 way	10T	5	4300T3	20.75	4350T3	41.50
4 way	5T	2	4300T4	34.75	4350T4	69.50

Single gang units available for flush mounting when specified, at \$1.00 list each, additional.

Switch combinations can be furnished. Prices on request.

Enclosures—Cast iron, corrosion resisting baked enamel finish. Can be furnished in tandem units and in combination with other R & S Type EFS devices.

Outlets—Unless otherwise specified, furnished with one 3/4-inch outlet per gang, top or bottom. Additional or larger outlets charged extra. Max. conduit 1-inch; single gang—top and bottom only, multiple gang—one per gang top and bottom and one each side. Specify size and location.

R & S Tumbler Switches
Explosion-Proof and Dust-Tight

Class I, Groups C and D
Type EGS Heavy Duty Switches
No Fuse—Quick Make and Quick Break

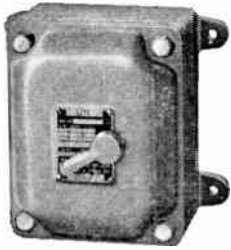

No. 4235FP

Enclosures—Cast iron, corrosion resisting baked enamel finish.

Outlets—Unless otherwise specified, furnished with one 3/4-inch outlet in top. Additional or larger outlets charged extra. Maximum conduit—size 1: one 1-inch top and bottom, size 2: two 1-inch top and bottom. Specify size and location.

*Enclosure size 2, all others size 1.

Enclosure Complete With Switch

Switch	Rating	No.	Each
2 pole	2 Hp., 115-600V., A.C. D.C. 10 A. 250 V., 20 A., 600 V.	4235DP	\$35.00
1 phase			
3 pole	2 Hp., 110-600 Volts, A.C. 30 A. 250 V., 20 A., 600 V., A.C.	4235TP	40.00
3 phase			
A.C. only	30 A. 250 V., 3/4 Hp. 220 V., A.C.	4235TW	40.00
3 way			
4 pole	2 Hp. 230, 460, 575 V. A.C. 2 phase 30 A. 250 V., 20 A. 600 V.	*4235FP	45.00
.....	Enclosure only	4235-1	20.00
.....	Enclosure only	*4235-2	22.50

Type EFS Three Position Switches

Switch Rating: 10 Amp., 125 V.; 5 Amp., 250 V.,
A.C. or D.C.

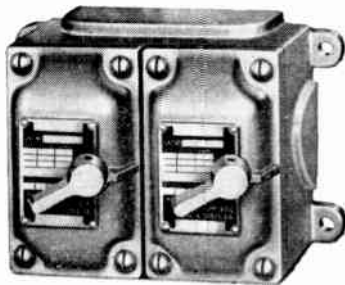

No. 4486

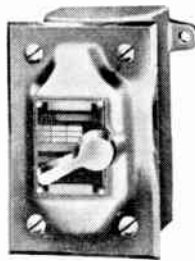

No. 4482F

No.	Single Pole 1-Off-2		Double Pole Double Throw With "Off" Position		Double Pole Reversing With "Off" Position	
	No.	Each	No.	Each	No.	Each
Single Gang—Surface Mounting						
4482	\$17.00	†4483	\$18.00	†4484	\$19.00	
Two Gang—Surface Mounting— With Like Switches						
4486	34.00	†4487	36.00	†4488	38.00	
Single Gang—Flush Mounting						
4482F	18.00	†4483F	19.00	†4484F	20.00	

†Also rated 3/4 Hp., 250 V., A.C. or V. D.C.

Switch combinations and other switches can be furnished. Prices on application.

Enclosures—Cast iron, corrosion resisting baked enamel finish. Flush mounting covers can be furnished polished chromium finish at additional cost. Can be furnished in two gang Flush Mounting, also three or four gang or tandem units and in combination with other R & S type EFS devices.

Outlets—Unless otherwise specified, furnished with one 3/4-inch outlet per gang, top or bottom. Additional or larger outlets charged extra. Maximum conduit 1-inch: single gang—top and bottom only, multiple gang—one per gang top and bottom and one each side. Specify size and location.

R & S Switches Type FS and FD

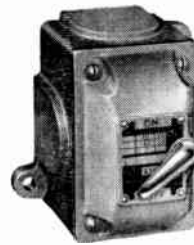

Waterproof

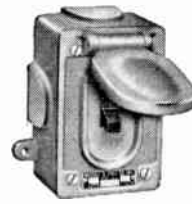

Weathertight

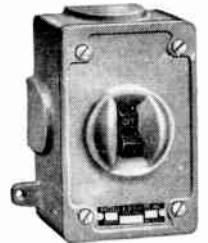

With Toggle Guard

Heavy Duty Tumbler Switches

Single Throw

Switch	Amperes		Cast Iron With Box No. 3701		Cast Brass With Box No. 3721	
	125 V.	250 V.	No.	Each	No.	Each
Waterproof						
†1 pole	10T	5	3705	\$8.00	3725	\$13.00
†1 pole	20T	20	3705S2	8.50	3725S2	13.50
†1 pole	30T	30	3705S3	10.75	3725S3	15.75
†2 pole	10T	10	3706	8.25	3726	13.25
†2 pole	20T	20	3706D2	8.75	3726D2	13.75
†2 pole	30T	30	3706D3	12.00	3726D3	17.00
†3 way	10T	5	3708	8.50	3728	13.50
†3 way	20T	20	3708T2	9.00	3728T2	14.00
†3 way	30T	30	3708T3	12.25	3728T3	17.25
†4 way	10T	5	3709	15.00	3729	22.00
†4 way	20T	10	3709F2	16.00	3729F2	23.00
†3 pole	20	20	3707	12.50	3727	17.50
†3 pole	30	30	*3707T3	18.00	*3727T3	23.00

Weathertight*

†1 pole	10T	5	3802	\$8.25	3812	\$13.50
†1 pole	20T	20	3802S2	8.75	3812S2	14.00
†1 pole	30T	30	3802S3	11.00	3812S3	16.25
†2 pole	10T	10	3803	8.50	3813	13.75
†2 pole	20T	20	3803D2	9.00	3813D2	14.25
†2 pole	30T	30	3803D3	12.25	3813D3	17.50
†3 way	10T	5	3805	8.75	3815	14.00
†3 way	20T	20	3805T2	9.25	3815T2	14.50
†3 way	30T	30	3805T3	12.50	3815T3	17.75
†4 way	10T	5	3806	15.25	3816	20.50
†4 way	20T	10	3806F2	16.25	3816F2	21.50
†3 pole	20	20	†3804	12.75	†3814	18.00
†3 pole	30	30	*3804T3	18.25	*3814T3	23.50

With Toggle Guard*

†1 pole	10T	5	3832	\$6.75	3852	\$11.50
†1 pole	20T	20	3832S2	7.25	3852S2	12.00
†1 pole	30T	30	3832S3	9.50	3852S3	14.25
†2 pole	10T	10	3833	7.00	3853	11.75
†2 pole	20T	20	3833D2	7.50	3853D2	12.25
†2 pole	30T	30	3833D3	10.75	3853D3	15.50
†3 way	10T	5	3835	7.25	3855	12.00
†3 way	20T	20	3835T2	7.75	3855T2	12.50
†3 way	30T	30	3835T3	11.00	3855T3	15.75
†4 way	10T	5	3836	13.75	3856	18.50
†4 way	20T	10	3836F2	14.75	3856F2	19.50
†3 pole	20	20	3834	11.25	3854	16.00
†3 pole	30	30	*3834T3	16.75	*3854T3	21.50

Rated—*Switches rated 15 amp. 277 volts A.C. can be furnished. Prices on application.

•A.C. only. *20 amperes 600 V. A.C.

Finish—Cast iron, corrosion resisting baked enamel finish. Cast brass, natural finish.

Gang Types—Can be furnished in gang or tandem units and in combination with other R & S type FS and FD devices.

Outlets—Unless otherwise specified, furnished with one 3/4-inch outlet top or bottom. Additional or larger outlets charged extra. Maximum conduit 1-inch, four way. Specify size and location.

**R & S Panelboards With Circuit Breakers
Explosion-Proof and Dust-Tight**

Class I, Groups C and D

- Type SPL—with 1 Pole 125 V. Branch Circuit Breakers
- Type DPL—with 2-Pole 250 V. Branch Circuit Breakers
- Type TPL—with 3-Pole 250 V. Branch Circuit Breakers

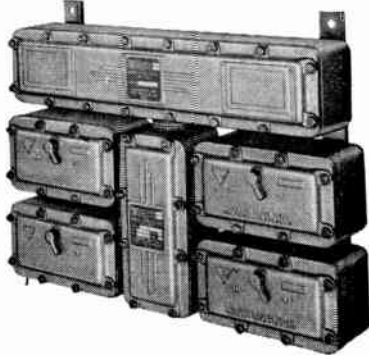

No. DPL4 or No. TPL4

Panelboards are completely assembled, tested, sealed and ready for field installation.

Can be furnished with combinations of 1, 2 or 3 pole breakers having same or varying capacities of 15, 20, 30 or 50 amps. Specify requirements. Prices on application to Graybar.

Panelboards Complete with Circuit Breakers

No. of Breakers	Ampere Rating of Circuit Breakers			Each
	15 No.	20 No.	30 No.	
Type SPL-*Mains—3 Wire, 1 ph., 125-250V.				
6	SPL615B	SPL620B	SPL630B	\$345.00
8	SPL815B	SPL820B	SPL830B	395.00
10	SPL1015B	SPL1020B	SPL1030B	475.00
12	SPL1215B	SPL1220B	SPL1230B	525.00
14	SPL1415B	SPL1420B	SPL1430B	670.00
16	SPL1615B	SPL1620B	SPL1630B	720.00
18	SPL1815B	SPL1820B	SPL1830B	800.00
20	SPL2015B	SPL2020B	SPL2030B	850.00
22	SPL2215B	SPL2220B	SPL2230B	965.00
24	SPL2415B	SPL2420B	SPL2430B	1015.00
26	SPL2615B	SPL2620B	SPL2630B	1100.00
28	SPL2815B	SPL2820B	SPL2830B	1150.00
Type DPL-*Mains—3 Wire, 3ph., 125V.				
4	DPL415D	DPL420D	DPL430D	405.00
6	DPL615D	DPL620D	DPL630D	540.00
8	DPL815D	DPL820D	DPL830D	740.00
10	DPL1015D	DPL1020D	DPL1030D	870.00
12	DPL1215D	DPL1220D	DPL1230D	1040.00
14	DPL1415D	DPL1420D	DPL1430D	1180.00
Type TPL-*Mains—3 Wire, 125-250 V.				
4	TPL415J	TPL420J	TPL430J	465.00
6	TPL615J	TPL620J	TPL630J	725.00
8	TPL815J	TPL820J	TPL830J	825.00
10	TPL1015J	TPL1020J	TPL1030J	975.00
12	TPL1215J	TPL1220J	TPL1230J	1150.00
14	TPL1415J	TPL1420J	TPL1430J	1325.00

*Other wiring systems will be furnished if specified.

Enclosures—Cast high tensile alloy, corrosion resisting finish. Specify size and location of outlets. Additional circuits available.

Prices and complete details on request to Graybar.

R & S Panelboards With Circuit Breakers

- Type SPH—with 1 pole 125 V. Branch Circuit Breakers
- Type DPH—with 2 pole 250 V. Branch Circuit Breakers
- Type TPH—with 3 pole 250 V. Branch Circuit Breakers

Explosion-Proof and Dust-Tight Class I, Group D

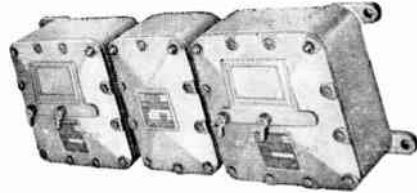

No. DPH4

Panelboards Complete With Circuit Breakers

No. of Breakers	Ampere Rating of Circuit Breakers			Each
	15 No.	20 No.	30 No.	
Type SPH-*Mains—3 Wire, 1ph., 125-250 V.				
4	SPH415B	SPH420B	SPH430B	\$205.00
6	SPH615B	SPH620B	SPH630B	330.00
8	SPH815B	SPH820B	SPH830B	350.00
12	SPH1215B	SPH1220B	SPH1230B	500.00
14	SPH1415B	SPH1420B	SPH1430B	520.00
16	SPH1615B	SPH1620B	SPH1630B	540.00
Type DPH-*Mains—3 Wire, 3ph., 125 V.				
4	DPH415D	DPH420D	DPH430D	360.00
6	DPH615D	DPH620D	DPH630D	515.00
8	DPH815D	DPH820D	DPH830D	560.00
Type TPH-*Mains—3 wire, 125-250 V.				
4	TPH415J	TPH420J	TPH430J	510.00

Enclosures—Cast high tensile alloy, corrosion resisting finish. Panels are completely assembled, tested, sealed and ready for connection of main and branch wires. Specify size and location of outlets.

- Type SWP—with 1 pole 125 V. Branch Circuit Breakers
- Type DWP—with 2 pole 250 V. Branch Circuit Breakers
- Type TWP—with 3 pole 250 V. Branch Circuit Breakers

Waterproof and Dust-Tight

Class II, Groups E, F and G; and Class III

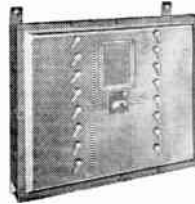

SWP16

Panels are completely assembled and tested, ready for connection of main and branch wires.

Enclosures—Corrosion resisting finish. Specify size and location of outlets.

Panelboards Complete With Circuit Breakers

No. of Breakers	Ampere Rating of Circuit Breakers			Each
	15 No.	20 No.	30 No.	
Type SWP-*Mains—3 Wire, 1ph., 125-250 V.				
8	SWP815B	SWP820B	SWP830B	\$280.00
16	SWP1615B	SWP1620B	SWP1630B	420.00
24	SWP2415B	SWP2420B	SWP2430B	675.00
32	SWP3215B	SWP3220B	SWP3230B	850.00
Type DWP-*Mains—3 Wire, 3ph., 125 V.				
4	DWP415D	DWP420D	DWP430D	290.00
8	DWP815D	DWP820D	DWP830D	440.00
12	DWP1215D	DWP1220D	DWP1230D	710.00
16	DWP1615D	DWP1620D	DWP1630D	900.00
Type TWP-*Mains—3 Wire, 125-250 V.				
2	TWP215J	TWP220J	TWP230J	275.00
6	TWP615J	TWP620J	TWP630J	440.00
8	TWP815J	TWP820J	TWP830J	675.00
12	TWP1215J	TWP1220J	TWP1230J	850.00

*Other wiring systems will be furnished if specified.

Can be furnished with combinations of 1, 2 or 3 pole breakers having same or varying capacities of 15, 20, 30 or 50 amps. Specify requirements. Prices and complete details on request.

R & S Circuit Breaker Cabinets

Types SWC and DWC

Waterproof and Dust-Tight

Class II, Groups E, F and G;

Class III—NEMA Types 3, 4, 5 and 9

Type SWC—With Single Pole Branch Circuit Breakers, 125 Volts, A.C. or D.C.

Type DWC—With Double Pole Branch Circuit Breakers, 250 Volts, A.C. or D.C.

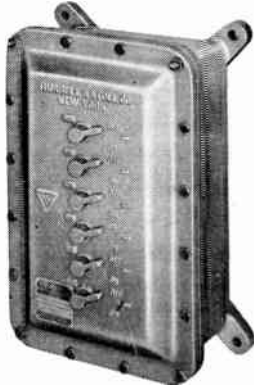

No. SWC615—Complete with Six Circuit Breakers

Conduit Drilling—Regularly furnished drilled and tapped for conduit as follows: Main—one 1½-inch outlet in bottom; Branches—three 1-inch outlets in top. Other sizes and combinations of conduit drilling can be furnished if specified on order. All conduit outlets are provided with dust caps.

Finish—Corrosion resisting.

Note—Cabinets are furnished with insulated neutral strip, so that circuit breakers may be used independently or as a panelboard.

Cabinet Complete with Circuit Breakers

No. of Breakers	Trip Amperes	No.*	Each
Type SWC with Single Pole Circuit Breakers†			
2	15	SWC215	\$ 95.00
	20	SWC220	95.00
	30	SWC230	95.00
3	15	SWC315	105.00
	20	SWC320	105.00
	30	SWC330	105.00
4	15	SWC415	135.00
	20	SWC420	135.00
	30	SWC430	135.00
5	15	SWC515	145.00
	20	SWC520	145.00
	30	SWC530	145.00
6	15	SWC615	155.00
	20	SWC620	155.00
	30	SWC630	155.00

Type DWC with Double Pole Circuit Breakers

2	15	DWC215	140.00
	20	DWC220	140.00
	30	DWC230	140.00
3	15	DWC315	160.00
	20	DWC320	160.00
	30	DWC330	160.00

†277 Volt A.C., 15 or 20 ampere, single pole breakers can be furnished. Prices on application.

Circuit Breakers—*Complete catalog number includes suffix letter to indicate make of breaker as follows: "E"—ITE, "T"—General Electric or "W"—Westinghouse. Can be furnished with General Electric, ITE or Westinghouse breakers. When breakers of particular make are required, add proper suffix to catalog number.

For circuit breaker trip ratings other than above, substitute ampere trip rating required in place of trip rating in the above catalog number. Ratings available: 25, 35, 40 and 50 Amperes.

Example—SWC250W.

**R & S Air Break Circuit Breakers
Explosion-Proof and Dust-Tight**

**Type CB
Class I, Group D**

Waterproof and Dust-Tight

Class II, Groups E, F and G

15 to 600 Amps. 120 to 600 V. A-C

125 to 250 V. D-C, 1, 2 or 3-Pole

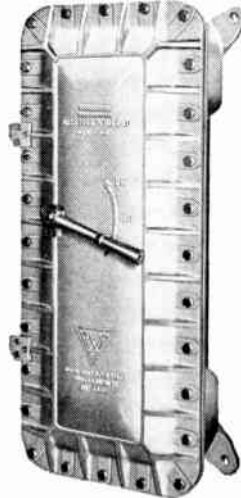

Explosion-Proof

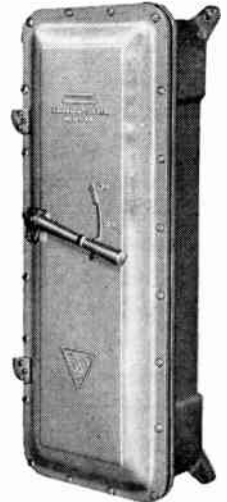

Watertight

Circuit Breaker Frame Sizes and Data

Frame Size	Amp. Range	NEMA Amp. Interrupting Cap.	Trip Unit
100-E	15-100	10,000	Non-Interchangeable
100-F	15-100	15,000	Non-Interchangeable
100-G	50-100	15,000	Interchangeable
225-J	70-225	15,000	Non-Interchangeable
225-K	70-225	25,000	Interchangeable
600-L	125-600	25,000	* Interchangeable

Voltage

100 amperes frame size—240 V. A-C, 125/250 V. D-C.
100 to 600 amperes frame size—600 V. A-C, 250 V. D-C.

Enclosure Data

All enclosures have precision ground joints and are constructed of high tensile alloy with a corrosion resisting finish. Cover bolts are stainless steel. Enclosures are designed to allow generous gutter space between the breaker and all four sides of enclosure for through wiring, and permit easy connection to breaker lugs of customer's in-coming and out-going lines. Enclosures for G, J, K and L frames are provided with hinged covers. All covers are removable, exposing entire breaker and gutter space.

Conduit Outlets

Enclosures are provided with heavy pads for conduit tapping on sides as well as top and bottom. Specify size and location of outlets when ordering.

Operating Data

Operating handles are of exceptionally rugged design and have means for padlocking in both the "ON" and "OFF" position. Substantially built slide mechanism on inside of cover transmits an in-line thrust to the breaker handle.

Complete details, listing and prices on application to Graybar.

Additional printed information on these and other products not listed is available on request to GRAYBAR.

R & S Push Button, Selector Switch, and Pilot Light Stations

Explosion-Proof, Dust-Tight, Class I, Groups C and D For Control Circuits of 10 Amp. 600 Volts A-C Maximum*

Heavy Duty—Type H



No. H4220S4



No. H4220S2L2

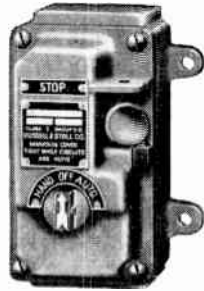

No. H4220SA

Description of Unit	No. & Type of Contacts	No.	Each
Single Push Button	One-N.O. One-N.C.	114220SB	\$20.00
Single Selec. Sw.	‡Selec. Sw.	114220SW	25.00
Double P.B.	Two-N.O. Two-N.C.	114220SS	35.00
Single P.B. & P. Selec. Sw.	One-N.O. One-N.C. ‡Selec. Sw.	114220SA	40.00
Single P.B. & 1-Pilot Lt.**	One-N.O. One-N.C.	114220SL*	40.00
3-P.B.	Three-N.O. Three-N.C.	114220S3	50.00
2-P.B. & Selec. Sw.	Two-N.O. Two-N.C. ‡Selec. Sw.	114220SSF	55.00
2-P.B. & 1-Pilot Lt.*	Two-N.O. Two-N.C.	114220SSL*	55.00
4-P.B.	Four-N.O. Four-N.C.	114220S4	60.00
3-P.B. & Selec. Sw.	Three-N.O. Three-N.C. ‡Selec. Sw.	114220S3S	70.00
2-P.B. & 2-Pilot Lt.**	Two-N.O. Two-N.C.	114220S2L2*	65.00

‡3-position selector switch.

*Insert symbols for colors of lenses as a suffix to catalog number as follows: A—amber, C—clear, G—green, R—red.

**Pilot Light — S-6 bulb; 6 watts, 120 volts regularly furnished. For higher voltages use of a transformer is recommended. One transformer is required for each lamp and requires space occupied by one light.

Push button rocker arm can be furnished with Mushroom Head Extension Button. Specify location and add suffix "E" to catalog number. Price on application.

Special Contact Push Buttons can be furnished. Prices on application to Graybar.

Name Plate — Stop-Start, On-Off, Hand-Off Auto regularly furnished. Other markings will be furnished; specify marking required.

Enclosures — Cast iron, corrosion resisting baked enamel finish. Covers are provided with holes to accommodate padlock for locking buttons in depressed position.

Outlets — Unless otherwise specified, furnished with one 3/4-inch outlet in top. Additional or larger outlets charged extra. Maximum conduit 1-inch, top and bottom. Specify size and location.

R & S Push Button and Selector Switch Stations

Type EFS—For Surface Mounting Explosion-Proof and Dust-Tight

Class I, Groups C and D



No. EFS213 Button Operated



No. EFS223 Rocker Operated

Standard Duty

For Control Circuits of 600 Volts, A.C. Maximum Enclosure Complete with Interiors as Listed

Standard Marking *	No. of Buttons and Circuit Types	No.	Rocker Operated	
			Each	No. Each
Start	One N.O.	EFS111	\$13.50	EFS121 \$13.50
Stop	One N.C.	EFS112	13.50	EFS122 13.50
Start Stop	One N.O. One N.C.	EFS213	17.00	EFS223 17.00
Forward Reverse	Two N.O.	EFS214	17.00	EFS224 17.00
Must be Specified*	One N.O. and N.C.	EFS110	14.00	EFS120 14.00
Must be Specified*	Two N.O. and N.C.	EFS210	18.00	EFS220 18.00
Auto, Off, Hand	3-position Selector Sw.	EFSW115	18.00	
Stop Auto, Off, Hand	One N.O. and N.C. 3-position Selector Sw.	EFS1SW116	22.00

*Special markings must be specified if desired.

Interiors are interchangeable, regularly furnished as listed. Other interiors available, information on request. Type HEFS for heavy duty also available.

Enclosures—Cast iron, corrosion resisting baked enamel finish. Covers are provided with hole to accommodate padlock for locking operator in depressed position.

Can be furnished with two, three or four gang or tandem units and in combination with other R & S type EFS devices.

Rocker type push button operator can be furnished with Mushroom Head Extension Button. When so required, specify location and add suffix "E" to catalog number. Price on application.

Outlets—Unless otherwise specified, furnished with one 3/4-inch outlet in top. Additional or larger outlets charged extra. Maximum conduit 1-inch top and bottom. Specify size and location.

R & S Push Button, Selector Switch and Pilot Light Stations

Type FS and FD—Waterproof

Standard Duty
For Control Circuits of 600 Volts, A.C. Maximum*

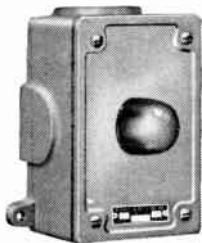

No. 3801C



No. 3859R

Standard ▲ Marking	No. and Type Unit	Cast Iron With Box No. 3701		Cast Brass With Box No. 3721	
		No.	Each	No.	Each

Pilot Lights—Complete with Lamps

.....	1 Pilot	3801	\$ 7.50	3811	\$10.50
.....	2 Pilots	3807	10.50	3817	13.50

Duplex Combination Pilot Lights and P.B. Stations

Start	1 Pilot 1 P.B.-N.O.	3858	18.00	3860	22.50
Stop	1 Pilot 1 P.B.-N.C.	3859	18.00	3861	22.50

Push Button Stations

Start	One-N.O.	3741	11.50	3751	16.00
Stop	One-N.C.	3748	11.50	3758	16.00
Start	One-N.O.	3749	15.00	3759	19.50
Stop	One-N.C.				
Auto	3-Pos.	3837	16.00	3857	20.50
Off Hand	Sel. Sw.				

*Insert symbols for colors of lenses as a suffix to complete catalog number as follows: A — amber, C — clear, G — green and R — red.

*Lamp — S-6 bulb; 6 watts, 120 volts regularly furnished. For higher voltages use of a transformer is recommended. One transformer is required for each lamp and requires extra gang box.

▲Special markings must be specified if desired.

Finish — Cast iron, corrosion resisting baked enamel finish. Cast brass, natural finish.

Can be furnished with lockout-latch to permit locking the button in depressed position. Latch is provided with hole to accommodate padlock. When so required, add suffix "L" to catalog number. Prices on application.

Gang Types — Can be furnished in gang or tandem units and in combination with other R & S type FS and FD devices.

Outlets — Unless otherwise specified, furnished with one 3/4-inch outlet in top. Additional or larger outlets charged extra. Maximum conduit 1-inch, four way. Specify size and location.

Flush Mounting — The above units are for surface mounting. They may be flush mounted by the addition of an R & S Flush Adapter Frame.

Call Graybar FIRST For . . .



**R & S Pilot Lights
Types EFS for Surface Mounting
Explosion-Proof and Dust-Tight
Class I, Groups C and D**



No. 4620R

S-6 bulb; 6 watts. 120 volts regularly furnished. For voltage above 230, use of a transformer is recommended.

Lampholder mounted in cover, factory-sealed. Leads require no sealing fitting in conduit run.

Enclosures—Cast iron, corrosion resisting baked enamel finish. Can be furnished in four gang or tandem units and in combination with other R & S type EFS devices.

Outlets—Unless otherwise specified, furnished with one 3/4-inch outlet per gang, top or bottom. Additional or larger outlets charged extra. Maximum conduit 1-inch; single gang—top and bottom only; multiple gang—one per gang top and bottom and one each side. Specify size and location.

Enclosure Complete with Lamps

Color Lens	Single Gang		Two Gang		Three Gang	
	No.	Each	No.	Each	No.	Each
Clear	4620C	\$16.00	4622C	\$32.00	4623C	\$48.00
Green	4620G	16.00	4622G	32.00	4623G	48.00
Red	4620R	16.00	4622R	32.00	4623R	48.00
Amber	4620A	16.00	4622A	32.00	4623A	48.00

For Panel Mounting

**TYPE XPL—Explosion-Proof and Dust-Tight
Class I, Groups C and D**

TYPE VPL—Vaportight and Weathertight

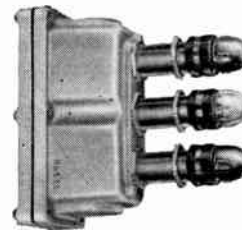

Three-gang
Vaportight
Enclosure Style VPA3
Cat. No. VPA3-L3

Enclosures have large cover opening at back of panel, providing complete access to the six-inch pigtail leads for connection to circuit conductors. They match in appearance corresponding Unilarm assemblies and are accommodated by the same panel drilling.

Pilot Lights With Small Enclosures*

(Will Not Accommodate Transformer or Switch Units)

**Type XPL
Explosion-Proof**

**Type VPL
Vaportight**

No. of Lights	No. Δ	Each	Encl- sure Size	Single Gang		Two Gang		Three Gang	
				No. Δ	Each	No. Δ	Each	No. Δ	Each
1	XPA-L	\$14.25	XPA	VPA-L	\$13.25	VPA			
2	XPA2-L2	24.50	XPA2	VPA2-L2	22.50	VPA2			
3	XPA3-L3	34.75	XPA3	VPA3-L3	31.75	VPA3			

Furnished complete with 120 volt lamps.

ΔLens—Complete catalog numbers by suffixing Lens Color as follows: "A"—Amber, "B"—Blue, "G"—Green, "R"—Red, "W"—White, otherwise assemblies will be furnished complete with red lenses.

Enclosures—Heavy cast alloy, corrosion resistant. Parts exposed on face of panel, dull black finish.

Outlets—Furnished with 1-inch outlet top and bottom. 1/2 or 3/4-inch outlets will be furnished if specified. Special multi-gang assemblies and combinations are available. Information and prices on request.

*Pilot lights with transformers can be furnished in type XP or VP enclosures. Prices and information on application.

R & S Combination Push Button, Selector Switch and Pilot Light Stations For Panel Mounting

TYPE XPLS—Explosion-Proof and Dust-Tight Class I, Groups C and D
TYPE VPLS—Vaportight and Weathertight

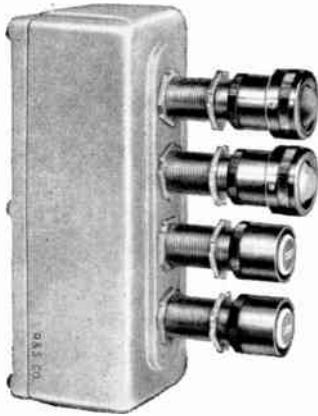

XP4-L2-S2-RG

Standard Duty
For Control Circuits of 600 Volts, A. C. Maximum*

Types XPLS and VPLS units may be ordered in other than combinations listed. Heavy duty and other forms of interiors are also available. Information on request.

Enclosure Complete with 120 Volt Lamps and Interiors as Listed

Description	Explosion-Proof		Vaportight	
	No.	Each	No.	Each
Single Gang with XP1 or VP1 Enclosure				
1 P. Button	XP1-S	\$18.00	VP1-S	\$18.00
1 Selector Sw. ‡	XP1-SW	22.00	VP1-SW	22.00
Two Gang with XP2 or VP2 Enclosure				
2 P. Buttons	XP2-S2	30.00	VP2-S2	30.00
1 Pilot Lt. Red Δ	XP2-L-S-R	28.75	VP2-L-S-R	27.75
1 P. Button				
1 P. Button	XP2-S-SW	34.00	VP2-S-SW	34.00
1 Selector Sw. ‡				
Three Gang with XP3 or VP3 Enclosure				
3 P. Buttons	XP3-S3	42.00	VP3-S3	42.00
1 Pilot Lt. Red Δ	XP3-L-S2-R	40.75	VP3-L-S2-R	39.75
2 Push Buttons				
2 Push Buttons	XP3-S2-SW	46.00	VP3-S2-SW	46.00
1 Selector Sw. ‡				
Four Gang with XP4 or VP4 Enclosure				
4 Buttons	XP4-S4	54.00	VP4-S4	54.00
1 Pilot Lt. Red Δ				
1 Pilot Lt. Green Δ	XP4-L2-S2-RG	51.50	VP4-L2-S2-RG	49.50
2 P. Buttons				
3 P. Buttons	XP4-S3-SW	58.00	VP4-S3-SW	58.00
1 Selector Sw. ‡				
1 Pilot Lt. Red Δ				
2 P. Buttons	XP4-L-S2-SW-R	56.75	VP4-L-S2-SW-R	55.75
1 Selector Sw. ‡				

‡3 position selector switch.

Marking—Nameplate markings for each push button and selector switch must be specified on order.

*Pilot Lights—S6 bulb; 6 watt, 120 volts regularly furnished. For higher voltage use transformers. Information and prices on request.

ΔLens—For other lens colors change suffix "R" to "A"—Amber, "B"—Blue, "G"—Green, "W"—White.

Enclosures—Heavy cast alloy, corrosion resistant. Parts exposed on face of panel, dull black finish.

Outlets—Furnished with 1-inch outlet top and bottom. 1/2 or 3/4-inch outlets furnished if specified.

Special multi-gang assemblies and combinations are available. Information and prices on request.

R & S Manual Moter Starters

NEMA SIZE 00—Single and Double Pole With Thermal Overload Protection

Maximum Ratings:

**Single Pole—1 Hp. 230 V.A.C., 125 V.D.C.
 1/4 Hp. 250 V.D.C., 32 V.D.C.**

**Double Pole—1 Hp. 250 V.A.C. or V.D.C.
 1/4 Hp. 32 V.D.C.**



EFS One Gang Surface Mounting



FS Waterproof



FS Weathertight

Starter Complete With Heater†

Type EFS

Explosion-Proof and Dust-Tight Class I, Groups C and D

Type	Single Pole		Double Pole	
	No.	Each	No.	Each
1 Gang Surface	4491—	\$17.50	4492—	\$18.75
2 Gang Surface				
1 Gang Flush	4491F—	18.50	4492F—	19.75
2 Gang Flush				

Enclosures — Cast iron, corrosion resisting baked enamel finish. Flush mounting covers can be furnished polished chromium finish at additional cost. Prices on application.

Outlets — Unless otherwise specified, furnished with one 3/4-inch outlet per gang, top or bottom. Additional or larger outlets charged extra. Maximum conduit 1-inch; single gang — top and bottom only; multiple gang — one per gang top and bottom and one each side. Specify size and location.

Type FS and FD

Type	Single Pole		Double Pole	
	No.	Each	No.	Each
Cast Iron with Box No. 3701				
Waterproof	3629—	\$16.00	3630—	\$17.50
Weathertight	3639—	16.50	3640—	18.00
With Toggle Guard	3649—	14.75	3650—	16.25

Cast Brass with Box No. 3721

Waterproof	3629B—	21.00	3630B—	22.50
Weathertight	3639B—	21.50	3640B—	23.00
With Toggle Guard	3649B—	19.75	3650B—	21.25

Finish — Cast iron, corrosion resisting baked enamel finish. Cast brass, natural finish.

Outlets — Unless otherwise specified, furnished with one 3/4-inch outlet top or bottom. Additional or larger outlets charged extra. Maximum conduit 1-inch, four way. Specify size and location.

†Full load current rating of motor must be specified on order.

R & S Manual Motor Starters

Type EC—Explosion-Proof and Dust-Tight
Class I, Groups C and D—NEMA Type 7

Type WC—Waterproof and Dust-Tight
Class II, Groups E, F and G—
NEMA Types 3, 4, 5 and 9

NEMA Sizes 0 and 1

Two, Three and Four Pole with Thermal Overload
Protection—Quick Make and Quick Break

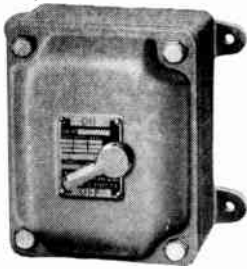

No. EC032

Enclosures — Cast iron, corrosion resisting baked enamel finish. Can be furnished with lock-type cover to permit locking in either "on" or "off" position. When so required, add suffix "L" to catalog number of the starter. Prices on application.

Outlets — Unless otherwise specified furnished with one 3/4-inch outlet top and bottom. Additional or larger outlets charged extra. Maximum conduit

— size A: one 1-inch top and bottom, size B: two 1-inch top and bottom. Specify size and location.

Maximum Horsepower Rating

NEMA Size	Poles	Phase	110 V. A. C.	220 V. A. C.	400 V. A. C.	115 V. D. C.	230 V. D. C.
0	2	1 & D.C.	1	1 1/2	...	1	1 1/2
0	2	2	1 1/2	2
0	3	3 & 2	1 1/2	2
0	4	2	1 1/2	2
1	2	1 & D.C.	1 1/2	3	...	1 1/2	2
1	4	1	1 1/2	3
1	2	2	3	5	7 1/2
1	3	3 & 2	3	5	7 1/2
1	4	2	3	5	7 1/2

Starter Complete With Heaters†

Type EC—Explosion-Proof

NEMA Size	Poles	No. Heaters	Phase	No.	Each	Enclosure Size
0	2	1	1 & D.C.	EC021—	\$41.50	A
0	2	2	2	EC022—	46.00	B
0	3	2	3 & 2	EC032—	49.00	B
0	4	2	2	EC042—	61.00	B
1	2	1	1 & D.C.	EC121—	59.00	A
1	4	1	1	EC141—	62.50	B
1	2	2	2	EC122—	50.00	A
1	3	2	3 & 2	EC132—	56.00	B
1	4	2	2	EC142—	69.00	B

Type WC—Waterproof

NEMA Size	Poles	No. Heaters	Phase	No.	Each	Enclosure Size
0	2	1	1 & D.C.	WC021—	41.50	A
0	2	2	2	WC022—	46.00	B
0	3	2	3 & 2	WC032—	49.00	B
0	4	2	2	WC042—	61.00	B
1	2	1	1 & D.C.	WC121—	59.00	A
1	4	1	1	WC141—	62.50	B
1	2	2	2	WC122—	50.00	A
1	3	2	3 & 2	WC132—	56.00	B
1	4	2	2	WC142—	69.00	B

†Full load current rating of motor must be specified on order.

R & S Manual Motor Starters

For A.C. and D.C. Motors

Type EC—Explosion-Proof and Dust-Tight
Class I, Group D—NEMA Type 7

Type WC—Waterproof and Dust-Tight
Class II, Groups E, F and G
NEMA Types 3, 4, 5 and 9

NEMA Sizes 0 and 1

Two and Three Pole with Thermal Overload
Protection—Quick Make and Quick Break

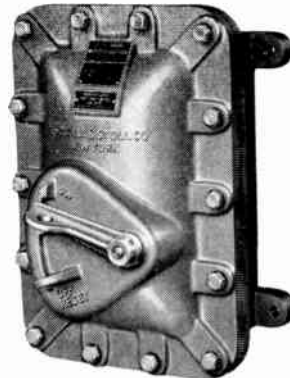

No. 4298

Trip Free — It is impossible to hold the starter in the "on" position against a damaging overload. The starter trips free of the handle.

Starter Complete With Heaters as Selected†

Type EC—Explosion-Proof

Poles	NEMA Size No.	110 V.	208-220 V.	440-600 V.	No.	Each
1 Ph.	{0	1	1 1/2	1 1/2	4298S0—	\$72.50
2 P.	{1	1 1/2	3	5	4298S1—	77.50
*3 Ph.	{0	1 1/2	2	2	4298S30—	77.50
3 P.	{1	3	5	7 1/2	4298S31—	87.50
D.C.	{0	1	1 1/2	...	4298D0—	72.50
2 P.	{1	1 1/2	2	...	4298D1—	77.50

Enclosure only —
 NEMA Size 0 & 1 **4298** **55.00**

Type WC—Waterproof

Poles	NEMA Size No.	110 V.	208-220 V.	440-600 V.	No.	Each
1 Ph.	{0	1	1 1/2	1 1/2	WP4298S0—	72.50
2 P.	{1	1 1/2	3	5	WP4298S1—	77.50
*3 Ph.	{0	1 1/2	2	2	WP4298S30—	77.50
3 P.	{1	3	5	7 1/2	WP4298S31—	87.50
D.C.	{0	1	1 1/2	...	WP4298D0—	72.50
2 P.	{1	1 1/2	2	...	WP4298D1—	77.50

Enclosure only —
 NEMA Size 0 & 1 **WP4298** **55.00**

*May be used on 2-phase 4-wire circuits by running one wire direct to motor.

Enclosures — Cast iron, corrosion resisting baked enamel finish.

Outlets — Unless otherwise specified, furnished with one 1-inch outlet top and bottom. Larger outlets charged extra. Maximum conduit 1 1/4-inch top and bottom. Specify size and location.

†Full load current rating of motor must be specified on order.

**R & S A.C. Magnetic Starters
Across-the-Line Type—110-600 Volts,
25-60 Cycles**

**Style XS—Explosion-Proof and Dust-Tight
Class I, Group D—NEMA Type 7**

**Style DS—Dust-Tight
Class II, Groups E, F and G—NEMA Type 9**

**Style WS—Waterproof and Dust-Tight
Class III—NEMA Types 3, 4 and 5**

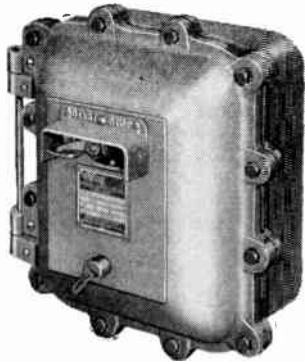

No. XS413 MARL

When ordering, specify catalog number, horsepower, voltage, phase, cycles and full load current rating of motor. Furnished complete with over load heaters.

Enclosures — Cast iron with hinged cover, corrosion resisting baked enamel finish.

Outlets — Unless otherwise specified, furnished with one outlet at top and bottom, size as listed. Additional or larger outlets charged extra. Maximum conduit: NEMA sizes 0, 1 and 2 — 2-inch at top and bottom, 1½-inch at sides; NEMA sizes 3 and 4 — 3-inch at top and bottom, 2-inch at sides. Specify size and location.

Enclosure Complete With Starter

NEMA Size	Volts	Max. Hp.	XS Explosion-Proof		WS Waterproof or DS Dust-Tight		Cond. Size
			Form No.*	List Each	Form No.*	List Each	
Two Pole							
0	115	1	XS102	\$115 00	WS102	\$105 00	1
0	230	1½	XS202	115 00	WS202	105 00	1
1	115	1½	XS112	120 00	WS112	110 00	1
1	230	3	XS212	120 00	WS212	110 00	1
Three Pole							
0	110	1½	XS103	120 00	WS103	110 00	1
0	208-220	2	XS203	120 00	WS203	110 00	1
0	410	2	XS403	120 00	WS403	110 00	1
0	550	2	XS503	120 00	WS503	110 00	1
1	110	3	XS113	125 00	WS113	115 00	1
1	208-220	5	XS213	125 00	WS213	115 00	1
1	440	7½	XS413	125 00	WS413	115 00	1
1	550	7½	XS513	125 00	WS513	115 00	1
2	110	7½	XS123	210 00	WS123	200 00	1¼
2	208-220	15	XS223	210 00	WS223	200 00	1¼
2	440	25	XS423	210 00	WS423	200 00	1¼
2	550	25	XS523	210 00	WS523	200 00	1¼
3	110	15	XS133	310 00	WS133	300 00	2
3	208-220	30	XS233	310 00	WS233	300 00	2
3	440	50	XS433	310 00	WS433	300 00	2
3	550	50	XS533	310 00	WS533	300 00	2
4	208-220	50	XS243	485 00	WS243	475 00	2½
4	440	100	XS443	485 00	WS443	475 00	2½
4	550	100	XS543	485 00	WS543	475 00	2½

*When ordering Type DS — Dust-Tight, substitute DS for WS in catalog number.

CATALOG NUMBER consists of above listed FORM NUMBER with the proper suffixes to designate the type of operation and interiors required as indicated below:

For Automatic Reset overload suffix "AR" to the Form number. Deduct \$6.00 from listed price.

For Manual Reset overload suffix "MAR" to the Form number. Price as listed.

For Local Stop-Start Push Button in cover add final suffix "L" to the completed catalog number. Add \$20.00 to listed price.

Reversing and two speed starters also available. Complete details and prices on request.

R & S A.C. Combination Starters

**Style CBS—Explosion-Proof and Dust-Tight
Class I, Group D—NEMA Type 7**

**Style DBS—Dust-Tight
Class II, Groups E, F and G—NEMA Type 9
Style CBSW—Waterproof and Dust-Tight
Class III—NEMA Types 3, 4 and 5**

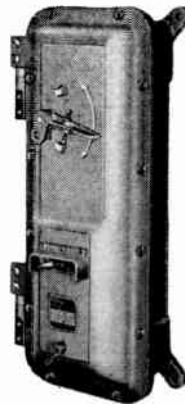

Types CBS Combination Starters combine an air brake circuit breaker with a line voltage magnetic starter in a single, convenient cast iron enclosure with hinged cover. Corrosion resisting baked enamel finish. Furnished with over load heaters.

When ordering, specify catalog number, horsepower, voltage, phase, cycles, full load current rating of motor and circuit breaker trip amperes.

Outlets — Unless otherwise specified, furnished with one outlet at top and bottom, size as listed. Additional or larger outlets charged extra. Maximum conduit: NEMA sizes 0, 1, 2 and 3 — 2-inch at top and bottom, 1½-inch at sides; NEMA size 4 — 4½-inch at top and bottom, 4-inch at sides. Specify size and location.

Enclosure Complete With Starter and Circuit Breaker

208-220 Volts, A.C.

NEMA Size	Max. Hp.	Trip Amps.	Poles	Frame	Form No.*	CBS Explosion-Proof	CBSW Waterproof or DBS Dust-Tight	Cond. Size	
						List Each	List Each		
0	1	15	2	E	2020	\$202 00	2020	\$182 00	1
0	1½	20	2	E	2021	202 00	2021	182 00	1
0	1½	30	2	E	2022	202 00	2022	182 00	1
0	2	15	3	E	2030	212 00	2030	192 00	1
1	2	20	2	E	2121	207 00	2121	187 00	1
1	3	30	2	E	2122	207 00	2122	187 00	1
1	2	15	3	E	2130	217 00	2130	197 00	1
1	3	20	3	E	2131	217 00	2131	197 00	1
1	5	30	3	E	2132	217 00	2132	197 00	1
1	5	40	3	E	2133	217 00	2133	197 00	1
2	10	50	3	E	2234	300 00	2234	270 00	1½
2	15	70	3	E	2235	310 00	2235	280 00	1½
2	15	100	3	E	2237	310 00	2237	280 00	1½
3	30	100	3	E	2337	475 00	2337	415 00	2
4	40	175	3	J	24310	850 00	24310	750 00	2½
4	50	200	3	J	24311	850 00	24311	750 00	2½

440 Volts, A.C.

0	2	15	3	F	4030	237 00	4030	217 00	1
1	5	15	3	F	4130	245 00	4130	225 00	1
1	7½	20	3	F	4131	245 00	4131	225 00	1
1	7½	30	3	F	4132	245 00	4132	225 00	1
2	10	30	3	F	4232	325 00	4232	295 00	1½
2	15	40	3	F	4233	325 00	4233	295 00	1½
2	25	50	3	F	4234	325 00	4234	295 00	1½
2	25	70	3	F	4235	335 00	4235	305 00	1½
3	30	70	3	F	4335	495 00	4335	435 00	2
3	50	100	3	F	4337	495 00	4337	435 00	2
4	60	125	3	J	4438	850 00	4438	750 00	2½
4	75	150	3	J	4439	850 00	4439	750 00	2½
4	100	200	3	J	44311	850 00	44311	750 00	2½

550 Volts, A.C.

550 Volt units available. Catalog numbers, prices and complete details on request.

*When ordering be sure to add prefix CBS for Explosion Proof, DBS for Dust-Tight, and CBSW for Watertight Starters to the numbers.

CATALOG NUMBER consists of above listed FORM NUMBER with the proper suffixes to designate the type of operation and interiors required as indicated below:

For Automatic Reset overload suffix "AR" to the Form number. Deduct \$6.00 from listed price.

For Manual Reset overload suffix "MAR" to the Form. Price as listed.

Above listings are for Remote Control. For Local Control with Push Button in cover, add final suffix "L" to the completed catalog number. Add \$20.00 to listed price.

Special combinations and unlisted ratings can be supplied.

Crouse-Hinds Condulets
Type EPC Circuit Breaker Condulets
Air Break Circuit Breakers

Explosion-Proof, Dust-Tight, and Weather Resistant (Raintight)

Class I, Group D (NEMA Type VII); Class II, Groups E, F, and G; and Class III (NEMA Types IX, V, and III)

100-Ampere Frame Size with Non-Interchangeable Thermal Trip and Non-Adjustable Magnetic Trip

Conduit With Breaker

Square D

250-V. A-C or 125-250-V. D-C—Two Pole

No.	Amps.	Size Hubs	Each
EPC437-DT170-2	70*	2	\$157.00
EPC437-DT100-2	100		157.00

250-V. A-C—Three Pole

No.	Amps.	Size Hubs	Each
EPC437-DT170-3	70*	2	168.00
EPC437-DT100-3	100		168.00

600-V. A-C or 250-V. D-C—Two Pole

No.	Amps.	Size Hubs	Each
EPC427-DT170-2	70*	2	180.00
EPC426-DT100-2	100		180.00

600-V. A-C—Three Pole

No.	Amps.	Size Hubs	Each
EPC427-DT170-3	70*	2	194.00
EPC427-DT100-3	100		194.00

225-Ampere Frame Size with Interchangeable Thermal-Magnetic Trip

Condulet Without Circuit Breaker

Square D

No.	Poles	Voltage Rating	Amps.	Size Hubs	Each
EPC430	2	250-V.A.C. or	125-225	3	\$270.00
		125-250-V.A.C. or D.C.			
EPC431	3	600-V.A.C. or	125-225	3	270.00
		250-V.D.C.			

Condulet With Breaker

250-V. A-C or 125-250-V. A-C or D-C—Two Pole

No.	Amps.	Size Hubs	Each
EPC430-DT125-2	125		\$410.00
EPC430-DT150-2	150		410.00
EPC430-DT175-2	175	3	410.00
EPC430-DT200-2	200		410.00
EPC430-DT225-2	225		410.00

600-V. A-C or 250-V. D-C—Two Pole

No.	Amps.	Size Hubs	Each
EPC431-DT125-2	125		410.00
EPC431-DT150-2	150		410.00
EPC431-DT175-2	175	3	410.00
EPC431-DT200-2	200		410.00
EPC431-DT225-2	225		410.00

250-V. A-C or 125-250-V. D-C—Three Pole

No.	Amps.	Size Hubs	Each
EPC430-DT125-3	125		438.00
EPC430-DT150-3	150		438.00
EPC430-DT175-3	175	3	438.00
EPC430-DT200-3	200		438.00
EPC430-DT225-3	225		438.00

600-V. A-C—Three Pole

No.	Amps.	Size Hubs	Each
EPC431-DT125-3	125		438.00
EPC431-DT150-3	150		438.00
EPC431-DT175-3	175	3	438.00
EPC431-DT200-3	200		438.00
EPC431-DT225-3	225		438.00

600-Ampere Frame Size with Interchangeable Thermal-Magnetic Trip

Condulet Without Circuit Breaker

Square D

No.	Poles	Voltage Ratings	Amps.	Size Hubs	Each
EPC446	2	250-V.A.C. or	250-600	4	\$600.00
		125-250-V.D.C.			
EPC460	3	600-V.A.C. or	250-600	4	600.00
		250-V.D.C.			

Condulet With Breaker

Square D

250-V. A-C or 125-250-V. D-C—Two Pole

No.	Amps.	Size Hubs	Each
EPC446-DT250-2	250		\$958.00
EPC446-DT275-2	275		958.00
EPC446-DT300-2	300		958.00
EPC446-DT325-2	325		958.00
EPC446-DT350-2	350	4	958.00
EPC446-DT400-2	400		958.00
EPC446-DT450-2	450		958.00
EPC446-DT500-2	500		958.00
EPC446-DT550-2	550		958.00
EPC446-DT600-2	600		958.00

600-V. A-C or 250-V. D-C—Two Pole

No.	Amps.	Size Hubs	Each
EPC460-DT250-2	250		958.00
EPC460-DT275-2	275		958.00
EPC460-DT300-2	300		958.00
EPC460-DT325-2	325		958.00
EPC460-DT350-2	350	4	958.00
EPC460-DT400-2	400		958.00
EPC460-DT450-2	450		958.00
EPC460-DT500-2	500		958.00
EPC460-DT550-2	550		958.00
EPC460-DT600-2	600		958.00

250-V. A-C or 125-250-V. D-C—Three Pole

No.	Amps.	Size Hubs	Each
EPC446-DT250-3	250		1044.00
EPC446-DT275-3	275		1044.00
EPC446-DT300-3	300		1044.00
EPC446-DT325-3	325		1044.00
EPC446-DT350-3	350	4	1044.00
EPC446-DT400-3	400		1044.00
EPC446-DT450-3	450		1044.00
EPC446-DT500-3	500		1044.00
EPC446-DT550-3	550		1044.00
EPC446-DT600-3	600		1044.00

600-V. A-C—Three Pole

No.	Amps.	Size Hubs	Each
EPC460-DT250-3	250		1044.00
EPC460-DT275-3	275		1044.00
EPC460-DT300-3	300		1044.00
EPC460-DT325-3	325		1044.00
EPC460-DT350-3	350	4	1044.00
EPC460-DT400-3	400		1044.00
EPC460-DT450-3	450		1044.00
EPC460-DT500-3	500		1044.00
EPC460-DT550-3	550		1044.00
EPC460-DT600-3	600		1044.00

Type EPC Condulets are available with ITE, Westinghouse, and Trumbull circuit breakers; information on request to GRAYBAR.

*Available in \$100.00 Condulet with 1 1/4" hubs.

Crouse-Hinds Condulets
Type FLB Circuit Breaker Condulets
Air Break Circuit Breakers

Explosion-Proof, Dust-Tight, and Weather Resistant (Raintight)

Class I, Group D (NEMA Type VII); Class II, Groups E, F, and G; and Class III (NEMA Types IX, V, and III)



The Condulets with air break circuit breakers are suitable for service entrance, feeder, or branch circuit protection, for lighting, appliance, and motor circuit conductors. For manual closing, opening or resetting, an external handle is provided. Two threaded through-feed hubs are provided. Other sizes and arrangements can be furnished. Prices on application to Graybar.

50-Ampere Frame Size with Non-Interchangeable Thermal Trip and Non-Adjustable Magnetic Trip

Condulet Without Circuit Breaker—Square D

No.	Poles	Voltage Rating	Amps.	Size Hubs	Each
FLB171	1	125 V. A-C or D-C		3/4	\$50.00
FLB172	2	250 V. A-C or	15-50	1	50.00
FLB173	3	125-250 V. D-C		1 1/4	70.00
FLB175	2	600 V. A-C or	15-50	1 1/4	70.00
	3	600 V. A-C			

Condulet With Breakers—Square D

125 V. A-C or D-C—One Pole

No.	Amps.	Size Hubs	Each
FLB171-DT15-1	15		\$59.00
FLB171-DT20-1	20		59.00
FLB171-DT30-1	30	3/4	59.00
FLB171-DT40-1	40		59.00
FLB171-DT50-1	50		59.00

Condulet With Breaker—Square D

250 V. A-C or 125-250 V. D-C—Two Pole

FLB172-DT15-2	15		\$72.00
FLB172-DT20-2	20		72.00
FLB172-DT30-2	30	1	72.00
FLB172-DT40-2	40		72.00
FLB172-DT50-2	50		72.00

250 V. A-C or 125-250 V. D-C—Three Pole

FLB173-DT15-3	15		\$103.00
FLB173-DT20-3	20		103.00
FLB173-DT30-3	30	1 1/4	103.00
FLB173-DT40-3	40		103.00
FLB173-DT50-3	50		103.00

600 V. A-C or 250 V. D-C—Two Pole

FLB175-DT15-2	15		\$118.00
FLB175-DT20-2	20		118.00
FLB175-DT30-2	30	1 1/4	118.00
FLB175-DT40-2	40		118.00
FLB175-DT50-2	50		118.00

600 V. A-C—Three Pole

FLB175-DT15-3	15		\$130.50
FLB175-DT20-3	20		130.50
FLB175-DT30-3	30	1 1/4	130.50
FLB175-DT40-3	40		130.50
FLB175-DT50-3	50		130.50

Type FLB Condulets are available with ITE, Westinghouse, and Trumbull circuit breakers; information on request, to GRAYBAR.

100-Ampere Frame Size with Non-Interchangeable Thermal Trip and Non-Adjustable Magnetic Trip

Condulet Without Circuit Breaker—Square D

No.	Poles	Voltage Rating	Amps.	Size Hubs	Each
FLB174	2	250 V. A-C or	70-100	1 1/2	\$80.00
	3	125-250 V. D-C			
		250 V. A-C			
FLB436	2	600 V. A-C or	70-100	1 1/2	100.00
	3	250 V. D-C			
		600 V. A-C			

Condulet With Breaker—Square D

250 V. A-C or 125-250 V. D-C—Two Pole

No.	Amps.	Size Hubs	Each
FLB174-DT70-2	70	1 1/2	\$117.00
FLB174-DT100-2	100		117.00

250 V. A-C—Three Pole

FLB174-DT70-3	70	1 1/2	\$128.00
FLB174-DT100-2	100		128.00

600 V. A-C or 250 V. D-C—Two Pole

FLB436-DT70-2	70	1 1/2	\$160.00
FLB436-DT100-2	100		160.00

600 V. A-C—Three Pole

FLB436-DT70-3	70	1 1/2	\$174.00
FLB436-DT100-3	100		174.00

225-Ampere Frame Size with Interchangeable Thermal-Magnetic Trip

Condulet Without Circuit Breaker—Square D

No.	Poles	Voltage Rating	Amps.	Size Hubs	Each
FLB342	2	250 V. A-C or 125-	125-225	2 1/2	\$220.00
		250 V. A-C or D-C			
	or	600 V. A-C or			
FLB346	3	250 V. D-C	125-225	2 1/2	220.00

Condulet With Breaker—Square D

250 V. A-C or 125-250 V. A-C or D-C—Two Pole

No.	Amps.	Size Hubs	Each
FLB342-DT125-2	125		\$360.00
FLB342-DT150-2	150		360.00
FLB342-DT175-2	175	2 1/2	360.00
FLB342-DT200-2	200		360.00
FLB342-DT225-2	225		360.00

600 V. A-C or 250 V. D-C—Two Pole

FLB346-DT125-2	125		\$360.00
FLB346-DT150-2	150		360.00
FLB346-DT175-2	175	2 1/2	360.00
FLB346-DT200-2	200		360.00
FLB346-DT225-2	225		360.00

250 V. A-C or 125-250 B. A-C or D-C—Three Pole

FLB342-DT125-3	125		\$388.00
FLB342-DT150-3	150		388.00
FLB342-DT175-3	175	2 1/2	388.00
FLB342-DT200-3	200		388.00
FLB342-DT225-3	225		388.00

600 V. A-C—Three Pole

FLB346-DT125-3	125		\$388.00
FLB346-DT150-3	150		388.00
FLB346-DT175-3	175	2 1/2	388.00
FLB346-DT200-3	200		388.00
FLB346-DT225-3	225		388.00

Crouse-Hinds Condulets
Type DVS Circuit Breaker Condulets

Air Break Circuit Breakers
Dust-Tight and Watertight
Class II, Groups E, F, and G; and Class III (NEMA Types IX, V, IV, and III)

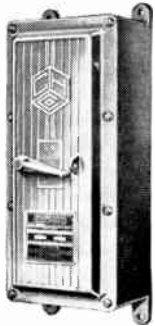

These Condulets are suitable for service entrance or branch circuit protection, for lighting, heating, appliance and motor circuits. They provide maximum safety and convenience of installation in Classes II and III hazardous locations, and give complete protection where exposed to corrosive vapors, abrasive dusts, or weather.

Two threaded through-feed hubs are provided. Other sizes or arrangements can be furnished. Prices on application to GRAYBAR.

50-Ampere Frame Size with Non-Interchangeable Thermal Trip and Non-Adjustable Magnetic Trip
Condulet Without Circuit Breakers—Square D

No.	Poles	Voltage Rating	Amps.	Size Hubs	Each
DVS121	1	125-V.A.C. or D.C.		3/4	\$44.00
DVS122	2	250-V.A.C. or	15-50	1	49.00
DVS123	3	125-250-V.D.C.		1 1/4	56.00
DVS936	2	600-V.A.C. or	15-50	1 1/4	70.00
	3	250-V.D.C.			
		600-V.A.C.			

Condulet With Breaker
125-V.A.C. or D.C.—One Pole

No.	Amps.	Size Hubs	Each
DVS121-DT15-1	15		\$53.00
DVS121-DT20-1	20		53.00
DVS121-DT30-1	30	3/4	53.00
DVS121-DT40-1	40		53.00
DVS121-DT50-1	50		53.00

250-V.A.C. or 125-250-V.D.C.—Two Pole

DVS122-DT15-2	15		71.00
DVS122-DT20-2	20		71.00
DVS122-DT30-2	30	1	71.00
DVS122-DT40-2	40		71.00
DVS122-DT50-2	50		71.00

250-V.A.C. or 125-250-V.D.C.—Three Pole

DVS123-DT15-3	15		89.00
DVS123-DT20-3	20		89.00
DVS123-DT30-3	30	1 1/4	89.00
DVS123-DT40-3	40		89.00
DVS123-DT50-3	50		89.00

600-V.A.C. or 250-V.D.C.—Two Pole

DVS936-DT15-2	15		118.00
DVS936-DT20-2	20		118.00
DVS936-DT30-2	30	1 1/4	118.00
DVS936-DT40-2	40		118.00
DVS936-DT50-2	50		118.00

600-V.A.C.—Three Pole

DVS936-DT15-3	15		130.50
DVS936-DT20-3	20		130.50
DVS936-DT30-3	30	1 1/4	130.50
DVS936-DT40-3	40		130.50
DVS936-DT50-3	50		130.50

Type DVS Condulets are available with ITE, Westinghouse, and Trumbull circuit breakers; information on request to GRAYBAR.

100-Ampere Frame Size with Non-Interchangeable Thermal Trip and Non-Adjustable Magnetic Trip
Condulet Without Circuit Breaker—Square D

No.	Poles	Voltage Rating	Amps.	Size Hubs	Each
DVS94	2	250-V.A.C. or	70-100	1 1/2	\$63.00
	3	125-250-V.D.C.			
		250-V.A.C.			
DVS946	2	600-V.A.C. or	70-100	1 1/2	70.00
	3	250-V.D.C.			
		600-V.A.C.			

100-Ampere Frame Size with Non-Interchangeable Thermal Trip and Non-Adjustable Magnetic Trip
Condulet With Breaker—Square D

250-V.A.C. or 125-250-V.D.C.—Two Pole					
No.	Amps.	Size Hubs	Each		
DVS94-DT70-2	70		\$100.00		
DVS94-DT100-2	100	1 1/2	100.00		

250-V.A.C.—Three Pole

DVS94-DT70-3	70		111.00		
DVS94-DT100-3	100	1 1/2	111.00		

600-V.A.C. or 250-V.D.C.—Two Pole

DVS946-DT70-2	70		130.00		
DVS946-DT100-2	100	1 1/2	130.00		

600-V.A.C.—Three Pole

DVS946-DT70-3	70		144.00		
DVS946-DT100-3	100	1 1/2	144.00		

225-Ampere Frame Size with Interchangeable Thermal-Magnetic Trip
Condulet Without Circuit Breaker—Trumbull

No.	Poles	Voltage Rating	Amps.	Size Hubs	Each
DVS23	2	250-V.A.C. or	125-225	2 1/2	\$220.00
	or	125-250-V.D.C.			
		600-V.A.C. or			
DVS236	3	250-V.D.C.	125-225	2 1/2	220.00

Condulet With Breaker—Square D

250-V.A.C. or 125-250-V.D.C.—Two Pole					
No.	Amps.	Size Hubs	Each		
DVS23-TT125-2	125		\$382.00		
DVS23-TT150-2	150		382.00		
DVS23-TT175-2	175	2 1/2	382.00		
DVS23-TT200-2	200		382.00		
DVS23-TT225-2	225		382.00		

600-V.A.C. or 250-V.D.C.—Two Pole

DVS236-TT125-2	125		382.00		
DVS236-TT150-2	150		382.00		
DVS236-TT175-2	175	2 1/2	382.00		
DVS236-TT200-2	200		382.00		
DVS236-TT225-2	225		382.00		

250-V.A.C. or 125-250-V.D.C.—Three Pole

DVS23-TT125-3	125		415.00		
DVS23-TT150-3	150		415.00		
DVS23-TT175-3	175	2 1/2	415.00		
DVS23-TT200-3	200		415.00		
DVS23-TT225-3	225		415.00		

600-V.A.C.—Three Pole

DVS236-TT125-3	125		415.00		
DVS236-TT150-3	150		415.00		
DVS236-TT175-3	175	2 1/2	415.00		
DVS236-TT200-3	200		415.00		
DVS236-TT225-3	225		415.00		

Crouse-Hinds Condulets

**Type EMH Instrument Condulets
Explosion-Proof and Dust-Tight**

Furnished with Mounting Plate and Supports for Instruments.

Four mounting lugs with fastening holes are provided at the back for surface mounting or at the front for flush mounting.

Bodies are equipped with mounting plates and posts to support the instruments near the cover window.



Surface



Flush

General Electric, Hickok, Westinghouse, and Weston instruments can be mounted in type EMH Condulets.

Conduit Openings	No.	Size In.	Each
EMH-			
One in Side	521-10000	1/2	\$34.00
	521-20000	3/4	34.00
One in Back	521-00001	1/2	34.00
	521-00002	3/4	34.00
Two in Sides (Through Feed)	521-10100	1/2	34.50
	521-20200	3/4	34.50
One in Side	511-10000	1/2	36.00
	511-20000	3/4	36.00
One in Back	511-00001	1/2	36.00
	511-00002	3/4	36.00
Two in Sides (Through Feed)	511-10100	1/2	36.50
	511-20200	3/4	36.50

Over-all Dimensions: Diameter of body, 5 3/4 inches; depth of body, 2 3/4 inches; height of cover, 3 inches.

**Type TCH Electric Clock Condulets
Factory Sealed**

Explosion-Proof and Dust-Tight

Class I, Groups C and D; Class II, Groups E, F, and G; and Class III

Type TCH explosion-proof and dust-tight self-starting synchronous motor operated clock Condulets are for use in hazardous locations.

The dial is 13 inches in diameter. A resetting knob protrudes beyond the bezel. The motor and all electrical connections are enclosed in an explosion-proof and dust-tight housing. The gear train is enclosed in a gasketed dust-tight chamber located directly in front of the explosion-proof housing and is attached to the back of the dial assembly.



With Enclosing Band

Two styles are available: one for flush mounting, and one for surface mounting. For surface mounting, a sheet metal notched hand can be supplied for enclosing the space between the wall and back of dial assembly.

No.	Motor	Watts	Size Hub	Style	Each
TCH2110	{ 115-Volt, 60 Cy. A-C	2.50	3/4	Flush	\$140.00
TCH2220				Surface	130.00
TCH202	Enclosing Band for Surface Mounting				6.00

25 and 50-cycle clocks can be furnished at an advance of \$10.00 in the list price.

**Type HRC Thermostat Condulets
Explosion-Proof and Dust-Tight**

Class I, Group D (NEMA Type VII); Class II, Groups E, F, and G; and Class III (NEMA Types IX and V)

Furnished with Thermostat, Thermometer, and Mercury Tube Switch



An external lever permits any temperature setting within the calibrated range. The thermostats will operate on a three-degree Fahrenheit differential. An accurate Fahrenheit thermometer is attached to the front for indicating room temperature.

Equipped with single pole switches. In units for refrigeration and air conditioning the switch makes contact on temperature rise. In units for heating the switch makes contact on temperature fall.**

Type HRC—Through Feed§

Have 1/2-inch union hubs.

No.	For	Fahrenheit Temperature Range of Thermostat	Each
HRC126	Refrigeration	25 to 60°	\$60.00
HRC137	Heating	38 to 70°	60.00
HRC158	Heating	56 to 80°	60.00
HRC169	Air Conditioning	65 to 90°	60.00

Furnished With Thermostat and Thermometer

The Condulets for air conditioning and/or heating are provided with single-pole, double-throw switches.

Connected for heating, the switch makes contact on temperature fall.

Positive-Off lever can be supplied on HRC42B and HRC42B-25 only.

Add suffix H1 to the catalog number and \$1.50 to the list price.

Positive-On lever can be supplied on HRC42A-23 only. Add suffix G1 to the catalog number and \$1.50 to the list price



No.	For	Fahrenheit Temperature Range of Thermostat	Size Hub	Each
HRC42B-23	{ Air Conditioning and/or Heating	42° to 75°	3/4	\$60.00
HRC42B-25			3/4	60.00
HRC42A-23	Heating	42° to 75°	3/4	60.00
HRC42A-24	Heating	56° to 84°	3/4	60.00

Type ECT Transformer Condulets

Explosion-Proof, Dust-Tight, and Weather Resistant (Raintight)

Class I, Group D (NEMA Type VII); Class II, Groups E, F, and G; and Class III (NEMA Types IXA, IX, V, and III)

Furnished with 50-133-cycle transformers.

25 and 50-volt-ampere transformers are provided with tapped primaries for 230, 460, or 575 volts and 115-volt secondaries.

75 to 750-volt-ampere transformers, inclusive, are provided with single voltage primaries for either 230, 460, or 575 volts and 115-volt secondaries. The voltage required must be specified.

Transformers for other secondary voltages can be furnished.

Information on request.



No.	Volt-Amperes (50-133 Cycles)	Size Hub	Each
ECT211	25	3/4	\$29.60
ECT215	50	3/4	50.00

§These HRC Condulets are furnished with threaded cap, GUH10, which can be used to close either hub.

**A manual "Hand—Off—Automatic" selector switch can be furnished. Add suffix MS to the catalog number and \$5.00 to the list price.

†Thermostat case is brushed silver bronze.

Crouse-Hinds Condulets

Type ESR Bell Signal Condulets

Explosion-Proof and Dust-Tight

Class I, Group D; Class II, Groups E, F, and G; and Class III



Furnished with either 6, 8, or 10-inch diameter gong and with vibrating or single stroke hammer.

25 to 60-cycle A-C.*
Size hub—3/4".

Vibrating Hammer

No.	Nom. Volts	Voltage Range	Decibels at Six Yards	Loudness Rating ASA Units	Diam. Bell	Each
ESR2675	12	11 to 13				\$84.00
ESR2674	24	22 to 26				84.00
ESR2673	48	44 to 52	88.5	33600	6"	84.00
ESR2672	115	104 to 126				70.00
ESR2671	230	207 to 253				70.00
ESR2695	12	11 to 13				85.25
ESR2694	24	22 to 26				85.25
ESR2693	48	44 to 52	92.5	47000	8"	85.25
ESR2692	115	104 to 126				71.25
ESR2691	230	207 to 253				71.25
ESR2615	12	11 to 13				86.00
ESR2614	24	22 to 26				86.00
ESR2613	48	44 to 52	92	45000	10"	86.00
ESR2612	115	104 to 126				72.00
ESR2611	230	207 to 253				72.00

Single Stroke Hammer

ESR2665	12	11 to 13				\$84.00
ESR2664	24	22 to 26				84.00
ESR2663	48	44 to 52	88.5	33600	6"	84.00
ESR2662	115	104 to 126				70.00
ESR2661	230	207 to 253				70.00
ESR2685	12	11 to 13				85.25
ESR2684	24	22 to 26				85.25
ESR2683	48	44 to 52	92.5	47000	8"	85.25
ESR2682	115	104 to 126				71.25
ESR2681	230	207 to 253				71.25
ESR2625	12	11 to 13				86.00
ESR2624	24	22 to 26				86.00
ESR2623	48	44 to 52	92	45000	10"	86.00
ESR2622	115	104 to 126				72.00
ESR2621	230	207 to 253				72.00

*Information on D-C bell signals upon request to Graybar.

Type ETH Horn and Siren Signal Condulets

Explosion-Proof and Dust-Tight

Class I, Group D; Class II, Groups E, F, and G; and Class III

Adjustable projectors may be rotated in a horizontal plane through 180 degrees to direct the sound. Hub size, 3/4-in.



Single Projector Non-Adjustable



Siren Signal

Standard Volume Horn Signal

Single Projector Non-Adjustable—50 to 60 Cycle A.C.

No.	Nom. Volts	Voltage Range	Nom. Watts	Decibels at 6 Yards	Loudness Rating ASA Units	Each
ETH2703	115	105 to 125	33	99	81000	\$75.00
ETH2702	230	207 to 253	32.5	100	88000	75.00

High Power Horn Signals

Grill—50 to 60 Cycle A.C.†

ETH2313	115	104 to 126	49	101	97000	\$ 90.00
ETH2413	125	113 to 138	30	99	81000	110.00

Single Projector Adjustable—50 to 60 Cycle A.C.†

ETH2323	115	104 to 126	49	101	97000	\$ 95.00
ETH2423	125	113 to 138	30	99	81000	115.00

Single Projector Adjustable—D.C.

ETH2423	125	113 to 138	30	99	81000	\$115.00
ETH2421	250	225 to 275	30	99	81000	115.00

Resonating Horn Signal

50 to 60 Cycle A.C. Only

ETH2553	115	104 to 126	70	104	126000	\$150.00
---------	-----	------------	----	-----	--------	----------

Siren Signal

A.C. or D.C. (Universal Motor)

ETH2603	115	104 to 126	195	108	180000	\$300.00
---------	-----	------------	-----	-----	--------	----------

†25-40 cycle range no additional charge. Add suffix S225.

Type WH Horn Signal Condulets—Weather Resistant (Raintight)

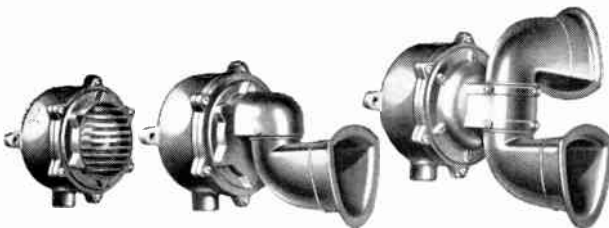

Type WH With Grill

Type WH With Single Projector

Type WH With Double Projector

Housings are provided with mounting feet and a hub for 1/2-inch threaded conduit. The construction of the grill style is such that the hub may be placed at the top, bottom, or either side. The horns with projector may be mounted with the hub at either the top or the bottom.

A gasket is furnished between the housing and horn assembly to make the joints raintight. Projectors may be rotated in a horizontal plane through 180° to direct the sound as desired.

With Grill

12 to 250 Volts—A-C—50 to 60 Cycles†§

No.	Volume	Decibels at Six Yards	Loudness Rating ASA Units	Nominal Watts	Each
WH1303A	Standard	92	45000	18.5	\$17.55
WH1313	High Power	104	125000	49	19.10

12 to 250 Volts—D-C§

WH1413	High Power	102	105000	30	\$28.00
--------	------------	-----	--------	----	---------

With Single Projector

12 to 250 Volts—A-C—50 to 60 Cycles†§

WH1303	Standard	92	45000	18.5	\$24.25
WH1323	High Power	104	125000	49	25.80

12 to 250 Volts—D-C§

WH1423	High Power	102	105000	30	\$35.00
--------	------------	-----	--------	----	---------

With Double Projector

12 to 250 Volts—A-C—50 to 60 Cycles†§

WH1503	Standard	92	45000	18.5	\$32.50
WH1333	High Power	104	125000	49	34.60

12 to 250 Volts—D-C§

WH1433	High Power	102	105000	30	\$43.75
--------	------------	-----	--------	----	---------

§Specify definite voltage of supply circuit when ordering.
†25- to 40-cycle range also available. If supply circuit is a-c, specify frequency when ordering.

Wiremold Surface Wiring Systems

Standard Wiremold Finish

Listed by Underwriters' Laboratories, Inc.

No. 200 Wiremold Raceway

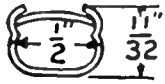

.025-inch steel. Furnished in 5-foot lengths, with couplings, 100 feet to a carton. Weight per 1000 feet, 150 pounds.

Wire No.....	6	8	10	12	14	16	18	19
Single Conductor Capacity:								
Type R, RH.....		2	2	4	4	..		
Type T, TW, RU.....		3	3	4	4	..		
Twisted Pair Capacity:								
Type R or RH.....		2	2	2				
No. 200.....	per foot \$.155							

No. 500 Wiremold Raceway

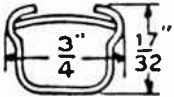

.040-inch steel. Furnished in 10-foot lengths, with coupling, 100 feet to a carton. Weight per 1000 feet, 320 pounds.

Wire No.....	6	8	10	12	14	16	18	19
Single Conductor Capacity:								
Type R or RH.....		2	2	3	6	6	..	
Type T, TW, or RU.....		2	3	4	5	10	10	..
Twisted Pair Capacity:								
Type R or RH.....		2	2	3				
No. 500.....	per foot \$.188							

No. 700 Wiremold Raceway

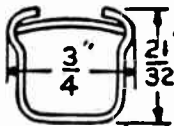

.040-inch steel. Furnished in 10-foot lengths, with coupling, 100 feet to carton. Weight per 1000 feet, 360 pounds.

Wire No.....	6	8	10	12	14	16	18	19
Single Conductor Capacity:								
Type R or RH.....		2	3	4	10	10	..	
Type T, TW, or RU.....		3	5	6	8	16	18	..
Twisted Pair Capacity:								
Type R or RH.....		4	4	4				
No. 700.....	per foot \$.211							

No. 1000 Wiremold Raceway

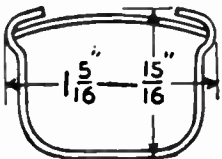

.040-inch steel. Furnished in 10-foot lengths, with coupling, 100 feet to carton. Weight per 100 feet, 62 pounds.

Wire No.....	6	8	10	12	14	16	18	19
Single Conductor Capacity:								
Type R or RH.....	4	5	6	10	10	24	24	..
Type T, TW, or RU.....	5	8	8	10	10	40	50	..
Twisted Pair Capacity:								
Type R or RH.....						10	10	11
No. 1000.....	per foot \$.439							

Use 32-Tooth Hack-Saw Blade to cut all sizes of Raceway.
Prices slightly higher in nine Western States.

No. 1900 Plugmold Multi-Outlet System

Permits the installation of any number of electrical outlets exactly where they are needed.

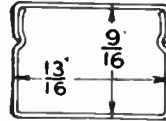

1900B, Base .025-inch steel. Base has screw knockouts at approximately 8-inch centers. Furnished in 10-foot lengths, without couplings, 100 feet to a carton. Weight per 100 feet, 18 pounds.

No. **1900B** (Channel) . . . per foot \$.143

1900C, Cover .025-inch steel. Furnished in 5-foot lengths, 100 feet to a carton. Weight per 100 feet, 11 pounds.

No. **1900C** (Cover) . . . per foot \$.105

Wire No.....	6	8	10	12	14	16	18	19
Single Conductor Capacity:								
Type R, RH, T, TW or								
RU with Receptacles ..		3	3
Without Receptacles ..		3	3	10	10	..		
Twisted Pair Capacity:								
Type R, RH, T, TW or RU								
Without Receptacles ..						10	10	10

Plugtrim



.025-inch steel. Standard Wiremold finish. Furnished in 5-foot lengths. Use with 1900 Plugmold as baseboard trim, chair rail trim, and to carry low potential wiring. Weight per 100 feet, 9 pounds.

No. **1900T** . . . per foot \$.116

Mounting Clip

No. **1903T** . . . per 100 5.40

Blank End Fitting

No. **1910BT** . . . per 100 12.20

Internal Elbow

No. **1917T** . . . per 100 30.10

External Elbow

No. **1918T** . . . per 100 29.20

No. 1900 Wired Plugmold

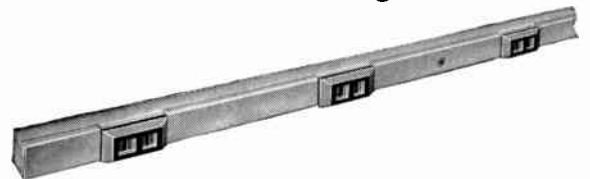

Prewired, packaged, available in two lengths. Wired with two No. 12 Type TW conductors. One end of each run of Wired Plugmold is equipped with a connector block and the opposite end has stripped wires ready for connection.

No. **19306** 3 foot length, 6 outlets,
6 inches on centers . . . per 100 \$590.00
Carton 1, Std. Pkg. 10, Std. Pkg. Wt., Lbs. 12 1/2.

No. **19606** 6 foot length, 12 outlets,
6 inches on centers . . . per 100 1120.00
Carton 1, Std. Pkg. 10, Std. Pkg. Wt., Lbs. 23 3/4.

No. **19618** 6 foot length, 4 outlets,
18 inches on centers . . . per 100 660.00
Carton No. 1, Std. Pkg. 10, Std. Pkg. Wt., Lbs. 22 1/4.

Prices slightly higher in nine Western States.

Wiremold Surface Wiring Systems

Listed by Underwriters' Laboratories, Inc.

Snapicoil Standard Wiremold Finish For Use with No. 1900B Channel

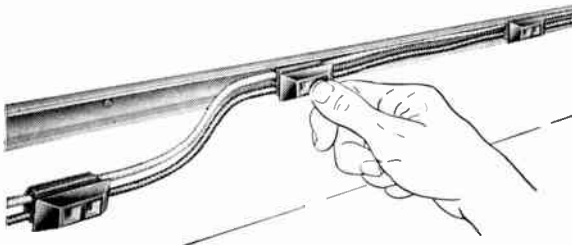

Snapicoil, furnished as coils of standard No. 1927 Plug Receptacles wired at the factory with two No. 12 Type TW conductors is your answer for wiring homes, apartments, hotels, stores and factories. Just attach No. 1900B channel to surface, snap in wired receptacles, insert factory-cut cover sections.

No.	Description	Wt. Lbs. Per Coil	Per Coil
19C03	13-in. length with 6 brown receptacles and one 1930 connector block	1 1/4	\$ 5 30
19C03V	Same as 19C03 except receptacles are ivory	1 1/4	6 00
19C12	25-ft. coil with 25 brown receptacles wired 12-in. on centers. 1900C cover sections furnished	5 1/2	24 00
19C12V	Same as 19C12 except receptacles are ivory	5 1/2	26 80
19C18	50-ft. coil with 33 brown receptacles wired 18-in. on centers. 1900C cover sections furnished	9 1/4	37 40
19C18V	Same as 19C18 except receptacles are ivory	9 1/4	41 10
19C24	50-ft. coil with 25 brown receptacles wired 24-in. on centers. 1900C cover sections furnished	9 1/4	30 90
19C24V	Same as 19C24 except receptacles are ivory	9 1/4	33 70
19C36	50-ft. coil with 16 brown receptacles wired 36-in. on centers. 1900C cover sections furnished	8 3/4	25 10
19C36V	Same as 19C36 except receptacles are ivory	8 3/4	26 90

No. 1500 Wiremold Pancake Galvanized

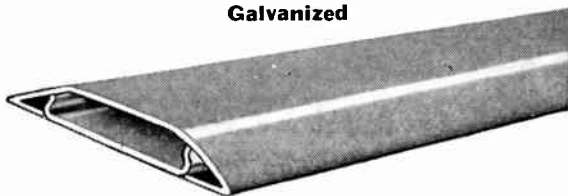

.040-inch steel, galvanized. Base has screw knockouts at approximately 8-inch centers. Furnished in 10-foot lengths, without couplings, 100 feet to carton. Weight per 100 feet, 47 pounds.

Wire No.	6	8	10	12	14	16	18	22
Single Conductor Capacity:								
Type R or RH	4	4	6	8				
Type T, TW or RU	4	4	6	8	10	14		
Twisted Pair Capacity:								
Type R or RH						3	4	5
No. 1500	per foot \$.347							

*No. 2600 Wiremold Pancake

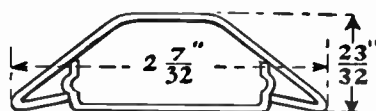

Cover, .050-inch steel; Base, .040-inch steel, galvanized. Base has screw knockouts at approximately 8-inch centers. Furnished in 10-foot lengths, without couplings, 50 feet to carton. Weight 14 pounds. Capacity: Two 26-pair telephone cables.

No. 2600 per foot \$.535
*Not Listed by Underwriters' Laboratories, Inc.
Prices slightly higher in nine Western States.

No. 2100 Plugmold Multi-Outlet System Standard Wiremold Finish

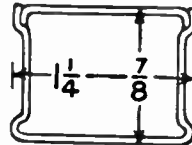
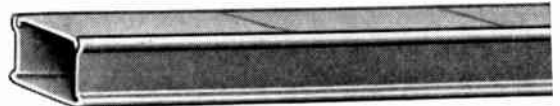

2100B—Base, .040-inch steel. Furnished in 10-foot lengths, without couplings, 100 feet to carton. Weight, per 100 feet, 43 pounds. No. 2100B (Channel) per foot \$.253

2100C*—Cover, .040-inch steel. Scored every 3-inches. Furnished in 5-foot lengths, 100 feet to a carton. Weight per 100 feet, 19 pounds. No. 2100C* (Cover) per foot \$.174

*Cover can be furnished unscored on special order—no additional cost.

Wire No.	6	8	10	12	14	16	18	22
Single Conductor Capacity:								
*Type R or RH, with Receptacles								
*Type T or RU, with Receptacles								
Type R or RH, without Receptacles	4	6	10	10	10	24	24	
Type T, TW, or RU, without Receptacles	5	8	10	10	10	40	50	
Twisted Pair Capacity:								
Type R or RH, without Receptacles							10	10

*See individual listings in catalog.

No. 3000 Wiremold Raceway Standard Wiremold or White Finish

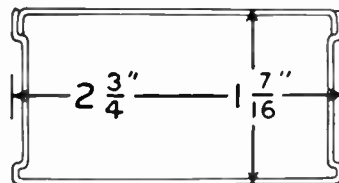

Has a wide application in industrial plants as a branch circuit feeder system, a multi-outlet wiring system to serve small motors, electric tools, etc., and is ideal for wiring infrared heating and drying units. Also serves as a basis for the Wiremold Fluorescent Lighting Units.

3000B Base, .040-inch steel. Furnished in 10-foot lengths, without couplings, 50 feet to a carton. Weight, per 100 feet, 80 pounds.

No. 3000B (Channel) per foot \$.487

3000C Cover, .040-inch steel. Furnished in 10-foot lengths, 50 feet to a carton. Weight, per 100 feet, 43 pounds.

No. 3000C (Cover) per foot \$.250

Wire No.	6	8	10	12	14	16	18	19
Single Conductor Capacity:								
Type R or RH, *with Devices in Place	6	8	10	10	10			
Without Devices	10	10	10	10	10	100	100	
Type T, TW or RU, *with Devices in Place	8	10	10	10	10			
without Devices	10	10	10	10	10	100	100	
Twisted Pair Capacity:								
Type R or RH, without Devices							50	50

*With standard flush-mounted snap switches and attachment plug receptacles of type not having pilot lights.

Prices slightly higher in nine Western States.

No. 2000 Wiremold Raceway

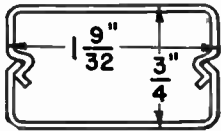

Capacity: Type R or RH, T, TW or RU with devices: 3 No. 12; 3 No. 14. Type R or RH, T, TW or RU without devices: 3 No. 12; 3 No. 14; 10 No. 16; 10 No. 18.

No.	Description	Per Foot
2000	Blank Fill-In Cover & Base	\$0.347
2000B	Channel	.178
2000C	Blank Cover	.168

No. 2000 Plugmold With Snapicoil (Wired With No. 12 Type TW Conductors)

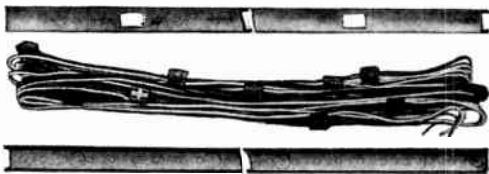

No. **20D30**—50-ft. Snapicoil with 20 duplex 2-wire black outlets (15A, 125V; 10A, 250V), wired 30" on centers, 10, 5-ft. lengths each of 2000B Base and 2000C Holecut Cover, 20, 2000WC Wire Clips and 10, 2001 couplings. . . . Each **\$41.90**
 No. **20D30V**—Same as 20D30; w/Ivory outlets.
 Each. . . . **\$43.60**

No. **20D60**—50-ft. Snapicoil with 10 Duplex, 2-wire black outlets (15A, 125V; 10A, 250V) wired 60" on centers, 10, 5-ft. lengths each of 2000B Base and 2000C Holecut Cover, 10, 2000WC Wire Clips, and 10, 2001 couplings. . . . Each **\$35.60**
 No. **20D60V**—Same as 20D60; w/Ivory outlets.
 Each. . . . **\$35.50**

No. **20G30**—50-ft. Snapicoil with 20 NEMA grounded black outlets (15A, 125V) wired 30" on centers, 10, 5-ft. lengths each of 2000B Base and 2000C Holecut Cover, 20, 2000WC Wire Clips, and 10, 2001 couplings. . . . Each **\$41.60**
 No. **20G30V**—Same as 20G30; w/Ivory outlets.
 Each. . . . **\$43.60**

No. **20G60**—50-ft. Snapicoil with 10 NEMA Grounded black outlets (15A, 125V), wired 60" on centers, 10, 5-ft. lengths each of 2000B Base and 2000C Holecut Cover, 10, 2000WC Wire Clips, and 10, 2001 couplings. . . . Each **\$35.50**
 No. **20G60V**—Same as 20G60; w/Ivory outlets.
 Each. . . . **\$36.40**

No. **20S30**—50-ft. Snapicoil with 20 duplex, 3-wire black outlets (15A, 125V; 10A, 250V), wired 30" on centers, 10, 5-ft. lengths each of 2000B Base and 2000C Holecut Cover, 20, 2000WC Wire Clips, 10, 2001 couplings. . . . Each **\$44.90**
 No. **20S30V**—Same as 20S30; w/Ivory outlets. Each **\$46.70**

No. **20S60**—50-ft. Snapicoil with 10 duplex, 3-wire black outlets (15A, 125V; 10A, 250V) wired 60" on centers, 10, 5-ft. lengths each of 2000B Base and 2000C Holecut Cover, 10, 2000WC Wire Clips, and 10, 2001 couplings. . . . Each **\$38.70**
 No. **20S60V**—Same as 20S60; w/Ivory outlets. Each **\$39.60**

No. 2000 Wired Plugmold



Outlets

No.	Lgth. Num. Centers			Type	Rating	Each
	Ft.	ber	In.			
20D103†	1	4	3	2-Wire Duplex	15A, 125V; 10A, 250V	\$ 3.90
20D306	3	6	6	2-Wire Duplex	15A, 125V; 10A, 250V	5.20
20D606	6	12	6	2-Wire Duplex	15A, 125V; 10A, 250V	10.50
20D618	6	4	18	2-Wire Duplex	15A, 125V; 10A, 250V	6.60
20G306	3	6	6	NEMA Grounded	15A, 125V	5.80
20G509	5	6	9	NEMA Grounded	15A, 125V	6.90
20GV509	5	6	9	NEMA Grounded	15A, 125V	8.20
20G606	6	12	6	NEMA Grounded	15A, 125V	10.50
20G618	6	4	18	NEMA Grounded	15A, 125V	6.60
20S618	6	4	18	3-Wire Duplex	15A, 125V; 10A, 250V	7.00

Note: All outlets black except 20D103 and 20GV509 which are ivory. †2000 Base not furnished.

No. 2200 Wiremold Raceway



Capacity: Type R or RH with devices: 4 No. 8; 6 No. 10; 10 No. 12; 10 No. 14. Type T, TW, or RU with devices: 3 No. 6; 7 No. 8; 10 No. 10; 10 No. 12; 10 No. 14.

Type T, TW, or RU with devices when 2217TC is Used as through fitting: 4 No. 8; 6 No. 10; 8 No. 12; 10 No. 14.

No.	Description	Per Foot
2200	Blank Fill-In Cover and Base	\$0.56
2200B	Channel	.258
2200C	Blank Cover	.302

No. 2200 Plugmold Baseboard With Snapicoil (Wired With No. 12 Type TW Conductors)

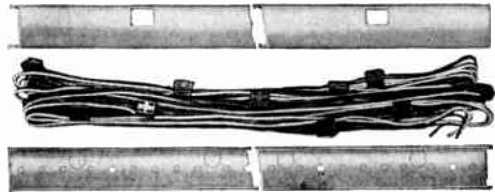

No. **22D30**—50-ft. Snapicoil with 20 duplex, 2-wire black outlets (15A, 125V; 10A, 250V) wired 30" on centers, 10, 5-ft. lengths each of 2200B Base and 2200C Holecut Cover, 20, 2200WC Wire and Device Clips, 10, 2201 couplings. . . . Each **\$57.70**

No. **22D30V**—Same as 22D30; w/Ivory outlets.
 Each. . . . **\$59.50**

No. **22D60**—50-ft. Snapicoil with 10 duplex, 2-wire black outlets (15A, 125V; 10A, 250V) wired 60" on centers, 10, 5-ft. lengths each of 2200B Base and 2200C Holecut Cover, 10, 2200WC Wire and Device Clips, and 10, 2201 couplings. . . . Each **\$51.40**

No. **22D60V**—Same as 22D60; w/Ivory outlets.
 Each. . . . **\$52.30**

No. **22G30**—50-ft. Snapicoil with 20 NEMA grounded black outlets (15A, 125V) wired 30" on centers, 10, 5-ft. lengths each of 2200 B Base and 2200C Holecut Cover, 20, 2200WC Wire and Device Clips and 10, 2201 couplings. . . . Each **\$57.50**
 No. **22G30V**—Same as 22G30; w/Ivory outlets.
 Each. . . . **\$59.40**

No. **22G60**—50-ft. Snapicoil with 10 NEMA grounded black outlets (15A, 125V) wired 60" on centers, 10, 5-ft. lengths each of 2200B Base and 2200C Holecut Cover, 10, 2200WC Wire and Device Clips, and 10, 2201 couplings. . . . Each **\$51.30**
 No. **22G60V**—Same as 22G60; w/Ivory outlets.
 Each. . . . **\$52.20**

No. **22S30**—50-ft. Snapicoil with 20 duplex 3-wire black outlets (15A, 125V; 10A, 250V), wired 30" on centers, 10, 5-ft. lengths each of 2200B Base and 2200C Holecut Cover, 20, 2200WC Wire and Device Clips, and 10, 2201 couplings. . . . Each **\$60.80**

No. **22S30V**—Same as 22S30; w/Ivory outlets. Each **\$62.50**

No. **22S60**—50-ft. Snapicoil with 10 duplex 3-wire black outlets (15A, 125V; 10A, 250V), wired 60" on centers, 10, 5-ft. lengths each of 2200B Base and 2200C Holecut Cover, 10, 2200WC Wire and Device Clips and 10, 2201 couplings. . . . Each **\$54.50**
 No. **22S60V**—Same as 22S60; w/Ivory outlets. Each **\$55.40**

No. 2200 Plugmold Baseboard Fittings

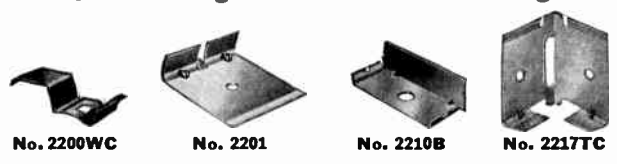

No.	Description	Ctn. Qty.	Each
2200WC	Wire and Device Clip	200	\$.063
2201	Coupling	50	.308
2210B	Blank End Fitting	20	.129
2217TC	Corner Coupling, Leg 1 1/8-in. Long	20	.524

Note: Other 2200 fittings available, contact GRAYBAR.

Fittings for Wiremold Surface Wiring Systems

Standard Wiremold Finish

Listed by Underwriters' Laboratories, Inc.



Flexible Sections

For getting around offsets, side bends, twisted turns, curved surfaces and other difficult situations.

Wiremold System No.	200	500	700	1000
No.	200F	5700F	5700F	1000F
Length, inches	18	18	18	18
Std. Pkg.	10	10	10	10
Wt. Lbs., Std. Pkg.	3½	5¾	5¾	13
Per 100	\$217.30	\$288.80	\$288.80	\$372.60



No. 201 Coupling



No. 202 Bushing



No. 203 Clip



No. 5703 Clip

Couplings

For joining and supporting lengths of Wiremold. One coupling furnished with each length of raceway.

Wiremold System No.	200	500	700	1000
No.	201	5701	5701	1001
Std. Pkg.	100	200	200	100
Wt. Lbs., Std. Pkg.	¾	3	3	6¾
Per 100	\$3.00	\$3.20	\$3.20	\$9.00

Bushings

Protect wires from abrasion.

Wiremold System No.	200	500	700	1000
No.	202	502	702	1002
Std. Pkg.	200	200	200	40
Wt. Lbs., Std. Pkg.	½	½	¾	½
Per 100	\$2.00	\$2.60	\$2.80	\$16.80

Supporting Clips

For supporting lengths of Wiremold.

Wiremold System No.	200	500	700	1000
No.	203	5703	5703	1003
Length, inches	2½	2½	2½	2½
Std. Pkg.	200	500	500	100
Wt. Lbs., Std. Pkg.	1¾	12¼	12¼	4¾
Per 100	\$3.70	\$5.20	\$5.20	\$12.40



No. 205 Strap



No. 504 Strap



No. 1005 Strap



No. 206 Connection Cover

Straps

Wiremold System No.	200	500	700	1000
No.	205	504	704	1004
Std. Pkg.	200	500	200	100
Wt. Lbs., Std. Pkg.	1	7½	4¼	4½
Per 100	\$2.00	\$2.60	\$4.00	\$18.00
No.	205	1005
Std. Pkg.	200	100
Wt. Lbs., Std. Pkg.	1	3½
Per 100	\$2.00	\$18.50

Connection Covers

No.	206	506	706	...
Std. Pkg.	200	200	200	...
Wt. Lbs., Std. Pkg.	5/8	1¾	2	...
Per 100	\$4.40	\$2.60	\$4.00	...

Prices slightly higher in nine Western States.



No. 5708 Fixture Hook



No. 1009 Ground Clamp



No. 211 90° Elbow

Fixture Hooks

For supporting lighting fixtures.

Wiremold System No.	200	500	700	1000
No.	5708	5708	5708	...
Std. Pkg.	20	20	20	...
Wt. Lbs., Std. Pkg.	1½	1½	1½	...
Per 100	\$48.20	\$48.20	\$48.20	...

Ground Clamps

Required when system is not otherwise grounded.

Wiremold System No.	200	500	700	1000
No.	5709	5709	5709	1009
Std. Pkg.	20	20	20	10
Wt. Lbs., Std. Pkg.	¾	¾	¾	¾
Per 100	\$52.30	\$52.30	\$49.30	\$49.30

90° Flat Elbows

For right angle turns on same surface.

Wiremold System No.	200	500	700	1000
No.	211	511	711	1011
Length, without tongue, in.	1¼	2	2	4½
Std. Pkg.	50	100	100	10
Wt. Lbs., Std. Pkg.	2½	14½	15¾	6¼
Per 100	\$32.00	\$27.80	\$30.00	\$99.70



No. 211RH



No. 512 45° Flat Elbow



No. 211LH

Internal Twisted Elbows

For 90° twist with 90° turn. Right hand or left hand, suffix RH or LH to number.

Wiremold System No.	200	500	700	1000
No.	211RH	5711RH	5711RH	1011RH
No.	211LH	5711LH	5711LH	1011LH
Length, base each leg without tongue, in.	2	2½	2½	2½ & 3¼
Std. Pkg.	20	50	50	4
Wt. Lbs., Std. Pkg.	1½	9¼	9¼	2¼
Per 100	\$48.50	\$68.70	\$68.70	\$208.60

45° Flat Elbows

For diagonal turns on same surface.

Wiremold System No.	200	500	700	1000
No.	512	712	712	...
Length, base without tongue, in.	...	7/8	1	...
Std. Pkg.	...	20	20	...
Wt. Lbs., Std. Pkg.	...	1½	1¾	...
Per 100	...	\$44.60	\$49.00	...

Prices slightly higher in nine Western States.

Fittings for Wiremold Surface Wiring Systems

Standard Wiremold Finish

Listed by Underwriters' Laboratories, Inc.



No. 1013
Adjustable Elbow



No. 214
Pull Box



No. 5715
Tee

Adjustable Flat Elbows

For bends 56° to 128°

Wiremold System No.	200	500	700	1000
No.				1013
Length, base each leg without tongue, in.				2 ⁵ / ₈
Std. Pkg.				4
Wt. Lbs., Std. Pkg.				2
Per 100				\$117.60

Pull Boxes

For use on straight runs where pull box is required.

Wiremold System No.	200	500	700	1000
No.	214			
Length, In.	5			
Std. Pkg.	20			
Wt. Lbs., Std. Pkg.	1 ¹ / ₂			
Per 100	\$39.00			

Tees

For branches at right angles

Wiremold System No.	500	700
No.	5715	5715
Length, Width, Depth, in.	3 ³ / ₄ x 1 ³ / ₄ x 7/8	3 ³ / ₄ x 1 ³ / ₄ x 7/8
Std. Pkg.	20	20
Wt. Lbs., Std. Pkg.	5 ¹ / ₄	5 ¹ / ₄
Per 100	\$62.90	\$62.90



No. 217
Internal Elbow



No. 1017
Internal Elbow



No. 5717A
Pull Elbow

Internal Elbows

For surfaces at right angles

Wiremold System No.	200	500	700	1000
No.	217	517	717	1017
Length, base each leg without tongue, in.	3	2 ¹ / ₆	2 ¹ / ₆	4 ¹ / ₄ x 5 ¹ / ₄
Length of tongue, in.	1/2	1/2	1/2	
Std. Pkg.	50	100	100	6
Wt. Lbs., Std. Pkg.	5	18 ¹ / ₂	20 ¹ / ₂	4 ⁵ / ₈
Per 100	\$49.20	\$36.90	\$39.50	\$137.60

Internal Pull Elbows

Wiremold System No.	200	500	700	1000
No.		5717A	5717A	
Length, base each leg without tongue, in.		5 ¹ / ₂	5 ¹ / ₂	
Std. Pkg.		10	10	
Wt. Lbs., Std. Pkg.		4 ⁵ / ₈	4 ⁵ / ₈	
Per 100		\$120.00	\$120.00	

Prices slightly higher in nine Western States.



No. 218
Elbow



No. 518
Elbow



No. 718
Elbow

External Elbows

For surfaces at right angles

Wiremold System No.	200	500	700	1000
No.	218	518	718	1018
Length, base, each leg without tongue, in.	7/8	2 ¹ / ₈	2 ¹ / ₈	2 ¹ / ₂
Length, scored tongue		1/2	1/2	
Std. Pkg.	50	100	100	4
Wt. Lbs., Std. Pkg.	2	13 ¹ / ₂	16	1 ⁵ / ₈
Per 100	\$34.20	\$28.60	\$30.20	\$87.70

†Adjustable.

Fittings for Nos. 500 and 700 Series Wiremold



No. 5719 Box



No. 5719D



No. 5721 Box



No. 5725 Base

No.	Description	Std. Pkg.	Wt. Lbs. Std. Pkg.	Per 100
5719	Corner Box, 2 ¹ / ₂ " L, 2 ³ / ₈ " W, 2 ¹ / ₂ " D.....	20	8	\$ 105.90
5719D	Corner Box, 4 ¹ / ₁₆ " L, 2 ¹ / ₂ " W, 1 ¹ / ₄ " D.....	20	7 ³ / ₄	79.60
5721	Utility Box, 3" Diam.....	40	11	87.50
5725	Receptacle Base, 3" Diam. with Fluted Ring 660 watts, 250 V.....	20	7	183.20
5726	Keyless Receptacle, 3" Diam. with Shade Holder Thread 660 Watts, 250 Volts.....	20	7 ³ / ₄	199.80

Interconnection Fittings

To go from 500 fittings to 200 Wiremold, use 289.
 To go from No. 200 Wiremold to all 5700 fittings, except 5732, use 289A.
 To go from 1000 fittings to 500 or 700 Wiremold, use 1089.
 To go from 1500 Pancake Wiremold to 200, 500, or 700 Wiremold, use 1517A.
 To go from No. 1900 Plugmold to 200 Wiremold, use 1942, 1989A, or 1989E.
 To go from 1900 Plugmold to 500 Wiremold, use 1989.
 To go from 2100 Plugmold to 500 or 700 Wiremold, use 2174.

Prices slightly higher in nine Western States.

Fittings for Wiremold Surface Wiring Systems

Standard Wiremold Finish

Listed by Underwriters' Laboratories, Inc.

Fittings for Nos. 500 and 700 Series Wiremold



Plug Receptacle—Bakelite Device
15 Amp., 125 Volt; 10 Amp., 250 Volt

No. 5727 Receptacle

No.	Description	Std. Pkg.	Wt., Lbs. Std. Pkg.	Per 100
5727	Double "T" Slots, 3" Diam.	40	13 1/8	\$199.00



No. 5728B



No. 5731 & No. 5736



No. 5734 Box



No. 5734A Box



No. 5732 Box

No.	Description	Std. Pkg.	Wt., Lbs. Std. Pkg.	Per 100
5728B	S.P. Switch with Box 10A, 125 V., 5A, 250 V.....	10	4 1/2	\$236.00
5731	Blank Cover, 2 3/8" Diam. for Nos. 5732 & 5733.....	50	3 3/4	29.10
5732	Outlet Box, 2 1/2" Diam.....	20	4 1/2	103.50
5733	Outlet Box, 3" Diam. 1 5/16"D....	20	5	100.40
5733G	Outlet Box, 3" Diam. 1 9/32"D....	10	3 1/4	122.30
5734	Blank Extension Box 4 3/4" Diam.....	20	11 1/4	131.80
5734A	Utility Box, 4 3/4" Diam.....	20	12 1/2	128.00
5736	Blank Cover, 4 3/8" Diam. for Nos. 5735, 5737A, 5738A, 5739, 5739A, 1035, 1039....	100	18	37.90

Fittings for 200, 500, 700, 1000 Series Wiremold



No. 228 Box Adjustable



No. 5728 Box Junction Boxes



No. 1028 Box

Wiremold System No....	200	500	700	1000
No.	228	5728	5728	1028
Length, Width, Depth, In.	2 1/2 x 3/4 x 7/8	4 1/4 x 1 5/8 x 1 3/32		4 5/8 x 2 7/8 x 1 3/8
Std. Pkg.	20	20	20	10
Std. Pkg., Wt., Lbs.	2 1/8	6 1/2	6 1/2	7 1/2
Per 100.	\$91.10	\$98.00	\$98.00	\$165.10

Prices slightly higher in nine Western States.

Fittings for 200, 500, 700, 1000 Series Wiremold

5700 series numbers are for either 500 or 700 wiremold.

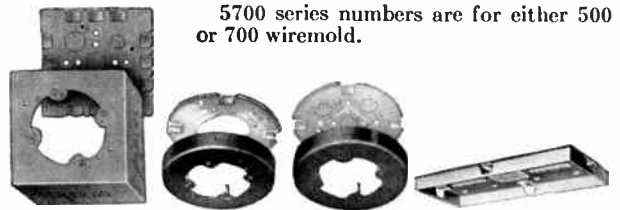

No. 5735 & 1035 Box **No. 5737A Extension Box** **No. 5738A Fixture Box** **No. 5738F Grounding Box**

No.	Description	Std. Pkg.	Wt., Lbs. Std. Pkg.	Per 100
5735	Distribution Box, 4 3/4" L, 1 3/4" W, 1 5/8" D.....	20	15 1/2	\$176.80
1035	Distribution Box, 6 3/8" L, 6 3/8" W, 1 5/8" D.....	6	11 1/4	281.00
5737A	Extension Box, 5 1/2" Diam....	60	41 1/2	143.70
5738A	Fixture Box, 5 1/2" Diam.....	60	45 1/2	121.60
5738F	Grounding Box for Fluorescent Fixtures 8" L, 3 1/8" W, 7/8" D.....	20	9 3/4	77.10
5739	Fixture Box, 6 3/8" Diam.....	40	39 3/4	148.70
1039	Fixture Box, 6 3/8" Diam.....	5	5 1/4	211.50
5739A	Extension Box, 6 3/8" Diam....	40	37 1/2	162.40



No. 240 Switch With Box



No. 242 Utility Box



No. 243 Duplex Receptacle



No. 5743G Duplex Receptacle

240	S.P. Switch with Box.....	40	11	\$202.00
240B	3-Way Switch with Box 10A, 125 V.; 5A, 250 V.....	40	11	214.30
5740	S.P. Switch with Box 10A., 125 V.; 5A., 250 V.....	40	20 3/4	224.00
5740B	3-Way Switch & Box, 10A., 125 V., 5A., 250 V.....	40	20 3/4	242.00
5741	Switch and Receptacle Box...	20	11	130.80
242	Utility Box, 3 1/4" L, 1 5/8" W, 7/8" D.....	20	3 3/4	101.90
243	Duplex Receptacle 15A., 125 V.; 10A., 250 V.....	40	8 1/2	119.40
5743	Duplex Receptacle and Box 15A., 125 V.; 10A., 250 V....	40	20 1/2	178.50
5743G	NEMA Grounded Receptacle 15A., 125 V.....	40	20 1/2	319.40
5744	Extra Deep Switch and Receptacle Box, 1-gang.....	20	18 3/4	207.70
5744S	Deep Switch and Receptacle Box, 1-Gang (Can be furnished up to 12-Gang on special order.).....	20	15 3/4	221.70
5745	Combination Switch and Receptacle Box.....	40	25 3/4	121.80

†5700 series numbers are for either 500 or 700 Wiremold.

Prices slightly higher in nine Western States.

Fittings for Wiremold Surface Wiring Systems

Standard Wiremold Finish
Listed by Underwriters' Laboratories, Inc.

Fittings for 200, 500, 700, 1000 Series Wiremold

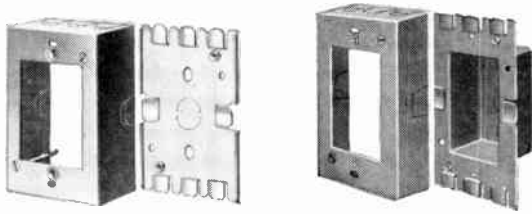

No. 5747 Box

No. 5749 Box

No.	Description	Std. Pkg.	Wt. Lbs. Std. Pkg.	Per 100
5747	Shallow Switch and Receptacle Box, 1-Gang.....	10	22½	\$ 102.50
5748	Switch and Receptacle Box, 1-Gang.....	10	25¾	111.60
1048	Switch and Receptacle Box 1-Gang.....	10	7¾	197.30
5748S	Shallow Receptacle Box.....	10	17¼	93.90
5749	Switch and Receptacle Box... 10	6¼	193.30	

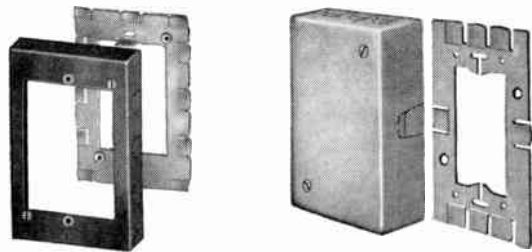

No. 251 Adapter

No. 5760 Box

†No.	Description	Std. Pkg.	Wt. Lbs. Std. Pkg.	Per 100
251	Extension Adapter 4¾" L, 3" W, ½" D.....	20	6¼	\$ 94.40
5751	Flush Type Extension Adapter, 1-gang 1⅝" L, 2⅞" W, 1⅛" D.....	40	15¼	96.00
5752	Same, 2-gang 1¾" L, 4¾" W, 1⅛" D.....	10	5	221.90
5753	Same, 3-gang 1⅝" L, 6½" W, 1⅛" D.....	10	6½	289.70
5760	Blank Extension Box 4⅝" L, 2⅞" W, 1⅛" D.....	10	4½	112.30



No. 5780 Nipple

No. 5781 Connector

No. 5782 Connector

No. 5783 Connector

5780	Special Nipple with ½" Locknut.....	20	1¼	\$ 68.40
5781	Box Connector ½" Male....	100	4¾	34.30
5781A	Box Connector ¾" Male....	20	2⅞	73.90
5782	Conduit Connector ½" Female	50	4¼	41.40
5782A	Conduit Connector ¾" Female	20	2¾	65.70
1082	Conduit Connector 1" Female.	10	4	226.20
5783	Elbow Box Connector ½" Male, 2⅞" L, 1¼" W.....	20	2½	86.40

†5700 series numbers are for either 500 or 700 wiremold.

Prices slightly higher in nine Western States.

Fittings for 200, 500, 700, 1000 Series Wiremold



No. 5784 Coupling

No. 5785 Connector

No. 5786 Connector

No.	Description	Std. Pkg.	Wt. Lbs. Std. Pkg.	Per 100
5784	Elbow Conduit Coupling ½" Female, 2⅞" L, 1¼" W....	10	1¾	\$ 87.60
5785	Combination Connector.....	50	6¼	47.70
5786	Adjustable Offset Connector, 2⅞" L, 1⅞" W, 2¼" D....	20	5	109.10
1086	Adjustable Offset Connector, 3⅞" L, 2⅞" W, 3½" D....	4	2⅞	172.90

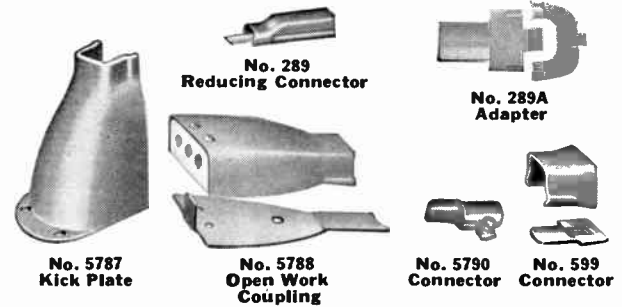

No. 289 Reducing Connector

No. 289A Adapter

No. 5787 Kick Plate

No. 5788 Open Work Coupling

No. 5790 Connector

No. 599 Connector

†No.	Description	Std. Pkg.	Wt. Lbs. Std. Pkg.	Per 100
5787	Kick Plate.....	10	4	\$87.30
1087	Kick Plate.....	10	5½	93.70
5788	Open Work Coupling.....	20	4½	68.50
289	Reducing Connector.....	20	¾	32.50
1089	Reducing Connector.....	20	2¾	39.40
289A	Adapter.....	40	½	5.50
*5790	Armored Cable Connector....	50	2¼	27.10
5790A	Armored Cable Connector....	50	2½	26.20
599	Connector (for metal moulding fittings).....	20	½	27.20

Screws: No. 200 Fittings use No. 6 flat head screws except No. 205 which requires No. 6 round head screws. No. 500, 700, 1000 Fittings use No. 8 flat head screws except on Nos. 504, 704, 1004 and 1005 which require No. 8 round head.

Fittings for 1500 and 2600 Pancake Wiremold



No. 1500WC Wire Clip

No. 1504 Strap

No. 1502 Bushing

No. 1508T

No.	Description	Std. Pkg.	Wt. Lbs. Std. Pkg.	Per 100
1500WC	Wire Clip.....	200	½	\$ 1.90
1502	Bushing.....	40	¾	8.90
1504	2-Hole Strap.....	50	1	8.00
1508T	B-Station Tubing (for telephone)	200	12½	11.40

Prices slightly higher in nine Western States.

Fittings for Wiremold Surface Wiring Systems

Standard Wiremold Finish

Listed by Underwriters' Laboratories, Inc.

Fittings for 1500 and 2600 Pancake Wiremold

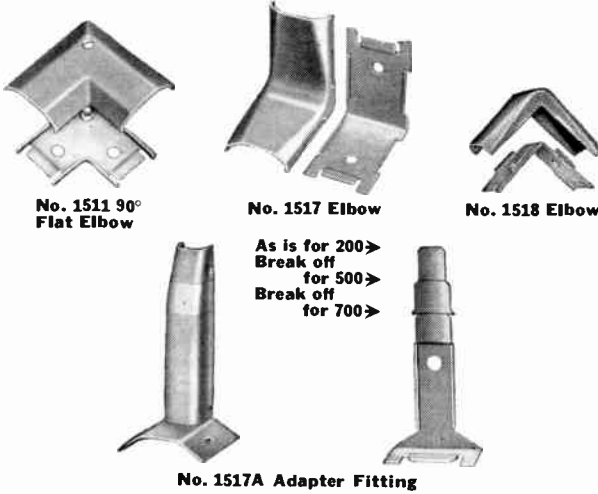

Flat Elbows		1500	2600
Wiremold System No.		1511	2611
No.		1511	2611
Length, each leg, In.		2 ⁵ / ₈	2 ⁵ / ₈
Std. Pkg.		20	5
Wt. Lbs. Std. Pkg.		3 ¹ / ₄	2 ¹ / ₈
Per 100		\$49.10	\$122.90

Internal Elbows		1500	2600
Wiremold System No.		1517	2617T
No.		1517	2617T
Length of legs, In.		2 ¹ / ₂	2 ³ / ₄ & 2 ⁷ / ₃₂
Std. Pkg.		20	20
Wt. Lbs. Std. Pkg.		4	7
Per 100		\$44.20	\$131.50

No.	Description	Std. Pkg.	Wt. Lbs. Std. Pkg.	Per 100
1517A	Adapter Fitting	20	3 ¹ / ₈	\$59.30
1518	External Elbow. Each leg 2 ¹ / ₂ -in. long	20	4 ³ / ₄	49.00



Telephone Outlets		1500	2600
Wiremold System No.		1524	2642H
No.		1524	2642H
Diameter, In.		4	5
Height overall, In.		3 ²⁹ / ₃₂	4
Std. Pkg.		20	8
Wt. Lbs., Std. Pkg.		11 ¹ / ₂	6
Per 100		\$150.90	\$204.30

No.	Description	Std. Pkg.	Wt. Lbs. Std. Pkg.	Per 100
1524A	Narrow Telephone Outlet 3 ¹ / ₄ -in. L. 1 ²¹ / ₃₂ -in. W. 3 ⁵ / ₈ -in. H.	20	6 ³ / ₄	\$123.90
1528	Utility Box. 3 ¹ / ₄ -in. L. 1 ²¹ / ₃₂ -in. W. 5/8-in. D.	10	2	79.10

Prices slightly higher in nine Western States.

Fittings for 1500 and 2600 Series Wiremold



No.	Description	Std. Pkg.	Wt. Lbs. Std. Pkg.	Per 100
1542A	Narrow Junction Box, 1/2-in. female bushing. 3 ¹ / ₄ -in. L., 1 ²¹ / ₃₂ -in. W., 1 ³ / ₁₆ -in. H.	20	4 ¹ / ₂	\$102.50
1542B	Base for Floor Receptacle, 3/4-in. Female Bushing 4 ³ / ₁₆ -in. Dia. 1 ¹⁵ / ₃₂ -in. H.	10	7 ³ / ₄	290.00



Junction Boxes		1500	2600
Wiremold System No.		1542D	2642D
No.		1542D	2642D
Diameter, In.		4	5
Height, In.		2 ³ / ₃₂	1
Std. Pkg.		20	10
Wt. Lbs., Std. Pkg.		7	6
Per 100		\$87.90	\$154.60

No.	Description	Std. Pkg.	Wt. Lbs. Std. Pkg.	Per 100
1542G	Narrow Junction Box (for telephone), 3 ¹ / ₄ -in. L., 1 ²¹ / ₃₂ -in. W., 1 ¹¹ / ₁₆ -in. H.	20	4 ¹ / ₄	\$115.10

Duplex Receptacles		Plug 1543L	Polarized 3-Wire 1543AL	NEMA Grounded 1543GL
Rating	15A, 125V; 10A, 250V	15A, 125V; 10A, 250V	15A, 125V	15A, 125V
Dimen. In.	5 ¹ / ₁₆ L. 3 ¹ / ₁₆ W. 1 ⁵ / ₁₆ H.	5 ¹ / ₁₆ L. 3 ¹ / ₁₆ W. 1 ⁵ / ₁₆ H.	5 ¹ / ₁₆ L. 3 ¹ / ₁₆ W. 1 ⁵ / ₁₆ H.	5 ¹ / ₁₆ L. 3 ¹ / ₁₆ W. 1 ⁵ / ₁₆ H.
Std. Pkg.	20	10	20	20
Wt. Lbs., Std. Pkg.	15 ³ / ₄	8 ³ / ₄	16	16
Per 100	\$197.20	\$542.40	\$280.30	\$280.30

Prices slightly higher in nine Western States.

Fittings for Wiremold Surface Wiring Systems

Standard Wiremold Finish

Listed by Underwriters' Laboratories, Inc.

Fittings for 1500 and 2600 Series Wiremold



No. 1599

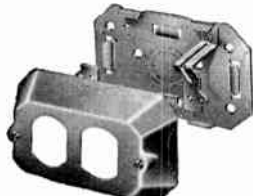

No. 1546B



No. 1546T



No. 1585 Combination Connector

No.	Description	Std. Pkg.	Wt., Lbs. Std. Pkg.	Per 100
1546A	Single Receptacle Box, 5 1/16-in. L. 3 1/16-in. W., 1 3/16 in. D.	10	6 1/2	\$147.60
1546B	Duplex Receptacle Box 5 1/16-in. L. 3 1/16-in. W. 1 3/16 in. D.	20	13	129.20
1546T	Telephone Outlet Box, 5 1/16-in. L. 3 1/16-in. W., 1 3/16 in. D.	10	7 1/2	204.10
1582T	B - Station Tubing Connector (for telephone)	200	23	48.70
1585	Combination Connector, 3 1/4-in. L. 1 1/2-in. W. 1 3/4-in. D.	20	4 1/2	50.40

Connectors (to Florduct)

Wiremold System No.	1500	2600
No.	1599	2699
Std. Pkg.	10	10
Wt. Lbs., Std. Pkg.	1 1/2	2 1/2
Per 100	\$40.00	\$30.60

Fittings for 1900, 2100, and 3000 Series Wiremold



No. 2000WC



No. 1901 Coupling

Wire Clips

Wiremold System No.	1900	2000	2100	3000
No.	2000WC	2100WC	2100WC	3000WC
Std. Pkg.	200	200	200	40
Wt. Lbs., Std. Pkg.	3/4	23/8	3	
Per 1000	\$3.00	\$5.50	\$11.10	

Couplings

Wiremold System No.	1900	2000	2100	3000
No.	1901	2001	2101	3001
Std. Pkg.	50	50	20	20
Wt. Lbs., Std. Pkg.	3/4	1	1	2 1/2
Per 100	\$5.60	\$6.30	\$8.20	\$28.70

Prices slightly higher in nine Western States.

Fittings for 1900, 2100, and 3000 Series Wiremold



No. 2101A Rigid Coupling



No. 1902



No. 3003

Rigid Inside Couplings

Wiremold System No.	1900	2000	2100	3000
No.	2101A	2101A	3101A	3101A
Std. Pkg.	20	20	10	10
Wt. Lbs., Std. Pkg.	3/4	3/4	3 1/2	3 1/2
Per 100	\$19.60	\$19.60	\$42.90	\$42.90

No.	Description	Std. Pkg.	Wt., Lbs. Std. Pkg.	Per 100
1902	Bushing	200	1 1/2	\$ 3.50
3003	Supporting Clip	50	2 1/2	26.60



No. 2106 Cover Clip



No. 2108A Hanger Clamp



No. 2108D Fixture Hook

Cover Clips

Wiremold System No.	1900	2000	2100	3000
No.	2106	2106	3006	3006
Std. Pkg.	100	100	10	10
Wt. Lbs., Std. Pkg.	7/8	7/8	1 1/2	1 1/2
Per 100	\$6.10	\$6.10	\$7.40	\$7.40

Hanger Clamps

Wiremold System No.	1900	2000	2100	3000
No.	2108A	2108A	3008A	3008A
Std. Pkg.	20	20	10	10
Wt. Lbs., Std. Pkg.	1 1/2	1 1/2	2	2
Per 100	\$37.90	\$37.90	\$76.20	\$76.20

Fixture Hooks

Wiremold System No.	1900	2000	2100	3000
No.	2108D	2108D	3008D	3008D
Std. Pkg.	20	20	20	20
Wt. Lbs., Std. Pkg.	1 1/4	1 1/4	1 3/4	1 3/4
Per 100	\$38.60	\$38.60	\$53.40	\$53.40



No. 3008F Hanger



No. 3008M Hanger



No. 2009

No.	Description	Std. Pkg.	Wt., Lbs. Std. Pkg.	Per 100
3008F	Adj. Ratchet Hanger, tapped for 1/2-in. conduit...	4	3 3/4	\$331.50
3008M	Messenger Cable Hanger, 1 3/4-in. long. For 3/8-in. cable...	10	1 1/2	115.10
2009	Ground Clamp...	10	1/2	22.50

Prices slightly higher in nine Western States.

Fittings For Wiremold Wiring Systems

Standard Wiremold Finish

Listed by Underwriters' Laboratories, Inc.

Fittings for 1900, 2100 and 3000 Series Wiremold



No. 1910A
End Fitting



No. 1910B
End Fitting

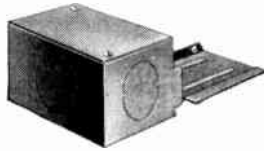

No. 3010C
End Fitting

End Connectors (to 1/2-in. Conduit)

Wiremold System No.	1900	2000	2100	3000
No.	1910A	2010A	2110A	3010A 3010C*
Std. Pkg.	20	10	20	20 5
Wt. Lbs., Std. Pkg.	4	1 3/4	3	6 2
Per 100	\$60.60	\$50.60	\$44.20	\$90.50 \$150.50

*To 1-in. Conduit.

Blank End Fittings

Wiremold System No.	1900	2000	2100	3000
No.	1910B	2010B	2110B	3010B
Std. Pkg.	20	20	20	20
Wt. Lbs., Std. Pkg.	3 8	1/2	3/4	2
Per 100	\$12.40	\$13.60	\$18.60	\$31.50



No. 1911



No. 1914A



No. 1914C



No. 2014E

Flat Elbows

Wiremold System No.	1900	2000	2100	3000
No.	1911	2011	2111	3011
Length of Legs, Base	3 1/4-in.	2 1/2-in.-2 9/16-in.	2 7/16-in.	5 3/8-in.
Length of Legs, Cover	2-in.
Std. Pkg.	10	10	20	5
Wt. Lbs., Std. Pkg.	1 7/8	2	4 1/4	4 1/2
Per 100	\$83.60	\$64.10	\$66.70	\$195.30

No.	Description	Std. Pkg.	Wt. Lbs. Std. Pkg.	Per 100
2014	Splice Cover, 6-in. long.	5	3/4	\$24.70
1914A	Connector Fitting, 6-in. long. Cover 7-in. long.	20	5 3/4	113.30
1914C	Wall Box Connector, 6-in. long. Cover 7-in. long.	8	3 1/4	95.70
2014E	Combination End Fitting and Splice Cover, 6-in. long.	10	1 1/4	62.80

Prices slightly higher in nine Western States.

Fittings for 1900, 2100, 3000 Series Wiremold



No. 1915



No. 1917



No. 2017TC



No. 1918

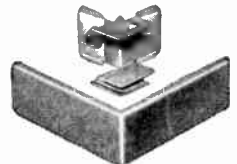

No. 2118A

Tees

Wiremold System No.	1900	2000	2100	3000
No.	1915	2015	2115	3015
Length	Base 6-in.	6-in.	4-in.	10 1/4-in.

Cover 7-in.

Width	2 3/4-in.
Std. Pkg.	30	10	4	5
Wt. Lbs., Std. Pkg.	6	3 1/4	1 1/4	8 1/2
Per 100	\$83.90	\$95.90	\$120.10	\$343.10

Internal Elbows

Wiremold System No.	1900	2000	2100	3000
No.	1917	2017
Length of Legs, Base	2 1/8, 3 3/16-in.	2-in.
Length of Legs, Cover	1-in.	7/8-in.
Std. Pkg.	20	20
Wt. Lbs., Std. Pkg.	3	4 1/4
Per 100	\$79.20	\$72.70

Corner Couplings

Wiremold System No.	1900	2000	2100	3000
No.	2017TC	2117TC	3017TC
Std. Pkg.	20	20	4
Wt. Lbs., Std. Pkg.	1 1/2	3 1/4	2
Per 100	\$16.30	\$68.20	\$89.00

External Elbows

Wiremold System No.	1900	2000	2100	3000
No.	1918	2018
Length of Legs, Base	2 1/8, 3 1/4-in.	1 5/8-in.
Length of Legs, Cover	1 1/2-in.	1 3/8-in.
Std. Pkg.	10	10
Wt. Lbs., Std. Pkg.	1 3/4	2 1/4
Per 100	\$84.60	\$68.20

External Corner Couplings

Wiremold System No.	1900	2000	2100	3000
No.	2118A	3018A
Length of Legs, Base	1 1/4-in.	1 3/8, 1 3/4-in.
Length of Legs, Cover	3-in.	4-in.
Std. Pkg.	20	4
Wt. Lbs., Std. Pkg.	5	3
Per 100	\$91.20	\$134.20

Prices slightly higher in nine Western States.

Fittings for Wiremold Surface Wiring Systems

Standard Wiremold Finish

Listed by Underwriters' Laboratories, Inc.

Fittings for 1900, 2100, 3000 Series Wiremold



No. 2018C



No. 3020



No. 2127



No. 3020S



No. 2121 Telephone Outlet



No. 1927 Receptacle



No. 3020A



No. 2126 Keyless Socket

No.	Description	Std. Pkg.	Wt., Lbs. Std. Pkg.	Per 100
2018C	External Elbow Cover. Each leg 1 7/8-in. long....	10	1	\$ 27.40
3020	Lampholder Clamp, 2 1/16-in. long.....	20	2 3/4	55.90
3020A	Lampholder and Starter Base Clamp, 2 1/16-in. long	20	2 1/2	58.40
3020S	Lampholder Clamp (Slim-line), 2 1/16-in. long.....	20	2 3/4	58.40
2121	Telephone Outlet 3-in. long.	20	1 1/2	43.90
2126	Keyless Socket, 660W, 250V 3 3/8-in. L. - 1 1/4-in. D....	20	7	151.30

Plug Receptacles (15A, 125V; 10A, 250V)

Wiremold System No.	1900	2000	2100	3000
No.....	1927	1927V	2127	2127V
Length.....	1 3/4-in.	..	2 3/16-in.	..
Std. Pkg.....	50	..	40	..
Wt. Lbs., Std. Pkg....	2 3/4	..	3 3/4	..
Per 100.....	\$58.00	\$70.60	\$79.70	\$88.30



No. 2127D Lumiline Receptacle



No. 2127G



No. 2127H

No.	Description	Std. Pkg.	Wt., Lbs. Std. Pkg.	Per 100
2127D	Lumiline Single Rec. 660W, 250V. 1 1/2-in. long.....	20	1 1/4	\$ 97.90
2127G	NEMA Grounded Rec. 15A, 125V. 2 3/16-in. long..	40	4	102.90
2127H	Midget Twistlock Rec. 15A, 125V; 10A, 250V. 3 1/4-in. long.....	20	4	281.50

Prices slightly higher in nine Western States.

Fittings for 1900, 2100, and 3000 Series Wiremold



No. 2127P



No. 2127S

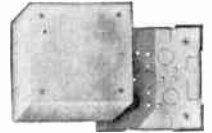

No. 3028



No. 2129 Adapter



No. 1930 Connector Block

No.	Description	Std. Pkg.	Wt., Lbs. Std. Pkg.	Per 100
2127P	3-Wire Polarized Rec. 15A, 125V; 10A, 250V. 2 3/16-in. long.....	20	3	\$302.60
2127S	T-Slot Receptacle 15A, 125V; 10A, 250V. 2 3/16-in. long.....	40	5 1/4	123.70
3028	Utility Box 6 3/8-in. L.-6 3/8-in. W.-1 7/8-in. D.....	6	11 1/2	463.40
2129	Adapter (Condulet Type) 6 1/16-in. long.....	10	1	81.70
1930	Connector Block 1 3/8-in. long.....	20	3/4	61.30



No. 2040



No. 2140



No. 1942 Junction Box



No. 2141



No. 2144

Switches

Wiremold System No.	1900	2000	2100	3000
No.....	2040	2140	2140B*	..
Rating.....	10A125V	10A125V	10A125V	..
	5A250V	5A250V	5A250V	..
Length.....	..	4 1/4-in.	4 1/4-in.	..
Std. Pkg.....	10	20	20	..
Wt. Lbs., Std. Pkg.....	2 3/4	5 1/4	5 1/4	..
Per 100.....	\$194.50	\$229.10	\$244.90	..

No.	Description	Std. Pkg.	Wt., Lbs. Std. Pkg.	Per 100
2141	Switch and Receptacle Box 4 5/8-in. L.-2 7/8-in. W. 1 3/8-in. D.....	10	6	\$127.40
1942	Junction Box 3 1/4-in. L. 5/8-in. W.-7/8-in. D.....	20	4	88.60
2144	Extra Deep Switch and Receptacle Box. 4 5/8-in. L. 2 7/8-in. W.-2 3/4-in. D.....	20	18 3/4	194.20

Prices slightly higher in nine Western States.

Fittings for Wiremold Surface Wiring Systems

Standard Wiremold Finish

Listed by Underwriters' Laboratories, Inc.

Fittings for 1900, 2100, 3000 Series Wiremold

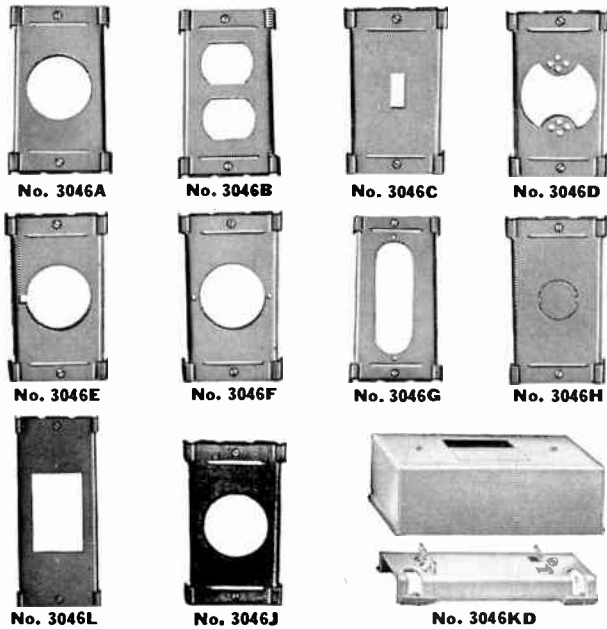

No.	Description	Std. Pkg.	Wt., Lbs. Std. Pkg.	Per 100
3046A	Single Receptacle Cover 4 5/8-in. long. Dia. of hole: 1 1/2-in.	10	2	\$ 66.70
3046B	Duplex Receptacle Cover 4 5/8-in. long.	10	2	66.70
3046C	Tumbler Switch Cover 4 5/8-in. long.	10	2	66.70
3046D	Surface Device Cover 4 5/8-in. long.	10	2	66.70
3046E	Screw Type Sign Receptacle Cover, 4 5/8-in. long.	10	2	66.70
3046F	Surface Type Sign Receptacle.	10	2	66.70
3046G	Condulet Device Cover 5-in. long.	10	2	66.70
3046H	Fixture and Drop Cord Cover 4 5/8-in. long.	10	2	66.70
3046J	Single Receptacle Cover 4 5/8-in. long. Dia. of hole, 1 1/2-in.	10	2	66.70
3046KD	Circuit Breaker Housing 6-in. long.	4	6	431.60
3046L	Fustat Device Cover 6 1/2-in. long.	10	2 1/4	85.40

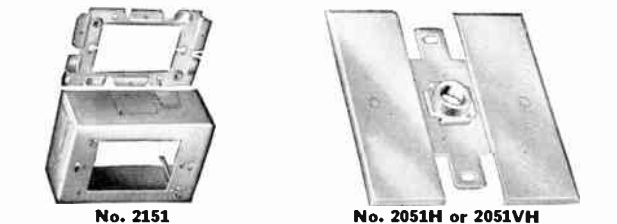

2151	Flush Type Extension Adapter 4 5/8-in. L-2 7/8-in. W. 1 3/8-in. D.	10	5 1/2	\$133.80
2051H	Flush Type Adapter Wiremold Finish.	10	1 1/2	110.40
2051VH	Flush Type Adapter White Finish 4 1/2-in. L.-1 1/2-in. W.	10	1 1/2	117.30

Prices slightly higher in nine Western States.

Fittings for 1900, 2100, and 3000 Series Wiremold

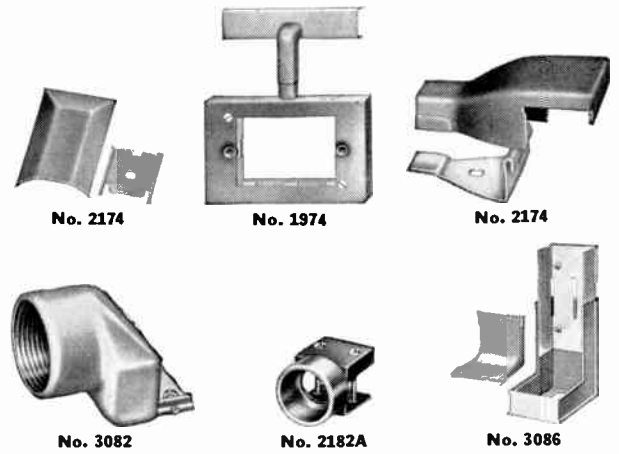

No.	Description	Std. Pkg.	Wt., Lbs. Std. Pkg.	Per 100
2173	Offset Connector 2 1/16-in. L. 3/8-in. D.	10	1	\$ 42.10
1974	Take-Off Connector.	4	1 5/8	160.60
2174	Take-Off Connector 3 3/8-in. L. 1 3/4-in. W. 1 1/16-in. D.	10	2	73.20
3082	Conduit Connector (for 1/2-in. conduit or armored cable). 2-in. L. 2 1/2-in. H.	10	4	424.50
2182A	End Fitting (3/4-in. Female Bushing). 2-in. long.	20	3 1/2	117.40
3086	Adjustable Offset Connector 5 7/16-in. H. without coupling; 3 3/16-in. D.	5	6 1/4	392.20



Reducing Connectors (to 500)

Wiremold System No.	1900	2000	2100	3000
No.	1989	2089
Std. Pkg.	5	5
Wt. Lbs., Std. Pkg.	1 1/4	1 3/4
Per 100	\$90.90	\$92.20

Reducing Connectors (to 200)

Wiremold System No.	1900	2000	2100	3000
No.	1989A	2089A
Std. Pkg.	5	5
Wt. Lbs., Std. Pkg.	1 1/4	1 3/4
Per 100	\$87.00	\$92.70

Reducing Connectors

Wiremold System No.	1900	2000	2100	3000
No.	1989E	2089E	..	3089E
Std. Pkg.	20	20	..	10
Wt. Lbs., Std. Pkg.	3 3/8	1 1/2	..	2 3/4
Per 100	\$23.10	\$15.50	..	\$79.90

1989E—1900 to 200; 2089E—2000 to 500; 3089E—3000 to 2100



No. 21211 & 21212

No.	Description	Std. Pkg.	Wt., Lbs. Std. Pkg.	Per 100
21211	Cover for 12-in. lumiline lamp	10	1 3/8	\$20.30
21212	Cover for 18-in. lumiline lamp	10	2 1/4	42.40

Prices slightly higher in nine Western States.

Wiremold Fluorescent Units

Listed by Underwriters' Laboratories, Inc.

Slimline Units

**Wired and Assembled, with Lampholders
Ballast and Lamp Not Included**

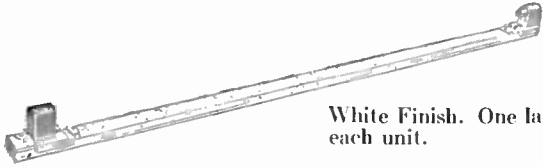

White Finish. One lamp each unit.

No.	Overall Lgth. In.	Lamp Size	Unit Quantity	Std. Pkg.	Wt., Lbs. Std. Pkg.	Each
21SW48	49 1/2	48T12	1	6	22 1/2	59.80
21SW72	73 1/2	72T8 or 72T12	1	6	31 1/2	11.00
21SW96	97 1/2	96T8 or 96T12	1	6	41 1/2	12.20

Catalog numbers without letter X designate units equipped with one No. 2110A End Connector and one No. 2110B Blank End Fitting.

Catalog numbers with letter X designate units without end fittings but equipped with one 2101A Coupling for extension use.

Fluorescent Showcase Units

**For One to Five 15-Watt Fluorescent Lamps
★110-125 Volts, 60 Cycle, Low Power Factor**



No. 21AR-13

Pearl Gray Finish. Reflecting Surface, White. Unit quantity, 1.

No.	Description	Over-all Lgth. In.	Std. Pkg.	Wt., Lbs. Std. Pkg.	Each
21AR-10	FS-2 starter. 3" leads in No. 2110A at end. For one 15-watt T-8 lamp†.	21 1/2	10	29 1/4	\$12.50
21AR-11	FS-2 starters. 3" leads in No. 2110A at end. For two 15-watt T-8 lamps†.	41 1/2	10	55	23.60
21AR-13	FS-2 starters. 3" leads in No. 2110A at end. For three 15-watt T-8 lamps†.	61 1/2	3	25 1/4	34.70
21AR-14	FS-2 starters. 3" leads in No. 2110A at end. For four 15-watt T-8 lamps†.	81 1/2	3	34 1/4	46.20
21AR-15	FS-2 starters. 3" leads in No. 2110A at end. For five 15-watt T-8 lamps†.	101 1/2	3	42 1/2	55.90

Two mounting clips furnished with 21AR-10 and 21AR-11; three with 21AR-13 and 21AR-14; four with 21AR-15.

†Lamps not included.

★Also available for 110-125V, 50 cycle. Prices on application.

Prices slightly higher in nine Western States.

Fluorescent Units

**For One to Five 15-Watt Fluorescent Lamps
★110-125 Volts, 60 Cycle, Low Power Factor**



No. 21A-11

White Finish.

No.	Description	Over-all Lgth. In.	Unit Quantity	Std. Pkg.	Wt., Lbs. Std. Pkg.	Each
21A-6	Combination push-button switch and starter. 6' cord and plug in 1/8" fiber bushing in No. 2110B Special. For one 15-watt T-8 lamp†.	21	1	10	24	\$10.60
21A-9	FS-2 starter. 6' cord and plug in 1/8" fiber bushing in No. 2110B Special. For one 15-watt T-8 lamp†.	20	1	10	23 3/4	10.00
21A-10	FS-2 starter. 3" leads in No. 2110A at end. For one 15-watt T-8 lamp†.	21 1/2	1	10	23 1/2	9.70
21A-11	FS-2 starters. 3" leads in No. 2110A at end. For two 15-watt T-8 lamps†.	41 1/2	1	10	45 1/4	19.40
21A-13	FS-2 starters. 3" leads in No. 2110A at end. For three 15-watt T-8 lamps†.	61 1/2	1	5	31 1/4	28.60
21A-14	FS-2 starters. 3" leads in No. 2110A at end. For four 15-watt T-8 lamps†.	81 1/4	1	3	26 1/2	37.60
21A-15	FS-2 starters. 3" leads in No. 2110A at end. For five 15-watt T-8 lamps†.	101 1/2	1	3	33 1/4	47.10

Two mounting clips furnished with 21A-6, 21A-9, 21A-10, 21A-11; three with 21A-13 and 21A-14; four with 21A-15.

Aluminum Continuous Reflectors

White Finish

No.	Description	Over-all Lgth. In.	Unit Quantity	Std. Pkg.	Wt., Lbs. Std. Pkg.	Per 100
21A-91	1 Lamp Reflector	..	5	10	6	\$202.50
21A-91A	1 Lamp Reflector for 21A-6	..	5	10	6	202.50
21A-90L	Reflector End Cap (left)	..	5	20	1/2	55.50
21A-90R	Reflector End Cap (right)	..	5	20	1/2	55.50

Prices slightly higher in nine Western States.

Call Graybar FIRST For . . .



Wiremold Accessories

Bender



No. 600

For 200, 500, and 700 Wiremold. Use 1/2" pipe for stand. Pipe is not furnished. 1 in a standard package.

Standard package weight, 2 1/2 lbs.

No. 600.....each \$7.00

Miter Box



No. 610

Made for handling the unusual job. Adjustable at many angles for cutting raceways. Ideal for mitering elbows.

1 in a standard package.

Standard package weight, 3 3/4 pounds.

No. 610.....each \$11.10

Miter Box Guide Fingers

For replacement of worn guide fingers on No. 610 Miter Box.

No. 611.....Per 100 \$92.40

Hacksaw Blades



No.	Description	Std. Pkg.	List Per 100
614	Low Carbon Steel.....	100	\$39.70
614A	Shatterproof, high-speed steel 12-in. long. 40 teeth per in.....	100	\$133.90

Wire Pulley



No. 615

For guiding wires directly into end of 500 or 700 Wiremold. 1 in a standard package.

Standard package weight, 1/4 pound.

No. 615.....each \$3.50

Snake Leader



6-in. long. For snaking conductors through 500, 700, and 1000 wiremold.

No.	Description	Std. Pkg.	List Per 100
616	Snake Leader	100	\$17.90

Wiremold Accessories

Canopy Cutter



No. 657

For cutting fluorescent fixture canopies to take 500 or 700 Wiremold. Assures a perfectly fitted job. Specially hardened steel die and punch will give long service.

1 in a standard package. Standard package weight, 4 pounds.

No. 657.....each \$43.20

Wiremold Enamel

For occasional jobs where it is advisable to retouch tool marks and other minor abrasions. Furnished in pint cans.

1 can in a standard package. Standard package weight, 1 1/4 pounds.

No. WE.....Per 100 \$155.40

National Electric Metal Molding Fittings

For Xtensionduct and Metal Molding

Listed by Underwriters' Laboratories, Inc.

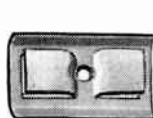

No. 344-X



No. 344



No. 345

No.	Description	Unit Pkg.	Std. Pkg.	Wt., Lbs. Std. Pkg.	Unit Pkg. Per 100
344-X	Coupling.....	50	200	4	\$2.30
345	Single strap.....	50	500	6	2.75
434	Single Strap, with Base, base plate type.	50	500	11	4.15



No. 322



No. 423



No. 422-X



No. 303



No. 412

322-X	Bending Tool for No. 333 metal molding.....	1	1	*2 1/2	\$13.29
422-X	Molding Shear.....	1	1	10	†
423	Cutting and Notching Gage.....	1	1	1/2	2.75
303	Adapter, to take metal molding into Wiremold boxes and devices.....	10	100	4
412	Connector. for 1 1/2, 12/2 and 10/2 Ovalflex to metal molding devices..	10	100	5 1/2	17.50

*Price each. *Ounces. †Available on loan basis.

Quantity prices on request.

National Electric "La-In" Metal Molding

Listed by Underwriters' Laboratories, Inc.



No. 333

Neutral gray finish, base and capping, are formed to snap together, capping snaps over base. Wires laid-in, not fished. 1 inch wide, 1/16 inch high, 8 feet 4 inches long. 3 fibre wire retaining clips with each length.

Capacity

Single Conductor					
Wire No.....	6	8	10	12	14
Type R or RH.....	2	2	3	6	7
Type T, TW and RU.	2	3	6	8	9

Annunciator..... 25 Twisted Pair... 8
Telephone: Cable..... Up to 1 1/2" Diam.

Packed 12 lengths, 8 feet 4 inches long; 100 feet in unit package; 1000 feet in standard package. Standard package weight, 110 pounds.

No. 333..... Per 100 Feet **\$15.75**

"La-In" Metal Molding Fittings



No. 319

No. 325

No. 335

No.	Description	Unit Pkg.	Std. Pkg.	Wt. Lbs. Std. Pkg.	Unit Pkg. Per 100
319	Take-off Tee for branch molding runs.....	5	50	8	\$39.10
325	Combination Twist Elbow or Tee.....	5	100	16	44.30
335	90° Flat Tee.....	5	50	8	39.10

No. 380 Twist Ell—R or L



Unit Pkg. — 1
Std. Pkg. — 20

No. 380R or L..... Per 100 **\$71.30**



No. 336

No. 337

No. 337-B

336	90° Flat Elbow.....	10	100	9	\$19.30
337	90° External Elbow....	10	100	9	19.45
337B	Cap for No. 337.....	30	120	6	14.95



No. 338

No. 338-B

No. 437

338	90° Internal Elbow....	10	100	8	\$25.40
338B	Cap for Internal Elbow No. 338.....	30	120	5	19.55
437	45° Flat Elbow.....	5	100	8	31.00

Quantity prices on request.

National Electric "La-In" Metal Molding Fittings

Listed by Underwriters' Laboratories, Inc.



No. 315

No. 316

No. 317

No.	Description	Unit Pkg.	Std. Pkg.	Wt. Lbs. Std. Pkg.	Unit Pkg. Per 100
315	1/2-inch Conduit to molding devices adapter.....	5	50	9	\$41.85
316	90° 1/2-inch Coupling molding to Conduit....	5	100	24 1/2	55.20
317	90° 1/2-inch Angle Box Connector.....	5	100	16 1/2	55.20

National Electric "La-In" Xtensionduct



No. 111

For extension wiring from existing convenience outlet. 2-piece, base and capping. Neutral gray finish. Wires laid-in, capping snaps on.

Capacity

Single Conductor					
Wire No.....	6	8	10	12	14
Type R or RH.....	2	3
Type T or TW and RU.	3	3

Annunciator..... 10

Telephone: Twisted Pair..... 4

Furnished in 5-foot lengths. 100 feet in unit package. 1000 feet in standard package. Weight per 100 feet, 16 pounds.

No. 111..... Per 100 Feet **\$12.10**

National Electric "La-In" Xtensionduct Fittings

Additional Interconnectable Fittings listed under 333 and 888 metal molding.



No. 100

No. 113

No. 122

No.	Description	Unit Pkg.	Std. Pkg.	Wt. Lbs. Std. Pkg.	Unit Pkg. Per 100
100	Low Potential Fibre Bushing. For covering bell or signal wire where Xtensionduct is used without fittings.....	10	100	1/2	\$ 3.10
113	Adapter, Xtensionduct to 333 molding fittings.....	10	100	2	18.40
122	Cutting and Notching Gage. Xtensionduct only.....	1	1	1 1/4	2.50*



No. 136

No. 137 90°

No. 138 90°

136	Flat Elbow.....	5	50	2	\$20.70
137	90° External Elbow Cap. For use at outside corners.....	5	50	1 1/2	20.95
138	90° Internal Elbow Cap. For use at inside corners.....	5	50	1	27.30

*Each.

Quantity prices on request.

National Electric "La-In" Xtensionduct Fittings

Listed by Underwriters' Laboratories, Inc.

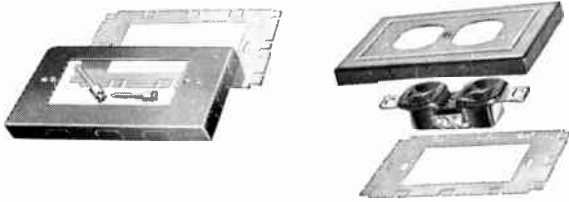

No.	Description	Unit Pkg.	Std. Pkg.	Wt., Lbs. Std. Pkg.	Unit Pkg. Per 100
139	Box Extension Adapter. To accommodate extensions from outlets requiring other than standard convenience receptacles. This fitting may be used with any standard wiring device including P & S Despard Line...	5	50	15 1/2	\$60.80
141	Box Extension Device. To accommodate extensions from existing outlets. Includes Plate and T-Slot receptacle.	1	20	5	92.40



144	Coupling, for connecting Base Sections.	10	50	1	\$ 1.95
176	Baseboard Offset Elbow. For runs from face to top of baseboard.	5	50	1 1/2	41.40

National Electric "La-In" Metal Molding



For main runs branching into 333 molding or 111 Xtensionduct. Neutral gray finish. 2-pieces, base and capping. Capping snaps over base. Wire laid-in—not fished. 3 wire retaining clips furnished with each length.

Capacity

Single Conductor	6	8	10	12	14
Wire No.	6	8	10	12	14
Type R or RH	4	7	9	10	10
Type T or TW and RU	5	10	10	10	10

Annunciator..... 60
 Telephone:
 Twisted Pair..... 12
 Cable, up to two.... 26 pair
 Packed 12 lengths, 8 feet 4 inches long, 100 feet in sealed corrugated container. Weight per 100 feet, 79 pounds.
 No. 888.....Per 100 Feet \$27.10

National Electric "La-In" Metal Molding Fittings



No.	Description	Unit Pkg.	Std. Pkg.	Wt., Lbs. Std. Pkg.	Unit Pkg. Per 100
841	Wire retaining clip, 3 clips furnished free with each length of No. 888.				
854	Coupling	10	100	3	
836	90° Flat Elbow	10	50	17 1/2	

Quantity prices on request.

National Electric "La-In" Metal Molding Fittings

Listed by Underwriters' Laboratories, Inc.

Unit Pkg. 1 — Std. Pkg. 10.



No.	Description	Wt. Lbs. Std. Pkg.	Each
837	90° External Elbow	5	\$88.70
838	90° Internal Elbow	4	88.55
826	6 1/2-in. Canopy Base Plate and Cover. Two pairs 8-32 tapped holes on 2 3/4-in. centers, and one pair on 3 1/2-in. centers. Has 6 double twist outs for 333 and 888. Five 1/2-in. KO's in base.	25	136.40

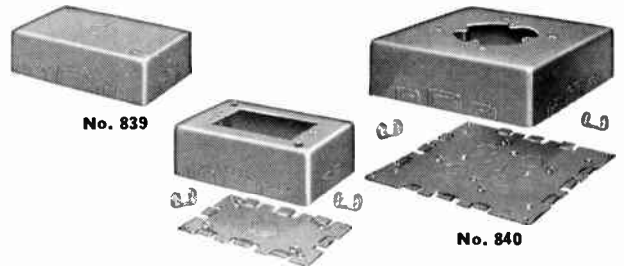

No. 839-S

839	Utility Box 4 7/8-in. x 3 1/8-in. x 1 3/8-in. deep. Twistouts for 111, 333 and 888. Top, combination 1/2-in. conduit KO, and drop cord eyelet. Base, combination 1/2 and 1-in. conduit KO.	7 1/2	106.40
839-S	One Gang Surface Switch and Receptacle Box, 4 7/8-in. x 3 1/8-in. x 1 3/4-in. deep. Same twist outs and KO's as No. 839, except top.	7 1/2	125.95
840	Distribution Box, 6 3/8-in. x 6 3/8-in. x 1 3/4-in. deep. Twist outs for 111 and 333 and 888. Cover top has 2 pair 8-32 tapped holes 2 3/4-in. centers, 1 pair 3 1/2-in. centers. Base, five 1/2-in. conduit KO's.	20	209.60

No. 880 Twist Ell—R or L



Unit Pkg. — 1
 Std. Pkg. — 20
 Wt. Lbs. Std. Pkg. — 8

No. 880R or L.....Per 100 \$134.55

Combination Fittings

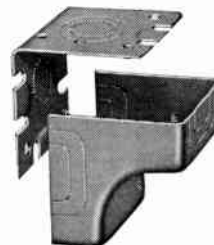

Double twistouts for Nos. 888 and 333 metal molding at each side and one at each end; 1/2-inch knockout in one arm of base and combination 1/2-inch and 1-inch knockout in other arm.

Unit package, 1.
 Standard package, 20.
 Weight per standard package, 9 1/2 pounds.

No. 876.....per 100 \$86.00

Quantity prices on request.

National Electric "La-In" Metal Molding Fittings

For Xtensionduct and Metal Molding

Listed by Underwriters' Laboratories, Inc.



No. 348



No. 348-X

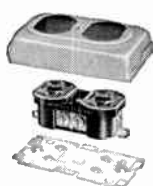

No. 350T&G

No.	Description	Unit Pkg.	Std. Pkg.	Wt., Lbs. Std. Pkg.	Unit Pkg. Per 100
348	Drop Cord Rosette 2½-inch with terminal block. 4 double twist-outs.	5	50	15	\$ 97.75
348-X	Drop Cord Rosette, 3-inch. 4 double twist-outs.	5	50	19	61.60
350-G	Grounding type receptacle 15-amp., 125 volt. 4 twist outs.	1	20	10	184.00
350-T	Duplex Receptacle with T-slots. Steel housing for surface mounting.	1	20	9	119.55



No. 339-X



No. 351



No. 356-X



No. 360

339-X	Blank Cover 2½-inch Combination ½-inch Conduit KO and Drop Cord Eyelet. For use with 342 or 343 boxes.	5	100	7½	\$ 18.75
*351	Single Pole Toggle switch 4 twistouts. Steel housing for surface mounting.	1	20	8½	144.45
356-X	Keyless Receptacle, 3-inch 660 watts, 4 double twistouts.	5	50	22	128.80
360	T-Slot Receptacle, 2½-inch, 660 watts. 2 double twistouts.	5	50	19	113.85

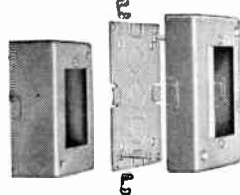

No. 439-D No. 439-X

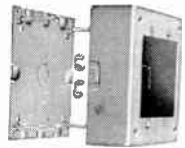

No. 440 No. 440-D

439-D	†1⅜-inches deep.	1	20	14	\$ 69.00
439-X	†1-inch deep.	1	20	7	69.00
440	†1¾-inches deep.	1	10	10	103.50
440-D	†1⅝-inches deep.	1	10	9	115.00

†Single Gang Surface Switch and Receptacle Box, 4⅞ x 3⅞-inches. 4 double twistouts.

‡Two Gang Surface Switch and Receptacle Box, 4⅞ x 5-inches, 8 double twistouts.

*Silent type switch available in 2-3 and 4 way prices on request.

Quantity prices on request.



No. 342



No. 352



No. 361

No.	Description	Unit Pkg.	Std. Pkg.	Wt., Lbs. Std. Pkg.	Unit Pkg. Per 100
342	10 ampere device box, 3-inch diam., 1-inch deep. ½-inch conduit KO in bottom. Two No. 6 32 x ⅞ screws furnished for mounting devices. 1 double twist-outs.	5	50	16	\$64.40
352	Utility Box, Combination ½-inch conduit KO and drop cord eyelet. 4 twistouts.	1	20	6½	65.00
361	Split Canopy Base plate and closed cover, 4¾-inch diam. Combination ½-inch conduit KO and drop cord eyelet. 6 double twist-outs.	5	20	33	86.15



No. 362



No. 365



No. 366

362	★Split Canopy Base Plate and Cover 4¾-in. diam. 6 double twistouts.	5	50	28½	\$ 92.70
365	★Canopy Base Plate and Cover, 4¾-in. diam. Five ½-inch conduit KO's in plate. 6 double twistouts.	5	50	35	82.60
366	★Canopy Base Plate and Cover, 6½-in. diam. 6 double twistouts.	5	20	25	106.30

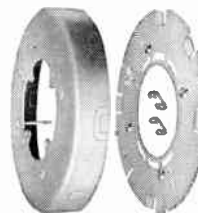

No. 367



No. 376

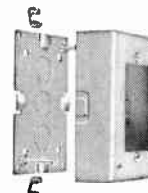

No. 439

367	★Split Canopy Base Plate and Cover, 6½-inch diameter.	5	20	23	\$115.35
376	Corner Box. Double twistouts on each side and one at each end. KO for ½-inch conduit in each arm of base.	5	50	21	76.40
438	One Gang Semi-Flush Switch and Receptacle Box, 4⅞ x 3⅞-inches. Surface Box ¾-inch deep, total depth 2⅝-inches. 4 double twistouts.	1	10	9	125.25
439	†1¾-inches deep.	1	20	13	71.90

†Single Gang Surface Switch and Receptacle Box, 4⅞ x 3⅞-inches. 4 double twistouts.

★2 pairs 8—32 tapped holes on 3¼ and 4-inch centers for standard outlet box covers or devices.

Quantity prices on request.

**National Electric Metal Molding Fittings
For Extensionduct and Metal Molding**

Listed by Underwriters' Laboratories, Inc.

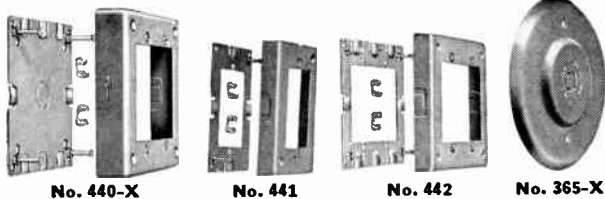

No.	Description	Unit Pkg.	Std. Pkg.	Wt. Lbs. Std. Pkg.	Unit Pkg. Per 100
440-X	1 1/2-inch deep	1	10	8	\$142.00
441	One Gang Switch and Receptacle Box Adapter, 4 7/8 x 3 3/8 x 3/4-inches deep, 1 double twistouts.	1	20	9	61.80
442▲	Two Gang Switch and Receptacle Box Adapter, 4 7/8 x 5 x 3/4-inches deep, 8 double twistouts.	1	10	6 1/2	143.00
365-X	Blank Cover, 4-inch diameter, combination 1/2-inch conduit KO and drop cord eyelet. For use with 362, 365, 365-A, 366, 367.	5	50	10	24.40

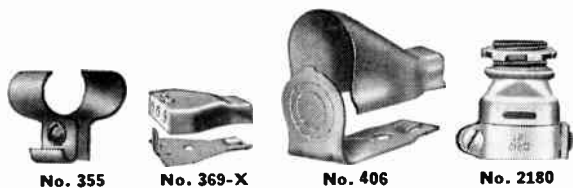

No.	Description	Unit Pkg.	Std. Pkg.	Wt. Lbs. Std. Pkg.	Unit Pkg. Per 100
355	Ground Clamp	5	20	4	\$32.20
369-X	Open Work Coupling	5	20	4	44.15
406	Combination Connector, 1/2-inch conduit KO in end and bottom, furnished with chase nipple and 1/2-inch locknut.	5	50	10 1/2	32.90
2180	Straight Box Connector, molding to 1/2-inch conduit KO, or to 1/2-inch conduit coupling.	10	100	14 1/2	26.05



352-F	Baseboard Junction Box. For branch from top to face of baseboard. Opening for 333 and elbow cap	1	20	7	\$101.00
357	Keyless Receptacle, 2 1/2-inch 600-watt. Slips over molding base, secured by set screw bakelite liner for high wattage lamps. Threaded for Uno shade holder	5	50	18	115.00
323	Joint cap	50	200	4	4.30

▲ Can be furnished up to six-gang.

† Two Gang Surface Switch and Receptacle Box, 4 7/8 x 5-inches, 8 double twistouts.

Quantity prices on request.

National Electric Surfaceduct

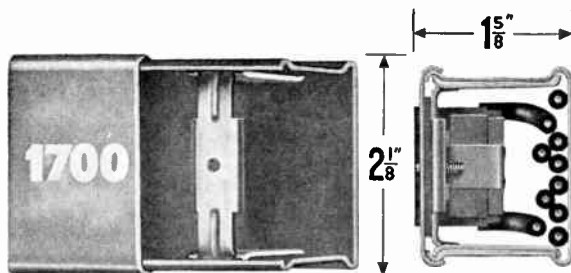

No. 1700

Listed by Underwriters' Laboratories, Inc. Conforms to Federal Specification W-R-32.

Neutral Gray Finish. Two pieces, base and capping. Capping secured in place by bridges, 4 of which are furnished with each length. 1/2- and 3/4-inch knockouts and mounting holes in base.

Capacity

Single Conductor:

Wire No.	6	8	10	12	14
With or Without Devices	10	10	10	10	10

Packed 5 lengths, 10 feet long (50 ft.) in sealed corrugated container. Package weight, 59 pounds.

Per 100 feet \$45.10

National Electric Surfaceduct Fittings

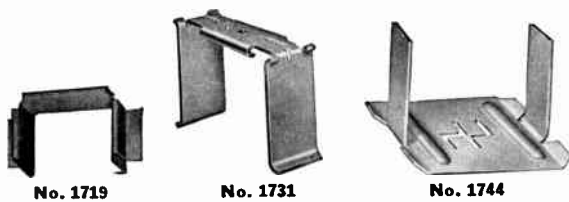

No.	Description	Unit Pkg.	Std. Pkg.	Wt. Lbs. Std. Pkg.	Unit Pkg. Per 100
1719	Bushing. Used on ends of Surfaceduct in 1739 and 1740 Boxes	2	10	1	\$23.00
1731	Bridge. For securing capping, mounting devices, and as a wire retainer. Furnished with surfaceduct and all fittings. Extra bridges should be purchased for short lengths of duct.	10	50	3	6.00
1744	Standard Coupling	5	20	2	9.80



No. 1790



No. 1736

1790	Hanger	2	10	2	\$ 33.35
1736	90° Flat Elbow. Use coupling to connect	1	10	8	115.80

Quantity prices on request.

National Electric Surfaceduct Fittings

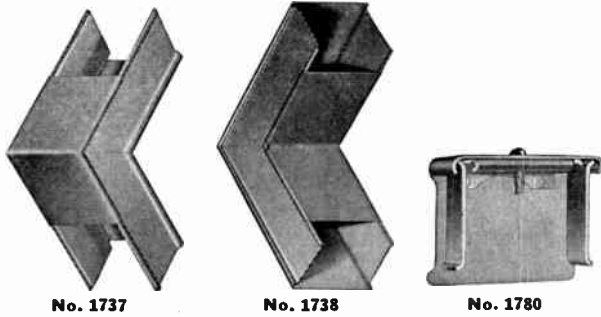

No.	Description	Unit Pkg.	Std. Pkg.	Wt. Lbs., Std. Pkg.	Unit Pkg. Per 100
1737	External Elbow. Use coupling to connect.....	1	10	8	\$116.70
1738	Internal Elbow. Use coupling to connect.....	1	10	6	120.00
1780	End Blank. Can be used with 1728 as an end box.....	2	10	1	46.00



No. 1715

1715	Conduit Adapter, with 1½-inch threaded hub. Takes rigid conduit into 1739 and 1740 Surfaceduct twistouts.....	1	10	10	\$200.00
1735	Combination Tee and Offset Service Fitting. For use as a Tee and as a method of installing devices in an offset position. Takes all device covers.....	1	10	19	190.00



No. 1740



No. 1739

1740	†Device Box 6 inches square, 2¾ inches deep. Two-gang opening in cover for standard 30, 50 and 60 ampere receptacles.....	1	10	23	\$382.55
1739	†Junction Box, 6 inches square, 2¾ inches deep.....	1	10	24	354.30

†Twistouts for 1700 Surfaceduct and 888 and 333 Metal Molding. Also used with E.M.T., Rigid, and Flexible Conduit.

National Electric Surfaceduct Device Covers

Furnished with 2 Bridges and Screws.

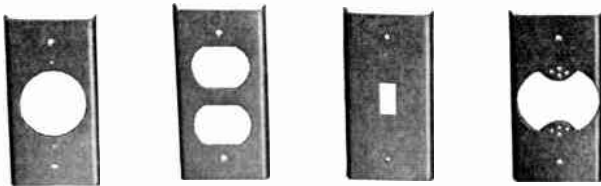

No.	Description	Unit Pkg.	Std. Pkg.	Wt. Lbs., Std. Pkg.	Unit Pkg. Per 100
1701	Single Receptacle Cover.....	1	10	2½	\$40.25
1702	Duplex Receptacle Cover.....	1	10	2½	40.25
1703	Toggle Switch Cover.....	1	10	2½	40.25
1704	Surface Device Cover.....	1	10	2½	40.25

Quantity prices on request.

National Electric Surfaceduct Fittings

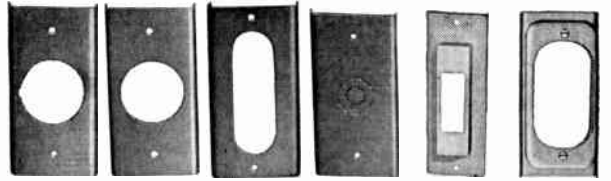

No.	Description	Unit Pkg.	Std. Pkg.	Wt. Lbs., Std. Pkg.	Unit Pkg. Per 100
1705	Sign Receptacle Cover....	1	10	2½	\$ 40.25
1706	Sign Receptacle Cover....	1	10	2½	40.25
1707	Conduit Device Cover. Will take all Obround conduit devices.....	1	10	2	40.25
1708	Fixture and drop cord cover.....	1	10	2½	40.25
1710-CB	For most makes of single pole circuit breakers, 10 to 15 amp.....	1	10	3½	172.50
1710-RS	For Russell & Stoll Ever-Lok devices.....	1	10	2½	57.50

National Electric "Lopo-Trim" Raceways

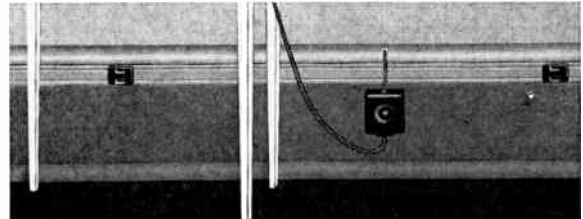

No Fishing—Just Tuck the Wires In.



Finish Trim for "Plug-in" Strip

A hollow steel quarter-round raceway used to carry low potential wires such as telephone, inter-communication and television antenna leads on top of the baseboard. Lopo-Trim has a neutral satin gray finish, matching "Plug-in" Strip, and harmonizes with all tones used in interior decoration. It can be quickly repainted to match baseboard, floor or walls.

Lopo-Trim fits neatly on top of any standard baseboard or on top of National Electric "Plug-in" Strip and held in place by projecting steel prongs. It is easily lifted to provide change of telephone placement or addition of wires. The design and positioning of steel prongs exert a tension that holds the trim snugly in place. No muss or fuss or scarred walls when installing Lopo-Trim for there are no nails, screws or fasteners of any type used. Approved by telephone companies, Lopo-Trim may be installed—

- As a baseboard trim
- As a toe-plate where wall or baseboard meet
- As a low potential wiring raceway at chair-rail moulding
- As a quarter-round trim above or beneath (or both) installations of National Electric "Plug-in" Strip.

Low potential wiring can be brought out of Lopo-Trim anywhere! Merely drill a hole through the rounded surface—insert a standard grommet and bring wires out. The 5-foot 8-inch sections of Lopo-Trim match perfectly for continuous installation. Sections are cut to fit and corners mitered identically like wood quarter-round.

Standard package: 18 lengths, 5 foot 8 inches long. Standard package weight, 20 pounds.
Per length..... \$1.54

Quantity prices on request.

National Electric "Plug-In" Strip Fittings

Center Feed Junction Boxes

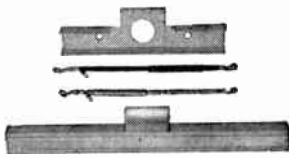

No. CF2-618

For connecting circuit wires to "Plug-in" Strip. Furnished with splicing jumpers ready for crimp-on connection. Has 1/2-in. KO in base. Unit Pkg. 5. Std. Pkg. 20.

No.	Lgth. In.	For Type "Plug-In" Strip	Wt. Lbs. Std. Pkg.	Each
CF2-618	11	CF2, CF2G	10	\$1.05
CF3-618	11	CF3, CF4, CF4G	8	1.16

Device and Outlet Box Cover

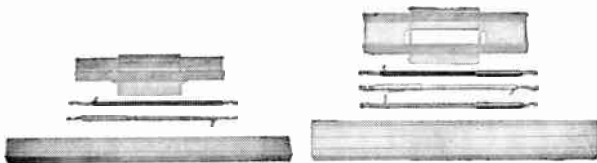

No. CF2-629

No. CF3-629

For use as cover plate on Device and Outlet Box feed installations. Furnished with two splicing jumpers. Unit Pkg.—5. Std. Pkg.—20.

No.	Lgth. In.	For Type	Wt. Lbs. Std. Pkg.	Each
CF2-629	12	CF2, CF2G	10	\$1.05
CF3-629	12	CF3, CF4, CF4G	12	1.62



No. CF2-623

Cutting Gage

For use in cutting "Plug-In" Strip and capping.

No.	Description	Each
CF2-623	For cutting CF2, and CF2G "Plug-in" Strip.....	\$1.76



No. CF3-623

CF3-623 For Cutting CF3, CF4 and CF4G "Plug-in" Strip. \$2.31

Unit Pkg.—1.
Std. Pkg.—1.
St. Std. Pkg. 1 lb.

Crimp Connectors



No. 600-2

Copper barrel connector, crimps into solid conductor mass. Has No. 12 copper conductivity. Allows no corrossions.



No. 600-1

Insulator Tubes

Transparent vinylite. Fits point of connection snugly... remains securely in place.

Elbows



No. CF2-637



No. CF2-638

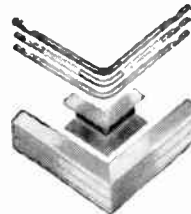

No. CF3-637



No. CF3-638

Two-piece, capping over base. Capping leg of elbow acts as Coupling Cover to adjoining length of "Plug-in" Strip. Furnished with Crimp Connectors and Insulator Tubes.

No.	Description	Unit Pkg.	Std. Pkg.	Wt. Lbs. Std. Pkg.	Each
CF2-637	Exterior Elbow.....	5	20	6 1/2	\$0.81
CF2-638	Interior Elbow.....	5	20	7 1/2	.81
CF3-637	Exterior Elbow.....	5	20	9	1.05
CF3-638	Interior Elbow.....	5	20	10	1.05



No. CF2-644

No. CF2-680



No. CF3-644

No. CF3-680

No.	Description	Unit Pkg.	Std. Pkg.	Wt. Lbs. Std. Pkg.	Each
CF2-644	Coupling Capping covers open end of adjoining lengths of "Plug-in" Strip. Furnished with Crimp Connectors and Insulator Tubes. Overall length, 5 inches.....	5	20	2 1/2	\$0.29
CF3-644	Same, but for CF3, CF4 and CF4G units.....	5	20	3	.31
CF2-680	End Blank and Wire Nuts. Covers cut-back opening at termination of "Plug-in" Strip runs. Furnished with two wire nuts for insulating conductor ends. Overall length, 2 1/2 inches.....	5	20	1 1/4	.23
CF3-680	Same, but for CF3, CF4 and CF4G units.....	5	20	2	.25

National Electric "Plug-In" Strips

Listed by Underwriters' Laboratories, Inc.



No. CF2-606-18
6-Foot Length, With Outlet Every 18 Inches



No. CF2-603-6
33-In. Length, With Five Outlets



No. CF2G-606-6
69-In. Length With 11 Outlets

15 Ampere, 125 Volts; 10 Ampere, 250 Volts

Easiest and simplest method of installing complete outlet adequacy.

All-steel, factory wired with No. 12 AWG conductors multi-outlet assemblies. Available in a wide variety of lengths and outlet spacings. Different types to fit any job.

Baked enamel neutral satin gray blends with any color of interior decoration, or may be repainted to desired shade or color.

Mounting clips and straps included to facilitate either baseboard or surface mounting.

Unit package, 1 length. Standard package — 10 lengths.

No.	Lgth. In.	Plug-Ins Per Lgth.	Wt. Lbs. Std. Pkg.	Per Length
Constant Service Strip				
CF2-603-6	33	5	15	\$3.75
CF2-606-6	69	11	26	6.25
CF2-606-18	72	4	26	4.35
CF2-615	72	Fill-in Strip	23	1.90
With Grounding Receptacles				
CF2G-606-6	69	11	26	7.50
CF2G-606-18	72	4	26	4.70

Three Wire Switch Controlled Multi-Outlet Wired Assembly



No. CF3-606-18

CF3-606-18	72	4	35	5.25
CF3-615	72	Fill-in Strip	27	2.50

Commercial Light Industrial Strip



No. CF4-606-18



No. CF4G-606-18

Consists of the present CF3 channel with a standard CF2 or CF2-G receptacle mounted in upper half. This leaves 5/8-in. x 3/4-in. space for installing up to three No. 12 conductors. Each end of strip has 1/2-in. knockout.

CF4-606-6	69	11	35	\$6.30
CF4-606-18	72	4	35	5.60

With Grounding Receptacles

CF4G-606-6	69	11	35	7.20
CF4G-606-18	72	4	35	6.85

National Electric Crimping Tools

For Connecting Crimp Connectors on CF2 and CF3 "Plug-in" Strip

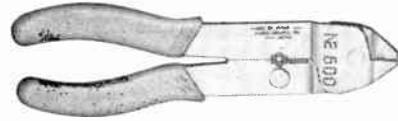

With wire cutter, stripper and measuring gauge.

No.	Std. Pkg.	Each
NE-600	1	\$3.47

National Electric "Plug-In" Strip Fittings

Mounting Clips and Straps



Furnished with every length of "Plug-In" Strip.

No.	Type Mtg.	Unit Pkg.	Std. Pkg.	Each
CF2-607	Baseboard	50	100	\$0.022
CF2-645	Surface	50	100	.013
CF3-607	Baseboard	50	100	.033
CF3-645	Surface	50	100	.02

End Feed Junction Boxes

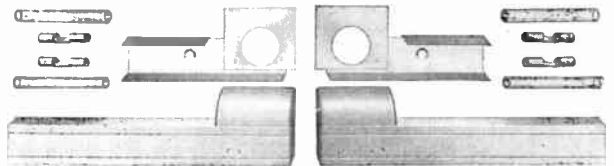

No. CF2-616-L

No. CF2-616-R

For bridging doorways, fireplaces, etc., or used as an end circuit feed. 1/2-inch conduit KO in base. Furnished with Crimp-Connectors and Insulator Tubes. Overall length 6 3/8 inches. Packed 5 in a unit package, 20 in a standard package. Standard package weight, 5 pounds.

No. CF2-616-L	Each	\$0.64
No. CF2-616-R	Each	.64

Straight End and 90° Junction Boxes



No. CF2-617-L

No. CF2-617-R

For use as a surface mounted feed, especially for light commercial installations. 1/2-inch conduit KO's on end and rear of base for connection to any kind of wiring. Furnished with Crimp Connectors and Insulator Tubes. Packed 5 in a unit package, 20 in a standard package. Standard package weight, 4 1/2 pounds.

No. CF2-617-L	Each	\$0.64
No. CF2-617-R	Each	.64

Quantity prices on request.

**B. F. Goodrich Rubaduct
For Low Tension Wiring**

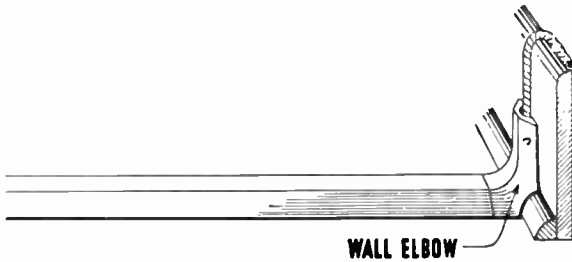

Rubaduct and Wall Elbow

Rubaduct is cemented to floor, thus eliminating the necessity of drilling cement floors and mutilating floor coverings. Installation requires minimum of labor, dirt, confusion and work interruption. May be taken up and relaid elsewhere without injuring surface on which originally applied. Furnished in Linoleum Brown. Takes cables up to 5/8-inch diameter, 8 pair, 5 triple or 5 quad telephone wire.

Size of Duct: 3-inches wide, 3/4-inch high, 3-feet long with aperture 1-inch x 5/8-inch.

Packed 50 to 56 lineal feet per case. (A maximum of 10% less than full length pieces per case is permitted). Weight, 1-pound per lineal foot.

Per lineal foot **\$0.41**

Rubaduct Fittings

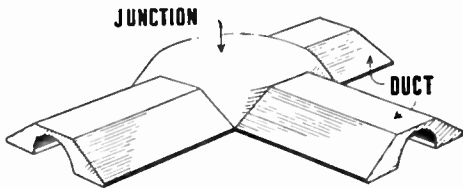
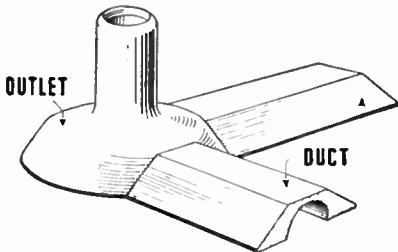

Outlet for protecting wires emerging from duct under desks and tables. 1 1/4-inch outside diameter, 3/4-inch inside diameter, 4 1/4-inch base diameter, 3 inches high.

Each **\$0.55**

Wall Elbow for protecting wires entering duct from walls. 3-inch long arm, 2-inch short arm.

Each **\$0.55**

Junction Box for right angle turns, or for joining main and lateral turns of duct. 4 1/4-inch outside diameter, 1-inch height, plus an allowable manufacturing tolerance of 1/8-inch.

Each **\$0.55**

10 Outlets, 10 Wall Elbows, and 5 Junction Boxes are packed in a combined case weighing 10 pounds.

B. F. Goodrich Plastikon Cement

For installation of Duct and Fittings. Holds securely without injury to floor surface. One gallon covers approximately 150 lineal feet. Quart containers packed 12 to a case. One gallon containers packed 6 to a case.

Per quart **\$0.75**
Per gallon **2.00**

**Winders & Geist Flexible Rubber Floor Ducts
"Flexiduct"**

A superior floor duct designed to solve problems of over the floor wiring. Flexiduct is easily and quickly applied on any floor and solves your over-floor inside wiring problems effectively and economically. Available in black or brown. Please specify.

Flexiduct is moisture proof; also a non-conductor. Hugs the floor, making it completely stumbleproof as each inch is cemented down. Tools are not required.



No. 1



No. 2

No. 1 Flexiduct: Is 2 3/4-in. wide at the base and rises from 1/2-in. at the outer edge to less than 1/2-in. high at the apex. This size accommodates from one to eight conductors. In 10 ft. lengths packed 100 ft. to a carton. Weight per carton 38 lbs.

No. 2 Flexiduct: Is 3 1/2-in. wide at the base and rises from 1/2-in. at the outside edge to less than 3/4-in. high at the apex. This size will accommodate up to fifty conductors or twenty five pair cloth cable. In 5 ft. lengths packed 50 ft. to a carton. Weight per carton 39 lbs. All fittings are one size and can be adapted to either No. 1 or No. 2 flexiduct.

Flexiduct Fittings



No. 3 Riser

Used with lip overlap on No. 1 duct. Butts against No. 2 duct by cutting away lip. Dimensions: 3 5/8 x 3 1/16 x 3 3/16-in. high. Packed 75 to carton. Weight 23 lbs.



No. 4 "L" Joint

For corner fittings has lip to overlap No. 1 duct, cut away lip and butt against No. 2 duct. Packed 150 in carton. Weight 41 lbs.



No. 5 "T" Joint

Has lip to overlap No. 1 duct. Cut-away tip to butt against No. 2 duct. Packed 75 to carton. Weight 25 lbs.



No. 6 Rubber Cement

A 5 ounce tube covers approximately 30 ft. of No. 1 duct. Tubes packed 6 in carton also 36 in carton.



No. 7 Quarter Round

Will accommodate #14 romex. 3/4-in. high 5/8-in. wide. 1/2-in. x 3/8-in. chase. Available in black and brown. 5 ft. lengths. Packed 240 ft. in carton. Weight per carton 44 lbs.

National Electric Florduct and Florduct Fittings

Listed by Underwriters' Laboratories, Inc.

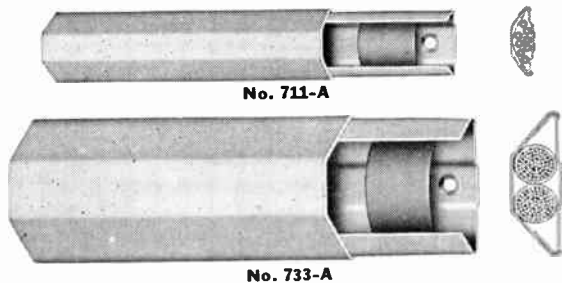

No. 711-A

No. 733-A

Neutral Gray Finish. Two pieces, base and capping. Cap snaps over base. Wires are laid in—not fished. 3 fibre Wire Retaining Clips with each length.

No. 711-A Metal Florduct Capacity

Single Conductor:							
Wire No.	6	8	10	12	14	16	18
Type R or RH.	2	2	4	7	6	8	
Type T or TW and RU.	3	4	5	9			
Annunciator.	20						
Telephone:							
Twisted Pair.	4	Pair					
No. 711-A.						*Per 100 Feet	\$22.75

No. 733-A Metal Florduct Capacity

Single Conductor:							
Wire No.	6	8	10	12	14	16	18
Type R or RH.	4	7	10	10	10	20	24
Type T or TW and RU.	6	10	10	10			
Annunciator.	50						
Telephone:							
Twisted Pair.	8	Pair					
Cable, up to two.	26	Pair					
No. 733-A.						*Per 100 Feet	\$34.65

*Packed 20 lengths, 5 feet long (100 ft.) in a sealed corrugated carton. Package weight, 41 pounds.

Florduct Fittings

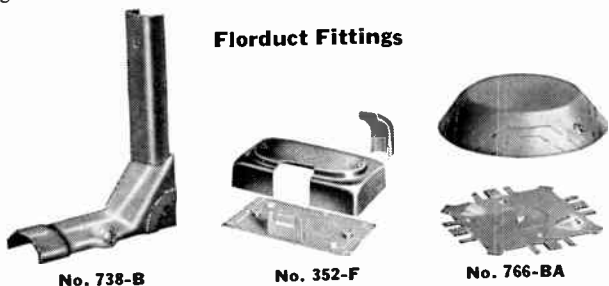

No. 738-B

No. 352-F

No. 766-BA

No.	Description	Unit Pkg.	Std. Pkg.	Wt., Lbs. Std. Pkg.	Unit Pkg. Per 100
738-B	Small Internal Adapter Elbow. For 711-A Florduct only. For making bends from Florduct to open wiring or 333 metal molding on baseboard.	5	20	3	\$ 43.55
352-F	Baseboard Junction Box. For branch from top to face of baseboard. Similar to 352 but provided with opening for 333 and elbow cap.	5	20	7	100.85
766-BA	Outlet Extension Cap. For 711-A or 733-A Florduct. Used as junction fitting between Florduct and the outlet from which extension is made. Arranged for mounting on wood floor. May be also used as a flat elbow or junction of Florduct.	10	20	4	92.00

Quantity prices on request.

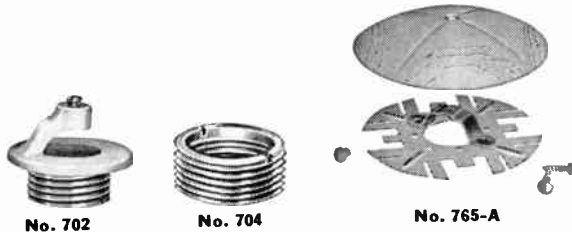

No. 702

No. 704

No. 765-A

No.	Description	Unit Pkg.	Std. Pkg.	Wt. Lbs. Std. Pkg.	Unit Pkg. Per 100
702	Adapter for connecting and fastening No. 765 Extension Cap to 1/2-inch threaded outlet on floor box.	10	20	1 1/4	\$51.75
703	Same as 702 except for 3/4-inch threaded outlet.	10	20	1 1/4	63.50
704	Adapter. Used with No. 703 for 1-inch threaded outlet on floor box.	10	20	1 1/4	92.00
765-A	Outlet Extension Cap for 711-A Florduct only. For mounting on wood floor. May be used as flat elbow or junction.	5	20	5 1/2	71.85



No. 715



No. 352

352	Utility Box Combination 1/2 and 1-in. KO's in base.	5	20	6 1/2	\$65.00
715	Strap. For 711-A Florduct.	50	500	7	5.50
745-A	Strap. For 733-A Florduct.	50	500	7	4.90

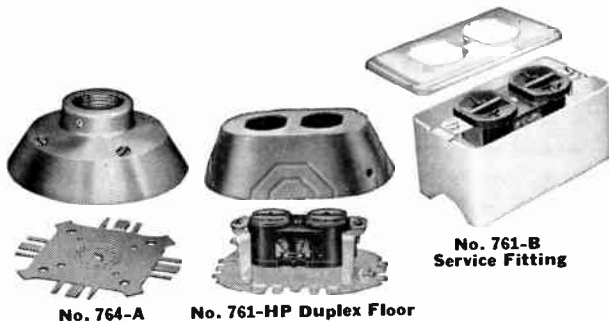

No. 764-A

No. 761-HP Duplex Floor

No. 761-B Service Fitting

High Potential Fittings

764-A	Base, Gray Iron. For standard 3/4-inch floor receptacle and fittings.	1	10	9	\$370.50
761-HP	Duplex Floor Receptacle. For 711-A and 733-A Florduct. T-Slots.	1	10	7	189.70
761-HPG	Same as 761-HP but 3-wire grounding type.	1	10	7	270.30
761-B	Service fitting for 711-A Florduct only. Furnished with duplex receptacle.	1	10	8 1/4
761-LP	Telephone fitting. Use with 47B telephone connecting block. Block not included.	1	10	4 1/2	178.20

*To make watertight, 753-A Gasket may be used.

†For 711-A and 733-A Florduct to be used at the new outlet location for protecting wires leaving Florduct and extending to apparatus on desks, etc. Equipped with four triple twist-outs used at ends, for through runs or for right angle branches.

Quantity prices on request.

National Electric Florduct Fittings



No. 740A



No. 839



No. 740-AR

No.	Description	Unit Pkg.	Std. Pkg.	Wt. Lbs., Std. Pkg.	Unit Pkg. Per 100
740-A	Large Internal Adapter Elbow. For 733-A Florduct only. For making bends from Florduct to molding on wall or baseboard. Twist-outs in base for 1/2-inch and 3/4-inch quarter round.	5	20	1 1/2	\$ 86.25
839	Utility Box 1 7/8 x 3 3/8 x 1 3/8 inches deep. Combination 1/2 and 1-inch KO in base.	1	10	7 1/2	106.40
740-AR	Adapter. 888 to 333 metal molding used with 740-A...	10	20	2 1/2	26.50



No. 739-A



No. 751-A

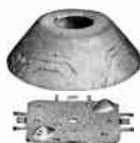

No. 750-BA

Low Potential Fittings

739-A	Internal Adapter Elbow. For open wiring to 733 Florduct. For telephone cables up to two 26 pair. Twist-outs for 1/2- and 3/4-inch quarter round.	5	20	1 1/2	\$86.25
751-A	In and Out Fitting. Will take up to two 26 pair telephone cables.	1	10	4	67.00
753-A	Rubber Gasket. For use with 749-A, 750-A, 750-BA, and 750-TA. To make fitting watertight.	10	50	2 1/4	16.70
*750-BA	Service Fitting. Same as 750-A without sheath. 7/8-inch opening for 1/2-inch conduit.	1	10	4	68.95



No. 749-A



No. 750-A



No. 750-TA

*749-A	Service Fitting	1	10	4 1/2	\$166.75
*750-A	Service Fitting. Sheath has .122 opening	1	10	4 1/2	102.00
*750-TA	Service Fitting. Sheath has opening for up to two 26 pair telephone cables	1	10	4 1/2	97.75

*See footnotes preceding column.

Quantity prices on request.

National Electric Nepcoduct

Standard System of Convenience Outlets in the Floor

Listed by Underwriters' Laboratories, Inc.

Installed under Article 354 of National Electric Code.



No. 7055H

Nepcoduct is a steel raceway system which provides convenience outlets at the floor surface. Standardization on one size raceway for both high and low potential wiring eliminates multiplicity of fittings. Nepcoduct may be used as a single duct system or it may be used in multiples of two or three ducts. For additional capacity and to provide separate wiring facilities for light, power, telephone, and signal circuits.

No.	No. of Outlets Per 10' Length	Diameter of Outlet
7005	None	Blank
7055L	5	1.900"
7055K	5	2.385"
7055II	5	2.385"

Junction Boxes

Nepcoduct Junction Boxes are castings with cross-overs, incorporated with completely separated high and low potential compartments.

Junction boxes may be brought to correct floor level conditions by the use of adjusting screws for leveling and rough height adjustment. Adjustable steel tops form a finer adjustment for height to meet newly finished floor elevations such as linoleum, cork or rubber. Ducts are secured to the boxes by tangent bearing set screws, assuring positive mechanical and electrical contact.



No. 7515

No.	Description	Conduit Size In.	Wt. Lbs. Each
7515	Single compartment with single duct and 4 conduit openings	1 1/4	5 1/2

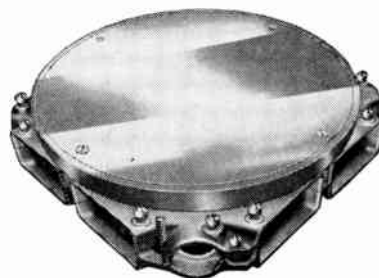

No. 7525-5NX

No.	Description	Conduit Size In.
7525-5NX	Two compartment with double duct and 4 conduit openings	1 1/4"

Prices on application.

National Electric Nepcoduct Fittings

Junction Boxes

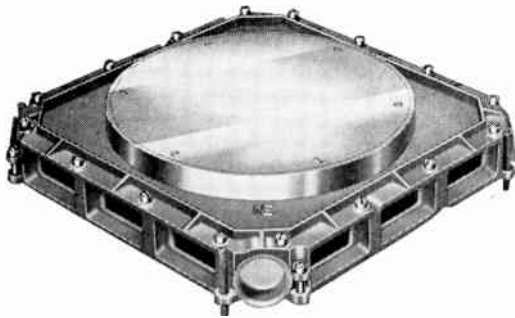

No. 7535-55

No.	Description	Conduit Size In.	Wt., Lbs. Each
7535-55	Three compartment with triple duct and 6 conduit openings	4-1 3/8	30
7535-55NX	Three compartment, 1/2 duct and 4-conduit openings.	2-3/4	
		4-1 1/4	41 1/2

Adjustable Hand-Hole Boxes



No. 7525

The No. 7525 Hand-Hole Box can be placed wherever necessary in a line of duct. The box is furnished with a 1/2-inch conduit knockout on one side and 3/4-inch conduit knockout on the opposite side. The steel top is adjustable for elevation with 3/8-inch range of adjustment. Leveling is accomplished

by the use of Nepcoduct saddle supports on either side of the cast aluminum box.

Service Fittings



No. 7903LC



No. 7904LC



No. 7930L



No. 7937L

No.	Description	Ship. Wt. Lbs. Per 100 Pcs.
7903-LC	Service Fitting with standard duplex T-slot receptacles for high potential, durable, light gray, enamel finish.	164
7904-LC	Service Fitting with single 3/4-in. composition bushing—for low potential, durable, light gray, enamel finish.	164
7930-L	Service Fitting with Floor Receptacle. Brushed brass or Aluminum Satin Finish.	66
7937-L	Service Fitting Standpipe with 1-inch Bushed Opening. Brushed Brass Finish.	113

Prices on application.

Standard Saddle Supports



No. 7455-A

The Saddle Support is a two-piece assembly which harmonizes with progressive methods of installation, wherein the "layout crew" establishes all measurements and lines of duct by installing the base. The base also serves as an indicator to all tradesmen, warning against interference, which is a very important item in costs. It can be installed as early in the building schedule as desired and withstand abuses of normal construction operations.

System Components

Marker Screw and Escutcheon



No. 7140-L

Zinc coated steel cap.

Shipping weight per 100 pcs., 7 pounds.

- No. 7140-L Red finish.
- No. 7141-L White finish.

Couplings



No. 7165

Formed of one-piece metal and welded for strength.

No. 7165 Shipping weight per 100 pcs., 55 pounds.

Duct to Cabinet Connectors



No. 7755

Assures maximum duct capacity and positive grounding connections between duct and cabinet. Smooth interior serves as bushing inside cabinet.

No. 7755 Shipping weight per 100 pcs., 31 pounds.

End Blanks



No. 7715

Closes off ends of duct runs and prevents ingress of concrete.

No. 7715 Shipping weight per 100 pcs., 29 pounds.

Duct Opening Plugs



No. 7745

For closing unused duct openings in Junction Boxes.

No. 7745 Shipping weight per 100 pcs., 12 pounds.

Prices on application.

Walker "Preset Locked-In" Underfloor Distribution Systems

For New Office Buildings and for Modernizing Existing Buildings

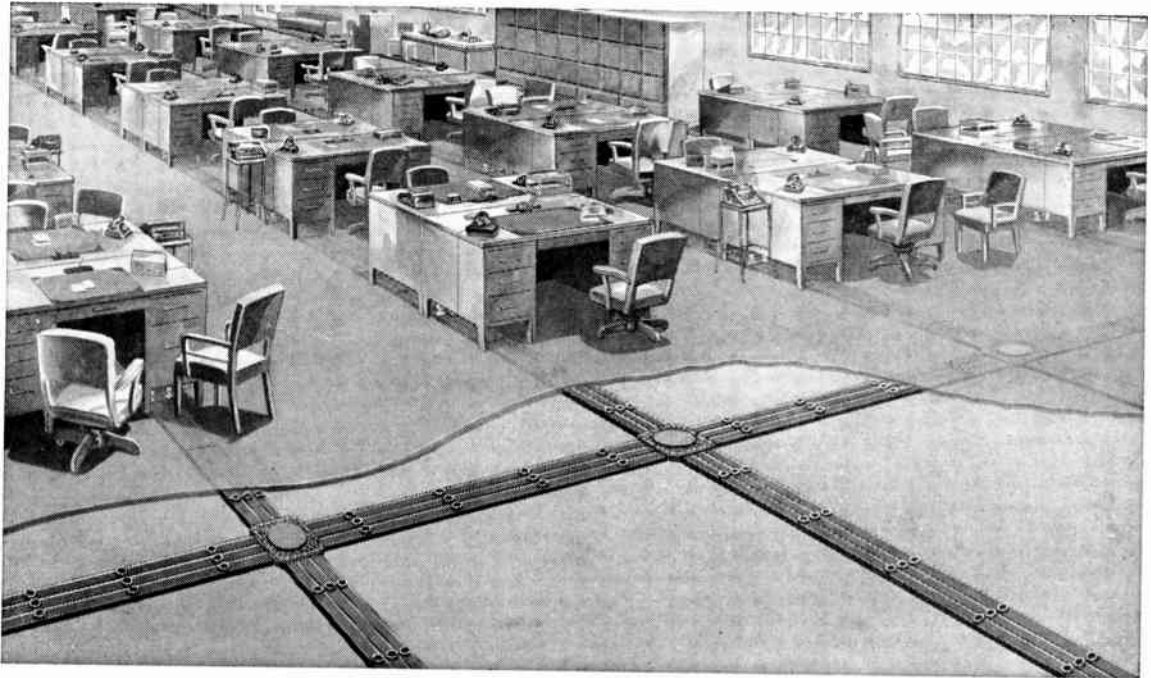

Phantom View of "Preset Locked-In" Underfloor Distribution System

A "Walkerduct" system is a network of one or more steel ducts with inserts cast in the concrete floor, forming continuous, concealed raceways for power, telephone, or signal wiring circuits. By means of closely spaced, "Preset" inserts formed in the duct during manufacture, convenient outlets for each service can be quickly provided to serve any desk or machine that may be placed anywhere on the floor area.

This planned method of underfloor distribution of electrical services is practical, economical and convenient. "Preset" steel raceways meet the highest standards of safety by insuring the continuity of the metallic ground throughout the system. Out of sight and under the floor, this system does not disturb the appearance of your office, presents no ob-

struction to a smooth floor surface, and yet offers immediate availability for any additional services required, or to meet the needs of office rearrangement. Confusion, dirt, and noise are practically eliminated in making connections during the occupancy of the building.

The advantages of the system are not limited to new construction. The "Flushduct" system has been designed to make it entirely practical to secure the same desirable features in existing offices and buildings.

The flush type of duct may be installed in finished floors quickly and efficiently; and once accomplished, will make it possible to secure the important advantages of the standard Underfloor Distribution Systems.

Duct

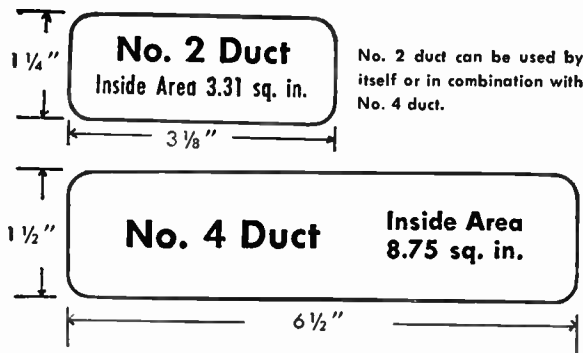

This is the new, large duct that is available for use in Walkerduct Systems. It has the large capacity required to meet today's electrical requirements and still have room for additional wiring in the future.

No. 2 duct can be used by itself or in combination with No. 4 duct.

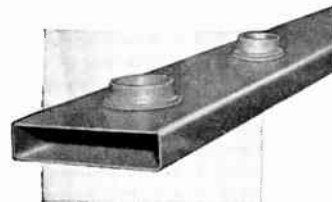

14-gauge steel protected inside and out by a layer of sherardized zinc and a specially formulated, corrosion-resistant outer coating. Furnished generally in 10-foot lengths and with five factory pre-set inserts spaced on 24-inch centers.

Inserts on No. 2 duct are 1.9-in. or 2 3/8-in. in diameter; No. 4 duct inserts are generally 2 3/8-in. in diameter. Open end of each insert sealed with removable steel cap, recessed to receive concrete.

Inserts are threaded on inside to provide secure fitting connections. Blank duct (without inserts) is provided for home runs to distribution panels or cabinets. Shipping weight No. 2 duct, 200 lbs. per 100 feet; No. 4 duct, 370 lbs. per 100 feet.

Prices and detailed information on request.

Walker "Preset Locked-In" Underfloor Distribution Systems

Junction Boxes

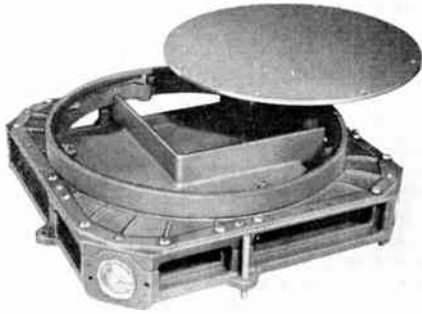

Sherardized grey iron castings, with chemical-resistant finish. Openings on 4 sides for either 1, 2 or 3 ducts. Adjustable top assembly to suit types of floor and height of inserts. Adjusting screws for leveling. All corners are drilled for conduit feeders.

Single Duct Boxes

No.	Description	Wt., Lbs. Each
12	For one No. 2 Duct.....	15

2 Duct Boxes

222	For two No. 2 Ducts.....	27
224	For one No. 2 and one No. 4 Duct.....	47

3 Duct Boxes

3222	For three No. 2 Ducts.....	43
3242	For one No. 1 and two No. 2 Ducts.....	125
3424	For one No. 2 and two No. 4 Ducts.....	135

Duct Supports

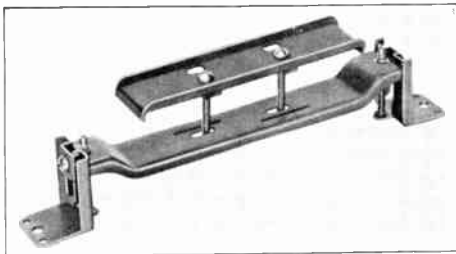

Stamped steel. Vertical adjustment, locking screws, and mounting holes. Arranged, for 1, 2 or 3 duct systems as required. Vertical members furnished in accordance with thickness of floor slab.

Average shipping weight per 100 pieces, 125 pounds.

Duct Couplings



No.	Description	Wt., Lbs. Per 100
302	For No. 2 Duct.....	66
H302	For No. 4 Duct.....	120

Marker Caps

Marker cap for locating preset inserts under floor covering.



No.	Description	Wt., Lbs. Per 100
412-B	For 1.9-inch Inserts....	8
415-B	For 2 3/8-inch Inserts...	12

Prices and detailed information on request.

Linoleum Holders

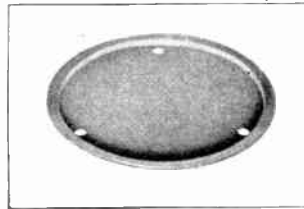

Brass holder for floor coverings such as linoleum. Depth as ordered.

No.	Wt., Lbs. Per 100
12-L.H.....	55
222-L.H.....	83
3222-L.H.....	150
224-L.H.....	158
3242-L.H.....	244
3424-L.H.....	235

Service Fittings



No.	Description	Wt., Lbs. Per 100
601L	Low Tension.....	73
612L	High Tension—2 Wire.....	80
613L-DPS-G	High Tension—3 Wire.....	82

New 500AL Series Fitting (Patent Pending)



Made of diecast aluminum; used for high and low tension service, including telephone.

Less than 3-in. high; has 3-position baseplate; accommodates wide range of standard receptacles.

Blanking Plates

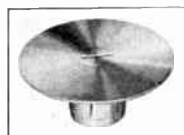

Brass blanking plates.

No.	For Insert Diam., In.	Shank Lgth., In.	Wt., Lbs. Per 100
1023	1.9	1	30
1033-2	2 3/8	1	53

Prices and detailed information on request.

Square D Lay-In Duct and Fittings

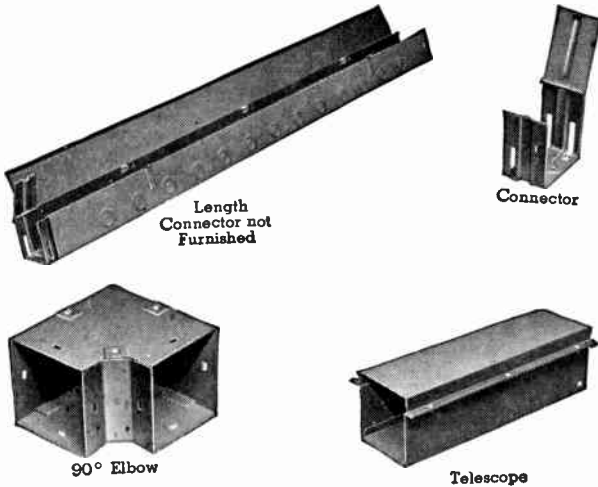

Hinge Cover Lay-In Duct: A UL approved steel enclosed wiring trough wireway and auxiliary gutter. All lengths and connectors hinged to provide an unobstructed wireway to "lay-in" conductors. Fittings have removable covers held by captive screws to continue the "lay-in" feature through the entire installation.

Knockouts match other Square D switches, breakers, service entrance equipment, contactors and starters. Finish, blue-gray enamel.

Size 2½ x 2½ in. equipped with ½, ¾ in. knockouts. Size 4 x 4 in. equipped with ½, ¾, 1, 1¼ in. knockouts. Size 6 x 6 in. has ½, ¾, 1, 1¼, 1½ and 2 in. knockouts.

2½" x 2½"		4" x 4"		6" x 6"		No. Connectors Furnished
No.	List	No.	List	No.	List	
One Foot Length Hinged Cover						
LD21	\$ 3.40	LD41	\$ 4.30	LD61	\$10.90	1
Two Foot Length Hinged Cover						
LD22	5.20	LD42	6.60	LD62	14.00	1
Five Foot Length Hinged Cover						
LD25	12.70	LD45	14.40	LD65	30.00	1
90 Degree Elbow						
LD290L	8.30	LD490L	9.00	LD690L	12.80	1
90 Degree Elbow Sweep Bend						
.....	LD490LS	15.70	LD690LS	20.80	1
45 Degree Elbow						
LD245L	6.20	LD445L	6.90	LD645L	9.50	1
22½ Degree Elbow						
LD225L	6.20	LD425L	6.90	LD625L	9.50	1
Tea—Branch from Runs						
LD2T	11.60	LD4T	12.00	LD6T	27.00	2
Junction Box						
For T. L. or Cross (4 sides—1 Opening Each)						
LD2J	12.80	LD4J	15.60	LD6J	15.70	2
Pull Box for T. L. or Cross						
(2 sides—1 Opening Each) (2 sides—2 Openings Each)						
.....	LD4PB	34.00	LD6PB	69.00	2
Telescope—Slide Adjustment						
LD2TF	10.10	LD4TF	10.50	LD6TF	36.00	0
Universal Hanger—Drop or Side						
LD2H	1.30	LD4H	1.30	LD6H	4.40	0
Closing Plate To Seal Openings						
LD2CP	0.70	LD4CP	0.90	LD6CP	1.50	0
Adaptor—Connects To Panel, Square Duct						
LD22A	4.40	LD44A	5.00	LD66A	16.90	0
Reducer (4x4 to 2½"x2½") (6x6 to 4"x4")						
.....	LD42R	6.50	LD64R	13.10	0
Gusset Bracket—Mount for Vertical Wall						
LD2GB	1.30	LD4GB	1.30	LD6GB	4.40	0
Extra Connector—Couples Lengths and Fittings						
LD2C	1.00	LD4C	1.00	LD6C	1.30	0
Three Inch Nipple						
LD23N	3.40	LD43N	4.30	LD63N	10.90	0
Six Inch Nipple						
LD26N	3.40	LD46N	4.30	LD66N	10.90	0
Nine Inch Nipple						
LD29N	3.40	LD49N	4.30	LD69N	10.90	0

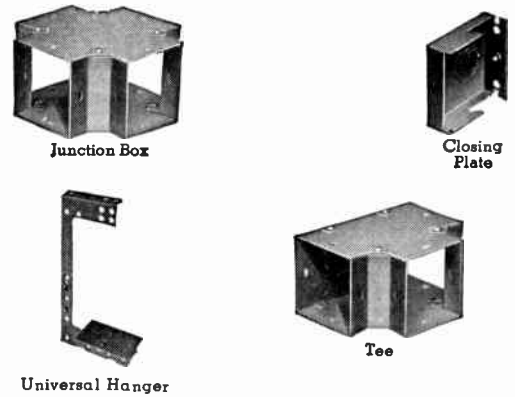

Screw Cover Lay-In Duct: A UL approved steel enclosed wiring trough wireway and auxiliary gutter. Lengths used in connecting loadside switches, meters, etc. Keyhole slots eliminate the necessity of entirely removing the screws when removing the cover.

Lay-in duct fittings may be used to extend lengths into UL approved wireway and auxiliary gutter installations. No connectors furnished with screw cover lengths. Finish blue-gray enamel.

Size 4x4 in. equipped with ¾, 1¼, 1½ and 2 in. knockouts; size 6x6 in. equipped with ¾, 1¼, 1½ and 2 in. knockouts; size 8x8 in. no knockouts.

Screw Cover Duct

Lgth. Ft.	4" x 4"		6" x 6"		8" x 8"	
	No.	List	No.	List	No.	List
1	SC41	\$ 3.30	SC61	\$ 7.40		
2	SC42	5.70	SC62	9.80	8824A	\$20.40
3	SC43	9.00	SC63	13.50	8836A	27.00
4	SC44	11.40	SC64	18.00	8848A	33.00
5	SC45	13.50	SC65	22.10	8860A	43.00

For 4x4" and 6x6" size fittings use fittings as shown under hinge cover duct.

Fittings for 8x8 In. Screw Cover Duct

No.	Description	No. Conn. Furnished	List
88L	90 degree elbow	1	\$15.00
88T	Tee for T, L, or Cross	2	32.00
88C	Connector, couples lengths and fitting	..	1.70
88E	Closing plate to seal openings	..	2.40

Conductor Table

Size Of Conductor	Area of Conductor Types R RH & RW Sq. In.	Maximum Number Of Conductors All Of One Size			
		2½" x 2½" Duct	4" x 4" Duct	6" x 6" Duct	8" x 8" Duct
14	.0230†	*54	*139	*313	*533
12	.0278†	*41	*115	*259	*410
10	.0460	27	* 69	*156	*266
8	.0760	16	* 42	* 94	*161
6	.1238	10	25	* 58	* 99
4	.1605	7	19	* 44	* 76
3	.1817	6	17	* 39	* 62
2	.2067	6	15	* 34	* 59
1	.2715	4	11	26	* 45
0	.3107	4	10	23	* 39
00	.3578	3	8	20	* 34
000	.4151	3	7	17	29
0000	.4840	2	6	14	25
250,000	.5917	2	5	12	21
300,000	.6837	1	4	10	18
400,000	.8365	1	3	8	15
500,000	.9834	1	3	7	12

†Areas in sq. inches for type RW in Nos. 14 and 12 are .0327 and .0384 respectively.

*1953 National Electrical Code limits installations to 30 conductors in one wire-way except where special permission has been obtained from local authority enforcing the Code or where conductors in excess of 30 are for signaling circuits or are control wires between a motor and its starter and used only for starting duty.

Square D Plug-In Duct Plug-In and Clamp-On Units

Schedule E

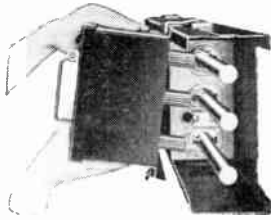

Easy Installation of Plug-in Units

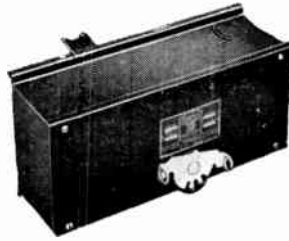

Circuit Breaker Plug-in Unit

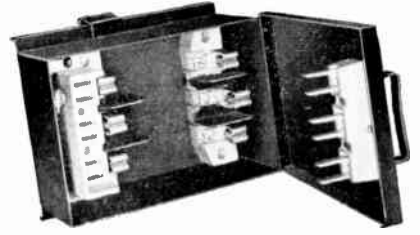

Fusible Plug-in Unit

Plug-In Units—Fusible (Saflex) Type

Rating Amp.	250 V. 2P 2 Fuse		250 V. 3P 3 Fuse		250 V. 4P 3 Fuse		600 V. 2P 2 Fuse		600 V. 3P 3 Fuse		600 V. 4P 3 Fuse	
	No.	Each	No.	Each	No.	Each	No.	Each	No.	Each	No.	Each
30A	SD-9251	\$37.00	SD-9351	\$39.00	SD-9451	\$50.00	SD-9241	\$39.00	SD-9341	\$41.00	SD-9441	\$52.00
60A	SD-9252	39.00	SD-9352	43.00	SD-9452	52.00	SD-9242	41.00	SD-9342	45.00	SD-9442	54.00
100A	SD-9253	52.00	SD-9353	56.00	SD-9453	67.00	SD-9243	54.00	SD-9343	63.00	SD-9443	71.00
200A	SD-9254	119.00	SD-9354	131.00	SD-9454	148.00	SD-9244	126.00	SD-9344	144.00	SD-9444	162.00

Fusible Switch Plug-In Units—30 to 200A. can be plugged in at any opening of a plug-in duct.

Unfused Switch Units—When required, use price of 250V. Fusible switch units for either 250V. or 575V. use.

Plug-In Units—Circuit Breaker Type

Type of Breaker Unit	Amps.	2 Pole Units		3 Pole Units		3φ, 4W., Units							
		250 V. A-C 125/250V. D-C No.	Each	600 V. A-C †250 V. D-C No.	Each	250 V. A-C 125/250 V. D-C No.	Each	600 V. A-C No.	Each	120/200 V. A-C No.	Each	277/480 V. A-C No.	Each
*ML and ML1 Frames	15	*SD-76215	\$65.00	†SD-75615	\$102.00	*SD-76315	\$80.00	SD-75715	\$119.00	*SD-76915	\$91.00	SD-75415	\$132.00
	20	*SD-76220	65.00	†SD-75620	102.00	*SD-76320	80.00	SD-75720	119.00	*SD-76920	91.00	SD-75420	132.00
	30	*SD-76230	65.00	†SD-75630	102.00	*SD-76330	80.00	SD-75730	119.00	*SD-76930	91.00	SD-75430	132.00
	40	*SD-76240	65.00	†SD-75640	102.00	*SD-76340	80.00	SD-75740	119.00	*SD-76940	91.00	SD-75440	132.00
	50	*SD-76250	65.00	†SD-75650	102.00	*SD-76350	80.00	SD-75750	119.00	*SD-76950	91.00	SD-75450	132.00
	70	SD-75270	93.00	SD-75670	119.00	SD-75370	108.00	SD-75770	138.00	SD-75970	117.00	SD-75470	147.00
	100	SD-75216	93.00	SD-75616	119.00	SD-75316	108.00	SD-75716	138.00	SD-75916	117.00	SD-75416	147.00
	125			SD-78617	264.00			SD-78717	311.00			SD-78417	326.00
	150			SD-78618	264.00			SD-78718	311.00			SD-78418	326.00
	175			SD-78619	264.00			SD-78719	311.00			SD-78419	326.00
	200			SD-78626	264.00			SD-78726	311.00			SD-78426	326.00
	225			SD-78627	264.00			SD-78727	311.00			SD-78427	326.00

Circuit Breaker Plug-in Units can be plugged in any opening of a plug-in duct.

†For 2 Pole 250 V. d-c in the 100 A. frame size, add suffix letters d-c following catalog number in this group.

*Catalog numbers preceded by asterisk indicate ML frame.

Clamp-On Units—Circuit Breaker Type

Type of Breaker Unit	Amps.	2 Pole Units		3 Pole Units		3 Phase 4-Wire Units	
		600 V. A-C 250 V. D-C No.	List	600 V. A-C No.	List	277/480 V. A-C No.	List
WL Frame	450	SD-69648	\$760.00	SD-69748	\$916.00	SD-69448	\$946.00
	500	SD-69656	760.00	SD-69756	916.00	SD-69456	946.00
	550	SD-69658	760.00	SD-69758	916.00	SD-69458	946.00
	600	SD-69666	760.00	SD-69766	916.00	SD-69466	946.00

Circuit Breaker Clamp-On Units may be bolted to busses of plug-in duct between any two straight sections or at end of plug-in duct run. When used at end of run, order an end closure.

When ordering clamp-on units specify end or center type and rating of duct to which units will be connected.

Clamp units can be supplied as lug to bus main breakers by adding suffix letters "LB" to above catalog numbers.

Square D Plug-In Duct

Schedule EZ

Straight Lengths and Fittings

Square D Plug-In Duct is an extremely flexible system of power distribution to branch circuits. Round bus bars provide greater mechanical strength and resistance to short circuit stresses. Steel enclosure and rotating doors over plug-in openings exclude dust and dirt.

Plug-in units are easily attached. Powerful contact jaws, affording positive pressure, can be "rocked" into position on bus bars. Five units may be attached to either side of each ten-foot section. Flexible couplings join Plug-in bus bars—absorb expansion or contraction and eliminate section alignment problems.



No. of Poles and Voltage	Rating Amp.	6-7-8-10 FT. Straight Lengths		No.	*Elbow Labor Only	Complete Device	No.	*Tee Labor Only	Complete Device	No.	*Cross Labor Only	Complete Device
		No.	Per Ft.									
2 P. 600V.	225A	SD-1242	\$10.00	SD-1242-L	\$102.00	\$142.00	SD-1242-T	\$122.00	\$182.00	SD-1242-X	\$144.00	\$224.00
	400A	SD-1243	16.00	SD-1243-L	102.00	166.00	SD-1243-T	122.00	218.00	SD-1243-X	144.00	272.00
	600A	SD-1245	19.00	SD-1245-L	102.00	178.00	SD-1245-T	122.00	236.00	SD-1245-X	144.00	296.00
	800A	SD-1247	24.00	SD-1247-L	102.00	198.00	SD-1247-T	122.00	266.00	SD-1247-X	144.00	336.00
	1000A	SD-1241	30.00	SD-1241-L	102.00	222.00	SD-1241-T	122.00	302.00	SD-1241-X	144.00	384.00
3P. 600V.	225A	SD-1342	11.00	SD-1342-L	102.00	146.00	SD-1342-T	122.00	188.00	SD-1342-X	144.00	232.00
	400A	SD-1343	19.00	SD-1343-L	102.00	178.00	SD-1343-T	122.00	236.00	SD-1343-X	144.00	296.00
	600A	SD-1345	24.00	SD-1345-L	102.00	198.00	SD-1345-T	122.00	266.00	SD-1345-X	144.00	336.00
	800A	SD-1347	32.00	SD-1347-L	102.00	230.00	SD-1347-T	122.00	314.00	SD-1347-X	144.00	400.00
	1000A	SD-1341	40.00	SD-1341-L	102.00	262.00	SD-1341-T	122.00	362.00	SD-1341-X	144.00	464.00
3φ 4W. 277/480V.	225A	SD-1852	14.00	SD-1852-L	122.00	178.00	SD-1852-T	144.00	228.00	SD-1852-X	168.00	280.00
	400A	SD-1853	25.00	SD-1853-L	122.00	222.00	SD-1853-T	144.00	294.00	SD-1853-X	168.00	368.00
	600A	SD-1855	30.00	SD-1855-L	122.00	242.00	SD-1855-T	144.00	324.00	SD-1855-X	168.00	408.00
	800A	SD-1457	39.00	SD-1457-L	122.00	278.00	SD-1457-T	144.00	378.00	SD-1457-X	168.00	480.00
	1000A	SD-1451	48.00	SD-1451-L	122.00	314.00	SD-1451-T	144.00	432.00	SD-1451-X	168.00	552.00

Straight Lengths—Available in 6, 7, 8, and 10-foot lengths. When ordering by catalog numbers add suffix number to designate other than 10-foot length (i.e., SD-1342-6, SD-1342-7, SD-1341-8). Other lengths can be furnished special and will require longer delivery. Sliding type hanger brackets are included in prices of straight lengths—one bracket for each 5 feet of duct.

Elbow—Labor only prices do not include duct material; complete device prices include labor and 4 feet of duct material.

Tee—Labor only, prices do not include duct material; complete device prices include labor and 6 feet of duct material.

Cross—Labor only, prices do not include duct materials; complete device prices include labor and 8 feet of duct material.

*When ordering elbows, tees, or crosses add suffix letter to catalog number "E" (edgewise) or "F" (flatwise) (i.e., SD-1342-LE, SD-1343-LF).

No. of Poles and Voltage	Rating Amp.	End Closure		★ Cable Tap Box		† Flanged End		Per Additional Ft.	Reducer (Unfused)			
		No.	Each	No.	Each	Without Bus Extension No.	Each		With 7" Bus Extension No.	Each	No.	Labor Only
2P. 600V.	225A	SD-1005-A	\$14.00	SD-3242	\$60.00	SD-1345-FE	\$42.00	SD-1245-FX-1	\$19.00	\$19.00		
	400A	SD-1005-A	14.00	SD-3245	70.00	SD-1345-FE	42.00	SD-1245-FX-1	19.00	19.00		
	600A	SD-1005-A	14.00	SD-3245	70.00	SD-1345-FE	42.00	SD-1245-FX-1	19.00	19.00		
	800A	SD-1001-A	14.00	SD-3241	96.00	SD-1341-FE	46.00	SD-1241-FX-1	31.00	31.00	SD-1241-R	\$96.00
	1000A	SD-1001-A	14.00	SD-3241	96.00	SD-1341-FE	46.00	SD-1241-FX-1	31.00	31.00	SD-1241-R	96.00
3P. 600V.	225A	SD-1005-A	14.00	SD-3342	68.00	SD-1345-FE	42.00	SD-1345-FX-1	25.00	25.00		
	400A	SD-1005-A	14.00	SD-3345	86.00	SD-1345-FE	42.00	SD-1345-FX-1	25.00	25.00		
	600A	SD-1005-A	14.00	SD-3345	86.00	SD-1345-FE	42.00	SD-1345-FX-1	25.00	25.00		
	800A	SD-1001-A	14.00	SD-3341	116.00	SD-1341-FE	46.00	SD-1341-FX-1	42.00	42.00	SD-1341-R	104.00
	1000A	SD-1001-A	14.00	SD-3341	116.00	SD-1341-FE	46.00	SD-1341-FX-1	42.00	42.00	SD-1341-R	104.00
3φ 4W. 277/480V.	225A	SD-1005-A	14.00	SD-3852	75.00	SD-1345-FE	42.00	SD-1855-FX-1	37.00	37.00		
	400A	SD-1005-A	14.00	SD-3855	96.00	SD-1345-FE	42.00	SD-1855-FX-1	37.00	37.00		
	600A	SD-1005-A	14.00	SD-3855	96.00	SD-1345-FE	42.00	SD-1855-FX-1	37.00	37.00		
	800A	SD-1001-A	14.00	SD-3451	149.00	SD-1341-FE	46.00	SD-1451-FX-1	56.00	56.00	SD-1451-R	136.00
	1000A	SD-1001-A	14.00	SD-3451	149.00	SD-1341-FE	46.00	SD-1451-FX-1	56.00	56.00	SD-1451-R	136.00

★Cable Tap Box price does not include an end closure, when tap box is used at end of run, order an end closure. When ordering cable tap box, add suffix letter to catalog number—"C" (center type) or "E" (end type), (i.e., SD-3342-C, SD-3341-E).

†Flanged End prices cover flanged collar fittings, either with or without bus extension as listed above and do not include any duct footage. For flanged end fitting with bus extensions longer than 7" standard, use price of fitting as listed without bus extension, then add for necessary bus extension from price table above.

Bus Extension—Used in conjunction with flanged ends. When connecting a flanged end to a panel or safety switch, a 2-foot bus extension is usually required. When connecting

a flanged end to a switchboard, a 3-foot bus extension is usually required.

Reducer (Unfused)—Is a joint where copper is reduced to a lower capacity, above prices include labor and material for reducer only. (Duct footage not included). Estimate duct footage of capacity required, to center of reducer and add price from above.

Plug-in duct reducers from 600A, or 400A, to a lower capacity do not require an addition in price or change in length of duct run. When plug-in or feed-in ducts of 800A, or larger are to be reduced, use the price of the larger duct capacity to be connected to the reducer. Local inspection ruling or National Electrical Code (1951), Article 364, shall govern the use of unfused reducers.

Finish—Blue-Gray.

Square D Feed-In Duct

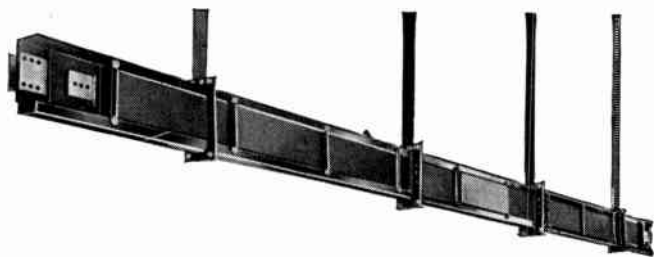

Straight Lengths And Fittings

A very high efficiency, heavy power feeder with lowest known voltage drop characteristics. Exclusive design requires no ventilation for limiting temperature rise, permits completely enclosed dust-excluding structure.

Rigid construction resists heavy electrical stresses. Absence of all-metal enclosure eliminates "hum" and iron losses. Underwriters' approved Feed-In Duct available with either aluminum or copper bus bars. Ebonized asbestos insulating sheets permit close spacing of bus bars to obtain extremely low energy loss and voltage drop.

The solid ebonized asbestos insulating plates which totally enclose bus, have great mechanical and high dielectric strength, conduct heat readily, are impervious to moisture and resistant to arc. The surge clamps provide structural and mechanical strength necessary to withstand high short circuit currents in accordance with NEMA standards.

Pricing Of A Feed-In Duct Run

Aluminum or copper feed-in duct runs are priced in the same manner. A layout sketch of the run showing all dimensions in feet and inches and all fittings such as elbows, tees, crosses, flanged ends, end closures, cable tap boxes, expansion joints and reducers should first be made. Add all dimensions together and adjust the total to the next higher whole foot. Multiply this total by the list price per foot as determined by the type (aluminum or copper) the ampere rating and the number of poles. To this add the labor only charge for each of the elbows, tees, crosses, flanged ends, expansion joints and reducers. To this add the list price for each of the cable tap boxes and end closures. Add for any bus extension needed. The sum total of all these items is the list price of the entire run of duct. The price breakdown for each of the various fittings will be done by the factory.

Straight Lengths

Aluminum straight lengths available in 3, 5, 7 and 10 foot lengths. When ordering by catalog number, add suffix number to designate length (i.e. AFD-3160-S7, AFD-5200-S10). Hanger brackets (one for each 5 feet of duct) and joint connection parts are included in duct prices.

Copper straight lengths are available in 6, 7, 8 and 10 foot lengths. When ordering by catalog number, add suffix number to designate length (i.e. FD-3080-S6, FD-3160-S10). Hanger brackets (one for each 5 feet of duct) and joint connection parts are included in duct prices.

Elbows

Aluminum elbow labor only price does not include duct footage. Edgewise elbows are adjustable from 12 to 18 in. on each leg. Flatwise elbows are adjustable from 12 to 18 in. on each leg in the 600 A. to 1000 A. ratings, from 15 to 21 in. on each leg in the 1350 A. to 2000 A. ratings, and from 18 to 24 in. on each leg in the 2500 A. to 3000 A. ratings. The 4000 A. duct consists of two parallel runs of 2000 A. duct, therefore the adjustment of 4000 A. elbows is the same as 2000 A. Catalog numbers indicate flatwise or edgewise type by "F" or "E" suffix letter. Factory set dimensions of each leg are indicated by suffix numbers in inches (i.e. a 15 in. by 13 in. edgewise elbow would be AFD-3160-LE1513).

Copper elbow labor only price does not include duct footage. Edgewise and flatwise elbows of all ratings from 600 A. to 3000 A. are 2 feet on each leg. The 4000 A. duct consists of two parallel runs of 2000 A. duct. Elbows are not adjustable.

Flanged Ends

Aluminum flanged end labor only price does not include duct footage but does include 6 inch flared bus extension. Flanged end footage is adjustable from 6 to 12 in. in length when connected to straight length. When connected to edgewise elbow, footage between switchboard and center line of elbow is adjustable from 12 to 18 in. When connected to flatwise elbow, footage between switchboard and center line of elbow is adjustable from 12 to 18 in. in the 600 A. to 1000 A. ratings, from 15 in. to 21 in. in the 1350 A. to 2000 A. ratings, and from 18 in. to 24 in. in the 2500 A. to 3000 A. ratings. The 4000 A. duct consists of two parallel runs of 2000 A. duct, therefore the adjustment of 4000 A. flanged ends is the same as 2000 A.

Copper flanged end labor only price does not include duct footage but does include 7 inch flared bus extension. Complete flanged end footage is 2 feet long. Flanged ends are not adjustable.

Cable Tap Box

Aluminum and copper cable tap boxes do not require end closures when used at end of run. When ordering cable tap box, add suffix letter to catalog number; "C" (center type) or "E" (end type). (i.e. AFD-3160-CTB, FD-5200-ETB).

Reducer (Unfused)

Aluminum and copper unfused reducers are used at a joint where copper is reduced to a lower capacity. Prices listed in table are labor only and do not include any duct footage. Reducers do not occupy any footage in the duct run.

Bus Extension

Aluminum and copper bus extension is used in conjunction with flanged ends or transformer tap connections. Price per foot listed in the table is for straight bus extension. For formed bus extension add 20% to price listed in table.

Tees And Crosses

Aluminum tee or cross labor only price does not include duct footage. Edgewise and flatwise tees and crosses are adjustable throughout exactly the same dimensional range per leg as elbows.

Copper tee or cross labor only price does not include duct footage. Flatwise tees and crosses are 2 feet on each leg. For dimensions of edgewise tees and crosses contact Graybar. Tees and crosses are not adjustable.

Expansion Joint

Aluminum and copper expansion joint labor only prices do not include duct footage. Expansion joints occupy 3 inches of duct length.

Joint Package Assembly

Aluminum joint package assemblies consist of all necessary parts to connect two straight lengths together and also hanger brackets (one for each 5 feet of duct). One package assembly is included with each straight length. Package assemblies are not needed with other fittings. Prices of package assemblies are included in duct prices.

Copper joint package assemblies consist of all necessary parts to connect any two straight lengths or fittings together and also hanger brackets (one for each 5 feet of duct). One package assembly is included with each straight length, elbow, tee, or flanged end and two with each cross. Prices of package assemblies are included in duct prices.

Adjustable Joint Assembly

Aluminum adjustable joint assemblies consist of all necessary parts to connect two straight lengths together and also two hanger brackets. This assembly is adjustable from 0" to 12" and is supplied for use on any run of duct when needed to obtain odd dimensions in feet and inches not possible with standard straight lengths and adjustable fittings. The need for an adjustable joint assembly will be determined by the factory from the sketch of the duct run. The assembly will be set to the exact dimension needed by the factory. Copper adjustable joint assemblies are not available.

Finish

Aluminum and Copper duct is finished in blue-grey baked enamel.

Square D Feed-In Duct and Fittings

Rating Amp.	Straight Lengths				Elbows			Flanged End			Bus Extension	
	Aluminum No.	List Price Per Foot	Copper No.	List Price Per Foot	Aluminum No.	Copper No.	List Labor Only	Aluminum No.	Copper No.	List Labor Only	Aluminum List Price Per Foot	Copper List Price Per Foot
Two Pole—600 Volts												
600			FD-2060-S	\$ 20.00		FD-2060-L	\$136.00		FD-2060-FE	\$56.00		\$ 19.00
800	AFM-2080-S	\$ 20.00	FD-2080-S	25.00	AFM-2080-L	FD-2080-L	136.00	AFM-2080-FE	FD-2080-FE	58.00	21.00	26.00
1000	AFM-2100-S	25.00	FD-2120-S	31.00	AFM-2100-L	FD-2120-L	136.00	AFM-2100-FE	FD-2120-FE	64.00	26.00	32.00
1350	AFD-2135-S	34.00	FD-2135-S	41.00	AFD-2135-L	FD-2135-L	136.00	AFD-2135-FE	FD-2135-FE	68.00	42.00	53.00
1600	AFM-2160-S	40.00	FD-2160-S	50.00	AFM-2160-L	FD-2160-L	136.00	AFM-2160-FE	FD-2160-FE	70.00	50.00	63.00
2000	AFD-2200-S	50.00	FD-2200-S	62.00	AFD-2200-L	FD-2200-L	136.00	AFD-2200-FE	FD-2200-FE	74.00	66.00	83.00
2500	AFD-2250-S	63.00	FD-2250-S	77.00	AFD-2250-L	FD-2250-L	136.00	AFD-2250-FE	FD-2250-FE	80.00	86.00	107.00
3000	AFD-2300-S	75.00	FD-2300-S	93.00	AFD-2300-L	FD-2300-L	170.00	AFD-2300-FE	FD-2300-FE	82.00	110.00	137.00
4000	AFD-2400-S	100.00	FD-2400-S	124.00	AFD-2400-L	FD-2400-L	170.00	AFD-2400-FE	FD-2400-FE	86.00	137.00	132.00
Three Pole—600 Volts												
600			FD-3060-S	\$ 25.00		FD-3060-L	\$136.00		FD-3060-FE	\$56.00		\$ 44.00
800	AFM-3080-S	\$ 28.00	FD-3080-S	33.00	AFM-3080-L	FD-3080-L	136.00	AFM-3080-FE	FD-3080-FE	58.00	46.00	57.00
1000	AFM-3100-S	33.00	FD-3120-S	41.00	AFM-3100-L	FD-3120-L	136.00	AFM-3100-FE	FD-3120-FE	64.00	58.00	72.00
1350	AFD-3135-S	47.00	FD-3135-S	54.00	AFD-3135-L	FD-3135-L	136.00	AFD-3135-FE	FD-3135-FE	68.00	67.00	84.00
1600	AFM-3160-S	56.00	FD-3160-S	66.00	AFM-3160-L	FD-3160-L	136.00	AFM-3160-FE	FD-3160-FE	70.00	84.00	104.00
2000	AFD-3200-S	66.00	FD-3200-S	82.00	AFD-3200-L	FD-3200-L	136.00	AFD-3200-FE	FD-3200-FE	74.00	112.00	140.00
2500	AFD-3250-S	83.00	FD-3250-S	102.00	AFD-3250-L	FD-3250-L	136.00	AFD-3250-FE	FD-3250-FE	80.00	142.00	177.00
3000	AFD-3300-S	99.00	FD-3300-S	123.00	AFD-3300-L	FD-3300-L	170.00	AFD-3300-FE	FD-3300-FE	82.00	180.00	225.00
4000	AFD-3400-S	132.00	FD-3400-S	164.00	AFD-3400-L	FD-3400-L	170.00	AFD-3400-FE	FD-3400-FE	86.00	225.00	323.00
Three Phase, 4 Wire 277/480 Volts—50% Neutral												
600			FD-4060-S	\$ 31.00		FD-4060-L	\$170.00		FD-4060-FE	\$56.00		\$ 47.00
800	AFM-4080-S	\$ 33.00	FD-4080-S	40.00	AFM-4080-L	FD-4080-L	170.00	AFM-4080-FE	FD-4080-FE	58.00	50.00	63.00
1000	AFM-4100-S	41.00	FD-4120-S	49.00	AFM-4100-L	FD-4120-L	170.00	AFM-4100-FE	FD-4120-FE	64.00	62.00	77.00
1350	AFD-4135-S	55.00	FD-4135-S	66.00	AFD-4135-L	FD-4135-L	170.00	AFD-4135-FE	FD-4135-FE	68.00	76.00	95.00
1600	AFM-4160-S	66.00	FD-4160-S	80.00	AFM-4160-L	FD-4160-L	170.00	AFM-4160-FE	FD-4160-FE	70.00	90.00	112.00
2000	AFD-4200-S	82.00	FD-4200-S	98.00	AFD-4200-L	FD-4200-L	170.00	AFD-4200-FE	FD-4200-FE	74.00	122.00	152.00
2500	AFD-4250-S	102.00	FD-4250-S	123.00	AFD-4250-L	FD-4250-L	170.00	AFD-4250-FE	FD-4250-FE	80.00	157.00	196.00
3000	AFD-4300-S	123.00	FD-4300-S	147.00	AFD-4300-L	FD-4300-L	202.00	AFD-4300-FE	FD-4300-FE	82.00	194.00	242.00
4000	AFD-4400-S	164.00	FD-4400-S	196.00	AFD-4400-L	FD-4400-L	202.00	AFD-4400-FE	FD-4400-FE	86.00	234.00	346.00
Three Phase, 4 Wire 277/480 Volt—100% Neutral												
600			FD-5060-S	\$ 38.00		FD-5060-L	\$170.00		FD-5060-FE	\$56.00		\$ 50.00
800	AFM-5080-S	\$ 38.00	FD-5080-S	46.00	AFM-5080-L	FD-5080-L	170.00	AFM-5080-FE	FD-5080-FE	58.00	55.00	69.00
1000	AFM-5100-S	46.00	FD-5120-S	57.00	AFM-5100-L	FD-5120-L	170.00	AFM-5100-FE	FD-5120-FE	64.00	66.00	83.00
1350	AFD-5135-S	62.00	FD-5135-S	77.00	AFD-5135-L	FD-5135-L	170.00	AFD-5135-FE	FD-5135-FE	68.00	84.00	104.00
1600	AFM-5160-S	76.00	FD-5160-S	92.00	AFM-5160-L	FD-5160-L	170.00	AFM-5160-FE	FD-5160-FE	70.00	97.00	121.00
2000	AFD-5200-S	92.00	FD-5200-S	114.00	AFD-5200-L	FD-5200-L	170.00	AFD-5200-FE	FD-5200-FE	74.00	130.00	163.00
2500	AFD-5250-S	115.00	FD-5250-S	143.00	AFD-5250-L	FD-5250-L	170.00	AFD-5250-FE	FD-5250-FE	80.00	165.00	206.00
3000	AFD-5300-S	138.00	FD-5300-S	171.00	AFD-5300-L	FD-5300-L	202.00	AFD-5300-FE	FD-5300-FE	82.00	208.00	260.00
4000	AFD-5400-S	184.00	FD-5400-S	228.00	AFD-5400-L	FD-5400-L	202.00	AFD-5400-FE	FD-5400-FE	86.00	258.00	378.00

No. of Poles and Voltage	Expansion Joint				Reducer (Unfused)			Joint Package Assembly		Adjustable Joint Assembly
	Rating Amp.	Aluminum No.	Copper No.	List Price Labor Only	Aluminum No.	Copper No.	List Price Labor Only	Aluminum No.	Copper No.	
2 Pole 600 V.	600		FD-2060-EJ	\$144.00		FD-2060-R	\$102.00		FD-206	
	800	AFM-2080-EJ	FD-2080-EJ	150.00	AFM-2080-R	FD-2080-R	128.00	AFM-208	FD-208	AFM-208-AJ
	1000	AFM-2100-EJ	FD-2120-EJ	156.00	AFM-2100-R	FD-2120-R	140.00	AFM-210	FD-212	AFM-210-AJ
	1350	AFD-2135-EJ	FD-2135-EJ	220.00	AFD-2135-R	FD-2135-R	168.00	AFD-213	FD-213	AFD-213-AJ
	1600	AFD-2160-EJ	FD-2160-EJ	240.00	AFD-2160-R	FD-2160-R	188.00	AFD-216	FD-216	AFD-216-AJ
	2000	AFD-2200-EJ	FD-2200-EJ	260.00	AFD-2200-R	FD-2200-R	228.00	AFD-222	FD-220	AFD-220-AJ
	2500	AFD-2250-EJ	FD-2250-EJ	310.00	AFD-2250-R	FD-2250-R	280.00	AFD-225	FD-225	AFD-225-AJ
	3000	AFD-2300-EJ	FD-2300-EJ	450.00	AFD-2300-R	FD-2300-R	330.00	AFD-230	FD-230	AFD-230-AJ
4000	AFD-2400-EJ	FD-2400-EJ	504.00	AFD-2400-R	FD-2400-R	408.00	AFD-240	FD-240	AFD-240-AJ	
3 Pole 600 V.	600		FD-3060-EJ	\$240.00		FD-3060-R	\$140.00		FD-306	
	800	AFM-3080-EJ	FD-3080-EJ	256.00	AFM-3080-R	FD-3080-R	172.00	AFM-308	FD-308	AFM-308-AJ
	1000	AFM-3100-EJ	FD-3120-EJ	266.00	AFM-3100-R	FD-3120-R	192.00	AFM-310	FD-312	AFM-310-AJ
	1350	AFD-3135-EJ	FD-3135-EJ	360.00	AFD-3135-R	FD-3135-R	224.00	AFD-313	FD-313	AFD-313-AJ
	1600	AFD-3160-EJ	FD-3160-EJ	390.00	AFD-3160-R	FD-3160-R	250.00	AFD-316	FD-316	AFD-316-AJ
	2000	AFD-3200-EJ	FD-3200-EJ	420.00	AFD-3200-R	FD-3200-R	316.00	AFD-320	FD-320	AFD-320-AJ
	2500	AFD-3250-EJ	FD-3250-EJ	528.00	AFD-3250-R	FD-3250-R	416.00	AFD-325	FD-325	AFD-325-AJ
	3000	AFD-3300-EJ	FD-3300-EJ	636.00	AFD-3300-R	FD-3300-R	490.00	AFD-330	FD-330	AFD-330-AJ
4000	AFD-3400-EJ	FD-3400-EJ	672.00	AFD-3400-R	FD-3400-R	618.00	AFD-340	FD-340	AFD-340-AJ	
3 Ph. 4 W. 277/480 V. 50% Neutral	600		FD-4060-EJ	\$288.00		FD-4060-R	\$170.00		FD-406	
	800	AFM-4080-EJ	FD-4080-EJ	322.00	AFM-4080-R	FD-4080-R	204.00	AFM-408	FD-408	AFM-408-AJ
	1000	AFM-4100-EJ	FD-4120-EJ	338.00	AFM-4100-R	FD-4120-R	228.00	AFM-410	FD-412	AFM-410-AJ
	1350	AFD-4135-EJ	FD-4135-EJ	438.00	AFD-4135-R	FD-4135-R	264.00	AFD-413	FD-413	AFD-413-AJ
	1600	AFD-4160-EJ	FD-4160-EJ	468.00	AFD-4160-R	FD-4160-R	290.00	AFD-416	FD-416	AFD-416-AJ
	2000	AFD-4200-EJ	FD-4200-EJ	498.00	AFD-4200-R	FD-4200-R	380.00	AFD-420	FD-420	AFD-420-AJ
	2500	AFD-4250-EJ	FD-4250-EJ	648.00	AFD-4250-R	FD-4250-R	482.00	AFD-425	FD-425	AFD-425-AJ
	3000	AFD-4300-EJ	FD-4300-EJ	750.00	AFD-4300-R	FD-4300-R	574.00	AFD-430	FD-430	AFD-430-AJ
4000	AFD-4400-EJ	FD-4400-EJ	792.00	AFD-4400-R	FD-4400-R	738.00	AFD-440P	FD-440	AFD-440-AJ	
3 Ph. 4 W. 277/480 V. 100% Neutral	600		FD-5060-EJ	\$332.00		FD-5060-R	\$200.00		FD-506	
	800	AFM-5080-EJ	FD-5080-EJ	360.00	AFM-5080-R	FD-5080-R	236.00	AFM-508	FD-508	AFM-508-AJ
	1000	AFM-5100-EJ	FD-5120-EJ	396.00	AFM-5100-R	FD-5120-R	264.00	AFM-510	FD-512	AFM-510-AJ
	1350	AFD-5135-EJ	FD-5135-EJ	480.00	AFD-5135-R	FD-5135-R	304.00	AFD-513	FD-513	AFD-513-AJ
	1600	AFD-5160-EJ	FD-5160-EJ	510.00	AFD-5160-R	FD-5160-R	330.00	AFD-516	FD-516	AFD-516-AJ
	2000	AFD-5200-EJ	FD-5200-EJ	552.00	AFD-5200-R	FD-5200-R	444.00	AFD-520	FD-520	AFD-520-AJ
	2500	AFD-5250-EJ	FD-5250-EJ	726.00	AFD-5250-R	FD-5250-R	548.00	AFD-525	FD-525	AFD-525-AJ
	3000	AFD-5300-EJ	FD-5300-EJ	834.00	AFD-5300-R	FD-5300-R	658.00	AFD-530	FD-530	AFD-530-AJ
4000	AFD-5400-EJ	FD-5400-EJ	876.00	AFD-5400-R	FD-5400-R	858.00	AFD-540	FD-540	AFD-540-AJ	

Square D Feed-In Duct Fittings

Rating Amp.	Aluminum Tee		List Price Labor Only	Aluminum Cross-Copper		List Price Labor Only	Aluminum End Closure Copper		List Price Each	Aluminum Cable Tap Box Copper		List Price Each
	No.	No.		No.	No.		No.	No.		No.	No.	
2 Poles, 600 Volts												
600		FD-2060-T	\$170.00		FD-2060-X	\$202.00		FD-5135-EC	\$28.00		FD-2060-TB	\$130.00
800	AFM-2080-T	FD-2080-T	170.00	AFM-2080-X	FD-2080-X	202.00	AFD-5100-EC	FD-5135-EC	28.00	AFM-2080-TB	FD-2080-TB	138.00
1000	AFM-2100-T	FD-2120-T	170.00	AFM-2100-X	FD-2120-X	202.00	AFD-5100-EC	FD-5135-EC	28.00	AFM-2100-TB	FD-2120-TB	146.00
1350	AFD-2135-T	FD-2135-T	170.00	AFD-2135-X	FD-2135-X	202.00	AFD-5200-EC	FD-4135-EC	28.00	AFD-2135-TB	FD-2135-TB	168.00
1600	AFM-2160-T	FD-2160-T	170.00	AFM-2160-X	FD-2160-X	202.00	AFD-5200-EC	FD-5200-EC	28.00	AFD-2160-TB	FD-2160-TB	176.00
2000	AFD-2200-T	FD-2200-T	170.00	AFD-2200-X	FD-2200-X	202.00	AFD-5200-EC	FD-5200-EC	28.00	AFD-2200-TB	FD-2200-TB	196.00
2500	AFD-2250-T	FD-2250-T	170.00	AFD-2250-X	FD-2250-X	202.00	AFD-5300-EC	FD-5300-EC	42.00	AFD-2250-TB	FD-2250-TB	216.00
3000	AFD-2300-T	FD-2300-T	202.00	AFD-2300-X	FD-2300-X	236.00	AFD-5300-EC	FD-5300-EC	42.00	AFD-2300-TB	FD-2300-TB	240.00
4000	AFD-2400-T	FD-2400-T	202.00	AFD-2400-X	FD-2400-X	236.00	AFD-5400-EC	FD-5400-EC	50.00	AFD-2400-TB	FD-2400-TB	354.00

Three Pole, 600 Volts												
600		FD-3060-T	\$170.00		FD-3060-X	\$202.00		FD-5135-EC	\$28.00		FD-3060-TB	\$162.00
800	AFM-3080-T	FD-3080-T	170.00	AFM-3080-X	FD-3080-X	202.00	AFD-5100-EC	FD-5135-EC	28.00	AFM-3080-TB	FD-3080-TB	172.00
1000	AFM-3100-T	FD-3120-T	170.00	AFM-3100-X	FD-3120-X	202.00	AFD-5100-EC	FD-4135-EC	28.00	AFM-3100-TB	FD-3120-TB	178.00
1350	AFD-3135-T	FD-3135-T	170.00	AFD-3135-X	FD-3135-X	202.00	AFD-5200-EC	FD-5135-EC	28.00	AFD-3135-TB	FD-3135-TB	206.00
1600	AFM-3160-T	FD-3160-T	170.00	AFM-3160-X	FD-3160-X	202.00	AFD-5200-EC	FD-5200-EC	28.00	AFD-3160-TB	FD-3160-TB	214.00
2000	AFD-3200-T	FD-3200-T	170.00	AFD-3200-X	FD-3200-X	202.00	AFD-5200-EC	FD-5200-EC	28.00	AFD-3200-TB	FD-3200-TB	240.00
2500	AFD-3250-T	FD-3250-T	170.00	AFD-3250-X	FD-3250-X	202.00	AFD-5300-EC	FD-5300-EC	42.00	AFD-3250-TB	FD-3250-TB	268.00
3000	AFD-3300-T	FD-3300-T	202.00	AFD-3300-X	FD-3300-X	236.00	AFD-5300-EC	FD-5300-EC	42.00	AFD-3300-TB	FD-3300-TB	292.00
4000	AFD-3400-T	FD-3400-T	202.00	AFD-3400-X	FD-3400-X	236.00	AFD-5400-EC	FD-5400-EC	50.00	AFD-3400-TB	FD-3400-TB	420.00

Three Phase, 4 Wire—277/480 Volt 50% Neutral												
600		FD-4060-T	\$202.00		FD-4060-X	\$236.00		FD-5135-EC	\$28.00		FD-4060-TB	\$178.00
800	AFM-4080-T	FD-4080-T	202.00	AFM-4080-X	FD-4080-X	236.00	AFD-5100-EC	FD-5135-EC	28.00	AFM-4080-TB	FD-4080-TB	184.00
1000	AFM-4100-T	FD-4120-T	202.00	AFM-4100-X	FD-4120-X	236.00	AFD-5100-EC	FD-5135-EC	28.00	AFM-4100-TB	FD-4120-TB	196.00
1350	AFD-4135-T	FD-4135-T	202.00	AFD-4135-X	FD-4135-X	236.00	AFD-5200-EC	FD-5135-EC	28.00	AFD-4135-TB	FD-4135-TB	226.00
1600	AFM-4160-T	FD-4160-T	202.00	AFM-4160-X	FD-4160-X	236.00	AFD-5200-EC	FD-5200-EC	28.00	AFD-4160-TB	FD-4160-TB	238.00
2000	AFD-4200-T	FD-4200-T	202.00	AFD-4200-X	FD-4200-X	236.00	AFD-5200-EC	FD-5200-EC	28.00	AFD-4200-TB	FD-4200-TB	262.00
2500	AFD-4250-T	FD-4250-T	202.00	AFD-4250-X	FD-4250-X	236.00	AFD-5300-EC	FD-5300-EC	42.00	AFD-4250-TB	FD-4250-TB	290.00
3000	AFD-4300-T	FD-4300-T	236.00	AFD-4300-X	FD-4300-X	270.00	AFD-5300-EC	FD-5300-EC	42.00	AFD-4300-TB	FD-4300-TB	322.00
4000	AFD-4400-T	FD-4400-T	236.00	AFD-4400-X	FD-4400-X	270.00	AFD-5400-EC	FD-5400-EC	50.00	AFD-4400-TB	FD-4400-TB	448.00

Three Phase, 4 Wire—277/480 Volt 100% Neutral												
600		FD-5060-T	\$202.00		FD-5060-X	\$236.00		FD-5135-EC	\$28.00		FD-5060-TB	\$194.00
800	AFM-5080-T	FD-5080-T	202.00	AFM-5080-X	FD-5080-X	236.00	AFD-5100-EC	FD-5135-EC	28.00	AFM-5080-TB	FD-5080-TB	196.00
1000	AFM-5100-T	FD-5120-T	202.00	AFM-5100-X	FD-5120-X	236.00	AFD-5100-EC	FD-5135-EC	28.00	AFM-5100-TB	FD-5120-TB	214.00
1350	AFD-5135-T	FD-5135-T	202.00	AFD-5135-X	FD-5135-X	236.00	AFD-5200-EC	FD-5135-EC	28.00	AFD-5135-TB	FD-5135-TB	246.00
1600	AFM-5160-T	FD-5160-T	202.00	AFM-5160-X	FD-5160-X	236.00	AFD-5200-EC	FD-5200-EC	28.00	AFD-5160-TB	FD-5160-TB	262.00
2000	AFD-5200-T	FD-5200-T	202.00	AFD-5200-X	FD-5200-X	236.00	AFD-5200-EC	FD-5200-EC	28.00	AFD-5200-TB	FD-5200-TB	284.00
2500	AFD-5250-T	FD-5250-T	202.00	AFD-5250-X	FD-5250-X	236.00	AFD-5300-EC	FD-5300-EC	42.00	AFD-5250-TB	FD-5250-TB	312.00
3000	AFD-5300-T	FD-5300-T	236.00	AFD-5300-X	FD-5300-X	270.00	AFD-5300-EC	FD-5300-EC	42.00	AFD-5300-TB	FD-5300-TB	352.00
4000	AFD-5400-T	FD-5400-T	236.00	AFD-5400-X	FD-5400-X	270.00	AFD-5400-EC	FD-5400-EC	50.00	AFD-5400-TB	FD-5400-TB	476.00

Weatherproof Feed-In Duct

Underwriters' Approved Weatherproof Copper Feed-In Duct Can Be Supplied for Vertical Riser or Horizontal

Installations In Either the Flatwise or Edgewise Mountings

Rating Amp.	No.	List Price Per Foot	Rating Amp.	No.	List Price Per Foot
2 Pole, 600 Volts					
600	FDW-2060-S	\$ 24.00	600	FDW-3060-S	\$ 30.00
800	FDW-2080-S	30.00	800	FDW-3080-S	40.00
1000	FDW-2120-S	37.00	1000	FDW-3120-S	49.00
1350	FDW-2135-S	49.00	1350	FDW-3135-S	65.00
1600	FDW-2160-S	60.00	1600	FDW-3160-S	79.00
2000	FDW-2200-S	74.00	2000	FDW-3200-S	98.00
2500	FDW-2250-S	92.00	2500	FDW-3250-S	122.00
3000	FDW-2300-S	112.00	3000	FDW-3300-S	148.00
4000	FDW-2400-S	149.00	4000	FDW-3400-S	197.00

Three Phase—Four Wire 277/480 Volt 50% Neutral					
600	FDW-4060-S	\$ 37.00	600	FDW-5060-S	\$ 46.00
800	FDW-4080-S	48.00	800	FDW-5080-S	55.00
1000	FDW-4120-S	59.00	1000	FDW-5120-S	68.00
1350	FDW-4135-S	79.00	1350	FDW-5135-S	92.00
1600	FDW-4160-S	96.00	1600	FDW-5160-S	110.00
2000	FDW-4200-S	118.00	2000	FDW-5200-S	137.00
2500	FDW-4250-S	148.00	2500	FDW-5250-S	172.00
3000	FDW-4300-S	176.00	3000	FDW-5300-S	205.00
4000	FDW-4400-S	235.00	4000	FDW-5400-S	274.00

Weatherproof duct enclosure consists of two-piece galvanized steel housing with drip hoods on top of duct, joint connections and cable tap boxes.

Blue gray baked enamel finish.

Pricing Weatherproof Duct: Use the price per foot from the adjacent table for the "footage charge" and add the "labor only" charges and cable tap box and end closure prices from the above tables.

Ordering Information: When ordering weatherproof feed-in duct, it is necessary that a layout sketch accompany the order. Sketch must bear all dimensions and also whether duct is in flatwise, vertical or edgewise mounting position. If duct passes through a wall be sure to indicate wall thickness and dimension from wall surface to tap box, elbow, flanged end or end of run.

Bulldog Flexible BUStribution[®]DUCT Systems

Ventilated LO-X[®] Duct for Feeder Circuits

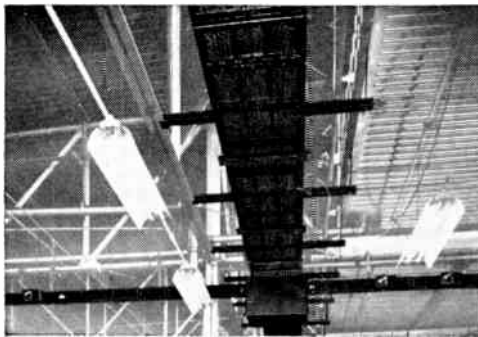

Available in capacities ranging from 800 to 4000 amperes inclusive, for 2-Pole, 3-Pole and 3-Phase, 4-Pole, 600 volts or less a-c or d-c, with Aluminum or Copper Bus bars.

Assures cooled electricity for feeder circuits, welders and similar heavy inductive loads.

It is a prefabricated busway designed for general feeder runs and for serving single or grouped welders and other large inductive loads.

Standard factory-built units, including elbows, tees and crosses, as well as straight sections are merely bolted together to form runs of desired length and arrangement.

Closely-spaced bus bars arranged in paired phase configuration neutralize magnetic fields and result in superior efficiency. This greatly reduces reactance and holds the voltage drop to a minimum.

Bus bars are wrapped with high-dielectric tape and securely positioned in the casing by compression type insulators. The ventilated nature of the reinforced expanded metal casing provides for natural heat dissipation, insuring cool operation.

DUCT SECTION—In addition to standard 10-foot duct sections, fittings can be furnished to meet any building contour or installation requirements.



Duct Section

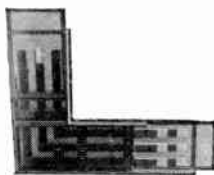

Flatwise Elbow



Edgewise Elbow

Standard 10-Foot Duct Section

Copper Conductor Pricing Data

Two Pole					Three Pole				3-Phase, 4-Wire—1/2 Cap. Neutral			
Amps.	No.	Bus Bars Per Leg	Ship. Wt. Ea. Lbs.	Each	No.	Bus Bars Per Leg	Ship. Wt. Each	Each	No.	Bus Bars Per Leg	Ship. Wt. Each	Each
800	XD208	1 1/4 x 2	150	\$250.00	XD308	2 1/4 x 1	205	\$330.00	XD408	2 1/4 x 1	235	\$400.00
1000	XD210	1 1/4 x 3	180	310.00	XD310	2 1/4 x 1 1/2	240	410.00	XD410	2 1/4 x 1 1/2	273	490.00
1350	XD213	1 1/4 x 4	205	410.00	XD313	2 1/4 x 2	285	540.00	XD413	2 1/4 x 2	325	660.00
1600	XD216	2 1/4 x 2 1/16	235	500.00	XD316	2 1/4 x 2 1/16	325	660.00	XD416	2 1/4 x 2 1/16	365	800.00
2000	XD220	2 1/4 x 3	285	620.00	XD320	2 1/4 x 3	390	820.00	XD420	2 1/4 x 3	445	980.00
2500	XD225	2 1/4 x 4	340	770.00	XD325	2 1/4 x 4	460	1020.00	XD425	2 1/4 x 4	525	1230.00
3000	XD230	2 1/4 x 5	400	930.00	XD330	2 1/4 x 5	535	1230.00	XD430	2 1/4 x 5	605	1470.00

Elbows

Amps.	2-Pole Nos.	3-Pole	Each	3-ph., 4-pole Nos.	4-pole	Each
800	EL208	EL308	\$136.00	EL408	EL700	\$170.00
1000	EL210	EL310	136.00	EL410	EL710	170.00
1350	EL213	EL313	136.00	EL413	EL713	170.00
1600	EL216	EL316	136.00	EL416	EL716	170.00
2000	EL220	EL320	136.00	EL420	EL720	170.00
2500	EL225	EL325	136.00	EL425	EL725	170.00
3000	EL230	EL330	136.00	EL430	EL730	170.00

Tees

Amps.	2-Pole Nos.	3-Pole	Each	3-ph., 4-pole Nos.	4-pole	Each
800	TE208	TE308	\$170.00	TE408	TE700	\$202.00
1000	TE210	TE310	170.00	TE410	TE710	202.00
1350	TE213	TE313	170.00	TE413	TE713	202.00
1600	TE216	TE316	170.00	TE416	TE716	202.00
2000	TE220	TE320	170.00	TE420	TE720	202.00
2500	TE225	TE325	170.00	TE425	TE725	202.00
3000	TE230	TE330	170.00	TE430	TE730	202.00

Crosses

Amps.	2-Pole Nos.	3-Pole	Each	3-ph., 4-pole Nos.	4-pole	Each
800	CR208	CR308	\$202.00	CR408	CR700	\$236.00
1000	CR210	CR310	202.00	CR410	CR710	236.00
1350	CR213	CR313	202.00	CR413	CR713	236.00
1600	CR216	CR316	202.00	CR416	CR716	236.00
2000	CR220	CR320	202.00	CR420	CR720	236.00
2500	CR225	CR325	202.00	CR425	CR725	236.00
3000	CR230	CR330	202.00	CR430	CR730	236.00

End Closers

Amps.	2-Pole No.	3-Pole No.	3-ph., 4-pole No.	Each
800	EC208	EC308	EC408	\$18.00
1000	EC210	EC310	EC410	24.00
1350	EC213	EC313	EC413	26.00
1600	EC216	EC316	EC416	28.00
2000	EC220	EC320	EC420	30.00
2500	EC225	EC325	EC425	40.00
3000	EC230	EC330	EC430	42.00

Transformer Tap Openings

Amps.	2-Pole No.	3-Pole No.	3-ph., 4-pole No.	Each
800	TT208	TT308	TT408	\$82.00
1000	TT210	TT310	TT410	90.00
1350	TT213	TT313	TT413	100.00
1600	TT216	TT316	TT416	106.00
2000	TT220	TT320	TT420	116.00
2500	TT225	TT325	TT425	124.00
3000	TT230	TT330	TT430	134.00

Flange Ends

Amps.	2-Pole No.	3-Pole No.	3-ph., 4-pole No.	Each
800	FE208	FE308	FE408	56.00
1000	FE210	FE310	FE410	58.00
1350	FE213	FE313	FE413	64.00
1600	FE216	FE316	FE416	68.00
2000	FE220	FE320	FE420	70.00
2500	FE225	FE325	FE425	74.00
3000	FE230	FE330	FE430	80.00

Ebony Ends

Amps.	2-Pole No.	3-Pole No.	3-ph., 4-pole No.	Each
800	EE208	EE308	EE408	56.00
1000	EE210	EE310	EE410	66.00
1350	EE213	EE313	EE413	74.00
1600	EE216	EE316	EE416	84.00
2000	EE220	EE320	EE420	92.00
2500	EE225	EE325	EE425	104.00
3000	EE230	EE330	EE430	112.00

Note—For Corrosion-Resistant Bus Duct suitable for installation outdoors or in wet or damp locations, contact Graybar. 600 Amp. and 4000 Amp. prices furnished on request—contact Graybar.

Bulldog Flexible BUStribution® DUCT Systems

Bus Plugs for Type BD Plug-in Duct for Branch Circuits



Circuit Breaker Plugs

Rated from 15 to 600 amperes, 2, 3 and 4 pole, 600 volts or less.

Used where an automatic protective device of the industrial breaker type with inverse time limit feature is required.

Quick-make and quick-break, with cover interlock.

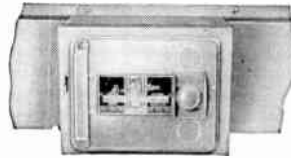

Temperature Indicating Plugs

This plug warns, by visual indication through a lamp, when temperatures along a Bus Duct run exceed an efficient operating temperature—100° C. (212° F.) so that remedial measures can be taken to relieve the situation.

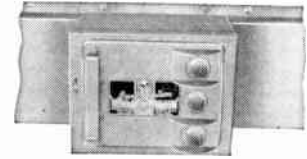

Ground Detector Plugs

For 1-Phase and 3-Phase, 480 volts and 240 volts.

Affords an easy means, through lamps, for quickly indicating grounds on the system. They also serve as potentializers by establishing a potential to ground between bus bars and casing.

Vacu-Break® Switch Plugs

2-Pole—240 Volts A-C—250 Volts D-C

Amp. Rating	*No.	Horsepower		Ship. Wt. Each, Lbs.	Each
		A-C	D-C		
30	BOS14221	2	5	15	\$45.00
60	BOS14222	5	10	15	50.00
100	BOS14223	10	15	18	76.00
200	BOS14224	15	30	25	134.00
400	BOS14225	30	50	100	278.00
600	BOS14226	110	362.00

2-Pole—600 Volts A-C

30	BOS14261	5	..	15	47.00
60	BOS14262	10	..	15	54.00
100	BOS14263	15	..	18	80.00
200	BOS14264	30	..	25	148.00
400	BOS14265	100	293.00
600	BOS14266	110	383.00

3-Pole—240 Volts A-C

30	BOS14321	3	..	18	49.00
60	BOS14322	7½	..	18	57.00
100	BOS14323	15	..	21	84.00
200	BOS14324	30	..	30	148.00
400	BOS14325	50	..	100	305.00
600	BOS14326	110	399.00

3-Pole 600 Volts A-C

30	BOS14351	7½	..	18	50.00
60	BOS14352	20	..	18	60.00
100	BOS14353	30	..	21	87.00
200	BOS14354	50	..	30	156.00
400	BOS14355	100	320.00
600	BOS14356	110	418.00

3-Phase, 4-Pole—240 Volts A-C

30	BOS16421	3	..	18	59.00
60	BOS16422	7½	..	18	66.00
100	BOS16423	15	..	21	92.00
200	BOS16424	30	..	30	166.00
400	BOS16425	10	..	100	335.00
600	BOS16426	110	426.00

“BP” Bus Plugs

2-Pole—240 Volts A-C—250 Volts D-C

Amp. Rating	*No.	Horsepower		Ship. Wt. Each, Lbs.	Each
		A-C	D-C		
30	BP221	2	5	11	\$37.00
60	BP222	5	10	11	39.00
100	BP2237	10	15	12	52.00

2-Pole—600 Volts A-C

30	BP251	5	..	11	39.00
60	BP252	10	..	11	41.00
100	BP2537	15	..	12	54.00

3-Pole—240 Volts A-C

30	BP321	3	..	11	39.00
60	BP322	7½	..	11	43.00
100	BP3237	15	..	12	56.00

3-Pole—600 Volts A-C

30	BP351	7½	..	11	41.00
60	BP352	20	..	11	45.00
100	BP3537	30	..	12	63.00

3-Phase, 4-Pole—240 Volts A-C

30	BP421	3	..	13	50.00
60	BP422	7½	..	13	52.00
100	BP4237	15	..	14	67.00

Ground Detector, Potentializer Plugs

240 and 480 Volt

No.	No. of Poles	Each
*PGR6214	Two	\$70.00
*PGR6314	Three	76.00

Temperature Indicating Plugs

230 and 460 Volts

*No. TIP614..... Ea. \$71.00

*When Bus Plugs are used on 800, 1000 or 1350 ampere Duct it is necessary to specify spacers for each plug.

Bull Dog fuse grips are standard on all Fusible Bus Plugs. Prices of Non-Fusible Plugs are same as 250 Volt Fusible.



Vacu-Break “BOS” Switch Plugs

The Vacu-Break principle minimizes arcing, also prevents pitting and beading of contacts. Plugs are Quick-make and quick-break and horsepower rated.

Fusible and non-fusible types are available from 30 to 600 amperes, 2 or 3-pole 600 Volts or less, or 4-pole solid neutral 240 Volts A-C.



“BP” Type Bus Plugs

Fusible and non-fusible “BP” plugs are for disconnecting purposes only. Opening and closing the hinged cover makes or breaks the circuit. They are horsepower rated.

Ratings are 30, 60 and 100 amperes for 2 or 3 pole, 600 volts or less, or 4-pole solid neutral 240 volts A-C.

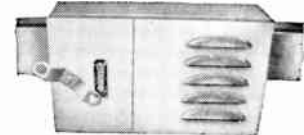

Capacitor Plugs

Afford a convenient and flexible means for reducing inductive heating and improving the power factor on Bus Duct systems. The thermal protective device and capacitor unit are contained in one housing.

Rated from 1 to 7.5 Kva at 240 volts and to 15 Kva at 480 volts, 60 cycles A-C.

Bulldog Flexible BUStribution® DUCT Systems

Type BD Plug-in Duct for Branch Circuits With Aluminum or Copper Conductors

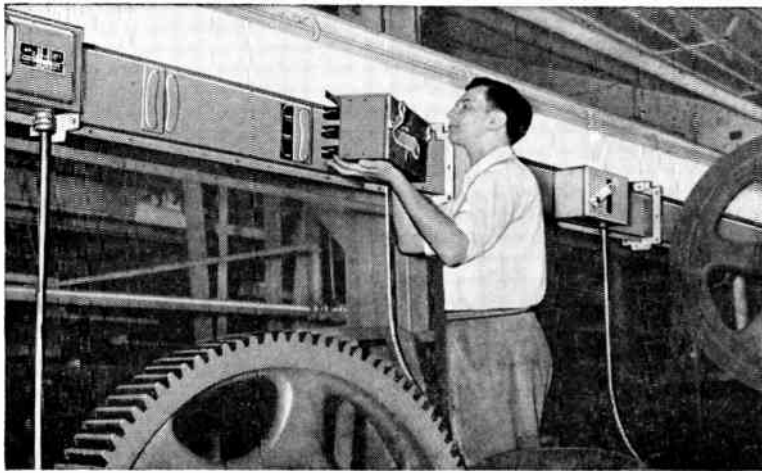

Capacities 225 to 1000 Amperes, for 2-Pole, 3-Pole Service, 600 Volts or less A-C or D-C; and For 3-Phase, 4-Pole, 250 Volts or Less.

Provides Flexible Plug-in Lighting and Motor Circuits wherever and whenever desired.

This prefabricated electrical distribution system has the flexibility to match today's dynamic production methods. It enables plant engineers to plan with freedom. Change-overs can be taken in stride because electrically driven equipment can be disconnected, moved and reconnected to the bus duct with minimum expenditure in time and money.

When moving a machine, the protective Bus Plug, or tap-off device, is removed from the Duct and reinserted at any convenient plug-in opening.

Each 10-foot section has ten plug-in openings, five on each side. Duct is installed by bolting together the standard sections, elbows, tees, crosses and fittings required to make runs of any desired length and pattern.

It is 100% salvageable — the factory-built units can be reused in the same or new combinations.

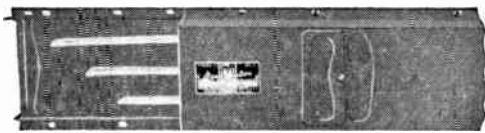

Standard 10-ft. Duct Section

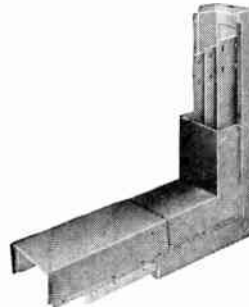

Edgewise Elbow



Edgewise Tee

Copper Conductors Pricing Data 10-Foot Duct Sections

Amps.	No.	Bus Bars per Leg	Two-Pole			Three-Pole			3-Phase, 4-Pole (Neutral—½ Rating)		
			No.	Shp. Wt., Lbs.	Each	No.	Shp. Wt., Lbs.	Each	No.	Shp. Wt., Lbs.	Each
225	1	.05 x 2	BDP202	80	\$100.00	BDP302	85	\$110.00	BDP402	90	\$140.00
400	1	¼ x 1½	BDP204	100	160.00	BDP304	115	190.00	BDP404	125	250.00
600	1	¼ x 2	BDP206	110	190.00	BDP306	130	240.00	BDP406	140	300.00
800	1	¼ x 3	BDP208	160	240.00	BDP308	190	320.00	BDP408	210	390.00
1000	1	¼ x 4	BDP210	180	300.00	BDP310	220	400.00	BDP410	240	480.00

Elbows, Tees and Crosses

Amps.	Elbows			Tees			Crosses					
	2-Pole No.	3-Pole No.	Each	2-Pole No.	3-Pole No.	Each	2-Pole No.	3-Pole No.	Each	2-Pole No.	3-Pole No.	Each
225	LDP202	BDP302	\$102.00	LDP402	BDP302	\$122.00	TDP202	TDP302	\$122.00	TDP402	CDP302	\$144.00
400	LDP204	BDP304	102.00	LDP404	BDP304	122.00	TDP204	TDP304	122.00	TDP404	CDP304	144.00
600	LDP206	BDP306	102.00	LDP406	BDP306	122.00	TDP206	TDP306	122.00	TDP406	CDP306	144.00
800	LDP208	BDP308	102.00	LDP408	BDP308	122.00	TDP208	TDP308	122.00	TDP408	CDP308	144.00
1000	LDP210	BDP310	102.00	LDP410	BDP310	122.00	TDP210	TDP310	122.00	TDP410	CDP310	144.00

Two BDII Hangers are furnished without charge with each "BD" elbow, tee or cross; Additional Hangers \$1.00 each.

Fittings for "BD" Plug-in Ducts

Amp. Rating	End Closers		Flange Ends No.	Trans. Tap Opening No.	Ebony End Closers	
	No.	Each			No.	Each
225				TTD2	EEP2	\$42.00
400	ECP6	\$14.00	FEP6	TTD4	EEP4	42.00
600				TTD6	EEP6	42.00
800	ECP10	14.00	FEP8	TTD8	EEP8	46.00
1000			FEP10	TTD10	EEP10	46.00

The arm or projection having the highest rating determines the fitting rating. Designate type elbow or tee by adding suffix figure to number: No. 1 — Right-hand Flatwise. No. 2 — Right-hand Edgewise. No. 3 — Left-hand Flatwise. No. 4 Left-hand Edgewise. Designate type of cross by adding suffix figure to number: No. 5 — Flatwise. No. 6 — Edgewise.

General Information and Ordering Instruction

Standard Ducts—Furnished in 10-ft. lengths only. Prices include labor and material for making duct. For ampere ratings below standard, use next larger size. Full rating neutral prices furnished on request—contact Graybar. (600 amperes is the maximum for which a full rating neutral can be supplied. **Elbows, Tees and Crosses**—Prices include labor charge only for manufacturing. Figure material required for these fittings on a footage basis. Prices for 3-Phase, 4-Pole are for fittings having ½ rating neutrals. Full rating neutral prices on request—contact Graybar. **End Closers**—Prices include labor and material. **Flange Ends**—Prices include labor and material. Bus bar extensions or hole in switchboard NOT included. **Transformer Tap Openings**—Prices include one opening in side of duct and ebony cover plate. Bus bar extensions NOT included. **Ebony Ends**—Furnished with or without bus bar openings as specified. Bus Bar extensions NOT included.

Bulldog Flexible BU Distribution® DUCT Systems

Ventilated LO-X Duct for Feeder Circuits — Continued

Tap Boxes for Ventilated “LO-X”® Duct

Two Pole

Box Ampere Rating	Wire Grips Per Leg	Catalog Numbers for Various Duct Ampere Ratings—						
		800	1000	1350	1600	2000	2500	3000
225	1-4/0	TB208-1	TB210-1	TB213-1	TB216-1	TB220-1	TB225-1	TB230-1
400	2-500MCM	TB208-2	TB210-2	TB213-2	TB216-2	TB220-2	TB225-2	TB230-2
600	2-500MCM	TB208-2	TB210-2	TB213-2	TB216-2	TB220-2	TB225-2	TB230-2
800	3-500MCM	TB208-3	TB210-3	TB213-3	TB216-3	TB220-3	TB225-3	TB230-3
1000	3-500MCM		TB210-3	TB213-3	TB216-3	TB220-3	TB225-3	TB230-3
*Tap Box Each	\$130.00	\$138.00	\$142.00	\$164.00	\$166.00	\$172.00	\$176.00

Also Available in Box Ampere Ratings of 1350, 1600, 2000, 2500, 3000 and 4000 Amperes. For complete construction details and catalog numbers, contact Graybar. Prices as follows:

Duct Rating..... Amperes	1350	1600	2000	2500	3000
*Tap Box..... Each	\$146.00	\$168.00	\$176.00	\$196.00	\$216.00

Three Pole

225	1-4/0	TB308-1	TB310-1	TB313-1	TB316-1	TB320-1	TB325-1	TB330-1
400	2-500MCM	TB308-2	TB310-2	TB313-2	TB316-2	TB320-2	TB325-2	TB330-2
600	2-500MCM	TB308-2	TB310-2	TB313-2	TB316-2	TB320-2	TB325-2	TB330-2
800	3-500MCM	TB308-3	TB310-3	TB313-3	TB316-3	TB320-3	TB325-3	TB330-3
1000	3-500MCM		TB310-3	TB313-3	TB316-3	TB320-3	TB325-3	TB330-3
*Tap Box List Each	\$162.00	\$172.00	\$175.00	\$200.00	\$208.00	\$218.00	\$222.00

Also Available in Box Ampere Ratings of 1350, 1600, 2000, 2500, 3000 and 4000 Amperes. For complete construction details and catalog numbers, contact Graybar. Prices as follows:

Duct Rating..... Amperes	1350	1600	2000	2500	3000
*Tap Box..... Each	\$178.00	\$206.00	\$214.00	\$240.00	\$268.00

Three-Phase, 4-Pole **Neutral 1/2 Rating

225	1-4/0	TB408-1	TB410-1	TB413-1	TB416-1	TB420-1	TB425-1	TB430-1
400	2-500MCM	TB408-2	TB410-2	TB413-2	TB416-2	TB420-2	TB425-2	TB430-2
600	2-500MCM	TB408-2	TB410-2	TB413-2	TB416-2	TB420-2	TB425-2	TB430-2
800	3-500MCM	TB408-3	TB410-3	TB413-3	TB416-3	TB420-3	TB425-3	TB430-3
1000	3-500MCM		TB410-3	TB413-3	TB416-3	TB420-3	TB425-3	TB430-3
*Tap Box Each	\$178.00	\$184.00	\$190.00	\$216.00	\$224.00	\$254.00	\$260.00

Also Available in Box Ampere Ratings of 1350, 1600, 2000, 2500, 3000 and 4000 Amperes. For complete construction details and catalog numbers, contact Graybar. Prices as follows:

Duct Rating..... Amperes	1350	1600	2000	2500	3000
*Tap Box..... Each	\$196.00	\$226.00	\$238.00	\$262.00	\$290.00

*Tap Box prices are based on maximum Duct Ampere Ratings. Suffix letters A, B and C designate 225, 400 and 600 Ampere lugs per leg. Suffix letters D and E designate 2 — 400 and 2 — 600 Ampere lugs per leg respectively. For larger rating boxes the size and number of cables per leg must be specified for each Tap Box required.

**Full Rating Neutral prices furnished on request — Contact Graybar.

Note—600 Amp. and 4000 Amp. prices furnished on request—Contact GRAYBAR

General Information and Ordering Instructions

Standard Ducts — Prices include labor and material for making duct. 10-ft. lengths are standard. Figure on pro rata basis for less than standard lengths. Do not figure fractional footage — figure the next higher even foot. For ampere ratings below standard ratings use next larger size. Full rating neutral prices furnished on request — contact Graybar.

These Ducts have Tap Box Opening provisions at each handhole opening. When Tap Box is required over a hand hole opening, add price of required Tap Box. When Tap Box is required in a location other than at the handhole opening, add to the price of the proper section of Duct the Tap Box Opening and price of the Tap Box. When Tap Box Opening only is required in a location other than at a handle opening, add the Top Box Opening price to the price of the section of duct.

Elbows, Tees and Crosses — Prices include labor charge only for manufacturing. Figure material required for these fittings on a footage basis.

Prices for 3-Phase, 4-Pole are for fittings having 1/2 rating neutrals. Full rating neutrals prices on request — contact Graybar.

The arm or projection having the highest rating determines the fitting rating. Designate type elbow or tee by adding suffix figure to catalog number: No. 1 — Right-hand Flatwise. No. 2 — Right-hand Edgewise. No. 3 — Left-hand Flatwise. No. 4 — Left-hand Edgewise. Designate type of cross by adding suffix figure to catalog number: No. 5 — Flatwise. No. 6 — Edgewise.

End Closers — Prices include labor and material.

Flange Ends — Prices include labor and material. Bus bar extensions or hole in switchboard NOT included.

Transformer Tap Opening — Prices include one opening in side of duct and ebony cover plate. Bus bar extensions NOT included.

Ebony Ends — Furnished with or without bus bar openings as specified. Bus bar extensions NOT included.

Bulldog Universal Type Trol-E-Duct® Systems "700" Line

**50A—2 Wire—250 Volts
Portable Electricity**

Duct



Rated capacity: 50 amperes, 250 volts. Length measured from ends of busbars.

No.	Length Ft.	Std. Pkg.	Wt. Std. Pkg. Lbs.	Each
D705	5	10	30	\$ 7.00
D710	10	10	60	12.50

Duct Couplings

They provide a means for joining the duct sections electrically and mechanically.

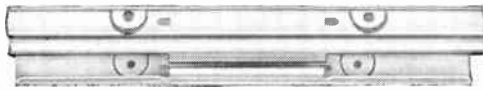

Standard Type

No.	Type	Std. Pkg.	Wt. Std. Pkg. Lbs.	Each
C710	Plain	40	15	\$2.00



No. FCB712

Feed-In Couplings, with Outlet Box.

No.	Type	Std. Pkg.	Wt. Std. Pkg. Lbs.	Each
FCB712	Center Feed	6	17	\$10.00
EFB712	End Feed	6	17	7.00

End Caps



TEC 210



PEP 250

For closing up the ends of duct runs; also as feed-in or trolley entrance point.

No.	Type	Std. Pkg.	Wt. Std. Pkg. Lbs.	Each
TEC210	Trolley Ent.	10	3	\$1.20
PEP250	Feed-in	5	5	3.50

Fustat Receptacles

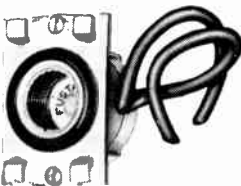

Equipped with No. 12 Dela-hestine lead wires, mounted on steel plate, for use with Bulldog Outlet Box assemblies TBG711 and PBG711.

No.	Cap. Amps.	Std. Pkg.	Pkg. Wt. Lbs.	Each
RB212	3 1/2-6 1/2	20	2 1/2	\$1.50
RB213	7-15	20	2 1/2	1.50

Note: 20 Amp.—2 Wire—250 Volt; 50 Amp.—3 Wire—250 Volt; 50 Amp.—2 Wire—300 Volt prices furnished on request, please contact GRAYBAR.

Duct Hangers

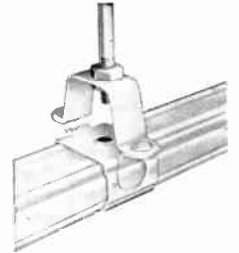

The following styles are available:

- (a) Plain: For flush mounting of duct.
- (b) Hook: For use with messenger cable.
- (c) Rod.

No.	Style	Std. Pkg.	Wt. Std. Pkg. Lbs.	Each
I1710-0	(a)	100	6 1/4	\$0.20
I1210-2	(b)	50	6 1/4	.40
I1210-4	(b)	50	12 1/2	.40
I1711	(c)	50	4 1/2	.40

Plugs



No. TPG712

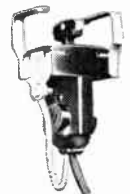

No. RPG713

The Terminal type is used where the connection to the light fixture or appliance is likely to be permanent. The Receptacle type where it is necessary to frequently disconnect the appliance or fixture. (Cord set not included.)

Plugs—A-C 125 Volts, 20 Amp. D-C 125 Volts, 15 Amp.

No.	Type	Std. Pkg.	Wt. Std. Pkg. Lbs.	Each
TPG712	Terminal	10	3	\$2.50
RPG713	Receptacle	10	2	2.00

Trolleys—A-C and D-C, 250 Volts, 20 Amp.

No.	Type	Std. Pkg.	Wt. Std. Pkg. Lbs.	Each
TTG712	Terminal	10	3 1/2	\$5.00
RTG712	Receptacle	10	3 1/2	5.00



Weight Supports

Heavy duty for supporting loads such as luminaires, transformers, etc. up to 75-lbs.

No.	Std. Pkg.	Pkg. Wt. Lbs.	Each
WS710B	50	4 1/2	\$0.50

Bulldog Flexible Trol-E-Duct® Systems
Industrial Type
Portable Electricity
Trolleys Only—575 Volts A-C or Less



Standard Type
30 Amperes Minimum

No.	No. Poles	Ship. Wt. Lbs.	Each
T131	2	4	\$30.00
T331	3	4	34.00



Curve Type
60 Amperes Maximum

No.	No. Poles	Ship. Wt. Lbs.	Each
T134	2	4	\$62.00
T334	3	4	70.00

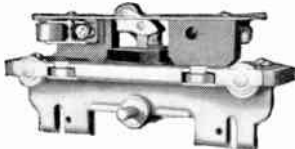

Roller Collector Type

20 Ampere Continuous; 30 Amperes Intermittent

No.	No. Poles	Ship. Wt. Lbs.	Each
TR131-2	2	4	\$30.00
TR331-2	3	4	34.00

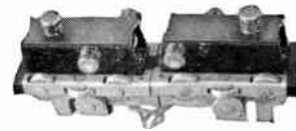

Heavy Duty Type
60 Amperes Minimum

No.	No. Poles	Ship. Wt. Lbs.	Each
T132	2	4	\$48.00
T332	3	4	56.00

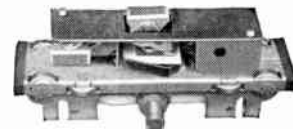

Shoe Type
30 Amperes Maximum

No.	No. Poles	Ship. Wt. Lbs.	Each
TR131-1	2	4	\$37.00
TR331-1	3	4	45.00

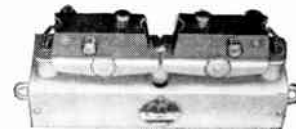

Transfer Type

30 Amperes Continuous; 60 Amperes Intermittent

No.	No. Poles	Ship. Wt. Lbs.	Each
T25	2	6	\$105.00
T35	3	6	113.00

Trolleys with Tool Hangers

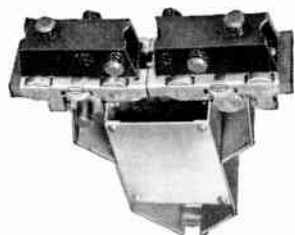

With Plain Tool Hanger

Designed for use with Standard and Heavy Duty Trolleys. The removable screw cover on the hanger makes wiring connections easily accessible for installation, inspection and maintenance.

No.	Type Trolley	No. Poles	Ship. Wt. Lbs.	Each
T13101	Standard	2	6	\$44.00
T33101	Standard	3	6	48.00
T13101-2	Roller Collector	2	6	44.00
T33101-2	Roller Collector	3	6	48.00
T13201	Heavy Duty	2	6	62.00
T33201	Heavy Duty	3	6	70.00

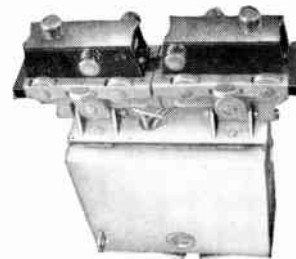

With Box Tool Hanger

Designed for use with Standard and Heavy Duty Trolleys. The hinged cover makes wiring connections, Safto-Fuse Units, Starters and Receptacles easily accessible.

No.	Type Trolley	No. Poles	Ship. Wt. Lbs.	Each
T13102	Standard	2	8	\$49.00
T33102	Standard	3	8	53.00
T13102-2	Roller Collector	2	8	49.00
T33102-2	Roller Collector	3	8	53.00
T13202	Heavy Duty	2	8	67.00
T33202	Heavy Duty	3	8	75.00

Note—The above are only partial listings. For complete data, layouts and estimates contact Graybar.

Bulldog Flexible Trol-E-Duct® Systems
Industrial Type
Portable Electricity

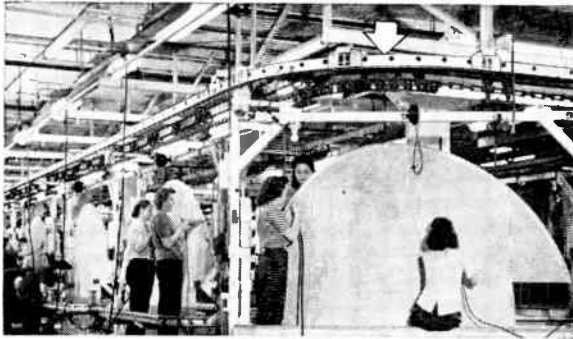

These mobile electrical systems provide a constant source of electrical power for cranes, hoists, portable electric tools and other moving loads. Current is carried through copper busbars enclosed in insulated steel ducts.

The current is collected by trolleys which are wired portable to movable devices. Their flexible, unit construction and standardized design makes it possible to install, dismantle and reinstall many times to meet the ever-changing nature of modern industry.

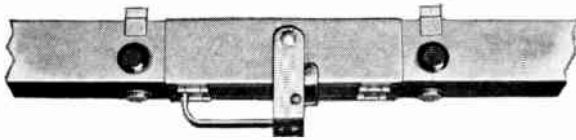

Drop-Out Section

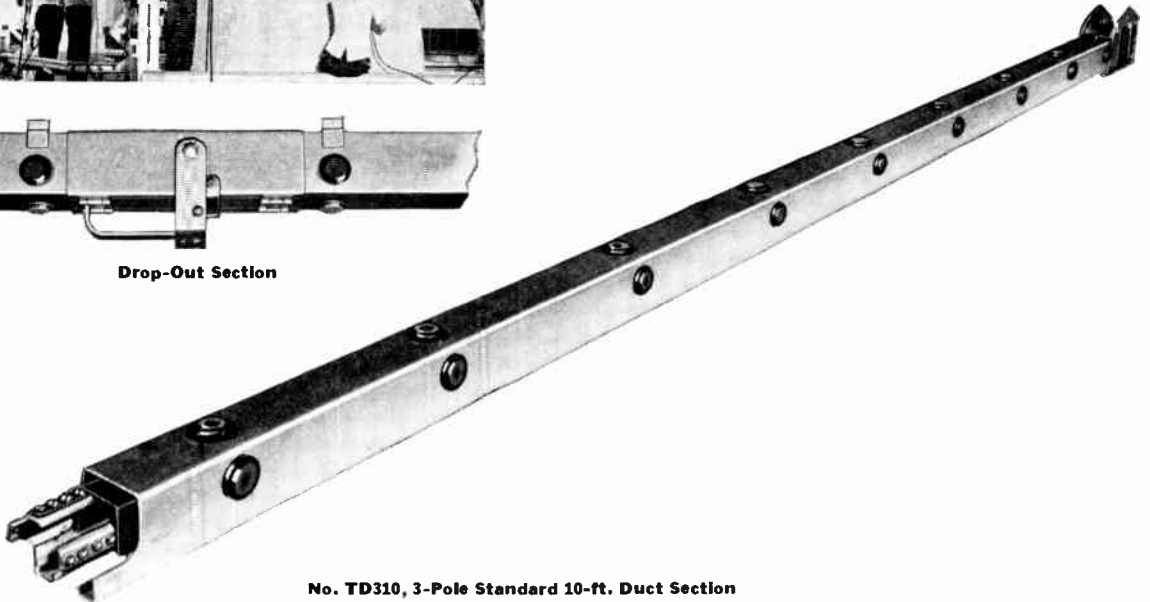

No. TD310, 3-Pole Standard 10-ft. Duct Section

With each Duct Section, Drop-Out and Drop-Out Sectionalizing Section is furnished as standard: One Hanger Assembly, complete with Hanger, Cover and Set of Bus Connectors.

Standard 10-Foot, 100-Ampere Duct Sections
575 Volts or Less

No.	Description	Ship. Wt. Lbs.	Each	No.	Description	Ship. Wt. Lbs.	Each
TD210	2-Pole, Standard 10-ft. Section	35	\$86.00	TD210R	2-Pole, Drop-Out Section (10-ft.)	35	\$101.00
TD310	3-Pole, Standard 10-ft. Section	40	95.00	TD310R	3-Pole, Drop-Out Section (10-ft.)	40	110.00
TD010	10-ft. Busless Section	28	55.00	TD310RS	3-Pole, 10-ft. Drop-Out Sectionalizing Section	40	143.00
				TD010R	10-ft. Busless Drop-Out Section	28	70.00

Complete Assemblies of Duct Accessories

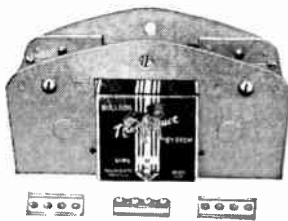

No. TDH3 Hanger Assembly



No. TRB23 End Plate and Bumper

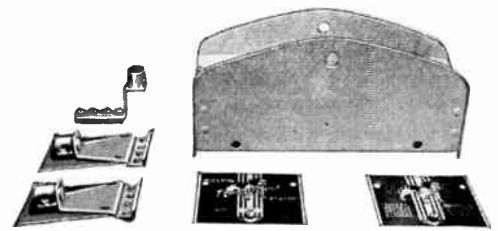

No. TDF3 Feed-in Adapter

No.	Description	Ship. Wt. Lbs.	Each
TDH3	2 or 3-Pole Hanger Assembly	2	\$ 8.00
TDF3	2 or 3-Pole Feed-in Adapter Set	2	14.00
TRB23	End Closer and Bumper Assembly	1	5.00

Note—The above are only partial listings. For complete data, layouts and estimates contact Graybar.

Feedrail* Pre-Fabricated Electrical Distribution Systems

FEEDRAIL® is the modern system of distributing electric power. Sturdy prefabricated track sections, enclosing copper bus conductors can be joined together to form runs of any length, straight or curved. Trolleys with positive pressured contacts roll freely in the track and act as electric power outlets which can be moved to any point along the track run.

The FEEDRAIL® Systems—engineered and constructed by specialists who devote their time exclusively to trolley busway electrification systems—are available in 60, 100, 225, 375 and 500 ampere capacities. Superior to ordinary wiring methods in safety, convenience and adaptability, they provide a dependable source of power for cranes and hoists, production and assembly lines, test lines, movable machinery, machine tools, business machines, lighting, etc. Feedrail Systems are readily installed without any special tools.

Feedrail "60" Straight Track Section 60 Amps—250 V.—A-C. or D-C.



10'-0" Lengths Complete with bus bars.

	Single Phase		Three Phase	
	No.	Each	No.	Each
Plain Track	FRS-200	\$38.00	FRS-100	\$44.00
Door Track	FRS-201	44.00	FRS-101	50.00

5'-0" Lengths complete with bus bars.

Plain Track	FRS-200-5	\$24.00	FRS-100-5	\$27.00
Door Track	FRS-201-5	30.00	FRS-101-5	33.00

Note: It is recommended that a minimum of one door section for insertion and removal of trolleys be used with every five sections of plain track.

For sections less than 10'-0" long, consider fractions of a foot as an extra foot and multiply this length by the per foot list price of the corresponding 10'-0" STRAIGHT and add \$12.00 list.

10'-0" Lengths without bus bars.

	No.	Each
Plain Track	FRS-130	\$26.00
Door Track	FRS-131	32.00

5'-0" Lengths without bus bars.

Plain Track	FRS-130-5	\$18.00
Door Track	FRS-131-5	24.00

For sections without bus bars less than 10'-0" long, consider fractions of a foot as an extra foot and multiply this length by the per foot list price of the corresponding 10'-0" STRAIGHT without bus bars and add \$9.00 list.

Feedrail "60" Sectionalizing Track Sections



10'-0" Lengths complete with bus bars.

	Single Phase		Three Phase	
	No.	Each	No.	Each
Plain Track	FRS-227	\$50.00	FRS-127	\$56.00
Door Track	FRS-228	56.00	FRS-128	62.00

5'-0" Lengths complete with bus bars.

Plain Track	FRS-227-5	\$36.00	FRS-127-5	\$39.00
Door Track	FRS-228-5	42.00	FRS-128-5	45.00

For sections less than 10'-0" long, consider fractions of a foot as an extra foot and multiply this length by the per foot list price of the corresponding 10'-0" STRAIGHT and add \$24.00 list.

*Registered Trade Mark.

Feedrail "60" Transfer Track Sections



10'-0" Lengths Complete with bus bars—one flared end.

	Single Phase		Three Phase	
	No.	Each	No.	Each
Plain Track	FRS-225	\$66.00	FRS-125	\$72.00
Door Track	FRS-226	72.00	FRS-126	78.00

5'-0" Lengths complete with bus bars—one flared end.

Plain Track	FRS-225-5	\$52.00	FRS-125-5	\$55.00
Door Track	FRS-226-5	58.00	FRS-126-5	61.00

For sections less than 10'-0" long, consider fractions of a foot as an extra foot and multiply this length by the per foot list price of the corresponding 10'-0" STRAIGHT and add \$40.00 list for one flared end and \$68.00 list for two flared ends. Add \$12.00 list for each feed box in a transfer section.

10'-0" Lengths Without bus bars—one flared end.

	No.	Each
Plain Track	FRS-132	\$45.00
Door Track	FRS-133	51.00

5'-0" Lengths without bus bars—one flared end.

Plain Track	FRS-132-5	\$37.00
Door Track	FRS-133-5	43.00

For sections without bus bars less than 10'-0" long, consider fractions of a foot as an extra foot and multiply this length by the per foot list price of the corresponding 10'-0" STRAIGHT without bus bars and add \$28.00 list for one flared end and \$47.00 list for two flared ends.

Feedrail "60" Accessories

Description	No.	Each
Coupling Set.....	FRS-102	\$1.50
Center Feed Set.....	FRS-103	6.00
Sectionalizing Insulator.....	FRS-104	4.00
Track Hanger Set.....	FRS-105	.60
End Feed Set.....	FRS-106	7.20
Dead End Cap.....	FRS-107	3.00
Messenger Cable Track Hanger Set.....	FRS-108	1.20
Junction Box with Lugs.....	FRS-110	8.00
Clevis Support.....	FR-105	2.00

Feedrail "60" Curved Track Sections



All curved sections have 4" of straight track additional on each end for coupling.

90° Curves Complete With Bus Bars

Radius	Ft.	In.	Two Pole		Three Pole	
			No.	Each	No.	Each
2	6		FRS-212	\$141.00	FRS-112	\$141.00
3	0		FRS-218	150.00	FRS-118	150.00
3	6		FRS-213	159.00	FRS-113	159.00
4	0		FRS-219	168.00	FRS-119	168.00
4	6		FRS-214	177.00	FRS-114	177.00
5	0		FRS-220	177.00	FRS-120	177.00
5	6		FRS-221	186.00	FRS-121	186.00
6	0		FRS-222	195.00	FRS-122	195.00
6	6		FRS-223	204.00	FRS-123	204.00

For each curved track section having radii or degree of arc other than those listed, figure lineal length of arc at \$9.00 List per foot and add \$210.00 List each special fabrication charge. Consider fraction of foot as an extra foot.

Feedrail Curved Track Adapter Couplings

FRS-116 Coupling plates have an opening in one end to fit the curved track and in the other end to fit the smaller straight track. These couplings must be used when joining curved track to straight track. Each **\$8.50**.

FRS-117 Coupling plates have an opening in each end to fit curved track sections. These couplings must be used when joining curved track to curved track. Each **\$8.50**.

Curved Track Trolleys

20 Amps.—250 V.—A-C or D-C

Non-fusible

No.	Phase	Contact	Each
FRS-94	2	Brush	\$18.00
FRS-84	3	Brush	20.00

Fusible

FRS-96	2	Brush	38.00
FRS-86	3	Brush	40.00

Fuses not included with fusible trolleys.

These trolleys must be used on any part of FEEDRAIL "60" system that includes a curved track section. Where motor propelled hoists are used on runs which include transfer points, two trolleys in tandem must be used to insure continuous current while crossing the transfer points.

Feedrail "60" Trolleys

15 Amps.—250 V.—A-C or D-C



Fusible Type



Non-Fusible Type

Non-Fusible with 1/2" Nipple

No.	Phase	Contact	Each
FRS-21	2	Brush	\$6.50
FRS-1	3	Brush	7.00
FRS-31	2	Roller	7.15
FRS-11	3	Roller	8.00

Non-Fusible with Cable Clamp

FRS-22	2	Brush	7.00
FRS-2	3	Brush	7.50
FRS-32	2	Roller	7.65
FRS-12	3	Roller	8.50

Non-Fusible with Tool Hanger

FRS-23	2	Brush	7.50
FRS-3	3	Brush	8.00
FRS-33	2	Roller	8.15
FRS-13	3	Roller	9.00

Fusible with Cabinet

FRS-29	2	Brush	26.50
FRS-9	3	Brush	28.00
FRS-39	2	Roller	27.15
FRS-19	3	Roller	29.00

Cleaning Tools

FRS-28	Dust Remover	\$15.00
FRS-77	Bus Bar Cleaner	15.00

Feedrail "60" Plug-In Jacks

8 Amps.—Single Phase—250 V.—A-C or D-C



Fusible Type



Non-Fusible Type

No. FRS-40: Non-fusible. Designed for use with standard 4" octagonal outlet box. Complete with 6" long leads. Each **\$4.00**

No. FRS-41: Non-fusible. Complete with 2-pole convenience receptacle and lug for supporting lighting fixtures. Each **\$8.00**

No. FRS-42: Fusible. Complete with 2-pole convenience receptacle and lug for supporting lighting fixtures. Will accommodate two 3 AG glass fuses. Each **\$15.00**

No. FRS-111: Fixture hanger designed as an auxiliary weight support in conjunction with "60" Plug-in Jacks. Each **\$.60**

Feedrail "100" Track Sections

100 Amps.—250-V. D-C, 575-V. A-C

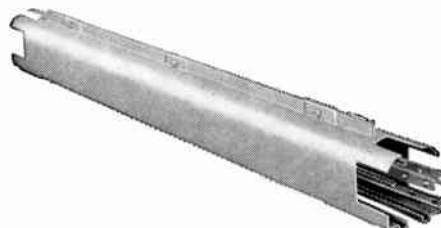

10'-0" Lengths complete with bus bars.
Straight Track

	Single Phase		Three Phase	
	No.	Each	No.	Each
Plain Track	FR-200	\$86.00	FR-100	\$95.00
Door Track	FR-201	101.00	FR-101	110.00

Transfer Track — one flared end.

Plain Track	FR-225	\$134.00	FR-125	\$143.00
Door Track	FR-226	149.00	FR-126	158.00

Transfer Track — two flared ends.

Plain Track	FR-235	\$182.00	FR-135	\$191.00
Door Track	FR-236	197.00	FR-136	206.00

Sectionalizing Track — one sectionalizing end.

Plain Track	FR-227	\$119.00	FR-127	\$128.00
Door Track	FR-228	134.00	FR-128	143.00

10 Ft. lengths without bus bar — straight track

Plain Track	FR-130	\$55.00		
Door Track	FR-131	70.00		

Transfer Track — one flared end.

Plain Track	FR-132	\$88.00		
Door Track	FR-133	103.00		

Transfer Track — two flared ends.

Plain Track	FR-142	\$121.00		
Door Track	FR-143	136.00		

For each section track less than 10 ft. 0 in. long, consider fractions of foot as an extra foot and multiply length of section required by the per foot list price of corresponding 10 ft. 0 in. straight section and add for—

Straight with Bus Bars	add	\$26.00
Straight without Bus Bars	add	13.00
Transfer with Bus Bars, one flared end	add	74.00
Transfer with Bus Bars, two flared ends	add	120.00
Transfer without Bus Bars, one flared end	add	46.00
Transfer without Bus Bars, two flared ends	add	79.00
Sectionalizing with Bus Bars—one sectionalizing end	add	58.00

Feedrail "100" Track Sections

Curved Track

90° Curves Complete With Bus Bars.

	Single Phase		Three Phase	
	No.	Each	No.	Each
3'-0" Radius	FR-213	\$242.00	FR-113	\$242.00
4'-6" Radius	FR-214	275.00	FR-114	275.00
5'-6" Radius	FR-211	286.00	FR-111	286.00
6'-6" Radius	FR-221	308.00	FR-121	308.00
7'-6" Radius	FR-212	319.00	FR-112	319.00

For each curved track section having radii or degree of arc other than those listed, figure lineal length at \$12.00 List per foot and add \$250.00 List each for set-up and engineering charge. Fractions of a foot to be figured as a foot. Minimum radii 2'6".

Feedrail "100" Accessories

	No.	Each
Coupling Plate Set	FR-102	\$ 8.00
Center Feed Box	FR-103	14.00
Clevis Support	FR-105	2.00
Dead End Cap	FR-107	5.00
End Feed Box—Reversible	FR-108	14.00
End Feed Box—Reversible with Cable Grip	FR-108G	20.00
Transfer Point Hanger Set	FR-124	7.00
Sectionalizing Insulator	FR-129	17.00

Note—One No. FR-102 Coupling Plate Set is furnished with each section of track.

Feedrail "100" Trolleys

Trolleys Without Cabinets

Non-Fusible—250 Volts D-C, 575 Volts A-C



Standard Type—for use with straight and curved track with radius of 5'-6" or over.

No.	Phase	Amps.	Contact	Each
FR-34	2	20	Roller	\$30.00
FR-90	2	30	Brush	37.00
FR-24	3	20	Roller	34.00
FR-80	3	30	Brush	44.50



Short Radius "C" Type



Heavy Duty "D" Type

Short Radius "C" Type—for use with straight and curved track—minimum radius of 2'-6".

No.	Phase	Amps.	Contact	Each
FR-36	2	20	Roller	\$30.00
FR-91	2	30	Brush	37.00
FR-26	3	20	Roller	34.00
FR-81	3	30	Brush	44.50

Heavy Duty "D" Type—for high amperage on straight and curved track—minimum radius of 2'-6".

No.	Phase	Amps.	Contact	Each
FR-37	2	10	Roller	\$62.00
FR-92	2	60	Brush	76.00
FR-27	3	40	Roller	70.00
FR-82	3	60	Brush	91.00

Note—"C" or "D" type trolleys must be used with curved track sections of less than 5'-6" radius. All trolleys listed can be furnished in "C" or "D" type by adding the suffix C or D to catalog number of the trolley selected. The rating of "D" type trolleys when furnished with receptacles or dead front fuse blocks is limited to the rating of those devices. For prices on "C" or "D" type trolleys with cabinet consult us. Fuses are not included with fusible trolleys.

Feedrail "100" Trolleys

Crane and Hoist Type Trolleys

250 Volts D-C, 575 Volts A-C—Non-Fusible—30 Amps.



Heavy Duty Type

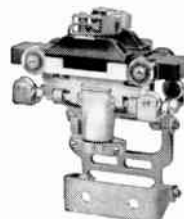

Short Radius "C" Type

Plain Type—For track without transfer points and for curves with radius of 5'-6" or over.

No.	Phase	220 A-C	440 A-C	550 A-C	230 D-C	Contact	Each
FR-66	DC				3 HP	Brush	\$57.00
FR-66	2	3	11P			Brush	57.00
FR-6	3	7½ HP	15 HP	20 HP		Brush	64.50

Short Radius "C" Type—For track without transfer points, and for curves—minimum radius of 2'-6".

No.	Phase	220 A-C	440 A-C	550 A-C	230 D-C	Contact	Each
FR-66C	DC				3 HP	Brush	\$57.00
FR-66C	2	3	11P			Brush	57.00
FR-6C	3	7½ HP	15 HP	20 HP		Brush	64.50

Non-Fusible—60 Amps.

Heavy Duty "D" Type—For high amperage on tracks without transfer points and for curves—minimum radius 2'-6"

No.	Phase	220 A-C	440 A-C	550 A-C	230 D-C	Contact	Each
FR-66D	DC				7½ HP	Brush	\$100.00
FR-66D	2	7½ HP				Brush	100.00
FR-6D	3	15 HP	30 HP	40 HP		Brush	115.00

Non-Fusible—100 Amps.

Special Service Type—For straight track without transfer points.

No.	Phase	220 A-C	440 A-C	550 A-C	230 D-C	Contact	Each
FR-65	2	10 HP			10 HP	Brush	\$166.00
FR-75	3	25 HP	50 HP	60 HP		Brush	198.00

Note—"C" or "D" type trolleys must be used with curved track sections of less than 5'-6" radius. All trolleys listed can be furnished in "C" or "D" type by adding the suffix C or D to the catalog number of the trolley selected. "D" type trolleys with receptacles or 110 volt fuse blocks have a maximum capacity of 30 amperes. For "C" type add \$13.00 to the list price. For "D" type add \$36.00 to the list price.

Trolleys With Beveled Type Ever-Lok Cabinets

Non-Fusible—With Receptacles

Volts: 575 A-C, 250 D-C

No.	Amps.	Phase	Contact	Each
FR-38	20	2	Roller	\$69.00
FR-12	20	3	Roller	73.00
FR-62	20	2	Brush	76.00
FR-72	20	3	Brush	83.50
FR-312	20	3	Roller	77.00
FR-372	30	3	Brush	87.50

Fusible—With Ever-lok Receptacles

Volts: 250 A-C, 250 D-C

No.	Amps.	Phase	Contact	Each
FR-30	20	2	Roller	\$79.00
FR-10	20	3	Roller	88.00
FR-60	20	2	Brush	86.00
FR-70	20	3	Brush	98.50
FR-310	20	3	Roller	92.00
FR-370	30	3	Brush	102.50



Motor Starters and Ever-lok Receptacles

No.	Phase	Volts	H.P.	Contacts	Each
FR-1	3	220 A.C.	2	Roller	\$135.00
FR-1	3	440 A.C.	2	Roller	135.00
FR-59	2	220 A.C.	1	Roller	97.00

Feedrail "100" Trolleys
Transfer Type
Non-Fusible—30 Amps.



Plain Type



Heavy Duty Type

Plain Type—For track with transfer points or curves—minimum radius 2'-6".

No.	Phase	Volts				Contact	Each
		220 A-C	440 A-C	550 A-C	230 D-C		
FR-64	DC	3 HP	Brush	\$81.00
FR-64	2 3	HP	Brush	81.00
FR-74	3	7½ HP	15 HP	20 HP	Brush	88.50

Heavy Duty Type—For track with transfer points or curves—minimum radius 2'-6".

FR-64D	DC	3 HP	Brush	148.00
FR-64D	2 3	HP	Brush	148.00
FR-74D	3	7½ HP	15 HP	20 HP	Brush	163.00

Trolleys With Box Type Cabinets



Non-Fusible—Without Receptacles—With Cable Clamps

No.	Amps.	Volts		Phase	Contact	Each
		A-C	D-C			
FR-31	20	575 A.C.-250	D.C.	2	Roller	\$49.00
FR-94	30	575 A.C.-250	D.C.	2	Brush	56.00
FR-41	20	575 A.C.-250	D.C.	3	Roller	53.00
FR-84	30	575 A.C.-250	D.C.	3	Brush	63.50

Fusible—Without Receptacles

*FR-29	20	250 A.C.-250	D.C.	2	Roller	57.00
*FR-9	20	250 A.C.-250	D.C.	3	Roller	64.00
FR-19	20	250 A.C.-250	D.C.	2	Roller	59.00
FR-19	20	250 A.C.-250	D.C.	3	Roller	68.00
*FR-96	30	250 A.C.-250	D.C.	2	Brush	64.00
*FR-86	30	250 A.C.-250	D.C.	3	Brush	74.50
FR-97	30	250 A.C.-250	D.C.	2	Brush	66.00
FR-87	30	250 A.C.-250	D.C.	3	Brush	78.50
*FR-23	20	575 A.C.-250	D.C.	2	Roller	79.00
*FR-43	20	575 A.C.-250	D.C.	3	Roller	93.00
*FR-98	30	575 A.C.-250	D.C.	2	Brush	86.00
*FR-88	30	575 A.C.-250	D.C.	3	Brush	103.50

Fusible—With Ever-lok Receptacles—With Cable Clamps

*FR-32	20	575 A.C.-250	D.C.	2	Roller	99.00
*FR-2	20	575 A.C.-250	D.C.	3	Roller	113.00
*FR-99	20	575 A.C.-250	D.C.	2	Brush	106.00
*FR-89	20	575 A.C.-250	D.C.	3	Brush	123.50
*FR-302	20	575 A.C.-250	D.C.	3	Roller	117.00
*FR-389	30	575 A.C.-250	D.C.	3	Brush	127.50

*These trolleys are equipped with open type fuse blocks. All other fusible trolleys are equipped with Feedrail Corporation dead front fuse blocks. Fuses are not included with fusible Trolleys.

Feedrail "100" Trolleys
Trolleys With Hanger Type Cabinets



Non-Fusible—Without Receptacles—With Cable Clamps

No.	Amps.	Volts		Phase	Contact	Each
		A-C	D-C			
FR-35	20	575 A.C.-250	D.C.	2	Roller	\$44.00
FR-5	20	575 A.C.-250	D.C.	3	Roller	48.00
FR-95	30	575 A.C.-250	D.C.	2	Brush	51.00
FR-85	30	575 A.C.-250	D.C.	3	Brush	58.50

Non-Fusible—With Ever-lok Receptacles

FR-33	20	575 A.C.-250	D.C.	2	Roller	64.00
FR-3	20	575 A.C.-250	D.C.	3	Roller	68.00
FR-303	20	575 A.C.-250	D.C.	3	Roller	72.00
FR-93	20	575 A.C.-250	D.C.	2	Brush	71.00
FR-83	20	575 A.C.-250	D.C.	3	Brush	78.50
FR-383	30	575 A.C.-250	D.C.	3	Brush	82.50

Feedrail Track Accessories

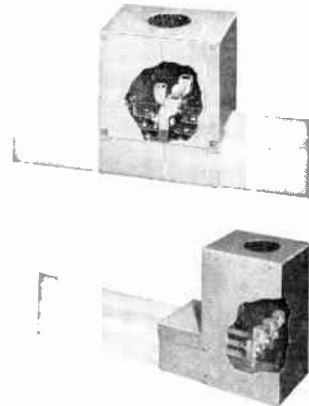

Description	Amp.	Two Pole		Three Pole	
		No.	Each	No.	Each
Center Feed Box	225	2203	\$76.00	2103	\$ 92.00
Center Feed Box	375	3203	86.00	3103	102.00
Center Feed Box	500	5203	96.00	5103	112.00
End Feed Box	225	2208	76.00	2108	92.00
End Feed Box	375	3208	86.00	3108	102.00
End Feed Box	500	5208	96.00	5108	112.00
Coupling Set	...	2102	6.00	2102	6.00
Dead End Cap	...	2107	12.00	2107	12.00
Track Hanger	...	2105	3.00	2105	3.00

Rain Shields

No.	Description	Each
1800	Track Section	\$ 74.00
1802	Coupling Set	16.00
1803	Center Feed Box	74.00
1808	End Feed Box	74.00
1807	Dead End Cap	36.00
1805	Track Hanger	7.00
1850	Expansion Track	214.00

Feedrail "Heavy Duty" Equipment

225-375-500 Amperes
575 Volts A-C, 250 Volts D-C
Straight Track Sections



10 Ft. Lengths Complete With Bus Bars

Track	Amp.	Two Pole		Three Pole	
		No.	Each	No.	Each
Plain	225	2200	\$200.00	2100	\$230.00
Plain	375	3200	244.00	3100	280.00
Plain	500	5200	280.00	5100	322.00

Door Track Sections

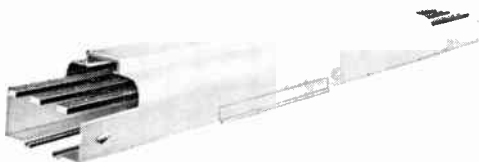

10 Ft. Lengths Complete With Bus Bars

Track	Amp.	Two Pole		Three Pole	
		No.	Each	No.	Each
Door	225	2201	\$230.00	2101	\$260.00
Door	375	3201	274.00	3101	310.00
Door	500	5201	310.00	5101	352.00

For sections less than 10 ft. 0-in. long, consider fractions of a foot as an extra foot and multiply this length by the per foot list price for corresponding 10 ft. section and add \$70.00 list.

Expansion Track Sections

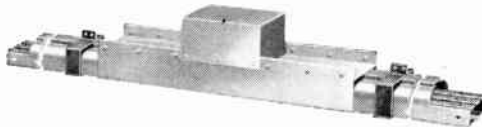

10 Ft. Lengths Complete With Bus Bars

Jumpers	Amp.	Two Pole		Three Pole	
		No.	Each	No.	Each
Built-in	225	2255	\$660.00	2155	\$710.00
Built-in	375	3255	724.00	3155	788.00
Built-in	500	5255	806.00	5155	874.00

Trolleys

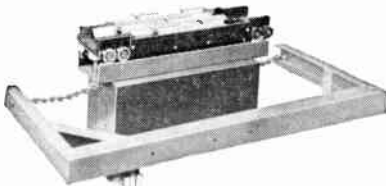

Complete with terminals, linkage and cable grip outlets.

Outlet	Amp.	Two Pole		Three Pole	
		No.	Each	No.	Each
Bottom or Side	225	2025E	\$340.00	2005E	\$390.00
Bottom	375	3025	580.00	3005	670.00

Hoffman Oil Tight Sectional Wireway

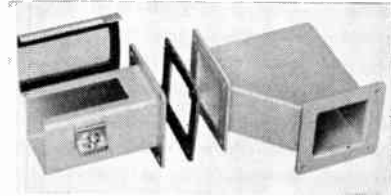

Used for electrical wiring on machinery, equipment and buildings, inside or outdoors, where protection is desired from oil, dirt, dust or water. A suitable substitute for conduit.

Constructed of 14 gauge sheet steel throughout except on the welded connection flanges which are made of 10 gauge.

No holes in cover, trough, or fittings to permit foreign material to enter. Cover, which has neoprene gasket, is hinged to trough on one side and held with external clamps on the other. Flanges are welded to both ends of each section, on all fittings and bolt together.

Standard finish is gray prime coat on a phosphatized surface. Special sizes and modifications may be specified.

No.	Size In.	Description	Std. Pkg.	Ship. Wt. Lbs.	Each
22W12	2 1/2 x 2 1/2 x 12	Straight	1	4	\$ 9.50
22W24	2 1/2 x 2 1/2 x 24	Straight	1	7	14.00
22W36	2 1/2 x 2 1/2 x 36	Straight	1	11	17.00
22W48	2 1/2 x 2 1/2 x 48	Straight	1	13	19.00
22W60	2 1/2 x 2 1/2 x 60	Straight	1	18	21.00
22W120	2 1/2 x 2 1/2 x 120	Straight	1	30	40.00
22WE90	2 1/2 x 2 1/2	90° Elbow	1	2	11.00
22WE45	2 1/2 x 2 1/2	45° Elbow	1	2	11.00
22WC	2 1/2 x 2 1/2	Cross	1	4	18.00
22WP	2 1/2 x 2 1/2	Closure Plate	1	1	1.40
22WT	2 1/2 x 2 1/2	Tee	1	3	15.00
22WA	2 1/2 x 2 1/2	Telescoping	1	4	14.00
44W12	4 x 4 x 12	Straight	1	6	11.50
44W24	4 x 4 x 24	Straight	1	12	16.00
44W36	4 x 4 x 36	Straight	1	16	19.00
44W48	4 x 4 x 48	Straight	1	21	22.00
44W60	4 x 4 x 60	Straight	1	26	25.00
44W120	4 x 4 x 120	Straight	1	53	44.00
44WE90	4 x 4	90° Elbow	1	4	14.00
44WE45	4 x 4	45° Elbow	1	3	14.00
44WC	4 x 4	Cross	1	6	24.00
22WG	2 1/2 x 2 1/2	Gasket and Screws	1	..	.50

Contact GRAYBAR for information on other sizes available.

Hoffman "JIC" Electrical Wiring Troughs

Listed by Underwriters' Laboratories, Inc.

Totally Enclosed

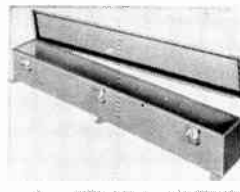

Used to provide protection against oil, coolant, water, dust or dirt.

The 2 1/2-in. square sizes made of 16 gauge steel; 4-in. square sizes are of 14 gauge. Mounting feet are of 12 gauge steel.

All seams of trough and cover are welded. Cover, which is gasketed with cellular neoprene, is held to trough by external clamps and lift-off hinges and chained to trough to prevent loss. Trough available with cover held on by screws. Mounting feet welded to trough.

Standard finish is a baked gray hammertone enamel over a phosphatized surface. Special finishes, sizes and modifications, such as holes for conduit, can be provided.

No.	Width In.	Depth In.	Length	Ship. Wt. Lbs.	Each
2212	2 1/2	2 1/2	12	5	\$ 8.20
2218	2 1/2	2 1/2	18	6	10.30
2224	2 1/2	2 1/2	24	7	12.20
2236	2 1/2	2 1/2	36	9	14.10
4418	4	4	18	9	12.00
4430	4	4	30	14	16.40
4448	4	4	48	21	20.50
4472	4	4	72	31	30.00

G-E Hinged-Cover Wireways

4" x 4", 6" x 6", 8" x 8"

(Listed by Underwriters' Laboratories as wireways and associated fittings under File E-6780)

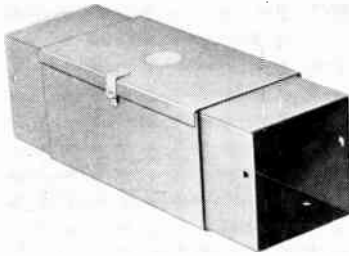

Telescopic Fitting

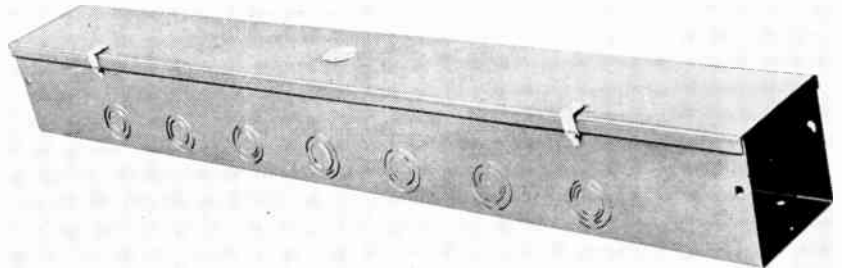

Standard 5-foot Length

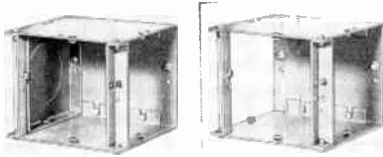

Elbow

Tee Fitting

The Type HW wireway is an enclosed wiring trough or auxiliary wiring gutter which is provided with a hinged cover. It is especially useful where space is limited and building contours complicated. All lengths and associated fittings are designed with a hinged cover arrangement which permits an unobstructed opening over the entire length of the run. Thus, all conductors can be "laid in" quickly and easily without the need of threading through the collars at the joints as is the case with conventional wireways.

The new design introduces a hook-and-slot arrangement which permits the quick assembly of sections and fittings. One screw is used for a grounding. The hinged covers are provided with snap latches which replace the conventional nuts and bolts. Ample knockouts on both sides of the wireway help as sure easy wiring. The wireway is finished in ASA No. 49 medium-light-grey enamel over a rust inhibitor.

Advantages

Low initial cost: G-E wireways provide today's most economical means of wiring factories, offices, and commercial buildings. Dollar for dollar, foot for foot, no other method of wiring can be installed at a comparable low cost.

Quick, easy installation: Hook-and-slot arrangement permits quick assembly of the wireway sections and fittings, eliminating need for screws. The elimination of all obstructions allows wiring to be "laid-in" without usual threading under collars.

Permits future expansion: Additional conductors can be laid in or existing wiring can be altered without extensive labor. No other method of wiring permits such easy expandability to meet changing load requirements.

Flexible: A complete line of standardized fittings are available, allowing the wireway to be virtually tailored to the requirements of any installation.

Selection Data

The National Electrical Code limits the use of wireways as follows:

No conductor larger than 500,000 cm shall be installed in any wireway.

Wireways shall not contain more than 30 conductors at any cross section, unless the conductors are for signaling circuits or are control conductors between a motor and its starter and used only for starting duty. The sum of the cross-sectional areas of all contained conductors at any cross-section of a wireway shall not exceed 20-percent of the interior cross-sectional area of wireway.

Splices or taps, made and insulated by approved methods, may be located within the wireway if they are accessible. The conductors, including splices and taps, shall not fill the wireway to more than 75 percent of its area.

Conductors of various sizes may be included in one wireway but the total cross-sectional area of all conductors must not exceed the above limitations.

Ratings, Dimensions, and Prices

Application	Description	4 by 4 Inches			6 by 6 Inches			8 by 8 Inches		
		No.	Each	Approx. Wt. Lb.	No.	Each	Approx. Wt. Lb.	No.	Each	Approx. Wt. Lb.
Straight wireway runs	1-ft. length*	DAH441	\$ 3.30	4	DAH661	\$ 7.40	5	DAH881	\$11.30	8
	2-ft. length*	DAH442	5.70	7	DAH662	9.80	10	DAH882	20.30	17
	3-ft. length*	DAH443	9.00	11	DAH663	13.50	16	DAH883	27.00	25
	4-ft. length*	DAH444	11.40	14	DAH664	18.00	21	DAH884	33.00	33
	5-ft. length*	DAH445	13.40	19	DAH665	22.10	26	DAH885	43.00	41
Joining lengths and/or fittings	Connector, standard	DAH44C	.90	1	DAH66C	1.30	1	DAH88C	1.60	1
	Connector, long, 5½ in. added length	DAH44D	3.30	2	DAH66D	7.40	3	DAH88D	11.30	5
Two taps from main run	Cross*	DAH44X	11.30	1	DAH66X	13.10	2	DAH88X	29.00	2
Turns: Up, down, left, right	Elbow, 90-degree*	DAH490L	8.00	2	DAH690L	11.40	4	DAH890L	13.40	7
	Elbow, 45-degree*	DAH445L	5.90	2	DAH645L	8.10	3	DAH845L	15.00	6
	Elbow, 22½-degree*	DAH425L	5.90	1	DAH625L	8.10	2	DAH825L	15.00	4
Sealing openings Connecting to switchboards Hanging wireway on walls	End enclosure	DAH44E	.90	1	DAH66E	1.50	1	DAH88E	2.40	2
	Flange	DAH44F	2.60	1	DAH66F	4.00	1	DAH88F	5.30	1
	Hanger	DAH44H	1.30	1	DAH66H	4.40	1	DAH88H	6.00	2
Branch wireway runs Adjustable length (10½ in. Min., 17 in. Max.)	Tee*	DAH44T	7.10	2	DAH66T	9.90	3	DAH88T	11.00	6
	Telescopic fitting*	DAH44S	8.70	8	DAH66S	36.00	11	DAH88S	56.00	17

*No connectors included. Order one connector for each joint between units.

**G-E Plug-In Flex-A-Power* Busway
Type DH**

100 Amperes 600 Volts Maximum 3 or 4-Wire



Fig. 1. Typical Length

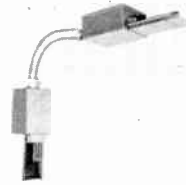

Fig. 2. Flexible Fitting



Fig. 3. Elbow Rigid



Fig. 4. End Tap Box



Fig. 5. Center Tap Box

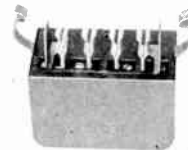

Fig. 6. Unfused Plug



Fig. 7. Fusible Non-operating Plug



Fig. 8. Type TQL Circuit Breaker Plug



Fig. 9. Universal Hanger



Fig. 10. Single Edgewise Hanger

Type DH is a low-cost, plug-in busway for indoor use wherever the convenience of plug-in receptacles over a wide area is desired. Its principal applications are in industrial plants, commercial buildings, manual training shops, laboratories, and garages.

Type DH busway is like a panelboard mounted overhead and extending out over the area served. With its nine outlets on each side of a ten-foot length, it is used as a feeder for lighting systems and as a feeder or branch circuit from switchboard or panelboard to a motor or other power-consuming equipment. When a 60 ampere (or less) power receptacle is required to feed a portable welder or similar machine, the busway can be run down a column or wall to the desired height.

The busway is rated 100 amperes, 600 volts maximum and manufactured in 3 and 4 wire construction. It will withstand a short circuit of 15,000 amperes RMS asymmetrical or 12,000 amperes RMS symmetrical.

A wide variety of fittings and accessories are available. Joints between the components are easily assembled by tightening six screws. Snap-on hangers for flatwise or edgewise mounting require minimum labor.

Type DH busway can be hung on ten-foot centers in the edgewise position or on five-foot centers in the flatwise position.

The adjustable length and flexible fitting (elbow, offset or expansion fitting) eliminate the necessity for exact field measurements before ordering. Simply order by catalog number.

There is a minimum number of units to meet virtually all installation requirements.

Standardized units can be taken down as load requirements change and moved to new location with complete reuse of all components.

Dead-front plug outlets, even with knockout covers removed, assure safety to personnel. The joints can be checked for tightness without shutting down the system.

Straight Lengths

The following lengths are available: 10-ft.—18 outlets; 5-ft.—10 outlets; 3-ft.—6 outlets; 2-ft.—4 outlets; and 1-ft.—2 outlets.

The outlets are arranged in pairs back-to-back on the busway, i.e., a 10-ft. length has 9 outlets on each side. A plug may be inserted in only one outlet of the pair on either side of the busway. The outlets are the knockout type.

Four-wire busway has full-capacity neutral.

Three Wire

No.	Length Ft.	Net Wt. Lbs.	List Price Each
DH1A31	10	27	\$30.00
DH1A315	5	14	20.00
DH1A313	3	10	16.00
DH1A312	2	6	13.00
DH1A311	1	4	10.00

Four Wire

DH1A41	10	28	\$40.00
DH1A415	5	15	26.00
DH1A413	3	10	20.00
DH1A412	2	6	16.00
DH1A411	1	4	12.00

Note: Standard packaging is two except for one-foot lengths. One-foot lengths come four to a package.

Adjustable Length

This straight length can be set at any length between 42 and 54 inches. There are no plug outlets on this length.

No.	Wire	Net Wt. Lbs.	List Price Each
DH1AA31	3	14	\$30.00
DH1AA41	4	15	40.00

Note: Standard packaging is two.

Flexible Fittings

Can be used as: an elbow (total length 56-in.); an offset (maximum offset 20-in.); or an expansion fitting ($\pm 1\frac{1}{2}$ -in.). This fitting eliminates the necessity of exact field measurements.

No.	Wire	Std. Pkg.	Net Wt. Lbs.	List Price Each
DH1AFF31	3	1	31	\$50.00
DH1AFF41	4	1	34	60.00

*Reg. trade-mark of General Electric Company.

G-E Plug-In Flex-A-Power* Busway

Type DH (Cont.)

100 Amperes 600 Volts Maximum 3 or 4-Wire

Rigid Elbows, Tees and Crosses

All three are standardized for easy installation. Same device is used for either 3 or 4-wire applications.

Rigid Elbows—3 or 4 Wire

No.	Description	Std. Pkg.	Net Wt. Lbs.	List Price Each
DH1AEU41	Up Elbow	1	4	\$20.00
DH1AEL41	Left Elbow	1	4	20.00
DH1AED41	Down Elbow	1	4	20.00
DH1AER41	Right Elbow	1	4	20.00

Rigid Tees—3 or 4 Wire

No.	Description	Std. Pkg.	Net Wt. Lbs.	List Price Each
DH1ATUC41	Up Tee	1	7	\$30.00
DH1ATLC41	Left Tee	1	7	30.00
DH1ATDS41	Down Tee	1	7	30.00
DH1ATRS41	Right Tee	1	7	30.00

Rigid Crosses—3 and 4 Wire

No.	Description	Std. Pkg.	Net Wt. Lbs.	List Price Each
DH1AXF41	Up-Down Cross	1	8	\$40.00
DH1AXE41	Left-Right Cross	1	8	40.00

Tap Boxes

Three types of tap boxes are available: offset bar and straight bar end types and center types. All tap boxes have #14-1/0 mechanical solderless lugs and an abundance of knockouts.

Offset Bar End Tap Box

No.	Description	Std. Pkg.	Net Wt. Lbs.	List Price Each
DH1ABC31	Three Wire	1	7	\$20.00
DH1ABC41	Four Wire	1	7	27.00

Straight Bar End Tap Box

No.	Description	Std. Pkg.	Net Wt. Lbs.	List Price Each
DH1ABS31	Three Wire	1	7	\$20.00
DH1ABS41	Four Wire	1	7	27.00

Center Tap Box

No.	Description	Std. Pkg.	Net Wt. Lbs.	List Price Each
DH1ABJ31	Three Wire	1	9	\$28.00
DH1ABJ41	Four Wire	1	9	38.00

End Boxes

One type is suitable for both ends.

No.	Description	Std. Pkg.	Net Wt. Lbs.	List Price Each
DH1E1	Three or Four Wire	10	1	\$4.00

Flanges

When passing through a wall, the busway is supported by a flange.

No.	Description	Std. Pkg.	Net Wt. Lbs.	List Price Each
DH1F	Three or Four Wire	10	1	\$4.00

Hangers

Snap-on type for rapid, easy installation. Hangers for edgewise mounting have an elastic stop nut 3/8-in. x 16 for hanger rod.

No.	Description	Std. Pkg.	Net Wt. Lbs.	List Price Each
DH1HU1	Universal Hanger	100		\$0.70
DE1HES	Edgewise Hanger (single run)	100		1.00
DE1HED	Edgewise Hanger (double run)	10		2.50

*Reg. trade-mark of General Electric Company

Unfused Plugs

These plugs are rated 60 amperes and are economical for tap-offs not exceeding 25-ft. in length.

No.	Std. Pkg.	Net Wt. Lbs.	List Price Each
3-Wire, 60 Amp., 600 Volts Max.			
DH1P3TB2	12	1	\$5.00
4-Pole SN, 60 Amp., 600 Volts Max.			
DH1P4TB2	12	1	7.00

Fusible, Non-Operating Plugs

These fusible tap-offs are rated 30 and 60 amperes, 250 and 600 volts, and are available in 3 and 4-wire type. They are not horsepower rated but may be used as a disconnect for portable motors per NEC Article 4402e.

30 Ampere

No.	Poles	Volts	Net Wt. Lbs.	Std. Pkg.	List Price Each
DFPB321	3	250	10	1	\$25.00
DFPB421	4SN	250	10	1	27.00
DFPB361	3	600	10	1	29.00
DFPB461	4SN	600	10	1	31.00

60 Ampere

No.	Poles	Volts	Net Wt. Lbs.	Std. Pkg.	List Price Each
DFPB322	3	250	10	1	\$26.00
DFPB422	4SN	250	10	1	28.00
DFPB362	3	600	10	1	30.00
DFPB462	4SN	600	10	1	32.00

Type TQL Circuit-Breaker Plugs

These plugs accept General Electric Type TQL or R breakers, and are provided with knockouts in the cover so that single, two, or three-pole breakers can be used. The breakers are rated from 15-50 amperes, maximum 250 volts. Neutral is provided with terminals for three wires.

No.	Std. Pkg.	Net Wt. Lbs.	List Price Each
3-Pole, 240 Volts, A-C Max.			
DFPTQL3	12	3	\$8.00
4-Wire, Solid Neutral			
DFPTQL4	12	3	\$10.00

Circuit Breakers For Type TQL Plugs

**Single Pole, Type R
120 Volts, A-C**

Amperes Rating	No.	List Price Each
10		
15	TRP1115	\$3.10
20	TRP1120	3.10
30	TRP1130	3.10
40	TRP1140	3.10
50	TRP1150	3.10

**Single Pole, Type TQL
120 Volts, A-C**

No.	List Price Each
TQ1.1110	\$3.50
TQ1.1115	3.50
TQ1.1120	3.50
TQ1.1130	3.50
TQ1.1140	3.50
TQ1.1150	3.50

**2 Pole, Type TQL
120/240 Volts, A-C**

Amperes Rating	No.	List Price Each
10	TQ1.2110	\$6.90
15	TQ1.2115	6.90
20	TQ1.2120	6.90
30	TQ1.2130	6.90
40	TQ1.2140	6.90
50	TQ1.2150	6.90

**2 Pole, Type TQL
240 Volts, A-C**

No.	List Price Each
TQ1.22015	\$18.00
TQ1.22020	18.00
TQ1.22030	18.00
TQ1.22040	18.00
TQ1.22050	18.00

**3 Pole, Type TQL
240 Volts, A-C**

Amperes Rating	No.	List Price Each
10		
15	TQ1.32015	\$22.00
20	TQ1.32020	22.00
30	TQ1.32030	22.00
40	TQ1.32040	22.00
50	TQ1.32050	22.00

**G-E Busways
Type LTG Plug-In**

50 Amperes, 300 Volts, A.C. or D.C. or Less

(Listed as busways by Underwriters' Laboratories under File E-22178, except as noted)

2, 3 or 4 Poles

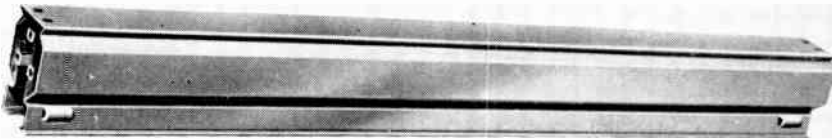

Straight Section of Type LTG Busway

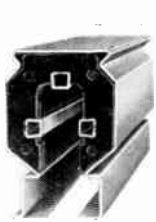

Cross-sectional View



Unfused Plug

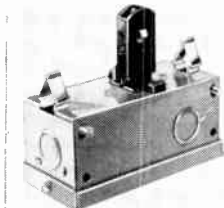

Fusible Plug



Circuit Breaker Plug

Type LTG busway provides a prefabricated power distribution system of 50-amp. capacity for use in industrial plants, office buildings, department stores, garages and warehouses. The formed steel housing provides a slot the full length of the run for insertion of tap-off plugs at any point. Plugs can be easily removed and relocated without disconnecting the system.

Can be used to feed groups of machines and to support lighting fixtures.

A complete system is made up of prefabricated units and fittings, and a large variety of accessories are available to conform with requirements of virtually any plant layout.

Should relocation of busway be necessary, an entire installation can be quickly and easily dismantled and reinstalled with complete reuse of all parts.

The "Roll-in" System of hanging LTG busway provides savings of as much as half the normal installation cost of busway and lighting fixtures.

Pricing Information—Plugs

Description	Two Pole System		Three Pole System		Four Pole System	
	No.	Each	No.	Each	No.	Each
Plugs						
2-Pole terminal only, with cable clamp and ground terminal. contact A&N* contact B&N* contact A&B*	DATP221A	\$ 3.70	DATP221A DATP221B DATOP231A	\$ 3.70		
2-Pole receptacle only, with slot for 3-prong grounding plug. contact A&N† contact B&N† contact A&B†▲	DARP221	3.10	DARP221A DARP221B DAROP221	3.10 3.10 3.10		
2-Pole terminal and receptacle, contact A&N† contact B&N† contact C&N†			DATRP221‡	3.70	DATRP2214A DATRP2214B DATRP2214C	\$ 4.40 4.40 4.40
3-Pole terminal only§			DATRP321	7.90		
4-Pole terminal only§					DATRP421	12.00
Plugs with Conduit Box						
2-Pole contact A&N* contact B&N* contact A&B* contact C&N*	DAUC221	9.80	DAUC221 DAUC221‡ DAUC221	9.80 9.80 9.80	DAUC2214A DAUC2214B DAUC2214C	11.00 11.00 11.00
3-Pole§			DAUC321	14.00		
4-Pole§					DAUC421	18.00
Fusible Plugs. Fuses not incl.						
2-Pole, single-cartridge fuse contact A&N★ contact B&N★ contact C&N★	DFC221	25.00	DFC221 DFC221‡	25.00 25.00	DFC2214A DFC2214B DFC2214C	27.00 27.00 27.00
3-Pole, 3-cartridge fuses§			DFC321	31.00		
4-Pole, 3-cartridge fuses§					DFC421	35.00
Circuit Breaker Plugs						
One 15-amp single-pole breaker contact A&Nφ contact B&Nφ contact C&Nφ	DATLB2115	17.00	DATLB2115 DATLB2115‡	17.00 17.00	DATLB21154A DATLB21154B DATLB21154C	18.00 18.00 18.00
One 20-amp single-pole breaker contact A&Nφ contact B&Nφ contact C&Nφ	DATLB2120	17.00	DATLB2120 DATLB2120‡	17.00 17.00	DATLB21204A DATLB21204B DATLB21204C	18.00 18.00 18.00
Two 15-amp single-pole breakers•			DATLB3115	24.00		
Two 20-amp single-pole breakers•			DATLB3120	24.00		

*15 amps, 300 v a.c.; 20 amps, 120 or 240 v a.c.; 15 amps., 125 v d.c.
 †15 amps, 125 v a.c. or d.c.
 ‡Rating same as note "†" when attachment plug is used. Otherwise, same as note "*".
 §20 amp, 250 v a.c.
 φ120 v a.c.
 •Change location of polarizing wedge in the field.
 •120/240 v a.c.
 ▲Does not have ground slot.
 ★20 amps, 125 volts, a-c or d-c.

G-E Busways
(Trumbull)
Type LTG Plug-In

50 Amperes, 300 Volts, A. C. or D. C. or Less

2, 3 or 4 Poles



No. DAOFEB322 Elbow



No. DFEB322 End Feed-in Box

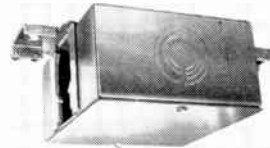

No. DFCB322 Center Feed-in Box



No. DLTG-M1



No. DLTG-MF-3



No. DFP-21



No. DLTG-EC



No. DLTG-FH



No. DLTG-UFS

Straight Lengths, Ft.	Two Pole		Three Pole		Four Pole	
	No.	Each	No.	Each	No.	Each
10	DLTGB222	\$17.50	DLTGB322	\$24.00	DLTGB422	\$31.00
5	DLTGB222-5	14.50	DLTGB322-5	20.00	DLTGB422-5	26.00
Coupling Set	DLTG8TP2	3.10	DLTG8TP3	3.90	DLTG8TP4	4.70
Elbows*†‡						
Edgewise Internal 1½" x 4½"	DAIEB322	24.00	DAIEB322	24.00	DAIEB422	29.00
Edgewise External 4½" x 1½"	DAEEB322	24.00	DAEEB322	24.00	DAEEB422	29.00
Flat Internal 3¾" x 3¾"	DAIFEB322	24.00	DAIFEB322	24.00	DAIFEB422	29.00
Flat External 3¾" x 3¾"	DAOFE322	24.00	DACFE322	24.00	DAOFE422	29.00
End Feed-In Boxes†						
20 Amp. 300 Volts	DFEB221	5.50	DFEB321	10.00	DFEB421	13.00
50 Amp. 300 Volts	DFEB222	11.00	DFEB322	14.00	DFEB422	17.00
Center Feed-In Boxes						
Suspended mounting,‡						
50 Amp. 300 Volts	DAOCB222	13.00	DAOCB322	18.00	DAOCB422	23.00
Center Feed	DAOCS222	15.00	DAOCS322	20.00	DAOCS422*	25.00
Center sectionalizing						
Center Feed-In Boxes						
Surface mounting,†						
50 Amp. 300 Volts	DFCB222	13.00	DFCB322	18.00	DFCB422	23.00
Center feed	DFCS222	13.00
Center sectionalizing						

*The location of the polarizing lip identifies internal or external type elbow. Dimensions are measured along centerline of housing.

†Cat. no. of these devices include built-in coupling set.

‡Cat. no. do not include coupling sets. Order separately the required number of sets.

Hanging Devices and Accessories

Description	No.	Each
Hanger plate, sliding type.....	DLTG-S	\$0.40
Hanger plate, screw clamp type.....	DLTG-F	.40
Messenger cable support hook only 1¼".....	DLTG-M1	.40
Messenger cable support hook only 3¼".....	DLTG-M3	.60
Assembly of sliding hanger plate DLTG-S and support hook DLTG-M1.....	DLTG-MS-1	.80
Assembly of sliding hanger plate DLTG-S and support hook DLTG-M3.....	DLTG-MS-3	.80
Assembly of screw clamp hanger plate DLTG-F and support hook DLTG-M1.....	DLTG-MF-1	.80
Assembly of screw clamp hanger plate DLTG-F and support hook DLTG-M3.....	DLTG-MF-3	.90
Assembly of coupling plate DLTG-CP and support hook DLTG-M1.....	DLTG-MCP-1	1.90
Assembly of coupling plate DLTG-CP and support hook DLTG-M3.....	DLTG-MCP-3	2.00
Universal End Cap with mounting screws.....	DLTG-EC	1.40
Roller Hanger for roll-in system.....	DLTG-HR1	3.00
Lead-in Coupling Plate for roll-in system.....	DLTG-LCP	8.00
Heavy-duty Coupling Plate for roll-in system.....	DLTG-HDCP	1.50
Self-aligning Towing Head for roll-in system.....	DLTG-HEAD	80.00
Universal Sectionalizing Coupling. (Two DLTG-EC back-to-back, for breaking electrical continuity in LTG run).....	DLTG-SEC‡	2.90
Fixture Hook.....	DLTG-FH	.50
Universal fluorescent fixture support, maximum 4 ft. fixture.....	DLTG-UFS	1.20
Fusible convenience plug (fuses not included) uses two ¼" x 1¼" 3 AG glass fuses.....	DFP-21	.80

* Not Underwriters' Laboratories, Inc., listed.

G-E Busways Type FVK Plug-In

225-1000 Amperes, 600 Volts Maximum

3 and 4 Wire

(Listed by Underwriters' Laboratories, Inc., except as noted.)



Standard 10-ft. Length

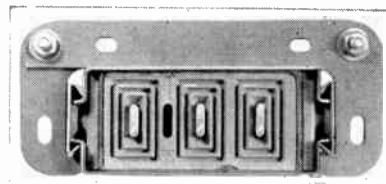

Cross-Section with Hanger

Application

Type FVK prefabricated Flex-A-Power busways are designed for 225- to 1000-ampere, 600-volt secondary feeder systems. They are used for 3-pole, 600-volt, and 3-phase, 4-wire, 120/208Y-volt, and 480Y/277-volt applications. 2-pole type also available.

1000-ampere aluminum bus type also available.

Construction of standardized sections permits busway to be virtually form-fitted to needs of industrial plants, schools, offices, commercial and public buildings. Type FVK busways are ideal as power risers in multi-storied buildings and as feeders for incoming services.

Each 10-foot straight section has outlets every foot along the run which permit plug-in to power right at load. Allows quick addition or relocation of machinery and other equip-

ment without lengthy shutdowns. Can be easily expanded to meet increased requirements. If necessary, entire system can be dismantled, moved, and reassembled in minimum time without unnecessary loss of material.

Ordering Directions

Except on simple installations of standard units the following information should be furnished:

- a. Complete layout plans showing location, and any limitations in dimensions or specifications.
- b. Whether system is to be run flat-wise, edgewise or as a vertical riser.
- c. Complete details of any equipment to which busway will be connected such as switchboards.
- d. Number and size of all cable terminal lugs.

Pricing Information

Three Pole

Ampere Rating	Straight Footage Per Foot (See Note 1)		Elbows (See Note 2)	Tees (See Note 2)	Each "X" Connections (See Note 2)	End Boxes (See Note 3)	Cable Tap Boxes (See Note 4)	
	Aluminum	Copper					End-of-run Type	Joint Mounting Type
225	\$10.00	\$11.00	\$102.00	\$122.00	\$144.00	\$14.00	\$ 82.00	\$ 68.00
400	14.00	19.00	102.00	122.00	144.00	14.00	90.00	76.00
600	20.00	24.00	102.00	122.00	144.00	14.00	100.00	86.00
800	27.00	32.00	102.00	122.00	144.00	14.00	130.00	116.00
1000	32.00	40.00	102.00	122.00	144.00	14.00	130.00	116.00

4 Wire, 3 Phase, Half Capacity Neutral, 120/208Y Volts, 480Y/277 Volts (See Note 10)

225	\$12.00	\$14.00	\$122.00	\$144.00	\$168.00	\$14.00	\$ 89.00	\$ 75.00
400	18.00	25.00	122.00	144.00	168.00	14.00	100.00	86.00
600	24.00	30.00	122.00	144.00	168.00	14.00	110.00	96.00
800	32.00	39.00	122.00	144.00	168.00	14.00	140.00	126.00
1000	40.00	48.00	122.00	144.00	168.00	14.00	140.00	126.00

4 Wire, 3 Phase, Full Capacity Neutral, 120/208Y Volts only

225	\$13.00	\$16.00	\$122.00	\$144.00	\$168.00	\$14.00	\$ 89.00	\$ 75.00
400	22.00	28.00	122.00	144.00	168.00	14.00	100.00	96.00
600	30.00	37.00	122.00	144.00	168.00	14.00	110.00	96.00
800	37.00	45.00	122.00	144.00	168.00	14.00	140.00	126.00
1000	45.00	56.00	122.00	144.00	168.00	14.00	140.00	126.00

Notes:

1. Price is per foot or any fraction thereof and includes material and labor of forming, two hangers per section, and necessary joint hardware.
2. Prices include labor of forming only. Add for material at straight footage price. Use forming price of highest ampere-rated Type FVK busway entering, "Tee" or "X" connections. Prices cover 90-degree angle units. For other angles, double the price.
3. Price includes material and labor of forming.
4. Price includes material and labor of forming and lugs of appropriate size. End-of-run type includes busway end closure.

G-E Busways

Type FVK Plug-In

225-1000 Amperes, 600 Volts Maximum

3 and 4 Wire

A complete Type FVK busway installation consists of standardized units which can be quickly and easily coupled and suspended to conform to the individual requirements of virtually any plant layout. These units consist of straight lengths, elbows, offsets, end and feed-in boxes, etc. The busway is available with either copper or aluminum bus bars.

Each 10-foot straight section has outlets on one-foot centers to permit plug-in directly at the load. Take-off is made by Flex-A-Plug units of either the fusible switch or circuit-breaker type. Cover plates keep unused outlets closed to dust and dirt.

These Flex-A-Plug units provide a direct plug-in to the bus bars, even when the run is energized. Safety for operating personnel is assured because handle must be switched to OFF position before the fuses can be reached.

Bus bars are supported on porcelain insulators of high-dielectric strength to eliminate possibility of tracking or carbonization. Supports in housing are spaced on maximum two-foot centers.

The housing is of formed 16-gage sheet steel with a baked grey enamel finish over a rust inhibitor. An 18-inch removable joint inspection cover is provided between sections to permit easy assembly of sections during installation and to provide easy access for inspections if necessary.

A complete line of fittings and accessories is available to meet the requirements of virtually any plant layout.

For changes in direction of runs and to permit run to avoid beams, columns, and obstructions, four types of elbows can be provided—edgewise internal; edgewise external; flat left; and flat right.

For intersections of runs there are flat or edgewise tees and flat or edgewise crosses available.

Cable tap boxes are used for connection of incoming power at end or center; transformer taps for connecting run to transformers; and switchboard stubs for connecting run to switchboards.

End boxes are used for closing the end of runs.

Other Types

Type FVK busway is available without plug outlets at same prices as listed below.

Standard short-circuit ratings are as follows: 225-ampere type, 15,000 amperes RMS asymmetrical; 400-1000 ampere type, 25,000 amperes asymmetrical.

The following ratings are available at a price increase of \$2.00 per ft.: 225-amp type, 25,000 amps RMS asymmetrical 400-1000 amp type, 50,000 amps RMS asymmetrical.

Pricing Information

Three Pole, 600 Volts Maximum

Ampere Rating	Expansion Fitting (See Note 5)	Switchboard Stubs or Transformer Taps (See Note 6)		Ebony End Closures, Flange End or Transformer Tap Opening (See Note 7)	Bus Bar Extensions, Formed Per Ft. (See Note 8)		Adaptors or Unused Reducers (See Note 9)
		Aluminum	Copper		Aluminum	Copper	
225	\$165.00	\$64.00	\$64.00	\$42.00	\$11.00	\$11.00	\$52.00
400	185.00	74.00	82.00	42.00	16.00	20.00	64.00
600	205.00	82.00	92.00	42.00	20.00	25.00	70.00
800	264.00	98.00	112.00	46.00	26.00	33.00	92.00
1000	297.00	114.00	130.00	46.00	34.00	42.00	104.00

4 Wire, 3 Phase, Half Capacity Neutral, 600 Volts Maximum (See Note 10)

225	\$194.00	\$80.00	\$80.00	\$42.00	\$19.00	\$19.00	\$76.00
400	211.00	90.00	102.00	42.00	24.00	30.00	88.00
600	240.00	102.00	116.00	42.00	30.00	37.00	96.00
800	290.00	122.00	142.00	46.00	38.00	48.00	118.00
1000	330.00	136.00	158.00	46.00	45.00	56.00	136.00

4 Wire, 3 Phase, Full Capacity Neutral, 600 Volts Maximum

225	\$194.00	\$86.00	\$96.00	\$42.00	\$22.00	\$27.00	\$88.00
400	211.00	104.00	120.00	42.00	31.00	39.00	112.00
600	240.00	122.00	142.00	42.00	40.00	50.00	124.00
800	290.00	130.00	154.00	46.00	42.00	54.00	140.00
1000	330.00	142.00	166.00	46.00	48.00	60.00	170.00

Notes:

- Prices include material and labor of forming.
- Price includes material and labor of forming but no busway footage. Switchboards stubs include flange, minimum length of bus-bar extensions, and lugs. Price of transformer taps includes opening in side of housing, slotted ebony-asbestos cover, minimum length bus-bar extensions, and lugs.
- Includes material and labor of forming. No bus-bar extensions or lugs included. Price of flange ends includes flange and slotted ebony-asbestos cover only. Price of transformer tap includes opening in side of housing and slotted ebony-asbestos cover only.
- Price is per foot or any fraction thereof. The price includes material, labor of forming, and drilling but no lugs.
- Price includes labor of forming only. Add for material at straight footage price. Use price of higher ampere-rated busway entering adapter or reducer. Adaptors are for connecting type DE, FVK or FAP busway systems of same or different ampere ratings. Unfused reducers are for changing size of type FVK busway.
- Price includes material and labor of forming. Floor or wall flange not included.

G-E Plug-In Busways Type FVK Flex-A-Plug Switch Units

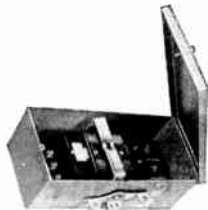

Type FG fusible switch plugs include Type HCl individually removable pole units. Type FD similar except include Type RBA mechanism.



Type FL hinged-cover-operated fusible plug.

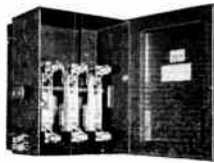

Type FCE molded-case circuit breaker plug.

Combination Ground Detector and Neutralizer Flex-A-Plug Units

Indicates grounds in system and maintains definite potential between bus bars and housing on ungrounded systems.

No.	Volts	No. of Poles	Each
DAGN34	208-480	3	\$76
DAGN36	550-600	3	76

Type FL Fusible Flex-A-Plug Units With N.E.C. Standard Fuse Clips (No Fuses Included)

Rating in Amp	240 Volts, A.C./D.C. Two Pole		240 Volts, A.C. Three Pole		120/208Y Volts 4 Wire, 3 Phase		600 Volts, A.C. Two Pole		600 Volts, A.C. Three Pole		480Y/277 Volts 4 Wire, 3 Phase†	
	No.*	Each	No.	Each	No.	Each	No.*	Each	No.	Each	No.	Each
30	DFL-221	\$ 37	DFL-321	\$ 39	DFLN-321	\$ 50	DFL-261	\$ 39	DFL-361	\$ 41	Not Available	
60	DFL-222	39	DFL-322	43	DFLN-322	52	DFL-262	41	DFL-362	45		
100	DFL-223	52	DFL-323	56	DFLN-323	67	DFL-263	54	DFL-363	63		

Type FG Fusible Switch Flex-A-Plug Units With N.E.C. Standard Fuse Clips (No Fuses Included)

30	DFG221	\$ 45	DFG321	\$ 49	DFG421SN	\$ 59	DFGA261	\$ 47	DFG361	\$ 50	DFG461SN	\$ 60
60	DFG222	50	DFG322	57	DFG422SN	66	DFGA262	54	DFG362	60	DFG462SN	68
100	DFG223	76	DFG323	84	DFG423SN	92	DFGA263	80	DFG363	87	DFG463SN	97
200	DFG224	134	DFG324	148	DFG424SN	166	DFGA264	148	DFG364	156	DFG464SN	173

Type FG Fusible Switch Flex-A-Plug Units With CLF Fuse Clips (No Fuses Included) †

30	DFG221-J6	\$ 48	DFG321-J6	\$ 53	DFG421SN-J6	\$ 63	DFGA261-J6	\$ 51	DFG361-J6	\$ 55	DFG461SN-J6	\$ 65
60	DFG222-J6	54	DFG322-J6	62	DFG422SN-J6	71	DFGA262-J6	59	DFG362-J6	66	DFG462SN-J6	74
100	DFG223-J6	85	DFG323-J6	96	DFG423SN-J6	104	DFGA263-J6	89	DFG363-J6	99	DFG463SN-J6	109
200	DFG224-J6	146	DFG324-J6	164	DFG424SN-J6	182	DFGA264-J6	160	DFG364-J6	172	DFG464SN-J6	189

Type FD Fusible Switch Flex-A-Plug Units With N.E.C. Standard Fuse Clips

400	DFD-225	\$278	DFD-325	\$305	DFDN-325	\$335	DFD-265	\$293	DFD-365	\$320	DFDN-465	\$348
-----	---------	-------	---------	-------	----------	-------	---------	-------	---------	-------	----------	-------

Type FCE Circuit Breaker Flex-A-Plug Units

100 Ampere (E-Frame)

15	DFCE2E015	\$ 65	DFCE3E015	\$ 80
20	DFCE2E020	65	DFCE3E020	80
30	DFCE2E030	65	DFCE3E030	80
40	DFCE2E040	65	DFCE3E040	80
50	DFCE2E050	65	DFCE3E050	80
70	DFCE2E070	93	DFCE3E070	108
100	DFCE2E100	93	DFCE3E100	108

225 Ampere (J-Frame) †

100	DFCE2J100	\$264	DFCE3J100	\$311
125	DFCE2J125	264	DFCE3J125	311
150	DFCE2J150	264	DFCE3J150	311
175	DFCE2J175	264	DFCE3J175	311
200	DFCE2J200	264	DFCE3J200	311
225	DFCE2J225	264	DFCE3J225	311

225 Ampere (K-Frame) †

100	DFCE2K100	\$307	DFCE3K100	\$365
125	DFCE2K125	307	DFCE3K125	365
150	DFCE2K150	307	DFCE3K150	365
175	DFCE2K175	307	DFCE3K175	365
200	DFCE2K200	307	DFCE3K200	365
225	DFCE2K225	307	DFCE3K225	365

400 Ampere (KL-Frame) †

125	DFCE2KL125	\$661	DFCE3KL125	\$780
150	DFCE2KL150	661	DFCE3KL150	780
175	DFCE2KL175	661	DFCE3KL175	780
200	DFCE2KL200	661	DFCE3KL200	780
225	DFCE2KL225	661	DFCE3KL225	780
250	DFCE2KL250	661	DFCE3KL250	780
300	DFCE2KL300	661	DFCE3KL300	780
350	DFCE2KL350	661	DFCE3KL350	780
400	DFCE2KL400	661	DFCE3KL400	780

600 Ampere (L-Frame) †

225	DFCE2L225	\$760	DFCE3L225	\$916
250	DFCE2L250	760	DFCE3L250	916
275	DFCE2L275	760	DFCE3L275	916
300	DFCE2L300	760	DFCE3L300	916
350	DFCE2L350	760	DFCE3L350	916
400	DFCE2L400	760	DFCE3L400	916
450	DFCE2L450	760	DFCE3L450	916
600	DFCE2L600	760	DFCE3L600	916

100 Ampere (F-Frame)

102	DFCE2F015	\$102	DFCE3F015	\$119	DFCEN4F015	\$132
102	DFCE2F020	102	DFCE3F020	119	DFCEN4F020	132
102	DFCE2F030	102	DFCE3F030	119	DFCEN4F030	132
102	DFCE2F040	102	DFCE3F040	119	DFCEN4F040	132
102	DFCE2F050	102	DFCE3F050	119	DFCEN4F050	132
119	DFCE2F070	119	DFCE3F070	138	DFCEN4F070	147
119	DFCE2F100	119	DFCE3F100	138	DFCEN4F100	147

\$264	DFCE2J100	\$311	DFCE3J100	\$311	DFCEN4J100	\$326
264	DFCE2J125	311	DFCE3J125	311	DFCEN4J125	326
264	DFCE2J150	311	DFCE3J150	311	DFCEN4J150	326
264	DFCE2J175	311	DFCE3J175	311	DFCEN4J175	326
264	DFCE2J200	311	DFCE3J200	311	DFCEN4J200	326
264	DFCE2J225	311	DFCE3J225	311	DFCEN4J225	326

\$307	DFCE2K100	\$365	DFCE3K100	\$365	DFCEN4K100	\$384
307	DFCE2K125	365	DFCE3K125	365	DFCEN4K125	384
307	DFCE2K150	365	DFCE3K150	365	DFCEN4K150	384
307	DFCE2K175	365	DFCE3K175	365	DFCEN4K175	384
307	DFCE2K200	365	DFCE3K200	365	DFCEN4K200	384
307	DFCE2K225	365	DFCE3K225	365	DFCEN4K225	384

\$661	DFCE2KL125	\$780	DFCE3KL125	\$780	DFCEN4KL125	\$810
661	DFCE2KL150	780	DFCE3KL150	780	DFCEN4KL150	810
661	DFCE2KL175	780	DFCE3KL175	780	DFCEN4KL175	810
661	DFCE2KL200	780	DFCE3KL200	780	DFCEN4KL200	810
661	DFCE2KL225	780	DFCE3KL225	780	DFCEN4KL225	810
661	DFCE2KL250	780	DFCE3KL250	780	DFCEN4KL250	810
661	DFCE2KL300	780	DFCE3KL300	780	DFCEN4KL300	810
661	DFCE2KL350	780	DFCE3KL350	780	DFCEN4KL350	810
661	DFCE2KL400	780	DFCE3KL400	780	DFCEN4KL400	810

\$760	DFCE2L225	\$916	DFCE3L225	\$916	DFCEN4L225	\$946
760	DFCE2L250	916	DFCE3L250	916	DFCEN4L250	946
760	DFCE2L275	916	DFCE3L275	916	DFCEN4L275	946
760	DFCE2L300	916	DFCE3L300	916	DFCEN4L300	946
760	DFCE2L350	916	DFCE3L350	916	DFCEN4L350	946
760	DFCE2L400	916	DFCE3L400	916	DFCEN4L400	946
760	DFCE2L450	916	DFCE3L450	916	DFCEN4L450	946
760	DFCE2L600	916	DFCE3L600	916	DFCEN4L600	946

*The cat. no. as listed identifies stab location for connection to outside bars. For stab connections to narrow spaced bars, add suffix "N". For stab connection to wide spaced bars add suffix "W".

†Not Underwriters' listed.

Capacitor type plugs Types FG and FCE also available consult your Graybar office.

‡These plugs have long neutral stub for FVK and FVA systems. For plugs with short neutral stub for FVK5, FVA5 and LVDP systems, add suffix "S" to catalog number. No change in price.

G-E Trolley Busways Type TK3 100 AMP Trolley System

For cranes, hoists, portable tools, cutting machines and other production-line equipment



Straight Section of Type TK3 Trolley Busway

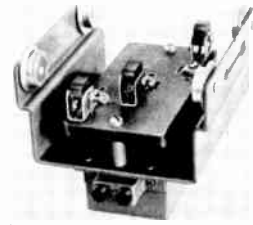

Standard-Duty Trolley

Trolleys

Standard-duty trolleys have one shoe contact per pole while the heavy-duty type have two shoe contacts per pole. Fusible-type trolleys have hinged-cover boxes containing a Convertifuse unit.

If tool hanger is required, order separate cat. no. DATK3II at \$3.00 each.

Straight Lengths and Fittings

No.	Description	Each*
DATK263†	2 Pole Standard 10 ft. Section.....	\$86
DATK363†	3 Pole Standard 10 ft. Section.....	95
DATK03	Std. 10 ft. Section without bus bars.....	55
DATK36B	End Box.....	5
DATK36MB	Combination End and Feed-in Box.....	19
DATK36M	Center Feed-in Box.....	14
Short Lengths—For each length less than 10 ft. use pro-rata price per ft. or any fraction thereof and add following set-up charge:		
	Section with or without bus bars.....	26

*Price includes two hangers and necessary coupling set.
†Slide-out Sections—for removing trolley—Add \$15.00 to price of straight section and suffix "0" to cat. no.

Curved Sections—90-degree Standard Sizes

Radius	Each‡	Radius	Each‡
3'0"	\$242	5'6"	\$286
3'6"	253	6'0"	297
4'0"	264	6'6"	308
4'6"	275	7'0"	308
5'0"	275	7'6"	319

Special Curved Sections—\$12.00 per lineal ft. or any fraction thereof, plus \$250.00 engineering and set-up charge for each section. Minimum radius 3 ft.

‡Price includes two hangers and necessary coupling set.

Standard Duty

Description	Two Pole		Three Pole	
	No.	Each	No.	Each
Unfused Type 250 or 600V				
30-ampere.....	DATS261	\$30	DATS361	\$34
60-ampere.....	DATS262	48	DATS362	56
100-ampere.....	DATS263	96	DATS363	112
Fusible Type 250V				
30-ampere.....	DATSF221	59	DATSF321	68
60-ampere.....	DATSF222	81	DATSF322	94
Fusible Type 600V				
30-ampere.....	DATSF261	79	DATSF361	93
60-ampere.....	DATSF262	101	DATSF362	119
Bus-Bar Cleaner				
Type.....	DAPC261BC	53	DAPC361BC	58

Heavy Duty

Unfused Type 250 or 600V				
30-ampere.....	DATH261	\$37	DATH361	\$45
60-ampere.....	DATH262	62	DATH362	70
100-ampere.....	DATH263	124	DATH363	140
Fusible Type, 250V				
30-ampere.....	DATHE221	66	DATHE321	79
60-ampere.....	DATHE222	95	DATHE322	108
Fusible Type, 600V				
30-ampere.....	DATHE261	86	DATHE361	104
60-ampere.....	DATHE262	115	DATHE362	133

Type TK4 225 AMP and Type TK5 400 AMP Trolley Systems

For cranes, hoists and other high capacity equipment in motion

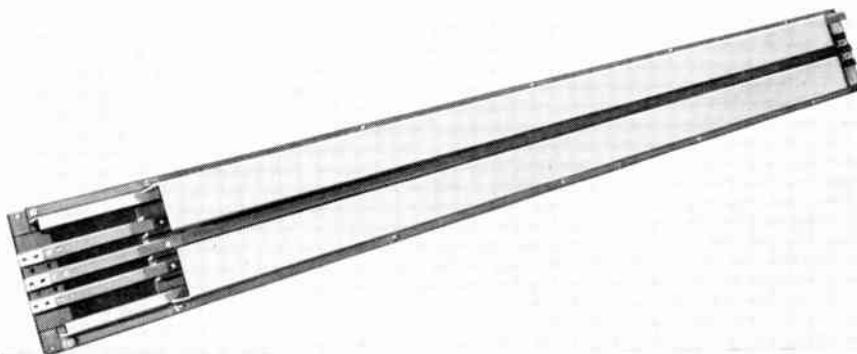

Length of TK-4 With Trolley

Description	225 Amps, 600 Volts, A.C. or D.C.				400 Amps, 600 Volts, D.C. or DC			
	Two Pole		Three Pole		Two Pole		Three Pole	
	No.	Each	No.	Each	No.	Each	No.	Each
Std. 10 ft. section with 2 hangers and coupling set*	DATK264S	\$210	DATK364S	\$240	DATK265S	\$254	DATK365S	\$290
Std. 10 ft. section with expansion fitting, 2 hangers & coupling set.....	DATKX264S	670	DATKX364S	720	DATKX265S	734	DATKX365S	798
End Closure Box.....	DATKB364S	12	DATKB364S	12	DATKB365S	12	DATKB365S	12
Combination End and Feed-in Box.....	DATKMB264S	76	DATKMB364S	92	DATKM265S	86	DATKM365S	102
Center Feed-in Box.....	DATKM264S	76	DATKM364S	92	DATKM265S	86	DATKM365S	102
Trolley, brush contact type, with lugs.....	DAPD264	340	DAPD364	390	DAPD265	580	DAPD365	670

*For sections less than 10 ft. long, use pro-rata price per foot or any fraction thereof and add set-up charge of \$70.00.

G-E Feeder Busways

Type LVD

600 to 4000 Amperes 600 Volts or Less
2, 3, or 4-Pole 3-Phase, 4-Wire, Solid Neutral

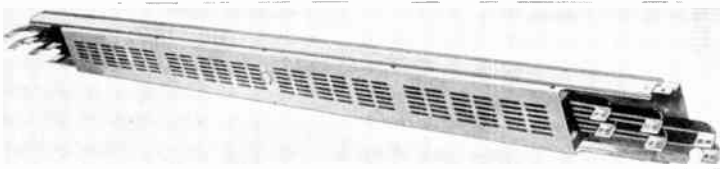

Straight Length of Type LVD Feeder Busway



Cross-Sectional View

The Type LVD is an enclosed bus-bar system incorporating low impedance with sturdy construction. It is extensively used for these applications:

Incoming service from transformers to switchboards

Feeders from switchboards to other distribution points or to branch busways

As complete riser distribution system for multi-story buildings

Welder feeders.

Type LVD is available in 600 to 4000 ampere ratings, 2, 3, or 4-pole and in 3-phase, 4-wire solid neutral construction. It is suitable for 600 volts or less. Because of its prefabricated standardized sections and fittings, it is simple to install and can be easily dismantled and moved to new locations without loss of materials. Additions to meet in-

creased production or expansion programs can be easily made at any time. A variety of hanging and supporting arrangements are available to permit horizontal mounting at any level between floor and ceiling or vertical mounting where risers are required. All parts are shipped ready for installation.

Available with either copper or aluminum bus bars. Aluminum bus bars are particularly recommended for applications where surrounding atmospheres contain high sulfur-dioxide concentrations. Both systems are alike in construction and both have the same performance features.

The housing is made of rigidly formed steel perforated to provide proper ventilation. Solid-cover-type housings for dusty or humid locations or enclosed weather-proof housings for outdoor use are also available.

Components of LVD Busway

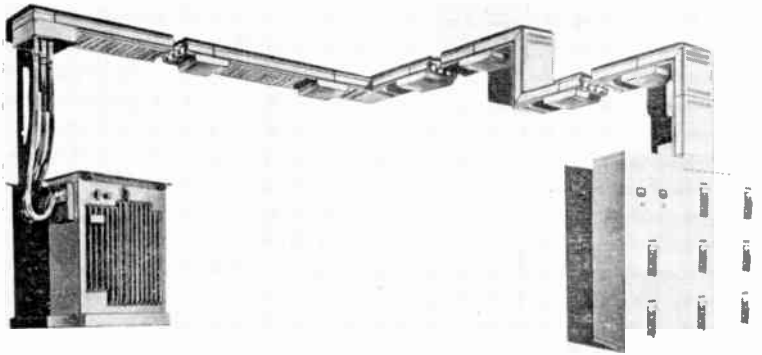

Typical Installation of Type LVD Busway

Standard Section—Consists of rigid steel housing which encloses bus bars of either hard-drawn, round-edge copper or aluminum. Low temperature rise at joints is assured through use of silver plating. Aluminum bus bars are first treated with a modified zincate process to prevent formation of high-resistance oxides and galvanic action. Special compression spring washers are provided to compensate for cold flow. Bus bars are narrow, closely spaced, and interlaced to assure low voltage drop. Air-rated type, designed for general purpose indoor use, has perforated cover to permit ventilation; solid cover type is designed for atmospheres of excessive dust or moisture; and weatherproof type is used for outdoor applications.

Elbows—Used where Type LVD runs in irregular paths around pillars, beams, pipes, etc. Available in four types: edgewise external, edgewise internal, flat right, and flat left.

Offsets—Used where run must move short distances up, down, or sideways to avoid obstacles or to conform to building contours. Flat offset consists of two flat elbows. Edgewise

offset is made up of two edgewise elbows fabricated in one piece.

T-Connections—Used where run is to be center-fed or where a branch is to be tapped from a main feeder.

"X"-Connection—Used to feed branch circuits from feeder runs; also to connect from an LVD circuit to branch or subfeeder on a multi-circuit installation.

Unfused Reducers—Used to decrease size of run without overcurrent protection.

End Boxes—Seal off end of run, giving mechanical and electrical protection to busway.

Switchboard Stubs—Used where LVD enters or leaves a switchboard.

Cable Tap Boxes—Serve as junctions for main cable feeders or branches or for connecting to power transformers. Boxes are mounted at end, or at any joint of LVD run.

Circuit Breaker Adapters and Fuse Adapters—Provide overcurrent protection on branch runs.

G-E Plug-In Busways
Type LVDP With Copper or Aluminum Bus Bars
 600 to 4000 Amperes 600 Volts or Less 3-Pole 3-Phase, 4-Wire

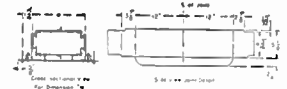
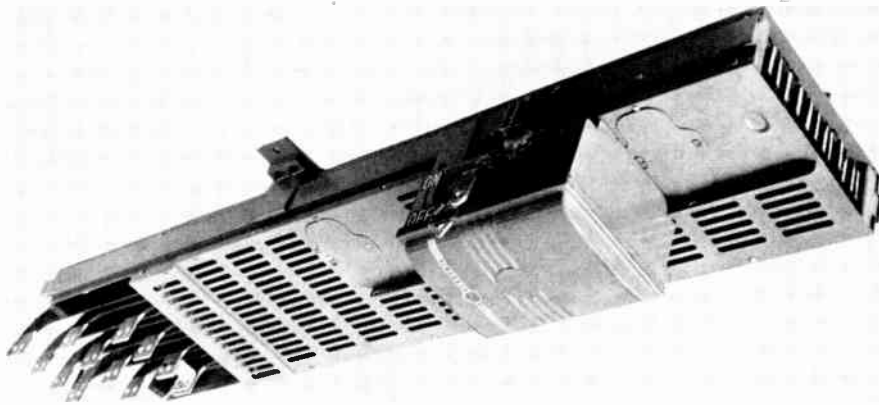

Cross-Sectional View for Dim. "W"

Standard 10-ft. Length of Type LVDP with Flex-A-Plug Switch Unit Installed

A plug-in-type, enclosed bus-bar system with low-voltage-drop characteristics. It can be installed at lower cost than most conventional low-voltage-drop feeder systems utilizing cable tap boxes for tap-offs.

Designed for use in industrial plants where high capacity and low voltage drop are required to feed welders and similar equipment. It is also used as risers in multi-story buildings where frequent tap-offs are required.

Type LVDP plug-in busway is provided in standard straight 10-ft. lengths only for use with components of the Type LVD3 and Type LVD5 feeder busways. Bus-bar sizes are the same, rating for rating, as for those systems. These standard lengths can be installed in new or existing Type LVD busway systems wherever plug-in tap-offs are required, as they are interchangeable with standard 10-ft. lengths of Type LVD busway. Each standard length is provided with 10 plug outlets—5 on each side. Standard Flex-A-Plug switch units such as are used with the Type FVK

Flex-A-Power* plug-in busway can be installed on Type LVDP busway without the need for alterations. The continuous current drawn from one 10-ft. length should normally not exceed a total of 400 amperes.

The low power loss and extremely low voltage drop of Type LVDP, even for low-power-factor loads, are obtained by interlacing closely spaced bus bars in recurring sequence with no adjacent bars having the same polarity.

Phase-collection straps are provided with each standard length of Type LVDP to assure that all bus bars of the same phase will be connected together at each joint in accordance with NEMA standards. This also provides higher short-circuit strength.

The general construction of the Type LVDP is the same as the Type LVD busway. The joints and plug contacts are silver plated and the bus bars are individually wrapped. A ventilated type housing is provided as standard, but a solid cover-type housing is also available.

3-Phase, 4-Wire, 346/600-Volt, Maximum, 3-Phase, 4-Wire, 346/600-Volt Maximum

Ampera Rating	Cat. No.	3-Pole, 600 Volts Maximum			Cat. No.	Half-size Neutral			Cat. No.	Full-size Neutral		
		Approx. Net Wt. Lbs.	Dim. "W" In.	Approx. Net Wt. Lbs.		Dim. "W" In.	Approx. Net Wt. Lbs.	Dim. "W" In.				
Type LVDP3 Ventilated Plug-In Busway With Copper Bus Bars												
800	DLVDP3-368	165	9 1/4	DLVDP3-468SN	190	11 1/2	DLVDP3-468	208	11 1/2			
1000	DLVDP3-3610	193	9 1/4	DLVDP3-4610SN	233	11 1/2	DLVDP3-4610	245	11 1/2			
1350	DLVDP3-3613	232	13 3/4	DLVDP3-4613SN	263	13 3/4	DLVDP3-4613	279	13 3/4			
1600	DLVDP3-3616	274	13 3/4	DLVDP3-4616SN	315	13 3/4	DLVDP3-4616	335	13 3/4			
2000	DLVDP3-3620	335	13 3/4	DLVDP3-4620SN	386	16	DLVDP3-4620	436	18 1/4			
2500	DLVDP3-3625	416	16	DLVDP3-4625SN	487	20 1/2	DLVDP3-4625	527	20 1/2			
3000	DLVDP3-3630	487	18 1/4	DLVDP3-4630SN	558	20 1/2	DLVDP3-4630	629	22 3/4			
4000	DLVDP3-3640	608	22 3/4	DLVDP3-4640SN	708	27 1/4	DLVDP3-4640	798	29 1/2			
Type LVDP5 Ventilated Plug-In Busway With Aluminum Bus Bars												
600	DLVDP5-366	111	9 1/4	DLVDP5-466SN	125	11 1/2	DLVDP5-466	141	11 1/2			
800	DLVDP5-368	120	9 1/4	DLVDP5-468SN	136	11 1/2	DLVDP5-468	146	11 1/2			
1000	DLVDP5-3610	150	13 3/4	DLVDP5-4610SN	159	13 3/4	DLVDP5-4610	164	13 3/4			
1350	DLVDP5-3613	167	13 3/4	DLVDP5-4613SN	182	16	DLVDP5-4613	200	18 1/4			
1600	DLVDP5-3616	178	13 3/4	DLVDP5-4616SN	203	16	DLVDP5-4616	224	18 3/4			
2000	DLVDP5-3620	217	16	DLVDP5-4620SN	240	20 1/2	DLVDP5-4620	259	20 1/2			
2500	DLVDP5-3625	266	20 1/4	DLVDP5-4625SN	297	22 3/4	DLVDP5-4625	331	27 1/4			
3000	DLVDP5-3630	286	22 3/4	DLVDP5-4630SN	331	27 1/2	DLVDP5-4630	366	29 1/2			
4000	DLVDP5-3640	343	27 1/4									

*Reg. trade-mark of General Electric Company.

Short-Circuit Ratings

When properly protected, the Type LVDP busway will mechanically and electrically operate the same after being subjected to its rated short-circuit current as it operated before the short circuit.

The following table shows the short-circuit ratings in RMS asymmetrical amperes which have been assigned to the Type LVDP busway. These ratings apply only when short circuits external to the busway are considered.

Note: In order to take advantage of these high ratings of LVDP, current-limiting fuses are recommended in Type FG Flex-A-Plugs.

Short Circuit Ratings in RMS Asymmetrical Amperes

Ampera Rating	NEMA Standard Aluminum or Copper Bus Bar Type	Actual Ratings Available	
		Aluminum Bus Bar Type	Copper Bus Bar Type
600	25000	70000
800	25000	80000	75000
1000	50000	100000	80000
1350	50000	110000	100000
1600	50000	160000	125000
2000	75000	200000	160000
2500	75000	200000	200000
3000	75000	200000	200000
4000	100000	200000	200000

Square D Light Duty Enclosed Safety Switches Type LD (Formerly Types D or G) Single Throw

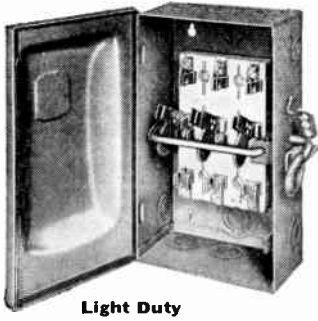

Light Duty

Type LD light duty safety switches are designed for residential and commercial applications where price is limited and the service factor is not great—such as lighting, room conditioning and appliance loads. U/L approved File E2875. Meets Federal Specification W-S-865 for type D switches.

Positive make, positive break spring assisted operating mechanism. Side operated.

Plug fuse switches rated 120/240 volts a-c only. All neutrals—Insulated groundable.

Blue-gray enamel finish. Raintight has extra coat of Glyptal. NEMA 1—General Purpose. NEMA 3R—Raintight.

Fusible

Indoor—NEMA Type 1				Fusible				Raintight NEMA Type 3R ▲ Type RO—Add Hub or Cap			Not Fusible Indoor NEMA Type 1 Flat Base		
Amps.	Rating A-C Horsepower		Fuse	Flat Base No.	Compact Type No.	List Price	No.	Max. Hub Size, In.	List Price	Amps.	No.	List Price	
	1 Ph.	3 Ph.											2 Ph.
2-Wire S/N (1 Blade, 1 Fuse) 120 Volts A-C													
30	3/4	..	Plug	D97211	90211	\$ 5.00	▲D97211RO	1 1/4	\$11.20	
30	3/4	..	Plug	..	†90211M	5.00	
30	3/4	..	Plug	..	*90211WH	5.90	
30	3/4	..	Plug	..	*97211WH	6.80	
30	3/4	..	Cart.	D97251	..	5.50	▲D97251RO	1 1/4	13.10	
2-Pole, 120/240 Volts A-C (Plug); 240 Volts A-C (Cart.)													
30	1 1/2	..	Plug	D99211	93211	\$ 6.20	▲D99211RO	1 1/4	\$12.80	
30	1 1/2	..	Plug	..	*93211WH	7.40	
30	Plug	..	†93011	13.80	
30	Plug	..	†*93011WH	16.00	
30	1 1/2	..	Cart.	D98251	93251	7.40	▲D98251RO	1 1/4	13.10	30	D91251	\$11.20	
60	3	D96252	..	14.90	D96252RO	1 1/4	23.30	60	D91252	14.90	
100	7 1/2	D96253	..	30.00	D96253RO	2	35.00	100	D91253	30.00	
200	15	D96254	..	65.00	D96254RO	2 1/2	88.00	200	D91254	65.00	
3-Wire S/N (2 Blade, 2 Fuses), 120/240 Volts A-C (Plug); 240 Volts A-C (Cart.)													
30	1 1/2	..	Plug	D97311	90311	\$ 6.50	D97311RO	1 1/4	\$13.10	
30	1 1/2	..	Plug	..	*90311WH	7.70	
30	Plug	..	*97311WH	8.90	
30	1 1/2	..	Cart.	..	97351	8.40	97351RO	1 1/4	13.80	
30	1 1/2	3	..	97351X	90351	8.40	
60	3	7 1/2	..	D97312	..	14.90	▲D97312RO	1 1/4	23.30	
100	7 1/2	15	..	D97313	..	30.00	▲D97313RO	2	36.00	
200	15	25	..	D97314	..	65.00	D97314RO	2 1/2	88.00	
400	..	50	..	97315	..	183.00	
600	97316	..	366.00	
3-Pole, 120 Volts A-C (Plug); 240 Volts A-C (Cart.)													
30	..	1 1/2	Plug	..	99311	\$11.20	99311RO	1 1/4	\$20.40	
30	..	1 1/2	Plug	D99311	..	12.20	
30	Plug	..	*99311WH	16.00	
30	..	3	Cart.	D96351	..	15.80	▲ 99351RO	1 1/4	20.90	30	91351	\$11.20	
30	..	3	Cart.	..	99351	14.40	30	D91351	12.20	
60	..	7 1/2	..	D96352	..	22.90	▲D96352RO	1 1/4	32.00	60	D91352	22.90	
100	..	15	..	D96353	..	42.00	▲D96353RO	2	59.00	100	D91353	42.00	
200	..	25	..	D96354	..	89.00	D96354RO	2 1/2	107.00	200	D91354	89.00	
400	..	50	..	96355	..	196.00	400	91355	157.00	
600	96356	..	392.00	600	91356	300.00	
4-Wire, S/N (3 Blades, 3 Fuses) 240 Volts A-C (Cart.)													
30	..	3	Cart.	..	97451	\$14.40	97451RO	1 1/4	\$20.90	
30	..	3	Cart.	D97451	..	15.80	
60	..	7 1/2	..	D97412	..	22.90	D97412RO	2	32.00	
100	..	15	..	D97413	..	42.00	D97413RO	2	59.00	
200	..	25	..	D97414	..	89.00	D97414RO	2 1/2	107.00	
400	..	50	..	97415	..	222.00	
600	97416	..	418.00	
4-Pole, 240 Volts A-C (Cart.)													
30	3	Cart.	D96451	\$20.90	30	D91451	\$17.70	
60	7 1/2	..	D97452	39.00	60	D91452	35.00	
100	15	..	D96453	90.00	100	D91453	86.00	
200	30	..	D96454	151.00	200	D91454	140.00	

Φ Catalog number 90000 series and 93000 series switches are rotor disc type—others are swing out type.

†Dual water heater switch not hp. rated. (Two 93211's in one box.)

‡Same as 90211 except in larger box.

*Has dead-front shield over interior not hp. rated. 120 or 120/240 volts, a-c.

▲Raintight switches without threaded openings available. Use R suffix instead of RO. Same price level.

▲Interchangeable Hubs for raintight enclosures. Type RO devices have threaded opening for interchangeable hubs or closing caps. Order hub or cap separately from table below, and simply screw into place.

Conduit Size	3/4	1	1 1/4	1 1/2	2	2 1/2	30-60 100A.	200 Amp.
Hub	IIC	IID	IIE	IIG	III	IIV	CE	CI
Cap	IIC2	IID2	IIE2	III4	CA2	CA4
List Each	\$2.60	\$2.60	\$2.60	\$2.60	\$4.40	\$7.80	\$0.20	\$0.20

Square D Normal Duty Safety Switches Type ND (Formerly Types H, S or A)—Single Throw

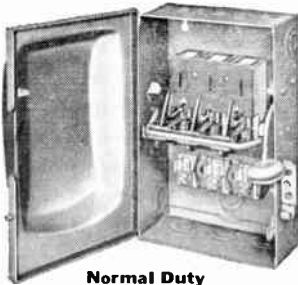

Normal Duty

Designed for application where safety is essential and reasonable performance and continuity of service are required. Meet the new NEMA standards and Federal Specifications W-S-865 for type A switches. U/L approved. File E2875. 800 and 1200 amp. are quick break only and have vault cover handle.

Quick make, quick break, independent of handle 30 to 600 amperes. 30 to 200 ampere are front operated, close ganging; 400 and up are side operated. NEMA 1—general purpose; NEMA type 3R—raintight.

All neutrals—insulated groundable. Finish: Blue-gray enamel, raintight—extra coat of glyptal.

Not Fusible

Amp.	H.P. Rating			D-C	Indoor NEMA Type 1 Sheet Steel Enclosure		Raintight NEMA Type 3R Type RO—Add Hub or Cap ▲		
	1 Ph.	3 Ph.	2 Ph.		No.	List Price	No.	Max. Hub Size In.	List Price
2 Pole, 240 Volts A-C—250 Volts D-C									
30	3	5	A81251	\$ 19.80			
60	10	10	A81252	36.00			
100	15	20	A81253	56.00			
200	15	40	A81254	87.00			
400	50	A81255	196.00			
600	A81256	347.00			
800	84257	528.00			
1200	84258	722.00			

Use 3 Pole Switch For 2 Pole Application

3 Pole, 240 Volts A-C

30	..	7 1/2	A81351	\$ 19.80	A81341RO	1 1/4	\$ 36.00
60	..	15	A81342	36.00	A81342RO	1 1/4	63.00
100	..	30	A81343	56.00	A81343RO	2	89.00
200	..	50	A81344	87.00	A81344RO	2 1/2	107.00
400	A81345	196.00	A81345R	▲	268.00
600	A81346	347.00	A81346R	▲	536.00
800	84347	706.00			
1200	84348	948.00			

2 Pole 600 Volts A-C or D-C—480 Volts A-C

30	10	15	A81261	\$ 19.80			
60	25	25	A81262	36.00			
100	40	50	A81263	56.00			
200	50	A81264	87.00			
400	A81265	196.00			
600	A81266	347.00			
800	84247	528.00			
1200	84248	722.00			

Use 3 Pole Switch For 2 Pole Application

3 Pole, 600 Volts A-C—480 Volts A-C

30	..	20	A81341	\$ 19.80	A81341RO	1 1/4	\$ 36.00
60	..	40	A81342	36.00	A81342RO	1 1/4	63.00
100	..	50	A81343	56.00	A81343RO	2	89.00
200	A81344	87.00	A81344RO	2 1/2	107.00
400	A81345	196.00	A81345R	▲	268.00
600	A81346	347.00	A81346R	▲	536.00
800	84347	706.00			
1200	84348	948.00			

4 Pole, 600 Volts A-C—480 Volts A-C

60	50	..	A81442	\$ 62.00			
100	50	..	A81443	114.00			
200	A81444	165.00			
400	A81445	353.00			
600	A81446	615.00			
800	84447	911.00			
1200	84448	1250.00			

*60 ampere switch with 30 amp. fuse spacings and clips.

†600 volts a-c—250 volts d-c only. ‡600 volts a-e only.

▲ Swing out base—no interlock.

▲ See interchangeable raintight hubs. Hubs larger than 2 1/2 in. available on order—welded.

Fusible

Amp.	H.P. Rating Standard Fuse			D-C	Indoor NEMA Type 1 Sheet Steel Enclosure		Raintight NEMA Type 3R Type RO—Add Hub or Cap ▲		
	1 Ph.	3 Ph.	2 Ph.		No.	List Price	No.	Max. Hub Size In.	List Price
2 Pole, 240 Volts A-C—250 Volts D-C									
30	1 1/2	5	45251	\$ 17.90			
30	1 1/2	5	A85251	17.90	A85251RO	1 1/4	\$32.00
30	1 1/2	5	*A86251	29.00			
60	3	10	A86252	33.00	A86252RO	1 1/4	61.00
100	7 1/2	20	A86253	53.00	A86253RO	2	79.00
200	15	40	A86254	94.00	A86254RO	2 1/2	113.00
400	50	A86255	194.00	A87315R	▲	276.00
600	A86256	386.00	A87316R	▲	517.00
800	88257	597.00	89317R	▲	915.00
1200	88258	826.00	89318R	▲	1295.00

3 Wire S/N (2 Blades—2 Fuses) 240 Volts A-C 125/250 Volts D-C

30	1 1/2	3	A87311	\$ 17.90	A87311RO	1 1/4	\$ 32.00
60	3	7 1/2	A87312	33.00	A87312RO	1 1/4	61.00
100	7 1/2	15	A87313	53.00	A87313RO	2	79.00
200	15	25	A87314	94.00	A87314RO	2 1/2	113.00
400	..	50	A87315	220.00	A87315R	▲	276.00
600	A87316	413.00	A87316R	▲	517.00
800	89317	652.00	89317R	▲	915.00
1200	89318	923.00	89318R	▲	1295.00

3 Pole, 240 Volts A-C

30	..	3	45351	\$ 21.90			
30	..	3	A85351	21.90	A85351RO	1 1/4	\$ 40.00
30	..	3	*A86351	36.00			
60	..	7 1/2	A86352	39.00	A86352RO	1 1/4	64.00
100	..	15	A86353	61.00	A86353RO	2	92.00
200	..	25	A86354	105.00	A86354RO	2 1/2	127.00
400	..	50	A86355	243.00	A86355R	▲	283.00
600	A86356	439.00	A86356R	▲	589.00
800	88357	811.00	88357R	▲	1129.00
1200	88358	1037.00	88358R	▲	1450.00

4 Wire S/N (3 Blades) 3 Fuses—240 Volts A-C

30	..	3	A87411	\$ 21.90	A87411RO	1 1/4	\$ 40.00
60	..	7 1/2	A87412	39.00	A87412RO	1 1/4	64.00
100	..	15	A87413	61.00	A87413RO	2	92.00
200	..	25	A87414	105.00	A87414RO	2 1/2	127.00
400	..	50	A87415	270.00	A87415RO	▲	352.00
600	A87416	464.00	A87416RO	▲	674.00
800	89417	1170.00			
1200	89418	1437.00			

4 Pole, 240 Volts, A-C

30	3	..	*A86451	\$ 43.00			
60	7 1/2	..	A86452	59.00			
100	15	..	A86453	94.00			
200	30	..	A86454	169.00			
400	50	..	A86455	322.00			
600	A86456	580.00			
800	88457	1230.00			
1200	88458	1504.00			

2 Pole 600 Volts A-C or D-C—480 Volts A-C

30	3	10	A85261	\$ 39.00			
60	10	25	A86262	46.00			
100	15	40	A86263	84.00			
200	30	50	A86264	125.00			
400	A86265	323.00			
600	A86266	545.00			
800	88247	732.00			
1200	88248	1030.00			

3 Pole, 600 Volts A-C—480 Volts A-C

30	..	7 1/2	A85341	\$ 39.00	A85341RO	1 1/4	\$ 65.00
30	..	7 1/2	*A86341	44.00			
60	..	15	A86342	46.00	A86342RO	1 1/4	77.00
100	..	30	A86343	84.00	A86343RO	2	119.00
200	..	50	A86344	125.00	A86344RO	2 1/2	164.00
400	A86345	323.00	A86345R	▲	386.00
600	A86346	545.00	A86346R	▲	759.00
800	86347	941.00			
1200	88348	1238.00			

Note—4 pole, 600 volts a-c also available. Contact GRAY-BAR.

Square D Heavy Duty Safety Switches New Type HD—Single Throw

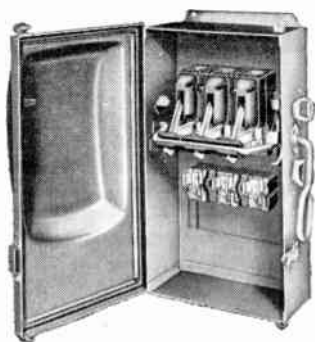

Heavy Duty

Designed for applications where safety, performance and continuity of service are emphasized, such as mass production industries. This type exceeds Federal Specification W-S-865 for Type A switches. U/L approved.

Side operated. File E2875 and E10673 full cover interlock and padlock attachment. Quick-make, quick-break independent of handle.

NEMA 12—industrial use (Gasketed); NEMA 4 & 5—watertight and dust-tight; NEMA 7 explosion resisting Class I—Group D. NEMA 9—explosion resisting Class II—Group G.

Not Fusible

Amp.	Hp. Rating			D-C	Industrial Use		Dust-Tight Watertight NEMA 4 & 5▲	Explosion Resisting NEMA 7 Class I, Group D
	1 Ph.	3 Ph.	2 Ph.		Cover Gasket NEMA 12	Price		

2 Pole, 240 Volts A-C—250 Volts D-C

30	3	5	H81251	\$30.00	53261D	\$120.00	54261	\$182.00
60	10	10	H81252	40.00	53262D	130.00	54262	212.00
100	15	20	H81253	64.00	53263D	331.00
200	15	40	H81254	91.00	53264D	459.00
400	50	H81255	209.00	H81265WP	860.00
600	H81266	353.00	H81266WP	1249.00

3 Pole, 240 Volts, A-C

30	..	7 1/2	H81341	\$43.00	53341D	\$133.00	54341	\$199.00
60	..	15	H81342	54.00	53342D	142.00	54342	232.00
100	..	30	H81343	79.00	53343D	353.00
200	..	50	H81344	105.00	53344D	482.00
400	H81345	272.00	H81345WP	965.00
600	H81346	436.00	H81346WP	1296.00

4 Pole, 240 Volts A-C

60	20	..	H81442	\$69.00
100	30	..	H81443	121.00
200	50	..	H81444	194.00
400	50	..	H81445	388.00
600	H81446	677.00

2 Pole, 600 Volts, A-C or D-C—480 Volts A-C

30	10	15	H81261	\$36.00	53261D	\$120.00	★54261	\$182.00
60	25	25	H81262	47.00	53262D	130.00	★54262	212.00
100	40	40	H81263	77.00	53263D	331.00
200	50	50	★H81264	100.00	53264D	459.00
400	H81265	244.00	H81265WP	860.00
600	H81266	353.00	H81266WP	1249.00

3 Pole, 600 Volts, A-C—480 Volts A-C

30	..	20	H81341	\$43.00	53341D	\$133.00	54341	\$199.00
60	..	40	H81342	54.00	53342D	142.00	54342	232.00
100	..	50	H81343	79.00	53343D	353.00
200	..	50	H81344	105.00	53344D	482.00
400	H81345	272.00	H81345WP	965.00
600	H81346	436.00	H81346WP	1296.00

4 Pole, 600 Volts, A-C—480 Volts A-C

60	50	..	H81442	\$69.00
100	50	..	H81443	121.00
200	50	..	H81444	194.00
400	H81445	388.00
600	H81446	677.00

▲Cast aluminum enclosures standard but cast iron supplied on order at no extra cost. Have threaded conduit holes as follows: 30 amp. one 3/4 in. top and bottom; 60 amp. one 1 1/4 in. top and bottom; 100 amp. two 1 1/2 in. bottom and 200 amp. two 2 1/2 in. bottom. Two additional holes of sizes shown will be furnished at no extra cost. Holes differing from standard supplied at extra charge. Specify drillings as required in 400 and 600 amp. W. P. switches.

Fusible

Amp.	Hp. Rating N.E.C. Fuse			D-C	Industrial Use		Dust-tight Watertight	
	1 Ph.	3 Ph.	2 Ph.		Cover Gasket NEMA 12	Price	No.	Price

2 Pole, 240 Volts A-C—250 Volts D-C

30	1 1/2	5	1186251	\$32.00	55251	\$119.00
30	1 1/2	5	*1186251	40.00
60	3	10	1186252	43.00	55252	128.00
100	7 1/2	20	1186253	65.00	55253	328.00
200	15	40	1186254	108.00	55254	482.00
400	50	1186255	244.00	1186255WP	979.00
600	1186256	427.00	1186256WP	1405.00

3 Wire, S/N, (2 blades—2 Fuses) 240 Volts A-C. 125/250 Volts D-C

30	1 1/2	3	..	5	1187311	\$36.00	50311	\$132.00
60	3	7 1/2	..	10	1187312	48.00	50312	144.00
100	7 1/2	15	..	20	1187313	77.00	50313	352.00
200	15	25	..	40	1187314	119.00	50314	508.00
400	..	50	..	50	1187315	271.00	1187315WP	1000.00
600	1187316	452.00	1187316WP	1425.00

3 Pole, 240 Volts A-C

30	..	3	1185351	\$40.00	55351	\$133.00
30	..	3	*1186351	48.00
60	..	7 1/2	1186352	56.00	55352	146.00
100	..	15	1186353	87.00	55353	361.00
200	..	25	1186354	130.00	55354	518.00
400	..	50	1186355	287.00	1186355WP	1011.00
600	1186356	479.00	1186356WP	1447.00

4 Wire, S/N, (3 Blades—3 Fuses) 240 Volts A-C

30	..	3	1187411	\$54.00	50411	\$146.00
60	..	7 1/2	1187412	65.00	50412	162.00
100	..	15	1187413	103.00	50413	380.00
200	..	25	1187414	152.00	50414	530.00
400	..	50	1187415	314.00	1187415WP	1011.00
600	1187416	505.00	1187416WP	1447.00

4 Pole, 240 Volts A-C

30	3	..	1186451	\$56.00
60	7 1/2	..	1186452	69.00
100	15	..	1186453	114.00
200	30	..	1186454	199.00
400	50	..	1186455	382.00
600	1186450	658.00

2 Pole, 600 Volts A-C or D-C—480 Volts A-C

30	3	10	1185261	\$54.00	55261	\$147.00
60	10	25	1186262	56.00	55262	160.00
100	15	40	1186263	87.00	55263	352.00
200	30	1186264	130.00	55264	508.00
400	50	1186265	355.00	1186265WP	1011.00
600	1186266	600.00	1186266WP	1447.00

3 Pole, 600 Volts A-C—480 Volts A-C

30	..	7 1/2	1185341	\$62.00	55341	\$162.00
60	..	15	*1186341	64.00
100	..	30	1186342	65.00	55342	175.00
200	..	50	1186343	100.00	55343	380.00
400	1186344	161.00	55344	530.00
600	1186345	355.00	1186345WP	1011.00
..	1186346	600.00	1186346WP	1447.00

4 Wire, (3 Blades—3 Fuses) 277/480 Volts A-C

30	..	5	1187441	\$69.00
60	..	15	1187442	74.00
100	..	25	1187443	116.00
200	..	50	1187444	197.00

4 Pole, 600 Volts A-C—480 Volts A-C

30	10	..	1186441	\$77.00
60	20	..	1186442	84.00
100	30	..	1186443	131.00
200	50	..	1186444	221.00
400	1186445	462.00
600	1186446	752.00

●Cast iron NEMA 7 enclosures have threaded conduit holes as follows: 30 amp. two 3/4 in. bottom; 60 amp. two 1 1/4 in. bottom.

*60 ampere switch with 30 amp. fuse spacings and clips.

★600 volts a-c—250 volts d-c only. †600 volts a-c only.

Square D Double Throw Safety Switches

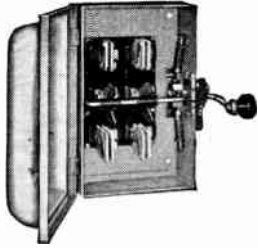

No. 82263

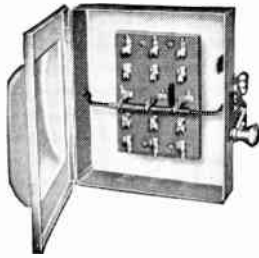

No. 92351F

Designed to transfer loads from one supply source to another. Horsepower ratings are not necessary, since use as motor circuit switches is not expected.

Fusible Top and Bottom Sheet Steel Enclosure—NEMA Type 1

Amps.	No.	List Price	No.	List Price
2 Pole, 240 Volts A-C.—250 Volts D-C				
30	†92251F	\$ 62.00	†92251	\$ 39.00
60	†82252F	112.00	†82252	61.00
100	†82253F	167.00	†82253	88.00
200	†82254F	234.00	†82254	118.00
400	92255F	473.00	92255	333.00
600	92256F	589.00	92256	472.00
3 Pole, 240 Volts A-C				
30	†92351F	66.00	†92351	44.00
60	†82352F	121.00	†82352	66.00
100	†82353F	204.00	†82353	107.00
200	†82354F	308.00	†82254	168.00
400	92255F	649.00	92355	446.00
600	92356F	784.00	92356	619.00
4 Pole, 240 Volts A-C				
30	92451F	94.00	†92451	65.00
60	92452F	149.00	†92452	94.00
100	92453F	239.00	†92453	191.00
200	82454F	388.00	†92454	265.00
400	92455F	722.00	92455	598.00
600	92456F	927.00	92456	779.00
2 Pole, 600 Volts A-C.—600 Volts D-C				
30	82261F	124.00	†82262	62.00
30-60	†82262F	129.00	†82263	96.00
60	†82263F	223.00	†82264	132.00
100	†82264F	272.00	†92245	374.00
200	†92245F	508.00	†92246	525.00
400				
600				
3 Pole, 600 Volts A-C				
30	82341F	132.00	†82342	74.00
30-60	†82342F	135.00	†82343	118.00
60	†82343F	204.00	†82344	182.00
100	†82344F	358.00	92345	411.00
200	92345F	666.00	92346	681.00
400				
600				
4 Pole, 600 Volts A-C				
30	92441F	198.00	†92441	103.00
30-60	92442F	204.00	†92443	219.00
60	92443F	353.00	†92444	292.00
100	82444F	455.00	92455	652.00
200	92445F	782.00	92446	845.00
400				
600				

Explosion Resisting Enclosure

Class 1, Group D, NEMA 7, Hazardous Locations Three 1½ In. Threaded Conduit Holes in Bottom
 No. 52262—60 amp.—2 Pole—600 V. A-C/D-C. List \$454.00
 No. 52342—60 amp.—3 Pole—600 V. A-C/D-C. List 473.00

Solderless Lug Sizes

Amp. Rating	Lug Size	Amp. Rating	Lug Size
30	4-14	400	2-350MCM-1
60	4-14		1-500MCM-1
100	0-14		
200	250MCM-6	600	2-500MCM-3/0

*600 Volts A-C.—250 Volts D-C only.
 †U/L approved File E2875E.

Data and Dimensions

No.	WL	Overall Dimensions			
		Height	Width	W-H	Depth
52262	230	20 1/8	17 1/2	20 1/16	7
52342	238	20 1/8	17 1/2	20 1/16	7
82252	16	13 3/8	9 1/8	12 3/4	6 3/8
82252F	24	23 1/8	9 3/16	11 1/16	6 5/16
82253	27	16 15/16	11 13/16	14 15/16	8 1/16
82253F	40	30 11/16	11 1/4	14 15/16	7 7/8
82254	47	22 13/32	15 23/32	19 15/16	9 11/16
82254F	75	38 15/16	15 3/4	19 3/8	9 9/16
82261F	25	23 1/8	9 3/16	11 1/16	6 5/16
82262	16	13 3/8	9 1/8	12 3/4	6 3/8
82262F	26	23 1/8	9 3/16	11 1/16	6 5/16
82263	26	16 15/16	11 3/16	14 15/16	8 1/16
82263F	35	30 11/16	11 1/4	14 15/16	7 7/8
82264	49	22 13/32	15 23/32	19 15/32	9 11/16
82264F	45	38 15/16	15 3/4	19 3/8	9 9/16
82341F	34	23 1/8	12 13/16	16 1/2	6 9/16
82342	20	12 7/8	12 13/16	16 7/16	6 9/16
82342F	33	23 1/8	12 13/16	16 1/2	6 9/16
82343	33	16 15/16	15 5/16	19 1/16	8 5/8
82343F	53	30 11/16	15 5/16	19	8 1/16
82344	63	23 1/16	20	23 3/4	11 1/16
82344F	93	38 15/16	19 31/32	23 23/32	13 11/64
82352	19	12 7/8	12 13/16	16 7/16	6 9/16
82352F	29	23 1/8	12 13/16	16 1/2	6 9/16
82353	32	16 15/16	15 5/16	19 1/16	8 5/8
82353F	43	30 11/16	15 5/16	19	8 1/16
82354	62	23 1/16	20	23 3/4	11 1/16
82354F	91	38 15/16	19 31/32	23 23/32	13 11/64
82444F	115	38 15/16	25 1/16	28 3/16	12 3/4
82454F	140	38 15/16	25 1/16	28 3/16	12 3/4
92245	81	31 1/8	16 3/4	20	12 1/8
92245F	111	46 3/4	25 3/4	29	12 3/4
92246	90	52 11/16	18 7/8	22	16 3/8
92 51	9	10 3/4	7 1/8	10 3/8	4 1/4
92251F	19	16 7/8	9 3/8	12 5/8	6 3/8
92255	81	31 1/8	16 3/4	20	12 1/8
92255F	131	46 3/4	25 3/4	29	12 3/4
92256	90	52 11/16	18 7/8	22	16 3/8
92256F	225	51 3/4	21	23 5/16	15 1/4
92345	110	31 1/8	21 1/16	25 15/16	12 1/4
92345F	210	46 3/4	25 3/4	29	12 3/4
92346	140	52 3/4	25 3/8	28 5/8	16 3/8
92351	14	10 3/4	7 1/8	10 3/8	4 1/4
92351F	25	16 7/8	14 1/2	16 1/2	6 1/2
92355	140	31 1/8	21 1/16	24 15/16	12 3/4
92355F	200	46 3/4	25 3/4	29	12 3/4
92356	140	42 3/4	25 3/8	28 5/8	16 3/8
92356F	230	51 5/8	33	36 5/16	14 3/8
92441F	42	12 7/8	17	20 1/4	7 1/2
92422	28	12 7/8	17	20 1/4	7 1/2
92442F	42	23	18 1/2	20 3/8	6 1/2
92443	58	22 1/2	20 1/4	23 1/2	11 1/8
92443F	80	30 1/2	18 1/4	19 7/8	7 1/2
92444	95	31 1/8	22 7/8	26 1/8	11 3/4
92445	130	38 5/8	24 3/4	27 7/8	14 15/16
92445F	190	46 3/4	36 1/4	37 5/8	10
92446	175	52 3/4	31 13/16	35 1/8	16 3/8
92451	19	12 7/8	13	14 5/8	6 1/2
92451F	36	16 7/8	17 5/8	21 3/8	5 1/4
92452	28	12 7/8	17	20 1/4	7 1/2
92452F	47	18	17 5/8	20 7/8	6 5/16
92453	58	22 1/2	20 1/4	23 1/2	11 1/8
92453F	70	30 1/2	18 1/4	19 7/8	7 1/2
92454	88	31 1/8	22 7/8	26 1/8	11 3/4
92455	175	38 5/8	24 3/4	27 7/8	14 15/16
92455F	210	46 5/8	36 1/4	37 5/8	10
92456	75	52 3/4	31 13/16	34 1/8	16 3/8
92456F	325	55	42 5/8	45 7/8	14 1/2

Note: One in standard package.

Bulldog Junior Vacu-Break Clampmatic®
and
Rotor Type Safety Switches



Bulldog Jr.

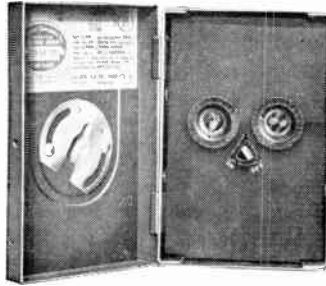

Rotor—With Dead Front Shield



Rotor—Cartridge Type



Rotor—Plug Type

Junior Vacu-Break Safety Switches

Junior Vacu-Break Safety Switches features, Vacu-Break head assembly, ample wiring gutters, pressure wire connectors, conveniently located concentric K. O.'s, and spring reinforced fuse grips.

Junior Vacu-Break Safety Switches exceed NEMA standards for Type LD (light duty) Switches.

Listed by Underwriters' Laboratories, Inc.

250 Volts Cartridge Fusible Fusible (Without Neutral)

No.	Amps.	Approx. Wt., Lbs.	Each
2 Pole, 2 Fuse			
*JN-321	30	6	\$ 8.40
JN-322	60	10	15.00
JN-323	100	15	30.00
JN-324	200	40	65.00
JN-325	400	142	183.00
JN-326	600	173	366.00

3 Pole, 3 Fuse

*JF-321	30	6	14.40
JF-322	60	9	22.90
JF-323	100	15	42.00
JF-324	200	41	89.00
JF-325	400	148	196.00
JF-326	600	179	392.00

Fusible with Insulated Groundable Neutral

3 Pole, 2 Fuse and Solid Neutral

*JN-321	30	6	8.40
JN-322	60	10	15.00
JN-323	100	15	30.00
JN-324	200	40	65.00
JN-325	400	142	183.00
JN-326	600	173	366.00

4 Pole, 3 Fuse and Solid Neutral

*JN-421	30	6	14.40
JN-422	60	10	22.90
JN-423	100	16	42.00
JN-424	200	43	89.00
JN-425	400	177	222.00
JN-426	600	222	418.00

*Packaged 5 to a carton. Carton Weight — 33 lbs.

Rotor Type Safety Switches

30 Amperes

Rotor Type Safety Switches features, highly compact unit, dead front shield, totally enclosed switch contacts, and handle locking provisions.

Rotor Safety Switches meet NEMA standards for Type LD (light duty) Switches.

Listed by Underwriters' Laboratories, Inc.

120-240 V. AC, 30 Amperes, 125-250 V. Fusible—Without Neutral

No.	No. & Type of Fuse	Volts	Each
RF-211	2 Plug	120 AC, 125 DC, 125-250	\$6.20
RF-221	2 Cart.	240 AC, 250 DC	7.40

Fusible with Insulated Groundable Neutral 2 Pole (1 Fuse & Solid Neutral)

RN-211	1 Plug	120 AC, 125 DC	5.00
--------	--------	----------------	------

3 Pole (2 Fuse & Solid Neutral)

RN-311	2 Plug	120 AC, 125 DC, 125-250	6.50
RN-321	2 Cart.	240 AC, 125-250	8.40

With Dead Front Shield Fusible—Without Neutral 2 Pole—2 Fuse

RF-211D	2 Plug	120 AC, 125 DC, 125-250	7.40
---------	--------	-------------------------	------

Fusible With *Insulated Groundable Neutral 2 Pole—1 Fuse & Solid Neutral

RN-211D	1 Plug	120 AC, 125 DC	5.90
---------	--------	----------------	------

3 Pole—2 Fuse & Solid Neutral

RN-311D	2 Plug	120 AC, 125 DC, 125-250	7.70
---------	--------	-------------------------	------

*Neutral can be readily grounded. Screw is provided.

NOTE: All rotor switches are packed 10 to a standard package; Standard package shipping weight is 33 Lbs.

Bulldog Master and Raintight Safety Switches

Vacu-Break Clampmatic® Type

Listed by Underwriters' Laboratories, Inc.



30 to 200 A. Switches are front operated



400 to 1200 A. Switches are side operated, 240 or 600 volts.



30 to 200 A. Raintight Switches are Side Operated

Master Vacu-Break Safety Switches

240V AC—Fusible—250V DC

480V—Fusible—600V.

No.	Amps.	Approx. Wt., Lbs.	Each
2 Pole, 2 Fuse			
SN321*	30	7	\$ 17 90
SN322	60	12	33 00
SN323	100	23	53 00
SN324	200	43	94 00
SN325	400	112	220 00
SN326	600	178	413 00
SN327†	800	370	652 00
SN328†	1200	381	923 00
3 Pole, 3 Fuse			
F-321*	30	8	21 90
F-322	60	12	39 00
F-323	100	23	61 00
F-324	200	44	105 00
F-325	400	153	243 00
F-326	600	185	439 00
F-327	800	370	811 00
F-328	1200	381	1037 00
4 Pole, 4 Fuse			
F-421	30	11	43 00
F-422	60	14	59 00
F-423	100	23	94 00
F-424	200	47	169 00
F-425	400	192	322 00
F-426	600	231	580 00
**Solid Neutral Type			
3 Pole, 2 Fuse & Solid Neutral			
SN321*	30	7	17 90
SN322	60	12	33 00
SN323	100	23	53 00
SN324	200	43	94 00
SN325	400	112	220 00
SN326	600	178	413 00
SN327†	800	370	652 00
SN328†	1200	381	923 00
4 Pole, 3 Fuse & Solid Neutral			
SN421*	30	8	21 90
SN422	60	12	39 00
SN423	100	23	61 00
SN424	200	44	105 00
SN425	400	180	270 00
SN426	600	223	464 00
SN427	800	379	1170 00
SN428	1200	390	1437 00

No.	Amps.	Approx. Wt., Lbs.	Each
2 Pole, 2 Fuse			
F-351	30	12	\$ 39 00
F-352	60	15	46 00
F-353	100	23	84 00
F-354	200	44	125 00
F-355	400	154	323 00
F-356	600	186	545 00
3 Pole, 3 Fuse			
F-351	30	12	39 00
F-352	60	15	46 00
F-353	100	23	84 00
F-354	200	44	125 00
F-355	400	154	323 00
F-356	600	186	545 00
F-357	800	370	941 00
F-358	1200	410	1238 00

240-250V—Not Fusible—480-600V

No.	Amps.	Approx. Wt., Lbs.	Each
**Not Fusible—3 Pole, No Fuse			
NF-351*	30	7	\$ 19 80
NF-352*	60	7	36 00
NF-353	100	22	56 00
NF-354	200	42	87 00
NF-355	400	132	196 00
NF-356†	600	183	347 00
NF-357†	800	367	706 00
NF-358†	1200	407	848 00

*Pkg. 5 to a carton.

**For 2 Pole applications, 3 Pole switches are used by wiring two fused poles only and ignoring third pole.

†Available only on special order. NOT CARRIED IN STOCK.

Raintight — Clampmatic Vacu-Break Safety Switches

U/L Listed "Raintight"—NEMA Type 3

240V AC—Fusible—250V DC

480V—Fusible—600V

**Solid Neutral Type

No.	Amps.	Approx. Wt., Lbs.	Each
3 Pole, 2 Fuse & S. Neutral			
NR-321	30	10	\$ 13 80
NR-322	60	14	23 20
NR-323	100	23	35 00
NR-324	200	44	88 00
4 Pole, 3 Fuse & S. Neutral			
NR-421	30	10	20 80
NR-422	60	14	32 00
NR-423	100	23	59 00
NR-424	200	44	107 00
Fusible 3 Pole, 3 Fuse			
FR-321	30	10	20 90
FR-322	60	14	32 00
FR-323	100	23	59 00
FR-324	200	44	107 00

Not Fusible 3 Pole, No Fuse

No.	Amps.	Approx. Wt., Lbs.	Each
NFR-351	30	9	36 00
NFR-352	60	13	63 00
NFR-353	100	22	89 00
NFR-354	200	43	107 00

Fusible 240 V. Raintight Safety Switches meet NEMA Standards for Type LD (light duty) Switches.

All 600 V. Raintight Safety Switches meet NEMA Standards for Type ND (normal duty) Switches.

Listed by Underwriters' as "Enclosed Switches Raintight" (also suitable for use as "Service Equipment").

Removable Hubs

Bulldog Raintight Switches have removable plates at the top of boxes to allow use of hubs where required.

Hubs are NOT supplied with Bulldog Raintight Switches, but must be ordered separately.

All Hubs listed except HU2-200 and HU 2-250 are adapted for 30-60-100A. switches. HU 2-200 are adapted only for 200A. switches.

Hubs are packed 5 to a standard package carton.



No.	Conduit Size, In.	Each
HU1-075	3/4	\$ 2.60
HU1-100	1	2.60
HU1-125	1 1/4	2.60
HU1-150	1 1/2	2.60
HU 1-200	2	4.40
HU 2-200	2	4.40
HU2-250	2 1/2	7.80

Master Vacu-Break Safety Switches exceed NEMA standards for Type ND (normal duty) switches. Comply with NEMA standards for Type HD (heavy duty) switches excepting switch mechanism is in a NEMA 1 enclosure.

The maximum horsepower ratings are applicable when fuses having time delay appropriate for the starting characteristics of the motor are used.

Listed by Underwriters' as "Enclosed Switches" (also suitable for use as "Service Equipment") under file E-4776.

NOTE: When ordering SN-327, SN-328, SN-427, SN-428, specify GROUNDING or GROUNDABLE NEUTRAL.

G-E Standard-Duty Industrial Safety Switches

Type ND, Style HCI

(U/L Listed as Enclosed Switches under File E-4669. Meet Federal Government Spec. WS-865 for Enclosed Safety Switches, Type A)

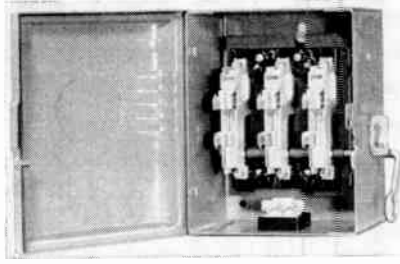

Switch is designed for all but the most severe applications. They are ideal for small industrial, institutional and commercial applications where service demands are not severe. Typical applications include motor-circuit protection and service entrance switches. These switches give circuit protection under normal indoor atmospheric conditions.

Features: meet NEMA standards for Type ND switches; general-purpose enclosure—NEMA Type 1; quick-make, quick-break; visible contact blades; double-break contacts; interlocking covers; finish—medium light grey.

Order by complete catalog number and specify cable lugs if other than standard.

Fusible 2 Pole (2 Blades, 2 Fuses) 240 Volts AC—250 Volts DC

Amperes	Lug Wire Size	Horsepower Rating		NEMA 1 Enclosure No.	Each	Approx. Ship. Wt. Lbs.	Dimensions, Inches		
		AC	DC				W	H	D
30	Single, 14-8	1½	5	TC60321SN	\$17.90	6	5¾	8½	5
60	Single, 14-4	3	10	TC60322SN	\$33.00	13	8¾	12½	5½
100	Single, 14-1/0	7½	20	TC60323SN	\$53.00	23	12¾	16½	6½
200	Single, 6-250MCM	15	40	TC60324SN	\$94.00	44	14¾	22¾	10¾
400	Single, 1/0-600MCM	...	50	*TC52325SN	\$220.00	103	17	37¾	10¾
600	Twin, 1/0-600MCM	*TC52326SN	\$413.00	157	18½	41¾	11¾

3 Wire SN (3 Poles, 2 Blades, 2 Fuses) 125/250 Volts AC and DC or 240 Volts AC

Amperes	Lug Wire Size	Horsepower Rating		NEMA 1 Enclosure No.	Each	Approx. Ship. Wt. Lbs.	Dimensions, Inches		
		AC	DC				W	H	D
30	Single, 14-8	3, 3 Ph; 1½, 1 Ph	5	TC60321SN	\$17.90	6	5¾	8½	5
60	Single, 14-4	7½, 3 Ph; 3, 1 Ph	10	TC60322SN	\$33.00	13	8¾	12½	5½
100	Single, 14-1/0	15, 3 Ph; 7½, 1 Ph	20	TC60323SN	\$53.00	23	12¾	16½	6½
200	Single, 6-250MCM	25, 3 Ph; 15, 1 Ph	40	TC60324SN	\$94.00	44	14¾	22¾	10¾
400	Single, 1/0-600MCM	50, 3 Ph	50	*TC52325SN	\$220.00	103	17	37¾	10¾
600	Twin, 1/0-600MCM	*TC52326SN	\$413.00	157	18½	41¾	11¾

3 Pole (3 Blades, 3 Fuses) 240 Volts AC

Amperes	Lug Wire Size	Horsepower Rating	Times Delay Fuses	NEMA 1 Enclosure No.	Each	Approx. Ship. Wt. Lbs.	Dimensions, Inches		
							W	H	D
30	Single, 14-8	3	7½	TC60421SN	\$21.90	9	7¾	9¾	5¾
60	Single, 14-4	7½	15	TC60422SN	\$39.00	13	8¾	12½	5½
100	Single, 14-1/0	15	30	TC60423SN	\$61.00	23	12¾	16½	6½
200	Single, 6-250MCM	25	50	TC60424SN	\$105.00	47	14¾	22¾	10¾
400	Single, 1/0-600MCM	50	...	TC52325	\$243.00	121	21	37¾	10¾
600	Twin, 1/0-600MCM	*TC52326	\$439.00	186	23	41¾	11¾

4 Wire SN (4 Poles, 3 Blades, 3 Fuses) 240 Volts AC

Amperes	Lug Wire Size	Horsepower Rating	Times Delay Fuses	NEMA 1 Enclosure No.	Each	Approx. Ship. Wt. Lbs.	Dimensions, Inches		
							W	H	D
30	Single, 14-8	3	7½	TC60421SN	\$21.90	9	7¾	9¾	5¾
60	Single, 14-4	7½	15	TC60422SN	\$39.00	13	8¾	12½	5½
100	Single, 14-1/0	15	30	TC60423SN	\$61.00	23	12¾	16½	6½
200	Single, 6-250MCM	25	50	TC60424SN	\$105.00	47	14¾	22¾	10¾
400	Single, 1/0-600MCM	50	...	*TC52425SN	\$270.00	120	21	37¾	10¾
600	Twin, 1/0-600MCM	*TC52426SN	\$464.00	195	23	41¾	11¾

4 Pole (4 Blades, 4 Fuses) 240 Volts AC

Amperes	Lug Wire Size	Horsepower Rating	Times Delay Fuses	NEMA 1 Enclosure No.	Each	Approx. Ship. Wt. Lbs.	Dimensions, Inches		
							W	H	D
30	Single, 14-8	3	10	TC60421	\$43.00	12	12¾	16½	6½
60	Single, 14-4	7½	20	TC60422	\$59.00	22	12¾	16½	6½
100	Single, 14-1/0	15	30	TC60423	\$94.00	30	14¾	22¾	10¾

3 Pole (3 Blades, 3 Fuses) 600 Volts AC

Amperes	Lug Wire Size	Horsepower Rating	Times Delay Fuses	NEMA 1 Enclosure No.	Each	Approx. Ship. Wt. Lbs.	Dimensions, Inches		
							W	H	D
30	Single, 14-8	7½, 600V; 5, 480V	20, 600V; 15, 480V	TC60361	\$39.00	9	7¾	9¾	5¾
60	Single, 14-4	15, 600V; 15, 480V	50, 600V; 30, 480V	TC60362	\$46.00	22	8¾	12½	5½
100	Single, 14-1/0	30, 600V; 25, 480V	50, 600V; 50, 480V	TC60363	\$84.00	23	12¾	16½	6½
200	Single, 6-250MCM	50, 600V; 50, 480V	...	TC60364	\$125.00	47	14¾	22¾	10¾

4 Pole (4 Blades, 4 Fuses) 600 Volts AC

Amperes	Lug Wire Size	Horsepower Rating	Times Delay Fuses	NEMA 1 Enclosure No.	Each	Approx. Ship. Wt. Lbs.	Dimensions, Inches		
							W	H	D
30	Single, 14-8	10, 600V; 7½, 480V	25, 600V; 20, 480V	TC60461	\$62.00	22	12¾	16½	6½
60	Single, 14-4	20, 600V; 15, 480V	50, 600V; 40, 480V	TC60462	\$73.00	22	12¾	16½	6½
100	Single, 14-1/0	30, 600V; 25, 480V	50, 600V; 50, 480V	TC60463	\$122.00	30	14¾	22¾	10¾

No Fuse

3 Pole—240 Volts AC

Amperes	Lug Wire Size	Horsepower Rating	Times Delay Fuses	NEMA 1 Enclosure No.	Each	Approx. Ship. Wt. Lbs.	Dimensions, Inches		
							W	H	D
30	Single, 14-8	7½	...	TC30361	\$19.80	9	7¾	9¾	5¾
60	Single, 14-4	15	...	TC30362	\$36.00	13	8¾	12½	5½
100	Single, 14-1/0	30	...	TC30363	\$56.00	23	12¾	16½	6½
200	Single, 6-250MCM	50	...	TC30364	\$87.00	47	14¾	22¾	10¾
400	Single, 1/0-600MCM	50	...	*TC26325	\$196.00	95	21	30¾	10¾
600	Twin, 1/0-600MCM	*TC26326	\$347.00	138	23	32¾	11¾

4 Pole—240 Volts AC

Amperes	Lug Wire Size	Horsepower Rating	Times Delay Fuses	NEMA 1 Enclosure No.	Each	Approx. Ship. Wt. Lbs.	Dimensions, Inches		
							W	H	D
30	Single, 14-8	10	...	TC30421	\$36.00	22	12¾	16½	6½
30	Single, 14-8	10	...	TC30461	\$36.00	22	12¾	16½	6½
60	Single, 14-4	20	...	TC30462	\$62.00	22	12¾	16½	6½
100	Single, 14-1/0	30	...	TC30463	\$114.00	30	14¾	22¾	10¾

3 Pole—600 Volts AC

Amperes	Lug Wire Size	Horsepower Rating	Times Delay Fuses	NEMA 1 Enclosure No.	Each	Approx. Ship. Wt. Lbs.	Dimensions, Inches		
							W	H	D
30	Single, 14-8	20, 600V; 15, 480V	...	TC30361	\$19.80	9	7¾	9¾	5¾
60	Single, 14-4	50, 600V; 30, 480V	...	TC30362	\$36.00	13	8¾	12½	5½
100	Single, 14-1/0	50, 600V; 50, 480V	...	TC30363	\$56.00	23	12¾	16½	6½
200	Single, 6-250MCM	50, 600V; 50, 480V	...	TC30364	\$87.00	55	14¾	22¾	10¾

4 Pole—600 Volts AC

Amperes	Lug Wire Size	Horsepower Rating	Times Delay Fuses	NEMA 1 Enclosure No.	Each	Approx. Ship. Wt. Lbs.	Dimensions, Inches		
							W	H	D
30	Single, 14-8	25, 600V; 20, 480V	...	TC30461	\$36.00	22	12¾	16½	6½
60	Single, 14-4	50, 600V; 40, 480V	...	TC30462	\$62.00	22	12¾	16½	6½
100	Single, 14-1/0	50, 600V; 50, 480V	...	TC30463	\$114.00	30	14¾	22¾	10¾

*400 and 600 Ampere Switches are Knife Blade Type construction. Prices do not include fuses.

G-E Light Duty Safety Switches General Purpose NEMA Type 1 Enclosures

(U/L Listed as Enclosed Switches Under File E4669. Meet Federal Government Spec. WS865, Type D.)

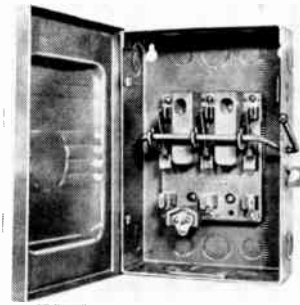

These switches are designed primarily for indoor use in distribution and branch circuits. They are used in service entrance applications in homes, commercial and farm-type buildings and for light industrial use where switch operation is infrequent. Typical industrial applications include heavy lighting circuits, power tools, air compressors, refrigerating and heating equipment.

Features: meet NEMA standards for Type LD switches; general purpose enclosures—NEMA Type 1; fusible, plug or cartridge; positive make and break; locking provision; Bonderite* treated for increased corrosion resistance; silver-plated current-carrying parts.

*Parker Rust Proof Company.

Fusible 2 Wire SN (1 Blade, 1 Fuse)

Am-peres	Lug Wire Size	Type of Fuse	General Use Voltage Rating	No.	Each	Approx. Ship. Wt. Lb.	Approximate Outside Dimensions inches (Including Cover)		
							W†	H	D
30	Single, 14-8	Plug	125	TC24111†	\$ 5.00	3*	3 ¹⁵ / ₁₆	6	3 ¹ / ₂
30	Single, 14-8	Plug	125	TC23111	5.00	4*	5 ¹ / ₈	8 ³ / ₈	3 ¹ / ₂
2 Pole (2 Blades, 2 Fuses)									
30	Single, 14-8	Plug	125-250	TC24211	6.20	4*	5 ¹ / ₈	8 ³ / ₈	3 ¹ / ₂
30	Single, 14-8	Cart.	250	TC24221	7.40	5*	5 ¹ / ₈	8 ³ / ₈	3 ¹ / ₂
60	Single, 14-4	Cart.	125-250; 240AC	TC23322	14.90	10	7	12 ¹ / ₁₆	5 ¹ / ₈
100	Single, 4-1/0	Cart.	125-250; 240AC	TC23323	30.00	15	7 ³ / ₈	15 ⁷ / ₁₆	6 ¹ / ₂
200	Single, 1/0-4/0	Cart.	125-250; 240AC	TC23324	65.00	28	11 ¹ / ₈	19 ⁹ / ₁₆	7 ¹ / ₈
400	Single, 1/0-600MCM	Cart.	250	TC24225	157.00	95	17	37 ³ / ₁₆	10 ³ / ₈
3 Wire SN (3 Poles, 2 Blades, 2 Fuses)									
30	Single, 14-8	Plug	125-250	TC23311	6.50	4*	5 ¹ / ₈	8 ³ / ₈	3 ¹ / ₂
30	Single, 14-8	Cart.	125-250; 240AC	TC23321	8.40	4*	5 ¹ / ₈	8 ³ / ₈	3 ¹ / ₂
60	Single, 14-4	Cart.	125-250; 240AC	TC23322	14.90	10	7	12 ¹ / ₁₆	5 ¹ / ₈
100	Single, 4-1/0	Cart.	125-250; 240AC	TC23323	30.00	15	7 ³ / ₈	15 ⁷ / ₁₆	6 ¹ / ₂
200	Single, 1/0-4/0	Cart.	125-250; 240AC	TC23324	65.00	28	11 ¹ / ₈	19 ⁹ / ₁₆	7 ¹ / ₈
400	Single, 1/0-600MCM	Cart.	125-250; 240AC	TC23325	183.00	102	17	37 ³ / ₁₆	10 ³ / ₈
3 Pole (3 Blades, 3 Fuses)									
30	Single, 14-8	Plug	120AC; 125-250	TC24311	11.20	8*	6 ¹⁵ / ₁₆	10 ³ / ₁₆	3 ⁵ / ₈
30	Single, 14-8	Plug	120AC; 125-250	TC24311)D)*†	16.00	8*	6 ¹⁵ / ₁₆	10 ³ / ₁₆	3 ⁵ / ₈
30	Single, 14-8	Cart.	240AC	TC23421	14.40	7*	6 ¹⁵ / ₁₆	10 ³ / ₁₆	3 ⁵ / ₈
60	Single, 14-4	Cart.	240AC	TC23422	22.90	12	9 ¹ / ₈	12 ¹ / ₁₆	5 ¹ / ₈
100	Single, 4-1/0	Cart.	240AC	TC23423	42.00	19	9 ³ / ₄	15 ⁷ / ₁₆	6 ¹ / ₂
200	Single, 1/0-4/0	Cart.	240AC	TC23424	89.00	32	13 ³ / ₈	19 ⁹ / ₁₆	7 ³ / ₈
400	Single, 1/0-600MCM	Cart.	240AC	TC24325	196.00	122	21	37 ³ / ₁₆	10 ³ / ₈
4 Wire SN (4 Poles, 3 Blades, 3 Fuses)									
30	Single, 14-8	Cart.	240AC	TC23421	14.40	7*	6 ¹⁵ / ₁₆	10 ³ / ₁₆	3 ⁵ / ₈
60	Single, 14-4	Cart.	240AC	TC23422	22.90	12	9 ¹ / ₈	12 ¹ / ₁₆	5 ¹ / ₈
100	Single, 4-1/0	Cart.	240AC	TC23423	42.00	19	9 ³ / ₄	15 ⁷ / ₁₆	6 ¹ / ₂
200	Single, 1/0-4/0	Cart.	240AC	TC23424	89.00	32	13 ³ / ₈	19 ⁹ / ₁₆	7 ³ / ₈
400	Single, 1/0-600MCM	Cart.	240AC	TC23425	222.00	122	21	37 ³ / ₁₆	10 ³ / ₈
4 Pole (4 Blades, 4 Fuses)									
400	Twin, 3/0-350MCM	Cart.	240AC	TC24425	268.00	122	25	37 ¹ / ₁₆	10 ³ / ₈
No Fuses									
2 Pole									
400	Single, 1/0-600MCM	250	TC12225	157.00	83	17	30 ³ / ₁₆	10 ³ / ₈
3 Pole									
30	Single, 14-8	240AC	TC12321	11.20	8*	6 ¹⁵ / ₁₆	10 ³ / ₁₆	3 ⁵ / ₈
60	Single, 14-4	240AC	TC12322	22.90	15	9 ¹ / ₈	12 ¹ / ₁₆	5 ¹ / ₈
100	Single, 4-1/0	240AC	TC12323	42.00	27	9 ³ / ₄	15 ⁷ / ₁₆	6 ¹ / ₂
200	Single, 1/0-4/0	240AC	TC12324	65.00	37	13 ³ / ₈	19 ⁹ / ₁₆	7 ³ / ₈
400	Single, 1/0-600MCM	240AC	TC12325	157.00	103	21	30 ³ / ₁₆	10 ³ / ₈
4 Pole									
400	Twin, 3/0-600MCM	240AC	TC12425	239.00	112	25	30 ³ / ₁₆	10 ³ / ₈

*Standard package 10 per ton.

†Compact design, interior mounted on saddle—entire interior unit easily removed.

‡Equipped with dead-front shield over interior for water heater applications.

Order by complete catalog number.

‡Additional Width in Inches for Handle:

30	60	100	200	400
Amperes	Amperes	Amperes	Amperes	Amperes
5 ³ / ₈	1 ¹ / ₁₆	1 ¹ / ₁₆	1 ¹ / ₄	2 ¹ / ₂

Prices do not include fuses.

G-E Normal-Duty Industrial Safety Switches

Type ND, Style HCI and Knife Blade — Raintight NEMA Type 3R Enclosures

(U/L Listed as Enclosed Switches under File E-4669. Meet Federal Government Spec. WS-865 for Enclosed Safety Switches, Type C)

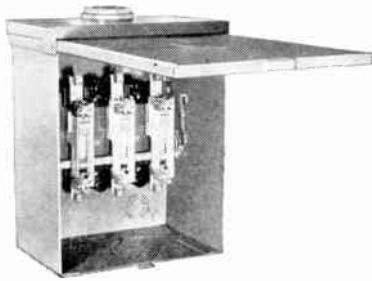

Switches are mounted in an enclosure which gives circuit protection under outdoor atmospheric conditions including a driving rain. They are designed for all but the most severe applications and are ideally suited for industrial, institutional and commercial applications.

Features: interchangeable raintight conduit hubs for ratings through 200 amp; non-releasable interlock available; quick-make, quick-break; visible contact blades; double-break contacts through 200 amp; handle padlocks ON or OFF; Bonderite* treated to resist corrosion; galvanealed steel enclosures.

*Parker Rust Proof Company.

Fusible

3-Wire SN (3 Poles—2 Blades—2 Fuses) 125/250 Volts AC and DC 240 Volts AC

Amperes	Lug Wire Size	Horsepower Ratings		Time Delay Fuses	No.	Each*	Provisions for Interchangeable Hub in Top	Approx. Ship. Wt. Lb.	Approx. Outside Dimensions, In.		
		AC	DC						W	H	D
30	Single, 14-8	3, 3 Ph; 1½, 1 Ph	5	7½, 3 Ph; 3, 1 Ph	TC44321SNR2	\$ 32	Up to 1½ in.	10	5¼	9½	5½
60	Single, 14-4	7½, 3 Ph; 3, 1 Ph	10	15, 3 Ph; 10, 1 Ph	TC44322SNR2	61	Up to 1½ in.	15	9	12½	5⅞
100	Single, 14-1/0	15, 3 Ph; 7½, 1 Ph	20	30, 3 Ph; 15, 1 Ph	TC44323SNR4	79	Up to 2½ in.	25	12½	16½	6⅞
200	Single, #6-250MCM	25, 3 Ph; 15, 1 Ph	40	50, 3 Ph; 25, 1 Ph	TC44324SNR4	113	Up to 2½ in.	47	14½	22¾	10½
400	Single, 1/0-600MCM‡	50, 3 Ph	50	TW41325†	276	Welded-in Hubs	113	21	37¾	10¾

3-Pole (3 Blades—3 Fuses) 240 Volts AC

30	Single, 14-8	3	7½	TC44321R2	40	Up to 1½ in.	10	7½	10½	5½
60	Single, 14-4	7½	15	TC44322R2	64	Up to 1½ in.	15	9	12½	5⅞
100	Single, 14-1/0	15	30	TC44323R4	92	Up to 2½ in.	25	12½	16½	6⅞
200	Single, #6-250MCM	25	50	TC44324R4	125	Up to 2½ in.	47	14½	22¾	10½
400	Single, 1/0-600MCM‡	50	TW40325†	283	Welded-in Hubs	130	21	37¾	10¾

4-Wire SN (4 Poles—3 Blades—3 Fuses) 240 Volts AC

30	Single, 14-8	3	7½	TC44421SNR2	40	Up to 1½ in.	10	7½	10½	5½
60	Single, 14-4	7½	15	TC44422SNR2	64	Up to 1½ in.	15	9	12½	5⅞
100	Single, 14-1/0	15	30	TC44423SNR4	92	Up to 2½ in.	25	12½	16½	6⅞
200	Single, #6-250MCM	25	50	TC44424SNR4	125	Up to 2½ in.	47	14½	22¾	10½

3-Pole (3 Blades—3 Fuses) 600 Volts AC

30	Single, 14-8	7½, 600V; 5, 480V	20, 600V; 15, 480V	TC44361R2	65	Up to 1½ in.	10	7½	10½	5½
60	Single, 14-4	15, 600V; 15, 480V	50, 600V; 30, 480V	TC44362R2	77	Up to 1½ in.	15	9	12½	5⅞
100	Single, 14-1/0	30, 600V; 25, 480V	50, 600V; 50, 480V	TC44363R4	119	Up to 2½ in.	25	12½	16½	6⅞
200	Single, #6-250MCM	50, 600V; 50, 480V	TC44364R4	164	Up to 2½ in.	47	14½	22¾	10½
400	Single, 1/0-600MCM‡	TW72365†	386	Welded-in Hubs	150	21	37¾	10¾

*Prices include one hub opening per box. Additional openings on request. Prices do not include fuses.

†Knife blade construction. Available with 3 in. or 3½ in. welded-in raintight box hubs. To specify 3 in. hub add suffix letter "J" to complete switch cat. no. For 3½ in. hub add suffix letter "Y" to complete switch cat. no.

‡Optional lugs for twin 1/0-1/0 cables per terminal can be furnished if specified on order.

§Additional Width in Inches for Handle.

30 Amp	60 Amp	100 Amp	200 Amp	400 Amp
1⅞	1⅝	1⅞	2⅞	2⅞

Type TC2 and TC4 Interchangeable Raintight Box Hubs

Conduit Diameter Inches	Type TC2 for Cat. No. Ending in 2			Type TC4 for Cat. No. Ending in 4		
	No.	Each	Std. Pkg.	No.	Each	Std. Pkg.
¾	TC2CH	\$2.60	10
1	TC2DH	2.60	10	TC4DH	\$2.60	10
1¼	TC2EH	2.60	10	TC4EH	2.60	10
1½	TC2GH	2.60	10	TC4GH	2.60	10
2	TC4HH	4.40	10
2½	TC4WH	7.80	10
Closing Cap	TC2GC	.25	10	TC4WC	.25	10

Ordering Directions

1. Order switch by complete catalog number. Specify cable lugs if other than standard, and non-releasable interlock if desired.

2. Order interchangeable raintight conduit hubs or closing cap by catalog number for conduit size required. Specify

Type TC2 hubs for switch catalog numbers ending in 2, and Type TC4 hubs for switch catalog numbers ending in 4.

3. Order 400-amp switches by complete catalog number and add catalog number suffix for size of welded-in raintight conduit hub desired.

G-E Light Duty Safety Switches

Type LD Raintight NEMA Type 3R Enclosures
Side Operated Fusible Single Throw

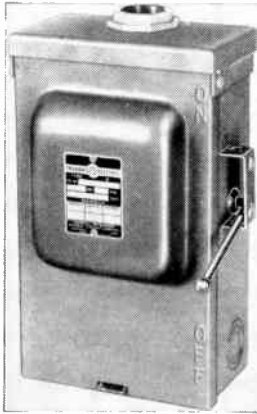

Switches are mounted in an enclosure which gives circuit protection under outdoor atmospheric conditions including a driving rain. Designed primarily for distribution and branch circuits and service entrance applications, they are used for homes, commercial and farm-type buildings and for light industrial use where switch operation is infrequent. Typical industrial applications include heavy lighting circuits, power tools, air compressors, refrigerating and heating equipment.

Order switch by catalog number. Order size hub needed or closing cap by catalog number. Select Type TC2 hubs for switches with catalog number ending in 2, and Type TC4 hubs for switches with catalog number ending in 4.

2 Wire SN (1 Blade, 1 Fuse)

Cat. No.	Amps.	Type Fuse	Voltage	Approx. Ship. Wt. Lb.	Each*
TC24111WP2	30	Plug	125	7	\$11.20

3 Wire SN (3 Poles, 2 Blades, 2 Fuses)

TC23311WP2	30	Plug	125-250	7	13.10
TC23321WP2	30	Cart.	125-250; 240AC	7	13.80
TC23322WP2	60	Cart.	125-250; 240AC	12	23.20

TC23323WP2	100	Cart.	125-250; 240AC	21	35.00
TC23324WP4	200	Cart.	125-250; 240AC	79	88.00

3 Pole (3 Blades, 3 Fuses)

TC24321WP2	30	Cart.	240AC	9	20.90
TC24322WP2	60	Cart.	240AC	15	32.00
TC24323WP4	100	Cart.	240AC	23	59.00
TC24324WP4	200	Cart.	240AC	61	107.00

*These prices include one hub opening per box. If more than one opening is required, consult Graybar for price.

Call Graybar FIRST For . . .

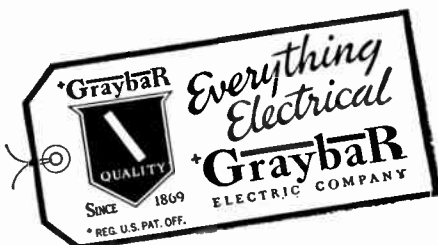

G-E Telephone or Battery Switches

Plain Finish
Front Connected—Mounted
30 Amperes—125 Volts
No Fuse Porcelain Base



No. 707



No. 711



No. 709

No.	No.	Size, In. Lgth., Width.	Std. Pkg.	Std. Pkg. Wt. Lbs.	Each
TC707	S.P.S.T.	2 ⁷ / ₁₆ x1 ¹ / ₄	10	2 ¹ / ₂	\$1.05
TC708	S.P.D.T.	3 ⁵ / ₈ x1 ⁵ / ₁₆	5	1 ¹ / ₄	1.40
TC709	D.P.S.T.	2 ⁷ / ₁₆ x2	10	5	1.60
TC710	D.P.D.T.	3 ⁵ / ₈ x2	5	2 ¹ / ₂	2.05
TC711	3 P.S.T.	3 ⁷ / ₁₆ x3 ¹ / ₄	5	2 ¹ / ₂	2.55
TC712	3 P.D.T.	3 ⁵ / ₈ x3 ¹ / ₄	5	5	3.20

Fiber Base

TC 7	S.P.S.T.	2 ¹ / ₂ x1 ¹ / ₈	20	5	\$1.50
TC 8	S.P.D.T.	3 ³ / ₄ x1 ¹ / ₈	10	2 ¹ / ₂	1.80
TC 9	D.P.S.T.	2 ¹ / ₂ x2	10	5	2.15
TC10	D.P.D.T.	3 ³ / ₄ x2	10	5	2.75
TC40	3 P.S.T.	2 ¹ / ₂ x3 ¹ / ₄	10	5	3.20
TC41	3 P.D.T.	3 ³ / ₄ x3 ¹ / ₄	10	5	4.45
TC42	4 P.S.T.	2 ¹ / ₂ x4 ³ / ₈	10	5	4.90
TC43	4 P.D.T.	3 ³ / ₄ x4 ³ / ₈	10	10	7.00

Trumbull Telephone or Battery Switches

Plain Finish
Back Connected—Unmounted

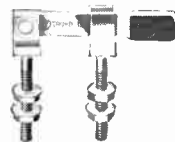

No. 783



No. 885

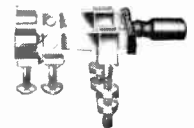

No Fuse

No.	Style	Std. Pkg.	Std. Pkg. Wt. Lbs.	Each
TC783	S.P.S.T.	50	12 ¹ / ₂	\$1.40
TC784	S.P.D.T.	50	12 ¹ / ₂	1.65
TC785	D.P.S.T.	50	12 ¹ / ₂	2.15
TC786	D.P.D.T.	25	12 ¹ / ₂	2.75
TC787	3 P.S.T.	25	12 ¹ / ₂	3.05
TC788	3 P.D.T.	10	5	4.30
TC789	4 P.S.T.	10	5	4.45
TC790	4 P.D.T.	10	7 ¹ / ₂	5.70
TC791	5 P.S.T.	10	5.55
TC792	5 P.D.T.	10	7.45
TC793	6 P.S.T.	5	6.80
TC794	6 P.D.T.	5	8.95

Fusible

TC883	S.P.S.T.	50	12 ¹ / ₂	\$2.00
TC885	D.P.S.T.	25	12 ¹ / ₂	2.75
TC887	3 P.S.T.	25	25	4.05
TC889	4 P.S.T.	10	10	5.55

Special finishes available. Apply to Graybar.

G-E Type A Open Knife Switches

**Single Throw—Front Connected
Slate Base Mounted—No Fuse—Brush Finish
250 Volts,—A-C or D-C,— 500 Volts A-C**

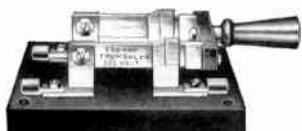

2-Pole

Cap. Amp.	1-pole		2-pole		3-pole	
	No.	Each	No.	Each	No.	Each
30	TC3721	\$ 3.60	TC3801*	\$ 5.05	TC3881*	\$ 7.80
30	TC3721½	4.85	TC3801½	6.95	TC3881½	10.55
60	TC3722	5.05	TC3802	7.55	TC3882	11.60
100	TC3724	9.70	TC3804	14.80	TC3884	23.20
200	TC3726	14.80	TC3806	21.10	TC3886	32.00
300	TC3728	23.20	TC3808	33.00	TC3888	48.00
400	TC3729	33.00	TC3809	50.00	TC3889	76.00
600	TC3731	48.00	TC3811	72.00	TC3891	108.00
800	TC3732	83.00	TC3812	123.00	TC3892	186.00
1200	TC3734	112.00	TC3814	169.00	TC3894	251.00
1600	TC3735½	213.00	TC3815½	319.00	TC3895½	477.00
2000	TC3736	236.00	TC3816	352.00	TC3896	530.00

600 Volts A-C or D-C—With Quick-Break Attachment

30	TC9000	\$ 7.80	TC9100	\$11.60	TC9200	\$17.95
60	TC9001	8.45	TC9101	12.65	TC9201	18.95
100	TC9003	14.80	TC9103	21.10	TC9203	32.00
200	TC9005	23.20	TC9105	33.00	TC9205	48.00
300	TC9006	33.00	TC9106	50.00	TC9206	76.00
400	TC9007	46.00	TC9107	70.00	TC9207	105.00
600	TC9009	61.00	TC9109	93.00	TC9209	139.00

**Double Throw—High Jaws—High Hinges
250 Volts A-C or D-C—500 Volts A-C**



30	TC3741	\$ 5.05	TC3821*	\$ 7.55	TC3901*	\$11.60
30	TC3741½	6.55	TC3821½	9.90	TC3901½	14.80
60	TC3742	7.55	TC3822	11.60	TC3902	16.85
100	TC3744	14.80	TC3824	21.10	TC3904	32.00
200	TC3746	23.20	TC3826	33.00	TC3906	48.00
300	TC3748	36.00	TC3828	55.00	TC3908	83.00
400	TC3749	53.00	TC3829	78.00	TC3909	116.00
600	TC3751	72.00	TC3831	108.00	TC3911	160.00
800	TC3752	126.00	TC3832	188.00	TC3912	283.00
1200	TC3754	171.00	TC3834	256.00	TC3914	384.00
1600	TC3755½	314.00	TC3835½	472.00	TC3915½	706.00
2000	TC3756	389.00	TC3836	580.00	TC3916	871.00

600 Volts A-C or D-C—With Quick-Break Attachments

30	TC9020	\$14.80	TC9120	\$21.10	TC9220	\$32.00
60	TC9021	14.80	TC9121	23.20	TC9221	32.00
100	TC9023	21.10	TC9123	32.00	TC9223	48.00
200	TC9025	33.00	TC9125	48.00	TC9225	73.00
300	TC9026	50.00	TC9126	73.00	TC9226	112.00
400	TC9027	70.00	TC9127	103.00	TC9227	154.00
600	TC9029	91.00	TC9129	135.00	TC9229	203.00

*Up to 250 volts only.

Ordering Directions—Order by complete Catalog Number.

Note: 4 Pole knife switches available.

Consult Graybar for complete specifications and dimensions.

Heinemann Magnetic Circuit Breakers

120-240 A-C



No. MH 802-50

**16 Gauge Corrosion-Proofed Steel.
Finish is Grey Alcoloid Resin Enamel.
Dimensions Shown are Approximate.**

All Service Equipment And Circuit Breakers Are Listed By The Underwriters' Laboratories.

Overall Height

10¾"

Height of Box

8¾"

Width

5¾"

Depth

3½"

Size of Hub*

1¼"

*Standard 1¼" hub will be furnished unless otherwise specified. 1" hub also available.

Outdoor type breaker which serves as main disconnect and over-current protection for the electrified farm. Install on yard pole or farm building.

Magnetic trip. Time delay holds breaker from tripping on harmless overloads, gives quick trip on short circuits, or dangerous overloads. After the circuit breaker opens, it may be closed at once if current has returned to normal. No resetting necessary, no confusing trip position—handle moves one way to "on" and the other way to "off." Wattage loss negligible since nothing heats. Wiring compartment may be secured with meter seal or padlock. Solderless connections to circuit breakers and to neutral.

No.	Description	Each
MH 801-35	Service Equipment with one 35 Amp. Breaker.....	\$15.10
MH 802-35	Service Equipment with two 35 Amp. Breakers.....	18.65
MH 802-50	Service Equipment with two 50 Amp. Breakers.....	18.65
0412-35	Circuit Breaker Only, 35 Amp.....	3.55
0412-50	Circuit Breaker Only, 50 Amp.....	3.55
0412-60	Circuit Breaker Only, 60 Amp.....	5.20
0412-70	Circuit Breaker Only, 70 Amp.....	6.90
MH 902-35	Combination Meter Socket and Service Equipment with two 35 ampere breakers.....	24.60
MH 902-50	Combination Meter Socket and Service Equipment with two 50 ampere breakers.....	24.60
*H 1002-70	Service Equipment with two 70 Amp. Breakers.....	34.00
*H 1002-100	Service Equipment with two 100 Amp. Breakers.....	34.00
1163 C-70	Circuit Breaker Only, 70 Amp.....	11.20
1163 C-100	Circuit Breaker Only, 100 Amp.....	11.20
H 1202-70	Combination Meter Socket and Service Equipment with two 70 Amp. Breakers.....	40.25
H-1202 100	Combination Meter Socket and Service Equipment, with two 100 Ampere Breakers.....	40.25

*Overall Height, 15"; Height of Box, 13¾"; Width, 6¾"; Depth of Box, 3½"; Size of Hub, 1½".

Square D Industrial Circuit Breakers

Thermal—Coilless Magnetic
Type ML—General and Special Purpose Enclosures
240 Volts A-C, 125/250 Volts D-C

All industrial circuit breakers are quick make and quick break. Types ML, ML-1 and ML-3 have permanently calibrated integral trip mechanisms. Type KL and WL are equipped with interchangeable trip mechanism.

U/L approved File E10027 and E10944. Blue-gray enamel finish.

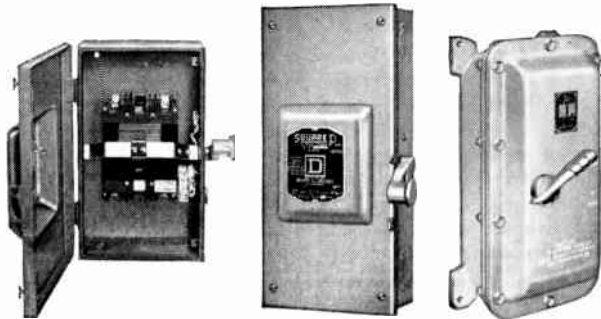

Cat. No. 75016

Cat. No. 75016

Cat. No. 75016X

Explosion-Resisting
Class II Group E, F, G
NEMA Type 9
‡Drill-
Ings
Ins.

Explosion-Resisting
Class I Group D
NEMA Type 7
‡Drill-
Ings
Ins.

Frame	Size	Amps.	No.	List Price	No.	List Price
-------	------	-------	-----	------------	-----	------------

2 Pole, 240 Volts A-C—125/250 Volts D-C

ML1	100A	70	75270Y	1½	\$158.00	75270X	1½	\$177.00
ML1	100A	100	75216Y	1½	158.00	75216X	2	177.00

Note: 225 Amp.—600 Amp. Frame use 2 pole high voltage device.

3 Wire—S/N 240 Volts A-C—125/250 Volts D-C

Insulated Groundable Neutral

ML1	100A	70	75070Y	1½	168.00	75070X	1½	187.00
ML1	100A	100	75016Y	1½	168.00	75016X	2	187.00
ML3	225A	125	78017Y	2½	425.00	78017X	2½	465.00
ML3	225A	150	78018Y	2½	425.00	78018X	2½	465.00
ML3	225A	175	78019Y	2½	425.00	78019X	2½	465.00
ML3	225A	200	78026Y	2½	425.00	78026X	2½	465.00
ML3	225A	225	78027Y	2½	425.00	78027X	2½	465.00

3 Pole, 240 Volts A-C

ML	50A	15	76315Y	¾	120.00	76315X	¾	139.00
ML	50A	20	76320Y	¾	120.00	76320X	¾	139.00
ML	50A	30	76330Y	1	120.00	76330X	1	139.00
ML	50A	40	76340Y	1¼	120.00	76340X	1¼	139.00
ML	50A	50	76350Y	1¼	120.00	76350X	1¼	139.00
ML1	100A	70	75370Y	1½	173.00	75370X	1½	191.00
ML1	100A	100	75316Y	1½	173.00	75316X	2	191.00

Note: 225 Amp.—600 Amp. Frame use 3 pole high voltage device.

4 Wire, S/N 240 Volts A-C

Insulated Groundable Neutral

ML	50A	15	76915Y	¾	127.00	76915X	¾	146.00
ML	50A	20	76920Y	¾	127.00	76920X	¾	146.00
ML	50A	30	76930Y	1	127.00	76930X	1	146.00
ML	50A	40	76940Y	1¼	127.00	76940X	1¼	146.00
ML	50A	50	76950Y	1¼	127.00	76950X	1¼	146.00
ML1	100A	70	75970Y	1½	183.00	75970X	1½	201.00
ML1	100A	100	75916Y	1½	183.00	75916X	2	201.00
ML3	225A	125	78917Y	2½	470.00	78917X	2½	510.00
ML3	225A	150	78918Y	2½	470.00	78918X	2½	510.00
ML3	225A	175	78919Y	2½	470.00	78919X	2½	510.00
ML3	225A	200	78926Y	2½	470.00	78926X	2½	510.00
ML3	225A	225	78927Y	2½	470.00	78927X	2½	510.00

‡These cast enclosures are furnished with standard conduit openings of sizes as shown, one in top, two in bottom, except 3 wire and 4 wire devices which have 2 in top and 1 in bottom. Holes differing from standard can be supplied at extra charge. All cast enclosures for KL and WL breakers furnished without conduit openings unless size and location are specified on order.

Frame	Size	Amps.	No.	Dust-Resisting With Gasket NEMA Type 1		Waterproof and Dust-Tight Types 4 and 5 ‡Drill-ings Ins.		List Price
				List Price	No.	List Price	No.	
2 Pole, 240 Volts, A-C—125/250 Volts D-C								
ML	50A	15	76215	\$49.00	76215D	¾		\$ 80.00
ML	50A	20	76220	49.00	76220D	¾		80.00
ML	50A	30	76230	49.00	76230D	1		80.00
ML	50A	40	76240	49.00	76240D	1¼		80.00
ML	50A	50	76250	49.00	76250D	1¼		80.00
ML1	100A	70	75270	67.00	75270D	1½		158.00
ML1	100A	100	75216	67.00	75216D	1½		158.00

Note: 225 Amp.—600 Amp. Frame use 2 pole high voltage device.

3 Wire—S/N 240 V. A-C, 125/250 V. D-C

Insulated Groundable Neutral

ML	50A	15	76015	56.00	76015D	¾		87.00
ML	50A	20	76020	56.00	76020D	¾		87.00
ML	50A	30	76030	56.00	76030D	1		87.00
ML	50A	40	76040	56.00	76040D	1¼		87.00
ML	50A	50	76050	56.00	76050D	1¼		87.00
ML1	100A	70	75070	78.00	75070D	1½		168.00
ML1	100A	100	75016	78.00	75016D	1½		168.00
ML3	225A	125	78017	240.00	78017D	2½		425.00
ML3	225A	150	78018	240.00	78018D	2½		425.00
ML3	225A	175	78019	240.00	78019D	2½		425.00
ML3	225A	200	78026	240.00	78026D	2½		425.00
ML3	225A	225	78027	240.00	78027D	2½		425.00
KL	400A	225	65027	506.00				
KL	400A	250	65028	506.00				
KL	400A	300	65036	506.00				
KL	400A	350	65038	506.00				
KL	400A	400	65046	506.00				
WL	*600A	450	69048	625.00				
WL	*600A	500	69056	625.00				
WL	*600A	550	69058	625.00				
WL	*600A	600	69066	625.00				

3 Pole, 240 Volts A-C

ML	50A	15	76315	62.00	76315D	¾		120.00
ML	50A	20	76320	62.00	76320D	¾		120.00
ML	50A	30	76330	62.00	76330D	1		120.00
ML	50A	40	76340	62.00	76340D	1¼		120.00
ML	50A	50	76350	62.00	76350D	1¼		120.00
ML1	100A	70	75370	81.00	75370D	1½		173.00
ML1	100A	100	75316	81.00	75316D	1½		173.00

Note: 225 Amp.—600 Amp. Frame use 3 pole high voltage device.

4 Wire S/N 240 Volts A-C

Insulated Groundable Neutral

ML	50A	15	76915	69.00	76915D	¾		127.00
ML	50A	20	76920	69.00	76920D	¾		127.00
ML	50A	30	76930	69.00	76930D	1		127.00
ML	50A	40	76940	69.00	76940D	1¼		127.00
ML	50A	50	76950	69.00	76950D	1¼		127.00
ML1	100A	70	75970	92.00	75970D	1½		183.00
ML1	100A	100	75916	92.00	75916D	1½		183.00
ML3	225A	125	78417	284.00	78917D	2½		470.00
ML3	225A	150	78418	284.00	78918D	2½		470.00
ML3	225A	175	78419	284.00	78919D	2½		470.00
ML3	225A	200	78426	284.00	78926D	2½		470.00
ML3	225A	225	78427	284.00	78927D	2½		470.00
KL	400A	225	65427	609.00				
KL	400A	250	65428	609.00				
KL	400A	300	65436	609.00				
KL	400A	350	65438	609.00				
KL	400A	400	65446	609.00				
WL	*600A	450	69448	760.00				
WL	*600A	500	69456	760.00				
WL	*600A	550	69458	760.00				
WL	*600A	600	69466	760.00				

*Type WL: 225A—400A. available upon order.

Square D Industrial Circuit Breakers

Thermal—Coilless Magnetic

Type ML—General and Special Purpose Enclosures

600 Volts, A-C., 250 Volts, D-C

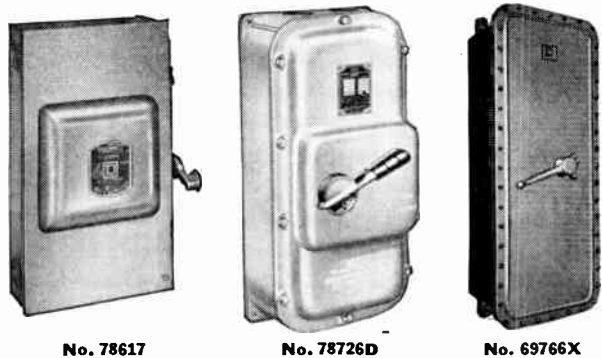

All industrial circuit breakers are quick make and quick break. Types ML, ML-1 and ML-3 have permanently calibrated integral trip mechanisms. Type KL and WL are equipped with interchangeable trip mechanism.

Amp.	No.	Explosion-resisting Class II, Group E, F, G NEMA Type 9		No.	Explosion-resisting Class I Group D NEMA Type 7	
		Drill-ings Ins.	List Price		Drill-ings Ins.	List Price

2 Pole, 600 Volts A-C—250 Volts D-C							
ML1 Frame—Size 100 Ampere							
15	75615Y	3/4	\$153.00	75615X	3/4	\$173.00	
20	75620Y	3/4	153.00	75620X	3/4	173.00	
30	75630Y	1	153.00	75630X	1	173.00	
40	75640Y	1 1/4	153.00	75640X	1 1/4	173.00	
50	75650Y	1 1/4	153.00	75650X	1 1/4	173.00	
70	75670Y	1 1/2	215.00	75670X	1 1/2	233.00	
100	75616Y	1 1/2	215.00	75616X	2	233.00	

ML3 Frame—Size 225 Ampere							
125	78617Y	2 1/2	410.00	78617X	2 1/2	450.00	
150	78618Y	2 1/2	410.00	78618X	2 1/2	450.00	
175	78619Y	2 1/2	410.00	78619X	2 1/2	450.00	
200	78626Y	2 1/2	410.00	78626X	2 1/2	450.00	
225	78627Y	2 1/2	410.00	78627X	2 1/2	450.00	

*WL Frame—Size 600 Ampere				
450	Use		69648X	1234.00
500	Class I		69656X	1234.00
550	Group		69658X	1234.00
600	D		69666X	1234.00

3 Pole, 600 Volts A-C							
ML1 Frame—Size 100 Ampere							
15	75715Y	3/4	170.00	75715X	3/4	189.00	
20	75720Y	3/4	170.00	75720X	3/4	189.00	
30	75730Y	1	170.00	75730X	1	189.00	
40	75740Y	1 1/4	170.00	75740X	1 1/4	189.00	
50	75750Y	1 1/4	170.00	75750X	1 1/4	189.00	
70	75770Y	1 1/2	227.00	75770X	1 1/2	252.00	
100	75716Y	1 1/2	227.00	75716X	2	252.00	

ML3 Frame—Size 225 Ampere							
125	78717Y	2 1/2	455.00	78717X	2 1/2	495.00	
150	78718Y	2 1/2	455.00	78718X	2 1/2	495.00	
175	78719Y	2 1/2	455.00	78719X	2 1/2	495.00	
200	78726Y	2 1/2	455.00	78726X	2 1/2	495.00	
225	78727Y	2 1/2	455.00	78727X	2 1/2	495.00	

*WL Frame—Size 600 Ampere				
450	Use		69748X	1369.00
500	Class I		69756X	1369.00
550	Group		69758X	1369.00
600	D		69766X	1369.00

Amps.	No.	Dust Resisting With Gasket NEMA Type 1		Waterproof and Dust-tight NEMA Type 4 and 5	
		List Price	No.	Drilling Ins.	List Price
2 Pole, 600 Volts A-C—250 Volts D-C					
▲ML1 Frame—Size 100 Ampere					
15	75615	\$ 86.00	75615D	3/4	\$153.00
20	75620	86.00	75620D	3/4	153.00
30	75630	86.00	75630D	1	153.00
40	75640	86.00	75640D	1 1/4	153.00
50	75650	86.00	75650D	1 1/4	153.00
70	75670	102.00	75670D	1 1/2	215.00
100	75616	102.00	75616D	1 1/2	215.00
ML3 Frame—Size 225 Ampere					
125	78617	225.00	78617D	2 1/2	410.00
150	78618	225.00	78618D	2 1/2	410.00
175	78619	225.00	78619D	2 1/2	410.00
200	78626	225.00	78626D	2 1/2	410.00
225	78627	225.00	78627D	2 1/2	410.00
KL Frame—Size 400 Ampere					
225	65627	488.00	65627D	Φ	
250	65628	488.00	65628D	Φ	
300	65636	488.00	65636D	Φ	
350	65638	488.00	65638D	Φ	
400	65646	488.00	65646D	Φ	
*WL Frame—Size 600 Ampere					
450	69648	607.00	69648D		1113.00
500	69656	607.00	69656D		1113.00
550	69658	607.00	69658D		1113.00
600	69666	607.00	69666D		1113.00
3 Pole, 600 Volts A-C					
ML1 Frame—Size 100 Ampere					
15	75715	\$103.00	75715D	3/4	170.00
20	75720	103.00	75720D	3/4	170.00
30	75730	103.00	75730D	1	170.00
40	75740	103.00	75740D	1 1/4	170.00
50	75750	103.00	75750D	1 1/4	170.00
70	75770	119.00	75770D	1 1/2	227.00
100	75716	119.00	75716D	1 1/2	227.00
ML3 Frame—Size 225 Ampere					
125	78717	269.00	78717D	2 1/2	455.00
150	78718	269.00	78718D	2 1/2	455.00
175	78719	269.00	78719D	2 1/2	455.00
200	78726	269.00	78726D	2 1/2	455.00
225	78727	269.00	78727D	2 1/2	455.00
KL Frame—Size 400 Ampere					
225	65727	591.00	65727D	Φ	
250	65728	591.00	65728D	Φ	
300	65736	591.00	65736D	Φ	
350	65738	591.00	65738D	Φ	
400	65746	591.00	65746D	Φ	
*WL Frame—Size 600 Ampere					
450	69748	742.00	69748D		1248.00
500	69756	742.00	69756D		1248.00
550	69758	742.00	69758D		1248.00
600	69766	742.00	69766D		1248.00

†These cast enclosures are furnished with standard conduit openings of sizes as shown, one in top, two in bottom, except 3 wire and 4 wire devices which have 2 in top and 1 in bottom. Holes differing from standard can be supplied at extra charge. All cast enclosures for KL and WL breakers furnished without conduit openings unless size and location are specified on order.

▲For 250 volt d-c devices add suffix D.C. after catalog number in this group.

●Explosion resisting enclosures for systems above 250 volt d-c are furnished without Underwriters' label. Enclosures for devices requiring hydrostatic tests—contact GRAYBAR.

ΦNot available—use WL Frame Breaker.

*Type WL: 225 A-400 A available upon order.

Square D Industrial Circuit Breakers

Thermal—Coilless Magnetic

Type ML—Service Entrance Type—Common Trip

Insulated groundable neutral. Blue-gray enamel finish. Raintight has extra coat Glyptal.

Amp. Rating	Flush No.	General Purpose Surface No.		List Price	Raintight—Add Hub or Cap	
		Surface No.	Surface No.		NEMA 3	Max. Hub In.
240 Volts A-C—125/250 Volts D-C						
Two Wire S/N						
15	ML115F	ML115S		\$21.60	ML115RO	1 1/4 \$21.60
20	ML120F	ML120S		21.60	ML120RO	1 1/4 21.60
30	ML130F	ML130S		21.60	ML130RO	1 1/4 21.60
40	ML140F	ML140S		21.60	ML140RO	1 1/4 21.60
50	ML150F	ML150S		21.60	ML150RO	1 1/4 21.60
Two Pole						
15	ML215F	ML215S		41.00		
20	ML220F	ML220S		41.00		
30	ML230F	ML230S		41.00		
40	ML240F	ML240S		41.00		
50	ML250F	ML250S		41.00		
70	ML1270F	ML1270S		59.00		
100	ML1216F	ML1216S		59.00		
125	ML3617F	ML3617S		206.00		
150	ML3618F	ML3618S		206.00		
175	ML3619F	ML3619S		206.00		
200	ML3626F	ML3626S		206.00		
225	ML3627F	ML3627S		206.00		
Three Wire S/N						
15	ML015F	ML015S		49.00	ML015RO	1 1/4 60.00
20	ML020F	ML020S		49.00	ML020RO	1 1/4 60.00
30	ML030F	ML030S		49.00	ML030RO	1 1/4 60.00
40	ML040F	ML040S		49.00	ML040RO	1 1/4 60.00
50	ML050F	ML050S		49.00	ML050RO	1 1/4 60.00
70	ML1070F	ML1070S		70.00	ML1070RO	2 85.00
100	ML1016F	ML1016S		70.00	ML1016RO	2 85.00
125	ML3017F	ML3017S		221.00	ML3017RO	2 1/2 244.00
150	ML3018F	ML3018S		221.00	ML3018RO	2 1/2 244.00
175	ML3019F	ML3019S		221.00	ML3019RO	2 1/2 244.00
200	ML3026F	ML3026S		221.00	ML3026RO	2 1/2 244.00
225	ML3027F	ML3027S		221.00	ML3027RO	2 1/2 244.00
Three Pole						
15	ML315F	ML315S		54.00		
20	ML320F	ML320S		54.00		
30	ML330F	ML330S		54.00		
40	ML340F	ML340S		54.00		
50	ML350F	ML350S		54.00		
70	ML1370F	ML1370S		73.00		
100	ML1316F	ML1316S		73.00		
125	ML3717F	ML3717S		250.00		
150	ML3718F	ML3718S		250.00		
175	ML3719F	ML3719S		250.00		
200	ML3726F	ML3726S		250.00		
225	ML3727F	ML3727S		250.00		
Four Wire S/N						
15	ML915F	ML915S		62.00	ML915RO	1 1/4 73.00
20	ML920F	ML920S		62.00	ML920RO	1 1/4 73.00
30	ML930F	ML930S		62.00	ML930RO	1 1/4 73.00
40	ML940F	ML940S		62.00	ML940RO	1 1/4 73.00
50	ML950F	ML950S		62.00	ML950RO	1 1/4 73.00
70	ML1970F	ML1970S		84.00	ML1970RO	2 101.00
100	ML1916F	ML1916S		84.00	ML1916RO	2 101.00
125	ML3917F	ML3917S		265.00	ML3917RO	2 1/2 288.00
150	ML3918F	ML3918S		265.00	ML3918RO	2 1/2 288.00
175	ML3919F	ML3919S		265.00	ML3919RO	2 1/2 288.00
200	ML3926F	ML3926S		265.00	ML3926RO	2 1/2 288.00
225	ML3927F	ML3927S		265.00	ML3927R	... 288.00

Use
3 Wire S/N
Device

Use
4 Wire S/N
Device

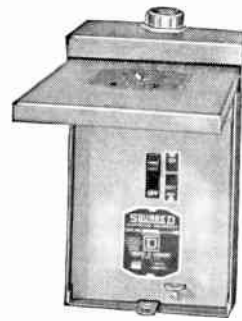

ML115RO

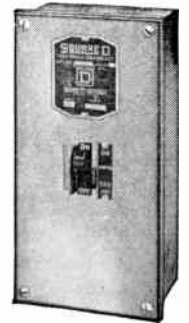

ML115S

Ampere Rating	Flush No.	General Purpose Type		List Price
		Surface No.	Surface No.	
600 Volts A-C—250 Volts D-C				
Two Pole				
15	ML1615F	ML1615S		\$ 76.00
20	ML1620F	ML1620S		76.00
30	ML1630F	ML1630S		76.00
40	ML1640F	ML1640S		76.00
50	ML1650F	ML1650S		76.00
70	ML1670F	ML1670S		92.00
100	ML1616F	ML1616S		92.00
125	ML3617F	ML3617S		206.00
150	ML3618F	ML3618S		206.00
175	ML3619F	ML3619S		206.00
200	ML3626F	ML3626S		206.00
225	ML3627F	ML3627S		206.00
Three Pole				
15	ML1715F	ML1715S		93.00
20	ML1720F	ML1720S		93.00
30	ML1730F	ML1730S		93.00
40	ML1740F	ML1740S		93.00
50	ML1750F	ML1750S		93.00
70	ML1770F	ML1770S		109.00
100	ML1716F	ML1716S		109.00
125	ML3717F	ML3717S		250.00
150	ML3718F	ML3718S		250.00
175	ML3719F	ML3719S		250.00
200	ML3726F	ML3726S		250.00
225	ML3727F	ML3727S		250.00

Interrupting Capacity (Based on NEMA Test Procedures)				Breaker Class Fed. Spec.
A-C		D-C		
120 V.	240 V.	480 V.	600 V.	WP-131-A
125/250 V.	250 V.			
Type ML—Ampere Rating 15 A. to 50 A.				
7,500	7,500	5,000	5,000	C
Type ML1—Ampere Rating 70 A. and 100 A.				
....	7,500	5,000	5,000	C
Type ML1—Ampere Rating 15 A. to 100 A.				
....	*20,000	15,000	15,000	5,000
Type ML3—Ampere Rating 125 A. to 225 A.				
....	25,000	20,000	15,000	10,000
Type KL—Ampere Rating 125 A. to 400 A.				
....	40,000	30,000	25,000	20,000
Type WL—Ampere Rating 125 A. to 600 A.				
....	50,000	35,000	25,000	20,000

*20,000 A. interrupting capacity of ML1 breaker on 240 V. a-c service applies only when 600 V. a-c ML1 breaker is used.

Interchangeable Hubs for Raintight Enclosures

Type RO devices have threaded opening for interchangeable hubs or closing caps. Order hub or cap separately and screw into place.

Hub. Cat. Number List Each	Conduit Size In.							Cap Cat. No. List Each	30-60-100 A. CE	200 A. CH
	3/4	1	1 1/4	1 1/2	2	2 1/2	Cap			
	HC	HD	HE	HG	HH	HW				
	\$2.60	\$2.60	\$2.60	\$2.60	\$4.40	\$7.80		\$0.20	\$0.20	

Square D Industrial Circuit Interrupters Type ML—Non-Automatic



NEMA 1



NEMA 4, 5, 7 and 9



Type ML
50 Amp. Frame
Low Voltage



Type ML1
100 Ampere Frame
High & Low Voltage



Type ML3
225 Ampere Frame
High Voltage

These non-automatic circuit interrupters are manually operated and are quick make, quick break. Construction is identical with corresponding size circuit breakers except for the omission of the automatic trip feature. Interruption capacity is much higher than comparable safety switches. Circuit interrupter units without enclosures are also available. Finish: Blue gray-enamel.

U/L Approved File E6294 and E19608.

Amps.	Dust-resisting With Gasket NEMA Type 1			Weatherproof and Dust-tight NEMA Type 4 and 5			Drill-ings Inches
	No.	List Price	No.	List Price	No.	List Price	
2 Pole, 240 Volts A-C—125/250 Volts D-C							
50	76200	\$ 49.00	76200D	\$ 80.00			1 1/4
100	75200	67.00	75200D	158.00			1 1/2
225	78600	187.00	78600D	372.00			2 1/2
3 Pole, 240 Volts A-C							
50	76300	\$ 62.00	76300D	\$120.00			1 1/4
100	75300	81.00	75300D	173.00			1 1/2
225	78700	222.00	78700D	408.00			2 1/2
2 Pole, 600 Volts A-C—250 Volts D-C							
100	75400	\$ 86.00	75400D	\$200.00			1 1/2
225	78600	187.00	78600D	372.00			2 1/2
3 Pole, 600 Volts A-C							
100	75500	\$103.00	75500D	\$216.00			1 1/2
225	78700	222.00	78700D	408.00			2 1/2
Amps.	Explosion-resisting Class II, Group E, F, G NEMA Type 9			Explosion-resisting Class I—Group D NEMA Type 7			Drill-ings Ins.
	No.	List Price	No.	List Price	No.	List Price	
2 Pole, 240 Volts A-C—125/250 Volts D-C							
100	75200Y	\$158.00	75200X	\$177.00			2
225	78600Y	372.00	78600X	412.00			2 1/2
3 Pole, 240 Volts A-C							
50	76300Y	\$120.00	76300X	\$139.00			1 1/4
100	75300Y	173.00	75300X	191.00			2
225	78700Y	408.00	78700X	448.00			2 1/2
2 Pole, 600 Volts A-C—250 Volts D-C							
100	75400Y	\$200.00	75400X	\$218.00			2
225	78600Y	372.00	78600X	412.00			2 1/2
3 Pole, 600 Volts A-C							
100	75500Y	\$216.00	75500X	\$234.00			2
225	78700Y	408.00	78700X	448.00			2 1/2

†These cast enclosures are furnished with standard conduit openings as shown: one in top, two in bottom, except two pole, 250 volts a-c which have one in top and one in bottom. Holes differing from standard can be supplied at extra charge.

Industrial Circuit Breakers and Interrupters Data and Dimensions*

Cat. Nos. From—To	Approx. Wt., Lbs.	Height	Overall Dimensions		
			Width	W/H	Depth
65027—946	...	29 13/32	15 3/8	17 1/16	8 5/16
65027D—746D
65027X—746X
69048—966	130	38 19/32	17 5/8	19 11/16	10 7/16
69048D—766D	375	43 1/2	18 1/4	...	12
69048X—766X	375	43 1/2	18 1/4	...	12
75070—916	15	13 1/4	7 15/16	9 5/16	4 13/16
75070D—916D	104	19 1/8	10	...	6 3/4
75070X—916X	104	19 1/8	10	...	6 3/4
75070Y—916Y	104	19 1/8	10	...	6 3/4
75615—750	15	13 1/4	7 15/16	9 5/16	4 13/16
75615D—750D	49	12 3/4	9 1/4	...	5 5/8
75615X—750X	104	12 3/4	9 1/4	...	5 5/8
75615Y—750Y	53	12 3/4	9 1/4	...	5 5/8
76015—950	11	12 1/4	6 3/4	8 1/8	4 1/8
76015D—950D	40	12 3/4	9 1/4	...	7
76300—950X	40	12 3/4	9 1/4	...	7
76300Y—950Y	40	12 3/4	9 1/4	...	7
78017—927	45	22 7/8	12 5/8	14 13/16	6 1/16
78017D—927D	240	25 1/8	16 5/8	...	9 3/4
78017X—927X	320	25 1/8	16 5/8	...	9 3/4
78017Y—927Y	240	25 1/8	16 5/8	...	9 3/4
ML.015—050F/S	6	10 3/8	5 1/16	...	3 21/32
ML.015—950RO	8	11 1/4	7 13/32	...	4 13/16
ML.115—250F/S	6	10 3/8	4 1/8	...	3 21/32
ML.315—350F/S	7	10 3/8	5 1/16	...	3 21/32
ML.915—950F/S	...	15 1/4	8 1/4	...	4
ML.1070—916F/S	...	15 1/4	8 1/4	...	4
ML.1070—916RO	...	14 1/2	8 25/32	...	5 3/32
ML.1615—750F/S	...	15 1/4	8 1/4	...	4
ML.3017—927F/S	...	20 5/8	10 1/8	...	5 5/16
ML.3017—927R	...	21 7/8	10 17/32	...	6 7/32

*Catalog numbers have been grouped together. The following example shows how to find dimensions on Industrial Breaker Enclosures: EXAMPLE—76340 lies between 76015-950, therefore, use the dimensions on that line. F/S dimensions do not include the cover.

Call Graybar FIRST For . . .

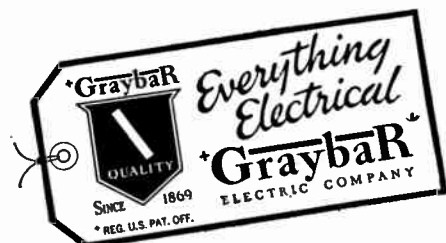

I-T-E Commercial Building and Service Equipment Type Circuit Breakers

Individually Enclosed—Sheet Steel Enclosures

General Purpose Surface Mounting NEMA 1, Flush Mounting NEMA 1B, and Weatherproof (Raintight) NEMA 3

120 to 600 Volts A-C, 125 to 250 Volts D-C, 15 to 225 Amps., 1, 2, 3 Poles

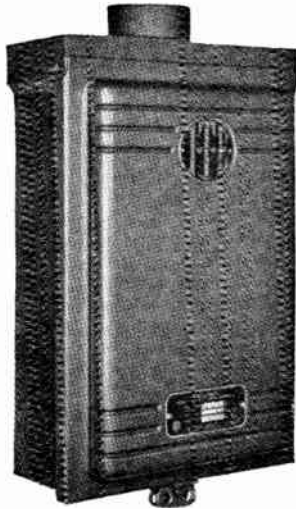

Weatherproof (Raintight) NEMA 3 Enclosure



General Purpose Surface Mounting NEMA 1 Enclosure for 100 Ampere "E" Frame Circuit Breaker

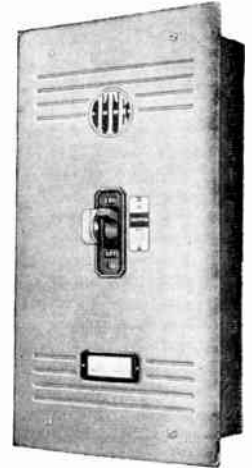

General Purpose Flush Mounting NEMA 1B Enclosure

General purpose surface mounting NEMA 1 enclosures are suitable for applications indoors where normal atmospheric conditions prevail.

The Flush mounted NEMA 1B enclosure is for recessed wall mounting. Enclosure cover serves as flush plate. The

circuit breaker operating handle extends through the cover in both enclosures.

The NEMA 3 is for outdoor use to provide protection against driving rain, snow or sleet. Enclosure is equipped with threaded conduit hub, matching knockout in bottom, and inner dead front sheet over the breaker.

"E" Frame 100 Amperes

Cont. Amps.	General Purpose NEMA Type 1		Flush Mtg. NEMA Type 1B		Weatherproof NEMA Type 3	
	No.	Each	No.	Each	No.	Each
1 Pole—240 Volts A-C—125 Volts D-C						
15	ET-1551-E1-N	\$31.00	ET-1551-E1B-N	\$31.00	ET-1551-E3-N	\$52.00
20	ET-1553-E1-N	31.00	ET-1553-E1B-N	31.00	ET-1553-E3-N	52.00
30	ET-1555-E1-N	31.00	ET-1555-E1B-N	31.00	ET-1555-E3-N	52.00
40	ET-1556-E1-N	31.00	ET-1556-E1B-N	31.00	ET-1556-E3-N	52.00
50	ET-1557-E1-N	31.00	ET-1557-E1B-N	31.00	ET-1557-E3-N	52.00
2 Pole—240 Volts A-C—125/250 Volts D-C						
15	ET-1561-E1-N	\$48.00	ET-1561-E1B-N	\$48.00	ET-1561-E3-N	\$72.00
20	ET-1562-E1-N	48.00	ET-1562-E1B-N	48.00	ET-1562-E3-N	72.00
30	ET-1563-E1-N	48.00	ET-1563-E1B-N	48.00	ET-1563-E3-N	72.00
40	ET-1564-E1-N	48.00	ET-1564-E1B-N	48.00	ET-1564-E3-N	72.00
50	ET-1565-E1-N	48.00	ET-1565-E1B-N	48.00	ET-1565-E3-N	72.00
70	ET-1567-E1-N	70.00	ET-1567-E1B-N	70.00	ET-1567-E3-N	89.00
90	ET-1568-E1-N	70.00	ET-1568-E1B-N	70.00	ET-1568-E3-N	89.00
100	ET-1569-E1-N	70.00	ET-1569-E1B-N	70.00	ET-1569-E3-N	89.00
*100	ETS-1543-E1-N	52.00	ETS-1543-E1B-N	52.00	ETS-1543-E3-N	76.00
3 Pole—240 Volts A-C—125/250 Volts D-C						
15	ET-1571-E1-N	\$61.00	ET-1571-E1B-N	\$61.00	ET-1571-E3-N	\$85.00
20	ET-1572-E1-N	61.00	ET-1572-E1B-N	61.00	ET-1572-E3-N	85.00
30	ET-1573-E1-N	61.00	ET-1573-E1B-N	61.00	ET-1573-E3-N	85.00
40	ET-1574-E1-N	61.00	ET-1574-E1B-N	61.00	ET-1574-E3-N	85.00
50	ET-1575-E1-N	61.00	ET-1575-E1B-N	61.00	ET-1575-E3-N	85.00
70	ET-1577-E1-N	84.00	ET-1577-E1B-N	84.00	ET-1577-E3-N	105.00
90	ET-1578-E1-N	84.00	ET-1578-E1B-N	84.00	ET-1578-E3-N	105.00
100	ET-1579-E1-N	84.00	ET-1579-E1B-N	84.00	ET-1579-E3-N	105.00
*100	ETS-1547-E1-N	65.00	ETS-1547-E1B-N	65.00	ETS-1547-E3-N	89.00

"F" Frame 100 Amperes

Cont. Amps.	General Purpose NEMA Type 1		Flush Mtg. NEMA Type 1B		Weatherproof NEMA Type 3	
	No.	Each	No.	Each	No.	Each
2 Pole—600 Volts A-C—250 Volts D-C						
15	ET-4011-F1-N	\$ 87.00	ET-4011-F1B-N	\$ 87.00	ET-4011-F3-N	\$121.00
20	ET-4012-F1-N	87.00	ET-4012-F1B-N	87.00	ET-4012-F3-N	121.00
30	ET-4013-F1-N	87.00	ET-4013-F1B-N	87.00	ET-4013-F3-N	121.00
40	ET-4014-F1-N	87.00	ET-4014-F1B-N	87.00	ET-4014-F3-N	121.00
50	ET-4015-F1-N	87.00	ET-4015-F1B-N	87.00	ET-4015-F3-N	121.00
70	ET-4016-F1-N	103.00	ET-4016-F1B-N	103.00	ET-4016-F3-N	138.00
90	ET-4019-F1-N	103.00	ET-4019-F1B-N	103.00	ET-4019-F3-N	138.00
100	ET-4017-F1-N	103.00	ET-4017-F1B-N	103.00	ET-4017-F3-N	138.00
*100	ETS-4020-F1-N	87.00	ETS-4020-F1B-N	87.00	ETS-4020-F3-N	121.00
3 Pole—600 Volts A-C						
15	ET-4031-F1-N	\$104.00	ET-4031-F1B-N	\$104.00	ET-4031-F3-N	\$140.00
20	ET-4032-F1-N	104.00	ET-4032-F1B-N	104.00	ET-4032-F3-N	140.00
30	ET-4033-F1-N	104.00	ET-4033-F1B-N	104.00	ET-4033-F3-N	140.00
40	ET-4034-F1-N	104.00	ET-4034-F1B-N	104.00	ET-4034-F3-N	140.00
50	ET-4035-F1-N	104.00	ET-4035-F1B-N	104.00	ET-4035-F3-N	140.00
70	ET-4036-F1-N	120.00	ET-4036-F1B-N	120.00	ET-4036-F3-N	156.00
90	ET-4039-F1-N	120.00	ET-4039-F1B-N	120.00	ET-4039-F3-N	156.00
100	ET-4037-F1-N	120.00	ET-4037-F1B-N	120.00	ET-4037-F3-N	156.00
*100	ETS-4040-F1-N	104.00	ETS-4040-F1B-N	104.00	ETS-4040-F3-N	140.00

*Non-automatic circuit interrupter.

"J" Frame 225 Amperes

Cont. Amps.	General Purpose NEMA Type 1		Flush Mounting NEMA Type 1B		Weatherproof NEMA Type 3	
	No.	Each	No.	Each	No.	Each
2 Pole—600 Volts A-C—250 Volts D-C						
70	ET-5900-J1-N	\$221.00	ET-5900-J1B-N	\$221.00	ET-5900-J3-N	\$256.00
90	ET-5901-J1-N	221.00	ET-5901-J1B-N	221.00	ET-5901-J3-N	256.00
100	ET-5902-J1-N	221.00	ET-5902-J1B-N	221.00	ET-5902-J3-N	256.00
125	ET-5903-J1-N	221.00	ET-5903-J1B-N	221.00	ET-5903-J3-N	256.00
150	ET-5904-J1-N	221.00	ET-5904-J1B-N	221.00	ET-5904-J3-N	256.00
175	ET-5905-J1-N	221.00	ET-5905-J1B-N	221.00	ET-5905-J3-N	256.00
200	ET-5906-J1-N	221.00	ET-5906-J1B-N	221.00	ET-5906-J3-N	256.00
225	ET-5907-J1-N	221.00	ET-5907-J1B-N	221.00	ET-5907-J3-N	256.00
*225	ETS-5908-J1-N	183.00	ETS-5908-J1B-N	183.00	ETS-5908-J3-N	218.00
3 Pole—600 Volts A-C—250 Volts D-C						
70	ET-5910-J1-N	\$265.00	ET-5910-J1B-N	\$265.00	ET-5910-J3-N	\$300.00
90	ET-5911-J1-N	265.00	ET-5911-J1B-N	265.00	ET-5911-J3-N	300.00
100	ET-5912-J1-N	265.00	ET-5912-J1B-N	265.00	ET-5912-J3-N	300.00
125	ET-5913-J1-N	265.00	ET-5913-J1B-N	265.00	ET-5913-J3-N	300.00
150	ET-5914-J1-N	265.00	ET-5914-J1B-N	265.00	ET-5914-J3-N	300.00
175	ET-5915-J1-N	265.00	ET-5915-J1B-N	265.00	ET-5915-J3-N	300.00
200	ET-5916-J1-N	265.00	ET-5916-J1B-N	265.00	ET-5916-J3-N	300.00
225	ET-5917-J1-N	265.00	ET-5917-J1B-N	265.00	ET-5917-J3-N	300.00
*225	ETS-5918-J1-N	225.00	ETS-5918-J1B-N	225.00	ETS-5918-J3-N	254.00

"KL" Frame 400 Amperes

Cont. Amps.	General Purpose NEMA Type 1		Flush Mounting NEMA Type 1B		Weatherproof NEMA Type 3	
	No.	Each	No.	Each	No.	Each
2 Pole—600 Volts A-C—250 Volts D-C						
125	ET-6100-KL1-N	\$454.00	ET-6100-KL1B-N	\$454.00	ET-6100-KL13-N	\$454.00
150	ET-6101-KL1-N	454.00	ET-6101-KL1B-N	454.00	ET-6101-KL13-N	454.00
175	ET-6102-KL1-N	454.00	ET-6102-KL1B-N	454.00	ET-6102-KL13-N	454.00
200	ET-6103-KL1-N	454.00	ET-6103-KL1B-N	454.00	ET-6103-KL13-N	454.00
225	ET-6104-KL1-N	454.00	ET-6104-KL1B-N	454.00	ET-6104-KL13-N	454.00
250	ET-6105-KL1-N	454.00	ET-6105-KL1B-N	454.00	ET-6105-KL13-N	454.00
275	ET-6106-KL1-N	454.00	ET-6106-KL1B-N	454.00	ET-6106-KL13-N	454.00
300	ET-6107-KL1-N	454.00	ET-6107-KL1B-N	454.00	ET-6107-KL13-N	454.00
350	ET-6108-KL1-N	454.00	ET-6108-KL1B-N	454.00	ET-6108-KL13-N	454.00
400	ET-6109-KL1-N	454.00	ET-6109-KL1B-N	454.00	ET-6109-KL13-N	454.00
*400	ETS-6110-KL1-N	350.00	ETS-6110-KL1B-N	350.00	ETS-6110-KL13-N	350.00
3 Pole—600 Volts A-C—250 Volts D-C						
125	ET-6120-KL1-N	\$557.00	ET-6120-KL1B-N	\$557.00	ET-6120-KL13-N	\$557.00
150	ET-6121-KL1-N	557.00	ET-6121-KL1B-N	557.00	ET-6121-KL13-N	557.00
175	ET-6122-KL1-N	557.00	ET-6122-KL1B-N	557.00	ET-6122-KL13-N	557.00
200	ET-6123-KL1-N	557.00	ET-6123-KL1B-N	557.00	ET-6123-KL13-N	557.00
225	ET-6124-KL1-N	557.00	ET-6124-KL1B-N	557.00	ET-6124-KL13-N	557.00
250	ET-6125-KL1-N	557.00	ET-6125-KL1B-N	557.00	ET-6125-KL13-N	557.00
275	ET-6126-KL1-N	557.00	ET-6126-KL1B-N	557.00	ET-6126-KL13-N	557.00
300	ET-6127-KL1-N	557.00	ET-6127-KL1B-N	557.00	ET-6127-KL13-N	557.00
350	ET-6128-KL1-N	557.00	ET-6128-KL1B-N	557.00	ET-6128-KL13-N	557.00
400	ET-6129-KL1-N	557.00	ET-6129-KL1B-N	557.00	ET-6129-KL13-N	557.00
*400	ETS-6130-KL1-N	410.00	ETS-6130-KL1B-N	410.00	ETS-6130-KL13-N	410.00

I-T-E Commercial Building and Service Equipment Type Circuit Breakers

Individually Enclosed—Sheet Steel Enclosures (Cont.)

“LM” Frame 800 Amperes 600 Volts A-C—250 Volts D-C

Ampere Rating	General Purpose Sheet Steel NEMA Type 1			Flush Mounting NEMA Type 1B			General Purpose Sheet Steel NEMA Type 1			Flush Mounting NEMA Type 1B		
	No.	Each		No.	Each		No.	Each		No.	Each	
2 Pole—600 Volts A-C—250 Volts D-C												
125	ET-8140-LM1-6-N	\$556.00		ET-8140-LM1B-6-N	\$556.00		ET-8170-LM1-6-N	\$691.00		ET-8170-LM1B-6-N	\$691.00	
150	ET-8141-LM1-6-N	556.00		ET-8141-LM1B-6-N	556.00		ET-8171-LM1-6-N	691.00		ET-8171-LM1B-6-N	691.00	
175	ET-8142-LM1-6-N	556.00		ET-8142-LM1B-6-N	556.00		ET-8172-LM1-6-N	691.00		ET-8172-LM1B-6-N	691.00	
200	ET-8143-LM1-6-N	556.00		ET-8143-LM1B-6-N	556.00		ET-8173-LM1-6-N	691.00		ET-8173-LM1B-6-N	691.00	
225	ET-8144-LM1-6-N	556.00		ET-8144-LM1B-6-N	556.00		ET-8174-LM1-6-N	691.00		ET-8174-LM1B-6-N	691.00	
250	ET-8145-LM1-6-N	556.00		ET-8145-LM1B-6-N	556.00		ET-8175-LM1-6-N	691.00		ET-8175-LM1B-6-N	691.00	
275	ET-8146-LM1-6-N	556.00		ET-8146-LM1B-6-N	556.00		ET-8176-LM1-6-N	691.00		ET-8176-LM1B-6-N	691.00	
300	ET-8147-LM1-6-N	556.00		ET-8147-LM1B-6-N	556.00		ET-8177-LM1-6-N	691.00		ET-8177-LM1B-6-N	691.00	
350	ET-8148-LM1-6-N	556.00		ET-8148-LM1B-6-N	556.00		ET-8178-LM1-6-N	691.00		ET-8178-LM1B-6-N	691.00	
400	ET-8149-LM1-6-N	556.00		ET-8149-LM1B-6-N	556.00		ET-8179-LM1-6-N	691.00		ET-8179-LM1B-6-N	691.00	
500	ET-8151-LM1-6-N	556.00		ET-8151-LM1B-6-N	556.00		ET-8181-LM1-6-N	691.00		ET-8181-LM1B-6-N	691.00	
600	ET-8153-LM1-6-N	556.00		ET-8153-LM1B-6-N	556.00		ET-8183-LM1-6-N	691.00		ET-8183-LM1B-6-N	691.00	
700	ET-8155-LM1-8-N	714.00		ET-8155-LM1B-8-N	715.00		ET-8185-LM1-8-N	901.00		ET-8185-LM1B-8-N	901.00	
800	ET-8156-LM1-8-N	714.00		ET-8156-LM1B-8-N	715.00		ET-8186-LM1-8-N	901.00		ET-8186-LM1B-8-N	901.00	
*800	ETS-8157-LM1-8-N	445.00		ETS-8157-LM1B-8-N	393.00		ETS-8187-LM1-8-N	548.00		ETS-8187-LM1B-8-N	489.00	

*Non-automatic circuit interrupter.

I-T-E Individually Enclosed (Large Air) Circuit Breakers

“Urelites”

600 Volts A-C—250 Volts D-C 15 to 4000 Amperes

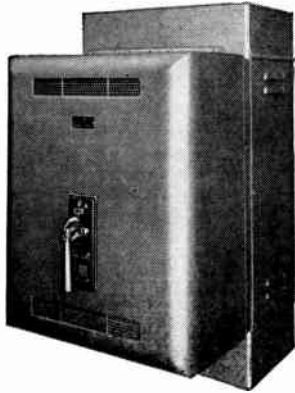

“K” line breakers provide overcurrent protection on main and feeder circuits where severe service, requiring frequent opening and closing operations, is encountered. Interrupting capacities are from 15,000 to 150,000 amperes, depending on the breaker selected. Breakers when incorporated into their own individual enclosures are referred to as Urelites.

Type KA, KB and KC Urelites are push-in, pull-out type with separable main contacts. Solderless connectors and stationary disconnect devices are mounted on insulating base attached to back of enclosure. This permits connection of cable before breaker is installed.

Type KC, KD and KE Urelites utilize a pull box with removable top, side, and bottom plates providing ample room for fast connection of cable.

Operating mechanism is compact and easy to operate with construction assuring simultaneous closing of all poles. Each pole is an assembly of stationary and movable silver composition main and arcing contacts. Contacts respond to pressure of compression springs at all times. Magnetic arc chutes provide short arcing time, safe confinement of arc within the extinguishing chamber.

“K” line circuit breakers are electrically and mechanically nonclosable (trip free) on overload. Urelite general purpose enclosure exteriors are finished in gray; weatherproof enclosures, blue black.

Two Pole		Three Pole		Four Pole		Two Pole		Three Pole		Four Pole	
No.	Each	No.	Each	No.	Each	No.	Each	No.	Each	No.	Each
Type KA 15 to 225 Amperes—15,000 Ampere Interrupting Rating											
General Purpose with Pullbox											
*KA-20-13-20	\$355.00	*KA-30-13-20	\$385.00	*KA-40-13-20	\$640.00	KA-21-13-20	\$545.00	KA-31-13-20	\$575.00	KA-41-13-20	\$925.00
General Purpose—Panel Mounted											
*KA-20-13-21	355.00	*KA-30-13-21	385.00	*KA-40-13-21	640.00	KA-21-13-21	545.00	KA-31-13-21	575.00	KA-41-13-21	925.00
Weatherproof with Pullbox											
*KA-20-13-30	505.00	*KA-30-13-30	535.00	*KA-40-13-30	710.00	KA-21-13-30	695.00	KA-31-13-30	725.00	KA-41-13-30	995.00
Dustproof with Pullbox											
*KA-20-13-33	390.00	*KA-30-13-33	420.00	*KA-40-13-33	710.00	KA-21-13-33	580.00	KA-31-13-33	610.00	KA-41-13-33	995.00
Type KB 40 to 600 Amperes—25,000 Ampere Interrupting Rating											
General Purpose with Pullbox											
*KB-20-13-20	660.00	*KB-30-13-20	730.00	*KB-40-13-20	1080.00	KB-21-13-20	900.00	KB-31-13-20	970.00	KB-41-13-20	1440.00
General Purpose—Panel Mounted											
*KB-20-13-21	660.00	*KB-30-13-21	730.00	*KB-40-13-21	1080.00	KB-21-13-21	900.00	KB-31-13-21	970.00	KB-41-13-21	1440.00
Weatherproof with Pullbox											
*KB-20-13-30	850.00	*KB-30-13-30	920.00	*KB-40-13-30	1350.00	KB-21-13-30	1090.00	KB-31-13-30	1160.00	KB-41-13-30	1750.00
Dustproof with Pullbox											
*KB-20-13-33	715.00	*KB-30-13-33	785.00	*KB-40-13-33	1190.00	KB-21-13-33	950.00	KB-31-13-33	1025.00	KB-41-13-33	1550.00
General Purpose with Pullbox											
*KC-20-13-20	1435.00	*KC-30-13-20	1575.00	*KC-40-13-20	2300.00	KC-21-13-20	1935.00	KC-31-13-20	2075.00	KC-41-13-20	3050.00
General Purpose—Panel Mounted											
*KC-20-13-21	1435.00	*KC-30-13-21	1575.00	*KC-40-13-21	2300.00	KC-21-13-21	1935.00	KC-31-13-21	2075.00	KC-41-13-21	3050.00
Weatherproof with Pullbox											
*KC-20-13-30	1785.00	*KC-30-13-30	1925.00	*KC-40-13-30	2750.00	KC-21-13-30	2285.00	KC-31-13-30	2425.00	KC-41-13-30	3550.00
Dustproof with Pullbox											
*KC-20-13-33	1485.00	*KC-30-13-33	1625.00	*KC-40-13-33	2400.00	KC-21-13-33	1985.00	KC-31-13-33	2125.00	KC-41-13-33	3190.00
Type KD 2000 to 3000 Amperes 75000 Ampere Interrupting Rating						Type KE 2000 to 3000 Amperes 75000 Ampere Interrupting Rating					
Two Pole		Three Pole		Two Pole		Three Pole		Two Pole		Three Pole	
No.	Each	No.	Each	No.	Each	No.	Each	No.	Each	No.	Each
General Purpose with Pullbox											
KD-21-13-20	\$3665.00	KD-31-13-20	\$4115.00	KE-21-13-20	\$5300.00	KE-31-13-20	\$5900.00				
Weatherproof with Pullbox											
KD-21-13-30	4225.00	KD-31-13-20	4675.00	KE-21-13-30	5875.00	KE-31-13-30	6475.00				
Dustproof with Pullbox											
KD-21-13-33	4225.00	KD-31-13-33	4675.00	KE-21-13-33	5875.00	KE-31-13-33	6475.00				

*Manually operated. All other models electrically operated.

Standard Continuous Ratings:

- For Type KA—15, 20, 30, 40, 50, 70, 90, 100, 125, 150, 175, 200 and 225 amperes.
 - For Type KB—40, 50, 70, 90, 100, 125, 150, 175, 200, 225, 250, 300, 350, 400, 500, and 600 amperes.
 - For Type KC—200, 225, 250, 300, 350, 400, 500, 600, 800, 1000, 1200, and 1600 amperes.
 - For Type KD—2000 and 3000. For Type KE—4000.
- Range of Tripping, Adjustment—80% to 160% ampere rating of breaker.
Special calibration additional. Please contact Graybar.
Specify a-c frequency. Applications higher than 60 cycles, contact Graybar.

I-T-E Individually Enclosed Circuit Breakers

125 to 250 Volts D-C—125 to 600 Volts A-C

15 to 800 Amperes—1, 2 and 3 Pole

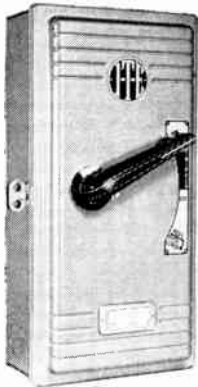

Semi-Dust-Tight

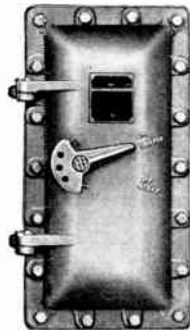

Explosion Proof

Type ET circuit breakers are designed to provide maximum over current protection and long service life under various conditions. Rugged quality construction and ability to restore power quickly without replacement of parts or elements, make them ideally suited for industrial applications. The semi-dust-tight, NEMA 1A enclosure, incorporating the I-T-E operating handle mechanism feature, and gasketed cover, is for indoor applications where limited protection is required.

Cont. Amp.	"E" Frame 100 Amperes		240 Volts A-C—125/250 Volts D-C	
	No.	Each	No.	Each
15	ET-1561-F1A	\$ 49.00	ET-1571-F1A	\$ 62.00
20	ET-1562-F1A	49.00	ET-1572-F1A	62.00
30	ET-1563-F1A	49.00	ET-1573-F1A	62.00
40	ET-1564-F1A	49.00	ET-1574-F1A	62.00
50	ET-1565-F1A	49.00	ET-1575-F1A	62.00
70	ET-1567-F1A	67.00	ET-1577-F1A	81.00
90	ET-1568-F1A	67.00	ET-1578-F1A	81.00
100	ET-1569-F1A	67.00	ET-1579-F1A	81.00
*100	ETS-1543-F1A	49.00	ETS-1547-F1A	62.00

Cont. Amp.	"F" Frame 100 Amperes		600 Volts A-C—250 Volts D-C	
	No.	Each	No.	Each
15	ET-4011-F1A	\$ 86.00	ET-4031-F1A	\$103.00
20	ET-4012-F1A	86.00	ET-4032-F1A	103.00
30	ET-4013-F1A	86.00	ET-4033-F1A	103.00
40	ET-4014-F1A	86.00	ET-4034-F1A	103.00
50	ET-4015-F1A	86.00	ET-4035-F1A	103.00
70	ET-4016-F1A	102.00	ET-4036-F1A	119.00
90	ET-4019-F1A	102.00	ET-4039-F1A	119.00
100	ET-4017-F1A	102.00	ET-4037-F1A	119.00
*100	ETS-4020-F1A	86.00	ETS-4040-F1A	103.00

Cont. Amp.	"J" Frame 225 Amperes		600 Volts A-C—250 Volts D-C	
	No.	Each	No.	Each
70	ET-5900-J1A	\$225.00	ET-5910-J1A	\$269.00
90	ET-5901-J1A	225.00	ET-5911-J1A	269.00
100	ET-5902-J1A	225.00	ET-5912-J1A	269.00
125	ET-5903-J1A	225.00	ET-5913-J1A	269.00
150	ET-5904-J1A	225.00	ET-5914-J1A	269.00
175	ET-5905-J1A	225.00	ET-5915-J1A	269.00
200	ET-5806-J1A	225.00	ET-5916-J1A	269.00
225	ET-5907-J1A	225.00	ET-5817-J1A	269.00
*225	ETS-5908-J1A	187.00	ETS-5918-J1A	222.00

Cont. Amp.	"K" Frame 225 Amperes		600 Volts A-C—250 Volts D-C	
	No.	Each	No.	Each
70	ET-7018-K1A	\$253.00	ET-7038-K1A	\$304.00
90	ET-7019-K1A	253.00	ET-7039-K1A	304.00
100	ET-7020-K1A	253.00	ET-7040-K1A	304.00
125	ET-7021-K1A	253.00	ET-7041-K1A	304.00
150	ET-7022-K1A	253.00	ET-7042-K1A	304.00
175	ET-7023-K1A	253.00	ET-7043-K1A	304.00
200	ET-7024-K1A	253.00	ET-7044-K1A	304.00
225	ET-7025-K1A	253.00	ET-7045-K1A	304.00
*225	ETS-1787-K1A	211.00	ETS-1788-K1A	248.00

Water-tight and dust-tight enclosures, NEMA 4 and 5, are suitable for applications outdoors or indoors, where the enclosure is exposed to rain, sleet and dust. The NEMA 12 enclosure is designed for applications where the surrounding atmosphere contains lint, fine dust, oils, or coolants. NEMA 1A and NEMA 12 enclosure prices are identical.

Cast iron enclosures for hazardous locations, NEMA 7 and 9, are designed for use in locations where combustible dust and flammable gases or vapors are or may be present to produce explosive or ignitable mixtures. Prices on cast iron enclosures supplied on request.

"Cordon" Circuit Breakers

Combine the operating features of the ET type molded case circuit breaker and the current limiting high interrupting characteristics of the Amp-trap to provide 100,000 rms amperes at 600 volts a-c, 250 volts d-c. The coordination is such that unless the magnitude of the fault reaches the fusing point of the Amp-traps they are unaffected and the standard circuit breaker overload devices perform their normal function.

Can be used in load centers, switchboards, panelboards, or individual enclosures. Prices for Cordon circuit breakers will be supplied on request.

Cont. Amp.	"KL" Frame 400 Amperes		600 Volts A-C—250 Volts D-C	
	No.	Each	No.	Each
125	ET-6100-KL1A	\$488.00	ET-6120-KL1A	\$591.00
150	ET-6101-KL1A	488.00	ET-6121-KL1A	591.00
175	ET-6102-KL1A	488.00	ET-6122-KL1A	591.00
200	ET-6103-KL1A	488.00	ET-6123-KL1A	591.00
225	ET-6104-KL1A	488.00	ET-6124-KL1A	591.00
250	ET-6105-KL1A	488.00	ET-6125-KL1A	591.00
275	ET-6106-KL1A	488.00	ET-6126-KL1A	591.00
300	ET-6107-KL1A	488.00	ET-6127-KL1A	591.00
350	ET-6108-KL1A	488.00	ET-6128-KL1A	591.00
400	ET-6109-KL1A	488.00	ET-6129-KL1A	591.00
*400	ETS-6110-KL1A	384.00	ETS-6130-KL1A	444.00

Cont. Amp.	"LM" Frame 800 Amperes		600 Volts A-C—250 Volts D-C	
	No.	Each	No.	Each
125	ET-8140-LM1A-6	607.00	ET-8170-LM1A-6	742.00
150	ET-8141-LM1A-6	607.00	ET-8171-LM1A-6	742.00
175	ET-8142-LM1A-6	607.00	ET-8172-LM1A-6	742.00
200	ET-8143-LM1A-6	607.00	ET-8173-LM1A-6	742.00
225	ET-8144-LM1A-6	607.00	ET-8174-LM1A-6	742.00
250	ET-8145-LM1A-6	607.00	ET-8175-LM1A-6	742.00
275	ET-8146-LM1A-6	607.00	ET-8176-LM1A-6	742.00
300	ET-8147-LM1A-6	607.00	ET-8177-LM1A-6	742.00
350	ET-8148-LM1A-6	607.00	ET-8178-LM1A-6	742.00
400	ET-8149-LM1A-6	607.00	ET-8179-LM1A-6	742.00
500	ET-8151-LM1A-6	607.00	ET-8180-LM1A-6	742.00
600	ET-8153-LM1A-6	607.00	ET-8181-LM1A-6	742.00
700	ET-8155-LM1A-6	770.00	ET-8183-LM1A-6	742.00
800	ET-8156-LM1A-8	770.00	ET-8185-LM1A-8	957.00
*800	ETS-8157-LM1A-8	501.00	ETS-8187-LM1A-8	604.00

Insulated Groundable Neutral (Shipped as Separate Assembly)

Amp.	No.	Each	Amp.	No.	Each
50	ET-0780	\$ 7.10	400	ET-0778	\$18.00
100	ET-0782	10.70	600	ET-0783	18.40
225	ET-0781	15.40	800	ET-0790	21.60

*Non-Automatic Circuit Interrupter.

Hope Current Limiting Type Enclosed Circuit Breakers

Weatherproof and Explosion Resisting

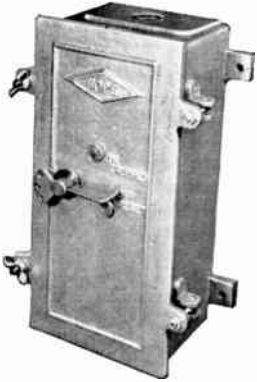

Weatherproof-Raintight Class III—NEMA III, IV, V



Explosion Resisting Class I, Group D—NEMA VII Class II, E, F, G—NEMA IX

Molded case air circuit breakers of high interrupting capacity that provide a practical, economic answer to low voltage distribution problems, are now available in the "Cordon" type. They combine the design and operating features of molded case circuit breakers and current limiting Amp-Traps in one compact unit to afford fault protection up to 100,000 rms amperes. Low magnitude fault conditions are cleared through the breaker without affecting the Amp-Traps. At higher magnitudes, the Amp-Traps assume the fault clearing duty in less than 1/2 cycle, limiting the short circuit current to a fraction of peak available value. Bus supporting members or current carrying parts need not be designed to withstand maximum peak currents.

Enclosures are fabricated of close-grained cast iron and finished in enduring hot dip galvanize. Wiring spaces exceed requirements and gutters will accommodate seven wires. To afford high strength and corrosion resistance, hinges on covers and breaker actuating mechanism are of manganese or silicon bronze. Handle and shaft are of one-piece construction; eccentric, adjustable stops on covers prevent overthrow of handle.

Boxes are additionally bossed in back and sides for tappings other than "standard" locations.

NEMA III, IV, V apparatus enclosures are equipped with raintight neoprene gaskets.

NEMA VII and NEMA IX enclosures are precision machined to exceed the requirements of the Underwriters' Laboratories, Inc. for flame- or dust-tight closure between bolt-on cover and flange of box.

Three Pole 600 Volts AC

Frame and Type	Trip Amps.	Weatherproof (Raintight) Dusttight NEMA III, IV, V		Explosion Resisting Class I, Group D NEMA VII		Explosion Resisting Class II, Groups E, F, G NEMA IX		Standard Conduit Tappings Centered Top and Bottom Inches
		No.	Each	No.	Each	No.	Each	
CF 100 A.	15	WCF15-3	\$364.00	XCF15-3	\$385.00	DCF15-3	\$385.00	1 1/4
	20	WCF20-3	364.00	XCF20-3	385.00	DCF20-3	385.00	1 1/4
	30	WCF30-3	364.00	XCF30-3	385.00	DCF30-3	385.00	1 1/4
	40	WCF40-3	364.00	XCF40-3	385.00	DCF40-3	385.00	1 1/4
	50	WCF50-3	364.00	XCF50-3	385.00	DCF50-3	385.00	1 1/4
	70	WCF70-3	364.00	XCF70-3	385.00	DCF70-3	385.00	1 1/4
	90	WCF90-3	364.00	XCF90-3	385.00	DCF90-3	385.00	2
	*100	WCF100-3	364.00	XCF100-3	385.00	DCF100-3	385.00	2
	CK 225 A.	70	WCK70-3	661.00	XCK70-3	707.00	DCK70-3	707.00
90		WCK90-3	661.00	XCK90-3	707.00	DCK90-3	707.00	2 1/2
100		WCK100-3	661.00	XCK100-3	707.00	DCK100-3	707.00	2 1/2
125		WCK125-3	661.00	XCK125-3	707.00	DCK125-3	707.00	2 1/2
150		WCK150-3	661.00	XCK150-3	707.00	DCK150-3	707.00	2 1/2
175		WCK175-3	661.00	XCK175-3	707.00	DCK175-3	707.00	2 1/2
200		WCK200-3	661.00	XCK200-3	707.00	DCK200-3	707.00	2 1/2
*225		WCK225-3	661.00	XCK225-3	707.00	DCK225-3	707.00	2 1/2
CKL 400 A.		125	WCKL125-3	1093.00	XCKL125-3	1189.00	DCKL125-3	1189.00
	150	WCKL150-3	1093.00	XCKL150-3	1189.00	DCKL150-3	1189.00	3
	175	WCKL175-3	1093.00	XCKL175-3	1189.00	DCKL175-3	1189.00	3
	200	WCKL200-3	1093.00	XCKL200-3	1189.00	DCKL200-3	1189.00	3
	225	WCKL225-3	1093.00	XCKL225-3	1189.00	DCKL225-3	1189.00	3
	250	WCKL250-3	1093.00	XCKL250-3	1189.00	DCKL250-3	1189.00	3
	275	WCKL275-3	1093.00	XCKL275-3	1189.00	DCKL275-3	1189.00	3
	300	WCKL300-3	1093.00	XCKL300-3	1189.00	DCKL300-3	1189.00	3
	*400	WCKL400-3	1093.00	XCKL400-3	1189.00	DCKL400-3	1189.00	3
CL 600 A.	125	WCL125-3	1554.00	XCL125-3	1800.00	DCL125-3	1800.00	4
	150	WCL150-3	1554.00	XCL150-3	1800.00	DCL150-3	1800.00	4
	175	WCL175-3	1554.00	XCL175-3	1800.00	DCL175-3	1800.00	4
	200	WCL200-3	1554.00	XCL200-3	1800.00	DCL200-3	1800.00	4
	225	WCL225-3	1554.00	XCL225-3	1800.00	DCL225-3	1800.00	4
	250	WCL250-3	1554.00	XCL250-3	1800.00	DCL250-3	1800.00	4
	275	WCL275-3	1554.00	XCL275-3	1800.00	DCL275-3	1800.00	4
	300	WCL300-3	1554.00	XCL300-3	1800.00	DCL300-3	1800.00	4
	350	WCL350-3	1554.00	XCL350-3	1800.00	DCL350-3	1800.00	4
	400	WCL400-3	1554.00	XCL400-3	1800.00	DCL400-3	1800.00	4
	500	WCL500-3	1554.00	XCL500-3	1800.00	DCL500-3	1800.00	4
	*600	WCL600-3	1554.00	XCL600-3	1800.00	DCL600-3	1800.00	4

Note: Prices include installed Amp-Traps.

*Non-automatic circuit interrupters available without circuit breaker trip unit for use as disconnect switch under high current conditions.

Insulated Groundable Neutral, Installed (240 v. A-C Max.)

15-50 amp. GSN50 . . . Ea. \$10.50	225-440 amp. GSN400 . . . Ea. \$26.00
30-100 amp. GSN100 . . . Ea. 16.00	400-600 amp. GSN600 . . . Ea. 26.00
100-225 amp. GSN225 . . . Ea. 21.00	600-800 amp. GSN800 . . . Ea. 30.00

Special Tappings in Non-Standard Positions

Conduit Size 1 1/4-in. and below Ea. \$ 5.40
Conduit Size 1 1/2 to 3-in. Ea. 11.00
Conduit Sizes 3 1/2 and 4-in. Ea. 16.00

G-E Circuit Breakers

E-Frame 100 Amperes Type TE 15 to 100 Amperes



1, 2, and 3 Pole

Voltage Ratings: single pole—125 a-c or d-c, two and three pole—240 a-c and 125/250 d-c.

Interrupting Rating: 7500 amps. a-c, 500 amps d-c.

Circuit breaker has the following features: Thermal-magnetic trip; Quick-make and Quick-break; Tamperproof; Trip Free and Trip Indicating and Straight-in wiring.

For use in panelboards or in individual enclosures for the protection of a-c or d-c lighting branch circuits and for power circuits.

Single Pole

Single-Pole 125 V A-C or D-C				2-Pole 240 V A-C—125/250 V D-C			
Ampere Rating	Catalog Number	Approx. Ship. Wt. Lbs.	Each	Catalog Number	Approx. Ship. Wt. Lbs.	Each	
15	TE11015	2	\$11.10	TE22015	3	\$28.00	
15	φTE131.015	2	14.30				
20	TE11020	2	11.10	TE22020	3	28.00	
20	φTE131.020	2	14.30				
30	TE11030	2	11.10	TE22030	3	28.00	
40	TE11040	2	11.10	TE22040	3	28.00	
50	TE11050	2	11.10	TE22050	3	28.00	
70	φ*TE16Y070	2	11.10	φ*TE26Y070	3	28.00	
70	TE11070	2	22.60	TE22070	3	46.00	
90	TE11090	2	22.60	TE22090	3	46.00	
100	TE11100	2	22.60	TE22100	3	46.00	
100	*TE11Y100	2	11.10	*TE22Y100	3	28.00	
100	φ*TE16Y100	2	22.60	φ*TE26Y100	3	46.00	

3-Pole 240 Volts A-C

15	TE32015	4	\$41.00
20	TE32020	4	41.00
30	TE32030	4	41.00
40	TE32040	4	41.00
50	TE32050	4	41.00
70	φ*TE36Y070	4	41.00
70	TE32070	4	60.00
90	TE32090	4	60.00
100	TE32100	4	60.00
100	*TE32Y100	4	41.00
100	φ*TE36Y100	4	60.00

*Circuit interrupters (Non-automatic breakers) are for use as a manual disconnecting device, in place of a fusible safety switch. Overload or short-circuit protection is not provided.

φNot listed with Underwriters' Laboratories, Inc., 600 V—Non-automatic Circuit Interrupter.

†Rated at 277 V - A-C, 125 V - D-C. Interrupting rating—10,000 amp.—complies with Class D-1 breakers as defined in Federal Government Specs. W-P 131a Amendment 2, 4/13/51.

Studs and Handi-lugs for Back Connection of Breakers

Breaker Ampere Rating	Cat. No.	Studs		Handi-Lugs			
		Length Back of Breaker In.	Each	Lug Wire Size	Cat. No.	Use Wrench No.	Each
15-50	TE1	3 ⁷ / ₁₆	\$1.90	14-4	TS1232	0	\$1.00
*70-100	TE2	3 ⁷ / ₁₆	4.00	4-1/0	TS1234	1	2.00
*70-100	TE3	4 ¹ / ₁₆	4.40	4-1/0	TS1234	1	2.00

*When assembling studs to panel or breaker a short and long stud must be assembled adjacent to each other in order to maintain Underwriters' clearances between poles on 250-volt circuits.

F-Frame 100 Ampere Type TF 600 V A-C, 250 V D-C

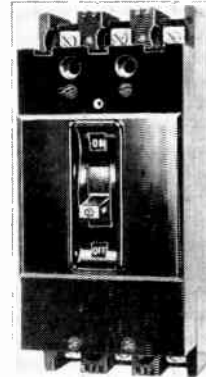

Volts	Interrupting Rating: Amp.
600 A-C	15,000
180 A-C	15,000
240 A-C	20,000
250 D-C	10,000

Feature thermal and independent magnetic trip. Quick-make and quick-break. Tamperproof. Trip free and trip indicating.

Ordering Directions:

Order by catalog number. The following basic requirements should be known and checked when selecting catalog number from table.

1. Rating—Amperes & Voltage.
2. Number of Poles.

2-Pole, 600 V AC, 250 V DC 3-Pole, 600 V AC

Ampere Rating	Catalog Number	Approx. Ship. Wt. Lb.	Each	Catalog Number	Approx. Ship. Wt. Lb.	Each
15	TF126015	6	\$60.00	TF136015	8	\$77.00
20	TF126020	6	60.00	TF136020	8	77.00
30	TF126030	6	60.00	TF136030	8	77.00
40	TF126040	6	60.00	TF136040	8	77.00
50	TF126050	6	60.00	TF136050	8	77.00
70	TF126070	6	76.00	TF136070	8	93.00
90	TF126090	6	76.00	TF136090	8	93.00
100	TF126100	6	76.00	TF136100	8	93.00
100	*TF126Y100	6	60.00	*TF136Y100	8	77.00

*Circuit interrupters (non-automatic breakers) for use as manual disconnecting device, in place of non-fusible safety switch. Overload or short circuit protection not provided.

Studs and Handi-Lugs For Back Connection of Breakers

Breaker Ampere Rating	Length Back of Breaker, In.	Studs		Handi-Lugs			
		Catalog Number	Each	Lug Wire Size	Catalog Number	Use Wrench Number	Each
*15-50	**1	TF0	\$3.60	14-4	TS1232	0	\$1.10
*15-50	**1	TF1	3.70	14-4	TS1232	0	1.10
*70-100	3 ³ / ₄	TF2	3.80	4-1/0	TS1234	1	2.00
*70-100	5 ³ / ₄	TF3	4.00	4-1/0	TS1234	1	2.00

*When assembling studs to panel or breaker a short and long stud must be assembled adjacent to each other in order to maintain proper clearance between poles on either 250- or 600-volt circuits.

**Provided with short and long insulating tubes respectively.

Type R Single-Pole



Available for standard duty applications in ratings from 15 to 50 amperes, 120 volts a-c. When two Type R breakers are used with handle ties for 2-pole applications, they are rated 120/240 volts a-c, 2-wire. Interrupting rating is 5000 amperes a-c. A thermal-magnetic trip element provides overload and short circuit protection for lighting and appliance circuits. Listed by Underwriters' Laboratories Inc.

Order by catalog number. The following basic requirements should be known and checked when selecting catalog numbers from table: (1) Rating—amperes and voltage; (2) Number of poles. For 2-pole operation, order handle extension, catalog number TH1-102. No charge if ordered with breakers.

No.	Amp. Rating	Each	Std. Pkg.	Approx. Ship. Wt. Each in Lbs.
TRP1115	15	\$3.10	20	0.3
TRP1120	20	3.10	20	.3
TRP1130	30	3.10	20	.3
TRP1140	40	3.10	20	.3
TRP1150	50	3.10	20	.3

G-E Circuit Breakers

Type TR "Twin"*

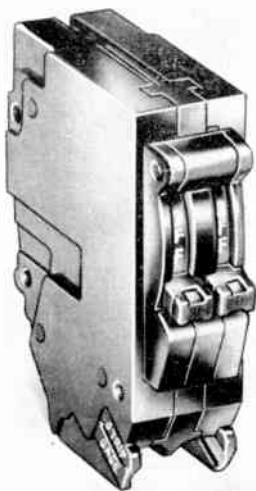

Available for standard duty application in ratings of 15 and 20 amperes, 120 v. a-c and 120/240 volts a-c, two-wire, and is suitable for use in protecting a-c lighting and appliance branch circuits.

Handle ties are available for combining one pole from each of two adjacent breakers for two-pole operation.

Rejection pins may be used in load centers at "twin" breaker positions to prevent over protecting wire with higher rated breakers at a later date.

No.	Amp. Rating		Each
	Left	Right	
TRP1515	15	15	\$6.20
TRP2015	20	15	6.20
TRP2020	20	20	6.20

*Trade-mark of General Electric Co.

Type TQL Two-Pole



Designed to meet standard duty 120/240 v. a-c lighting and appliance circuit requirements. Thermal and independent magnetic trip elements provide automatic short circuit and overload protection. If one pole trips, the common trip action will cause the other pole to trip, thereby completely disconnecting the circuit.

Available in rating from 10 to 70 amps., 120/240 v. a-c. Interrupting rating 5000 amps. a-c.

No.	Amp. Rating	Each
TQL2110	10	\$6.90
TQL2115	15	6.90
TQL2120	20	6.90
TQL2130	30	6.90
TQL2140	40	6.90
TQL2150	50	6.90
TQL2170	70	13.00

Type TQL 2-pole switching neutral breaker is designed for use in gasoline station dispensing pump circuits. It provides circuit protection in compliance with NEC Article 510, Section 5120e.

One pole, with line and load terminals, contains thermal and independent magnet trip elements for automatic short circuit and overload protection. The other pole provides an isolated terminal for connecting the incoming neutral wire to a nonautomatic switching mechanism. A wired-in lead completes the neutral circuit to the load center neutral assembly.

Available in ratings of 15 and 20 amperes, 120 volts a.c. Interrupting rating: 5000 amperes a.c.

No.	Amp. Rating	Each
TQL21WY15	15	\$9.10
TQL21WY20	20	9.10

Above circuit breakers are listed by Underwriters' Laboratories, Inc. (except TQL2170).

Standard packaging quantity—10. Approx. Ship. Wt.—6 lbs.

Accessories For Circuit Breakers

No.	Description	Std. Pkg.	Each
TRT-100	Handle tie for adjacent Type TR "twin" breakers	20	\$0.10
THT-102	Handle tie for two adjacent Type R breakers	20	.40

Note: No charge when ordered with appropriate circuit breakers.

G-E Circuit Breaker Enclosures



General Purpose, Semi-dust-tight, NEMA Type 1A.

General Purpose NEMA Type 1, surface or flush mounting, grounded solid neutral.

Boxes and covers are Bondrite* treated to resist corrosion.

Die-cast aluminum operating handles on front provide extra ease of operation.

Handles can be padlocked in ON or OFF position.

For complete information on molded case circuit breakers in NEMA type 4 & 5 enclosures, consult Graybar.

NEMA Type 1A, General Purpose, Semi-dust-tight Enclosures

Surface	Catalog Number (Enclosure Only)		Circuit Breaker Frame Size	Cont. Current Rating Amp.	No. of Poles	Maximum Circuit Voltage		Each
	Flush	Surface				A-C	D-C	
TE100G	E	15-100	1/2/3	240†	125/250	\$17.00
TF100G	F	15-100	2/3	600	250	22.60
TJ225G	J	70-225	2/3	600	250	35.00
TK225G	K	70-225	2/3	600	250	46.00
TKM100G	KM	125-100	2/3	600	250	78.00
TL600G	KM,L	125-600	2/3	600	250	106.00

NEMA Type 1, General Purposes Enclosure with Grounded Solid Neutral‡

TE100NS	TE100NF	E	15-100	1/2/3	240†	125/250	\$24.10
TF100NS	TF100NF	F	15-100	2/3	600	250	33.00
TJ225NS	TJ225NF	J	70-225	2/3	600	250	50.00
TK225NS	TK225NF	K	70-225	2/3	600	250	61.00
TKM400NS	TKM400NF	L	125-100	2/3	600	250	124.00
TL600NS	TL600NF	KM,L	125-600	2/3	600	250	124.00

Dimensions and Weights for Surface or Flush Mounted Breaker Enclosures

Type	Approximate Dimensions in Inches of Box with Cover			Approx. Shipping Weight Lbs.
	Height	Width	Depth	
TE	13 1/4	7 1/4	4 7/8	10
TF	16 1/4	8 1/2	5 1/2	12
TJ	18 7/8	12 1/2	6 1/4	23
TK	26	12 1/2	6 5/8	33
TKM	28 1/8	15 7/8	8 5/8	46
TL	39 1/2	16	8 1/2	99

Note: Flush cover is approx. 9/16-in. larger all around.

*Parker Rust Proof Company.

†Single-pole rated 120 v, a-c, 125 v, d-c.

‡Insulated groundable neutrals may be ordered for these enclosures, contact Graybar for complete information.

Note: Order general purpose enclosures by complete catalog number.

Molded case circuit breakers for these enclosures are listed separately. Order circuit breakers by complete catalog number.

Square D Fusible Service Equipment

With Plug-In Construction



FSP230
FSP260
30 Amp. or
60 Amp.
Cartridge Fuse
Pullout

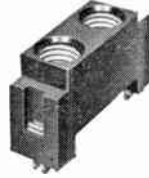

FSP130
30 Amp. Twin
Plug Fuse
Section

New fusible service equipment with plug-in construction is the answer to today's increasing residential loads. Devices are available with either 100 ampere or 200 ampere main pullouts feeding busses which will take plug-in fusible branches — plug fuses or 30 and 60 ampere pullouts.

Select the number and rating of the necessary branches and plug them into the exact combination needed for each job. Two twin plug fuse sections (4 plugs) occupy the same space as a single 30 or 60 ampere pullout.

120/240 volt a-c, single phase, 3 wire systems. U/L approved — File E23600.



FSP28M

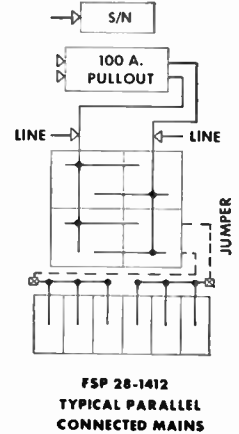
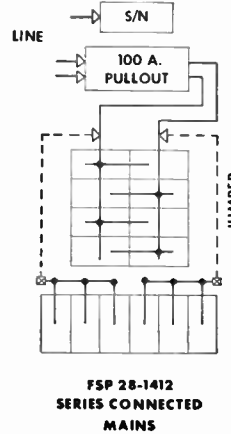
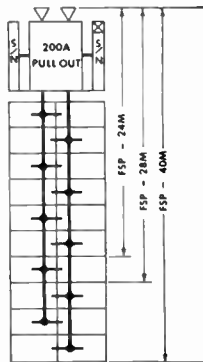

Device and Cover

(Order Plug-In Section Separately)

Mains	Rating	Max. Branch Space		No.	List	Surface	Cover and Door Order Separately		List
		120/240 Volts Pullout	120 Volts Plugs				Flush	Flush Dry Wall	
200 Amp. Service									
1	1-200A	0	40	FSP40M	\$89.00	FSC40MS	FSC40MF	FSC40MTF	\$10.00
1	1-200A	0	28	FSP28M	81.80	FSC28MS	FSC28MF	FSC28MTF	10.00
1	1-200A	0	24	FSP24M	79.40	FSC28MS	FSC28MF	FSC28MTF	10.00
150 Amp. Service									
5	1-100A 4-30/60A	1 0	8 12	FSP28-1412A	45.80	FSC28-1412S	FSC28-1412F	FSC28-1412TF	5.00
100 Amp. Service									
1	1-100A	2	20	FSP28-1412	40.80	FSC28-1412S	FSC28-1412F	FSC28-1412TF	5.00
5	1-100A 4-30/60A	1 0	8 12						

Maximum branch space column tabulates maximum pullouts with maximum plug combinations. Any intrinsic combinations available by substituting pullouts for each 4 plug branches. Plug branches may vary in steps of two and pullouts in steps of one.

Plug-In Fuse Sections

No.	Description	Order Separately	Std. Pkg.	List
FSP130	Twin — 30 ampere plug fuse unit		10	\$5.00
FSP230	One — 30 ampere cartridge pullout unit		5	5.50
FSP260	One — 60 ampere cartridge pullout unit		5	5.50

Dimensions

Pullout Sections occupy same space as two twin plug fuse sections.



Device	Hgt., In.	Wdth., In.	Depth, In.	Std. Pkg.
FSP40M	40	14	4 1/8	1
FSP28M	35 1/2	14	4 1/8	1
FSP24M	35 1/2	14	4 1/8	1
FSP28-1412 and A	26 1/8	14	4 1/8	1

Square D Fusible Service Equipment Fusible Pullout Equipment

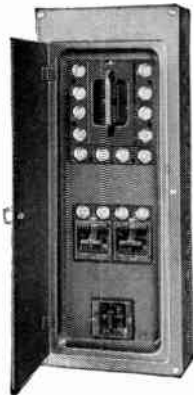

No. 31693S

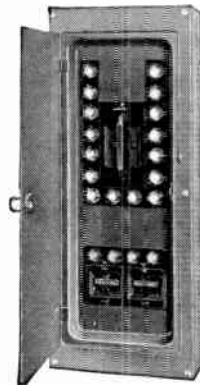

No. 32053S

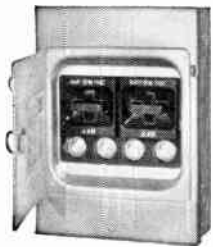

No. 33582

Fusible service entrance equipment with pullout type switches and plug fuse branches.

120 volt and 120/240 volt a-c single phase, 3 wire systems.

U/L approved—File E10582.

Raintight Type

(Order Hub Separately)

Raintight No.*	Max. Hub Size, In.	Mains No.	Mains Rating	Branches		List Each
				120/240 Volt Pullouts	120 Volt Plugs	
60 Ampere Service—Series Connected (Single Main 60 Ampere Pullout)						
39512RO	1 1/4	1	1-60A	4	\$18.30 [†]
39712RO	1 1/4	1	1-60A	6	24.90 [†]
39912RO	1 1/4	1	1-60A	8	41.00 [†]
31002RO	1 1/4	1	1-60A	10	44.00 [†]
31202RO	1 1/4	1	1-60A	12	48.00 [†]
33582RO	1 1/4	1	1-60A	1-60A	4	24.90 [†]
33582R	None	1	1-60A	1-60A	..	24.90 [†]
33782RO	1 1/4	1	1-60A	1-60A	6	41.00 [†]
33982RO	1 1/4	1	1-60A	1-60A	8	45.00 [†]

100 Ampere Service—Series Connected (Single Main 100 Amp. Pullout)

31253RO	2	1	1-100A	1-60, 1-30	12	\$84.10 [†]
31653RO	2	1	1-100A	1-60, 1-30	16	96.50 [†]
32053RO	2	1	1-100A	1-60, 1-30	20	113.30 [†]
*31693RO	2	1	1-100A	1-60, 2-30	16	108.80 [†]

100 Ampere Service—Parallel Connected Main Pullouts (6 Circuit Sub-Division Rule)

30023PRO	2	2	2-60A	0	0	\$24.90 [†]
33583PRO	2	2	2-60A	4	24.90 [†]
33783PRO	2	2	2-60A	6	41.00 [†]
33983PRO	2	2	2-60A	8	45.00 [†]
*30493PRO	2	2	2-60A	1-30A	4	40.90 [†]
*30693PRO	2	2	2-60A	1-30A	6	46.00 [†]
*30893PRO	2	2	2-60A	1-30A	8	48.50 [†]

*One pullout not wired. Can be sealed by adding barrier.

†Plug fuses fed by two 60 amp. pullouts.

*Type RO raintight device has threaded opening for interchangeable Hubs or Closing Cap.

Order size required separately.

General Purpose Type

Surface No.	Flush No.	Mains No.	Mains Rating	Branches		List Each
				120/240 Volt Pullouts	120 Volt Plugs	
60 Ampere Service—Series Connected						
39512	37522	1	1-60A	4	\$14.40
39712	37722	1	1-60A	6	19.60
39912	37922	1	1-60A	8	29.00
31002S	31002F	1	1-60A	10	43.00
31202S	31202F	1	1-60A	12	47.00
33582S	33582F	1	1-60A	1-60A	4	18.00
33782S	33782F	1	1-60A	1-60A	6	27.00
33982S	33982F	1	1-60A	1-60A	8	35.00
30462S	30462F	1	1-60A	1-60A, 1-30	4	31.00
30662S	30662F	1	1-60A	1-60A, 1-30	6	35.00
30862S	30862F	1	1-60A	1-60A, 1-30	8	43.00

70 Ampere Service—Parallel Connected Main Pullouts

33582PS	33582PF	2	2-60A	4	\$18.00
33782PS	33782PF	2	2-60A	6	27.00
33982PS	33982PF	2	2-60A	8	35.00

100 Ampere Service—Series Connected

30613S	30613F	1	1-100A	1-60A	6	\$45.50
30813S	30813F	1	1-100A	1-60A	8	51.70
31013S	31013F	1	1-100A	1-60A	10	57.90
31213S	31213F	1	1-100A	1-60A	12	64.10
30823S	30823F	1	1-100A	2-60A	8	59.60
31023S	31023F	1	1-100A	2-60A	10	65.80
31223S	31223F	1	1-100A	2-60A	12	72.00
31623S	31623F	1	1-100A	2-60A	16	84.40
32023S	32023F	1	1-100A	2-60A	20	96.80
30853S	30853F	1	1-100A	1-60, 1-30	8	59.60
31053S	31053F	1	1-100A	1-60, 1-30	10	65.80
31253S	31253F	1	1-100A	1-60, 1-30	12	72.00
31653S	31653F	1	1-100A	1-60, 1-30	16	84.40
32053S	32053F	1	1-100A	1-60, 1-30	20	96.80
*31693S	*31693F	1	1-100A	1-60, 2-30	16	92.30

100 Ampere Service—Parallel Connected Main Pullouts

33583PS	33583PF	2	2-60A	0	4	\$18.00
33783PS	33783PF	2	2-60A	0	6	27.00
33983PS	33983PF	2	2-60A	0	8	35.00
31023PS	31023PF	2	2-60A	0	10	43.00
31223PS	31223PF	2	2-60A	0	12	47.00
30433PS	30433PF	2	2-60A	1-60A	4	31.00
*30483PS	*30483PF	2	2-60A	1-60A	4	31.00
30633PS	30633PF	2	2-60A	1-60A	6	35.00
*30683PS	*30683PF	2	2-60A	1-60A	6	35.00
30833PS	30833PF	2	2-60A	1-60A	8	43.00
*30883PS	*30883PF	2	2-60A	1-60A	8	43.00
30463PS	30463PF	2	2-60A	1-30A	4	31.00
*30493PS	*30493PF	2	2-60A	1-30A	4	31.00
30663PS	30663PF	2	2-60A	1-30A	6	35.00
*30693PS	*30693PF	2	2-60A	1-30A	6	35.00
30863PS	30863PF	2	2-60A	1-30A	8	43.00
*30893PS	*30893PF	2	2-60A	1-30A	8	43.00
30853PS	30853PF	3	2-60, 1-30	8	43.00
30843PS	30843PF	4	2-60, 2-30	8	51.00
31243PS	31243PF	4	2-60, 2-30	12	65.00
†31643PS	†31643PF	4	3-60, 1-30	16	81.20
†32043PS	†32043PF	4	3-60, 1-30	20	93.60
*31293-PWHIS	*31293-PWHIF	6	2-60, 4-30	12	80.70

Square D Fusible Service Equipment Pullout Disconnects

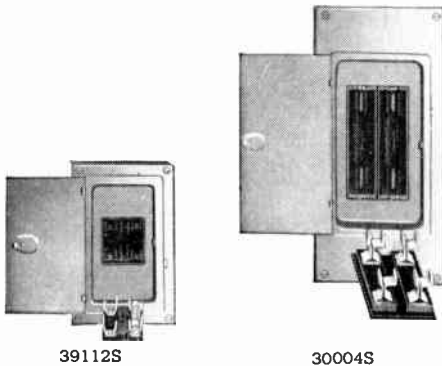

39112S
120/240 volts a-c, insulated ground-able neutral. No branch circuits.

30004S

General Purpose Type

Surface No.	Flush No.	Mains		Rating	List Each
		System			
39112	37122	1 Ph. 3 W.		60	\$12.00
39113S	39113F	1 Ph. 3 W.		100	30.00
30004S	30004F	1 Ph. 3 W.		200	65.00

Raintight Type

(Order Hubs Separately)

No.	Max. Hub, In.	Mains		Rating	List Each
		System			
39112RO	1 1/4	1 Ph. 3 W.		60	\$13.10
39113RO	2	1 Ph. 3 W.		100	35.00
30004RO	2 1/2	1 Ph. 3 W.		200	88.00

Not-Fusible Main Switches

Toggle Type, 120/240 Volts, A-C. One Phase, 3 Wire Grounded Neutral.

General Purpose Type

Surface No.	Flush No.	Mains		Branches 120 V. Plugs	List Each
		No.	Rating		
32481	32471	1	30 A.	4	\$14.40
32681	32671	1	30 A.	6	18.30
32482	32472	1	60 A.	4	14.40
32682	32672	1	60 A.	6	18.30

Raintight Type

No.	Max. Hub, In.	Mains		Branches 120 V. Plugs	List Each
		No.	Rating		
32481RO	1 1/4	1	30 A.	4	\$18.30
32681RO	1 1/4	1	30 A.	6	22.20
32482RO	1 1/4	1	60 A.	4	18.30
32682RO	1 1/4	1	60 A.	6	22.20

Fuse Cabinets

For outside dimensions of Flush front, add approximately 1/4 in. to height and width of box.

Fronts: Spring door catch.

Mains: 120/240 Volts a-c or d-c.

Finish: Blue-gray enamel. Conduit endwalls.

Branches: Single pole, no switch, 30 ampere 120 volts.



37421
Type NSP

No. Branches	Amp.	Lug Mains		Wgt. Lbs.	Hgt. In.	Box Dimensions (Inside)			1 Phase-3 Wire		
		Amp.	Size			Width In.	Depth In.	Flush In.	Surface No.	List Price	
2	30	8-14	6	6 5/8	6 5/8	2 3/4	37221	39221	\$5.70		
4	30	8-14	6	6 5/8	6 5/8	2 3/4	37421	39411	7.80		
6	45	6-10	11	11 1/8	7 3/8	3 1/8	37621	39611	13.10		
8	60	4-10	12	12 7/8	7 3/8	3 1/8	37821	39811	17.70		
10	60	4-10	15	15 5/8	8 5/8	3 1/8	37021	39011	26.00		
12	60	4-10	17	16 7/8	8 5/8	3 1/8	37121	39111	34.00		

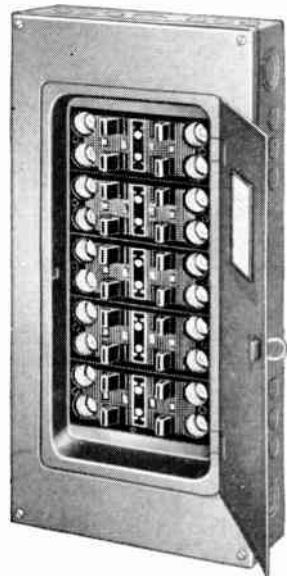

Type NTPS-20-3L

Fusible Load Centers

Mains: 120/240 Volts A-C only.

Branches: Single Pole Switch, 30 Ampere 120 Volts.

Side gutters 1 7/8 in., end gutters 2-in. on 4, 8 and 12 circuits; 3-in. on 16 and 20 circuits. Box dimensions: 12-in. wide, 4-in. deep.

Blue-gray fronts; boxes galvanized steel. Spring door catch fronts.

When ordering add suffix letter "S" or "F" to catalog number to indicate surface or flush mounting.

1 Phase 3 Wire A-C Only			3 Phase 4 Wire A-C Only			No. Branches	Lugs Mains Amp.	Size	Wgt. Lbs.	Hgt. In.
No.	List Price		No.	List Price						
NTPS04-3L	\$19.00		NTPS08-4L	\$42.00		4	30	1-14	30	10
NTPS08-3L	29.00		NTPS12-4L	62.00		8	60	1-14	33	12 1/2
NTPS12-3L	56.00		NTPS16-4L	91.00		12	60	1-10	37	16
NTPS16-3L	84.00		NTPS20-4L	131.00		16	100	1-10	41	21
NTPS20-3L	118.00					20	100	1-10	44	24

Buss Super-Lag Renewable Fuses and Renewal Links



Save time and money by decreasing out-of-service losses. Buss Super-Lag Renewable fuses and renewal links will reduce the number of shutdowns caused by needless blows. Patent fuse-case and Super-Lag link make this possible.



Super-Lag design gives Buss Links a long time-lag that reduces number of blows on starting currents or other harmless overloads.

Links are made in one piece in all sizes. This makes renewal handy and prevents possibility of poor contact.

For convenience and to prevent dust, moisture or oxidation from affecting them, links are packed in sealed boxes, each holding a small quantity.

BUSS Super-Lag links are interchangeable with all makes of standard fuse links.

For complete information contact Graybar.

250 Volts

Complete Fuses				Renewal Links				
Symbol and Amperes	Lgth. In.	No. in Ctn.	Wt. Lbs. Per 100	Each	Symbol and Amperes	No. in Ctn.	Wt. Lbs. Per 100	Each
REN3	2	10	5.5	\$.60	LKN3	20	.25	\$0.07
REN6	2	10	5.5	.557	LKN6	20	.25	.028
REN10	2	10	5.5	.557	LKN10	20	.25	.028
REN15	2	10	5.5	.557	LKN15	20	.25	.028
REN20	2	10	5.5	.557	LKN20	20	.25	.028
REN25	2	10	5.5	.557	LKN25	20	.25	.028
REN30	2	10	5.5	.557	LKN30	20	.25	.028
REN35	3	10	11	1.11	LKN35	20	1	.056
REN40	3	10	11	1.11	LKN40	20	1	.056
REN45	3	10	11	1.11	LKN45	20	1	.056
REN50	3	10	11	1.11	LKN50	20	1	.056
REN60	3	10	11	1.11	LKN60	20	1	.056
REN70	5 7/8	5	16	2.49	LKN70	10	2	.125
REN80	5 7/8	5	16	2.49	LKN80	10	2	.125
REN90	5 7/8	5	16	2.49	LKN90	10	2	.125
REN100	5 7/8	5	16	2.49	LKN100	10	2	.125
REN110	7 1/8	1	109	5.57	LKN110	5	5	.279
REN125	7 1/8	1	109	5.57	LKN125	5	5	.279
REN150	7 1/8	1	109	5.57	LKN150	5	5	.279
REN175	7 1/8	1	109	5.57	LKN175	5	5	.279
REN200	7 1/8	1	109	5.57	LKN200	5	5	.279
REN225	8 5/8	1	266	10.02	LKN225	5	11	.501
REN250	8 5/8	1	266	10.02	LKN250	5	11	.501
REN300	8 5/8	1	266	10.02	LKN300	5	11	.501
REN350	8 5/8	1	266	10.02	LKN350	5	11	.501
REN400	8 5/8	1	266	10.02	LKN400	5	11	.501
REN450	10 3/8	1	389	15.31	LKN450	2	16	.763
REN500	10 3/8	1	389	15.31	LKN500	2	16	.763
REN600	10 3/8	1	389	15.31	LKN600	2	16	.763

600 Volts

RES3	5	10	18	\$1.48	LKS3	20	1	.153
RES6	5	10	18	1.39	LKS6	20	1	.07
RES10	5	10	18	1.39	LKS10	20	1	.07
RES15	5	10	18	1.39	LKS15	20	1	.07
RES20	5	10	18	1.39	LKS20	20	1	.07
RES25	5	10	18	1.39	LKS25	20	1	.07
RES30	5	10	18	1.39	LKS30	20	1	.07
RES35	5 1/2	10	36	2.23	LKS35	20	3	.111
RES40	5 1/2	10	36	2.23	LKS40	20	3	.111
RES45	5 1/2	10	36	2.23	LKS45	20	3	.111
RES50	5 1/2	10	36	2.23	LKS50	20	3	.111
RES60	5 1/2	10	36	2.23	LKS60	20	3	.111

Buss Super-Lag Renewable Fuses and Renewal Links

600 Volts

Complete Fuses					Renewal Links				
Symbol and Amperes	Lgth. In.	No. in Ctn.	Wt. Lbs. Per 100	Each	Symbol and Amperes	No. in Ctn.	Wt. Lbs. Per 100	Each	
RES70	7 7/8	5	83	\$ 5.01	LKS70	10	5	\$0.25	
RES80	7 7/8	5	83	5.01	LKS80	10	5	.25	
RES90	7 7/8	5	83	5.01	LKS90	10	5	.25	
RES100	7 7/8	5	83	5.01	LKS100	10	5	.25	
RES110	9 5/8	1	183	9.74	LKS110	5	14	.488	
RES125	9 5/8	1	183	9.74	LKS125	5	14	.488	
RES150	9 5/8	1	183	9.74	LKS150	5	14	.488	
RES175	9 5/8	1	183	9.74	LKS175	5	14	.488	
RES200	9 5/8	1	183	9.74	LKS200	5	14	.488	
RES225	11 5/8	1	373	19.48	LKS225	5	29	.975	
RES250	11 5/8	1	373	19.48	LKS250	5	29	.975	
RES300	11 5/8	1	373	19.48	LKS300	5	29	.975	
RES350	11 5/8	1	373	19.48	LKS350	5	29	.975	
RES400	11 5/8	1	373	19.48	LKS400	5	29	.975	
RES450	13 3/8	1	573	27.83	LKS450	2	37	1.39	
RES500	13 3/8	1	573	27.83	LKS500	2	37	1.39	
RES600	13 3/8	1	573	27.83	LKS600	2	37	1.39	

Buss One-Time Fuses Non-Renewable

Listed as standard by Underwriters' Laboratories, Inc.

Buss fuses give dependable protection, and can be trusted to operate as intended—no needless blows because of poor workmanship or inferior materials. Buss fuses are known and recognized everywhere for high quality.



70 to 600 Amperes

Carton quantities: 10 in 1-60 amp. sizes; 5 in 70-100 amp. sizes; one in 110-600 amp. sizes.

250 Volts

600 Volts

Ferrule Contact—1 to 60 Amperes

Symbol and Amperes	Lgth. In.	Wt. Lbs. Per 100	Each	Symbol and Amperes	Lgth. In.	Wt. Lbs. Per 100	Each
NON1	2	3.8	\$0.11	NOS1	5	11.5	\$0.587
NON3	2	3.8	.11	NOS3	5	11.5	.587
NON6	2	3.8	.11	NOS6	5	11.5	.587
NON10	2	3.8	.11	NOS10	5	11.5	.587
NON15	2	3.8	.11	NOS15	5	11.5	.587
NON20	2	3.8	.11	NOS20	5	11.5	.587
NON25	2	3.8	.11	NOS25	5	11.5	.587
NON30	2	3.8	.11	NOS30	5	11.5	.587
NON35	3	10.0	.22	NOS35	5 1/2	26.0	.88
NON40	3	10.0	.22	NOS40	5 1/2	26.0	.88
NON45	3	10.0	.22	NOS45	5 1/2	26.0	.88
NON50	3	10.0	.22	NOS50	5 1/2	26.0	.88
NON60	3	10.0	.22	NOS60	5 1/2	26.0	.88

Knife Blade Contact—70 to 600 Amperes

NON70	5 7/8	32	\$0.98	NOS70	7 7/8	56	\$1.96
NON80	5 7/8	32	.98	NOS80	7 7/8	56	1.96
NON90	5 7/8	32	.98	NOS90	7 7/8	56	1.96
NON100	5 7/8	32	.98	NOS100	7 7/8	56	1.96
NON110	7 1/8	79	2.18	NOS110	9 5/8	124	3.82
NON125	7 1/8	79	2.18	NOS125	9 5/8	124	3.82
NON150	7 1/8	79	2.18	NOS150	9 5/8	124	3.82
NON175	7 1/8	79	2.18	NOS175	9 5/8	124	3.82
NON200	7 1/8	79	2.18	NOS200	9 5/8	124	3.82
NON225	8 5/8	165	3.95	NOS225	11 5/8	303	7.66
NON250	8 5/8	165	3.95	NOS250	11 5/8	303	7.66
NON300	8 5/8	165	3.95	NOS300	11 5/8	303	7.66
NON350	8 5/8	165	3.95	NOS350	11 5/8	303	7.66
NON400	8 5/8	165	3.95	NOS400	11 5/8	303	7.66
NON450	10 3/8	276	6.03	NOS450	13 3/8	463	10.97
NON500	10 3/8	276	6.03	NOS500	13 3/8	463	10.97
NON600	10 3/8	276	6.03	NOS600	13 3/8	463	10.97

Sizes from 1 to 600 not listed, in any quantity, take larger quantity price on next larger amperage, plus a set-up charge of \$2.50 on each size or type on each shipment.

Buss Fusetron Dual-Element Fuses
250 and 600 Volts



0 to 60 Amperes



70 to 600 Amperes

Fits ordinary fuse holders. A Fusetron fuse has both a fuse link element and a thermal cut-out element. Has long time lag and less electrical resistance.

For all types of circuits or feeders. Long time-lag prevents blowing on starting currents or other harmless overloads, yet they protect against short-circuit with speed of a fuse.

On normal installations, a size about 100 to 125% ampere rating of motor, installed in disconnect switch or branch circuit panel gives safe and dependable motor-running protection.

Carries Underwriters' Laboratories label and is approved for both motor-running and circuit protection.

250 Volts

600 Volts

Symbol and Amperes	Lgth. In.	Car-ton	Each	Symbol and Amperes	Lgth. In.	Car-ton	Each
FRN-1/10	2	10	\$ 0.33	FRS-1/10	5	10	\$ 0.83
FRN-15/100	2	10	.33	FRS-15/100	5	10	.83
FRN-2/10	2	10	.33	FRS-2/10	5	10	.83
FRN-3/10	2	10	.33	FRS-3/10	5	10	.83
FRN-4/10	2	10	.33	FRS-4/10	5	10	.83
FRN-1/2	2	10	.33	FRS-1/2	5	10	.83
FRN-6/10	2	10	.33	FRS-6/10	5	10	.83
FRN-8/10	2	10	.33	FRS-8/10	5	10	.83
FRN1	2	10	.33	FRS1	5	10	.83
FRN1-1/8	2	10	.33	FRS1-1/8	5	10	.83
FRN1-1/4	2	10	.33	FRS1-1/4	5	10	.83
FRN1-4/10	2	10	.33	FRS1-4/10	5	10	.83
FRN1-6/10	2	10	.33	FRS1-6/10	5	10	.83
FRN1-8/10	2	10	.33	FRS1-8/10	5	10	.83
FRN2	2	10	.33	FRS2	5	10	.83
FRN2-1/4	2	10	.33	FRS2-1/4	5	10	.83
FRN2-1/2	2	10	.33	FRS2-1/2	5	10	.83
FRN2-8/10	2	10	.33	FRS2-8/10	5	10	.83
FRN3-2/10	2	10	.33	FRS3-2/10	5	10	.83
FRN3-1/2	2	10	.33	FRS3-1/2	5	10	.83
FRN4	2	10	.33	FRS4	5	10	.83
FRN4-1/2	2	10	.33	FRS4-1/2	5	10	.83
FRN5	2	10	.33	FRS5	5	10	.83
FRN5-6/10	2	10	.33	FRS5-6/10	5	10	.83
FRN6-1/4	2	10	.33	FRS6-1/4	5	10	.83
FRN7	2	10	.33	FRS7	5	10	.83
FRN8	2	10	.33	FRS8	5	10	.83
FRN9	2	10	.33	FRS9	5	10	.83
FRN10	2	10	.33	FRS10	5	10	.83
FRN12	2	10	.33	FRS12	5	10	.83
FRN15	2	10	.33	FRS15	5	10	.83
FRN17-1/2	2	10	.33	FRS17-1/2	5	10	.83
FRN20	2	10	.33	FRN20	5	10	.83
FRN25	2	10	.39	FRS25	5	10	.94
FRN30	2	10	.39	FRS30	5	10	.94
FRN35	3	10	.77	FRS35	5 1/2	10	1.65
FRN40	3	10	.77	FRS40	5 1/2	10	1.65
FRN45	3	10	.77	FRS45	5 1/2	10	1.65
FRN50	3	10	.77	FRS50	5 1/2	10	1.65
FRN60	3	10	.77	FRS60	5 1/2	10	1.65
FRN70	5 7/8	5	1.82	FRS70	7 7/8	5	3.52
FRN80	5 7/8	5	1.82	FRS80	7 7/8	5	3.52
FRN90	5 7/8	5	1.82	FRS90	7 7/8	5	3.52
FRN100	5 7/8	5	1.82	FRS100	7 7/8	5	3.52
FRN110	7 1/8	1	3.96	FRS110	9 5/8	1	6.88
FRN125	7 1/8	1	3.96	FRS125	9 5/8	1	6.88
FRN150	7 1/8	1	3.96	FRS150	9 5/8	1	6.88
FRN175	7 1/8	1	3.96	FRS175	9 5/8	1	6.88
FRN200	7 1/8	1	3.96	FRS200	9 5/8	1	6.88
FRN225	8 5/8	1	7.15	FRS225	11 5/8	1	13.75
FRN250	8 5/8	1	7.15	FRS250	11 5/8	1	13.75
FRN300	8 5/8	1	7.15	FRS300	11 5/8	1	13.75
FRN350	8 5/8	1	7.15	FRS350	11 5/8	1	13.75
FRN400	8 5/8	1	7.15	FRS400	11 5/8	1	13.75
FRN450	10 3/8	1	11.00	FRS450	13 3/8	1	19.80
FRN500	10 3/8	1	11.00	FRS500	13 3/8	1	19.80
FRN600	10 3/8	1	11.00	FRS600	13 3/8	1	19.80

Buss 15 to 30-Ampere Fusetron Dual-Element Plug Fuses



For Voltages up to 125

On the ordinary circuit a 15 ampere fuse is the largest size that can safely be used, but such fuses often blow when motors start on washing machines and other devices. 15 ampere Fusetron dual-element fuses won't blow on motor starting currents or any momentary harmless overload, because of their thermal element, yet give exacting protection on dangerous overloads or short circuits. Larger ampere sizes give the same dependable protection on appliance circuits. Packed 4 in a box. 100 in a shelf package.

Symbol	Amperes	Wt., Lbs. Per 100	Per 100
T15	15	6.8	\$10.00
T20	20	6.8	10.00
T25	25	6.8	10.00
T30	30	6.8	10.00

Buss 15 to 30-Ampere Fustats
Type "S" Base

For Voltages up to 125



The Buss Fustat is a dual-element fuse with a fuse link and a thermal cutout.

A Fustat will not blow from motor starting currents or harmless overloads of short duration, but gives safe, dependable protection on dangerous overloads or short circuits.

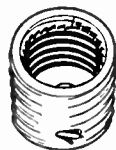

Stops dangerous practice of over-fusing as a larger ampere fuse will not fit adapter. Adapter locks in place so that Fustat can be changed like a fuse.

Packed 4 in a box. 100 in a shelf package.

Fustats

Adapters

Amperes	Symbol	Wt., Lbs. Per 100	Per 100	Symbol	Wt., Lbs. Per 100	Per 100
15	S15	6 1/2	\$15.00	SA15	1	\$12.00
20	S20	6 1/2	15.00	SA20	1	12.00
25	S25	6 1/2	15.00	SA30	1	12.00
30	S30	6 1/2	15.00	SA30	1	12.00

Buss 0 to 14 Ampere Fustats

To protect against burn-out of motors and apparatus of voltages up to 125.

Correct size Fustats protect 0-125 volt motors against burn-out from such causes as dry bearings, tight belts, overload, etc. Adapter makes Fustats fit any plug fuse holder, locks in place so that Fustat can be changed just like a fuse. Prevents the use of oversize Fustats.

Fustats and Adapters are packed separately, each 4 in a carton. 100 in a shelf package.

Fustats

Adapters

Amperes	Symbol	Per 100	Symbol	Per 100
1.	S 1	\$20.00	SA 1	\$12.00
1.25	S 1-1/4	20.00	SA 1-1/4	12.00
1.6	S 1-6/10	20.00	SA 1-6/10	12.00
2.	S 2	20.00	SA 2	12.00
2.5	S 2-1/2	20.00	SA 2-1/2	12.00
3.2	S 3-2/10	20.00	SA 3-2/10	12.00
4.	S 4	20.00	SA 4	12.00
5.	S 5	20.00	SA 5	12.00
6.25	S 6-1/4	20.00	SA 6-1/4	12.00
8.	S 8	20.00	SA 8	12.00
10.	S10	20.00	SA10	12.00
12.	S12	20.00	SA15	12.00
14.	S14	20.00	SA15	12.00

Many other sizes from 3/10 to 9 ampere can also be obtained.

Adapters are not included with Fustats—order them separately and specify size Fustat for which they are required. Fusetron and Buss plug fuses and Buss Fustats may be assorted to obtain quantity price.

Weight per 100: Fustats, 7 lbs.; Adapters, 4 lbs.

Listed as standard by Underwriters' Laboratories, Inc.

For further information contact your nearest Graybar office.

Buss Special Fuses

Special fuses for every purpose can be furnished. Submit a sample of the fuse needed if possible, otherwise submit full details as to type, voltage, amperage, etc. Care must be exercised in ordering fuses as they are made to order and are not returnable. Contact Graybar.

Buss Open Link Fuses

Buss open link fuses can be obtained with many other styles of terminals and in larger capacities. For open link fuses not listed below send sample or complete description.

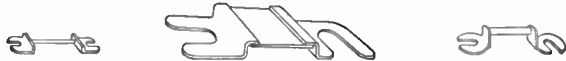

Terminal OO Terminal OL, OS, ON, or OW Terminal OH or OJ

Amperes	Terminal Symbol	Each	SET-UP CHARGE
1 to 30	OD or OH	\$0.056	\$1.50 for each size and type fuse ordered on each shipment.
35 to 60	OH or OJ	.07	
65 to 100	OJ	.11	
100 to 200	OL or OS	.18	
225 to 400	OS or ON	.30	
450 to 600	ON or OS	.56	
650 to 1000	OW or ON	1.10	

Unless otherwise specified, first mentioned terminal as above listed will be furnished.

Symbol	Dimensions of Terminals		
	Old No.	Slot	Width
OD	1	5/32"	3/8"
OH	3	3/16"	9/16"
OJ	5	1/4"	11/16"
OL	7	3/8"	3/4"
OS	16	7/16"	1 1/32"
ON	10	1/2"	1 3/8"
OW	28	5/8"	2 1/16"

If terminals larger than those shown with above amperages are desired, the price is not determined by the amperage of the fuse—the price that will apply will be the lowest shown for terminal desired.

Slots are slightly larger than dimensions given so that bolts of such sizes will fit the slot. Terminals are all copper.

In ordering, be sure to specify exact 1" A 3" N 1 1/4" C 3 1/2" R 1 1/2" D 4" S 1 3/4" F 5" U 2" H 6" X 2 1/4" J 7" Y 2 1/2" L 8" Z

By length is meant the center to center dimension of the slots in the terminals. This dimension will be indicated by one of symbols shown alongside. This symbol immediately follows the terminal symbol.

Buss Stamped Open Link Fuses

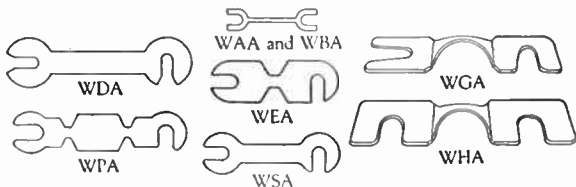

WGA and WHA are usually made of copper. All others are usually made of zinc.

Symbol	Old No.	Center to Center	Slot	Max. Width of Terminal Portion	Usual Amperages	Each	Set-up Charge
WAA	A	1 1/4"	3/16"	3/8"	3 to 60	\$0.04	\$1.50
WBA	B	1 5/8"	3/16"	1 5/32"	3 to 175	.04	1.50
WSA	S	1 3/4"	9/32"	3/4"	10 to 200	.05	2.50
WDA	D	2 7/16 to 2 5/8"	1/4"	7/8"	15 to 700	.05	1.50
WPA	P	2 3/8"	9/32"	2 3/32"	30 to 150	.05	1.50
WGA	G	2 3/8"	7/16"	1"	15 to 100	.15	2.50
					125 to 300	.20	2.50
					350 to 600	.30	2.50
					650 to 1000	.40	2.50
WHA	H	3"	3/16"	2"	100 to 450	.30	2.50
					500 to 3000	.50	2.50
WEA	66A	1 9/16"	1/4"	3/4"	75 to 250	.05	1.50

SET-UP CHARGE applies on each shipment ON EACH SIZE AND TYPE.

Buss Large Open Link Fuses



Terminals of cold rolled copper—entirely flat, one edge being slotted to receive the fuse strip.

When ordering, specify:

- ampere rating desired,
- width, length and thickness of terminals,
- size of hole desired,
- center to center dimensions of terminal hole.

If more than one hole in each terminal is desired, a sketch of the fuse must be submitted in addition to the information above requested.

Buss Clear Window Plug Fuses

Carry Underwriters' Laboratories Inspected label.



Buss fuses have an extra large, clear window which makes it easy to see if fuse is blown. Metal cap protects fuse against any chipping of the top. Insulated with porcelain and mica.

Packed 5 in a box. Information printed on box tells what to do when a fuse blows. Shelf package, 100. Weight Per 1000, 65 pounds.

No.	W3	W5	W6	W8	W10	W15	W20	W25	W30
Amperes	3	5	6	8	10	15	20	25	30
Each	.09	.09	.09	.09	.08	.08	.08	.08	.08

Economy Clearsite Non-Renewable Plug Fuses



Fuse link mounted under fuse window gives clear vision of the link.

Drop-out type link lessens the internal operating pressure.

Black fuse body made of heat-resisting molded insulation.

Standard package 50 plugs to a carton.

Retail package 5 plugs to a package, 100 plugs to a carton.

Cap. Amp.	Standard Sizes			Each	Sub-Standard Sizes			Each
	Regular Package No.	Retail Package No.	Each		Cap. Amp.	Regular Package No.	Retail Package No.	
10	4310	5710	.08	3	4303	5703	\$.09	
15	4315	5715	.08	5	4305	5705	.09	
20	4320	5720	.08	6	4306	5706	.09	
25	4325	5725	.08	8	4308	5708	.09	
30	4330	5730	.08					

Economy Renewable Plug Fuses



Fuses packed 10 in a carton; weight, 1 1/4 pounds.

Links packed 100 in a carton; weight, 2 ounces.

Standard Sizes

Fuses No.	Cap. Amp.	Each	Drop Out Renewal Links		
			No.	Cap. Amp.	Each
PF1068	10	\$.50	PR6810	10	\$.02
PF1568	15	.50	PR6815	15	.02
PF2068	20	.50	PR6820	20	.02
PF2568	25	.50	PR6825	25	.02
PF3068	30	.50	PR6830	30	.02

Sub-Standard Sizes

PF368	3	.50	PR6803	3	.02
PF568	5	.50	PR6805	5	.02
PF668	6	.50	PR6706	6	.02
PF868	8	.50	PR6808	8	.02

Fuse



Link

Economy Dual-Element Cartridge Fuses



Cutaway Ferrule Type

Ferrule Type



Cutaway—Knife Type



Knife Type

Econ Dual—Element Cartridge provides dual protection. 1. Time control protection against unnecessary blowouts from temporary and harmless overloads. 2. Instantaneous protection against short circuits. Especially adaptable for motor circuits with high starting torques.

Catalog Symbol ECN—250 Volt

Ferrule Type

Amperes	Lgth., In.	Diam. Cap., In.	Ctn. Qty.	Lbs. Per 100	Each
1/10, 15/100, 3/40, 3/10, 1/2, 6/10, 3/10, 1, 1 1/8, 1 1/4, 1 1/10, 1 1/10, 1 5/10, 1 8/10, 2, 2 1/4, 2 1/2, ...	2	9/16	10	3 1/2	\$0.33
2 8/10, 3 2/10, 3 1/2, 4, 4 1/2, 5, 5 5/10, 6 1/4, 7, 8, 9, 10, 12, 15, 17 1/2, 20, ...	2	9/16	10	5	.33
25, 30, ...	2	9/16	10	5	.39
35, 40, 45, 50, 60, ...	3	1 1/16	10	11	.77

Knife Blade Type

Amperes	Lgth., In.	Blade Wdth., In.	Ctn. Qty.	Lbs. Per 100	Each
70, 80, 90, 100, ...	5 7/8	3/4	5	30	\$1.82
110, 125, 150, 175, 200, ...	7 1/8	1	1	80	3.96
225, 250, 300, 350, 400, ...	8 5/8	1 5/8	1	170	7.15
450, 500, 600, ...	10 3/8	2	1	290	11.00

Catalog Symbol ECS—600 Volt

Ferrule Type

Amperes	Lgth., In.	Diam. Cap., In.	Ctn. Qty.	Lbs. Per 100	Each
1/10, 15/100, 3/40, 3/10, 1/2, 6/10, 3/10, 1, 1 1/8, 1 1/4, 1 1/10, 1 1/10, 1 5/10, 1 8/10, 2, 2 1/4, 2 1/2, 2 5/10, 3 2/10, 3 1/2, 4, 4 1/2, 5, 5 5/10, 6 1/4, 7, ...	5	1 3/16	10	14	\$0.83
8, 9, 10, 12, 15, 17 1/2, 20, ...	5	1 3/16	10	15	.83
25, 30, ...	5	1 3/16	10	17	.94
35, 40, 45, 50, 60, ...	5 1/2	1 1/16	10	24	1.65

Knife Blade Type

Amperes	Lgth., In.	Blade Wdth., In.	Ctn. Qty.	Lbs. Per 100	Each
70, 80, 90, 100, ...	7 7/8	3/4	5	48	\$3.52
110, 125, 150, 175, 200, ...	9 5/8	1 1/8	1	122	6.88
225, 250, 300, 350, 400, ...	11 5/8	1 5/8	1	315	13.75
450, 500, 600, ...	13 3/8	2	1	500	19.80

Buss Aircraft Fuses

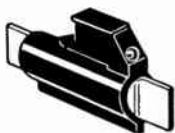

A complete line of Buss aircraft fuses is available.

For detailed information, write Graybar,

Economy Delay Renewable Cartridge Fuses

250 and 600 Volts

Listed by Underwriters' Laboratories, Inc.

Always operate at rated capacities. May be used successfully under all conditions of service without filling material.

The delay renewal link is quickly and easily replaced. Takes only a few moments to restore a blown fuse to its original efficiency.

Complete Fuses—Ferrule Type—3 to 60 Amperes



250 Volts					600 Volts				
Amp.	No. in Ctn.	No.	Wt. Lb. Per Ctn.	Each	No.	Wt. Lb. Per Ctn.	Each		
3	10	F-325	5/8	\$.60	F-305	1 5/8	\$1.48		
6	10	F-625	5/8	.56	F-605	1 5/8	1.39		
10	10	F-1025	5/8	.56	F-1005	1 5/8	1.39		
15	10	F-1525	5/8	.56	F-1505	1 5/8	1.39		
20	10	F-2025	5/8	.56	F-2005	1 5/8	1.39		
25	10	F-2525	5/8	.56	F-2505	1 5/8	1.39		
30	10	F-3025	5/8	.56	F-3005	1 5/8	1.39		
35	10	F-3525	1 3/8	1.11	F-3505	3 3/8	2.23		
40	10	F-4025	1 3/8	1.11	F-4005	3 3/8	2.23		
45	10	F-4525	1 3/8	1.11	F-4505	3 3/8	2.23		
50	10	F-5025	1 3/8	1.11	F-5005	3 3/8	2.23		
60	10	F-6025	1 3/8	1.11	F-6005	3 3/8	2.23		

Dimensions

Amperes	250 Volts		600 Volts	
	Length Inches	Diameter Inches	Length Inches	Diameter Inches
1-30	2	9/16	5	1 3/16
35-60	3	1 3/16	5 1/2	1 1/16

Complete Fuses—Knife Blade Type—61 to 600 Amperes



250 Volts					600 Volts				
Amp.	No. in Ctn.	No.	Wt. Lb. Per Ctn.	Each	No.	Wt. Lb. Per Ctn.	Each		
70	5	F-7025	2	\$2.49	F-7005	3 3/8	\$5.01		
80	5	F-8025	2	2.49	F-8005	3 3/8	5.01		
90	5	F-9025	2	2.49	F-9005	3 3/8	5.01		
100	5	F-10025	2	2.49	F-10005	3 3/8	5.01		
110	1	F-11025	1 1/16	5.57	F-11005	1 3/4	9.74		
125	1	F-12525	1 1/16	5.57	F-12505	1 3/4	9.74		
150	1	F-15025	1 1/16	5.57	F-15005	1 3/4	9.74		
175	1	F-17525	1 1/16	5.57	F-17505	1 3/4	9.74		
200	1	F-20025	1 1/16	5.57	F-20005	1 3/4	9.74		
225	1	F-22525	2 3/16	10.02	F-22505	3 1/2	19.48		
250	1	F-25025	2 3/16	10.02	F-25005	3 1/2	19.48		
300	1	F-30025	2 3/16	10.02	F-30005	3 1/2	19.48		
350	1	F-35025	2 3/16	10.02	F-35005	3 1/2	19.48		
400	1	F-40025	2 3/16	10.02	F-40005	3 1/2	19.48		
450	1	F-45025	3 1/2	15.31	F-45005	5 1/2	27.83		
500	1	F-50025	3 1/2	15.31	F-50005	5 1/2	27.83		
600	1	F-60025	3 1/2	15.31	F-60005	5 1/2	27.83		

Dimensions

Amperes	250 Volts		600 Volts	
	Length Inches	Blade Width Inches	Length Inches	Blade Width Inches
61-100	5 7/8	3/4	7 7/8	3/4
110-200	7 7/8	1 1/8	9 7/8	1 1/8
225-400	8 5/8	1 5/8	11 5/8	1 5/8
450-600	10 3/8	2	13 3/8	2

ECO Non-Indicating Non-Renewable Enclosed Fuses

250 and 600 Volts

Listed by Underwriters' Laboratories, Inc.

Made of heavy tubing. Caps are all brass, permanently rolled on the tube. Heavy copper lead-in terminals.

Ferrule Type



250 Volts			600 Volts		
Cap. Amps.	No.	Each	No.	Each	No. in Carton
1	111	\$.11	161	\$.587	10
3	113	.11	163	.587	10
6	116	.11	166	.587	10
10	1110	.11	1610	.587	10
15	1115	.11	1615	.587	10
20	1120	.11	1620	.587	10
25	1125	.11	1625	.587	10
30	1130	.11	1630	.587	10
35	1135	.22	1635	.88	10
40	1140	.22	1640	.88	10
45	1145	.22	1645	.88	10
50	1150	.22	1650	.88	10
60	1160	.22	1660	.88	10

Knife Blade Type

70	1170	\$.98	1670	\$ 1.96	5
80	1180	.98	1680	1.96	5
90	1190	.98	1690	1.96	5
100	11100	.98	16100	1.96	5
110	11110	2.18	16110	3.82	1
125	11125	2.18	16125	3.82	1
150	11150	2.18	16150	3.82	1
175	11175	2.18	16175	3.82	1
200	11200	2.18	16200	3.82	1
225	11225	3.95	16225	7.66	1
250	11250	3.95	16250	7.66	1
300	11300	3.95	16300	7.66	1
350	11350	3.95	16350	7.66	1
400	11400	3.95	16400	7.66	1
450	11450	6.03	16450	10.97	1
500	11500	6.03	16500	10.97	1
600	11600	6.03	16600	10.97	1

Economy Delay Renewal Links



Ferrule Type
3 to 60 Amperes

250 Volts					600 Volts				
No.	Cap. Amps.	Car-ton	Wt. Lb. Carton	Each	No.	Cap. Amps.	Car-ton	Wt. Lb. Carton	Each
R-203	3	100	3/16	\$.07	R-603	3	100	1 1/16	\$.153
R-206	6	100	3/16	.028	R-606	6	100	1 1/16	.07
R-210	10	100	3/16	.028	R-610	10	100	1 1/16	.07
R-215	15	100	3/16	.028	R-615	15	100	1 1/16	.07
R-220	20	100	3/16	.028	R-620	20	100	1 1/16	.07
R-225	25	100	3/16	.028	R-625	25	100	1 1/16	.07
R-230	30	100	3/16	.028	R-630	30	100	1 1/16	.07
R-235	35	100	5/8	.056	R-635	35	100	2 3/16	.07
R-240	40	100	5/8	.056	R-640	40	100	2 3/16	.11
R-245	45	100	5/8	.056	R-645	45	100	2 3/16	.11
R-250	50	100	5/8	.056	R-650	50	100	2 3/16	.11
R-260	60	100	5/8	.056	R-660	60	100	2 3/16	.11

Economy Delay Renewal Links



Knife Blade Type
70 to 600 Amperes

250 Volts					600 Volts				
No.	Cap. Amps.	Car-ton	Wt. Lb. Carton	Each	No.	Cap. Amps.	Car-ton	Wt. Lb. Carton	Each
R-270	70	50	7/8	\$.125	R-670	70	50	1 1/2	\$.25
R-280	80	50	7/8	.125	R-680	80	50	1 1/2	.25
R-290	90	50	7/8	.125	R-690	90	50	1 1/2	.25
R-2100	100	50	7/8	.125	R-6100	100	50	1 1/2	.25
R-2110	110	25	1	.279	R-6110	110	25	2 3/4	.488
R-2125	125	25	1	.279	R-6125	125	25	2 3/4	.488
R-2150	150	25	1	.279	R-6150	150	25	2 3/4	.488
R-2175	175	25	1	.279	R-6175	175	25	2 3/4	.488
R-2200	200	25	1	.279	R-6200	200	25	2 3/4	.488
R-2225	225	12	1	.501	R-6225	225	12	2 5/8	.975
R-2250	250	12	1	.501	R-6250	250	12	2 5/8	.975
R-2300	300	12	1	.501	R-6300	300	12	2 5/8	.975
R-2350	350	12	1	.501	R-6350	350	12	2 5/8	.975
R-2400	400	12	1	.501	R-6400	400	12	2 5/8	.975
R-2450	450	10	1 1/4	.763	R-6450	450	10	4 7/8	1.39
R-2500	500	10	1 1/4	.763	R-6500	500	10	4 7/8	1.39
R-2600	600	10	1 1/4	.763	R-6600	600	10	4 7/8	1.39

Buss Glass Tube Fuses

For Auto, Radio, TV and Instrument Protection

NEW STANDARD FUSES

OLD TYPE "AG" FUSES

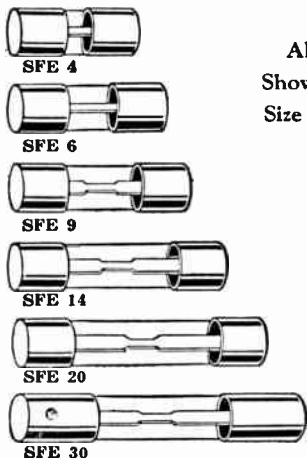

All Cuts
Show Actual
Size of Fuses

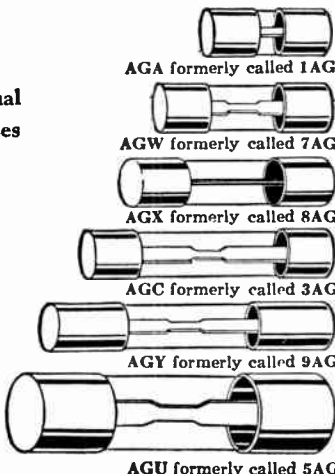

Type	Former No.	Amperes	D men. in.	Wt. Lb. Per 100	Price Each
SFE4	4	1/4 x 5/8	0.70	\$.055
SFE6	6	1/4 x 3/4	.71	.055
SFE7 1/2	7 1/2	1/4 x 7/8	.72	.05
SFE9	9	1/4 x 7/8	.72	.05
SFE14	14	1/4 x 1 1/16	.77	.045
SFE20	20	1/4 x 1 1/4	.83	.045
SFE30	30	1/4 x 1 1/16	1.05	.06
AGA	1AG	1 or 2	1/4 x 5/8	0.70	.08
AGA	1AG	3	1/4 x 5/8	.70	.07
AGA	1AG	5, 6 or 7 1/2	1/4 x 5/8	.70	.06
AGC	3AG	1, 2	1/4 x 1 1/4	.83	.08
AGC	3AG	1/4 x 1 1/4	.83	.07
AGC	3AG	5, 6, 10 or 15	1/4 x 1 1/4	.83	.05
AGC	3AG	25 or 30	1/4 x 1 1/4	.83	.06
AGU	5AG	10, 20 or 30	13/32 x 1 1/2	2.00	.16
AGW	7AG	7 1/2	1/4 x 7/8	.72	.05
AGX	8AG	20	1/4 x 1	.82	.05
AGY	9AG	50	1/4 x 1 1/16	1.10	.12

Type AGC fuses 3 amperes and smaller can be used on 250-volt circuits.

G-E Type CLF Fuses
High-Interrupting Capacity
6-4000 Amps. Continuous 200,000 RMS Symmetrical
Amps. Interrupting Rating

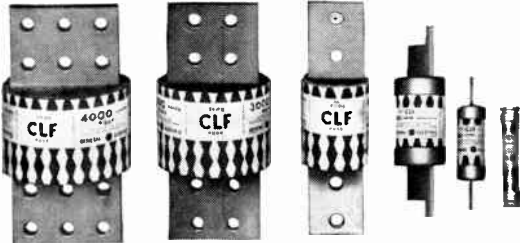

High-interrupting-capacity fuses are required in power circuits where available short-circuit currents exceed the interrupting rating of NEC fuses. (NEC fuses are usually considered to have an interrupting rating of 10,000 amp.) Has a tested interrupting rating of 200,000 rms symmetrical amps. at rated voltage and frequency. In addition, it provides improved protection because of its current-limiting action even on circuits where the NEC fuse can be properly applied.

Provides efficient and economical short-circuit protection for feeders, lighting-branch circuits, motor-branch circuits, motor starters, control power circuits, and similar application, at 600 volts and below.

Silvered copper ferrules or knife blades at each end fit any standard NEC fuse holder or corresponding voltage and current rating, 600 amps. and below. Above 600 amps. tangs are provided for bolt mounting.

No.	Current Amp. Rating	Std. Pkg. Qty.	Per Std. Pkg.
250 Volts, A-C or D-C			
GF6A6	6	6	\$ 8.40
GF6A15	15	6	8.40
GF6A20	20	6	8.40
GF6A30	30	6	8.40
GF6A40	40	6	14.40
GF6A60	60	6	14.40
GF6A80	80	3	15.60
GF6A100	100	3	15.60
GF6A150	150	1	9.70
GF6A200	200	1	9.70
250 Volts, 60 Cycles, A-C			
GF7A300	300	1	\$18.00
GF7A400	400	1	18.00
GF7A500	500	1	23.00
GF7A600	600	1	23.00
600 Volts, A-C or D-C			
GF6B6	6	6	\$14.40
GF6B15	15	6	14.40
GF6B20	20	6	14.40
GF6B30	30	6	14.40
GF6B40	40	6	26.40
GF6B60	60	6	26.40
GF6B80	80	3	18.90
GF6B100	100	3	18.90
GF6B150	150	1	12.90
GF6B200	200	1	12.90
600 Volts, 60 Cycles, A-C			
GF7B300	300	1	\$20.50
GF7B400	400	1	20.50
GF7B500	500	1	26.50
GF7B600	600	1	26.50
GF7B800	800	1	48.50
GF7B1000	1000	1	48.50
GF7B1200	1200	1	48.50
480 Volts, 60 Cycles, A-C			
GF7C1600	1600	1	\$64.80
GF7C2000	2000	1	81.00
GF7C2500	2500	1	101.50
GF7C3000	3000	1	121.25
GF7C4000	4000	1	161.70

Note—Special fuse clips are recommended wherever the CLF fuse is applied. These clips prevent substitution of conventional fuses of inadequate capacity.

Bryant Cartridge Fuse Cutout Bases

Listed by Underwriters' Laboratories, Inc.

Single Pole—250 Volts

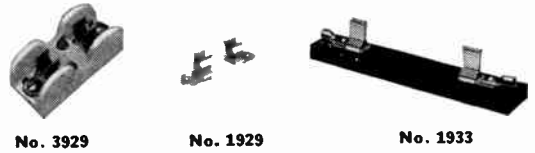

No.	Amps.	Length	Width	Height	Car-ton	Std. Pkg.	Wt. Lbs. Std. Pkg.	Per 100
3929	1-30	3 ¹ / ₁₆	1 ¹⁷ / ₃₂	1 ¹ / ₂	5	50	24	\$ 78.50
3930	31-60	5	1 ²⁹ / ₃₂	2 ³ / ₁₆	2	50	62	166.00

Barrier Type—Porcelain Base

No.	Amps.	Length	Width	Height	Car-ton	Std. Pkg.	Wt. Lbs. Std. Pkg.	Per 100
1929	1-30	3 ¹ / ₁₆	1 ¹⁵ / ₃₂	1 ³ / ₈	5	50	17	\$ 72.00
1930	31-60	4 ⁷ / ₈	1 ¹ / ₂	1 ³¹ / ₃₂	2	50	35	108.00
1931	61-100	7 ¹⁵ / ₁₆	2 ¹ / ₄	2 ⁹ / ₁₆	1	50	90	226.50
1932	101-200	10	2 ¹ / ₄	3 ³ / ₃₂	1	50	135	602.00

Porcelain Base

No.	Amps.	Length	Width	Height	Car-ton	Std. Pkg.	Wt. Lbs. Std. Pkg.	Per 100
1933	61-100	10	2	2 ³ / ₈	1	50	115	\$ 364.00
1934	101-200	10	2 ¹ / ₄	3 ³ / ₃₂	1	25	85	595.50
1935	201-400	14 ³ / ₄	2 ³ / ₄	3 ³ / ₄	1	10	70	1433.50

Slate Base

Double Pole—250 Volts



No.	Amps.	Dimensions In Inches	Car-ton	Std. Pkg.	Wt. Lbs. Std. Pkg.	Per 100
1917	1-30	3 ⁵ / ₁₆ x 2 ¹³ / ₁₆	5	50	40	\$112.00
1918	31-60	5 x 3 ⁵ / ₈	2	50	115	259.50

Barrier Type Porcelain Base

Double Pole—Main Line

No.	Amps.	Dimensions In Inches	Car-ton	Std. Pkg.	Wt. Lbs. Std. Pkg.	Per 100
1917	1-30	3 ⁵ / ₁₆ x 2 ¹³ / ₁₆	5	50	40	\$112.00
1918	31-60	5 x 3 ⁵ / ₈	2	50	115	259.50

Double Pole—Single Branch

1919	1-30	4 ¹³ / ₁₆ x 2 ¹³ / ₁₆	1	50	72	\$197.00
1920	31-60	6 ¹³ / ₁₆ x 3 ⁵ / ₈	1	50	155	376.00

Double Pole—Double Branch

1922	1-30	7 ³ / ₄ x 2 ¹³ / ₁₆	1	25	55	\$327.50
------	------	---	---	----	----	----------

Triple Pole—250 Volts

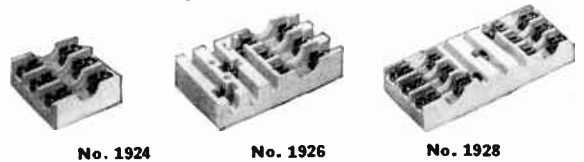

No.	Amps.	Dimensions In Inches	Car-ton	Std. Pkg.	Wt. Lbs. Std. Pkg.	Per 100
1924	1-30	3 ⁵ / ₁₆ x 4 ¹ / ₁₆	5	50	58	\$154.00
1925	31-60	5 x 5 ⁵ / ₁₆	1	50	150	378.50

Barrier Type—Porcelain Base

Triple Pole—Main Line

No.	Amps.	Dimensions In Inches	Car-ton	Std. Pkg.	Wt. Lbs. Std. Pkg.	Per 100
1924	1-30	3 ⁵ / ₁₆ x 4 ¹ / ₁₆	5	50	58	\$154.00
1925	31-60	5 x 5 ⁵ / ₁₆	1	50	150	378.50

Triple Pole—Single Branch

1926	1-30	6 ¹ / ₁₆ x 4 ¹ / ₁₆	1	50	120	\$306.50
1927	31-60	8 ¹ / ₁₆ x 5 ⁵ / ₁₆	1	50	300	640.50

Triple Pole—Double Branch

1928	1-30	8 ⁷ / ₈ x 4 ¹ / ₁₆	1	50	185	\$ 486.00
1998	31-60	11 ⁷ / ₈ x 5 ⁵ / ₁₆	1	10	85	1009.00

Bryant Cartridge Fuse Cutout Bases

Listed as standard by Underwriters' Laboratories, Inc.

**Single Pole—600 Volts
Barrier Type—Porcelain Base**



No.	Amps.	Dimensions, Inches			Car- ton	Std. Pkg.	Wt. Lbs. Std. Pkg.	Per 100
		Length	Width	Height				
3937	1-30	6 ⁷ / ₁₆	1 ¹¹ / ₁₆	1 ³ / ₄	1	50	54	\$113.50
3938	31-60	7 ⁹ / ₁₆	2 ¹ / ₈	2 ¹ / ₄	1	50	110	231.00

Porcelain Base

1937	1-30	7	1 ¹ / ₂	1 ³¹ / ₃₂	1	50	40	\$ 94.00
1938	31-60	7 ⁵ / ₈	1 ³ / ₄	2 ¹ / ₃₂	1	50	56	143.50
1939	61-100	12	2	2 ⁹ / ₁₆	1	50	115	273.00
1940	101-200	14 ¹ / ₂	2 ¹ / ₂	3 ⁵ / ₃₂	1	50	175	460.00

Slate Base

1941	61-100	12	2	2 ¹ / ₂	1	50	150	\$ 386.50
1942	101-200	14 ¹ / ₂	2 ¹ / ₂	3 ³ / ₃₂	1	25	125	677.50
1943	201-400	17 ³ / ₄	3	3 ⁷ / ₈	1	10	95	1615.50

Seeger Williams Pocket Size Fuse Puller



Rugged laminated construction, for strength and durability. Red vulcanized fiber, 5 sections, 7¹/₂-in. long. For fuses 0-200 amperes 250 volts and 0-100 amperes 600 volts. Standard cartridge fuses. Individually packed, imprinted free. Per Dozen \$12.00

**Knox N. E. C. Cartridge Fuse Cutouts
With Solderless Connectors**



2587-60

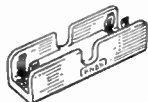

525693

2-wire, double pole, double branch. 60 amps—250 volts. Packed 1 to a carton.

No.	Length In.	Width In.	Height In.	Hole Spacing In.	Std. Pkg.	Std. Pkg. Wt. Lbs.	Per 100
2587-60	10 ³ / ₄	3 ¹ / ₄	1 ⁷ / ₈	5 ¹³ / ₁₆	10	52	\$531.30

Single pole, main line. 30 amps—600 volts. 1 per ctn.

525693	6 ⁵ / ₈	1 ¹ / ₁₆	1 ³ / ₄	2 ⁹ / ₁₆	10	12	\$110.40
--------	-------------------------------	--------------------------------	-------------------------------	--------------------------------	----	----	----------

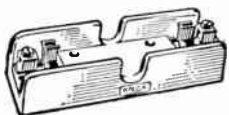

525691

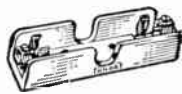

525696

Single pole, main line. 100 amps—600 volts. 1 per carton.

No.	Length In.	Width In.	Height In.	Hole Spacing In.	Std. Pkg.	Std. Pkg. Wt. Lbs.	Per 100
525691	10 ¹ / ₂	2 ³ / ₄	2 ⁷ / ₈	3 ¹ / ₂	10	55	\$366.80

Single pole, main line. 60 amps—600 volts. 1 per carton.

525696	7 ⁵ / ₈	2 ¹ / ₈	2 ¹ / ₁₆	2 ¹ / ₂	10	20	\$182.80
--------	-------------------------------	-------------------------------	--------------------------------	-------------------------------	----	----	----------

**Knox N. E. C. Cartridge Fuse Cutouts
With Solderless Connectors**

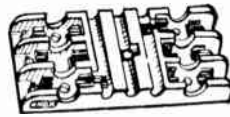

No. 2135-30



No. 2199-30

3-wire, triple pole. Double branch. 30 amps—250 volts. Packed 1 to a carton.

No.	Length In.	Width In.	Height In.	Hole Spacing In.	Std. Pkg.	Std. Pkg. Wt. Lbs.	Per 100
2135-30	9 ¹ / ₈	3 ¹⁵ / ₁₆	1 ³ / ₄	5 ¹ / ₂	10	40	\$379.50

3-wire, double pole. Double branch. 30 amps—250 volts. Packed 1 to a carton.

No.	Length In.	Width In.	Height In.	Hole Spacing In.	Std. Pkg.	Std. Pkg. Wt. Lbs.	Per 100
2199-30	9 ¹ / ₈	2 ³ / ₄	1 ⁵ / ₈	5 ¹ / ₂	10	28	\$303.60



No. 2199-60

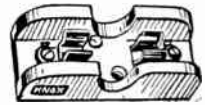

No. 2569-30

3-wire, double pole, double branch. 60 amps—250 volts. Packed 1 to a carton.

No.	Length In.	Width In.	Height In.	Hole Spacing In.	Std. Pkg.	Std. Pkg. Wt. Lbs.	Per 100
2199-60	12 ¹ / ₈	3 ¹ / ₄	1 ³ / ₄	7 ¹ / ₁₆	10	45	\$645.20

Single pole, main line. 30 amps—250 volts. 5 per carton.

No.	Length In.	Width In.	Height In.	Hole Spacing In.	Std. Pkg.	Std. Pkg. Wt. Lbs.	Per 100
2569-30	3 ³ / ₈	1 ¹ / ₂	1 ¹ / ₁₆	1 ¹ / ₂	10	5	\$65.50

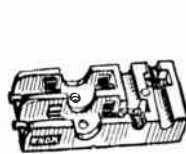

1935-60

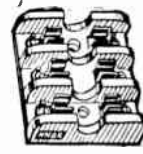

No. 2165-30

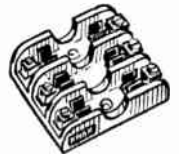

No. 2165-60

2-wire, double pole, single branch. 60 amps—250 volts. Packed 1 per carton.

No.	Length In.	Width In.	Height In.	Hole Spacing In.	Std. Pkg.	Std. Pkg. Wt. Lbs.	Per 100
1935-60	7 ¹ / ₈	3 ¹ / ₄	2	2 ¹⁵ / ₁₆	10	15	\$278.30

Triple pole, main line. 30 amps—250 volts. 1 per carton.

No.	Length In.	Width In.	Height In.	Hole Spacing In.	Std. Pkg.	Std. Pkg. Wt. Lbs.	Per 100
2165-30	4	3 ³ / ₈	1 ³ / ₈	2 ¹ / ₂	10	12	\$126.50

Triple pole, main line. 60 amps—250 volts. 1 per carton.

No.	Length In.	Width In.	Height In.	Hole Spacing In.	Std. Pkg.	Std. Pkg. Wt. Lbs.	Per 100
2165-60	5 ¹ / ₄	4 ³ / ₄	2	3	10	28	\$305.90



No. 8042-30



No. 2569-60

3-wire, triple pole, single branch. 30 amps—250 volts. Packed 1 to a carton.

No.	Length In.	Width In.	Height In.	Hole Spacing In.	Std. Pkg.	Std. Pkg. Wt. Lbs.	Per 100
8042-30	6 ¹ / ₈	3 ¹⁵ / ₁₆	1 ¹ / ₂	3 ¹ / ₄	10	28	\$217.30

Single pole, main line. 60 amps—250 volts. 5 per carton.

No.	Length In.	Width In.	Height In.	Hole Spacing In.	Std. Pkg.	Std. Pkg. Wt. Lbs.	Per 100
2569-60	4 ³ / ₄	1 ³ / ₄	2	7 ¹ / ₈	10	12	\$105.80

**Knox N. E. C. Cartridge Fuse Cutouts
With Solderless Connectors**

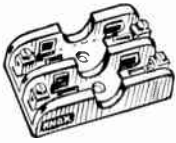

No. 2965-60

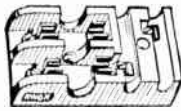

No. 1935-30



No. 2965-30

Double pole, main line, 60 amps—250 volts. 1 per carton.

No.	Length In.	Width In.	Height In.	Hole Spacing In.	Std. Pkg.	Std. Pkg. WL Lbs.	Per 100
2965-60	5 1/8	3 1/4	1 13/16	1 1/2	10	20	\$227.70

2-wire, double pole, single branch. 30 amps—250 volts.
Packed 1 to a carton.

No.	Length In.	Width In.	Height In.	Hole Spacing In.	Std. Pkg.	Std. Pkg. WL Lbs.	Per 100
1935-30	5 1/8	2 3/4	1 5/8	2 1/8	10	16	\$127.60

Double pole, main line, 30 amps—250 volts. 1 per carton.

No.	Length In.	Width In.	Height In.	Hole Spacing In.	Std. Pkg.	Std. Pkg. WL Lbs.	Per 100
2965-30	3 5/16	2 11/16	1 3/8	1 1/4	10	8	\$90.80



No. 2587-30

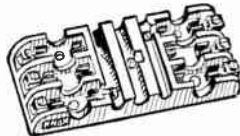

No. 2135-60

2-wire, double pole, double branch. 30 amps—250 volts.
Packed 1 to a carton.

No.	Length In.	Width In.	Height In.	Hole Spacing In.	Std. Pkg.	Std. Pkg. WL Lbs.	Per 100
2587-30	7 15/16	2 3/4	1 1/16	4 1/4	10	24	\$253.00

3-wire, triple pole, double branch. 60 amps—250 volts.
Packed 1 to a carton.

No.	Length In.	Width In.	Height In.	Hole Spacing In.	Std. Pkg.	Std. Pkg. WL Lbs.	Per 100
2135-60	12 3/16	4 3/4	1 15/16	7 1/8	10	80	\$885.50

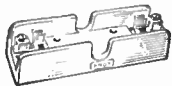

No. 2569-100

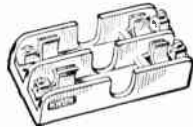

No. 2965-100

Single pole, main line, 100 amps—250 volts. 1 per carton.

No.	Length In.	Width In.	Height In.	Hole Spacing In.	Std. Pkg.	Std. Pkg. WL Lbs.	Per 100
2569-100	7 3/4	2	2 1/4	2	10	28	\$265.70

Double pole, main line, 100 amps—250 volts. 1 per carton.

No.	Length In.	Width In.	Height In.	Hole Spacing In.	Std. Pkg.	Std. Pkg. WL Lbs.	Per 100
2965-100	7 7/8	3 7/8	2 3/8	1 7/8	10	28	\$445.00

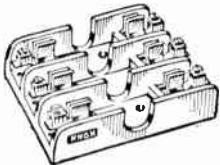

No. 2165-100

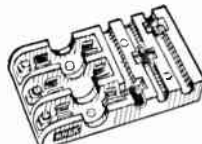

No. 8042-60

Triple pole, main line, 100 amps—250 volts. 1 per carton.

No.	Length In.	Width In.	Height In.	Hole Spacing In.	Std. Pkg.	Std. Pkg. WL Lbs.	Per 100
2165-100	7 7/8	5 7/16	2 11/16	2	10	72	\$657.80

3-wire, triple pole, single branch. 60 amps—250 volts.
Packed 1 to a carton.

No.	Length In.	Width In.	Height In.	Hole Spacing In.	Std. Pkg.	Std. Pkg. WL Lbs.	Per 100
8042-60	8 1/4	4 3/4	2	4 1/8	10	56	\$473.80

**Knox Plug Fuse Cutouts
Porcelain Base—30 Amps—125 Volts**

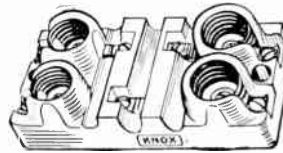

No. 2199

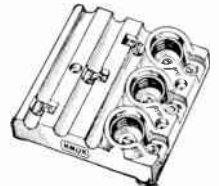

No. 8042

3 to 2-wire, double branch. Packed 5 to a carton.

No.	Length In.	Width In.	Height In.	Hole Spacing In.	Std. Pkg.	Std. Pkg. WL Lbs.	Per 100
2199	6 1/8	3	1 7/16	5 1/2	50	152	\$139.10

3-wire, single branch. Packed 5 to a carton.

No.	Length In.	Width In.	Height In.	Hole Spacing In.	Std. Pkg.	Std. Pkg. WL Lbs.	Per 100
8042	4 1/2	4 7/16	1 1/2	3 3/8	25	100	\$151.80

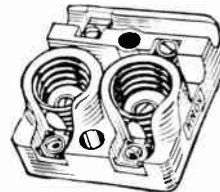

No. 1935

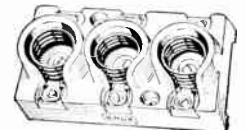

No. 2165

2-wire, single branch. Packed 5 to a carton.

No.	Length In.	Width In.	Height In.	Hole Spacing In.	Std. Pkg.	Std. Pkg. WL Lbs.	Per 100
1935	3 1/2	2 15/16	1 1/2	2 3/16	50	80	\$73.60

3-wire, main line. Packed 5 to a carton.

No.	Length In.	Width In.	Height In.	Hole Spacing In.	Std. Pkg.	Std. Pkg. WL Lbs.	Per 100
2165	4 3/8	2 1/2	1 3/8	1 3/4	50	84	\$92.00

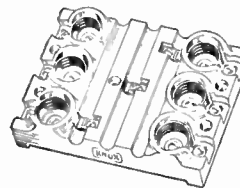

No. 2135



No. 2965

3-wire, double branch. Packed 5 to a carton.

No.	Length In.	Width In.	Height In.	Hole Spacing In.	Std. Pkg.	Std. Pkg. WL Lbs.	Per 100
2135	6 7/16	4 1/2	1 1/2	5 3/8	25	110	\$223.10

2-wire, main line. Packed 10 to a carton.

No.	Length In.	Width In.	Height In.	Hole Spacing In.	Std. Pkg.	Std. Pkg. WL Lbs.	Per 100
2965	2 9/16	2 1/8	1 1/2	1 7/8	100	54	\$63.20



No. 2569

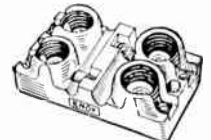

No. 2587

Single pole, main line. Packed 10 to a carton.

No.	Length In.	Width In.	Height In.	Hole Spacing In.	Std. Pkg.	Std. Pkg. WL Lbs.	Per 100
2569	2 1/2	2	1 7/16	1 7/8	100	40	\$43.70

2-wire, double branch. Packed 5 to a carton.

No.	Length In.	Width In.	Height In.	Hole Spacing In.	Std. Pkg.	Std. Pkg. WL Lbs.	Per 100
2587	5 1/8	3	1 3/8	4 1/2	50	130	\$119.60

Knox Unfused Neutral Plug Type Fuseholders
Porcelain Base—30 Amps—125 Volts

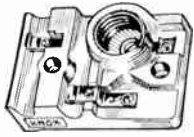

No. 1935-O



No. 2965-O



No. 3115

2-wire, single branch. Packed 5 to a carton.

No.	Length In.	Width In.	Height In.	Hole Spacing In.	Std. Pkg.	Std. Pkg. Wt. Lbs.	Per 100
1935-0	3 ⁹ / ₁₆	2 ⁷ / ₁₆	1 ¹ / ₂	2 ¹ / ₄	100	72	\$73.60

2-wire, main line. Packed 10 to a carton.

No.	Length In.	Width In.	Height In.	Hole Spacing In.	Std. Pkg.	Std. Pkg. Wt. Lbs.	Per 100
2965-0	2 ⁹ / ₁₆	2 ³ / ₁₆	1 ⁷ / ₁₆	1 ³ / ₄	100	38	\$59.80

2-wire, double branch. Packed 10 to a carton.

No.	Length In.	Width In.	Height In.	Hole Spacing In.	Std. Pkg.	Std. Pkg. Wt. Lbs.	Per 100
3115	3	3	1 ¹ / ₂	1 ⁷ / ₁₆	100	112	\$81.60

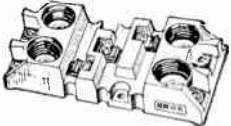

No. 3415



No. 2199-O

3-wire, 4—two-wire branches. Packed 1 to a carton.

No.	Length In.	Width In.	Height In.	Hole Spacing In.	Std. Pkg.	Std. Pkg. Wt. Lbs.	Per 100
3415	6 ⁵ / ₁₆	3 ¹ / ₁₆	1 ¹ / ₂	1 ¹ / ₈	50	92	\$228.80

3 to 2-wire, double branch. Packed 5 to a carton.

No.	Length In.	Width In.	Height In.	Hole Spacing In.	Std. Pkg.	Std. Pkg. Wt. Lbs.	Per 100
2199-0	6 ¹ / ₈	2 ¹ / ₂	1 ¹ / ₂	5 ¹ / ₄	50	72	\$111.50

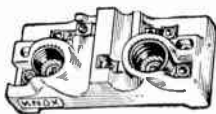

No. 2587-O



No. 3215

2-wire, double branch. Packed 5 to a carton.

No.	Length In.	Width In.	Height In.	Hole Spacing In.	Std. Pkg.	Std. Pkg. Wt. Lbs.	Per 100
2587-0	5 ¹ / ₈	2 ⁷ / ₁₆	1 ¹ / ₂	4 ¹ / ₂	50	65	\$97.70

2-wire, 3—two-wire branches. Packed 5 to a carton.

No.	Length In.	Width In.	Height In.	Hole Spacing In.	Std. Pkg.	Std. Pkg. Wt. Lbs.	Per 100
3215	4 ⁷ / ₁₆	3	1 ⁹ / ₁₆	1 ⁵ / ₈	50	56	\$136.80

Bryant Neutral Wire Fuseless Plug

Listed as standard by Underwriters' Laboratories, Inc.

30 Amperes, 125 Volts

For use in neutral of cutouts in compliance with the National Electrical Code.

Packed 75 in a carton. 300 in a standard package. Package weight, 10 pounds.



No.	Per 100
559	\$18.00

Bryant Plug Fuse Cutouts

Listed as standard by Underwriters' Laboratories, Inc.

30 Amperes, 125 Volts Fused Neutral

The fused neutral cutouts listed here can be converted for solid neutral application by inserting No. 559 fuseless plug in the neutral line which complies with the 1951 N.E.C.



No. 410



No. 220



No. 221

Single Pole—Main Line

No.	Dimensions In Inches	Carton	Std. Pkg.	Wt. Lbs. Std.	Per 100
410	2 ³ / ₄ x 1 ² ⁹ / ₃₂	10	100	36	\$62.50

Double Pole—Main Line

220	2 ¹⁵ / ₁₆ x 2 ⁹ / ₁₆	10	100	60	\$106.50
-----	--	----	-----	----	----------

Double Pole—Single Branch

221	2 ¹⁵ / ₁₆ x 3 ¹⁹ / ₃₂	5	50	14	\$116.00
-----	---	---	----	----	----------



No. 222



No. 232



No. 330

Double Pole—Double Branch

222	2 ¹⁵ / ₁₆ x 5 ⁹ / ₃₂	5	50	64	\$172.00
-----	--	---	----	----	----------

Triple to Double Pole—Double Branch

232	2 ¹⁵ / ₁₆ x 6 ⁵ / ₁₆	5	50	70	\$201.50
-----	--	---	----	----	----------

Three-Pole—Main Line

330	2 ⁹ / ₁₆ x 4 ⁷ / ₁₆	5	50	50	\$123.00
-----	---	---	----	----	----------



No. 120

Solid Neutral

30 Amperes, 125 Volts

Double Pole—Main Line

120	2 ⁹ / ₃₂ x 2 ⁷ / ₁₆	10	150	60	\$103.50
-----	---	----	-----	----	----------

Bryant Entrance Switches With Fixed Blades

Listed as standard by Underwriters' Laboratories, Inc.

30 Amperes, 125 Volts

Packaged 2 in a carton. 25 in a standard package. Package weight, 37 lbs. for No. 1695; 39 lbs. for No. 1981.



Double Pole—Main Line

No.	Dimensions In Inches	Per 100
1695	5 ¹⁷ / ₃₂ x 3 ³ / ₁₆	\$210.00
1981	5 ¹⁷ / ₃₂ x 3 ³ / ₁₆	210.00

No. 1695 has fuses at top. No. 1981 has fuses at bottom.

Buss Fuse Holder and Fuse Assemblies

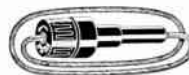

Mount in wire. Protect radios, instruments, electronic equipment, spotlight, or any accessory.

Bakelite body with bayonet type knob and terminals already staked and soldered to 19 inches of No. 14 wire.

Symbol	Description	Each
HRJ	Complete with SFE 20 fuse	\$0.50
HRH	Complete with SFE 14 fuse	.50
HRH	Complete with SFE 9 fuse	.50

Buss Fustat Box-Cover Units

Simple, Low Cost Way To Protect 125 Volt Motors

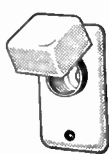

No. SOU



No. SRU

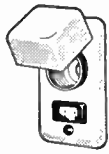

No. SSU



No. SSY-L

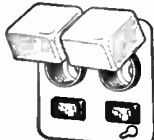

No. SCY

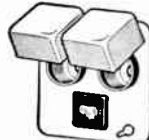

No. STY

A box-cover on which a Fustat can be mounted—alone or in combination with a plug-in receptacle or switch.

There are four different cover sizes to fit box you have. Units have Edison base fuseholder so proper size Fustat Adapter can be used. They are listed as approved by Underwriters' Laboratories when Adapter has been inserted.

Use them to guard motors on home, farm, office, factory appliances and equipment—from such things as lack of oil, worn bearings, tight belts, overloading wrong or low voltage.

Simply install desired cover on box, then screw in proper size Fustat and Adapter. Units without switch for any motor 3/4 h.p. or smaller. Units with switch for a-c motors only 1/2 h.p. or smaller.

On normal installations use Fustat of a size nearest to ampere rating of motors or a little larger.

Holder For Fustat Only

No.	Description	Wt. Lbs. Per 100	Price Each
SOU	2 1/4 inch cover for Handy box.....	36	\$0.65
SOW	2 3/4 inch cover for Switch box.....	37	.65
SOX	4 inch cover for Octagon box.....	55	.80
SOY	4 inch cover for Square box.....	62	.80

Holder for Fustat With Grounding Type Plug-In Receptacle

SRU	2 1/4 inch cover for Handy box.....	39	1.15
SRW	2 3/4 inch cover for Switch box.....	40	1.15
SRX	4 inch cover for Octagon box.....	58	1.25
SRY	4 inch cover for Square box.....	60	1.25

Holder for Fustat With S. P. Switch.

SSU	2 1/4 inch cover for Handy box.....	38	1.15
SSW	2 3/4 inch cover for Switch box.....	39	1.15
SSX	4 inch cover for Octagon box.....	57	1.25
SSY	4 inch cover for Square box.....	59	1.25

Holder for Fustat With S.P. Switch and Pilot Light
SSY-L 4 inch cover for Square box..... 68 2.25

Holder for Fustat With S.P. Switch, Pilot Light and Grounding Type Plug-In Receptacle
SSY-RL 4 inch cover for Square Box..... 75 3.25

Holders for Two Fustats With Two S.P. Switches
SCY 4 inch cover for Square box..... 75 2.15

Holders for Two Fustats With One Tandem Blade Grounding Type Receptacle
SKA 4 1/8 inch cover for Square box..... 101 2.30

Holders for Two Fustats With One Double Pole Switch
STY 4 Inch cover for Square box..... 70 2.40

Holders for Two Fustats With Two Grounding Type Plug-In Receptacle
SRA-R 4 1/8 inch cover for Square Box..... 2.55

Note: Fustats and Adapters are not included with Box-Cover Units, order them separately.

Buss Fuse Wire and Strip



Will carry indefinitely current shown under heading "Carrying Capacity." Will open the circuit when subjected to overload 25 per cent in excess thereof.

This is based on a distance between contacts or terminals of 2 inches.

When used on contacts of other distances the carrying capacity is affected as shown in the table below.

Will Carry More Current			Will Carry Less Current		
Distance Between Contacts Inches	Per Cent Additional		Distance Between Contacts Inches	Per Cent Less	
1/2	100		2 1/2	5	
3/4	70		3	10	
1	45		4	15	
1 1/4	30		5	20	
1 1/2	15		6	25	

The size of terminal and other local conditions will greatly affect these figures. They are only approximate.

Fuse Wire

The 1/4-ampere size is furnished on 250-foot spools; sizes 1/2 to 3-amperes, on 1/2-pound spools; and 4 to 100-amperes, on 1-pound spools.

Furnished only in full spools.

Size Amp.	Carrying Capacity Amperes	Feet per Pound	Per Spool	Size Amp.	Carrying Capacity Amperes	Feet per Pound	Per Spool
1/4	.15	12920	\$2.50	20	27	39	\$1.88
1/2	1.25	2616	6.25	25	33	30	1.88
1	2.2	1020	2.50	30	38	25	1.88
2	4.3	420	2.19	40	49	17.6	1.88
3	6	273	1.88	50	59	14	1.88
4	7.3	213	2.81	60	75	10.5	1.88
5	8	172	2.81	70	85	9	1.88
6	9	148	2.81	80	101	7.3	1.88
8	12	109	2.81	90	125	5.8	1.88
10	14	87	2.50	100	141	5.1	1.88
15	20	57	2.50

Fuse Strip

Packed in 5-pound cans. All in one piece. Each strip is marked at the inner end of the coil with the ampere rating. Width of strip, 1 inch.

Furnished only in full cans.

Size Amp.	Thick. Inches	Carrying Capacity Amperes	Feet Per Lb.	Per Can	Size Amp.	Thick. Inches	Carrying Capacity Amperes	Feet Per Lb.	Per Can
100	.028	125	7.3	\$9.38	300	.092	310	2.2	\$9.38
125	.035	155	5.8	9.38	350	.110	405	1.9	9.38
150	.043	180	4.7	9.38	400	.128	410	1.6	9.38
175	.051	200	4	9.38	500	.166	515	1.2	9.38
200	.059	225	3.5	9.38	600	.204	625	1	9.38
250	.075	285	2.7	9.38

Ideal Safe-T-Grip Fuse Pullers

Ideal Safe-T-Grip Fuse Pullers have notched edges which give a sure grip, eliminating any possibility of slipping. Eliminates the danger of pulling and replacing cartridge fuses by hand and the bending of fuse clips through improper removal. Also adapted for adjusting loose cutout clips, handling electrical parts, etc.



No.	Size	Description	Each
34-001	Midget	For Small Fuses, 1/4 to 1/2-in. in Diameter.....	\$0.45
34-002	Pocket	1 to 200-Amp., 250-Volt, & 1 to 100-Amp., 600-Volt.....	1.00
34-003	Giant	100 to 600-Amp., 250-Volt & 60 to 400-Amp., 600 Volt.....	2.65

Buss Fuse Reducers

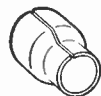

60 to 30 Amp.

Make it possible to use ordinary or Fusetron fuses of a size smaller than the fuse clips are intended to hold.

Will fit any form of the spring type or clamp type clip, in any panel or switch.

They take no more space than would a fuse of a size to fit clips.

Reducers provide clamp contact throughout eliminating troubles resulting from poor contacts.

Packed, one pair in a carton.



200 to 100 Amp.

250 Volt

No.	Amperes	Wt., Lbs. Per 100	Per Pair
263	60 to 30	16	\$0.70
213	100 to 30	31	1.30
216	100 to 60	34	.95
226	200 to 60	60	2.90
2621	200 to 100	30	1.90
2642	400 to 200	35	2.90

600 Volt

663	60 to 30	16	.80
216	100 to 30	34	.95
616	100 to 60	39	1.70
626	200 to 60	65	4.75
2621	200 to 100	30	1.90
2642	400 to 200	35	2.90

600 to 100 amp. size reducer not needed. 225 to 400 amp. fuses will fit in 600 amp. clips—contact surface is reduced some, but if necessary the effect of that can be offset by using clip-clamps to give tighter contact.

Ideal Fuse Reducers



Protect overfused circuits without expense of special fuses, change in switch panel or equipment. Handy for emergency use. Fully approved. Listed by Underwriters' Laboratories.

250-Volt			600-Volt		
No.	Amperes	Each	No.	Amperes	Each
33-001	60-30	\$0.65	33-025	60-30	\$1.19
33-002	100-30	1.08	33-026	100-30	1.24
33-003	100-60	1.08	33-027	100-60	1.72
33-006	200-100	2.86	33-030	200-100	3.23
33-010	100-200	5.71	33-034	400-200	6.41
33-015	600-100	7.10	33-039	600-100	7.81

Other sizes and prices upon request to GRAYBAR.

Ideal Fuse Puller and Testlite



Safe, convenient, dual-purpose electrician's tool with "Sure Grip" handles.

Used for pulling cartridge-type fuses and checking electrical connections.

Constructed of sturdy dielectric plastic. One end serves as sure-grip fuse puller; test prods on opposite end fit both parallel and tandem slot receptacles. Test prods are only exposed metal parts. Internal wires connecting test prods fully insulated.

Designed for use on fuses up to 100 amp., 250 v. and 60 amp., 600 v. Test capacity from 100 v. to 600 v. a-c or d-c.

No.	Description	Each
34-012	Fuse Puller and Testlite Only	\$2.95
34-013	One 30-in. Lead with Test Prods	1.00
34-014	One 30-in. Lead with Insulated Clip	1.00

Ideal Fuse Clip Clamps



Assure proper alignment and positive contact.

Ferrule Type

No.	Capacity, Amps.		Std. Pkg.	Each
	250 V.	600 V.		
32 001	30	...	12	\$0.61
32 002	60	30	12	.77
32 003	...	60	6	.95

Knife Type

32 004	100	100	6	\$0.91
32 005	200	200	6	1.31
32 006	400	400	6	1.88
32 007	600	600	6	2.38

Knox Pyrex Brand Glass Electrode Housings



No. 7032-B

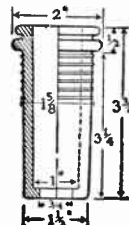

No. 7033-B

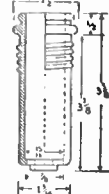

Panel opening 1 3/4 in. Assembled with coil spring.

Panel opening 1 5/16 in. Assembled with coil spring.

No.	Wt. Per 100, Lbs.	Per 100	No.	Wt. Per 100, Lbs.	Per 100
7032-B	46	\$20.50	7033-B	20	\$19.50

Buss Clip-Clamps



Built for hard service.

Insure good contact between clips and ordinary or Fusetron fuses. Eliminates heating from poor contact that often causes fuses to blow. Clip-clamps make replacement of fuse-clips unnecessary as they generally permit even injured clips to be used with perfect satisfaction. To prevent corrosion, all steel parts are heavily cadmium plated.

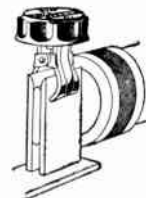

No.	Size of Clamp	Car-ton	Wt. Lbs. Per 100	Each
1	0- 30 Amp. 250 Volt	12	5	\$ 0.84
2	31- 60 Amp. 250 Volt	12	8	1.05
	0- 30 Amp. 600 Volt	(Use No. 2 listed above)		
4	31- 60 Amp. 600 Volt	12	12	1.32
5	61-100 Amp. 250 or 600 Volt	12	10	1.25
6	101-200 Amp. 250 or 600 Volt	6	21	1.88
7	201-400 Amp. 250 or 600 Volt	6	31	2.72
8	401-600 Amp. 250 or 600 Volt	6	42	3.44

Hoffman "JIC" Electrical Wiring Boxes

Listed by Underwriters' Laboratories, Inc.



Constructed of 14 gauge steel, except the three small sizes, which are of 16 gauge. Mounting feet are made from 12 gauge steel.

Cover is chained to box to prevent loss. No holes in box or cover; all seams welded. Cover is gasketed with cellular neoprene and held to box by external clamp and lift-off hinges. Covers held on by screws available.

Standard finish is baked gray hammerstone enamel over a phosphatized surface. Special finishes, sizes and modifications including holes for conduit connections and continuous hinges can be provided.

All models except 404 LP have four weld-nuts for supporting panel on which chassis, terminal strips, relays and other components can be assembled.

Boxes Without Panels

No.	Length	Box Size In. Width	Height	Std. Pkg. Boxes	Wt. Lbs. Std. Pkg.	Each
404LP*	4	4	3	24	49	\$5.30
604LP	6	4	3	20	54	6.30
606LP	6	6	4	10	42	7.80
806LP	8	6	3 1/2	8	45	8.90
1008LP	10	8	4	6	51	10.20
1210LP	12	10	5	3	37	12.50
1412LP	14	12	6	2	35	16.70
1614LP	16	14	6	1	21	20.46

*404LP not designed for panel.

Panels Only

No.	For Box No.	Length In.	Width In.	Std. Pkg. Boxes	Wt. Lbs. Std. Pkg.	Each
6P4	604LP	4 7/8	2 7/8	20	6	\$0.54
6P6	606LP	4 7/8	4 7/8	10	6	.74
8P6	806LP	6 3/4	4 7/8	8	6	.86
10P8	1008LP	8 3/4	6 7/8	6	8	1.18
12P10	1210LP	10 3/4	8 7/8	3	7	1.40
14P12	1412LP	12 3/4	10 7/8	2	7	1.60
16P14	1614LP	14 3/4	12 7/8	1	5	1.80

Panels not installed in boxes, but packaged separately.

Call Graybar FIRST For . . .

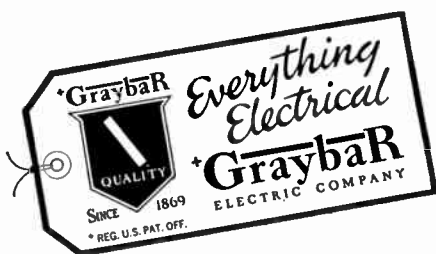

**Hoffman Control Panel Enclosures
NEMA Standards**

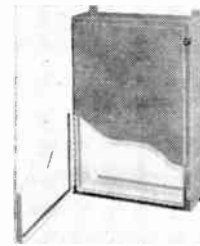

NEMA Type 12

Used to house electrical controls providing protection from dust, dirt, oil, coolant or water.

Door hinged to body with a continuous hinge, and gasketed with cellular neoprene. All 14 gauge enclosures have rolled edge extending around door opening. Special clamps welded to body hold door closed. Single door units have padlock hasp and feet for wall mounting. Each enclosure has removable print pocket.

Two door units have specially gasketed, overlapping doors which eliminate the need for center-posts. They are floor mounted on 12-in. stands and fitted with lifting eyes. Two door units have locking handle with three point latch.

Mounting panels finished with baked white enamel. The interior finished with baked white enamel. Exterior has gray prime coat. All surfaces phosphatized prior to painting. Special materials, sizes, modifications and corrosion resistant finishes quoted on request. Disconnect switches installed on request.

Single Door Wall Mounted Units

No.	Length In.	Width In.	Depth In.	Steel Body	Gauge Panel	Ship. Wt. Lbs.	Each
161206	16	12	6	14	12	26	\$41.90
201606	20	16	6	14	12	37	49.96
202006	20	20	6	14	12	44	57.20
242006	24	20	6	14	12	52	62.90
302006	30	20	6	14	12	66	68.62
302406	30	24	6	14	12	78	74.34
362406	36	24	6	14	12	92	80.06
242408	24	24	8	14	12	70	72.50
302408	30	24	8	14	12	90	82.00
362408	36	24	8	14	12	99	88.00
363008	36	30	8	14	12	123	99.00
422408	42	24	8	14	12	109	99.00
423008	42	30	8	14	12	142	107.00
423608	42	36	8	14	12	170	118.00
482408	48	24	8	14	12	128	107.00
483008	48	30	8	14	12	150	112.50
483608	48	36	8	14	12	181	128.00
603608	60	36	8	14	12	224	138.00

Two Door Floor Mounted Units

544208	54	42	8	14	12	273	203.00
604808	60	48	8	12	10	428	260.00
604810	60	48	10	12	10	431	310.00
606010	60	60	10	12	10	540	380.00
726010	72	60	10	12	10	597	426.00
604812	60	48	12	12	10	450	350.00
606012	60	60	12	12	10	535	410.00
726012	72	60	12	12	10	637	450.00

Columbia Type A Surface Cabinets

Adapted to nearly all installations where a cabinet for surface mounting is to be used as a junction, service, switch, panel, or cutout cabinet.

Construction. Sheet steel, required thickness to conform with Underwriters' Laboratories specifications.

Finish. The standard finish is a high grade baked on, durable gray enamel or aluminum paint. Olive green, all enamels or other special finishes can be furnished at an extra charge.

Hardware. Cabinets up to 18 inches in width or height are regularly equipped with flush ring handle and friction catch. Over 18 inches wide and not exceeding 24 inches high a turn knob and latch is used. Larger cabinets and all double door cabinets are fitted with vault handle latch. Unless otherwise specified, all boxes are hinged on the long side. Code



requirements for double and three-point catches are provided for in these listings.

Knockouts. Boxes 15 inches wide and up; one 1 1/4"-1" one 1" knockout near center of each side, two 3/4"-1/2" concentric knockouts on each side, balance 1/2"-3/8" concentric. Boxes 10 to 12 inches wide; one 3/4"-1" concentric knockout in ends, two 3/4"-1" concentric knockouts in sides, balance 1/2"-3/8" concentric. Smaller size boxes; one 3/4"-1" concentric knockout in center of each side, balance 1/2"-3/8" concentric. Boxes narrower than 6 inches; 1/2"-3/8" concentric knockouts only. Special knockouts can be made at an extra charge. Box can also be furnished without knockouts on request.

Galvanized Cabinets can be furnished at an additional charge.

See cost sheet.

Width Inches	Height Inches	Depth, Inches					
		3 Each	4 Each	6 Each	8 Each	10 Each	12 Each
*4 1/2	5	\$1.72	\$2.34
*4 1/2	9	2.00	2.64
6	6	1.88	2.16	\$3.76	\$4.10
*6	9	2.30	2.96	4.52	5.08
*6	10	2.64	3.16	4.82	5.40
*6	11	2.82	3.40	4.52	5.96
*6	12	3.00	3.36	5.32	6.12
*6	16	3.60	4.08	6.00	7.56
*6	8	2.10	2.64	4.26	4.72
8	8	2.56	3.06	4.60	5.52
8	10	2.94	3.44	5.10	6.32	\$7.20
8	12	3.44	4.02	5.80	7.10	8.00	\$8.70
8	15	4.02	4.62	6.60	8.20	9.40	10.50
8	18	4.62	5.34	7.20	9.50	10.80	12.00
9	9	2.96	3.78	5.10	6.40	7.50	8.10
9	12	3.66	4.26	6.00	7.60	8.70	9.60
9	15	4.20	4.90	7.00	8.90	10.00	11.20
9	16	4.56	5.04	7.34	9.20	10.50	11.70
9	18	4.86	5.82	7.90	9.90	11.50	12.70
9	20	5.40	6.34	8.50	10.70	12.40	13.70
9	24	6.12	7.10	9.60	12.34	14.40	15.80
9	28	10.90	12.30	15.10	18.70	20.10	23.10
9	32	12.50	13.60	16.80	20.90	23.36	25.72
9	36	13.56	15.20	18.40	23.10	25.80	28.36
10	10	3.56	4.02	5.90	7.20	8.30	9.10
10	12	3.96	4.50	6.50	8.10	9.20	10.50
10	15	4.68	5.22	7.40	9.30	10.70	11.84
10	18	5.34	5.60	8.40	10.60	12.20	13.50
10	20	6.32	7.16	9.30	11.32	12.70	14.10
10	24	7.40	8.30	10.60	13.10	14.60	16.20
10	28	11.96	13.14	16.14	19.88	21.56	24.40
10	32	13.20	14.70	17.94	21.38	24.60	27.20
10	36	14.70	16.24	19.92	24.40	27.20	30.00
12	12	4.90	5.56	7.44	8.80	9.90	11.00
12	16	6.10	6.70	8.90	10.74	12.00	13.24
12	18	6.64	7.10	9.60	11.70	13.00	14.20
12	20	7.12	7.70	10.30	12.60	14.10	15.50
12	24	8.48	9.00	11.76	14.60	16.20	17.80
12	28	13.50	14.88	17.94	22.10	24.40	26.98
12	32	15.06	16.68	19.86	24.60	27.20	29.80
12	36	16.80	18.48	21.90	27.20	30.00	32.80
12	40	18.48	20.14	23.88	28.90	32.80	35.80
16	12	6.10	6.60	8.90	10.76	12.00	13.26
16	32	18.90	20.40	24.00	29.46	32.30	35.00
16	36	21.00	22.74	26.34	30.90	35.60	38.44
16	20	9.06	9.50	12.20	15.30	16.80	18.48
15	24	10.00	10.80	13.60	16.80	18.56	20.30
16	28	16.80	18.36	21.60	26.48	28.96	31.60
16	32	18.90	20.40	24.00	29.46	32.30	35.00
16	36	21.00	22.74	26.34	30.90	35.60	38.44
16	40	21.16	24.96	28.80	35.60	38.80	42.10
18	18	9.20	10.20	12.50	15.30	17.00	18.54
18	20	10.00	11.00	13.40	16.50	18.30	20.00
18	24	16.16	17.76	20.80	25.24	27.90	30.90
18	28	18.48	20.16	23.40	28.60	30.70	34.00
18	32	20.76	22.50	26.00	31.80	34.90	37.76
18	36	23.16	24.90	28.62	35.00	38.40	41.48
18	40	25.50	27.30	31.20	38.40	41.92	44.40
21	21	16.38	18.00	21.00	25.60	28.04	31.36
21	24	18.30	19.92	23.28	27.56	31.00	33.60
21	28	21.00	22.80	26.16	32.00	34.88	37.70
21	32	23.70	25.50	29.46	35.52	38.70	41.72

Width Inches	Height Inches	Depth, Inches					
		3 Each	4 Each	6 Each	8 Each	10 Each	12 Each
21	36	\$26.28	\$26.20	\$32.10	\$39.10	\$42.50	\$46.14
21	40	28.98	30.90	35.04	42.76	46.34	49.92
24	24	20.64	22.32	25.68	31.10	34.04	37.00
24	28	23.52	25.38	28.92	35.10	38.28	41.34
24	32	26.52	28.44	32.22	38.92	42.44	45.76
24	36	29.52	31.44	35.52	42.88	46.70	50.24
24	40	32.40	34.44	38.10	47.00	50.80	54.72
24	42	56.60	59.78	66.20	82.90	88.64	95.36
24	48	63.20	68.30	75.62	87.36	90.24	97.50
30	24	33.08	34.88	38.60	45.00	48.30	48.70
30	28	36.56	38.60	42.56	49.92	52.40	56.60
30	32	39.44	42.20	46.52	54.40	55.00	61.76
30	36	68.40	72.20	79.60	87.60	93.00	98.40
30	40	75.80	80.20	86.40	97.20	103.20	109.20
30	44	83.40	88.20	94.80	107.00	113.60	120.20
30	48	91.00	96.20	103.00	116.80	123.80	131.00
30	54	119.80	126.30	139.40	162.20	171.80	181.40
30	60	133.20	140.40	155.00	180.00	190.80	201.00
30	66	142.20	149.60	165.20	192.00	203.60	215.60
30	72	159.80	168.40	185.60	216.00	228.80	241.80
36	36	83.40	88.00	94.60	107.00	114.20	120.20
36	42	112.40	118.60	130.80	152.00	161.20	170.20
36	48	128.00	135.00	148.80	173.00	183.40	193.80
36	54	143.60	151.20	166.80	194.20	205.60	217.40
36	60	159.80	168.60	185.80	216.00	228.80	242.00
36	66	175.70	185.40	204.20	237.50	251.60	266.00
36	72	191.60	202.20	222.60	259.00	274.40	290.00
36	78	207.60	219.00	241.60	281.00	297.60	314.60
36	84	223.40	235.60	259.80	302.00	320.00	328.00
42	42	131.00	138.00	152.40	177.00	187.80	198.40
42	48	149.40	157.60	173.80	202.00	214.20	226.40
42	54	168.00	177.10	195.10	227.00	240.60	254.20
42	60	186.60	196.60	216.40	252.00	267.00	282.00
42	66	204.80	216.00	238.00	277.00	293.60	310.20
42	72	223.40	235.60	259.80	302.00	320.00	338.00
42	78	242.60	255.80	282.00	328.00	348.00	367.60
42	84	261.00	275.00	303.60	353.00	374.00	395.00
42	90	279.60	294.60	325.00	378.00	400.40	423.40
42	96	298.40	314.80	347.00	403.60	427.80	452.00
48	48	171.00	180.20	196.80	230.80	244.60	258.60
48	54	191.60	203.60	222.60	258.80	274.40	290.00
48	60	213.00	224.60	247.60	288.00	305.60	322.40
48	66	234.40	247.00	272.40	316.60	335.60	354.60
48	72	256.00	270.00	297.60	356.00	366.80	387.60
48	78	276.60	291.00	321.60	374.00	396.80	419.20
48	84	298.60	314.80	347.20	403.60	427.40	452.00
48	90	319.00	336.20	372.60	431.00	457.00	483.60
48	96	340.40	358.80	395.60	460.00	487.60	513.60
54	54	215.80	227.60	250.80	292.00	309.40	327.00
54	60	239.60	252.80	278.40	324.00	343.60	363.00
54	66	263.40	277.60	306.00	356.00	367.40	398.80
54	72	287.00	302.40	333.60	388.00	411.40	434.40
54	78	310.80	327.60	361.40	420.00	445.20	470.80
54	84	333.60	351.40	387.00	450.00	477.20	504.20
54	96	377.60	397.80	439.00	510.00	540.40	571.60
60	60	262.80	277.00	305.60	355.00	376.40	397.60
60	66	288.60	304.20	335.60	390.00	413.60	416.40
60	72	318.40	335.60	370.00	430.00	456.00	482.00
60	78	341.60	360.00	397.00	462.40	489.60	516.80
60	84	370.00	390.00	430.00	500.00	530.00	560.00
60	90	396.00	417.00	460.00	517.60	567.60	599.20
60	96	421.60	444.00	490.00	570.00	604.00	638.00

*Hinged on width or short side.

Columbia Type P Flush Cabinets

Construction. Sheet steel, required thickness to conform with Underwriters' Laboratories specifications. Removable trim and door. Plain type without ornamental beads; body is formed from one piece of steel with corners folded in and securely welded.

Finish. Standard finish is gray enamel or aluminum paint.

Hardware. Cabinet is regularly equipped with knob and turn catch. Cabinets with surface area of over 360 square inches are furnished with vault handle. Cabinets can be supplied with any style hinges, catch or lock.

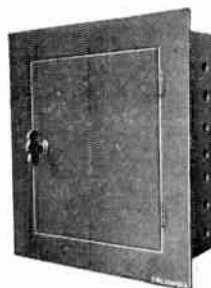

Knockouts. Boxes 15 inches wide and up; one 1 1/4", one 1" knockout near center of each side, two 3/4"-1" concentric knockouts on each side, balance 1/2-3/4" concentric. Boxes 10 to 12 inches wide; one 3/4"-1" concentric knockout in ends, two 3/4"-1" concentric knockouts in sides, balance 1/2-3/4" concentric. Smaller size boxes; one 3/4"-1" concentric knockout in center of each side, balance 1/2-3/4" concentric. Boxes narrower than 6 inches; 1/2-3/4" concentric knockouts only. For special knockouts, add \$2.00 for each additional size change. Specify if boxes are desired without knockouts.

Width In.	HL In.	Depth, Inches					
		3 Each	4 Each	6 Each	8 Each	10 Each	12 Each
4 1/2	5	\$7.12	\$7.80				
4 1/2	9	7.38	8.00	\$10.50			
6	6	7.32	7.90	9.20			
6	9	7.76	8.42	10.00			
6	10	7.94	8.60	10.40	\$10.60	\$11.20	\$12.00
6	11	8.18	8.90	10.60	11.00	11.50	12.50
6	12	8.42	9.08	10.30	12.90	13.14	13.80
6	16	9.38	10.16	12.00	14.00	15.90	17.00
6	8	7.62	8.22	9.70	10.00	10.66	11.70
8	8	8.22	8.82	10.50	11.20	11.92	12.90
8	10	8.76	9.48	11.10	12.20	13.10	13.90
8	12	9.10	9.88	11.50	13.10	14.00	15.00
9	9	8.66	9.38	11.00	12.30	13.10	13.90
8	15	9.94	10.54	12.30	14.70	15.78	17.40
8	18	10.78	11.08	14.00	16.50	17.70	18.54
9	12	9.50	10.22	11.80	13.90	14.90	16.00
9	15	10.40	11.24	13.10	15.80	16.90	18.00
9	16	10.76	11.60	14.00	16.40	17.54	18.62
9	18	11.36	12.40	15.50	17.60	18.80	19.62
9	20	12.20	13.40	16.70	18.80	19.34	21.24
9	21	14.50	16.00	18.20	19.60	22.40	24.56
9	28	20.60	22.32	26.90	28.62	31.58	34.74
9	32	22.76	25.02	29.96	31.68	35.64	38.70
9	36	22.92	27.72	33.02	34.74	39.68	42.74
10	10	9.22	9.94	11.60	13.46	14.70	15.36
10	12	9.88	11.26	13.10	14.74	15.50	17.60
10	15	10.84	11.68	14.20	16.58	18.16	18.36
10	18	12.00	13.10	16.60	18.34	18.72	20.70
10	20	13.50	15.00	17.20	18.50	20.44	22.58
10	24	15.10	16.50	18.80	21.24	23.56	25.92
10	28	21.84	24.04	28.70	30.40	33.44	36.54
10	32	26.64	27.00	32.84	34.20	37.40	41.04
10	36	27.44	30.00	36.96	38.00	41.40	45.54
12	12	10.00	11.50	14.50	15.80	17.00	17.70
12	16	12.70	14.10	17.00	17.70	19.36	24.84
12	18	14.80	15.70	18.50	19.08	21.04	23.12
12	20	15.30	16.90	18.50	20.64	22.84	25.02
12	21	17.20	17.80	21.16	22.96	26.28	28.70
12	28	25.00	27.16	31.96	33.76	37.20	40.40
12	32	28.00	30.30	35.44	38.00	41.40	45.00
12	36	30.96	33.44	39.00	42.20	46.50	49.94
12	40	33.90	36.72	42.48	46.40	50.80	54.90
16	12	13.00	14.60	16.50	17.60	19.36	21.24
16	15	15.00	16.30	18.10	20.16	22.50	22.38
16	18	16.60	17.30	20.32	22.84	25.20	27.44
16	20	17.20	18.72	21.84	24.84	27.16	31.60
15	21	19.00	20.50	24.12	27.24	29.84	31.58
16	28	31.04	33.30	38.54	41.08	44.48	48.78
16	32	35.00	37.40	43.04	45.90	49.84	53.54
16	36	38.96	41.50	47.50	50.76	57.24	58.36
16	40	42.92	45.68	52.00	54.76	60.60	63.10
18	18	17.32	18.80	22.12	24.84	27.36	29.76
18	20	18.72	20.44	23.86	26.84	29.50	31.96
18	21	29.70	32.20	37.36	39.54	42.80	46.32
18	28	34.20	36.72	41.84	44.76	46.24	51.84
18	32	38.70	41.20	46.32	49.76	53.64	57.30
18	36	43.20	45.76	50.84	54.88	59.00	62.80
18	40	47.70	50.32	55.30	60.00	64.40	68.36
21	21	24.16	26.10	29.70	33.40	36.00	38.80
21	24	34.10	36.44	41.76	44.84	48.42	52.00
21	28	38.96	41.56	47.00	50.04	54.00	58.00
21	32	43.84	46.76	52.20	55.20	59.60	63.90

Width In.	HL In.	Depth, Inches					
		3 Each	4 Each	6 Each	8 Each	10 Each	12 Each
21	36	\$48.72	\$51.90	\$57.40	\$60.48	\$65.10	\$69.90
21	40	53.52	56.88	63.50	65.70	70.70	75.70
24	24	38.00	40.50	46.10	48.80	52.50	56.44
24	28	43.40	46.10	51.90	55.20	59.40	64.40
24	32	48.80	51.60	57.60	61.56	66.30	70.70
24	36	54.10	57.24	63.36	69.90	73.10	79.70
24	40	59.60	62.80	69.10	74.40	79.90	84.90
24	42	72.90	77.40	87.30	105.30	113.40	122.40
24	48	87.40	90.00	101.24	122.40	126.90	137.10
30	24	56.24	48.10	54.88	58.50	63.00	67.50
30	28	52.70	55.60	61.90	65.90	70.50	75.40
30	32	59.30	62.30	68.90	73.30	78.10	83.00
30	36	79.60	84.80	94.10	100.80	106.20	113.40
30	40	87.20	92.40	102.70	107.80	115.20	123.10
30	44	95.60	101.80	111.20	114.80	123.00	131.00
30	48	103.50	108.80	119.60	125.60	133.40	142.60
30	54	136.20	145.80	162.00	187.80	194.40	200.80
30	60	151.20	162.00	180.00	208.80	216.00	223.20
30	66	165.20	173.00	192.20	225.60	230.80	238.20
30	72	185.60	194.40	216.00	251.20	259.00	267.40
36	36	93.20	97.00	109.40	117.00	125.50	133.20
36	42	130.80	136.80	152.20	176.40	182.40	188.60
36	48	148.60	155.60	173.00	200.80	207.60	214.80
36	54	166.80	174.80	194.00	225.00	233.00	240.80
36	60	185.60	194.40	216.00	250.80	259.00	268.00
36	66	212.20	222.20	246.80	261.60	296.00	306.00
36	72	222.80	232.80	259.20	300.40	310.80	321.20
36	78	241.60	252.80	280.80	325.80	337.00	348.20
36	84	259.60	271.60	302.00	350.40	362.40	374.40
42	42	147.20	158.00	176.00	204.80	212.00	219.20
42	48	173.80	181.80	201.00	232.00	240.00	248.00
42	54	195.20	204.00	227.00	263.60	272.80	281.60
42	60	216.80	227.00	252.00	292.20	302.40	312.40
42	66	238.00	249.00	276.80	321.60	332.00	343.00
42	72	259.60	271.60	302.00	350.20	362.20	374.20
42	78	282.00	295.00	328.00	380.40	393.60	404.80
42	84	301.00	315.00	350.00	406.00	420.00	434.00
42	90	321.60	337.00	374.00	413.60	449.20	463.60
42	96	342.40	358.20	398.00	462.00	478.00	493.60
48	48	199.00	208.00	231.20	268.20	277.60	286.40
48	54	220.80	230.80	257.20	298.40	308.80	319.20
48	60	247.60	259.60	284.80	329.60	340.00	351.00
48	66	272.40	283.60	318.00	364.00	378.20	388.20
48	72	293.00	305.00	338.00	390.40	403.60	414.80
48	78	318.40	333.00	370.00	409.60	445.20	459.60
48	84	342.40	358.20	398.00	462.00	478.00	493.60
48	90	369.60	386.60	429.60	498.00	507.60	532.40
48	96	394.20	412.20	458.00	531.60	549.60	568.00
54	54	251.60	263.60	288.80	333.60	344.00	355.00
54	60	275.00	285.60	320.00	366.00	380.20	390.20
54	66	303.00	317.00	352.00	408.00	422.00	436.00
54	72	331.00	347.00	384.00	423.60	459.20	473.60
54	78	360.00	376.20	416.00	480.00	496.00	511.60
54	84	387.00	404.20	450.00	523.60	541.60	560.00
54	96	442.00	461.00	514.00	596.00	616.00	636.00
60	60	305.00	317.00	350.00	402.20	415.60	428.80
60	66	335.00	350.20	390.00	454.00	470.00	485.60
60	72	369.60	386.60	429.60	498.00	507.60	532.40
60	78	397.00	414.20	462.00	535.60	553.60	572.00
60	84	431.00	449.00	502.00	584.00	604.00	624.00
60	90	460.00	481.60	534.00	620.00	641.60	664.00
60	96	490.00	512.80	570.00	661.60	684.00	707.60

Square D QO Circuit Breaker Load Centers

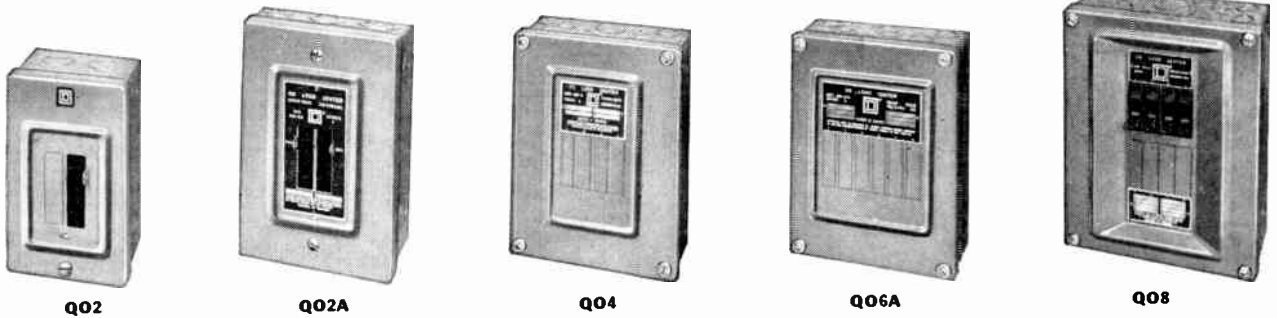

One to Eight Circuits—No Door

Order Breakers Separately

Box, Interior and Cover No.	Max. No. Poles	Type Enclosures	Main Ratings Amps.	Description	List
QO2S	2	Surface	30	General Purpose	\$3.30
QO2F	2	Flush	30	General Purpose	4.00
QO2RO	2	Raintight	30	1 1/4" Max. Hub	9.10*
QO2AS	2	Surface	70	General Purpose	5.50
QO2AF	2	Flush	70	General Purpose	5.50
QO2ARO	2	Raintight	70	1 1/4" Max. Hub	10.50*
QO4S	4	Surface	70	General Purpose	5.80
QO4F	4	Flush	70	General Purpose	5.80
QO4RO	4	Raintight	70	1 1/4" Max. Hub	11.00*
QO8S	8	Surface	100	General Purpose	11.60
QO8F	8	Flush	100	General Purpose	11.60
QO8RO	8	Raintight	100	2" Max. Hub	22.40*
QO4WHIS	2 D.P.	Surface	50	Water Heater separate feed	7.30
QO4WHF	2 D.P.	Flush	50	Water Heater separate feed	7.30
QO403S	3	Surface	50	With 3 Phase 4-wire interior	8.80
QO403F	3	Flush	50	With 3 Phase 4-wire interior	8.80
QO403RO	3	Raintight	50	1 1/4" Max. Hub	14.00*
QO6AS	6	Surface	70	{ Six S.P. or	8.70
QO6AF	6	Flush	70	{ 1 D.P. with	8.70
QO6ARO	6	Raintight	70	{ 1 S.P.	13.90

*Type RO Raintight device has threaded opening for interchangeable hub or closing cap. Order size required separately.

Note: Models QO2R, QO2AR, QO4R, QO403R and QO6AR with blank endwalls available at RO prices.

Note: Any two adjacent single poles may be tied together with handle tie for 120/240V A.C. 3W, individual trip serv.

Call Graybar FIRST For . . .

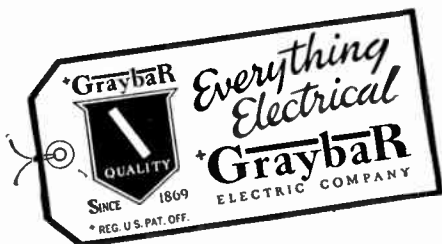

Twelve to Forty-Two Circuits—With Door

Order Breakers Separately

One Phase—3 Wire Lugs Only

Max. No. Poles	Mains Rating Amps.	Basic Device—Box & Interior Only No.	List	Cover With Door (Order Separately) Flush	Surface	List
General Purpose Enclosure						
12	100	QO12	\$14.40	QOC12F	QOC12S	\$3.00
16	100	QO16	19.20	QOC16F	QOC16S	4.00
20	100	QO20	25.00	QOC20F	QOC20S	4.00
24	125	QO24	29.90	QOC24F	QOC24S	7.40
30	100*	QO30	41.10	QOC30F	QOC30S	7.40
42	200	QO42	61.50	QOC42F	QOC42S	9.40

Raintight Enclosure

12	100	QO12RO	*28.20
20	100	QO20RO	*41.10
30	150*	QO30RO	*72.70

Three Phase—4 Wire Lugs Only
General Purpose Enclosures

12	100	QO412	24.40	QOC12F	QOC12S	3.00
20	100	QO420	35.00	QOC20F	QOC20S	4.00
30	100	QO430	46.10	QOC30F	QOC30S	7.40
42	200	QO442	71.50	QOC42F	QOC42S	9.40

Raintight Enclosure

12	100	QO412RO	*38.50
20	100	QO420RO	*50.10
30	100	QO430RO	*77.70

One Phase—3 Wire Main Disconnect
General Purpose Enclosure

12	100	QO12M	36.80	QOC12MF	QOC12MS	4.00
20	100	QO20M	45.00	QOC20MF	QOC20MS	7.40
30	200	QO30MP	108.50	QOC30MPF	QOC30MPS	10.00
30	200			†QOC30MPTF		10.00
40	200	QO40MP	123.00	QOC40MPF	QOC40MPS	10.00
40	200			†QOC40MPTF		10.00

Raintight Enclosures

12	100	QO12MRO	*52.90
20	100	QO20MRO	*64.50

Three Phase—4 Wire Main Disconnect
General Purpose Enclosure

12	50	QO412M	91.00	QOC412MF	QOC412MS	4.00
20	100	QO420M	132.60	QOC20MF	QOC20MS	7.40

Raintight Enclosures

12	50	QO412MRO	*107.00
20	100	QO420MRO	*164.60

*Type RO Raintight device has threaded openings for interchangeable hub or closing cap. Order size required separately.

†TF Covers are for flush drywall construction.

*200 Amp. mains available — specify Cat. No. QO30A and QO30ARO — add \$5.00 list.

Square D Type QO Circuit Breaker Load Centers Service Entrance Devices

6 Circuit Sub-Division Rule—Split Buss

Order Breakers Separately



QO12

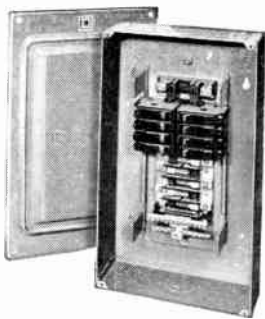

QO20
Basic Device and Trim

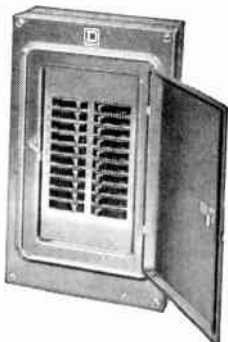

QO20
Assembled Device
Door Open

Double Pole Circuits	Single Pole Circuits	Description Bus Divided or Split Into Sections. Top Section Contains Main Disconnects Per NEC Para. 2351A. Remaining Bus Fed from Disconnects on Top Bus.	Type Enclosure	Basic Device	
				Box, Interior and Cover With Door	List
2	8	One lighting main and one additional double pole connected in parallel. 100 A. Main.	Surface	QO12-208S	\$22.40
			Flush	QO12-208F	22.40
			Raintight	QO12-208RO	34.50*
3	8	One lighting main. Two additional double poles connected in parallel. 100 A. Main.	Surface	QO14-308S	25.30
			Flush	QO14-308F	25.30
			Raintight	QO14-308RO	37.40*
4	10	One lighting main. Three additional double poles connected in parallel. 100 A. Main.	Surface	QO18-410S	31.10*
			Flush	QO18-410F	31.10
			Raintight	QO18-410RO	43.20*
4	12	One lighting main. Three additional double poles plus two single poles connected in parallel. 100 A. Main.	Surface	QO20-4210S	34.00
			Flush	QO20-4210F	34.00
			Raintight	QO20-4210RO	46.10*
6	8	One lighting main and five additional double poles connected in parallel. 100 A. Mains.	Surface	QO20-608S	34.00
			Flush	QO20-608F	34.10
			Raintight	QO20-608RO	46.10*
6 or 4 D.P. plus 1 T.P.	10	One lighting main. Three additional double poles connected in parallel. Two additional double poles, independently fed for water heater service, sealable, or one independently fed three pole. 100 A. Main.	Surface	QO22-410WHS	36.90
			Flush	QO22-410WHF	36.90
			Raintight	QO22-410WHRO	49.00*
6	14	One lighting main. Five additional double poles connected in parallel. 150 A. Mains. [▲]	Surface	QO26-614S	47.70
			Flush	QO26-614F	47.70
			Raintight	QO26-614RO	71.90*
6 or 4 D.P. plus 2 T.P.	14	One D.P. lighting main and five additional double poles or Four D.P. plus two three poles connected in parallel. 150 A. Mains. [▲]	Surface	QO428-614S	60.60
			Flush	QO428-614F	60.60
			Raintight	QO428-614RO	84.80*
6	18	Two lighting mains and four additional double poles connected in parallel. 150 A. Mains. [▲]	Surface	QO30-618S	58.50
			Flush	QO30-618F	58.50
			Raintight	QO30-618RO	82.70*
6	30	Three lighting mains and three additional double poles connected in parallel. 200 A. Mains.	Surface	QO42-630S	80.90
			Flush	QO42-630F	80.90

Circuit Breakers—Plug-In Type QO

Amp. Rating	Single Pole 120 Volts A-C		Two Pole Common Trip 120/240 Volts A-C		Three Pole Common Trip 240 Volts A-C		Switched Neutral			
	No.	List	No.	List	No.	List	Two Wire 120 Volts A-C		Three Wire 120/240 Volts A-C	
15	QO115	\$3.10	QO215	\$6.90	QO315	\$22.00	QO215SWN	\$9.10	QO315SWN	\$12.80
20	QO120	3.10	QO220	6.90	QO320	22.00	QO220SWN	9.10	QO320SWN	12.80
30	QO130	3.10	QO230	6.90	QO330	22.00
40	QO140	3.10	QO240	6.90	QO340	22.00
50	QO150	3.10	QO250	6.90	QO350	22.00
70	QO270	13.00

Any two adjacent single poles may be tied together with handle tie for 120/240 volts a-c, 3 wire, individual trip service.

Standard Carton: Single poles—10; double poles—5, three poles—1.

Accessories

No.	Description	List	No.	Description	List
QO1HT	Handle Ties	\$0.10	HC	Interchangeable Hub— $\frac{3}{4}$ in.	\$2.60
QO1CP	Closure Plate (S.P.)	.70	HD	Interchangeable Hub—1 in.	2.60
QO1LO	Handle Lock-Off	.20	HE	Interchangeable Hub— $1\frac{1}{4}$ in.	2.60
PK2FL	Flush Lock	5.90	HG	Interchangeable Hub— $1\frac{1}{2}$ in.	2.60
QO2PA	Handle Padlock Attachment (2 and 3 Poles)	2.80	HH	Interchangeable Hub—2 in.	4.40
CE	Closing Cap (Up to 100 A.)	.20	HW	Interchangeable Hub— $2\frac{1}{2}$ in.	7.80
CH	Closing Cap 100 to 200 A.	.20			

*Type RO raintight device has threaded opening for interchangeable hub or closing cap. Order size required separately.
[▲]200 Amp. Mains available—specify Cat. No. QO30-618AS/F/RO or QO428-614AS/F/RO . . . add \$5.00 list.

Square D Interchangeable Hubs



Raintight with Removable Hubs

Square D Raintight enclosures use interchangeable hubs. Thus a minimum stock of boxes, together with a variety of hubs can easily satisfy any customer application.

Flexibility is provided, merely screw hub into special threaded opening at top of the raintight box. Inside of hub is threaded for conduit.

Interchangeable hubs are available in the following conduit sizes: 3/4, 1, 1 1/4, 1 1/2, 2 and 2 1/2 inches. Type RO raintight devices having mains rating up to 70 amperes will accept 3/4, 1 and 1 1/4 inch hubs. RO devices rated 100 amperes will accept 1 1/2 and 2 inch hubs directly, and the 3/4, 1 and 1 1/4 inch hubs through a reducer furnished with the raintight device. RO devices having 200 amperes mains will accept the 2 1/2 inch hub directly and the 1 1/2 and 2 inch hub through a reducer furnished with the device.

Closing caps may be used to close the threaded openings when no hub is required. Hubs may be added to any device by cutting a hole and locking the hub in place with a locking nut of the size shown.

Type R devices without the threaded hub provisions are available in popular sizes.

No.	Conduit Size In.	Description	Each
HC	3/4	Interchangeable Hub	\$2 60
HC2	3/4	Interchangeable Hub	2 60
HD	1	Interchangeable Hub	2 60
HD2	1	Interchangeable Hub	2 60
<hr/>			
HE	1 1/4	Interchangeable Hub	2 60
HE2	1 1/4	Interchangeable Hub	2 60
HG	1 1/2	Interchangeable Hub	2 60
<hr/>			
HH	2	Interchangeable Hub	4 40
HH4	2	Interchangeable Hub	4 40
HW	2 1/2	Interchangeable Hub	7 80

No.	Size Hole to Cut When Using Hub and Nut	Description	Each
NE	1 3/4	Locking Nut	\$1 00
HN2G	1 3/4	Locking Nut	1 00
<hr/>			
NH	2 1/2	Locking Nut	1 00
HN4G	2 1/2	Locking Nut	1 00
NW	3	Locking Nut	1 00

No.	Device Rating	Description	Each
CE	30-100 Amp.	Closing Cap	\$0 20
CA2	30-100 Amp.	Closing Cap	.20
CH	100-200 Amp.	Closing Cap	.20
CA4	100-200 Amp.	Closing Cap	.20

Call Graybar FIRST For . . .

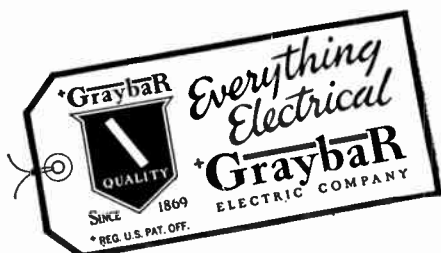

Square D Class 9070 Control Circuit Transformers



Class 9070 Type ACO-50 Transformer

These control circuit transformers are specifically designed for industrial control applications, to provide good transformer regulation when high inrush currents are drawn.

50-60 cycles, 25 cycle transformers also available in 500 VA and smaller ratings.

Standard voltage transformers.

General Purpose Enclosure NEMA Type 1

No.	Continuous VA	Nominal Allowable Inrush VA	Can Be Used With Contactor Size	Each
AAG-50	50	165	1	\$23 00
AAG-100	100	500	2	33 00
AAG-150	150	775	3	36 00
<hr/>				
AAG-300	300	1500	4 (3 Pole)	44 00
AAG-500	500	2200	4 (5 Pole)	56 00
AAG-750	750	3300	...	86 00
AAG-1000	1000	4400	5	101 00

Open Type

No.	Continuous VA	Nominal Allowable Inrush VA	Can Be Used With Contactor Size	Each
AAO-50	50	165	1	\$15 00
AAO-100	100	500	2	21 00
AAO-150	150	775	3	24 00
<hr/>				
AAO-300	300	1500	1 (3 Pole)	30 00
AAO-500	500	2200	1 (5 Pole)	40 00
AAO-750	750	3300	...	68 00
AAO-1000	1000	4400	5	81 00

Separate Fuse Blocks

No.	Description	Each
AP-1	Fuse Block and Bracket Assembly (unmounted)	\$3 00

Square D Voltage Testers



No. 5008

No. SK3986

Tests without lamps—eliminates breakage. Voltage directly indicated on easily read, colored scale. May be operated using one or both hands. Can be carried in pocket.

Heavy fibre case withstands 10,000 volts. Lead wires have vulcanized oil resisting insulation and 4-in. fibre grips covering insulation—piercing prongs.

Testers cover the a-c and d-c scale up to 600 volts and from 25 to 400 cycles. Polarity cap indicates d-c polarity and is optional on all testers.

Testers Complete With Polarity Cap

No.	Description	Each
5008	110-220-140-550 volts a-c, 60 cycles, 125-250-600 volts d-c.	\$16 50
5006	12-24-36-18-60 volts a-c, 60 cycles, 10-20-30-10 volts d-c.	16 50
5007	110-220-140-550 volts a-c, 400 cycles, 30-60-90-120 volts d-c.	16 50

Polarity Indicating Cap

SK-3986	For any Square D voltage tester.	4 00
---------	--	------

Voltage Tester Case

5002	Imitation leather case.	2 00
5002D	Genuine leather.	4 00

Square D Fusible Distribution Panelboards—Unassembled With QMB Saflex HP Rated Plug-In Switch Units

Single Phase 2 Wire, 250 Volts A-C or D-C

Single Phase 3 Wire, S/N 125/250 Volts

Three Phase 3 Wire, 250 Volts or 600 Volts A-C

Three Phase 4 Wire S/N 120/208 Volts or 277/480 Volts A-C



QMB Saflex Available Locally

Panelboards with any combination of 30, 60, 100 or 200 ampere, 2 or 3 pole switches, 250 volts or 600 volts and main lugs up to 600 amperes are now available from your local Graybar distributor.

For switches over 200 amperes or mains in excess of 600 amperes contact GRAYBAR so that these custom built panelboards can be ordered for you direct from factory.

Switch Units

Each unit individually enclosed in steel. Dead front construction. Quick make, quick break, horsepower rated. Heavy duty cast operating handle. Double spring mechanism insures positive opening under full load.

Visible blades for maximum safety. Positive pressure fuse clips and switch jaws assure maintenance free connections. Cover interlock prevents unauthorized access but permits entrance for maintenance. 30 ampere thru 200 ampere units are plug-in type. Service entrance approved with six circuits or less or with main switch.

Mains: Main lug only: 200, 400 or 600 ampere, main switch 200 ampere only.

Branches: Quick-make, quick-break hp. rated plug-in switch units, two or three pole, 30 to 200 ampere capacity.

Boxes: Code gauge steel without knockouts, finished blue-grey over rust resisting phosphate primer. Dimensions: 30-in. wide by 10½-in. deep.

Fronts: Code gauge steel, flush or surface mounting, with or without door with adjustable indicating trim clamps. Finished blue-grey.

Wire Gutters: End gutters 7 inch. Side gutters 5½ inch.

Selection of Components

1. List required circuits including main switch if desired (ampere rating and poles).
2. Select catalog numbers of switch units and determine total required unit space from Table One. If solid neutral is required, select from Table Three and include height required when determining unit space.
3. Select interior, box and front catalog numbers based on required unit space from Table Two (or Mains capacity).
4. Select blanks if required to complete unit space from Table Three. For 1 ph. 2 W. or 1 ph. 3 W. applications select switch units having CA bus connections. For 3 ph. 4 W. "Delta" applications all 2P switch units should have CA bus connections. For distributed phasing of 2P switch units select proper assortment of AB, CA and BC bus connections.

Table One—Plug-In Switch Units

Unit Ampere Rating	Unit Hgt. In.	250 Volts A-C or D-C Two Pole Bus Connections				Each	600 Volts A-C		
		AB	CA	BC	Three Pole				
		Catalog No.	Catalog No.	Catalog No.	Catalog No.		Each	Each	
Branch Units									
30-30 twin	6	QMB-2203-TL	QMB-2203-T	QMB-2203-TR	\$ 50.00	QMB-3203-T	\$ 60.00	QMB-3603-T	\$ 89.00
60-60 twin	6	QMB-2206-TL	QMB-2206-T	QMB-2206-TR	56.00	QMB-3206-T	76.00	QMB-3606-T	89.00
100-100 twin	7½	QMB-2210-TL	QMB-2210-T	QMB-2210-TR	83.00	QMB-3210-T	106.00	QMB-3610-T	130.00
200 single	9	QMB-2220-L	QMB-2220	QMB-2220-R	98.00	QMB-3220	143.00	QMB-3620	162.00
Main Switch									
100A	9	QMB-2210-M	119.00	QMB-3210-M	173.00	QMB-3610-M	189.00
200A	9	QMB-220-M	119.00	QMB-3220-M	173.00	QMB-3620-M	189.00

Table Two—Interiors, Boxes and Fronts (Without Solid Neutral)

Total Unit Mtg. Space†	Amp. Rating of Mains	Type	Complete Price (Less Units)	Box Hgt. In.	Component Ordering Tables					
					Interior Assembly (Less Units)		Front		Box	
					Catalog No.	Each	Catalog No.	Each	Catalog No.	Each
24	200	QMB-24-2	\$157.00	44	QMB-2444-2	\$ 82.00	QM-2144-TS or TF	\$ 29.00	QM-2144-B	\$ 46.00
24	100	QMB-24-4	167.00	44	QMB-2444-4	92.00	QM-2144-TS or TF	29.00	QM-2144-B	46.00
36	200	QMB-36-2	184.00	56	QMB-3656-2	92.00	QM-2156-TS or TF	35.00	QM-2156-B	57.00
36	100	QMB-36-4	205.00	56	QMB-3656-4	113.00	QM-2156-TS or TF	35.00	QM-2156-B	57.00
48	100	QMB-48-4	251.00	68	QMB-4868-4	130.00	QM-2168-TS or TF	43.00	QM-2168-B	78.00
48	600	QMB-48-6	275.00	68	QMB-4868-6	154.00	QM-2168-TS or TF	43.00	QM-2168-B	78.00

Table Three—Blanks, Neutrals and Adaptor Kits

Blanks				Solid Neutral Assemblies				Adaptor Kits—To Convert 60 A. to 30 A. Units			
Catalog No.	Hgt. In.	Std. Pkg. Qty.	Each	Catalog No.	Amps. Cap.	Hgt. In.	Each	Catalog No.	Type Unit	Each	
QMB-1BL	1½	8	\$1.70	QM-2SN	200 A.	6	\$25.00	QMB-263-AL	2 P. 250 V.	\$3.20	
QMB-3BL	3	4	2.10	QM-4SN	400 A.	6	32.00	QMB-363-AL	3 P. 250 V.	4.30	
QMB-6BL	6	4	2.20	QM-6SN	600 A.	6	46.00	QMB-363-AH	3 P. 600 V.	3.90	
QMB-12BL	12	2	2.50								

†If a solid neutral is required, actual unit mounting space is reduced by the solid neutral height.

Square D Lighting and Distribution Panelboards

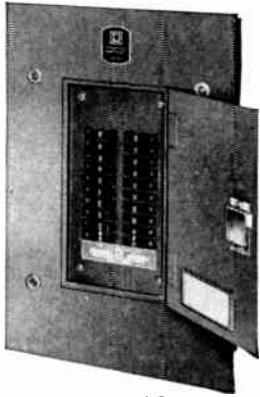

Type NQO

Lighting Panelboards

Panel No.	Service	Branch Units	Box Size	
			Width In.	Depth In.
NQO	120/240 Volts A.C.	Circuit Breaker*	14	4 or 5 3/4
NQO-LX	120/240 Volts A.C.	Circuit Breaker*	8 5/8	5
NQB	120/240 Volts A.C.	Circuit Breaker	20	5 3/4
NAB	125/250 Volts AC/DC	Circuit Breaker	20	5 3/4
NAB-LX	125/250 Volts AC/DC	Circuit Breaker	8 5/8	5
NYB	277/480 Volts A.C.	Circuit Breaker	20	5 3/4
NYB-LX	277/480 Volts A.C.	Circuit Breaker	8 5/8	5
NTPR	125/250 Volts AC/DC	Plug Fuse & Switch	17	4 1/4

*Modern Plug-in Construction.

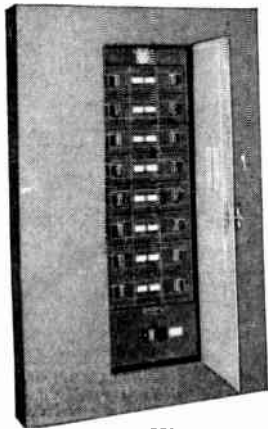

Type ML

Distribution Panelboards

Panel No.	Service	Branch Units	Box Size	
			Width In.	Depth In.
MHP	120/240 Volts A.C.	Circuit Breaker*	14	5 3/4
			20	5 3/4
MLN	120/250 Volts AC/DC	Circuit Breaker	20	5 3/4
ML	250 Volts AC/DC	Circuit Breaker	30	8 5/8
	600 Volts A.C.		40	10
QMB	250 Volts AC/DC	Fusible*	30	10 1/2
	600 Volts A.C.		30	13 5/8
			36	17 3/4
Saflex	250 Volts AC/DC	Fusible	20	5 3/4
			27	10 3/4
			13	13 1/2

*Modern Plug-in Construction.

Circuit Breaker Selection Table

Panel-board Types	Type	Ampere Ratings	120V. A-C	240V. A-C	480V. A-C	600V. A-C	125/250V. D-C	250V. D-C	Fed. Specs. WP-131a Breaker Class	Circuit Breaker Contacts	
										Manual Operation	Automatic Tripping
NQO	QO	15-50	5000A.	15000A.	A	} Quick Make } Quick Break	} Quick Break
NQB	QB	15-50	5000A.	A			
NAB	ML	15-50	10000A.	5000A.	C			
NYB	ML(Y)	15,20	10000A.	D			
MHP	MM	15 to 50A.	5000A.	5000A.	B	} Slow Make } Slow Break	} Quick Break
MHP	M1	15 to 50A.	5000A.	5000A.	A			
MHP	M2	70 and 100A.	5000A.	5000A.	A			
MLN	ML	15 to 50A.	10000A.	5000A.	C	} Quick Make } Quick Break	} Quick Break
MLN	ML1	70 and 100A.	10000A.	5000A.	C		
ML	ML1	15 to 100A.	*20000A.	15000A.	15000A.	5000A.	C,D,E	} Quick Make } Quick Break	} Quick Break
ML	ML3	125 to 225A.	25000A.	20000A.	15000A.	10000A.	D,E		
ML	KL	125 to 400A.	40000A.	30000A.	25000A.	20000A.	D,E		
ML	WL	125 to 600A.	50000A.	35000A.	25000A.	20000A.	D,E		

*20,000A. interrupting capacity of ML1 breaker on 240 volts a-c service applies only when 600 volts a-c ML1 breaker is used.
 †5,000A. interrupting capacity of QO on 240 volts a-c service applies only when three pole breaker is used.

Square D Circuit Breaker Lighting Panelboards

With Type QO Swingrip Mounted Thermal-Magnetic Branch Breakers

Unassembled Type

Type NQO 3-Wire Panelboards

Three Phase, 3 Wire S/N A-C Only

Mains: 120/210 volts a-c only.

Branches: Single pole, 120 volts, 2-wire S/N breakers.†

Boxes: 14 in. wide, galvanized steel. All boxes 4 in. deep, except 200 ampere main breaker boxes are 5¾ in. deep.

Fronts: Trim with door and flush lock. Blue-gray finish.

Gutters: Side and end gutters 1 inches.

Mains—Lugs Only

*Max. No. of Single Poles Available	Type	Complete List Price Less Breakers		Basic Device Only (Less Breakers) List Price		Front Only List Price	
		Cat. No.	List Price	Cat. No.	List Price	Cat. No.	List Price
Capacity of Mains—100 Amperes							
14	NQO-14	\$ 79.00	QO19-143	\$ 55.00	QO-19T	\$24.00	
20	NQO-20	91.00	QO21-203	65.00	QO-21T	26.00	
Capacity of Mains—200 Amperes							
30	NQO-30	110.00	QO25-303	79.00	QO-25T	31.00	
42	NQO-42	128.00	QO31-423	95.00	QO-31T	33.00	
Mains—Circuit Breaker—2 Pole							
Capacity of Mains—70 Amperes							
14	NQO-14	112.00	QO25-143M	81.00	QO-25T	31.00	
Capacity of Mains—100 Amperes							
20	NQO-20	144.00	QO28-203M	112.00	QO-28T	32.00	
Capacity of Mains—200 Amperes							
30	NQO-30	315.00	QO35-303M	276.00	QO-35T	39.00	
Capacity of Mains—225 Amperes							
42	NQO-42	333.00	QO41-423M	288.00	QO-41T	45.00	

Note: For flush front add letter F to catalog number, for surface front add letter S to catalog number.

†Single pole branches: 15, 20, 30, 40, and 50 ampere single pole branches are available.

*Two pole branches: 15, 20, 30, 40, 50 and 70 ampere double pole, individual or common trip branches occupy the same space as two (2) single poles.

Three pole branches: 15, 20, 30, 40, and 50 ampere three pole common trip branches occupy the same space as three (3) single poles.

Type QO Plug-In Circuit Breaker

Amp. Rating	Single Pole 120 Volt A-C		Double Pole Common Trip 120-240 V. A-C		Three Pole Common Trip 240 Volt A-C	
	Cat. No.	List Price	Cat. No.	List Price	Cat. No.	List Price
15	QO-115	\$3.10	QO-215	\$ 6.90	QO-315	\$22.00
20	QO-120	3.10	QO-220	6.90	QO-320	22.00
30	QO-130	3.10	QO-230	5.90	QO-330	22.00
40	QO-140	3.10	QO-240	6.90	QO-340	22.00
50	QO-150	3.10	QO-250	6.90	QO-350	22.00
...	QO-270	13.00		

Switched Neutral QO Plug-In Circuit Breakers

Amp. Rating	2 Wire Switched Neutral 120 Volt A-C		3 Wire Switched Neutral 120-240 Volt A-C	
	Cat. No.	List Price	Cat. No.	List Price
15	QO-215SWN	\$9.10	QO-315SWN	\$12.80
20	QO-220SWN	9.10	QO-320SWN	12.80

Accessories

No.	Description	Each
QO-1HT	Handle Tie.....	\$ 0.10
QO-1LO	Handle Lock-Off.....	.20
QO-1CP	Closure Plate (Single Pole).....	.60
QO-2PA	Handle Padlock Attachment (2 & 3 Pole).....	2.50
QO-100SF	100 Amp. Sub-Feed Lug Kit (3 Pole).....	20.00
QO-200SF	200 Amp. Sub-Feed Lug Kit (3 Pole).....	24.00

▲Handle ties permit conversion of two single breakers to double pole 120/208 volts, individual trip breaker.

†Sub-feed lug kits do not provide for neutral connections.

Type NQO 4-Wire Panelboard

3 Phase, 4 Wire, S/N A-C Only

Mains: 120/208 volts a-c only.

Branches: Single pole, 120 volts 2-wire S/N breakers.†

Boxes: 14 in. wide galvanized steel, all boxes 4 in. deep, except 200 ampere main breaker boxes are 5¾ in. deep.

Fronts: Trim with door and flush lock. Blue-gray finish.

Gutters: Four inch side and end gutters.

Mains—Lugs Only

*Max. No. of Single Poles Available	Type	Complete List Price Less Breakers		Basic Device Only (Less Breakers) List Price		Front Only List Price	
		Cat. No.	List Price	Cat. No.	List Price	Cat. No.	List Price
Capacity of Mains—100 Ampere							
14	NQO-14	\$ 89.00	QO19-144	\$ 65.00	QO-19T	\$24.00	
20	NQO-20	101.00	QO21-204	75.00	QO-21T	26.00	
30	NQO-30	116.00	QO25-304	85.00	QO-25T	31.00	
Capacity of Mains—200 Ampere							
42	NQO-42	141.00	QO31-424	108.00	QO-31T	33.00	
Mains—Circuit Breaker—3 Pole							
Capacity of Mains 50 Ampere							
14	NQO-14	137.00	QO25-144M	106.00	QO-25T	31.00	
Capacity of Mains 100 Ampere							
20	NQO-20	170.00	QO28-204M	138.00	QO-28T	32.00	
30	NQO-30	185.00	QO31-304M	152.00	QO-31T	33.00	
Capacity of Mains 200 Ampere							
42	NQO-42	393.00	QO41-424M	348.00	QO-41T	45.00	

Complete Device Price Table

(Includes Basic Device, Front And Plug-In Breakers)

The breakers are packaged separate from basic device and front. Single poles 10 per carton; double poles 5 per carton; three poles individually packaged.

▲No. of 1-Pole Branches	▲No. of 1-Pole Spaces	*Complete List Price			
		1 Ph. 3W. S-N Main Lugs	Main Breaker	3 Ph. 4W. S-N Main Lugs	Main Breakers
Type NQO-14					
0	14	\$ 79.00	\$112.00	\$ 89.00	\$137.00
2	12	85.20	118.20	95.20	143.20
4	10	91.40	124.40	101.40	149.40
6	8	97.60	130.60	107.60	155.60
8	6	103.80	136.80	113.80	161.80
10	4	110.00	143.00	120.00	168.00
12	2	116.20	149.20	126.20	174.20
14	0	122.40	155.40	132.40	180.40
Type NQO-20					
16	4	140.60	193.60	150.60	219.60
18	2	146.80	199.80	156.80	225.80
20	0	153.00	206.00	163.00	232.00
Type NQO-30					
22	8	178.20	338.20	184.20	253.20
24	6	184.40	389.40	190.40	259.40
26	4	190.60	395.60	196.60	265.60
28	2	196.80	401.80	202.80	271.60
30	0	203.00	408.00	209.00	278.00
Type NQO-42					
32	10	227.20	432.20	240.20	492.20
34	8	233.40	438.40	246.40	498.40
36	6	239.60	444.60	252.50	504.60
38	4	245.80	450.80	258.80	510.80
40	2	252.00	457.00	265.00	517.00
42	0	285.20	463.20	271.20	523.20

*For each double pole common-trip breaker substituted for two single pole breakers, add \$0.70 list to above prices. For each three pole breaker substituted for three single pole breakers, add \$11.20 list to the above prices.

▲Handle ties permit conversion of two single breakers top double pole 120/208 volts individual trip breaker.

Square D Circuit Breaker Lighting Panelboards With Type QO Swingrip Mounted Thermal-Magnetic Branch Breakers

Factory Assembled Type

Type NQO-3

Single Phase, 3 Wire S/N A-C Only, Standard Width

‡Mains: 120/240 volts a-c only.

Branches: Single pole, 15 ampere 120 volt 2-wire S/N type QO Breakers.†

*Boxes: 14 in. wide galvanized steel, 200 ampere main breaker boxes 5¾ in. deep. All others 4 in. deep.

Fronts: Trim with door and flush lock. Blue-gray finish.

No. Br.	Amps. Mains	Cat. No.	List Price	Box Cat. No.	Interior Cat. No.	Front Cat. No.
Mains—Lugs Only						
8	100	NQO08-3L	\$105.00	QO19B	QO1.30819	QO19T
10	100	NQO10-3L	116.00	QO19B	QO1.31019	QO19T
12	100	NQO12-3L	127.00	QO19B	QO1.31219	QO19T
14	100	NQO14-3L	138.00	QO19B	QO1.31419	QO19T
16	100	NQO16-3L	149.00	QO21B	QO1.31621	QO21T
18	100	NQO18-3L	160.00	QO21B	QO1.31821	QO21T
20	100	NQO20-3L	171.00	QO21B	QO1.32021	QO21T
22	200	NQO22-3L	186.00	QO25B	QO1.32225	QO25T
24	200	NQO24-3L	197.00	QO25B	QO1.32425	QO25T
26	200	NQO26-3L	208.00	QO25B	QO1.32625	QO25T
28	200	NQO28-3L	219.00	QO25B	QO1.32825	QO25T
30	200	NQO30-3L	230.00	QO25B	QO1.33025	QO25T
32	200	NQO32-3L	241.00	QO31B	QO1.33231	QO31T
34	200	NQO34-3L	252.00	QO31B	QO1.33431	QO31T
36	200	NQO36-3L	263.00	QO31B	QO1.33631	QO31T
38	200	NQO38-3L	274.00	QO31B	QO1.33831	QO31T
40	200	NQO40-3L	285.00	QO31B	QO1.34031	QO31T
42	200	NQO42-3L	296.00	QO31B	QO1.34231	QO31T

Mains—Circuit Breaker—2 Pole

8	50	NQO08-3AB	138.00	QO25B	QOM30825	QO25T
10	50	NQO10-3AB	149.00	QO25B	QOM31025	QO25T
12	70	NQO12-3AB	180.00	QO25B	QOM31225	QO25T
14	70	NQO14-3AB	191.00	QO25B	QOM31425	QO25T
16	100	NQO16-3AB	202.00	QO28B	QOM31628	QO28T
18	100	NQO18-3AB	213.00	QO28B	QOM31828	QO28T
20	100	NQO20-3AB	224.00	QO28B	QOM32038	QO28T
22	200	NQO22-3AB	391.00	QO535B	QOM32235	QO35T
24	200	NQO24-3AB	402.00	QO535B	QOM32435	QO35T
26	200	NQO26-3AB	413.00	QO535B	QOM32635	QO35T
28	200	NQO28-3AB	424.00	QO535B	QOM32835	QO35T
30	200	NQO30-3AB	435.00	QO535B	QOM33035	QO35T
32	200	NQO32-3AB	446.00	QO541B	QOM33241	QO41T
34	200	NQO34-3AB	457.00	QO541B	QOM33441	QO41T
36	200	NQO36-3AB	468.00	QO541B	QOM33641	QO41T
38	200	NQO38-3AB	479.00	QO541B	QOM33841	QO41T
40	200	NQO40-3AB	490.00	QO541B	QOM34041	QO41T
42	225	NQO42-3AB	501.00	QO541B	QOM34241	QO41T

Note: Approximate box height is indicated by last two figures of box number. Wiring gutters—side and end gutters are 4-in. in. all panels.

†Ratings: 15 ampere single pole branches will be furnished unless otherwise specified. 20, 30, 40 and 50 ampere single pole breakers can be substituted without price change. Use of branch breakers rated more than 15 amperes may necessitate increased mains.

Two-Pole (Individual Trip): For each double pole, 15, 20, 30, 40 or 50 ampere (individual trip) 120/240 volt circuit substituted for two single pole circuits add \$0.50 list to panel figured on basis of all single pole circuits.

Two-Pole (Common Trip): For each double pole 15, 20, 30, 40 or 50 ampere (common trip) 120/240 volt circuit substituted for two single pole circuits, add \$0.70 (list to panel figured on basis of all single pole circuits.

Three Pole (Common Trip): For each three pole 15-50 ampere (common trip) 240 volt circuit substituted for three single pole circuits, add \$12.70 list to panel figured on basis of all single pole circuits.

Type NQO-4

3 Phase 4 Wire S/N A-C Only Standard Width

‡Mains: 120/208 volts a-c only.

Branches: Single pole, 15 ampere 120 volts, 2-wire S/N type QO breakers.†

*Boxes: 14-in. wide galvanized steel, 200 ampere main breaker boxes 5¾ in. deep; all other 4 in. deep.

Fronts: Trim with door and flush lock. Blue-gray finish.

No. Br.	Amps. Mains	Cat. No.	List Price	Box Cat. No.	Interior Cat. No.	Front Cat. No.
Mains—Lugs Only						
8	100	NQO08-4L	\$115.00	QO19B	QO1.40819	QO19T
10	100	NQO10-4L	126.00	QO19B	QO1.41019	QO19T
12	100	NQO12-4L	137.00	QO19B	QO1.41219	QO19T
14	100	NQO14-4L	148.00	QO19B	QO1.41419	QO19T
16	100	NQO16-4L	159.00	QO21B	QO1.41621	QO21T
18	100	NQO18-4L	170.00	QO21B	QO1.41821	QO21T
20	100	NQO20-4L	181.00	QO21B	QO1.42021	QO21T
22	100	NQO22-4L	192.00	QO25B	QO1.42225	QO25T
24	100	NQO24-4L	203.00	QO25B	QO1.42425	QO25T
26	100	NQO26-4L	214.00	QO25B	QO1.42625	QO25T
28	100	NQO28-4L	225.00	QO25B	QO1.42825	QO25T
30	100	NQO30-4L	236.00	QO25B	QO1.43025	QO25T
32	200	NQO32-4L	254.00	QO31B	QO1.43231	QO31T
34	200	NQO34-4L	265.00	QO31B	QO1.43431	QO31T
36	200	NQO36-4L	276.00	QO31B	QO1.43631	QO31T
38	200	NQO38-4L	287.00	QO31B	QO1.43831	QO31T
40	200	NQO40-4L	298.00	QO31B	QO1.44031	QO31T
42	200	NQO42-4L	309.00	QO31B	QO1.44231	QO31T

Mains—Circuit Breaker—3 Pole

8	50	NQO08-4AB	163.00	QO25B	QOM40825	QO25T
10	50	NQO10-4AB	174.00	QO25B	QOM41025	QO25T
12	50	NQO12-4AB	185.00	QO25B	QOM41225	QO25T
14	50	NQO14-4AB	196.00	QO25B	QOM41425	QO25T
16	100	NQO16-4AB	228.00	QO28B	QOM41628	QO28T
18	100	NQO18-4AB	239.00	QO28B	QOM41828	QO28T
20	100	NQO20-4AB	250.00	QO28B	QOM42028	QO28T
22	100	NQO22-4AB	261.00	QO31B	QOM42231	QO31T
24	100	NQO24-4AB	272.00	QO31B	QOM42431	QO31T
26	100	NQO26-4AB	283.00	QO31B	QOM42631	QO31T
28	100	NQO28-4AB	294.00	QO31B	QOM42831	QO31T
30	100	NQO30-4AB	305.00	QO31B	QOM43031	QO31T
32	200	NQO32-4AB	506.00	QO541B	QOM43241	QO41T
34	200	NQO34-4AB	517.00	QO541B	QOM43441	QO41T
36	200	NQO36-4AB	528.00	QO541B	QOM43641	QO41T
38	200	NQO38-4AB	539.00	QO541B	QOM43841	QO41T
40	200	NQO40-4AB	550.00	QO541B	QOM44041	QO41T
42	200	NQO42-4AB	561.00	QO541B	QOM44241	QO41T

Sub-Feed Breaker: 70-100 ampere, two and three pole breakers are available as sub-feed branches with no more than one per Main Lug Only panel at \$52.50 for each two pole and \$69.00 for each three pole. No sub-feed breakers are available for main breaker panels.

Space Only: When space only for future branches is required, figure panel on basis of total number of branches, including the future branches, and deduct \$3.10 list for each breaker pole omitted.

*Deep Boxes: When 14-in. wide by 5¾ in. deep boxes are required, add the number "5" to the box catalog number, i.e. QO519B. No extra charge.

120/208 volts a-c only rating when one and two pole branches are in panel. A 240 volt a-c only rating may be obtained when all three pole branches are used.

Square D Circuit Breaker Lighting Panelboards With Type QB Thermal-Magnetic Branch Breakers

Factory Assembled Type

Type NQB-3

Single Phase, 3 Wire S/N A-C Only Standard Width

Mains: 120/240 volts a-c only.

Branches: Single pole, 15 ampere, 125 volts 2-wire S/N type QB breakers. †

Boxes: 20-in. wide, 5¾ in. deep. Galvanized steel.

Fronts: Trim with door and flush lock. Blue-gray finish.

No. Branch Poles	Amp. Mains	Cat. No.	List Price	Box Cat. No.	Interior Cat. No.	Front Cat. No.
Mains—Lugs Only						
8	100	NQB08-3L	\$115.00	MII17	CB8102	MII2017
10	100	NQB10-3L	128.00	MII20	CB8103	MII2020
12	100	NQB12-3L	141.00	MII20	CB8104	MII2020
14	100	NQB14-3L	154.00	MII20	CB8105	MII2020
16	100	NQB16-3L	167.00	MII23	CB8106	MII2023
18	100	NQB18-3L	180.00	MII23	CB8107	MII2023
20	100	NQB20-3L	193.00	MII23	CB8108	MII2023
22	200	NQB22-3L	210.00	MII26	CB8109	MII2026
24	200	NQB24-3L	223.00	MII26	CB8110	MII2026
26	200	NQB26-3L	236.00	MII26	CB8111	MII2026
28	200	NQB28-3L	249.00	MII29	CB8112	MII2029
30	200	NQB30-3L	262.00	MII29	CB8113	MII2029
32	200	NQB32-3L	275.00	MII29	CB8114	MII2029
34	200	NQB34-3L	288.00	MII32	CB8115	MII2032
36	200	NQB36-3L	301.00	MII32	CB8116	MII2032
38	200	NQB38-3L	314.00	MII32	CB8117	MII2032
40	200	NQB40-3L	327.00	MII35	CB8118	MII2035
42	200	NQB42-3L	340.00	MII35	CB8119	MII2035

Mains—Circuit Breaker—2 Pole

8	50	NQB08-3AB	148.00	MII23	CB8122	MII2023
10	50	NQB10-3AB	161.00	MII26	CB8123	MII2026
12	100	NQB12-3AB	194.00	MII26	CB8124	MII2026
14	100	NQB14-3AB	207.00	MII26	CB8125	MII2026
16	100	NQB16-3AB	220.00	MII29	CB8126	MII2029
18	100	NQB18-3AB	233.00	MII29	CB8127	MII2029
20	100	NQB20-3AB	246.00	MII29	CB8128	MII2029
22	200	NQB22-3AB	415.00	MII38	CB8129	MII2038
24	200	NQB24-3AB	428.00	MII38	CB8130	MII2038
26	200	NQB26-3AB	441.00	MII38	CB8131	MII2038
28	200	NQB28-3AB	454.00	MII41	CB8132	MII2041
30	200	NQB30-3AB	467.00	MII41	CB8133	MII2041
32	200	NQB32-3AB	480.00	MII41	CB8134	MII2041
34	200	NQB34-3AB	493.00	MII44	CB8135	MII2044
36	200	NQB36-3AB	506.00	MII44	CB8136	MII2044
38	200	NQB38-3AB	519.00	MII44	CB8137	MII2044
40	200	NQB40-3AB	532.00	MII47	CB8138	MII2047
42	225	NQB42-3AB	545.00	MII47	CB8139	MII2047

Note: Box height is indicated by last two figures of box number. Wiring gutters—side and end gutters are 4-in. in all panels.

†Ratings: 15 ampere single pole branches will be furnished unless otherwise specified. 20, 30, 40, and 50 ampere single pole breakers can be substituted without price change. Use of branch breakers rated more than 15 amperes may necessitate increased mains.

Two-Pole (Individual Trip): For each double pole (individual trip) circuit substituted for two single pole circuits, add \$0.50 list to panel figured on basis of all single pole circuits.

Two-Pole (A.C. Only Common Trip): For each two pole common trip A.C. only breaker substituted for 2 single pole circuits, add \$6.30 list. Single pole breakers cannot be mounted opposite the 2 pole common trip breaker.

Type NQB-4

3 Phase, 4 Wire S/N A-C Only Standard Width

Mains: 120/208 volts a-c only.

Branches: Single pole, 15 ampere 125 volts 2 wire S/N type QB breakers. †

Boxes: 20-in. wide, 5¾ in. deep. Galvanized steel.

Fronts: Trim with door and flush lock. Blue-gray finish.

No. Branch Poles	Amp. Mains	Cat. No.	List Price	Box Cat. No.	Interior Cat. No.	Front Cat. No.
Mains—Lugs Only						
8	100	NQB08-4L	\$126.00	MII17	CB8142	MII2017
10	100	NQB10-4L	139.00	MII20	CB8143	MII2020
12	100	NQB12-4L	152.00	MII20	CB8144	MII2020
14	100	NQB14-4L	165.00	MII20	CB8145	MII2020
16	100	NQB16-4L	178.00	MII23	CB8146	MII2023
18	100	NQB18-4L	191.00	MII23	CB8147	MII2023
20	100	NQB20-4L	204.00	MII23	CB8148	MII2023
22	100	NQB22-4L	217.00	MII26	CB8149	MII2026
24	100	NQB24-4L	230.00	MII26	CB8150	MII2026
26	100	NQB26-4L	243.00	MII26	CB8151	MII2026
28	100	NQB28-4L	256.00	MII29	CB8152	MII2029
30	100	NQB30-4L	269.00	MII29	CB8153	MII2029
32	200	NQB32-4L	288.00	MII29	CB8154	MII2029
34	200	NQB34-4L	301.00	MII32	CB8155	MII2032
36	200	NQB36-4L	314.00	MII32	CB8156	MII2032
38	200	NQB38-4L	327.00	MII32	CB8157	MII2032
40	200	NQB40-4L	340.00	MII35	CB8158	MII2035
42	200	NQB42-4L	353.00	MII35	CB8159	MII2035

Mains—Circuit Breaker—3 Pole

8	50	NQB08-4AB	174.00	MII23	CB8162	MII2023
10	50	NQB10-4AB	187.00	MII26	CB8163	MII2026
12	50	NQB12-4AB	200.00	MII26	CB8164	MII2026
14	50	NQB14-4AB	213.00	MII26	CB8165	MII2026
16	100	NQB16-4AB	247.00	MII29	CB8166	MII2029
18	100	NQB18-4AB	260.00	MII29	CB8167	MII2029
20	100	NQB20-4AB	273.00	MII29	CB8168	MII2029
22	100	NQB22-4AB	286.00	MII32	CB8169	MII2032
24	100	NQB24-4AB	299.00	MII32	CB8170	MII2032
26	100	NQB26-4AB	312.00	MII32	CB8171	MII2032
28	100	NQB28-4AB	325.00	MII35	CB8172	MII2035
30	100	NQB30-4AB	338.00	MII35	CB8173	MII2035
32	200	NQB32-4AB	540.00	MII41	CB8174	MII2041
34	200	NQB34-4AB	553.00	MII44	CB8175	MII2044
36	200	NQB36-4AB	566.00	MII44	CB8176	MII2044
38	200	NQB38-4AB	578.00	MII44	CB8177	MII2044
40	200	NQB40-4AB	591.00	MII47	CB8178	MII2047
42	200	NQB42-4AB	604.00	MII47	CB8179	MII2047

Two or Three-Pole 15-50 Ampere (Common Trip). When 2 or 3 pole common trip breakers are required in combination with panels listed above; select the panel having the required number of single pole branches, then add for the 2 or 3 pole breakers. Add for increased mains, if required.

Two or Three Pole: 70-100 ampere breakers may be furnished as sub-feed breakers with not more than two per panel.

Space Only: When space only for future branches is required, figure panels on basis of total number of branches, including the future branches, and deduct \$3.60 list for each breaker pole omitted.

Handle Lock-Off Device: Cat. No. SK-5400 list \$0.70 each.

Square D Column Type Lighting Panelboards With Types QO & ML Thermal-Magnetic Branch Breakers

Factory Assembled Type

Type NQO-3LX

Single Phase, 3 Wire, S/N A-C Only Narrow Width

Mains: 120/240 volts a-c only.

Branches: Single pole, 15 ampere, 120 volts 2-wire S/N type QO breakers. ‡

Boxes: 8 5/8 in. wide, 5 in. deep. Galvanized steel.

Fronts: Trim with door and flush lock. Blue-gray finish.

No. Branch Poles	Amp. Mains	Cat. No.	List Price	Box Cat. No.	Interior Cat. No.	Front Cat. No.
Mains—Lugs Only						
8	100	NQO08-3LX	\$105.00	QO824B	QOX30824	QO824T
10	100	NQO10-3LX	116.00	QO824B	QOX31024	QO824T
12	100	NQO12-3LX	127.00	QO824B	QOX31224	QO824T
14	100	NQO14-3LX	138.00	QO824B	QOX31424	QO824T
16	100	NQO16-3LX	149.00	QO830B	QOX31630	QO830T
18	100	NQO18-3LX	160.00	QO830B	QOX31830	QO830T
20	100	NQO20-3LX	171.00	QO830B	QOX32030	QO830T
22	200	NQO22-3LX	186.00	QO838B	QOX32238	QO838T
24	200	NQO24-3LX	197.00	QO838B	QOX32438	QO838T
26	200	NQO26-3LX	208.00	QO838B	QOX32638	QO838T
28	200	NQO28-3LX	219.00	QO838B	QOX32838	QO838T
30	200	NQO30-3LX	230.00	QO838B	QOX33038	QO838T
32	200	NQO32-3LX	241.00	QO847B	QOX33247	QO847T
34	200	NQO34-3LX	252.00	QO847B	QOX33447	QO847T
36	200	NQO36-3LX	263.00	QO847B	QOX33647	QO847T
38	200	NQO38-3LX	274.00	QO847B	QOX33847	QO847T
40	200	NQO40-3LX	285.00	QO847B	QOX34047	QO847T
42	200	NQO42-3LX	296.00	QO847B	QOX34247	QO847T

Type NAB-3LX

Single Phase, 3 Wire, S/N A-C or D-C Narrow Width

Mains: 125/250 volts a-c or d-c.

Branches: Single pole, 15 ampere 125 volts 2-wire S/N type ML breakers. ‡

Boxes: 8 5/8 in. wide, 5 in. deep. Galvanized steel.

Fronts: Trim with door and flush lock. Blue-gray finish.

No. Branch Poles	Amp. Mains	Cat. No.	List Price	Box Cat. No.	Interior Cat. No.	Front Cat. No.
Mains—Lugs Only						
8	100	NAB08-3LX	\$171.00	MO824	CB7402	MO1824
10	100	NAB10-3LX	198.00	MO828	CB7403	MO1828
12	100	NAB12-3LX	225.00	MO828	CB7404	MO1828
14	100	NAB14-3LX	252.00	MO834	CB7405	MO1834
16	100	NAB16-3LX	279.00	MO834	CB7406	MO1834
18	100	NAB18-3LX	306.00	MO834	CB7407	MO1834
20	100	NAB20-3LX	333.00	MO838	CB7408	MO1838
22	200	NAB22-3LX	364.00	MO838	CB7409	MO1838
24	200	NAB24-3LX	391.00	MO844	CB7410	MO1844
26	200	NAB26-3LX	418.00	MO844	CB7411	MO1844
28	200	NAB28-3LX	445.00	MO844	CB7412	MO1844
30	200	NAB30-3LX	472.00	MO848	CB7413	MO1848
32	200	NAB32-3LX	499.00	MO848	CB7414	MO1848
34	200	NAB34-3LX	526.00	MO852	CB7415	MO1852
36	200	NAB36-3LX	553.00	MO852	CB7416	MO1852
38	200	NAB38-3LX	580.00	MO856	CB7417	MO1856
40	200	NAB40-3LX	607.00	MO856	CB7418	MO1856
42	200	NAB42-3LX	634.00	MO860	CB7419	MO1860

Note: Box height is indicated by last two figures of box number. Wiring gutters at top, bottom and left side. Top and bottom gutters are 1-in. high in Type NQO and 5 in. high in Type NAB; left side gutter is 2 1/2 in. wide on NQO type and 1 1/4 in. wide on NAB type.

‡Ratings: 15 ampere single pole branches will be furnished unless otherwise specified; 20, 30, 40 and 50 ampere single pole breakers can be substituted without price change. Use of branch breakers rated more than 15 amperes may necessitate increased mains.

Cable Troughs and Pull Boxes: Can be furnished with these panels for H-Beam mounting.

Type NQO-4LX

3 Phase, 4 Wire, S/N A-C Only Narrow Width

Mains: 120/208 volts a-c only.

Branches: Single pole 15 ampere 120 volts 2-wire S/N.

Boxes: 8 5/8 in. wide, 5 in. deep. Galvanized steel.

Fronts: Trim with door and flush lock. Blue-gray finish.

No. Branch Poles	Amp. Mains	Cat. No.	List Price	Box Cat. No.	Interior Cat. No.	Front Cat. No.
Mains—Lugs Only						
8	100	NQO08-4LX	\$115.00	QO824B	QOX40824	QO824T
10	100	NQO10-4LX	126.00	QO824B	QOX41024	QO824T
12	100	NQO12-4LX	137.00	QO824B	QOX41224	QO824T
14	100	NQO14-4LX	148.00	QO824B	QOX41424	QO824T
16	100	NQO16-4LX	159.00	QO830B	QOX41630	QO830T
18	100	NQO18-4LX	170.00	QO830B	QOX41830	QO830T
20	100	NQO20-4LX	181.00	QO830B	QOX42030	QO830T
22	100	NQO22-4LX	192.00	QO838B	QOX42238	QO838T
24	100	NQO24-4LX	203.00	QO838B	QOX42438	QO838T
26	100	NQO26-4LX	214.00	QO838B	QOX42638	QO838T
28	100	NQO28-4LX	225.00	QO838B	QOX42838	QO838T
30	100	NQO30-4LX	236.00	QO838B	QOX43038	QO838T
32	200	NQO32-4LX	254.00	QO847B	QOX43247	QO847T
34	200	NQO34-4LX	265.00	QO847B	QOX43447	QO847T
36	200	NQO36-4LX	276.00	QO847B	QOX43647	QO847T
38	200	NQO38-4LX	287.00	QO847B	QOX43847	QO847T
40	200	NQO40-4LX	298.00	QO847B	QOX44047	QO847T
42	200	NQO42-4LX	309.00	QO847B	QOX44247	QO847T

Type NAB-4LX

3 Phase, 4 Wire, S/N A-C or D-C Narrow Width

Mains: 120/208 volts a-c or d-c.

Branches: Single pole 15 ampere 125 volts, 2-wire, S/N type ML breakers. ‡

Boxes: 8 5/8 in. wide, 5 in. deep. Galvanized steel.

Fronts: Trim with door and flush lock. Blue-gray finish.

No. Branch Poles	Amp. Mains	Cat. No.	List Price	Box Cat. No.	Interior Cat. No.	Front Cat. No.
Mains—Lugs Only						
8	100	NAB08-4LX	\$182.00	MO828	CB7422	MO1828
10	100	NAB10-4LX	209.00	MO828	CB7423	MO1828
12	100	NAB12-4LX	236.00	MO834	CB7424	MO1834
14	100	NAB14-4LX	263.00	MO834	CB7425	MO1834
16	100	NAB16-4LX	290.00	MO834	CB7426	MO1834
18	100	NAB18-4LX	317.00	MO838	CB7427	MO1838
20	100	NAB20-4LX	344.00	MO838	CB7428	MO1838
22	100	NAB22-4LX	371.00	MO844	CB7429	MO1844
24	100	NAB24-4LX	398.00	MO844	CB7430	MO1844
26	100	NAB26-4LX	425.00	MO844	CB7431	MO1844
28	100	NAB28-4LX	452.00	MO848	CB7432	MO1848
30	100	NAB30-4LX	479.00	MO848	CB7433	MO1848
32	200	NAB32-4LX	512.00	MO852	CB7434	MO1852
34	200	NAB34-4LX	539.00	MO852	CB7435	MO1852
36	200	NAB36-4LX	566.00	MO856	CB7436	MO1856
38	200	NAB38-4LX	593.00	MO856	CB7437	MO1856
40	200	NAB40-4LX	620.00	MO860	CB7438	MO1860
42	200	NAB42-4LX	647.00	MO860	CB7439	MO1860

Space Only: When space only for future branches is required, figure panels on basis of total number of branches including space for futures and deduct:

(a) NQO Panels—\$3.10 list for each breaker pole omitted.

(b) NAB Panels—\$9.70 list for each breaker pole omitted.

NQB-LX will be substituted at same price as NQB standard width.

NQO, NQB and NAB-LXX may be furnished at same price as L-X panelboards. Boxes are 6 7/8 in. wide, 5-in. deep.

Square D Circuit Breaker Lighting Panelboards With Type ML Thermal-Magnetic Branch Breakers

Factory Assembled Type

Type NAB-3

Single Phase 3 Wire, S/N A-C or D-C Standard Width

Mains: 125/250 volts a-c or d-c.

Branches: Single pole 15 ampere 125 volts 2 wire S/N type ML breakers. ‡

Boxes: 20-in. wide, 5¾ in. deep. Galvanized steel.

Fronts: Trim with door and flush lock. Blue-gray finish.

No. Branch Poles	Amp. Mains	Cat. No.	List Price	Box Cat. No.	Interior Cat. No.	Front Cat. No.
Mains—Lugs Only						
8	100	NAB08-3L	\$171.00	MII17	CB7002	MII2017
10	100	NAB10-3L	198.00	MII20	CB7003	MII2020
12	100	NAB12-3L	225.00	MII20	CB7004	MII2020
14	100	NAB14-3L	252.00	MII20	CB7005	MII2020
16	100	NAB16-3L	279.00	MII23	CB7006	MII2023
18	100	NAB18-3L	306.00	MII23	CB7007	MII2023
20	100	NAB20-3L	333.00	MII23	CB7008	MII2023
22	200	NAB22-3L	364.00	MII26	CB7009	MII2026
24	200	NAB24-3L	391.00	MII26	CB7010	MII2026
26	200	NAB26-3L	418.00	MII26	CB7011	MII2026
28	200	NAB28-3L	445.00	MII29	CB7012	MII2029
30	200	NAB30-3L	472.00	MII29	CB7013	MII2029
32	200	NAB32-3L	499.00	MII29	CB7014	MII2029
34	200	NAB34-3L	526.00	MII32	CB7015	MII2032
36	200	NAB36-3L	553.00	MII32	CB7016	MII2032
38	200	NAB38-3L	580.00	MII32	CB7017	MII2032
40	200	NAB40-3L	607.00	MII35	CB7018	MII2035
42	200	NAB42-3L	634.00	MII35	CB7019	MII2035
Mains—Circuit Breaker—2 Pole						
8	50	NAB08-3AB	204.00	MII23	CB7022	MII2023
10	50	NAB10-3AB	231.00	MII26	CB7023	MII2026
12	100	NAB12-3AB	278.00	MII26	CB7094	MII2026
14	100	NAB14-3AB	305.00	MII26	CB7095	MII2026
16	100	NAB16-3AB	332.00	MII29	CB7096	MII2029
18	100	NAB18-3AB	359.00	MII29	CB7097	MII2029
20	100	NAB20-3AB	386.00	MII29	CB7098	MII2029
22	200	NAB22-3AB	569.00	MII38	CB7029	MII2038
24	200	NAB24-3AB	596.00	MII38	CB7030	MII2038
26	200	NAB26-3AB	623.00	MII38	CB7031	MII2038
28	200	NAB28-3AB	650.00	MII41	CB7032	MII2041
30	200	NAB30-3AB	677.00	MII41	CB7033	MII2041
32	200	NAB32-3AB	704.00	MII41	CB7034	MII2041
34	200	NAB34-3AB	731.00	MII44	CB7035	MII2044
36	200	NAB36-3AB	758.00	MII44	CB7036	MII2044
38	200	NAB38-3AB	785.00	MII44	CB7037	MII2044
40	200	NAB40-3AB	812.00	MII47	CB7038	MII2047
42	225	NAB42-3AB	839.00	MII47	CB7039	MII2047

Note: Box height is indicated by last two figures of box number. Wiring gutters—Side and end gutters are 4-in. in all panels.

‡ Ratings: 15 ampere single pole branches will be furnished unless otherwise specified. 20, 30, 40 and 50 ampere single pole breakers can be substituted without price change. Use of branch breakers rated more than 15 amperes may necessitate increased mains.

Two or Three Pole: 15-50 ampere branches. When 2 or 3 pole common trip breakers are required in combination with panels listed above; select the panel having the required number of single pole branches, then add for the 2 and 3 pole breakers. Add for increased mains, if required.

Type NAB-4

3 Phase, 4 Wire S/N A-C or D-C Standard Width

Mains: 120/208 volts a-c or d-c.

Branches: Single pole 15 ampere 125 volts 2 wire S/N type ML breakers. ‡

Boxes: 20-in. wide, 5¾ in. deep. Galvanized steel.

Fronts: Trim with door and flush lock. Blue gray finish.

No. Branch Poles	Amp. Mains	Cat. No.	List Price	Box Cat. No.	Interior Cat. No.	Front Cat. No.
Mains—Lugs Only						
8	100	NAB08-4L	\$182.00	MII17	CB7042	MII2017
10	100	NAB10-4L	209.00	MII20	CB7043	MII2020
12	100	NAB12-4L	236.00	MII20	CB7044	MII2020
14	100	NAB14-4L	263.00	MII20	CB7045	MII2020
16	100	NAB16-4L	290.00	MII23	CB7046	MII2023
18	100	NAB18-4L	317.00	MII23	CB7047	MII2023
20	100	NAB20-4L	344.00	MII23	CB7048	MII2023
22	100	NAB22-4L	371.00	MII26	CB7049	MII2026
24	100	NAB24-4L	398.00	MII26	CB7050	MII2026
26	100	NAB26-4L	425.00	MII26	CB7051	MII2026
28	100	NAB28-4L	452.00	MII29	CB7052	MII2029
30	100	NAB30-4L	479.00	MII29	CB7053	MII2029
32	200	NAB32-4L	512.00	MII29	CB7054	MII2029
34	200	NAB34-4L	539.00	MII32	CB7055	MII2032
36	200	NAB36-4L	566.00	MII32	CB7056	MII2032
38	200	NAB38-4L	593.00	MII32	CB7057	MII2032
40	200	NAB40-4L	620.00	MII35	CB7058	MII2035
42	200	NAB42-4L	647.00	MII35	CB7059	MII2035
Mains—Circuit Breaker—3 Pole						
8	50	NAB08-4AB	230.00	MII23	CB7062	MII2023
10	50	NAB10-4AB	257.00	MII26	CB7063	MII2026
12	50	NAB12-4AB	284.00	MII26	CB7064	MII2026
14	50	NAB14-4AB	311.00	MII26	CB7065	MII2026
16	100	NAB16-4AB	359.00	MII29	CB7086	MII2029
18	100	NAB18-4AB	386.00	MII29	CB7087	MII2029
20	100	NAB20-4AB	413.00	MII29	CB7088	MII2029
22	100	NAB22-4AB	440.00	MII32	CB7089	MII2032
24	100	NAB24-4AB	467.00	MII32	CB7090	MII2032
26	100	NAB26-4AB	494.00	MII32	CB7091	MII2032
28	100	NAB28-4AB	529.00	MII35	CB7092	MII2035
30	100	NAB30-4AB	548.00	MII35	CB7093	MII2035
32	200	NAB32-4AB	764.00	MII41	CB7074	MII2041
34	200	NAB34-4AB	791.00	MII44	CB7075	MII2044
36	200	NAB36-4AB	818.00	MII44	CB7076	MII2044
38	200	NAB38-4AB	845.00	MII44	CB7077	MII2044
40	200	NAB40-4AB	872.00	MII47	CB7078	MII2047
42	200	NAB42-4AB	899.00	MII47	CB7079	MII2047

Two or Three Pole: 70-100 ampere breakers may be furnished as sub-feed breakers with not more than two per panel.

Space Only: When space only for future branches is required, figure panels on basis of total number of branches and deduct \$9.70 list for each breaker pole omitted.

Solid Neutral Bar: Deduct \$11.00 if solid neutral is not required.

Handle Lock-Off Device: Cat. No. SK-2894, List price \$0.65 each.

Square D Type MHP Circuit Breaker Distribution Panelboards With Plug-In Type MM, M1 and M2 Thermal-Magnetic Circuit Breakers Unassembled Type

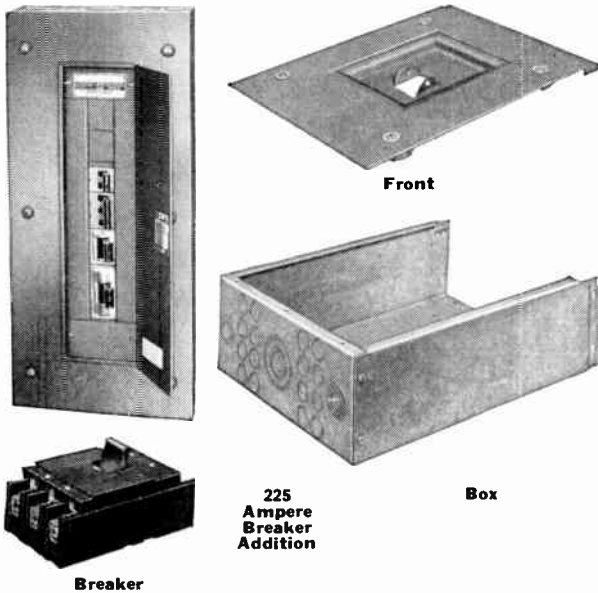

- 3 Phase, 4 Wire, S/N 120/208 Volts A-C
- 3 Phase, 3 Wire, 240 Volts A-C
- 1 Phase, 3 Wire, S/N 120 240 Volts A-C
- 1 Phase, 2 Wire, 240 Volts A-C

Mains: Lugs only.

Branches: Single pole 15 to 50 ampere 120 volts a-c. Two pole 15 to 100 ampere 240 volts a-c. Three pole 15 to 100 ampere 240 volts a-c.

Boxes: Galvanized steel. Single row—14 in. wide, 5 3/4 in. deep. Double row—20 in. wide, 5 3/4 in. deep.

Fronts: Trim with door and flush lock. Blue gray finish.

Wiring Gutters: Single row—1 in. end and side gutters. Double row—6 in. end gutters, 1 in. side gutters.

Selection of Components

1. List required circuits (ampere rating and poles).
2. Determine total breaker mounting space required from breaker mounting space dimensions under "Plug-In Breakers" table. Include breaker mounting space for planned future circuits.
3. Select interior from "Interior Box and Front" table on basis of total "Breaker Mounting Space" required. Corresponding box and front are also listed in this table.
4. Select required breakers from "Plug-In Breakers" table.

*Single Phase Three Wire mains are accommodated by selecting breaker units having Type CA bus connections.

Three Phase Four Wire "Wye" mains arrangement is a standard feature.

Three Phase Four Wire "Delta" mains can be accommodated. The neutral on three phase four wire "Delta" systems is derived by center tapping one of the transformer phases. For this application, all single-pole and two pole branches requiring a neutral are connected to the two outside bus bars through the use of breaker units having Type CA bus connections. The third bus bar would be used only for 3 pole breakers in this system.

Distributed Phase bus connections for single pole or two pole branches are available by selecting proper assortment

of Type AB, BC and CA breaker units to provide sequence phase connections.

Subfeed Lugs package assembly kits are available for adding a second set of lugs in the panelboards:

- SK-4052 200 A. lugs for MHP-18 and MHP-27 **\$15.00**
- SK-4053 400 A. lugs for MHP-36 and MHP-54 **20.00**

*Handle Tie can be used for converting two single poles to a double pole individual trip heater No. 40HT List Each \$0.10

Handle Lock-Off Devices

No.	Description	List
SK-5400	Single Pole 15 to 50 Ampere.....	\$0.70
SK-5453	Two Pole 15 to 50 Ampere.....	1.90
SK-5454	Three Pole 15 to 50 Ampere.....	1.90
SK-5455	Two Pole 70 and 100 Ampere.....	3.60
SK-5455	Three Pole 70 and 100 Ampere.....	3.60

Interiors, Boxes and Fronts

Total Breaker Mtg. Space In.	Amp. Rating of Mains	Type	Complete List Less Breakers	Breaker Rows	Box Width In.	Box Hgt. In.
18	200	MHP-18	\$ 92.00	Single	14	33
27	200	MHP-27	107.00	Single	14	42
36	400	MHP-36	173.00	Double	20	41
54	400	MHP-54	194.00	Double	20	50

Component Ordering Tables

Interior Assembly (Less Breakers) No.	Each	Front		Box	
		No.	Each	No.	Each
MHP-4218	\$ 58.00	P-1433F or S	\$22.00	P-33	\$12.00
MHP-4227	68.00	P-1442F or S	25.00	P-42	14.00
MHP-4436	102.00	DF-142F or S	43.00	MII-41	28.00
MHP-4454	112.00	DF-151F or S	49.00	MII-50	33.00

Plug-In Breakers

Amp. Trip Rating	Bkr. Mtg. Space In.	*2 Single Poles				Bkr. Mtg. Space In.	2 Pole				Bkr. Mtg. Space In.	3 Pole	
		AB No.	BC No.	CA No.	List Each		AB No.	BC No.	CA No.	List Each		No.	List Each
15	2	MHAB-115	MHBC-115	MHCA-115	\$10.80	2	MHAB-215	MHBC-215	MHCA-215	\$25.00	3	MH-315	\$35.00
20	2	MHAB-120	MHBC-120	MHCA-120	10.80	2	MHAB-220	MHBC-220	MHCA-220	25.00	3	MH-320	35.00
30	2	MHAB-130	MHBC-130	MHCA-130	10.80	2	MHAB-230	MHBC-230	MHCA-230	25.00	3	MH-330	35.00
40	2	MHAB-140	MHBC-140	MHCA-140	10.80	2	MHAB-240	MHBC-240	MHCA-240	25.00	3	MH-340	35.00
50	2	MHAB-150	MHBC-150	MHCA-150	10.80	2	MHAB-250	MHBC-250	MHCA-250	25.00	3	MH-350	35.00
70	.					3	MHAB-270	MHBC-270	MHCA-270	36.00	4 1/2	MH-370	48.00
100	.					3	MHAB-216	MHBC-216	MHCA-216	36.00	4 1/2	MH-316	48.00

225 Ampere Breaker Addition

Flush or surface type fronts with blue-gray finish. Type ML-3 thermal magnetic breakers 2 or 3 pole, 240 volts a-c ratings from 125 to 225 amps.; meets Federal spec.

Galvanized steel 14-in. wide by 18-in. high by 5 3/4-in. deep for single row panels. Available 20-in. wide for double row panels. Will not mount in P-33RO boxes.

14-in. Wide Box No.	Each	20-in. Wide Box No.	Each	Item
P-225-B	\$10.00	P-20225-B	\$18.00	Box
P-225-TF	18.00	P-20225-TF	20.00	Trim (Flush)
P-225-TS	18.00	P-20225-TS	20.00	Trim (Surface)

Trip Rating	2 Pole Breakers		3 Pole Breakers	
	Cat. No.	Each	Cat. No.	Each
125 A.	997217	\$190.00	997317	\$234.00
150 A.	997218	190.00	997318	234.00
175 A.	997219	190.00	997319	234.00
200 A.	997226	190.00	997326	234.00
225 A.	997227	190.00	997327	234.00

Raintight Enclosure NEMA III for MHP Panelboards

No.	Hgt. In.	Width In.	Depth In.	Each
†P-33-RO	35	14	6	\$56.00

†Cabinet does not include interior or breaker.

Square D Power-Style Switchboards

Series I

For Compact Installations to 2000 A.

Series I Power-Style switchboards are completely standardized front-connected switchboards that are used mainly on service entrance in small and medium size commercial, industrial, and institutional type buildings. The wide selection of section arrangements plus complete standardization make possible a compact, economical service installation with the shortest possible delivery.

- Entirely front connected.
- Only 14-in. deep, 90-in. high.
- Can always be mounted against a wall.
- Removable rolled-edge steel plates on front sides, and top.

Standardized current transformer compartments to meet Power-Company's requirement.

- Standard horizontal main bus from 400 A. to 2000 A.
- Bus duct connections to Feed-in or Plug-in Duct.
- Molded case main or branch circuit breakers up to 800 A.
- Fusible switches up to 600 A. in either QMB or Saflex construction.
- Knife type and bolted pressure contact main switches up to 2000 A.
- Standard bus provisions for future sections.
- Complete standardization for fast delivery.

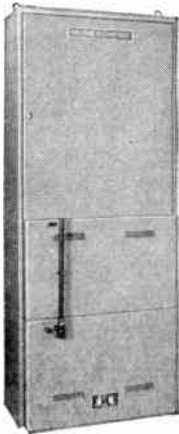

Bolted Contact Switch Service Station

Standard current transformer compartment.
1200 A. bolted contact main switch.

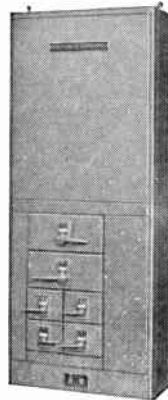

QMB Combination Service Section

Standard current transformer compartment.
Six QMB main switches.

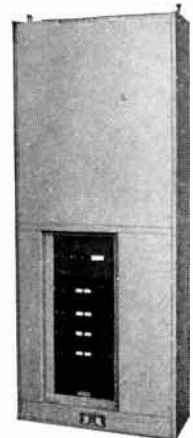

ML Combination Service Section

Standard current transformer compartment.
400 A. molded case main breaker.
Molded case branch breakers.

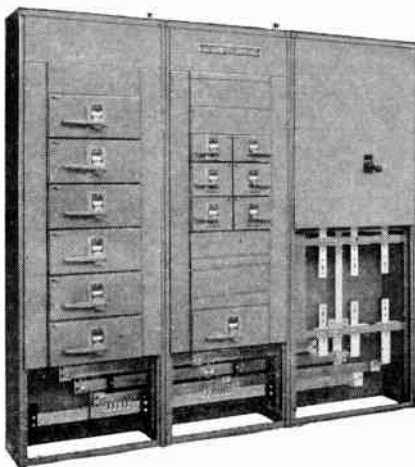

QMB Switchboard

800 A. molded case main breaker.
Standard current transformer compartment.
QMB branch switches.
Standard horizontal main bussing.
Standard drillings for future sections on either end.

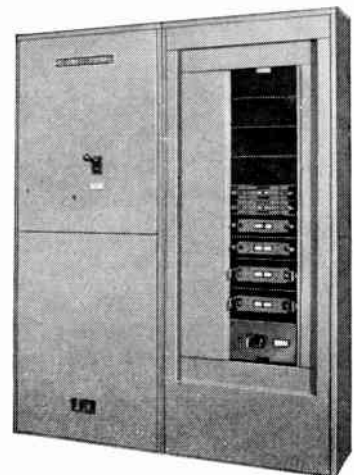

ML Switchboard

800 A. molded case main breaker.
Standard current transformer compartment.
Molded case branch breakers.

Square D Power-Style Switchboards

Series II

For Large Services and Equipment

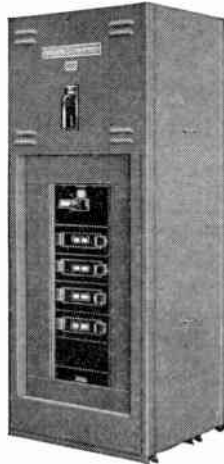

ACB-ML Switchboard

1600 A. main air circuit breaker.
ML mounted molded case branch breakers.



ACB-QMB Switchboard

1600 A. main air circuit breaker.
Quick-make, quick-break QMB branch switches.
Power Company C/T compartment.



ACB-CBI Switchboard

1600 A. main air circuit breaker.
CBI mounted molded case branch breakers.

Series II Power-Style switchboards are designed for use on service entrance and power distribution in commercial, industrial and institutional type buildings. The unlimited range of available equipment coupled with the following features make this the finest and most complete line of switchboards on the market:

- Die formed steel framework, welded and bolted together.
- Removable rolled-edge steel plates all around.
- Standard depths from 20-in. to 60-in.
- Main bussing from 600 A. to 6000 A.
- Channel iron sills.
- Stationary mounted air circuit breakers up to 5000 A.
- Molded case circuit breakers up to 800 A. in either ML or CBI construction.
- Fusible switches up to 600 A. in either QMB or Saflex construction.
- Knife type and bolted pressure contact switches up to 5000 A.
- Any arrangement of Power Company or customer's metering equipment.
- Bus duct connections to Plug-in or Feed-in Duct.
- Weather-proof construction.
- 18-in. or 30-in. high pullboxes.

Square D Control Centers

Class 8998



Matched Design of the New Square D Power-Style Switchboards and Plug-In Control Centers

Square D "Plug-In" Model 3 control centers offer all the advantages of simplified planning, safety and economy gained by grouping electric motor controls in factory assembled, free standing structures. Control centers basically consist of standardized combination starter units and vertical sections, but are custom-assembled for the job.

Space Economy: Up to six combination starter units fit in 20-in. x 20-in. x 90-in. sections. Sections 20-in. deep accommodate all starters through size 5.

Plant Changes: Units or whole sections may be added, removed or exchanged at will. Plug-in design and a wide variety of standard, interchangeable units provide the economical way to keep motor control in step with plant changes. Salvage value is practically 100%.

Safety Features: Disconnect operators are specifically designed with full cover interlocking provisions to encourage modern safety practices. Busses and wiring are fully enclosed and designed for ample full load and short circuit capacity. Unit enclosures isolate the control equipment for each motor.



NEMA 5 Dust-Tight Control Center for Excessively Dusty Locations

Front-of-Board Mounting: Usually recommended because it allows full use of floor area next to walls or locations where the rear of the control center is not accessible. All equipment is mounted on the front face of the structure and wiring gutters are front accessible.

Back-to-Back Mounting: Provides control units mounted on both faces of the structure. Less length is required, but greater depth of floor area is needed for aisle room on each side. Sections for front-of-board and back-to-back type mountings are 20-in. deep.

Control Units: Available in wide variety to handle any a-c installation. Standard units cover the normal requirements for disconnecting means, magnetic starters, lighting transformers, and lighting panels. Special control units are designed and built to order for the more unusual requirements.

Combination Starter Units: Include both disconnect and starter elements. The disconnect may be either a circuit breaker or a fusible switch. The starters may be reversing or non-reversing, line voltage or reduced voltage, single speed or two speed, and may have such optional features as push buttons, pilot lights, control transformers, and extra electrical interlocks.

Special Purpose Control

Class 8930 A-C

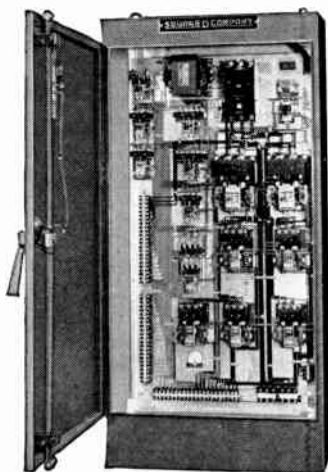

A-C Special Purpose Control Panel for Multiple Spindle Drilling Machines

Custom-built control is recommended for efficient operation of machine tools, processing machinery, conveyor systems, and other equipment involving motor drives or electrically controlled hydraulic or pneumatic systems. Such control requires careful engineering to include features which insure maximum safety, uninterrupted production, and long service.

Square D special purpose control panels are grouped assemblies of motor starters, relays, timers, and other devices, complete with user terminals and interwiring for convenience of installation and maintenance. Circuits are usually designed for automatic dequencing of machine functions with minimum attention required of the operator.

Standard lines of devices are physically and electrically proportioned for efficient combination on special panels. A complete variety of enclosure types are available, and open panels can be supplied for mounting within machine cavities.

Other features available include line and reduced voltage starting, main line disconnect means with external operating handles, low voltage control circuits, branch circuit over-current protection, and motor running protection. Square D custom-built control can be furnished to conform with the latest NMTBA or JIC standards.

Square D Stage Dimmerboards

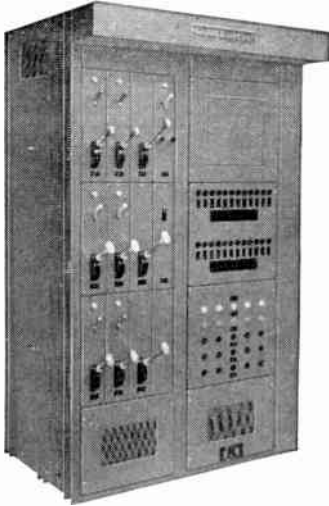

Cross-Connect Stage Dimmerboard

**Separable Cord System—Motor Driven House Dimmer
Master Assembly—Branch Breakers**

Square D Company now provides a complete line of stage dimmerboards for complete control of stage lighting. Each board contains all necessary control and protective devices arranged in a neat, convenient manner for maximum ease of operation. A large variety of control systems are available, making it possible to select the right board for every application.

In addition to free standing stage dimmerboards designed for controlling stage lighting in large auditoriums, small wall mounted dimmer banks and single units are available for variable lighting control in smaller installations.

Among the many optional features available in Square D stage dimmerboards are direct and multi-scene preset, electrical and mechanical mastering, motor driven auto-transformer dimmers, and various types of cross-connect systems. These, and many other fine standard and optional features, make this a truly outstanding line of stage lighting control equipment.

Square D QMB Motor Centers



QMB Motor Starter Switchboard

This switchboard contains two 30A. 3P., QMB switches feeding two size 1 starters, two 60A. 3P., QMB switches feeding two size 2 starters, and two 100A. QMB switches, one of which feeds a size 3 starter. The other 100A switch can be used either to feed an external device or feed future size 3 starter. This section is 14-in. deep, 30-in. wide and 90-in. high.

Motor Starters can now be mounted in QMB Switchboards or QMB Panelboards.

Starters: Twin Units—Size 0 to 5; Cover Interlocked with Disconnect Switch; Line Side Wiring to Disconnect Switch above Starter; Non-Reversing (or Reversing—Single Unit)—Across the Line Type; External Reset—Melting Alloy Overloads; Pushbuttons and Pilot Lights in Covers of Units (Optional).

QMB Disconnect Switches: Quick-Make, Quick-Break; Visible Blades; Plug-In Type; Horsepower Rated—250 volt or 600 volt; Voidable Cover Interlock to permit testing of fuses.

Starters combined in same Enclosure with Light and Power Distribution. Starters and Disconnect Switches are integrally mounted.

Factory mounting and wiring of Starters saves labor. Extra Conduit Fittings not required.

Can be used any place where Motor Control can be combined with Distribution Equipment.

Square D Manual Starters

A-C Manual Starters—Line Voltage Type

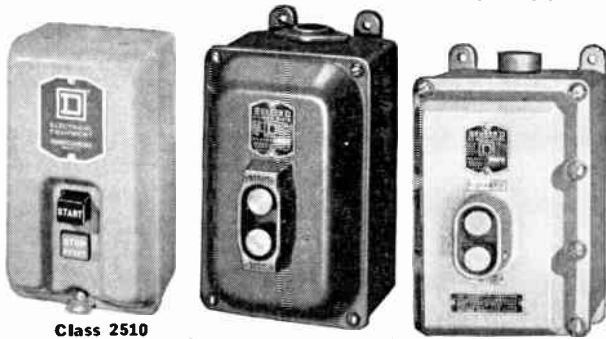

Class 2510 General Purpose Enclosure
Class 2510—Water and Dust-Tight Enclosure

Used where it is convenient for the operator to start and stop small single phase or polyphase motors by pressing push buttons mounted in the cover of the starter enclosure.

Low voltage protection and low voltage release are not available with the manually operated mechanism. If power should fail, the starter contacts will remain closed until the stop button is operated. Type W starters are operated from push buttons and employ melting alloy overload relay units.

Push Button Type Operation
For General Purpose Applications
Melting Alloy Type Thermal Overload Relays
600 Volts Maximum—Non-Reversing

Class No.	Type	No. of Poles	Size	Volts	Rating		Each
					Max. Poly-Phase	H.P. Single Phase	
General Purpose Enclosure NEMA Type 1							
2510	BG-1	2	0	115	...	1	\$20.00
2510	BG-1	2	0	230	...	1½	20.00
2510	CG-1	2	1	115	...	1½	25.00
2510	CG-1	2	1	230	...	3	25.00
2510	BG-2	3	0	110	1½	1	25.00
2510	BG-2	3	0	220	2	1½	25.00
2510	BG-2	3	0	440-550	3	...	25.00
2510	CG-3	3	1	110	3	1½	30.00
2510	CG-3	3	1	220	5	3	30.00
2510	CG-3	3	1	440-550	7½	...	30.00
Water And Dust-tight Enclosure NEMA Type 4, and 5							
2510	BW-1	2	0	115	...	1	\$52.00
2510	BW-1	2	0	230	...	1½	52.00
2510	CW-1	2	1	115	...	1½	64.00
2510	CW-1	2	1	230	...	3	64.00
2510	BW-2	3	0	110	1½	1	57.00
2510	BW-2	3	0	220	2	1½	57.00
2510	BW-2	3	0	440-550	3	...	57.00
2510	CW-3	3	1	110	3	1½	69.00
2510	CW-3	3	1	220	5	3	69.00
2510	CW-3	3	1	440-550	7½	...	69.00
Class I Group D or Class II Group E, F, & G NEMA Types 7 and 9							
2510	BR-1	2	0	115	...	1	\$66.00
2510	BR-1	2	0	230	...	1½	66.00
2510	CR-1	2	1	115	...	1½	78.00
2510	CR-1	2	1	230	...	3	78.00
2510	BR-2	3	0	110	1½	1	71.00
2510	BR-2	3	0	220	2	1½	71.00
2510	BR-2	3	0	440-550	3	...	71.00
2510	CR-3	3	1	110	3	1½	83.00
2510	CR-3	3	1	220	5	3	83.00
2510	CR-3	3	1	440-550	7½	...	83.00
Open Type							
2510	BO-1	2	0	115	...	1	\$18.00
2510	BO-1	2	0	230	...	1½	18.00
2510	CO-1	2	1	115	...	1½	23.00
2510	CO-1	2	1	230	...	3	23.00
2510	BO-2	3	0	110	1½	1	23.00
2510	BO-2	3	0	220	2	1½	23.00
2510	BO-2	3	0	440-550	3	...	23.00
2510	CO-3	3	1	110	3	1½	28.00
2510	CO-3	3	1	220	5	3	28.00
2510	CO-3	3	1	440-550	7½	...	28.00

600 Volts Maximum—Reversing

Class No.	Type	No. of Poles	Size	Volts	Rating		Each
					Max. Poly-Phase	H.P. Single Phase	
General Purpose Enclosure NEMA Type 1							
2511	BG-1	3	0	208-220	2	...	\$75.00
2511	BG-1	3	0	440-550	3	...	75.00
2511	CG-1	3	1	208-220	5	...	90.00
2511	CG-1	3	1	440-550	7½	...	90.00
Water And Dust-tight Enclosure NEMA Types 4, and 5							
2511	BW-1	3	0	208-220	2	...	\$122.00
2511	BW-1	3	0	440-550	3	...	122.00
2511	CW-1	3	1	208-220	5	...	154.00
2511	CW-1	3	1	440-550	7½	...	154.00
Open Type							
2511	BO-1	3	0	208-220	2	...	\$ 69.00
2511	BO-1	3	0	440-550	3	...	69.00
2511	CO-1	3	1	208-220	5	...	84.00
2511	CO-1	3	1	440-550	7½	...	84.00
600 Volts Maximum—Two Speed*							
General Purpose Enclosure NEMA Type 1							
2512	BG-1	3	0	208-220	2	...	\$75.00
2512	BG-1	3	0	440-550	3	...	75.00
2512	CG-1	3	1	208-220	5	...	90.00
2512	CG-1	3	1	440-550	7½	...	90.00
Water And Dust-tight Enclosure NEMA Types 4 and 5							
2512	BW-1	3	0	208-220	2	...	\$122.00
2512	BW-1	3	0	440-550	3	...	122.00
2512	CW-1	3	1	208-220	5	...	154.00
2512	CW-1	3	1	440-550	7½	...	154.00
Open Type							
2512	BO-1	3	0	208-220	2	...	\$69.00
2512	BO-1	3	0	440-550	3	...	69.00
2512	CO-1	3	1	208-220	5	...	84.00
2512	CO-1	3	1	440-550	7½	...	84.00

Note: Prices include thermal overload relay units. Deduct \$1.50 each if relay units are omitted.

*These two speed starters are suitable for star-connected separate winding motors only.

Ordering Instructions: Specify class and type number of starters; give horsepower, voltage, phase and full load current rating of motor. For starters in NEMA 7 and 9 enclosures specify location of conduit fittings.

A-C Manual Compensators



Class 2605 Manual Compensator

Designed for starting a-c squirrel cage motors when it is practical to have manually operated control, but where inrush currents must be reduced or starting torque limited.

Reduced voltage for starting is obtained through the windings of an auto-transformer.

Prices are for 3 pole, 50-60 cycle, compensators. Four pole or 25-40 cycle compensator prices on request.

Three pole overload protection available at additional cost.

Auto-Transformer Type Reduced Voltage Starters
Oil Immersed Contacts—Three Wire Control
Magnetic Overload Relays

Class No.	Max. H.P. Rating		Each	Class No.	Max. H.P. Rating		Each
	220V.	440-550V.			220V.	440-550V.	
2605	15	15	\$375.00	2605	50	..	\$710.00
2605	25	25	393.00	2605	..	50	429.00
2605	30	30	407.00	2605	..	60	765.00
2605	40	..	710.00	2605	..	100	765.00
2605	..	40	429.00				

Note: When ordering specify class number, horsepower, voltage, phase, cycles and full load current rating of motor.

Square D Manual Starters
Fractional Horsepower Manual Starters

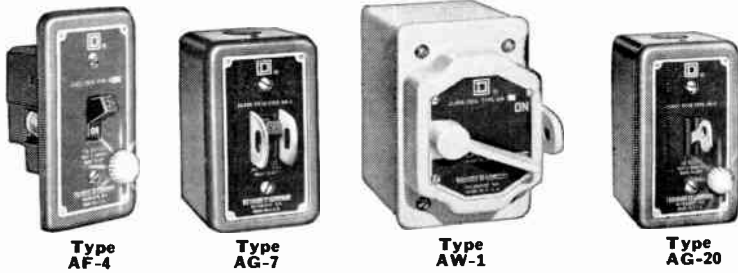

Used whenever it is desired to have overload protection as well as "off-on" control of small a-c single phase or d-c motors. Motor is started at line voltage. Low voltage protection and low voltage release are not possible with these manually operated starters. Open type starters fit in a standard switch or conduit box, and can be used with a standard flush plate.

Melting Alloy Type Thermal Overload Relays
115-230 Volts A-C and D-C

Class No.	Type	No. of Poles	Description	Each
General Purpose Enclosure Surface Mounting NEMA Type 1				
2510	AG-1	1	Standard	\$ 7.50
2510	AG-3	1	†Pilot light	13.00
2510	AG-7	1	Handle guard	8.50
2510	AG-5	1	†Pilot light and handle guard	14.00
2510	AG-18	1	Key operated	9.50
2510	AG-20	1	†Key operated and pilot light	15.00
2510	AG-2	2	Standard	8.50
2510	AG-4	2	†Pilot light	14.00
2510	AG-8	2	Handle guard	9.50
2510	AG-6	2	†Pilot light and handle guard	15.00
2510	AG-19	2	Key operated	10.50
2510	AG-21	2	†Key operated and pilot light	16.00

Class No.	Type	No. of Poles	Description	Each
General Purpose Enclosure Flush Mounting				
2510	AF-1	1	Standard	\$ 7.00
2510	AF-3	1	†Pilot light	12.50
2510	AF-7	1	Handle guard	8.00
2510	AF-5	1	†Pilot light and handle guard	13.50
2510	AF-9	1	Key operated	9.00
2510	AF-11	1	Key operated, pilot light	14.50
2510	AF-2	2	Standard	8.00
2510	AF-4	2	†Pilot light	13.50
2510	AF-8	2	Handle guard	9.00
2510	AF-6	2	†Pilot light and handle guard	14.50
2510	AF-10	2	Key operated	10.00
2510	AF-12	2	†Key operated and pilot light	12.50

Class No.	Type	No. of Poles	Description	Each
Water-Tight and Dust-Tight Enclosure NEMA Types 4 and 5				
2510	AW-1	1	Handle guard	\$24.00
2510	AW-5	1	Two conduit hubs	26.00
2510	AW-7	1	†Pilot light and 2 conduit hubs	62.00
2510	AW-2	2	Handle guard	25.00
2510	AW-4	2	†Pilot light and handle guard	60.00
2510	AW-6	2	Two conduit hubs	27.00
2510	AW-8	2	†Pilot light and 2 conduit hubs	62.00

Class No.	Type	No. of Poles	Description	Each
For Hazardous Locations Class I Group D and Class II Group G NEMA Types 7 and 9				
2510	AR-1	1	Handle guard	\$24.00
2510	AR-5	1	Two conduit hubs	26.00
2510	AR-2	2	Handle guard	25.00
2510	AR-6	2	Two conduit hubs	27.00

Class No.	Type	No. of Poles	Description	Each
Open Type (With Nameplate)				
2510	AO-1	1	Standard	\$ 6.50
2510	AO-5	1	Key operated	8.50
2510	AO-2	2	Standard	7.50
2510	AO-6	2	Key operated	9.50

Price includes one thermal overload relay unit. Deduct \$1.00 if relay unit is omitted. Select relay unit from table shown on this page. NEMA Type 1 enclosures have one ½ in. knockout at each end. NEMA Type 4-5 and 7-9 enclosures have one ¾ in. conduit hub at either top or bottom as standard; types with ¾ in. hub at both ends are also available.

†Neon pilot light.

Electrical Ratings

No. of Poles	Volts	Maximum Horsepower	
		A-C Single Phase	D-C
1	115	1	½
1	230	1	½
2	115	1	1
2	230	1	1

Starters With Double Box
115-230 Volts A-C and D-C

Class No.	Type	No. of Poles	Description	Each
General Purpose Surface Mounting Enclosure NEMA 1				
2510	AG-10	2	Two pole starter with auto-off-hand selector switch*	\$18.00
2510	AG-12	2	Two—2 pole starters	20.00
2510	AG-14	2	One—2 pole starter	12.50
2510	AG-15	2	One—2 pole starter with auto-off-hand selector, switch and pilot light†	24.00
2510	AG-16	2	Two—2 pole starters, each with a pilot light†	31.00
2510	AG-17	2	One—two pole starter with pilot light†	19.00

*Device with selector switch are not satisfactory for d-c operation.

†Neon pilot light.

ORDERING INSTRUCTIONS

1. Specify Class and Type Number of starters; give horsepower, voltage, and full load current rating of motor.
2. Order thermal overload relay units by relay number from table below.

Fractional Horsepower Manual Starters—Selection Table for Melting Alloy Thermal Relay Units for 40° C. Motors Operating Under Normal Conditions

Full Load Motor Current	Relay No.	Full Load Motor Current	Relay No.	Full Load Motor Current	Relay No.
0.38—0.42	W .47	1.21—1.34	W1.51	4.16—4.74	W5.20
0.43—0.46	W .54	1.35—1.49	W1.69	4.75—5.29	W5.94
0.47—0.50	W .59	1.50—1.69	W1.88	5.30—5.99	W6.65
0.51—0.56	W .65	1.70—1.84	W2.12	6.00—6.49	W7.47
0.57—0.63	W .71	1.85—2.05	W2.32	6.50—7.79	W8.15
0.64—0.69	W .80	2.06—2.27	W2.58	7.80—8.89	W9.75
0.70—0.77	W .87	2.28—2.56	W2.85	8.90—9.59	W11.1
0.78—0.86	W .98	2.57—2.91	W3.21	9.60—10.3	W12.0
0.87—0.96	W1.09	2.92—3.30	W3.65	10.4—11.9	W13.0
0.97—1.07	W1.21	3.31—3.69	W4.13	12.0—13.3	W15.0
1.08—1.20	W1.35	3.70—4.15	W4.62	13.4—15.0	W16.7

Additional relay units (order by relay number) each . . . \$1.00

Square D Loom Switches

Manual Starters For Textile Industry Applications

Class 2510



Lint Tight Enclosure



General Purpose Enclosure

The Class 2510 Type R and S manual starters are particularly designed for severe service required of loom motor starters. They have a toggle lever for operation and use protected type melting alloy overload relays. May be group fused if all motors are rated 2 hp. or less. Low voltage protection and low voltage release are not provided.

These starters are also suitable for general use, similar to the type W manual starters.

Protected Type Melting Alloy Thermal Overload Relay 600 Volts Maximum

Class No.	Type	No. of Poles	Size	Volts	Ratings		Each
					Maximum Poly-Phase	Maximum Hp. Single Phase	
General Purpose Enclosure, Line Terminals at Top							
2510	RG-1	2	0	115	..	1	\$20.00
2510	RG-1	2	0	230	..	1½	20.00
2510	SG-1	2	1	115	..	1½	25.00
2510	SG-1	2	1	230	..	3	25.00
2510	SG-7	2	1½	115	..	3	36.00
2510	SG-7	2	1½	230	..	5	36.00
2510	RG-2	3	0	110	1½	1	25.00
2510	RG-2	3	0	208-220	2	1½	25.00
2510	RG-2	3	0	410-550	3	2	25.00
2510	SG-2	3	1	110	3	1½	30.00
2510	SG-2	3	1	208-220	5	3	30.00
2510	SG-2	3	1	410-550	7½	5	30.00
2510	RG-3	4	0	110	1½	..	35.00
2510	RG-3	4	0	208-220	2	..	35.00
2510	RG-3	4	0	410-550	3	..	35.00
2510	SG-3	4	1	110	3	..	42.00
2510	SG-3	4	1	208-220	5	..	42.00
2510	SG-3	4	1	440-550	7½	..	42.00

Class No.	Type	No. of Poles	Size	Volts	Ratings		Each
					Maximum Poly-Phase	Maximum Hp. Single Phase	
General Purpose Enclosure, Line Terminals at Bottom							
2510	RG-4	2	0	115	..	1	\$20.00
2510	RG-4	2	0	230	..	1½	20.00
2510	SG-4	2	1	115	..	1½	25.00
2510	SG-4	2	1	230	..	3	25.00
2510	SG-8	2	1½	115	..	3	36.00
2510	SG-8	2	1½	230	..	5	36.00
2510	RG-5	3	0	110	1½	1	25.00
2510	RG-5	3	0	208-220	2	1½	25.00
2510	RG-5	3	0	410-550	3	2	25.00
2510	SG-5	3	1	110	3	1½	30.00
2510	SG-5	3	1	208-220	5	3	30.00
2510	SG-5	3	1	410-550	7½	5	30.00
2510	RG-6	4	0	110	1½	..	35.00
2510	RG-6	4	0	208-250	2	..	35.00
2510	RG-6	4	0	410-550	3	..	35.00
2510	SG-6	4	1	110	3	..	42.00
2510	SG-6	4	1	208-220	5	..	42.00
2510	SG-6	4	1	410-550	7½	..	42.00

Lint Tight Enclosure, Line Terminals at Bottom

2510	RA-4	2	0	115	..	1	27.00
2510	RA-4	2	0	230	..	1½	27.00
2510	SA-4	2	1	115	..	1½	32.00
2510	SA-4	2	1	230	..	3	32.00
2510	RA-5	3	0	110	1½	1	32.00
2510	RA-5	3	0	208-220	2	1½	32.00
2510	RA-5	3	0	440-550	3	2	32.00
2510	SA-5	3	1	110	3	1½	37.00
2510	SA-5	3	1	208-220	5	3	37.00
2510	SA-5	3	1	410-550	7½	5	37.00
2510	RA-6	4	0	110	1½	..	42.00
2510	RA-6	4	0	208-220	2	..	42.00
2510	RA-6	4	0	410-550	3	..	42.00
2510	SA-6	4	1	110	3	..	49.00
2510	SA-6	4	1	208-220	5	..	49.00
2510	SA-6	4	1	410-550	7½	..	49.00

Prices include thermal overload relay units. Select relay units from Table. Deduct \$1.50 each if relay units are omitted.

Ordering Instructions: Specify Class and Type number of starter; give horsepower, voltage, phase and full load current rating of motor.

Square D Reversing Drum Switches

Class 2601



May be used for across-the-line starting and reversing of a-c polyphase or single phase motors, or d-c motors.

Compact and inexpensive, ruggedly constructed.

Type AG-3 breaks two lines to the motor; type AG-2 breaks three lines. These switches do not provide overload protection or low voltage protection.

600 Volts Maximum A-C and D-C

Class No.	Type	Volts	Rating			Each
			A-C Single Phase	Maximum Horsepower A-C Poly-phase	D-C	
General Purpose Enclosure NEMA Type 1						
2601	AG-3	115	1	\$11.00
2601	AG-3	230	1	11.00
2601	AG-3	110	..	1	..	11.00
2601	AG-3	220	..	1	..	11.00
2601	AG-2	115	1	..	¼	11.00
2601	AG-2	230	1½	..	¼	11.00
2601	AG-2	110	..	1½	..	11.00
2601	AG-2	220	..	2	..	11.00
2601	AG-2	440-550	..	2	..	11.00
2601	BG-1	115	1½	..	2	30.00
2601	BG-1	230	3	..	2	30.00
2601	BG-1	110	..	3	..	30.00
2601	BG-1	220	..	5	..	30.00
2601	BG-1	440-550	5	7½	..	30.00

Ordering Instructions: Specify Class and Type Number of drum switch. Give horsepower, voltage and phase of motor.

Square D A-C Magnetic Relays
Class 8501

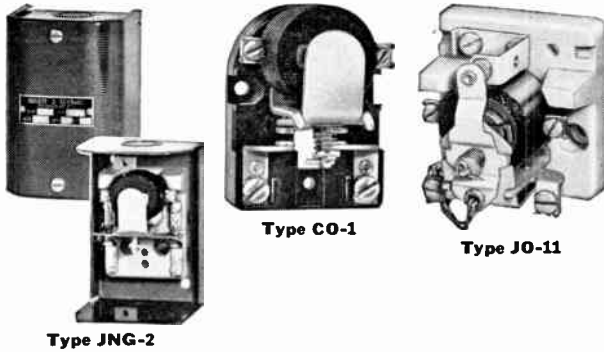

Used as auxiliary devices for controlling small single phase motors or other light loads such as electric heaters, pilot lights or audible signals.

They do not provide motor overload protection and are ordinarily used in a two-wire control system; however any available normally open contact can be wired to serve as a holding circuit in a three-wire system when a momentary contact pilot device is used. Pushbuttons, float switches, pressure switches and thermostats can be used for pilot service.

Two Wire Separate Control
25-60 Cycles—6-230 Volts

Class No.	Type	No. of Poles Normally Open	No. of Poles Normally Closed	Non-Inductive Amp. Rating	Maximum Single Phase Horsepower		Each
					115 Volts	230 Volts	
8501	CG-1	1	0	15*	3/4	1	\$ 8.00
8501	†JG-11	1	0	15	1/2	3/4	9.50
Double Pole, Single Throw							
8501	JNG-2	2	0	10	1/2	1/2	11.00
8501	JNG-3	1	1	10	1/2	1/2	12.50
8501	JNG-4	0	2	10	1/2	1/2	12.50

Open Type
Single Pole, Single Throw

8501	CO-1	1	0	15*	3/4	1	5.50
8501	†JO-11	1	0	15	1/2	3/4	7.00

Double Pole, Single Throw

8501	JN-2	2	0	10	1/2	1/2	8.50
8501	JN-3	1	1	10	1/2	1/2	10.00
8501	JN-4	0	2	10	1/2	1/2	10.00

*Double break contacts.

General Purpose Enclosure NEMA Type 1
Single Pole, Double Throw

8501	†JG-12	1	1	10	1/2	3/4	\$11.00
------	--------	---	---	----	-----	-----	---------

Open Type
Single Pole, Double Throw

8501	†JO-12	1	1	10	1/2	3/4	8.50
------	--------	---	---	----	-----	-----	------

25-60 Cycles—6-600 Volts
General Purpose Enclosure NEMA Type 1

Class No.	Type	Poles	Number of Contacts		Non-Inductive Rating	Each
			Normally Open	Normally Closed		
8501	PG-1	1	1	1	10A	\$18.00
8501	PG-2	2	2	2	10A	21.00
8501	PG-3	3	3	3	10A	24.00
8501	PG-4	4	4	4	10A	26.50

Open Type

8501	PO-1	1	1	1	10A	15.00
8501	PO-2	2	2	2	10A	18.00
8501	PO-3	3	3	3	10A	21.00
8501	PO-4	4	4	4	10A	23.50

†Relays are available with coils rated 300 volts, 25 cycles or 480 volts 60 cycles maximum.

‡Each pole of the relay consists of an isolated normally open and normally closed circuit. Due to electrical clearance, the normally open and normally closed circuits of any one pole must be used on circuits of the same polarity.

Ordering Instructions: Specify Class and Type number of relay; give voltage and frequency of operating coil.

Square D A-C Machine Tool Relays
Class 8501

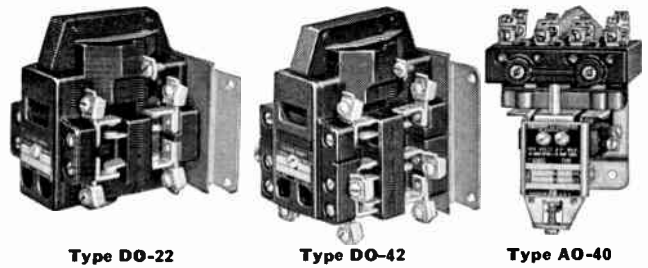

Type D compact machine tool relays available with from 2 to 10 contacts. The two pole version requires only 8 square in. of panel space, yet is easy to wire.

Type D—Compact—Multipole
50-60 Cycles—10 Amperes—6-600 Volts

General Purpose Enclosure NEMA Type 1	Type	Each	No. of Poles N.O.	No. of Poles N.C.	Open Type	
					Type	Each
DG-20		\$16.00	2	0	DO-20	\$13.00
DG-02		19.00	0	2	DO-02	16.00
DG-22		21.00	2	2	DO-22	18.00
DG-40		20.00	4	0	DO-40	17.00
DG-42		27.00	4	2	DO-42	23.50
DG-44		27.00	4	4	DO-44	23.50
DG-60		28.00	6	0	DO-60	25.00
DG-62		36.00	6	2	DO-62	33.00
DG-64		38.00	6	4	DO-64	35.00
DG-80		33.00	8	0	DO-80	30.00
DG-82		44.00	8	2	DO-82	41.00

Class 8501 Standard Non-Plug-In Type
25-60 Cycles—10 Ampere—6-600 Volts

General Purpose Enclosure NEMA Type 1	Type	Price	No. of Poles	No. of Poles N.O.	No. of Poles N.C.	Open Type	
						Type	Each
AG-20		\$18.00	2	2	0	AO-20	\$15.00
AG-11		21.00	2	1	1	AO-11	18.00
AG-02		21.00	2	0	2	AO-02	18.00
AG-30		21.00	3	3	0	AO-30	18.00
AG-21		24.00	3	2	1	AO-21	21.00
AG-12		24.00	3	1	2	AO-12	21.00
AG-03		24.00	3	0	3	AO-03	21.00
AG-40		23.00	4	4	0	AO-40	20.00
AG-31		26.00	4	3	1	AO-31	23.00
AG-22		26.00	4	2	2	AO-22	23.00
AG-13		26.00	4	1	3	AO-13	23.00
AG-04		26.00	4	0	4	AO-04	23.00
AG-60		33.00	6	6	0	AO-60	30.00
AG-51		36.00	6	5	1	AO-51	33.00
AG-42		36.00	6	4	2	AO-42	33.00
AG-33		36.00	6	3	3	AO-33	33.00
AG-24		36.00	6	2	4	AO-24	33.00
AG-15		38.00	6	1	5	AO-15	35.00
AG-06		38.00	6	0	6	AO-06	35.00

*Relay less plug-in receptacle may be ordered as Form Y-37, deduct \$10.00 list.

Ordering Instructions: Specify Class and Type number of relay; number of poles; and voltage and frequency of the operating coil.

Square D A-C Machine Tool Relays

Class 8501

Multipole, 15 Ampere



General Purpose
NEMA 1 Enclosure



Class 8501
Type BHO-40

Types BR and B11 multipole 15 ampere heavy duty relays may be used for switching control circuits or for controlling small single phase or polyphase motors. If motor overload protection is required it must be provided separately.

Extremely long mechanical life is an important feature of these relays to the machine tool industry. All steel parts with wearing surfaces are hardened, this includes the complete magnet assembly, movable contacts and movable contact guides.

The resilient contacts on the BR type relays provide overlap between normally open and normally closed poles. The "wipe" characteristics of the beryllium copper resilient contacts makes these devices suitable where low voltage and low current may tend to give trouble with normally closed contacts.

Class 8501

Multipole—Without Overload Protection or Holding Circuit—Unwired

Hardened Parts—Rigid Contacts
25-60 Cycles—15 Ampere—6-600 Volts

No. Of Poles	No. Of Poles		General Purpose Enclosure NEMA Type 1		Open Type	
	N.O.	N.C.	Type	Each	Type	Each
2	2	0	▲BHG-20	\$24.00	▲BHO-20	\$21.00
2	1	1	BHG-11	27.00	BHO-11	24.00
2	0	2	BHG-02	27.00	BHO-02	24.00
3	3	0	▲BHG-30	27.00	▲BHO-30	24.00
3	2	1	BHG-21	30.00	BHO-21	27.00
3	1	2	BHG-12	30.00	BHO-12	27.00
3	0	3	BHG-03	30.00	BHO-03	27.00
4	4	0	▲BHG-40	29.00	▲BHO-40	26.00
4	3	1	BHG-31	32.00	BHO-31	29.00
4	2	2	BHG-22	32.00	BHO-22	29.00
4	1	3	BHG-13	32.00	BHO-13	29.00
4	0	4	BHG-04	32.00	BHO-04	29.00
5	5	0	▲BHG-50	38.00	▲BHO-50	35.00
5	4	1	BHG-41	41.00	BHO-41	38.00
5	3	2	BHG-32	41.00	BHO-32	38.00
5	2	3	BHG-23	41.00	BHO-23	38.00
5	1	4	BHG-14	41.00	BHO-14	38.00
5	0	5	BHG-05	43.00	BHO-05	40.00
6	6	0	▲BHG-60	43.00	▲BHO-60	40.00
6	5	1	BHG-51	46.00	BHO-51	43.00
6	4	2	BHG-42	46.00	BHO-42	43.00
6	3	3	BHG-33	46.00	BHO-33	43.00
6	2	4	BHG-24	46.00	BHO-24	43.00
6	1	5	BHG-15	48.00	BHO-15	45.00
6	0	6	BHG-06	48.00	BHO-06	45.00
6	8	0	▲BHG-80	49.00	▲BHO-80	46.00
8	7	1	BHG-71	52.00	BHO-71	49.00
8	6	2	BHG-62	52.00	BHO-62	49.00
8	5	3	BHG-53	52.00	BHO-53	49.00
8	4	4	BHG-44	52.00	BHO-44	49.00
8	3	5	BHG-35	54.00	BHO-35	51.00
8	2	6	BHG-26	54.00	BHO-26	51.00
8	1	7	BHG-17	54.00	BHO-17	51.00
8	0	8	BHG-08	54.00	BHO-08	51.00

Contacts on Types BH and BR multipole relays are easily convertible from normally open to normally closed (or vice versa), without the addition of extra parts.

▲Devices with all normally open contacts are built in quantities for stock. Devices with normally closed contacts are built to order only. It is therefore generally recommended that devices with all normally open contacts be purchased. This will result in a minimum inventory of relays and yet will permit coverage of all contact arrangement requirements by the simple conversion operation.

Hardened Parts—Resilient Contacts
25-60 Cycles—15 Ampere—6-600 Volts

No. Of Poles	No. Of Poles		General Purpose Enclosure NEMA Type 1		Open Type	
	N.O.	N.C.	Type	Each	Type	Each
2	2	0	▲BRG-20	\$24.00	▲BRO-20	\$21.00
2	1	1	BRG-11	27.00	BRO-11	24.00
2	0	2	BRG-02	27.00	BRO-02	24.00
3	3	0	▲BRG-30	27.00	▲BRO-30	24.00
3	2	1	BRG-21	30.00	BRO-21	27.00
3	1	2	BRG-12	30.00	BRO-12	27.00
3	0	3	BRG-03	30.00	BRO-03	27.00
4	4	0	▲BRG-40	29.00	BRO-40	26.00
4	3	1	BRG-31	32.00	BRO-31	29.00
4	2	2	BRG-22	32.00	BRO-22	29.00
4	1	3	BRG-13	32.00	BRO-13	29.00
4	0	4	BRG-04	32.00	BRO-04	29.00
5	5	0	▲BRG-50	38.00	BRO-50	35.00
5	4	1	BRG-41	41.00	BRO-41	38.00
5	3	2	BRG-32	41.00	BRO-32	38.00
5	2	3	BRG-23	41.00	BRO-23	38.00
5	1	4	BRG-14	41.00	BRO-14	38.00
5	0	5	BRG-05	43.00	BRO-05	40.00
6	6	0	▲BRG-60	43.00	▲BRO-60	40.00
6	5	1	BRG-51	46.00	BRO-51	43.00
6	4	2	BRG-42	46.00	BRO-42	43.00
6	3	3	BRG-33	46.00	BRO-33	43.00
6	2	4	BRG-24	46.00	BRO-24	43.00
6	1	5	BRG-15	48.00	BRO-15	45.00
6	0	6	BRG-06	48.00	BRO-06	45.00
8	8	0	▲BRG-80	49.00	▲BRO-80	46.00
8	7	1	BRG-71	52.00	BRO-71	49.00
8	6	2	BRG-62	52.00	BRO-62	49.00
8	5	3	BRG-53	52.00	BRO-53	49.00
8	4	4	BRG-44	52.00	BRO-44	49.00
8	3	5	BRG-35	54.00	BRO-35	51.00
8	2	6	BRG-26	54.00	BRO-26	51.00
8	1	7	BRG-17	54.00	BRO-17	51.00
8	0	8	BRG-08	54.00	BRO-08	51.00

Ordering Instructions

1. Specify Class and Type number of relay; number of poles; and the voltage and frequency of the operating coil.
2. Order suitable accessories and pilot control devices.
3. Describe clearly any special features or modifications of standard devices that are desired.

Square D A-C Magnetic Contactors

Sizes 00 to 7, Three Wire Control
Class 8502

Without Overload Protection

Magnetic contactors are commonly used for many types of non-inductive loads. May be used also for electric motor loads within the horsepower rating shown, if overload protection is not required, or if other provision is made for it.

A holding circuit interlock for three wire control is provided on all of these Class 8502 magnetic contactors.

When ordering, specify Class and Type number; give hp., voltage, phase, cycles and full load motor current. Order suitable pushbutton stations. Describe clearly any special features or modifications of standard devices which are desired.

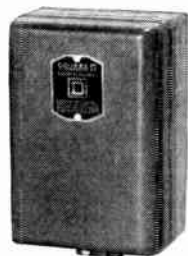

General Purpose
NEMA 1



Type CO-2

25-60 Cycles—600 Volts Max.—Class 8502—†Prices Include Interlock for 3-Wire Control

Size	Volts	Horsepower Ratings	Max. Hp.	8 Hour Ampere Ratings		General Purpose Enclosure NEMA Type 1		Water-Tight Enclosure NEMA Type 4		Dust-Tight Industrial Use Enclosure NEMA Type 12		Open Type	
				En-closed	Open	Type	Each	Type	Each	Type	Each	Type	Open Type
Two Pole—Single Phase													
00	115		1/2	9	10	AG-1	\$ 22.00	AO-1	\$ 20.00
00	230		3/4	9	10	AG-1	22.00	AO-1	20.00
0	115		1	18	20	BG-1	28.00	BW-1	63.00	BA-1	40.00	BO-1	26.00
0	230		2	18	20	BG-1	28.00	BW-1	63.00	BA-1	40.00	BO-1	26.00
1	115		2	27	30	CG-1	33.00	CW-1	69.00	CA-1	45.00	CO-1	31.00
1	230		3	27	30	CG-1	33.00	CW-1	69.00	CA-1	45.00	CO-1	31.00
2	115		3	45	50	DG-1	68.00	DW-1	140.00	DA-1	90.00	DO-1	58.00
2	230		7 1/2	45	50	DG-1	68.00	DW-1	140.00	DA-1	90.00	DO-1	58.00
3	115		7 1/2	90	100	EG-1	112.00	EW-1	214.00	EA-1	138.00	EO-1	92.00
3	230		15	90	100	EG-1	112.00	EW-1	214.00	EA-1	138.00	EO-1	92.00
4	135	150	FG-1	264.00	FW-1	438.00	FA-1	350.00	FO-1	222.00
4	135	150	FG-1	264.00	FW-1	438.00	FA-1	350.00	FO-1	222.00
5	270	300	GG-1	558.00	GW-1	778.00	GA-1	778.00	GO-1	481.00
5	540	600	HG-1	1461.00	HW-1	2105.00	HA-1	2105.00	HO-1	1144.00
5	540	600	HG-1	1461.00	HW-1	2105.00	HA-1	2105.00	HO-1	1144.00
7	675	750	JG-1	1987.00	JW-1	2631.00	JA-1	2631.00	JO-1	1670.00
7	675	750	JG-1	1987.00	JW-1	2631.00	JA-1	2631.00	JO-1	1670.00
Three Pole—Polyphase													
00	208-220		1	9	10	AG-2	25.00	AO-2	23.00
00	440-550		1	9	10	AG-2	25.00	AO-2	23.00
0	208-220		3	18	20	BG-2	31.00	BW-2	66.00	BA-2	43.00	BO-2	29.00
0	440-550		5	18	20	BG-2	31.00	BW-2	66.00	BA-2	43.00	BO-2	29.00
1	208-220		7 1/2	27	30	CG-2	36.00	CW-2	72.00	CA-2	48.00	CO-2	34.00
1	440-550		10	27	30	CG-2	36.00	CW-2	72.00	CA-2	48.00	CO-2	34.00
2	208-220		15	45	50	DG-2	72.00	DW-2	144.00	DA-2	94.00	DO-2	62.00
2	440-550		25	45	50	DG-2	72.00	DW-2	144.00	DA-2	94.00	DO-2	62.00
3	208-220		30	90	100	EG-2	120.00	EW-2	222.00	EA-2	146.00	EO-2	100.00
3	440-550		50	90	100	EG-2	120.00	EW-2	222.00	EA-2	146.00	EO-2	100.00
4	208-220		50	135	150	FG-2	282.00	FW-2	456.00	FA-2	368.00	FO-2	240.00
4	440-550		100	135	150	FG-2	282.00	FW-2	456.00	FA-2	368.00	FO-2	240.00
5	208-220		100	270	300	GG-2	600.00	GW-2	820.00	GA-2	820.00	GO-2	523.00
5	440-550		200	270	300	GG-2	600.00	GW-2	820.00	GA-2	820.00	GO-2	523.00
6	208-220		200	510	600	HG-2	1652.00	HW-2	2297.00	HA-2	2297.00	HO-2	1335.00
6	440-550		400	510	600	HG-2	1652.00	HW-2	2297.00	HA-2	2297.00	HO-2	1335.00
7	208-220		250	675	750	JG-2	2222.00	JW-2	2867.00	JA-2	2867.00	JO-2	1905.00
7	440-550		500	675	750	JG-2	2222.00	JW-2	2867.00	JA-2	2867.00	JO-2	1905.00
Four Pole—Polyphase													
00	220		1	9	10	AG-3	33.00	AO-3	31.00
00	440-550		1	9	10	AG-3	33.00	AO-3	31.00
0	220		3	18	20	BG-3	39.00	BW-3	75.00	BA-3	51.00	BO-3	37.00
0	440-550		5	18	20	BG-3	39.00	BW-3	75.00	BA-3	51.00	BO-3	37.00
1	220		7 1/2	27	30	CG-3	44.00	CW-3	80.00	CA-3	56.00	CO-3	42.00
1	440-550		10	27	30	CG-3	44.00	CW-3	80.00	CA-3	56.00	CO-3	42.00
2	220		15	45	50	DG-3	90.00	DW-3	190.00	DA-3	112.00	DO-3	80.00
2	440-550		25	45	50	DG-3	90.00	DW-3	190.00	DA-3	112.00	DO-3	80.00
3	220		30	90	100	EG-3	148.00	EW-3	278.00	EA-3	174.00	EO-3	128.00
3	440-550		50	90	100	EG-3	148.00	EW-3	278.00	EA-3	174.00	EO-3	128.00
4	220		50	135	150	FG-3	376.00	FW-3	622.00	FA-3	492.00	FO-3	334.00
4	440-550		100	135	150	FG-3	376.00	FW-3	622.00	FA-3	492.00	FO-3	334.00
5	220		100	270	300	GG-3	1115.00	GW-3	1357.00	GA-3	1357.00	GO-3	961.00
5	440-550		200	270	300	GG-3	1115.00	GW-3	1357.00	GA-3	1357.00	GO-3	961.00
6	220		200	510	600	HG-3	2922.00	HO-3	2288.00
6	440-550		400	510	600	HG-3	2922.00	HO-3	2288.00
7	220		250	675	750	JG-3	3973.00	JO-3	3340.00
7	440-550		500	675	750	JG-3	3973.00	JO-3	3340.00

▲Also functionally equivalent to NEMA Type 5.

†No deduction for omission of holding circuit interlock.

Note: Contactors with enclosures for Class II Groups E, F, and G, and Class I Group D Hazardous Locations are also available.

Square D A-C Magnetic Starters Class 8536—Line Voltage Type



**Type DG-1
General Purpose
Enclosure**



**Size 1 Starter in
Water-tight Enclosure
with Push Button**

Melting Alloy Overload Relays

Line voltage magnetic starters provide the simplest method for starting and stopping a-c squirrel cage motors. They are used when full starting torque may be safely applied to the driven machine and where the resulting current inrush is not objectionable.

Motor overload protection is provided by melting alloy type thermal overload relays.

600 Volts Maximum—25-60 Cycles Two Pole

NEMA Size	Rating		General Purpose Enclosure NEMA Type 1	Water-tight Enclosure NEMA Type 4	Dust-tight Industrial Use Enclosure NEMA Type 12	For Hazardous Locations		Open Type
	Volts	Poly-phase				Max. Hp. Single Type	Class II Groups E, F and G NEMA Type 9	
0	115	...	BG-1 \$ 34.00	BW-1 \$ 69.00	BA-1 \$ 46.00	BE-1 69.00	Use Size 1	BO-1 \$ 32.00
0	230	...	BG-1 34.00	BW-1 69.00	BA-1 46.00	BE-1 69.00	Use Size 1	BO-1 32.00
1	115	...	CG-1 39.00	CW-1 75.00	CA-1 51.00	CE-1 75.00	CR-1 \$141.00	CO-1 37.00
1	230	...	CG-1 39.00	CW-1 75.00	CA-1 51.00	CE-1 75.00	CR-1 141.00	CO-1 37.00
1 1/2	115	...	CG-2 50.00	CW-2 86.00	CA-2 62.00	CE-2 86.00	CR-2 152.00	CO-2 48.00
1 1/2	230	...	CG-2 50.00	CW-2 86.00	CA-2 62.00	CE-2 86.00	CR-2 152.00	CO-2 48.00

Three Pole

0	110	1 1/2	BG-2 \$ 39.00	BW-2 \$ 74.00	BA-2 \$ 51.00	BE-2 \$ 74.00	Use Size 1	BO-2 \$ 37.00
0	208-220	3	BG-2 39.00	BW-2 74.00	BA-2 51.00	BE-2 74.00	Use Size 1	BO-2 37.00
0	440-550	5	BG-2 39.00	BW-2 74.00	BA-2 51.00	BE-2 74.00	Use Size 1	BO-2 37.00
1	110	3	CG-3 44.00	CW-3 80.00	CA-3 56.00	CE-3 80.00	CR-3 \$146.00	CO-3 42.00
1	208-220	7 1/2	CG-3 44.00	CW-3 80.00	CA-3 56.00	CE-3 80.00	CR-3 146.00	CO-3 42.00
1	440-550	10	CG-3 44.00	CW-3 80.00	CA-3 56.00	CE-3 80.00	CR-3 146.00	CO-3 42.00
2	110	7 1/2	DG-1 84.00	DW-1 156.00	DA-1 106.00	DE-1 190.00	DR-1 262.00	DO-1 74.00
2	208-220	15	DG-1 84.00	DW-1 156.00	DA-1 106.00	DE-1 190.00	DR-1 262.00	DO-1 74.00
2	440-550	25	DG-1 84.00	DW-1 156.00	DA-1 106.00	DE-1 190.00	DR-1 262.00	DO-1 74.00
3	110	15	EG-1 138.00	EW-1 240.00	EA-1 164.00	EE-1 284.00	ER-1 372.00	EO-1 118.00
3	208-220	30	EG-1 138.00	EW-1 240.00	EA-1 164.00	EE-1 284.00	ER-1 372.00	EO-1 118.00
3	440-550	50	EG-1 138.00	EW-1 240.00	EA-1 164.00	EE-1 284.00	ER-1 372.00	EO-1 118.00
4	208-220	50	FG-1 308.00	FW-1 482.00	FD-1 394.00	FE-1 556.00	FO-1 266.00
4	440-550	100	FG-1 308.00	FW-1 482.00	FD-1 394.00	FE-1 556.00	FO-1 266.00
5	208-220	100	GG-1 684.00	GW-1 904.00	GD-1 904.00	GE-1 1054.00	GO-1 607.00
5	440-550	200	GG-1 684.00	GW-1 904.00	GD-1 904.00	GE-1 1054.00	GO-1 607.00
6	208-220	200	HG-2 2017.00	HW-2 2598.00	HD-2 2598.00	HO-2 1637.00
6	440-550	400	HG-2 2017.00	HW-2 2598.00	HD-2 2598.00	HO-2 1637.00
7	208-220	250	JG-1 2629.00	JW-1 3210.00	JD-1 3210.00	JO-1 2248.00
7	440-550	500	JG-1 2629.00	JW-1 3210.00	JD-1 3210.00	JO-1 2248.00

Four Pole

0	220	3	BG-3 \$ 50.00	BW-3 \$ 89.00	BA-3 \$ 62.00	BE-3 \$ 89.00	Use Size 1	BO-3 \$ 47.00
0	440-550	5	BG-3 50.00	BW-3 89.00	BA-3 62.00	BE-3 89.00	Use Size 1	BO-3 47.00
1	220	7 1/2	CG-4 56.00	CW-4 94.00	CA-4 68.00	CE-4 94.00	CR-4 \$158.00	CO-4 53.00
1	440-550	10	CG-4 56.00	CW-4 94.00	CA-4 68.00	CE-4 94.00	CR-4 158.00	CO-4 53.00
2	220	15	DG-2 103.00	DW-2 207.00	DA-2 125.00	DE-2 241.00	DR-2 309.00	DO-2 93.00
2	440-550	25	DG-2 103.00	DW-2 207.00	DA-2 125.00	DE-2 241.00	DR-2 309.00	DO-2 93.00
3	220	30	EG-2 168.00	EW-2 298.00	EA-2 194.00	EE-2 342.00	ER-2 446.00	EO-2 150.00
3	440-550	50	EG-2 168.00	EW-2 298.00	EA-2 194.00	EE-2 342.00	ER-2 446.00	EO-2 150.00
4	220	50	FG-2 404.00	FW-2 650.00	FD-2 520.00	FE-2 750.00	FO-2 364.00
4	440-550	100	FG-2 404.00	FW-2 650.00	FD-2 520.00	FE-2 750.00	FO-2 364.00
5	220	100	GG-2 1200.00	GW-2 1442.00	GD-2 1343.00	GE-2 1640.00	GO-2 1046.00
5	440-550	200	GG-2 1200.00	GW-2 1442.00	GD-2 1343.00	GE-2 1640.00	GO-2 1046.00
6	220	200	HG-3 3287.00	HO-3 2653.00
6	440-550	400	HG-3 3287.00	HO-3 2653.00
7	220	250	JG-2 4380.00	JO-2 3747.00
7	440-550	500	JG-2 4380.00	JO-2 3747.00

Price includes thermal overload relay units. Deduct \$1.50 each if relay units are omitted. Select relay units from Tables 1 and 3.

▲Also functionally equivalent to NEMA Type 5.

Ordering Instructions

Specify class and type number of starter. Give hp., voltage, phase, cycles and full load motor current. Select thermal units or heaters from proper tables. Order suitable push button stations and accessories shown elsewhere in catalog.

Square D Thermal Overload Relay Units

For 40° C. Motors Operating Under Normal Conditions



Table 1—Class 8536 Enclosed Starters

Full Load Motor Current	Relay No.	Full Load Motor Current	Relay No.	Full Load Motor Current	Relay No.	Full Load Motor Current	Relay No.	Full Load Motor Current	Relay No.
For Use With Types R, S, B & C (Both Series A and Prior to Series A)—Sizes 0, 1, and 1½									
0.32-0.34	B .44	0.98-1.12	B1.30	2.82-3.19	B3.7	7.65-8.41	B10.2	16.9-18.6	B28.
0.35-0.38	B .51	1.13-1.19	B1.45	3.20-3.61	B4.15	8.42-8.77	B11.5	18.7-20.2	B32.
0.39-0.44	B .57	1.20-1.34	B1.67	3.62-4.14	B4.85	8.78-9.90	B12.8	20.3-22.8	B36.
0.45-0.53	B .63	1.35-1.54	B1.88	4.15-4.40	B5.5	10.0-10.6	B14.	22.9-24.7	B40.
0.51-0.58	B .71	1.55-1.78	B2.1	4.41-4.78	B6.25	10.7-11.4	B15.5	24.8-26.9	B45.
0.59-0.66	B .81	1.79-1.96	B2.4	4.79-5.44	B6.9	11.5-12.3	B17.5	27.0-29.6	B50.
0.67-0.74	B .92	1.97-2.23	B2.65	5.45-6.16	B7.7	12.4-13.6	B19.5	29.7-32.5	B56.
0.75-0.84	B1.03	2.24-2.50	B3.0	6.17-6.86	B8.2	13.7-14.6	B22.	32.6-36.0	B62.
0.85-0.97	B1.16	2.51-2.81	B3.3	6.87-7.64	B9.1	14.7-16.8	B25.

Table 2—Classes 8538, 8539, 8541, 8547, 8606, 8640, 8736, 8738, 8739, 8810, 8811 and 8812 Enclosed Starters

Full Load Motor Current	Relay No.	Full Load Motor Current	Relay No.	Full Load Motor Current	Relay No.	Full Load Motor Current	Relay No.	Full Load Motor Current	Relay No.
For Use With Types Q, R, S, A, B & C (Both Series A and Prior to Series A)—Sizes 00, 0 and 1									
0.33-0.35	B .44	0.89-1.02	B1.16	2.32-2.60	B3.0	5.61-6.34	B 7.7	12.0-13.0	B17.5
0.36-0.40	B .51	1.03-1.17	B1.3	2.61-2.91	B3.3	6.35-7.13	B 8.2	13.1-14.4	B19.5
0.41-0.46	B .57	1.18-1.25	B1.45	2.92-3.30	B3.7	7.14-7.91	B 9.1	14.5-15.6	B22.
0.47-0.54	B .63	1.26-1.41	B1.67	3.31-3.73	B4.15	7.92-8.69	B10.2	15.7-16.9	B25.
0.55-0.62	B .71	1.42-1.63	B1.88	3.74-4.29	B4.85	8.70-9.04	B11.5	17.0-19.5	B28.
0.63-0.70	B .81	1.64-1.88	B2.1	4.30-4.60	B5.5	9.05-10.2	B12.8	19.6-21.9	B32.
0.71-0.78	B .92	1.89-2.05	B2.4	4.61-4.89	B6.25	10.3-10.9	B14.0	22.0-25.1	B36.
0.79-0.88	B1.03	2.06-2.31	B2.65	4.90-5.60	B6.9	11.0-11.9	B15.5	25.2-26.6	B40.

Table 3—Classes 8536, 8538, 8539, 8541, 8547, 8606, 8640, 8736, 8738, 8739, 8810, 8811 and 8812 Enclosed Starters

Full Load Motor Current	Relay No.	Full Load Motor Current	Relay No.	Full Load Motor Current	Relay No.	Full Load Motor Current	Relay No.	Full Load Motor Current	Relay No.
For Use With Type D, T—Size 2									
3.24-3.77	B4.15	6.01-6.39	B 7.7	9.99-10.8	B12.8	17.2-19.4	B22.	31.2-35.0	B40.
3.78-4.28	B4.85	6.40-7.09	B 8.2	10.9-12.0	B14.	19.5-21.7	B25.	35.1-38.9	B45.
4.29-4.83	B5.5	7.10-7.95	B 9.1	12.1-13.5	B15.5	21.8-24.9	B28.	39.0-43.6	B50.
4.81-5.37	B6.25	7.96-8.92	B10.2	13.6-15.1	B17.5	25.0-28.0	B32.	43.7-45.0	B56.
5.38-6.00	B6.9	8.93-9.98	B11.5	15.2-17.1	B19.5	28.1-31.1	B36.
For Use With Type E, U—Size 3									
15.6-17.1	C20.	23.4-26.4	C30.	32.8-35.0	C42.	45.2-51.4	C58.	61.7-69.9	C83.
17.2-20.2	C22.	26.5-31.1	C34.	35.1-39.7	C45.	51.5-58.4	C66.	70.0-79.9	C90.
20.3-23.3	C26.	31.2-32.7	C40.	39.8-45.1	C51.	58.5-64.6	C75.	80.0-88.9	C103.

Class 8536 Type F—Size 4 Enclosed Starters

48.6-51.8	DD59.	59.1-63.4	DD73.	75.6-80.9	DD105.	97.6-105	DD140.	127-135	DD185.
51.9-55.4	DD63.	63.5-71.1	DD79.	81.0-86.4	DD112.	106-111	DD150.
55.5-59.0	DD68.	71.2-75.5	DD98.	86.5-97.5	DD121.	112-126	DD160.

Class 8538, 8539, 8541, 8547, 8606, 8640, 8736, 8738, 8739, 8810, 8811 & 8812 Enclosed—Size 4

47.0-50.3	DD55.	58.6-61.6	DD68.	75.2-80.5	DD98.	93.1-106	DD121.	124-135	DD160.
50.4-54.6	DD59.	61.7-66.1	DD73.	80.6-86.3	DD105.	107-114	DD140.
54.7-58.5	DD63.	66.2-75.1	DD79.	86.3-93.0	DD112.	115-123	DD150.

***For Use With All Size 5 Clapper Type Starters**

60.0-63.4	B6.25	76.9-84.9	B 9.1	113-121	B14.	163-179	B22.	230-245	B36.
63.5-67.9	B6.9	85.0-93.7	B10.2	122-136	B15.5	180-195	B25.	246-263	B40.
68.0-71.5	B7.7	93.8-102	B11.5	137-149	B17.5	196-212	B28.	264-280	B45.
71.6-76.8	B8.2	103-112	B12.8	150-162	B19.5	213-229	B32.	281-300	B50.

For Use With 8536—Size 5—Vertical Action Type Starters

91.4-99.4	DD112.	116-124	DD140.	150-167	DD185.	206-233	DD265.
99.5-107	DD121.	125-134	DD150.	170-192	DD220.	234-249	DD300.
108-115	DD128.	135-149	DD160.	193-205	DD250.	250-270	DD320.

Classes 8538, 8539, 8547, 8606, 8640, 8736, 8738, 8739 & 8810—Size 5—Vertical Action Starters

95.0-100	DD112.	118-129	DD140.	158-177	DD185.	226-249	DD280.
101-110	DD121.	130-139	DD150.	178-203	DD220.	250-270	DD300.
111-117	DD128.	140-157	DD160.	204-225	DD250.

*Relays operate from secondary of a current transformer. Order relay units by number. Price Each \$1.50

Selection of Relay Units for Special Applications

Motor Duty Rating	Ambient Temperature of Motor Same as Controller	Ambient Temperature of Motor 15° C. (27° F.) Higher Than Controller	Ambient Temperature of Motor 15° C. (27° F.) Lower Than Controller
40°C. Continuous	Select Relay from table	Use 1 Size smaller than in table	May be 1 size smaller than table
50-55°C. Continuous	Use 1 Size smaller than in table	Use 2 Sizes smaller than in table	Select Relay from table
1 Hour Intermittent	Use 1 Size smaller than in table	Use 2 Sizes smaller than in table	Select Relay from table

Square D Class 8538 A-C Switch Type Combination Magnetic Starters

3 Pole Line Voltage Type—25-60 Cycles—600 V Max.

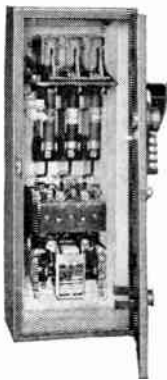

**Class 8538
Switch Type
General Purpose
Enclosure**

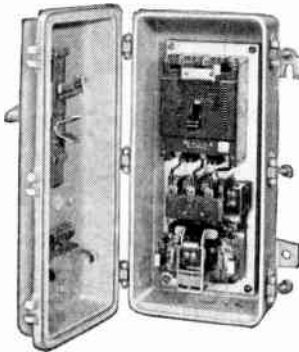

**Class 8539
Water-Tight
Enclosure**

Combination starters provide all the control functions of Class 8536 line voltage starters, described on the preceding pages, plus all the advantages of a disconnect means in the same enclosure. Class 8538 starters have a knife switch—either fusible or non-fusible—while Class 8539 covers similar devices with a circuit breaker.

The single enclosure used has many advantages over separate starters and disconnects. A single device takes up less mounting space, and makes a neat installation. Installation and wiring costs are less because all wiring between the starter and the disconnect is made at the factory. Greater safety for the operator is provided in a combination starter, as the cover of the enclosing case is interlocked with the disconnect means to prevent opening of the cover with the disconnect closed—a feature not available with separate devices.

Order by Class and Type number of starter. Give horsepower, voltage, phase, and full load current rating of motor.

If special features are desired order Class....., Type....., Form....., selecting the correct Form letter from the table on the following page. If more than one Form letter is used, arrange the Form letters in alphabetical order as "Class 8538, Type DG-1, Form APT." Describe modification which cannot be covered by Form Letters.

		Maximum Ratings													
Size	Volts	Hp. Poly-phase	Fuse Clip Size Amps.	Class	General Purpose Enclosure NEMA Type 1		General Purpose Enclosure with Fejt Gasket		Dust-Tight Industrial Use Enclosure NEMA Type 12		Water-tight Enclosure NEMA Type 4		For Hazardous Locations Class II Groups E, F, G NEMA Type 9		
					Type	Each	Type	Each	Type	Each	Type	Each	Type	Each	
0	208-220	3	None	8538	BG-1	\$ 94.00	BS-1	\$ 104.00	BA-1	\$ 118.00	CW-1	\$195.00	CE-1	\$192.00	
0	208-220	3	30	8538	BG-2	97.00	BS-2	107.00	BA-2	121.00	CW-2	198.00	CE-1	192.00	
0	440-550	3	None	8538	BG-1	94.00	BS-1	104.00	BA-1	118.00	CW-1	195.00	CE-1	192.00	
0	440-550	3	30	8538	BG-3	99.00	BS-3	109.00	BA-3	123.00	CW-4	200.00	CE-1	192.00	
0	440-550	5	None	8538	BG-1	94.00	BS-1	104.00	BA-1	118.00	CW-1	195.00	CE-1	192.00	
0	440-550	5	30	8538	BG-3	99.00	BS-3	109.00	BA-3	123.00	CW-4	200.00	CE-1	192.00	
1	208-220	5	None	8538	CG-1	99.00	CS-1	109.00	CA-1	123.00	CW-1	195.00	CE-1	192.00	
1	208-220	5	30	8538	CG-2	102.00	CS-2	112.00	CA-2	126.00	CW-2	198.00	CE-1	192.00	
1	208-220	5	60	8538	CG-3	104.00	CS-3	114.00	CA-3	128.00	CW-3	200.00	CE-1	192.00	
1	208-220	7 1/2	None	8538	CG-1	99.00	CS-1	109.00	CA-1	123.00	CW-1	195.00	CE-1	192.00	
1	208-220	7 1/2	30	8538	CG-2	102.00	CS-2	112.00	CA-2	126.00	CW-2	198.00	CE-1	192.00	
1	208-220	7 1/2	60	8538	CG-3	104.00	CS-3	114.00	CA-3	128.00	CW-3	200.00	CE-1	192.00	
1	440-550	7 1/2	None	8538	CG-1	99.00	CS-1	109.00	CA-1	123.00	CW-1	195.00	CE-1	192.00	
1	440-550	7 1/2	30	8538	CG-4	104.00	CS-4	114.00	CA-4	128.00	CW-4	200.00	CE-1	192.00	
1	440-550	10	None	8538	CG-1	99.00	CS-1	109.00	CA-1	123.00	CW-1	195.00	CE-1	192.00	
1	440-550	10	30	8538	CG-4	104.00	CS-4	114.00	CA-4	128.00	CW-4	200.00	CE-1	192.00	
1	440-550	10	60	8538	CG-9	106.00	CS-9	116.00	CA-9	130.00	CW-9	202.00	CE-1	192.00	
2	208-220	10	None	8538	DG-1	155.00	DS-1	171.00	DA-1	189.00	DW-1	303.00	DE-1	338.00	
2	208-220	10	60	8538	DG-2	159.00	DS-2	175.00	DA-2	193.00	DW-2	307.00	DE-1	338.00	
2	208-220	10	100	8538	DG-3	171.00	DS-3	187.00	DA-3	205.00	DW-3	319.00	DE-1	338.00	
2	208-220	15	None	8538	DG-1	155.00	DS-1	171.00	DA-1	189.00	DW-1	303.00	DE-1	338.00	
2	208-220	15	60	8538	DG-2	159.00	DS-2	175.00	DA-2	193.00	DW-2	307.00	DE-1	338.00	
2	208-220	15	100	8538	DG-3	171.00	DS-3	187.00	DA-3	205.00	DW-3	319.00	DE-1	338.00	
2	440-550	15	None	8538	DG-1	155.00	DS-1	171.00	DA-1	189.00	DW-1	303.00	DE-1	338.00	
2	440-550	15	60	8538	DG-4	162.00	DS-4	178.00	DA-4	196.00	DW-4	310.00	DE-1	338.00	
2	440-550	25	None	8538	DG-1	155.00	DS-1	171.00	DA-1	189.00	DW-1	303.00	DE-1	338.00	
2	440-550	25	60	8538	DG-4	162.00	DS-4	178.00	DA-4	196.00	DW-4	310.00	DE-1	338.00	
2	440-550	25	100	8538	DG-5	173.00	DS-5	189.00	DA-5	207.00	DW-5	321.00	DE-1	338.00	
3	208-220	25	None	8538	EG-1	260.00	ES-1	282.00	EA-1	304.00	EW-1	518.00	EE-1	542.00	
3	208-220	25	200	8538	EG-2	288.00	ES-2	310.00	EA-2	332.00	EW-2	546.00	EE-1	542.00	
3	208-220	30	None	8538	EG-1	260.00	ES-1	282.00	EA-1	304.00	EW-1	518.00	EE-1	542.00	
3	208-220	30	200	8538	EG-2	288.00	ES-2	310.00	EA-2	332.00	EW-2	546.00	EE-1	542.00	
3	440-550	30	None	8538	EG-1	260.00	ES-1	282.00	EA-1	304.00	EW-1	518.00	EE-1	542.00	
3	440-550	30	100	8538	EG-3	271.00	ES-3	293.00	EA-3	315.00	EW-3	529.00	EE-1	542.00	
3	440-550	50	None	8538	EG-1	260.00	ES-1	282.00	EA-1	304.00	EW-1	518.00	EE-1	542.00	
3	440-550	50	100	8538	EG-3	271.00	ES-3	293.00	EA-3	315.00	EW-3	529.00	EE-1	542.00	
3	440-550	50	200	8538	EG-4	292.00	ES-4	314.00	EA-4	336.00	EW-4	550.00	EE-1	542.00	
4	208-220	50	None	8538	FG-1	491.00	FS-1	529.00	FA-1	613.00	FW-1	821.00	EE-1	542.00	
4	208-220	50	400	8538	FG-2	557.00	FS-2	595.00	FA-2	679.00	FW-2	887.00	EE-1	542.00	
4	440-550	60	None	8538	FG-1	491.00	FS-1	529.00	FA-1	613.00	FW-1	821.00	EE-1	542.00	
4	440-550	60	200	8538	FG-3	512.00	FS-3	550.00	FA-3	634.00	FW-3	842.00	EE-1	542.00	
4	440-550	100	None	8538	FG-1	491.00	FS-1	529.00	FA-1	613.00	FW-1	821.00	EE-1	542.00	
4	440-550	100	200	8538	FG-3	512.00	FS-3	550.00	FA-3	634.00	FW-3	842.00	EE-1	542.00	
4	440-550	100	400	8538	FG-4	565.00	FS-4	603.00	FA-4	687.00	FW-4	895.00	EE-1	542.00	
5	208-220	60	None	8538	GG-1	1060.00	GS-1	1126.00	GA-1	1356.00	GW-1	1950.00	EE-1	542.00	
5	208-220	60	600	8538	GG-2	1195.00	GS-2	1261.00	GA-2	1491.00	GW-2	2070.00	EE-1	542.00	
5	208-220	100	None	8538	GG-1	1060.00	GS-1	1126.00	GA-1	1356.00	GW-1	1950.00	EE-1	542.00	
5	208-220	100	600	8538	GG-2	1195.00	GS-2	1261.00	GA-2	1491.00	GW-2	2070.00	EE-1	542.00	
5	440-550	125	None	8538	GG-1	1060.00	GS-1	1126.00	GA-1	1356.00	GW-1	1950.00	EE-1	542.00	
5	440-550	125	400	8538	GG-3	1096.00	GS-3	1162.00	GA-3	1392.00	GW-3	1980.00	EE-1	542.00	
5	440-550	200	None	8538	GG-1	1060.00	GS-1	1126.00	GA-1	1356.00	GW-1	1950.00	EE-1	542.00	
5	440-550	200	400	8538	GG-3	1096.00	GS-3	1162.00	GA-3	1392.00	GW-3	1980.00	EE-1	542.00	
5	440-550	200	600	8538	GG-4	1237.00	GS-4	1303.00	GA-4	1533.00	GW-4	2130.00	EE-1	542.00	

Square D A-C Combination Magnetic Starters
Class 8539 Circuit Breaker Type Combination Starters
Line Voltage Type

Circuit Breaker Type Melting Alloy Overload Relays
25-60 Cycles 3 Pole 600 Volts Max.

Max. H.P. Poly-phase	Volts	NEMA Size	Bkr. Trip Rating	Bkr. Type	General Purpose Enclosure NEMA Type 1		General Purpose Enclosure With Felt Gaskets		Dust-Tight Industrial Use Enclosure** NEMA Type 12		Water-Tight Enclosure NEMA Type 4		For Hazardous Locations Class I Group D NEMA Type 7		For Hazardous Locations Class II Groups E, F, G NEMA Type 9	
					Type†	Each	Type†	Each	Type†	Each	Type†	Each	Type†	Each	Type†	Each
2	208-220	0	15	ML	BG-1	\$101.00	BS-1	\$111.00	BA-1	\$130.00	BW-1	\$202.00	BR-1	\$260.00	BE-1	\$210.00
2	440-550	0	15	ML-1	BG-2	130.00	BS-2	140.00	BA-2	159.00	BW-2	231.00	BR-2	289.00	BE-2	239.00
3	208-220	0	20	ML	BG-3	101.00	BS-3	111.00	BA-3	130.00	BW-3	202.00	BR-3	260.00	BE-3	210.00
3	440-550	0	15	ML-1	BG-2	130.00	BS-2	140.00	BA-2	159.00	BW-2	231.00	BR-2	289.00	BE-2	239.00
5	208-220	1	30	ML	CG-3	106.00	CS-3	116.00	CA-3	130.00	CW-3	202.00	CR-3	260.00	CE-3	210.00
5	440-550	0	15	ML-1	BG-2	130.00	BS-2	140.00	BA-2	159.00	BW-2	231.00	BR-2	289.00	BE-2	239.00
7½	208-220	1	50	ML	CG-5	106.00	CS-5	116.00	CA-5	130.00	CW-5	202.00	CR-10	260.00	CE-5	210.00
7½	440-550	1	20	ML-1	CG-4	135.00	CS-4	145.00	CA-4	159.00	CW-4	231.00	CR-4	289.00	CE-4	239.00
10	208-220	2	50	ML-1	DG-2	161.00	DS-2	177.00	DA-2	195.00	DW-2	309.00	DR-2	356.00	DE-2	345.00
10	440	1	30	ML-1	CG-6	135.00	CS-6	145.00	CA-6	159.00	CW-6	231.00	CR-1	289.00	CE-6	239.00
10	550	1	20	ML-1	CG-4	135.00	CS-4	145.00	CA-4	159.00	CW-4	231.00	CR-4	289.00	CE-4	239.00
15	208-220	2	*70	ML-1	DG-10	161.00	DS-10	177.00	DA-10	195.00	DW-10	309.00	DR-10	356.00	DE-10	345.00
15	440	2	40	ML-1	DG-5	190.00	DS-5	206.00	DA-5	224.00	DW-5	338.00	DR-5	385.00	DE-5	374.00
15	550	2	30	ML-1	DG-6	190.00	DS-6	206.00	DA-6	224.00	DW-6	338.00	DR-6	385.00	DE-6	374.00
20	208-220	3	100	ML-1	EG-1	275.00	ES-1	297.00	EA-1	319.00	EW-1	533.00	ER-1	600.00	EE-1	577.00
20	440	2	50	ML-1	DG-7	190.00	DS-7	206.00	DA-7	224.00	DW-7	338.00	DR-7	385.00	DE-7	374.00
20	550	2	40	ML-1	DG-8	190.00	DS-8	206.00	DA-8	224.00	DW-8	338.00	DR-8	385.00	DE-8	374.00
25	208-220	3	100	ML-3	EG-2	275.00	ES-2	297.00	EA-2	319.00	EW-2	533.00	ER-2	600.00	EE-2	577.00
25	440	2	50	ML-1	DG-7	190.00	DS-7	206.00	DA-7	224.00	DW-7	338.00	DR-7	385.00	DE-7	374.00
25	550	2	50	ML-1	DG-9	190.00	DS-9	206.00	DA-9	224.00	DW-9	338.00	DR-9	385.00	DE-9	374.00
30	208-220	3	*125	ML-3	EG-9	275.00	ES-9	297.00	EA-9	319.00	EW-9	533.00	ER-9	600.00	EE-9	577.00
30	440	3	70	ML-1	EG-3	275.00	ES-3	297.00	EA-3	319.00	EW-3	533.00	ER-3	600.00	EE-3	577.00
30	550	3	50	ML-1	EG-4	275.00	ES-4	297.00	EA-4	319.00	EW-4	533.00	ER-4	600.00	EE-4	577.00
40	208-220	4	175	ML-3	FG-1	600.00	FS-1	638.00	FA-1	722.00	FW-1	930.00	FR-1	1050.00	FE-1	984.00
40	440	3	100	ML-1	EG-5	275.00	ES-5	297.00	EA-5	319.00	EW-5	533.00	ER-5	600.00	EE-5	577.00
40	550	3	70	ML-1	EG-6	275.00	ES-6	297.00	EA-6	319.00	EW-6	533.00	ER-6	600.00	EE-6	577.00
50	208-220	4	200	ML-3	FG-2	600.00	FS-2	638.00	FA-2	722.00	FW-2	930.00	FR-2	1050.00	FE-2	984.00
50	440	3	100	ML-3	EG-7	275.00	ES-7	297.00	EA-7	319.00	EW-7	533.00	ER-7	600.00	EE-7	577.00
50	550	3	100	ML-1	EG-8	275.00	ES-8	297.00	EA-8	319.00	EW-8	533.00	ER-8	600.00	EE-8	577.00
60	208-220	5	*225	KL	GG-1	1349.00	GS-1	1415.00	GA-1	1645.00	GW-1	2191.00	GR-1	2615.00	GE-1	2355.00
60	440	4	125	ML-3	FG-3	600.00	FS-3	638.00	FA-3	722.00	FW-3	930.00	FR-3	1050.00	FE-3	984.00
60	550	4	100	ML-3	FG-4	600.00	FS-4	638.00	FA-4	722.00	FW-4	930.00	FR-4	1050.00	FE-4	984.00
75	208-220	5	*300	KL	GG-2	1349.00	GS-2	1415.00	GA-2	1645.00	GW-2	2191.00	GR-2	2615.00	GE-2	2355.00
75	440	4	150	ML-3	FG-5	600.00	FS-5	638.00	FA-5	722.00	FW-5	930.00	FR-5	1050.00	FE-5	984.00
75	550	4	125	ML-3	FG-6	600.00	FS-6	638.00	FA-6	722.00	FW-6	930.00	FR-6	1050.00	FE-6	984.00
100	208-220	5	*400	KL	GG-3	1349.00	GS-3	1415.00	GA-3	1645.00	GW-3	2191.00	GR-3	2615.00	GE-3	2355.00
100	400	4	200	ML-3	FG-7	600.00	FS-7	638.00	FA-7	722.00	FW-7	930.00	FR-7	1050.00	FE-7	984.00
100	550	4	150	ML-3	FG-8	600.00	FS-8	638.00	FA-8	722.00	FW-8	930.00	FR-8	1050.00	FE-8	984.00
125	208-220	6	▲	WL	HG-1	3100.00	HIS-1	3220.00	HW-1	3486.00
125	440	5	*250	KL	GG-4	1349.00	GS-4	1415.00	GA-4	1645.00	GW-4	2191.00	GR-4	2615.00	GE-4	2355.00
125	550	5	*200	KL	GG-5	1349.00	GS-5	1415.00	GA-5	1645.00	GW-5	2191.00	GR-5	2615.00	GE-5	2355.00
150	208-220	6	▲	WL	HG-1	3100.00	HIS-1	3220.00	HW-1	3486.00
150	440	5	*300	KL	GG-6	1349.00	GS-6	1415.00	GA-6	1645.00	GW-6	2191.00	GR-6	2615.00	GE-6	2355.00
150	550	5	*225	KL	GG-7	1349.00	GS-7	1415.00	GA-7	1645.00	GW-7	2191.00	GR-7	2615.00	GE-7	2355.00
200	208-220	6	▲	WL	HG-1	3100.00	HIS-1	3220.00	HW-1	3486.00
200	440	5	*400	KL	GG-8	1349.00	GS-8	1415.00	GA-8	1645.00	GW-8	2191.00	GR-8	2615.00	GE-8	2355.00
200	550	5	*300	KL	GG-9	1349.00	GS-9	1415.00	GA-9	1645.00	GW-9	2191.00	GR-9	2615.00	GE-9	2355.00
400	440	6	▲	WL	HG-1	3100.00	HIS-1	3220.00	HW-1	3486.00
400	550	6	▲	WL	HG-1	3100.00	HIS-1	3220.00	HW-1	3486.00

Prices include thermal overload relay units. Deduct \$1.50 each if relay units are omitted.

*These trip ratings and breaker types do not necessarily apply to starters in NEMA 7 enclosures.

**Functionally equivalent to NEMA Type 5. Standard devices do not include external reset for overload relays. External reset will be furnished as an optional feature.

†Current production is design Series A, except NEMA Size 5, which is design Series B.

▲Give motor horsepower, full load current, and locked rotor current or KVA, to select proper breaker trip unit.

Ordering Instructions: Specify Class and Type Number of starters; give horsepower, voltage, phase, cycles and full load current rating of motor. Select thermal relays from proper table. If special features are desired, order class 8539, type . . . , form . . . , selecting the correct form letter from table. If more than one form letter is used arrange the letters in alphabetical order as "Class 8539, Type EG-2, Form AFT." Describe clearly any modification which cannot be covered by form letters.

Square D A-C Magnetic Starters

Reduced Voltage, Primary Resistor and Part Winding Types

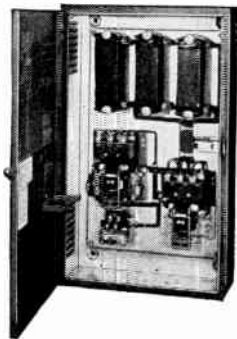

**Class 8547
Type CG-3**

**Class 8547 and 8549
Primary Resistor Type**

Primary resistor starters provide smooth acceleration and reduced starting current by inserting resistors in series with the motor windings.

Ordering Instructions: Specify Class and Type Number of starter; give hp., voltage, phase, cycles, full load current and type of motor.

Melting alloy overload relays.

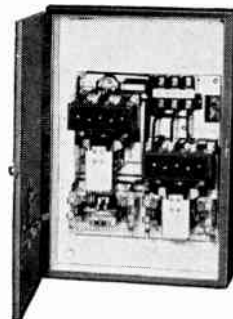

**Class 8640
Type DG-1**

**Class 8640
Part Winding Motor Starters**

Class 8640 starters are used with part winding squirrel cage motors to provide reduced starting torque and current.

Melting alloy overload relays.

When ordering specify Class and Type Number of starter; give hp., voltage, phase, and cycles of motor and full load current of each motor winding.

25-60 Cycles—NEMA Class 116 Resistors—600 Volts Maximum

Max. Hp. Poly-phase	Volts	Class 8547, Non-Reversing				Class 8549 Reversing			
		General Purpose Enclosure NEMA Type 1		Dust-tight Enclosure NEMA Type 5		General Purpose Enclosure NEMA Type 1		Dust-Tight Enclosure NEMA Type 5	
		Type	Each	Type	Each	Type	Each	Type	Each
Three Pole, Three Phase*									
5	208-220	CG-3	\$286.00	CD-3	\$506.00	CG-1	\$430.00	CD-1	\$740.00
5	440-550	CG-3	286.00	CD-3	506.00	CG-1	430.00	CD-1	740.00
7½	208-220	CG-5	296.00	CD-5	516.00	CG-2	445.00	CD-2	755.00
7½	440-550	CG-3	296.00	CD-3	516.00	CG-1	445.00	CD-1	755.00
10	208-220	DG-2	420.00	DD-2	730.00	DG-1	814.00	DD-1	1124.00
10	440-550	CG-5	316.00	CD-5	536.00	CG-2	465.00	CD-2	775.00
15	208-220	DG-2	450.00	DD-2	760.00	DG-1	844.00	DD-1	1154.00
15	440-550	DG-2	450.00	DD-2	760.00	DG-1	844.00	DD-1	1154.00
20	208-220	EG-2	600.00	ED-2	910.00	EG-1	1010.00	ED-1	1320.00
20	440-550	DG-2	484.00	DD-2	794.00	DG-1	878.00	DD-1	1188.00
25	208-220	EG-2	610.00	ED-2	920.00	EG-1	1026.00	ED-1	1336.00
25	440-550	DG-2	504.00	DD-2	814.00	DG-1	913.00	DD-1	1223.00
30	208-220	EG-2	638.00	ED-2	948.00	EG-1	1054.00	ED-1	1364.00
30	440-550	EG-2	638.00	ED-2	948.00	EG-1	1054.00	ED-1	1364.00
40	208-220	FG-1	1296.00	FD-1	1682.00	FG-1	2198.00	FD-1	2768.00
40	440-550	EG-2	662.00	ED-2	972.00	EG-1	1078.00	ED-1	1388.00
50	208-220	FG-1	1296.00	FD-1	1682.00	FG-1	2198.00	FD-1	2768.00
50	440-550	EG-2	684.00	ED-2	994.00	EG-1	1113.00	ED-1	1423.00
60	208-220	GG-1	2022.00	GD-1	2484.00	GG-1	2222.00	GD-1	2790.00
60	440-550	FG-1	1320.00	FD-1	1706.00	FG-1	2222.00	FD-1	2790.00
75	208-220	GG-1	2022.00	GD-1	2484.00	GG-1	2222.00	GD-1	2790.00
75	440-550	FG-1	1320.00	FD-1	1706.00	FG-1	2222.00	FD-1	2790.00
100	208-220	GG-1	2178.00	GD-1	2640.00	GG-1	2222.00	GD-1	2790.00
100	440-550	FG-1	1320.00	FD-1	1706.00	FG-1	2222.00	FD-1	2790.00
125	208-220	HG-1†	3740.00	GD-1	2556.00	GG-1	2222.00	GD-1	2790.00
125	440-550	GG-1	2094.00	GD-1	2556.00	GG-1	2222.00	GD-1	2790.00
150	208-220	HG-1†	3902.00	GD-1	2556.00	GG-1	2222.00	GD-1	2790.00
150	440-550	GG-1	2094.00	GD-1	2556.00	GG-1	2222.00	GD-1	2790.00
200	208-220	HG-1†	4044.00	GD-1	2834.00	GG-1	2222.00	GD-1	2790.00
200	440-550	GG-1	2372.00	GD-1	2834.00	GG-1	2222.00	GD-1	2790.00
250	208-220	JG-1†	6948.00	GG-1	2372.00	GG-1	2222.00	GD-1	2790.00
250	440-550	HG-1†	3934.00	GG-1	2372.00	GG-1	2222.00	GD-1	2790.00
300	440-550	HG-1†	4166.00	GG-1	2372.00	GG-1	2222.00	GD-1	2790.00
400	440-550	HG-1†	4288.00	GG-1	2372.00	GG-1	2222.00	GD-1	2790.00
500	440-550	JG-1†	7486.00	GG-1	2372.00	GG-1	2222.00	GD-1	2790.00

Prices include thermal overload relay units. Deduct \$1.50 each if relay units are omitted.

*Two pole and four pole starters available, contact GRAYBAR.

†MFG. by EC and M Division.

Part Winding Motor Starters

25-60 Cycles—Two Step Part Winding Motor Starters*—600 Volts Maximum

NEMA Size	Max. Hp. Polyphase		Class	General Purpose Enclosure NEMA Type 1		Water-tight Enclosure NEMA Type 4		Dust-tight Enclosure NEMA Type 5		For Hazardous Locations Class I, Group D NEMA Type 7	
	208-220 Volts	440-550 Volts		Type	Each	Type	Each	Type	Each	Type	Each
Three Pole, Three Phase											
1PW	15	20	8640	CG-1	\$225.00	CW-1	\$319.00	CD-1	\$287.00	CR-1	\$455.00
2PW	30	50	8640	DG-1	318.00	DW-1	436.00	DD-1	390.00	DR-1	660.00
3PW	60	100	8640	EG-1	446.00	EW-1	618.00	ED-1	546.00	ER-1	1008.00
4PW	100	200	8640	FG-1	947.00	FW-1	1219.00	FD-1	1145.00	FR-1	1980.00
5PW	200	400	8640	GG-1	1900.00	GW-1	2470.00	GD-1	2362.00	GR-1	3960.00

Prices include four thermal overload relay units. Deduct \$1.50 each if relay units are omitted.

*Four pole two step part winding motor starters and three pole step part winding motor starters also available.

Square D A-C Magnetic Starters

**Class 8606—Reduced Voltage—Auto-Transformer Type—Air Break
*Three Phase—Melting Alloy Overload Relays**

25-60 Cycles

Starters are fully automatic in operation.

These starters apply a reduced voltage across the motor terminals during the acceleration period by means of an auto-transformer.

Greater starting torque per ampere of line current is provided than with any other form of reduced voltage starter.

Ordering Instructions

1. Specify Class and Type number; give horsepower, voltage, phase, cycles and full load current rating of motor.
2. Select relay units from Table 3, listed elsewhere in this catalog.
3. Order suitable push button station. Spare parts, electrical interlock, and user modification kits may be ordered.
4. If special features are required order "Class 8606 similar to Type . . ." and state clearly features required.

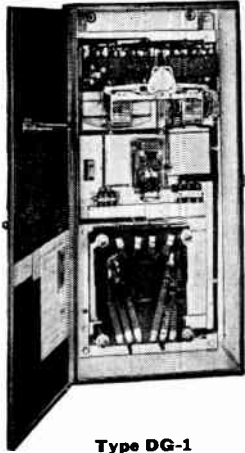

Type DG-1

Hp. Ratings	Volts	Cycles	Class	General Purpose Enclosure NEMA Type 1		Water-tight Enclosure NEMA Type 4		Dust-tight Enclosure NEMA Type 5		For Hazardous Locations Class II Groups E, F and G NEMA Type 9	
				No.	Each	No.	Each	No.	Each	No.	Each
5	208-220	50-60	8606	DG-1	\$570.00	DW-1	\$880.00	DD-1	\$880.00	DE-1	\$880.00
7 1/2	410-550	50-60	8606	DG-1	570.00	DW-1	880.00	DD-1	880.00	DE-1	880.00
10	208-220	25	8606	DG-1	598.00	DW-1	908.00	DD-1	908.00	DE-1	908.00
10	440-550	25	8606	DG-1	598.00	DW-1	908.00	DD-1	908.00	DE-1	908.00
15	208-220	50-60	8606	DG-1	570.00	DW-1	880.00	DD-1	880.00	DE-1	880.00
15	440-550	50-60	8606	DG-1	570.00	DW-1	880.00	DD-1	880.00	DE-1	880.00
15	208-220	25	8606	DG-1	598.00	DW-1	908.00	DD-1	908.00	DE-1	908.00
15	440-550	25	8606	DG-1	598.00	DW-1	908.00	DD-1	908.00	DE-1	908.00
20	208-220	50-60	8606	EG-1	670.00	EW-1	980.00	ED-1	980.00	EE-1	980.00
20	440-550	50-60	8606	DG-1	570.00	DW-1	880.00	DD-1	880.00	DE-1	880.00
20	208-220	25	8606	EG-1	698.00	EW-1	1008.00	ED-1	1008.00	EE-1	1008.00
20	440-550	25	8606	DG-1	598.00	DW-1	908.00	DD-1	908.00	DE-1	908.00
25	208-220	50-60	8606	EG-1	670.00	EW-1	980.00	ED-1	980.00	EE-1	980.00
25	440-550	50-60	8606	DG-1	570.00	DW-1	880.00	DD-1	880.00	DE-1	880.00
25	208-220	25	8606	EG-1	698.00	EW-1	1008.00	ED-1	1008.00	EE-1	1008.00
25	440-550	25	8606	DG-1	598.00	DW-1	908.00	DD-1	908.00	DE-1	908.00
30	208-220	50-60	8606	EG-1	698.00	EW-1	1008.00	ED-1	1008.00	EE-1	1008.00
30	440-550	50-60	8606	EG-1	698.00	EW-1	1008.00	ED-1	1008.00	EE-1	1008.00
30	208-220	25	8606	EG-1	956.00	EW-1	1266.00	ED-1	1266.00	EE-1	1266.00
30	440-550	25	8606	EG-1	956.00	EW-1	1266.00	ED-1	1266.00	EE-1	1266.00
40	208-220	50-60	8606	FG-1	1296.00	FW-1	1866.00	FD-1	1682.00	FE-1	1866.00
40	440-550	50-60	8606	FG-1	722.00	FW-1	1032.00	FD-1	1032.00	FE-1	1032.00
40	208-220	25	8606	FG-1	1356.00	FW-1	1926.00	FD-1	1742.00	FE-1	1926.00
40	440-550	25	8606	EG-1	956.00	EW-1	1266.00	ED-1	1266.00	EE-1	1266.00
50	208-220	50-60	8606	FG-1	1296.00	FW-1	1866.00	FD-1	1682.00	FE-1	1866.00
50	440-550	50-60	8606	EG-1	722.00	EW-1	1032.00	ED-1	1032.00	EE-1	1032.00
50	208-220	25	8606	FG-1	1356.00	FW-1	1926.00	FD-1	1742.00	FE-1	1926.00
50	440-550	25	8606	EG-1	956.00	EW-1	1266.00	ED-1	1266.00	EE-1	1266.00
60	208-220	50-60	8606	GG-1	2022.00	GW-1	2592.00	GD-1	2484.00	GE-1	2592.00
60	440-550	50-60	8606	FG-1	1320.00	FW-1	1890.00	FD-1	1706.00	FE-1	1890.00
60	208-220	25	8606	GG-1	2076.00	GW-1	2646.00	GD-1	2538.00	GE-1	2646.00
60	440-550	25	8606	FG-1	1496.00	FW-1	2066.00	FD-1	1882.00	FE-1	2066.00
75	208-220	50-60	8606	GG-1	2022.00	GW-1	2592.00	GD-1	2484.00	GE-1	2592.00
75	440-550	50-60	8606	FG-1	1320.00	FW-1	1890.00	FD-1	1706.00	FE-1	1890.00
75	208-220	25	8606	GG-1	2076.00	GW-1	2646.00	GD-1	2538.00	GE-1	2646.00
75	440-550	25	8606	FG-1	1496.00	FW-1	2066.00	FD-1	1882.00	FE-1	2066.00
100	208-220	50-60	8606	GG-1	2178.00	GW-1	2748.00	GD-1	2640.00	GE-1	2748.00
100	440-550	50-60	8606	FG-1	1320.00	FW-1	1890.00	FD-1	1706.00	FE-1	1890.00
100	208-220	25	8606	GG-1	2278.00	GW-1	2848.00	GD-1	2740.00	GE-1	2848.00
100	440-550	25	8606	FG-1	1598.00	FW-1	2168.00	FD-1	1984.00	FE-1	2168.00
125	208-220	50-60	8606	HG-1	3740.00
125	440-550	50-60	8606	GG-1	2094.00	GW-1	2664.00	GD-1	2556.00	GE-1	2664.00
125	208-220	25	8606	GG-1	2178.00	GW-1	2748.00	GD-1	2640.00	GE-1	2748.00
150	208-220	50-60	8606	HG-1	3902.00
150	440-550	50-60	8606	GG-1	2094.00	GW-1	2664.00	GD-1	2556.00	GE-1	2664.00
150	208-220	25	8606	GG-1	2436.00	GW-1	3006.00	GD-1	2898.00	GE-1	3006.00
200	208-220	50-60	8606	HG-1	4044.00
200	440-550	50-60	8606	GG-1	2372.00	GW-1	2942.00	GD-1	2834.00	GE-1	2942.00
200	208-220	25	8606	GG-1	2674.00	GW-1	3244.00	GD-1	3136.00	GE-1	3244.00
250	208-220	50-60	8606	JG-1	6948.00
250	440-550	50-60	8606	HG-1	3934.00
300	440-550	50-60	8606	HG-1	4166.00
400	440-550	50-60	8606	HG-1	4288.00
500	440-550	50-60	8606	JG-1	7486.00

*Prices include thermal overload relay units. Deduct \$1.50 each if relay units are omitted.

Square D A-C Reversing Magnetic Contactors

Class 8702—Without Overload Protection

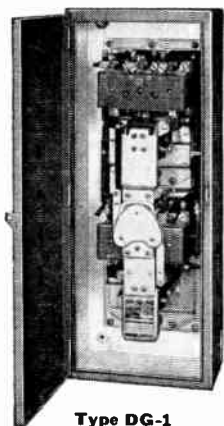

Type DG-1

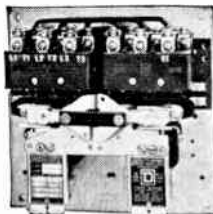

Type CO-8

Reversing type magnetic contactors are used to start, stop and reverse a-c squirrel cage motors where overload protection is not needed or is provided separately.

25-60 cycles; 600 volts maximum.

Ordering instructions: Specify Class and Type Number of contactor; give horsepower, voltage phase, cycles and full load current rating of motor. Spare parts, electrical interlock and user modification kits also available.

NEMA Size	Volts	Max. Hp.	Type of Motor	Vertical No.	General Purpose Enclosure NEMA Type 1		Each	Water-tight Enclosure NEMA Type 4		Each	Dust-Tight Industrial Use Enclosure NEMA Type 12		Each	Vertical No.	Open Type		Each	
					Horizontal No.	Each		Horizontal No.	Each		Horizontal No.	Each			Horizontal No.	Each		
Two Pole, Single Phase																		
00	115	1/2	3-Wire	AG-1	AG-1	\$ 62.00	AW-1	\$ 108.00		Use NEMA	AO-1	\$ 58.00				
00	230	3/4	3-Wire	AG-1	AG-1	62.00	AW-1	108.00		Size 0	AO-1	58.00				
0	115	1	3-Wire	BG-1	BG-1	74.00	BW-1	120.00		BA-1	\$ 92.00	BO-1	70.00			
0	230	2	3-Wire	BG-1	BG-1	74.00	BW-1	120.00		BA-1	92.00	BO-1	70.00			
1	115	2	3-Wire	CG-1	CG-2	CG-2	86.00	CW-1	150.00		CA-1	104.00	CO-1	CO-2	80.00			
1	230	3	3-Wire	CG-1	CG-2	CG-2	86.00	CW-1	150.00		CA-1	104.00	CO-1	CO-2	80.00			
Three Pole, Single Phase																		
00	115	1/2	4-W.Rep.-Ind.	AG-2	AG-2	64.00	AW-2	110.00		Use NEMA	AO-2	60.00				
00	230	3/4	4-W.Rep.-Ind.	AG-2	AG-2	64.00	AW-2	110.00		Size 0	AO-2	60.00				
00	115	1/2	4-W.Split Ph.	AG-3	AG-3	64.00	AW-3	110.00		Use NEMA	AO-3	60.00				
00	230	3/4	4-W.Split Ph.	AG-3	AG-3	64.00	AW-3	110.00		Size 0	AO-3	60.00				
0	115	1	4-W.Rep.-Ind.	BG-2	BG-2	76.00	BW-2	122.00		BA-2	94.00	BO-2	72.00			
0	230	2	4-W.Rep.-Ind.	BG-2	BG-2	76.00	BW-2	122.00		BA-2	94.00	BO-2	72.00			
0	115	1	4-W.Split Ph.	BG-3	BG-3	76.00	BW-3	122.00		BA-3	94.00	BO-3	72.00			
0	230	2	4-W.Split Ph.	BG-3	BG-3	76.00	BW-3	122.00		BA-3	94.00	BO-3	72.00			
1	115	2	4-W.Rep.-Ind.	CG-3	CG-4	CG-4	88.00	CW-2	152.00		CA-2	106.00	CO-3	CO-4	82.00			
1	230	3	4-W.Rep.-Ind.	CG-3	CG-4	CG-4	88.00	CW-2	152.00		CA-2	106.00	CO-3	CO-4	82.00			
1	115	2	4-W.Split Ph.	CG-5	CG-6	CG-6	88.00	CW-3	152.00		CA-3	106.00	CO-5	CO-6	82.00			
1	230	3	4-W.Split Ph.	CG-5	CG-6	CG-6	88.00	CW-3	152.00		CA-3	106.00	CO-5	CO-6	82.00			
Three Pole, Polyphase																		
00	208-220	1	3 Phase	AG-4	AG-4	64.00	AW-4	110.00		Use NEMA	AO-4	60.00				
00	410-550	1	3 Phase	AG-4	AG-4	64.00	AW-4	110.00		Size 0	AO-4	60.00				
0	208-220	3	3 Phase	BG-4	BG-4	76.00	BW-4	122.00		BA-4	94.00	BO-4	72.00			
0	410-550	5	3 Phase	BG-4	BG-4	76.00	BW-4	122.00		BA-4	94.00	BO-4	72.00			
1	208-220	7 1/2	3 Phase	CG-7	CG-8	CG-8	88.00	CW-4	152.00		CA-4	106.00	CO-7	CO-8	82.00			
1	410-550	10	3 Phase	CG-7	CG-8	CG-8	88.00	CW-4	152.00		CA-4	106.00	CO-7	CO-8	82.00			
2	208-220	15	3 Phase	DG-1	DG-2	DG-2	172.00	DW-1	276.00		DA-1	202.00	DO-1	DO-2	156.00			
2	410-550	25	3 Phase	DG-1	DG-2	DG-2	172.00	DW-1	276.00		DA-1	202.00	DO-1	DO-2	156.00			
3	208-220	30	3 Phase	EG-1	EG-2	EG-2	287.00	EW-1	441.00		ED-1	353.00	EO-1	EO-2	259.00			
3	410-550	50	3 Phase	EG-1	EG-2	EG-2	287.00	EW-1	441.00		ED-1	353.00	EO-1	EO-2	259.00			
4	208-220	50	3 Phase	FG-1	FG-3	FG-3	698.00	FW-1	970.00		FD-1	800.00	FO-1	FO-3	646.00			
4	410-550	100	3 Phase	FG-1	FG-3	FG-3	698.00	FW-1	970.00		FD-1	800.00	FO-1	FO-3	646.00			
5	208-220	100	3 Phase	GG-1	1466.00	GW-1	1818.00		GD-1	1818.00	GO-1	1165.00			
5	410-550	200	3 Phase	GG-1	1466.00	GW-1	1818.00		GD-1	1818.00	GO-1	1165.00			
6	208-220	200	3 Phase	HG-10	3650.00	HO-10	3142.00			
6	410-550	400	3 Phase	HG-10	3650.00	HO-10	3142.00			
7	208-220	250	3 Phase	JG-1	5038.00	JO-1	4523.00			
7	410-550	500	3 Phase	JG-1	5038.00	JO-1	4523.00			
Four Pole, Polyphase																		
0	220	3	2 Ph. 4-Wire	BG-5	BG-5	96.00	BW-5	142.00		BA-5	114.00	BO-5	92.00			
0	410-550	5	2 Ph. 4-Wire	BG-5	BG-5	96.00	BW-5	142.00		BA-5	114.00	BO-5	92.00			
1	220	7 1/2	2 Ph. 4-Wire	CG-9	CG-10	CG-10	109.00	CW-5	173.00		CA-5	127.00	CO-9	CO-10	105.00			
1	410-550	10 1/2	2 Ph. 4-Wire	CG-9	CG-10	CG-10	109.00	CW-5	173.00		CA-5	127.00	CO-9	CO-10	105.00			
2	220	15	2 Ph. 4-Wire	DG-3	DG-4	DG-4	214.00	DW-2	324.00		DA-2	244.00	DO-3	DO-4	198.00			
2	410-550	25	2 Ph. 4-Wire	DG-3	DG-4	DG-4	214.00	DW-2	324.00		DA-2	244.00	DO-3	DO-4	198.00			
3	220	30	2 Ph. 4-Wire	EG-3	EG-4	EG-4	358.00	EW-2	510.00		ED-2	422.00	EO-3	EO-4	328.00			
3	410-550	50	2 Ph. 4-Wire	EG-3	EG-4	EG-4	358.00	EW-2	510.00		ED-2	422.00	EO-3	EO-4	328.00			
4	220	50	2 Ph. 4-Wire	FG-2	FG-4	FG-4	888.00	FW-2	1162.00		FD-2	992.00	FO-2	FO-4	834.00			
4	410-550	100	2 Ph. 4-Wire	FG-2	FG-4	FG-4	888.00	FW-2	1162.00		FD-2	992.00	FO-2	FO-4	834.00			
5	220	100	2 Ph. 4-Wire	GG-2	1757.00	GW-2	2327.00		GD-2	2109.00	GO-2	1455.00			
5	410-550	200	2 Ph. 4-Wire	GG-2	1757.00	GW-2	2327.00		GD-2	2109.00	GO-2	1455.00			

▲Also functionally equivalent to NEMA Type 5.

Square D A-C Reversing Magnetic Starters

Class 8736—Melting Alloy Overload Relays

25-60 Cycles

Reversing type line voltage magnetic starters are used to start, stop and reverse a-c squirrel cage motors where full motor starting torque will not damage the driven machinery and where the starting inrush current is not objectionable.

Motor protection is provided by melting alloy type thermal overload relays.

Ordering instructions: Specify Class and Type Number of starter; give horsepower, voltage, phase, cycles and full load current rating of motor. Spare parts, electrical interlock and user modification kits also available.

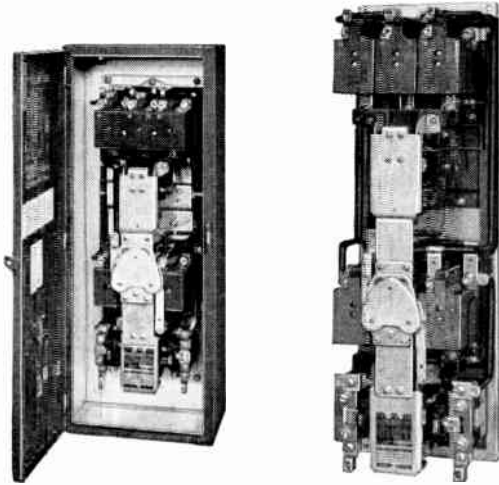

Type DG-1

Type EO-1 Two Pole, Single Phase

NEMA Size	Ratings		Type of Motor	General Purpose Enclosure		Water-Tight Enclosure		Dust-Tight Industrial Use Enclosure		Open Type	
	Volts	Max. Hp.		NEMA Type 1	NEMA Type 4	NEMA Type 12	Vertical No.	Horizontal No.	Each	Each	Vertical No.
00	115	1/2	3-Wire	AG-1	\$ 66.00	AW-1	\$ 112.00	Use NEMA Size 0		AO-1	\$ 62.00
00	230	3/4	3-Wire	AG-1	66.00	AW-1	112.00			AO-1	62.00
0	115	1	3-Wire	BG-1	78.00	BW-1	124.00	BA-1	\$ 96.00	BO-1	74.00
0	230	2	3-Wire	BG-1	78.00	BW-1	124.00	BA-1	96.00	BO-1	74.00
1	115	2	3-Wire	CG-1	90.00	CW-1	154.00	CA-1	108.00	CO-1	84.00
1	230	3	3-Wire	CG-1	90.00	CW-1	154.00	CA-1	108.00	CO-1	84.00
Three Pole, Single Phase											
00	115	1/2	4-W.Rep.-Ind.	AG-2	68.00	AW-2	114.00	Use NEMA Size 0		AO-2	64.00
00	230	3/4	4-W.Rep.-Ind.	AG-2	68.00	AW-2	114.00			AO-2	64.00
00	115	1	4-W.Split Ph.	AG-3	68.00	AW-3	114.00			AO-3	64.00
00	230	3/4	4-W.Split Ph.	AG-3	68.00	AW-3	114.00			AO-3	64.00
0	115	1	4-W.Rep.-Ind.	BG-2	80.00	BW-2	126.00	BA-2	98.00	BO-2	76.00
0	230	2	4-W.Rep.-Ind.	BG-2	80.00	BW-2	126.00	BA-2	98.00	BO-2	76.00
0	115	1	4-W.Split Ph.	BG-3	80.00	BW-3	126.00	BA-3	98.00	BO-3	76.00
0	230	2	4-W.Split Ph.	BG-3	80.00	BW-3	126.00	BA-3	98.00	BO-3	76.00
1	115	2	4-W.Rep.-Ind.	CG-3	92.00	CW-2	156.00	CA-2	110.00	CO-3	86.00
1	230	3	4-W.Rep.-Ind.	CG-3	92.00	CW-2	156.00	CA-2	110.00	CO-3	86.00
1	115	2	4-W.Split Ph.	CG-5	92.00	CW-3	156.00	CA-3	110.00	CO-5	86.00
1	230	3	4-W.Split Ph.	CG-5	92.00	CW-3	156.00	CA-3	110.00	CO-5	86.00
Three Pole, Polyphase											
00	208-220	1	3 Phase	AG-4	72.00	AW-4	118.00	Use NEMA Size 0		AO-4	68.00
00	410-550	1	3 Phase	AG-4	72.00	AW-4	118.00			AO-4	68.00
0	208-220	3	3 Phase	BG-4	84.00	BW-4	130.00	BA-4	102.00	BO-4	80.00
0	410-550	5	3 Phase	BG-4	84.00	BW-4	130.00	BA-4	102.00	BO-4	80.00
1	208-220	7 1/2	3 Phase	CG-7	96.00	CW-4	160.00	CA-4	114.00	CO-7	90.00
1	410-550	10	3 Phase	CG-7	96.00	CW-4	160.00	CA-4	114.00	CO-7	90.00
2	208-220	15	3 Phase	DG-1	184.00	DW-1	288.00	DA-1	214.00	DO-1	168.00
2	410-550	25	3 Phase	DG-1	184.00	DW-1	288.00	DA-1	214.00	DO-1	168.00
3	208-220	30	3 Phase	EG-1	305.00	EW-1	459.00	EA-1	371.00	EO-1	277.00
3	410-550	50	3 Phase	EG-1	305.00	EW-1	459.00	EA-1	371.00	EO-1	277.00
4	208-220	50	3 Phase	FG-1	724.00	FW-1	996.00	FA-1	826.00	FO-1	672.00
4	410-550	100	3 Phase	FG-1	724.00	FW-1	996.00	FA-1	826.00	FO-1	672.00
5	208-220	100	3 Phase	GG-1	1551.00	GW-1	1903.00	GA-1	1903.00	GO-1	1250.00
5	410-550	200	3 Phase	GG-1	1551.00	GW-1	1903.00	GA-1	1903.00	GO-1	1250.00
6	208-220	200	3 Phase	HG-1	4015.00	HO-1	3507.00
6	410-550	400	3 Phase	HG-1	4015.00	HO-1	3507.00
7	208-220	250	3 Phase	JG-1	5445.00	JO-1	4930.00
7	410-550	500	3 Phase	JG-1	5445.00	JO-1	4930.00
Four Pole, Polyphase											
0	220	3	2 Ph.4-Wire	EG-5	104.00	BW-5	150.00	BA-5	122.00	BO-5	100.00
0	410-550	5	2 Ph.4-Wire	EG-5	104.00	BW-5	150.00	BA-5	122.00	BO-5	100.00
1	220	7 1/2	2 Ph.4-Wire	CG-9	117.00	CW-5	181.00	CA-5	135.00	CO-9	113.00
1	410-550	10	2 Ph.4-Wire	CG-9	117.00	CW-5	181.00	CA-5	135.00	CO-9	113.00
2	220	15	2 Ph.4-Wire	DG-3	226.00	DW-2	336.00	DA-2	256.00	DO-3	210.00
2	410-550	25	2 Ph.4-Wire	DG-3	226.00	DW-2	336.00	DA-2	256.00	DO-3	210.00
3	220	30	2 Ph.4-Wire	EG-3	376.00	EW-2	528.00	ED-2	440.00	EO-3	346.00
3	410-550	50	2 Ph.4-Wire	EG-3	376.00	EW-2	528.00	ED-2	440.00	EO-3	346.00
4	220	50	2 Ph.4-Wire	FG-2	914.00	FW-2	1188.00	FD-2	1018.00	FO-2	860.00
4	410-550	100	2 Ph.4-Wire	FG-2	914.00	FW-2	1188.00	FD-2	1018.00	FO-2	860.00
5	220	100	2 Ph.4-Wire	GG-2	1841.00	GW-2	2411.00	GD-2	2193.00	GO-2	1540.00
5	410-550	200	2 Ph.4-Wire	GG-2	1841.00	GW-2	2411.00	GD-2	2193.00	GO-2	1540.00

Prices include thermal overload relay units. Deduct \$1.50 each if relay units are omitted.

▲Also functionally equivalent to NEMA Type 5.

Square D A-C Multi-Speed Magnetic Starters

Class 8810—8811—8812

Ordering Instructions



Class 8810—Type DG-3

Line voltage type a-c multi-speed starters designed to control separate winding and consequent pole winding squirrel cage motors which operate at 2, 3, or 4 different speeds.

Starters available for constant torque, variable torque and constant hp. motor applications.

Motors protected by melting alloy type thermal overload relay.

Specify Class and Type Number of starter; hp., voltage, phase, cycles, Rpm and full load current of the motor at each speed. Furnish motor connection diagram.

Order suitable push button stations from Class 9001 section. Specify either two or three wire control.

If Form 1 compelling relay is required, add suffix "F1" to Type number. If Form 2 accelerating relays are required, add suffix "F2" to type number. If other special features are desired, order "Class . . . similar to Type . . ." and state clearly the features required.

Type of Motor	NEMA Size	Maximum Horsepower		Class 8810 Two Speed General Purpose Enclosure NEMA Type 1		Class 8810 Two Speed Open Type		Class 8811 Three Speed General Purpose Enclosure NEMA Type 1		Class 8812 Four Speed General Purpose Enclosure NEMA Type 1	
		208-220 Volts	440-550 Volts	Type	Each	Type	Each	Type	Each	Type	Each
Three Phase (Consequent Pole)											
Constant Horsepower	0	1½	3	BG-1	\$ 160.00	BO-1	\$ 156.00	BG-1	\$ 408.00	BG-1	\$ 606.00
	1	3	5	CG-1	172.00	CO-1	166.00	CG-1	430.00	CG-1	644.00
	2	10	20	DG-1	308.00	DO-1	290.00	DG-1	636.00	DG-1	954.00
	3	20	40	EG-1	462.00	EO-1	434.00	EG-1	914.00	EG-1	1420.00
	4	30	60	FG-1	1224.00	FO-1	1114.00	FG-1	2214.00	FG-1	3342.00
Constant Torque	0	3	5	BG-2	160.00	BO-2	156.00	BG-2	408.00	BG-2	606.00
	1	7½	10	CG-2	172.00	CO-2	166.00	CG-2	430.00	CG-2	644.00
	2	15	25	DG-2	308.00	DO-2	290.00	DG-2	636.00	DG-2	954.00
	3	30	50	EG-2	462.00	EO-2	434.00	EG-2	914.00	EG-2	1420.00
	4	50	100	FG-2	1224.00	FO-2	1114.00	FG-2	2214.00	FG-2	3342.00
Variable Torque	0	3	5	BG-2	160.00	BO-2	156.00	BG-3	408.00	BG-3	606.00
	1	7½	10	CG-2	172.00	CO-2	166.00	CG-3	430.00	CG-3	644.00
	2	15	25	DG-2	308.00	DO-2	290.00	DG-3	636.00	DG-3	954.00
	3	30	50	EG-2	462.00	EO-2	434.00	EG-3	914.00	EG-3	1420.00
	4	50	100	FG-2	1224.00	FO-2	1114.00	FG-3	2214.00	FG-3	3342.00
Three Phase, Y-Y Connected (Separate Winding) Only											
Constant Horsepower	0	1½	3	BG-3	116.00	BO-3	112.00	BG-4	290.00	BG-4	416.00
	1	3	5	CG-3	130.00	CO-3	124.00	CG-4	316.00	CG-4	440.00
	2	10	20	DG-3	228.00	DO-3	212.00	DG-4	462.00	DG-4	630.00
	3	20	40	EG-3	354.00	EO-3	326.00	EG-4	662.00	EG-4	892.00
	4	30	60	FG-3	860.00	FO-3	808.00	FG-4	1548.00	FG-4	2174.00
Constant Torque or Variable Torque	0	3	5	BG-4	116.00	BO-4	112.00	BG-5	290.00	BG-5	416.00
	1	7½	10	CG-4	130.00	CO-4	124.00	CG-5	316.00	CG-5	440.00
	2	15	25	DG-4	228.00	DO-4	212.00	DG-5	462.00	DG-5	630.00
	3	30	50	EG-4	354.00	EO-4	326.00	EG-5	662.00	EG-5	892.00
	4	50	100	FG-4	860.00	FO-4	808.00	FG-5	1548.00	FG-5	2174.00

Prices include thermal overload relays, deduct \$1.50 each if omitted.

EC & M Synchronous Motor Starters

Full and reduced voltage types. The synchronous motor starters provide fully automatic push button operation. Motor is brought up to speed as a squirrel-cage motor and pulled into synchronism by automatic application of direct current to the field.

The polarized field-frequency relay applies full field excitation at the most favorable speed and also provides field removal and re-synchronization automatically.

Class 8820—8821, 25-60 cycles, 600 volts max.

Maximum Horsepower	1.0 PF	0.8 PF	Class 8820 Full Voltage NEMA 1 Enclosure†				Class 8821 Reduced Voltage (Primary Resistor)† NEMA 1 Enclosures‡			
			220 Volt		440-550 Volt		220 Volt		440-550 Volt	
			Type	Each▲	Type	Each▲	Type	Each▲	Type	Each▲
30	25		AG-1	\$2270.00	AG-1	\$2197.00	AG-1	\$2954.00	AG-1	\$2788.00
40	30		AG-2	2270.00	AG-2	2270.00	AG-2	3010.00	AG-2	3010.00
50	40		BG-1	2454.00	AG-3	2270.00	BG-1	3532.00	AG-3	3046.00
60	50		BG-2	2454.00	AG-4	2270.00	BG-2	3532.00	AG-4	3046.00
100	75		CG-1	2856.00	BG-1	2454.00	CG-1	3948.00	BG-1	3564.00
125	100		CG-2	2856.00	BG-2	2454.00	CG-2	4260.00	BG-2	3564.00
150	125		DG-1	3806.00	CG-1	2856.00	DG-1	6048.00	CG-1	4139.00
175	150		DG-2	3806.00	CG-2	2856.00	DG-2	6283.00	CG-2	4139.00
250	200		DG-3	3806.00	CG-3	2856.00	DG-3	6488.00	CG-3	4471.00
	250		EG-1	4959.00	DG-1	3806.00	EG-1	9292.00	DG-1	6247.00
300	...		EG-2	4996.00	DG-2	3851.00	EG-2	9495.00	DG-2	6290.00
350	...		EG-3	5361.00	DG-3	3851.00	EG-3	9854.00	DG-3	6290.00
	300		EG-4	5361.00	DG-4	3851.00	EG-4	10033.00	DG-4	6623.00
500	400		FG-1	5361.00	DG-5	3851.00	FG-1	10137.00	DG-5	6670.00
600	450		5361.00	EG-1	4996.00	EG-1	9744.00

▲Price includes a-c line and d-c field ammeters and separate "start-stop" push button. If specified on order, push button will be mounted on door of enclosure at no additional cost.

†For open starters, deduct \$500.00 on full voltage starters; \$550.00 on reduced voltage starters.

‡NEMA Class 116 EC&M TAB-WELD Resistors supplied for separate mounting.

Ordering Instructions: Specify Class and Type Number, hp., voltage, phase and frequency. Complete motor data on Form 12-21 or equivalent. State undervoltage protection or undervoltage release. Include exciter field rheostat drilling and outline dimensions if drilling only or mounting and wiring of rheostat is required.

Square D Class 9001 Push Button Stations

Standard Duty



Class 9001
Type B-30

Class 9001 standard duty control stations are designed for use with magnetic motor starters to govern the starting, stopping, or reversing of all types of electric motors. Push buttons, either momentary contact or maintained contact, are assembled in various combinations to form unified control stations. Enclosures are furnished for surface or flush mounting.

Order by Class and Type number. Specify voltage and frequency for pilot lights.

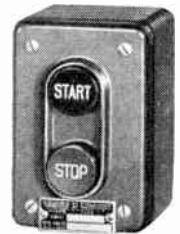

Class 9001
Type BW-40

600 Volts A-C and D-C*

No. of Units	Nameplate Markings	General Purpose Enclosure NEMA I		Flush Mounting Without Pullbox*		Water-Tight, Dust-Tight Enclosure NEMA IV-V		For Hazardous Locations Class I, Group D Class II, Group G NEMA VII-IX	
		Type	Each	Type	Each	Type	Each	Type	Each
1	Start	9001 B-32	\$ 6 00	BB-1	\$ 7 50	BW-46	\$19 00	BR-14	\$23 00
1	Stop	9001 B-33	6 00	BB-2	7 50	BW-47	19 00	BR-15	23 00
1	Stop (Lockout)	9001 B-38	9 00	BB-3	10 50	BW-48	22 00	BR-16	26 00
Momentary	Start-Stop	9001 B-30	6 00	BB-4	7 50	BW-40	19 00	*BR-11	23 00
	Start-Stop (Lockout on Stop)	9001 B-31	9 00	*BF-13	11 00	BW-41	22 00	BR-13	26 00
Contact	Forward-Reverse	9001 B-34	7 50	BB-6	9 00	BW-42	19 00
	Up-Down	9001 B-35	7 50	BB-7	9 00	BW-43	19 00
	Open-Close	9001 B-36	7 50	BB-8	9 00	BW-44	19 00
3	Start-Stop (110V Pilot Light)	9001 B-39	22 00	*BF-14	22 00
3	Start-Stop (220V Pilot Light)	9001 B-39	22 00	*BF-15	22 00
3	Forward-Reverse-Stop	9001 RK-2A	12 00	RK-3A	13 50	RM-1A	58 00
3	Up-Down-Stop	9001 RK-2B	12 00	RK-3B	13 50	RM-1B	58 00
3	Open-Close-Stop	9001 RK-2C	12 00	RK-3C	13 50	RM-1C	58 00
3	High-Low-Stop	9001 RK-2D	12 00	RK-3D	13 50	FM-1	58 00
Main- tained Contact	Start-Stop	9001 C-41	9 00	CB-1	10 50	CW-5	22 00
	On-Off	9001 C-42	9 00	CB-2	10 50	CW-6	22 00
	Manual-Automatic	9001 C-43	9 00	CB-3	10 50	CW-7	22 00

*Types BR, RM, and FM are limited to 250 Volts d-c. Type BR-11 limited to 600 Volts a-c, no d-c rating.
*Pullbox provided only on Types BF-13, BF-14, and BF-15. These three types also have brass flush plates.



Class 9001
Type GA-21



Class 9001
Type GD-21

Class 9001 Heavy Duty

Class 9001 heavy duty stations are available in almost any combination of momentary contact push button units, selector switch units, and indicating lights, assembled in general purpose, water- and dust-tight enclosures, or in enclosures for use in hazardous locations.

Order by Class and Type number. Specify voltage and frequency for pilot lights.



Class 9001
Type HD-18

600 Volts A-C and D-C

No. of Units	Nameplate Markings	General Purpose Enclosure NEMA I		Flush Mounting Without Pullbox		Water-Tight, Dust-Tight Enclosure NEMA IV-V		For Hazardous Locations Class II, Group G NEMA IX		Class I, Group D NEMA VII	
		Type	Each	Type	Each	Type	Each	Type	Each	Type	Each
1	Start	GA-11	\$11 00	GB-11	\$11 00	GD-11	\$23 00	GE-11	\$27 00	GR-11	\$27 00
1	Stop (Lockout)	GA-13	14 00	GB-13	14 00	GD-13	26 00	GE-13	30 00	GR-13	30 00
1	Stop (Mushroom)	GA-17	14 00	GB-17	14 00	GD-17	26 00	GE-17	30 00	GR-17	30 00
1	Start (Mushroom)	GA-18	14 00	GB-18	14 00	GD-18	26 00	GE-18	30 00	GR-18	30 00
1	Auto-Off-Hand (Selector Sw.)	HA-18	14 00	HB-18	14 00	HD-18	26 00	HE-18	30 00	HR-18	30 00
2	Start-Stop	GA-21	17 00	GB-21	17 00	GD-21	26 00	GE-21	30 00	GR-21	30 00
2	Start-Stop (Lockout)	GA-26	20 00	GB-26	20 00	GD-29	29 00	GE-28	33 00	GR-29	33 00
3	Forward-Reverse-Stop	GA-31	22 00	GB-31	22 00	GD-31	44 00	GE-31	58 00	GR-31	58 00
3	Up-Down-Stop	GA-32	22 00	GB-32	22 00	GD-32	44 00	GE-32	58 00	GR-32	58 00
3	Start-Jog-Stop	GA-39	22 00	GB-39	22 00	GD-39	44 00	GE-39	58 00	GR-39	58 00
3	Start-Stop (110-220V a-c Pilot Light)	GA-326	29 00	GB-326	29 00	GD-35	51 00	GE-35	65 00
3	Start-Stop (110-600V a-c Pilot Light)	GA-326	30 50	GB-326	30 50	GD-35	52 50	GE-35	66 50

Note: Contact GRAYBAR for additional types available.

Square D Oil-Tight Push Button Stations

Class 9001

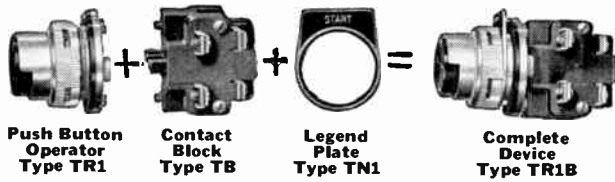

Heavy duty oil-tight push button stations are well suited for machine tool controls or similar industrial applications. They may be purchased in three different ways, to meet a variety of requirements.

1. Individual units—operators, contact blocks and legend plates may be purchased separately and combined as needed. Since any block fits any operator, a wide variety of combinations can be readily assembled from a small stock of standard parts.

2. Complete devices can be ordered, consisting of an operator, a block and a legend plate, packed together in one carton.

3. Assembled control stations are available, with any desired arrangement of units in an oil-tight cast enclosure.



Push Button Units Operator Only

Type No.	Type of Operator	Color of Button	*Each
TR1	Std. half guard	Black	\$ 3.00
TR2	Std. half guard	Red	3.00
TR6	Full guard	Black	3.00
TR7	Full guard	Red	3.00
TR13	Without guard	Black	3.00
TR14	Without guard	Red	3.00
TR3	1 3/8" Mushroom button	Black	6.00
TR4	1 3/8" Mushroom button	Red	6.00
TR10	2 1/4" Mushroom button	Black	6.00
TR11	2 1/4" Mushroom button	Red	6.00

Operator With Type TA Single Pole Double Throw Contact Block

TR1A	Std. half guard	Black	6.00
TR2A	Std. half guard	Red	6.00
TR6A	Full guard	Black	6.00
TR7A	Full guard	Red	6.00
TR13A	Without guard	Black	6.00
TR14A	Without guard	Red	6.00
TR3A	1 3/8" Mushroom button	Black	9.00
TR4A	1 3/8" Mushroom button	Red	9.00
TR10A	2 1/4" Mushroom button	Black	9.00
TR11A	2 1/4" Mushroom button	Red	9.00

Operator With Type TB Duplex Double Throw Contact Block

TR1B	Std. half guard	Black	9.00
TR2B	Std. half guard	Red	9.00
TR6B	Full guard	Black	9.00
TR7B	Full guard	Red	9.00
TR13B	Without guard	Black	9.00
TR14B	Without guard	Red	9.00
TR3B	1 3/8" Mushroom button	Black	12.00
TR4B	1 3/8" Mushroom button	Red	12.00
TR10B	2 1/4" Mushroom button	Black	12.00
TR11B	2 1/4" Mushroom button	Red	12.00

*Includes a Type TN1 plate with standard markings. Deduct \$0.30 if legend plate is not required.

Selector Switch Units

Two Position Switches

Type Of Operator	Type No.	*Each	Operator Only Type No.	*Each
Standard Operator	TS1A	\$ 7.00	TS1	\$ 4.00
Coin Operated	TSA1A	9.00	TSA1	6.00
Key Operated†	TS1K-A	13.00	TS1K	10.00
Standard Operator	TS1B	10.00	TS1	4.00
Coin Operated	TSA1B	12.00	TSA1	6.00
Key Operated†	TS1K-B	16.00	TS1K	10.00

Three Position Switches

Manual Return Operator

Standard Operator	TS3A	7.00	TS3	4.00
Coin Operated	TSA3A	9.00	TSA3	6.00
Key Operated†	TS3K-A	13.00	TS3K	10.00
Standard Operator	TS3B	10.00	TS3	4.00
Coin Operated	TSA3B	12.00	TSA3	6.00
Key Operated†	TS3K-B	16.00	TS3K	10.00

Spring Return To Center Operator

Standard Operator	TS9A	9.00	TS9	6.00
Key Operated	TS9K5A	15.00	TS9K5	12.00
Standard Operator	TS9B	12.00	TS9	6.00
Key Operated	TS9K5B	18.00	TS9K5	12.00

*Prices include TN2 legend plate with standard markings. Deduct \$0.30 list if legend plate not required.

†Key operated selector switch type numbers must be completed by selecting appropriate key withdrawal number from table. Positions marked "yes" are those in which key can be withdrawn, thereby locking switch in that position. Insert the appropriate number to complete the type number.

Key Withdrawal Arrangement

No.	2 Position Switches		3 Position Switches			
	Left	Right	No.	Left	Center	Right
1	Yes	No	4	Yes	No	No
2	No	Yes	5	No	Yes	No
3	Yes	Yes	6	No	No	Yes
			7	Yes	Yes	No
			8	Yes	No	Yes
			9	No	Yes	Yes
			10	Yes	Yes	Yes

Note: For further information concerning Selector-Push Button Operators and Combinations contact GRAYBAR.

Pilot Lights



Pilot light unit with transformer, 6-8 volt bulb and color cap. Specify color cap desired. Available in Red, Green, Blue, Amber, White or Clear.

Volts	Cycles	Standard Type No.	*Each	Push-to-Test Type No.	*Each
110	50-60	TP1	\$11.00	TP-21	\$14.00
208-220	50-60	TP3	11.00	TP-23	14.00
380-440	50-60	TP5	12.50	TP-25	15.50
550	50-60	TP6	12.50	TP-26	15.50

*Prices include type TN2 legend plates with standard markings. Deduct \$0.30 if legend plate is not required.

Contact Blocks Only

Class No.	Type No.	Description	Each
9001	TA	Single pole, double throw	\$3.00
9001	TB	Duplex double throw	6.00
9001	†TE	Duplex double throw	7.50
9001	*TF	Dup. D. T. tandem mounting	6.00

*It is not possible to mount more than one Type TF and one additional contact block on one operator.

†Type TE contact block is for use where safety interlocking requires that one pole always close before the other.

Square D Class 9001 Attachments

Type	Description	Each
TL-1	Padlock attachment, latch type (holds button depressed).....	\$3.00
TL-2	Padlock attachment, cover type (prevents depressing button).....	3.00
TL-3	Padlock attachment, window in cover (prevents operation of selector switch or push-button).....	3.00
TM-1	Maintained Contact Attachment (Use with 2 type TR operators, 1 contact block)....	3.00
TU-1	Black, Neoprene Cap for push button.....	2.00
TU-2	Red, Neoprene Cap for push button.....	2.00
TU-3	Blue, Neoprene Cap for push button.....	2.00
TU-4	Brown, Neoprene Cap for push button.....	2.00
TU-5	Green, Neoprene Cap for push button.....	2.00
TU-6	Yellow, Neoprene Cap for push button.....	2.00
144-X5	Washer for use when Legend plates are not used.....	.30
.....	Wrench for mounting Type T units.....	3.00
TW-1	Wobble Stick complete with operator.....	5.00
TO-1	Closing plate, for covering unused holes in enclosure cover.....	1.00

Table 1—Standard Markings for Legend Plates

For Push Buttons or Pilot Lights Types TN1, TN3		For Selector Switches Types TN2, TN3	
		2 Position	3 Position
Start	Down	Off-On	Auto-Off-Hand
Stop	On	Safe-Run	Hand-Off-Auto
Jog	Off	Jog-Run	For-Off-Rev.
Reset	Raise	High-Low	Open-Off-Close
Forward	Lower	Open-Close	Up-Off-Down
Reverse	In	Up-Down	Jog-Safe-Run
Fast	Out	For.-Rev	
Slow	Jog-For.	Man.-Auto	
High	Jog-Rev.	Start-Stop	
Low	Inch	Run-Jog	
Open	Run		
Close	Emerg. Stop		
Up	Start-Jog		

Table 2—Additions for Devices Requiring Special Legend Plate Markings

Quality of Devices With Identical Marking	Addition to List Price of Each Device	
	TN1, TN2	TN3
1-3	\$1.10	\$1.30
4-9	.90	1.10
10-24	.80	1.00
25-49	.70	.90
50-99	.60	.80
100 or More	.40	.60

Table 3—Separate Legend Plates

Type	Each	Quality of Legend Plates With Special Identical Markings	TN1, TN2	TN3
			Each	Each
TN1	\$0.30	1-3	\$1.40	\$1.60
TN2	.30	4-9	1.20	1.40
TN3	.30	10-24	1.10	1.30
		25-49	1.00	1.20
		50-99	.90	1.10
		100 or More	.70	.90

Ordering Instructions:

- Order as Class 9001, Type....., and give the following additional information.
- For pilot lights, specify color cap, voltage and frequency.
- For push button units, selector switch units and pilot lights with legend plates, specify legend plate marking.
 - If standard legend plate marking is desired, use unit price as shown. (See table No. 1 for list of standard markings).
 - If special legend plate marking is desired, add price of specially marked legend plate to price of unit. (See table No. 2 above for price additions).
 - If a unit with TN3 large size legend plate is required, order control unit by Class and Type number. Specify "with TN3 Legend plate". See table No. 1 for standard markings. Use table No. 2 for additions.

Square D Oil-Tight Push Button Stations Class 9001



Heavy duty oil-tight control stations available for surface or flush mounting. One, two, three, four, six, nine, twelve and sixteen control units can be accommodated in any desired location.

Completely assembled stations can be supplied, or enclosures only and various control units can be purchased for assembly as control stations.

Standard Assembled Control Stations

Type No.	No. of Units	Name Plate Marking	Feature	Each
Surface Mounting Type				
TY-11	1	Start	\$19.00
TY-12	1	Start	Mushroom Button	22.00
TY-13	1	Stop	19.00
TY-14	1	Stop	Mushroom Button	22.00
TY-111	1	Auto-Off-Hand	Selector Switch	20.00
TY-21	2	Start-Stop	26.00
TY-22	2	Start-Stop	Mushroom on Stop	29.00
TY-23	2	Start-Stop	Lockout on Stop	29.00
TY-31	3	For.-Reverse-Stop	36.00
TY-32	3	Up-Down-Stop	36.00
TY-33	3	Open-Close-Stop	36.00
Cover Plate Type				
TZ-11	1	Start	15.00
TZ-12	1	Start	Mushroom Button	18.00
TZ-13	1	Stop	15.00
TZ-14	1	Stop	Mushroom Button	18.00
TZ-111	1	Auto-Off-Hand	Selector Switch	16.00
TZ-21	2	Start-Stop	21.00
TZ-22	2	Start-Stop	Mushroom on Stop	24.00
TZ-23	2	Start-Stop	Lockout on Stop	24.00
TZ-31	3	For.-Reverse-Stop	31.00
TZ-32	3	Up-Down-Stop	31.00
TZ-33	3	Open-Close-Stop	31.00

Note: Joy Stick Type — 4 position operator with one lever to operate four type TA or TB contact blocks are available.

Enclosures Only and Base Prices for Non-Standard Stations

No. of Units	Enclosure Only	For Customer Assembly		Surface Mtg. Base▲	Cover Plate Base▲			
		Type	Cover Plate Only					
1	TY-1	\$10.00	TZ-1	\$6.00	TY-10	\$13.00	TZ-10	\$9.00
2	TY-2	11.00	TZ-2	6.00	TY-20	14.00	TZ-20	9.00
3	TY-3	13.00	TZ-3	7.00	TY-30	18.00	TZ-30	13.00
4	TY-4	20.00	TZ-4	14.00	TY-40	25.00	TZ-40	20.00
6	TY-5	25.00	TZ-5	19.00	TY-50	36.00	TZ-50	30.00
9	TY-6	36.00	TZ-6	29.00	TY-60	53.00	TZ-60	45.00
12	TY-7	50.00	TZ-7	42.00	TY-70	72.00	TZ-70	64.00
16	TY-8	66.00	TZ-8	58.00	TY-80	96.00	TZ-80	88.00

Closing plate assembly for covering unused hole in cover Type TO-1.....Each \$1.00

▲Base prices include enclosure only, any closing plate assemblies necessary and charge for assembly of units, include box and cover plate.

Note: Sheet Steel NEMA 12 heavy duty oil-tight enclosures for mounting Type T control units available.

Ordering Instructions:

- Order enclosure only, flush plate only or closing plate assembly by Class and Type number. Order separate oil-tight control units, legend plates or attachments.
- Order standard assembled stations by Class and Type number. Select control units desired. Furnish sketch or list control units by Class and Type number, reading from top to bottom of station in successive vertical columns from left to right.
- Price assembled stations at base price from table above plus total of prices for all control units specified. Use price of control unit with legend plate. For markings other than standard add \$1.10 list per legend plate.
- Specify conduit drilling if other than standard.

Square D Class 9007 Limit Switches



Type AF-2

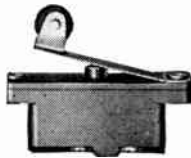

Type AB-2

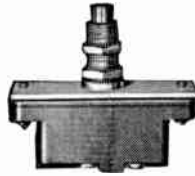

Type AP-221

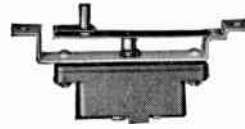

Type AC-1



Type AW12-B1

Type A Limit Switch: Designed for modern machine tools, to govern starting, stopping, or reversing of electric motors and for use as a "built-in" contact mechanism on other types of applications. Highly accurate, precision snap action; capable of withstanding severe service without losing its accuracy or reliability of performance.

Type M Limit Switch: Designed primarily for machine tool applications. Provides accurate tripping, quick make and break contact mechanisms and latch type mechanisms. Can be furnished with several kinds of roller arms, all adjustable through 360°. Only 8° travel is necessary for operation and 8° overtravel is provided.

Type A Small Precision Limit Switches
Quick Make and Break
600 Volts Maximum—A-C and D-C
Oil-Tight Enclosure—Spring Return

Roller Arm Operated

Surface Mounting		Roller	Lgth. of Arm In.	Flush Mounting	
Type	Each			Type	Each
AW12-A1	\$17.00	Plain 5/8" Dia. 1/4" Wide	7/8	AF12-A1	\$16.00
AW12-B1	16.00		1 3/8	AF12-B1	15.00
AW12-C1	17.00		2	AF12-C1	16.00
AW12-D1	17.00		2 1/2	AF12-D1	16.00
AW12-E1	17.00	Plain 5/8" Dia. 5/8" Wide	3	AF12-E1	16.00
AW12-A2	17.00		7/8	AF12-A2	16.00
AW12-B2	17.00		1 3/8	AF12-B2	16.00
AW12-C2	17.00		2	AF12-C2	16.00
AW12-D2	17.00	2 1/2	AF12-D2	16.00	
AW12-E2	17.00	3	AF12-E2	16.00	
AW12-B3	19.00	One Way 1 1/4" Dia. 1/4" Wide	1 3/8 Only	AF12-B3	18.00

Push Rod Operated (One Side)

AW-22	16.00	None	...	AF-22	\$15.00
-------	-------	------	-----	-------	---------

Operating Arms Only

Class	For Switch Type	Type No. of Arm Only	Roller	Length of Arm In.	Arm Only	
9007	AW12-A1	AA-1	Plain	7/8	\$2.50	
9007	AW12-B1	BA-1		1 3/8	1.50	
9007	AW12-C1	CA-1		5/8 in. Diam.	2	2.50
9007	AW12-D1	DA-1		1/4 in. Wide	2 1/2	2.50
9007	AW12-E1	EA-1	Plain	3	2.50	
9007	AW12-A2	AA-2		7/8	2.50	
9007	AW12-B2	BA-2		1 3/8	2.50	
9007	AW12-C2	CA-2		5/8 in. Diam.	2	2.50
9007	AW12-D2	DA-2	5/8 in. Wide	2 1/2	2.50	
9007	AW12-E2	EA-2	3	2.50		
9007	AW12-B3	BA-3	One Way 1 1/4 in. Diam. 1/4 in. Wide	1 3/8	2.50	

Basic Contact Mechanisms

Class	.020" Contact Gap Type	Each	.040" Contact Gap Type	Each	Contact Arrangement
9007	AO-1	\$3.30	AO-2	\$3.30	1 N. O. 1 N. C.
9007	AO-1A	3.10	AO-2A	3.10	1 N. C.
9007	AO-1B	3.10	AO-2B	3.10	1 N. O.

Type M Machine Tool Limit Switches
Dust-Tight and Oil-Tight Enclosure NEMA Type 5
With Solid Backplate, Conduit Opening In End
0-600 Volts—Quick Make and Quick Break
Single Pole—Double Throw

Class No.	Type	Description	Each
9007	M11	Without operating arm.....	\$18.00
9007	M11A	Single roller, plain hub.....	22.00
9007	M11B	Single roller, overtravel hub.....	24.00
9007	M11C	One way roller, plain hub.....	25.00
9007	M11D	One way roller, overtravel hub....	27.00
9007	M11F	Double roller, overtravel hub.....	29.00
9007	M11G	Double roller, overtravel hub, one way roller on one side.....	32.00
9007	M11H	Double roller, overtravel hub, one way rollers both sides.....	34.00

Three Point, Double Throw

9007	M12	Without operating arm.....	20.00
9007	M12A	Single roller, plain hub.....	24.00
9007	M12B	Single roller, overtravel hub.....	26.00
9007	M12C	One way roller, plain hub.....	27.00
9007	M12D	One way roller, overtravel hub....	29.00
9007	M12F	Double roller, overtravel hub.....	31.00
9007	M12G	Double roller, overtravel hub, one way roller on one side.....	34.00
9007	M12H	Double roller, overtravel hub, one way rollers both sides.....	36.00

With Hole In Backplate, Plug In Conduit Opening—Gasket for Back

Class	Type	Description	Each
9007	M21	Without operating arm.....	\$19.00
9007	M21A	Single roller, plain hub.....	23.00
9007	M21B	Single roller, overtravel hub.....	25.00
9007	M21C	One way roller, plain hub.....	26.00
9007	M21D	One way roller, overtravel hub....	28.00
9007	M21F	Double roller, overtravel hub.....	30.00
9007	M21G	Double roller, overtravel hub, one way roller on one side.....	33.00
9007	M21H	Double roller, overtravel hub, one way rollers both sides.....	35.00

Three Point, Double Throw

9007	M22	Without operating arm.....	21.00
9007	M22A	Single roller, plain hub.....	25.00
9007	M22B	Single roller, overtravel hub.....	27.00
9007	M22C	One way roller, plain hub.....	28.00
9007	M22D	One way roller, overtravel hub....	30.00
9007	M22F	Double roller, overtravel hub.....	32.00
9007	M22G	Double roller, overtravel hub, one way roller on one side.....	35.00
9007	M22H	Double roller overtravel hub, one way rollers both sides.....	37.00

Basic Contact Mechanisms—Special Operators
Contact Arrangement—1 N. O., 1 N. C.

Class	Type	Type of Operator	Each
9007	AP-221	Plunger type, panel mounting....	\$ 7.70
9007	AB-2	Roller leaf type.....	5.00
9007	AC-1	Cabinet door type.....	5.50

Note: For further information concerning Operating Lever Arms, contact GRAYBAR.

Square D Class 9050 Pneumatic Timing Relays

Adjustable Range—2 Seconds to 3 Minutes
Single Pole, Double Throw, Separate Circuit



Type CO-1E

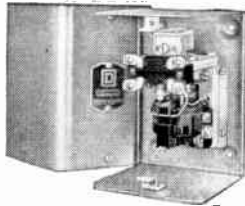

Type AG-1E

Timing relays are used in many industrial applications where dependable operation and ease of adjustment over suitable ranges of timing are required.

Timers of the pneumatic type may be obtained for delay in making or breaking a circuit either after energization or de-energization of the relay. All a-c timing relays, except flush mounting types have an invertible magnet which allows conversion from one type of operation to other in the field.

Type A 50-60 Cycle Operation 600 Volts Max.

Type of Operation	Type	General Purpose Enclosure NEMA Type 1		Open Type		Volts	A-C Pilot Duty—Amperes	
		Type	Each	Type	Each		Make	Break
Time Delay after De-energization of Relay (Off Delay)	AG-1D		\$41.00	AO-1D	\$38.00	110	30	3
Time Delay after Energization of Relay (On Delay)	AG-1E		41.00	AO-1E	38.00	220	15	1.5
						440	7.5	.75
						550	6	.6

Type B 25-60 Cycle Operation 600 Volts Max.

Type of Operation	Dial	No. of Interlocks	General Purpose Enclosure NEMA Type 1		Surface Mounting Water and Dust-Tight Enclosure NEMA Types 4 and 5		For Hazardous Locations NEMA Types 7 and 9		Flush Mounting Without Pull Box			
			Type	Each	Type	Each	Type	Each	Type	Each		
Time Delay after De-energization of Relay	W/O	0	BG-1D	\$60.00	BW-1D	\$90.00	BR-1D	\$160.00	BO-1D	\$50.00	BF-1D	\$58.00
	W/O	1	BG-2D	65.00	BW-2D	95.00	BR-2D	165.00	BO-2D	55.00	BF-2D	63.00
	W/O	2	BG-3D	70.00	BW-3D	100.00	BR-3D	170.00	BO-3D	60.00	BF-3D	68.00
	W/D	0	BG-4D	65.00	BW-4D	95.00	BR-4D	165.00	BO-4D	55.00	BF-4D	63.00
	W/D	1	BG-5D	70.00	BW-5D	100.00	BR-5D	170.00	BO-5D	60.00	BF-5D	68.00
	W/D	2	BG-6D	75.00	BW-6D	105.00	BR-6D	175.00	BO-6D	65.00	BF-6D	73.00
Time Delay after Energization of Relay	W/O	0	BG-1E	60.00	BW-1E	90.00	BR-1E	160.00	BO-1E	50.00	BF-1E	58.00
	W/O	1	BG-2E	65.00	BW-2E	95.00	BR-2E	165.00	BO-2E	55.00	BF-2E	63.00
	W/O	2	BG-3E	70.00	BW-3E	100.00	BR-3E	170.00	BO-3E	60.00	BF-3E	68.00
	W/D	0	BG-4E	65.00	BW-4E	95.00	BR-4E	165.00	BO-4E	55.00	BF-4E	63.00
	W/D	1	BG-5E	70.00	BW-5E	100.00	BR-5E	170.00	BO-5E	60.00	BF-5E	68.00
	W/D	2	BG-6E	75.00	BW-6E	105.00	BR-6E	175.00	BO-6E	65.00	BF-6E	73.00

Type A and Type B timing contacts consist of an isolated normally open and normally closed circuit. Due to electrical clearance, the normally open and normally closed circuits must be used on circuits of the same polarity.

Type C For D-C Operation 250 Volts Max.

Type of Operation	Dial	Inter-lock	General Purpose Enclosure NEMA Type 1		Water and Dust-Tight Enclosure NEMA Types 4 and 5		Surface Mounting Hazardous Locations NEMA Types 7 and 9		Open Type	
			Type	Each	Type	Each	Type	Each	Type	Each
Time Delay after De-energization of relay	W/O	W/O	CG-1D	\$65.00	CW-1D	\$95.00	CR-1D	\$165.00	CO-1D	\$55.00
	W/O	With	CG-2D	70.00	CW-2D	100.00	CR-2D	170.00	CO-2D	60.00
	With	W/O	CG-3D	70.00	CW-3D	100.00	CR-3D	170.00	CO-3D	60.00
	With	With	CG-4D	75.00	CW-4D	105.00	CR-4D	175.00	CO-4D	65.00
Time Delay after Energization of relay	W/O	W/O	CG-1E	65.00	CW-1E	95.00	CR-1E	165.00	CO-1E	55.00
	W/O	With	CG-2E	70.00	CW-2E	100.00	CR-2E	170.00	CO-2E	60.00
	With	W/O	CG-3E	70.00	CW-3E	100.00	CR-3E	170.00	CO-3E	60.00
	With	With	CG-4E	75.00	CW-4E	105.00	CR-4E	175.00	CO-4E	65.00

Hardened Magnet Parts—Form HA \$6.00 list additional. (Available on a-c timers only, furnished as standard on flush mounting type timers.)

Electrical Interlock Kit (containing parts required to add one interlock unit to a timer—a total of 2 interlock units may be mounted on a Class 9050 Timer). Class 9999, Type R-1 \$5.00 list each.

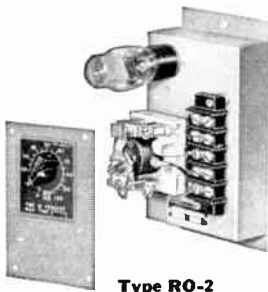

Type RO-2

Square D Electronic Timing Relays

Time Delay After Energization—Adjustable Range 0 to 30 Seconds

115 Volts A-C—50/60 Cycles

Class	Panel Mounting Timer	Open Type		General Purpose Enclosure	
		Type	Each	Type	Each
9050	With adjustable dial on base	EO-1	\$76.00	EG-1	\$78.00
9050	With separate adjuster dial for remote mounting	EO-2	78.00	EG-2	80.00

Ordering instructions: Order by Class and Type number. Specify voltage and if a-c the frequency.

**Square D User Modification Kits
Class 9999**



For motor control and pump control. The Class 9999 push button and selector switch kits are provided to enable one of these units to be added to the cover of a magnetic starter. Easily and quickly installed. These kits may be used on any Series A under Class 8502, 8536, 8538 or 8539 starter in NEMA 1 enclosure only.

**For A-C Series A Contactors and Starters
In NEMA 1 Enclosures***

Class	Type	NEMA Size	Description	Each
9999	A-1	0 or 1	Start-Stop momentary contact push button	\$8.00
9999	C-1	0 or 1	Hand-Off-Auto selector switch	8.00
9999	A-2	2 or 3	Start-Stop momentary contact push button	8.00
9999	C-2	2 or 3	Hand-Off-Auto selector switch	8.00
9999	A-3	4	Start-Stop momentary contact push button	8.00
9999	C-3	4	Hand-Off-Auto selector switch	8.00

*Usable with Classes 8502, 8536, 8538 and 8539 with series letter designation only.

**Square D Class 9998 Parts Kits
For Starters, Contactors and Relays**

Class	Parts Kit Type	Description	Equipment To Be Serviced	Type	Size	Each
9998	PD-1	Manual Compensators	A, Q	*	00	\$17.00
9998	RA-21	Manual Starters	W	0	0	3.00
9998	SA-21	Manual Starters P. Button	W	1	0	6.00
9998	RA-22	Man. Starter Toggle Type	R	0	0	5.00
9998	SA-22	Man. Starter Toggle Type	S	1	0	6.00
9998	†QA-81	Mag. Starters, Cont. Relays	A, Q	00	00	5.00
9998	†RA-81	Mag. Starters, Cont. Relays	B, R	0	0	5.00
9998	†BA-81	Mag. Starters, Cont. Relays	B	0	0	5.00
9998	†RA-83	Mag. Starters, Cont. Relays	BR	5.00
9998	†SA-81	Mag. Starters, Cont. Relays	C, S	1	0	6.00

*One kit required for 14 contact compensators, two kits for 28 compensators.

†Contains sufficient parts to service a 3 pole device.

Note: Other types available, contact GRAYBAR.

For Pressure, Float and Vacuum Switches

Class	Parts Kit Type	Class	Description	Equipment To Be Serviced	Type	Each
9998	PC-1	*9013	ASG, ALG, AMG, BSG, AHG, ALR, AMR, AHR, ASR, A, AH, AK, AL, AM, AR, V, VR			\$3.15
9998	PC-1	9016	ASG, ASR			3.15
9998	PC-1	9017	ASG, AHG			3.15
9998	PC-1	*9036	AG-5, BKG, A, AK			3.15
9998	PC-2	9013	GSG, GHG			3.00
9998	PC-2	9036	GG			3.00
9998	PC-2	9037	GG			3.00
9998	PC-3	9013	FSG			2.75
9998	PC-3	9036	FG-1			2.75
9998	PC-3	9037	HG-1 and 2			2.75
9998	PC-3	9044	ESG, A			2.75
9998	PC-3	9048	A, AR, AW			2.75
9998	PC-4	9213	DSG, DHG, A, AH, AH-3, G, GH, GH3			3.00
9998	PC-4	9017	BSG, BHG			3.00
9998	PC-4	9237	CG, FA-3			3.00
9998	PC-4	9238	EG, A3			3.00
9998	PC-5	9016	GVG			5.20
9998	PC-6	9013	JSG			2.50

*Used on all switches except code letters A through G.

**Square D Class 9999 Electrical Interlocks
For A-C Magnetic Controls**



Interlock kits provide all the necessary parts needed to install an electrical interlock on Size 0 and 1 Series A devices and any Size 2, 3, or 4 vertical action magnetic contactor or starter or on a Class 9050 Types B & R timer with invertible magnet.

**For Addition To A-C Magnetic Contactors
Starters and A-C Pneumatic Timers**

Class	Type	Contact Arrangement	N.O.	N.C.	Location	Each
0 Or 1 (For Series A Devices Only)—Side Mounted						
9999	BC-1	1	...		L. H. or R. H.	\$6.00
9999	BC-2	...	1		L. H. or R. H.	6.00
9999	BC-3	1	1		L. H. or R. H.	8.00

NEMA Size 2—Base Mounted Long Terminal

9999	DT-1	1	...		R. H.	6.00
9999	DT-2	1	...		L. H.	6.00
9999	DT-3	...	1		R. H.	6.00
9999	DT-4	1	...		Center	6.00
9999	DT-9	...	1		L. H.	6.00
9999	DT-12	1	1		R. H. or L. H.	8.00

NEMA Size 2—KB Unit Side Mounted*

9999	DT-5	1	...		R. H.	6.00
9999	DT-6	1	...		L. H.	6.00
9999	DT-7	...	1		R. H.	6.00
9999	DT-8	...	1		L. H.	6.00
9999	DT-10	1	1		R. H.	8.00
9999	DT-11	1	1		L. H.	8.00

NEMA Size 3—Base Mounted Long Terminal

9999	EU-1	1	...		R. H.	6.00
9999	EU-2	1	...		L. H.	6.00
9999	EU-3	...	1		R. H.	6.00
9999	EU-4	1	...		Center	6.00
9999	EU-9	...	1		L. H.	6.00
9999	EU-12	1	1		R. H. or L. H.	8.00

NEMA Size 3—KB Unit Side Mounted*

9999	EU-5	1	...		R. H.	6.00
9999	EU-6	1	...		L. H.	6.00
9999	EU-7	...	1		R. H.	6.00
9999	EU-8	...	1		L. H.	6.00
9999	EU-10	1	1		R. H.	8.00
9999	EU-11	1	1		L. H.	8.00

NEMA Size 4—Base Mounted

9999	F-1	1	...		R. H.	6.00
9999	F-2	1	...		L. H.	6.00
9999	F-3	1	...		Center	6.00
9999	F-4	...	1		R. H.	6.00
9999	F-5	...	1		L. H.	6.00
9999	F-6	...	1		Center	6.00
9999	F-7	1	1		Any	8.00

**Class 9050 Types B&R Timer With Invertible Magnet
KB Unit—Front Mounted**

9999	R-1	1	1		Center	5.00
------	-----	---	---	--	--------	------

*For 2 pole or 3 pole starters only.

Square D Class 9999 A-C Magnet Coils



These magnet coils are easily installed on any standard a-c magnetic contactor or starter.

Size 00-3 coils in the 110 and 440 volt, 60 cycle ratings are attractively packaged and marked for easy identification and convenience in stocking.

A large selection of coils are available. Contact GRAYBAR for additional information.

**Square D Class 9013 Pressure Switches
Water Pump and Air Compressor Types**

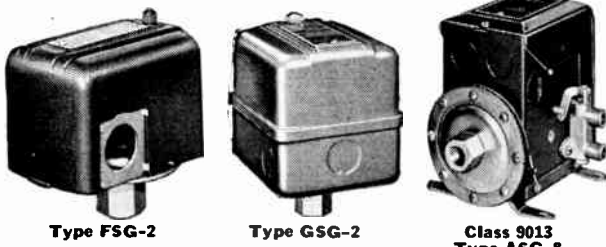

Used for the control of electrically driven water pumps and air compressors. Class 9013 devices cover the important electrical ratings for the direct control of motors in the usual pump and compressor applications. Switches are of two pole construction to open both lines.

Standard enclosure finished in machine gray enamel. The special enclosures of Types ASW and ASR are of sheet steel and cast iron respectively to provide dripproof and explosion resisting features where required. Interior parts treated to prevent corrosion.

For air compressor applications a pressure release valve is desired; feature ordered as "Form X" or "Form Y."

**Two Poles—Diaphragm Actuated
Contacts Open on Increased Pressure
General Purpose Enclosure**

Class	Type	Pressure Range (P. S. I.)	Differential (P. S. I.)	Pipe Tap In.	Each
Heavy Duty Application					
9013	ASG-8	20-180	10-40	1/4	\$22.10
9013	ASG-11	25-250	18-45	1/4	22.10
9013	*ASG-14	20-180	10-40	1/4	29.20
9013	*ASG-17	25-250	18-45	1/4	29.20
Standard Duty Application					
9013	GSG-2	20-80	12-35	1/4	15.00
9013	GHG-2	40-200	18-40	1/4	15.00
Domestic Duty Application					
9013	FYG-2	20-80	10-30	1/4	9.05
9013	FSG-2	20-65	10-30	1/4	6.10
9013	JSG-2	20-60	15-25	1/4	6.10
Dripproof Enclosure Heavy Duty Application					
9013	ASW-8	20-180	10-40	1/4	59.40
9013	ASW-11	25-250	18-45	1/4	59.40
9013	*ASW-14	20-180	10-40	1/4	66.50
9013	*ASW-17	25-250	18-45	1/4	66.50
Standard Duty Application					
9013	GSW-2	20-80	12-35	1/4	83.80
9013	GHW-2	40-200	18-40	1/4	83.80
Explosion Resisting Enclosure Heavy Duty Application					
9013	ASR-8	20-180	10-40	1/4	118.00
9013	ASR-11	25-250	18-45	1/4	118.00
9013	*ASR-14	20-180	10-40	1/4	122.00
9013	*ASR-17	25-250	18-45	1/4	122.00
Standard Duty Application					
9013	GSR-2	20-80	12-35	1/4	80.75
9013	GHR-2	40-200	18-40	1/4	80.75

*Three pole.

1/8 or 3/8 in. taps also available.

†Differential increases with range.

Electrical Ratings—Horsepower

Type	Single Phase				Polyphase		D-C	
	115 Volt	230 Volt	220 Volt	440 Volt	550 Volt	115 Volt	230 Volt	
A	2	3	5	5	5	1	1	
FS, J	1	1	1	1/4	1/4	
FY	1 1/2	2	3	3	3	1/2	1/2	
GS, GH	2	3	5	5	5	1	1	

Prices for Additions and Special Features

Form Letter	Feature	With Type ASG	With Type ASW	With Type ASR
Form R	Reverse Action	\$4.90	\$4.90	\$4.90
Form X	2-Way Release Valve	5.70	12.30	15.70
Form Y	3-Way Release Valve	8.80	16.10	19.50

Square D Industrial Pressure Switches

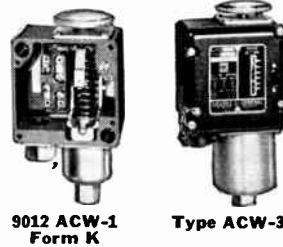

Industrial pressure switches are designed for the control of pneumatic or hydraulic machines—welders, machine tools, lubricating systems, etc. Devices are SPDT and are usually used as piloting controls for magnetic starters. Rating: a-c single phase 15 amperes, 115V; 10 amperes 230V; d-c 1/2 ampere, 115V; 1/4 ampere 230V.

Cast Aluminum Dripright and Oil Resistant Enclosure Bellows Actuated

Class	Type	Range* Setting (P. S. I.)	Differential† Setting (P. S. I.)	Max. Allowable (P. S. I.)	Stock Setting (P. S. I.)	Each
9012	ACW-3	1-10	1/2-5	30	5 5 1/2	\$30.80
9012	ACW-4	1-20	1-6	30	10 11	30.80
9012	ACW-5	1-75	3-15	100	40 43	28.60
9012	ACW-1	1-115	6-30	255	44 50	26.40
9012	ACW-8	20-180	10-30	255	90 100	26.40
9012	ACW-9	10-275	15-25	300	135 150	37.40
9012	ACW-2	10-300	25-125	600	155 180	35.20

Piston Actuated—Hydraulic Only

9012	ADW-3	135-1000	35-135	10000	535 570	\$52.80
9012	ADW-4	400-3000	100-400	10000	1600 1700	52.80
9012	ADW-5	135-1000	70-150	10000	475 570	53.80
9012	ADW-6	400-3000	210-475	10000	1390 1700	53.80

Cast Iron Class I group D Explosion Resisting Enclosure Bellows Actuated

9012	ACR-3	1-10	1/2-5	30	5 5 1/2	\$70.90
9012	ACR-4	1-20	1-6	30	10 11	70.90
9012	ACR-5	1-75	3-15	100	40 43	68.70
9012	ACR-1	1-115	6-30	255	44 50	66.50
9012	ACR-8	20-180	10-30	255	90 100	66.50
9012	ACR-9	10-275	15-25	300	77.50
9012	ACR-2	10-300	25-125	600	155 180	75.30

Piston Actuated

9012	ADR-3	135-1000	35-135	10000	535 570	\$92.90
9012	ADR-4	400-3000	100-400	10000	1600 1700	92.90
9012	ADR-5	135-1000	70-150	10000	475 570	93.90
9012	ADR-6	400-3000	210-475	10000	1390 1700	93.90

Footnote symbols apply to bellows actuated (ACW) switches only.

*Limits of pressure between which switch can be adjusted to operate on falling pressure.

†Add to range setting to obtain operating point on rising pressure.

Note: The following applies to piston units ADW only: Range setting is limit of adjustment on rising pressure. Subtract differential to obtain operating point on falling pressure.

Type ADW Surge Reducer (Specify 9049A25) \$8.00 Add'l.

Type ACW Surge Reducer (Specify 9049A26) \$8.00 Add'l.

Square D Vacuum Pump Controls

Class 9016



Designed for the control of electrically driven vacuum pumps. Controls cover the important electrical ratings for direct control of motors.

Contacts close on loss of vacuum. Pipe tap 1/4 inch. Two pole. Range (inches of Hg.) 5-25. Differential (inches of Hg.) 4-12.

Heavy Duty Type

Class	Type	General Purpose Each	Watertight Each	Explosion Resisting		
				Type	Each	
9016	ASG-3	\$41.00	ASW-3	\$78.50	ASR-3	\$156.00
9016	*ASG-4	48.10	*ASW-4	85.60	*ASR-4	162.00

Standard Duty Type

9016	GVG-1	28.40
------	-------	-------	-------	-------	-------

*Three Pole.

Ordering Instructions: Specify Class 9016, Type ... and give vacuum settings.

Square D Float Switches

Open Tank or Sump Application Class 9036

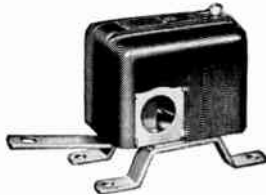

Type FG-1

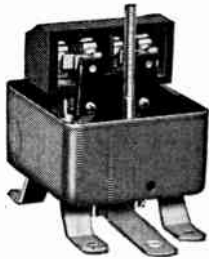

Type GG-2

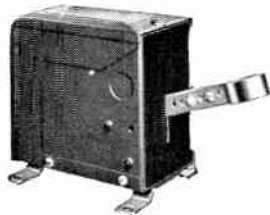

Class 9036
Type AG-2

Float switches for open tank control with sump or standard operation. Enclosures are finished in machine gray enamel. Interior parts treated to prevent corrosion. Two pole.

*Contacts Open on Liquid Rise Heavy Duty Type

Class	General Purpose		Drip-Proof		Explosion Resisting	
	Type	Each	Type	Each	Type	Each
9036	AG5	\$22.10	AW5	\$59.40	AR5	\$111.00
†9036	AG6	29.20	AW6	66.50	AR6	118.10

*Contacts Close on Liquid Rise Standard Duty

9036	GG-2	15.00
------	------	-------	-------	-------	-------	-------

General Duty

9036	FG-1	9.75	
9036	DG-2	15.00	DW1	48.00	DR1	50.00

*For reverse action, add "Form R" to Class and Type number. Type A and Type G switches can be reversed in the field.

†Three Pole.

Class 9037 Condensate Pumps

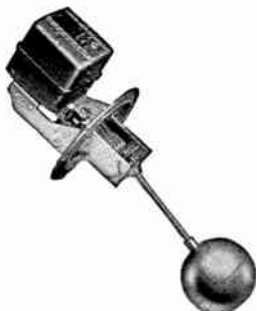

Class 9037, Type GG-4

Class 9037 Type GG controls are primarily used on condensate pumps.

Float movement is through a bellows seal. Switches are flange mounted.

8-in. rod length is measured from fulcrum of rod to center of round float. Lengths of 6, 10, 12, 14 and 16 inches also available. Two pole. Contacts close on liquid rise. For standard duty application.

General Purpose Enclosures

Class	Type	Float Movement	Each
9037	GG-4	Above and below center line	\$52.30
9037	GG-5	Below center line	52.30
9037	GG-6	For vertically mounted switch	52.30

Class 9036 Sumptrols

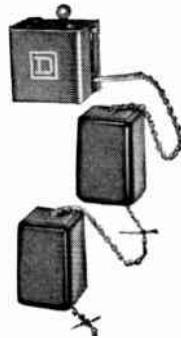

Designed specifically for sump pumps or cellar drainers of the small domestic type.

A wide selection of switches with various enclosure modifications are available.

Controls can easily be adapted to practically all sump pump applications. Contacts close on liquid rise.

Class 9036, Type KG-1

General Purpose Enclosures With Mounting Bracket and Two Cord Entrances

Class	Type	One Pole		Type of Operation	Two Poles	
		Each	Weight		Type	Each
9036	KG-7	\$5.75	Float	KG-1	\$7.00
9036	KG-8	4.40		KG-2	5.65

With Conduit Bushing

9036	KG-9	5.75	Weight	KG-3	7.00
9036	KG-10	4.40	Float	KG-4	5.65

With Conduit Bushing and One Extra Cord Entrance

9036	KG-11	5.75	Weight	KG-5	7.00
9036	KG-12	4.40	Float	KG-6	5.65

Accessories for Float Switches

Standard accessories consist of one 7-in. float (tapped at top or with center hole) and 5 feet of threaded tubing and stops. Accessories available in brass, aluminum, monel or stainless steel.

Float Tapped At Top

Class	Type	Float Description	Each
9049	A6	Copper coated with brass tubing	\$ 19.60
9049	A6A	Copper coated with aluminum tubing.....	19.60
9049	A6S	Stainless steel float and tubing....	95.70
9049	A6M	Monel float and Monel tubing....	83.90

Float With Center Hole

9049	A6C	Copper coated with brass tubing	27.40
9049	A6AC	Copper coated with aluminum tubing.....	27.40
9049	A6CS	Stainless steel float and tubing....	161.90
9049	A6CM	Monel float and Monel tubing....	148.90

Electrical Ratings—Horsepower Single Phase

Class	Types	115	230
		Volts	Volts
9036	AG-5, AW-5, AR-5	2	3
9036	GG-2	2	3
9036	FG-1	1	1
9036	DG-2, DW-1, DR-1	1	1
9036	GG-4, GG-5, GG-6	2	3
9036	KG	1/2	..
Direct Current			
9036	AG-5, AW-5, AR-5	1	1
9036	GG-2	1	1
9036	FG-1	1/4	1/4
9036	DG-2, DW-1, DR-1	1/4	1/4
9036	GG-4, GG-5, GG-6	1	1
9036	KG	1/4	..

Polyphase

Class	Types	220 V.	440 V.	550 V.
9036	AG-5, AW-5, AR-5	5	5	5
9036	GG-2	5	5	5
9036	FG-1	1
9036	DG-2, DW-1, DR-1	1	1	1
9036	GG-4, GG-5, GG-6	5	5	5
9036	KG

Note: Order float switches by Class and Type number.

Marathon Medium Duty Terminal Blocks

200 Series Controlead® Medium Duty Terminal Blocks

Class A—Group 1

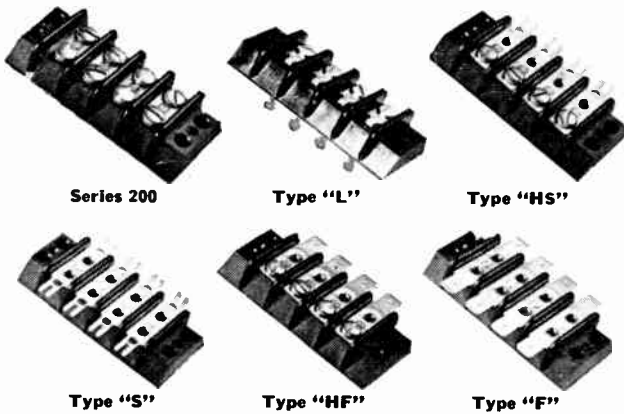

Improved disposition of material in this block results in barriers that are stronger, better supported on a base that resists breakage. Insulating plugs are molded as an integral part of the block, yet are designed for clean knock-out to readily provide end holes or additional thru-holes.

Unobstructed circuit identification is possible without disturbing the ease of wiring. Blocks also furnished with marking directly on the blocks.

- Series 200: Standard screw terminals both sides.
- Series 200-L: Screw Terminals on one side. Through-type solder terminals other side.
- Series 200-HS: Screw Terminals one side. Solder terminals other side.
- Series 200-S: Solder terminals both sides.
- Series 200-HF: Screw Terminals one side. Push-on wire terminals other side.
- Series 200-F: Push-on Terminals both sides.

Series 200 No.	Type "L" No.	Type "HS" No.	Type "S" No.	Type "HF" No.	Type "F" No.	No. of Lines	Mounting Lgth., In.	O.A. Lgth., In.
201	201-L	201-HS	201-S	201-HF	201-F	1	7/8	1 1/16
202	202-L	202-HS	202-S	202-HF	202-F	2	1 1/16	1 3/8
203	203-L	203-HS	203-S	203-HF	203-F	3	1 3/4	2 1/16
204	204-L	204-HS	204-S	204-HF	204-F	4	2 1/16	2 1/2
205	205-L	205-HS	205-S	205-HF	205-F	5	2 5/8	2 3/16
206	206-L	206-HS	206-S	206-HF	206-F	6	3 1/16	3 3/8
207	207-L	207-HS	207-S	207-HF	207-F	7	3 1/2	3 3/16
208	208-L	208-HS	208-S	208-HF	208-F	8	3 13/16	4 1/4
209	209-L	209-HS	209-S	209-HF	209-F	9	4 3/8	4 11/16
210	210-L	210-HS	210-S	210-HF	210-F	10	4 13/16	5 1/8
211	211-L	211-HS	211-S	211-HF	211-F	11	5 1/4	5 9/16
212	212-L	212-HS	212-S	212-HF	212-F	12	5 11/16	6
213	213-L	213-HS	213-S	213-HF	213-F	13	6 1/8	6 7/8
214	214-L	214-HS	214-S	214-HF	214-F	14	6 9/16	6 7/8
215	215-L	215-HS	215-S	215-HF	215-F	15	7	7 1/16
216	216-L	216-HS	216-S	216-HF	216-F	16	7 7/16	7 3/4
217	217-L	217-HS	217-S	217-HF	217-F	17	7 7/8	8 1/8
218	218-L	218-HS	218-S	218-HF	218-F	18	8 3/16	8 5/8
219	219-L	219-HS	219-S	219-HF	219-F	19	8 3/4	9 1/16
220	220-L	220-HS	220-S	220-HF	220-F	20	9 3/16	9 1/2
221	221-L	221-HS	221-S	221-HF	221-F	21	9 5/8	9 13/16
222	222-L	222-HS	222-S	222-HF	222-F	22	10 1/16	10 3/8
223	223-L	223-HS	223-S	223-HF	223-F	23	10 1/2	10 13/16
224	224-L	224-HS	224-S	224-HF	224-F	24	10 13/16	11 1/4
225	225-L	225-HS	225-S	225-HF	225-F	25	11 3/8	11 1/16
226	226-L	226-HS	226-S	226-HF	226-F	26	11 13/16	12 1/8
227	227-L	227-HS	227-S	227-HF	227-F	27	12 1/4	12 1/16
228	228-L	228-HS	228-S	228-HF	228-F	28	12 11/16	13
229	229-L	229-HS	229-S	229-HF	229-F	29	13 1/8	13 7/16
230	230-L	230-HS	230-S	230-HF	230-F	30	13 1/16	13 7/8

Contact GRAYBAR for all your requirements.

300 Series Controlead® Medium Duty Terminal Blocks

Class A—Group 1

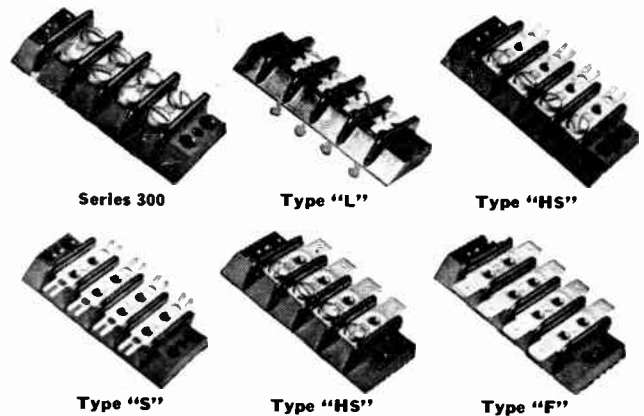

Improved disposition of material in this block results in barriers that are stronger, better supported on a base that resists breakage. Insulating plugs are molded as an integral part of the block, yet are designed for clean knock-out to readily provide end holes or additional thru-holes.

Unobstructed circuit identification is possible without disturbing the ease of wiring. Blocks also furnished with marking directly on the blocks.

- Series 300: Standard Screw Terminals both sides.
- Series 300-L: Screw Terminals on one side. Through-type solder terminals other side.
- Series 300-HS: Screw Terminals one side. Solder Terminals other side.
- Series 300-S: Solder Terminals both sides.
- Series 300-HF: Screw Terminals one side. Push-on wire terminals other side.
- Series 300-F: Push-on Terminals both sides.

Series 300 No.	Type "L" No.	Type "HS" No.	Type "S" No.	Type "HF" No.	Type "F" No.	No. of Lines	Mounting Lgth., In.	O.A. Lgth., In.
301	301-L	301-HS	301-S	301-HF	301-F	1	1 1/8	1 17/32
302	302-L	302-HS	302-S	302-HF	302-F	2	1 11/16	2 3/32
303	303-L	303-HS	303-S	303-HF	303-F	3	2 1/4	2 21/32
304	304-L	304-HS	304-S	304-HF	304-F	4	2 13/16	3 7/32
305	305-L	305-HS	305-S	305-HF	305-F	5	3 3/8	3 23/32
306	306-L	306-HS	306-S	306-HF	306-F	6	3 15/16	4 11/32
307	307-L	307-HS	307-S	307-HF	307-F	7	4 1/2	4 29/32
308	308-L	308-HS	308-S	308-HF	308-F	8	5 1/16	5 15/32
309	309-L	309-HS	309-S	309-HF	309-F	9	5 5/8	6 1/32
310	310-L	310-HS	310-S	310-HF	310-F	10	6 3/16	6 19/32
311	311-L	311-HS	311-S	311-HF	311-F	11	6 3/4	7 5/32
312	312-L	312-HS	312-S	312-HF	312-F	12	7 5/16	7 29/32
313	313-L	313-HS	313-S	313-HF	313-F	13	7 7/8	8 9/32
314	314-L	314-HS	314-S	314-HF	314-F	14	8 1/16	8 27/32
315	315-L	315-HS	315-S	315-HF	315-F	15	9	9 13/32
316	316-L	316-HS	316-S	316-HF	316-F	16	9 9/16	9 31/32
317	317-L	317-HS	317-S	317-HF	317-F	17	10 1/8	10 17/32
318	318-L	318-HS	318-S	318-HF	318-F	18	10 11/16	11 3/32
319	319-L	319-HS	319-S	319-HF	319-F	19	11 1/4	11 21/32
320	320-L	320-HS	320-S	320-HF	320-F	20	11 13/16	12 7/32
321	321-L	321-HS	321-S	321-HF	321-F	21	12 3/8	12 25/32
322	322-L	322-HS	322-S	322-HF	322-F	22	12 15/16	13 11/32
323	323-L	323-HS	323-S	323-HF	323-F	23	13 1/2	13 29/32
324	324-L	324-HS	324-S	324-HF	324-F	24	14 1/16	14 15/32

Note: Marking strips are not included.

Marathon Heavy Duty Terminal Blocks

1000 Series Solderless Connector Controlead® Blocks

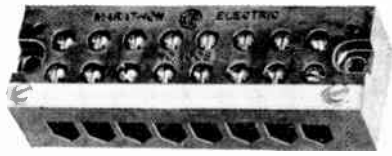

For solid or stranded wires. Positive wire insertion guide. Secure wire grip—no wire damage. Most compact design available.

Specifications:

- Sizes: 2, 4, 6, 7, 8 and 12 lines.
- Rating: (At 30° Rise) 750 Volts—80 ampere.
- Dielectric: Line-to-line, 8000 volts (RMS).
Line-to-ground, 9000 volts (RMS).
- Wire size: No. 6 to No. 18 Awg. Solid, No. 8 to No. 16 Awg. stranded.

Series 1000 with Standard Markers, No Covers

No.	No. of Lines	Pieces in Std. Pkg.	Mtg. Length, In.	O.A. Length, In.	Ship. Wt., Lbs. Per 100 Pcs.
1002	2	25	1 ⁵ / ₁₆	1 ¹¹ / ₁₆	16
1004	4	25	2 ¹ / ₈	2 ¹ / ₂	24
1006	6	25	3	3 ³ / ₈	34
1007	7	25	3 ¹ / ₂	3 ⁷ / ₈	36
1008	8	25	3 ⁷ / ₈	4 ¹ / ₄	42
1012	12	25	5 ⁵ / ₈	6	60

Note: When ordered with blocks to correspond, covers and screws are furnished in sets and enclosed in same packages as the blocks.

6000 Series Screw Terminal Controlead® Blocks

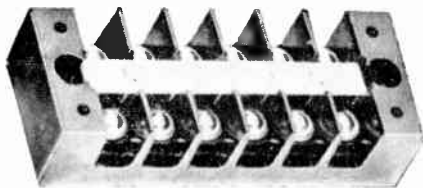

Wide slot openings for lugs. Terminals accommodate two lugs each. Nickel plated brass hardware.

Specifications:

- Sizes: 2, 3, 4, 6, 8 and 12 lines.
- Rating: (At 30° Rise) 750 Volts—60 ampere.
- Dielectric: Line-to-line, 11000 Volts (RMS).
Line-to-ground, 13000 Volts (RMS).
- Wire Size: (Max.) No. 8 AWG.

Series 6000 with Standard Markers, No Covers

No.	No. of Lines	Pieces in Std. Pkg.	Mtg. Length, In.	O.A. Length, In.	Ship. Wt., Lbs. Per 100 Pcs.
6002	2	25	1 ²⁵ / ₃₂	2 ¹ / ₂	28
6003	3	25	2 ⁷ / ₁₆	3 ⁵ / ₃₂	32
6004	4	25	3 ³ / ₃₂	3 ¹³ / ₁₆	37
6006	6	25	4 ¹³ / ₃₂	5 ¹ / ₈	50
6008	8	25	5 ²³ / ₃₂	6 ⁷ / ₁₆	62
6012	12	25	8 ¹¹ / ₃₂	9 ¹ / ₁₆	85

Marathon Marker Strips



MEMC



Fibre or Bakelite

Markers or circuit identification strips are for use with Class A—Group I Terminal Blocks. Three kind available. 1. MEMC Markers. 2. Fibre Markers. 3. Bakelite Markers. Markers are available either plain or imprinted.

Marathon Sectional Terminal Blocks
Heavy Duty—Controlead® Pre-Assembled Units

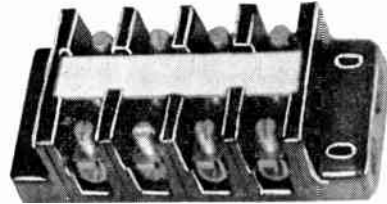

The new sectional controlead® offers versatility of hardware; arrangement; assembly, wire ranges, and electrical ratings. Double barrier guards assure you of positive protection. White vinylite strip provides flexible marking.

Stainless steel mounting channel may be quickly and easily attached. Provides rigid, accurate alignment of block.

No special tools required for mounting.
Series 10,000; Screw Terminals; Series 11,000: "Sems" Connectors; Series 12,000; Pressure Connectors.

Pre-Assembled Units

Series 10000 No.	Series 11000 No.	Series 12000 No.	No. of Lines	Mtg. Lgth., In.	O.A. Lgth., In.	Pcs. in Std. Pkg.
10001	11001	12001	1	1 ³ / ₈	1 ⁷ / ₈	25
10002	11002	12002	2	2	2 ¹ / ₂	25
10003	11003	12003	3	2 ⁵ / ₈	3 ¹ / ₈	25
10004	11004	12004	4	3 ¹ / ₄	3 ³ / ₄	25
10005	11005	12005	5	3 ⁷ / ₈	4 ³ / ₈	25
10006	11006	12006	6	4 ¹ / ₂	5	25
10007	11007	12007	7	5 ¹ / ₈	5 ⁵ / ₈	25
10008	11008	12008	8	5 ³ / ₄	6 ¹ / ₄	25
10009	11009	12009	9	6 ³ / ₈	6 ⁷ / ₈	25
10010	11010	12010	10	7	7 ¹ / ₂	25
10011	11011	12011	11	7 ³ / ₈	8 ¹ / ₈	25
10012	11012	12012	12	8 ³ / ₄	8 ³ / ₄	25
10013	11013	12013	13	8 ⁷ / ₈	9 ³ / ₈	25
10014	11014	12014	14	9 ¹ / ₂	10	25
10015	11015	12015	15	10 ¹ / ₈	10 ⁵ / ₈	25
10016	11016	12016	16	10 ³ / ₄	11 ¹ / ₄	25
10017	11017	12017	17	11 ³ / ₈	11 ⁷ / ₈	25
10018	11018	12018	18	12	12 ¹ / ₂	25
10019	11019	12019	19	12 ⁵ / ₈	13 ¹ / ₈	25
10020	11020	12020	20	13 ¹ / ₄	13 ³ / ₄	25
10021	11021	12021	21	13 ⁷ / ₈	14 ³ / ₈	25
10022	11022	12022	22	14 ¹ / ₂	15	25
10023	11023	12023	23	15 ¹ / ₈	15 ⁵ / ₈	25
10024	11024	12024	24	15 ⁵ / ₄	16 ¹ / ₄	25
10025	11025	12025	25	16 ³ / ₈	16 ⁷ / ₈	25
10026	11026	12026	26	17	17 ¹ / ₂	25
10027	11027	12027	27	17 ⁵ / ₈	18 ¹ / ₈	25
10028	11028	12028	28	18 ¹ / ₄	18 ⁷ / ₈	25
10029	11029	12029	29	18 ⁵ / ₈	19 ³ / ₈	25
10030	11030	12030	30	19 ¹ / ₂	20	25

Note: Each unit completely assembled and individually boxed with the type and size (No. of lines) clearly indicated on the box. White vinylite marking strips are included. Mounting screws are not included.

Components for Field Assembly

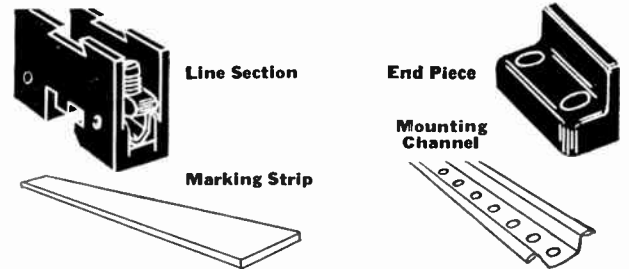

Series 10000 No.	Series 11000 No.	Series 12000 No.	Description	Pcs. in Std. Carton
10500	11500	12500	Line Section	100
10501	10501	10501	End Piece	25
10502	10502	10502	Mounting Channel (Stainless Steel)	25
10503	10503	10503	Marking Strip (White Vinylite)	25

Superior "Luxtrol" Equipment

The light control equipment exactly right for your needs. Provides smooth, stepless dimming, brightening and blending from full-on to blackout. Operation is cool, silent, efficient

and economical. Will control any number of lamps up to their full rated capacity and can be used with incandescent, cold cathode or fluorescent.

Non-Interlocking LUXTROL Light Controls Manually Operated Models Two Wire—Single Phase

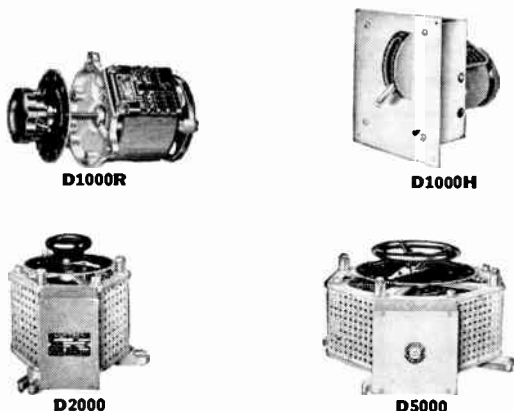

In auditoriums, single rooms and other installations where only a few circuits require dimming, non-interlocking LUXTROL controls find their widest use.

Type	Each	Type	Each
D1000R	\$35.00	D5000-3P	\$517.50
D1000H	50.00	D5000-4E	726.00
D2000	67.50	D5000-4P	750.00
D2000-2E	141.00	D5000-2E2P	732.00
D2000-3E	216.00	D5000-5E	1048.50
D2000-4E	350.00	D5000-6E	1200.00
D5000	151.50	D5000-6P	1236.00
D5000-2E	332.00	D5000-3E2P	1218.00
D5000-2P	342.00	D5000-2E3P	1236.00
D5000-3E	499.50		

Note: Three wire-single phase and four wire-three phase also available in D2000 and D5000 series.

Motor-Driven Models Two Wire—Single Phase

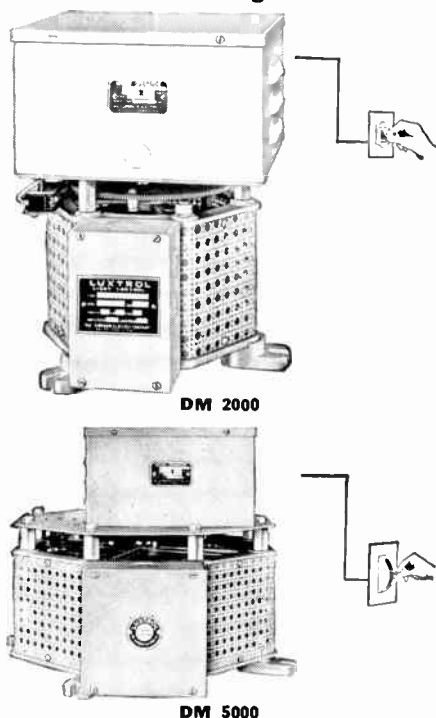

Packaged LUXTROL Light Controls

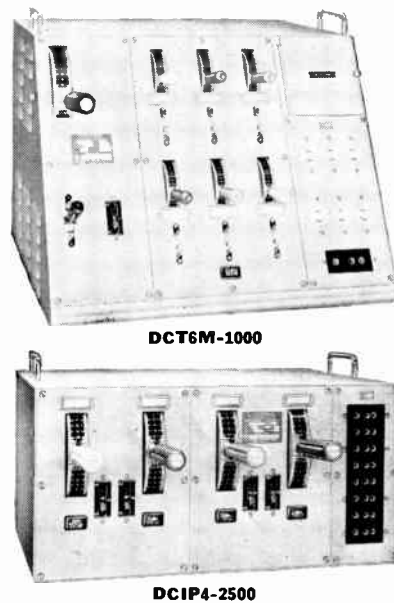

Particularly well suited for small theaters, schools, churches and other applications where expense is a governing factor, PACKAGED LUXTROL controls provide big switchboard effects at modest cost. Numerous models are available in ratings from 6,000 to 15,000 watts.

Units may be purchased singly and others added later as finances permit.

Type	Description	Each
DCT6M-1000	With 6000 watt master-dimmer. . . .	\$690.00
DC1P4-2500	Other models equipped with 3, 5 and 6 independent handles and with separate master handle.	772.00

For effortless operation of the larger models or for convenient remote control, motor-driven LUXTROL controls are available in the same ratings as manually operated assemblies.

To 15,000 Watt Capacity

Type	Each
DMZ2000	\$250.00
DMZ2000-2E	323.00
DMZ2000-3E	398.00
DMZ2000-4E	532.00
DMZ5000	335.00
DMZ5000-2E	514.00
DMZ5000-2P	524.00
DMZ5000-3E	683.00
DMZ5000-3P	700.00

Above 15,000 Watt Capacity

Type	Each
DMY5000-4E	\$908.00
DMY5000-4P	932.00
DMY5000-2E2P	914.00
DMY5000-5E	1232.00
DMY5000-6E	1382.00
DMY5000-6P	1418.00
DMY5000-3E2P	1400.00
DMY5000-2E3P	1418.00

Note: Three-wire single phase and four-wire three phase also available in DM2000 and DM5000 series.

For Mounting in a Wall

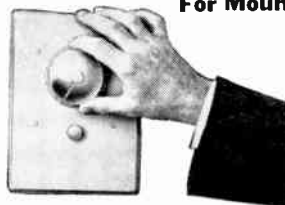

This new concept in light control is used in place of regular wallswitches and is easy to install.

Available in several optional finish wall plates, knob and fuse cap combinations.

Type	Each
WBD360	\$33.00

G-E Circuit Breaker Load Centers
(Trumbull)

General Purpose NEMA Type 1 and Raintight NEMA Type 3R Enclosures

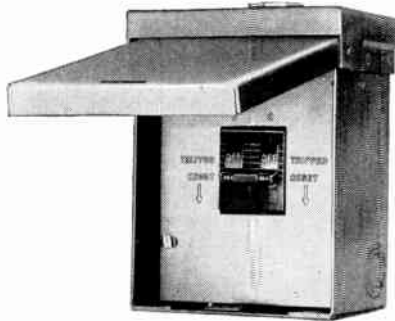

Raintight Circuit Breaker Load Center
No. TRP240R2

G-E circuit breaker load centers can be used for the distribution of electric energy in homes of all sizes, farms, apartment houses, light commercial applications such as garages, and small office buildings. The smaller load centers can be used in small apartments and for the connection of water heaters, dryers and other 220-volt appliance loads.

The 2- through 12-circuit load centers, as well as the 12- through 20-circuit split-bus load centers, are suitable for use as service entrance equipment when installed with a maximum of six operating handles where main disconnect not required ahead of the load center.

Raintight circuit breaker load centers provide for the distribution of electrical energy in the same types of applications as do the general purpose enclosures. Also permits installation outdoors for areas in which this is desirable.

In these devices, conduit may enter the box through an interchangeable hub in the top or through convenient knockouts in the bottom, sides and back.

Raintight NEMA Type 3R Enclosures with Interchangeable Conduit Hubs

(Prices do not include hub. Order hubs separately.)

Lugs in Mains—120/240 Volts A-C, Single-Phase, Three-Wire

Catalog Number (Box with Front)	Device Rating in Amperes	Maximum Number of Single Poles with Twins	Maximum Number of Double Poles	Approximate Over-all Dimensions in Inches			Approx. Ship. Wt. Lbs.	List Price Each †
				H	W	D		
TRP240R2	40	2	1	7 ¹³ / ₁₆	6	4 ³ / ₁₆	6	\$ 9.10
TRP270R2	70	4	1	7 ¹³ / ₁₆	6	4 ³ / ₁₆	6	10.70
TRP470R2	70	4	2	10 ¹³ / ₁₆	7 ³ / ₈	4 ¹ / ₂	9	11.20
TRP810R2	100	8	4	13 ¹ / ₄	12 ¹ / ₂	5	17	22.70
TRP1210R4	100	12	6	17 ³ / ₈	12 ¹ / ₂	5 ¹ / ₁₆	24	29.00
TRP2010R4	100	20	10	22 ¹³ / ₁₆	12 ¹ / ₂	5 ¹ / ₁₆	31	41.00

Lugs in Mains—120/208 Volts A-C, Three-Phase, Four-Wire

TRP1214R4	100	12	4	17 ⁹ / ₁₆	12 ¹ / ₂	5 ¹ / ₁₆	25	40.00
TRP2014R2	100	20	10	22 ¹³ / ₁₆	12 ¹ / ₂	5 ¹ / ₁₆	31	51.00

Circuit Breaker in Mains—120/240 Volts A-C, Single-Phase, Three-Wire

TRM1210R4	100	12	6	54.00
-----------	-----	----	---	------	------	------	----	-------

Split-Bus Load Centers—120/240 Volts A-C, Single-Phase, Three-Wire

TRX1210R2	100	Up to 12	Up to 4	35.00
TRX1610R2	100	Up to 8	Up to 8°	41.00
TRX2010R2	100	Up to 20	Up to 10°	47.00

Enclosed Circuit Breakers—120/240 Volts A-C, Single-Phase, Three-Wire

TEZ1100NFR4	100	(Two single-pole E-frame circuit breakers with handle ties)		38.50
TEZ1100NSR4	100	(Two single-pole E-frame circuit breakers with handle ties)		38.50

†These prices include one hub opening per box. If more than one hub opening is required, consult Graybar for price.
°One double-pole breaker acts as subfeed main breaker.

General Purpose NEMA Type 1 Enclosures
Lugs in Mains—120/240 Volts A-C, Single-Phase, Three-Wire

Flush	Catalog No.	Surface	Device Rating in Amperes	Lug Wire Size AWG	Total Usable Branch Circuits	Max. No. of Breakers			Approx. Shipping Wt. Lbs.	List Price Each
						Twin	Single-Pole	Type R		
TRP240F	TRP240S	40	14-4	2	0	2	1	1.8	\$ 4.00
TRP270F			50	14-4	4	4	2	1	4.8	5.70
TRP470F	TRP470S	70	14-4	8	8	4	2	5.6	6.00
TRP810F	TRP810S	100	14-0	14	12	8	4	11	13.00
TRP810FL	TRP810SL	100	14-0	14	12	8	4	10	11.90
TRP1210F	TRP1210S	100	14-0	20	16	12	6	14	17.90
TRP2010F†	TRP2010S†	100	14-0	20	0	20	10	16	29.00
TRP2420F*	TRP2420SL*	200	6-250MCM	40	40	24	12	29	46.00

Lugs in Mains—120/208 Volts A-C, Three-Phase, Four-Wire

TRP1214F	TRP1214S	100	14-0	24	24	12	4	13	28.00
TRP2014F†	TRP2014S†	100	14-0	20	0	20	10	18	39.00

Circuit Breaker in Mains—120/240 Volts A-C, Single-Phase, Three-Wire

TRM1210F	TRM1210S	100	6-1	20	16	12	6	21	42.00
----------	----------	-------	-----	-----	----	----	----	---	----	-------

Fuse Puller in Mains—120/240 Volts A-C, Single-Phase, Three-Wire

TRF2420FL*	TRF2420SL*	200	2/0-4/0	40	40	24	12	55	111.00
------------	------------	-------	-----	---------	----	----	----	----	----	--------

Split-Bus Load Centers—120/240 Volts A-C, Single-Phase, Three-Wire

(No Sub-Feed Breakers Included)

TRX1210F	TRX1210S	100	14-0	13	Up to 8	Up to 12	Up to 4	13	22.90
TRX1610F	TRX1610S	100	14-0	15	Up to 10	Up to 8	Up to 8°	16	29.00
TRX2010F	TRX2010S	100	14-0	15	Up to 10	Up to 20	Up to 10°	18.5	35.00
TRX2020FL*	TRX2020SL*	200	6-250MCM	15	22	20	10	29	45.00
TRX3020FL*	TRX3020SL*	200	6-250MCM	22	0	Up to 18	Up to 13	36	60.00

Enclosed Circuit Breakers—120/240 Volts A-C, Single-Phase, Three-Wire

TEZ1100NF	TEZ1100NS	100	6-1	(Two single-pole E-frame circuit breakers with handle ties in enclosure.)			33.00
-----------	-----------	-------	-----	-----	---	--	--	------	-------

*No door.
†This device has insulated, nongroundable neutral assembly.
°One double-pole breaker acts as subfeed main breaker.
For further information, please contact GRAYBAR.

G-E Panel-Base Assemblies

Single, 2 and 3 Pole Plug-In Branch Breakers Lugs or Circuit Breakers in Mains Maximum 240 Volts A-C

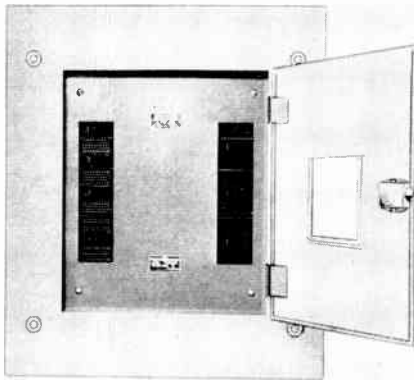

Type TQLP Panel-base Assembly with Breakers

Standard-duty assemblies designed for control and protection of power, distribution, lighting and appliance circuits. Single, 2 and 3 pole branch breakers available. For a-c only. Plug-in branch circuit breakers and unit packaging provide for flexibility in stock handling.

Box, panel interior and surface front are packaged as one unit. Plug-in circuit breakers are ordered separately.

Assemblies are furnished only as listed. No modifications available.

Interior mounted on reinforced back plate with panel busing arranged to maintain sequence phasing. Bus bars and connection straps supported by thermal-setting plastic insulators. Solderless main lugs. Code-gage galvanized steel box has NEC-size wiring gutters and amplet knockouts. Special knockout arrangements not available.

Fronts constructed of code-gage sheet steel, ASA No. 49 medium-light-grey enamel finish over rust inhibitor, single door with heavy-duty semi-concealed steel hinges and paracentric tumbler combination catch and lock, with directory card and card holder inside door. Surface fronts are standard. Dual-purpose type also available.

Panel-Base Assemblies (Branch Breakers Not Included)

Max. No. Poles	Main Amp	Mains With Lugs Only				Mains With Circuit Breaker ‡					
		Main Lug Size	Cat. No.*	List Price Each	Box Height In. †	Approx. Ship. Wt. Lb.	Main Lug Size	Cat. No.*	List Price Each	Box Height In. †	Approx. Ship. Wt. Lb.
2-Wire, Single-Phase, 120 or 240 Volts AC or 3-Wire, Single-Phase, 120/240 Volts AC Solid Neutral											
18	225	#6-250 MCM	DB2A3N1812ES	\$112	22½	54	#6-350 MCM	DB2A3N18B2ES	\$317	31½	114
30	225	#6-250 MCM	DB2A3N3012ES	130	28½	63	#6-350 MCM	DB2A3N30B2ES	335	40½	123
30	400	2-#6-250 MCM	DB2A3N3014ES	159	31½	77	2-3/0-250 MCM	DB2A3N30B4ES	584	49½	175
42	100	2-#6-250 MCM	DB2A3N4214ES	177	40½	110	2-3/0-250 MCM	DB2A3N42B4ES	602	55½	210
51	100	2-#6-250 MCM	DB2A3N5414ES	195	46½	125	2-3/0-250 MCM	DB2A3N54B4ES	620	61½	225
42	600	2-1/0-500 MCM	DB2A3N4216ES	213	16½	125
51	600	2-1/0-500 MCM	DB2A3N5416ES	231	52½	140
3-Wire, 3-Phase, 240 Volts AC or 4-Wire, 3-Phase, 120/208Y Volts, AC Solid Neutral											
18	225	#6-250 MCM	DB2A4N1812ES	125	22½	55	#6-350 MCM	DB2A4N18B2ES	377	31½	118
30	225	#6-250 MCM	DB2A4N3012ES	143	28½	64	#6-350 MCM	DB2A4N30B2ES	395	40½	127
30	400	2-#6-250 MCM	DB2A4N3014ES	174	31½	80	2-3/0-250 MCM	DB2A4N30B4ES	704	49½	180
42	100	2-#6-250 MCM	DB2A4N4214ES	192	40½	115	2-3/0-250 MCM	DB2A4N42B4ES	722	55½	215
51	100	2-#6-250 MCM	DB2A4N5414ES	210	46½	130	2-3/0-250 MCM	DB2A4N54B4ES	740	61½	230
42	600	2-1/0-500 MCM	DB2A4N4216ES	228	46½	130
51	600	2-1/0-500 MCM	DB2A4N5416ES	246	52½	150

*Catalog Number includes surface front. If dual-purpose front is required, change suffix letter S to F. No change in price.

†Boxes are 20 inches wide and 5¾ inches deep, inside dimensions. For outside dimensions, add ¼ inch to dimensions shown.

‡225-ampere breakers Type TJ. 400-ampere breakers Type TKL.

Branch Circuit Breakers

Plug-in single, two, and three-pole circuit breakers used in branches. Interrupting rating of 5000 amperes RMS. Double-pole branch circuit breakers can be provided by using two single-pole Type R or TQL circuit breakers with handle

extensions, permitting simultaneous manual operation but independent tripping of each pole or by 2-pole, common-trip circuit breakers, Type TQL.

Ampere Rating	Single Pole, Type R 120 Volts, A-C			Single Pole, Type TQL 120 Volts, A-C			2 Pole, Type TQL 120/240 Volts, A-C			2 Pole, Type TQL 240 Volts, A-C			3 Pole, Type TQL 240 Volts, A-C		
	Cat. No.	List Price Each	Cat. No.	List Price Each	Cat. No.	List Price Each	Cat. No.	List Price Each	Cat. No.	List Price Each	Cat. No.	List Price Each			
10	TQL1110	\$3.50	TQL2110	\$6.90			
15	TRP1115	\$3.10	TQL1115	3.50	TQL2115	6.90	TQL22015	\$18.00	TQL32015	\$22.00			
20	TRP1120	3.10	TQL1120	3.50	TQL2120	6.90	TQL22020	18.00	TQL32020	22.00			
30	TRP1130	3.10	TQL1130	3.50	TQL2130	6.90	TQL22030	18.00	TQL32030	22.00			
40	TRP1140	3.10	TQL1140	3.50	TQL2140	6.90	TQL22040	18.00	TQL32040	22.00			
50	TRP1150	3.10	TQL1150	3.50	TQL2150	6.90	TQL22050	18.00	TQL32050	22.00			
70	TQL2170	13.00	TQL22070	28.00	TQL32070	42.00			

Accessories Available for Branch Circuit Breakers

Handle extensions for two single-pole circuit breakers to provide double-pole manual operation with independent tripping. Cat. No. DAHL102.....List Price per set \$0.40.

Handle locking device for locking circuit breaker in ON or

OFF position, non-padlocking, for plug-in circuit breakers. Cat. No. DAHL-103.....List Price each \$0.70.

Knockout closure for single-pole plug-in circuit breaker, Cat. No. DNC-100.....List Price each \$0.20.

G-E Lighting Panelboards

Type NAB

(Trumbull)

8 to 42 Branch Circuits
Lugs or Breakers in Mains

3 Wire, 125/250 Volts, A.C. or D.C.
4 Wire, 120/208Y Volts, A.C.

(Listed as panelboards by Underwriters' Laboratories under File E-2366; comply with U. S. Federal Spec. W-P-131a, Classes A & C.)

Heavy-duty panelboards designed for control and protection of 2-wire, 120-volt lighting and appliance branch circuits. Recommended where highest quality, most dependable equipment is required. Suitable for both alternating and direct current.

4-Wire, 3-Phase 277/480Y-Volt Service.

Type NHB panels for this service and type NHBX column type also available for this service. Consult Graybar.

Description

Panel Interiors: Type TE interchangeable, single-pole breakers in branch circuits, and in mains (if required). Breakers are quick-make, quick-break, trip-free, trip-indicating with thermal-magnetic tripping mechanism.

Mains: Solderless lugs only or circuit breakers: 50 and 100 amp, Type TE (E frame), with interrupting rating of 7500 amp RMS, ac; 5000 amp dc; or 225 amp, Type TJ (J frame), with interrupting rating of 25,000 amp RMS at 240v, ac, 10,000 amp dc.

Branches: 15 to 50 amp, single-pole, Type TE breakers (E frame) with interrupting rating of 7500 amp RMS, ac; 5000 amp dc.

Boxes: Code-gage steel with 1-in. wiring gutters and plenty of knockouts.

Fronts: Code-gage steel finished in ASA No. 49 medium light-grey enamel over a rust inhibitor; single door with semi-concealed heavy-duty hinges and cylinder tumbler combination catch and lock. For flush or surface mounting. Circuit directory, card and cardholder on inside of door.

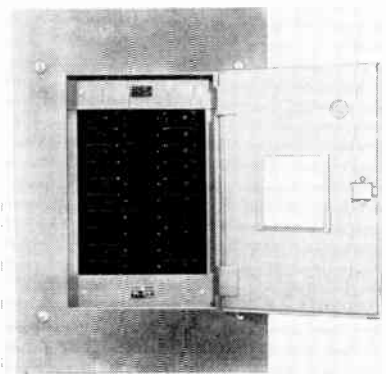

No. NAB320L with door open

Type NAB3—3 Wire, 125/250 Volts, Solid Neutral, A.C. or D.C.

No. of Branch Circuits	Rating of Mains in Amp	Lug Wire Size in AWG	Mains with Lugs Only				Lug Wire Size in AWG	Mains with Circuit Breaker							
			Complete Panelboard		Box Only			Complete Panelboard		Box Only					
			Model No.	Each* Wt. Lb.	Approx. Ship. Cat. No.	Ht. In.†	Model No.	Each* Wt. Lb.	Approx. Ship. Cat. No.	Ht. In.†	Front Cat. No.				
8	50	14-1/0	NAB308L	\$171	70	DA51201	19 1/2	DA51301AB	14-4	NAB308AB	\$204	76	DA51202	22 1/2	DA51302AB
10	50	14-1/0	NAB310L	198	76	DA51202	22 1/2	DA51302AB	14-4	NAB310AB	231	78	DA51202	22 1/2	DA51302AB
12	100	14-1/0	NAB312L	225	78	DA51202	22 1/2	DA51302AB	14-1	NAB312AB	278	84	DA51203	25 1/2	DA51303AB
14	100	14-1/0	NAB314L	252	84	DA51203	25 1/2	DA51303AB	14-1	NAB314AB	305	86	DA51203	25 1/2	DA51303AB
16	100	14-1/0	NAB316L	279	86	DA51203	25 1/2	DA51303AB	14-1	NAB316AB	332	95	DA51204	28 1/2	DA51304AB
18	100	14-1/0	NAB318L	306	95	DA51204	28 1/2	DA51304AB	14-1	NAB318AB	359	98	DA51204	28 1/2	DA51304AB
20	100	14-1/0	NAB320L	333	98	DA51204	28 1/2	DA51304AB	14-1	NAB320AB	386	106	DA51205	31 1/2	DA51305AB
22	225	6-250MCM	NAB322L	364	108	DA51205	31 1/2	DA51305AB	6-350MCM	NAB322AB	569	165	DA61209	43 1/2	DA51309AB
24	225	6-250MCM	NAB324L	391	112	DA51205	31 1/2	DA51305AB	6-350MCM	NAB324AB	596	167	DA61209	43 1/2	DA51309AB
26	225	6-250MCM	NAB326L	418	125	DA51206	34 1/2	DA51306AB	6-350MCM	NAB326AB	623	175	DA61210	46 1/2	DA51310AB
28	225	6-250MCM	NAB328L	445	130	DA51206	34 1/2	DA51306AB	6-350MCM	NAB328AB	650	177	DA61210	46 1/2	DA51310AB
30	225	6-250MCM	NAB330L	472	145	DA51207	37 1/2	DA41307AB	6-350MCM	NAB330AB	677	185	DA61211	49 1/2	DA51311AB
32	225	6-250MCM	NAB332L	499	151	DA51207	37 1/2	DA51307AB	6-350MCM	NAB332AB	704	187	DA61211	49 1/2	DA51311AB
34	225	6-250MCM	NAB334L	526	168	DA51208	40 1/2	DA51308AB	6-350MCM	NAB334AB	731	195	DA61212	52 1/2	DA51312AB
36	225	6-250MCM	NAB336L	553	175	DA51208	40 1/2	DA51308AB	6-350MCM	NAB336AB	758	197	DA61212	52 1/2	DA51312AB
38	225	6-250MCM	NAB338L	580	194	DA51209	43 1/2	DA51309AB	6-350MCM	NAB338AB	785	205	DA61213	55 1/2	DA51313AB
40	225	6-250MCM	NAB340L	607	202	DA51209	43 1/2	DA51309AB	6-350MCM	NAB340AB	812	207	DA61213	55 1/2	DA51313AB
42	225	6-250MCM	NAB342L	634	210	DA51210	46 1/2	DA51310AB	6-350MCM	NAB342AB	839	215	DA61214	58 1/2	DA51314AB

Type NAB4—4 Wire, 3 Phase, 120/208Y Volts, Solid Neutral, A.C.

8	50	14-1/0	NAB408L	\$182	70	DA51201	19 1/2	DA51301AB	14-4	NAB408AB	\$230	77	DA51202	22 1/2	DA51320AB
10	50	14-1/0	NAB410L	209	76	DA51202	22 1/2	DA51302AB	14-4	NAB410AB	257	83	DA51203	25 1/2	DA51303AB
12	50	14-1/0	NAB412L	236	78	DA51202	22 1/2	DA51302AB	14-4	NAB412AB	284	85	DA51203	25 1/2	DA51303AB
14	50	14-1/0	NAB414L	263	84	DA51203	25 1/2	DA51303AB	14-4	NAB414AB	311	94	DA51204	28 1/2	DA51304AB
16	100	14-1/0	NAB416L	290	86	DA51203	25 1/2	DA51303AB	14-1	NAB416AB	359	97	DA51204	28 1/2	DA51304AB
18	100	14-1/0	NAB418L	317	95	DA51204	28 1/2	DA51304AB	14-1	NAB418AB	386	107	DA51205	31 1/2	DA51305AB
20	100	14-1/0	NAB420L	344	98	DA51204	28 1/2	DA51304AB	14-1	NAB420AB	413	111	DA51205	31 1/2	DA51305AB
22	100	14-1/0	NAB422L	371	108	DA51205	31 1/2	DA51305AB	14-1	NAB422AB	440	124	DA51206	34 1/2	DA51306AB
24	100	14-1/0	NAB424L	398	112	DA51205	31 1/2	DA51305AB	14-1	NAB424AB	467	129	DA51206	34 1/2	DA51306AB
26	100	14-1/0	NAB426L	425	125	DA51206	34 1/2	DA51306AB	14-1	NAB426AB	494	144	DA51207	37 1/2	DA51307AB
28	100	14-1/0	NAB428L	452	130	DA51206	34 1/2	DA51306AB	14-1	NAB428AB	521	150	DA51207	37 1/2	DA51307AB
30	100	14-1/0	NAB430L	479	145	DA51207	37 1/2	DA51307AB	14-1	NAB430AB	548	167	DA51208	40 1/2	DA51308AB
32	225	6-250MCM	NAB432L	512	151	DA51207	37 1/2	DA51307AB	6-350MCM	NAB432AB	764	190	DA61211	49 1/2	DA51311AB
34	225	6-250MCM	NAB434L	539	168	DA51208	40 1/2	DA51308AB	6-350MCM	NAB434AB	791	198	DA61212	52 1/2	DA51312AB
36	225	6-250MCM	NAB436L	566	175	DA51208	40 1/2	DA51308AB	6-350MCM	NAB436AB	818	200	DA61212	52 1/2	DA51312AB
38	225	6-250MCM	NAB438L	593	194	DA51209	43 1/2	DA51309AB	6-350MCM	NAB438AB	845	208	DA61213	55 1/2	DA51313AB
40	225	6-250MCM	NAB440L	620	202	DA51209	43 1/2	DA51309AB	6-350MCM	NAB440AB	872	210	DA61213	55 1/2	DA51313AB
42	225	6-250MCM	NAB442L	647	210	DA51210	46 1/2	DA51310AB	6-350MCM	NAB442AB	899	218	DA61214	58 1/2	DA51314AB

*Prices include 15-amp branch breakers. Also available in 20, 30, 40 and 50 amp ratings at no increase in price.

†All boxes are 20 in. wide by 4 1/2 in. deep except as noted. For outside box dimensions, add 1/4 in. to dimensions shown. Boxes provided with knockouts.

‡Box is 5 3/4 in. deep.

1. Space for future circuits—Select panelboard as if all circuits were required. A price deduction of \$9.70 is allowed for each single-pole breaker omitted and space provided.

2. Two- and/or three-pole circuits using Class C, Type TE circuit breakers, 15 to 50 amperes—Convert 2- and/or 3-pole circuit breakers to equivalent number of single-pole circuit breakers. Select panel having total number of single-pole branches required and add \$5.50 for each 2-pole breaker substituted for two single-pole breakers and \$7.00 for each 3-pole breaker substituted for three single-pole breakers. 70 to 100 amps—Not more than two breakers per panel are allowed and they must always be furnished as subfeed circuit breakers. Add \$52.50 for each 2-pole breaker and \$69.00 for each 3-pole breaker.

G-E Lighting Panelboards

Type NLAB

(Trumbull)

8 to 42 Circuits
Lugs or Breakers in Mains

3-Wire, 120/240 Volts, A-C
4-Wire, 120/208Y Volts, A-C

(Listed as panelboards by Underwriters' Laboratories under File E-2366; comply with U. S. Federal Specification W-P-131a, Class A)

Type NLAB standard-duty panelboards are designed for control and protection of 2-wire, 120-volt lighting and appliance branch circuits. For a-c only.

Description

Panel interiors: Type TQ interchangeable, single-pole breakers in branch circuits, and Type TE or TJ breakers in mains (if required). Breakers are quick-make, quick-break, trip-free, trip-indicating with thermal-magnetic tripping mechanism.

Mains: Solderless lugs only or circuit breakers: 50 and 100 amp, Type TE (E frame) with interrupting rating of 7500 amp RMS; or 225 amp, Type TJ (J frame) with interrupting rating of 25,000 amp RMS.

Branches: 10- to 50-amp, single-pole, Type TQ breaker, with interrupting rating of 5000 amp RMS. Double-pole breakers also available. See below.

Boxes: Code-gage steel with 4-in. wiring gutters and plenty of knockouts.

Fronts: Code-gage steel finished in ASA No. 49 medium light-gray enamel over a rust inhibitor; single door with semi-concealed heavy-duty hinges and cylinder tumbler combination catch and lock. For flush or surface mounting. Circuit directory card and cardholder on inside of door.

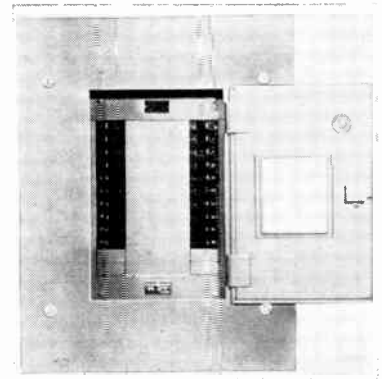

No. NLAB420L with door open

Rating, Dimensions, and Prices

Type NLAB3—3 Wire, Single-Phase, 120/240 Volts, A.C., Solid Neutral

No. of Branch Circuits	Rating of Mains in Amp	Lug Wire Size in AWG	Mains with Lugs Only				Mains with Circuit Breaker								
			Complete Panelboard		Box Only		Complete Panelboard		Box Only						
			Model No.	Each* Wt. Lb.	Approx. Ship. Cat. No.	Ht. In.†	Model No.	Each* Wt. Lb.	Approx. Ship. Cat. No.	Ht. In.†					
8	50	14-1/0	NLAB308L	\$115	48	DA51201	19 1/2	DA51301AB	14-4	NLAB308AB	\$148	72	DA51203	25 1/2	DA51303AB
10	50	14-1/0	NLAB310L	128	49	DA51201	19 1/2	DA51301AB	14-4	NLAB310AB	161	73	DA51203	25 1/2	DA51303AB
12	100	14-1/0	NLAB312L	141	50	DA51201	19 1/2	DA51301AB	14-1	NLAB312AB	194	74	DA51203	25 1/2	DA51303AB
14	100	14-1/0	NLAB314L	154	55	DA51202	22 1/2	DA51302AB	14-1	NLAB314AB	207	79	DA51204	28 1/2	DA51304AB
16	100	14-1/0	NLAB316L	167	56	DA51202	22 1/2	DA51302AB	14-1	NLAB316AB	220	80	DA51204	28 1/2	DA51304AB
18	100	14-1/0	NLAB318L	180	57	DA51202	22 1/2	DA51302AB	14-1	NLAB318AB	233	81	DA51204	28 1/2	DA51304AB
20	100	14-1/0	NLAB320L	193	64	DA51203	25 1/2	DA51303AB	14-1	NLAB320AB	246	90	DA51205	31 1/2	DA51305AB
22	225	6-250MCM	NLAB322L	210	65	DA51203	25 1/2	DA51303AB	6-350MCM	NLAB322AB	415	122	DA61207	37 1/2	DA51307AB
24	225	6-250MCM	NLAB324L	223	66	DA51203	25 1/2	DA51303AB	6-350MCM	NLAB324AB	428	123	DA61207	37 1/2	DA51307AB
26	225	6-250MCM	NLAB326L	236	74	DA51204	28 1/2	DA51304AB	6-350MCM	NLAB326AB	441	135	DA61208	40 1/2	DA51308AB
28	225	6-250MCM	NLAB328L	244	75	DA51204	28 1/2	DA51304AB	6-350MCM	NLAB328AB	454	136	DA61208	40 1/2	DA51308AB
30	225	6-250MCM	NLAB330L	262	76	DA51204	28 1/2	DA51304AB	6-350MCM	NLAB330AB	467	137	DA61208	40 1/2	DA51308AB
32	225	6-250MCM	NLAB332L	275	80	DA51205	31 1/2	DA51305AB	6-350MCM	NLAB332AB	480	146	DA61209	43 1/2	DA51309AB
34	225	6-250MCM	NLAB334L	288	81	DA51205	31 1/2	DA51305AB	6-350MCM	NLAB334AB	493	147	DA61209	43 1/2	DA51309AB
36	225	6-250MCM	NLAB336L	301	82	DA51205	31 1/2	DA51305AB	6-350MCM	NLAB336AB	506	148	DA61209	43 1/2	DA51309AB
38	225	6-250MCM	NLAB338L	314	91	DA51206	34 1/2	DA51306AB	6-350MCM	NLAB338AB	519	158	DA61210	46 1/2	DA51310AB
40	225	6-250MCM	NLAB340L	327	92	DA51206	34 1/2	DA51306AB	6-350MCM	NLAB340AB	532	159	DA61210	46 1/2	DA51310AB
42	225	6-250MCM	NLAB342L	340	93	DA51206	34 1/2	DA51306AB	6-350MCM	NLAB342AB	545	160	DA61210	46 1/2	DA51310AB

Type NLAB4—4 Wire, 3-Phase, 120/208Y Volts, A.C., Solid Neutral

8	50	14-1/0	NLAB408L	\$126	48	DA51201	19 1/2	DA51301AB	14-4	NLAB408AB	\$174	73	DA51203	25 1/2	DA51303AB
10	50	14-1/0	NLAB410L	139	49	DA51201	19 1/2	DA51301AB	14-4	NLAB410AB	187	75	DA51203	25 1/2	DA51303AB
12	50	14-1/0	NLAB412L	152	50	DA51201	19 1/2	DA51301AB	14-4	NLAB412AB	200	75	DA51203	25 1/2	DA51303AB
14	50	14-1/0	NLAB414L	165	55	DA51202	22 1/2	DA51302AB	14-4	NLAB414AB	213	80	DA51204	28 1/2	DA51304AB
16	100	14-1/0	NLAB416L	178	56	DA51202	22 1/2	DA51302AB	14-1	NLAB416AB	247	81	DA51204	28 1/2	DA51304AB
18	100	14-1/0	NLAB418L	191	57	DA51202	22 1/2	DA51302AB	14-1	NLAB418AB	260	82	DA51204	28 1/2	DA51304AB
20	100	14-1/0	NLAB420L	204	61	DA51203	25 1/2	DA51303AB	14-1	NLAB420AB	273	91	DA51205	31 1/2	DA51305AB
22	100	14-1/0	NLAB422L	217	65	DA51203	25 1/2	DA51303AB	14-1	NLAB422AB	286	92	DA51205	31 1/2	DA51305AB
24	100	14-1/0	NLAB424L	230	66	DA51203	25 1/2	DA51303AB	14-1	NLAB424AB	299	93	DA51205	31 1/2	DA51305AB
26	100	14-1/0	NLAB426L	243	74	DA51204	28 1/2	DA51304AB	14-1	NLAB426AB	312	102	DA51206	34 1/2	DA51306AB
28	100	14-1/0	NLAB428L	256	75	DA51204	28 1/2	DA51304AB	14-1	NLAB428AB	325	103	DA51206	34 1/2	DA51306AB
30	100	14-1/0	NLAB430L	269	76	DA51204	28 1/2	DA51304AB	14-1	NLAB430AB	338	104	DA51206	34 1/2	DA51306AB
32	225	6-250MCM	NLAB432L	288	82	DA51205	31 1/2	DA51305AB	6-350MCM	NLAB432AB	540	118	DA61209	43 1/2	DA51309AB
34	225	6-250MCM	NLAB434L	301	83	DA51205	31 1/2	DA51305AB	6-350MCM	NLAB434AB	553	149	DA61209	43 1/2	DA51309AB
36	225	6-250MCM	NLAB436L	314	84	DA51205	31 1/2	DA51305AB	6-350MCM	NLAB436AB	566	150	DA61209	43 1/2	DA51309AB
38	225	6-250MCM	NLAB438L	327	93	DA51206	34 1/2	DA51306AB	6-350MCM	NLAB438AB	579	160	DA61210	46 1/2	DA51310AB
40	225	6-250MCM	NLAB440L	340	94	DA51206	34 1/2	DA51306AB	6-350MCM	NLAB440AB	592	161	DA61210	46 1/2	DA51310AB
42	225	6-250MCM	NLAB442L	353	95	DA51206	34 1/2	DA51306AB	6-350MCM	NLAB442AB	605	162	DA61210	46 1/2	DA51310AB

*Price includes 15-amp branch breakers. 20, 30, 40 and 50 amp ratings also available at no increase in price.

†All boxes are 20 in. wide by 4 1/2 in. deep, except as noted. For outside dimensions, add 1/4 in. to dimensions shown. Boxes provided with knockouts.

‡Box is 5 3/4 in. deep.

1. Space for future circuits—select panel-board as if all circuits were required. A price deduction of \$3.60 is allowed for each single-pole breaker omitted and space provided.

2. Double-pole breakers can be provided as follows:

Class A, Type TQ circuit breakers, 15 to 50 amps—Convert the 2-pole breakers to equivalent number of single-pole breakers. Select panel having total no. of single-pole breakers required and add as follows:

Independent trip type—Add handle extension to two adjacent breakers at \$0.50 for each 2-pole breaker.

Common trip type—For each 2-pole (common trip) breaker substituted for two single-pole breakers add \$6.30.

3. Two, and/or three-pole circuits using Class C, Type TE circuit breakers:

15 to 50 amps—Select the Type NLAB panelboard having required no. of Class A (Type TQ) breakers. Add \$32.50 for each 2-pole, Class C (Type TE) breaker and \$47.50 for each 3-pole, Class C (Type TE) breaker required.

70 to 100 amps—Not more than two breakers per panel are allowed and they must be furnished as sub-feed breakers. Add \$52.50 for each 2-pole breaker and \$69.00 for each 3-pole breaker.

G-E Lighting Panelboards Type NLP Panel Base Assemblies (Trumbull)

6 to 42 Circuits

Lugs or Circuit Breakers in Mains

(Listed by Underwriters' Laboratories as panel base assemblies under File E-24521; comply with U. S. Federal Spec. W-P-131a, Class A)

3 Wire, 120/240 Volts A.C., Solid Neutral

4 Wire, 120/208Y Volts A.C., Solid Neutral

Type NLP panels are standard-duty panel assemblies designed for control and protection of 2-wire, 120-volt lighting and appliance circuits. For A.C. only. Plug-in branch circuit breakers and unit packaging provide for flexibility in stock handling.

Box and panel interior are packaged as one unit; dual-purpose or surface front as a second unit; and plug-in circuit breakers as third unit.

Assemblies are furnished only as listed. No modifications are available.

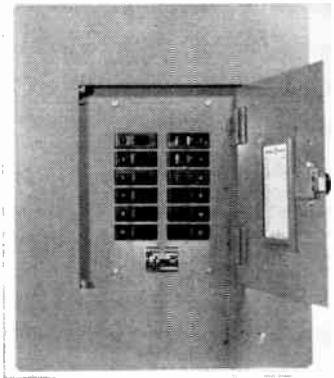

Type NLP with breakers

provided by using two single-pole Type R or TQL circuit breakers with handle extensions, permitting simultaneous manual operation but independent tripping of each pole or by 2-pole, common-trip circuit breakers, Type TQL.

Description

Panel Interior and Box: Unit-type interior mounted on reinforced back plate with panel bushing arranged to maintain sequence phasing. Bus bars and connection straps supported by thermal-setting plastic insulators, each accommodating six branch circuits. Solderless main lugs. Code-gage galvanized steel box with 4 in. wiring gutters and ample knockouts. Special knockout arrangements not available.

Fronts: Code-gage sheet steel, ASA No. 49 medium-light-grey enamel finish over rust inhibitor, single door with heavy-duty semi-concealed steel hinges and cylinder tumbler combination catch and lock, and directory card and card holder inside door. Choice of dual-purpose or surface front.

Circuit Breakers: Plug-in single-, two- and three-pole circuit breakers used in branches.

Interrupting rating of 5000 amps RMS. Double-pole branch circuit breakers can be provided by using two single-pole Type R or TQL circuit breakers with handle extensions, permitting simultaneous manual operation but independent tripping of each pole or by 2-pole, common-trip circuit breakers, Type TQL.

Ratings, Dimensions, and Prices

3-Wire, Single-Phase, 120/240 Volts A.C., Solid Neutral, Lugs Only in Mains

Max. No. Single Pole Breakers	Main Amp	Main Lug Size	Cat. No.	Box and Interior Unit, Less Breakers			Approx. Ship. Wt. Lb.	Front		Approx. Ship. Wt. Lb.
				Each	Wid.	Box Dimensions in Inches † Ht. Dep.		Dual Purpose Cat. No.	Surface Cat. No.	
6	100	14-1/0	DB1A306LE	\$ 44	14	18 4 1/2	12	DB1A2F	DB1A2S	\$23 13
12	100	14-1/0	DB1A312LE	53	14	18 4 1/2	14	DB1A2F	DB1A2S	23 13
18	100	14-1/0	DB1A318LE	64	14	21 4 1/2	19	DB1A3F	DB1A3S	24 15
20	100	14-1/0	DB1A320LE	65	14	27 4 1/2	22	DB1A5F	DB1A5S	26 19
24	219	6-250MCM	DB1A324LE	75	14	27 4 1/2	29	DB1A5F	DB1A5S	26 19
30	219	6-250MCM	DB1A330LE	83	14	30 4 1/2	34	DB1A6F	DB1A6S	27 21
36	219	6-250MCM	DB1A336LE	91	14	33 4 1/2	37	DB1A7F	DB1A7S	28 23
42	219	6-250MCM	DB1A342LE	98	14	36 1 1/2	42	DB1A8F	DB1A8S	30 25

3-Wire, Single-Phase, 120/240 Volts A.C., Solid Neutral, 2-Pole Breaker in Mains †

6	50*	14-4	DB1A306BE	\$ 85	14	24 4 1/2	32	DB1A4F	DB1A4S	\$25 17
10	50*	14-4	DB1A310BE	91	14	24 4 1/2	34	DB1A4F	DB1A4S	25 17
12	100*	14-1	DB1A312BE	104	14	24 4 1/2	35	DB1A4F	DB1A4S	25 17
18	100*	14-1	DB1A318BE	115	14	27 4 1/2	39	DB1A5F	DB1A5S	26 19
20	100*	14-1	DB1A320BE	116	14	33 4 1/2	44	DB1A7F	DB1A7S	28 23
24	225*	6-350MCM	DB1A324BE	278	20	40 1/2 5 3/4	96	DA51308AB	DA51408AB	28 26
30	225*	6-350MCM	DB1A330BE	285	20	43 1/2 5 3/4	97	DA51309AB	DA51409AB	30 28
36	225*	6-350MCM	DB1A336BE	292	20	46 1/2 5 3/4	98	DA51310AB	DA51410AB	32 30
42	225*	6-350MCM	DB1A342BE	298	20	49 1/2 5 3/4	99	DA51311AB	DA51411AB	35 32

4-Wire, 3-Phase, 120/208Y Volts A.C., Solid Neutral, Lugs Only in Mains

6	100	14-1/0	DB1A406LE	\$ 54	14	18 4 1/2	13	DB1A2F	DB1A2S	\$23 13
12	100	14-1/0	DB1A412LE	63	14	18 4 1/2	15	DB1A2F	DB1A2S	23 13
18	100	14-1/0	DB1A418LE	74	14	21 4 1/2	20	DB1A3F	DB1A3S	24 15
20	100	14-1/0	DB1A420LE	75	14	27 4 1/2	23	DB1A5F	DB1A5S	26 19
24	100	14-1/0	DB1A424LE	81	14	27 4 1/2	30	DB1A5F	DB1A5S	26 19
30	100	14-1/0	DB1A430LE	89	14	30 4 1/2	36	DB1A6F	DB1A6S	27 21
36	219*	6-250MCM	DB1A436LE	104	14	33 4 1/2	39	DB1A7F	DB1A7S	28 23
42	219*	6-250MCM	DB1A442LE	111	14	36 4 1/2	44	DB1A8F	DB1A8S	30 25

4-Wire, 3-Phase, 120/208Y Volts A.C., Solid Neutral, 3-Pole Breaker in Mains †

6	50*	14-4	DB1A406BE	\$100	14	24 4 1/2	35	DB1A4F	DB1A4S	\$25 17
12	50*	14-4	DB1A412BE	109	14	24 4 1/2	37	DB1A4F	DB1A4S	25 17
18	100*	14-1	DB1A418BE	141	14	27 4 1/2	42	DB1A5F	DB1A5S	26 19
20	100*	14-1	DB1A420BE	142	14	33 4 1/2	47	DB1A7F	DB1A7S	28 23
24	100*	14-1	DB1A424BE	148	14	33 4 1/2	54	DB1A7F	DB1A7S	28 23
30	100*	14-1	DB1A430BE	155	14	36 4 1/2	62	DB1A8F	DB1A8S	30 25
36	225*	6-350MCM	DB1A436BE	352	20	46 1/2 5 3/4	108	DA51310AB	DA51410AB	32 30
42	225*	6-350MCM	DB1A442BE	358	20	49 1/2 5 3/4	109	DA51311AB	DA51411AB	35 32

*Rating of main breaker in amp.

†For outside dimensions, add 1/4 in. to dimensions shown.

‡Also suitable for use as service entrance equipment.

Handle extensions for two single-pole circuit breakers to provide double-pole manual operation with independent tripping. Cat. No. DAHT102.

Knockout closure for single-pole plug-in circuit breaker, Cat. No. DNC-100.

Handle locking device for locking circuit breaker in ON or OFF position, non-paddocking, for plug-in circuit breakers, Cat. No. DAHL-103. For E-frame circuit breakers Cat. No. DLDI.

Branch Circuit Breakers

Rating	Single Pole, Type TQL 120V A-C		2-pole, Type TQL 120/240V A-C		2-pole, Type TQL 240V A-C		3-pole, Type TQL 240V A-C	
	No.	List Price Each	No.	List Price Each	No.	List Price Each	No.	List Price Each
10	TQL1110	\$3.50	TAL2110	\$6.90				
15	TQL1115	3.50	TQL2115	6.90	TQL22015	\$18.00	TQL32015	\$22.00
20	TQL1120	3.50	TQL2120	6.90	TQL22020	18.00	TQL32020	22.00
30	TQL1130	3.50	TQL2130	6.90	TQL22030	18.00	TQL32030	22.00
40	TQL1140	3.50	TQL2140	6.90	TQL22040	18.00	TQL32040	22.00
50	TQL1150	3.50	TQL2150	6.90	TQL22050	18.00	TQL32050	22.00

Note: Single Pole, Type R, 120-Volt A-C available.

G-E Distribution Panelboards

Type CCB Convertible Circuit Breaker

15-800 Amp Molded Case Breakers

(Trumbull)

Maximum 600 Volts A.C., 250 Volts D.C.

(Listed by Underwriters' Laboratories as panelboards under File E-2366. Comply with U. S. Federal Specification W-P-131A, Classes A, C, D, and E)

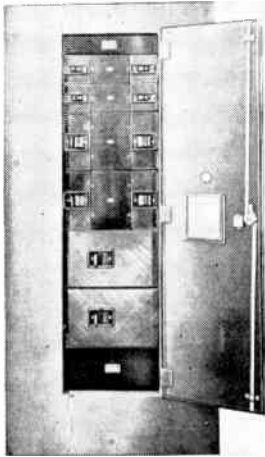

Type CCB panelboard with four E frame breakers at top, four J frame breakers in middle & two K frame breakers at bottom as branch circuits.

Type CCB is a heavy-duty panel-board designed for distribution of power from main feeders to power loads, to other distribution panelboards, and to lighting panelboards. For service where rating of mains does not exceed 1200 amps. when lugs are used or 800 amps. when circuit breaker mains are used. Suitable for 600-v a.c. or 250-v d.c. service, 2- or 3-wire, single-phase, or d.c., 3- or 4-wire, 3-phase applications.

Unitized construction of Type CCB permits easy expansion to meet future requirements. New circuits can be added without removing panel from box.

Description

Molded case heavy-duty circuit breakers used in branch circuits, and in mains (if required). Breakers are quick-make, quick-break, trip-free, trip-indicating with thermal-magnetic tripping mechanism.

Interrupting Ratings: The lowest-rated breaker in the panel-board determines the rating of the panel-board. The following interrupting ratings for G-E molded case circuit breakers are based on NEMA test procedures:

Frame Type	240-V A.C. RMS Amperes	480-V A.C. RMS Amperes	600-V A.C. RMS Amperes	250-C D.C. Amperes	125/250-V D.C. Amperes
TE*	7,500	5,000
TF	20,000	15,000	15,000	10,000	10,000
TJ	25,000	20,000	15,000	10,000	10,000
TKM	50,000	35,000	25,000	20,000	20,000

*Ratings shown are for 1- 2- and 3-pole breakers. The 277-volt, single-pole breaker is rated 10,000 amps a.c. or d.c.

Mains: Max. 1200 amp. lugs or 800 amp. molded case circuit breakers.

Branches: Molded case breakers in six types—E Frame - 15 to 100 amp; 1, 2, and 3 pole F Frame - 15 to 100 amp; 2 and 3 pole J and K Frame - 70 to 225 amp; 2 and 3 pole KM Frame - 125 to 800 amp; breakers have sealed interchangeable trip units.

Boxes: Code-gage galvanized sheet steel with ample code-size wiring gutters. Furnished as standard without knockouts.

Fronts: Code-gage sheet steel, finished in ASA No. 49 medium-light-grey enamel finish over rust inhibitor, single door with heavy-duty flush hinges and cylinder tumbler combination catch and lock, directory inside door. Surface-type front furnished as standard.

Modifications Sub-Feed, Double, or Feed-Thru Lugs

No. of Bus Bars	200 Amps	400 Amps	600 Amps	800 Amps	1200 Amps
2	\$18	\$37	\$65	\$ 92	\$110
3	24	43	72	102	120

Split Bus or Meter Loop (Including Lugs)*

	2	3	4	5	6
	\$46	\$55	\$65	\$ 92	\$110
	55	65	72	102	119

*Price of split bus or meter loop is based on size and no. of poles of separately controlled or metered section, and not on mains of panelboard. For increased dimensions, refer to Company.

Dimensions

- Determine the total "X" units of ht. Be sure to include "X" units for top and bottom sections if required. Each "X" unit equals 1 3/8 in.
- Note that circuits 225 amps. or less (except K frame) are arranged double branch.
- Select box size from table below. Note box width and depth shown in table. Specify cat. no. of box.
- Select appropriate front from same table. Specify cat. no. Panelboards are furnished with front for surface mounting as standard. Where flush-mounting front is required, please specify. Change suffix letter in cat. no. from S to F. No change in price.

Boxes and Fronts

Total "X" Heights	Box Height Inches*	Box 31 In. Wide by 9 1/2 In. Deep*				Box 35 In. Wide by 11 1/2 In. Deep*			
		Boxes		Fronts		Boxes		Fronts	
		No.	Each ‡	No. †	Each ‡	No.	Each ‡	No. †	Each ‡
15X	32 7/8	DASW 3109	\$ 56	DACB3109S	\$ 43	DACB3509	\$ 62	DACB3509S	\$ 51
18X	37	DASW 3112	62	DACB3112S	48	DACB3512	68	DACB3512S	56
21X	41 1/8	DASW 3115	68	DACB3115S	53	DACB3515	74	DACB3515S	61
24X	45 1/4	DASW 3118	74	DACB3118S	58	DACB3518	80	DACB3518S	66
27X	49 3/8	DASW 3121	84	DACB3121S	68	DACB3521	90	DACB3521S	76
30X	53 1/2	DASW 3124	90	DACB3124S	73	DACB3524	96	DACB3524S	81
33X	57 5/8	DASW 3127	96	DACB3127S	78	DACB3527	102	DACB3527S	86
36X	61 3/4	DASW 3130	102	DACB3130S	83	DACB3530	108	DACB3530S	91
39X	65 7/8	DASW 3133	108	DACB3133S	88	DACB3533	114	DACB3533S	96
42X	70	DASW 3136	114	DACB3136S	93	DACB3536	120	DACB3536S	101
45X	74 1/8	DASW 3139	120	DACB3139S	98	DACB3539	126	DACB3539S	106
48X	78 1/4	DASW 3142	126	DACB3142S	103	DACB3542	132	DACB3542S	111
51X	82 3/8	DASW 3145	132	DACB3145S	108	DACB3545	138	DACB3545S	116

*For outside box dimensions, add 1/4 in. to dimensions shown. Box ht. includes both top and bottom gutters.

†Cat. no. fronts are for surface mounting. Flush fronts available at same price. Change suffix letter S to F.

‡List prices apply only when box or front is ordered separately.

Sheet metal gage of boxes and fronts (U/L standards) are as follows: DASW3109-18, DACB3509-15 and DACB4009-12 boxes and respective fronts . . . 12 gage; all other boxes and fronts . . . 10 gage.

G-E Distribution Panelboards

Type CCB Convertible Circuit Breaker

15-800 Amp Molded Case Breakers

(Trumbull)

Maximum 600 Volts A.C., 250 Volts D.C.

Pricing Information

Type CCB panelboards are not listed by cat. no. because of the wide range of combinations available. The desired panelboard is priced from the table below. The total list price of the panelboard, including box and front, is the sum of the prices for the following items:

1. Neutral bar (if required). Select rating the same as the mains.

2. Branch circuits (note that list prices are "per circuit" but circuits 225 amps. or less, except TK-frame, are arranged in double branch construction.

3. Base list price, main lugs or main circuit breaker.

4. Additions for modifications.

Each..... Units of Ht.*, 4-wire, 3-phase.....	End Section With or Without Neutral		No Neutral ¹	Rating of Neutral Bar in Amperes					
			None	200 or Less	400	600	800	1200	
			2X	\$25	\$32	\$46	\$65	\$77	
				2X	4X	6X	6X	8X	
240 Volts, A.C., 125/250 Volts A.C.									
Branch Circuits	No. of Poles	Unit of Height	Frame Size	Per Circuit	Space Only	Frame Size	600 Volts A.C., 250 Volts D.C. Per Circuit	Space Only	
15, 20, 30, 40, 50 Amp	1	1X	E	\$ 19.50 †	\$5.50 †	F †	\$22.00 §	\$5.50 §	
	2	2X	E	39.00	6.50	F †	71.00	6.50	
	3	3X	E	56.00	8.50	F †	92.00	8.50	
70, 100 Amp	1	1X	E	29.00	5.50	F †	Not Available		
	2	2X	E	57.00	6.50	F †	87.00	6.50	
	3	3X	E	75.00	8.50	F †	108.00	8.50	
70, 100, 125, 150, 175, 200, 225 Amp	2	6X	J ¶	218.00	13.00	J ¶	218.00	13.00	
	3	6X	J ¶	276.00	18.50	J ¶	276.00	18.50	
	2	4X	K	246.00	24.00	K	246.00	24.00	
	3	6X	K	318.00	37.00	K	318.00	37.00	
250, 300, 350, 400 Amp	2	6X	KM	459.00	37.00	KM	459.00	37.00	
	3	6X	KM	584.00	37.00	KM	584.00	37.00	
450, 500, 550, 600 Amp	2	6X	KM	566.00	37.00	KM	566.00	37.00	
	3	6X	KM	731.00	37.00	KM	731.00	37.00	
700-800 Amp	2	6X	KM	737.00	37.00	KM	737.00	37.00	
	3	6X	KM	953.00	37.00	KM	953.00	37.00	

Main Lugs Only (All Voltages)	Units of Height*	Largest Branch Circuit, Each			
		225 Amp E, F, J, or K-Frame	400 Amp KM-frame	600 Amp KM-frame	800 Amp KM-frame
200 Amp (6-250 MCM lugs)	2X	\$ 86			
400 Amp (2-#6-250 MCM lugs)	4X	108	140		
600 Amp (500-1000 MCM lugs)	6X	140	173	\$208	
800 Amp (2-1/0-500 MCM lugs per pole)	6X	173	208	273	\$347
1200 Amp (2-500-1000 MCM lugs per pole)	8X	238	273	347	430

Main Circuit Breaker	250 Volts A.C., 125/250 Volts D.C.			600 Volts A.C., 250 Volts D.C.				
	2-Pole	3-Pole	Frame Size	2-Pole	3-Pole	Frame Size	2-Pole	3-Pole
15, 20, 30, 40, 50 Amp	4X	5X	E	\$125	\$142	F †	\$157	\$178
70, 100 Amp	4X	5X	E	143	161	F †	173	194
125, 150, 175, 200, 225 Amp	8X	8X	J ¶	304	362	J ¶	304	362
125, 150, 175, 200, 225 Amp	6X	8X	K	332	404	K	332	404
250, 275, 300, 350, 400 Amp	8X	8X	KM	599	724	KM	599	724
500, 600 Amp	8X	8X	KM	774	939	KM	774	939
700, 800 Amp	8X	8X	KM	1084	1300	KM	1084	1300

Note: X—1 3/8 inches.

*Height of end sections includes necessary space to provide larger wiring gutter. All wiring gutters conform to Underwriters' Laboratories standards.

†F-frame branch breakers can be located opposite each other, either 2- or 3-pole (double-branch construction), except that no breaker can be placed opposite an F-frame breaker which is serving as a main breaker.

‡Branch breaker, single-pole, with frame rated 125 volts a.c./d.c. maximum.

§Single-pole, E-frame breaker rated 277 volts a.c. with 15- or 20-amp trips only available.

¶Only J-frame breakers or blank fillers can be mounted opposite J-frame breakers in double-branch construction.

Ordering Directions

The following information should be included when ordering:

1. Service characteristics: wires, phase, voltage, a.c. or d.c.
2. Mains: Ampere rating, type (lugs or breakers), incoming wire size and location (top or bottom).

3. Branches: quantity, ampere rating, number of poles and frame type.
4. Neutral connections, if any.
5. Modifications.
6. Mounting: flush or surface.
7. Any special arrangement instructions.

G-E Distribution Panelboards

Type NCB Convertible Circuit Breaker (Trumbull)

15-100 Amp E-Frame Branch Breakers

(Listed by Underwriters' Laboratories as panelboards under File E-2366. Comply with U. S. Federal Specifications W-P-131a, Classes A and C)

Maximum 240 Volts A.C., 125/250 Volts D.C.

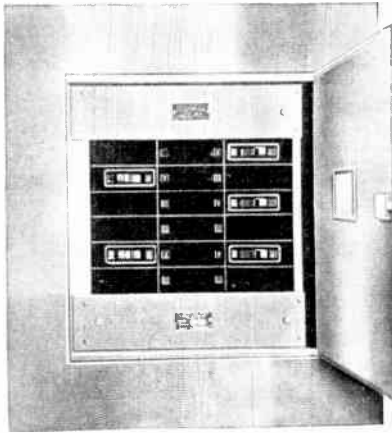

Type NCB with two 3-pole breakers on left side and one single-pole, one 2-pole, and one 3-pole breaker on right side as branch circuits.

A heavy-duty panelboard designed for distribution of power from main feeders to power loads, to other distribution panelboards, and to lighting panelboards. Designed for service where rating of mains does not exceed 600 amps, when lugs are used or 400 amps, when circuit breaker mains are required. Suitable for maximum 240 volt a.c., or 125/250 volt d.c. service, single-phase or d.c., 2- or 3-wire, or three-phase, 3- or 4-wire applications.

Description

Panel Interior: Heavy-duty circuit breakers used in branch circuits and in mains (if required). Breakers are quick-make, quick-break, trip-free, trip-indicating, with thermal-magnetic tripping mechanism.

Mains: Maximum 600 amp. lugs or 400 amp. circuit breakers.

Branches: 15- to 100-ampere, 1-, 2-, and 3-pole Type TE breakers (E frame) with interrupting rating of 7500 amps. RMS, a.c. or 5000 amps. d.c.

Boxes: Code-gage galvanized sheet steel with code-size wiring gutters (minimum 4-inch) and ample knockouts.

Fronts: Code-gage sheet steel, finished in ASA No. 49 medium-light-grey enamel over a rust inhibitor, single door with heavy-duty flush hinges and cylinder tumbler combination catch and lock, directory inside door. Dual-purpose front furnished as standard.

Pricing Information

The total list price of the panelboard, including box and front is the sum of the prices for the following items:

1. Neutral bar (if required). Select rating the same as the mains.
2. Branch circuits (note that list prices are "per circuit" but circuits are arranged in double branch construction).
3. Base list price, main lugs or main circuit breaker.
4. Additions for modifications.

End Section With/Without Neutral	Each	Ht. in.*
No Neutral.....	None	3
100 Amp Neutral Bar Max.....	\$20.00	3
225 Amp Neutral Bar.....	25.00	3
400 Amp Neutral Bar.....	32.00	3
600 Amp Neutral Bar.....	46.00	3

	2 Pole	3 Pole	Ht. in.*
100 Amp Feed-Thru Lugs (#14-1/0).....	\$11.00	\$16.00	3X
225 Amp Feed-Thru Lugs (#6-250MCM).....	11.00	16.00	3X
400 Amp Feed-Thru Lugs (2-#6-250MCM).....	32.00	40.00	3X
1—J-frame Subfeed Breaker 70, 100, 125, 150, 175, 200, 225 Amp	218.00	27.60	10X
2 (Max.) J-frame Subfeed Breakers			16X

Dimensions

Determine the total "X" units of height. Be sure to include extra "X" units for top and bottom sections if required. Each "X" unit equals 1 3/8 inches. Note that all circuits are arranged in double-branch construction.

Select box size from table below. Note box width and depth shown.

Panels with Max. 225 Amp Main Lugs or Breakers		Panels with Max. 600 Amp Main Lugs or 400 Amp Main Breaker	
Total "X" Ht.	Box Ht. in.	Total "X" Ht.	Box Ht. in.
2	16 1/2	5	24 5/8
4	19 1/2	10	31 3/4
6	22 1/2	15	38 7/8
8	25 1/2	20	46
10	28 1/2	25	53 1/8
12	31 1/2	30	60 1/4
14	34 1/2	35	67 3/8
16	37 1/2	40	74 1/2
18	40 1/2		
20	43 1/2		
22	46 1/2		
24	49 1/2		
26	52 1/2		
28	55 1/2		
30	58 1/2		
32	61 1/2		
34	64 1/2		

Type TQ and TQ1 breakers rated 10, 15, 20, 30, 40, or 50 amp, a.c. only, can be supplied mounted in Type NCB panelboards. Minimum 4 single-pole or 2 double-pole. Refer to Graybar for panel dimensions.

Branch Circuits	Trip	Frame	Poles	Per Circuit	Space Only†	Ht. in.*
15, 20, 30, 40, 50 Amp	E	1	1	\$13.50	\$4.00	1X
15, 20, 30, 40, 50 Amp	E	2	2	32.50	6.50	2X
15, 20, 30, 40, 50 Amp	E	3	3	47.50	8.50	3X
70, 100 Amp	E	1	1	26.00	4.00	1X
70, 100 Amp	E	2	2	52.50	6.50	2X
70, 100 Amp	E	3	3	69.00	8.50	3X

Lugs in Mains			Circuit Breaker in Mains					
Main Capacity Amps	Lug Wire Size AWG Per Leg	No. of Poles	Space Re-quired	Lug Wire Size AWG Per Leg	No. of Poles	Frame	Each	Space Re-quired
50	1-#14-1/0	2	\$56.00	3"	1-#14-4	2 E	\$89.00	3" †
		3	67.00			3 E	115.00	
100	1-#14-1/0	2	56.00	3"	1-#14-1	2 E	109.00	3" †
		3	67.00			3 E	136.00	
225	1-#6-250 MCM	2	60.00	3"	1-#6-350 MCM	2 J	265.00	3"
		3	73.00			3 J	325.00	plus 8X
400	2-#6-250 MCM	2	82.00	3"	2-#3/0-250 MCM	2 KL	507.00	3"
		3	97.00			3 KL	627.00	plus 14X
600	2-#1/0-500 MCM	2	104.00	3"	Not Available			
		3	119.00					

*Height of end sections includes necessary space to provide larger wiring gutters. All wiring gutters conform to Underwriters' Laboratories standards.

†Price includes necessary straps and mounting provisions for future breakers.

‡Allow space for E-frame main breaker of required no. of poles in branch circuit section of panel in same manner as for a branch circuit.

Bulldog Duo-Guard® Pushmatic® Circuit Breakers

Pushbutton Convenience Bolt-Tight Connection Pushmatic Protection

Listed by Underwriter's Laboratories, Inc. Capacities: 15, 20, 30, 40, 50 amperes at 120 V. AC Single Pole; 15, 20, 30, 40, 50 amperes at 120/240 V. AC Two Pole Common Trip. Short Circuit Interrupting capacity: 5000 amperes.

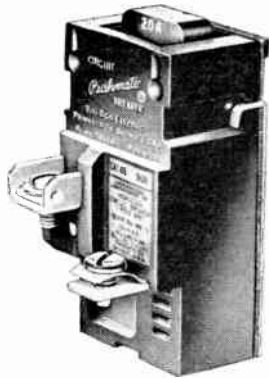

Pushmatics are small, compact, single and two pole (common trip) devices for controlling and protecting electric circuits. Their operation is simple. A slight push of the single operating button switches the circuit either "ON" or "OFF". Another push, ONE MOTION, restores service after automatic tripping without any intermediate reset procedure. With Pushmatic there is only one operating rule: Push the Button.

Ambient compensated Pushmatics (single pole only) employ an additional thermal element that automatically compensates for the effects of the surrounding air temperatures on the main thermal element. Constant tripping characteristics are maintained over a broad range of ambient temperatures (30° F. to 150° F.).

Single Pole Pushmatic shown at right.

Two Pole—Common Trip—Pushmatic, left.

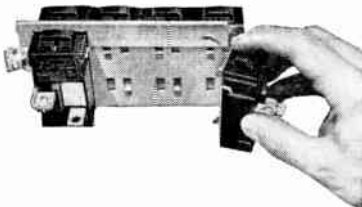
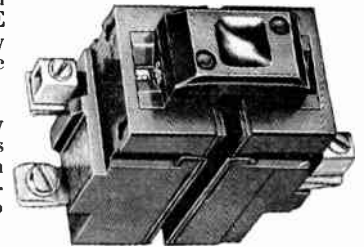

To add or change Pushmatic units they are merely hooked on mounting rib.

Easy to Install or Change

A screwdriver is all that is needed to remove or attach a Pushmatic to any point along the mounting rib. Disconnect service, raise locking bar on mounting rib, remove wiring from the Pushmatic and remove Pushmatic. To install or replace, the procedure is merely reversed. Both operations are easily and quickly made.

The extreme compactness of the Pushmatic means that more space is available in the cabinet for uncluttered wiring. If more space is required, the adjustable interior may be raised on its mounting posts until it is completely out of the cabinet, providing unlimited wiring space.

Wiring, itself, is easy. The "line" side of the Pushmatic is quickly attached to the tapped silvered bus bars by a screw with a smooth pointed leader. Threads quickly align themselves without unnecessary fumbling. The "load" side terminal consists of a washer-head screw with a deep, rugged slot. The branch circuit wire is inserted straight into the terminal that can be tightened down without fear of destroying the slot.

Single Pole Duo-Guard Pushmatic Units

No.	Without Ambient Compensator		No.	With Ambient Compensator	
	Amps.	Each		Each	Each
31115*	15	\$3.10	41115	\$3.50	
31120*	20	3.10	41120	3.50	
31130**	30	3.10	41130	3.50	
31140**	40	3.10	41140	3.50	
31150**	50	3.10	41150	3.50	

*100 in a std. pkg.; Wt. 28 lbs.

**50 in a std. pkg.; Wt. 14 lbs.

Two Pole — Common Trip — Duo-Guard Pushmatic Units

No.	Amps.	Each
31215	15	\$6.90
31220	20	6.90
31230	30	6.90
31240	40	6.90
31250	50	6.90

25 in a std. pkg.; Wt. 15 lbs.

Bulldog Pushmatic Accessories

No.	Standard Package	Handle Locking Devices	Standard Package Weight, Lbs.	Each
PHL-1	10		1/4	\$0.20
PHL-2	5		1/8	.30
Two-Pole Tie Handles				
PTH-3	40		2	.30
PTH-2	40		2	.30
Filler Plates				
FFP-2	100		7	.10
Enclosing Doors (P1 Panels Only)				
PMD-20	5		13	8.50
PMD-24	5		16	9.50

Pull Boxes

No.	Description	Wt., Lbs.	Each
NTB2448	Top Mounted	26	\$28.00
NFB56	Front Mounted	25	28.00

Wireway Extensions

No.	Size, In.	Wt., Lbs.	Each
NEX24	24 Extension	15	\$19.00
NEX48	48 Extension	30	37.00
NEX2548	25-48 Adj. Extension	31	37.00
NEX56	56 Extension	34	38.00

Bulldog Duo-Guard® Pushmatic® Electri-Centers®
Pushbutton Convenience with Pushmatic Protection
and Bolt-Tight Connection

Listed by Underwriters' Laboratories, Inc.

2-Circuit (Max.)



3-Wire, 120/240 V. A-C
Insulated (Groundable) Neutral
Main Lugs 40 Amps. (Max.)

BASIC DEVICE consists of BOX, FRONT AND INTERIOR, but NO PUSHMATICS or FILLER PLATES.

No.	Item	Wt., Lbs.	Each
2000F	2-Cir. Flush Front	3	\$4.00
2000S	2-Cir. Surface Front	3	3.30

Box 8¼-in. high, 6-in. wide, 3¼-in. deep.

4-Circuit (Max.)

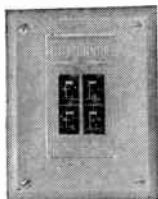

3-Wire, 120/240 V. A-C
Insulated (Groundable) Neutral
Main Lugs 50 Amps. (Max.)

BASIC DEVICE consists of BOX, FRONT AND INTERIOR, but NO PUSHMATICS or FILLER PLATES.

No.	Item	Wt., Lbs.	Each
4000F	4-Cir. Flush Front	5	\$5.80
4000S	4-Cir. Surface Front	5	5.80

Box 8¼-in. high, 6-in. wide, 3¼-in. deep

8-Circuit (Max.)

3-Wire, 120/240 V. A-C

Insulated (Groundable) Neutrals
Main Lugs 70 Amps. (Max.)



6100F

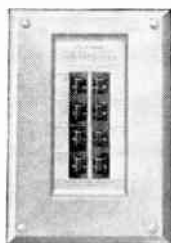

8100F

BASIC DEVICE consists of BOX, FRONT and INTERIOR, but NO PUSHMATICS or FILLER PLATES.

No.	Item	Wt., Lbs.	Each
6100F	6-Cir. Flush Front	8	\$8.70
6100S	6-Cir. Surface Front	8	8.70
8100F	8-Cir. Flush Front	8	11.60
8100S	8-Cir. Surface Front	8	11.60

Box 12-in. high, 7½-in. wide, 3½-in. deep.
 Ten in a standard package.

14 & 20 Circuit Electri-Centers

14-Circuit (Max.)

Main Lugs 100 Amps.

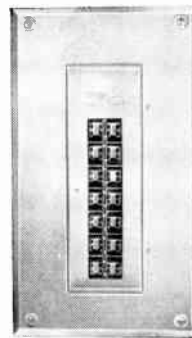

P1-14-3L



P1-20-3LF

BASIC DEVICE consists of BOX, FRONT and INTERIOR, but NO PUSHMATICS or FILLER PLATES.

1-Phase, 3-Wire, Solid Neutral, 120/240 V. A-C

No.	Item	Wt., Lbs.	Each
P1-14-3LF	14-Cir. Flush Front	20	\$20.30
P1-14-3LS	14-Cir. Surface Front	20	20.30

See table immediately below for Doors.

3-Phase, 4-Wire, Solid Neutral, 120/208 V. A-C

No.	Item	Wt., Lbs.	Each
P1-14-4LF	14-Cir. Flush Front	20	\$30.30
P1-14-4LS	14-Cir. Surface Front	20	30.30

Box — 20¼-in. high, 10¾-in. wide, 3¾-in. deep.

20-Circuit (Max.)

Main Lugs 100 Amps.

BASIC DEVICE consists of BOX, FRONT AND INTERIOR, but NO PUSHMATICS or FILLER PLATES.

1-Phase, 3-Wire, Solid Neutral, 120/240 V. A-C

No.	Item	Wt., Lbs.	Each
P1-20-3LF	20-Cir. Flush Front	22	\$29.00
P1-20-3LS	20-Cir. Surface Front	22	29.00

See table immediately below for Fronts.

3-Phase, 4-Wire, Solid Neutral, 120/208 V. A-C

No.	Item	Wt., Lbs.	Each
P1-20-4LF	20-Cir. Flush Front	22	\$39.00
P1-20-4LS	20-Cir. Surface Front	22	39.00

Box — 24¼-in. high, 10¾-in. wide, 3¾-in. deep.

*Prices do not include doors. See below for door prices.

Doors for 14- and 20-Circuit Electri-Centers

No.	Item	Std. Pkg. Wt., Lbs.	Std. Pkg. Wt., Lbs.	Each
PMD-20	14-Circuit	5	13	\$8.50
PMD-24	20-Circuit	5	16	9.50

Bulldog Duo-Guard Pushmatic Electri-Centers®

Pushbutton Convenience with Pushmatic Protection and Bolt-Tight Connection

Listed by Underwriters' Laboratories, Inc.

"PD" Panels

100 Ampere—14 & 20 Branch Circuits
1 Phase, 3 Wire—3 Phase, 4 Wire
120/240V. AC — 120/208V. AC

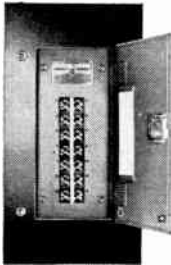

Type PD Panel

Panel consists of box, front, and door. Has space and provisions for 11 or 20 1-Pole branch lighting Pushmatics or any approved combination of 1 Pole or 2 Pole Common Trip Pushmatics. Available with flush or surface front.

No.	Max. No. Br. Cir.	Wt. Lbs.	Each
PD-14-3L	14	31	\$ 79.00
PD-20-3L	20	35	91.00
PD-14-4L	14	31	89.00
PD-20-4L	20	35	101.00

Dimen. In.,

14 Cir. Box: 20¼ x 10¾ x 3¾
20 Cir. Box: 21¼ x 10¾ x 3¾

"P2" Panels

100 & 200A.—28 & 40 Branch Circuits. 1 Phase, 3 Wire — 3 Phase 4 Wire. 120/240 V. AC — 120/208 V. AC



Type P2 Panel

Panel consists of box, front, interior & door. Has space for 28 or 40 1 Pole Branch lighting Pushmatics or any approved combination of 1 Pole or 2 Pole Common Trip Pushmatics. Available with flush or surface front.

Dimen. In.:

28 Cir. Box: 26 x 20 x 5½
30 Cir. Box: 32 x 20 x 5½

No.	Max. No. Br. Cir.	Approx. Ship. Wt., Lbs.	Amp. Mains	Each
P2-28-3L	28	70	200	\$107.00
P2-40-3L	40	86	200	125.00
P2-28-4L	28	70	100	113.00
P2-40-4L	40	86	200	138.00

"NP" Panels

100 & 175 Ampere—
16-24-32 Branch Circuits. 1 Phase, 3 Wire—
3 Phase, 4 Wire. 120/240V. AC—120/208V. AC

Wire. 120/240V. AC—120/208V. AC

Panel consists of box, front and interior. Has space and provisions for 16, 24 or 32 1-Pole Branch lighting Pushmatics, or any approved combinations of 1 Pole or 2 Pole Common Trip Pushmatics. Available with flush or surface front.

No.	Max. No. Br. Cir.	Amp. Mains	Approx. Ship. Wt., Lbs.	Each
NP-16-3L	16	100	55	\$ 85.00
NP-24-3L	24	175	60	101.00
NP-32-3L	32	175	65	113.00
NP-16-4L	16	100	55	95.00
NP-24-4L	24	100	60	107.00
NP-32-4L	32	175	65	126.00

Box Dimensions, Inches:

16 Cir.: 36 x 6¾ x 6⅝
24 Cir.: 42 x 6¾ x 6⅝
32 Cir.: 48 x 6¾ x 6⅝

Type P2B

Complete Factory Assembled

Single Phase, 3-Wire, Solid Neutral, 120/240 Volts A-C

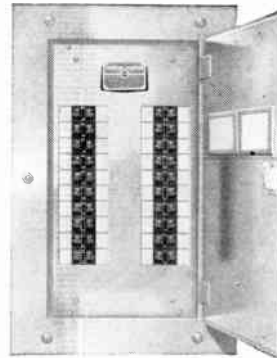

Type P2B Panel

Designed to provide group phasing of 1-pole branch circuits. Where 2-pole branches are required a tie-handle is available for joining two horizontally adjacent 1-pole Pushmatics.

Ideally suited for installation where available space requires a compact control center having a minimum height. (See table for heights).

Mains: Lugs only (Solderless Wire Grips).

Branches: 1-pole, 15-amp. 120 volt Pushmatics, with Solid Neutral.

(20, 30, 40 or 50 amp. units may be specified; Price is same except when use of higher rated units necessitate increased mains.)

Boxes: Code gauge galvanized steel 20-in. wide, 5½-in. deep. Wiring gutters 4 in. (I. D.). Height indicated by numerals in box numbers.

Fronts: Code gauge steel, attractive gray finish.

Main Lugs Only

No.	Branch Circuits	Amps. Main	Box No.	Wt. Lbs.	Each
PDB12-4L	12	100	PD25	35	\$137.00
PDB14-4L	14	100	PD25	35	148.00
PDB16-4L	16	100	PD29	40	159.00
PDB18-4L	18	100	PD29	41	170.00
PDB20-4L	20	100	PD29	41	181.00
P2B22-4L	22	100	W26	77	192.00
P2B24-4L	24	100	W26	77	203.00
P2B26-4L	26	100	W26	78	214.00
P2B28-4L	28	100	W26	78	225.00
P2B30-4L	30	200	W32	94	243.00
P2B32-4L	32	200	W32	94	254.00
P2B34-4L	34	200	W32	95	265.00
P2B36-4L	36	200	W32	95	276.00
P2B38-4L	38	200	W32	96	287.00
P2B40-4L	40	200	W32	96	298.00

Main Circuit Breaker

PDB12-4AB	12	50	PD30	52	185.00
PDB14-4AB	14	50	PD30	52	196.00
PDB16-4AB	16	100	PD34	57	228.00
PDB18-4AB	18	100	PD34	58	239.00
PDB20-4AB	20	100	PD34	58	250.00
P2B22-4AB	22	100	W38	106	261.00
P2B24-4AB	24	100	W38	107	272.00
P2B26-4AB	26	100	W38	107	283.00
P2B28-4AB	28	100	W38	108	294.00
P2B30-4AB	30	100	W50	148	305.00
P2B32-4AB	32	200	W50	163	506.00
P2B34-4AB	34	200	W50	164	517.00
P2B36-4AB	36	200	W50	164	528.00
P2B38-4AB	38	200	W50	165	539.00
P2B40-4AB	40	200	W50	165	550.00

Note—Circuit identification adhesive strips supplement the regular directory frame on Electri-Center door. Each strip is divided into spaces the same height as face of Pushmatic unit, for writing positive and easy identification of each Pushmatic-controlled circuit.

Bulldog Duo-Guard® Pushmatic® Electri-Centers®

Pushbutton Convenience with Pushmatic Protection and Bolt-Tight Connection

Listed by Underwriters' Laboratories, Inc.

Service Entrance Panels

XD (Splitbus) Panels

100 Ampere—12 and 18 Branch Circuits

3-Wire, Single-Phase, Solid Neutral 120/240-Volt A-C

For residential and commercial use

Provide a separate lighting section controlled by a 2-pole, 50-amp. Commontrip Pushmatic. Ahead of, and independent of, the lighting section there is space for adding 2-pole 120/240 v. a-c Pushmatics for electric range, dryer, or similar sub-feed circuits.

Split bus feeds two separate sections of Pushmatic circuits as follows:

- (a) 1-pole, 120 v. a-c branch lighting circuits.
- (b) 2-pole, 120/240 v. a-c circuits for range, dryer or other appliances.

Panelboard consists of box, interior and front. Interior includes one 50A.

2-pole Commontrip Pushmatic lighting Main circuit Breaker.

Mains: 100 amp. wire grips.

12 Circuit Type: Has space and provisions for installing these additional circuits; two 2 Pole Pushmatics above Lighting Main, eight 1 Pole Pushmatics below Lighting Main.

Box 20 1/4-in. high, 10 3/4-in. wide, 3 3/4-in. deep.

18 Circuit Type: Has space and provisions for installing these additional circuits; four 2 Pole Pushmatics above Lighting Main; ten 1 Pole Pushmatics below Lighting Main.

Box 24 1/4-in. high, 10 3/4-in. wide, 3 3/4-in. deep.

No.	Max. No. of Branch Circuits	Type Front	Shipping Wt. Each, Lbs.	Each
XD-12-3S	12	Surface	19	\$32.20
XD-12-3F	12	Flush	19	32.20
XD-18-3S	18	Surface	22	40.90
XD-18-3F	18	Flush	22	40.90

Standard pkg. quantity, 1.

200 Ampere (Main Lug) — 18 Circuit

Single Phase, 3 Wire—120/240 V. AC

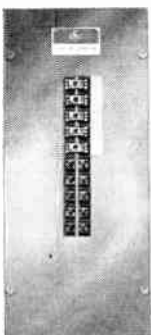

XD18-250

Panelboard consists of Box, Interior and Front. Interior includes one 50A 2-Pole Common Trip Pushmatic Lighting Main Circuit Breaker, with space and provisions for installing four 2 pole 220 V. Appliance circuits above lighting Main and ten 1 Pole 110V. or five 2 Pole 220V. lighting circuits below lighting Main.

Box Dimen., In.—30 5/8 x 12 1/2 x 3-7/8.

No.	Max. No. Br. Cir.	Type Front	Wt. Lbs.	Each
XD18-250F	18	Flush	36	\$50.90
XD18-250S	18	Surface	36	50.90

3 New Service Entrance Panels

70 Amp. 2 Pole Common Trip Pushmatics

as

Main Disconnects

12-18-24 Branch Circuits
1 Phase, 3 Wire—120/240 V. AC
For Residential & Commercial Use

Flush or Surface Mounted, Single Row Panel with 1-70A, 2 Pole Common Trip Pushmatic. Main and Space for 12-1 Pole or 6-2 Pole Pushmatics. U/L listed for use as service equipment.

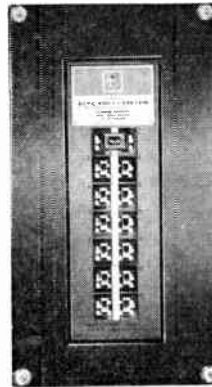

12-70-PM

No.	Max. No. Br. Cir.	Type Front	Wt. Lbs.	Each
12-70-PMF	12	Flush	19	\$33.30
12-70-PMS	12	Surface	19	33.30

Box Dimen., In. 20 1/4 x 10 3/4 x 3 3/4.

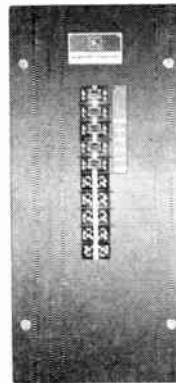

X410-270

Flush or surface mounted, single row split bus panel with space at top for 4-2 pole Pushmatics and space below 70A, 2 Pole common trip Pushmatic Main for 10-1 Pole or 5-2 Pole Pushmatics. U/L listed as suitable for use as Service Equipment.

No.	Max. No. Br. Cir.	Type Front	Wt. Lbs.	Each
X410-270F	18	Flush	36	\$57.00
X410-270S	18	Surface	36	57.00

Box Dimen., In.—30 5/8 x 12 1/2 x 3 7/8.

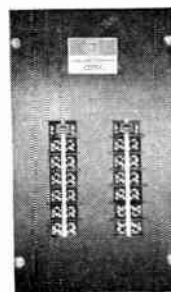

24-270-2PM

Flush or Surface Mounted, Double Row Panel with 2-70A, 2 Pole Common Trip Main Pushmatics and Space for 2+1-Pole or 12-2 Pole Pushmatics. U/L listed as suitable for use as Service Equipment.

No.	Max. No. Br. Cir.	Type Front	Wt. Lbs.	Each
24-270-2PMF	24	Flush	50	\$81.60
24-270-2PMS	24	Surface	50	81.60

Box Dimen., In.—26 1/2 x 14 1/4 x 4.

Bulldog Duo-Guard Pushmatic Electric-Centers®

Pushbutton Convenience with Pushmatic Protection and Bolt-Tight Connection

Listed by Underwriters' Laboratories, Inc.

Panels and Cabinets

Type P3B

Complete Factory Assembled

Line-A-Phase Panels for Sequence Wiring

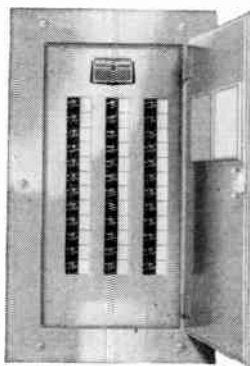

Type P3B Panel

3-Phase, 4-Wire, Solid Neutral, 120/208 Volts A-C.

These Electric-Centers, when properly installed and operated provide perfect sequence phasing for constant balanced loading of phases.

Three vertical rows (one for each phase) are assembled side by side in the enclosure. Each row of Pushmatic units is connected to one main bus bar or phase. This provides evident and natural phase association for each Pushmatic unit and its branch circuit.

Mains: Lugs Only (Solderless Wire Grips).

Branches: 1-Pole, 15-Amp. 120 Volt Pushmatics with solid neutral.

(20, 30, 40 or 50 amp. Pushmatics may be specified; price is same except when use of higher rated units necessitate increased mains.)

Boxes: Code gauge galvanized steel 20-in. wide, 5½-in. deep, with four wiring gutters 4-in. (1. D.), Height indicated by numerals in box numbers.

Fronts: Code gauge steel, attractive gray finish.

Note—Circuit identification adhesive strips supplement the regular directory frame on Electric-Center door. Each strip is divided into spaces the same height as face of Pushmatic unit, for writing positive and easy identification of each Pushmatic-controlled circuit.

Main Lugs Only

No.	Branch Circuits	Amp. Mains	Box No.	Wt. Lbs.	Each
P3B12-4L	12	100	W26	73	\$137.00
P3B15-4L	15	100	W26	74	154.00
P3B18-4L	18	100	W26	74	170.00
P3B21-4L	21	100	W26	75	187.00
P3B24-4L	24	100	W32	92	203.00
P3B27-4L	27	100	W32	93	220.00
P3B30-4L	30	100	W32	94	236.00
P3B33-4L	33	200	W38	116	260.00
P3B36-4L	36	200	W38	117	276.00
P3B39-4L	39	200	W38	117	293.00
P3B42-4L	42	200	W38	118	309.00

Main Circuit Breaker

P3B12-4AB	12	50	W38	106	185.00
P3B15-4AB	15	50	W38	107	202.00
P3B18-4AB	18	100	W38	107	239.00
P3B21-4AB	21	100	W38	108	256.00
P3B24-4AB	24	100	W44	132	272.00
P3B27-4AB	27	100	W44	132	289.00
P3B30-4AB	30	100	W44	133	305.00
P3B33-4AB	33	200	W56	186	512.00
P3B36-4AB	36	200	W56	187	528.00
P3B39-4AB	39	200	W56	187	545.00
P3B42-4AB	42	200	W56	188	561.00

Narrow Type Panels

Complete Factory Assembled

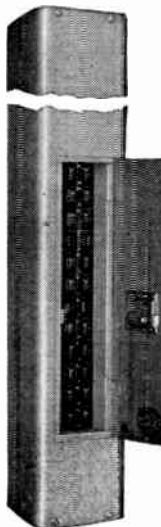

Branches: 1-Pole, 15-Amp. 120 Volt 2-wire Solid Neutral Pushmatics; (20, 30, 40 or 50 Amp. Pushmatics may be specified; price is same except when use of higher rated units necessitates increased mains.)

Cabinets: Surface Type, with hinged fronts, made of code gauge steel — size 6¾-in. wide, 6½-in. deep, of various heights as in table below. The boxes (back section of cabinet) are shipped with main wire grips and branch circuit wiring retainers in place, so that wires can be pulled through ready for connection to panel assembly (interior) later. Finish: attractive gray.

Neutral: Is located in Panel.

Panelboard and Cabinet Only

With Neutral

Without Pull Box or Wireway Extension

Main Lugs Only

Single Phase, 3 Wire

No.	Branch Circuits	Amp. Mains	Height In.	Wt. Lbs.	Each
NPB08-3L	8	100	36	57	\$105.00
NPB10-3L	10	100	36	58	116.00
NPB12-3L	12	100	36	58	127.00
NPB14-3L	14	100	36	59	138.00
NPB16-3L	16	100	36	59	149.00
NPB18-3L	18	175	42	65	164.00
NPB20-3L	20	175	42	65	175.00
NPB22-3L	22	175	42	66	186.00
NPB24-3L	24	175	42	66	197.00
NPB26-3L	26	175	48	72	208.00
NPB28-3L	28	175	48	72	219.00
NPB30-3L	30	175	48	73	230.00
NPB32-3L	32	175	48	73	241.00

3 Phase, 4 Wire

NPB08-4L	8	100	36	57	115.00
NPB10-4L	10	100	36	58	126.00
NPB12-4L	12	100	36	58	137.00
NPB14-4L	14	100	36	59	148.00
NPB16-4L	16	100	36	59	159.00
NPB18-4L	18	100	42	65	170.00
NPB20-4L	20	100	42	65	181.00
NPB22-4L	22	100	42	66	192.00
NPB24-4L	24	100	42	66	203.00
NPB26-4L	26	175	48	72	221.00
NPB28-4L	28	175	48	72	232.00
NPB30-4L	30	175	48	73	243.00
NPB32-4L	32	175	48	73	254.00

Bulldog Duo-Guard Pushmatic Electri-Centers®

**Pushbutton Convenience with Pushmatic Protection
and Bolt-Tight Connection**

Listed by Underwriters' Laboratories, Inc.

Accessories for Narrow Column Panels

Narrow column Electri-Centers are usually combined with a wireway extension designed to extend up the columns and pull boxes to be mounted at top of extension. Such combinations permit free wiring space in the Electri-Center, obviate the use of conduits running down to the Electri-Center and lend a streamlined appearance to the finished installation.

Extensions

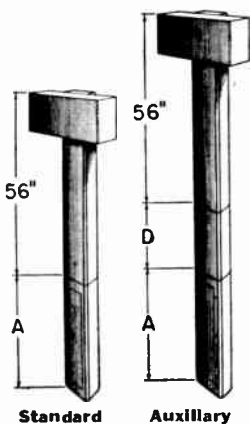

Standard Extensions: 56-in. long. One end provided with a sleeve that fits snugly over a collar provided at the top of the Electri-Center. The opposite end of the extension is closed. A large rectangular hole near top of extension matches with a similar hole in the back of pull box when pull box is to be mounted on face of extension to complete the wireway. Where a pull box is to be mounted at the top of wireway extension, the end plate for extension is omitted and pull box without cut-out in backplate is mounted in its place. When ordering it is necessary to state type of pull box required.

Auxiliary Extensions: Short pieces of wireway designed to fit between Electri-Center (A) and Standard extensions where additional wireway height is required. Available in 24- and 48-in. lengths (D). Each auxiliary extension is provided with a sleeve on one end and a collar on the other. These lengths will permit wireway extensions to 14- or 16-ft. ceiling or truss heights. For intermediate heights between 12- and 14- ft. and 14- and 16-ft., the sleeve end only of the auxiliary extensions may be cut down by user to the length required.

Wireway Extensions

No.	Size, In.	Type	Wt., Lbs.	Each
NEX24	24	Extension	15	\$19.00
NEX48	48	Extension	30	37.00
NEX2548	48	Adjustable Extension	31	37.00
NEX56	56	Extension	34	38.00

Pull Boxes

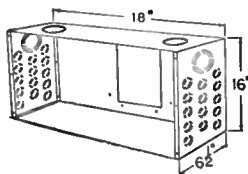

Two types of pull boxes are available — one for front mounting and one for top mounting. The front-mounted pull box can only be installed on the surface or front of the 56-in. standard extensions. The top-mounted is for mounting on the top of the panel proper or either of the 24- or 48-in. auxiliary extensions. Where a pull box is used, the neutral connections can be mounted therein.

Pull Boxes

No.	Description	Wt., Lbs.	Each
NTB2448	Top Mounted	26	\$28.00
NFB56	Front Mounted	25	28.00

Chance Holdfast Lamp Changers

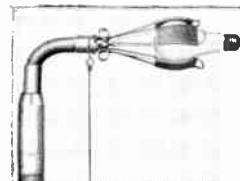

Rubber covered flexible spring fingers grip lamp bulb firmly for removal or replacement in high places such as ceilings, side walls, electric signs, etc. Pull-cord at base of fingers will bend wristlike coil spring at any angle from vertical to 90 degrees. Changer will work as easily at right angle to the rotating pole as it will in the vertical position. Also available with rigid neck.

Changers are equipped with a coupling adapter for attachment to specifically designed pole, when purchased in combination with one or more of these poles. When ordered individually, changers are equipped with regular neck for receiving round poles of the specified diameters. Coupling adapters can be purchased separately.

Flexible Neck Changers

- | No. | Description |
|-----|---|
| 1.2 | For 50-Watt Rough Service, 15 to 100-Watt Mazda, and other lamps up to 3 inches in diameter. Shipping weight 1 pound. |
| 1.3 | For 150 to 500-Watt Mazda Lamps and other large and odd shapes up to 5 inches in diameter. Shipping weight, 1 pound. |

Rigid Neck Changers

- | | |
|-----|---|
| 1.4 | For 50-Watt Rough Service, 15 to 100-Watt Mazda and other lamps up to 3 inches in diameter. Shipping weight, 1 pound. |
| 1.5 | For 150 to 500-Watt Mazda Lamps and other large and odd shapes up to 5 inches in diameter. Shipping weight, 1 pound. |

Poles and Couplings

The Standard Pole has one coupling which attaches to the Lamp-Changer.

The Extension Pole, has two couplings: one coupling attaches to the Lamp-Changer; the other attaches to the coupling of a Standard Pole or another Extension Pole.

- | No. | Description |
|------|--|
| 1377 | Pole, 6 foot. Shipping weight, 1¾ pounds. |
| 1376 | Extension Pole, 6 foot. Shipping weight, 2 pounds. |

Prices on application.

Ericson Heavy Duty Extension Cords



With No. 18/2 Type S cord, Neoprene rubber handle, weatherproof socket, steel wire reflector guard and Neoprene plug.

Carton quantity 6. Std. Pkg. 12.

No.	100 Watt Guards	Pkg. Wt. Lbs.	Each
725-R	25-ft. keyless	42	\$ 9.96
750-R	50-ft. keyless	64	13.76
725-RS	25-ft. switch	42	10.86
750-RS	50-ft. switch	64	14.66

No. 725-R

Ericson Neoprene Rubber Portable Lamps

Oil Resistant



No. 744-R

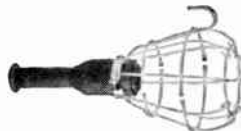

No. 747

With heavy duty industrial type Neoprene rubber handle, weatherproof socket, and steel wire guard with hook.

No.	100 Watt Guards	Carton	Std. Pkg.	Pkg. Wt. Lbs.	Each
744	Open guard	12	21	31	\$3.94
744-S	Open guard with switch	12	21	31	4.54
744-R	Reflector guard	12	21	37	4.38

744-RS	Reflector guard with switch	12	21	37	4.98
747	Open end guard	12	21	31	4.58
747-S	Open end guard with switch	12	21	31	5.18

The above portable lamps are of black neoprene, but yellow can be supplied at the same price. If yellow is desired, specify so after Cat. No.

Ericson Vaporproof Portable Lamps

Oil Resistant



No. 70

With husky Neoprene rubber handle, socket, heat and impact resistant globe, and heavy steel wire guard with hook.

No.	Description	Carton	Std. Pkg.	Pkg. Wt. Lbs.	Each
70	Vaporproof, 75 watts	6	12	42	\$12.90
70-I	With neoprene insulated gd.	6	12	45	16.85
70-N	Vaporproof, 100 Watt	6	12	48	14.45
70-NI	With neoprene insulated gd.	6	12	51	18.40

McGill Adaptable Lamp Changers

With Rubber Suction Cup Assembly



Designed for bottom contact of lamps mounted flush in window lighting and similar installations. Three rubber suction cups securely grip the bottom of 200-Watt, spot or flood lamps.

No.	Description	Wt., Dz. Each	Each
157-C	Suction Cups, 200-watt, spot or flood	5	\$6.00

Steel Lamp Changer Poles Insulated for Safety



No. 160-P

Available in 5-foot sections, fully insulated and interchangeable. Opposite ends telescope and lock to complete desired multiple section length. A rubber bumper for pole end furnished with each changer head.

No.	Description	Wt., Dz. Each	Each
160-P	Steel Interchangeable, 5 ft. sections . . .	14	\$4.10

Lamp Base Removers Fibre Insulated Fits Lamp Changer Pole

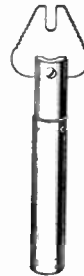

Provides a fully insulated, safe and sure way to remove bases of broken lamp bulbs without possibility of injury to hands from shock or broken glass. Fits lamp changer pole and will handle standard and mogul lamp base.

No.	Description	Wt., Dz. Each	Each
200	Lamp Base Remover	4	\$1.70

McGill Adaptable Lamp Changers

With Rubber Covered Fingers and Coil Spring



Insulated for Safety. For convenient replacement of light bulbs in any location. A coil spring around the ends of the rubber covered fingers grips the bulb firmly.

The angle adjustment on the No. 150-CA and No. 151-CA, permits tilting of the head for bulbs in horizontal position.

Steel Lamp Changer poles are furnished in interchangeable 5-foot sections. Opposite ends telescope and lock to complete desired multiple length.

Each section is insulated for positive protection against shock should Lamp Changer come in contact with live wires.

With Angle Adjustment

No.	Description	Lamp Size	Wt., Dz. Each	Each
150-CA	Coil Spring	15- 75-w	8	\$5.50
151-CA	Coil Spring	100-200-w	9	5.50

No Angle Adjustment

152-C	Coil Spring	300- 500-w	10	6.00
153-C	Coil Spring	750-1500-w	10	6.50
154-C	Coil Spring	400-w Merc. Lamp	8	6.50
155-C	Coil Spring	500-w, R-52	..	7.50
156-C	Coil Spring	PAR-38, R-40	12	6.00
158-C	Coil Spring	E-H1—J-H1 Mercury 100-w	14	7.50

McGill Lamp Guards

Approved by Underwriters' Laboratories, Inc.

LoXon Locking Lamp Guards



No. 1100

Prevent theft and breakage of lamps—lock them on with McGill LoXon Guards. Easily attached and locked with key. Made of steel wire, heavily zinc plated, available in sizes to fit all sockets and for regular and mill type lamps. Key fits two triangular head screws protected by collars just large enough to admit key only. Guard bottoms are closed, making use of key necessary for removal.

Used in garages, factories, yards, shops, basements, closets, securing double protection against breakage and unauthorized removal.

No.	Lamp Size Watts	Fits Socket	Wt., Lbs. Per Doz.	Each
1075	75	Brass	2 1/2	\$0.80
1075-A	75	W.P. Socket A	2 3/4	.80
1075-B	75	W.P. Socket B	3 1/4	.80
1100	100	Brass	3	.88
1100-A	100	W.P. Socket A	3	.88
1100-B	100	W.P. Socket B	3 1/2	.88
1200	200	Brass	4	1.00
1200-A	200	W.P. Socket A	4 1/2	1.00
1200-B	200	W.P. Socket B	4 3/4	1.00

With Reflectors

1075-R	75	Brass	3 1/2	1.04
1075-RA	75	W.P. Socket A	3 3/4	1.04
1100-R	100	Brass	4 1/2	1.10
1100-RA	100	W.P. Socket B	4 1/2	1.10

Three keys furnished with each dozen guards. Extra keys are \$0.12 each or \$1.30 per dozen list.

Gripon Non-Locking Lamp Guards



No. 2075

These guards are the same in construction as LoXon guards, except that the key locking device is replaced with plain steel screws. Full protection against breakage. Easily detached for lamp renewal. Gripon guards are built of heavily zinc plated, steel wire, made to withstand hard use and abuse. For both regular and mill type lamps, brass shell and W.P. sockets.

No.	Lamp Size Watts	Fits Socket	Wt., Lbs. Per Doz.	Each
2075	75	Brass	2 1/2	\$0.76
2075-A	75	W.P. Socket A	2 3/4	.76
2075-B	75	W.P. Socket B	3	.76
2100	100	Brass	3	.84
2100-A	100	W.P. Socket A	3	.84
2100-B	100	W.P. Socket B	3 1/2	.84
2200	200	Brass	4	.96
2200-A	200	W.P. Socket A	4 1/2	.96
2200-B	200	W.P. Socket B	4 3/4	.96

With Reflectors

2075-R	75	Brass	3 1/2	1.00
2075-RA	75	W.P. Socket A	3 3/4	1.00
2100-R	100	Brass	4 1/2	1.06
2100-RA	100	W.P. Socket A	4 3/4	1.06

*All LoXon and Gripon Guard Numbers followed by "A" fit Weather Proof Sockets with bottom bead measuring 1 9/16" to 1 11/16" in extreme diameter; numbers followed by "B" fit 1 3/4" extreme diameter.

All Protector "O," LoXon, Gripon, and Wall and Receptacle Guards may be assorted to make up quantity.

McGill Wall and Receptacle Guards



No. 1436

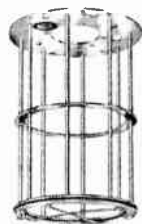

No. 1440

Durable stationery socket guards with slotted holes in base rings for easy mounting in wall, ceiling and all sizes of outlet boxes.

Steel wire ribs and stamped metal rings and plates electrically welded and zinc plated.

No.	Lamps Watts	Description	Wt., Lbs. Per Doz.	Each
1436	60	for 3-in. box, closed bottom	6 1/4	\$1.50
1438	100	for 4-in. box closed bottom	7 1/2	1.70
1439	100	for 3- 4-in. box, open bottom	8 3/4	1.80
1439-B	100	for 3- 4-in. round and 4-in. square box, open bottom	9 1/2	1.80

With Trap and LoXon Attachment

1440	100	for 3- 4-in. box, bottom trap with LoXon attachment	10	2.40
1440-B	100	for 3- 4-in. round and 4-in. square box, bottom trap with LoXon Attachment	10 1/2	2.40

McGill Lamp Guards

Approved by Underwriters' Laboratories, Inc.

Protector "O" Lamp Guards



No. 1429

Protector "O" Lamp Guards give full protection to lamp bulbs—removable trap at bottom prevents pilfering. Trap can be attached and removed quickly and easily for lamp replacement and cleaning. Simply press inward on the guard rim where the trap hooks on it and snap the trap on or off.

Guards are built of heavily zinc plated steel wire, and are furnished with plain steel screws for attaching to sockets.

No.	Lamp Size	Description	Wt. Lbs. Per Doz.	Each
1429	60W	for Brass Socket	1 1/2	\$0.86
1432	60W	for 1 1/2-in. dia. Socket	4 1/2	.86
1433	100W	for 1 1/2-in. dia. Socket	4 1/2	.92
1434	200W	for 1 1/2-in. dia. Socket	7	1.70
2932		Trap only to Close Bottom20

Portable Lamp Guards

Hard Wood Handle—Open End Cage



No. 1450

Compact, light weight and durable. Heavy tinned steel wire cage is securely fastened to polished hard wood handle. 660-watt, 250-volt socket with spring contacts firmly imbedded in handles. Used particularly by railroads and maintenance shops.

No.	Description	Wt., Dz. Each	Each
1450	Lamp size max. 50-w, RS, Keyless	15	\$3.40
1450-R	No. 1450 with Reflector	17	3.80
1451	Lamp size max. 75-w, Keyless	17	3.40
1452	Lamp size max. 100-w, RS, Keyless	18	3.80

Hard Wood Handle—Closed End Cage



Heavy duty portable with cage of heavy steel rods and stamped metal rings, zinc plated. 660-watt, 250-volt socket firmly inset in hard wood handle.

Preferred by quarries and other heavy industries.

No.	Description	Wt., Dz. Each	Each
4000	Lamp size 60-110-w, RS, Keyless Socket	21	\$4.10

Hard Wood Handle—Closed End Cage



Heavy duty portable with cage of best grade steel wire, electrically welded and zinc plated. Polished hard wood handle fitted with Levolver switch and 660-watt, 250-volt socket.

No.	Description	Wt., Dz. Each	Each
4675	Lamp size 60-100-W, RS, with Levolver Switch	19	\$4.70
4675-R	No. 4675 with Reflector and Levolver Switch	21	5.20

Portable Lamp Guards

Rubber Hook Handle



No. 650

Moulded black rubber handle formed with steel reinforced hook. Pliable socket section holds 660 watt, 250-volt socket, and cord strain relief disk. No-Rol cage of heavy steel wire, zinc plated and electrically welded. Hook on both cage and handle.

Closed End Cage

No.	Description	Wt., Dz. Each	Each
Lamp Size 60-100-w, RS			
650	Keyless	23	\$3.30
650-R	With Reflector	26	3.50
650-S	With Levolver Switch	23	3.70
650-SR	With Reflector and Levolver Switch	26	3.90

Lamp Size Max. 50-w, RS

650-M	Keyless	21	3.20
650-MR	With Reflector	22	3.40
650-MS	With Levolver Switch	21	3.60
650-MSR	With Reflector and Levolver Switch	22	3.80

Open End Cage

Lamp Size 60-100-w, RS

651	Keyless	22	\$3.50
651-R	With Reflector	24	3.70
651-S	With Levolver Switch	22	3.90
651-SR	With Reflector and Levolver Switch	24	4.10

Lamp Size Max. 50-w, RS

651-M	Keyless	21	3.40
651-MR	With Reflector	23	3.60
651-MS	With Levolver Switch	22	3.80
651-MSR	With Reflector and Levolver Switch	23	4.00

Rubber Hook Handle—Plastic Closed End Cage



No. 999R

For use wherever thorough protection is desired against shorts—no exposed metal. The macerated plastic cage is strong and tough—withstands impacts and hard usage, and has high resistance to heat, cold, moisture, oils, fumes, most chemicals and weak alkalis.

For 50 Watt Rough Service Lamps

No.	Description	Wt. Dz. Each	Each
999	Lamp size max. 50-w, RS, Keyless Socket	19	\$5.40
999R	No. 999 with Reflector	20	5.60
999S	No. 999 with Levolver Switch	19	5.80
999SR	No. 999 with Reflector and Levolver Switch	20	6.00

McGill Portable Lamp Guards

Approved by Underwriters' Laboratories, Inc.

Vaporproof—Dust-Tight Plastic Handle—Annealed Globe Brass Wire Cage

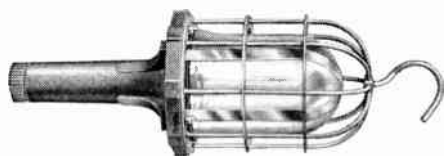

No. 3005

A heavy duty vaporproof portable with 1/16-inch hard brass bands to hold the glass globe rigid. Glass globe seals against a shoulder on a pliable rubber gasket.

Fire resisting, breakproof plastic handle uses a grounded 660-watt, 250-volt socket. Pliable rubber gasket squeezes around wire and in handle recess to seal out air, moisture and vapor.

Safe for use where vapor and dust-infused air is encountered.

No.	Description	Wt. Oz. Each	Each
3002	Lamp size max. 60-w, Keyless, Grounded Socket	50	\$14.50
3002R	No. 3002 with Reflector	54	17.00
3005	Lamp size max. 100-w, Keyless, Grounded Socket	56	16.50
3005R	No. 3005 with Reflector and Grounded Socket	60	19.00

Vaporproof—Dust-Tight Plastic Handle—Annealed Globe—Steel Wire or Fibre Cage



No. 3007

Watertight dust-tight and moisture-proof. The plastic handle, and fibre cage on the No. 3007 are shock-proof and non-sparking. A rubber gasket placed between the cage and handle absorbs all stress and strain, preventing breakage. The heavy glass protective globe eliminates possibility of breakage of the lamp bulb inside from splashing liquids. Safe for use where vapor and dust infused air is prevalent. They have no equal for safety, service and convenience in flour mills, paint booths, finishing rooms, airports, warehouses, food processing plants, shipyards, aboard ships, and many other places.

No.	Description	Wt. Oz. Each	Each
3006	Lamp size max. 60-w, Steel Cage, Keyless Socket	35	\$ 9.50
3006R	No. 3006 with Reflector	38	10.50
3007	Lamp size max. 60-w, Fibre Cage, Keyless Socket	32	10.50

Neoprene-Butyle Handle—Closed End Cage Keyless Watertight Lampholder

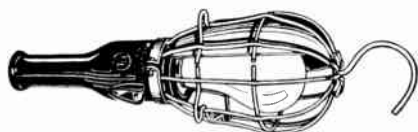

No. 7600

Same as 7000 series guards except equipped with keyless watertight lampholder.

No.	Description	Wt. Oz. Each	Each
7600	Lamp size 60-100-w, Rs.	20	\$2.80
7600-R	No. 7600 with Reflector	23	3.00
7600-M	Lamp size max. 50-w, RS.	18	2.70
7600-MR	No. 7600M with Reflector	20	2.90

Phenolic Plastic Handle with Convenience Outlet



No. 5000-R

Sturdily constructed with a 15 Amp. 125 volt, 10 Amp. 250 volt outlet, 660 watt, 250 volt socket, cord strain relief and cord seal.

No-Rol cage of heavy steel wire, zinc plated and electrically welded. Convenience outlet built into an impact resisting brown phenolic plastic handle. Handy for all repair work because of convenience outlet and oil and grease-proof handle. Available with or without Levolver switch.

No.	Description	Wt. Oz. Each	Each
Lamp Size 60-100-w, RS			
5000	Keyless	17	\$3.40
5000-R	With Reflector	20	3.60
5000-S	With Levolver Switch	17	3.90
5000-SR	With Reflector and Levolver Switch	20	4.10
Lamp Size Max. 50-w, RS			
5000-M	Keyless	15	3.30
5000-MR	With Reflector	17	3.50
5000-MS	With Levolver Switch	15	3.80
5000-MSR	With Reflector and Levolver Switch	17	4.00

Plastic Handle—Concentrating Lens— Reflector Assembly—Convenience Outlet



No. 5000-SLR

Features the new, approved 15-amp., 125-volt convenience outlet molded-in the phenolic plastic handle.

Provides on-the-spot power source for tools, etc.

Uses the open cage fitted with lens for concentrating light through an end lens.

No.	Description	Wt. Oz. Each	Each
5000LR	Lamp size 60-100-w, RS with Keyless Socket	27	\$5.60
5000SLR	5000LR with Levolver Switch	27	6.10

Neoprene-Butyl Handle—Open End Cage



No. 7001

660-Watt, 250-volt Lampholder. Cage is open end type, heavily zinc plated with chromate finish. Side hook and No-Rol feature.

No.	Description	Wt. Oz. Each	Each
Lamp Size 60-100-w, RS			
7001	Keyless	19	\$2.80
7001-R	With Reflector	22	3.00
7001-S	With Levolver Switch	19	3.20
7001-SR	With Reflector and Switch	22	3.40
Lamp Size Max. 50-w, RS			
7001-M	Keyless	19	2.70
7001-MR	With Reflector	21	2.90
7001-MS	With Levolver Switch	19	3.10
7001-MSR	With Reflector and Switch	21	3.30
7002	Lamp size 200-w Grounded	24	4.10
7002-R	No. 7002 with Reflector	25	5.00

McGill Portable Lamp Guards

Approved by Underwriters' Laboratories, Inc.

Neoprene-Butyl Handle—Open End Cage
For PAR-38, 150 Watt Lamps
Or 75-R-30, 75 Watt Lamps

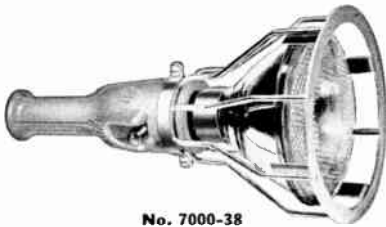

No. 7000-38

Basically the same as other 7000 series guards except equipped with cages to accommodate PAR-38 and 75-R-30 lamps.

No.	Description	Wt., Oz. Each	Each
Lamp PAR-38, 150-w			
7000-38	Keyless.....	16	\$4.60
7000-S-38	With Levolver Switch.....	16	5.00
Lamp 75-R-30, 75-w			
7000-30	Keyless.....	15	4.40
7000-S-30	With Levolver Switch.....	15	4.80

Phenolic Handle—Closed End Cage
Clamping Collar



The 5100 series of guards is the same as the 5000 series except with thumb-clamp cage for easy bulb replacement without tools.

Lamp Size 60-100-w, RS

No.	Description	Wt., Oz. Each	Each
5100	Keyless.....	18	\$3.40
5100-R	With Reflector.....	21	3.60
5100-S	With Levolver Switch.....	18	3.80
5100-SR	With Reflector and Switch.....	21	4.10

Lamp Size Max. 50-w, RS

5100-M	Keyless.....	16	3.30
5100-MR	With Reflector.....	18	3.50
5100-MS	With Levolver Switch.....	16	3.80
5100-MSR	With Reflector and Switch.....	18	4.00

Neoprene-Butyl Handle—Closed End Cage



No. 7100

The No. 7100 series of guards is essentially the same as No. 7000 series, except that a wire collar is used instead of the flat steel collar. The cage is held to the handle by a clamp arrangement—thus eliminating screws.

No.	Description	Wt., Oz. Each	Each
7100	Lamp size 60-100-w, RS, Keyless Socket.....	20	\$2.60
7100R	No. 7100 with Reflector.....	23	2.80
7100S	No. 7100 with Levolver Switch.....	20	3.00
7100SR	No. 7100 with Reflector and Levolver Switch.....	23	3.20
7100M	Lamp size max. 50-w, RS, Keyless Socket.....	19	2.50
7100MR	No. 7100-M with Reflector.....	21	2.70
7100MS	No. 7100-M with Levolver Switch.....	19	2.90
7100MSR	No. 7100-M with Reflector and Levolver Switch.....	21	3.10

Watertight lampholder No. 4016 available in above keyless portables.

Hardwood Handle—Closed End Cage



No. 8000-SR

Polished wood handles and 660 watt, 250 volt sockets. Electrically welded No-Rol steel wire cages, heavily zinc plated. Serviceable around oil and grease.

No.	Description	Wt., Oz. Each	Each
8000	Lamp size 60-100-w, RS, Keyless Socket.....	17	\$2.60
8000R	No. 8000 with Reflector.....	20	2.80
8000S	No. 8000 with Levolver Switch.....	17	3.00
8000SR	No. 8000 with Reflector and Levolver Switch.....	20	3.20
8000M	Lamp size max. 50-w, RS, Keyless Socket.....	15	2.50
8000MR	No. 8000M with Reflector.....	17	2.70
8000MS	No. 8000M with Levolver Switch.....	15	2.90
8000MSR	No. 8000M with Reflector and Levolver Switch.....	17	3.10

Grounded Models
Phenolic Handle—Closed End Cage



No. 5000-SR-G

The 5000 series grounded guards offer industry the first completely grounded lamp guard that is equipped with an approved 3-wire convenience outlet. The cage is grounded by means of internal handle construction with a third terminal providing contact with the attached cord.

Convenience Outlet with U Shaped Ground
Lamp Size 60-100-w, RS

No.	Description	Wt., Oz. Each	Each
5000-G	Keyless.....	19	\$4.30
5000-RG	With Reflector.....	22	4.50
5000-SG	With Levolver Switch.....	19	4.80
5000-SRG	With Reflector and Levolver Switch.....	22	5.00

Lamp Size Max. 50-w, RS

5000-MG	Keyless.....	17	\$4.20
5000-MRG	With Reflector.....	19	4.40
5000-MSG	With Levolver Switch.....	17	4.70
5000-MSRG	With Reflector and Levolver Switch.....	19	4.90

For models without convenience outlet, change catalog number to 5500 and deduct \$0.20 from price.

Phenolic Handle—Concentrating End Lens and Reflector Assembly—Convenience Outlet with U Shaped Ground



No. 5000-SLRG

Handles are equipped with a Levolver switch and convenience outlet designed to receive plugs having 2 parallel heads and U shaped third blade for ground.

Convenience Outlet with U Shaped Ground
Lamp Size 60-100-w, RS

No.	Description	Wt., Oz. Each	Each
5000-LRG	Keyless.....	26	\$6.40
5000-SLRG	With Levolver Switch.....	26	6.90

For models without convenience outlet, change catalog number to 5500 and deduct \$0.20 from price.

McGill Portable Lamp Guards

Grounded Models

Phenolic Handle—Closed End Cage—Clamping Collar



No. 5100-SRG

The 5100 series grounded models is the same as the 5000-G series except with thumb-clamp cage for easy replacement of bulbs without tools.

Lamp Size 60-100-w, RS

No.	Description	Wt., Oz. Each	Each
5100-G	Keyless.....	20	\$4.30
5100-RG	With Reflector.....	23	4.50
5100-SG	With Levolver Switch.....	20	4.80
5100-SRG	With Reflector and Switch.....	23	5.00

Lamp Size Max. 50-w, RS

5100-MG	Keyless.....	18	4.20
5100-MRG	With Reflector.....	20	4.40
5100-MSG	With Levolver Switch.....	18	4.70
5100-MSRG	With Reflector and Switch.....	20	4.90

Complete Service Lights

With Cord and Plug Attached

The Lamp Guards listed may be ordered as complete assemblies with either 25 or 50 feet of cord.

The 5000 and 8000 series ungrounded models are equipped with 18-2 SJ black rubber cord and plug; the 7000 series ungrounded models are equipped with 18-2 SJ pearl gray cord and plug.

All grounded models are equipped with 16-3 SJ black rubber cord and plug.

To order, change the last two digits of the number to 25 or 50 (for either 25 or 50 feet of cord) and add to lamp guard price as follows:

	25 Ft. Cord Set	50 Ft. Cord Set
Ungrounded Models.....	\$2.60	\$4.50
Grounded Models.....	4.40	7.10

1. Grounding arrangements are available on Portable Lamp Guards as follows:

7000-LR, 7001, 7100 Series with:

Key Lampholders..... add \$0.20 each

Keyless Lampholders..... add .20 each

3006 Vaporproof..... add .40 each

2. Rubber, Watertight Lampholders furnished in place of standard composition keyless lampholders add \$0.24 each list.

3. All Portable Guards can be furnished with Cord and Plug attached.

Cord	Description	25 Ft. Cord Set	50 Ft. Cord Set
18-2-S	Black Rubber.....	\$3.80	\$ 6.90
18-2-SJ	Black Rubber.....	2.60	4.50
18-2-SJT	Red Thermoplastic.....	3.20	6.40
16-2-S	Black Rubber.....	4.40	8.20
16-3-SJ	Black Rubber.....	4.40	7.10
16-3-SJT	Red Thermoplastic.....	7.50	12.80

Plug furnished on all above sets.

4. Cages for all Portable Lamp Guards can be furnished with rubber coated wires at additional cost.

5. All Portable Guards may be assorted to make up quantity.

6. RS indicates Rough Service lamps.

McGill Portable Lamp Guards

Grounded Models

Neoprene-Butyl Handle—Closed End Cage



No. 7000-SR

Gray, neoprene-butyl handle equipped with 660 watt, 250 volt lampholder. Electrically welded steel wire cage with No-Rol feature, heavily zinc plated.

7000 Series Ungrounded Models

Lamp Size 60-100-w, RS

No.	Description	Wt., Oz. Each	Each
7000	Keyless.....	19	\$2.60
7000-R	With Reflector.....	22	2.80
7000-S	With Levolver Switch.....	19	3.00
7000-SR	With Reflector and Switch.....	22	3.20

Lamp Size Max. 50-w, RS

7000-M	Keyless.....	18	\$2.50
7000-MR	With Reflector.....	20	2.70
7000-MS	With Levolver Switch.....	17	2.90
7000-MSR	With Reflector and Switch.....	20	3.10

For grounded models add the suffix "G" to catalog number and add \$0.30 to price.

Daniel Woodhead Bunghole Lamps

Vaprotex—Vaportight



No. 1300



No. 1301

Vaprotex bunghole lamp is a vaporproof lighting unit for inspecting gasoline, oil, chemical and other drums. Made of non-sparking metal throughout. Furnished with 15 or 25-watt, 120-volt lamp. Can be had with spear if desired.

No.	Watts	Length	Size, Inches O.D.	Std. Pkg.	Wt. Lbs. Std. Pkg.	Each
1300	15	30	1 1/2	1	4	\$37.75
1301	15	12	1 1/2	1	3	27.00
1303	25	32	1 1/2	1	5	38.00
1304	25	14	1 1/2	1	3	28.25

Protex—Non-Vaportight



No. 1302

Protex bunghole lamp is a non-vaporproof lighting unit for inspecting barrels used for non-explosive solutions. Furnished with a 15- or 25-watt, 120-volt lamp. Exceptionally suitable for use in brewery wash-houses as foreign matter can be removed from barrels by spear.

No.	Watts	Length	Size, Inches O.D.	Std. Pkg.	Wt. Lbs. Std. Pkg.	Each
1302	15	30	1	1	3	\$25.65
1305	25	32	1	1	4	26.60

The above prices do not include cord and plug, but these items can be furnished assembled to the lamps, either 2 or 3 conductor cord, at additional costs. Prices furnished upon application to Graybar.

**Daniel Woodhead Protex Portable Lamps
With "Safety Yellow" Neotex Handle**

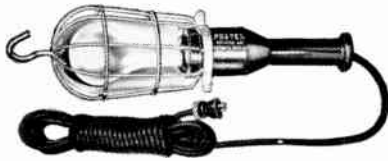

Protex "Safety Yellow" portables wired complete with "Safety Yellow" cord and cord grip cap, add the following prices to any Protex portable:

Type Cord	Lgth., Cord Ft.	Each	Type Cord	Lgth., Cord Ft.	Each
18-2-S	25	\$ 8.15	16-2-S	25	\$ 8.99
18-2-S	50	14.30	16-2-S	50	15.95
18-2-S	100	26.60	16-2-S	100	29.90
18-3-S	25	10.14	16-3-S	25	11.49
18-3-S	50	18.00	16-3-S	50	20.70
18-3-S	100	33.75	16-3-S	100	39.15

How to Order: Add to Protex catalog number length of cord and size. Example: No. 102 with 50 ft. of 16-3-S cord would be 102-50-16-3-S.

With Open End Wire Guard

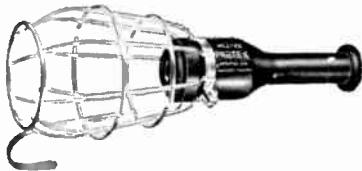

No. 110

Constructed with open end guard so unit can be relamped without removing guard.

Packed 6 in a carton. 30 in a standard package.

No Reflector

With Reflector

No.	Watts	Wt. Lbs. Std. Pkg.	Each	No.	Watts	Wt. Lbs. Std. Pkg.	Each
109	25-40	44	\$5.15	114	75-100	55	\$6.40
110	100	17	5.65	115	300	73	7.25
111	300	66	6.55				

With Fibre Insulated Guard



No. 117R

Consists of rubber handle, keyless socket and screwless type closed end, fibre guard with hook and with or without reflector.

Packed 6 in a carton. 30 in a standard package.

No.	Description	Lamp Watts	Wt. Lbs. Std. Pkg.	Each
117R	With Reflector	75	39	\$9.40
117	No Reflector	75	38	7.85
118R	With Reflector	60-100	42	9.95
118	No Reflector	60-100	41	8.10

With Bakelite Insulated Guard



No. 120

Sturdy molded bakelite construction. Designed for applications where insulation and small size is necessary. Packed 6 in a carton, 30 in a standard package.

No.	Description	Lamp Size	Wt. Lbs. Std. Pkg.	Each
119	No Reflector	25-40	40	\$9.30
120	With Reflector	25-40	42	9.35

**Daniel Woodhead Vaprotex Portable Lamps
Vaporproof**

With "Safety Yellow" Neotex Handle

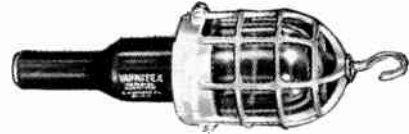

No. 1202

With Steel Wire Guard

Recommended for use where gas, dust and other explosives exist. When properly assembled they may be used in the most hazardous locations with absolute safety. Lamps include synthetic rubber "Safety Yellow" Neotex handle Neotex socket, heat and temperature-resisting glass globe and steel wire guard.

Vaprotex Wire Guards with Neotex Covering—If desired, specify the letter (1) after any of the wire guard types and add \$5.25 to list price.

No.	Watts	Car-ton	Std. Pkg.	Wt. Lbs. Std. Pkg.	Each
1200	60-75	2	12	37	\$15.95
1201	100	2	12	39	17.15
*1202	60-75	2	12	41	17.75
*1203	100	2	12	43	18.95

*With stuffing box in handle.

With Cast Aluminum Guard



No. 1206

Equipped with non-ferrous metal guard. Will not cause mechanical spark. Extra safe for grain elevators and other locations where mechanical sparking might prove hazardous.

No.	Watts	Car-ton	Std. Pkg.	Wt. Lbs. Std. Pkg.	Each
1204	60-75	2	12	40	\$23.50
1205	100	2	12	44	24.45
*1206	60-75	2	12	42	25.30
*1207	100	2	12	45	26.25

*With stuffing box in handle.

Ground clip for third wire for any of above, type "CLIP" list each \$.65.

Glass Globes Only

For Vaprotex Portable Lamps

No.	Description	Watts	Car-ton	Std. Pkg.	Wt. Lbs. Std. Pkg.	Each
1252	Heat-Resisting Glass	60-75	2	12	14	\$3.50
1253	Heat-Resisting Glass	100	2	12	18	3.90

Daniel Woodhead Protex Miniature Inspection Light



Oil-proof handle and cord set with removable fibre guard. Ideal when servicing business machines, etc. Operates on 110-volt.

No.	Description	Carton	Std. Pkg.	Wt. Lbs. Std. Pkg.	Each
611	7-watt Inspection Light	5	50	30	\$3.85
612	15-watt Inspection Light	5	50	31	5.45

Daniel Woodhead "500" Line Portable Hand Lamps

A sturdy rubber handle portable hand lamp complete with heavy duty wire guard and locked-in bakelite weatherproof pig tail socket. Made in 40 to 100-watt sizes, open and closed end guards.

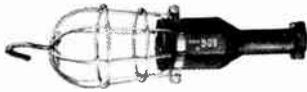

No. 500

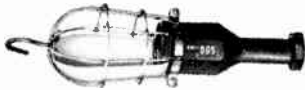

No. 504

Watts	No Reflector				With Reflector			
	Closed End No.	Each	Open End No.	Each	Closed End No.	Each	Open End No.	Each
60	500	\$2.35	508	\$2.35	504	\$2.55	512	\$2.55
75-100	502	2.45	510	2.45	506	2.65	514	2.60

Equipped with Cord and Cap



No. 523

No. 523 Consists of No. 500 with 25 ft. of No. 18-2SJ cord and No. 1120 cap. Price each \$5.74.

No. 524 Consists of No. 500 with 25 ft. of No. 18-2S cord and No. 1121 cap. Price each \$8.14.

For additional lengths of cord add to list: No. 18-2SJ, \$.085 per ft.; No. 18-2S, \$.18 per ft.

If ground clip is desired specify so and add to list price \$.65 each.

Daniel Woodhead Protex Portable Hand Lamps



No. 102U

With NEMA "U" Blade Side Outlet

All Protex portables are available with the new "U" blade side outlet for NEMA type grounding caps. Add to Protex catalog number the letter "U" and add \$1.85 to the list price.

Daniel Woodhead Protex Portable Lamps With New "Safety Yellow" Neotex Handle

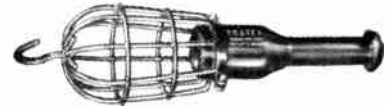

No. 100

With Wire Guard

Protex lamps are designed to meet exacting safety requirements. All handles are oilproof and are made of new "Safety Yellow" Neotex synthetic rubber. Socket is molded Neotex and is water tight. Guards are extra heavy steel wire, spot welded and heavily plated to prevent rusting. Packed 6 in a carton. 30 in a standard package.

Closed End Guards

No Reflector				With Reflector			
No.	Watts	Wt. Lbs. Std. Pkg.	Each	No.	Watts	Wt. Lbs. Std. Pkg.	Each
100	60	44	\$5.25	104	60	48	\$5.90
102	100	45	5.40	106	100	51	6.15
103	300	63	6.60	107	300	68	7.25

With Side Outlet

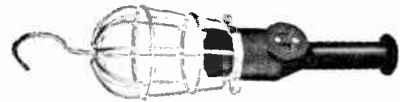

No. 100K

Often the availability of an additional outlet near light source proves of great convenience—especially if user is working in close quarters where use of small tool or heating device is necessary.

Any Protex unit can be obtained with side convenience outlet in any of the following three types:

Parallel: Add letter "K" after catalog number and add to list price each \$1.50.

Polarity: (2-wire "T" type)—add letter "T" after catalog number and add to list price each \$1.70.

Polarity: (3-wire type)—add letter "Y" after catalog number and add to list price each \$1.95.

With Neotex Covered Guard

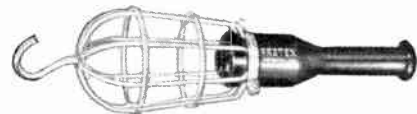

No. 100-I

All steel wire guards are available with oilproof synthetic Neotex insulation in sizes up to 100 watts with or without reflector; add letter "I" to catalog number and add to list price each, \$3.10 for Neotex covered guard only; for Neotex covered guard and reflector add \$5.10. If ground clip is desired, specify so, and add \$.65 each to list price.

With Key Socket

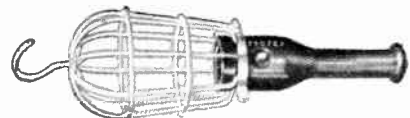

No. 100S

All Protex portable lamps are available with push through key sockets. Key is removable fibre type for extra safety. Add to catalog number, letter "S" and add to list price each \$1.00.

Daniel Woodhead Portable Lighting Units
Safeway LoVolt Portable
Made with New "Safety Yellow" Neotex



No. 1621

The ultimate in portable lighting units where electrical hazards exist due to dampness. A step down transformer is inserted in the line resulting in a low secondary voltage that assures the user of complete safety regardless of moisture conditions. Complete unit is made from "Safety Yellow" Neotex synthetic rubber including cord, transformer cover, handle and plug cap. Oil, grease, most chemicals will not affect the unit. Available in longer secondary lengths than listed and also available with vaporproof or non-vaporproof handle.

Transformer capacity, 75 watts. Voltage: Primary, 110; secondary, 6, 60 cycle; 1 in a standard package.

Wired Complete with Protex Unit

No.	Length, Feet		Reflector	Wt., Lbs. Each	Each
	Primary	Secondary			
1600	10	20	No	12	\$81.10
1601	10	20	Yes	12	81.85

Wired Complete with Vaprotex Unit with Steel Guard

No.	Length, Feet		Sealing Gland	Wt., Lbs. Each	Each
	Primary	Secondary			
1620	10	20	No	14	\$92.90
1621	10	20	Yes	14	94.70

Wired Complete with Vaprotex Unit with Aluminum Guard

No.	Primary	Secondary		Wt., Lbs. Each	Each
1631	10	20	Yes	14	102.40

Additional cable lengths are obtainable within the output capacity of the transformer.

While only the 110 to 6-volt stepdown is listed, other combinations are available: 110 to 12 volts, 110 to 32 volts, 220 to 6 volts, 220 to 12 volts and 220 to 32 volts.

All Lo-Volt transformer units come equipped with 50-watt lamps.

Daniel Woodhead Safeway 4-Way LoVolt



No. 1640

Low voltage protection for more than one operator. Four light units can be used simultaneously. Individually fused circuits, watertight construction. Listed complete with 50 ft. primary cord only.

Secondary cord sets available on request. Size depends on secondary voltage.

No.	Description	Std. Pkg.	Wt., Lbs. Std. Pkg.	Each
1640	4-Way LoVolt	1	40	\$338.00

Seeger-Williams Appliance Replacement Cord

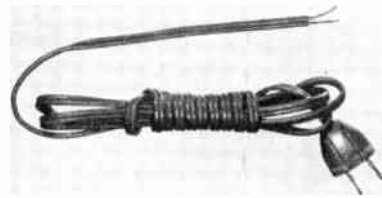

No. 1808HT

Replacement cord for radios, lamps, clocks, etc. Brown or Ivory.

No. 1808-HT with 6 ft. POSJ 18/2 Cord..... Each \$0.50

Seeger-Williams Rubber Cord Sets



No. 1810CE

No.	Description	Each
1810-CE	10 Ft. SJ 18/2 Power Supply. Eyeleted.....	\$1.10
1820-CE	20 Ft. SV 18/2 Vacuum Power Supply. Eyeleted.....	1.50
1825-CE	24 Ft. SV 18/2 Vacuum Power Supply. Eyeleted.....	1.70
1830-CE	20 Ft. SV 18/2 Tank Cleaner. Female Plug.....	2.75
1834-CE	24 Ft. SV 18/2 Tank Cleaner. Female Plug.....	3.00
1608-CE	8 Ft. SJ 16/2 Refrigerator. Eyeleted. Gray or Black.....	1.25
1610-CE	10 Ft. SJ 16/2 Washer. Eyeleted. Gray or Black.....	1.38
1615-CE	15 Ft. SJ 16/2 All Purpose. Eyeleted Gray or Black.....	1.46

Seeger-Williams TV Power Supply Cord

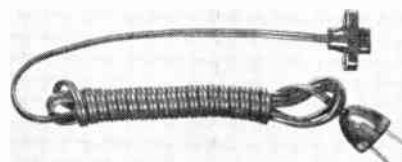

No. 1802H

Replacement power supply cord for most TV sets. Moulded female plug.

No. 1802-H with 8 ft. POT 18/2 Cord..... Each \$0.60

Hubbell Bakelite Feed-Thru Cord Switch

6 Amperes, 125 Volts; 3 Amperes, 250 Volts



No. 271

Single Pole. Cord hole diameter .406-in. to .250-in.

No.	Each	Per 100
271	271	\$89.00

Bryant Switchless Cord Sets

10 Amperes, 125 Volts; 5 Amperes, 250 Volts



No. HC633

No. HR0618

Packed 10 in a carton. 50 in a standard package.

Switchless Appliance Cord Set

No.	Description	Wt. Lbs. Std. Pkg.	Per 100
*HC633	6-Foot 3m Cycle Heater Cord	22	\$137.50

Switchless Cube Tap Set

HR0618	6-Foot Rubber Cord	16	\$100.50
HR0918	9-Foot Rubber Cord	17	114.50

Bryant Plastic Switchless Plugs



No. 738



No. 966

10 Amperes, 125 Volts; 5 Amperes, 250 Volts

Packed 10 in a carton. 100 in a standard package.

No.	Description	Wt. Lbs. Std. Pkg.	Per 100
*738	Plug, Steel Contacts, 1/16 inch Spacing	12	\$40.50
*966	Plug, Table Appliance. Contact points 1/2-inch Spacing	10	33.00

Bryant Plastic Switch Plug and Cord Switches



No. 280



No. 2880



No. 271

Packed 10 in a carton. 50 in a standard package.

10 Amperes, 125 Volts; 5 Amperes, 250 Volts

No.	Description	Wt. Lbs. Std. Pkg.	Per 100
*280	Switch Plug, Red Operating Handle	10	\$87.00
2880	Cord Switch, Black, Black Handle Cord Hole Diameter, 13/32-inch	5	97.00

6 Amperes, 125 Volts; 3 Amperes, 250 Volts

271	Cord Switch, Brown, Red Handle Cord Hole Diameter, 13/32-inch	5	\$89.00
-----	---	---	---------

Both cord switches are single pole—feed through.

*Not listed as standard by Underwriters' Laboratories, Inc. All others listed as standard.

Morse Eureka Cord Connectors



Hard rubber body. Bakelite cap. Set screws. Split male pin.

No.	Diam., In.	Overall Lgth., In.	Std. Pkg.
116	1/2	2 1/2	100
117	5/8	2 1/2	100



Hard rubber body. Bakelite caps. Split male pins.

No.	Diam., In.	Overall Lgth., In.	Std. Pkg.
166A	1/2	2 1/2	100
166	5/8	2 1/2	100
167	3/4	2 1/2	100



Double contact. Hard rubber. Can also be furnished in Bakelite. For Panel Mounting thru 1/16" hole. Standard package, 100.

No. 167A—Body Diam. 1/16-inch. Overall length, 2-inches.



All molded Bakelite Body and Caps.

No.	Diam., In.	Overall Lgth., In.	Std. Pkg.
167B	1/16	2 1/2	100



Midget. All molded Bakelite Body and Caps. Standard package, 100.

No. 6001—9/16" Diam. 1 7/8" Lgth.

Morse Eureka Plug Receptacles



Hard rubber, straight side Bakelite cap. Can also be furnished in Bakelite. Nickel-plated flange.

No.	Diam., In.	Overall Lgth., In.	Std. Pkg.
169	1/2, 5/8	2 1/4	100



Hard rubber, straight side Bakelite cap. Oval or round nickel-plated flange. Can be furnished in Bakelite.

No.	Diam., In.	Overall Lgth., In.
2366	5/8	2 1/4

All of above connectors and receptacles furnished with brass inserts and set screws for wire binding. Can also be furnished for soldered wiring connections if desired.

Prices on application.

Daniel Woodhead Safeway Neotex Covered Plugs

Listed by Underwriters' Laboratories, Inc.

Safeway Neotex Covered Plugs are built for heavy duty industrial and railroad service. The brass blades, which are mounted on approved insulating material, can be removed from the rubber body. These plugs are practically non-breakable and are safe to handle.

2-Wire Caps

15 Amperes, 125 Volts



No. 1400



No. 1401



No. 1402

No.	Description	Carton	Std. Pkg.	Wt., Lbs. Std. Pkg.	Each
1400	2-Wire Cap	10	100	11	\$.70
1401	2-Wire Tandem	10	100	11	.80
1402	2-Wire Polarity	10	100	11	.80

2-Wire Caps With Cord Grip

15 Amperes, 125 Volts



No. 1404



No. 1405



No. 1406

No.	Description	Carton	Std. Pkg.	Wt., Lbs. Std. Pkg.	Each
1404	2-Wire Cap Cord Grip	10	100	17	\$1.00
1405	2-Wire Tandem Cord Grip	10	100	17	1.10
1406	2-Wire Polarity Cord Grip	10	100	17	1.10

Daniel Woodhead Safeway Neotex Covered Plugs

Listed by Underwriters' Laboratories, Inc.

3-Wire Caps—Grounded

15 Amperes, 125 Volts; 10 Amperes, 250 Volts



No. 1403



No. 1407

3-Wire Grounded					
No.	Carton	Std. Pkg.	Wt., Lbs. Std. Pkg.	Each	
1403	10	100	12		\$.90

3-Wire Grounded Cord Grip					
No.	Carton	Std. Pkg.	Wt., Lbs. Std. Pkg.	Each	
1407	10	100	18		\$1.25

Daniel Woodhead Protex Rubber Covered Plugs

**Junior and Midget Types
15 Amperes, 125 Volts**



No. 1422



No. 1420

No.	Cord Hole	Carton	Std. Pkg.	Wt., Lbs. Std. Pkg.	Each
1420	5/16	10	100	7	\$.34
1421	3/16	10	100	7	.34
1422	1/4	10	100	4	.29

Daniel Woodhead Safeway Neotex Cord Connectors

**2-Wire Body and Cap
15 Amperes, 125 Volts**



No. 1500



No. 1504

No.	Description	Carton	Std. Pkg.	Wt., Lbs. Std. Pkg.	Each
1500	Parallel Body only	10	100	12	\$1.10
1504	Parallel Body and Cap	5	50	13	1.80
1501	Polarity Body only	10	100	12	1.20
1505	Polarity Body and Cap	5	50	13	2.00

With Cord Grip



No. 1502



No. 1506

No.	Description	Carton	Std. Pkg.	Wt., Lbs. Std. Pkg.	Each
1502	Parallel Body and Grip	10	100	18	\$1.40
1506	Parallel Body, Cap and Grip	5	50	18	2.40
1503	Polarity Body and Grip	10	100	18	1.50
1507	Polarity Body, Cap and Grip	5	50	18	2.60
1508	3-Wire Body and Grip	10	100	20	1.80
1509	3-Wire Body, Cap and Grip	5	50	20	3.05

Daniel Woodhead Safeway Neotex Covered 3 Wire Plug and Connector

**NEMA "U" Blade Grounded Type
15 Amperes—125 Volts**



No. 1447



No. 1547

No.	Description	Ctn.	Std. Pkg.	Wt. Lbs. Std. Pkg.	Each
1447	3-wire cord grip cap	10	100	20	\$1.25
1547	3-wire cord grip conn.	10	100	21	1.80

Daniel Woodhead Turnex Locking Caps and Connectors

Made with "Safety Yellow" Neotex

Turnex Neotex covered locking caps and connectors are made for rugged service, and made from only heavy duty materials with the regular high quality construction. Features... heavy duty Neotex cover, molded-in cord grip large enough for heavier cords, laminated phenolic inserts and extra heavy brass contacts.

Interchangeable with other standard locking caps and connectors.

2 and 3 Wire Turnex Caps

10 Amperes, 250 Volts; 15 Amperes, 125 Volts



No. 2404



No. 2407

No.	Description	Ctn.	Std. Pkg.	Wt. Lbs. Std. Pkg.	Each
2404	2-wire cord grip	10	100	28	\$1.20
2407	3-wire cord grip	10	100	29	1.40

2 and 3 Wire Turnex Connectors

10 Amperes, 250 Volts; 15 Amperes, 125 Volts



No. 2502



No. 2508

No.	Description	Ctn.	Std. Pkg.	Wt. Lbs. Std. Pkg.	Each
2502	2-wire cord grip	10	100	28	\$1.60
2508	3-wire cord grip	10	100	30	2.45

3 Wire Turnex Cap and Connector

20 Amp. 250 Volts, AC/DC; 10 Amp. 600 Volts AC



No. 2608



No. 2708

No.	Description	Ctn.	Std. Pkg.	Wt. Lbs. Std. Pkg.	Each
2608	3-wire cord grip cap	10	100	30	\$1.75
2708	3-wire cord grip conn.	10	100	34	2.60

Ericson Neoprene Rubber Safety Plugs

Oil Resistant

15 Amperes.—125 Volts

10 Amperes.—250 Volts



No. 15-PGC



No. 17



No. 15-PC



No. 19-PC

No rivets to break or loosen; blades held firmly in unbreakable hard rubber insert, which fits into tough Neoprene oil resistant jacket. Fits cords up to 5/16 in. Carton Qty. 10.

No.	Description	Std. Pkg.	Pkg. Wt. Lbs.	Each
15-PC	Parallel blades w/cord grip clamp	100	16	\$0.68
19-PC	2 wire connector w/cord grip clamp	100	16	.78
17	3 wire polarized	100	19	.85
15-PGC	3 wire polarized, parallel blades w/third grounding pin, cord grip	100	17	.88

Bryant Flat Cord Connectors

Black Plastic

10 Amps., 125 Volts



No. 2956



No. 2958

Body and plug do not have standard prong spacings. Cord hole diameter, 3/32-inch.

Body, for use with No. 2958 Plug only.

No.	Carton	Std. Pkg.	Wt. Lbs. Std. Pkg.	Per 100
2956	10	100	5	\$54.00

Plug, for use with No. 2956 Body only.

No.	Carton	Std. Pkg.	Wt. Lbs. Std. Pkg.	Per 100
2958	10	100	5	\$4.00

Bryant Plastic Cube Taps

15 Amperes, 125 Volts



No. 207



No. 17



No. 18

No.	Description	Carton	Std. Pkg.	Wt. Lbs. Std. Pkg.	Per 100
207	Compact Construction	10	100	10	\$58.50
17	Standard Design	20	100	9	32.00
18	Cord Connection	20	100	9	40.50

Bryant Caps

Parallel Blades

15 Amperes, 125 Volts

Plastic Handle Grip



No. HF

No.	Description	Carton	Std. Pkg.	Wt. Lbs. Std. Pkg.	Per 100
HF	1 1/32-Inch Hole	10	100	5	\$16.50

Add prefix "M" to catalog number for wide polarity.

Black Rubber Handle Grip Short Shank, Two-Piece



No. HRE

No.	Hole Size In Inches	Carton	Std. Pkg.	Wt. Lbs. Std. Pkg.	Per 100
HRA	5/16 to 13/32	25	100	8	\$29.00
HRB	1/4 to 5/16	25	100	8	30.50
HRS	33/64 to 37/64	25	100	8	29.00

Long Shank, Two-Piece

No.	Hole Size In Inches	Carton	Std. Pkg.	Wt. Lbs. Std. Pkg.	Per 100
HRE	5/16 to 13/32	25	100	9	33.50
HRF	17/64 to 21/64	25	100	9	32.50

Small Cord Connectors

Black Composition

15 Amperes, 125 Volts; 10 Amperes, 250 Volts



No. 7257



No. 7357

No.	Description	Cord Hole Inches	Carton	Std. Pkg.	Wt. Lbs. Std. Pkg.	Per 100
7257	Cord Grip Body	13/32 to 5/8	10	50	8	\$86.00
7357	Cord Grip Cap	13/32 to 5/8	10	50	5	57.50
*9357	Cord Grip Cap	13/32 to 5/8	10	50	8	69.50

*Polarized—one wide and one narrow blade.

The above small size devices will not fit standard parallel blade devices.

Hubbell Wiring Devices

Rubber Finger Grip Attachment Plug Caps

Parallel Blades—15 Amperes, 125 Volts
Tandem Blades—15 Amperes, 250 Volts

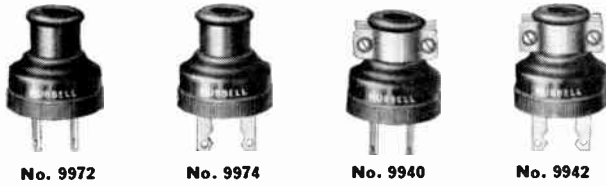

Without Cord Grip

No.	Blades	Cord Hole Inches	Car-ton	Std. Pkg.	Wt. Lbs. Std. Pkg.	Per 100
9972	Parallel	$\frac{5}{16}$ to $\frac{7}{16}$	25	100	10	\$34.50
*9973	Parallel	$\frac{5}{16}$ to $\frac{7}{16}$	25	100	10	42.50
9934	Parallel	$\frac{5}{8}$	25	100	9	34.50
*9935	Parallel	$\frac{5}{8}$	25	100	9	42.50
9974	Tandem	$\frac{1}{8}$ to $\frac{7}{16}$	25	100	10	43.50
9936	Tandem	$\frac{5}{8}$	25	100	9	43.50

With Cord Grip

9940	Parallel	$\frac{5}{16}$ to $\frac{7}{16}$	25	100	12	50.50
*9941	Parallel	$\frac{5}{16}$ to $\frac{7}{16}$	25	100	12	57.50
9937	Parallel	$\frac{5}{8}$	25	100	12	50.50
*9938	Parallel	$\frac{5}{8}$	25	100	12	57.50
9942	Tandem	$\frac{1}{8}$ to $\frac{7}{16}$	25	100	12	59.50
9939	Tandem	$\frac{5}{8}$	25	100	10	59.50

*Polarized—one wide and one narrow blade.

Composition Cord Connector Bodies

15 Amperes, 125 Volts



Bodies with cord grip have steel covers.

With Double T Slots—Composition

No.	Description	Cord Hole Inches	Car-ton	Std. Pkg.	Wt. Lbs. Std. Pkg.	Per 100
5574	Body, Less Cord Grip	$\frac{1}{2}$	10	50	6	\$77.00
7080	Body, Less Cord Grip	$\frac{5}{16}$	10	50	8	77.00
7611	Body, With Cord Grip	$\frac{1}{2}$ to $\frac{9}{16}$	10	50	10	84.50
7614	Body, With Cord Grip	$\frac{7}{32}$ to $\frac{5}{16}$	10	50	10	84.50
7084	Body, Armored with Cord Grip	$\frac{1}{8}$ to $\frac{9}{16}$	10	50	8	100.50
7187	Body, Armored with Cord Grip	$\frac{1}{2}$ to $\frac{5}{8}$	10	50	8	100.50

The above connector bodies will take 10 Ampere Plug caps having tandem, parallel, or polarized parallel blades.

With Parallel Slots—Bakelite

Diameter of connector body, $1\frac{3}{16}$ inches; height $1\frac{3}{8}$ inches.

7430	Body, Brown	$\frac{5}{16}$	10	50	4	\$39.00
7431	Cap, Brown	$\frac{9}{32}$ to $\frac{3}{8}$	25	500	18	15.50

Small Flush Motor Plugs

Black Composition

15 Amperes, 125 Volts; 10 Amperes, 250 Volts



Nos. 6808 or 9808

No. 9819

No. 6631

Screw holes spaced $1\frac{3}{4}$ -inches. Diameter shell, $1\frac{3}{8}$ -inches.

No.	Description	Cord Hole Inches	Car-ton	Std. Pkg.	Wt. Lbs. Std. Pkg.	Per 100
6808	Male Base, Brass Casing	$13/32$	10	50	8	\$83.50
9808	Male Base, Brass Casing Pol.	$13/32$	10	50	6	99.00
9819	Female Base, Brass Casing	$13/32$	10	50	8	104.50
6631	Male Base, less Casing		10	50	3	45.00

Polarized—Armored with Cord Grip

†7257	Body	$13/32$ to $5/8$	10	50	8	\$86.00
†7259	Body	$19/64$ to $13/32$	10	50	7	86.00

These bodies fit Flush Motor Bases Nos. 6808 or 9808, listed above. Takes caps Nos. 7357 or 9357.

†Takes polarized or non-polarized caps.

Hubbell Flush Motor Plug Receptacles

Double T-Slots—Black Bakelite
15 A., 125 V.



No. 7608

No.	Description	Cord Hole Inches	Per 100
7608	Exposed Terminals		\$88.00
7609	Covered Terminals	$13/32$	105.50
7610	Covered Terminals, Adjustable Cord Grips	$19/64$ to $9/16$	112.00

Standard package 50, carton 10.

Surface Motor Plugs

Male Base with Parallel Blades

Exposed Wiring

15A., 125 V.

This plug takes bodies Nos. 5574, 7080, 7187, 9952, 9953, and 9955.

Packed 10 in a carton, 50 in a standard package. Package weight, 7 pounds.

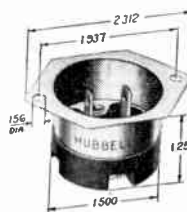

No. 4891

No.	Per 100
4891	\$79.50

Bryant Cord Connector Bodies
15 Amps., 125 Volts



No. 130



No. 103



No. 5103

Brown Plastic—Parallel Slots

No.	Description	Carton	Std. Pkg.	Wt. Lbs. Std. Pkg.	Per 100
130	Diameter $1\frac{3}{16}$ -Inches Cord Hole $\frac{5}{16}$ -Inches	10	50	4	\$39.00

Black Composition—"T" Slots

103	Diameter $1\frac{3}{8}$ -Inches Cord Hole $1\frac{1}{32}$ -Inches	10	50	7	\$77.00
-----	--	----	----	---	---------

Black Composition—Armored Cord Grip—"T" Slots

5103	Cord Hole $\frac{1}{64}$ to $\frac{1}{16}$ -Inches	10	50	9	\$100.50
------	--	----	----	---	----------

Bryant Connector Base With Mounting Cup
15 Amps., 125 Volts



No. UR

Back connected. Cup diameter $1\frac{1}{2}$ -inches. Depth $1\frac{1}{4}$ -inches. Screw spacing $1\frac{15}{16}$ -inches. For use with Nos. 103 and 5103 Bodies. Add prefix "M" to catalog number for wide polarity blade.

No.	Carton	Std. Pkg.	Wt. Lbs. Std. Pkg.	Per 100
UR	10	50	7	\$79.50

Bryant Plastic Parallel Blade Caps
15 Amps., 125 Volts

Brown Plastic Standard Type.



No. HUT

No.	Hole Size in Inches	Carton	Std. Pkg.	Wt. Lbs. Std. Pkg.	Per 100
HUT	$\frac{9}{32}$	25	500	18	\$15.50
HUV	$1\frac{3}{32}$	25	500	18	15.50

Bryant Screw Plug Bodies for Parallel Blades
660 Watts, 125 Volts



No. 100

No.	Description	Carton	Std. Pkg.	Wt. Lbs. Std. Pkg.	Per 100
706	Brown Plastic	25	500	19	\$20.50
100	Black Plastic	10	250	14	28.50

Bryant Composition Connector Base
Parallel Blades

15 Amps., 125 Volts



No. KG

Diameter $1\frac{17}{32}$ -inches, thickness $1\frac{1}{16}$ -inches. Screw spacing, 1-inch. Cord hole, $1\frac{1}{32}$ -inch. Packed 10 in a carton. 50 in a standard package. Package weight, 5 pounds.

No. *KG..... Per 100 \$40.50

Bryant Double "T" Blade Cap
Armored Cord Grip
15 Amps., 125 Volts



No. TW

$1\frac{3}{32}$ -inch cord hole. For use with "T" slot devices. Packed 10 in a carton. 30 in a standard package. Package weight, 5 pounds.

No. TW..... Per 100 \$89.00

*Add prefix "M" to catalog number for wide polarity blade.

Listed as standard by Underwriters' Laboratories, Inc.

Bryant Black Composition Caps

15 Amps., 125 Volts

Parallel Blades

Nos. JK and JM have armored cord grips. Cord hole diameter: JK $1\frac{1}{32}$ to $\frac{5}{8}$ -inch; JM, cord hole $\frac{1}{2}$ -inch; KA $1\frac{1}{32}$ -inch.

JK and JM packed 10 in carton, 50 in a standard package. Package weight, 7 pounds. KA packed 10 in a carton, 250 in a standard package. Package weight, 18 pounds.



No. JK

No.	Per 100
*JK, with Cord Grip	\$53.00
*JM, with Cord Grip	53.00
KA, No Cord Grip	36.50

No. JX has armored cap with cord grip. Cord hole diameter: JX, $1\frac{1}{32}$ to $\frac{5}{8}$ -inch. KZ, $1\frac{1}{32}$ -inch.



No. JX

JX packed 10 in a carton. 50 in a standard package. Package weight, 6 pounds. KZ packed 10 in a carton. 250 in a standard package. Package weight, 21 pounds.

No.	Per 100
*JX, with Cord Grip	\$61.50
*KZ, No Cord Grip	33.50

Bryant 3-Wire Polarized Grounding Devices

20 Amps. 250 Volts

Flush Mounting Outlets
Black Plastic

Depth $1\frac{1}{16}$ -inches. For standard single outlet plates.



No. 9326

No.	Carton	Std. Pkg.	Wt. Lbs. Std. Pkg.	Per 100	
9326	Black	10	30	6	\$202.50
*9326-G	Black	10	30	6	202.50
9326-I	Ivory	10	30	6	214.00
*9326-GI	Ivory	10	30	6	202.50

Black Composition Cord Connector

Cord grip for $\frac{3}{8}$ to $\frac{5}{8}$ -inch cords.



No. 9322

9323	10	20	8	\$239.50
------	----	----	---	----------

Cap

Armored, with cord grip $\frac{3}{8}$ to $\frac{5}{8}$ -inch.

9322	10	20	5	\$163.50
------	----	----	---	----------

Box Mounting Outlets on
4-Inch Covers

Covers finished to resist corrosion.

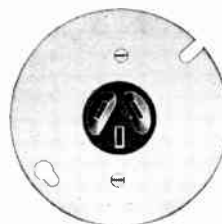

No. 9324

No.	Carton	Std. Pkg.	Wt. Lbs. Std. Pkg.	Per 100
9324	5	30	15	\$224.50
*9324-G	5	30	15	224.50

*Has grounded yoke.

Listed as standard by Underwriters' Laboratories, Inc.

Bryant Polarized Connecting Devices

Listed as standard by Underwriters' Laboratories, Inc.

2-Wire Polarized Caps

20 Amperes, 250 Volts



No. 652

Black composition.
Cord hole, $\frac{9}{16}$ -inch.
Packed 10 in a carton, 30 in a standard package. Package weight, 5 pounds.
No. 652 per 100 **\$82.50**

With Cord Grip



No. 723

Armored, metal covered.
Cord grip for $\frac{3}{8}$ to $\frac{9}{16}$ -inch cord.
Packed 10 in a carton, 30 in a standard package. Package weight, 7 pounds.
No. 723 per 100 **\$127.00**

With Cord Grip



No. 9758

Rubber.
Cord hole $\frac{13}{32}$ to $\frac{5}{8}$ -inch.
Packed 10 in a carton, 30 in a standard package. Package weight, 7 pounds.
No. 9758 per 100 **\$122.50**

Cord Connector



No. 3856

For caps Nos. 652, 723, and 9758.
Black composition.
Cord grip $\frac{13}{32}$ to $\frac{5}{8}$ -inch.
Packed 10 in a carton, 30 in a standard package. Package weight, 11 pounds.
No. 3856 per 100 **\$169.00**

Box Mounting Outlet

2-Wire Polarized
20 Amperes, 250 Volts



No. 5554

On 4-inch cover finished to resist corrosion.
Packed 5 in a carton, 30 in a standard package. Package weight, 15 pounds.
No. 5554 per 100 **\$180.50**

2-Wire Flush Outlet
20 Amperes, 250 Volts
2-Wire



Brown plastic.
Takes single outlet plate. Packed 10 in a carton, 30 in a standard package. Pkg. Wgt. 7 lbs.
No. 556 Per 100 **\$160.50**

3-Wire Duplex Flush Outlets

15 Amperes, 125 Volts; 10 Amperes, 250 Volts



No. 4326

Brown Plastic. Takes standard duplex outlet plate. Back or side wired.
Depth, $\frac{15}{16}$ -inches. Screw spacing, $3\frac{3}{32}$ -inches.
No. Carton Std. Pkg. Wt., Lbs. Std. Pkg. Per 100
4326 10 30 8 **\$253.00**
*4327 10 30 8 **253.00**
*I has grounded yoke.

3-Wire Polarized Grounding Devices

15 Amp., 125 Volts; 10 Amp., 250 Volts

Surface Mounting Outlet

Porcelain



No. 9119

Concealed base. Diameter $2\frac{1}{2}$ -inches.
Screw spacing $1\frac{3}{4}$ -inches.

No.	Carton	Std. Pkg.	Wt., Lbs. Std. Pkg.	Per 100
9119	10	50	21	\$123.00

Flush Mounting Outlets

Black Plastic



No. 9116

Depth $\frac{25}{32}$ -inch. For standard single outlet plate.

No.	Carton	Std. Pkg.	Wt., Lbs. Std. Pkg.	Per 100
9116	10	50	9	\$182.50
*9120	10	50	9	182.50

Ivory Plastic

9116-I	10	50	9	\$194.00
9120-I	10	50	9	194.00

Mounted on 4-inch covers

Covers finished to resist corrosion.

9121	5	50	31	\$204.50
*9121-G	5	50	31	204.50

Black Composition Connector Bodies



No. 9113

No.	Carton	Std. Pkg.	Wt., Lbs. Std. Pkg.	Per 100
9113	10	50	9	\$114.50
9114	10	50	13	\$155.00

3-Wire Polarized Caps

Brown Plastic



No. 9110

Cord hole $\frac{13}{32}$ -inch.
9110 10 50 4 **\$54.50**

Black Composition

Cord hole $\frac{13}{32}$ -inch.
9111 10 50 5 **\$54.50**

Armored

Cord grip for $\frac{3}{8}$ to $\frac{1}{2}$ -inch cords.
9112 10 50 8 **\$94.00**

Black Rubber



Cord hole .406 inch.
9109 10 50 7 **\$55.50**

Armored—Metal
Covered With Cord Grip



For .296 to .562 inch cord.
7055 10 50 7 **\$93.50**

Bryant Grounding Connecting Devices

3-Wire Nema and ASA Standard
15 Amperes 250 Volts

Flush Mounting Outlets

Plastic—Single Outlet

Side or Back Wiring

No.	Description	Ctn. Qty.	Std. Pkg.	Wt. Lbs. Std. Pkg.	Per 100
5661	Brown	10	50	9	\$175.00
5661-I	Ivory	10	50	9	185.00

Side Wiring

5651	Brown	10	50	9	\$ 80.00
5651-I	Ivory	10	50	9	85.00

Duplex Outlet—Plastic

Takes standard duplex outlet plate. Break-off terminals for switch control of one outlet.

Side or Back Wiring

No.	Description	Ctn. Qty.	Std. Pkg.	Wt. Lbs. Std. Pkg.	Per 100
5662	Brown	10	50	12	\$253.00

With Two Grounding Terminals

Side Wiring

5652	Brown	10	50	12	144.00
------	-------	----	----	----	--------

With One Grounding Terminal

5642	Brown	10	50	11	90.00
5642-I	Ivory	10	50	11	95.00

Single Outlet—Plastic

Back or Side Wiring Short Yoke

No.	Description	Ctn. Qty.	Std. Pkg.	Wt. Lbs. Std. Pkg.	Per 100
5684	Brown	10	50	6	\$139.00

Box Mounting Outlets

On 4 Inch Covers

Finished to Resist Corrosion

Brown

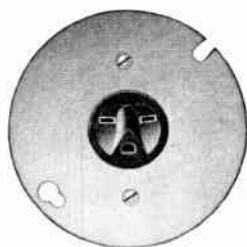

No. 5681

Back or Side Wiring

No.	Type	Ctn. Qty.	Std. Pkg.	Wt. Lbs. Std. Pkg.	Per 100
5681	Single	10	50	22	\$195.00
5682	Duplex	10	50	24	274.00

Side Wiring

5654	Single	10	50	22	\$144.00
5653	Duplex	10	50	22	164.00

Connector Base

Body diameter 1¹³/₃₂ in. Depth, 1¹³/₃₂ in.
Screw spacing 2 in.

No.	Ctn. Qty.	Std. Pkg.	Wt. Lbs. Std. Pkg.	Per 100
5678	10	50	7	\$126.00



Caps



No. 5663



No. 5674



No. 5664



No. 5666

Brown Plastic

No.	For Cord, In.	Ctn. Qty.	Std. Pkg.	Wt. Lbs. Std. Pkg.	Per 100
5663	.437	10	50	5	\$ 55.50

Black Rubber Handle Grip

5674	.312 to .468	10	50	6	122.00
------	--------------	----	----	---	--------

Black Rubber With Cord Grip Handle Grip

5676	.312 to .468	10	50	7	133.00
------	--------------	----	----	---	--------

Armored With Cord Grip

5664	.296 to .625	10	50	7	89.50
------	--------------	----	----	---	-------

Black Rubber With Cord Grip

5666	.296 to .625	10	50	7	89.50
------	--------------	----	----	---	-------

Connector Bodies

Armored With Cord Grip

Brown Plastic

Universal cord grip takes full range of wire sizes. For .296 to .625 inch cord.

No.	Ctn. Qty.	Std. Pkg.	Wt. Lbs. Std. Pkg.	Per 100
5669	10	50	8	\$207.00



Rubber With Cord Grip

Practically indestructible. The rigid "Fiberite" face insert prevents accidental forcing of male cap blades into improper slots.

Universal cord grip takes full range of wire sizes. For .296 to .625 inch cord.

No.	Ctn. Qty.	Std. Pkg.	Wt. Lbs. Std. Pkg.	Per 100
5694	10	50	10	\$130.00



Duplex Combination Outlets

15 Amperes 125 Volts And
15 Amperes 250 Volts

Side and Back Wired

No.	Type	Ctn. Qty.	Std. Pkg.	Wt. Lbs. Std. Pkg.	Per 100
5292	Brown	10	50	11	\$236.00
5292-I	Ivory	10	50	11	248.00

Side Wired

5280	Brown	10	50	10	\$127.00
5280-I	Ivory	10	50	10	139.00



Bryant Grounding Connecting Devices
3-Wire NEMA and ASA Standard
15 Amperes, 125 Volts

Flush Mounting Outlets
Plastic

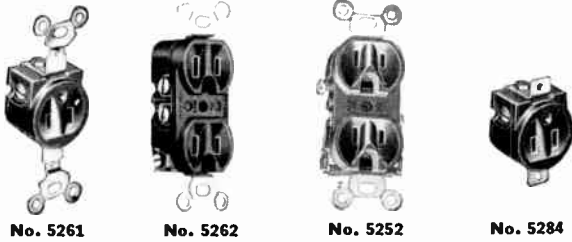

No.	Type	Color	Ctn. Qty.	Std. Pkg.	Wt., Lbs., Std. Pkg.	Per 100
5261	Single	Brown	10	50	9	\$158.00
5261-I	Single	Ivory	10	50	9	168.00
5262	Duplex	Brown	10	50	12	219.00
5262-I	Duplex	Ivory	10	50	12	231.00

Back or Side Wiring

No.	Type	Color	Ctn. Qty.	Std. Pkg.	Wt., Lbs., Std. Pkg.	Per 100
5251	Single	Brown	10	50	9	80.00
5251-I	Single	Ivory	10	50	9	85.00

Side Wiring—Two Grounding Terminals

5252	Duplex	Brown	10	50	11	110.00
5252-I	Duplex	Ivory	10	50	12	122.00

Side Wiring—One Grounding Terminal

5242	Duplex	Brown	10	50	11	90.00
5242-I	Duplex	Ivory	10	50	11	95.00

Back or Side Wiring—Short Yoke

5284	Single	Brown	10	50	6	122.00
------	--------	-------	----	----	---	--------

Weatherproof Outlet

Back or Side Wiring

Provides a permanent weatherproof convenience outlet for outdoor installation. Plate and cover finished to resist corrosion. With thread-on cover.

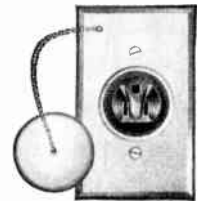

No.	Ctn. Qty.	Std. Pkg.	Wt., Lbs., Std. Pkg.	Per 100
5260	2	10	6	\$359.00

Connector Bodies

Brown Plastic
Armored with Cord Grip

Universal cord grip takes full range of wire sizes. For .296 to .625 inch cord.



No.	Ctn. Qty.	Std. Pkg.	Wt., Lbs., Std. Pkg.	Per 100
5269	10	50	8	\$126.00

Rubber with Cord Grip

The rubber body combined with the high impact and dielectric qualities of the "Fiberite" face insert makes this connector practically indestructible. Rigid face insert prevents forcing of male cap blades into improper slots.



Universal cord grip takes full range of wire sizes.

No.	For Cord, In.	Ctn. Qty.	Std. Pkg.	Wt., Lbs., Std. Pkg.	Per 100
5294	.296 to .625	10	50	10	\$120.00

Caps

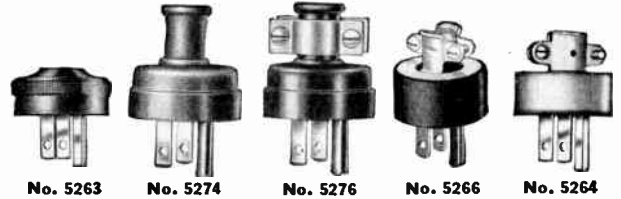

No.	For Cord, In.	Ctn. Qty.	Std. Pkg.	Wt., Lbs., Std. Pkg.	Per 100
5263	.437	10	50	4	\$47.00
5263-I	.437	10	50	4	52.00
5274	.312 to .468	10	50	6	49.80
5276	.312 to .468	10	50	7	60.50
5266	.296 to .625	10	50	7	81.00
5264	.296 to .625	10	50	6	81.00

Plastic—Brown

Plastic—Ivory

Black Rubber—Handle Grip

Black Rubber with Cord Grip—Handle Grip

Black Rubber with Cord Grip

Armored with Cord Grip

Box Mounting Outlets

On 1-inch covers finished to resist corrosion.

Back or Side Wiring

Single—Brown

No.	Ctn. Qty.	Std. Pkg.	Wt., Lbs., Std. Pkg.	Per 100
5281	10	50	22	\$178.00

Duplex—Brown

5282	10	50	23	240.00
------	----	----	----	--------

Side Wiring

Single—Brown

5254	10	50	22	110.00
------	----	----	----	--------

Duplex—Brown

5253	10	50	22	130.00
------	----	----	----	--------

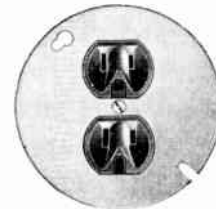

No. 5282

Connector Base

Body diameter 1 7/32 in. Depth 1 13/32 in. Screw spacing 2 inches.



No.	Ctn. Qty.	Std. Pkg.	Wt., Lbs., Std. Pkg.	Per 100
5278	10	50	7	\$109.00

Pilot Light Combination

For control of portable equipment and appliances. Light indicates that switch controlled outlet is in use. Outlet: 15 amp., 125 v. D.P. switch: 20 amp., 125 v. 20 amp., 250 v.

Pilot light combination comes complete with .040-in. dull chromium plate.

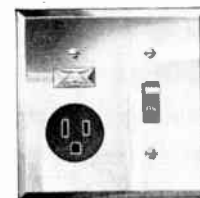

No.	Ctn. Qty.	Std. Pkg.	Wt., Lbs., Std. Pkg.	Per 100
5349	2	10	12	\$846.00

Adapter

To adapt standard 2-wire outlets for use with 3-wire grounding caps.

Brown plastic with 3 inch thermoplastic lead.



No.	Ctn. Qty.	Std. Pkg.	Wt., Lbs., Std. Pkg.	Per 100
5273-I	10	50	11	\$86.00

Bryant Heavy Duty Connecting Devices

**3-Wire Polarized Connectors
30 Amperes 250 Volts—Nema and ASA Standard**

With L-Shaped Grounding Slots and Blades

These power outlets, equipped with clamp type pressure terminals for faster, more secure connections, are especially recommended for electric dryer, commercial cooking and built-in range top installation.

Especially recommended for the connection of electric dryers, commercial cooking and built-in range top installation.

Caps

Ungrounded

For .750 inch cord.

Black Plastic

No.	Ctn. Qty.	Std. Pkg.	Wt. Lbs. Std. Pkg.	Per 100
9331	2	10	6	\$150.00

Grounded

For .750 inch cord.

No.	Ctn. Qty.	Std. Pkg.	Wt. Lbs. Std. Pkg.	Per 100
9332	2	10	8	\$241.50

Armored with Cord Grip

Ungrounded, for .625 to 1.000 inch cord.

No.	Ctn. Qty.	Std. Pkg.	Wt. Lbs. Std. Pkg.	Per 100
9337	2	10	7	\$241.50

Armored with Cord Grip

Grounded, for .625 to 1.000 inch cord.

No.	Ctn. Qty.	Std. Pkg.	Wt. Lbs. Std. Pkg.	Per 100
9338	2	10	7	\$263.50

**Black Plastic
With Solderless Terminals**

Accommodates armored and rubber cable. Has clamp terminals and grounding prongs.

No.	Ctn. Qty.	Std. Pkg.	Wt. Lbs. Std. Pkg.	Per 100
9305	2	10	10	\$373.00

Connector Body

Black Composition

Armored with Cord Grip.

For .625 to 1.000 inch cord.

No.	Ctn. Qty.	Std. Pkg.	Wt. Lbs. Std. Pkg.	Per 100
9341	1	5	7	\$584.50

Cord Sets

Non-Removable Plastic Cap

No. 9339: 36-in. long, #10 wire.

No. 9339-B: 48-in. long, #10 wire.

No. 9339-C: 60-in. long, #10 wire.



No.	Description	Ctn. Qty.	Std. Pkg.	Wt. Lbs. Std. Pkg.	Per 100
9339	Cord Set	2	10	13	\$220.00
9339-B	Cord Set	2	10	16	262.00
9339-C	Cord Set	2	10	18	290.00

Flush Outlets

Can be mounted in a single gang box. Can also be mounted in 1 or 1 1/16 inch square boxes with plaster cover raised 1/2 inch or more.

Use No. 9301 or 9302 plate.



Black Plastic

No.	Ctn. Qty.	Std. Pkg.	Wt. Lbs. Std. Pkg.	Per 100
9303	2	10	4	\$180.00

No. 9340

Use No. 7114 plate

Black Porcelain

No.	Ctn. Qty.	Std. Pkg.	Wt. Lbs. Std. Pkg.	Per 100
9340	1	5	7	\$422.00

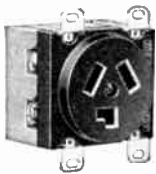

Surface Outlets

Harmonized with metal kitchen and laundry equipment.

Heavy gage aluminum enclosure provides a near-indestructible device.

Outlet with aluminum enclosure.



No.	Ctn. Qty.	Std. Pkg.	Wt. Lbs. Std. Pkg.	Per 100
9304	2	10	9	\$236.50

Flush Plates

For No. 9303 Outlet

Stainless Steel
1-Gang, Single Opening

No.	Ctn. Qty.	Std. Pkg.	Wt. Lbs. Std. Pkg.	Per 100
9301	2	10	1	\$46.00

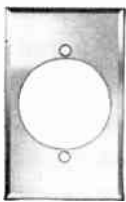

Stainless Steel

Two-Gang
Single Opening

No.	Ctn. Qty.	Std. Pkg.	Wt. Lbs. Std. Pkg.	Per 100
9302	2	10	2	\$61.50

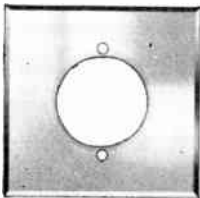

For No. 9340 Outlet

Stainless Steel
2-Gang, Single Opening

No.	Ctn. Qty.	Std. Pkg.	Wt. Lbs. Std. Pkg.	Per 100
7114	1	5	2	\$199.00

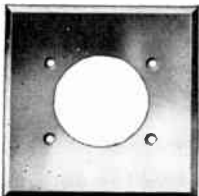

Hubbell Wiring Devices

3-Wire Indestructible Polarized Rubber Cord Connectors

15 Amperes, 125 Volts; 10 Amperes, 250 Volts



Roll-back handle section of body, easily detached and attached for wiring.

Self-aligning phosphor bronze contact springs. Brass contact blades securely riveted to specially designed brass inserts which are moulded solidly into rubber body of cap.

Without Cord Grip

No.	Description	Cord Hole Inches	Car-ton	Std. Pkg.	Wt. Lbs. Std. Pkg.	Per 100
9409	Body	5/16 to 15/32	10	50	9	\$115.50
9411	Body	5/8	10	50	8	115.50
9975	Cap	5/16 to 15/32	10	50	6	55.50
9976	Cap	5/8	10	50	6	55.50

With Cord Grip

9410	Body	5/16 to 15/32	10	50	10	\$130.00
9412	Body	5/8	10	50	10	130.00
9413	Cap	5/16 to 15/32	10	50	8	67.00
9414	Cap	5/8	10	50	7	67.00

3-Wire Polarized Cord Connectors



Without Cord Grip

15 Amperes, 125 Volts; 10 Amperes, 250 Volts

No.	Description	Cord Hole Inches	Car-ton	Std. Pkg.	Wt. Lbs. Std. Pkg.	Per 100
6409	Body, Composition	7/16	10	50	12	\$114.50
6149	Cap, Bakelite	7/16	10	50	4	54.50
7252	Cap, Bakelite	1/4	10	50	5	54.50

Armored—With Cord Grip

15 Amperes, 125 Volts; 10 Amperes, 250 Volts

Cap is metal covered, finished to resist corrosion. If desired grounded, suffix letter G to number.

*7082	Body, Composition	19/64 to 9/16	10	50	8	\$155.00
7055	Cap, Composition	19/64 to 9/16	10	50	7	93.50
*7308	Body, Composition	13/32 to 5/8	10	50	14	155.00
7309	Cap, Composition	13/32 to 5/8	10	50	7	93.50

20 Amperes, 250 Volts

*7088	Body, Composition	13/32 to 5/8	10	20	9	\$239.50
7089	Cap, Composition	13/32 to 5/8	10	20	5	163.50

*Not available grounded.

3-Wire Polarized Cord Connectors

With Cord Grip
30 Amperes
250 Volts



No.	Description	Cord Diameter Inches	Car-ton	Std. Pkg.	Wt. Lbs. Std. Pkg.	Per 100
7283	Composition Body	5/8 to 1	2	5	6	\$614.00
7113	Armored Cap	5/8 to 1	2	5	4	241.50

3-Wire Polarized Surface Receptacles



Nos. 7513 and 7520 caps with ground contacts removed may be used with this receptacle.

50 Amperes, 250 Volts

No.	Description	Car-ton	Std. Pkg.	Wt. Lbs. Std. Pkg.	Per 100
9306	White Porcelain	2	10	5	\$220.00

30 Amperes, 250 Volts

9307	Black Composition	2	10	10	254.00
------	-------------------	---	----	----	--------

Nos. 7113, 7514 and 9316 caps fit this receptacle.

4-Wire Polarized Flush Receptacles

20 Amperes, 250 Volts

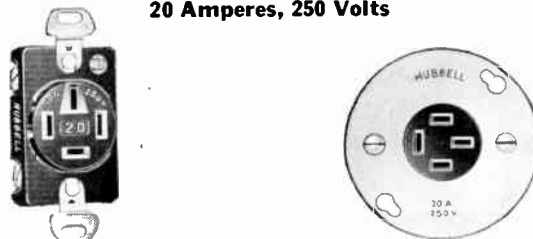

No.	Description	Car-ton	Std. Pkg.	Wt. Lbs. Std. Pkg.	Per 100
†7250	Black Bakelite Receptacle	10	20	8	\$251.00
†7279	Receptacle on 4-Inch Cover	5	20	11	263.50

4-Wire Polarized Cord Connectors

With Cord Grips

20 Amperes, 250 Volts



No. †7351	Per 100	\$303.00
-----------	-------	---------	----------

Black Bakelite. Cord grip diameter, 1/8 to 3/4-inch.

Packed 10 in a carton. 20 in a standard package. Package weight, 9 pounds.

4-Wire Polarized Caps

With Cord Grips

20 Amperes, 250 Volts



No.	Description	Car-ton	Std. Pkg.	Wt. Lbs. Std. Pkg.	Per 100
7251	Metal Covered Cap	10	20	6	\$194.00
▲9251	Grounded Metal Covered Cap	10	20	5	194.00
†9951	Rubber Cap	10	20	5	194.00

*Takes standard single outlet plates. Gang plates must be of special size.

▲Has shunt from ground blade to metal cover for grounding to metal-sheathed 3-wire cable.

†If No. 7250, 7279 or 9951 is desired grounded, suffix letter G to catalog number.

‡Is not available grounded.

All exposed metal parts finished to resist corrosion.

Hubbell Wiring Devices

Surface Motor Plugs

15 Amperes, 125 Volts



No. 6823 and 6118



No. 5574



No. 5896

Parallel Blades and Slots

No.	Description	Cord Hole Inches	Carton	Std. Pkg.	Wt., Lbs. Std. Pkg.	Per 100
6823	Male Base	1 3/32 to 1/16	10	50	6	\$40.50
6118	Connector Body	1 3/32	10	50	8	66.00

Double T Slots and Tandem Blades

5574	Connector Body	1 3/32	10	50	6	77.00
7080	Connector Body	5/16	10	50	8	77.00
†5896	Male Base	1 3/32 to 5/16	10	50	4	37.50

*Rated—15 amp., 125 v.

†Tandem Blades.

Polarized Plug Caps Without Cord Grip



No. 6730



No. 6720

Standard finish on brass covered caps is brush brass.

15 Amperes, 125 Volts; 10 Amperes, 250 Volts

No.	Description	Cord Diam. Inches	Carton	Std. Pkg.	Wt., Lbs. Pkg.	Per 100
6730	Composition, Black	3/32	10	30	3	\$69.50

20 Amperes, 250 Volts

6720	Composition, Black	1/2	10	30	4	82.50
------	--------------------	-----	----	----	---	-------

2-Wire Polarized Plug Caps With Cord Grips



Nos. 9970 or 9758



Nos. 7092 or 7058

All exposed metal parts finished to resist corrosion.

Rubber Cord Grip

15 Amperes, 125 Volts; 10 Amperes, 250 Volts

No.	Cord Diam. Inches	Carton	Std. Pkg.	Wt., Lbs. Std. Pkg.	Per 100
9970	1 3/4 to 2	10	30	5	\$103.00
9971	1 3/8 to 5/8	10	30	5	108.00

20 Amperes, 250 Volts

9758	1 3/8 to 5/8	10	30	6	122.50
------	--------------	----	----	---	--------

Armored Composition Cord Grip

15 Amperes, 125 Volts; 10 Amperes, 250 Volts

7092	1 3/4 to 2	10	30	4	108.00
7241	1 3/8 to 5/8	10	30	4	108.00

20 Amperes, 250 Volts

7058	1 3/8 to 5/8	10	30	6	127.00
------	--------------	----	----	---	--------

Polarized Flush Receptacles



Nos. 5566 or 5552

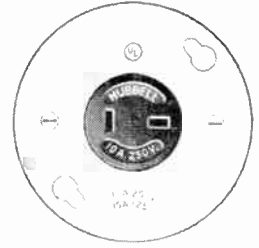

Nos. 7270 or 7272

15 Amperes, 125 Volts; 10 Amperes, 250 Volts

No.	Description	Carton	Std. Pkg.	Wt., Lbs. Std. Pkg.	Per 100
5566	Black Porcelain	10	30	11	\$92.50
5566-B	Bakelite, Black	10	30	7	92.50
5566-I	Ivory	10	30	11	101.50
*7270	Bakelite, with 3 1/4-in. Cover	10	30	12	108.00
7271	Bakelite, with 4-in. Cover	5	30	15	120.50

20 Amperes, 250 Volts

5552	Black Porcelain	10	30	11	160.50
5552-B	Bakelite, Black	10	30	7	160.50
5552-I	Ivory	10	30	11	170.00
*7272	Bakelite, with 3 1/4-in. Cover	10	30	12	172.00
7273	Bakelite, with 4-in. Cover	5	30	14	180.50

*Use 3 1/4-inch cover receptacle with one box connector. Use 4-inch cover receptacle with two or more box connectors.

Four Outlet Cluster Receptacle

15 Amperes, 125 Volts



No. 9225

Cap held securely by Twist-Tite Contact.

Takes Standard parallel bladed cap.

Cord is not furnished.

No.	Carton	Std. Pkg.	Wt. Lbs. Std. Pkg.	Per 100
9225	2	10	8	\$370.50
*9225G	2	10	8	370.50

*Grounded.

Call Graybar FIRST For . . .



Hubbell Wiring Devices

**Attachment Plug Caps
With Parallel Blades
15 Amperes, 125 Volts**



Pony Size—Black Composition

No.	Cord Hole Inches	Carton	Std. Pkg.	Wt. Lbs. Std. Pkg.	Per 100
7002	$\frac{9}{32}$ to $\frac{3}{8}$	25	500	27	\$15.00
7066	$\frac{5}{16}$	25	500	23	22.00
7068	$\frac{13}{32}$	25	500	28	22.00

Pony Size—Brown Bakelite

9010	$\frac{9}{32}$ to $\frac{3}{8}$	25	500	22	15.50
------	---------------------------------	----	-----	----	-------

Standard Size—Black Composition

5964	$\frac{13}{32}$	10	250	17	36.50
6708	$\frac{5}{16}$	10	250	20	36.50

**Standard Size—Black Composition
Polarized***

One Wide and One Narrow Blade

No.	Cord Hole, Inches	Carton	Std. Pkg.	Wt. Lbs. Std. Pkg.	Per 100
6764	$1\frac{3}{32}$	10	250	20	\$24.00

**With Tandem Blades
15 Amperes, 250 Volts**

Heavy Duty—Black Bakelite

No.	Cord Hole, Inches	Carton	Std. Pkg.	Wt. Lbs. Std. Pkg.	Per 100
5420	$1\frac{3}{32}$	10	100	7	\$36.50

**T-Slot Plug Taps
15 Amperes, 125 Volts
Black Composition**

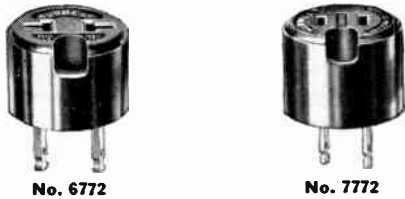

No.	Description	Carton	Std. Pkg.	Wt. Lbs. Std. Pkg.	Per 100
6772	Multiple, Parallel Blades T-slots	10	20	3	\$68.00
7772	Series, Single Slots Parallel Blades	10	30	6	\$68.00

**Rubber Cord Connector Bodies
15 Amperes, 125 Volts**



No.	Description	Cord Hole Inches	Carton	Std. Pkg.	Wt. Lbs. Std. Pkg.	Per 100
9952	Body	$\frac{5}{16}$ to $\frac{13}{32}$	10	50	8	\$ 65.00
9954	Body	$\frac{5}{8}$	10	50	8	65.00
9953	With Cord Grip	$\frac{5}{16}$ to $\frac{13}{32}$	10	50	10	78.50
9955	With Cord Grip	$\frac{5}{8}$	10	50	10	78.50

Rubber Plug Caps

With Adjustable Metal Cord Grips
Tandem Blades—15 Amperes, 250 Volts
Parallel and Double T Blades—15 Amperes, 125 Volts



No.	Blades	Cord Diameter Inches	Car- ton	Std. Pkg.	Wt. Lbs. Std. Pkg.	Per 100
9752	Tandem	$\frac{19}{64}$ to $\frac{9}{16}$	10	50	7	\$56.50
9753	Tandem	$\frac{13}{32}$ to $\frac{5}{8}$	10	50	7	56.50
9754	Parallel	$\frac{19}{64}$ to $\frac{9}{16}$	10	50	7	56.50
*9755	Parallel	$\frac{19}{64}$ to $\frac{9}{16}$	10	50	8	68.00
9756	Parallel	$\frac{13}{32}$ to $\frac{5}{8}$	10	50	7	56.50
*9757	Parallel	$\frac{13}{32}$ to $\frac{5}{8}$	10	50	7	68.00
9759	Double T	$\frac{19}{64}$ to $\frac{9}{16}$	10	50	8	84.50
*9760	Double T	$\frac{19}{64}$ to $\frac{9}{16}$	10	50	8	103.00

*Polarized—one wide and one narrow blade.

Armored Cord Grip Caps

Tandem Blades—15 Amperes, 250 Volts
Parallel Blades—15 Amperes, 125 Volts



Made of a special impact resisting composition, steel covered, finished to resist corrosion.

No.	Blades	Cord Diameter Inches	Car- ton	Std. Pkg.	Wt. Lbs. Std. Pkg.	Per 100
7056	Tandem	$\frac{19}{64}$ to $\frac{9}{16}$	10	50	7	\$61.50
7057	Parallel	$\frac{19}{64}$ to $\frac{9}{16}$	10	50	7	61.50
*7059	Parallel	$\frac{19}{64}$ to $\frac{9}{16}$	10	50	7	73.00
7183	Tandem	$\frac{13}{32}$ to $\frac{5}{8}$	10	50	7	61.50
7184	Parallel	$\frac{13}{32}$ to $\frac{5}{8}$	10	50	7	61.50
*7185	Parallel	$\frac{13}{32}$ to $\frac{5}{8}$	10	50	7	73.00
9076	Tandem Angle	$\frac{1}{2}$ to $\frac{5}{8}$	10	50	8	92.50
9077	Parallel Angle	$\frac{1}{2}$ to $\frac{5}{8}$	10	50	8	92.50

*Polarized—one wide and one narrow blade.

Attachment Plug Caps

With Double "T" Blades
15 Amperes, 125 Volts



No.	Description	Cord Diameter Inches	Car- ton	Std. Pkg.	Wt. Lbs. Std. Pkg.	Per 100
7162	Armored, Composi- tion	$\frac{19}{64}$ to $\frac{9}{16}$	10	30	4	\$ 89.00
*7286	Armored	$\frac{19}{64}$ to $\frac{9}{16}$	10	30	4	101.50
7196	Bakelite	$\frac{13}{32}$	10	50	4	79.50

*Polarized—one wide and one narrow blade.

Hubbell Wiring Devices

**Round Flush Receptacles
With Double "T" Slots
15 Amperes, 125 Volts**



No. 7331



No. 7255



No. 7332

Takes standard 10 Amperes Caps parallel, tandem, or polarized blades. Tapped for 8 x 32 screws.

No.	Description	Screw Hole Ctrs. In.	Diam. In.	Car-ton	Std. Pkg.	Wt. Lbs. Std. Pkg.	Per 100
7331	Bakelite, Brown	1 3/4	1 5/8	10	50	6	\$55.50
5614	Porcelain, Black	1 3/4	1 7/16	10	50	7	55.00
7255	Composition, Black	1 5/8	1 5/8	10	50	6	55.00
7332	Composition, Black with Flange	2 1/16	1 1/2	10	50	11	92.50

**Polarized
15 Amperes, 125 Volts; 10 Amperes, 250 Volts**



Diameter 1 1/16-Inches. 6 x 32 Screw Spacings, 1 5/8-Inches. Furnished with mounting bridges of various dimensions on special orders. Packaged 10 in a carton. 30 in a package. Package weight, 5 lbs.

No.	Description	Per 100
10108	Porcelain, Black	\$65.00

**Porcelain Receptacles
With Double "T" Slots
15 Amperes, 125 Volts**



No. 5617



No. 5619

No.	Description	Car-ton	Std. Pkg.	Wt. Lbs. Std. Pkg.	Per 100
5617	Concealed Base, Screws 1 1/32-Inch Centers.....	10	50	17	\$90.50
5619	Moulding Base, Screws 1 1/8-Inch Centers.....	10	50	18	89.50



No. 5624



No. 7027

†5624	Conduit Box Base, Screws 5/8-Inch Centers.....	10	50	12	\$97.00
7027	Outlet Box Receptacle.....	10	50	15	89.50

†Fits Appleton "W" Unilet and No. 5680 Cover, also fits Crouse Hinds "W" Condulet.

Weatherproof Utility Plate

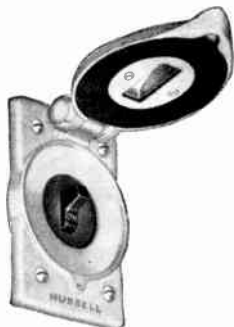

Featuring

Recessed Cover to Accept Toggle Switches

Designed to afford protection where moisture, conductive dust or metal filings may cause maintenance difficulties.

Cast aluminum plate resists corrosion. Spring-hinged cover snaps shut automatically when cap is removed.

Has rubber gasket in cover and vellumoid gasket beneath plate.

No.	Description	Car-ton	Std. Pkg.	Wt. Lbs. Std. Pkg.	Per 100
7420	Aluminum Weatherproof Plate Complete with Gaskets.....	10	20	11	\$330.00

**Separable Attachment Plugs
Pony Size—With Parallel Blades
15 Amperes, 125 Volts**



No. 9013 and No. 9010

Brown is standard finish.



No. 9014

No.	Description	Cord Hole Inches	Car-ton	Std. Pkg.	Wt. Lbs. Std. Pkg.	Per 100
9013	Body, Bakelite, 660 watts, 125 V.	25	500	18	\$20.50
9010	Cap, Bakelite	3/32 x 3/8	25	500	22	15.50
9014	Finger-grip	5/16	10	100	8	16.50

**Standard Size
Composition—With Parallel Blades
15 Amperes, 125 Volts**



No. 5917 and No. 5964

No.	Description	Cord Hole Inches	Car-ton	Std. Pkg.	Wt. Lbs. Std. Pkg.	Per 100
5917	Body, Black, Com. 660 watts, 125 V.	...	10	250	20	\$28.50
5964	Cap, Black, Com.	13/32	10	250	17	36.50
6708	Cap, Black, Com.	5/16	10	250	20	36.50

**Bakelite Attachment Plug Caps
With Double "T" Slots
Tandem Blades—Plug Base**



No. 5420



No. 5612

No.	Description	Cord Hole Inches	Car-ton	Std. Pkg.	Wt. Lbs. Std. Pkg.	Per 100
5420	Cap, Tandem, 15 A., 250 V.	13/32	10	100	7	\$36.50
5612	Body, Double T-Slots; 660 watts, 125V.		10	100	11	65.00

**Weatherproof Plug Receptacles
With Double "T" Slots
15 Amperes, 125 Volts**



No. 6293

Composition.
Packed 10 in a carton.
30 in a standard package.
Package weight 8 pounds.

No.	Per 100
6293	\$143.50

Hubbell New Wiring Devices

**3-Wire Convenience Outlets
Grounding Type—Polarized**

For grounding exposed metal parts of portable electrical equipment.

15 Amperes, 125 Volts



No. 5262



No. 5284



No. 5261

For back or side wiring.
Also takes standard 2-wire regular or polarized caps.
Takes standard outlet plates.

Duplex

No.	Description	Car- ton	Std. Pkg.	Wt. Lbs. Std. Pkg.	Per 100
5262	Brown Bakelite.....	10	50	13	\$219.00
5262-I	Ivoryine.....	10	50	13	231.00
5282	On 4" Metal Box Cover....	5	50	24	240.00

Single

5261	Brown Bakelite.....	10	50	11	158.00
5261-I	Ivoryine.....	10	50	11	168.00
5271	On 3 1/4" Metal Box Cover...	10	50	20	172.00
5281	On 4" Metal Box Cover....	5	50	22	178.00

Single—With Short Strap

5284	Brown Bakelite.....	10	50	11	122.00
------	---------------------	----	----	----	--------

**3-Wire Weatherproof Outlet
Grounding Type—Polarized
15 Amperes, 125 Volts**

Receptacle complete with plate, metal cover and weatherproof mat. Shield No. 7793 is not furnished and if desired must be ordered extra.

When in use the plug cap may be protected by metal shield No. 7793.



No. 7793

No. 5260

*This shield can only be used with 5263 3-wire grounding cap or 5964, 7002 or 9010 regular 2-wire caps.

No.	Car- ton	Std. Pkg.	Wt. Lbs.	Per 100
5260	2	10	6	\$359.00
*7793	2	10	1	87.00

**3-Wire Cord Connectors
Grounding Type—Brown Bakelite
Polarized
15 Amperes, 125 Volts**



No. 5268



No. 5269 or 5270

No.	Description	Cord Diam.	Car- ton	Std. Pkg.	Wt. Lbs.	Per 100
5268	Without Cord Grips	7/16	10	50	8	\$ 99.00
5269	With Cord Grips	1 1/16 to 9/16	10	50	10	126.00
5270	With Cord Grips	1 1/8 to 5/8	10	50	10	126.00

**3-Wire Caps for Use With the New Grounding
Type Outlets and Connectors
Polarized
15 Amperes, 125 Volts**



No. 5264
or 5265



No. 5266
or 5267



No. 5274
or 5275

Packed 10 in a carton, 50 in a standard package.

No.	Description	Cord Diam. Inches	Wt. Lbs. Std. Pkg.	Per 100
5263	Cap, Brown Bakelite.....	7/16	5	\$47.00
5263-I	Cap, Ivoryine.....	7/16	5	52.00
5264	Armored Cap with Cord Grips.....	1 9/64 to 9/16	6	81.00
5265	Armored Cap with Cord Grips.....	1 3/32 to 5/8	8	81.00
5266	Rubber Cap with Cord Grips.....	1 9/64 to 9/16	7	81.00
5267	Rubber Cap with Cord Grips.....	1 3/32 to 5/8	7	81.00
5274	Rubber Fingergrasp Cap...	5/16 to 15/32	6	49.80
5275	Rubber Fingergrasp Cap...	5/8	6	49.80
5276	Rubber Fingergrasp Cap, with Cord Grips.....	5/16 to 15/32	8	60.50
5277	Rubber Fingergrasp Cap, with Cord Grips.....	5/8	8	60.50

**3-Wire Grounding Type Adapter
For Grounding Exposed Metal Parts of
Portable Electrical Equipment**



No. 5273-L

This device will adapt standard 2-wire convenience outlets for use with new 3-wire grounding caps listed on this page.

Portable Appliances or Tools equipped with the new type "Grounding Caps" can be quickly adapted to regular 2-wire outlets with the No. 5273-L Adapter.

"Grounding Lead" should be placed beneath nearest "grounded" connection.

No.	Description	Car- ton	Std. Pkg.	Wt. Lbs. Std. Pkg.	Per 100
*5273	Brown Bakelite Adapter, less Lead.....	10	50	8	\$80.00
5273-L	Brown Bakelite Adapter, with Green 3 1/2" Thermoplastic Lead..	10	50	7	86.00

*No. 5273 Adapter less lead is not listed by Underwriters' Laboratories, Inc.

**3-Wire Grounding Type Adapter
For Converting Nos. 7055, 9975 and 6149
Style of Caps to the No. 5262 Line of 3-Wire
Grounding Outlets**



No. 5285

Can be used with other devices in metallic or non metallic wiring systems.

Will fit corresponding receptacles made by other manufacturers. Has "U" shaped grounding blade for "U" shaped grounding slot.

Designed for 2 current-carrying contacts and one grounding contact.

No.	Description	Car- ton	Std. Pkg.	Wt. Lbs.	Per 100
5285	Composition and Bakelite...	10	50	7	\$190.00

Hubbell 3-Wire Grounding Type Convenience Outlets With 2 Grounding Terminals
15 Amperes, 125 Volts, Polarized—Side Wired Only



No. 5252

For grounding exposed metal parts of portable electrical equipment.

Competitive, dependable, duplex flush-mounted receptacle for all practical applications.

Can be used with metallic or non-metallic wiring systems.

Two green hexagonal grounding screws, one per side, permits wiring flexibility.

Has break-off feature for two-circuit installations. Accommodates two armored or rubber caps. Has slots for 2-wire regular and 3-wire polarized caps. U-shaped slots for ground blade.

Washer-type plaster ears and wire looping slot. Rugged 2-piece bakelite construction.

No.	Description	Car- ton Pkg.	Std. Pkg.	Wt., Lbs. Std. Pkg.	Per 100
5251	Single Outlet, Brown Bakelite	10	50	9	\$80.00
5251-I	Single Outlet, Ivorine	10	50	9	85.00
5252	Duplex Outlet, Brown Bakelite	10	50	12	110.00
5252-I	Duplex Outlet, Ivorine	10	50	12	122.00
5253	No. 5252 Duplex Outlet on 4-in. Cover, Standard Line	10	50	24	130.00
5254	No. 5251 Single Outlet on 4-in. Cover, Standard Line	10	50	22	110.00

3-Wire Grounding Type Single Outlets

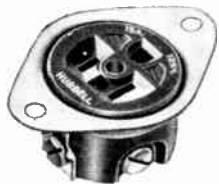

No. 5256

Shallow, compact device, designed for panel applications. Small round "shoulderless" body takes up no more width than its face dimensions.

Can be used with metallic or non-metallic wiring systems.

Slots for 2-wire parallel and 3-wire polarized grounding caps.

Green hexagonal grounding screw. Rugged bakelite construction.

5258	Single Outlet with 1 3/4-in. Short Strap, Side Wired Only	10	50	7	\$78.00
*5256	Female Grounding Motor Base, Flush-Mounted	10	50	14	150.00
*5288	Male Grounding Motor Base, Surface-Mounted	10	50	12	132.00

*Parallel contacts.

3-Wire Grounding Type Outlets Motor Plug Bases

15 Amperes, 125 Volts—Polarized



No. 5278

Male plug has round pin for grounding in addition to standard parallel blades. Exposed metal parts plated to resist corrosion.

Female unit has parallel polarized slots. Takes standard 2-wire 10 ampere regular or polarized standard caps.

5278	Male Unit	10	50	8	\$109.00
5279	Female Unit	10	50	14	160.00

3-Wire Combination Duplex Outlets

15 Amperes, 250 Volts—1 Circuit

15 Amperes, 125 Volts—1 Circuit

Common ground serves both 125 and 250 volt outlets.

Available side wired or side and back wired.

Green hexagonal grounding screw.

Slots for 2-wire regular or polarized caps.

Takes standard outlet plates.



No. 5292

**5292	Combination Duplex Grounding Outlet, Back Wired	10	50	12	\$236.00
**5292-I	No. 5292 Unit in Ivorine	10	50	12	248.00
**5290	Combination Duplex Grounding Outlet, Side Wired	10	50	12	127.00
**5290-I	No. 5290 Unit in Ivorine	10	50	12	139.00

**Brown Bakelite.

Hubbell 250 Volt Grounding Devices
3-Wire Back or Side Wiring
15 Amperes, 250 Volts—Polarized



No. 5662



No. 5684



No. 5661

This series features tandem slots in receptacles and tandem blades in caps.

Can be used with metallic or non-metallic wiring systems. Grounding of metallic wiring system is directly through metal enclosure. Grounding of non-metallic systems is through a third wire acting as a grounding connector.

U-shaped slots take grounding blade, also assures positive identification of grounding circuit.

These outlets are designed with holes for back wiring as well as binding screws for conventional side wiring.

Has wire strip gauge, break-off feature for two-circuit installations, and washer type plaster ears.

No.	Description	Car- ton Pkg.	Std. Pkg.	Wt., Lbs. Std. Pkg.	Per 100
5661	Single Receptacle	10	50	11	\$175.00
5661-I	Single Receptacle Ivorine	10	50	10	185.00
5662	Duplex Receptacle, Brown Bakelite	10	50	12	253.00
5662-I	Duplex Receptacle, Ivorine	10	50	12	265.00
5663	Cap. Brown Bakelite	10	50	4	55.50
5664	Armored Cap with Cord Grips, .296-in.—.625-in. Cord Hole	10	50	5	89.50
5666	Rubber Cap with Cord Grips .296-in.—.625-in.	10	50	6	89.50
5669	Connector Body, .296-in.—.625-in. Cord Hole	10	50	10	207.00
5674	Rubber Cap, .312-in.—.468-in. Cord Hole	10	50	10	122.00
5676	Rubber Cap with Cord Grips, .312-in.—.468-in.	10	50	11	133.00
5678	Flush Motor Connector Base	10	50	6	126.00
5684	Single Receptacle with 1 1/16-in. Short Strap, Back Wired and Side Wired	10	50	7	139.00
5651	Single Receptacle, Brown, Side Wired Only, Standard Line	10	50	9	80.00
5651-I	No. 5651 Unit in Ivorine	10	50	9	85.00
*5652	Duplex Receptacle, Brown	10	50	12	144.00
5652-I	No. 5652 Unit in Ivorine	10	50	12	156.00
*5653	No. 5652 Unit on 4-in. Cover	10	50	21	164.00
*5654	No. 5651 Unit on 4-in. Cover	10	50	22	144.00

*Standard Line.

Single Grounding Outlets
15 Amperes, 250 Volts—Side Wired



No. 5658

Shallow, compact device, round "shoulderless" design permits mounting in restricted spaces.

Slots for 2-wire parallel and 3-wire polarized grounding caps. Used with metallic or non-metallic wiring systems.

Designed with two current-carrying contacts and one grounding contact.

Has green hexagonal grounding screw. Rugged bakelite construction.

5658	Single Receptacle on 1 3/4-in. Short Strap, Side Wired Only	10	50	7	\$87.00
5656	3-Wire Brown Bakelite Female Grounding Motor Base, Flush-Mounted, Tandem Contacts	10	50	14	167.00
5668	3-Wire Brown Bakelite Male Grounding Motor Base, Surface-Mounted, Tandem Contacts	10	50	12	147.00

Hubbell Wiring Devices

2-Wire and 3-Wire Combination Receptacles

See Illustrations For Ratings

This end for 2-wire equipment Rated 15A 125 V.

This end for 3-wire equipment Rated 10A-250 V., 15A-125 V.



No. 7053

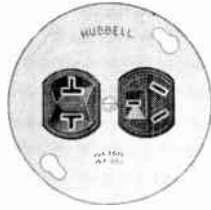

No. 7333

Fit standard duplex receptacle plates and standard switch boxes.

No.	Description	Car-ton	Std. Pkg.	Wt. Lbs. Std. Pkg.	Per 100
7053	Black Bakelite, each outlet wired independently.....	10	30	8	\$239.50
7333	Same as No. 7053, on 4-inch cover.....	5	30	21	253.00
7054	Black Bakelite, one feed and one return common to both outlets; 3-wire end permanently grounded to supporting strap.....	10	30	8	239.50
7334	Same as No. 7054, on 4-inch cover.....	5	30	21	253.00

7064	Black Bakelite, one feed and one return common to both outlets; grounding terminal 3-wire end equipped with binding screw.....	10	30	8	239.50
7335	Same as No. 7064, on 4-inch cover.....	5	30	21	253.00
7666	Black Bakelite, independent feeds, end ground terminal connected to strap.....	10	30	12	239.50
7667	Same as No. 7666, on 4-inch box cover.....	5	30	21	253.00



No. 6047

3-Wire Surface Receptacles

Polarized—Porcelain

Screw holes, 1 3/4-inches on centers. Outside diameter of base, 2 1/2 inches.

15 Amperes, 125 Volts; 10 Amperes, 250 Volts

No.	Description	Car-ton	Std. Pkg.	Wt. Lbs. Std. Pkg.	Per 100
6047	Concealed wiring.....	10	50	22	\$123.00

20 Amperes, 250 Volts

**6059	Concealed wiring.....	10	30	14	157.00
--------	-----------------------	----	----	----	--------

**White Glazed Porcelain.

3-Wire Polarized Caps
15 Amperes, 125 Volts; 10 Amperes, 250 Volts



Nos. 6149 or 7252



No. 9975

Finger Grip

No.	Description	Cord Hole Inches	Car-ton	Std. Pkg.	Wt. Lbs. Std. Pkg.	Per 100
9975	Black Rubber.....	5/16 to 15/32	10	50	6	\$55.50

Regular

*6149	Black Bakelite....	7/16	10	50	4	54.50
*7252	Black Bakelite....	3/4	10	50	5	54.50



No. 7055

Armored Cord Grip
Plated to Resist Corrosion



No. 7089

15 Amperes, 125 Volts; 10 Amperes, 250 Volts

*7055	Armored.....	1 9/64 to 9/16	10	50	7	\$93.50
*7309	Armored.....	1 3/32 to 5/8	10	50	7	93.50
*7368	Armored, Angle....	1/2 to 5/8	10	50	9	122.50

20 Amperes, 250 Volts

*7089	Armored.....	1 3/32 to 5/8	10	20	5	163.50
-------	--------------	---------------	----	----	---	--------

*If desired Grounded, suffix "G" to catalog number

Rubber Cord Grip



No. 9750



No. 9977

15 Amperes, 125 Volts; 10 Amperes, 250 Volts

*9750	Rubber.....	1 9/64 to 9/16	10	50	8	\$93.50
*9751	Rubber.....	1 3/32 to 5/8	10	50	8	93.50

20 Amperes, 250 Volts

*9977	Rubber.....	1 3/32 to 5/8	10	20	5	154.00
-------	-------------	---------------	----	----	---	--------

*If desired Grounded, suffix "G" to catalog number

2 to 3-Wire Composition Plug Adapters
15 Amperes, 125 Volts; 10 Amperes, 250 Volts



No. 7052

Third blade grounded by use of a binding post at side of body. Wire is led to flush plate screws.



No. 9052-L

No.	Description	Car-ton	Std. Pkg.	Wt. Lbs. Std. Pkg.	Per 100
7052	Tandem Blades.....	10	30	6	\$86.00
9052	Parallel Blades.....	10	30	6	87.00
*7052-L	Tandem Blades with Ground Wire.....	10	30	7	92.50
*9052-L	Parallel Blades with Ground Wire.....	10	30	7	92.50

*Standard lead is 3 1/2-in.

Hubbelock Wiring Devices

These devices combine a highly practical and exceptionally safe medium of applying electric current to industrial use. Cap contacts are heavy brass stock machined to dimension and molded into special impact-resisting Bakelite supporting posts. This sturdy construction assures ground connection and position polarity at all times, and under any condition. The lock is positive and prevents any loss of production through the accidental breaking of electric current. The Dead Front Safety Shutter isolates contacts, snuffs arc, and keeps out dust.

3-Wire Connectors

Adjustable Cord Grip

10 Amperes, 250 Volts D-C; 460 Volts A-C
20 Amperes, 125 Volts A-C or D-C



No. 23002



No. 23005

All metal parts finished to resist corrosion. Suffix letter G to number if desired with ground shunt from contact to casing or cover.

No.	Description	Cable Diameter Inches	Car-ton	Std. Pkg.	Wt. Lbs. Std. Pkg.	Per 100
23002	Connector Body...	19/64 to 9/16	5	20	12	\$532.50
23005	Cap.....	19/64 to 9/16	5	20	8	376.50
23003	Connector Body...	13/32 to 5/8	5	20	12	532.50
23006	Cap.....	13/32 to 5/8	5	20	8	376.50
23009	Connector Body with 1/2-Inch Female Pipe Thread in place of cord grip.....		5	20	9	555.50
23016	Cap, 1/2-Inch Female Pipe Thread in place of cord grip.....		5	20	8	434.50

3-Wire Receptacle and Plates

10 Amperes, 250 Volts D-C; 460 Volts A-C
20 Amperes, 125 Volts A-C or D-C



No. 23000



Nos. 23000 and 23007 Assembled to Outlet Box

Receptacle and plate will fit FS and FD outlet boxes. Fits any single convenience outlet plate. Receptacle will also fit standard switch and outlet boxes.

Outlet Box not supplied. All metal parts finished to resist corrosion. Suffix letter G to number if desired grounded.

No.	Description	Car-ton	Std. Pkg.	Wt. Lbs. Std. Pkg.	Per 100
23000	Bakelite Receptacle.....	5	20	6	\$419.00
*23007	Cast Metal Plate with Lift Cover.....	5	20	8	201.50
*23008	Cast Metal Plate without Cover.....	5	20	11	137.50
23015	Male Receptacle permanently attached to Cast Metal Cover Plate.....	5	20	20	552.00

*Fits Crouse-Hinds and Appleton FS Boxes. All 3-wire "Hubbellocks" regularly shipped ungrounded.

4-Wire Connectors and Caps Adjustable Metal Cord Grips

All 4-wire Hubbellocks are shipped grounded unless otherwise specified. 20-Amperes, 250 Volts D-C; 30 Amperes, 600 Volts A-C



No. 20415



No. 20414

No.	Description	Cable Diameter Inches	Car-ton	Std. Pkg.	Wt. Lbs. Std. Pkg.	Per 100
20414	Connector Body	.400 to .750	2	10	12	\$739.00
20415	Cap	.400 to .750	2	10	7	494.00



No. 21415



No. 21414

No.	Description	Cable Diameter Inches	Car-ton	Std. Pkg.	Wt. Lbs. Std. Pkg.	Per 100
21414	Connector Body	.360 to .184	2	10	10	\$738.00
21415	Cap	.360 to .184	2	10	9	543.50

4-Wire Receptacle and Plates

20-Amperes, 250 Volts D-C; 30-Amperes, 600 Volts A-C

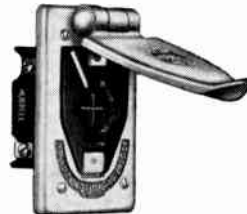

No. 20403 Receptacle with No. 20416 Plate



No. 20403

Receptacle and plates will fit FS and FD outlet boxes. Plated to resist corrosion.

Furnished Grounded unless otherwise specified.

No.	Description	Car-ton	Std. Pkg.	Wt. Lbs. Std. Pkg.	Per 100
20403	Bakelite Receptacle	2	10	5	\$647.00
20416	Metal Plate, with Cover	2	10	9	201.50
20417	Metal Plate, without cover	2	10	3	137.50

Sealtite Rubber Covers For 4-Wire Hubbellock Connectors



Covers are designed to fit the following Hubbellock units: Cover No. 20424 fits Nos. 20414, 21424, 21414, 21427, 21442, and 21418.

Cover No. 20425 fits Nos. 20415, 21415, 21425, 21426, 21443 and 21419.

No.	Description	Car-ton	Std. Pkg.	Wt. Lbs. Std. Pkg.	Per 100
20424	Sealtite Rubber Cover for No. 20414 20-ampere 4-wire "Hubbellock" Connector Body.....	2	10	4	\$357.50
20425	Sealtite Rubber Cover for No. 20415 20-ampere 4-wire "Hubbellock" Male Cap.....	2	10	3	297.00

Hubbell "Twist-Lock" Devices

10 Amperes, 250 Volts; 15 Amperes, 125 Volts

By a mere twist of the cap Twist-Lock devices make a fast and positive electrical connection which cannot be accidentally disconnected. Twist-Lock devices meet the recommendations of the National Electric Code rules advising installation of polarized and grounded devices to protect the operators of portable motor driven tools and equipment. These devices combine the no-break contact feature of a permanent connection with the convenience of a plug-in connection for easy servicing of electrically operated and motor driven machines.

2-Wire Midget Cord Connectors Brown Bakelite

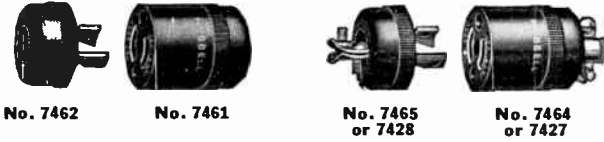

Without Cord Grip— $\frac{3}{8}$ -Inch Cord Hole

No.	Description	Carton	Std. Pkg.	Wt. Lbs. Std. Pkg.	Per 100
7462	Cap Only	10	50	1 $\frac{1}{4}$	\$30.50
▲7477	Cap Only, Polarized	10	50	1 $\frac{1}{4}$	36.50
*7461	Connector Body Only	10	50	2 $\frac{1}{2}$	60.50

With Cord Grip—For $\frac{7}{32}$ to $\frac{5}{16}$ -Inch Cord

7465	Cap Only	10	50	2	\$40.50
▲7479	Cap Only, Polarized	10	50	1 $\frac{1}{2}$	47.50
*7464	Connector Body Only	10	50	3	73.00

With Cord Grip—For $\frac{5}{16}$ to $\frac{1}{2}$ -Inch Cord

▲7429	Male Cap, Polarized	10	50	1 $\frac{1}{2}$	\$47.50
7428	Male Cap	10	50	1 $\frac{1}{2}$	40.50
*7427	Connector Body	10	50	3	74.50

2-Wire Midget Flush Bases



No.	Description	Carton	Std. Pkg.	Wt. Lbs. Std. Pkg.	Per 100
7466	Male Base	10	50	4	\$87.50
▲7467	Male Base, Polarized	10	50	7	105.50
7468	Female Base	10	50	3 $\frac{1}{4}$	105.50
*7473	No. 7468 Base on 3 $\frac{1}{4}$ -Inch steel Box Cover	10	50	16	132.00
*7471	Female Base, Covered Terminals Without Cord Grips	10	50	5	111.50
*7472	Female Base, Covered Terminals with Cord Grips ($\frac{7}{32}$ to $\frac{5}{16}$)	10	50	4	122.50
*7474	Female Base, for Reverse Mounting on Panels	10	50	4	120.00

*Will accommodate both polarized and non-polarized caps
 ▲Has one wide and one narrow blade to fit corresponding polarized slots of connector bodies.
 Exposed metal parts plated to resist corrosion.

3-Wire Midget Male Flush Base

Conform to N.E.C. Standards

10 Amperes, 250 Volts; 15 Amperes, 250 Volts

Polarized



No. 7699

Male Receptacle in Casing, for Nos. 7693, 7694 and 7695 Connectors.

No.	Carton	Std. Pkg.	Wt. Lbs. Std. Pkg.	Per 100
7699	10	50	3	\$122.50
7699G	10	50	3	122.50

3-Wire Midget Connectors 10 Amperes, 250 Volts; 15 Amperes, 125 Volts Black Bakelite—Polarized Conform to N.E.C. Standards



Standard finish for cord grips is black oxidize. Not furnished grounded.

Without Cord-Grip— $\frac{1}{2}$ -Inch Cord Hole

No.	Description	Carton	Std. Pkg.	Wt. Lbs. Std. Pkg.	Per 100
7481	Body	10	50	2 $\frac{1}{2}$	\$130.00
7482	Male Cap	10	50	1 $\frac{1}{4}$	87.50

With Cord-Grip for $\frac{9}{32}$ to $2\frac{7}{64}$ -Inch Cord

7484	Body	10	50	5	\$138.00
7485	Male Cap	10	50	3 $\frac{1}{2}$	95.50

3-Wire Armored Midget Connectors

Rubber Cord Grips

10 Amperes, 250 Volts; 15 Amperes, 125 Volts



No. 7695

No. 7692

Black Bakelite Body. Heavy steel casing finished to resist corrosion.

3-Wire—Not Grounded

No.	Description	Cord Diameter Inches	Carton Pkg.	Std. Pkg.	Wt. Lbs. Std. Pkg.	Per 100
7690	Male Cap	.360-.484	10	50	12	\$369.00
7693	Connector Body	.360-.484	10	50	12	396.00

3-Wire—Grounded to Casing

7691	Male Cap	.360-.484	10	50	12	\$396.00
7694	Connector Body	.360-.484	10	50	12	422.50

4-Wire—With Equipment Ground

7692	Male Cap	.360-.484	10	50	12	\$422.50
7695	Connector Body	.360-.484	10	50	12	449.50

3-Wire Midget Flush Bases



No. 7486

No. 7489

No. 7487

Black Bakelite body.

No.	Description	Carton	Std. Pkg.	Wt. Lbs. Std. Pkg.	Per 100
†7486	Male Base	10	50	8	\$122.50
†7487	Female Base	10	50	3	149.00
†7488	Female Base, Covered Terminals, without Cord Grips	10	50	3 $\frac{1}{2}$	165.00
7489	Female Base, Covered Terminals, with Cord Grips	10	50	4	179.50

Exposed metal casings finished to resist corrosion.

†Suffix letter "G" to catalog number if desired grounded.

Hubbell "Twist-Lock" Devices

Conform to N.E.C. Standards

10 Amperes, 250 Volts; 15 Amperes, 125 Volts

**2-Wire Receptacles
Standard Size**



No. 7535



No. 7540



No. 7543

Single

No.	Description	Car- ton	Std. Pkg.	Wt. Lbs. Std. Pkg.	Per 100
*7535	Bakelite	10	50	9	\$ 92.50
*7536	Bakelite, 3 1/4-Inch Cover	10	30	8	109.00
*7537	Bakelite, 4-Inch Cover	5	30	14	115.00

Duplex

*7540	Bakelite	10	50	13	150.50
*7543	Bakelite, 3 1/4-Inch Metal Cover	10	50	22	158.50
*7544	Bakelite, 4-Inch Cover	5	30	15	172.50

*Will accommodate both polarized and non-polarized caps. Exposed metal parts plated to resist corrosion.

**3-Wire Black Bakelite Receptacles
Standard Size—Single—Polarized**



No. 7582



No. 7418 for No. 7582

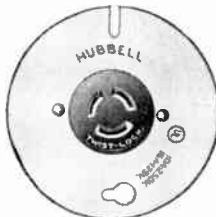

Nos. 7583 or 7584

No. 7582 takes any standard single receptacle flush plate.

†No.	Description	Car- ton	Std. Pkg.	Wt. Lbs. Std. Pkg.	Per 100
7582	Receptacle	10	50	9	\$194.50
7583	Receptacle, 3 1/4-Inch Box Cover	10	30	11	209.00
7584	Receptacle, 4-Inch Box Cover	5	30	13	224.50
7586	Receptacle, with Short Strap	10	50	9	194.50
*7418	Cast Metal Plate with Lift Cover	10	20	8	201.50
*7419	Cast Metal Plate without Cover	10	20	10	137.50

*Fits FS and FD outlet boxes. Finished to resist corrosion.

3-Wire Duplex Receptacle



No. 7580



No. 7581

**Black Bakelite
Polarized**

No. 7580 takes any standard duplex receptacle flush plate.

†No.	Description	Car- ton	Std. Pkg.	Wt. Lbs. Std. Pkg.	Per 100
7580	Receptacle	10	50	13	\$282.50
7581	Receptacle, 4-Inch Cover	5	30	11	314.50

†Exposed metal casings plated to resist corrosion.

†Suffix letter "G" to catalog number if desired grounded.

Combination Polarized Receptacles



No. 7680

**3-Wire Twist Lock and
2-Wire Double T Slot**

Black Bakelite

No.	Description	Car- ton	Std. Pkg.	Wt. Lbs. Std. Pkg.	Per 100
*7680	Each outlet wired independently	10	30	8	\$246.50
*7681	Like No. 7680 on 4-inch Cover	5	30	21	276.00
*7686	Each outlet wired independently. 3-Wire end permanently grounded to supporting strap	10	30	12	246.50
*7687	Like No. 7686 on 4-inch Cover	5	30	21	276.00
*7682	One feed and one return common to both outlets. 3-Wire End permanently grounded to supporting strap	10	30	9	259.00
*7683	Like No. 7682, on 4-inch Cover	5	30	21	290.50
*7684	One feed and one return common to both outlets. Grounding terminal 3-wire end equipped with binding screw	10	30	12	259.00
*7685	Like No. 7684 on 4-inch Cover	5	30	21	290.50

*Not listed by Underwriters.

**Medium Screw Base Adapters
For 10-Ampere 3-Wire Twist Lock Receptacles**



No. 7645
(Wire not furnished)

Black bakelite body—Side Wire Outlet.

Nos. 7645 and 7646 accommodate either a screw base plug for 2-wire parallel bladed caps, or a medium base lamp.

No. 7647 accommodates a screw base fuse plug or Fusetron.

No.	Description	Car- ton	Std. Pkg.	Wt. Lbs. Std. Pkg.	Per 100
*7644	Adapter to correct a standard 2-wire Polarized Parallel Slot Receptacle to a 10A, 3W, Grounded "Twist-Lock" outlet	10	50	12	\$278.50
*7645	660 W. 250 V., Multiple	10	50	7	159.00
*7646	660 W. 250 V., Series	10	50	7	159.00
*7647	0-15 Amp. 125-V., Series with Fuse Plug Cut-Out	10	50	7	159.00

*Does not conform to N.E.C. Standards.

Call Graybar FIRST For . . .

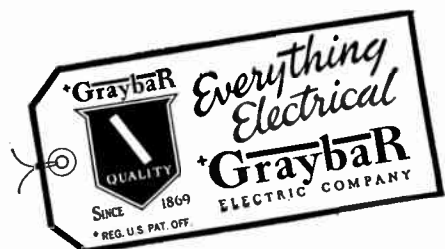

Hubbell "Twist-Lock" Devices

Conform to N.E.C. Standards

3-Wire Black Bakelite Connector Bodies

10 Amperes, 250 Volts; 15 Amperes, 125 Volts



No. 7555 or 7559

†No.	Description	Cord Diameter Inches	Car-ton	Std. Pkg.	Wt. Lbs. Std. Pkg.	Per 100
7555	Body, Cord Grip	1 ⁹ / ₆₄ to 9 ¹⁶ / ₁₆	10	50	8	\$179.50
7559	Body, Cord Grip	1 ³ / ₃₂ to 5 ⁸ / ₈	10	50	8	179.50
7564	Rubber Casing for 7555 and 7559 (Use as a Shock Absorber).....		10	30	5	60.50

3-Wire Polarized Flush Bases



No. 7556

Black Bakelite with Metal Casings



No. 7557

Screw Spacing 1⁵/₁₆ Inch on Center. Base Diameter 1¹/₂ Inches.
Height No. 7556 1¹/₈ Inches; No. 7557 1¹¹/₃₂ Inches.

†No.	Description	Car-ton	Std. Pkg.	Wt. Lbs. Std. Pkg.	Per 100
7556	Male, Polarized.....	10	50	6	\$149.00
7557	Female, Polarized.....	10	50	7	165.00

Exposed metal casings plated to resist corrosion.
†Suffix Letter "G" to catalog number if desired grounded.

2-Wire Motor Bases

20 Amperes, 250 Volts



No. 7191



No. 8809



Nos. 8808 or 9105

Bodies may be used with polarized or non-polarized bases.

Surface Base

No.	Description	Car-ton	Std. Pkg.	Wt. Lbs. Std. Pkg.	Per 100
7191	Composition Male.....	10	30	3 ¹ / ₂	\$ 66.50
*9104	Composition Male.....	10	30	3	76.50

Flush Base

8808	Male.....	10	30	6	112.50
*9105	Male.....	10	30	5 ¹ / ₄	136.00
8809	Female.....	10	30	7	149.00
8815	Male, Exposed Wiring.....	10	30	6	112.50
*8816	Male, Exposed Wiring Polarized.....	10	30	6	136.00
8817	Male, Exposed Wiring, Round Flange.....	10	30	6	120.00
*8818	Male, Exposed Wiring, Round Flange.....	10	30	6	143.00

All exposed metal parts plated to resist corrosion.
*Polarized—one wide and one narrow blade.

2-Wire Flush Single Receptacles Side and Backwired



No. 7210

20 Amperes
250 Volts



Nos. 7216 or 7217

No. 7210 and No. 7210 B may be used with polarized or non-polarized "Twist-Lock" Caps. Will fit standard single receptacle plate. Metal covers finished to resist corrosion.

No.	Description	Car-ton	Std. Pkg.	Wt. Lbs. Std. Pkg.	Per 100
No. 7210	Black Porcelain Receptacle...	10	50	12	\$ 99.50
*7210B	Black Bakelite Receptacle...	10	50	10	99.50
7216	Porcelain Receptacle, 3 ¹ / ₄ -Inch Cover.....	10	50	12	115.00
*7216B	Bakelite Receptacle, 3 ¹ / ₄ -Inch Cover.....	10	50	13	115.00
7217	Porcelain Receptacle, 4-Inch Cover.....	5	30	16	125.00
*7217B	Bakelite Receptacle, 4-Inch Cover.....	5	30	15	125.00
::7418	Cast Metal Plate with Lift Cover.....	10	20	8	201.50
::7419	Cast Metal Plate without Lift Cover.....	10	20	10	137.50

::Fits FS and FD Boxes.
■Not Back Wired.

2-Wire Plug Caps 20 Amperes, 250 Volts



No. 9763



No. 7102



No. 7062

With Cord Grips

No.	Description	Cord Diameter Inches	Car-ton	Std. Pkg.	Wt. Lbs. Std. Pkg.	Per 100
9763	Rubber	1 ⁹ / ₆₄ to 9 ¹⁶ / ₁₆	10	30	5	\$ 94.00
*9764	Rubber	1 ⁹ / ₆₄ to 9 ¹⁶ / ₁₆	10	30	5	111.00
9765	Rubber	1 ³ / ₃₂ to 5 ⁸ / ₈	10	30	5	94.00
*9766	Rubber	1 ³ / ₃₂ to 5 ⁸ / ₈	10	30	5	111.00
7102	Armored	1 ⁹ / ₆₄ to 9 ¹⁶ / ₁₆	10	30	5	76.00
*9102	Armored	1 ⁹ / ₆₄ to 9 ¹⁶ / ₁₆	10	30	5	87.00
7238	Armored	1 ³ / ₃₂ to 5 ⁸ / ₈	10	30	5	76.00
*9103	Armored	1 ³ / ₃₂ to 5 ⁸ / ₈	10	30	5	87.00
7228	Armored	1 ¹ / ₂ to 5 ⁸ / ₈	10	30	5	104.50

Without Cord Grips

7062	Composition	1 ³ / ₃₂ to 5 ⁸ / ₈	10	50	6	60.50
*7063	Composition	1 ³ / ₃₂ to 5 ⁸ / ₈	10	50	6	69.50

2-Wire Porcelain Receptacles 20 Amperes, 250 Volts



No. 7624

Appleton Type W Unilet with their No. 5681 Cover accommodates this receptacle or Crouse Hinds No. "W" series Condulets with "O" Steel Cover or No. OG Cast Cover. Mounting screw holes 3¹/₃₂ inches. Diameter 1³/₄ inches. Height, 1²/₆₄ inches. Face diameter, 1¹/₂ inches.

No.	Car-ton	Std. Pkg.	Wt. Lbs. Std. Pkg.	Per 100
7624	10	50	13	\$99.50

All exposed metal parts finished to resist corrosion.
*Polarized—one wide and one narrow blade.

Hubbell Twist-Lock Devices

Conform to N.E.C. Standards

2-Wire Connectors and Plug Base



**20 Amperes
250 Volts**

No. 7101 or 7224



No. 7612

Black Bakelite. Steel covers plated to resist corrosion. Bodies may be used with either polarized or non-polarized caps.

No.	Description	Cord Diameter Inches	Car-ton	Std. Pkg.	Wt. Lbs. Std. Pkg.	Per 100
7101	Body, Cord Grip	1 ⁹ / ₆₄ to 9 ¹ / ₁₆	10	30	7 ¹ / ₄	\$126.00
7224	Body, Cord Grip	1 ³ / ₃₂ to 5 ¹ / ₈	10	30	7 ¹ / ₂	126.00
†7612	Screw Base Plug, 600 W., 250 V...		10	100	23	117.00

†Does not conform to N.E.C. Standards.

3-Wire Polarized Caps and Connector With Adjustable Cord Grips

20 Amperes, 250 Volts A-C or D-C; 10 Amperes, 600 Volts, A-C



No. 9965



No. 7311



No. 7313

No.	Description	Cord Diameter Inches	Car-ton	Std. Pkg.	Wt. Lbs. Std. Pkg.	Per 100
*9965	Rubber Cap.....	7 ¹ / ₁₆ to 3 ¹ / ₄	10	30	6 ¹ / ₂	\$172.00
*7311	Armored Cap.....	7 ¹ / ₁₆ to 3 ¹ / ₄	10	30	8 ¹ / ₂	163.00
*7354	Armored Angle Cap.....	1 ¹ / ₂ to 5 ¹ / ₈	10	30	9	194.50
*7313	Bakelite Body....	7 ¹ / ₁₆ to 3 ¹ / ₄	10	30	11	251.00

3-Wire Flush Receptacles

Side and Back Wired

20 Amperes, 250 Volts, A-C or D-C;

10 Amperes, 600 Volts, A-C



No. 7310 or 7310-B

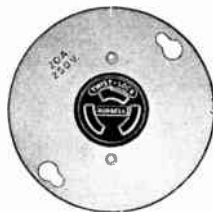

No. 7517

No.	Description	Car-ton	Std. Pkg.	Wt. Lbs. Std. Pkg.	Per 100
*7310	Porcelain.....	10	30	11	\$226.50
*7310B	Bakelite.....	10	30	9	226.50
*7517	Porcelain with 4-Inch Box Cover.....	5	20	12	251.00
*7517B	Bakelite 4-Inch Box Cover.....	5	20	10	251.00
†7502	Rectangular Brass Plate .060 Inches for two No. 7310 Receptacles.....	5	10	5	327.50
*7418	Cast Metal Plate with Lift Cover.....	10	20	8	201.50
*7419	Cast Metal Plate less Lift Cover.....	10	20	10	137.50

■Not Back Wired

†Requires 3-gang outlet box.

No. 7310 and No. 7310-B take standard single outlet plates. Steel Box Covers plated to resist corrosion.

*Fits "FS" and "FD" outlet boxes.

*If desired grounded, suffix letter "G" to catalog number.

Motor Plugs

20 Amperes, 250 Volts, A-C or D-C; 10 Amperes, 600 Volts, A-C



No. 7318



No. 7327



No. 7328

Screw holes in Nos. 7327 and 7328 are spaced 120° on 1¹/₄-inch radius for No. 8 screws.

3-Wire Motor Plugs

No.	Description	Car-ton	Std. Pkg.	Wt. Lbs. Std. Pkg.	Per 100
*7318	Surface Base, Composition Male.....	10	30	6	\$ 83.50
*7327	Flush Base in Casing, Male.....	10	30	10	172.00
*7328	Flush Base, Female, Black... ..	10	30	10	297.00

4-Wire Motor Plugs

Screw holes are spaced 90°.

*7415	Surface Base, Composition, Male.....	10	20	7	\$115.00
*7408	Flush Base in Casing, Male.....	10	20	9	179.50
*7409	Flush Base, Female.....	10	20	9	343.00

4-Wire Caps and Connector

20 Amperes, 250 Volts, A-C or D-C; 10 Amperes, 600 Volts, A-C

Polarized—Adjustable Cord Grips



No. 9967



No. 7411



No. 7413

*9967	Rubber Cap.....	7 ¹ / ₁₆ to 3 ¹ / ₄	10	20	6	\$247.00
*7411	Armored Cap.....	7 ¹ / ₁₆ to 3 ¹ / ₄	10	20	7	226.50
*7426	Armored Angle Cap.....	1 ¹ / ₂ to 5 ¹ / ₈	10	20	9	251.00
*7413	Bakelite Body....	7 ¹ / ₁₆ to 3 ¹ / ₄	10	20	10 ¹ / ₂	314.50

4-Wire Flush Receptacles

Side and Back Wired

20 Amperes, 250 Volts, A-C or D-C;

10 Amperes, 600 Volts, A-C



No. 7410 or 7410-B



No. 7417

*7410	Porcelain.....	10	20	8	\$284.00
*7410B	Bakelite.....	10	20	7	284.00
*7417	Porcelain 4-Inch Metal Box Cover.....	5	15	10	299.00
*7417B	Bakelite 4-Inch Metal Box Cover.....	5	15	10	299.00
**7421	Rectangular, Brass, Single Plate, .060 Ineh.....	10	20	4	100.50
†7422	Rectangular, Brass Plate, .060 Ineh for Two No. 7410 Receptacles.....	5	10	5	327.50

■Not Back Wired

**Fits standard single outlet box.

†Requires 3-gang outlet box.

Covers finished to resist corrosion.

*If desired grounded, suffix letter "G" to catalog number.

Hubbell "Twist-Lock" Devices

Conform to N.E.C. Standards

50 Amperes, 3-Wire and 4-Wire Connectors

With Fully Adjustable Metal Cord Grips
Solderless Connectors



No. 7760 No. 7761

Will take cable sizes from 7/16-in. to 1 1/8-in. diam. 50 Amperes, 250 Volts D-C; 50 Amperes, 600 Volts A-C.

No.	Description	3-Wire Not Grounded		Per 100	
		Car-ton	Std. Pkg.		
7760	Connector Body.....	2	5	7	\$744.50
7761	Male Cap.....	2	5	5	596.00
3-Wire Grounded to Casing					
7762	Connector Body.....	2	5	7	744.50
7763	Male Cap.....	2	5	5	596.00
4-Wire with Equipment Ground					
7764	Connector Body.....	2	5	7	785.50
7765	Male Cap.....	2	5	5	634.50

3-Wire Conduit Box Twist-Lock Receptacle

20 Amperes, 250 Volts



No. 7329

Designed for permanent grounding from one contact to conduit system.

Mounting screws spaced 5/8-inch centers. Suitable for use with Crouse-Hinds "W" condulets and "O" cover, Appleton Electric Co. "W" unlets with No. 5680 cover, and Adalet Mfg. Co. fittings Nos. G2H, G3H and G4H.

No.	Description	Car-ton	Std. Pkg.	Wt. Lbs. Std. Pkg.	Per 100
7329	Porcelain, polarized, black....	10	30	10	\$194.50

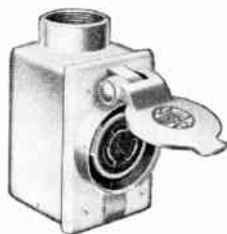

▲ Nos. 7380 and 7382 Assembled to Outlet Box

Flush Receptacles and Plates

3-Wire Polarized
With Solderless Connections
50 Amperes, 250 Volts D-C;
50 Amperes, 600 Volts A-C

Receptacle and plate will fit FS and FD boxes.

Outlet Box is not supplied.

Packed 2 in a carton, 5 in a standard package.

No.	Description	Wt. Lbs. Std. Pkg.	Per 100
7380	Flush Receptacle, 2-Way Wiring....	3	\$596.00
7381	Flush Receptacle, 2-Way Wiring, grounded.....	3	596.00
7960	Flush Male Motor Base, 3-Wire, not grounded.....	5	588.50
7961	Flush Male Motor Base, 3-Wire.....	5	588.50
7958	Flush Male Motor Base, 4-Wire.....	5	627.00
7382	Cast Iron Plate, with Lift Cover....	7	201.50
7383	Cast Iron Plate, without Lift Cover..	5	137.50

Metal Casings finished to resist corrosion.
†Solderless wiring clamps can be swiveled so as to admit wire from end or bottom. ▲Outlet box not supplied.

"Seal-Tite" Rubber Covers For Complete "Twist-Lock" Connectors



No. 7510 Rubber Cover

Assembled to Twist-Lock Cap No. 7102 and Body No. 7101. Catalog number covers one-half only.

A protective device for "Twist-Lock" Connectors against breakage and moisture. Recommended for use in dairies, tunnels, bottling plants, packing plants, mines, fire departments, and general industrial requirements. Two covers of same number are needed for each complete connector Plug or Wire.

No.	Description	Car-ton	Std. Pkg.	Wt. Lbs. Std. Pkg.	Per 100
7510	For Nos. 7101 or 7102 2-Wire..	10	30	5	\$ 60.50
7521	Long Cover for No. 7101 when used with No. 7511.....	10	30	5	60.50
7530	For Nos. 3421, 3423 4-wire super "Twist-Lock" and Nos. 7311 or 7313 3-Wire..	10	30	7	83.50
7522	Long Cover for No. 3423 4-wire Super "Twist-Lock" or No. 7313 when used with No. 7531.....	10	30	8	83.50
7569	For Nos. 7554 or 7555 3-Wire..	10	30	5	60.50
7435	For Nos. 7411 or 7413 4-Wire..	10	20	6	104.50
7509	Long Cover for No. 7413 when used with No. 7511.....	10	20	6	104.50

Short Rubber Covers

For "Twist-Lock" Caps Used with Flush Receptacles

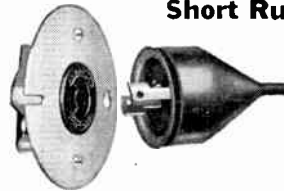

No. 7216 Listed on Page 451
No. 7511 Rubber Cover on No. 7102 Cap

Short rubber covers are necessary when Twist-Lock Caps are to be used interchangeably with a flush receptacle and connector body.

Short rubber covers are necessary when Twist-Lock Caps are to be used interchangeably with a flush receptacle and connector body.

7511	For No. 7102, 2-Wire Cap....	10	30	4	\$ 60.50
7531	For No. 3421 4-Wire Super "Twist-Lock" or No. 7311, 3-Wire Cap.....	10	30	5 1/2	83.50
7541	For No. 7411, 4-Wire Cap....	10	20	4	104.50

For Midget "Twist-Lock" Connectors



No. 7470 Assembled to Nos. 7464 and 7465

For Midget Connectors. Nos. 7464 or 7465.
Packed 10 in carton, 3 in standard package. Package weight, 3 lbs.

No. 7470.....	Per 100	\$53.00
---------------	---------	---------

For 2-Wire Super "Twist-Lock" Devices

No.	Description	Carton	Std. Pkg.	Wt. Lbs. Std. Pkg.	Per 100
7740	For Nos. 3221 or 3223.....	10	30	5	\$ 60.50
7741	Short cover for No. 3221.....	10	30	5 1/2	60.50
7742	Long cover for No. 3223.....	10	30	5	60.50

For 3-Wire Super "Twist-Lock" Devices

7743	For Nos. 3321 or 3323.....	10	30	5	60.50
7744	Short cover for No. 3321.....	10	30	4	60.60
7745	Long cover for 3323.....	10	30	5	60.50

Hubbell "Twist-Lock" Devices 2-Wire Black Bakelite Connector Bodies

Standard Size

10 Amperes, 250 Volts, 15 Amperes, 125 Volts



No. 7503



No. 7506

No.	Description	Cord Diameter Inches	Car-ton	Std. Pkg.	Wt. Lbs. Std. Pkg.	Per 100
7503	Body, less Cord Grip	$\frac{3}{8}$	10	50	6	\$83.50
7506	Body, Cord Grip	$\frac{19}{64}$ to $\frac{9}{16}$	10	50	7	99.50
7696	Body, Cord Grip	$\frac{7}{32}$ to $\frac{3}{16}$	10	50	6	99.50

Will accommodate both polarized and non-polarized caps listed below.

2-Wire Plug Caps

10 Amperes, 250 Volts, 15 Amperes, 125 Volts



No. 7504



No. 7507 or 7697



No. 7545 or 7546



No. 7542

No.	Description	Cord Diameter Inches	Car-ton	Std. Pkg.	Wt. Lbs. Std. Pkg.	Per 100
7504	Bakelite	$\frac{3}{8}$	10	50	3	\$55.50
7507	Bakelite, Cord Grip	$\frac{19}{64}$ to $\frac{9}{16}$	10	50	4	64.00
†7505	Bakelite, Polarized	$\frac{3}{8}$	10	50	6	55.50
7508	Bakelite, Cord Grip	$\frac{19}{64}$ to $\frac{9}{16}$	10	50	4	73.00
7545	Rubber	$\frac{19}{64}$ to $\frac{9}{16}$	10	50	7	89.50
7546	Rubber	$\frac{13}{32}$ to $\frac{5}{8}$	10	50	7	89.50
†7547	Rubber, Polarized	$\frac{19}{64}$ to $\frac{9}{16}$	10	50	7	109.00
†7548	Rubber, Polarized	$\frac{13}{32}$ to $\frac{5}{8}$	10	50	8	109.00
7542	Armored	$\frac{19}{64}$ to $\frac{9}{16}$	10	50	7	74.50
7549	Armored	$\frac{13}{32}$ to $\frac{5}{8}$	10	50	6	74.50
†7588	Armored, Polarized	$\frac{19}{64}$ to $\frac{9}{16}$	10	50	6	86.50
†7589	Armored, Polarized	$\frac{13}{32}$ to $\frac{5}{8}$	10	50	6	86.50
7697	Bakelite	$\frac{7}{32}$ to $\frac{5}{16}$	10	50	4	64.00
†7698	Bakelite, Polarized	$\frac{7}{32}$ to $\frac{5}{16}$	10	50	6	73.00
7642	Armored, Angle Cord Grip	$\frac{1}{2}$ to $\frac{5}{8}$	10	50	8	109.00

3-Wire Polarized Caps with Cord Grips

Standard Size

10 Amperes, 250 Volts, 15 Amperes, 125 Volts



No. 7567 or 7568



No. 7554 or 7558



No. 7572 or 7573

No.	Description	Cord Diameter Inches	Car-ton	Std. Pkg.	Wt. Lbs. Std. Pkg.	Per 100
7567	Rubber	$\frac{19}{64}$ to $\frac{9}{16}$	10	50	8	\$137.00
7568	Rubber	$\frac{13}{32}$ to $\frac{5}{8}$	10	50	8	137.00
7554	Black Bakelite	$\frac{19}{64}$ to $\frac{9}{16}$	10	50	6	104.50
7558	Black Bakelite	$\frac{13}{32}$ to $\frac{5}{8}$	10	50	7	104.50
7572	Armored	$\frac{19}{64}$ to $\frac{9}{16}$	10	50	7	113.50
7573	Armored	$\frac{13}{32}$ to $\frac{5}{8}$	10	50	8	113.50

†Polarized—One wide and one narrow blade. Suffix letter "G" to catalog number if desired grounded. Metal parts plated to resist corrosion.

Hubbell Super "Twist-Lock" Connectors 2-Wire—3-Wire—4-Wire



No. 3321



No. 3323

With screwless pressure-grip terminals for faster, safer, more secure wiring. Both cap and connector body

are designed in two independent sections.

Terminal pockets hold wire ends securely in position and prevent spreading. The dead front "locks in" the strands, no wires are exposed on the surface.

Super "Twist-Lock" is small, light in weight, compact and rugged. Either cap or connector body can be interchanged with regular "Twist-Lock" units of equal size and rating.

2-Wire 20 Amp., 250 V.

No.	Description	Cord Grip Diam., In.	Car-ton	Std. Pkg.	Wt. Lbs. Std. Pkg.	Per 100
3221	Armored Cap	.296-.625	10	30	5	\$79.50
3222	Armored Cap, Polarized	.296-.625	10	30	5	91.50
3223	Armored Body	.296-.625	10	30	8	132.00

3-Wire

20 Amp., 250 V. (A-C or D-C)		10 Amp., 600 V. (A-C Only)	
3321	Armored Cap	.437-.750	10 30 7 170.50
3323	Armored Body	.437-.750	10 30 8 263.00

4-Wire

20 Amp., 250 V. (A-C or D-C)		10 Amp., 600 V. (A-C Only)	
3421	Armored Cap	.437-.750	10 20 6 237.50
3423	Armored Body	.437-.750	10 20 6 330.00

Hubbell "Insulprene" "Twist-Lock" Connectors

2-Wire 3-Wire—4-Wire

Strongest, toughest, most wear-resistant Rubber Connector ever produced—Oil resistant, water resistant, impact resistant.



No. 9966

Tough fibre disc has been molded into the Insulprene $\frac{1}{8}$ -in. from the face to insure positive polarity and anchor the blades securely in position, thus preventing accidental pull-out. Blade slots in disc accurately de-stamped, prevent incorrect insertion of blades.

Fibre retaining piece anchors terminal plates and seals off wiring area from lint and dust. Large screws with No. 8 heads simplify wiring and provide a secure connection.

Powerful Hubbell cord grips eliminate tension from terminals. Extra rugged $\frac{1}{16}$ -in. brass terminal plates.

Double wire lugs on each terminal plate effectively confine wires strands. Will accommodate same caps used with regular Twist-Lock units.

2-Wire 20 Amp., 250 V. (A-C or D-C)

No.	Description	Cord Grip Diam., In.	Car-ton	Std. Pkg.	Wt., Lbs. Std. Pkg.	Per 100
9768	Connector Body	.296-.625	10	30	8	\$231.00
9770	2-Wire "Insulprene" Cap	.296-.625	10	30	5	112.00
9771	2-Wire "Insulprene" Cap, Polarized	.296-.625	10	30	5	129.00

3-Wire

20 Amp., 250 V. (A-C or D-C)		10 Amp., 600 V. (A-C Only)	
9960	3-Wire "Insulprene" Cap	.437-.750	10 30 6 1/2 198.00
9960-G	3-Wire "Insulprene" Cap, Grounded	.437-.750	10 30 6 1/2 198.00
9966	Connector Body	.437-.750	10 30 11 286.00
9966-G	Connector Body, Grounded	.437-.750	10 30 11 286.00

4-Wire

20 Amp., 250 V. (A-C or D-C)		10 Amp., 600 V. (A-C Only)	
9962	4-Wire "Insulprene" Cap	.437-.750	10 20 6 267.50
9962-G	4-Wire "Insulprene" Cap, Grounded	.437-.750	10 20 6 267.50
9968	Connector Body	.437-.750	10 20 10 330.00
9968-G	Connector Body, Grounded	.437-.750	10 20 10 330.00

Hubbell "Seal-Tite" Rubber Closure Plugs
*For Female Receptacles
Conform to N.E.C. Standards



Closure plugs are made of rubber and are designed to protect Twist-Lock flush receptacles from dust and moisture. Furnished complete with chain and attaching ring as illustrated.

No.	Description	Car- ton	Std. Pkg.	Wt., Lbs. Std. Pkg.	Per 100
7648	For No. 7535 2-Wire 10-Amp. Receptacle	10	20	3	\$79.00
7532	For No. 7210 2-Wire 20-Amp. Receptacles	10	20	3	79.00
7529	For No. 7582 3-Wire 10-Amp. Receptacles	10	20	3	79.00
7533	For No. 7310 3-Wire 20-Amp. Receptacles	10	20	3	79.00
7534	For No. 7410 4-Wire 20-Amp. Receptacles	10	20	3	92.50

*Closure plugs for male receptacles are also available.

Bryant Duplex Twist-Tite Grip Contact Outlets



No. 9200

15 Amperes, 125 Volts

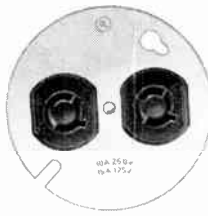

No. 9205

For Standard Wall Boxes

No.	Description	Carton	Std. Pkg.	Wt. Lbs. Std. Pkg.	Per 100
9200	Brown Plastic	10	100	25	\$79.50
9206	For 1-Inch Box	5	50	20	\$88.00

With Cover Finished to Resist Corrosion

P & S Separable Attachment Plugs
Conform to N.E.C. Standards



Standard Size Black Plastic

660 Watts, 250 Volts

Body—Double T-Slots
15 Amps., 250 Volts

Cap—Tandem Blades
1 3/32" Cord Hole



Nos. 8203 and TA

No.	Description	Carton	Std. Pkg.	Wt., Lbs. Std. Pkg.	Per 100
TA	Cap	10	100	10	\$36.50
8203	Body	10	100	11	65.00

P & S Polarized Caps
Two, Three, and Four-Wire



No. 7056



No. 7057



No. 7089



No. 7251

Fibre Insulating Discs are supplied partly inserted—easy to remove for wiring—handy because it eliminates hunting for discs in a separate container.

Packed 10 in a carton.

No.	Description	Card Diam.	Amperes 125 V. 250 V.	Std. Pkg.	Wt. Lbs. Std. Pkg.	Per 100
7056	Two-Wire, Tandem	1/4" - 9/16"	15 10	50	7	\$ 61.50
7057	Two-Wire, Parallel	1/4" - 9/16"	15 10	50	7	61.50
7058	Two-Wire, Right Angle	1/4" - 5/8"	.. 20	30	8	127.00
7092	Two-Wire, Right Angle	1/4" - 9/16"	15 10	30	5	108.00
*7055	Three-Wire	1/4" - 9/16"	15 10	50	7	93.50
*7089	Three-Wire	1/4" - 5/8"	.. 20	20	5	163.50
*7251	Four-Wire	1/4" - 3/4"	.. 20	20	9	194.00

*Add suffix "G" for grounded caps.

P. & S. Polarized Outlets
3-Wire Grounding Outlets



No. 5662

Plastic Tandem Slots

Metal box covers finished to resist corrosion.

Packed 10 in carton. 50 in standard package.



No. 5652

Rating—15 Amps., 250 Volts

Side or Back Wiring

No.	Description	Wt., Lbs. Std. Pkg.	Per 100
5661-1	Single, Ivory	10	\$185.00
5661	Single, Brown	11	175.00
5662-1	Duplex, Ivory	12	265.00
5662	Duplex, Brown	12	253.00
5671	Single on 3 1/4 in. Metal Cover	20	189.00
5681	Single on 4 in. Metal Cover	22	195.00
5682	Duplex on 4 in. Metal Cover	24	274.00

Side Wiring Only

5651-1	Single, Ivory	10	\$ 85.00
5651	Single, Brown	10	80.00
5652-1	Duplex, Ivory	12	156.00
5652	Duplex, Brown	12	144.00
5654	Single on 4 in. Metal Cover	22	144.00
5653	Duplex on 4 in. Metal Cover	24	164.00

P & S Polarized Outlets

Conform to N.E.C. Standards

Black Plastic

**Top Wired—Plaster Ears
Two, Three, and Four-Wire**



No. 6810



No. 7250

No.	Description	Amperes		Carton	Std. Pkg.	Wt., Lbs. Std. Pkg.	Per 100
		125 V.	250 V.				
5552	Two-Wire	20	10	10	30	8	\$160.50
5566	Two-Wire	15	10	10	30	7	\$92.50
*6051	Three-Wire	15	10	10	50	12	\$182.50
*6810	Three-Wire	20	10	10	30	7	\$202.50
*7250	Four-Wire	20	10	10	20	7	\$251.00

*Add suffix "G" for grounded receptacles.

P. & S. Polarized Power Outlets

Three Wire



With L Shaped Slots

Outlets have pressure terminals. No. 3853 and No. 3855 may be mounted in 4-in. or 4 1/16 in. square box with plaster cover.

No. 3851 and 3856 is enclosed in heavy gauge aluminum box with k.o.'s in bottom and back.

Rating—30 Amps., 250 Volts

No.	Description	Std. Pkg.	Car-ton	Wt., Lbs. Std. Pkg.	Per 100
3853	Flush outlet only	10	2	4	\$220.00
3854	Surface outlet, metal encl.	10	2	8	\$236.50

Rating—50 Amps., 250 Volts

3855	Flush outlet only	10	2	4	\$220.00
3856	Surface outlet, metal encl.	10	2	9	\$253.00

Chrome X Plate for Use With No. 3853 and No. 3855

3851	Single Gang Plate	10	2	1	\$ 66.00
3852	Two Gang plate	10	2	2	\$113.50

P. & S. Polarized Power Outlets

Three-Wire

L-Shaped Slots



No. 3836-G



No. 3826-G

Equipped with easy-to-wire "lay-in" type pressure terminals.

Have 3/4 and 1-in. knockouts for conduit in bottom and back.

Rating—30 Amps., 250 Volts

No.	Description	Std. Pkg.	Car-ton	Wt., Lbs. Std. Pkg.	Per 100
3836	Black outlet only	10	2	13	\$220.00
3836-G	No. 3836 with grd strap	10	2	13	\$292.50
3836-W	White outlet only	10	2	13	\$239.00
3836-WG	No. 3836 with grd. strap	10	2	13	\$311.50

Rating—50 Amps., 250 Volts

3826	Black Outlet	10	2	13	\$220.00
3826-G	No. 3826 with grd. strap	10	2	13	\$292.50
3826-W	White Outlet	10	2	13	\$239.00
3826-WG	No. 3826 with grd. strap	10	2	13	\$311.50

P & S Range Cord Sets



No. 3829

36-Inch Rubber Cord Set
Moulded Rubber Cap

Packed 2 in a carton. 10 in a standard package.

50 Amperes, 250 Volts

No.	Description	Std. Pkg. Wt., Lbs.	Per 100
3830	Cord Set, Two No. 8, One No. 10	23	\$317.00

35 Amperes, 250 Volts

3829	Cord Set, Two No. 6, One No. 8	19	\$284.00
------	--------------------------------	----	----------

Bryant Rubber Cable Cord Sets

Listed as standard by Underwriters' Laboratories, Inc.

**Non-Removable Plastic Caps
35 Amperes, 250 Volts**

Two No. 8 and One No. 10 Wires.



No. 3829

No.	Length	Wt. Lbs. Std. Pkg.	Per 100
3829	36-Inches	13	\$230.00
3829-B	48-Inches	18	\$270.00
3829-C	60-Inches	22	\$310.00

50 Amperes, 250 Volts

Two No. 6 and One No. 8 Wires.

3830	36-Inches	16	\$250.00
3830-B	48-Inches	24	\$310.00
3830-C	60-Inches	24	\$368.00

Bryant 3-Wire Polarized Heavy Duty Connectors

Listed by Underwriters' Laboratories, Inc.

Heavy Duty Cap

50 Amperes, 250 Volts

Plastic, with solderless terminals. Accommodates either armored or rubber cable. Has clamp terminals and grounding prongs.



No. 3833

No.	Carton	Std. Pkg.	Wt. Lbs. Std. Pkg.	Per 100
3833	2	10	9	\$351.00

Surface Mounting Outlet

50 Amperes, 250 Volts

Plastic, with pressure terminals. Has 3/4-inch and 1-inch knockouts for conduit in back and bottom.



No. 3826

3826	2	10	10	\$220.00
------	---	----	----	----------

Grounding Strap

For use with No. 3826 outlet. Packed 2 in a carton. 10 in a standard package.



No. 3827	Per 100	\$76.50
----------	---------	---------

Surface Mounting Outlet

With Heavy Gage Aluminum Enclosure 50 Amperes, 250 Volts



No. 3926

3926	2	10	9	\$253.00
------	---	----	---	----------

Hubbell 3-Wire Surface Type Range Receptacles

Conform to N.E.C. Standards

Patented Pressure Type Terminals Polarized
For Range and General Installations
50 Amperes, 250 Volts



No. 7990



No. 7989



No. 7977

No.	Description	Carton	Std. Pkg.	Wt. Lbs. Std. Pkg.	Per 100
*7990	Surface Receptacle, Black Bakelite	2	10	15	\$220.00
7990-I	Surface Receptacle Ivorine	2	10	15	275.00
7989	Ground Strap for No. 7990	2	10	1	76.50
7977	Black Bakelite Range Cap	2	10	10	351.00

Regularly furnished without No. 7989 grounding clamp.
*When used with 1-inch conduits omit the clamps, and in its place use a regular conduit bushing and lock nuts.

Surface Type

30 Amperes, 250 Volts, Polarized

For dryers, air conditioners and other general installations.

L-shaped slot positively prevents interchangeability with 50-amp. units.

Large binding screw terminals take up to #8 wire. Built-in cable clamp interchangeable for back or bottom wiring.

Regularly furnished without No. 7989 grounding clamp.

Grounding clamp designed to connect with ground strap on cap, providing secure ground connection.



No. 9390

No.	Description	Carton	Std. Pkg.	Wt. Lbs. Std. Pkg.	Per 100
9390	Surface Receptacle, Black Bakelite	5	20	22	\$220.00
9390-I	Ivorine	5	20	22	275.00

Surface Type Power Outlet with Metal Cover Features Hubbell swing-type pressure terminals. Designed to meet Underwriters' Laboratories requirements for metal cover, surface type units.

Withstands rough usage in industrial-commercial applications.

"Sandblast" aluminum cover and back plate blends well with all kitchen interiors.



No. 9395



No. 7940

Phosphor-bronze springs insure strong grip. Channel takes up to #6 wire.

No.	Description	Carton	Std. Pkg.	Wt. Lbs. Std. Pkg.	Per 100
9395*	30 Amperes, 250 Volts, Brown Face	2	10	9	\$236.50
9396	30 Amperes, 250 Volts Brown Face with ground clamps	2	10	9	297.00
7940**	50 Amperes, 250 Volts, Black Face	2	10	9	253.00
7946**	50 Amperes, 250 Volts Brown Face with ground straps	2	10	9	313.50

*L-shaped slot to prevent interchange with 50-amp. units.

**Straight slots to prevent interchange with 30-amp. units.

Hubbell Range Cord Sets

Conform to N.E.C. Standards

No. 7915; 35 Amperes, 125 or 250 Volts

No. 7914; 50 Amperes, 250 Volts

No.	Description	Carton	Std. Pkg.	Wt. Lbs. Std. Pkg.	Per 100
7914	36-Inch Rubber Cord Set, 2 No. 6 and 1 No. 8 Wires	2	10	22	\$336.50
7915	36-Inch Rubber Cord Set, 2 No. 8 & 1 No. 10 Wires	2	10	18	311.50

Flush Type Power Outlet

Shallow, compact design simplifies wiring.

Auxiliary steel spring provides constant contact pressure, keeping heat rise to a minimum even when used at its maximum rating.

Terminals recessed for extra safety.



No. 7962

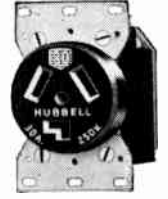

No. 9350

Terminals cadmium plated to resist corrosion and permit use of aluminum building wire. Accommodates up to #6 wire. Captive binding screws cannot contact sides of box.

No.	Description	Carton	Std. Pkg.	Wt. Lbs. Std. Pkg.	Per 100
7962**	50 Amperes Single Receptacle Black Bakelite	2	10	5	\$220.00
7962G**	50 Amperes Single Receptacle, Grounded Black Bakelite	2	10	5	220.00
9350*	30 Amperes Single Receptacle Brown Bakelite	2	10	5	220.00
9350G*	30 Amperes Single Receptacle, Grounded, Brown Bakelite	2	10	5	220.00
9353	Single Stainless Steel Plate	2	10	3	66.00
9354	2-Gang Single Opening Stainless Steel Plate	2	10	2	113.50

7955—#7962 with #9420

*L-shaped slot to prevent interchange with 50-amp. units.

**Straight slots to prevent interchange with 30-amp. units.

3-Wire Power Outlet

Patented Swing Type Pressure Type Terminals Polarized 50 Amperes, 250 Volts

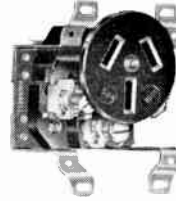

No. 7974

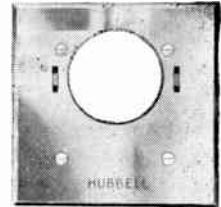

No. 7975

Range outlet No. 7974 Swing type pressure terminal is designed for 4 or 4 1/16-inch box and standard 3/4-inch plaster cover. Requires no special attachment.

Will accommodate No. 7977 Bakelite Range Cap or standard rubber connection cord sets.

No.	Description	Carton	Std. Pkg.	Wt. Lbs. Std. Pkg.	Per 100
7974	Receptacle Only	2	10	9	\$220.00
7975	.040-Inch Brush Brass Plate only with Ground Slots and Contacts	2	10	3	137.50

Flush Type Outlet

Polarized 50 Amperes, 250 Volts

Fits standard boxes 4 1/8 inches square and 2 1/8 inches deep.



No. 9301 with Cover

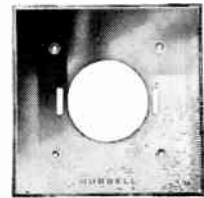

No. 9309

No.	Description	Carton	Std. Pkg.	Wt. Lbs. Std. Pkg.	Per 100
9301	Receptacle with Box Cover	2	10	17	\$864.00
9309	Steel Plate, 5 1/2 In. Sq.	2	10	5	175.00

Ground Slots and Springs plated to resist corrosion.

Hubbell Wiring Devices

Conform to N.E.C. Standards

**3-Wire Power Outlet
Polarized
With "L" Shaped Grounding Slot
30 Amperes, 250 Volts**



No. 9335

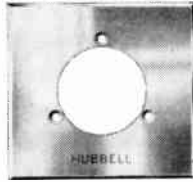

No. 9336



Nos. 9337 or 9338

Does not require a separate outlet box. Will mount through 3 1/8" hole drilled in wall. Angle cable clamp takes BX, or other metal sheathed cable also non-metallic cable measuring .750 to 1.187". Maximum depth from underside of flange is 3 1/2". Supplied with three nickel plated wood screws.

No.	Description	Car- ton	Std. Pkg.	Wt. Lbs. Std. Pkg.	Cord Diam. Inches	Per 100
†▲9335	Bakelite Receptacle	2	10	13		\$514.50
9337	Armoured Cord Grip Cap, Ungrounded	2	10	6	5/8 to 1	241.50
9338	Armoured Cord Grip Cap, Grounded	2	10	6	5/8 to 1	263.50
9336	Stainless Steel Face Plate without Slots, Semi-Polished Finish.	2	10	3		125.50
**9327	Steel Sub Plate	10	2	3		67.00

†Specify No. 9335G if desired with one contact grounded to metal casing.
**Equipped with extra set of mounting holes. For use under flange of steel housing when necessary to cover carelessly cut hole in plaster wall. Finished to resist corrosion.
▲ Takes cap No. 9337 or 9338.

**3-Wire Power Outlet
50 Amperes, 250 Volts
Does Not Require A Separate Outlet Box
Polarized**



No. 9325

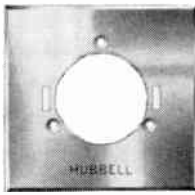

No. 9326

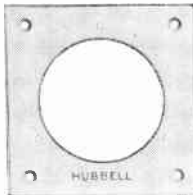

No. 9327

Requires a 3 1/8-inch hole. Black Bakelite body. Supplied with grounding slots through plate for caps with independent ground clips as on No. 7977. Also takes all standard 50-ampere, 250-volt, 3-wire caps without grounding clips. Angle cable grip clamp will take BX, or other metal sheathed cable, or non-metallic cable measuring 3/4-inch to 1 3/16-inches. Flange diameter 1 5/16-inches. Maximum depth from underside of flange to bottom of cord clamp, with largest cable in place is 3 1/2 inches. Supplied with three nickel-plated wood screws.

If desired with one contact grounded to metal casing, suffix letter "G" to catalog number.

No.	Description	Car- ton	Std. Pkg.	Wt. Lbs. Std. Pkg.	Per 100
9325	Black Bakelite Receptacle	2	10	14	\$514.50
9326	Stainless Steel Face Plate, Semi-Polished Finish	2	10	3	125.50
*9327	Steel Sub Plate	2	10	3	67.00

*No. 9327 sub plate is equipped with an extra set of mounting holes and is for use under the face plate, where it may be necessary to cover up a carelessly cut hole in the plaster wall. Finished to resist corrosion.

**3-Wire
Receptacle—Connector—Surface Base
With L-Shaped Grounding Slots and Blade
Polarized—Black
30 Amperes, 250 Volts**



No. 9340 and
No. 7114 Plate



No. 9341



No. 9342

No.	Description	Cord Diam. Inches	Car- ton	Std. Pkg.	Wt. Lbs.	Per 100
*▲9340	Flush Receptacle, Black Porcelain, Less No. 7114 Plate		1	5	8	\$422.00
▲9341	Connector Body, Black Composition	5/8 to 1	1	5	8	584.50
9342	Male Base, Black Composition	15/16	1	5	4	238.00
●7114	.060" Brass Plate		2	5	2	199.00

▲Takes cap No. 9337 or 9338.
●No. 7114 Plate is standard 2-gang size, brush brass finish.
*Suffix "G" to catalog number if desired grounded.

**3-Wire Composition Caps
30 Amperes, 250 Volts**



No. 9316

Black Composition,
Cord Hole 3/4 Inch.

No.	Carton	Std. Pkg.	Wt. Lbs.	Per 100
9316	2	10	6	\$150.00

Receptacles Nos. 7112, 7283 & 9307 take this Cap.

**4-Wire Flush Receptacles
Polarized
60 Amperes, 250 Volts**

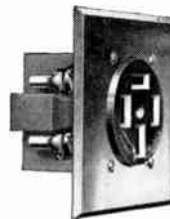

Nos. 7301 and 7114



No. 7303

Soldering lugs accommodate No. 4 wires. Caps are armored, cord grip, and accommodate up to 1 1/4-inch diameter cords.

Standard finish of plates is brush brass.

No.	Description	Car- ton	Std. Pkg.	Wt. Lbs. Std. Pkg.	Per 100
7301	Receptacle, Porcelain, Black Glazed Face	2	5	9	\$750.50
7302	Angle Cap, Black Composition	2	5	9	561.50
7303	Cord Grip Cap, Black Composition	2	5	8	507.00
7114	.060-Inch Brass Plate 4 1/2 x 4 9/16- Inches	2	5	2	199.00

Hubbell Wiring Devices

Conform to N.E.C. Standards

Polarized Composition Cord Connectors With Armored Cord Grip

All metal parts finished to resist corrosion.



15 Amperes, 125 Volts; 10 Amperes, 250 Volts

No.	Des.	Cord Diameter Inches	Carton	Std. Pkg.	Wt. Lbs. Std. Pkg.	Per 100
7091	Body	$\frac{9}{64}$ to $\frac{9}{16}$	10	30	8	\$148.00
7092	Cap	$\frac{9}{64}$ to $\frac{9}{16}$	10	30	4	108.00
7240	Body	$\frac{13}{32}$ to $\frac{5}{8}$	10	30	8	148.00
7241	Cap	$\frac{13}{32}$ to $\frac{5}{8}$	10	30	4	108.00

20 Amperes, 250 Volts

7086	Body	$\frac{13}{32}$ to $\frac{5}{8}$	10	30	10	\$169.00
7058	Cap	$\frac{13}{32}$ to $\frac{5}{8}$	10	30	6	127.00

2-Wire Flush Receptacle, Plate and Caps Single Gang Size—Polarized 30 Amperes, 250 Volts

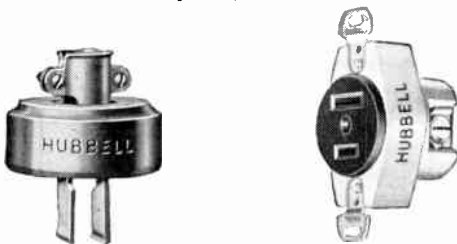

No. 7436

No. 7438

The face diameter of No. 7438 is larger than standard and requires special plate No. 7439. Large outside diameter will not permit two gang installation of No. 7438 receptacle.

No.	Description	Carton	Std. Pkg.	Wt. Lbs. Std. Pkg.	Per 100
7436	Cord Grip Cap, $\frac{5}{8}$ -Inch, Cord Hole	5	30	18	\$232.50
7438	Porcelain Receptacle, Black Face	10	30	16	216.00
7439	.040" Brush Brass Plate Size $2\frac{3}{4}$ " x $4\frac{1}{2}$ "	10	30	6	71.50

Two-Gang Size

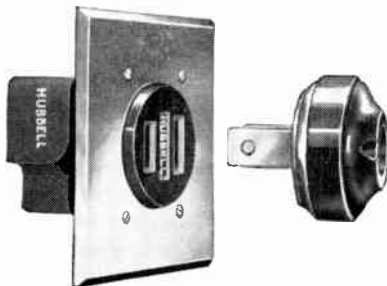

Nos. 7070, 7071 and 7072

Supporting lugs have mounting holes spaced to fit standard 2-gang outlet boxes 2 inches deep or over.

Standard finish of plate is brush brass. Other exposed metal parts finished to resist corrosion.

7070	Black Porcelain Receptacle	2	5	7	\$507.00
7071	Black Porcelain Cap, $\frac{3}{32}$ Inch, Cord Hole	2	5	3	252.00
7127	Armored Cord Grip Cap, Cord Hole, $\frac{5}{8}$ to 1 inch	2	5	3	303.00
7072	.060" Brass Plate, $4\frac{1}{2}$ x $4\frac{1}{8}$ Inches	2	5	2	199.00

3-Wire Single Flush Receptacles Polarized



Nos. 6051 and 6810



Nos. 7275 and 7277

No. 7189 same design as No. 6051 but has ground shunt from one terminal to the back supporting strap.

15 Amperes, 125 Volts; 10 Amperes, 250 Volts

No.	Description	Carton	Std. Pkg.	Wt. Lbs. Std. Pkg.	Per 100
6051	Bakelite	10	50	9	\$182.50
7189	Bakelite, Grounded	10	50	9	182.50
*9051	Porcelain	10	50	20	181.50
*7607	Bakelite, with $3\frac{1}{4}$ -Inch Cover	10	50	20	199.00
*7275	Bakelite, with 4-Inch Cover	5	50	15	204.50

20 Amperes, 250 Volts

*6810	Bakelite	10	30	5	\$202.50
*6810-1	Ivoryine Receptacle	10	30	5	214.00
*7277	Bakelite, with 4-Inch Cover	5	30	13	224.50

*If desired grounded, suffix letter G to number.

3-Wire Single Flush Receptacles With Short Mounting Ears 15 Amperes, 125 Volts; 10 Amperes, 250 Volts



No. 7214 or 7215

Screw holes, $1\frac{3}{4}$ inches on centers, tapped for 8 x 32 screws.

Fits in $1\frac{3}{4}$ -inch diameter hole.

No.	Description	Carton	Std. Pkg.	Wt. Lbs. Std. Pkg.	Per 100
7214	Bakelite, Grounded, 2 Binding Screws	10	30	6	\$141.50
7215	Bakelite, Not Grounded, 3 Binding Screws	10	30	7	141.50

3-Wire Duplex Polarized Receptacles Back or Side Wiring

**15 Amperes, 125 Volts;
10 Amperes, 250 Volts**



No. 7051

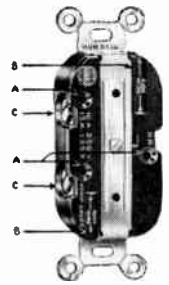

No. 7051 Back

A—Back Wiring Holes.

B—Wire Strip-Gauge for side or back wiring.

C—Binding Screws for conventional side wiring.

If desired with ground shunt, suffix letter G to number.

No.	Description	Carton	Std. Pkg.	Wt. Lbs. Std. Pkg.	Per 100
7051	Black Bakelite	10	30	8	\$253.00
7051-1	Ivoryine	10	30	8	265.50
7208	Black Bakelite with 4-Inch Steel Cover	5	30	15	277.00

Bryant 3-Wire Polarized Outlets



**50 Amperes, 250 Volts
Flush Mounting**

Plastic Receptacles—Stainless Steel Plates—Solderless Terminals.

No.	Carton	Std. Pkg.	Wt. Lbs. Std. Pkg.	Per 100
3846	2	10	11	\$333.50

Plastic Receptacle Only

3845	2	10	7	\$220.00
------	---	----	---	----------

Fits standard 4-inch box (Universal No. 52151-S with 3/4-inch knockouts and No. 52C18 cover) and standard 4 1/16-inch square box (Universal No. 72171-1 with No. 72C18 cover).



Stainless Steel Plate Only

3847	2	10	3	\$137.50
------	---	----	---	----------

No. 3845

For No. 3845 Receptacle. Has grounding contacts.

Hubbell 3-Wire Flush Receptacles

Conform to N.E.C. Standards

Polarized

30 Amperes, 250 Volts

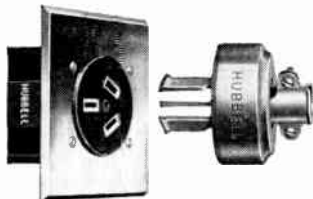

Nos. 7112, 7113 and 7114

No. 7112 fits standard 2-gang box 2 inches deep or over, as listed below.

No. 7114 is standard 2-gang size. Finished in brush brass.

Nos. 7113 and 7114 armored caps, finished to resist corrosion. Adjustable cord grip, 5/8 to 1-inch.

No.	Description	Carton	Std. Pkg.	Wt. Lbs. Std. Pkg.	Per 100
*†7112	Black Porcelain Receptacle	2	5	7	\$422.00
*7113	Cord Grip Cap	2	5	4	241.50
*7514	Grounded Cord Grip Cap	2	5	3	241.50
7114	.060-inch Brass Plate	2	5	2	199.00

*If desired grounded, suffix letter G to catalog number.

†Does not conform to N.E.C. Standards.

*Not U. L.

Hubbell 3-Wire Flush Receptacles

Conform to N.E.C. Standards

Polarized

With Soldering Terminals

50 Amperes, 250 Volts

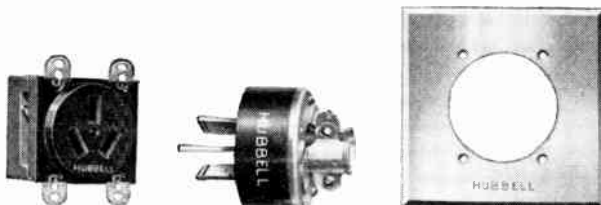

No. 7512

No. 7513

No. 7114

If desired grounded, suffix letter G to number.

No. 7114 is standard 2-gang size. Finished in brush brass.

No.	Description	Carton	Std. Pkg.	Wt. Lbs. Std. Pkg.	Per 100
*7512	Black Porcelain Receptacle	2	5	8	\$514.50
*7513	Cord Grip Cap, 7/8 to 1 3/2"	2	5	1	290.50
*7520	Cord Grip Cap, 5/8 to 1 1/8"	2	5	5	290.50
7114	.060-Inch Brass Plate	2	5	2	199.00

*Add "G" to catalog number if desired grounded.

P & S Duplex Convenience Outlets

Conform to N.E.C. Standards

**15 Amperes, 125 Volts
3-Wire Grounding Type**



No. 5262



No. 5261

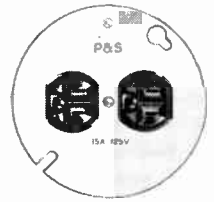

No. 5282

For use with metallic or non-metallic wiring systems. Designed for grounding exposed metal parts of portable electrical equipment. May be side-wired or back-wired. Will fit standard duplex and single outlet plates. Will take standard two-wire caps. Standard 3-wire caps will not fit. Use special 3-wire grounding caps listed below.

Packed 10 in a carton, 50 in a standard package.

No.	Description	Wt. Lbs. Std. Pkg.	Per 100
5262	Duplex Outlet, Brown Bakelite.....	11	\$219.00
5262-1	Duplex Outlet, Ivory.....	11	231.00
5261	Single Outlet, Brown Bakelite.....	10	158.00
5271	Single Outlet on 3 1/4" Metal Box Cover.....	20	172.00
5281	Single Outlet on 4" Metal Box Cover	22	178.00
5282	Duplex Outlet on 4" Metal Box Cover	24	240.00

P & S 3-Wire Caps

For Use With 3-Wire Grounding Type Outlets
Cord Connectors and Adapters



No. 5264



No. 5263



No. 5267

These caps have standard parallel blades, plus a U-shaped blade for grounding and can be used only with 3-wire grounding type outlets.

Packed 10 in a carton, 50 in a standard package.

Rating—15 Amperes, 125 Volts

No.	Description	Cord Diam. In.	Wt. Lbs. Std. Pkg.	Per 100
5263	Brown Bakelite Cap	7/16	5	\$47.00
5263-1	Ivory Cap	7/16	5	52.00
5264	Armored Cap with Cord Grip	1 9/64-9/16	8	81.00
5265	Armored Cap with Cord Grip	1 3/32-5/8	7	81.00
5266	Rubber Cap with Cord Grip	1 9/64-9/16	8	81.00
5267	Rubber Cap with Cord Grip	1 3/32-5/8	9	81.00

All of the above devices are listed by the Underwriters' Laboratories and comply with National Electrical Code.

Additional printed information on these and other products not listed is available on request to Graybar.

Hubbell Triplex Table Tap

Conform to N.E.C. Standards

15 Amperes, 125 Volts

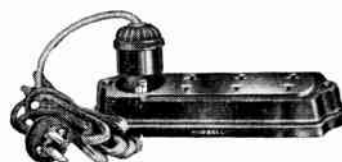

Composition body with connector cap, and 8 feet of black cord. Packed 2 in a carton. 5 in a standard package. Package weight, 10 pounds.

*No. 6900 Per 100 \$959.00

*Not U/L.

P & S Convenience Outlets

Conform to N.E.C. Standards

Specification Type

Double Grip Contacts



No. 1570

Parallel Slots—Side Wired

Packed 10 in a carton

Meets REA and Federal Specifications

15 Amperes, 125 Volts

No.	Description	Std. Pkg.	Wt. Lbs. Std. Pkg.	Per 100
1570	Brown Bakelite.....	100	16	\$42.00
1570-I	Ivory.....	100	16	48.50



No. 1565

Single Grip Contacts

With Wide Mounting Ears

Parallel Slots—Side Wired

Packed 10 in a carton

15 Amperes, 125 Volts

No.	Description	Std. Pkg.	Wt. Lbs. Std. Pkg.	Per 100
1565	Brown Bakelite.....	100	16	\$23.00
1565-I	Ivory.....	10	16	28.50

Double Grip Contacts

T-Slots

For Back or Side Wiring



No. 9260

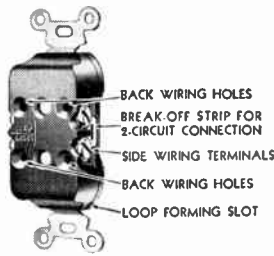

No. 9260—Back View

No. 9260 is a sturdily constructed two-piece outlet with pressure type terminals which permit either back or side wiring. For back wiring strip wire to length indicated on strip gauge at back, insert wires in recesses and tighten binding screws at side. Convenient slots under plaster ears can be used for looping wire when outlet is side wired. Outlet becomes two-circuit type when connection between binding screws is broken.

15 Amperes, 125 Volts

No.	Description	Std. Pkg.	Carton	Wt. Lbs. Std. Pkg.	Per 100
9260	Brown Bakelite.....	100	10	19	\$75.00
9260-I	Ivory.....	50	10	11	81.50

P & S Combination Polarized Outlets

Combination Three-Wire Grounding Outlets



No. 5290

Plastic

One half of outlet rated at 15 amps. 125 volts and has parallel slots; other half rated 15 amps., 250 volts has tandem slots; both have U shaped grounding slots.

15 Amperes, 125 and 250 Volts

Side Wired

No.	Type	Color	Std. Pkg.	Carton	Wt. Lbs. Std. Pkg.	Per 100
5290	Comb. Duplex	Brown	50	10	12	\$127.00
5290-I	Comb. Duplex	Ivory	50	10	12	139.00

Side and Back Wired

5292	Comb. Duplex	Brown	50	10	12	\$236.00
5292-I	Comb. Duplex	Ivory	50	10	12	248.00

P & S Polarized Outlets and Caps

30 Ampere—Two-Wire



No. 7438



No. 7436

Parallel slots and blades.

No. 7438 outlet has a porcelain body with black composition face. Double grip type contacts.

Caps and cord grips finished to resist corrosion.

Rating—30 Amps., 250 Volts

No.	Description	Std. Pkg.	Carton	Wt. Lbs. Std. Pkg.	Per 100
7438	Single Outlet.....	30	10	16	\$196.50
7436	Armored Cap, cord grip..	30	5	20	211.50

Daniel Woodhead "Multi-Tap" Outlet Boxes

Made of "Safety Yellow" Neotex

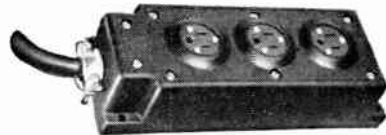

No. 31593

Available with Various Types of Receptacles



"K" Type Tandem "T" Type "Y" Type Crowfoot "U" Type Blade "X" Type

Made in the tradition of Woodhead high quality for all industries requiring portable multiple electrical outlets.

No.	Description	Std. Pkg.	Wt. Lbs.	Each
31550	15 A. 125 V. parallel K Type....	1	2	\$14.40
31551	15 A. 125 V. polarity T Type... ..	1	2	14.45
31552	3-wire 15 A. 125 V., 10A. 250 V., Crowfoot Y Type.....	1	2	15.25
31593	3-wire 15 A. 125 V. Nema U Type..	1	2	15.25
32550	10 Amp. 2-wire Turnex X Type..	1	2	15.70
32553	10 Amp. 3-wire Turnex XX Type	1	2	17.45
32753	20 Amp. 3-wire Turnex XX Type	1	2	18.35

Note: All multi-tap boxes are available with cord set. Prices on application. Specify cord size, number of conductors and length.

Hubbell Wiring Devices

Conform to N.E.C. Standards

Convenience Outlets

15 Amperes, 125 Volts

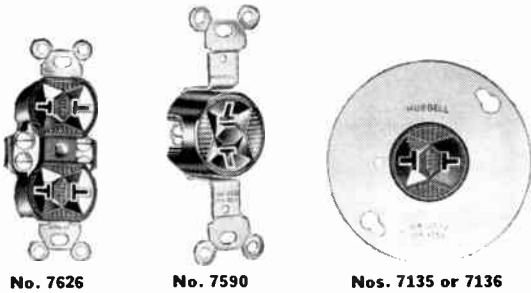

Duplex—Top Wired—*Single and †Double Binding Screws

No.	Description	Carton	Std. Pkg.	Wt. Lbs. Std. Pkg.	Per 100
†7626	Bakelite, Wide Ears	10	100	22	\$ 98.50
†7626-1	Ivoryine, Wide Ears	10	50	13	120.00
*6257	Black Porcelain	10	100	34	87.00

Single Side Wired

7590	Bakelite, Wide Ears	10	100	15	\$55.50
7550	Bakelite, Narrow Ears	10	100	18	55.50
7135	With 3¼-Inch Cover	10	100	34	57.00
7136	With 4-Inch Cover	5	50	13	64.50



No. 9690

Duplex Convenience Outlets Intermediate Grade
15 Amperes, 125 Volts

Bakelite—Double Contact Springs
Washer Ears—Parallel Slots

No.	Description	Carton	Std. Pkg.	Wt. Lbs. Std. Pkg.	Per 100
9690	Brown.....	10	100	15	\$42.00
9690-1	Ivoryine.....	10	100	15	48.50
9693	Brown, with 3¼-Inch Steel Box Cover.....	10	100	30	57.00
9694	Brown, with 4-Inch Steel Box Cover.....	5	50	13	65.00



No. SP-49

Duplex "Safety-Plus" Receptacle
15 Amperes, 125 Volts

Makes contact only when standard cap is inserted.

The SP-49 Receptacle is not available in 3¼-Inch Steel Box Covers. Available in Counter Displays at no extra cost. 20 devices to a display. 5-Displays to a carton. Order by amount of display cartons, not by amount of receptacles.

No.	Description	Carton	Std. Pkg.	Wt. Lbs. Std. Pkg.	Per 100
SP-49	Brown, Safety Receptacle.....	10	100	23	\$103.50
SP-49-1	Ivoryine, Safety Receptacle.....	10	50	12	111.50
SP-49-4	Brown, Safety Receptacle on 4" Steel box cover.....	5	50	25	126.50

P & S Convenience Outlets

Conform to N.E.C. Standards

"T" Slots

15 Amperes, 125 Volts

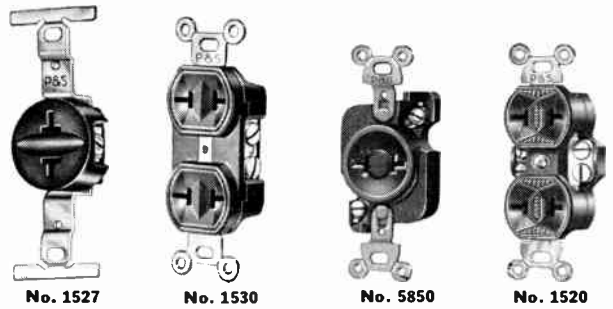

No. 1527

No. 1530

No. 5850

No. 1520

Bakelite with plaster ears. The face of each receptacle is molded to guide the cap blades into the contact slots.

Side Wired

No.	Description	Carton	Std. Pkg.	Wt. Lbs. Std. Pkg.	Per 100
1527	Single, Brown.....	10	100	15	\$55.50
1527-1	Single, Ivory.....	10	50	7	63.50
1530	Duplex, Brown.....	10	100	18	50.50
1530-1	Duplex, Ivory.....	10	100	18	58.50

Top Wired

*5850	Single.....	10	100	28	\$69.50
1520	Duplex.....	10	100	23	98.50

*Black Porcelain.

Plastic—Parallel Slots

15 Amperes, 125 Volts



No. 1500

No. 1540

Nos. 1500 and 1500-1: Parallel slots, plaster ears, screwless terminals. Specification type duplex receptacles. Double grip contacts. Designed for use with No. 12 and No. 14 solid wire.

Nos. 1540 and 1540-1: Parallel slots, side wired binding screw terminals, plaster ears. Single outlets, single grip contacts.

No.	Type	Color	Carton	Std. Pkg.	Wt. Lbs. Std. Pkg.	Per 100
1500	Duplex	Brown	10	100	14	\$28.50
1500-1	Duplex	Ivory	10	100	14	33.00
1540	Single	Brown	10	100	12	31.50
1540-1	Single	Ivory	10	50	6	40.50

With Metal Box Covers

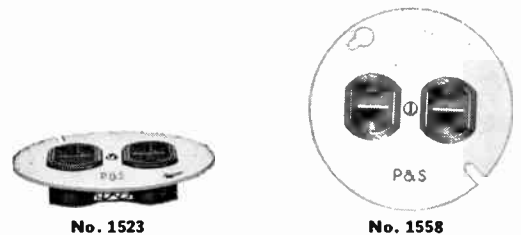

No. 1523

No. 1558

"T" Slots

1522	Bright metallic finish box covers. Duplex, for 4-Inch Outlet Box.....	5	50	19	\$73.50
1523	Duplex, for 3¼-Inch Outlet Box.....	5	50	15	67.00

Parallel Slots

1558	With 3¼-In. Cover..	10	50	14	\$53.00
1559	With 4-In. Cover....	10	50	18	59.50

Bryant Plastic Flush Outlets

Listed by Underwriters' Laboratories, Inc.

15 Amperes, 125 Volts

Duplex Top Wiring Terminals

T-Slots—Double-Sided Contacts—Wide Yoke

Furnished with four terminal screws.

No. 4812 per 100 \$98.50

†Wt. per Standard Package in pounds, 20.



No. 4812

Single and Duplex Side Wiring Terminals

T-Slots—Double-Sided Contacts—Single—Wide Yoke

No. 4831 per 100 \$55.50

†Wt. per Std. Pkg. in Lbs., 14.

No. 4831-1 Ivory per 100 \$63.50

*Wt. per Std. Pkg. in Lbs., 7.



No. 4831

Double

Furnished with four terminal screws.

Equipped with Break-off Feature permits outlet to be wired so that one outlet can be switch controlled with the other outlet always alive for connection of vacuum cleaner or other appliance.



No. 4832

No. 4832 Brown per 100 \$50.50

†Wt. per Std. Pkg. in Lbs., 20.

No. 4832-1 Ivory per 100 \$58.50

*Wt. per Std. Pkg. in Lbs., 10.

Double-Sided Contacts

T-Slots, Back or Side Wiring

Back Wiring—Clamp Terminals

Double

Equipped with Break-off Feature permits outlet to be wired so that one outlet can be switch controlled with the other outlet always alive for connection of vacuum cleaner or other appliance.

†No. 9260 Brown per 100 \$75.00

Wt. per Std. Pkg. in Lbs., 21

*No. 9260-1 Ivory per 100 \$81.50

*Packed 10 in a carton, 50 in a standard package.

†Packed 10 in a carton, 100 in a standard package.



No. 9260

15 Amperes, 125 Volts

Duplex—Spring Grip Terminals

No.	Color	Carton	Std. Pkg.	Wt., Lbs. Std. Pkg.	Per 100
6100	Brown	10	100	17	\$39.50
6100-1	Ivory	10	100	17	\$46.00

For use with Solid No. 10, 12 or 14, Stranded Wire No. 14 or 12.

6142 Brown 10 100 15 \$28.50

6142-1 Ivory 10 100 15 33.00

For use with Solid No. 12 or 14 Wire Only.



No. 6100

Bryant Plastic Flush Outlets

Listed by Underwriters' Laboratories, Inc.

Triple Outlet With Plate Spring Grip Terminals

6123	Brown	10	50	11	\$59.50
6123-1	Ivory	10	50	11	68.00

For use with Solid No. 10, 12 or 14, Stranded Wire No. 14 or 12.

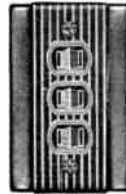

No. 6123

Bryant Flush Convenience Outlets Standard Types

Plastic Round Outlets

Brush Brass Plate

15 Amps, 125 Volts

Plate diameter, 2¹/₃₂-inches. Body diameter, 1¹⁵/₃₂-inches. Screw spacing 1⁷/₈-inches.



No. 115



No. 4413

No.	Carton	Std. Pkg.	Wt. Lbs. Std. Pkg.	Per 100
115	2	50	8	\$183.50

Less Plate

4413 10 50 5 \$55.50

Screw spacing, 1¹¹/₁₆-inches.

Bryant Box Mounting Outlets

Listed by Underwriters' Laboratories, Inc.

15 Amperes, 125 Volts Brown Plastic

Metal covers finished to resist corrosion.

Single—Parallel Slots

No.	Box Size	Car- ton	Std. Pkg.	Wt. Lbs. Std. Pkg.	Per 100
341	3 ¹ / ₄ -Inches	10	50	14	\$51.50
441	4 -Inches	10	50	20	58.00

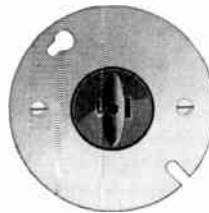

No. 341

Duplex—Parallel Slots

342	3 ¹ / ₄ -Inches	10	50	14	\$50.50
442	4 -Inches	10	50	19	59.50

Metal covers finished to resist corrosion.

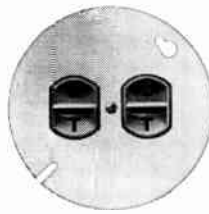

No. 3781

Single—"T" Slots Side Wired

No.	Box Size	Car- ton	Std. Pkg.	Wt. Lbs. Std. Pkg.	Per 100
3780	3 ¹ / ₄ -Inches	10	50	17	\$57.00
4780	4 -Inches	10	50	19	64.50

Duplex—"T" Slots Side Wired

3781	3 ¹ / ₄ -Inches	10	50	15	\$67.00
4782	4 -Inches	10	50	21	73.50

Daniel Woodhead Safeway (Inner-Lock)

Neotex Duplex Receptacles

10 Amp., 250 Volt—15 Amp., 125 Volt

Have a positive grip. The contacts will withstand a direct pull up to 15 pounds before releasing the engaged plug blades. These receptacles will withstand considerable abuse without showing signs of wear or weakness. Available in two styles. Parallel and 2-wire polarized.

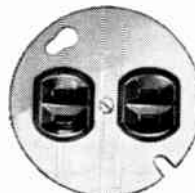

No. 802

No.	Description	Carton	Std. Pkg.	Wt., Lbs. Std. Pkg.	Each
800	Parallel	5	25	8	\$2.20
801	2-Wire Polarized	5	25	8	2.30

Outlet Box Receptacles With Covers

No.	For Box Size	Description	Carton	Std. Pkg.	Wt., Lbs. Std. Pkg.	Each
802	3 ¹ / ₄	Parallel	5	25	13	\$2.40
803	3 ¹ / ₄	2-Wire Polarized	5	25	13	2.50
804	4	Parallel	5	25	16	2.50
805	4	2-Wire Polarized	5	25	16	2.60

Hubbell Wiring Devices

Conform to N.E.C. Standards

Convenience Outlets Specification Grade



No. 9595

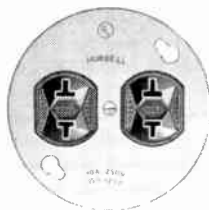

Nos. 7260 or 7137



No. 9573

Duplex Side Wired—Double Binding Screws 15 Amperes, 125 Volts

No.	Description	Car- ton	Std. Pkg.	Wt. Lbs. Std. Pkg.	Per 100
9595	Bakelite, Washer Ears	10	100	21	\$50.50
9595-1	Ivoryine, Washer Ears	10	100	21	58.50
9575	Bakelite, Narrow Ears	10	100	25	50.50
7260	With 3 1/4-Inch Cover	10	50	14	67.00
7137	With 4-Inch Cover	5	50	17	73.50

Duplex Side Wired—With Separate Feeds Each Outlet; 15 Amperes, 125 Volts

Can be wired to permit one live outlet at all times and one switch controlled outlet.

No.	Description	Car- ton	Std. Pkg.	Wt. Lbs. Std. Pkg.	Per 100
9571	Bakelite, 2 Feeds, 1 Return	10	100	25	\$65.00
9573	Bakelite, 2 Feeds, 2 Returns	10	100	25	70.50

Duplex Convenience Outlets Specification Grade Back or Side Wired—Double T-Slots 15 Amperes, 125 Volts



No. 9260

No.	Description	Car- ton	Std. Pkg.	Wt. Lbs. Std. Pkg.	Per 100
9260	Bakelite, Brown, Washer Ears	10	100	22	\$75.00
9260-1	Ivoryine, Washer Ears	10	50	12	81.50
9261	Bakelite, Brown with 3 1/4-Inch Steel Box Cover	10	100	20	86.00
9262	Bakelite, Brown with 4-Inch Steel Box Cover	5	50	25	92.50

Twist-Tite Bakelite Receptacles 15 Amperes, 125 Volts



No. 9200



No. 9210

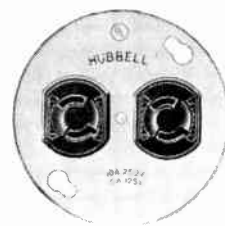

No. 9206

Takes standard parallel bladed caps. Plug in standard cap and twist clockwise slightly to engage blades in Twist-Tite position that holds cap firmly.

Duplex

No.	Description	Car- ton	Std. Pkg.	Wt. Lbs. Std. Pkg.	Per 100
9200	Brown, Washer Ears	10	100	24	\$79.50
9200-1	Ivoryine, Washer Ears	10	50	13	86.00
9206	With 4-inch Box Cover	5	50	26	88.00

Single

9210	Brown, Washer Ears	10	100	15	60.50
9211	With 3 1/4-inch Box Cover	10	100	35	73.00
9212	With 4-inch Box Cover	5	50	22	75.50

Hubbell Outdoor Flush Receptacles 15 Amperes, 125 Volts



No. 7792



No. 7793
Metal Shield Over Cap



No. 7794

Receptacle is complete with brass plate, metal screw cap with chain, and rubber mat under plate. The addition of No. 7793 Metal Shield will protect standard plug cap when it is in use. No. 7793 Metal Shield is not furnished and if desired must be ordered separately.

Exposed metal parts are plated to resist corrosion.

No.	Description	Car- ton	Std. Pkg.	Wt. Lbs. Std. Pkg.	Per 100
7792	Single, 2-Wire, "T" Slots	2	10	6	\$286.00
7791	Duplex, 2-Wire, Parallel Slots	2	10	7	372.00
7790	Single, 2-Wire, for FS Type fittings "T" Slots	2	10	7	335.50
7793	Metal Threaded Shield for regular cap	2	10	1	87.00

10 Amperes, 250 Volts, 15 Amperes, 125 Volts

*7794	Single, 3-Wire, Polarized	2	10	7	371.50
-------	---------------------------	---	----	---	--------

*No. 6149 3-Wire cap should be used with No. 7794.

Hubbell Floor Receptacles

Conform to N.E.C. Standards

15 Amperes, 125 Volts

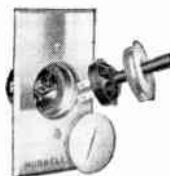

No. 7797

Two threaded solid brass covers are supplied—one with cord hole; the other for completely closing the receptacle when not in use.

Packed 2 in a carton. 10 in a standard package. Package weight, 7 pounds.

No.	Description	Per 100
7797	Bevel Edge, .060" Plate	\$435.50
*7798	Square Edge, Solid Brass Plate	556.50

*For flush mounting in Floor.

Bryant Plastic Flush Outlets

Listed as standard by Underwriters' Laboratories, Inc.

Parallel Slots—Side Wiring
15 Amps., 125 Volts



No. 6122



No. 141



No. 142-E

Double Sided Contacts

No.	Description	Carton	Std. Pkg.	Wt. Lbs. Std. Pkg.	Per 100
6122	Duplex Outlet, Brown	10	100	16	\$42.00
6122-I	Duplex Outlet, Ivory	10	50	8	48.50

Single Sided Contacts
With Plaster Ears

141	Single Outlet, Brown	10	100	13	\$31.50
142	Duplex Outlet, Brown	10	100	15	23.00
141-I	Single Outlet, Ivory	10	50	7	40.50
142-I	Duplex Outlet, Ivory	10	50	8	28.50

Without Plaster Ears

Designed especially for competitive housing projects.

142-E	Duplex Outlet, Brown	10	100	15	\$21.00
142-EI	Duplex Outlet, Ivory	10	50	8	26.50

Knox Range Receptacle



Surface type range receptacle made of brown bakelite. 3-wire type for 50 amps—250 volts. Steel back plate with .750-in. and 1-in. knockouts for conduit in bottom and back.

Reversible cable clamps for both back and bottom connections. Easy-to-wire pressure type terminals.

Packed 1 to a carton.

No.	Std. Pkg.	Wt. Lbs. Std. Pkg.	Per 100
599	10	12	\$174.00

Bryant Weatherproof Outlets

Listed as standard by Underwriters' Laboratories, Inc.

15 Amps., 125 Volts

Duplex

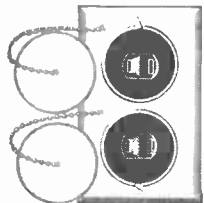

No. 3894

2-wire. Double sided contacts. Parallel slots. For outdoor installations. Weatherproof mat. Packed 2 in a carton. 10 in a standard package. Package weight, 7 pounds.

No.	Per 100
3894	\$372.00

Single

For permanent outdoor installations.

Thread-On Cover, "T" Slots

No.	Carton	Std. Pkg.	Wt. Lbs. Std. Pkg.	Per 100
3795	2	10	5	\$286.00

Clamp-On Cover, Parallel Slots

3880	10	30	14	\$203.50
------	----	----	----	----------



No. 3795

Bryant Screw Ring Mounting Outlet

Listed as standard by Underwriters' Laboratories, Inc.

15 Amps., 125 Volts



No. 4730

For Appliance and Fixture Use

Requires 1 1/8-inches mounting hole. Plastic body with 6-inch leads of No. 14 R.C. stranded wires.

No.	Carton	Std. Pkg.	Wt. Lbs. Std. Pkg.	Per 100
4730	10	50	5	\$67.00

Bryant Composition Conduit Box Mounting Outlet

15 Amps., 125 Volts



No. 113

Brown composition. Fibre lock nut mounting. For standard 1/2-inch knock-outs.

No.	Carton	Std. Pkg.	Wt. Lbs. Std. Pkg.	Per 100
*113	10	50	6	\$96.00

*Not listed as standard by Underwriters' Laboratories, Inc.

P & S Floor Outlet

Conform to N.E.C. Standards

15 Amps., 125 Volts

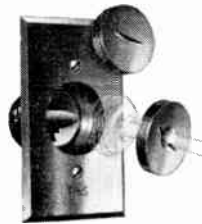

No. 1532

Furnished with two caps. One for retaining attachment plug in outlet and the other a screw cap which covers outlet when not in use. Has .060" brush brass plate.

Packed 2 in a carton. 10 in a standard package. Package weight, 8 pounds.

No.	Per 100
1532	\$435.50

P. & S. Single Weatherproof Outlets

T-Slots

With Positive Latching Cap

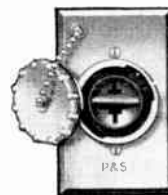

Furnished complete with plate, cover, gaskets and outlet.

Plates and covers made of cast metal.

No. 4510 plate, cover and gasket will fit P.S. outlets Nos. 7535, 7582, 7210, 5566 and 6051.

Rating—15 Amps., 125 Volts

No.	Description	Std. Pkg.	Wt. Lbs. Std. Pkg.	Per 100
1533	Single Outlet, T-Slot	10	8	\$286.00
4540	Plate, Cover and gasket for No. 1533	10	6	220.00

Parallel Slots

With Positive Latching Cap



Furnished complete with plate, cover, gaskets and outlet. Plates and cover made of cast metal.

Double grip Despard type outlet may be converted to lock switch by replacing outlet with No. 1311-L lock switch.

Rating—15 Amps., 125 Volts

No.	Outlet	Slots	Std. Pkg.	Wt. Lbs. Std. Pkg.	Per 100
4529	Single	Parallel	10	4	\$248.50

Hoffman Weatherproof Power Outlets

125-Volt—15-Ampere

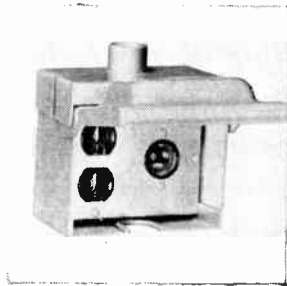

Weatherproof outlet box with grounded duplex receptacle. 15 Ampere fuse holder. Ideal for small motors, utility tools, etc. Handi-lift covers on all models. Quickly installed with wrap-around mounting brackets.

Has durable baked-on finish of "Hammer-tone" enamel.

Available with 3/4-in. knockout in bottom and 3/4-in. hub on top.

No.	Std. Pkg.	Shp. Wt. Lbs.	Each
34	1	3 3/4	\$8.40

20 Ampere Weatherproof Power Outlets

NEMA Type 3 Standards

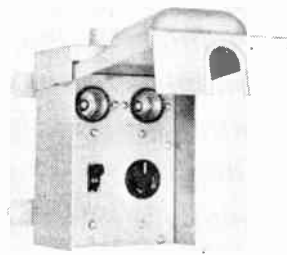

Consists of a 20 ampere, 250 volt polarized three prong receptacle. Fused with two screw type plug fuses. Power controlled to the receptacle by a 20 ampere, 250 volt double pole switch.

Completely weather resistant. Constructed of heavy 16 gauge steel. Has baked gray hammer-tone enamel finish over a phosphatized surface.

Unit is for an outdoor source of electricity for power cords equipped with three prong 20 ampere polarized plugs where fusing and switching are desirable.

Hub size 3/4-in. and knockout on bottom 3/4-in.

No.	Outlet Size In.	Std. Pkg.	Shp. Wt. Lbs.	Each
20	7x1 3/4x3 1/2	1	5	\$16.00

**50 Ampere Weatherproof Power Outlets
NEMA Type 3 Standards**



Designed for use in mobile home parks and will receive power cords fitted with a variety of plugs and adapters. Features both a 50 ampere, 3-wire power receptacle with grounding slots and contacts protected by two 30 ampere Quiklag circuit breakers and a 15 ampere grounding-type, duplex receptacle with 30 ampere fuse plug receptacle.

Completely weather resistant. Constructed of heavy 16 gauge steel. Finished in baked gray hammer-tone enamel over a phosphatized surface.

Hub size 1-in. with two 3/4-in. and a 1-in. knockout on the bottom.

No.	Outlet Size In.	Std. Pkg.	Shp. Wt. Lbs.	Each
5015	14x7x5 1/2	1	11	\$23.00

Bryant Porcelain "T" Slot Outlets

Listed as standard by Underwriters' Laboratories, Inc.

15 Amps., 125 Volts

Surface Mounting

Concealed wiring. Diameter 2 7/32-inches. Height 1 3/8-inches. Screw spacing 1 1/2-inches.



No. 105

No.	Carton	Std. Pkg.	Wt. Lbs. Std. Pkg.	Per 100
105	10	50	16	\$90.50

Cleat wiring. Diameter 1 3/4-inches. Height 1 1/2-inches. Screw spacing 5/8-inches.



No. 112

No.	Carton	Std. Pkg.	Wt. Lbs. Std. Pkg.	Per 100
112	10	50	14	\$97.00

Panel or Plate Mounting

Requires 1 7/16-inch hole. Projects 1/2-inch above and 3/32-inch below mounting level. Diameter 1 1/16-inches.



No. 114

No.	Carton	Std. Pkg.	Wt. Lbs. Std. Pkg.	Per 100
114	10	50	12	\$89.50

Hubbell Fan Hanger Outlets

Conform to N.E.C. Standards

15 Amperes, 125 Volts

2-Wire



No. 7710

No.	Description	Car-ton	Std. Pkg.	Wt. Lbs. Std. Pkg.	Per 100
7710	Yoke Support and .060" Brass Plate	10	20	14	\$416.00
7714	Stud Support and .060" Brass Plate	10	20	13	416.00

**10 Amperes, 250 Volts—
15 Amperes, 125 Volts
3-Wire**



No. 7718

7718	Yoke Support with .060" Brass Plate	10	20	19	\$483.00
7719	Stud Support with .060" Brass Plate	10	20	19	483.00

Bryant Fan Hanger Outlets

15 Amps., 125 Volts

Listed by Underwriters' Laboratories, Inc.



No. 3751

Plastic outlet and .010-inch brass plate. The brass flush plate is a cover. A cadmium plated steel sub-plate supports the plastic outlet. The box supports the weight of the fan by means of a stud or yoke.

Packed 10 in a carton, 20 in a standard package. Standard package weight, 14 lbs. for No. 3750; 16 lbs. for No. 3751. Standard package weight, less plate, 12 lbs.

No.	Description	Per 100
3750	Yoke Mounting Type	\$416.00
3750	Less Plate	363.00
3751	Stud Mounting Type	416.00
3751	Less Plate	363.00



No. 1535-S

P & S Fan Hanger Outlet
15 Amps., 125 Volts

Conform to N.E.C. Standards

Safety design—easy to install on standard 4-inch square boxes with plaster covers.

Packed 10 in a carton. 20 in a standard package. Package weight, 10 pounds.

No.	Description	Per 100
1535-S	Stud Type	\$416.00

Hubbell Clock Hanger Outlets

Conform to N.E.C. Standards

15 Amperes, 125 Volts



No. 7707

No.	Description	Car- ton.	Std. Pkg.	Wt. Lbs. Std. Pkg.	Per 100
7707	2-Wire .040" Plate	2	10	5	\$233.00
	10 Amperes, 250 Volts, 15 Amperes, 125 Volts				
7708	3-Wire .040" Plate	2	10	6	389.50

Bryant Clock Hanger Outlet

15 Amps., 125 Volts

One-Piece Plastic—Parallel Slots

Listed by Underwriters' Laboratories, Inc.

Provides support and electrical connection for wall clocks. Outlet is completely concealed by clock. Cord nests in recess. Packed 10 in a carton. 30 in a standard package.



No. 2992

No.	Description	Wt. Lbs. Std. Pkg.	Per 100
2992	Brown	9	\$117.00
2992-I	Ivory	9	134.00

**Removable Brass Plate - "T" Slots
For Commercial Use.**

2828	.040-inch plate	6	\$233.00
------	-----------------	---	----------

Packed 2 in a carton. 10 in a standard package.

P. & S. Clock Hanger Outlets

15 Amps., 125 Volts

Parallel Slots



Outlet recessed for plug cap, allows clock to hang flush with wall.

Plastic one-piece construction. Brass clock hook furnished. Packed 30 in Standard package.

No.	Description	Per 100
1515	Brown	\$122.00
1515-I	Ivory	134.00

P & S Clock Hanger Outlet

Conform to N.E.C. Standards

15 Amperes, 125 Volts

T-Slots



No. 1534

Outlet recessed for plug cap, allows clock to hang flush with wall. .040" brush brass plate.

Packed 2 in a carton. 10 in a standard package. Package weight, 5 pounds.

No.	Description	Per 100
1534		\$233.00

**Daniel Woodhead Protex Neotex-Covered
Sockets**

Push and Keyless Types
660 Watts, 250 Volts



No. 700

No. 705

No. 710

No. 717

Push Type

Keyless Type

Description	Push Type			Keyless Type		
	No.	Wt. Lbs. Std. Pkg.	Each	No.	Wt. Lbs. Std. Pkg.	Each
Pendant with 7/16" Cord Hole.....	700	25	\$2.50	710	19	\$1.25
With 1/8-inch Cap....	701	26	2.70	711	20	1.50
With 1/4-inch Cap....	702	26	2.95	712	20	1.65
With 3/8-inch Cap....	703	27	3.15	713	22	2.10
With 1/2-inch Cap....	704	28	3.25	714	23	2.15
Pendant with 1/8" to 1/2" Cord Grip....	705	32	3.50	717	30	1.45

Packed 10 in a carton. 50 in a standard package.

**Daniel Woodhead Watertite Weatherproof
Sockets**

660 Watts, 600 Volts



No. 600

No. 601

Waterproof and non-breakable. May be used under water indefinitely without injury or short-circuit in socket or lamp. Meets all requirements for outside use. Fits standard sign receptacle cover.

Standard weatherproof shade holder or lamp guard will fit Watertite socket.

Pendant Type

No.	Diam. Cover	Screw Spacing	Car- ton	Std. Pkg.	Wt. Lbs. Std. Pkg.	Each
600	10	100	20	\$.85

With Outlet Box Cover

601	3 1/2	2 3/4	10	100	37	\$1.05
602	4 1/8	3 1/2	10	100	42	1.10

All rubber No. 11 stranded wire leads 6 inches long. For leads longer than 6 inches add to above list prices for each additional lineal foot desired, \$.10.

**Daniel Woodhead Neotex Lamp Receptacles
Watertight**

For temporary lighting where conduit is not used. Standard Edison base socket that gives watertight seal due to Neotex construction. Wired both side and back. Screw spacing on 2 inch centers.



No. 604

No.	Description	Carton	Std. Pkg.	Wt. Lbs. Std. Pkg.	Each
603	Side Wired.....	10	100	31	\$1.65
604	Back Wired.....	10	100	31	1.65

Bryant Lampholders Lumiline Type

Listed as standard by Underwriters' Laboratories, Inc.

These holders provide a compact means for mounting Lumiline lamps for proper lighting of display windows, signs, show cases, cove and trough lighting and similar installations.

660 Watts, 250 Volts End Caps



No. 3890



No. 3889



No. 3893

A secure contact is insured by a five-point engagement with lamp.

Shallow Collar

No.	Description	Carton	Std. Pkg.	Wt. Lbs. Std. Pkg.	Per 100
3890	Black	50	200	3	\$19.50
3890-W	White	50	200	3	20.50

Deep Collar

3889	Black	50	200	6	\$23.50
3889-W	White	50	200	6	25.50

Deep Collar—With Switch

3893	Black	50	200	8	\$67.00
3893-W	White	50	200	8	70.00

Bases—Flush or Surface Mounting



No. 3891

Ease of installation is aided by off-center terminal arrangement in wire channel.

Single

No.	Description	Carton	Std. Pkg.	Wt. Lbs. Std. Pkg.	Per 100
3891	Black	50	200	9	\$38.00
3891-W	White	50	200	9	43.50

Mounting hole spacings for all bases are standard 1 1/8-inches for flush and 1-inch for surface.

Bryant Plastic Pin Type

Listed as standard by Underwriters' Laboratories, Inc.



No. 5464

Terminals are pointed and pierce the wire insulation when cap is screwed on. No stripping necessary. For decorative, streamer, and outdoor fixture work. Packed 10 in a carton. 100 in a standard package.

Medium Base 660 Watts, 250 Volts

No.	Wire Size	Wt. Lbs. Std. Pkg.	Per 100
5464	No. 12 or No. 14	12	\$33.00

Intermediate Base 75 Watts, 125 Volts

54644	No. 16 or No. 18	4	\$21.00
-------	------------------	---	---------

Candelabra Base 75 Watts, 125 Volts

No. 54644	*54643	No. 18	2	\$17.00
-----------	--------	--------	---	---------

*Hooks not included. If required add \$1.00 per 100.

Bryant Brass Socket Bodies

Listed as standard by Underwriters' Laboratories, Inc.

Medium Base

Standard Size—Fluted Catch



No. 10



No. 13



No. 15



No. 34

Key Type

250 Watts—250 Volts

No.	Carton	Std. Pkg.	Wt. Lbs. Std. Pkg.	Per 100
10	25	100	13	\$66.00

Keyless Type

660 Watts, 250 Volts

13	25	100	11	\$51.50
----	----	-----	----	---------

Pull Chain Type

250 Watts, 250 Volts

15	25	100	13	\$82.50
----	----	-----	----	---------

Push Button Type

660 Watts, 250 Volts

34	25	100	13	\$59.50
----	----	-----	----	---------

Standard finish is Bright Dipped. Special finishes at extra cost.

Bryant Fluted Catch Brass Socket Caps

Listed as standard by Underwriters' Laboratories, Inc.

For Standard Size Bodies

Female Threaded



No. HA



No. HT



No. HQ

No.	Size	Carton	Std. Pkg.	Wt. Lbs. Std. Pkg.	Per 100
HIA	1/8-Inch	25	100	5	\$19.50
HIB	1/4-Inch	5	25	1	45.00
HIC	3/8-Inch	25	100	6	30.50
HID	1/2-Inch	25	50	4	48.00

Pendant

HIT	1 3/32-Inch	25	100	3	\$18.00
-----	-------------	----	-----	---	---------

Cord Grip

HQ	3/8 to 1/2-Inch	25	100	7	\$47.50
----	-----------------	----	-----	---	---------

Angle

HIM	1/8-Inch	25	50	3	\$59.50
-----	----------	----	----	---	---------

Standard finish is Bright Dipped. For information and prices on special finishes write GRAYBAR.

Bryant Lampholders

Listed as standard by Underwriters' Laboratories, Inc.

**Brass Socket Caps and Bodies—Threaded Catch
Medium Base—Standard Size**



The cap is securely attached to the socket body by a removable threaded ring. The ring is packed with the socket body. Caps are packed separately.

The caps are interchangeable with all bodies.

Illustration shows method of attaching TA cap to No. 4315 body.

Caps

No.	Cap Description	Carton	Std. Pkg.	Wt. Lbs. Std. Pkg.	Per 100
TA	1/8-Inch	25	100	5	\$46.00
TC	3/8-Inch	25	100	6	50.50
TQ	3/8 to 1/2-Inch Cord Grip	25	100	7	65.00

**Socket Bodies with Rings (Less Caps)
250 Watts, 250 Volts**

4310	Key	25	100	15	\$103.50
4315	Pull Chain	25	100	19	123.00

660 Watts, 250 Volts

4313	Keyless	25	100	12	\$79.00
4314	Push-Button	25	100	17	97.00

Bryant Insulated Shell Lampholders

Listed as Standard by Underwriters' Laboratories, Inc.

**Black Composition Caps and Bodies—
Two-Screw Fastening**

These devices are suitable for applications where metal shell lampholders may not prove satisfactory. The caps are interchangeable with either body.



No.	Cap Description	Carton	Std. Pkg.	Wt. Lbs. Std. Pkg.	Per 100
FA	1/8-Inch Metal Bushing	10	100	13	\$65.00
FC	3/8-Inch Metal Bushing	10	100	15	72.50
FQ	3/8 to 1/2-Inch Cord Grip	10	100	16	83.00
FT	Pendant, 1 13/32-Inch.....	10	100	10	38.50

Bodies for Weatherproof Shade Holders With Groove



No.	Description	Carton	Std. Pkg.	Wt. Lbs. Std. Pkg.	Per 100
3770	Key, 250 Watts, 250 Volts	10	100	24	\$79.00
3773	Keyless, 660 Watts, 250 Volts	10	100	14	56.00

Bryant Bodies—Medium Base

Listed as standard by Underwriters' Laboratories, Inc.



**Porcelain—Two-Screw Fastening
250 Watts, 250 Volts**

No.	Description	Carton	Std. Pkg.	Wt. Lbs. Std. Pkg.	Per 100
70	Key Type	10	100	26	\$ 71.50
75	Pull Chain Type	10	100	30	122.00

Chain has insulating link.



660 Watts, 250 Volts

71	Push Button Type	10	100	30	\$128.00
73	Keyless Type	10	100	16	48.50

Bryant Porcelain Caps

Listed as standard by Underwriters' Laboratories, Inc.

Two-Screw Fastening

No.	Cap Description	Carton	Std. Pkg.	Wt. Lbs. Std. Pkg.	Per 100
No. PA	1/8-Inch Female Threaded	10	100	13	\$68.50
No. PC	3/8-Inch Female Threaded	10	100	14	\$70.50
No. PD	1/2-Inch Female Threaded	10	100	16	\$90.50
No. PT	Pendent Cap 1 13/32-Inch Cord Hole	10	100	10	\$35.50
No. PQ	Cord Grip Cap For 3/8 to 1/2-Inch Cord	10	100	17	\$77.50

**Bryant Surface and Outlet Box Lampholders
Brass Covered**

Listed as Standard by Underwriters' Laboratories, Inc.

**Keyless, 660 Watts, 250 Volts
Pull, 250 Watts, 250 Volts**



For mounting with or without outlet boxes. Suitable for use on ceilings or walls over metal lath or on metal surfaces.

Standard finish is brush brass. For 3 1/4 and 4-inch outlet boxes.

No.	Description	Carton	Std. Pkg.	Wt. Lbs. Std. Pkg.	Per 100
4100	Keyless	2	50	43	\$238.50
4104	Pull, Chain and Cord	2	50	55	322.50

Bryant Lampholders

Listed as standard by Underwriters' Laboratories, Inc.

Bryant Box Mounting Lampholders—Medium Base

Porcelain Outlet Box Lampholders



No. 5288

For Universal Mounting
Keyless, 660 Watts, 250 Volts
Pull, 250 Watts, 250 Volts

Designed for mounting on 3¼ or 4-inch outlet boxes. Bases are over-size, extending well beyond edge of box.

No.	Description	Carton	Std. Pkg.	Wt. Lbs. Std. Pkg.	Per 100
5228	Keyless	5	50	38	\$41.00
5287	Pull, Chain and Insulator	5	50	40	80.00
5288	Pull, Chain and Cord	5	50	40	73.50



No. 4278

Concealed Mounting Type
Keyless, 660 Watts, 250 Volts
Pull, 250 Watts, 250 Volts

For mounting on 3¼ or 4-inch outlet boxes and switch boxes.

No.	Description	Carton	Std. Pkg.	Wt. Lbs. Std. Pkg.	Per 100
4273	Keyless	2	50	58	\$182.00
4275	Pull, 6-inch chain	2	50	58	262.00
4278	Pull, Chain and Cord	2	50	58	262.00

Porcelain Lampholders



No. 227



No. 173

With shadeholder groove and screw terminals.

660 Watts, 250 Volts

No.	Description	Carton	Std. Pkg.	Wt. Lbs. Std. Pkg.	Per 100
227	For 3¼-inch boxes	5	100	56	\$64.00

660 Watts, 600 Volts

173	On 3¼-inch covers	10	100	48	65.00
174	On 4-inch covers	5	100	60	73.00

Covers finished to resist corrosion.

Porcelain Cleat Medium Base Lampholders

660 Watts, 250 Volts

Screw spacing, 25/16-inches.

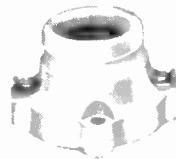

No. 4013

No.	Description	Per 100
9402	No Shadeholder Groove	\$56.50
4013	With Shadeholder Groove	57.50

Packed 10 in carton, 100 in standard package. No. 9102 Std. Pkg., Wt., 37 Lbs.; No. 4013, 35 Lbs.

Porcelain Flush Mounting

Standard Design for Metal Signs, Border Lights

660 Watts, 600 Volts



No. 4063

Diameter, 15/8-inches. Depth, 1 1/2-inches. Screw spacing, 1 3/16-inches. Hole required, 1 3/8-inches. Two mounting screws and grooved back. Binding screws are staked and will not fall out.

No.	1000 Lot	Per 100
4063		\$38.00

Porcelain Sign Lampholders

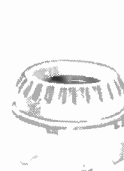

No. 400



No. 401



No. 402



No. 414

660 Watts, 600 Volts

No.	Description	Carton	Std. Pkg.	Wt. Lbs. Std. Pkg.	Per 100
400	With Binding Screws	25	250	53	\$35.50
401	With Covered Back	25	250	70	41.00

30 Amperes, 125 Volts

402	For Plug Fuses	25	250	51	43.00
-----	----------------	----	-----	----	-------

660 Watts, 250 Volts

414	6-inch Leads No. 11 R. C. Stranded Wire	25	250	65	46.00
418	6-inch Leads No. 18 Code Fixture Wire	25	250	70	45.00



No. 715

Cleat Wiring and Pull



No. 975

660 Watts, 250 Volts

No.	Description	Carton	Std. Pkg.	Wt. Lbs. Std. Pkg.	Per 100
715	Cleat, Plastic	10	100	11	\$34.50

250 Watts, 250 Volts

975	Pull, with 6-inch Chain	10	100	37	67.00
978	Pull, Chain and Cord	10	100	36	65.00

Knox Porcelain Lampholders



Combination keyless outlet box receptacle. With shadeholder groove. Flat back type mounts on 3 1/4 or 4-in. outlet box through slotted holes. 660W—250 volts. Hole spacing 2 3/4 and 3 1/2 in. 4 3/4-in. O.D.

No.	Std. Pkg.	Wt. Lbs. Std. Pkg.	Per 100
1634	50	40	\$30.00



Combination pull chain receptacle with shadeholder groove. Flat back type mounts on either 3 1/2 or 4-in. outlet boxes. 660W—250 volts. Hole spacing 2 3/4 and 3 1/2 in. 4 3/4 in. O.D. Supplied with chain and cord.

No.	Std. Pkg.	Wt. Lbs. Std. Pkg.	Per 100
1734	50	38	\$52.00



Combination pull chain receptacle with convenience outlet and shadeholder groove. Flat back type mounts on either 3 1/4 or 4-in. outlet boxes. 660W—250 volts. Convenience outlet, 15 amps—125 volts. 4 3/4 in. O.D.

No.	Std. Pkg.	Wt. Lbs. Std. Pkg.	Per 100
1934	50	4 1/2	\$62.00

Bryant Miscellaneous Lampholders

Listed as standard by Underwriters' Laboratories, Inc.

Porcelain Surface Mounting
660 Watts, 250 Volts



Diameter, 2 3/8-inches. Screw spacing, 1 5/8-inches. Standard design.

No.	Carton	Std. Pkg.	Wt. Lbs. Std. Pkg.	Per 100
4000	10	100	37	\$94.00

Porcelain Weatherproof
660 Watts, 600 Volts



Side wires. Screw spacing, 2 3/16-inches. Side wires 6-inch No. 14 rubber covered stranded.

No.	Carton	Std. Pkg.	Wt. Lbs. Std. Pkg.	Per 100
9407	10	100	68	\$92.50

Porcelain Pony Cleat Type
660 Watts, 250 Volts



Screw spacing, 1 31/32-inches.

No. 50715

Call Graybar FIRST For . . .

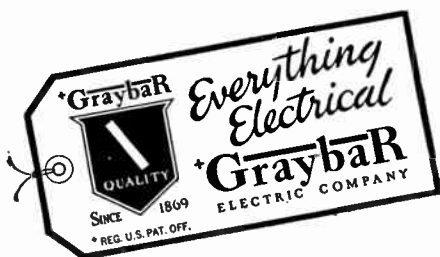

Bryant Sign and Fixture Lampholders

Listed as standard by Underwriters' Laboratories, Inc.

Porcelain Ring Mounting

For Outlet Boxes, Metal Signs, and Lighting Units
Bryant Porcelain Deep Body

660 Watts, 600 Volts



1/2-inch glazed ring. Binding screws. One non-rotating lug. Distance from mounting surface to bottom of wire groove, 1-inch. Depth of back, 1 1/4-inches. Hole required, 1 1/2-inches. Device diameter, 1 3/4-inches.

No.	Carton	Std. Pkg.	Wt. Lbs. Std. Pkg.	Per 100
61988	10	100	28	\$50.50

Porcelain Shallow Body
660 Watts, 600 Volts



5/8-inch glazed ring. Binding screws. One non-rotating lug. Distance from mounting surface to bottom of wire groove, 5/8-inch. Depth of back, 1 3/16-inch. Hole required, 1 1/2-inches. Device diameter, 1 3/4-inches.

No.	Carton	Std. Pkg.	Wt. Lbs. Std. Pkg.	Per 100
59108	10	100	23	\$43.00



5/8-inch glazed ring. Covered binding screws. One non-rotating lug. Distance from mounting surface to bottom of wire groove, 5/8-inch. Depth of back, 1 5/32-inches. Hole required, 1 1/2-inches. Device diameter, 1 3/4-inches.

No.	Carton	Std. Pkg.	Wt. Lbs. Std. Pkg.	Per 100
4109	10	100	28	\$66.00



5/8-inch glazed ring. Equipped with 6-inch leads of No. 14 stranded rubber covered wire. One non-rotating lug. Depth of back, 2 7/32-inch. Hole required, 1 1/2-inches. Device diameter, 1 3/4-inches.

No.	Carton	Std. Pkg.	Wt. Lbs. Std. Pkg.	Per 100
4003	10	100	26	\$65.00



Glazed shadeholder ring. Equipped with 6-inch leads of No. 14 stranded rubber covered wire. One non-rotating lug. Distance from mounting surface to bottom of wire groove, 2 7/32-inch. Depth of back, 2 7/32-inches. Hole required, 1 1/2-inches. Device diameter, 1 3/4-inches.

No.	Carton	Std. Pkg.	Wt. Lbs. Std. Pkg.	Per 100
4135	10	100	26	\$59.50

Porcelain Screw Rings for Above



No. 3803



No. 3804



No. 3805

No.	Description	Carton	Std. Pkg.	Wt. Lbs. Std. Pkg.	Per 100
3803	Shallow, 1/2-inch Ring	25	100	7	\$33.00
3804	Deep, 5/8-inch Ring	25	100	9	26.00
3805	Shadeholder Ring	25	100	8	23.00

Bryant Porcelain Medium Base Lampholders

Listed as standard by Underwriters' Laboratories, Inc.

Two Piece Rectangular Base With Shadeholder Groove

660 Watts, 250 Volts

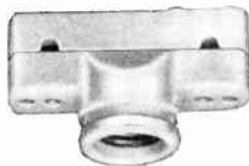

No. 58300

For clear wiring. Base, 3¹⁵/₁₆ x 1-inch. Screw spacings, 7/₁₆ and 3¹/₂-inch.

No.	Carton	Std. Pkg.	Wt. Lbs. Std. Pkg.	Per 100
58300	5	100	55	\$88.00

Combination Base For Cleat or Concealed Wiring

660 Watts, 250 Volts



No. 4229

Diameter of base, 2¹/₈-inches. Screw spacings, 1³/₈ to 1⁵/₈-inches.

No.	Per 100
4229	\$61.00

Two Piece for Wood Molding

660 Watts, 250 Volts



No. 42453

Length, 2⁵/₁₆-inches. Width, 2¹/₈-inches. Screw spacing, 1¹/₁₆-inches.

No.	Carton	Std. Pkg.	Wt. Lbs. Std. Pkg.	Per 100
42453	10	100	43	\$93.50

Porcelain Fixture Type Sockets With Die Cast Caps

660 Watts, 600 Volts



No. 9856

No.	Carton	Std. Pkg.	Wt. Lbs. Std. Pkg.	Per 100
9856	10	100	24	\$57.00
9858	10	100	24	57.00
9861	10	100	30	77.00

Height overall:

Nos. 9856 and 9858, 2³/₁₆ inches.
No. 9861, 2⁷/₁₆ inches.

Keyless Body

Length overall, 1¹¹/₁₆-inches. Diameter, 1¹/₂-inches.



No. 9429

No.	Carton	Std. Pkg.	Wt. Lbs. Std. Pkg.	Per 100
9429	10	100	19	\$38.00

Bryant Weatherproof Medium Base Lampholders

Listed as standard by Underwriters' Laboratories, Inc.

Porcelain Weatherproof

660 Watts, 600 Volts

Equipped with 4¹/₂-inch leads of No. 14 stranded wire.



No. 399

Without Shadeholder Groove

No.	Carton	Std. Pkg.	Wt. Lbs. Std. Pkg.	Per 100
399	10	100	23	\$37.00

Composition Weatherproof 660 Watts, 600 Volts With Shadeholder Groove

Equipped with 4¹/₂-inch leads No. 14 stranded wire.



No. 60666

No.	Description	Carton	Std. Pkg.	Wt. Lbs. Std. Pkg.	Per 100
60666	Black	10	100	24	\$61.00

Equipped with 4¹/₂-inch leads No. 14 stranded wire.

43310	Brown	10	100	20	\$42.50
-------	-------	----	-----	----	---------

Plastic Weatherproof 660 Watts, 600 Volts

Brown Plastic. Equipped with 4¹/₂-inch leads of No. 14 stranded wire.



No. 310

No.	Carton	Std. Pkg.	Wt. Lbs. Std. Pkg.	Per 100
310	10	100	12	\$43.00

High Impact 660 Watts, 600 Volts

Molded from canvas impregnated material. Will withstand the most severe usage encountered in steel mills, industrial plants, shipyards, parking lots, amusement parks, and wherever temporary lighting is desired. Equipped with 6-inch leads of No. 14 stranded wire.



No. 63310

No.	Ctn.	Std. Pkg.	Wt. Lbs. Std. Pkg.	Per 100
63310	10	100	15	\$66.00

Aluminum Shell Die Cast Type Weatherproof 660 Watts, 250 Volts



No. 3996



No. 3997



No. 3998

With 1/2-Inch Hexagonal Nipple

No.	Description	Carton	Std. Pkg.	Wt. Lbs. Std. Pkg.	Per 100
3996	For 2 ³ / ₄ -In. Shades	10	100	60	\$142.00

With 1/2-Inch 90° Angle Nipple

3997	For 2 ³ / ₄ -In. Shades	10	100	58	\$151.50
------	---	----	-----	----	----------

With 1/2-Inch Hexagonal Nipple

3998	No Shadeholder	10	100	50	\$137.50
------	----------------	----	-----	----	----------

Hubbell Shade Holders

Conform to N.E.C. Standards

For Medium Base Brass Shell Sockets

3-Screw Type

Standard finish is brush brass.



No. 501

No.	Size In.	Car- ton	Std. Pkg.	Wt. Lbs. Std. Pkg.	Per 100
501	2 1/4	50	500	27	\$46.00

For Medium Base Weatherproof Sockets



No. 6633

6633	2 1/4	25	250	14	\$46.00
------	-------	----	-----	----	---------

Hubbell Weatherproof Socket

Conform to N.E.C. Standards

With Shade Holder Groove

660 Watts, 600 Volts



No. 310

Brown Bakelite. Furnished with 4 1/2-inches of molded-in No. 14 B. & S. stranded rubber covered wire.

No.	Car- ton	Std. Pkg.	Wt. Lbs. Std. Pkg.	Per 100
310	10	100	12	\$43.00

**Hubbell Porcelain Sign Receptacles
Shallow Type**

Conform to N.E.C. Standards

660 Watts, 250 Volts

With Unglazed Rings



No. 4112



No. 4113

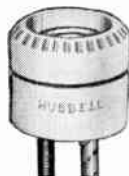

No. 4114 and 4118

No.	Description	Car- ton	Std. Pkg.	Wt. Lbs. Std. Pkg.	Per 100
4112	Exposed Terminals	10	250	5 1/2	\$35.50
4113	Covered Terminals	10	100	2 1/2	41.00
4114	With 9-in. Leads, No. 14 Wire	10	250	59	46.00
4118	With 9-in. Leads, No. 18 Wire	10	100	20	45.00

Hubbell Keyless Pony Wall Sockets

Conform to N.E.C. Standards

660 Watts, 250 Volts



No. 50717



No. 50718

Standard finish is brush brass.
Dimensions: Diameter, 2 inches. Height, 2 inches.
Screw spacing, 1 1/8 inches.

No.	Description	Car- ton	Std. Pkg.	Wt. Lbs. Std. Pkg.	Per 100
50717	Solid Base	10	100	22	\$105.00
50718	Slotted Base	10	100	19	105.00

Carton and standard package quantities of all the above items are subject to change.

Hubbell Weatherproof Sockets

Conform to N.E.C. Standards



No. 60666



No. 43310



No. 43320

660 Watts, 600 Volts

Furnished with 4 1/2-inch No. 14 B. & S. stranded rubber covered wire.

With Shade Holder Groove

No.	Description	Car- ton	Std. Pkg.	Wt. Lbs. Std. Pkg.	Per 100
60666	Bakelite	10	100	20	\$61.00

Without Shade Holder Groove

43310	Composition	10	100	21	44.00
-------	-------------	----	-----	----	-------

With Moulded-In Leads and Shade Holder Groove

43320	Mica Compound	10	100	21	\$42.50
-------	---------------	----	-----	----	---------

Rubber with Shade Holder Groove

660 Watts, 600 Volts



No. 311

Made of high-grade, soft rubber with 4 1/2-inch leads of No. 14 rubber-covered wire. With spring center contact.

No.	Car- ton	Std. Pkg.	Wt. Lbs. Std. Pkg.	Per 100
311	10	100	15	\$60.00

Pin Type Bakelite Weatherproof Socket

660 Watts—250 Volts



For No. 12 or No. 14 wire.

Packed 10 in a carton. 100 in a standard package.

Package weight, 12 pounds.

No.	Per 100
7454	\$33.00

With Cast Aluminum Shell

660 Watts, 250 Volts



No. 4006

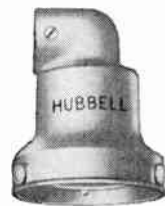

No. 4016

Designed for inexpensive industrial installations and similar applications. The 2 1/4-inch shade holder is for either shallow bowl or standard dome type reflectors.

No.	Description	Wt. Lbs. Std. Pkg.	Per 100
4006	1/2-Inch Threaded Bushing.....	40	\$142.00
4016	1/2-Inch 90° Angle Bushing.....	65	151.50

Carton and standard package quantities of all the above items are subject to change.

Ericson Neoprene Rubber Sockets
Oil Resistant



No. 4



No. 4-5



No. 4-W

Sockets are of rugged construction and will withstand hard usage. The heavy brass screw shells with spring contacts are covered with tough Neoprene rubber jacket.

Carton Qty. 10. Std. Pkg. 100.

No.	Description	Wt. Lbs. Per Pkg.	Each
*4	Keyless with cord grip clamp	23	\$1.25
4-S	Switch	23	1.00
4-W	Weatherproof with 6-in. Neoprene leads	19	.70

*Has a built-in cord grip clamp.

Union Weatherproof Sockets

Listed by Underwriters' Laboratories, Inc.

Schedule A

600 Volts, 660 Watts

Heavily constructed insulating bodies, copper screw shells. Phosphor bronze spring contacts. Leads of No. 14 stranded rubber covered cotton braid, code wire. Different types of wire or additional lead lengths available on special order at extra cost.

Medium impact sockets are recommended for installations subjected to heavy and rough treatment.



No. 43310

Medium Screw Base

Packed 25 in a carton, 100 in standard package.

No.	Kind	Wt. Lbs. Per Pkg.	Per 100
43310	Bakelite	11	\$28.00
*43310-8	Bakelite	13	33.50
43320	Medium Impact	13	31.00
*43320-8	Medium Impact	13	36.50



No. 60666

Packed 25 in a carton, 100 in a standard package.

No.	Kind	Wt. Lbs. Per Pkg.	Per 100
60666	Bakelite	13	\$32.30
*60666-8	Bakelite	13	37.20

*With theft-proof left-hand screw shells.

For locations where sockets are subject to the most severe conditions.

Insulated bodies of very heavy construction. Molded from canvas impregnated bakelite. 6-in. leads of No. 14 stranded RW-RH code wire.

Available with left hand thread order No. 63310-8.

No.	Ctn.	Std. Pkg.	Wt. Lbs. Per Pkg.	Per 100
63310	25	100	15	\$52.50
63310-8	25	100	15	58.00

Bryant Brass Shadeholders

Listed by Underwriters' Laboratories, Inc.

Threaded Mounting

Ventilated. Equipped with screws. For medium base lampholders. Wedge thread assures rigid fit between socket-shell and holder. Bright Dipped finish.



No. 501

No.	Size	Ctn.	Std. Pkg.	Wt. Lbs. Std. Pkg.	Per 100
501	2 1/4-In. Shade	50	500	27	\$46.00



No. 628

No.	Size	Ctn.	Std. Pkg.	Wt. Lbs. Std. Pkg.	Per 100
628	2 1/4-In. Shade	25	250	14	\$46.00

Clamp Mounting

For porcelain or composition medium base lampholders with shadeholder groove. Bright dipped finish.

Union Sign Receptacles

Schedule A



Pin Terminal—Screw Mounting
250 Volts—660 Watts

Medium base. Use on stranded wire only. No stripping, no soldering, no waxing. 100 percent weather-proof, no exposed terminals.

Supplied with two brass plated screws per socket.



No. 22208

No.	Description	Ctn.	Std. Pkg.	Wt. Lbs. Std. Pkg.	Per 100
22208	Packed, Caps Assem.	25	100	10	\$29.00
22208-1	Bulk, Caps Unassem.	250	250	23	27.00

Pin Terminal
Speed Nut Mounting



Spring steel "speed-nut" offers quickest most convenient receptacle mounting. Rigid and durable.

Packed 1000 in standard package.

No.	Base Size	Rating	Wt. Lbs. Std. Pkg.	Per 100
22108-1	Candelabra	125 V. 75W.	16	\$17.00
22408-1	Intermediate	250 V. 75 W.	36	21.00
*22308-1	Medium	250 V. 660 W.	24	28.00

(Bulk packed caps and nuts unassembled)

*Packed 250 in standard package.

P & S Plastic Pin Type Lampholder

Conform to N.E.C. Standards

Medium Base—660 Watts, 250 Volts



Indoor or outdoor decorative lighting. No stripping, splicing, soldering or tapping of wires. Lampholder applied directly to wire. Sharp pointed pins pierce insulation and make positive contact. Wires held in place by lampholder cap.

Lampholders may be positioned or moved to any desired spacing at any time, as pin contacts will not injure insulation of wire.

A detachable hook is furnished with each lampholder for hanging from tree or messenger wire.

For No. 12 or 11RW stranded wire.

No.	Car- ton	Std. Pkg.	Wt. Lbs. Std. Pkg.	Per 100	Price Per 100
5464	10	100	12		\$33.00

Union Pin Type Weatherproof Sockets

Schedule A

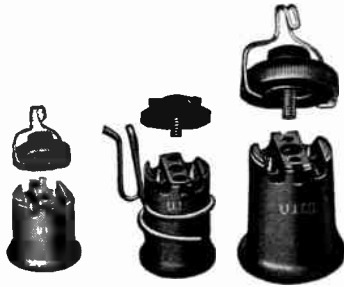

Weatherproof. For use on stranded wire only. Use for outdoor or indoor decorative lighting. The most convenient and economical means of obtaining temporary lighting. Each carton supplied with handy wrench for quicker cap tightening.

Each socket supplied with supporting hook except No. 11108. 100 sockets per standard package.

No. 43308 No. 11108 No. 44408

Medium Base—250 Volt, 660 Watt

No.	Wire Size	Carton	Wt. Lbs. Std. Pkg.	Price Per 100
43308	14-12	25	9½	\$30.00
43318	12-10	25	10	30.00
63318	12-10 Type R	25	10½	52.50

Intermediate Base—250 Volt, 75 Watt

44408	18¾-16-14	20	3½	19.00
11108	Candelabra Base—125 Volt, 75 Watt 18-¾	25	1½	15.50

Union Bakelite Bushings

Schedule A

With And Without Locknuts



No. 1-18 No. 1-18-0

Pipe thread bushings molded of bakelite for good electrical insulation, strength and sharp threads. Standard package: No. 1-1, one hundred, Nos. 1-114, 1-112, fifty; No. 1-2, forty-eight; Nos. 1-212, 1-3, twenty; No. 1-312, eight.

Without Locknuts		With Locknuts		Pipe Thread Size, In.	I. D. In.	Lgth. Under Head, In.
No.	Per 100	No.	Per 100			
1-18	\$3.20	1-18-0	\$4.90	1/8	17/64	1/4
1-14	3.40	1-14-0	5.20	1/4	5/16	5/16
1-38	3.80	1-38-0	5.40	3/8	29/64	5/16
1-12	4.20	1-12-0	5.40	1/2	9/16	11/32
1-122*	5.26	1-122-0	7.26	1/2	27/32	11/32
1-34	7.36	1-34-0	11.52	3/4	3/4	1/2
1-1	11.52	1-1-0	18.66	1	15/16	5/8
1-114	38.78	1-114-0	55.84	1 1/4	1 1/4	3/4
1-112	49.64	1-112-0	69.80	1 1/2	1 1/2	23/32
1-2	60.48	1-2-0	113.72	2	1 15/16	13/16
1-212	103.92	1-212-0	162.86	2 1/2	2 11/32	3/4
1-3	152.00	1-3-0	240.40	3	3	3/4
1-312	165.96	1-312-0	294.70	3 1/2	3 3/8	3/4

*Two hole.

Union Decorating Lighting Streamers

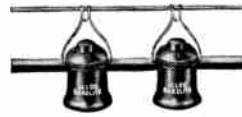

Medium Base



Intermediate Base

Pin type sockets assembled on stranded code wire. Supporting hooks supplied with each socket.

**Medium Base—No. 43308 Sockets
With No. 14 Type R Stranded Code Wire**

No.	Spacing In.	Std. Pkg.	Wt. Lbs. Per Streamer	Price Per 100
412	12	100	14	\$44.00
418	18	100	17	49.00
424	24	100	21	54.00
430	30	100	24	59.00
436	36	100	27	64.00

With No. 12TW Stranded Code Wire

612	12	100	14	\$49.50
618	18	100	17	55.75
624	24	100	21	62.00
630	30	100	25	68.25
636	36	100	29	74.50

With No. 10TW Stranded Code Wire

512	12	100	20	\$57.00
518	18	100	26	67.00
524	24	100	32	77.00
530	30	100	38	87.00
536	36	100	43	97.00

**Intermediate Base—No. 44408 Sockets
With No. 18 Red and Green Type CXT Wire**

712	12	100	7	\$31.50
718	18	100	9	34.75
724	24	100	11	38.00
730	30	100	13	41.25
736	36	100	15	44.50

With No. 16 Red and Green Type CXT Wire

812	12	100	7	\$34.00
818	18	100	9	37.50
824	24	100	11	41.00
830	30	100	13	44.50
836	36	100	16	48.00

With No. 14TW Stranded Code Wire

912	12	100	7	\$38.00
918	18	100	9	43.00
924	24	100	11	49.00
930	30	100	14	54.00
936	36	100	16	59.00

P & S Aluminum Shell Lampholders

Weatherproof

Conform to N.E.C. Standards

**660 Watts
250 Volts**



No. 8006



No. 8008

For industrial or other installations requiring a weather-proof lampholder. Die cast metal shells, baked-on aluminum spray finish. 2¼-inch shade-holder will fit either shallow bowl or standard dome type reflectors.

No. 8006 has hexagon cap for ½-inch conduit.

No. 8008 has 90° angle cap for ½-inch conduit.

No.	Carton	Std. Pkg.	Wt. Lbs. Std. Pkg.	Per 100	Price Per 100
8006	10	100	56		\$142.00
8008	10	100	58		142.00

Bryant Prefocusing Type Lampholders

Listed as standard by Underwriters' Laboratories, Inc.



No. 3740

For installations where correct focusing and reflecting of light are essential. Prefocusing lampholders keep the light source always at the focal point of the reflector. Uses include landing lights of airplanes, landing field lights, projection lamps, locomotive headlights, photo-electric cells, general photographic work and many other applications.

Medium Base—1000 Watts, 250 Volts

Black Plastic—Surface Mounting

No.	Overall Inches	Screw Centers Inches	Carton	Std. Pkg.	Wt. Lbs. Std. Pkg.	Per 100
3740	1 7/8	2	10	100	19	\$203.50

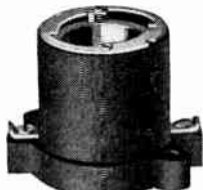

No. 3842

Mogul Base—2500 Watts, 250 Volts Porcelain—Surface Mounting

Height overall, 2 3/4-inches. Diameter of base, 3 3/4-inches. Screw spacing, 3-inches.

Packed 5 in a carton. 50 in a standard package. Package weight, 55 pounds.

No. 3842.....Per 100 \$736.00

Bryant Marine Lampholders

Listed as standard by Underwriters' Laboratories, Inc.



No. 4160

Plastic base. Furnished with two 3/4-inch, 8 x 32 round head pointed screws. Each terminal has two binding screws.

Base dimensions: Diameter, 2-inches. Height, 1 13/16-inches. Screw spacing, 1 3/8-inches. Center of base to end of key, 1 11/16-inches.

Packed 10 in a carton. 100 in a standard package. Package wt., 22 lbs. for No. 4160; 21 lbs. for No. 4161.

250 Watts, 250 Volts

No.	Description	Per 100
4160	Key	\$141.00

660 Watts, 250 Volts

No.	Description	Per 100
4161	Keyless	\$102.50

Plastic Screw-Shell Insulators

For Nos. 4160 and 4161. Mounts on 2-inch diameter base.

No.	Carton	Std. Pkg.	Wt. Lbs. Std. Pkg.	Per 100
4260	10	100	11	\$60.50

Bryant Porcelain Mogul Base Cleat Type

Listed as standard by Underwriters' Laboratories, Inc.

1500 Watts, 250 Volts

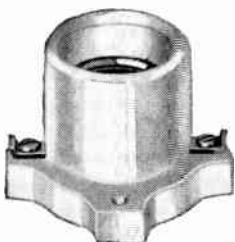

No. 4073

Base diameter, 3 1/2-inches. Neck diameter, 2 1/4-inches. Height, 2 5/8-inches. Screw spacing, 2 7/8-inches.

Packed 5 in a carton, 50 in a standard package.

No.	Wt. Lbs. Std. Pkg.	Per 100
4073	37	\$126.00

Bryant Watertight Type Lampholders

Listed as standard by Underwriters' Laboratories, Inc.



No. 4146

Keyless—Composition Base 660 Watts, 250 Volts

One binding screw in each terminal. Diameter, 2 3/4-inches. Height above mounting surface, 7/8-inch. Four mounting screw holes on 2 5/8-inch circle.

No.	Carton	Std. Pkg.	Wt. Lbs. Std. Pkg.	Per 100
*4146	10	100	36	\$66.00

Keyless, Porcelain Base 660 Watts, 600 Volts

With Two Binding Screws in Each Terminal

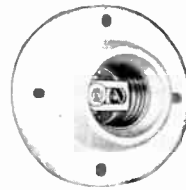

No. 4147

No.	Ctn.	Std. Pkg.	Wt. Lbs. Std. Pkg.	Per 100
4147	10	100	42	\$62.50

Diameter, 2 3/4 inches. Height above mounting surface, 1 5/8 inch.

Four mounting screw holes on 2 5/8 inch circle.

Bryant Mogul Base Porcelain Keyless Bodies

Listed as standard by Underwriters' Laboratories, Inc.

1500 Watts, 600 Volts



No. 4123



No. 4062

Diameter, 2 3/32-inches. Length, 2 1/2-inches.

Screw spacing, 1 13/32-inches for both numbers. Packed 5 in a carton, 50 in a standard package.

Diameter, 2 1/4-inches. Length, 2 1/2-inches.

No.	Description	Wt. Lbs. Std. Pkg.	Per 100
4123	With Binding Screws at Top	23	\$106.00
4062	With Binding Screws at Side	25	\$118.50

Aluminum Caps

For Use with Bodies Nos. 4123 and 4062



No. SA



No. SB

Packed 10 in a carton, 50 in a standard package.

No.	Description	Wt. Lbs. Std. Pkg.	Per 100
SA	3/8-Inch Female Cap	4	\$143.00
SB	1/2-Inch Female Cap	5	\$171.50

Bryant Porcelain Two Piece Rosette for Concealed Wiring

2 Amps., 125 Volts



No. 1502

Fusible Cap. Diameter, 2 11/32-inches. Screw spacing, 1 5/8-inches. Packed 10 in a carton, 100 in a standard package.

No.	Wt. Lbs. Std. Pkg.	Per 100
*1502	43	\$85.00

*Not listed as standard by Underwriters' Laboratories, Inc.

Bryant Intermediate, Candelabra and Miniature Base Lampholders

Listed as Standard by Underwriters' Laboratories, Inc.

Intermediate Base

Socket Caps



No. 1A No. 1T

1/8-Inch

No.	Car-ton	Std. Pkg.	Wt. Lbs. Std. Pkg.	Per 100
1A	25	100	3	\$40.50

Pendent

1T	25	100	2	\$40.50
----	----	-----	---	---------

With Plastic bushing
1 3/32-inch cord hole.

Above caps and bodies are Fluted type and are interchangeable. Standard finish is brush brass.

Socket Bodies



No. 4610 No. 4613

Key

75 Watts, 125 Volts

No.	Car-ton	Std. Pkg.	Wt. Lbs. Std. Pkg.	Per 100
4610	25	100	8	\$105.50

Keyless

75 Watts, 250 Volts

4613	25	100	8	\$80.00
------	----	-----	---	---------

Candelabra Base

75 Watts, 125 Volts

Brass Shell

Keyless Socket with Threaded Catch.
1/8" Cap, Brush Brass.

No.	Car-ton	Std. Pkg.	Wt. Lbs. Std. Pkg.	Per 100
321	25	100	7	\$136.50

Plastic

Keyless Socket with Male Thread Stud. Male stud is 5/16-inch diameter, 27 threads per inch. Overall length of Plastic 1 3/8-inches. Diameter, 1 1/16-inch.

No.	Car-ton	Std. Pkg.	Wt. Lbs. Std. Pkg.	Per 100
328	25	100	3	\$67.00

Keyless Socket with Female Thread Bushing. 1/8-inch female bushing. Overall length of Plastic 1 25/32-inches, diameter 1 1/16-inch.

347	25	100	5	\$70.50
-----	----	-----	---	---------

Candelabra and Miniature Bases

75 Watts, 125 Volts

Porcelain, Round Cleat Base Standard Type—Long Neck Diameter base, 1 13/32-inches. Thickness base, 1/2-inch. Height, No. 367, 1 9/32-inches. Screw spacing, 1 1/16-inches.

No.	Description	Car-ton	Std. Pkg.	Wt. Lbs. Std. Pkg.	Per 100
367	Candelabra	25	100	11	\$52.00

Porcelain, Round Cleat Base

Smaller Type—Short Neck

Diameter base, 1 11/32-inches. Thickness base, 5/16-inch. Height, 7/8-inch. Screw spacing, 1 1/16-inches.

*9446	Candelabra	25	100	13	\$44.00
-------	------------	----	-----	----	---------

Diameter of base, 1 3/16-inches. Thickness of base, 9/32-inch. Height, 3/4-inch. Screw spacing, 1 5/16-inch.

*9445	Miniature	25	100	10	\$44.00
-------	-----------	----	-----	----	---------

Porcelain, Oblong Cleat Base

Base, 1 9/16 x 1-inch. Thickness of base, 1 7/32-inch. Height, 1 5/16-inches.

325	Candelabra	10	100	10	\$48.50
-----	------------	----	-----	----	---------

Composition, Oblong Cleat Base

Base, 1 9/16 x 1-inch. Thickness of base, 1 1/32-inch. Height, 1 1/16-inches.

*612	Candelabra	10	100	8	\$67.00
------	------------	----	-----	---	---------

Porcelain, Two Screw, Flush Mounting

For Metal signs. Hole required, 3/4-inch. Depth, 1-inch. Screw spacing, 1 3/16-inches.

No.	Description	Car-ton	Std. Pkg.	Wt. Lbs. Std. Pkg.	Per 100
388	Candelabra	10	100	9	\$46.00

Porcelain, Screw Ring, Flush Mounting

For metal signs. Removable ring. Hole required, 3/4-inch. Diameter, 1 3/16-inches. Depth, 7/8-inch. Thickness of ring, 1/4-inch.

390	Candelabra	25	100	9	\$72.50
-----	------------	----	-----	---	---------



Sign and Fixture

Porcelain Cleat Type

75 Watts, 250 Volts

For surface wiring. Overall height, 1 7/16-inches; screw spacing, 1 1/2-inches.



No.	Car-ton	Std. Pkg.	Wt. Lbs. Std. Pkg.	Per 100
9653	25	100	16	\$44.00

Porcelain Bases for Metal Signs

75 Watts, 250 Volts



Front



Back

No. 9663



No. 9690

Flush type. Two screw mounting, screw terminals. Fits 1-inch holes. Depth of back, 1 1/32-inches.

No.	Car-ton	Std. Pkg.	Wt. Lbs. Std. Pkg.	Per 100
9663	25	100	14	\$54.50

Flush type. Screw ring, screw terminals. Fits 1 1/16-inch holes; diameter of device, 1 3/8-inches. Depth of back, 1 1/16-inch.

No.	Car-ton	Std. Pkg.	Wt. Lbs. Std. Pkg.	Per 100
9690	25	100	15	\$55.50

Reducer—Medium Base to Intermediate Base



No.	Car-ton	Std. Pkg.	Wt. Lbs. Std. Pkg.	Per 100
9691	25	100	4	\$40.50

*Not listed as standard by Underwriters' Laboratories.

Bryant Porcelain Rosettes for Outlet Boxes

Listed as standard by Underwriters' Laboratories, Inc.

With Screw Terminals
660 Watts, 250 Volts

For 4-Inch Boxes

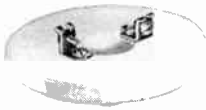

No. 575

Outside diameter, 4²¹/₃₂-inches.
Screw spacing, 3⁹/₃₂ and 3¹/₂-inches.

No.	Carton	Std. Pkg.	Wt. Lbs. Std. Pkg.	Per 100
575	5	50	46	\$107.00

Bryant Socket Interiors

Listed as standard by Underwriters' Laboratories, Inc.

Medium Base Standard Size

Packed 25 in a carton. 100 in a standard package.



No. 5925

No.	Type	Watts	Wt. Lbs. Std. Pkg.	Per 100
5920	Key	250	9	\$55.00
5925	Pull	250	9	59.50
5963	Keyless	660	11	42.00
5964	Push	660	10	58.50

Bryant Chain and Cord Items

Listed by Underwriters' Laboratories, Inc.



No. 5969



No. 5962



No. 810



No. 5830



No. 513



No. 5933

No.	Description	Carton	Std. Pkg.	Wt. Lbs. Std. Pkg.	Per 100
5969	250 Foot spool #6 Chain	...	1	4	†\$38.00
5962	Complete replacement chain, pull lampholders	100	100	3	37.50
5933	White Pull Cord for porcelain lampholders. In 2 1/2 ft. hanks only	100	100	1	7.50
5830	Pendant, nickel plated, for No. 5933 Cord	100	100	1	17.50
810	Link, splicing for Cord, or No. 6 Chain	100	100	..	9.00
513	Link, insulating, for No. 6 chain	100	100	..	18.50

†Per spool of 250 ft.

Hubbell Standard Socket Bodies



No. 61

Brush brass standard finish.
250 Watts, 250 Volts

No.	Type	Car- ton	Std. Pkg.	Wt. Lbs. Std. Pkg.	Per 100
60	Pull	25	250	33	\$82.50
61	Key	25	250	44	66.00

660 Watts, 250 Volts

62	Keyless	25	250	34	51.50
----	---------	----	-----	----	-------

Hubbell Standard Socket Caps



No. 411

Brush brass standard finish.



No. 418



No. 414



No. 415

No.	Carton	Std. Pkg.	Wt. Lbs. Std. Pkg.	Per 100
1/8-Inch Female Threaded				
411	25	250	11	\$19.50
3/8-Inch Female Threaded				
413	25	250	15	\$30.50
1/2-Inch Female Threaded				
419	25	250	20	\$48.00
1/8-Inch Female Threaded Angle				
418	25	250	20	\$59.50
3/8-Inch Female Threaded Angle				
420	25	250	25	\$67.00
Pendant				
414	25	250	8	\$18.00
Pendant with Cord Grip For 3/8 to 1/2-Inch Cords				
415	25	100	8	\$47.50

Carton and standard package quantities subject to change.

Hubbell Aluminum Shell Sockets

One-Piece Type
660 Watts, 600 Volts

Fitted with inside ring for holding porcelain body in shell.

Packed 10 in a carton. 50 in a standard package. Package weight, 16 pounds.



No. 3136

No.	Description	Per 100
3136	With 1/2-inch Nipple	\$151.00

Aluminum Shade Holder

For use only with No. 3136 socket.

Package weight, 3 pounds.



No. 3137

3137	2 1/4-inch	\$68.00
------	------------	---------

Hubbell Socket Bushings and Reducers



No. 5380



No. 421



No. 392



No. 492

Composition Bushing

No.	Description	Car- ton	Std. Pkg.	Wt. Lbs. Std. Pkg.	Per 100
*5380	1/8-inch Socket	200	1000	3	\$ 4.50
*5381	3/8-inch Socket	200	1000	10	9.00

Reducers

421	Mogul to Medium	10	100	19	\$66.00
392	Medium to Candelabra	25	100	6	43.00
492	Medium to Intermediate	25	100	5	40.50

*Packed in bulk.

Hubbell Standard Wiring Devices

Conform to N.E.C. Standards

Assembled Brass Shell Sockets



Standard finish is Bright Dipped.

Pull Type—250 Watts, 250 Volts

No.	Description	Carton	Std. Pkg.	Wt. Lbs. Std. Pkg.	Per 100
2618	With 1/8-Inch Cap	25	250	42	\$ 97.00
2632	With 3/8-Inch Cap	25	250	35	102.50
2620	With Pendant Cap	25	250	50	94.50

Key Type—250 Watts, 250 Volts

No.	Description	Carton	Std. Pkg.	Wt. Lbs. Std. Pkg.	Per 100
2664	With 1/8-Inch Cap	25	250	55	\$75.00
2634	With 3/8-Inch Cap	25	250	54	80.50
2666	With Pendant Cap	25	250	50	75.00

Keyless Type—660 Watts, 250 Volts

No.	Description	Carton	Std. Pkg.	Wt. Lbs. Std. Pkg.	Per 100
2667	With 1/8-Inch Cap	25	250	45	\$64.00
2635	With 3/8-Inch Cap	25	250	45	72.50
2669	With Pendant Cap	25	250	42	64.00

Brass Shell Socket Bodies with Threaded Rings



Threaded Ring is included as part of socket body. Caps are separate.

The caps and bodies are firmly attached by the threaded ring, and when assembled will not become separated.

Recommended for industrial use. Brush brass is standard finish.

250 Watts, 250 Volts

No.	Description	Carton	Std. Pkg.	Wt. Lbs. Std. Pkg.	Per 100
1637	Key Type	25	250	18	\$103.50
1639	Pull Chain Type	25	250	15	123.00

660 Watts, 250 Volts

No.	Description	Carton	Std. Pkg.	Wt. Lbs. Std. Pkg.	Per 100
1638	Keyless Type	25	250	39	\$79.00

Brass Socket Caps



Brush brass is standard finish.

No.	Description	Carton	Std. Pkg.	Wt. Lbs. Std. Pkg.	Per 100
1630	1/8-Inch Cap	25	250	10	\$46.00
1632	3/8-Inch Cap	25	250	33	50.50
1634	Pendant Cap	25	250	13	33.00

With Cord Grip for 3/8 to 1/2-Inch Cord

No.	Description	Carton	Std. Pkg.	Wt. Lbs. Std. Pkg.	Per 100
2502	Pendant Cap	25	100	8	\$65.00

Porcelain Socket Bodies Two-Screw Type



Standard finish of exposed brass parts is brush brass, which will be furnished unless special finish is specified.

250 Watts, 250 Volts

No.	Description	Carton	Std. Pkg.	Wt. Lbs. Std. Pkg.	Per 100
160	Pull Chain Type Body	10	100	31	\$122.00
161	Key Type Body	10	100	25	71.50

660 Watts, 250 Volts

No.	Description	Carton	Std. Pkg.	Wt. Lbs. Std. Pkg.	Per 100
162	Keyless Type Body	10	100	17	\$ 48.50

Porcelain Socket Caps Two-Screw Type



Standard finish of exposed brass parts is brush brass, which will be furnished unless special finish is specified.

No.	Description	Carton	Std. Pkg.	Wt. Lbs. Std. Pkg.	Per 100
150	Pendant	10	100	11	\$ 35.50
151	1/8-inch Brass	10	100	13	68.50
153	3/8-inch Brass	10	100	14	70.50
191	1/2-inch Brass	10	100	20	90.50
175	3/8-inch Angle Brass	10	100	19	172.00
198	Pendant Cord Grip	10	100	18	77.50

Cleat Type Lampholders With Binding Screws 660 Watts, 250 Volts



No.	Description	Carton	Std. Pkg.	Wt. Lbs. Std. Pkg.	Per 100
50715	Porcelain Base, 2 1/2 x 2 3/8-ins. Screw Hole Centers, 1 1/8-in. Bakelite Base,	10	100	24	\$34.50
50715-B	2 1/2 x 2 3/8-ins. Screw Hole Centers, 1 1/8-in. Porcelain Base,	10	100	36	\$56.50
9402	2 1/8 x 2 3/8-ins. Screw Hole Centers 2 3/8-in.				

Electrolier Socket Bodies and Cap 660 Watts, 250 Volts



No.	Description	Carton	Std. Pkg.	Wt. Lbs. Std. Pkg.	Per 100
73	Short Shell Keyless Body	25	250	26	\$44.00
441	1/8-inch Female Cap	25	250	11	18.50

Standard finish is brush brass. No. 59 has Bakelite Button. Carton and standard package quantities subject to change.

Hubbell Brass Covered Ceiling Receptacles



No. 4100

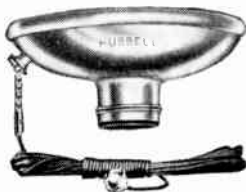

No. 4104

Standard finish brush brass.

Screw spacings, 2¾ inches and 3½ inches.

**For 3¼ and 4-Inch Boxes
660 Watts, 250 Volts**

No.	Description	Carton	Std. Pkg.	Wt. Lbs. Std. Pkg.	Per 100
4100	Keyless	10	50	43	\$238.50

250 Watts, 250 Volts

4104	Pull, with short chain, 4 foot black cord and composition ball.....	10	50	58	\$322.50
------	---	----	----	----	----------

**Hubbell Outlet Box Receptacles
With Metal Cover and No. 14 Wires**

660 Watts, 600 Volts



No. 456 or 457



No. 458 or 459

Height, 1⅜ inches above cover.

For 3¼-Inch Outlet Boxes

No.	Description	Carton	Std. Pkg.	Wt. Lbs. Std. Pkg.	Per 100
456	Screw Terminals	10	100	49	\$65.00
458	6-Inch Leads	10	50	26	80.00

For 4-Inch Outlet Boxes

457	Screw Terminals	5	50	30	\$73.50
459	6-Inch Leads	5	50	31	88.00

Hubbell Porcelain Receptacles



No. 829

**Shade Holder Groove
Flush Back**

Pull—250 Watts, 250 Volts

Packed: 10 Ctn., 20 Std. Pkg.

No.	Description	Wt. Lbs. Std. Pkg.	Per 100
829	Pull, Short Chain and Cord	28	\$262.00
830	Pull, Short Insulated Chain	37	262.00

**Hubbell Porcelain Sign Receptacles with
Glazed Rings**

660 Watts, 250 Volts



No. 4003



No. 59108



No. 4109



No. 61988

With 6-Inch No. 14 Wire Leads

No.	Description	Carton	Std. Pkg.	Wt. Lbs. Std. Pkg.	Per 100
4003	⅙-Inch Ring	10	100	28	\$65.00

Shallow Type

59108	⅙-Inch Ring, Binding Screws	10	100	21	\$43.00
4109	⅙-Inch Ring, Covered Terminals	10	100	29	66.00

Deep Type

61988	⅜-Inch Ring, Binding Screws	10	100	23	\$50.50
-------	-----------------------------	----	-----	----	---------

**One-Piece Sign Receptacles
660 Watts, 600 Volts**

Requires a 1⅜-inch hole.
Screw spacing, 1⅜-inches.
Furnished with binding screws.



No.	Carton	Std. Pkg.	Wt. Lbs. Std. Pkg.	Per 100
4063	10	100	21	\$49.50

**Mogul Cleat Receptacles
1500 Watts, 250 Volts**

Screw spacing, 2⅞-inches
Base diameter, 3½-inches.



No.	Carton	Pkg.	Wt. Lbs. Std. Pkg.	Per 100
3464	2	50	40	\$149.00

McGill Levolver Fixture Sockets

Approved by Underwriters' Laboratories, Inc.

660 Watts, 250 Volts

For brackets and chandeliers using candles, husks, and other types of socket covers. White plastic lever serves as a finishing knob and does away with unsightly black keys, slots in husks or chains coming out of the side.
Carton 10; Standard package, 100.



No. 121

No.	Nipple In.	Lever	Ctn.	Std. Pkg.	Wt. Lbs. Std. Pkg.	Each
103	5/8	Brass or nickel	10	100	13	\$102.00
119	5/8	Plain	10	100	12	102.00
121	5/8	White plastic	10	100	13	106.00
122	3/8	White plastic	10	100	15	104.00
127	Sq.	Plain	10	100	14	98.00
128		White plastic knob	10	100	..	12.00

McGill Levolver Industrial Sockets

Approved by Underwriters' Laboratories, Inc.

Series 4100

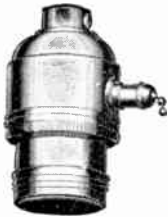

No. 4100

Sturdily constructed throughout with a screw shell .006-inch heavier than standard practice—for added strength at the lamp base. Double thickness wall section locked together with threaded collar prevents cap and casing separation with actuating pull.

No. 4100 with Universal Lever control uses a No. 41 Levolver switch.

No. 4100-PB with Push Button control involves this basic mechanism and provides the same positive action.

**Single Circuit—Lever Operated
Push Button**

660 Watts—250 Volts

With 1/8-In. Cap		With Pendant Cap		Description	Std. Pkg. Wt., Lbs.
No.	Per 100	No.	Per 100		
4100	\$130 00	4101	\$126 00	Pull Chain	20
4100-FL	130 00	4101-FL	126 00	Fibre Lever	18
4100-PL	130 00	4101-PL	126 00	Plain Brass Lever	19
4100-PB	130 00	4101-PB	126 00	Red Plastic Push Button	18

With Nipple

4102	130 00	4102	130 00	Pull Chain	21
4102-FL	130 00	4102-FL	130 00	Fibre Lever	19
4102-PL	130 00	4102-PL	130 00	Plain Brass Lever	20

With 3/8-In. Cap		With 1/4-In. Cap		Description	Std. Pkg. Wt., Lbs.
No.	Per 100	No.	Per 100		
4103	140 00	4104	140 00	Pull Chain	20
4103-FL	140 00	4104-FL	140 00	Fibre Lever	18
4103-PL	140 00	4104-PL	140 00	Plain Brass Lever	19
4103-PB	140 00	4104-PB	140 00	Red Plastic Push Button	18

With 3/8-In. Cap and Cord Clamp

44103	160 00	44103	160 00	Pull Chain	21
44103-FL	160 00	44103-FL	160 00	Fibre Lever	19
44103-PL	160 00	44103-PL	160 00	Plain Brass Lever	20
44103-PB	160 00	44103-PB	160 00	Red Plastic Push Button	19

Two Circuit for Two Filament Lamps

Lever Operated—Push Button
250 Watt—250 Volt

With 1/8-In. Cap		With 3/8-In. Cap		Description	Std. Pkg. Wt., Lbs.
No.	Per 100	No.	Per 100		
4120	\$140 00	4123	\$150 00	Pull Chain	20
4120-FL	140 00	4123-FL	150 00	Molded Lever	18
4120-PL	140 00	4123-PL	150 00	Plain Brass Lever	19
4120-PB	140 00	4123-PB	150 00	Red Plastic Push Button	18

With 1/4-In. Cap		Description	Std. Pkg. Wt., Lbs.
No.	Per 100		
4124	150 00	4124	150 00
4124-FL	150 00	4124-FL	150 00
4124-PL	150 00	4124-PL	150 00
4124-PB	150 00	4124-PB	150 00

Carton 10; standard package 100.

4300 Series Phenolic Lampholders
Single Circuit—Lever Operated—Push Button
600 Watt—250 Volt

The molded phenolic shell is double-thick and impact resistant. It is fully insulated and has no exposed metal in the push-button model. Available with push button or universal lever control. Cap and Casing screw together for easy opening and wiring.



No. 4303-PB

With 1/8-In. Cap		With Pendant Cap		Description	Std. Pkg. Wt., Lbs.
No.	Per 100	No.	Per 100		
4300	\$140 00	4301	\$140 00	Pull Chain	26
4300-FL	140 00	4301-FL	140 00	Fibre Lever	24
4300-PL	140 00	4301-PL	140 00	Plain Brass Lever	25
4300-PB	140 00	4301-PB	140 00	Red Plastic Push Button	24

With Nipple

4302	140 00	4302	140 00	Chain	27
4302-FL	140 00	4302-FL	140 00	Fibre Lever	25
4302-PL	140 00	4302-PL	140 00	Plain Brass Lever	26

With 3/8-In. Cap		With 1/4-In. Cap		Description	Std. Pkg. Wt., Lbs.
No.	Per 100	No.	Per 100		
4303	140 00	4304	140 00	Pull Chain	26
4303-FL	140 00	4304-FL	140 00	Fibre Lever	24
4303-PL	140 00	4304-PL	140 00	Plain Brass Lever	25
4303-PB	140 00	4304-PB	140 00	Red Plastic Push Button	24

Carton 10; standard package 100.

With 3/8-Inch Cap and Cord Clamp

44303	\$160 00	44303	\$160 00	Pull Chain	27
44303-FL	160 00	44303-FL	160 00	Fibre Lever	25
44303-PL	160 00	44303-PL	160 00	Plain Brass Lever	26
44303-PB	160 00	44303-PB	160 00	Red Plastic Push Button	25

Two Circuit for Two Filament Lamps

Lever Operated—Push Button
250 Watt—250 Volt

With 1/8-In. Cap		With 3/8-In. Cap		Description	Std. Pkg. Wt., Lbs.
No.	Per 100	No.	Per 100		
4320	\$150 00	4323	\$150 00	Pull Chain	26
4320-FL	150 00	4323-FL	150 00	Fibre Lever	24
4320-PL	150 00	4323-PL	150 00	Plain Brass Lever	25
4320-PB	150 00	4323-PB	150 00	Red Plastic Push Button	24

With 1/4-In. Cap		Description	Std. Pkg. Wt., Lbs.
No.	Per 100		
4324	150 00	4324	150 00
4324-FL	150 00	4324-FL	150 00
4324-PL	150 00	4324-PL	150 00
4324-PB	150 00	4324-PB	150 00

Carton 10; standard package 100.

4400 Series Phenolic Lampholders

With Shade Threads—Lever Operated—Push Button



No. 4400

Equipped with shade threads, this model has a molded phenolic shell, double thick and impact resistant. Fully insulated—no exposed metal in push button or universal lever control. Cap and casing screw together for easy opening and wiring.

Single Circuit—600 Watt—250 Volt

With 1/8-In. Cap		With Pendant Cap		Description	Std. Pkg. Wt., Lbs.
No.	Per 100	No.	Per 100		
4400	\$140 00	4401	\$140 00	Pull Chain	23
4400-FL	140 00	4401-FL	140 00	Fibre Lever	21
4400-PL	140 00	4401-PL	140 00	Plain Brass Lever	22
4400-PB	140 00	4401-PB	140 00	Red Plastic Push Button	21

With Nipple		Description	Std. Pkg. Wt., Lbs.
No.	Per 100		
4402	140 00	4402	140 00
4402-FL	140 00	4402-FL	140 00
4402-PL	140 00	4402-PL	140 00

With 3/8-In. Cap		With 1/4-In. Cap		Description	Std. Pkg. Wt., Lbs.
No.	Per 100	No.	Per 100		
4403	140 00	4404	140 00	Pull Chain	23
4403-FL	140 00	4404-FL	140 00	Fibre Lever	21
4403-PL	140 00	4404-PL	140 00	Plain Brass Lever	22
4403-PB	140 00	4404-PB	140 00	Red Plastic Push Button	21

With 3/8-Inch Cap and Cord Clamp

44403	\$160 00	44403	\$160 00	Pull Chain	24
44403-FL	160 00	44403-FL	160 00	Fibre Lever	22
44403-PL	160 00	44403-PL	160 00	Plain Brass Lever	23
44403-PB	160 00	44403-PB	160 00	Red Plastic Push Button	22

Two Circuit for Two Filament Lamps

250 Watt—250 Volt

With 1/8-In. Cap		With 3/8-In. Cap		Description	Std. Pkg. Wt., Lbs.
No.	Per 100	No.	Per 100		
4420	\$150 00	4423	\$150 00	Pull Chain	23
4420-FL	150 00	4423-FL	150 00	Fibre Lever	21
4420-PL	150 00	4423-PL	150 00	Plain Brass Lever	22
4420-PB	150 00	4423-PB	150 00	Red Plastic Push Button	21

With 1/4-In. Cap		Description	Std. Pkg. Wt., Lbs.
No.	Per 100		
4424	\$150 00	4424	150 00
4424-FL	150 00	4424-FL	150 00
4424-PL	150 00	4424-PL	150 00
4424-PB	150 00	4424-PB	150 00

P & S Porcelain Lampholders

Conform to N.E.C. Standards

One-Piece Sign Lampholders

Bronze screws are used for holding metal parts in complete assembly and insuring long life. Equipped with heavy terminals, electrolytic copper contact shells and phosphor bronze spring center contacts. Mounting screws and studs are made of bronze.

**Medium Base
Spring Studs—Screw Terminals
660 Watts, 600 Volts**



Length of back, 1 7/16-inches.
Hole required, 1 3/8-inches.
Screw spacing, 1 13/16-inches.

No.	Carton	Std. Pkg.	Wt. Lbs. Std. Pkg.	Per 100
5403	10	100	24	\$38.00

**Mounting Screws—Screw Terminals
660 Watts, 600 Volts**

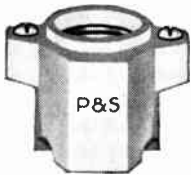

Length of back, 1 7/16-inches.
Hole required, 1 3/8-inches.
Screw spacing, 1 13/16-inches.

No.	Carton	Std. Pkg.	Wt. Lbs. Std. Pkg.	Per 100
54	10	100	23	\$38.00

**Cleat Lampholder
With Screw Terminals—For Signs and Surface Wiring
660 Watts, 250 Volts**



Pony size.
Diameter of base, 2 1/2-inches.
Height, 1 5/8-inches.
Screw holes are spaced 1 31/32-inches.

No.	Carton	Std. Pkg.	Wt. Lbs. Std. Pkg.	Per 100
50715	10	100	26	\$34.50

Screw Ring Lampholder

**Pull Chain
For Lighting Fixtures
250 Watts, 250 Volts**



Porcelain clamping rings and gaskets. For use in units with 1 1/2-inch throat.

Overall height 2 3/8-inches. Depth of body under gasket, 1 3/16-inches. Hole required, 1 7/16-inches.

Furnished with short chain and long cord.

No.	Carton	Std. Pkg.	Wt. Lbs. Std. Pkg.	Per 100
998	10	100	33	\$65.00

Screw Ring Lampholders

Shallow Back

For Signs and Fixtures

Length of back, 1 3/16 inches.
Hole required, 1 1/2 inches.



No. 4100



No. 4101



No. 4114

**660 Watts, 250 Volts
With Screw Terminals**

No.	Carton	Std. Pkg.	Wt. Lbs. Std. Pkg.	Per 100
*4100	25	250	53	\$35.50

No.	Carton	Std. Pkg.	Wt. Lbs. Std. Pkg.	Per 100
*4101	25	250	60	\$41.00

No.	Carton	Std. Pkg.	Wt. Lbs. Std. Pkg.	Per 100
*4114	25	250	69	\$46.00

No.	Carton	Std. Pkg.	Wt. Lbs. Std. Pkg.	Per 100
*4118	25	250	53	\$45.00

*Furnished with unglazed shell and ring.

†Can be supplied with extra length leads at slight additional cost.

Box Mounting with Shadeholder Groove

Keyless—660 Watts, 250 Volts

For 3 1/4-Inch Boxes

Outside diameter, 3 5/8 inches; height overall, 1 7/16 inches. Holes for supporting screws spaced 2 3/4 inches on centers.



No. 41

No.	Carton	Std. Pkg.	Wt. Lbs. Std. Pkg.	Per 100
41	10	100	48	\$35.50

For 3 1/4 and 4-Inch Boxes

Outside diameter, 4 5/8 inches; height overall, 1 9/16 inches. Elongated holes for supporting screws spaced for 3 1/4 or 4-inch boxes.

No.	Carton	Std. Pkg.	Wt. Lbs. Std. Pkg.	Per 100
110	5	50	38	\$41.00

One-Piece Box Mounting

With Shadeholder Groove and Convenience Outlet

Rating: 250 Watts, 125 Volts Outlet, 15 Amperes, 125 Volts

Convenience outlet is connected internally, eliminating extra wires, soldering, and taping.



No. 5026-2

For 3 1/4-Inch Outlet Boxes

Dimensions: diameter of base, 3 5/8 inches; height overall, 2 1/4 inches; screw hole spacing, 2 3/4 inches.

No.	Description	Carton	Std. Pkg.	Wt. Lbs. Std. Pkg.	Per 100
5026-2	Short Chain and Long Cord	10	50	40	\$105.00

For 3 1/4 and 4-Inch Outlet Boxes

Dimensions: diameter of base, 4 1/16 inches; height overall, 2 1/4 inches; elongated holes for supporting screws spaced for 3 1/4 or 4-in. boxes.

No.	Description	Carton	Std. Pkg.	Wt. Lbs. Std. Pkg.	Per 100
5046	Insulated Nickel Chain	10	50	53	\$117.50
5046 2	Short Chain and Long Cord	10	50	53	\$107.00

P & S Porcelain Lampholders

Conform to N.E.C. Standards

One-Piece—Box Mounting
Flush Back—Shade-Holder Groove
250 Watts, 250 Volts



No. 4026-2

For 3 1/4-Inch Boxes

One piece construction. Can be used without removing interior. Diameter of base 3 5/8 inches; height overall, 2 1/4 inches. Supporting screws spaced 2 3/4 inches on center.

No.	Description	Car- ton	Std. Pkg.	Wt. Lbs. Std. Pkg.	Per 100
4026-2	Short Chain, Long Cord	10	50	40	\$73.50

Order P & S 41 for similar device in keyless style.

For 3 1/4 and 4-Inch Boxes

Diameter of base, 4 1/16 inches; height overall, 2 1/4 inches. Elongated screw holes with knockouts spaced for 3 1/4" or 4" boxes.

4046	Insulated Nickel Chain	10	50	53	\$80.00
4046-2	Short Chain, Long Cord	10	50	53	73.50

Order P & S 110 for similar device in keyless style.

Two-Piece—Box Mounting
Recessed Back—Shadeholder Groove
Pull—250 Watts, 250 Volts
Keyless—660 Watts, 250 Volts



No. 4011

Recessed back simplifies installation when boxes are tilted or project from the wall. Furnished complete with all necessary screws, straps and lock nuts for mounting on boxes.

For 3 1/4-Inch Boxes

Diameter of base, 4 inches; height over all, 2 21/32. Supporting screws spaced 2 3/4 inches on centers.

For Mounting on Boxes with Ears

No.	Description	Car- ton	Std. Pkg.	Wt. Lbs. Std. Pkg.	Per 100
4011	Pull, Short Chain, Long Cord	10	50	55	\$131.00

For 4-Inch Boxes

Diameter of base, 1 3/4 inches; height over all, 2 21/32. Supporting screws spaced 3 1/2 inches on centers.

For Mounting on Boxes with Ears

4012	Pull, Short Chain, Long Cord	10	50	60	\$147.00
4057	Keyless	10	50	63	126.00

Interchangeable 1-Screw Sockets

P & S porcelain 1-screw socket parts are not interchangeable with P & S 2-screw socket parts.



No. S-26



No. PA



No. PY



No. PC



No. O-26



No. O-27



No. O-47



No. O-PA



No. O-PC

Socket Bodies
Key—250 Watts,
250 Volts

No.	Car- ton	Std. Pkg.	Wt. Lbs. Std. Pkg.	Per 100
S-26	10	100	30	\$71.50



S-27

Keyless—660 Watts,
250 Volts

S-27	10	100	17	\$48.50
------	----	-----	----	---------

Pull—250 Watts, 250 Volts

Insulated nickel flash chain.

No.	Car- ton	Std. Pkg.	Wt. Lbs. Std. Pkg.	Per 100
S-47	10	100	29	\$122.00

Caps

Standard finish of brass caps is nickel flash.

Pendant for Reinforced Cord

No.	Cap Inches	Car- ton	Std. Pkg.	Wt. Lbs. Std. Pkg.	Per 100
PA	..	10	100	13	\$35.50

Pendant with Cord Grip

PY	3/8—1/2	10	100	19	\$77.50
----	---------	----	-----	----	---------

Straight Nipple—Brass

PC	1/8	10	100	17	\$68.50
PE	3/8	10	100	17	70.50
PZ	1/2	10	100	17	90.50

Interchangeable 2-Screw Sockets and Caps

P & S 2-screw porcelain socket parts are not interchangeable with P & S 1-screw porcelain socket parts.

The standard finish of brass caps and brass chain is nickel flash.

Socket Bodies

Key—250 Watts, 250 Volts

No.	Car- ton	Std. Pkg.	Wt. Lbs. Std. Pkg.	Per 100
O-26	10	100	28	\$71.50

Keyless 660 Watts, 250 Volts

O-27	10	100	17	\$48.50
------	----	-----	----	---------

Pull—250 Watts, 250 Volts

With Insulated Chain and Tassel.

O-47	10	100	28	\$122.00
------	----	-----	----	----------

Caps

Pendant for Reinforced Cord.

No.	Cap Inches	Car- ton	Std. Pkg.	Wt. Lbs. Std. Pkg.	Per 100
O-PA	..	10	100	13	\$35.50
*O-PY	..	10	100	19	77.50

*Has cord grip for 3/8 to 1/2" cord.

Straight Nipple—Brass

O-PC	1/8	10	100	17	\$68.50
O-PE	3/8	10	100	17	70.50
O-PZ	1/2	10	100	17	90.50

McGill Sockets

Approved by Underwriters' Laboratories, Inc.

With or Without Levolver Switch Mechanism
660-Watt—250-Volt

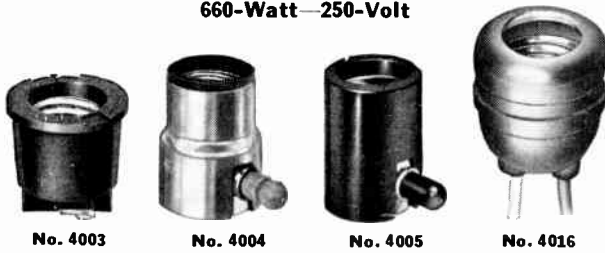

Available in Keyless and Levolver switch types.
Nos. 1004 and 4005 are Levolver types, thoroughly insulated, with fibre levers. No. 4003, brown phenolic, is firmly embedded in the handles of all keyless models.

No.	Description	Carton	Std. Pkg.	Wt., Lbs. Std. Pkg.	Per 100
4003	Brown Phenolic Keyless.....	10	100	19	\$ 56.00
4004	Brass Case, Fibre Lever.....	10	100	12	100.00
4005	Phenolic Case, Fibre Lever... 10	100	12		92.00
4015	Brown Phenolic Grounded... 10	100	23		74.00
4016	Rubber Watertight, Keyless... 10	100	21		80.00

Lampholder No. 4003 used in all Standard Portables without switch. No. 4005 used in all Standard Portables with switch—Except:

No. 4004—Portable No. 4675 and 4675-R.

No. 4015—All Standard Portables with grounded lampholders. For Vaporproof Nos. 3002 and 3005 specify short ground.

No. 4016—All Standard Portables requiring water-tight lampholders to replace Lampholder No. 4003.

Lampholders are not replaceable on 5000 Series Portables. Specify new handle for Portable involved.

P & S Porcelain Two-piece Cablettes

Keyless: 660 Watts, 250 Volts
Pull: 250 Watts, 250 Volts

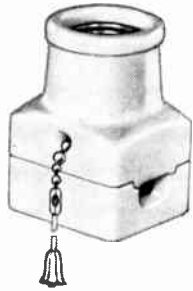

No. 1701

Designed for use with non-metallic sheathed cable to permit installation directly on the surface without the use of boxes, clamps, connectors, or soldering.

Each Cablette has a removable knockout to close lead out opening when feed-thru run is not required.

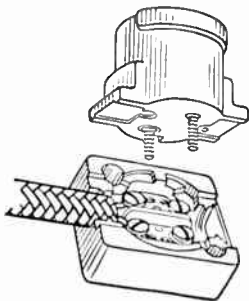

No. 1700

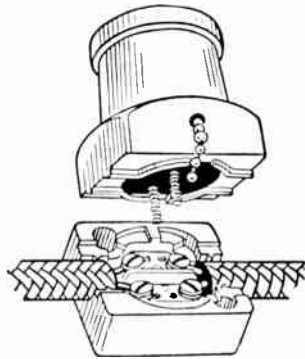

No. 1701

No.	Description	Carton	Std. Pkg.	Wt., Lbs. Std. Pkg.	Per 100
1700	Keyless.....	10	50	19	\$ 63.00
1701	Pull.....	10	30	18	105.00

Benjamin Benco Weatherproof Lampholders



No. 4200

Sturdy one-piece porcelain interiors with insulated aluminum casings and aluminum retaining rings. The removal of the threaded retaining ring at the bottom of the lampholder allows the lampholder interior to be separated from the casing for wiring. Ring can be removed and lampholder attached to Type N reflectors equipped with Type S snap-in reflector holders.

No.	Description	Each
4200	Tapped for 1/2-in. iron pipe	\$1.37
4201	Tapped for 3/8-in. iron pipe	1.37

Bryant Plastic Plural Plugs

Listed by Underwriters' Laboratories, Inc.

660 Watts, 250 Volts

Brown Plastic
Two Lamp Outlet
One-Piece Molded Construction



No. 200

No.	Carton	Std. Pkg.	Wt. Lbs. Std. Pkg.	Per 100
200	10	100	21	\$93.50

Standard Design

No.	Carton	Std. Pkg.	Wt. Lbs. Std. Pkg.	Per 100
200	10	100	10	49.50

Two Power and One Lamp Outlet
660 Watts, 125 Volts



No. 204



No. 124



No. 125

No.	Description	Carton	Std. Pkg.	Wt. Lbs. Std. Pkg.	Per 100
204	One-piece Molded Design	10	100	15	\$110.00
124	Standard Design	10	100	13	65.00
125	Pull Chain Design	10	100	16	100.50

Hubbell Pull Socket Te-Taps

Conform to N.E.C. Standard

Plug Outlets: 660 Watts, 125 Volts

Socket Outlets: 250 Watts, 250 Volts



No. 3190



No. 3191

Standard finish is brush brass.

No.	Description	Carton	Std. Pkg.	Wt. Lbs. Std. Pkg.	Per 100
3190	With Medium Screw Base.....	2	10	5	\$254.00
3191	With 1/8-Inch Cap.....	2	10	4	231.00
3193	With 3/8-Inch Cap.....	2	10	4	242.50
3194	With Pendant Cap.....	2	10	14	231.00



Hubbell Pull Sockets With Screw Base
250 Watts, 250 Volts

Medium screw base. Equipped with 6 1/2-inch pull chain. Standard finish is brush brass. Packed 2 in a carton. 10 in a standard package. Package weight, 4 pounds.

No. 35024 Per 100
\$173.50

Daniel Woodhead Safeway and Protex Neotex Wiring Devices

Screw Base Plug, Twin Sockets and Double Receptacles



No. 1535



No. 720



No. 1536



No. 1537

Unbreakable Neotex construction assures long life. Makes additional socket or receptacle available for temporary service jobs.

No.	Description	Carton	Std. Pkg.	Wt., Lbs. Std. Pkg.	Each
1535	Screw Base Plug.....	10	50	10	\$2.20
720	Double Socket.....	5	50	20	2.95
1536	Double Parallel Receptacle.....	5	50	20	3.25
1537	Combination Socket and Receptacle.....	5	50	20	3.10

Hubbell Adjustable Angle Adapter Sockets
660 Watts, 250 Volts



No. 3597

For use with Projector and Reflector Lamps.

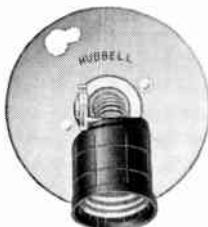

No. 3598

No.	Description	Wt., Lbs. Std. Pkg.	Per 100
3597	Angle Adapter Socket	19	\$214.50
3598	Socket on 3 1/4-inch Galv. Cover	42	274.00
3599	Socket on 4-inch Galv. Cover	54	277.00

Hubbell Medium Screw Base Adapters
660 Watts, 250 Volts



No. 5897

Black composition with tandem blades. Packed 10 in a carton. 50 in a standard package. Package weight, 8 pounds.

No. 5897 Per 100
\$72.50

Bryant Composition Adapters

Listed by Underwriters' Laboratories, Inc.

660 Watts, 250 Volts



No. KL

To connect convenience outlet to medium base screw shell. Packed 10 in a carton. 50 in a standard package. Package weight, 8 pounds.

No. KL Per 100
\$66.50

P & S Porcelain Lampholder Adapters

Listed by Underwriters' Laboratories, Inc.

Packed 10 in a carton. 100 in a standard package. Package weight, 18 pounds.



No. 292

No. 292 Per 100
\$66.00

Bryant Socket Adapters

Listed by Underwriters' Laboratories, Inc.



No. 392

No.	Description	Carton	Std. Pkg.	Wt., Lbs. Std. Pkg.	Per 100
421	Mogul to Medium 660 Watts, 250 V.	10	100	17	\$66.00
392	Medium to Candelabra 75 Watts, 125 V....	25	100	7	43.00

Morse Socket Extensions

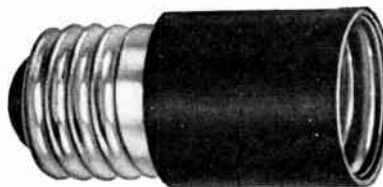

Style 100

Mogul socket extension. 2 1/2-inch lamp extension. Other lengths made to order. Paper, Fibre or Bakelite sleeve. Specify lamp extension length or overall length. Standard package, 100.



Socket Extension

Miniature, Candelabra, Intermediate, Standard, or Foreign. Paper, Fibre or Bakelite sleeve. Any length made to order.

Prices on application.

Morse Lamp Socket Adapters



From Candelabra bayonet to standard medium screw.
Standard package, 100.
No. 65 Double Contact Base
No. 66 Single Contact Base

No. 66

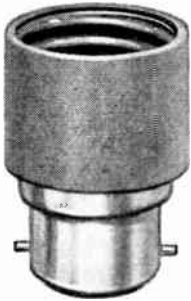

From foreign or medium double contact bayonet to standard screw base.
Standard package, 100.
No. 69 Double Contact Base
No. 69-A Single Contact Base

No. 69



From standard screw base to double contact foreign or medium bayonet base.
Standard package, 100.
No. 83 Double Contact Socket
No. 83-A Single Contact Socket

No. 83

Prices on application.



No. 67

From standard screw base to Candelabra Bayonet.
Standard package, 100.

No. 67 Double Contact Socket
No. 68 Single Contact Socket

Prices on application.



No. 681

Photo-Flash

From standard screw base to single contact bayonet socket.

No. 68 for replacing No. 7 and 11 photo-flash bulbs.
No. 681 for replacing No. 21 photo-flash bulb.

Prices on application.



Style 81

From standard medium base to mogul screw socket. Paper, Fibre or Bakelite sleeve.

Standard package, 100.

Prices on application.

Benjamin Swivel Attachment Plugs

Standard Bushing



Has a knurled edge, stamped, insulating ring for turning the swivel, a threaded shell and a porcelain base to which the wiring connections are made. Plug has a bakelite bushing with a 1 3/8-in. opening to accommodate cords commonly used with electrical appliances. Rated 660 W.—250 V.

No. 903.....Each \$0.69

Mechanic's Heavy-Duty Plug



For attachment to any medium screw base lampholder. Base has a bakelite swiveling shell and is designed for use in railroad shops and yards, industrial plants, garages, and machine shops. Chuck type brass bushing (self-adjusting) grips standard portable cords from 2 7/8-in. to 3 1/8-in. outside diameter. Rated 660 W.—250 V.

No. 916.....Each \$1.67

Bryant One-Piece Attachment Plugs

Listed as standard by Underwriters' Laboratories, Inc.

**Molded Composition—Weatherproof
660 Watts, 600 Volts**



Weatherproof one-piece with wires molded in. Equipped with 4 1/2-inch No. 14 stranded rubber covered wire leads. Packed 10 in a carton. 250 in a standard package. Package weight, 45 pounds.

No. 345

Per 100
\$123.00

Union's Weatherproof Attachment Plugs

Schedule A

660 Watts—600 Volts



Molded of impact resistant phenolic material. Copper screw shell. 6-inch No. 14 stranded RW-RH code wire leads.

Also available with left hand screw threads No. 1159-8.

No.	Std. Pkg.	Std. Pkg. Wt., Lbs.	Price Per 100
1159	100	12	\$58.00
1159-8	100	12	63.50

Daniel Woodhead Safeway Weatherproof Neotex Plugs



Plug body made of a high quality oil and heat-resisting Neotex compound, molded into a nickel-plated screw base with No. 14 stranded, all-rubber. 6-inch leads vulcanized to form a one-piece, waterproof and non-breakable attachment plug.

For leads longer than 6-inches add to the list price for each additional lineal foot, \$1.10.

No.	Car- ton	Std. Pkg.	Wt., Lbs. Std. Pkg.	Each
1409	10	100	20	\$1.70

Morse Candelabra Bayonet Sockets



No. 4005

Combination mechanical and soldering connection. Terminal type. Hard rubber or Bakelite inserts. Standard package, 100.

No. 4005D.C.—
Double Contact

No. 4005S.C.—
Single Contact



No. 32

Single Contact—Bracket Mounting. Used where desirable to burn both filaments of double filament lamp at one time for greater candle power. Bakelite or fibre washers. Especially designed for projection service. Standard package, 100.

No. 32—Single contact.
Prices on application.

Morse Miniature Bayonet Sockets



No. 5000

Single contact. Brass, nickel plated. 10-inch pigtail lead wires. Bone fibre washer.

Standard package, 100.

No. 5000—Single contact.



No. 5010

Single contact. Brass, nickel plated. 10-inch pigtail lead wire. Bone fibre washer. Has two brass hexagon nuts. For use on 1/4-inch maximum thickness panel.

Standard package, 100.

No. 5010—Single contact.

Prices on application.

Morse Candelabra Bayonet Sockets



No. 31

Candelabra Prefocus Regular Style

Designed for sleeve, clamp, or fixture mounting.

Standard Package 100.

No.	Description
31	Single contact with one 8-in. lead wire.
31-A	Double contact with two 8-in. lead wires.
31-BH	Single contact with one binding head screw.
31-A-BH	Double contact with two binding head screw connections.

Candelabra Prefocus

With Mounting Flange

Designed for panel mounting by top mounting flange. Standard Package 100.



No. 31-MF

No.	Description
31-MF	Single contact with one 8-in. lead wire.
31-A-MF	Double contact socket with two 8-in. lead wires.
31-MF-BH	Single contact with one binding head screw connection.
31-A-MF-BH	Double contact with two binding headscrew connections.

Double End Socket

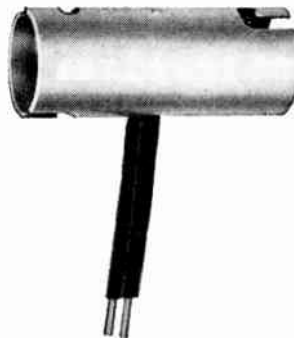

No. 4006 D.C.

Machine tool socket designed to illuminate grinding wheels. Hard rubber insert. Nickel plated brass shell. Built-in lead wires to desired length.

Standard Package 100.

No.	Description
4006 D.C.	Double Contact
4006 S.C.	Single Contact

Round Flange



No. 12 D.C.

Flange on either bottom or top of shell; located on bottom unless otherwise specified. Hard rubber inserts. Bakelite inserts also available. Brass shell and flange, nickel plated.

Standard Package 100.

No.	Description
12 D.C.	Double Contact
15 S.C.	Single Contact

Prices on application.

Morse Candelabra Bayonet Sockets



No. 20

Bakelite base. Surface mounting. Base diameter $1\frac{3}{8}$ -inches. Overall height $1\frac{1}{16}$ -inch. Plunger inserts, brass shell and screws, nickel plated.

No.	Description	Std. Pkg.
20	Double Contact	100
21	Single Contact	100



No. 21A

Single contact only.

Bakelite base. Plunger inserts. Brass shell, nickel plated. With focusing slots. Designed for Film Viewers or Projectors.

No.	Base Diam. In.	Overall Ht.	Std. Pkg.
21A	$1\frac{3}{8}$	$1\frac{3}{16}$	100
21B	$1\frac{3}{8}$	$1\frac{3}{64}$	100

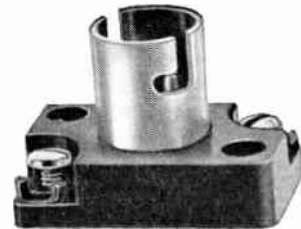

No. 30

Bakelite base. High voltage test. Base $1\frac{5}{8}$ x $1\frac{1}{16}$ inches. Overall height $1\frac{1}{8}$ inches. Plunger inserts, brass shell and screws, nickel plated.

No.	Description	Std. Pkg.
30 D.C.	Double Contact	100
30 A.S.C.	Single Contact	100



No. 4010

Panel Mounting Receptacle

Hard rubber or Bakelite inserts. Furnished with two hexagonal lock nuts. Designed for electric eye operations. Overall length to suit requirements. Indexing "J" slots available on request.

Brass inserts and set screws. Springs, steel or phosphor bronze. Binding screw or soldered wiring connections. Specify type desired.

No.	Description	Std. Pkg.
4010 D.C.	Double Contact	100
4010 S.C.	Single Contact	100

Pig Tail Candelabra Bayonet Socket



No. 4012

Hard rubber or Bakelite insert. Brass shell. Built-in lead wires to desired length.

No.	Description	Std. Pkg.
4012 D.C.	Double Contact	100
4012 S.C.	Single Contact	100

Prices on application.



No. 23

Flange on either bottom or top of shell. Specify type desired. Hard rubber inserts. Bakelite inserts also available. Metal parts nickel plated.

No.	Description	Std. Pkg.
*23	Double Contact	100
*24	Single Contact	100



No. 10

Hard rubber inserts. Bakelite inserts also available. Nickel plated.

No.	Description	Std. Pkg.
*10	Double Contact	100
*11	Single Contact	100



No. 9

Round or oval flange. Specify type desired. Hard rubber inserts. Bakelite inserts also available. Nickel plated.

No.	Description	Std. Pkg.
*9	Double Contact	100
*8	Single Contact	100



No. 71

Metal cap tapped $\frac{1}{8}$ -inch I. P. S. Overall length $1\frac{7}{8}$ -inches. Hard rubber insert. Bakelite insert also available. Nickel plated.

No.	Description	Std. Pkg.
71	Double Contact	100
71A	Single Contact	100



No. 10C

End wiring with cap. Hard rubber inserts. Bakelite inserts also available. Nickel plated metal parts. Bakelite acorn-shaped cap, or straight side cap.

No.	Description	Std. Pkg.
10C	Double Contact	100
11C	Single Contact	100

*Plunger inserts and set screws are all brass. Springs, steel or phosphor bronze. Binding screw or soldered wiring connections. Specify type desired.

Prices on application.

Bryant Surface Wiring Devices

Listed by Underwriters' Laboratories, Inc.

Easy installation. No boxes, connectors, soldering or tape necessary. Brown Plastic. Knockouts take No. 12 or No. 14 standard non-metallic sheathed cable. Knockouts in side for knob or tube wiring. Bus bar for third wire or feed through connections. Can be mounted on 2 x 4 studs.



No. 4661

Switches "T" Rating

10 Amps., 125 Volts; 5 Amps., 250 Volts

Length 1 1/2-inches. Width 2 1/4-inches. Height 1 1/16-inches.

Single Pole

No.	Carton	Std. Pkg.	Wt. Lbs. Std. Pkg.	Per 100
4661	10	50	27	\$105.00

Three-Way

4663	10	50	28	\$118.00
------	----	----	----	----------

Lampholders

Length 4-inches. Width 2 1/4-inches. Height 2 1/4-inches.

Keyless Type

660 Watts, 250 Volts

4666	10	50	23	\$92.00
------	----	----	----	---------

Pull Switch Type

250 Watts 250 Volts

4667	10	50	24	\$114.00
------	----	----	----	----------

Rosette

660 Watts 250 Volts

Length 4-inches. Width 2 1/4-inches. Height 1 1/2-inches.

4668	10	50	18	\$86.00
------	----	----	----	---------

Junction Box

15 Amps., 125 Volts; 10 Amps., 250 Volts

Length 4-inches. Width 2 1/4-inches. Height 1 1/2-inches.

4669	10	50	19	\$86.00
------	----	----	----	---------

Duplex Convenience Outlet Double Sided Contacts

2 Wire

15 Amps., 125 Volts

Length 4-inches. Width 2 1/4-inches. Height 1 1/16-inches.

4670	10	50	21	\$75.00
------	----	----	----	---------

3-Wire Grounding Type

15 Amperes, 125 Volts

Has two current carrying contacts and one grounding contact built into the device. Ground terminals identified by green hexagonal binding screws. Length 4 inches, width 2 1/4 inches, height 1 3/32 inches.

4672	10	50	22	\$160.00
------	----	----	----	----------



No. 4666



No. 4667



No. 4668



No. 4670

P & S All-Plastic Devices

Listed by Underwriters' Laboratories, Inc.

For Surface Wiring

All current carrying parts mounted on Arc-Resisting Urea Bases. Switches are "T" rated.

Designed for general purpose surface wiring with non-metallic sheathed cable in all locations where there is no excessive moisture or dust.

Easy to wire—no boxes, no soldering, no taping. Mount the device, run the wire, connect to terminals. These devices all have bus bars for third wire or feed-thru connections. Devices can be mounted on 2 x 4 studs.

Meet REA and Federal specifications.



No. 8661



No. 8666



No. 8667



No. 8668



No. 8669



No. 8670

Packed 10 in a carton. 50 in a standard package.

10 Amps. "T", 125 Volts; 5 Amps., 250 Volts

No.	Description	Wt. Lbs. Std. Pkg.	Per 100
8661	Single pole feed-thru switch.....	28	\$105.00
8661-MIO	Single Pole, Momentary Contact.	6	224.00
8663	Three-way feed-thru switch.....	27	118.00

660 Watts, 250 Volts

8666	Keyless lampholder.....	22	\$92.00
8668	Rosette.....	18	86.00

250 Watts, 250 Volts

8667	Pull lampholder.....	23	\$114.00
------	----------------------	----	----------

15 Amps., 125 Volts

8670	Duplex Convenience Outlet.....	20	\$75.00
8672	Three Wire Grounding Duplex Outlet.....	22	160.00
8669	Junction Box.....	20	86.00

P & S Despard Interchangeable Devices

Switch, pilot light and convenience outlet, or any three devices, may be assembled—right on the job—into one gang combinations in an inexpensive one-gang wall plate.

Specification Type Switches

Conform to N.E.C. Standards
All Plastic—Totally Enclosed
"T" Rated



No. 1311



No. 1413

Brown

No.	Description	Amperes		Carton	Std. Pkg.	Wt. Lbs. Std. Pkg.	Per 100
		125 V.	250 V.				
1311	S-Pole	10T	5	10	100	10	\$ 67.00
1312	D-Pole	10T	10	2	10	2	126.50
1313	3-Way	10T	5	10	50	6	92.50
1314	4-Way	5T	2	2	10	2	273.00

Ivory

1411	S-Pole	10T	5	10	100	10	\$ 71.50
1412	D-Pole	10T	10	2	10	2	132.00
1413	3-Way	10T	5	10	50	6	97.00
1414	4-Way	5T	2	2	10	2	277.00

Lock Type



No. 1311-L

Single Pole and Three-Way Switches have polished metal tops. Double Pole and Four-Way Switches have bakelite tops. One key furnished with each Lock Switch.

No.	Description	Amperes		Carton	Std. Pkg.	Wt. Lbs. Std. Pkg.	Per 100
		125 V.	250 V.				
1311-L	S-Pole	10T	5	10	100	12	\$163.00
1312-L	D-Pole	10T	10	2	10	2	268.50
1313-L	3-Way	10T	5	10	50	6	207.00
1314-L	4-Way	5T	2	2	10	2	550.00

1498	Key for 1311-L and 1313-L	1	1	..	22.00
1499	Key for 1312-L and 1314-L	1	1	..	22.00

Luminous handles available at extra cost on all switches in this group. Suffix LT to catalog number.

Residential Type

Conform to N.E.C. Standards

Plastic—Totally Enclosed
10 Amps., 125 Volts; 5 Amps., 250 Volts



No. 1491

Brown

No.	Type	Carton	Std. Pkg.	Wt. Lbs. Std. Pkg.	Per 100
1391	S-Pole	10	100	9	\$44.00
1393	3-Way	10	50	5	57.00

Ivory

1491	S-Pole	10	100	9	\$48.50
1493	3-Way	10	50	5	61.50

Note—When installing P&S-Despard switches it is necessary to use mounting straps. See illustrations and listings on page 675. The correct style of mounting strap is furnished, without charge, packed with each P&S-Despard plate.

Single Convenience Outlets

Conform to N.E.C. Standards



No. 1320



No. 1341



No. 1327

For assembly in combination with switches, pilot lights or other P&S-Despard devices—double, wide contacts grip both sides of the plug cap fingers—spring at bottom far removed from arcing point.

15 Amperes, 125 Volts

No.	Description	Carton	Brown		Per 100
			Std. Pkg.	Wt. Lbs. Std. Pkg.	
1320	Single Outlet	10	100	5	\$23.00
1341	Pilot Light Outlet	10	30	3	44.00
1327	Insulating Adapter	10	50	1/2	17.50

Ivory

1420	Single Outlet	10	100	5	\$33.00
1441	Pilot Light Outlet	10	30	3	50.50
1427	Insulating Adapter	10	50	1/2	24.00

Pilot Lights and Night Lights

Conform to N.E.C. Standards



No. 1340

With Metal Hoods and Reflectors. Each night light and pilot light is furnished complete with S-6, 6 Watt, 120 Volt lamp and metal reflector or hood.

Packed 10 in a carton. 30 in a standard package. Package weight, 3 pounds.



No. 1339

**Rating—75 Watts, 125 Volts
Night Lights With Clear Lamps**

No.	Description	Per 100
1339	With Chromium Plated Reflector	\$131.00

Pilot Lights With Red Lamps

1340	With Chromium Plated Hood	\$131.00
------	---------------------------	----------

When above Night Lights and Pilot Lights are desired without lamps specify regular catalog number with suffix "LL." When Pilot Lights are desired with Clear Lamps, specify regular catalog number with suffix "CL."

Flush Neon Pilot Lights

Listed by Underwriters' Laboratories, Inc.



No. 1375

1/25 Watt, 125 Volts

Cold—gives off no heat. Has unbreakable, prismatic, red Plexi-glass dome.

Ideal for all types of pilot light applications.

No.	Description	Carton	Std. Pkg.	Wt. Lbs. Std. Pkg.	Per 100
1375	Brown	10	30	3	\$102.50
1475	Ivory	10	30	3	108.00

Also available with 220-volt rating. Specify "1375-220" or "1475-220."

P & S Despard Interchangeable Devices

Conform to N.E.C. Standards

Flush Pilot Lights

Rating, 75 Watts, 125 Volts

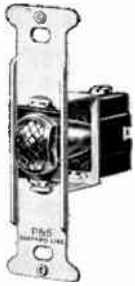

No. 1376

Furnished complete with S-6, 6-watt, 120-volt, clear Mazda lamp and red glass jewel.

Packed 10 in a carton. 30 in a standard package. Package weight, 6 pounds.



No. 1377

No.	Description	Per 100
1376	Single Pilot Light for use in Single Vertical Opening Plate	\$141.00
1377	Combination Pilot Light for use with Switch or Outlet	141.00

Note—Cat. Nos. 1376 and 1377 are furnished complete with necessary mounting straps. When desired without lamps, specify regular catalog number with suffix "LL."

Mounting Straps



No. 1347
Single Opening Strap



No. 1348
Three Opening Strap



No. 1354
Appliance Strap

No.	Description	Carton	Std. Pkg.	Wt. Lbs. Std. Pkg.	Per 100
1347	Single Opening	10	50	3	\$13.00
1348	Three Openings (camstrap)	10	50	3	13.00
1354	Appliance Strap	10	100	2	5.00

Metal Box Covers

For P & S Despard Devices



No. 1361



No. 1363

For mounting one P & S Despard device directly on a 3 1/4-inch outlet box, or one or two P & S Despard devices on a 4-inch outlet box. Especially adapted for surface or exposed work. Bright metallic finish. Furnished complete with the necessary straps for installing devices.

No.	Description	Std. Pkg.	Wt. Lbs. Std. Pkg.	Per 100
1361	Single Opening for 3 1/4-In. Box	100	20	\$26.50
1362	Single Opening for 4-In. Box	100	32	31.00
1363	Double Opening for 4-In. Box	50	16	35.00

Radio Outlets, Caps, and Box Divider



No. 1322



No. 1323



No. 1346

Outlet for antenna and ground connections. Cap blades are set at an angle to prevent plugging in power outlets. Install No. 1346 box divider to keep antenna and ground wires separate from any power circuit in same box. Packed 2 in a carton. 10 in a standard package. Package weight, 1 pound. No. 1346 packed 5 in a carton. 10 in a standard package. Package weight, 3 pounds.

No.	Description	Per 100
1322	Brown Radio Outlet	\$64.00
1323	Brown Radio Cap, 9/32-inch cord hole	28.50
1422	Ivory Radio Outlet	68.00
1423	Ivory Radio Cap, 9/32-inch cord hole	33.00
1346	Box divider for 1 1/2", 2", or 2 1/2-inch switch boxes	39.50

Duplex and Triplex Convenience Outlets



No. 13202



No. 13202Y



No. 13203

15 Amps., 125 Volts

One-piece bakelite bodies, four binding screws for feed-thru circuits, and have the same constant tension contacts as single convenience outlets.

Brown

No.	Description	Std. Pkg.	Car- ton	Per 100
13202	Duplex	100	10	\$42.00
13202-Y	Duplex, 2 circuit	100	10	48.50
13203	Triplex	100	10	42.00
13203-Y	Triplex, 2 circuit	100	10	48.50

Ivory

14202	Duplex	100	10	\$46.00
14202-Y	Duplex, 2 circuit	100	10	53.00
14203	Triplex	100	10	46.00
14203-Y	Triplex, 2 circuit	100	10	53.00

Attachment Plug Caps

Plastic

Parallel blades; 9/32-inch cord hole.



No.	Description	Std. Pkg.	Wt. Lbs. Std. Pkg.	Per 100
1321	Brown	100	5	\$22.00
1421	Ivory	100	5	26.50
1326	Polarized, Brown	100	5	24.00
1426	Polarized, Ivory	100	5	28.50

Note. The use of P & S Despard Convenience Outlets with non-insulated metal plates is not recommended unless the plates are equipped with bakelite insulating adapters.

P & S Despard Accessories

Conform to N.E.C. Standards

**Reflectors, Hoods, Jewels, and Lamps
For Night Lights and Pilot Lights**



No. 1342



No. 1343



No. 1352



No. S-6

No.	Description	Carton	Std. Pkg.	Wt. Lbs. Std. Pkg.	Per 100
1342	Red Plastic Jewel for Nos. 1376 and 1377	10	30	1	\$53 00
1343	Chromium Plated Hood for No. 1310	10	30	2	31 00
1352	Chromium Plated Reflector for No. 1339	10	30	2	31 00
†S-6	Clear Lamp	10	120	5	55 50
†S-6	Red Lamp	10	120	5	66 50

†For use in pilot light receptacles and night lights. Lamps are rated 6 watts, 120 volts.

§No. 1342 can be furnished on special order in Amber, Green, Opal, Blue and Clear—Specify regular catalog number with suffix A, G, O, B or C, respectively.

Name Plates



No. 1330

For use with all P & S Despard plate openings. Consists of a rust-proof frame, transparent window and white card. Packed 10 in a carton. 30 in a standard package.

No.	Description	Per 100
1330	With Stainless Steel Frame	\$24.00



No. 1344

Bell Push and Blank Inserts

Plastic



No. 1345

Bell Push for 6 to 12 volt circuits can be assembled in same strap with P & S-Despard switch, outlet or night light.

Blank Insert may be used to fill unused openings in plates—is made with knock-out which can be punched through for use as cord hole or telephone outlet.

No.	Description	Carton	Std. Pkg.	Wt. Lbs. Std. Pkg.	Per 100
1344	Bell Push, Brown	10	20	1	\$35.00
1444	Bell Push, Ivory	10	20	1	42.00
1345	Blank Insert, Brown	5	10	1	15.50
1445	Blank Insert, Ivory	5	10	1	24.00

When installing the above devices, it is necessary to use mounting straps.

New Process Metal Plates for P & S Despard Devices

Conform to N.E.C. Standards

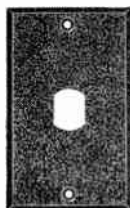

No. 98041

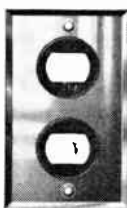

No. 97141

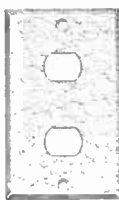

No. 99021

Brown-X and Ivory-X plates have a multiple coat of baked-on, insulating enamel. Closely resembling bakelite, they will not warp or crack, and are very satisfactory for painting.

Chrome-X plates are made of .010-inch stainless steel. Their soft, semi-polished, silverlike finish will last indefinitely.

Plates are supplied complete with the necessary straps for mounting P & S-Despard devices. When P & S-Despard outlets are used with non-insulated metal plates, we recommend the use of insulating adapters.

**Brown-X
Single-Gang**

No.	Description	Carton	Std. Pkg.	Wt. Lbs. Std. Pkg.	Per 100
98011	One Opening, Horizontal	10	100	20	\$19 50
98021	Two Openings	10	50	9	19 50
98031	Three Openings	10	30	5	19 50
98041	One Opening, Vertical	10	100	18	19 50

Two-Gang

98012	Two Openings, Horizontal	2	10	3	38 50
98022	Four Openings	2	10	3	46 00
98032	Six Openings	2	10	3	46 00
98042	Two Openings, Vertical	2	10	3	38 50

Three-Gang

98013	Three Openings, Horizontal	2	10	5	59 50
98023	Six Openings	2	10	5	64 00
98033	Nine Openings	2	10	4	64 00
98043	Three Openings, Vertical	2	10	5	59 50

**Ivory-X
Single-Gang**

No.	Description	Carton	Std. Pkg.	Wt. Lbs. Std. Pkg.	Per 100
99011	One Opening, Horizontal	10	100	20	\$23 00
99021	Two Openings	10	50	9	23 00
99031	Three Openings	10	30	5	23 00
99041	One Opening, Vertical	10	100	18	23 00

Two-Gang

99012	Two Openings, Horizontal	2	10	3	46 00
99022	Four Openings	2	10	3	57 00
99032	Six Openings	2	10	3	57 00
99042	Two Openings, Vertical	2	10	3	46 00

Three-Gang

99013	Three Openings, Horizontal	2	10	5	66 00
99023	Six Openings	2	10	5	81 50
99033	Nine Openings	2	10	4	81 50
99043	Three Openings, Vertical	2	10	5	66 00

**Chrome-X—(.040-Inch Stainless Steel)
Single-Gang**

97011	One Opening, Horizontal	10	100	20	44 00
97021	Two Openings	10	50	9	44 00
97031	Three Openings	10	30	7	44 00
97041	One Opening, Vertical	10	100	20	44 00

*97131	Two Openings, One Insulating Adapter	2	10	3	48 50
*97141	Two Openings, Two Insulating Adapters	2	10	3	60 50

Two-Gang

97012	Two Openings, Horizontal	2	10	4	97 00
97022	Four Openings	2	10	4	123 00
97032	Six Openings	2	10	3	128 50
97042	Two Openings, Vertical	2	10	4	97 00

Three-Gang

97013	Three Openings, Horizontal	2	10	5	141 00
97023	Six Openings	2	10	5	168 50
97033	Nine Openings	2	10	4	168 50
97043	Three Openings, Vertical	2	10	5	141 00

*Regularly supplied with brown bakelite insulating adapters. For ivory adapters, specify regular number with suffix I.

Bryant Multi-Control Wiring System

**Switches With Wire Leads
3 Amperes, 25 Volts**

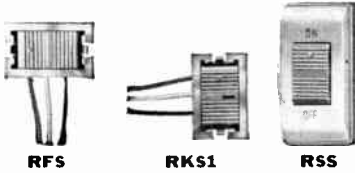

Neat, modern and compact.
Normally open S.P.D.T. Momentary Contact.

No.	Description	Ctn. Qty.	Std. Pkg.	Wt., Lbs. Std. Pkg.	Per 100
RFS	Flush Mounted	10	100	5	\$49.50
RKS-1	Flush Mounted, Lock Type (2 keys furnished)	10	40	2	240.00

Buff Plastic ON-OFF Button

Ivory Plastic Cover

RSS	Surface Mounted	10	40	4	72.50
-----	-----------------	----	----	---	-------

Master Selector Switches



For selective control of up to nine circuits. Ivory plastic plate with buff controls.

For single gang mounting.

No.	Ctn. Qty.	Std. Pkg.	Wt., Lbs. Std. Pkg.	Per 100
RMS	1	5	2	\$704.00

Motor Driven Master Switch



For non-selective control of up to 25 circuits. 1 in Std. Pkg.

No.	Wt., Lbs. Std. Pkg.	Per Each
RCS	14	\$55.00

**Multi-Control Relays
1 Hp. 20 Amp. 125 Volts A-C
20 Amp. 277 Volts A-C**

Two Coil Solenoid Type
Wire Leads
Silver Switch Contacts

Mounts in 1/2 in. knockout.



No.	Ctn. Qty.	Std. Pkg.	Wt., Lbs. Std. Pkg.	Per 100
RR	5	50	12	\$363.00

**Transformers
Energy Limiting Type**



Requires no fusing on load side.

Mounted on Universal box cover for 3 1/4 in. or 4 in. outlet boxes.

**35 Volt Ampere 125 Volts 60 Cycle
24 Volts—Open Circuit**

No.	Description	Ctn. Qty.	Std. Pkg.	Wt., Lbs. Std. Pkg.	Per 100
RT	Transformer	1	5	23	\$1,200.00

**35 Volt Amperes 277 Volts
60 Cycle 30 Volts**

RT277	For use with 480/277 volt network system	1	5	25	1,200.00
-------	--	---	---	----	----------

Plates

For Nos. RFS and RKS Switches



RP1

RP2

RP3

Complete with No. RS mounting strap.

Ivory Plastic

No.	Description	Ctn. Qty.	Std. Pkg.	Wt., Lbs. Std. Pkg.	Per 100
RP1	1 gang for 1 switch	10	20	3	\$30.50
RP2	1 gang for 2 switches	10	20	3	30.50
RP3	1 gang for 3 switches	10	20	3	30.50
RP24	2 gang for 4 switches	1	10	3	60.50

Stainless Steel Satin Finish

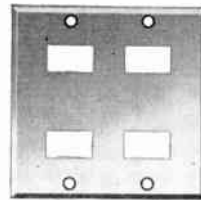

RP022

Standard beveled type. Especially recommended for commercial installations such as schools, hospitals, etc.

.010-in. brass plates also available. Other combinations of openings on inquiry.

No.	Description	Ctn. Qty.	Std. Pkg.	Wt., Lbs. Std. Pkg.	Per 100
RP011	1 gang for 1 switch	2	10	2	\$66.00
RP021	1 gang for 2 switches	2	10	2	66.00
RP031	1 gang for 3 switches	2	10	2	66.00
RP022	2 gang for 1 switches	2	10	3	132.00
RP032	2 gang for 6 switches	2	10	3	132.00
RP033	3 gang for 9 switches	2	10	3	198.00

Ivory Plastic Plates

To Match Multi-Control System Ivory Plates

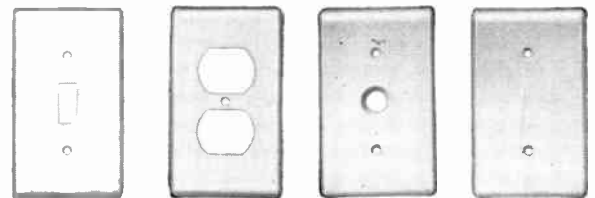

RP071

RP101

RP181

RP121

For Standard Tumbler Switches

No.	Description	Ctn. Qty.	Std. Pkg.	Wt., Lbs. Std. Pkg.	Per 100
RP071	1 gang	10	20	2	\$18.50

For Duplex Convenience Outlet

RP101	1 gang	10	20	2	18.50
-------	--------	----	----	---	-------

For Telephone Outlet

RP181	1 gang	10	20	3	29.00
-------	--------	----	----	---	-------

Blank Plates

RP121	1 gang	10	20	3	29.00
-------	--------	----	----	---	-------

Bryant Multi-Control Wiring System

Wire N.E.C. Article 725 Class 2 Circuits Parallel Multi-Control Wire For Indoor Use—#20-10 Ivory



Flat construction ideal for surface work. Improved stranding and insulation prevents damage when pulled over beams or around sharp corners.

No.	Description	Per 1000 Ft.
BRR2	2 Conductor, black and red, for master switch runs. Wt. 12 lbs.	\$24.00
RBW2	2 Conductor, black and white, for transformer runs. Wt. 13 lbs.	24.00
RBWR3	3 Conductor, black and white and red, for individual switch and relay connection. Wt. 19 lbs.	34.00

Note: Standard package, two 500-ft. spools.

19 Conductor Cable #20-10 Red



RMC19: For low voltage connections between No. RMS Master switch and relay gang box. Consists of 9 pairs of color coded conductors and 1 solid white conductor for the 24 volt transformer circuit. Std. Pkg. one 500 ft. coils. Wt. 65 lbs.

List price..... Per M Ft. **\$330.00**

RRW3: For outdoor use. Three conductor parallel plastic wire. Std. Pkg. one 500 ft. coil. Wt. 22 lbs.

List..... Per M Ft. **\$72.50**

Triple Outlets Integral With Plates



No. RO1

15 Amperes, 125 Volts

Modern distinctive design. Double sided contacts.

Ivory plastic.

Std. Pkg. No. RO1, 100; No. RO2, 50. Carton 10.

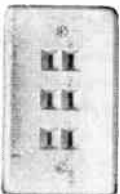

No. RO2

No.	Description	List Per 100
RO1	One feed, one return.....	\$63.50
RO2	Two feeds, one return.....	69.50



No. RPL

Low Voltage Pilot Light 6 Watts, 12 Volts

For use with remotely controlled circuits to indicate circuit "on."

No.	Description	List Per 100
RPL	Mounts on Nos. RPI or RP2 plastic plates. No jewel required. Light shines through plastic plate. Operates from standard 8-10 volt bell-ringing transformer.....	\$165.00

Std. Pkg. 20, Carton 10, Wt. 31 lbs.

Accessories Gang Boxes for Mounting No. RR Relays



No. RGS12

Surface Type With Hinged Covers

No.	Description	Wt. Lbs.	List Per 100
RGS6	6 Gang	6	\$880.00
RGS12	12 Gang	8	1100.00
RGS18	18 Gang	14	1320.00

Std. Pkg. 1.



No. RGB12 Box

Flush Type

No.	Description	Wt. Lbs.	List Per 100
RGB6	6 Gang	6	\$880.00
RGB12	12 Gang	8	1100.00
RGB18	18 Gang	11	1320.00

Std. Pkg. 1.

RGB12 Cover

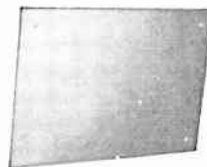

No. RGB12 Cover

Box Dimension

Gang	Lgth., in.	Width, in.	Depth, in.
6	7 $\frac{3}{4}$	7	3 $\frac{1}{4}$
12	13	7 $\frac{3}{4}$	3 $\frac{1}{4}$
18	19	7 $\frac{3}{4}$	3 $\frac{1}{4}$

Switch Support

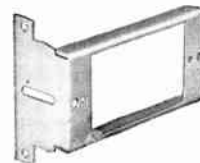

For multi-control flush and Master selector switches. Accommodates up to 3 Multi-control switches or one master selector switch. Std. Pkg. 20, Wt. 5 lbs.

No.	Description	List Per 100
RSB	Mounts to side of stud. Contoured side plate shows settings for $\frac{3}{8}$ in., $\frac{5}{8}$ in. or 1 in. wall thickness.....	\$22.00

Grommet



No.	Description	List Per 100
RG	Rubber grommet for adapting relays to $\frac{3}{4}$ in. knockouts. Cushions vibration of relay.....	\$9.00

Std. Pkg. 100, Wt. 2 lbs.



No. RS

Mounting Strap

No.	Description	List Per 100
RS	Mounting strap 3 openings.....	\$14.50

Std. Pkg. 20, Carton 10, Wt. 1 lb.

Bryant Pilot Light Devices

Listed as standard by Underwriters' Laboratories, Inc.

**Pilot Light Receptacles
75 Watts, 125 Volts**

For All Jeweled or Louvre Plates

With 125 volt lamp.
Plastic base cups.



No. 427

No.	Description	Carton	Std. Pkg.	Wt. Lbs. Std. Pkg.	Per 100
427	With Lamp	10	30	6	\$177.00

Available Less Lamp, \$130.00 per 100.

For Round Jeweled Plates

Equipped with 125 volt lamp.



No. 3851

No.	Description	Carton	Std. Pkg.	Wt. Lbs. Std. Pkg.	Per 100
3851	With Lamp	10	30	9	\$172.50

Available Less Lamp, \$132.50 per 100.

**Pilot Lamp
6 Watts, 125 Volts**

Candelabra base.

618	Lamp Only	10	30		\$55.50
-----	-----------	----	----	--	---------

Plastic Jewels

Available in red, or green.

Round Type

With solid brass rim removable from front of plate for lamp replacement.
For standard single outlet plate.



No. 3850

No.	Carton	Std. Pkg.	Wt. Lbs. Std. Pkg.	Per 100
3850	10	30	1	\$65.00

Rectangular Type

With brass rim for permanent mounting.
For standard switch plate.



No. 746

No.	Carton	Std. Pkg.	Per 100
746	10	30	\$57.00

Brass Louvre Plate

For pilot light or buzzer installations.
Plate is .010-inch brass. Brush brass finish.



No. 94631

No.	Carton	Std. Pkg.	Wt. Lbs. Std. Pkg.	Per 100
94631	5	30	6	\$208.00

**Mounting Yoke
With Plastic Insert**

To fill opening in tumbler switch plate.
Brown Plastic insert on metal yoke.



No. 756

No.	Carton	Std. Pkg.	Wt. Lbs. Std. Pkg.	Per 100
756	10	30	2	\$33.50

Hubbell Pilot Lamp Receptacles

Conform to N.E.C. Standards

Candelabra Base



No. 432



No. 427

Bakelite

No.	Description	Carton	Std. Pkg.	Wt. Lbs. Std. Pkg.	Per 100
432	With 125-Volt Lamp	10	30	6	\$177.00
433	Lamp Only, 125 Volts	10	30	2	\$55.50

Porcelain

427	With 125-Volt Lamp	10	30	12	\$172.50
433	Lamp for No. 427	10	30	2	\$55.50

Hubbell Outlets with Pilot Lights

Conform to N.E.C. Standards

15 Amperes, 125 Volts

Light goes on when plug is inserted. No. 433 lamp fits No. 7711. Jewel can be removed from front.



No. 7711

No.	Description	Carton	Std. Pkg.	Wt. Lbs. Std. Pkg.	Per 100
7711	With Plate	2	10	8	\$395.00
7728	With No. 7729 Bakelite Plate	2	10	7	\$395.00
736	Round Jewel Only	10	30	2	\$65.00

Hubbell Switches with Pilot Lights

Conform to N.E.C. Standards

**Single Pole and 3-Way, 10 Amperes, 125 Volts;
5 Amperes, 250 Volts**

Double Pole; 10 Amperes, 250 Volts



No. 7739



No. 7759

No.	Description	Carton	Std. Pkg.	Wt. Lbs. Std. Pkg.	Per 100
7739	Single Pole, with Brass Plate	2	10	8	\$572.00
7956	Double Pole, with Brass Plate	2	10	8	\$584.00
7953	3-Way, with Brass Plate. . . .	2	10	15	\$584.00

With Ornamental Bakelite Plate

7759	Single Pole.	2	10	7	\$572.00
7957	Double Pole.	2	10	12	\$584.00
7954	3-Way.	2	10	12	\$584.00

Hubbell Outlets and Switches

Conform to N.E.C. Standards

Switch Rating: 10 Amperes, 125 Volts "T"; 10 Amperes, 250 Volts

Receptacle Rating: 15 Amperes, 125 Volts; 10 Amperes, 250 Volts



Single Pole



Double Pole



No. 8885

Wiring Diagram Showing Variation of Control. Left view receptacle always on; switch controls lights only. Right view switch controls receptacle and light.

Switch and receptacle are a completely assembled unit.

Single Pole

No.	Description	Carton	Std. Pkg.	Wt. Lbs. Std. Pkg.	Per 100
8885	With .060" Brass Plate.....	2	10	7	\$398.00
8886	Without Plate.....	2	10	1	314.50
8891	With Bakelite Plate.....	2	10	5	385.00

Double Pole

8887	With .060" Brass Plate.....	2	10	7	427.00
8888	Without Plate.....	2	10	4	343.00
8892	With Bakelite Plate.....	2	10	5	430.00

Separate Plates

8894	.060" Brass Plate.....	2	10	1	83.50
8895	Sand Blast Bakelite Plate....	2	10	3	70.50

Bryant Switch and Outlet Combinations

Listed as standard by Underwriters' Laboratories, Inc.

All outlet ratings: 15 Amps., 125 Volts; 10 Amps., 250 Volts

Packed 2 in carton, 10 in standard package.

With Brass Plate

Switch: 10 Amps., 250 V.; 10 Amps., 125 V.



No. 2994

No.	Description	Wt. Lbs. Std. Pkg.	Per 100
2994	Double Pole	7	\$427.00
2994	Less Plate	7	343.00

With Brown Plastic Plate

Switch: 20 Amps., 250 V.; 20 Amps., 125 V.

2999	Double Pole	4	\$371.50
2999	Less Plate	4	323.50

Bryant Switch, Outlet and Pilot Light Combination

Listed as standard by Underwriters' Laboratories, Inc.

Double Pole Switch

Outlet: 15 A., 125 V

Switch: 20 A., 125 V.; 20 A., 250 V.

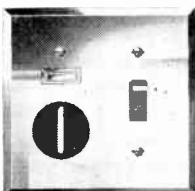

No. 55350

Equipped with 125 volt lamp. Pilot light indicates that switch controlled outlet is in use.

Plates are .040-inch polished chromium.

Packed 2 in Ctn., 10 in Std. Pkg.

No.	Description	Wt. Lbs. Std. Pkg.	Per 100
55350	Combination	13	\$787.50

Bryant Outlet and Pilot Light Combinations

Listed as standard by Underwriters' Laboratories, Inc.

Outlet: 15 A., 125 V.

Single gang. Porcelain cup. Equipped with 125 Volt lamp.

Packed 2 in a carton, 10 in a standard package. Standard package weight in pounds: No. 5121, 6 lbs.



No. 5121

No.	Description	Per 100
5121	With Brush Brass Plate	\$377.00
5121	Less Plate	263.50

P & S Weatherproof Devices

Conform to N.E.C. Standards

Designed for installations where protection against moisture and weather conditions is desirable, such as Industrial Plants, Dairies, Garages, Loading Platforms, Residences, etc. Each device is sealed with cover and plate gaskets and gives complete protection. Any one of these weatherproof devices may be installed in a single gang switch box or flat face FS fitting.

P & S Despard Combination Devices

Conform to N.E.C. Standards

For Single Gang Installation

**Outlet Rating—15 Amps., 125 Volts
Switch Rating—10 Amps., 125 Volts "T";
5 Amps., 250 Volts**

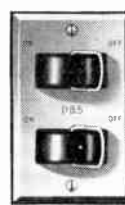

No. 4525

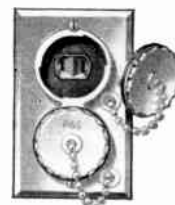

No. 4527



No. 4528



No. 4526

Nos. 4525 and 4526 are furnished with single pole switches. Switches may be easily interchanged with other P & S-Despard switches for double pole, three-way or four-way installations.

Switches are "T" rated for Type C lamp loads. Outlets have constant tension contacts. Plates are .040" brass with sprayed aluminum finish not affected by atmospheric conditions.

No.	Description	Carton	Std. Pkg.	Wt. Lbs. Std. Pkg.	Per 100
4525	2 S-P Switches.....	2	10	7	\$378.50
4526	S-P Switch and Outlet..	2	10	7	385.00
4527	Duplex Outlet.....	2	10	5	372.00
4528	Protective Cap for No. 4526.....	2	10	1	161.50



No. 4521

Weatherproof Switches

Switches are "T" rated for Type C lamp loads. Plates are .040" brass with sprayed aluminum finish, not affected by atmospheric conditions.

No.	Type	Amperes 125 V.	250 V.	Carton	Std. Pkg.	Wt. Lbs. Std. Pkg.	Per 100
4521	S-P	10T	5	2	10	6	\$259.50
4522	D-P	10T	10	2	10	6	325.50
4523	3-Way	10T	5	2	10	6	288.00
4524	4-Way	5T	2	2	5	3	623.50

Hubbell Flush Plates

**Brass Flush Plates
For Single Telephone Outlet**

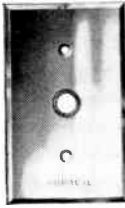

No. 94181

Furnished with adapter to $3\frac{3}{32}$ inches and screw spacings $2\frac{3}{8}$ " on centers.

All kinds of telephone plates may be assorted to make standard package or carton quantity.

**Struck-Up—.040-Inch Metal
Brush Brass Finish**

No.	Description	Dimensions Inches	Wt. Lbs. Std. Pkg.	Per 100
94181	Single	$4\frac{1}{2} \times 2\frac{3}{4}$	10	\$ 80.50
94182	2-Gang	$4\frac{1}{2} \times 4\frac{9}{16}$	7	168.50
94183	3-Gang	$4\frac{1}{2} \times 6\frac{3}{8}$	6	251.00

**Struck-Up—.060-Inch Metal
Brush Brass Finish**

No.	Description	Dimensions Inches	Wt. Lbs. Std. Pkg.	Per 100
96181	Single	$4\frac{1}{2} \times 2\frac{3}{4}$	14	\$103.50

Brass Flush Plates

For Single and Duplex Convenience Outlets



No. 94091, Single

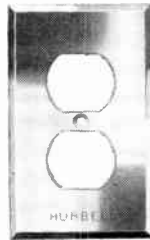

No. 94101, Duplex

Special finishes are available at extra cost.

**Struck-Up—.040-Inch Metal
Brush Brass Finish**

For Single Convenience Outlets			For Duplex Convenience Outlets			Description	Dimensions Inches
No.	Per 100	Wt. Lbs. Std. Pkg.	No.	Per 100	Wt. Lbs. Std. Pkg.		
94091	\$ 58.50	17	94101	\$ 58.50	16	Single	$4\frac{1}{2} \times 2\frac{3}{4}$
94092	165.00	13	94102	165.00	12	2-Gang	$4\frac{1}{2} \times 4\frac{9}{16}$
94093	264.00	12	94103	260.50	11	3-Gang	$4\frac{1}{2} \times 6\frac{3}{8}$

**Struck-Up—.060-Inch Metal
Brush Brass Finish**

For Single Convenience Outlets			For Duplex Convenience Outlets			Description	Dimensions Inches
No.	Per 100	Wt. Lbs. Std. Pkg.	No.	Per 100	Wt. Lbs. Std. Pkg.		
96091	\$ 80.50	24	96101	\$ 80.50	21	Single	$4\frac{1}{2} \times 2\frac{3}{4}$
96092	214.50	20	96102	214.50	18	2-Gang	$4\frac{1}{2} \times 4\frac{9}{16}$
96093	326.50	18	96103	326.50	15	3-Gang	$4\frac{1}{2} \times 6\frac{3}{8}$

**Brass Flush Plates
For Toggle and Push Switches**

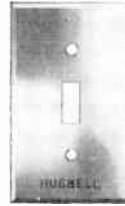

No. 94071—For Standard
Toggle Switches

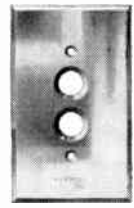

No. 94081—For Push
Switches

**Struck-Up—.040-Inch Metal
Brush Brass Finish**

For Toggle Switches		For Push Switches		Description	Wt. Lbs. Std. Pkg.
No.	Per 100	No.	Per 100		
94071	\$ 58.50	94081	\$ 60.50	Single	19
94072	116.50	94082	119.00	2-Gang	15
94073	175.00	94083	179.50	3-Gang	13
94074	233.00	4-Gang	15

**Struck-Up—.060-Inch Metal
Brush Brass Finish**

96071	\$ 80.50	96081	\$ 84.50	Single	26
96072	160.50	96082	169.50	2-Gang	22
96073	242.00	96083	255.00	3-Gang	18
96074	308.00	4-Gang	20

Brass Combination Plates

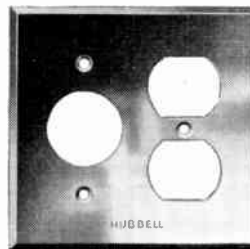

No. 94572

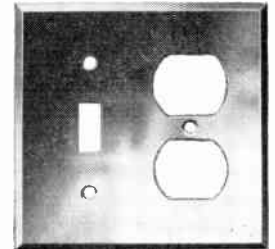

No. 94532

For Single and Duplex Convenience Outlets.

No.	Description	Car- ton	Std. Pkg.	Wt. Lbs. Std. Pkg.	Per 100
94572	.040-Inch Metal	2	10	3	\$157.50
96572	.060-Inch Metal	2	10	5	203.50

For Toggle Switch and Duplex Convenience Outlets.

94532	.040-Inch Metal	2	10	3	\$153.00
96532	.060-Inch Metal	2	10	5	198.00

Hubbell Combination Brass Plates

Hubbell Standard Combination Plates are made in .100-inch solid brass, also struck up .060 and .040-inch brass. Combination plates with sections for Interchangeable Line made in .060-inch brass only. Standard finish is brush brass. Special finishes are available at extra cost.

If plates are ordered by letter only and no finish is specified, brush brass will be supplied. A combination plate must be made of 2 or more different letters and not gangs of standard plates. For example: AA is not a combination plate.



A—For Push Switch

.040-Inch
.060-Inch



C—With Round Bull's-Eye for Pilot Light Receptacle

.040-Inch
.060-Inch



T—With Rectangular Bull's Eye for Pilot Light Receptacle

.040-Inch
.060-Inch



S—For No. 7739 Switch and Bull's-Eye

.040-Inch
.060-Inch



***O—For 1/2-Inch Push Button**

.040-Inch
.060-Inch

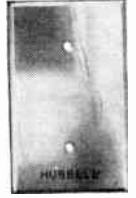

***D—For Outlet Box**

.040-Inch
.060-Inch

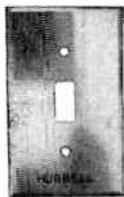

P—For Standard Toggle Switch

.040-Inch
.060-Inch



§G—For Single Convenience Outlets and All Other Std. 2, 3, and 4-Wire Flush Receptacles with Round Faces

.040-Inch
.060-Inch

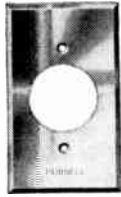

§Y—For No. 7410 4-Wire Twist-Lock Receptacle Only

.040-Inch
.060-Inch

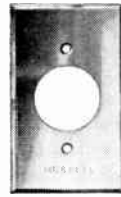

§K—For No. 7438 Receptacle Only

.040-Inch
.060-Inch

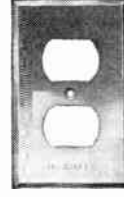

H—For Duplex Convenience Outlet

.040-Inch
.060-Inch

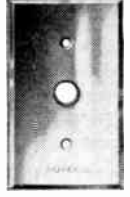

***M—For Telephone Outlet—One Bushing**

.040-Inch
.060-Inch



E—For Switch and Receptacle No. 8888, etc.

.040-Inch
.060-Inch

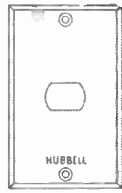

‡A1—Single Opening (Horizontal) for one Interchangeable Device

.060-Inch

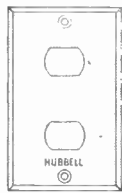

‡B1—Two Openings for Two Interchangeable Devices

‡.060-Inch



‡C1—Three Openings for Three Interchangeable Devices

‡.060-Inch

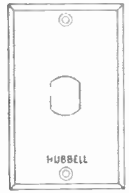

‡G1—Single Opening (Vertical) for One Interchangeable Device

.060-Inch

*Screw spacing, 2 3/8 inches. Adapter to 3 1/2 inches for box mounting supplied with this section.

‡Available in .060-inch metal only.

§Combinations embracing two adjacent G,Y, or K sections for Nos. 7250, 7310, 7410 or 7438 receptacles, require an extra blank gang between them to provide space for insertion of caps.

¶Vertical openings are available without extra cost.

Standard package of special combination plates consists of 10 identical plates; carton, 2 identical plates.

In ordering combination plates, use letter symbols from left to right, or bottom to top, in the position plates are to be ganged, i.e., P C G .060-inch would specify a plate to take one toggle switch, one bull's-eye, and one single convenience outlet—in that sequence, to be of .060-inch brass.

Order all of the above plates by symbol letters.

Prices on application.



No. 7169 Screw Driver (Special Equipment)

*Ivoryine.

Screws for Hubbell Flush Plates

Brass screws (No. 7311) to match bakelite are supplied on all bakelite plates. Bakelite headed screw No. 7213 available on special order at extra cost. Special ornamental head screws and special screwdriver will be supplied with standard package quantities of plates when so specified without extra charge, or may be purchased separately.



No. 7213

Ornamental Brass Plate Screws

No.	Car- ton	Std. Pkg.	Wt. Lbs. Std. Pkg.	Per 100
7169	100	100	1/4	\$5.00

Special Screwdriver for No. 7169

7170	2	5	1/4	\$24.50
------	---	---	-----	---------

Bakelite Headed Screws

7213	20	100	1/2	\$ 6.00
*7213-I	20	100	1/2	7.00

Bryant Flush Plate Combinations

Combination plates can be furnished in .040 inch and .060 inch thicknesses of stamped brass. When ordering combination plates specify type symbols as shown with the illustration of each plate. In ordering place the symbols from left to right or top to bottom as the plates are to be mounted, and give the thickness desired, i.e., "BSV .060-Inch". For multiple gang plates, prices will be furnished upon application.

Standard Finish is Brush Brass.

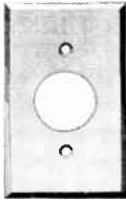

Type F Single Outlet Plates

Without door. Can be used with Nos. 556, 1708, 4831, 5261, 5661, 9116, 9120, and 9326 receptacles.

.060-Inch
.040-Inch



Type G Telephone Plates

One cord hole.

.060-Inch
.040-Inch



Type K Blank Plates

.060-Inch
.040-Inch

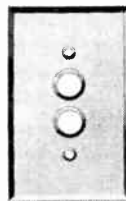

Type P Two-Button Push Switch Plates

For all two-button push switches.

.060-Inch
.040-Inch

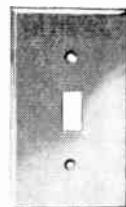

Type S Tumbler Switch Plates

For all single vertically operated tumbler switches.

.060-Inch
.040-Inch

Bryant Flush Plate Combinations

Type V Duplex Outlet Plates

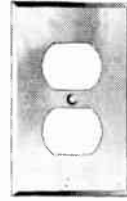

Without doors. Can be used with Nos. 112, 142-E, 322, 4812, 4832, 4833, 5242, 5252-5262, 5612, 5652, 5662, 6122, 9200, and 9260 duplex outlets.

.060-Inch
.040-Inch

Prices on application.

Bryant Special Finishes for Flush Plates

Finish	Per 100 Gangs
Barff, Bauer (Lacquer).....	\$27.50
Bronze, Statuary.....	38.50
Chromium, Polished.....	78.00
Nickel, Polished.....	38.50
"Telephone Red" (Lacquer).....	27.50
Verde Antique (Lacquer).....	27.50

Plates for Painting

Plates which are to be painted by the purchaser should be ordered "for painting". They will be billed at the price of the corresponding Standard Finish Plates.

**Bryant Flush Plates
For Tumbler Switches**

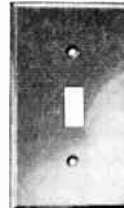

1 Gang

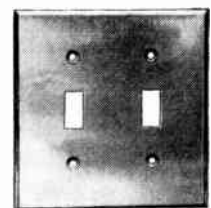

2 Gang

Brass brush finish with brass mounting screws. Installation of No. 746 jewel converts any "S" plate into a pilot light plate.

.040-Inch Stamped Brass

One Horizontal Row, Symbol "S"

No.	No. of Gangs	Carton	Std. Pkg.	Wt. Lbs. Std. Pkg.	Per 100
94071	1	10	100	16	\$ 58.50
94072	2	5	50	15	116.50
94073	3	3	30	13	175.00

Call Graybar FIRST For . . .

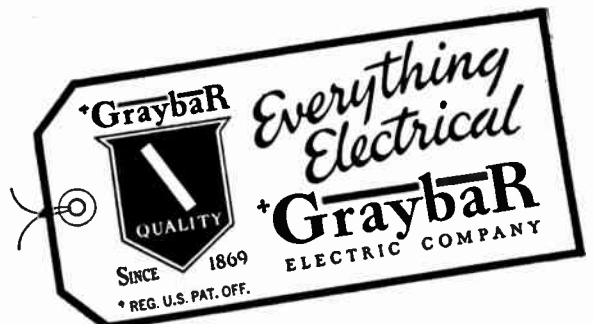

**Bryant Flush Plates
For Standard Devices**

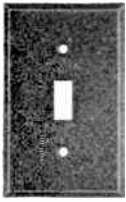

98071



98101



97091

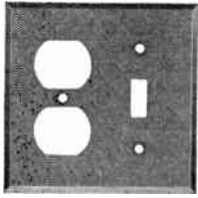

98532

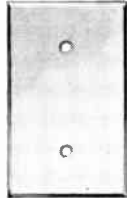

97121

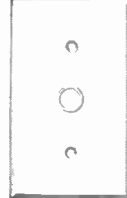

97181

Brown and Ivory Plates are made of steel with a multiple coating of baked-on insulating enamel.
.010-inch stainless steel plates, satin finish.

Tumbler Switch Plates

No. of Gangs	Brown		Ivory		Satin Finish	
	No.	Per 100	No.	Per 100	No.	Per 100
1	98071	\$16.50	99071	\$17.50	97071	\$36.50
Packed 10 in a carton, 100 in a standard package.						
2	98072	32.00	99072	34.00	97072	90.00
Packed 5 in a carton, 50 in a standard package.						
3	98073	57.00	99073	60.50	97073	136.50
Packed 3 in a carton, 30 in a standard package.						
4	98074	77.00	99074	88.00	97074	176.00
Packed 3 in a carton, 25 in a standard package.						
5	98075	88.00	99075	123.00	97075	242.00
Packed 2 in a carton, 20 in a standard package.						
6	98076	101.00	99076	143.00	97076	275.00
Packed 2 in a carton, 15 in a standard package.						

**Convenience Outlet Plates
Duplex**

No. of Gangs	Brown		Ivory		Satin Finish	
	No.	Per 100	No.	Per 100	No.	Per 100
1	98101	\$16.50	99101	\$17.50	97101	\$36.50
1	†94101	58.50				
Packed 10 in a carton, 100 in a standard package.						
2	98102	31.00	99102	35.00	97102	90.00
2	†94102	165.00				
Packed 5 in a carton, 50 in a standard package.						

Single

1	98091	\$20.00	99091	\$28.50	97091	\$36.50
Packed 10 in a carton, 100 in a standard package.						

**Combination Plates
Tumbler Switch and Single Outlet**

2	98512	\$39.50	99512	\$50.50	97512	\$92.50
2	†94512	153.00				
Packed 2 in a carton, 10 in a standard package.						

Tumbler Switch and Duplex Outlet

2	98532	\$39.50	99532	\$50.50	97532	\$92.50
2	†94532	153.00				
Packed 2 in a carton, 10 in a standard package.						

Two Tumbler Switches and Duplex Outlet

3	98543	\$59.50	99543	\$70.50	97543	\$141.00
3	†94543	226.50				
Packed 2 in a carton, 10 in a standard package.						

Blank Plates

1	98121	\$27.50	99121	\$31.00	97121	\$48.50
Packed 10 in a carton, 50 in a standard package.						

Telephone Plates

1	98181	\$23.00	99181	\$28.50	97181	\$49.50
Packed 10 in a carton, 50 in a standard package.						
†Brass (.010")						

Bryant Plastic Uniline* Flush Plates

Tumbler Switch

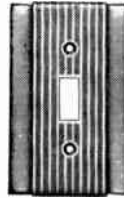

No. 91071

Push Switch

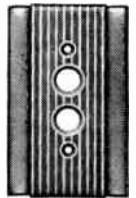

No. 91081

Tumbler Switch

No. of Gangs	Carton	Brown Std. Pkg. Gangs		Ivory Std. Pkg. Gangs	
		No.	Per 100	No.	Per 100
1	10	91071	100 \$12.00	92071	50 \$16.50
2	5	91072	50 24.00	92072	25 33.00
3	3	91073	30 46.00	92073	15 70.50
4	3	91074	25 81.50	92074	15 103.50
5	2	91075	20 185.00	92075	10 222.00
6	2	91076	15 202.50	92076	10 267.50

Push Switch

1	10	91081	100 \$20.00	92081	50 \$26.50
---	----	-------	-------------	-------	------------

Convenience Outlet

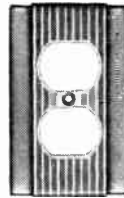

No. 91101

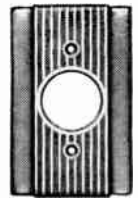

No. 91091

Duplex

No. of Gangs	Carton	Brown Std. Pkg. Gangs		Ivory Std. Pkg. Gangs	
		No.	Per 100	No.	Per 100
1	10	91101	100 \$12.00	92101	50 \$16.50
2	5	91102	25 64.00	92102	25 75.00

Single

1	10	91091	100 \$20.00	92091	50 \$26.50
---	----	-------	-------------	-------	------------

Blank and Telephone

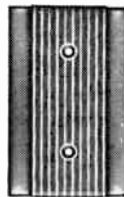

No. 91121

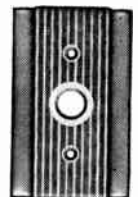

No. 91181

Blank

No. of Gangs	Carton	Brown Std. Pkg. Gangs		Ivory Std. Pkg. Gangs	
		No.	Per 100	No.	Per 100
1	10	91121	50 \$27.50	92121	30 \$33.00
2	5	91122	25 81.50	92122	15 94.50

Telephone

1	10	91181	50 \$27.50	92181	30 \$33.00
---	----	-------	------------	-------	------------

Standard package of 100 weighs approximately 10 pounds.
*Design Registered U. S. Pat. Office.

Bryant Plastic Uniline* Flush Plates
Interchangeable Unit Devices

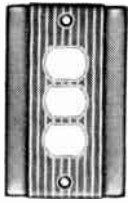

No. 91031

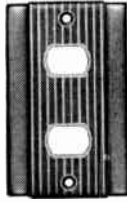

No. 91021

No. of Gangs	No. of Open.	Carton	Brown Std. Pkg. Gangs			Ivory Std. Pkg. Gangs		
			No.	Per 100	Price	No.	Per 100	Price
1	1	10	91011	100	\$20.00	92011	100	\$25.50
1	2	10	91021	50	20.00	92021	50	25.50
1	3	10	91031	30	20.00	92031	30	25.50
1	†1	10	91041	100	20.00	92041	100	25.50
2	4	10	91022	30	53.50	92022	30	66.00
2	2	10	91012	50	39.50	92012	30	53.50
3	6	10	91023	20	101.00	92023	20	121.00

†Vertical, all others horizontal openings.

Combination

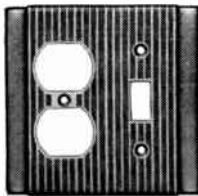

No. 91532

One Tumbler Switch and One Single Outlet

No. of Gangs	Carton	Brown Std. Pkg. Gangs			Ivory Std. Pkg. Gangs		
		No.	Per 100	Price	No.	Per 100	Price
2	2	91512	10	\$46.00	92512	10	\$64.00

One Tumbler Switch and One Duplex Outlet

2	2	91532	10	\$39.50	92532	10	\$53.00
---	---	-------	----	---------	-------	----	---------

One Single and One Duplex Outlet

2	2	**91572	10	\$94.50	**92572	10	\$105.50
---	---	---------	----	---------	---------	----	----------

Two Tumbler Switches and One Duplex Outlet

3	2	91543	10	\$81.50	92543	10	\$103.50
---	---	-------	----	---------	-------	----	----------

Three Tumbler Switches and One Duplex Outlet

4	2	**91554	10	\$209.00	**92554	10	\$226.50
---	---	---------	----	----------	---------	----	----------

*Design Registered U. S. Pat. Office.

**Available in old style "Uniline" design only.

Bryant Residential Type Switches

Listed as Standard by Underwriters' Laboratories, Inc.

"T" Rating

10 Amps., 125 Volts; 5 Amps., 250 Volts

Side Wired

For average construction and nominal lighting loads.

Plastic cups. Cup dimensions: Length 1²¹/₃₂-inches, Width 2⁹/₃₂-inches, Depth 1¹/₃₂-inches.



No. 61



No. 63



No. 51



No. 51-E



No. 53



No. 151

Single Pole

No.	Handle Color	Carton	Std. Pkg.	Wt. Lbs. Std. Pkg.	Per 100
61	Brown	10	100	14	\$44.00
61-I	Ivory	10	100	15	48.50

Three-Way

63	Brown	10	50	8	\$60.50
63-I	Ivory	10	50	8	66.00

For moderately priced residential installations.

10 Amperes, 125 Volts; 5 Amperes, 250 Volts
Porcelain Cups—Top Wired

Dimension of cups: 2¹/₁₆ x 1¹/₂ x 1⁹/₃₂-inches deep.

No.	Description	Carton	Std. Pkg.	Wt. Lbs. Std. Pkg.	Per 100
51	S. P., Brown Handle	10	100	24	\$33.00
51-I	S. P., Ivory Handle	10	100	24	38.50
53	3-Way, Brown Handle	10	50	13	48.00
53-I	3-Way, Ivory Handle	10	50	13	54.00

Without Plaster Ears

51-E	S. P., Brown Handle	10	100	24	\$29.50
51-EI	S. P., Ivory Handle	10	100	23	35.00
53-E	3-Way, Brown Handle	10	50	12	44.50
53-EI	3-Way, Ivory Handle	10	50	12	50.00

Plastic Cups—Side Wired

Dimensions of cups: 1⁵/₈ x 1⁹/₆₄ x 1³/₃₂-inches deep.

151	S. P., Brown Handle	10	100	15	\$31.00
151-I	S. P., Ivory Handle	10	100	15	36.50
153	3-Way, Brown Handle	10	50	8	46.00
153-I	3-Way, Ivory Handle	10	50	8	53.00

"T" Rating

10 Amps., 125 Volts; 5 Amps., 250 Volts

Top Wired

Plastic cup. Cup dimensions: Length 1¹/₂-inches, Width, 7/8-inch, Depth 1¹/₈-inches.

Single Pole

No.	Handle Color	Carton	Std. Pkg.	Wt. Lbs. Std. Pkg.	Per 100
1815-D	Brown	10	100	17	\$67.00
1915-D	Ivory	10	50	9	71.50

Three-Way

No. 1815-D	1835-D	Brown	10	50	9	\$92.50
	1935-D	Ivory	10	30	6	97.00

Bryant Residential Type

Listed as Standard by Underwriters' Laboratories, Inc.

**"T" Rating
Porcelain Cups**



No. 3951

Depth of cup 1 3/32-inches.

Single Pole

10 Amperes, 125 Volts; 5 Amperes, 250 Volts

No.	Description	Car- ton	Std. Pkg.	Wt. Lbs. Std. Pkg.	Per 100
3951	Brown Handle	10	100	28	\$ 71.50
3951-I	Ivory Handle	10	50	14	76.00
3951-L	Lock Type	10	100	31	157.50
3951-M	Momentary Contact	10	100	31	263.50

Double Pole

10 Amperes, 125 Volts; 10 Amperes, 250 Volts

3952	Brown Handle	10	50	17	\$126.50
3952-I	Ivory Handle	10	25	9	132.00
3952-L	Lock Type	10	50	17	268.50

Three-Way

10 Amperes, 125 Volts; 5 Amperes, 250 Volts

3953	Brown Handle	10	50	15	\$ 97.00
3953-I	Ivory Handle	10	25	8	101.00
3953-L	Lock Type	10	50	16	190.50

Four-Way

5 Amperes, 125 Volts; 2 Amperes, 250 Volts

3954	Brown Handle	2	10	4	\$286.00
3954-I	Ivory Handle	2	10	4	290.50
3954-L	Lock Type	2	10	4	550.00

One No. 6000 key is furnished with each lock switch.

**Switches
With T Rating**

Switches having the letter T as part of the rating are capable of controlling tungsten filament or gas filled lamp loads corresponding to the 125-volt ampere rating of switches. For 5-ampere this means 625 watts, for 10-ampere, 1250 watts, for 20-ampere, 2500 watts and for 30-ampere, 3750 watts.

P & S Residential Type

Conform to N.E.C. Standards



No. 5301

**Porcelain Cups
Wide Mounting Ears**

10 Amps., 125 Volts; 5 Amps., 250 Volts

Cup Dimensions: Width, 1 1/2-inches; length, 1 1/16-inches; depth, 1 3/16-inches.

No.	Description	Carton	Std. Pkg.	Wt. Lbs. Std. Pkg.	Per 100
5301	Single-Pole, Brown	10	100	23	\$31.00
5301-I	Single-Pole, Ivory	10	100	23	36.50
5303	Three-Way, Brown	10	50	13	46.00
5303-I	Three-Way, Ivory	10	50	13	53.00

P & S Specification Type Switches

All Plastic—Totally Enclosed

T Rated as Indicated

Fully enclosed in a dust-proof plastic body. Will fit standard flush tumbler switch plate.



Small size allows more wiring room in box.

Dimensions of single-pole and 3-way bodies, 1 3/4 x 2 3/8 x 1 3/16-inches; double-pole and 4-way bodies, 1 1/2 x 7/8 x 1 5/16-inches.

One key is furnished with each lock switch.

For special appliance application, 15-ampere switch can be furnished. Prices and complete information on request to Graybar.

Brown

No.	Description	Amperes		Carton	Std. Pkg.	Wt. Lbs. Std. Pkg.	Per 100
		125 V.	250 V.				
▲*1815D	Single-Pole	10T	5	10	100	18	\$ 67.00
▲*1825D	Double-Pole	10T	10	10	50	10	126.50
▲ 1835D	Three-Way	10T	5	10	50	10	92.50
▲ 1844D	Four-Way	5T	2	2	10	2	273.00

Ivory

▲1915D	Single-Pole	10T	5	10	100	18	\$ 71.50
▲1925D	Double-Pole	10T	10	10	50	10	132.00
▲1935D	Three-Way	10T	5	10	50	10	97.00
▲1944D	Four-Way	5T	2	2	10	2	277.00

Lock Type

1815DL	Single-Pole	10T	5	10	100	19	\$163.00
1825DL	Double-Pole	10T	10	10	50	11	268.50
1835DL	Three-Way	10T	5	10	50	10	207.00
1844DL	Four-Way	5T	2	2	10	2	550.00
1498	†Key	1	1	..	22.00
1499	†Key	1	1	..	22.00

*Indicating type. †For Nos. 1815DL and 1835DL.

‡For Nos. 1825DL and 1844DL.

▲Luminous handles available at extra cost. Suffix "LT" to catalog number, i.e. "1815DLT".

P & S Residential Type Switches

Conform to N.E.C. Standards



All Plastic. Totally Enclosed
10 Amps., 125 Volts; 5 Amps., 250 Volts

Body dimensions: Length, 1½ inches;
 width, 1⅛ inches; depth, 1⅛ inches.

Brown

No.	Description	Carton	Std. Pkg.	Wt. Lbs. Std. Pkg.	Per 100
1871	Single-Pole	10	100	15	\$37.50
1873	Three-Way	10	50	8	53.00

Ivory

1971	Single-Pole	10	100	15	\$43.00
1973	Three-Way	10	50	8	58.50

P & S Flush Tumbler Switches

Quiet Type, 15 Ampere A-C For Residential Use



No. AC11

Compact totally enclosed plastic bodies allow ample wiring room in box. Switches may be installed in any position.

Available in two types—with easy-to-wire, screwless (pressure) terminals and with conventional binding screw terminals.

15 Amperes, 120 Volts, A-C

*Strap Type With Binding Screw Terminals

No.	Description	Color	Std. Pkg.	Car-ton	Each
AC1-IV	Single Pole	Ivory	50	10	\$84.00
AC2-IV	Double Pole	Ivory	10	2	124.00
AC3-IV	Three-Way	Ivory	30	10	124.00
AC4-IV	Four-Way	Ivory	10	2	333.00
AC1	Single Pole	Brown	100	10	80.00
AC2	Double Pole	Brown	10	2	120.00
AC3	Three-Way	Brown	50	10	120.00
AC4	Four-Way	Brown	10	2	329.00

†Strap Type With Pressure Terminals

AC11-IV	Single Pole	Ivory	50	10	84.00
AC21-IV	Single Pole w/Ground Shunt	Ivory	50	10	92.00
AC22-IV	Single Pole w/Line Shunt	Ivory	50	10	92.00
AC12-IV	Double Pole	Ivory	10	2	124.00
AC13-IV	Three-Way	Ivory	30	10	124.00
AC23-IV	Three-Way w/Line Shunt	Ivory	30	10	128.00
AC14-IV	Four-Way	Ivory	10	2	333.00
AC11	Single Pole	Brown	100	10	80.00
AC21	Single Pole w/Ground Shunt	Brown	100	10	88.00
AC22	Single Pole w/Line Shunt	Brown	100	10	88.00
AC12	Double Pole	Brown	10	2	120.00
AC13	Three-Way	Brown	50	10	120.00
AC23	Three-Way w/Line Shunt	Brown	50	10	124.00
AC14	Four-Way	Brown	10	2	329.00

*Dimensions of bodies—Length 1½-in.; width 1⅛-in.; depth 1⅛-in.

†Dimensions of bodies—Length 1⅞-in.; width 1⅛-in.; depth 1¼-in.

P & S Flush Tumbler Switches

Approved by Underwriters' Laboratories



No. 20AC1-I



No. 20AC1

Quiet, High Capacity, Specification Type

20 Amperes, A-C
For Heavy Duty Service

Large silver alloy contacts assure long life under continuous, heavy duty service. Can be used to full rated capacity on fluorescent loads at voltages from 120 to 277. Can be used at full rated capacity on tungsten filament lamp loads and on motor loads up to 277 volts at 80% of switch rating.

Designed for side or back wiring—will accommodate up to No. 10 solid or stranded wire.

Length 2⅝-in.; width 1½-in.; depth 1⅞-in.

20 Amps., 120/277 Volts, A-C

No. Ivory	Per 100	No. Brown	Per 100	Description	Std. Pkg.	Car-ton
20AC1-I	\$215.00	20AC1	\$203.00	Single Pole	30	10
20AC2-I	255.00	20AC2	243.00	Double Pole	10	2
20AC3-I	246.00	20AC3	234.00	Three Way	10	2
20AC4-I	532.00	20AC4	519.00	Four-Way	10	2

15 Amps., 120/277 Volts, A-C

15AC1-I	\$131.00	15AC1	\$127.00	Single Pole	50	10
15AC2-I	217.00	15AC2	213.00	Double Pole	10	2
15AC3-I	191.00	15AC3	187.00	Three-Way	20	10
15AC4-I	480.00	15AC4	476.00	Four-Way	10	2

Quiet, High Capacity Specification Type
For Heavy Duty Use



No. 20AC1-L

Lock Type

Lock Type switches have polished metal tops. One No. 1498 lock switch key is furnished with each lock switch.

Length 2⅝-in.; width 1½-in.; depth 1⅞-in.

20 Amps., 120/277 Volts, A-C

No.	Description	Std. Pkg.	Car-ton	Each
20AC1-L	Single Pole	10	2	\$300.00
20AC2-L	Double Pole	10	2	340.00
20AC3-L	Three-Way	10	2	333.00
20AC4-L	Four-Way	10	2	616.00
1498	Key	10	2	

15 Amps., 120/277 Volts, A-C

15AC1-L	Single Pole	50	10	\$228.00
15AC2-L	Double Pole	10	2	307.00
15AC3-L	Three-Way	20	10	266.00
15AC4-L	Four-Way	10	2	575.00
1498	Key	10	2	22.00

Hubbell Sphinx Mercury Flush Toggle Switches

Conform to N.E.C. Standards
**10 Amp., 125 Volts T; 15 Amp., 120 Volts
 A-C—5 Amp., 250 Volts**

Bakelite Base



No. 9711

Switch must be mounted vertically. "Top" on one support indicates correct mounting position.

Sphinx 3 and 4-way Mercury switches cannot be used with Master Control or Emergency Systems of wiring where all lights are turned on by a master switch.

With Brown Bakelite Handle

No.	Description	Car- ton	Std. Pkg.	Wt. Lbs. Std. Pkg.	Per 100
9711	S.P., indicating	10	100	20	\$ 99 00
**9712	D.P., Indicating	10	50	14	187 00
9713	3-Way	10	50	13	187 00
9714	4-Way	2	10	3	385 00

With Ivorine Handle

9711-I	S.P., Indicating	10	50	11	\$110 00
**9712-I	D.P., Indicating	10	30	9	198 00
9713-I	3-Way	10	30	9	198 00
9714-I	4-Way	2	10	3	396 00

**Rated: 10 Amp., 125 Volts; 5 Amp., 250 Volts—5 Amp.,—125 Volts, T.

Hubbell Mercury Switch

Silent—Easy to Find

Light Up Handle Shines in Dark when in "Off" Position



For any area where quick location of light switch in the dark is important. Also useful as a "reverse" pilot light.

Operates like any other mercury activated switch, plus the advantage of a translucent ivory handle which, when in off position, is lighted by a tiny neon lamp.

Has convenient top wiring, large head binding screws, compact size.

Available in Single Pole and 3-Way types.

Meets REA and Federal specifications.

No.	Description	Rating—Amperes		Car- ton	Std. Pkg.	Wt. Lbs. Std. Pkg.	Per 100
		120 V. A-C	250 V. T				
9717-I	Single Pole, Lighted Handle	15	5	10	10	100 18	\$150 00
9718-I	3-Way Lighted Handle	15	5	10	10	50 13	240 00

Hubbell Flush Toggle Switches

Conform to N.E.C. Standards

Specification Grade

T Rating. Enclosed Bakelite Base. With Bakelite Handle. Will fit 1½-inch switch boxes. Brown Bakelite handles are standard.



No. 9801



No. 9801-I



No. 9701

No.	Description	Amperes 125 V. 250 V.	Std. Pkg.	Pkg. Wt. Lbs.	Per 100
9801	S.P., Ind.	10 5	50	12	\$135 50
9802	D.P., Ind.	10 10	10	3	224 50
9803	3-Way	10 5	20	7	165 00
9933	3-Way	20 10	10	4	249 50
9804	4-Way	5 2	10	3	530 00
9805	S.P., Ind.	20 10	20	8	211 50
9806	D.P., Ind.	20 10	10	4	256 50

With Ivorine Handle

9801-I	S.P., Ind.	10 5	25	7	\$139 50
9802-I	D.P., Ind.	10 10	10	8	229 50
9803-I	3-Way	10 5	10	4	169 50
9933-I	3-Way	20 10	10	7	254 00
9804-I	4-Way	5 2	10	6	538 00
9805-I	S.P., Ind.	20 10	10	7	216 00

Locking Type

One No. 1209 key furnished with each switch. Keyway finished Brown to match Bakelite. Regularly supplied grounded. Carton quantity, 10.

No.	Description	Amperes 125 V. 250 V.	Std. Pkg.	Pkg. Wt. Lbs.	Per 100
9701	S.P.	10 5	50	12	\$253 50
9702	D.P.	10 10	10	3	331 50
9703	3-Way	10 5	20	6	291 00
9613	3-Way	20 10	10	3	359 50
9704	4-Way	5 2	10	3	645 50
9705	S.P.	20 10	20	6	320 00
9706	D.P.	20 10	10	3	391 50
1209	Key	10	5/16	23 00

Hubbell Heavy Duty Flush Toggle Switches

Conform to N.E.C. Standards

**T-Rated
 Bakelite Base**



No. 2971



No. 2971-L

Length, 2¾ inches. Width, 1¼ inches. Depth, 1¾ inches. One key furnished with each lock switch.

Bakelite Handle No.	Per 100	Lock Type No.	Per 100	Description	Amperes		Car- ton	Std. Pkg.	Pkg. Wt. Lbs.
					125 V. V.T.	250 V.			
2971	\$268 50	2971-L	\$385 00	Single Pole	20	20	10	30	20
2972	347 50	2972-L	462 00	Double Pole	20	20	2	10	6
2973	347 50	2973-L	440 00	3-Way	20	20	2	10	6
2974	787 00	2974-L	911 50	4-Way	20	10	2	10	4
2923	311 50	2923-L	450 00	Single Pole	30	30	10	30	20
2924	447 50	2924-L	577 50	Double Pole	30	30	2	10	6
2925	425 50	2925-L	529 00	3-Way	30	30	2	10	6
2926	954 50	2926-L	1066 50	4-Way	20	10	2	10	4
..	..	2308	25 50	Key	10	100	2

Hubbell "Topper" A-C Switches To Withstand Inductive Loads of Large Fluorescent Lighting Installations



No. 1201

Economical and efficient for use at full rated capacity on inductive loads. Controls many more fixtures than conventional switches.

Heavier circuits can be operated, and fewer of them, resulting in lower material and labor costs for wiring. Features shallow size, quiet operation (without mercury), large silver contacts. Upset binding screws, back and side wiring with easy-to-find back wiring entry holes.

Operates in any position. Balanced action eliminates annoying click-click of ordinary switches.

Brown top indicates 15 ampere, 120-277 volt units.

Red top indicates 20 ampere, 120-277 volt units.

15 Amperes, 120 Volts—15 Amperes, 277 Volts Back and Side Wiring

No.	Description	Car- ton	Std. Pkg.	Wt. Lbs. Std. Pkg.	Per 100
1201	Single Pole, Brown	10	50	12	\$127.00
1201-I	Single Pole, Ivorine	10	50	12	131.00
1202	Double Pole, Brown	2	10	4½	213.00
1202-I	Double Pole, Ivorine	2	10	4½	217.00
1203	3-Way, Brown	10	20	7	187.00
1203-I	3-Way, Ivorine	10	20	7	191.00
1204	4-Way, Brown	2	10	4	476.00
1204-I	4-Way, Ivorine	2	10	4	480.00

Topper Lock Switches

1201-L	Single Pole, Brown	10	50	11	228.00
1202-L	Double Pole, Brown	2	10	4½	307.00
1203-L	3-Way, Brown	10	20	4	266.00
1204-L	4-Way, Brown	2	10	4	575.00

20 Amperes, 120 Volts—20 Amperes, 277 Volts Back and Side Wiring

1221	Single Pole, Brown	10	30	11	203.00
1221-I	Single Pole, Ivorine	10	30	11	215.00
1222	Double Pole, Brown	2	10	4	243.00
1222-I	Double Pole, Ivorine	2	10	4	255.00
1223	3-Way, Brown	2	10	4	234.00
1223-I	3-Way, Ivorine	2	10	4	246.00
1224	4-Way, Brown	2	10	4	519.00
1224-I	4-Way, Ivorine	2	10	4	532.00

Topper Lock Switches

1221-L	Single Pole, Brown	2	10	4	300.00
1222-L	Double Pole, Brown	2	10	4	340.00
1223-L	3-Way, Brown	2	10	4	333.00
1224-L	4-Way, Brown	2	10	4	616.00

Double-Ended Key for A-C and D-C Switches

1209	Key for Topper and Pace- maker Switches	2	10	5 Oz.	23.00
------	--	---	----	-------	-------



No. 1101

Hubbell Pacemaker A-C Switches For Residential Buildings

Standard grade switch for use at full rated capacity on tungsten filament and fluorescent lamp loads. Quiet in operation, thoroughly dependable, easy to install, compact in size, and available at competitive prices.

Designed for 120-volt applications only.

Silver contacts hold temperature rise to a minimum. Side wiring convenience with large, deep-slotted screws "upset" to prevent falling out. Withstands resistance, surge, or inductive loads, also motor loads up to 80% of switch rating.

1101	Single Pole, Brown	10	100	9½	\$80.00
1101-I	Single Pole, Ivorine	10	50	9½	84.00
1102	Double Pole, Brown	2	10	10	120.00
1102-I	Double Pole, Ivorine	2	10	10	124.00
1103	3-Way, Brown	10	50	9	120.00
1103-I	3-Way, Ivorine	10	30	5	124.00
1104	4-Way, Brown	2	10	2	329.00
1104-I	4-Way, Ivorine	2	10	2	333.00

Pace Maker Lock Switches

1102-L	Single Pole, Brown	10	50	11	168.00
1102-L	Double Pole, Brown	2	10	4	205.00
1103-L	3-Way, Brown	10	20	7	205.00
1104-L	4-Way, Brown	2	10	4	425.00

Hubbell Flush Toggle Switches

Conform to N.E.C. Standards

Standard Grade

T Rating. Porcelain Base. Bakelite Handle. If desired grounded, suffix letter G to number.

Brown

No.	Description	Amperes 125 V. T 250 V.	Car- ton	Std. Pkg.	Pkg. Wt. Lbs.	Per 100
8801	*S.P.	10 5	10	100	34	\$ 71.50
8941	*S.P.	20 20	10	50	19	159.50
8942	*D.P.	.. 20	10	20	9	225.50
8802	*D.P.	10 10	10	50	19	126.50
8803	3-Way	10 5	10	50	19	97.00
8943	3-Way	20 10	2	10	5	205.50
8804	4-Way	5 2	2	10	4	286.00



No. 8801



No. 8801-I

Ivory Handle

8801-I	*S.P.	10 5	10	50	19	\$ 76.00
8941-I	*S.P.	20 20	2	10	6	164.00
8942-I	*D.P.	.. 20	2	10	7	230.00
8802-I	*D.P.	10 10	10	25	10	132.00
8803-I	3-Way	10 5	10	25	10	101.00
8943-I	3-Way	20 10	2	10	5	210.00
8804-I	4-Way	5 2	2	10	5	290.50

*Indicating.

Locking Type—Porcelain Base

For use with standard rectangular opening switch plates. One No. 8965 key furnished with each lock switch.

Keyway finished Brown to match Bakelite.

Regularly supplied grounded.

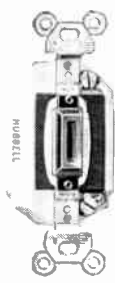

No. 8961

No.	Description	Amperes 125 V. T 250 V.	Car- ton	Std. Pkg.	Pkg. Wt. Lbs.	Per 100
8961	S.P.	10 5	10	100	30	\$157.50
8962	D.P.	10 10	10	50	19	268.50
8963	3-Way	10 5	10	50	19	190.50
8964	4-Way	5 2	2	10	4	550.00
1209	Key	10	¾	23.00

P & S General Purpose Type Switches

Conform to N.E.C. Standards

All Plastic—Totally Enclosed T-Rated

In Moderate Price Class
For Residential and REA Wiring

Features

Torsionally pre-loaded contacts for long life and smooth action—give exceptional performance on Type C lamp loads . . . Positive kick-off . . . Easy to wire—large head binding screws conveniently located on compact bodies . . . Plaster ears of break-off washer type . . . Meets Federal Specification W-S-896 and conforms to REA requirements.

Body Dimensions: Length, 1½-inches, width 1¼-inches, depth 1¼-inches.

10 Amps., 125 Volts T; 5 Amps., 250 Volts

No.	Description	Car- ton	Std. Pkg.	Wt. Lbs. Std. Pkg.	Per 100
7301	Single-Pole, Brown	10	100	16	\$44.00
7301-1	Single-Pole, Ivory	10	100	16	48.50
7303	Three-Way, Brown	10	50	9	60.50
7303-1	Three-Way, Ivory	10	50	9	66.00

Bryant Flush Tumbler Switches

Quiet A-C Type

Designed specifically for interrupting Alternating Current; consequently much quieter than the conventional a-c/d-c type. They are able to handle inductive and fluorescent lamp loads, as well as tungsten filament lamp loads, up to the full rating of the switch. This means fewer switches and lower job costs.

**Residential Type
15 Amperes, 120 Volts**

Back Wired



Equipped with spring grip terminals, these switches are easily and quickly wired.

Mechanism enclosed in strong plastic cups.

Accommodate Nos. 14, 12 or 10 solid and No. 14 or 12 stranded wire.

Dimensions of cup: 1 3/4 x 1 1/32 x 1 3/64 inches deep.

Single Pole

No.	Handle	Ctn. Qty.	Std. Pkg.	Wt. Lbs. Std. Pkg.	Per 100
4501	Brown	10	100	13	\$ 80.00
4501-I	Ivory	10	100	13	84.00

Three Way

4503	Brown	10	50	8	\$120.00
4503-I	Ivory	10	50	7	124.00

Side Wired



Equipped with binding screws for those who prefer the conventional type wiring.

Large head binding screws take up to No. 10 wire.

Cup dimensions: 1 1/2 x 1 1/2 x 1 1/16 inches deep.

Mounting screws attached to yoke.

Single Pole

No.	Handle	Ctn. Qty.	Std. Pkg.	Wt. Lbs. Std. Pkg.	Per 100
4621	Brown	10	100	14	\$ 80.00
4621-I	Ivory	10	50	7	84.00

Double Pole

4622	Brown	2	10	2	\$120.00
4622-I	Ivory	2	10	2	124.00

Three-Way

4623	Brown	10	50	7	\$120.00
4623-I	Ivory	10	30	5	124.00

Four Way

4624	Brown	2	10	2	\$329.00
4624-I	Ivory	2	10	2	333.00

Quiet A-C Heavy Duty Type

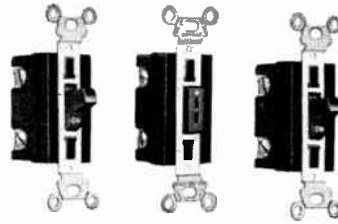

No. 4801 No. 4802L No. 4901

Back or Side Wired

Switches also suitable for use on 4-wire 480/277 volt network systems and for motor control up to 80% of switch rating.

Equipped with screw clamp terminals. Accommodates solid or stranded wire up to #10.

Mechanisms totally enclosed in strong plastic housings. One No. 6000 key furnished with each Lock switch. Cup dimensions: Single pole Nos. 4801 and 4901, 2 1/4 x 1 5/16 x 1 1/32 inches; Double pole, 3 and 4-way, 2 1/4 x 1 x 1 1/32 inches deep.

**15 Amperes, 277 Volts
Brown Plastic Cup**

Single Pole

No.	Handle or Type	Ctn. Qty.	Std. Pkg.	Wgt. Lbs. Std. Pkg.	Per 100
4801	Brown	10	50	10	\$127.00
4801-I	Ivory	10	50	10	131.00
4801-L	Lock	2	10	2	228.00

Double Pole

4802	Brown	2	10	3	\$213.00
4802-I	Ivory	2	10	3	217.00
4802-L	Lock	2	10	3	307.00

Three Way

4803	Brown	10	20	5	\$187.00
4803-I	Ivory	10	20	5	191.00
4803-L	Lock	2	10	2	266.00

Four Way

4804	Brown	2	10	3	\$476.00
4804-I	Ivory	2	10	3	480.00
4804-L	Lock	2	10	3	575.00

**20 Amperes, 277 Volts
Black Plastic Cup—Red Cover**

Single Pole

4901	Brown	10	30	6	\$203.00
4901-I	Ivory	10	30	6	215.00
4901-L	Lock	2	10	2	300.00

Double Pole

4902	Brown	2	10	3	\$243.00
4902-I	Ivory	2	10	3	255.00
4902-L	Lock	2	10	3	340.00

Three Way

4903	Brown	2	10	3	\$234.00
4903-I	Ivory	2	10	3	246.00
4903-L	Lock	2	10	3	333.00

Bryant Push Button Switches

A-C/D-C Type



No. 5501



No. 5504

Porcelain—Shallow Cup
Depth of cups: 1 1/4 inches.

Single Pole

10 Amps., 125 Volts; 5 Amps., 250 Volts

No.	Ctn. Qty.	Std. Pkg.	Wgt. Lbs. Std. Pkg.	Per 100
5501	10	100	30	\$132.00

Quadruple Break

20 Amps., 125 Volts; 5 Amps., 250 Volts

5520	10	50	18	\$221.00
------	----	----	----	----------

Double Pole

10 Amps., 125 Volts; 10 Amps., 250 Volts

5502	10	50	18	\$210.50
------	----	----	----	----------

20 Amps., 125 Volts; 10 Amps., 250 Volts

5505	10	50	19	\$257.50
------	----	----	----	----------

Three Way

10 Amps., 125 Volts; 5 Amps., 250 Volts

5503	10	50	20	\$153.00
------	----	----	----	----------

Four Way

5 Amps., 125 Volt; 2 Amps., 250 Volts

5504	2	10	4	\$528.00
------	---	----	---	----------

Bryant High Capacity Enclosed Switches

Listed as standard by Underwriters' Laboratories, Inc.
Plastic Enclosed Cup Type—"T" Rating
Yoke Insulated From Mechanism

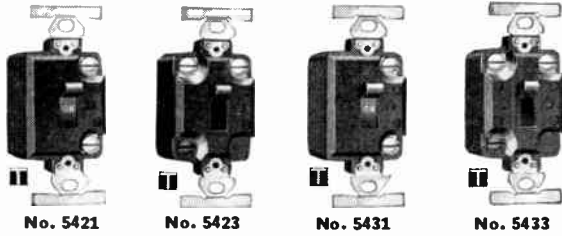

These switches will meet the exacting load conditions of commercial and industrial applications. Mechanisms equipped with arc snuffers are totally enclosed in strong plastic housings. Meet all specifications.

Deep Cup—1 $\frac{1}{16}$ -Inches Deep—"T" Rating
20 Amperes, 125 Volts; 20 Amperes, 250 Volts

*No.	Description	Carton	Std. Pkg.	Wt., Lbs. Std. Pkg.	Per 100
5421	Single Pole	10	30	11	\$268.00
5421-L	S.P., Lock Type	10	30	12	385.00
5422	Double Pole	2	10	4	347.50
5422-L	D.P., Lock Type	2	10	5	462.00
5423	Three-Way	2	10	4	347.50
5423-L	Three-Way, Lock Type	2	10	5	440.00

30 Amperes, 125 Volts; 30 Amperes, 250 Volts

5431	Single Pole	10	30	11	\$311.50
5431-L	S.P., Lock Type	10	30	11	450.00
5432	Double Pole	2	10	4	447.50
5432-L	D.P., Lock Type	2	10	5	577.50
5433	Three-Way	2	10	4	425.50
5433-L	Three-Way, Lock Type	2	10	5	529.00

20 Amperes, 125 Volts; 10 Amperes, 250 Volts

5424	Four-Way	2	10	5	\$787.00
5424-L	Four-Way, Lock Type	2	10	5	911.50
5434	Four-Way	2	10	4	954.50
5434-L	Four-Way, Lock Type	2	10	5	1066.50
6000	Universal Key for rotary and flush tumbler lock sw.	2	10	..	25.50



No. 5861

Shallow Cup—1 $\frac{1}{32}$ -Inches Deep

20 Amperes, 125 Volts;
20 Amperes, 250 Volts



No. 5863

Single Pole

5861	Brown Handle	10	30	10	\$215.00
5861-I	Ivory Handle	10	30	9	226.50
5861-L	Lock Type	10	30	11	321.00
5861-M	Momentary Contact	10	30	9	395.50

Double Pole

5862	Brown Handle	2	10	4	\$244.00
5862-I	Ivory Handle	2	10	4	258.00
5862-L	Lock Type	2	10	4	352.50
5862-M	Momentary Contact	2	10	4	429.00

Three-Way

5863	Brown Handle	2	10	4	\$242.50
5863-I	Ivory Handle	2	10	4	255.50
5863-L	Lock Type	2	10	4	352.50
5863-M	Momentary Contact	2	10	4	429.00

Four-Way
10 Amperes, 125 Volts
5 Amperes, 250 Volts

5864	Brown Handle	2	10	4	\$573.00
5864-I	Ivory Handle	2	10	4	587.00
5864-L	Lock Type	2	10	4	684.00

*One No. 6000 key furnished with each lock switch.

Bryant High Capacity Tumbler Switches

Listed by Underwriters' Laboratories, Inc.

Gray Porcelain Cups—"T" Rating
Yoke Insulated From Mechanism



No. 3971



No. 3971-SH

Depth of cup 1 $\frac{1}{2}$ -inches. One No. 6000 key furnished with each lock switch. Furnished with Brown Plastic handle. Steel handle at extra cost.

20 Amperes, 125 Volts; 20 Amperes, 250 Volts

No.	Description	Carton	Std. Pkg.	Wt., Lbs. Std. Pkg.	Per 100
3971	Single Pole	10	50	22	\$215.00
3971-SH	S. P., Steel Handle	2	10	23	237.00
3973	Three-Way	2	10	5	242.50

20 Amperes, 125 Volts; 20 Amperes, 250 Volts

3972	Double Pole	2	10	5	\$244.00
------	-------------	---	----	---	----------

10 Amperes, 125 Volts; 5 Amperes, 250 Volts

3974	Four-Way	2	10	5	\$573.00
------	----------	---	----	---	----------

Bryant Mercury Silent Type Switches

Listed as standard by Underwriters' Laboratories, Inc.

10 Amp., 125 Volts; 5 Amp., 250 Volts, A.C., D.C.

15 Amp. 120 Volts A.C.

"T" Rating

Fully enclosed Plastic housing. For residential, hospital, or other installations where silent operation is desired.

Single Pole

No.	Handle Color	Carton	Std. Pkg.	Wt., Lbs. Std. Pkg.	Per 100
4701	Brown	10	100	18	\$99.00
4701-I	Ivory	10	50	9	110.00

No. 4701

Three-Way

4703	Brown	10	50	14	\$187.00
4703-I	Ivory	10	30	9	198.00



No. 4703

Double Pole

4702	Brown	10	50	12	\$187.00
4702-I	Ivory	10	30	8	198.00

Four-Way

4704	Brown	2	10	4	\$385.00
4704-I	Ivory	2	10	4	396.00



No. 4701-GL

With Illuminated Handle

Equipped with tiny neon lamps which provides a soft glow when switch is in "off" position. In 3-way switches both handles are lighted when either switch handle is moved to turn "off" the light.

Single Pole

4701-GL	Ivory	10	50	9	\$150.00
---------	-------	----	----	---	----------

Three-Way

4703-GL	Ivory	10	50	12	240.00
---------	-------	----	----	----	--------

Bryant Enclosed Cup Type Switches

Listed as Standard by Underwriters' Laboratories, Inc.

Black Composition Cups

"T" Rating



No. 4961

Fully enclosed. Yoke insulated from mechanism. A sturdy switch which combines strength with quiet operation.

Depth of cup 1 3/8-inches.

Brown Plastic handles and bosses are standard. Ivory handles at extra cost.

10 Amperes, 125 Volts; 5 Amperes, 250 Volts

No.	Description	Car-ton	Std. Pkg.	Wt. Lbs. Std.	Lbs. Pkg.	Per 100
4961	Single Pole	10	50	16		\$135.50
4961-L	S. P., Lock Type	10	50	18		253.50
4963	Three-Way	10	20	8		165.00
4963-L	Three-Way, Lock Type	10	20	9		291.00

10 Amperes, 125 Volts; 10 Amperes, 250 Volts

4962	Double Pole	2	10	4		\$224.50
4962-L	D. P., Lock Type	2	10	4		331.50

5 Amperes, 125 Volts; 2 Amperes, 250 Volts

4964	Four-Way	2	10	5		\$530.00
4964-L	Four-Way, Lock Type	2	10	5		645.50

20 Amperes, 125 Volts; 10 Amperes, 250 Volts

4965	Double Pole	2	10	1		\$256.50
4967	Three-Way	10	20	8		249.50

20 Amperes, 125 Volts; 20 Amperes, 250 Volts

4966	S. P., Quadruple Break	10	20	8		\$211.50
------	------------------------	----	----	---	--	----------

One No. 6000 key is furnished with each lock switch. Nos. 4961, 4962, 4963, and 4964 can also be furnished momentary contact at extra cost.

Hubbell Push Button Switches

Conform to N.E.C. Standard



No. 4401

No.	Description	Amperes 125V. 250V.	Car-ton	Std. Pkg.	Wt. Lbs. Std.	Lbs. Pkg.	Per 100
4401	S.P.	10	5	10	100	3.5	\$132.00
4402	D.P.	10	10	50	18		210.50
4403	3-Way	10	5	10	50	20	153.00
4404	4-Way	5	2	2	10	5	528.00

Hubbell Surface Toggle Switches

With Bakelite Covers

5 Amperes, 125 Volts; 3 Amperes, 250 Volts

Diameter of base, 2 inches. Screw spacings on centers, 1 3/8 inches.

No.	Description	Car-ton	Std. Pkg.	Wt. Lbs. Std.	Lbs. Pkg.	Per 100
4442	Single Pole, Slotted Base	10	50	10		\$62.50
4443	Single Pole, Solid Base	10	50	10		66.00
4444	3-Way, Slotted Base	10	50	10		77.00

Hubbell Surface Toggle Switches

With Bakelite Covers—For Outlet Boxes



**Single Pole: 5 Amperes, 125 Volts;
3 Amperes, 250 Volts**
**3-Way: 5 Amperes, 125 Volts;
3 Amperes, 250 Volts**

No.	Description	Car-ton	Std. Pkg.	Wt. Lbs. Std.	Lbs. Pkg.	Per 100
4431	Single Pole, for 3 1/4-inch Box	10	50	20		\$95.50
4451	Single Pole, for 4-inch Box	10	50	17		101.00
4453	3-Way, for 4-inch Box	10	50	28		109.00

Bryant Tumbler Switches

Box Mounting Type—Flush Handle

Listed by Underwriters' Laboratories, Inc.

"T" Rating



No. 361

10 Amperes, 125 Volts; 5 Amperes, 250 Volts
With Covers Finished to Resist Corrosion

No.	Description	Carton	Std. Pkg.	Wt. Lbs. Std.	Lbs. Pkg.	Per 100
361	Single Pole, 3 1/4-Inch	10	50	20		\$67.00
461	Single Pole, 4-Inch	10	50	24		72.50
363	Three-Way, 3 1/4-Inch	10	50	21		79.50
463	Three-Way, 4-Inch	10	50	26		86.00

Bryant Tumbler Switches

Listed as standard by Underwriters' Laboratories, Inc.

Quadruple Break—Single Pole

20 Amps., 125 Volts; 10 Amps., 250 Volts

Solid 2 7/16-Inch Base

Plastic cover. Height over cover, 1 9/16-inches. Screw spacing, 1 3/4-inches.

Packed 2 in a carton. 10 in a standard package. Package weight, 4 pounds.



No. 3916

No.	Per 100
3916	\$244.00

Bryant Oil Burner Switch

Listed by Underwriters' Laboratories, Inc.

Single-Pole—Flush Handle

10 Amps., 125 Volts; 5 Amps., 250 Volts

For emergency remote control of oil burner motor.

3 1/4-inch metal box cover, red lacquered with black letters.

Packed 10 in a carton. 50 in a standard package. Package weight, 20 pounds.



No. 3883

No.	Per 100
3883	\$104.50

Hubbell Bakelite Flush Toggle Switches
 Conform to N.E.C. Standard
 Intermediate Grade
Residential Type—Washer Ears
 10 Amperes, 125 V.T.; 5 Amperes, 250 Volts
 For 3 1/4 and 4-Inch Outlet Boxes

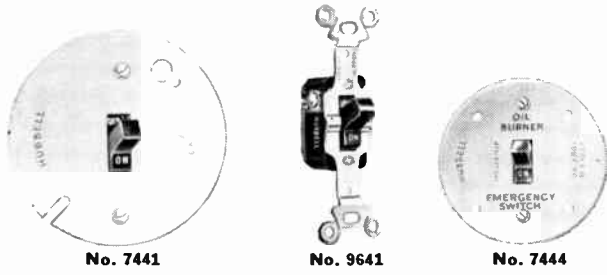

No.	Description	Car- ton	Std. Pkg.	Wt. Lbs. Std. Pkg.	Per 100
9641	Single Pole, Indicating	10	100	15	\$44.00
9641-I	Single Pole, Ivorine	10	100	15	48.50
9643	3-Way	10	50	8	60.50
9643-I	3-Way, Ivorine	10	50	8	66.00
7441	S.P., 3 1/4-inch Cover	10	50	11	67.00
7443	3-Way, 3 1/4-inch Cover	10	50	20	79.50
7451	S.P., 4-inch Cover	10	50	14	72.50
7453	3-Way, 4-inch Cover	10	50	24	86.00
7444	S.P., Oil Burner Switch on 3 1/4-inch Red Cover	10	50	18	104.50
7445	S.P., Oil Burner Switch on 4-inch Red Cover	10	50	15	116.00

P & S Box Cover Switches
 Conform to N.E.C. Standard
T-Rated as Indicated



No. 1231

10 Amps., 125 Volts
 One-Piece Plastic Housing.
 Positive kick-off — Arc-snuffers —
 Pre-loaded contacts.
 Standard package weight, 3 1/4" devices, 11 lbs.; 4" devices, 13 lbs.

With 3 1/4" Covers

No.	Description	Amperes 125 V	250 V.	Car ton	Std. Pkg.	Per 100
1131	Single Pole, Brown	10	5	10	50	\$ 91.50
1133	Three-Way, Brown	10	5	10	50	106.50
*1231	Single Pole, Black	10T	5	10	50	103.50
*1233	Three-Way, Black	10T	5	10	50	116.50
1131-RC	S.P., Oil Burner, Red	10	5	10	50	104.50

With 4" Covers

1141	Single Pole, Brown	10	5	10	50	\$102.50
1143	Three-Way, Brown	10	5	10	50	113.50
*1241	Single Pole, Black	10T	5	10	50	116.50
*1243	Three-Way, Black	10T	5	10	50	125.50

*T-rated.

Bryant Tumbler Switches

Listed as standard by Underwriters' Laboratories, Inc.



No. 211



No. 31



No. 3912



No. 3931

Plastic Cover—Solid 2 1/16-Inch Base

Height over cover, 1 9/16-inches.
 Screw spacing, 1 3/4-inches.

10 Amperes, 125 Volts; 5 Amperes, 250 Volts

No.	Description	Carton	Std. Pkg.	Wt. Lbs. Std. Pkg.	Per 100
3911	Single Pole	10	100	37	\$160.50
3913	Three-Way	10	100	39	224.50

10 Amperes, 125 Volts; 10 Amperes, 250 Volts

No.	Description	Carton	Std. Pkg.	Wt. Lbs. Std. Pkg.	Per 100
3912	Double Pole	10	100	39	\$230.00

5 Amperes, 125 Volts; 2 Amperes, 250 Volts

No.	Description	Carton	Std. Pkg.	Wt. Lbs. Std. Pkg.	Per 100
3914	Four-Way	2	10	4	\$544.50

Shallow Plastic Cover—2-Inch Porcelain Base

Height over cover, 1 9/32-inches.
 Screw spacing, 1 3/8-inches.

6 Amperes, 125 Volts; 3 Amperes, 250 Volts

No.	Description	Carton	Std. Pkg.	Wt. Lbs. Std. Pkg.	Per 100
211	Single Pole, Slotted	10	50	12	\$62.50

5 Amperes, 125 Volts; 2 Amperes, 250 Volts

213	Three-Way, Slotted	10	50	12	77.00
-----	--------------------	----	----	----	-------

Box Mounting Type—Metal Box Cover—Shallow Plastic Switch Cover

6 Amperes, 125 Volts; 3 Amperes, 250 Volts

No.	Description	Carton	Std. Pkg.	Wt. Lbs. Std. Pkg.	Per 100
31	Single Pole, 3 1/4-Inch	10	50	21	\$ 95.50
41	Single Pole, 4-Inch	10	50	25	101.00

5 Amperes, 125 Volts; 2 Amperes, 250 Volts

33	Three-Way, 3 1/4-Inch	10	50	21	\$104.50
43	Three-Way, 4-Inch	10	50	25	109.00

Deep Plastic Cover

6 Amperes, 125 Volts; 3 Amperes, 250 Volts

3931	Single Pole, 3 1/4-Inch	5	50	25	\$124.50
3941	Single Pole, 4-Inch	5	50	30	131.00

5 Amperes, 125 Volts; 2 Amperes, 250 Volts

No.	Description	Carton	Std. Pkg.	Wt. Lbs. Std. Pkg.	Per 100
3933	Three-Way, 3 1/4-Inch	5	50	26	\$144.00
3943	Three-Way, 4-Inch	5	50	32	149.50

Bryant Surface Rotary Switches

Listed as standard by Underwriters' Laboratories, Inc.

Single Pole



No. 2000



No. 2834

Plastic Cover—2-Inch Porcelain Base

Height over cover, 1¹³/₃₂-inches. Screw spacing, 1³/₈-inches.

6 Amperes, 125 Volts; 3 Amperes, 250 Volts

No.	Description	Car- ton	Std. Pkg.	Wt. Lbs. Std. Pkg.	Per 100
2220	Solid Base	10	100	24	\$119.00
2000	Slotted Base	10	100	24	119.00
2035	Indicating, Solid B.	10	100	25	139.50
2047	Indicating, Slotted B.	10	100	25	144.50

Plastic Cover—2⁷/₁₆-Inch Porcelain Base

Height over cover, 1⁹/₁₆-inches. Screw spacing, 1³/₄-inches.

10 Amperes, 125 Volts; 5 Amperes, 250 Volts

2036	Indicating, Solid B.	10	100	36	\$171.50
2048	Indicating, Slotted B.	10	100	38	171.50

Metal Cover—3¹/₃₂-Inch Porcelain Base

Height over cover, 1¹¹/₁₆-inches. Screw spacing, 2³/₁₆-inches.

20 Amperes, 125 Volts; 10 Amperes, 250 Volts

2833	Indicating, Solid B.	2	30	18	\$374.00
2834	Indicating, Slotted B.	2	30	18	436.50

Rotary Switch Lock Attachment

Use to convert rotary switch to lock switch.

2384	Polished Nickel	2	20	2	\$81.00
------	-----------------	---	----	---	---------

Three and Four-Way Porcelain Bases—Plastic Covers



Three-Way, Non-Indicating

3 Amperes, 125 Volts; 1 Ampere, 250 Volts

Base Diameter, 2-inches. Height over cover, 1¹³/₃₂-inches. Screw spacing, 1³/₈-inches.

No.	Description	Car- ton	Std. Pkg.	Wt. Lbs. Std. Pkg.	Per 100
2456	Solid Base	10	100	25	\$252.50

10 Amperes, 125 Volts; 5 Amperes, 250 Volts

Base Diameter, 2⁷/₁₆-inches. Height over cover, 1⁹/₁₆-inches. Screw spacing, 1³/₄-inches.

2030	Slotted Base	10	50	18	\$264.50
------	--------------	----	----	----	----------

Four-Way, Non-Indicating

5 Amperes, 125 Volts; 2 Amperes, 250 Volts

For use in connection with two three-way switches to control current from any of more than two points. At each additional point between the three-way switches a four-way switch is installed.

Diameter over base, 2⁷/₁₆-inches. Height over cover, 1⁹/₁₆-inches. Screw spacing, 1³/₄-inches.

No.	Description	Car- ton	Std. Pkg.	Wt. Lbs. Std. Pkg.	Per 100
2033	Slotted Base	10	30	12	\$579.50

Double Pole



No. 2040

10 Amperes, 125 Volts; 10 Amperes, 250 Volts Porcelain Base—Plastic Cover

Base diameter 2⁷/₁₆-inches. Height over cover 1⁹/₁₆-inches. Screw spacing, 1³/₄-inches.

No.	Description	Car- ton	Std. Pkg.	Wt. Lbs. Std. Pkg.	Per 100
2050	Indicating, Slotted B.	10	100	37	\$242.50

20 Amperes, 125 Volts; 20 Amperes, 250 Volts Porcelain Base—Metal Cover

Base Diameter 3¹/₃₂-inches. Height over cover, 1²³/₃₂-inches. Screw spacing, 2³/₁₆-inches.

Has No. 2779 flat composition handle.

No.	Description	Car- ton	Std. Pkg.	Wt. Lbs. Std. Pkg.	Per 100
2040	Indicating, Solid Base	2	30	21	\$532.50
2052	Indicating, Slotted B.	2	30	19	532.50

Motor Control—Double Throw

20 Amperes, 125 Volts; 10 Amperes, 250 Volts Porcelain Base—Plastic Cover

Indicated Operation: Circuit 1, Off, Circuit 2, Off.

Base Diameter 2¹¹/₁₆-inches. Height over cover 1²⁹/₃₂-inches. Screw spacing, 2¹/₃₂-inches.

Has No. 2779 flat composition handle.

No.	Description	Car- ton	Std. Pkg.	Wt. Lbs. Std. Pkg.	Per 100
2614	Indicating, Slotted B.	2	10	6	\$1203.50

Rotary switches can be converted into lock switches by use of No. 2384 Universal Rotary Switch Lock Attachment.

Bryant Car Lighting Control Switch



No. 2315

Surface Mounting Rectangular Fusible



No. 2316

Single-Pole. Brown Porcelain Base, Cover, and Handle. Takes cartridge fuse No. 2316. Fuse not included. Base, 3⁷/₈ x 3-inches.

No.	Description	Car- ton	Std. Pkg.	Wt. Lbs. Std. Pkg.	Per 100
*2315	Indicating, Solid Base	2	25	32	\$482.00
*2316	Cartridge Fuse	10	100	4	71.50

*Not listed as standard by Underwriters' Laboratories, Inc.

McGill Levolver Switches

Approved by Underwriters' Laboratories, Inc.

Lever Operated—Single Circuit

6 Amp. "T," 125 Volt—3 Amp., 250 Volt



No. 41

$\frac{5}{8}$ -inch thick. One of the smallest 6 amp., 250-volt pull switches made, yet has unusual capacity. Single pole, double break mechanism, equipped with 6-ft. cord or plain lever control. Standard finishes: brass, dark bronze, and burnished nickel.

Widely adaptable for canopy or conduit box mounting for individual control of incandescent or fluorescent lighting, F.H.P. motors, etc.

No.	Diam.	Stem, In. Length	Carton	Std. Pkg.	Pkg. Wt. Lbs.	Per 100
41	$\frac{7}{16}$	$\frac{3}{16}$	10	100	8	\$100.00
42	$\frac{7}{16}$	$\frac{3}{8}$	10	100	8	106.00
43	$\frac{7}{16}$	$\frac{3}{4}$	10	100	8	106.00

Lever Operated—Single Circuit

6 Amp. "T," 125 Volt—3 Amp., 250 Volt



No. 39

Can be used on any chain fixture, and between any two links of chain. When installed in fixtures that have been previously hung it fits in place of one of the chain links without altering the length of the fixture or necessitating rewiring or splicing of lead wires.

The Levolver link switch consists of a standard Levolver pull switch, and Levolver link.

No.	Description	Carton	Std. Pkg.	Pkg. Wt.	Per 100
39	With Mounting Link	10	100	13	\$110.00

Lever Operated—Two Circuit

3 Amp., 125 Volt—1 Amp., 250 Volt



No. 201

Designed to operate with three-light lamps. When installed in the canopy of a fixture using the three-light lamp, it operates as follows: First pull turns on smaller filament, second pull turns off small filament and turns on the larger filament, third pull turns both filaments on and fourth turns both off. Standard finishes: brass, dark bronze and burnished nickel. Size $\frac{7}{8}$ x $1\frac{3}{8}$ inches.

No.	Diam.	Stem, In. Length	Carton	Std. Pkg.	Pkg. Wt.	Per 100
201	$\frac{7}{16}$	$\frac{3}{16}$	10	100	11	\$114.00
202	$\frac{7}{16}$	$\frac{3}{8}$	10	100	11	118.00
203	$\frac{7}{16}$	$\frac{3}{4}$	10	100	12	118.00

Lever Operated—Three Way

3 Amp., 125 Volt—1 Amp., 250 Volt



No. 301

Permits the control of one or more lights from two different points. Also used as reversing switch and for fractional horsepower motors. Standard finishes: brass, burnished nickel. Size $\frac{7}{8}$ x $1\frac{3}{8}$ inches.

No.	Diam.	Stem, In. Length	Carton	Std. Pkg.	Pkg. Wt.	Per 100
301	$\frac{7}{16}$	$\frac{3}{16}$	10	100	12	\$118.00
302	$\frac{7}{16}$	$\frac{3}{8}$	10	100	12	126.00
303	$\frac{7}{16}$	$\frac{3}{4}$	10	100	13	126.00

Lever Operated—Single Circuit

10 Amp. "T," 125 Volt—5 Amp., 250 Volt



No. 1010

Smallest 10 Amp. pull switch made yet has the ability to withstand the same loads as switches much larger. Single pole double break mechanism with 6-ft. cord and bell. For individual control of high wattage lamps and fluorescent banks up to six 4-tube fixtures. 1-piece molded phenolic casing.

No.	Diam.	Stem, In. Length	Carton	Std. Pkg.	Pkg. Wt.	Per 100
1010	$\frac{1}{2}$	$\frac{3}{8}$	10	100	20	\$180.00
1010L	$\frac{1}{2}$	$\frac{5}{8}$	10	100	20	180.00
1039	With Mounting Link		10	100	26	180.00

Pull Chain—Single Circuit

3 Amp. "T," 125 V.—1 Amp., 250 V.



No. 21

A durable, inexpensive 3 Amp., 250-Volt switch with single pole, double break mechanism, enclosed in plastic case. 6-inch wire leads secured to terminals by pressure connections—no soldered terminals. Equipped with 6-ft. cord and bell. Size 1 x $1\frac{1}{4}$ inches.

No.	Diam.	Stem, Inches Length	Carton	Std. Pkg.	Pkg. Wt.	Per 100
21	$1\frac{3}{32}$	$\frac{5}{16}$	10	100	7	\$72.00

Lever Operated—Two Circuit

10 Amp. "T," 125 Volt—5 Amp., 250 Volt



No. 1020-S

Sturdy single pole 10 Amp. switch to control double filament, three light lamps. Also suitable for fluorescent groups where it is desirable to light one or more tubes in individual fixtures. Circuit control sequence: 1, 2, 1 and 2, off. Equipped with 6-ft. cord and bell. Standard finishes: brass, nickel and burnished nickel. Size $\frac{7}{8}$ x $1\frac{3}{4}$ inches.

No.	Diam.	Stem, In. Length	Carton	Std. Pkg.	Pkg. Wt.	Per 100
1020	$\frac{7}{16}$	$\frac{3}{8}$	10	100	13	\$186.00
1020L	$\frac{7}{16}$	$\frac{3}{4}$	10	100	13	186.00

Toggle—Single and 2 Circuits

6 Amp., 125 Volt—3 Amp., 250 Volt



No. 10

A toggle switch that provides lever action operating in line with the switch body. Has a horizontal acting metal lever. Especially suited for power tools, appliances, etc. Size $\frac{1}{2}$ " x $\frac{1}{2}$ " x 1".

No.	Description	Std. Pkg. Wt. Lbs.	Price Per 100
10	Single Circuit, Wire Leads.....	6	\$64.00
10-L	Single Circuit, w/sold. Lugs.....	5	64.00
10-T	Single Circuit, w/terminals.....	5	70.00
12	Two Circuit, Wire Leads, No Off....	6	84.00

Switch No. 12 can be furnished with soldering lugs or terminals. Prices on request.

McGill Levolver Switches

Approved by Underwriters' Laboratories, Inc.

For Multiple Circuits



No. 400

The following are typical of the many Special Use Switches built by McGill for controlling all types of circuits. Others can be designed readily with the McGill method of assembling interchangeable component parts.

Rated from 4 to 10 Amps., 250-volt, these switches are especially serviceable for ventilating fans, circulators and fractional horsepower motors. Overall sizes are small.

No.	Stem, In.	Length	Ampers	Std. Pkg.	Pkg. Wt.	Per 100
			125V 250V			
			1-2-off, D.P.D.T.			
206	1/2	3/8	6 3	100	15	\$212.00
			1-off-2-off, D.P.D.T.			
265	1/2	3/8	6 3	100	15	192.00
			1-2-off, D.P.D.T.			
266	1/2	3/8	6 3	100	15	186.00
			1-off-2-off, S.P.D.T.			
272	1/2	3/8	10 5	100	15	186.00
			1-off-2-off, D.P.D.T.			
275	7/16	3/8	6 3	100	15	186.00
			off-on, D.P.S.T.			
276	1/2	3/8	6 3	100	15	186.00
			1-off-2-off, D.P.D.T.			
282	1/2	3/8	6 3	100	15	206.00
			1-2-3-off, S.P.			
400	7/16	3/8	4 2	100	12	138.00
			1-off-2-off, S.P.			
402	7/16	3/8	4 2	100	12	128.00
			1-2-3-4-no off, S.P.			
404	7/16	3/8	4 2	100	13	140.00
			1-2-3-4-5-no off, S.P.			
405	1/2	3/8	4 2	100	15	190.00
			1-2-off, S.P.			
406	7/16	3/8	4 2	100	13	130.00
			1-2-off, D.P.D.T.			
450	1/2	11/16	6 3	100	16	212.00
			1-2-3-off, S.P.			
471	1/2	3/8	10 5	100	15	250.00
			1-2-3-off, D.P.T.T.			
472	1/2	3/8	6 3	100	15	254.00
			1-2-3-off, D.P.			
473	1/2	3/8	6 3	100	15	250.00
			 fwd.-off-rev.-off, D.P.D.T.			
480	1/2	3/8	6 3	100	15	214.00
			1-off-2-off, D.P.D.T.			
482	1/2	3/8	6 3	100	15	202.00
			Line Reversing, D.P.			
501	7/16	3/8	4 2	100	15	200.00
			on-off, T.P.S.T.			
841	1/2	3/8	6 3	100	15	260.00
			1-off-2-off, T.P.D.T.			
842	1/2	3/8	6 3	100	15	260.00
			1-2-3-off, T.P.T.T.			
843	1/2	3/8	6 3	100	15	280.00

Brass Caps and Casings for above Special Use Switches Nos. 275, 400, 402, 404, 406 and 501 furnished at \$40.00 per 100 list. Caps and Casings for above Special Use Switches Nos. 405, 471, 472, 473, 841, 842 and 843 not available. Other Special Use Switches take No. 1080 Molded Phenolic Housings.

Levolver Vertical Pull Adapter

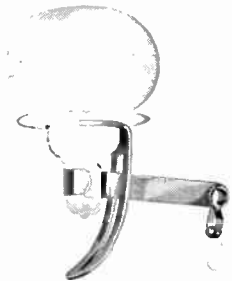

No. 84

For Levolver Switches With 7/16-inch Stem Diameter

Adapts Levolver switches to vertical or straight down mounting in odd shaped or close to the ceiling canopies. It has a short extension arm that clips to switch lever and is aligned by slot in guide arm that is tightened under mounting nut. Adapter can be installed in a few seconds.

No.	Carton	Std. Pkg.	Wt. Lbs. Std. Pkg.	Per 100
84	10	100	2	\$22.00

Lever Operated—Single Circuit

6 Amp. "T," 125 Volt—3 Amp., 250 Volt



No. 71

The thinnest 6 Amp., 250 Volt "T" rated switch made—only 15/32 inch thick. Plastic cased with 6-inch wire leads, it has the famous Levolver mechanism. Size 1 1/2 x 1 1/2 inches.

Ideal for small, and especially thin sectional fixture canopies.

No.	Diam.	Length	Carton	Std. Pkg.	Pkg. Wt.	Per 100
71	15/32	3/2	10	100	8	\$96.00

Push Type—Single Circuit

6 Amp. "T", 125 Volt—3 Amp., 250 Volt



No. 71P

Similar to the No. 71 switch with molded phenolic case and wire leads. Has push type control instead of universal lever. Stem dia. 15/32", stem length 1/2" SPST.

Cat. No.	Description	Carton	Std. Pkg.	Pkg. Wt.	Price Per 100
71-P	Single Circuit, Wire Leads....	10	100	8 1/2	\$96.00

Single Circuit—Two Circuit—Three Way

6 Amp., 125 Volt—3 Amp., 250 Volt

Plastic cased toggle switches, wire leads or soldering lugs. Single pole, double break mechanism. No. 25 is single circuit for individual control of lights, "T" rated. Size 1 1/2 x 1 1/2 inch.



No. 25

No. 27 is three-way for control of one or more lights from two points. No. 28 for controlling either of two circuits. No off position.

No.	Description	Carton	Std. Pkg.	Pkg. Wt.	Per 100
25	Single Circuit, Wire Leads....	10	100	6	\$ 66.00
25-L	Same, w/sold. Lugs.....	10	100	5	66.00
25-T	Same, w/Terminals.....	10	100	5	74.00
27	Three-Way, Wire Leads.....	10	100	6	82.00
28	Two Circuit, Wire Leads.....	10	100	6	102.00

All stem diameters 15/32", length 1/4".

Standard with metal lever but plastic levers available in ivory, black, red, dark red, green, yellow, blue, brown, grey or orange. Switches Nos. 27 and 28 can be furnished with soldering lugs or terminals. Prices on request.

Levolver Extension Arms

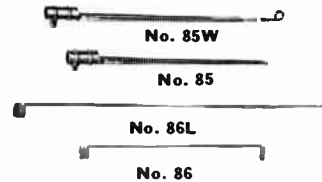

No. 85W

No. 85

No. 86L

No. 86

Prevents the pulling of lamp cords against reflectors, shades, and bowls that causes needless wear, expense, fixture swaying and risk. The arm slips over the Levolver switch lever, cord is inserted through end hole and knotted to hold.

No. 85-W can be extended for use with 18-22-in. and larger basin fixtures. Standard or special finished to match all Levolver switches.

No.	Overall Length Inches	Carton	Std. Pkg.	Wt. Lbs. Std. Pkg.	Per 100
85	5 1/4	10	100	3	\$20.00
85-W	9	10	100	4	26.00
*86	5	10	100	2	16.00
*86-L	9	10	100	3	20.00

*For No. 71 Switch only.

Bryant 600-Volt Surface Switches

For Inductive Loads and Electric Railway Circuits



No. 2049

Solid porcelain base. All switches are indicating excepting No. 2179.

Single Pole

10 Amperes, 250 Volts; 5 Amperes, 600 Volts

No.	Diameter	Screw Spacing	Car-ton	Std. Pkg.	Wt. Lbs. Std. Pkg.	Per 100
*2049	2 ⁷ / ₁₆ -Inches	1 ³ / ₄ -Inches	2	50	21	\$451.00

Double Pole

10 Amperes, 250 Volts; 5 Amperes, 600 Volts

No.	Diameter	Screw Spacing	Car-ton	Std. Pkg.	Wt. Lbs. Std. Pkg.	Per 100
*2773	2 ⁷ / ₁₆ -Inches	1 ³ / ₄ -Inches	2	50	20	\$545.50

Three-Way

10 Amperes, 250 Volts; 5 Amperes, 600 Volts

No.	Diameter	Screw Spacing	Car-ton	Std. Pkg.	Wt. Lbs. Std. Pkg.	Per 100
*2179	2 ⁷ / ₁₆ -Inches	1 ³ / ₄ -Inches	2	50	19	\$341.00

Hubbell Toggle Appliance Switches

Conform to N.E.C. Standard

Center Hole Mounting

Single Pole



Nos. 8745 and 8659



Nos. 8650 and 8657

Diameter of neck, 1/2-inch. Diameter of base, 1 1/4-inches. Standard finishes are brush brass or polished nickel.

6 Amperes, 125 Volts; 3 Amperes, 250 Volts

Depth, 3/4-inch.

No.	Description	Car-ton	Std. Pkg.	Pkg. Wt. Lbs.	Per 100
8650	With 1 1/4-Inch Neck.....	10	50	4	\$115.50
8656	With 1/2-Inch Neck.....	10	50	5	131.00
8745	With 1 1/4-Inch Neck, Ind....	10	50	4	121.50
8746	With 1/2-Inch Neck, Ind....	10	50	6	143.50

15 Amperes, 125 Volts; 10 Amperes, 250 Volts

Depth 1 3/16-inch.

No.	Description	Car-ton	Std. Pkg.	Pkg. Wt. Lbs.	Per 100
8657	With 1 1/4-Inch Neck.....	10	50	5	\$136.50
8658	With 1/2-Inch Neck.....	10	50	4	154.00
8659	With 1 1/4-Inch Neck, Ind....	10	50	4	143.50
8660	With 1/2-Inch Neck, Ind....	10	50	6	185.00

Hubbell Surface Toggle Switches

Conform to N.E.C. Standard

With Brass Covers and Metal Handles



No. 8171



No. 8112

Black porcelain base. Screw holes are elongated. If desired grounded, suffix letter "G" to catalog number. Brush brass is standard finish for Covers.

With 2 1/4-Inch O.O. Base

Screw spacings, 1 1/2 to 1 21/32-inches.

No.	Description	Amperes 125V. 250V.	Car-ton	Std. Pkg.	Wt. Lbs.	Per 100
8171	S.P., Solid.....	5 3	10	100	35	\$135.50
8191	S.P., Slotted.....	5 3	10	100	38	135.50
8421	S.P., Solid.....	10 5	10	100	37	160.50
8431	S.P., Slotted.....	10 5	10	100	37	160.50
8173	3-Way, Solid.....	5 3	10	100	36	201.50
8193	3-Way, Slotted.....	5 3	10	100	36	201.50

With 2 5/8-Inch O.D. Base

Screw spacings, 1 21/32 to 1 25/32-inches.

No.	Description	Amperes 125V. 250V.	Car-ton	Std. Pkg.	Wt. Lbs.	Per 100
8112	D.P., Solid.....	10 10	100	57	\$319.00	
8162	D.P., Slotted.....	10 10	100	57	319.00	
8153	3-Way, Solid.....	10 5	10	50	20	369.50
8233	3-Way, Slotted.....	10 5	10	50	28	369.50

McGill Levolver Switches

Approved by Underwriters' Laboratories, Inc.

Toggle—Single and 2 Circuit

15 Amp., 125 Volt—10 Amp., 250 Volt



No. 90

Designed for AC operation. 3/4 H.P. capacity. Heavy silver button contacts, 1 5/32"-32 threaded nipple, 1/16" long. Nickel finish with molded phenolic case.

No. 90 has a single-pole, single-throw mechanism; No. 91 with single-pole, double-throw with center off; No. 92 is same as No. 91 without "off."

No.	Description	Pkg. Wt.	Per 100
90	Single Circuit, Screw Terminals.....	10	\$ 94.00
90-L	Same, w/sold. Lugs.....	9	90.00
90-S	Same, w/spade Terminals.....	9	90.00
91	Two Circuit, Screw Terminals.....	10	106.00
91-L	Same, w/sold. Lugs.....	9	102.00
91-S	Same, w/spade Terminals.....	9	102.00
92	Two Circuit, Screw Terminals, No Off.....	10	106.00
92-L	Same, w/sold. Lugs.....	9	102.00
92-S	Same, w/spade Terminals.....	9	102.00

Carton, 10; standard package, 100.

Momentary Contact—Single Circuit

.75 Amp., 125 Volt



No. 29

Similar to the No. 25 switch with molded phenolic case and wire leads. Has button control and switch is normally on. Stem dia. 1 5/32", stem length 9/32" SPST.

No.	Description	Car-ton	Std. Pkg.	Pkg. Wt. Lbs.	Per 100
29	Single Circuit, Wire Leads.....	10	100	5 1/2	\$68.00

Carling Toggle Switches For A-C Operation



Single Pole
"F" Series



Double Pole
"G" Series

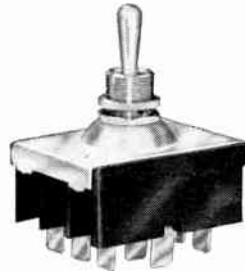

Three Pole
"H" Series

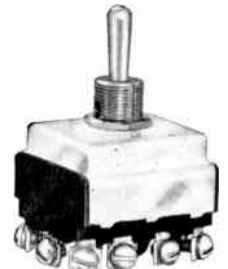

Four Pole
"I" Series

"F" and "G" Series

For Tab Terminals
Add Suffix—TABS

Nominal Ratings

15 Amp., 125 V.	6 Amp., 125 V.		
10 Amp., 250 V.	3 Amp., 250 V.		
3/4 Hp. 115-230 V.	1/4 Hp. 115-230 V.		
Solder Lugs No.	Screw Terminals No.	Solder Lugs No.	Screw Terminals No.
2FA53*	2FA54*	2FA63	2FA64
6FA57	6FA58	6FA67	6FA68
6FA53	6FA54	6FA63	6FA64
2FB53	2FB54	2FB63	2FB64
2FC53	2FC54	2FC63	2FC64
6FB53	6FB54	6FB63	6FB64
6FC53	6FC54	6FC63	6FC64
6FC57	6FC58	6FC67	6FC68

Electrical Circuit Characteristics
Position of Toggle
(Note: Keyway Indicates "Down" Position)

Up Position	Center Position	Down Position
On	None	Off
On	None	Momentarily Off
Off	None	Momentarily On
On	None	On
On	Off	On
On	None	Momentarily On
Momentarily On	Off	Momentarily On
On	Off	Momentarily On

For Tab Terminals
Add Suffix—TABS

Nominal Ratings

15 Amp., 125 V.	6 Amp., 125 V.		
10 Amp., 250 V.	3 Amp., 250 V.		
3/4 Hp. 115-230 V.	1/4 Hp. 115-230 V.		
Solder Lugs No.	Screw Terminals No.	Solder Lugs No.	Screw Terminals No.
2GK53	2GK54	2GK63	2GK64
6GK57	6GK58	6GK67	2GK68
6GK53	6GK54	6GK63	6GK64
2GL53	2GL54	2GL63	2GL64
2GM53	2GM54	2GM63	2GM64
6GL53	6GL54	6GL63	6GL64
6GM53	6GM54	6GM63	6GM64
6GM57	6GM58	6GM67	6GM68

Ratings

13 Amp., 125 V.
10 Amp., 250 V.
1 Hp. 1, 2, 3 Phase 115-575 V.

Lug No.	Terminals Screw No.	Tab No.
HK233	HK234	HK23A
HK637	HK638	HK63B
HK633	HK634	HK63A
HL233	HL234	HL23A
HM233	HM234	HM23A
HL633	HL634	HL63A
HM633	HM634	HM63A
HM637	HM638	HM63B

Electrical Circuit Characteristics
Position of Toggle
(Note: Keyway Indicates "Down" Position)

Up Position	Center Position	Down Position
On	None	Off
On	None	Momentarily Off
Off	None	Momentarily On
On	None	On
On	Off	On
On	None	Momentarily On
Momentarily On	Off	Momentarily On
On	Off	Momentarily On

Ratings

15 Amp., 125 V.
10 Amp., 250 V.

Lug No.	Terminals Screw No.	Tab No.
IK253	IK254	IK25A
IK657	IK658	IK65B
IK653	IK654	IK65A
IL253	IL254	IL25A
IM253	IM254	IM25A
IL653	IL654	IL65A
IM653	IM654	IM65A
IM657	IM658	IM65B

Note: For Toggle and Threaded Stem lengths wanted on "F", "G", "H", "I" Series Switches, add proper Suffix

Number as follows (If not specified, -73 Standard Suffix will be furnished):

Toggle Lgth., In.	Stem Lgth., In.	Suffix Number	Rain and Dust Resistant
1 3/32	1 1/32	-52	-57
9/16	1 1/32	-62	-67
1 1/16	1 1/32	-72	-77
1	1 1/32	-A2	-A7

Toggle Lgth., In.	Stem Lgth., In.	Suffix Number	Rain and Dust Resistant
9/16	15/32	-63	-68
1 1/16	15/32	-73	-78
2	15/32	-E3	-E8
3	15/32	-I3	-I8

**"G" Series Momentary Types Suffix -73 only.

Single Pole "A" Series



With Metal Toggle

Ratings
15 Amp., 125 V.
7 1/2 Amp., 250 V.
1/2 Hp. 115-23 V.



With Plastic Toggle

Lug No.	Terminals Screw No.	Tab No.	Up Position	Center Position	Down Position
AA252	AA254	AA25A	On	None	Off
AB252	AB254	AB25A	On	None	On
AC252	AC254	AC25A	On	Off	On
Rating: 3 Amp., 125 V. (Below)					
AA232	AA234	AA23A	On	None	Off

Note: For Metal Toggle Type add suffix -71. For Colored Plastic Toggle Types add the following suffixes for the desired color: Black-BL; Brown-BR; White-WH; Red-RD.

Carling Switches



"B" Series

"B" Series			Nominal Rating A-C or D-C
No.	Type of Terminals	Poles-Circuit	
T-110	Lugs-End	S.P.-S.T.	3 Amp., 250 V. 6 Amp., 125 V.* *T Rated
T-110-B	Lugs-Bottom	S.P.-S.T.	
T-110-S	Screw	S.P.-S.T.	
T-111-16	Wire	S.P.-S.T.	
110	Lugs-End	S.P.-S.T.	3 Amp., 250 V. 6 Amp., 125 V.
110-B	Lugs-Bottom	S.P.-S.T.	
110-D	Lugs-S Ends	S.P.-S.T.	
110-S	Screw	S.P.-S.T.	
111-16	Wire	S.P.-S.T.	
111-D	Wire-2 Ends	S.P.-S.T.	1 Amp., 250 V. 3 Amp., 125 V.
112	Lugs-End	S.P.-D.T.	
112-A	Wire	S.P.-D.T.	
216	Lugs-End	D.P.-S.T.	
216-A	Wire	D.P.-S.T.	
216-B	Lugs-Bottom	D.P.-S.T.	3 Amp., 250 V. 6 Amp., 125 V.
316	Lugs	D.P.-D.T.	
316-A	Wire	D.P.-D.T.	
316-B	Lugs-Bottom	D.P.-D.T.	3 Amp., 250 V. 6 Amp., 125 V.
2BK 62	Lugs-End	D.P.-S.T.	
2BK 62	Lugs-End	D.P.-S.T.	
2BK 62	Lugs-End	D.P.-S.T.	
2B1.62	Lugs-End	D.P.-D.T.	10 Amp., 125 V. 5 Amp., 250 V.
2B1.63	Lugs-Bottom	D.P.-D.T.	
160	Lugs-End	S.P.-S.T.	12 Amp., 125 V. 6 Amp., 250 V. 1 Hp. 125-250 V.
160-A	Wire	S.P.-S.T.	
160-B	Lugs-Bottom	S.P.-S.T.	
160-S	Screw	S.P.-S.T.	
2DA25	Screw	S.P.-S.T.	12 Amp., 125 V. 6 Amp., 250 V. 1 Hp. 125-250 V.
2DK 25	Screw	D.P.-S.T.	

"E" Series

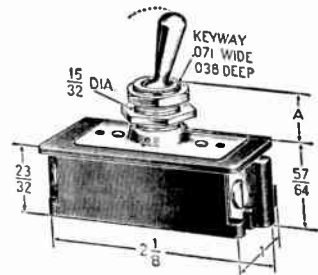

"E" Series

"E" Series			Nominal Rating A-C or D-C
No.	Type of Terminals	Poles-Circuit	
EA255	Screw	S.P.-S.T.	15 Amp., 125 V. 10 Amp., 250 V. 1 1/2 Hp. 125-250 V.
EK255	Screw	D.P.-S.T.	
600-C	Screw	S.P.-S.T.	

Above furnished with 1/16-in. Bat Toggle and 1 1/2-in. Threaded Stem length standard. Other lengths and types available.—Exception No. 600-C.

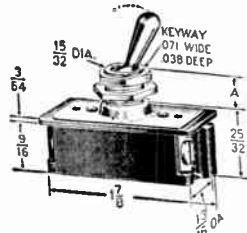

"D" Series

"D" Series			Nominal Rating A-C or D-C
No.	Type of Terminals	Poles-Circuit	
15	Lugs-End	S.P.-S.T.	3 Amp., 250 V. 6 Amp., 125 V.* *T Rated
15	Lugs-Bottom	S.P.-S.T.	
15	Screw	S.P.-S.T.	
15	Wire	S.P.-S.T.	
110	Lugs-End	S.P.-S.T.	3 Amp., 250 V. 6 Amp., 125 V.
110-B	Lugs-Bottom	S.P.-S.T.	
110-D	Lugs-S Ends	S.P.-S.T.	
110-S	Screw	S.P.-S.T.	
111-16	Wire	S.P.-S.T.	
111-D	Wire-2 Ends	S.P.-S.T.	1 Amp., 250 V. 3 Amp., 125 V.
112	Lugs-End	S.P.-D.T.	
112-A	Wire	S.P.-D.T.	
216	Lugs-End	D.P.-S.T.	
216-A	Wire	D.P.-S.T.	
216-B	Lugs-Bottom	D.P.-S.T.	3 Amp., 250 V. 6 Amp., 125 V.
316	Lugs	D.P.-D.T.	
316-A	Wire	D.P.-D.T.	
316-B	Lugs-Bottom	D.P.-D.T.	3 Amp., 250 V. 6 Amp., 125 V.
2BK 62	Lugs-End	D.P.-S.T.	
2BK 62	Lugs-End	D.P.-S.T.	
2BK 62	Lugs-End	D.P.-S.T.	
2B1.62	Lugs-End	D.P.-D.T.	10 Amp., 125 V. 5 Amp., 250 V.
2B1.63	Lugs-Bottom	D.P.-D.T.	
160	Lugs-End	S.P.-S.T.	12 Amp., 125 V. 6 Amp., 250 V. 1 Hp. 125-250 V.
160-A	Wire	S.P.-S.T.	
160-B	Lugs-Bottom	S.P.-S.T.	
160-S	Screw	S.P.-S.T.	
2DA25	Screw	S.P.-S.T.	12 Amp., 125 V. 6 Amp., 250 V. 1 Hp. 125-250 V.
2DK 25	Screw	D.P.-S.T.	

No. 600-C



"L" Series



"B-4" Series

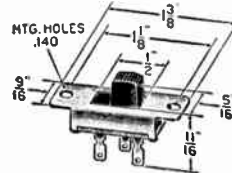

"S-6" Series

"L" Series
Nominal Ratings

"L" Series Nominal Ratings				"B-4" Series				
15 Amp., 125 V. A-C	10 Amp., 250 V. A-C	1/2 Hp. 115-230 V. A-C	3 Amp., 250 V. A-C	6 Amp., 125 V. A-C	Solder Lugs No.	Screw Terminals No.	Tab Terminals No.	Poles or Circuit
LA453	LA454	LA45A	LA463	LA464	LA46A	LB46A	LB46A	S.P.-S.T.
LB453	LB454	LB45A	LB463	LB464	LB46A	LC46A	LC46A	S.P.-D.T.
LB453	LC454	LC45A	LC463	LC464	LC46A	LC46A	LC46A	S.P.-D.T.

Standard color slide Black. Other colors available.

"B-4" Series

"B-4" Series			
No.	Type of Terminals	Poles or Circuit	Nominal Rating
S-110	Lugs-End	S.P.-S.T.	6 Amp., 125 V. 3 Amp., 250 V. A-C or D-C
S-110-B	Lugs-Bottom	S.P.-S.T.	
S-110-S	Screw	S.P.-S.T.	
S-111	Wire Leads	S.P.-S.T.	
S-111-D	Wire-2 Ends	S.P.-S.T.	3 Amp., 125 V. 1 Amp., 250 V. A-C or D-C
S-112	Lugs	S.P.-D.T.	
S-112-A	Wire	S.P.-D.T.	
S-216	Lugs	D.P.-S.T.	
S-216-A	Wire	D.P.-S.T.	3 Amp., 125 V. 1 Amp., 250 V. A-C or D-C
S-316	Lugs	D.P.-D.T.	
S-316-A	Wire	D.P.-D.T.	S.P. 2 Circuit S.P. 2 Circuit
S-516	Lugs	S.P. 2 Circuit	
S-516-A	Wire	S.P. 2 Circuit	

"S-6" Series

"S-6" Series			
No.	Type of Terminals	Poles or Circuit	Nominal Rating
S60A	Lugs	S.P.-S.T.	4 Amp., 125 V. A-C
S60B	Lugs	S.P.-D.T.	

Standard color slide Black. Red or Gray also available.



"700" Series

Lug No.	Terminals	Lug No.	Terminals
700-1	RRA43	700	RRQ43
700-7	RRB43	700-3	RRP43
700-6	RRC43	700-9	RRQ43
700-4	RRD43	700-2
700-8	RRE43		
700-5	RRF43		



"RR" Series

Circuit Characteristics			
Position	1	2	3 4
Off-On			
On-On			
On-Off-On			
Off-On-On			
On-On-On			
Off-On-Off			
Off-On-On-On			
Off-On-On-Off			
Off-On-Off-On			
Off-On-On-On-Repeat			

(8 Position-No Stop-Operates Either Direction)

Color of Knob: Black
Brown
Gray

Rating: 4 Amp., 125 V. A-C
1 Amp., 125 V. D-C
Tab terminals available on request

Carling Switches



No. 215



No. 220



No. 221



No. 222

Mounting: Rectangular opening 1 1/32-in. x 2 1/32-in. in .045-in. to .065-in. thick panel.

Screw Terminals No.	Wire Leads No.	Tab Terminals No.	Item	Nominal Rating
215	215-A	MAAOA	S.P.—S.T. Switch	20 Amp., 125 V. A-C 10 Amp., 250 V. A-C 1/2 Hp.
220	220-A	220-B	Outlet	
221	221-A	Cap	15 Amp., 125 V. 10 Amp., 250 V. A-C or D-C 110 V. A-C or D-C 230 V.
222	222-A	222-B	Pilot Light	

Note: Add the following suffixes for the color desired. Brown-BR; White-WH; Black-BL; Gray-GY; Red-RD.

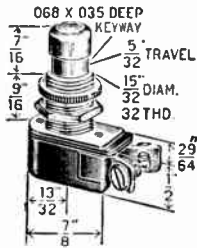

"B-3" "B-7" Series

"B-3" — "B-7" Series

Maintained Contacts No.	Momentary Contacts		Type of Terminals	Poles or Circuit	Nominal Rating
	Normally Open No.	Normally Closed No.			
110-P	110-PM-OFF	110-PM-ON	Lug	S.P.-S.T.	6 Amp., 125 V. 3 Amp., 250 V. A-C or D-C
110-PP	110-PBM-OFF	110-PBM-ON	Lug-Bottom	S.P.-S.T.	
110-SP	110-SPM-OFF	110-SPM-ON	Screw	S.P.-S.T.	10 Amp., 125 V. 5 Amp., 250 V. A-C or D-C
111-16P	111-PM-OFF	111-PM-ON	Wire	S.P.-S.T.	
160-P	None	None	Lug	S.P.-S.T.	3 Amp., 125 V. 1 Amp., 250 V. A-C or D-C
160-BP	None	None	Lug-Bottom	S.P.-S.T.	
160-SP	None	None	Screw	S.P.-S.T.	
160-AP	None	None	Wire	S.P.-S.T.	
216-PP	216-PM-OFF	216-PM-ON	Lug	D.P.-S.T.	1 Amp., 250 V. A-C or D-C
216-PPA	216-PAM-OFF	216-PAM-ON	Wire	D.P.-S.T.	
112-P	112-PM	112-PM	Lug	S.P.-D.T.	
112-PA	112-PAM	112-PAM	Wire	S.P.-D.T.	
316-PP	316-PM	316-PM	Lug	D.P.-D.T.	
316-PPA	316-PAM	316-PAM	Wire	D.P.-D.T.	
516-PP	516-PM	516-PM	Lug	2 Circuit	1 Amp., 250 V. A-C or D-C
516-PPA	516-PAM	516-PAM	Wire	2 Circuit	

"16" Series (Momentary Action Only)



"16" Series with Metal Plunger



"16" Series with Colored Plastic Cap

Standard Plunger No.	Cap Plunger No.	Type of Terminals	Poles or Circuit	Nominal Rating
16-3POFF	16-3POFF-C	Lug	S.P.-S.T. Normally Open (Off) (Momentarily On)	3 Amp. 125 V. A-C
16-3APOFF	16-3APOFF-C	Wire		
16-3PON	16-3PON-C	Lug	S.P.-S.T. Normally Closed (On) (Momentarily Off)	1 Amp. 125 V. A-C
16-3APON	16-3APON-C	Wire		
116-P	116-P-C	Lug	S.P.-D.T.	1 Amp. 125 V. A-C
116-AP	116-AP-C	Wire	S.P.-D.T.	
516-P	516-P-C	Lug	S.P. 2 Circuit	
516-AP	516-AP-C	Wire	(1 On-1 Off)	

Color of Caps: Black, White, Red, Green, Yellow, Blue
Suffix Number: -BL -WH -RD -GN -YL -LU

"17" Series (Momentary Action Only)

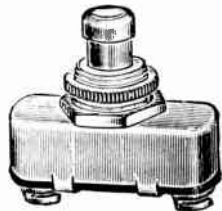

"17" Series



"KA-3" Series

Screw Terminals No.	Solder Lugs No.	Wire Leads No.	Poles or Circuit	Nominal Rating
172	172-B	172-A	S.P.-S.T. Normally Open (Off)	10 Amp. 125-250 V. A-C
170	170-B	170-A	S.P.-S.T. Normally Closed (On)	

"KA-3" Series

No.	Type of Terminal	Poles or Circuit	Nominal Rating
KA331	Wire Leads	S.P.-S.T. Push On-Push Off (Maintained Contacts)	3 Amp., 125 V. 1 Amp., 250 V.

Push Buttons (Momentary)

For Doorbells and Other Low Voltage Applications



Nos. 90 and 91

No.	Description	Carton	Std. Pkg.	Wt. Lbs. Std. Pkg.
90	Black with Ivory Button	20	200	8
91	Ivory with Black Button	20	200	8

(Furnished 2 on a card with wood screws.)

Prices upon request.

Superior "Luxtrol" Light Control

Type WBD360
For Mounting in the Wall

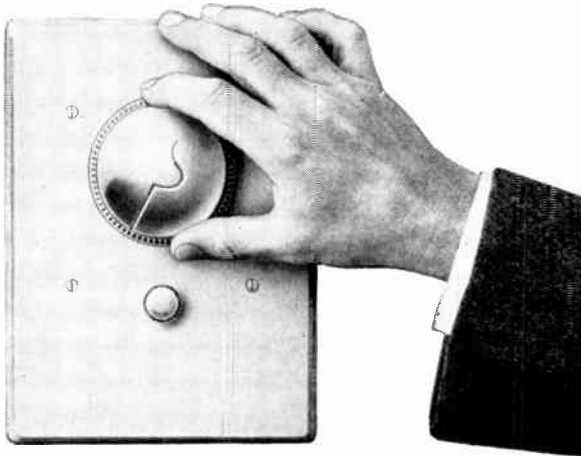

LUXTROL replaces old-style "on-off" switches in new or existing structures to produce any desired light intensity from complete darkness to full brightness by auto-transformer action. Because it is not a rheostat, operation is always cool, smooth and without flicker—only the current required to produce the desired illumination is used.

LUXTROL type WBD360 controls 360 watts of incandescent or cold-cathode lamp load or up to six 40-watt rapid start fluorescent lamps. A switch incorporated at the "off" position shuts off the entire circuit. Both a fuse and a thermal overload are provided to assure complete safety. The knob and faceplate are smartly styled to harmonize with any room decor.

Standard LUXTROL Light Controls

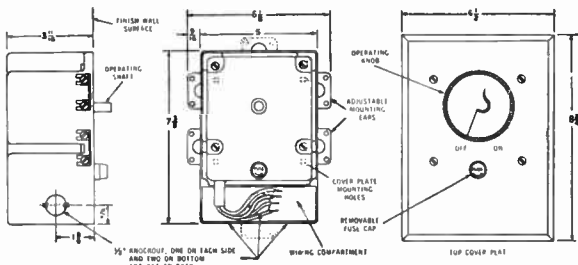

No.	Cover Plate Material and Finish	Knob and Fuse Cap, Color	Each
WBD360-P2-K1	Prime Painted—Steel	Ivory	\$33.00
WBD360-P2-K2	Prime Painted—Steel	Black	33.00
WBD360-P2-K3	Prime Painted—Steel	Gray	33.00
WBD360-P3-K1	Brushed Aluminum	Ivory	33.00
WBD360-P3-K2	Brushed Aluminum	Black	33.00
WBD360-P3-K3	Brushed Aluminum	Gray	33.00
WBD360-P4-K1	Bright Chrome	Ivory	33.00
WBD360-P4-K2	Bright Chrome	Black	33.00
WBD360-P4-K3	Bright Chrome	Gray	33.00
WBD360-P5-K1	Brushed Brass	Ivory	33.00
WBD360-P5-K2	Brushed Brass	Black	33.00
WBD360-P5-K3	Brushed Brass	Gray	33.00

Easy To Install

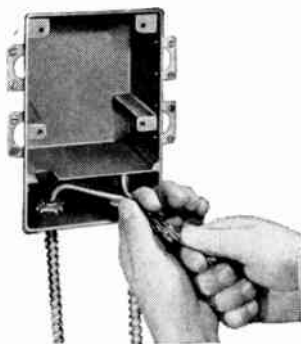

1. Attach wallbox to studs . . . feed input and output load BX through knockouts.

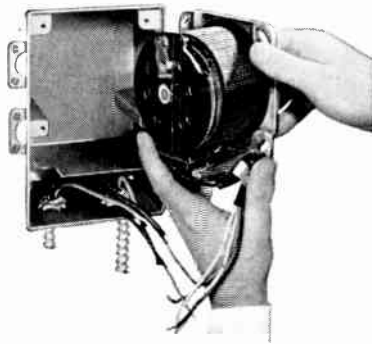

2. Screw control assembly to wallbox.

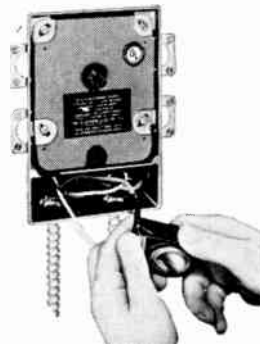

3. Connect circuit leads to color identified control leads.

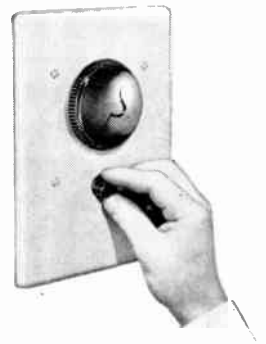

4. Screw on face plate, attach dial, insert fuse . . . and LUXTROL is ready for operation.

FOR LOADS UP TO 750 WATTS . . .

LUXTROL light control type WBD750 provides control up to a full 750 watts of incandescent lamp load or 12-40-watt rapid-start fluorescents. The functionally designed prime painted faceplate can be repainted or wallpapered to match or contrast with the wall finish. Knobs are either ivory, black or gray plastic.

An input switch disconnects the unit and load when the knob is in the "off" position. A thermal overload and a fuse link protect the unit from accidental overloads and excessive overheating conditions.

Price \$49.00

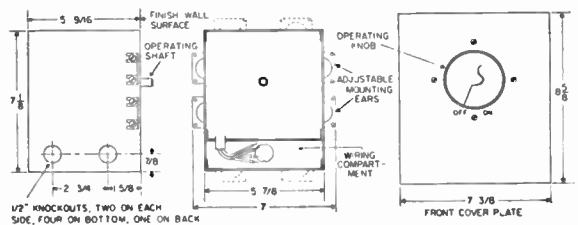
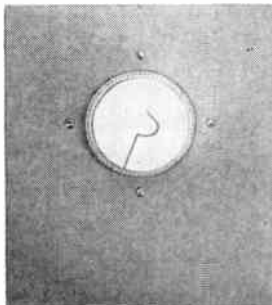

SEE PAGE 590 FOR INFORMATION ON OTHER LUXTROL LIGHT CONTROL EQUIPMENT

Touch-Plate Remote Control Switch System



**Low Voltage
Home Lighting Control**

Touch-Plate low voltage remote control wiring brings to the home lighting field a combination of utility, convenience, attractiveness, and safety that is actually amazing.

This superlative method of home lighting control costs only slightly more than conventional wiring and offers so many new and exceptional advantages over older methods of home lighting that Touch-Plate is being installed in both new and older homes of every price category. Here are the reasons why TOUCH-PLATE has received such widespread acceptance all over the country.

1. Switches at the entrances of all rooms which eliminates groping in the dark and the needless burning of lights.
2. An intriguing master panel which controls all lights from one convenient location and shows which lights are on in the home.
3. The lightest touch of the hand or elbow and lights go on or off. This easy operation is attractive to every member of the family.
4. It's safe because of the low voltage, even current. Carrying parts can be touched safely with wet hands.
5. The switches operate noiselessly.

You get all these extra, luxury features with Touch-Plate plus the fact that the units are built to last longer than the lifetime of the home.

Switches

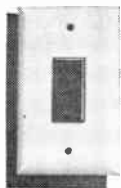

No. 1400A

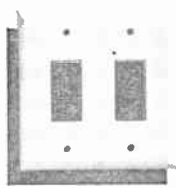

No. 1400B

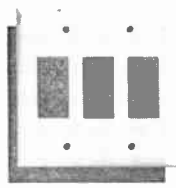

No. 1400C

Low voltage momentary contact switches only should be used to operate Touch-Plate relays. Wiring to Touch-Plate switches is open run low voltage—no conduit necessary.* No BOX NEEDED because of low voltage.* Touch-Plate switches can be attached directly to plywood, etc. Wire in parallel for multiple switches. Switches fit standard outlet boxes or plaster rings. Both two-gang and three-gang switches fit two-gang boxes or plaster rings. Available in both ivory or brown with either ivory or brown buttons. Specify colors when ordering.

No.	Type	Car- ton	Std. Pkg.	Wt. Lbs. Std. Pkg.	Each
1400A	Single	10	30	4	\$ 90
1400B	2 Gang	10	30	7	1 80
1400C	3 Gang	10	10	3	2 70

*Consult local codes.

Master Panels With Pilot Lights



No. CC6

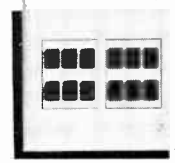

No. CC12

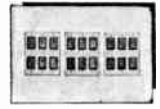

No. CC18

Provides a central point—such as the master bedroom—for the individual control of all house lights. The Famous TOUCH-PLATE Master Panel. All lights can be controlled from any convenient location (near bedside, in garage, etc.). Lucite buttons automatically illuminate indicating which lights are on in the home. Most installations have two master panels; one in the garage to turn on or off all lights before entering or after leaving the house, the other in the bedroom. Touch buttons control individual relays. The low voltage indicator pilot lamps are controlled by individual transformers, also in GB gang box, which are wired in parallel with individual fixtures. Touch-Plate master panels mount on single or two-gang switch rings, or, where code requires—to extra deep (3 1/2") switch box.

No.	Description	Car- ton	Std. Pkg.	Wt., Lbs. Std. Pkg.	Each
CC6	6 buttons, 6 lights	1	2	1	\$17 50
CC12	12 buttons, 12 lights	1	2	2	30 00
CC18	18 buttons, 18 lights	1	1	1 1/2	45 00

Control Units



MRU-6



RU-6

Prewired relay control units are completely color coded and can be ganged in multiples to fit any installation. The MRU 6 unit has 6 pilot light transformers for master panel indicator lights. The RU 6 unit is not equipped with pilot light transformers. Both units consist of 6 relays mounted in a GB6 gang box available for either flush or surface mounting.

For Lights on Master Control

No.	Std. Pkg.	Pkg. Wt., Lbs.	Each
MRU6	2	25	\$52.00

For Lights Not on Master Control

No.	Std. Pkg.	Pkg. Wt., Lbs.	Each
RU6	2	20	35.00

Transverter

TVR-1



Transverter is the source of the low voltage direct current to operate the relays. One such power supply only is needed for each complete installation. Built around a current limiting transformer and gives an impulse of direct current for operation. Cannot be burned out or damaged by direct short circuit on low voltage side. Comes installed in PWU Series. May be attached to mounting holes on MRU-6 and RU-6 units. All gang boxes have provisions for mounting the TVR-1. For separate installation a mounting plate is available that fits a standard 4-S box.

No.	Description	Std. Pkg.	Pkg. Wt., Lbs.	Each
TVR-1	Transverter.....	10	10	\$10.00

Touch-Plate Display in Carrying Case



Use This Display to Up-Sell Wiring Jobs

This display board is a very effective sales tool—it will create interest and desire wherever it is shown. It effectively demonstrates entire system including the Master Panel. Let your customer see this amazing low voltage system in actual operation. This display will aid you in presenting your sales story so that your prospect can readily visualize the convenience, utility and safety features and many other advantages of having Touch-Plate lighting control in his home.

Touch-Plate Gang Boxes

For group mounting of relays

No. GB20 made to receive up to 20 No. 1550A relays, and 1 TVR-1 transverter. Adequate KO's provided for 115V runs.

115 V. wiring is within box and low voltage connections are outside box. Dimensions 5 x 20 x 4 inches. For surface mounting only.

No. GB15 made to receive 20 No. 1550A relays (and 1 TVR-1 transverter. All 115 V and low-voltage connections within box. Dimensions: 9 x 24 x 4 inches. GB15 should be used when Master Panels are installed and can be either surface or flush mounted.

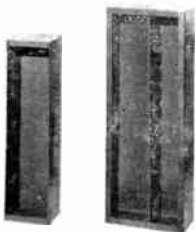

No. 1620 GB9

No.	Description	Car- ton	Std. Pkg.	Wt., Lbs. Std. Pkg.	Each
GB20	Gang Boxes	1	4	32	\$ 9.00
GB15	Gang Boxes	1	1	17	16.00

Spare Parts List

No.	Description	Car- ton	Std. Pkg.	Each
1078	4-inch square transformer steel mounting plate.....	1	1	\$.30
1401	Single Plate.....	1	1	.30
1402	2 Gang Plate.....	1	1	.50
1403	3 Gang Plate.....	1	1	.80
1410	Touch Button.....	1	1	.20
1414	Switch-Back assembly.....	1	1	.50
2031	Dresser plate for 1/CC6.....	1	1	.40
2032	Dresser plate for #CC12.....	1	1	.60

Hoffman "Switch-O-Lite" Controls

Listed by Underwriters' Laboratories, Inc.

Remote Control



Consists of single-pole, single-throw, magnetically operated relay, fuse holder, and terminal board, all housed in die-cast aluminum enclosure, machined and gasketed to provide a completely weather-proof container. Relay rated at 115 volts, 60 cycle A.C., 10 ampere tungsten rating, with an operating coil suitable for continuous duty.

Connection outlets provided on both top and bottom of relay box, which permits installation with either conduit or flexible cable.

Used for Yard lights, Motors, Pumps, Machines, etc. Controls lighting, etc. from any number of wired locations with a single extra wire. Tested at 40° below zero.

No.	Std. Pkg.	Ship. Wt. Lbs.	Each
560	1	3	\$23.10

Minneapolis-Honeywell Dim-A-Lite

Listed By Underwriters' Laboratories, Inc.

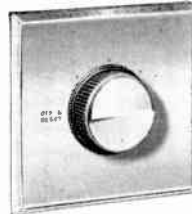

A multi-stage wall switch that varies light intensity to fit every activity in any room.

For use in homes, churches, mortuaries, restaurants or wherever controlled lighting is desirable.

By turning dial, light can be dimmed to 6 7/8 illumination; softened to 38% illumination; moderated to 68% illumination and brightened to 100% illumination.

Has full 175 watt rating and overload safety. No extra wiring, relays or transformers required.

Equipped with durable Plexiglas cover that snaps off easily allowing four background insert colors provided with each switch to be interchanged.

Cover and conduit box included in each unit package.

No.	Each
Dim-A-Lite.....	\$27.95

Minneapolis-Honeywell Tap-Lite

Listed By Underwriters' Laboratories, Inc.

Flush Wall Switches



No. 22WS1
No. 22WS2
No. 25WS1
No. 25WS2



No. 23WS1
No. 23WS2

Equipped with feather-touch pushbutton actuator. Has rotary switching action for smooth, quiet operation. Micro Switch mechanism assures long, trouble-free life.

Enclosed mechanism seals out dirt and dust and insures against electrical shock. Operates in any position.

Special spring loaded, screwless terminals cut installation time. Fits standard switch boxes.

Rectangular Button will fit Standard Toggle Switch Plate. It can be used with duplex or where 5-gang and over is specified.

Guaranteed 5 years.

No.	Switching Action	Color	Button	Each
25WS1	Single Pole	Satin-Ivory	Round	\$1.65
22WS1	Single Pole	Gold	Round	1.65
25WS2	3-Way	Satin-Ivory	Round	2.15
22WS2	3-Way	Gold	Round	2.15
23WS1	Single Pole	Rectangular	1.65
23WS2	3-Way	Rectangular	2.15

Minneapolis-Honeywell Tap-Lite Flush Plates



No. 11PA3

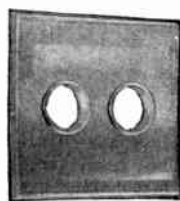

No. 11PA4

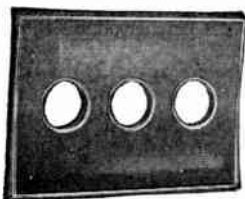

No. 11PA5

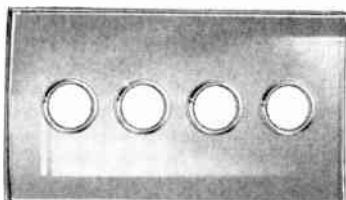

No. 11PA6

Made of durable Plexiglas. Four colored inserts come with every flush plate. Easily installed, snaps into place without screws. All flush plates individually packaged.

No.	Type	Each
11PA3	1-gang.....	\$0.30
11PA4	2-gang.....	.70
11PA5	3-gang.....	1.00
11PA6	4-gang.....	1.80

Bryant Automatic Door Switches

Listed as standard by Underwriters' Laboratories, Inc.

6 Amperes, 125 Volts; 3 Amperes, 250 Volts

Equipped with No. 18 wire leads and adjustable plunger. Galvanized box, cover, and strike plate.



No. 2968

Box dimensions: Length 2 1/16-inches, Width 1 3/32-inches, Depth 1 1/2-inches. Cover: Length 4-inches, Width 1 1/2-inches.

Packed 10 in a carton. 50 in a standard package.

No.	Description	Wt. Std. Pkg.	Per 100
2968	"On"—Door Open	58	\$302.50
2969	"Off"—Door Open	56	302.50

Furnished with box and round strike plate. Adjustable plunger.

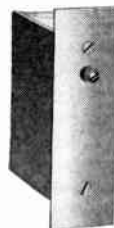

No. 2355

Box dimensions: Length 3 9/16-inches, Width 1 1/4-inches, Depth 2 5/8-inches. Brush brass cover: Length 1 5/8-inches, Width 1 3/8-inches.

Packed 2 in a carton. Standard package: No. 2355, 25; No. 2356, 10.

2355	"On"—Door Open	33	\$630.50
2356	"Off"—Door Open	13	630.50
	Switch less plate		572.00
	Switch less box		560.00

Bryant Pendent Push Switches

Listed as standard by Underwriters' Laboratories, Inc.

Single Pole

6 Amps., 125 Volts; 3 Amps., 250 Volts

Brush brass casing. Push through button. 1 3/32-inch cord hole.

Packed 10 in a carton. 100 in a standard package. Package weight, 16 pounds.



No. 2572

No.	Per 100
2572	\$112.00

Bryant Ceiling Pull Switches

Listed as standard by Underwriters' Laboratories, Inc.



No. 2387



No. 2863



No. 2694



No. 4341

Each switch furnished with short chain, cord, and pendant ball. Plastic cover. Porcelain base. Diameter of base, 2 5/16-inches. Screw spacing, 1 3/4-inches.

Surface Mounting

Single Pole

No.	Description	Amperes 125 V.	250 V.	Carton	Std. Pkg.	Wt. Lbs. Std. Pkg.	Per 100
2387	Solid Base	10	5	10	30	17	\$345.50
2309	Slotted Base	10	5	10	30	16	345.50

Three-Way

2310	Slotted Base	10	5	2	10	6	\$424.50
------	--------------	----	---	---	----	---	----------

Double Pole

2314	Slotted Base	10	10	2	10	6	\$452.00
------	--------------	----	----	---	----	---	----------

Three Circuit—1, 2, 3, Off

Porcelain base flush with cover. Diameter 2 1/4-inches. Screw spacing, 1 5/8-inches.

2863	Solid Base	10	5	2	10	5	\$480.50
------	------------	----	---	---	----	---	----------

For Conduit Fittings—Single Pole

Fits Unilets and No. 500 Adaptiboxes. Porcelain base. Diameter, 2 5/8-inches. Screw spacing, 2 5/16-inches.

2694	Solid Base	10	5	10	20	12	\$321.00
------	------------	----	---	----	----	----	----------

Box Mounting

Metal box covers. Finished to resist corrosion. Plastic switch covers.

Single Pole

No.	Box Size	Amperes 125 V.	250 V.	Carton	Std. Pkg.	Wt. Lbs. Std. Pkg.	Per 100
4341	4-Inches	10	5	10	30	25	\$389.50
4346	4-Inches	20	10	2	10	9	396.00

Three-Way

4343	4-Inches	10	5	2	10	8	\$438.00
------	----------	----	---	---	----	---	----------



No. 2769

For 3/4 and 1-Inch Outlet Boxes. Diameter 1 5/8-inches.

Packed 2 in a carton. 10 in a standard package. Package weight, 13 pounds.

10 Amps., 125 V.; 5 Amps., 250 V.

No.	Description	Per 100
2769	Single Pole	\$397.00

Keys for Lock Switches

Universal key for rotary and flush tumbler lock switches.



No. 6000

6000	2	10	..	\$25.50
------	---	----	----	---------

Bryant Heater and Hot Plate Switches

Listed as standard by Underwriters' Laboratories, Inc.



No. 6269

Surface mounting. Reversible rotating. Black Plastic angle cover. White indications of High, Medium, Low, off. Black porcelain handle and solid base. Packed 2 in a carton. 10 in a standard package.

Series Parallel—Three Heat.

Single Pole

No.	Amperes 125 V. 250 V.	Base Diam. Inches	Mounting Screw Centers Inches	Wt. Lbs. Std. Pkg.	Per 100
6259	10 5	2 3/16	1 1/16 to 1 1/2	5	\$451.00
6269	15 7 1/2	2 1/2	1 1/32 to 1 3/4	6	480.50
6279	20 10	2 13/16	1 1/32 to 1 3/4	8	529.00
6289	30 15	3 5/16	2 1/16 to 2 3/16	12	770.00

Double Pole

No.	Amperes 125 V. 250 V.	Base Diam. Inches	Mounting Screw Centers Inches	Wt. Lbs. Std. Pkg.	Per 100
6258	10 5	2 3/16	1 1/16 to 1 1/2	5	\$504.00
6278	20 10	2 13/16	1 1/32 to 1 3/4	8	626.00
6288	30 15	3 5/16	2 1/16 to 2 3/16	12	867.00

Bryant Rotary Switch Handles

Listed as standard by Underwriters' Laboratories, Inc.

Black Composition



No. 2777



No. 2779

No.	Description	Carton	Std. Pkg.	Wt. Lbs. Std. Pkg.	Per 100
2777	Round	10	100	2	\$27.50
2779	Small, Flat	10	100	2	32.50

Bryant Pendant Switch and Outlet

Listed as standard by Underwriters' Laboratories, Inc.

**Brown Plastic
6 Amps., 125 V.**



No. 9081

Provides switch control of fixture with outlet always alive. Requires 3 wires.

No.	Carton	Std. Pkg.	Wt. Lbs. Std. Pkg.	Per 100
9081	10	50	10	\$142.00

Bryant Weatherproof Switches

Listed as standard by Underwriters' Laboratories, Inc.

"T" Rating

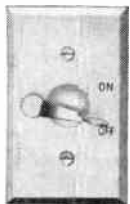

No. 4421

For porches, terraces, barnyards, industrial or other installations subject to exposed or humid conditions.

Weatherproof mat and plate provide weather-tight seal. Fits any standard switch box. Packed 2 in a carton. 10 in a standard package. No. 4424, 5 in a standard package.

Single-Pole

No.	Rating	Wt. Lbs. Std. Pkg.	Per 100
4421	10 A., 125 V.; 5 A., 250 V.	6	\$259.50

Three-Way

No.	Rating	Wt. Lbs. Std. Pkg.	Per 100
4423	10 A., 125 V.; 5 A., 250 V.	6	\$288.00

Double-Pole

No.	Rating	Wt. Lbs. Std. Pkg.	Per 100
4422	10 A., 125 V.; 10 A., 250 V.	6	\$325.50

Four-Way

No.	Rating	Wt. Lbs. Std. Pkg.	Per 100
4424	5 A., 125 V.; 2 A., 250 V.	3	\$623.50

Hubbell Outdoor Weatherproof Flush Switches

Conform to N.E.C. Standard



No. 7981



No. 7991

For installations wherever protection from moisture or weather conditions is desired. On and Off indications are stamped on brass plate.

Switch is furnished complete with rubber mat under brass plate to make it watertight.

No.	Description	Amperes 125 V. T. 250 V.	Car- ton	Std. Pkg.	Pkg. Wt. Lbs.	Per 100
7981	Single Pole	10 5	2	10	8	\$259.50
7982	Double Pole	10 10	2	10	7	325.50
7983	3-Way	10 5	2	10	7	325.50
7984	4-Way	5 2	2	5	4	623.50

For FS Type Fittings

Same as switches above, except furnished with steel plate with rounded edges, for FS type fittings.

No.	Description	Amperes 125 V. T. 250 V.	Car- ton	Std. Pkg.	Pkg. Wt. Lbs.	Per 100
7991	Single Pole	10 5	2	10	7	\$317.00
7992	Double Pole	10 10	2	10	8	390.50
7993	3-Way	10 5	2	10	7	348.50
7994	4-Way	5 2	2	5	4	654.50

Hubbell Self-Restoring Door Switches

Conform to N.E.C. Standard

With Box—Single Pole

6 Amperes, 125 Volts; 3 Amperes, 250 Volts



No. 2355

Length of box, 3 5/8 inches. Width, 1 1/4 inches. Depth, 2 5/8 inches. One 5/8-inch knockout in bottom, one 5/8-inch knockout in one end, and one 7/8-inch knockout in other end. Adjustable plunger, 5/16 to 9/16 inches. Brush brass plate, 4 5/8 by 1 1/4 inches. Round strike plate.

No.	Description	Car- ton	Std. Pkg.	Pkg. Wt. Lbs.	Per 100
2355	Switch On, door open	2	25	30	\$630.50
2356	Switch Off, door open	2	10	12	630.50

Small Size Door Switch—Porcelain Lined Steel Box



No. 2022



No. 2035

Box length, 2 7/8 inches. Width, 1 1/4 inches. Depth 2 3/4 inches. Requires Hole 1 1/16 inches wide, 2 3/8 inches long, 1 1/2 inches deep. Plate, 3 3/4 by 1 1/4 inches.

No.	Description	Car- ton	Std. Pkg.	Pkg. Wt. Lbs.	Per 100
2022	Switch On, door open	5	25	14	\$631.00
2023	Switch Off, door open	2	10	6	631.00
2035	Steel Box for Nos. 2022 & 2023	5	25	16	125.50

Bryant Canopy Pull Switch

Single Pole

6 Amps., 125 Volts; 3 Amps., 250 Volts



No. 2842

Brass casing and screw terminals.

Dimensions: Diameter 1¹¹/₃₂-inches. Height, 1⁵/₁₆-inches. Stem 1³/₃₂-inches long.

Furnished with short chain and 1 feet of cord. Two washers are supplied for mounting in knockouts of outlet boxes.

Packed 10 in a carton. 100 in a standard package. Package weight, 16 pounds.

No.	Per 100
2842	\$165.00

Bryant Motor Control—Triple Pole

Surface Mounting

20 Amps., 125 V.; 10 Amps., 250 V.



No. 2046

Porcelain Base—Plastic Cover.

Base diameter, 2¹¹/₁₆-inches. Height over cover, 1²⁹/₃₂-inches. Has No. 2779 flat composition handle. Screw spacing, 2¹/₃₂-inches.

Packed 2 in a carton, 10 in a standard package. Package weight, 6 pounds.

No.	Description	Per 100
2046	Indicating, Solid Base	\$599.50

Bryant Motor Control Switches



No. 782

Triple Pole—Reversible Type—Surface Mounting

Completely Enclosed—Dust Tight

30 Amperes, 125 Volts; 20 Amperes, 250 Volts

1 Hp., 3-Phase, 575 Volts

2 Hp., 3-Phase, 230 Volts

Available with stamped steel, or Plastic cover. Finish: Black. White indications.

No.	Description	Carton	Std. Pkg.	Wt. Lbs. Std. Pkg.	Per 100
780	Switch Only, no cover	2	10	11	\$ 858.00
782	Stamped Steel Cover	2	10	15	1034.00
4781	Flat Top Plastic Cover	2	10	13	1111.00

Bryant New Motor Sentinel and Starting Switch

Flush Type

Positive Motor Protection—Interchangeable Heaters

A combination starting switch and protective device for single phase motors. Calibrated to permit momentary overload without breaking the circuit. Fits standard tumbler switch flush plates. Mechanism completely enclosed in Plastic housing. Self-aligning silver contacts.



No. 10001

Single Pole

Maximum 1 HP 230 V. A-C., 125 V. D-C Ratings: 1/4 HP 250 V. D-C., 32 V. D-C.

Housing dimensions: Length 2²⁵/₃₂-inches. Width, 1²⁹/₁₆-inches. Depth, 1⁵/₆₄-inches. Screw spacing, 3⁹/₃₂-inches.

Packed 2 in a carton, 10 in a standard package. Package weight, 3 pounds.

No.	Per 100
10001	\$658.50



No. 10002

Double Pole

Maximum 1 HP 250 V. A-C or D-C Ratings: 1/4 HP 32 V. D-C

Housing dimensions: Length, 2²⁵/₃₂-inches. Width, 1²⁹/₁₆-inches. Depth, 1⁵/₆₄-inches. Screw spacing, 3⁹/₃₂-inches.

Packed 2 in a carton, 10 in a standard package. Package weight, 4 pounds.

No.	Per 100
10002	\$778.00

Motor Sentinels Complete With Standard NEMA 1 Die Cast Enclosures



No. 10003



No. 10006

Packed 2 in a carton, 10 in a Std. Pkg. Package weight Nos. 10003 and 10005 9 lbs. Nos. 10004 and 10006 9 lbs.

No.	Description	Per 100
10003	Single Pole	\$ 778.00
10005	Double Pole	1017.50

With Handle Guard

10004	Single Pole	\$1017.50
10006	Double Pole	1137.00

Removable and Replacement Heater Units

To select the heater capacity, take ampere rating on motor nameplate and compare with the nearest "Motor Full Load Amperes" on list below.

No.	Heater Amperes	Motor Full Load Amperes	No.	Amperes	Full Load Load Amperes
10050	.50	.40-.45	10300	3.00	2.40-2.70
10057	.57	.46-.52	10350	3.50	2.80-3.10
10066	.66	.53-.60	10400	4.00	3.20-3.60
10076	.76	.61-.69	10460	4.60	3.70-4.20
10087	.87	.70-.79	10530	5.30	4.30-4.90
10100	1.00	.80-.91	10620	6.20	5.00-5.60
10110	1.10	.92-1.03	10710	7.10	5.70-6.50
10130	1.30	1.04-1.20	10820	8.20	6.60-7.50
10150	1.50	1.24-1.38	10940	9.40	7.60-8.50
10170	1.70	1.39-1.55	11070	10.70	8.60-9.90
10200	2.00	1.60-1.80	11250	12.50	10.00-11.30
10230	2.30	1.90-2.00	11430	14.30	11.40-13.00
10260	2.60	2.10-2.30			

List per 100 \$114.00

Packed 2 in a carton, 10 in a standard package.

Listed as standard by Underwriters' Laboratories, Inc.

Robot Operators

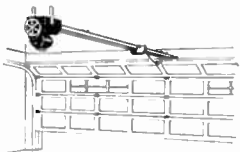

Model CC

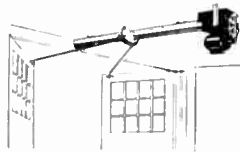

Model CC-DOS

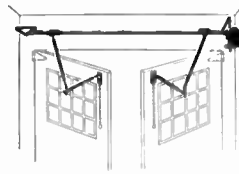

Model CC-DIS

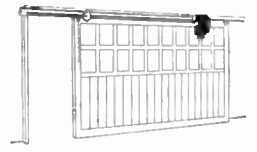

Model CC-SS

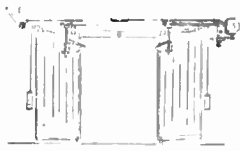

Model CC-DS

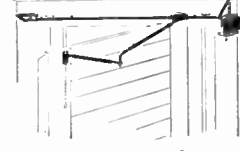

Model CC-RS

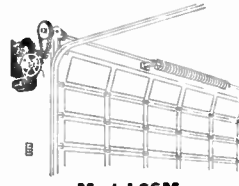

Model SSM



Model LSM



Model LSM-VL

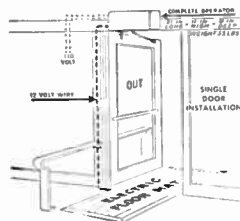

Model SD

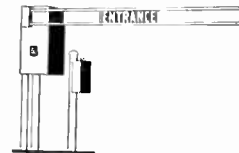

Model BG

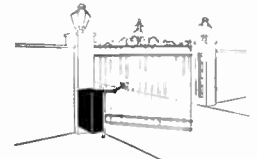

Model SWG-SS

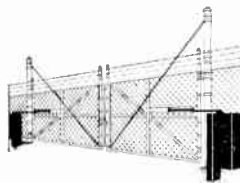

Model SWG-DS

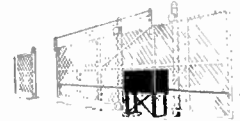

Model LSG-SS

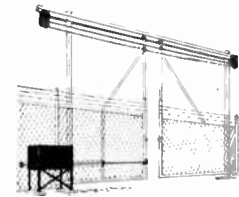

Model LSG-DS



Model LSG-VL

Doors and gates can be operated by standard remote controls, or by Robot Remote Control from cars or trucks operated by the drivers while vehicles are in motion.

The Robot Operator gives trouble-free service 24 hours

Model	Description	Each
CC	Sectional Overhead Door	\$196.00
CC-DOS	Two-Piece Outward Swing Door	248.00
CC-DIS	Two-Piece Inward Swing Door	276.00
CC-SS	One-Piece Single Slide Door	239.00
CC-OS	Two-Piece Opposite Slide Door	258.00
CC-RS	Walk-In Refrigerator Door	256.00
SSM	Sectional Door, or Grille	235.00
LSM	Steel Rolling Door	558.00

a day in all kinds of weather. Ideal for opening, closing and locking doors because it does all these automatically, eliminating manual lifting, pushing, pulling, usually associated with manual opening and closing of doors.

Model	Description	Each
LSM-VL	Vertical-Lift Door	\$639.00
SD	Single Swing Door	388.00
BG	Barrier-Gate	559.00
SWG-SS	Single Swing-Gate	610.00
SWG-DS	Double Swing-Gate	1220.00
LSG-SS	Single Slide-Gate (Cantilever Type)	582.00
LSG-DS	Double Slide-Gate (Overhead Track Type)	715.00
LSG-VL	Vertical-Lift Gate	725.00

Note: Always submit a Filled-in "Form-G1", or "Form-GAI" with your purchase order.

Used as automatic control in commercial, industrial and other institutions for electric doors, electric gates, lighting, safety and intruder alarms.

Top surface is attractive vinyl plastic, durable, will not crack or chip. Mat is waterproof, cannot be harmed by oil, grease, most solvents or chemicals.

Flat-thin construction 5/16-in. makes it easy to mount flat on any surface. Sensitive to 5 pounds pressure.

*Standard Sizes

Width, In.	Length, In.	Thickness, In.	Each
12	30	5/16	\$22.50
18	30	5/16	33.50
24	30	5/16	44.50
30	45	5/16	83.50
30	60	5/16	111.50

*Other sizes available upon request.



Kett Tall Reach Joist Borer

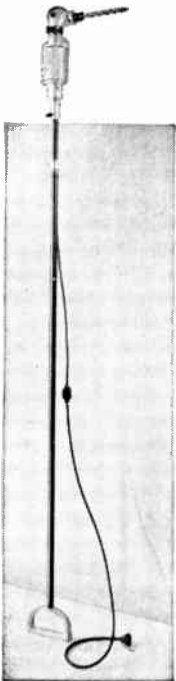

Here, in a single tool, is all needed for drilling holes, anywhere at any angle, and through any material.

Requiring less than eight inches clearance, the wood borer operates between joists and studs. Users report that often this new tool pays for itself on one or two wiring jobs. Saves climbing up and down ladders, giving a big saving in time and money.

The rugged Tall Reach Borer has ample power for every job and stands up under severe use. It has ball-bearing construction with sealed in lubrication. Takes standard 1/2-in. shank machine bits with 3/8-in. flat. Total weight with 9-ft. extension is less than 18 lbs. Supplied with 12-ft. cord.

Removed from extension with a twist of the wrist, the head becomes a light, easy to use hand borer.

No.	Description	Each
KU-21	Complete with extension	\$149.50
KU-21	Less extension	137.50

Kett Joist Boring Auger Bits

Diam., In.	Machine Auger Bit Length Twist, In.	Each
11/16	2 1/2	\$2.50
11/16	4	2.75
11/16	6	3.00
12/16	2 1/2	2.75
12/16	4	3.10
12/16	6	3.35
16/16	2 1/2	3.35
16/16	4	3.75
16/16	6	3.95
No. 230-XB	Kett machine expansive bit, boring range 3/8 to 3-inch	\$ 8.50
No. 230-BS	Small cutter, 3/8 to 1 3/4-inch for Kett expansive bit	1.15
No. 230-BL	Large cutter, 1 3/4 to 3-inch for Kett expansive bit	1.30
No. JC-2	1/2-inch capacity Jacobs chuck and adapter for KU-21	10.00
No. 251-3	Metal carrying case for KU-21	6.50

Kett Panel Master Saws



The Panel Master Saw with its 3/8-in. depth of cut is designed expressly for cutting metal laminated wall panelings such as Armorply, Met-L-Wall, Mirawal, Porc-Lin-Ply, chalkboard, etc. It is the ideal tool for store front and interior contractors; partition installers; custom auto body, trailer, truck, and bus builders; and plastic fabricators.

It will cut mild steel, aluminum, brass, lead, fibreglas, reinforced polyesters and resins, and all laminated and plain plastic sheets.

Powered with a 3/16-in. capacity heavy duty, industrial type ball bearing, 110-volt universal motor. It comes complete with four assorted blades and wrenches. A carrying case is also available for the tool.

No. KS-3AM	Panel Master Saw	Each \$124.50
------------	----------------------------	---------------

Call Graybar FIRST for Everything Electrical

Toledo Ratchet Boring Tools

1 to 3-in. Expansive Bit

Bores through joist and beams where parallel or adjoining timbers interfere with use of brace and bit.

Bit is automatically fed by means of strong steel spring in telescopic barrel of tool, making it easy to operate in confined quarters. Bits have long shank, providing an adjustment range of approximately 6-in.

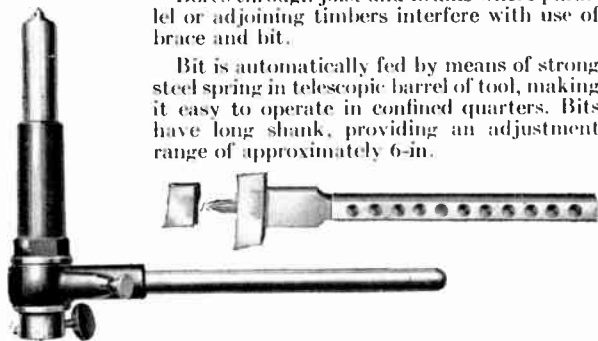

Ratchet boring tool, without bit	5	\$18.00
Expansive bit for tool	1	9.75

Greenlee Ship-Auger Electric-Drill Bits

No. 64-PT



Available in 17 sizes from 5/16 in. through 3/16 in. with 12 in. twist and over-all length approx. 16 in. on sizes up to 15/16 in. Larger sizes have 15 in. twist with an over-all length of approximately 18 in. Shank sizes same as No. 56-PT except 1/2 in. on bits of 15/16 in. and larger. Has single twist and a single-cutter head, but no outlining spur.

Size, 16th In. (12-in. Twist)	Each	Size, 16th In. (12-in. Twist)	Each	Size, 16th In. (15-in. Twist)	Each
6	\$2.90	12	\$3.75	18	\$6.00
7	2.95	13	3.95	20	6.60
8	3.00	14	4.15	22	7.20
9	3.30	15	4.40	24	7.80
10	3.40	16	4.65	28	11.85
11	3.65			32	15.70
				36	20.00

Greenlee Power Pipe Bits

No. 87



Designed for electricians to bore holes for pipe or conduit. Double twist type, having twist lengths ranging from 7 1/4 to 8 1/2 inch. Overall dimensions, 14 to 17 in. Shanks are 2 inches long milled with three flats, milled 120° apart for securely gripping by 3-jaw chuck. Flat cut heads permit boring with minimum of power. Screw points have a lead of 16 turns to the inch to accommodate power driven equipment. The elimination of spurs makes regrinding easy if damage occurs from nails or other obstructions.

Size, In.	Each	Size, In.	Each
1 1/4	\$5.60	2	\$ 9.15
1 1/2	6.70	2 1/2	14.00
1 3/4	7.95

Greenlee Single-Twist Electric Drill Bits

No. 28-PT



Single-Twist Bit available in 13 sizes from 1/16 in. to 15/16 in. with 3 3/8 in. to 1 3/4 in. twist and overall length approx. 5 in. to 7 in. Bits up through 5/8 in. size have 1/4 in. shank, all other sizes have 23/64 in. shank.

Size, 16th In.	Each	Size, 16th In.	Each	Size, 16th In.	Each
4	\$1.30	9	\$1.95	13	\$2.65
5	1.30	10	1.95	14	2.85
6	1.50	11	2.05	15	3.00
7	1.60	12	2.40	16	3.20
8	1.70				

Greenlee Solid-Center Electric-Drill Bit

No. 53-PT



Available in 11 sizes from 5/16 in. to 15/16 in. with 8 in. twist and over-all length approx. 10 in. to 10 1/2 in. Sizes 5/16 in. and smaller have 1/4 in. shank, 9/16 in. size has 5/32 in. shank, 10/16 in. size has 5/16 in. shank, and sizes 11/16 in. and above have 23/64 in. shanks.

Solid-center construction adds stiffness, and single-spiral twist provides chip elevation. Head is of the extension-lip type with double cutters and two outlying spurs.

Size, 16th In.	Each	Size, 16th In.	Each	Size, 16th In.	Each
6	\$1.90	10	\$2.40	14	\$3.05
7	1.95	11	2.65	15	3.35
8	2.00	12	2.75	16	3.45
9	2.25	13	2.95		

No. 56-PT



Available in 11 sizes from 5/16 in. through 15/16 in. with 12 in. twist and over-all length of approx. 16 in. Bits in sizes 5/16 in., 1/4 in., and 3/8 in. have 1/4 in. shanks, 9/16 in. bit has 5/32 in. shank, 10/16 in. bit has 5/16 in. shank, and bits in 11/16 in. size and larger have 23/64 in. shanks. Same as No. 53-PT except for increased length, which provides for greater reach and increased depth of boring.

Size, 16th In.	Each	Size, 16th In.	Each	Size, 16th In.	Each
6	\$2.25	10	\$2.75	14	\$3.75
7	2.30	11	2.95	15	4.15
8	2.40	12	3.30	16	4.35
9	2.55	13	3.55		

Ryan Wood Chisels

No. 948



Tough, unbreakable plastic handle. Blade hot forged of finest quality alloy tool steel, scientifically heat treated. Bevvels precision ground. Thin, blade butt. All blades are 3-in. long.

Blade, In.	Overall Length, Inch	Each
1/4	7 5/8	\$1.60
3/8	7 5/8	1.65
1/2	7 5/8	1.70
3/4	8	1.80
1	8	1.90
1 1/2	8 3/8	2.85

Greenlee Tang Butt Chisels

No. 407



Bevel-edged thin blade of high-carbon tool steel. Blade is tempered for hard usage and polished over all. Handle is of durable green plastic, with protective metal cap. Over-all lengths from 7 5/8 in. to 8 3/4 in.

Size, In.	Each	Size, In.	Each	Size, In.	Each
1/4	\$2.55	5/8	\$2.90	1 1/4	\$3.70
3/8	2.55	3/4	3.00	1 1/2	4.20
1/2	2.55	1	3.10	2	5.00

**Greenlee Socket Butt Chisels
No. 203**



Has the new HARD-WEAR handle of green transparent plastic. Bevel edged thin blade of high carbon steel. Socket and blade of one piece, with socket machined to insure accurate fit of handle. Overall length, 9 to 10 in.

Size, In.	Each	Size, In.	Each	Size, In.	Each
1/4	\$2.30	5/8	\$2.50	1 1/4	\$3.30
3/8	2.30	3/4	2.75	1 1/2	3.95
1/2	2.30	1	2.90	2	4.75

**Greenlee Short Socket Firmer Chisels
No. 223**



Has the new HARD-WEAR handle of transparent plastic. For all types of woodworking, with bevel edge blade of finest quality high carbon tool steel. Blade length, 4 1/2 inches. Overall length, 11 1/2 to 12 1/2 inches, according to size.

Size, In.	Each	Size, In.	Each	Size, In.	Each
1/4	\$2.65	5/8	\$2.90	1 1/4	\$3.55
3/8	2.65	3/4	3.05	1 1/2	4.15
1/2	2.65	1	3.25	2	5.00

**Greenlee Razor Blade Draw Knives
No. 600**

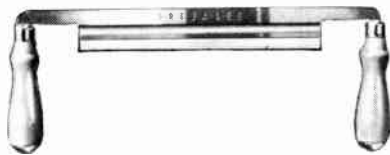

Blade is 1 3/8 in. in width, constructed from single piece of steel. Hardwood handle mounted on shanks which pass through

handles and are riveted on top of nickel plated caps.

Lgth., In.	Each	Lgth., In.	Each
8	\$3.70	9	\$3.80
10	4.00	12	5.20

Ryan Scratch Awls



No. 800

A general utility tool for scratching metals, punching or lining-up.

Hot-forged tool steel blade, heat-treated and polished; extends through handle.

Blade length, 3 1/2 in. Overall length, 6 1/2 in. Diameter of shank, 1/4 in.

No. 800 Scratch Awl.....	Each \$0.80
No. 853 Scratch Awl with Plastic Handle.....	Each 1.00

Greenlee Automatic Push Drills



All exposed metal parts, except drill points, are chromium plated. Working parts are fully enclosed. Drive nut is phosphor bronze. Handle serves as magazine for drill points. 8 drill points, 1/16 to 1/64 included with drill.

No.	Description	Each
482	Hardwood Handle.....	\$4.60
483	Transparent Handle.....	5.25

**Greenlee Bit Extensions
No. 900**



Strong enough to drive a bit up to 1-in. diameter, yet small enough to follow 5/8-in. size. Positive locking insures absolute grip on shank at all times to prevent holding sleeve from loosening while boring or withdrawing. Packed one-third dozen in a box.

Length, Inch	Each	Length, Inch	Each
15	\$4.15	21	\$4.40
18	4.30	24	4.60

**Greenlee Bit Extensions
No. 925**

Similar to No. 900 but made extra heavy to follow a 1 1/16-in. bit and drives tools up to 2-in. Packed one-third dozen in a box.

Length, In.	Each	Length, In.	Each
18	\$5.50	24	\$5.95

**Greenlee Bit Extensions
No. 902**



Has a 2 1/32-in. body section 1 1/2 in. in length provided with two set screws to hold bits with a 23/64-in. shank. Three flats milled 120° apart on the shank of the extension fit the standard 3-jaw chuck, one flat has two set screw holes to allow two or more extensions to be locked together for a longer reach. Shaft portion between body and shank is 3/8 in. in diameter.

Length, In.	Each	Length, In.	Each
18	\$2.35	24	\$2.50

**Greenlee Brace Adapters
No. 902-1**



Permits the use of No. 18 or No. 45 power bits, or the No. 902 extension, in any standard brace. 4 1/2 in. long with standard brace shank and 2 1/32-in. diameter head provided with two set screws for positive coupling.

No. 902-1 Brace Adapter.....	Each \$1.80
------------------------------	-------------

**Greenlee Heavy-Duty Bit Extensions
No. 904**



A heavy-duty extension for use with the Greenlee No. 18 Unispur Power Electricians' Bit in sizes 1 1/16 in. and 2 1/16 in., the Greenlee No. 45 short Unispur Power Bit in sizes 1 1/16 in. through 3/16 in., and other tools with 1/2 in. shanks. Head size is 1 1/16 in., shank size is 1/2 in., hole size is 1/2 in. Available in 18 and 24 in. lengths.

This extension is similar to the Greenlee No. 902 Power Bit Extension with three flats, 120° apart, milled on the extension to fit standard 3-jaw chucks. On flat has two set-screw holes enabling two or more extensions to be locked together for longer reach.

Lgth., In.	Each	Lgth., In.	Each
18	\$3.15	24	\$3.40

Greenlee Auger, Car and Bell Hanger Drills

No. 44 Short Unispur Auger Bits



Specially designed with a short twist and the proper overall length for electrician's use in boring holes for pipe and conduit. Medium pitch screw point for smaller sizes, finer point for larger sizes. Sizes up to 1-in. have 3-in. twist and 5 1/2-in. overall length. Larger sizes, 2 1/2-in. twist and 5 1/2-in. overall length.

Size, 16th In.	Each	Size, 16th In.	Each	Size, 16th In.	Each
11	\$2 00	16	\$2 80	21	\$5 30
12	2 10	18	3 55	28	6 55
13	2 45	20	4 15	32	7 80
14	2 55	22	4 75	40	11 00

No. 16 Unispur Electricians' Auger Bits



Smooth boring, fast double twist bit with long twist and single cutter head. 10-pitch single screw point for boring one inch in ten turns. Twist 5 1/2-in. long for 10/16 and larger. Smaller sizes standard auger bit dimensions.

Size, 16th In.	Each	Size, 16th In.	Each	Size, 16th In.	Each
4	\$1 60	9	\$1 95	14	\$2 80
5	1 60	10	2 05	15	3 00
6	1 60	11	2 20	16	3 20
7	1 75	12	2 30	18	3 85
8	1 80	13	2 65	20	4 40

No. 21 Solid Center Electricians' Auger Bits



Solid center to provide full strength for heavy use. Single spiral for positive chip clearance. Single screw point for feeding 10 turns to the inch. Twist, 5 1/2-in. Overall length, 10 inches.

Size, 16th In.	Each	Size, 16th In.	Each	Size, 16th In.	Each
10	\$1 65	11	\$1 85	12	\$1 95

No. 22 Solid Center Auger Bits



Double cutter head with extension lips. Medium pitch screw point. Center stem adds stiffness. Single spiral cleanly elevates chips. Fully polished. Ideal for general wood-working requirements.

Size, 16th In.	Each	Size, 16th In.	Each	Size, 16th In.	Each
4	\$1 00	10	\$1 20	16	\$1 60
5	1 00	11	1 25	17	2 00
6	1 00	12	1 30	18	2 10
7	1 05	13	1 35	20	2 30
8	1 10	14	1 40	22	2 60
9	1 15	15	1 55	24	2 90

No. 56 Solid Center Car Bits



Provides greater range than an ordinary length auger bit. Single spiral and center stem gives a broad channel for clearance and elevation for chips. Head is extension lip pattern and is fitted with medium coarse screw. Fully polished. Excellent for general woodwork.

Size, 16th In.	Each	Size, 16th In.	Each	Size, 16th In.	Each
6	\$1 85	11	\$2 40	16	\$3 55
7	1 85	12	2 55	17	4 00
8	1 90	13	2 75	18	4 35
9	2 00	14	3 00	20	4 95
10	2 15	15	3 30		

No. 48 Bell Hangers' Drills



Made of high grade alloy steel, heat treated for additional strength so that drill will not damage if metal is encountered. Twist length, 3 3/4-in. A 3/32-in. hole is drilled about 1-in. from point of drill. Available in three lengths.

12-Inch

Size, 32nd In.	Each	Size, 32nd In.	Each	Size, 32nd In.	Each
6	\$1 65	10	\$1 90	14	\$2 35
8	1 80	12	2 10	16	2 70

18-Inch

Size, 32nd In.	Each	Size, 32nd In.	Each	Size, 32nd In.	Each
6	\$2 10	11	\$2 75	22	\$4 10
8	2 25	16	3 05	24	5 10
10	2 30	18	3 30
12	2 50	20	3 70

24-Inch

Size, 32nd In.	Each	Size, 32nd In.	Each	Size, 32nd In.	Each
6	\$2 65	10	\$2 85	14	\$3 30
8	2 75	12	3 05	16	3 60

No. 64 Ship Auger Car Bits



Highly recommended for its strength, rigidity, easy cutting and free clearance. Has 12-in. twist and measures 17 to 18 inches overall. Fully polished.

Size, 16th In.	Each	Size, 16th In.	Each	Size, 16th In.	Each
1	\$2 55	10	\$2 75	16	\$3 55
5	2 55	11	2 80	17	3 90
6	2 55	12	2 85	18	4 30
7	2 60	13	3 00	20	4 90
8	2 65	14	3 10	24	6 35
9	2 70	15	3 40

No. 57 Single Spur Car Bits



Designed for pole, bridge, dock and other heavy wood construction. Made of tough alloy steel, heat treated. Head fitted with single cutter with outlying spur to insure smooth boring and long life. Single spiral twist provides smooth chip clearance. Fully polished.

12-Inch Twist

Size, 16th In.	Each	Size, 16th In.	Each	Size, 16th In.	Each
6	\$3 10	10	\$3 35	14	\$4 40
7	3 20	11	3 45	15	4 75
8	3 25	12	3 80	16	5 00
9	3 30	13	4 05	17	5 35

18-Inch Twist

Size, 16th In.	Each	Size, 16th In.	Each	Size, 16th In.	Each
9	\$4 60	12	\$5 40	15	\$6 80
10	4 70	13	5 90	16	7 25
11	5 10	14	6 30	17	7 65

24-Inch Twist

Size, 16th In.	Each	Size, 16th In.	Each	Size, 16th In.	Each
9	\$5 85	12	\$6 85	15	\$8 50
10	6 00	13	7 40	16	9 10
11	6 35	14	7 95	17	9 60

Greenlee Brace Countersinks



For soft metals and wood. 4 1/2-in. overall length and will countersink up to 5/8-in. Clearance for cutting edge is water ground for accuracy.

No. 701 Countersink	Each	\$.85
---------------------	------	--------

Greenlee Electricians' Unispur Power Bits
No. 18



Twist length, 5 1/2-in., shank diam. 23/64-in., overall length, 8 1/2-in. Three milled flats 120° apart to eliminate slippage in 3-jaw chuck. One flat has two recesses which fit set screws in extension to prevent loss of bit when withdrawing from bored hole. Feeds 16 turns to inch.

Size, 16th	Each	Size, 16th	Each	Size, 16th	Each
11	\$2.60	13	\$3.00	16	\$3.50
12	2.70	14	3.20	18	4.40
				20	4.95

Greenlee Short Unispur Power Bit
No. 45

Head and shank details same as No. 18. Twist length, 3-in. Overall length, 6-in.

Size, 16th	Each	Size, 16th	Each	Size, 16th	Each
11	\$2.40	16	\$3.30	21	\$5.90
12	2.50	18	4.20	28	7.25
13	2.85	20	4.70	32	8.50
14	2.95	22	5.35	40	12.00

Greenlee Pipe Bit Set

No. 1440



Specially designed for boring holes in wood for pipe and conduit. Six bits in set for following pipe sizes:

- Bit diam., 7/8-in. for 1/2-in. pipe.
- Bit diam., 1 1/8-in. for 3/4-in. pipe.
- Bit diam., 1 3/8-in. for 1-in. pipe.
- Bit diam., 1 3/4-in. for 1 1/4-in. pipe.
- Bit diam., 2-in. for 1 1/2-in. pipe.
- Bit diam., 2 1/2-in. for 2-in. pipe.

Bits have overall length of 6-in.

Have 1/2-in. milled shanks for use in portable electric or pneumatic drills or stationary boring machines.

Adapter is provided for using standard auger-bit brace. In metal set box with carrying handle. Weight, 7 pounds.

No.	Each
1440 Pipe Bit Set Complete.....	\$45.00

Diamond Di-Forge Twist Drills
No. 720



A tough and durable drill forged from a solid bar of Vanadium tool steel. Use with hand or electric hammer. May be used with Diamond Drill Holders Styles A, B, and C.

Diam. In.	Length Overall In.	Depth Hole In.	Wt., Lbs. Per Doz.
3/16	2 3/4	1 3/8	1/2
1/4	3 3/8	1 3/4	3/4
5/16	4 3/8	2 1/2	1
3/8	5 3/8	3	1 1/4
7/16	5 3/4	3 1/4	1 1/2
1/2	5 1/2	3 1/4	2
9/16	5 5/8	3 3/4	2 1/2
5/8	6 1/8	4	2 1/2

Prices on application.

Greenlee Setfast Expansive Bits



Patented quick adjusting-locking feature—quarter turn with screw driver tightens and loosens parts—cutter set by adjusting barrel with thumb. The No. 5 bores 5/8 to 1 3/4-in. and the No. 6, 7/8 to 3-in. Extra length cutter can be supplied for No. 6 to bore up to 4-in. diameter.

No.	Description	Size, Inches	Each
5	Bit.....	5/8 to 1 3/4	\$4.00
5A	Cutter.....	5/8 to 1 1/8	.85
5B	Cutter.....	1 1/8 to 1 3/4	1.00

Extra Adjusting Barrels.....	\$.35
Extra Eccentric Pins.....	.35

6	Bit.....	7/8 to 3	\$4.75
6A	Cutter.....	7/8 to 1 3/4	1.20
6B	Cutter.....	1 3/4 to 3	1.30
6C	Cutter.....	2 1/2 to 4	1.90

Extra Adjusting Barrels.....	\$.40
Extra Eccentric Pins.....	.40

Greenlee Expansive Bits
Nos. 3 and 4

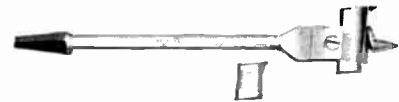

Equipped with new wide, open throat to insure positive clearance. The No. 3 bores up to 1/2 to 1 1/2-in. and the No. 4, 7/8 to 3-in. For boring holes up to 4-in. diameter an extra cutter can be supplied for No. 4.

No.	Description	Size, Inch	Each
3	Bit.....	1/2 to 1 1/2	\$2.85
3A	Cutter.....	1/2 to 7/8	.65
3B	Cutter.....	7/8 to 1 1/2	.80

Extra Clamps.....	\$.30
Extra Clamp Screws.....	.15

4	Bit.....	7/8 to 3	\$3.60
4A	Cutter.....	7/8 to 1 3/4	.90
4B	Cutter.....	1 3/4 to 3	1.10
4C	Cutter.....	2 1/2 to 4	1.60

Extra Clamps.....	\$.35
Extra Clamp Screws.....	.15

TEC Drill-Routers

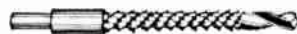

Designed for the 1/4" electric drill. A sawing-routing-notching tool, for plaster, plasterboard, lumber, plastics, masonite, formica and for piercing and cutouts.

No.	Shank Diam., In.	Length, In.	Tool Diam., In.	Each
318-1	1/4	2 3/8	1/4	\$1.40
318-2	1/4	4 1/2	1/4	1.60
318-3	1/4	2	5/16	1.65

318-4	1/4 & 1/2	4 3/8	3/16	2.75
318-5	1/4	2 1/4	11/32	1.95
318-6	1/4 & 1/2	7	11/32	3.25

Set of these 6 in plastic bag..... 11.95

TEC Combination Drill and Saw Drillsaws

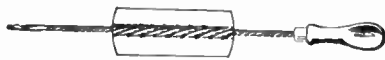

No. 1

Drills its own hole, then saws rapidly in any direction. Fine steel blade has fast-boring tip; main portion of blade is sharply toothed spirally. Works without clogging on plywood, hardwood, plaster, wallboards and plastic.

Blade of tough alloy steel, hollow-ground; will take rough usage, but is not brittle. Set securely in lacquered hardwood handle.

No.	Length, Inch	Diameter, Inch	Each
1	7	3/16	\$1.85
2	10	1/4	2.45
3	13	5/16	2.95
4	15	3/8	3.25

Saw Rasp

Similar to Drillsaws, but without boring tip. Specify coarse or fine tooth.

No.	Length, Inch	Diameter, Inch	Each
5	13	1/2	\$2.25

Porter Standard Insulated Screwdrivers



Made of Stanley 100 plus quality blade to U.S. Navy specifications. Cohardite insulated all the way down the blade up to 3/8-in. of point. Meets Federal specifications GGG-S-121A for standard screwdrivers.

No.	Blade Length, In.	D.A. Length, In.	Dia. of Insul. on Blade, In.	Dia. of Handle, In.	Wt., Oz.	List Each
13-SD	3	8	11/32	1 1/16	3	\$3.00
14-SD	4	9	11/32	1 1/16	4	3.30
16-SD	6	11 7/8	7/16	1 1/4	8	3.90
18-SD	8	13 7/8	7/16	1 1/4	10	4.40

Porter Meterman's Screw Drivers

Insulated



Insulated the full length of the blade to within 3/8-in. of the point with a special semi-hard rubber with ideal properties—maximum toughness, high dielectric strength and resistance to oxidation and chemicals. Individually factory tested for 5,000 volts. Blade has straight tip to reach counter-sunk screws. No. 145 is extra thin for deeply recessed screws.

No.	Blade Length, Inch	Diam. Insul. On Blade, Inch	Wt. Oz.	Each
125SD	5 1/2	3/8	3	\$3.00
145SD	5 1/2	5/16	5	3.30
155SD	5 1/2	3/8	5	3.60

Ryan Screw Driver Bits No. 45



Best quality, heat treated and polished.

Point Width, In.	Overall Length, In.	Diam., In.	Each
1/4	1	1/4	\$.45
3/16	1 1/2	5/16	.45
3/8	5	3/8	.50
7/16	5	3/8	.50
1/2	5 1/2	3/8	.55

Ryan Screw Drivers



Handles are tough unbreakable plastic. Blades are of high quality steel, manufactured to precision requirements.

Phillips Type

No.	Size, In.	Each
PH	6	\$1.30
PH	4	1.00
PH	3	.80

Pocket Type



B18	3	\$.25
B18	2	.25

Stubby Type



S141	1 1/2	\$.60
------	-------	--------

Cabinet Type 3/16-in. Diameter



C316	2	\$.60
C316	4	.70
C316	6	.75
C316	8	.90

Square Blade



S14	4	\$.95
S516	6	1.15
S38	8	1.55

Round Blade



No.	Blade Length, Inch	Diam., Inch	Each
R14	2	1/4	\$.70
R14	4	1/4	.75
R14	6	1/4	.85
R14	8	1/4	1.00
R516	4	5/16	.95
R516	6	5/16	1.05
R516	8	5/16	1.10
R38	8	3/8	1.30
R38	10	3/8	1.70

Greenlee Screw Driver Bits No. 723



Finest grade steel, heat treated to insure long life. Overall lengths, 4 1/2 to 5 1/2 inches.

Size, In.	Each	Size, In.	Each
1/4	\$.50	5/16	\$.55
3/8	.50	1/2	.60

Utica Screw Drivers

Deep fluted plastic Tenite II transparent, unbreakable, shock proof, non-burning handles. Practically indestructible and provides a firm grip.

Blades are full length, drop forged from alloy steel, carefully hardened and full polished.

Regular Pattern



No.	Size, In.	Each	No.	Size, In.	Each
810-4	1	\$0.88	810-8	8	\$1.53
810-5	5	.95	810-10	10	1.72
810-6	6	1.18	810-12	12	1.87

Cabinet Pattern



No.	Size, In.	Each	No.	Size, In.	Each
819-4	4	\$0.74	819-8	8	\$0.95
819-5	5	.79	819-10	10	1.10
819-6	6	.83	819-12	12	1.30

Square Blade



No.	Size, In.	Each	No.	Size, In.	Each
820-4	4	\$1.11	820-8	8	\$1.72
820-5	5	1.14	820-10	10	1.94
820-6	6	1.38	820-12	12	2.15

Phillips



No.	Size, In.	Each	No.	Size, In.	Each
1831-1	1	\$0.70	1833-3	3	\$1.38
1832-2	2	1.03	1833-4	4	1.80

Stubby Square Blade

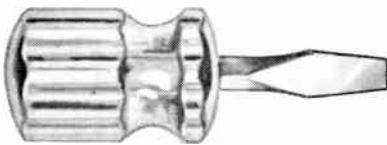

No.	Size, In.	Each
830-2	2	\$0.76

Greenlee Spiral Screw Drivers



Plastic handle. Exposed metal parts chromium plated. Drive nuts of phosphor bronze. Each screw driver is supplied with three sizes of bits.

With Spring Return

No.	Size	Wt., Lbs.	Each
457	Small	1	\$ 7.80
458	Medium	1 1/4	8.90
459	Large (wood handle)	1 3/4	11.00

Greenlee Enclosed Spiral Screw Drivers



Covering sleeve gives room to grasp the tool with the guiding hand without possibility of pinching fingers. The completely enclosed screw driver permits thorough lubrication while keeping spiral free of dirt and preventing oil from getting on work. Inside and outside sleeves are stainless steel. Drive nuts are phosphor bronze. Easy adjustment for right or left hand ratchet or fixed position. Hard wear plastic handle. Three sizes of bits included. Return spring easily removed for converting to regular type.

No.	Description	Each
451	Closed length, 11 inches.....	\$8.30
452	Closed length, 11 3/4 inches.....	9.65

Accessories for Greenlee Spiral Screw Drivers

With adapter, Greenlee drill points and countersink can be used in both styles of Greenlee spiral screw drivers. No. 714 fits small. No. 715 fits medium size. No. 716 fits large size.

No.	Description	Each
714	Adapter.....	\$1.35
715	Adapter.....	1.40
716	Adapter.....	1.55
705	Countersink.....	.75
484	Drill points, 1/16 to 1/16-in., set of 8.....	1.65

**Capewell Ball Pein Hammers
Charter Oak**



No. BP202

Intermediate polish except neck of face and neck of poll painted. Golden hickory handle.

No.	Wt. Oz.	Each	No.	Wt. Oz.	Each
BP202	2	\$1.48	BP220	20	\$1.91
BP204	4	1.48	BP224	24	2.05
BP208	8	1.56	BP232	32	2.19
BP212	12	1.63	BP240	40	2.33
BP216	16	1.77	BP248	48	2.68

**Capewell Charter Oak Hammers
Nail and Ripping Bell Face**



No. C-231

Intermediate polish except neck and under claw painted. Golden hickory handle.

No.	Style	Wt. Oz.	Each
C231	Nail	20	\$2.40
C231R	Ripping	20	2.40
C231 1/2	Nail	16	2.27
CC231 1/2 R	Ripping	16	2.27
C232	Nail	13	2.27
C233	Nail	7	2.12

Capewell "300" Bell Face Hammer
Nail and Ripping

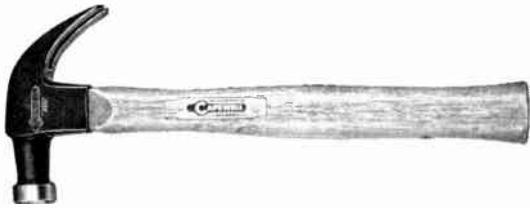

No. C331½

Ground head. Painted except face and back of claw polished. Stained hickory handle.

No.	Style	Wt. Oz.	Each
C331½	Nail	16	\$1.64
C331½R	Ripping	16	1.64

Arrow Automatic Gun Tackers
Type T-75



For non-metallic sheathed cable up to ½ in. in diameter. No short circuits possible. The driving blade automatically stops short—does not allow staple to injure wire covering. Patented jam-proof mechanism uses ¼, ⅜, ⅞ in. divergent pointed (.075 wire) staples, galalloy coated for high rust resistance, rosin coated for greater holding power. Also in rustproof monel; and in ivory and brown.

Type T-75 Automatic Gun Tacker..... Each \$15.00

Type T-25

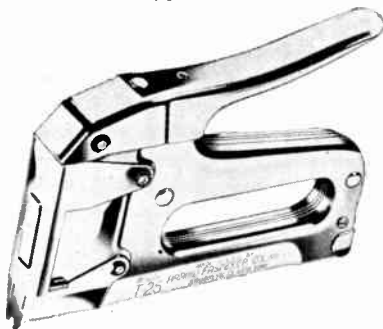

For any wire up to ¼ in. in diameter—telephone, bell, thermostat, hi-fi, radiant heat, inter-com wires, etc. Patented jam-proof mechanism. Driving blade automatically stops short—does not allow staple to injure wire covering. Tapered head gets into tight corners. Uses round top (.050 wire) ⅜, ⅞, ⅞ in. galalloy coated staples. Also in rustproof monel.

Type T-25 Automatic Gun Tacker..... Each \$15.00

Capewell All-Purpose Saw Blades
Dafiles—Cut in Any Direction

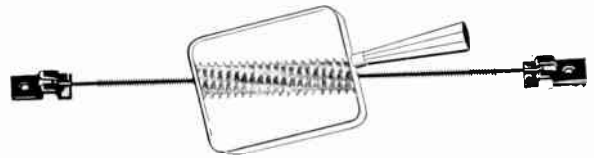

Cuts any material in any direction. Can be used for high-speed cutting in a power jig. Manufactured from a mild steel, cyanide hardened and water quenched.

Case hardened to a depth of approximately .005-in., the core remaining relatively soft to give pliability and tensioning strength. Fits any standard hack saw frame when used with Dafile links. Blades: rough, medium and smooth. Specify when ordering.

No.	Description	Per Doz.
D-10	10-in. Dafiles blades.....	\$2.80
D-12	12-in. Dafiles blades.....	3.33
D-L	Dafiles, links (pair).....	1.47

Capewell Hack Saw Frames



Model HSF

One piece steel tube back, fitted into precision-machine cast aluminum handle, permits tightening of blade to high tension and maintenance of true alignment without twisting blade or warping frame.

Comfortable handle designed so that the thrust is directed behind the blade and not above it. Steel parts are cadmium plated.

Model	Weight, Lbs.	Each
HSF	2	\$5.00

Fowle Compass Saws
Set and Filed Ready for Use



Standard teeth are filed straight across, and are designed for best cutting features. Fleam filed teeth available at slightly higher cost.

No.	Description	Each
8	Cutting edge 10, 12 or 14-in. (specify).....	\$1.80

K-D Convertible Hack Saw Frames

Spans Obstructions and Projections on Difficult Jobs. Cuts Around Corners.



A finely balanced, solid steel frame. Quick, easy adjustment for 3, 4½, 6, 8, 10, or 12-inch blades. One 3-inch and one 12-inch blade furnished. Net weight, 1 lb., 7 oz.

No. 99..... Each \$4.45

Capewell Hand Hack Saw Blades



Technite High Speed: Made from special alloy steel for use on hardest metals and are the finest hand hack saw blades for cutting high speed steel, carbon tool steel, chrome, chrome-nickel and other hard alloys.

Safetech High Speed Shatterproof: Designed to cut tough metals easily and with complete safety. Hardened tooth edge eliminates stripping and its soft, tough back makes it a truly safe, shatterproof blade.

High Speed Tungsten: Made from tungsten high speed steel for cutting hard metals. An excellent all-hard blade for use principally by the skilled mechanic.

Standard Package, 100 Blades		Lgth. In.	Wdth. In.	Thick-ness In.	Teeth Per In.	Wt. Lbs. Per 100	Per 100
Technite No.	Safetech No.						
1018T	1018S	10	1 1/2	.025	18	3 3/4	\$67.50
1024T	1024S	10	1 1/2	.025	21	3 3/4	67.50
1032T	1032S	10	1 1/2	.025	32	3 3/4	67.50
1214T	1214S	12	1 1/2	.025	11	4 1/2	80.75
1218T	1218S	12	1 1/2	.025	18	4 1/2	80.75
1224T	1224S	12	1 1/2	.025	24	4 1/2	80.75
1232T	1232S	12	1 1/2	.025	32	4 1/2	80.75

High Speed No.	Length In.	Width In.	Thick-ness In.	Teeth Per In.	Wt. Lbs. Per 100	Per 100
1018H	10	1 1/2	.025	18	4	\$71.50
1024H	10	1 1/2	.025	21	4	71.50
1032H	10	1 1/2	.025	32	4	71.50
1214H	12	1 1/2	.025	11	4 3/4	84.75
1218H	12	1 1/2	.025	18	4 3/4	84.75
1224H	12	1 1/2	.025	24	4 3/4	84.75
1232H	12	1 1/2	.025	32	4 3/4	84.75

Capewell Flexloy Hack Saw Blades



This blade is all-hard, yet so flexible it is practically unbreakable when used in a hack saw frame. It is the economical blade for electricians and other mechanics.

No.	Length Inch	Thickness, Inch	Teeth Per Inch	Wt. Lbs. Per 100	Per 100
1018C	10	.025	18	3 1/4	\$17.25
1024C	10	.025	21	3 1/4	17.25
1032C	10	.025	32	3 3/4	17.25
1214C	12	.025	11	4	21.25
1218C	12	.025	18	4	21.25
1224C	12	.025	24	4	21.25
1232C	12	.025	32	4	21.25

Capewell Welded Edge Hole Saws

Safetech High Speed



No. S09



No. S0

No.	Diam. In.	Pipe Sizes		Each	No.	Diam. In.	Pipe Sizes		Each
		Pipe Tap	Pipe Entrance				Pipe Tap	Pipe Entrance	
S09	9/8	\$4.80	S36	2 1/4	2	...	\$6.40
S10	5/8	3.60	S37	2 3/16	6.40
S11	1 1/16	3.60	S38	2 3/8	6.40
S12	3/4	...	3/8	3.60	S40	2 1/2	...	2	6.40
S13	13/16	3.60	S41	2 9/16	6.40
S14	7/8	3/4	1/2	3.60	S42	2 5/8	6.40
S15	15/16	3.60	S44	2 3/4	6.40
S16	1	3.60	S46	2 7/8	6.40
S17	1 1/16	3.60	S48	3	...	2 1/2	6.40
S18	1 1/8	1	3/4	3.60	S50	3 1/8	6.40
S19	1 3/16	3.60	S52	3 1/4	3	...	6.40
S20	1 1/4	3.60	S54	3 3/8	6.40
S21	1 3/16	3.60	S56	3 1/2	6.40
S22	1 3/8	...	1	3.60	S58	3 5/8	...	3	8.40
S23	1 7/16	3.60	S60	3 3/4	3 1/2	...	9.60
S24	1 1/2	1 1/4	...	3.60	S62	3 7/8	10.20
S25	1 9/16	3.60	S64	4	10.80
S26	1 5/8	3.60	S66	4 1/8	...	3 1/2	12.00
S27	1 11/16	3.60	S68	4 1/4	15.60
S28	1 3/4	1 1/2	1 1/4	4.80	S70	4 3/8	18.60
S29	1 13/16	4.80	S72	4 1/2	...	4	21.60
S30	1 7/8	4.80	S76	4 3/4	24.00
S32	2	...	1 1/2	4.80	S80	5	26.60
S33	2 1/16	6.40	S88	5 1/2	31.80
S34	2 1/8	6.40	S96	6	37.20

Arbors

Complete With High Speed Pilot Drills

No.	For Chuck In.	Fitting Saws	Follows Through	Shank In.	Each
S0	1/4	9/16-3/16 S09-S19	9/16-3/16 S09-S19	1/4 Rd.	\$3.40
S1	1/2	9/16-13/16 S09-S19	9/16-13/16 S09-S19	1/16 Hex.	4.80
S2	1/2	1 1/4-6 S20-S96	1 1/4-6 S20-S96	7/16 Hex.	7.60
S3	3/4	1 1/4-6 S20-S96	1 1/2-6 S21-S96	5/8 Hex.	7.60
S500	1/2	12" extension fitting all 9/16" shanks			4.80
Extra	..	High speed pilot drills			1.80

Morse Taper Adapters

No.	Morse Taper	For Arbor	Each
MTA2	2	7/16 Hex.	\$ 5.00
MTA3	3	7/16 Hex.	9.80
MTA4	3	5/8 Hex.	10.00

Ryan Chisel and Punch Sets

Ryan cold chisels and machinists punches are hot forged of fine quality octagon tool steel. They are heat treated in automatic equipment, and will give excellent service.

Kits are of durable plastic in attractive red; pockets are transparent edged with silver braid.

Ryan Punch Sets

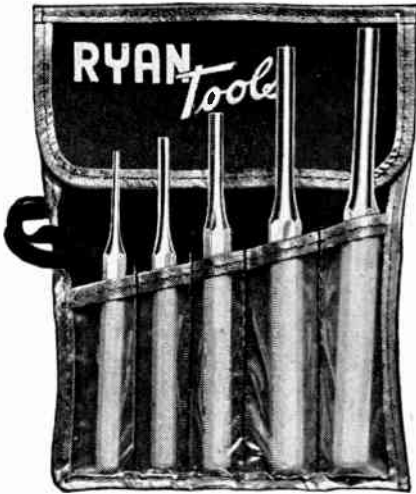

No. 11 Ryan Kit

Contains 1 each of the following pin punches:

- $\frac{3}{16} \times \frac{3}{32} \times 1\frac{1}{2}$
- $\frac{3}{16} \times \frac{1}{8} \times 1\frac{1}{2}$
- $\frac{3}{8} \times \frac{3}{16} \times 5$
- $\frac{1}{16} \times \frac{1}{4} \times 6$
- $\frac{1}{16} \times \frac{3}{16} \times 6$

Kit weight, 1 lb.
Kit, Complete
Each... \$2.40



No. 10 Ryan Kit

Contains chisels and punches as listed.

- 1 Cold Chisel $\frac{1}{2} \times \frac{5}{8} \times 6$
- 1 Cold Chisel $\frac{3}{8} \times \frac{3}{16} \times 5$
- 1 Solid Punch $\frac{1}{2} \times \frac{3}{16} \times 6$
- 1 Pin Punch $\frac{3}{8} \times \frac{3}{16} \times 5$
- 1 Center Punch $\frac{3}{8} \times 1$

Kit Weight, 1 lb.
Kit, Complete
Each... \$2.40

Ryan Chisel Sets



No. 12 Ryan Kit

Contains 1 each of the following Cold Chisels:

- $\frac{1}{4} \times \frac{1}{4} \times 1\frac{1}{2}$
- $\frac{3}{16} \times \frac{3}{16} \times 5$
- $\frac{3}{8} \times \frac{3}{16} \times 5$
- $\frac{1}{16} \times \frac{1}{2} \times 5\frac{1}{2}$
- $\frac{1}{2} \times \frac{5}{8} \times 6$

Kit weight, 1 lb.
Kit, Complete
Each... \$2.40

Ryan Chisel Sets



No. 948K Kit

Contains 4 popular size wood chisels.

1 each of the following sizes:

- $\frac{1}{4}$ -inch
- $\frac{1}{2}$ -inch
- $\frac{3}{4}$ -inch
- 1-inch

Kit weight, 1 $\frac{1}{4}$ lbs.

Kit, Complete
Each... \$7.00

Simonds Red Tang Files



MILL files . . . are single cut used in sharpening saws and knives and for draw filing.

FLAT files . . . are double cut, a utility file for general use.

ROUND files . . . are used for enlarging round holes and on curved surfaces.

Kind Length	Cut Inches	Price Per Dozen				
		4	6	7	8	10
MILL	Bastard	\$ 4.60	\$ 5.30	\$ 5.90	\$ 6.50	\$ 8.40
	2nd cut	6.00	6.00	6.00	7.30	9.50
	Smooth	6.80	6.80	6.80	8.00	10.50
FLAT	Bastard	5.80	6.80	6.80	8.30	11.00
	2nd cut	6.80	7.50	7.50	9.50	12.70
	Smooth	7.40	8.30	8.30	10.30	13.60
ROUND	Bastard	4.80	5.50	6.10	6.80	8.80
	2nd cut	5.50	6.20	6.20	7.60	9.90
	Smooth	6.10	7.10	7.10	8.40	11.00
Length	Inches	12	14	16	18	20
	MILL	Bastard	11.20	16.00	22.00	22.00
	2nd cut	12.80	18.20	18.20	18.20	18.20
	Smooth	14.00	19.60	19.60	19.60	19.60
FLAT	Bastard	15.20	20.80	27.80	37.40	37.40
	2nd cut	17.20	24.00	31.50	31.50	31.50
	Smooth	18.90	26.20	34.80	34.80	34.80
ROUND	Bastard	11.70	16.80	23.00	23.00	23.00
	2nd cut	13.40	19.10	19.10	19.10	19.10
	Smooth	14.70	20.50	20.50	20.50	20.50

Call Graybar FIRST For . . .

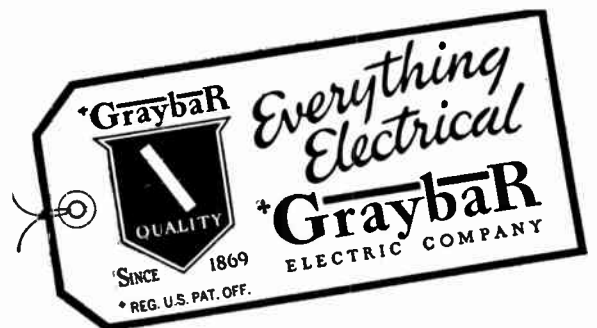

Bartlett Shears

For Heavy Metal Cutting

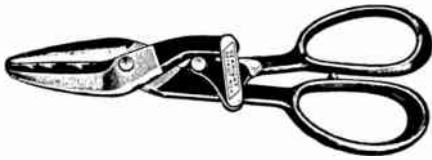

Snips are forged with solid blades of crucible tool steel, heat treated. All pivots and parts made for the most trying work on metal.

Compound lever action gives an evenly distributed cutting strain from a close throat start to the finish at the point of the blade. In difficult cutting it is not necessary to start with blades open to the full span, because of the even pressure at all positions. The short cutting blade is connected to the short lever handle by links on each side with close fitting shoulder rivets, making a rigid connecting frame without side springing tendencies.

No. 10: Length 10½-in., cut 20 gauge or multiples of thinner gauges.

No. 12: Length 12-in., cuts seams or multiples of thicknesses: is used for splitting large sheets and for many classes of work that usually require bench shears.

No. 14: Length 14-in., is capable of much heavier work than the usual hand shear of the same length and in many ways takes the place of a bench shear for heavy cutting.

No.	Wt., Lbs.	Each
10	1⅛	\$11.00
12	1⅜	14.50
14	2½	17.00

Evans Pocket Tapes



Practical for measurements in production and maintenance work. Chrome plated die cast case. ½-in. tempered steel blade finished with bonderized white enamel on both sides.

Jet black "quick conversion" foot and inch markings on blade which is marked in eighths and sixteenths, thirty-seconds on first six inches. Packed 12 in a box.

No.	Lgth., Ft.	Wt., Lbs. Per Box	Each
106W	6	3⅜	\$0.98
108W	8	3⅝	1.19
110W	10	3¾	1.49
112W	12	4¼	1.89

English-Metric Markings

Millimeters on upper edge, inches to sixteenths on lower edge.

No.	Description	Wt., Lbs. Per Box	Each
106WE/M	2 Meters—78⅜ ins.	3⅜	\$1.10
110WE/M	3 Meters—119 ins.	3¾	1.49

Mainco Distance Measuring Wheels



Sturdily built aluminum chassis carries the wheel which is exactly 3-ft. in circumference. Flat rubber tire insures accurate rolling without slip. Counter geared to the wheel indicates feet. Inches are graduated on the stationary disc. Spring operated plunger brake keeps wheel locked; is released by means of trigger shown inside handle.

Counter has capacity of 99,999-ft. but can be reset at will of operator.

Measuring Wheel	Wt., Lbs.	Each
	5½	\$75.00

Evans Long Tapes



Vinyl leatherette covered steel case. Snow-white ¾-in. steel blade has black figures and is marked in eighths. Foot marked at every inch. Each tape equipped with hook ring at no extra charge. Packed in plastic carrying case.

No.	Length of Blade	Wt., Lbs. Each	Each
25W	25 Foot	¾	\$3.98
50W	50 Foot	1	4.98
75W	75 Foot	1⅝	5.98
100W	100 Foot	1¾	6.98

Evans Folding Rules



White plastic sticks with jet black markings. Can be cleaned with soap and water. Heavily plated steel joints. Packed 12 in a box.

No.	Lgth., Ft.	Type Reading	Each
FR1	6	Outside	\$0.98
FR2	6	Inside	

Lufkin Flexible Spring Joint Rules



5/8-in. wide, white enameled. Six-inch folds. Marked consecutive inches to 16ths, both sides. 6-ft. length.

No. 8616.....Each **\$1.45**

Lufkin Folding Extension Rules



For inside measurements. A six-inch graduated brass slide fitted into first section. Rule is hardwood, 1/8-in. thick for durability. Marked both sides consecutive inches to 16ths. Length, 6-ft.

No. X-46.....Each **\$2.50**

Lufkin Sterling Linen Tapes



Two color markings, one side only, to feet, inches and half inches. Case is genuine leather over rust resisting metal case. Folding flush handle. Nickel plated trimmings.

No.....	400	403	405	406
Weight, Ounces.....	8	12	19	24
Length, Feet.....	25	50	75	100
Each.....	\$8.20	\$11.50	\$15.60	\$18.50

Lufkin Michigan Chain Tapes

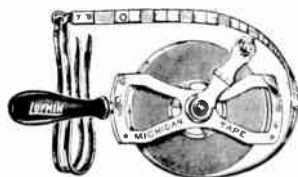

Line is of extra tough steel, white metal coated. Graduations and figures are deeply stamped into babbit metal. Line is detachable from reel, and has heavy brass end clips, and is furnished with a pair of leather thongs. Sturdy metal reel

is dull nickel plated finish with polished hardwood handle.

No. 3100, 100-Ft. Length, with Reel.....Each **\$22.70**
 No. 03100, Tape Only, 100-Ft. Length.....Each **14.70**

Lufkin Leader Chrome-Clad Steel Tapes



Chromium plated; resists rust and is easily kept clean. Markings are extremely easy to read, being jet black against the cream white chrome. Has plated steel ring at end of tape. Markings are inches and 8ths. The case is covered with maroon-covered vinyl over a substantial rust-resistant coated steel liner.

A strong, durable and very easy to read tape at a moderate price. Width, 3/8-in.

No.	Length Feet	Weight Ounces	Each
C-250	25	9	\$ 6.60
C-253	50	15	8.00
C-255	75	20	10.70
C-256	100	25	13.10

Lufkin Anchor Chrome-Clad Steel Tapes



This is a high grade chrome-plated steel tape in genuine leather case. The heavy chrome plate is extremely durable and the jet black markings made for great ease in reading. Blade is 3/8-in. wide. The case is finest grade genuine leather, hand sewed over a heavy steel plated inner case.

Choice of markings: feet, inches and 8ths; or 10ths, and 100ths.

No. Feet, In., and 8ths	No. Feet, 10ths and 100ths	Length Feet	Weight Ounces	Each
C-210	C-210-D	25	9	\$ 9.00
C-213	C-213-D	50	15	10.80
C-215	C-215-D	75	21	14.00
C-216	C-216-D	100	26	18.20

Lufkin Mezurall Chrome-Clad Tape Rules



1/2 steel blade, chrome plated to resist rust and wear. Non glare black markings against chrome white background. Has self-adjusting end hook for butt end and hooked-over measurements. Blade marked inches to 16ths, on both edges, first 12 inches upper edge to 32nds. The blades are replaceable.

Tape Rules

No.	Lgth., Ft.	Each
C-926	6	\$1.75
C-928	8	1.95
C-9210	10	2.25
C-9212	12	2.65

Replaceable Blades Only

RC-6	6	\$0.95
RC-8	8	1.10
RC-10	10	1.25
RC-12	12	1.45

Lufkin Mezurall Tape Rule Nickel Plated Blades



This rule is identical to the chrome clad rule with the exception that the blades are nickel plated instead of chrome plated which permits a lower price.

Tape Rules

No.	Lgth., Ft.	Each
926	6	\$1.50
928	8	1.70
9210	10	2.00
9212	12	2.40

Replaceable Blades Only

RN-6	6	\$0.70
RN-8	8	.80
RN-10	10	1.00
RN-12	12	1.20

Armstrong Ratchet Burring Reamers



Built for rough, hard usage. Heads easily removed. Worn heads are replaceable.

All parts of the ratchet burring reamers are interchangeable. All reamer heads fit the same ratchet collar.

No.	Reams Pipe, Inches	Lbs.	Weight Oz.	Each
*210R	1/4 to 3	6	13	\$17.50
244R	1/4 to 2	6	2	15.40

*Type 1, Class 2, in accordance with MIL. Spec. MIL-R-1256.

Armstrong Bit Brace Burring Reamers



No. 242

Spiral fluted; removes burrs from pipe and conduit.

Blades cut smoothly and rapidly.

No.	Reams Pipe, Inches	Lbs.	Weight Oz.	Each
242	1/8 to 1	..	9	\$2.70
243	1/4 to 1 1/4	..	11	3.00
244	1/4 to 2	1	11	6.00

Toledo Ratchet Pipe Reamers

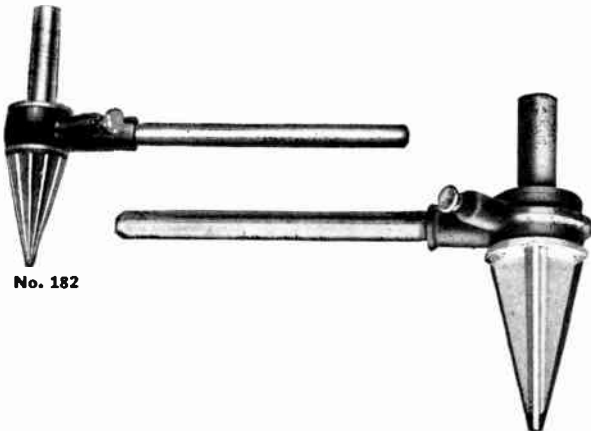

No. 182

No. 383

No. 182 is a small, compact, all steel pipe or conduit reamer. Multiple tooth reamer head made from heat treated alloy steel. Ratchet handle. 16 1/2-in. long. No. 383 has cutter blades of high speed steel cast solidly in the head. Blades can be sharpened or entire head replaced at moderate cost.

No.	Pipe Size Inches	Weight Lbs.	Each
182	1/8 to 2	5	\$15.40
383	3/8 to 3	8	21.65

**Spiral for Power Drive Use Only
Plain—No Ratchet**

142	1/4 to 2	6	16.50
-----	----------	---	-------

Nye Ratchet Reamers



For reaming pipe 1/4 to 3 in.

Blades specially ground and are replaceable if ever necessary.

No.	Description	Approx. Ship. Wt. Lbs.	Each
NRR	Ratchet reamer, complete...	6 1/2	\$15.85
NRR-B	Extra blades, each.....	1/4	2.10
NRR-BO	Body.....	2	4.55
NRR-RH	Ratchet housing.....	1	1.95
NRR-RR	Ratchet retainer.....	1/2	1.25
NRR-PR	Palm rest.....	1/2	1.55
NRR-H	Handle.....	2	1.55
NRR-RP	Ratchet pawl, complete....	1/4	1.65
NRR-RS	Ratchet spring.....	..	.30

**Nye Bit Brace Reamers
Spiral Flute**



No. N42

Reamers made with tapered shank to fit any standard bit brace.

Spiral flutes give a shearing action, providing clean and satisfactory job.

No.	Size, In.	Approx. Ship. Wt. Lbs.	Each
N42	1/8 to 1	3/4	\$3.80
N42 1/2	1/8 to 1 1/4	3/4	4.60
N44	1/4 to 2	1 1/4	8.75

Nye Quality Pipe Taps



Briggs standard (N. P. T.) right hand taper pipe taps furnished.

Carbon Steel No. NT1

No.	Pipe Size	Threads Per Inch	Approx. Ship. Wt. Lbs.	Each
NT1	1/8	27	1/4	\$1.05
NT2	1/4	18	1/4	1.25
NT3	3/8	18	1/4	1.70
NT4	1/2	14	1/4	2.05
NT5	3/4	14	1/4	3.05
NT6	1	11 1/2	1/4	4.55
NT7	1 1/4	11 1/2	3/4	6.35
NT8	1 1/2	11 1/2	1 1/4	8.55
NT9	2	11 1/2	3	12.65

**Nye Triplex Solid Die Stock
For Pipe or Conduit Dies**



Lightweight one-piece with generous openings in body, for oiling and chip clearance.

Ideal for hand threading or use with power vise.

Supplied in two combinations: 3/8 to 3/4 in. and 1/2 to 1 in.

No.	Item Complete With R.H. Skip-Tooth Dies	Approx. Ship. Wt. Lbs.	Each
NT-30	Stock, 3/8, 1/2, 3/4 in.....	11 1/4	\$20.15
NT-31	Stock, 1/2, 3/4, 1 in.....	11 1/4	20.15
NT-0	Stock less dies and bushings.....	8 1/4	11.45
ND-1	Extra solid skip tooth dies.....	1	4.55
NT-G	Extra guides.....	1/4	.75
NT-TPS	Top plate with screws and springs..	1/2	1.40
NT-H	Handles, each.....	2	1.55
NT-BS	Bushing set screw.....	..	.15

Nye Triad Dies

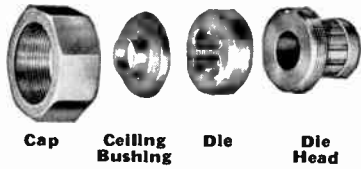

One piece dies assure operator perfect alignment and size. Die is locked in place by threaded screw cap. Same dies are used with all Triad stocks but diehead diameters vary for each ratchet stock.

For threading short nipples or a stub of pipe, even to within 1/4 in. of wall or ceiling, the dies can be quickly reversed and a ceiling bushing inserted between die and cap.

Triad Dies for Pipe or Conduit

No.	Description	Approx. Ship. Wt. Lbs.	Each
*ND-T	Triad dies only, 1/8, 1/4, 3/8 in.	1/4	\$3.70
*ND-T	Triad dies only, 1/2, 3/4 in.	1/2	4.55
*ND-T	Triad dies only, 1, 1 1/4 in.	1/2	5.60

*Specify size.

Nye Three Way Triad Stocks

3/8 to 3/4 In. and 1/2 to 1 In.

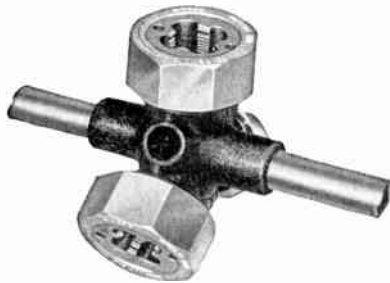

No.	Item Complete with R.H. Dies	Approx. Ship. Wt. Lbs.	Each
N3W-30	3/8, 1/2, 3/4 In.	7 1/2	\$17.45
N3W-31	1/2, 3/4, 1 In.	11 1/4	20.10
*N3W-30-0	Stock only	2	9.75
*N3W-31-0	Stock only	3	10.90
NCB	Ceiling bushing	1/4	.45

*Less dies, handles and screw caps.

Nye Receding Die Stocks

Regular Bushings—Capacity 1 to 2 In.

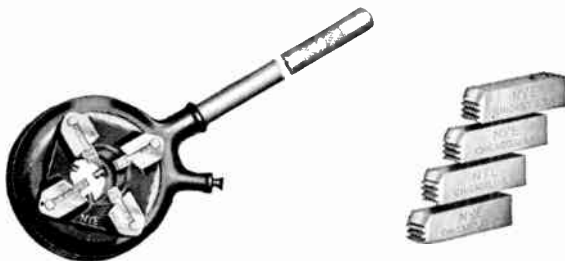

No.	Description	Approx. Ship. Wt. Lbs.	Each
N1R-4	Receding stock (ratchet) complete with bushings and dies 1, 1 1/4, 1 1/2 and 2-in.	23	\$39.35
N1R-0	Stock less dies and handle	16 1/2	25.10
N1-DC	Die chasers, four segments per set, 1, 1 1/4, 1 1/2 in. (alloy steel)	1	4.30
	2-in. (high speed steel)	1	5.15

Nye Triad Ratchet Stock

No. 50

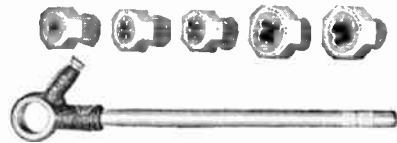

Dies 1/2—1 1/4 in. may be furnished either for pipe or conduit. Please specify.

No.	Item Complete with R.H. Dies	Approx. Ship. Wt. Lbs.	Each
N50-5	Stock, 1/8, 1/4, 3/8, 1/2, 3/4 in.	9 1/2	\$33.05
N50-4	Stock, 1/4, 3/8, 1/2, 3/4 in.	8 3/4	27.35
N50-3	Stock, 3/8, 1/2, 3/4 in.	7 3/4	21.65
N50-2	Stock, 1/2, 3/4 in.	6	15.95
N50-R	*Ratchet with handle	2 3/4	4.45
N50-II	†*Die head with die, 1/8, 1/4, 3/8 in.	1 1/4	5.70
N50-11	†*Die head with die, 1/2, 3/4 in.	1 1/2	5.75
N50-P	Pawl only with spring	1/4	1.65
NCB	Ceiling bushing	1/4	.45

*Interchangeable with Toledo No. 00, Armstrong No. 90R and Beaver No. 2 die heads and stocks.

†Specify size.

No. 60



No.	Item Complete with R.H. Dies	Approx. Ship. Wt. Lbs.	Each
N60-7	Stock, 1/8, 1/4, 3/8, 1/2, 3/4, 1, 1 1/4 in.	21 1/2	\$51.35
N60-6	Stock, 1/4, 3/8, 1/2, 3/4, 1, 1 1/4 in.	19 3/4	45.10
N60-5	Stock, 3/8, 1/2, 3/4, 1, 1 1/4 in.	17 3/4	38.85
N60-4	Stock, 1/2, 3/4, 1, 1 1/4 in.	15 3/4	32.60
N60-61	Stock, 1/8, 1/4, 3/8, 1/2, 3/4, 1 in.	19	43.95
N60-51	Stock, 1/4, 3/8, 1/2, 3/4, 1 in.	17 1/4	37.70
N60-41	Stock, 3/8, 1/2, 3/4, 1 in.	14 1/2	31.45
N60-31	Stock, 1/2, 3/4, 1 in.	12 1/2	25.20
N60-R	*Ratchet with handle	4 1/4	4.65
N60-II	†*Die head with die, 1/8, 1/4, 3/8 in.	2	6.25
N60-11	†*Die head with die, 1/2, 3/4 in.	2	6.75
N60-H1	*Die head with die, 1 in.	2 1/2	7.05
N60-H1 1/4	*Die head with die, 1 1/4 in.	3 1/2	7.40
N60-P	Pawl only with spring	1/4	1.65
NCB	Ceiling bushing	1/4	.45

*Interchangeable with Toledo No. 11 die heads and stock.

†Specify size.

Nye Carrying Boxes

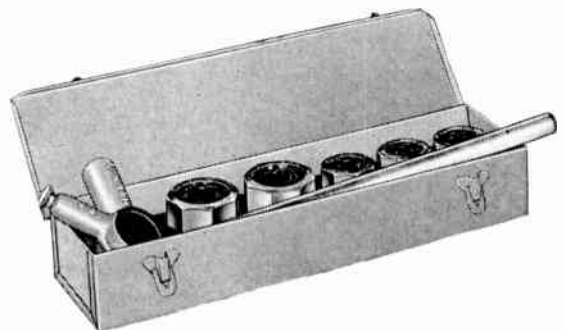

Sturdy 20 gauge steel baked enamel carrying boxes. Two sizes available.

No.	Size, In.	Approx. Ship. Wt. Lbs.	Price Box Only
N50-X	17 x 4 1/2 x 2 7/8 in.	4 1/4	\$6.30
N60-X	24 1/4 x 5 1/2 x 4 in.	7 1/2	7.25

Nye Improved Heavy Duty Self-Locking Vises



No. 61 Chain Vise

Vises No. 52 and No. 53 are similar to No. 61 chain vise, except for style of jaws, and no pipe rest or bender.

No.	Takes Pipe Inch	Weight Lbs.	Each
61	1/8 to 2 1/2	8 3/4	\$ 9.10
52	1/4 to 1	15	18.45
53	1/4 to 8	37	44.30



Nye Clamp Kit Vise

No.	Takes Pipe In.	Wgt. Lbs.	Each
900	1/8 to 1 1/2	8	\$10.50
90	1/8 to 2	13 1/4	15.15
91	1/8 to 2 1/2	16 3/4	18.65

No. 900

Nye Solid Skip-Tooth Dies



Features the removal of every alternate tooth in back of die to reduce friction and permit more chip clearance when backing off. New easier starting lead in threaded throat feature assures easy starting.

Will fit all makes of solid stocks corresponding to stock numbers with their die capacities listed below.

No.	Dimension of Dies	Sizes	Approx. Ship. Wt. Lbs.	Each
ND-1	2 1/2 x 2 1/2 x 3/4	1/8, 1/4, 3/8, 1/2, 3/4, 1	1	\$ 4.55
ND-2	1 x 1 x 7/8	1/2, 3/4, 1, 1 1/4, 1 1/2, 2	2 1/2	6.95
ND-4	5 x 5 x 1	2 1/2, 3	3 1/2	19.50

Nye No. 1 Solid Bolt Dies



These solid bolt dies can be used in any stock accommodating No. 1, 2 1/2 x 2 1/2 x 3/4 dies.

No.	Appr. Ship. Wt. Lbs.	Each
ND-1B	1	\$3.75

Sizes In.	Threads Per In.	Sizes In.	Threads Per In.	Sizes In.	Threads Per In.
1/4	20	1/2	13	3/8	9
5/16	18	9/16	12	1	8
3/8	16	5/8	11	1 1/8	7
7/16	14	3/4	10		

Solid Skip-Tooth Conduit Dies

For use in any stock accommodating No. 1, 2 1/2 x 2 1/2 x 3/4 dies.

No.	Size, In.	Approx. Ship. Wt. Lbs.	Each
ND-1C	1/2, 3/4, 1	1	\$ 4.55

Oster "Bull Dog" Stocks and Dies



Plain Type Bull Dog



Ratchet Type Bull Dog

The tools with five big features. Lever-locking, adjustable dies, self-locking, self-centering guides. No backing off, dies open and release tool from pipe. Dies reset to size instantly. Big range of sizes, right and left hand threads. The self-centering universal guides with which all Bull Dog die stocks are equipped accurately center all sizes of pipe and eliminate pipe bushings and set screws. The guides which are controlled by a lever handle, will pass a coupling so that short nipples as well as longer lengths of pipe can be threaded.

Bull Dog dies are made of high quality tool steel, properly hardened and ground to size on all sides.

Equipment furnished as standard consists of tool body, self-centering guides, 1 set handle and one complete set of R.L. pipe dies to cover the designated range. Made in plain and ratchet types.

Number		Range, Inches	Bolts	Plain	Ratchet
Plain	Ratchet	Pipe		Each	Each
111	1/4 to 3/4	1/4 to 3/4	\$23.50	\$.....
111 1/2	1/8 to 3/4	1/4 to 3/4	27.40
112	112R	1/4 to 1 1/4	1/4 to 1	30.00	33.00
113	113R	1 to 2	1/4 to 1 1/4	33.00	37.50
114	114R	1/2 to 2	1/4 to 1 1/4	38.50	43.00
114 1/2	114 1/2R	1/4 to 2	1/4 to 1 1/4	44.00	48.50
.....	115R	1 1/2 to 3	79.00
.....	115 1/2R	1 to 3	87.25
.....	117R	2 1/2 to 4	85.50
.....	117 1/2R	1 1/2 to 4	97.00

Extra Dies

Single sets of extra dies consist of these size combinations: 1/8 in.; 1/4 & 3/8 in.; 1/2 & 3/4 in.; 1 & 1 1/4 in.; 1 1/2 & 2 in.; 2 1/2 & 3 in.; 3 1/2 & 4 in.

Extra Dies for Bull Dog

Ratchet No.	Extra Pipe Dies Single Set	Extra Bolt Dies Single Sets
111	\$ 3.90	\$5.75
111 1/2	3.90	5.75
112	4.50	6.50
113	5.50	7.70
114	5.50	7.70
114 1/2	5.50	7.70
.....	115R	8.25
.....	115 1/2R	8.25
.....	117R	11.50
.....	117 1/2R	11.50

**Oster Leader Die Stocks
2 1/2-inch to 4-inch Pipe**

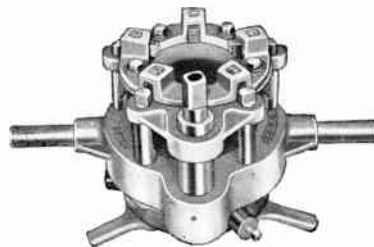

A high quality tool. Designed for use with power drives, as well as for hand operation. No. 54 dies are extra wide for longer life and ground with a special long lead for easy starting. Standard equipment consists of tool body, self-centering chuck, handles, separate ratchet frame and

four individual sets of dies to standard range. Weight, 72 pounds.

No. 54 Complete	Each	\$116.60
Extra pipe dies, 1 set for each size	Set	9.90

Armstrong Adjustable Stocks and Dies For Pipe or Conduit



Set consists of adjustable stock with "Kalarized" adjustable pipe or conduit dies and ring bushings for each threading size, with screws, handles and wrench.

"Kalarized" dies are stronger, tougher, yet slide smoothly around the pipe. The full sizes leading threads in the throat pull the dies on pipe, even over the meanest burrs. No wavy threads.

Set No.	For Threading Pipe Sizes, Inches	No. of Sizes	Weight Lbs.	Each
1 1/2	3/8 to 1/2	2	4 1/2	\$10.70
1 1/2	3/8 to 3/4	3	5	13.10
1 1/2	1/4 to 3/4	4	5 1/2	15.50
1 1/2	1/8 to 3/4	5	6	17.90
2	1/2 to 1	3	10 1/2	15.10
2	3/8 to 1	4	11 1/2	18.15
2	1/4 to 1	5	12 1/2	21.20
2	1/8 to 1	6	13 1/2	24.20
2 1/2	1/2 to 1 1/4	4	12 1/2	24.20
2 1/2	1/2 to 1 1/2	5	14	28.50
2 1/2	1/4 to 1 1/4	6	16	32.80
2 1/2	1/8 to 1 1/4	7	17 3/4	37.10
2 1/2	1/8 to 1 1/2	8	18 3/4	41.40
3	1 1/4 to 2	3	28	28.60
3	1 to 2	4	32	33.40
3	3/4 to 2	5	36	38.30
3	1/2 to 2	6	40	42.90

Note: Type J stocks and Type C dies, in accordance with Fed. Spec. GGG-T-581.

Extra Bushings for Adjustable Stocks For Pipe or Conduit

No.	Wt. Lbs.	Each	No.	Wt. Lbs.	Each
1 1/2	1/4	50.85	2 1/2	1/2	\$1.10
2	1/4	.85	3	1 1/4	1.35

For Bolts and Rods

2	1/4	.853	3	1 1/2	\$1.35
---	-----	------	---	-------	--------

Adjustable Stocks and Dies for Bolts and Rods with Ring Bushings

1/4, 5/16, 3/8, 7/16, 1/2, 5/8, 3/4, 7/8, 1, 1 1/8 and 1 1/4 in. Available in NC and WHIT.

No.	Size In.	No. of Sizes	Wt. Lbs.	Each
2	1/4 to 1 1/4	11	20 1/2	\$57.50
2	1/4 to 1 1/8	10	19 1/2	52.80
2	1/4 to 1	9	18 1/2	48.10
2	3/8 to 1 1/4	8	17 1/2	43.40
2	1/4 to 1	7	16	38.80
2	1/2 to 1 1/4	6	15	34.10
2	1/2 to 1	5	14	29.40
2	5/8 to 1	4	13	24.80
2	3/4 to 1	3	12	20.10

1/2, 5/8, 3/4, 7/8, 1, 1 1/8, 1 1/4, 1 3/8, 1 1/2, 1 5/8, 1 3/4, 1 7/8 and 2 in. Available in NC and WHIT in all sizes.

3	1/2 to 2	13	71	\$138.00
3	1/2 to 2	12	67	128.70
3	1/2 to 2	11	63	119.20
3	Any 10 sizes	10	59	109.80
3	1/2 to 1 1/2	9	54	100.30
3	Any 8 sizes	8	50	90.80
3	1 to 2	7	45	81.40
3	1 1/8 to 2	6	41	71.90
3	1 to 2	5	37	62.50
3	1 1/4 to 2	4	33	52.80
3	1 1/2 to 2	3	30	43.10

Beaver Ratchet Threaders

1 Set of Dies Threads 1 to 2 In.



The only fully adjustable tool that will cut under or over-standard lengths.

The only threader that will cut either standard taper threads or electric conduit straight threads with same dies.

The only threader with radio dial setting. Dies easily removable from outside in few seconds. Very rugged and easy working. Low upkeep cost.

No. 26-R. Ratchet Threader, 1 to 2-in. Each \$50.90

Beaver Geared Threaders

1 Set of Dies Threads 2 1/2 to 4 In.



Will cut standard, oversize or undersize threads of standard length.

Being adjustable, it is always possible to compensate for variations in off-standard or reused pipe fittings, still giving tight joints. Very rugged and easy working. Threads pipe or conduit with same set of dies.

No. 41-E. Geared Threader, 2 1/2 to 4-in. Each 134.10

No. 61-E. Geared Threader, 2 1/2 to 6-in. Each 275.00

No. 61-EX. Geared Threader, 4 to 6-in. Each 235.00

Beaver Pipe and Conduit Threaders

Delux with Fully Enclosed Ratchet



Finest set available. Ratchet mechanism fully enclosed, prevents wear on teeth and thereby eliminates danger of slipping which might result in serious injury to workman. Die-heads available for pipe, bolt, conduit, right or left.

No. 3. Ratchet with handle Each \$5.90

Diehead with Dies. 1/8, 1/4, 3/8, 1/2, 3/4 in.,

R. or L. Each 5.80

1" as above. Each 6.40

Die Segments Only. R. or L. 1/8 to 3/4" Per Set 4.20

1" Per Set 5.05

Beaver 3-Way Threaders



Many advantages.

Oil hole between dies for oiling and chip clearance.

Dies square, no offset to break.

Dies easily removed for resharpening. Extra long handle bosses give great strength.

No. 34. 1/2 to 1 in. pipe or conduit (specify which). 3-Way threaders. Each \$20.10

Toledo Geared Adjustable Threading Devices
Capacity, 2½ to 4 In. Pipe



Receding die principle produces a perfect tapered thread. Net weight only 57 lbs. Easily handled by one man. Consists of tool body, complete set of 2½ to 4 in. dies and bushings, set screw wrench and ratchet handle.

No. 2 BR same as No. 2 except equipped with new type 3-jaw pipe holder. No bushings needed; action is more positive than cam operated mechanism. Either model can be furnished to produce straight running conduit threads for electrical work.

For Pipe

No.		Size Range Inches	Wt., Lbs.	Each
2	R.H. complete	2½ to 4	94	\$128.35
2	R.H. complete	2½, 3, 4 only	89	120.70
2 BR	R.H. complete	2½ to 4	90	134.10
2 BR	R.H. complete	2½, 3, 4 only	87	128.25

Dies R.H., 2½, 3, 3½, 4 in., single set, \$10.50

For Conduit

No. 2. Complete for conduit, 2½ to 4 in. Shipping weight, 96 pounds.....	Each	\$151.60
No. 2 BR. Complete for conduit, 2½ to 4 in. Shipping weight, 94 pounds.....	Each	\$151.60
Electric Conduit Dies, R.H., 2½, 3, 3½, 4-in. Shipping weight, 3 pounds.....	Each	\$11.65

Toledo Pipe Threading Devices

No. 00—Capacity ⅛ to ¾ Pipe

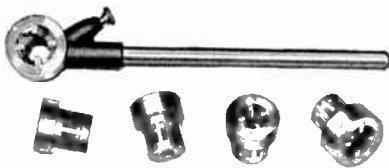

Light, compact, and will thread pipe in corners. Cuts threads of full taper. Cover on each die head protects dies from damage. Die segments can be removed from die heads with screw driver for regrinding or replacing. Complete tool consists of ratchet handle 17 in. long, ⅛, ¼, ⅜, ½ and ¾-in. die heads with R.H. dies.

Complete

No.	Cap. In.	Shipping Wt., Lbs.	Each
00	⅛ to ¾	9	\$32.95
00	¼ to ¾	8¼	27.25
00	⅜ to ¾	7	21.55
00	½ to ¾	5½	15.85

Accessories

No. 00. Ratchet Handle complete. Ship. weight, 3 lbs. Each	\$4.45.
No. 00. Die Heads with R.H. Dies, ⅛, ¼ or ⅜-in. Each size	\$5.70.
No. 00. Die Heads with R.H. Dies, ½ or ¾-in. Each size	\$5.70.

Toledo Ratchet Type Threading Devices
Capacity, ⅛ to 1¼ In. Pipe

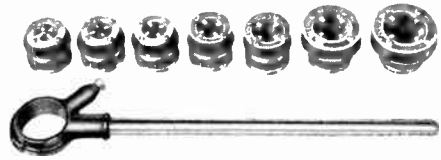

No. 11

Light and compact, reaches corner jobs. Right hand only. Die heads instantly changed by pulling ratchet pawl knob, dropping out one head and inserting another. Ratchet handle, 21 in. long. Die segments can be reground or replaced at small expense. Complete tool consists of ratchet handle, ⅛, ¼, ½ and 1¼ in. right hand die heads with dies, and is so furnished unless otherwise specified. Any combination of die heads may be ordered. Conduit dies same cost as pipe dies.

Complete

Cap. In.	Shipping Wt., Lbs.	Each	Cap. In.	Shipping Wt., Lbs.	Each
1/2 to 1 1/4	13	\$32.65	1/4 to 1 1/4	15	\$46.65
1/2 to 1	10	25.65	1/4 to 1	14	39.65
1/8 to 1 1/4	18	53.65	3/8 to 1 1/4	14	39.65
1/8 to 1	15 1/2	46.65	3/8 to 1	14	32.65

Toledo 3-Way Pipe Threading Devices



Capacities: No. 30—¾, ½, ¼-in. pipe.
No. 31—½, ¼, 1-in. pipe.

A very easy tool to use. Tool bodies are about the size of a baseball, each die head being on center.

Handles projecting from both sides produce a balanced tool. Die segments easily removable for regrinding or replacing. No adjustments necessary and no loose parts. Tool body is designed to readily clear itself of chips and will not become clogged with dirt. No. 31 excellent for conduit.

No.	Size Range Inches	Wt., Lbs.	Each
30 complete	¾ to ¾	5¼	\$17.45
31 complete	½ to 1	8¼	20.10

⅜, ½, ¾ in. R.H. dies, set, \$4.20—1 in., set, \$5.05

Armstrong Handy Threaders

With Ring Bushings For Pipe



No. 70B

A practical tool for the home mechanic or maintenance man. Light in weight. Easy to handle. Equipped with regular "Kalarized" solid dies. Slotted handle permits storing on nail or peg.

Size, Inches	No. of Sizes	Lbs.	Oz.	Each
¼ to ¾	4	5¼	..	\$13.50
½ to 1	4	5½	..	13.50
¾ to 1	5	5¾	..	16.70
Extra No. OS dies	4	3.00
Extra No. OS bushings	2	.85
Stock only	3	4.00

Nye Ratchet Pipe Threaders

No. 51B

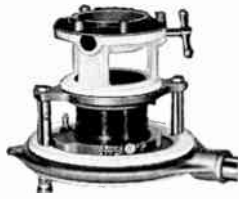

Cuts pipe thread or straight thread for plumbing, conduit or mechanical joints with one set of high speed dies on pipe sizes 1, 1 1/4, 1 1/2 and 2-in.

Opens automatically on both power and hand operation, when approximately eleven threads have been cut. Cannot jam lead screw.

Opens manually at any time during cut if spin back knob is pulled out. Pipe size selector can be changed from one size to another in an instant. Simple adjustment is provided for deep or shallow threads.

Adjustable guide allows quick clamping to pipe by three jaws synchronized to operate with one movement of guide ring. Dual purpose spin back knob permits turning stock back in a few seconds to starting position before removal from pipe.

Chaser removal easy and quick. Change effected in one minute without loosening a single screw.

No.	Description	Approx. Ship. Wt. Lbs.	Each
N51B	Ratchet pipe threader complete with dies	23 1/2	\$50.90
N51DC	High speed dies (set of four segments)	1/2	6.30

Nye Receding Stock

No. 2

Capacity 2 1/2 to 4 in.

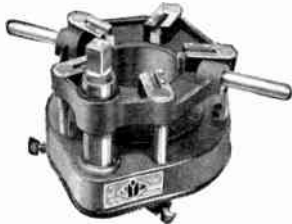

Separate guides.

Cuts standard, oversize or undersize threads.

(Fits Fed. Spec. GGG-T-581 Fig. 12 Type 1).

No.	Description	Approx. Ship. Wt. Lbs.	Each
N2-R4	Stock complete 2 1/2, 3, 3 1/2, 4-in.	100	\$128.25
N2-R3	3 Sets of dies and guides	97	120.70
N2-R2	2 Sets of dies and guides	93	114.00
N2-R1	1 Set of dies and guides	88	107.25
N2-R0	Stock less ratchet handle, dies and guides	67 1/4	100.60
N2-RH	Ratchet and handle, complete	14	13.40
N2-RG	Guides (bushings) 2 1/2, 3, 3 1/2, 4-in. each size	23 1/4	3.50
N2-RS	Set screw, each	1/4	.60
N2-DC	Die chasers—five segments per set, 2 1/2, 3, 3 1/2, 4 in. alloy steel.	2	11.20

Nye Improved Pipe Threading Oil



Dark or clear with sulphur base.

Recommended where highest film strength is desired. Unless otherwise specified, dark oil will be furnished.

No.	Quantity	Approx. Ship. Wt. Lbs.	Per Gal.
NO-1	1 Gallon can	10	\$1.60
NO-5	5 Gallon can	45	1.40
NO-55	55 Gallon drums	470	1.15

Armstrong Pipe Threading Oil



Quantity	Std. Pkg.	Price Each
Pint	24	\$0.45
Quart	12	.70
1 gallon	6	1.45
5 gallons	1	6.25
		Per Gallon
30 gallon drums	1	1.10
50 gallon drums	1	1.10

Toledo Cutting Oils

Sulphur Base

High grade, superior thread cutting oil. Antiseptic.

Will not turn rancid. Assures smooth threads and longer die life. Keeps hands and clothes clean.

The dark oil is used for power machines; clear oil used for hand tools.



Size	Each
1 Gal. Can	\$1.45
5 Gal. Can	6.25
55 Gal. Drum	49.50

Black Sulphur Base

1 Gal. Can	\$1.45
5 Gal. Can	6.25
55 Gal. Drum	49.50

Clear Cutting Oil

1 Gal. Can	1.60
------------	------

Oster Cutting Oil

Absorbs and throws off heat. Flows freely in cold weather. Available in light and dark color.



	Dark	Light
4 oz.	\$ 0.25	*
1 pt. with 4-in. spout	.50	.60
Quart	.70	.80
Gallon	1.45	1.60
5 gal.	6.25	7.25
30 gal.	31.50	36.00
55 gal.	49.50	56.50

*Not available.

Armstrong General Service Ratchet Diestocks

No. GS-1—With Integral Dropheads

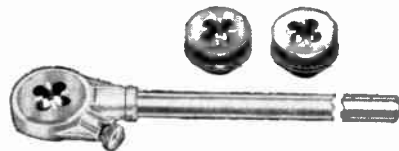

No. GS-1

No.	Description	Weight		Each
		Lbs.	Dz.	
GS-1	1/2, 3/4, 1 in.	7	13	\$15.93
52065-3/8	Extra 3/8 in. drophead, each	1	14	4.00
52065-1/2	Extra 1/2 in. drophead, each	1	14	4.00
52065-3/4	Extra 3/4 in. drophead, each	1	14	4.00
52065-1	Extra 1 in. drophead, each	1	14	4.00
52063	Extra 1 1/4 in. drophead, each	2	8	5.13
52000	Ratchet collar and handle complete	3	8	3.93
52067	Ratchet collar, each	1	8	3.13
R9117	Handle, each	2		.80

General Machine Washer Cutters

Type B



For cutting polyethylene washers used in splice and terminal cases.

Consist of a reversible steel blade mounted in an aluminum handle. Each end of blade provided with a guard marked to facilitate guiding the cutting edge.

No. 7512—Wt. 1/2-lb. Price on application.

Armstrong No. 291R Drophead Ratchet Diestocks with Segmental Dies

For Pipe and Conduit

Type D, In Accordance With Fed. Spec. GGG-T-581

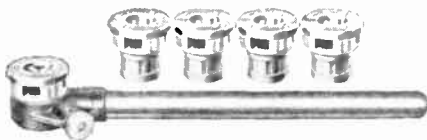

No. 291R

When ordering for conduit add C in front of Catalog number.

Size, In.	No. of Sizes	Wt. Lbs.	Each
1/8 to 1 1/4	7	15 1/2	\$50.30
1/8 to 1	6	13 1/2	43.60
1/4 to 1 1/4	6	11	43.80
1/4 to 1	5	12	37.10
3/8 to 1 1/4	5	12 1/2	37.30
3/8 to 1	4	10 1/2	30.60
1/2 to 1 1/4	1	11 1/4	30.80
1/2 to 1	3	9 1/4	24.10



Die Head & Dies Complete



Pipe & Conduit Dies Only

No. 291R Die Heads and Dies Complete

Size, In.	Wt. Lbs.	Each	Size, In.	Wt. Lbs.	Each
1/8	1 1/2	\$6.50	3/4	1 1/2	\$6.50
1/4	1 1/2	6.50	1	1 3/4	6.70
3/8	1 1/2	6.50	1 1/4	2	6.70
1/2	1 1/2	6.50			

No. 291R Pipe and Conduit Dies Only

Size, In.	Wt. Oz.	Each
1/8—3/8, 1/2—3/4	2	\$3.95
1	3	4.75
1 1/4	4	4.75

Armstrong No. 292R Diestocks

Type D, In Accordance With Fed. Spec. GGG-T-581



Dies Only



Adapter

No. 292R Ratchet Diestock

Description	No. of Sizes	Wt. Lbs.	Each
1 1/4 to 2 complete	3	18 1/4	\$35.00

No. 292R Dieheads and Dies Complete R.H. Pipe or Conduit

Size In.	Wt. Lbs.	Each	Size In.	Wt. Lbs.	Each
2	5	\$10.50	1 1/4	3	\$9.50
1 1/2	4	9.50			

No. 292R Dies Only R.H. Pipe or Conduit

1 1/2 and 2	6	\$5.30	1 1/4	6	\$4.75
-------------	---	--------	-------	---	--------

No. 292R Adapter

Allows 291R die heads, sizes 1/8-1 in. to be used with 292R ratchet handle. Wt. 1 1/2 lbs. Each \$5.00

Armstrong Heavy Duty Pipe Cutters



No. 2A



No. 4A

No.	Size In.	Wt. Lbs.	Each
2A	1/8 to 2	7	\$13.10
4A	2 to 4	20	39.90

Wheels, Pins and Rolls

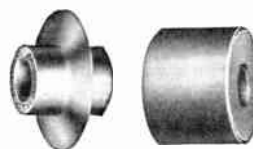

Rolls and wheels are interchangeable. Can be supplied as either a 1-wheel or 3-wheel cutter at same price.

In accordance with Federal Specifications GGG-C-771.

No.	Description	Wt. Oz.	Each
2A	Wheels	1	\$1.00
4A	Wheels	3	1.75
2A	Pins	3	.40
4A	Pins	6	.45
2A	Rolls	1	.60
4A	Rolls	1	.80

Armstrong Roller Pipe Cutters
(Saunders Type)



No.	Size In.	Wt. Lbs.	Each
1S	3/8 to 1	3	\$ 8.00
2S	1 to 2	6	12.00
3S	2 to 3	11	19.80
4S	2 1/2 to 4	25	40.20
5S	4 to 6	23	60.00

No.	Description	Wt. Oz.	Price Each
1S	Wheels	1	.90
2S	Wheels	1	1.00
3S, 4S, 5S	Wheels	4	1.85
1S	Rolls	2	.40
2S	Rolls	3	.70
3S, 4S, 5S	Rolls	5	1.10

No.	Description	Wt. Oz.	Per Doz.
1S	Pins	1	\$2.30
2S	Pins	1	2.30
3S, 4S, 5S	Pins	2	4.00

Nye Heavy Duty Pipe Cutters



Solid malleable construction and all steel handle make this an exceptionally dependable and durable tool. Wheel blocks travel on extra wide-ways which assures continued alignment. Every pipe cutter is checked for alignment and tested at the factory.

No.	Size In.	Wheels Pins Rollers Used	Wt. Lbs.	Each
1N	1/8 to 1 1/4	1 and 2N	5	\$10.40
2N	1/8 to 2	1 and 2N	5 1/2	13.90
4N	2 to 4	4N	17	39.90

Nye Pipe Cutters
For Use With Power Units



Long sleeve for thread protection. Three roller balancing. Self aligning, assuring square cuts and eliminating spirals. Can be applied to pipe while pipe is in motion. Cuts with less effort and saves half the usual cutting time.

No.	Size In.	Wheels Used	Wt. Lbs.	Each
2NP	1/8 to 2	2N or 2R	7	\$14.00

Armstrong Tube Cutters
Split Roller Type

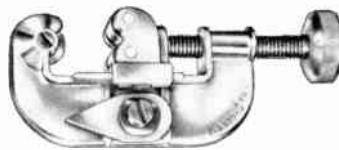

Two roller type with knife blade wheel and bevel ground reamer.

Both sets of rolls are separated so that cuts can be made close to flared end of tube.

Thin edge of cutter wheel is protected by a positive stop, preventing it from pressing against the rollers.

No.	Cuts Tube Inches, O.D.	Wt. Lbs.	Each
100	1/8 to 1 1/8	1/2	\$3.65
Wheels, weight 1 oz. Each			.60
Wheels or roll pins, weight 1 oz.			.25
Split rolls (per 2 halves) weight 1 oz.			.30

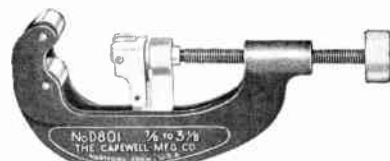

No.	Cuts Tube Inches, O.D.	Wt. Lbs.	Each
D801	1/8 to 3 1/8	2 3/4	\$12.00

Toledo Pipe and Tube Cutters

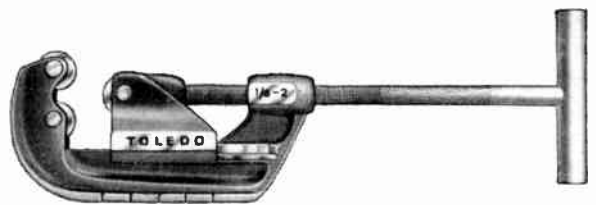

A wheel and roller cutter that tracks perfectly and cuts easily. Frame formed to fit the hand.

Cutter wheels leave practically no burr. The roller in hook provides a square base when starting to cut.

The Tubing Cutter handles brass and copper tubing easily and quickly. The handy reamer slides out of way when not being used.

No.	Description	Each
20	1/8 to 2 In. Pipe Cutter (With 2 rollers)	\$13.90
600	1/8 to 1 In. Tubing Cutter	2.95

Nye Tube Cutters with Rollers



No. N00C: 3/16-1 1/8 in. o.d. Recommended for copper, aluminum and other non-ferrous metals.

No. N25SB: For steel tubing. 1/2-2 1/8 in. o.d. Equipped with cross bar handle for better leverage. Suggested for thinwall conduit up to 1 1/2 in.; pipe to 3/4 in. Cuts copper tubing to 2 1/8 in.

No.	Description	Approx. Ship. Wt. Lbs.	Each
N00C	Copper, Aluminum, etc.	1	\$ 3.85
N25SB	With sliding "T" handle for steel tubing and small pipe.	2 1/2	7.35

**Toledo Heavy Duty Pipe Wrenches
Straight And Offset**

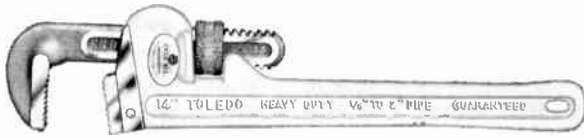

Rugged, durable wrenches with spin-easy nut and strong single spring that provides positive jaw action. The improved handle design increases strength and gives better hand grip.

Type Size, In.	Cap., In.	Wgt. Lbs.	Each
6 Straight	3/4	1 1/2	\$ 1.80
8 Straight and 8 offset	1	3 1/4	2.10
10 Straight and 10 offset	1 1/2	13 1/4	2.75
12 Straight	2	23 1/4	3.20
14 Straight and 14 offset	2	31 1/2	3.70
18 Straight and 18 offset	2 1/2	51 1/4	5.30
24 Straight	3	9	8.35
36 Straight	4	16 1/2	17.65
48 Straight	6	33	26.50

**Toledo Aluminum Pipe Wrenches
Heavy Duty**



Has heat treated, forged alloy steel jaws that are replaceable. Drop-forged aluminum hook, housing and handle insures strength for years of hard usage.

Tough steel nut assures equal load distribution on threads. Rugged steel spring provides instant grip.

Can also be furnished in non-sparking type.

Wrench Size In.	Wt. Lbs.	Each	Wrench Size In.	Wt. Lbs.	Each
10	15/16	\$3.90	18	2 5/8	\$ 7.85
14	1 3/4	5.45	24	3 3/4	12.10
			36	8	24.40

Nye Pipe Wrenches



Wrenches of life time service. Unconditionally guaranteed. Have hardened forged jaws and alloyed handles. Straight or offset patterns.

6-In. to 36-In. Straight or Offset at Same Price

Size, In.	Each	Size, In.	Each
6	\$ 1.80	8	\$ 2.10
10	2.75	14	3.70
18	5.30	24	8.35
36	17.65		

48-In. In Straight Only

48	\$26.50		
----	---------	--	--

Toledo Chain Wrenches



Redi-Grip

Powerful, light weight, fast acting chain wrenches. Ideal for close quarters.

Safe-strong forged handles. Fit over any shaped object.

Will not crush pipe or conduit.

No.	Description	Each
RG-4	Chain Wrench, 1/2 to 4 inch	\$ 4.95
RG-6	Chain Wrench, 3 to 6 inch	11.95

**Nye Ratcheting Chain Wrenches
Forged Alloy Handle**

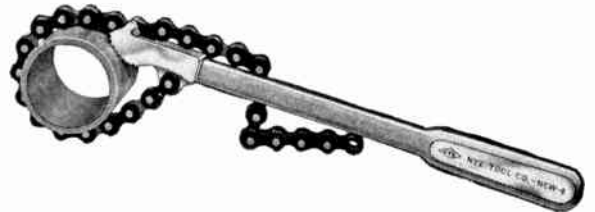

Does everything a pipe wrench will do and more. The ideal wrench for "hard to get at" spot. Designed to handle work against walls, in corners or on parallel pipe lines.

Ratcheting action allows a new bite without removing wrench from work. Wrench suitable for all types of pipe, conduit or bars,—round, square, hexagonal or octagonal. Holds firmly without crushing.

No.	Description	Approx. Ship. Wt. Lbs.	Each
NCW-4	Wrench complete 1/2 to 4 in.	1 3/4	\$ 4.95
NCW-6	Wrench complete 3 to 6 in.	4 1/2	11.95
NCW-4C	16 in. chain only for NCW-4	1/2	1.98
NCW-6C	22 in. chain only for NCW-6	3/4	3.95

**Nye 22 1/2° Angle Adjustable Wrenches
Strong—Light—Thin**



Made Of
High Grade
Forged Alloy
Steel

No. NAW-4

Chrome plated and highly polished. The minimum of corner lip on the movable jaw permits a square nut to fit flat against the inside surface. Deep full-bite throat creates all round utility on hex and square nut and the precision mesh teeth operate smoothly and hold adjustment firm to withstand leverage.

Military Descriptions: "22 1/2° Angle, Heavy-Duty Adjustable Open End Wrench." Specs.; MIL-W-15671A, Type 1; or GGG-W-631a, Type 1, Class A or B.

No.	Length In.	Maximum Opening, In.	Approx. Ship. Wt. Lbs.	Each
NAW-4	4	1/2	1/8	\$ 1.60
NAW-6	6	3/4	1/4	1.60
NAW-8	8	1 1/4	1/2	1.80
NAW-10	10	1 1/8	3/4	2.35
NAW-12	12	1 5/16	1 1/2	3.40

TEC One-Hander Wrenches

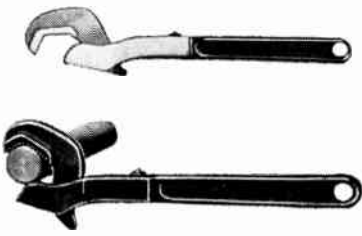

For Nuts and Pipes

One-hand operation. Just slap it on the pipe or nut. One side of jaw, actuated by a spring, is only moving part. No adjustments to wear or loosen.

Gives a positive and instant grip.

Double-leaf spring. Wrench available in special alloy steel or chrome vanadium.

For Nuts

Carbon Steel No.	Chrome Vanadium	Length, In.	Range, In.	Steel Each	Chrome Vanadium Each
15-6	17-6	6	3/16-3/8	\$1.85	\$1.95
15-8	17-8	8	3/16-5/8	2.35	2.75
15-10	17-10	10	3/8-3/4	3.25	3.95
15-12	17-12	12	1/2-1	4.95	5.75
15-15	—	15	3/4-1 1/4	8.95	—
15-20	—	20	1-1 5/8	12.95	—

For Pipes

16-6	18-6	6	1/8-3/8	1.85	1.95
16-8	18-8	8	1/4-3/4	2.35	2.75
16-10	18-10	10	3/8-1	3.25	3.95
16-12	18-12	12	1/2-1 1/4	4.95	5.75
16-15	—	15	1-1 1/2	8.95	—
16-20	—	20	1 1/4-2 1/4	12.95	—
16-36	—	36	2 1/4-3 1/2	27.95	—

Toledo Open-Side Pipe Vises



Eliminates unlatching and tipping back yoke for lengths of pipe. Handles are extra long, permitting easier setting of pipe jaws. Both upper and lower jaws are heat treated steel, full overlapping for perfect pipe hold. Frame is made of iron, extra heavy.

No.	Jaws, Inches	Wt., Lbs.	Each
00	2 1/4	7 1/4	\$13.80
0	2 1/2	12 3/4	16.95
3	3 1/4	27	33.90

Armstrong Post Vises

No. 163X

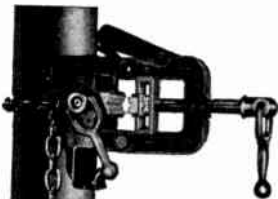

Post vise holds pipe from 1/8 to 2 1/2 in.

Weight 20 lbs.

Each.....\$24.00

Pipe Vise Parts

No.	Description	Wt. Oz.	Each
231, 241	Upper Broad Jaw	3	\$1.25
232, 233, 142BX	Upper Broad Jaw	4	1.65
143BX, 163X	Upper Broad Jaw	4	1.65
234	Upper Broad Jaw	5	2.20
231, 241	Lower Broad Jaw	3	2.20
232, 233, 142BX	Lower Broad Jaw	8	2.90
143BX, 163X	Lower Broad Jaw	8	2.90
234	Lower Broad Jaw	8	3.30
135, 136	Set of 3 Jaws	4 lb.	9.70

Armstrong Chain Vises



No. 1



Nos. 3 & 4

Type X, Class A, in accordance with Federal Specification GGG-V-436a.

No.	Holds Pipe Inches	Wt. Lbs.	Each
1	1/8 to 2 1/2	4 1/4	\$ 8.60
2	1/8 to 4	11 1/4	17.45
3	1/2 to 6	20 1/2	31.40
4	1/2 to 8	30 3/4	41.80

Jaws

No.	Wgt. Lbs.	Each	No.	Wt. Lbs.	Each
1	1/4	\$ 3.10	3	5	\$ 8.80
2	5/16	4.90	4	9	11.50

Armstrong Heavy Duty Vistands

Hinged and Chain Type



No. 833BX



No. 933



No. 934C

Integral Vistand is three units in one; a vise, a three legged stand and pipe bender. Light and well balanced. Can be easily carried in one hand.

The three legs, correctly adjusted for height and 3 point suspension, are bolted to platform so that each Vistand is completely assembled when received.

Nos. 833BX and 933 are equipped with the regular No. 233 Armstrong hinged pipe-vise tops.

No. 833BX has 3/4-in. pipe bender and slot for tools. The platform provides space for oil can and loose fittings.

Nos. 933 and 934C heavy duty have all the features of the No. 833BX, plus 2 extra benders, 1/2 and 3/4 in. for reverse bends, more slots for tools, a ceiling brace and a cast-in dope pot.

No.	Type	Holds Pipe Inches	Wt. Lbs.	Each
833BX	Hinged	1/8 to 2 1/2	42	\$34.70
933	Hinged	1/8 to 2 1/2	48	38.95
934C	Chain	1/8 to 4	42	39.50

Vistand Jaws

No.	Description	Wt. Oz.	Each
833BX & 933	Upper Jaw only	5	\$1.65
833BX	Lower Jaw only	8	2.90
933	Lower Jaw only	8	2.90
934C	Lower Jaw only	10	4.90

Armstrong Pipe Vises

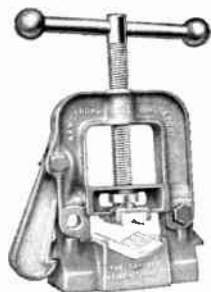

No. 231

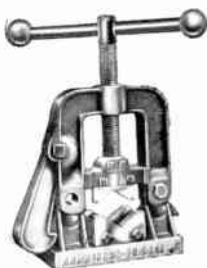

No. 135

Full length broad jaws, single upper and single lower, grip pipe along their entire length assuring a tight, firm and sure grip without marring the pipe. Mis-use cannot loosen, bend or separate the two bolts holding upper jaw in place. Has double pitch feed screw and upset lower jaw.

Broad Jaw Vises

No.	Holds Pipe Inches	Wt. Lbs.	Each
231	1/8 to 1 1/2	3 1/2	\$ 9.90
232	1/8 to 2	8	11.65
233	1/8 to 2 1/2	12 1/2	13.75
234	1/8 to 3 1/2	15 3/4	20.90

Three Jaw Vises

135	1/8 to 1 1/2	28 3/4	\$28.80
136	1/8 to 6	36 1/4	64.70

Note: Type X, Class B, in accordance with Fed. Spec. GGG-V-436a.

Armstrong Kit Vises

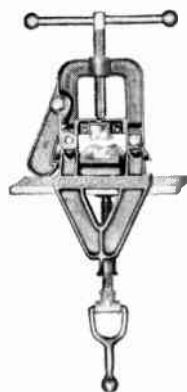

No. 241

Clamp Type

Clamps onto plank, bench or post.

Husky and serviceable. Has frictionless disk and four point bearing slide. I-beam structure and lightweight.

No.	Holds Pipe Inches	Wt. Lbs.	Each
241	1/8 to 1 1/2	4	\$13.00
142BX	1/8 to 2	11 1/2	14.30
143BX	1/8 to 2 1/2	15 1/2	17.60

Toledo Vise Stands



No. 8

All one unit, no loose parts. Sets up or takes down easily.

Extra rugged, won't fold up in use. Has large size vise base for easy mounting of vise. Three pipe benders, plenty of tool slots, pipe rest, ceiling brace.

No.	Description	Each
8	Vise Stand—to 2 1/2 inch pipe.....	\$28.00

Nye Convertible Combination Vises and Stands
Capacity up to 4-Inch Pipe



No. N88A



No. N88B

Base designed so yoke vise parts (1/8 to 2 1/2 in.) can be alternated with chain vise parts (1/2 to 4-in.).

Stands have double socket efficiency benders for 1/2 and 3/4-in. pipe. Slots for holding tools. Hole in rear of base is tapped for 1-in. pipe to take extension pipe rest arrangement. Each leg of stand has locking arrangement for open and closed positions, no chain required.

No.	Description	Size in.	Wgt. Lbs.	Each
N88A	Stand with Yoke Vise (Convertible to N88B and N88C).....	1/8 to 2 1/2	45	\$44.00
N88C	Stand complete with all parts for Nos. N88A and N88B.....		47	49.15
N88B	Stand with Chain Vise.....	1/2 to 4	43	44.60
N88A P	Parts to convert Nos. N88B to N88A.....		4 1/2	11.00
N88B P	Parts to convert No. N88A to N88B.....		2 1/2	12.15
N88B P L	Parts to convert N88A to N88B (New style 1 piece Jaw).....		2	10.65
N88B P R	Extension pipe rest yoke.....		1 1/2	3.00

Nye Self Locking Pipe Vises

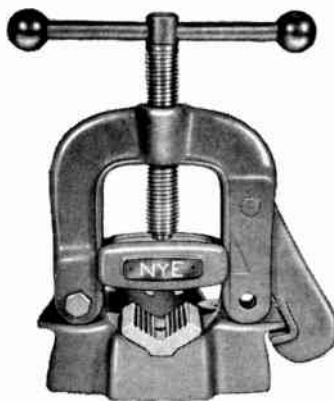

No. N1

Equipped with long jaws and solid cast upper jaw retainer guide.

All yoke type vises have pipe rest and benders on base.

Smallest rod and pipes up to 3/8-in. are held securely at either side of vise jaws in the larger vises such as N2 and N3.

No.	Takes Pipe In.	Each
N00	1/8-1 1/2	\$ 9.10
N0	1/4-2	12.35
N1	1/8-2 1/2	14.55
N2	1/8-3 1/2	22.15
N3	1/8-4 1/2	26.80

Toledo Universal Power Drives

Provides power right where it is needed on the job. Particularly designed for use with hand threading or cutting tools, but is equally efficient in any application where a portable power source is needed for rolling, cranking or turning operations.



Motor automatically adjusts speed to load, increasing power and decreasing speed on heavy loads and increasing speed on light loads. Under load, bushing rotates about 30 rpm.

Has 1/2 hp. universal motor. Operates from light socket on 115 volt current, or can be furnished with

230 volt universal motor. Motor is reversible to back off dies.

Weighs only 165 lbs. Furnished with 20-ft. rubber-covered cable. In ordering, be sure to specify whether 115 or 230 volt motor is desired. Shipping wt., 238 lbs.

Universal Power Drive..... Each **\$408.00**

Toledo Power Drive

With Semi-Automatic Chuck

No. 78-A

A portable power drive that provides effortless cutting, threading and reaming of pipe and conduit.

Sturdily built with all gear drive. The chuck grips like a pipe wrench and is self-centering. Machine equipped with folding legs; can be carried over the shoulder.

Provides power for hand operated pipe tools. Excellent for fitting make up work.

1/2 hp. 115 volt motor. Weight 75 lbs.

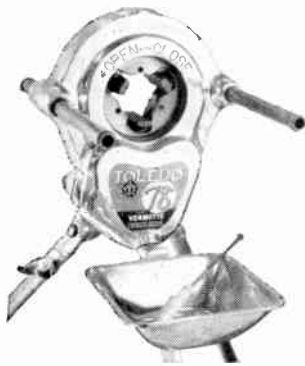

No.	Description	Each
78-A	Complete with legs, oil pot, fork tool holder.....	\$295.00
..	2-In. Adjustable Pipe Rest	24.20
..	4-In. Adjustable Pipe Rest	34.50

Toledo Power Drive

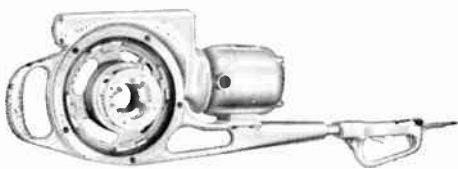

This power drive unit operates most standard die stocks with special adaptors that can be supplied. Provides ample power to operate even geared threaders. Portable, easily carried. Weight 33 lbs.

No.	Description	Each
68	Power Drive with 115 Volt Electric Motor.....	\$199.50
68	Power Drive with Air Motor.....	495.00

Toledo Power Drive

With Spin-Torque Chuck

No. 88

**Powerful
Efficient
Fast**

**Capacity
1/8 to 2 In.
Pipe
1/4 to 1 1/2
In. Bolts**

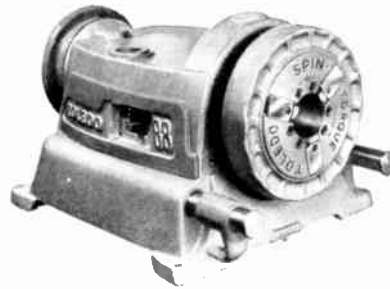

A light power drive for operating hand tools. Aluminum housing. Positive gripping spin torque chuck, opens and closes easily. Grip increases with torque. Large size operating ring. Equipped with rear centering device.

Powerful 1/2 hp. universal 115 volt motor. Can be mounted on bench, service truck or on legs with tray.

No.	Description	Each
88	Drive with Spin-Torque Chuck (less legs and tray).....	\$285.00
88	Drive with Regular 3-Jaw Chuck (less legs and tray).....	285.00
..	Set of four legs.....	9.55
..	Tray.....	11.95

Oster Portable Power Vise Stands

Has new power-matic chuck. Positive gripping for all kinds of pipe—no hammering to close or open—right or left hand operation.

Gears and shafts are ball bearing mounted.

Universal, reversible, variable speed motor with nominal hp. rating 1/2 (continuous duty). Spindle speeds (variable with load rpm) 22 to 36.

Pipe capacity regular range 1/8-in. to 2-in., with special drive unit 2 1/2-in. to 12-in.



Extra light in weight with tough, durable, aluminum alloy frame.

Available with electric, gas or air power drives. All three quickly interchangeable by simply removing 5 bolts which hold drive on the machine.

Over-all height, less legs, 18 3/4-in.; over-all width, less legs, 15-in.; over-all length, less legs and oil pan, 11 1/2-in. Net weight, 11 1/2 lbs.

No.	Description	Each
142	With Electric Motor Drive.....	\$285.00
142	With Gasoline Engine Drive.....	395.00
142	With Air Motor Drive.....	405.00
	Gasoline Engine Drive Unit, only.....	200.00
	Air Motor Unit, only.....	210.00

Oster "Tom Thumb" Portable Pipe Machines

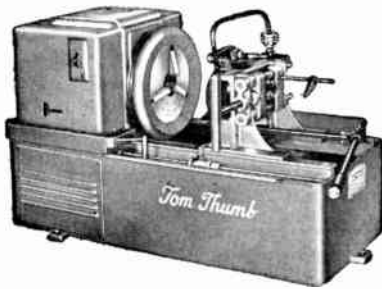

Equipped with ball-bearing mounted spindle and worm drive, giving it suitable speeds for most every requirement. New "Power-Matic" Front chuck speeds up operation and eliminates the use of chuck bar or wrench. Nipples as short as 4 1/2-in. in the 2-in. size can be held in the regular chuck and threaded on both ends without using a nipple chuck. Pipe or studs as short as 3 1/2-in. can be held and threaded on one end. Standard range 1/2 to 2-in. pipe. Extra range 1/8 to 3/8-in. pipe. Range with drive shaft 2 1/2 to 12-inch pipe. Bolt range 1/4 to 2-in.

Standard equipment includes roller type cutter, self-centering with length gauge, "Power-Matic" wrenchless type front chuck, universal centering rear chuck, universal variable speed 110 volt, a-c or d-c motor, reversing switch, gauge for thread length, reversible oil pump with relief valve, 3-gal. Oster cutting oil. Weight, 525 lbs.

No. 582 Complete with standard equipment, but less all dieheads and dies Each **\$790.85**

**"Tom Thumb" Portable Pipe Machine
No. 582R**

Differs from No. 582 by having revolving diehead. Its revolving dieheads and open type vise make it possible to thread long or short, straight or bent pipe, as well as nipples, rods, studs and bolts. Standard range 1/2 to 2-in. pipe. Extra range 1/8 to 3/4-in. pipe. Range with drive shaft 2 1/2 to 8-in. pipe. Bolt range 1/4 to 2-in.

No. 582R. With standard equipment and three sets of dies to cover standard pipe ranges, carbon steel 1/2 to 3/4-in.—high speed steel 1 to 2-in. Each **\$1060.00**

**"Tom Thumb" Portable Bolt Machines
Nos. 581A and 582A**

These machines embody all the basic quality features of the Tom Thumb line plus the added advantages of the semi-automatic opening and closing of the dieheads which give greater production. Nos. 581A and 582A are identical with the exception that the bore of the diehead of the No. 582A and its spindle speeds permit pipe up to 2 in. to be handled. No. 581A standard bolt range 1/4 to 1 1/2-in. pipe or nipple range 1/8 to 1 1/4-in. No. 582A standard bolt range 1/4 to 2-in. Pipe or nipple range 1/4 to 2-in.

No. 581A. With standard equipment, less dies (order only dies required)..... Each **\$1485.00**

No. 582A. With standard equipment, less dies (order only dies required)..... Each **\$1540.00**

Oster "Rapiduction Jr." Pipe Machines

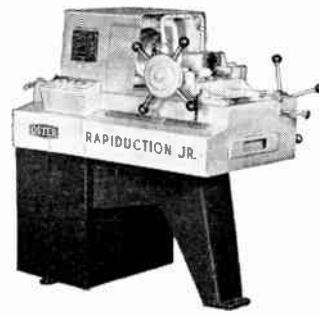

No. 792A

These completely new, modern machines are designed both for general purpose threading work and long run, high speed production.

Using tangential die-heads the standard range is 1/4-in. to 2-in. pipe. With radial die-heads the standard range is 1/8-in. to 2-in. pipe. Bolt range 1/4-in. to 2-in.

Constructed of fabricated steel, with spindle mounted in Timken tapered, roller bearings. Other entirely new features are the front chuck with Oster "power-matic" jaws which grip securely in both right and left hand direction and the availability of tangential die-heads and dies as well as the radial type.

Regular equipment includes 3 hp., 1800 rpm., 3-phase, 60 cycle motor; reamer; roller cutter; "power-matic" front chuck; self-centering, revolving, rear chuck; thread length gauge; oil pump and 5 gal. Oster "Bestoil."

No.	Net WL Lbs.	Ship. WL Lbs.	Each
*792 Machine with Standard Equip- ment, less Die-Heads and Dies	900	1200	\$1545.00

Die-heads and dies extra.

*Also available in revolving radial die-head type No. 792R.

**"Rapiduction Jr." Bolt Machines
With Semi-Automatic, Revolving Die-Heads**

Newly designed Nos. 791A and 792A machines are high-quality, high-production units, suitable for a wide variety of threading work. Movement of carriage opens and resets die-heads to size, automatically. Open type vises permit quick handling of work in and out of machine without stopping the motor. Spindles are mounted in Timken tapered, roller bearings, for long life and accuracy.

Regular equipment includes 3 hp., 1800 rpm., 3-phase, 60 cycle motor; revolving, semi-automatic, adjustable die-head; die-head control; quick-acting, open type vise; automatic stock stop; thread length gauge; oil pump and 5 gal. Oster "Bestoil."

No.	Standard Bolt Range In.	*Extra Bolt Range In.	Pipe or Nipple Range In.	*Extra Pipe or Nipple Range, In.	Each
791A	1/2 to 1/4	1/4 to 7/16	1/4 to 1 1/4	1/8	\$2120.00
792A	1/2 to 2	1/4 to 1/16	1/4 to 2	1/8	2120.00

*Auxiliary jaws required.

Oster "Pipe Master" Portable Pipe Machines

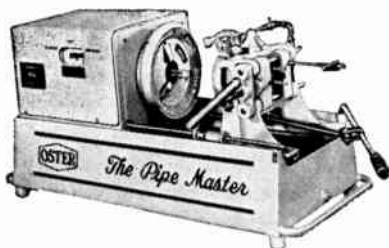

"Pipe Master" is a low priced, complete portable power pipe machine. Equipped with "Power-Matic" Front chuck which eliminates the use of a chuck bar or wrench and quick opening adjustable diehead. Nipples as short as 4 1/2-in. in the 2-in. size can be held in the regular chuck and threaded on both

ends without using special nipple holder. Pipe or studs as short as 3 1/2-in. can be threaded on one end.

Standard equipment includes roller type cutter; self-centering with length gauge; "Power-Matic" wrenchless front chuck; universal centering rear chuck; universal geared type motor, 110 volts either a-c, single phase or d-c; reversing switch; gauge for thread length; oil pump and 3-gal. Oster cutting oil. Weight, 370 pounds.

No. 552

Standard range 1/2 to 2-in. pipe. Extra range 1/8 to 3/8-in. pipe. With drive shaft 2 1/2 to 12-in. pipe. Bolt range 1/4 to 2-in.

Complete with standard equipment, with 1 diehead and 3 sets of dies, 1/2 to 2-in. Each **\$460.00**

With 3 dieheads and 3 sets of dies, 1/2 to 2-in. **518.00**

With 4 dieheads and 4 sets of dies, 1/4 to 2-in. **554.00**

With 6 dieheads and 6 sets of dies, 1/2 to 2-in. **626.45**

With 8 dieheads and 8 sets of dies, 1/4 to 2-in. **698.75**

Beaver Pipe and Bolt Machines

Model A

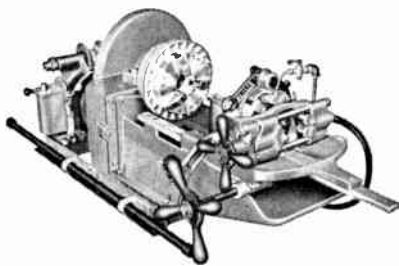

The world's fastest portable machine. A 2-in. thread in 12 seconds, for example. A rugged heavy duty, deluxe pipe and bolt machine that cuts, threads and reams 1/8-in. to 2-in. pipe.

With a drive shaft and geared tools it will cut and thread 2 1/2 to 12-in. pipe. Threads bolts 1/4-in. to 2-in. Cuts off bolts (with wheel cutter) up to 1/8-in.

Features include: New Power-Grip Wrenchless Chuck, right hand lathe-like operation, all controls in front, new Quadra-Type Die Head, 12-in. of working space and oil pump forward or reverse. Increased oil flow delivers two gallons oil per minute — means perfect threads and long die life. Pump accessible for easy cleaning. High speed steel dies throughout for pipe, bolt or conduit. Choice of wheel or automatic knife cutoff. Built-in outboard Pipe Support — instantly indexes for size — no double chucking. Equipped with thread length gauge.

Your choice of 110 or 220 volt universal, reversible motor.

Knife cutoff **\$25.00** extra.

This is a greatly improved version of the old Beaver Model A machine. Productivity has been increased at least 40 per cent, by faster, more powerful motor and many new advantages.

Weight 226 lbs.

With Quadra-Type and Duo-Type Die Heads

No.	Description	Each
A-5	With one Quadra-type die head and one set of quadra-type dies to thread 1, 1 1/4, 1 1/2 and 2-in.	\$680.00
A-6	With one Quadra-type die head to thread 1 to 2-in. and one duo-type die head with dies to thread 1/2-in. to 3/4-in.	720.00
A-7	With one Quadra-type die head to thread 1-in. to 2-in. and two duo-type die heads with dies to thread 1/2 x 3/4-in. and 1/4 x 3/8-in.	755.00
A-8	With one Quadra-type die head 1-in. to 2-in. and one each duo-type die head and dies 1/2-in. x 3/4-in. 1/4 x 3/8 and 1/8-in.	795.00

Note: Also available with Duo type or Mono-type die-heads and dies.

Speed-O-Matic

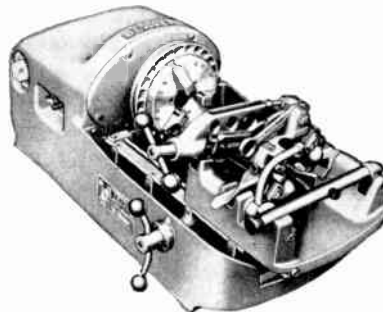

Fastest — most powerful — most rugged — lightest weight pipe and bolt machine in its class. Weights only 170 lbs. Equipped with amazing new power grip wrenchless chuck. 1/8 to 2-in. pipe, 1/4 to 2-in. bolts. Up to 12-in. with drive shaft. Motor and switch fully protected. 110 or 220 volt, single phase. Machine lubricated for life.

Cut-off, dieheads and reamer all pivot mounted, swing out of way when not needed. New full-floating Clear-Vu self-centering wheel and roller cut off. Pulsating oil flow produces even distribution of oil on all dies for perfect threads and long die life. Instant and accurate easy setting rear pipe support, quickly indexes for size of pipe or bolt, eliminates double chucking.

All parts accessible for minimum upkeep and maintenance. Quick acting alloy steel 3-flute reamer. Carriage always protected against damage.

Renewable bearings for long life and low up keep. Lathe type thread length indicator located right before your eyes. Made of high grade, tough alloy aluminum housing.

With Quadra-Type and Duo-Type Die Heads

No.	Description	Each
S-5	With one Quadra-type die head and one set of quadra-type dies to thread 1, 1 1/4, 1 1/2 and 2-in.	\$490.00
S-6	With one Quadra-type die head to thread 1 to 2-in. and one duo-type die head and dies to thread 1/2-in. x 3/4-in.	520.00
S-7	With one Quadra-type die head to thread 1-in. to 2-in. and two duo-type die heads with dies to thread 1/2-in. x 3/4-in. and 1/4-in. x 3/8-in.	550.00
S-8	With one Quadra-type die head 1 to 2-in. and one each duo-type die head and dies 1/2 x 3/4-in., 1/4 x 3/8 and 1/8-in.	575.00

Note: Also available with Duo-type or Mono-type Die-heads and dies.

Beaver Porto-Mite Super-Drive

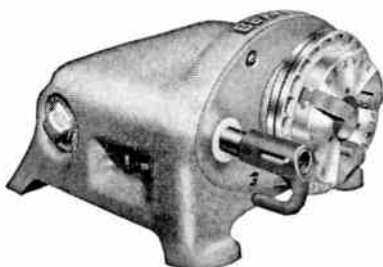

The world's lightest 4-legged power drive — with tremendous power and ruggedness. Weighs only 84 pounds. Lubricated for life. Faster, more powerful, completely new and greatly improved motor. Motor and switch fully protected. Quick-acting power grip wrenchless chuck — positive grip forward or reverse. Accurate and easy-setting rear pipe support eliminates double chucking.

All parts easily accessible for minimum upkeep and maintenance. Power to spare to drive up to 12-in. geared tools. Entirely new throughout.

	Each
Beaver Porto-Mite	\$285.00
Legs	9.00
Tool Tray	11.25

Greenlee Hydraulic Benders
For Pipe, Conduit and Bus-Bars



Greenlee Hydraulic Benders greatly speed conduit and pipe installations. One-man operated. Pumping the handle produces a powerful hydraulic force resulting in smooth, accurate bends without kinks or damage to pipe or conduit. No. 770 Series has a 25-ton hydraulic power unit. No. 775 Series has a 40-ton hydraulic power unit.

- No. **770** For 1¼, 1½, 2, 2½ and 3-inch rigid conduit and pipe. Weight, 205 pounds.....Each **\$197.50**
- No. **770T** For bending thin wall electric metallic tubing ¾, 1, 1¼, 1½ and 2-inch. Weight, 350 lbs.....Each **\$330.00**
- No. **770R** For bending small conduit and pipe in ½, ¾, 1, 1¼, 1½ and 2-inch sizes. Especially adaptable for radiant heating installations. Weight, 360 lbs.....Each **\$397.50**
- No. **770BB** For making U-bends in a wide range of sizes up to 4 inches wide and ¾ inches thick. Wt., 155 lbs.....Each **\$181.00**
- No. **775** For bending larger size pipe and conduit—3, 3½, 4 and 5-inch pipe. Weight, 402 pounds.....Each **\$276.50**
- No. **775R** For bending small pipe (including full 90° bend). For pipe sizes, ½, ¾, 1, 1¼, 1½, 2, 2½, 3-inch. Weight, 760 pounds.....Each **\$787.50**
- No. **775BB** Bus-Bar Bender. For making U-bends in material up to 6-in. wide by 1-in. thick. Wt., 235 lbs.....Each **\$252.50**

Greenlee Power Pipe Benders
For Bending Pipe or Rigid Conduit

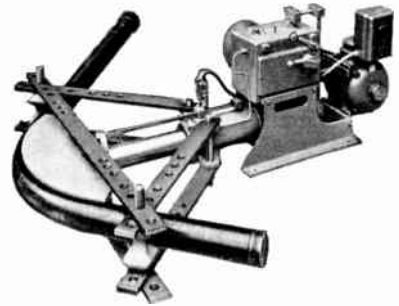

A powerful portable bender capable of licking the toughest pipe bending job. Handles rigid conduit or standard pipe 1¼ to 5 in. diam. Is rugged enough to bend 5-in. extra heavy material. Hydraulically operated. Gives fast smooth bends. 100-ton ram pressure. 20-in. stroke permits 90° bends in one setting. Can be driven by any suitable electric or gasoline motor.

Furnished complete with 2 upper connecting bars; 2 lower connecting bar assemblies; 1 upper cross bar; 1 lower cross bar assembly; 1 piston insert; 4 pipe supports, range 1¼- to 5-in.; 2 pipe support pins and 2 cylinder head pins. Weight, 609 pounds.

- No. **785-BE** Hydraulic Bender (without Motor or Shoes).....Each **\$1525.00**

Bending Shoes for Greenlee Power Pipe Bender

No.	Size, In.	Radius, In.	Wt., Lbs.	Each
785-BE-23	1¼	5	12	\$ 40.75
785-BE-24	1½	7½	14	46.75
785-BE-25	2	10	26	59.00
785-BE-26	2½	12½	37	78.75
785-BE-27	3	15	71	110.00
785-BE-28	3½	17½	96	141.75
785-BE-29	4	20	144	175.00
785-BE-30	5	25	199	195.00

Greenlee Hand Pipe Benders

For Hand Bending Steel, Iron and Non-Ferrous Pipe, Conduit and Tubing



Makes small radius bends without flattening or kinking and especially designed to make neat bends for sharp corners. Save up to 75% in time and material on many jobs. For the larger sizes of pipe and conduit, the bender is clamped in a vise. The smaller sizes can be bent without using a vise. No. 761 is for pipe and rigid conduit. No. 764 is for thinwall conduit (EMT-Electrical Metallic Tubing). Nos. 760 and 762 for soft copper and aluminum tubing. No. 763 for steel, copper, brass and aluminum tubing.

For Pipe and Rigid Conduit

No.	Nominal Size, In.	Center Radius, In.	Wt., Lbs.	Each
761	½ pipe	15/16	5¼	\$14.00
	¾ pipe	1¼	7	16.30
	1 pipe	1¾	8¾	20.40
	1½ pipe and rigid conduit	2¾	15¼	25.00

For Thin Wall Conduit

No.	Nominal Size, In.	Center Radius, In.	Wt., Lbs.	Each
764	3/8	1¾	8¾	\$16.40
	½	1¾	12¼	20.40
	¾	2½	17	26.30

For Steel, Copper, Brass and Aluminum Tubing

No.	Tubing O. D., In.	Center Radius, In.	Wt., Lbs.	Each
763	1/4	5/8	3¾	\$11.50
	5/16	25/32	4¾	11.50
	3/8	1¾	5	12.80
	1/2	1¾	7	14.00
	5/8	1¾	8¾	16.40
	¾	1¾	12	20.40
760	7/8	2¾	15¼	25.00
	1	2½	16¾	29.00

For Soft Copper and Aluminum Tubing

No.	Tubing O. D., In.	Center Radius, In.	Wt., Lbs.	Each
760	3/8, 1/2	1½	5	\$18.00
762	5/8, ¾	2½	3	18¼
	1, 1½	4	4	45.00

Greenlee Lightweight Hydraulic Power Bender

No. 884



Bends pipe and rigid conduit to 90° with one ram stroke. Handles 10 sizes from 1 in. down to 1/2 in. Develops 10 tons of ram pressure. High-strength aluminum alloy is used for the plates, pipe supports, bending shoes, and ram. The piston is of high-alloy steel.

One man can set up and operate. Applied to pipe in any position without loss of fluid or power.

For faster jobs bender may be used with Greenlee No. 797-E-SA Power Pump which can bend 4-in. pipe 90° in only 30 seconds.

No.	Description	Each
884	Bender, complete with No. 798-AC-SA Hydraulic Power Pump, to bend 10 sizes, 1/2" to 4".....	\$1239.50
884-A	Bender, (same as above—complete with pump) to bend only four sizes, 2 1/2", 3", 3 1/2", 4".....	1185.50

Greenlee Lightweight Hydraulic Bender

No. 880



Portable hydraulic bender designed for bending 6 sizes of pipe and rigid conduit from 1/2 in. to 2 in. up to 90° with one ram stroke. Consisting of a hydraulic hand pump and a bending ram assembly, the Bender units can be quickly disconnected by using a special speed coupling on the hose and hand pump.

Power punch of 15 tons. Safety valve in the hand pump opens any time the pressure limit is exceeded. Aluminum alloy used in construction wherever possible.

Has a two speed hydraulic hand pump with fast approach for moving ram rapidly to work piece. Can be used with No. 798 AC-SA Power Pump to speed bending.

No.	Description	Each
880	For 1/2 in. to 2 in. Pipe or Conduit.....	\$235.00
880-A	For 3/4 in. to 2 in. Pipe or Conduit.....	230.00
880-B	For 1 in. to 2 in. Pipe or Conduit.....	225.00

Tal Tube Benders

No. TT-57

Bends 5/8-in. and 7/8-in. O.D. hard and soft copper tubing. Has one forming section with two grooves for both sizes. Easy... Quick... Efficient. Low Cost.

Made of lightweight aluminum alloy with only two loose parts.



Nominal Tube Size In.	Tube O.D. In.	Radius to Center of Bend In.
1/2	5/8	3
3/4	7/8	3

No. TT-57 Tube Bender. Approx. ship. wt. 9 lbs. for two sizes. Without pipe handle.....Each **\$26.40**

Tal Pipe Benders

RC 200 Remote Control Benders

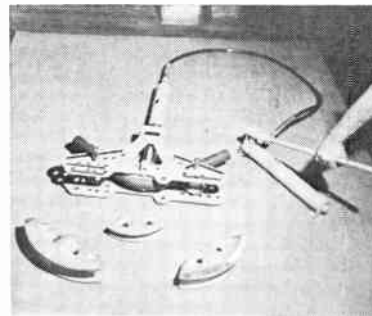

RC200 C or PH

Lightest One-Shot Bender

Only 68 lbs.

Two speeds, step-up bending time.

Removable top plate on frame lets pipe be inserted in bender three ways; Top, side, or hook over installed pipe.

Easily retract bends from shoes because of push-out pin and holes in shoes.

Easy assembling and durable construction—No threads, the few parts are assembled with pins. One bender, with one frame only.

No.	Description	Ship. Wt., Lbs.	Each
RC200C	For conduit: 1, 1 1/4, 1 1/2, 2-in. shoes	96	\$189.00
RC200PH	For pipe: 1/2, 3/4, 1, 1 1/4, 2-in. shoes	100	204.00

2 and 3-Inch Hydraulic Portable Pipe Benders

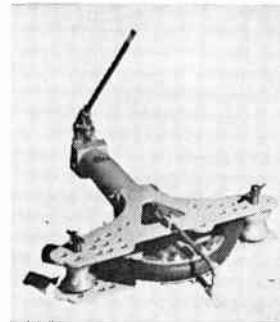

No. 3C or No. 3PH

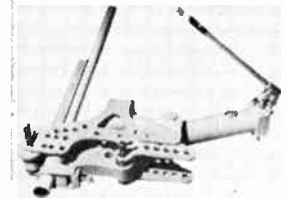

No. 2EMT or CT For Steel or Copper Tubing

Only Tal one-shot benders have one and the same universal frame that can be used to make "one-shot" bends for the following purposes.

Code Letter	Bend
PH	Pipe
CT	Copper Tubing
X	180° Radiant Heat
EMT	Thinwall Conduit
C	Rigid Conduit
BB	Bus Bar
MP	Motor Pump (MP-26)
RC	Remote Control

Motor pump and remote control is available for all models of the 2 and 3-in. benders.

No.	Conduit Type	Shoes Include, In.	Ship. Wt. Lbs.	Each
2C	Rigid	1 to 2	136	\$225.00
225C	Rigid	1 1/4 to 2	...	217.00
3C	Rigid	1 to 3	216	308.00
325C	Rigid	1 1/4 to 3	...	300.00
2EMT	Thinwall	1 to 2	183	307.00
225EMT	Thinwall	1 1/4 to 2	...	288.00
2C/EMT	Rig. & Thinwall	1 to 2	221	375.00
225C/EMT	Rig. & Thinwall	1 1/4 to 2	...	348.00
3C/EMT	Rig. & Thinwall	1 to 3, 1 to 2	301	458.00
325C/EMT	Rig. & Thinwall	1 1/4 to 3, 1 1/4 to 2	...	431.00
2PH	Pipe	3/8 to 2	110	240.00
3PH	Pipe	3/8 to 3	220	323.00
2CT	Copper Tubing	1 to 2	183	307.00
2PH/CT	Pipe & Cop'r T.	3/8 to 2, 1 to 2	225	390.00
3PH/CT	Pipe & Cop'r T.	3/8 to 3, 1 to 2	305	473.00
TAL Hydraulic Oil, 1 Gallon Can.....				\$2.50

All benders are offered with Standard Hydraulic Unit No. 99 which on special request can be exchanged for RC Remote Control Unit. Price remains the same.

Tal Large One Shot Benders

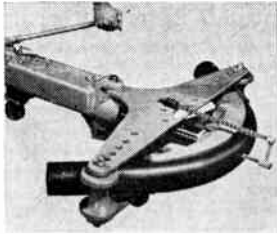

No. 400

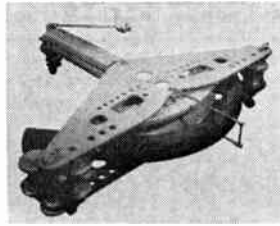

No. 600

For bending pipe (standard X, XX) rigid and thinwall conduit, copper tubing, bus bar, shapes in any size from 3/8-inch to 8-inch and larger.

Bends cold without filling and in one shot, without moving the pipe. Larger benders can be had with built-in hoist for handling and positioning pipe. Saves expensive handling, cutting, threading or welding, assembly and costly fittings such as elbows and couplings. Takes only 3 minutes actual bending time on the job to make a complete 90° bend in an 8-inch pipe.

No.	Capacity In.	Without Motor Pump		With Motor Pump (MP-26)	
		Ship. Wt. Lbs.	Each	Ship. Wt. Lbs.	Each
400	3/8 to 1	400	\$ 543.00	170	\$ 843.00
500	3/8 to 5	930	1160.00	1000	1460.00
600	3/8 to 6	980	1800.00	1330	*2450.00
800	3/8 to 8	Includes 8-in. former & 2 H.P. motor 6250.00			

*With 2 H.P. motor.

90° Bending Shoes for Above Basic Benders

Set No.	No. Shoes	Capacity Inches	Ship. Wt. Lbs.	Per Set
For Rigid Conduit				
2	4	1, 1 1/4, 1 1/2, 2	17.5	\$ 58.00
25C	3	1 1/4, 1 1/2, 2	15.5	50.00
For Pipe				
0	4	3/8, 1/2, 3/4, 1	6	25.00
25PH	3	1 1/4, 1 1/2, 2	15.5	50.00
For Both Rigid Conduit and Pipe				
3	2	2 1/2, 3	26	76.00
4	2	3 1/2, 4	159	165.00
5	1	5	300	302.00
6	1	6	320	503.00

Special Long Radius Shoes for Rigid Conduit

CL-90	No.	Capacity Inches	Ship. Wt. Lbs.	Each
	4	1, 1 1/4, 1 1/2, 2	46	152.00

Special shoes are available for pipe or conduit in any size up to 36 and 48-inches together with appropriate hydraulic unit.

Tal Pipe Benders

Bus Bar Bending Attachment



No.	Fits Bender Size, In.	Takes Bus Bar Size In.	Ship. Wt. Lbs.	Each
BB2	2	1 x 4	10	\$28.50
BB3	3	1 x 5	21	31.50
BB4	4	1 1/2 x 6 5/8	28	58.00

180° Radiant Heat Wings

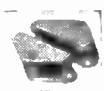

No.	Fits Bender Size, In.	Ship. Wt. Lbs.	Each
82X	2	30	\$62.00
83X	3	31	64.00
84X	4	35	73.00

180° Radiant Heat Bending Shoes for Pipe

Pipe Size In.	6-In.	9-In.	Centers 12-In.	15-In.	18-In.
1/2	\$22.50				
3/4	15.00	\$21.00	\$24.50	\$30.50	\$36.50
1		23.50	25.00	32.50	38.50
1 1/4			31.50	35.50	41.00
1 1/2			33.00		

Tal Manual One-Shot Benders

Tal Copper Tube Benders 180°—3/8-in. to 1-in.



For hard and soft copper tubing (Type K & L) especially recommended for radiant heat (complete 180° bends or less), to be used on the job. Get smooth bends in less than a minute. Bends straight or coiled tubing on the job or in the shop. Packed in specially designed tool box.

Approx. wt. lbs., 69.
No. CT-1 Basic Bender.....Each \$69.00
Work Bench Attachment.....Each 4.85

Formers

Tube Sizes* Nom. Inches	O.D.	Centers				Rollers Each
		4-Inch Each	6-Inch Each	9-Inch Each	12-Inch Each	
3/8	1/2	\$8.70				\$16.25
3/8	1/2		\$12.95	\$29.00	\$38.10	14.60
1/2	5/8		15.70	18.45	21.90	15.00
3/4	7/8		16.80	19.25	23.65	17.90
1	1 1/8			21.20	26.00	19.15

*Copper tube sizes and centers shown are those recommended by tube manufacturers and H. P. & A. C. Others are available to order.

Tal Manual Six-Way Hickey

Guaranteed for Life Against Breakage

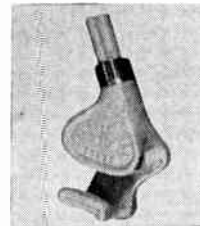

Long, safety neck extending into pipe handle guards against accidents caused by pipe handle breakage. New, extra stub hole for bending very short offsets or working conduit protruding from concrete. Sure grip jaws will not let conduit slip in the grooves of the hickey. An ideal tool for perfect work. Special design assures accurate, rapid and easy bending.

No.	Size, In.	Std. Pkg.	Ship. Wt. Lbs.	Each
50	1/2	10	3.5	\$3.70
75	3/4	10	5	4.65
100	1	3	8.5	7.95

Tal Handy Bendy

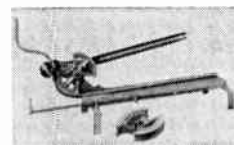

No. HB 2100

Makes perfect kink-free, uniform offsets and bends up to 1/2 and 3/4-in. thinwall and rigid conduit, up to 90° with one pull. Rugged, simple, and fast. For the shop or on the job.

Set on any desired distance and degree. Makes uniform and streamlined bends in less than a minute. No experience necessary.

Approximate weight 44 lbs.
HB2100 Complete with 1/2-in. and 3/4-in. Thin-wall and Rigid formers.....Each \$73.70
Work Bench Attachment. Wt. 6 lbs...Each 13.20

Tal MP 26 Motor Pumps

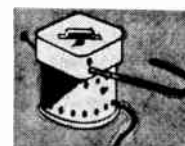

Available for all benders.

Takes only 1 minute actual bending time on the job to bend a 3-in. 90° elbow in a full length of pipe. When disconnected, bender will work hand operated.

No.	Description	Ship. Wt. Lbs.	Each
MP26	Motor Pump, 1/2 HP Compl.	70	\$329.00
12	Complete Coupling Set	1	9.75
14	6-ft. Hydraulic Hose (With Couplings)	3.5	20.00

Lidseen Chicago Pipe Benders Hand Portable

These pipe benders may be attached to any brace, beam, or 2x4 on the job and used without stand. When ordering

without stand, plates (see list of parts) are necessary for attaching.

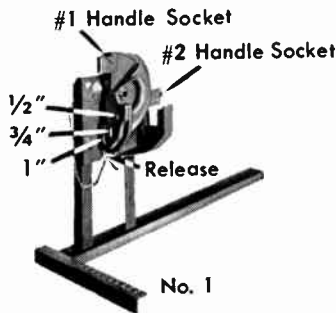

For 1/2, 3/4 and 1-inch Pipe

No. 1 Chicago Pipe Bender for regular 1/2, 3/4 and 1-inch conduit or pipe. Makes 4-inch diameter bends with 1/2-inch pipe, 8-inch diameter bends with 3/4-inch pipe, 11-inch diameter bends with 1-inch pipe. No. 1T Chicago Pipe Bender for 1/2, 3/4 and 1-inch thinwall conduit.

Both the **No. 1** and **No. 1T** pipe benders each have two operating handles. No. 1 handle is direct acting. Only one draw necessary for all kinds of uniform bends or offsets with 1/2 or 3/4-inch pipe. No. 2 handle operates toggle attachment for 1-inch pipe. 4 or 5 strokes required for a 90° bend.

No.	Description	Shipping Wt. Lbs.	Each
1	With Stand	66	\$110.00
1T	With Stand	94	110.00
1	Without Stand	37	94.00
1T	Without Stand	65	94.00

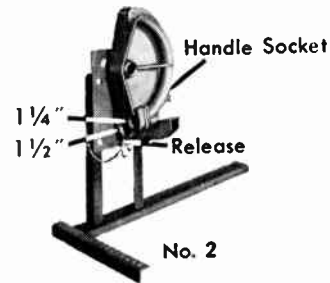

For 1 1/4 and 1 1/2-inch Pipe

No. 2 Chicago Pipe Bender for regular 1 1/4 and 1 1/2-inch conduit or pipe. Makes 14-inch diameter bends with 1 1/4-inch pipe, 17-inch diameter bends with 1 1/2-inch pipe.

No. 2T Chicago Pipe Bender for 1 1/4 and 1 1/2-inch thinwall conduit.

These benders are toggle operated. 12 to 14 strokes necessary for a 90° bend.

No.	Description	Shipping Wt. Lbs.	Each
2	With Stand	89	\$185.00
2T	With Stand	120	185.00
2	Without Stand	60	169.00
2T	Without Stand	91	169.00

Steel Benders Serial No. 100 and up Since Jan. 54

Cast Malleable Benders

Name	No. 1		No. 2		No. 1 & 1T		No. 2 & 2T	
	Wt. Lbs.	Each	Wt. Lbs.	Each	Wt. Lbs.	Each	Wt. Lbs.	Each
Stand	29	\$15.95	29	\$15.95	29	\$15.95	29	\$15.95
Backplate	18	42.00	25	76.25	25	42.00	28	64.00
†Carriage Bolt (4 required)	3/16	.19	3/16	.19	3/16	.20	3/16	.20
Pawl Release Assembly	3/16	2.50	3/16	3.10	3/16	1.60	3/16	1.85
*Pawl & Pin	5/16	3.60	19/16	4.40
Handle & Pawl Assembly	4	13.50	6	19.00
*Handle	6	8.75	7	16.50
*Handle Shaft	1	2.25	1	2.50
Sector Brake (Spring & Plunger)	3/16	1.00	3/16	1.30	3/16	.60	3/16	.75
Sector	11	44.50	26	86.25	21	44.50	38	76.00
*Sector Shaft	2	2.50	2	3.00
Sector Lock Snap Ring	1/16	.20	1/16	.20
Jaw	3	9.00	4	10.00	5	9.00	5	11.70
Clamp Bars (2) for Mounting without Stand Specify No. 1 or No. 2	5	6.20	5	6.20	5	6.20	5	6.20

*For Cast Malleable Benders prior to Jan. 54 only.

†No. 1 and No. 2 steel Benders have 1/2-in. x 1-in. Carriage Bolt. No. 1 & 1T and No. 2 & 2T Cast Malleable Benders have size 1/2-in. x 1 1/2-in. Carriage Bolt.

T&B Lakin Hickeys



Extra-long shank assures great strength. Shank has bushed hole designed to slip over end of conduit for making short bends at end of conduit.

Bushed opening in shank fits snugly over end of conduit; prevents damaging threads while bend is being made.

No.	Size In.	Std. Pkg.	Each
335	1/2	10	\$3.76
336*	3/4	10	6.00
337	1	2	10.40

*Can also be used to bend 1/2-inch conduit.

T&B Benders and Hickeys For E.M.T.



Bender



Hickey

No.	Size	Std. Pkg.	Wt., Lbs.	Each
4195	1/2 Bender	1	2.5	\$4.40
4196	3/4 Bender	1	4	7.76
4197	1 Bender	1	6	13.28
4185	1/2 Hickey	1	2	4.32
4186	3/4 Hickey	1	3.5	5.92

T&B Standard Conduit Elbow Formers For 1/2-Inch and 3/4-Inch Conduit



Not merely a pipe bender; this practical conduit Elbow Former forms standard shaped elbows perfectly and accurately, exactly where wanted.

Saves time over old methods and saves material by eliminating the waste of conduit.

No.	Wt., Lbs. Each	Each
339	38	\$163.20

Steel City Allen Conduit Benders Schedule S For Heavy Wall Conduit



Heat treated, case hardened. Made from electric steel. Will not crush or deform conduit.

Nos. 1 and 6: For conduit sizes 1/4-, 3/8-, 1/2- and 3/4-in.

Nos. 2 and 7: For conduit sizes 3/4-, 1- and 1 1/4-in.

No.	Ends Size Inches		Std. Pkg.	Wt., Lbs. Each	Each
	Tapped Female	Threaded Male			
1	1	...	10	2 1/2	\$5.45
6	1 1/4	...	10	2 1/2	5.45
2	...	1 1/2	5	3 3/4	8.05
7	1 1/2	...	5	4 1/2	8.05

Republic E.M.T. Benders



This bender enables workmen to make bends accurately and quickly on this larger size of E.M.T. It is portable for use anywhere on the job and rugged enough to withstand bench installation.

No.	Size, In.	Pipe Handle Size, In.	Wt., Lbs.	Std. Pkg.	Each
2475	1 1/4	3/4	18	1	\$53.00

Republic Electrinite E.M.T. Benders



Cast in one piece from tough malleable iron.

Conveniently marked on side for making accurate stubs, offsets and back-to-back bends.

No.	Size, In.	Pipe Handle Size, In.	Std. Pkg.	Wt., Lbs. Per 100	Each
1472	1/2	3/4	10	250	\$2.86
1473	3/4	3/4	10	420	4.85
1474	1	1	1	800	8.24

Republic Electrinite Mandrel Springs

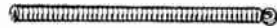

Used inside E.M.T. when making bends, permitting short-radius bends to be made with Hickey Type benders without "inching" bender.

Springs serves as a mandrel, supporting the tube wall and preventing crimping. Easily removed by twisting.

No.	Size, In.	Wt., Lbs.	Each
50	1/2	1/2	\$0.80
75	3/4	1	1.00

Republic Hickory Benders



For making bends of any desired radius; particularly useful for making short or close bends or for stubbing-up in concrete work.

Standard package, 1.

No.	Size, In.	Pipe Handle Size, In.	Wt., Lbs.	Each
2195	1/2	3/4	1 3/4	\$ 2.65
2196	3/4	1	2 3/4	3.30
2197	1	1	4	6.60
2198	1 1/4	1 1/4	10	8.25
2199	1 1/2	1 1/4	12 1/2	10.05
2200	2	1 1/2	15	15.50

National "Redege" Benfield Benders



Constructed of tough, Pearlitic iron. One piece solid hook. No inserts needed, same groove used for rigid or thinwall.

Built-in "back-pusher"; extended foot treadle. For right or left-handed use.

Guaranteed 5 years.

No.	Use		Bender Threaded For Pipe Handle Size, In.	Std. Pkg.	Wt., Lbs. Std. Pkg.	Each
	Thin-wall In.	Heavy Wall In.				
1050	1/2	...	3/4	10	22 1/2	\$2.90
1075	3/4	1/2	1	10	44	5.15
1100	1	3/4	1	2	17	8.75

"Powr Jack" Models with booster step now available. Contact Graybar for further information.

Appleton Tiger-Grip Hickeys And Couplings

Schedule CF



No. 7290 Hickey



No. 7295 Coupling



No. 7291 Hickey

Cadmium finish. Sharp steel teeth in lower jaw grips conduit and prevents slipping. Coupling attachment strengthens hold on handle to prevent breakage. No. 7291 combines coupling and hickey in one casting.

No.	Description	For Conduit Inches	Car-ton	Std. Pkg.	Wt., Lbs. Std. Pkg.	Each
7290	Hickey	1/2 and 3/4	1	10	19	\$ 2.80
7291	Hickey	1	1	10	55	7.80
7295	Coupling	1/2 and 3/4	1	10	16	2.10
7296	Jaws for Tiger-Grip Hickey					.70

Appleton Bending Tools

Schedule TW



For Electrical Metallic Tubing

The special design of this tool makes it easy to bend electrical metallic tubing in exactly the right place with very little effort.

No.	Size Inches	Std. Pkg.	Wt., Lbs. Each	Each
14195	1/2	1	2 1/2	\$ 2.70
14196	3/4	1	4 1/8	4.80
14197	1	1	7	8.30

Appleton Bending Hickeys

Schedule TW



For Electrical Metallic Tubing

A special design for making short bends, tight corners and for stubbing up in concrete work.

No.	Size Inches	Use Pipe Handle Size, Inches	Std. Pkg.	Wt., Lbs. Std. Pkg.	Each
12195	1/2	3/4	1	1 3/4	\$ 2.70
12196	3/4	1	1	2 3/4	3.70
12197	1	1	1	4	6.60
12198	1 1/4	1 1/4	1	10	8.25
12199	1 1/2	1 1/4	1	12 1/2	10.05
12200	2	1 1/2	1	15	15.50

Ideal BX Armor Cutters



Cuts BX Armor of any make, two or three wire, in one operation. Hardened steel cutting blade is removable for sharpening or replacement.

No. 45-079 BX Armor Cutter.....Each \$3.95

Steel City Allen Conduit Benders

Schedule S

For Thinwall Conduit



No. 4 and 5



No. 3

Alloy-steel. Nos. 4 and 5 for true offsets, accurate stubs and perfect back-to-back bends on thinwall. No. 3 is a combination bender for thin or heavy wall.

No.	Description	Size Inches	Wt., Lbs. Each	Each
3	For EMT, or 1/2" Heavy Wall	1/2-3/4	1 3/4	\$4.20
4	End Threaded 3/4" Male	1/2	2	3.85
5	End Threaded 1" Male	3/4	4	5.00

Ideal Cable Ripper and Wire Gauge



For use on non-metallic sheathed duplex cable or lead-covered cable where outside diameter is 5/8 inches or smaller.

No. 45-018.....Each \$0.43

Ideal E-Z Automatic Wire Strippers



For stripping standard lamp and fixture wire, automotive wire and all other stranded wire.

Provided with lever to stop the return of the arms until the wire is removed after stripping. This prevents crushing of stranded wire by returning stripper arm.

Suitable for stripping solid wires.

No.	Wire Gauge No.	No. of Holes	Per Pair
45-200	16 through 26	6	\$5.75
45-201	10 through 18	5	5.75
45-202	10 through 22	6	5.75
45-203	8 through 14	4	5.75
45-204	T.V.		5.75
45-205	P.W.C.		5.75
Extra Blades for the E-Z Stripper			1.15

Ideal T-5 Wire Strippers



Used for stripping, cutting and looping wires.

Sturdy, compact, constructed of hardened steel for rugged duty and long service life. Comfortable plastic

grips for sure handling and safety.

Strips wires from 10 to 18 gauge size. Has flat design to conveniently fit in pocket or tool kit.

No.	Overall Length, In.	Wt., Oz.	Each
45-120	6	5	\$1.95

Ideal Teflon Wire Strippers



Makes Teflon as easy to strip as any other insulation. Unique blade construction and extreme holding power of broad jaws permits fast, accurate stripping while meeting most rigid inspection standards—where marking of insulation must be kept to an absolute minimum. Simple one-squeeze operation—just insert wire between blades at desired length (or adjust wire stop), squeeze handle and release. Jaws snap back into position, ready for next strip.

No.	Description	Each
45-170	For Nos. 10 through 14 Wire	\$16.95
45-171	For Nos. 16 through 26 Wire	16.95
45-172	For Nos. 26 through 30 Wire	16.95
45-180	For Nos. 10 through 14 Wire (Includes Short Stop Latch and Transparent Wire Stop)..	20.75
45-181	For Nos. 16 through 26 Wire (Includes Short Stop Latch and Transparent Wire Stop)..	20.75
45-182	For Nos. 26 through 30 Wire (Includes Short Stop Latch and Transparent Wire Stop)	20.75

Ideal Stripmaster Wire Strippers



The only hand type Wire Stripper with automatic single-squeeze operation. Exclusive automatic feature holds jaws open after stripping to permit removal of wire and prevent crushing. A single squeeze of the handles strip wire clean up to a full 7/8 inch. No nicking or fraying. Blades can be changed with the removal of only two screws. Strips building, fixture or telephone wire. Automotive, radio and aviation wire, also FM and TV down lead wire.

No.	Wire Ga.	Weight Oz.	Each
45-090	8 to 10	10	\$5.75
45-091	10 to 18	10	5.75
45-092	10 to 22	10	5.75
45-093	14 to 22	10	5.75
45-095	16 or 18, and POSI	10	5.75
45-098	20 to 30	10	5.75

Ideal Bench Type Wire Strippers



Strips solid or stranded wire up to 3/16" diam. For single conductor plastic, cotton or rubber covered wire where quantities are limited. Has 8-hole dial wire guide to center different sized wire between cutting blades.

No. 45-069 Complete..... Each \$31.80

Ideal Rotary Type Wire Strippers



Strips all types of solid or stranded wire up to a maximum of 1/2 inch outside diameter. Motor is reversible, stripping according to natural twist of wire. Wire is properly twisted and polished after stripping. Furnished with 1/8, 1/4 and 3/8-inch guide bushings.

No. 45-009 Complete, 115 v., 60 cy..... Each \$166.75

Ideal Production Wire Strippers

Ideal Brush Type



Strips and cleans enamel, cotton, silk, string asbestos and similar types of light insulation from round, flat, or rectangular wires—solid or stranded. Removes coating from "Formex" or "Formvar" wire—cleans fibre glass insulation — removes gummy insulation embedded in stranded wires.

No.	Description	Each
45-070	115 v., 60 cy., Unit complete.....	\$283.60
45-072	230 v., 60 cy., a-c Unit.....	302.65

Ideal Hot Blade Wire Strippers

Burns off insulation. Strips cotton, silk, synthetic (plastic) insulation or rubber coverings from stranded or solid conductors, that do not exceed 3/8-inches. Stripping length adjustable from 1/4-to 1 1/2-inch. Except for foot pedal, all parts are in a single unit. (Note: this unit is not suited for stripping asbestos, metallic, or other weather-proof covering.)



No. 45-073 115 v., 50-60 cy..... Each \$310.80

Ideal Lever Type Cable and Wire Strippers



Production Stripper strips single and parallel conductors and cables up to 5/8" diam. Recommended for Type S, SJ and Power Cables. Blades are available in 15 standard sizes to accommodate other sizes and types of wire.

No. 45-064 Complete..... Each \$114.65

Ideal Twin Wheel Wire Strippers

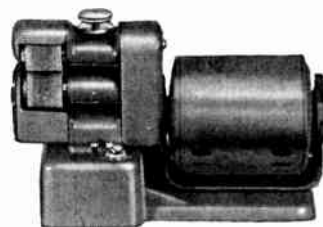

Bench Type

Quickly strips every known type of film insulation from AWG No. 50 to No. 25 wires. The fibre glass cylindrical wheels strip up to 3/4-in. from body of winding. Simplicity of operation results in increased production, fewer rejects.

No.	Description	Each
45-107	With 115 volt a-c Motor.....	\$145.00
L-5278	Replacement Wheels per pair.....	3.90

Ideal Twin Cone Wire Strippers

Bench Type



The fibre glass conical wheels of this stripper remove all types of film-insulation from AWG No. 50 to No. 25 wires efficiently without damage to wires or coils.

Designed to permit close stripping, within 1/8-in. of coils, armatures, etc.

Recommended for miniaturized components when work can be brought to the stripper.

No.	Description	Each
45-101	With 115 volt a-c Motor	\$175 00
L-5279	Replacement wheels, per pair	4 25

Hand Type



Efficiently removes film insulation from AWG No. 50 to No. 30 wire. Long flexible shaft permits portable motor to be suspended overhead. Rheostat foot pedal gives operator complete control for added out put and safety.

Fibre glass conical wheels allow perfect stripping of leads to within 1/8-in. of gang-wound coils without dismantling set-up.

Unit can be moved anywhere in the production line, thus eliminating double handling of parts to be stripped. Light-weight feature of hand stripper increases speed of operation—decreases operator fatigue.

No.	Description	Each
45-104	With 115 volt a-c/d-c Motor	\$150 00
L-5279	Replacement Wheels per pair	4 25

Greenlee Hydraulic Knockout Drivers



Specifically designed for driving the standard Greenlee Punches. Develops over eleven tons of ram pressure and easily cuts holes up to 4 1/2-in. in 10-gauge metal. Can be used even in tight places.

Consists of hand hydraulic pump, high pressure hose, 1 1/8-in. threaded sleeve, 3/8-in. stud and bushing. Pump body machined from single piece of steel with attached reservoir of steel tubing. Air locks eliminated by automatic follower. By unscrewing the steel tube it is simple to add oil.

Will handle knockout punches for cutting 1/2 to 4-in. conduit holes and all Greenlee radio punches using 3/8-in. diameter screw. Packed in strong metal case. Priced without punches. Weight, 20 pounds.

No. 7646A	Each	\$100 00
-----------	------	----------

Nye Knockout Punches

Four Point—Hydraulic



No. NHPS

All hydraulic sets furnished in sturdy metal boxes. Patented coupler in RAM connecting piston and cutter prevents damage to piston and punch. The high pressure coupler is tested to 21,000 p.s.i. Size feet of high pressure 10,000 pound hose tested for 21,000 lbs. bursting pressure.

Each set has own special ram. Capacity of rams #1 — 10 ton, #2 — 20 ton, #3 — 25 ton. Pump develops 10,000 lbs. p.s.i.

No.	Description	Each
N1HS	Cuts 1/2, 3/4, 1 and 1 1/4 in. pipe size holes in 1/8 in. steel. 3/4, 1 and 1 1/4 in. cuts holes in 3/32 in. steel. Shipping weight 6 lbs. . . .	\$52 00
N2HS	Cuts 1 1/2, 2 and 2 1/2 in. pipe size holes in 1/4 in. steel. Shipping weight 13 lbs. . . .	75 10
N3HS	Cuts 3, 3 1/2 and 4 in. pipe size holes in 1/4 in. steel. Shipping weight 33 lbs.	114 35
NHPS	Hydraulic pump complete with hose and coupler. Shipping weight 26 lbs.	56 50

Nye Knockout Punches

"Four Point" Ball Bearing—Hand Operated



No. N 1/2MS



No. N1MS

Small, light, compact punches made of highest grade steel and engineered to do the best possible work. Ball bearing equipped chuck eliminates steel on steel friction thus producing a fast, easy out. Cuts clean burrless holes thus eliminates reaming.

Four cutting points provide greater shear angle, and consequently double the number of shearing edges. Four sets available, ten different sizes.

No.	Description	Each
N1/2MS	Cuts 1/2 in. pipe size holes in 1/8 in. steel. Furnished in leather pouch. Shipping weight 6 1/2 oz.	\$5 25
N1MS	Cuts 3/4, 1 and 1 1/4 in. pipe size holes in 3/32 in. steel. Furnished in sturdy metal box. Shipping weight 3 3/4 lbs.	14 20
N2MS	Cuts 1 1/2, 2 and 2 1/2 in. pipe size holes in 3/16 in. steel. Furnished in sturdy metal box. Shipping weight 11 3/4 lbs.	45 05
N3MS	Cuts 3, 3 1/2 and 4 in. pipe size holes in 3/16 in. steel. Shipping weight 33 lbs.	86 85

Whitney Punches

Hand Lever Punches

Built for the hardest kind of service according to their rated capacity. Fine balance, simple construction make punches easy to use and keep maintenance at minimum.

All main parts of the punches are made of drop-forged high-grade alloy steel, with wearing parts heat-treated. Punches and dies are of A-1 grade tool steel, heat-treated and tempered, and are guaranteed against defects in material and workmanship.

May be furnished with button (tip) punches.

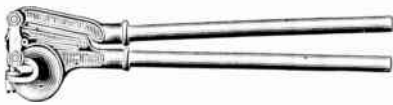

No. 1
For Punching $\frac{3}{16}$ -In. Hole Through $\frac{1}{4}$ -In. Iron

Has insertable pipe handles. Furnished complete with one punch and one die of specified size, and with die adjusting key.

Supplied with $\frac{5}{16}$ -inch punch and die, unless otherwise specified. Extra punches and dies made in squares and ovals on specification; largest size, $\frac{13}{32}$ -in. square.



No. 2
For Punching $\frac{3}{16}$ -In. Hole Through $\frac{1}{4}$ -In. Iron

Furnished complete with one punch and one die of specified size, and with die adjusting key.

Supplied with $\frac{1}{4}$ -in. punch and die unless otherwise specified. Extra punches and dies made in square and oval on specification; largest size, $\frac{3}{8}$ -in. square.



No. 4-B
Tinner's Punch for punching $\frac{1}{4}$ -in. hole through 16 gauge iron.

Furnished complete with 7 punches and 7 dies of specified size and with die adjusting key and metal box.

Unless otherwise specified, supplied with $\frac{3}{32}$, $\frac{1}{8}$, $\frac{5}{32}$, $\frac{3}{16}$, $\frac{1}{2}$, $\frac{1}{4}$, and $\frac{5}{32}$ -in. punches and dies.



No. 8-B
For Punching $\frac{1}{4}$ -in. Hole Through $\frac{1}{2}$ -In. Iron

Has side gauge marked in fractions of inches. Upper lever does not throw back to right-angle.

Furnished complete with three punches and three dies ($\frac{3}{16}$, $\frac{7}{32}$ and $\frac{1}{4}$ -in. unless otherwise specified) and with die-adjusting key.

Special square or oval punches and dies on specification; largest size, $\frac{3}{16}$ -inch square.

No.	Stock Sizes of Punches, Inches	Depth of Throat, In.	Lgth. In.	Wt. Lbs.	Resale Each
1	$\frac{1}{8}$ to $\frac{9}{16}$ by $\frac{1}{64}$ ths	$1\frac{1}{8}$	34	23	\$32.70
2	$\frac{3}{32}$ to $\frac{1}{2}$ by $\frac{1}{64}$ ths	$1\frac{1}{16}$	23	14	25.50
*4-B	$\frac{1}{16}$ to $\frac{3}{32}$ by $\frac{1}{64}$ ths	2	$8\frac{1}{2}$	3	11.00
8-B	$\frac{1}{16}$ to $\frac{7}{16}$ by $\frac{1}{64}$ ths	2	$18\frac{1}{2}$	$7\frac{1}{2}$	17.14

*Also available with three punches and dies and corrugated carton, complete \$8.50

Skylight, Ventilating and Tank Flange Punch



No. 6
For Punching $\frac{1}{4}$ -in. Hole Through $\frac{3}{16}$ -In. Iron

Particularly adapted for button punching, fastening standing seams without making a hole.

Punches within $\frac{3}{8}$ -in. of inside corner of angle iron; punch will strip where handle cannot be opened to 90 degrees.

Supplied complete with three punches and dies of specified sizes, and with die adjusting key. Unless other sizes are specified, $\frac{3}{16}$, $\frac{7}{32}$ and $\frac{1}{4}$ -in. dies and punches will be furnished.

No.	Stock Sizes of Punches, Inches	Depth of Throat, In.	Lgth. In.	Wt. Lbs.	Each
6	$\frac{1}{8}$ to $\frac{9}{32}$ by $\frac{1}{32}$ nds	$1\frac{3}{4}$	$26\frac{1}{2}$	$10\frac{1}{2}$	\$21.42

Lever Type Bench Punches



No. 91

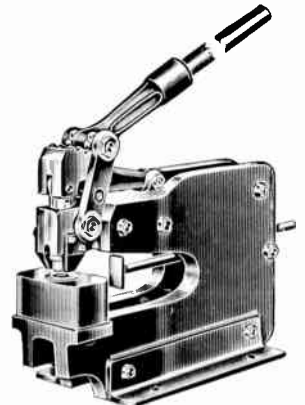

No. 92

Provide powerful punching action for work on heavier angles and channels. Available with 5 or 10-in. throat depth.

Will punch $\frac{1}{2}$ -in. hole through $\frac{1}{4}$ -in. iron, $\frac{3}{4}$ -in. hole through $\frac{3}{16}$ -in. iron or a 2-in. hole through $\frac{1}{8}$ -in. iron. Will also punch oval holes $\frac{1}{2}$ -in. wide by 1-in. long in $\frac{3}{16}$ -in. iron.

Made of drop forged steel, with chrome-nickel cast steel jaw.

Furnished complete with one round punch and die for any one size up to $\frac{3}{16}$ -in. round, and with one bolster plate. Special shape punches and dies available on request.

Bench Punches

No.	Stock Sizes of Punches, Inches		Depth of Throat, In.	Wt. Lbs.	Each
	By 32nds, In.	By 16ths, In.			
91	$\frac{1}{8}$ to 1	$1\frac{1}{16}$ to 2	5	79	\$ 92.66
92	$\frac{1}{8}$ to 1	$1\frac{1}{16}$ to 2	10	146	138.90

Bolster Plates for Bench Punches

*Size In.	For Hole Sizes, In.		Size In.	For Hole Sizes, In.	
	Each	Each		Each	Each
$\frac{7}{8}$	†Up to $\frac{5}{8}$	\$8.00	$1\frac{1}{16}$	$\frac{1}{16}$ to $1\frac{1}{2}$	\$8.00
$1\frac{1}{16}$	$\frac{1}{16}$ to $\frac{3}{8}$	8.00	$2\frac{7}{16}$	$1\frac{1}{16}$ to 2	8.00

*Bolster sizes denote outside diameter of dies.

†Also for angles and channels.

Notching Attachment: For making right-angle bends in angle iron up to $1\frac{1}{2}$ x $1\frac{1}{2}$ $\frac{1}{8}$ -in. each \$37.50.

Whitney Bench Punches

Lever Type

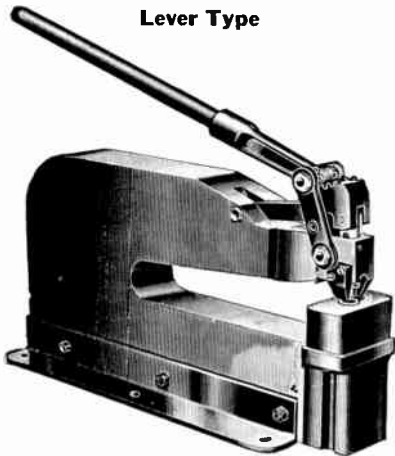

No. 93



No. 94

All parts chrome nickel drop forgings except the jaw, which is made from steel plate. Construction and capacity same as No. 91 punch. All parts interchangeable with No. 91 and No. 92 bench punch including punches, dies and bolsters. Equipped with one round punch and die up to 5/16 in. and one bolster plate.

No.	Plate, In.	Depth of Throat, In.	Approx. Weight, Lbs.	Each
93	4	18	125	\$198.00
94	6	24	675	298.50

Whitney Clip Punches

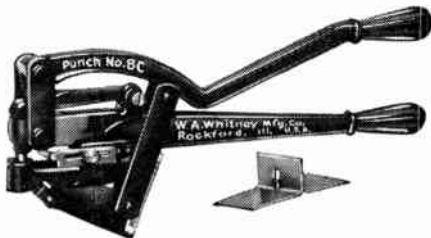

A special tool for fastening seams in duct and sheet metal work. No second operation or hammering down necessary, accurate—fast—neat; guaranteed to please.

Capacity—three thicknesses of No. 20 gauge steel. Equipped with one punch and die.

No.	Description	Length, In.	Wt., Lbs.	Each
8-C	Clip punch	18 1/2	8	\$38.00

Whitney Hydraulic Punches

No. 95A Cabinet Model

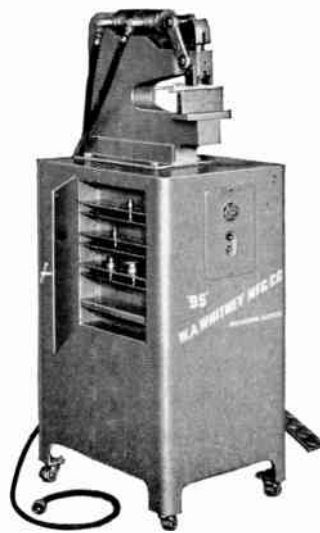

Built on same principle as the well known No. 91 bench punch but hydraulically operated. Tooling cost low, because all punches, dies, bolsters and notcher punch and die interchangeable with No. 91 punch.

Depth gauge at punch line. Can be used on channel or angle iron as well as on sheets. Operated by foot treadle.

Standard motor, 1 1/2 hp., 1750 rpm's. 110-220 volt single phase; 220-440 volt, three phase. Depth throat, 10-in.

Rated capacity 12 1/2 tons. 5/8-in. hole through 1/4-in. iron; 3/8-in. hole through 3/16-in. iron; 2-in. hole through 1/8-in. iron. 20 strokes per minute. Floor space 18 x 25 in. Weight 525 lbs.

No.	Description	Each
95A	12 1/2-ton hydraulic punch press, less motor, with one round punch, one round die, up to 5/16" round, one bolster plate, model A cabinet type.....	\$692.00

No. 95B Hydraulic Bench Punch



Same as No. 95A except for cabinet. Punch unit can be placed below, above or on either side of power pack. Standard hose 6 feet, additional lengths at slight extra cost.

No.	Description	Each
95B	Bench type, less motor.....	641.00
.....	Electricals—110/220 volt (motor included)....	179.00
.....	Electricals—220/440 volt (motor included)....	145.00
.....	Castors (optional).....	23.00

Whitney Chicago Steel Slitting Shears



Main frame made of one-piece steel. Lever and gear segment is one-piece steel drop forging.

Has adjustable hold down.

Capacity
3/16 x 2 In. Bars
10 gauge sheets

Chicago Steel Slitting Shear.....	Each \$39.60
-----------------------------------	--------------

Bartlett Bench Shears

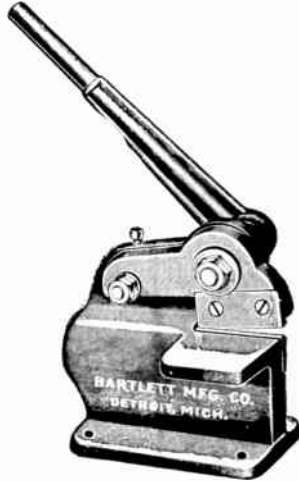

For tool room, garage use and metal patterns shops. Powerful tool with steel castings used in its construction. Blades made from fine grade of crucible steel.

Designed to cut metal up to 12 gauge easily and the eccentric principle embodied makes it possible to adjust the blade to suit the operator's requirements.

Adopted for use in cutting automobile brake bands, leather belting, wire cloth and strip metal. In order that wide sheets may be handled to advantage, tool designed to allow the sheared portion to clear the knife freely.

Blades adjusted by means of a taper wedge.

No.	Length, Inc. Handle, In.	Length Blade, In.	Wt., Lbs.	Each
20	13 1/2	3	24	\$45 00
25	17 1/2	4 1/2	40	60 00



Made with the Bartlett compound lever principle. Constructed of well designed steel casting with all parts interchangeable for duplicate shears. Blades are solid crucible tool steel 1/32-in. thick. Blades run full length of the jaw, including pivot hole, so that the bearing back of this point is on hardened steel. Can be removed for sharpening when desired.

Will cut 12 gauge steel easily and the arrangement of the jaws allows a full sheet to be handled to advantage.

Furnished with either right or left hand cut.

No.	Length Overall, In.	Length Blade, In.	Length of Cut, In.	Wt., Lbs.	Each
30	33	8	4 1/2	17	\$50 00

Greenlee Knockout Cutters



Enlarges knockouts to take 1 1/2, 2, 2 1/2 and 3-in. conduit by cutting holes 1 1/16, 2 3/8, 2 7/8 and 3 1/2-in. respectively.

Cutting is done by drive action of two wheel cutters. Operation is simple; an ordinary wrench drives the tool. Packed in leather case. Weight, 4 1/2 lbs.

No. 740..... Each \$17.50

Greenlee Radio Chasis Punches

Round



Cuts clean accurate round holes in radio chassis for connectors and other receptacles. Operates simply with ordinary wrench for drive power. No reaming or filing. Hole is smooth and perfect.

Thirteen sizes from 1/2 to 2 1/4-in. diameter. Packed individually in boxes.

No.	Punch Sizes, Inch	Each
730	1/2, 5/8, 11/16, 3/4, 13/16, 7/8.....	\$2.60
	1.....	2.85
	1 1/16, 1 1/8, 1 1/4, 1 3/8, 1 1/2 and 1 3/4.....	3.00
	1 3/8.....	3.40
	1 1/2.....	3.85
	1 5/8.....	4.50
	1 3/4.....	5.10
	1 7/8.....	6.35
	2.....	6.85
	2 1/4.....	7.45

Square



For quickly cutting square and oblong holes in radio chassis. Available in three sizes for making 5/8, 3/4 and 1-in. square holes. Punch has 4 cutting edges. Simple to operate with ordinary wrench.

Packed individually in metal edged box.

No.	Description	Each
731	1/2-in. Size, Complete.....	\$4.15
	5/8-in. Size, Complete.....	4.25
	3/4-in. Size, Complete.....	4.75
	1-in. Size, Complete.....	5.60

Key Punch

For cutting holes for keyed sockets.



No.	Description	Each
732	1 5/32-in., Complete.....	\$4.90
	1 5/16-in., Complete.....	4.65
	1 11/64-in., Complete.....	5.00
	1 17/64-in., Complete.....	5.30
	1 21/64-in., Complete.....	5.60

"D" Punch

Simplifies and speeds the work of making "D" shaped opening for high frequency miniature tube sockets and other equipment using this type opening.



No.	Description	Each
733	1/2-in., Complete.....	\$4.35
	5/8-in., Complete.....	4.60

Greenlee Knockout Punch Sets



For cutting or enlarging holes and knockouts for conduit in metal boxes or cabinets. Cuts metals through 10-gauge easily and quickly; leaves neat smooth holes.

No.	Description	Wt., Lbs.	Each
735	Set, with Punches and Dies for Conduit sizes 1/2, 3/4, 1 and 1 1/4-in.....	2 3/4	\$11.60
737	Set, with Punches and Dies for Conduit sizes 1 1/2 and 2-in.....	4 1/4	12.00

Blackhawk Porto-Power Hydraulic Equipment



Knock-Out Punches

For pull boxes, cabinets, troughs, panels. Work in cramped quarters and punch clean holes exactly where you want them. No distortion or loosening of boxes. Kit includes punches and "pull-ram" for use with the same "Porto-Power" hydraulic pump and pressure hose serving Blackhawk benders.

No.	Description	Each
SB-62	Kit—punch conduit openings from 1/2 to 4-in. Weight 60 lbs.	\$234.00
SB-61	Kit—punch conduit openings from 1/2 to 2-in. Weight 30 lbs., 2 oz.	124.85

Electrically Driven Pumps



Helps you install conduit up to 3 times faster. Converts hand-operated hydraulic equipment (such as benders and knock-out punches) into speedy, electrically driven equipment. Can be used on benders other than Blackhawk type. Prevents fatigue and loss of efficiency. Pushbutton action permits continuous output. Adaptable to all popular types of current. Wt., 90 lbs.

No.	Description	Each
P-182	With a-c motor	\$355.00
P-254	With d-c motor	467.50

"Featherweight" Pipe and Conduit Benders

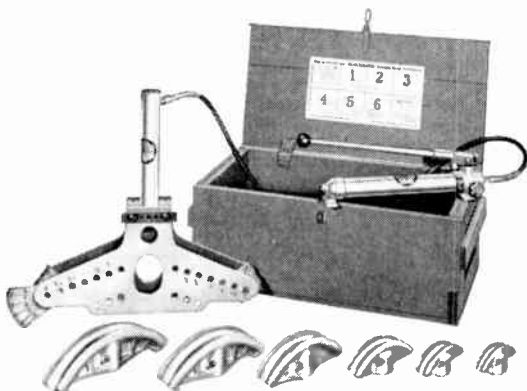

Makes 90 degree bends in one setup. Completely portable. Bending frame weighs only 16 1/2 lbs. Frame, swivel and bending shoes are rigid lightweight aluminum. Degree of bend constantly indicated with Optik Angle gauge. Speeds making 180° bends, double offsets, compound bends. Removable top plate. Lock-on bending shoes eliminates threading. Bends 1/2-in. through 2-in. pipe and rigid conduit.

No.	Description	Each
S-130	Weight 111 lbs., 7 oz.	\$218.90
S-132	Same as above but has speedy electric P-182 Pump.	546.00

Blackhawk Rigid Pipe and Conduit Benders

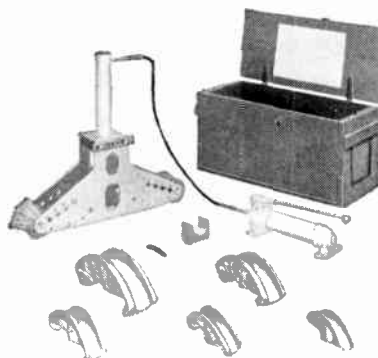

It is now possible to make 90-degree bends through 3-in. pipe and rigid conduit in just one setting—only three quick setups through 4-in. Modeled after S-130, all units are completely portable. Easy-to-read Optik Angle gauge eliminates multi-setups, assures perfect bend everytime.

All models constructed of rigid, lightweight aluminum. All have removable top plates. Newly designed ram has longer stroke, requires less effort. Ram works in any position, upright, vertical, overhead—all angles.

No.	Description	Each
S-137	Bends 1 1/4-in. through 4-in. pipe and rigid conduit. Includes P-80 pump.	\$621.50
S-138	Bends 1 1/4-in. through 3-in. pipe and rigid conduit. Has P-80 pump.	522.50
S-139	Same as S-138 except includes P-182 electric pump for production bends.	803.00
S-140	Same as S-137 except has P-182 electric pump.	902.00

Greenlee Knockout Punches

Cuts clean holes quickly and easily with a few turns of the drive nut.

Packed and sold individually in boxes.

No. 738—Cuts hole 2 5/8-in. diameter for 2 1/2-in. conduit.

No. 739—Cuts hole 3 1/2-in. diameter for 3-in. conduit.

No. 741—Cuts hole 4-in. diameter for 3 1/2-in. conduit.

No. 742—Cuts hole 4 1/2-in. diameter for 4-in. conduit.

No. 743—Cuts hole 5 5/8-in. diameter for 5-in. conduit.

No.	738	739	741	742	743
Weight Lbs.	5 3/4	7 1/4	10 3/8	12 1/8	17 7/8
Each	\$16.25	\$22.00	\$43.00	\$53.00	\$78.30

Appleton Utility Tools

Schedule TW

For use with Compression-type Couplings, Connectors, and Appleton 2-Piece Connectors.



Combines a unique non-slip wrench and a handy de-burring tool for smoothing

both inside and outside of freshly cut thin wall conduit.

All steel, smoothly finished for comfortable gripping and scientifically balanced for proper leverage. Has case hardened replaceable plate for the de-burring and non-slip sections.

The non-slip plate holds wrench positively on the individual nut to be tightened and will not slip from one nut to another. Rough edges of pipe are rotated in the V-shaped slots of the de-burring plate.

No.	For Conduit, In.	Length, In.	Wt., Lbs. Each	Each
TW-W5075	1/2 and 3/4	8 1/4	1	\$4.00
TW-W1125	1 and 1 1/4	14	1 1/2	6.25

T&B Combination Wrench and Reamer

For E.M.T.



A combination tool, extremely handy for all 1/2-inch and 3/4-inch E. M. T. installations. The same tool tightens the glands on couplings and connectors, removes burrs from tubing, and reams edge of conduit. Drop-forged steel, heat-treated and tempered.

No. 33.....Each **\$2.02**

T&B Fish Tapes

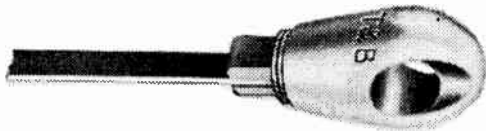

Furnished with patented ball-points which enable the wire to turn sharpest bends with ease.

Wire has rounded edges; made of best grade of tempered steel, insuring strength and flexibility.

Furnished in 50, 100, 150, or 200-ft. coils. Standard package, 1000 feet.

No.	Size Inches	Per 100 Ft.	No.	Size Inches	Per 100 Ft.
3600	1/8 x .030	\$5.75	3602	3/16 x .060	\$10.60
3601	1/8 x .060	8.50	3603	1/4 x .060	13.80

T&B Fish Tape Balls



For use with any standard make of fish tape. Consists of threaded insert and ball. Tape is installed in slot in insert; ball is then screwed onto insert.

Unit quantity, 10; Standard package, 50.



No.	Description	Wt., Lbs. Per 100	Per 100
3615	1/8 x .060	2	\$80.00
3616	3/16 x .060	6	96.00
3617	1/2 x .060	6	96.00

Barth Snake Charmers



"Leads" flat fish tape through conduit having twists between 90° bends. Tapered for maximum flexibility which helps on many impossible pushes. Makes any push easier.

Complete with wrench for fastening to flat fish tape.

No.	Description	Each
120	For tape 1/8-in. wide	\$3.90
121	For tape 1/4-in. wide	4.08

Klein Chicago Fish Tape Pullers



A simple, husky come-along for fish-tape.

Fish-tape slips sideways into slot and a ratchet wheel assures a strong, positive grip. For a new bite slide the puller forward on the tape. Simple, strong, automatic... grips like a vise... never slips. Will not injure tape. Pocket size.

No.	Description	Each
1629	For Std. fish-tapes	\$1.80
1629-A	For No. 12 iron wire	1.80

Steel City Fish Wire Pullers

Schedule S

Red Head



Operates on lever principal, guard holds wire in place and it is not necessary to remove wire to secure new grip. 6 1/2-inches long, 2 1/4-inches wide.

No.	Std. Pkg.	Wt., Lbs. Each	Each
15	5	1	\$2.00

Ideal Fish Tape Pullers



Mechanical advantage of 2 1/2 times for tough pulling jobs. Tapes "frozen" into conduit can be readily freed with this new tool.

This tool pulls tape and presses the box or other outlet firmly against wall or structural member—no chance of pulling outlet loose.

Can be used in outlet boxes, fuse boxes, large pull boxes, large & small conduits—wherever there is a tough wire pulling job.

No.	Description	Each
31-185	Fish Tape Puller	\$20.50

Ideal Fish Tape Reels and Pullers



For building construction and industrial work. Reel serves as handle to give firm grip in pulling on fish tape, eliminating special pullers, or dangerous bare-hand pulling.

Keeps tape fully protected. Tape is locked in reel when not in use and can not spring loose. Nine stock sizes of complete Fish Tape, Reels, and Pullers.

No.	Length and Size of Tape	Each
31-007	50 ft. x 1/8 x .015 (3/64")	\$ 3.00
31-008	50 ft. x 1/8 x .060 (1/16")	4.40
31-009	100 ft. x 1/8 x .060 (1/16")	7.45
31-011	100 ft. x 1/4 x .060 (1/16")	8.95
31-016	200 ft. x 1/8 x .060 (1/16")	10.95

Ideal Round Fish Tape



Constructed for use in small conduit (1/2-in. and less). Easily goes through small radius bends.

Has less friction-resistance than flat tapes so it can be readily pushed or pulled through conduit. Rolls onto reel without kinking or binding.

Tape is .080-in. in diameter with Fish Tape Ball on one end which lets it swivel and turn.

No.	Description	Ship. Wt. Lbs.	Length Ft.	Each
31-191	Tape with Reel	5	100	\$8.45
31-195	Round Tape & Ball	1 1/2	50	2.90
31-196	Round Tape & Ball	3	100	4.10
31-197	Round Tape & Ball	5 1/2	200	7.40
31-084	Fish Tape Ball for Round Tape			1.15

Ideal Fish Tape

Highest grade tempered spring steel is used. No curling. Flexible and easy to use on long runs of conduit having several bends.

No.	Length and Size of Tape	Each
31-004	50 ft. x 1/8 x .060 (1/16")	\$ 1.65
31-036	100 ft. x 1/8 x .060 (1/16")	2.95
31-038	200 ft. x 1/8 x .060 (1/16")	5.70
31-050	100 ft. x 1/4 x .060 (1/16")	4.65
31-052	200 ft. x 1/4 x .060 (1/16")	9.30
31-078	50 ft. x 1/8 x .045 (3/64")	1.35
31-079	100 ft. x 1/8 x .045 (3/64")	2.45

Ideal Fish Tapes

Nylon Covered



Nylon-insulated Round Fish Tape gives more protection to workmen and equipment than bare fish tape when pulling new wires into live panel boards, switches and other "hot" equipment.

Wire is .080-in. in diameter and nylon is .020-in. thick. For easy turning and swiveling, tape has special Fish Tape Ball.

No.	Description	Ship. Wt. Lbs. Oz.	Length Ft.	Each
31-211	Nylon Covered Tape & Reel	4 12	100	\$15.80
31-215	Nylon Covered Tape & Ball	1 9	50	7.30
31-216	Nylon Covered Tape & Ball	2 9	100	10.70
31-217	Nylon Covered Tape & Ball	4 10	200	20.90

Ideal Coil-Flex Fish Tape



For all types of conduit. The Ideal Coil-Flex is extremely flexible; can be pushed or pulled with little effort through any and all bends allowed by the electrical code. Positively prevents cutting or damaging of aluminum. Ends are smooth and round to avoid catching or snagging.

The Coil-Flex consists of a 25-ft. length of steel spring 1/2 inch in diameter with a rustproof inner steel cable. A male fitting on one end and a

female fitting on the other makes it easy to join together two or more lengths for jobs requiring a longer tape. Easy on the hands, it gives a safe, positive grip. Every Coil-Flex is factory inspected and tested at 400 pounds pull.

No. 31-081	25-ft. length	Each	\$9.60
------------	-------------------------	------	--------

Ideal Fish Tape Winders

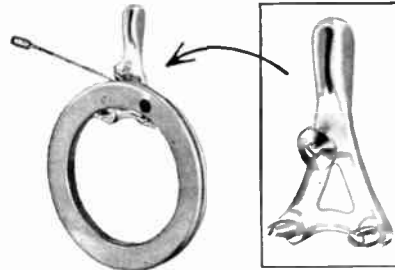

A new tool designed to make the Ideal Fish Tape Reel and Puller still easier to use.

As the Winder handle is pulled around the Reel, a wheel spreads the reel housing allowing the fish tape to wind or unwind easily. Tape can be reeled in or out with less effort.

Three sizes available for all Ideal Fish Tape Reels.

No.	Description	Each
31-180	For Reels No. 31-007 & 31-008	\$2.90
31-181	For Reels No. 31-009, 31-016, 31-191 & 31-211	2.90
21-182	For Reel No. 31-011	2.90

Ideal Fish Tape Leaders



"Guides" flat fish tape easily around bends in conduit—allows the tape to slide without jamming or binding around 90° bends. Leader fastens easily to flat tape. Factory tested for 400-lb. pull.

No. 31-082	20 in. Leader	Each	\$4.20
No. 31-083	Fish Tape Ball	Each	1.15

Steel City Fish Wire

Schedule S



Flat shape increases flexibility. Efficient for conduit having several bends and is stiff enough for pushing through long runs.

Tempered wire does not have tendency to curl after constant use. Furnished in an assortment of cut lengths, in coils of 100 feet or more, or in reels holding from 2,000 to 4,000 feet according to size of wire. Various sizes may be combined to obtain lowest price.

Heavy — For Hand Fishing

Packed in individual cartons

No.	Size Inches	Approx. Wt. Lbs. Per M Ft.	Per 100 Ft.
1000	1/8 x .060	24	\$3.14
1001	3/16 x .060	35	3.89
1002	1/4 x .060	50	4.91
1009	3/8 x .060	78	9.25

Light — for Conduit Fishing Machines

1003	1/8 x .030	13	2.22
1004	3/16 x .030	20	3.14
1005	1/4 x .030	25	3.25

Extra Heavy

1006	1/2 x .090	150	11.09
1008	3/4 x .090	312	20.34

Appleton Fish Tape

Schedule CF



Furnished in thicknesses of 0.030-inch or 0.060-inch.

Stock lengths of fish tape are 50, 100, 150 and 200 feet. Can be furnished longer lengths if desired. Put up in coils, packed in individual cartons.

Unless otherwise specified, 100-ft. lengths will be furnished.

.030-Inch				.060-Inch			
Width Inches	No.	Coil Lgth. Feet	Per 100 Ft.	No.	Coil Lgth. Feet	Per 100 Ft.	
1/8	7130-50	50	\$2.30	7133-50	50	\$3.30	
1/8	7130-100	100	2.30	7133-100	100	3.30	
1/8	7130-150	150	2.30	7133-150	150	3.30	
1/8	7130-200	200	2.30	7133-200	200	3.30	
3/16	7131-50	50	3.30	7134-50	50	4.05	
3/16	7131-100	100	3.30	7134-100	100	4.05	
3/16	7131-150	150	3.30	7134-150	150	4.05	
3/16	7131-200	100	3.30	7134-200	200	4.05	
1/4	7132-50	50	3.40	7135-50	50	5.12	
1/4	7132-100	100	3.40	7135-100	100	5.12	
1/4	7132-150	150	3.40	7135-150	150	5.12	
1/4	7132-200	200	3.40	7135-200	200	5.12	

Ungar Soldering Kit



All-purpose, heavy-duty, precision soldering and electrical kit. Set consists of the Ungar heavy-duty handle; Screw-in soldering tip delivering 825° F.; Precision heating element and tiplet for fine work. Tip temperature 600° F.; Trouble light; Circuit tester; Terminal connectors and Emery paper; Resin core solder and generous quantity of Insulating Tape.

No.	Wt., Lbs.	Each
507	1	\$4.95

Ungar Pencil Soldering Iron Handles



Pencil soldering iron with series of interchangeable soldering tips, designed to speed soldering production. Feather-light, red phenolic plastic, less than 5-in. in length. Contour cork grip keeps handle tilted at 10 degree angle.

Molded protector on flexible rubber cord prevents wear. 110-120 volts. Heat deflector head reflects heat away from handle.

No.	Description	Weight	Each
776	Handle and Cord Set	3-oz.	\$1.50

Ungar Pencil Soldering Iron Tips

4000 Super Hi-Heat Series
47 1/2 Watts, 115 Volts, A-C/D-C



No. 4033 Long Chisel Tip



No. 4036 Pyramid Tip

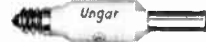

No. 4035 Threaded Heating Unit



No. 4039 Chisel Tip

No. 4033: For all types of soldering operations on production lines, service and repair. Also for AN connectors. 1 5/8-in. long; tip 1/4-in. wide. 900° F. tip temperature.

No. 4039: For extremely heavy production line soldering. 3/8-in. diam., 1 1/8-in. long. 1000° F. tip temperature.

No. 4036: For extra heavy duty soldering, work on heavy wire-wrapped joints, hermetic sealing, heavy ground joints. 3/8-in. diam., 1 1/8-in. long. 1000° F. tip temperature.

No. 4035: Used with Elkaloy Tiplets Nos. 331, 332, 333. Ideal for germanium diodes, resistor wiring and AN connectors. 3/8-in. diam., 850° F. tip temperature.

1200 Hi-Heat Series
37 1/2 Watts, 115 Volts A-C/D-C



No. 1235 Threaded Heating Unit



No. 1236 Pyramid Tip



No. 1239 Chisel Tip

No. 1235: Used with No. 300 Tiplets for soldering printed circuits, bearing aid assemblies and miniature electronic equipment. 750° tip temperature. 3/8-in. diam.

No. 1236: For general service. 1 1/8-in. long, 3/16-in. diameter tip. 800° tip temperature.

No. 1239: For general service, medium production line work. 1 1/8-in. long, 3/8-in. diam. 800° tip temperature.

500 Standard Series
23 1/2 Watts, 115 Volts A-C/D-C



No. 535 Threaded Heating Unit



No. 536 Pyramid Tip



No. 539 Chisel Tip

No. 535: Used with No. 300 Elkaloy "A" tiplets for small-est miniaturized components, fine instrument repair.

No. 536: For instrument repair, general purpose repair, ideal for home craftsmen and hobbyists. 1 1/8-in. long, 3/16-in. diameter. 700° F. tip temperature.

No. 539: For small broad surface joints, general repair, home workshops, hobbyists, delicate joints. 1 1/8-in. long, 3/8-in. diameter. 700° F. tip temperature.

No.	Description	Each	No.	Description	Each
4033	Chisel Tip	\$3.00	1236	Pyramid Tip	\$1.50
4039	Heavy Chisel Tip	3.00	1239	Chisel Tip	1.50
4036	Pyramid Tip	3.00	535	Heating Unit	1.25
4035	Heating Unit	3.00	536	Pyramid Tip	1.25
1235	Heating Unit	1.50	539	Chisel Tip	1.25

Ungar 300 Series Elkaloy "A" Tiplets



Designed especially for use with Heating Units Nos. 4035, 1235, 535 for fine, light work. Tiplets are interchangeable with each other.

No.	Description	Each
331	Pencil Tip	\$0.20
332	Offset Pencil Tip	.20
333	Chisel Tip	.20

G-E Soldering Irons



Cutaway view of Industrial Soldering Iron, 6A161 and 6A162 Series



Cutaway view of Industrial Soldering Iron 6A200, 6A201 and 6A202 Series

Highly efficient for all work requiring soft soldering. Recommended for continuous production soldering as well as for intermittent duty.

Available with the following features:

Calorized Copper Tips: Durable, interchangeable, designed for extra-long life. Calorized coating retards corrosion and oxidation, prevents freezing of tips to tip holder, slows pitting action of solder and flux on body of tip, and increases tip life.

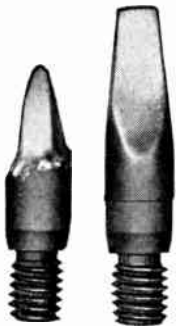

Ironclad Copper Tips: Last up to 10 times longer than conventional tips. For high-speed, repetitive soldering. Affords greater protection in use with solder having minimum of 35% tin. Prevents amalgamation of tin with copper for extra-long life.

Illustration at left shows effect of solder (250° C. for 363.5 hours) on plain copper (left) and Ironclad copper (right) soldering tips.

Heating Elements: Provide quick, dependable heating.

Heat-resistant Shell: Provides high corrosion resistance and low heat loss.

Handle: Cool, easy to grip.

Cord Strain Insulator: Will withstand pull of 35 lbs.

***Soldering Irons 6A161 and 6A162 Series**

Soldering Iron, Less Tip				Renewal Heater	
No.	Rating		List Price Each	No.	List Price Each
	Volts	Watts			
6A161	115	75	\$14.50	6A31	\$4.45
6A162	115	100	14.50	6A32	4.45
6A162G6	115	110	14.50	7C342	4.45
6A162G3	115	125	14.50	8A88	4.45

Tips listed below will fit any iron in 6A161, 6A162 Series

No. *	Size In.	Type	List Price Each
6851732P21	3/8	Calorized	\$1.00
6851732P22	3/8	Ironclad	1.80
6808345AAP2	1/2 short	Calorized	1.00
6851775P21	1/2 short	Ironclad	1.80
6808345AAP3	1/2 long	Calorized	1.70
6851775P22	1/2 long	Ironclad	3.45
9817171P22	13/64	Ironclad	1.80

*Available for 230 volt operation on special order.

Soldering Irons 6A200, 6A201 and 6A202 Series

Soldering Iron, With Tip				Renewal Heaters		
No. *	Rating		Tip	List Price Each	No.	List Price Each
	Volts	Watts	Size In. Type			
6A200	115	100	3/4 Calorized	\$17.70	6A32	\$4.45
6A200G7	115	100	3/4 Ironclad	20.70	6A32	4.45
6A201	115	200	1 Calorized	20.80	9A77	5.85
6A201G7	115	200	1 Ironclad	23.70	9A77	5.85
6A202	115	300	1 1/4 Calorized	25.80	9A78	6.65
6A202G7	115	300	1 1/4 Ironclad	28.30	9A78	6.65

*Standard package quantity is six.

**G-E Soldering Irons
Lightweight Industrial Irons**



No. 6A273



No. 6A283

Iron with Tip and Heater

No.	Rating		List Price Each
	Volts	Watts	
6A273	120	60	\$13.80
6A283	120	60	13.80
6A283G23	120	60	13.80

Tip and Heater

No.	List Price Each
6A300	\$6.75
6A301	6.75
6A301G4	6.75

***Tip Only**

No.	Size In.	List Price Each
326A964P21	1/4, Chisel	\$1.75
326A964P22	3/16, Pyramid	1.75
166V707P21	3/16, Chisel	1.75

*Tips must be brazed on.

Midget Soldering Irons



3/16" Chisel



3/16" Pyramid

Soldering Iron Including Tip and Heater Assembly

No.	Rating		Tip Diam. In.	List Price Each
	Volts	Watts		
6A210	6	25	1/4, Chisel	\$7.60
6A212	6	25	1/8, Pyramid	7.60
6A214	6	25	3/16, Pyramid	7.60
6A216	6	25	3/16, Chisel	7.60

Renewal Tip and Heater only

6A211	6	25	1/4, Chisel	3.95
6A213	6	25	1/8, Pyramid	3.95
6A215	6	25	3/16, Pyramid	3.95
6A217	6	25	3/16, Chisel	3.95

G-E Soldering Iron Transformers



Four-Tap

Specially designed transformers available as optional equipment in two types. Single-tap, for use where only one soldering heat is required. Four-tap, gives wide range of heats (from 25 to 35 watts) for close temperature control of tips.

No.	115 Volt Primary	List Price Each	No.	230 Volt Primary	List Price Each
Single-Tap					
6A362G2	\$6.90		6A362G22		\$12.30
Four-Tap					
6A364G2	9.20		6A364G22		12.95

G-E Miniature Soldering Irons



Developed especially for use by electronics component and instrument manufacturers who are required to do production line soldering of subminiature equipment, printed circuits, and instruments.

Equipped with long life vacuum processed iron tip, with tubular heater built into tip. Transformer is integral part of cord, plugs into any standard 115-volt outlet. Wt. less than 1 1/2 oz.

*No.	Description	Chisel Tip and Heater Size In.	Shank Lgth. In.	List Price Each
6A428G3	Complete iron including tip and heater assem. 6-ft. cord and transf.	1/8	3	\$15.00
6A428G4	Complete iron including tip and heater assem. 6-ft. cord and transf.	1/8	6	15.00

Renewal Tip and Heater Assembly

†No.	Chisel Tip Size, In.	Shank Length In.	List Price Each
6A429G3	1/8	3	\$5.50
6A429G4	1/8	6	5.50

§Renewal Transformer

No. 6A430..... List Price Each \$7.80

*Also available with 6-ft. cord, but less transformer, List Price..... \$9.00

†Standard package quantity is six.

§Includes 6-ft. integral cord set.

American Beauty Electric Soldering Irons

Transformer Type



No. T-30

Designed primarily for production line use, it is intended for heavy duty, fine, precision soldering requiring extremely high tip-temperatures constantly maintained.

Tip-elements

made of ARMCO ingot iron brazed to stainless steel casings — are pre-tinned, will maintain their shape. Split-collet receptacle in handle permits quick change of tip-elements, either hot or cold with transformer remaining connected to outlet.

Has heavy duty, adequately ventilated transformer 110-120 or 220-240* volts (a-c only). 12 volt output, 30-watt maximum capacity, 2500 volt-insulation.

Equipped with 7-ft., Type SV, rubber-covered cord. Handle constructed of bright red, hi-impact thermo-setting plastic.

No.	Tip Diam. In.	Watts	Overall Length In.	Wt. Lbs.	Each
T-30	1/8	30	7 3/4	1 3/4	\$18.25
T-30	1/4	30	7 1/2	1 3/4	18.25

Tip Elements

T-3018	1/8	30	4 1/16	1/2 oz.	\$2.75
T-3025	1/4	30	4 3/16	1/2 oz.	2.75

*On special order. No extra charge.

American Beauty Electric Soldering Irons

Bantam



No. 3118-SC

Lightweight irons with flared handles protect hand of user from coming in contact with casing of hot iron.

Especially designed for the electronic trade. Available for 110 volts only. Diamond point tips standard. Equipped with chisel type if specified.

Stainless steel casing; nickel-chromium heating element, mica insulated. Equipped with 6 foot Type HPD super-flexible heater cord and Sta-tite rubber attachment plug-cap. Type SV rubber-covered cord also available. Separate heat-insulating stand supplied with each iron. For a-c/d-c use.

No.	Diam. of Tip, In.	Watts	Lgth. O.A., In.	Net Wt., Oz.	Ship. Wt., Oz.	Each
3118-SC	1/8	30	8	6	12	\$5.51
3120-SC	3/16	30	8 1/4	6	12	5.51
3118-SCP	1/8	30	8	6	12	5.51
3120-SCP	3/16	30	8 1/4	6	12	5.51
3118	1/8	30	9 1/4	6 1/4	12	5.51
3120	3/16	30	9 1/4	6 1/2	12	5.51

Angle-Type Casing



Designed and intended especially for use on soldering jobs difficult to accomplish with conventional straight-casing soldering irons.

Streamlined, one-piece, projection-free casings, highest grade material throughout.

All irons equipped with attached 6 foot Type HPD heater cord and Statite rubber attachment plug-cap.

Diamond point tips standard. Equipped with chisel point if specified.

Available with rubber-covered cord, also 3 conductor cord either HPD or SJ or HJSJ at additional charge.

No. 3118-A and 3120-A: For use in television, radio, radar and similar lines of work.

No. 3128-A: Intended for servicing TV, electronic and radio equipment and similar work.

No. 3138-A: Designed for production and maintenance in TV, radio, telephone, telegraph, ignition, switchboard and telephone installation work and similar applications.

No.	Diam. Tip, In.	Watts	Net Wt., Oz.	Casing Diam., In.	Each
3118-A	1/8	30*	6 1/4	1 1/2	\$ 5.88
3120-A	3/16	30*	6 1/4	1 1/2	5.88
3128-A	1/4	60	10	9/16	6.62
3138-A	3/8	100**	16	7/8	10.45

*Available in 40 watt input. **Available in 150 watt input.

Transformer Type Electric Soldering Iron For Precision Soldering



For fine precision soldering on miniature and sub-miniature electronic components and similar assemblies. Equally adapted to other light soldering operations.

Tip elements are extremely quick-heating. Heavy duty type transformer. Equipped with 7 ft. Twin-parallel thermoplastic cord.

110-120 volts a-c only. Diamond point tip standard. Specify if chisel point is desired.

No.	Diam. of Tip, In.	Watts	Lgth. O.A., In.	Net Weight Lbs. Oz.	Each
T-12	1/16	17	7 3/4	1 3	\$15.75
T-12	1/8	17	7 3/4	1 3	15.75
T-12	1/4	17	7 3/4	1 3	15.75

Note: Specify number and diam. of Tip when ordering.

American Beauty Electric Soldering Irons



3128 3138 3158 3178 3198

Sturdily constructed of fine material. Will withstand for long periods the hard service of industrial usage.

For use on either alternating or direct current.

Solid steel rod core wound with chrome-nickel ribbon resistance wire, mica insulated. Metal outer casing and shank.

Equipped with attached 6 ft. length of Type HPD super flexible heater cord and Sta-Tite rubber attachment plug cap. Available also with 3 conductor cord, either Type HPD or SJ or HSJ, one wire grounded without attachment cap at additional charge.

Equipped with heat insulating stand, 110 volts.

No. **3128**: For servicing TV, electronic and radio equipment and similar light work. Also available with angle-type casing covered by No. 3128-A.

No. **3128**: For production and maintenance in TV, radio, telephone, telegraph, ignition, switchboard and telephone installation work and similar applications. Popular as a general purpose iron for home use. If angle-type casing is required order No. 3138-A.

No. **3158**: For same general uses as No. 3138 but for those particular applications that require an iron of greater heat capacity and larger tip.

No. **3178**: For still heavier work than that for which the No. 3158 is adapted: for medium-heavy soldering of all kinds.

No. **3198**: For use on the very heaviest soldering operations.

No.	Diam. of Tip In.	Watts	Net Wgt. Oz.	Lgth. O.A. In.	Casing Diam. In.	Ship. Wgt. Lbs.	Each
3128	1/4	60	7 1/2	12 1/4	9/16	1	\$ 6.09
3128A	1/4	60	10	...	9/16	1	6.62
* 3138	3/8	100	16	12 7/8	7/8	2	9.66
3138A	3/8	100	16	...	7/8	2	10.45
3158	5/8	200	28	13 5/8	1 1/4	3	11.29
3178	7/8	300	42	11 3/8	1 9/16	4	14.91
3198	1 1/8	550	60	15	1 3/4	5 3/4	19.32

*A modified model of standard No. 3138 is the No. 3138-X. Equipped with 175 watt heating element and tip of 3/8-in. diameter. Intended for special applications on production lines of radio, television and electronics plants. Recommended that it be placed only on production lines where high soldering rates are maintained. Price \$11.03. The No. 3138-XY same as No. 3138-X except equipped with tip of 1/4-in. diameter. Price \$11.03

Pencil Type



Designed especially for the electronics industry. Equally adapted to many other uses where fine or extremely intricate connections necessitating fast, precision soldering are required.

Lightweight, rugged construction. Hi-heat output, ultra fast recovery. Streamlined, satin finished stainless steel casing. Unique, simple tip-element holding method. Cool, comfortable, resilient, pencil-type handle, 110 volts only.

Equipped with attached 6 foot length Type S-P-1 rubber covered heater cord and molded-on rubber plug cap. Separate heat-insulating stand supplied with each iron.

No.	Diam. of Tip, In.	Watts	Lgth. O.A., In.	Net Wt., Oz.	Ship. Wt., Oz.	Each
P-100	1/8	30	7 1/4	4	8	\$4.50
P-100	3/16	30	7 1/4	4	8	4.50
P-100	3/8	30	6 3/8	4	8	4.50

Note: Specify tip element desired.

American Beauty Temperature Regulating Stands



Automatic device for controlling tip temperature of electric soldering iron while iron is connected to current.

Sturdy base made from high-impact heat-resistant, shatter-proof plastic. A steel covering plate encloses bottom to protect connections and thermostat.

Enameled steel adjustable handle support-bracket provides a sure, safe and easy rest for the handle of soldering iron. Cradle of stand is of high-heat conductivity copper-alloy for maximum transmission of heat from casing of soldering iron to thermostat of stand.

Designed for use with electric soldering irons from 80 to 660 watts output. Equipped with 6 foot HPD super-flexible heater cord and Sta-Tite rubber attachment plug-cap. Available with 3 conductor cord either HPD or rubber covered SJ or HSJ and 3 prong attachment plug-cap; also grounding receptacle. Both may be had at additional cost.

No.	Max. Watts	Lgth. O.A., In.	Wdth. In.	Hgt. In.	Net Wt. Lbs.	Each
475	660	6 1/2	5 5/8	3 3/8	1 3/4	\$7.50

Heating Elements

For American Beauty Electric Soldering Irons

No.	For Sold. Iron Nos.	List Each
9281	3118, 3118-A	\$3.05
9281-SC	3118-SC, 3118-SCP	3.05
9280	3120, 3120-A	3.05
9280-SC	3120-SC, 3120-SCP	3.05
9272	3128*	3.31
9272-A	3128-A*	3.99
9273	3138	3.99
9273-F	3138-A	3.99
9273-X	3138-X	5.51
9273-XY	3138-XY	5.51
9275	3158	5.30
9277	3178	7.19
9279	3198	9.45

*Includes handle-springs, tube and terminal assembly.

Standard Copper Tips For American Beauty Electric Soldering Irons



Diamond Point

Chisel Point

Made from commercially pure drawn copper rod, heavily nickled to resist corrosion and oxidation. Plug type.

Tip lengths are proportioned to size of the iron for which they are intended. All available in either diamond or chisel point.

Their heat-transfer qualities are such that their basic design has remained virtually unchanged. Plug type tip and set-screw method of holding it in casing of the soldering iron allows quick and easy removal for replacement or cleaning purposes.

No.	Diam. In.	Lgth. In.	For Soldering Irons	Each
3718	1/8	3	3118, 3118SC, 3118SCP	\$0.23
3720	3/16	3 1/4	3120, 3120SC, 3120SCP	.28
3728	1/4	3 3/4	3128, 3128A, 3138XY	.43
3728-S	1/4	3 3/4	3128	.43
3738	3/8	4 1/2	3138	.60
3738-S	3/8	4 1/2	3138	.62
3738	1/2	4 1/2	1/2-in. Tip	1.20
3758	5/8	4 11/16	3158	1.40
3778	7/8	5 5/8	3178	2.73
3798	1 1/8	5 7/8	3198	4.72

Note: In addition to the standard copper tip, many special shapes are available.

Drake Electric Soldering Irons

For 110 Volts A-C and D-C

General Purpose and Radio Types

Heating element nichrome wire, wound on amber mica. Copper tip. Blued finish. Complete with 5 ft. Underwriters' Laboratories Inc. approved heater cord, rubber plug and stand.



For general purpose light radio work.

No. 225 80 Watts; 3/8 in. Tip. Shipping weight 1 1/2 lbs.... \$6.00 Each



Recommended for general radio work.

325 100 Watts; 3/8 in. Tip. Shipping weight 1 1/2 lbs... \$6.50



An extra hot iron for service men.

326 125 Watts; 3/8 in. Tip. Shipping weight 2 lbs.... \$7.00



Recommended for medium heavy work.

425 200 Watts; 5/8 in. Tip. Shipping weight 2 lbs.... \$12.00

Heating Elements, With Housing

For No.	Each
225.....	\$3.40
325.....	4.00
326.....	5.00
425.....	9.00

Copper Tips

For No.	Each
225.....	\$.75
325.....	.75
326.....	.75
425.....	2.50

Automotive and Home Types

Heating element nichrome wire. Copper tip. Large baffle plates. Blued finish. Complete with Underwriters' Laboratories Inc. approved heater cord, rubber plug and stand.



For light automotive work. Element sealed in ceramic housing.

700 80 Watts; 5/8 in. Tip. Shipping weight 1 lb.... \$3.70



For medium automotive work. Element sealed in ceramic housing.

701 100 Watts; 7/8 in. Tip. Shipping weight 1 1/4 lbs... \$4.20



For garages, machine shops, etc. Element wound in amber mica and sealed in steel housing.

703 150 Watts; 1 1/8 in. Tip. Shipping weight 1 5/8 lbs.. \$7.20

Heating Elements

For No.	Each
700.....	\$1.00
701.....	1.50
703.....	3.75

Copper Tips

For No.	Each
700.....	\$1.00
701.....	1.25
703.....	3.75

Drake Electric Soldering Irons

Heater element nichrome wire, wound on amber mica; Copper tip. Blued Finish. Complete with Underwriters' Laboratories Inc. approved heater cord, rubber plug, and stand. Baffle plates radiate heat away from handle.

Industrial Irons for Delicate Work



Compact, continuous duty iron. Equipped with extra tip bent at 45°. Complete with 6-ft. cord, rubber plug, stand.

No. 350 40 Watts; 1/8 in. Tip. Shipping weight 13 Oz.... \$6.00
Replacement Element..... 4.00
Replacement Tips..... .25



Handle with cork insulator, 5-ft. rubber cord and stand.

360 35 Watts; 3/16 in.; 1/8 in. Tips. Ship. wt. 8-oz.... \$5.50
Replacement Element..... 3.00
Replacement Tips..... .30



Small industrial iron for production soldering.

365 35 Watts; 3/16 in.; 1/8 in. Tips. Ship. wt. 4 oz.... \$5.00
Replacement Element..... 3.00
Replacement Tips..... .30



A small, continuous duty iron for close industrial work. Length 9 in., weighs 8 ozs.

No. 400 60 Watts; 1/4 in. Tip. Shipping weight 1 lb.. \$6.50
Replacement Element..... 4.50
Replacement Tips..... .50

Vulcan Safety Soldering Iron Holders With Thermostatic Control

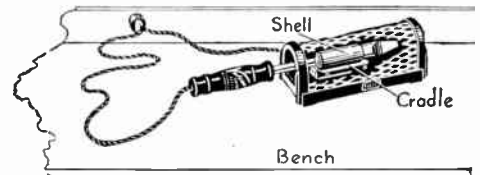

No. 2100-T

Holds and guards soldering iron and keeps tip at soldering temperature while in stand. Prevents overheating, tips retain timing, saves current and assures long life of iron.

When iron is removed from holder full current is automatically applied. Adjusting screw on bottom of holder for setting thermostat to maintain proper temperature for iron used. Complete with cord and attachment plug for connection to current, and receptacle for plugging in soldering iron.

Cast iron stand, with slip-proof feet. Protecting cage made of expanded steel.

For Use on A-C Only

No. 2100-T—As described; weight 4 lbs..... each \$7.30
No. 2100—Without thermostatic control; weight 3 3/4 lbs..... each 4.50

Vulcan Electric Soldering Irons

Approved by Underwriters' Laboratories, Inc.

These high powered irons are light in weight and have the hang or balance which makes them convenient to use. Very efficient; will produce maximum work for current used.

Made of the best grade materials obtainable for the purpose; finest forged copper tips; steel element housing and tube; selected birch handles shaped to fit the hand; fireproof terminals. Fitted with 6-ft. heater cord and unbreakable rubber plug.



Screw Tip Type



Plug Tip Type

Nos. 20 and 25—For fine instruments, small fuses, light telephone repairs, radio and all very light soldering.

Nos. 30 and 35—For radio and home use, fuses, instruments, inspectors' or linemen's tool kits, etc.

Nos. 40 and 45—High speed tools; for telephone switchboards, electrical instruments, light manufacturing, fuses and radio apparatus.

No. 453—For high speed soldering for radio, television and electronic assembly and parts.

No. 50 For fast telephone work, art glass, light tinware and general home use.

Nos. 55 and 60 For light automobile repairs, light tinware, general utility and home use.

Nos. 70 and 75—For medium tinware, general manufacturing, metal patterns, automobile work, etc.

No. 80—For heavy tinware, sheet steel and galvanized iron, metal boats, refrigerators, automobile radiators, roofing, etc.

No. 90—For automobile radiators, copper sinks, roofs, leaders, heavy metal patterns and all heavy soldering.

No. 900—For extra heavy soldering.

For Operation on A-C or D-C—Specify Voltage

Screw Tip Type					Plug Tip Type				
No.	Watts	Diam. Tip, In.	Net Wt., Lbs.	Each	No.	Watts	Diam. Tip, In.	Type Wt., Lbs.	Each
20	50	7/16	5/8	\$ 6.55	25	50	1/4	5/8	\$ 6.25
30	60	1/2	3/4	8.95	35	100	3/8	1 1/8	9.80
40	90	1/2	7/8	9.80	*453	150	3/8	1 1/4	10.65
50	130	7/8	1 1/8	11.65	45	150	1/2	1 1/4	11.15
60	175	1	1 3/8	13.35	55	200	5/8	1 5/8	11.55
70	220	1 1/8	1 3/4	15.50	75	300	5/8	2 3/8	15.10
80	310	1 3/8	2 3/8	17.70					
90	430	1 5/8	3 1/8	20.15					
900	700	1 3/4	5 1/4	37.30					

*Made to take 3/8-in. tip for high speed radio production.

Unique Soldering Copper Handles

Air-Cooled



Hardwood handle, cool and safe. Clings to the soldering copper shank. Piano wire grip, expands and contracts as the iron heats and cools and prevents charring of wood. Ample air circulation over the entire length of shank. Easy to attach—simply drive the handle over the pointed shank.

Handle 6 in. long, 1 1/4 in. diameter.

No.	For Shanks, In.	Each
1	7/8 to 3/8	\$2.90
2	3/8 to 1/2	3.30

Vulcan Industrial Soldering Pencils



No. P314

The new "Dart" industrial soldering pencil is a heavy duty tool recommended for rapid, continuous production line work on electrical or electronic components and assemblies. Weighs only three ounces, less cord.

Slim tapering plastic handle with pencil grip stays cool even after eight hours of continuous use.

Easily replaceable plug type tips held in place in tip chamber with nonoxidizing set screw. Heating elements replaceable.

Equipped with 6-ft. approved rubber cord and plug cap. Operates equally well on a-c or d-c current.

Standard voltage 110/120.

Special features available: odd tip sizes and shapes and three wire cord and attachment plug.

No.	Watts	Tip Diam. In.	Ship. Wt. Lbs.	Each	Tips	Heating Elements
P314	30	1/4	1/2	\$5.80	\$0.40	\$4.40
P318	30	*1/8	1/2	5.85	.45	4.40

*Standard 1/4-in. tip turned down to 1/8-in. at working end.

Ideal Thermo-Tip Soldering Tools

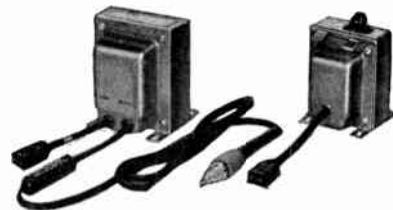

For soldering electronic circuits and parts, instruments, Radio and TV work in production or repair.

Heats instantly—concentrates heat only on the part to be soldered.

No.	Description	Each
12-123	250 Watt Power Unit.....	\$20.95
12-124	125 Watt Power Unit.....	14.20

The soldering pencil is small and light making it ideal for confined work.

12-141	1/8-in. Single Carbon Attachment.....	7.90
12-142	.062 Single Metal Attachment.....	7.90
12-155	3/16-in. Double Carbon Attachment.....	7.90
12-156	1/8-in. Double Carbon Attachment.....	7.90
12-157	.062 Double Metal Attachment.....	7.90

Chisel Tip Irons are also available.

Ideal Thermo-Grip Soldering Tools

1000 Watt Standard Model



Faster
Safer
Easier

1000-watt model Thermo-Grip is adaptable to practically all soldering jobs—closely grouped parts, difficult positions, cramped spaces, inflammable surroundings. Does all type of soldering quicker, safer and easier. Heats instantly and concentrates heat only on the part to be soldered. Eliminates fire hazard and danger of melting nearby joints or burning other parts. Does not oxidize the tin in solder, weaken the solder, or discolor the finished job. Reaches soldering temperature in less than one minute. Handy thumb-switch permits close heat control for better soldering. All parts are fully insulated. Current is reduced to harmless low voltage. Operates on resistance heating principle. Can be used for long periods of time without overheating.

Attachments

Plier Attachment (Illustrated above with Power Unit) — for soldering applications—where work may be held in jaws and heated; i.e., removing or applying solder lugs, sweating and unsweating copper tubing and fittings. Carbons are replaceable. Rating: 1000 volts amps.

Fork Attachment—for soldering in restricted spaces—where straight tools cannot be used; i.e., soldering lugs, terminals or connections in switch boxes, switchboards, inside machines, etc. The electrode holders can be turned locked in any position. Rating: 600 volt amps.



Pencil Attachment—for spot soldering—where ground clamp may be attached to a metal part of work to complete secondary circuit; i.e., spot soldering, soldering sheet metal, wire joints, commutator risers, etc. Includes "C" type ground clamp. Rating: 600 volt amps.



No.	Description	Each
12-094	Deluxe Set—includes Power Unit, 115 v., 50-60 cycle, Secondary Leads and Plier Attachment—complete with Thumb-Switch	\$86 20
12-067	Plier Attachment Only	12 95
12-068	Fork Attachment only	14 55
12-069	Pencil Attachment only	10 20

Call Graybar **FIRST** For . . .

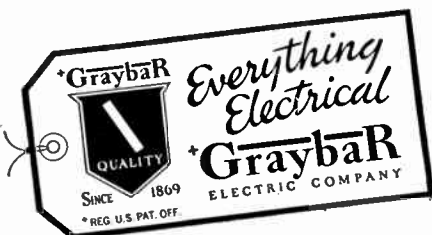

Ideal 450-Watt Model Thermo-Grips



Heats 1/2-inch copper tubing to soldering temperature in 40 seconds using 40-60 solder. Handles solder lugs up to 225 amperes.

Heats quickly — has thumbswitch for close heat control — modern in design, light-weight, compact — can be used with ease and safety on small parts, wires, terminals, lugs, copper tubing up to 3/4-inch, etc.

Safe — all current carryings parts fully insulated.

Attachments—identical to 1000 Watt Unit except proportionately smaller in size. When ordering specify (1) Power Unit; (2) Secondary Leads; (3) Attachments desired.

No.	Description	Each
12-072	Power Unit only 115 v., 50-60 cy.	\$50 85
12-074	Power Unit only, 230 v., 50-60 cy.	54 85
12-076	Secondary Lead Assembly Set	8 05
12-077	Plier Attachment only	9 35
12-078	Fork Attachment only	11 85
12-079	Pencil Attachment only	8 40

Heavy Duty Model

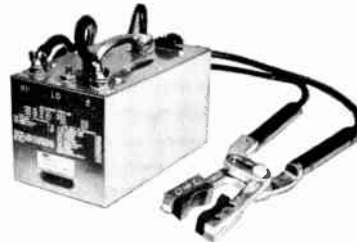

Designed for big soldering jobs. 2500 watt capacity. Stud type lugs for attaching secondary leads. Has Hi-Lo heat switch Hi—2500 watts intermittent, Lo—2125 watts.

Has Plier Attachment for soldering lugs up to 1050 amp.

size, making stator connections, sweating copper pipe and fittings up to 4-in. diameter with soft solder.

12-115	115 v., 50-60 cycle, Power Unit	\$110 90
12-116	230 v., 50-60 cycle, Power Unit	114 35
12-120	Heavy Duty Plier Attachment	56 05

WEN Soldering Guns

Model 250



Heats instantly in 3 seconds. Heat capacity up to 250 watts, 120 v., a-c only.

Rigid, nickel-plated "long reach" tip fits into tightest corners. Tip designed so that with normal operation it will remain tinned indefinitely, burning and corrosion materially retarded.

Has built-in spotlight for greater visibility.

Sturdily constructed Black Ebony finished handle and case both heat and shock resistant.

No.	Units Per Carton	Ship. Wt., Lbs. Per Carton	Each
250	3	12	\$12 95
25A4	Standard Soldering Tip (one in an envelope)		
25X20	"Feraloy" Long-Life Tip (one in an envelope)		
25C1	Plastic File Cutting Tip (one in an envelope)		
25-F-33	Flat Iron (Dent Removing) Tip (one in an envelope) (Same as 28-F-33)		
			.60

WEN Soldering Guns

"Quick-Hot"
120 V.A.C.—60 Cycle 1.1 Amp. Max.



Constructed with new type steel nose long-life tips, extra long and narrow making it easy to reach tight spots. Tips easily removed by loosening set screws. Heats working hot in 2½ seconds. Built-in spot light angled to focus light on work at tip. Light, small slips readily into tool kit or pocket. Sturdy molded, red cherry handle and case, both heat and shock resistant.

No.	Overall Length, In. Without Tip	Units Per Carton	Ship. Wt., Lbs. Per Carton	Each
199	5	6	15	\$7.95

Model 199K Home Utility Kits



This kit includes: Model 199 Gun with 1 long-nosed Soldering Tip No. 19-B-4; plastic Tile Cutting and Putty removing Tip No. 19-C-1; Flat Iron Tip for removing dents from wood and many other uses No. 19-F-33; package 5-in. Rosin Core Solder.

Kit box constructed of heavy gauge metal. Order in multiples of six.

No.	Units Per Carton	Ship. Wt., Lbs. Per Carton	Each
199K	6	24	\$9.95
19-B-4	Long-Life Soldering Tip (one in an envelope) .50		
19-C-1	Plastic Tile Cutting Tip (one in an envelope) .60		
19-F-33	Flat Iron Tip (one in an envelope) .60		

Heavy Duty Model 288

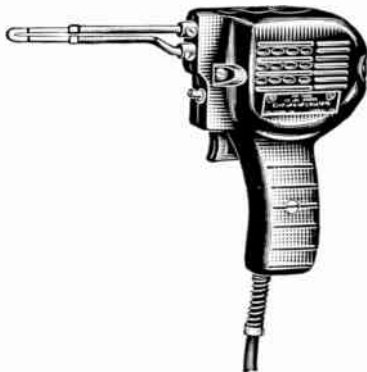

Delivers a large volume of heat; over 200 Watts. Working hot in less than 5 seconds. Has Silver-Plated Tip and Connectors to insure positive electrical contact. Equipped with a rigid, long nose, long-life heavy gauge steel nose tip. Has built-in spotlight angled to work without shadow.

Operates on 110-120 v. 60 cycles a-c only. 2 amps. max. Furnished with 6-ft. Prenex cord with molded plug. Approved by Underwriters' Laboratories. Provided with high impact, shatter proof, Ebony Black plastic handle and case.

No.	Overall Lgth., In. With Tip	Units Per Carton	Ship. Wt., Lbs. Per Carton	Each
288	9½	3	10	\$9.95
28-C-4	Long-Life Soldering Tip (one in an envelope)60
28-C-1	Plastic Tile Cutting Tip (one in an envelope)60
28-F-33	Flat Iron (Dent Removing) Tip (one in an envelope) (Same as 25-F-33)60

Chromalox Electric Metal Melting Pots

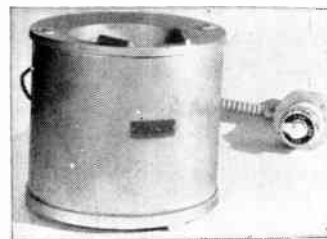

Shows 3-Heat Switch and Flexible Conduit Furnished with P-15, P-25 and P-50

Type P—For Soft Metals

For melting solder, lead, babbitt metal, tin and type metal (other than zinc).

High grade nickel-chrome cast iron pot, with heating elements clamped to bottom or sides totally enclosed by sheet metal jacket and insulating material. The location of heaters leaves interior of pot free for maximum capacity.

P-100A to P-750 inclusive have lifting lugs. Shows Model MS Thermostat for automatic control (Not included)

Maximum safe operating temperatures: Type P8 to P50, 750°F with or without control; larger sizes 900°F.

Controls—Types P15 to P50 have 3-heat manual switch mounted on a conduit box, with 3 ft. flexible conduit. Type P8 is supplied with 3 ft. flexible conduit and an armored attachment plug for single heat operation only.

Type P100A to P750 must be controlled by a thermostat and magnetic contactor to prevent excessive temperature. (For prices of Model MS Control and Magnetic Contactor contact Graybar).

For 115, 230 and 460 Volts, Single Phase, A-C or D-C

No.	Watts	Voltage	Capacity, Lbs. (Max. Contents)		Single Heat, Each	3-Heat Switch, Each
			Tin	Lead		
P-8	250	115	3	3.5	4.5	\$20.55
P-15	500	115-230	12	15	18	33.35 37.20
P-25	750	115-230	22	27	34	42.75 50.55
P-50	1380	115-230	41	52	64	76.95 85.80
*P-100A	3000	115-230-460	90	113	144	145.25 155.25
*P-350	5000	115-230-460	280	355	435	230.50
*P-750	9000	230-460	725	930	1125	367.70

*Available in 230 and 460 volts, 3 phase.

Dimensions, Inches

No.	Inside		Outside		Ship. Wt., Lbs.
	Diam.	Depth	Diam.	Depth	
P-8	2⅜	2½	5⅛	5¾	15
P-15	3¾	1	7⅞	8⅜	20
P-25	5	4¼	7⅞	8¼	26
P-50	6⅜	5	11⅞	11½	54
P-100A	7⅝	8	14⅞	15½	118
P-350	10⅜	14¼	18¼	20⅞	280
P-750	14	20⅞	22⅞	26	390

Rate of Melting (Lbs. per Hour) Maximum Operating Temperatures

No.	500°F.			650°F.		
	Tin.	50-50	Lead	Tin.	50-50	Lead
P-8	11	14	...	7	9	14
P-15	22	28	...	14	18	38
P-25	32	41	...	20	26	46
P-50	75	110	...	50	80	115
P-100A	160	245	...	120	175	265
P-350	275	405	...	210	300	470
P-750	525	750	...	410	580	870
750°F.						
P-8	3	4	7
P-15	7	9	16
P-25	9	12	20
P-50	35	50	70
900°F.						
P-100A	80	115	160	50	60	80
P-350	140	200	310	90	125	190
P-750	300	410	595	215	285	400

General Electric Metal Melting and Glue Pots

For Soft Metals



No. 2881146



Nos. 2666404 and 2666407

For melting lead, babbitt, tin, solder, type metal and similar metals at a temperature up to 950°F.

Zinc (spelter) should not be used in these pots as that metal will erode cast-iron. For these metals the jacketed-type pot is recommended. Lead is usually used in the jacket with cast-iron heaters immersed in lead.

Some of the applications are dip soldering of subassemblies, pretinning before soldering, can soldering, remelting metal, curing rubber hose, storing molten metal, etc.

Other applications—railway repair shops, electric service shops, newspaper and printing plants, tin-plating shops, storage battery manufacturing plants, auto-body repair shops, bearing and fitting manufacturing plants and foundries.

Maximum Operating Temperature, 950° F

Metal Melting Pots

Cat. No.	Volts	Approx. Capacity, Lbs.*				Wattage				Approx. Ship. Wt., Lbs.	Each
		50-50 Solder	Lead	‡Babbitt	Tin	High	Med.	Low			
2881146G3	230	28	35	†	25	750	50	\$67.15	
2881146G2	115	28	35	†	25	750	50	67.15	
2881146G5	230	28	35	33	25	1000	50	67.15	
2881146G4	115	28	35	33	25	1000	50	67.15	
2666404G1	230	100	135	125	90	2500	1500	1000	130	180.15	
2666404G2	115	100	135	125	90	2500	1500	1000	130	180.15	
2666407G1	230	330	425	390	270	5000	3000	2000	250	254.30	
2666407G2	115	330	425	390	270	5000	3000	2000	250	254.30	
3887186G2	230	1200	1600	1400	1000	15000	600	899.90	

*Larger sizes to 3000-lb. capacity are also standard.

†When this size pot is wanted for melting babbitt, it is necessary to use either Cat. No. 2881146G4 or 2881146G5

‡None of these pots are recommended for use with babbitt alloy containing more than 4 per cent copper.

Melting Pot Heating Units

Cat. No.	Approximate Dimensions, Inches						Single Units Approx. Ship. Wt., Lbs.	
	Inside Crucible Diam.	Inside Crucible Depth	Inside Clearance Diam.	Inside Clearance Depth	Outside Diam.	Outside Depth	Rating Watts	Each
3A227G4	6	6	3 7/8	4	9	10	750	12 \$42.95
3A227G3	6	6	3 7/8	4	9	10	750	12 42.95
3A228G4	6	6	3 7/8	4	9	10	1000	12 42.95
3A228G3	6	6	3 7/8	4	9	10	1000	12 42.95
3A229G4	8	9	6 1/2	6	14	14	1000	14 42.95
3A230G4							1500	14 62.90
3A229G3	8	9	6 1/2	6	14	14	1000	14 42.95
3A230G3							1500	14 62.90
3A231G4	12	13	10	8 1/4	18 3/4	20 1/2	2000	30 55.65
3A232G4							3000	30 67.75
3A231G3	12	13	10	8 1/4	18 3/4	20 1/2	2000	30 55.65
3A232G3							3000	30 67.75
3A233G4	18	20	12	14 1/2	29	31	5000	40 129.45

Vulcan Electric Glue Pots

Water Jacket Type, with Thermostat Control



Will hold glue to a maximum temperature of 150° F. The liquid heating medium used in these pots permits controlled transfer of heat to the glue without danger of localized over-heating which safeguards the quality of the adhesive.

Heavy cast aluminum with attached base. Aluminum inside pot or bowl. Heated with long-life, flat, enclosed replaceable heating elements. Complete with 6-ft. Underwriters' listed heater cord.

For 110-120 or 220-230 Volts A-C or D-C
(Please specify voltage and whether for A-C or D-C)

No.	Glue Cap. Qts.	Watts	*Minutes Req.	Size Outside, Inches		Ship. Wt. Lbs.	Each
				Diam.	Ht.		
1809	1/2	200	45	6 1/4	6 1/2	8	\$18.20
1810	1	250	45	7	7 1/4	10	23.00
1811	2	450	45	8 1/2	8 1/2	15	35.45
1812	4	700	50	8 3/4	11 1/8	30	58.00

*Average time required to heat from 70 to 145° F.

Fairmount Solder Pots

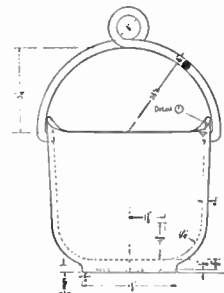

6 Inch

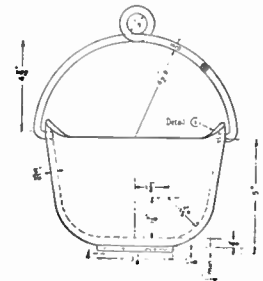

8 Inch

Solder Pots shipped from stock.

Prices on request.

Vulcan Electric Solder Pots
For Fast Dip-Soldering of Small Parts

Ideal for tinning parts, leads and fast-dip soldering. The rate of speed of pot soldering depends on correct size of pot, size of parts and the melting point of solder used. Elements are replaceable — when ordering specify number of pot and voltage.



No. 1600



No. 1606

For a-c or d-c (specify voltage).

All numbers have cast iron pots and heat-resisting base. All have Underwriters' Laboratories Inc. approved cord.

No. 1700 to 1740 inclusive have heavy sheet steel outer casings.

Flat Type Elements—Nos. 1600, 1606, 1701, 1703, 1713.

Cartridge Type Elements—Nos. 1700, 1702, 1704, 1704S, 1706, 1716-30 incl. Band Type Elements—No. 1740.

Cords, Plugs and Switches—Nos. 1600, 1606, 1701, detachable cord and plug only. Nos. 1703, 1713, 1716, 1740, attached cord, plug and switch. Nos. 1700, 1702, 1704, 1704S, 1706, 1730, attached cord, plug and 3-heat switch.



No. 1700



No. 1706

Single Heat

No.	Cap. Solder Lbs.	Watts	Dimensions, In.				Ship. Wt. Lbs.	Each
			High	Med.	Low	Depth		
1600	7/8	150	1 5/8	1 3/8	3 5/16	3 5/16	4 1/2	\$9.00
1606	3	350	3	1 1/2	5	4 1/8	7 1/2	9.95
1701	1	250	3 1/4	1 1/2	5	5 3/4	6 3/4	19.15
1703	7/8	200	2	7/8	4 3/8	4 3/16	6	13.95
*1713	7/8	300	1 5/8	1 3/8	4 3/8	4 3/16	5	19.40
1716	15	1600	8	4	12	7	55	103.00
1740	368	6000	10 3/8	14	15	18 3/4	300	223.35

Three-Heat

No.	Cap. Solder Lbs.	Watts			Dimensions, In.				Ship. Wt. Lbs.	Each
		High	Med.	Low	Inside Diam.	Depth	Outside Diam.	Depth		
1700	1 1/4	200	120	80	2	1 3/8	5	5 3/4	6 3/4	\$ 24.60
1702	5	250	150	100	3 3/8	2 1/2	5	5 3/4	7 1/2	28.45
1704	10	500	250	125	3 3/8	4 1/2	7 1/2	8	17	32.75
*1704SX	10	800	400	200	3 3/8	4 1/2	7 1/2	8	18	48.15
1706	20	750	375	187.5	5	4 3/8	7 1/2	8	23 1/2	36.00
1730	100	2500	1395	1095	7 1/2	7 3/4	13	10 3/4	99	163.75

*These are high-powered types and are insulated to reach temperatures of No. 1704S, 1000° F.; No. 1713, 850° F.

Unique Balanced Ladles



Air-Cooled

Makes it possible to pour metal drop by drop or in a steady stream, exactly where wanted. The positive "close-to-bowl" grip on the cool wood handle reduces overhang to a minimum, eliminates strain, and makes it easy to direct and control flow of the molten metal.

Pressed steel ladle, treated to prevent sticking of solder. Wood handle inexpensive and easy to replace.

Diam. Bowl, In.	Capacity, Pints	Weight Each, Lbs.	Each
3	1/8	3/8	\$3.90
3 1/2	1/4	7/8	4.20
4	3/8	1	4.40

G-E Industrial Heating Thermostats



Type "N"

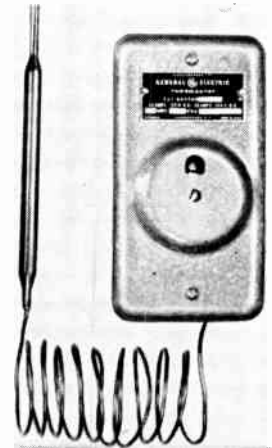

Type "S"

General-purpose industrial thermostat, diaphragm-type; maximum temperature of thermostat is 700 F. Supporting base constructed of steel; cover is pressed aluminum.

Switching mechanism is double-pole, single-throw, snap-action construction. Contacts close at temperature below dial setting and open when dial temperature is reached.

Has Underwriters' approval, except for d-c operation with capacitors.

Two types of cases available: Type S (screwdriver adjustment) in the 30-110 F. range. Type N (knob adjustment) for all other listed ranges. Bulbs will stand 400 lbs. per sq. in. external pressure.

Approximate shipping weight is 4 lbs.

Normally Closed Contacts—A-C Operation*

Cat. No.	Temp. Range In Deg. F.	Max. Temp. Differential In Deg. F.	Bulb Size In.	Capillary Lgth. In.	Case Type	List Price, Each
6A426G1	30-110	6 1/2	3/8x6 1/2	24	S	\$20.15
6A426G2	30-110	6 1/2	3/8x6 1/2	60	S	20.15
6A426G3	30-110	6 1/2	3/8x6 1/2	120	S	21.80
6A426G4	60-250	10	3/8x1 1/2	24	N	20.15
6A426G5	60-250	10	3/8x1 1/2	60	N	20.15
6A426G6	60-250	10	3/8x1 1/2	120	N	21.80
6A426G110	200-250	11	3/8x3 7/8	24	N	20.15
6A426G7	200-550	14	3/16x13	24	N	20.15
6A426G8	200-550	14	3/16x13	60	N	20.15
6A426G9	300-700	15	3/8x3 3/4	24	N	20.15
6A426G10	300-700	15	3/8x3 3/4	60	N	20.15
6A426G11	300-700	15	3/16x13	24	N	20.15
6A426G12	300-700	15	3/16x13	60	N	20.15

*Thermostats with normally open contacts or for d-c operation are available at slightly higher cost.

Dillon Wiping Solder Thermometers



For obtaining the correct temperatures of wiping solder, compounds, impregnation and cable damming waxes, paraffin, etc. Stainless steel, with 2 1/4 in. easy to read dial. Stem 7 1/16 in. long, 9/32 in. diameter.

Working range from 200° to 1000° F.

No. **DWST**—Weight each 3 ozs. Each **\$7.25**

Babcock Safety Step Ladders

**U-L Inspected
Twin-Front**



Heavy Duty Industrial

Perfect stepladder for maximum convenience.

Twin-front safety steps provides 1-in. thick steps on both sides of ladder. Bottom steps braced with steel.

Equipped with heavy duty steel spreaders and heavy duty "U" hinges.

Truss blocks; 1/4-in. steel rods.

Steps 1 x 3 3/4-in., rails 1 1/16 x 3 1/4-in.

Ladders available in sizes from 4 to 12 feet.

Length, Feet. 4 to 12

Length, Feet. 14 to 16

Length, Feet. 18 to 20

Safety Type

Light, durable air-dried 1 1/4-in. lumber, with strong oval hickory bars on back legs.

Front risers 1 1/16 x 3 1/4-in.; back legs 1 1/16 x 2 1/2-in., with bars 1 3/16 x 1 3/4-in. Steps 1 x 3 3/4-in.

All steps are reinforced with a strong steel rod with wood block to form a truss. All parts are heavily riveted. Hinges and spreaders 1 1/4-in. iron. Back section rung braced each 4 ft. of ladder length. Front section bottom step braced.



Lengths, Ft.: 4, 5, 6, 7, 8, 10, 12, 11, 16, 18, 20.
Prices on application.

Babcock Safety Step Ladders

Mechanics

U-L Inspected Through 12 Feet

For use by electricians, carpenters, painters, masons and mechanics generally.

These ladders are made of light, durable air-dried lumber, with strong hickory rungs on back legs.

Front risers 1 3/16 x 3 1/4-in.; back legs 1 1/16 x 2 1/4-in., with 1 1/8-in. rungs. Complete with bucket shelf.

Steps are 1 3/16 x 3 3/4-in. reinforced with a strong steel rod with wood block in center to form a truss. Strong, durable hinges or ears, securely riveted. All metal parts are zinc plated to prevent rust.



Back section rung braced each 4 ft. of ladder length. Front section every other step braced.

Length, Ft. 4 to 10 12 to 16

Babcock Platform Step Ladders

U-L Inspected

Heavy Duty

A safe, practical ladder for overhead work, especially in schools, churches, stock rooms and theaters. Also for sign work and on ships.

Light, durable air-dried lumber with strong oval hickory bars on back legs.

Front risers 1 1/16 x 3 1/4-in.; back legs 1 1/16 x 3 1/4-in., with bars 7/8 x 1 3/4. Steps 1 x 3 3/4-in.

All steps are reinforced with a strong steel rod with wood block to form a truss. All metal parts are heavily riveted, zinc plated to prevent rust.



No. 28

Height to Platform, Feet. . . . 4, 6, 8, 10, 12, 14, 16, 18

Height over all, Feet. 6, 8, 10, 12, 14, 16, 18, 20

Shipping weight 3 1/2 lbs. per foot.

Babcock Extension Ladders

U-L Inspected

Champion Extension: Heavy industrial with "A" spring locks. Rails 1 5/16 x 3 and 3 1/2. Rungs, 1 1/4-in. hickory. Furnished in straight or spread bottom style.

Length, Ft. 20 to 32
34 to 40
42 to 44

Eastern Extension: Medium duty, with "B" spring locks. Rails 1 3/16 x 2 3/4, 3 and 3 1/2. Rungs 1 1/2 hickory. Complete with rope and pulley.

Length, Ft. 20 to 32
34 to 44
42 to 44

Three Section 36 to 60

Prices on application.



White Metal Superlight Magnesium Ladders

Stepladders



Feature 3-in. wide smoothly contoured channel side rails; fluted non-skid steps 3-in. wide, reinforced by strong underribs; strong bucket rack; heavy front and back bracing; and serrated hard rubber feet.

Size Ft.	Approx. Wt., Lbs.	Each
3	7 1/2	\$18.50
4	8 1/2	20.50
5	9 1/2	23.00
6	11 1/2	27.00
7	14	32.50
8	16	37.50
9	18 1/2	43.00
10	21	47.00

Industrial Stepladders



Feature 4-in. wide channel side rails; fluted non-skid steps 4-in. wide reinforced by strong underribs; extra-heavy front and back bracing; strong bucket rack; and serrated hard rubber feet.

Size Ft.	Approx. Wt., Lbs.	Each
4	13 1/4	\$30.00
5	17	35.00
6	20 1/2	45.00
7	23 1/2	54.00
8	27 1/4	61.00
9	31	69.00
10	35	77.00
12	43 1/4	100.00
14	53 1/4	126.00
16	62 1/2	146.00
18	69 1/2	175.00
20	79	206.00

Platform Stepladders



Fold as compactly as regular stepladders and feature strong working platforms, 18-in. x 12 1/2-in. over-all, set two ft. from the top of the ladder; fluted steps reinforced by strong underribs; strong bucket rack; heavy front and back bracing; and serrated hard rubber feet.

Over-all Ht. Ft.	Approx. Wt., Lbs.	Each
4	9	\$22.50
5	10	25.00
6	12	29.00
7	14 1/2	34.50
8	16 1/2	39.50
9	19	45.00
10	21 1/2	49.00

Heavy-Duty Platform Stepladders (4-in. Step)

Over-all Ht., Ft.	Approx. Wt., Lbs.	Each	Over-all Ht., Ft.	Approx. Wt., Lbs.	Each
4	14 1/2	\$32.00	10	36 1/4	\$80.00
5	18 1/4	37.00	12	41 1/2	108.00
6	21 3/4	47.00	14	51 1/2	132.00
7	24 3/4	57.00	16	63 3/4	152.00
8	28 1/2	64.00	18	70 3/4	180.00
9	32 1/4	72.00	20	80 1/4	210.00

Junior Stepladders



Individually cartoned, stand by themselves when folded. Channel side rail 3-in. wide; fluted non-skid steps 3 1/4-in. wide; heavy front and back bracing; hard rubber feet.

Sold in Minimum Quantities of 1 dozen.

Approx. Wt.: 3 3/4 Lbs.

Approx. Cartoned Wt.: 5 1/2 lbs.

Each..... \$9.98

Straight and Extension Ladders



Strong, rigid and durable, yet amazingly light. Fluted, non-skid rungs rest right on the I-Beam side rails and are strongly secured by continuous outside welds. Extension Ladders are made with interlocking sections for maximum safety and sliding ease. Rope, pulley and spring safety locks are included.

Straight Ladders

Size Ft.	Approx. Wt., Lbs. Per Ft.	Side Rail Width, In.	Each
Up to 20	1 1/10	2 3/4	\$2.80/ft.
21-25	1 1/8	3	3.50/ft.
26-30	1 3/8	3 1/2	4.10/ft.

Extension Ladders

Type	Size, Ft.	Approx. Wt., Lbs. Per Ft.	Side Rail Width, In.	Each
2-Section	Up to 28	1 1/8	3	\$3.00/ft.
2-Section	30-40	1 3/8	3 1/2	3.40/ft.
2-Section	42-50	1 5/8	4	4.40/ft.
3-Section	Up to 50	1 3/8	3 1/2	3.80/ft.
3-Section	52-60	1 5/8	4	4.80/ft.
3-Section	61-72	1 5/8	4	6.00/ft.

All 3-section Extension Ladders 61 ft. and over are equipped with staypole, ground stakes and guy ropes.

Rubber Safety Feet for Straight and Extension Ladders

Type	Description	Per Pr.
Small	For Straight Ladders up to and incl. 20 ft...	\$3.50
Medium	For 2-Section Extension Ladders up to and including 28 ft.....	3.50
Large	For 2-Section Extension Ladders from 30 ft. up to and including 40 ft.....	3.50
	For all 3-Section Extension Ladders up to and including 60 ft.....	3.50
	For Straight Ladders from 21 ft. up to and including 30 ft.....	3.50
Large Plus	For 2-Section Extension Ladders from 42 ft. up to and including 50 ft.....	3.50

NOTE: When ordering safety feet be sure to stipulate size and type of ladder for which the feet are intended.

Ideal Commutator Resurfacers

Hand Type Resurfacers

Equipped with various style handles to meet conditions in any commutator or slip ring. Simply hold against the commutator as the motor turns over.

Pencil Type

For fans, auto generators, locomotive headlight motors and other fractional hp. motors.



No.	*Grade	Size	Each
80-075	X,C,M,F,P,E	5/8 x 3/8 x 6	\$1.05

Fan—Small Motor Type

Has a medium-grade stone on one end and a finish-grade stone on the other end of the handle. For use on small fractional hp. motors.



No.	*Grade	Size	Each
80-012	A,B,D,G,H	3/4 x 1/2 x 3/8	\$1.65

Pocket Type

A handy "two-in-one" utility tool. Available in any two grade combination. Especially designed for use on small fractional hp. motors.



No.	*Grade	Size	Each
80-112	A,B,D,G,H	2 x 1 x 6	\$5.30
80-137	A,B,D,G,H	2 x 1 x 8	7.05

Straight Handle Types

Used primarily on inaccessible types of commutators on small enclosed motors.



No.	*Grade	Size	Each
80-155	X,C,M,F,P	1 x 1 x 1	\$1.65
80-165	X,C,M,F,P	1 x 1 x 2	1.65
80-174	X,C,M,F,P	2 x 1 x 1	1.65
80-184	X,C,M,F,P	2 x 1 x 2	1.75
80-193	X,C,M,F,P	3 x 1 x 2	2.65

For Medium Sized Motors and Small Generators

Tramway Handle—10 1/2 in. handle permanently mounted at a 45-degree angle.



No.	*Grade	Size	Each
80-255	X,C,M,F,P	2 x 1 1/2 x 2	\$2.65
80-265	X,C,M,F,P	2 x 2 x 2	3.50
80-274	X,C,M,F,P	3 x 2 x 2	5.30
80-284	X,C,M,F,P	3 x 3 x 2	7.90
80-293	X,C,M,F,P	4 x 3 x 2	10.55

Vertical Adjustable Handle—The 10 in. rod handle adjustable to three positions.

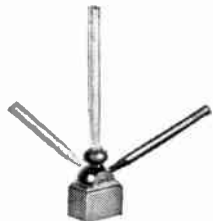

No.	*Grade	Size	Each
80-205	X,C,M,F,P	2x1 1/2x2	\$2.65
80-215	X,C,M,F,P	2x2 x2	3.50
80-224	X,C,M,F,P	3x2 x2	5.30
80-234	X,C,M,F,P	3x3 x2	7.90
80-243	X,C,M,F,P	4x3 x2	10.55

Railway Handle—7 1/2 in. handle permanently mounted in a vertical position.



No.	*Grade	Size	Each
80-305	X,C,M,F,P	2 x 1 1/2 x 2	\$2.65
80-315	X,C,M,F,P	2 x 2 x 2	3.50
80-324	X,C,M,F,P	3 x 2 x 2	5.30
80-334	X,C,M,F,P	3 x 3 x 2	7.90
80-343	X,C,M,F,P	4 x 3 x 2	10.55

Saw Handle Type

For use on large motors, small rotary converters, motor-generator sets, telephone generators, etc.



No.	*Grade	Size	Each
80-353	X, C, M, F, P	4x1 x3	\$ 5.30
80-357	X, C, M, F, P	4x1 1/2x3	7.90
80-362	X, C, M, F, P	1x3 x2	10.55
80-366	X, C, M, F, P	4x1 x3	21.10
80-371	X, C, M, F, P	5x2 x2	8.80
80-376	X, C, M, F, P	5x2 x3	13.20
80-380	X, C, M, F, P	5x3 x2	13.20
80-385	X, C, M, F, P	5x3 x3	19.80
80-389	X, C, M, F, P	6x2 x3	15.85
80-393	X, C, M, F, P	6x4 x3	31.70
80-397	X, C, M, F, P	8x1 x3	42.25

Double Saw Handle

For use on large rotary converters, large engine-driven generators and very large motors such as are used in steel mills, etc.



No.	*Grade	Size	Each
80-407	X, C, M, F, P	4x 8x3	\$42.25
80-419	X, C, M, F, P	5x 7x3	46.20
80-432	X, C, M, F, P	5x 9x3	59.40
80-444	X, C, M, F, P	6x10x3	79.20

Block Handle

For use with precision grinders, or lathe type truing device. Equipped with wood block handles.



No.	*Grade	Size	Each
80-454	X, C, M, F, P	1 x1 1/2x5	\$ 3.30
80-461	X, C, M, F, P	1 x2 x5	4.40
80-468	X, C, M, F, P	1 1/2x2 1/2x5	8.25
80-475	X, C, M, F, P	2 x2 x5	8.80
80-482	X, C, M, F, P	1 x1 1/2x8	5.30
80-489	X, C, M, F, P	1 1/2x2 1/2x8	13.20
80-496	X, C, M, F, P	2 x2 x8	14.10

Ideal Flexible Abrasive

A fine grain, non-dusting abrasive serves as a Commutator Cleaner and burnisher.



No.	Size	Each
82-001	3/8x 1/2x5	\$0.50
82-002	3/8x 3/4x5	.80
82-003	5/8x1 x5	1.55
82-004	1 x2 x5	3.05
82-005	1 x4 x5	6.05

Ideal Brush Seater

For seating carbon-graphite or metal composition brushes. Will not remove or scratch copper. Available in 11 sizes.

Standard Size: Length 4 3/4-in.; face, 1 1/2-in. x 5/8-in.

Grades: Soft, Medium or Hard. Specify grade desired. No. 23-008.....Each \$0.60

Specifications and Prices on Request to GRAYBAR.

Dimensions are given as: (length) x (width) x (thickness).

*Code letters for different grade resurfacers are:

- A—medium/finish
- B—coarse/finish
- D—finish/polish
- G—coarse/medium
- H—medium/polish
- X—extra coarse
- C—coarse
- M—medium
- F—finish
- P—polish
- E—extra polish

Ideal Hand Type Cleaners



Developed through years of air-engineering experience, the improved Ideal Cleaner will do a better job, faster, at less cost. These light weight, perfectly balanced cleaners handle a wide range of work. Blows, vacuums and sprays. Can be operated continuously at peak efficiency and with amazing economy. Delivers air at higher velocity (Heavy Duty Model—26,500 feet per minute), yet, because it blows only dry air at low pressure the Ideal Cleaner does not harm even delicate equipment. Blower Nozzle is furnished as standard with Ideal Hand Type Cleaners.

No.	Description	Each
22-110	Heavy Duty Model (1 1/3 Hp.)	\$129.25
22-113	Medium Duty Model (2/3 Hp.)	102.75
22-163	Light Duty Model (2/5 Hp.)	70.00



Standard Attachments for Use With Hand Type Cleaners

Dust-proof bag, hose connection (inlet side), flexible hose (4 ft. x 1 1/2 inches), metal nozzle (5-inch) and brush, flat fibre nozzle and shoulder strap.

No. 22-109 Std. Attachment Set.....Each \$26.55

Heater Nozzle



Fits any Ideal Light Duty Hand Type Cleaner. Especially suitable for use where rapid removal of moisture is desirable in conjunction with cleaning. Also for quickly drying paints, varnish, ink, etc.

No. 22-116 Heater Nozzle.....Each \$18.15

Scrap Collector



(For Hand Type when used as Vacuum Cleaner). Catches and holds heavy metal particles such as nails, screws, nuts, washers, etc. Protects fan and fan housing. Separates dust and dirt from scrap.

No. 22-138 Scrap Collector.....Each \$9.50

Sprayer Attachment

For spraying liquids, insecticides, varnish, lacquer, calamine, etc.

No. 22-139 Quart size.....Each \$ 5.10

Ideal Tank-Type Cleaners



Ideal Tank-Type Cleaner—for better, faster cleaning. Particularly valuable for scrap collection and in removing water from factory or service station floors.

Unique filtering system eliminates the (conventional) external bag. Easily emptied. Remove the vacuum sealed lid and lift out the 9-gallon tank and dust bag.

Cleaner has large 5-inch wheels. Swivel wheels in the front. Small width clearance permits the Cleaner to be moved down narrow aisles. Low center of gravity makes it difficult to upset.

The 1 1/3 hp. motor provides ample power without overheating. Complete with 30-foot cord and a handy storage compartment for attachments.

Order Attachments Separately

No.	Description	Each
22-200	Tank Cleaner Only, 115 v. ac, dc.....	\$362.25*
22-201	Tank Cleaner Only, 230 v., ac, dc.....	365.35*

*Price does not include attachments.

Ideal Standard Tank Cleaners

Tank Cleaner, Hand Cleaner and Blower All in One



Here is the answer to cleaning requirements for industrial, and commercial establishments, theatres and institutions. Does the work of two or more ordinary Cleaners. Used as a Tank Cleaner, it picks up dirt, dust and metal particles. Quickly removes water from floors after scrubbing and it is especially valuable in scrap collection. The power unit is complete in

itself. Removed from the tank it becomes a powerful, hand-type vacuum cleaner or blower.

Standard Cleaners are available in two models: Heavy Duty (1 1/3 hp.) and Medium Duty (2/3 hp.) Furnished with attachments.

No. 22-210	1 1/3 hp., 115 v., ac, dc.....	Each \$225.25
No. 22-213	2/3 hp., 115 v., ac, dc.....	Each 198.75

Ideal Tank Cleaner Attachments

No. 22-217 All Purpose Tank-Type Set of attachments. (May be used with all Tank-Type Cleaners.) Includes Nos. 22-130 Hose (10-ft.), 22-175 Floor Nozzle (12-inch), K-1706 Brush, 22-178 Fibre Floor Tool, 22-199 Two Section Metal Floor Wand.
Each.....\$57.25

Many other special attachments available. Complete information on request to Graybar.

Ideal Conversion Pack

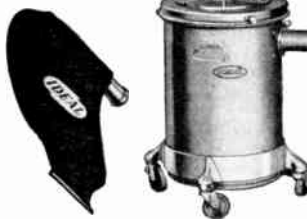

Convert your Ideal Blower into a Tank Cleaner with the Conversion Pack. Consists of 12-gallon tank and dust-tight bag. Adaptable to any of the following:
Heavy Duty Models: Nos. 22-110, 22-111, 22-112, Medium Duty Models: Nos. 22-113, 22-114, 22-115.

No. 22-216.....Each \$96.00

Additional printed information on these products and other items not listed is available on request to Graybar.

Ideal Conversion Packs

55-Gallon Drum



A conversion unit that quickly converts Ideals' Heavy - Duty Hand Cleaner into an economical, large-capacity industrial cleaner. Large capacity eliminates frequent stopping to empty tank and bag.

Powerful suction picks up dirt, water and scrap metal.

Also available is a 25-in. x 25-in. dolly with two 4-in. rubber wheels and two 4-in. rubber casters. Dolly makes unit almost impossible to tip, very easily rolled.

No.	Description	Each
22-219	Conversion Pack (cover and bag)	\$105 70
22-220	Cleaner Dolly	56 45

Premier Central Vacuum Cleaning Systems

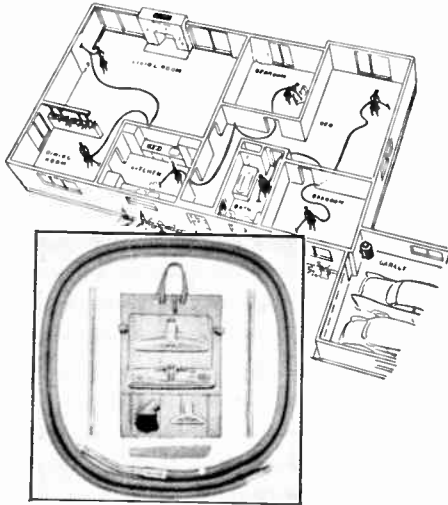

Kit No. 2

Here's a complete low-cost answer to vacuum cleaning problems in old homes and new. Since the system is built right into the home, no portable cleaners are needed. Feather-light attachments slide into convenient wall inlets. Dirt and dust are carried out of the home through concealed ducts into one centralized unit, usually in the garage. Requires emptying only 2 or 3 times yearly.

The System is quiet, and creates a healthier, dustless home atmosphere. Easily installed in old or new homes. The central vacuum unit is the industrial type Premier P-950.

Model	Each
P-950	\$112 50

The following is a list of installation material and attachments. Recommend 30 min. Timer Switch.

Kit No. 1 includes: 48-ft. S-100 2-in. aluminum tubing extended 12-ft. lengths; 3 S-101 Wall inlet assemblies, choice of plating; 1 S-102 Wall inlet assembly; 3 S-103 TY-90's; 1 S-105 90 degree els; 2 S-106 45 degree els; 2 S-110 2-in. slip couplings; 1 S-115 1/2 pt. Pliobond cement and 1-SX500 Reducer Coupling. Other special fittings available. Each \$92.64

Kit No. 2 includes: 21-ft. hose (1 1/2 x 10); Floor Brush; Dusting Brush; Crevice tool; Carpet nozzle with polisher; 2 Steel wands; Upholstery tool; Attachment storage bag. Each \$69.50

Premier Floor Machines

Listed by Underwriters' Laboratories, Inc.

Model PR-12A

An easy to carry, easy to use, portable floor machine. Ideal for buildings that lack elevators. Scrubs, waxes, polishes, and steel wools all types of floors without effort.

Brush speed of 175 rpm. gives highest quality polishing and scrubbing without splatter.

Equipped with 1/3 hp. GE motor with quiet sealed gear case.



Model	Description	Each
PR-12A	With Polishing Brush	\$155.00

Model PR-12AW

Same as PR-12A but includes simple wheel attachment kit (small photo) for much greater portability and handling ease.

Model	Description	Each
PR-12AW	Includes Polishing Brush	\$175.00
700312	Wheel Kit only (W Kit)	20.00

Model PR-22

22-Inch

A heavy duty machine of balanced construction that scrubs, waxes, polishes, shampoos, buffs, steel wools, and does many other jobs.

Also available in 13-in., 15-in. and 18-in. sizes. All sizes give you professional maintenance for all type floors.

Heavy duty GE motor is wound for 110/220 v. or reverse rotation by simple adjustment.

Price includes polishing brush.



Model	Size, In.	Each
PR-22	22	\$475.00
PR-18	18	395.00
PR-15	15	339.50
PR-13	13	295.00

If your floor area requires 1 hour of cleaning with Model PR-12A, it will take the following:

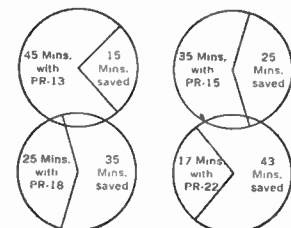

Use PR-13 in areas to 5,000 sq. ft., PR-15 to 10,000 sq. ft., PR-18 to 20,000 sq. ft., and PR-22 over 20,000 sq. ft.

Premier Heavy-Duty Cleaners

Listed by Underwriters' Laboratories, Inc.

**Model P-901-S
Quiet Type**



For wet or dry pick-up in large installations. Equipped with GE1000W series-type motor (comparable input watts hp. = 1½, actual shaft hp. = 1).

Has stainless steel tank with 13 gal. liquid-capacity, 1¼ bu. dry capacity; giant 1000 sq. in. filter area for powerful suction.

Provided with ball-bearing casters.

Model	Description	Each
P-901-S	With Hose and Coupling only	\$349.50
700151	Basic Dry Tool Kit	22.50
601375-2	Wet Pic-up Kit	38.80

**Model P-905
Quiet Type**



Ideal for hospitals, hotels, industry, etc. Top cleaning performance at low cost.

Equipped with GE1300W air bypass motor (comparable input watts hp. = 1½, actual shaft hp. = 1¼). Has 10 gal. liquid capacity, 1 bu. dry capacity; 1000 sq. in. filter area. Weight 38 lbs.

Model	Description	Each
P-905	With Hose and Coupling only	\$249.50
700151	Basic Dry Tool Kit	22.50
400142	Wet Squeegee	12.00

**Model P-908
"Old Reliable"**



Triple purpose wet-dry cleaner for industry, furnace and boiler cleaning. Equipped with GE1100W motor (comparable input watts hp. = 1½, actual shaft hp. = 1).

Designed for separate use as shoulder vac, blower. Separate cooling fan permits use on "hot jobs".

Has 10 gal. liquid capacity, 1.04 bu. dry. Huge 1625 sq. in. filter area. Weighs 40 lbs.

Model	Description	Each
P-908	With Hose and Coupling only	\$197.50
700151	Basic Dry Tool Kit	22.50
400142	Wet Squeegee	12.00

**Model P-909
Quiet Type**



Portable; tops for wet or dry use in limited areas. Equipped with GE600W air-bypass motor (comparable input watts hp. = ¾, actual shaft hp. = ½ hp.). Compact, weighs 32 lbs. and has carrying handle and rubber bumper guard.

Capacity, 3¾ gal. liquid, ½ bu. dry. Has 750 sq. in. filter area.

Perfect for hospital, hotel or office.

Model	Description	Each
P-909	With Hose coupling only	\$189.50
700025	Master Dry Tool Kit	36.00
400142	Wet Squeegee	12.00

Premier Heavy-Duty Cleaners

Model P-150

Blower



Same power unit as Master Vac Model P-908 (220 cfm). Utmost in mobility, weighs just 16 lbs.

Special tools available for conversion to hand or shoulder cleaner.

Model P-66 Blower (not illustrated) features same design with

lower hp. rating (comparable input watts hp. = ½, actual shaft hp. = ⅓).

Model	Each
P-150	\$119.50
P-66	69.50

Ideal Dust Collectors

For Precision Grinders

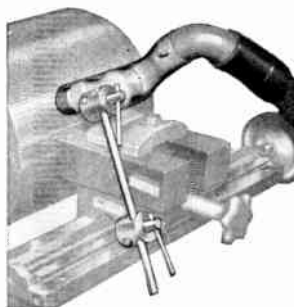

An industrial vacuum attachment that picks up metal and stone dust before it can cause bearing trouble and hard-to-locate short circuits.

Unit mounts on either grinder, generator frame, or motor. Simple and compact; easily attached to any Ideal industrial vacuum cleaner hose.

Unit includes adjustable nozzle with brush and all necessary mounting brackets.

No.	Description	Each
24-073	For "Midget" Model Grinder.....	\$44.10
24-074	For "Perfect" or "Ideal" Model Grinder....	44.10

Ideal Motor Maintenance Tools

Commutator, Motor Winding and Repair Shop

Commutator Turning Tool Heads

A good tool for removing the bead or ridge of copper left on the inside of the commutator next to the riser.

Net weight, 7 pounds.

No. 24-045, for Perfect and Ideal Model Precision Grinders..... Each \$53.25

No. 24-046, for Midget Model Precision Grinders..... Each 49.95

Slotting Files

Specially designed and constructed for commutator use.

Weight per dozen, 1 pound.

No. 20-007, Large 8-Inch Type..... Each \$2.00

No. 20-009, 9½-Inch Single End Type (Specify Draw-Cut or Double-Cut)..... Each 1.85

No. 20-006 Hand Type Commutator Mica Slotters and Scrapers

Designed for use on small commutators, and for plants which do not have sufficient work to justify the cost of a power driven unit.

No. 20-006..... Each \$3.95

Ideal Motor Maintenance Products

Ideal Electric Tachometer

Two sizes for speeds up to 5000 rpm. Accurate to plus or minus 1 per cent of full scale deflection.

Consists of small generator coupled to electric meter, which is capable of withstanding a momentary overload up to four times the maximum speed. The meter has two scales—"high" and "low" easily changed from one to the other with a switch. The units may be used together as a "Hand Type" Tachometer, or for many applications including permanent mounting.



No.	Description	Wt., Lbs. Each	Each
50-001	0-2500 rpm.....	3	\$108.95
50-002	0-5000 rpm.....	3	108.95

Ideal Electric Etchers

"Universal" Etcher marks iron, steel and their alloys, such as tools, parts and material. Four etching heats—120, 210, 420 and 700 watts—give a wide range of marking control. Cover forms work plate for small tools and parts. Unit includes 4 oz. etching tool, ground clamp with 4-ft. leads. Size 8⁵/₈ in. x 5³/₈ in. x 7 in. Shipping weight 19 lbs. Standard unit for lighter work; "Machine Shop" for heavy duty service.



No.	Description	Each
11-009	Standard, 115 v., 50-60 cy.....	\$34.35
11-048	Machine Shop, 115 v., 50-60 cy.....	85.80
11-081	Universal, 115 v., 50-60 cy.....	61.30

Ideal Insulation Tester



Detects grounds, shorts and broken wires. Test up to 2500 volts. Seven test voltages: 500, 1000, 1250, 1500, 1750, 2000, and 2500.

Operates from any electrical outlet. All current carrying parts are fully and carefully insulated. Spring operated safety sleeves, conceal the test points, which can only be bared by pressing forward the buttons on side of handles. Has three wire safety type cord. Rating 600-volt amp. (maximum).

No.	Description	Each
41-001	115 v., 50-60 cy.....	\$75.00

Ideal Precision Grinders For Commutators and Slip Rings



Portable. For truing commutators and slip rings in their own bearings at normal operating speeds. Accurate to 1/1000-inch. Inherent "slaps" and bearing eccentricities automatically allowed for. New bracket supports make possible use on practically every type of machine. Carrying case at no extra charge.

No.	Description	Each
24-004	"Perfect" Grinder, 12-in. bedplate.....	\$130.45
24-020	"Ideal" Grinder, 12-in. bedplate.....	166.40
24-033	"Midget" Grinder, 6 in. overall length...	96.55

Ideal Universal Commutator Mica Undercutters

For field and shop use—heavy duty service. Used for large or small commutators. Undercuts in narrow, confined spaces and to within 1/4-inch of risers; works in spaces only 2 3/4 inches wide. Undercuts without removing brush rigging. Speedy, accurate and easily controlled. Carrying case at no extra charge.



No.	Description	Each
25-029	Complete with 115 v., 60 cy. motor.....	\$166.40
25-032	Complete with 230 v., 60 cy. motor.....	169.75

Ideal Direct Drive Undercutters



The Direct Drive Model for medium service in the field and shop requires no dismantling of brushes or motor. The Cutter Head only 2 1/2 inches wide cuts to within 3/16 inch of the riser. Designed

for use with 2 3/32 inch diam. x 3/16-inch bore Ideal Saws and Milling Cutters. Overall length, 14 1/2 inches; width of head 2 1/2 inches; cutter spindle speed approximately 3,000 rpm. Motor is "universal" type for either a-c or d-c. Shipping weight 9 pounds.

No.	Rating	Each
25-001	115 volt, a-c, d-c.....	\$108.30
25-002	230 volt, a-c, d-c.....	116.50

Ideal Small Motor Undercutters

For fractional horsepower motors having armature 1-in. to 7-in.

No.	Description	Each
25-048	115 volts, a-c, d-c.....	\$84.25

Ideal Commutator Slotting Saws and Milling Cutters



High speed steel and special high speed steel. Available in all types and sizes.

Specifications and prices on request to Graybar.

National Carbon Brush Assortments

For Fractional Horsepower Motor



Contains brushes for fans, vacuum cleaners, vibrators, electric ironers, washing machines, sewing machines, food and drink mixers, heat regulators, pumps, electric tools, cash registers and office appliances.

Assortment No. 40 and No. 55 each contain brushes of 17 different sizes and three different sizes of springs.

Assortment of the finest quality and will take care of replacements on fractional horsepower motors (a-c/d-c and Universal) used on the popular makes of home, office and shop appliances and equipment.

Each assortment provides brush replacements for over 100 types of vacuum cleaners. Packed in container designed for effective counter or store display.

No.	Contents	Each
40	Assortment consist of 102 brushes (17 types and sizes) 55 springs (3 sizes)	\$13.20
55	Assortment consist of 198 brushes (17 types and sizes) 100 springs (3 sizes)	21.65

Dillon Weight Indicators



Weighs light or heavy objects with equal ease. Can be hung on crane or hoist hook or suspended from any convenient support. Will save many man hours at inventory time and throughout the entire year.

This indicator is dampened; that is, the pointer comes to rest quickly. Large dial, 16 in. diameter, makes accurate reading possible even from considerable distance. Can be used indoors or outdoors.

Incoming shipments can be weighed as they are lifted from the car. Heavy loads can be weighed at the stock rack and replaced in the same operation—no lost motion.

Heavy metal case encases the precision mechanism. Dial is fully linear and is covered with thick plastic crystal to prevent breakage.

The calibrated beam is set in frictionless precision needle bearings. Loads hang straight—no critical leveling or balancing necessary.

Manufacturer guarantees accuracy to ONE division at any point on the dial. This represents 1/2 lb. on the 250-lb. model, 5 lbs. on the 2500-lb. model, etc. All readings can be split visually to one-half this value.

Comes complete with oversize attachment eye and swiveling hook. (Can be replaced with any type special fitting desired.) Quickly adjustable for tare.

Cap. Lbs.	Dial Div. Lbs.	Each
0- 250	1/2	\$395.00
0- 500	1	395.00
0- 750	1	395.00
0-1000	2	395.00
0-2500	5	395.00
0-5000	10	450.00

Approx. weight, each 42 lbs. net.

Ideal Test Glo



Industrial quality for safe, easy testing of electrical circuits, spark-plugs, motors, fuses, etc.

High-grade resistors between each test prod and lead reduce voltage reaching leads.

Long thin handles with "no-slip" safety rings permit deep probing.

Neon lamp at front of prod handle, always in line of vision. 24-in. lead wire (rated 10,000 v.) permits wide span. Cement sealed and moisture proof. For 80 to 600 v. a-c or d-c.

No. 61-040 Each \$2.75

Ideal Fluorescent Fixture Testers

Flur-Test



New pocket-size tester that quickly locates the trouble and indicates whether it is in the circuit, starter or the tube.

Tester simply plugs into starter socket to make all three tests. Two models are available—one for fixtures with 15 to 40 watt tubes and one of fixtures with 85 to 100 watt tubes.

Each tester has a lead of 8-in. between the Flur-Test tube and the male plug, which fits into the starter socket of the fixture.

No.	Description	Each
61-015	Tests 15 to 40 Watt	\$5.25
61-016	Tests 85 to 100 Watt	5.25

Ideal Continuity Testers



Handy tester for checking continuity of dead circuits, grounds on conduit systems, identifying wires in multi-wire cables. Perfect for checking electrical control equipment, panel-board wiring and many other uses.

Unit is powered with two pen-lite batteries (not furnished) and gives light signal to indicate completed circuit.

Has 4-ft. removable cord equipped with alligator clip. Fits into pocket like fountain pen.

No.	Description	Length In.	Wt. Oz.	Each
61-030	Tester (less batteries)	5 1/2	3	\$2.75

Ray-O-Vac Continuity Testers



A combination continuity tester and flashlight. The flashlight is unaffected by all common chemicals and withstands extremes of temperature. Completely replaceable parts. Uses two No. 3LP or 2LP batteries and bulb No. PR6.

The tester has heavily insulated jack and leads, with positive grip clips. Tests fuses, bulbs, wire leads, switches, etc. The jack is removed for flashlight use.

It is not a voltage tester and is not to be used on live wiring.

No. N22T Each \$6.75

Brach Test-O-Lites



For locating burned-out fuses, motor troubles, short circuits, etc. For all voltages from 100 to 550 a-c or d-c. Bakelite, neon tube, small size. Guaranteed for a lifetime.

Longer leads can be furnished at nominal extra charge.

Test-O-Lite, With 3 3/4-in. Leads. Each **\$1.25**

Kett Universal Saws

Cuts Practically Any Sheet Material



This Kett saw cuts mild steel, cast iron, copper, lead, zinc, aluminum, Masonite, plywood, plastic, Fiberglas and other similar materials. It is compact, sturdy, powerful and easy to use. It cuts plastics and other soft materials up to 1/4-in., aluminum up to 3/16-in. and mild steel up to 12 gauge. Specially designed lead guide enables operator to follow contours and cut shapes of 6-in. radius or larger. Starts anywhere without starting holes. Cuts to any desired depth up to 1/4-in. Cuts over ribs and supporting structures without fear of damage. Standard equipment includes three 1 1/4-in. x 41 tooth blades, three 1 1/2-in. x 60 tooth blades. Weight, 8 1/2 lbs.

No. KS-1AM, with a-c/d-c Universal Motor and Standard Equipment. Each **\$103.50**

Kett Attachments

KS-1, Kett 1/4-in. capacity saw unit complete with geared angle head, portable tool connectors and six blades. Each **\$54.50**

JC-1, Kett Jacobs chuck adapter with 1/4-in. capacity No. 7B Jacobs chuck for use with Kett universal cutting tools to instantly convert them into portable electric drills. Each **\$ 7.50**

Kett Saw Blades

For Kett Cutting Tools

No. of Teeth	Diam., In.	Max. Depth of Cut, In.	For Use With	Per Doz.
22	1 1/4	1/8	KS-1 & KS-2	\$10.20
22	1 1/2	1/4	KS-1 & KS-2	10.80
22	2	1/2	KS-2	11.40
44	1 1/4	1/8	KS-1 & KS-2	10.80
44	1 1/2	1/4	KS-1 & KS-2	11.40
44	2	1/2	KS-2	12.00
60	1 1/4	1/8	KS-1 & KS-2	11.40
60	1 1/2	1/4	KS-1 & KS-2	12.00
60	2	1/2	KS-2	12.60

R. C. S. Electric Saws

Model 250

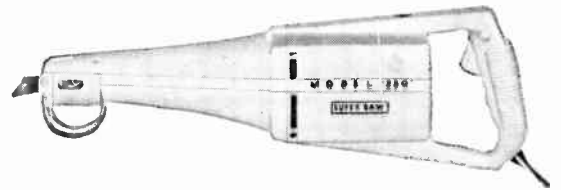

Has Extra Heavy Duty 5.0 Amp. motor for fast cutting, 2500 strokes per minute. Lightweight; ruggedly constructed with high-grade bearings for long life.

Counterbalanced; no vibration; always perfect control. Has more blade clamping surface than any other saw.

Safe; no exposed moving parts. With exclusive Rocker Guide no starting hole is necessary in wood or composition material.

Provided with metal carrying case, six blades, and blade wrench.

Model No.	Wt. Lbs.	Shipping Wt. w/ Case	Each
250	7 1/2	18 lbs.	\$97.50

Model T Super Saw For Electric Drills



This direct drive attachment fits any 1/4-in. or 5/16-in. or 3/8-in. heavy duty drill, compressed air or flexible shaft equipment.

Has complete 360° rotating ability for hard-to-get-at places. No starting hole necessary.

Equipped with drill spindle adapter and drill chuck adapter, blade and wrench. Unless specified standard drill spindle adapter with 3/8-24 thread furnished. Adapter stays on drill allowing you to switch saw and drill easily.

Safe; rugged; no torque or spin. Furnished with built-in blower.

Model	Overall Length In.	Wt. Lbs.	Each
T	10 3/4	4	\$49.50

Super Saw Kit

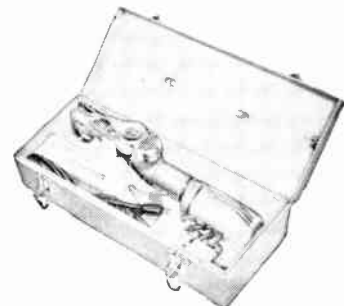

Includes Super Saw; Heavy Duty 1/4-in., 3.0 amp. Pet Electric Drill (2500 rpm), lubricant, assortment of 6 blades, wrenches and metal carrying case.

	Wt. Lbs.	Each
Super Saw Kit Complete	16	\$107.00

R. C. S. Super Saw Blades

Shatter Proof

For Wood and Composition Materials (Cuts Nails)

No.	Teeth Per In.	Wt. Per Pkg., Oz.	Price Per Pkg.
1	14	3	\$2.35
2-10	10	4	2.65
2-18	18	4	2.65
4-10	10	6	3.35
4-18	18	6	3.35
5-10	10	7	3.80
6-10-12-in.	10	14	6.00
6-18-12-in.	18	14	6.00
6-18-18-in.	18	20	9.00
7-7	7	5	5.50
8-7 keyhole	7	15	8.00

For rapid hole and contour sawing (Cuts Nails)

S-1	7	3 1/2	4.20
S-2	7	1 1/2	4.50

For Metal Cutting

T-1	18	3	3.00
T-1	24	3	3.00
T-1	32	3	3.00
ST-1	18	2	3.00
ST-1	24	2	3.00
ST-1	32	2	3.00
HD-1	18	2 1/2	3.25
HD-1	24	2 1/2	3.25
HD-1	32	2 1/2	3.25
HD-2	18	4	4.20
HD-2	24	4	4.20
HD-2	32	4	4.20
HD-3	18	6	4.50
ST-3	24	2	7.50
NF-1	5	7	7.00

R. C. S. Flush-Cut Kits
For Use With Model 250 Super Saw



Entirely new concept in the field of Reciprocating Saws. Enables operator to cut flush with any surface in any position.

No.	Wt. Oz.	Each
IU-200	7	\$9.75

R. C. S. Korner Kings

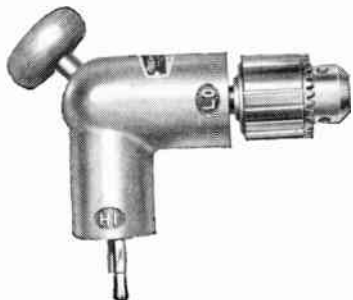

Korner King enables you to drill in tight corners between studs and joists.

Easily attached to drill. Precision built for rugged, continuous trouble free service.

Easily snaps on either end and you're ready to drill. Has 2-1 speed reduction.

No.	Each
K-300	\$28.65

Greenlee Electric Drills Sets



For use in 1/4-in. electric drill for boring 1/2-in. or smaller holes in soft or hard wood. Made with a solid center twist. Head is single cutter, extension lip type. Feed 30 turns to the inch. Shank is 1/4 x 1-in.

Five bits to the set.

No. 275-P Each.....\$5.25

Porter-Cable Electric Sanders

3-In. x 24-In. Belt Sander

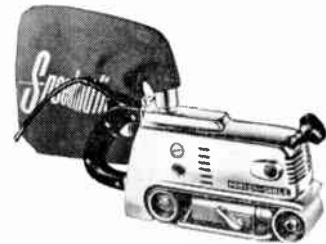

Sander with a powerful vacuum system that removes most of the dust. Suited for all types of rough sanding or finishing in wood-working shops, maintenance departments, millwork shops, schools and throughout the construction industry.

Polished aluminum frame. 9 ampere universal motor, 115 volts, a-c or d-c, 25-60 cycle. Sander comes complete with dust bag and nozzle; worm gear grease; chain grease; three assorted abrasive belts and operating manual.

No.	Belt Size In.	Belt Speed Idle SFPM	Belt Speed Load SFPM	Lgth. In.	Wdth. In.	Ht. In.	Net Wt. Lbs.	Price Each
503	3 x 24	1100	860	16 3/4	5 1/2	8	15	\$150.00

3-In. x 21-In. Belt Sander

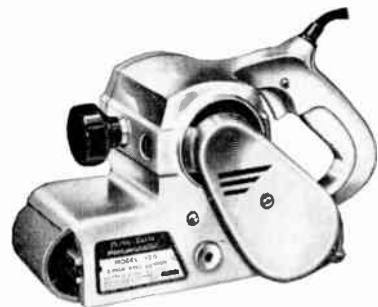

Produces fine straight-line finish without ripples or gouges. Special belt tension device permits changing abrasives in seconds. Easy to use in any position, horizontal, vertical or overhead.

Polished aluminum housing. 6 ampere universal motor, 115 volts, a-c or d-c, 25-60 cycles. Equipped with 7 ft. cord. Comes complete with 3 assorted abrasive belts, operating manual.

136 3 x 21 1125 850 11 3/4 6 5/8 7 10 \$69.50

Model 153 is basically the same as Model 136 except it is a heavy-duty model.

Porter Cable Finishing Sanders

Heavy Duty

Orbital motion finishing sander that is used for "all day" production surfacing. Simplified transmission reduces service problems and assures trouble free operation.

Polished aluminum frame. 2.5 ampere Universal motor 115 volts, a-c or d-c, 25-60 cycle. 3/16-in. diameter orbit size.

Sander comes complete with wrench; tube of grease; package of assorted abrasive sheets; operating manual.



No.	Sandpaper Size In.	Pad Speed Idle RPM	Pad Speed Load RPM	Lgth. In.	Wdth. In.	Hgt. In.	Net Wgt. Lbs.	Price Each
509	3 2/3 x 9	6000	5000	8	4 3/4	7 1/4	8	\$99.50

Porter-Cable Electric Sanders

4-In. x 27-In. Belt—Speedmatic Sander



Heavy duty model, excellent for broad, flat areas. Widely used in millwork and furniture shops for finishing desks, tables, cabinets and bookcases.

Polished aluminum frame. 12 ampere universal motor, 115 volts, a-c or d-c, 25-60 cycle. 4-in. x 2 3/16-in. rubber-covered drive pulley. Ten foot cord included. Sander comes complete with dust bag and nozzle; worm gear grease; wrench; chain grease; three assorted abrasive belts and operating manual.

No.	Belt Size In.	Belt Speed Idle SFPM	Belt Speed Load SFPM	Lgth. In.	Wdth. In.	Hgt. In.	Net Wgt. Lbs.	Price Each
500	4 x 27	1440	1140	18 1/8	5 5/8	8 3/8	25	\$185.00

3-In. x 24-In. Belt—All Purpose Sander

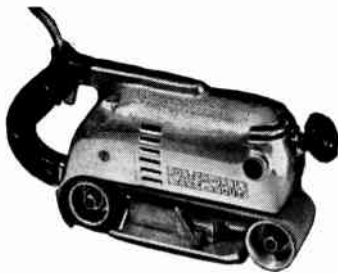

All-purpose sander saves valuable time in chamfering, rounding edges and surfacing wood, metal, plastic and other material. Lightweight and balanced design make it an easy to use sander.

Polished aluminum frame. 9 ampere universal motor, 115 volts, a-c or d-c, 25-60 cycle. Shoe covering of resilient cork and steel. Equipped with 10 ft. cord. Complete with worm gear grease; chain grease; 3 assorted abrasive belts and operating manual.

No.	Belt Size In.	Belt Speed Idle SFPM	Belt Speed Load SFPM	Lgth. In.	Wdth. In.	Hgt. In.	Net Wgt. Lbs.	Price Each
A-3	3 x 24	1600	1000	16	5 1/8	7 3/4	14	\$125.00

Porter-Cable Electric Saws

8 1/4-in. Dia. Blade

Low price special designed particularly for builder who needs added power and big cutting capacity. Combines lightweight, maximum power, kickproof clutch and auxiliary front blade guard.

Cuts a full 2 7/8-in. depth at 90° angle and 2 1/8-in. at 45° angle. Precision ball bearings. 10 ampere Universal motor, 115 volts a-c or d-c. Equipped with 10 ft. cord.

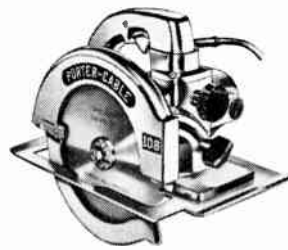

No.	Blade Diam. Size In.*	Blade Speed Idle RPM	Blade Speed Load RPM	Lgth. In.	Wdth. In.	Hgt. In.	Net Wgt. Lbs.	Price Each
108	8 1/4	4500	3400	12 1/2	10	10 1/2	13 1/2	\$99.50

*8 1/4-in. diam. blade; 5/8-in. round hole.

8 1/4-In. Speedmatic

For all types of extra heavy duty cutting; includes a new and safer telescoping guard and an exclusive calibrated depth gauge which eliminates guesswork as to how deep you are cutting.

Equipped with sawdust ejector; kickproof clutch and instant bevel adjustment. Comfortable new handle design; trigger switch located under index finger.

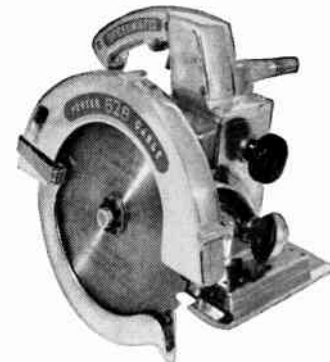

Broad base constructed from sturdy die cast aluminum. Complete with 10 ft. cord.

Cuts a full 2 7/8-in. at 90° angle and 2 1/8-in. at 45° angle. Powerful universal motor, 115 volts, a-c or d-c, 25-60 cycles. Saw also available in economical kit form.

No.	Blade Diam. Size In.*	Blade Speed Idle RPM	Blade Speed Load RPM	Lgth. In.	Wdth. In.	Hgt. In.	Net Wgt. Lbs.	Price Each
528	8 1/4	6300	3425	12	8 3/8	11 1/2	16	\$135.00

*8 1/4-in. diam. blade; 5/8-in. hole.

6 1/2-In. Heavy Duty

Lightweight, well balanced, easy to handle on any type of cutting operation. Easily cuts a full 2 3/8-in. at 90° and bevel cuts dressed 2-in. lumber at 45°.

Ball bearing motor; kickproof clutch automatically puts blade into neutral if it jams when cutting. Equipped with calibrated depth gauge and safety telescoping guard.

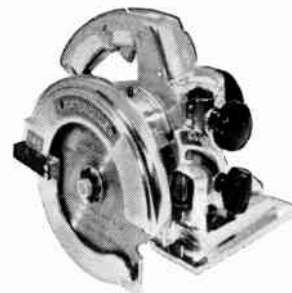

May be used with 6-in. abrasive blades to cut all types of problem material. 9 ampere motor 115 volts, a-c or d-c. Also available in 230 volts.

No.	Blade Diam. Size In.*	Blade Speed Idle RPM	Blade Speed Load RPM	Lgth. In.	Wdth. In.	Hgt. In.	Net Wgt. Lbs.	Price Each
146	6 1/2	5900	3670	11	7 5/8	9 3/8	11	\$69.50

*6 1/2-in. diam. 5/8-in. round hole combination.

Porter-Cable Electric Saws

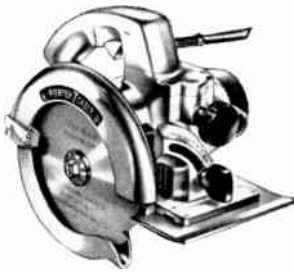

7-In. Heavy Duty

Rugged all purpose saw, ideal for every type of general cutting operation because of its light weight and extremely powerful motor. Equipped with kickproof clutch.

10 amp. universal motor, 115 volt a-c or d-c, 25-60 cycle. Max. depth of cut: 90°—2⁵/₁₆ in. 45°—1³/₄-in.

Wrench, gear grease and operating manual furnished.

No.	Blade Diam. Size In.*	Blade Speed Idle RPM	Blade Speed Load RPM	Lgth. In.	Width In.	Hgt. In.	Net Wgt. Lbs.	Price Each
115	7	5500	4500	11	8 ¹ / ₄	9 ³ / ₄	12 ¹ / ₂	\$79.50

*7-in. diam. blade; 5/8-in. round hole.

7¹/₄-In. Saw With Blade On The Left

Heavy duty saw with blade on the left side of motor. Lightweight, two full size handles, easy to use for both horizontal and vertical cutting. Equipped with kickproof clutch.

Cuts 2¹/₂-in. at 90° angle and 1¹/₈-in. at 45°. Ball bearing, 12 ampere 115 volt a-c d-c motor. King size lever assures quick and convenient re-

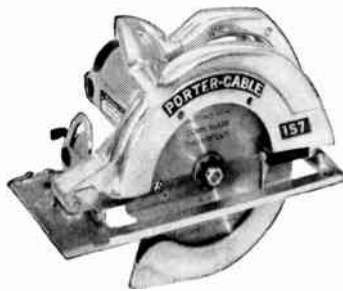

traction of guard for pocket cutting and scoring. Also available in kit form.

No.	Blade Diam. Size In.*	Blade Speed Idle RPM	Blade Speed Load RPM	Lgth. In.	Width In.	Hgt. In.	Net Wgt. Lbs.	Price Each
157	7 ¹ / ₄	5650	3675	13	9	8 ³ / ₄	13	\$95.00

*7¹/₄-in. diam. blade; 5/8-in. round hole combination.

Porter-Cable Bayonet Saws



Rapidly cuts wide variety of materials from hard and soft woods to ferrous and non-ferrous metals. Makes straight or angle cuts; plunge-cuts with no starting hole. Easy to grasp handle equipped with trigger switch for instant control of power.

Polished aluminum housing. 3.5 ampere Universal motor. 115 volts, a-c or d-c, 25-60 cycle. Maximum depth of cut: wood, 2-in., aluminum, 3/4-in., steel, 1/4-in. Nine ft. cord furnished. Saw comes complete with package of 4 assorted blades; 1 base insert; 1 allen wrench; 1 wrench holder; tube of grease and instruction manual.

No.	Strokes Per Min. Idle	Strokes Per Min. Cutting	Lgth. In.	Hgt. In.	Base Width. In.	Net Wgt. Lbs.	Price Each
548	4500	4250	7 ¹ / ₈	6 ¹ / ₄	4	5	\$99.50

Porter-Cable Portable Band Saws

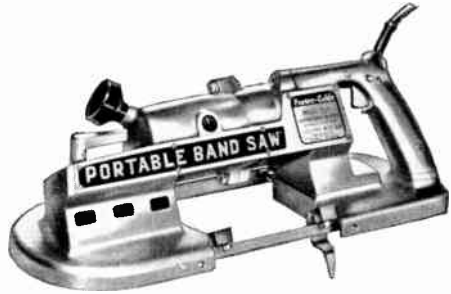

Designed for fast, smooth cutting of all ferrous and non-ferrous metals, plastics and problem materials. Well balanced, easy to handle. Assortment of band saw blades available for cutting various materials.

Aluminum alloy frame. 6.5 ampere Universal motor, 115 volts a-c or d-c, 25-60 cycles. Worm gear and chain drive, 6-in. diameter rubber covered drive pulley. Capacity: Rectangular stock, 3¹/₄-in. x 1¹/₄-in. Round stock 3¹/₄-in. diameter. Blade is 44⁷/₈-in. long, 1/2-in. wide, .020-in. thick; 10 teeth per inch.

Saw equipped with 10 ft. cord and complete with grease and operating manual.

No.	Speed SFPM	Lgth. In.	Wdth. In.	Hgt. In.	Net Wgt. Lbs.	Price Each
524	240	19 ¹ / ₂	7 ¹ / ₂	7 ¹ / ₂	16	\$225.00

Porter-Cable Electric Chain Saws



Lightweight, balance, and the wrap-around handle combine to permit ease of operation in any position. V-shape design gives greater leverage, keeps chain away from dirt when saw is placed on ground, also allows cutting practically flush to ground.

Aluminum alloy housing. Full 12 ampere Universal motor, 115 volts, a-c or d-c, 25-60 cycles. Heavy duty ball bearings throughout. Oversized worm gear drive. Push-button control lubricates chain even during cutting. Chain speed: 1,750 ft. per minute, free running.

No.	Cutter Bar In.	Lgth. In.	Wdth. In.	Hgt. In.	Net Wt. Lbs.	Ship. Wt. Lbs.	Price Each
154	14	29 ¹ / ₂	6 ¹ / ₂	9 ¹ / ₄	18	21	\$134.50
156	16	31 ¹ / ₂	6 ¹ / ₂	9 ¹ / ₄	18 ¹ / ₂	21 ¹ / ₂	144.50

Call Graybar **FIRST** For . . .

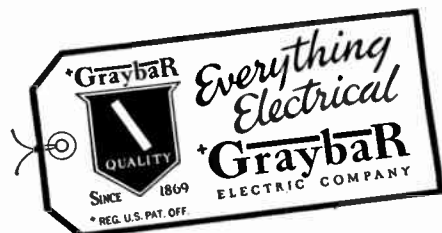

Porter-Cable Routers
Heavy Duty—1½ Hp.



No. 532

Gives perfect edges on all stock including pine and fir planks, glue-bonded plywood, or plastic laminates. Has exceptional speed of 22,000 rpm. Exclusive Kam-Grip chuck and collet provide greatest possible accuracy while eliminating vibration and "run out."

Has lock-button trigger providing instant power control. Plastic knob may be used in two different positions. Constructed with sealed ball bearings, dial depth adjustment non-marking sub-base, and polished aluminum housing.

For accurate straight edge routing, a guide No. 532-86 is provided as standard equipment. Available as accessory equipment is the No. 532-S Shaper Table, No. 5011-511 Sharpening Attachment and No. 5023 Trimming Kit.

No.	Width In.	Height In.	Depth In.	Net Wt. Lbs.	Each
532	8	9¾	10	8	\$130.00

Other Routers Available

- No. 150—1¼ hp., Speed 22,000 rpm., Size 7½-in. wide, 7-in. high, 9¾-in. deep. Each **\$79.50**
 No. 162—½ hp., Speed 21,000 rpm., Size 5½-in. wide, 7-in. high, 5½-in. deep. Each **\$49.50**

For further information on other Models please contact Graybar.

Porter-Cable Electric Routers



⅞ H.P. Router

Model 100 used for variety of jobs on wood, plastic and composition. Has 6.5 ampere, ⅞ hp. Universal motor, 115 volts, a-c or d-c, 25-60 cycles. Split-type, ¼-in. capacity collet, precision ball bearings.

Polished aluminum housing. Equipped with recessed double pole switch and 10 ft. cord. Router includes motor adapter, base, 2 wrenches, collet and Operating Manual.

1½ H.P. Router

Model 511 is a heavy-duty router used by builders and woodworkers for a wide variety of cutting and shaping operations. Over 150 bits and cutters available for use with this router. New threadless Kam-Grip chuck provides positive accuracy. Has 8 amperes, 1½ hp. Universal motor, 115 volts, a-c or d-c, 25-60 cycles. Oversized sealed bearings.

Polished aluminum housing. Equipped with recessed double pole switch and 10 ft. cord. Router includes motor adapter, base, 2 wrenches; ¼-in. collet; ½-in. collet; straight gauge; templet guide; grinding wheel; lock nut and Operating Manual.

No.	H.P.	Speed RPM	Dimensions, Inches			Net Wgt. Lbs.	Price Each
			Width	Hgt.	Dpth.		
100	⅞	20,000	5½	7	5½	5¾	\$57.50
511	1½	22,000	8¾	9¾	5¾	8¾	130.00

Thor Safety Balancers

For Tool Suspension



No. 5LB6

Has automatic, built-in brake. Positively prevents load from dropping under any circumstances.

Provided with full swivel upper hook for easier handling, longer life, greater safety. Auxiliary suspension provision for double safety.

Adjustable counterweight tension; no special tool required. Shock-absorber cable stop has simple adjustment from zero to full 6-ft. travel.

Constructed of heavy gauge steel housing with ¾-in. nylon-sheathed steel cable and durable aircraft-type cable fittings.

Equipped with self-lubricating oilite bearings.

The No. 5LB6 features in-line hook-to-hook suspension. The No. 10LB6 has tangential suspension for minimum cable wear with heavier tools.

No.	Max. Cap. Lbs.	Min. Cap. Lbs.	Distance Hook to Hook In.	Wt. Lbs.	Each
5LB6	5	0	11¼	3⅝	\$18.00
10LB6	10	1	10	3⅝	26.00

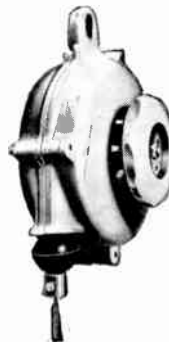

Size 0

Provides the safest and most convenient method of suspending screwdrivers and other tools over the work within easy reach for frequent or rapid use.

Ideal for assembly line operations. A slight pull brings the tool down, upon release it rises out of the way.

No.	Capacity, Lbs.	Range of Travel Ft.	Hook-to-Hook Distance, In.		Wgt. Lbs.	Each
	Max.	Min.	*Std.	†Min.		
5LB6	5	0	6	11¼	3⅝	\$18.00
0	8	0	5	19	13	35.00
10LB6	10	1	6	10	3⅝	26.00
0X	10	3	5	19	13	35.00
10B	10	5	5	35	16	85.00
10BX	20	10	5	35	16	95.00
20B	20	10	6	51	17½	95.00
30B	30	20	6	51	17½	100.00

*As shipped with standard length cable.
†Obtainable by shortening cable.

Thor Portable Electric Drills

Equipped with A-C/D-C Universal Motors—Standard Voltages, 115 Volts

Also Available in 220 and Special Voltages on Specifications

1/4-Inch—Standard Duty

1/4-Inch Silver Line



For general use in maintenance and production service. Available in seven speeds and right-angle model. Has pistol-grip handle and plunger switch with locking pin. Right-Angle: Supplied with 1/4-in. chuck as standard; 1/4-in. collet optional. Head length, 3 11/16 inch with chuck; 2 5/8 inch with collet.

Standard Specifications

No.	Type	Free Speed RPM	Wt. Lbs.	Overall Lgh., In.	Each
ED2	Straight	1800	3	7 7/16	\$42.00
ED111	Rt. Angle	2250	3 7/8	10	78.00

Optional Speed Models

No.	RPM	Each
ED5	5000	\$42.00
ED0	3700	42.00
ED1	2500	42.00

Low Speed Models

No.	RPM	Each
ED3	1100	\$48.00
ED7	800	48.00
ED4	550	48.00

1/4-Inch Copper Line



For home workshops and other intermittent service. Die cast aluminum housing. Has self-lubricating bearings and alloy steel gears.

Geared chuck, standard speed 2000 rpm. Overall length 8 1/2 inches. Weight 3 lbs.

No.	Description	Each
16CL	With Geared Chuck	\$25.00

1/4-Inch—Heavy Duty

1/4-Inch Silver Line—Pistol Grip

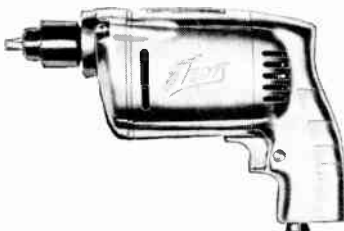

Particularly efficient for production work.

Easy handling, with convenient pistol-grip handle and trigger switch.

Also supplied with side handle.

Available in seven speeds.

No. Pistol Grip	No. Side Handle	Free Speed RPM	Wt. Lbs.	Overall Length In.	Each
U14F	U14FS	2500	3 7/8	8 3/4	\$52.00
U12F	U12FS	3750	3 3/4	8 9/16	52.00
U13F	U13FS	5000	3 3/4	8 9/16	52.00

Stainless Steel Drilling Speed Models

No. RPM	U 22FD	U16FD	U18FD	U17FD
Each	500 \$61.00	750 \$61.00	1000 \$61.00	1500 \$52.00

1/4-Inch—Heavy Duty

1/4-Inch Silver Line—Grip Handle



For continuous service in either metal or wood work.

Grip handle has momentary trigger switch.

Furnished with geared chuck, cable with ground wire, and plug. Free speed, 2000 rpm. Overall length, 12 5/16 in.; weight 6 1/2 lbs.

No. EJO.....Each \$59.00

5/16 and 3/8-Inch—Heavy Duty

Silver Line



Ball bearings used throughout.

Recommended for continuous performance heavy duty drilling.

EJ1, EJ2 and EJ3 furnished with grip handle and momentary trigger switch. All other sizes furnished with momentary side switch handle and dead handle.

No.	Capacity Inches	Free Speed RPM	Wt. Lbs.	Overall Length Inches	Each
EJ1	5/16	1500	6 5/8	12 7/16	\$61.00
*	5/16	1000	7 3/4	12 7/8	61.00
†EJ6	5/16	1500	6 5/8	12 7/16	61.00
EJ2	3/8	1000	7 3/4	12 7/8	68.00
EJ3	3/8	750	7 3/4	12 7/8	68.00
†EJ7	3/8	1000	7 3/4	12 7/8	68.00
†EJ8	3/8	750	7 3/4	12 7/8	68.00

†Have side handle.

*Specify "Code EJ2 with 5/16-in. chuck."

1/2-Inch—Heavy Duty

Non-Reversible—and Reversible

Silver Line



Compact, powerful design develops stall-proof drilling torque at rated capacity.

Full ball-bearing construction.

Slotted ventilating ports and new design fan maintain lower operating temperature.

Free speed, 500 rpm. Overall length, 12 1/4 inches; weight 8 lbs.

Reversing switch on handle available \$10.00 extra, specify EJ9R-T.

No. EJ9.....Each \$68.00

Thor Drills

Copper Line

1/4-In. To 3/8-In. Capacity Standard Duty



Pistol grip series drills, 4 1/2 lbs. weight. Length 9-in. overall.

Bearings: Ball on armature and spindle; anti-friction; oilless.

Available in standard duty classification, speeds for drilling 1/4, 5/16 or 3/8 in. holes in steel.

No.	Capacity In.	Speed RPM*	Each
1116CL	1/4	2000	\$29.95
20CL	5/16	1500	45.00
24CL	3/8	1000	46.00

Thor Portable Electric Drills

1/2-Inch—Standard Duty Copper Line

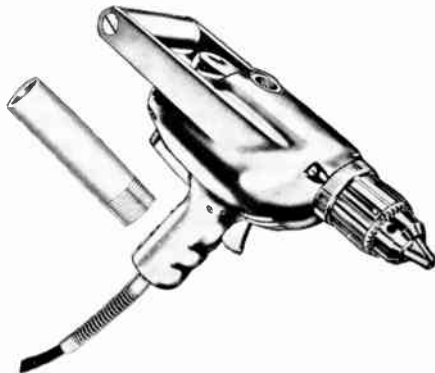

For standard duty, intermittent service, home workshops, etc. Housing of die cast aluminum.

Furnished with self-lubricating bearings, alloy steel gears, geared chuck and key.

Has side switch handle with trigger switch and locking pin for continuous or intermittent operation. Free speed 650 rpm. Overall length, 13-inches; weight 8 3/4 lbs.

No. 32CL..... Each **\$39.50**

3/8-In. To 5/8-In. Capacity



Side handle drills. All sealed ball bearings for heavy duty service. Speeds for drilling 3/8, 1/2 or 5/8 in. holes in steel.

No.	Capacity In.	Speed* RPM	O.A. Lgth., In.	Wt. Lbs.	Each
H24CL	3/8	1000	13 1/2	11	\$62.50
H32CL	1/2	600	14	11 1/4	62.50
H40CL	5/8	400	14	11 1/2	65.00

*Additional speeds available at extra charge.

Thor Drills and Reamers

1/2-Inch—Extra Heavy Duty

Non-Reversible, and Reversible

Silver Line

Equipped with a.c./d.c. Universal motors. Standard voltage, 115 volts; also available in 220 and special voltages upon specification.

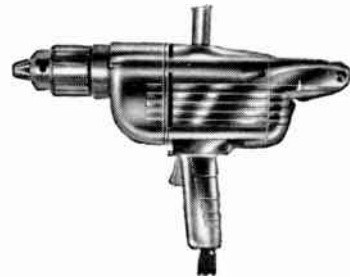

Designed for deep drilling where dependable power and strength are required.

Furnished with highest grade alloy steel gears and chuck.

Has safety switch side handle, spade handle and dead handle.

Standard with 3-conductor cable with ground wire, and with plug.

Reversing switch on handle available at **\$10.00** extra. Feed screw optional. Available in two speeds.

No.	Free Speed RPM	Wt. Lbs.	Overall Length, In.	Each
*E1.5	525	15	14 1/4	\$100.00

*Available at 750 rpm. at **\$7.50** extra (specify No. E1.4).

Standard and Extra Heavy Duty Silver Line

5/8 and 3/4-Inch

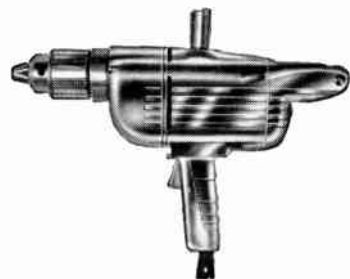

Furnished with momentary switch, side handle, spade handle, dead handle and 3 cond. cable with ground wire and plug.

Geared chuck and key supplied as standard. Feed Screw Assembly complete **\$10.00** extra.

Standard Duty: Designed for general purpose work.

Extra Heavy Duty: Reserve power and sturdy construction for continuous production service and maintenance work. Minimum upkeep under extreme service conditions. Reversing switch on handle available all sizes, **\$10.00** extra.

Standard Duty

No.	Capacity In.	Free Speed RPM	Wt. Lbs.	Overall Lgth., In.	Each
E1.6	5/8	425	15 1/4	14 1/4	\$105.00
E1.7	3/4	350	15 7/8	14 5/8	115.00

Extra Heavy Duty

EN5	5/8	430	17	16 1/4	\$125.00
EN6	3/4	350	17 3/4	16 5/8	135.00

Thor Drills and Reamers

Silver Line

7/8, 1 and 1 1/4-Inch—Heavy Duty

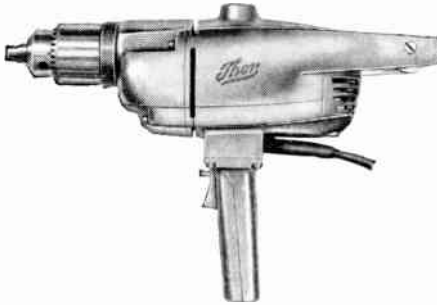

No. EN7

Constructed to withstand the hardest kind of continuous production and maintenance service.

Nos. EN7 and EN8: Spade handle, standard; feed screw, **\$10.00** extra. Reversing switch on handle, **\$10.00** extra.

Nos. U3Z and U3S: Furnished with side handle, momentary switch, dead handle and 3-conductor cable with ground wire. (All sizes equipped with No. 3 Internal Morse Taper Socket). Feed screw, standard. Spade handle, optional, 1 1/4 in. square hole, chuck optional.

No.	Capacity In.	Free Speed RPM	Wt. Lbs.	D.A. Lgth. In.	Each
EN7	7/8	350	16	16 7/16	\$145 00
EN8	1	300	16	16 7/16	150 00
U3Z	1 1/4	350	49 1/2	19 7/8	250 00
U3S	1 1/4	78	93	27 1/4	*

*Prices on application.

Thor Bench Grinders

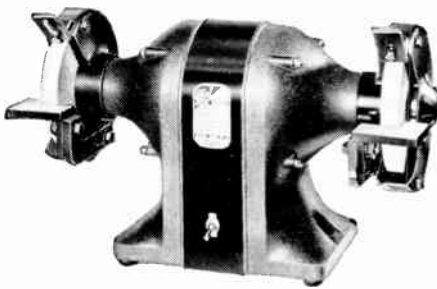

No. 624

Suited for all-round service in grinding, buffing and wire wheel work. All ball-bearings are over size and dust tight, requiring only annual greasing attention. Adjustable tool rests.

Standard Duty

No.	Voltage	Wheel Diam. In.	Wheel Wdth. In.	Bore In.	Low Speed RPM	*Each
B634	115 or 220	6	1/2	1/2	3450	\$60 00

Heavy Duty

B6S	Specify	6	3/4	1/2	3450	70 00
B7S	for 115	7	1	5/8	3450	107 50
B8S	or 220	8	1	5/8	3450	125 00
B10	volt	10	1	3/4	1750	210 00

*Prices for a-c single phase, 60 or 50 cycles. For prices on additional models, contact Graybar.

Thor Impact Wrenches

3/8 and 5/8-Inch



No. EW6

Reversible, all purpose power wrenches. For drilling in wood, steel, stone, tapping, etc., as well as driving and removing screws and nuts.

No kicking or twisting. Motor runs continuously, even when spindle is stopped. Cannot stall or burn out because of overload. Nos. EW6, EN6 have ring reverses; No. 5b has push button reverse in handle.

No.	Nut Running Cap., In.	Free Speed RPM	Spindle Drive Sq. In.	Wt. Lbs.	Each
EW5	3/8	1900	1/2	7	\$94 50
EW6	3/8	2150	1/2	6 7/8	135 00
EW10	5/8	2000	5/8	11 1/2	220 00

Kits—With Carrying Case

No.	Description	Each
EW5KC	Carrying case kit with No. 56 wrench, 6 nut-running sockets.....	\$104 50
EW6KC	With No. EW6 wrench, 6 nut-running sockets.....	150 00
EW10KC	With No. EW10 wrench, 4 nut running sockets.....	238 00

Note: Additional kits available with complete impact accessories.

Thor Electric Drill Stands

Extend the application of Thor electric drills to stationary as well as portable service.

Rigid clamping and proper leverage allows easy application of tremendous pressures and handling of many stationary jobs where the extreme sensitivity of the drill press is not required.

Drill Capacities

No. 8: All drills up to 1/2-in.

No. 26: All drills 1/2 to 1-in.

*No. 30: All drills, 1/2 to 1-in.

No. 16DS: Copper Line, 1/4-in.

No. 32DS: Copper Line, 1/2-in.

*Post type.



No. 26

To obtain correct drill yoke for stand ordered, specify size drill to be used.

No.	Vertical Movement In.	Adjusted Vertically In.	Bench Size In.	Wt. Lbs.	Each
8	3	12	13x8 3/16	30	\$28 00
26	5	14	15x9	50	62 00
30	5	14	†14 1/2	68	70 00
16DS	3	10	10 3/8x10	14 3/4	12 95
32DS	5	14	12 1/4x8 1/16	32	19 95

†Distance: Wall or Post to center of drill.

Thor Screwdrivers and Nut Setters

Class 14
Silver Line



Takes up to No. 14 screw; 5/16-inch nut capacity.

All have pistol grip with momentary trigger switch except U18FL, which is lever handle type; and U18FF, foot switch type. Weight range 1 5/8 to 1 3/4 lbs.

Equipment: One finder and three 1/4-inch hexagon shank screwdriver bits, or one standard length socket wrench shank, 3/8-in. or 1/2-in. square drive and one socket. Reversing switch in all sizes, \$7.50 extra.

No.	Attach. Type	Angle	Speed RPM	Each
U18FL	**Dbl. Slip	Straight	1000	\$120.00
*U18FF	Dbl. Slip	Straight	1000	145.00
U22F	**Dbl. Slip	Straight	500	120.00
U16F	**Dbl. Slip	Straight	750	120.00
U18F	**Dbl. Slip	Straight	1000	120.00
U22F-P	Positive	Straight	500	90.00
U16F-P	Positive	Straight	750	90.00
U18F-P	Positive	Straight	1000	90.00
U19F	Dbl. Slip	Rt. Angle	† 600	160.00
†U19FN	Kickout	Rt. Angle	†† 375	155.00

*Furnished with reversing type foot switch.

**Available with 25° double slip clutch attachment \$15.00 extra.

†Can also be furnished at 400 or 800 rpm at no extra charge.

††Furnished only as a nut setter, 3/8 or 1/2-inch square drive.

‡Can also be furnished at 250 or 500 rpm at no extra charge.

Class 18
Silver Line

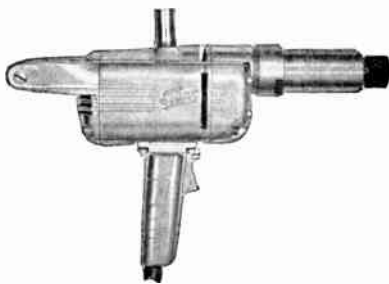

Available with grip handle and momentary switch as illustrated; or with side handle, spade handle and dead handle (similar to Thor 1/2-in. Silver Line Drill). Can be supplied with positive or kickout clutch.

Equipment: One standard 9/16" hexagon socket wrench shank (1/2-in. square drive) and one socket; or one 3/16-in. hexagon shank screwdriver bit and finder assembly. Reversing switch in cord, \$10.00 extra.

No.	Type Clutch	Type Handle	Speed RPM	Each
EJ18	Positive	Side	500	\$105.00
EJ23	Kickout	Grip	500	152.50
EJ12	Positive	Grip	750	105.00
EJ22	Kickout	Grip	750	152.50
EJ27	Kickout	Side	750	152.50

Thor Universal Electric Screwdrivers and Nut Setters

EB Series



Heavy duty, heat treated gearing. One armature used for various speeds. More power, lighter weight than UL Series. Plastic shell commutator, cast aluminum baffle. Streamlined, rugged, cast aluminum case.

Straight attachments Nos. 500 Double slip clutch and 580 Uni-Tork are standard. Equipped with 7 ft. of 3 conductor cable and plug. Bonnet switches will be furnished instead of lever type on request.

No. 8 Screw or Nut Capacity

No.	Type Switch	Speed RPM	Net Wt. Lbs.	Ship. Wt. Lbs.	Length In.	Each
-----	-------------	-----------	--------------	----------------	------------	------

Straight Attachment Angle—Double Slip Type Clutch

EBL-14	Lever	2500	3 3/16	6	12 1/4	\$85.00
--------	-------	------	--------	---	--------	---------

Straight Attachment Angle—Uni-Tork Type Clutch

EBLU-14	Lever	2500	3 3/4	6	13 3/16	\$130.00
---------	-------	------	-------	---	---------	----------

No. 10 Screw or Nut Capacity

Straight Attachment Angle—Double Slip Type Clutch

EBL-14	Lever	2500	3 3/16	6	12 1/4	\$85.00
EBL-13	Lever	1500	3 3/16	6	12 1/4	90.00
EBL-12	Lever	1000	3 3/16	6	12 1/4	90.00
EBL-10	Lever	550	3 3/16	6	12 1/4	90.00

Straight Attachment Angle—Uni-Tork Type Clutch

EBLU-13	Lever	1500	3 3/4	6	13 3/16	\$135.00
EBLU-12	Lever	1000	3 3/4	6	13 3/16	135.00
EBLU-10	Lever	550	3 3/4	6	13 3/16	135.00

Thor Electric Screwdrivers

Class 12—Silver Line



No. ED17

Takes up to No. 12 screw; 1/4-inch nut capacity.

All models have pistol grip and momentary trigger switch with lock for continuous or intermittent operation. Weight range, 3 to 4 1/8 lbs.

Equipment: One finder and one 1/4-in. hexagon shank screwdriver bit, or one standard length socket wrench shank, 1/4, 5/16 or 3/8 in. square drive, and one socket.

Reversing switch in cord, \$7.50 extra.

Straight Type

With Positive Attachment			With Double Slip Attachment		
No.	Speed RPM	Each	No.	Speed RPM	Each
ED17	800	\$70.00	ED12	800	\$85.00
ED16	1100	70.00	ED11	1100	85.00
ED18	500	70.00	ED13	500	85.00

25° Type With Double-Slip Attachment

ED47	800	\$100.00
ED46	1100	100.00
ED48	500	100.00

Right Angle Type

*ED41	880	\$138.50
*ED42	660	138.50
†ED51	880	119.50
†ED52	660	119.50

*Has double slip attachment.

†Has kickout attachment. Equipped as nut setter only.

Thor Electric Saws

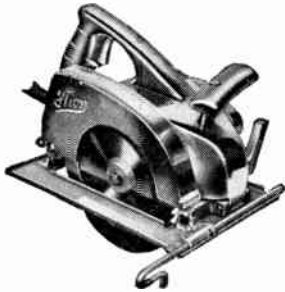

All sizes furnished with one combination blade, 10 feet of 3-conductor cord with 2-prong connectors, wrench and lubricant.

No.	Blade Size In.	Speed RPM	Weight Lbs.	Wood Cutting Capacity, In. Vert. 45°	Each
-----	----------------	-----------	-------------	--------------------------------------	------

Silver Line Saws

T6	6 1/4	5000	13 1/2	2 1/32	1 3/8	\$ 75.00
T7	7 1/4	4500	17 1/4	2 1/2	1 7/8	130.00
T8	8 1/4	4500	18	2 15/16	2 5/32	150.00
T10	10	3000	35	3 5/8	2 5/8	200.00
T12	12	3000	36 1/2	4 7/16	3 1/4	250.00

Speed Saws

450	6 1/2	5400	12	2 1/8	1 21/32	49.95
475	7 1/4	5400	14 1/2	2 7/16	1 3/4	64.95

Saw Blades

Combination

No.	Diam., In.	Each
73863	6 1/4	\$ 2.65
73875	7 1/4	3.00
73881	8 1/4	3.25
73894	10	4.75
73899	12	6.55

Cut-Off

73865	6 1/4	2.65
73876	7 1/4	3.00
73883	8 1/4	3.25
73895	10	4.75
73900	12	6.55

Mitre

73867	6 1/4	4.15
73877	7 1/4	4.75
73885	8	5.95
73896	10	11.20

Metal Cutting

73874	5 7/8	10.10
73888	8	10.50

Rip

No.	Diam., In.	Each
73898	10	\$ 4.75
73901	12	6.55

Flooring

73873	6 1/4	2.65
73878	7 1/4	3.00
73886	8	3.25
73897	10	4.75

Fine Tooth

73869	6 1/4	2.65
73879	7	3.00
73887	8	3.25

Friktion

73871	6 1/4	11.60
73884	8	12.65

†Carbide Tipped

22315	6	9.50
22313	7	11.50
22314	8	11.50

†For abrasive composition materials—cemesto board, transite and other asbestos cement boards and all kinds of wood.

Thor Saber Saw Attachments

For Electric Drills



Converts electric drill to heavy duty Saber Saw. Cuts its own starting hole in wood, plaster or composition. No gears. Few moving parts—pre-lubricated for years of maintenance free service. Can be chucked in 1/4 in. or larger chuck, or threaded on 1/2 in. x 20 or 3/8 in. x 24 spindle.

Weight, 3 lbs. 3 oz.; length 7 1/4 in.; blade offset 1 in.; stroke 1 1/16 in.; driver speed 1000 to 2500 rpm.

No.	Description	Each
567	Saber Saw Attachment	\$45.00

Thor Orbital Speedsanders

With Universal Motors For A-C or D-C



No. 1500: High-speed heavy-duty production sander. Perfect for all automotive feather-edging and all marine work. 3/16 in. orbit.

Full load speed 5000 rpm. Sanding area 4 1/2 x 9 in. Paper size 4 1/2 x 11 in. Equipped with 10 ft. 3 conductor "SJ" cord. Net weight 7 3/4 lbs. Each \$54.50

Thor Utility Air Hammers

Combination Star Drill And Chipping Hammer



A new light-weight air hammer that offers choice of automatic rotation for star drilling, or "stop rotation" for straight non-rotative hammering. Simple external lever control. Weight 14 lbs.; length overall 17 1/4 in.; chuck for shank size 7/8 x 3 1/4 in.; 3/8 in. air inlet for 3/8 in. air hose.

No.	Description	Each
15D	Utility Air Hammer	\$280.00
15DK	Carrying Case Kit, includes hammer, adapters, steel and bits	305.00

Note: Available also for WET operation.

Thor Electric Hammers

Well-balanced, easy to handle. Designed for star drilling, channelling, chipping, cleaning, cutting and numerous other jobs in stone, wood or metal.

Over-capacity motor, housed at right-angle to the barrel, delivers power to "slingshot" drive through heavy duty helical gears.

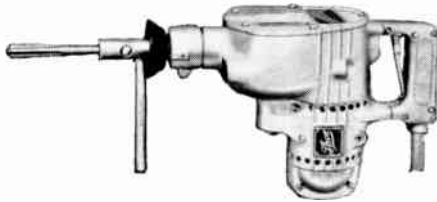

For use in concrete, takes up to 1 1/8 inch star drill. Blows per minute, 1600. Net weight, 14 lbs. Overall length 13 1/2 inches.

Equipment: 1 turning handle; 1 ejector pin; 1 extra rubber slingshot connector; 3-conductor cable with ground wire and plug; momentary grip switch with lock; carrying case; dust shield.

No. U100 Each **\$155.00**

Star Drills



Recommended for use with Thor Electric Hammer.

Point Size Inch	5-In. Drilling Depth		Taper Shank 9-In. Drilling Depth		12-In. Drilling Depth	
	No.	Each	No.	Each	No.	Each
1/4	70336	\$1.30
5/16	70337	1.30	70445	\$1.80
3/8	70338	1.30	70345	1.80	70446	\$2.00
7/16	70339	1.30	78645	1.80	70353	2.00
1/2	70340	1.30	70346	1.80	70354	2.00
9/16	70447	1.30	70347	1.80
5/8	70341	1.30	70348	1.80	70355	2.00
11/16	70349	2.05
3/4	70342	1.60	70350	2.05	70356	2.25
7/8	70343	1.70	70351	2.30	70357	2.35
1	70344	1.85	70352	2.40	70358	2.60
1 1/8	74842	2.85	74843	3.20	74844	3.45

Drilling depths of 18 to 24 inches also available.

Quantity discounts on all sizes upon application to Graybar.

Thor Electric Polishers

7-In.—Silver Line

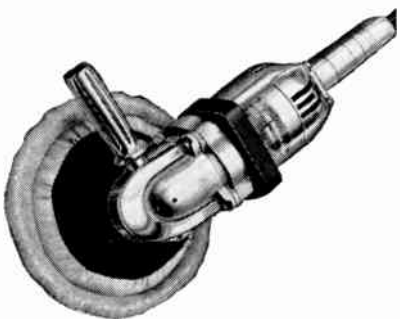

Compact, powerful design.

Light-weight for ease of handling.

Equipped with 7-inch flexible rubber pad, 7-inch felt cushion pad, lambs wool polishing bonnet.

No. EL92, Standard duty.

No. EN92, Heavy duty.

No.	Free Speed RPM	Weight Pounds	Overall Length, In.	Each
EL92	1400	9	14 1/4	\$80.00
EN92	1400	15 1/4	17 3/4	95.00

Thor Sanders and Grinders

Silver Line—Standard and Heavy Duty

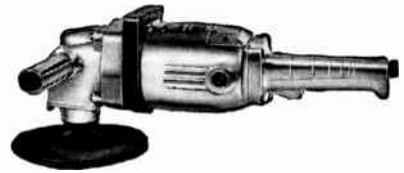

Sanders: Available in 7-in. and 9-in. sizes. Designed for every abrasive application. Furnished with flexible rubber pad and box of three assorted abrasive discs.

Grinder: Right-angle, heavy duty 6-in. cup wheel capacity. Equipped with wheel guard and 6-in. cup wheel. Speed, 4,000 rpm; overall length, 17-in.

Silver Line Sanders

No.	Std. Duty 7-Inch	Heavy Duty	
	*EL82	7-Inch EN82	9-Inch EN87
Free Speed, rpm	4500	4500	4500
Weight, lbs.	8 1/2	14 1/4	14 1/4
Overall Length, inches	13 1/2	17	17
Each	\$78.00	\$88.00	\$90.00

Right-Angle Grinder

No. EN72 Each **\$95.00**

*Can be equipped with 4 in. cup wheel and guard. Specify No. EL72 Each **\$85.00**

Straight Portable Grinders

Silver Line—Heavy Duty



Shock absorber spindle prevents vibration from reaching the motor.

Shaped grips on the spindle housing and straight end handle prevent tool turning in operator's hand. Furnished with adjustable wheel guard, straight horizontal handle with trigger type switch, 3-conductor cable, ground wire and plug. Wheel included.

No.	Wheel Size In.	Free Speed RPM	Weight Pounds	Overall Length, In.	Each
EL60	4	6000	10	18 3/4	\$ 90.00
EL62	5	4500	10 1/4	18 3/4	95.00
EN62	6	4000	15 1/4	23 3/4	110.00

Call Graybar FIRST For . . .

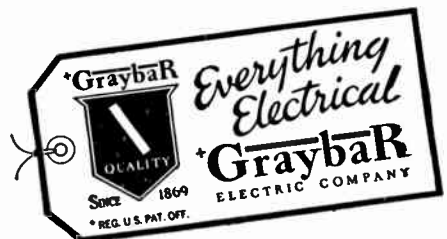

Lyon Steel Equipment

**Shop Desks
Standing Type**



No. 2250

Smooth working surface. Sloping top 43 inches high at front. Drawer, 24 x 28 x 3½-inches, has nylon glides, rolled handle, built-in lock. Two hooks on right side. Adjustable bottom shelf. Lyon Green baked-on enamel finish. 34½" wide, 30" deep, 53" high. Shipping weight, 117 pounds.

No. 2254

Portable type, same as No. 2250 except with swivel casters. Front casters have foot controlled locking lever. Shipping weight, 107 pounds.

Cabinet Type

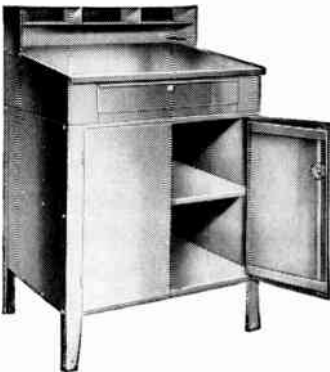

No. 2251

Top and drawer same as No. 2250. Cabinet 32-inches wide, 28-inches deep. Doors have cadmium plated handle, grooved key lock, three point locking device. Interior shelf adjustable. Lyon Green baked-on enamel finish.

34½" wide, 30" deep, 53" high. Shipping weight, 184 pounds.

No. 2251.

Steel Cabinets

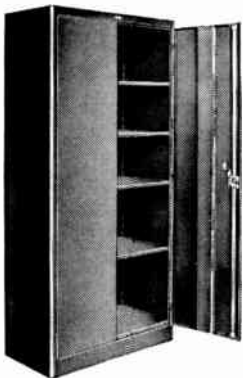

No. 1000

Modern styling includes rounded front corners. Three point locking device, polished chrome handles and built-in locks. Double doors swing open a full 180 degrees. Four shelves adjustable every 2 inches without tools. Extra shelves may be added. Shelf reinforcements available for heavy storage. Lyon Gray baked-on enamel finish.

No.	W. D. H. Inches	Ship. Weight
1000	36x21x78	168**
1001	36x21x78	155*
1050	Extra Shelf	9
1070	Shelf Reinforcement	4.3

**Shipped set up.
*Shipped knocked down.

Parts Cases



No. 2385

Used on benches, shelves and counters for small parts. Stops prevent drawers from being pulled out and spilled.

Combination pull and label holder on each drawer. Lyon Green baked-on enamel finish.

3-Drawer

No. 2385, 27 adjustable compartments. 11¼" wide, 11⅞" deep, 7¾" high. Shipping weight, 16 pounds.

Stools

Made in 5 heights and 80 models. If the stool you want is not listed below contact Graybar for complete listing.



No. 1912



No. 1715

14-inch square seat with rounded corners. All welded non-breakable construction. Lyon Green baked-on enamel finish.

Pressed Wood Seat—With Back

Ht., In.	Steel Feet	Rubber Feet	Product No.		Casters
			Rubber Feet Steel Glide	Rubber Feet Steel Glide	
18	1712	1713	1714	1715	1715
22	1762	1763	1764	1765	1765
24	1812	1813	1814	1815	1815
26	1862	1863	1864	1865	1865
30	1912	1913	1914	1915	1915

Pressed Wood Seat—No Back

18	1708	1709	1710	1711
22	1758	1759	1760	1761
24	1808	1809	1810	1811
26	1858	1859	1860	1861
30	1908	1909	1910	1911

Drawer Cases



18 Drawer Unit

Used on counters, shelves or in Lyon No. 1000 series cabinets, for storing small parts. Each drawer operates in its own individual compartment. Lyon Green baked-on enamel finish. Extra drawer dividers available.

12 Drawer Unit

No. 2360, 34¼" wide, 17" deep, 10⅝" high. Shipping weight, 84 pounds.

18 Drawer Unit

No. 2362, 34¼" wide, 11" deep, 10⅝" high. Shipping weight, 54 pounds.

No. 2363, 34¼" wide, 17" deep, 10⅝" high. Shipping weight, 73 pounds.

24 Drawer Unit

No. 2365, 34¼" wide, 11" deep, 10⅝" high. Shipping weight, 60 pounds.

No. 2366, 34¼" wide, 17" deep, 10⅝" high. Shipping weight, 83 pounds.

Lyon Steel Equipment

Flat Drawer Files



For flat storage of drawings, tracings, blueprints, maps, charts, large papers, photographs, glass slides, etc. Hinged paper-weight on front and protecting hood on back of drawer prevents edges of paper from curling.

Each cabinet has five drawers. May be stacked to any desired height. Closed base 6-in. high. Lyon Grey baked-on enamel finished.

No.	Description	Sh. Wt.
1210	40" x 27 3/4" x 17 1/8"	191
1213	Closed Base	23
1220	11" x 33 3/4" x 17 1/8"	228
1223	Closed Base	36
1230	52 3/4" x 40 1/4" x 17 1/8"	333
1233	Closed Base	34

Steel Top Work Benches

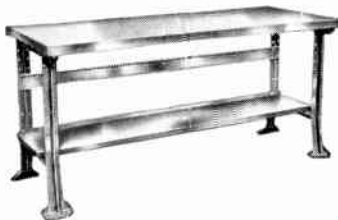

No. 2524 With Shelf

Suitable for every type of heavy duty bench work. Lyon Green baked-on enamel finish. All benches are 34-inches high.

Length	Depth	With Stringer		With Shelf	
		No.	Ship. Wt.	No.	Ship. Wt.
60	28	2502	112	2522	136
60	34	2503	121	2523	148
72	28	2504	132	2524	152
72	34	2505	144	2525	172

Bench Legs



No. 2750

For wood or steel top benches. Riveted and welded construction. Flared feet for maximum stability. Double thickness uprights. Lyon Green baked-on enamel finish. 32 1/4-inches high.

No.	Depth	Ship. Wt.
2750	28"	16.8
2755	34"	18.7

Additional printed information on these and other products NOT LISTED is available on request to Graybar.

Cabinet Benches

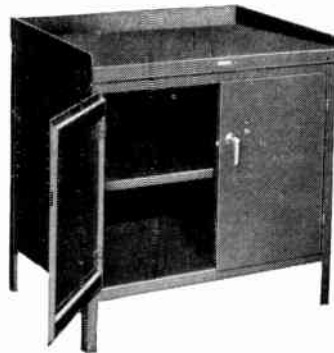

No. 3000

Heavy steel top makes sturdy mounting for small grinders, vises, and office machines. 12 square feet of storage space. Double swinging doors, 3-point locking device. Adjustable center shelf. Lyon Green baked-on enamel finish. End stops detachable. 36-inches wide, 24-inches deep, 34-inches high (plus 3-inch backstop). Shipping weight, 125 pounds.

Tool Stand Cabinets

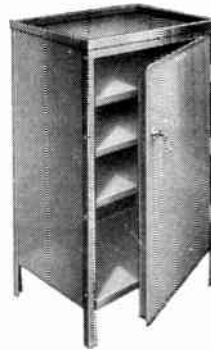

No. 3010

Furnishes small working surface and space to lock up blueprints, valuable tools, precision instruments, etc. 3 shelves adjustable every 2 inches. Top reverses to give flat working surface. Lyon Green baked-on enamel finish. 21 1/4-inches wide, 15 1/4-inches deep.

No. 3010, 34 inches high.

Shipping weight, 55 pounds.

Tools Stands



No. 3107

With drawer, and top, bottom and center trays. Lyon Green baked-on enamel finish. 37 3/4 inches high. (With glide feed 34-inches.)

No. 3107, 20 x 28 inches. Shipping weight, 80 pounds.

No. 3105, w/o drawer. Shipping weight, 64 pounds.

No. 3127, 24 x 36 inches. Shipping weight, 106 pounds.

No. 3125, w/o drawer. Shipping weight, 88 pounds.

Tool Toters



No. 3160

Used in machine shops, assembly lines, garages, laboratories, etc. Riveted construction. 2 built-in drawers, 15 inches wide, 23 inches deep, 4 5/8 inches deep. Padlock hasp on cross piece locks both drawers at one time. Toter is 18 inches wide, 24 inches deep, 34 1/2 inches high. Lyon Green baked-on enamel finish.

Shipping weight, 71 pounds.

Lyon Steel Equipment

Service Carts



No. 3030

For use as an assembly line feeder, or in stock rooms, shipping and receiving departments, etc. Casters are stationary in front and swivel in the back. Steel push bar. Pan type trays are 3 inches deep. Lyon Green baked-on enamel finish. Available in two sizes.

No. 3030—30" long, 16" wide, 32" high. Shipping weight, 47 pounds.

No. 3033—36" long, 24" wide, 32" high. Shipping weight 66.7 pounds.

Shop Boxes

Style "R"

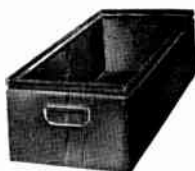

No. 3611

For handling and storing medium loads. 16-gage three-piece construction. Reinforced corners. Drop handles. 10 inches wide, 20 inches deep, 8 inches high. Shipping weight, 13.6 pounds.

No.	Description
3610	No Finish
2611	Lyon Green

Style "RB"



No. 3621

May be used for regular bin type storage. Hopper end permits easy removal of contents from boxes even when stacked. Front top rail rounded for use as handle. Opposite end has drop handle. 16 gage steel. 10 x 20 x 8 inches. Shipping weight, 13.2 pounds.

No.	Description
3620	No Finish
3621	Lyon Green

Style "H"



No. 3601

Exceptional strength for heavy loads and hard usage. Shallow "V" shaped runners. 18 gage steel. No. 3600 no finish. No. 3601 Lyon Green.

No.	W. L. H. Inches	Ship. WT. Lbs.
3600	12 x 18 x 6	12.6
3601	12 x 18 x 6	12.6

Style "L"



No. 3633

Pans not in use nest compactly. Made from a single sheet of 18 gage folded steel. Four thicknesses where hem overlaps corner braces.

No. 3632, no finish.
No. 3633, Lyon Green.

3632	11 x 22 x 6	9.3
3633	11 x 22 x 6	9.3

Bar, Pipe and Rod Units



No. 3710 Double Face



Horizontal Type

Horizontal arms permit loading or removal of long pieces without requiring wide aisles normally needed. Arms are adjustable every 1½ inches with spacing as close as 7½ inches to accommodate varying quantities. Lyon Green baked-on enamel finish.

Single Face

No.	W. L. H. Inches	Ship. WT. Lbs.
3700	36x21 7/8x79 1/4	98
3701	Rack End	77

Double Face

3710	36x33 3/4x79 1/4	128
3711	Rack End	107

IMPORTANT: When ordering one section be sure to order one rack and one rack end. When sections are to be used in a continuous rack, order the correct number of sections—plus one rack end. Only one rack end is required to end a continuous run of racks.

Accessories

Extra arms, shelves, and separator pegs are available to meet your special applications. Write Graybar for complete information.

Clothing Lockers

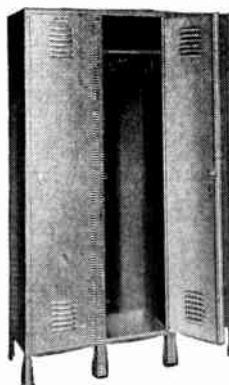

All types and sizes are available. Write or phone your nearest Graybar office for complete information.

Additional printed information on these and other products NOT LISTED is available on request to Graybar.

Lyon Steel Equipment

Steel Shelving

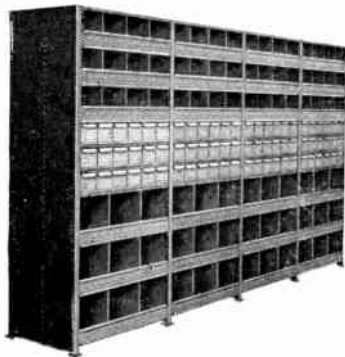

Bin Type



Open Type

Bin Type

Bin type shelving with shelf boxes will store a wide variety of bulk parts in bins and small parts in drawers.

All sections are 3 feet wide, 1, 1½ or 2 feet deep, and 7 feet high.

A continuous rack may be assembled from as many sections as required. Shelf and bin spacing can be assembled to meet your particular requirements. Write your nearest Graybar office for complete information.

Open Type

Generally used for storage of packages, cartons, stationery, bulky items and long parts.

All types of open or closed shelving to meet your particular requirements can be furnished.

Write your nearest Graybar office for complete information and prices.

Bin Units

All bin sections are 36 inches wide, 12 inches deep, 78 inches high.



No. 3830



No. 3815

No. 3830, one bin 36 inches wide, 12 inches deep, 7½ inches high. 90 shelf boxes, 5¾ inches wide, 11¼ inches deep, 3⅞ inches high with 3 adjustable dividers each. Shipping weight, 380 pounds.

No. 3815, 66 bins 6 inches wide, 12 inches deep, 6 inches high. 6 bins 6 inches wide, 12 inches deep, 9 inches high. Shipping weight, 181 pounds.

Quickly and easily erected or adjusted with Lyon's patented shelfclip and stud—no nuts, bolts or tools required.

Bin Units

All bin sections are 36 inches wide, 12 inches deep, 78 inches high.



No. 3805

No. 3805, 11 bins 36 inches wide, 12 inches deep, 6 inches high. 1 bin 36 inches wide, 12 inches deep, 9 inches high. Shipping weight, 140 pounds.



No. 3810

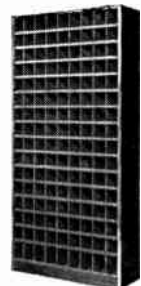

No. 3820

No. 3810, 28 bins 9 inches wide, 12 inches deep, 9 inches high. 4 bins 9 inches wide, 12 inches deep, 12 inches high. Shipping weight, 145 pounds.

No. 3820, 126 bins 4 inches wide, 12 inches deep, 4½ inches high. 18 bins 4 inches wide, 12 inches deep, 6 inches high. Shipping weight, 237 pounds.

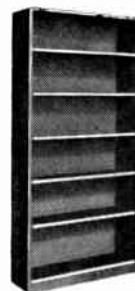

No. 3800

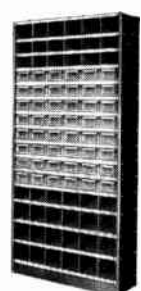

No. 3825

No. 3800, 5 bins 36 inches wide, 12 inches deep, 12 inches high. 1 bin 36 inches wide, 12 inches deep, 15 inches high. Shipping weight, 105 pounds.

No. 3825, 12 bins 6 inches wide, 12 inches deep, 4½ inches high. 30 bins 6 inches wide, 12 inches deep, 6 inches high. 48 shelf boxes 5¾ inches wide, 11¼ inches deep, 3⅞ inches high with 3 adjustable dividers each. Shipping weight, 304 pounds.

Allen Steel Shelving

Combine These Parts to Meet Your Specific Storage Needs



Above illustration is a "composite" assembly of standard shelving parts, to show many possible applications.

- No. 1—POST—Has adjustment holes punched on 1-in. centers. Four per unit.
- No. 2—LEDGE POST—Same as full-height posts, with notch where bottom rests on ledge. Two per unit.
- No. 3—PARTITION—Used on ends. One furnished between each two units in a rack.
- No. 4—BACK—One used on single units, or in between back-to-back units.
- No. 5—SHELF—All sides channel-formed for extra strength and safety. Reinforcements available. May be spaced with openings as little as 3/4-in. apart.
- No. 6—CORNICE TOP—Used at top of full or counter height shelving. Extra heavy gauge.
- No. 7—LEDGE SHELF—Used on ledge units or as top of counter-high unit.
- No. 8—BASE PLATE—Used to fill space between bottom shelf and floor.
- No. 9—DIVIDER—Can be bolted anywhere on shelf. Adjustable right or left on 1-in. centers. Beaded at front and back.
- No. 10—DOUBLE-BEADED BIN FRONT and Label Holder Combined—For use on first opening above a ledge, or any shelf, if desired.
- No. 11—LABEL HOLDER—Continuous type 1-in. high, bolted to shelf. 5-in. by 1-in. snap-on type available.
- No. 12—SWAY BRACES—Used on sides and backs of open type units.
- No. 13—LEDGE OR SHELF SUPPORT ANGLE—Used under sides of ledge shelves, and to reinforce regular shelves.
- No. 14—CORNER COVER PLATE—Covers adjustment holes on exterior of post. Intermediate and side cover plates also available.
- No. 15—DOOR—Has 3-point latch, malleable iron handle and flat key lock (optional).
- No. 16—FLOOR SHOE—Single type, for corner posts. Double type used between units. Protects floor.
- No. 17—ANGLE SWAY BRACE—Used when back or side sway braces are omitted to permit access to shelves.
- No. 18—FLUSH BAR—Used to keep books or packages from getting behind posts.



Open Type

Consists of posts, shelves (any number) and sway braces. Two units are shown, bolted side by side. Each is self-supporting, having four posts. When used as separate units only extra side braces are needed. Any number of units can be bolted together to form a continuous rack.

Dimensions				Each
Width	Depth	Height		
36-in.	18-in.	6 ft. 3-in.		\$28. 04

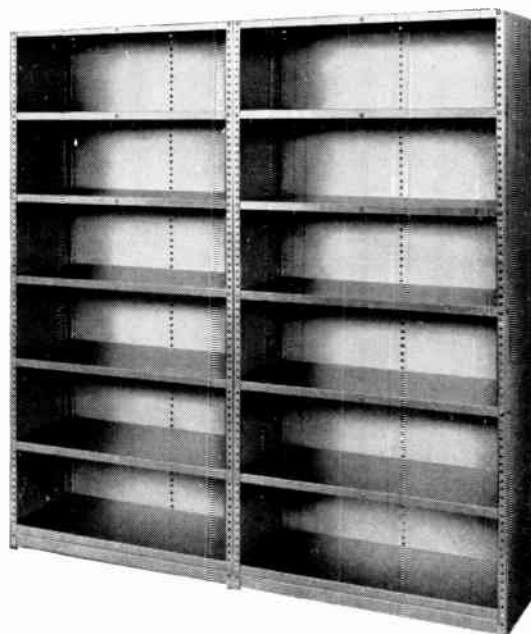

Closed Type

Consists of posts, shelves (any number), backs, partitions and bases. Two units are shown, bolted side by side. Each unit is self-supporting. Any number can be bolted together to form a continuous rack with partitions between units.

Dimensions				Each
Width	Depth	Height		
36-in.	18-in.	6 ft. 3-in.		\$37. 02

Allen Storage Racks



Storage racks transform square feet into cubic feet. Inventories more accessible; service to customers faster. Allen is equipped to make storage racks, pallet racks and stacking racks of all sizes and types; of angle, channel, plate, tubing and bar. Decks of wood, steel or skeleton construction. Available in 17 sizes and capacities of platforms; 13 sizes of Legs.



Allen Stacking Racks

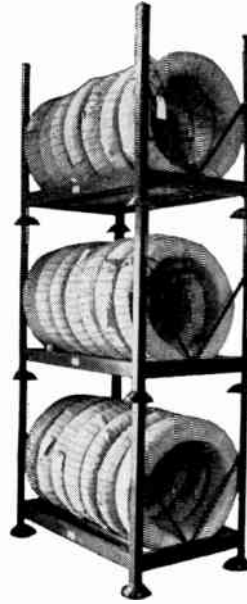

Constructed of ruggedly welded 3-in. channel; 2-in. x 2-in. angle. Has formed cup feet and sturdy tube supports.

Stack or store reels, coils, or messenger strands up to 36-in. in diameter, and weighing up to 2,000 pounds. Racks can be stacked two or three high.

Finished in Green enamel.

Other sizes to order.

No.	Dimensions, In.		Each
	Width	Lgth. Ht.	
STKR-3052	30	52 41½	\$39.50

Allen Conduit Racks

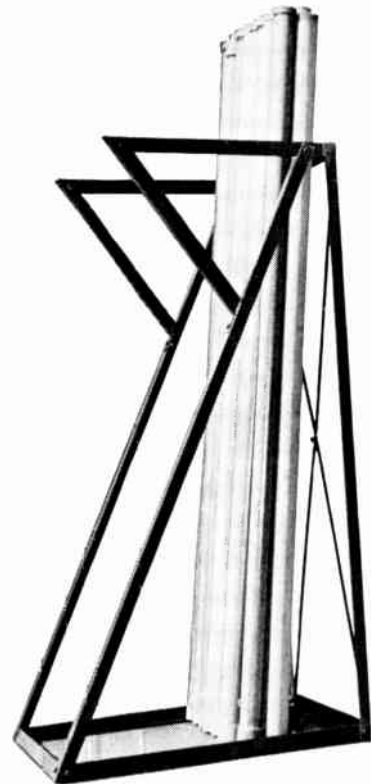

Constructed of heavy steel plate. Uprights: 2-in. x 2-in. x ¼-in. steel angles. Back Brace: 1¼-in. x ¼-in. flat bar. Base back stop: 2½-in. x 1½-in. x ⅜-in. steel angle. Base and U-frame welded. Uprights and back braces bolted. Has Green enamel finish.

Provides 9 square feet of storage space.

Width, In. at Base	Depth, In. at Base	Height, Ft.	Depth, In. at Top	Each
36	48	8	36	\$73.00

Allen Elevating Scaffold

Portable and Adjustable



Place 8-ft. long fixtures, pipe, bus duct at ceiling height with a one man crew instead of three. Lifts material weighing up to 1,000 lbs. with one operator. Folds flat for passing through narrow doors. All welded tubular frame. Capacity 13 fixtures, 8 ft. long. Shipped knocked down. Patent Pending.

Maximum Lifting height 14'. Accessories available for 30-4 ft. fixtures and higher ceilings. Each **\$550.00**

Allen Scissors Tables



Used to support material at proper level for machine and press work; transfer heavy dies; raise or lower heavy loads from one level to another; transport them from place to place.

Ruggedly constructed with 1,000 lb. capacity. Rear wheels are rubber tired or semi-steel; 8-in. diameter with roller bearings. Caster wheels are rubber tired, or semi-steel; 4-in. diameter with ball bearings. Screw is 1-in. diameter, Acme threads with ball thrust bearing. Simple release type Floor Lock; easy acting and firm holding.

Table Top In.	Table Height, In.		Overall Lgth., In.	Unit Width, In.	Wt., Lbs.	Each
	Raised	Lowered				
23½ x 34	42	26	41½	28¼	247	\$180.00

Allen Storage Cabinet

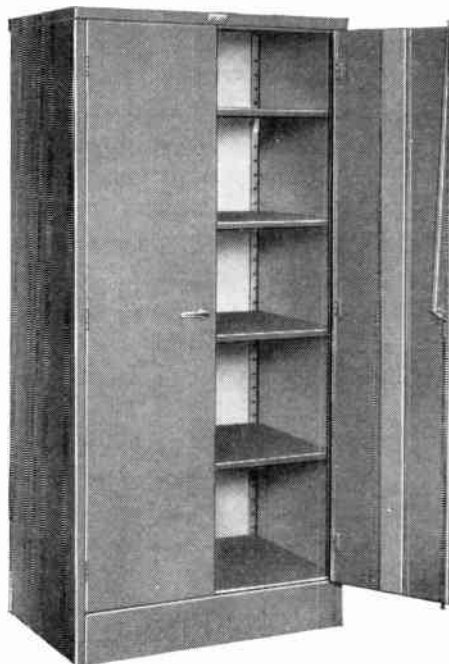

Double Door

A dustproof, space-saving "stockroom" that safely stores office supplies, materials, fine tools, dies and instruments.

Constructed of heavy gauge, first grade furniture steel, and has four shelves, each adjustable in 2-in. multiples without tools.

Equipped with three-point "security" latching and chrome door handles, with built-in grooved key lock and two keys.

Shelves may be removed and adjusted to accommodate any desired shelf spacing. Extra shelves (with adjustment clips) may be ordered at small additional cost.

Unless otherwise specified, cabinets are shipped completely assembled, one to a carton.

No.	Dimensions, In.			Each
	Width	Depth	Height	
5141	36	18	78	\$84.00
5142	36	24	78	92.50

Call Graybar FIRST For . . .

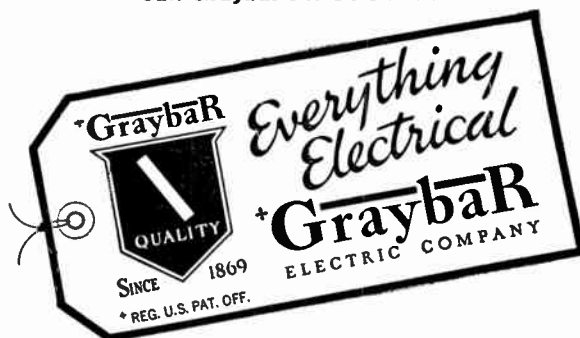

Allen Lockers

The benefits of a private locker are fully realized with the single tier type preferred by workers and students because clothes hang full length without crowding or mussing.

Lockers 18-in. or more in depth are equipped with a coat rod for the use of clothes hangers. Lockers less in depth have

double prong ceiling hooks, in addition to standard back and side hooks.

Silent automatic prelocking is featured which locks door automatically or by key. Equipped with number plates.

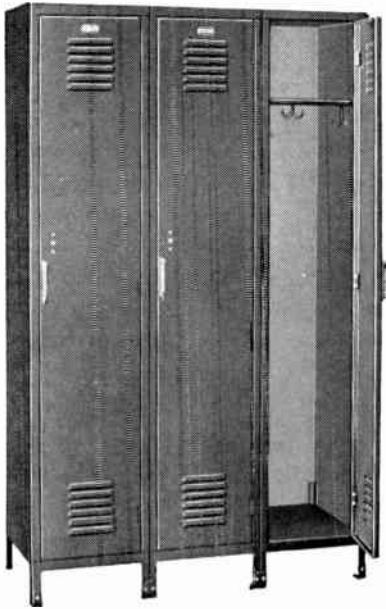

Type 50

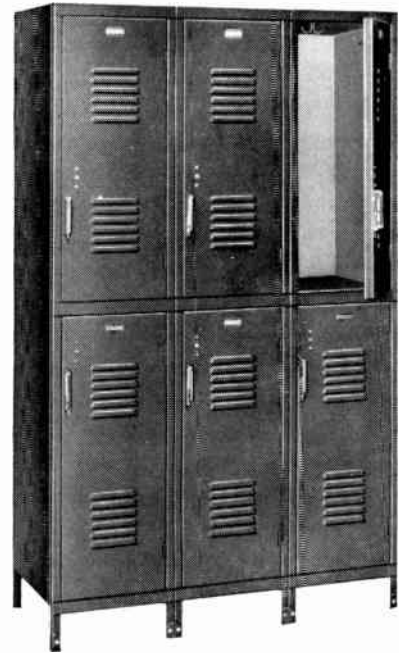

Type 50 Double Tier

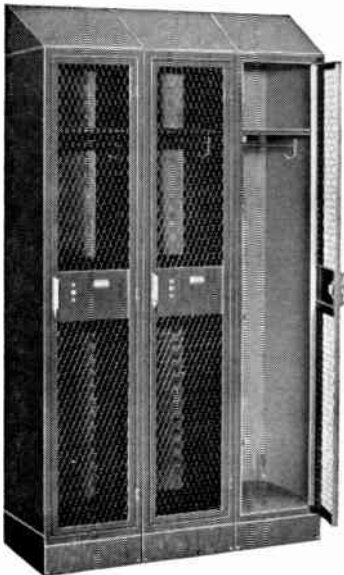

Type 50-P Air-Lite

Standard Sizes—Type 50 Lockers

Width, In.	Depth, In.	Trade Height, In.
12 (single door)	12 (ceiling hook)	60 or 72
12 (single door)	15 (ceiling hook)	60 or 72
12 (single door)	18 (coat rod)	60 or 72
15 (single door)	15 (ceiling hook)	60 or 72
15 (single door)	18 (coat rod)	60 or 72
18 (single door)	18 (coat rod)	60 or 72
18 (single door)	21 (coat rod)	72
24 (double doors)	21 (coat rod)	72
24 (double doors)	24 (coat rod)	72

*For overall outside height with legs, add 6-in. Add 1 1/16-in. for lockers without legs. Slope tops increase height by half of locker depth.

Unique Gasoline and Kerosene Blow Torches

Designed especially for those requiring large volume of flame and extra heat and for heavy duty hard service under severe weather conditions.

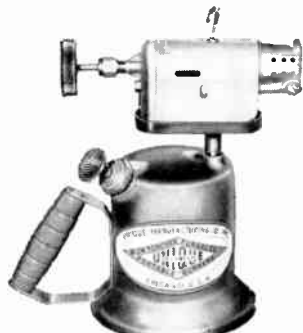

No. 3L



No. 7

Steel tank, copper brazed throughout. Filled through bottom funnel filler. Flame 1½ x 12-in. 2000° F. can be regulated to small jet. Replaceable needle and orifice block. Removable channel plugs for cleaning. Powerful dependable pump.

No.	For	Tank Capacity, Quarts	Wt. Ea. Lbs.	Each
3-L	Gasoline	1	4½	\$19.25
3-K	Kerosene	1	4½	21.00
7	Gasoline	2	5½	29.00
7-K	Kerosene	2	5½	30.50

Unique Gasoline Blow Torches



A safe, compact torch for many practical uses. Fine for use in close quarters and for sweating joints on small size copper tubing.

Flame 1 x 6-in., 1900° F., can be regulated to a fine-pointed jet. Closing valve forces needle through orifice, keeping it clean and full size. Replaceable needle and orifice block. Removable channel plugs for cleaning.

Flat steel tank, welded construction, with brazed fittings, 2¾-in. thick, 5-in. diameter. Top filler

opening. Attractively finished in red. Powerful, dependable pump. Complete with generator windshield.

Capacity 1 pint.

No. 0—Weight each 3 lbs. Each \$12.52



A high-grade torch for the electrician, plumber, tinsmith, mechanic and maintenance man.

Steel tank, copper brazed throughout. Filled through bottom funnel filler. Flame 1 x 6-in. 1900° F. can be regulated to small jet.

Closing the valve forces slender needle through orifice, keeping it clean and full size. Replaceable needle and orifice block. Removable channel plugs for cleaning. Powerful dependable pump. Attractively finished in red.

No. 1—Capacity 1 qt.; Wt. each 3¾ lbs. Each \$12.52

Unique Solder Melting Furnaces

These heavy duty furnaces are for use by utilities, municipalities, railroad, telephone and heavy industries, plumbers and others for melting solder, paraffin and compounds.

Their powerful blast melts 50 lbs. of solder in approximately 10 minutes. Built to withstand the abuse of splicing service.

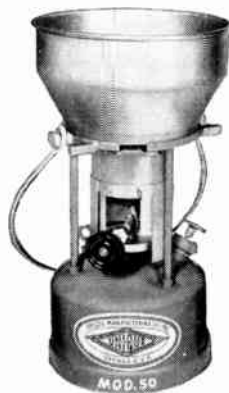

For Gasoline

Generator—Finest nonscalable bronze alloy casting, fitted with replaceable orifice block. Easily cleaned throughout by removing plugs from straight lined channel.

Produces a clean flame 1½x12-in., of 2000° F.

Tank—Heavy steel, with broad base. Copper brazed throughout.

Windproof—requires no additional protection. When revolving shield is open the generator is in full view for priming and attention.

Top-Plate—Rugged, with ample lug support for large pots and kettles. The handle locks to support solder irons.

Hood—Style "A" open top hood is standard and is usually furnished. Style "B" soldering iron hood accommodates iron up to 12 lbs. per pair, and can be substituted; heating time 4 minutes.

Tank capacity 1 gallon. Size of furnace 8 x 13-in. No. 50—Weight each 15 lbs. Each \$34.30



For Kerosene

A kerosene furnace is just the thing if unleaded gasoline cannot be secured. It starts in 4 minutes and is just as efficient in every way as a gasoline furnace.

Generator is the figure-8 type that burns kerosene without carbon formation, produces a clean flame of 2000° F. Regulating the flame volume valve for full or reduced flame automatically passes the scraper blades under orifice, clearing it of foreign particles.

Tank—Heavy steel, copper brazed throughout, with powerful, dependable pump.

Hood—Style "A" open top hood is standard and is usually furnished. Style "B" soldering iron hood accommodates irons up to 12 lbs. per pair and can be substituted; heating time 4 minutes.

Tank capacity 1 gallon. Size of furnace 8 x 13-in. No. 55—Weight each 13 lbs. Each \$30.95

Unique Safety Folding Shields

For Furnaces and Fire Pots

For protecting workers and the public from flame and hot materials. Shields furnace from wind and affords a storage space for pot, ladle and small tools.

Made of galvanized iron, completely rust-proof. Panel edges rolled around ¼-in. rod—no sharp corners. Folds flat for carrying and storing.



No.	Description	Each
50-C	Three-Panel Type; Wt. each 15 lbs.	\$10.30
50	Four-Panel Type; with welded steel grate and supporting brackets; broad supports for large pots and kettles; Wt. each 27 lbs.	22.00

No. 50

Klein Pliers

Side Cutting Pliers

No.	Size, In.	Each
201-5	5 ³ / ₁₆	\$3.75
201-6	6 ¹ / ₄	4.15
201-7	7 ³ / ₁₆	4.60
201-8	8 ¹ / ₂	5.20
201-9	9 ¹ / ₄	5.85

With Sleeve Joint Twister

No.	Size, In.	Each
212-6	6 ¹ / ₄	\$4.40
212-7	7 ³ / ₁₆	4.85
212-8	8 ¹ / ₂	5.50

N. E. Type (Streamlined)

No.	Size, In.	Each
201-5NE	5 ³ / ₁₆	\$3.75
201-6NE	6 ¹ / ₄	4.15
201-7NE	7 ³ / ₁₆	4.60
201-8NE	8 ¹ / ₂	5.20
201-9NE	9 ¹ / ₄	5.85

N. E. Type With Sleeve Joint Twister

No.	Size, In.	Each
212-6NE	6 ¹ / ₄	\$4.40
212-7NE	7 ³ / ₁₆	4.85
212-8NE	8 ¹ / ₂	5.50

High Leverage Pliers

No.	Size, In.	Each
213-9	9 ¹ / ₄	\$6.60

N. E. Type (Streamlined)

No.	Size, In.	Each
213-9NE	9 ¹ / ₄	\$6.60

A C S R Cutter

No.	Size, In.	Each
055	8 ⁵ / ₈	\$10.50
055-K	Extra knives	Per Pr. \$2.00

End Cutting Pliers

No.	Size, In.	Each
232-5 ¹ / ₂	5 ¹ / ₂	\$4.40
232-7	7 ¹ / ₂	5.00

Transverse End Cutting Pliers

No.	Size, In.	Each
204-6	6 ¹ / ₄	\$3.80

Oblique Cutting Pliers

No.	Size, In.	Each
202-5	5 ¹ / ₂	\$3.40
202-6	6 ¹ / ₁₆	3.45

No.	Size, In.	Each
245-5	5	\$3.40

Bell System Type

With "W" stripping notches, sleeve openings and .052-in. skinning hole.

No.	Size, In.	Each
202-5SW	5 ¹ / ₂	\$4.10
252-6SW	6	4.20

With "W" Stripping Notches

No.	Size, In.	Each
245-5W	5	\$3.70

With .052-In. Skinning Hole

Equipped with sleeve openings.

No.	Size, In.	Each
240-5S	5 ¹ / ₂	\$3.65

With .052-In. Skinning Hole

No.	Size, In.	Each
240-5	5 ¹ / ₂	\$3.60
240-6	6 ¹ / ₁₆	3.65

Heavy Duty Pattern, "Handform" Handles

No.	Size, In.	Each
220-7	7 ¹ / ₁₆	\$4.25

Short nose heavy duty pattern with "Handform" handles.

No.	Size, In.	Each
220-7SN	7 ¹ / ₄	\$4.25

Klein Pliers

Needle Nose Pliers



Side cutting knives on 203-6SCP.

No.	Size, In.	Each
301-6SCP	6 ⁵ / ₈	\$3.75
203-6SCP	6 ⁵ / ₈	4.40

Slim Long Nose Pliers



No.	Size, In.	Each
307-5 ¹ / ₂	5 ¹³ / ₁₆	\$3.30

Duck Bill Pliers



No.	Size, In.	Each
306-5 ¹ / ₂	5 ¹³ / ₁₆	\$3.85

Long Nose Side Cutting Pliers



Similar in design to 203 but has two notches to strip insulated wire gage 19 and 22.

No.	Size, In.	Each
203-6112	6 ⁵ / ₈	\$4.85

Long Nose Pliers



No.	Size, In.	Each
301-5	5 ⁹ / ₁₆	\$2.95
301-6	6 ⁵ / ₈	3.00
301-7	7 ¹ / ₈	3.25

Long Nose Side Cutting Pliers



No.	Size, In.	Each
203-5	5 ⁹ / ₁₆	\$3.55
203-6	6 ⁵ / ₈	3.60
203-7	7 ¹ / ₈	3.80

Long Nose Cutting Pliers



Has skinning hole for No. 12 B & S insulated wire.

No.	Size, In.	Each
203-8	8 ⁵ / ₁₆	\$4.70
203-8N	8 ⁵ / ₁₆	4.95

Long Needle Nose Pliers



Similar to 301 Series but with point only ¹/₁₆-in. diam.

No.	Size, In.	Each
303-6	6 ⁵ / ₈	\$3.00

Chain Nose Pliers



Has side cutting knives on 217-6.

No.	Size, In.	Each
317-6	6	\$3.00
217-6	6	3.60



No.	Size, In.	Each
317-5	5 ¹ / ₄	\$3.40

Long Flat Nose Pliers



Normally supplied with inside jaws knurled. May be had with jaws smooth on special order.

No.	Size, In.	Each
305-6	6 ¹ / ₂	\$3.10
206-6*	6 ¹ / ₂	3.70

*With side cutting knives.

Long Nose Duck Bill Pliers



Jaws are smooth on inside. Side cutting knives on 205-6.

No.	Size, In.	Each
304-6	6 ¹ / ₂	\$3.10
205-6	6 ¹ / ₂	3.70

Long Flat Nose Spring Adjusting Pliers



Hollow ground on the outside of jaws to reach between and grasp springs easily. Inside jaws are smooth.

No.	Size, In.	Each
311-5 ¹ / ₂	5 ¹⁵ / ₁₆	\$3.70

Heat Coil Pliers



Nose is shaped to fit heat coils. Also helpful in holding cylindrical objects.

No.	Size, In.	Each
313-6	6	\$3.60

Curved Nose Pliers



No.	Size, In.	Each
302-6	6 ¹ / ₄	\$3.80

Long Nose Sleeve Pliers

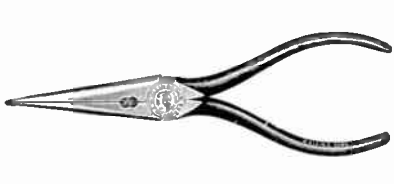

Bell system type. Identical with 301-6 but with sleeve opening for twisting No. 17 N. B. S. and smaller copper sleeves.

No.	Size, In.	Each
316-s	6 ⁵ / ₈	\$3.40

Klein Pliers Available With Coil Spring

Pliers listed here may be had with plated coil spring to hold jaws in open position. Sturdy spring is guaranteed for the life of the plier. Inside of handle is left free of any obstruction.



No. 203-6C

Long Nose Pliers

All pliers listed have 1/16-in. point.

No.	Each	No.	Each
301-5C	\$3.25	317-5C	\$3.70
301-6C	3.30	306-5 1/2 C	4.15
301-7C	3.55	204-6C	4.10
301-6PC	4.40	203-5C	3.85
301-6SCPC	4.05	203-6C	3.90
203-6SCPC	4.70	203-7C	4.10
307-5 1/2 C	3.60		

Oblique Cutting Pliers

No.	Each	No.	Each
210-5C	\$3.90	202-5C	3.70
210-6C	4.00	202-6C	3.75
209-5C	4.00	245-5C	3.70

Klein Oblique Cutting Pliers



Lightweight, Pointed Nose

No.	Size, In.	Each
209-5	5	\$3.70



For cutting small wire or trimming plastic. No bevel on knives so they cut flush against the surface.

No.	Size, In.	Each
210-5	5 1/2	\$3.60
210-6	6 1/16	3.70



Bell system type "V" notch pattern. "W" notch to slit insulation. Good for switchboard and amplifier work.

No.	Size, In.	Each
528	5	\$4.20

Klein Cord Tip Closing Pliers



Sturdy jaws permit using plier as press for closing cord tips such as W. E. new Nos. 120 and 130. Holes are .129 and .156-in. diam.

No.	Size, In.	Each
039	5 7/16	\$3.50

Klein Pump Pliers

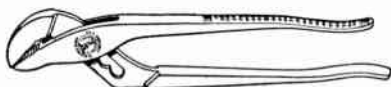

One hand operation possible. Over 2-in. capacity. Positive grip. Zinc plated. High strength.

No.	Length, In.	Each
510	9 1/2	\$3.00

Klein Plastic Handle Covers

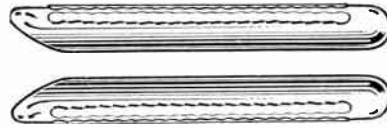

"Klein-Koat"

Provides non-skid grip and greater comfort. Made of transparent "Tenite" plastic in bright maroon. Does away with taping handles.

No.	Description	Pair
60	To fit 6-in. pliers	\$0.65
70	To fit 7-in. pliers	.70
89	To fit 8 or 9-in. pliers	.75

Utica Plastic Handles

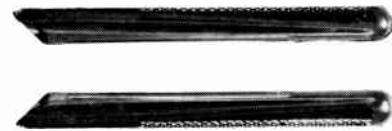

Red plastic handles with deep knurling for a positive but comfortable grip. Non-burning and non-explosive they will stand up under extreme temperature changes. Easily applied, "just hammer them on."

Size, In.	Each	Size, In.	Pair
6	\$0.80	8	\$1.00
7	.90		

Utica Cushion Grip Handles



Dipped plastisol handles give extra comfort. These handles are dipped at the factory and are adaptable to any pliers or wrench in the Utica Line.

Standard colors are red, blue and black. To order, add letter C to part number. Plier or Wrench

Size, In.	Each	Size, In.	Each
4	\$0.20	8	\$.60
5	.25	10	.80
6	.30	12	1.00
7	.50	15	1.20

Ideal Electricians' Pliers

With Crimping Die



Eliminates the need for special crimping tool. New England nose easily gets into hard-to-reach places. Can be used for twisting wires and burring conduit.

Single crimping die located at the point of maximum leverage makes double indentation.

Plastic grips give comfortable, powerful hold.

No.	Size, In.	Each
30-420	8 1/2	\$4.75

Utica Pliers

Lubring

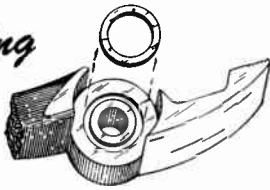

Utica Lubring Pliers No. 200 series, are made with a porous metal free floating ring in the joint. This ring is impregnated in oil, releasing the oil as the pliers are used thus insuring a smooth-working life long joint.



Long spring tempered nose. Lubring joint.

No. 227-6 1/2

Size, In. 6 1/2

Each \$3 16

Lineman's Pliers



Rounded nose permits ease of cutting bare and insulated wire in confined and restricted places. Induction hardened cutting edges.

No. 259-P-6
259-P-7
259-P-8

Size, In. 6
7
8

Each \$4.20
4.62
5.20

Lubring Joint



The stripping hole and "W" notches are used for stripping wire. Tool also furnished with sleeve grooves.

No. 242-SW-6

Size, In. 6

Each \$4.00

With Splicing Grooves



Same as No. 259-P with addition of splicing grooves for twisting and splicing sleeve joints.

No. 259-X-8

Size, In. 8

Each \$5.50

"Rib-Joint" Utility Pump Pliers

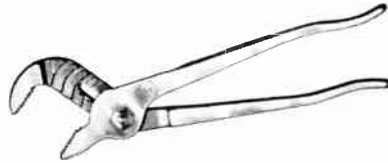

Fully forged ribs. Fine jaw openings for a wide range of work in any field. Toughest plier of its type in the industry.

No. 507-10

Size, In. 10

Each \$3.00

Diagonal Cutting Pliers



Designed to give great leverage in cutting as well as pulling cotter keys.

No. 241-5
241-6

Size, In. 5
6

Each \$3.40
3.60

Slip-Joint Adjustable Pliers



Heavy duty, alloy steel, highest quality gas type pliers.

No. 511-6

Size, In. 6

Each \$2.20

Side Cutting Long Nose Pliers

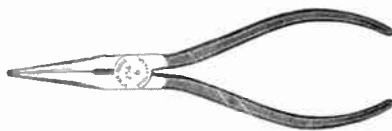

Long spring tempered nose and induction hardened edges. Best for stripping, twisting, looping, as well as cutting most electrical wires.

No. 254-6 1/2

Size, In. 6 1/2

Each \$3.62

Telephone Lamp Extracting Tool



Primarily designed for telephone repair work in extracting lamp caps and number plates.

No. 6305

Size, In. 5

Each \$4.20

Chain Nose Pliers

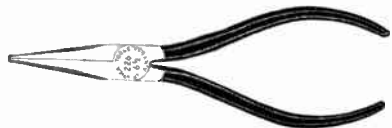

Fine nose permits use in restricted and confined places.

No. 226-P-6 1/2

Size, In. 6 1/2

Each \$3.04

Telephone Adjusting Tool



Specially designed for adjusting universal type keys in telephone installation and repair work.

No. 6015

Size, In. 6

Each \$2.94

Utica Pliers

Heavy Duty Diagonal Pliers



Designed to give great leverage in cutting most sizes of electrical wires. Induction hardened cutting edges.

No.	Size, In.	Each
39-7	7	\$3.68

Midget Diagonal Pliers



For radio and electrical use. Induction hardened edges with slim nose for use in cramped quarters. Induction hardened cutting edges.

No.	Size, In.	Each
46-4	4	\$3.05

Angle Locknut Pliers



Designed for electrical wiring work. Tightens locknuts in outlet boxes. Cuts and skins rubber covered wire.

No.	Size, In.	Each
750-8	8	\$4.70

Pocket Armor Cutters



Specially designed to cut and shape armor cable. Used to cut any flat metal or metal lath.

No.	Size, In.	Each
100-BX-7	7	\$5.00

Telephone Special Diagonal Pliers



Designed for telephone installation and maintenance work. "W" notch for back stripping insulation. Insulation crusher above

joint on cutting edge. Has induction hardened cutting edges.

No.	Size, In.	Each
V-41-5	5	\$3.96

Telephone Insulation Skinning Pliers



Designed for telephone field work. Nose is ground for immediate removal of insulation from wire.

No.	Size, In.	Each
2291-6	6	\$3.15

Midget Ignition Pliers



Excellent for tiny nuts and small assemblies. Has surprising strength. Three adjustments.

No.	Size, In.	Each
517-5	5	\$1.70

Long Chain Nose Side Cutting Pliers

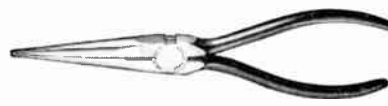

Fine pointed nose and special shaped handles. Induction hardened edges.

No.	Size, In.	Each
654-6	6	\$3.25
654-7	7	4.00

Long Chain Nose Pliers with Cutters



To crimp, pull or twist wire in confined and restricted places.

No.	Size, In.	Each
1033-6	6	\$2.56
1033-7	7	2.90

Lineman's Heavy Duty Side Cutting Pliers



Powerful leverage on all electrical wire. Induction hardened edges.

No.	Size, In.	Each
1950-6	6	\$3.36
1950-7	7	3.88
1950-8	8	4.62

Electrician's Side Cutting Pliers



For use on all electrical wires. Induction hardened jaws.

No.	Size, In.	Each
50-6	6	\$3.00
50-7	7	3.42
50-8	8	3.80

Electrician's Diagonal Pliers



Excellently designed all around diagonal cutting pliers. Induction hardened cutting edges.

No.	Size, In.	Each
41-4	4	\$2.64
41-5	5	2.88
41-6	6	3.30

Utica Telephone Heat Coil Pliers



Specially adaptable with nose points machined for removal of heat coils from switchboards and telephone terminals.

No.	Size, In.	Each
2827	5	\$3.16

Utica Telephone Straightening and Adjusting Tool



Parallel midget duckbill jaws to reach into confined places to pull and straighten lead and guide tabs.

No.	Size, In.	Each
7782	5	\$5.90

Utica Adjustable Wrenches



No. 91

Alloy steel with Nickel Chrome finish.



No. 90

Black rust resistant oxide handles with polished heads. Otherwise, same as No. 91.

No.	Size, In.	Each	No.	Size, In.	Each
90-4	4	\$1.88	91-4	4	\$2.38
90-6	6	1.88	91-6	6	2.38
90-8	8	2.28	91-8	8	2.76
90-10	10	2.84	91-10	10	3.54
90-12	12	4.20	91-12	12	5.18
90-15	15	6.60	91-15	15	7.88
90-18	18	9.70	91-18	18	12.90

Locking Adjustable Wrenches



Locks and unlocks with one hand. Positive lock in any position. Will not slip or un-

No.	Size, In.	Each
93-6	6	\$2.38
93-8	8	2.76
93-10	10	3.54
93-12	12	5.18

Klein Adjustable Wrenches

A high quality adjustable end wrench for any purpose. Drop forged alloy steel for maximum strength and lighter weight. Chrome plated. Packed 6 to a box.



No.	Size, In.	Cap., In.	Each
500-6	6	3/4	\$2.40
500-8	8	1 1/16	2.80
500-10	10	1 1/8	3.55
500-12	12	1 5/16	5.20

Parts Kit for above Klein adjustable wrenches. Contains parts to repair all of above listed wrenches.

No. WP-1	10.95
----------	-------

Champion DeArment Pliers

"Channel-Lock" Gripping Pliers



A heavy duty self-gripping plier which will hold work of any shape with a positive pipe-wrench grip. Will exceed a pipe wrench in usefulness because

of its light weight and streamline design. Four adjustments. Polished steel finish. Length, 9 1/2 in. Capacity 3/16 to 1 1/8 in. Weight per dozen, 12 1/2 lbs.

No. 410	Each \$3.30
---------	-------------

"Channel-Lock" Multi-Purpose Pump Pliers



Five adjustments. Polished steel finish. Undercut channels. Reinforced tension edge. Terrific gripping power. Easy to use in hard-to-get-

at places. Packed six per carton. Length 9 1/2 in. Capacity 1 3/4 in. Weight 9 lbs. per doz.

No. 420	Each \$3.00
---------	-------------

"Channel-Lock" Ignition Pliers

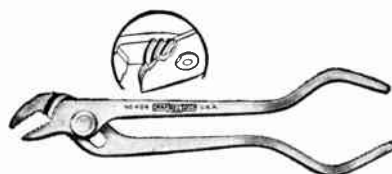

With Channel-lock adjustment to eliminate wear on the joint bolt.

A midget plier. Length, 4 1/2 in. Capacity, 1/2 in. Four adjustments.

Polished steel finish. Wt. per dozen, 16 oz.

No. 424	Each \$2.10
---------	-------------

"Channel-Lock" Diagonal Cutting



Standard pattern.

Box joint. Polished steel finish, with knurled grips. Length 7-in.; wt. 6 1/4 lbs. per doz.

No. 437	Each \$3.68
---------	-------------

Champion DeArment Pliers

"Channel-Lock" Curved Diagonal Cutting



Standard pattern. Lap joint. Polished steel finish. Length 7-in.; weight 7 lbs. per dozen.

No. 447 Each \$3.80

Klein "XELA" Electrician's Scissors

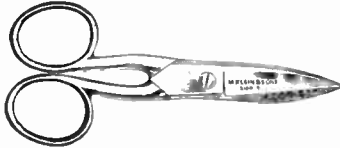

Specially designed for electrician and mechanic for hard service. High grade carefully tempered steel. Screw adjusting hinge. Nickel plated finish. Size—5-in.

No. 2100-5 Each \$1.85

Klein Inspector's Pocket Tool Kits

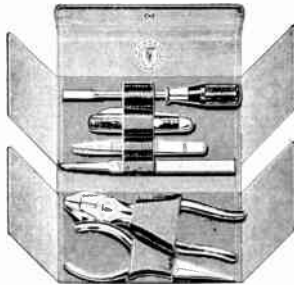

Genuine black leather folding case containing the following tools:

- 1 No. 201-6NE Side Cutg. Pliers.
- 1 No. 301-6 Long Nose Plier
- 1 No. 1550-2 "Xela" Electrician's knife.
- 1 5-in. Electrician's Tweezers.
- 1 4-in. File & Handle
- 1 3-in. Blade Screwdriver (Insulated). Size closed 6½ x 3½ x 1½

No. 1305-2 Each \$18.60

Klein Pocket Tool Rolls

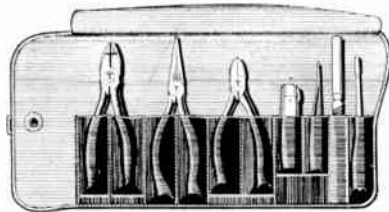

Leatherette roll with strap and buckle contains:

- 1 No. 201-6NE Side Cutg. Plier.
- 1 No. 301-6 Long Nose Plier.
- 1 No. 202-5 Oblique Cutg. Plier.
- 1 No. 1550-2 Electrician's knife.

1 4-in. file and handle. 1 5-in. Electrician's Tweezers. 1 Insulated Screw Driver with a 3-in. blade.

No. 1305-33A Each \$23.70

Klein Wiremen's Tool Holders

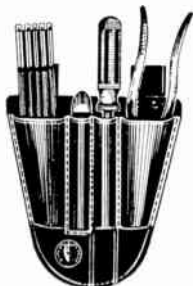

Made of heavy harness leather with four pockets. An extra long 6½-in. pocket is provided for screwdriver. Has riveted straps for attaching to belt.

Over-all size 7 x 9-in.
No. 5125 Each \$3.25

Klein Combination Tool Pouches

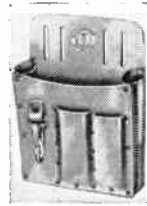

High quality leather pouch especially designed for electricians. Has large gusseted utility pocket, two plier pockets, two screwdriver pockets, and a knife snap. Used with 5207 Waist Belt.

Over-all size 6½-in. x 8½-in.
No. 5126 Each \$3.60

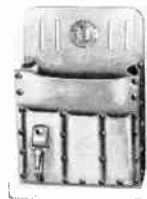

A high quality leather pouch with extra large gusseted utility pockets, three plier pockets, two screwdriver pockets, and knife snap. Designed especially for the electrician. May be used with 5207 Waist Belt.

Over-all size 7-in. x 10-in.
No. 5127 Each \$4.35

Klein Combination Tool Pockets



Made of high quality harness leather. An all-purpose pocket for pliers, folding rule, and screwdriver. Openings at bottom helps eliminate accumulation of water or dirt. Top is constructed with a double thickness of leather to permit riveting to belt.

Over-all size 6½ x 8¾-in.
No. 5118-PRS Each \$3.60



No. 5118-K



No. 5118-R



No. 5118-S

Made of heavy harness leather. Opening at bottom prevents accumulation of dirt or water. Top flap of double thickness leather for riveting to belt.

Over-all size: 4¾-in. x 8-in.

No.	Description	Each
5118-K	For Pliers and knife.	\$2.60
5118-R	For pliers and 6-ft. rule.	2.60
5118-S	For pliers and screwdriver.	2.60

Klein Flashlight Pockets



A pocket of high-quality leather designed to hold a typical flashlight or torch. A must for night line-pole work and installers.

Over-all size 3 x 8-in.
No. 5129 Each \$1.65

Klein Leather Plier Pockets

Made of heavy harness leather. These pockets will carry either 6, 7, 8, or 9-in. pliers. All are 3½-in. wide.



No. 5107



No. 5112



No. 5116

No.
5107
5112
5116

Length, In.
8½
9
10

Each
\$1.15
2.05
2.60

Klein Hip Pocket Tool Cases



Ideal for carry pliers or other tools in the hip pocket. Prevents wear and cutting of clothes or possible injury.

Made of harness leather.

Over-all size 5 x 7-in.

No. 5111.....Each \$2.40

Klein Knife Pocket

A harness leather pocket for holding skinning knives. It can be carried in the hip pocket or riveted to a belt. Opening at bottom prevents accumulation of water or dirt.

No. 5163.....Each \$2.20

Klein Utility Pouches

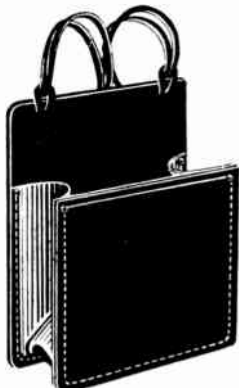

A large, roomy pouch. Harness leather front and back with gussets of soft latigo leather.

Useful for holding a variety of tools, bolts, etc.

Attaches to belt with latigo leather thongs.

Pouch expands to 6½ x 3¼-in.

Over-all size 7 x 9-in.

No. 5140-K.....Each \$4.45

Klein Canvas Tool Packs



A sturdy white canvas bag approx. 6-in. x 12-in. with a strong zipper that closes the full length of the mouth. Ideal for small tools, pliers, screw-driver, wrenches, etc.

No. 5139.....Each \$1.45

Klein "XELA" Electricians' Knives



Especially designed for the electrician. Made of high grade cutlery steel, carefully tempered. Special no-crack or chip plastic handle. Locks open automatically, thumb lock release. Wrought shackle riveted in handle. Blade length 2½-in. Screw-driver 3-in. Closed length 3¾-in.

No. 1550-2.....Each \$1.80

Klein "XELA" Lineman's Knives

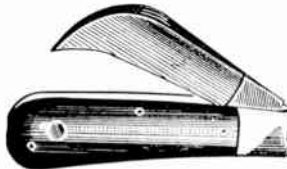

Made of carefully tempered cutlery steel. 3-in. blade automatically locks open. Special no-crack or chip plastic handle. Fitted with wrought shackle riveted in handle. Single blade. Closed length 4-in.

No. 1550-4.....Each \$2.00

Klein "XELA" Skinning Knives



Specially designed for skinning wire. Finest cutlery steel carefully tempered. Hardwood handle has ring for attaching to snap. Wrought shackle riveted in handle. Closed length 3½-in.

No. 1550-5.....Each \$1.65

Klein Skinning Knives

Rubber Handle



An ideal skinning knife for lineman. High quality steel carefully tempered. Molded handle is half-hard rubber, provides insulation and a comfortable grip. Blade back ground flat for scraping. Handle hole through solid rubber.

No.	Blade Lgth., In.	O.A. Lgth., In.	Each
1560-3	3	8	\$2.00

Klein Plastic Handle Skinning Knives



Carefully tempered steel. Red, molded on flame-resistant plastic handle, provides excellent insulation. Blade back ground flat for scraping. Handy ring for fastening to snap is imbedded in handle. Molded finger guard prevents accidents. Blade 3-in. long. Length less ring 8-in.

No. 1570-3.....Each \$2.00

Klein Cable Sheaths Splitting Knives
Heavy Duty Bell System Type



Heavy duty for splitting cable sheaths. Cutlery steel blade. Leather riveted handle. Tempered blue finish. 4 1/2-in. blade. Overall length 8 3/4-in.

No. 1515-1...Each \$2.75

Utica Cable Sheath Chipping Knife



Fine steel blade properly honed and tempered. Riveted leather handles. Has hammer head on back of blade.

No. 20821.....Each \$2.60

General Machine Shave Hooks



For scraping lead sheath in splicing operations.

Consists of detachable wood handle with triangular and oval-shaped scraper blades. Blades easily removed for storage or safety in transit.

No. 7151—Wt. 1/2 lb.....Prices on Application

Klein Linemen's Wrenches
Bell System Type



Forged from selected bar steel heat treated. Open end type with two openings of different sizes at each end. Hole is provided at the larger end so wrench may be used for turning in standard pole steps.

Wrench is particularly suited for use on the heavier three bolt guy clamps on which clearance is limited. Generally suitable for 5/8-in. hardware.

Openings: Large end—1 3/32 and 29/32 inch. Small end 13/16 and 5/8 inch.

No.	Size	Each
3146	13 in. for 5/8 in. hardware	\$2.75



Same as above but modified for 3/4-in. hardware. Openings: Large end—1 1/16 and 1 5/16 inch. Small end 5/8 and 7/8 inch.

No.	Size	Each
3146-A	13-in. for 3/4-in. hardware	\$2.75

General Machine Ratchet Wrenches
Type B



Box type; 7/16-in.; for use in assembly and mounting of splice and terminal cases.

Nickel-plated finish.

No. 7511—Wt. 1/4 lb.....Price on application.

Porter Insulated Socket Wrenches



Spintite type forged and tempered steel blade hardened socket. Colhardite insulation to socket head. Tested to 10,000 volts.

No.	Hex. Nut Size, In.	Length, In.	Dia. of Handle, In.	Wt., Oz.	List Each
19-SW	1/4	6 1/2	1 1/4	4	\$3.40
21-SW	5/16	6 1/2	1 1/4	4	3.50
23-SW	3/8	6 1/2	1 1/4	4	3.70
25-SW	7/16	6 1/2	1 1/4	5	3.90
27-SW	1/2	6 5/8	1 1/4	6	4.10
29-SW	9/16	6 3/4	1 1/4	8	4.20
31-SW	5/8	6 3/4	1 1/4	8	4.30

Klein Lineman's Canvas Tool Bags
With Leather Bottoms



No. 5102
Leather 3 1/2-in. Up Sides



No. 5105
Leather 8-in. Up Sides

Made of one-piece No. 10 white duck reinforced all around the bottom with heavy bag leather. The bottom is leather outside and duck inside. Sides and bottom are joined with lock stitch and cemented. Steel studs protect the bottom. Mouth has 12-gauge steel frame. Has harness leather handles and two retaining straps. May be furnished with lock and key, also shoulder straps to order.

No.	Size, In.	Each
5102-12	12	\$9.95
5102-14	14	10.55
5102-16	16	11.20
5102-18	18	11.70
5102-20	20	12.05
5102-22	22	12.60
5102-24	24	12.90
5105-16	16	11.50
5105-18	18	12.30
5105-20	20	12.80
5105-22	22	13.45
5105-24	24	13.70

Klein Inspector's Leather Tool Bags

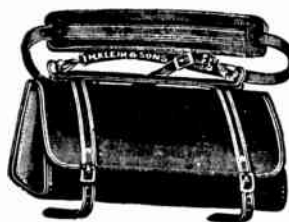

Made of harness leather to stand hard usage. Has a leather shoulder strap combined with pad and hand strap. The bottom is three ply protected with steel studs. Retaining straps pass clear around the back for security. All seams lock stitched with hot waxed linen thread. Bottom is 8-in. wide.

No.	Size, In.	Each
5108-14	14	\$15.00
5108-16	16	15.90
5108-18	18	17.25
5108-20	20	19.65
5108-22	22	21.05
5108-24	24	22.05



Salisbury Tool Bags

Non-Metallic

Offer an efficient way of raising tools and supplies to the pole top. Made of 31-oz. duct. Heavy leather bottom extends 3-inches up sides. Top is held open in round form by stout non-metallic ring.

A 1/2-in. rope handle is firmly spliced to bag through leather reinforcements. Has utility pocket on inside for small tools. Bag is collapsible. Diam., 12 in. Height, 16-in. Weight, 2 1/4 lbs.

No. 30 Bag..... Each **\$8.00**

Klein Linemen's Torches

"Staysalite"



A compact torch that stays lighted even in a wind. Lit in a moment, burns alcohol without odor or noise. No adjusting parts to get out of order. Can be carried on belt. Hang directly on the wire under the joint to be soldered. Can also be used as a small heater. Cup provided for holding soldering paste.

No. 3420..... Each **\$7.40**

Klein Safety Harness

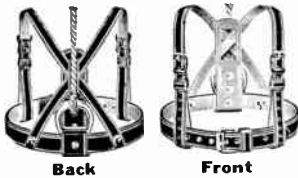

Designed so that the wearer is in a perpendicular position even when unconscious and may be readily lifted through a manhole opening.

Solid harness leather back plate 2 1/4-in. by 10-in. is stitched and riveted around the 1 1/4-in. adjustable belt. Back plate carries a drop

forged "D" ring to which 25-ft. of 3/4-in. rope is permanently attached. Shoulder straps are 3/4-in. adjustable and riveted to the belt at back.

No.	Description	Each
5209	With life line	\$18.90

Klein Steel Worker's Belts



One piece 2-in. wide harness leather. 3 "D" rings for attachment of life line, etc. Loop provided for wrench. Double tongue buckle. Adjustable from 36 to 44 inches. Distance between outer "D" rings 24-in.

No. 5214..... Each **\$12.00**

Klein Derrick Belts



Made to stand a load of 250 pounds with a dead fall of five feet. One three inch forged "D" ring for life line. Double tongue buckle. Adjustable from size 36 to 44-in.

No.	Each
5212	\$14.15
5212KK	22.65*

*In Klein-Kord fabric.

Klein Leather Tool Belts

Semi-Floating



Semi-floating belt made of soft, russet latigo leather with comfortable rolled edges. Body strap is finest harness leather 2-in. wide stitched to the cushion at the back and passed through loops at end of cushion and single bar "D" ring. Harness leather tool strap 1 3/4-in. wide with five loops in

the 1 1/4-in. loop strap. No rivets come through the inside of the belt. Fitted with knife snap, tape thong ring for glove pouch and 4 rings for gut strap or suspenders.

Width of leather tool belt, 4 3/4-in.

No. 5228..... Each **\$21.60**

Klein Tool Belts

Full-Floating "Klein-Line"

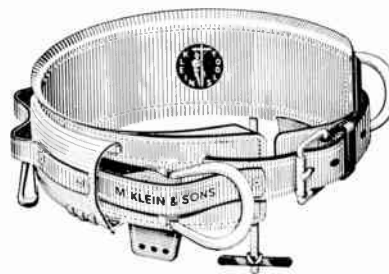

Sizes 34, 36, 38, 40, 42, 44, 46 and 48-in. Others made to order.

A full floating trace of famous "Klein-Kord" 1 3/4-in. wide. Carries single bar "D" ring. Trace allows about 6-in. of free movement. Improved apron design permits visual

inspection of trace throughout its entire length. Apron securely riveted to belt. A 1 1/4-in. harness leather strap is formed into five tool loops. Standard accessories—tape thong, knife snap, ring for glove pouch, pocket tabs on both sides and 4 rings for gut strap or suspenders. Soft pliable leather 4 3/4-in. wide is pad lined and edge rolled for comfort. No rivets come through the body pad.

No. 5249..... Each **\$28.20**

Klein Standard "D" Tool Belts

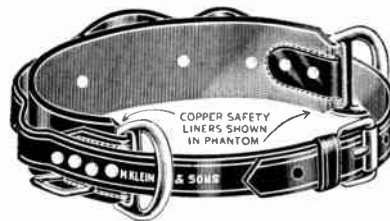

Finest harness leather. 3 1/2-in. wide cushion carries "D" rings. 1 1/2-in. wide loop straps. "D" ring wearing surfaces protected with copper safety liners. Sizes 34-48 inches.

DROP FORGED DEE RINGS AND BUCKLE

No.	Each
5204	\$10.20
5204-L	13.35*

*Has latigo leather liner lock stitched to cushion, eliminating exposed rivets.

No. 5202 Tool Belts



Same construction as 5204 belt above, but has 2 1/4-in. wide cushion. Sizes 36-46 inches.

DROP FORGED DEE RINGS AND BUCKLE

No. 5202 Each **\$9.60**

Klein Texas Belts

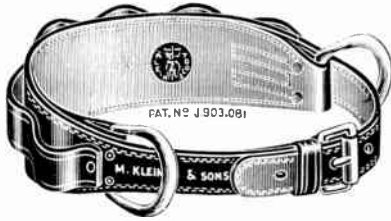

Lined with latigo leather. Standard "D" rings. 4-in. wide at back tapering to 2 1/4-in. at hips. Sizes 36 to 6. No rivets go through the belt.

No. 5204 T.S.O.
Each . . . \$19.10

Klein Leather Tool Belts

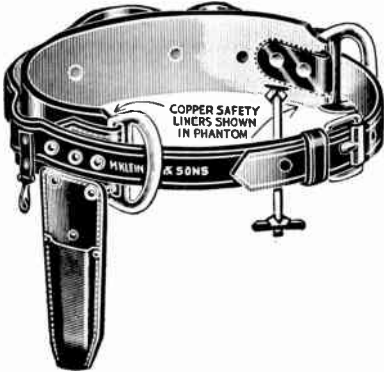

Made of finest harness leather. Cushion is 3 1/2-in. wide and carries the double bar "D" rings. The outer strap is passed through "D" rings for additional safety. Surfaces taking the wear of the "D" rings are copper safety liners. Furnished with plier pocket, knife snap, and tape thong. Sizes 36 to 46.

No.	Each
5204-DE	\$13.65
5204-DE-L	16.95*

*Has latigo leather liner lock stitched to cushion, eliminating exposed rivets.

Klein Cotton Fabric Tool Belts



Made of multiple plies of long staple cotton of great strength and flexibility. Designed to provide maximum comfort and safety. Equipped with plier pocket, knife snap, tape thong ring, tool loops and lag wrench holder. Available in sizes 36 to 46-in.

No.	Description	Each
5204-KK	4-in. wide, standard "D" rings	\$18.80
5204-KKL	Leather lined	20.60

Klein Electrician's Waist Belts

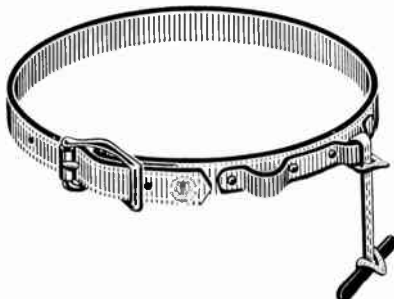

A lightweight belt of genuine harness leather with tool loops and tape thong.

May be used with Klein tool pouches 5125, 5126, 5127.

Size adjustable.

No.	Description	Each
5207M	32 in. to 40 in.	\$3.40
5207L	38 in. to 46 in.	3.40

Klein Waist Belt Supporters

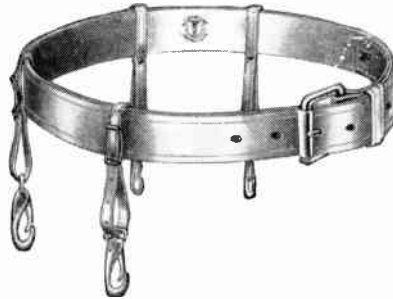

Commonly referred to as a "Gut" strap. Has four point suspension with snap. Each strap is provided with buckle to permit easy adjustment.

Adjustable in size from 36 to 46-in.

No. 5208 . . . \$5.60

Klein Tree Trimmers' Belts



"Klein-Kord" Nylon Red Cotton Center

Weight of the wearer is distributed along the leg straps as well as the body strap. The safety line is attached to a floating "D" ring at the front. Made of multiple plies of nylon bonded in neoprene. Drop forged hardware is set with solid copper rivets. Provided with harness snap. Adjustable from 36 to 46-in. Life line not supplied.

No. 5210 Each \$25.60

Klein Tool Belt Suspenders

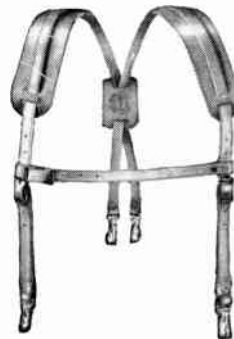

Made out of the finest quality harness leather.

Has four point suspension with snaps. Each strap is provided with a buckle to permit easy adjustment.

No. 5213 Each \$5.75

Klein Belt Accessories



No. 5130



No. 5131



No. 5132

No.	Description	Each
5130	10-in. tape thong, fiber crossbar	\$0.40
5131	Knife strap with strap and rivets45
5132	Ring with strap and rivets40

Bartlett Safety Saddles



Safety saddle provides a belt and saddle combination. Main belt made of 3½-in. heavy leather reinforced by the tightening strap which is adjustable from 36-inches to 44 inches. Equipped with two D rings and a ½-in. 4 strand rope which passes thru supports on the belt to encircle the leg supports, which are of 3-in. leather.

With Manila Rope

No. 205L Each **\$18.50**

With Nylon Rope

No. 205NL Each **\$25.00**

Klein Leather Safety Straps

All leather safety straps are cut from finest quality harness leather. Solid copper rivets, hand set with burrs. Snaps and buckles solid steel drop forgings tested to 1500 lbs. and have a galvanized finish.



1¾-in. x 5-ft.
8-in. size.
Have stainless clips.

No.	Description	Each
5250	Standard Snaps	\$10.30
KL-5250	"Klein-Lok" Snaps	12.40



1¾-in. x 5-ft.
8-in. size.
Leather wear pad at buckle. Stainless clips.

No.	Description	Each
5251	Standard Snaps	\$10.60
KL-5251	"Klein-Lok" Snaps	12.70



2-in. x 5-ft.
8-in. size.
Have stainless clips.

No.	Description	Each
5253	Standard Snaps	\$12.15
KL-5253	"Klein-Lok" Snaps	14.05



2-in. x 5-ft.
1½-in. size, for No. 5257-S, 2-in. x 5-ft.
10-in. size for No. 5257-L.
Standard Snaps.

No.	Description	Each
5257-S	"Bell System" type	\$12.20
5257-L	"Bell System" type	12.40



2-in. x 5-ft.
6-in. size.
Stainless Clips.

No.	Description	Each
5258	Standard Snaps	\$12.90
KL-5258	Klein-Lok" Snaps	14.95

Klein-Kord Safety Straps

An original fabric material developed by Klein for safety straps.

"Klein-Kord" consists of multiple plies of fabric of special weave available in cotton, cotton and nylon, or all nylon fabric. The plies are bonded together with neoprene frictioning and vulcanized—a construction that provides maximum strength and safety.

Red center plies provide an unmistakable signal when the use of the traps should be discontinued. "Klein-Kord" may be used with perfect safety until the two outer plies are worn through.

Cotton Safety Straps—Red Center



1¾-in. x 5-ft.
8-in. size. Other lengths furnished to order.
Stainless Clips.

No.	Description	Each
5233	Standard Snaps	\$11.85
KL-5233	"Klein-Lok" Snaps	14.00

Nylon Safety Straps—Red Cotton Center



1¾-in. x 5-ft.
8-in. size. Other lengths furnished to order.
Stainless Clips.
Also available in all Nylon.

No.	Description	Each
5294	Standard Snaps	\$12.40
KL-5294	"Klein-Lok" Snaps	14.40

All Nylon Safety Straps

No.	Description	Each
5295	Standard Snaps	13.00
KL-5295	"Klein-Lok" Snaps	15.20

Cotton Extension Straps—Red Center



1¾-in. x 15-in.
Use with safety strap when extra length is needed.
Std. "D" rings.

No.	Description	Each
5236	Standard Snaps	\$5.70
KL-5236	"Klein-Lok" Snaps	6.75

Cotton Diving Board Straps—Red Center



1¾-in. x 7-ft.
Gives extra reach and length when working from a diving board or platform.
2 std. "D" rings; 1 fixed, 1 adjustable.

No.	Description	Each
5238	Standard Snaps	\$11.50
KL-5238	"Klein-Lok" Snaps	12.45

Klein Climber Gaff Guards

Use on any Klein climber. Made of top grade harness leather.

No. 1901-MG

One piece leather with fiber to keep point from penetrating guard.

No. 1945-G

Top piece riveted construction. Harness leather.

No. 1901-MG or 1945-G. Pair **\$0.80**



Klein Climbers

Safety and comfort are vital in the design of any climber. These climbers are drop forged from selected electric furnace steel and are individually tempered and tested. The gaff is drop forged from electric furnace alloy tool steel and set into the leg iron at the proper angle.

For maximum life, leg irons are fully polished in critical sections before aluminum finish is applied.

"Pole Master" Climbers Adjustable or Fixed Length



Matched pairs. One right, one left. Wide stirrup gives better support. Offset shank brings gaff in proper line with leg bone to provide greater security and comfort. Adjustable 15-18 inches, 17-20 inches, or fixed length sizes of 15, 15½, 16, 16½, 17, 17½, and 18-inches, measured from instep to top of slide. Gaff 3½-in. long measured on the out side.

No.		Per Pair
1945	Fixed Length	\$7 80
1945A	Adjustable	9 60
C-1945A	Adjustable	17 80*
1945AL	Adjustable	9 60**

*Has straps and pads.
**Adjustable 17-20-inches.

Standard Climbers Adjustable or Fixed Length

Accepted as standard by utilities for many years. Adjustable 15-18 inches, 17-20 inches, or fixed length sizes of 15, 15½, 16, 16½, 17, 17½, and 18-inches, measured from the instep to the top of the slide. Gaff 3½-in. long measured on the outside. Riveted strap loops.

No.		Per Pair
1901M	Fixed Length	\$7 00
1901MA	Adjustable	8 80
C-1901MA	Has straps and pads	15 55
1901MAL	Adjustable 17-20 in.	8 80



Triangular Ring—Standard Pattern

Same design as the standard climber above except that a drop forged triangular ring carries the ankle strap. Adjustable 15-18 inches and 17-20 inches.

No.		Per Pair
1956A	Adj. 15-18 in.	\$9 60
C-1956A	Has straps and pads	17 80
1956AL	Adjustable 17-20 in.	9 60

Riveted Loop "Pole Master" Climbers Adjustable

Same as 1945A except that a riveted loop is provided to carry the ankle strap in place of a triangular ring. Adjustable 15-18 inches and 17-20 inches.

No.		Per Pair
1957A	Adj. 15-18 in.	\$9 60
C-1957A	Has straps and pads	17 20
1957AL	Adjustable 17-20-in.	9 60



Klein Tree Climbers

The tree climber used by forest rangers, high riggers, fire wardens and surveyors. Extra long gaff to penetrate bark of trees. Gaffs are 3½-in. long measured on the underside and are set high in the leg iron so points clear the ground when walking. Fixed length pattern in the following sizes: 15, 15½, 16, 16½, 17, 17½, and 18 inches, measured from instep to end of shank. Special sizes to order. Straps loops are riveted. Aluminum finish. Every climber individually tested.



No.	Per Pair
1907	\$7 60

Adjustable Tree Climbers

Same as 1907 except that it is made in the adjustable pattern. Sliding portion is made in one-piece steel construction and permits adjustment to 15, 15½, 16, 16½, 17, 17½, and 18-inch sizes. Riveted strap loops. Every climber individually tested.



No.	Per Pair
1907A	\$9 30
C-1907A	Has straps and pads 16 05

Klein Nylon Climber Straps

No.	Description	Per Pair
5301-18	Calf straps, 1 x 22-in.	\$3 40
5301-21	Calf straps, 1¼ x 22-in.	3 45
5301-19	Ankle straps, 1 x 26-in.	3 40
5301-22	Ankle straps, 1¼ x 26-in.	3 60

Nylon Special Ankle Straps Supplied In Two Pieces With Rivet And Burr

5301-20	Ankle strap, 1 x 24-in.	4 85
5301-23	Ankle strap, 1¼ x 24-in.	5 00

Square Climber Pads

8200	Sheep lined	1 40
8201	Felt lined	1 40
8202	Plain leather	.95

"Bell System" Climber Pads

8203	Plain leather	1 60
8204	Sheep lined	2 55
8205	Felt lined	2 60

Pear Shape Climber Pads

8206	Plain leather	1 20
------	---------------	------

Long Climber Pads

8207	Plain leather	1 80
8208	Sheep lined	2 65
8209	Felt lined	2 65

Angle Climber Pads

8210	Horsehair padded	4 40
------	------------------	------

Klein Climber Straps and Pads

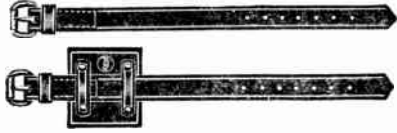

Set consist of two upper (calf straps), 2 lower (ankle straps), 2 pads. Straps 1 1/4 x 22-in.

Leather Climber Straps With Square Pads

No.	Description	Size, In.	Per Set
5301-1	Plain pads	1 1/4 x 22	\$6 15
5301-2	Sheep-lined pads	1 1/4 x 22	6 60
5301-3	Felt-lined pads	1 1/4 x 22	6 60

Leather Climber Straps Without Pads

No.	Pair	Straps	Size, In.	Per Pair
5301-4	1	Calf	1 1/4 x 22	\$2 60
5301-9	1	Calf	1 x 22	2 40
5301-14	1	Ankle	1 1/4 x 26	2 75
5301-10	1	Ankle	1 x 26	2 55

Leather Special Ankle Straps

Supplied in two pieces with rivet and burrs. Punched for quick attachment. Without ring. For No. 1945 and No. 1956 climbers.

No.	Description	Per Pair
5301-16	One pair, 1 1/4 in. x 24 in.	\$4 45
5301-26	One pair, 1 in. x 24 in.	4 00

Klein Gaff Gauge

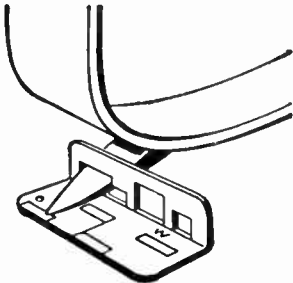

Made of steel, rustproof for long life, will assure you of properly sharpened gaffs at all times and obviate the hazards due to dull or incorrectly prepared gaffs.

Packed in a hinged plastic box complete with instructions.

No.	Each
KG-1	\$0.75

T&B Cable Cutters



Cuts cable to exactly the right length, without jagged ridges across center, without burring strains or deformation of cable.

Designed to cut copper or aluminum cables. Should not be used to cut steel cables, ACSR, nor Copperweld.

Black with yellow plastic grips, tubular handles. Forged hardened steel cutting blade with 1/8-in. overlap.

No. 364: Takes cable sizes up to 4/0, insulation sizes up to 1-in.

No. 365: Takes cable sizes up to 500 MCM, insulation sizes up to 1 1/2-in. O.D.

No.	Lgth. O. A. In.	Std. Pkg.	Wt. Lbs. Each	Each
364	20 3/4	1	3	\$27.20
365	23 1/4	1	5 1/2	36.00

Porter Cutters



Center Cut Cutter

For free or general cutting of medium hard rods, bolts, etc., cold drawn spring wire, stranded guy wire, alloy wire and rods and other medium hard steel.

Cutting edge is in middle of blade with an equal bevel on each side. Center cut type of jaws are always recommended where flush cuts are not required.

No.	Approx. Length, In.	Capacities		Approx. Wgt., Lbs.	List Each
		Med. Hard Bolts in Thread, In.	Med. Hard Metals, In.		
1490-C	14	3/16	1/4	2 7/8	\$11 20
090-C	18	3/8	5/16	4 1/4	12 20
190-C	21	7/16	3/8	6 3/4	15 10
290-C	30	9/16	1/2	10 1/2	19 40
390-C	36	5/8	5/8	14 3/4	25 20
590-C	42	3/4	5/8	18	36 30

Special Shear Cable Cutter



For free or general cutting of soft, non-steel cable. Cuts Copper and aluminum cable only. Do not use on ACSR cable.

Designed for cutting power cables, insulated or otherwise, up to its rated capacity. This tool is especially needed by every company making, selling or using copper or aluminum cable.

No.	Approx. Length, In.	Capacity Copper or Aluminum Cable, In.	Approx. Wt., Lbs.	List Each
290-CN	30	1 3/8 O.D.	9 1/2	\$28.50

Notched Shear Steel Cable Cutter



For free or general cutting of all soft or hard steel cable or wire rope up to capacities shown. Excellent for ACSR cable, soft wire rope and cable, hard wire rope, stranded guy wire.

Cutting edges pass each other for complete shear action. Cuts coarse or fine strand material easily and cleanly. Jaws are notched to lock cable in during cut.

No.	Approx. Length, In.	Capacities		Approx. Wt., Lbs.	List Each
		Wire Rope and Cable, In.			
1490-TN	14	1/4		3	\$18 10
190-TN	24	3/8		6 1/2	22 20
390-TN	36	5/8		14 1/2	31 10
590-TN	42	3/4		17 1/2	48 10

Porter Lead-Sheathed Cable Cutters



For cutting lead-sheathed communication cable. Identical hooked jaws pass each other with true shearing action. Designed to minimize flattening the cable and crushing inside wires. Cutting head of tough alloy tool steel, drop forged and heat treated.

No.	Length In.	Wire Capacities		Wt. Lbs.	Each
		Communication Cable	Insulated Stranded Copper Wire		
190CS	23 1/2	1-in.	375 MCM	5 1/4	\$28.00
390CS	37	2 1/4-in.	750 MCM	10 3/4	30.00

Porter Electric Wire Cutters

Insulated



For "hot" wire work. Handles insulated with special molded insulation, a semi-hard rubber with ideal properties — maximum toughness, high dielectric strength, and resistance to oxidation and chemicals. Each tool individually tested at the factory to 20,000 volts.

No.	Length In.	Capacity Solid Copper Wire, In.	Jaw Opening, In.	Wt. Lbs.	Each
090XC	19	5/16	1/2	4 1/2	\$22.70
190XC	25	3/8	3/4	7 3/4	29.40
290XC	31 1/2	1/2	1 1/8	11 3/4	37.70

Porter Strap Cutters



For cutting steel strapping. Wedge shaped bottom jaw slips under tightest bound straps.

Squeeze-down action makes cutting easier. Entire tool made of tool steel forgings with

special heat-treated cutting edges. For use in shipping and receiving departments, freight cars, trucks, warehouses, shops, stores, etc.

No.	Approx. Length In.	Capacity Steel Strapping, In.	Approx. Wgt. Oz.	List Each
990-1'	9	.035 x 3/4	16	\$8.00

Bartlett Heavy Duty Shears

For Metal Cutting



Compound lever snip with bulldog jaw. Extra length handle makes it a powerful tool. Made of drop forged crucible tool steel, with the bolts and links proportioned to the capacity of the shear. Designed to be used with both hands or as a bench shear supported in a vise. Capacity, 14 gauge mild steel. Overall Length, 20 in. Cut, 2 1/2-in. Wt., 3 1/2 lbs.

No. 19	Each	\$24.00
No. 1919, Bracket for Bench Attachment	Each	2.50

Klein "Die-Stock" Sleeve Twisters

Heavy Duty

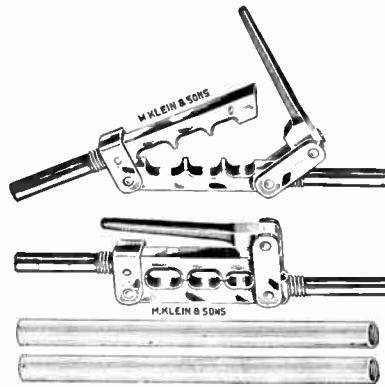

Similar to No. 107-20 but of heavier construction. Ample capacity for sleeves from 3/0 to 500 MCM. Tubular steel handles, 1 1/16 - in. diam., threaded into head. Hand lock lever, closes head on sleeve and holds it securely. Distance between yokes, approx. 4 - in. allows ample room for two or three sleeve openings of large size.

Stocked blank and finished with sleeve openings as ordered. Oval or double sleeve, copper or aluminum.

No.	Size, In.	No. Sleeve Openings	Each
107-34	34	1	\$25.75
107-34	34	2	27.00
107-34	34	3	28.25

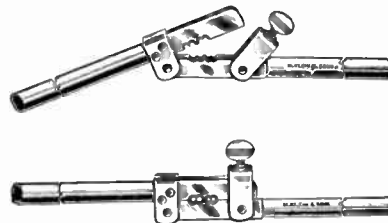

For use on sleeves from 4 B. & S. solid up to No. 3/0 B. & S. strand. (For larger sizes, see No. 107-34).

Space between yokes is 3-in., usually sufficient for three openings. Handles tubular steel 7/8-in. in diam.

thread on to head. Head is tightened onto sleeve and held by thumb screw. Held in blank and finished with sleeve openings as ordered. Length, overall 23 1/2-inches.

No.	No. of Sleeve Openings	Each
107-20	1	\$14.00
107-20	2	15.00
107-20	3	16.00

Klein Splicing Clamps

Klein Splicing Clamps are properly proportioned and designed to give years of satisfactory service. A single hand tool accommodates a wide range of sleeve and wire sizes. The die-stock clamps are designed for the larger sizes and are supplied on special order.



Has five round holes and one oval hole. For bare wire. For: Copper wire Nos. 2, 4, 6, 8, 10, 12, B & S. Iron wire Nos. 4, 6, 8, 10, 12, 14, B. W. G. Size 10 3/4-in.

No. 102-30	Each	\$5.40
------------	------	--------



Has five sets of chambers. For twisting double tube sleeves. For: Copper sleeves Nos. 6, 8, 10, 12, 14, B. & S. Nos. 12, 14, 17, N. B. S. Iron sleeves Nos. 8, 10, 12, 14, 16, 19, B. W. G. Size 10 3/4-in.

No. 105-17	Each	\$5.00
------------	------	--------

Klein Wire and Sleeve Clamps

No. 132-15



Has five round holes for bare wire, one oval hole for guy strand. Reverse side has five chambers for double tube sleeves.

- For: Copper wire Nos. 4, 6, 8, 10, 12, B. & S.
- Iron wire Nos. 6, 8, 10, 12, 14, B. W. G.
- Guy strand .437 x .624
- Copper Sleeves Nos. 6, 8, 10, 12, 14, 17, B. & S.
- Iron sleeves Nos. 8, 10, 12, 14, 16, 19, B. W. G.

Size 11 1/4-in.

No. 132-15..... Each **\$5.75**

No. 132-46



Has five round holes for bare wire, one oval hole for guy strand. Reverse side has five chambers for double tube sleeve.

- For: Copper wire Nos. 4, 6, 8, 10, 12, B. & S.
- Iron wire Nos. 6, 8, 10, 12, 14, B. W. G.
- Guy strand .437 x .624
- Copper sleeves Nos. 4, 6, 8, 10, 12, B. & S.
- Iron sleeves Nos. 6, 8, 10, 12, 14, B. W. G.

Size 11 1/4-in.

No. 132-46..... Each **\$5.75**

General Machine Sleeve Pressers

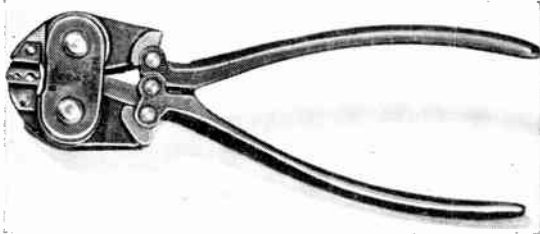

Type B

For pressing single-tube brass sleeves in splicing and dead-ending drop and block wires. May also be used in splicing aluminum conductor.

Designed specifically for field work. Convenient in size; handles easily on poles among wires. Light weight; can be easily carried in lineman's belt.

No. 7149—Wt. 6-oz..... Price on application

T&B Method Compression Tool

For No. 8AWG to 250MCM Copper Conductors



Tool is mechanical, lightweight, and develops tons of pressure. Dies snap in and out. Dies are located in one position for a given wire size. High strength steel tool with tubular aluminum handles and forged steel dies.

Complete with steel carrying case and 3 color-coded dies.

No.	Description	Each
TBM5	Compression Tool	\$80.00

Klein "Chicago" Grips

Klein grips have been the accepted standard of public utility companies and others requiring a strong, non-slipping grip.

Klein Grips are available for use on any type of conductor and patterns are available specially designed for hot line work.

These grips are to be used for pulling up lines to tension only and are not recommended for use as anchors.

Recommended are Klein "Chicago" Grips with bronze-lined jaws to avoid possible damage to surface of conductor.

Grips with bronze-lined jaws are indicated by the letter "B" after the catalog number. All grips furnished with galvanized finish.

All Chicago Grips are furnished with self-locking loop handles which allow the Grip Jaws to be locked in any open position. To lock, open Jaws and fold loop handle toward side plates.

For Bare Wire (Solid and Strand)

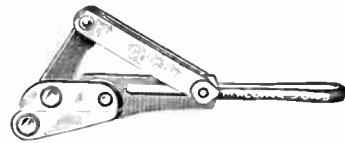

No.	B & S Wire Size		Safe Load Lbs.	Each
	Maximum	Minimum		
1613-30	6 S (.162")	12 S (.081")	1,500	\$3.20
1613-30B	6 S (.162")	12 S (.081")	1,500	4.80
1613-40	0 St. (.373")	10 S (.102")	2,250	5.20
1613-40B	0 St. (.373")	10 S (.102")	2,250	7.40
1613-50	1/0 St. (.552")	6 S (.162")	4,000	9.60
1613-50B	1/0 St. (.552")	6 S (.162")	4,000	14.20

Note: S—Solid; St.—Strand; B—Bronze-lined jaws.

For Weatherproof Wire

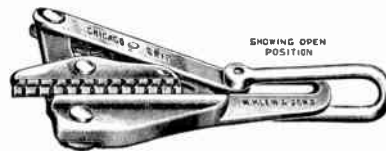

All sizes of wire shown below are for weatherproof.

No.	Wire Size, In.		Safe Load, Lbs.	Each
	Maximum	Minimum		
1611-20	.420	.250	2,200	\$5.20
1611-30	.500	.313	3,500	6.20
1611-40	.700	.500	3,750	10.25
1611-50	.860	.672	3,750	10.25

Note: Due to various types of weatherproof coatings, selection of proper grips is determined by outside diameter of cable.

Improved "Chicago" Grips

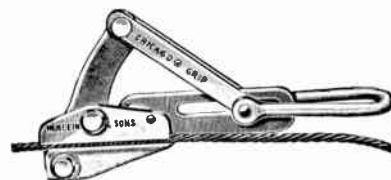

For messenger, and guy strand and conductors up to 1/2-in. diameter.

No.	Max. Cable Size B & S	Min. Cable Size A.C.S.R.	Safe Load, Lbs.	Each
1628-5B	Same as above but with Bronze-lined Jaws.			11.80

Klein "Chicago" Grips

For Bare Aluminum and Copper Cables



Series especially designed for use on bare A.C.S.R. aluminum and stranded copper cables.

No.	Maximum Conductor A.C.S.R.	Minimum Conductor A.C.S.R.	Safe Load, Lbs.	Each
1656-20	1/0 (.398)	4 (.250)	2,200	\$5.20
1656-20B	Same as above—Bronze-lined jaws			8.40
1656-30	3/0 (.502)	2 (.316)	3,500	6.20
1656-30B	Same as above—Bronze-lined jaws			9.20
1656-40	336,000 CM (.711)	3/0 (.502)	8,000	12.75
1656-40B	Same as above—Bronze-lined jaws			17.25
1656-50	177,000 CM (.883)	397,500 CM (.783)	8,000	12.75
1656-50B	Same as above—Bronze-lined jaws			17.25
1656-AB*	500,000 CM (.901)	3/0 (.502)	8,000	21.60

*Made for one size cable only. Specify size and O.D.

For Messenger and Guy Strand Wire Rope



No.	Galvanized Steel Strand Max. Cable Size, In.	Min. Cable Size, In.	Safe Load, Lbs.	Each
1628-6	7/16 (.438)	3/16 (.188)	8,000	\$13.00
1628-6B	Same as above—Bronze-lined jaws			17.25
1628-16	5/8 (.625)	3/16 (.312)	15,000	23.00
1628-16B	Same as above—Bronze-lined jaws			27.00
1628-16BP*	605M CM (.970)	2 ACSR (.316)	15,000	32.00

*Made for one size cable only. Specify size and O.D.

Bell System Type

1628-5AT is identical to Bell System Type "L" strand puller and 1628-16 AT identical to Bell System Type "H" strand puller. Fitted with chain, toggle and shackle as shown.



No.	Max. Cable Size	Min. Cable Size	Safe Load, Lbs.	Each
1628-5AT	4/0 B&S 7 Str. Copper	No. 4 B&S S. Copper (.201)	8,000	\$11.50
	3/0 ACSR (.502)	No. 6 ACSR (.198)		
1628-16AT	5/8-in. Gal. Steel Str. (.625)	5/16-in. Gal. Steel Str. (.312)	15,000	26.00
	300,000 CM Copper Str. (.629)	1/0 B&S Copper S. (.325)		
	4/0 ACSR (.563)	2 ACSR (.316)		

Klein Improved "Chicago" Grips

For Hot Line Work

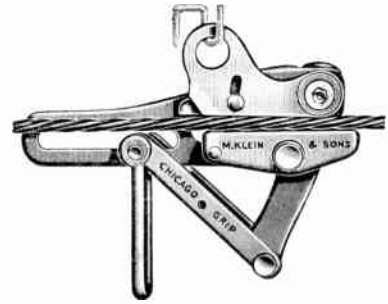

May be placed on wire with hot line stick. When stick is removed, safety latch automatically closes—cannot fall off accidentally.

No.	Maximum Conductor Strand	Minimum Conductor Solid	Safe Load, Lbs.	Each
Furnished without spring for hot-line work.				
1628-3BH	1/0 B&S (.373)	10 B&S (.102)	4,500	\$9.20
1628-5BH	1/0 B&S (.522)	4 B&S (.201)	8,000	13.80
*1656-ABL	500M CM ACSR (.901)	3/0 ACSR (.502)	8,000	23.10

Furnished with spring for hot or dead line work.

S-1628-3BH	1/0 B&S (.373)	10 B&S (.102)	1,500	9.20
S-1628-5BH	1/0 B&S (.522)	4 B&S (.201)	8,000	13.80
1613-40H	0 B&S (.375)	10 B&S (.102)	2,250	6.20
1628-5H	4/0 B&S (.522)	4 B&S (.201)	8,000	10.75

*For use on copper or aluminum conductors or wire rope; jaws are milled to fit diameter desired. Range of conductor size is given for general information and is made for one cable size only. Furnished with bronze-lined jaws. Orders must specify exact outside diameter of cable.

For Large Diameter Conductors

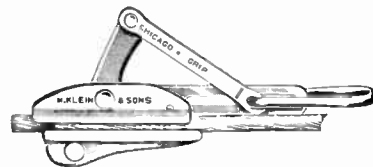

For hollow conductors and other large cables the jaws of the grip must be shaped to provide maximum contact with the circumference of the cable. Grips held in blank, finished to order.

No.	Max. Cable Size ACSR	Min. Cable Size ACSR	Safe Load, Lbs.	Each
1628-30B	1,033,500 CM (1.216)	177M CM (.833)	20,000	\$75.00
1628-40B	1,590,000 CM (1.515)	1,033M CM (1.216)	25,000	98.20

Klein Howe Wire Tools



Fine harness leather strap. Large open swivel hook, shank lengthened to reach under insulator. Locking device on other end holds load at any length. Gal. Finish.

No. 1702-20	Strap 1 1/4-in. wide, 7-ft. long	Each	\$7.75
Strap only			3.15

"Chicago" Linemen's Tools



Combines above tool with a No. 1613-30 "Chicago" Grip. For 6 wire and smaller down to 12 B&S.

No. 1700-30	Each	\$10.75
Strap only		3.15

Klein "Haven" Steel Grips

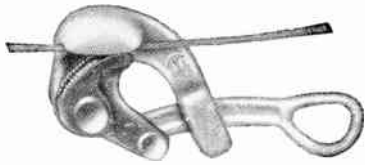

No. 1604-10

Eye is pear shaped. 1 1/8-in. wide.



No. 1625-20

Pear shaped eye 1 1/4-in.

No.	Maximum Cable Size	Minimum Cable Size	Safe Load, Lbs.	Each
1604-10	4 B&S (.201)	14 B&S (.061)	2,500	\$3.60
1604-20	.500 Steel Strand	7 B&S (.111)	5,000	4.60
1604-20L	Same as 1604-20 but with swing latch as supplied on 1625-20.....			5.40

Improved "Haven" Grips

*1625-20	.750 Wire Rope	2 B&S (.281)	3,000	\$8.40
----------	----------------	--------------	-------	--------

*Can be furnished for 3/8-in. or 1-in. cable to order

Bartlett Tree Pruners and Saws

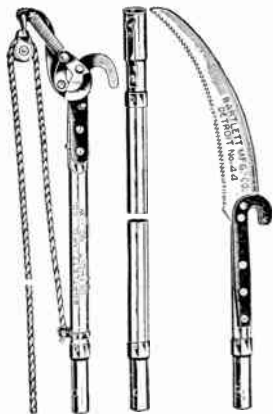

This combination has two head tool sections, one a pruner, one a saw. Each mounted on a short pole with ferrule. Each is 30-in. overall. Handles of desired length is obtained by the addition of a pole section, or sections. Either head can be used with the same handle section. The pole is 1 1/4-in. octagon Sitka spruce.

No.	Description	Wt., Lbs.	Each
1-WE	Pruner Head	2 3/4	\$11.30
44-WE	Saw Head	1 1/2	8.50

Bartlett Extension Pole Sections, Rectangular

1 1/4 x 1 1/8-in. pole sections to extend pole length of tree trimmers and pole saws. For use with Nos. 1-W and 1-B Tree Trimmers and Nos. 41 and 50 Pole Saws.

Length, Feet	Intermediate Section, Each	Bottom Section, Each	Length, Feet	Intermediate Section, Each	Bottom Section, Each
4	\$4.40	\$3.50	10	\$6.95	\$6.00
6	5.20	4.35	12	6.90
8	6.10	5.20			

Bartlett Pole Extension Sections, Octagon

Length, Feet	Intermediate Section		Bottom Section	
	Wt., Lbs.	Each	Wt., Lbs.	Each
4	1 1/2	\$4.40	1 1/4	\$3.50
6	2	5.20	1 3/4	4.35
8	2 1/2	6.10	2 1/4	5.20

Oshkosh Tree Trimmers



A light, strong and efficient trimmer that cuts limbs up to 1 1/2 in. diameter very easily.

The head is made of two pieces of light forged steel, properly reinforced and riveted together; and acts as a guide for the thin saw steel cutting blade, and will not permit the blade to climb over the wood and wedge to one side.

Blade being pivoted starts cutting with a slicing motion the instant the rope is pulled.

Pole consists of three sections of straight-grained clear Washington fir 1 1/2 in. in diameter—one 6-ft. section attached to head and two 7-ft. sections each fitted with positive couplings; very rigid when coupled but easily dismantled.

Complete with short section of rope, pulley and ring. (Any size or kind of rope can be attached to lengthen pull; 1/2-in. rope is suggested for best results.)

No.	Description	Wt. Lbs.	Each
915	Complete Trimmer	13	\$26.50
915S	Spring	1/8	1.15
915EM	7-Ft. Middle Section Pole	4	8.70
915EE	7-Ft. End Section Pole	4	6.55
915R	20-Ft. 1/2-In. Rope	1 1/2	4.45
915B	Extra Blade for Tree Trimmer		6.75

Oshkosh Tree Saws



This tree saw, and tree trimmer listed above, fills need of the lineman and others when trimming around wires, etc.

Steel frame and cap, with hook for hanging saw in tree and pulling out cut hanging branches. Strong, thin, fine-tooth steel blade 18-in. long, cuts fast and clean and leaves a smooth cut. Blade is fastened in frame so that parts cannot fall if blade is broken.

Handle is clear, straight-grained Washington fir 6 ft. long, 1 1/2 in. diameter, with ferrule at bottom which can be connected to pole sections of No. 915 trimmer.

No.	Description	Wt. Lbs.	Each
916	Complete Tree Saw	5	\$15.85
9161B	Saw Blade 18-In. Long	1/4	3.65
9161T	Saw Tightener	1/4	2.90

Bartlett Pole Saws

No. 44



For limbs larger than the capacity of a tree trimmer. Head is made of two strips of steel riveted together so as to form a truss shaped support for the blade which is fastened between the two sides.

Saw can be adjusted to three angles to suit operator's position. The hook serves to hang the tool on a limb when not in use. The pruning saw is 16-inches long, peg tooth with 7 teeth to the inch.

Complete with pole and saw.

Pole Length, Feet	Wt., Lbs.	Each
4	3	\$10.00
6	3 1/2	10.60
8	4	11.15
10	4 1/2	11.70
12	5	12.25
14	5 1/2	12.75
16	6	13.25

If ferrules are required for adding extra sections, add \$1.05 ea.

Bartlett Tree Trimmers, Saws and Pruners

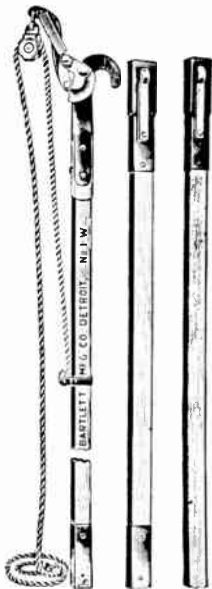

No. 1-WJ and No. 1-W Pulley Type Tree Trimmer
 The compound lever plus the double leverage of the pulley which is attached to the curved lever makes this a powerful cutting tool. It will easily cut any branch up to 1 1/4 inch diameter.
 A special coil spring immediately and positively returns the blade to cutting position. Pole is rectangular, 1 1/4 x 1 1/8 in. Price is complete with pole and rope.
 No. 1-WJ (2-4' sections).... **\$15.95**
 No. 1-WJ (3-4' sections).... **20.35**
 No. 1-WJ (4-4' sections).... **24.75**

No. 1-W

Pole Length, Feet	Wt., Lbs.	Each
4	4	\$12.45
6	4 1/2	13.15
8	5	13.80
10	5 1/2	14.50
12	6	15.20
14	6 1/2	16.00
16	7	16.90

Head and Pulley for No. 1-W Trimmer.....Each **\$8.70**

Bartlett Tree Trimmers, Saws and Pruners



No. 1-B Bakelite-Insulated Tree Trimmer
 An efficient trimming tool which will handle all light-weight branches . . . plus insulation. It has been tested and proven safe at 105,000 volts.
 The insulator is 1/2 inch round Bakelite 30 inches long, divided between the short top and bottom pull rounds. For further insulation, the pull lever handle is made of wood. The pull lever is 42 inch from the head.
 Price is complete with pole and rope.
 Pole is laminated spruce 1 1/4" x 1 1/8".

Pole Length, Feet	Wt., Lbs.	Each
6	5	\$21.50
8	5 1/2	22.30
10	6	23.25
12	6 1/2	24.15
14	7	25.15
16	7 1/2	26.15

Head complete for 1-B Trimmer.....Each **\$7.60**

Bartlett Wire Raising Tools



Wire raising tool made of malleable casting with two hooks for the simultaneous placing of steel strand and open telephone line.
 A hole in the base of the casting permits the locking pin to fasten the head securely to pole and more than one section can be attached if a longer pole is required.
 Ideal wire raising tool for telephone industry.

No.	Weight of Head Only, Lbs.	Each
LC-65	1 lb. 3 oz.	\$5.25

Bartlett Pole Saws and Hand Saws

Safety-Back Pole Saw



The safety wood back protects against metallic contact with energized wires. The bent wood back tapers from regular size pole to a narrow point. This enables the saw to work in close crotches.

Blade can be adjusted to three angles. Rigidity of frame and tension of blade adjusted by a thumb screw.

Saw is 36 in. long by 7/8 in. wide, with a draw cut of 5 points to the inch. Will cut limbs up to 5 in. diameter. The head with pole, fitted with ferrule, is 5 ft. in length. The desired length can be provided by the addition of a pole section, or sections, as listed for tree trimmers.

No. 50, Wt., 5 lbs. Each **\$13.25**

Utility Saw

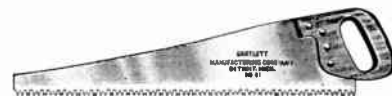

Has special extra large, easy grip handle. Tuttle tooth blade. Designed for heavy cutting.

No.	Description	Wt., Lbs.	Each
41	20-In. Blade	1 1/2	\$6.60
41	24-In. Blade	1 5/8	8.40

Pruning Saw



Has two styles of teeth on same cutting edge. A 10-in. section at the point has 6 points to the inch for starting, and balance of blade has large tooth similar to the Tuttle tooth. Handle has large opening for glove hand. Has 26 in. blade, 1 1/2 in. wide at point. Wt., 1 7/8 lbs.

No. 26.....Each **\$9.20**

Tree Experts' Saw



Has large opening, easy grip handle. Special set teeth, 6 points to the inch and beveled forward. A special saw preferred by many tree experts. 1 1/2 in. wide at point. Wt., 2 lbs.

No.	Description	Each
27W	26-In. Length	\$8.50
28	28-In. Length	9.20

Bracket Type Pole Saws



A bracket type saw with a 11 1/2-inch blade, 3 points to the inch. A convenient and easy saw to use. It is not suitable for large limbs. Tightening screw keeps blade at proper tension. The hook is used for pulling out cut branches and hanging the saw on a limb when not in use. Furnished with a 10-ft. 1 1/4 x 1 1/8 in. pole. Weight, 4 1/2 lbs.

No. 45.....Each **\$11.50**

Bartlett Utility Saws

D-Type Handle



A fast cutting saw. Lightning teeth, 1 point to the inch. Gives a smooth cut, 24 in. length. Wt., 1 1/4 lbs.

No. 124-B.....Each \$8.20

Horn Type Handle



Similar to No. 124-B except for the horn type handle. 26 in. length. Can be had either with or without snap for fastening to belt. Weight, 1 3/8 lbs.

No. 114-B, Without Snap.....Each \$8.45
 No. 114-B, With Snap.....Each 9.00

Rapid Cut Saw



This saw cuts faster than any other style. The teeth are diamond point with a well shaped raker. Handle has extra large grip for use with gloves. With or without belt snap. Length, 26 in. Wt., 1 1/8 lbs.

No. 114, Without Snap.....Each \$8.50
 No. 114, With Snap.....Each 9.20
 No. 124-24", Without Snap (D Handle).....Each 8.30

Bartlett Forester Saws



A saw that can be used equally well on light branches and heavy limbs. Blade length, 26 in. Wt., 1 1/4 lbs.

No. 170.....Each \$5.50

Bartlett Paragon Pruning Saws



A curved pruning saw with an extra large handle. It has a draw cut and high clearance, resulting in fast cutting. Length must be specified on orders. 6 points per inch.

No.	Length In.	Wt Lbs.	Each
127	18	1	\$4.25
127	22	1 1/16	4.75
127	24	1 1/8	5.25
127	26	1 3/8	5.50

Bartlett Leather Saw Sheaths



Sheaths give double protection . . . protection to the saw and protection to the user. Bartlett saw sheaths are expertly made of high grade substantial 8 oz. oak tanned leather.

For Saw No.	Each	For Saw No.	Each
26	\$5.55	114-B	\$4.40
27	5.55	124-B	4.30
41-20"	5.10	127-18"	4.05
41-24"	5.40	127-26"	4.40
114	4.40	170	4.60
4402-16"	4.00	127-24" and 114B Professional grade (sole Leather)	8.00

Bartlett Two Hand Pruners



Blade and hook are drop forged crucible tool steel. Blade will not cut or dig into hook. By dropping hook below the center line, a positive draw cut of the blade is produced, allowing a straight thrust at the branch. Has 26-in. white ash handle. Overall length, 31 1/2-in. Wt., Approx. 4 lbs.

No. 777, Plain Ferrules.....Each \$6.95
 No. 777, Strap Ferrules.....Each 7.30

Bartlett Hand Pruners



The handles and hooks are dropped forged from high grade special steel. The blades are stamped crucible tool steel. Both blade and hook are hardened. The hook acts as guide for the blade when cutting. Adjusting nut on the pivot bolt keeps shears at proper tension. Safety catch locks blade and hook in closed position. Fully polished. Length, 9-in. Wt., 1 1/8 lbs.

No. 999.....Each \$6.30

Bartlett Tree Paint



Made with a pure Egyptian asphalt base; contains only ingredients which are helpful to the healing of tree wounds. Will not crack or peel. Especially adapted to fall and winter trimming work because it retains its liquid consistency under freezing temperatures.

Size Can	1/4 Pt.	1 Pt.	1 Qt.	1 Gal.	5	30	50
Each.....	\$0.60	\$0.90	\$1.60	\$3.50	\$10.00	\$42.50	\$70.00

Bartlett Tree Paint Cans



Available in one pint size. Has adjustable round brush which enters the can through a brass tube that is tightly sealed at all times. There is a screw top for filling. Completely encased in leather, with belt loop on the back apron.

No.	Description	Each
TP-4	Tree Paint Can complete with brush and leather case.	\$5.00
TP-1	Can only	2.35
TP-2	Brush only	.90
TP-3	Leather case only	1.75

Vaughan & Bushnell Linemen's Double-Faced Hammers

Bell System Type



Drop forged head, with short neck to permit heavy blows in confined space. Overall length, 15-in. Weight, 3 lbs.

No. WM-13 Each \$3.00

Champion DeArment Linemen's Double-Faced Hammers



A short, heavy, double-faced hammer, one face flat, one face rounded. NuRed enamel body. Selected hickory handle. Weight per dozen, 37 lbs.

No. 85 Each \$4.30

Champion DeArment Electrician's Hammers

Drop Forged



Designed for working over conduit to secure clamps, for nailing junction boxes, outlet boxes, etc. Polished finish NuRed enamel neck and under claw; selected hickory handle. Weight per dozen—18¼ lbs.

No. 88 Each \$3.60

General Machine Mud Buckets

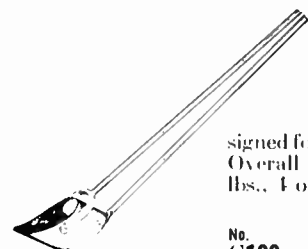

Easier to use; more efficient in removing mud, gravel, sand or rock, dry or in water.

Made of non-rusting aluminum. Durable; designed for the demands of utility service. Overall length 9-ft., 1-in. Weight 8 lbs., 4 oz.

No.	Bucket Capacity Quarts	Handle Length Ft.
G100	5, liquid	8

Oshkosh Pole Hole Spoons

Handles are selected second growth Northern white ash, tough, strong Highland hickory, or hard rock maple as below. They are 1³/₁₆ in. diameter. (All have footage marks to indicate depth of hole.)

Blades and straps are natural black finish. Straps 22 in. long, riveted.



Western Pattern



Eastern Pattern

Hard Rock Maple Handles

Western Pattern				Eastern Pattern			
No.	Length, Handle Ft.	Ship. Wt. Lbs.	Each	No.	Length, Handle Ft.	Ship. Wt. Lbs.	Each
859	7	10	\$10.35	859E	7	10	\$10.35
860	8	10	11.10	860E	8	10	11.10
861	9	11	12.20	861E	9	11	12.20
862	10	12	13.05	862E	10	12	13.05
*Ash or Hickory Handles							
1023	7	10	\$10.90	1023E	7	10	\$10.90
1024	8	10	11.55	1024E	8	10	11.55
1025	9	11	12.45	1025E	9	11	12.45
1026	10	12	13.50	1026E	10	12	13.50
1027	12	14	15.00	1027E	12	14	15.00

Master

Heat-treated Alloy Steel Blades

*Ash or Hickory Handles			
No.	Length, Handle Ft.	Ship. Wt. Lbs.	Each
2023	7	10	\$11.60
2024	8	10	12.40
2025	9	11	13.55
2026	10	12	14.65
2027	12	14	16.45

*If hickory handles are wanted add "H" to catalog number.

Oshkosh Short-Handled Shovels

Blades and straps are natural black finish. Handles are selected second growth Northern white ash, air seasoned and of best quality.



Used for starting and filling in holes.

Bent Handle 4½ ft. Long

High Carbon Steel Blades			With Alloy Steel Blades		
No.	Style of Blade	Each	No.	Style of Blade	Each
1090R	Round Point	\$5.10	2090R	Round Point	\$5.50
1090S	Square Point	5.10	2090S	Square Point	5.50

Shipping weight, 5 lbs.



D-Handle

Used for trench work.

No.	Style of Blade	Each	No.	Style of Blade	Each
*1092R	Round Point	\$5.10	†2092R	Round Point	\$5.50
*1092S	Square Point	5.10	†2092S	Square Point	5.50

Shipping Weight, 4 lbs.

*High Carbon Steel blades
†Alloy Steel blades

Oshkosh Short-Handled Shovel Handles

Select second growth white ash.

Bent Handle				D-Handle With Pressed Steel D			
No.	Length, Ft.	Ship. Wt., Lbs.	Each	No.	Length, Ft.	Ship. Wt., Lbs.	Each
1091	1½	2	\$2.80	1093	...	2	\$2.80
2091	1½	2	2.80	2093	...	2	2.80

Oshkosh Pole Hole Shovels



Straight Patterns

These shovels are absolutely straight from end to end. This makes them stiff and much handier in lining up the sides of hole.

Handles are selected second growth Northern white ash, tough strong Highland Hickory, or hard maple as below. They are 1 1/8-in. diameter. (All have footage marks to indicate depth hole.)

Blades and straps are natural black finish. Straps 22 in. long, riveted.

With Carbon Steel Blades

Maple Handles				*Ash or Hickory Handles			
No.	Length, Handle Ft.	Ship. Wt. Lbs.	Each	No.	Length, Handle Ft.	Ship. Wt. Lbs.	Each
867	7	8	\$10.20	1032	7	8	\$10.70
868	8	9	13.55	1033	8	9	11.50
869	9	10	12.15	1034	9	10	12.40
870	10	11	13.05	1035	10	11	13.50

Master

Heat-treated Alloy Steel Blades

***Ash or Hickory Handles**

No.	Length, Handle In.	Ship. Wt. Lbs.	Each
2032	7	8	\$11.45
2033	8	9	12.35
2034	9	10	13.55
2035	10	11	14.65

*If hickory handles are wanted add "H" to catalog number.

Oshkosh Pole Hole Shovel and Spoon Handles

Selected second growth Northern White ash, tough, strong Highland Hickory, or Hard Rock Maple. 1 1/8-in. diameter.

Rock Maple				*Ash or Hickory			
No.	Length, Ft.	Ship. Wt. Lbs.	Each	No.	Length, Ft.	Ship. Wt. Lbs.	Each
993	7	4	\$4.10	1005	7	6	\$5.20
994	8	5	5.10	1006	8	6	5.95
995	9	6	6.55	1007	9	7	7.00
996	10	7	8.30	1008	10	7	8.65
				1009	12	8	10.25

***Ash or Hickory**

Air Seasoned, Best Grade

No.	Length, Ft.	Ship. Wt., Lbs.	Each
2005	7	6	\$ 5.25
2006	8	6	6.00
2007	9	7	7.05
2008	10	7	8.70
2009	12	8	10.30

*If hickory handles are wanted add "H" to catalog number.

Oshkosh Pole Hole Diggers



Will dig a hole 6 in. in diameter. Handles are conveniently marked to enable workman to determine depth of hole.

Special alloy steel blades securely welded to fulcrum members which are heavy channel-shaped steel forgings. One pivot point on each side of blade give greater leverage and durability.

Handles are straight-grained hardwood 3 ft. long.

Made in two models—with split handles or with two solid handles.

No.	Type Handle	Ship. Wt., Lbs.	Each
2050	Split	13	\$17.05
2051	Two, Solid	14 1/2	17.05
Extra Handles			
2050A	Split	6	Per Pr. \$7.25
2051A	Two, Solid	6 1/2	Per Pr. 7.25

Oshkosh Tamping Bars



With Light Steel Shoe

Hand rock maple handle and head. Tamping head 1 3/4 x 4 in., faced with light steel shoe 1/4 in. thick.

No.	Length, Ft.	Ship. Weight, Lbs.	Each
854	7	13	\$10.70
855	8	14	11.50
856	9	16	13.45



With Heavy Steel Shoe

Hard Rock maple handle and head. Handle 1 5/8 in. diameter; tamping head 1 1/4 x 3 1/2 in., faced with heavy steel shoe 1/2 in. thick.

No.	Length, Ft.	Ship. Weight, Lbs.	Each
1054	7	13	\$12.00
1055	8	15	13.00
1056	9	17	14.15



Electric Pattern

Steel tubing 1 1/8 in. diameter, with malleable iron tampers on each end—one 2 3/4 x 6 in., the other 2 1/2 x 3 3/4 in.

No. 1044 Length, 8 ft., Ship. wt., 15 lbs. Each \$13.95

Oshkosh Crow and Digging Bars



Octagon shape special crucible steel, strong and stiff with ability to hold edge with 2-in. chisel on one end, pointed on the other.

No.	Length, Ft.	Diam., In.	Ship. Wt., Lbs.	Each
1061	7	1	20	\$11.50
1062	8	1	23	12.35
1064	7	1 1/8	26	12.95
1065	8	1 1/8	28	14.20
1066	9	1 1/8	31	16.35

**Oshkosh Tamping Bars
With Curved Head**



Tamping head is a 7-in. radius curved steel forging 7-in. wide, 3-in. high, 1 7/8-in. thick at the middle tapering to 5/8-in. thick at each end. A 12-in. steel socket is welded to the head to hold a straight-grained second growth hard-wood handle.

Complete Tamping Bar				Extra Handle		
No.	Lgh., Ft.	Ship. Wgt., Lbs.	Each	No.	Ship. Wgt., Lbs.	Each
3698-7	7	12	\$11.70	3698A-7	4	\$4.15
3698-8	8	13	12.90	3698A-8	5	5.25
3698-9	9	14	14.00	3698A-9	6	6.35

Oshkosh Tamping and Digging Bars



Octagon shape special crucible steel, strong and stiff with ability to hold edge. Has 2-in. chisel one end and malleable iron tamper on the other.

No.	Length, Ft.	Diam., In.	Ship. Wt., Lbs.	Each
1071	7	1	21	\$11.75
1072	8	1	24	12.55
1074	7	1 1/8	27	13.80
1075	8	1 1/8	30	15.30

Oshkosh Plain Digging Bars



Octagon shape special crucible steel, strong and stiff with ability to hold edge with 2-in. chisel on one end.

No.	Length, Ft.	Diam., In.	Ship. Wt., Lbs.	Each
1081	7	1	20	\$11.60
1082	8	1	23	12.65
1084	7	1 1/8	26	13.35
1085	8	1 1/8	28	14.50

Oshkosh Digging Spuds



An Evenly Balanced Light Digging and Tamping Tool

Steel tubing handle, 1 5/16 in. diameter, with malleable iron tamping head. Blade and socket of one piece forged high carbon steel. Blade 3 1/2 in. wide.

No. 852—Length, 9 ft.; Ship. weight, 20 lbs. ... Each \$21.05

Oshkosh Carrying or Lug Hooks



Chisel Point Pattern

For Carrying Poles, Timbers, Etc.

Clear straight-grained, first quality rock maple handle. Crucible tool steel hooks attached to malleable iron clasp and swivel for easy carrying.

Complete Hooks				Extra Handles			
No.	Length Handle Ft.	Diam. Handle In.	Ship. Wt., Lbs.	Each	No.	Ship. Wt., Lbs.	Each
295	4	2 1/2	7	\$ 9.10	593	3	\$4.00
296	4 1/2	2 1/2	8	9.50	594	4	4.30
297	5	2 1/2	8	9.95	595	4	4.55
298	5	3	12	14.10	963	5	5.55
299	6	3	13	14.70	964	6	6.50
300	7	3	14	15.15	965	7	8.05

Oshkosh Swivel Point Lug Hook



Clear, straight-grained, first quality hardwood handles. Malleable iron clasp and swivel, crucible steel hook and swivel plates. Swivel plates further heat-treated for additional strength.

Complete Lug Hook

No.	Length Handle Ft.	Diam. Handle In.	Ship. Wgt., Lbs.	Each
4004	4	2 1/2	10	\$16.30
4005	4 1/2	2 1/2	11	16.75
4006	5	2 1/2	12	17.15

Extra Handles

593	4	2 1/2	3	\$ 4.00
594	4 1/2	2 1/2	4	4.30
595	5	2 1/2	4	4.55

Oshkosh Peavies



Malleable iron socket. Duck bill hook and pike hammered out of crucible steel. Has stop to prevent hook falling back on handle.

With Hard Rock Maple Handles

Complete Peavy				Extra Handles			
No.	Length Handle Ft.	Diam. Handle In.	Ship. Wt., Lbs.	Each	No.	Ship. Wt., Lbs.	Each
121	4	2 1/4	7	\$ 9.05	541	3	\$3.10
122	4 1/2	2 1/4	7	9.75	542	3	3.30
124	4	2 1/2	9	9.85	544	3	3.30
125	4 1/2	2 1/2	9	10.30	545	4	3.65

With Second Growth Hickory Handles

134	4	2 1/4	8	\$11.20	572	3	3.45
135	4 1/2	2 1/4	8	11.70	573	3	3.85
137	4	2 1/2	9	11.60	575	4	3.85
138	4 1/2	2 1/2	10	12.25	576	4	4.15

Oshkosh Pole Supports

Wood Jenney

Clear, straight-grained fir, strong and rigid when set up. Folds easily to small size for carrying in trucks.

Steel bushings reinforce center or pivot holes for bolt in cross pieces.

Steel pikes at bottom of each leg prevents side slipping. Cross brace placed high to prevent interference while walking.

Uprights 1 3/4 x 3 1/2 in.



No.	Height, Ft.	Ship. Wt., Lbs.	Each
842	6	25	\$27.40
843	7	30	30.75
844	8	35	33.75

Oshkosh Pole Supports

Both ends are banded, with rivets entirely through band, wood, fork or pike.



Deadman—Fir

Clear, straight-grained fir, 3 x 3 in. square, with three-pronged steel fork. Lower end provided with pike to prevent sliding. Length over all 8½ ft.

No. 740—Shipping wt. 40 lbs. Each **\$37.85**



Standard Deadman—Rock Maple

A. T. & T. Pattern

Rock maple support 2 x 4 in., with rounded edges. Steel fork fastened in upper end; pike in other end.

No. 848—Length 8 Ft.; Ship. Wt. 29 Lbs. . . . Each **\$39.50**



Wooden Mule

Washington fir pole 4 in. diameter, tapers slightly toward each end. Has forged crucible steel fork on one end and pike in other.

No.	Length, Ft.	Ship. Weight, Lbs.	Each
845	6	23	\$33.90
846	7	26	35.20
847	8	29	38.20

Oshkosh Pike Poles



One piece special steel pike with upset face to take the end thrust and distribute it over entire end of handle. Pike set in oil with rivet through malleable iron ferrule, handle and pike. (Pike projects 1 in.)

Straight, close-grained old growth yellow Washington fir handle (No Finish). Coated with Special Finish at Slight additional cost.

Standard Light Pattern

*Diameter Handle 2 In.

Pike Pole Complete				Extra Handles		
No.	Length, Ft.	Ship. Wt., Lbs.	Each	No.	Ship. Wt., Lbs.	Each
806	12	8	\$ 8.80	971	7	\$ 7.50
807	14	10	9.55	972	9	8.30
808	16	11	10.30	973	11	9.15

A. T. & T. Pattern

Diameter Handle 2½ In.

818	12	13	\$11.15	982	12	\$ 9.70
819	14	14	12.35	983	13	10.65
820	16	15	13.45	984	14	11.65
821	18	18	14.35	985	16	12.65
822	20	20	15.65	986	19	13.80

*Diameter at center; tapers to 2 in. at both ends.

Oshkosh Pike Pole Guards



For guarding the dangerous point on pike poles. Will fit either the 2" or 2½-inch poles.

The guard works very easy and fastens securely in either guarding or open position. When in guarding position it locks automatically in place and affords complete protection from pike point. When not in guarding position it fits snugly around the pole completely out of the way.

(Can be attached to Pike Pole at Cost of guard only.)

No. 10—Shipping weight ¾ lb. Each **\$2.80**

Oshkosh Pike Pole Coating

A special prepared smooth, hard and transparent finish for coating pike poles to prevent raising of grain and loss of time caused by splinters and splinters. It is also a non-conductor of electricity.

Can be applied to above pike poles at a slight additional charge.

Oshkosh Cant Hooks

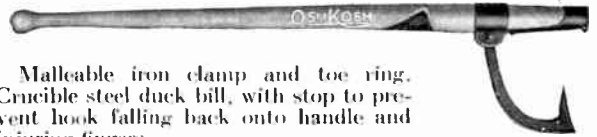

Malleable iron clamp and toe ring. Crucible steel duck bill, with stop to prevent hook falling back onto handle and injuring fingers.

With Hard Maple Handles

Complete Cant Hook					Extra Handles		
No.	Length Handle Ft.	Diam. Handle In.	Ship. Wt., Lbs.	Each	No.	Ship. Wt., Lbs.	Each
188A	4	2¼	7	\$ 7.80	541	3	\$3.10
189A	4½	2¼	8	8.15	542	3	3.30
188	4	2½	8	8.15	544	3	3.30
189	4½	2½	8	8.55	545	4	3.65

With Second Growth Hickory Handles

199A	4	2¼	7	\$ 9.70	572	3	\$3.45
200A	4½	2¼	8	10.10	573	3	3.85
199	4	2½	8	10.10	575	4	3.85
200	4½	2½	9	10.50	576	4	4.15

Oshkosh Swivel Point Cant Hooks



Malleable iron clasp and toe ring. Hooks of crucible steel, swivel points of crucible steel and also heat-treated for further strength. Stop to prevent hook falling back onto handle and injuring fingers. Clear straight-grained, first quality hardwood handle.

Complete Cant Hook					Extra Handles		
No.	Length Handle Ft.	Diam. Handle In.	Ship. Wgt., Lbs.	Each	No.	Ship. Wgt., Lbs.	Each
3989	4	2¼	8	\$11.45	572	3	\$3.45
3990	4½	2¼	9	11.85	573	3	3.85
3994	4	2½	9	14.55	575	4	3.85
3995	4½	2½	10	15.00	576	4	4.15

Oshkosh Pole Cradles

E-Z-UP



For lifting poles in position to work on them.

Can be operated by one man without much lifting strain. Works on the simple cam system and rocks the pole off the ground and up.

Is operated by placing the cradle against the pole and dropping the point of a cant hook or peavy between the two rockers. Then by catching the hook in the opposite side of the pole and pulling back on the handle it is placed in the cradle.

Pole can be rotated in saddle of cradle by using a cant hook. Made of high grade malleable iron.

No. 3668—Shipping Weight, 26 Lbs. Each **\$38.70**

Chance Pike Poles With Standard Points



Straight poles available in tough Maplac plastic coating or linseed oil finish. Tapered poles in linseed oil finish only.

Maplac Plastic Finish Poles

Straight Pole (2-in. Diam.)				Straight Pole (2 1/4-in. Diam.)			
No.	Length, Feet	Approx. Wt. Each, Pounds	Each	No.	Length, Feet	Approx. Wt. Each, Pounds	Each
210M	10	8	\$10.70	214SM	11	13	\$15.55
212M	12	9	12.35	216SM	16	15	17.45
214M	14	11	13.90	218SM	18	17	19.20
216M	16	13	15.55	220SM	20	20	21.00
218M	18	15	17.10				
220M	20	17	18.75				

With Reversible Safety Point



Reversible safety point pike poles eliminate the hazard of exposed, sharp points during transportation and handling prior to use. Points may be replaced when worn.

Poles are laminated for greater rigidity and warp-resistance. Reinforced at head and butt.

Wire lift is available for maneuvering telephone or secondary conductors during installation. Available with straight or tapered poles.

Maplac Plastic Finish Poles

Straight Pole (2-in. Diam.)				Straight Pole (2 1/2-in. Diam.)			
No.	Length, Feet	Approx. Wt. Each, Pounds	Each	No.	Length, Feet	Approx. Wt. Each, Pounds	Each
210PM	10	8	\$11.35	214SPM	11	13	\$16.30
212PM	12	9	13.00	216SPM	16	15	18.05
214PM	11	11	14.65	218SPM	18	17	19.85
216PM	16	13	16.20	220SPM	20	20	21.65
218PM	18	15	17.85				
220PM	20	17	19.40				

Pike Pole Fittings



Pike Point



Wire Lift



Ferrule

No.	Description	Approx. Wt. Each Pounds	Each
F-2X	Ferrule	3/4	\$1.20
PP-2X	Pike Point	1/2	2.05
W-2X	Wire Lift	5/8	2.75
B-2XM	Butt Ring	1	.45

Chance Pole Tongs



Permit one man to guide and control the setting of a pole while it is lowered by a winch line.

Sharp points hook firmly into pole as the workman regulates the forward, backward and rotary movements.

Use of pole tongs replaces the clumsy system of setting poles using two peavies or cant hooks.

Adjustable jaws fit poles from 7 to 18-in. diameter.

Sturdy three-ft. handles put the workman a safe distance from the pole.

No.	Handle Length, Ft.	Wt., Lbs.	Each
C200T	3	11 1/2	\$20.05

General Machine Warning Signs



Type B

Unusually stable; panel is pivoted on A-frame so that wind pressure exerts a downward force, anchoring sign more firmly.

Panel is free to move 35° from vertical; 1 1/2-ft. square. Frame is held in open position by spreaders.

Socket on side supports warning flag or lantern.

No. 7358—Wt. 23 lbs. Prices on Application

General Machine Warning Stands



For use as base for B Warning Mast or demountable warning signs, or as support for Warning Flasher.

Four-legged; collapsible.

Spring-actuated ring detent locks strand in open or closed position.

Open dimensions: base 31-in. square; height 38-in. Closed dimensions: 4-in. wide; 32-in. high.

No. 7328—Wt. 20 lbs. Prices on application

General Machine C Warning Masts



Used with B Warning Stand. Consists of 3/4-in. aluminum pipe with sliding aluminum rod. Collapsed length 71-in.; extended length 115-in.

No. 7603—Wt. 6 lbs. Prices on application

Oshkosh Warning Signs



A lightweight, extremely durable sign, the legs of which are made of 1/2 in. high carbon steel and will not bend. Has 1 1/4 in. flange around the edge of sign that acts as a reinforcement and protects the lettering from damage when being transported in trucks.

Each sign is equipped with two convenient handles for adjusting the angle of the legs. Handles are hollow and can also serve as flag sockets. Each handle is also fitted with a handy lantern lock.

The solid black 5 1/2-in. letters on a 20 x 20-in. background of brilliant traffic yellow flashes a signal which cannot be ignored.

The sign proper can be made luminous for night use and still be as efficient for day time use. (For prices see below).
 Dimensions: 43 in. high, 28 in. wide. Folds to 28 x 28 x 1 1/4 in. Shipping weight 23 lbs.

- No. **3513**—As Described.....Each **\$17 20**
- No. **3513.1**—Luminous, One Side Only.....Each **\$23 20**
- No. **3513.2**—Luminous, Both Sides.....Each **28. 40**

Bartlett Road Signs

Automatic Type

A durable warning signal which folds into a compact form for carrying.

Locking cam on base of tripod locks legs when open, preventing the wind from blowing sign over. Black letters on yellow background for maximum visibility.

Flagholder has three sockets; two flags supplied with each complete outfit.

Four feet high.

Available with sign illustrated, 18 x 18-in., or with following warn-

ings: Men Working (15 x 15-in.); Men Working Above (18 x 18-in.).



Description	Wt., Lbs.	Each
Complete Sign as Described	13	\$15 00
Metal Sign Only (18 x 18-in.)	3	4. 40
Metal Sign Only (15 x 15-in.)	2 1/2	4. 15
Flags Only (Red)	1	.50

Coffing Flag and Flag Holders



Flag holder eliminates need of nailing the flag staff to pole, prevents split flag staffs and is easier and faster to attach.

Holder will fit any size pole. Chain wraps around pole and fastens to main body of clamp.

Equipped with a strong coil spring that provides strong tension on the chain.

Flag is made of 6 oz. Army Duck, 12-in. x 16-in. Hardwood flag staff is 1-in. x 18-in.

Description	Each
Flag only (with staff) Ship. Weight 1 lb.....	\$1.75
Flag Holder only, Ship. Weight 2 1/2 lbs.....	3.95
Flag Holder and Flag, Ship. Weight 3 1/2 lbs.....	5.70

Oshkosh Folding Barricades

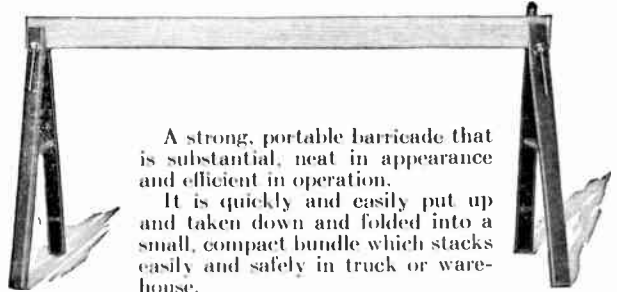

A strong, portable barricade that is substantial, neat in appearance and efficient in operation.

It is quickly and easily put up and taken down and folded into a small, compact bundle which stacks easily and safely in truck or warehouse.

To set up quickly and easily, open the legs, latch the cross-piece, put in the cross-rail and turn the handle. The cross-rail is then held in a vice-like grip without injury. Will hold wood from 1 to 3 in. thick.

Heavy gauge steel legs, with steel pipe handle, latch and extension swivel. Hollow in pipe handle is handy for holding danger flag. Also equipped with lantern lock to hold lantern securely. Orange enamel finish.

Extension swivel makes it possible to erect a square barricade with two pairs of barricade legs instead of four. (Extension swivel not included—see below.)

No.	Height, In.	Width Open, In.	Size Folded, In.	Ship. Wt., Lbs.	Per Pair
3372-101	32	20 to 23	3x2x35	25	\$17 60
3372-102	42	25 to 29	3x2x44	32	22. 40

Extension Swivels.....Each **\$4.75**

Note—Wooden cross rails are not included.

Fairmount B Warning Flag Bases



Red cast iron base used to support B warning flag. 1-3/16-in. hole in center accommodates flag staff; may be used in either of two positions. With convex surface down base is self sighting, when reversed serves as fixed support for flag. Approx. Wt. 8 Lbs.

Neo-Flasher Warning Lights

Model 0-100LSY

Shines in two directions. Flashes 1000 hours on one battery. Locks to barricade. Tamper proof switch. Clear, red or amber lens.



Model **0-100LSY** Each **\$27 00**

Model 1-100LSY

Visible from all directions. Flashes 1000 hours on one battery. Locks to any barricade. Tamper proof switch. Clear, red or amber lens.



Model **1-100LSY** Each **\$25 35**

Model 2-100LSY "Two-Head"

Super bright in two directions. Flashes 600 hours on one battery. Locks to any barricade. Tamper proof switch. Clear, red or amber lens.



Model **2-100LSY** Each **\$35 40**

Model 4-100LSY Directional Light

Super bright in one direction. Flashes 1000 hours on one battery. Locks to any barricade. Tamper proof switch. Clear, red or amber lens.



Model **4-100LSY** Each **\$31 10**

Neo-Flasher Warning Lights

**Model 9-100
Truck Flasher**

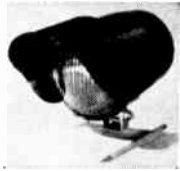

Wire connects to truck battery with switch on dash board. Will flash for long periods without discharging battery. Lens 5 3/8-in. Hood is optional.

Model **9-100** Each **\$35.40**

**Model 5-100
12 Volt
"Stop" or "Caution" Light**



Used for stop signs or school crossings. Will operate 750 hours (30 days and nights) on two ignition dry cell batteries. Standard 8 3/8-in. lens. Neon tube does not burn out. Red or amber lens. Aluminum case.

Model **5-100** Each **\$110.00**

Neo-Flasher Utility Flashers



**Warning Stand With
Model A-100 Flasher**



360° Alternate Head

Model A-100 Telephone Company Flasher is a very bright flasher for use at manholes. Mounts on General Machine Warning Stand. Directional lens visible for 4 miles. Will flash continuously for 750 hours on two 6 volt ignition dry cells.

Equipped with plastic lens. Head mounts on telescope mast and tightens with wing nut. Steel battery case on ground has 12-ft. cord.

Model **A-100** (Without Warning Stand) Each **\$92.50**

360° Alternate Head

Has glass Fresnel and Prismatic clear lens. Neon tube does not burn out. Sleeve same as Directional Head.

Model **360° Alternate Head** Each **\$20.00**

Warning Stand (General Machine Products Co.)

For use as base for Neo-Flasher Model A-100 and Warning Signs. four legged, collapsible. Spring actuated ring detent locks stand in open or closed position.

Open dimensions, base 31-in. sq., 38-in. high. Closed dimensions, 4-in. wide, 32-in. high.

Model **7328** Model B Warning Stand Each **\$16.25**
7605 Model C Warning Mast **14.50**

Neo-Flasher Public Utility Barricade

Model B



For use with warning light at manholes. Made with 1-in. angle iron into two frames 21-in. x 38-in. and hinged together at top.

Holds swinging 20-in. x 24-in. panel, painted yellow, reading "MEN AND EQUIPMENT WORKING".

Flashers mount on top, if desired.

Model **B** (Without Light) Each **\$17.00**

Neo-Flasher Neo-Power Pak Batteries

6 Volt



For use in Models 0-100, 1-100, 2-100 and 4-100 lights. Metal encased and leakproof. Will operate lights approximately five weeks.

Model **100BM** Each **\$1.75**

Neo-Flasher Battery Cases

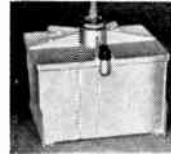

For use with "Stop" or "Caution" Light Model 5-100. Complete with 6-in. wheels. Hinged lid is threaded to receive 2-in. pipe standard and may be locked closed. Will hold four 6 volt ignition dry cell batteries. Portable. Painted yellow. Dimensions 15-in. x 11-in. x 9 1/4-in.

Model **A. W.** Each **\$77.50**

**Standard Railway Fusee Linemen's
Flare Lights**



Yellow Light

For Night Repairs and Line Patrol

These lights burn with a brilliant yellow light for approximately 30 minutes. Equipped with a friction cap ignition for instantaneous lighting, without matches. Not affected by wind, rain or snow.

They are invaluable during outages or other emergencies which require a quick, general illumination. Has spike point in one end which makes it possible to attach to a post or tree, or on the cross arms of a pole, where they afford ample illumination for safe, speedy work. Can be carried in the hand on line patrol.

No.	No. Per Case	Wt., Lbs. Per Case	Per Case
3025	72 Yellow Flares	56	\$27.00
2725	36 Red & 36 Yellow	52	23.75



Red Flare Light

Protection on the Highways After Dark

An unmistakable warning signal for use in case of highway accidents, truck breakdowns, or when power lines are down on thoroughfares. They serve a two-fold purpose of warning the public of existing danger and protecting men and equipment on the highways at night.

Equipped with friction cap ignition for instantaneous lighting, without matches. Has spike point for attaching to wood surface or other convenient place.

No.	Burns, Minutes	Std. Pkg., Case	Ship. Wt., Lbs.	Per Case
2715	15 Red	72	29	\$14.00
2720	20 Red	72	34	15.50
2730	30 Red	36	25	10.50

Flare Rack For Truck Cabs

No. **500** Rack holds 5 Flares, Ship. Wt., 2 lbs. Each **\$1.10**

Oshkosh Combination Pay-Out and Take-Up Reels

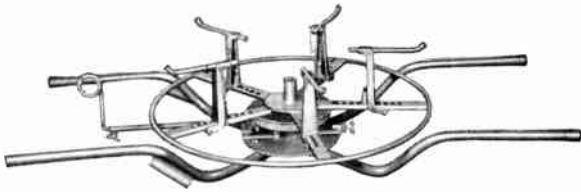

An extremely lightweight, strong and durable Pay-Out and Take-Up Reel all in one. Steel tubing frame. The guide pins fold flat and the entire reel is compact and easy to carry or slide on truck.

Guide pins are easily and quickly adjusted to take coils of wire as below.

Automatic Brake—as the wire is pulled the brake releases and the wire pays out freely. The instant tension is slackened the brake sets and prevents backlashing.

Easily converted into a take-up reel by using two braces furnished to hold reel in upright position. Hand crank, which is also furnished makes possible a fast and easy job of taking-up.

Carrier frame easily removable so that reel can be bolted to truck. A thumbscrew terminal is provided for grounding reel.

Will hold coils of wire—inside diameter 13 to 27 in.; Outside diameter 34 in.

Dimensions: Length over all 63 in.; width 34 in.; height over all (guides up) 13¼ in.; guides down, 8¾ in.

No.	Description	Each
3555	Complete; Shipping Weight 75 Lbs.	\$153.20
3555A	Reel Only, without Carrying Frame. Shipping Weight 60 Lbs.	139.45

Oshkosh Pay-Out Reels



For mounting in gangs on wagons or trucks when paying out several wires simultaneously.

Finished hardwood braced and reinforced with sheet steel.

Overall dimensions: Diameter 34 in.; height 19 in.

Reels are adjustable for 12, 18 and 24 inch reels.

No. 902—Shipping Weight 40 Lbs. Each \$32.00

Oshkosh Barrow Reels

Heavy Western Union Type



Made of heavy material for heavy wire and heavy work. Fine quality hardwood, braced and reinforced with steel. A wide bearing, with long pivot and sleeve permits reel to turn easily no matter how heavy the coil of wire on the reel. The friction developed by this bearing is not sufficient to prevent the reel from turning easily, but keeps reel from paying out the wire too fast and tangling it. Strong steel legs.

Reel pins adjustable for 12, 18 and 24 in. coils. Dimensions: 72 in. long, 42 in. wide; height over all 31 in.

No. 900	Shipping Weight 80 Lbs.	Each	\$63.35
No. 901	Extra Guard Pins; Weight Set		
	1½ Lbs.	Per Set of 4	5.90

Oshkosh Folding Take-Up Reels



A handy tool to have on a truck. When taking down good wire it will coil it neatly in standard sized coils entirely undamaged. Even when taking down or picking up wire to be sold as scrap it is easier to handle and takes up less space when in coils, and takes no longer to coil with the reel as to throw it loosely on the truck.

The reel is made of malleable iron and steel. The stand is hardwood, mortised and framed, and reinforced with steel. Both the reel and the stand collapse, so that when not in use takes up very little space.

Dimensions: Stand is 36 in. high, 19 in. wide; collapses to 4½ x 19 x 39 in.

For 21 inch coil.

No. 897—Shipping Weight 42 Lbs. Each \$43.60

General Machine Terminal Wire Reels

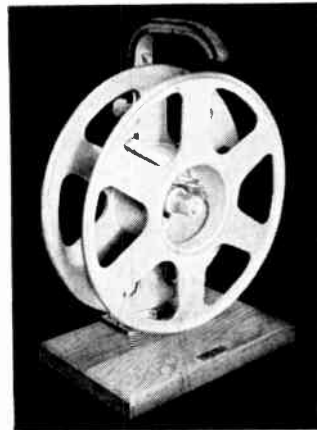

Used in terminal room for paying out or re-reeling standard interior wiring. Made entirely of heat treated aluminum alloy. Handle at top for easy carrying. Fool-proof spring device allows outer half of reel to be disengaged quickly to remove completed reel of wire. Two flanges may be adjusted by this spring device to vary the inside width of reel from 3¾ to 4¾ inches. Automatic brake prevents over-running. 1¼-inch solid oak base with non-skid

rubber washers. Two holes are provided for mounting on wall or side of truck. Overall dimensions of reel: 21¾ x 16 x 9 inches. Weight, approximately 18 pounds. Bright aluminum finish.

No. 8047 Price on application

General Machine Wire Portable Reels

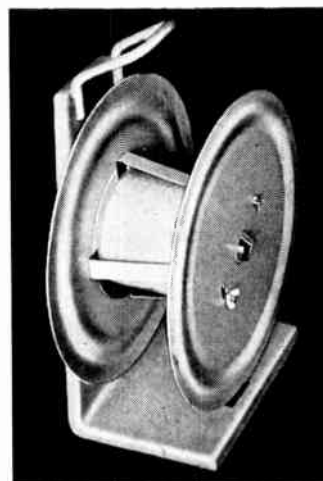

Consist of flanged steel drum mounted on a spindle extending from the vertical surface of an L-shaped sheet steel base.

Outer flange readily removed; drum has spring takeup for gripping the center of coil. Handle makes portable use easy.

No. 8289—Wt. 24 lbs.

Price on application

General Machine Power Reels

Type RS

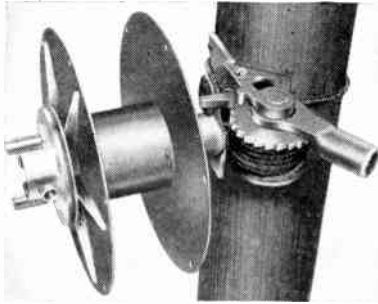

Consist of one spool, driving spindle, pole spindle and two brake assemblies.

Spool mounts on either spindle; has capacity for 1000-ft. of 1/4-in. wire rope. Spool of heavy-gage steel, welded construction throughout, reinforced on outer facings; 18-in. diameter, 7 1/4-in. wide.

Driving spindle mounts on the extending winch shaft on line construction trucks. Length 18 1/16-in.

Pole spindle used to support spool on the side of a pole. Length 13 1/4-in.

No. DL436—Wt. 114 lbs. Price on application

Allen Payout Reels

With Brake



Used to hold coils of wire or other material when using Coiling Machine No. 1200. Reel is made of metal to carry heavy loads. Will hold coils with inside diameter from 12-in. to 21-in. inclusive.

No.	Shipping Wt., Lbs.	Each
1300	112	\$66.00

Allen Payout Reels

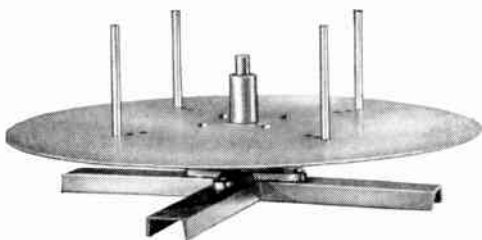

All metal construction. Turntable of reel is 36-in. in diameter and will not wobble. Reel pins can be moved for coils 17-in., 19-in. and 21-in. diameter circles.

Furnished with brake.

No. 100 Each \$64.00

Allen Twin Payout Reels

With Brake

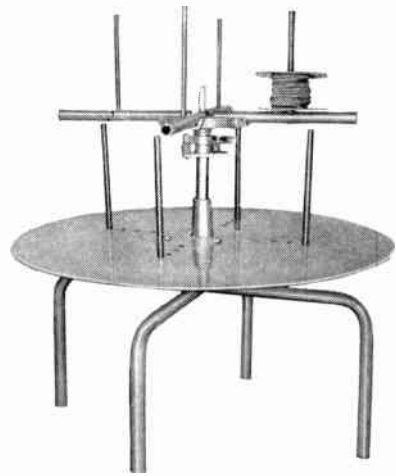

Sturdy reel constructed of metal to carry heavy loads. Will hold coils with inside diameter from 12-in. to 21-in. inclusive. Has small pay-out reel mounted directly on top of spindle for paying out small and medium wire in coils or from spools. A companion reel to the No. 1250 Twin Coiling Machine.

No. 1350 Each \$98.00

Allen Utility Reels



Mounted on strong steel tubing stand. Handy reel has 12-in. diameter. Used for coiling and paying out wire leads to public addressing systems, electric tools and other wire handling uses.

No. 400 Each \$70.00

Call Graybar FIRST For . . .

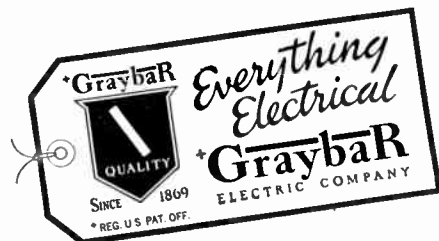

Allen Reel-O-Matics

With Reel-O-Matic equipment one man can measure, coil and cut an order of cable, wire rope, or messenger strand from pay-out to take-up reel all in a matter of minutes. All models are furnished with permanent drive-shaft attachment

for the Coil-O-Matic reel. With this device either coiling or reeling or both may be accomplished without setting up or changing.

Model 30-60 "Giant"

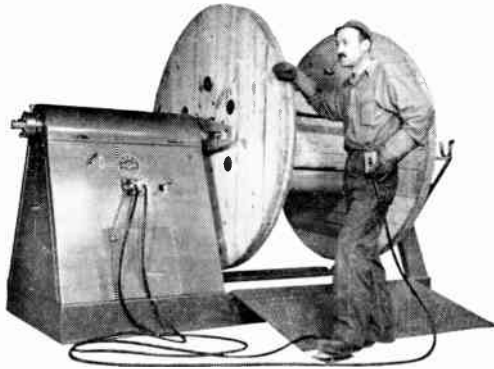

Designed to handle larger reels of cable, wire rope and messenger strand and lead cable. Reel capacity to 66-in. diameter, 41-in. wide weighing 4,100 lbs. Fits in space 3 x 8 ft. Variable speed reel drive is remotely controlled (note control clipped to operator's belt.) Hydraulic lift platform raises and lowers reels quickly and safely.

Other models of the "Giant" handle reels of 72-in. and 81-in. diameter.

Model 30-60 "Giant"..... Each **\$3,960.00**

Model A



Equipped with two NEMA standard 110 volt A.C. motors, one for raising and lowering the lift platform by finger-tip control, the other for turning the take-up reel which is controlled by a foot pedal.

Mounted on 30-in. by 60-in. cold-rolled steel base. Has four driving speeds. Built to handle reels up to 51-in. in diameter and 36-in. in width. Supplied with foot control and cord and power-supply cord.

Model A..... Each **\$950.00**

Model B

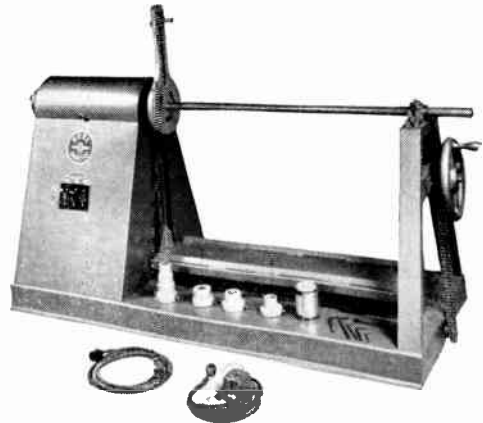

Equipped with a single NEMA standard 110-volt A.C. 1/2 H.P. motor which actuates the take-up reel by foot pedal start-and-stop operation. Platform is raised and lowered manually by wheel-crank mechanism. Other specifications the same as Model "A".

Model B..... Each **\$792.00**

Model E "Midget"



Handles reels up to 51-in. in diameter by 36-in. wide. Four speeds for various sizes of wire cable. Compact, fits 30-in. by 60-in. floor space. Has stationary platform. Equipped with permanent drive shaft attachment for Coil-O-Matic Reel.

Model E "Midget"..... Each **\$530.00**

Model F, Single Speed, no reverse, 48" Reel.... Each **\$454.00**

Allen Kart-O-Matics

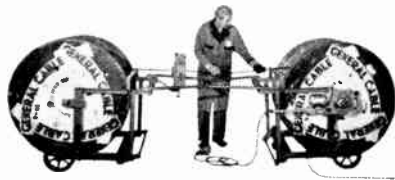

Designed to provide an economical, efficient method of reeling and coiling wire and cable from a standard Reel-O-Matic reel cart or a rack-mounted reel.

Accomodate reels to 51-in. diameter by 32-in. in width.

Complete with 2 carts, power unit, meter . . . Each **\$670.50**

Allen Reel Carts



Sturdily constructed of heavy gauge steel to meet a wide range of everyday warehousing and material-handling operations. Supports reels up to 51-in. in diameter by 32-in. in width. 2000 Lb. capacity.

Top cross member is drilled for quick, easy placing of measuring meter.

Model R Each **\$176.00**
 Model F, Hydraulic, 48" Reels, 2000 Lbs. Each **\$198.00**

Allen Coiling Machines



For measuring and coiling small and medium wire, cordage and other materials to be taken from large coils or spools and rewound to special lengths. Will make coils 12-in. inside diameter.

Designed for maximum strength from high quality steel tubing. Meter not included.

No.	Base Length, In.	Base Width, In.	Each
500	48	24	\$129.00

Allen Twin Coiling Machines

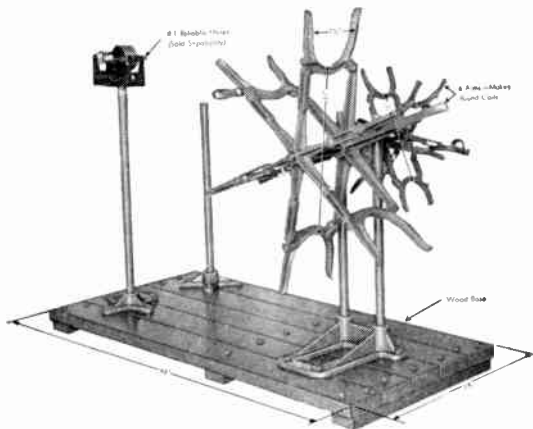

Composed of two reels mounted on one stand. Large reel measures and coils heavy wire, cable cordage, hose and other materials that can be successfully coiled. Large reel makes coils 21-in. inside diameter. Small reel makes coils 12-in. inside diameter and is used for small and medium wire. It will handle 500 feet of No. 8 Type R rubber covered wire or its equivalent. Both reels are collapsible for easy removal of coils and are provided with a friction brake to prevent backlash.

The Measuring Meter can be moved from one standard to another in line with reel being used.

Furnished as a complete package unit or as separate parts as follows: Twin Reels (with stand); Wood Base; Stands for Meter; No. 1 Meter.

No.	Base Length, In.	Base Width, In.	Each
1250	60	28	\$283.00

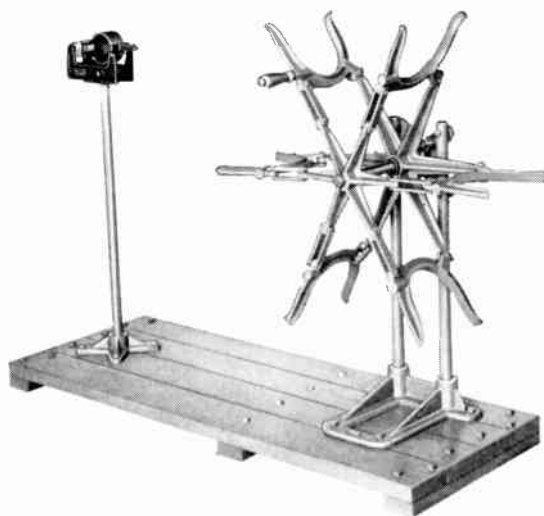

Same as the No. 1250, except that the small reel and one meter stand have been omitted. Furnished as a complete package unit, or separate parts as follows: Reel with stand; Wood Base; Meter with stand.

No.	Base Length, In.	Base Width, In.	Wt. Lbs.	Each
1200	60	22	224	\$212.00

Allen Reliable Meters

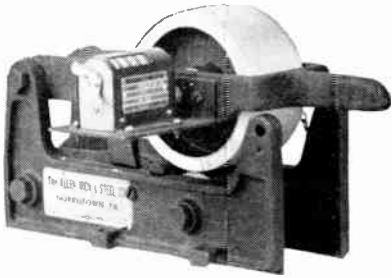

Meters are used to measure accurately lengths of wire, cable, cordage, tape, small hose, strip steel, plastic products, etc.

Measuring wheel rides the material eliminating error caused by bends or twists in material. Brake on meter stops wheel immediately when material runs out. Counts up to four digits.

Will measure up to and including 1 1/4-in. diameter material, with standard counter. (Special counter on request.)

No.	Shipping Wt.,	Each
1	Lbs. 22	\$65.00

Allen Type CVM Meters

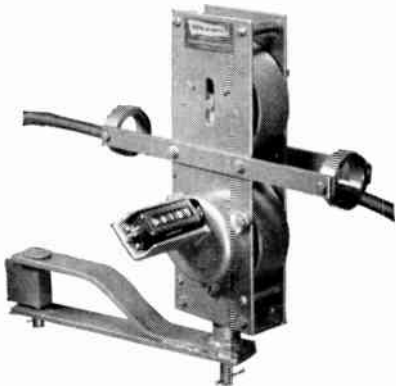

Available with or without swivel bracket to fit Reel Cart. Mechanical action; oilite bearings; no maintenance; great accuracy; direct reading.

Capacity, from building wire up to 750,000 MCM.

Type CVM, with bracket. Each **\$88.00**

Chance Guy Wire Dispensers



Feed guy wire smoothly and rapidly through a square opening. The square hole catches strand, prevents uncoiling and protects the workman from the whipping of loose ends.

Wire can be unreeled from either vertical or horizontal position, permitting dispenser to be hung from truck by the ring holder or placed flat on the ground.

Excellent for storage; convenient to use when guys are cut and made up in the warehouse.

No.	Wt. Lbs.	Each
3001	21	\$16.75

**American Brand Rope
Manila Rope**



Rope in Cartons

Six sizes and 10 put-ups individually packaged for ease of handling and cleanliness. All types of rope are available. Each coil is marked at five-foot intervals for fast measuring.

Sizes 1/4-in., 5/16-in., 3/8-in., 1/2-in. diam. in 600 and 1200-ft. coils. Sizes 5/8-in. and 3/4-in. diameter in 600-ft. coils only.

Manila and Sisal Handy Coils



First grade pure manila rope in 100-ft. connected coils. Also in sisal fiber.

Available in 1/4-in., 5/16-in., 3/8-in., 1/2-in. diameters.

Nylon Handy Coils



Individual connected coils, available in the following sizes:

Diameter In.	No. of Coils	Individual Length, Ft.
1/4	7	50
5/16	5	50
3/8	4	50
1/2	4	25

Tarred Marline



For use principally by power and light companies, contractors, telephone companies and by manufacturers of conduits and cables.

Either 2 or 3 yarn construction in 1 lb. balls and 10 lb. tubes.

American Brand Rope

Manila Rope



Standard 3-Strand



4-Strand Transmission



Cable Lay

Specifications — 3-Strand

Diam. In.	Cir. In.	Approx. Length Full Coil Feet	*Approx. Weight. Coil. Lbs.	Approx. Feet Per Lb.	**Min. Tensile Strength. Lbs.
3/16	5/8	3,000	45	66.6	450
1/4	3/4	2,750	55	50.0	600
5/16	1	2,250	65	31.5	1,000
3/8	1 1/8	1,620	66	24.4	1,350
7/16	1 1/4	1,200	63	19.0	1,750
15/32	1 3/8	1,200	75	16.0	2,250
1/2	1 1/2	1,200	90	13.3	2,650
9/16	1 3/4	1,200	125	9.61	3,450
5/8	2	1,200	160	7.50	4,400
3/4	2 1/4	1,200	200	6.00	5,400
13/16	2 1/2	1,200	234	5.13	6,500
7/8	2 3/4	1,200	270	4.45	7,700
1	3	1,200	324	3.71	9,000
1 1/16	3 1/4	1,200	375	3.20	10,500
1 1/8	3 1/2	1,200	432	2.78	12,000
1 1/4	3 3/4	1,200	502	2.40	13,500
1 5/16	4	1,200	576	2.09	15,000
1 1/2	4 1/2	1,200	720	1.67	18,500
1 5/8	5	1,200	893	1.34	22,500
1 3/4	5 1/2	1,200	1,074	1.12	26,500
2	6	1,200	1,290	.930	31,000

*Weight of 4-strand approximately 7% more than above.

**Safe working load 20% of Tensile Strength.

Floterope



Made of pure polyethylene fiber. Non-absorbent, it retains its buoyancy indefinitely. Comes in contrasting color combinations.

Available in all sizes up to 1 1/2-in.

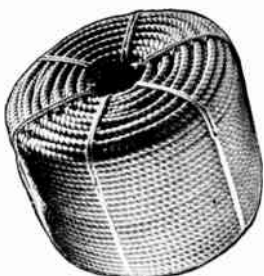

Tarred Ratline

Can be furnished in 9, 12, 15 and 18 thread. In 50 lb. coils.

Contact Graybar for additional information and prices.

General Machine Wire Raising Tools



Made with two hooks for the simultaneous placing of steel strand and open telephone line. Made of solid, cast bronze or malleable iron and is provided with a shaft for placing on the end of a wooden tree pruning pole. A hole in the shaft allows the locking pin in the sleeve of the pole to fasten the tool securely to the pole. Length, 11 5/16 inches. Weight, 1 pound, 3 ounces. Oiled finish.

No. 6355.....Price on application

General Machine Extension Handles

For Use with Wire Raising Tools and Cable Block Lifters



Female end of handles have spring-mounted pin to lock tool handles securely in place. Other extension handle sections may be added similarly for greater lengths.

Of seasoned lumber, 1 1/4-in. diameter, 6-feet long.

No. 6600—Wt. 3 lbs.....Price on application

B & L Pole Butt Pullers

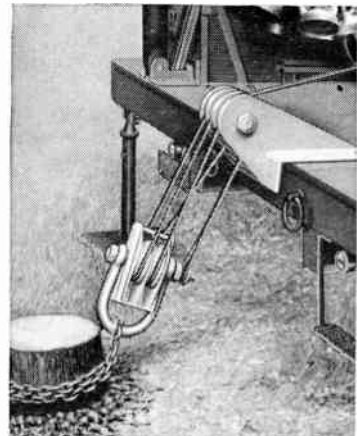

Eliminates use of line truck derrick or lazy bar. Consists of a double block with a shackle and a triple block for mounting on a truck. 6 In. diameter bronze bushed steel sheaves for 1/2 in. or 5/8 in. diameter winch line. Heavy duty construction for 10 ton safe working load.

Small loop splice easily dead ended to sheave pin becket, saving valuable head room. May be furnished with 10 ft. of 1/2 in. alloy steel sling chain with grab hook—please specify if this is required when ordering.

No. 5111.....Prices on application

B & L Star Brand Metal Blocks

For Manila Rope

With Beckets

With Loose Side Hook



**No. 3041A
Single**



**No. 3042A
Double**



**No. 3043A
Triple**

With Flatted Loose Safety Swivel Snap Hooks



**No. 3041G
Single**



**No. 3042G
Double**



**No. 3043G
Triple**

With Flatted Loose Safety Snap Hooks



**No. 3041F
Single**



**No. 3042F
Double**



**No. 3043F
Triple**

With Shackles



**No. 3041K
Single**



**No. 3042K
Double**



**No. 3043K
Triple**

Specifications

Safety latches are fitted with a steel spring wire spring and will not open until released by operator.

Shells constructed to prevent rope from jamming between shell and sheaves.

Straps extend to bottom of shell. All connections drop forged. Sides are recessed, covering ends of sheave pins.

Available with iron, roller or graphite bronze bushings.

Specify japanned or galvanized finish.

Contact GRAYBAR for prices.

Lgth. Shell In.	For Rope Diam. In.	Size Sheave, In.			Pin Diam.
		D.D.	Rim Thick.		
3	$\frac{3}{8}$	$1\frac{3}{4}$	$\frac{1}{2}$	$\frac{3}{8}$	
4	$\frac{1}{2}$	$2\frac{1}{4}$	$\frac{5}{8}$	$\frac{3}{8}$	
5	$\frac{5}{8}$	3	$\frac{3}{4}$	$\frac{3}{8}$	
6	$\frac{3}{4}$	$3\frac{1}{2}$	1	$\frac{1}{2}$	
7	$\frac{7}{8}$	$4\frac{1}{4}$	1	$\frac{1}{2}$	
8	1	$4\frac{3}{4}$	$1\frac{1}{8}$	$\frac{5}{8}$	
10	$1\frac{1}{4}$	$6\frac{1}{4}$	$1\frac{1}{2}$	$\frac{3}{4}$	
12	$1\frac{1}{2}$	8	$1\frac{5}{8}$	$\frac{3}{4}$	

B & L Star Brand Wood Tackle Blocks

**For Manila Rope—Regular Mortise
Inside Iron Strapped—With Iron Sheaves**

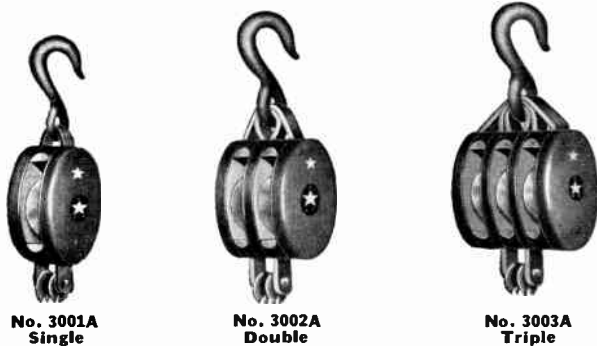

With Loose Side Hooks and Beckets

Available with either iron, roller or graphite bronze bushings.
Specify jappaned or galvanized finish.

Lgth. Shell In.	For Rope Diam. In.	O.D.	Size Sheave, In. Rim Thick.	Pin Diam.
3	3/8	1 3/4	1/2	3/8
4	1/2	2 1/4	5/8	3/8
5	5/8	3	3/4	3/8
6	3/4	3 1/2	1	1/2
7	7/8	4 1/4	1 1/8	5/8
8	1	4 3/4	1 1/4	5/8
10	1 1/8	6 1/4	1 3/4	5/8
12	1 1/4	8	1 3/8	3/4

B & L Snubbing Blocks



For taking slack out of light wire; working loads up to 700 pounds.

Snap hook easily and safely engages come-along; anchor hook fits around insulator pin.

Use with 3/8-in. diameter manila rope or No. 10 sash cord.

With iron, roller or self-lubricating bronze bushings. Galvanized. Sheaves are easily replaced.

Furnished without rope and anchor hook unless otherwise specified. Weight, less hook and rope 2 3/4 lbs.

No. 5021 Price on application

B & L Light Wire Blocks

**"Bosloc"
Self-Locking**

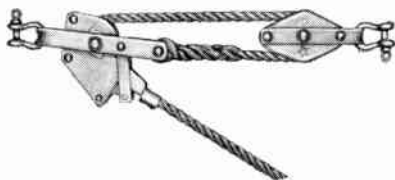

For pulling or snubbing wire where maximum load is about 500 lbs. Lock when fall line is pulled to one side; release when pulled to straight position.

Consist of two single blocks with replaceable roller-bushed sheaves. Pressed steel shells and forged steel shackles; all parts galvanized.

No. 5023—Weight per set 2 1/4 lbs.

Klein Self-Locking Block Tackles



Light gal. steel shell blocks with snubbing hook to lock load in any position. Bronze bushed aluminum

alloy sheaves. Furnished with 25-ft. 3/8-in. 4-strand Manila rope. Supplied with drop forged No. 258 hook or swivel hook No. 259. Both hooks designed to fit under insulator and engage pin on cross arm. Rope not spliced to block.

No.	Description	Each
1802-30	With detachable hook No. 258	\$6.05
1802-30S	With detachable swivel hook No. 259	6.45

With Guarded Snaps



Same as above except with guarded snaps. Hook noses lengthened to extend over latch or keeper. Safe load 1,200 pounds.

No.	Description	Each
11802-30	With detachable hook No. 258	\$7.15
11802-30S	With detachable swivel hook No. 259	7.55

Klein Heavy Block Tackles

Self-Lubricating



Two double sheaved blocks. Spring guarded snap hooks. Bronze bushed pulleys, self-lubricating. 4-strand Manila rope, spliced to block eye

with galvanized thimble. Furnished with 30-ft. rope.

No.	Rope Size, In.	Each
1802-40	1/2	\$17.60
1802-50	5/8	20.20
1802-60	3/4	21.35

B & L Star Brand Safety Locking Snatch Blocks

Steel Plate Shells—For Wire Rope

For use with pole derrick for pulling aerial cable, erecting a pole for replacement (using the old pole in place of the derrick).

Sheave has graphite bronze self-lubricating bushing. Impressions on each side of shell prevent rope from jamming between shell and sheave. Safety locking attachment prevents block from becoming disengaged while in use.

Flatted swivel hook. All connections are drop forged.



No. 5042H—All Galvanized

Diam. Sheave In.	For Rope, In.	Complete Blocks Wt. Lbs.	Extra Iron Sheaves Wt. Lbs.
6	3/8-1/2	15	3 1/2
8	1/2-5/8	32	8
10	5/8	52	12

B & L Conductor Stringing Snatch Blocks

Aluminum Shell

Drop Link or Safety Locking Pattern

With Drop Forged Flatted Swivel Hooks, Heads and Links



**No. 5071H
Drop-Link
Pattern**



**No. 5072H
Safety-Lock
Pattern**

Aluminum-alloy ball-bearing sheaves, with polished score for aluminum cable.

Made almost entirely of high-grade aluminum; combines lightness with strength; will not injure aluminum conductor when stringing. The steel straps, drop-forged hooks and safety device which carry the concentrated load never come in contact with the conductor.

Drop link pattern furnished unless otherwise specified. When ordering specify number, size of sheave, size cable to be used.

Size Sheave, In.	Size Aluminum Cable		Wt Lbs
	Min. CM	Max. CM	
7x1 ³ / ₈	No. 2 0	300,000	14
10x1 ¹ / ₂	336,100	500,000	18
10x2 ¹ / ₄	874,500	20
14x2	500,000	795,000	37
16x2 ¹ / ₄	795,000	1,272,000	40

**Wood Shell
Drop Link Pattern**

Roller bearing sheaves, iron or aluminum alloy with polished scores. Drop forged flatted swivel hooks and links.

These blocks are used in the same manner as the aluminum type.

The specially designed roller bearings insure freedom of action that prevents abrasion of conductors.

When ordering specify figure number, size and type of sheave with size of cable to be used, copper or aluminum, and finish of sheave.



No. 5081H



No. 5082H

No. 5081H—Straight Mortise

Size Sheave, In.	Throat In.	Maximum Size Cable, C.M.	
		Copper	Aluminum
7x1 ¹ / ₈	...	188,700	300,000
7x1 ³ / ₈	...	188,700	300,000
10x1 ¹ / ₂	...	250,000	397,500

No. 5082H—Wide Throat

Allows large splicing to run over sheave.

7x1 ³ / ₈	2 ³ / ₈	188,700	300,000
10x1 ¹ / ₂	2 ⁵ / ₈	250,000	387,500
10x1 ⁵ / ₈	2 ⁷ / ₈	300,000	477,000
10x1 ⁷ / ₈	3 ¹ / ₈	311,500	500,000

B & L Star Brand Conductor Stringing Snatch Blocks

**Wood Shell—Drop Link Pattern
With Shell Recessed for Sheave**

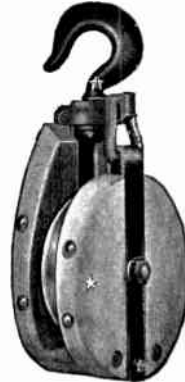

**No. 5091H
Swivel Hook**

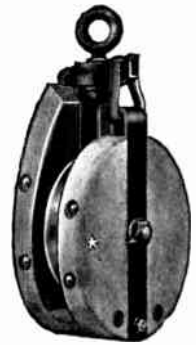

**No. 5094
Swivel Eye**

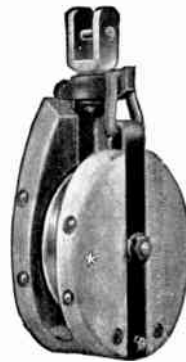

**No. 5095
Swivel Jaw**

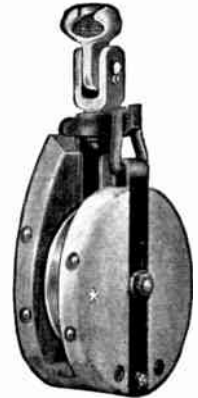

**No. 5096
Swivel Jaw
with Socket Eye**

Supplementary steel sleeve over sheave pin increases strength of block.

All connections drop forged. Roller bushed galvanized iron or aluminum alloy sheave with polished score.

Size Sheave In.	Max. Cable Size, C.M.		Wt., Lbs.
	Copper	Aluminum	
4 x 1 ¹ / ₄	188,700	300,000	9
6 x 1 ¹ / ₄	188,700	300,000	13
8 x 1 ¹ / ₄	188,700	300,000	22
10 x 1 ¹ / ₄	188,700	300,000	26

Malleable Iron Shell—For Manila Rope

Iron Sheaves, with shallow score. Round drop forged 5/8-in. swivel hooks.



No. 5101



No. 5102

No. 5101—Sheaves 3 x 3/4 x 3/8 in.; for 5/8-in. rope. Weight each 3 3/4 lbs.

No. 5102—Sheave 3 x 1 x 1/2 in.; for 3/4-in. rope. Weight each 4 1/4 lbs.

Available galvanized or japanned.

B & L Star Brand Snatch Blocks

**Public Utility - Eastern Pattern
For Manila Rope**

Flatted swivel hook. Safety locking link. All connections are drop forged.



No. 3075H

For Rope Diam., In.	Size Sheave, In.	Length Shell, In.	Weight, Lbs.
7/8	3 1/2 x 1 3/8 x 1 1/2	6	9
1	4 1/2 x 1 3/8 x 1 5/8	8	16
1 1/4	5 3/4 x 1 7/8 x 3 1/4	10	27

B & L Lineman's Snatch Block

For stringing light conductor wire.

Hook will fit around insulator pin, in insulator pin hole or can be easily driven into pole or cross arm.

Roller or graphite bronze bushed or ball bearing bushed with pressure grease lubrication.

Can be furnished drop link or safety locking; also can be supplied with or without locking spring.



No. 5022.....Price on Application

B & L Star Brand Aerial Hand Lines

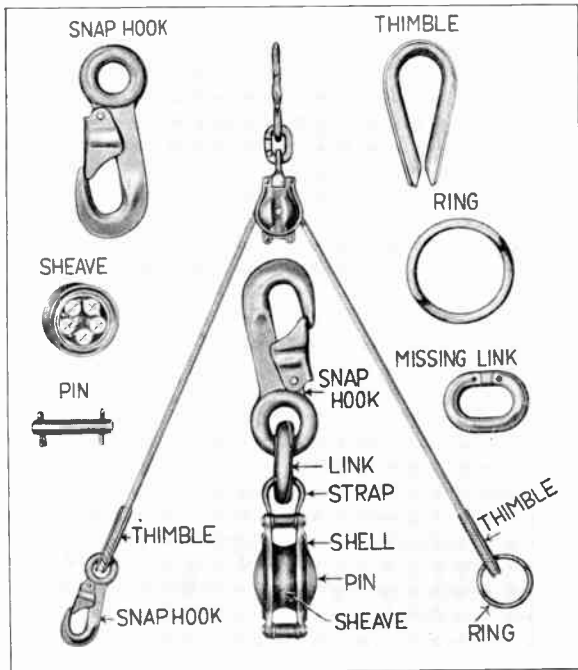

No. 5041

Complete outfit consists of one 3-in. single roller-bushed galvanized B & L Star metal block, two snap hooks, one ring, two thimbles, one missing link and rope as specified below.
 With 60 ft. Manila Rope.
 With 75 ft. Manila Rope.
 Block Only, Without Rope or Connections.

Klein Hand Lines

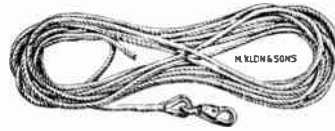

High grade 4-strand Manila rope spliced to eye of snap hook No. 413-A, or No. 470 swivel snap. Other lengths of rope can be furnished to order. 75-ft. of rope normally supplied.

No.	Rope Size, In.	Snap No.	Each
1803-60	3/8	413-A	\$5.95
1804-60	3/8	470	6.05
1803-75	1/2	413-A	9.60
1804-75	1/2	470	9.80

Klein Hand Line Hooks

Snap Type



Drop forged steel. Length overall 5 1/2-in. Eye diam. 1 1/16-in. Snap opens to 3/4-in. Safe load 2,000-lbs.

No. 443-A.....Each \$1.60

Swivel Type

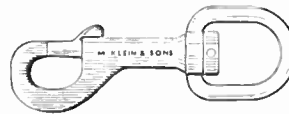

Drop forged steel. Swivel clevis. Quick acting plunger style latch. Takes 1/2-in. or lighter hand lines. Swivel action prevents accidental fouling in secondary wires. Safe load 750-lbs.

No. 470.....Each \$1.70

Klein Utility Snap Hooks

Heavy Duty

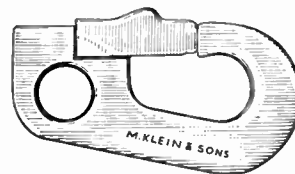

No. 455

This hook is designed to meet requirements of safety engineers. It will not come loose on a slack line, is easy to apply and is able to pull up a transformer or other heavy load. No taping or wiring of the throat is necessary. Quickly pays for itself in time and material saved.

Working load of 8,000-lbs. with adequate safety factor.

Can be used on any conventional steel block 4-in. or smaller.

No. 455 has 1 5/16-in. eye can be had with 1 1/4-in. eye for larger block. No. 455 4 1/2-in. long, all others 7 1/2-in.

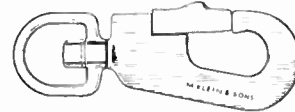

No. 455-S

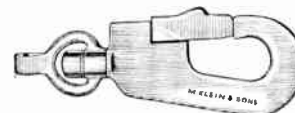

No. 455-SH



No. 455-SP

No.	Type Eye and Description	Each
455	Solid	\$2.60
455-S	Swivel	4.00
455-SH	Swivel, for 3/4 ton hoist	4.20
455-SH-3	Swivel, for 1 1/2 ton hoist	4.20
455-SP	Male fixture for 1 1/2 ton hoist swivel housing	3.60
455-SP-6	Male fixture for 3 ton hoist swivel housing	3.60

Klein Anchor Hooks for Tackles

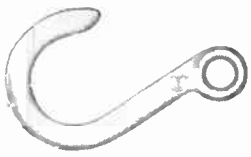

A drop forged steel hook approx. 5½-in. long by 3¼-in. across the hook. Eye I.D. 5/8-in. Engages with snap on Klein Tackle Nos. 1802-30 and H1802-30. Gal. finished. Designed to slip under insulator and engage pin on the cross arm. Safe load 1,500-lbs.

No. 258.....Each \$1.20

Swivel Type

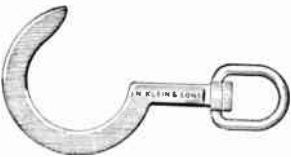

Drop forged steel. Approx. 6½-in. long by 3¼-in. across the hook. Swivel clevis will engage with snap on Klein Tackles Nos. 1802-30 and H1802-30. Swivel prevents twisting and kinking of rope. Safe load 1,500-lbs. Designed to engage pin as above No. 258 hook.

No. 259.....Each \$1.60

B & L Star Brand Booster Hooks



Specially designed to support the cable while being pulled through the supporting rings.

These hooks are securely clamped to the messenger strand and present a smooth rounded surface to the moving cable. While in this position it performs the dual function of supporting and resisting movement while the cable is being placed.

No. 5011—Weight, 3 lbs.

B & L Star Brand Come-Along Hooks



Forged steel flatted hook and swivel eye.

No. 5012—Galvanized

Half-inch size for use with 3-in. single, double and triple blocks and 4-in. single.

Five-eighths size for use with 4-in. double and triple blocks.

Size Steel, In.	Overall Length, In.	Opening In.	Wt., Lbs.
1/2	7 1/4	2	5/8
5/8	8	2 1/8	1 1/4

B & L Anchor Hooks



For use with B & L Snubbing block. Fit around insulator pin.

Galvanized.

Weight, ¼ lb.

No. 5014..... Price on application.

B & L Star Brand Hooks



No. 4182 Reversed Eye Hooks Drop Forged Flatted



No. 4181 Round Loose Hooks Drop Forged



No. 4185 Swivel Hooks Drop Forged Flatted

No. 4182 available in sizes 22 through 36; No. 4181 available in 7/16 through 2-inches; No. 4185 available in sizes 1 through 11. Available either galvanized or japanned.

For prices contact Graybar.

B & L Star Brand Bosloc Winch Rope Hooks



Used primarily in telephone work for pulling and lifting poles.

Made of drop forged steel. Serves as a choker at end of truck mounted winch line.

Quickly installed in small loop splice—point of hook inserted through splice and allowed to pass along hook until stopped by button.

No. 5015 Approx. net wt. 5 lbs. Overall length 8 in.

Hooks furnished with 9/16-in. opening at narrowest point for 1/2-in. winch line unless larger winch line specified.

Coffing Safety Hooks

(Patent No. 2,706,318)

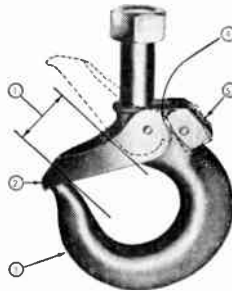

Stays Open Until Closed

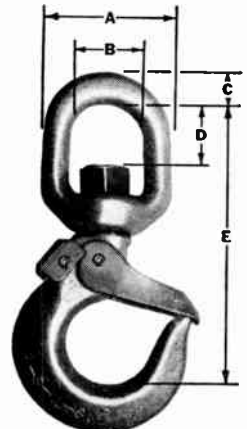

Safety Hook With Swivel Eye

1. Full Throat opening allows full use of inside hook area.
2. Latch fits snugly over the point of the hook to prevent snagging.
3. Highest tensile strength for its size. Plated to prevent rust and corrosion.
4. Positive lock securely holds latch in place.
5. Slight pressure on the release unlocks the latch. Latch stays open until closed.

No.	Rated Cap. Lbs.	Throat Open. In.	Wt. Oz.	O.A. Length In. Less Shank	Price Per Hook Each	Price With Hoist Each	Price With Swivel Eye Each
A-3-SH	3000	1 1/8	18 1/2	3 3/4	\$5.00	\$2.20	\$ 7.25
F-3-SH	6000	1 1/4	26	4 5/16	7.00	3.30	10.00
	Rated Cap. Lbs.	A	B	C	D	E	
AA-3-1-SH-7	3000	2 3/8"	1 1/16"	1/2"	1 1/8"	5 1/2"	
FF-3-1-SH-7	6000	3"	1 1/2"	5/8"	1 1/2"	6 3/8"	

B & L Star Brand C Hooks



Very convenient for connecting a winch or pulling line to a cable grip or core hitch. Can also be used at the end of a winch line for attaching to poles, transformers, etc.

No. 5013—Wt., each 2½ lbs.

B & L Star Brand Cable Blocks



This one-sheave block is a companion piece to the aerial guide and can be clamped to the messenger strand in a similar manner.

Used for guiding the winch line from the cable rings and messenger to the winch or other power apparatus.

Also for pulling cable around a slight corner; when used this way it guides the pulling-in line and also the cable when it reaches this point.

Steel frame, with steel roller and supplementary steel sleeve over sheave pin. Frame is hinged and fitted with clamp for fastening to messenger.

No.	Description	Wt. Lbs.
5051	For cable 2½-in. in diameter	11

For cable blocks to handle larger cables contact Graybar.

General Machine Wire Cable Blocks



A quick detachable cable block, used as a temporary support for multi-wire cable in rural areas where poles are considerable distance apart.

Easily mounted or demounted from the suspension bolt with unique opening for wires or cable.

Limited space on suspension bolt permits cable block to be mounted between pole and suspension clamp. Wt. ¾ lb.

No. G1023.....Price on application

General Machine Cable Blocks



For supporting aerial cable on suspension strand prior to lashing cable.

Frame and sheave of heat-treated aluminum alloy; sheave has oilite bearings. Strand hooks have steel inserts on bearing surfaces.

Locking lever reversible; blocks may be locked in either position so cable can be pulled in opposite direction.

No. 7268—Wt. 3¼ lbs.....Price on application

General Machine Cable Block Lifters



Used with tree pruner handle sections for placing cable blocks on suspension strand. Consists of an aluminum alloy tubular section which fits into the tree pruner handle, an aluminum alloy cradle for supporting the block, and a hook for operating the block cam lever. The hook can be set in either of two positions 180° apart for either right or left hand cable positioning. Height over all, 11¾ inches; cradle width, 3¾ inches. Weight, approximately ¾ pound. Steel hook is zinc or cadmium plated.

No. 7163. Price on application

General Machine Cable Block Pushers



No. 7180

Used for pushing cable blocks along 6,000, 10,000 and 16,000 suspension strand during lashing operations. Consists of a slotted tube with semi-rotatable sleeves at each end which lock in open and closed positions. One end has a circular flange for bearing against the lashing machine. The other end bears against the strand hooks of the cable blocks. Cannot fall off during the lashing operation. Diameter 1¼ inches, diameter of flange, 1¾ inches; length 35 inches. Weight, approximately 2 pounds. Zinc or cadmium plated.

No. 7180.....Price on application

B & L Aerial Cable Guide & Straighteners



For guiding cable into supporting rings when pulling; also serve to straighten out small kinks or waves in cable. Made of pressed steel in two parts readily joined together, a curved open section for guiding and a straight closed section for straightening.

Easily attached to messenger wire; securely clamped to prevent end motion.

No.	Description	Wt. Lbs.
5053	Complete for up to 2½ in. Diam. Cable.....	24
	Straighteners only, for 2½ in. Diam. Cable.....	9
	Guides only, for 2½ in. Diam. Cable.....	15

General Machine Aerial Cable Guides

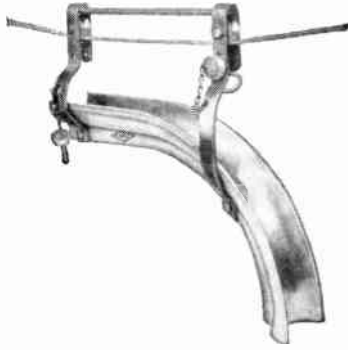

Used ahead of cable lasher to raise cable into position for lashing to strand.

Ideal in construction using cable 1-in. diameter or less.

Shoe is cast aluminum with steel insert on bend to eliminate excessive wear; suspended by steel straps from two strand rollers locked on strand.

No. G1012—Wt. 11 lbs. Price on application

Type C—With Straightener Section



For use with cable up to 3-in. size. Where no obstructions exist, it may be used approximately 3-feet ahead of lasher, or may be mounted stationary on the strand above the cable reel to straighten cable. Size, 40-in. long, 25-in. high.

No. 7474—Wt. 60 lbs. Price on application

B & L Aerial Cable Rollers

Single



No. 5061



No. 5062



No. 5063

For medium span construction. Use with pin-type insulators.

Double

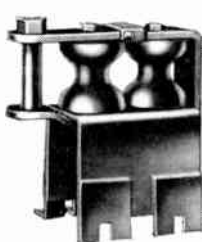

No. 5064

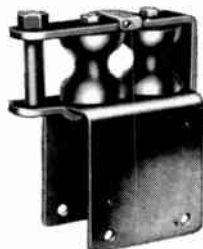

No. 5065

For use on long pulls or on curves. Latch opens easily and locks securely. Specify size of cross arm when ordering. Other types available on application.

B & L Star Brand Aerial Cable Guides

With Wood Rollers



For pulling large cable in the supporting rings.

When attached to the strand by a hook and special clamp, the lower part, carrying tow sheaves, provides an easy bend for the cable as it approaches the ring.

Consists of a steel frame, with the necessary hooks and clamps to fasten to the strand and two well seasoned hardwood sheaves, with smooth finished groove which will not damage cable sheath. Sheaves have brass bushings which can be lubricated for easy operation.

No. 5052—Weight, each 32 lbs.

Simplex Aerial Cable and Wire Tensioning Jacks

Single Acting—Ratchet Releasing



A lightweight jack, sufficiently powerful to pull overhead and underground cables easily and to take up slack in trolley, guy and transport wires. For public and private utility maintenance and construction work.

Speed trigger permits instant slack take up when jack is not under load. Non-flexible rack bar facilitates set up. Steel lever is held securely with spring safety clip

Capacity 2 Tons—20 1/4 In. Travel

No. 324—Shipping Weight 13 Lbs. Each \$38.00

Extra Equipment Needed—For tensioning bare wire as shown in illustration: Two bare wire grips and two wire slings. For splicing overhead cable: Two double-eye split cable grips, two three-bolt clamps and two wire slings—This equipment IS NOT FURNISHED WITH JACK—consult this catalog for this equipment.

General Machine Cable Suspension Hooks



For use on long spans where two messenger strands are necessary to support cable, the second messenger acting as a suspension strand.

Hook allows cable car to pass over strand.

Made of galvanized steel forging; will withstand tensile load of 4000 pounds.

Size, 17 5/8 x 7-in.

No. 6523—Wt. 13 lbs. Price on Application

Diamond Manhole Cover Hooks



A useful tool for the subway construction force. Designed to easily raise a heavy manhole cover by prying the wedged-point end of the hook under the groove provided in the cover.

Made of excellent quality electric tool steel, suitably hardened to prevent bending and breakage. Overall length 26½ inches.

No. 860 Price on application

Fairmount B Manhole Sumps

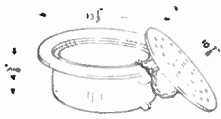

Cast iron sump used in manholes. Cover 10⅞-in. wide.

Height In.	Width In.	Wt. Lbs.
4⅜	13½	33

General Machine Manhole Tents

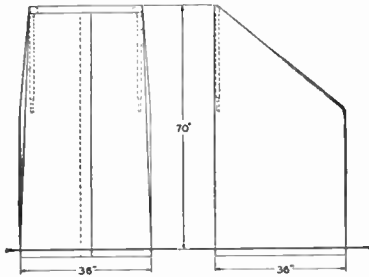

Used in conjunction with manhole guard rail for protection against inclement weather.

Made of mildew-resistant canvas and two pipe members, attached to front corners of cover, which insert into manhole guard.

Size, 36-in. square; 70-in. overall height.

No. 6881—Wt. 15 lbs. Price on application

General Machine Ground Tents

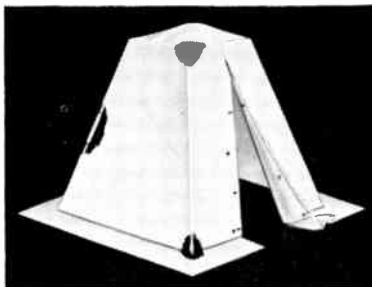

For the protection of personnel in cold or inclement weather. Consists of fire, water and mildew-resistant canvas cover on collapsible metal frame.

Size, 6'9½" square at base, with 1-ft. sod flap; 6'5" high.

No. 6282—Wt. 64 lbs. Prices on application

Oshkosh Sectional Ladders



These ladders are handy to have around for miscellaneous uses where a long extension ladder cannot be used. For small service trucks, one or two of these sections can be hooked on and carried all the time for emergency use.

The sections join together interchangeably. One section fits into the other at either end as shown in illustration. The joint is stiff, solid and secure. Do not use more than three sections to make one long ladder.

The material used in these ladders is the same as in Safety Extension Ladders, but do not include any of their safety features. Sections lap 1-ft. when joined together.

Length 6 feet. Outside width, top, 16½ in.; inside width, bottom, 17 in. Rungs 1⅞ in. diameter. Rails 1⅞ x 2¾ in. Wt. 11 lbs.

Special length sections can be furnished if wanted; also rubber pikes on special order. Contact Graybar for specials.

Sectional Ladders—6-ft. Length Per Section **\$13 55**

Chance Swivel Hook Maintenance Ladders



Makes line repairs possible at almost-inaccessible places on maintenance and construction jobs.

Hooks swivel in complete circle. Ladder can be suspended from virtually any point on H-frame or towers.

Strong link chains are anchored to top reinforcing rod. Safety snap-hooks make chains easy to attach to swivel hooks with one hand.

Heavy-duty rungs spaced at 12-in. intervals. Reinforcing rods at top and bottom.

No.	Description	Overall Length		Wt. Lbs.	Each
		Ft.	In.		
M4903-8	8-ft. Ungrounded	8	4	33	\$58.25
M4903-8G	8-ft. Grounded	8	4	33½	60.50
M4903-12	12-ft. Ungrounded	12	4	42½	73.00
M4903-12G	12-ft. Grounded	12	4	43½	75.50
M4903-18	18-ft. Ungrounded	18	4	58½	93.50
M4903-18G	18-ft. Grounded	18	4	60	96.75
M14908	Hook for 8-in. diam. arms			11¾	22.50
M1904-12	Hook for 12-in. diam. arms			22½	24.00
M1904-14	Hook for 14-in. diam. arms			24½	24.00

General Machine Ladder Hooks



Designed to enable ladders to be hooked over and supported by steel suspension strands for aerial cable. When not in use, hooks may be swung inside uprights parallel to the rungs. Hooks are formed hot from steel pipe. Heavy phosphor bronze springs and a square manganese bronze collar holds the hooks firmly in either of the two positions. Hooks will support a load of approximately 300 pounds each. Finish: Steel parts cadmium plated. Weight, 1 $\frac{3}{4}$ lbs.

No. 7254 Price on application

Pennington Steel Buildings



No. 952 Tee Pee

Portable, all-steel building that's completely adaptable; useful on a construction project storing heavy equipment; handsome enough to be placed in yard of any home. Has 512 cubic ft. of storage space. Easily assembled, screw driver and wrench are only tools required.

Bevel edged steel walls and formed steel shingle roof. Can be erected on wood or concrete foundation. All parts are precision pre-cut and pre-drilled for bolt type construction.

Window openings are factory pre-cut. Two beautifully crafted V-panel doors. Natural finish, kiln-dried, clear yellow pine with sturdy cross panels, interlocking corners and weatherproof glue throughout. Doors are dipped in the finest type clear wood preservative, to assure long life. Doors open to a service width of 48-in. Each door is 1 $\frac{1}{2}$ -in. thick, 24-in. wide and 72-in. high and hinged at right and left, overlap in center. Comes complete with four black nickel hinges and two "L" cabinet handles, one with lock. There is a 52-in. rain gutter above the doors.

No.	Building Dimensions (At Eaves)	Height at Peak, In.	Base Measurement Width, In.	Base Measurement Length, In.	Shp. Wt. Lbs.
952	8-ft. x 11-ft.	87	88	124	625
956	Wood Floor (Optional) is 1-in. tongue-and-grooved flooring and 2-in. x 4-in. supporting members, cut to size and metal strapped.				

No. 950 Hideaway

Same building as Model No. 952 Tee Pee, except without windows. Shipping weight 600 lbs.

**Pennington Steel Buildings
No. 957 Cottage Cabin**

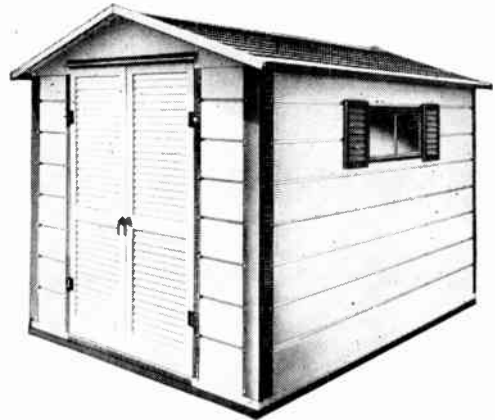

Designed for all around use. This rugged steel building can be put up by anyone in just a few hours. Constructed for long life without maintenance, the bevel edged steel walls and formed steel shingle roof are bonderized and zinc coated for years of weather protection. Has 85 mph wind load and unlimited snow load.

Building with 512 cu. ft. of storage space is shipped knocked down, only tools needed to assemble are a screw driver and wrench. Can be converted as a trailer. (Trailer available upon request.)

Two solid louver shutter doors (open to a service width of 48-in.); each door is 1 $\frac{1}{2}$ -in. thick, 24-in. wide and 72-in. high, are hinged at right and left, overlap in center, come complete with black nickel hinges and two "L" cabinet handles, one with lock. Four matching louvered shutter windows.

Base and truss framing is constructed of 10 $\frac{1}{2}$ -gauge steel; 5-in. x 5-in. corners are 14-gauge steel; roof and sides are 26-gauge steel.

No.	Building Dimensions (At Eaves)	Base Measurement Width, In.	Base Measurement Length, In.	Shp. Wt. Lbs.
957	8-ft. x 11-ft.	88	124	635
956	Wood Floor (Optional) is 1-in. tongue-and-grooved flooring and 2-in. x 4-in. supporting members, cut to size and metal strapped.			

Prices on request.

Call Graybar FIRST For . . .



Oshkosh Safety Extension Ladders

Designed and built especially for public utilities. Has many outstanding features, the most outstanding one being the automatic safety lock, which is absolutely foolproof.

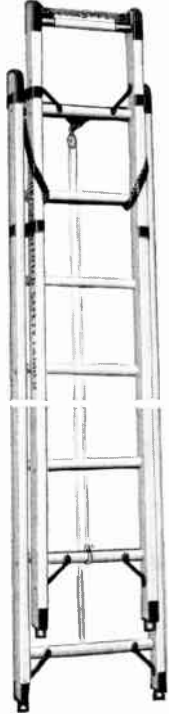

When extending the ladder, the locking device lifts up automatically to allow the rungs to pass; but, the instant operator lets go of rope, the locking device drops in place and the top section is firmly locked. To lower, the operator gives a slight pull on rope, then lets top section descend slowly—it cannot drop accidentally.

Side rails are straight - grained, properly seasoned airplane spruce. Rungs are tough Mountain Hickory, absolutely straight - grained. Each rung has a shouldered tenon joint which is pressed tightly into side rails, assuring a safe, tight fit. The side rails of each section are connected at top, middle and bottom with steel tie rods.

Each section is equipped with safety-tips and pikes and either section can be used as an individual ladder.

Other exclusive safety features: rubber faced tips; transparent safety finish; safety pole grippers; rubber guarded safety pikes. All metal parts are parkerized.

BE SURE to specify whether Straight Side Rails or Flared Side Rails are wanted—for STRAIGHT Side Rails add letter "S" to number; for FLARED Side Rails add letter "F".

No.	Length, Ft.		Each	No.	Length, Ft.		Each
	Full	Extended			Full	Extended	
EX-16	16	13	\$43.00	EX-32	32	29	\$85.40
EX-18	18	15	48.35	EX-34	34	31	90.80
EX-20	20	17	53.65	EX-36	36	33	96.05
EX-22	22	19	59.15	EX-38	38	34	101.35
EX-24	24	21	64.40	EX-40	40	36	106.90
EX-26	26	23	69.65	EX-42	42	38	112.05
EX-28	28	25	74.80	EX-44	44	40	117.40
EX-30	30	27	80.20	EX-46	46	42	123.15

Average Weight per Foot approx. 2½ lbs.

Oshkosh Single Ladders

The material used in these ladders is the same as on Safety Extension Ladders, but features only rubber tips and rubber guarded safety pikes.

For STRAIGHT Side Rails add letter "S" to number. For FLARED Side Rails add letter "F".
Wt. 2 lbs. per ft.

No.	Full Length, Feet		Each
	Full	Extended	
SIN-10	10		\$19.95
SIN-12	12		24.90
SIN-14	14		28.75
SIN-16	16		32.60
SIN-18	18		35.90

Chance Safety Tread

Non-slip, fast drying rough coat for application to platforms, loading docks, etc.

No.	Description	Weight, Lbs.	Each
M1913	1 Qt.	3½	\$ 3.95
M1913-1	1 Gal.	13	10.00



Hubbard Manhole Ladders
Hot Galvanized



Made to the specifications of the largest telephone and central station companies. Ladders 6 through 13 feet long have sides of 1½ x ¾ x ¼-inch channel; 14-foot ladders have 2½ x ⅝ x ¼-inch channel sides. ⅝-inch round rungs.

Hook ends can be furnished for any size ladder at a slight extra cost. When ordering, specify whether hooks are to be bolted or permanently riveted to ladder.

No.	*Overall Feet	No. of Rungs	Ship. Wt. Lbs. Per 100
9110	6	5	2500
9111	6½	6	2700
9112	8	7	3300
9113	10	9	4200
9114	11	10	4600
9115	12	11	5000
9117	14	13	5900

*Above sizes also available in aluminum alloy.

General Machine B Ladder Supports

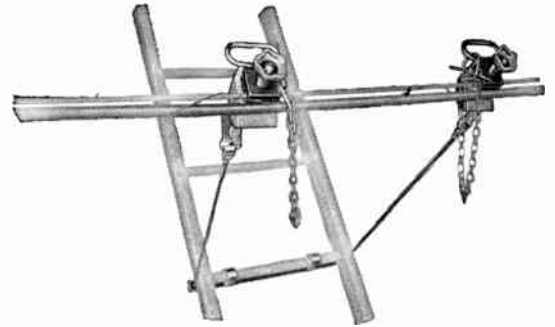

Support ladder at top from strand; make cable work convenient and safe. Enable both sides of cable to be reached with ease.

Consist of two heavy strand clamps with safety chain, steel ladder bar with two steel rung clips and two 3/4-in. wire ropes with snaps for connecting to strand clamps.

No. 7462—Wt. 11 lbs. Prices on application

Bond Ladder Blocks

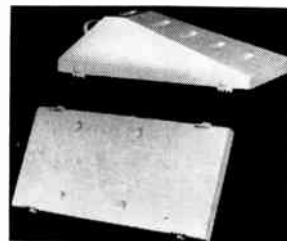

For leveling and chocking ladders. Laminated construction, securely screwed and bolted together.

With four saw-toothed hard metal cleats.

Finished with three coats of "Highway yellow" paint.

Furnished in hard maple or oak.

No.	Size, In.	Each
11-W-91	6½ x 13½ x 3¾	\$9.50

Bond Tree Guards
Type C

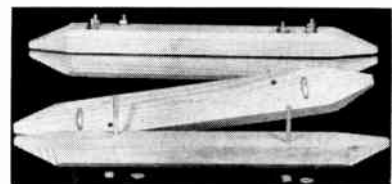

Made of oak. Hardware hot-dip galvanized.

No.	Size	Wt., Lbs.	Each
6317	C	5½	\$2.70

Bond Wheel Chocks

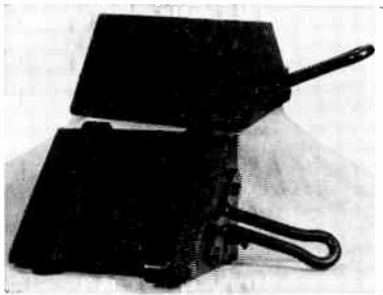

For secure chocking. Made of laminated oak or maple, laminated with T & G joints under pressure.

Soaked in impregnating varnish for several hours and finished with two coats of green enamel.

With steel pull-handles bolted to chock; handy for attaching rope.

Also available with two steel shoes with spikes to prevent slipping.

No.	Description	Wt., Lbs.	Each
7280	Without Shoes	9	\$8.70
6409	Shoes Only	1	4.25

Bond Cable Splicer Seats

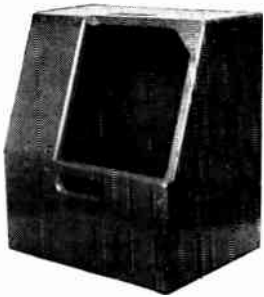

Have convenient handgrips and opening for accessories.

Made of sturdy high-grade poplar, lock corner construction. Reinforced corners; screws imbedded in glue.

Shipped in individual fibre board containers.

No.	Wt., Lbs.	Each
7186	18	\$16.70

Bond Tree and Trolley Guards

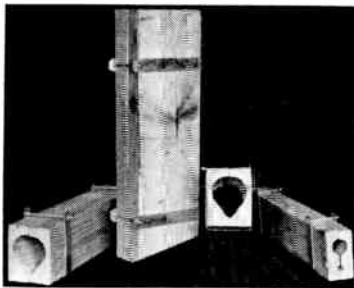

For cable protection. Made from Southern pine; can be furnished treated or untreated, creosoted or Penta-preserved.

All hardware hot-dip galvanized.

Type D—For Use on Hanger Cable Tree Guards 2-ft. Length

No.	Size, In.	Each
6503-1 1/2	1 1/2	\$2.40
6503-2	2	3.50
6503-2 1/2	2 1/2	3.50
6503-2 7/8	2 7/8	4.40
5603-3 1/4	3 1/4	5.70

Type L—For Use on Spun Cable Tree Guards 5-ft. Length

No.	Size, In.	Each
6862-1 3/4	1 3/4	2.45
6862-2 3/8	2 3/8	3.20
6862-3	3	3.40

Trolley Guards 5-ft. Length

No.	Size, In.	Each
6862-1 3/4	1 3/4	\$5.00
6862-2 3/8	2 3/8	6.90
6862-3	3	7.80

Note: Type D Trolley Guards have been discontinued. Add 10% to prices if item is Penta-Treated.

Bond Drift Plugs

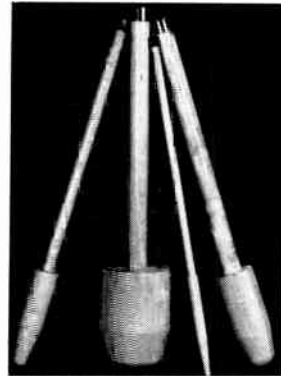

For restoring lead sleeves or cable coverings to their original shape.

Made of hard maple, varnished. Have steel ferrules on driving end.

Overall length, 36-in.

No.	Diam. Large End, In.	Each	No.	Diam. Large End, In.	Each
6636-3/4	3/4	\$2.75	6636-3	3	\$7.90
6636-1	1	3.00	6636-3 1/2	3 1/2	10.00
6636-1 1/4	1 1/4	3.10	6636-4	4	10.80
6636-1 1/2	1 1/2	3.50	6636-4 1/2	4 1/2	11.90
6636-1 3/4	1 3/4	3.90	6636-5	5	13.50
6636-2	2	5.00	6636-5 1/2	5 1/2	15.30
6636-2 1/4	2 1/4	5.50	6626-6	6	17.60
6636-2 1/2	2 1/2	5.50	6636-6 1/2	6 1/2	19.50
6636-2 3/4	2 3/4	6.50	6636-7	7	21.30

General Machine Aerial Tents

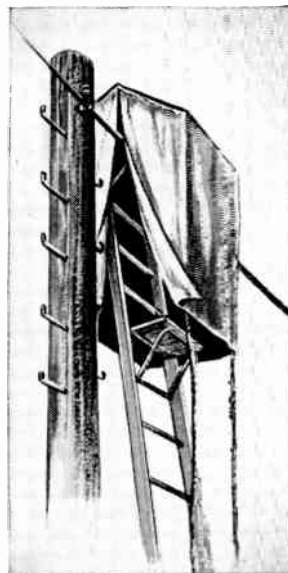

For the protection of workers on aerial cable in cold or stormy weather. Made of fire- and water-resistant canvas. Collapsible aluminum frames support the tents from cable suspension strand. Heavy canvas covers are reinforced at points of contact with frames. Vertical openings on both sides accommodate single cables. The C cover has T-shaped opening on both sides for second cable when supported on opposite sides of the pole. Openings are equipped with ropes and grommets for closing the tents securely. Finish: Cover, unbleached 10-oz. cotton duck. Frame, natural aluminum; steel parts galvanized.

No.	Size	Width Inches	Weight Lbs.
7237	B	52	30
7237	C	64	32

Specify B or C size when ordering.

Price on application.

General Machine Ladder Tents



One-man tents designed for the cable splicer working from a ladder.

Frame of $\frac{3}{16}$ -in. diameter stainless steel strand attached to bronze clamps which fasten on messenger in two places to form a 42-in. diameter circle to support canvas.

Weather-resistant canvas.

No. 7524—Wt. 15 lbs. Price on application

General Machine Cable Lashers

Type B

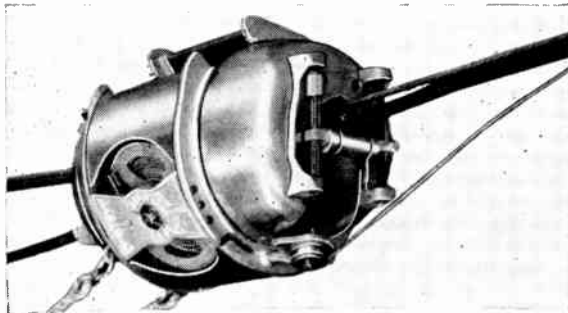

No. 7019-2

A quick-adjusting automatic aerial cable lasher for cables from $\frac{1}{2}$ -inch to $2\frac{1}{2}$ -inch diameter, using .091 to .061 lashing wire. Aluminum alloy casting gives maximum strength with minimum weight. Spinning drum operates on 10 sealed ball-bearing surfaces, and lashing machine has 24 ball bearings and 5 needle bearings. All parts enclosed in streamlined housing prevents fouling in tree branches. Two cable lifting arrangements, one at each end. Two rubber strand wheels located on opposite ends of the cable lasher provide continuous power to the drum. When tension on the pulling bridle is relieved, a back tensioning device allows practically no slack in the lashing. All steel parts are cadmium plated; other metal parts are non-corrosive metals. Overall length, $19\frac{1}{2}$ inches; overall diameter, $12\frac{1}{4}$ inches; weight, 43 lbs. Lashing Wire: diameter of coil, 7 inches; lengths, 325 feet; tensile strength, 390 lbs. weight, $7\frac{1}{8}$ lbs.

No. 7019-2 Type B Cable Lasher, complete with towing bridle and instruction manual. Price on application.

No. 6991-1 Sturdy fiber carrying case for No. 7019-2, size, 22 x 11 x 14 inches. Price on application.

Can be supplied with conversion unit using 045 stainless steel lashing wire.

General Machine Cable Lashers

Type C

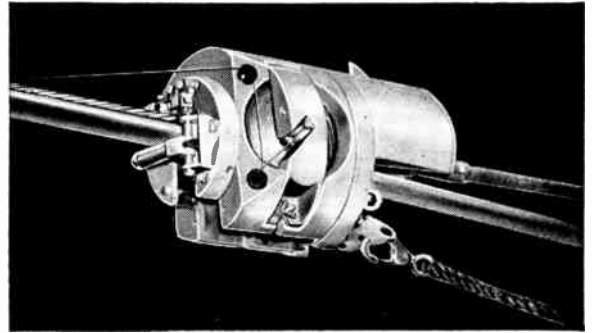

No. 7142-2

Holds two 1200-ft. coils of .045 lashing wire. Will lash all cables up to $1\frac{5}{8}$ -inch diameter. Aluminum alloy casting. Has sealed-for-life ball bearings on all vital shafts and on the spinning drum. Other moving parts are mounted on Oilite bushings. Two rubber strand drive wheels are mounted in the forward part of the carriage and a small trailer wheel is located in the rear. Driving is accomplished by direct gearing. This lasher embodies all the engineering principles of the "B" Lasher, plus automatic features, including the fingertip operated all-range tensioning device; the self-registering drum lock; the two-way brake to prevent back roll and the center feed non-rotating wire coil. Weight without wire, approximately 33 lbs.

No. 7142-2 Type C cable lasher complete with operating instructions.

No. 7143-2 Sturdy carrying case.

Prices on application

General Machine Cable Lashers

Type D

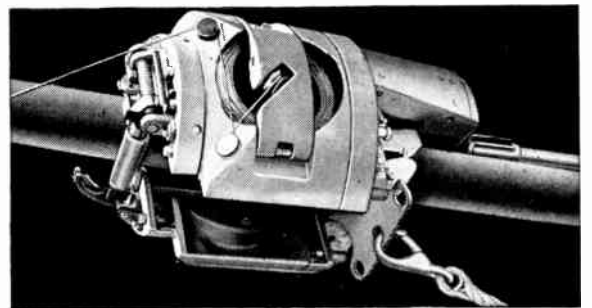

Latest model in automatic cable lashers for aerial cable up to $3\frac{1}{4}$ -in. diameter. Will lash to suspension strand with diameters from $\frac{1}{4}$ to $\frac{1}{2}$ -in. New tensioning device assures traction on strand far superior to previous lashers.

Two or more cables can be lashed to one strand if total diameter of cable assembly does not exceed 3-in.

Hold two 1200 foot coils of .045-in. lashing wire at one loading; can be operated by one man from the ground.

No. 7360—Wt. 43 lbs. Price on application

**General Machine Cable Lashers
Type G**

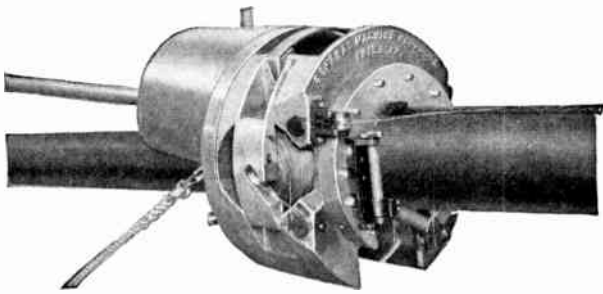

Similar to the Type D Cable Lasher, except designed to lash 2½-in. to 5-in. diameter cable to ½ up to ⅝-in. diameter strand with one or two left lay spiral wrapping of .045 SS wire. The lead of the lashing wire will vary from 15 ½-in. to 17 ½-in., depending on the size of the strand.

The pulling mechanism pivots about the axis of the rear driving roller and applies a hold down force on the strand roller approximately 2.2 times the forward component of the towing force. Approximate weight 75 lbs.

No. G1050—Shipping weight w/case 106 lbs.

Price on application.

General Machine Lashing Wire Grips

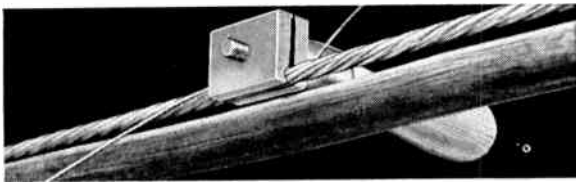

For securing lashing wire to suspension strand before releasing tension in wire. May also be used for temporarily fastening wire before lashing.

May be used with .065 or .091-in. lashing wire on all strand sizes and with .045-in. lashing wire on 6M and 10M strands. Not for use as a permanent installation.

No. 7362, Wt. 10 oz. Price on application

Perfection Cable Splicers' Tent Heaters



Affords a convenient, safe, economical and dependable method of tent heating. Portable and easy to operate.

Has built-in soldering iron holder and will heat iron for any soldering purpose.

Tank holds ½-gallon of kerosene and will burn from 5 to 24 hours on one filling.

Sturdily constructed of heavy metal, securely welded and riveted. Heavy iron bottom band to prevent wear.

Body and inside base has baked enamel finish; zinc-plated steel top and ventilating cone; porcelain-enameled heating drum.

Famous Perfection "High-Power" wick-type burner gives instant heat, finger-tip control.

Dimensions: 11⅜ in. diameter, 19¾ in. high.

No. 11-B—Approx. shipping weight 12 lbs.

Price on application.

Chance Adjustable Cable Cars



Adjustable to desired height for the convenience and comfort of the user. Can be collapsed and strapped or tied for convenient transportation. Safety hand brake holds car steady during cable hanging or splicing and makes it possible to stop car anywhere on the line.

High quality rubber tread wheels provide long wearing service.

No.	Height	Width In.	WL Lbs.	*Each
27	Adjustable	21	27	\$38.35

*Western zone prices; Eastern prices lower.

Chance Pole-Top Gins

Transformer Gin

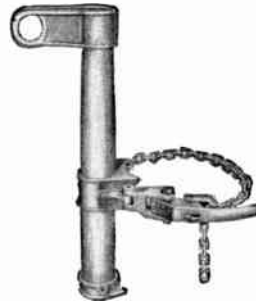

Designed for hoisting small distribution and rural line transformers, circuit breakers, and reclosers for pole mounting. May be used for other hoisting jobs. Fittings are aluminum for lightweight and easy handling. May be quickly applied to pole with safety latching chain tightener.

Wood mast provides insulation—tested to withstand 75,000 volts per foot.

Rated maximum load including pull on fall line—1500 lbs.

No.	Chain Length, In.	Approx. WL, Lbs.	Each
*30 TG	21	11	\$32.00
30 TG-1	36	11¾	33.00

*Lineman's Preference (LP)—recommended by Chance Hot Line Tool Demonstrators.

Rotating Gin

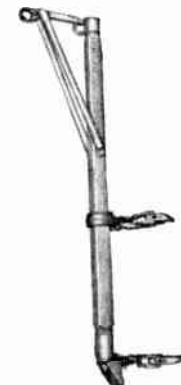

Designed for quick attachment to poles for hoisting transformers, crossarms, switches, or other heavy equipment.

Swivels to positions desired for hoisting equipment up around crossarms, conductors, etc. This also aids in maneuvering the load to desired positions.

Rated maximum load including pull on fall line—1300 lbs.

No.	Length, In.	WL, Lbs.	Each
C50	82	53	\$100.00

Chance Multi-Duty Gins

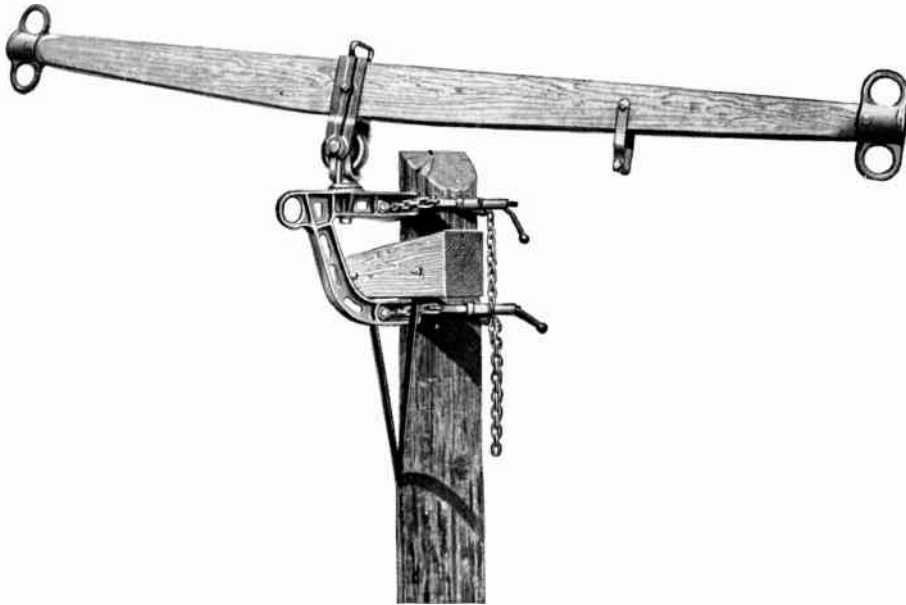

Pole-Top Gin

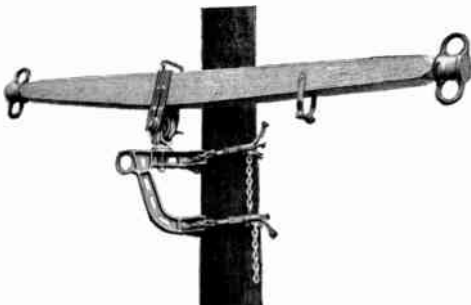

Side Mounting Gin

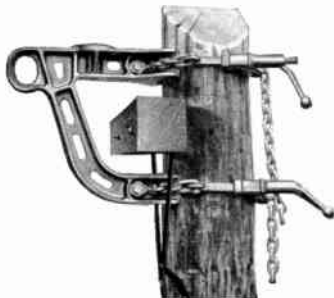

Transformer Gin

This gin will serve as the workhorse of line-construction and maintenance crews. It's a pole-top gin, a side mounting gin and a transformer gin in one tool.

The Multi-Duty Gin clamps on top of the pole to lift heavy equipment. On ridge pins and other types of construction where a gin cannot be mounted on top of the pole, the gin can be mounted down the pole without changing the mounting bracket. With the beam removed, the bracket can be used by itself for hanging single transformers or transformer clusters.

The "Y" design of the aluminum-alloy bracket, and the sturdy maple beam, account for the great lifting power of the gin. The wide opening between the two arms of the mounting bracket gives sufficient clearance so that the bracket can be fitted over cross arms when used as a pole-top gin. Chain binders with wind-up tighteners speed application to the pole.

The bracket will also straddle a cross-arm when mounted at the top of the pole.

The Multi-Duty Gin is available with two sizes of beams. The same mounting-bracket assembly is used for both ratings.

No.	Description	Max. Loads, Lbs.*	Each
C55	Light Multi-Duty Gin	1500	\$133 05
C55B	Light Multi-Duty Beam Only	1500	67 25
^C65	Heavy Multi-Duty Gin	2500	154 40
C65B	Heavy Multi-Duty Beam Only	2500	88 60
C75	Multi-Duty Bracket Only, with Pulley Wheel Assembly	2500	65 80
C85	Multi-Duty Bracket Only, without Pulley Wheel Assembly	2500	56 00

^Linemen's Preference (L.P) — Recommended by Chance Hot Line Tool Demonstrators.

*Based on proper installation of gin as shown on the instruction tag.

Chance Insulated Gin Poles



Made for lifting heavy conductors or heavy line materials. May be used as a pole top gin or as a boom pole for heavy duty work. Provided with means for guying at top when used on extra heavy loads. Heavy wood laminated; voltage tested construction provides exceptional strength and insulation protection.

No.	Length FL	Bending Strength FL-Lbs.	Approx. Wt., Lbs.	Each
N1970	8	5000	41 1/4	\$119.00
N1970-10	10	5000	46	130.00

Coffing Transformer Gins

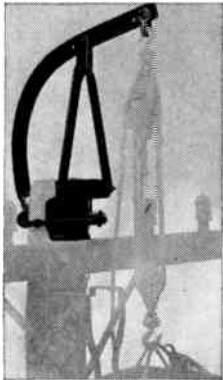

Model OST



Model WT

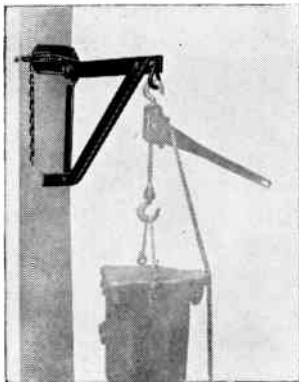

Model ST

Model OST: Constructed of spring steel curved edgways with two angle iron legs bolted to a malleable iron clamp. Constructed for pole top use. Rated capacity 2000 lbs.

Model WT: Constructed of well-seasoned hardwood with a malleable iron clamp. It cannot be pulled off the pole. Constructed as a non-conductor. Rated capacity 1500 lbs.

Model ST: Made of steel with malleable iron clamp. Constructed for side of pole use. Rated 1500 lb. capacity.

No.	Description	Ship. Wgt., Lbs.	Each
OST	Transformer Gin	35	\$35.50
WT	Transformer Gin	30	45.50
ST	Transformer Gin	25	32.50

Coffing Temporary Guy Clamps

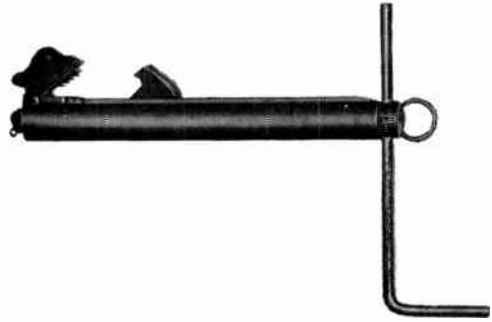

Designed on the vise principle with vise screw and enclosed in a steel tube. Easy to use, provides powerful grip. Permits necking close to the pole. Temporary guy clamp makes it unnecessary to drive 3-bolt clamp on and prevents stripping off the protective coating.

Description	Ship. Wt. Lbs.	Each
Temporary Guy Clamp	3 1/2	\$15.00

Chance Load-Indicating Chain Hoists

1-Ton

Have all the features of Chance 1-ton chain hoist, plus visual load indication.

Scale graduated in 250-lb. increments up to 2000 lbs.

A quick-operating tool for sagging conductors or for determining sag loads of conductors on wire tongs.

Indicator easily calibrated with an Allen wrench.



No.	Safety Latch	Standard Lift, Ft.	WL Lbs.	Each
3010L	No	5 1/2	14	\$63.00
3010S	Yes	5 1/2	14 1/8	64.00

Chance Chain Hoists

1-Ton

Simple controls can be operated without removing work gloves. Easy-to-grip ball end handle keeps hand from sliding off.

Half link and full link take-up. Chain free-wheels at a flip of the lever, which locks automatically when hoist is under load. Swivel hooks on both housing and chain.

Ratchet-type handle operates from either side of housing. Permanently lubricated oilite bearings. Hoist can be completely disassembled in the field.

Only 100-lb. pull required to lift 1 ton load.



No.	Safety Latch	Standard Lift, Ft.	WL Lbs.	Each
3010	No	5 1/2	12	\$51.00
3010S	Yes	5 1/2	12 1/8	52.00

Coffing Mighty Midget Pullers



Operates both as a crank for fast action or as a lever where operating space is limited. Handle bends, warning of overload.

A handy, tool-belt-size, puller for linemen, welders and all around maintenance crews.

No.	Rated Cap. Lbs.	Std. Lift In.	Extra Chain Per Lift Ft.	Appr. Ship. Wgt., Lbs.	Each
MP-5	500	57	\$.90	7½	\$32.50
MP-10	1000	56½	1.40	10½	42.50

Coffing Ratchet Lever Hoists



AG



ATG



FTG

Lightweight, safe and dependable. Operate in any position, horizontal, vertical, diagonal or upside down. No friction discs to slip or "freeze". Safety lever will bend at approximately 100% overload before hooks fail or chain breaks; gives visible warning of dangerous overload.

Hooks are drop forged, alloy steel with highest tensile strength for their size. Chain thoroughly tested before use.

All multiple chained hoists through 6 tons can be instantly converted to next smaller capacity by merely unhooking a special lug.

Roller Chain

No.	Rated Cap. Tons	Std. Lift In.	Appr. Net Wgt., Lbs.	Min. Dist. Bet. Hooks In.	Lever Pull Req'd. for Full Load Lbs., Appr.	Extra Chain P. Lift Ft.	Each
AG	¾	56½	14	13	56	\$1.80	\$ 58.00
*AGI	¾	56½	14	13	56	1.80	65.25
ATG	1½	57	17	15	60	3.60	72.00
*ATGI	1½	57	17	15	60	3.60	79.25
FG	1½	56½	25	16	116	3.70	81.00
*FGI	1½	56½	25	16	116	3.70	88.25
FTG	3	57	34	17	120	7.40	103.00
*FTGI	3	57	34	17	120	7.40	110.25
ZG4½	4½	51	49	25	124	11.10	185.00
ZG6	6	53	59	25	124	14.80	199.00
WG9	9	60	120	30	124	18.50	394.00
WG11	11	60	130	30	124	22.20	423.00
WG13	13	60	140	30	124	25.90	450.00
WG15	15	60	150	30	124	29.60	489.00

*Denotes double pawls; can be operated with half strokes of lever.

Coffing Ratchet Lever Hoists

Coil Chain



RG



RTG



L 1½

*RG	¾	56½	14½	11¼	56	\$1.75	\$ 58.00
*RTG	1½	57	18½	14	60	3.50	72.00
#LA1½	1½	56½	20	14	60½	2.20	81.00
†LA1½	1½	56½	26½	14	60½	2.20	81.00
#LDA3	3	57	28	18½	62	4.40	103.00
†LDA3	3	57	34½	18½	62	4.40	103.00
L2½	2½	57	35½	16	71	2.50	103.00
LD5	5	53	55½	21	74	5.00	190.00

*Denotes Double Pawls; can be operated with half strokes of lever. # Aluminum. † Malleable.

Coffing Safety Load Binders



Safest boomer on the market. Without releasing the binder the load can be adjusted a fraction of an inch.

One man can pull the rated capacity without using a cheater. Handle will not fly as in the eccentric type binders.

No.	Rated Cap. Lbs.	Std. Lift In.	Extra Chain Per Lift Ft.	Appr. Ship. Wgt., Lbs.	Each
A	3000	20½	\$1.80	15	\$31.65
F	6000	19½	3.70	26	42.35

Double-Chain

A	6000	20½	\$3.60	19	\$40.45
F	12000	19½	7.40	30	55.30

Chance Safety Pole Unloaders



Designed to take the danger out of pole unloading. Saves crew time. Only two men needed for unloading poles. Applied to flat cars with cable to support load while tie bands and standards are removed.

Will not trip until safety pin is removed and trip lever is pulled with long hand line. Men are in safe positions before load is released.

Sold in complete sets, consisting of 2 safety trips, bolts and large washers, 2 steel rope cables, 2 Thimbleye bolts with large washers and 4 rope clamps.

No.	Description	Approx. Wt., Lbs.	*Each
325	Complete Set.....	58½	\$77.00
329	Safety Trip with Bolt and Larger Washer (Two Required).....	13¾	23.00

*Western zone prices; Eastern prices lower.

Bartlett Emergency Wire Cutters

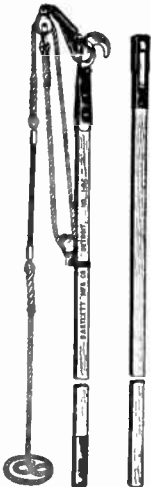

The double pulley and compound lever provides tremendous power, ease of operation.

Lightweight, convenient sectional handle. Laminated sitka spruce pole is furnished in two 6 ft. lengths. Can be used as a 6 ft. pole or easily joined together with a PI56 Sleeve to make a 12 foot pole.

Wire cutters are used to cut 110 and 220 RC wire. Can easily be used from the ground without use of a ladder.

Can also be used safely for cutting hot 4800 volt primary and service wire when hanging down close to the ground.

Weight 8 lbs. 5 oz.

No.	Each
1-BC	\$26.00

Bartlett Wire Cutters



Especially made to facilitate the unloading of car lots of poles.

Operated from a safe distance, it easily cuts No. 7 bare wire or steel straps at one stroke.

Has compound lever action. Head has a hardened hook with serrated edges.

Blade is ½-in. crucible 4001 steel, operated with pull lever.

Pole is 1¼ x 1⅞-in. laminated, treated to prevent moisture absorption. Pole length, 12-ft.

No.	Each
1-SC	\$30.00

Coffing Chain Electric Hoists

"Quik-Lift"



With Lug and Trolley Suspension

With Hook Suspension

Built for rugged, continuous production line operation. Special hoist motor with very high starting torque, pendant rope controls with fool-proof safety limit switches, large heavy duty contact points provide sensitive action.

For added safety and durability the positive action shoe type brake has 10 to 12 sq. inches of breaking surface.

Model J Hoists: Have a four step gear reduction. Available with 110/220 volts, 1 phase, 60 cy. motors or 220/440 volts, 3 phase, 60 cycles motors.

Model S Hoists: Uses exclusive Perry speed reducer. With this type of gearing there are more teeth in contact for better load holding. Available with 220/440 volts, 3 phase, 60 cycles motors. Special currents available on application.

J and JD Models—1 or 3 Phase

No.	Cap. in Lbs.	Lifting Speed in F.P.M.	Motor Hp.	Net Wgt., in Lbs.	Extra Chain Per Lift Ft.	Each
J-500-22	500	22	1/8	128	\$1.80	\$231.00
J-500-33	500	33	1/8	131	1.80	251.80
J-500-49	500	49	3/4	131	1.80	285.55
J-1000-11	1000	11	1/8	133	1.80	231.00
J-1000-17	1000	17	1/2	131	1.80	251.80
J-1000-24	1000	24	3/4	143	1.80	285.55
J-1500-17	1500	17	3/4	145	2.50	291.50
J-2000-8	2000	8	1/2	144	2.50	267.50
J-2000-12	2000	12	3/4	156	2.50	291.50
JD-3000-8½	3000	8½	3/4	183	5.00	338.10
JD-4000-4	4000	4	1/2	175	5.00	328.90
JD-4000-6	4000	6	3/4	183	5.00	338.10

S and SD Models—Heavy Duty—3 Phase Only

S-1000-36	1000	36	1½	190	2.50	379.50
S-2000-18	2000	18	1½	185	2.50	379.50
S-2000-36	2000	36	2	190	2.50	429.55
SD-4000-9	4000	9	1½	207	5.00	396.00
SD-4000-18	4000	18	2	217	5.00	443.20
SD-5000-9	5000	9	2	217	5.00	443.20

Accessories

Description	Each
Waterproof Canvas Cover.....	\$ 7.00
Chain Containers.....	15.00 and up
Current Collectors.....	15.40 and up
Cable Trolley (One for every 5 ft.) Adj. for 4-in.-10-in. I-Beams.....	4.50
Lug Suspension.....	7.00

**Coffing Spur Gear Hoists
Model YC**



Quality built for long life. Heavy duty suspension plates provide an unbreakable support between top hook cross head and the load sheave; also support malleable iron saddle for double chain hook up. This eliminates use of a top yoke, saving weight and headroom.

Weston type brake and planetary spur gears are fully protected against dirt and grit.

Rated Cap. Tons	Std. Lift Ft.	Appr. Ship. Wgt. Lbs.	Extra Chain Per Lift. Ft.	Each
1/2	8	70	\$3.95	\$119.00
1	8	100	4.10	152.00
1 1/2	8	150	4.40	202.00
2	9	215	4.55	236.00
3	10	189	6.60	330.00
4	10	258	6.90	396.00
5	12	271	6.90	463.00

Duff-Norton Pole Pulling Jack

Genuine Barrett

Single Acting, Ratchet Lowering

For light, power, railroad, street railways, telephone and telegraph companies.

With this handy jack, one or two men can pull or straighten poles, remove butts or move loaded poles without interrupting service. Regardless of size of poles or depth in ground no digging is required to loosen them for pulling.

The hinged channel base permits jack to be operated at an angle on level ground, or upright on a hillside.

The No. 500 Duff-Norton polejack has the power to pull, straighten or move the heaviest poles. With steel operating lever 1 1/4 x 66 in. long. Has 3/4-in. BBB chain.



No. 500

No.	Cap., Tons	Ht., In.	Raise, In.	Lgh. Chain, Ft.	Size Base, In.	Wt. Ea., Lbs.	Each
500	15	37 1/2	23	10	10 x 24	250	\$118.00

If wanted without chain, please specify "Without Chain," and deduct \$11.00.

**Simplex Emergency Jacks
Ratchet Lowering**



For Utilities and general duty service in industry. Also for pushing and pulling.

Lifts vertically—lifts or pushes at any angle. Double lever socket for close quarter operation. Any link of chain can be engaged on the recessed cap. Base locking hook is foot operated. Corrugated toe keeps load from slipping. Large base area insures stability. Convenient carrying handle.

Complete with 5 ft. chain, auxiliary cap shoe and lever.

Capacity 15 tons; Height 22 1/4 inches; Lift 13 1/2 inches; Minimum toe lift 2 1/4 inches. Weight; Jack only, 74 lbs.; Complete 109 lbs.

No. 310A.....Each \$101.75

**Simplex Pole Pulling and
Straightening Jacks**

For telephone and telegraph, light and power, railroad and street railway companies to pull or straighten poles.

One or two men can pull, straighten or move poles, with no service interruption and without digging, regardless of pole size or depth in the ground.



No. 325



No. A1538

No. 325 Simplex Junior Jack: will handle poles up to 30 ft. high. Pivots on its channel base to any angle; also used as guy line tightener or for pulling underground cables. Complete with 8-ft. pike pole for straightening poles located beside ditches. Recommended for rural maintenance and repair.

Nos. 1538 and A1538 Jacks will pull or straighten any size pole. The "I" beam base provides a firm foundation and the jack will pivot on its base when base pawl is disengaged.

The No. A1538 has an aluminum housing, making it much lighter for easier portability without sacrifice of strength.

No.	Cap., Tons	Height, In.	Lift, In.	Wt., Jack Only, Lbs.	Complete Weight, Lbs.	Each
*325	5	50	36	34	98	\$ 87.75
**1538	15	37 3/4	22	100	182	128.00
**A1538	15	37 3/4	22	60	142	136.00

*Has 5 ft. steel pinch lever bar, tapered and heat treated; 5 ft. steel chain; 8 in. x 15 in. steel channel base; 8 ft. pike pole of seamless tubing, with malleable forked cap for biting into wood on pole-straightening jobs.

**Equipped with 7 ft. heat treated alloy steel chain with pear-shaped link; "I" beam base 10 in. x 20 in., with hand hole; 5 ft. steel lever bar, tapered and heat treated.

Call Graybar FIRST For . . .

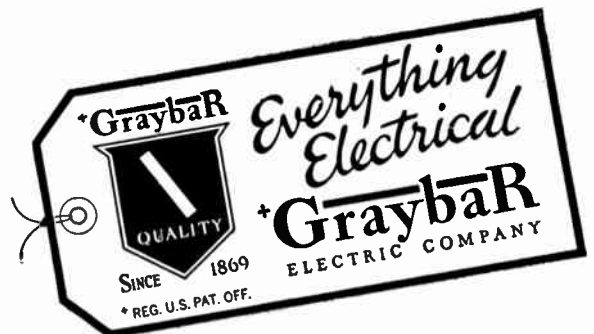

Duff-Norton Ratchet Lowering Jacks

Genuine Barrett

Single Acting, With Foot Lift



These jacks are expertly engineered, scientifically designed and constructed of the finest and best materials, specially selected for the purpose for which they are intended.

Each one is guaranteed by the maker to lift its full-rated capacity with maximum safety.

The rack bar can be pulled up to the required load height and lifting begins with the first down-stroke of the lever bar.

Being single acting, the load is raised only on the down-stroke of the lever bar, but can be ratchet-lowered, notch by notch.

Nos. 514MT to 521MT: For contractors, mills, mines, quarries and general farm and industrial use. Can be dropped instantly (tripped) when not under load.

Nos. 1020 to 1528: For use in mines, shipyards and industrial plants; building and road work; by riggers, drillers, truckers, etc.

No. 2028: For boilermakers, contractors, riggers, wreckers, railroads, heavy machinery manufacturers and movers.

All have round double sockets. 10 and 20-ton models can be furnished with small single round socket. Equipped with operating lever of adequate diameter and length for ease of operation. Nos. 1522, 1528 and 2028 can be furnished with large round sockets for use with wooden operating lever; or with square sockets to fit lining bars.

5-Ton Sizes

No.	Cap. Tons	Hgt. In.	Raise, In.	Base, In.	Head, In.	Foot Lift, Ht., In.	Wt. Ea., Lbs.	Each
514MT	5	14	7 1/2	5 1/4 x 7 3/4	2 1/2 x 2 3/4	1 1/2	31	\$31.00
516MT	5	16	9 1/2	5 1/4 x 7 3/4	2 1/2 x 2 3/4	1 1/2	34	\$33.00
521MT	5	21	14 1/2	5 1/4 x 7 3/4	2 1/2 x 2 3/4	1 1/2	41	\$37.00

10, 15 and 20 Ton Sizes

1017	10	17	9	7x10	3x3	2 1/4	55	\$44.00
1020	10	20	11 1/2	7x10	3x3	2 1/4	56	\$44.00
1022	10	22	12	7x10	3x3	2 1/4	63	\$44.00
1522	15	22	11 1/2	8x11	3x3 1/2	2 1/2	77	\$72.00
1528	15	28	18	8x11	3x3 1/2	2 1/2	96	\$74.00
2028	20	28	18	8x11	3x3 1/2	2 1/2	98	\$82.00

Simplex Ratchet Lowering Jacks

Single Acting



No. 85A

These jacks cannot be tripped—they raise or lower the load notch by notch.

General purpose jacks, ruggedly constructed—permit safe lifting, lowering, skidding, moving and leveling.

Fine material, precision machined and heat treated; adjustable cadmium plated springs and links; reinforced inner-ribbed housings.

For moving machinery, re-railing mine locomotives, mine track work and for lifting or skidding mechanical equipment.

Minimum toe lift 1 5/8 in.

Capacity 5 Tons

No.	Height, In.	Lift, In.	Base, In.	Lever, In.	Ship. Wt., Lbs.	Each
84A	14	7	5 x 7 3/8	30	28	\$32.00
85A	17	10	5 x 7 3/8	30	30	\$35.00
86A	20	13	5 x 7 3/8	36	35	\$38.75

Simplex Ratchet Lowering Jacks

Single Acting



No. A1022



No. 1017

Nos. 22 and A1022. For use with drilling equipment, for railroad draft gear, bolster and coupler repairs and mill and factory. Their speed and lifting range make them ideal for maintenance service in all types of industry—wherever machinery and equipment requires moving. No. A1022 has an aluminum alloy housing and smaller rack bar teeth. It is easier lifting and 16 pounds lighter.

No. 1017: Lifts easier and is lighter than the No. 22 in weight. Has safety speed trigger.

Capacity 10 Tons

No.	Height, In.	Lift, In.	Min. Toe Lift, In.	Base, In.	Lever, In.	Ship. Wt., Lbs.	Each
22	21 1/4	12 1/2	2 1/8	6 1/2 x 10	60	58	\$56.00
1017	17	9 1/2	1 5/8	6 x 8 3/4	60	40	\$44.75
A1022	20 1/2	12	2	6 1/2 x 10 1/4	60	42	\$73.75



No. 24A



No. 29

These jacks are exceptionally efficient for heavy duty jacking. All models lift full capacity on cap or toe.

No. 24A is the huskiest.

No. 29 is for faster and higher lifting.

Both models have a minimum toe lift of 2 1/2 in., plus portability and balance for safe, fast jacking.

Furnished with 1 1/4" round double socket with 5 ft. steel lever bar. Available, upon request, oval or round socket and 6 ft. oval or 6 ft. round hickory pole, or square socket for your lining bars. Specify type wanted.

Capacity 15 Tons

No.	Height, In.	Lift, In.	Base, In.	Ship. Wt., Lbs.	Each
24A	23 1/4	13	8 x 10 1/4	90	\$75.00
29	28 1/4	19	8 1/8 x 11 1/4	96	\$77.75

Simplex Ratchet Lowering Jacks

Single Acting



Sturdy, efficient jacks for heavy work. Recommended for railway refrigerator and empty car repairs; also for rigging, street railways, utilities and heavy duty construction jobs.

Can be used in pairs in lieu of overhead cranes for loading and unloading heavy machinery, equipment, forgings or castings. Minimum toe lift 2½ in. Lifts 27% easier than the No. 29.

Furnished with 1¼-in. round double socket with 5-ft. steel lever bar. Available, upon request, oval or round socket and 6-ft. oval or 6-ft. round hickory pole, or square socket for your lining bars. Specify type wanted.

No.	Capacity 20 Tons			Ship. Wt., Lbs.	Each
	Height, In.	Lift, In.	Base, In.		
2029	28¼	18	8x11	101	\$85.50

Single Acting—Geared Type



No. 126

The powerful geared type mechanism of these jacks provides both speed and ease of lifting—and considerably faster than standard speed jacks.

No. 135: For refrigerator and loaded car repair.

Nos. 126 and 127: For trencher, power shovel repair; for construction, oil field, tank erector, rigging and other heavy duty lifting. These models have 3 x 3¼ right and left hand toe lifts, respectively, for operation in pairs.

All are complete with oval lever sockets and oval hickory poles which cannot be inserted across the grain.

No.	Cap., Tons	Height, In.	Lift, In.	Min. Toe Lift, In.	Ship. Wt., Lbs.	Each
126	25	27½	12½	3 (R.H.)	192	\$265.25
127	25	27½	12½	3 (L.H.)	192	265.25
135	35	27	16	228	290.75

Duff-Norton Ratchet Reel Jacks

Genuine Barrett

Single Acting—Ratchet Lowering

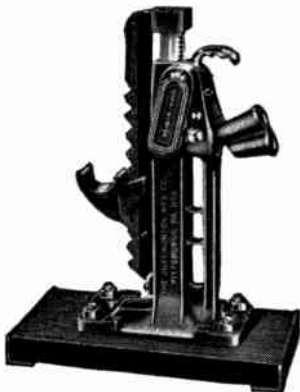

No. 524-MCR



No. 1022-MCR

For the speedy handling of reels of different diameters. Hooks will seat 2-in. spindles.

No. 524-MCR: Especially adapted to industrial, shop and warehouse use for handling reels of cable, wire, rope, leather belting, etc. Fitted with adjustable hook lifts for handling reels of different diameters. Has double round operating lever 1- x 30-in. long. Reinforced solid oak base for outdoor use.

No. 1022-CR: For utilities as well as warehouses, industrial plants, shipbuilders and contractors for a wide range of applications. Fitted with extra long lifting racks with hooks placed at various heights for handling reels of different sizes. Furnished with single round socket and steel operating lever 1¼- x 62-in. long. Hooks are located 12, 22½, 33 and 38-in. from ground level; housing bolted to solid oak base.

No.	Cap., Tons	Height, In.	Raise, In.	For Reels, In.	Base, In.	Wt., Lbs.	Each
524-MCR	5	21	14	40-60	9 x 19	68	\$56.00
1022-CR	10	38	12	25-90	9¼x24	100	95.00

Duff-Norton Ratchet Reel Jacks

Genuine Barrett

Single Acting—Ratchet Lowering

"T" Frame Base



For lifting and holding heavy reels on outdoor jobs. This jack is standard with many major utility companies throughout the country. Designed to meet the most exacting service demands of cable crews under adverse field conditions. Laminated oak weatherproof base, firmly bolted to prevent splitting. Tough malleable iron jack housing is spray-painted for protection against rust.

"T" frame base overcomes rocking on uneven ground; swivel joint of head hook allows most advantageous spotting without binding spindles.

For rapid jacking, the rack bar is pulled up until the selected hook engages reel spindle—then a few easy down strokes of operating lever and the reel is clear of the ground.

Can be furnished in pairs—one right and one left—so operators can lift in sight of each other for uniform raise.

Top swivel hook holds 3 in. diameter spindles, two lower hooks hold 2½ in. diameter spindles.

Single round socket; complete with operating lever 1¼ x 62 in. long. "T" leg 7½ x 11¼ in.

No.	Cap., Tons	Height, In.	Raise, In.	For Reels, In.	Base, In.	Wt., Lbs.	Each
1030CR	10	30	14	20-84	7½x30	110	\$108.00

Duff-Norton Journal Jacks

Low Height Ball-Bearing Screw Type



No. 2510-C-2

Small, lightweight jacks that are easy to operate and easy to carry.

For inspecting and renewing journal brasses, bridge and structural steel erection, machine and mill work, shipbuilding and in all other industries where powerful lifting and low height are required.

Rapid raising and lowering, powerful in lifting ability, absolutely safe up to rated capacity.

Low height range and small base diameters permit quick spotting and full operation in cramped areas and

limited heights. Mechanical design permits safe operation at any angle or upside-down.

Smooth ball-bearing screw action permits even precise increments of lifting and lowering.

Weatherproofed for rough outdoor use. Lifting mechanism is totally enclosed, packed in grease and sealed against leakage. Ratchet unit is open and accessible for cleaning and oiling.

No.	Cap., Tons	Height, In.	Raise, In.	Diam. Base, In.	Wt. Each, Lbs.	Each
1507	15	7	2 1/2	4 3/4	23	\$61.00
111-C-2	15	10	5	4 3/4	26	64.00
2509-C-2	25	9	1 1/2	5 3/8	35	89.00
2510-C-2	25	10	5	5 3/8	36	89.00
2510-A-2*	25	10	5	5 3/8	29	99.00
3510-C-2	35	10	5	5 7/8	48	114.00
3510-A-2*	35	10	5	5 7/8	35	127.00
5010-C-2	50	10	4 1/2	7 1/8	64	198.00
100-A-12*	100	12	4	8 3/4	100	323.00

*Aluminum Alloy.

Duff-Norton Screw Type Reel Jacks

With Three-Way Nut

"A" Frame Base



For lifting and holding cable, wire, rope and belting in shops and warehouses.

Sturdy, lightweight and fast to operate.

Frame is built of "L" shaped steel angles, securely welded. Lateral spread of legs 38 1/2 in. to insure firm, nontipping support. Screw is machine cut, heat-treated alloy steel for lasting service.

The operation is simple and quick. Only necessary to lift the curved cap to the reel spindle and spin the three-way nut down to the frame—lifting begins at the first turn of the lever. Lifting hook will accommodate spindles up to 2 1/2 in. diameter.

No.	Cap., Tons	Height, In.	Raise, In.	For Reels, In.	Base, In.	Wt. Ea., Lbs.	Each
520-CR	5	20	11 1/2	42-60	12 1/2 x 26 1/2	66	\$37.00
530-CR	5	30	16 1/2	60-90	15 1/2 x 38 1/2	90	49.00

Simplex Lever Type Reel Jacks

For the fast, safe handling of cable, wire, rope or belting on reels.

All are equipped with laminated, oil-treated oak bases for protection against dampness and exposure to weather.



No. 320A

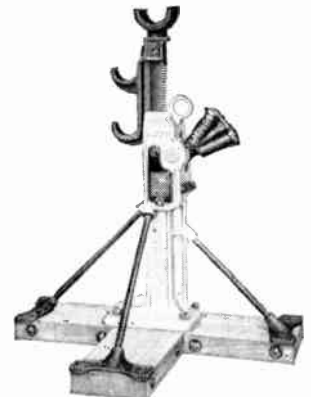

No. A-1029

No. 320A: **Single Acting.** For lighter service than No. 321. Handles reels from 20-in. to 60-in. in diameter. Equipped with 3 lifting hooks 9 1/2, 15 1/2-in. and 21-in. respectively from ground level. Top hook for 2 1/2-in. spindles and other 2 for 2-in. spindles.

No. 321: **Single Acting.** Handles reels from 20-in. to 96-in. in diameter. Equipped with 5 lifting hooks 9-in., 15 1/4-in., 21 3/4-in., 28-in. and 39-in. respectively from ground level. Top hook for 3 1/2-in. spindles, second from top for 3-in. spindles and the remaining 3 hooks for 2 1/2 in. spindles.

No. A1029: **Single Acting.** Aluminum alloy housing reduces weight 21 lbs. For outside work where footing may be uneven. T-shaped base has total area of 319 square inches with three threaded and adjustable steel rods. Furnished with left and right hand bases. Handles reels from 36 to 84-in. in diameter. Equipped with 3 lifting hooks 17-in., 23-in. and 29-in. respectively from ground level. Top hook, for 3-in. spindles and other 2 for 2 1/2-in. spindles.

No.	Cap., Tons	Height, In.	Lift, In.	Approx. Wt., Lbs.	Lgth. of Lever, In.	Each
320A	5	21	10	48	30	\$ 60.50
321	10	34 1/4	15	108	60	99.25
A1029	10	29 1/2	13 3/4	83	60	118.00

Simplex Screw Type Reel Jacks

Nos. 1CR, 2CR: For low cost handling of standard weight reels. No. 1CR handles reels from 40 to 60-in. in diameter. No. 2CR handles reels from 60 to 92-in. in diameter. Both have caps for 2 1/4-in. spindles.

No. 3CR: For heavy duty field use. Handles reels from 50 to 84-in. in diameter. Braced T-base has total area of 210 sq. inches. Ratchet head socket gives advantage over Nos. 1CR and 2CR. Cap takes 2 1/4-in. spindle.



1 CR

No.	Cap., Tons	Height, In.	Lift, In.	Wt., Lbs.	Lgth. of Lever, In.	List, Each
1CR	5	19 3/4	13 1/4	60	..	\$38.75
2CR	5	30 1/2	18	88	..	50.00
3CR	15	25 1/2	17 1/2	72	42	77.00

Duff-Norton Hy-Power Hydraulic Jacks

3 to 100-Ton Capacities

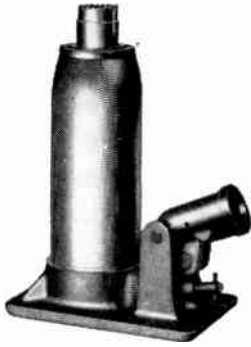

No. 8H9

For all industrial applications—in mines, mills and factories, oil fields, and ship yards; in railroad shops and on repair tracks.

Precision manufacture assures smooth, positive and unfailing operation, saves time and energy on every lifting and lowering job.

3 to 12-Ton Models—Have extension screws which can be quickly run up by hand to load height—lifting begins with the first stroke of the lever bar. Bases are heavily ribbed, one-piece malleable iron, with integral pump barrels.

20-Ton Model: Single pump jacks designed for strength with light weight.

30 to 50-Ton Models: Have dual pumps; the speed pumps brings head up to load position instantly—switchover to power pump is then automatic without changing or missing a lever stroke. Bases are special alloy steel, with "Armor Plate" steel guards to protect pump barrels.

Rams and cylinders are high carbon seamless steel tubing, accurately machined and ground to gauges for close sliding fit.

No.	Cap., Tons	Closed Ht., In.	Extension Screw, In.	Power Raise, In.	Total Ht., In.	Oiam. Head, In.	Size Base, In.	Lgh. Htle., In.	Wt. Ea. Lbs.
3119	3	8 1/2	3 1/2	6	18	1 1/8	3 3/4 x 6 5/8	33 1/2	16
5119	5	9	4	6 1/4	19 1/4	1 3/8	4 1/8 x 7 1/8	33 1/2	19
8119	8	9	4 1/4	6 1/4	19 1/2	1 1/2	4 5/8 x 7 3/8	33 1/2	22
12119	12	9 1/4	3 1/4	5 1/2	18	1 3/4	4 5/8 x 8 3/8	23 1/2	28
20111S	20	10 3/4	...	7 3/4	18 1/2	2 1/4	5 1/2 x 7	23 1/2	40
25117.5	25	7 1/2	...	4	11 1/2	2 1/2	5 x 7	27 1/2	35
25119.3	25	9 3/8	...	6	15 3/8	2 1/2	5 x 7	27 1/2	38
*30114.5	30	4 1/2	...	2	6 1/2	2 3/4	4 1/2 diam.	23 1/2	38
30111	30	11	...	7 1/8	18 1/8	2 5/8	6 1/4 x 8	23 1/2	67
35119.7	35	9.7	...	6	15 3/4	2 5/8	6 x 8	23 1/2	57
50111	50	11	...	6	17	3 5/8	8 x 9 7/8	23 1/2	110
100112	100	12	...	6 1/8	18 1/8	5	9 1/2 x 12	23 1/2	225

*Independent pump jack. Prices on application.

Simplex Rol-Toe Hydraulic Jacks

10, 25 and 50 Ton Capacities

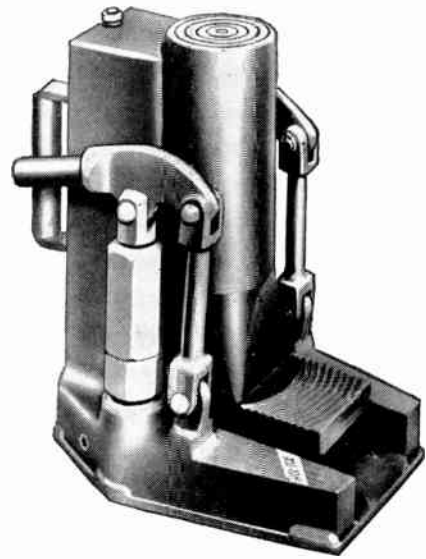

Will operate equally well in either horizontal or upright position and are ideal for lifting heavy machinery, transformers, etc., with minimum effort and maximum speed.

The lifting toe rides on a roller bearing which carries the radial load against the stationary ram's flat-milled surface. The lifting capacity on the toe is the same as that on the cap. The heavy, sturdy body lifts the load, reducing off-center loading by bringing the toe closer to the center of the ram.

The oil reservoir is independent of the load-lifting housing. Double pumps provide extremely quick operation. The high speed pump, positions, and lifts lighter loads and the high pressure pump handles the heavy lifting.

No.	Cap., Tons	Height, Closed	Travel, In.	Ht. Toe, Closed	Base, In.	Wt., Lbs.	Each
TJ-10	10	11 3/4	6	1 3/4	9 1/2 x 8	54	\$271.05
TJ-25	25	14	7	2 1/2	9 x 12	110	321.10
TJ-50	50	18	10	3 1/2	11 1/2 x 14 1/4	230	567.75

Simplex Hydraulic Jacks

These jacks are precision made of the very best materials selected especially for the purpose and engineered for ease of operation, safety and versatility. Their lifting power makes them suitable for general application as well as for specialized jobs.

All models are tested to lift 50% over rated capacities. Can be operated in either vertical or horizontal position with same high efficiency and safety.

Single Pump Models



No. 5HJ

Single, long stroke pump, positioned for maximum lift with minimum effort.

Tough malleable iron bases, pressure tested and ribbed on top for extra strength.

Single lever sockets. Complete with lever—1/2-in. pipe, 20-in. long.



No. 20HJ

No.	Cap., Tons	Low Ht., In.	Hyd. Lift, In.	Ext. Screw, In.	Total Ht., In.	*Ship. Wt., Lbs.	Each
311J	3	9	6 9/16	2	17 9/16	15	\$16.45
511J	5	9	6 1/2	3	18 1/2	18	16.90
811J	8	9	6 3/8	4 3/8	19 3/4	21 1/2	23.65
1211J	12	9	6 1/16	3	18 1/16	29 1/2	30.80
2011J	20	10	6 1/16	...	16 7/16	32 1/2	50.30

*Includes operating lever.

Double Pump Models

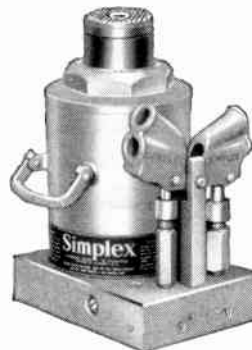

No. 50HJ

These jacks have both high and low speed pumps which can be operated singly or in unison. Double lever sockets for close quarter operation.

Suitable for mill and factory work; for construction, mining, drilling, journal inspection, bridge work, culvert pushing or pipe bending.

High carbon solid rolled plate bases. No. 100HJ has safety by-pass.

Complete with operating lever, 1 3/16 in. solid steel, 20-in. long.

No.	Cap., Tons	Low Ht., In.	Hyd. Lift, In.	Total Ht., In.	*Ship. Wt., Lbs.	Each
3011J	30	11	7	18	65	\$ 98.00
5011J	50	12	7	19	115	145.20
10011J	100	12	6 1/8	18 1/8	203	304.20

*Includes operating lever.

Simplex Re-Mo-Trol Hydraulic Pumps and Rams Remote Controlled



Consists basically of a powerful pump and a remotely controlled hydraulic ram, connected by a high pressure hose. Offers extremely simple operation for a thousand and one applications that it does better. Re-Mo-Trol's adaptability unlimited; can be used to apply force in any direction.

Re-Mo-Trol can be used where cramped space or other difficulties make the use of self-contained jacks or pullers impossible. One outstanding advantage is the famous "Center Hole" tubular ram (on 7 models). It is only necessary to insert a pull rod or screw through the tubular ram plunger. Rod is drawn through in a direct-line pull.

Ram Specifications

No.	Capacity, Tons	Minimum Height, Inches	Plunger Travel, Inches	Hole Diameter, Inches	Weight, Lbs.	Weight, Each
RC102	10	19 ¹ / ₁₆	2	...	5	\$ 29.55
**RC106	10	12	5 ¹ / ₂	...	11	30.10
RC302	30	5	2	1 ¹ / ₈	13 ¹ / ₂	55.85
RC306	30	9 ³ / ₄	6	1 ¹ / ₈	21 ¹ / ₂	81.60
*RC315	30	11 ¹ / ₄	5	1 ¹ / ₈	44	137.75
RC506	50	10 ⁷ / ₈	5 ¹ / ₂	...	39	105.09
**RC613	60	9 ⁵ / ₈	3	1 ⁵ / ₈	62	179.30
*RC6010	60	18 ¹ / ₂	10	1 ⁵ / ₈	120	280.00
**RC1103A	100	10 ¹ / ₂	3	2 ¹ / ₈	96	214.50
*RC1110A	100	16 ¹ / ₂	10	2 ¹ / ₈	180	315.00
RC2112	20	10 ⁷ / ₈	12	...	45	112.00

*Two way—retracts hydraulically. **Spring return.

Pumps

RP3—Hand pump, 7/16 in. Dia. Piston—1 in. Stroke—51 cu. in. capacity for RC102, RC106 and RC302 rams. \$26.95

RP6A—Two speed hand pump with automatic changeover from high to low speed with pressure increase. 126 cu. in. capacity for RC306—RC506—RC613—RC1103A—RC2112 rams. \$67.90

RP8A—Hand pump similar to RP6A with the addition of a selector valve to reverse oil flow to raise and lower two way rams. 161 cu. in. oil capacity. Used with RC315—RC6010—RC1110A rams. \$112.00

No. 798AC—Electric Hydraulic Pump. Operates at continuous pressures of 5,000 P.S.I. and intermittent pressures of 10,000 P.S.I. Has built-in 3/4 horsepower 1725 R.M.P., 115-230 volt, 60 cycle, A. C., single phase capacitor start motor. Selector valve reverses flow of oil to raise or lower ram plunger. For all rams. \$373.50

All pumps have built-in Safety By-Pass Valve. Also available Air and Gasoline Powered Hydraulic Pumps.

B & L Star Brand Pulling-In Frames



Designed to aid in installing cable in underground ducts. Consists of two 13-ft. sections of 6-in. steel channel, each with 24 holes on 6-in. centers to permit spacing the two sheaves to the proper position for any cable installation.

Has two aluminum sheaves, one 20 in. and one 5 3/4 in. in diameter, each provided with Graphite Bronze self-lubricating bushings which do not require lubrication.

The diameter and groove of the large sheave are of sufficient size to allow cable to be pulled over it without injuring cable sheath when it is necessary to pull sufficient cable into the manhole for splicing.

No. 5032—Weight Each 260 Lbs.

Simplex Pipe Pushing and Pulling Jacks

For contractors and public utilities engaged in pipe, duct and culvert installations under streets, alleys, tracks, walks or lawns.

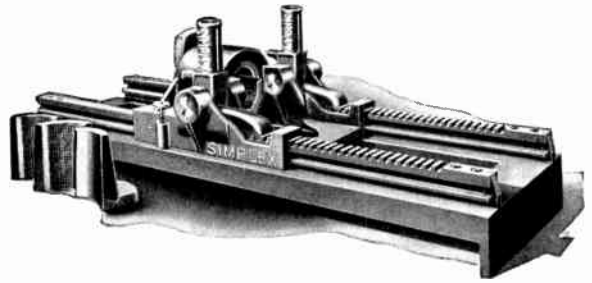

A powerful, accurate and economical jack with reversible carriage which eliminates the need of reversing track when pulling pipe. Its design permits use of longer pipe lengths and considerable saving in threading and coupling. Tapered steel jaws completely surround the pipe—no crushing or flattening.

Has double levers and extensions for operating singly, alternately or in unison on double tracks.

Equipment Includes: One set tapered jaws and one pilot for single diameter pipe, two 3 1/2-ft. steel lever bars and two steel pipes for extending levers. (Specify size of jaws and pilot required).

No.	Cap., Tons	For Pipe Diam., In.	Travel, In.	Jack Only Weight, Lbs.	Complete Each
*R-334A	25	2 to 4	28 1/2	208	321 \$377.25

*An adapter can be furnished for this model which permits pushing pipe from 3/4- to 2-in. diameter—Write Graybar for price.

Optional Equipment: Prices on application.

Extra Jaws		Extra Pilots	
For	Sizes	For	Sizes
R-334A:	2, 2 1/2, 3, 3 1/2 or 4 in.	R-334A:	2, 2 1/2, 3, 3 1/2 or 4 in.

Greenlee Hydraulic Power Pumps No. 797

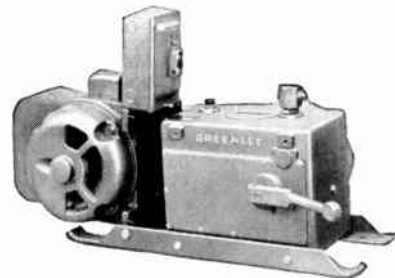

Pumps consist of double-piston, single-valve, high-pressure units, specifically designed for operating Greenlee hydraulic equipment and other hydraulic systems adaptable to their power. These pumps deliver 106 cubic in. of oil per min. at 10,000 psi max. pressure with a 2 hp electric motor and 213 cubic in. of oil per min. with a 3 hp motor.

They operate at an intermittent pressure of 10,000 psi and at a continuous pressure of 6000 psi. Available with either a four-way valve (TA) for two-direction operation (high-pressure advance and low-pressure return of a ram or piston) or a two-way (SA) valve for one-direction operation (high-pressure advance only).

No.	Description	Each
797E-SA	Electric Power Pump—Single Acting Valve without motor and control.	\$425.00
797E-TA	Electric Power Pump—Double Acting Valve without motor and control.	475.00

Greenlee Portable Power Pumps

No. 798



No. 798-AC

The fast approach, high pressure No. 798 Portable Hydraulic Power Pumps can be used with any Greenlee Bender, Knockout Punch Ram, and other hydraulic systems requiring similar power. The same pump is used on all three basic models and features a low pressure pumping arrangement for high volume delivery and rapid advance of the ram to the work and automatic change-over to low volume, high pressure delivery when the ram pressure exceeds 150 psi. The pump unit is a two piston radial type, capable of developing 6000 psi constant pressure and up to 10,000 psi intermittent pressure.

Each basic model is supplied with a choice of two valve controls: SA type for one-direction operation (high pressure advance only) and TA type for two-direction operation (high-pressure advance and low-pressure high-speed return of ram). Base dimensions all models, 10 in. x 12 in. Ht., 19 in., except No. 798-CO which is 15 in. Useable oil volume, 4½ qts., reservoir oil capacity, 1½ gals.

No.	Type	Motor HP	Pumping Cap., Cu. in. per min.			Each
			100 psi	1000 psi	10000 psi	
798-AC-TA	ac	¾	170	36	28	\$385 00
798-AC-SA	Constant speed 115-230v.	direct drive				\$370 00
798-CO-TA	Universal ac or dc 115 volts	½ geared drive	170	36	22	\$395 00
798-CO-SA						\$380 00
798-GM-TA	1 cycle Briggs & Stratton Gas. Eng.	1.7 geared drive	170	36	28	\$380 00
798-GM-SA						\$365 00

Hose not included in price.

Duff-Norton Push and Pull Jacks

Screw Type, With Ratchet Lever Sockets



For contractors, drillers, riggers, railroads, shipyards and industrial plants.

Widely used in erecting bridges, docks, tanks and piling, and for pulling together or pushing apart steel plates, sheets and beams. Also handy for straightening sides and ends of steel freight cars, as well as spreading or drawing in bent or split center sills.

With chains, hooks or pipe sleeves the range of application is greatly increased. (These items are not included in price.)

Steel screw, nuts and ratchet wheel are machine cut for easy, positive operation.

Nos. 1024 and 1029 furnished with wooden operating lever 1½ x 21 in. long; No. 1538 square socket, without lining bar.

No.	Cap. Tons	Screw Diam., In.	Overall Length, In.	Weight Each, Lbs.	Each
1024	10	2	24	46	\$48 00
1029	10	2	28	50	50 00
1538	15	2½	38	97	84 00

Can be furnished in greater lengths than listed above. Contact Graybar for specifications and prices.

Simplex Trench Braces

Drop-Forged

The only trench and timber braces constructed entirely of steel drop forgings. Blunt safety lever nut prevents injuries and damage; ball and socket joints at each end allow quick adjustment, tight gripping. Has nail holes in shoes. Three-way nuts furnished in place of lever nuts if specified.

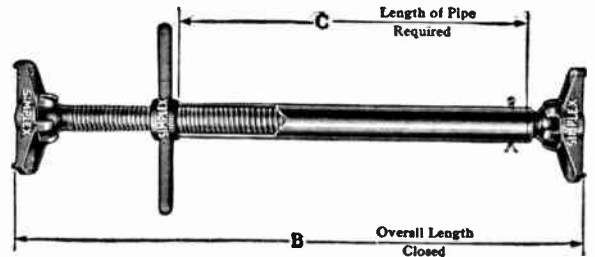

Complete With Pipe

Pipe and Screw Diam., In.	Length of Screw, In.	"B" Lgth. of Braced Closed, In.	"C" Lgth. of Pipe, In.	Safe Extn. of Screw, In.	Weight with Pipe, In.	Each
1½	12	18	10½	7	16	\$ 7.00
1½	14	21	13½	9	17½	7.30
1½	16	24	16½	9	18	7.30
1½	16	27	19½	10	19½	7.90
1½	18	30	22½	10	20	7.90
2	18	36	26	10	40	15.50
2	18	42	32	10	42	15.75
2	18	48	38	10	43½	16.15
2	18	54	44	10	45½	16.40
2	18	60	50	10	47	16.70

Without Pipe

Screw Diam., In.	Length of Screw, In.	Safe Extension of Screw, In.	Unit Weight, Lbs.	Each
1½	12	7	11	\$ 6.10
1½	14	9	14½	6.35
1½	16	10	15¼	6.60
2	18	10	32¼	13.90

Note: Screw ends only and butt ends only are available separately.

Simplex Timber Braces

Drop-Forged

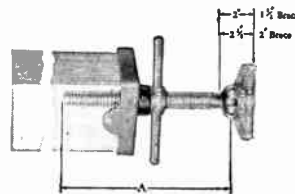

Especially practical for wide and deep trenches, foundations and subway work. Timbers not furnished. Three-way nuts in place of lever nuts at no extra cost if desired. Please specify.

Screw ends are same as Simplex Trench braces.

Diam. of Screw, In.	Length of Screw, In.	Size of Timber Caps	Unit Wt., Lbs.	Each
1½	12	4 x 4	11½	\$ 6.85
1½	12	6 x 6	14	7.60
1½	14	4 x 4	12¼	7.15
1½	14	6 x 6	15	7.90
1½	16	4 x 4	13	7.50
1½	16	6 x 6	15½	8.20
2	18	6 x 6	27½	13.15
2	18	8 x 8	28½	14.70

Simplex Manhole Sheaves



For pulling cable or carrying winch line at right angles in utility maintenance work.

Can be used on the end of a truck or over top of manhole in connection with snatch block in manhole. Eliminates need for manhole skids. Handles cable up to 3 in. diameter and any size winch line.

Complete with 1/4-in. chain, 24 in. long, with special hook for anchoring and protection when winch line is released suddenly.

Large sheave 7 3/4 in. diameter, 3 in. wide. Small sheave 1 3/4 in. diameter, 3 in. wide.

No. 220 - Shipping Weight 100 Lbs. Each **\$119.00**

Ideal Wire Guides



Prevents kinks and enables several conductors to slide into conduit smoothly and easily. Tempered steel spring forms smooth bend for wire to follow.

Knurled aluminum fitting can be used with all types and sizes of boxes, in any position with plaster rings on or off. Spring will not slip off under pull, yet can be removed with single twist.

No.	Description	Each
31-230	Set of four sizes.	\$9.20
*31-231	1/2-inch.	1.90
31-232	3/4-inch.	2.15
31-233	1-inch.	2.65
31-234	1 1/4-inch.	3.60

*No bushing necessary with 1/2-inch size.

General Machine Cable Feeders and Nozzles

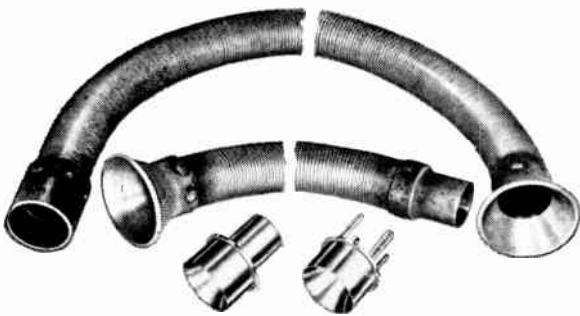

For protection of cables being pulled into underground conduit. Complete feeders consist of main section and extension section with appropriate nozzles to fit conduit.

Main section is a 4-in. flexible metal hose with bell mouth on one end and sleeve for nozzle on other end. Extension section is a 4-in. hose with bell mouth on one end and tube on the other end.

Separate bell-mouthed nozzles available for both round and square conduit.

No.	Description	Nozzle I. O.	Dimensions, In.		Wt. Lbs.
			O. D.	Length	
6058	Main Section	. . .	7 1/2	90	35
6058	Extension Section	. . .	7 1/2	13 1/4	18
6058	3-in. Nozzle	2 5/8	1 3/4	6 1/4	7
6058	3 1/4-in. Nozzle	2 7/8	1 3/4	8 1/8	8
6058	3 1/2-in. "S" Nozzle	3 1/8	1 3/4	5 3/4	5
6058	4 1/4-in. Nozzle	3 9/16	5 1/4	6 1/4	8

Prices on application.

Greenlee Cable Pullers

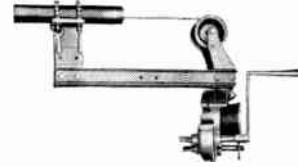

For pulling cable through conduit without damaging cable insulation or loosening hangers. Provides all the power needed, easy to operate and portable. Has positive anchorage. Clamps directly to the conduit and pulls in line with it so that hangers are not loosened. Can be used to pull horizontal or vertical conduit. With flexible elbow attachment works on concealed conduit.

Cable is not furnished, but 3/8-in., 6-9 strand having a breaking strength of 11,000 lbs., or higher, is recommended.

No.	Description	Wt., Lbs.	Each
765	With Two Cranks (without cable). . . .	225	\$215.00
765-4	Flexible Elbow Attachment, complete.	86	65.00

Barth Cable Pullers

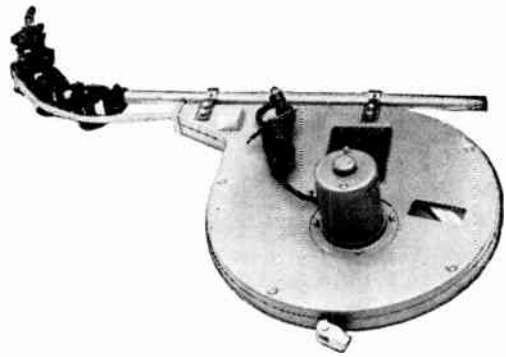

A power-driven tool which pushes the tape into the conduit and then pulls the cable through. Will push 30% more bends than the code allows at a speed of 45 ft. per minute.

Has safety control which stops the pushing if an obstruction is encountered, and is overload protected. Will pull 1200 lbs. dead weight (approximate pull of 8 men) which is sufficient for all normal runs of 3/4-in. through 2-in. conduit sizes at 15 ft. per minute full load. Can be used in any position on 115 volt a-c or d-c.

Use cable tape length is 175 ft. of .060 x 1/4-in. best quality. Light weight and compact for easy set up. Complete with attachments ready to use.

No.	Wt., Lbs.	Each
1-CP	65	\$469.00

Accessories for Use with Model 1-CP Barth Cable Puller

Part No.	Description	Each
60	Replacement Tape Assembly.	\$24.50
84	75-ft. Tape Extension.	13.40
116	2 1/2-in. Conduit Adapter.	4.50
117	3-in. Conduit Adapter.	4.95
118	3 1/2-in. Conduit Adapter.	6.00
119	4-in. Conduit Adapter.	6.50

General Machine Slack Pullers

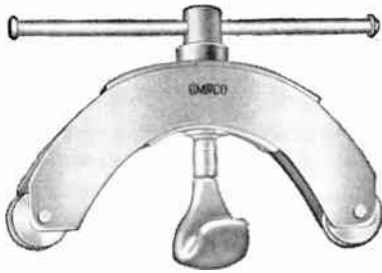

Type E

For temporarily deflecting suspension strand in order to introduce slack into aerial cables for splicing and repair work.

Consist of an arc-shaped frame supporting grooved pulleys at each end and a lifting screw in the center. Screw is mounted on roller bearings and has a hook at the lower end for engaging the strand; has handle at the upper end.

No. **7522**—Wt. 10¾ lbs.....Price on Application

General Machine Duct Rod Rollers



For use between lengths of rods for ease in movement.

Consists of aluminum disc having 6 fiber rollers around its edge which enable assembly to move easily through duct or conduit.

Furnished with one bronze swivel joint. Three-inch diameter only.

No. **G1017**—Wt. 2½ lbs.....Price on application

General Machine Test Mandrels



Round



Square

Available round or square, of seasoned hardwood.

Tool steel cutting ends provide means of testing conduit before laying cable. Specify size and shape on orders.

No.	Shape	Size, In.	Wt., Lbs.
6318-T	Round	3¼	7
6318-T	Square	3¼	7
6318-T	Square	4¼	8

Price on application.

General Machine Laying Mandrels



For use in laying conduit. Made of hardwood, with steel disc at front end and leather wiping washer at other end.

Length 36-in., made in 3¼-in. round only.

No. **6318-L**—Wt. 16 lbs.....Price on application

General Machine Washer Duct Cleaners



For cleaning conduit before laying cable.

Tough leather washers, graduated in sizes, wipe inside of conduit clean.

Three-inch diameter.

No. **G1014**—Wt. 8 lbs.....Price on application

General Machine Crisscross Cleaners



For cleaning conduit of all foreign matter before laying cable.

Made of flexible spring steel; tool presents sharp cutting edge to interior of conduit, regardless of direction pulled.

Three-inch diameter.

No. **G1011**—Wt. 5 lbs.....Price on application

General Machine Flexible Mandrels



For use in conduit with extreme bends; flexible cable of mandrel will follow contour of conduit.

Graduated discs of hardened steel provide a means of efficiently cleaning out obstructions within conduit.

Three-inch diameter.

No. **G1010**—Wt. 15 lbs.....Price on application

General Machine Cable Benders

Type D

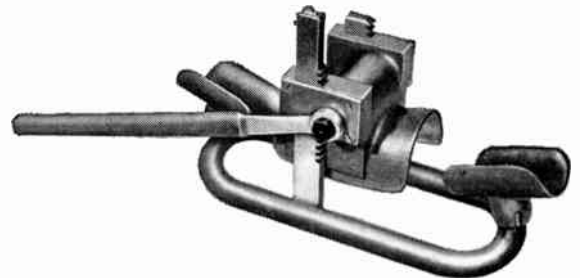

For making compound bends in lead cable up to 3-in. diameter. Saddles are swivel-mounted for any kind of bend, including spiral. Tool may be rotated around cable for compound bends in restricted areas such as manholes.

Central section arched to bend cables without harm. Frame of aircraft alloy steel tubing. Hardened steel ratchets have deep-cut teeth.

Over 1-ton pressure can be applied on cable with approximately 100 pounds pressure on handle.

No. **7410**—Wt. 13 lbs.....Price on application

General Machine Water Tool Brush



For use by installers for washing and cleaning the base plate of terminals. With nylon bristles 1-in. in diameter and 2½-in. long, vulcanized into heavy ferrule of varnished wood handle. Overall length 7¼-in.

No. **7260**—Wt. ½-lb.....Price on Application

General Machine Jar Hammers



For transmitting hammer blows by rod to working end. Used with cutting tool in removing obstructions.

Heavy plunger, with 12-in. stroke, delivers a solid blow when rod is pulled back and forth.

Two-inch diameter.

No. G1015—Wt. 8 lbs.....Price on application

General Machine Rod Grapples



For use in rod-ding long lengths or muddy conduit.

Two loops on one grapple and four hooks on other permit positive engagement.

Useful in working from both ends of conduit at the same time.

No. 6931—Wt. per pair 2 lbs.....Price on application

General Machine Pipe Rippers



Re-designed to efficiently cut a longitudinal slot in pipe used as a conduit for cable, preparatory to removing the pipe from the cable. Tool consists of a hardened steel cutting blade, two bearing points which serve as the pivot for the cutting action on the pipe, and a tubular handle. Removable blades are heat-treated tool steel with two cutting edges. Heat-treated tool steel bearing points are triangular in shape, so that three individual cutting edges are available by rotating their position. Tubular handle is attachable to the head in two different positions. For greater leverage, a bar may be inserted in handle. Ripper can be used in restricted areas. Finish: Oiled. Length overall, 42 inches; handle, 30½ inches. Weight, 18 lbs.

No. 7044.....Price on application

General Machine Soldering Coppers



Consists of pyramid-type forged copper bits swaged on one end of one-piece steel shanks. With coolant-type handles.

Available in 1, 1½, 2 and 2½ lb. sizes.

Length, approximately 16-in.

No. 6722.....Price on application

General Machine Numbering Dies



For stamping numbers on tools or other steel items.

Roller, made of hardened tool steel, has figures 1 to 9, dash-mark and letter X.

Overall length 3½-in.

No. 6688—Wt. ½ lb.....Price on application

General Machine Lead Sleeve Spreaders



Facilitates the work of spreading split-lead sleeves, particularly the smaller sizes difficult to open by hand. Steel handle is formed at an angle of 45° to the flattened shank to provide clearance for the hands in the spreading operation. Two steel blades, pivoted to the flattened shank, are so spaced that openings up to 2 inches may be obtained. Length, 8½ inches. Finish: Oiled. Weight, 10½ ounces.

No. 6748.....Price on application

General Machine Pipe Spreaders



Quickly and easily enlarges the slot produced by the pipe ripper to facilitate the removal of conduit from a cable. Hardened steel fork engages the edges of the pipe wall at the slot. Handle is made of 1½-inch steel pipe for lightness and also so that a bar may be inserted when greater leverage is required. Length, 39 inches; width of fork, 2 inches. Finish: Oiled. Weight, 9½ pounds.

No. 7045.....Price on application

General Machine Products Co.

Special purpose items manufactured in accordance with telephone companies' specifications.

No.	Description
6925	Asphalt—Pressure Plug (25 Lb. Can)
6272	Bag—Bandage, Rubber
6885	Bag—Gas Cylinder
6265	Bag—Junk, Canvas
6880	Bag—Manhole Tent
6068	Bag—Tool, Canvas
6068	Bag—Tool, Canvas Carrying Strap
7421	Balance—B Counter
G1007	Bandage—Rubber Splice 6-in. x 6-ft.
6948	Battery
7889	Battery
14495	Battery—1½ Volt
7405	Block—E Cable
6016	Board—Transposition Running
6301	Board—Wire Insulated Asbestos Lumber (2 half sections)
BA750793	Bolt—Manhole Cover
7133	Bond—B Cable
7133	Bond—C Cable
7056	Box—First Aid
6936	Brace—B Ratchet
7022	Brace—Back
7222	Bracket—B Station Tubing (Pkg. of 10)
6731	Bracket—Contactor
6733	Bracket—Contactor Terminal
221221-B-76	Bracket—Fire Extinguisher Weighing
6760	Bracket—Sign 25 A

No.	Description
6726	Bracket—Sign Type 170, Size 2
6726	Bracket—Sign Type 170 Size 3
6726	Bracket—Sign Type 170 Size 4
6726	Bracket—Sign Type 188 Size 6
6726	Bracket—Sign Type 188 Size 10
6622	Bracket—Warning Flag
7272	Brush—Soap
6673	Bucket—Canvas 9-in.
6673	Bucket—Canvas 12-in.
7271	Bucket—Soap w/Brush
7084	Bushing—B Insulator (Pkg. of 40)
7219	Bushing—B Station Tubing (Pkg. of 10)
4320	Candle—Stearine 1¼ x 3½ (6 to a lb.)
6886	Carrier—Storage Battery
7058	Cartridge—B Gas Flow
6981	Case—Type B Cable Lasher
7143	Case—C Cable Lasher
7378	Case—D Cable Lasher
6821	Case—Manhole Lamp
6745	Case—Pressure Testing Apparatus
7189	Case—Submarine Splice 2-in.
7189	Case—Submarine Splice 3-in.
7189	Case—Submarine Splice 4-in.
6475	Case—Tool, Pocket
7167	Cement—C 4-oz. Bottle
7167	Cement—C Qt. Can less Applicator
6147	Chain—Warning Flag

General Machine Products Co.

Special purpose items manufactured in accordance with telephone companies' specifications.

No.	Description	No.	Description
7256	Chuck—B Pressure Testing	7406	Frame—Cable Block B
7306	Clamp—B Flange	7406	Frame—Cable Block C
7419	Clamp—C Flange	7406	Frame—Cable Block D
6732	Clamp—Contactor Terminal	7406	Frame—Cable Block E
7380	Clamp—Drop Wire	7406	Frame—Cable Block F
6301	Clamp—Fireproofing	7253	Frame—Strand Payout
6299	Clamp—Ground L	7470	Gauge—B Pressure
7090	Clamp—B Ground Wire	7210	Gauge—Gaff
7285C	Clamp—Lashing Wire, Bronze $\frac{9}{16}$ -in.	6712	Gauge—Sag
7285	Clamp—Lashing Wire	8463	Gloves—Asbestos
6627	Clamp—Paraffin Pot Cover	7471	Grease—Teletype (1 lb. Can)
6565	Clamp—Pressure Testing	7471	Grease—Teletype (5 lb. Can)
6565	Clamp—Pressure Testing Gasket Only	7362	Grip—Lashing Wire
7212	Clamp—Span	7422	Guard—B Cable $\frac{1}{2}$ -in.
7182	Clamp—Strand Ground	7422	Guard—B Cable 1-in.
7188	Clamp—Submarine Cable 4-in.	7422	Guard—B Cable $1\frac{1}{2}$ -in.
7188	Clamp—Submarine Splice 2-in.	7422	Guard—B Cable 2-in.
7188	Clamp—Submarine Splice 3-in.	11R46	Guard—Blasting 3-ft. Long
6861	Clamp—Wire Snubbing (1R & 1L)	7215	Guard—Gaff
6819	Clasp—Cable No. 7 Brown	6867	Guard—Rail Manhole
6819	Clasp—Cable No. 9 Brown	102L17	Guard—Sheave
6819	Clasp—Cable No. 14 Brown	7413	Gun—Pressure, Nozzle Only
6549	Cleat—Inside Wiring	7534	Gun—C Pressure
6869	Clip—B Transfer Cable	7190	Handle—B Exploring Coil w/Adapter
6869	Clip—B Cable	6859	Handline—Aerial
6869	Clip—C Transfer Cable	6859	Handline—Underground
6869	Clip—C Cable	6840	Heater—Ampoule w/Case
G1021	Clip—Cord—Red, White, Black, Yellow, Min. 3 Doz., Any Color	6830	Holder—Guy Clamp
6928	Clip—Test No. 1	38Y 3688	Holder—Purse Group 1 (Pkg. 10)
6928	Clip—Test No. 2	38Y 3688	Holder—Purse Group 2 (Pkg. 10)
7166	Cloth—Wire (Pkg. of 20)	7170	Hook—B Pot
6301	Connector for Aerial Cable Fireproofing	7151	Hook—Shave w/Riveted Blade and Guard
6743	Connector—Cylinder Charging	6598	Hook—Manhole Cover
6978	Constrictor—Cable Sheath	6744	Hose—Pressure Testing Assembly 8-ft.
8434	Container—Asbestos Glove	7361	Injector—Desiccant
6910	Cord—Solder Pot 20 lb.	8288	Ink—Multiple Marking Ink, Blue, 4-oz.
6910	Cord—Solder Pot 35 lb.	8287	Ink—Multiple Marking Ink, Green, 4-oz.
6627	Cover—Paraffin Pot	8286	Ink—Multiple Marking Ink, Red, 4-oz.
7023	Crimper—B Clip	7432	Ink—Multiple Marking Ink, Yellow, 4-oz.
7512	Cutter—Washer, Blade Only	7433	Ink—Multiple Marking Ink, White, 4-oz.
7168	Cylinder—B Nitrogen	6798	Insulator—Binding Post No. 1
7385	Damper—B Cable	6798	Insulator—Binding Post No. 2
7488	Damper—B Vibration	6798	Insulator—Binding Post No. 3
7064	Depressor—B Cable Core	6798	Insulator—Binding Post No. 6
7014	Desiccant—"B" 160 Gr. Can	6798	Insulator—Binding Post No. 4
7014	Desiccant—"B" 650 Gr. Can	6798	Insulator—Binding Post No. 5
7194	Desiccant—C (10—4-oz. bag to can)	6798	Insulator—Binding Post No. 7
6688	Die—Steel Lettering, A-M and N-Z $\frac{3}{16}$ -in. character—2 unit set	4552	Iron—Pulling In 9-in.
DL478	Digger—B Hydraulic Inc. 16-in. Auger	4552	Iron—Pulling In 12-in.
6679	Dipper—Paraffin	6722	Iron—Soldering Copper—I lb., $1\frac{1}{2}$ lb., 2 lb., $2\frac{1}{2}$ lb.
DL397	Drawbar—CB	11R76	Iron—Soldering Copper No. 1
6765	Dresser—Iron Cable	11R76	Iron—Soldering Copper No. 2
6797	Drill—Cable	7438	Jack—B Corner Cable
6797	Drill—Cable Bit Only	7286	Jack—B Cable Racking
7533	Drill—Cable $\frac{3}{8}$ -in. Size	6605	Jack—Small Cable Reel
7533	Drill—Cable $\frac{3}{8}$ -in. Size, Bit Only	6605	Jack—Small Cable Reel (Spindle Only)
6496	Fixture—Sidewalk Guying (2-in. Pipe 6-ft. Long)	6130	Kettle—Compound
7028	Flag—B Warning	6085	Ladle—Solder
6621	Flag—Warning 13-in. x 13-in.	6828	Lamp—Manhole
6621	Flag—Warning (16-in. x 16-in.)	7019	Lasher—(Reconditioned) B Cable w/Case
6489	Flange—Pressure Testing (Pkg. of 50)	7019	Lasher—Modification of Type B to Use .015 S. S. Wire
ME74004	Flange—Pressure Testing (1 Body and 1 Plug)	7142	Lasher—(Reconditioned) C Cable w/Case
7548	Flange—C Pressure Testing (Pkg. of 25)	7142	Lasers—Equipped at Factory w/Peanut Strand Pulley Addt.
7548	Flange—D Pressure Testing (Pkg. of 25)	7403	Lasher—E Cable (Inc. Counterbalance)
6974	Form—Cable Soldering ($1\frac{1}{2}$ -in. Round Hole or $\frac{3}{8}$ -in. Square Hole—Pkg. 6)	7404	Leader—C Cable
7171	Frame—B Pulling 12 $\frac{1}{2}$ -ft. Long w/2 Pins no Sheaves Inc.	7309	Lifter—C Cable
7171	Frame—B Pulling 15-ft. Long w/2 Pins, No Sheaves Inc.	7147	Lifter—Sheath
7171	Frame—Pulling Sheaves "B"	7439	Locator—B Leak
7171	Frame—Pulling Sheaves "L"	7437	Lubricant—Cable Pulling Bentonite, Regular (40 lb. Drum)
7171	Frame—Pulling Sheaves "S"	7437	Lubricant—Cable Pulling Bentonite, Winter (40 lb. Drum)
14123	Frame—Card, Beige Color		

General Machine Products Co.

Special purpose items manufactured in accordance with telephone companies' specifications.

No.	Description
7437	Lubricant—Cable Pulling Lead Sheath (40 lb. Drum)
S10378-144	Marker—Manhole
7423	Mirror—Splicers
7292	Mold—B End Plate
7132	Mold—Soldering B
7132	Mold—Soldering C
7132	Mold—Soldering D
6473	Nails—Ground Wire 7/8-in. (5 lb.)
6473	Nails—Ground Wire 7/8-in. (100 lb.)
G1020	Nails—Oval Head Galvanized Strap, 1 1/2-in. Long 10 lb. Carton
G1020	Nails—Oval Head Galvanized Strap, 2-in. Long 10 lb. Carton
7470	Oil—Teletype (Qt. Can)
7470	Oil—Teletype (Gal. Can)
7274	Opener—B Cable Sheath
6681	Pan—Paraffin Large
6681	Pan—Paraffin Small
6877	Pan—Solder
6865	Pasters—Cable 1-in.
6865	Pasters—Cable 2-in.
6491	Pick—Needle Point Test
6491	Pick—Needle Point Only
G1013	Pick-up
6216	Plates—Cable Location Number
7062	Platform—B Aerial Open
7062	Platform—B Aerial Closed 52-in.
7062	Platform—B Aerial Closed 64-in.
7062	Platform—B Aerial (Saddle Only)
7062	Platform—B Aerial (K Hook Only)
6874	Plier—Ring Crimping
6872	Plier—Shield Cutting
7020	Pliers—B Cable
7278	Plug—B Screw (Pkg. of 50)
7548	Plug—C Pressure Testing Flange (Pkg. of 25)
11198	Pocket—Platform Splicing
PE65	Polish—Metal Paste
6627	Pot—Paraffin
6156	Pot—Solder Melting 6-in.
6156	Pot—Solder Melting 8-in.
7149	Presser—B Sleeve
7149	Presser—C Sleeve
7142	Pulley—Peanut Strand Drive B. C. & D. Lasher Pair
6174	Punch—Cotton Sleeve 5/8-in.
7267	Punch 1/8-in. Pin
G1009	Rasp—Lead w/Handle 12-in.
DI436	Reel—RS Power
DI436	Reel—RS Power (Spool Only)
DI436	Reel—RS Power (Driving Spindle)
DI436	Reel—RS Power (Pole Spindle)
6656	Regulator—Two Gauge
6670	Remover—Split Conduit Plug
8526	Rest—Soldering Copper
6868	Ribbon—Bonding Type L
6868	Ribbon—Bonding Type S
6868	Ribbon—Plain Bonding (5 lb. Spool)
7434	Ring—B Support
7323	Rod—B Clearance
6792	Rod—Ranging
6792	Rod—Ranging Extension
7402	Roll—Impregnated Tape Coat 4-in.
6727	Roll—Muslin 2-in. x 4-yd. Long
6727	Roll—Muslin 4-in. x 8-yd. Long
7176	Roller—Coaxial Sleeve
7176M	Roller—Sleeve
G1008	Scissors—Electrician
G1016	Scoop—Sand
6934	Shackle—Pressure Regulator
7350	Shield—B Manhole
ES-774072	Shield—Suspension Lead B
ES-774072	Shield—Suspension Lead C
ES-774072	Shield—Suspension Lead D
7322	Shifter—Strand B or C
7407	Shifter—Strand D or E

No.	Description
6735	Shoe—Cable Bending
6698	Sign—Demountable Warning
6436	Sleeves—5/8-in. Double Cotton
1030	Sleeving—Cotton 180-ft. x 5/8-in.
7264	Sling—Gas Cylinder
6774	Sling—Rope
7273	Slitter—B Cable Sheath
7449	Slitter—B Lead Sleeve
6501	Soap Solution—Regular Grade Qt.
6501	Soap Solution—Regular Grade Gal.
6501	Soap Solution—Winter Grade Qt.
6501	Soap Solution—Winter Grade Gal.
8446	Solvent—(2-oz. Bottle)
8446	Solvent—(1-oz. Can)
8446	Solvent—(16-oz. Can)
7396	Spacer—B Cable 1/4-in., 1/2-in., 3/4-in.
6975	Sprayer—Insecticide
7245	Spur—Ladder, Pair
7024	Stand—Ladder
6914	Stem—Valve C. F, H or P
6914	Stem—Valve Inside
6320	Stick—Orange (Pkg. of 10)
6320	Stick—Orange
6290	Strap—Cable Bender
7093	Stripper—B Braid
6389	Support—Cable Rack Type L
6389	Support—Cable Rack Type S
6716	Support—Loading Case Strand (L or S)
6799	Support—Loading Coil Case SV
6799	Support—Loading Coil Case SII
6802	Support—Loading Case, Crossarm Type S or L
7169	Supports—B Lashed Cable 16-in.
7169	Supports—B Lashed Cable 22-in.
7169	Supports—B Lashed Cable 28-in.
7169	Supports—B Lashed Cable 34-in.
7169	Supports—B Lashed Cable 45-in.
7169	Supports—B Lashed Cable 66-in.
7169	Supports—B Lashed Cable 78-in.
7172	Support—B Manhole Platform
7236	Support—Splice
7270	Tag—Cable Strap
7270	Tag—Cable Terminal
7270	Tag—Cable Round
7270	Tag—Cable Octagon
6684	Tape—Cotton 1/2-in. x 36-yd.
6684	Tape—Cotton 1-in. x 36-yd.
6631	Tape—Lead Serving
7237	Tent—Aerial B Frame
7237	Tent—Aerial B Canvas
7237	Tent—Aerial C Frame
7237	Tent—Aerial C Canvas
11A	Terminal—6 Pair
G1018	Thermometer—Armored 12-in. Long—30°—120° F.
G1018	Thermometer—Armored 14-in. Long—0°—600° F.
5000	Tool—DeRigner
19458-110	Tool—Insulated Protector Block
6939	Tool—Removing and Placing Ring
5010	Tool—Unlashing
7471	Tool—Valve Repair
38Y3734	Tray—Coin and Bill
6361	Trough—Paraffin Small 14-in. x 28-in.
6361	Trough—Paraffin Large 20-in. x 35-in.
7231	Valve—Relief C or D
7220	Washer—B Station Tubing (Pkg. of 10)
6923	Wax—No. 1 Cerese AA (11 lb. Slab) (per lb.)
6783	Wedge—Lead—Nos. 0, 1, 2, 3, 4, 5, 6, 7, 8, 9, 10
7289	Wrench—B protector
7119	Wrench—C Socket
BA750794	Wrench—Manhole Cover Bolt
7511	Wrench—Ratchet
6968	Wrench—Screw Angle
6490	Wrench—Socket Sealing
6662	Wrench—Split Conduit Plug

General Machine B Cable Lubricators

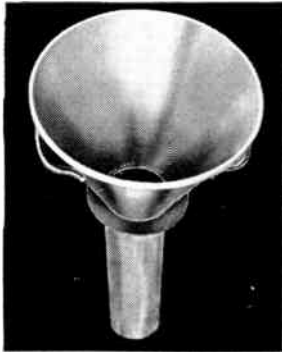

For use in applying lubricant to underground cable by passing the cable directly through the lubricator. It consists of a sheet-steel funnel for holding the lubricant, a flexible leather tube for spreading and controlling the amount of lubricant applied, and a hose clamp for attaching the tube to the funnel. Funnel is equipped with two handles. This device is the most effective method of spreading lubricant evenly over an entire length of cable. Height, 22³/₄ inches; diameter of funnel, 11 inches. Funnel has 3-inch throat.

Weight, 7 pounds. Finish: Metal parts oiled.
No. 7287.....Price on application.

**B & L Star Brand Cable Sheaves and Shackles
No. 5033**



For use instead of a pulling-in frame when advisable or possible to locate the truck directly over a manhole.

This device is attached to the manhole pulling iron, the winch line going over a roller or sheave at the rear of the truck, then down and under the cable sheave and shackle, then into the duct.

Special aluminum alloy sheave 20 in. in diameter with groove large enough to take 2⁵/₈-in. cable. Steel yoke, with drop forged steel hook.

Description
Complete Sheave and Shackle; Weight Each 65 Lbs.
Complete Frame, without Sheave; Weight Each 37 Lbs.
Aluminum Sheave Only, 20 in. Diam.; Weight Each 28 Lbs.

**Empire Conduit and Sewer Rods
With or Without Wheels**



Best quality hickory, with quick acting automatic couplings. Furnished with straight sticks of uniform 1 inch diameter throughout. Furnished in three and four foot lengths. Specify whether rods are wanted with or without wheels, and length.

No.	Length Feet]	Weight, Lbs.	Wheel Diam.
850	3	1 ¹ / ₂	1 ¹ / ₂
851	4	1 ³ / ₄	1 ¹ / ₂
852	3	1 ¹ / ₄	No wheels
853	4	1 ¹ / ₂	No wheels

Diamond Screw Duct Rods



⁷/₈-inch diameter best quality hickory, bronze new type coupling. Furnished in three and four foot lengths.

No.	Length, Ft.	Wt., Lbs.
855	3	1 ¹ / ₄
856	4	1 ¹ / ₂

Chance Conductor Cleaning Brushes

V-position of brushes gives 2-sided cleaning action. As brushes wear, they can be rotated, by loosening the anchor screws, so that unused bristles will come in contact with conductor.

Steel bristles. Will handle a wide range of conductor sizes.



No. M4455-63



No. M1889

No.	Description	Wt. Oz.	Each
M4455-63	Universal Conductor Cleaning Brush.....	11	\$4.65
M1889	Hand Conductor Cleaning Brush.....	12	5.30

Rawl Spiral Carbide Drills



No.	Nominal Diam., In.	Overall Lgth., In.	Shank Diam., In.	Pkd. in Boxes of	Wt., Lbs. Per Doz.	Each
8500	¹ / ₈	2 ¹ / ₂	¹ / ₈	12	¹ / ₄	\$2.03
8502	⁵ / ₃₂ (6)	3	⁵ / ₃₂	12	¹ / ₄	2.03
8504	¹¹ / ₆₄ (8)	3	¹¹ / ₆₄	12	¹ / ₃	2.03
8506	³ / ₁₆ (10)	3	³ / ₁₆	12	¹ / ₃	2.03
8508	¹ / ₄ (12)	4	¹ / ₄	12	³ / ₄	2.03
8510	⁹ / ₃₂ (11)	4	¹ / ₄	12	³ / ₄	2.19
8512	⁵ / ₁₆ (16)	4	¹ / ₄	12	1	2.19
8514	³ / ₈ (20)	4	¹ / ₄	12	1	2.40
8516	⁷ / ₁₆	6	³ / ₈	6	1 ¹ / ₂	2.70
8520	¹ / ₂	6	³ / ₈	6	3	3.03
8522	¹ / ₂	6	¹ / ₄	6	2 ³ / ₄	3.03
8524	⁹ / ₁₆	6	⁷ / ₁₆	6	4	3.38
8526	⁵ / ₈	6	¹ / ₂	6	5	3.71
8528	¹¹ / ₁₆	6	¹ / ₂	6	5 ³ / ₄	4.22
8530	³ / ₄	6	¹ / ₂	6	6 ¹ / ₂	4.73
8532	⁷ / ₈	6	¹ / ₂	6	9	5.73
8534	1	6	¹ / ₂	1	11	8.10
8536	1 ¹ / ₈	6	¹ / ₂	1	12	9.79
8538	1 ¹ / ₄	10	¹ / ₂	1	29	11.81
8540	1 ³ / ₈	10	¹ / ₂	1	36	13.16
8542	1 ¹ / ₂	10	¹ / ₂	1	43 ¹ / ₂	14.51

Most diameters available on special order from factory in overall lengths of 12-in. and 18-in. One week delivery notice required.

Rawl Spiral Carbide Drill Kits

No.	Kit No.	Drills in Kit, In.	Per Set
8591	1	¹ / ₄ , ⁵ / ₁₆ , ³ / ₈ , ¹ / ₂	\$9.65
8592	2	³ / ₁₆ , ¹ / ₄ , ⁵ / ₁₆ , ³ / ₈ , ¹ / ₂ , ⁵ / ₈	15.38
8593	3	¹ / ₄ , ⁵ / ₁₆ , ³ / ₈ , ¹ / ₂ , ⁵ / ₈ , ³ / ₄	18.08

Each kit complete with tool kit roll.

Diamide Masonry Drills
Spiral Twist Carbide Tipped



Does not bind. Drills full length without stopping or removing drill. Carbide tip and drill shank are same diameter eliminating bent shanks and overhang on tip to cause snagging, reduces breakage, drills faster and runs cooler.

No.	Nominal Diameter Inches	Shank Inches	Overall Length Inches	No.	Nominal Diameter Inches	Shank Inches	Overall Length Inches
7703	3/16	1/4	3	7710	5/8	1/2	6
7704	1/4	1/4	4	7711	11/16	1/2	6
7705	5/16	1/4	4	7712	3/4	1/2	6
7706	3/8	1/4	4	7714	7/8	1/2	6
7707	7/16	1/4	4	7716	1	1/2	6
7708-A	1/2	1/4	4	7718	1 1/8	1/2	6
7708-B	1/2	3/8	6	7720	1 1/4	1/2	10
7709-A	9/16	7/16	6	7724	1 1/2	1/2	10

Prices on application.

Rawl Percussion Masonry Drills



Machined (M T)



Twist Type (R/T)



Drill Holder

For fast, efficient drilling into brick, stone and concrete.

Drill Holders and M/T or R/T Drills

M/T	No.	R/T	Size	Use Rawl Drill Holder No.	Pkd. in Boxes of	Shp. Wt. Lbs. Per 100	Per Doz.
8106	8156	6	(3/32)	14	12	1/4	\$11.50
8108	8158	8	(1/64)	14	12	1/4	11.50
8110	8160	10	(3/16)	14	12	1/4	11.50
8111		10 x 5		14	12	1/2	14.50
8112	8162	12	(1/4)	14	12	1/2	11.50
8113		12 x 6		14	12	3/4	14.50
8114	8164	14	(9/32)	14	12	1/2	12.50
8116	8166	16	(5/16)	20	12	1	13.60
8120	8170	20	(3/8)	20	12	1 1/4	15.70
8124	8174		1/16	20	12	1 1/2	31.00
	8177		1/2	20	6	2	34.00
	8180		5/8	20	6	2 3/4	45.00
	8183		3/4	20	6	4	60.00

Rawl-Grips



To Fit Standard Tool Holders

Made of live hard rubber in two sizes, easily applied to No. 14 and No. 20 Rawl drill holders. Gives safe, comfortable and firm cushion grip.

No.	Description	Each
8703	Fits No. 14 Holder.....	\$2.25
8704	Fits No. 20 Holder.....	2.25

Rawl-Chucks

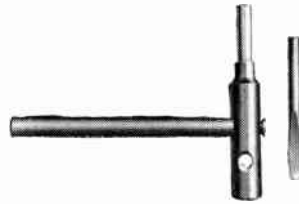

For Electric or Pneumatic Hammer. Made of special tool steel accurately machined and heat treated for severe service in all standard electric and pneumatic chipping hammers.

Available for all popular Electric and Air Hammers.

No.	Description	Each
8730	14 Drill Taper.....	\$8.00
8740	20 Drill Taper.....	8.00
8758	5/8-In. Drill Taper.....	8.00
8753	Chuck Ejector Pin, Air.....	.90
8754	Chuck Ejector Pin, Electric.....	.90
8755	Shank Pin, Air.....	1.90

When ordering specify make of hammer, size, and, if pneumatic, whether round or hexagon barrel.

Rawl Hand Drills



Standard Type Forged Drills for hand drilling.

No.	Diam., In.	Lgth., In.	Per Doz.	No.	Diam., In.	Lgth., In.	Per Doz.
8400	3/8	9	\$20.40	8414	7/8	12	\$26.40
8402	7/16	10	20.40	8416	1	12	27.00
8404	1/2	10	20.40	8420	*1 1/8	12	36.00
8406	*9/16	12	20.40	8422	*1 1/4	12	45.00
8408	5/8	12	20.40	8424	*1 3/8	12	60.00
8410	*11/16	12	24.00	8426	*1 1/2	12	75.00
8412	3/4	12	24.00	8428	*1 5/8	12	90.00

*These sizes available on special order from factory with one week's notice for delivery. 18-in. and 24-in. lengths also available.

Tilden Rotary Concrete Core Drills



Drills concrete up to 6-in. per minute and up to 300-in. in concrete before resharpening is required. Has interchangeable shanks for any depth hole on the 5/8-in. drills and over.

Triple Cutter Centerless Type

No.	Drill Size In.	Overall Length In.	Each
TC-4	1/4	5	\$ 3.60
TC-5	5/16	5	3.95
TC-6	3/8	5	4.60
TC-7	7/16	5	5.80

Core Type

KK-8	1/2	6	7.80
KK-9	9/16	6	8.90
KK-10	5/8	8	9.90
KK-11	11/16	8	11.00
KK-12	3/4	8	11.90
KK-13	13/16	8	14.40
KK-14	7/8	10	16.80
KK-16	1	10	17.90
KK-18	1 1/8	12	20.40
KK-20	1 1/4	12	22.60
KK-22	1 3/8	12	24.90
KK-24	1 1/2	12	27.30
KK-26	1 5/8	12	29.60
KK-28	1 3/4	12	32.90
KK-30	1 7/8	12	34.00
KK-32	2	12	36.00

Larger sizes available.

Rawl Drill-Hammers

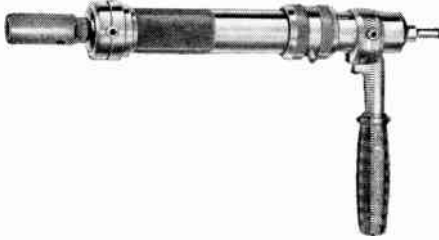

Designed to convert 1/4-in. electric drill into a fast Power Hammer. Adjustable for 3 striking forces. Has automatic clutch. Capacity to 3/8-in. Rawldrills.

No. 8760 Wt., Lbs. 2 3/4 Each \$30.00

Rawl Power Hammer Drills



Forged drills with Taper Shank.

With No. 20 Rawldrill Taper

6-in. Length Overall			12-in. Length Overall		
No.	Diam., In.	Per Doz.	No.	Diam., In.	Per Doz.
8300	3/8	\$15.00	8304	7/16*	\$19.80
8302	7/16*	15.60	8308	1/2	19.80
8306	1/2	17.40			
8310	9/16*	19.80	8314	5/8	24.00
8312	5/8	19.80	8322	3/4	26.40
8316	11/16*	22.80	8328	7/8	30.00
8320	3/4	22.80			
8324	13/16*	25.20			
8326	7/8	25.20			

With No. 5/8 Rawldrill Taper

8200	3/8	\$22.80	8206	7/16*	\$30.00
8204	7/16*	23.40	8210	1/2	30.00
8208	1/2	26.40	8216	5/8	36.00
8212	9/16*	30.00	8224	3/4	36.00
8214	5/8	30.00	8230	7/8	36.00
8218	11/16*	30.00	8234	1	36.00
8222	3/4	30.00	8238	1 1/8	37.80
8226	13/16*	30.00	8242	1 1/4	49.20
8228	7/8	30.00	8244	1 3/8	52.80
8232	1	30.00	8246	1 1/2*	60.00
8236	1 1/8	33.60	8248	1 5/8*	72.00
8240	1 1/4	44.40			

*These diameters available on special order from factory with one week's notice for delivery. 18-in. and 24-in. lengths also available.

Diamond N Drill Points

No. 730



Point is carefully tempered to sufficient hardness to withstand the wear of cutting and the temper is drawn away toward the shank, to produce a softer steel where it enters the handle to prevent its breaking off at that point.

May be used with Diamond Drill Holders Styles A, B and C.

Size In.	Length In.	Depth Hole In.	Wt., Lbs. Per Dozen	Size In.	Length Overall In.	Depth Hole In.	Wt., Lbs. Per Dozen
1/4	4 1/2	2	1 1/4	9/16 & 5/8	6 1/4	5	3 3/4
5/16	4 1/4	2	1 1/4	1 1/16 & 3/4	6 1/2	5 1/2	4 1/2
3/8	4 1/4	2	1 1/2	13/16 & 7/8	7	6	6
7/16	4 3/8	3 3/4	2	1	7 1/4	7	7 3/4
1/2	5	4	2				

Prices on application.

Diamond N Drills



No. 700 4-Point or Star Type Drill

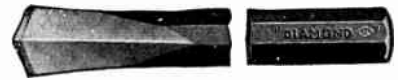

No. 710 Diamond or Single Point Drill

Highest grade octagon drill rod. Quality of steel is tested for uniformity. Heat treatment is scientifically conducted; heats for hardening and drawing the temper are determined by pyrometer and thermometer. Actual tests on various kinds of stone are made from each batch of drills.

Diam. Drill In.	8-in. Length Wt., Lbs. Per Doz.	12-in. Length Wt., Lbs. Per Doz.	18-in. Length Wt., Lbs. Per Doz.	24-in. Length Wt., Lbs. Per Doz.
1/4	1 1/8	1 3/4	3	3 1/2
5/16	1 1/2	2 1/4	3 7/8	5 1/8
3/8	2 1/4	3 1/2	5	7 1/8
7/16	3 1/8	4 3/4	7	9
1/2	3 3/4	4 3/8	7 3/4	10 1/4
9/16 & 5/8	5 1/2	8 1/2	13 3/4	18 1/4
1 1/16 & 3/4	6 3/4	10 1/2	16 3/4	22 1/4
1 3/16 & 7/8	8 1/4	12 1/2	20 1/2	27 1/2
1	10	19	30	40
1 1/8	16	25	42	54
1 1/4	...	25	42 1/2	57
1 3/8	...	33	53	72
1 1/2	...	33	54	72
1 5/8	...	40	63	84
1 3/4	...	44 1/2	70	93
1 7/8	...	50	80	106
2	...	52	81	108
2 1/4	...	53	83	110
2 1/2	...	75	119	158

Can be furnished with tapered shanks to fit electric hammers. Supplied on order in lengths up to 6 feet for rock drilling. Prices on application.

Diamond Drill Holders

To Fit Di-Forge and Diamond "N" Points

Style A



Forged from solid bar of Vanadium tool steel. Has a rubber guard. Shipping weight per dozen, 9 pounds.

No. 745.....Price on application

Style B



Shipping weight per dozen, 8 1/2 pounds.

No. 750.....Price on application

Rubber Grip

Style C



Shipping weight per dozen, 10 1/2 pounds.

No. 755.....Price on application

Rawplug Screw Anchors



Made of tough braided jute fibre. For use with sheet metal or standard wood screws. Std. Pkg. contains ten boxes same size and length or 1 doz. M/T or R/T Rawdrills.

No.	Rawplug No.	Rawplug Lgh., in.	Rawdrill No.	Rawdrill Diam., in.	Pkd. in Boxes of	Wt., Lbs. Std. Pkg. (10 Boxes)	Per 100
9001	6	5/8	6	5/32	100	1	\$2 70
9003	6	3/4	6	5/32	100	1	2 80
9005	6	1	6	5/32	100	1 1/4	3 00
9009	8	5/8	8	11/64	100	1 1/4	3 10
9011	8	3/4	8	11/64	100	1 1/4	3 20
9013	8	1	8	11/64	100	1 3/4	3 40
9015	8	1 1/4	8	11/64	100	2	3 60
9017	8	1 1/2	8	11/64	100	2	3 80
9019	8	2	8	11/64	100	2	4 20
9024	10	3/4	10	3/16	100	1 1/2	3 40
9026	10	1	10	3/16	100	2	3 80
9028	10	1 1/4	10	3/16	100	2 1/4	4 20
9030	10	1 1/2	10	3/16	100	2 3/4	4 60
9032	10	2	10	3/16	100	2 3/4	5 40
9037	12	3/4	12	1/4	100	2	4 20
9039	12	1	12	1/4	100	3	4 60
9041	12	1 1/4	12	1/4	100	4	5 00
9043	12	1 1/2	12	1/4	100	4 1/2	5 40
9045	12	2	12	1/4	100	4 1/2	6 20
9050	14*	1	14	9/32	100	3 3/4	5 40
9052	14*	1 1/4	14	9/32	100	4 1/2	6 00
9054	14*	1 1/2	14	9/32	100	5	6 60
9055	14*	1 3/4	14	9/32	100	5 1/2	7 20
9056	14*	2	14	9/32	100	6 1/2	7 80
9061	16	1	16	5/16	50	2	6 10
9063	16	1 1/2	16	5/16	50	3	7 60
9065	16	2	16	5/16	50	4	9 10
9070	20†	1	20	3/8	50	3	9 00
9072	20†	1 1/2	20	3/8	50	4 1/2	11 00
9074	20†	2	20	3/8	50	6 1/4	13 00
9076	22	2	20	3/8	50	7 3/4	13 00

*For 1/4-in. lag screw use No. 14 Rawplug.
†For 5/16-in. lag screw use No. 20 Rawplug.

For Lag Screws

9078	3/8	1 1/2	7/16	25	3	19 00
9080	3/8	2	7/16	25	3 3/4	20 00
9082	3/8	2 1/2	7/16	25	4 1/2	21 00
9084	3/8	3	7/16	25	5 1/2	22 00
9086	7/16	1 1/2	1/2	25	3 3/4	26 00
9087	7/16	2	1/2	25	4	27 00
9088	7/16	2 1/2	1/2	25	4 1/2	28 00
9089	7/16	3	1/2	25	6 1/4	29 00
9090	1 1/2	1 1/2	5/8	25	6 3/4	31 00
9091	1 1/2	2	5/8	25	6 3/4	32 00
9092	1 1/2	2 1/2	5/8	25	7	33 00
9093	1 1/2	3	5/8	25	8 1/2	34 00
9094	1 1/2	3 1/2	5/8	25	9	35 00
9095	5/8	2 1/2	3/4	25	9	38 00
9096	5/8	3	3/4	25	11	39 00
9097	5/8	3 1/2	3/4	25	12 1/2	40 00

Call Graybar **FIRST** For . . .



Diamond Multi-Size Screw Anchors



Designed to accommodate in one anchor several diameters of wood screws. Made of non-corroding rust-proof composition metal. Packed 100 in a box.

No.	Size No. and In.	Drill Size, Inches	Wt., Lbs. Per 100
5212	6-8 x 3/4	1/4	1
5216	6-8 x 1	1/4	1 3/8
5224	6-8 x 1 1/2	1/4	1 3/4
5312	10-14 x 3/4	5/16	1 1/2
5316	10-14 x 1	5/16	1 3/4
5324	10-14 x 1 1/2	5/16	2 1/2
5516	16-18 x 1	3/8	2 3/4
5524	16-18 x 1 1/2	3/8	4
5628	20-24 x 1 3/4	7/16	5 1/4

Diamond N. Y. Screw Anchors

For Use with Wood Screws



Made of non-corroding, rust-proof composition metal. Packed 100 in a box. Screws not furnished.

Cat. No.	Size Inches	Takes Wood Screw No.	Drill Size, in.	Wt. Per 100, Lbs.
6208	1/8 x 1/2	5-6-7	1/4	1
6212	1/8 x 3/4	5-6-7	1/4	1
6312	3/16 x 3/4	8-9-10-11	5/16	2
6316	3/16 x 1	8-9-10-11	5/16	3
6320	3/16 x 1 1/4	8-9-10-11	3/8	5
6326	3/16 x 1 5/8	8-9-10-11	5/16	3 1/2
6412	1/4 x 3/4	12-13-14	7/16	3
6416	1/4 x 1	12-13-14	7/16	4
6424	1/4 x 1 1/2	12-13-14	7/16	6
6512	5/16 x 3/4	15-16-17-18	7/16	3
6516	5/16 x 1	15-16-17-18	7/16	3 1/2
6524	5/16 x 1 1/2	15-16-17-18	7/16	6 1/4
6532	5/16 x 2	15-16-17-18	7/16	8 1/4
6616	3/8 x 1	20-22-24	9/16	6 1/2
6632	3/8 x 2	20-22-24	9/16	11
6840	1/2 x 2 1/2	26-28-30 & 1/2" Lag Screw	3/4	28

Diamond Crimp Nuts

The Sheet Metal Fastener



Screws are not furnished. Packed 100 in a box.

No.	Screw Size	Length Inches	Hole Diam. Inches	Wt., Lbs. Per 100
7620	6-32	9/16	3/8	0.7
7625	8-32	9/16	3/8	0.7
7630	10-24	9/16	3/8	0.7
7632	10-32	9/16	3/8	0.7
7640	1/4-20	1/2	15/32	0.9
7650	9/16-18	1/2	17/32	1.0

When fastening is complete the Crimp-Nut is crimped tightly to the metal and it will not turn when screw is entered or removed. This is particularly essential where provision must be made for removing and replacing work.

Prices on application.

Diamond P Lag Screw Expansion Shields

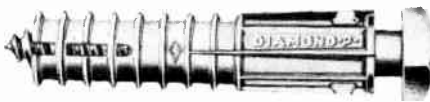

Malleable iron except 1/4 and 5/16 in. Prices do not include lag screws.

Series 1000 Short

No.	Diam. of Lag Inches	Length Inches	Drill Size Inches	No. Per Box	Wt., Lbs. Per 100
†1004	1/4	1	7/16	100	2
†1005	5/16	1	1/2	100	2 1/2
††1006	3/8	2	5/8	50	7 1/2
††1008	1/2	2	3/4	50	10
1010	5/8	2	7/8	50	13
1012	3/4	2	1 1/8	25	21

Series 1100 Long

†1104	1/4	1 1/2	1/2	100	4
†1105	5/16	1 3/4	9/16	100	5
††1106	3/8	2 3/4	5/8	50	11
††1108	1/2	3 1/2	3/4	50	18
1110	5/8	3 1/2	7/8	25	23
1112	3/4	3 1/2	1 1/8	25	35
1114	7/8	5	1 3/8	25	75
1116	1	5	1 1/2	25	90
1120	1 1/4	8	1 7/8	20	270

†These sizes furnished in die cast only.
 ††Can be supplied in die cast as well as malleable.

Di-En-Key Expansion Shields

Interlocking Key



INTERLOCKING KEY

Malleable iron. Closed back or bottom bearing. For making attachments where direct bearing of the work against the surface is not required. Smaller

sizes are particularly adapted to opera chairs and school furniture work.

Prices do not include machine bolt.

Closed Back No.	Bolt Diam. In.	Length In.	Drill Size In.	No. Per Box	Wt., Lbs. Per 100
1606	3/8	2	1 1/16	50	9
1608	1/2	2 1/2	7/8	50	17
1610	5/8	2 1/2	1	50	21
1612	3/4	3 3/4	1 1/4	25	34

Keystone Single Expansion Shields

For Machine Bolts



No.	Diam. Bolt Inches	Length Inches	Drill Size Inches	No. Per Pkg.	Wt., Lbs. Per 100
1504	1/4	1 3/8	1/2	100	3
1505	5/16	1 3/8	9/16	100	4
1506	3/8	1 7/8	3/4	50	9
1508	1/2	1 7/8	7/8	50	14
1510	5/8	2	1	25	19
1512	3/4	2 3/4	1 1/8	25	38

Prices on application.

Keystone Interlocking Expansion Shields

Double—For Use with Machine Bolts



Interlocking feature prevents nut being drawn out of shield when heavy loads are applied.

No.	Bolt Diam. In.	Length In.	Drill Size In.	No. Per Box	Wt., Lbs. Per 100
1404	1/4	1 1/2	1/2	100	4
1405	5/16	1 3/4	9/16	100	6
1406	3/8	2 1/16	3/4	50	11
1408	1/2	2 1/2	7/8	50	12
1410	5/8	2 7/8	1	25	18
1412	3/4	3 1/4	1 1/8	25	35
1414	7/8	4	1 1/2	25	85
1416	1	4 1/4	1 5/8	25	100
1420	1 1/4	6	2 1/8	20	240

Rawl Lag-Shields

For Use with Lag Screws

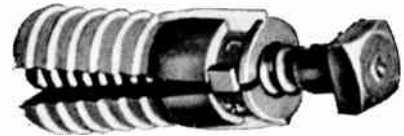

Completely rustproof precision cast lag shield made of durable alloy. Horizontal fins prevent shield turning in hole. Tapered outside rings have tremendous biting power. Ideal for all masonry fastening.

Short Style

No.	Size In.	Drill Diam. In.	Length In.	Pkd. in Boxes of	Ship. Wt., Lbs. Per 100	Per 100
S105	1/4	1/2	1	50	3 1/2	\$15.00
S110	5/16	1/2	1 1/4	50	3 1/2	18.00
S115	3/8	5/8	1 3/4	50	7	25.00
S120	1/2	3/4	2	50	12	38.00
S125	5/8	7/8	2	25	13	45.00
S130	3/4	1	2	25	16 1/2	65.00

Long Style

L105	1/4	1/2	1 1/2	50	5	15.00
L110	5/16	1/2	1 3/4	50	5	18.00
L115	3/8	5/8	2 1/2	50	10	25.00
L120	1/2	3/4	3	50	17	38.00
L125	5/8	7/8	3 1/2	25	22 1/2	45.00
L130	3/4	1	3 1/2	25	29	65.00

Diamond Calking Tools



One tool packed in each box of anchors. Additional tools at nominal charge.

Prices on application.

Diamond "Wing Ding" Hollow Wall Anchor



For securing objects to hollow walls, floors, ceilings (wall board or lath and plaster), glass, tile, plywood, or sheet metal. Smallest size hole of any hollow wall anchors.

No.	Length In.	Hole Size In.	Wall Thickness In.	Packed	Shipping Cartons
4 S-L 7922	2	1/4	1/16 to 3/4	50 to Box	500-1000
5 S-L 7923	2 3/4	5/16	3/4 to 1 1/4	25 to Box	250-500

Rawl-Drives

One Piece Expansion Bolts

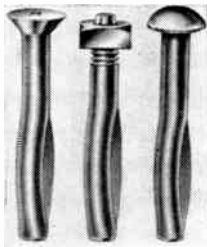

The only expansion bolt that combines anchor and bolt in one piece. Made from high grade heat-treated steel.

Easily installed, drives like a nail into drilled hole no larger than diameter of bolt itself. Has great holding power.

Used only in solid masonry, brick, concrete and stone.

No.	Diam. In.	Lgth. In.	Rawl No.	Drill Diam. In.	Pkd. In Boxes of	Ship. Wt. Lbs. Per 100	Round Head	Per 100 Countersunk Head	Stud Type
303	3/16	1	10	3/16	100	1 3/4	\$8.00	\$8.00	
306	3/16	1 1/4	10	3/16	100	2	8.40	8.40	\$15.00
309	3/16	1 1/2	10	3/16	100	2	9.40	9.40	
312	3/16	2	10	3/16	100	2 1/4		11.40	
315	3/16	2 1/2	10	3/16	100	2 1/4		13.40	
321	1/4	1 1/4	12	1/4	100	3	10.20	10.20	
324	1/4	1 1/2	12	1/4	100	3 1/2	11.20	11.20	18.00
327	1/4	2	12	1/4	100	4	13.00	13.00	20.00
330	1/4	2 1/2	12	1/4	100	4 1/4	15.00	15.00	
333	1/4	3	12	1/4	100	4 1/2		17.00	
336	1/4	3 1/2	12	1/4	100	5		19.00	
339	1/4	4	12	1/4	100	5 1/2		21.00	
342	1/4	4 1/2	12	1/4	100	5 3/4		23.00	
345	5/16	1 1/2	16	5/16	50	6	14.30		
348	5/16	2	16	5/16	50	7	16.35*	16.35*	
351	5/16	2 1/2	16	5/16	50	8	18.20*	18.20*	
354	5/16	3	16	5/16	50	9	19.70*	19.70*	
360	3/8	2	20	3/8	25	10	18.60	18.60	
363	3/8	2 1/2	20	3/8	25	12	22.00*	22.00*	32.50
366	3/8	3	20	3/8	25	13	25.50*	25.50*	35.50
369	3/8	3 1/2	20	3/8	25	15	29.00	29.00	38.50
372	3/8	6	20	3/8	25	25			53.50*
378	1/2	3		1/2	25	25	44.00	44.00	
381	1/2	3 1/2		1/2	25	28	48.00*	48.00*	60.00
384	1/2	4		1/2	25	30		52.00	65.00
387	1/2	6		1/2	25	35			85.00*

*These sizes available on special order from factory with one week's notice for delivery.

Note: When ordering, add prefix letter to catalog number to indicate head style desired: R for Round Head; C for Countersunk Head; S for Stud Type.

Rawl Calk-Ins



Improved machine screw anchor. Sleeve precision-cast of Rawloy, exclusive lead alloy developed for masonry anchors. Has tremendous holding power.

Free calking tool included in every box.

No.	Size, In.	Drill Diam., In.	Min. Depth, In.	Pkd. in Boxes of	Ship. Wt. Lbs. Per 100	Per 100
9200	6 x 32	5/16	1/2	100	1 1/4	\$6.00
9205	8 x 32	5/16	1/2	100	1 1/2	6.50
9210	10 x 24	3/8	5/8	100	2	7.50
9215	12 x 24	1/2	7/8	100	4 1/4	9.50
9220	1/4 x 20	1/2	7/8	100	4 1/2	11.00
9225	3/16 x 18	5/8	1	50	8	15.00
9230	3/8 x 16	3/4	1 1/4	50	14	20.00
9240	1/2 x 13	7/8	1 1/2	50	19	26.00
9245	5/8 x 11	1	2	50	39	50.00

Diamond Super-Grip Expansion Bolts

Furnished Complete with Galvanized Bolts



Style B

Style B Super-Grip Bolts are sold complete and not separately. The shield is expanded by the long, tapered conical end of the bolt.

The bolts and nuts are "Diamond" Intergalvanized.

No.	Size, In. Diam. Length	Drill Size In.	No. Per Box	Length of Sleeve In.
2041A	1/4 x { 1 1/2, 2, 2 1/2, 3 }	7/16	100	7/8
2042				
2042A				
2043				
2052	5/16 x { 2, 2 1/2, 3 }	1/2	100	1
2052A				
2053				
2062A	3/8 x { 2 1/2, 3, 3 1/2, 4, 5, 6 }	9/16	100	1 3/8
2063				
2063A				
2064				
2065				
2066				
2083	1/2 x { 3, 4, 5, 6 }	3/4	100	1 15/16
2084				
2085				
2086				
2103	5/8 x { 3, 4, 5, 6 }	7/8	50	2 1/4
2104				
2105				
2106				

One Calking Tool Furnished in each box of Style B Bolts.

Hubbard Lead Sleeve Expansion Bolts

Galvanized



Consists of a steel bolt which has a wedge or cone shaped head, tapering toward shank and provided with a lead sleeve. Quickly installed.

No.	Bolt Size In.	Overall Length In.	Drill Hole Diam In.	Shipping Wt., Lbs. Per 100
0	1/4	1 1/2	1/2	6.5
1	1/4	1 3/4	1/2	6.75
2	1/4	2	1/2	7.0
3	1/4	2 1/2	1/2	7.5
3A	1/4	3	1/2	8.0
4	1/4	3 1/2	1/2	8.5
4A	1/4	4	1/2	9.0
4C	3/8	2	5/8	14.5
5	3/8	2 1/2	5/8	15.75
6	3/8	3	5/8	17.0
7	3/8	3 1/2	5/8	18.5
7A	3/8	4	5/8	19.5
8	3/8	4 1/2	5/8	20.75
9	3/8	5	5/8	22.0
10	3/8	5 1/2	5/8	23.25
11	1/2	2 1/2	7/8	42.5
12	1/2	3 1/2	7/8	45.0
13	1/2	4	7/8	47.5
14	1/2	4 1/2	7/8	50.0
15	1/2	5	7/8	52.5
17	1/2	6 1/2	7/8	57.5

Extra Lead Sleeves

No.	Dimensions—Inches For Bolt Diam.	Overall Length	Approx. Shipping Wt., Lbs., 100 Pcs.
22	1/4	9/16	3.3
23	3/8	3/4	5.5
24	1/2	1 1/2	19.0

Hubbard Expansion Nuts



Steel or Brass cone.

Installed independently, and tapped to receive the bolt. Hole depth must be correlated to length of bolt.

No.	Cone Material	Mach. Screw No. or Size In.	Diam. Drill In.	Min. Depth Hole In.	Shipping Wt., Lbs. Per 100
6200	Brass	6	1/4	3/8	.6
6202	Brass	8	5/16	1/2	1.0
6204	Brass	10	3/8	5/8	1.5
6206	Brass	12	7/16	3/4	2.6
6208	Brass	1/4	1/2	7/8	4.0
6210	Brass	5/16	5/8	1	6.5
6212	Steel	3/8	3/4	1 1/4	13.0
6214	Steel	1/2	7/8	1 1/2	22.0
6216	Steel	5/8	1 1/8	2	37.0
6220	Steel	3/4	1 3/8	2 1/4	59.0

Diamond Calking Anchors

For Use with Machine Screws



No.	Screw Size	Drill Size In.	Anchor Length In.	Std. Pkg.	Wt., Lbs. Per 100
3020	6-32	1/4	3/4	100	5/8
3025	8-32	5/16	1/2	100	7/8
3030	10-24	3/8	5/8	50 or 100	1 1/4
3035	12-24	7/16	3/4	50 or 100	2 3/4
3040	1/4-20	1/2	7/8	50 or 100	3 3/4
3050	5/16-18	5/8	1	50	9
3060	3/8-16	3/4	1 1/4	50	15
3070	7/16-14	7/8	1 1/2	50	20 3/4
3080	1/2-13	7/8	1 1/2	50	20
3100	5/8-11	1 1/8	2	50	39 1/4
3120	3/4-10	1 1/4	2 1/4	50	55

1/4-20 and smaller furnished with aluminum nuts. Can be supplied with brass nuts at extra cost.

Diamond DHD Hammer Drive Anchors



For attaching trim, partitions, flooring and fixtures to concrete structures.

Aluminum. Steel nails, hot galvanized by the patented Diamond Process. Holds a greater load when fastened to stone than a wood screw of same diameter screwed into wood. No special skill or tools needed, drill hole, place shield through hardware and hammer nail in.

Anchors are packed with nails in same containers.

Use same diameter drill as diameter of anchor.

Double headed nails for temporary installations can be supplied at no extra cost.

No.	Diameter and Length of Shield In.	Diameter Drill to Use In.	Std. Pkg.	Wt., Lbs. Per 100
4314	3/16 x 7/8	3/16	100	1
4320	3/16 x 1 1/4	3/16	100	1 1/8
4416	1/4 x 1	1/4	100	1 1/2
4420	1/4 x 1 1/4	1/4	100	2
4424	1/4 x 1 1/2	1/4	100	2 1/8
4520	5/16 x 1 1/4	3/16	100	2 3/4
4528	3/16 x 1 3/4	3/16	100	3 1/2
4536	3/16 x 2 1/4	3/16	100	4 1/2
4544	3/16 x 2 3/4	3/16	100	5
4632	3/8 x 2	3/8	100	6 1/2
4652	3/8 x 3 1/4	3/8	100	8 1/4
4836	1/2 x 2 1/4	1/2	25	11 1/2
4856	1/2 x 3 1/2	1/2	25	15 1/2

Prices on application.

Rawl Hammer-Sets

Non-Caulking Anchors for Machine Bolts



No.	Hammer-Set Size, In.	Rawl Drill Diam., In.	Min. Depth Hole, In.	Pkd. in Boxes of	Ship. Wt., Lbs. Per 100	Per 100
9310	3/16	3/8	7/8	100	1 3/4	\$15.00
9320	1/4	3/8	7/8	100	1 3/4	16.00
9330	5/16	5/8	1 3/8	100	5 1/2	18.00
9340	3/8	5/8	1 3/8	100	5 1/2	22.00
9350	1/2	3/4	1 3/4	50	8 3/4	36.00
9360	5/8	1	2 1/8	50	19	48.00

Rawl Scru-Leads

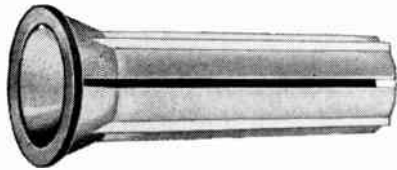

Lead anchors for use with wood or sheet metal screws. One anchor will accommodate several size screws. Flange facilitates work in hollow material. Made of exclusive Rawloy, a special lead alloy designed for masonry anchors.

No.	Screw Size No.	Anchor Length, In.	Drill Size No.	Drill Diam., In.	Pkd. in Boxes of	Ship. Wt., Lbs. Per 100	Per 100
9410	6-8	3/4	12	1/4	25	1	55.00
9420	6-8	1 1/2	12	1/4	25	2	5.60
9430	10-12-14 (or 1/4" lag screw)	1	16	5/16	25	2 1/4	5.60
9440	10-12-14	1 1/2	16	5/16	25	3 1/2	8.00
9460	16-18	1 1/2	20	3/8	25	4 1/2	9.00
9470	20-22-24 (or 5/16" lag screw)	1 3/4		7/16	25	7	10.00

**Rawl Spring-Wings
Steel Spring Toggle Bolts**

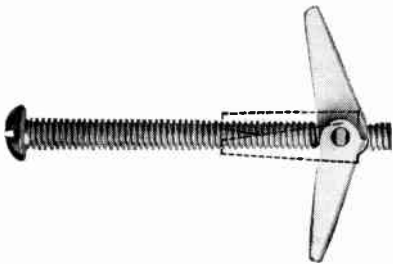

Spring-Wings are rustproof and have positive automatic spring action installation in hollow walls, pressed board walls, tile, sheet metal, etc. Easily installed.

No.	Bolt Diam., In.	Bolt Length, In.	Drill Diam., In.	Pkd. in Boxes of	Ship. Wt., Lbs. Per 100	Per 100
602	1/8*	2	3/8	50	1 1/4	88.00
603	1/8*	3	3/8	50	1 1/2	9.00
604	1/8*	4	3/8	50	2	10.00
612	3/16	2	1/2	50	3	8.50
613	3/16	3	1/2	50	3 3/4	9.50
614	3/16	4	1/2	50	4 1/2	10.00
615	3/16	5	1/2	50	5 1/4	12.00
616	3/16	6	1/2	50	6	12.50
623	1/4	3	5/8	50	6	10.50
624	1/4	4	5/8	50	7	11.00
625	1/4	5	5/8	50	8 1/2	14.00
626	1/4	6	5/8	50	9 1/2	15.50
633	5/16	3	7/8	25	11	16.00
634	5/16	4	7/8	25	13	17.00
635	5/16	5	7/8	25	15	21.50
636	5/16	6	7/8	25	17	23.00
643	3/8	3	7/8	25	14	21.00
644	3/8	4	7/8	25	17	23.00
645	3/8	5	7/8	25	20	28.50
646	3/8	6	7/8	25	22	30.00

*1/8-in. size also available with Mushroom Head.

Note: To order, add prefix letter to catalog number to indicate head style desired: R for Round Head; F for Flat Head; M for Mushroom Head.

Diamond Steel Spring Toggle Bolts



Gives a fast, sure-fit in making attachments to Hollow Brick, Tile, or Lath Walls. Both wings align on uneven surfaces.

Has patented anti-turning feature, wings do not turn on the bolt, preventing damage to threads.

No.	Size, In.	Size Drill Required In.	Shipping Wt., Lbs. Per 100
7023	1/8 x 3	3/8	1 3/4
7024	1/8 x 4	3/8	2 1/4
7033	3/16 x 3	1/2	4
7034	3/16 x 4	1/2	4 1/2
7035	3/16 x 5	1/2	5
7036	3/16 x 6	1/2	5 1/2
7043	1/4 x 3	11/16	7
7044	1/4 x 4	11/16	8
7045	1/4 x 5	11/16	9
7046	1/4 x 6	11/16	10
7053	5/16 x 3	7/8	11
7054	5/16 x 4	7/8	13
7055	5/16 x 5	7/8	15
7056	5/16 x 6	7/8	17
7063	3/8 x 3	7/8	17
7064	3/8 x 4	7/8	19
7065	3/8 x 5	7/8	22
7066	3/8 x 6	7/8	25
7084	1/2 x 4	1 1/8	42
7086	1/2 x 6	1 1/8	51

Prices on application.

Diamond Toggle Bolts



Furnished with round, flat head (specify type head).

No.	Size Inches	Shipping Wt., Lbs. Per 100	No.	Size Inches	Shipping Wt., Lbs. Per 100
7523	*1/8 x 3	2	7546	1/4 x 6	10 1/2
7524	*1/8 x 4	2 1/4	7553	3/16 x 3	12
7533	3/16 x 3	4 1/4	7554	3/16 x 4	13 3/4
7534	3/16 x 4	4 3/4	7555	3/16 x 5	15 1/2
7535	3/16 x 5	5 1/2	7556	3/16 x 6	17 3/4
7536	3/16 x 6	6	7563	3/8 x 3	14 3/4
7543	1/4 x 3	7	7564	3/8 x 4	17 1/2
7544	1/4 x 4	8	7565	3/8 x 5	20
7545	1/4 x 5	9 1/2	7566	3/8 x 6	23 1/4

*Mushroom head bolts on these sizes only.

Types of Heads available on No. 7500 series and No. 7000 series toggle bolts.

Type F—With flat head screws.

Type R—With round head screws.

Type M—With mushroom head—certain sizes.

Type N—Revere R & F screw and add nut.

Prices on application.

Ramset Hammer-In Fastening Tools



Shure-Set®

For Masonry . . . Concrete . . . Light Gauge Steel
Drives Like a Nail . . . Holds Like an Anchor

Shure-Set holds and guides fasteners with pin-point accuracy. No need to drill, fill, chip or plug. Just drive with a few hammer blows and the job is done. Use 2½-lb. hammer for best results.

Austempered Shure-Set Fasteners



Drive Pins

No.	Lgth., In.	Shank Diam., In.	Ship. Wt. Per 100	Price Per 100
P106	¾	9/64	7 oz.	\$ 5.25
P108	1	9/64	9 oz.	7.00
P110	1¼	9/64	10 oz.	8.00
P112	1½	9/64	12 oz.	9.50
P114	2	5/32	18 oz.	10.25
P116	2½	5/32	22 oz.	11.25
P118	3	5/32	26 oz.	12.25



Threaded Studs

Threaded Studs 10-24

S106	1	9/64	9 oz.	7.50
S108	1½	9/64	12 oz.	8.00

Threaded Studs ¼-20

S206	1½	5/32	18 oz.	9.50
S210	2	5/32	23 oz.	10.50

Phone Line Fasteners



Wire Loops (Bridle Rings and Fasteners)

No.	Loop Size In.	Shipping Weight	Price Per 100
W1	½	500 pcs. 1 lb. 6 oz.	\$1.00
W2	7/8	300 pcs. 4½ lbs.	2.00
W3	1¼	200 pcs. 6½ lbs.	3.00
W4	1¾	100 pcs. 4 lbs.	4.00

No.	Length, In.	Shank Diam., In.	Wt. Per 500	Price Per 100
PW206	13/8	5/32	5½ lbs.	7.50
PW208	15/8	5/32	6½ lbs.	8.50
PW210	17/8	5/32	7½ lbs.	9.00

Ramset Contractor's Kit

Model R-150



Complete kit contains Model R-150 Shure-Set tool assembled with 3/16-in. fastener holder and drive rod, deluxe metal carrying case with tray 2½ lb. Shure-Set hammer, heavy duty contractor's two-pocket apron, complete instructions.

Wt. of tool, 1 lb. 7 oz.

Shipping wt of complete kit, 9 lbs. \$27.95

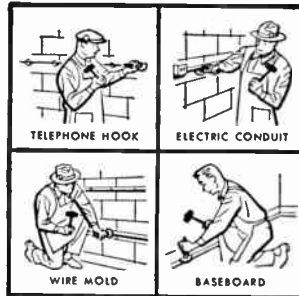

Shure-Set Tool Uses

Used for conduit straps; conduit boxes, panel boards; fixtures; standoffs; wire mold; switch boxes; Wall ties; channels and raceways.

Truco Drill Motor and Swivel Kit



Heavy duty 2500 rpm drill motor; integral Truco Water Swivel attached; complete in carrying case—weighs 17½ lbs. Drills holes up to 1¾ in. in all masonry except where reinforcing bars may be encountered. Excellent for anchor holes.

No. THK-114 Each \$95.00

Truco Hand Swivel Drill Motor and Stand



Hand Swivel Drill Motor (TH-111) mounted in Drill Stand (TDS-111) permits drilling larger holes in vertical positions or in horizontal positions with machine anchored to wall.

No. TH-111 Each \$175.00
No. TDS-111 Each \$127.50

Truco Portable Masonry Diamond Drilling Machines

1. Drill holes ten to fifteen times faster than any other method in reinforced concrete, tile, marble, granite. Easy one-man drilling in any location.
2. Can save its cost in a single day's use in air conditioning, plumbing, tile setting, electrical, maintenance, utilities work.
3. Pivot permits drilling at any angle through 360°.

4. Telescopic post locks unit between floor and ceiling or between walls for rigidity.
5. Column slide bracket locks on post at any point.
6. Motor carriage advances along track by gear and rack (screw feed on Model A) to give pressure for cutting.



Model A

Model B

Model A:	1000 rpm motor.	For drilling holes 1-in. through 5-in. O.D.	Ea. \$ 450.00
Model B:	750 rpm motor.	For drilling holes 1-in. through 6¼-in. O.D.	Ea. \$ 780.00
Model C:	350 rpm motor.	For drilling holes 3-in. through 9-in. O.D.	Ea. \$ 780.00
Model D:	78 rpm motor.	For drilling holes 7-in. through 14-in. O.D.	Ea. \$ 815.00
Model E:	300 rpm air motor.	For drilling holes 3-in. through 14-in. O.D.	Ea. \$1075.00

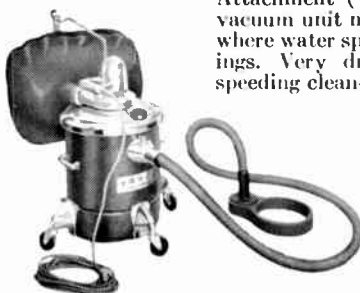

No. T-440

Vacuum Water Pick-Up (T-440)

Shown with Truco Water Collector Ring (T-153) and Attachment (T-153A). Water is instantly picked up by vacuum unit mounted on 12-gallon steel container. Useful where water spillage might damage floors, carpets, furnishings. Very dry condition maintained. Also useful in speeding clean-up work.

No.	Description	Each
T-440	Vacuum Water Pick-up	\$190.00
T-153	Water Collector Ring	\$ 15.00
T-153A	Attachment	\$ 5.50

Water Collector Ring Pump No. T-153B

Small automatic unit for use where extreme care in water removal is not necessary. Fits into the small opening of the Truco Water Collector Ring (T-153).
 No. T-153B Each \$17.50



No. T-153B

Swivel Surface Set Diamond Bits (Resettable)

Nominal Bit O.D. In.	4½ In. Long Each			12 In. Long Each			Bit Adaptors	
	Part No.	Price	Resetting Charge*	Part No.	Price	Resetting Charge*	Part No.	Each
¼	FA25045	\$ 39.75	\$33.50	None Required	
⅜	FA37545	42.25	34.00	FA37512	\$ 44.75	\$ 36.50	T-410 Thread	
½	FA50045	43.25	34.50	FA50012	45.75	37.00	On These	
⅝	FA62545	46.75	35.50	FA62512	49.25	38.00	Bits	
¾	F75045	51.50	36.50	F75012	54.00	39.00	A750	\$ 5.50
7/8	F87545	57.50	37.50	F87512	60.50	40.50	A875	5.50
1	FE100045	63.50	38.50	FE100012	67.00	42.00	EB1000	3.00
1 1/8	FE112545	71.25	40.00	FE112512	74.75	43.50	EB1125	3.20
1 1/4	FE125045	77.75	41.50	FE125012	81.25	45.00	EB1250	3.40
1 1/2	FE150045	90.50	43.00	FE150012	94.00	46.50	EB1500	3.80
1 3/4	FE175045	105.00	45.00	FE175012	109.00	49.00	EB1750	4.25
2	FE200045	117.75	49.00	FE200012	121.75	53.00	E2000	6.50
2 1/4	FE225045	130.75	52.00	FE225012	134.75	56.00	E2250	6.65
2 3/8	FE237545	136.75	53.00	FE237512	141.25	57.50	E2375	6.75
2 1/2	FE250045	144.50	57.00	FE250012	148.50	61.00	E2500	6.85
3	Letter "A" indicates threads for Standard Duty Truco Swivels.			FE300012	172.00	67.00	E3000	7.00
3 1/4	Letters "EB" indicate threads for Medium Duty Truco Swivels.			FE325012	184.75	71.00	E3250	7.75
3 1/2	Letter "E" indicates threads for Heavy Duty Truco Swivels and drilling Machines.			FE350012	197.50	75.00	E3500	8.50
4				FE400012	227.00	87.00	E4000	9.50
4 1/4				FE425012	238.75	90.00	E4250	10.00
4 1/2				FE450012	252.25	93.50	E4500	10.50
5				FE500012	276.50	101.50	E5000	11.50
5 1/4				FE525012	288.75	105.00	E5250	12.25
5 1/2	Shaft adaptors available for interchangeability of swivels.			FE550012	302.00	109.50	E5500	12.75
6				FE600012	330.50	118.00	E6000	13.50
6 1/4				FE625012	350.50	128.00	E6250	16.00
7	Special Sizes and lengths available upon request.			FE700012	383.50	158.50	E7000	25.00
8				FE800012	476.50	201.50	E8000	32.50
9				FE900012	636.50	249.00	E9000	39.50
10	*Plus cost of new diamonds required.			FE1000012	700.00	288.00	E10000	46.50
12				FE1200012	850.00	350.00	E12000	62.00
14				FE1400012	1110.00	410.00	E14000	78.00

Truco Diamond Drilling Water Swivels and Equipment

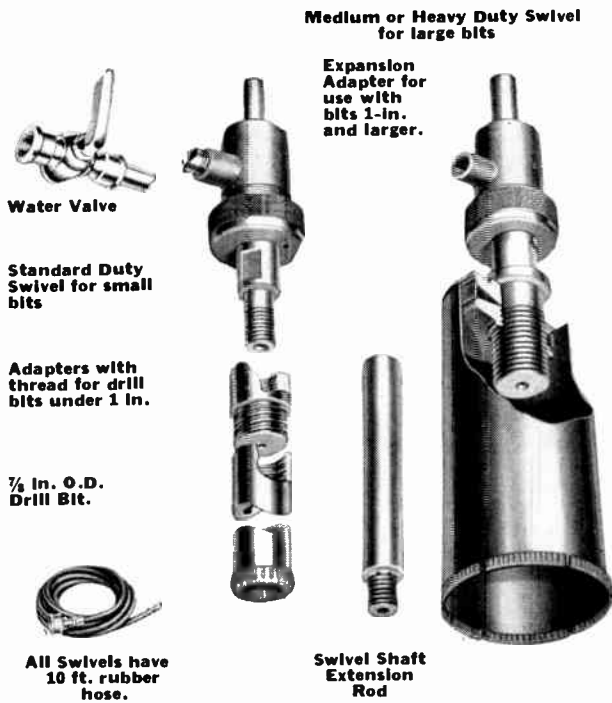

Standard Duty Truco Water Swivel for drills 1/4 in. to 1 3/4 in.
 Medium Duty Truco Water Swivel for drills 1 in. to 4 in.
 Heavy Duty Truco Water Swivel for drills 2 in. and over.

Swivel Shaft Extensions

No.	Description	Each
T-410EXT	Truco Standard Extension	\$8 50
T-415EXT	Truco Medium Extension	13 50
T-420EXT	Truco Heavy Extension	19 50

Swivel Shaft Couplings

T-410415	Standard-Medium Shaft Coupling	10 00
T-415410	Medium-Standard Shaft Coupling	12 50
T-415420	Medium-Heavy Shaft Coupling	12 50
T-420415	Heavy-Medium Shaft Coupling	12 50
T-150A	Swivel Industrial Water Supply Tank	19 00

Bit Adapter Spanner Wrenches

T-430	For Bits From 3 in. to 4 1/2 in. O.D.	3 50
T-442	For Bits From 5 in. to 8 in. O.D.	7 00

Truco Swivel Splash Guards; four types available. Details on request.

Seeger-Williams Sheet Metal Screws

Slotted head tapping screws available in flat head, round head, oval head, pan head and truss head.

Contact GRAYBAR for gross or bulk prices.

Seeger-Williams Machine Screw Nuts



Cold Pressed Steel or Brass

Furnished in square or hexagonal types, plain or chamfered.

Coarse threads (56 to 13) are the most commonly used. Packed in 1-gross papers.

Size	Threads Per Inch		Steel		Brass	
	Coarse	Fine	Square Per Gross	Hexagon Per Gross	Square Per Gross	Hexagon Per Gross
2	56	64	\$0.67	\$0.75	\$2.30	\$2.15
3	48	56	.67	.75	2.30	2.15
4	40	48	.62	.66	2.40	2.30
5	40	44	.64	.70
6	32	40	.64	.70	3.15	2.90
8	32	36	.67	.76	3.80	3.40
10	24	32	.70	.82	4.05	3.65
12	24	28	.90	1.05
1 1/4"	20	28	1.00	1.20	7.10	6.10
5/16"	18	24	1.60	1.90	8.15	6.90
3/8"	16	24	2.20	2.60	16.00	13.25
1/2"	13	..	4.80	5.90	21.40	17.80

Prices for nickel or cadmium finish or other finishes, on application.

Seeger-Williams Steel Stove Bolts

Slotted—Flat, Round or Truss Head



Bolts up to and including 3-in. long are threaded to the head; all other lengths are threaded 3-in. long.

Available with nickel, cadmium, Parkerized or electro-galvanized finish.

Packed 100 bolts and 100 unassembled square nuts to a paper. For hex nuts, add the following to prices per 100. Nut Diam., In. 1/8 5/32 3/16 1/4 5/16 3/8 1/2. Add to Price per 100 \$.16 \$.20 \$.24 \$.30 \$.42 \$.60 \$ 1.40

Length Inches	Diameter, Inches						
	3/8	1/2	5/8	3/4	7/8	1	1 1/8
1/2	\$1.66	\$1.82	\$1.96	\$3.20
5/8	1.74	1.92	2.12	3.34
3/4	1.76	1.98	2.18	3.48	\$5.94	\$8.40
7/8	1.78	2.04	2.26	3.58	6.12	8.68	\$18.18*
1	1.80	2.08	2.38	3.72	6.30	8.94
1 1/8	2.44	2.20	2.50	3.84	6.76
1 1/4	2.48	2.32	2.58	4.04	6.96	9.48	19.20*
1 3/8	2.82	2.88	2.84	4.38	7.34	10.06	20.20*
1 1/2	2.94	3.06	3.40	4.78	7.72	10.62
2	3.02	3.14	3.60	5.02	8.12	11.26	22.32*
2 1/4	3.66	4.04	5.68	8.70	12.00
2 1/2	3.76	4.50	6.02	9.16	12.52	25.02*
2 3/4	4.06	4.84	6.34	9.98
3	4.18	5.22	6.62	10.36	14.62	26.62*
3 1/2	5.56	7.66	11.12	16.18*
4	5.90	8.16	12.34*	17.28*
4 1/2	6.20	8.70	13.10*	18.48*
5	6.52	9.20	13.98*	19.56*
5 1/2	6.84	9.66	14.74*	20.64*
6	7.12	10.14	15.52*	21.76*

*Packed 50 to a paper.

Anaconda Filling Compounds



Anaconda filling compounds are available in several formulas to provide the best temperature characteristics and insulation for a particular job.

Superseal Compounds

No. 100—For High Temperatures: A hard, asphaltic compound not subject to flow at unusually high temperatures. Recommended for use in potheads operating continuously at high ambient temperatures.

Pouring temperatures: Summer 375°F.; Winter 425°F.

No. 150—For General Use: Plastic; recommended for use where a wide variation of operating temperatures is encountered. Remains plastic at low temperatures, yet has a minimum tendency to flow at high temperatures. Adheres to both porcelain and metals, thus preventing internal creepage.

Pouring temperatures: Summer 325°F.; Winter 375°F.

No. 250—For Flushing Potheads and Joints: Also used between layers of insulated tapes in hand-wrapped insulation. A compounded mineral oil, having relatively high viscosity.

Pouring temperatures: Summer 225°F.; Winter 250°F.

No. 300: For high voltage joints and potheads with reservoirs.

Pouring temperatures: Summer 225°F.; Winter 250°F.

Packaging

Superseal Nos. 100 and 150: Available in one and two-gallon steel buckets, or in tin cans 1/2 and 5 gallons.

Superseal No. 250 and 300: Available in 1/2-, 1-, 2- and 5-gallon tin cans.

Insoluseal Compound

For filling cable joints and potheads of paper or varnished-cambric insulated cables. Compounded of mineral oil and other hydrocarbons.

Recommended for voltages up to and including 69 kv.

As hydrocarbons are injurious to rubber, this compound is not recommended for use with rubber-insulated cables.

Pouring temperatures: Summer 250°F.; Winter 250°F.

Available in one- or two-gallon steel buckets.

Prices on application.

Anaconda Safety Compound Kettles



A double-jacketed kettle for safe melting of filling compounds.

Heat-conducting tube, brazed to the bottom of the outer jacket, extends through the inner jacket into the compound chamber, allowing vents to form. This prevents accumulation of gas which otherwise might develop pressure at the bottom of the kettle.

Capacity, 5 qts. Shipping weight, 7 lbs.

Prices on application.

Anaconda Jointing Material

Unit Packages for Making One Complete Joint on a Specific Size and Type of Cable



Jointing materials in unit packages are available for all sizes and types of cable . . . solid, paper-insulated, varnished-cambric, rubber or thermoplastic insulated or jacketed.

Each Unit Package contains all the materials necessary to make one complete, secure joint on the specified cable.

Drawing and Bill of Materials

FOR: John Doe Electric Co		ANACONDA WIRE & CABLE CO		STRAIGHT JOINT FOR TYPE CB	
C.O. NO. 1234-G		ENGINEERING DEPARTMENT		SHIELDED PAPER-LEAD CABLE	
P.O. NO. 2A-3301		HASTINGS-ON-HUDSON, N.Y.		THREE CONDUCTOR, SIZE 4/0	
NO. OF UNITS 15		BY: J. E. H.		CONDUCTOR SHAPE Compact Sector	
DATE: 1-16-50		DATE: 1-16-50		INSULATION THICKNESS 1.2 mil	
APP. A. C. L.		DATE: 1-16-50		LEAD SHEATH THICKNESS 7.2 mil	
				RATED VOLTAGE 15,000 Volts Neutral	

ITEM NO.	DESCRIPTION	QUANTITY PACKED
1	LEAD SLEEVE 4" IN ID 20" IN LONG 9/64" IN WALL	4
2	SPLIT THINNED COPPER CONNECTION SIZE 4/0	5
3	V.C. TAPE, 3/16" IN WIDE X 4" VD PER ROLL	1 ROLL
4	V.C. TAPE, 1/2" IN WIDE X 4" VD PER ROLL	2 ROLLS
5	V.C. TAPE, 3/4" IN WIDE X 4" VD PER ROLL	6 ROLLS
6	V.C. TAPE, 1" IN WIDE X 4" VD PER ROLL	31 ROLLS
7	COPPER MESH TAPE 3/4" IN WIDE 5" VD PER ROLL	3 ROLLS
8	BAR SOLDER	1/2 LB.
9	FILLING COMPOUND, NO. 150 Superseal	8 PINTS
10	SPRING SOLDER	3 LB.
11	FLUSHING COMPOUND, NO. 250 Superseal	4 PINTS
12	STEARINE FLUX	2 OZ.
13	PAPER PASTER	6
14	COTTON TAPE 1" IN WIDE 3" VD PER ROLL	1 ROLL
15	COTTON YARN 1/8" OZ. PER ROLL	1 ROLL
16	SMOKE ENDS	2 OZ.

STEP NO.	LENGTH IN INCHES	TAPES TO REMOVE
6	---	---
7	---	---
8	---	---
9	6	Shield and CB Tapes
10	3 3/4	12
11	3	10
12	2 1/2	8
13	1 1/2	All

For each type of cable the Unit Package is shipped with a bill of materials and a drawing showing the steps in making a proper splice. Makes splicing simpler and easier for the workman. A typical bill of materials is shown above.

Prices on application.

Alcoa Joint Compounds



No. 2 Electrical Joint Compound

For superior results with aluminum to aluminum or aluminum to copper connections, either bolted or non-tension compression types.

The compound is noncorrosive to aluminum or copper.

Available in cartons of 12—8 oz. polyethylene bottles.

No. 2 Electrical Compound for bus conductor use is now available in 1-pint and 25-lb. bulk containers.

Zinc Chromate Paste

Approximately 70 percent zinc chromate powder and 30 percent boiled linseed oil, by weight. Recommended as a filler for compression fittings used on conductor subject to tension. Compressing the fitting forces the paste between the strands and effectively seals out air and moisture.

Zinc Chromate Paste in plastic bags containing 1¼-lb. or compound are packed 12 per carton.

Salisbury Non-Spillable—P. B. Compound Pots



Made of semi-hard durable rubber, they are non-conducting, non-breakable and not affected by usual P.B. compounds. Safer; more convenient; both materials and brush are contained in one unit.

Will stand upright or can be hung on wire, bus bar or brace. Inner flange of compound pot prevents contents from splashing out with rough handling.

Single Compartment, holds 1 pint, Each **\$5.50**
 Double Compartment, holds 1 pint with added small pocket for soldering paste..... Each **\$5.80**

Graybar Permagem



Soft, plastic, weatherproof, mastic compound for use on metal, wood, and other surfaces.

Keeps out moisture-laden air, protecting insulation against saturation and reduction of its insulating efficiency.

Readily workable, it can be thumbbed into any opening and formed for sealing around inspection plates, conduits, openings, cable joints, etc.

Soft mastic consistency permits easy working with fingers at temperatures as low as 30° F. Will not melt or run at any temperature up to 350° F. Non-oxidizing, remains soft and plastic for an indefinite period at 70° F. Does not become brittle at 0° F.

Will not irritate or adhere to skin.

Pkg. per Carton	Wt., Lb. per Pkg.	Price per 5 Lb. Carton
10	5	\$2.10

Graybar Permagem—On Spools

Conveniently packaged, six handy rolls per carton. Easy to use, the lineman can handle even with gloves, tear off a section at a time, no waste material. The roll fits onto the tape thong attached to lineman's belt.

The dielectric strength is much higher than friction tape and is not affected by extreme cold or hot weather conditions.

Permagem can be kneaded or worked into any desired shape or size as the material will adhere to itself permanently. Packaged 5-ft. of Permagem 4-in. wide on a spool.

No.	Std. Carton, Spools	Carton Wt. Lbs.	Per Carton, Each
G1031	6	9	\$11.50

Minerallac Insulating Compounds

For High and Low Voltage Cable Joints, Potheads, Junction Boxes, Terminal Bells, etc.

High Voltage Compounds



No. 33. A specially compounded oil-insoluble insulating medium for Cable Joints, Potheads, Terminals and other electrical apparatus where a close seal against oil filtration is specified. Also as a protection to transformer bushings on oil-filled transformers. Melting point 49 degrees C. Dielectric strength 627 volts per mil at 30 degrees C.

No. 78. Cable Joint or Pothead Compound. Dense and very adhesive. Recommended as an all-purpose insulating material. For voltages 600 and up. Melting point 90° C. Dielectric strength 940 volts per mil at 30 degrees C.

No.	Per Gallon				
	In ½ Gal. Cans	In 1 Gal. Cans	In 2 Gal. Cans	In 5 Gal. Cans	In Drums*
33	\$4.70	4.00	3.60	3.50	\$3.10
78	3.05	2.35	2.05	1.80	1.10

Approximate shipping weight, 10 pounds, 1 gallon.
 *In drums of approximately 400 lbs.

G & W Insulating Compounds



Compound is not included in the price of G&W cable devices, except splicing kits (Ozite B) and oil fuse cutouts (Novoid A).

Asphalt Base

Novoid A (medium soft). For hermetically sealed high and low voltage potheads, boxes and cableheads.

Novoid C (medium hard). For splice boxes and indoor potheads without definite seals.

Ozite B. For cable joints.

Oil Insoluble

Novoid X (medium hard). For special cases to help prevent migration of impregnating oil and compound in paper-insulated cables.

General Machine Sealing Compound



When mixed, sealing compound and activator form the proper flowable compound to produce a plug or dam when desirable to seal cable terminals. Compound and activator packed as one unit to a carton.

No. 7458..... Prices on application

O. Z. Sealing Compound



This compound is recommended for use in compound bushings, cable terminators and other electrical equipment where a high grade sealing compound is indicated.

Made of fine materials, expertly blended for the purpose for which it is intended.

Flashpoint..... 415° F.
 Specific Gravity..... 1.02
 Coefficient of Expansion..... .00045
 Pouring Temperature..... 375°F.

Container Size	Per Container
1 Pint.....	\$ 1.15
1 Quart.....	1.95
1 Gallon.....	3.35
5 Gallon.....	10.50

Minerallac "Pull-In" Compounds

Listed by Underwriters' Laboratories, Inc.

For Rubber, Synthetic, Plastic or Lead-Covered Wires or Cables

For lubricating wires and cables to facilitate pulling them into conduits. Not injurious to wire or wire covers. Free of objectionable odors. White in color. Will not drip or run. Packed in pint, quart, 1/2-gal., gal., and 5-gal. cans.



No. 100 Compound

Pint cans, 12 per case.....	Per Can	\$0.50
Quart cans, 12 per case.....	Per Can	.85
1/2-gallon cans.....	Per Can	1.50
1-gallon cans.....	Per Can	2.00
5-gallon cans.....	Per Can	8.25

Minerallac Cable Pulling Compounds

For lead-covered cables. Not recommended for rubber.

Minerallac Cable Pulling Compound is applied with a stiff brush to the cable at the entrance of the cable feeder. This compound clings to and lubricates the full length of the cable and conduit. The compound follows through curves and bends in the conduit, eliminating damage to the cable sheath. It is chemically inert and causes no deterioration to either cable or conduit, including fiber conduit. To pull a 2.83-inch diameter cable into approximately 400 feet of 3 1/2-inch tile conduit requires only 5 to 7 pounds. Feature of economy that should not be overlooked. Temperature does not affect it and cables may be pulled at temperatures as low as 10° above zero (F.).

Size Can..... pounds	12	25	60	*600
No. 150..... per pound	\$0.19	\$0.18	\$0.16	\$0.14

*Steel drum approximately 650 pounds shipping wt.

Y-er Eas Wire Pulling Lubricants

(Say: "Wire Ease")



For pulling lead, rubber, braided, or synthetic covered cables. Not messy or greasy to use. Saves time and labor by giving more slip to electric cables. Prevents sticking and setting of cable. Will not run back on cable. Facilitates removal of cable at a later date. Not harmful to hands or clothing. Will not deteriorate in transit or storage.

Approved by Underwriters' Laboratories, Inc.

Packaged in wooden pails as follows:

1 gal. Approx. shipping weight, pounds.....	5
2 gal. Approx. shipping weight, pounds.....	11
3 gal. Approx. shipping weight, pounds.....	14
4 gal. Approx. shipping weight, pounds.....	19

Also available in 1 Qt. cans and 55 Gal. Steel drums.

Prices on application.

Ideal Wire-Pulling Lubricants

"Wire-Lube"

Makes wire pulling easier and saves time. Protects insulation against breaks and strains. It can be used on rubber, lead or plastic covered wire or cable. The lubricant may be applied by hand or brush. Wire or cable actually "rides" on a film of lubricant which dries to a fine powder. Ideal for use when adding extra wires in a conduit already containing wires.



No	Description	Each
31-247	Tube (Packed 12 per carton)	\$.50
31-250	Quart (Packed 12 quarts per case)	.80
31-251	Gallon (Packed 4 gallons per case)	2.00
31-253	Three Gallon	4.90
31-254	Four Gallon	5.40
31-255	Five Gallon	6.50
31-265	55 Gallon Drum (Non-returnable)	68.75

"Scotchkote" Electrical Coating

A fast drying sealant and strong bonding agent.

Recommended for use as an inner and outer seal over cable splices subjected to oils, acids, alkalis and severe weathering in man-holes, underwater cable installations and corrosive atmospheric conditions in chemical plants, oil refineries, etc.

Resists oil, moisture and aliphatic hydrocarbons.



Size, Oz.	Cans Per Ctn.	Ship. Wt. Per Ctn.	Per Can
8	12	8	\$0.85

"Scotchfil" Electrical Insulation Putty

Useful for filling voids and padding sharp edges of cable connectors, motor terminals, bus bars and tee connectors. Will not corrode copper.

Uniform thickness of 1/8 inch, gives rapid build-up to the full thickness of the cable.

Good dielectric and excellent aging properties insure thorough seal and long service life.



Width, In.	Per Roll, In.	Packing Type	Carton	Ship. Wt. Per Ctn.	Per Roll
1 1/2	60	1/Box	48	26 1/2	\$1.17

"Scotchcast" Resins

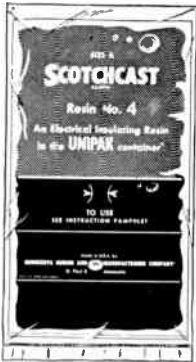

No. 4 "UNIPAK"

An all epoxy type resin of 100% solids, offering advantages of high adhesion, minimum shrinkage and greater heat stability than other synthetic resin classes.

No. 4 is a semi-rigid, insulating, moisture sealing resin.

The "UNIPAK" is a two-part plastic bag separated by a dividing membrane. When the seal is broken the container is kneaded, mixing the two parts. A corner of the container is clipped and the resin poured.

Through its own chemical action the resins become a solid in approximately 15 minutes, depending on size of molds, temperature, etc. Class A Temperature Classification.

	Size, Fl. Oz.	Unipaks Per Ctn.	Ship. Wt. Per Ctn.	Per Unipak
A	2 3/4	10	3	\$2.00
B	6 1/4	10	6.3	3.40
C	12 1/2	10	13	6.35

"Scotchcast" Splicing Kits

82-A Series

For straight or wye splices. Designed to provide a tailor-made field splice conforming in strength and electrical properties to the cable itself.

Provides excellent physical and electrical protection and uniformity of moisture-proof qualities.

Splicing kits contain all the materials necessary for encapsulating cable splices.

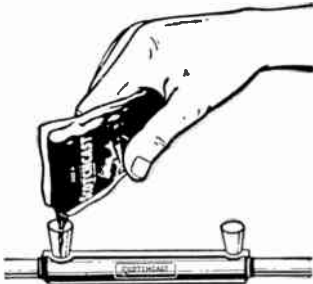

No.	Kits Per Ctn.	Ship. Wt. Per Ctn.	Cable O.D. Range		Per Kit
			Min. In.	Max. In.	
82-A	10	6 1/2	1/4	3/4	\$4.66
82-A1	10	6	1/4	5/8	4.30
82-A2	10	6	5/8	1	6.50
82-A3	10	6	1	1 1/16	10.45
82-B1 (Wye)	10	9 1/2	1/4	5/8	6.95

"Scotchlok" Electrical Spring Connectors



Wires spliced with "SCOTCH-LOK" connectors will not shake loose regardless of vibration.

Simple to apply and zinc plating over the spring steel prevents corrosion.

To apply, simply twist connector on wires using winding stem as a handle.

To complete the splice, wrap with "SCOTCH" No. 33.

Wire Ranges: Solid or Stranded

Type S	18 to 12	18S to 14S
Type M	16 to 10	16S to 14S
Type L	12 to 6	12S to 6S
Type D	8 to 2	8S to 2S

Type	Conn. Per Box	Boxes Per Ctn.	Ship. Wt. Per Ctn.	Per Box
S	100	50	14	\$2.65
M	100	50	28	3.50
L	100	10	20	7.25
D	50	10	20	6.65

"Scotchcast" Splicing Kits

No. 90-B1



Designed to give positive service in cathodic protection ground bed splicing, street lighting and traffic signal systems.

Offers speedy, easy-to-make, factory-tailored

splices which are moisture-proof and electrically tight. No special skill is required. Each kit contains "SCOTCHCAST" Resin No. 4, Size B, in the "UNIPAK" container.

The self-venting split mold, made of durable plastic, offers a choice of 3 different positions from which the mold may be filled.

The stepped ends snugly accommodate cables of varying outside diameters simply by cutting the mold ends at the proper step diameter.

Range of Cable O.D.	Min., In.	Max., In.
Branch Cable	3/8	13/16
Feeder Cable	1/2	13/16

No.	Kits Per Ctn.	Ship. Wt. Per Ctn.	Per Kit
90-B1	10	8 1/2	\$5.22 (Min. 10)

"Scotchcast" Resin Pressure Splices

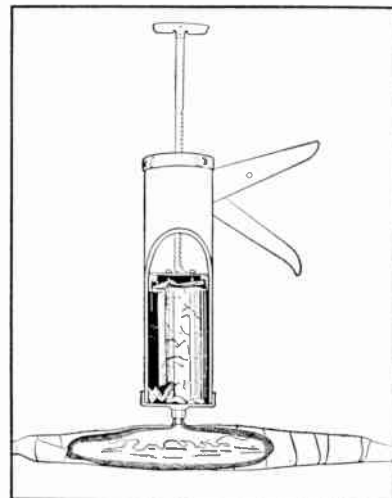

Combines the features of epoxy resin sealing and insulating and easy field application with adaptability to all configurations.

Is the most universal moisture seal and insulation.

Ease and simplicity of application afford it wide acceptance as a splice sealing and insulating medium.

Items needed are sold individually as its universal application makes a combined package impractical due to varying requirements.

Description	Packing	Each
Resin Pressure Gun—Model E 4	1/Ctn.	\$15.00
P1 Injection Fitting	10 or 100/Ctn.	.44
P2 "UNIPAK" Spout	10 or 100/Ctn.	.09
P3 Screen Spacer Tape		
1 1/2 In. x 10 Yds.	10 or 100/Ctn.	1.56
P4 Restricting Tape		
1 1/2 In. x 10 Yds.	10 or 100/Ctn.	.49
"SCOTCH" No. 22 Electrical Tape		
1 1/2 In. x 10 Yds.	1/Box 12/Ctn.	4.50
"SCOTCHCAST" Resin No. 4 "UNIPAK"		
Size A	1/Box 10/Ctn.	2.00
Size B	1/Box 10/Ctn.	3.40
Size C	1/Box 10/Ctn.	6.35

G & W Telephone Cable Splicing Kits

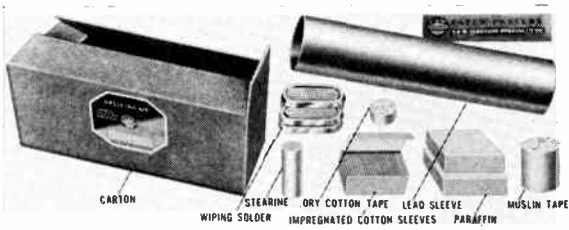

Typical Unit Package Kit for Paraffin Type Splice

Paraffin Type (TP)

Unit package includes all necessary splicing materials in the proper quantity and size for one straight 2-Way joint.* Lead sleeve, for housing the joint. Wiping solder, for wiping lead sleeve to cable sheaths. Stearine, flux for wiping joints. Paper pasters, for limiting the wipes. Dry cotton tape, for protecting the individual conductors at the ends of the lead sheaths. Insulating sleeves, woven impregnated cotton tubes for enclosing splices of individual conductors. Muslin, for wrapping the spliced conductors. Paraffin, for removing moisture by boiling out the core.

Desiccant Type (TD)

Same as paraffin type, except instead of paraffin it contains desiccant for removing moisture by absorption and Stripping oil to facilitate removal of insulation.

No. 22 A.W.G. Conductors				
No.	No. of Pairs of Conductors	Lead Sleeve I.D. In.	Approx. Lgth. In.	Approx. Ship. Wt. Lb.
622TP	6	3/4	15	9
1122TP	11	3/4	15	9
1622TP	16	3/4	15	9
2622TP	26	1	15	9 1/2
5122TP	51	1 1/4	15	10
7622TP	76	1 1/2	15	11
10122TP	101	1 1/2	15	11 1/2
15222TP	152	2	17	14 1/2
20222TP	202	2 1/4	17	15 1/2
30322TP	303	2 3/4	20	20 1/2
40422TP	404	3	20	22
45522TP	455	3	20	22
60622TP	606	3 1/2	20	25
90922TP	909	4	20	28 1/2
622TD	6	1	15	9
1122TD	11	1	15	9
1622TD	16	1	15	9
2622TD	26	1 1/4	15	9 1/2
5122TD	51	1 1/2	15	10
7622TD	76	1 3/4	15	11
10122TD	101	1 3/4	15	11 1/2
15222TD	152	2 1/4	17	14 1/2
20222TD	202	2 1/2	17	15 1/2
30322TD	303	3	20	20 1/2
40422TD	404	3 1/2	20	22
45522TD	455	3 1/2	20	22
60622TD	606	4	20	25
90922TD	909	4 1/2	20	28 1/2

No. 19 A.W.G. Conductors				
No.	No. of Pairs of Conductors	Lead Sleeve I.D. In.	Approx. Lgth. In.	Approx. Ship. Wt. Lb.
619TP	6	3/4	15	9
1119TP	11	3/4	15	9
1619TP	16	3/4	15	9
2619TP	26	1	15	9 1/2
5119TP	51	1 1/2	15	11
7619TP	76	1 3/4	17	12 1/2
10119TP	101	2	17	13 1/2
15219TP	152	2 1/4	20	18
20219TP	202	2 3/4	20	20 1/2
30319TP	303	3 1/2	20	25 1/2
40419TP	404	4	20	28 1/2
45519TP	455	4	20	29
619TD	6	1	15	9
1119TD	11	1	15	9
1619TD	16	1	15	9
2619TD	26	1 1/4	15	9 1/2
5119TD	51	1 3/4	15	11
7619TD	76	2	17	12 1/2
10119TD	101	2 1/4	17	13 1/2
15219TD	152	2 1/2	20	18
20219TD	202	3	20	20 1/2
30319TD	303	4	20	25 1/2
40419TD	404	4 1/4	20	28 1/2
45519TD	455	4 1/2	20	29

*Bridge (3-way) joint kits quoted on request. Give complete cable data.

Splicing Kits

G & W splicing kits are also available for all types of cables and all kinds of joints. Printed bulletins will be sent on request to Graybar. Please give complete cable data, fully describe cable, give operating voltage and state whether grounded or ungrounded neutral.

Prices on application.

G & W Splicing Kits

Each item supplied in the correct quantity for properly designed joint. Economical; accumulation of dead stock avoided.

Each kit is labeled for easy identification.

Splicing Kits For Light & Power Cable Joints

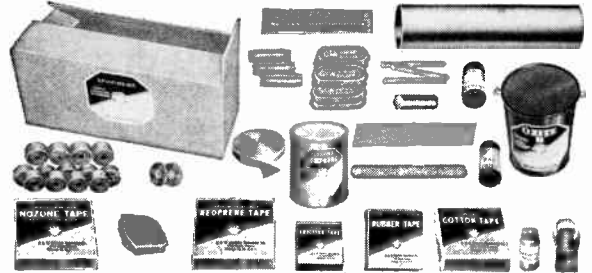

Fig. 13—Kits are available for ANY kind of cable, single or multiple conductor, lead, braid or Neoprene covered.

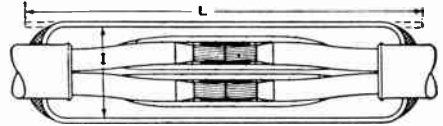

Fig. 21—Straight 2-way joint. Kits also furnished for 3-way Y.

- When ordering splicing kits specify:
 - Total number of joints to be made
 - Type of joint (straight 2-way, 3-way Y, etc.)
 - Complete description of the cable:
 - Number of conductors (1/c, 2/c, 3/c, 4/c)
 - Size of conductors
 - Type of conductors (solid, concentric stranded, compact round, compact sector, etc.)
 - Type and thickness of insulation
 - Type of cable (shielded or unshielded) 1/c (belted or shielded) 3/c
 - Lead sheath or jacket thickness
 - Operating voltage as:
 - Grounded or ungrounded neutral (Important)
 - Catalog number of kit, if available
 - Shipment wanted (specify date)

Ruberoid Rapid Asphalt Paint



A very quick-drying, glossy black coating with high insulating and moisture-proofing qualities. Resistant to acid, acid fumes and alkali.

For coating switchboards, wires, cables, fibre conduit joints, taped connections and other electrical insulating applications. Also for coating the inside of tanks, vats, troughs holding liquids, refrigerators, etc., and for all surfaces subject to extreme moisture or severe exposure.

Sold Only in Full Cases

Quantity Cans	Cans in Case	Approx. Weight Per Case, Lbs.	Per Gallon
1 Pint	12	15	\$2.00
1 Quart	10	25	1.70
1/2 Gallon	10	50	1.50
1 Gallon	6	55	1.40
5 Gallons	..	50	1.25
55 Gallon Drums	..	475	1.10

Ruberoid Rapid Asphalt Paint Thinner

1 Gallon	(Any Q'ty.)	8	\$1.40
----------	-------------	---	--------

Graybar Insulating Materials

Quality Insulation Meeting Rigid Specifications

Class H—180° C.

Graybar Silicone Glass (Extra Thin)—An extra thin material of high tensile strength, good flexibility, exceptional dielectric strength.

Graybar Elastic Fiberglas—Fully cured silicone rubber coated fiberglas, flexible, tough, abrasive resistant, high dielectric strength, low power factor.

Graybar Silicone Asbestos—An inorganic asbestos paper saturated and coated with silicone resin. Extremely flexible, plus high dielectric and mechanical strength.

Graybar Silicone Glass (Regular)—Impregnated and coated with silicone resin, having exceptional resistance to moisture, corrosive vapors. Mechanical stability and flexibility. High dielectric, low power factor.

Class B—130° C.

Graybar Bias-Glass—Has good dielectric and mechanical strength. As a tape it provides uniform, tight, and smooth lapping over irregular surfaces. Retention of varnish film after elongation, high abrasion resistance and protection of fraying action of the glass fibres.

Graybestos—Reinforced combination of treated glass cloth and purified asbestos paper. High degree of flexibility, maximum electrical and physical properties. A low cost composite insulation.

Graybar Adhesi-Glass—Varnished fiberglas with pressure sensitive adhesive. Provides excellent sealing without the use of added adhesion or further processing.

Graybar Varnished Glass—An insulating material of exceptionally high tensile strength, flexibility, thermal conductivity and dielectric strength.

Class A—105° C.

Graybar Glass—New low cost Varnished Glass Cloth which provides stronger more permanent support for insulating varnish than organic textile, material of equal thickness. Stronger and longer lasting, permitting Class A rated machines to withstand higher temperatures.

Dielectric Board—Highly refined coated paper which eliminates the necessity of vacuum impregnation of untreated paper when used as layer insulation in transformers. Can be activated by heat; it softens and cures, providing a firm bond between wire and paper.

Graybar Varnished Cambric—General purpose insulating material possessing high dielectric and mechanical strength. Available in straight cut and bias woven. Both types possess good flexibility in tape or sheet form. Exceptional elongation without film rupture.

Graybar Pli—An insulating material using polyester film bonded to Rag or Kraft paper, possessing exceptional high dielectric and mechanical strength, available in duplex or tri-ply combinations.

Newer Insulations Available

Graybar Isocyanate Glass

A flexible high temperature insulation suitable for continuous service at temperatures up to 150° C. Exceptional resistance to mechanical stress, flexing and creasing. High dielectric, approximately 1900 VPM, non-corrosive, low temperature flexibility.

Graybar Banding Tape

High tensile, high modulus, high impact strength, thermosetting tying and banding tape with good electrical properties. Thermoseals to continuous tape at point of contact with no loss of tensile. Furnished in the "B" stage (semi-cured), complete curing effected after baking 3½ hours at 125° C.

Graybar Polyester Glass

Specially constructed woven fiberglas cloth pre-impregnated with a modified temperature stable polyester resin.

Available in a semi-cured stage requiring heat and pressure to effect the final cure.

Can be formed, molded, or laminated at low pressure, even contact pressure, curing completely at 5 to 10 minutes at 250° to 300° F.

Graybar Coated Mylar®

Flexible polyester film coated on one or two sides with a special compound producing a very hard surface which reduces slippage and provides a wettable surface permitting varnish to adhere to the roughened surface.

Has good chemical and moisture resistance, high dielectric and mechanical strength.

List of Graybar Insulation

Write Graybar's nearest office and warehouse for complete details on Electrical Insulation.

Product	Temp. Class	Description
Graybar Varnished Cambric	A	Varnished Cambric Seamless Bias
Graybar Varnished Cambric Extra Thin	A	Varnished Cambric Straight Cut
Graybar Varnished Cambric Extra Thin	A	Varnished Cambric Extra Thin
Graybar Extra Thin Varnished Silk; Varnished Rayon; Varnished Nylon	A	
Graybar Varnished Electrical Grade Paper	A	Varnished Paper Organic Varnish Coating
Graybar No. 3 Duo Ply—Cambric Slot	A	Varnished Cambric 100% Rag
Graybar No. 4 Duo Ply—Glass Slot	A	Varnished Glass Cloth 100% Rag
Graybar Fortisan	A	Varnished Fortisan Fabric
Graybar Coated Mylar®	A	Polyester Film
Graybar Dielectric Board (Heat Activated)	A	Heat Activatable Resin Ctd. Paper 1-Side & 2-Side
Graybartex	A	Plastic Insulating Tape
Graybar Varnished Duck	A	Varnished Duck
Graybar Varnished Glass	B	Varnished Glass Cloth
Grayglass	B	Varnished "A" Glass
Graybar Bias Glass	B	Varnished Bias Woven Fiberglas
Graybar Treated Asbestos Cloth	B	Varnish Treated Asbestos Cloth
Graybar Varnished Asbestos Paper	B	Varnish Coated or Saturated Asbestos Paper
Graybar Glass-Asbestos Duplex	B	Comb. Varn. Glass Cloth and Asbestos Paper
Graybar Glass-Asbestos Triplex	B	Comb. of Layers Varnished Glass Cloth and Asbestos Paper
Graybar Isocyanate Glass	B	Polyurethane Treated Glass Cloth
Graybar Silicone Glass (Regular)	II	Silicone Resin Treated Glass Cloth
Graybar Silicone Glass (Extra Thin)	II	Silicone Resin Treated Glass Cloth
Graybar Silicone Asbestos	II	Silicone Resin Treated Asbestos Paper
Graybar Elastic Fiberglas	II	Silicone Rubber Coated Glass Cloth Uncured or Fully Cured
Graybar Electric Bias Fiberglas	II	Silicone Rubber Coated Bias Glass Cloth

Atlas Insulating Materials

Glaspun* Woven Tapes

All-purpose electrical insulating tape which resists moisture, rot, chemicals and high temperatures. Will not burn. Good carrying medium and reinforcement for impregnants used to insulate. Made entirely of glass fibre yarn.

Approximate Temperature Limit: Strength begins to decrease at 600° F. and declines to limiting temperature of about 1000 to 1500° F. Softens at 1500° F.

Applications: Electric motor windings—field coil wrapping, field coil supports, armature coil lead separators. Flame-proofing of cable. Protective wrapping on exposed aircraft engine parts and exhausts.

Continuous Filament Types

Has high strength—low bulk ratio, smooth, white, evenly woven.

Made with colored center stripe to guide operator's eye on half-laps in coil winding. Style 2151 has black line; Style 2152 has orange line.

"B" Weave

Tight Weave—Conforms to O-C ECC-11B

Style No.	Warp Yarn	Fill Yarn	Std. Width In.	Std. Thickness In.	Approx. Wt. Lbs. Per Gr. Yds.	Length Yds. Per Roll
2171	450	450	3/8 to 1 1/2	.003	.25 to 1.2	72
2171	450	450	1/2 to 1 1/2	.005	.7 to 1.9	36
2171	450	450	1/2 to 1 1/2	.007	.82 to 2.3	36

"B" Weave

Tight Weave—Modification of ECC-11B

2151	225	450	1/2 to 1 1/2	.005	.75 to 1.95	36
2151	225	450	1/2 to 1 1/2	.007	.85 to 2.4	36

"A" Weave

Medium Open Weave—Modification of ECC-11A

2152	225	225	1/2 to 1 1/2	.005	.6 to 1.65	36
2152	225	225	1/2 to 1 1/2	.007	.75 to 2.25	36
2152	225	225	1/2 to 1 1/2	.010	1.1 to 3.35	36
2152	225	225	1/2 to 1 1/2	.015	1.65 to 4.65	36

"C" Weave

Medium Open Weave—Similar to No. 2152

2153	150	150	1/2 to 1 1/2	.005	.7 to 1.85	36
2153	150	150	1/2 to 1 1/2	.007	.9 to 2.4	36
2153	150	150	1/2 to 1 1/2	.010	1.1 to 3.3	36
2153	150	150	1/2 to 1 1/2	.015	1.45 to 4.7	36
2153	150	150	1/2 to 1 1/2	.020	2.5 to 6.95	36
2153	150	150	1/2 to 1 1/2	.025	3.3 to 10.25	36

Note: Wider widths in all styles up to 6-in., thicknesses .005-in. and above available on request.

Staple Fibre Types

Used where a more resilient wrapper is desired and space is not of primary importance. Appearance similar to natural wool.

Conforms to O-C Type ESS-13A

Style No.	Width In.	Thickness In.	Roll Length Yd.
2275	1/2 to 2	.010	36
2275	3/4 to 2	.015, .020, .025	36

Style 2514: Generally lighter in weight and somewhat more open in weave than Style 2275. Widths 1/2-in. to 3-in. Thicknesses .010-in., .015-in., .020-in., .025-in., .030-in., .040-in. and .060-in.

Widths over 3-in. and other thicknesses or designs on request.

Treatments Available at Extra Cost

No. 2519: Chemical treatment to remove most of binder oils.

No. 1713: Heat treatment to remove binder oils completely and anneal glass to reduce fraying.

No. 1983: Chemical stiffening treatment—applied to base fabric or after either above treatment, as desired.

*Trademark of Atlas Asbestos Co.

Asbestos Woven Cloth

Used for packings, safety clothing, pipe insulating jackets, fire blankets, theatre and welding curtains, laminated plastics, conveyor belts, covers for laundry rolls and ironing boards, etc. Custom fabrics made on request.

Standard widths 36-in. and 40-in.

Standard roll lengths approximately 50 yds.

Underwriters' Grade Only (Or Grades A, AA, AAAA to Order)

Style No.	Group	Pounds Per Sq. Yd.	Approx. Thickness In.	Warp Ends	Picks	Type
1481	Light Cloths	.45	.015	17	17	27P015
1644	Light Cloths	.7	.020	30	19	26P070
1425	Medium Cloths	1.	.030	15	13	18P100
1114	Medium Cloths	1.2	.030	20	17	18/24P120
915	Medium Cloths	1.4	.045	18	14	18P140
3029	Medium Cloths	1.65	.050	14	14	11P165
3030	Medium Cloths	1.8	.065	20	10	14P180
2653	Herringbone	2.4	.065	28	12	1411240

Commercial or Underwriters' Grade (Other Grades to Order)

2690	Heavy Cloths	1.4	.060	8	8	10P140
1537	Heavy Cloths	1.65	.060	10	10	10P165
1555	Heavy Cloths	2.1	.062	18	8	10P210
3300	Heavy Cloths	2.1	.065	16	..	8P210
1449	Heavy Cloths	2.25	.065	18	9	10P225
1448	Heavy Cloths	2.5	.065	20	10	10P250
*2530	Heavy Cloths	5.	.120	40	14	10P500
1620	Twill	2.9	.070	30	9	12P290
2319	Metallic Cloths	2.85	.070	20	10	10M285
*2666	Metallic Cloths	6.	.125	35	14	10M600

*Roll length 25 yds.

Textile Products

Glaspun Tapes for Plastic Reinforcement: Continuous filament with woven selvages. Widths—1/2-in. to 12-in. Thicknesses—.005-in. to .022-in. Treatments—"114" chrome-complex, Volan A, Garan, or Heat-Annealed.

Glaspun Tape for Pipe Lagging: Navy Spec. 32-G-9 Class "C", MIL-C-20079B.

Glaspun Webbing: With Staple Fibre. Thicknesses to 1/4-in. Widths to 6-in.

Glaspun Cloths for Tooling by Plastic-Reinforcement: Heavy Staple Fibre. Width 38-in. Thickness to .120-in. Requires fewer plies in lay-up than conventional fabrics.

Glaspun Rope: With Braided Staple Fibre.

Glaspun-Dacron and Glaspun-Asbestos: Tapes of combination fibres.

Ceramic Fibre Tapes: Withstand temperatures to 2000°F.

Other tapes, tubings and cloths available. When ordering forward details of requirements.

Asbestos Textiles

For industrial applications. Made of high-grade asbestos yarn. Non-combustible, withstand high temperatures, durable. Resist moisture, fire, corrosion, heat, alkalis, mild acids, vermin. Insulate against heat, vibration, electricity and sound.

Asbestos Textile Grade Classification

(A. S. T. M.)

Grade	Asbestos Content By Weight	Approx. Temp. Limit
Commercial	75% up to but not incl. 80%	Up to 400° F.
Underwriters'	80% up to but not incl. 85%	Up to 405° F.
Grade A	85% up to but not incl. 90%	Up to 550° F.
Grade AA	90% up to but not incl. 95%	Up to 600° F.
*Grade AAA	95% up to but not incl. 99%	Up to 750° F.
Grade AAAA	99% to 100% inclusive	Up to 900° F.

*Not offered, use Grade AAAA.

Data in tables cover grades shown in headings.

Other grades can be furnished on request.

Atlas Insulating Materials

Asbestos Woven Tapes
Selvage Edges—Ferrous Type
Underwriters' Grade

For electrical insulating, such as motor windings. Capable of absorbing a high percentage of resin to provide moisture barrier for efficient motor operation.

†**Best Quality**

Style No.	Std. Width In.	Std. Thickness In.	Approx. Wt. Lbs. Per Roll	Approx. Ft. Lbs.	Lgth. Yds. Per Roll
1770	1/2 to 2	.010	.18 to .7	310 to 82	18
*2008	1/2 to 3	.015	.4 to 2.	270 to 50	36
1772	1/2 to 3	.020	.5 to 2.8	237 to 38	36
1773	1/2 to 3	.025	.6 to 3.7	178 to 29	36
1792	1/2 to 3	.030	.65 to 3.75	174 to 27	36

††**Competitive Quality**

2548	1/2 to 1 1/2	.010	.32 to .84	339 to 129	36
2549	1/2 to 3	.015	.4 to 1.89	270 to 57	36
2553	1/2 to 3	.020	.5 to 2.4	216 to 45	36
2658	1/2 to 3	.025	.6 to 3.6	180 to 30	36

*Where heavier, more closely woven tape is desired use No. 1975. Width 1/2-in. to 3-in., thickness .015-in., giving more asbestos insulation per sq. in.

†Standard Line to ASTM Spec. D315, MIL-I-3053 Class 6.

††Does not conform strictly to ASTM Spec. D315.

Commercial Grade

Heavier tapes, used for thermal insulation, flame-proofing lead sheathed cable, to make packings and gaskets.

Plain Tapes

For insulating, cushioning, sealing vital parts of assemblies in equipment for aircraft, railroad, mining, oil, chemical, automobile, electrical and other industries.

Style No.	Std. Width In.	Std. Thickness In.	Approx. Wt. Lbs. Per Roll	Approx. Ft. Lbs.	Lgth. Ft. Per Roll
903	1/2 to 3	1/32	.9 to 4.5	120 to 24	108
1774	1/2 to 6	1/16 to 3/32	*1 to 16	*100 to 6.25	100
1775	3/4 to 6	1/8 to 1/4	†2 to 15	†25 to 3.5	50

*Data for 1/16-in. thickness.

†Data for 1/8-in. thickness.

Metallic Tapes

Wire-inserted for service conditions requiring higher tensile strength at higher temperatures.

Style No.	Std. Width In.	Std. Thickness In.	Approx. Wt. Lbs. Per Roll	Approx. Ft. Lbs.	Lgth. Ft. Per Roll
2074	1/2 to 6	1/16 to 3/32	*1.1 to 9	*90 to 5.5	100
2075	3/4 to 6	1/8 to 1/4	†2.18 to 9	†23 to 2.85	50

*Data for 1/16-in. thickness.

†Data for 1/8-in. thickness.

Asbestos Braided Tubing

A flexible sleeving for insulating electrical conductors. Used as a jacket for high-temperature packing, fire-proofing fuel lines, covering on items such as tongs (to protect hot glass-ware from injury in handling during production), numerous other uses. Can be expanded or contracted to fit slightly larger or smaller diameters.

Yarn used conforms to ASTM Spec. D299.

Underwriters' Grade 1/16-in., 1/32-in. or 1/64-in. Wall
Commercial Grade 1/16-in. Wall Only

I.O. In.	Covers B & S Wire Ga. Nos.	Approx. Ft. Per Lb. 1/16-in. Wall	Approx. Ft. Per Lb. 1/16-in. Wall
1/32	18-25	410	150
1/16	13-17	250	110
3/32	10-12	210	100
1/8	8-9	150	66
5/32	6-7	140	64
3/16	4-5	110	60
1/4	3	100	50
5/16	2	85	48
3/8	1	80	47
7/8	0-00	75	22

Underwriters' Grade 1/16-in. or 1/32-in. Wall
Commercial Grade 1/16-in. Wall Only

1/16	000	70	21
1/2	0000	61	20

Underwriters' Grade 1/16-in. Wall Only
Commercial Grade 1/16-in. Wall Only

1/16	19
3/8	20
3/4	17
7/8	12
1	11

Note: Up to 3/16-in. I.D. packaged on 5-lb. spools. Larger sizes on 25-lb. reels.

Standard Line includes 1/16-in. Wall Underwriters' or Commercial Grade in additional I.D.'s as follows: 1 1/8-in., 1 1/4-in., 1 3/8-in., 1 1/2-in., 1 3/4-in., 2-in. and 2 1/2-in. Other sizes on request.

Tubing can be treated or sized at extra cost.

Metallic tubing (brass wire inserted yarn) is furnished with 1/16-in. wall, on special order.

Grades A, AA, AAAA furnished with 1/16-in. wall only, on special order.

Woven asbestos tubings which have non-flexible diameters and do not fray as readily when cut available on request.

Call Graybar FIRST For . . .

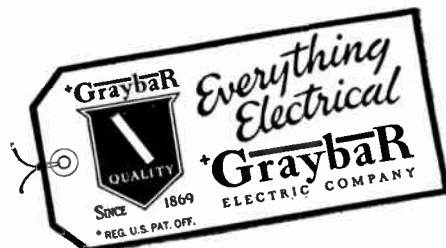

G-E Insulating Materials

Irrathene® Irradiated Polyethylene Insulating Tape

A new electrical insulating tape providing all the excellent mechanical and electrical properties of conventional polyethylene plus being non-melting. Will heat shrink and heat bond when exposed to 135-150°C. temperatures, shrinking to the configuration of the object on which it is wrapped forming a tough, tight, waterproof sheath impervious to dirt and dust.

Available in unspliced roll lengths from 36 yds. to 360 yds. Tape widths vary in 1/8-in. increments from 1/2-in. up to 6-in. for the shrinkable grades and to 12-in. for the regular grades. Standard mil thicknesses are 4 and 8 for shrinkable grades and 5 and 10 for the regular.

Grade	Type	Color	Oxidation Stabilized
101	Regular	Clear	No
110	Shrinkable	Clear	No
201	Regular	Clear	Yes
210	Shrinkable	Clear	Yes
202	Regular	Black	Yes
212	Shrinkable	Black	Yes

Mica Mat Electrical Insulation

A new insulating product produced in a thin, uniform, flexible continuous sheet. Made from tiny mica flakes without the use of binders or other strengthening agents. Has dielectric strength of about 500 volts per mil, a tensile strength of about 1500 psi, and a thickness variation of less than 10 per cent.

Can be used to form molded insulating products. Can also be treated with silicones or other resins to improve tensile strength and water resistance. Mica Mat is limber and flexible. Mica Mat raw material can be bonded to glass cloth, synthetic films or paper-backing materials, to improve its tensile and tearing strength.

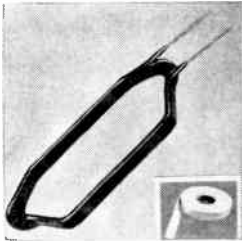

Tapes and wrappers applied to end turns



Pressed composite sheets as slot liners

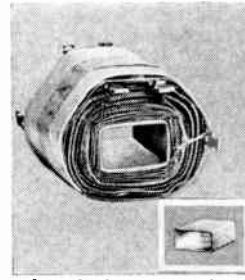

In tube form as center of coil form



Segments for insulation in commutators

Mica Mat Composites

Product No.	Types and Uses	Construction	Thickness, In.	Diel. Strength Volts Per Mil. ASTM D149-44	Coverage 0.010 In. Thick Sq. Ft. Per Lb.	Shelf Life (Yrs.)†
Glyptal Resin Bonded—Class B						
78050	Slot liners and phase insulation	Glass Cloth	10, 12, 15, & 20 mils.	1000	1.01	2
78051	Used in Class A equipment where spring back is required	Glass Cloth Rag Paper	10, 15, & 20 mils.	1000	1.03	2
78052	Used where Tensile of glass and abrasion resistance of Polyester Film is required	Glass Cloth DuPont Mylar Polyester Film*	8, 10, 15, & 20 mils.	1000	1.0	2
78053	Used where toughness and tear resistance are essential	DuPont Mylar Polyester Film*	5, 8, 10, 12, 15, & 20 mils.	1000	.89	2
Silicone Bonded—Class H						
78054	General purpose slot liner and phase separation	Glass Cloth	7, 10, 12, 15, & 20 mils.	750	1.01	2
78055	Used where the tensile of glass and abrasion resistance of Mylar is required	Glass Cloth DuPont Mylar Polyester Film*	8, 10, & 15 mils.	750	.89	2
78056	Used where toughness and tear resistance are essential	DuPont Mylar Polyester Film*	5, 8, & 10 mils.	1000	1.07	2

Mica mat composites are supplied in 36 x 36 inch sheets.
 *Registered Trade-Mark of E. I. DuPont de Nemours Co.
 †When stored in original package.

G-E Insulation Materials
Mica Mat Electrical Insulation

Mica Mat Tapes and Wrappers

Product No.	Types and Uses	Thickness, In.	Diel. Strength Volts Per Mil. ASTM D149-44	Tensile Lb./In. of Width	Coverage Sq. Ft. Per Lb.	Shelf Life, Yrs.‡
77851	A general purpose silicone bonded, glass backed product for Class II applications.	0.005 0.006	325	70	31	2
77855	A flexible Glyptal resin bonded, paper backed and faced product for use on conductors and small coils.	0.0047 0.0057	700	15	26	2
77859	A flexible Glyptal bonded, cotton cloth faced paper backed product for use where high tensile and abrasion resistance are required.	0.0085 0.0095	800	25	12	2
77864	A Glyptal bonded tape backed with glass thread paper and faced with paper for machine taping of conductors and small coils.	0.005 0.006	700	20†	27	2
77865	A Glyptal bonded, glass cloth backed, paper faced tape for use where high tensile strength is required.	0.0073 0.0083	800	70	15	2
77866	A polyester bonded tape of glass cloth and mica mat backed and faced with DuPont Mylar polyester film for conductor and small coil insulation.	0.0055 0.0065	900	70	28	2
77869	Similar to 77866 except that thicker Mica Mat is used. For use on larger coils as ground insulation.	0.008 0.009	900	70	16	2

Note—Mica mat tapes and wrappers are supplied in widths from 1/2 to 38 inches in 1/4 inch increments.

Tapes are supplied in 1 inch OD cores in 36 yd. lengths.

‡When stored in the original package.

†Tensile is difficult to measure due to the glass threads.

Mica Insulation

When properly selected and processed, mica has exceptionally good electrical properties, high dielectric strength, very low power factor and stability under varying humidity conditions and over a wide range of temperatures.

G-E segments and heater plate make use of special heat

resistant and stable resins with high resistance to flow and distortion. G-E insulating varnishes are used in making flexible mica sheets and composites. These varnishes give added resistance to heat and chemicals, excellent electrical properties and good mechanical strength.

Typical Grades and Uses—Mica Plate

G-E No.	Principal Uses	Kind of Mica Used	Pasting Varnish	Range, Inches	Thickness Var. Average Inches Plus	Thickness Minus	Approx. Weight Per Cu. In., Lb.	Approx. Size of Sheets, Inches
140	Commutator segment insulation	White or Amber‡	Shellac	0.020 0.062	0.001	0.001	0.092	25 x 37
1631	Commutator segment insulation	White or Amber‡	Alkyd-Vinyl	0.015 0.062	0.001	0.001	0.092	25 x 37
3540	Hi-temp commutator segment insulation.	White or Amber‡	Silicone	0.020 0.062	0.001	0.001	0.092	25 x 37
131	Used for molding or forming into commutator cones; flanged rings, collars, shell insulation and miscellaneous molded parts such as channels for slot or shaft insulation.	White	Shellac	0.010 0.062	0.002	0.002	0.082	25 x 37
1630	Used for molding or forming into commutator cones; flanged rings, collars, shell insulation and miscellaneous molded parts such as channels for slot or shaft insulation.	White	Alkyd-Vinyl	0.010 0.062	0.002	0.002	0.086	25 x 37
146	Used in heating devices such as ironing equipment where heat resistance is of importance.	White or Amber‡	Glyptal* Alkyd Resin	0.010 0.020	0.005	0.005	0.096	25 x 37
77520	Useful where it is desired to wrap on the mica insulation in sheet form. Used extensively as insulation in armature slots, under end windings, at crossovers, under terminals of field coils, etc.	White	Epoxy	0.005 0.010 0.020 0.062	0.003 0.003 0.005	0.001 0.003 0.005	0.074	25 x 38

‡Drawings and orders should definitely indicate the kind of mica required; i.e., "white" or "amber."

*Registered trade mark of General Electric Company.

G-E Insulation Materials

Mica Insulation

Mica Tapes

G-E No.	Principal Uses	Type	Backing Material	Average Thickness and Tolerance	Standard Length of Rolls, Ft.	Approx. Wt. Stand. Roll 1 In. Wide, Lb.	Varnish Type
127	Turbine generator field coils and in applications where it is not practical to mold coils after winding.	Hand Laid	Paper both sides	0.004 ±0.0006	160	0.50	Gum
1607	Turbine generator field coils and in applications where it is not practical to mold coils after winding.	Hand Laid	Paper both sides	do	do	do	Phenolic
1754	Turbine generator field coils, end wound field coils or where greater thickness can be used.	Machine Laid	Paper both sides	0.0065 ±0.001	100	0.56	Asphalt
1769	Railway stator coils or where tape of higher mechanical strength of type similar to No. 127 is required.	Hand Laid	Cotton cloth on one side, paper on other	0.0055 ±0.0006	120	0.44	Gum

Sealing and Filling Compounds

Used for filling and sealing spaces in windings as in revolving a-c fields; between coils and case as in transformers, or over screw and bolt heads as in receptacles, sockets, and other wiring devices. They are highly filled and will not saturate porous materials like paper or cotton. The bonding constit-

uent is most often a natural or synthetic resin or varnish. Treating compounds such as G-E 1332 are made especially for the penetration of porous materials such as wood, asbestos board, cloth and paper.

Applications and Properties

G-E No.	Recommended for	Characteristics	Color	Type of Base	Weight Per Gallon, Lb., Av.	Method of Application	Thinner (If Required)
805	Filling between primary and secondary windings of transformers; also between coils and leads.	A putty like material which becomes infusible, hard, and stonelike on baking 2-4 hrs. at 100°C. Oil resistant.	Brown	Clear Synthetic Varnish	13.5	Knife	Toluene or Xylene
1282	Filling and coating of end windings which must be completely smoothed over on motors and generators.	An asbestos-filled compound which cures to a tough, infusible, oil-resistant coating on baking approx. 1-1½ hrs. at 150°C.	Brown	Clear Synthetic Varnish	12.2	Knife	G-E 1500 or Xylene
1287	Filling and protecting of end windings of motors and generators and random wound stators.	A mineral-filled compound for providing a smooth surface and extra protection. Gives much heavier coating and filling than G-E 1201.	Red	Clear Synthetic Varnish	13.3	Dip, flow, spray, or brush	G-E 1500 or Xylene
1332	Filling solid-filled cable accessories.	An oil-resistant compound which flows at 65-70°C. High dielectric strength.	Clear	Resin-Oil	7.8	Pours at 170-190°C.	

Electrical Insulating Varnishes

Used for impregnation and filling of the spaces in porous insulation and the interstices between coil turns and assemblies of transformers and all forms of rotating apparatus. Varnishes are useful in building up film insulation upon wires, coils and coil assemblies. The varnish coating serves as a seal to pro-

tect windings and insulation against moisture, dirt, oil and chemicals. It is also useful in bonding coils and winding assemblies, as in transformers or in cementing together mica splittings to produce built-up mica insulation.

G-E No.	Type of Varnish	Typical Uses
457	Black air drying	General purpose fast air drying varnish especially useful in treating white cotton coils, pole leads, collector rings, armature coils, and all types of windings. Excellent for use where baking is not practical.
9470	Black baking	Treating form and random wound coils, stators, armature and field coils and form windings requiring multiplicity of dips and bakes. Suited to high voltage machines when it can be well baked.
9564 and 1202	Clear air drying	Quick-drying varnish, suitable for treating small windings or as a finishing coat, particularly when baked. Not recommended for deep coils or uses where a thermo-setting type is needed. Good finish coat where resistance to moisture, acid, salt water and oil is desired, especially when baked. Often used as the final coat over other varnishes. G-E 1202 gives a faster air dry.

G-E Insulation Materials
Electrical Insulating Varnishes

G-E No.	Type of Varnish	Typical Uses
1673	Clear baking	Especially suited for treating all types of coils, windings, etc., as found in motors and transformers. Has good heat life and flexibility combined with excellent penetration and good moisture, acid, and oil resistance. Not recommended where high bonding strength at elevated temperatures is required. Where good hot bonding strength is necessary use G-E 9700 or 9700C.
9700 and 9700C	Clear baking	General-purpose, giving maximum protection. Treats all types of windings, rotors, stators, etc., except high-speed armatures. Can be used as packaged or can be thinned. Good bonding strength at elevated temperatures. G-E 9700 is medium viscosity, medium baking grade and G-E 9700C is low viscosity, fast baking grade.

Properties—General Electric Varnishes

G-E No.	9470	457	9700	9700C	9564	1202	1673
Specifications	Asphalt	Asphalt	Phenolic	Phenolic	Phenolic	Synthetic	Synthetic
Type of base	Drying Oil	Drying Oil	Drying Oil	Drying Oil	Drying Oil	Resin	Resin
Percent solids, Av.	50	38	50	50	52	50	50
Viscosity @ 25C, CP Av.	300	300	450	200	200	300	1100
Gravity at 21c, Av.	0.87	0.83	0.93	0.93	0.88	0.98	0.91
Flash Point, °F	100	0	80	80	100	80	100
Electrical properties							
Dielectric strength							
volts/mil.	2500	1200	2500	2500	1600	2500	2200
After 24 hrs. water immersion.	1600	400	1200	1200	600	600	900
Baking cycles, min. hrs.							
100C-212F	—	4-6	—	—	10-12	3-5	—
110C-230F	—	3-5	—	—	6-8	2-4	—
125C-257F	5-9	2-4	6-8	3-4	4-6	1-3	7-9
135C-275F	2-3	1-3	4-6	2-3	2-4	1-3	5-7
150C-300F	1-3	1-2	2-4	1-2	1-3	1-2	4-6
Air Drying Time, hours	—	2-2½	—	—	4-6	1-4	—
Thinner	Mineral Spirits	VM&P Nap.	Xylene, VM&P Nap. or Mineral Spirits	Xylene, VM&P Nap. or Mineral Spirits	Mineral Spirits	G-E 1500 or Xylene	Mineral Spirits

Glyptal Insulating Finishes

Glyptal Alkyd resin finishes used as protective coatings, insulating compounds and adhesives and are noted for their stability when exposed to heat, arcs, moisture, acid and oil.

Available in a variety of colors, and presents an attractive appearance, and provides rapid-drying, hard, glossy, durable surfaces which withstand oil spray and splash, weak acid and saline conditions.

Properties—Glyptal Insulating Finishes

G-E No.	Dri Film® 88 Water Repellent	1201	8001	7815
Specifications	Silicone	Synthetic resin	Synthetic resin	Synthetic resin
Type of base				
Percent Solids, Av.	10	59	58	44
Viscosity @ 25C, cp. Av.		325	675	500
Specific Gravity @ 21C, Av.	.80	1.17	1.08	0.97
Flash Point, °F	40	80	50	80
Electrical Properties				
Dielectric strength				
volts/mil. dry		1400	1400	1700
volts/mil. after 24 hrs. in water		350	350	700
Arc Resistance, sec.		480	480	240
Baking Cycles, min. hrs.				
100C (212F)	No baking	5-8	5-8	3-4
110C (230F)	required	4-6	4-6	2-3
125C (257F)		2-3	2-3	1-2
135C (275F)		1-2	1-2	1-2
150C (300F)		½-1½	½-1½	1-2
Air Drying Time, hrs.	1/6-1/3	2-8	2-8	1-4
Thinner	Toluene	G-E 1500	VM&P Nap.	G-E 1500

® Registered trade mark of General Electric.

G-E Insulation Materials

Varnished Cloths and Tapes

Due to their flexibility and high mechanical strength, they may be wound or wrapped tightly in place on many different devices such as cables, armature, field, transformer, and various types of coils. Their high dielectric strength, greater resistance to moisture, and superior heat-aging characteristics make them preferable to untreated fabrics.

The base cloth used in G-E tapes is selected for its high mechanical strength and controlled sizing content. This permits thorough penetration by the treating varnishes.

The varnishes are chemically inert in relation to the cloth to which they are applied, producing varnished cloth tapes which have high dielectric strength, permanent flexibility and high resistance to heat, oil and water.

Applications and Properties

G-E No.	Typical Uses	Color	Type	Thickness, Inches	Tensile Strength, Lb. Per Inch Width	Tearing Strength Crosswise, GMS Force	Dielectric Strength Short-time ASTM Average		Weight, Pounds Per Sq. Yd.
							25 C	75 C	
505	Wrapping motor coils; and general insulating use where a high dielectric strength straight cut tape is required and where oil resistance is not a factor.	Black	Straight	0.005	42	150	1500	1300	0.280
				0.007	53	199	1350	1250	0.434
				0.010	57	246	1250	1200	0.545
				0.012	60	280	1350	1250	0.635
510	Wrapping coils; insulating transformers; particularly advantageous for use in applications where varnished cloth is exposed to oil.	Yellow	Straight	0.005	40	—	1400	1200	0.285
				0.007	44	340	1400	1200	0.364
				0.010	50	342	1100	1000	0.610
				0.012	51	360	1100	1000	0.689
992	For insulating cable joints, coil black ends and irregular shapes.	Black	Bias	0.007	48	—	1250	950	0.412
				0.010	50	—	1400	1225	0.560
				0.012	50	—	1500	1250	0.690
1786	Same as No. 992 but where better resistance to oil is required or where greater abrasion resistance is desired.	Black	Bias	0.010	50	—	1400	1200	0.560
				0.012	50	—	1350	1200	0.690
991	Same as No. 992 but particularly useful where good oil resistance is required.	Yellow	Bias	0.007	45	—	1050	3900	0.400
				0.010	45	—	1250	1000	0.538
				0.012	45	—	1250	1100	0.635
634	An oil packed tape (but not vacuum processed) having a higher electrical factor of safety than No. 992. Used for insulating solid-filled joints in oil-treated paper or varnished-cloth insulated cables rated 23 kv and less.	Black	Bias	0.007	—	—	1200	1000	0.412
				0.010	—	—	1400	1200	0.560
				0.012	41	—	1400	1200	0.690
76510	Silicone rubber-coated glass cloth used on high temperature coils, wrappers, layer, phase insulation and as class II cable tape.	White	Straight	0.005	—	—	—	—	0.325
				0.007	—	—	—	—	0.470
				0.010	140	—	1000	1100	0.700
				0.012	—	—	—	—	0.830
76511	Silicone resin-coated glass cloth for general purpose up to 200 C—Better dielectric strength and oil resistance than 76510.	White	Straight	0.003	—	—	—	—	0.198
				0.004	—	—	—	—	0.268
				0.005	—	—	—	—	0.316
				0.007	—	—	1200	—	0.500
				0.010	—	—	1200	—	0.580
				0.012	—	—	—	—	—
76521	A varnished glass used as class B coil type, wrappers, phase and layer insulation.	Black	Bias	0.010	70	—	1800	1600	0.610
				0.012	—	—	1800	1600	—
76522	A varnished glass used as class B coil tape, wrappers, phase and layer insulation.	Black	Straight	0.007	—	—	—	—	—
				0.010	150	374+	2100	1900	0.570
				0.012	—	—	—	—	—
76528	A black varnished poly-glass cloth with the stretch of bias cotton and better humidity and heat aging properties. Used wherever bias cut cotton is used.	Black	Straight	0.012	44	—	1500	—	0.95

M-S-A All-Weather First Aid Kits

All M-S-A first aid materials for kits are packaged uniformly and to great advantage in the Type D System. This method employs cardboard packages of a standard unit size (or multiples of the unit size) for each type of dressing or treatment.

Each package contains one or more complete dressings or treatments for a single injury; each treatment is complete in itself, avoiding waste.

The unit packages fit like blocks in the cases, enabling rapid selection and use of the desired material, and simplifying refilling and maintenance.

All dressings are sterilized for instant use; all liquids are contained in hermetically-sealed ampoules or vials to prevent leakage or deterioration.

Kit cases are heavy-gauge steel, with welded rounded corners, durable blue metallic finish. Rubber gasket seals out dust and moisture. Have snap lock and carrying handle. Mounting brackets enable attachment to wall or vehicle. All packages extend above sides of case for easy removal.

Ten-Unit Kit



- Packages**
 1 1-in. compress bandage.
 1 2-in. compress bandage.
 2 1-in. adhesive bandages.
 1 1/8-oz. tube Foille for burns.
 1 Merthiolate Swabs.
 1 Ammonia inhalants
 1 10-in. triangular bandage.
 1 Tourniquet and forceps.
 Size of Kit: 7 7/8 x 5 1/2 x 2 1/2 in.

No. FA-12035—Weight Each 4 Lbs. Each **\$8.27**

Twenty-four Unit Kit



- Packages**
 3 4-in. compress bandages.
 3 2-in. compress bandages.
 3 1-in. adhesive bandages.
 2 10-in. triangular bandages.
 1 1/8-oz. tube Foille for burns.
 1 5/8-oz. tube Foille for burns.
 2 Absorbent gauze compresses.
 2 Merthiolate Swabs.
 1 Ammonia inhalants.
 1 Ammonia ampoules.
 1 Wire splint.
 1 1-in. gauze bandage.
 1 Paper cups.
 1 Tourniquet and forceps.
 Size of Kit: 9 1/4 x 10 x 2 1/2 in.

No. FA-12037—Weight Each 9 Lbs. Each **\$16.37**

M-S-A Snake Bite Outfits



This outfit contains selected and tested materials for the treatment of snake bite. All in a sturdy plastic case 4 x 2 1/4 x 1 in.

- Contents include:**
 Plastic suction pump for removing venom.
 Lancet for enlarging wound.
 Tourniquet. Antiseptic swabs for painting around wound.
 Ammonia inhalant.

All in 1 1/2-unit Type D packages. With instructions.

No. FA-12619—Weight each 4 oz. Each **\$3.00**

M-S-A Pocket First Aid Packets



Small

A metal hinged-cover box 4 x 2 1/2 x 7/8 in. containing a handy assortment of first aid materials for minor injuries—fits in the pocket.

Contents include:

- Ammonia inhalants.
- Merthiolate applicator.
- Adhesive bandages.
- Compress bandages.
- Foille for burns.

No. FA-12260—Weight Each 3 Oz. Per 100 **\$98.00**

M-S-A Poison Ivy Wash

Effectively relieves irritation and dries up inflammation if applied in early stages. Type D package of six.

No. FA-2682—In 4 cc. Vials. Each **\$0.57**

M-S-A Creosote-Burn Wash

For the effective treatment of burns or irritation of the skin caused by contact with creosote from line pole, ties and creosoted timber. Type D package of six.

No. FA-2604—In 1 cc. Vials. Each **\$0.57**

M-S-A Foille For Burns

A modern treatment for burns; for emergency and hospital use. Rapidly anesthetizes injured tissues with characteristic absence of infection. Aids rapid healing, lessens contractures and reduces scarring.

Can be applied directly to injured area at scene of accident and does not require removal when treatment is continued by physician. Provides quicker emergency aid with marked control of pain and resultant shock. Type D package of two.

No. FA-12560 In 5/8-oz. Tubes. Each **\$0.53**

Note—Available in emulsion or ointment; and in larger packages.

Salisbury Marshall Tagging Devices

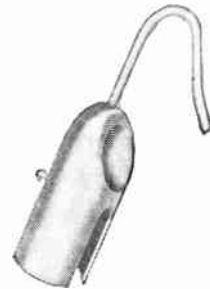

For tagging out open disconnect switches. "Hold Cards" can be placed directly at source of the circuit's energy and thus prevent anyone from inadvertently closing the switch.

Equipped with rubber spear-shaped button to hold as many as five cards. A slot through one side of the cup accommodates the pulling lug of the switch pole.

Marshall Tagging Device. Each **\$1.30**

Salisbury Static Resisting Linemens' Coats



Special construction coat that retards static tingling at neck or wrists when garment is used during wet weather on work adjacent to energized conductors.

This safety factor plus comfort and strength makes coat popular with linemen and troublemen. Recently redesigned; now lighter in weight and more pliable, collar less rigid and cuffs are larger with an accordion pleat construction for easier insertion of glove gauntlets.

No metal used in construction of this coat. Button fastened. Material is a bright yellow Neoprene surfaced on cotton sheeting. Will not crack or peel or stiffen up in cold weather.

Guaranteed to be free from all defects in material or workmanship.

Length 47 inches. Weight 4 lbs. Two-piece suits instead of full length coats as rain gear is also available.

Coat Size.....	36 to 46	48	50
Each.....	\$18.70	\$19.20	\$19.70

Static Resisting All Rubber Line Suits, Jackets and Pants

Small, Medium, Large.....	Per Suit	\$25.10
Extra Large, per unit.....	Additional	1.00

Salisbury Curved Jaw Clamp Pins

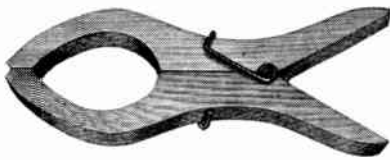

Jaws open wide enough to clamp a blanket over line hose, the arm of an insulator hood or even a cross arm and yet grip firmly when used simply to hold the edges of a blanket together.

Strong spring provides lasting hold and steel washer is inserted to prevent jaws from racking. Constructed from oiled oak and sanded for a sliver free finish.

No.	Length, in.	Opening Jaw, in.	Per Dozen
20	8 1/2	4 3/4	\$6.80

Salisbury Linemen's Rubber Sleeves Curved Elbow

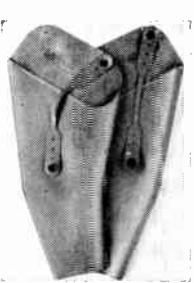

Full length sleeves used to protect electrical worker's arms and shoulders from accidental contact with energized equipment.

Seamless new curved elbow style is comfortable to wear and convenient to use.

Available in either the "regular" or the new "light" weight.

Two adjustable rubber straps are furnished with each pair. Each sleeve tested at factory at 10,000 volts for three minutes. Packed 1 pr. in carton. Approx. ship. wt., 3 lbs.

Curved Elbow Sleeves

No.	Type	O.A. Lgth., in.	Underarm Lgth., in.	Color	Per Pair
75	Regular	26 1/2	20	Maroon	\$10.50
75-41	Light	26 1/2	20	Black	10.50
85	Regular	28	20 1/2	Maroon	10.50
85-41	Light	28	20 1/2	Black	10.50

Straight Pattern Sleeves

40	Regular	25	17 1/2	Maroon	\$10.50
40-41	Light	25	17 1/2	Black	10.50
45	Regular	27	19	Maroon	10.50
45-41	Light	27	19	Black	10.50
50	Regular	27	18	Maroon	10.50
50-41	Light	27	18	Black	10.50

Salisbury Linemen's Rubber Gloves Curved Finger Style

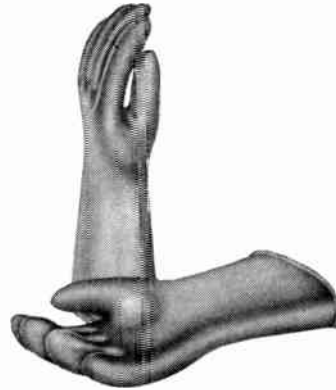

The curved finger style offers linemen the advantage of greater comfort and convenience. There is no surplus rubber to "bunch" in the palm and thus permits a better grasp on tools.

The curved shape of the fingers is less conducive to hand fatigue. Standard length of gloves 14-in.; also available in 16 and 18-inch lengths.

Sizes are 9, 9 1/2, 10, 10 1/2, 11, 11 1/2 and 12.

Color: Maroon. Black available.

All gloves are steam cured, seamless and form fitting, with finger lengths and widths adjusted to best meet average conditions. Guaranteed to meet A.S.T.M. specifications.

No.	Class	Voltage	Per Dozen Pairs		
			14 In.	16 In.	18 In.
100-10	Class 1	10 K.V.	\$ 93.00	\$ 96.96	\$114.12
100-15	Class 2	15 K.V.	104.28	106.92	124.68
100-20	Class 3	20 K.V.	114.12	117.48	132.60

All Sizes 9 to 12 Packed one Pair to box.

Note: When ordering specify catalog number, size and length desired.

Salisbury Gauntlet Protector Gloves



Made from specially tanned Grade "A" buffed leather. They remain soft and pliable under all conditions.

Solid nylon thread used throughout. Extra wide reinforcement at thumb seam.

Equipped with leather pull straps and self engaging buckle to tighten at wrist. Maroon color.

Average weight 1/2 lb. per pair. Semi-gauntlet and hand top styles are also available.

Semi-Gauntlet Style

No.	Sizes		Per Dozen
	9, 9 1/2, 10	10 1/2, 11	
118-C	9, 9 1/2, 10	10 1/2, 11	\$48.60
120-C	10 1/2, 11	11 1/2, 12	49.56
140-C	11 1/2, 12		50.52

Full Gauntlet Style

122-C	9, 9 1/2, 10	\$46.92
124-C	10 1/2, 11	47.88
144-C	11 1/2, 12	48.84

Salisbury Rubber Cuff Protector Gloves



To be worn over rubber gloves, protecting them from sagging and abrasive wear.

Glove part is Grade A buffed leather, remaining soft and pliable under all conditions.

Cuffs are made of fabric-inserted voltage resisting rubber, extending to 1/4-in. of top of rubber gloves.

These protector gloves give much greater safety to the lineman, and result in a substantial saving in rubber glove cost.

Regular style has tapered cuff. Flared style cuff can be furnished.

No.	Sizes		Per Dozen
	9, 9 1/2 and 10	10 1/2 and 11	
130	9, 9 1/2 and 10	10 1/2 and 11	\$60.24
132	10 1/2 and 11	11 1/2 and 12	61.08
134	11 1/2 and 12		61.80

Salisbury Bags for Linemen's Gloves



Made of tight-woven 12-oz. duck with non-raveling edges. They are water-proof and very durable, 8-in. wide and large enough to hold one pair of rubber gloves together with leather protector gloves.

The 17- and 19-in. length bags made with expansion sides. A snap hook and "D" ring attached to each bag.

No.	Lgth., In.	For Glove Size, In.	Wt., Lbs.	Each
35-15	15	14	3/4	\$2.50
35-17	17	16	1	2.95
35-19	19	18	1 1/4	3.15

Other lengths furnished special orders.

Salisbury Protective Bags for Linemen's Sleeves

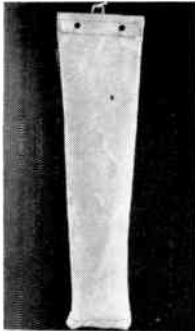

Sleeve bags for protection of sleeves while in field storage.

Full length tube shaped bag accommodates one pair of sleeves when rolled lengthwise. Ring attached for hanging on truck. Top opening 7 1/2 inches, length 29 inches.

Description	Size, In.	Each
Tube Shape	29	\$1.90
Roll-up	29	3.75
Combination	16	3.75

Salisbury Rib-Grip Rubber Insulator Hoods

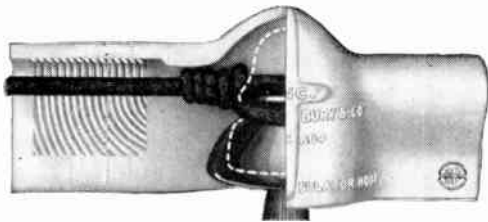

Used in conjunction with line hose to cover tie wires and conductors as they pass the insulators, completely covering this hazard point in a close-fitting, positive manner.

Require no accessory attachments to hold them in place; securely lock themselves to the under side of the insulators and cannot open, turn or become accidentally dislodged.

Easily installed and removed. Can be placed from a position below the cross arms as well as from above. May be used on double arm as well as single arm construction.

Made in new rib-grip style to firmly hold line hose.

Type Hood	Lgth., In.	Hgt., In.	Wt., Lbs.	Each
Universal	14 3/4	6 1/4	5	\$7.50
Style J	16	6 1/4	6 1/2	8.00

For Telephone Use

Telephone and telegraph companies use a special hood that is shaped to fit telephone style insulators. As it is used on single arm poles only, both extending arms of the hood are of the same diameter and will grip the 1/4-in. size line hose. Rubber Insulator Hoods.....Each \$6.00

Salisbury Cable Bandages



Rubber cable bandages are for general use as temporary insulation.

Flexible, unusually strong, made of highest grade pure gum rubber.

Furnished in rolls.

Lgth., In.	Width, In.	Wt., Oz. Per Roll	Per Roll
14	3	10	\$2.10
14	4	12	2.75

Salisbury Rib Grip Rubber Line Hose

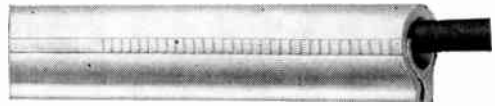

Rib-Grip line hose furnished in three sizes and in three lengths. When ordering specify both the inside diameter and the length of line hose desired also whether it is to be connector end or straight type.

Used for protection from live wires by completely surrounding the wire with a substantial wall of voltage resisting rubber. Snaps on wire and is self-locking. Stays secure even under bends.

I.D. In.	3-Ft. Length		4 1/2-Ft. Length		6-Ft. Length	
	Wt., Lbs.	Each	Wt., Lbs.	Each	Wt., Lbs.	Each
1	2 3/4	\$3.90	4 1/2	\$5.55	5 3/4	\$7.30
1 1/4	3 1/2	5.30	5 1/4	7.70	7 1/4	10.10
1 1/2	5 1/2	6.80	6 3/4	9.95	8 3/4	13.10

Note: Plain rubber line hose available.

Salisbury Rib-Grip Connector End Line Hose



Standard line hose with connector end. The connector end overlaps adjoining line hose, forming continuous, unbroken protective line. Also used to overlap ends of line hose separated by bulky joints.

The adapter at one end of Connector End Type Line Hose is additional to the stock lengths of straight line Hose; but for convenient reference, the sizes are designated the same although the actual overall length is 8-in. longer.

I.D. In.	3-Ft. Length		4 1/2-Ft. Length		6-Ft. Length	
	Wt., Lbs.	Each	Wt., Lbs.	Each	Wt., Lbs.	Each
1	4 1/2	\$6.70	5 3/4	\$8.80	7 1/2	\$10.90
1 1/4	5 1/2	10.90	7	13.50	8 3/4	16.10
1 1/2	6 3/4	14.00	9	17.30	11 1/4	20.50

Note: Plain Connector end line hose available.

Rib-Grip Line Hose Connectors

This connector overlaps line hose and is designed for use where two pieces of line hose meet. It prevents the pieces from slipping apart and eliminates possibility of conductor being exposed between adjoining ends. Also used to overlap line hose at bulky joints. Length 12-in.

Type	Description	Each
Line Hose Connector	For 1-in. Line Hose	\$3.00

Salisbury Line Hose Bag



For raising Salisbury line hose up the pole. Will hold 8 pieces of 3 or 4 1/2-ft. lengths of 1-in. diameter.

Can also be used to raise protective blankets. Made of 18-oz. duck. Bottom is hardened and water-proofed leather, reinforced with 3-in. cuff of harness leather.

Top held in form with non-metallic ring. Heavy rope handle is spliced through leather reinforcements.

Weight, 2 1/4 lbs.

Description	Each
Line Hose Bag	\$7.00

Klein Rubber Glove Pouches



Made of leather for carrying rubber gloves (folded).

Equipped with snap and ring for attaching to body belt.

No.	Size, In.	Each
5120-15	7½ x 15	\$4.65

Chance Insulator and Conductor Hoods

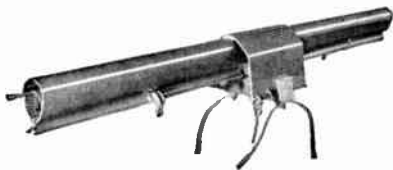

Made of formica, equipped with stops that lock them securely together. Each cover is locked on the conductor by a spring hook. Ropes on the hood tie under cross arm.

Designed for covering distribution lines, and underbuild lines that hamper getting to and working on the lines above. Recommended for use in place of rubber.

Hoods and covers are tested to withstand 34.5 Kv. 48-in. long covers can be swung from the hood at a 15-degree angle. Both hood and cover will fit over all straight armor rod clips. Both have aluminum fittings for installation with Grip-All Clamp Sticks.

No.	Description	Wt. Lbs.	Each
M4912	3-piece set for single arms, 2 conductor covers & 1 insulator hood	15¾	\$113.50
M4912-1	Conductor cover	6¾	42.50
M4912-2	Insulator Hood	3¾	28.50
M4912-3	4-piece set for double arms, 2 conductor covers & 2 insulator hoods	19¼	142.00

Salisbury Switchboard Rubber Matting

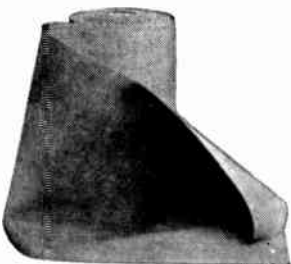

Provides insulation when placed before switchboards or at any location where protection from a possible ground is necessary. It is solid rubber with a corrugated surface. Meets A. S. T. M. specifications. Weight, 15 lbs. per square yard.

Widths, 21, 30, 36-in. Thickness, ¼-in. Lengths, up to 75 ft.

Prices on Application.

Salisbury Snap Button Blankets and Jackets

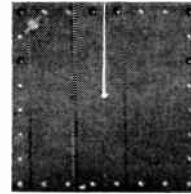

Will fold, wrap or hang in any position; particularly useful in covering secondary racks, dead ends, cut outs, pot heads, arresters and similar equipment, or for use in station and underground work. Because of the button method of fastening these blankets can be fixed in practically any shape. Buttons hold blanket edges fast and prevent opening or shifting of its position. Thickness, ½-inch.

With Slot To Center			
Size In.	Description	Wt., Lbs.	Each
22 x 22	Jacket	2¾	\$ 5.00
Without Slot To Center			
36 x 36	Blanket	6¾	13.60

Salisbury Protector Blankets



All rubber. It is light in weight, extremely flexible and yet tough enough for the hardest kind of usage. Blankets are ½-in. thick and have beaded edges. Two sizes, either plain or with six reinforced eyelets to the blanket.

No.	Size, In.	Wt., Lbs.	Eyelets	Each
300	36 x 36	6½	No	\$12.50
300-E	36 x 36	6¾	Yes	13.00
400	27 x 36	5	No	10.10
400-E	27 x 36	5¼	Yes	10.60

Salisbury Slotted Rubber Blankets

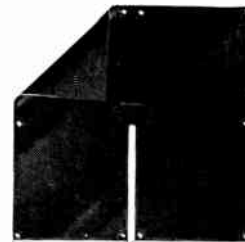

A blanket of larger than the standard size and provided with a slot from one edge to center has been found especially useful in covering the electrical hazard usually present around secondary racks.

By centering this blanket over the top wire, the slot permits the divided side to hang down as a curtain on the pole side of the secondary lines. The opposite side either hangs down or is draped over the service wires. As all parts of the rack, as well as the wires, are adequately covered, the workmen are well protected when climbing past, working above or closely adjacent to this type of construction. Size 46 x 46 x ½-in. Weight, 12¾ lbs.

Slotted Rubber Blanket..... Each \$23.00

Salisbury Lineman's Blanket Cannisters



Rubber blankets should not be folded when in storage. Folding will damage the blanket and considerably shorten its life. These cannisters, holding rolled blankets, provide safe storage and convenient and safe transportation. They are made of strong galvanized iron, with caps of same material fastened to cannister with a chain.

No.	Length, In.	Oiam., In.	Wt., Lbs.	No. Blankets Held	Each
1	37	4	4 1/2	1	\$5 60
2	37	5	6	2	6 00
3	37	6	7	3	6 60
4	37	7	8 1/2	4	7 20
5	37	8	9 3/4	5	9 00
6	37	9	11 3/4	6	9 25

General Machine Pressure Guns

Type B

For injecting plugging compound into cable for making pressure plugs.

Screw-actuated cup type, operated by a ratchet wrench. Handle provided for holding gun.

Both end caps removable for ease in loading and cleaning. Replaceable nozzle. Length 7 1/4-in.; diameter of caps 2 5/8-in.

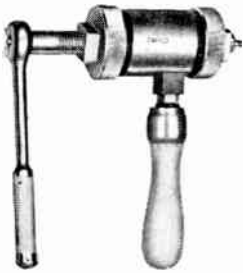

No. 7413—Wt. 4 lbs. Prices on application

General Machine C Gun



For injecting plugging compound into cables for making pressure plugs. It is a screw-actuated cup type, operated by a ratchet wrench. Replaceable nozzle with 1/8-in. pipe thread.

The "C" does not supersede the type "B" gun. Length 8-in. Wt. 2 lbs.

No. 7534 Price on application

General Machine Pressure Gun Cleaning Rod



For cleaning the orifice of Type B pressure gun nozzle and for mixing plugging compound in the gun barrel.

Consists of flat steel blade with 1/8-in. diameter rod at one end for inserting into nozzle. Blade width 1/2-in.; overall length 6 1/8-in.

No. 7415—Wt. 1/4 lb. Prices on application

General Machine Pressure Gun Holders

For Use with Type B Guns



Hold gun in a vertical position for loading and mixing plugging compound in the gun barrel.

Frame has four prongs to prevent holder from slipping when secured to pole or other support by spring-tensioned chain, 36-in. long.

Size 3 3/8-in. long, 2 5/16-in. high, 3-in. deep.

No. 7414—Wt. 3/4 lb. Prices on application

General Machine Pull Finder

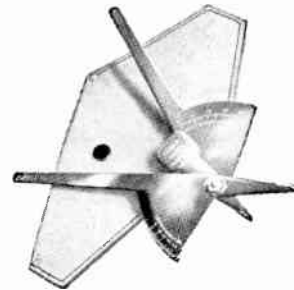

For determining the "pull" on corner poles and for bisecting the corner angle to facilitate locating guy wire. It consists of a prod which screws into the corner pole and supports two pivoted sighting arms. A pointer on one arm indicates the pull on a scale inscribed on the other arm. A scale on the first arm and an index mark on the second arm enables one arm to be set to point along the bisecting line of the corner angle. A fine-grain cowhide carrying case is provided with each pull finder.

Finish: Metal parts brass, heavily nickel plated and polished. Weight, 1/2 lb. including case.

No. 7200 Price on Application

General Machine Pressure Plug Flanges



For attaching the threaded nozzle of pressure gun to lead-covered cable.

Consists of a body for soldering to cable sheath and a screw for sealing the hole in the body.

Length 5/8-in.; diameter 7/16-in.

Packed 50 flanges and 50 screws per box.

No. 7418—Wt. 1 lb. Prices on application

General Machine Flange Clamps



Type C

For holding pressure plugs in place while soldering to cable sheath.

One jaw of spring clip has pilot for holding and centering flange over hole in sheath.

Length 4-in.; height 2-in.; width 1 1/8-in.

No. 7419—Wt. 1/2 lb. Prices on Application

General Machine Contactor Terminals

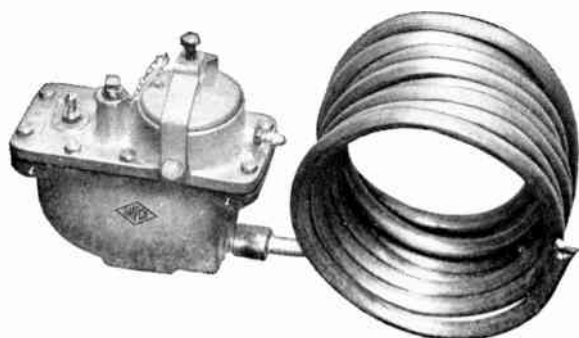

Type T

Used on cables maintained under gas pressure where talking facilities are required. Contactor mechanism and a terminal for the alarm and talking pair are contained in a metal housing with an external adjustment screw to secure desired operating pressure.

Terminal chamber sealed against entrance of gas from the main housing by means of a fused glass-to-metal seal. A pressure-testing valve is provided for testing operating pressure and another one for flash-testing terminal cover to determine the possibility of the entrance of any moisture.

Factory adjusted at 17.7 p.s.i. at 60°F. Size, approximately 8 1/2 x 8 1/2 x 4-in. plus 15-ft. lead stub.

No. 6766—Wt. complete 27 lbs. Price on Application

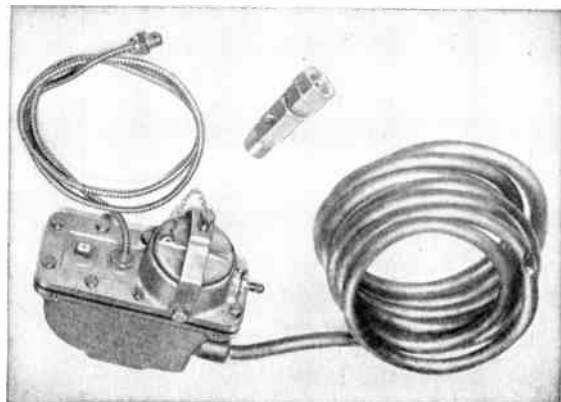

Type E—High Pressure

For use in connection with supplementary gas reservoirs to operate an alarm when auxiliary gas supply falls to a predetermined value.

Have a relief valve in housing to prevent damage to apparatus and cable should a leak occur in the high-pressure Bourdon tube.

Factory adjusted at 800 lbs., including 15-ft. lead stub and 4-ft. capillary tube. Approximate size, 8 1/2 x 8 1/2 x 4-in. plus stub.

No. 7229—Wt. complete 28 lbs. Price on Application

General Machine Pressure Contactors

Type G



For use at contactor points on cables maintained under gas pressure. Supersede Type C; have adjustment screw to secure desired operating pressure outside the brass casting which houses the Bourdon tube and contact spring assembly. Factory adjusted at 17.7 p.s.i. at 60° F. as standard.

Furnished with 15-ft. stub containing two conductors for bridging to alarm pair of cable.

Approximate size 6 x 4 1/2 x 2 1/4-in. plus stub.

No. 7442—Wt. 20 lbs. Price on application.

Type H



For use on cables maintained under gas pressure; designed for installation within a cable sleeve. Pressure-operated switches of the Bourdon tube type; adjustment switch provided outside the brass case that may be locked at the desired operating pressure. Factory adjusted at 20.7 p.s.i. at 60° F. as standard for underground and buried cables.

Two insulated leads from the contact springs extend through the case for bridging to the alarm pair of the cable.

Size 1 1/4 x 3 3/4-in.

No. 7443—Wt. 1 lb. Price on application.

General Machine B Pressure Testing Kits



Complete equipment necessary for cable pressure testing, in convenient carrying case.
 Consists of apparatus case, testing clamp for temporary reading points, two-gauge regulator for use in charging cables with dry nitrogen for testing, cable drill for sheath and sleeves, regulator and acetylene torch wrench, 2-in. pressure gauge for approximate measurements, valve repair tool and 8-ft. hose assembly for connecting regulator to testing valve.
 No. 7267—Wt. complete 18 lbs.....Price on Application

Pressure Testing Accessories

Flanges

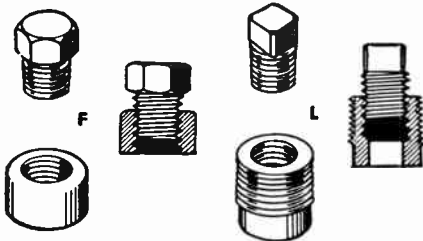

Consist of body to be soldered to cable and plug for sealing hole.
 Bodies and plugs available in Type F for Type F pressure-testing valves and Type L for installing pressure testing plugs.

No.	Type	No. of Bodies	No. of Plugs
6808F	F	25	30
6808L	L	6	7

Valve Stem and Caps

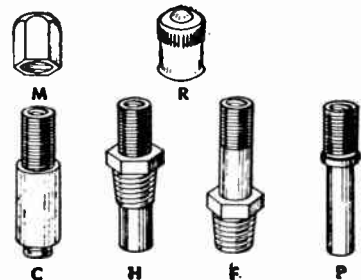

Provide pressure measuring and gas admission points for cable testing.

Available in Types C, F, H and P; have valve cores with stainless steel springs; furnished with stems and cores assembled.

No.	Type	Ctn. Qty.
6914C	C	5
6914F	F	5
6914H	H	5
6914P	P	5

Prices on application.

General Machine Pressure Testing Accessories

B Flow Indicators

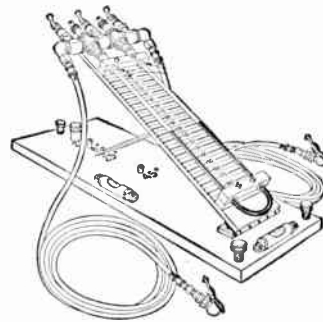

For determining direction of flow of gas for locating leaks in cables maintained under pressure. Can be used to show quantitatively the pressure difference between two cable points. Consists of alcohol manometer mounted on hinged aluminum plate and base, wood carrying case, and two 10-ft. lengths of rubber hose with snap-on chucks for connecting to pressure testing valves.

No. 7291—Wt. 21 lbs.....Price on Application

Pressure Testing Ells



For use in soldering 1/4-in. i.d. lead pipes to lead covered cables. Made of seamless copper tubing, tinned for soldering.

Length 1 5/8-in.; height 1/2-in. Furnished 10 in a package.

No. 6817.....Price on Application

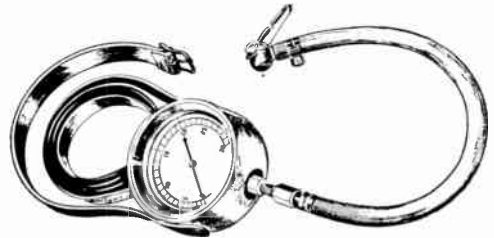

Portable Pressure Testing Gauges

For use where more accurate pressure measurements are necessary. Gauge has a 3 1/2-in. dial. Graduated from 0 to 30 lbs. in 0.2 lb. steps. Complete with 18-in. rubber hose and leather carrying case with shoulder strap.

No. 6215.....Price on Application

General Machine Bypass Valves

Type B



For use in connection with pressure testing work on telephone cables where it is desirable to isolate a portion of the gas pressure system for leak locating purposes.

When closed, valve should withstand 25-lb. gas pressure; when open, valve will allow an uninterrupted flow of gas.

Main construction of brass with exposed parts tin-coated. Size: 1 1/16-in., 2-in. wide.

No. 7050—Wt. 1/2 lb.....Price on Application

General Machine B Desiccant Injectors



Aluminum body injector with brass fittings.
Used with standard 160-gram desiccant can.
Compressed air, applied to tank valve, forces granules of desiccant into cable joints.

No.	Description	Wt. Oz.
7014	160-gram can	
7361	Injector	2

Price on application

Dillon Wire Stringing Dynamometers

Model "AN"



This traction type instrument is widely used for placing conductor, strand and guys at correct tension. It indicates load applied to new lines going up or can be used to check tension in old lines long standing.

Uses no springs or hydraulic pistons. Scientifically designed on cantilever beam principle and individually calibrated for greatest possible accuracy. Compact, 5 in. dia. dial is easy to read even from distance. Red maximum pointer remains at peak load until manually reset.

Dial protected by thick, shatterproof crystal. Each unit furnished with set of alloy steel shackles and pins. All capacities will sustain substantial accidental overloads without injury to calibration. Extremely high safety factor. No levers to adjust. No charts to refer to. All loads are read directly on the face of the dial the instant applied. Strong steel storage case included at prices shown.

Net wt. with shackles and pins: 8½ lbs. Gross wt.: 12½ lbs.

Cap. Lbs.	Scale Division, Lbs.	Each	Cap. Lbs.	Scale Division, Lbs.	Each
500	5	\$140.00	15000	125	\$210.00
1000	10	140.00	20000	250	250.00
2500	50	140.00	30000	200	575.00
3500	50	140.00	40000	200	625.00
5000	50	160.00	50000	250	690.00
7500	50	170.00	100000	500	999.00
10000	100	180.00			

Chance Telefaults



A compact instrument that will exactly locate shorts of all kinds, damp spots, crosses, grounds, split pairs — in fact every kind of cable trouble except "opens."

Very easy to operate — uses only one dry cell battery (Battery not included).

Because of the inductive field created it does not "noise" up other pairs.

With the instrument connected, the exploring coil is moved along the cable until a point is reached where the woodpecker tapping tone cannot be heard in the earphone, which indicates the exact location of the fault. The woodpecker tapping tone is very distinct and cannot be confused with other inductive noises. Maximum voltage under 5 volts.

Expertly constructed of finest material obtainable for the purpose. Hardwood, nicely finished. Size: 4 x 7¾ x 10-in.

No.	Description	Each
1.	Telefault, complete with Coil, Cord and Receiver: Weight 15 lbs.....	\$86.00
	Extra Exploring Coil only; Wt. 2 lbs.....	21.15
	Extra Receiver only; Wt. 2 lbs.....	9.25

Chance Teleheight

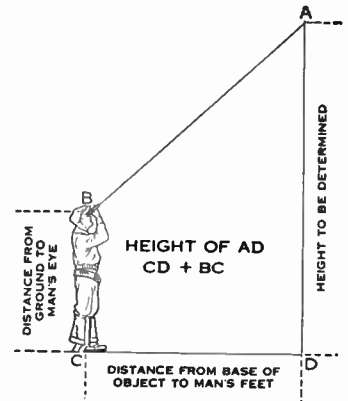

This handy little instrument will save valuable time in quickly and accurately figuring heights of poles, trees, wires, buildings or other objects. No moving parts. Eliminates guessing.

Used by power companies, municipalities, electrical contractors, telephone and telegraph companies, and railroads.

Highly recommended for appraisal work. Real estate men use them for figuring cubical contents of buildings.

Finest quality materials and workmanship. Complete with leather carrying case. Size: 1 x 2¼ x 5¼-in.

No. CW—Weight Each 1 lb.....Each \$13.80

Chance Safety Pole Guards



Protects linemen from shock by preventing the power line pole from touching energized lines when being raised or lowered through them. Safe to remove or replace poles from hot lines up to 45 kv. between phases. Easily assembled and disassembled. Attaches to poles ranging in diameter from 6 to 12-inches.

No.	Length Ft.	Approx. Wt., Lbs.	Each
M4810	8	22	\$61.50
M4810-1	10	26½	71.50
M4810-2	12	31	82.00

Chance Hot Line Auxiliary Arm Tool Sets

For Use on 3-Phase Circuits through 15,000 Volts

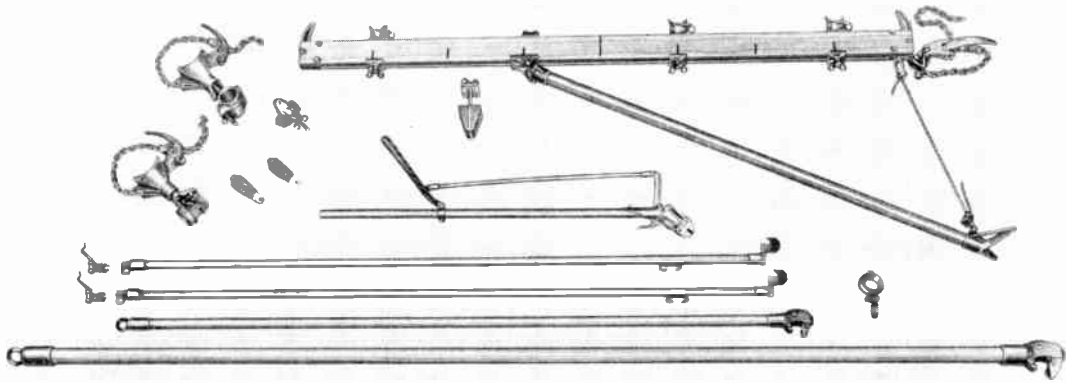

Contain the essential tools for working straight rural line construction. Fittings are heat treated aluminum, minimizing weight for easier handling

Laminated poles and auxiliary crossarm are of Sitka spruce, tested to withstand 75,000 volts per foot. Durable, weather-proof, canvas tool bags, for sets or individual tools are available. Poles are plastic protected.

No.	Quantity	Description	Each	Bag No.	Each
M4800-10	.	Side Arm Tool Set Complete with Hand Tools.....	\$363.30	P630-18	\$60.00
M4801-10	.	Side Arm Tool Set Less Hand Tools.....	275.75		
M4800-18	1	Wire Tong Arm Stirrup.....	7.00		
M4800-1	1	Auxiliary Cross Arm.....	92.25		
M4741-1	1	Wire Tong Saddle Pole Clamp (1½-in.).....	9.00		
M4740-18	2	Wire Tong Saddle with 2½-in. Pole Clamp and 4-in. Extension.....	42.25		
M4657-1	1	Wire Tong (2½-in. x 12-ft.).....	62.00		
M4655-2	1	Wire Tong (1½-in. x 8-ft.).....	32.25		
M1729-1	1	Wire Tong Band (2½-in.).....	11.00		
Hand Tools					
M4455-69	2	Univ. Rotary Prong Tie Stick Head.....	6.50		
M1871-6	1	Insulated Lever Wire Cutter (6-ft.).....	31.00		
M1855-26	2	Rotary Blade Tie Stick with Univ. Head (8-ft.).....	22.75		

Chance Rigid Auxiliary Arms

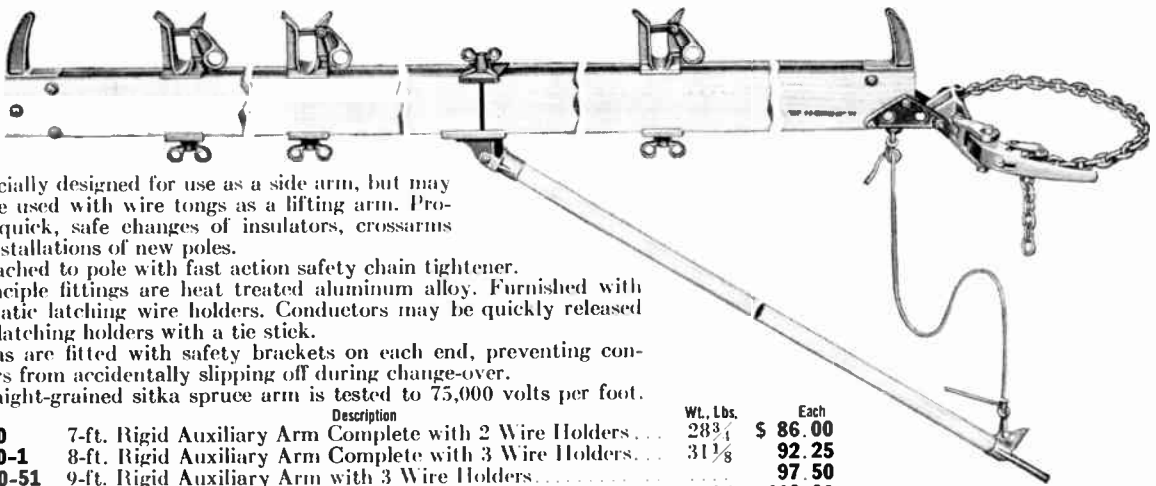

Specially designed for use as a side arm, but may also be used with wire tongs as a lifting arm. Provides quick, safe changes of insulators, crossarms and installations of new poles.

Attached to pole with fast action safety chain tightener.

Principle fittings are heat treated aluminum alloy. Furnished with automatic latching wire holders. Conductors may be quickly released by unlatching holders with a tie stick.

Arms are fitted with safety brackets on each end, preventing conductors from accidentally slipping off during change-over.

Straight-grained sitka spruce arm is tested to 75,000 volts per foot.

No.	Description	Wt., Lbs.	Each
M4800	7-ft. Rigid Auxiliary Arm Complete with 2 Wire Holders....	28¾	\$ 86.00
M4800-1	8-ft. Rigid Auxiliary Arm Complete with 3 Wire Holders....	31½	92.25
M4800-51	9-ft. Rigid Auxiliary Arm with 3 Wire Holders.....	33	97.50
M4800-2	10-ft. Rigid Auxiliary Arm with 3 Wire Holders.....	33¾	110.00

Auxiliary Arm Attachments

No.	Description	Weight	Each
M4800-11	Wire Holder.....	1 lb., 10 oz.	\$6.75
M4800-16	Wire Holder Tong Attachment.....	1 lb., 9 oz.	8.25
M4800-18	Wire Tong Arm Stirrup.....	2 lbs.	7.00
M4800-17	Dual Auxiliary Arm Clamp Attachment.....	1½ lbs.	5.90

Chance Hot-Line Dual Arm Tool Sets

For Use on 3-Phase Circuits through 15,000 Volts

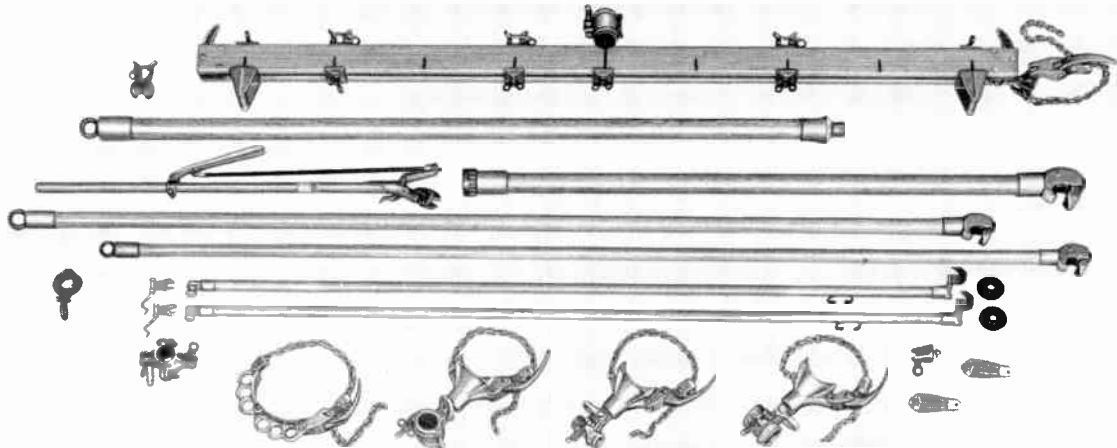

The majority of rural line construction can be maintained with this set.

Designed primarily for work on delta or four-wire grounded neutral systems.

Fittings are heat treated aluminum for ease of handling. Laminated Sitka spruce poles, tested 75,000 volts per foot. Bags available for set or individual tools. Poles are plastic protected.

No.	Quantity	Description	Each	Bag No.	Each
M14800-15	.	Set Complete with Hand Tools.....	\$504.50	P630-20	\$60.00
M14801-15	.	Set Less Hand Tools.....	413.00		
M14800-9A	1	Dual Auxiliary Arm.....	101.65		
M14740-3	1	Wire Tong Saddle with 1½-in. Pole Clamp.....	31.50		
M14740-14	1	Wire Tong Saddle Clevis.....	7.50		
M14740-18	2	Wire Tong Saddle and 2½-in. Pole Clamp with 4-in. Extension.....	42.25		
M14657-5	1	Spliced Tong (2½-in. x 16-ft.).....	83.25		
M14656-1	1	Wire Tong (2-in. x 10-ft.).....	46.25		
M14655-3	1	Wire Tong (1½-in. x 10-ft.).....	34.75		
M1846	1	Rope Snubbing Bracket.....	18.50		
M1729-1	1	Wire Tong Band (2½-in.).....	11.00		
M1728-5	1	Wire Tong Pole Clevis.....	16.75		
Hand Tools					
M13002	2	Hand Guard for 1¼-in. D. Pole.....	2.10		
M14455-69	2	Univ. Rotary Prong Tie Stick Head.....	6.50		
M1871-6	1	Lever Wire Cutter (6-ft.).....	31.00		
M1855-26	2	Rotary Prong Tie Stick with Univ. Head (8-ft.).....	22.75		

Chance Dual Auxiliary Arm

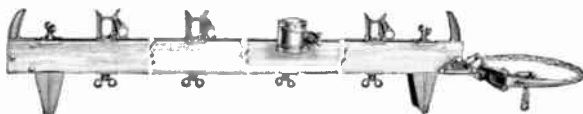

For lifting or holding conductors away from working area.

Lever operated chain tightener provides quick, safe attachment to pole.

Wire tongs used with arm for lifting or bracing.

9-ft. Dual Auxiliary Arm, complete with 3 wire holders, 2 wire tong stirrups, wire tong clamp (2½ in.), wire tong clamp attachment, wire holder tong attachment.

No.	Description	Wt., Lbs.	Each
M14800-9A	Dual Auxiliary Arm	31½	\$101.65
M14800	Rigid Arm Brace	10	86.00

Call Graybar FIRST For . . .

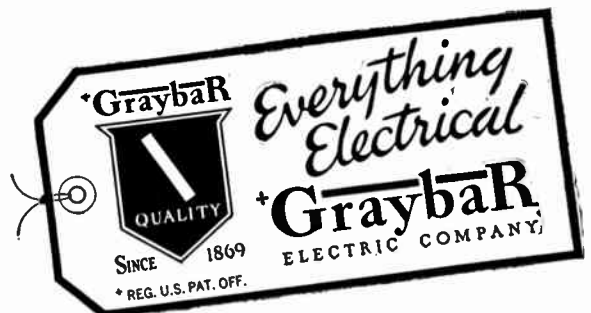

Chance Wire Tongs and Fittings

For maneuvering and holding live conductors clear of working area or for moving conductors to secure positions on auxiliary arms.



Have aluminum fittings for lightweight, easy handling. Jaws have wide bearing surface for protection to conductors. Poles are laminated Sitka spruce of carefully selected aircraft grade. Kilm dried and plastic coated. Poles are tested to withstand 75,000 volts per foot.

No.	Pole Diam. Inches	Pole Length Feet	Approx. Overall Length	Wire Size Inches		Approx. Weight		Each
				Min.	Max.	Lbs.	Oz.	
†M4655-2	1½	8	8'-7"	0.16	1.50	7	9	\$32.25
†M4655-3	1½	10	10'-7"	0.16	1.50	8	9	34.75
M4656	2	8	8'-8"	0.16	1.50	9	10	42.75
M4656-1	2	10	10'-8"	0.16	1.50	10	13	46.25
M4656-3	2	12	12'-8"	0.16	1.50	12		49.50
M4657	2½	10	10'-8"	0.16	1.50	17	8	57.65
†M4657-1	2½	12	12'-8"	0.16	1.50	19	10	62.00
M4657-2	2½	14	14'-8"	0.16	1.50	21	10	66.75
M4657-7	2½	8	8'-8"	0.16	1.50	15	6	49.00
M4658	3	10	10'-9"	0.16	1.50	20	10	68.25
M4658-1	3	12	12'-9"	0.16	1.50	23	6	74.95
M4658-2	3	14	14'-9"	0.16	1.50	26	2	82.00
M4666-8	2	8	8'-10"	0.36	2.00	10	6	46.75
M4666-10	2	10	10'-10"	0.36	2.00	11	9	50.25
M4666-12	2	12	12'-10"	0.36	2.00	12	12	53.50
M4667-8	2½	8	8'-10"	0.36	2.00	15	13	53.00
M4667-10	2½	10	10'-10"	0.36	2.00	18	5	61.65
M4667-12	2½	12	12'-10"	0.36	2.00	20	7	66.00
M4667-14	2½	14	14'-10"	0.36	2.00	22	7	70.75
M4668-10	3	10	10'-10"	0.36	2.00	21	11	72.25
†M4668-12	3	12	12'-10"	0.36	2.00	24	5	78.95
M4668-14	3	14	14'-10"	0.36	2.00	27	1	86.00
M4677-10	2½	10	10'-10"	1.50	2.88	21		66.65
M4677-12	2½	12	12'-10"	1.50	2.88	23		72.20
M4677-14	2½	14	14'-10"	1.50	2.88	25		78.90
M4678-10	3	10	10'-10"	1.50	2.88	25		78.50
M4678-12	3	12	12'-10"	1.50	2.88	28		86.15
M4678-14	3	14	14'-10"	1.50	2.88	31		94.20
*M4661-6	2½	6	7'	...	#	11½		46.00
*M4661-8	2½	8	9'	...	#	13		51.50
**M4657-5	2½	8'&8"	17'-11¼"	0.16	1.50	27		83.25

†Linemen's Preference (LP)—Recommended by Chance Hot Line Tool Demonstrators.
#397.5 MCM ACSR.
*Roller Wire Tongs.
**Spliced Wire Tongs.

Wire Tong Heads and Butts

May be ordered separately and applied to voltage tested poles.

Heat treated aluminum alloy except for bronze butt ring and steel screw shaft.

Heads

No.	Pole Diam. In.	Conductor Size, Inches		Approx. Weight		Each	
		Min.	Max.	Lbs.	Oz.		
M3396	1½	.156	D 1.50	D	2	0	\$10.65
M3396-1	2	.156	D 1.50	D	2	6	11.30
M3396-2	2½	.156	D 1.50	D	2	11	11.85
M3396-3	3	.156	D 1.50	D	3	0	15.15
M3396-11	2	.368	D 2.00	D	3	4	15.45
M3396-12	2½	.368	D 2.00	D	3	9	15.85
M3396-13	3	.368	D 2.00	D	3	14	19.15
M3396-14	2½	1.500	2.875		5	5	23.85
M3396-15	3	1.500	2.875		6	6	24.65

Butts

No.	Pole Diam., In.	Weight		Each
		Lbs.	Oz.	
M1941-5	1¼	1		\$ 4.75
M1941	1½	1	2	5.25
M1941-1	2	2	7	7.50
M1941-2	2½	2	14	9.25
M1941-3	3	3	10	10.25

Chance Wire Tongs and Fittings (Cont.)

Wire Tong Band

For attaching rope blocks to wire tongs. Made of aluminum alloy with Everdur hinge and rope rings.



No.	Pole Diam. Inches	WT., Lbs.	Each
M1729-3	1½	1½	\$ 9.10
M1729	2	1⅝	9.40
M1729-1	2½	1¾	11.00
M1729-2	3	1⅞	11.50

Wire Tong Blocks Clamp and Pole Clevis



Clamp

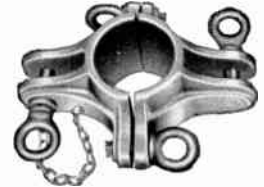

Clevis

Blocks Clamp. For attaching blocks to wire tong where blocks pull in line with tong.

Pole Clevis. Clamps around vertical wire tongs used to support auxiliary crossarms. For attaching butt of other tongs used as side braces. Heat treated aluminum alloy except for bronze eye screws.

No.	Description	Pole Diam. Inches	Approx. Lbs.	WT. Oz.	Each
M4743	Blocks Clamp	1½	2	10	\$10.25
M1728-4	Pole Clevis	2	2	5	15.00
M1728-5	Pole Clevis	2½	2	8	16.75
M1728-6	Pole Clevis	3	2	14	18.25

Chance Wire Tong Saddles



Lightweight aluminum alloy makes saddle and clamp easy to handle. Saddle is fitted with lever operated safety chain tightener for speedy application to poles.

No.	Description	Approx. Lbs.	WT. Oz.	Each
*M4740-3	With 1½" clamp	8	3	\$31.50
M4740-4	With 2" clamp	8	7	34.00
*M4740-5	With 2½" clamp	8	11	36.50
M4740-9	With 3" clamp	8	14	38.75
M4740-10	Without clamp	6	2	23.25
M4741-1	1½" pole clamp only	2	1	9.00
M4741-2	2" pole clamp only	2	5	10.80
M4741-3	2½" pole clamp only	2	9	12.75
M4741-5	3" pole clamp only	2	12	15.60

*Linemen's Preference (LP)—Recommended by Chance Hot Line Tool Demonstrators.

Extension Chain

Extension chain for large poles is easily attached to saddle or auxiliary arm. Tested working load, 2500 pounds. Length 18-in.

No. M1847 Weight 1 lb., 10 oz. Each \$3.85



Cross Arm Type Wire Tong Saddle

For attaching wire tong clamps where it is necessary to mount wire tongs on cross-arms. Clamp attachment swivels. Adjustable.

No.	WT., Lbs.	Each
M4744	6	\$21.25

**Chance Wire Tong Saddles
Tower Type**

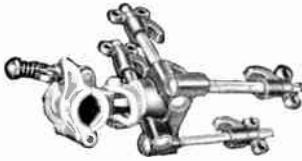

Designed to fit tower legs. Tong clamp swivels in two directions to aid use of wire tongs. Bronze with steel bolts. Clamps, aluminum alloy.

No.	Description	Approx. Wt. Lbs. Ozs.	Each
M14742	Saddle less clamp	11 4	\$29.00
M14742-1	Saddle and 1½" clamp	13 5	37.50
M14742-2	Saddle and 2" clamp	13 9	40.00
M14742-3	Saddle and 2½" clamp	13 13	43.00
M14742-4	Saddle and 3" clamp	14	45.50

Wire Tong Saddle Fittings



Extension



Clevis

Extension: Provides 4-inch additional clearance for wire tong saddle.

Clevis: For attaching wire tong butt ring to wire tong saddle. Applicable where wire tongs are used as a brace for auxiliary arms.

No.	Description	Approx. Wt., Oz.	Each
M14740-6	Extension	12	\$5.75
M14740-14	Clevis	9	7.50

Chance Wire Tong Supports

For attaching wire tongs to poles for lifting and lowering conductors. Secured to poles with safety chain tightener.



Single Lever. Specially designed for use on H-frames or where working space is limited. Loop permits block attachment. Aluminum alloy.

Double Lever. For lifting two wire tongs simultaneously. Generally used on H-frame suspension insulator changes with heavy conductors. Aluminum alloy.

No.	Description	Lift Inches	Working Load, Lbs.	Approx. Wt., Lbs.	Each
M14760	Single	20¾	750	9¾	\$40.00
M14760-1	Double	13	*750	15½	43.50

*Per holder.

Slide Type

For attaching wire tongs on hot line jobs where considerable vertical movement of tongs is required. Attaches to pole or tower. Has rings for attaching rope blocks. Binding chains are steel. Seamless steel tubing galvanized. Holder and end fittings are bronze.

No.	Overall Length	Tong Holders	Approx. Wt. Lbs.	Each
M1741-1	40 in.	1	23½	\$ 47.25
M1741-2	72 in.	3	35	64.00
M1741-3	76 in.	4	38½	76.00
M1741-4	96 in.	3	39½	76.00
M1741-5	100 in.	4	43	87.00
M1741-6	108 in.	6	51	111.00
M1741-7	{Wire tong holder only}	3		10.75



Chance Rope Snubbing Brackets



For snubbing hand lines or hitching blocks at base of pole. Each ring has 1000 pound working load. Attached with chain tightener.

Heat treated aluminum alloy with high strength steel chain.

No.	Description	Approx. Wt.	Each
M1846	Bracket and Block Hitch with Chain Tighteners and 36" Chain.....	7 lbs.	\$18.50
M1847	18" Extension Chain for Tightener.....	1 lb. 10 ozs.	3.85

Chance Temporary Grounding Equipment

Designed to furnish extra protection to linemen making repairs on supposedly "cold" lines, overhead or in substations. Prevent injury due to accidental energization of lines while work is in progress.

3-Wire Grounding Set



With Eye Screws

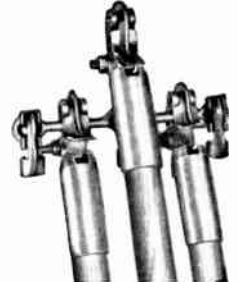

Mounted on Poles

For 3-phase lines. Lightweight, high-strength clamps furnished with duck bills for ease of installation. Pressure type jumper contacts provide high-conductivity connections.

Main line maximum wire size, 4/0 stranded copper or 3/0 A.C.S.R. Jumper maximum wire size, No. 2 ground cable.

No.	Description	Net Wt. Pounds	Each
G1710-3	Mounted, 1¼" x 6' Laminated Spruce	8½	\$45.50
G1710-5	Eye Screw.....	4½	17.60

Chance Screw Ground Rod



High-conductivity, copper-clad rod.

No.	Rod Diam. Inches	Screw Length Inches	Overall Length	Net Wt. Pounds	Each
G3370	½"	14	6'2"	15	\$17.10

Chance Grounding Clamps
Flat Face For Temporary Grounds



Used for attaching cable to ground rod, bus bar, tower leg, or other flat surfaces. Special set screws provide low resistance contact on rusted or painted surfaces.

Copper to Copper Connections

Max. Jumper — 2/0 Flex. Grd. Cable or 4/0 Str. Cu.

No.	Type	Net Wt. Lbs.	Each
G3363-1	Eye Screw	3 1/2	\$8.50
G3363-2	Tee Handle	3 1/2	8.50

Aluminum to Aluminum Connections

Max. Jumper — 3/0 ACSR

G3363-3	Eye Screw	2 1/2	\$8.50
G3363-4	Tee Handle	2 1/2	8.50



Chance Jumper Clamps
For Use Through 5 KV

Polyethylene Insulated

Main Line Sizes:

No. 10 Sol. Cu. to 750 MCM Str. Cu.

Jumper Sizes:

No. 4 to 4/0 cable, 5000 Volt.

Furnished with tough, weather resistant polyethylene plastic handles and caps. This material has high dielectric strength and is less subject to deterioration from aging and weather than crude rubber. Not affected by oil, water, grease, or dirt.

Tested to 15,000 volts before shipment.

Overall length 9-in. Clamps weight 1 pound, 10 ounces each.

Furnished in pairs. Also available with cable completely assembled; prices on application; specify size and length of cable desired for complete assembly and add suffix "A" to catalog number.

Main Line Sizes: No. 10 Sol. Cu. to 750 MCM Str. Cu.

Jumper Sizes: No. 4 to 4/0 cable, 5000 Volt.

No.	Description	Each
G4767-04	2 Clamps for No. 4 Cable.....	\$15.40
G4767-02	2 Clamps for No. 2 Cable.....	15.40
G4767-10	2 Clamps for No. 1/0 Cable.....	15.40
G4767-20	2 Clamps for No. 2/0 Cable.....	15.40
G4767-40	2 Clamps for No. 4/0 Cable.....	15.40

Jumper Sleeves Only

G4787-04	For No. 4 Cable.....	\$1.10
G4787-02	For No. 2 Cable.....	1.10
G4787-10	For No. 1/0 Cable.....	1.10
G4787-20	For No. 2/0 Cable.....	1.10
G4787-40	For No. 4/0 Cable.....	1.10

Spindle and Nut Only

G4787	Spindle and Nut.....	
-------	----------------------	--

Chance Storm Tools



Pole-Mounted



Universal Type

For emergency work on energized lines during stormy weather. Special insulated skirts protect upper portion of tool from moisture and break up water streams. Designed for attaching Chance universal tools for varied maintenance jobs. Pole is tested to exceed the rate shown below. Also available as a universal tool for attachment to universal pole.

No.	Description	Voltage	Wt., Lbs.	Each
M1761	1 1/4" x 8' Two Insulators...	23 KV	3 1/4	\$16.85
M4455-64	Universal, Two Insulators..	23 KV	1 1/4	11.00

Chance Lever Type Wire Cutters

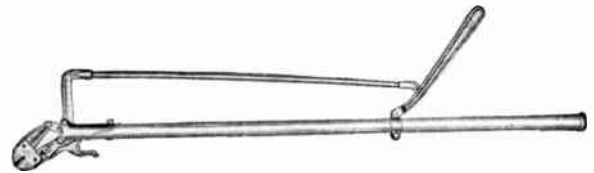

Lever Type Cutters

Lightweight with heat treated aluminum alloy fittings. Leverage 4 to 1. Blades are forged steel. Poles are laminated hardwood tested to 75,000 volts per foot. Lever pull rod has high dielectric strength.

No.	Pole Size	Cutting Max.	Wt., Lbs.	Each
M1871-4	1 1/4" x 4'	2/0 Weatherproof Sol... Cu. or 1/0 ACSR.	6 1/4	\$28.50
*M1871-6	1 1/4" x 6'		6 3/4	31.00
M1873-4	1 1/2" x 4'	2/0 Weatherproof Str. Cu.	9 1/4	35.50
*M1873-6	1 1/2" x 6'			
M1875		Head Only.....	4 5/8	23.00
M1875-4	1 1/2" x 4'	4/0 Weatherproof Sol. Cu. or 250 MCM Cu.	10 3/8	\$38.50
*M1875-6	1 1/2" x 6'		11 3/8	42.00

*Linemen's Preference (LP)—Recommended by Chance Hot Line Tool Demonstrators.

Coffing Temporary Cross Arms

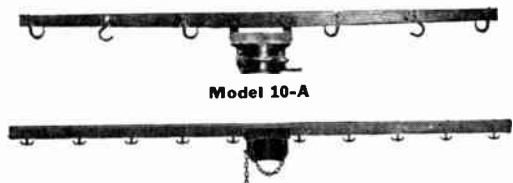

Model 10-A

Model 10-C

Model 10-A: Constructed for electrical use. Hooks are self-locking and large enough to hold line hose to prevent current arcing. Well seasoned hardwood for crossarm. Built to stand hard usage.

Model 10-C: Crossarm constructed of seasoned hardwood. This model is designed for changing crossarms on corners. Malleable iron hooks are constructed so either side can be used.

No.	Description	Ship. Wgt., Lbs.	Each
10-A	Temporary Cross Arms.....	30	\$48.50
10-C	Temporary Cross Arms.....	35	44.50
....	Pole Clamp only without crossarm....		16.50

Chance Temporary Distribution Cross Arms

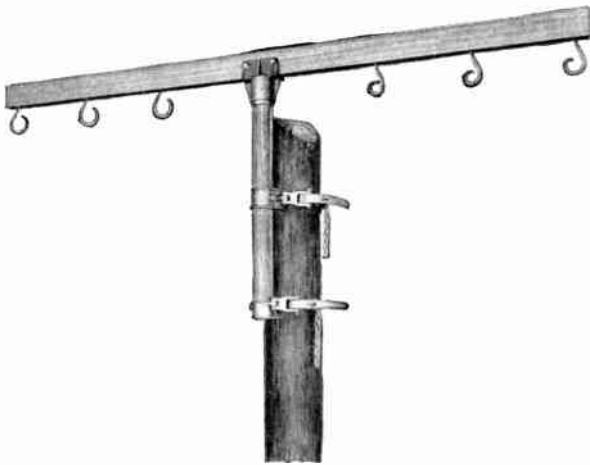

For changing cross arms, insulators or poles on short spans up to and including 4 kv, quickly and without interrupting service.

Secure lines protected with rubber line hose; hold up to six conductors in the clear. Unbalanced load, 150 lbs. Each hook rated at 150 lbs.

Cross arm assembly can be lifted from the mast pole and replaced with Gin Head Adapter, converting the rig to a transformer gin. Maximum load as a gin, 2000 lbs.

No.	Description	Wt. Lbs.	Each
M4800-30	Complete cross arm with mast pole	38	\$109.00
M4800-31	Cross arm only		46.50
*C-51	Complete gin assembly	25	62.50
C-51-1	Gin head adapter only	3 1/4	6.70

*—Lineman's Preference (LP)—recommended by Chance Hot Line Tool Demonstrators.

Chance Positive Grip Clamp Sticks



Made for use on eye screw grounding or tap off clamps. Socket holds eye screw securely, body rests in a groove holding the clamp rigid for easy mounting on the line. When a clamp is picked up, a one-quarter turn locks it in the clamp stick head. Clamp cannot be dislodged accidentally.

Clamp can be mounted on the line and tightened at angles.

Maplac® coated, laminated Sitka spruce poles, tested to 75 kv. per foot for five minutes.

Can be furnished with an extra long head for long eye screw ground clamps. Can also be furnished with a strong rigid splice.

No.	Description	Approx. Wt. Lbs.	Each
G3030-2	1 1/4" x 8' pole, with comb. tool hanger & universal head	3 3/4	\$17.60
G3030-3	Same as above with splice	5 3/4	23.25
G3030-12	1 1/4" x 8', with long head, comb. tool hanger & universal head	3 13/16	18.80
G3042-2	Reg. Clamp stick head only	15/16	5.60
G3042-5	Special long clamp stick head	1	6.80
M4455B	Universal pole head with tool hanger	5/8	3.50

Chance Hand Line Hooks



Can be attached any place along the hand line by the two large holes. Long point accommodates most items to be raised or lowered at the pole.

Working load of the hook is 500 pounds.

Weight, 1/2-lb.

No. M1849	Each	\$2.00
-----------	------	--------

Chance Wire-Holding Sticks



Used on or around energized lines for forming, bending, and positioning jumper wires; for holding conductors during splicing operations; for pulling tie wires tight before tying. Many other similar and related applications, and can often be used on jobs usually done by hand. Strong, tool will bend 4/0 ACSR. Gripper has eye. Can handle No. 8 solid copper through 4/0 ACSR.

Maplac® coated laminated pole. Tested to 75 kv. per foot for five minutes. Aluminum and bronze castings. 1 1/2-in. diam.

No.	Length, Ft.	Weight, Lbs.	Each
M1954-6	6 1/4	5 1/2	\$35.75
M1954-8	8 1/4	6 1/4	42.50

Chance Roller Link Sticks



Used to spread and hold conductors aside at mid-span when relocating poles.

Also useful for measuring span clearance to ground. Hook opening, 1 1/4 inches. Will roll over maximum wire size of 605 MCM ACSR. Working load, 1000 pounds.

No.	Description	Approx. Wt.	Each
M4714-4	Complete, 1 1/4" x 4' pole	3 lbs. 12 oz.	\$26.45
M4714-6	Complete, 1 1/4" x 6' pole	4 lbs. 4 oz.	28.50
M4714-1	Head only (for 1 1/4" pole)	1 lb. 14 oz.	15.60

Chance Cum-a-Long Hook



The Cum-a-Long Hook is designed to engage wire grips sometimes used with the Chance Rural Strain Carrier.

Fits in Strain Clamp Socket.

No.	Weight	Each
M1843-9	1 lb., 7 oz.	\$4.10

Chance Suspension Link Stick



Laminated, voltage tested pole with heat treated aluminum alloy hook used for lifting conductors for making suspension insulator changes. Lift adjusts to size of insulator string.

No.	Pole Diam. Inches	Overall Length	Working Load, Lbs.	Weight	Each
M4710-4	2 1/2	6' 4"	2500	12 lbs., 8 oz.	\$44.50

Chance Dead-End Tools and Link Sticks

Rural Strain Carrier

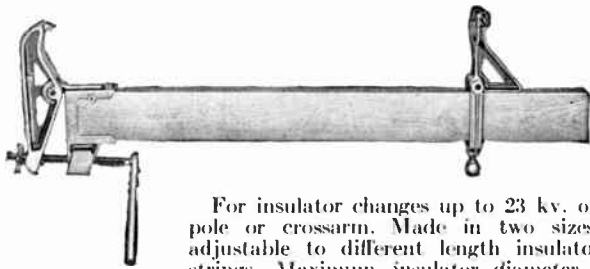

For insulator changes up to 23 kv. on pole or crossarm. Made in two sizes, adjustable to different length insulator strings. Maximum insulator diameter—10". Conductor slack is taken up with removable ratchet handle. Lightweight, aluminum castings—hardwood board.

No.	Take-up Insulator Space	Min. In.	Max. In.	Maximum Work. Load Pounds	Approx. Weight Pounds	Each
M1843-6	4"	17	47	2500	17	\$ 83.00
M1843-7	4"	17	71	2500	21½	89.25

Combination Cradle

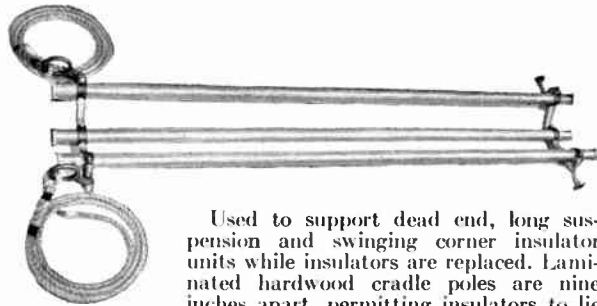

Used to support dead end, long suspension and swinging corner insulator units while insulators are replaced. Laminated hardwood cradle poles are nine inches apart, permitting insulators to lie securely between them. Castings are aluminum and bronze.

No.	Overall Length In.	Number of Insulators Single Dead End	Multiple Dead End	WL Lbs.	Each
M1840-4	48	3 to 6	8 to 11	13½	\$43.35
M1840-6	72	5 to 10	11 to 16	19¾	55.65
M1840-8	96	8 to 12	16 to 21	25¼	62.00
M1840-10	120	10 to 12	18 to 23	30¾	70.00
M1840-12	144	12 to 16	20 to 25	35½	75.00

Cradle Carrier

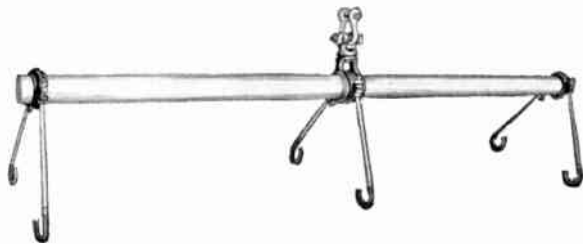

Used with Combination Cradle on a swinging boom for long tower dead ends. When loaded, the cradle cannot be accidentally unlatched. Pole is made of laminated spruce. Castings are bronze and aluminum. Cradle can be used up through 330 kv. Furnished with clevis to attach boom pole.

No.	Hook Openings, In.	Wt., Lbs.
M1950-8	1¾	18

Price on application

Single-String Dead-End Insulator Tool

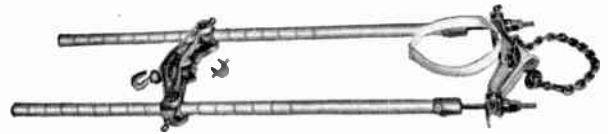

Used on wood crossarms or tower arm dead-ends on H-frames or vertical construction. Mounting brackets are not required. The carrier is chained or roped to the structure. The strain is taken up by a removable ratchet jack or crescent wrench. Self-locking latch holds the conductor in place in the bronze pulling shoe.

With Spruce Poles

No.	Length Between Yokes, Inches Max.	Min.	Inside Width, In.	Take-up In.	*Working Strength	Approx. Wt., Lbs.	Each
M2943-6	75	26	16	7½	7000	42	\$210.00
M2943-8	99	26	16	7½	7000	44	222.00
M2943-10	123	44	16	7½	7000	46	226.85

With Hardwood Poles

M2944-8	99	26	16	7½	10000	50	231.15
M2944-10	123	44	16	7½	10000	52	238.00
M1942	Extra 3½ ft. Steel Loading Chain and Grab Hook.....					5	7.00
M2945-11	Extra Front Yoke Assembly.....					15	61.00

*Used with chain or with load bracket behind pole — secured with rope.

Self Aligning Shepherd Hook



For handling insulators in dead end or suspension insulator changes while conductors are energized. Swivel action permits self-aligning with insulator string.

No.	Description	Approx. WL	Each
M1863-4	On 1½" x 8' Pole with Butt Ring.....	6 lbs., 5 oz.	\$22.85
M1863-5	On 1½" x 10' Pole without Butt Ring.....	6 lbs., 3 oz.	19.25

Strain Link Stick



For lifting or helping to lift heavy conductor loads on high voltage suspension or dead end insulator changes. Butt ring for attaching rope blocks. Rounded jaws to prevent scarring conductors. Aluminum fitted. Hardwood poles. Voltage tested.

No.	Pole Diam., In.	Pole Length	Jaw Opening Min.	Max.	Max. Work Load, Lbs.	Approx. Wt. Lbs.	Each
M4715-1	1¼	2'	.22	.75	3500	3¾	\$20.00
*M4715-2	1¼	4'	.22	.75	3500	4½	22.25
M4716-1	1½	2'	.44	1.06	5500	4¾	23.90
M4716-2	1½	4'	.44	1.06	5500	5¾	27.50
M4716-3	1½	6'	.44	1.06	5500	6¾	30.00
M4717	2	4'	.72	1.50	6500	9¾	38.50
M4717-1	2	6'	.72	1.50	6500	11¾	42.45
**M4718-1	2	4'	1.00	2.50	6500	13	44.75
M4718-2	2	8'	1.00	2.50	6500	15	48.60
M4718-3	2	10'	1.00	2.50	6500	17	52.25
M4718-4	2	12'	1.00	2.50	6500	19	56.25
M4707	1½	*	.44	1.06	5500	2½	15.40
M4707-1	2	*	.72	1.50	6500	3¾	16.75
M4707-3	1¼	*	.22	.75	3500	1¾	10.25
M4707-4	2	*	1.00	2.50	6500	5	20.00

*Head only.

**Linemen's Preference (LP)—recommended by Chance Hot Line Demonstrators.

Chance Hot Line Tie Sticks

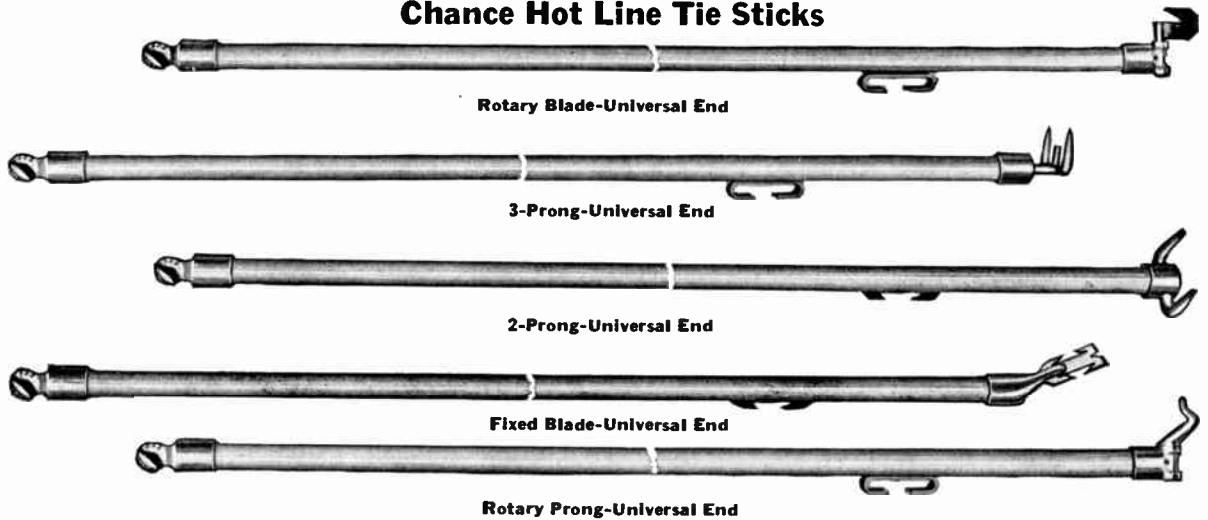

The sticks for quick, easy installation and removal of all types of ties are available as single tools, in combinations of two heads on one pole, or with tie wire heads on one end and, a Universal fitting on the other. With Universal heads, other line tools may be attached to provide two tools in one. Poles are plastic protected. Single tools have plastic cap on opposite end of pole.

Rotary Blade, a new development with swivel action that permits greater freedom of movement than the fixed blade type.

3-Prong, for handling hot ties with loops. Third prong is a short, stubby finger for making short bends in tie wire.

2-Prong, provides additional clearance between prongs. **Fixed Blade**, particularly suited for undoing close ties that do not have looped ends. Sharp, notched blades pry tight ties loose.

Rotary Prong, permits greater maneuverability than fixed prong for handling looped ties.

Rotary Blade			
No.	Pole Lgth. Feet	Description	Approx. Wt., Lbs.
M1855-23	6	Single Tool	2 3/8
M1855-24	8	Single Tool	2 3/4
M1855-26	8	Universal End	3 1/4
M1855-22	..	Head only	1 1/2
3-Prong			
M1855-9	6	Single Tool	2 3/4
M1855-1	8	Single Tool	3 1/4
M1855-20	8	Universal End	4
M1855-3	..	Head only	1
2-Prong			
M1855-15	6	Single Tool	2 1/4
M1855-14	8	Single Tool	2 3/4
M1855-17	8	Universal End	3 3/4
M1855-18	..	Head only	1 1/4

Fixed Blade			
No.	Pole Lgth. Feet	Description	Approx. Wt., Lbs.
M1855-7	6	Single Tool	2 1/2
M1855-2	8	Single Tool	3
M1855-6	8	Universal End	3
M1855-4	..	Head only	3/8
Rotary Blade			
M1855-11	6	Single Tool	2
M1855-12	8	Single Tool	2 1/2
M1855-19	8	Universal End	2 7/8
M1855-21	..	Head only	1 1/2
Combinations			
M1855-13	8	Fixed Blade—Rotary prong	4
M1855-16	8	2-Prong—Fixed Blade	3 1/2
*M1855-25	8	Rotary Prong—Rotary Blade	3 1/2

Chance Universal Poles

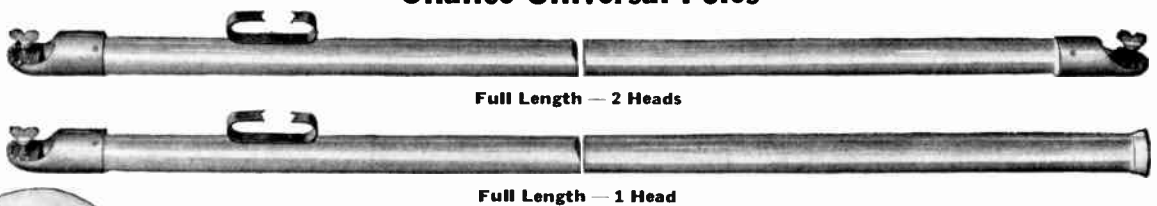

For attaching a variety of universal tools used on hot line jobs. Poles are laminated spruce, covered with Chance Maplac plastic and tested to 75,000 volts. Made as full length poles with rigid splices or with hinged splices and with universal fittings on one or both ends. The hinged splice has an automatic lock which is released by spring buttons. Single tools have plastic cap on opposite end of pole.

Hinged					
No.	Description	Pole Diam., In.	Pole Length	Weight	Each
M1760	With Tie Wire Assistant, One Head	1 1/4	8-ft.	3 lbs.	\$14.00
M1760-2	With Tie Wire Assistant and Splice	1 1/4	Two 4-ft. Lengths	5 lbs.	19.50
*M1760-4	Tie Wire Assistant, Two Heads	1 1/4	8-ft.	3 lbs., 11 ozs.	16.85
M1760-6	Tie Wire Assistant, Splice and Two Heads	1 1/4	Two 4-ft. Lengths	5 lbs., 14 ozs.	22.00
M1951	Tie Wire Assistant and Hanger	4 ozs.	1.95
M4455	Universal Pole Head	1 1/4	..	9 ozs.	3.00
M4455A	Universal Pole Head	1 1/2	..	14 ozs.	3.60
M4455B	Special Universal Pole Head with Tool Hanger	1 1/4	..	10 ozs.	3.50
M1770	Hinged Universal Pole	1 1/4	8-ft.	4 1/2 lbs.	20.00
M13357	Hinged Splice for 1 1/4-in. Poles	1 1/4 lbs.	6.60

*Linemen's Preference (LP)—Recommended by Chance Hot Line Tool Demonstrators.

Chance Universal Tools
For Use with Chance Universal Poles



Rotary Prong Heads

Prongs swivel freely, permitting a full turn on the tie wire without releasing contact.

*No. M4455-69—Wt. 6 oz..... Each \$6.50



Rotary Blade Heads

Wire is wrapped or unwrapped without turning universal pole. A V-notched carbon steel blade grasps tie wire securely.

*No. M4455-70—Wt. 6 oz..... Each \$8.00



Adjustable Insulator Forks

Designed to grasp 8 and 10-in. disk type insulators used in dead end construction. It will raise most pin type insulators up to 15 lbs. Fiber jaws are opened and closed by rotating spline screw.

*No. M4455-67—Wt. 1 lb., 11 oz. Each \$18.00



Self Aligning Shepherd Hooks

For pulling and lifting insulator strings. Swivel action permits it to rotate and maintain its alignment with the insulator at all times.

*No. M4455-39—Wt. 14 oz..... Each \$7.50



Ball Socket Adjusters

Useful in controlling the adapter between clevis clamps and ball and socket insulator pins. Chisel point for spreading cotter keys.

*No. M4455-22—Wt. 9 oz..... Each \$2.75



Bolt Holders

For replacing pins and bolts up to 5/8-in. diameter.

*No. M4455-2—Wt. 10 oz..... Each \$6.75



Cotter Key Installing Tools

Used for replacing cotter keys in insulator fittings or in fittings which are out of reach of linemen or near energized lines. Spring gripping jaw traps cotter key on tool, making installation easy.

*No. M4455-18—Wt. 3 oz..... Each \$3.75



Snapout Cotter Key Removers

Hammer-like action makes it extremely useful in pulling out stuck cotter keys. Release of the compression spring by a quick jerk of the pole deals the cotter key a hammer blow without disengaging the eye.

*No. M4455-12—Wt. 8 oz..... Each \$5.50

Snap Out Disconnects



Impart a hammer blow to the pulling ring of a cutout door or disconnect switch. Release of the compression spring by a downward jerk of pole gives momentum to the blow, permitting operation in a confined area.

No. M4455-13—Wt. 8 oz..... Each \$6.25

*—Lineman's Preference (LP)—recommended by Chance Hot Line Tool Demonstrators.

Chance Insulated Hand Tools
Poles Tested to 75,000 Volts per Foot
Flexible Wrenches



The flexibility of these wrenches permits application of nuts on hardware at varied angles. They may be provided with or without ratchet handle. Socket plugs are 1/2" square. Pole diameter, 1 1/2 inches.

No.	Description	Pole Lgth. Feet	Approx. WL Lbs. & Oz.	Each
M1891-2	With Flexible and Fixed Plugs	6	5 8	\$25.35
M1891-3	With Flexible and Fixed Plugs	8	6 10	28.00
M1891-4	Mounted Ratchet Wrench...	6	5 8	21.75
*M1891-5	With Flexible Plug and Univ. Head.....	6	5 10	28.35
M1891-6	With Flexible Plug and Univ. Head.....	8	6 12	31.25
M1891-7	With Flexible Plug and Ratchet Wrench with Reversible Plug.....	6	6 10	32.25
M1891-8	With Flexible Plug and Ratchet Wrench with Reversible Plug.....	8	7 12	35.25
66780	Ratchet Wrench.....	1	8	4.95

Deep Throat Sockets

Size In.	Double Broached—Square			Single Broached—Hex		
	No.	Lgth. In.	WL Oz.	No.	Lgth. In.	WL Oz.
3/8	M4766-12	3	3 1/2	\$2.50		
7/16	M4766-13	3	3 1/2	2.50		
1/2	M4766-14	3 1/4	5 1/2	2.75	M4766-1	3 1/4 5 \$2.50
5/8	M4766-15	3 1/4	5	2.75	M4766-2	3 1/4 5 1/2 2.50
5/8	M4766-16	3 1/4	5 1/2	2.75	M4766-3	3 1/4 5 2.50
11/16	M4766-17	3 1/4	5	2.75	M4766-4	3 1/4 6 1/2 2.50
3/4	M4766-18	3 1/4	6 1/2	2.75	M4766-5	3 1/4 6 2.50
13/16	M4766-19	3 1/4	6	2.75	M4766-6	3 1/2 8 1/2 2.75
7/8	M4766-20	3 1/2	8 1/2	3.00	M4766-7	3 1/2 8 2.75
15/16	M4766-21	3 1/2	8	3.00	M4766-8	3 1/2 10 2.75
1	M4766-22	3 1/2	10	3.00	M4766-9	3 1/2 9 2.75
1 1/16	M4766-23	3 1/2	9	3.00	M4766-10	3 1/2 10 2.75
1 1/8	M4766-24	3 1/2	10	3.00	M4766-11	3 1/2 12 1/2 2.75
1 1/4	M4766-25	3 1/2	12 1/2	3.00		

All Angle Cog Wrench



Adjusts nuts easily in any position. Thumb lever on side of pole controls the position of the head until socket is fitted over the nut to be tightened. A cog wheel arrangement permits tightening nut at any position within 140° angle by simply turning the pole. Pole is laminated spruce. Cogs are case hardened steel. Wrench fits any standard socket with 1/2" square recess.

No.	Description	Approx. WL	Each
M1892	Mounted on 1 1/2" x 4' pole	2 lbs.....	\$33.00
*M1892-1	Mounted on 1 1/2" x 6' pole	2 lbs., 14 oz..	36.25

Amertong

For Weston Model 633 Ammeter



For holding and manipulating ammeter when taking readings on or near energized conductors where insulation is necessary or for reaching inaccessible points. Holds ammeter at 120° angle for easy reading. May be converted to fit other ammeters. Laminated spruce pole. Plastic control rod has high dielectric strength.

No.	Pole Size	Weight	Each
M1868-4	1 1/2" x 4'	2 lbs., 15 oz.	\$25.00
M1868-6	1 1/2" x 6'	3 lbs., 9 oz.	27.75

*—Linemen's Preference (LP)—recommended by Chance Hot Line Tool Demonstrators.

Chance Insulated Hand Tools
Poles Tested to 75,000 Volts per Foot
Grip-all Clamp Sticks



Straight Pole



Hinged Pole

For applying tap clamps, grounding clamps, grounding sets and suspension cutouts to conductors. The jaws are opened and closed by sliding the hand grip. Clamps may be pulled down into the barrel for control in hanging clamp on the line.

Locking screw holds jaws in any position. A safety latch prevents accidental dropping of the load. The pole and operating rod are of specially selected hardwood. The 12" fiber sleeve has high dielectric strength. Fittings are heat treated aluminum alloy except for bronze locking screws, safety latch, and jaws. Poles tested to 75,000 volts per foot. Plastic protected.

Hinged. Folds to half its length for easy transportation. Held securely in open position by two spring buttons, operates in the same manner as the regular Grip-all clamp stick.

Straight Pole

No.	Pole Diam. & Length	Approx. Weight	Each	Bag No.	Each
M1864-4	1 1/2" x 4'	4 1/2 lbs.	\$25.00	P643-4	\$ 7.50
*M1864-6	1 1/2" x 6'	5 1/4 lbs.	27.75	P643-6	9.50
*M1864-8	1 1/2" x 8'	6 lbs.	30.00	P643-8	10.25
M1864-10	1 1/2" x 10'	6 3/4 lbs.	35.75	P643-10	14.00
M1864-12	1 1/2" x 12'	7 1/2 lbs.	42.00	P643-12	16.75

Hinged Pole

M1874-6	1 1/2" x 6'	6 lbs. 7 oz.	38.75	P643-1	8.25
*M1874-8	1 1/2" x 8'	7 lbs. 8 oz.	42.00	P643-2	9.00

Disconnect Sticks



Available with either aluminum or plastic heads. Aluminum heads are heat treated aluminum alloy. A small notch on the end of the prong aids in manipulating open link fuses.

Pole Size	No.	With Aluminum Head Wt., Each	Each	No.	With Plastic Head Wt., Each	Each
1 1/4" x 4'	M13046-11	1 lb. 3 oz.	\$ 7.00	M13046-5	1 lb. 4 oz.	\$ 9.25
1 1/4" x 6'	*M13046-12	1 lb. 9 oz.	9.50	M13046-6	1 lb. 12 oz.	11.75
1 1/4" x 8'	*M13046-13	2 lbs. 3 oz.	12.00	M13046-7	2 lbs. 4 oz.	14.00
1 1/2" x 10'	*M13046-14	2 lbs. 9 oz.	14.25	M13046-8	1 lb. 12 oz.	16.75
1 1/2" x 12'	M13046-15	4 lbs. 6 oz.	21.50	M13046-9	4 lbs. 8 oz.	21.50
1 1/2" x 16'	M13046-16	5 lbs. 2 oz.	25.25	M13046-10	5 lbs. 4 oz.	27.00

Pointed Head



No.	Description	Wt., Lbs.	Each
M3048-1	1 1/4" x 6' Pole	2 1/4	\$10.00
M3048-2	1 1/4" x 8' Pole	2 3/4	12.50
M3048	Head only	2 1/4	2.70

Safety Pole Hand Guard



No.	For Pole Diam., In.	Approx. Wt., Oz.	Each
M3002	1 1/4	4	\$2.10
M3002-1	1 1/2	4	2.50

*—Linemen's Preference (LP)—recommended by Chance Hot Line Tool Demonstrators.

Adams Winch Rope Winder

This is a positive drive, level winding device for use on power winches to distribute the coils of line evenly onto the drum. This increases the capacity of the drum, makes possible smoother, steadier pulls, makes accurate alignment of the truck with the pull unnecessary and prevents the line from cutting down through the lower coils with the resulting damage to the line and difficulty in unwinding.

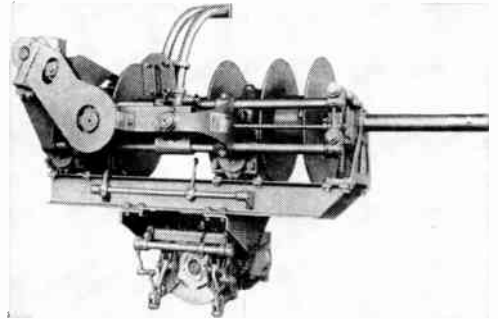

Ruggedly constructed of highest grade materials, accurately machined for long, smooth and satisfactory operation.

This rope winder can be installed on A. T. & T. type winches already in service, as illustrated above.

For other installations consult Graybar. Wt. each 255 lbs. No. C. H. Winch Rope Winder.

Prices on Application

Adams Winches and Power Take-Offs

The A. T. & T. Type equipment includes all the latest changes dictated by up-to-date operation in every section of the country.

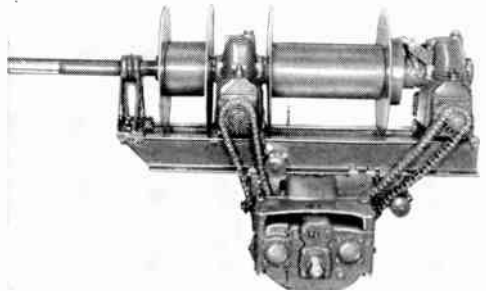

Double Drum Winch and Power Take-Off Assembly

Winch and power take-off integrally mounted and complete with sprockets, idlers, chains and spacers—ready for mounting on chassis. It is engineered and designed to eliminate costly mounting expenses and installation costs. (Available with adjustable mounting brackets which permit rapid adjustment of the power take-off of truck propeller shaft). Single drum winch and power take-off package unit assembly is also available.

Single Door Package Assembly.

Double Door Package Assembly.

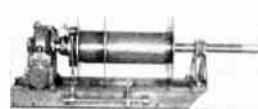

Single Drum Winch



Double Drum Winch

These winches are standard for either 86 or 90 in. body widths. Drum diameter 8 in., flanges 19 in. diameter. Single drum has a flange dividing the drum into 6 in. and 16 in. sections. Double drums are 6 in. and 16 in. between flanges. (Special Drum Widths available).

No.	Description	Wt., Lbs.
L6-16-DE	Single Drum Winch	573
L16D-KE	Double Drum Winch	834

Prices on Application

Adams Collapsible Power Reels

For winding and stringing small diameter cable and wire quickly and easily.

Due to its construction and light weight one man can mount the reel on an extended winch shaft and manage its operation.

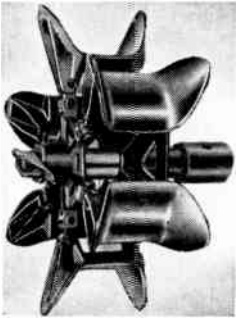

CR Reel

A half-turn of locking handle collapses outer rim segments, reduces diameter and allows wire to be slipped on or off reel.

All parts are precision machined to insure easy and trouble-free operation. Box section, reinforced edges of rim segments, fixed spider, yokes and segments are heat-treated aluminum alloy.

Handle and sliding spider are cast steel. Spindle and shaft seamless carbon steel tubing.

Reel dimensions: Inside, 20-in.; expanded,

28-in.; collapsed, 18³/₄-in. Winch shaft 2⁷/₁₆-in. diameter. Finish — Red.

No. CR — Weight each 70 lbs.

Prices on application

Adams Adaloy Winches

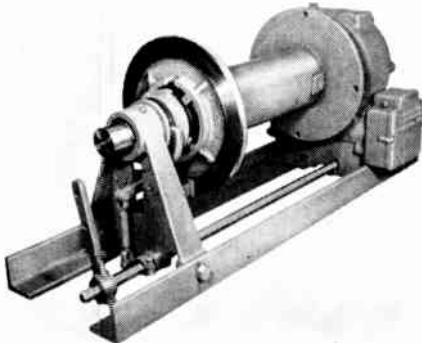

No. M-18-BS

Designed to safely handle a working load of 18,000 pounds, and have many exclusive features to assure longer service, with minimum maintenance cost.

The large braking surface, positive clutch action, flush-type cable clamp and the exclusive oil-cooled automatic fast operating safety worm brake make these the outstanding winches for all kinds of general work.

The large pitch worm and gear absorb shock and heavy loads. Cast steel drum. Rugged overall construction with easy interchangeability of parts.

Dimensions: Drum 6-in. diameter; flange, 14-in. diameter; length overall 67-in.

No.	Description
M-18-BS	*With Band Brake.
M-18-DS	With Double Action Drag Brake, preloaded for more even braking (approximately 450 pounds).
M-18-BE	*Band Brake type with extended Shaft for Bayonet Type Niggerhead or Collapsible Power Reel.
M-18-DE	Drag Brake Type with extended Shaft for Bayonet Type Niggerhead or Collapsible Power Reel (approximately 510 pounds).

Winches equipped with oilless trouble-free bearings in the drum are also available. When ordering designate as "O" type.

*Band Brake feature provides 20% more braking area than other comparable makes.

Prices on application

**Adams Light Cable Reel Trailers
or
Pole and/or Cargo Trailer (Optional)**

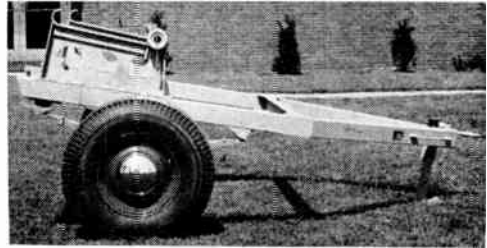

This trailer can be quickly and easily converted from a Cable Reel Trailer to a Pole Carrying and/or Cargo Carrying Trailer by adding optional items: Crossbar and Pole Seat Assembly, and/or Quick Removable Body.

Capacity: 2000 lbs. with 7.00 x 15 (6 ply) Tires (Standard)
4000 lbs. with 7.50 x 16 (8 ply) Tires (Optional)

Maximum Capacity: Up to 6000 lbs. with larger tires (Optional)

Reel Capacity Width: Up to 38 in. (Standard)
Up to 48 in. (Optional)

Maximum: Up to 58 in. (Optional)

Reel Capacity Diameter: Up to 60 in. (Standard)
Maximum: Up to 67 in. with Spacer (Optional)

Track: 56 in.—Trailer made for 38 in. Reel
66 in.—Trailer made for 48 in. Reel
76 in.—Trailer made for 58 in. Reel

Model: SRC-1 (2000 lb. capacity)
SRC-2 (4000 lb. capacity)
SRC-3 (6000 lb. capacity)

Prices on Application.

Adams Pole and Anchor Hole Diggers



For digging holes up to 20 in. diameter to a depth of 9 ft. either vertical or at an angle, and can be maneuvered for digging on hills, in gullies or other rough terrain.

Can be operated by regular line crew from any line truck carrying pole derricks.

Operator has complete control of auger speed, direction and depth. Hand control lever with five operating positions in a 180°

arc permits operator to work from the most desirable position.

Has 8 hp. engine mounting assembly which clamps on truck bed — easily removed — no power take-off needed. Power is transmitted through automatic clutch providing automatic overload control — engine will not stall if auger strikes obstruction (therefore no shear pins to replace). Nor does auger flight start to rotate until operator brings engine up to predetermined operating speed.

All steel construction, with castings of electric furnace steel. Finest material and workmanship.

Uses 9, 12, 16 or 20 inch augers and digs holes up to 9 feet deep at distances to 15 feet from truck. (Augers not included.) Shipping weight approximately 525 pounds.

No.	Description
P. E.	Digger, including Transmission, Flexible Drive Shaft, Engine Mounting Assembly and Torque Arm, less Auger Flight.

Adams Take-Offs

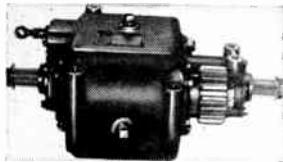

Single Power Take-Off

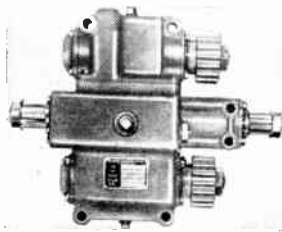

Double Power Take-Off

Have split propeller shaft, and are made for single or double drive applications. Main drive shafts of the standard take-off have 1 3/4-in. — 10 splined ends, although a heavy duty unit is available having shafts with a 1 3/2 in. — 10 spline.

No.	Description	Wt. Lbs.
LP	Single Power Take Off	152
LP2	Double Power Take Off	183

Note—When ordering, give name of truck, model and year for which winch, side take-off or split take-off is wanted. For additional information contact Graybar.

Prices on Application.

Adams Hydraulic Loading Cable Reel Trailers

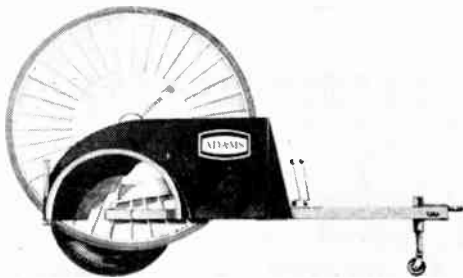

Reels weighing up to 12000 lbs. can be quickly and easily loaded and unloaded safely, by one man, without the use of a winch or truck.

Cantilever spring provided on each wheel keeps road shock at a minimum. Also provided with independent wheel suspension which is recognized as the finest method for safe easy riding.

Shipping weight: Approximately 3800 lbs.

Model: HRC.

Prices on Application.

General Machine Collapsible Power Reels

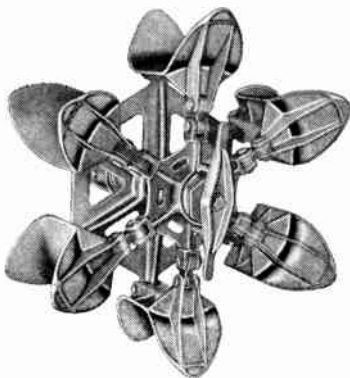

Type CR

For rewinding and stringing small diameter wire or cable; mount on the extending winch shaft of line construction tracks.

Wire easily mounted or removed by a half-twist locking member on end of shaft, collapsing the movable segments.

Fixed spider, yokes and segments are heat-treated aluminum alloy for lightness.

No. 176-A-80—Wt. 62 lbs. Price on application

Premax Embossed Aluminum Letters and Figures



Made of 99% pure aluminum rolled especially for this purpose, will neither rust, tarnish nor corrode. Plain finish. Smooth letters and figures do not catch or hold dirt. Standard package, 100 per carton.

Size, In.	Type	Size, In.	Type
1/2	Roman	2	Roman
3/4	Roman	3	Roman
1	Roman	4	Roman
1 1/2	Roman	6	Roman
1 1/2	Gothic (Figures only)

Escutcheon Pins and Nails

Size, In.	Description	No. Per Lb.
1	No. 15 Galvanized Steel	700
1	No. 15 Brass	700
3/4	No. 15 Brass	950
5/8	No. 15 Brass	1100
5/8	No. 15 Cadmium Plated Steel	1200

Smaller or special sizes of pins furnished on request.

Standard Embossed Aluminum Tags



To determine the length of Tag needed for any specified lettering, multiply total number of letters by the figures shown in column.* Periods or spaces, if required, equal one-half the width of letter.

Longer or shorter lengths, Vertical Tags, Special Designs and Consecutively Numbered Tags quoted on request.

Prices shown are for 1000 on length shown. Quantities less than 1000 at prices shown plus \$5.75 net set-up charge.

Design No.	Style	Height of Letters, Inches	Width of Tag, Inches	*Length per Letter Inches	
				3	8
12	1-line	1/2	3/4		.60
716	1-line	7/16	3/4		.75
78	1-line	7/8	1 3/4		1.25
114	1-line	1 1/4	2 1/4		1.35
212	2-line	1/2 & 1/2	1 3/4		.60
762	2-line	7/16 & 7/16	1 3/4		.75
782	2-line	7/8 & 7/8	2 1/4		1.25
778	2-line	7/16 & 7/8	1 3/4		.75—1.25
787	2-line	7/8 & 7/16	1 3/4		1.25—1.75
RR-122	2-line	1/2	1 3/4		1 3/4 by 6 1/4

Design No.	Length, Inches				8
	3	5	6	Per 1000	
12	\$20.50	\$22.00	\$23.50	\$25.00	\$28.00
716	20.50	22.00	23.50	25.00	28.00
78	27.00	30.00	33.00	36.00	42.00
78A	23.50	26.00	28.50	31.00	36.00
114	28.00	32.00	36.00	40.00	48.00
212	28.00	31.00	34.00	37.00	43.00
762	28.00	31.00	34.00	37.00	43.00
782	29.00	33.00	37.00	41.00	49.00
778	28.00	31.00	34.00	37.00	43.00
787	28.00	31.00	34.00	37.00	43.00

RR-122—1 3/4" by 6 1/4" long, High Voltage Tag \$37.00

National Poles

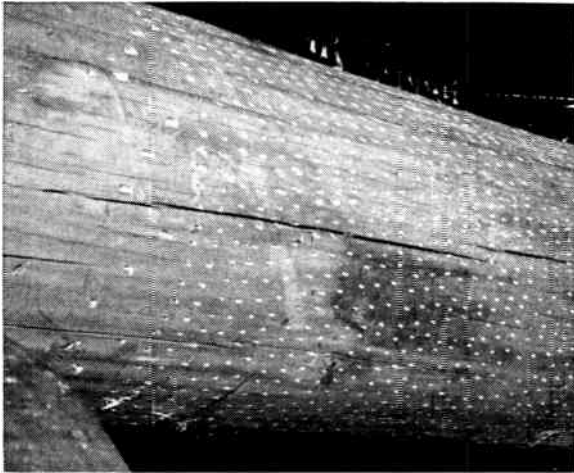

No more than two incising heads touch the pole at any one time. Action is thorough, but not damaging.

“Wood Engineered Incising”

National’s exclusive incising method insures uniform penetration of preservative in a band 1-ft. above and 2-ft. below the critical ground line where rot is most likely to strike. “Wood-engineered” knives cut, rather than crush, the wood cells, with incisions spaced at regular intervals. Famous “Super Cedar,” is incised full length, then pressure treated with creosote, giving one of the most lasting poles known.

Quality Controlled Treating

National Pole is a pioneer in butt treatment, starting about 1914, and pressure treatment, starting about 1920. Its mechanical facilities are complete at both plants. Pressure and open tank creosote and full length open tank Penta treatment is available for National customers. All treating operations are supervised by a graduate chemist and a graduate timber pathologist. Temperature, pressure and duration of each treatment is carefully controlled by scientific instruments. Complete records are kept, insuring consistency, from one cycle to another.

National Pole maintains at its concentrating yards, trained workmen who, for a small extra charge, roof, gain and stain poles to specifications.

Pressure Treated Cedar and Fir Poles

Full Length, Incised, Pressure Treated

“Super Cedar”

Butt Treated Cedar and Fir Poles

Full Length Open Tank Penta Treatment

Specifications, prices and full information will be furnished on application to your nearby Graybar Company office.

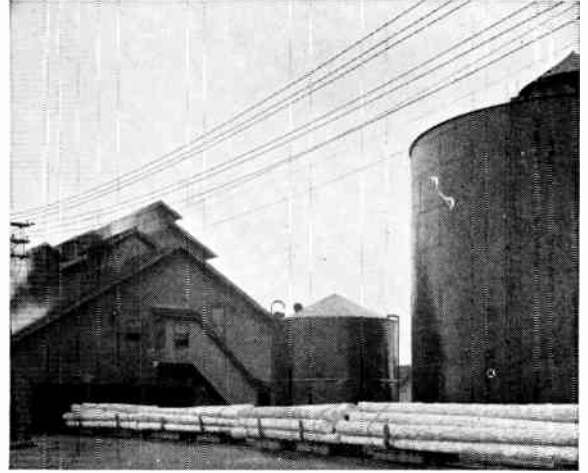

Full length treatment is given in pressure retorts, equipped to give any standard type of creosote treatment.

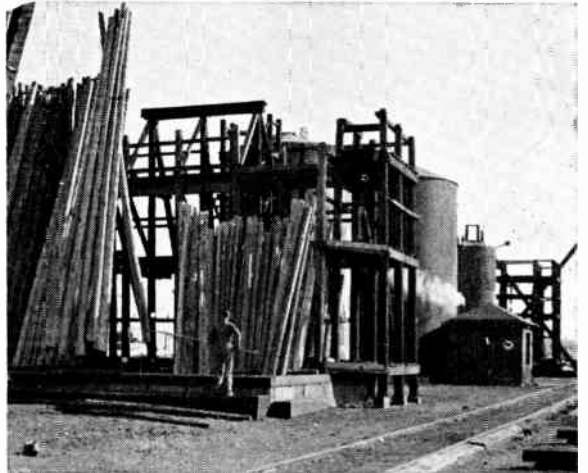

Poles receiving open tank butt treatment at the Minnesota Transfer Plant. Nine carloads can be treated simultaneously.



All poles comply with A. S. A. current standard specifications, and all treatments comply fully with American Wood Preservers Association Specifications.

International Creosoted Pine Poles

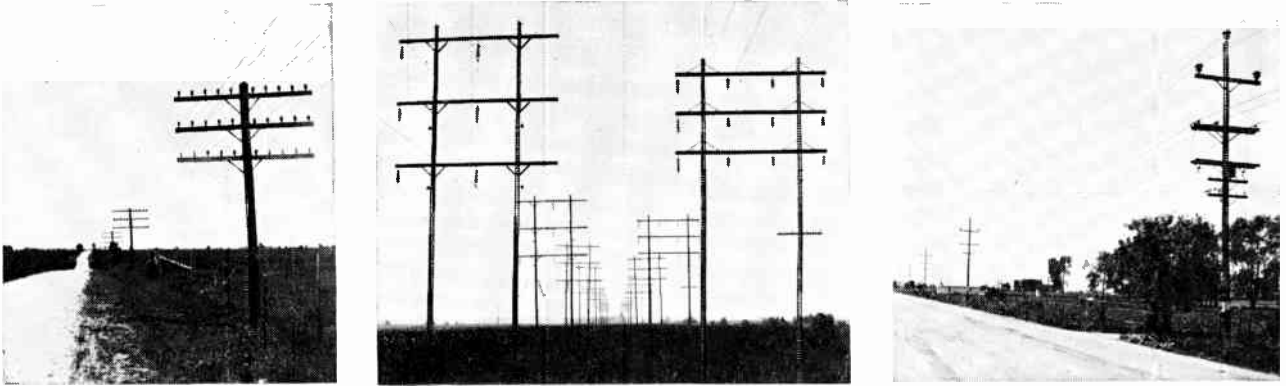

**New Lines of International Creosoted Pine Poles
In Above Lines—4026 Poles—No Replacements in 18 Years of Service**

Specifications for Southern Pine Poles

(Continued)

Knots” and “Defective Butts”; Nails, spikes, and other metal not specifically authorized by the purchaser.

2.3—Permitted Defects

2.3.1. Sap Stain. Sap stain that is not accompanied by softening or other disintegration (decay) of the wood is permitted.

2.3.2. Firm Red Heart. Firm red heart not accompanied by softening or other disintegration (decay) of the wood is permitted.

2.3.3. Spiral Grain. Spiral grain (twist grain) is permitted as follows:

Length of pole	Maximum Twist of Grain Permitted
30 feet and shorter	1 complete twist in any 10 feet.
35 feet to 45 feet, incl.	1 complete twist in any 16 feet.
50 feet and longer	1 complete twist in any 20 feet.

2.3.4. Hollow Pith Centers. Hollow pith centers in the tops or butts are permitted.

2.4—Limited Defects

2.4.1. Checks and Splits in Butts. Through-checks or splits in the butt surface are permitted, provided that their height from the butt along the side surface does not exceed 2 feet.

2.4.2. Shakes. Shakes in the butt surface extending through an arc of not more than 90 degrees are permitted. Shakes extending through an arc of more than 90 degrees are permitted when they are inside of a circle the center of which corresponds to the center of the butt surface and the diameter of which is not greater than one-half the average butt diameter.

Shakes in the top surface are permitted in poles that are to be given full-length treatment provided that the width of the shake does not exceed 1/16 inch and provided that the diameter of the shake is not greater than one-half the diameter of the top of the pole.

2.4.3. Insect Damage. Insect damage consisting of holes 1/16 inch or less in diameter, or surface scoring or channeling are permitted. All other forms of insect damage are prohibited.

2.4.4. Knots. The diameter of any single knot or the sum of the diameters of all knots in any 1-foot section shall not exceed the limits set up in the following table. Knots 1/2-inch or less in diameter shall be ignored in applying the limitations for the sum of diameters.

Limitations of Knot Size

Length of Pole (Feet)	Maximum Sizes Permitted		
	Diameter of Any Single Knot (Inches) Classes 1 to 3	4 to 10	Sum of Diameters of All Knots in Any One-Foot Section (Inches)
15 and shorter.....	4	3	8
50 and longer.....	5	5	10

2.4.4.1. Dead Knots. Decay is permitted in knots provided it is not associated with heart rot.

2.4.5. Scars. No pole shall have a scar or turpentine face (southern pine) located within 2 feet of the ground line. Turpentine scars need be trimmed only to the extent necessary to examine for evidence of fungus infection and insect damage. Other sound scars are permitted elsewhere on the pole surface, provided they are smoothly trimmed and do not interfere with the cutting of any grain, and provided: (a) That the circumference at any point on trimmed surfaces located between the butt and 2 feet below the ground line is not less than the minimum circumference specified at 6 feet from the butt for the class and length of the pole; and (b) That the depth of the trimmed scar is not more than 2 inches, if the diameter is 10 inches or less, or one-fifth of the pole diameter at the location of the scar if such diameter is more than 10 inches.

2.4.6. Dead Streaks. Sound dead streaks, not wider than one-fourth of the circumference of the pole at the point of measurement, are permitted.

2.4.7. Compression Wood. The outer 1-inch of all poles shall be free from compression wood.

2.4.8. Defective Butts. Hollowing in the butt caused by “splinter pulling” in felling the tree is permitted, provided that the area of such a hollow is less than 10 percent of the butt area.

2.4.9. Shape. Poles shall be free from short crooks. A pole may have sweep subject to the following limitations:

(a) Where sweep is in one plane and one direction only, a straight line joining the surface of the pole at the ground line and the edge of the pole at the top shall not be distant from the surface of the pole at any point by more than 1 inch for each 6 feet of length between those points. (See Diagram 1 of subsidiary drawing entitled “Measurement of Sweep and Short Crook in Poles”).

(Continued on following page.)

International Creosoted Pine Poles

Specifications for Southern Pine Poles

(Continued)

(b) Where sweep is in two planes (double sweep), or in two directions in one plane (reverse sweep), a straight line connecting the mid-point at the ground line with the mid-point at the top shall not at any intermediate point pass through the surface of the pole. (See Diagram 2 of subsidiary drawing entitled "Measurement of Sweep and Short Crook in Poles").

3.—Pole Dimensions

3.1 Length. Poles less than 50 feet in length shall be not more than 3 inches shorter or 6 inches longer than the nominal length. Poles 50 feet or more in length shall be not more than 6 inches shorter or 12 inches longer than the nominal length.

Length shall be measured between the extreme ends of the pole.

3.2 Circumference. The minimum circumferences at 6 feet from the butt (except for Classes 8, 9 and 10) and at the top, for each length and class of pole, are listed in the tables of dimensions. The circumference at 6 feet from the butt of poles in Classes 1 to 7, inclusive, shall be not more than 7 inches larger than the specified minimum.

The top dimensional requirement shall apply at a point corresponding to the minimum length permitted for the pole.

3.3 Classification. The true circumference class shall be determined as follows:

Measure the circumference at 6 feet from the butt. This dimension shall determine the true class of the pole, provided that its top (measured at the minimum length point) is large enough. Otherwise the circumference at the top will determine the true class, provided that the circumference at 6 feet from the butt does not exceed the specified minimum by more than 7 inches.

**Dimensions of Creosoted Southern Pine Poles
(Fiber Stress 7400 pounds per square inch)**

Length of Pole Ft.	*Ground Line Dist. from Butt Feet	Class									
		1	2	3	4	5	6	7	▲8	▲9	▲10
		Minimum Top Circumference, Inches									
Minimum Circumference at 6 Feet from Butt, Inches											
16	3½	27	25	23	21	19	17	15	18	15	12
18	3½	27	25	23	21	19	17	15	18	15	12
20	4	31.5	29.5	27.5	25.5	23.5	22.0	20.0	22.0	20.0	18.0
22	4	33.0	31.0	29.0	26.5	24.5	23.0	21.0	23.0	21.0	19.0
25	5	34.5	32.5	30.0	28.0	26.0	24.0	22.0	24.0	22.0	20.0
30	5½	37.5	35.0	32.5	30.0	28.0	26.0	24.0	26.0	24.0	22.0
35	6	40.0	37.5	35.0	32.0	30.0	27.5	25.5	27.5	25.5	23.5
40	6	42.0	39.5	37.0	34.0	31.5	29.0	27.0	29.0	27.0	25.0
45	6½	44.0	41.5	38.5	36.0	33.0	30.5	28.5	30.5	28.5	26.5
50	7	46.0	43.0	40.0	37.5	34.5	32.0	29.5	32.0	30.0	28.0
55	7½	47.5	44.5	41.5	39.0	36.0	33.5	31.5	33.5	31.5	29.5
60	8	49.5	46.0	43.0	40.0	37.0	34.5	32.5	34.5	32.5	30.5
65	8½	51.0	47.5	44.5	41.5	38.5	35.5	33.5	35.5	33.5	31.5
70	9	52.5	49.0	46.0	42.5	39.5	36.5	34.5	36.5	34.5	32.5
75	9½	54.0	50.5	47.0	44.0	41.0	38.0	36.0	38.0	36.0	34.0
80	10	55.0	51.5	48.5	45.0	42.0	39.0	37.0	39.0	37.0	35.0
85	10½	56.5	53.0	49.5	46.0	43.0	40.0	38.0	40.0	38.0	36.0
90	11	57.5	54.0	50.5	47.0	44.0	41.0	39.0	41.0	39.0	37.0
95	11	58.5	55.0	51.5	48.0	45.0	42.0	40.0	42.0	40.0	38.0
100	11	60.0	56.0	52.5	49.0	46.0	43.0	41.0	43.0	41.0	39.0

*The figures in this column are intended solely for use whenever a definition of ground line is necessary in order to apply specification requirements relating to scurs, straightness, etc.

▲ No butt requirements on Classes 8, 9, and 10.

4.—Manufacturing Requirements

4.1 Bark Removal. Outer bark shall be completely removed from all poles.

On all poles no patch of inner bark more than 1 inch wide shall be left on the pole surface between the butt and 2 feet below the ground line.

No patch of inner bark larger than 1 inch wide and 6 inches long shall be left on the pole surface between the top and 2 feet below the ground line.

4.2 Sawing. All poles shall be neatly sawed at the top (unless otherwise ordered) and at the butt along a plane which shall not be out of square of the axis of the pole by more than 2 inches per foot of diameter of the sawed surface. Bevelling at the edge of the sawed butt surface not more than one-twelfth of the butt diameter in width, or an equivalent area unsymmetrically located, is permitted.

4.3 Trimming. Completely overgrown knots rising more than one inch above the pole surface, branch stubs, and partially overgrown knots shall be trimmed close. Completely overgrown knots less than 1 inch high need not be trimmed. Trimming may be done by shaving machine or by hand.

4.4 Framing. All poles shall be roofed, gained, and bored in accordance with the terms of the purchase order before treatment.

All gains (mortise or slab type) shall be cut on the face of the pole; and the gained surfaces shall be in approximately parallel planes.

5.—Storage and Handling

5.1 Storage. When it is necessary to hold poles in storage, they shall be stacked on treated skids of such dimensions and so arranged as to support the poles without producing noticeable distortion of any of them. The height of the piles shall be limited so as to avoid damage to poles on the bottom layers.

Poles shall be piled and supported in such a manner that all poles are at least 1 foot above the general ground level and any vegetation growing thereon.

No decayed or decaying wood shall be permitted to remain underneath stored poles.

5.2 Handling. Treated poles shall not be dragged along the ground. Cant hooks, pole tongs, or other tools shall not be applied to the ground line section of any pole.

6.—Definition of Terms

The following definitions shall apply in these specifications:

6.1 Check. A check is a separation of the wood along the grain, the greater part of which occurs across the rings of annual growth.

A through check extends from surface to surface of the pole, usually through the pith center.

6.2 Compression Wood. Compression wood is abnormal wood that often forms on the lower side of branches and inclined trunks of coniferous trees. Compression wood is:

(a) Characterized by relatively wide annual rings, usually eccentric;

(b) Has a relatively high proportion of summerwood (frequently more than 50 per cent of the width of the annual rings in which it occurs);

(c) Exhibits but little contrast in color between springwood and summerwood; and

(d) Shrinks excessively lengthwise as compared with normal wood.

6.3 Cross-break (Crack). A cross-break is a separation of the wood cells across the grain. Such breaks may be due to internal strains resulting from unequal longitudinal shrinkage or to external forces.

6.4 Dead Knot. A dead knot is a knot left by a branch that dies before the tree is cut. An encased knot is a dead knot in which the growth layers are not intergrown with those of the surrounding wood. Dead knots may contain soft fibers (decay) that usually do not extend deeper than an inch or two from the pole surface. They are distinct from rotten or decayed knots in which the loose or soft fibers (decay) may extend the full length of the knot into the pole, and which are frequently associated with heart rot.

(Continued on following page.)

International Creosoted Pine Poles Specifications for Southern Pine Poles (Concluded)

6.5. **Dead Streak.** A dead streak is any portion of the sapwood in which the life processes had ended prior to the cutting of the tree. A dead streak starts from the butt and differs from a wound, such as a cat face or scar, where the growth of new wood shows that life processes are still acting to repair the injured part.

6.6. **Decay.** Decay is the disintegration of wood substance due to the action of wood-destroying fungi. Rot and dote mean the same as decay.

6.7. **Face of Pole.** The face of a pole is the concave side, or the side of greatest curvature in poles having reverse or double sweep, between the ground line and top.

6.8. **Ground Line Section.** The ground line section is that portion of a pole between 1 foot above and 2 feet below the ground line as defined in the pole dimension tables.

6.9. **Hollow Heart.** A hollow heart is a hollow in the heartwood of a living tree caused by insects or fungi.

6.10. **Hollow Pith Center.** A hollow pith center is a small hole at the pith center of the trunk or of a knot, caused by disintegration of the pith (small soft core occurring in the structural center of a tree or branch).

6.11. **Insect Damage.** Insect damage is the result of boring in the pole by insects or insect larvae. Scoring or channeling of the pole surface is not classed as insect damage.

6.12. **Knot Diameter.** A knot diameter is the diameter of a knot on the surface of the pole measured in a direction at right angles to the lengthwise axis of the pole.

6.13. **Red Heart.** Red heart is caused by a fungus, *Fomes pini*, that occurs in the living tree. It is characterized in the early stages of infection by a reddish or brownish color in the heartwood. This is known as "firm red heart." Later the wood, in the case of the living tree, disintegrates (decays) in small, usually distinct, areas that develop into white-line pockets.

6.14. **Sap Stain.** Sap stain is a discoloration of the sapwood caused by the action of certain molds and fungi that is not accompanied by softening or other disintegration of the wood.

6.15. **Scar (Cat Face).** A scar is a depression in the surface of the pole resulting from a wound where healing has not re-established the normal cross section of the pole.

6.16. **Shake.** A shake is a separation along the grain, the greater part of which occurs between the rings of annual growth.

6.17. **Short Crook.** A short crook is a localized deviation from straightness which, within any section 5 feet or less in length, is more than one-half the mean diameter of the crooked section. (See Diagram 3 of the subsidiary drawing entitled "Measurement or Sweep and Short Crook in Poles.")

6.18. **Spiral Grain (Twist Grain).** Spiral grain is a type of growth in which the fibers take a spiral course about the bole of a tree instead of the normal vertical course. The spiral may extend right-handed or left-handed around the tree trunk. The amount of spiral grain in a pole is measured as the distance in feet, along the axis of the pole, in which one complete twist of the spiral occurs, and is expressed as, for example, 1 in 10.

6.19. **Split.** A split is a lengthwise separation of the wood due to the tearing apart of the wood cells, extending from surface to surface of the pole.

6.20. **Sweep.** Sweep is the deviation of a pole from straightness. (See Diagrams 1 and 2 of the subsidiary drawing entitled "Measurement of Sweep and Short Crook in Poles.")

7.—Subsidiary Drawing

The following drawing is subsidiary to the text of these specifications:

"Measurement or Sweep and Short Crook in Poles."

8.—Subsidiary Standard

The foregoing dimension table is subsidiary to the text of these specifications: It is designated as: American Standard Dimensions of Creosoted Southern Pine Poles (05.1-1948).

International Creosoted Pine Poles



Stacks Such as Here Shown on One of International's Conditioning Yards Make Possible Our Quick Shipment of Quality Creosoted Pine Poles

Top Dimension Poles

Top dimension poles conform in all respects to American Standards Association Specification poles, with the sole difference that top diameter poles specify minimum top diameter only; whereas A.S.A. Specification poles specify both minimum top circumference and circumference six feet from the butt.

Length Feet	Top Diameter in Inches*							
	4-5	5-6	6-7	7-8	8-9	9-10	10-11	11-12
16	4-5	5-6	6-7
18	4-5	5-6	6-7
20	4-5	5-6	6-7	7-8
25	4-5	5-6	6-7	7-8	8-9
30	...	5-6	6-7	7-8	8-9
35	...	5-6	6-7	7-8	8-9
40	6-7	7-8	8-9	9-10
45	6-7	7-8	8-9	9-10
50	7-8	8-9	9-10
55	7-8	8-9	9-10
60	7-8	8-9	9-10	10-11	...
65	7-8	8-9	9-10	10-11	...
70	7-8	8-9	9-10	10-11	...
75	7-8	8-9	9-10	10-11	...

Anchor Logs

Anchor logs conform in all respects to the specification for top dimension poles.

3	5-6	6-7	7-8	8-9	9-10	10-11	11-12	12-13
4	5-6	6-7	7-8	8-9	9-10	10-11	11-12	12-13
5	5-6	6-7	7-8	8-9	9-10	10-11	11-12	12-13
6	5-6	6-7	7-8	8-9	9-10	10-11	11-12	12-13
7	5-6	6-7	7-8	8-9	9-10	10-11	11-12	12-13
8	5-6	6-7	7-8	8-9	9-10	10-11	11-12	12-13
9	5-6	6-7	7-8	8-9	9-10	10-11	11-12	12-13
10	5-6	6-7	7-8	8-9	9-10	10-11	11-12	12-13
11	5-6	6-7	7-8	8-9	9-10	10-11	11-12	12-13
12	5-6	6-7	7-8	8-9	9-10	10-11	11-12	12-13
13	5-6	6-7	7-8	8-9	9-10	10-11	11-12	12-13
14	5-6	6-7	7-8	8-9	9-10	10-11	11-12	12-13
15	5-6	6-7	7-8	8-9	9-10	10-11	11-12	12-13

*Note: Top diameter is determined by placing a tape around the circumference of the pole at the base of the roof.

What an Order Should Show

To avoid delays and prevent the possibility of error, an inquiry or an order for International poles should contain the following information:

- 1—Name of consignee.
- 2—Destination of shipment.
- 3—Date shipment is desired.
- 4—Number of poles required.
- 5—Length and minimum top diameter.
- 6—Number of pounds of creosote required per cubic foot of wood.
- 7—Type of framing desired. A blue print or sketch is preferable. Poles can be framed more economically at a treating plant than in the field at point of installation. Insofar as possible therefore complete framing instructions are desirable.

International Creosoted Pine Poles
Measurement of Sweep and Short Crook in Poles

Diagram 1—Measurement of Sweep in One Plane and One Direction

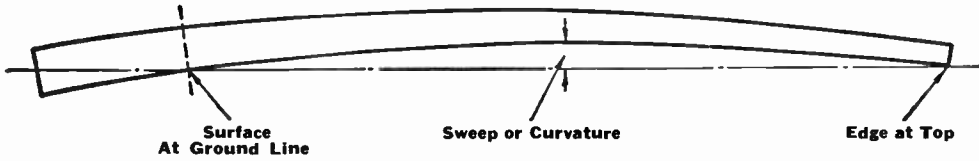
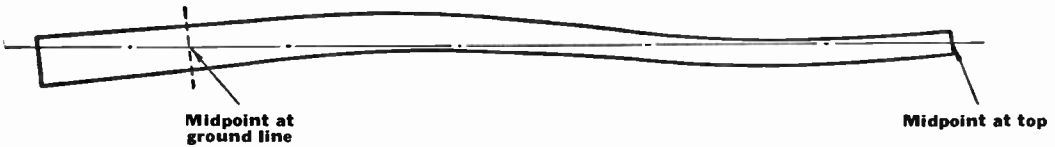

Diagram 2—Measurement of Sweep in 2 Planes (Double Sweep) or in 2 Directions in One Plane (Reverse Sweep)



Note: Diagram No. 2 applies to the measurement of double sweep in Western Red Cedar and Southern Pine Poles.

For measurement of double sweep in Northern White Cedar and Chestnut Poles, see text.

Diagram 3—Measurement of Short Crook (Three Cases Shown)

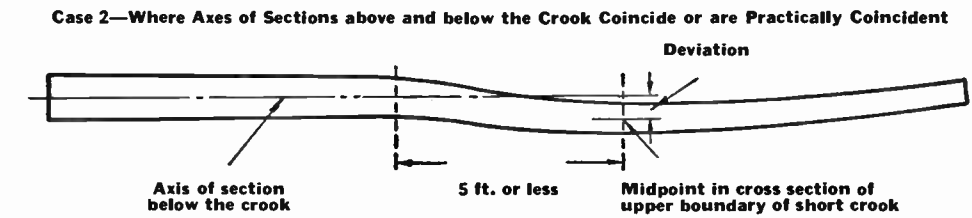
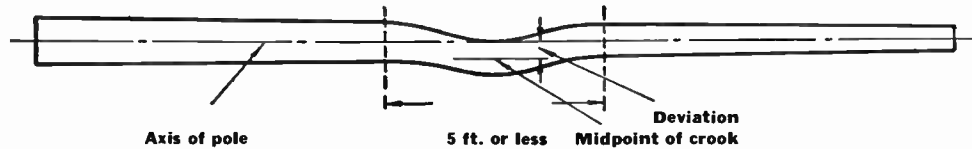
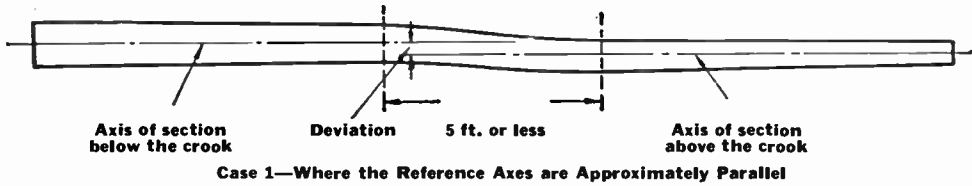

Case 3—Where Axis of Section above Short Crook is not Parallel or Coincident with Axis below the Crook

Note: The three cases shown under diagram 3 are typical and are intended to establish the principle of measuring

short crooks. There may be other cases not exactly like those illustrated.



International Pine Poles have the Straightness and Symmetry of a Machined Product

International Creosoted Pine Poles

*Specification for the Preservative Treatment of Southern Yellow Pine Poles

Rueping Empty Cell Process

*Note: A descriptive specification only. It must be recognized that specifications do not guarantee quality, and should not be regarded as adequate protection to the buyer. In any treated wood, the all important factor is the source of supply.

General

The following specification is intended to obtain an empty cell treatment for the poles; and if the material to be treated is in a different condition as to moisture and seasoning, material for each retort charge shall be selected as to condition of moisture so that there will be no great difference in degree of seasoning in any one charge. Only perfectly sound poles shall be treated. The treating plant shall be equipped with indicating and recording gauges and other necessary apparatus for accurately observing and recording the treating process. Above the level of the creosoting cylinder there shall be an overhead drum for the purpose of determining that the cylinder is full of preservative and free from air and the gauge reading indicating a full cylinder shall not be taken until the preservative is seen to overflow through the valve on top of this drum; there shall also be a sap drum below the level of the cylinder by means of which sap and condensation shall be removed regularly. The treating plant must have all the necessary chemicals, a laboratory and laboratory apparatus to enable the quality of preservative to be determined.

Seasoning

Air-Seasoning

In air-seasoning, the poles shall be stacked in such a manner as to provide free air circulation and minimum contact between individual pieces in each stack. These stacks shall be placed on treated or otherwise permanent skids at least six inches above the ground on a well drained storage yard free from vegetation and decaying wood, so located that prevailing winds strike it freely, and each layer shall be separated by creosoted strips. Alleys between the stacks shall be wide, continuous and straight. The material shall remain until in the judgment of the inspector it is sufficiently seasoned to obtain the maximum benefit from the treatment.

Seasoning By Steam

When time for air-seasoning is not available, steam seasoning shall be used. Live, saturated steam shall be admitted to the treating cylinder taking care that all air is swept from the cylinder before the outlet valve is closed. Pressure shall then be raised gradually to the maximum temperature desired, this maximum being determined by the treating inspector. It should not be less than 254° F., not more than 259° F. The duration of the steaming process is dependent upon the degree of seasoning of the poles in the cylinder charge but shall in no case be carried to such an extent as to injure the timber.

Initial Vacuum

After the steaming process has been completed the steam shall be blown off and the treating cylinder exhausted as quickly as possible to as high a vacuum as possible, which must be at least twenty-four inches at sea level or proportionately less at higher altitudes. This vacuum shall be maintained for at least one hour or for whatever longer period is necessary, so that the wood may be as dry and free from air as practicable. During the exhaustion process the temperature within the treating cylinder shall be maintained by means of steam under pressure in the closed coils. The cylinder shall be relieved of sap and condensation continuously.

Seasoning—Continued

Initial Air Pressure

In the case of air-seasoned poles, Initial Air Pressure is the first step in the treating process. With steam-seasoned poles this step immediately follows the Initial Vacuum.

The poles shall be subjected to air pressure of sufficient intensity and duration (usually 10 lbs. to 100 lbs.) to provide under a quick high vacuum the ejection of surplus preservative, and to insure a retention and proper distribution of the stipulated number of pounds of preservative per cubic foot of wood.

Treatment

The creosote shall be introduced between 170° F. and 210° F., the cylinder pressure being maintained constant until the cylinder is filled. The oil must be seen by the inspector to flow from the overhead drum on top of the treating cylinder, thus assuring him that the cylinder is completely filled with the preservative. The pressure shall then be gradually raised to and maintained at a minimum of 150 lbs. per square inch until there is obtained the largest gross absorption that can be reduced to the stipulated final retention, calculation being based on readings of the working tank gauges and the weight of the creosote at 100° F. The quantity of oil for final retention shall be based on the cubic content of wood in the treating cylinder as determined by actual measurement of the top and butt of each pole in each charge. Under no conditions may shortage of oil in one charge be offset by overage in another; the minimum final retention in each case must be 100 per cent of the quantity of creosote specified.

Final Vacuum

After pressure is completed and the cylinder is emptied of oil a sufficient vacuum shall be promptly created and maintained until the timber can be removed from the cylinder free from dripping oil.

Penetration

The treating processes shall be directed toward complete sapwood penetration with the preservative.

Preservative

For preservative see Creosote Specification:

Note: A final retention of 8, 10 or 12 pounds of creosote per cubic foot is most frequently used. Of these, the 8-pound treatment is specified in the great majority of cases. Nonetheless, 12-pound final retention gives 50% more preservative in the wood at very little extra cost. Important pole lines, costing more all the time to build, merit ample preservation.

For areas that are climatically severe; that is, high humidity or prolonged warm temperatures, or areas of abnormally heavy rainfall, 12-pound creosote final retention is urged. While the 8-pound treatment, even in these areas, gives superb service the small cost of the additional creosote to protect poles and pole lines, whose value is constantly increasing, is an investment in efficiency.

Creosote . . . Pentachlorophenol

Since International began business in 1875 there has been a constant stream of new preservatives entering the wood preserving field. They have been tried for a while—and they almost invariably have been discarded after having been found wanting in some characteristic. International will continue to watch and test new preservatives, but will offer them to the trade only when sure of their value. Meanwhile as to the standard preservatives:

CREOSOTE has stood the test of time and has had such widespread use as to prove its effectiveness under all conditions. It stays well in the wood, whether the service condition is dry area, swamp, or even salt water subject to marine borer attack. International pole lines ten, twenty, thirty years in service still in perfect preservation, attest to creosote's lasting qualities.

PENTACHLOROPHENOL while not nearly as long used as creosote has given a good record since its introduction into the treating industry, and is having growing acceptance.

**Standard Specification for Creosote Oil
American Wood Preservers' Association**

- 1—The oil shall be a distillate of coal-gas tar or coke-oven tar¹.
- 2—It shall not contain more than three per cent of water.
- 3—It shall not contain more than 0.5 per cent of matter insoluble in benzol².
- 4—The specific gravity of the oil at 38° C., compared with water at 15.5° C., shall not be less than 1.03.
- 5—The distillate, based on water-free oil, shall be within the following limits:
Up to 210° C., not more than 5 per cent.
Up to 235° C., not more than 25 per cent.
- 6—The oil shall yield not more than 2 per cent of coke residue.
- 7—The foregoing tests shall be made in accordance with the standard methods of the American Wood-Preservers' Association.
(See Manual—Methods of Analysis.)

¹Owing to the complexity of the chemical composition and physical properties of coal tar creosote, and to the fact that some of the same compounds and properties which characterize coal tar creosote are found in certain petroleum derivatives, the determination of the purity of creosote is difficult. When there is not certain assurance that the creosote is a pure product, the following tests will aid in arriving at an opinion as to its coal tar origin:

- A. Fraction distilling between 210° and 235° C. is usually solid or contains some solids when cooled to 25° C.
- B. All of the fractions up to 315° C. contain tar acids in varying amounts, usually at least 1%, calculated on the amount of the fraction tested. (See MANUAL-MI.)
- C. The specific gravity of the fraction between 235° and 315° C. is usually not lower than 1.025 and specific gravity of the fraction between 315° and 355° is usually not lower than 1.085 at 38° C. compared with water at 15.5° C. However, some pure coal tar distillates fall slightly below these limits.

If the sample does not comply with at least one of the foregoing tests it is undoubtedly not a pure coal tar creosote.

²Samples of creosote taken from working tanks may show increases in matter insoluble in benzol and coke residue due to treating operations. If neither the matter insoluble in benzol, nor the coke residue exceeds the specification limits by more than 1 per cent of the sample, and if it can be shown that the original creosote was of specified quality, the used creosote shall be regarded as conforming to the specification.

Depth of Preservative Penetration

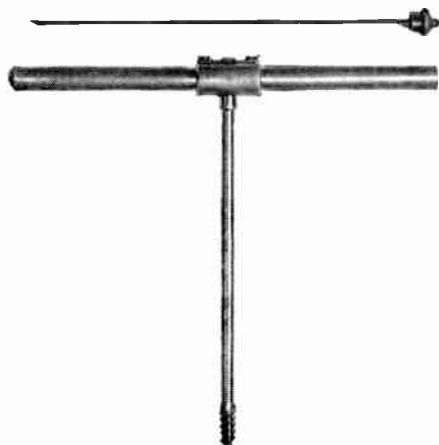

Increment Borer

The increment borer shown here is used for extracting sections of wood from poles to determine how deeply the preservative has penetrated into the wood.

**Standard Specification for Creosote Oil
American Wood Preservers' Association**

Depth of Preservative Penetration—Continued

The use of this instrument is recommended as one means by which the buyer can gauge the quality of the product he receives. It does not damage the pole and the only precaution is that a creosoted wood plug be driven into the hole after the boring has been extracted.

For adequate protection it is essential that the preservative penetrates wood deeply (see discussion on penetration later in this section).

Price for increment borers, on request to Graybar.

Machine Trimming

The surface of all International poles is machine-smoothed over the entire length. These lathe-like turning machines are a modern improvement in the pole industry. Only a light shaving is made to remove the knots and other protuberances. The grading into sizes is done after trimming.

Machine trimming has many advantages. The freshly trimmed surface facilitates seasoning. Unnecessary cutting into the body of the pole by hand trimming or gouging is eliminated. The appearance of the pole is greatly improved and bleeding is further reduced.

**International Creosoted Pine Poles
Characteristics of Quality Pine Poles**

Status of Pine Poles

During the period covering the past several years, more treated pine poles have been used than all other treated poles. The utility company that uses treated pine poles is using the most generally accepted pole of the utility field. Important lines that must stand up under greatest stress and for the longest period of time are well built when built with quality treated pine poles. Every sleet storm brings a further degree of proof of this fact. Knowing the salvage value even of an abandoned line of treated pine poles, the costliness of individual pole failures, and treated pine's comparatively low annual cost, it is difficult to think of any line not sufficiently important to justify their use.

Transmission and Distribution Use

International treated pine poles of long length are being used increasingly in the higher voltage lines that continue to gain favor in power-line construction. Lines carrying 330-K.V. are in the planning stage for International pine poles and such construction undoubtedly will be used in the near future.

Life of Creosoted Pine Poles

Entire lines of creosoted pine poles furnished by our supplier 25 and 30 years ago are still in use with practically no replacements, and are obviously good for many years to come. Estimates have been made by many of the life to expect, and Pennsylvania Electric Association, as the result of a research and study, estimated 35 years. This estimate of longevity seems conservative with so many International creosoted pine lines now approaching that age and still in good condition. The oldest lines still standing, and differences in climatic conditions, make it impossible to forecast definitely just what life to expect from the creosoted pine pole.



**Section of the Chemistry Laboratory
Scientific Control is Essential**

International Creosoted Pine Poles

Characteristics of Quality Pine Poles

(Continued)

Value of Penetration

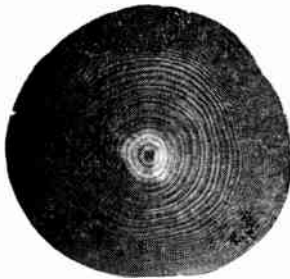

**Uniform Penetration
Is a Criterion of Good
Treatment**

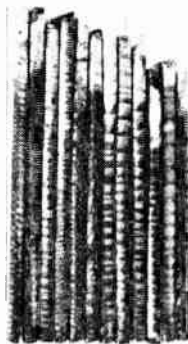

**Deep Penetration
Means Long Life
For the Poles**

Several factors are important, particularly the grade of preservative, but no single factor has such bearing on the life and the quality of treated pine poles as the depth and the uniformity of preservative penetration. Untreated wood of any kind commonly used for poles will decay eventually, and the only preventive is to have the penetration of the preservative deep and uniform and of proper grade. This is accomplished only when skilled technicians analyze the preservative and apply the treating process.

Strength

The standard for ultimate fiber stresses for the commonly used pole woods has been developed by the Sectional Committee on Wood Poles under the sponsorship of the Telephone Group, American Standards Association.

These ultimate fiber stresses quoted verbatim are tabulated below.

Northern White Cedar.....	3600 lbs. per sq. in.
Western Red Cedar.....	5600 lbs. per sq. in.
Chestnut.....	6000 lbs. per sq. in.
Southern Yellow Pine (Creosoted).....	7100 lbs. per sq. in.

Fire Resistance

Fires raging across the dry cane fields of Cuba crack insulators, melt steel, and burn untreated wood to ashes, but creosoted pine poles stand the flames. This is the actual experience. Along railroad right-of-ways fire gangs burn the weeds and it is a matter of common record that untreated posts burn completely while creosoted pine poles are undamaged. Under these severe conditions the creosoted pine pole may take fire and smolder and smoke, but finally the fire smothers itself out, leaving the pole practically undamaged. The action is analogous to a burning oil lamp wherein the wick though it forms the support for the flame is itself consumed very slowly.

Appearance and Cleanliness

Early in the history of the development of creosoted pine poles the question was raised to their use on city streets. It was believed the bleeding of some of the poles might cause trouble if the clothing of pedestrians rubbed against them. Such objections are heard no longer either in protest or propaganda.

International's care in timber selection, the skill of its production and manufacturing forces, and advances in the science of timber treatment have all contributed to overcome these objections and to give to business district and residential area the economy and security of the creosoted pine pole.

Graybar-International poles are in use in the business and residential districts of the largest cities of the United States, and in thousands of the smaller ones.

The present-day pole is clean, smooth, shapely, and stands with the appearance of tapered wrought-iron pipe, rather than of processed trees.

Termites

Termite attacks on poles are attracting more and more attention. Termites are native to the forest, but as the forests become depleted they seek shelter elsewhere and find their way into untreated structural wood. Untreated pole lines have been accused of acting as termite highways by means of which they could fly from pole to pole and then to residences; infesting new areas. Termites have now been found in all but three states of the United States.

Creosoted pine poles are practically immune to termite attack. Checks in the wood may form, but they do not go deep enough to expose untreated interior wood that would afford shelter for termites.

Improved Roof



The illustration shows a new type of pole roof that many of the utility companies are standardizing upon. It is a one-way roof, cut at an angle of 15°. It is to be recommended. The advantages of this roof are:

1. Reduces Checking

A roof cut in this  manner leaves a minimum of wood along the center line, the natural cleavage point of the pole. This invites checking. The one-way roof eliminates this disadvantage.

2. Provides Better Drainage

As the roof of a pole weathers, the springwood rings of any species being softer than the summerwood, weather faster, causing the summer wood to stand out in ridges. On the two-way roof these ridges form retaining cups for rain water while on the one-way roof they drain.

3. Conserves the Preservative

Evaporation is a surface phenomenon. There is less surface on a one-way than on a two-way roof.

Marked Poles



Above are the marks by which Graybar-International poles are identified wherever found. A date-brand is on the side ten feet from the butt of the pole; and is supplemented by an identifying brand on the top and the butt of each pole. These marks are positive evidence of our confidence in the quality of the product and the desire to be permanently identified with it.

Beware of unmarked poles. If in a few years they began to fail, the experience is that it is not possible to tie them definitely to the source of supply. On the other hand when a company consistently uses high grade materials and good preservation treatment which result in long-time dependable service, the company willingly and permanently attaches its name to the product.

International Creosoted Pine Poles
Estimated Weights of Poles

American Standards Association Specification Poles
8-Pounds Final Retention

Top Dimension Poles
8-Pounds Final Retention

Length Pole Feet	Estimated Weights in Pounds										Length Pole Feet	Estimated Weights in Pounds						
	A.S.A. Size Group											Top Diameter, Inches						
	1	2	3	4	5	6	7	8	9	10		4-5	5-6	6-7	7-8	8-9	9-10	10-11
16	234	202	165	188	138	110	16	138	165	202
18	380	326	275	234	188	211	151	133	18	151	188	234
20	710	564	467	394	330	284	231	261	202	160	20	202	231	284	330
25	990	811	671	573	490	422	341	389	289	235	25	289	344	422	490	573
30	1280	1082	921	784	660	550	451	513	371	30	454	550	660	784
35	1567	1313	1155	1004	862	742	646	697	35	646	742	862	1004
40	1881	1622	1403	1219	1059	921	807	40	921	1059	1219	1403
45	2222	1911	1661	1411	1274	1114	976	45	1111	1274	1444	1664
50	2585	2214	1925	1687	1494	1329	1169	50	1494	1925	2214
55	2993	2567	2200	1934	1718	1563	55	1718	2200	2567
60	3765	3210	2710	2385	2130	1965	60	2130	2710	3210	3765
65	4380	3645	3070	2680	2410	65	2410	3070	3645	4380
70	5040	4125	3430	2980	2715	70	2715	3430	4125	5040
75	5670	4620	3825	3295	75	3295	3825	4620	5670
80	6400	5170	4240	3615	80	3615	4240	5170	6400
85	7200	5745	4690	85	4690	5745	7200
90	8140	6405	5160	90	5160	6405	8140
10-Pounds Final Retention										10-Pounds Final Retention								
16	213	207	171	194	143	114	16	143	171	207
18	394	338	285	243	194	219	157	138	18	157	191	243
20	736	584	484	408	342	291	243	271	209	166	20	209	243	291	342
25	1026	841	699	594	508	437	357	403	300	244	25	300	357	437	508	594
30	1327	1121	954	813	684	570	471	532	385	30	471	570	684	813
35	1624	1392	1197	1041	893	769	670	722	35	670	769	893	1041
40	1953	1681	1454	1263	1098	955	836	40	955	1098	1263	1454
45	2303	1981	1725	1496	1320	1155	1012	45	1155	1320	1496	1725
50	2679	2295	1995	1748	1548	1377	1212	50	1548	1995	2295
55	3102	2660	2280	2004	1781	1620	55	1781	2280	2660
60	3891	3317	2831	2465	2201	2031	60	2201	2831	3317	3891
65	4526	3767	3172	2769	2521	65	2521	3172	3767	4526
70	5208	4263	3544	3079	2806	70	2806	3544	4263	5208
75	5859	4774	3953	3405	75	3405	3953	4774	5859
80	6613	5342	4381	3736	80	3736	4381	5342	6613
85	7440	5936	4846	85	4846	5936	7440
90	8411	6619	5332	90	5332	6619	8411
12-Pounds Final Retention										12-Pounds Final Retention								
16	251	216	177	202	148	118	16	118	177	216
18	408	350	295	251	202	226	162	143	18	162	202	251
20	761	605	501	423	354	305	251	280	217	172	20	217	251	305	354
25	1062	870	723	615	526	453	369	417	310	252	25	310	369	453	526	615
30	1373	1161	988	841	708	590	487	550	398	30	487	590	708	841
35	1681	1441	1239	1077	925	796	693	748	35	693	796	925	1077
40	2021	1740	1505	1308	1136	988	866	40	988	1136	1308	1505
45	2384	2050	1785	1519	1367	1195	1047	45	1195	1367	1519	1785
50	2773	2375	2065	1810	1603	1426	1254	50	1603	2065	2375
55	3211	2754	2360	2075	1843	1677	55	1843	2360	2754
60	4016	3424	2923	2544	2272	2096	60	2272	2923	3424	4016
65	4672	3888	3275	2859	2603	65	2603	3275	3888	4672
70	5376	4400	3659	3179	2896	70	2896	3659	4400	5376
75	6048	4928	4080	3515	75	3515	4080	4928	6048
80	6827	5515	4523	3856	80	3856	4523	5515	6827
85	7680	6128	5003	85	5003	6128	7680
90	8683	6832	5504	90	5504	6832	8683

Rainier Douglas Fir Crossarms



Indispensable characteristics in crossarms are strength and durability. Strength to carry the dead load of conductor, sleet and wind, and to withstand shock within any combination of these two duties that may be imposed upon the arm in service. Durability is as necessary as strength because the arm is intended for many years of service and the cost to replace an arm in the line is many times the price of the arm itself.

Light weight is also important. Lighter arms cost less to transport and install, and place a lighter burden on the pole structures.

Rainier fir crossarms meet all of these requirements. They are carefully graded with strength-reducing defects eliminated and are seasoned to approximately equilibrium moisture content which adds further to the strength. These crossarms are seasoned slowly and so controlled that from the start to the finish of the seasoning process, the moisture content of the interior is substantially the same as the surface of the arm.

Microscopic as well as visible checking is held to a minimum, and the finished arm is sound and solid. It will not readily soak up moisture nor admit decay fungi to the interior of the arm.

The largest factory is at Chehalis, Washington. The finest dry kilns and kiln control equipment are located there. Dry kiln operations are supervised by specialists and experts in the drying of crossarm sizes of Douglas fir. Carload orders are shipped economically from Chehalis to all parts of the United States.

Minimum Carload Weight—Fir from Pacific Coast Mills, 41,000 pounds. Small cars are scarce and a weight of not less than 50,000 pounds should be figured on. Cars to contain as much as 90,000 pounds can be had.

For customers who desire LCL quantities of crossarms, particularly with drillings of non-standard sizes or specially spaced, and to provide immediate delivery of any quantities in emergencies, factories are maintained at Chicago, Minneapolis, Kansas City, Danville, Pa. and Gainesville, Florida. These factories are fully provided with manufacturing equipment and are substantially stocked with crossarm lumber which permits prompt attention to the requirements of users in all parts of the country. Kiln drying at these factories is not economical due to the cost of fuel, but each point carries a reasonable stock of blanks, kiln dried on the West Coast, for customers who ask for kiln dried arms. All these factories have well designed drying sheds with controlled ventilation and are also equipped with precision instruments for checking the character of drying while the lumber is being conditioned. In all of them the highest standards of lumber grading are followed.

Actual use in the line proves that untreated Douglas Fir crossarms have given satisfactory service for over 50 years, and have an average life of 25 to 35 years. With the use of full length pressure treated poles has created a demand for pressure treated crossarms. We can furnish Douglas Fir crossarms incised or unincised, treated with either Pentachlorophenol or Creosote, either pressure, hot and cold dip, or five-minute hot dip.

Rainier Douglas Fir Crossarm Specifications

1.2 Species. These specifications cover crossarms made of Douglas Fir (*Pseudotsuga taxifolia*), air dried or kiln dried, treated or untreated.

1.3 Grades. Two grades are included, namely: *Dense and †Close Grain. Manufacturers may supply a mixture of both grades in any shipment.

1.4 Strength of Both Grades. It is the intent of these specifications to have the quality of both grades so described and limited that a crossarm meeting the minimum requirements for one grade will have equal strength with a crossarm meeting the minimum requirements for the other grade. (Crossarms of both grades having better quality than the minimum limits of these specifications will, of course, have greater strength, depending upon other factors, such as density, straightness of grain and freedom from strength-affecting defects.)

1.5 Cross-Section Limits. These specifications are intended for crossarms having cross sections of not more than four (4) inches on one face by not more than six (6) inches on the other face.

2.1 General. Unless otherwise specified on the purchase order, all crossarms furnished under these specifications shall conform in all respects to the requirements hereinafter stated. The definitions in these specifications and the drawings which will be supplied, supplement the text and all shall be considered as parts of the specifications.

3. Options in these Specifications

3.1 Because these specifications cover crossarms for use throughout the entire United States where usage may be different and exposure to decay and insect damage varies between extremes, it is not logical to limit these specifications to but one grade, dimension, treatment or preservative. Therefore the following options are listed and the selection desired must be specified on the purchase order.

3.11 Grade. If a mixture of both grades is not acceptable to the purchaser, then the grade desired shall be specified, that is, whether dense or close grain.

*Dense Grade formerly was called Dense Select Structural Grade. (Type B).

†Close Grain Grade formerly was called Standard Crossarm Stock (Type A).

(Continued on following Page)

Rainier Douglas Fir Crossarm Specifications

3.12 Dimensions, length, drilling details and allowable tolerances shall be specified. (These details are customarily shown by drawings.)

3.13 A preservative treatment, if required, shall be specified. The options covering preservative treatment are:

- (a) Pressure treatment and retention, namely, 6 or 4 pounds per cubic foot, or
- (b) An open tank hot and cold treatment.

3.14 The preservative to be used (if crossarms are to be given a preservative treatment) shall be specified. (See paragraph 7.4.) Options for preservatives are:

- (a) Creosote,
- (b) Pentachlorophenol, or
- (c) Mixtures of (a) and (b) above.

3.15 If the identifying letters "DF" for Douglas Fir are required on each crossarm, it shall be specified.

3.16 When the purchaser does not wish to have the top center 12 inches of crossarms chamfered or rounded he shall so specify.

4. Grade Conformance

4.1 All close grain grade crossarms shall conform to the limitations listed in Tables I and III. However, if the density of the wood in a crossarm is determined to be in accordance with the requirements of the density rule, as stated in Table II, item I, the crossarm shall then be considered to be dense and required to meet only the more lenient limitations of Tables I and II. Therefore, the density of the wood shall first be determined prior to further examination.

5. Manufacturing Requirements

5.1 Workmanship. All crossarms shall be of first quality workmanship. Crossarms shall be dressed on four sides, although heavy skips on the bottom and slight skips on one side are permissible. Splintering around holes resulting from bits breaking through shall be kept to a minimum.

5.2 Dimensions and Tolerances. The dimensions and drilling details of crossarms supplied shall conform to specifications or drawings supplied by the purchaser.

5.41 Marking, Treated Crossarms. All treated crossarms shall be legibly and permanently marked or branded with the following information: (a) manufacturer's designation, (b) year of manufacture, and (c) code (as shown below) indicating treatment given. When specified on the purchase order all treated crossarms shall also be legibly and permanently marked or branded with the letters "DF" to indicate Douglas Fir.

(a) Coding. The type of treatment shall be indicated first, "6" or "4" to indicate a pressure treatment with 6 or 4 pounds final retention, respectively; or, "0" to indicate non-pressure "hot and cold" method.

The preservative to be used shall be indicated next, "C" for creosote; "P" for pentachlorophenol. For example, "6C" would indicate a pressure treatment having a final retention of 6 pounds with number 1 creosote. "0P" would indicate "hot and cold" non-pressure treatment with pentachlorophenol.

Other letters as found necessary may be used to indicate other treatments and preservatives.

5.42 Untreated Crossarms. All untreated crossarms shall be legibly and permanently marked or branded with the manufacturer's designation and the year of manufacture.

6. Limitations

6.1 Limitations shall be in accordance with Tables I, II and III as applicable.

7. Preservative Treatment

7.1 Explanation. It seems logical to have crossarms last as long as poles. There is now a definite trend toward full length treatment of all poles, whether southern pine, cedar or miscellaneous conifers. Therefore, to make the normal life expectancy of crossarms the same as poles, it is recommended that all crossarms—particularly for use with full length treated poles—be given a preservative treatment.

The treatment to be given crossarms must be decided upon after consideration is given to the conditions favoring decay and insect damage encountered in the area where the arms are to be used. Since crossarms do not have direct contact with soil, as do poles, the need for heavy retentions of preservative is not so great. The major penetration resulting from any treatment of non-incised fir crossarms will be (1) in the sapwood, (2) longitudinally from the ends and from all drilled holes. Fir crossarms usually have little volume of sapwood. They have many drilled holes which improve cast of penetration of preservative where needed.

7.2 Available Options. The required preservative, treatment and retention—where applicable—shall be specified on the purchase order.

7.3 Treatments. Any treatment giving the results required by paragraph 7.5 and 7.6 is acceptable. The most common acceptable treatments are:

- (a) Pressure treatments with final retentions of 6 or 4 pounds per cubic foot.
- (b) Non-pressure treatments using the "hot and cold" method. It is generally necessary to use a minimum treating time of 2 hours at approximately 230 F and 2 hours at approximately 130 F.

7.4 Preservatives. There are a number of satisfactory preservatives. Those preservatives, acceptable at present are:

- (a) No. 1 creosote, in accordance with Specification P1 of the American Wood-Preservers' Association, except that the residue above 355 C shall be less than 25%.
- (b) 5% solution of pentachlorophenol in a suitable petroleum carrier.
- (c) Mixture of (a) and (b) above. Usually about 15% of creosote is used.

7.5 Penetration. The preservative should penetrate all the sapwood. It shall penetrate longitudinally not less than one and one-half inches from pinholes, bolt holes and from the ends.

7.6 Effects of Treatments, and Cleanliness. The treating method used shall not injure the wood. After treatment, crossarms shall be reasonably clean to the touch and should remain so.

8. Inspection

8.1 Inspection and acceptance shall be made at the place of manufacture, treating plant, or upon delivery. The supplier shall give to the purchaser, or his representative, such access to his works during working hours as is reasonable and necessary to determine the suitability of material to be supplied, and shall furnish all necessary apparatus, labor and other facilities for making the tests herein called for without cost to the purchaser. Inspection by the purchaser's representatives or the waiving of inspection shall not relieve the supplier from obligation to furnish material in accordance with these specifications.

9. Rejection

9.1 All crossarms not in accordance with these specifications shall be rejected.

(Continued on following Page)

Rainier Wood Crossarms

Specify Pin Hole Diameters on All Orders

No.	Length	Pin	Pin Holes Spacing, Inches			Diameter Center Bolt Hole, Inches	Distance Apart	*Brace Bolt Holes, In. Diam.	Wt., Lbs. Per 100 Arms	S.Y.P. Creosoted 8#
			Center	Sides	Ends					
Pony Arms, 2 3/4 x 3 3/4 Inches										
RA101	2'	2	17	3 1/2	1 1/16	..	7/16	510	800
RA102	2' 6"	2	23	3 1/2	1 1/16	..	7/16	675	1000
RA103	3'	2	29	3 1/2	1 1/16	..	7/16	810	1200
RA104	3' 6"	4	16	9 1/2	3 1/2	1 1/16	28	7/16	945	1300
RA105	5' 2"	6	16	9 3/4	3 1/2	1 1/16	28	7/16	1395	2000
RA106	6' 10"	8	16	9 3/4	3 3/4	1 1/16	28	7/16	1845	2600
RA107	8' 6"	10	16	9 3/4	3 3/4	1 1/16	28	7/16	2295	3200
RA108	10'	12	16	9 5/8	3 7/8	1 1/16	28	7/16	2700	3800
Electric Light Arms, 3 1/4 x 4 1/4 Inches										
RA110	3'	2	28	4	1 1/16	25	7/16	1062	1500
RA111	4'	4	16	12	4	1 1/16	28	7/16	1116	2100
RA112	5'	4	18	17	4	1 1/16	28	7/16	1770	2600
RA113	6'	4	22	21	4	1 1/16	32	7/16	2124	3100
RA114	6'	6	16	12	4	1 1/16	32	7/16	2124	3100
RA115	8'	6	18	17 1/2	4	1 1/16	32	7/16	2832	4100
Light Distribution Arms, 3 1/4 x 4 1/4 Inches										
RA120	3' 2"	2	30	4	1 1/16	28	7/16	1120	1600
RA121	5' 7"	4	30	11 1/2	4	1 1/16	38	7/16	1976	2900
RA122	8'	6	30	11 1/2	4	1 1/16	38	7/16	2832	4100
RA123	9' 2"	8	30	12	4	1 1/16	38	7/16	3245	4700
New England Arms, 3 1/4 x 4 1/4										
RA130	3'	2	30	3	1 1/16	33	7/16	1062	1500
RA131	5' 6"	4	30	13 1/2	4 1/2	1 1/16	36	7/16	1947	2800
RA132	7' 9"	6	30	13 1/2	4 1/2	1 1/16	36	7/16	2743	3950
RA133	10'	8	30	13 1/2	4 1/2	1 1/16	36	7/16	3510	5100
Pacific Arms, 3 1/4 x 4 1/4 Inches										
RA140	3'	2	28	4	1 1/16	32	7/16	1062	1500
RA141	5'	4	28	12	4	1 1/16	32	7/16	1770	2600
RA142	7'	6	28	12	4	1 1/16	32	7/16	2178	3600
RA143	9'	8	28	12	4	1 1/16	12	7/16	3186	4600
RA144	11'	10	28	12	4	1 1/16	12	7/16	3894	5610
Telephone Arms, 3 1/4 x 4 1/4 Inches										
RA150	6'	6	16	12	4	1 1/16	32	7/16	2124	3100
RA151	8' 6"	10	16	9 3/4	4	1 1/16	32	7/16	3009	4300
RA152	10'	10	16	12	4	1 1/16	12	7/16	3540	5100
RA153	10'	10	32	10	4	1 1/16	42	7/16	3540	5100
Telegraph Arms, 3 1/4 x 4 1/4 Inches										
RA160	6'	6	19	11 1/4	4	1 1/16	36	7/16	2124	2900
RA161	10'	10	22	11 1/4	4	1 1/16	36	7/16	3540	4800
RA162	10'	10	33	10	3 1/2	1 1/16	37	7/16	3540	4800
Medium Distribution Arms, 3 1/2 x 4 1/2 Inches										
RA170	3' 2"	2	30	4	1 1/16	28	7/16	1266	1900
RA171	4'	2	40	4	1 1/16	32	7/16	1600	2400
RA172	5' 7"	4	30	11 1/2	4	1 1/16	38	7/16	2233	3100
RA173	8'	6	30	14 1/2	4	1 1/16	38	7/16	3200	4600
RA174	9' 2"	8	30	12	4	1 1/16	38	7/16	3666	5500
Heavy Distribution Arms, 3 3/4 x 4 3/4 Inches										
RA190	10'	4	38	36	5	1 3/16	60V	9/16	4660	7000
RA191	10'	8	30	13 3/8	4 1/8	1 1/16	38	7/16	4660	7000
Heavy New England Arms, 3 3/4 x 4 3/4 Inches										
RA200	3'	2	30	3	1 1/16	33	7/16	1398	2100
RA201	5' 6"	4	30	13 1/2	4 1/2	1 1/16	36	7/16	2563	3700
RA202	7' 9"	6	30	13 1/2	4 1/2	1 1/16	36	7/16	3612	5400
RA203	10'	8	30	13 1/2	4 1/2	1 1/16	36	7/16	4660	7000

Rainier Special Crossarms

No.	RA1	RA3	RA4	RA5	RA6	RA7	RA8	RA9
Size, Inches.....	2 3/4 x 3 3/4	3 1/4 x 4 1/4	3 1/2 x 4 1/2	3 3/4 x 4 3/4	3 3/4 x 5 3/4	4x5	4 3/4 x 5 3/4	5 3/4 x 7 3/4
Douglas Fir: Wt. per Lineal Ft., Pounds.....	2.70	3.54	4.00	4.66	6.00	5.20	7.50	12.00
Southern Yellow Pine Creosoted 8 lbs.: Wt. Per Lineal Foot, Pounds.....	3.80	5.10	6.00	7.00	9.00	7.80	11.30	18.00

*Brace bolt holes marked V drilled through the arm vertically; all others drilled horizontally.
Prices on application.

Rainier Wood Insulator Pin Specifications



Standard

Scope. This specification covers wood pins made of yellow locust (sometimes called black locust from the color of its bark).

General. The specifications and drawings are intended to include all instructions necessary for the guidance of the manufacturer in his work. They are intended to supplement each other and any details indicated in one and not in the other shall be executed the same as if indicated in both.

Dimensions. Pins shall be of the style and dimensions shown, and allowable variations must not be exceeded. Pins and threads shall be smoothly and accurately formed. Figures on the drawing shall be followed in preference to scale measurements.

Seasoning. Pins manufactured from green or partially seasoned wood shall, when seasoned, conform to the requirements of this specification.

Material

Finished pins shall not contain any of the defects listed below, and where any of these defects are present, they shall be cause for rejection.

Annular Rings. Rings which depart from parallelism with the center line of pin by a sufficient amount to allow a ring starting at the center of the bottom of the pin to run out of the side below the lower thread.

Checks. Checks exceeding 3 inches in length or 1/16-inch in width.

Knots. Loose or unsound knots. Sound knots exceeding 1/8 inch in diameter above the shoulder or exceeding 1/4 inch in diameter below the shoulder. The least diameter of a knot shall be considered its diameter for the purpose of this specification.

Loose Heart. Pitch Pockets. Rot. Sapwood. Sapwood exceeding 1/8 inch in thickness except on the shoulder of the pin.

Shakes. Cracks or splits concentric to the annular rings of the wood.

Wane. Wane or bark above the shoulder.

Worm Holes. In the top 7-inch section of the pin.

Allowable Variations

No. of threads per inch, 4, tapering 1.11 inch per foot.

Dimension	a	d	u	xd
Over...inches	1/64	1/8	1/32	3/8
Under...inches	1/64	1/8	3/16	1/8

No. of threads per inch, 4, tapering 1/16 inch per inch.

Dimension	a	c	d	f	xb
Over...inches	1/64	1/16	1/8	1/4	...
Under...inches	1/64	1/16	1/8	1/4	1/32

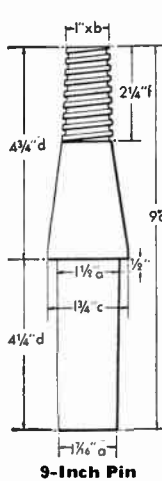

9-Inch Pin

Standard Pins

No.	Size In.	Diam. Top In.	Wt. Lbs. per 100
RPL-508	1 1/4 x 8	1	32.5
RPL-509	1 1/2 x 9	1	48

Transposition Pins

RPL-512	1 1/4 x 9	1	40
RPL-514	1 1/2 x 10	1	55

High Tension Pins

RPL-520	1 1/2 x 9	1 3/8	60
RPL-522	1 1/2 x 11	1 3/8	75
RPL-524	1 1/2 x 12	1	62.5
RPL-525	1 1/2 x 12	1 3/8	80
RPL-527	1 3/4 x 12	1	120
RPL-528	1 3/4 x 12	1 3/8	130

Duplex Pins

RPL-530	1 1/4 x 11 1/2	1	50
RPL-531	1 1/4 x 12	1	55
RPL-533	1 1/2 x 12	1	65
RPL-535	1 1/2 x 13	1	75

Prices Upon Application

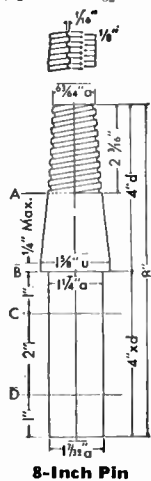

8-Inch Pin

Rainier Wood Insulator Bracket Specifications



Bracket



Pole Step

Scope. Specification covers wood brackets made of oak. Brackets shall be free from cracks, shakes, brashy wood and all other imperfections, except as hereinafter specified.

Seasoning. The maximum moisture content of seasoned brackets shall be 20%.

Checks. Presence of checks is permitted provided they do not extend into threaded section of bracket or intersect any nail hole and are not greater than 2 inches in length.

Grain. The grain shall be straight and shall be practically parallel to the axis of the threaded portion of the bracket. The grain at either of the right-angled corners at the end of the bracket shall not run out below the bottom thread of the opposite side of the bracket.

Insect-Holes. In wood otherwise sound, a few small insect holes not exceeding 1/16 inch in diameter may be present, provided that they are scattered and appear only in the portion of the bracket between the turned section and the small nail hole. No more than 5% of the brackets furnished shall contain such insect holes.

Knots. Brackets shall be free from loose or unsound knots. Sound knots are permitted in the turned section of the bracket up to a diameter not greater than 1/4 inch, provided that the distance between 2 knots is not less than 1 inch. Sound knots are also permitted in the portion between the turned section and the small nail hole up to a diameter not greater than 1/2 inch, provided that not more than 3 knots are present in this portion of the bracket and that all such knots are at least 1/4 inch distant from either nail hole.

Sapwood. Brackets may contain sapwood along any edge provided it does not appear on any face to a distance greater than 1/4 inch from the edge.

Standard Wood Brackets

No.	Size Inches	Wt. Lbs. Per 100
ROB-550-4	1 1/2 x 2 x 10	60
ROB-552-5 (AT&T)	1 5/8 x 2 x 12	80
ROB-555-6 (WU)	2 x 2 3/8 x 12	100
ROB-556-7 (WU)	2 x 2 3/4 x 12	115

Standard Wood Pole Steps

ROB-576	1 3/4 x 2 3/4 x 7	70
---------	-------------------	----

Rainier Wood Ground Wire Moldings

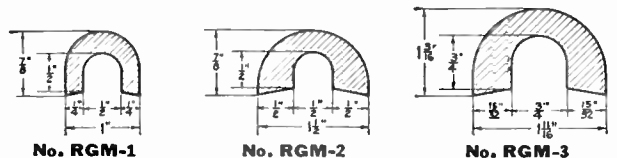

No. RGM-1

No. RGM-2

No. RGM-3

No.	RGM-1	RGM-2	RGM-3
Wt. Per 1000 Lin. Ft. Lbs.	120	180	310

Prices upon application.

Rainier Wood Cross Braces

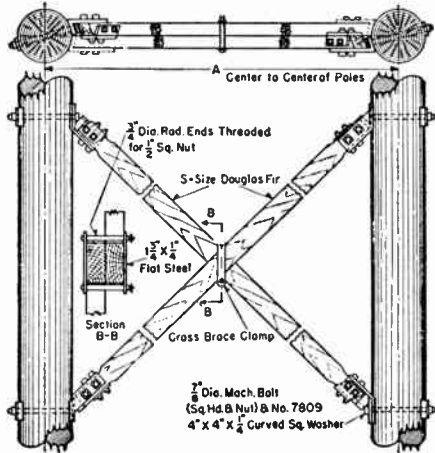

Wood cross braces increase the transverse strength of II-frame structures. Steel fittings are tapped to insure static-free performance and are double-dip hot galvanized. Wood is structural grade Rainier fir.

No.	Size of Wood (Inches)	A	Mtg. Bolt Diam. in.	Wt. Lbs. 100 Pcs.
1000	3 3/8 x 4 3/8	7' to 8' 4"	7/8	11500
		8' 6" to 9' 10"	7/8	12500
		10' to 11' 0"	7/8	13500
		11' 6" to 12' 6"	7/8	17000
		12' 8" to 13' 10"	7/8	18000
		14' 6" to 15' 4"	7/8	20500
1100	3 3/8 x 5 3/8	14' to 15' 4"	7/8	22500
		15' 6" to 16' 10"	7/8	25000
			7/8	25000
		17' to 18' 6"	7/8	27500

Ordering Data: Specify center to center pole spacing and series number on order.

Braces are furnished with all Necessary Mounting Bolts. Unless otherwise specified each set will include two 1/8" x 14" and two 7/8" x 16" bolts.

Rainier "Vee" & "Knee" Braces 2000 Series

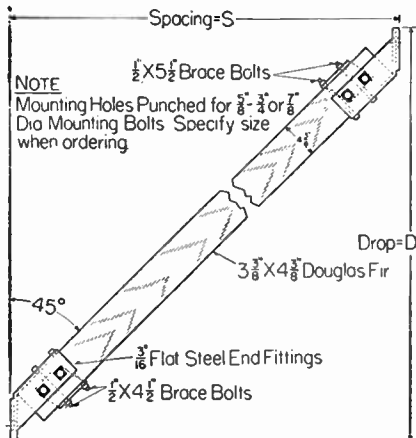

The mounting holes for Knee and Vee Braces may be punched for 5/8, 3/4, or 7/8 inch mounting bolts. Specify size of hole and give dimensions S & D when ordering.

Knee and Vee Braces are identical except for angle fitting on one end. Knee Braces fit against side of pole and top of wood filler block. Vee Braces fit against side of pole and side of metal spacer fitting. Mounting bolts for both Knee and Vee Braces are ordered separately as they are not included with the brace assembly.

Prices on application.

Treated Wood Braces

Unless otherwise specified wooden members of these braces are furnished treated with a pentachlorophenol dip. Other types of treatment are readily available upon request.

Rainier Wood Crossarm Braces

1/2" Dia. Mach. Bolts not Included

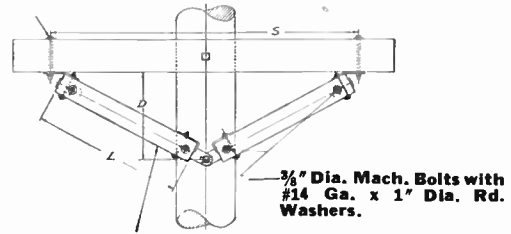

Wood Members, 1 1/2" x 2 1/2" Treated Douglas Fir. Mtg. Bolt Hole in top Fitting 9/16" Dia. for 1/2" Bolt. Mtg. Bolt Hole in Bottom Fitting 3/16" Dia. for 1/2" Bolt. Unless Otherwise Specified.

Stock No.	Spacing "S"	Drop "D"	Length "L"	Wt. Lbs. Per Pair
100 Series				
100	42"	12"	20"	10
105	42"	21"	26"	10
110	48"	18"	26"	10
115	48"	24"	30 1/2"	11.5
120	60"	18"	30 1/2"	11.8
125	60"	30"	38 1/2"	12
130	62"	23 5/8"	31 1/2"	12
135	72"	22"	38 1/2"	12
140	72"	36"	47 1/8"	14
145	84"	21"	44 3/8"	14
150	86"	33 5/8"	50 9/16"	15
155	90"	33 5/8"	52 1/16"	15
200 Series				
(Similar to 100 series except wood 1 5/8" x 2 1/4".)				
202	37"	12"	18 3/4"	5.6
203	37"	18 1/2"	23"	6.2
204	42"	12"	21"	6.1
205	42"	21"	26"	6.8
210	48"	18"	26 3/4"	7
215	48"	24"	30 3/4"	7.5
220	60"	18"	31 3/4"	7.6
225	60"	30"	39"	8.7
240	72"	36"	48"	10

3/4" Dia. Mach. Bolts not Included

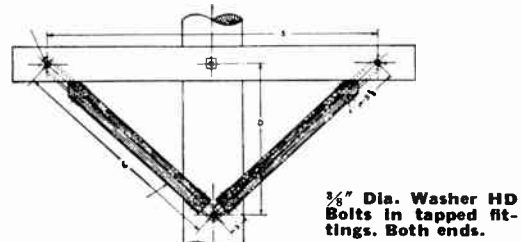

Wood Members, 1 5/8" x 2 1/4" Treated Douglas Fir. Mtg. Bolt Hole in Top Fitting 3/8" Dia. for 3/8" Bolt. Mtg. Bolt Hole in Bottom Fitting 1/2" Dia. for 1/2" Bolt. Unless Otherwise Specified.

Stock No.	Spacing "S"	Drop "D"	Length "L"	Wt. Lbs. Per Pair
600 Series				
600	38"	18"	21 1/2"	

1/2" Dia. Mach. Bolts not Included

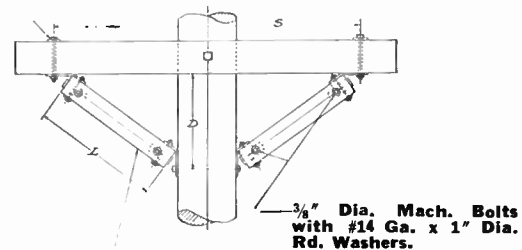

Wood Members, 1 1/2" x 2 1/2" Treated Douglas Fir. Mtg. Bolt Hole in Top Fitting 9/16" Dia. for 1/2" Bolt. Mtg. Bolt Hole in Bottom Fitting 3/16" Dia. for 1/2" Bolt. Unless Otherwise Specified.

Stock No.	Spacing "S"	Drop "D"	Length "L"	Wt. Lbs. Per Pair
200 Series				
400	48"	20"	24"	10
405	60"	26"	30"	12

All braces are available for special drop and span.

Rainier Transmission Line Fir Crossarms and Timbers

American Crossarm & Conduit Company crossarms for transmission lines are manufactured from carefully graded Douglas Fir timbers.

Douglas Fir is "King of Trees" in the great forests of the Northwest. Douglas Fir grows in dense stands and produces a clear, straight grained heartwood that is materially stronger than the average wood of its weight. Because of its close, tight grain, it is highly resistant to weather in any climate and has the strength and long lasting qualities so vital to a transmission line structure.

Kiln drying and air seasoning operations are scientifically controlled by expert timber engineers, and each piece of wood conditioned for long years of service in the line.

Each of the manufacturing plants of the American Crossarm & Conduit Company is fully equipped for precision manufacture of transmission line crossarms, timbers, and braces.

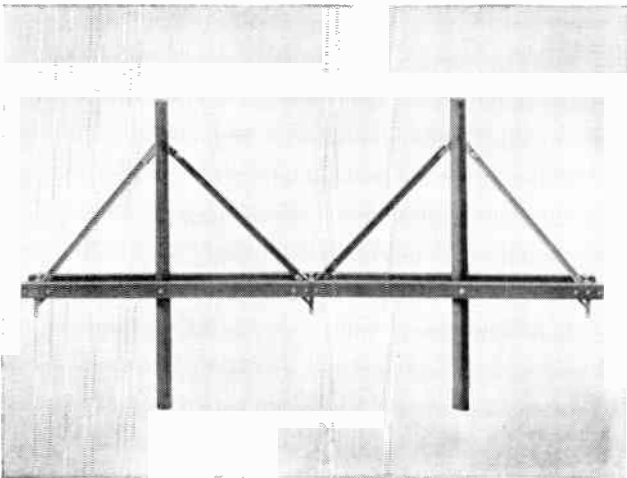
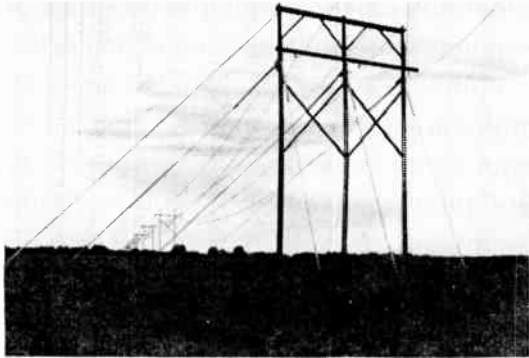

Complete transmission line crossarm units, manufactured to the customer's own specification, either with or without hardware attached, are available from their plants at Chehalis, Wash.; Kansas City, Mo.; Chicago, Ill.; Minneapolis, Minn.; Danville, Pa.; Gainesville, Florida.

The 50 foot dual member crossarms, together with the cross braces and knee braces for this 230 kv. transmission line, were fabricated, shipped, and serving in the line less than four months after the order was received.

Design engineers may specify different sizes for their structures to suit some special service demands. We are prepared to furnish crossarms, timbers, and braces to meet the engineers' specifications, and your nearby Graybar sales office will gladly supply full and complete data, including treating, stress and loading tables for all sizes and types of transmission timber.

Prices on application.

Soil Classification

As an aid in determining the type and size of anchor best suited for a specific job, classification has been made of anchor holding strengths in different types of soil and under different moisture conditions. Classification of holding power on the basis of soil type alone has been found to be insufficient, not only from the standpoint of soil identification, but also because of variations experienced in the holding power values.

Numerous tests under different moisture conditions and in all types of soil have proven moisture content to be a greater factor than soil composition in determining soil-anchor holding power. The following soil classifications give consideration to both the type of soil and the moisture content, providing a more accurate and easily-recognized means of soil identification.

Class 1. HARD ROCK (solid).

Class 2. SHALE, SANDSTONE, (solid or in adjacent layers).

Class 3. HARD, DRY, (hardpan). Usually found under a Class 4 strata, resembling soft rock. Requires use of digging bar).

Class 4. CRUMBLY, DAMP, (usually clay predominates. Insufficiently moist to pack into a ball when squeezed by hand. Particles crumble off).

Class 5. FIRM, MOIST, (usually clay predominates. Other soils commonly present. When squeezed by hand will form into a firm ball. Most soils in well drained areas will fall into this classification).

Class 6. PLASTIC WET, (usually clay predominates as in Class 5. Due to unfavorable moisture conditions such as areas subjected seasonally to heavy rainfall, sufficient water is present to penetrate the soil to appreciable depth and though the area is fairly well drained, the soil during such seasons becomes plastic and when squeezed will readily assume any shape. This soil is not uncommon in fairly flat terrain).

Class 7. LOOSE, DRY, (found in arid regions; usually sand and gravel predominates. Filled in or built up areas in dry regions fall into this class. As the term implies, there is very little bond to hold the particles together).

LOOSE, WET, (same as Loose, Dry, for holding power. High in sand, gravel, or loam content. Holding power at some seasons good, but during rainy seasons absorbs excessive moisture readily with resultant loss of holding power. Predominant in poorly drained areas. This Class also includes very soft wet clay).

Class 8. SWAMPS and MARSHES (includes areas that are marshes only seasonally).

Moist soils will vary in their classification during the year due to changes in their moisture content. Extreme conditions should be estimated.

Ultimate Holding Strengths

The ultimate soil-anchor holding strengths evaluated on the basis of the preceding soil classifications are the values at which the anchor will start to pull out in the type of soil and under the conditions indicated. Values given in the tables on the following pages are based on tests with anchor rods set at 45° and anchors set 7-feet deep. For lesser depths, values are about 15% less for the first foot and 10% less for the next foot. A safety factor of 2 to 1, or greater, is suggested.

Chance Expanding and Tamping Bars



For use with expanding anchors; the weight of the bar does the work. Also used for tamping-in the dirt above the anchor.

Hook wraps around the anchor rod for guide.

No.	Lgth., Ft.	Wt., Lbs.	*Each
10	10	24	\$15.40
12	12	25	16.85

Chance 8-Way Expanding Anchors

Without Rods



Eight steel blades expand to form a square, distributing the load evenly over the entire anchor area.

There are no non-holding areas between blades.

Base plate causes anchor to expand in a cone shape. Anchor has no hinges or moving parts to hinder its smooth operation. Furnished with nut retainer and coated with special asphalt paint to guard against corrosion.

No.	Hole Size In.	Area Sq. In.	Ultimate Soil-Anchor Holding Str. in 1000 Lbs.				Approx. Wt. Pkg. Per 100, Pounds	*Each	
			Soil Classification						
			3	4	5	6	7		
6860	6	60	10	8.5	7	5.5	4	5 503	\$1.70
6870	6	70	16	14	11	8.5	5	5 167	2.15
88100	8	100	22	18.5	15	13	8	3 811	2.75
88115	8	115	24.5	20.5	17	14	9	3 880	3.00
88135	8	135	26.5	22	18.5	15	10	3 1056	3.40
88135-1	8	135	26.5	22	18.5	15	10	3 1056	3.40
1082	10	200	31	26.5	21	16.5	12	2 1900	6.10

Anchor Rod Specifications

Chance 8-Way anchors are designed for use with standard threaded anchor rods. The following table shows rod sizes for each anchor. Rods must be ordered separately.

Anchor No.	Rod Size	Anchor No.	Rod Size
6860	1/2" x 6', 5/8" x 7' and 5/8" x 8'	88115	5/8" x 7' and 3/4" x 8'
6870	1/2" x 6', 5/8" x 7' and 5/8" x 8'	88135	5/8" x 7' and 3/4" x 8'
88100	5/8" x 7' and 3/4" x 8'	88135-1	1" x 10'
		1082	1" x 10'

Anchor Accessories

Designed to make anchor installing quicker and easier. Provide efficient tools for all steps of installation, from digging of hole to tamping of backfill.

Chance Telescoping Trip Augers



Handle can be gradually extended for boring deep holes. Trip mechanism and movable blade make dirt-dumping easy. Blades are sharpened for fast digging.

Simple to use. Constructed to take rough treatment.

No.	Hole Diam., in.	Max. Hole Depth, Ft.	Wt. Lbs.	*Each
610-A	6 1/2 to 10	8	24	\$14.20
612-A	6 1/2 to 10	10	27 1/2	16.15
812-A	8 1/4 to 11 3/8	8	24 3/4	15.35
813-A	8 1/4 to 11 3/8	10	28 1/2	17.30
814-A	8 1/4 to 11 3/8	12	32	19.25

*Western zone prices; eastern prices lower. Contact Graybar for quantity prices.

Everstick Expanding Anchors

Certified Malleable Iron

Expand into undisturbed earth to provide maximum holding power. Malleable iron provides toughness and unexcelled rust-resistance.

2-Way Anchors

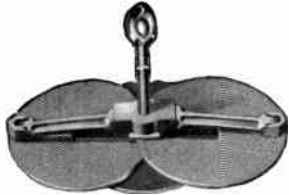

Open



Closed

A dependable anchor for guying with a minimum of installation time and expense.

No	Anchor and Hole Size, In.	Max. Rod Size, In.	Area Expanded, Sq. In.	Wt. Ea., Lbs.	Holding Power, Lbs.			†Each
					Sand	Clay	Hardpan	
62	6	5/8	55	7	3000	5000	7000	\$1.78
82	8	5/8	100	11	6000	11000	16000	2.67

3-Way Anchors

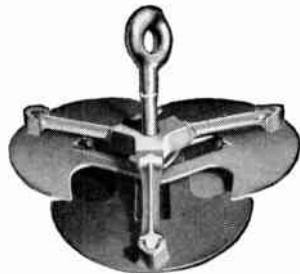

Open



Closed

A sturdy anchor to meet all-around guying requirements. Easy to install and expand.

633	6	5/8	65	7 1/2	5000	8000	11000	\$2.15
834	8	5/8	90	11	6000	10000	14000	2.67
836	8	3/4	110	14	8000	13000	18000	3.36
8310	8	3/4	125	15	12000	18000	24000	3.67
8312	8	1	125	16	12000	18000	24000	3.67
10316	10	1	175	28	18000	32000	45000	6.82

4-Way Anchors

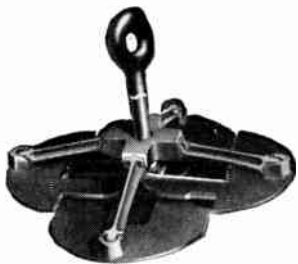

Open



Closed

Designed to meet the toughest guying requirements. Heavy-duty design throughout.

84	3/4"	8	3/4	125	16	12000	18000	24000	\$3.93
84	1"	8	1	132	16	12000	18000	24000	3.93
104		10	1	210	30	20000	35000	50000	7.45
124		12	1 1/4	310	55	30000	50000	70000	11.44

†Prices slightly higher in the west. Quantity prices on request.

Chance Never-Creep Plate Anchors



For permanent or temporary guys.

Pull entirely against solid earth, providing holding power independent of tamping of back-filled earth.

Formed of structural steel and dipped in asphalt paint. Steel plate is heavily reinforced in areas of greatest stress.

Creep guards welded to the top of plate prevent creep and aid in guiding rod into the rod sockets.

Never-Creep Anchor Dimensions, Weights and Prices

No.	Size of Anchor, Inches	Area, Sq. In.	Wt., Lbs. Per 100	†Each
617	6 x 17	102	808	\$ 3.00
622	6 x 22	132	1064	4.00
822	8 x 22	176	1531	5.15
827	8 x 27	216	1743	6.30
835S	8 x 35	280	3207	11.10
1040S	10 x 40	400	4692	18.50

Soil-Anchor Holding Strengths

Anchor No.	Holding Strengths In Pounds				
	Class *3	Class *4	Class *5	Class *6	Class *7
617	21,500	18,500	14,500	11,500	7,500
622	25,000	21,500	17,500	13,500	9,500
822	30,000	26,000	20,500	16,000	11,500
827	34,000	29,000	23,500	18,500	13,500
835S	41,000	34,500	27,500	22,000	16,500
1040S	50,000	43,000	34,000	27,500	21,000

Anchor Rod Specifications

Chance Never-Creep anchors are designed for use with drive-point rods. The following table shows rod sizes for each anchor. Rods must be ordered separately.

Anchor No.	Rod Size	Anchor No.	Rod Size
617	5/8" x 7'	827	3/4" x 8'
622	3/4" x 8'	835S	1" x 8'
822	3/4" x 8'	1040S	1" x 8'

*Soil classifications, see page 753.

Chance Never-Creep Plate Anchor Installing Bar



Have hook on one end for installing or retrieving anchor plate; tamp furnished on other end.

Hook and tamp castings of malleable iron.

No.	Length, Ft.	Wt. Each, Lbs.	†Each
15	10	9	\$8.90

Chance Never-Creep Maul



Specially designed for driving drive-point rods. Has seasoned hickory inserts for protection to rods.

No.	Wt. Each, Lbs.	†Each
16	12	\$5.70

†Western zone prices; eastern prices lower. Contact Graybar for quantity prices.

Everstick Tamping Bars

Blackburn's Patent



Extra strong and well-balanced. Locks on anchor rod and will not jump off. Strikes a true blow and expands Everstick Anchors with a minimum of effort. Selected hickory or oak wood handle with heavy Malleable Iron Shoe.

Made in 9 and 12 ft. lengths.

No.	Length, Ft.	Wt., Lbs.	Each
9	9	23	\$10.00
12	12	24	12.65

Prices slightly higher West of the Rockies, or in other zones.

Everstick Auger Handles

Blackburn's Telescope

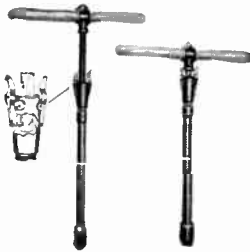

Fits all Iwan and Standard Auger Blades as well as 3-in. Iwan "Pilot" Blade. Extension holders make length easily adjustable.

No.		Wt., Lbs.	Each
8	For boring hole up to 8 ft. in depth....	19	\$6 50
10	For boring hole up to 10 ft. in depth....	22	6 50

Prices slightly higher West of the Rockies, or in other zones.



Hubbard Steelwing Screw Anchors

Hot Galvanized

Provide quickly installed, permanent anchorage with sufficient holding power for normal pole line work. Easily reclaimed; has no parts to come loose and remain underground. To indicate holding strength, wing diameters are stamped on rod below eye (except Nos. 7542 and 7543). Available with Three-Hubeye or E.E.I. oval eye. Three-Hubeye eliminates need for a thimble. Nos. 7542 and 7543 designed for anchoring fences, trees and for similar light guying.

Three-Hubeye No.	E. E. I. Oval Eye No.	†Nominal Rating Pounds	Dimensions, Inches			Rod Diam.	Length Feet	Approx. Ship. Wt. Per 100, Pounds
			Diam.	Pitch	Wing			
.....	*7542	2 3/4	1 3/8	1/2	1 1/2	130	
.....	7543	2 3/4	1 3/8	1/2	2 1/2	200	
7524	7524-A	4500	4	1 3/4	3/4	4 1/2	800	
7526	7526-A	6500	6	1 1/2	3/4	5 1/2	1040	
7528	7528-A	8000	8	2	1	5 1/2	1900	
7530	10000	10	2 1/2	1 1/4	5 1/2	3200	
7550	12500	10	2 1/2	1 1/4	8	4100	

*Eye formed — all others are drop forged.

†Average Soil.

Chance Swamp Screw Anchors



For guying in swamp areas, marshy or sandy soil or other difficult locations where anchor must be set deep to reach firm soil.

Swamp anchors are set to the desired depth by attaching the required lengths of standard pipe. Pipe is not furnished.

Threaded to receive standard pipe.

Flanged cutting edge is sharpened to aid in cutting through roots, etc. Hub is pointed to aid installation.

Cast iron anchor shipped complete with malleable iron Tripleye nut. Single Thimbleye nut available on specification.

Asphalt dipped.

No.	Anchor Size Inches	Area Sq. In.	Pipe Size In.	Approx. Wt. Per 100, Pounds	§Holding Power Class 8	‡Each
8125-A	8	50	1 1/4	725	6000	\$ 7.55
10150-A	10	78	1 1/2	1100	9000	9.41
122-A	12	113	2	1800	12000	12.58
152-A	15	176	2	2750	15000	16.44

§Eight feet into plastic clay. For soil classifications see page 753.

Chance No-Wrench Screw Anchors



May be installed by hand or by machine. "King Size" Thimbleye® or Tripleye® on the rod has a large opening to admit a turning bar for screwing the anchor down. Eye will also fit adapters for most boring machines. One piece Screw Anchor consists of a drop forged heavily galvanized steel Thimbleye or Tripleye rod, double arc welded to a high strength structural steel blade, dipped in rust-resistant black asphalt paint.

More accurately pitched cutting blade than any other type of screw anchor. Every size anchor is individually "pitch controlled" for fastest installation and greatest holding power. A small hub minimizes friction and also reduces earth disturbance during installation, helps increase holding power of the anchor.

Thimbleye groove designed to protect the guy strand during slack pulling or under load.

Tripleye No.	Anchor Size In.	Area Sq. In.	Rod Size In.	Approx. Lgth. In.	Approx. Wt. Per 100 Lbs.	‡Each
*4345	4	12 1/2	3/4	54	805	\$ 2.89
*6346	6	28	3/4	66	1087	4.14
* 816	8	50	1	66	1815	7.44
10146	10	78	1 1/4	66	3030	10.83
10148	10	78	1 1/4	96	4107	12.47
15148	15	177	1 1/4	96	5500	26.98

Ultimate Soil Anchor Holding Strength No Safety Factors Included

Tripleye No.	Class 4	Class 5	Class 6	Class 7
*4345	6000	4500	3000	1500
*6346	8500	6500	5000	2500
* 816	8000	6500	3500
10146	10,000	8000	4500
10148	12,500	10,000	6000
15148	16,500	13,500	9000

*Available with Thimbleye. When ordering, add suffix "-1" to number.

‡Western Zone prices; slightly lower in Eastern Zone.

Contact GRAYBAR for quantity prices.

Everstick Cone Type Anchors

Malleable Iron



Special ribbed construction adds to holding power and strength. New patented "nut housing" assures compact, tight connection between anchor and rod.

No.	Anchor and Hole Size, In.	Max. Rod Size, In.	Wt. Per 100 Anchors Lbs.	Each
6-C	6	5/8	315	\$0.99
8-C	8	3/4	545	1.41
10-C	10	3/4	1050	2.52
12-C	12	1	1440	3.04
16-C	16	1	2000	6.30
19-C	19	1	3700	12.07
23-C	23	1 1/4	5000	15.64

Prices slightly higher West of the Rockies, or in other zones.

Chance Cone Anchors

Recommended for use with rock backfill for maximum efficiency. Particularly effective in hardpan, adobe clay or rocky soil.



Chance Steel Cone Anchor Without Rod

Has eight flat faces which are directly opposite, forming flat wedges against tamped rock.

Flaring base supports rock at the bottom of the hole, greatly increasing the effectiveness of the wedge.

Nut retainer prevents anchor from riding up during installation and permits salvaging of rod.

Made of drop forged steel, dipped in corrosion-resistant black asphalt paint.

No.	Anchor Diam. In.	Area Sq. In.	Approx. Wt. Per 100	No. in Bundle	Ultimate Soil-Anchor Holding Str., Lbs.				Each
					§ Soil Classification			†	
					2	3	4	5	
6S	6	37	300	5	*	10000	8000	6000	\$1.05
8S	8	63	450	5	*	14000	11000	9000	1.45
10S	10	104	536	5	*	19000	15000	11500	2.35
12S	12	132	808	5	*	21500	17500	14000	3.55
16S	16	239	1750	2	*	31000	25000	20000	7.00
16S-1	16	239	1750	2	*	31000	25000	20000	7.00

*Rod Strength.

§For soil classifications, see page 753.

Anchor Rod Specifications

Chance cone anchors are designed for use with standard threaded anchor rods. The following table shows rod sizes for each anchor. Rods must be ordered separately.

Anchor No.	Rod Size	Anchor No.	Rod Size
6S	1/2" x 6' & 5/8" x 7'	12S	5/8" x 7' & 3/4" x 8'
8S	5/8" x 7' & 3/4" x 8'	16S	5/8" x 7' & 3/4" x 8'
10S	5/8" x 7' & 3/4" x 8'	16S-1	1" x 10'

†Western zone prices; slightly lower in Eastern zone.



Closed Expanded

Chance Expanding Rock Anchor

Provides secure anchorage in rock without use of concrete or lead grouting.

Anchor expands against the side of a 2-inch drilled hole. After anchor is expanded the pull on the rod tends to wedge the anchor tighter against the edge of the hole.

Anchor is malleable iron, dipped in corrosion-resistant asphalt paint. Drop forged steel rods have large Triplexy to accommodate bar for expanding anchor.

Holding power limited to rod strength of 25,000 pounds.

No.	Anchor Size In.	Rod Diam. In.	Rod Length In.	Approx. Wt. Per 100, Lbs.	Each
R315	1 3/4	3/4	15	500	\$3.90
R330	1 3/4	3/4	30	680	4.20
R353	1 3/4	3/4	53	965	4.65
R115L	2 1/4	1	15	1031	5.40
R130L	2 1/4	1	30	1385	6.10
R153L	2 1/4	1	53	1827	7.20
R172L	2 1/4	1	72	2376	8.20
R184L	2 1/4	1	84	2635	8.80
R196L	2 1/4	1	96	2894	9.20

Set in holes drilled 12-in. deep in class 1 hard rock, these anchors will develop the full strength of the anchor rod. 3/4-in. rod ultimate strength of 25,000 pounds. 1-in. rod ultimate strength of 40,000 pounds.

Hubbard Rock Guy Anchors Hot Galvanized

No. 7545 consists of two drop-forged wedge-shaped sides, one shim and a 3/4 by 2 1/2 inch machine bolt. Installed by placing sides in hole, driving shims between sides and assembling bolt.

Rock anchors provide maximum holding power when installed at right angle to line of guy pull.



No. 7545

No.	Size Hole to be Drilled Inches	Overall Length Inches	Approx. Ship. Wt. per 100, Pounds
†7545	1 3/4	9 1/2	520

Hubbard Rock Guy Bolts Hot Galvanized



No. 7547

Used in solid rock formations or in stone or concrete walls. Made of 1-inch diameter steel.

No. 7547 and No. 7547-G have bottom end split and are furnished with a wedge which spreads the end as bolt is driven against bottom of hole.

No. 7547 has standard oval eye; No. 7547-G has Hubeye.

No.	Type Eye	Size Hole To Be Drilled Inches	Overall Length Inches	Approx. Ship. Wt. per 100, Pounds
7547	oval	1	18	665
7547-G	hubeye	1	18	665

†Western Std. *A.A.R. Std.

Chance Cross-Plate Anchors



Helps speed up big line-construction jobs.

An inexpensive anchor that will take the place of logs, iron slugs, cross planks, and concrete dead-men for man-dug holes in areas where loose rock or other obstructions make it difficult to bore holes with an auger and expand or install conventional anchors. It's less expensive than putting an opened expanding anchor of comparable area in this type of hole. Can be installed in a smaller hole than usually required for log or concrete dead-men.

Nut retainer helps control and prevent anchor from riding up the rod when dropped in the hole.

Formed of two structural steel plates, heavily ribbed, for reinforcement, and securely welded together with a steel reinforcing plate at the base.

No.	Dimensions, In.		Area Sq. In.	Rod Size In.	Approx. Wt. 100 Lbs.	Each
	Diagonal	Square				
X-16	16	13	150	5/8, 3/4	1000	\$2.85
X-20	20	16 1/2	250	5/8, 3/4	1650	4.45
X-20-1	20	16 1/2	250	1	1650	4.45
X-24-3/4	24	22 1/2	400	5/8, 3/4	3600	8.20
X-24	24	22 1/2	400	1	3600	8.20
X-24-1	24	22 1/2	400	1 1/4	3600	8.20

**Ultimate Soil-Anchor Holding Strength In Pounds
7-Ft. Depth. No Safety Factor Included**

No.	Class 3	Class 4	Class 5	Class 6	Class 7
X-16	26500	22500	18500	11500	9500
X-20	34000	29000	24000	19000	14000
X-20-1	34000	29000	24000	19000	14000
X-24-3/4	45000	37000	30000	23500	18000
X-24	45000	37000	30000	23500	18000
X-24-1	45000	37000	30000	23500	18000

‡Western Zone prices; slightly lower in Eastern Zone.

Contact GRAYBAR for quantity prices.

Chance Pole Keys



An economical means for keying poles at their butt to reinforce them against unbalanced loads in soft soils.

No trench needed. Frequently used in urban areas.

Can be installed in fifteen minutes.

No.	Expanded Width, In.	Blade Width, In.	Expanded Area, Sq. In.	Approx. Wt. Lbs.	Each ‡
P4817	27 1/4	7	276	25	\$7.20

‡Western zone prices; eastern prices lower. Contact Graybar for quantity prices.

Hubeye Anchor Rods

Hot Galvanized



Hubeye



Tu-Hubeye

Three Hubeye

Drop-forged to provide a rounded connection for the guy that eliminates the use of thimbles. The round shape of the guy loop is maintained by side wall support and no individual strands are subjected to derangement or higher stresses than others.

Diam. Rod In.	Overall Length Ft.	Hubeye No.	Tu-Hubeye No.	Three Hubeye No.
1/2	5	8405
1/2	6	8406
1/2	7	8407
5/8	5	8415
5/8	6	8416	\$8516
5/8	7	8417	\$8517
5/8	8	8418	\$8518
3/4	6	8426	8526
3/4	7	8427	\$8527	\$8557
3/4	8	8428	\$8528	\$8558
3/4	9	8429	\$8529	\$8559
3/4	10	8430	8530	8560
1	7	8437
1	8	8438	\$8538	\$8568
1	9	8439	8539
1	10	8440	\$8540	\$8570
1 1/4	10	\$8541	\$8574
1 1/4	12	\$8575

§E.E.I. Std.

Hubbard Anchor Rods

Hot Galvanized



Standard oval eye anchor rods have been used for many years to form the dead-man type of anchorage. The eye is drop forged and is stronger than the rod itself.

Diameters of 3/4-inch or under have rolled threads, larger diameters have cut threads. All length rods threaded 3 1/2 inches.

No.	Diam. Rod In.	Overall Length Ft.	Width Eye In.	Length Eye In.	Shipping Wt. Lbs. Per 100
7355	1/2	5	1 1/4	1 1/2	350
#7356	1/2	6	1 1/4	1 1/2	105
7415	5/8	5	1 1/2	2	550
7416	5/8	6	1 1/2	2	650
#7417	5/8	7	1 1/2	2	750
7418	5/8	8	1 1/2	2	850
7426	3/4	6	1 1/2	2	910
7427	3/4	7	1 1/2	2	1060
#7428	3/4	8	1 1/2	2	1220
7430	3/4	10	1 1/2	2	1520
#7438	1	8	1 1/2	2	2265
7440	1	10	1 1/2	2	2735
7442	1	12	1 1/2	2	3200

#A.A.R. Std.

Hubbard Guy Shims
Hot Galvanized



Six or more guy shims are used per pole to prevent messenger or guy strand from cutting into the wood. Nail holes are 1/4-inch diameter.

No. **7571**
Dimensions inches 1 1/4 x 1/4 x 8
Ship. Wt. Per 100 pounds 54

Hubbard Strain Plates
Hot Galvanized



No. 7576



No. 7577

Used to protect the wood fibres of pole and moulding from being cut by the guy or messenger strand. No. 7574 and No. 7577 are combination guy hooks and strain plates. Nail holes are 3/16-inch. On No. 7577 the mounting hole is 1 1/16-inch and on No. 7574—9/16-inch. The holes at either side of the hook are 3/16-inch for 3/8-inch lag screws.

No.	Type	Dimensions Inches	Approx. Shipping Wt., Lbs. 100 Pcs.
7574	Guy Hook	4 x 4 x 14 Ga.	134
*7575	Standard	4 x 8 x 14 Ga.	95
7576	Moulding	4 x 8 x 14 Ga.	95
7577	Guy Hook	4 x 8 x 14 Ga.	134

†A.A.R. Std. *Western Union Std.

Hubbard Storm and Guy Hooks
Hot Galvanized



No. 6001



No. 6004



No. 6007



No. 6009



No. 7585



No. 7586

Guy hooks and storm guy hooks are made in a large variety of styles to cover every need.

No.	Description	Steel Size and Length Inches	Hole Diameters Inches		Approx. Shipping Wt., Lbs. 100 Pcs.
			Upper	Lower	
6001	Storm	1/4 x 1 1/2 x 7	9/16	13/16	117
6002	Storm	1/4 x 2 x 7 1/4	9/16	13/16	195
6004	Storm	1/4 x 1 1/2 x 1 7/8	..	1 1/16	86
6005	Storm	1/4 x 2 x 1 7/8	..	13/16	137
6006	Storm	1/4 x 2 x 4 1/4	..	1 1/16	110
6007	Storm	3/8 x 2 x 5 3/16	..	1 1/16	146
6009	Storm	3/8 x 2 x 7 3/4	9/16	13/16	200
6011	Storm	1/4 x 1 1/2 x 7	9/16	1 1/16	119
7583 1/2	Light	1/4 x 1 1/4 x 3 1/4	..	9/16	40
*7584	Heavy	3/8 x 1 3/4 x 4	..	1 1/16	89
7585	Medium	3/8 x 1 1/2 x 3 1/2	..	9/16	65
7586	Heavy	3/8 x 1 1/2 x 6	9/16	9/16	91

*Western Union Std. †A.A.R. Std.

Hubbard Hubeye Bolts
Hot Galvanized



No. 9056



No. 9149

Hubeye straight and angle bolts are mainly used for dead-ending messengers and for guying. Forged to the proper shape to give complete protection to the strand.

Straight No.	Angle No.	Diam.	Dimensions, Inches		Approx. Ship. Wt., Lbs. per 100
			Lgth. Under Eye	Lgth. of Thread	
9056	9149	5/8	6	4	110
9057	9149 1/2	5/8	7	6	121
9058	9150	5/8	8	6	132
9059	9150 1/2	5/8	9	6	113
9060	9151	5/8	10	6	154
9062	9152	5/8	12	6	176
9064	9153	5/8	14	6	198
9066	9154	5/8	16	6	220
9068	9155	5/8	18	6	242
9070	9156	5/8	20	6	264
9078	9160	3/4	8	4	204
9080	9161	3/4	10	6	229
9082	9162	3/4	12	6	255
9084	9163	3/4	14	6	280
9086	9164	3/4	16	6	319
9088	9165	3/4	18	6	344
9090	9167	3/4	20	6	369
9092	9168	3/4	22	6	395
9094	9169	3/4	24	6	420
8458	9170	1	8	6	400
8460	9171	1	10	6	448
8462	9172	1	12	6	497
8464	9173	1	14	6	546
8466	9174	1	16	6	594
8468	9175	1	18	6	642

§E.E.I. Std.

Hubbard Screw Eye Bolts

Hot Galvanized



E.E.I. type eyes. Threads are gimlet point style.

No.	39929	39940	39931	39932
Diameter inches	3/8	1/2	5/8	3/4
Length Under Eye inches	2 1/2	6	6 3/4	6 3/4
Length to Center Eye inches	3 1/8	7 1/4	8 1/2	8 1/2
Ship. Wt. per 100 lbs.	25	70	96	160

Hubbard Guy Wire Protectors
Hot Galvanized

Loxfast Type

Top attachment accommodates strand up to 5/8-inch diameter. Bottom clamps are adjustable to fit rods up to 1 1/4-inch in diameter. Furnished in two lengths.

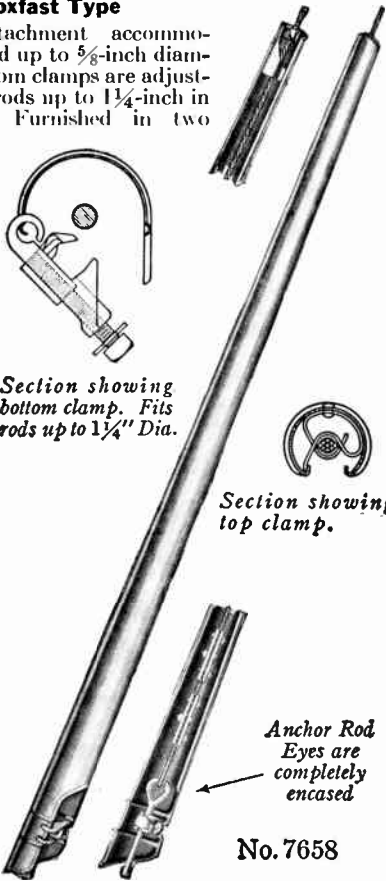

Section showing bottom clamp. Fits rods up to 1 1/4" Dia.

Section showing top clamp.

Anchor Rod Eyes are completely encased

No. 7658

Loxfast-Light

No.	Overall Length Feet	Diameter In.		Steel Gage	Shipping Wt. Lbs. Per 100
		Inside Top	Inside Bottom		
7657	7	2	3 3/4	18	1100
7658	8	1 3/4	3 3/4	18	1200

Loxfast-Heavy

27657	7	2	3 3/4	16	1400
27658	8	1 3/4	3 3/4	16	1550

Half-Round

Clamping is accomplished by U-bolts designed to fit strand, rod or clamp. The protector will not turn over on the wire.

No.	Length Feet	Steel Gage	No. Bolts	Shipping Wt. Lbs. Per 100
7557	7	14	2	1100
7558	8	14	2	1200

Hubbard Pole Struts

Hot Galvanized

Used to make pole self-supporting by hog-guying when circumstances prevent normal guying. Struts are made of heavy steel channel with a broad bearing surface against the pole. They may be sprung slightly during installation to fit a variation in pole diameter. Two struts are needed for each pole. Three 1/2-inch lag screws attach them rigidly in position.

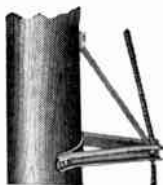

Braces are 1 x 1/2 x 1 1/4-inch channels for all sizes listed.

No.	1500	1518	1519
Extension from Pole, in.	11	18	24
Channel Horizontal			
Legs	2 x 1/2 in. x 3/16	2 x 1/2 in. x 3/16	2 1/2 x 5/8 x 3/16
Shipping Weight, Per 100	850	1050	1600

Hubbard Pipe Sidewalk Guy Arms And Attachments

Hot Galvanized



No. 1501



No. 1511



No. 1502

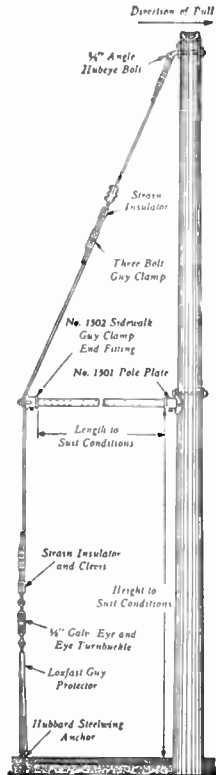

Sidewalk Guy Arms provide a substantial anchorage, using minimum space where the standard method of guying is not practicable. The fittings listed on this page are designed for 2 or 2 1/2-inch pipe.

Nos. 1501 and 1502 are the standard Pole Plate and End Clamp for this style of guy. No. 1511 replaces the clamp plate of No. 1502 to form assembly No. 1503, for separating the guy into two parts above and below the arm. No. 1512 consists of No. 1502 with an extra clamp plate so that two guy wires may be used and attached at two points on the pole. Pipe is not included unless specified. Set screw fittings Nos. 1521 and 1522 require no drilling of pipe.

No.	Description	Pipe Size In.	Approx. Shipping Wt. Lbs. Per 100 Pcs.
1501	Pole Plate	2	350
1502	Clamp End Fitting	2	500
1503	Guy Connector End Fitting	2	573
1511	Guy Connector		225
1512	Double Clamp End Fitting	2	527
1521	Pole Plate—Set Screw	2 & 2 1/2	127
1522	End Fitting—Set Screw	2 & 2 1/2	337
*1541	Pole Plate—3/8" Mach. Bolt	2 & 2 1/2	490
*1542	End Fitting—3/8" Mach. Bolt	2 & 2 1/2	355

Steel Angle Sidewalk Guy Arms

Hot Galvanized

No.	Style	Extension from center of Pole inches	Approx. Shipping Wt. Lbs. Per 100 Pcs.
1506	Bottom Brace	45	3600
1509	Top Brace	78	13000

*Machine bolt types, Nos. 1511 and 1542, are drilled through all four walls of the casting to receive a 3/8" machine bolt. Pipe must be drilled to correspond.

**Hubbard Cable Suspension Clamps
Hot Galvanized**

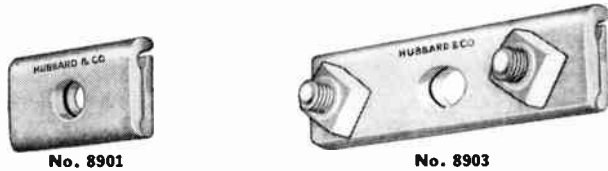

For use over crossarm or double arming bolts which are also employed as a clamp bolt. One or more nuts or washers are generally used between clamp and pole to provide clearance.

No. 8902 Clamps are used on small angles without benefit of side support.

Strand size all Clamps, 1/4 x 7/16-inches.

No.	†8901	8902	†8903	8904
Type	1-Bolt	3-Bolt	3-Bolt	3-Bolt
Overall Length.....in.	2 3/8	7	5 5/8	5 5/8
Mounting Hole Diam. in.	1/16	1 3/32	1 1/16 x 1 5/16	1 3/16
Shipping Weight per 100.....lb.	84	375	224	224

**Hubbard Cable Suspension Screws
Hot Galvanized**



Used in place of a standard through bolt or double arming bolt. Suspension clamps are mounted over the 5/8-inch stud.

Overall length, 8 3/8-inches. Length lag end under shoulder, 5 1/2-inches; length machine screw end above shoulder, 2 1/8-inches.

No. 8966, Ship. Wt., 131 Pounds

**Hubbard Reinforcing Links
Hot Galvanized**



Used to relieve side stresses at angles in the line. Will stand loads of 4000 pounds.

No.	8919	†8929
Overall Length.....in.	5 3/4	8 3/8
Steel Size	1 1/2	1 1/2
Mounting Hole Diam.in.	9/16	9/16
Ship. Wt. per 100.....lb.	107	125

**Hubbard Reinforcing and Safety Straps
Hot Galvanized**



No. 8905 No. 8906 No. 8907

Used as an added safeguard for cable suspension clamps at points of extreme stress. No. 8905 is employed to reinforce messenger bolt. No. 8906 is a safety strap to prevent cable from falling if the messenger gives way. No. 8907 combines the two items in one piece.

Nos. 28904 and 28905 are similar to 8905 except bottom holes are 13/16-inch and 1 1/16-inch in diameter respectively.

No.	Size Steel In.	Shipping Wt., Lbs. Per 100
†8905	1 1/2 x 1 3/8	40
†8906	1 3/4 x 1 3/8	79
†8907	1 3/4 x 1 3/8	122
28904	2 x 1 3/8	53
28905	2 x 1 3/8	53

†Western Union Std.

†A.A.R. Std.

Hubbard-Copperweld Ground Rods



Offer the permanence of copper because of their mollen-welded, rust-proof, copper exterior, and the steel core makes them extremely rigid for quick driving without bending.

No.	Diam. In.	Length Feet	Approx. Shipping Wt., Lbs. 100 Pcs.
9415	3/8	5	170
9416	3/8	6	205
9387	3/8	7	240
9388	3/8	8	270
9425	1/2	5	305
9426	1/2	6	370
9427	1/2	7	430
9428	1/2	8	490
9429	1/2	9	550
9430	1/2	10	615
9431	1/2	11	675
9432	1/2	12	735
9433	1/2	13	795
9434	1/2	14	860
9434 1/2	1/2	15	920
9435	5/8	5	485
9436	5/8	6	580
9437	5/8	7	675
9438	5/8	8	775
9439	5/8	9	870
9440	5/8	10	965
9441	5/8	11	1060
9442	5/8	12	1160
9443	5/8	13	1260
9443 1/2	5/8	14	1350
9444	5/8	15	1450
9656	5/8	16	1550
9657	5/8	17	1640
9658	5/8	18	1740
9659	5/8	19	1840
9660	5/8	20	1930
9445	3/4	5	700
9446	3/4	6	810
9447	3/4	7	980
9448	3/4	8	1120
9449	3/4	9	1260
9450	3/4	10	1400
9451	3/4	11	1450
9452	3/4	12	1680
9453	3/4	13	1820
9454	3/4	14	1960
9455	3/4	15	2100
9456	3/4	16	2240
9457	3/4	17	2380
9458	3/4	18	2520
9459	3/4	19	2660
9460	3/4	20	2800
9466	1	6	1610
9467	1	7	1880
9468	1	8	2150
9469	1	9	2420
9470	1	10	2690
9471	1	11	2960
9472	1	12	3220
9473	1	13	3490
9473 1/2	1	14	3760
9474	1	15	4030
9476	1	16	4300
9477	1	17	4570
9478	1	18	4840
9478 1/2	1	19	5110
9479	1	20	5370
9691	1	25	6720
9693	1	30	8060
9695	1	35	9400
9697	1	40	10850

Hubbard-Copperweld Sectional Ground Rods

Molten-Welded



Cutaway View Showing Coupling and driving stud installed

Designed to meet the requirements for deep, dependable, low resistance grounds. May be driven to satisfactory depths by hand, air hammer, or mechanical rotary drivers. Rod sections are joined by heavy, tapped, bronze couplings. Steel driving studs protect the threading.

No.	Inch	Description	Approx. Shipping Wt., Lbs. 100 Pcs.
9533	1/2	Bronze Coupling.....	18
9534	5/8	Bronze Coupling.....	30
9535	3/4	Bronze Coupling.....	46
9536	1	Bronze Coupling.....	100
29533	1/2	Driving Stud.....	15
29534	5/8	Driving Stud.....	23
29535	3/4	Driving Stud.....	35
29536	1	Driving Stud.....	75
29428	1/2"x8'	Sectional Rod.....	490
29430	1/2"x10'	Sectional Rod.....	615
29438	5/8"x8'	Sectional Rod.....	775
29440	5/8"x10'	Sectional Rod.....	965
29448	3/4"x8'	Sectional Rod.....	1120
29450	3/4"x10'	Sectional Rod.....	1400
29468	1" x8'	Sectional Rod.....	2150
29470	1" x10'	Sectional Rod.....	2690

Hubbard Sectional Ground Rods

Hot Galvanized



No. 9609



No. 9515

For use where deep grounding is desired.

Rods are 5/8-inch diameter steel. All rods are pointed on one end and threaded on the other, except No. 9609 Extension which is threaded both ends. No. 9512 which is threaded on both the blunt and pointed end.

Continuous sections may be coupled together with a No. 9611 coupling and driven to any desired depth.

For driving by hammer, No. 9607 driving tool is furnished. It screws securely over end threads of ground rod and will not jam or injure threads during driving.

No.	Description	Length Feet	Approx. Shipping Wt., Lbs. 100 Pcs.
9607	Driving Tool.....	..	156
9609	Extension Rod.....	6	626
9610	Hi-Carbon Rod.....	10	1043
9611	Galvanized Coupling.....	..	15
9512	Hi-Carbon Rod.....	10	1013
9513	Hi-Carbon Rod.....	12	1251
9515	Hi-Carbon Rod.....	15	1564

Hubbard-Copperweld Ground Wire Clamps

Type A



No. 9492 with Safety Set-Screw



No. 9592 with Square Head Bolt

The great strength and high elastic limit of these non-ferrous clamps enables them to maintain permanently low-resistance grounding connections.

They accommodate solid or stranded ground wires, and are furnished either with safety set-screws or square head set-screws.

Safety Screw Type	Sq. Hd. Bolt Type	Rod Diam. in.	Wire Size	Approx. Ship. Wt., Lbs. Per 100
†9490	9590	3/8	6 to 12 A.W.G. Solid	15
†9491	9591	1/2	4 to 10 A.W.G. Solid	25
†9492	9592	5/8	2 to 8 A.W.G. Solid	35
†9493	9593	3/4	2 to 8 A.W.G. Solid	45
†9495	9595	1	2 to 8 A.W.G. Solid	50
....	9593A	{Special	4/0 Strand to 1 A.W.G. Solid	70

Type B



With Safety Set-Screw

Designed to allow the use of Hubbard - Copperweld ground rods and clamps at a lower assembly cost. Provide a permanent, high pressure connection, which is made quickly without the use of solder.

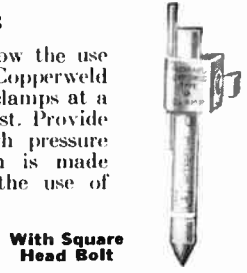

With Square Head Bolt

†6490	6590	3/8	6 to 14 A.W.G.....	7
†6491	6591	1/2	2 to 10 A.W.G.....	15
†6492	6592	5/8	2 to 8 A.W.G.....	25
†6493	6593	3/4	2 to 8 A.W.G.....	30

†Five wrenches furnished with each lot of 1000 clamps. One wrench each lot 30 clamps or less.

Hubbard-Copperweld Alarm Box Grounders

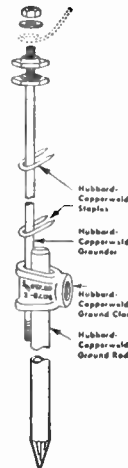

No. 9335

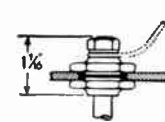

For Boxes Having No Boss

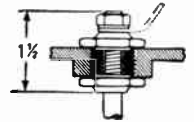

For Boxes Having Boss

The alarm-box grounder takes the place of the conduit and grounding wire previously used for connecting police and fire alarm boxes to ground. Consists of 3/8-inch Copperweld rod with a universal connector.

Copperweld staples for attachment to pole are also included. At bottom, it is connected to a 3/8-inch ground rod by a Copperweld Ground Rod Clamp one size over-size. Clamps not furnished.

No.	9335	9336	9337
Diameter Rod.....	3/8	3/8	3/8
Length Rod.....	5	6	7
Ship. Wt., per 100.....	235	275	315

Hubbard Drive-Head Ground Rods
Hot Galvanized—With Non-Ferrous Fittings

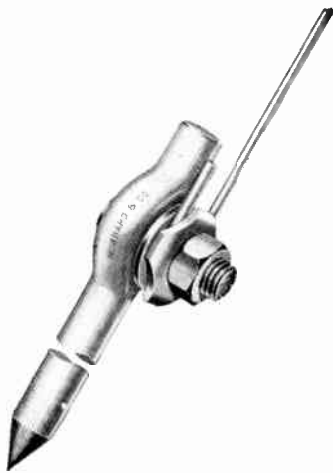

A combination of rod and clamp designed to eliminate the fault of battering a rod by driving to such an extent that a clamp will not slide down over the abnormally expanded top. Heads of all rods are formed to prevent malformation by driving. These rods are furnished in permanent Hubbard-Copperweld or galvanized steel as listed. Non-Ferrous Stud and Clip Washer will accommodate ground wires from No. 000 to No. 8 A.W.G. bare solid, or No. 00 to No. 8 stranded bare.

Hot Galvanized Non-Ferrous Fittings

No.	Diam. In.	Length Feet	Approx. Shipping Wt., Lbs. Per 100 Pcs.
2665	5/8	5	526
2666	5/8	6	626
2667	5/8	7	726
2668	5/8	8	826
2670	5/8	10	1026
2676	3/4	6	988
2678	3/4	8	1288
2680	3/4	10	1588

Copperweld

21667	5/8	7	726
21668	5/8	8	826
21678	3/4	8	1288

Hubbard Steel Ground Rods
Hot Galvanized

Made of new open hearth steel. Has a length of No. 12 gage copper wire bonded firmly to upper end with five inches free for making ground wire connection. Top turn is looped under itself, relieving the bond from carrying strain concentrated at that point. Special lengths of wire can be furnished.



With Copper Wire

No.	Diam. In.	Length Feet	Wt., Lbs. Per 100
9505	1/2	5	365
9506	1/2	6	418
9516	5/8	6	660
9538	1	8	2420

Without Copper Wire

9555	3/8	5	203
9556	3/8	6	245
9565	1/2	5	346
9566	1/2	6	415
9567	1/2	7	485
9568	1/2	8	553
9570	1/2	10	691
9576	5/8	6	650
9577	5/8	7	750
9578	5/8	8	850
9580	5/8	10	1050
9618	3/4	8	1250
9620	3/4	10	1550
8580	1	10	2730

Hubbard-Copperweld and Galvanized Staples



Larger sizes of Hubbard-Copperweld Staples are used for attaching ground wire moulding to the pole and the smaller sizes for insulated or bare ground wires.

Use Nos. 7521 and 7522 for standard 1-inch moulding attachments.

Hubbard-Copperweld Rolled Point Staples

No.	Length In.	Width Inside In.	Thickness In.	Approx. Shipping Wt. Lbs. Per 100
7493	1 1/4	1/4	.114	0.7
7494	1 1/2	5/16	.144	1.3
7495	1 3/4	3/8	.144	1.5
7496	2	1/2	.162	2.25
7497	3	3/4	1/4	7.3
7498	3	1 1/2	1/4	8.3
7499	3 3/4	1 3/4	5/16	15.0
7521	2	1 1/16	3/16	3.0
7522	3	1	1/4	7.8
7522 1/2	3	1 1/16	1/4	8.0
7523	3 1/2	1 1/2	1/4	10.0

Hubbard-Copperweld Cut Point (Fence) Staples

7650	2	1/2	.162	2.25
7651	1 3/8	1/2	.162	1.75
7652	1 1/2	3/8	.162	2.00
7653	2	1/4	.162	2.25
7654	1 1/4	3/16	.114	.75

Galvanized Rolled Point Staples

8511	1	3/8	1/8	.75
8512	2	1/2	.162	2.25
8513	2	1 1/16	3/16	2.80
8521	3	3/4	1/4	6.65
8522	3	1 1/16	1/4	7.00
8523	3	1 1/2	1/4	7.75

Galvanized Cut Point Staples

8534	1 1/2	1/4	.148	1.63
------	-------	-----	------	------

Seeger-Williams Insulated Wiring Nails



No. 14
Fibre Head



No. 12SW
Steel Cap



No. 18
Fibre Head

No. 18 for installation of communications, signal systems, telephone, radio and general wiring.

No. 14 has smaller head. For TV lead-in, and other applications where small head is desired.

No. 12SW has 3/8-inch steel driving head insulated from work by fibre washer.

Brown, Ivory, or Green. White at \$0.25 extra per 1000. Packed 100 or 1000 per box.

No.	Head Diam. Inches	Nail Length Inches	Per 1000	1000 in Box
18	.450	1/2, 5/8, 3/4, 7/8	\$3.00	\$2.80
14	.350	1/2, 5/8, 3/4, 7/8	2.70	2.50
12SW	.375	1/2, 5/8, 3/4, 7/8	2.70	2.50

Hubbard Copperweld Nails

Used for attaching strain plates, or for locking pins and detachable pole steps, mounting conduit or cable guard straps and many other attachments where permanent safety from corrosion is necessary.

No.	Size	Length Inches	Shipping Wt., Lbs. Per 100
8252	2d	1	1/9
8253	3d	1 1/4	1/6
8254	4d	1 1/2	1/4
8255	5d	1 3/4	1/2
8256	6d	2	3/4
8258	8d	2 1/2	1 1/5
8259	9d	2 3/4	1 2/5
8260	10d	3	1 3/5
8262	12d	3 1/4	1 3/4
8266	16d	3 1/2	2 1/4
8270	20d	4	3 1/4
8280	30d	4 1/2	4 3/4
8290	40d	5	6 1/4
8300	50d	5 1/2	7 1/2
8310	60d	6	10

Reliable Ground Rod Clamps

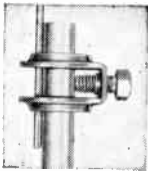

These clamps are bronze or galvanized steel as specified below. Coated to resist corrosion and galvanic action. Complete with hexagon head screw. Corners become rounded at pressures of 200-225 lbs.

Bronze Clamps—For copper and copperweld rods.
Galvanized Steel Clamps—For steel rods and pipes.

No.	Bronze		No.	Galv. Steel		Rod, In.	Wire A.W.G.		Std. Pkg.	Shp. Wt. Per 100 Lbs.
	Net Price Per 100			Net Price Per 100			Max.	Min.		
E48	\$23.75		S48	\$17.92	1 1/2	3/8	1	14	100	9 1/2
E58	33.00		*S58	21.18	5/8	1/2	2/0	14	100	15
E68	37.70		*S68	22.81	3/4	3/8	3/0	14	100	20

*Standard Package, 50.
 Quantity prices on request.

Reliable Ground Rod Clamps
Kling Klamps

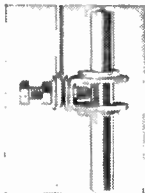

For use with steel rods and pipes. Heavily galvanized steel, with tinned washers to clamp small copper or iron ground wires. Galvanized steel set screws with cupped points to bite into rods and insure good contact.

No.	Rod, In.		Wire A.W.G.	Std. Pkg.	Shp. Wt. Per 100 Pounds	Net Price Per 100
	Max.	Min.				
K48	1/2	3/8	2 14	100	13 1/2	\$24.73
K58	5/8	1/2	2 14	100	20	29.39

Station Type



For grounding of communication circuits.
 For telephone, radio and signal circuit station grounds.
 Round edge copper strip. Close-fitting threads on screws and retaining nut.
 For 3/8- to 1 1/4-in. rod or pipe.
 Standard pkg., 100; Ship. wt. per 100, 6 lbs.

No. 1. Net Price Per 100 \$15.75

Quantity prices on request.

Hubbard Double Arming Bolts
Hot Galvanized



All Double Arming Bolts, with the exception of 7/8-inch diameter, are furnished with full length thread and four nuts. Bolts 7/8-inch diameter are threaded 8 inches on each end.

No.	Diameter Inches	Length Overall Inches	Shipping Wt., Lbs. Per 100
9842	1/2	12	111
9844	1/2	14	120
9846	1/2	16	129
9848	1/2	18	138
9850	1/2	20	146
9852	1/2	22	163
9854	1/2	24	172
§9862	5/8	12	165
†§9864	5/8	14	194
†§9866	5/8	16	200
†§9868	5/8	18	218
†§9870	5/8	20	235
†§9872	5/8	22	253
†§9874	5/8	24	271
9882	3/4	12	257
§9884	3/4	14	279
§9886	3/4	16	301
§9888	3/4	18	350
§9890	3/4	20	372
§9892	3/4	22	383
§9894	3/4	24	427
†29826	7/8	16	397
†29828	7/8	18	430
†29830	7/8	20	462
†29832	7/8	22	501
†29834	7/8	24	530

†A.A.R. Std.
 §E.E.I. Std.

*Western Union Std.
 †Threaded 8 inches each end.

Hubbard Stud Bolts

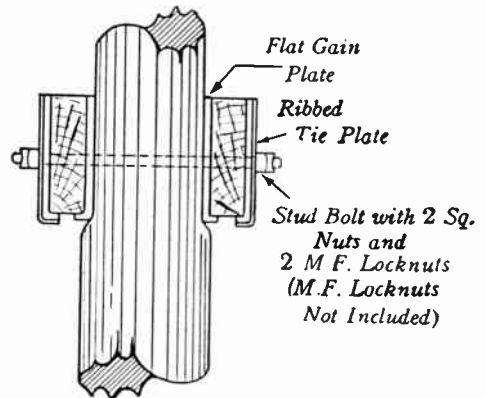

Arm attachment on a dual plank structure using a Hubbard Stud Bolt

Hubbard Stud Bolts are furnished with two square nuts and are threaded 8 inches on each end.

For convenience of installation or reclaiming, all Hubbard Stud Bolts are furnished with the Drivepoint, which adds 1 1/8-inch to the lengths given below.

No.	Diam. In.	Length In.	Thread Length In.	Shipping Wt., Lbs. Per 100
29716	7/8	16	8	326
29718	7/8	18	8	359
29720	7/8	20	8	391
29722	7/8	22	8	430
29724	7/8	24	8	459

**Hubbard Drivepoint Crossarm Bolts
Hot Galvanized**



Roller threads uniform in size and depth. Length is measured from base of bevel to underneath the head.

For bolts 6 inches or greater in length, add Drivepoint length as indicated in table headings. Nuts are included; washers are not included.

**3/8-Inch Dia.
No Drivepoint**

No.	Lgth. In.	Lgth. Thrd. In.	Ship. Wt. Lb. Per 100
9601	1	1	8.2
9601 1/4	1 1/4	1 1/4	8.8
9601 1/2	1 1/2	1 1/2	9.9
9602	2	2	11.4
9602 1/2	2 1/2	2 1/2	12.8
*9603	3	3	13.8
9603 1/2	3 1/2	3	16.8
*9604	4	3	18.1
9604 1/4	4 1/2	3	18.9
9605	5	3	20.1
*9605 1/2	5 1/2	3	22.8
9606	6	3	23.5
29608	8	6	28.5
29610	10	6	35.5
29612	12	6	41.5

**1/2-in. Dia. Drivepoint on
Bolts 7-inches in Length
or Longer**

No.	Lgth. In.	Lgth. Thrd. In.	Ship. Wt. Lb. Per 100
9701	1	1	15.0
9701 1/4	1 1/4	1 1/4	17.6
9701 1/2	1 1/2	1 1/2	20.2
9702	2	2	22.7
9702 1/2	2 1/2	2 1/2	24.6
9703	3	3	27.3
9703 1/2	3 1/2	3	29.7
††9704	4	3	33.6
*†9704 1/2	4 1/2	3	36.6
†9704 3/4	4 3/4	3	38.5
9705	5	3	41.6
*†9706	6	3	45.1

**1/2-in. Dia. No Drivepoint
on Bolts 7" length
or Longer**

No.	Lgth. In.	Lgth. Thrd. In.	Ship. Wt. Lb. Per 100
9707	7	5	51.9
9708	8	6	60.6
9709	9	6	68.4
9710	10	6	76.2
9712	12	6	85.8
9714	14	6	91.6
9716	16	6	106.0
9718	18	6	121.0
9720	20	6	133.0

3/4-In. Dia. Drivepoint

No.	Lgth. In.	Lgth. Thrd. In.	Ship. Wt. Lb. Per 100
9801 1/2	1 1/2	1 1/2	37.0
9802	2	2	41.0
9802 1/2	2 1/2	2 1/2	45.0
9803	3	3	49.0
9803 1/2	3 1/2	3 1/2	53.0
9804	4	3	57.0
9805	5	3	67.0
9806	6	3	80.0
9806 1/2	6 1/2	4	85.0

*Western Union Std.

§E.E.I. Std.

†A.A.R. Std.

Hubbard Double Arming Eye Bolts



Furnished with three square nuts and are roll-threaded full length. Has the standard E.E.I. oval eye.

Maximum thread length is 22".

No.	Diam. Rod In.	Length Under Eye In.	Width Eye In.	Length Eye In.	Shipping Wt., Lbs. Per 100
29784	5/8	14	1 1/2	2	229
29786	5/8	16	1 1/2	2	253
29788	5/8	18	1 1/2	2	267
29790	5/8	20	1 1/2	2	286
29792	5/8	22	1 1/2	2	305
29793	5/8	26	1 1/2	2	335
29794	3/4	14	1 1/2	2	290
29796	3/4	16	1 1/2	2	310
29798	3/4	18	1 1/2	2	330
29800	3/4	20	1 1/2	2	350
29806	3/4	26	1 1/2	2	410

**Hubbard Eye Bolts
Hot Galvanized
Standard Oval Eye Bolts**



No.	Diam. Rod In.	Length Under Eye In.	Width Eye In.	Length Eye In.	Shipping Wt., Lbs. Per 100
39937	1/2	6	1 1/4	1 5/8	74
39939	1/2	8	1 1/4	1 5/8	86
39941	1/2	10	1 1/4	1 5/8	99
39943	1/2	12	1 1/4	1 5/8	112
39945	1/2	14	1 1/4	1 5/8	126
39947	1/2	16	1 1/4	1 5/8	139
39949	1/2	18	1 1/4	1 5/8	152
39951	1/2	20	1 1/4	1 5/8	164
§39954	5/8	4	1 1/2	2	102
§39956	5/8	6	1 1/2	2	116
39957	5/8	7	1 1/2	2	124
§39958	5/8	8	1 1/2	2	133
39959	5/8	9	1 1/2	2	141
§39960	5/8	10	1 1/2	2	148
§39962	5/8	12	1 1/2	2	162
§39964	5/8	14	1 1/2	2	178
§39966	5/8	16	1 1/2	2	187
§39968	5/8	18	1 1/2	2	211
§39970	5/8	20	1 1/2	2	224
§39972	5/8	22	1 1/2	2	249
39974	5/8	24	1 1/2	2	262
§39976	3/4	6	1 1/2	2	169
§39978	3/4	8	1 1/2	2	187
§39980	3/4	10	1 1/2	2	205
§39982	3/4	12	1 1/2	2	222
§39984	3/4	14	1 1/2	2	251
§39986	3/4	16	1 1/2	2	282
§39988	3/4	18	1 1/2	2	319
39990	3/4	20	1 1/2	2	348
39992	3/4	22	1 1/2	2	378
39994	3/4	24	1 1/2	2	408

**Hubbard Carriage Bolts
Hot Galvanized**



For attaching braces to crossarms. Furnished with standard heads, shoulders, nuts and rolled threads.

No.	Diam. In.	Length In.	Length Thread In.	Approx. Shipping Wt., Lbs. Per 100
9633	3/8	3	1 3/4	14.5
9633 1/2	3/8	3 1/2	1 3/4	16.5
†*9634	3/8	4	1 3/4	18.3
†*9634 1/2	3/8	4 1/2	1 3/4	20.0
9635	3/8	5	1 3/4	21.1
9635 1/2	3/8	5 1/2	1 3/4	22.5
9636	3/8	6	3	23.3
9643	1/2	3	2 1/2	26.7
9643 1/2	1/2	3 1/2	3	29.2
9644	1/2	4	3	33.3
9644 1/2	1/2	4 1/2	3	36.7
9645	1/2	5	3	38.6
9645 1/2	1/2	5 1/2	3	41.2
9646	1/2	6	3	44.0
9647	1/2	7	3	50.0
9648	1/2	8	4	59.0
9650	1/2	10	4	72.0
9652	1/2	12	6	85.0
9676	5/8	6	3	70.0

Hubbard Steps for Steel Poles and Towers

Hot Galvanized



No. 7140



No. 7142

No. 7141 is made for exclusive use with Adjustable Pole Bands.

All steps are 5/8-inch diameter.

No.	Length Under Head	Dimensions—Inches Extension From Pole	Approx. Shipping Wt. Lbs., 100 Pcs.
7140	6	4 to 5	101
7141	5 3/4	5	93
§7142	6 1/2	5	100

Hubbard Pole Steps for Wood Poles

Hot Galvanized



No. 7125



No. 7126



No. 7129



No. 7130

Steps are made of new open hearth steel—strong without being brittle. Hook head steps have drive heads, fetter drive threads and a mark to indicate driving depth. Button head steps have twist drive threads and square shoulders.

No.	Type Head	Diameter Inches	Length Overall Inches	Approx. Shipping Wt., Lbs. Per 100
7123	Standard Hook	9/16	9	70
7124	Standard Hook	5/8	9	88
‡7125	Standard Hook	5/8	10	94
7126	Long Hook	5/8	10	116
‡7129	Button	5/8	9 11/16	94
7130	Button	9/16	10	110

Hubbard Detachable Pole Steps

Hot Galvanized

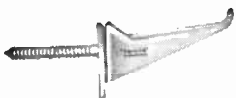

To install, slip the plate, which acts as a bearing surface for the step, over lag screw and drive lag in until plate bites into pole. Step slips down in a groove on each side of the lag screw head and

is prevented from turning by a lug projecting from bottom of the plate. A nail driven through a hole in the plate offers additional security against turning. Five steps per pole are generally used. Uncensored climbing is prevented by removing steps.

No.	Description	Lag Screw Inches	Extension from Pole Inches	Approx. Shipping Wt., Lbs. Per 100
§7235	Lag and Plate	1/2 x 4	...	65
§7236	Step	5 1/4	50

*Western Union Std. §E.E.I. Std. ‡A.A.R. Std.

Hubbard Pole Gains and Reinforcing Plates

Hot Galvanized

Pole Gains

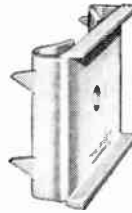

Used to attach crossarms to poles efficiently and quickly without the need for gaining the pole.

They permit easy adjustment for alignment of the crossarm and space the arm away from the pole allowing drainage and ventilation.

Compared with gaining a pole for double arming, an added spacing of approximately 2-inches between arms is obtained by using metal gains. Four spurs on the gain hold the original alignment.

No.	Arm Size In.	Bearing Surface on Crossarm Inches	Steel Gage No.	Ship. Wt., Lbs. Per 100
5091	3 1/4 x 4 1/4	4 1/4 x 6	9	288
5092	3 1/2 x 4 1/2	4 1/2 x 6	9	288
5093	3 3/4 x 4 3/4	4 3/4 x 6	9	288
5094	4 x 5	5 x 6	9	288
5095	3 x 4 to 4 x 5	4 3/4 x 7 1/4	7	175

Hubbard Crossarm Reinforcing Plates



Designed to give greater effectiveness than the square washer and at the same time prevent checking and splitting of the crossarm at the point of attachment.

No.	Arm Size In.	Bearing Surface on Crossarm Inches	Steel Gage No.	Ship. Wt., Lbs. Per 100
5042	3 1/4 x 4 1/4	4 1/4 x 3 7/8	7	120
5043	3 1/2 x 4 1/2	4 1/2 x 3 7/8	7	128
5044	3 3/4 x 4 3/4	4 3/4 x 3 7/8	7	136
5045	4 x 5	5 x 3 7/8	7	144
5046	3 3/4 x 5 3/4	5 3/4 x 3 7/8	7	160
5047	6 x 8	8 x 3 7/8	7	206

Hubbard Galvanized Pole Dating Nails



Used for indicating the year or pole heights. Any two numerals may be ordered. Square head, 9/16-inch. Square shank, 1/4-inch. Length, 2 1/2-inches.

No.	Stamped No.	No.	Stamped No.	Lgth. In.	Approx. Ship. Wt. Lbs., 100 Pcs.
1900	Blank	*1955	55	2 1/2	5.5
1950	50	1956	56	2 1/2	5.5
1951	51	1957	57	2 1/2	5.5
1952	52	1958	58	2 1/2	5.5
1953	53	1959	59	2 1/2	5.5
1954	54	1960	60	2 1/2	5.5

*Additional numbers with any two digits available.

Hubbard Pole Markers

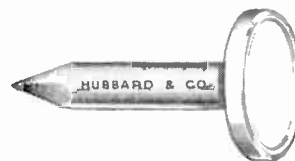

Any marking will be quoted on request. A heavy rim protects stamping from hammer blows. Consecutively numbered markers are furnished with depressed numerals, all other characters in relief.

No.	Material	Diam. Head In.	Diam. Shank In.	Approx. Ship. Wt. Lbs., 100 Pcs.
2000	Copper	1	.298	8.0
6000	Aluminum	1	.298	2.5
7000	Copper	1 1/4	.328	9.5
7006	Aluminum	1 1/4	.328	3.0

Hubbard Square Washers
Hot Galvanized



Available with nail holes at slight extra cost.

No.	Size Inches	Diameter Hole Inches	Diameter Bolt Inches	Wt., Lbs. Per 100
\$7811	2 x 2 x 1/8	9/16	1/2	16
\$7812	2 x 2 x 1/8	11/16	5/8	16
\$7812 1/2	2 x 2 x 3/16	13/16	3/4	21
\$7813	2 1/4 x 2 1/4 x 3/16	11/16	5/8	25
\$7813 1/2	2 1/4 x 2 1/4 x 3/16	9/16	1/2	25
* † \$7814	2 1/4 x 2 1/4 x 3/16	13/16	3/4	25
\$7816	3 x 3 x 3/16	13/16	3/4	53
* † \$7817	3 x 3 x 1/4	13/16	3/4	69
\$7817 1/2	3 x 3 x 1/4	7/8	3/4	66
\$7818	4 x 4 x 3/16	13/16	3/4	96
\$7818 1/2	4 x 4 x 1/4	7/8	3/4	127
† \$7819	4 x 4 x 1/4	15/16	3/4 & 7/8	127
\$7819 1/2	4 x 4 x 1/2	13/16	3/4	251
* † \$7820	4 x 4 x 1/2	1 1/8	1	251
\$7820 1/2	4 x 4 x 3/8	1 1/8	1	170
* \$7826	3 1/2 x 3 1/2 x 3/8	15/16	3/4 & 7/8	136
\$7827	6 x 6 x 3/8	1 1/8	1	407

*Western Union Std. †E.E.I. Std. ‡A.A.R. Std.

Hubbard Curved Washers
Hot Galvanized



Cleanly cut. No irregularities to interfere with the proper seating of bolt heads or nuts.

No.	Size Inches	Diameter Hole Inches	Diameter Bolt Inches	Wt., Lbs. Per 100
\$7809 1/2	4 x 4 x 1/4	15/16	7/8	127
\$7810	3 x 3 x 3/16	7/8	3/4	46
\$7810 1/2	2 1/4 x 2 1/4 x 3/16	11/16	5/8	27
\$7822	2 1/2 x 2 1/2 x 3/16	3/4	5/8	31
\$7822 1/2	3 x 3 x 1/4	13/16	3/4	66
\$7823	3 x 3 x 1/4	7/8	3/4	66
\$7823 1/2	3 x 3 x 1/4	11/16	5/8	66
\$7824	3 x 3 x 5/16	1 1/8	1	94
† \$7825	3 1/4 x 3 1/4 x 1/4	13/16	3/4	85
† \$7829	3 1/2 x 3 1/2 x 3/8	7/8	3/4	120
† \$7830	3 1/2 x 3 1/2 x 3/8	1 1/8	1	120
\$7830 1/2	4 x 4 x 3/8	1 1/8	1	170

†A.A.R. Std.

Hubbard Round Washers
Hot Galvanized



Cleanly cut. No irregularities to interfere with the proper seating of bolt heads or nuts.

Available with nail holes at slight extra cost.

No.	O. D. In.	Ga. No.	Diameter Hole Inches	Diameter Bolt Inches	Wt., Lbs. Per 100
* \$7801	1	14	7/16	3/8	1.8
\$7802	1 1/4	14	9/16	3/8 Carriage	2.9
* † \$7803	1 3/8	12	9/16	1/2	4.6
* \$7805	1 3/4	10	11/16	5/8	9.2
\$7805 1/2	1 3/4	10	13/16	3/4	9.2
\$7806	2	9	13/16	3/4	11.5
\$7808	2 1/2	8	1 1/16	1	19.0

*Western Union Std. †E.E.I. Std. ‡A.A.R. Std.

Hubbard Lock Washers
Hot Galvanized
Spring Washers



No.	Size In.	Hole Diam. In.	Bolt Diam. In.	Wt., Lbs. Per 100
5034	5/32 x 7/64	0.416	3/8	1.1
5035	3/16 x 9/64	0.573	1/2	2.4
5036	7/32 x 11/64	0.700	5/8	3.3
5037	1/4 x 13/64	0.827	3/4	5.5
5038	19/64 x 1/4	1.037	1	10.1

Hubbard Palnut Locknuts
Hot Galvanized

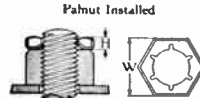
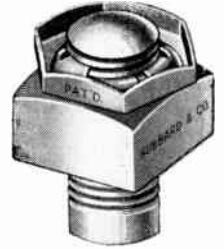

Showing how Palnut Prongs are drawn into the root of the bolt thread thus preventing the nut from working off

Applied after the regular nut is completely tightened. By continued turning of the Palnut, after it has contacted the regular nut, the prongs of the Palnut are drawn into the root of the bolt thread locking the nut permanently.

The resilient Palnut takes no load from the regular nut. The Palnut grips like the jaws of a chuck.

No.	Bolt Size	Threads Per Inch	Dimensions—Inches		Approx. Wt., Lbs. 100 Pcs.
			W	H	
4530	3/8	16	5/8	.160	.39
4531	1/2	13	13/16	.190	.72
4532	5/8	11	1	.224	1.20
4533	3/4	10	1 1/8	.246	1.50
4534	7/8	9	1 1/8	.272	2.20
4534-1	1	8	1 5/8	.324	4.00

Hubbard Square M.F. Locknuts
Hot Galvanized

Has a spring jam action for a permanently tight connection.



No.	Bolt Size In.	Wt., Lbs. Per 100
4510	3/8	1.1
4511	1/2	2.4
4512	5/8	4.2
4513	3/4	6.0
4514	7/8	9.2
4515	1	11.5

Hubbard Spring Washers
Hot Galvanized
Static-Proof Hardware



Used extensively to eliminate radio interference. They insure a permanent, tight fit, thereby eliminating the static and burning that often result from loose fittings.

No.	Bolt Size	Steel Size	Overall Length	Approx. Ship. Wt., Lbs. Per 100
4538	3/8	5/32 x 1	27/16	25
4539	1/2	5/32 x 1	27/16	25
4540	5/8	1/4 x 1 3/4	3 1/2	100
4541	3/4	1/4 x 1 3/4	3 1/2	100
4542	7/8	1/4 x 1 3/4	3 1/2	100

Hubbard Alley Arm Braces
Hot Galvanized

Used in alleys or where obstructions make it necessary to support wires on one side of pole or where poles must be set slightly out of alignment. Arm off-set is to avoid a slight angle in the line. Braces are attached to pole with 1/2-inch lag screws and to the arm with 1/2-inch machine bolts. Furnished with steps.

Type A



For side arm mounting.

No.	Length Ft.	Size Angle Inches	Shipping Wt., Lbs. Per 100
7972	6	1 3/4 x 1 3/4 x 3/16	1750
7974	8	1 3/4 x 1 3/4 x 3/16	1975

Type B

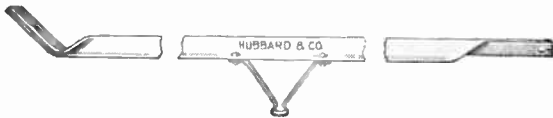

The standard brace for side arm mounting.

7979	5	1 3/4 x 1 3/4 x 3/16	1210
7981	5	1 1/2 x 1 1/2 x 3/16	1000
7982	6	1 1/2 x 1 1/2 x 3/16	1200
7983	7	1 1/2 x 1 1/2 x 3/16	1100
7984	7	1 3/4 x 1 3/4 x 3/16	1660
7985	10	2 x 2 x 1/4	3800

Type C



Used either under or on the side of the arm.

7996	6	1 3/4 x 1 3/4 x 3/16	1796
7998	8	1 3/4 x 1 3/4 x 3/16	2200

§E.E.I. Std.

Hubbard Crossarm Back Braces
Hot Galvanized



Used to reinforce crossarms at corners and terminal poles and in many cases eliminate the necessity for double arming. The angles are made of new open hearth steel.

Nos. 7966, 7967 and 7979 are attached to the arm by means of two 1/2-inch machine bolts at each end. Nos. 7964 and 7965 use only one 1/2-inch bolt at each end.

If vertical braces are not used, crossarm attachment may be made by using 1/2-inch carriage bolts.

No.	Angle Size Inches	Overall Length Inches	Shipping Wt., Lbs. Per 100
7965	1 1/2 x 1 1/2 x 3/16	60	825
7967	1 3/4 x 1 3/4 x 3/16	94	1510
7969	1 3/4 x 1 3/4 x 3/16	109	2204

Hubbard Angle Crossarm Braces
Hot Galvanized



In the construction of heavy pole lines, the one-piece angle steel crossarm brace is in general use. It fastens under the arm with 1/2-inch

crossarm bolts and to the pole with a 5/8-inch crossarm bolt or lag screw. Special sizes supplied on request. When ordering, state size of angle steel, spread, drop, and hole sizes.

No. 7940 Brace is for use with 7 foot, 2-pin medium voltage crossarms, the No. 7942 with the 10 foot, 4-pin medium voltage arms, and the No. 7943 for special high voltage crossarms.

No.	Angle Size Inches	Dimensions Inches		Ship. Wt., Lbs. Per 100
		Hole to Hole	Drop	
7940	1 1/2 x 1 1/2 x 3/16	42	12	858
7941	1 1/2 x 1 1/2 x 3/16	48	18	1067
7942	1 1/2 x 1 1/2 x 3/16	60	18	1210
7943	1 3/4 x 1 3/4 x 3/16	72	22	1716
7948	1 1/2 x 1 1/2 x 3/16	48	14	974
7950	1 1/2 x 1 1/2 x 3/16	37	12	781
7952	1 1/2 x 1 1/2 x 3/16	48	14 3/4	979
7953	1 3/4 x 1 3/4 x 3/16	60	18	1108
7954	1 3/4 x 1 3/4 x 3/16	66	20	1551
7955	1 3/4 x 1 3/4 x 3/16	72	18	1639
7956	2 x 2 x 3/16	72	22	1958

Hubbard Extension Fixtures
Hot Galvanized

No. 8054

Vertical Brace

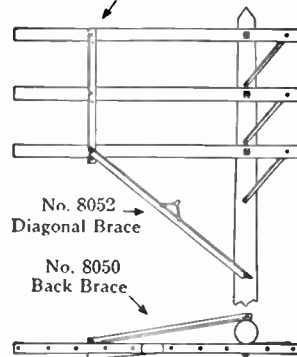

Diagonal Brace, Back Brace, and Vertical Brace Installed

Used to clear buildings or trees without the use of high poles, or to offset arms on a pole to partially relieve the strain of a slight angle in the line. With extension fixtures the poles may be set at the roadside, and by extending arms either toward road or away from road, to compensate for conditions, the wires may be strung in a straight line.

Hubbard Diagonal Brace, Back Braces and Vertical Brace Communication Type

The Diagonal Brace is intended for use on both the 6 and 10-pin arms. It is provided with a 6-inch step for the lineman and may be used on either side of the pole.

No. 8051 is used with 6-pin arms, and the No. 8052 with 10-pin arms. They are attached to the pole by a 5/8-inch crossarm bolt and to the crossarm by a 1/2-inch crossarm or carriage bolt.

The Vertical Brace shown is designed for 3 arms spaced 12 inches apart, or 2 arms on 24 inch centers; additional arms being cared for by placing other Vertical Braces in "Series" with the first.

No.	Description	Dimensions—Inches		Approx. Shipping Wt., Lbs. 100 pcs.
		Length Overall	Size of Angle	
8050	Diagonal	83	2 x 2 x 3/16	1892
8051	Back	51 1/2	2 x 2 x 1/4	1364
8052	Back	66 7/16	2 x 2 x 1/4	1892
8054	Vertical	30 3/8	2 1/2 x 2 x 3/16	792

Hubbard Flat Crossarm Braces
Hot Galvanized

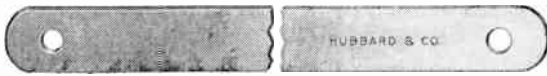

Hole for 1/2-inch bolt at the pole end and 3/8-inch carriage bolt at the arm end. All braces have rounded ends.

Flat Braces No.	Size Steel Inches	Length Overall Inches	Ship. Wt. Lbs. Per 100
†§8020	7/32x1 1/32	20	156
8021	7/32x1 1/32	14	164
8022	7/32x1 1/32	22	172
8023	7/32x1 1/32	16	180
8024	7/32x1 1/32	21	187
8026	7/32x1 1/32	26	202
††§8028	7/32x1 1/32	28	218
8030	7/32x1 1/32	30	233
8032	7/32x1 1/32	32	219
8120	1/4x1 1/4	20	184
8122	1/4x1 1/4	22	201
8124	1/4x1 1/4	24	220
8126	1/4x1 1/4	26	238
8128	1/4x1 1/4	28	256
8130	1/4x1 1/4	30	275
8132	1/4x1 1/4	32	293

*Prices on application.

Hubbard Standard Type Vertical Braces
Hot Galvanized



Will fit 2, 3, or 4 arms with either 18 or 24-inch spacing between arms.

No.	No. of Arms	Spacing Inches	Length Overall Inches	Angle Size Inches	Ship. Wt. Lbs. Per 100
§7976	2	18	20	1 1/2 x 1 1/2 x 3/16	300
§7977	3	18	33	1 1/2 x 1 1/2 x 3/16	520
§7978	1	18	56	1 1/2 x 1 1/2 x 3/16	810
§7986	2	24	26	1 1/2 x 1 1/2 x 3/16	380
§7987	3	24	50	1 1/2 x 1 1/2 x 3/16	700
§7988	4	24	71	1 1/2 x 1 1/2 x 3/16	1010

†A.A.R. Std. ‡Western Union Std. §E.E.I. Std.

Rainier Crossarm Braces
Made Entirely of Wood



No right or left hand members. Any 2 braces make a pair. Interchangeable with double span steel braces. Absolutely no chance of radio interference.

Ample strength, average 1800 lbs. load 4 in. from one end of 3 1/2 x 4 1/2 x 8 Ft. arm. Fully as strong as comparable braces with metal fittings.

No.	Size Inches	Span In.	Drop In.	Wt. Lbs. Per Pair
RB4212-5	1 3/4 x 2 3/4	12	12 1/2	7
RB4814-5	1 3/4 x 2 3/4	48	11 1/2	7 1/2
RB4818	1 3/4 x 2 3/4	18	18	7 1/2
RB4824	1 3/4 x 2 3/4	18	21	8 1/2
RB6018	1 3/4 x 2 3/4	60	18	9 1/2
RB6030	1 3/4 x 2 3/4	60	30	10
RB7221-5	1 3/4 x 2 3/4	72	21 1/2	10 1/2
RB7236	1 3/4 x 2 3/4	72	36	12 1/2

Hubbard Wood Crossarm Braces
"4800 Series"—Fir Wood

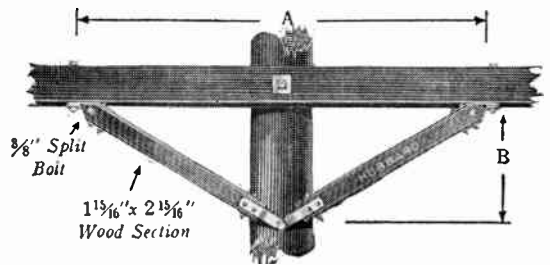

No. 4800 Series Braces are made from a wood section of 1 15/16 by 2 15/16 inches of clear, straight grained Douglas Fir; treated by immersion in Pentachlorophenol.

Extensive testing has shown that these braces are the strongest that Hubbard and Company has ever produced.

No. 4800 series braces are neat in appearance, are easily installed, and are interchangeable since there are no "rights" or "lefts."

Number For 1/2-Inch Mounting Bolt	Dimensions—Inches		Approx. Ship. Wt. Lbs., 100 Pairs
	Spread A	Drop B	
4886	42	12	1265
4887	42	21	1385
4888	48	18	1395

4889	48	24	1475
4890	60	18	1500
4891	60	30	1660

4893	72	22	1650
4894	72	36	1810
4896	86	33 5/8	1920

Hubbard Square 2-Piece Wood Crossarm Braces

Hickory Wood

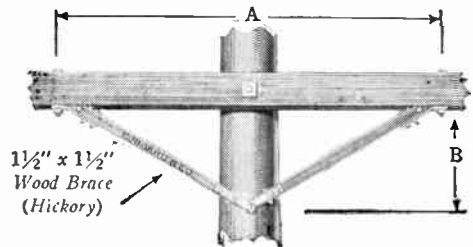

Made of 1 1/2 x 1 1/2-inch square hickory, creosote dipped.

Members may be interchanged or mounted on either side of the pole.

A 1/2-inch bolt is used at the crossarm end for mounting the No. 5537 series. Pole and arm mounting bolts are not included. Catalog numbers cover two pieces.

Number For 1/2-Inch Mounting Bolt	Dimensions—Inches		Approx. Ship. Wt. Lbs., 100 Pairs
	Spread A	Drop B	
5537	37	12	550
5542	42	12	580
5544	44	22	710

5548	48	18	675
5560	60	18	735
5561	60	26 1/2	815
5572	72	22	850

Prices on application.

**Hubbard Lag Screws
Hot Galvanized**



Gimlet Point



Fetter Drive

Furnished with either Gimlet point or Fetter Drive threads except 1/4 and 5/16-inch diameters, which are Gimlet point only. Specify style wanted.

No.	Diam. In.	Length In.	Length Thread In.	Approx. Shipping Wt., Lbs. Per 100
9721 1/2	1/4	1 1/2	1 1/8 GP	2.0
9722	1/4	2	1 3/8 GP	3.5
§9722 1/2	1/4	2 1/2	1 1/2 GP	5.0
9723	1/4	3	2 GP	6.5
9724	1/4	4	2 1/2 GP	8.0
9732	5/16	2	1 1/2 GP	5.2
9732 1/2	5/16	2 1/2	1 1/2 GP	6.2
9733	5/16	3	1 7/8 GP	7.5
9733 1/2	5/16	3 1/2	2 GP	9.7
9734	5/16	4	2 1/2 GP	11.9
†9742 1/4	3/8	2 1/4	1 1/2	8.8
*9742 1/2	3/8	2 1/2	1 5/8	9.7
§9743	3/8	3	2	11.0
9743 1/2	3/8	3 1/2	2 1/2	12.8
§9744	3/8	4	2 1/2	14.6
9744 1/2	3/8	4 1/2	2 1/2	16.4
§9745	3/8	5	3	16.9
9746	3/8	6	3 1/2	19.9
9752 1/2	1/2	2 1/2	1 3/4	18.4
§9753	1/2	3	2	20.9
§9753 1/2	1/2	3 1/2	2 1/4	23.4
§9754	1/2	4	2 1/2	26.0
†9754 1/2	1/2	4 1/2	2 3/4	27.8
§9755	1/2	5	3	32.1
9755 1/2	1/2	5 1/2	3	33.9
§9756	1/2	6	3 1/2	38.3
†9756 1/2	1/2	6 1/2	3 1/2	43.2
9757	1/2	7	4	46.1
§9764	5/8	4	2 1/2	42.6
9764 1/2	5/8	4 1/2	3	46.0
§9765	5/8	5	3	50.6
§9766	5/8	6	3 1/2	60.0

†A.A.R. Std.

§E.E.I. Std.

*Western Union Std.

Hubbard Tapped Flanged Washers



Used in static proof construction. Washers measure 2 5/8" inside flanges.

No.	Threaded Hole*	Dimensions, Inches		Thick-ness	Approx. Ship. Wt. Lbs. Per 100
		Lgth.	Width		
5552	1/2	3	3	3/16	60
5553	5/8	3	3	3/16	60
5554	3/4	3	3	3/16	60

*Can be furnished with any size tapped holes. Specify if other than the standard tap is desired.

Hubbard Static-Proof Hardware

Static-proof hardware is a type of hardware that can be permanently locked in place by using threaded washers and lock nuts.

Standard hardware is subject to loosening by shrinkage of wood and vibration; it is necessary to retighten hardware regularly twice a year.

Static-proof hardware provides a bond between all metal parts, secured by threaded washers and lock nuts and has the effect of making the hardware into a one-piece assembly.

All holes in arms of poles should be bored the same size as the bolt, for a drive fit. When ordering brace bolts, add 1/2-inch to standard lengths to allow for the use of threaded washers, and 1-inch to standard lengths where both standard nuts and washer nuts are to be used.

Hubbard Washer Nuts



Dimensions, Inches

No.	Bolt Diam.	Size of Square	Nut Diam.	Nut Thick-ness	Approx. Ship. Wt., Lbs. Per 100
4193	1/2	13/16	1 1/2	1/2	12
4194	5/8	15/16	2 1/2	13/16	35
4195	3/4	1 1/8	3	13/16	50
4196	7/8	1 5/8	4 1/2	1 1/16	110

Hubbard Static-Proof Washer Head Crossarm Bolts

Hot Galvanized
With Washer Nuts



No. 4163

No.	Bolt Diam.	Dimensions—Inches		Thread Length	Approx. Ship. Wt. Lbs., 100 Pcs.
		Bolt Length	Thread Length		
4162	1/2	6	3 1/4	4	54
4163	1/2	7	3	4	64
4164	1/2	8	4	4	69
4164 1/2	1/2	9	4	4	75
4165	1/2	10	4	4	79
4166	1/2	11	6	4	85
4167	5/8	1	2	4	138
4168	5/8	8	4	4	163
4169	5/8	10	4	4	179
4170	5/8	12	6	4	193
4171	5/8	11	6	4	208
4172	5/8	16	6	4	223
4173	5/8	18	6	4	238
4174	5/8	20	6	4	253
4182	3/4	12	6	4	277
4183	3/4	14	6	4	300
4184	3/4	16	6	4	323
4185	3/4	18	6	4	346
4186	3/4	20	6	4	369
4187	3/4	22	6	4	392
4188	3/4	24	6	4	415

Hubbard Static-Proof Double Arming Bolts

Hot Galvanized
With Washer Nuts



See standard double-arming bolts and Washer Nuts.

Hubbard Adjustable Pole Bands

Hot Galvanized



Single Cup Type



Plain Type

Adjustable pole bands may be used for attaching racks, pole steps, crossarms, guys, hook brackets, and almost any standard hardware adaptable to 1/2 or 5/8-inch bolts, to wood, steel, or concrete poles.

Plain No.	Single Cup No.	Double Cup No.	Outside Pole Diameter Adjustable Range—Inches
333	8353	8373	3 1/2 - 4
334	8354	8374	4 - 4 1/2
335	8355	8375	4 1/2 - 5 1/2
336	8356	8376	5 1/2 - 7
338	8358	8378	7 - 9
340	8360	8380	9 - 11 1/2
342	8362	8382	11 1/2 - 14 1/2

Carriage bolts are not included.

Hubbard Adjustable Pole Band Accessories

Hot Galvanized



No. 7141



No. 8390

No. 163-A standard lamp lead bracket with split type insulator.

Nos. 5096, 5097 are gains for crossarm attachments.

No. 7141 standard button head pole step.

No. 8390 1/2-inch shank, 5/8-inch bolt head to fit trap in the pole band cup.

No.	Item	Size Inches	Oiam. Hole In.
163-A	Lamp Lead Brkt. Wire Hole	3/8 x 1 1/8 to	1 x 1 1/8
5096	Gain—Poles 4"-6 1/2" Diam..	All Arms	1/16
5097	Gain—Poles 7" Diam. up...	All Arms	1/16
7141	Pole Step.....	5/8 Shank
8390	Bolt—1/2" Fittings.....	1/2 x 1 1/2

†Used on Wood, Steel and Concrete Poles.

Hubbard Pole Reinforcing Material

Hot Galvanized

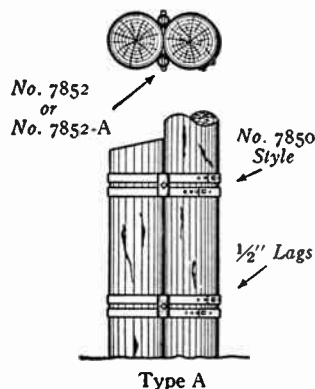

When pole butts become rotted and weakened, reinforcing is accomplished by banding to a stub. Band and pipe assemblies are tightened in place by drawing the band together. No. 7852-A is a malleable casting which serves the same purpose as the pipe.

The band is first attached by a nail through the small hole in the end of the band. After wrapping pole and stub tightly by hand, a 1/2-inch lag screw is driven through the loose end so that it engages both inside and outside wrap. Lag screws may be driven in either of end holes which are spaced farther apart than others. This allows lining up with nearest inside hole. Four bands and four pipes are needed for a set. Lag screws and take-up bolts should be ordered separately.

Type "A"

No.	Description	Size	Shipping Wt., Lbs. Per 100
7850	Reinforcing Band	12-Ga. x 2" x 68 1/2"	451
7851	Reinforcing Band	12-Ga. x 2" x 89 1/2"	577
7852	Reinforcing Pipe	Ex. Hvy. 2" x 5"	242
7852A	Reinforcing Casting	5 1/8" ong. 1 1/4" Rad.	150
7855	Reinforcing Band	12-Ga. x 2" x 99"	858
7856	Reinforcing Band	12-Ga. x 2" x 120"	1100

Type "B" Sleeve Nut Style



Tension is provided by the turnbuckle nut. In general, poles are stubbed across the line. If they must be stubbed on the line, dowels are used. Peep-holes are provided in the nut for gauging take-up. Order two or more bands for a set.

No.	Pole and Stub Oiam. In.	Length Sleeve Nut In.	Shipping Wt., Lbs. Per 100
7750	8	4 1/2	367
7751	10	6	550
7752	12	6	625
7753	14	6	700
7754	16	6	780

Hubbard Universal Messenger Hangers
Hot Galvanized



Universal Hangers are formed from new open hearth steel. They have a curved messenger groove which permits their use on slight angles as well as straight runs. Two 1/2-inch clamp bolts hold the messenger securely in place. The hanger is mounted by means of a 5/8-inch cross-arm bolt and a 1/2-inch lag screw.

No.	Steel Size	Dimensions—Inches		Size of Strand	Approx. Wt., Lbs. Per 100
		Length of Legs	Width of Groove		
§8911	2 x 1/2	4 7/8 x 4 1/4	3/4	5/16 to 1/2	345
§8912	1 3/4 x 3/8	4 7/8 x 3 3/4	3/4	3/16 to 1/2	250

Hubbard Non-Breakable Messenger Hangers
Hot Galvanized



Made of certified malleable iron, the non-breakable messenger hanger combines spacer and clamp. It is used over a 5/8-inch machine bolt and is curved to fit the pole. Messengers are held in place while stringing by a vertical finger-like projection.

No.	Dimensions—Inches		Size of Strand	Ship. Wt., Lbs. Per 100
	Length Clamping Surface	Width of Groove		
§8914	3	3/4	1/4 to 5/16	150
§8915	3	3/8	3/8 to 1/2	150

Hubbard Crossover Clamps
Hot Galvanized



For clamping messengers together when they cross at right angles.

Size of strand, 5/16 to 1/2 inch. Size of clamping members 3 1/4 x 1 1/2 x 1/2 inches.

Bolts furnished are 1/2 inch oval shoulder, clamp bolts. No. 8930, Ship. Wt., 170 Lbs.

Hubbard Angle Steel Cable Crossarms
Hot Galvanized



For telephone cables. Furnished complete with No. 8901 messenger clamps, clamp bolts and nut spacers. Braces and mounting bolts are not included.

No.	Use Crossarm Brace No.	No. of Cables	Overall Length In.	Spacing Between Cables, Inches		Size Angle In.	Ship. Wt., Lbs. Per 100
				Center Two	Slide		
§8938	8130	4	48	32	6	5 x 3 x 1/2	6525

Hubbard Strand Ground Clamps
Hot Galvanized



Used to provide a permanent electrical ground between cable sheath and messenger. The connection is soldered to cable sheath and mechanically clamped to the messenger wire. The bolt can be completely removed so that clamp can be dropped over the messenger.

Size steel, 3/16 x 1 3/4-inches. Overall length, 1 3/4-inches. Bolt size, 1/2 x 1 3/4-inches. No. 8956, Ship. Wt., 57 pounds.

Hubbard Strand Connectors
Hot Galvanized



No. 8900



No. 8913

No. 8900 used to connect spiral wrapped messenger cable at the pole. No. 8913 used with two or more guy clamps for joining messenger ends. Both are non-insulating.

No.	Width Groove	Dimensions—Inches		Approx. Shipping Wt. Lbs., 100 Pcs
		Diameter Holes	Length	
8900	3/4	1 3/16 (Mtg.)	3 3/4	398
8913	9/16	3/4	3 3/4	100

Hubbard Cable Extension Arms
Hot Galvanized

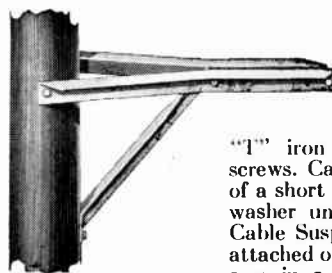

Cable Extension Arms are used to suspend cables at a distance from the pole. They are attached at the top by one 5/8-inch crossarm bolt. The

"T" iron brace is fastened by lag screws. Cables are attached by means of a short 5/8-inch machine bolt with a washer under the head. A three-bolt Cable Suspension Clamp, No. 8903 is attached on the machine bolt under the arm in a flat position. When drawn tight, the machine bolt clamps the

entire assembly firmly together. Extension of the cable from the pole can be varied 8 1/2-inches with No. 8920 and 18-inches with No. 8921.

No.	Extensions From Center of Pole	Angle Size	Approx. Shipping Wt. Lbs., 100 Pcs.
8920	17 1/2 to 26	3 x 2 1/2 x 1/4	3050
8921	26 1/2 to 41 1/2	3 1/2 x 2 1/2 x 5/16	6050

Hubbard Guard Arm Hooks
Hot Galvanized



Used on guard arms as dead-ends for telephone services. They bolt through the arm.

Diameter steel, 1/2-inch. Overall length, 5 7/8-inches.

Diameter eye, 7/8-inch.

Approximate shipping weight, 45 pounds per 100.

No. 9245.

Hubbard Guard Arm Braces
Hot Galvanized



No. 9240

Guard arm braces are used for supporting guard arms at points on poles where a cable is suspended.

Steel size, 18 x 1 1/2 x 1/2 inches. Diameter hole straight end, 1/16 inch. Diameter hole bent end, 9/16 inch.

Approximate shipping weight, 170 pounds per 100 pcs.

No. 9240.

Hubbard U-Cable Guards and Straps

Hot Galvanized

U-Cable guards protect power cables entering the ground at the base of poles or buildings. Made from No. 11 gage steel.

U-Cable Guards

No.	Length Feet	Inside Diam. Inches		Shipping Wt., Lbs. Per 100
		Top	Bottom	
7531	5	1 1/8	1 1/8	495
7531 1/2	8	1 1/8	1 1/8	720
7532	5	2 3/16	2 3/16	825
7533	8	2 3/16	2 3/16	1408
7534	5	3 3/16	3 3/16	1210
7535	8	3 3/16	3 3/16	1925
7535 1/2	8	3 11/16	3 11/16	2135
7536	5	1 1/4	2 1/8	550
7537	8	1 1/4	2 1/8	875



No. 7533



No. 7537

Mounting Straps

No.	Size Steel In.	Used with Cable Guard No.	Diam. Holes In.	Shipping Wt., Lbs. Per 100
7538	1/8 x 3/4	7531	9/32	19
7539	1/8 x 3/4	7532-3	9/32	23
7540	3/16 x 1	7534-5	1 1/32	61
7540 1/2	3/16 x 1	7535 1/2	1 1/32	65
7541	1/8 x 3/4	7536-7	9/32	19

Hubbard Grade Clamps

Hot Galvanized

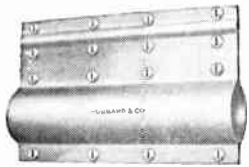

No. 8984

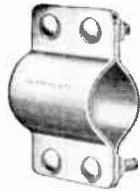

No. 8989

Used to prevent creepage where cables are run on grades. The pressed steel type is made with a large clamping area so that the soft cable may be firmly gripped but not crushed. It is tightened by means of the 3/8 x 1-inch stove bolts furnished.

Drop-forged clamps are equipped with four 1/2-inch, oval neck clamp bolts, which cannot turn while nuts are being tightened.

Tolerances on all styles are held very close in order to grip both cable and messenger with the proper pressure when tightened in place.

Pressed Steel — Stove Bolt Type

No.	For Messenger Size Inches	For Cable Size Inches	Size Clamp Inches	Shipping Wt., Lbs. Per 100
8984	3/8 to 5/8	2 5/8	7 1/8 x 12	836
8985	3/8 to 5/8	3 1/2	7 1/8 x 12	850

Drop Forged — 4-Bolt Type

8986	5/16 to 1/2	1 3/8	5 1/4 x 4	495
8987	5/16 to 1/2	2 1/16	6 1/4 x 4	591
8988	5/16 to 1/2	2 1/2	7 x 4	659
8989	5/16 to 1/2	2 7/8	7 3/8 x 4	704
8999	5/16 to 1/2	3 3/8	7 7/8 x 5	781

Malleable Iron — 4-Bolt Type

8982	5/16 to 1/2	1	4 3/4 x 4	495
------	-------------	---	-----------	-----

Malleable Iron — 3-Bolt Type

9005	1/4 to 1/2	3/8 to 1/2	2 x 3 7/8	250
9006	1/4 to 1/2	9/16 to 11/16	2 x 3 7/8	255
9007	1/4 to 1/2	3/4 to 15/16	2 x 3 7/8	260
9008	1/4 to 1/2	1 to 1 1/4	2 x 3 7/8	265

General Machine Cable Guards

Type B



For use on cable at poles to prevent abrasion to sheath from wind, etc.

Made of polyethylene; 8 inches long. Available in four sizes: 1/2-in., 4 lbs. per carton; 1-in., 6 lbs. per carton; 1 1/2-in., 8 lbs. per carton; 2-in., 10 lbs. per carton. Specify sizes on orders. Packed 50 in carton.

No. 7422 Price on application

Diamond "C" Cable Lashing Clamps

Hot Dipped Galvanized

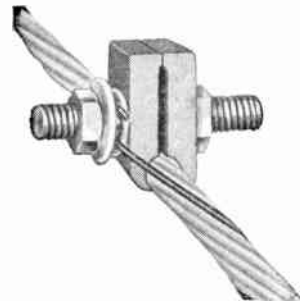

For securing cable lashing wire at end of span. Bolt end peined over to prevent nuts running off. Can be securely attached to messenger before taking up tension on cable lashed wire. Square hole in plate and square shoulder under head of stud bolt, prevent rotation of bolt while tightening clamp.

No. 900 Packed carton 100
Shipping weight per 100 pounds 15 1/2

Diamond "C" Span Clamps

Hot Dipped Galvanized

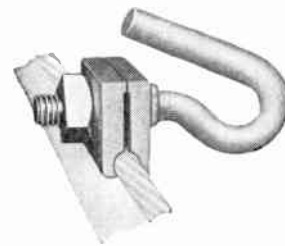

Used to take off drop wire leads along the span and for pull-offs to hold cable from trees and so avoid use of tree guards. Can be used with suspended or lashed cable.

No. 869 Packed carton 100
Shipping weight per 100 pounds 41

Call Graybar FIRST For . . .

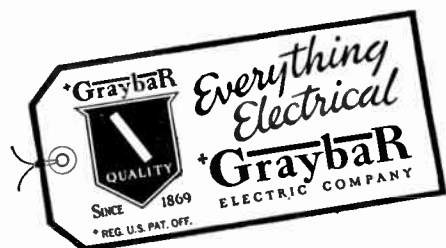

Diamond Aerial Cable Supports

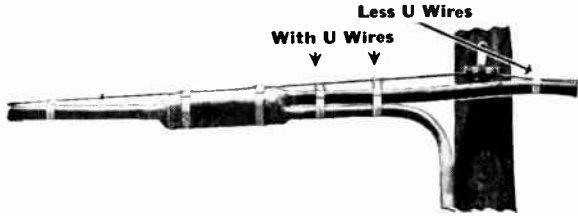

Illustration shows the use of both styles of Diamond Aerial Cable Supports. In practically each case, two of the cable supports are used at the poles (20 inches apart) to prevent rim cut.

With "U" Shaped Wires

No.	Length Strap, In.	Maximum Cable or Sleeve Diam., In.	Circum., In.
891	10	3/4	2 5/16
892	16	1 3/16	3 5/8
893	22	2	6 5/16
894	28	2 5/8	8 5/16
895	34	3 1/8	10
896	50	5 S	15 13/16
897	64	6 1/2 S	20 1/2
898	64	6 1/2 S	20 1/2

No.	Carton	Wt., Lbs. Per 100
891	500	8 1/2
892	500	11
893	300	13
894	300	16
895	300	18 1/2
896	200	25 1/2
897	200	31 1/2
898	200	35

All supports have 5" long U shaped wires, except No. 898 which is 10" and otherwise same as No. 897.

Less "U" Shaped Wires (For Lashed Cable)

L-891	500	5 1/2
L-892	500	8
L-893	300	10
L-894	300	13
L-895	300	15 1/2
L-896	200	22 1/2
L-897	200	28 1/2

Diamond Toggle Bridle Rings



Packed 100 in a box.

No.	Size, inches	Eye, inches	Weight per 100, pounds	TBR2 3/16x1 3/4	TBR4 1/4x1 1/4
8	3/16	3/4	8		
17	1/4	1 1/4	17		

Reliable Steel Drive Hooks



Hot dipped galvanized. Length 5 1/4 in.; diameter 7/16 in. Standard Package, 50; Shipping weight 26 lbs. per 100.

No. 5501.....Net Price Per 100 **\$16.00**

Diamond Drive Rings

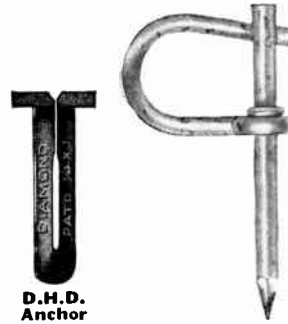

For use with the new Neoprene jacketed Drop and Block Wires. 5/8 and 7/8-inch sizes. These new designs have larger loops to increase the wire carrying capacity to accommodate six 5/8-inch and sixteen 7/8-inch Neoprene jacketed Drop Wires. Hot dip galvanized by Diamond process, eliminating flaking of the galvanizing if the pin is bent to 45° angle.

When installed in masonry use the size Diamond Hammer Drive Anchor shown below.

D.H.D. Hammer Drive Anchors are listed on page 856. Order "less nails".

No.	801	804	805	807
Diameter of Eye.....inches	1 1/2	5/8	7/8	1 1/4
Length overall.....inches	2 1/16	2 1/4	2 3/16	2 5/16
Anchor Size.....inches	3/16x7/8	1/4x1	1/4x1	5/16x1 3/4
Weight per 1000.....pounds	18	33	64	95

Reliable Cable Hangers



The use of the hangers eliminate wear on cable sheath. Grade clamp is not required as the entire sheath is grounded solidly to messenger, cable does not creep on steepest grade.

Zinc: For supporting lead covered cable or insulated conductors to galvanized strand. They wrap around the cable — no sheath cuts. They also bond the sheath and strand to give added protection against lightning. Should be used with neoprene jacketed wires.

Copper: For supporting insulated wires or cable to copperweld and bronze strand. Hold firmly and will not cut the cable. Where cable consists of separate insulated conductors held together against the messenger, this close-fitting support will reduce wear or wind whipping.

Zinc No.	Alum. No.	Net Price Per 1000	Copper No.	Net Price Per 1000	Length In.	Cable Dia., In. Max.	Min.
1	1A	\$27.91	1C	\$57.10	7 7/8	3/4	1/2
2	2A	44.22	2C	74.50	11	1 1/8	1/2
3	3A	51.18	3C	129.20	14	1 5/8	1/2
4	4A	98.93	4C	217.30	16	2	1 1/2
5	5A	107.00	5C	239.70	18	2 1/4	2
6	6A	114.08	6C	260.80	19 1/2	2 1/2	2 1/4
7	7A	162.94	7C	296.80	21	2 3/4	2 1/2
8	8A	172.22	8C	326.60	22 1/2	3	2 3/4
9	9A	180.40	9C	352.70	24 1/2	3 1/4	3
10	10A	197.87	10C	385.00	26 3/4	3 1/2	3 1/4
11	11A	228.04	11C	442.10	30	4 1/2	3 1/2

Tie Straps (Cable Hangers)

For Triplex Type Service Drop Cables

No.	Material	Lgth. In.	Min. 2-Insulated	Max. 1-Bare	Ship. Wt. Lbs. Per M.	Net Price Per 1000
0	Zinc	6	6 Sol.	4ACSR	14	\$25.25
0A	Aluminum	6	6 Sol.	4ACSR	6	23.15
1A	Aluminum	7 7/8	2 Str.	1/0ACSR	11	27.91
0C	Copper	6	6 Sol.	2 Sol.	13	40.00

Sizes of Cable Hangers may be assorted to obtain quantity prices. Standard package all sizes 100.

Diamond Angle Screw Fixtures



For attaching knobs for drop wiring on wood or stone structures. On masonry use multi-size screw anchors. Price does not include porcelain knobs.

No.	840	841
Size.....inches	5/16	3/8
Length Screw End.....inches	1 3/4	2
Length Shank.....inches	2 1/4	3 1/2
Size Anchor.....	16-18x1"	20-24x1 3/4"
Weight per 100.....pounds	12	20

Diamond Insulated Screw Eyes



Steel screw eye hot galvanized by the Diamond process. (Patented) diagonal opening in porcelain ring allows easy insertion of wires.

When pulled taut they cannot become released from the ring. Porcelain surfaces of the slot and interior surface of the ring are glazed. If used in masonry use Diamond multi-size screw anchor. Size steel, 1/4-inch. Opening 5/32-inch, in all sizes. Packet 100 in a container.

No.	830	831	832	833
Type.....	5/8" S	5/8" L	1" S	1" L
Eye.....inches	5/8	5/8	1	1
Shank under bend inches	1 1/4	2 1/8	1 3/4	2 3/4
Length Overall.....inches	2 7/8	3 3/4	3 7/8	5
Weight per 100...pounds	85	95	180	190

Diamond Bridle Rings



Style A, C, E, F

Style K, M, Q, R

Use multi-size screw anchors to adapt wood screw type to masonry use.

Wood Screw Thread

Hot-Dip Galvanized or Enameled

No.	Style	Eye In.	Shank In.	Steel In.	Wt., Lbs., Galv.	Per 1000 Enam.
810	A	1 5/8	1 1/4	1/4	110	150
812	C	1 1/4	1 1/4	1/4	95	125
814	E	5/8	7/8	3/16	35	50
816	F	3	1 7/8	5/16	300	335

Opening in all sizes 5/16-inch. Specify galvanized or enameled.

Machine Screw Thread

Hot-Dip Galvanized Only

No.	Style	Eye In.	Thread	Wt., Lbs. Per 100
821	K	3/4	10-24	4
823	M	1 1/4	10-24	6
825	Q	1 1/4	1/4-20	9.5
827	R	1 5/8	1/4-20	11

Bridle rings with machine screw threads are used with Insulator Supports. Tapped—10-24 or 1/4-20 as indicated.

Prices on application.

Hubbard Point Type Transposition Brackets

Hot Galvanized

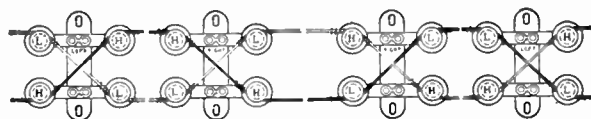
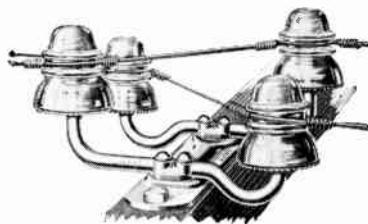

H-On Insulator—High Point. L-On Insulator—Low Point

The "Point Type" Bracket is designed to effect the transposition of a pair of wires on a single, solid bracket by providing two diagonally opposite pins at the correct elevation, approximately 2-inches above that of the other diagonally opposite pair. No cutting of wires is necessary at each location. For existing pairs which are to be transposed, it is practical and efficient from a labor-saving standpoint, to THROW IN the transposition. The utility of this process is its applicability for voice frequencies on carrier systems (single or multi-channel) where brackets support the wires above the arms.

Right and left hand Point Type Transposition Brackets are a thoroughly tried and proven development. They have been in use for many years. Patent No. 2,299,960 covers a method or system of transposing wires. Hubbard Point Type Brackets listed on this page were designed specifically for use with this system. The purchaser of Hubbard Brackets is assured a license permitting the transposing of wires as covered by the above patent.

The bracket is attached to standard-bored crossarms through adjacent pin holes by 1/2-inch by 6-inch crossarm bolts fitted with clipped washers. Both attachment holes are slotted to provide a total of two inches of adjustment. Additional mechanical features may be noted in the illustrations. Transpositions taken place on a rigid bracket, mounted above the arm, and wire spacings are maintained uniformly the entire length of the span. There is no spiraling of wires about each other as is the case with ordinary transposing methods. This is a tremendous advantage in cases of damaged or destroyed lines where restoration of transpositions must be made.

With the right and left point type method of transposing, it is unnecessary to cut wires to straighten out tangles during reconstruction. Simply untie the transposed wires and pull out of the working lengths of line ready for re-stringing.

Mounting bolts and washers are furnished. Threads, either of the wood cob or lead variety, are made to fit transposition insulators having 1-inch pin holes. Specify the type of thread desired.

For more complete information communicate with the nearest Graybar office.

No.	Description	Mtg. Hole Spacing In.	Approximate Shipping Wt. Lbs., 100 Pcs. Inc. Bolts
9272-LT	Right—Lead Thrd.	10 to 12	900†
9273-LT	Left—Lead Thrd.	10 to 12	900†
9272	Right—Wood Cob	10 to 12	800†
9273	Left—Wood Cob	10 to 12	800†
9706	1/2" x 6" Bolt*	45.1
7881	1/2" Clipped Wash.*	3.3

†Including Bolts.

*Two furnished per bracket.

Hubbard Standard Transposition Brackets

Hot Galvanized



No. 9251

Nos. 9252 and 9255 furnished in heavy stock for use with pins having transposition insulators.

Except for No. 9255 all sizes have 3/8-inch hole for a wood screw. Nos. 9249 and 9250 have holes for 3/8-inch carriage bolts. Nos. 9251, 9252, and 9255 have holes for 1/2-inch carriage bolts. Nos. 9253 and 9255 are fitted for 5/8-inch pin shanks. All others for 1/2-inch short shanks. Pins and carriage bolts not included.

No.	Steel Size In.	Crossarm Size In.	Ship. Wt., Lbs. Per 100
9249	1 1/4 x 5/16	2 3/4 x 3 3/4	277
*9250	1 1/4 x 5/16	3 x 4	286
9251	1 1/4 x 5/16	3 1/4 x 4 1/4	284
9252	1 1/2 x 3/8	3 1/4 x 4 1/4	416
9253	1 1/2 x 5/8	3 1/4 x 4 1/4	600
9255	1 1/2 x 1/2	3 1/2 x 4 1/2	475

*Western Union Std.

Hubbard Transposition Brackets

For Phantom Circuits

Hot Galvanized



No. 9275

Furnished in two pieces covered by a single catalog number.

Pin holes are for 1/2-inch short shank pins.

Assembly on arm is accomplished with 1/2-inch machine bolts. Can be used on all sizes of crossarms. Pins and bolts are not included.

Size steel, 1 1/2 x 3/8 inches.

Western Union Std.

Approximate shipping weight, 797 pounds per 100.

No. 9275.....

Hubbard One-Piece Transposition Brackets

For Phantom Circuits

Hot Galvanized

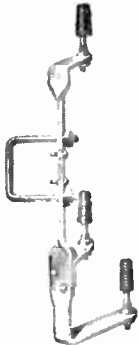

No. 9263

Bracket Nos. 9260 and 9261 are similar to No. 9251 except that their ends are turned up and fitted with standard wood cobs. No Pin is necessary. No. 9262, is mounted with 1/2-inch machine bolts. No. 9263 Brackets do not include insulator pins. Forged steel teeth bite into arm, when the No. 9263 is installed, and prevent slipping.

No.	No. of Points	Dimensions — Inches			Approx. Ship. Wt., Lbs. 100 Pcs.
		Dia. and Type Mounting Bolt	Steel Size	Cross Arm Size	
9260	1	3/8" — Carr.	1 1/4 x 5/16	3 x 4	311
9261	1	3/8" — Carr.	1 1/4 x 5/16	3 1/4 x 4 1/4	316
9262	3	1/2" — Mach.	1 1/2 x 3/8	All Sizes	918
9263	3	1/2" — U Bolt	1 1/2 x 3/8	3 1/4 x 4 1/4	735
9264	3	Furnished	1 1/2 x 5/8	3 1/4 x 4 1/4	1360

Hubbard Channel Transposition Brackets

Hot Galvanized

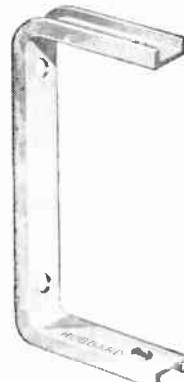

No. 9265

Popular in the oil lands of the Southwest. Mounted on the side of a pole by 1/2-inch mounting bolts on an 8-inch spacing. 5/8-inch threaded short shank insulator pins are used.

Dimensions: Pin hole, 1 1/16-inch; Pole mounting hole, 9/16-inch; Mounting hole spacing 8-inches; Channel size, 1 1/2 x 9/16 x 3/16-inches; Approximate shipping weight, 250 pounds per 100.

No. 9265.....



No. 7838

Bridging washer (not included) No. 7838, made from 12 gage by 1 1/2-inch steel, provides a base for the top pin. Weight 11 lbs., per 100.

No. 7838.....

Hubbard Crossarm U-Bolts

Hot Galvanized

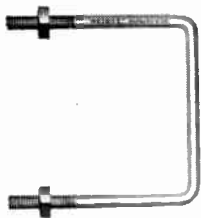

Horizontal Construction
Used in position illustrated.

3/8-inch round steel with 1 1/2-inches of thread.

No.	1018	1021	1022	1023	1024
Size					
Cross-arm, in.	2 3/4 x 3 3/4	3 1/4 x 4 1/4	3 1/2 x 4 1/2	3 3/4 x 4 3/4	4 x 5
Diam. of Steel, in.	3/8	3/8	3/8	3/8	3/8
Spread, in.	3 3/4	4 1/4	4 1/2	4 3/4	5
Length of Bolt, in.	3 3/4	4 1/4	4 1/2	4 3/4	5
Ship. Wt. per 100 lb.	45	53	59	66	73

Hubbard Single Point Type Transposition Brackets

Hot Galvanized

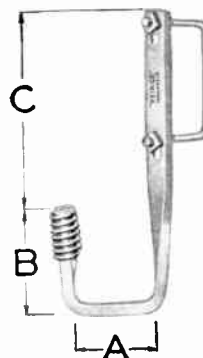

No. 110

Made of channel steel and equipped with standard 1-inch diameter lead threads.

Unless otherwise specified, cross-arm U-bolt No. 1021, for 3 1/4 x 4 1/4 inch arms, will be furnished.

Brackets are punched and slotted for U-bolts.

No.	Dimensions, Inches			Approx. Ship. Wt., Lbs. Per 100
	Channel	A	B	
110	3/4 x 3/8 x 1/8	3 1/2	4 3/8	6 1/2
111	1 x 1/2 x 1/8	3 1/2	4 1/2	8

Hubbard Wire, Pinch and Transposition Brackets

Hot Galvanized

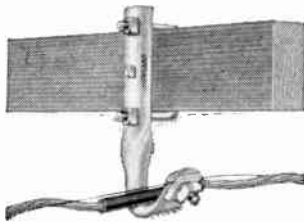

No. 9256

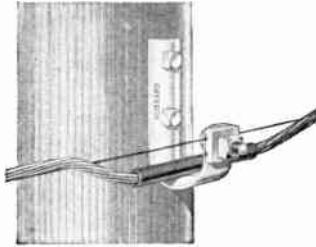

No. 9266

The Pinch bracket is employed as a device for balancing a carrier on each side of the transposition.

Hubbard Wire Brackets are used for pole and arm attachments of multiple wire communication lines. Attachment is made by means of the clamp which is designed to take the messenger contained in the cable group. An insulating tube is employed to prevent abrasion of the cable against the bracket. One 5/16-in. lag screw is used in the center hole on No. 9256.

Point transposition brackets are used with short shank, 5/8-in. diameter pins and attached to the arm with a 1/2-in. carriage bolt. Transposition clearance is 5/8 in.

No.	Description
9256	C Wire Bracket
9266	B Wire Bracket
9288	Pinch Bracket
9289	Transposition Bracket

Hubbard Offset Neutral Bracket

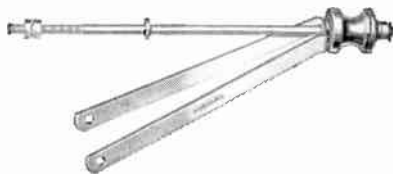

Bracket is intended to hold the neutral conductor away from the surface of the pole, so that the neutral conductor is placed in a different vertical plane from the phase wire carried above the neutral on single phase construction. The need for this bracket is due to the consideration that when the neutral and phase conductors are subjected to ice loading, and the ice subsequently drops from the neutral conductor, the conductor flips up into the phase wire and causes burning of the phase and neutral conductors. This bracket materially reduces the possibility of this contact occurring.

Spool insulator No. 355 or No. 455 should be ordered separately.

No.	Description	Wt., Lbs. Per 100
4473	For Poles 6" to 8 1/2" in diameter	567
4474	For Poles 8 1/2" to 12 1/2" in diameter	617

Prices on application.

Hubbard Service Brackets

Hot Galvanized

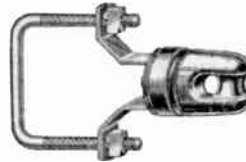

No. 1690

Brackets are used for service attachments on ranch type homes. Three brackets are normally mounted on a short length of 1 1/4 in. to 2 1/2 in. standard pipe which also serves as the "mast" and has a service entrance cap attached at the top. Most masts are 2 or 2 1/2 in. nominal pipe diameter.

No.	Wire Hole Diam.	Dimensions—In.			Approx. Wt., Lbs. (100 Pcs.)
		Length U-Bolt Thread	U-Bolt Diam.	U-Bolt Spread	
1680 (Bkt. only)	..	2 3/4	3/8	3	57
1690 (1664 Ins.)	5/8	2 3/4	3/8	3	122

Hubbard Service Mast Kits

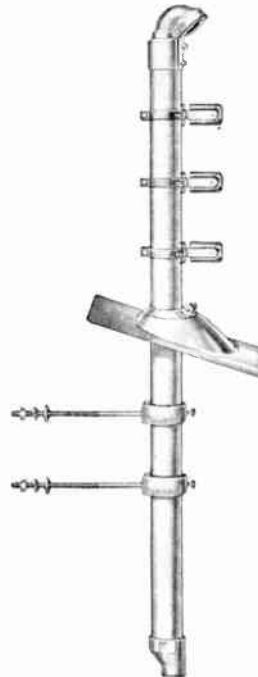

No. 2200

A complete kit consists of one each of Items No. 1, 3, and 5 and two of Item No. 4.

Wireholders for one, two or three-wire service attachments (Item No. 2) and the Pull-off Fitting used for cable grip attachments (Item 6) are not included in the kit and must be ordered separately stating quantity per kit.

Standard kit offset adapters fit a 1 1/4 in. pipe meter connection. If 1 1/2 in. size meter connection (Item No. 5) is needed it should be specified. In ordering kits or wireholders it is important to specify either the 2 in. or 2 1/2 in. kit according to the nominal pipe size of the mast to be used. Masts are not supplied.

No.	Item No.	Description	Wt., Lbs. Per 100
2200		Kit for 2" masts	555
2201	1	Slip Fitter entrance head	150
2202	2	Pipe mounting wireholder	100
2203	3	Neoprene roof flashing	135
2204	4	Mounting brackets	110
2205	5	2" to 1 1/4" offset adapter	50
2208	6	Pull off fitting	100
22200		Kit for 2 1/2" masts	662
22201	1	Slip Fitter entrance head	170
22202	2	Pipe mounting wireholder	110
22203	3	Neoprene roof flashing	140
22204	4	Mounting brackets	136
22205	5	2 1/2" to 1 1/4" offset adapter	80
22208	6	Pull off fitting	140
2207	5	2" to 1 1/2" offset adapter	45
22207	5	2 1/2" to 1 1/2" offset adapter	75

Hubbard Tandem Transposition Brackets
Hot Galvanized

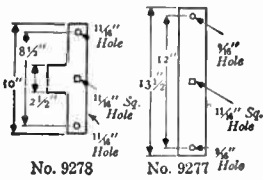

No. 9277 is for straight sections or corners where the "pull" is 15 feet or less. No. 9278 is used at corners where the "pull" is 15 to 50 feet.

Mounting holes are 1 1/16 inch square. Mounting bolts and pins are not included.

For more complete information communicate with the nearest Graybar office.

No.	Steel Size	Pin Hole Diam.	Approx. Ship. Wt. Lbs. per 100 Pcs.
9277	3/8 x 2	9/16	280
9278	1/2 Flat Steel	1 1/16	300
9279	1/2 x 2	1 1/16	365
9676	5/8 x 6" Carriage Bolt		67

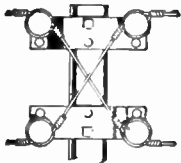

Method of transposing with two No. 9285 Transposition Brackets

Hubbard Transposition Break Iron Brackets
Hot Galvanized

No. 9284 is similar to No. 9286 except lighter and 6" x 9" pin spacing.

No. 9285 includes a plate, one round washer, and a machine bolt. Two brackets are needed for transposition. No. 8061 pins, with non-standard steel threads, or 8015 pins with standard 1-inch wood cobs may be used; either pin must be ordered separately.

No. 9286 and 9287 accomplish the same result as No. 9285, except that the entire assembly is made up in one piece. Nos. 9286 and 9287 do not include pins or mounting bolts.

Pin hole diameter on all numbers is 1 1/16 inch. Mounting hole size on No. 9285 is 1 1/16 inch; on Nos. 9286 and 9287, 9/16 inch square. Approximate shipping weights per 100 are: No. 9284, 480 pounds; No. 9285, 470 pounds; No. 9286, 660 pounds; No. 9287, 1100 pounds.

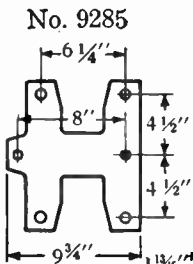
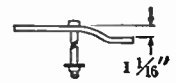
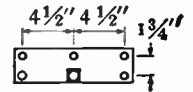

No.	Type	Steel Size Inches
9284	Double	1 1/4
9285	Single	1 1/2
9286	Double	5/16
9287	Riveted	3/8

Hubbard Break Iron Brackets
Hot Galvanized



No. 9280

Used for dead-ending and breaking communication system wires for a take-off. Furnished complete with pins, clipped washer and bolt equipped with 1-inch wood cobs. Pin spacing 6 1/2 inches; pin extension, 1 1/4 inches. Approximate shipping weight, 447 pounds per 100. Western Union Standard.

No. 9280.....

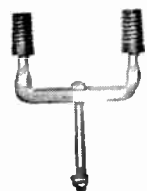

No. 9281

One Piece Type

Similar to No. 9280 except that bracket and pins are one piece made of 1 1/2 x 5/8 inch steel. Pin threads are 1-inch wood cobs. Mounting bolts and clipped washer are included. Pin spacing, 6 1/2 inches; pin extension, 4 3/4 inches. Approximate shipping weight, 340 pounds per 100.

Associated American Railroads Standard.

No. 9281.....

Hubbard Vise and Safety Clips
Hot Galvanized



No. 5447



No. 5470

Two clamping members provide a large gripping area. There are no sharp edges or corners to injure the strand.

Vise Clips

No.	Size of Strand Inches	Diam. Carriage Bolts Inches	Approx. Ship. Wt. Lbs. Per 100
5447	1/4	3/8	45
5448	5/16	1/2	57
5449	3/8	1/2	80
5450	1/2	1/2	80

Safety Clips

No.	Size of Strand Inches	Approx. Ship. Wt. Lbs. Per 100
5470	1/4 to No. 8	25
5471	5/16	30
5472	3/8	36
5474	1/2	57

Hubbard Wire Rope Clips



No. 7486



No. 8487

Size Strand Inches	No.	Drop-Forged Approx. Wt. Lbs. Per 100	No.	Malleable Approx. Wt. Lbs. Per 100
1/4	7480	33	8480	16
5/16	7481	33	8481	18
3/8	7482	50	8482	24
7/16	7483	77		
1/2	7484	77	8484	44
5/8	7485	126	8485	61
3/4	7486	165	8486	94
7/8	7487	270	8487	138
1	7488	285	8488	160
1 1/8	7489	335	8489	264
1 1/4	7490	484	8490	330
1 3/8	7491	500		
1 1/2	7492	698		

Hot galvanized. Japanned available, prices on application.

Call Graybar FIRST For . . .



Hubbard Telephone House Brackets
Hot Galvanized

L House Type



No. 9200

Used at the house end of a telephone service for dead ending twisted pair telephone wires. Size steel, $\frac{3}{16}$ x $1\frac{3}{4}$ inches. Length back, $3\frac{1}{16}$ -inches; bottom to hole center, 2-inches. Approximate shipping weight, 56 pounds per 100.

No. 9200.....

L Pole Type

For taking off telephone services, or for short runs on poles. Steel size, $\frac{1}{4}$ x 2 inches. Length back, 1-inches; bottom to hole center, 2-inches.

Approximate shipping weight, 100 pieces, 97 pounds.

No. ***9202**
Number of Holes..... 3
Size Holes, inches..... $1\frac{1}{32}$

*Western Union Std.

Hubbard Telephone Corner Brackets
Hot Galvanized



Used where leads from the pole come to the building at an angle and to carry leads around the corner of a building.

No.	*9204	*9205	9206	9207	9208
Size Steel.....in.	$1\frac{1}{2}$ x $1\frac{7}{8}$	$1\frac{1}{2}$ x $1\frac{7}{8}$	$\frac{3}{8}$ x $1\frac{1}{2}$	$\frac{1}{4}$ x $1\frac{1}{2}$	$1\frac{1}{2}$ x $1\frac{1}{2}$
Insulator Holes.....in.	$1\frac{1}{2}$	$1\frac{1}{2}$	$1\frac{1}{2}$	$1\frac{1}{2}$	$1\frac{1}{2}$
Mtg. Hole Size.....in.	$1\frac{1}{2}$	$1\frac{1}{2}$	$1\frac{1}{2}$	$1\frac{1}{2}$	$1\frac{1}{2}$
Mtg. Hole Ctrs.....in.	$3\frac{1}{8}$	$3\frac{1}{8}$	$2\frac{23}{32}$	$2\frac{23}{32}$	$3\frac{1}{8}$
Ship. Wt. per 100.....lb.	66	96	71	121	66

*Western Union Std.

Hubbard Porcelain Knobs for Telephone Brackets

White glaze Dry Process, porcelain knob insulator for use with brackets listed above.



No. 9225



No. 9226

No.	9225	9226
Number of Grooves.....	2	4
Diam. Bolt Hole.....in.	$\frac{3}{8}$	$\frac{7}{16}$
O. D.....in.	$1\frac{5}{8}$	$1\frac{3}{4}$
Height.....in.	$1\frac{1}{16}$	$2\frac{1}{4}$
Approx. Ship. Wt. per 100.....lb.	22	40

Hubbard Bolts for Telephone Brackets
Hot Galvanized

Used for attaching porcelain knob insulators to pole or house brackets.

No.	Stove Bolt		Machine Bolt	
	9232	9233	9603	9605 $\frac{1}{2}$
Diam.....in.	$\frac{5}{16}$	$\frac{5}{16}$	$\frac{3}{8}$	$\frac{3}{8}$
Length.....in.	2	3	3	$5\frac{1}{2}$
Ship. Wt. per 100.....lb.	6.6	8.6	13.8	22.9

Hubbard Drive Hooks
Hot Galvanized



Used for wire clamp attachments on poles, arms or buildings. Has a drive head and fetter drive threads. Steel diameter, $\frac{7}{16}$ inch. Overall length, $5\frac{1}{16}$ inches. Length of thread, 2 inches.

Ship. Wt. per 100, 29 pounds.

No. 1316.....
No. 1318—Steel Dia. $\frac{1}{2}$ "—Overall $5\frac{1}{16}$ ". Length of Thrd.—3". Wt. 29.....

Hubbard Span Clamps
Hot Galvanized



No. 8908



No. 8917



No. 8918

No. 8908 Span Clamps are attached to messenger and a telephone service clamp is engaged over hook. Used for taking off service connections between spans. No. 8917 is for the same purpose but is used in connection with wire clamps which attach through the wire attachment loop. No. 8918 Span Clamp is used with No. 9225 Knob. It consists of a clamp and spacer with holes for two knobs.

No. In.	Messenger Size In.	Steel Size In.	Messenger Length Groove to Wire Attachment Loop	Insulator Spacing	Approx. Shipping Wt., Lbs. 100 Pcs.
8908	$\frac{1}{4}$ to $\frac{3}{8}$	$\frac{3}{8}$ Dia.	41
8917	$\frac{1}{4}$ to $\frac{3}{8}$	11 Ga.	$3\frac{1}{4}$...	144
8918	$\frac{1}{4}$ to $\frac{1}{16}$	$\frac{1}{8}$ x $1\frac{1}{2}$...	$5\frac{3}{4}$	152

Hubbard Insulated Telephone Knob Screws

Hot Galvanized



No. 2919

No. 2919 Porcelain Knob is used generally for running telephone wires along the sides of buildings. No. 2920 may be used for dead-ending duplex or twisted pair telephone wires. The latter is also used occasionally as a service attachment for low voltage power lines in localities not subjected to snow and sleet. Overall length of No. 2919 is 3-inches and of No. 2920, $4\frac{1}{4}$ -inches. No. 2919 uses insulator No. 2917; No. 2920 uses insulator No. 2927.

No.	Type Insulator	Size of Screw—Inches	Approx. Shipping Wt. Lbs., 100 Pcs.
2919	Small—White Glaze	No. 11 x $1\frac{7}{8}$	11
2920	Large—Brown Glaze	No. 22 x $2\frac{1}{2}$	48

Hubbard Dead End Telephone Brackets

Hot Galvanized

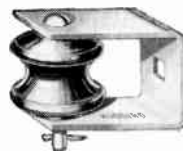

No. 2944

Hubbard Dead End Telephone Brackets are used for dead ending telephone lines on cross arms.

The $1\frac{1}{32}$ -inch square mounting hole permits the use of either a crossarm bolt or carriage bolt for installation. However, a carriage bolt is recommended.

No. 1663 Porcelain insulators are used with No. 2944 Dead End Telephone Brackets.

No.	Dimensions—Inches Mtg. Hole	Steel Size	Insulator No.	Approx. Ship. Wt. Lbs., 100 Pcs.
2944	$1\frac{1}{32}$ sq.	$\frac{1}{8}$ x $1\frac{1}{2}$	1663*	78

*Stock No. 1663 insulator is furnished unassembled.

**Hubbard Western Union or Signal Type Pins
Hot Galvanized**

Furnished with air dried oak cobs, boiled in paraffine. Pins of high-carbon steel, with clean threads and square nuts. For use with standard insulators having one-inch pin holes.



No. 8000



No. 8011



No. 8010

**Long Shank Pins
For Wood Crossarms**

No.	Diam. Shank In.	Length—Inches Above Shoulder	Length—Inches Below Shoulder	Approx. Shipping Wt., Lbs. 100 pcs.
†*8000	1/2	4 1/4	5	88
8004	5/8	4 1/4	5 7/8	112
†*8005	5/8	4 1/4	5 7/8	125
8013	5/8	4 1/4	5 1/2	110

Short Shank Pins

For Steel Cross Arms, Transposition Brackets, and Break Irons.

8008	1/2	4 1/4	1 1/6	42
8009	1/2	4 1/4	1 1/2	48
†*8010	1/2	4 1/4	1 1/2	55
8012	5/8	4 1/4	1 3/8	78
8014	5/8	4 1/4	1 3/4	78
†*8015	5/8	4 1/4	1 3/4	82

Short Shank Pins

With Long Cob for Transposition Insulators

8011	1/2	5	1	58
8016	5/8	5	1	100

*Western Union Std.

†A.A.R. Std.

**Hubbard Wood Top Pins
With Steel Bolts**

Bolt Hot Galvanized

Tops made of properly seasoned wood, thoroughly impregnated with paraffine. The head of the solid bolt is sunk in the pin top to eliminate pressure against insulator. Furnished assembled.



No. 8070

No.	Wood Top Size				Bolt Size Lgh. Below Wood Top In.	Ship. Wt. Lbs. per 100	
	Oiam. Top In.	Oiam. Bottom In.	Lgh. In.	Oiam. Lgh. In.			
8064	1	1 13/16	4	1/2	9	5	80
8070	1	1 7/8	4 1/2	1/2	5 1/2	1	60
8071	1	2 1/4	5 1/4	1/2	6 1/2	1 1/4	78
8074	1	1 7/8	4 1/2	1/2	9 1/2	5	87
8075	1	2 1/4	5 1/4	1/2	10 1/2	5 1/4	101
8076	1	2 1/4	5 1/4	1/2	11 1/2	6 1/4	113

**Hubbard Forged Steel Pins
With Lead Threads for Low Voltage Insulators
Hot Galvanized**

Long shank type pins for wood arms are furnished with lock washers and square washers. Short shank pins for steel arms are furnished with spring lock washers. The wide base on this style pin adds materially to its strength if properly tightened on the arm. For use on roofed crossarms, order pins with saddle washers.

**Long Shank Type — With 1-Inch Lead Thread
For Wood Crossarms**

Flat Base

No.	Diam. Shank In.	Diam. Base In.	Length—Inches Above Base	Length—Inches Below Base	Over-all	Approx. Shipping Wt., Lbs. 100 Pcs.
971	1/2	1 3/4	5	5 1/2	10 1/2	162
981	5/8	2	5	5 3/4	10 3/4	210
981-A	5/8	2	5	6 1/2	11 1/2	214
983	5/8	2	6	6 1/2	12 1/2	220
984	5/8	2	6	5 3/4	11 3/4	228
985	5/8	2	5	8	13	245
990-A	3/4	2 1/2	5	6 1/2	11 1/2	262
990	3/4	2 1/2	6	6 1/2	12 1/2	271



No. 981S

Saddle Base

981-S	5/8	2	5	5 3/4	10 3/4	210
981-AS	5/8	2	5	6 1/2	11 1/2	214
983-S	5/8	2	6	6 1/2	12 1/2	220
984-S	5/8	2	6	5 3/4	11 3/4	228
985-S	5/8	2	5	8	13	245
990-AS	3/4	2 1/2	5	6 1/2	11 1/2	262
990-S	3/4	2 1/2	6	6 1/2	12 1/2	271



No. 986

Short Shank Type — With 1-Inch Lead Thread

For Steel Crossarms

972	1/2	1 3/4	5	1 1/4	6 1/4	125
986	5/8	2	5	1 1/2	6 1/2	151
987	5/8	2	6	1 1/2	7 1/2	171
993-A	3/4	2 1/2	5	1 3/4	6 3/4	190
993	3/4	2 1/2	6	1 3/4	7 3/4	202



No. 988

Lag Screw Type — With 1-Inch Lead Thread

For Pole and Transformer Wiring

973	1/2	1 3/4	5	3	8	111
975	1/2	1 3/4	6	3	9	147
988	5/8	2	5	3	8	163
989	5/8	2	7 1/2	4	11 1/2	195

*Prices on application.

Hubbard Transformer Pins

With 1-Inch Thread

Hot Galvanized

Used for running transformer leads from the line cross-arm to transformer arm. May also be used on pole for lamp leads, or for attaching any wires which are not subjected to line stresses.



Forged Steel Type, Square Shoulder

No.	†123
Size of Screw	22 x 2
Length Above Shoulder	4 3/4
Length Overall	6 3/4
Diameter Base	2 1/2
Shipping Weight, Pounds, per 100	110

†Other new type pins for transformer work are available. Write Graybar.

Hubbard 1-Inch Drop-Forged Clamp Pins
Hot Galvanized

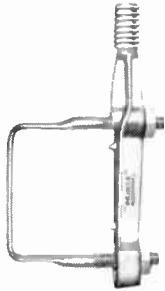

No. 4420
Cross Arm Strap
Not Included

May be used at angles in the line when assembled with a crossarm reinforcing plate.

On straight line runs the pin is used without the plate and is prevented from canting by two 1/4-inch lugs. Mounting slots are for 1/2-inch diameter crossarm straps. Straps are not included.

Has 1-inch lead thread.
Size of crossarm, 4 x 5 inches or smaller.
Pin height above arm, 4 3/4 inches.

No. 4420 4420
Approx. Shipping Weight Pounds, per 100 175

Hubbard Wide Base Clamp Pins

For 1-Inch Pin Hole
Hot Galvanized

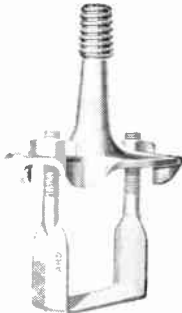

No. 4320

Designed for angle and corner construction.

Each pin is forged from a single piece of hot rolled open hearth steel. The broad base rests evenly on the arm and prevents pin from cutting into the wood, while the four lugs hold the pin from twisting on the crossarm.

U-Strap type pins include crossarm mounting strap. Carriage bolt type includes 2 carriage bolts, 2 square nuts, 2 M. F. locknuts and a 5/16-inch flat steel washer plate. Pin height above arm, 5 3/4 inches.

Carriage Bolt Type

Flat Base No.	Curved Base No.	Size of Cross Arm	Carriage Bolt Size	Approximate Shipping Wt. Lbs., 100 Pcs.
24320	3 1/4 x 4 1/4	1/2 x 5 1/2	500
24321	3 1/2 x 4 1/2	1/2 x 6	500
24322	3 3/4 x 4 3/4	5/8 x 7	530

U-Strap Type

4320	4220	3 1/4 x 4 1/4	405
4321	4221	3 1/2 x 4 1/2	405
4322	4222	3 3/4 x 4 3/4	475

Hubbard Pressed Steel Corner Pins

Hot Galvanized



No. 4724

Formed from 3/16-inch flat steel. Stabilizing "leg" on these pins is placed toward the inside of the corner angle. Includes strap and carriage bolts.

For roofed crossarms. One inch diam. Lead threads.

No.	Dimensions, Inches Size of Arm	Height Above Arm	Approx. Shipping Wt. Lbs. Per 100
4724	3 1/2 x 4 1/2 to 3 3/4 x 4 3/4	5 18/16	360

Hubbard—OB Insulator Pins

Hot Galvanized—Patented



No. 71850



No. 71810



No. 71552

The listing below covers Hubbard-OB High Tension Pins for flat or roofed top wood arms and for steel arms.

These pins are furnished with 1-inch and 1 3/8-inch lead threads. Lead Threads are permanently bonded to the steel and carefully formed to meet the standards of insulator manufacturers. Separable forged steel bases may be interchanged to fit pins to curved or flat topped arms.

Long Shank for Wood Arms

No.	Circ. Flat Base	Rect. Curved Base	Dimensions—Inches					Approx. Ship. Wt., Lbs. 100 Pcs.
			A	B	C	L	T	
71305	71345	5	6 1/2	3/8	3/8	2 1/2	235	
71308	71348	6	6 1/2	3/8	3/8	2 1/2	250	
71807	71857	6	6 1/2	3/4	1	2 1/2	401	
71820	71860	7	7	3/4	1	2 3/4	414	

1 3/8-inch Lead Threads—Separable Base

71810	71850	6	6 1/2	3/8	3/8	2 1/2	350
71811	71851	7	7	3/8	3/8	2 3/4	410
71814	71852	8	7	3/8	3/8	2 3/4	440
*71404	*71454	5	6 1/2	3/4	1	2 1/2	425
71407	71457	6	6 1/2	3/4	1	2 1/2	426
71411	71461	7	7	3/4	1	2 3/4	439
71414	71464	8	7	3/4	1	2 3/4	457
71417	71467	9	7	3/4	1	2 3/4	473
71420	71470	10	7	3/4	1	2 3/4	491
71423	71473	11	7	3/4	1	2 3/4	650
71426	71476	12	7	3/4	1	2 3/4	680
71608	71658	8	7	3/4	1 1/8	2 3/4	578
71611	71661	9	7	3/4	1 1/8	2 3/4	616
71614	71664	10	7	3/4	1 1/8	2 3/4	674
71617	71667	11	7	3/4	1 1/8	2 3/4	810
71620	71670	12	7	3/4	1 1/8	2 3/4	872
71623	71673	13	7	3/4	1 1/8	2 3/4	964

Short Shank for Steel Arms

1-inch Lead Threads—Separable Base

No.	Dimensions Inches					Approx. Shipping Wt., Lbs. 100 pcs.
	A	B	C	E	L	
71952	6	1 3/4	3/4	1	1	335
71953	7	1 3/4	3/4	1	1	348

1 3/8-inch Lead Threads—Separable Base

71552	6	1 3/4	3/4	1 3/8	1	360
71553	7	1 3/4	3/4	1 3/8	1	373
71554	8	1 3/4	3/4	1 3/8	1	391
71555	9	1 3/4	3/4	1 3/8	1	407
71556	10	1 3/4	3/4	1 3/8	1	425
71557	11	1 3/4	3/4	1 3/8	1	570
71558	12	1 3/4	3/4	1 3/8	1	604
71752	8	1 3/4	3/4	1 3/8	1 1/8	414
71753	9	1 3/4	3/4	1 3/8	1 1/8	560
71754	10	1 3/4	3/4	1 3/8	1 1/8	606
71755	11	1 3/4	3/4	1 3/8	1 1/8	703
71756	12	1 3/4	3/4	1 3/8	1 1/8	792
71757	13	1 3/4	3/4	1 3/8	1 1/8	832

Symbol Explanation

- A = Above base
- B = Below base
- C = Shank Diam.
- E = Thread Diam.
- L = Body Diam.
- T = Thread Length

**Hubbard Forged Steel Pins
Tapered Body—Lead Thread
Hot Galvanized**

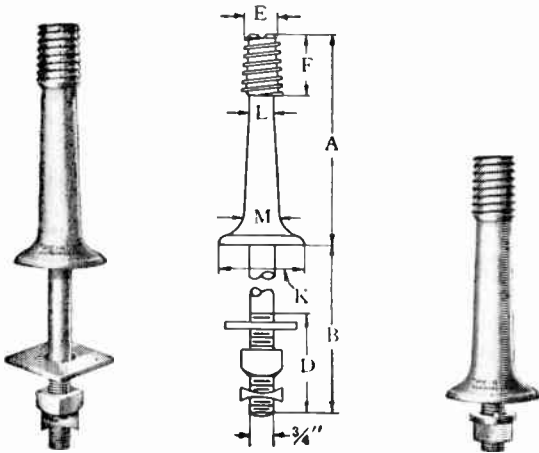

**No. 5724
Long Shank Type**

**No. 5725
Short Shank Type**

Lead threads are securely bonded to the steel and carefully formed to meet insulator manufacturers' standards. There are no troublesome fins or mold marks. Pins for use on wood crossarms are furnished with Square Washer, Square Nut, and M.F. Locknut. A Saddle Washer adapts these pins for use with roofed crossarms. Short shank Pins, for use on steel crossarms, are furnished with a square nut and spring lock washer.

**Long Shank for Wood Arms
1-inch Lead Threads—Tapered Body Style**

No.	Dimensions—Inches							M	Approx. Shipping Wt., Lbs. Per 100 pcs.
	A	B	D	E	F	K	L		
■†*5705	5	6 1/2	2 1/2	1	1 3/4	2 3/4	7/8	7/8	200
■†*5706	6	6 1/2	2 1/2	1	1 3/4	2 3/4	7/8	7/8	280
5711	6	1 3/4	1 5/8	1	1 3/4	2 3/4	3/4	15/16	216
†*5712	6	6 1/2	3	1	1 3/4	2 3/4	3/4	15/16	288
*5713	7	1 3/4	1 5/8	1	1 3/4	2 3/4	3/4	15/16	210
*5714	7	6 1/2	3	1	1 3/4	2 3/4	3/4	15/16	245

1 1/2-Inch Lead Threads—Tapered Body Style

■†*5716	6	7	2 1/2	1 3/8	2 5/16	3	1	1	410
■†*5717	7	7	2 1/2	1 3/8	2 5/16	3	1	1	410
■†*5718	8	7	2 1/2	1 3/8	2 5/16	3	1	1	473
5723	6	1 3/4	1 5/8	1 3/8	2 5/16	3	1 1/8	1 9/32	390
†*5724	6	7	3	1 3/8	2 5/16	3	1 1/8	1 9/32	495
5725	7	1 3/4	1 5/8	1 3/8	2 5/16	3	1 1/8	1 11/32	435
†*5726	7	7	3	1 3/8	2 5/16	3	1 1/8	1 11/32	546
5727	8	1 3/4	1 5/8	1 3/8	2 5/16	3	1 1/8	1 13/32	479
†*5728	8	7	3	1 3/8	2 5/16	3	1 1/8	1 13/32	630
5729	9	1 3/4	1 5/8	1 3/8	2 5/16	3 1/2	1 1/8	1 15/32	600
†*5730	9	7	3	1 3/8	2 5/16	3 1/2	1 1/8	1 15/32	710
5731	10	1 3/4	1 5/8	1 3/8	2 5/16	3 1/2	1 1/8	1 17/32	613
†*5732	10	7	3	1 3/8	2 5/16	3 1/2	1 1/8	1 17/32	740
5735	12	1 3/4	1 5/8	1 3/8	2 5/16	3 3/4	1 1/8	1 21/32	780
†*5736	12	7	3	1 3/8	2 5/16	3 3/4	1 1/8	1 21/32	920

*Add letter "S" to Stock No. for Pins with Saddle Washers at slight additional cost.

†With 2 1/2" Square Washer, Sq. Nut and Locknut.

■5/8" diam. shank instead of 3/4".

Short Shank for Steel Arms

1-inch Lead Threads—Tapered Body Style

No.	Dimensions—Inches					M	Approx. Shipping Wt., Lbs. Per 100 pcs.
	A	E	F	K	L		
5703	4	1	1 3/4	2 1/2	3/4	13/16	205
5707	5	1	1 3/4	2 1/2	3/4	7/8	219
5711	6	1	1 3/4	2 1/2	3/4	15/16	233

1 1/2-inch Lead Threads—Tapered Body Style

5723	6	1 3/8	2 5/16	3	1 1/8	1 9/32	420
5725	7	1 3/8	2 5/16	3	1 1/8	1 11/32	456
5727	8	1 3/8	2 5/16	3	1 1/8	1 13/32	526
5729	9	1 3/8	2 5/16	3 1/2	1 1/8	1 15/32	616
5731	10	1 3/8	2 5/16	3 1/2	1 1/8	1 17/32	666

**Hubbard Crossarm Reinforcing Plates
Hot Galvanized**



No. 5072

Used on angles and corners of lines as a reinforcement for clamp pins.

Holds the pin rigid under loads of 1200 pounds in any direction.

Furnished for flat or roofed top arms from 3 1/4 x 1 1/4-inches to 3 3/4 x 1 3/4-inches. They are used in connection with the crossarm straps listed below.

Flat Top Arm No.	Roofed Top Arm No.	Hole Diam. In.	Size of Arm In.	Use Cross-Arm Strap No.	Shipping Wt., Lbs. Per 100
5072	5082	9/16	3 1/2 x 1 1/2	1002	116
5073	5083	9/16	3 3/4 x 1 3/4	1003	122
5076	5086	1 1/16	3 1/2 x 1 1/2	2002	116
5077	5087	1 1/16	3 3/4 x 1 3/4	2003	122

**Hubbard Drop-Forged Crossarm Straps
Hot Galvanized**

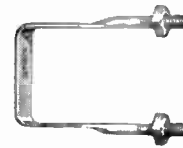

For Side Arm Mounting

For attaching clamp pins. Designed with the spread equal to the larger dimension of the arm. Thread length is 2 inches for all sizes.

No.	Size of Arm In.	Size Strap, Inches		Flat Section	Round Section	Shipping Wt., Lbs. Per 100
		Spread & Lgth.	Flat Section			
Light Type						
1001	3 1/4 x 4 1/4	4 1/4 x 5	3/16 x 1 1/8	1/2	103	
1002	3 1/2 x 4 1/2	4 1/2 x 5 1/4	3/16 x 1 1/8	1/2	108	
1003	3 3/4 x 4 3/4	4 3/4 x 5 1/2	3/16 x 1 1/8	1/2	112	
1004	4 x 5	5 x 5 3/4	3/16 x 1 1/8	1/2	121	

For Mounting on Top or Bottom of Arm

Similar to the crossarm straps listed above except that the spread is equal to the smaller dimension of the arm.

Thread length is 2-inches for all sizes.

Heavy Type

1881	3 1/4 x 4 1/4	3 1/4 x 5 3/8	1/4 x 1 3/8	5/8	145
1882	3 1/2 x 4 1/2	3 1/2 x 5 5/8	1/4 x 1 3/8	5/8	152
1883	3 3/4 x 4 3/4	3 3/4 x 5 7/8	1/4 x 1 3/8	5/8	158
1884	4 x 5	4 x 6 1/8	1/4 x 1 3/8	5/8	165

Hubbard Crossarm Saddles

**Hot Galvanized
Pressed Steel Type**



No. 5002

For adapting a roofed top arm to a flat base pin. Fits the curve of the arm and presents a broad, flat area as a seat for the pin base.

No	Width of Crossarm Inches	Diameter Pin Hole Inches	Ship. Wt., Lbs. Per 100
5001	3 1/4	2 7/32	104
5002	3 1/2	2 7/32	114
5003	3 3/4	2 7/32	124
5004	4	2 7/32	134
5005	5	2 7/32	144

Hubbard Saddle Washers

Adapts flat base pins to roofed crossarms.



No.	Size	Hole Diam.	Approx. Ship. Wt. Lbs., 100
5206	2 1/2 x 2 1/2	1 1/16	31
5207	2 1/2 x 2 1/2	1 3/16	31
5209	3 1/2 x 3 1/2	1 1/16	78
5210	3 1/2 x 3 1/2	1 3/16	78

Hubbard Malleable Iron Centering Washers

Hot Galvanized

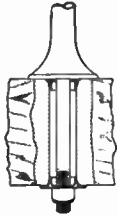

No. 5664 and No. 5684 Installed

Hubbard Centering Washers, often called Pin Hole Adapters, are used on stock crossarms, which have been drilled for wood pins, to adapt them to the smaller shanks of steel pins. Top Centering Washers are designed to draw down into the pin hole, when the pin is tightened on the arm, leaving the top surface clear for the pin base. They may be used on either flat or roofed arms.

A Top Centering Washer may also be used on the bottom of the arm if a standard flat washer is placed between it and the nut.

Top Centering Washers



No. 5664

No.	Diam. Pin Hole In Arm	Diam. Pin Hole In Washer	Outside Diam. Washer	Approx. Ship. Wt. Lbs. 100 Pcs.
5660	1 1/4	9/16	1 1/2	9
5661	1 1/4	1 1/16	1 1/2	8
5662	1 1/4	1 3/16	1 1/2	7
5663	1 1/2	9/16	1 3/4	11
5664	1 1/2	1 1/16	1 3/4	10
5665	1 1/2	1 3/16	1 3/4	10

Bottom Centering Washers



No. 5684

No.	Diam. Pin Hole In Arm	Diam. Pin Hole In Washer	Outside Diam. Washer	Approx. Ship. Wt. Lbs. 100 Pcs.
5680	1 1/4	9/16	2	19
5681	1 1/4	1 1/16	2	18
5682	1 1/4	1 3/16	2	17
5683	1 1/2	9/16	2 1/4	22
5684	1 1/2	1 1/16	2 1/4	21
5685	1 1/2	1 3/16	2 1/4	21

Hubbard Ribbed Tie Plates and Flat Gain Plates

Hot Galvanized

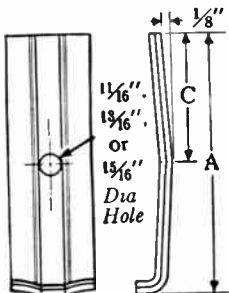

No 1855

Hubbard Ribbed Tie Plates and Flat Gain Plates are used extensively on double plank construction. Made from 1/4 by 3-inch steel, they are used with the Gain Plate on the inside of the arm and the Ribbed Tie Plate on the outside. Specify mounting hole diameter — 1 1/16, 1 3/16 or 1 5/16-inch.

Ribbed Tie Plate	Number	Flat Gain Plate	Number	Dimensions, In.	A	C	Approx. Shipping Wt. Lbs., 100 Pcs.
1855	1855	1857	1857	6	2 7/8	135	
1878	1878	1887	1887	10	4 7/8	230	

Hubbard Pressed Steel Corner Pole Top Pins

Hot Galvanizee



Made of 3/16-inch sheet steel. Lead threaded pin top makes an angle of 20° with pole face, back is curved on a 4-inch radius. There are two 1/16-inch mounting holes and one 1 1/4 x 1 1/4 inch mounting slot for 5/8-inch bolts. Vertical bolt spacing can be 5 or 8 inches.

Insulator threads are standard 1-inch lead threads.

Mounting bolts are not included.

No.	Length Overall	Ship. Wt. Lbs. Per 100
3029	16-inches	490

Hubbard Pressed Steel Pole Top Pins

Hot Galvanized



These pressed steel pole top pins have great strength and endurance. They have a specially formed conical top and the channel size is 1 7/8 by 1 9/16 by 5/32-inch.

Straight base pins are mounted with the flat back next to the pole surface.

Pins are made with either straight or flared bases.

Pole Top Pins for use with separable thimbles are also made from 5/32-inch flat steel. The lead thread thimble No. 5052 is recommended for use with these pins.

No.	Straight Base	Flared Base	Length In.	Hole Spacing In.		of Thread In.
				A	B	
3026	15	6	2	1
3162	15	5	5	1
3163	...	3183	16	5	5	1
3163	...	3136	16	6	6	1
3167	18	6	6	1
3167	...	3190	18	8	2	1
3170	18	8	3	1
3174	20	8	3	1
3171	...	3191	24	8	2	1
3195	20	8	...	1 5/8
3196	24	8	...	1 5/8
...	...	3193	24	8	2	1 5/8



No. 8090

Hubbard Clip Washers

Hot Galvanized

Used to attach wood insulator brackets to a pole. They grip the wood firmly across its width and prevent splitting. Made from 12 gage by 1-inch steel. Mounting holes 5/16-inch diameter.

No.	Description	Dimensions, In. Spread Between Legs	Approx. Shipping Wt. Lbs., 100 Pcs.	Mounting Hole Diam. In.
8089	Top Strap	1 1/2	17	5/16
8090	Bottom Strap	1 1/2	6	5/16
8098	Top Strap	2	28	5/16
8099	Bottom Strap	2	8	5/16

Hubbard Bracket Straps

Hot Galvanized

Two bracket straps, top and bottom, are used on each wood bracket. Made from 12 Ga. x 1 7/8 Steel.

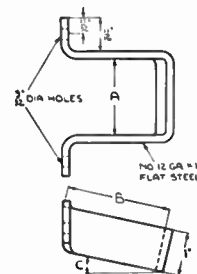

No. 8065

No.	Description	Dimensions			Mounting Hole Diam. In.	Ship. Wt. Lbs. Per 100
		A In.	B In.	C In.		
8065	Bottom	1 5/8	1 5/8	19°	9/32	16
8066	Top	1 5/8	2 7/8	19°	9/32	25
8067	Top	1 3/4	2	15°	9/32	22
8068	Bottom	1 3/4	7/8	15°	9/32	15
8069	Top	1 3/4	2 7/8	15°	9/32	25

Hubbard Pole Top Brackets

For Long or Short Shank Insulator Pins or Post Type Insulators

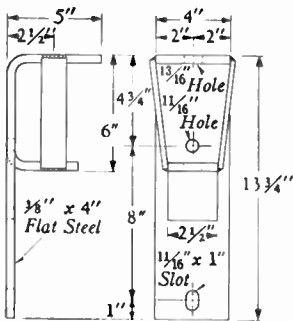

By using a No. 3051 Pole Top Bracket, forged steel insulator pins — commonly used on crossarms — may be employed at the top of the pole. This bracket will accommodate not only long or short shank pins, but will also take Post Type Insulators. Mounted by two 5/8-inch diameter mounting bolts. Holes for Pin mounting are 13/16-inch diameter.

No.	Steel Size	Dimensions — Inches Mtg. Hole Diam.	Mtg. Slot Size	Approx. Ship. Wt. Lbs., 100
3051	3/8 x 4	1 1/16	1 1/16 x 1	1031

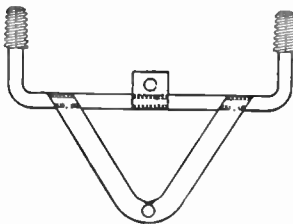

**Two Point Brackets
Hot Galvanized**

Recommended for areas where woodpeckers, termites, and other wood destroying insect pests are prevalent. Also much used on pipe line communication lines.

No. 3144

No.	Steel Size	Dimensions — Inches Spread	Mtg. Hole Diam.	Mtg. Hole Spacing	Approx. Ship. Wt. Lbs., 100 Pcs.
3144	3/4 dia.	16	9/16	7 3/8	540

Hubbard Wire Stringing Tools

Hot Galvanized



No. 1240
Pin Type

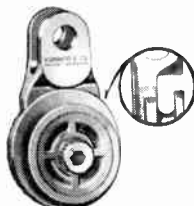

No. 1243
Suspension

Economical aids in the stringing and sagging of conductors. When a section of conductor has been sagged properly and tied in, the Wire Stringing Tools are removed and employed further along the line.

Made in two styles. The Pin type tool is placed over the threads of a 1-inch lead thread insulator pin for sagging along a straight run or a slight angle, while the Suspension type is used for stringing conductors on angles of from 30 to 60 degrees and is attached to the insulator string. Both types are assembled with special alloy steel stripper bolts and oil retaining bronze bushings.

No.	Clearance For Conductor, Inches	Attachment	Approx. Shipping Wt. Lbs., 100 Pcs.
1240	13/32	1-in. lead thread pin	315
1243	1 5/32	5/8-inch Bolt	335

Hubbard Static Wire Supports

Loop Type

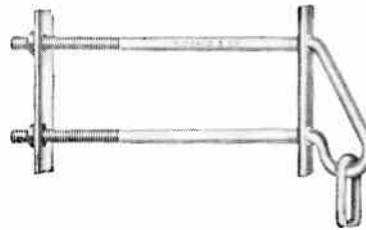

Made from 5/8-inch diameter steel and include one No. 6783 end link for wire clamp attachment. Inside pole plate is welded to the support legs for greater strength. Thread length, 7 1/2-inches.

No.	Pole Diam.	Dimensions, Inches Steel Size	Washer Plate Size	Approx. Ship. Wt. Lbs., 100 Pcs.
6432	8 to 10	5/8 diam.	7 x 2 1/2 x 1/4	565
6433	10 to 12	5/8 diam.	7 x 2 1/2 x 1/4	600
6434	12 to 14	5/8 diam.	7 x 2 1/2 x 1/4	635

Band Type

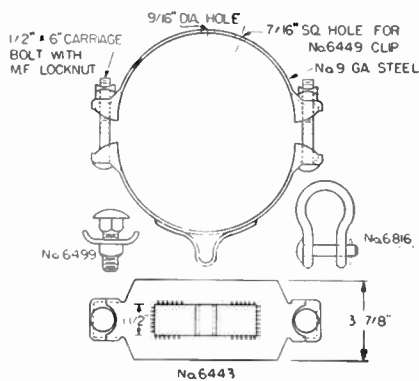

Bands are made from No. 9 ga. by 3/8 inch open hearth steel. Grounding clip and clevis are not included and must be ordered separately. Grounding clip may be attached through a 7/16 inch hole in the band.

No. 6816 Shackle not included.

No.	Pole Diam.	Dimensions, Inches Size Band Steel	Carriage Bolt Size	Approx. Ship. Wt. Lbs., 100 Pcs.
6443	7 to 9	3 7/8 x No. 9 Ga.	1/2 x 6	661
6444	8 1/2 to 11	3 7/8 x No. 9 Ga.	1/2 x 7 1/2	748
6445	10 to 13	3 7/8 x No. 9 Ga.	1/2 x 7 1/2	835
6499	Ground Clip for above bands (Not incl.)			25

Prices on application.

Hubbard Static Wire Brackets

Angle Steel Type

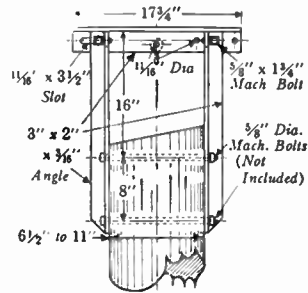

No. 6464

Static wire clamp is attached to a No. 6801 Clevis which in turn is attached to the No. 6464 Bracket through the 1 1/16-inch hole of the ridge member. Ridge member may be raised and the neutral inserted without threading. Side members restrain the neutral at the top of the pole where it cannot fall across conductors. The two necessary 5/8-inch diameter mounting bolts are not included.

No.	Angle Steel Size	Dimensions, Inches Range Pole Diam.	Approx. Ship. Wt. Lbs., 100 Pcs.
6464	3 x 2 x 3/16	6 1/2 to 11	1550

Hubbard Ridge Irons

Hot Galvanized

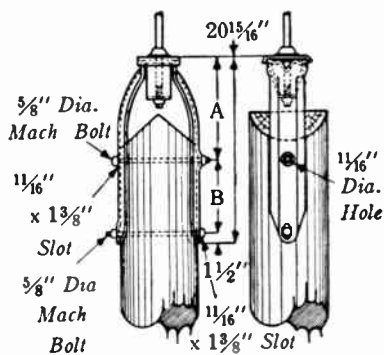

No. 5908

Mounting bolt size 5/8-inch. Pin hole size 1 3/16-inch.

Less "V" Block No.	With "V" Block No.	Dimensions, Inches			*Approx. Ship. Wt. Lbs. Per 100
		Pole Diam.	A	B	
6308	5908	5 1/2 to 6 3/4	11 7/16	8	1420
6309	5909	6 3/4 to 8	11 7/16	8	1420
6310	5910	8 to 8 1/2	11 7/16	8	1420

Hubbard Double Arming Ridge Irons

Hot Galvanized

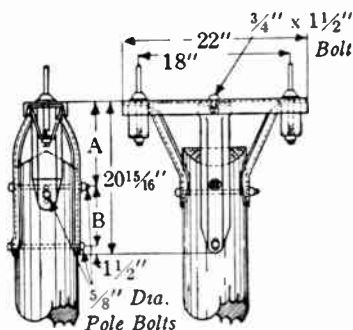

No. 5920

Mounting bolt size 5/8-inch. Pin hole size 1 3/16-inch.

6320	5920	6 3/4 to 5 1/2	11 7/16	8	3230
6321	5921	6 3/4 to 8	11 7/16	8	3230
6322	5922	8 to 8 1/2	11 7/16	8	3230

*Weight include "V" blocks, subtract 320 pounds per block if desired without blocks.

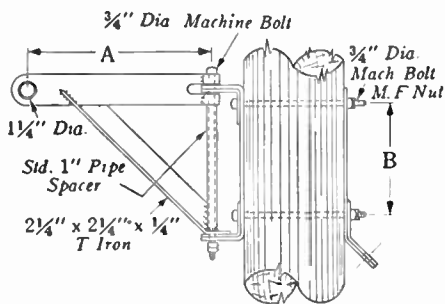

Hubbard Swinging Angle Brackets Horizontal Type

No.	Dimensions, Inches		Angle Plate Steel Size	Approx. Ship. Wt. Lbs., 100 Pcs.
28120	A: 12	B: 6	3 x 3/8	2500
28121	A: 15	B: 9	3 x 3/8	3000
28122	A: 18	B: 12	3 x 3/8	3500
28123	A: 21	B: 15	3 x 3/8	4000

Prices on application.

Hubbard Insulator Bolts

Hot Galvanized
Double Up-Set Type

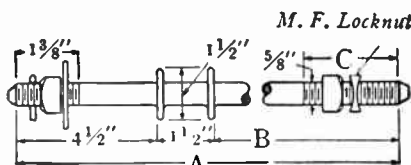

No. 8822 Key to Dimensions.

Double upset bolts are furnished as shown. Insulators are not included.

No.	Dimensions, Inches			Thread Diam.	For Use With Insul. No.		Approx. Ship. Wt. Lbs. Per 100
	A	B	C		Dry	Wet	
8822	12	6	3 1/2	5/8	355 or 455		172
8824	13	7	3 1/2	5/8	355 or 455		179
8826	11	8	4 1/2	5/8	355 or 455		188
8828	15	9	5 1/2	5/8	355 or 455		196
8830	16	10	5 1/2	5/8	355 or 455		204
8832	18	12	5 1/2	5/8	355 or 455		220

Hubbard Insulator Bolts

Hot Galvanized
Single Up-Set Type

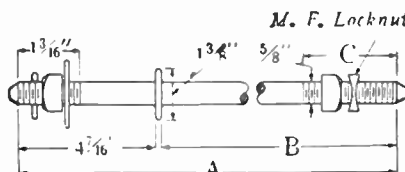

No. 8740 Key to Dimensions.

Attachment is made through the pole, and a rack type insulator is employed on the insulator end. Single upset bolts are furnished, as shown, with nuts. Insulators are not included.

No.	Dimensions Inches			Thread Diam.	For Use With Insul. No.		Approx. Ship. Wt. Lbs. Per 100
	A	B	C		Dry	Wet	
8739 1/2	10 3/4	6	1	5/8	355 or 455		160
8740	11 3/4	7	5	5/8	355 or 455		170
8741	12 3/4	8	6	5/8	355 or 455		180
8741 1/2	13 3/4	9	6	5/8	355 or 455		189
8742	14 3/4	10	6	5/8	355 or 455		197
8743	16 3/4	12	6	5/8	355 or 455		215
8744	18 3/4	11	6	5/8	355 or 455		234

Hubbard Insulator Attachments

Medium Strain
Hot Galvanized

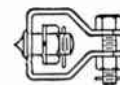
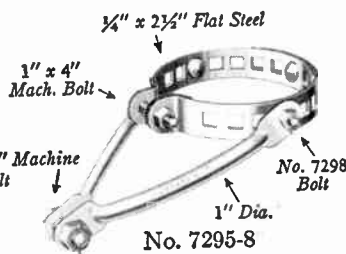

No. 7296



No. 7297



No. 7298

Adjustable. Steel size 1/4 x 2 1/2 inches.

No.	Item	Approx. Shipping Wt., Lbs. 100 Pcs.
7295-8	Band for Pole Diams., 7 to 9-in.	1900
7295-10	Band for Pole Diams., 9 to 11-in.	2000
7295-13	Band for Pole Diams., 11 to 14-in.	2200
7296	Clevis—Steel Size 1/4 x 2-in.	305
7297	Grounding Clip—Steel Size 1/4 x 2-in.	175
7298	Cone Head Bolt—1 x 2 1/4-in.	145

Hubbard Universal Dead-End Clevises

Hot Galvanized



Universal clevises may be used to attach any of three types of insulators; eye type, hook type and clevis type.

No.	Extension to Center of Cotter Bolt	Mounting Hole	Diam. Cotter Bolt	Steel Size	Approx. Ship. Wt. Lbs. Per 100 Pcs.
555	3 1/2	1 1/16 Dia.	5/8	3/16 x 1 1/2	129
556	3 7/16	1 3/16 Dia.	3/4 Mach.	5/16 x 2 1/2	175
593	4	1 13/16 Sq.	5/8	1/4 x 2	174

No. 555

Peirce Drop Forged Steel Thimble Clevises

Hot Galvanized



No. 655 Installed

For dead-ending lines to suspension insulators. The wire groove is designed to provide a safe bending radius for the strand and to maintain the shape of the strand under heavy stresses.

Dimensions: No. 655, Cotter bolt diameter, 5/8-inch; Groove diameter, 1 1/4-inches; Strand or Wire size, 3/4-inch or under.

No. 654 is identical to No. 655 except that it has a 1/2-inch Cotter Bolt.

Approximate shipping weight of No. 655, 122 pounds per 100.

Approximate shipping weight of No. 654, 115 pounds per 100.

Hubbard Standard Thimble Clevises

Hot Galvanized



No. 673

Used for dead-ending lines to suspension insulators.

Formed with a 2-inch diameter for the conductor loop and a groove to accommodate 3/4-inch strand or smaller.

No.	Steel Gauge	Cotter Bolt Diam.	Strand or Wire Size	Approx. Ship. Wt. Lbs. Per 100
673	9	5/8	3/4 or under	95

Hubbard Open Side and Open End Thimble Clevises

Hot Galvanized



No. 674



No. 675

Nos. 674 and 675 are designed for corner or dead-end conductor attachments. No. 674 is particularly desirable due to its open side design which eliminates threading of the conductor through the clevis.

No.	Steel Gauge	Dimensions—Cotter Bolt Diameter	Inches Strand or Wire Size	Approx. Ship. Wt. Lbs. 100 Pcs.
674	14 (thimble)	5/8	3/4 or under	145
675	12	5/8	3/4 or under	95

Hubbard Four-Way Wood Strain Insulators

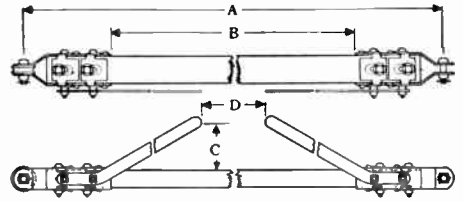

Horn gap and clearance dimensions D and C may be varied but must be specified when ordering. Sheave wheel* and cotter machine bolt are included. Arcing horns are included unless otherwise specified.

20,000 Lb. Min. Breaking Load—Wood Section 1 15/16 x 2 15/16 inches.

Nos.	With Arcing Horns	Less Arcing Horns	Dimensions				Approx. Wt. Lbs. With Arcing Horns	Shipping 100 pcs. Less Arcing Horns
			A	B	C In.	D In.		
7011	27011		5'—10 3/8"	4'—1"	10	14	2228	1718
7012	27012		6'—3 3/8"	1'—9"	10	19	2288	1808
7013	27013		6'—9 3/8"	5'—3"	10	25	2358	1878
7014	27014		7'—6 3/8"	6'—0"	10	34	2468	1988

35,000 Lb. Min. Breaking Load—Wood Sections 2 3/4 x 3 in.

7017	27017		7'—2 5/8"	5'—1"	13	19	3879	3295
7018	27018		7'—10 5/8"	6'—0"	13	27	4019	3435
7019	27019		11'—0 5/8"	9'—2"	20	42	4669	3905

*All sheave wheels 2 1/2" outside diameter with 9/16" groove diameter.

Hubbard Full Adjustable Pole Bands

Hot Galvanized

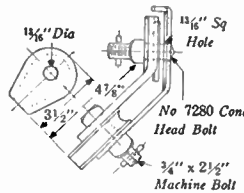

No. 7278

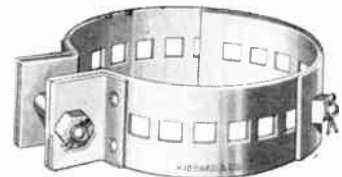

No. 7277

Designed so that deadends and guys may be attached at many different angles.

Shipped assembled with one 3/4 x 1-inch curved bolt and one 3/4 x 2 1/2-inch cone head bolt. Extra cone head bolts for attaching dead-end clevises and clips must be ordered separately.

No. 7278 guy clip attaches around the band by means of No. 7280 conical head bolt. Guy clip is furnished in two pieces, the top part of 3/8 x 2 1/2-inch steel and the bottom of 3/8 x 2 1/2-inch steel. The clevis bolt is a 3/4 x 2 1/2-inch cotter fitted machine bolt.

No. 7279 Square Curved Washer is used under the head of the Cone Head Bolt when the Guy Clip is used over a single thickness of the band.

No. 7299 is furnished with conical head bolt, lock washer, and clip plate. Ground wire is inserted between the clip plate and the band.

Nos. 7281 and 7282 have reinforced "ears" for greater strength.

No.	Description	Pole Diam. In.	Steel Size In.	Approx. Shipping Wt. Lbs. 100 Pcs.
556	Dead End Clevis	5/16 x 2 1/2	175
593	Dead End Clevis	1/4 x 2	175
7276	Pole Band	6 to 10	3/16 x 1	950
7277	Pole Band	8 to 14	3/16 x 1	1170
7278	Guy Clip	See Text	306
7279	Washer	3 x 3 x 3/16	48
7280	Cone Head Bolt	3/4 x 2 1/2	50
7281	Pole Band	6 to 10	3/16 x 3	900
7282	Pole Band	8 to 14	3/16 x 3	1030
7299	Ground Wire Clip	1/4 x 2	99

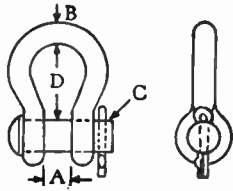

Hubbard Shackle Clevises

Used extensively to provide a flexible attachment for clamps such as in the case of static wire brackets, where the static wire clamp is attached to a No. 6801 shackle. Diameter of clevis pin $\frac{5}{8}$ -inch.

No.	A	Dimensions, Inches			D	Approx. Ship. Wt. Lbs. 100 Pcs.
		B	C			
6801	$\frac{3}{4}$	$\frac{1}{2}$	$\frac{5}{8}$	$2\frac{7}{32}$	90	
6816	$1\frac{9}{16}$	$\frac{9}{16}$	$\frac{5}{8}$	$2\frac{1}{16}$	142	
6817	$\frac{7}{8}$	$\frac{9}{16}$	$\frac{5}{8}$	$2\frac{1}{2}$	129	

Hubbard Strain Insulator Clevises

Hot Galvanized



Drop-forged from $\frac{1}{2}$ inch diameter open hearth steel. Ultimate strength, 13,000 pounds. Has $\frac{1}{2}$ inch bolt and lock washer. A $1\frac{1}{2}$ inch inside diameter eye is required to accommodate this clevis.

No.	Dimensions Inches		Used With Hubbard Insulator No.	Shipping Wt., Lbs. Per 100
	Inside Length	Inside Width	Wet Process	
825	3	2	521	119
827 $\frac{1}{2}$	$3\frac{1}{2}$	$2\frac{1}{4}$	522	136
831 $\frac{1}{2}$	$4\frac{1}{2}$	$2\frac{1}{2}$	523	156
832	5	$2\frac{1}{2}$	524	161

Hubbard Barmack Strain Insulator Clevises

Hot Galvanized—Patented

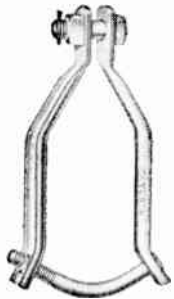

Pressed Steel Type

No.	Inside Length	Minimum Inside Width	Approx. Shipping Wt., Lbs. Per 100
900	$2\frac{3}{4}$	$1\frac{1}{2}$	68
902	$4\frac{1}{4}$	$2\frac{1}{4}$	83

Hubbard Flexible Bail Clevises

Hot Galvanized

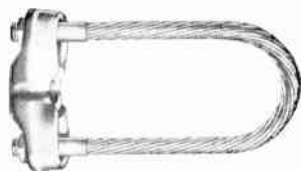

The stranded bail, when placed under tension, forms to fit any size or curvature of insulator. Yokes are designed for mounting on eye bolts or machine bolts (square head recommended). A groove around side of yoke is provided to keep eye centered.

Bail Diameter, $\frac{7}{16}$ inch; with $\frac{1}{2}$ -inch machine threaded studs on ends. Bail nuts are trapped in yoke.

Galv. Strand Bails No.	Inside Lgth. In.	Inside Width Inches		For Use With Hubbard Insulator No.	Ship. Wt., Lbs. Per 100
		Min.	Max.		
1552	$3\frac{7}{8}$	$1\frac{3}{4}$	$2\frac{1}{2}$	521	160
1554	$4\frac{13}{16}$	$1\frac{3}{4}$	$2\frac{1}{2}$	523	165
1556	$5\frac{1}{2}$	$1\frac{3}{4}$	$2\frac{1}{2}$	524	170

†31502 or 31350. *31501 or 31351. ‡31506 or 31352

Hubbard Wireholders

Multi-Point Type Hot Galvanized



Insulators can be installed after back is mounted to building.

Back pressed from 12-gage steel; has $\frac{7}{16}$ inch holes in center of $\frac{5}{16}$ x $1\frac{1}{2}$ inch slot.

No.	No. Wires	Wire Spacing Inches	Ext. to Ctr. of Wire Hole, In.	Insulator No.	Ship. Wt. Lbs. Per 100
4296	2	6	$2\frac{3}{8}$	1664	295
4299	2	9	$2\frac{3}{8}$	1664	325
4394	3	$4\frac{1}{2}$	$2\frac{3}{8}$	1664	425
4396	3	6	$2\frac{3}{8}$	1664	460
5296	2	6	$2\frac{1}{2}$	1674	310
5299	2	9	$2\frac{1}{2}$	1674	340
5394	3	$4\frac{1}{2}$	$2\frac{1}{2}$	1674	450
5396	3	6	$2\frac{1}{2}$	1674	480
1664	Insulator with $\frac{3}{8}$ -in. bolt & cork washer				100
1674	Insulator with $\frac{3}{8}$ -in. bolt & cork washer				110

Hubbard Wedge-Grip Brackets

Hot Galvanized



No. 3930

Wedge Grip Brackets provide an ample anchorage for all house service tensions. They may be attached to any solid, flat surface or the rack bolt of a secondary rack. Cable must be threaded through the solid jaw bracket, while the open jaw style requires no threading or cutting of cable during installation.

Open Jaw Type

3930	Flat Cable	$\frac{1}{4}$ x 1 to $1\frac{1}{16}$ x $1\frac{1}{8}$	132
3932	Round Cable	$\frac{9}{16}$ to $1\frac{5}{16}$	132

Hubbard Snub-Grip Brackets

Hot Galvanized



Snub Grips are furnished in two sizes, one with a "snub" diameter of $1\frac{3}{4}$ " (No. 3910) and the other $2\frac{1}{2}$ " (No. 3942). They have many and varied uses, the most common of which are attachments to secondary racks or to frame buildings. No. 3945, a bail and plate combination for attaching snub grips to wooden surfaces, must be ordered separately.

No.	Item	Cable Sizes—Inches				Approx. Ship. Wt. Lbs. 100 Pcs.
		Round		Flat		
		Min.	Max.	Min.	Max.	
3940	Snub-Grip	.350	.563	.350 x .500	.561 x .687	85
3942	Snub-Grip	.450	.650	.450 x .590	.650 x .931	110
3945	Buse & Bail					40



**Hubbard Wireholders
Hot Galvanized Fittings**

Wire hole $\frac{7}{8}$ x 1-inch. The strong Copper-weld wire bail is firmly positioned by the first few hundred pounds of pull applied on it, providing perfect insulator bearing for heavier stresses.

Screws are smooth, sharp pointed for easy starting, and full threaded so they will hold any normal loading, even when attached through timbers thinner than the length of the screw.

No. 4-11-100 furnished with non-ferrous base and screw.

No.	Type Bolt or Screw	Size Screw or Bolt	Length Screw or Bolt, In.	Ship. Wt., Lbs. Per 100
No. 4-11-44				
0611-44	Wood Screw	No. 22	2 1/2	76
4-11-40	Toggle Bolt	5/16	4 1/2	80
4-11-42	Carriage Bolt	3/8	5	80
4-11-43	Toggle Bolt	5/16	6 1/2	84
4-11-44	Wood Screw	No. 22	2 1/4	65
4-11-45	Wood Screw	No. 22	3	67
4-11-46	Wood Screw	No. 22	4	69
4-11-48	Wood Screw	No. 22	6	73
4-11-49	Wood Screw	No. 22	7 1/2	76
4-11-50	Wood Screw	No. 22	2 1/2	66
4-11-64	Stud Bolt	3/8	7/16	65
4-11-100	Wood Screw	No. 22	2 1/4	65



All-Porcelain Type



No. 1607

No. 1618

No. 1621

No. 1625

Furnished with wood screw, carriage bolt, toggle bolt, and stud bolt attachments.

**With Insulators as Shown on No. 1607 —
Wire Hole $\frac{3}{4}$ x $\frac{13}{16}$ "**

No. *	Size of Screw or Bolt, In.	Insulator Process	Approx. Ship. Wt., Lbs., 100 Pcs.
1607	No. 22 x 2 1/4 Cadmium Pl. Screw	Dry	95
1617	No. 22 x 2 1/4 Non-Ferrous Screw	Dry	97
1627	5/16 x 1 1/2 Toggle Bolt	Dry	105
1637	3/8 x 5 Carriage Bolt	Dry	125
1657	5/16 x 1 1/2 Non-Ferrous Tog. Bolt	Dry	105
1667	No. 22 x 3 Cadmium Pl. Screw	Dry	92

**With Insulators as Shown on No. 1618 —
Wire Hole $\frac{1}{2}$ " Dia.**

1618	No. 14 x 1 3/8 Cadmium Pl. Screw	Dry	40
-------------	----------------------------------	-----	----

**With Insulators as Shown on No. 1621 —
Wire Hole $\frac{5}{8}$ " Dia.**

1621	No. 20 x 2 1/4 Cadmium Pl. Screw	Dry	65
1621-A**	No. 20 x 1 1/2 Cadmium Pl. Screw	Dry	60
1623	No. 22 x 2 1/4 Cadmium Pl. Screw	Dry	70
1633	No. 22 x 2 1/4 Non-Ferrous Screw	Dry	65

**With Insulators as Shown on No. 1625 —
Wire Hole $\frac{29}{32}$ " Dia.**

1625	No. 22 x 2 1/4 Cadmium Pl. Screw	Dry	125
1635	No. 22 x 2 1/4 Non-Ferrous Screw	Dry	125
1725	No. 22 x 2 1/4 Cadmium Pl. Screw	Wet	135

*Suffix "L" to No. for Screw or Bolt Leaded in.

**Leaded in.



No. 190

**Hubbard Wireholders
Standard Type
Hot Galvanized Fittings**

Not affected by temperature changes or by difference in coefficient of expansion of its various parts. No. 190 is for making house service connections. All wood screws are full threaded. No. 290 is similar to No. 190 except No. 290 has wet process porcelain insulator and $\frac{5}{8}$ " diameter wire hole.



No. 1190

No.	Size of Screw, Bolt, or Tap	Extension Base to Ctr. Wire Hole In.	Size of Wire Hole In.	Ship. Wt., Lbs. Per 100
190	No. 22 x 2" Wood Screw	1 5/8	7/8 x 15/16	105
190A	No. 22 x 2" Wood Screw	2 1/4	7/8 x 15/16	115
190R	No. 22 x 2" Wood Screw	4 1/4	7/8 x 15/16	150
195	3/8" x 4 1/2" Carriage Bolt	1 5/8	7/8 x 15/16	140
390	No. 22 x 3" Wood Screw	1 5/8	7/8 x 15/16	107
1190	No. 24 x 2 1/2 Wood Screw	1 15/16	1 1/8 x 1 1/8	228

Rack Type



No. 191



No. 191-A



No. 296



No. 396

No. 299A is same as No. 299 except that it has a hole in center of back. When No. 191A is mounted in this hole it changes No. 299 from 2-wire 9-inch spacing to 3-wire 1 1/2-inch spacing. No. 191A is equipped with 5/16 x 5/8-inch stove bolt for attaching to back. Mounting slots are for 1/4 and 3/8-inch screws. Insulator Wire Hole is 9/16 x 3/4-inch.

No.	No. Wires	Wire Spacing In.	Ship. Wt., Lbs. Per 100	No.	No. Wires	Wire Spacing In.	Ship. Wt., Lbs. Per 100
191	1	9	94	394	3	4 1/2	299
191A	1	9	77	396	3	6	330
296	2	6	211	494	4	4 1/2	130
299	2	9	220	1602	Insulator Only		
299A	2*	9	220	Wire Hole 9/16 x 3/4		38	

*No. 191A may be added to this wire holder to convert it to a three point bracket with 4 1/2-inch spacing.

**Hubbard Single Neutral Wire Brackets
Hot Galvanized**

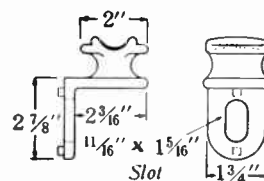

No. 4470

No. 4470.....

Wire size, 1/2-inch or under. Mounting bolt size, 5/8-inch. Length of pole bearing surface, 2 7/8 inches. Mtg. Bolt not included. Approx. ship. wt. per 100 pcs., 105 pounds.

**Hubbard Insulated Clevises
Hot Galvanized**

Nos. 1342 and 1333



Used extensively in rural areas. Flat steel size $\frac{3}{16}$ x $1\frac{1}{2}$ inches. Mounting hole size $\frac{11}{16}$ x $\frac{3}{4}$ inch. Mounting bolt, $\frac{5}{8}$ inch. Approximate shipping weight 279 pounds per 100.

No. 1342, with Insulators (No. 355 Dry).....
No. 1333, with Insulators (No. 455 Wet).....

Nos. 1341 and 1343



Uses No. 1606 dry process insulator. Clevises are similar except for the attachment hole. No. 1341 has oval hole for $\frac{5}{8}$ inch bolts; No. 1343 has round hole for $\frac{1}{2}$ inch bolts.

No.	Steel Size	Extension	Mounting Hole	Approx. Ship. Wt. Lbs., Per 100
1341	$\frac{3}{16}$ x $1\frac{1}{2}$	$\frac{13}{16}$	$\frac{11}{16}$ x $\frac{3}{4}$	154
1343	$\frac{3}{16}$ x $1\frac{1}{2}$	$\frac{13}{16}$	$\frac{9}{16}$ diam.	154

No. 1339



Popular for rural construction. Has sufficient conductor clearance for low or medium voltage lines. Uses No. 1608 wet process insulator. Oval mounting hole, $\frac{11}{16}$ x $\frac{3}{4}$ inches.

Approximate shipping weight, 165 pounds per 100.
No. 1339, with Insulators.....

No. 1340

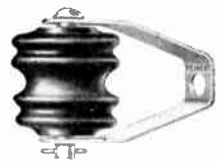

Has a higher flashover rating than the No. 1339. An asset on lines requiring high mechanical strength and endurance. Steel size $\frac{3}{16}$ x $1\frac{1}{2}$ inch with $\frac{5}{8}$ inch diameter cotter clevis bolt. Uses No. 1609 wet process insulator. Oval mounting slot $\frac{11}{16}$ x $\frac{3}{4}$ inches. Approximate shipping weight, 315 pounds per 100.

No. 1340, with Insulators.....

No. 1330

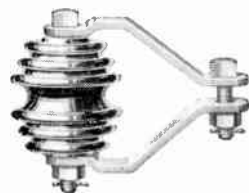

Used extensively on medium voltage lines for corner or dead-end attachments. Recommended especially for 4000-volt primaries. The $\frac{5}{8}$ inch attachment bolt is designed for fastening on eye or hook bolts. Pole mounting bolts not included. Lead sleeve on insulator bolt available at extra cost. Uses No. 1613 wet process insulator.

Shipping weight, 609 pounds per 100.
No. 1330, with Insulators.....

No. 1344



Designed for through bolt or crossarm bolt mounting. Similar to No. 1330 clevis shown above. Mounting bolts on insulator available at extra cost. Uses No. 1613 wet process insulator. Oval mounting slot, $\frac{11}{16}$ x $\frac{3}{4}$ inches. Approximate shipping weight 550 pounds per 100.

No. 1344, with Insulators.....

**Hubbard Spool Insulators
Wet and Dry Process Porcelain and Glass**

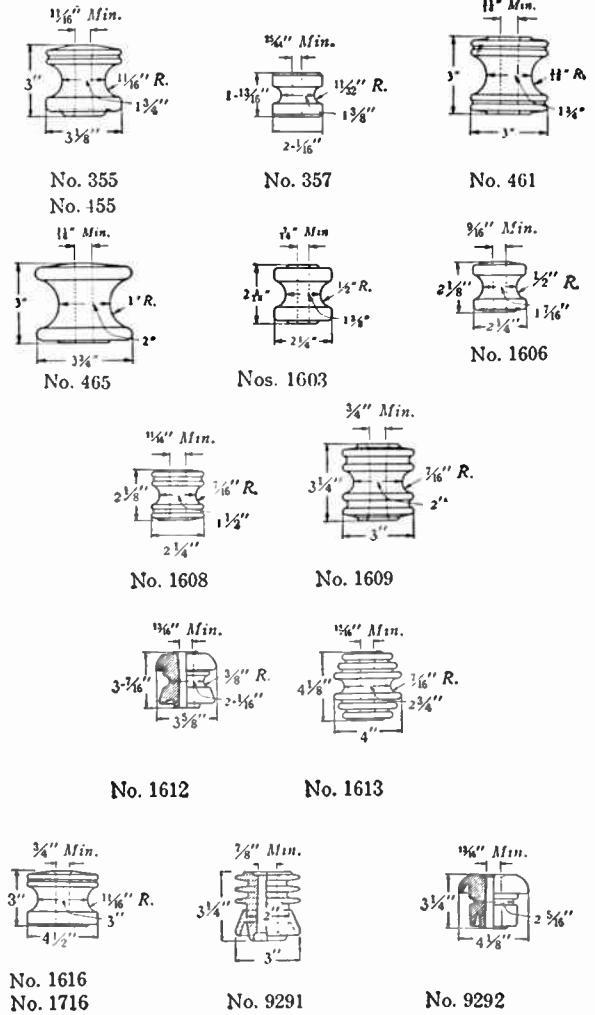

No.	Color of Glaze	Type of Porcelain	Overall Length Inches	Approx. Ship. Wt. Pounds Per 100
355	Brown	Dry Process	3	130
355-W	White	Dry Process	3	130
455	Brown	Wet Process	3	130
357	Brown	Dry Process	$1\frac{13}{16}$	44
461	Brown	Wet Process	3	118
465	Brown	Wet Process	3	165
1603	Brown	Dry Process	$2\frac{15}{16}$	48
1606	Brown	Dry Process	$2\frac{1}{8}$	70
1606-W	White	Dry Process	$2\frac{1}{8}$	70
1706	Brown	Wet Process	$2\frac{1}{8}$	70
1608	Brown	Wet Process	$2\frac{1}{8}$	55
1609	Brown	Wet Process	$3\frac{1}{4}$	132
1612	Brown	Wet Process	$3\frac{7}{16}$	187
1613	Brown	Wet Process	$4\frac{1}{8}$	286
1616	Brown	Dry Process	3	275
1716	Brown	Wet Process	3	275

Glass Double Skirt Style

No.	Color of Glass	Overall Length Inches	Approx. Ship. Wt. Lbs. Per 100
9292	Brown Wet Process	$3\frac{1}{4}$	193

**Hubbard Insulated Clevises
Hot Galvanized**



No. 561
Formed of heavy channel steel. A sturdy dead-end or corner attachment. Used with No. 355 dry process insulator for low voltage lines. Oval mounting hole, $\frac{1}{16}$ x $2\frac{25}{32}$ inches. Approximate shipping weight, 306 pounds per 100.

No. 561, with Insulators.....

Nos. 8820 and 8821

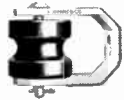

Formed of flat steel. Has $\frac{1}{16}$ -inch diameter mounting hole for $\frac{3}{8}$ -inch mounting bolts. Uses No. 357 dry process insulator. Shipping weight, per 100, No. 8820, 131 lbs. No. 8821, 131 lbs.

No. 8820, with Insulators.....

No. 8821, same as No. 8820, except with $\frac{9}{16}$ -inch mounting hole. Includes $\frac{1}{2}$ x $4\frac{1}{2}$ -in. Mach. Bolt and Round Washer.....

Nos. 1352 and 1353



$\frac{5}{8}$ " Cotter Insulator bolt. Steel size $\frac{3}{16}$ x $1\frac{1}{2}$ inches. Extension to center of bolt, 5 inches.

No.	Style of Insulator	Approx. Ship. Wt. Lbs. Per 100
1352	355 Dry	292
1353	455 Wet	292

No. 1352

Hubbard Swinging Type Insulated Clevises



Includes No. 2969 Shackle which provides flexibility and allows mounting bolt to be inserted without dismantling the clevis. Mounting slot size, $\frac{1}{16}$ x $1\frac{13}{16}$ inches.

No. 2978 With No. 2969 Shackle

No.	Dimensions, Inches Extension to Center of Bolt	Steel Size Inches	Style of Insulator	Approx. Ship. Wt. Lbs. Per 100
2968	$7\frac{7}{16}$	$\frac{3}{16}$ x $1\frac{1}{2}$	455 Wet	320
2978	$7\frac{9}{16}$	$\frac{3}{16}$ x $1\frac{1}{2}$	355 Dry	320

**Hubbard Shackle for Use with Swinging Clevises
Hot Galvanized**



The No. 2969 Shackle is used to convert clevises that are non-flexible to swinging type. Has $\frac{1}{16}$ " x $1\frac{13}{16}$ " mounting slot for $\frac{5}{8}$ inch mounting bolt. Approximate shipping weight, 39 pounds per 100.

No.	Overall length	Clevis Slot	Steel Size
2969	$2\frac{15}{16}$	$2\frac{1}{16}$ x 1	No. 12 gauge x $1\frac{3}{4}$

**Hubbard Insulated Fork Bolts
Type No. 1
Hot Galvanized**

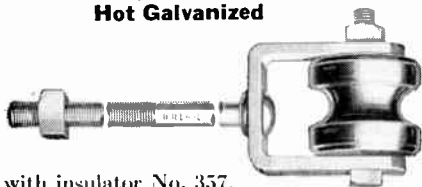

Equipped with insulator No. 357.

No.	Length Bolt In.	Diam. Bolt In.	Approx. Shipping Wt. Lbs. Per 100 Pcs.
8810	$7\frac{13}{16}$	$\frac{1}{2}$	191
8811	$9\frac{13}{16}$	$\frac{1}{2}$	205
8812	$11\frac{13}{16}$	$\frac{1}{2}$	218

**Hubbard Railway Clevises
Hot Galvanized**



No. 9290

These clevises are installed over a crossarm and are attached by carriage bolts through $\frac{9}{16}$ -inch square top and bottom mounting holes, and a $\frac{7}{16}$ -inch square back mounting hole.

Insulators are not included. Insulator used with No. 9290 are Nos. 1612, 9291 and 9292. Insulator used with 29290 is No. 1609.

No.	Cross Arm Size	Steel Size	A = Distance from back to center of Insulator Bolt	Approx. Ship. Wt. Lbs. Per 100 Pcs.
9290	$3\frac{1}{4}$ x $4\frac{1}{4}$	$\frac{3}{16}$ x $1\frac{3}{16}$	$6\frac{1}{4}$	265
29290	$3\frac{1}{4}$ x $4\frac{1}{4}$	$\frac{3}{16}$ x $1\frac{3}{16}$	$6\frac{1}{4}$	214

**Hubbard Dead End Brackets
Hot Galvanized**



A very popular rural bracket. Wide back resists line pull. The same bracket applies to all three stock numbers.

No. 1327 includes bracket only. Nos. 1328 and 1329 include the insulators listed.

Center hole is $\frac{1}{16}$ inch and side holes are $\frac{9}{16}$ inch. Extension from back to center of insulator bolt is 4-inches.

No.	Style of Insulator	Back Radius	Steel Gauge	Approx. Ship. Wt. Lbs. Per 100
1327	Not inc.	$2\frac{3}{8}$	9	350
1328	No. 455	$2\frac{3}{8}$	9	462
1329	No. 1716	$2\frac{3}{8}$	9	600

**Hubbard Sagger Brackets
Hot Galvanized—Patented**

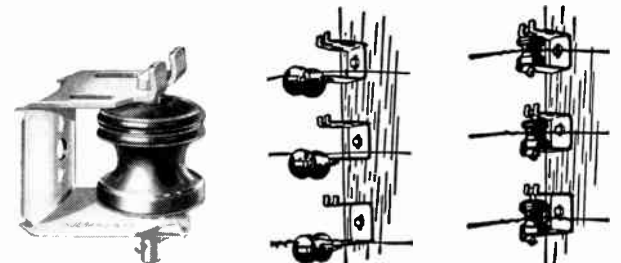

No. 710

Fig. 1

Fig. 2

Sagger Brackets provide flexibility in the solution of secondary distribution problems. They serve as single point secondary racks which may be used with any desired spacing in whatever numbers the situation requires. Figure 1 is of an installation approaching a three wire secondary rack with the spacing defined by the engineer. 1† shows the sagger bracket with insulators in horizontal position free to rotate about insulator bolt and act as a wire stringing tool. When the correct sag has been set, the conductor is "tied in" to the insulator and the insulator is raised to the vertical position, Figure 2 to be snapped home over the two keeper lugs. Sagger bracket snap fit assures faultless service and yet allows for on-the-spot repairs.

No.	Extension Pole to Bolt Ctr.	Width of Back	Mfg. Hole	Insul. No.	Approx. Ship. Wt. Lbs. Per 100 Pcs.
710	$3\frac{3}{16}$	3	$1\frac{1}{16}$	355 Dry	396
720	$3\frac{3}{16}$	3	$1\frac{1}{16}$	455 Wet	396

Hubbard Racks

**Hub-Rak—Light Type
Hot Galvanized**



Designed for light service. Forged steel rack points, solidly riveted construction. A special indentation in the back allows for a secure wrench hold when the side slots are to be used for mounting. Furnished with No. 1606 dry process porcelain insulators.

No.	Dimensions, Inches				Approx. Ship. Wt. Lbs., 100 Pcs. Inc. Insul.
	No. of Line Wires	Line Wire Spacing	End Mtg. Hole Spacing	Overall Length	
20044	2	4	12	14	387
20046	2	6	14	16	437
20048	2	8	16	18	482
20052	2	12	20	22	531
30044	3	4	16	18	589
30046	3	6	20	22	640
30048	3	8	24	26	713
30052	3	12	32	34	805
40044	4	4	20	22	788
40046	4	6	26	28	1062
40048	4	8	32	34	1184

§E.E.I. Std.

**Hubbard Extension Brackets
For Secondary Racks
Hot Galvanized**



No. 3355

Used for mounting secondary racks when a greater extension from the supporting structure is desired than the rack itself offers.

Made in two styles, with flat and curved backs, for wall and pole use respectively. Both styles have one 1/16-inch hole and two 9/16-inch holes for mounting. Made from No. 9 gage steel, they have a 4-inch bearing on the pole or wall.

Equipped with one 5/8 x 2-inch carriage bolt.

Also has two 3/32-inch holes in bottom (one at each end) to allow water to drain out.

No.	Type Back	Type Mtg.	Ext. In.	Mounting Holes		Approx. Ship. Wt. Lbs. Per 100
				Diameter, Center	Inches Side	
3355	Curved	Pole	6	1 1/16	9/16	286
3356	Flat	Wall	6	1 1/16	9/16	286
3357	Curved	Pole	9	1 1/16	9/16	300

**Hubbard Insulator Hook Bolts
Hot Galvanized**



No. 612

Used on rural secondary lines, on 5- to 11-inch pole diameters. The boss under the base seats in the pole and restrains the hook bolt from canting.

Furnished with square washer and M. F. Locknut.

No.	Dimensions, Inches					Approx. Ship. Wt. Pounds Per 100
	Lgth. of Shank	Extension From Pole	Height Above Bend	Thread Diam.	Base Diam.	
612	8	6 1/4	4 1/2	5/8	2	286
613	10	6 3/4	4 1/2	5/8	2	297
614	12	6 3/4	4 1/2	5/8	2	308

Hubbard Secondary Racks

Rural Type



Light weight rack that gives a high standard of service. Furnished with No. 355 dry process insulator, 5/8-inch button head rack bolt, with brass cotter pin at the bottom. Backs are formed of 3/16 x 2-inch steel, slightly curved to fit the pole.

No.	No. of Line Wires	Line Wire Spacing In.	Overall Back Lgth. In.	Approx. Ship. Wt. Lbs. Per 100
2428	2	8	12	696
2438	3	8	20	1082
2438-A	3	8	26	1110
2448	4	8	28	1392
2448-A	4	8	34	1458

†Including Insulators. §E.E.I. Std.

Hub-Rak

Medium and Heavy

Hot Galvanized

A solidly constructed durable rack, the criterion for rack quality and workmanship. Forged steel points are permanently aligned and riveted to the Hub-Rak back. The permanent alignment of points assures a more even stress distribution along the entire length of the 5/8-inch diameter rack bolt.

Hub-Rak Secondary Racks are furnished with No. 355 dry process porcelain insulators.

Available with either extended or nonextended backs. See table below for ordering data.

**Medium Type
Extended Back**

No.	No. of Line Wires	Dimensions, Inches			Approx. Ship. Wt. Lbs., 100 Pcs.
		Line Wire Spacing	End Mtg. Hole Spacing	Overall Length of Back	
1271	1	7	7	9	338
1278	2	8	15	18	786
1282	2	12	19	22	831
1374	3	4	15	18	879
1378	3	8	23	26	1234
1382	3	12	31	34	1259
1478	4	8	31	34	1612

Non-Extended Back

1728	2	8	8	13 3/4	761
1732	2	12	12	17 3/4	834
1734	3	4	8	13 3/4	816
1738	3	8	16	21 3/4	1189
*AL-1738	3	8	16	21 3/4	629
1742	3	12	24	29 3/4	1276
1748	4	8	24	29 3/4	1557

*Made of Aluminum Alloy. §E.E.J. Std.

Heavy Type

No.* Ex-tended Back	Number of Line Wires	Line Wire Spacing Inches	End Mounting Hole Spacing		Overall Length Back Inches		Approx. Ship. Wt. Lbs., 100 Pcs. Inc. Insul. Ex-tended Back†
			Ex-tended Back	Non-Ex-tended Back	Ex-tended Back	Non-Ex-tended Back	
20644	1	..	7 1/4	..	9 1/4	..	318
20646	2	4	12	4	14	9 3/4	751
20646	2	6	14	6	16	11 3/4	830
20648	2	8	16	8	18	13 3/4	861
20652	2	12	20	12	22	17 3/4	902
30644	3	4	16	8	18	13 3/4	979
30646	3	6	20	12	22	17 3/4	1116
30648	3	8	24	16	26	21 3/4	1141
30652	3	12	32	24	34	29 3/4	1303
40644	4	4	20	12	22	17 3/4	1221
40646	4	6	26	18	28	23 3/4	1437
40648	4	8	32	24	34	29 3/4	1521

*For non-extended back, add suffix "A" to catalog number.

†Extended back only. ▲Weight of non-extended back is approximately 65 pounds less. §E.E.I. Std.

**Knox House Brackets
1200 Series**

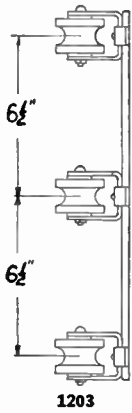

Secondary rack type. Rigidly constructed with 7/8-in. channel. Insulator supports and mounting straps are of 1/8x7/8-in. steel and both are securely riveted to the channel.

No.	Insulators No.	Spacing, In.	Length In.	Lbs. per 100
1201	1	..	2	88
1202	2	8	10	200
1203	3	6	14	280
1208	3	8	18	295

1300 Series House Brackets

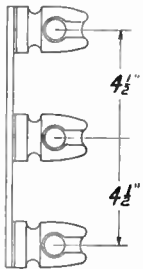

Standard wireholder type. Backs made of 13 gauge, 1 7/8-in. steel channel which is hot dip galvanized. Insulators are equipped with 1 3/8x3 3/8-in. machine bolts and screwed securely into tapped channel. Cork washer is provided between channel and insulator.

No.	Insulators No.	Spacing, In.	Length In.	Lbs. per 100
1302	2	9	11	210
1303	3	4 1/2	11	275
1306	3	6	14	300

Knox Cable Bushings and Supports

Assembled Cable Bushing



Glazed white, with all metal parts cadmium plated. Panel opening, 1 in. Inside diameter, 1/2 in.

No.	Length In.	Weight Per 100 Lbs.	Per 100
7011	4	20	\$13.18

Assembled Cable Support



Highly vitreous porcelain support assembled with screw set and screw.

No.	Height In.	Width In.	Groove Diam., In.	Wt. per 100 Lbs.	Per 100
7060-S	2 3/8	1 1/8	9/16	25	\$8.98

Screw Type Cable Support



Special screw type cable support of highly vitreous porcelain for wooden signs. Screw size 8x1 1/4 in. Height over-all, 3 1/4 in. Height porcelain, 2 3/8 in.

No.	Width In.	Groove Diam. In.	Wt. Per 100 Lbs.	Per 100
7060-B	1 1/8	9/16	26	\$8.98

Ohio Brass Strain Insulators

Multifin

Primarily designed for guy or span installations. Also may be used for low-voltage dead ends. Rugged, wet-ware porcelain; not subject to mechanical breakage. Straight holes make assembly easy, even with stiff guy strand.

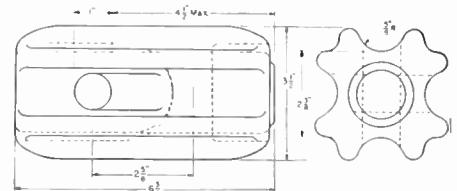

No. 31352

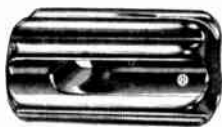

No.	EI-NEMA Class	Flashover, Kilovolts	Leakage Distance Inches	*Rated Ultimate Strength, Lbs.	Std. Pkg.	Shp. Wt., Pounds Per 100
31352	(54-4)	Dry 40 Wet 23	3	20,000	16	415

Type JB

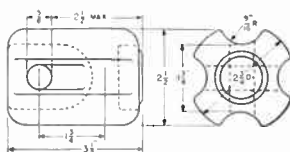

No. 31502

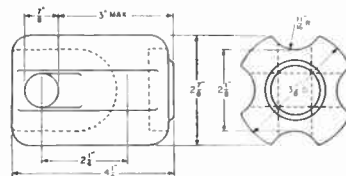

No. 31504

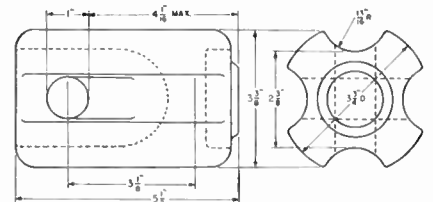

No. 31506

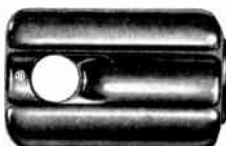

No.	EI-NEMA Class	Flashover, Kilovolts	Leakage Distance Inches	*Rated Ultimate Strength, Lbs.	Std. Pkg.	Shp. Wt., Pounds Per 100
31502	(54-1)	Dry 2.5 Wet 1.2	1 5/8	10,000	50	105
31504	(54-2)	30 15	1 7/8	12,000	50	160
31506	(54-3)	3.5 1.8	2 1/4	20,000	25	300

*Mechanical strength ratings are values which may be developed with hard drawn copper or mild steel cable.

Prices on application.

Ohio Brass Low Voltage Insulators

For Primary Distribution and Rural Lines

Pintype

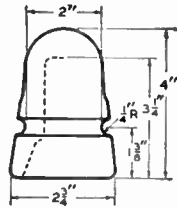

No. 30418

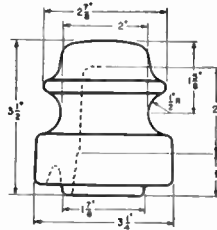

No. 29207

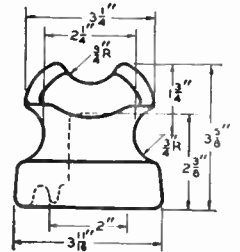

No. 9953

No.	EEI-NEMA Class	Flashover in Kilovolts		Leakage Distance Inches	Dry Arcing Distance Inches	Mechanical Strength Pounds	Pinhole Diameter, Inches	Recommended Pin In.	Std. Pkg.	Ship. Wt. Lbs. Per 100
		Dry	Wet							
30418	(55-1)	30	15	2 5/8	2	2500	1	4	50	102
29207		35	20	4	2 1/4	3000	1	4	50	128
9953		50	25	4	3 1/4	3000	1	4	50	170

Untreated Units and Conduction-Glazed Silentyes

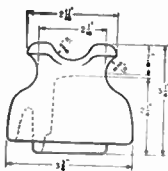

No. 12847

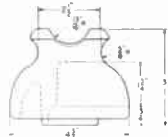

No. 38148

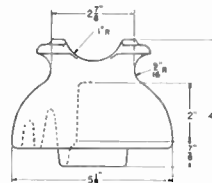

No. 38149

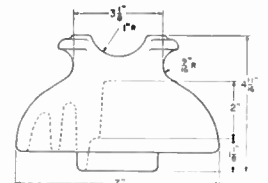

Nos. 38151 and 38152

No.	EEI-NEMA Class	Flashover in Kilovolts		Impulse Flashover in Kilovolts 1 1/2 x 40		Leakage Distance Inches	Dry Arcing Distance Inches	Mechanical Strength Pounds	Pinhole Diam. In.	Recommended Pin, In.	Std. Pkg.	Ship. Wt. Lbs. Per 100
		*Dry	Wet	Positive	Negative							
12847	(55-2)	50	25	75	95	5	3 3/8	2500	1	4	50	157
38148 †	(55-3)	65	35	100	130	7	4 1/2	2500	1	5	32	248
38149 †	(55-4)	70	40	110	110	9	5	3000	1	5	18	360
38151 †	(55-5)	85	45	110	170	12	6 1/4	3000	1	6	12	635
38152 †		85	45	110	170	12	6 1/4	3000	1 3/8	6	12	625

*Flashover values shown are for untreated insulators. Silentye insulators may have flashover values as much as 5 kv. below these values.

†Silentye units.

Porcelain Products Guy Strains

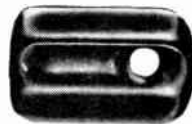

No. 500-D

No. 500-D

No. 502-D

Length
Diameter
Hole Diameter
Standard Carton Quantity
Weight per M

2 1/8 In.
1 9/16 In.
3/8 In.
100
23 Lbs.

Length
Diameter
Hole Diameter
Standard Carton Quantity
Weight per M

3 1/2 In.
2 1/2 In.
5/8 In.
50
128 Lbs.

No. 506-D

No. 504-D

Length
Diameter
Hole Diameter
Standard Carton Quantity
Weight per M

5 1/2 In.
3 3/8 In.
1 In.
25
368 Lbs.

Height
Diameter
Hole Diameter
Standard Carton Quantity
Weight per M

4 1/4 In.
2 7/8 In.
7/8 In.
25
178 Lbs.

Ohio Brass Spools

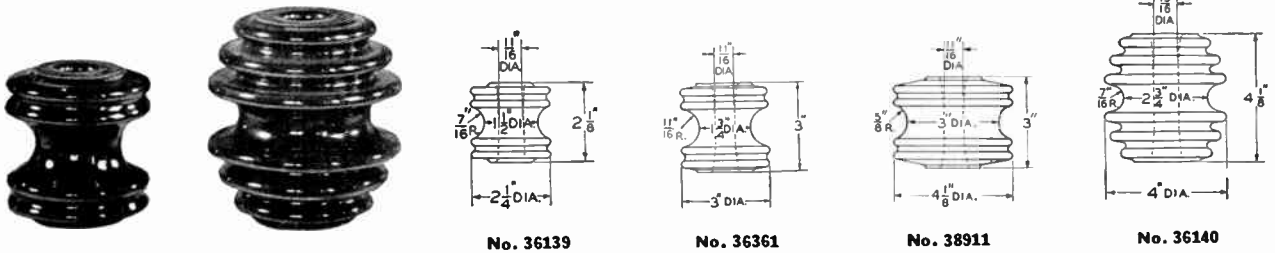

Made of highest grade wet process porcelain, providing high electrical and mechanical values.

Have tapered hole which distributes load more evenly and minimizes the possibilities of breakage.

No.	EEI-NEMA Class	Size, In.	Ship. Wt. Lbs. Per 100
36139	(53-1)	2 1/8	16
36361	(53-2 & 3)	3	112
38911	(53-4)	3	215
36140	(53-5)	1 1/8	275

Ohio Brass Insulated Clevis Assemblies

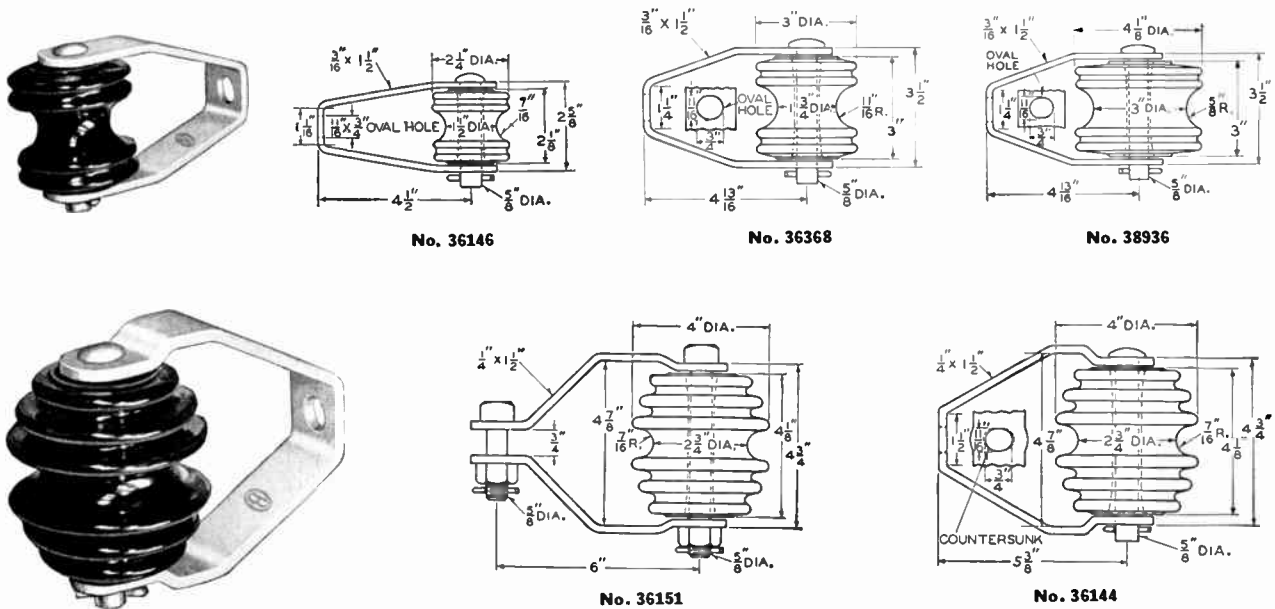

Clevises are made of steel, hot-dip galvanized. On the larger two assemblies, the clevis is offset near the spool, increasing the flashover value of the units.

***Complete Assemblies**

No.	Ultimate Strength Lbs.	Dry Flashover KV.	Wet Flashover Kilovolts		Ship. Wt. Pounds Per 100
			Vertical	Horizontal	
36146	2000	20	8	10	168
36368	1000	25	12	15	252
38936	1500	25	12	15	385
36151	6000	35	18	25	563
36144	6000	35	18	25	491

*Hardware and spools packed separately; not shipped assembled.

Clevises Only

No.	Description	Ship. Wt. Pounds Per 100
82250	Closed, for 2 1/8-In. Spool	122
82336	Closed, for 3-In. Spool	140
82251	Closed, for 4 1/8-In. Spool	216
82252	Split, for 4 1/8-In. Spool	288

Prices on application.

Ohio Brass Suspension Insulators

For Primary Distribution and Rural Lines

6-In. Diameter Units

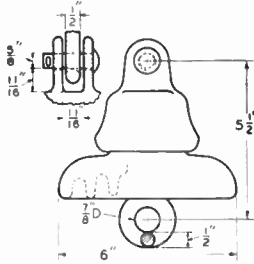

No. 32433

7 1/2-In. Diameter Units

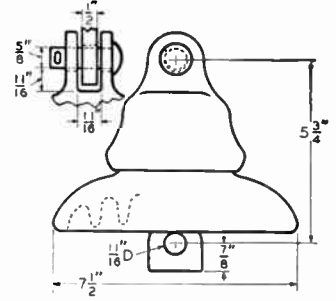

No. 32435

15,000 Pound Units

Standard Types

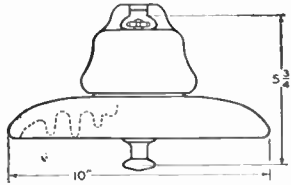
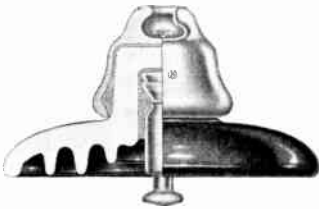

No. 32440

HuskiTypes

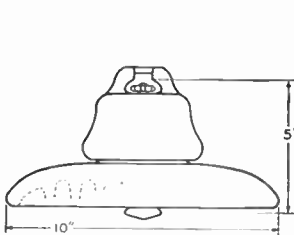
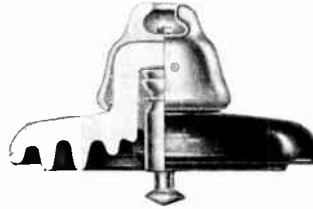

No. 32436

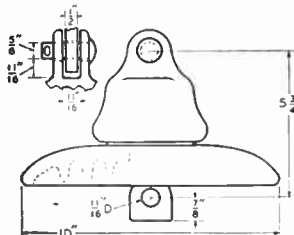

No. 32439

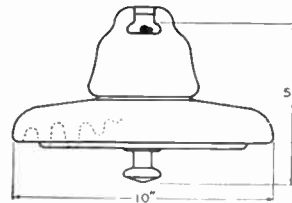

No. 34500

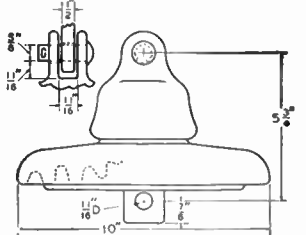

No. 35301

No.	6-Inch Diam. Unit	7 1/2-Inch Diam. Unit	Standard Type		15,000-Pound Units		HuskiType	
			32436	32440	32439	34500	35301	
EEI-NEMA	52-1	52-2	None	52-3	52-4	None	None	
Dry Flashover	60	65	80	80	80	80	80	
Wet Flashover	30	35	50	50	50	50	50	
Leakage Distance	7	8 1/4	11 1/2	11 1/2	11 1/2	11	11	
Dry Arcing Distance	1 1/2	5 3/4	7 3/4	7 3/4	7 3/4	8	8	
Mechanical and Electrical Strength	10,000	15,000	15,000	15,000	15,000	15,000	15,000	
Mechanical Impact Strength	45	50	55	55	55	90	90	
Standard Package	8	8	6	6	6	6	6	
Shipping Weight per 100	550	910	1160	1180	1190	1380	1390	

Ohio Brass Angle Clamps

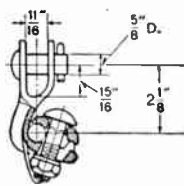

No. 81460

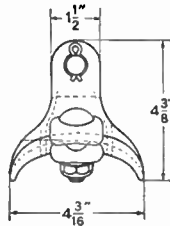

No. 82860

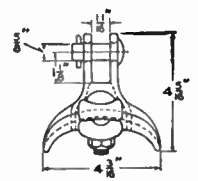
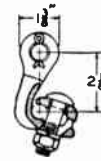

For turning angles from 10 to 120 degrees. Clamp attaches directly to eye or clevis of suspension insulator.

Reversible keeper piece; clamp takes conductors from No. 6 A. W. G. copper to No. 2 ACSR with armor rod.

Clamp body and keeper of malleable iron; bolt of steel. All parts hot-dip galvanized.

No.	Clevis Type	Min. Cable Diam., In.	Max. Cable Diam., In.	Ultimate Strength, Pounds	Shp. Wt., Pounds Per 100
81460	Parallel	.162	.600	7000	145
82860	Rt.-Angle	.162	.600	7000	145

Prices on application.

Ohio Brass Pintype and Line Post Insulators Conduction-Glazed Silintypes

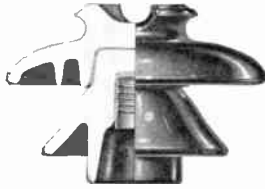

No. 38246
EEI-NEMA Class 56-1

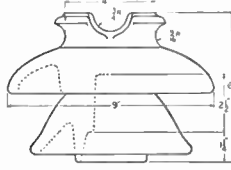

No. 38222
EEI-NEMA Class 56-2

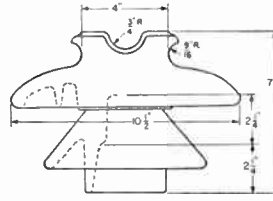

No. 38223
EEI-NEMA Class 56-4

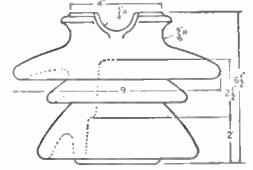

No. 38122

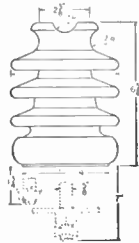

No. 37600

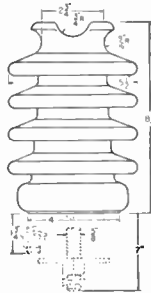

No. 37610
EEI-NEMA Class
57-1L and 57-1S

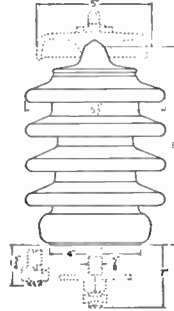

No. 37615

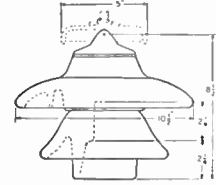

No. 35700

Cat. No.	EEI-NEMA Class	Flashover—Voltage Kv		Critical* Neg.	Radio Influence Kv to Ground	Voltage Max. RIV at 1000 kc	Leakage Dist., in.	Dry Arc Dist., in.	Cantilever Strength, Lbs.	Pinhole or Stud Diam., in.	Ship. Wt. Per 100, Lbs.	Std. Pkg.
		Low Frequency Dry	Wet									
38246	56-1	95	60	150	15	100	13	7	2500	1 3/8	885	6
38222	56-2	110	70	175	22	100	17	8 1/4	3000	1 3/8	1185	6
38223	56-3	125	80	200	30	200	21	9 1/2	3000	1 3/8	1550	6
38122	110	70	175	22	100	17	8 3/4	3000	1 3/8	1365	6
37600	70	50	100	125	50	10	5	2800	5/8	940	6
37610	57-1L(S)	80	60	130	155	100	14	6 1/2	2800	5/8	1100	6
37615	80	60	130	155	100	14	6 1/2	2800	5/8	1390	6
35700	125	80	200	265	200	21	9 1/2	2000	1 3/8	2065	3

*1 1/2 x 10 MU-SEC Wave.

Additional O-B Pintypes and Line Posts are available through 69 kv. Other assemblies are described below.

	PINTYPE			LINE POST		
	WITH 1 1/8" ZINC THIMBLE	WITH 1 1/8" ZINC THIMBLE	WITH 3/4" MALLEABLE IRON THIMBLE	WITH NO STUD	WITH SHORT STUD FOR STEEL CROSSARM	WITH LONG STUD FOR WOOD CROSSARM
TIE TOP HEAD						
SUFFIX NO	Z 10	Z 20	M 10	P 10	P 20	P 30
CLAMPTOP HEAD WITHOUT CLAMP						
SUFFIX NO	Z 11	Z 21	M 11	P 11	P 21	P 31
CLAMPTOP HEAD CLAMP NO 81910 CONDUCTOR DIA 0.25" MIN - 0.56" MAX						
SUFFIX NO	Z 12	Z 22	M 12	P 12	P 22	P 32
CLAMPTOP HEAD CLAMP NO 81920 CONDUCTOR DIA 0.50" MIN - 1.06" MAX						
SUFFIX NO	Z 13	Z 23	M 13	P 13	P 23	P 33
CLAMPTOP HEAD CLAMP NO 87530 CONDUCTOR DIA 1.00" MIN - 1.50" MAX						
SUFFIX NO	Z 14	Z 24	M 14	P 14	P 24	P 34

Suffix Number System

O-B high-voltage pintype and line post insulators combine a choice of pinhole dimensions or stud arrangements, and in certain cases offer an option between Tie-Top and Clamptop heads. Because of the large number of possible combinations involved, a suffix system is used. The basic catalog numbers above describe the porcelain body. A suffix number should be selected from this chart to specify the complete assembly required.

Line Posts



With Clamptop



Without Clamptop

Hemingray Communications Insulators

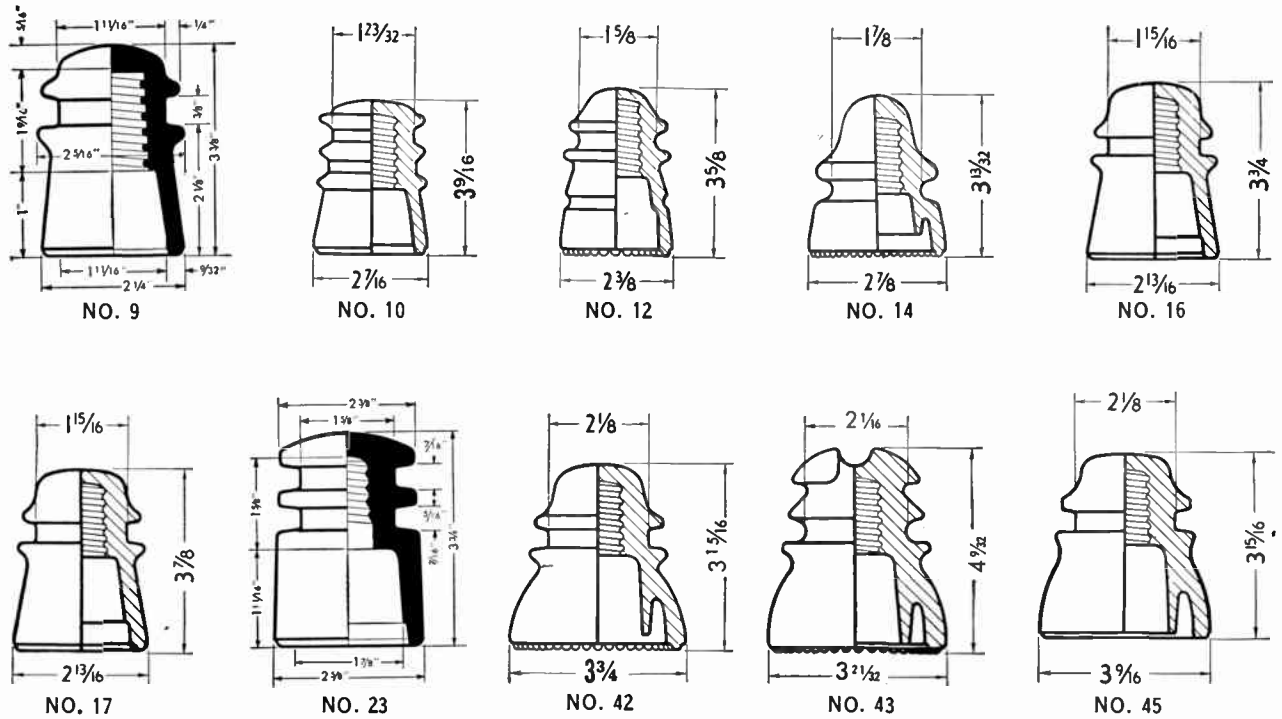

No.	No. Per Carton	Carton Wt., Lbs.	Approx. Wt., Lbs. Per 100	No.	No. Per Carton	Carton Wt., Lbs.	Approx. Wt., Lbs. Per 100
9	50	31	620	17	50	51 1/2	1030
10	50	35 1/2	710	23	50	49 1/2	990
12	50	32 1/2	650	42	40	59 1/2	1187
14	50	39 1/2	790	43	30	52 1/2	1750
16	50	54 1/2	1090	45	40	65	1625

All insulators have pin holes size of 1-inch.

Hemingray General Purpose Insulators

All Insulators Have Pin Hole Size of 1-Inch

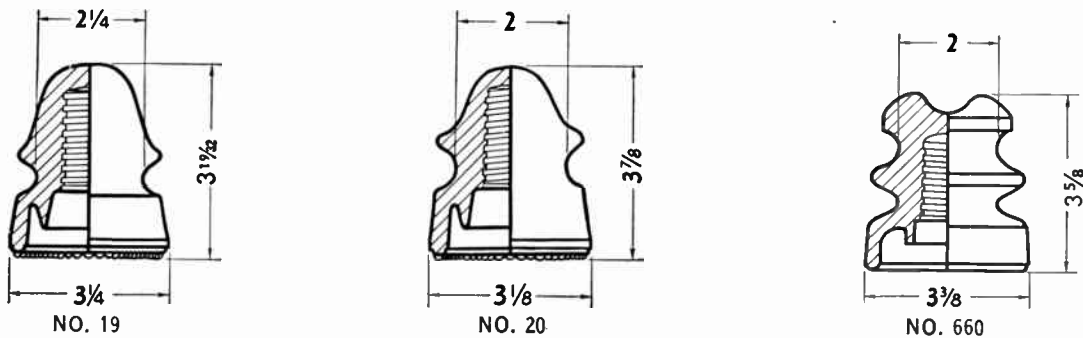

No.	Flashover in Kilovolts			Leakage Distance Inches	Arcing Distance, Inches		Mechanical Strength Lbs.	Min. Pin HL in.	Std. Pkg.	Std. Pkg. Wt., Lbs.
	60 Cycles Dry	60 Cycles Wet	1 1/2 x 40 Ms. Wave		Dry	Wet				
19	35	20	75	4 1/8	2 3/8	1	2500	4	50	59 1/2
20	35	20	75	4 3/8	2 3/8	1	2500	4	50	58
660	55	35	85	5 3/8	3 1/2	1	2500	4	40	55

Prices on application.

Armstrong Glass Insulators For Communication and Signal Service

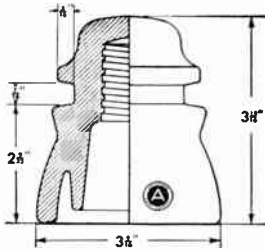

No. 1 Double Petticoat Type; For Long Distance Lines.

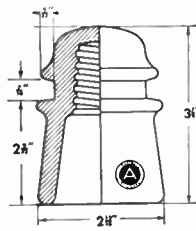

No. 2 Single Petticoat Type. Old Toll Line Type. For Medium Distance Lines.

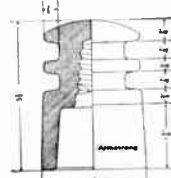

No. TS For Carrier Service

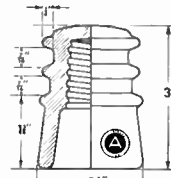

No. 3 For Telephone Exchange Systems. For Twisted Pairs of Wires.

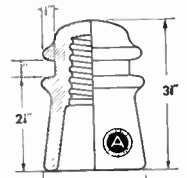

No. 9 For Rural Telephone Lines. Long Leakage Path.

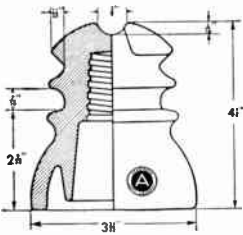

No. 10 Double Petticoat Type. For Easy Tying in Hilly Sections.

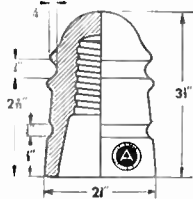

No. 13 Double Groove Pony Type. Where Frequent Drop Wires are Necessary.

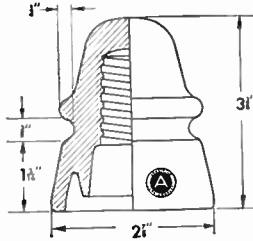

No. 14 Double Petticoat Type. For Rural Lines. Long Leakage Path.

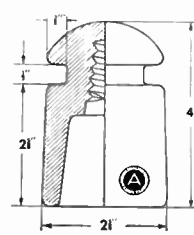

No. CSC For Carrier Circuits. For Mounting on Steel Pin with .016 in. Lead Sheathed Thimble.

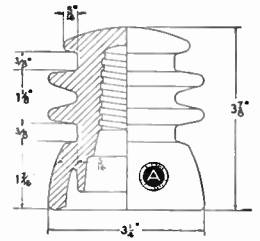

No. TW Improved Transposition Type. Permits Point Transpositions Mounted on Std. Pins.

No.	Wet Flash-Over Voltage	Dry Flash-Over Voltage	Leakage Distance, In.	Dry Arcing Distance, In.	Wet Arcing Distance, In.	Standard Package	Ship. Wt., Std. Pkg., Lbs.	Average Weight Each, Oz.	Appr. Ship. Weight Per 100
1	25,000	52,900	6.4	3.7	1.1	40	65	24 1/4	1625
2	22,000	39,300	4.9	3.3	0.7	50	54	16	1080
3	22,300	38,600	4.4	3.2	0.5	50	36	10 3/4	720
9	20,800	34,900	4.0	2.7	0.4	50	31	9 3/8	620
10	26,700	59,500	8.0	3.8	1.0	40	72	27 1/4	1800
13	20,100	37,000	4.0	2.9	0.5	50	32	9 5/8	610
14	16,500	35,600	3.9	2.2	0.8	50	41	12 1/2	820
CSC	22,700	43,600	5.3	3.8	0.9	50	56	17	1120
TS	26,400	49,300	5.8	1.6	0.9	50	52.5	16	1050
TW	30,800	48,500	8.1	5.8	0.9	40	58.4	20 3/4	1460

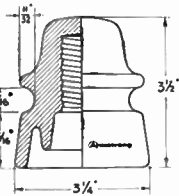

No. 4

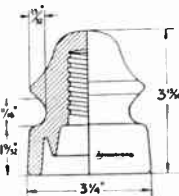

No. 5

Power Insulators

For handling the requirements of the low and medium voltage power distribution field. Each insulator meets or exceeds the electrical and mechanical specifications set up by the Edison Electrical Institute for its class of service.

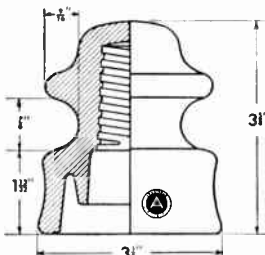

No. 51-C1 Class 1 Brown and Clear Glass

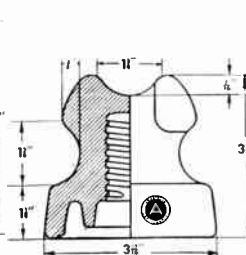

No. 51-1A Class 1A Brown and Clear Glass

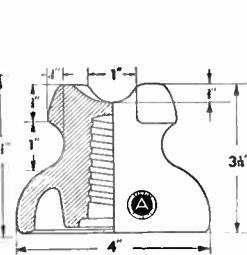

No. 51-C1A Class 1A Brown Glass Only

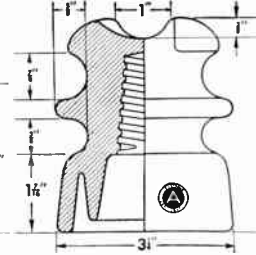

No. 51-2U Class 2 Brown and Clear Glass

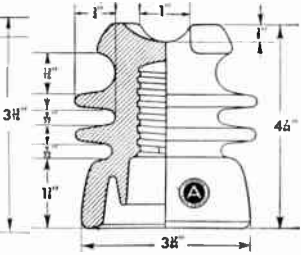

No. 51-C3 Class 3 Brown Glass Only

No.	Wet Flash-Over Voltage	Dry Flash-Over Voltage	Leakage Distance, In.	Dry Arcing Distance, In.	Wet Arcing Distance, In.	Mechanical Strength, Lbs.	Standard Package	Ship. Wt., Std. Pkg., Lbs.	Average Weight Each, Oz.	Appr. Ship. Weight Per 1000
4	20,500	42,100	4 1/2	2.62	0.87	2500	50	59	17 1/4	1174
5	23,000	43,000	4 9/16	2.56	0.93	2500	50	61	19	1220
51-C1	23,500	43,000	4.8	2.1	0.9	3400	50	53	16 3/4	1017
51-1A	26,000	59,000	4.3	2.9	1.3	2900	32	50	23 3/4	1562
51-C1A	26,500	57,500	5.0	3.3	1.9	2500	40	53	21	1325
51-2U	23,000	59,000	7.0	4.4	0.9	2500	50	73	22	1440
51-C3	41,000	63,000	8.0	5.6	1.0	2560	40	63	24	1565

Ohio Brass Suspension Clamps

Available in a wide variety of sizes to obtain proper fits with all commonly used transmission conductors. Light in weight; minimize conductor fatigue from vibration.

tact between clamp and cable, thus preventing burning of cable in clamp seat.

Available with or without socket and clevis fittings.

Bolts are of ample size and strength to assure proper con-

Malleable Clamps

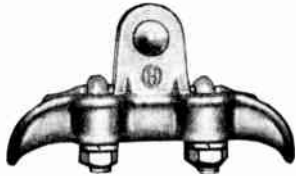

Without Fitting

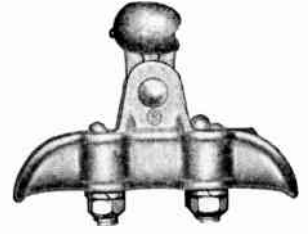
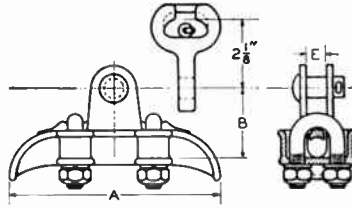

With Socket Fitting

U-Bolt Cat. No.	Con- nector	Conductor Diameter-Inches*		Clamp Dimensions-Inches			Connector Cat. No.	Ultimate Strength Lbs.	Pkd. Wt. Lbs. Per 100
		Min.	Max.	A	B	E			
83044	None	0.12	0.16	5 3/4	2 1/8	0.56	None	16,000	180
83045	Socket						78721		280
83064	None	0.20	0.60	6 3/4	2 1/4	0.60	None	16,000	295
83065	Socket						78721		405
83074	None	0.30	0.70	7 1/8	2 1/4	0.70	None	18,000	335
83075	Socket						74593		435
83084	None	0.40	0.83	7 1/2	2 3/8	0.83	None	18,000	410
83085	Socket						78728		520
83104	None	0.50	1.00	8	2 3/8	1.00	None	25,000	520
83105	Socket						82891		635
83106	Clevis						79085		655
83114	None	0.75	1.15	8	2 7/16	1.12	None	25,000	620
83115	Socket						82892		765
83116	Clevis						76026		785
83124	None	0.85	1.27	8 1/2	2 5/8	1.27	None	25,000	665
83125	Socket						82892		805
83126	Clevis						75384		860
Aluminum									
87074	None	0.40	0.72	7 1/8	2 1/4	0.80	None	18,000	200
87075	Socket						78728		315
87084	None	0.40	0.85	7 1/2	2 1/4	0.90	None	18,000	285
87085	Socket						78728		400
87104	None	0.50	1.02	8	2 7/16	1.08	None	25,000	365
87105	Socket						82891		515
87106	Clevis						76026		520
87114	None	0.70	1.117	8	2 7/16	1.24	None	25,000	435
87115	Socket						82892		585
87116	Clevis						76026		600
87124	None	0.90	1.29	8 3/4	2 13/16	1.35	None	25,000	495
87125	Socket						82893		665
87126	Clevis						78732		680
87134	None	0.90	1.39	8 3/4	2 13/16	1.45	None	25,000	510
87135	Socket						82893		680
87136	Clevis						78732		690
87144	None	1.00	1.47	9	2 7/8	1.57	None	25,000	535
87145	Socket						82893		720
87146	Clevis						75711		735
87164	None	1.10	1.62	9 1/2	3 1/16	1.70	None	25,000	655
87165	Socket						82894		830
87166	Clevis						75450		840
87184	None	1.25	1.82	10	3 1/4	1.90	None	25,000	670
87185	Socket						82895		860
87186	Clevis						75450		870
87204	None	1.40	2.02	10 1/2	3 3/4	2.12	None	25,000	770
87205	Socket						82896		965
87206	Clevis						78845		990
Bronze									
86964	None	0.20	0.60	6 3/4	2 1/4	0.60	None	16,000	325
86965	Socket						78721		435
86984	None	0.40	0.83	7 1/2	2 3/8	0.83	None	18,000	450
86985	Socket						78728		560

*Information on larger sizes furnished upon request.

Malleable clamps will be furnished with either copper or aluminum liners when specified. Deduct 0.1 in. from max. conductor diameter to allow for liner.

Prices on application.

Ohio Brass Strateline Clamps

These clamps provide an inexpensive and effective means for deadending distribution primaries and station buses. Easily hooded for hot-line work, they can be detached from supporting insulators simply by removing cotter pin and rivet. Holding power of these clamps meets the requirements of primary distribution service where larger sizes of aluminum cable are involved.

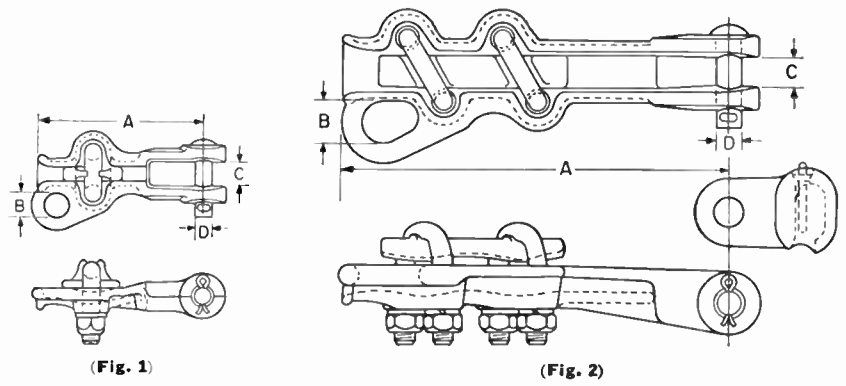

Malleable Iron*

Cat. No.	Fig. No.	Connector	Conductor Diameter-Inches		Clamp Dimensions-Inches				Connector Cat. No.	Ultimate Strength Lbs.	Pkd. Wt. Lbs. Per 100
			Min.	Max.	A.	B.	C.	D.			
87652	1	None	.15	.37	4½	1	11/16	½	None	4000	210
87662	2	None	.30	.60	8¼	1	¾	5/8	None	8000	315
87663		Socket							74593		430
87672	2	None	.46	.86	9¼	1	¾	5/8	None	8000	440
87673		Socket							74593		555
87682	2	None	.65	1.25	11	1	¾	5/8	None	8000	600
87683		Socket							74593		715
87692	2	None	.82	1.55	12½	1 1/16	¾	5/8	None	10000	745
87693		Socket							74593		860

Aluminum

87650	1	None	.15	.37	4½	1	11/16	½	None	4000	130
89650	2	None	.23	.46	6½	1	¾	5/8	None	6000	160
89651		Socket							74593		275
87660	2	None	.30	.60	8¼	1	¾	5/8	None	8000	185
87661		Socket							74593		300
87670	2	None	.46	.86	9¼	1	¾	5/8	None	8000	270
87671		Socket							74593		385
87680	2	None	.65	1.25	11	1	¾	5/8	None	8000	390
87681		Socket							74593		505
87690	2	None	.86	1.55	12½	1 1/16	¾	5/8	None	10000	520
87691		Socket							74593		635

Bronze

87654	1	None	.15	.37	4½	1	11/16	½	None	4000	215
87664	2	None	.30	.60	8¼	1	¾	5/8	None	8000	320
87665		Socket							74593		435
87674	2	None	.46	.86	9¼	1	¾	5/8	None	8000	440
87675		Socket							74593		555
87684	2	None	.65	1.25	11	1	¾	5/8	None	8000	600
87685		Socket							74593		715
87694	2	None	.86	1.55	12½	1 1/16	¾	5/8	None	10000	745
87695		Socket							74593		860

*Malleable iron clamps can be furnished with aluminum or copper liners when specified.

Prices on application.

Continental Rubber Communications Insulators

Western Union Standard



Eliminates danger of insulator breakage in transit or during installation; minimizes breakage due to rifle-fire or other maliciousness.

Resilience of these insulators reduces line breakage due to crystallization or abrasion of the line near poles. Provide ample strength to take the increased load on angle turns.

High operating efficiency in severe fog and humidity conditions; excellent weather resistance. One model designed for standard wood pin or the threaded wood cob on steel pin, and one model designed for steel pins. Interior threading gives tight, screw fit on pins.

No.	Pin Type	Wt., Lbs. Per 100	*Unit Qty.	†Per 1000	
				Less Than Unit Qty.	Unit Qty. and Over
R-3	Steel	17½	1200	\$220 50	\$198 50
R-4	Wood	40	500	402 50	365 20

†Prices slightly higher West of the Mississippi River.

*Minimum quantity on which freight allowances will apply.

Hubbard Linemen's Safety Platforms

Patented

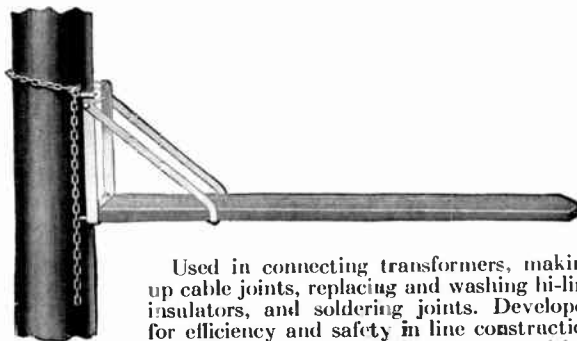

Used in connecting transformers, making up cable joints, replacing and washing hi-line insulators, and soldering joints. Developed for efficiency and safety in line construction and operation. Is readily adaptable to almost any position. Steel spears for pole contact are designed to eliminate side movement of the platform while in use. Width, 9⁵/₈-inches; length, 71-inches.

No. 600, Shipping Wt., Lbs., Each 50.....

Hubbard Pole Balconies

Hot Galvanized



Used for convenience and comfort in telephone terminal box work and serve as switching platforms with the power companies. Frame, braces, and guard rails of this balcony are made of open heart steel. Platform wood is thoroughly seasoned and, painted with two coats of standard green pole paint. Seat 14 x 30-inches. Nos. 9035 and 9045 are identical except railing of No. 9035 fastens to a telephone terminal box and No. 9045 fastens to pole. The complete balcony includes all bolts for fastening the parts together but not the bolts for attaching to pole.

No.	Description	Approx. Shipping Wt., Lbs. 100 Pcs.
9033	Collapsible	6200
9035	Box Fastening	6300
9045	Pole Fastening	6700

Hubbard Pole Seats

Hot Galvanized



Under test, these seats are found to be capable of supporting more than three fourths of a ton safely. The frames and braces of all sizes are of 1x½-inch channel steel, except No. 758 which is constructed from 1½x1½x³/₁₆-inch angle steel.

No.	Style of Seat	Size of Seat, In.	Approx. Shipping Wt., Lbs. 100 Pieces
753	Wood-Creosoted	11x20	1400
755	Steel-Galv.	12x13 ⁷ / ₈	1400
758	Pinta Dipped.	8x20	2603

Prices on application.

Chance Universal Platforms

Universal platforms provide a safe, time- and labor-saving means for working on transmission and distribution lines, switches and other equipment. Particularly useful for prolonged jobs or work on lines otherwise inaccessible from pole or tower leg.

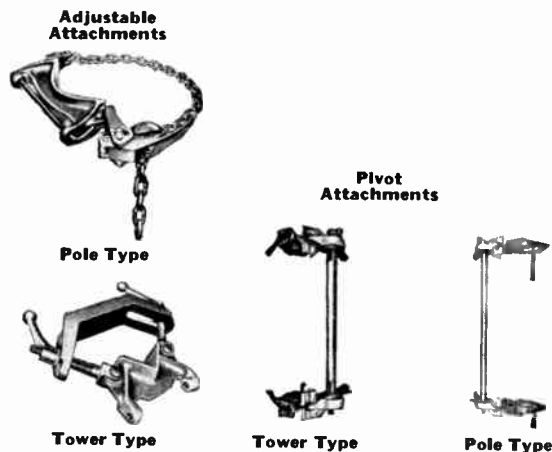

Universal Platform With Pole Type Adjustable Attachments

High-strength aluminum alloy is used in most platform fittings to minimize weight. Double brace provides extra stability; folds for easy transportation. A wood keel provides added rigidity on 8-foot platform. All platforms furnished with non-skid safety tread.

Platform Assemblies: Universal platforms are available in either adjustable or pivot type assemblies. Pole and tower attachments of both adjustable and pivot designs are interchangeable; by removing a hinge pin and attaching the de-

sired fitting, the platform is quickly adapted to the specific job. Attachments are available separately.

Pivot Type Platform: Use of pivot attachments facilitates work on H-frame suspension construction and other jobs requiring platforms to be set at several angles. This can be done without changing the position on the pole. Platform may be rotated within a 180° arc; turning hand nut holds platform in desired working position.

Adjustable Assembly

No.	Description	Length Feet	Wt. Lbs.	Each
*M4901-2	Pole Type assembly, less keel	6	44	\$78.00
M4901-3	Pole Type assembly, with keel	8	55 1/4	90.00
M4901-6	Tower type assembly, less keel	6	41 1/2	71.50
M4901-7	Tower type assembly, with keel	8	53 1/2	82.00
*M4901-10	Pole attachment only	..	5 3/8
M4901-11	Tower attachment only	..	8 1/4

Pivot Type Assembly

No.	Description	Length Feet	Wt. Lbs.	Each
*M4901	Pole type assembly, less keel	6	68 3/4	\$127.00
M4901-4	Pole type assembly, with keel	8	77 1/2	138.00
M4901-1	Tower type assembly, less keel	6	67 1/4	115.50
M4901-5	Tower type assembly, with keel	8	76 1/4	127.00
*M4901-13	Pole attachment only	..	27 1/4
M4901-15	Tower attachment only	..	30 1/2

Chance Rope Railings

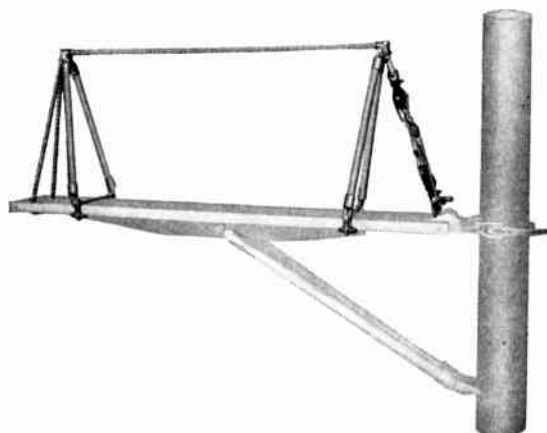

Provides additional security to linemen on platforms. Railing is made of 3/4" manila fiber rope and 4 laminated spruce poles. Stands 24" above board. Complete with 2" double blocks. Folds flat for easy transportation.

No.	Platform Size	Wt., Lbs.	Each
*M4901-35	1 5/8" x 11" x 6'	12 3/4	\$38.00
M4901-45	1 5/8" x 11" x 8'	13 1/8	39.00

*—Linemen's Preference (L.P.)—Recommended by Chance Hot Line Tool Demonstrators.

Chance Utility Platforms



Designed for use on poles, in substations where space is limited, or where linemen must work for long periods. Attached with a single safety locking chain tightener. Cannot be accidentally loosened. Aluminum alloy fittings keep weight down.

Has folding brace for convenience of transportation.

Non-skid tread and cleats at end provide safe, sure footing.

No.	Platform Size, In.	Wt., Lbs.	Each
*M4950	1 5/8" x 11 x 30	20	\$40.75
M4950-42	1 5/8" x 11 x 42	22	44.55
M4960-30	1 5/8" x 11 x 30	22	40.75
M4960-42	1 5/8" x 11 x 42	24	44.50

Hanlon & Wilson Rail Bonds

Type RHD-9



Made with solid cadmium copper terminals. Selected because of its similarity of expansion to railroad steel, excellent "cold flow" properties, and high conductivity.

Average pull-out test is more than double ordinary other types.

Punch supplied with every 200 RHD-9 Bonds.

Type BSB-6CH

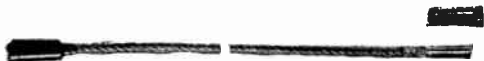

A high conductivity conductor made entirely of cadmium copper and stainless steel.

Powerful wedging action makes strong positive electrical connection.

Has maximum resistance to vibration fatigue.

Quickly and easily installed with a hammer. The flexible strand permits rapid and easy forming into the most suitable shape and location.

This bond was designed for use at switch points and frogs.

Type 7B-10C



A hard drawn "copper-weld" strand. No heat or welding used in compression process.

Has pulled as high as 10,000 lbs. in destruction tests.

Added Copper Sleeve serves as a cushion for the strand in the steel terminal and at point of greatest stress.

No special skill to install the one-piece pin. Available in other strand constructions on request.

Type BSB-5CH



An improved and perfected plug-type signal bond easily installed behind or in front of the splice bar.

Stainless steel terminals offer maximum resistance to corrosion.

The strand is composed of hard drawn cadmium copper with a high fatigue resistance.

Type RHD-6



A high conductivity strand mechanically applied. Non-chipping tool steel drive pins assure safety in installation.

Has complete over-all protective zinc plating and pull test equaling the tensile strength of wire.

Expands excessively to fit over-sized holes.

Type DS-1T



Bonds and jumpers, shunt connectors, track circuit connectors made of a combination of copper and steel wires, butt welded.

Prices on application.

Macoid Plastic Tree Wire Guards

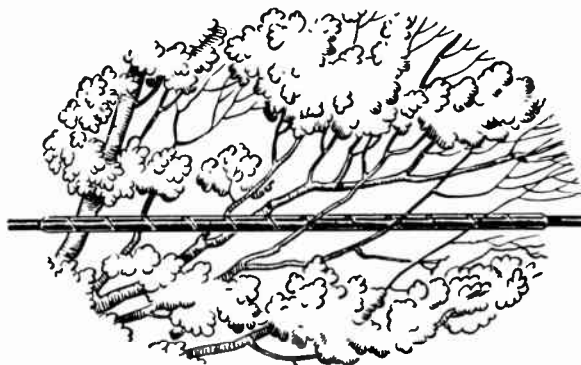

For auxiliary protection on power and light conductor or telephone drop wire where it is impracticable to obtain adequate clearance from trees, making it necessary to protect conductor or wire from abrasion. Particularly useful where conditions require protection on a considerable length of wire. Can be spiraled on wire already in place or can be threaded over the free end of a wire. Furnished in five types:

Type "P", 1/16" I.D. x .045" wall, 36" length. Tree guard. 10 pieces in a package. Also furnished in coils 100 to 500 feet long. Approx. weight per package, 1.4 pounds. Price per package, \$2.40.

Type "S", 1/16" I.D. x .045" wall, 36" length. Tree guard. 10 pieces in a package. Approx. weight per package, 1.4 pounds. Price per package, \$1.80.

Type "L", 3/16" I.D. x .037" wall. For use in insulating line wires. 100 feet in a coil, 10 coils in a carton. Approx. weight per carton, 16 pounds. Price per coil, \$1.90.

Type "E", 1/4" x .040" wall. To protect station wires where attached to walls or passed through partitions. 50 feet per coil, 10 coils in a carton. Approx. weight per carton, 11 1/2 pounds. Price per coil, \$1.80.

Type "LL", 3/8" O.D. x .035" wall. For insulating line wires. 100 feet in a coil, 5 coils in a carton. Approx. weight per carton, 11 1/2 pounds. Price per coil, \$2.90.

Copperweld Grip-Flex Insulator Ties



Use Copperweld Grip-Flex Ties wherever Copperweld or copper line wires are being tied to pin-type insulators. This preformed tie assures uniformity of construction—reinforces the conductor over the entire length of the tie and prevents chafing of conductors. It's strong, non-rusting, simple in design, easy and inexpensive to apply. When ordering specify the size of the line conductor. Each tie consists of one preformed Copperweld Reinforcing Wire plus a length of straightened, annealed Copperweld Binding Wire sufficient for making a pigtail type of binding on any standard type of side groove insulator.

Complete Grip-Flex Tie packed in bundles of 100.

No.	Approx. Weight Per 100 Ties	Line Wire Size, In.
GFC-78	14 Lbs.	.128
GFC-910	8 Lbs.	.104
GFC-1012	7 Lbs.	.080

Crapo Galvanized High-Tensile Telephone Line Wire



These high-tensile, low-resistance telephone line wires make possible longer-span, lower-cost construction on new lines; provide stronger spans, with lower maintenance expense, on present lines. Development of Indiana Steel and Wire Company.

Galvanized by the Crapo process, which produces a heavy, dense, uniform coating of zinc that adheres tenaciously to the wire and provides dependable protection against corrosion.

Crapo HTL-85

Used extensively for both new construction and for replacement. When used on existing pole structures it tends to increase strength of line, lessens hazard of ice and wind, minimizes service interruptions, and reduces maintenance costs.

Affords improved transmission at voice frequency with currents of voice frequency magnitude.

Has a tensile strength more than 60 per cent greater than standard B.B. wire of the same diameter. No. 12 B.W.G. size makes possible spans of 210 feet in heavy loading, 330 feet in medium loading, and 440 feet in light loading districts.

Furnished in continuous lengths without splices or joints. Galvanized steel compression-type sleeves are recommended for splicing this wire.

Size B.W.G.	9	10	12	14
Diameter, in.	.148	.134	.109	.083
Approx. Wt. per Mile, lbs.	314	258	170	99
Coil Length, mile	1 1/2	1 1/2	1 1/2	1 1/2
Min. Breaking Load, lbs.	1162	1199	793	460
Max. Resistance per Mile, ohms	18.47	22.48	34.12	58.59

COPYRIGHT 1936, 1939, AND 1945 BY INDIANA STEEL & WIRE CO.

Crapo HTL-135

Possesses two and one-half times the strength of standard B.B. wire, which makes possible spans of 350 feet in heavy loading districts, 510 feet in medium loading districts, and 650 feet in light loading districts.

The average number of pole structures per mile can usually be reduced to approximately one-half the number required for B.B. wire.

The effective resistance at voice frequencies with currents of voice frequency magnitude is superior to that of the older grade.

Regularly furnished in No. 12 B.W.G. and in continuous lengths without splices or joints.

Galvanized steel compression-type sleeves and dead-ends are recommended for use with this wire.

Size	No. 12 B.W.G.
Nominal Diameter, inches	.109
Minimum Breaking Strength, pounds	1213
Resistance per Mile, ohms	38.23
Approximate Weight per Mile, pounds	170
Weight per Coil, Approximate, pounds	150
Length per Coil, Approximate, feet	4659

Prices on application.

COPYRIGHT 1939 AND 1945 BY INDIANA STEEL & WIRE CO.

Crapo Galvanized Telephone and Telegraph Wire



Drawn from iron or steel, of specific properties, processed under laboratory supervision, galvanized by the Crapo process, and rigidly inspected. Meets all standard specifications for electrical conductivity, tensile strength, elongation, galvanizing, and ductility which users of line wire require.

Size B.W.G.	Diam. In.	Wt. Lb. Per Mile	Coil Length Mile	Minimum Breaking Strength, Pounds		Maximum Resistance Per Mile at 68°F., International Ohms	
				E.B.B.	B.B.	E.B.B.	B.B.
4	.238	811	1/4	2028	2271	5.98	7.15
6	.203	590	1/3	1475	1652	8.22	9.83
8	.165	390	1/2	975	1092	12.43	14.87
9	.148	314	1/2	785	879	15.44	18.47
10	.134	258	1/2	615	722	18.79	22.48
11	.120	206	1/2	515	577	23.51	28.16
12	.109	170	1/2	425	476	28.52	34.12
14	.083	99	1/2	247	277	48.98	58.59

Crapo Galvanized Tie Wires

Manufactured specially to facilitate tying in telephone line wire. Galvanized by Crapo process.

Furnished in coils or straightened and cut to length.

Size B.W.G.	Nominal Diam. In.	Standard Coils		Straightened and Cut To Length		For Tie Splints No. Pieces
		Approx. Wt., Lbs.	Approx. Lgth., Ft.	Horseshoe Ties Length In.	No. Pieces	
9	.148	100	1700	13	395	...
10	.134	100	2040	18	350	...
10	.134	100	2040	16	390	...
12	.109	100	3100	14	675	30
13	.095	100	4165	18
13	.095	100	4165	20
13	.095	100	4165	30
14	.083	50	2650	14	1150	26

Note: Unless otherwise specified, tie wire 10 up to 24-in. long are packed full burlapped; tie wires 24-in. and longer are packed ends only burlapped.

Crapo Galvanized Ground Wire

For pole grounds. Regularly furnished in coils of approximately 150 pounds.

Size B.W.G.	Diameter Inches	Approx. Wt. Lb. Per Coil	Approx. Length Feet
4	.238	150	976
6	.203	150	1320
8	.165	150	2030
9	.148	150	2520

Crapo Extra High-Tensile Telephone Line Wire Crapo HTL-195

Extra high-tensile galvanized steel telephone line wire designed for 600 to 700-foot spans in all loading districts. Regularly furnished in No. 12 B.W.G.

Approved galvanized steel compression-type sleeves and dead-ends are recommended for use with this wire.

Size	No. 12 B.W.G.
Nominal diameter, inches	.109
Minimum tensile strength, pounds	1300
Resistance per mile, ohms	38.8
Approximate weight per mile, pounds	170
Nominal weight per coil, pounds	160
Approximate coil length, feet	4970

Prices on application.

COPYRIGHT 1950 BY INDIANA STEEL & WIRE CO.

Crapo Galvanized Steel Strand

Class A, B and C Coatings



All wire used in forming a particular size and grade is produced from steel of selected properties, scientifically processed under laboratory supervision and galvanized by heavy, uniform zinc coatings. Both wire and strand are subjected to laboratory tests for tensile strength, elongation galvanizing, ductility and gage to insure high uniform quality in the finished product.

Available in Class A, B & C coatings, conforming respectively with ASTM designations A122-54T, and A218-5 FT or latest revisions thereof.

Furnished in following standard lengths: 3/8-inch diameter and smaller in 250, 500 and 1000-foot coils and 2500 and 5000-foot reels; 7/16-inch diameter and larger in 250 and 500-foot coils and 1000, 2500 and 5000-foot reels. When ordering, specify size and grade, method of packing (coils or reels) and number of feet per coil or reel.

Guy and Messenger Strand

7 Wires Twisted into 1 Strand

Nom. Diam. Strand In.	Wire Diam. In.	Wt. Per 1000 Ft. Lb.	Minimum Breaking Strength, Pounds			
			Common Grade	Siemens-Martin Grade	High Strength Grade	Extra High Strength Grade
5/8	.207	813	11600	19100	29600	12400
1/2	.165	517	7400	12100	18800	26900
7/16	.115	399	5700	9350	14500	20800
3/8	.120	273	4250	6950	10800	15100
5/16	.101	205	3200	5350	8000	11200
9/32	.093	161	...	4250	6400	8950
1/4	.080	121	1900	3150	4750	6650
3/16	.062	72.9	1150	1900	2850	3990

Specification Grade 7-Wire Strand

Utilities—Western Union—A.T.&T.

Nominal Diameter Inches	Trade Designation	Wire Diameter Inches	Weight Pounds Per 1000 Feet	Minimum Breaking Strength Pounds
1/2	25000 Lb.	.165	517	25000
7/16	16000 Lb.	.115	399	18000
3/8	10000 Lb.	.120	273	11500
5/16	6000 Lb.	.109	225	6000
9/32	4000 Lb.	.093	161	4600
3/16	2200 Lb.	.065	80.3	2400

Utilities Grade 3-Wire Strand

1/4120	116.7	3150
1/4120	116.7	4500
5/16145	170.6	6500
3/8165	220.3	8500

Prices on application

Crapo Preformed Armor Rods

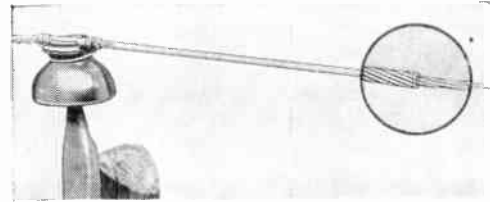

Preformed Armor Rods provide a simple, practical economical method of reinforcing and protecting overhead conductors and static wires at the point of, and in the region of, the supports. They minimize wear and chafing, eliminate danger from ties and clamps, absorb and dissipate vibration, and act as an armor over the conductor, protecting it against flash-overs and arcing. Provide excellent holding power against slippage.

Installation

Easily and quickly installed. Each rod accurately preformed into an open helix or spiral with an inside diameter slightly less than the outside diameter of the conductor.

Applied in sets, the rods form a snug-fitting, compact, cylindrical armor over the conductor.

No clamps or clips are required to hold the rods in place. Installations on energized circuits can be made with "hot-line" tools designed for the purpose.

Repair of Conductors

Used successfully to repair stranded conductors and to restore the strength of worn or broken conductors where lines are being rebuilt.

Short length rods are also available to protect conductors against abrasion where taps are applied.

Made by Indiana Steel & Wire Company. Available in Galvanized Steel, Stainless Steel, Aluminum, Copperweld and Bronze for all sizes and types of overhead conductor and static wire.

**Preformed Armor Rods for Galvanized Strand
Left-Hand Pitch Standard**

Strand Size In.	Type	Rod Diam. In.	Galvanized Steel Rods		Wt. Per 100 Sets Lbs.
			No. Rods Per Set	Rod Length In.	
1/4	3/W	.088	10	35	65
5/16	3/W	.088	12	42	94
3/8	3/W	.102	12	50	150
1/4	7/W	.088	10	35	65
5/16	7/W	.088	12	42	94
3/8	7/W	.102	12	50	150
7/16	7/W	.121	12	56	236
1/2	7/W	.140	12	63	256

*Recommended for double pin-type insulators and single suspension insulator supports.

**Crapo Galvanized Steel Strand
For Overhead Ground (Static) Wire**



Designed and manufactured for shielding transmission lines against lightning. Produced in continuous lengths, without welds or joints in the individual wires or finished strand.

Made in accordance with ASTM designation A363-55T or latest revision thereof.

Available in Class A, B and C coatings in High Strength and Extra High Strength Grades in 1/16-in., 3/8-in., 1/4-in., and 1/2-in. sizes.

Furnished in the following lengths for at least 95% of the order.

1/2-in., 3600 to 6100-ft., 1/16-in., 4700 to 7900-ft.; 3/8-in., (a) 3600 to 5800-ft.; 5/16-in. (b) 4800 to 7700-ft.

Up to 5% of the order may be furnished in lengths below these minimums but not in less than 1500-ft. lengths.

(a) Lengths up to 9400-ft. and (b) 12,000-ft. available on special order.

Prices on application.

Crapo Galvanized Steel Cable Lashing Wire

"C" Coated



Used with modern cable spinning machines to lash cable to messenger strand. Extra heavy Class "C" coating.

Wire Diam.—.091 & .061-in. In neat, compact, three-layer coils with straight or tapered arbor holes. Packed 6 in crtn.

Dimensions: Straight Hub Arbor hole—1 7/8-in.; Tapered Hub, 2 to 2 1/2-in.; Coil O.D.—6-in.; Width—1 1/2-in. Length Wire: Size .091" — 325-ft.; .061" — 650-ft. Weight: .091" — 7.2 lbs.; .061" — 6.45 lbs.

Crapo Stainless Steel Cable Lashing Wire

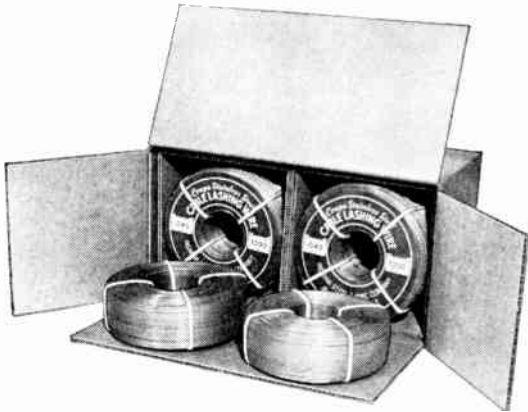

Developed specifically to meet demands for a spinning wire with a high strength to weight ratio and superior resistance to corrosion.

For general application, regularly produced from Type 430 Stainless Steel—A chrome alloy. Also available in Type 302 — A chrome-nickel, and Type 316 — A chrome-nickel-molybdenum steel.

Size Diam., In.	Type Arbor Hole	Nominal Coil Length, Ft.	Nominal Coil Wt., Lbs.
.045	Straight	1200	612
.061	Straight or Tapered	735	717
.065	Straight	450	500

Put up in neat, compact, thread-lay coils. Packed 6 coils to the carton.

Crapo Deadends

For Plastic-Coated Telephone Line Wire

Designed to hold the rated breaking strength of one-pair parallel rural telephone distribution wire.

Formed from tough, springy stainless steel, neoprene coated. Oval shaped to conform to the conductor. No abrasives necessary to provide ample holding power. Extra long length of spiral sections tends to distribute load over greater area and reduce stress concentration.

No.	For Use With	Section Length In.	Approx. Gross Wt. Lb.
064DE109	1 pr. .061 Copper/Steel	18	12
080DE109	1 pr. .080 Copper/Steel	31	20
083DE109	1 pr. .083 Galvanized Steel	31	20

Deadends are packed in corrugated cartons, 50 sets to the carton.

Crapo Galvanized Steel Conductors



A high tensile, low-resistance steel conductor which makes possible long spans, reduces the number of pole structures required, saves man-hours and material, and reduces over-all construction expense.

Used for rural taplines and single-phase extensions, high-tension transmission lines and branches, primary distribution lines, primary circuits; for mixed commercial, residential and farm service, primary neutrals of three-phase rural feeders and series street lighting circuits.

Available in two grades: Crapo HTC-130 and Crapo HTC-80. Each grade available in stranded (3-wire) construction.

Resistance and Reactance in Ohms per Mile of Single Conductor at 60 Cycles for Various Currents and Conductor Spacing When the Ambient Temperature is 20°C. (68°F.)

COPYRIGHT 1938, 1943, 1945 BY INDIANA STEEL & WIRE CO.

Crapo HTC-130							
Conductor Size B.W.G.	Current Am-peres	Maximum Resistance Per Mile	Internal Reactance Per Mile	*Total Reactance Per Mile			
				24 Inch	36 Inch	48 Inch	60 Inch
4	1.0	8.07	0.72	1.35	1.40	1.43	1.46
	5.0	8.39	0.77	1.40	1.45	1.48	1.51
	10.0	8.83	0.85	1.48	1.53	1.56	1.59
	15.0	9.53	0.90	1.53	1.58	1.61	1.64
6	1.0	11.29	0.72	1.37	1.42	1.45	1.48
	5.0	11.36	0.77	1.42	1.47	1.50	1.53
	10.0	11.53	0.85	1.50	1.55	1.58	1.61
	15.0	11.81	0.96	1.61	1.66	1.69	1.72

Crapo HTC-80							
4	1.0	7.17	1.05	1.67	1.73	1.76	1.79
	5.0	7.25	1.07	1.69	1.75	1.78	1.81
	10.0	7.40	1.10	1.72	1.78	1.81	1.84
	15.0	7.62	1.15	1.77	1.83	1.86	1.89
6	1.0	9.97	1.06	1.70	1.76	1.79	1.82
	5.0	10.09	1.09	1.73	1.79	1.82	1.85
	10.0	10.28	1.15	1.79	1.85	1.88	1.91
	15.0	10.56	1.23	1.87	1.93	1.96	1.99

Physical Properties

COPYRIGHT 1938, 1943 AND 1945 BY INDIANA STEEL & WIRE CO.

Conductor Size B.W.G.	Type of Construction	Wires No.	Size In.	Approx. Weight Pounds		Minimum Breaking Strength, Pounds	
				Per 1000 Ft.	Per Mile	HTC-130	HTC-80
4	3-Wire	3	.138	156	823	5610	3624
6	3-Wire	3	.117	112	590	4295	2604
8	3-Wire	3	.096	75	396	2915	1753

Standard Shipping Lengths

Conductor Size B.W.G.	Type of Construction	Foot Per Coil		Reels Feet Per Reel	Weight Per Reel
		150 Pound Coil	300 Pound Coils		
4	3-Wire	960	1920	†5760	900
6	3-Wire	1335	2670	†8020	900
8	3-Wire	2000	4000	†12000	900

*Of each conductor of a single, 2, or 3-phase circuit, at stated distances between centers of conductors.

†When specified, conductors can be shipped on 450-pound reels.

Values for weights and lengths are approximate.

Crapo Galvanized Construction Wire

For miscellaneous construction purposes, such as light guys, wrapping stubbed poles, lashing brackets to poles, etc.

Size B.W.G.	Diam. Inches	Approx. Weight Per Coil Pounds	Approx. Length Per Coil Feet	Breaking Strength Pounds
6	.203	150	1320	1618
8	.165	100	1320	1069
10	.134	100	2050	705
12	.109	100	3150	467
14	.083	50	2700	271

Prices on application.

**Crapo Tie Splints
For Telephone Line Wire**

Crapo Pre-Tied Splints

A radically new method of "tying-in" telephone line wire. Tie wire and insulator can be pre-assembled in the shop or warehouse on a production line basis, or on the ground at the project site. The applied splint grips the line wire securely and prevents slippage. Protects line wire against wear and abrasion. Simplifies the re-sagging problem. In galvanized steel for use with galvanized line wire and in copper covered steel for use with a copper/steel or copper line wire.

Galvanized Pre-Tied Splints

No.	Line Wire Diam., In.	Diam. In.	Length In.	Wt. Lbs. Per 100
109PT134	.109	.134	17.5	8

Copper/Steel Pre-Tied Splints

080PT114	.080	.114	16.5	6
102PT128	.102	.128	17.5	8

Crapo Double V Tie Splints

Especially designed for long span construction. Reinforce and protect telephone line wire at the point of support. The twin "V" notches prevent contact between line wire and insulator, minimizing wear and abrasion. Spiral sections provide a gripping action to prevent slippage under loading.

Available in galvanized steel for use with galvanized line wire and in copper-covered steel for use with copper-steel or copper line wire.

Galvanized Double V Tie Splints

No.	Line Wire Diam., In.	Diam. In.	Length In.
083VS109	.083	.109	16 ⁵ / ₁₆

Copper/Steel Double V Tie Splints

080VC081	.080	.081	16 ⁵ / ₁₆
102VC102	.102	.102	16 ⁵ / ₁₆
102VC102	.104	.102	16 ⁵ / ₁₆
128VC128	.128	.128	17 ¹ / ₄
165VC144	.165	.144	21

Crapo Preformed Spiral Tie Splints

A simple, economical means of reinforcing and protecting telephone line wire from abrasion and wear at the insulator. Prevents stress concentration at points of support, reduces possibility of failure due to vibration. Easily and quickly applied by hand. No tools required.

Available in galvanized steel for use with galvanized steel telephone wire. Can also be furnished in copper-covered steel for copper/steel or copper telephone line wire.

No.	Size B.W.G.	Line Wire Spiral Tie Splints Diam. In.	Length In.	Wt. Lbs. Per 1000
134SP136	10	.136	21	93
109SP109	12	.109	17	49
83SP94	14	.094	16	33

Crapo Tangent Supports

For plastic-coated one-pair parallel rural telephone distribution wire of galvanized steel or copper-covered steel.

Performed from tough, springy, corrosion-resistant stainless steel wire, and coated with neoprene. Provides simplest and most effective method for suspending plastic-coated one-pair parallel telephone wire.

Neoprene coating increases friction between support and conductor, further reducing the possibility of slippage.

Support is formed from a large single stainless steel wire of 109-in. diam. The spirals conform to conductor shape, provide a closer, more uniform gripping action. Loop eye attaches support to pole easily and quickly.

Packed 125 pieces in corrugated carton. Weight, 9.5 Lbs.

No.	For Use With	Length In.
064CRW109	1 pr. .064 Copper/Steel	15 ¹ / ₂
080CRW109	1 pr. .080 Copper/Steel	15 ¹ / ₂
083VRW109	1 pr. .083 Galvanized Steel	15 ¹ / ₂

Copperweld Power Transmission and Distribution Conductors

Copperweld-Copper—3-Wire Stranded



Used for all types of overhead distribution lines and are particularly well suited for long span lines where high strengths are advantageous. They provide safe, permanent and economical construction, and are available in a wide range of strengths and conductances.

The three wire triangular shape of these conductors tends to minimize line vibration, and their large individual wires provide a very substantial and rugged conductor. Easily installed and give excellent performance.

They combine the high conductance of copper with the high strength of Copperweld. The Type A conductors are composed of one extra high strength Copperweld wire and two hard-drawn copper wires. Other types include the Type C, composed of one 40% conductivity Copperweld wire and two hard-drawn copper wires, and the Type D, composed of two Copperweld wires and one copper wire.

The following table includes the more generally used sizes of Copperweld-copper 3-wire strands. Other sizes, and Copperweld-copper 7-wire strands used principally for the higher conductance requirements are available upon request to GRAYBAR.

No.	AWG	Equivalent Stranded H.D. Copper Conductance CM	Resistance 68° F. Ohms per 1000 FL	Diameter of Cable Inch	Diameter of Wires Inch
2A	2	66,370	.1641	.366	.1699
3A	3	52,630	.2070	.326	.1513
4A	4	41,740	.2610	.290	.1347
5A	5	33,100	.3291	.258	.1200
5D	5	33,100	.3291	.310	.1438
6A	6	26,250	.4150	.230	.1068
6C	6	26,250	.4150	.225	.1046
6D	6	26,250	.4150	.276	.1281
7A	7	20,820	.5232	.223	.1266*
7D	7	20,820	.5232	.246	.1141
8A	8	16,510	.6598	.199	.1127*
8C	8	16,510	.6598	.179	.08081*
8D	8	16,510	.6598	.219	.1016
9 ¹ / ₂ D	9 ¹ / ₂	11,750	.9170	.174	.08081

No.	Breaking Load Pounds	Weight, Pounds Per 1000 FL	Per Mile	Cross-Section Sq. In.
2A	5,876	256.8	1,356	.06799
3A	4,810	203.6	1,075	.05392
4A	3,938	161.5	852.8	.04276
5A	3,193	128.1	676.3	.03391
5D	6,035	178.9	944.4	.04874
6A	2,585	101.6	536.3	.02689
6C	2,143	97.34	514.0	.02577
6D	4,942	141.8	748.9	.03866
7A	2,754	93.66	491.6	.02516
7D	4,022	112.5	594.0	.03066
8A	2,233	74.27	392.2	.01995
8C	1,362	60.67	320.3	.01604
8D	3,256	89.21	471.0	.02431
9 ¹ / ₂ D	1,743	56.46	298.1	.01539

Modulus of Elasticity		Coefficient of Expansion per Degree F.		*Copper Wires—Diameter
2A to 6A Incl.	19,000,000	2A to 6A Incl.	.000,008,5	7A .08949
7A and 8A C	21,000,000	7A and 8A C	.000,008,1	8A .07969
D	19,000,000	D	.000,008,5	8C .08336
	22,000,000		.000,007,8	

Prices on application.

Copperweld Telephone Line Wire



Use Copperweld Line Wire wherever you need to combine strength with good conductance. It is non-rusting, light in weight, easy to handle and economical to string.

Copperweld's voice transmission characteristics are better than any other high-strength conductor. It is the only long-span wire suitable for carrier current systems. The permanent high strength of Copperweld permits

safer long spans that stand up under severe weather conditions. For long distance and carrier current lines, the recommended sizes are .128-in. 40% conductivity High Strength and .101-in. 40% conductivity High Strength. The choice usually depends

on electrical requirements. For short subscriber loops, the .080-in. 30% conductivity Extra High Strength Copperweld Wire has adequate conductance and is most economical. For longer loops where the electrical requirements are more demanding, use .101-in. 10% or .080-in. 40% High Strength Copperweld.

Diameter In.	Breaking Strength Lbs.	Weight		DC Resistance Ohms Per 1000 ft. at 68 F.	Cross Section Sq. In.
		Lbs. Per 1000 Ft.	Lbs. Per Mile		
H.S. 40% Conductivity					
.128	1617	45.47	240.1	1.611	.01287
.101	1177	30.01	158.5	2.415	.008195
.080	770	17.76	93.77	4.133	.005027
E.H.S. 30% Conductivity					
.080	900	17.76	93.77	5.509	.005027

Alcoa Stockbridge Dampers

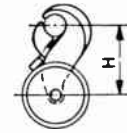
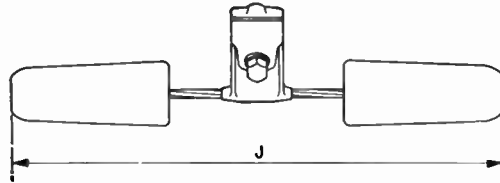

Dimensions in Inches

No.	Nominal Wt. Lbs. Damper Assembly	Conductor Diam. In.		H	J	Cap-screw Diam.	Maximum O.D. of Socket Wrench
		Minimum	Maximum				
1602C	2.4	0.261	0.293	1 7/8	12	5/16	3/4
1602E	2.4	0.291	0.325	1 7/8	12	5/16	3/4
1603C	3.5	0.326	0.355	2 1/8	13 3/8	3/8	7/8
1603F	3.5	0.356	0.390	2 1/8	13 3/8	3/8	7/8
1603G	3.5	0.391	0.434	2 1/8	11	3/8	7/8
1603H	3.5	0.435	0.470	2 1/8	11	3/8	7/8
1606A	7.0	0.471	0.512	2 3/8	17	1/2	1 1/8
1606C	7.0	0.513	0.543	2 3/8	17	1/2	1 1/8
1606D	7.0	0.544	0.590	2 3/8	17	1/2	1 1/8
1608A	9.0	0.591	0.636	2 1/2	18 5/8	1/2	1 1/8
1608G	9.0	0.637	0.667	2 1/2	18 5/8	1/2	1 1/8
1608D	9.0	0.668	0.700	2 1/2	18 3/8	1/2	1 1/8
1610B	11	0.701	0.744	2 15/16	20 1/4	5/8	1 3/8
1610C	11	0.745	0.791	2 15/16	20 1/4	5/8	1 3/8
1610J	11	0.792	0.830	2 15/16	20 1/4	5/8	1 3/8
1612B	14	0.831	0.884	3 1/16	21 13/16	5/8	1 3/8
1612D	14	0.885	0.931	3 1/16	21 13/16	5/8	1 3/8
1612F	14	0.932	0.970	3 1/16	21 13/16	5/8	1 3/8
1614C	16	0.971	1.023	3 1/4	24 1/8	5/8	1 3/8
1614G	16	1.024	1.085	3 1/4	24 1/8	5/8	1 3/8
1614K	16	1.086	1.140	3 1/4	24 1/8	5/8	1 3/8
1616C	18	1.141	1.196	3 7/16	25	5/8	1 3/8
1616D	18	1.197	1.256	3 7/16	25	5/8	1 3/8
1616E	18	1.257	1.300	3 7/16	25	5/8	1 3/8
1616F	18	1.301	1.349	3 3/4	26 1/4	5/8	1 3/8
1616G	18	1.350	1.396	3 3/4	26 1/4	5/8	1 3/8
1616H	18	1.397	1.450	3 3/4	26 1/4	5/8	1 3/8

Preformed Armor Rods for A.C.S.R. Sizes 4 A.W.G. to 336,400 CM

Right-Hand Pitch Standard

Aluminum Alloy Rods

Galvanized Steel Rods

Size A.W.G. or CM	Conductor		Diam. In.	Rod Diam. In.	No. Rods Per Set	Single Support		*Double Support		Rod Diam. In.	No. Rods Per Set	Single Support		*Double Support	
	Type					Rod Length In.	Wt. Per 100 Sets Lbs.	Rod Length In.	Wt. Per 100 Sets Lbs.			Rod Length In.	Wt. Per 100 Sets Lbs.	Rod Length In.	Wt. Per 100 Sets Lbs.
4	6 x 1		.250	.116	7	40	47	52	62	.094	10	40	85	52	110
4	7 x 1		.257	.116	7	40	47	52	62	.094	10	40	85	52	110
2	6 x 1		.316	.116	9	44	67	56	85	.094	12	44	112	56	142
2	7 x 1		.325	.116	9	44	67	56	85	.094	12	44	112	56	142
1	6 x 1		.355	.116	9	48	73	60	91	.094	13	48	132	60	165
1/0	6 x 1		.398	.167	9	52	104	64	128	.109	13	52	193	64	238
2/0	6 x 1		.447	.167	10	54	120	66	147	.109	14	54	215	66	265
3/0	6 x 1		.502	.167	11	56	137	68	167	.136	13	56	323	68	392
4/0	6 x 1		.563	.182	11	60	176	72	211	.136	14	60	373	72	448
266,800	6 x 7		.633	.182	12	64	205148	15	64	506
266,800	26 x 7		.642	.182	12	64	205148	15	64	506
300,000	26 x 7		.680	.204	12	68	274162	14	68	600
300,000	30 x 7		.700	.204	12	68	274162	15	68	642
336,400	26 x 7		.721	.204	12	72	290162	15	72	680
336,400	30 x 7		.741	.204	13	72	314162	15	72	680

*Double support rods are recommended for double-pin-type insulators and single suspension insulator supports.

Specifications of rods for larger sizes of A.C.S.R. and for All-Aluminum Cable furnished on request.

Aluminum Alloy Preformed Armor Rods

For A. C. S. R. Conductors

AWG or CM Size	Conductor		Armor Rod		Length In.				
	Type	Diam. In.	D.O., In. Rods on Conductor	No. Rods Per Set					
6	6 x 1	.198	.121	.440	7	32	42	40	52
5	6 x 1	.223	.121	.465	8	37	48	40	52
4	6 x 1	.250	.146	.542	7	47	62	40	52
4	7 x 1	.257	.146	.549	7	47	62	40	52
3	6 x 1	.281	.146	.573	8	54	70	40	52
2	6 x 1	.316	.146	.608	9	67	85	44	56
2	7 x 1	.325	.146	.617	9	67	85	44	56
1	6 x 1	.355	.146	.647	9	73	91	48	60
1/0	6 x 1	.398	.167	.732	9	104	128	52	64
2/0	6 x 1	.447	.167	.781	10	120	147	54	66
3/0	6 x 1	.502	.167	.836	11	137	167	56	68
4/0	6 x 1	.563	.182	.927	11	176	211	60	70
266,8M	18 x 1	.609	.182	.973	12	205	..	64	..
266,8M	6 x 7	.633	.182	.997	12	205	..	64	..
266,8M	26 x 7	.642	.182	1.006	12	205	..	64	..
300M	26 x 7	.680	.204	1.088	12	274	..	68	..
300M	30 x 7	.700	.204	1.108	12	274	..	68	..
336,4M	18 x 1	.684	.204	1.092	12	274	..	68	..
336,4M	18 x 1	.684	.204	1.092	12	323	..	68	..
336,4M	26 x 7	.721	.204	1.129	12	290	..	72	..
336,4M	30 x 7	.741	.204	1.149	13	314	..	72	..
397,5M	18 x 1	.743	.204	1.151	13	314	..	72	..
397,5M	26 x 7	.783	.250	1.283	11	421	..	76	..
397,5M	30 x 7	.806	.250	1.306	11	421	..	76	..
477M	18 x 1	.814	.250	1.314	12	459	..	76	..
477M	24 x 7	.816	.250	1.346	12	471	..	78	..
477M	26 x 7	.858	.250	1.358	12	471	..	78	..
477M	30 x 7	.883	.250	1.383	12	471	..	78	..
556,5M	18 x 1	.879	.250	1.379	12	471	..	78	..
556,5M	24 x 7	.914	.250	1.414	13	523	..	80	..
556,5M	26 x 7	.927	.250	1.427	13	523	..	80	..
556,5M	30 x 7	.953	.250	1.453	13	549	..	84	..
605M	24 x 7	.953	.250	1.453	13	549	..	84	..
605M	26 x 7	.966	.250	1.466	13	575	..	88	..
605M	30 x 19	.994	.310	1.614	11	784	..	92	..
636M	36 x 1	.930	.250	1.430	13	523	..	80	..
636M	24 x 7	.977	.310	1.597	11	750	..	88	..
636M	54 x 7	.977	.310	1.597	11	750	..	88	..
636M	26 x 7	.990	.310	1.610	11	784	..	92	..
636M	30 x 19	1.019	.310	1.639	12	856	..	92	..
666,6M	24 x 7	1.000	.310	1.620	12	856	..	92	..
666,6M	54 x 7	1.000	.310	1.620	12	856	..	92	..
715,5M	54 x 7	1.036	.310	1.656	12	893	..	96	..
715,5M	26 x 7	1.051	.310	1.671	12	893	..	96	..
715,5M	30 x 19	1.081	.310	1.701	12	893	..	96	..
795M	36 x 1	1.040	.310	1.660	12	893	..	96	..
795M	54 x 7	1.093	.310	1.713	12	930	..	100	..
795M	26 x 7	1.108	.310	1.728	12	930	..	100	..
795M	30 x 19	1.140	.310	1.760	13	1008	..	100	..
874,5M	54 x 7	1.146	.310	1.766	13	1008	..	100	..
900M	54 x 7	1.162	.310	1.782	13	1008	..	100	..
954M	54 x 7	1.196	.310	1.816	13	1008	..	100	..
1033,5M	54 x 7	1.246	.365	1.976	12	1290	..	100	..
1113M	54 x 19	1.293	.365	2.023	12	1290	..	100	..
1272M	54 x 19	1.382	.365	2.030	13	1398	..	100	..

Aluminum Alloy Armor Rods

For All-Aluminum Conductors

AWG or CM Size	Conductor		Armor Rod		Length In.				
	Type	Diam. In.	D.O., In. Rods on Conductor	No. Rods Per Set					
6	7 Wire	.184	.121	.426	7	32	42	40	52
4	7 Wire	.232	.121	.474	8	37	48	40	52
3	7 Wire	.260	.146	.552	7	47	62	40	52
2	7 Wire	.292	.146	.584	8	54	70	40	52
1	7 Wire	.328	.146	.620	9	64	82	42	54
1/0	7 Wire	.368	.146	.660	10	78	98	46	58
2/0	7 Wire	.414	.146	.706	10	85	105	50	62
3/0	7 Wire	.464	.146	.756	11	97	119	52	64
4/0	7 Wire	.522	.167	.856	11	130	159	53	65
266,8M	7 Wire	.586	.182	.950	12	179	218	56	68
266,8M	19 Wire	.593	.182	.957	12	179	..	56	..
266,8M	37 Wire	.594	.182	.958	12	..	218	..	68
300M	19 Wire	.629	.182	.993	12	186	..	58	70
336,4M	19 Wire	.666	.182	1.030	13	215	..	62	74
397,5M	19 Wire	.724	.204	1.132	12	266	..	66	..
477M	19 Wire	.793	.250	1.293	11	376	..	68	..
477M	37 Wire	.795	.250	1.295	11	376	..	68	..
500M	19 Wire	.812	.250	1.312	11	376	..	68	..
556,5M	19 Wire	.856	.250	1.356	12	423	..	70	..
556,5M	37 Wire	.858	.250	1.358	12	423	..	70	..
636M	37 Wire	.918	.250	1.418	13	471	..	72	..
715,5M	37 Wire	.974	.250	1.474	13	484	..	74	..
715,5M	61 Wire	.975	.250	1.475	13	484	..	74	..
750M	37 Wire	.997	.310	1.617	11	699	..	82	..
750M	61 Wire	.998	.310	1.618	11	699	..	82	..
795M	37 Wire	1.026	.310	1.646	12	781	..	84	..
795M	61 Wire	1.028	.310	1.648	12	781	..	84	..
874,5M	37 Wire	1.077	.310	1.697	12	781	..	84	..
874,5M	61 Wire	1.078	.310	1.698	12	781	..	84	..
954M	37 Wire	1.124	.310	1.744	12	837	..	90	..
954M	61 Wire	1.126	.310	1.746	12	837	..	90	..
1033,5M	37 Wire	1.170	.310	1.790	13	947	..	94	..
1033,5M	61 Wire	1.172	.310	1.792	13	947	..	94	..

Rods can be bulked packed or furnished in sets. If requested, armor rods .182-in. and larger are center-marked at no additional charge. A small charge will be made for center-marking rods smaller than .182-in.

Specifications for the following Preformed Armor Rods furnished on request:

Aluminum alloy rods for A.C.S.R. Generally used as overhead ground wire.

Copperweld and bronze rods for copperweld, copperweld-copper and copper conductors.

Aluminum alloy line guards for A.C.S.R. and all-aluminum conductors.

Aluminum alloy line guards for self-supporting service-drop cable.

Aluminum alloy tap rods for A.C.S.R. and all-aluminum conductors.

Copperweld and bronze tap rods for copper and copperweld conductors.

Aluminum alloy patch rods for A.C.S.R. and all-aluminum conductors

Alcoa Tapered Armor Rods

For A.C.S.R.

Illustrations below show the common applications of tapered armor rods on the larger sizes of A.C.S.R. Table below gives detailed information for ordering by catalog number, and for choosing suitable cable grooves in clamps or insulators.

Where double supports are widely spaced, as sometimes occurs when two strings of suspension insulators are used, armor rods of special length may be required. When ordering such special armor rods, specify distance between centers of supports.

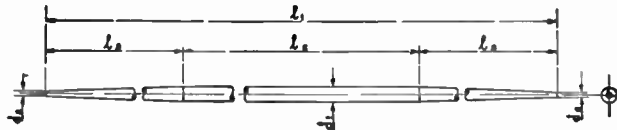

Detail of tapered armor rods

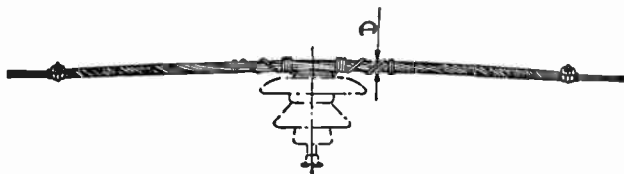

Installed on Pin-Type Construction

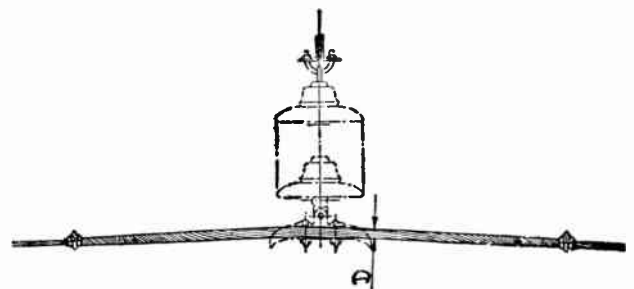

Installed on Suspension-Type Construction

Armor Rods Catalog Number Per Set	A.C.S.R. Size A.W.G. or CM	A.C.S.R. Stranding		No. of Rods Per Set	Armor Rods Dimensions in Inches					*Overall Diam. at Center	Alum. Weight in Lbs. Per Set	†Armor Rod Clip Cat. No.	†Armor Rod Clamp Cat. No.	Requires Wrench Frame Size	Die Cat. No.
		Alum.	Steel		L1	L2	L3	d1	d2						
1241	2/0	6	1	10	55	30	12 1/2	0.194	0.065	0.835	1.3	1104	1312.0	C	4207
1245	3/0	6	1	10	56	28	14	0.218	0.073	0.938	1.6	1105	1312.1	C	4209
1249	4/0	6	1	10	57	26	15 1/6	0.244	0.081	1.051	2.0	1105	1312.4	C	4209
§1291	2/0	6	1	10	71	46	12 1/2	0.191	0.065	0.835	1.8	1104	1312.0	C	4207
§1295	3/0	6	1	10	72	44	14	0.218	0.073	0.938	2.2	1105	1312.1	C	4209
§1299	4/0	6	1	10	73	42	15 1/6	0.244	0.081	1.051	2.8	1105	1312.4	C	4209
1251	266800	18	1	10	61 1/2	28 1/2	16 1/2	0.258	0.086	1.125	2.4	1106	1312.6	C	4210
1253	266800	6	7	10	62	27	17 1/2	0.273	0.091	1.179	2.6	1106	1312.7	C	4210
1253	266800	26	7	10	62	27	17 1/2	0.273	0.091	1.188	2.6	1106	1312.7	C	4210
1256	336400	18	1	10	63	25	19	0.297	0.099	1.278	3.0	1107	1313.2	B	4211
1258	336400	26	7	10	71 1/2	31 1/2	20	0.314	0.105	1.349	4.1	1107	1313.3	B	4211
1258	336400	30	7	10	71 1/2	31 1/2	20	0.311	0.105	1.369	4.1	1107	1313.4	B	4211
1258	397500	18	1	10	71 1/2	31 1/2	20	0.314	0.105	1.371	4.1	1108	1313.4	B	4211
1260	397500	26	7	10	72	30	21	0.332	0.111	1.447	4.5	1108	1314.0	B	4212
1261	397500	30	7	10	73	29	22	0.342	0.114	1.490	4.7	1108	1314.1	B	4212
1262	477000	18	1	10	73	28	22 1/2	0.352	0.117	1.518	4.9	1108	1314.1	B	4212
1263	477000	24	7	10	85	39	23	0.362	0.121	1.570	6.3	1108	1314.3	B	4212
1264	477000	26	7	10	86	38	24	0.372	0.124	1.602	6.8	1109	1314.3	BA	4212
1265	477000	30	7	10	86	37	24 1/2	0.383	0.128	1.649	7.2	1109	1314.4	BA	4213
1266	556500	24	7	10	86	36	25	0.394	0.131	1.702	7.5	1109	1314.6	BA	4213
1266	556500	26	7	10	86	36	25	0.394	0.131	1.715	7.5	1109	1314.6	BA	4213
1267	556500	30	7	10	99	47	26	0.405	0.135	1.763	9.4	1109	1315.1	BA	4213
1267	605000	24	7	10	99	47	26	0.405	0.135	1.763	9.4	1109	1315.1	BA	4213
1268	605000	26	7	10	99	46	26 1/2	0.416	0.139	1.798	10.0	1110	1315.2	BA	4213
1269	605000	30	19	10	100	45	27 1/2	0.428	0.143	1.850	11.0	1110	1315.3	BA	4213
1268	636000	24	7	10	99	46	26 1/2	0.416	0.139	1.809	10.0	1110	1315.2	BA	4213
1269	636000	26	7	10	100	45	27 1/2	0.428	0.143	1.846	11.0	1110	1315.3	BA	4213
1270	636000	30	19	10	112	56	28	0.441	0.147	1.901	13.0	1110	1315.4	A or AAA	4214

Armor rods are shipped in straight bundles tied in sets as follows:

- (a) 67" and less in length are tied at each end and at two intermediate points equally spaced.
- (b) Over 67" in length are tied at each end and at three intermediate points equally spaced.

*Choose suspension clamps or pin insulators with grooves preferable 5 to 15 per cent larger than this dimension.

§Armor rods for double supports.

†Armor rod clips (V-bolt type) or armor rod clamps are required for holding the ends of the armor rods. On high voltage lines where corona is a factor, armor rod clamps are preferred. Two clips or two clamps are required per set of rods.

For prices, and for details of larger-size rods, contact Graybar.

Alcoa A.C.S.R. Conductor Accessories
Armor Rod Clip (V-Bolt Type)

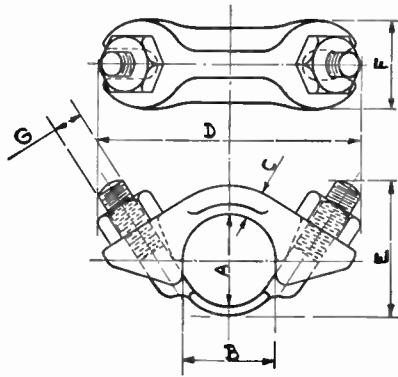

Armor Rod Clip Stock No.	Overall Diameter Accommodated "A" Inches		Dimensions Inches					Total Wt. Lbs.	
	Min.	Max.	B	C	D	E	F		G
1100	0.340	0.400	0.410	1/4	11 15/16	1 1/8	3/4	1/4	0.034
1101	0.401	0.490	0.460	1/4	2	1 9/16	3/4	1/4	0.036
1103	0.491	0.600	0.610	1/4	2 3/16	1 3/16	3/4	1/4	0.044
1104	0.601	0.660	0.660	5/16	2 11/16	1 9/16	29/32	5/16	0.075
1105	0.661	0.760	0.770	5/16	2 3/4	1 5/8	29/32	5/16	0.079
1106	0.761	0.860	0.870	5/16	2 7/8	1 5/8	59/64	5/16	0.085
1107	0.861	0.975	0.990	5/16	3 1/16	1 3/4	59/64	5/16	0.090
1108	0.976	1.115	1.130	5/16	3 1/4	1 7/8	15/16	5/16	0.096
1109	1.116	1.265	1.280	3/8	3 7/8	2 1/8	19/64	3/8	0.180
1110	1.266	1.440	1.455	3/8	4 1/16	2 1/4	15/32	3/8	0.190
1111	1.441	1.620	1.635	3/8	4 5/16	2 5/16	11 3/64	3/8	0.220
1112	1.621	1.815	1.830	3/8	4 9/16	2 1/2	17/32	3/8	0.220

Armor rod clips are made of strong aluminum alloy.

Armor Rod Clamps
For Tapered Armor Rods

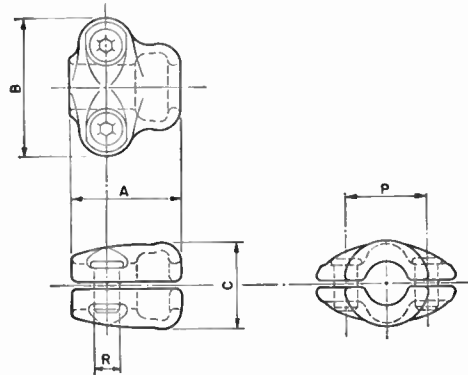

Armor Rod Clamp Catalog Number	Dimensions Inches					Total Wt. In Lbs.	Armor Rod Clamp Wrench Catalog Number
	A	B	C	P	R		
1312.0 to 7	2 1/4	2 3/4	1 5/8	1 1/16	1 1/2	0.28	4315
1313.1 to 6	2 7/16	3	1 7/8	1 7/8	9/16	0.42	4316
1314.0 to 6	2 5/8	3 3/8	2 1/8	2 1/8	5/8	0.58	4317
1315.1 to 8	2 13/16	3 5/8	2 3/8	2 3/8	5/8	0.67	4317
1316.0 to 6	3 1/16	4 1/4	2 3/4	2 3/4	3/4	1.02	4318
1317.1	3 1/4	4 1/2	3	3	3/4	1.10	4318

Note: For cable size and respective armor rod clamp see table, preceding page.

Aluminum Round Tie Wire

Bare				Covered			
Size AWG	Diam. In.	Tensile Strength Lbs.	Wt. Per 1000 Ft. Lbs.	Size AWG	Overall Diam. In.	Aluminum	Wt. Per 1000 Ft. Lbs. Total
Aluminum Tie Wire				DBWP			
6	0.162	210	24.2	4	0.330	38.4	63.0
4	0.204	333	38.4	6	0.290	24.2	44.7
2	0.258	625	61.1	2/64-In. Polyethylene			
Strong Aluminum Alloy Tie Wire				4	0.267	38.4	48.0
6	0.162	433	24.2	3/64-In. Neoprene			
				4	0.298	38.4	64.0

Standard shipment of Round Tie Wire is in 10, 25 and 50 lb. coils.
 Polyethylene Tie Wire is recommended for use on Polyethylene or Neoprene covered line wire.
 Neoprene Tie Wire is satisfactory for use on Neoprene covered line wire.

Alcoa Aluminum Flat Armor Wire
For A.C.S.R.

A.C.S.R. Size A.W.G.	A.C.S.R. Stranding	Diameter Over Cable and Armor	Flat Armor Wire Required Per Inch of Conductor Length, Feet	A.C.S.R. Size C. M. or A.W.G.	A.C.S.R. Stranding	Diameter Over Cable and Armor	Flat Armor Wire Required Per Inch of Conductor Length, Feet
6	6 A1./1 St.	0.258	0.24	266800	18 A1./1 St.	0.709	0.58
5	6 A1./1 St.	0.283	0.27	266800	26 A1./7 St.	0.742	0.61
4	6 A1./1 St.	0.350	0.27	266800	6 A1./7 St.	0.733	0.60
4	7 A1./1 St.	0.357	0.27	300000	26 A1./7 St.	0.780	0.64
3	6 A1./1 St.	0.381	0.31	336400	18 A1./1 St.	0.784	0.64
2	6 A1./1 St.	0.416	0.31	336400	30 A1./7 St.	0.841	0.69
2	7 A1./1 St.	0.425	0.33	336400	26 A1./7 St.	0.821	0.68
1	6 A1./1 St.	0.455	0.36	397500	18 A1./1 St.	0.843	0.69
1/0	6 A1./1 St.	0.498	0.39	397500	30 A1./7 St.	0.906	0.75
2/0	6 A1./1 St.	0.547	0.44	477000	26 A1./7 St.	0.883	0.73
3/0	6 A1./1 St.	0.602	0.49	477000	18 A1./1 St.	0.914	0.75
4/0	6 A1./1 St.	0.663	0.54	477000	30 A1./7 St.	0.983	0.82
					26 A1./7 St.	0.958	0.80

Prices on application.

Alcoa Aluminum Flat Armor Wire For Stranded Aluminum Conductors

Size AWG	Stranding	Stranded Aluminum Diameter Over Armor In.	Flat Armor Wire Required Per In. of Conductor Lgth., Ft.	Size C.M. or AWG	Stranding	Stranded Aluminum Diameter Over Armor In.	Flat Armor Wire Required Per In. of Conductor Lgth., Ft.
6	7	0.244	0.23	4/0	7	0.622	0.51
4	7	0.292	0.28	266,800	19	0.693	0.57
2	7	0.352	0.32	336,400	19	0.766	0.63
1/0	7	0.468	0.37	397,500	19	0.821	0.68
2/0	7	0.511	0.40	477,800	19	0.893	0.74
3/0	7	0.564	0.45				

Alcoa Straight Armor Rods for A.C.S.R.

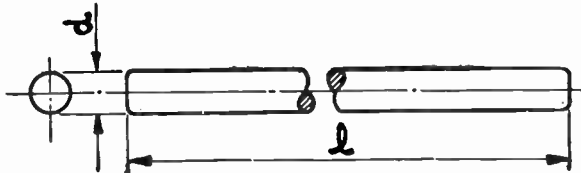

Armor Rods Cat. No. Per Set	A.C.S.R. Size A.W.G. or CM	A.C.S.R. Stranding		Number of Rods Per Set	Armor Rods Dimensions Inches			Alum. Weight in Pounds Per Set	†Requires Armor Rod Clip Cat. No.	Requires Wrench	
		Alum.	Steel		Rod Diam. (d) Inches	Lgth. (l) Inches	*Overall Diam. Inches			Frame Size	Die Cat. No.
1122	6	6	1	8	0.118	35	0.434	0.30	1101	C	1203
1123	5	6	1	8	0.134	35	0.491	0.39	1103	C	1203
1124	4	6	1	8	0.149	40	0.518	0.51	1103	C	1203
1124	4	7	1	8	0.149	40	0.555	0.51	1103	C	1203
1125	3	6	1	10	0.120	45	0.521	0.50	1103	C	1205
1126	2	6	1	10	0.135	45	0.586	0.63	1103	C	1205
1126	2	7	1	10	0.135	45	0.595	0.63	1103	C	1205
1127	1	6	1	10	0.151	50	0.657	0.87	1104	C	1207
1128 1	1/0	6	1	10	0.173	50	0.714	1.14	1105	C	1207
1129	2/0	6	1	12	0.149	55	0.745	1.12	1105	C	1225
1130	3/0	6	1	12	0.167	60	0.836	1.54	1106	C	1225
1131	4/0	6	1	12	0.188	65	0.939	2.11	1107	C	1225
1185 1	80000	8	1	10	0.160	50	0.688	0.98	1105	C	1207

For Double Supports

1152	6	6	1	8	0.118	47	0.434	0.40	1101	C	1203
1153	5	6	1	8	0.134	47	0.491	0.52	1103	C	1203
1154	4	6	1	8	0.149	52	0.518	0.71	1103	C	1203
1154	4	7	1	8	0.149	52	0.555	0.71	1103	C	1203
1155	3	6	1	10	0.120	57	0.521	0.63	1103	C	1205
1156	2	6	1	10	0.135	57	0.586	0.80	1103	C	1205
1156	2	7	1	10	0.135	57	0.595	0.80	1103	C	1205
1157	1	6	1	10	0.151	62	0.657	1.08	1104	C	1207
1158 1	1/0	6	1	10	0.173	66	0.714	1.51	1105	C	1207
1159	2/0	6	1	12	0.149	71	0.745	1.45	1105	C	1225
1160	3/0	6	1	12	0.167	76	0.836	1.95	1106	C	1225
1161	4/0	6	1	12	0.188	81	0.939	2.63	1107	C	1225

Straight armor rods are shipped in straight bundles tied in sets. †Two Clips required per set of rods.
 *Choose insulators or suspension clamps with grooves preferable 5 to 15 per cent larger than this dimension.
 ‡Wrench size "E" with integral die may be used for these sizes. †Wrench size "D" with integral die may be used for these sizes.

Alcoa Twisting Joints for A.C.S.R.



Cat. No.	A.C.S.R. Size A.W.G. or CM	Overall Diam. Cable In.	Oval Sleeve Dimensions		Thickness of Wall of Sleeve In.	Length Each Sleeve In.	I. D. Round Tubing Inches Before Being Made Oval Shape	Twists Each Sleeve	Total Weight Per Joint Lbs.
			Minor I.D. In.	Major I. D. In.					
551.2†	80000	0.367	0.439	0.854	0.065	18	45/64	4 1/2	0.58
546	6	0.198	0.266	0.511	0.065	10	27/64	4	0.20
545	5	0.223	0.297	0.567	0.065	11	15/32	1	0.25
544	1	0.250	0.328	0.623	0.065	12	33/64	4	0.28
543	3	0.281	0.359	0.679	0.065	11	9/16	4	0.34
542	2	0.316	0.391	0.758	0.065	15	5/8	4	0.42
541	1	0.355	0.433	0.833	0.065	17	11/16	4	0.52
540	1/0	0.398	0.469	0.910	0.065	19	3/4	4 1/2	0.61
529	2/0	0.447	0.525	1.000	0.065	21	53/64	4 1/2	0.75
528	3/0	0.502	0.578	1.118	0.065	23	59/64	4 1/2	0.89
527	4/0	0.563	0.640	1.254	0.065	26	11/32	4 1/2	1.20

Each joint consists of two aluminum sleeves. Catalog number specifies complete joint i. e., two sleeves. For making this joint two twisting wrenches are required. In ordering wrenches, specify same catalog number as joint. Prices on application.
 †Order Catalog No. 551 Twisting Joint Wrenches.



Perma-Grip Clamp

Chance Hot-Line Clamps

Provide secure, high-conductivity connections. Current carrying capacity is in proportion to that of the maximum jumper wire for which each clamp is designed.

Perma-Grip Clamps: These clamps made in a complete range of sizes, each being scientifically proportioned to give electrical conductivity without heating. They have high mechanical strength and have been proved in use for many years. Gripping jaws make a 3-point contact with conductors. USS threads permit quick, easy application and a tight, positive grip.

Protected Thread "P.C." Clamps: Have protective hood over all working parts and include a sealed waterproof thread chamber filled with corrosion-resistant compound. Clamps may be easily removed from the line after long periods of exposure and use.

Wide jaws assure good current distribution. Secure contact assured by locking spring. Jumper terminal above the conductor balances the eye screw to alleviate torsional stress.

"P.C." Clamps are available with contact surfaces precoated with Chance z.l.n. 100 Electrical Contact Aid. Each clamp is sealed in a transparent plastic bag to protect it from damage and foreign matter. Linemen can remove clamp without removing their globes by snipping end of bag with side-cutters.



Protected Thread Clamp

Perma-Grip Clamps

For Copper to Copper Connections

Number	Main Line Wire Sizes, A.W.G. or MCM			Jumper Wire Sizes, A.W.G. or MCM			Net Weight Pounds Per 100	Each
	Maximum Stranded Copper	Minimum Stranded Copper	Solid Copper	Maximum Stranded Copper	Minimum Stranded Copper	Solid Copper		
S1725-CC	2/0	6	8	2	8	10	64	\$1.29
S1730-CC	300	2	4	4/0	8	8	95	1.70
S1735-CC	550	1	1/0	250	4	4	155	3.48

For Copper to Aluminum Connections

Number	Main Line Wire Sizes, A.W.G. or MCM			Jumper Wire Sizes, A.W.G. or MCM			Net Weight Pounds Per 100	Each
	Maximum Stranded Copper	Minimum Stranded Copper	Solid Copper	Max. Bare	Min. Bare	Solid Copper		
S1735-CA	550	1	1/0	4/0	6	156	156	\$3.53

For Aluminum to Aluminum Connections

Number	Main Line Wire Sizes, A.W.G. or MCM			Jumper Wire Sizes, A.W.G. or MCM			Net Weight Pounds Per 100	Each
	Maximum ACSR Bare	Minimum ACSR w/Armor	Solid ACSR Bare	Maximum ACSR Bare	Minimum ACSR Bare	Solid ACSR Bare		
S1725-AA	2/0	6	8	2	8	10	64	\$1.50
S1730-AA	266.8	2	4	1/0	8	8	55	1.42
S1735-AA	397.5	3/0	2	6	4/0	6	95	2.97

For Aluminum to Copper Connections

Number	Main Line Wire Sizes, A.W.G. or MCM			Jumper Wire Sizes, A.W.G. or MCM			Net Weight Pounds Per 100	Each
	Maximum ACSR Bare	Minimum ACSR w/Armor	Solid ACSR Bare	Max. Copper	Min. Copper	Solid Copper		
S1725-AC	2/0	6	8	2	8	10	64	\$1.08
S1730-AC	266.8	2	4	1/0	8	8	56	1.45
S1735-AC	397.5	3/0	2	6	4	4	96	3.02

For General Purpose Connections

Number	Main Line Wire Sizes, A.W.G. or MCM			Jumper Wire Sizes, A.W.G. or MCM			Net Weight Pounds Per 100	Each
	Maximum Stranded Copper	Minimum ACSR Bare	Solid ACSR w/Armor	Maximum Stranded Copper	Minimum Stranded Copper	Solid ACSR Bare		
S1725-GP	2/0	6	8	2	8	10	64	\$1.34
S1730-GP	300	2	4	1/0	8	8	95	1.76
S1735-GP	550	3/0	2	6	4	4	155	3.64

Aluminum General Purpose—For ALL Connections

Number	Main Line Wire Sizes, A.W.G. or MCM			Jumper Wire Sizes, A.W.G. or MCM			Net Weight Pounds Per 100	Each
	Maximum ACSR Bare	Minimum ACSR w/Armor	Solid ACSR Bare	Maximum ACSR Bare	Minimum ACSR Bare	Solid ACSR Bare		
S1725-AGP	2/0	6	8	2	8	10	64	\$1.12
S1730-AGP	300	2	4	1/0	8	8	57	1.51
S1735-AGP	550	3/0	2	6	4	4	90	3.14

Protected Thread P.C. Clamps

For Copper to Copper Connections

Number	Main Line Wire Sizes, A.W.G. or MCM			Jumper Wire Sizes, A.W.G. or MCM			Net Weight Pounds Per 100	Each
	Maximum Stranded Copper	Minimum Stranded Copper	Solid Copper	Maximum Stranded Copper	Minimum Stranded Copper	Solid Copper		
S1515-CC	1	8	8	1	8	8	80	\$1.40
S1530-CC	250	6	6	4/0	6	6	115	2.10
S1540-CC	800	4/0	300	4	4	4	210	4.79
S1545-CC	1500	700	300	4	4	4	255	8.61

For Aluminum to Aluminum Connections

Number	Main Line Wire Sizes, A.W.G. or MCM			Jumper Wire Sizes, A.W.G. or MCM			Net Weight Pounds Per 100	Each
	Maximum ACSR Bare	Minimum ACSR w/Armor	Solid ACSR Bare	Maximum ACSR Bare	Minimum ACSR Bare	Solid ACSR Bare		
S1515-AA	2	8	8	2	8	8	80	\$1.39
S1530-AA	4/0	6	6	3/0	6	6	66	1.76
S1540-AA	636	266.8	300	4	4	4	130	3.80
S1545-AA	1431	556.5	605	4/0	4	4	155	7.06

For Aluminum to Copper Connections

Number	Main Line Wire Sizes, A.W.G. or MCM			Jumper Wire Sizes, A.W.G. or MCM			Net Weight Pounds Per 100	Each
	Maximum ACSR Bare	Minimum ACSR w/Armor	Solid ACSR Bare	Maximum Stranded Copper	Minimum Stranded Copper	Solid Copper		
S1515-AC	2	8	8	1	8	8	45	\$1.44
S1530-AC	4/0	6	6	4/0	6	6	67	1.81
S1540-AC	636	266.8	300	300	4	4	135	3.89
S1545-AC	1431	556.5	605	300	4	4	160	7.14

For General Purpose Connections

Number	Main Line Wire Sizes, A.W.G. or MCM			Jumper Wire Sizes, A.W.G. or MCM			Net Weight Pounds Per 100	Each
	Maximum Stranded Copper	Minimum ACSR Bare	Solid ACSR w/Armor	Maximum Stranded Copper	Minimum Stranded Copper	Solid ACSR Bare		
S1515-GP	1	8	8	1	8	8	80	\$1.50
S1530-GP	250	6	6	4/0	6	6	120	2.26
S1540-GP	800	4/0	300	300	4	4	215	5.12
S1545-GP	1500	1431	605	300	4	4	260	9.04

Aluminum General Purpose—For ALL Connections

Number	Main Line Wire Sizes, A.W.G. or MCM			Jumper Wire Sizes, A.W.G. or MCM			Net Weight Pounds Per 100	Each
	Maximum ACSR Bare	Minimum ACSR w/Armor	Solid ACSR Bare	Maximum Stranded Copper	Minimum Stranded Copper	Solid ACSR Bare		
S1515-AGP	1	8	8	1	8	8	80	\$1.49
S1530-AGP	400	336	6	4/0	6	6	120	1.85
S1540-AGP	800	636	300	300	4	4	215	4.01
S1545-AGP	1500	1431	605	300	4	4	260	7.43

*Straight and Preformed Aluminum Armor.

To order precoated individually packaged "P.C." Clamps, substitute "P" for "S" in the catalog numbers listed above. For example, S1515-CC becomes P1515-CC.

Quantity prices on request.

Chance Uniclamp Connectors



510 AGP Uniclamp

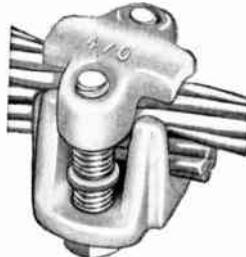

O-UC Uniclamp

Made in cadmium-coated and uncoated aluminum-bodied and copper-alloy bodied styles.

One-piece construction means there are no loose parts to drop. Castings swivel independently for easy installation.

For connecting large size copper or aluminum wires from No. 1/0 to 1000 Mcm.

Series 500 are available with contact surfaces precoated with z.l.n. 100 Electrical Contact Aid. Each clamp is sealed in a transparent plastic bag to protect it from damage and foreign matter. Linemen can remove clamp without removing their gloves by snipping end of bag with sidecutters.

Plated—For Aluminum and Copper Wires

No.	Max. Wire Size	Std. Pkg.	Per 100 Wt., Lbs.	Per 100
UC510AGP	1/0 ACSR	100	42	\$115.00
UC540AGP	4/0 ACSR	100	48	174.00

For Aluminum Wires

UC510A	1/0 ACSR	100	42	94.00
UC540	4/0 ACSR	100	48	151.00

For Copper to Copper Wires

0-UC	1/0 Copper	25	20	73.20
00-UC	2/0 Copper	25	27	85.60
0000-UC	4/0 Copper	12	55	138.10
35-I C	*350 Copper	6	100	270.40
50-UC	*500 Copper	6	120	315.40
75-I C	*750 Copper	5	167	402.10
100-UC	*1000 Copper	1	263	567.90

Plated—For Aluminum Wire

0-UC-A	1 ACSR	25	20	94.20
00-UC-A	2/0 ACSR	25	27	121.40
0000-UC-A	4/0 ACSR	12	55	195.90
35-UC-A	*300 ACSR	6	100	383.20
50-I C-A	*397.5 ACSR	6	120	447.20
75-I C-A	*666 ACSR	5	168	506.60
100-I C-A	*1033 ACSR	1	269	715.50

Add 15% to above prices for spacer bars.

*Mcm.

To order precoated individually packaged Series 500 Uniclamps, add "With z.l.n. and Package" after catalog number. Add \$5.00 per 100 to price shown.

Reliable Flip-On Tap Clamps

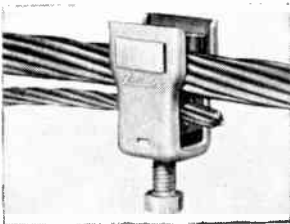

No. 555AL

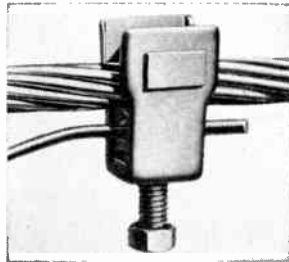

No. 555ALC

High strength heat treated aluminum alloys.

For connecting to copper or copperweld wires, bimetallic aluminum-copper inserts are used. The copper faces of this bimetal contact the copper wire, and the aluminum sides are locked into heavy sections of aluminum alloy which separate dissimilar wires and prevent corrosive action between them.

For ACSR Over Armor Rods to Aluminum or Steel Taps

No.	Line Side				Tap Side				Std. Pkg.	Ship. Wt. Per 100 Lbs.	Net Price Per 100
	Size, ACSR	Max.	Min.	Size, In.	Size, ACSR	Max.	Min.	Size, In.			
438AL	1/16	2	8	3/8	3/8	50	11 1/2	\$40.30
555AL	4	8	3/8	3/8	4	8	3/4	3/4	50	12	40.30
600AL	2	4	1/8	1/8	4	8	3/4	3/4	50	12	40.30
*744AL	1/0	4	3/8	3/8	1/0	4	3/8	3/8	25	10 1/2	52.30

For ACSR Over Armor Rods or Steel to Copper Taps

No.	Line Side				Tap Side				Std. Pkg.	Ship. Wt. Per 100 Lbs.	Net Price Per 100
	Size, ACSR	Max.	Min.	Size, In.	Size, ACSR	Max.	Min.	Size, In.			
438ALC	1/16	2AWG	10	3/8	3/8	50	13	\$42.10
555ALC	4	8	3/8	3/8	1AWG	12	3/4	3/4	50	13 1/2	42.10
600ALC	2	4	1/8	1/8	2AWG	8	3/4	3/4	50	13 1/2	42.10
*744ALC	1/0	4	3/8	3/8	1/0AWG	6	3/8	3/8	25	41	62.40

*744 Galvanized steel body and screw.

For Copper or Copperweld to Steel Guys or Aluminum Taps

No.	Line Side				Tap Side				Std. Pkg.	Ship. Wt. Per 100 Lbs.	Net Price Per 100
	AWG	AWG	Max.	Min.	Size, In.	Size, In.	Max.	Min.			
438CUG	1/0	6	3/8	1/8	2	4	1/4	1/4	50	14 1/2	\$42.10

Quantity prices on request.

Reliable Splitbolt Connectors



No. 4F



No. 9F



No. 206

For use with all types of conductors.

Tap connections for copper, copperweld, aluminum and steel conductors, and for guy strand.

Have precision threads to maintain high pressure solderless connections.

High copper content high strength bronze. Will resist corrosion and are not subject to season cracking.

For Copper and Copperweld Wires

Nos.	Forged	Machined	Max. Wire Sizes		Copper-weld	Std. Pkg.	Ship. Wt. Per 100 Pounds	Net Price Per 100 Broken Pkg
			A.W.G. Solid	A.W.G. Strand				
*9F	10	9	...	100	2	\$ 14.80
†*9FB	10	9	...	100	2 1/4	15.30
*8F	8	8	...	100	2 3/4	19.20
†*8FB	8	8	...	100	4	20.20
†6F	6	8	8A	100	7	21.20
†4F	4	5 & 6	6A	100	8 1/2	25.80
.....	230	3	4	5A	100	8 1/2	25.80
2F	2	3	4A	100	10 1/2	36.40
.....	1260	2	3	4A	100	14	38.90
1F	1/0	1 & 2	3A	100	13 1/2	39.80
1/0F	2/0	1/0	2A	50	19	53.10
2/0F	3/0	2/0	...	25	25	87.60
.....	528	4/0	4/0	...	25	54	148.70
.....	679	...	350MCM	...	12	78	303.90
.....	813	...	500MCM	...	12	97	394.80
.....	996	...	750MCM	...	6	172	759.50
.....	1152	...	1000MCM	...	6	271	1032.70

Reliable Split Bolt Connectors



No. 6FUU

Two Bimetal Separators

For: Copper to aluminum, aluminum to copper and copper or aluminum to steel.

Aluminum on inside radius of bimetal separators.

No.	Maximum Wire Size			Slot Size Inches	Std. Pkg.	Ship. Wt. Per 100, Lbs.	Net Price Per 100 Broken Pkg.
	Copper or Alum. AWG Solid	Alum. AWG Strand	ACSR				
6FUU	6	8168	100	7	\$29.40
4FUU	4	5	6	.218	100	10	34.10
2FUU	2	3	4	.272	100	13 1/2	44.70
1FUU	1/0	1	2	.316	100	15 1/2	48.00
1/0FUU	2/0	1/0	1	.377	100	25 1/2	61.30
2/0FUU	...	2/0	1/0	.437	25	34	91.70

Bimetal Separator Only As Used In FUU Above

6U for 6 solid AWG Split Bolt Connector.

4U for 4 solid AWG Split Bolt Connector.

2U for 2 solid AWG Split Bolt Connector.

1U for 2 strand AWG Split Bolt Connector.

1/0U for 1 0 strand AWG Split Bolt Connector.

2/0U for 2/0 strand AWG Split Bolt Connector.

Standard Package . . . 200—Shipping Wt. per 100 1 lb.
Net Price per 100 \$3.15

Plated Connectors



No. 9FGB



No. 2FGP

For Galvanized Steel to Copper

Made of a high strength bronze of 98% copper, with tin coating. A heavy separator spaces the dissimilar wires. With this connector it is easy to clamp a copper or copperweld neutral to a pigtail of stiff wire and maintain a high pressure joint.

Nos.	Maximum Wire Sizes Steel, B.W.G.				Copper Sol. A.W.G.	Std. Pkg.	Ship. Wt. Per 100, Pounds	Net Price Per 100 Broken Pkg.
	Forged	Machined	ACSR	Sol. Steel, B.W.G.				
*9FGB	12	9	100	2 1/4	\$20.50
*8FGB	10	7	100	...	22.20
6FGP	8	6	100	7 1/4	25.50
4FGP	6	6	8	...	4	100	9 3/4	31.00
2FGP	4	4	6	1/4"	2	100	13 1/2	43.80
1FGP	2	...	1	5/16"	1	100	17	47.90
1/0FGP	1	...	2	3/8"	2/0	50	23	63.80
2/0FGP	2/0	7/16"	3/0	25	30	105.40
528GP	4/0	4/0	25	75	171.00

For Two Galvanized Steel Wires

*9FG	12	9	100	2	\$18.70
*8FG	10	7	100	2 3/4	20.20
6FG	8	6	100	7	22.30
4FG	6	6	8	...	4	100	9	27.10
2FG	4	4	6	1/4"	2	100	11 1/2	38.30
1FG	2	...	4	5/16"	1/0	100	15 1/2	41.80
1/0FG	1	...	2	3/8"	2/0	50	21	55.70
2/0FG	2/0	7/16"	3/0	25	28	92.00
528G	4/0	4/0	25	62	156.10

*Bridging connectors for telephone and signal lines.

†Has washer.

‡Two- or three-wire.

#Three-wire.

Quantity prices on request.

Reliable Aluminum Connectors



No. 4AL

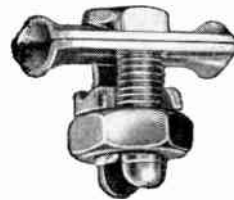

No. 2ALWW



No. 4ALA



No. 2ALCW

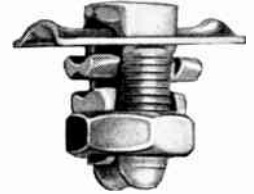

No. 6ALAW

High strength heat treated aluminum alloys. Provide maximum strength with minimum of corrosion problems. Also recommended for use on rural steel conductors.

Aluminum to Aluminum or Steel to Steel

No.	Maximum Wire Sizes Aluminum				Steel		Std. Pkg.	Ship. Wt. Per 100, Pounds	Net Price Per 100 Broken Pkg.
	SoL A.W.G.	Str. A.W.G.	ACSR	Solid B.W.G.—In.	Str. B.W.G.	Str. B.W.G.			
6AL	4	5	6	6	..	8	100	4	\$24.20
4AL	2	4	4	4	1/4	6	100	1 1/4	28.07
2AL	1	2	2	..	5/16	4	100	5 3/4	30.49
10AL	2/0	1/0	1/0	..	3/8	2	25	9	68.73

Aluminum to Aluminum With *Two Bell-Mouth Washers

6ALWW	4	6	6	6	..	8	100	5	\$30.26
4ALWW	2	4	4	4	1/4	6	100	5 1/2	35.09
2ALWW	1	2	2	..	5/16	4	100	7	38.12
10ALWW	2/0	1/0	1/0	..	3/8	2	25	11	85.92

*Also available with one bell-mouth washer only — less 5%.

Aluminum to Aluminum, Steel to Steel, Steel to Aluminum

6ALA	4	5	6	6	..	8	100	5	\$26.62
4ALA	2	4	4	4	1/4	6	100	5 1/2	30.88
2ALA	1	2	2	..	5/16	4	100	7	33.54
10ALA	2/0	1/0	1/0	..	3/8	2	25	11	75.60

Aluminum to Copper or Steel to Copper With Bi-Metal Separator, One Bell-Mouth Washer

No.	Maximum Wire Sizes Aluminum				Steel		Copper Str. A.W.G.	Std. Pkg.	Ship. Wt. Per 100, Pounds	Net Price Per 100 Broken Pkg.
	SoL A.W.G.	Str. A.W.G.	ACSR	Solid B.W.G.—In.	Str. B.W.G.	Str. B.W.G.				
6ALCW	4	5	6	6	..	8	6	100	8 1/2	\$31.64
4ALCW	2	4	4	4	1/4	6	4	100	10 1/2	36.69
2ALCW	1	2	2	..	5/16	4	2	100	14	39.85
10ALCW	2/0	1/0	1/0	..	3/8	2	1/0	25	16 1/2	89.82

Aluminum to Copper, Steel to Copper

6ALC	6	5	6	6	..	8	6	100	6	\$28.74
4ALC	2	4	4	4	1/4	6	4	100	8	33.34
2ALC	1	2	2	..	5/16	4	2	100	11	36.21
10ALC	2/0	1/0	1/0	..	3/8	2	1/0	25	15 1/2	81.62

Aluminum to Aluminum

6ALAW	4	5	6	6	..	8	8	100	6	\$30.26
4ALAW	2	4	4	4	1/4	6	6	100	6 1/2	35.09
2ALAW	1	2	2	..	5/16	4	4	100	7 3/4	38.12
10ALAW	2/0	1/0	1/0	..	3/8	2	2	25	12	85.92

Chance U-Bolt Connectors



1U-Bolt Connector

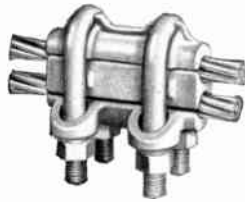

2U-Bolt Connector

Excellent for general-transmission and heavy-distribution connections, loops, taps, etc.

Available in a 1-bolt (with either aluminum or steel hardware) and a 2-bolt type (with aluminum hardware only).

Cast of high-strength, heat-treated aluminum alloy, these connectors are designed for making aluminum-to-aluminum connections.

They are "brightdipped" and coated with compound to assure low-resistance contact surfaces.

Both 1U-Bolt and 2M-Bolt Connectors are engineered for long-lived joint efficiency.

Contact surfaces have the area required to make tight, low-resistance connections.

Conductor grooves are contoured to trap all outside conductor strands — within the clamp-design range — to prevent "bird caging" under surge conditions.

Normal installation torque places castings and bolts under a resilient stress that maintains a good connection under varying operating loads and temperatures.

Chance 1U-Bolt and 2U-Bolt Connectors are designed to meet all applicable NEMA and REA specifications. They have been thoroughly tested to assure performance.

Available with contact surfaces precoated with Chance z.l.n. Electrical Contact Aid. Each connector is sealed in a transparent plastic bag to protect it from damage and foreign matter. Linemen can remove connector without removing their gloves by snipping end of bag with sidecutters.

Wire-Brush Conductors—Apply Contact Aid

1U-Bolt Connectors

Aluminum Hardware

No.	Main ASCR		Jumper ASCR		Main AWG Str.		Jumper AWG Str.		Each
	Max.	Min.	Max.	Min.	Max.	Min.	Max.	Min.	
A610AA	1/0	4	1/0	4	2/0	3	2/0	3	\$1.15
A640AA	4/0	1/0	4/0	1	250	2/0	250	1/0	1.41
					MCM	MCM	MCM		
A650AA	336.4	4/0	336.4	2/0	400	250	400	3/0	1.71
		MCM		MCM	MCM	MCM	MCM		

Steel Hardware

S610AA	1/0	4	1/0	4	2/0	3	2/0	3	\$0.85
S640AA	4/0	1/0	4/0	1	250	2/0	250	1/0	1.20
					MCM	MCM	MCM		
S650AA	336.4	4/0	336.4	2/0	400	250	400	3/0	1.40
		MCM		MCM	MCM	MCM	MCM		

2U-Bolt Connectors

Aluminum Hardware

A740AA	4/0	1/0	4/0	1/0	250	MCM	250	2/0	\$2.35
					MCM	MCM	MCM		
A750AA	336.4	266.8	336.4	266.8	400	300	400	300	2.55
	MCM	MCM	MCM	MCM	MCM	MCM	MCM	MCM	
A760AA	477	397.5	477	397.5	600	450	600	450	5.00
	MCM	MCM	MCM	MCM	MCM	MCM	MCM	MCM	

To order precoated individually packaged U-Bolt Connectors, add "With z.l.n. and Package" after catalog number. Add \$5.00 per 100 to price.

Contact GRAYBAR for quantity prices.

Reliable Two-Bolt Connectors

For Copper and Copperweld Wires

Designed to give high clamping pressure over the largest possible area. One-piece design . . . even when supplied with spacer.

Also supplied plated for use in making aluminum-to-aluminum connections and aluminum-to-copper connections.



Without Spacer

No.	Max. Wire Size, AWG		Std. Pkg.	Ship. Wt. Per 100, Lbs.	Net Price Per 100 Broken Pkg.
	Solid	Strand			
6000	3/0	2/0	25	25 1/2	\$ 85.60
6001	4/0	4/0	25	43	138.10
6002	...	350MCM	10	70	270.40
6003	...	500MCM	10	98	315.40

Spacer Type Two-Bolt Connectors

No.	Solid	Strand	Min. AWG	Std. Pkg.	Ship. Wt. Per 100, Lbs.	Net Price Per 100 Broken Pkg.
6010	3/0	2/0	8 Sol	25	27	\$ 98.40
6011	4/0	4/0	8 Sol	25	49 1/2	158.90
6012	...	350MCM	2 Str	10	77	310.90
6013	...	500MCM	1/0 Str	10	110	362.80
6014	...	750MCM	2 Sol	1	160
6015	...	1000MCM	2 Sol	1	262

Plated Two-Bolt Connectors—No Spacer

No.	ACSR	Maximum Wire Size		Str. Copper	Std. Pkg.	Ship. Wt. Per 100, Lbs.	Net Price Per 100 Broken Pkg.
		Str. Alum.	Str. Copper				
6020	2/0	2/0	2/0	2/0	25	26	\$ 92.00
6021	4/0	4/0	4/0	4/0	25	40	148.50
6022	300MCM	300MCM	300MCM	300MCM	10	71	290.70
6023	397.5MCM	500MCM	500MCM	500MCM	10	101 1/2	339.10

Spacer Type Plated Two-Bolt Connectors

No.	ACSR	Wire Size			Min. AWG	Std. Pkg.	Ship. Wt. Per 100, Lbs.	Net Price Per 100 Broken Pkg.
		Maximum Str. Alum.	Str. Copper	Str. Copper				
6030	2/0	2/0	2/0	2/0	8 Sol	25	37	\$ 121.40
6031	4/0	4/0	4/0	4/0	6 Sol	25	46	195.90
6032	300MCM	350MCM	350MCM	350MCM	2 Str	10	80	383.20
6033	397.5MCM	500MCM	500MCM	500MCM	1/0 Str	10	113	447.20
6034	666.6MCM	750MCM	750MCM	750MCM	2 Sol	1	163
6035	900MCM	1000MCM	1000MCM	1000MCM	2 Sol	1	265

Reliable Service Entrance Connectors

Aluminum Bodies

An extruded aluminum body with a lot of area and with slotted aluminum screw and two spacers provides a technically proper connector for aluminum to copper and aluminum to aluminum—the entire connection, when made up with conductors, is preponderantly aluminum.

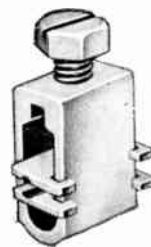

The first spacer under the screw protects the one conductor from screw. The second spacer separates the two conductors. Opposing spacer surfaces are grooved to line up the conductor. Aluminum bodies and aluminum spacers are cleaned and treated to eliminate oxidized contact surfaces.

Two Aluminum Spacers For Aluminum to Aluminum

No.	Size	Std. Pkg.	Ship. Wt. Lbs. Per 100	Net Price Per 100 Brkn. Pkg.
AL46KK	4-6 sol, str, ACSR	200	3	\$17.65
AL24KK	2-4 sol, str, ACSR	200	4	22.35

Two Bimetal Spacers For Aluminum to Copper

AL46U	4-6 sol, str, ACSR	200	3	\$21.20
AL24U	2-4 sol, str, ACSR	200	4	26.50

Reliable Service Entrance Connectors



No. R-68

Hexagon bodies have all corners rounded to allow minimum of tape without piercing. All connectors are clearly marked with wire size. Connectors take one maximum wire plus one or more smaller wires (AWG).

**Bronze Body—Slotted Screw
No Plate—No Spacer
For Copper to Copper**

No.	Size	Std. Pkg.	Shp. Wt. Lbs. Per 100	Net Price Per 100 Brkn. Pkg.
R-68	6-8 sol, str, AWG	200	3	\$10.50
R-46	4-6 sol, str, AWG	200	4	13.60
R-24	2-4 sol, str, AWG	200	5	27.00

Plated—With Spacer

**For Aluminum to Copper, Copper to Copper,
Aluminum to Aluminum**

R-68GP	6-8 sol, str, AWG	200	3 1/4	\$13.90
R-46GP	4-6 sol, str, AWG, 4ACSR	200	4 1/4	18.00
R-24GP	2-4 sol, str, AWG, 4ACSR	200	5 1/4	33.80

Service Entrance Connectors may not be assorted with Split Bolt Connectors to obtain quantity price. Quantity prices on request.

Chance Parallel Groove Clamps



No. PG100



No. PG200

These aluminum-alloy-bodied clamps are designed for low-cost, easy-to-install power-line connections. They are made in "AA" series for aluminum-to-aluminum connections and an "APG" series for all connection combinations. "AGP" clamps are protected with a heavy FORTIFIED cadmium coating that wards off oxidation and corrosion between unlike metals. "AA" clamps are uncoated.

There are two types of clamps as to contacts. Series 100 clamps have overlapping contacts on one side and a straight slide-in groove on the other. Series 200 clamps have overlapping contacts on both sides. Clamps are available with steel hardware.

Clamps are available with contact surfaces precoated with Chance z.l.n. 100 Electrical Contact Aid. Each clamp is sealed in a transparent plastic bag to protect it from damage and foreign matter. Linemen can remove clamp without removing gloves by snipping end of bag with sidecutters.

100 Series

No.	Line	Description	Tap	Wt. Per 100, Lbs.	Per 100
PG110-AA	1/0 to 6		1/0 to 6	18	\$ 29.25
PG110-AGP	1/0 to 6		1/0 to 6	18	49.00
PG120-AA	4/0 to 2		1/0 to 6	29.3	39.55
PG120-AGP	4/0 to 2		1/0 to 6	29.3	58.45
PG130-AA	336 MCM to 1/0		1/0 to 6	31.6	41.75
PG130-AGP	336 MCM to 1/0		1/0 to 6	31.6	57.55
PG140-AA	4/0 to 2		4/0 to 2	29.4	63.00
PG140-AGP	4/0 to 2		4/0 to 2	29.4	74.65
PG150-AA	556 MCM to 4/0		4/0 to 2	55.3	121.90
PG150-AGP	556 MCM to 4/0		4/0 to 2	55.3	174.20

200 Series

PG210-AA	1/0 to 8		1/0 to 8	19	29.25
PG210-AGP	1/0 to 8		1/0 to 8	19	49.00
PG220-AA	4/0 to 2		1/0 to 6	30.3	39.55
PG220-AGP	4/0 to 2		1/0 to 6	30.3	58.45
PG240-AA	4/0 to 2		4/0 to 2	30.4	63.00
PG240-AGP	4/0 to 2		4/0 to 2	30.4	74.65

Note: If aluminum hardware is desired, substitute "1" for "0" in the above numbers. For example: PG110-AA becomes PG111-AA.

To order precoated individually packaged Parallel Groove Clamps, add the suffix "P" to the Catalog numbers. For example, PG110-AA becomes PG110-AA-P.

Chance Parallel Groove Clamps



2-Bolt Clamp



3-Bolt Clamp

Designed to withstand high mechanical and electrical stress, for maximum joint efficiency and current-carrying capacity. They are adaptable to both distribution and heavy-service connections—for making jumper connections at dead-ends, or to connect tap lines or branch feeders to main-line conductors. They meet NEMA and REA specifications for power connectors.

Clamps are cast of high-strength, heat-treated aluminum alloy for use on ACSR or all-aluminum conductors. "Bright dipping" and a coating of compound assure low-resistance contact surfaces. Clamps available with either aluminum or steel hardware.

Clamp body is contoured to make the bolts self-aligning and self-centering, thus applying equal pressure on both main and tap lines. Conductor grooves contact and support all conductor strands.

Installed on brushed conductors, they will carry fault currents without pitting, arcing, or burning. Fault currents ranging from 8500 to 25,000 amperes were employed in tests.

Available with contact surfaces precoated with Chance z.l.n. 100 Electrical Contact Aid. Each clamp is sealed in a transparent plastic bag to protect it from damage and foreign matter. Linemen can remove clamp by snipping end of bag with sidecutters.

2-Bolt Parallel Groove Clamps

Catalog Numbers		Main Line and Jumper Line			
Al. Hrd.	Steel Hrd.	Max. ACSR	Min.	Max. AWG Str.	Min.
A310A	S310A	1/0	6	2/0	6 Sol.
A340A	S340A	4/0	2	250 MCM	1
A350A	S350A	336.4 MCM	1/0	400 MCM	1/0

3-Bolt Parallel Groove Clamps

A360A	S360A	447 MCM	4/0	600 MCM	250 MCM
-------	-------	---------	-----	---------	---------

To order precoated individually packaged 2 and 3-Bolt Parallel Groove Clamps, add "With z.l.n. and Package" after catalog number. Add \$5.00 per 100 to price.

Chance Cable Clamps

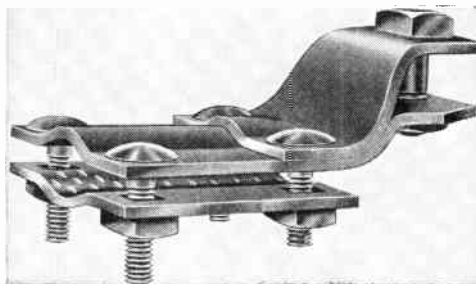

For use on outside and inside cable installations; also for supporting power cables at dead ends, corner turns, etc.

Can be used on all copper power cables from 3/0 to 2000 MCM inclusive. Only one size required. Must be clamped on bare wire after removing 4 1/2 in. of insulation.

They eliminate the need for costly splices, hazardous soldering operations and waste of costly cable, where power cable is used in industrial plants or on transmission cable where strains do not exceed 1200 lbs. (They are not for use on telephone or aluminum power cables.)

No.	Description	Wt. Per 100, Lbs.	Each
CC2	3/0-1500 MCM, galvanized for d-c	400	\$2.42
CC3	3/0-1500 MCM, galvanized (except for 2 Everdur bolts and nuts)	400	3.08
CC4	3/0-2000 MCM, galvanized for d-c	400	POA
CC5	3/0-2000 MCM, galvanized (except for 2 Everdur bolts and nuts)	400	POA

Reliable Straight-Thru Deadends

**For Aluminum Conductors
Solid Stainless Bail**



No.	Max. Wire Size (AWG)		AAA3	Std. Pkg.	Ship. Wt. Lbs. Per 100	Net Price Per 100 Broken Pkg.
	Solid	7 Strand				
AL61FDS	50	17	\$ 58.80
AL41FDS	6	6	6 Str. (7)	50	25	63.50
AL21FDS	3 & 4	4	4 Str. (7)	25	39	81.10
AL27FDS	2	25	37	103.50
AL101FDS	1	2	2 Str. (7)	25	39	110.50
AL107FDS	1/0	25	41	128.20
AL207FDS	2/0	...	1/0 Str. (7)	10	61	157.60
AL307FDS	3/0	...	2/0 Str. (7)	10	66	175.20
AL407FDS	4/0	...	3/0 Str. (7)	10	113	238.80

Deadends for ACSR, Flexible Bail

No.	Wire Size	Std. Pkg.	Ship. Wt. Lbs. Per 100	Net Price Per 100 Broken Pkg.
271FD	2ACSR 7/1	25	52	\$188.25
261FD	2ACSR 6/1	25	52	188.25
471FD	4ACSR 7/1	25	44	152.95
461FD	4ACSR 6/1	25	44	152.95

Deadends for ACSR, Stainless Bail

No.	Wire Size	Std. Pkg.	Ship. Wt. Lbs. Per 100	Net Price Per 100 Broken Pkg.
271FDS	2ACSR 7/1	25	52	\$144.68
261FDS	2ACSR 6/1	25	52	144.68
471FDS	4ACSR 7/1	25	41	131.89
461FDS	4ACSR 6/1	25	41	131.89

Only core wire extends through the jaws. Has pilot cup to cap aluminum strand ends.

Aluminum strands do not enter jaws unless core is properly located.

**Stranded Bronze
Neoprene Insulated Flexible Bail**



No.	Max. Wire Size (AWG)		*ACSR	Std. Pkg.	Ship. Wt. Lbs. Per 100	Net Price Per 100 Broken Pkg.
	Solid	7 Strand				
61FDN	6	8	...	50	26	\$102.50
41FDN	4	6	6	50	34	118.40
21FDN	2 & 3	3 & 4	4	25	49	150.20
27FDN	1	2	3	25	55	156.90
101FDN	1/0	1	2	25	76	187.40
107FDN	2/0	1/0	1	25	83	199.10
207FDN	3/0	2/0	1/0	10	127	290.90
307FDN	4/0	3/0	...	10	136	363.20
407FDN	...	4/0	...	10	245	423.50
250FDN	...	250MCM	...	10	250	441.20

Standard length Formed Bail (Centerline), 6 3/4-in.

**Deadend Adapters Only
For Use with Tension Splices and Strain Insulators**



No.	Max. Wire Size (AWG) Solid	7 or 19 Strand	Bail Length In.	Std. Pkg.	Ship. Wt. Lbs. Per 100	Net Price Per 100 Broken Pkg.
61DD	6	8	5 3/4	50	7	\$19.50
41DD	4	6	5 7/8	50	11 1/4	22.40
21DD	2 & 3	3 & 4	6	50	17 3/4	28.30

Rigid Clevis Type

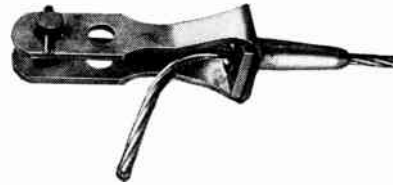

For Disc Insulators

Has sufficient length to allow space to feed the end of the wire through. Play is allowed between the cartridge and clevis hole to permit tilting so the wire may easily be fed through. The clevis is hot galvanized steel, with hole for inserting bolt or hook for pulling up slack.

For Copper Wires

No.	Max. Wire Size, A.W.G.			Std. Pkg.	Shipping Wt. Lbs. Per 100	Net Price Per 100 Broken Pkg.
	Solid	7 or 19 Strand	3 Strand			
61LD	6	8	...	50	54	\$121.40
41LD	4	6	6	50	52	126.70
21LD	2 & 3	3 & 4	4	25	118	141.60
27LD	1	2	3	25	122	192.40
101LD	1/0	1	2	25	132	217.00
107LD	2/0	1/0	1	25	132 1/2	217.00
*207LD	3/0	2/0	1/0	10	187 1/2	223.80
*307LD	4/0	3/0	...	10	195	307.10
*407LD	...	4/0	...	10	227	307.10
*250LD	...	250MCM	...	10	229	319.00

*Can be supplied with extra-length 13-in. clevis... change suffix to LLD and add \$23.00 per 100.

For ACSR

No.	Wire Size	Std. Pkg.	Ship. Wt. Lbs. Per 100	Net Price Per 100 Broken Pkg.
271LD	2ACSR 7/1	25	135	\$188.25
261LD	2ACSR 6/1	25	135	188.25
471LD	4ACSR 7/1	25	116	141.20
461LD	4ACSR 6/1	25	116	141.20

Only core wire extends through the jaws. Has pilot cup to cap aluminum strand ends. Aluminum strands do not enter jaws unless core is properly located.

For Aluminum

No.	Max. Wire Size (AWG)			AAAC	Std. Pkg.	Ship. Wt. Lbs. Per 100	Per 100
	Solid	7 Strand	*ACSR				
AL61LD	6	50	42 1/2	\$ 84.70
AL41LD	4	6	6	6 Str. (7)	50	45	87.00
AL21LD	2 & 3	3 & 4	4	4 Str. (7)	25	102	120.00
AL27LD	1	2	25	108	143.50
AL101LD	1/0	1	2	2 Str. (7)	25	113 1/2	150.50
AL107LD	2/0	1/0	25	114 1/2	176.40
†AL207LD	3/0	2/0	...	1/0 Str. (7)	10	161	194.10
†AL307LD	4/0	3/0	...	2/0 Str. (7)	10	168	198.80
†AL407LD	...	4/0	...	3/0 Str. (7)	10	194	234.10

*When used to support ACSR these automatic deadends develop more than the rated strength of the aluminum strand.

†For extra long (13") clevis use code LLD.

Reliable Straight-Thru Deadends

Flexible Clevis Type

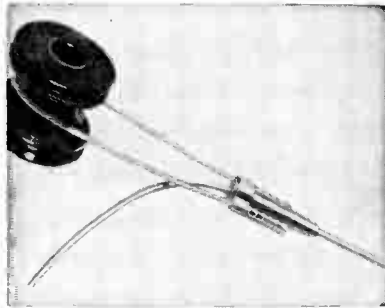

For deadending to spool or strain insulators... bail and yoke are of high strength bronze. The cartridge contains interlocked jaws, cold forged of silicon bronze, which grip with many tiny points and do not injure the wire or reduce its breaking strength. Permits easy adjustment of slack.

For Copper Wires

No.	Solid	Max. Wire Size, A.W.G. 7 or 19 Strand	3 Strand	Std. Pkg.	Shipping Wt. Lbs. Per 100	Net Price Per 100 Broken Pkg.
61FD	6	8	...	50	21½	\$87.80
41FD	4	6	6	50	30½	102.30
21FD	2 & 3	3	4	25	47	130.70
27FD	1	2	3	25	49	136.90
101FD	1 0	1	2	25	69½	164.80
107FD	2 0	1 0	1	25	72	167.60
207FD	3/0	2/0	1/0	10	114	246.50
307FD	4/0	3 0	...	10	121	309.90
407FD	...	4 0	...	10	208	377.80
250FD	...	250 MCM	...	10	212	417.00

For Aluminum Conductors

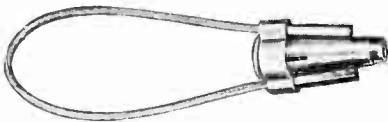

No. AL161FD

No.	Solid	Max. Wire Size (AWG) 7 Strand	*ASCR	AAAC	Std. Pkg.	Shp. Wt. Lbs. Per 100	Net Price Per 100 Broken Pkg.
A1.61FD	6	50	15	\$ 96.40
A1.41FD	4	6	6 Str. (7)	...	50	22	99.40
A1.21FD	2 & 3	3 & 4	4 4 Str. (7)	...	25	36	120.00
A1.27FD	...	2	25	34	142.30
A1.101FD	1/0	1	2	2 Str. (7)	25	35½	164.70
A1.107FD	2/0	1/0	25	37½	187.00
A1.207FD	3/0	2/0	...	1/0 Str. (7)	10	55½	202.30
A1.307FD	4/0	3/0	...	2/0 Str. (7)	10	59	235.20
A1.407FD	...	4/0	...	3/0 Str. (7)	10	101	316.40

*When used to support ACSR these automatic deadends develop more than the rated strength of the aluminum strand.

Extra Flexible Clevis Type

No.	Solid	Max. Wire Size—A.W.G. 7 or 19 Strand	3 Strand	Std. Pkg.	Shipping Wt. Lbs. Per 100	Net Price Per 100 Broken Pkg.
61FFD	6	8	...	50	21	\$ 95.50
41FFD	4	6	6	50	29	111.40
21FFD	2 & 3	3	4	25	46	142.20

Reliable Straight-Thru Deadends
Stainless Steel Clevis



Stainless steel bail is light, flexible, strong, and extremely corrosion resistant. Interchangeable with FD type.

Solid Stainless Bail

No.	Solid	Max. Wire Size, A.W.G. 7 or 19 Strand	3 Strand	Std. Pkg.	Shipping Wt. Lbs. Per 100	Net Price Per 100 Broken Pkg.
61LDS	6	8	...	50	16	\$91.00
41LDS	4	6	6	50	27	106.15
21LDS	2 & 3	3 & 4	4	25	45	135.50
27LDS	1	2	3	25	50	141.85
101LDS	1 0	1	2	25	100	170.95
107LDS	2/0	1 0	1	25	110	173.75

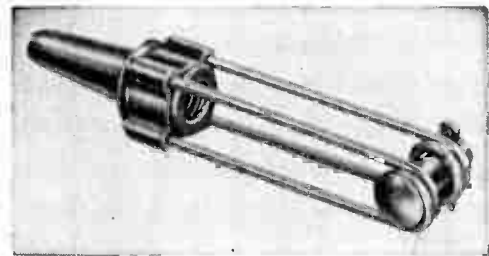

Stainless steel clevis assures long life in areas where rapid corrosion is a maintenance problem. Interchangeable with LD type.

Rigid Stainless Steel Clevis

No.	Solid	Max. Wire Size, AWG 7 or 19 Strand	3 Strand	Std. Pkg.	Shp Wt. Per 100, Pounds	Net Price Per 100 Broken Pkg.
61LDS	6	8	...	50	54	\$121.40
41LDS	4	6	6	50	55	126.70
21LDS	2 & 3	3 & 4	4	25	63	141.60
27LDS	1	2	3	25	66	192.40
101LDS	1/0	1	2	25	91	226.90
107LDS	2/0	1/0	1	25	94	226.90
207LDS	3/0	2/0	1/0	25	98	234.00
307LDS	4/0	3/0	...	25	156	321.10
407LDS	...	4/0	...	10	210	321.10
250LDS	...	{4/0-12 Str. } 250MCM	...	10	286	333.50

Stainless steel clevis pins supplied for LDS Deadends at a small additional cost.

Call Graybar FIRST For ...

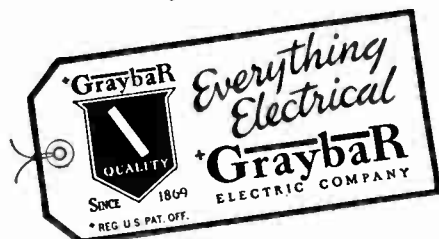

Reliable Deadend Pulling Hooks

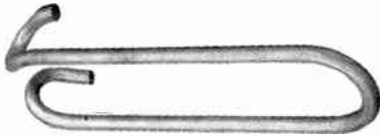

No. 9051

No.	Description	Net Price Each
9051	For 61 & 41 FD, FDS; all FD, FDS deadends for ACSR.....	\$0.75
9052	For 3/16 in. Strandvise; 47, 21, 27 FD, FDS.....	.85
9054	For 420 Snub Clamp; 47, 21, 27 LD; 8A thru 4ALD; 8AM thru 4AMLD.....	.75
9055	For 1/4 in. thru 5/16 in. Strandvise; 407, 250, FD, FDS.....	1.40
9056	For 101, 107, 207, 307, 407, 250 FD, FDS.....	.90
9057	For 61 & 41 LD.....	1.00
9058	For 101, 107, 207, 307, 407, 250 LD.....	1.00

Reliable Wirelink and Wirevise

Tension Splice and Deadend (Automatic Type)
For Communications Steel, Copper and Copperweld Wires

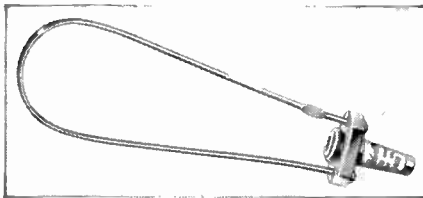

Wirevise

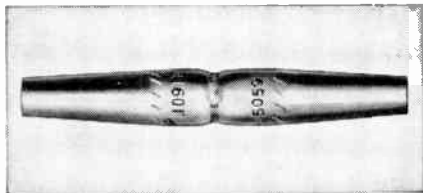

Wirelink

Wirevise

For use with rural distribution telephone cable supporting wire, and .109 and .120 conductor, and all 12 BWG steel wire. Heat-treated aluminum tubes with case-hardened, triple-protected steel jaws—deadend has aluminum yoke and stainless steel bail.

No.	Description	Wire Size	Ship. WL Lbs. Per 100	Net Price Per 100 Broken Package
5058	Wirevise	12 BWG .109	4 1/2	\$52.50
5062	Wirevise	.120-.134	18 3/4	70.60
5059	Wirelink	12 BWG .109	4	35.00
5063	Wirelink	.120-.134	8	45.90
*5059N	Wirelink	12 BWG .109	6	59.00
*5063N	Wirelink	.120-.134	11

*Neoprene covered.

Wirelink

Copper tubes, bronze jaws—deadend has bronze yoke and stainless steel bail for use with copper and copperweld.

5078	Wirevise	9 and 10 AWG	7 1/2	65.00
5079	Wirelink	9 and 10 AWG	6 1/2	45.00

Wirelink and Wirevise may be assorted in carton quantities or standard packages along with Straudlink and Strandvise to obtain quantity prices.

Quantity prices on request.

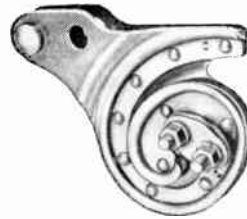

Reliable Snub Deadends

For use on ACSR without armor tape.

Develops approximately the strength of the conductor and distributes the strain equally on all strands. The spiral form carries the snub principle to full advantage.

Easy to install; has enough margin of holding power so that moderate tightening of the clamp develops the full strength of the wire.

The light weight of the clamp minimizes vibration fatigue strains and prolongs the life of the conductor.

For Sizes 2 or 1 ACSR Wires.

No. 420 Shipping Weight 1 1/4 lbs. Each \$1.42

Pulling Hook for Snub Deadend



No. 9054—Pulling Hook for Snub Deadend.... Each \$0.75

Reliable Strandvise With Stainless Steel Bail



For deadending galvanized, corrosion resistant or stainless steel suspension strand; guy strand; static wire. All grades and all tension ratings.

Short Bail for All Standard Hardware Eyes

No.	Strand Size Inches	Ship. WL Lbs. Per 100	Net Price Per 100 Brkn. Pkg.
5099	3/16	45	\$110.00
5100	1/4	48	114.00
5101	5/16, 9/32	85	134.00
5102	3/8, 11/32	110	165.00
5103	7/16	121	195.00

Long Bail for 502 and 504 Insulator Types

5149	3/16	50	113.00
5150	1/4	55	118.00
5151	5/16, 9/32	105	147.00
5152	3/8, 11/32	130	179.00
5153	7/16	140	220.00

Long Bail for 506 Insulator Type

5151-6	5/16, 9/32	105	147.00
5152-6	3/8, 11/32	130	179.00
5153-6	7/16	140	220.00

With Flexible Bail



Universal Bail 8-In.

No.	Strand Size Inches	Ship. WL Lbs. Per 100	Net Price Per 100 Brkn. Pkg.
5170	1/4	85	\$159.00
5171	5/16, 9/32	90	188.25
5172	3/8, 11/32	130	220.00
5173	7/16	155	271.00

False Deadend, Long Bail—18-In.

5175	5/16, 9/32	116	205.90
5176	3/8, 11/32	170	249.40
5177	7/16	178	294.00

False Deadend, Long Bail—24-In.

5179	5/16, 9/32	140	229.00
5180	3/8, 11/32	174	282.00
5181	7/16	182	329.00

Quantity prices on request.

Reliable Steelcase Strandviser and Gripping Chucks

End Anchors for Prestressed Concrete



The self-acting parts are removable. Gripping chuck, catalogued separately by the set, can be speedily renewed. Strandviser is packed two pieces in a sealed oil proof pouch with twelve pair (24 pcs.) in a carton or std. pkg.

Steelcase Strandviser (Complete)

No.	Wire Range	Dimensions, In. Width Lgth.	Ship. Wt. Lbs. Per 100	Net Price Each
5972	8BWG-(.144-.165 Dia.)	5/8 27/32	16	\$1.05
5973	6BWG-(.180-.206 Dia.)	3/4 229/64	20	1.10
5974	4BWG and 1/4" (7 Str.) (.230-.260 Dia.)	7/8 259/64	32	1.20
5975	5/16" (7 Str.) and Rod (.280-.320 Dia.)	1 1/8 3 11/32	55	1.65
5976	3/8" (7 Str.) and Rod (.340-.380 Dia.)	1 1/4 3 41/64	79	2.10
5977	1/2" (7 Str.) and Rod (.430-.445 Dia.)	1 1/2 3 51/64	83	2.20

Replacement Gripping Chucks Sets—3 Jaws with Suspension Ring

No.	Size	Dimensions, In. Width Lgth.	Ship. Wt. Lbs. Per 100 Sets	Net Price Per Set
5982	8BWG	5/8 2 3/8	2.5	\$0.40
5983	6BWG	3/4 2 11/32	3.5	.40
5984	1/4"	7/8 2 47/64	7.0	.40

5985	5/16"	1 1/16	3 3/64	13.3	.48
5986	3/8"	1 3/16	3 29/64	19.0	.52
5987	7/16"	1 1/4	3 9/16	19.0	.52

Packed 1 set per envelope.

Wax Wraps for Steelcase Strandviser

For enclosing the gripping chucks. Reduces the problem of removing a piece of strand following heavy tensions

No.	Envelope Quantity (approx.)	Steelcase Chuck Sizes	Net Price Per 100
5972-W	100	#8 & 6 BWG	\$0.25
5974-W	100	1/4" & 5/16"	.25
5976-W	100	3/8" & 7/16"	.25

Strandviser Capped Aluminum Tube



End anchors for prestressed concrete. Also used as strand end anchors on leaders in preloading equipment for utility cables.

An automatic terminal for anchoring wire, strand, or rod.

No.	Wire Size	Ship. Wt. Lbs. Per 100	Net Price Per 100
5952-A	8BWG (.144-.165 dia.)	17	\$ 52.00
5953-A	6BWG (.180-.206 dia.)	12	58.00
5954-A	4BWG and 1/4" (7 str.) (.230-.260 dia.)	8	53.00
5955-A	5/16" (7 str.) and rod (.280-.320 dia.)	35	80.00
5956-A	3/8" (7 str.) and rod (.340-.380 dia.)	48	88.00
5957-A	1/2" (7 str.) and rod (.420-.445 dia.)	57 1/2	108.00

Quantity prices on request.

Reliable Strandlinks



For splicing galvanized, corrosion resistant or stainless steel suspension strand; guy strand; static wire. All grades and all tensile ratings.

No.	Strand Size Inches	Ship. Wt. Lbs. Per 100	Net Price Per 100 Brkn. Pkg.
4999	3/16	31	\$103.00
5000	1/4	33	105.00
5001	5/16, 9/32	63	121.00
5002	3/8, 11/32	85	141.50
5003	7/16	106	179.00

Reducer Strandlink



No.	Strand Size Inches	Ship. Wt. Lbs. Per 100	Net Price Per 100 Brkn. Pkg.
5022	3/8 or 11/32 to 5/16 or 9/32	85	\$155.00
5023	7/16 to 3/8 or 11/32	95	193.00

Quantity prices on request.

Reliable Insulated Tension Splices



Consist of two straightline splice units attached to an insulating section of strong, tough glass melamine with high dielectric strength, low moisture absorption and great chemical stability. Convenient for sectionalizing secondaries, for secondary banking, for series street lighting and wherever a break is needed in the line. They will develop full line wire strength and can be installed on existing construction without splicing in an extra piece of wire or resagging the line.

For Copper Wires

No.	Max. Wire Size, A.W.G. 7 or 19 Strand		Insulated Lgth. In.	Std. Pkg.	Ship. Wt. Per 100, Pounds	Net Price Per 100 Broken Pkg.
	Solid	Strand				
61XM-1	6	8	1	50	23	\$204.60
41XM-1	4	6	1	50	32	244.00
*21XM-1	2	3	1	50	42	289.40
*27XM-1	1	2	1	50	44	346.30
61XM-3	6	8	3	50	25	254.70
41XM-3	4	6	3	50	34	291.20
*21XM-3	2	3	3	50	45	404.70
*27XM-3	1	2	3	50	47	486.40

With Clips for Attaching to Fuse or Tap Wires

No.	Max. Wire Size, A.W.G. 7 or 19 Strand		Insulated Lgth. In.	Std. Pkg.	Ship. Wt. Per 100, Pounds	Net Price Per 100 Broken Pkg.
	Solid	Strand				
61XMC-1	6	8	1	50	30	\$230.60
41XMC-1	4	6	1	50	40	271.70
*21XMC-1	2	3	1	50	49	318.90
*27XMC-1	1	2	1	50	52	374.10
61XMC-3	6	8	3	50	32	280.70
41XMC-3	4	6	3	50	42	319.00
*21XMC-3	2	3	3	50	52	432.50
*27XMC-3	1	2	3	50	55	451.20

*Maximum load capacity, 2,000 lbs.

Reliable Reducer Splices



These combination splices will save money in urban distribution where a line drops a portion of its load and the next smaller wire size will carry the current flowing through the rest of the line.

For Copper Wire Combinations

No.	Wire Size, AWG		Std. Pkg.	Ship. Wt. Per 100, Pounds	Net Price Per 100 Broken Pkg.
	Large End	Small End 7 or 19 Strand			
4161	4	6	6	8	50 22 1/2 \$ 84.90
4741	4	4	4	6	50 28 99.80
2161	2 & 3	3	6	8	50 24 99.80
2141	2 & 3	3	4	6	50 33 99.80
2761	1	2	6	8	25 26 1/2 120.10
2741	1	2	4	6	25 31 120.10
2721	1	2	2 & 3	3	25 35 120.10
10121	1/0	1	2 & 3	3	25 42 142.60
10141	1/0	1	4	6	25 42 142.60
10127	1/0	1	1	2	25 45 142.60
10721	2/0	1/0	2 & 3	3	25 43 157.80
10727	2/0	1/0	1	2	25 44 1/2 157.80
10741	2/0	1/0	4	6	25 36 157.80
107101	2/0	1/0	1/0	1	25 59 157.80
20721	3/0	2/0	2 & 3	3	25 48 180.20
20727	3/0	2/0	1	2	25 54 180.20
207101	3/0	2/0	1/0	1	25 62 180.20
207107	3/0	2/0	2/0	1/0	25 68 180.20
30727	4/0	3/0	1	2	25 66 225.30
307107	4/0	3/0	2/0	1/0	25 69 225.30
307207	4/0	3/0	3/0	2/0	25 73 225.30
407107	4/0	2/0	1/0	1	25 82 267.30
407207	4/0	3/0	2/0	1	25 91 267.30
407307	4/0	4/0	3/0	2/0	25 109 267.30
250407	250MCM	4/0	20	158	296.10

Quantity prices on request.

Reliable Straightline Splices

These splices will break soft, medium or hard drawn copper, solid, three-strand, or seven-strand at approximately its full strength. All have screwdriver slot release.



For Copper Wires

No.	Max. Wire Size, A.W.G.		Std. Pkg.	Ship. Wt. Per 100, Pounds	Net Price Per 100 Broken Pkg.
	Solid	7 or 19 Strand			
61	6	8	50	13 1/2	\$59.20
41	4	6	50	22	75.30
21	2 & 3	3 & 4	50	32	88.70
27	1	2	25	37	106.60
101	1/0	1	25	48 1/2	126.70
107	2/0	1/0	25	53	139.90
207	3/0	2/0	25	68	160.10
307	4/0	3/0	25	80	200.00
407	4/0	4/0	25	126	237.40
250	250MCM	20	133		262.80



For ACSR (Aluminum Cable, Steel Reinforced)

No.	Size ACSR	Std. Pkg.	Ship. Wt. Per 100, Pounds	Net Price Per 100 Broken Pkg.
271	2 ACSR 7/1	25	56	\$162.52
261	2 ACSR 6/1	25	56	162.52
471	4 ACSR 7/1	25	40	148.39
461	4 ACSR 6/1	25	40	148.39

Reliable Straightline Splices

"55" Series Tension Splice For Copper Conductors



A new splice designed to prevent improper installation of stranded conductors. Conductor ends reach well past the gripping jaws. Factory-installed pilot cups prevent jaws from gripping conductor until conductor is "home".

No.	Solid	Max. Wire Size (AWG) 7 or 19 Str.	3 Str.	Std. Pkg.	Ship. Wt. Lbs. Per 100	Net Price Per 100 Broken Pkg.
5527	1	2	3	25	46 1/2	\$122.80
55101	1/0	1	2	25	60	145.70
55107	2/0	1/0	1	25	62	161.10
55207	3/0	2/0	1/0	25	90	184.10
55307	4/0	3/0	...	25	102	230.10
55407	...	4/0	...	25	144	272.90
55250	...	{4/0-12Str.}	...	20	152	302.20

"55" Series Feed-Thru Type Tension Splice For Aluminum Conductors



Heat treated aluminum tubes, housing heat treated aluminum gripping chucks make up these tension splices and deadends for all aluminum solid and stranded conductors. These same splices and deadends are also suitable for aluminum alloy conductors.

Only splice cat. nos. AL61, AL41 and AL21 for solid conductors have release slots. Starting with cat. no. AL5547, all splices for stranded conductors are "55" Series feed-thru type with pilot cups. Strand end is enclosed by cup and guided through gripping chuck to center stop. All splices are greased and individually packaged at the factory.

No.	Max. Wire Size (AWG)			Std. Pkg.	Ship. Wt. Lbs. Per 100	Net Price Per 100 Broken Pkg.
	Solid	7 Strand	AAAC			
AL5547	3	4	...	25	18	\$ 71.70
AL5527	1	2	...	25	18 1/2	107.00
AL55101	1/0	1	2 Str. (7)	25	23	112.90
AL55107	2/0	1/0	...	25	24 1/2	120.00
AL55207	3/0	2/0	1/0 Str. (7)	25	37 1/2	129.40
AL55307	4/0	3/0	2/0 Str. (7)	25	38	138.80
AL55407	...	4/0	3/0 Str. (7)	25	55 1/2	194.10

Release Slot Type Tension Splice For Aluminum Conductors

No.	Max. Wire Size (AWG)		Std. Pkg.	Ship. Wt. Lbs. Per 100	Net Price Per 100 Broken Pkg.
	Solid	AAAC			
AL61	6	...	50	5 1/2	\$43.50
AL41	4	6 Str. (7)	50	8	48.20
AL21	2 & 3	4 Str. (7)	50	13	67.00

Reliable Tension Splices for Solid Steel Wire



No.	Wire Size	Std. Pkg.	Ship. Wt. Lbs. Per 100	Net Price Per 100 Broken Pkg.
5060	8BWG (.144-.165 dia.)	50	14	\$94.00
5061	6BWG (.180-.206 dia.)	25	21	96.50

Quantity prices on request.

Reliable Insulated Splicing Assemblies

An insulated splicing assembly made up of two FDS Dead-ends assembled on a wet process insulator. Ideal for sectionalizing secondaries and cutting line for series street lighting circuits. Have flash-over values at 60 cycles as follows: Dry 20 kv.; Fog Conditions 7 kv.; Wet 4 kv. (500 type)



For Copper

No.	Type Insulator	Max. Wire Size (AWG)			Std. Pkg.	Net Price Per 100 Broken Pkg.
		Solid	7 or 19 Strand	3 Strand		
5725	500	6	8	...	25	\$204.60
5726	500	4	6	6	25	244.00
5727	500	2 or 3	3 or 4	4	25	291.20
5728	500	...	2	3	25	307.00
5735	502	6	8	...	25	204.80
5736	502	4	6	6	25	244.20
5737	502	2 or 3	3 or 4	4	25	291.40
5738	502	...	2	3	25	307.20
5729	504	...	1	2	25	323.60
5730	504	...	1/0	1	10	329.00
5731	504	...	2/0	1	10	483.30
5732	504	...	3/0	1/0	10	607.40
5733	504	...	4/0	...	10	607.40

For ACSR

No.	Type Insulator	Wire Size	Std. Pkg.	Net Price Per 100 Broken Pkg.
5739	500	2 ACSR 7/1	10	\$315.00
5740	500	2 ACSR 6/1	10	315.00
5741	500	4 ACSR 7/1	10	287.50
5742	500	4 ACSR 6/1	10	287.50
5743	502	2 ACSR 7/1	10	323.70
5744	502	2 ACSR 6/1	10	323.70
5745	502	4 ACSR 7/1	10	294.30
5746	502	4 ACSR 6/1	10	294.30

For Aluminum

No.	Type Insulator	Max. Wire Size (AWG)			Std. Pkg.	Net Price Per 100 Broken Pkg.
		Solid	7 Strand	ACSR		
AL5725	500	6	25	\$216.40
AL5726	500	4	6	6	25	222.30
AL5727	500	2 or 3	3 or 4	4	25	263.50
AL5728	500	...	2	...	25	308.20
AL5735	502	6	25	216.70
AL5736	502	4	6	6	25	222.50
AL5737	502	2 or 3	3 or 4	4	25	263.70
AL5738	502	...	2	...	25	308.40
AL5729	504	...	1	2	25	352.90
AL5730	504	...	1/0	...	10	397.60
AL5731	504	...	2/0	...	10	316.10
AL5732	504	...	3/0	...	10	351.40
AL5733	504	...	4/0	...	10	478.40

Call Graybar FIRST For ...

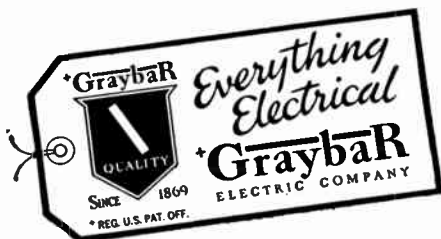

Reliable Split Cable Sleeves

Tinned Copper

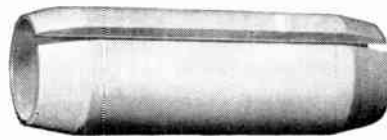

Conform to E.E. I. recommended specification TD-8, 1940, for straight tinned copper connectors for stranded conductors. Smoothly tinned; easily soldered.

For use on round or sector cable. Dead soft anneal permits tight clamping on conductor before soldering.

No.	A.W.G. (B. & S.) Size and Type Stranding				Lgth. In.	Std. Pkg.	Ship. Wt. Per 1000 Pounds	Net Price Per 100
	Solid Wire	Round Conc. Strand	Round Compact Strand	Sector & Strand Compact Strand				
SC10	12	1 1/2	500	5	\$ 5.62
SC11	10	12	1 1/2	300	5	7.68
SC12	9	10	1 1/2	200	5 1/2	8.07
SC13	8	9	1 1/2	200	6 1/2	8.51
SC14	7	8	1 1/2	200	6 1/2	9.37
SC15	6	7	1 1/2	200	10	10.19
SC16	5	6	1 1/2	150	20	11.20
SC17	4	5	1 1/2	125	20	12.22
SC18	3	4	2	100	30	12.98
SC19	2	3	2	100	25	13.64
SC20	1	2	2	100	40	14.74
SC21	1/0	1	1/0	...	2	100	40	16.54
SC22	2/0	1/0	2/0	1/0	2	100	50	27.18
SC23	3/0	2/0	3/0	2/0	2	100	65	28.84
SC24	4/0	3/0	4/0	3/0	2	75	85	33.57
SC25	...	1/0	250MCM	1/0	2 1/2	50	140	38.62
SC26	...	250MCM	300MCM	250MCM	2 1/2	50	150	44.73
SC27	...	300MCM	350MCM	300MCM	2 1/2	20	180	48.67
SC28	...	350MCM	400MCM	350MCM	2 1/2	20	240	54.92
SC29	...	400MCM	500MCM	...	3	10	280	72.26
SC30	...	450MCM	550MCM	400MCM	3	10	320	73.66
SC31	...	500MCM	600MCM	450MCM	3	10	310	75.00
SC32	...	550MCM	650MCM	500MCM	3	10	410	94.43
SC33	...	600MCM	700MCM	550MCM	3 1/2	10	500	118.82
SC34	...	650MCM	750MCM	600MCM	3 1/2	10	520	129.46
SC35	...	700MCM	800MCM	650MCM	3 1/2	10	510	134.40
SC36	...	750MCM	900MCM	700MCM	3 1/2	10	600	135.91
SC37	...	800MCM	950MCM	750MCM	4	Bulk	620	152.58
SC38	...	850MCM	1000MCM	...	4	Bulk	690	168.67
SC39	...	900MCM	4	Bulk	750	182.31
SC40	...	950MCM	4	Bulk	840	199.07
SC41	...	1000MCM	4 1/2	Bulk	1030	211.11
SC42	...	1250MCM	4 1/2	Bulk	1200	307.34
SC43	...	1500MCM	5	Bulk	1650	374.73
SC44	...	1750MCM	5 1/2	Bulk	2100	467.05
SC45	...	2000MCM	6	Bulk	2725	630.00
SC46	...	2500MCM	6 1/2	Bulk	3300	770.24

Reliable Repair and Transportation Sleeves

For Solid Copper Wire

No.	Wire Size	Die Groove	Std. Pkg.	Ship. Wt. Lbs. Per 100	Net Price Per 100
12L-C-1	12 AWG	C	50	6	\$10.65
12L-D-1	12 AWG	D	100	7 1/4	18.67
10L-C-1	10 AWG	C	100	5 3/4	12.45
10L-D-1	10 AWG	D	100	6	18.67
9L-D-1	9 AWG	D	100	6 1/2	18.67
8L-D-1	8 AWG	D	100	7 1/2	18.67
8L-J-1	8 AWG	J	100	16 3/4	26.70
6L-J-1	6 AWG	J	100	17 1/4	26.70

For Galvanized Steel Conductors

14L-C-2	14 BWG	C	100	6	\$11.77
12L-C-4	12 BWG	C	100	5 1/4	13.57
12L-D-2	12 BWG	D	100	6 3/4	13.57
10L-J-2	10 BWG	J	100	17	26.17
9L-J-2	9 BWG	J	100	16 3/4	28.87
8L-J-2BB	8 BWG	J	100	18 1/2	32.02

Quantity prices on request.

Reliable Squeez Sleeves
Single Tube Compression Type

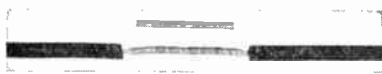

For Drop, Bridle and Inside Wire — Copper, Copperweld and Bronze

No.	Wire Size	Die Groove	Std. Pkg.	Ship. Wt. Per 100, Pounds	Net Price Per 100
19-22-A-3	19-20-22 AWG	A	200	1 ³ / ₄	\$ 2.25
19-24-A-3	19-24 AWG	A	200	1 ³ / ₄	2.25
17-18-B-3	17-18 AWG	B	100	1 ¹ / ₂	2.25
16-B-3	16 AWG	B	100	1 ¹ / ₂	2.25
14-B-3	14 AWG	B	100	1 ¹ / ₂	2.25

For Solid Copper Wire

14-C-1	14 AWG	C	100	1 ³ / ₄	4.09
12-C-1	12 AWG	C	100	1 ¹ / ₂	4.27
12-D-1	12 AWG	D	100	2	7.48
10-C-1	10 AWG	C	100	1 ³ / ₄	4.99
10-D-1	10 AWG	D	100	1 ³ / ₄	7.48

9-D-1	9 AWG	D	100	1 ³ / ₄	7.48
8-D-1	8 AWG	D	100	1 ³ / ₄	7.48
8-J-1	8 AWG	J	100	4 ¹ / ₄	10.69
6-J-1	6 AWG	J	100	4 ¹ / ₂	10.69
6-M-1	6 AWG	M	50	5 ³ / ₄	10.69

4-M-1	4 AWG	M	50	7 ¹ / ₂	19.42
4-P-1	4 AWG	P	50	8 ³ / ₄	19.42
3-P-1	3 AWG	P	50	4 ¹ / ₂	22.82
2-X-1	2 AWG	X	50	11 ³ / ₄	38.49
2-T-1	2 AWG	T	50	12	30.12
1-X-1	1 AWG	X	50	13	38.49



For Stranded Copper Wire

6 Str-J-1	6 AWG 7 str.	J	100	4 ³ / ₄	\$10.69
4 Str-M-1	4 AWG 7 str.	M	50	6	19.42
4 Str-P-1	4 AWG 7 str.	P	50	9	19.42

2 Str-T-1	2 AWG 7 str.	T	50	10 ¹ / ₂	30.12
2 Str-X-1	2 AWG 7 str.	X	50	11 ¹ / ₂	38.49
2/3 Str-X-1	2 AWG 3 str.	X	25	12 ³ / ₄	38.49

3 No. 10-P-1	3 No. 10	P	50	19 ¹ / ₂	19.42
4/3 Str-X-1	4 AWG 3 str.	X	50	11 ¹ / ₂	38.49

For Solid Copperweld Wire

No.	Wire Size	Die Groove	Std. Pkg.	Ship. Wt. Per 100, Pounds	Net Price Per 100
14-C-1	14 AWG CW	C	100	1 ³ / ₄	\$ 4.09
12-D-1	12 AWG CW	D	100	2	7.48
10-D-3	10 AWG CW	D	100	2 ¹ / ₂	8.10
8-D-3	8 AWG CW	D	100	2	8.10

*10-J-1	10 AWG CW	J	100	5 ¹ / ₄	10.69
9-J-1	9 AWG CW	J	100	5	10.69
8-J-1	8 AWG CW	J	100	11 ¹ / ₄	10.69
8-J-3	8 AWG CW	J	100	5 ¹ / ₂	14.74

*8-M-1	8 AWG CW	M	50	9 ¹ / ₂	18.00
*8-P-1	8 AWG CW	P	50	15 ¹ / ₂	24.00
7-M-1	7 AWG CW	M	50	10 ¹ / ₂	18.00
6-P-1	6 AWG CW	P	50	13	24.00
4-X-1	4 AWG CW	X	50	25	38.49

*Oversize sleeves.

Reliable Squeez Sleeves

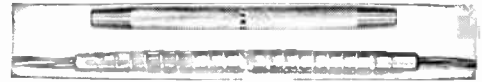

For 3-Strand Copperweld

No.	Wire Size	Die Groove	Std. Pkg.	Ship. Wt. Per 100, Pounds	Net Price Per 100
8A-M-1	8A	M	50	14	\$28.12
8A-P-1	8A	P	50	16 ³ / ₄	28.12
6A-P-1	6A	P	50	17 ¹ / ₂	30.98
6A-X-1	6A	X	50	29 ¹ / ₄	41.25
4A-X-1	4A	X	50	27 ¹ / ₂	41.25

3 No. 12-M-1	(3 No. 12, 8C, 9 ¹ / ₂ D)	M	50	9	19.42
--------------	---	---	----	---	-------

3 No. 12-P-1	(3 No. 12, 8C, 9 ¹ / ₂ D)	P	50	13 ¹ / ₄	24.00
--------------	---	---	----	--------------------------------	-------

3 No. 10-P-3	3 No. 10	P	50	16 ¹ / ₂	23.31
--------------	----------	---	----	--------------------------------	-------

Single Tube Compression Type

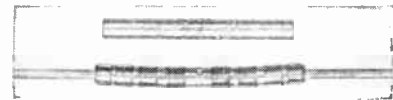

Squeez Sleeves and Tools with standard dies are made to the close tolerances characteristically necessary for the work to be done. Sleeve sizes, as well as die groove dimensions, are pre-determined by the size and tensile strength of the wire to be joined.

All types of Reliable Squeez Sleeves except Squeez Taps, are internally impregnated with a dispersion of fine, sharp silicon carbide particles to assist holding ability. The electrical properties of a made-up joint are highly efficient. The resistance of a made-up joint is less than an equal length of wire. This high electrical efficiency is stable.

For Galvanized Steel Conductors

No.	Wire Size	Die Groove	Std. Pkg.	Ship. Wt. Per 100, Pounds	Net Price Per 100
14-C-2	14 BWG BB	C	100	1 ¹ / ₂	\$ 4.72
14-C-5	14 BWG 85	C	100	1 ¹ / ₂	6.25
14-D-2	14 BWG BB & 85	D	100	1 ³ / ₄	5.44

12-C-2	12 BWG Old	C	100	1 ¹ / ₄	5.44
12-C-4	12 BWG BB	C	100	1 ¹ / ₄	5.44
12-C-5	12 BWG BB & 85	C	100	1 ¹ / ₄	6.67

12-D-2	12 BWG BB	D	100	1 ¹ / ₂	5.44
12-D-5BB	12 BWG BB	D	100	1 ¹ / ₂	7.50
12-D-5-85	12 BWG 85	D	100	1 ³ / ₄	9.00
12-D-5-135	12 BWG 135	D	100	2 ¹ / ₂	10.50
12-D-5-190	12 BWG 190	D	100	1 ³ / ₄	14.63

10-J-2	10 BWG	J	100	6 ¹ / ₂	10.47
10-J-2-85	10 BWG 85	J	100	6 ¹ / ₂	10.47
9-J-2	9 BWG	J	100	4 ³ / ₄	11.55
8-J-2BB	8 BWG	J	100	4 ¹ / ₄	12.82

Reliable Reducing Squeeze Sleeves



For Copperweld to Copperweld

No.	Wire Size AWG	Die Groove	Std. Pkg.	Ship. Wt. Lbs. Per 100	Net Price Per 100
10 x 12-C-1	10 to 12	C	100	1 1/2	\$ 7.50
10 x 12-D-1	10 to 12	D	100	1 3/4	11.23
10 x 12-J-1	10 to 12	J	100	4 1/4	16.05
9 x 10-J-1	9 to 10	J	100	3 3/4	16.05
8 x 10-J-1	8 to 10	J	100	3 1/2	16.05
8 x 9-J-1	8 to 9	J	100	3 1/2	16.05
6 x 8-P-1	6 to 8	P	100	15	36.00
6A x 8A-P-1	6A to 8A	P	50	16	46.46

For Steel to Steel

No.	Wire Size BWG	Die Groove	Std. Pkg.	Ship. Wt. Lbs. Per 100	Net Price Per 100
12 x 14-C-4	12 to 14	C	100	1 1/4	\$ 8.17
12 x 14-D-2	12 to 14	D	100	2	8.17
10 x 14-J-2	10 to 14	J	100	3	15.70
10 x 12-J-2	10 to 12	J	100	4 3/4	15.70
9 x 12-J-2	9 to 12	J	100	5	16.98
9 x 10-J-2	9 to 10	J	100	4	16.98
8 x 10-J-2	8 to 10	J	100	4 1/2	18.86
8 x 9-J-2	8 to 9	J	100	4 1/2	18.86

For Steel to AWG Drop Wire

No.	Wire Size BWG AWG	Die Groove	Std. Pkg.	Ship. Wt. Lbs. Per 100	Net Price Per 100
14 x 17-18-C-21	14 to 17-18	C	100	1 3/4	\$ 7.09
14 x 16-C-21	14 to 16	C	100	1 3/4	7.09
12 x 19-22-C-41	12 to 19-22	C	100	1 1/2	8.17
12 x 17-18-C-41	12 to 17-18	C	100	1 1/2	8.17
12 x 17-18-D-21	12 to 17-18	D	100	1 1/2	8.17
12 x 16-C-41	12 to 16	C	100	1 3/4	8.17
12 x 16-D-21	12 to 16	D	100	1 3/4	8.17
12 x 14-C-41	12 to 14	C	100	1 1/2	8.17
12 x 14-D-21	12 to 14	D	100	2	8.17
10 x 17 x 18-J-21	10 to 17-18	J	100	5	15.70
10 x 16-J-21	10 to 16	J	100	5	15.70
10 x 14-J-21	10 to 14	J	100	4 3/4	15.70
9 x 17-18-J-21	9 to 17-18	J	100	4 3/4	17.32
9 x 16-J-21	9 to 16	J	100	4 3/4	17.32
9 x 14-J-21	9 to 14	J	100	5 3/4	17.32
8 x 16-J-21	8 to 16	J	100	5 1/2	19.24
8 x 14-J-21	8 to 14	J	100	5 1/2	19.24

For Copper to Copper

No.	Wire Size AWG	Die Groove	Std. Pkg.	Ship. Wt. Lbs. Per 100	Net Price Per 100
12 x 17-18-C-1	12 to 17-18	C	100	1 1/2	\$ 6.42
12 x 17-18-D-1	12 to 17-18	D	100	1 3/4	11.23
12 x 16-C-1	12 to 16	C	100	1 1/2	6.42
12 x 14-C-1	12 to 14	C	100	1 1/2	6.42
12 x 16-D-1	12 to 16	D	100	1 3/4	11.23
12 x 14-D-1	12 to 14	D	100	1 3/4	11.23
10 x 17-18-C-1	10 to 17-18	C	100	1 1/2	7.50
10 x 17-18-D-1	10 to 17-18	D	100	2	11.23
10 x 16-C-1	10 to 16	C	100	1 1/2	7.50
10 x 16-D-1	10 to 16	D	100	1 3/4	11.23
10 x 14-C-1	10 to 14	C	100	1 1/2	7.50
10 x 14-D-1	10 to 14	D	100	1 3/4	11.23
10 x 12-C-1	10 to 12	C	100	1 1/2	7.50
10 x 12-D-1	10 to 12	D	100	1 3/4	11.23
9 x 17-18-D-1	9 to 17-18	D	100	2	11.23
9 x 16-D-1	9 to 16	D	100	1 3/4	11.23
9 x 14-D-1	9 to 14	D	100	1 3/4	11.23
9 x 12-D-1	9 to 12	D	100	1 3/4	11.23
9 x 10-D-1	9 to 10	D	100	1 3/4	11.23
8 x 16-D-1	8 to 16	D	100	1 3/4	11.23
8 x 14-D-1	8 to 14	D	100	1 3/4	11.23
8 x 12-D-1	8 to 12	D	100	1 3/4	11.23
8 x 10-D-1	8 to 10	D	100	1 3/4	11.23
8 x 9-D-1	8 to 9	D	100	1 3/4	11.23
10 x 12-J-1	10 to 12	J	100	3 1/2	16.05
8 x 16-J-1	8 to 16	J	100	3 1/2	16.05
8 x 14-J-1	8 to 14	J	100	5 1/2	16.05
8 x 12-J-1	8 to 12	J	100	4 3/4	16.05
8 x 10-J-1	8 to 10	J	100	5 1/4	16.05
8 x 9-J-1	8 to 9	J	100	5 1/4	16.05
6 x 14-J-1	6 to 14	J	100	5 1/4	16.05
6 x 10-J-1	6 to 10	J	100	5 1/4	16.05
6 x 9-J-1	6 to 9	J	100	5 1/4	16.05
6 x 8-J-1	6 to 8	J	100	4 3/4	16.05
6 Str. to 6-J-1	6 to 6-7 Str.	J	100	4	16.05
4 x 6-P-1	4 to 6	P	50	8	29.14
4 x 6-M-1	4 to 6	M	50	8 1/2	29.14
4 Str. x 4-M-1	4 to 4-7 Str.	M	50	8 1/2	29.14
2 x 4-T-1	2 to 4	T	50	11	56.54
2 x 4 Str.-T-1	2 to 4-7 Str.	T	50	11	56.54

Reliable Aluminum Squeeze Sleeves
Service Tension Sleeves

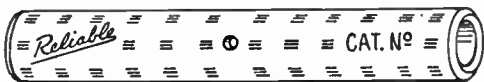

For service extension or repair, sleeves develop the ultimate strength of all-aluminum and approximately 50% of ultimate with ACSR and are coated internally with inhibitor compound.

All sleeves and deadends are clearly marked showing Cat. No., conductor size and die groove. Std. Pkg. 50.

Design Strength, AL—Ultimate, ACSR—800 Lbs. Min.

No.	Conductor Sizes	Die Groove	Compress. Per Side	Net Price Per 100
7064	6 str. AL, ACSR 4 sol. AL to same	P	6	\$15.20
7065	4 str. AL, ACSR 2 sol. AL to same	P	6	15.40
7066	4 str. AL, ACSR 2 sol. AL to same	X	6	15.50

Design Strength, AL—Ultimate, ACSR—1200 Lbs. Min.

No.	Conductor Sizes	Die Groove	Compress. Per Side	Net Price Per 100
7067	2 str. AL, ACSR to same	X	6	13.70

Reliable Aluminum Service Squeeze Deadends



One piece squeeze deadend releases one leg of stainless steel bail through key slot in yoke. Capped sleeve and retaining yoke are aluminum. Any length aluminum strand or ACSR can be fed through before compressing. Std. Pkg. 50.

Design Strength, AL—Ultimate, ACSR—800 Lbs. Min.

No.	Conductor Sizes	Die Groove	Compress. Per Side	Net Price Per 100
7084	6 str. AL, ACSR 4 sol. AL	P	6	\$39.30
*7084N	6 str. AL, ACSR 4 sol. AL	P	6	47.30
7085	1 str. AL, ACSR 2 sol. AL	P	6	38.20
*7085N	1 str. AL, ACSR 2 sol. AL	P	6	46.20
7086	4 str. AL, ACSR 2 sol. AL	X	6	44.00
*7086N	4 str. AL, ACSR 2 sol. AL	X	6	52.00

Design Strength, AL—Ultimate, ACSR—1200 Lbs. Min.

No.	Conductor Sizes	Die Groove	Compress. Per Side	Net Price Per 100
7088	2 str. AL, ACSR	X	6	46.00
*7088N	2 str. AL, ACSR	X	6	54.00

*N suffix—Neoprene insulated bail.
Quantity prices on request.

Reliable Offset-Deadend Squeez Sleeves



Copper Conductors

No.	Conductor Size	Die Groove	Std. Pkg.	Ship. Wt. Lbs. Per 100	Net Price Per 100
OD-12-C-1	12AWG-080	C	100	11 1/2	\$ 7 49
OD-12-D-1	12AWG-080	D	100	13 3/4	13 10
OD-10-C-1	10AWG-102-104	C	100	11 1/2	8 75
OD-10-D-1	10AWG-102-104	D	100	13 3/4	13 10
OD-10-D-3	10AWG-102-104	D	100	21 1/2	14 18
OD-10-J-1	10AWG-102-104	J	100	6	18 72
OD-9-D-1	9AWG-114	D	100	13 3/4	13 10
OD-8-D-3	8AWG-128	D	100	21 1/2	14 18
OD-8-J-1	8AWG-128	J	100	5 1/2	18 72
OD-6-J-1	6AWG-162	J	100	6	18 72
OD-10-E-1	10AWG-102-104	E	100	2	15 29
OD-9-E-1	9AWG-114	E	100	2	15 29
OD-8-E-1	8AWG-128	E	100	13 3/4	15 29

Copperweld Conductors

OD-12-D-1	12AWG-080	D	100	13 3/4	\$13 10
OD-10-D-3	10AWG-102-104	D	100	21 1/2	14 18
OD-10-J-1	10AWG-102-104	J	100	6	18 72
OD-8-D-3	8AWG-128	D	100	21 1/2	14 18

Galvanized Steel Conductors

OD-14-C-2	14BWG-083	C	100	11 1/2	\$ 8 27
OD-14-C-5	14BWG-083	C	100	11 1/2	10 95
OD-14-D-2	14BWG-083	D	100	13 3/4	9 53
OD-12-C-5	12BWG-109	C	100	11 1/2	11 69
OD-12-D-5-BB	12BWG-109	D	100	11 1/2	13 13
OD-12-D-5-85	12BWG-109	D	100	13 3/4	15 75
OD-12-D-5-135	12BWG-109	D	100	21 1/2	18 38
OD-12-D-2-BB	12BWG-109	D	100	13 3/4	9 53
OD-10-J-2	10BWG-134	J	100	5 1/2	18 33
OD-9-J-2	9BWG-148	J	100	5	20 22
OD-8-J-2-BB	8BWG-165	J	100	5	22 44

Reliable Compression Sleeves

For Service Entrance

For all combinations: Aluminum, ACSR, Copper. Solid center barrier, No. 10 thru No. 1/0; colored caps with size code; lubricated, ready for use. Use standard "X" and "Y" die or tested substitute.

End A			End B			Net Price Per 100				
ACSR Sol	Copper or Aluminum Str	Color	ACSR Sol	Copper or Aluminum Str	Color					
...	8	10	Brown	7575X	...	8	10	Brown	\$18 10	
...	8	10	Brown	7576X	...	6	8	Green	18 10	
...	8	10	Brown	7577X	...	6	4	5&6	Blue	18 10
...	8	10	Brown	7578X	...	4	2	3&4	Orange	18 10
...	8	10	Brown	7579X	...	2	...	2	Red	18 10
...	6	8	Green	7580X	...	6	8	Green	18 10	
...	6	8	Green	7581X	...	6	4	5&6	Blue	18 10
...	6	8	Green	7582X	...	4	2	3&4	Orange	18 10
...	6	8	Green	7583X	...	2	...	2	Red	18 10
6	4	5&6	Blue	7584X	6	4	5&6	Blue	18 10	
6	4	5&6	Blue	7586X	4	2	3&4	Orange	18 10	
6	4	5&6	Blue	7587X	2	...	2	Red	18 10	
4	2	3&4	Orange	7588X	4	2	3&4	Orange	18 10	
4	2	3&4	Orange	7589X	2	...	2	Red	18 10	
2	...	2	Red	7590X	2	...	2	Red	18 10	
...	6	8	Green	7580Y	...	6	8	Green	18 75	
...	6	8	Green	7581Y	6	4	5&6	Blue	18 75	
...	6	8	Green	7582Y	4	2	3&4	Orange	18 75	
...	6	8	Green	7583Y	2	...	2	Red	18 75	
6	4	5&6	Blue	7584Y	6	4	5&6	Blue	18 75	
6	4	5&6	Blue	7586Y	4	2	3&4	Orange	18 75	
6	4	5&6	Blue	7587Y	2	...	2	Red	18 75	
4	2	3&4	Orange	7588Y	4	2	3&4	Orange	18 75	
4	2	3&4	Orange	7589Y	2	...	2	Red	18 75	
2	...	2	Red	7590Y	2	...	2	Red	18 75	
...	6	8	Green	7591Y	1/0	...	1/0	Yellow	18 75	
6	4	5&6	Blue	7592Y	1/0	...	1/0	Yellow	18 75	
4	2	3&4	Orange	7593Y	1/0	...	1/0	Yellow	18 75	
2	...	2	Red	7594Y	1/0	...	1/0	Yellow	18 75	
1/0	...	1/0	Yellow	7595Y	1/0	...	1/0	Yellow	18 75	

*All units with cat. no. ending in X have 1/2" (.531) diameters.

All units with cat. no. ending in Y have 5/8" (.640) diameters. Quantity prices on request.

Reliable Squeez Taps



For Copper, Copperweld and Bronze

No.	Wire Size A.W.G. to A.W.G.	Die Groove	Std. Pkg.	Ship. Wt. Per 100 Pounds	Net Price Per 100
T-17-18-B-2	17 or 18	17 or 18	B	100	3/4 \$4 04
T-14-16-B-2	14 or 16	14 or 16	B	100	3/4 4 04
T-12-C-1	12	12	C	100	2 1/4 9 00
T-12 x 17-18-C-1	12	17 or 18	C	100	2 1/2 13 87
T-12 x 14-16-C-1	12	14 or 16	C	100	2 1/2 13 87
T-10-D-1	10	10	D	100	2 3/4 10 50
T-10 x 17-18-D-1	10	17 or 18	D	100	2 1/2 15 00
T-10 x 14-16-D-1	10	14 or 16	D	100	3 15 00
T-10 x 12-D-1	10	12	D	100	3 15 00
T-9-D-1	9	9	D	100	2 1/4 10 50
T-9 x 17-18-D-1	9	17 or 18	D	100	2 1/2 15 00
T-9 x 14-16-D-1	9	14 or 16	D	100	2 1/2 15 00
T-8-D-1	8	8	D	100	2 1/4 10 50
T-8 x 17-18-D-1	8	17 or 18	D	100	2 1/2 15 00
T-8 x 14-16-D-1	8	14 or 16	D	100	2 1/2 15 00
T-8-J-1	8	8	J	50	5 1/4 22 12
T-8 x 14-16-J-1	8	14 or 16	J	50	5 1/2 32 25
T-6J-1	6	6	J	50	4 1/2 22 12
T-6 x 14-16-J-1	6	14 or 16	J	50	5 32 25

For Steel to Copper, Copperweld and Bronze

No.	Wire Size B.W.G. to A.W.G.	Die Groove	Std. Pkg.	Ship. Wt. Per 100 Pounds	Net Price Per 100
T-14 x 17-18-C-2	14	17 or 18	C	100	2 1/2 \$14 44
T-12 x 17-18-D-2	12	17 or 18	D	100	2 3/4 15 78
T-12 x 14-16-D-2	12	14 or 16	D	100	3 15 78
T-10 x 17-18-J-2	10	17 or 18	J	50	5 1/2 35 25
T-10 x 14-16-J-2	10	14 or 16	J	50	5 1/2 35 25
T-9 x 17-18-J-2	9	17 or 18	J	50	5 1/2 35 25
T-9 x 14-16-J-2	9	14 or 16	J	50	5 1/2 35 25
T-8 x 14-16-J-2	8	14 or 16	J	50	5 1/4 35 25
T-8 x 12-J-2	8	12	J	50	5 1/4 35 25

For Steel to Steel

No.	Wire Size B.W.G. to B.W.G.	Die Groove	Std. Pkg.	Ship. Wt. Per 100 Pounds	Per 100
T-14-C-2	14	14	C	100	2 1/4 \$9 45
T-12-D-2	12	12	D	100	2 1/2 11 02
T-12 x 14-D-2	12	14	D	100	3 15 78
T-10-J-2	10	10	J	50	5 1/4 27 37
T-9-J-2	9	9	J	50	5 1/4 27 37
T-8-J-2	8	8	J	50	4 1/2 27 37

Reliable Span Clamps

For One or More Mid-Span Service Drops



No. 6066 Copper Saddle

No. 5535 Span Clamp

Designed for 1/4 in. thru 1/2 in. Dia. steel, copper-weld or ACSR ground or supporting strand.

No.	Description	Equivalent Conductor Size	Std. Pkg.	Ship. Wt. Lbs. Per 100	Net Price Per 100
5535	Galvanized Steel Span Clamp (Less Saddle)		25	126	\$72 00
A15535	Aluminum Span Clamp (Less Saddle)		25	57	89 00
6066	Copper Saddle	4 Cu	25	18	27 60
6067	Plated Copper Saddle	4 Cu, 2 Al	25	18	30 00
6068	Aluminum Saddle	4 Al	25	6	18 00
6069	Aluminum Saddle (Heavy)	2 Al	25	6 1/2	20 50

Appropriate saddles are listed separately. They provide means for ground connections.

Reliable Squeeze Deadends

For Communication Circuits and Power Distribution



Reliable Squeeze Deadends consist of a Squeeze Sleeve (splicing) with a factory-assembled loop (bail) in one end. The other end is for the line wire, and only the line wire is installed by the lineman. The loop, or bail, is a corrosion resistant, high strength, D-shaped wire (stainless steel or bronze) which is factory-assembled by power compression to one-half of the sleeve. Thus you have a prefabricated loop deadend, ready for insulator, or other deadend fixture, that is stronger than the line wire itself.

For Copper Conductors

No.	Conductor Size	Die Groove	Std. Pkg.	Shp. Wt. Per 100, Pounds	Net Price Per 100
DE-12-C-1	12 AWG	C	25	3	\$19.83
DE-12-D-1	12 AWG	D	25	4 3/4	17.50
DE-10-C-1	10 AWG	C	25	3 1/2	17.50
DE-10-D-1	10 AWG	D	25	3 3/4	18.67
DE-9-D-1	9 AWG	D	25	4 3/4	19.83
DE-8-J-1	8 AWG	J	25	7 3/4	28.58
DE-6-J-1	6 AWG	J	25	10 1/4	29.17
DE-6STR-J-1	6-7 Str.	J	25	7	29.17

For Copperweld Conductors

No.	Conductor Size	Die Groove	Std. Pkg.	Shp. Wt. Per 100, Pounds	Net Price Per 100
DE-12-D-1	12 AWG CW	D	25	3	\$17.50
DE-10-D-3	10 AWG CW	D	25	5 1/4	21.59
DE-10-J-1	10 AWG CW	J	25	7 3/4	29.17
DE-9-J-1	9 AWG CW	J	25	7	29.17
DE-8-J-3	8 AWG CW	J	25	9 1/2	28.00
DE-8-M-1	8 AWG CW	M	25	11	32.66
DE-8-P-1	8 AWG CW	P	25	7	43.16
DE-7-M-1	7 AWG CW	M	25	11	32.66
DE-6-P-1	6 AWG CW	P	25	7	43.16

For Galvanized Steel Conductors

No.	Conductor Size	Die Groove	Std. Pkg.	Shp. Wt. Per 100, Pounds	Net Price Per 100
DE-14-C-4	14 BWG-BB & 85	C	25	3	\$17.50
DE-14-D-2	14 BWG-BB & 85	D	25	3	18.67
DE-12-C-4	12 BWG-BB	C	25	4 3/4	18.67
DE-12-C-5	12 BWG-BB & 85	C	25	3 3/4	22.16
DE-12-D-2	12 BWG-BB	D	25	3 1/2	19.83
DE-12-D-5 (BB)	12 BWG-BB	D	25	4 1/2	22.16
DE-12-D-5 (85)	12 BWG-85	D	25	4 1/2	24.50
DE-12-D-5 (135)	12 BWG-135	D	25	5 1/4	25.66
DE-12-D-5(190)	12BWG-190	D	25	6 1/2	29.79
DE-10-J-2	10 BWG-BB & 85	J	25	7	33.83
DE-9-J-2	9 BWG-BB & 85	J	25	7	33.83
DE-8-J-2	8 BWG-BB & 85	J	25	7	29.17

Reliable Telephone Drop Wire Clamps
With or Without Stainless Steel Floating Type Shim



All-Stainless Steel Clamps for general purpose use (including Coastal), and economical combination Stainless and Aluminum Clamps for "normal" areas.

Advantages of floating type shim are: (1) Permits smoother clamping of the drop wire; (2) Clamps sets-in readily at initial installation yet will compensate for further loading and (3) Plain floating shim makes removal easy and prevents damage to insulation.

Reliable Concentric Cable Clamps



Flexible Bail Type

Low cost clamps that hold the cable securely under all conditions without bending or snubbing, or otherwise damaging the insulation. Have a large margin of strength over field requirements, are easy to install and neat in appearance.

Made of non-corrosive materials — the phosphor bronze bail is a universal attachment for racks, wire-holders, eye-bolts, hooks, messengers, etc.

For Round Conductors

No.	Cable No.	Range of Clamp Cond. In.	Min. In.	Width, In.	Bail Lgth., In.	Std. Pkg.	Shp. Wt. Per 100, Lbs.	Net Price Per 100
82	8	2 .410	.350	...	9	25	31	\$76.80
62	6	2 .530	.400	...	9	25	34	82.30
22	2	2 .700	.560	...	10	25	52	100.60

For Oval Conductors

83	8	3 .450	.350	.770	9	25	39 1/2	\$93.30
63	6 or 8	3 .580	.450	.900	10	25	46 1/2	102.40
63A	6 or 8 Arm.	3 .620	.500	.900	10	25	46 1/2	102.40
43	4	3 .720	.560	1.100	10 1/2	10	77 1/2	146.30



Solid Bail Type

A particularly economical design, is convenient for attaching to drive hooks or secondary racks.

For Round Conductors

No.	Cable No.	Range of Clamp Max. Cond. In.	Min. In.	Width, In.	Bail Lgth., In.	Std. Pkg.	Shp. Wt. Per 100, Lbs.	Net Price Per 100
82S	8	2 .410	.350	...	6 1/2	25	32 1/2	\$53.00
62S	6	2 .530	.400	...	6 1/2	25	36 1/2	60.30
22S	2	2 .700	.560	...	7 1/2	25	62	82.30

For Oval Conductors

83S	8	3 .450	.350	.770	6 1/2	25	42 1/2	\$75.00
63S	6 or 8	3 .580	.450	.900	6 1/2	25	48	75.00
63AS	6 or 8 Arm.	3 .620	.500	.900	6 1/2	25	51	75.00
43S	4	3 .720	.560	1.100	6 1/2	10	82 1/2	109.80

Note — For Emery treated shells add \$4.00 to quantity price.

No.	Description	Std. Pkg.	Wt. Lbs. Per 100	Net Price Per 100
*PS-1	All stainless—with shim	25	9 1/2	\$16.50
*PS-2	Stainless wedge, bail and shim—Aluminum shell	25	5 3/4	13.65
†P-1	All stainless—no shim	25	8 3/4	15.90
†P-2	Stainless wedge and bail Aluminum shell—no shim	25	5 1/4	13.15
†PR-1	All stainless—no shim	25	10 1/4	18.50
†PR-2	Stainless wedge and bail Aluminum shell—no shim	25	6	13.65
†PRS-1	All stainless—with shim	25	10 3/4	19.00
†PRS-2	Stainless wedge, bail and shim—Aluminum shell	25	6 1/2	14.20

*For Dumbell Drop Wire Nos. 20-17.
†For Non-reinforced Parallel and Twisted Pair Nos. 20-17.
‡For Reinforced Parallel 20-17 and 16-14 Twisted Pair.

Note: Suffix (1) to catalog number indicates all-stainless steel. Suffix (2) to catalog number indicates combination stainless and aluminum.

Reliable Service Wedge Clamps
For Bare Neutral Service Drops



No.	Type Service	Description	Conductor Sizes	Bail Centerline	Net Price Per 100
7076	Copper	All-Stainless	4-6 cu.	Crossed-6 1/2"	566 10
7077	Copper	All-Stainless	4-6 cu.	Crossed-11"	69 80
7078	Copper	All-Stainless	1/0 Str-2 Sol	Crossed-6 1/2"	109 00
7079	Copper	All-Stainless	1/0 Str-2 Sol	Crossed-11"	116 30
7080	Aluminum	Wedge-Stainless Shell-Alum.	4-6 ACSR	Crossed-6 1/2"	53 00
7081	Aluminum	Wedge-Stainless Shell-Alum.	4-6 ACSR	Crossed-11"	58 00
7090	Aluminum	Wedge-Stainless Shell-Alum.	2-6 ACSR	Crossed-6 1/2"	59 00
7091	Aluminum	Wedge-Stainless Shell-Alum.	2-6 ACSR	Crossed-11"	64 00
7082	Aluminum	Wedge-Stainless Shell-Alum.	1/0-4 ACSR	Crossed-6 1/2"	77 00
7083	Aluminum	Wedge-Stainless Shell-Alum.	1/0-4 ACSR	Crossed-11"	83 00

Nos. 7079 and 7083, standard package, 25; all others, 50. Use Above Cat. No. and Add Suffix as Shown Below

For	Use Suffix	Add. Cost
Uncrossed Bail	U	None
Flexible Bail		
#7080—12" Centerline	F	\$15 00
#7082—11" Centerline		40 00
#7090—12" Centerline		15 00
Emery Treat Copper Shell	T	4 00

(For some smaller copper wires)

Sizes and types service clamps may be assorted in std. pkgs. to obtain quantity prices.

Terms: Net 30 days, F.O.B. point shipment with freight allowed on 50 lbs. or more.

Note: Crossed bails are standard. The spring tension with crossed bail insures that detachable leg will not disengage before installation is completed.

Chance Nico-Press Splice Tools



Used with the Universal Splice Tool to apply Nico-Press type sleeve splices on energized lines. Crimps sleeves to form a firm, fast bond when conductors are spliced.

Maplac® coated pole, tested to 75 kv. per foot for five minutes to assure safety.

Heavy Duty Nico-Press Splice Tool is of the same design as the standard tool, but has a four-step rack incorporated into the handle-lever assembly, which permits travel necessary for the smooth operation of the jaws . . . supplies leverage for crimping.

No.	Description Length, Ft.	Type	For Nico-Press Jaws No.*	Wt. Lbs.	Each
M1880-4	4	Standard	51 & 53	8 1/2	\$30 00
†M1880-6	6	Standard	51 & 53	10 1/4	38 50
M1890-4	4	Heavy Duty	88	10	56 00
M1890-6	6	Heavy Duty	88	13 1/2	62 00

*Jaws not included.

LINEMEN'S PREFERENCE—Recommended by Chance Hot Line Tool Demonstrators.

Chance Universal Splice Tools

Used in conjunction with Nico-Press splice tool or with any automatic splices.

M4455-52 Universal Splice Tool Each \$12.25

Alcoa Hydraulic Compressors



Model 12-A

Designed primarily for installing Alcoa Tubular Compression Accessories on distribution line conductor. Twelve tons thrust can be developed by this portable hand-operated compressor.

With a C-head capable of being rotated through 180 degrees, the compressor is easily hooked over conductor or accessory. Dies are advanced, closed under compression, and retracted by simple manipulations at the compressor handles. An audible safety valve operates when the compression is completed.

Neoprene covering for body and handles is recommended to provide mechanical protection for tool as well as guard against contact with live parts. It is not intended to afford protection to operator for hot line work.

The Model 12-A may be adapted to use with "Hot Sticks."

Metal case provided for the compressor contains steel rack for dies.

Model No.	Length, In.	Width, In.	Height, In.	Wt. Lbs.
12-A	23	4 3/4	2 3/4	11
Shipping Case	24 1/2	7	4	12.5

Reliable Squeeze Tools

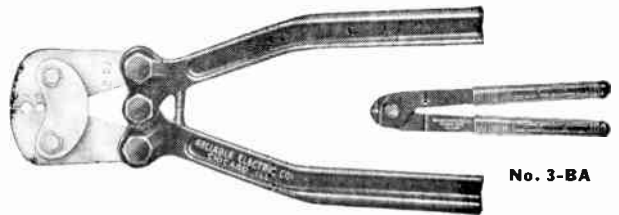

No. 2-DJ

No. 3-BA

The Reliable Squeeze Tools are made in two types. The Number 1, 2 and 10 tools are rugged toggle type tools which operate smoothly and easily, yet which apply a maximum amount of pressure on the sleeve. Can be easily and accurately adjusted. The Number 3 tool has Vinyl Plastisol handles. Other tools available with insulated handles, at additional cost, when specified.

No.	Grooves	*For Sleeves	Length In.	Ship. Wt. Lbs.	Net Price Each
10-XPJ	X, P & J	X, P & J	16 1/2	4	\$19.70
10-XMJ	X, M & J	X, M & J	16 1/2	4	19.70
1-MJ	M & J	M & J	15 1/2	3 1/2	19.40
1-PJ	P & J	P & J	15 1/2	3 1/2	19.40
1-XJ	X & J	X & J	15 1/2	3 1/2	19.40
2-DC	D & C	C & D	12	3	12.60
2-CJ	C & J	C & J	12	3	12.60
2-DJ	D & J	D & J	12	3	12.60
3-BA	B & A	A & B	8 1/2	3/8	2.05

*Indicate letters in Sleeve Numbers.

Quantity prices on request.

Hubbard Underground Cable Racks
Channel Steel
Hot Galvanized

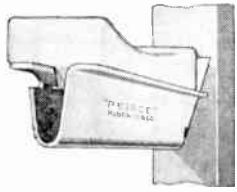

No. 2115 Insulator Installed

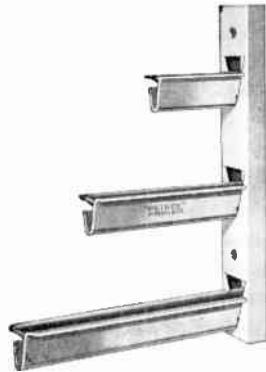

Made from 4 x 1¹⁹/₃₂ x 3¹⁶/₁₆-inch channel and attached to manhole wall by 1¹/₂ x 4-inch expansion bolts or No. 2216 Anchor Bolts. Cable rack extensions for mounting racks away from wall are available. 12 gage pressed steel hooks will accommodate from one to four cable rack insulators installed as shown in the above illustration. Insulators No. 2114 and 2115 occupy the same hook length and are interchangeable. That is, No. 2114 designed for 1³/₄-inch cable requires 4¹/₂-inches of hook length, and No. 2115, while designed for 2⁵/₈-inch cable requires the same space.

When more than one insulator is used, they are generally placed an inch or so apart to provide electrical and mechanical clearance. A stop is provided on each hook to prevent the insulators from sliding off the end.

No.	No. of Slots	Dimensions, Inches Slot Spacing	Overall Length	Approx. Shipping Wt. Lbs., 100 Pcs.
2471	1	..	8	360
2472	2	8	16	685
2473	3	8	24	1010
2474	4	8	32	1335
2475	5	8	40	1660
2476	6	8	48	1985

Hooks

No.	Dimensions—Inches Extension From Face of Rack	Overall Length	Approx. Shipping Wt. Lbs., 100 Pcs.
2291	5 ¹ / ₄	6 ⁵ / ₈	115
2292	10 ⁵ / ₈	12	265
2293	16 ⁵ / ₈	18	385
2294	22 ⁵ / ₈	24	505

Insulators — White Glaze

No.	Radius For Cable	Dimensions—Inches Overall Length	Overall Width	Approx. Shipping Wt. Lbs., 100 Pcs.
2115	2 ⁵ / ₈	4 ¹ / ₂	2 ⁷ / ₈	160

Hubbard Cable Rack Insulators
For Locktype and Heavy Type Racks



Cable Rack Insulators — White Glaze.

No.	Radius for Cable	Dimensions—Inches Length Along Hook	Width	Approx. Shipping Wt. Lbs., 100 Pcs.
▲2122	1 ¹ / ₂	3	3	129
▲2123	2 ¹ / ₄	3 ¹⁵ / ₁₆	3	160
†2117	3 ¹ / ₄	2 ¹ / ₄	3 ³ / ₄	90
†2118	1 ¹ / ₂	3	3 ³ / ₄	115
†2121	2 ⁵ / ₈	3 ³ / ₄	3 ³ / ₄	125

▲Locktype Rack.

†Heavy Type Rack.

Hubbard Cable Rack Extensions
Hot Galvanized

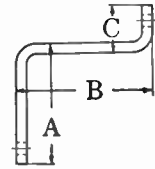

For mounting racks away from the wall. Racks mounted on extensions take approximately 4¹/₂-inches less wall space than is needed for the rack. If extension is turned around and mounted, it will occupy 10 to 13-inches more wall space than the length of rack. Mounting holes are for 1¹/₂-inch bolts. Order two extensions for each rack to be mounted.

No.	Steel Size	2101	2102
Dimension A	inches	1 ¹ / ₂ x 1	1 ¹ / ₂ x 1 ¹ / ₄
Dimension B	inches	4 ¹ / ₄	5 ³ / ₄
Dimension C	inches	3 ⁵ / ₈	6 ⁹ / ₁₆
Diameter Holes	inches	2 ¹ / ₄	2 ³ / ₈
Ship. Wt. per 100	pounds	176	270

Hubbard Cable Duct Shields



No. 9142

Zinc and Hot Galvanized Steel. Protect cable sheaths at the entrance of ducts.

.050-Inch Sheet Zinc

No.	Diameter Inches	Length Inches	Shipping Weight Pounds per 100
9141	3	6	63
9122	3	8	68
9123	3	10	84
9125	3 ¹ / ₄	6	53
9126	3 ¹ / ₄	8	71
9129	3 ¹ / ₂	6	55
9130	3 ¹ / ₂	8	75
9133	4	6	62
9134	4	8	82

No. 20-Gage Sheet Steel

9140	3	6	57
------	---	---	----

No. 12-Gage Sheet Steel

9142	2 ⁵ / ₈	9	187
------	-------------------------------	---	-----

Hubbard Pulling-In Irons

For Manholes
Hot Galvanized



Set into the concrete or brick walls of street vaults opposite duct entrances to provide a convenient and strong attachment for block and tackle when installing or removing cables.

No.	Diameter Steel	9119	*9120
Extension from Wall	in.	7 ⁸ / ₈	7 ⁸ / ₈
Ship. Wt. per 100	lbs.	550	660

*Western Union Std.

**Hubbard Underground Cable Racks
Hot Galvanized**



The Rack sections are made in three lengths which can be combined into almost any desired length. Made from 1½ x ¾ x ⅜-inch open hearth steel channel, strong enough to support the heaviest cable. Fasten to man-hole wall with ½ x 4-inch Peirce Expansion Bolts. The hooks are cut from open hearth steel T sections and have a smooth, well rounded top surface 1½ inches wide which will not injure the sheaths of cables. Hooks are easily attached and, with the weight of the cable on them, hold securely to the channel back.

	Racks	*2124	*2125	*2126	2127
No.		8	14	18	37
No. of Holes.		1½	1½	1½	1½
Hook Hole Spacing...in.		15	24	30	55¼
Overall Length.....in.		13½	22½	28½
Bolt Hole Spacing...in.		155	265	315	570
Ship. Wt. per 100...lb.					

"T" Hooks

No.	*2131	*2132	*2133
Steel Size.....	1½ x 1¼ x ⅜	1½ x 1¼ x ⅜	1½ x 1¼ x ⅜
Extension from Face of Rack...in.	4	7½	10
Ship. Wt. per 100...lb.	61	110	135

*Western Union Std.

"U" Hooks

No.	2134	2135	2136
Steel Size.....	1½ x 1¼ x ⅜	1½ x 1¼ x ⅜	1½ x 1¼ x ⅜
Extension from Face of Rack...in.	4	7½	10
Ship. Wt. per 100...in.	60	95	120

Locktype

Designed to allow for variations of cable spacings where desired. Hooks are certified malleable iron, and lock into place easily. Locktype design eliminates loose, wobbly fits and insures minimum movement in all directions. Insulators are locked on the hook by a stop at the outer end.

Heavy Type

Offset at the lower end to permit the joining of successive racks vertically. Racks may be mounted to manhole walls with two ½-inch by 4-inch expansion bolts or two No. 2246 anchor bolts. Insulators fit snugly over the pressed steel hooks and are held in place by the weight of the cable.

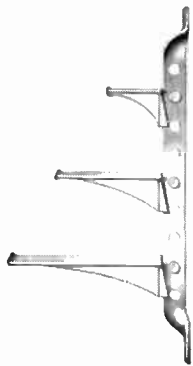

Locktype Racks

Rack Section — ⅜ x 1¼-in. Steel

No.	No. of Holes	Hook Hole Spacing	Length Overall	Bolt Hole Spacing	Approx. Shipping Wt. Lbs., 100 Pcs.
2285	3	2⅝	14¾	13	280
2286	6	2⅝	21¾	20	385
2287	9	2⅝	28¾	27	535
2288	12	2⅝	35¾	34	645
2289	5	7	42¾	41	775
2290	7	7	56¾	55	1017
2297	9	3	39¾	38	719
2298	15	3	56¾	55	1037

Heavy Type Racks

Rack Section — 2¼ x 2¼ x ¼-in. "T" Steel

2225	14	1½	27½	25½	800
2246					193

Cable Rack Hooks

Rack Section — ⅜ x 3-in. Steel

No.	Type of Rack	Extension From Rack Face	Width	Approx. Shipping Wt. Lbs., 100 Pcs.
2254	Locktype	4¼	2	183
2258	Locktype	8¼	2	260
2262	Locktype	12¼	2	341
2264	Locktype	15¼	2	320
2231	Heavy Type	5	2½	180
2232	Heavy Type	9½	2½	308
2233	Heavy Type	14	2½	489

**Reliable Steel Cable Grips
Single Eye Luffing**

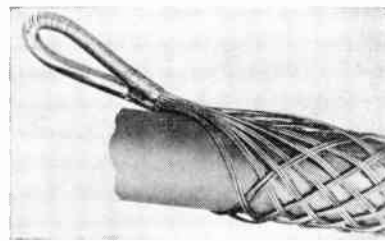

Preferred by some operators as the eye lies flat against the cable when strain is applied.

Single Weave — Length 18-in.

No.	Cable Diameter, In. Min.	Max.	Tensile Strength, Lbs.	Ship. Wt. Each, Lbs.	Net Price Each
1842	¾	1	3,300	1½	\$5.20
1843	1	1½	6,300	2½	5.50

Double Weave — Length 24 -in.

1954	1½	2	12,600	2½	\$8.50
1955	2	2½	16,800	3	9.15
1956	2½	3	24,600	4	9.80
1957	3	3½	24,600	4	10.50
1958	3½	4	24,600	4	11.10

Double Eye Luffing

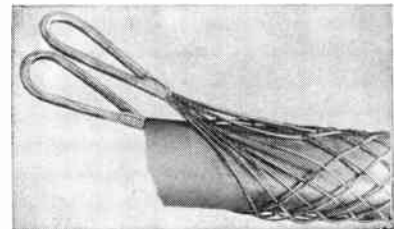

Single Weave — Length 18-In.

842	¾	1	3,300	1½	\$5.20
843	1	1½	6,300	1½	5.50

Double Weave — Length 24-In.

954	1½	2	12,600	2½	\$8.50
955	2	2½	16,800	3	9.15
956	2½	3	24,600	4½	9.80
957	3	3½	24,600	4½	10.50
958	3½	4	24,600	4½	11.10

Plain Flexible Pulling Grips

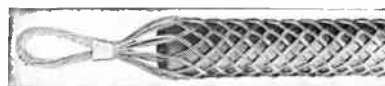

Single weave are for pulling aerial cable and feed through rings without displacing

them. Also for small underground cables where ducts are clean or soil is not gritty.

Double weave are for pulling underground cables where wear is light and use of reinforced grips is not required.

Single Weave — Length 18-In.

No.	Cable Diameter, In. Min.	Max.	Tensile Strength, Lbs.	Ship. Wt. Each, Lbs.	Net Price Each
821	½	¾	2,800	1	\$3.40

Single Weave — Length 24-In.

822	¾	1	3,350	1	\$4.50
823	1	1½	6,300	1¾	4.80
824	1½	2	8,400	2	5.20
825	2	2½	12,300	2½	5.55
826	2½	3	15,400	3	5.85
827	3	3½	15,400	3	6.25
828	3½	4	15,400	3	6.50

Double Weave — Length 36-In.

933	1	1½	10,500	2½	\$6.85
934	1½	2	12,500	2¾	7.15
935	2	2½	18,500	3¾	7.55
936	2½	3	24,500	4¾	7.85
937	3	3½	27,700	5½	8.20
938	3½	4	27,700	5½	8.50

Reliable Reinforced Flexible Pulling Grips



For pulling underground cables, Reinforcement protects wires of the grip at shoulder where wear is greatest. Eye is formed of the wire itself and reinforced. There is no joint at the working end of grip, and no loss of strength.

Double Weave — Length 24-In.

No.	Cable Diameter, In.		Tensile Strength, Lbs.	Ship. Wt. Each, Lbs.	Net Price Each
	Min.	Max.			
1023	1	1½	10,500	2½	\$ 7.90
1024	1½	2	12,600	2¾	8.50
1025	2	2½	18,500	3½	9.15
1026	2½	3	24,500	5	9.80
1027	3	3½	33,500	5¼	10.50
1028	3½	4	33,500	5¼	11.10

Double Weave — Length 36-In.

No.	Cable Diameter, In.		Tensile Strength, Lbs.	Ship. Wt. Each, Lbs.	Net Price Each
	Min.	Max.			
1033	1	1½	10,500	2¾	\$ 9.80
1034	1½	2	12,600	3	10.50
1035	2	2½	18,500	4	11.10
1036	2½	3	24,500	5	12.00
1037	3	3½	33,500	6	12.50
1038	3½	4	33,500	6¼	13.00

Double Weave — Length 48-In.

No.	Cable Diameter, In.		Tensile Strength, Lbs.	Ship. Wt. Each, Lbs.	Net Price Each
	Min.	Max.			
1043	1	1½	10,500	3¼	\$12.00
1044	1½	2	12,600	4	12.50
1045	2	2½	18,500	4½	13.00
1046	2½	3	24,500	6	13.75
1047	3	3½	33,500	7¼	14.40
1048	3½	4	33,500	7¼	15.00

Reliable Hard Wire Pulling Grips
Solid Wire — Double Weave



These grips are very tough and rather stiff and will withstand great

wear. For use where large quantities of underground cable must be pulled. The grip must fit exactly for proper performance.

For swabbing ducts this grip can be heavily packed with waste and is very satisfactory.

Length 18-In.

No.	Cable Diameter, In.		Tensile Strength, Lbs.	Ship. Wt. Each, Lbs.	Net Price Each
	Min.	Max.			
801	½	¾	5,300	1	\$5.90

Length — 22-In.

802	¾	1	6,300	1	\$6.20
803	1	1½	6,300	1½	6.55
804	1½	2	8,500	1½	6.85
805	2	2½	15,000	2¼	7.20

Length 30-In.

806	2½	3	18,300	3	\$7.50
807	3	3½	23,000	3	7.85
808	3½	4	23,000	4	8.20

Length 24-In.

811	½	¾	5,300	1	\$6.20
-----	---	---	-------	---	--------

Length 30-In.

812	¾	1	6,300	1½	\$7.50
813	1	1½	6,300	1½	7.85
814	1½	2	8,500	2	8.20
815	2	2½	15,000	2½	8.50

Length 45-In.

816	2½	3	18,300	3	\$8.85
817	3	3½	23,000	4¼	9.15
818	3½	4	23,000	4¼	9.50

Reliable Bronze Cable Grips

Used for permanent fastenings and supports for cable. Can be furnished in all standard designs and sizes specified for steel.

To determine prices: Add 20% to steel prices for sizes ½-in. minimum diameter to 1½-in. minimum diameter. For sizes 2-in. minimum diameter and larger, add 30%. Example: No. 1023, steel price \$7.90; Bronze price, \$9.48.

Reliable Split Grips

For moving working cable or any cables where the end is not accessible. A special arrangement of strong hooks, with few hooking operations, makes the grip easy to fasten or loosen.

Double Eye Split



Single Weave — Length 18-In.

No.	Cable Diameter, In.		Tensile Strength, Lbs.	Ship. Wt. Each, Lbs.	Net Price Each
	Min.	Max.			
*862	¾	1	3,300	1½	\$5.85
*863	1	1½	6,300	1½	6.25

Double Weave — Length 24-In.

974	1	1½	12,600	3½	\$ 9.00
975	1½	2	16,800	4½	9.75
976	2	2½	24,600	6	10.50
977	2½	3	24,600	6	11.30
978	3	3½	24,600	6	12.10

*No hooks — Lacing furnished.

Single Eye Split



Single Weave — Length 18-In.

*1862	¾	1	3,300	1½	\$5.85
*1863	1	1½	6,300	2	6.25

Double Weave — Length 24-In.

1974	1	1½	12,600	3½	\$ 9.00
1975	1½	2	16,800	4½	9.75
1976	2	2½	24,600	5½	10.50
1977	2½	3	24,600	6	11.30
1978	3	3½	24,600	6	12.10

Reliable Multiple Wire Pulling Grips



For pulling a number of wires through conduit.

No.	Cable Diameter, In.		Tensile Strength, Lbs.	Ship. Wt. Each, Lbs.	Length, In.	Net Price Each
	Min.	Max.				
205	1/32	1/2	500	1½	8½	\$3.30
407	1/2	5/8	900	1½	8¾	3.30
509	5/8	¾	1,400	1½	8¾	3.30
712	1/16	13/16	1,600	1½	9¼	3.30
1220	13/16	1	2,100	1½	9¾	3.30
2030	1	1½	2,100	1½	9¾	3.30

Note: When ordering grips, please specify outside diameter of cable.

Quantity prices on request.

Call Graybar FIRST For . . .

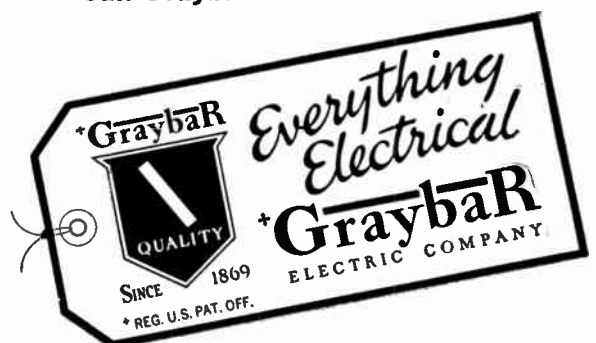

G & W Potheads
Type "T" Capnut Outdoor 1/c

Aerial lugs included.
 Specify style wanted.

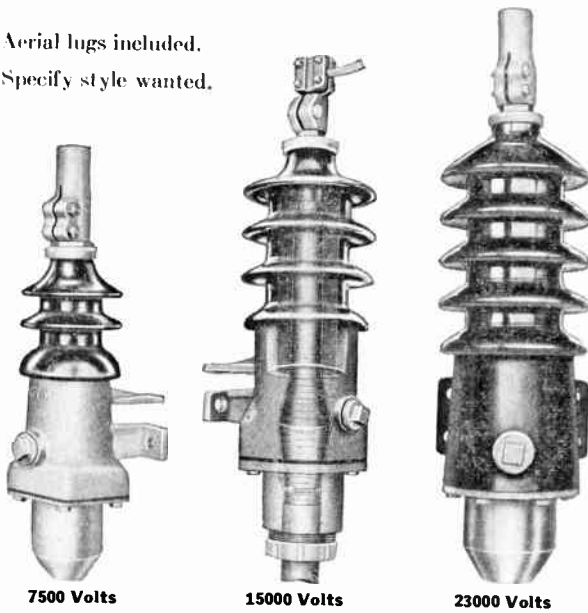

7500 Volts

15000 Volts

23000 Volts

Type "T" Capnut Outdoor 3/c—Shape "B"

Aerial lugs included. Specify style wanted.

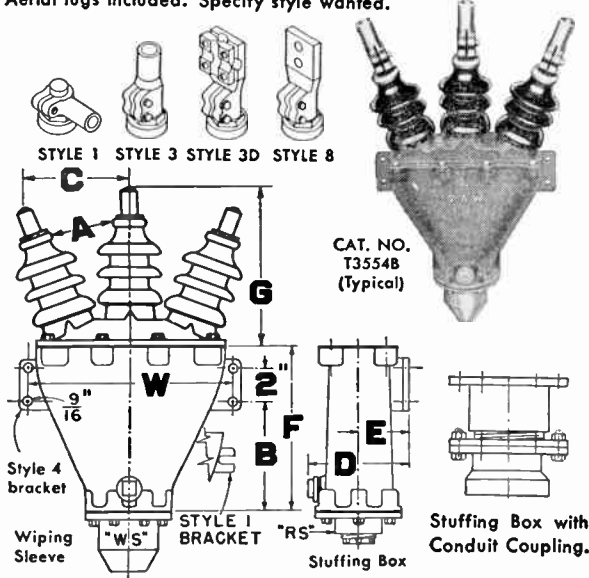

CAT. NO.
 T3554B
 (Typical)

Stuffing Box with
 Conduit Coupling.

Other Body Shapes Available

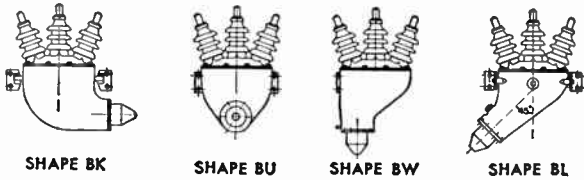

SHAPE BK

SHAPE BU

SHAPE BW

SHAPE BL

When ordering potheads specify: Single or three conductor pothead; shape; voltage rating and operating voltage; 1/c, 3/c or 3/1/e cable; cable conductor size; kind of insulation (paper, var. cam., or rubber); shielded, unshielded or belted; lead sheath or neoprene jacket—diam.; style of aerial lugs; style of base seal (wiping sleeve or stuffing box); conduit or armor fitting (kind and size); and catalog number of pothead, if available.

Prices on application

Anaconda Potheads

For use in sealing, insulating and protecting terminations of insulated power cables and to provide a means for continuing the electrical conducting path beyond the pothead.

Designed to exclude moisture, prevent compound leakage and to avoid internal flashover.

Typical potheads and accessories are illustrated below. A complete line of cable terminating equipment is available to meet your particular system requirements. For detailed information, ask Graybar for Anaconda Catalog No. C-79-13-14.

Multiple Conductor Outdoor Potheads

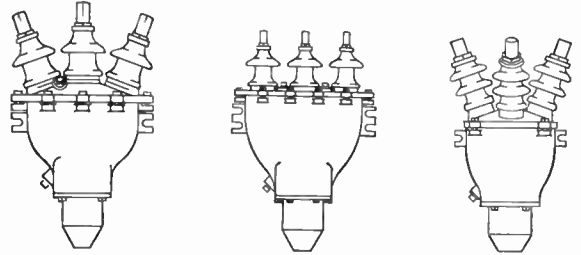

Shape No. 1 Flat Straightaway

Shape No. 7 Round

Also available with corrugated insulators for indoor service.

Interchangeable Flat Bell Shapes

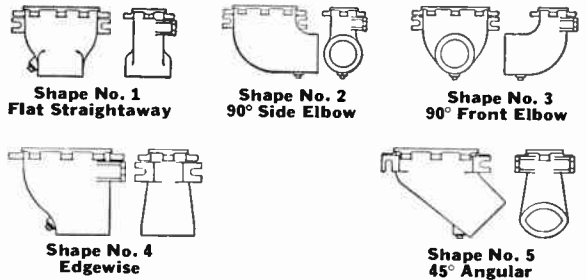

Shape No. 1
 Flat Straightaway

Shape No. 2
 90° Side Elbow

Shape No. 3
 90° Front Elbow

Shape No. 4
 Edgewise

Shape No. 5
 45° Angular

Interchangeable Aerial Lugs

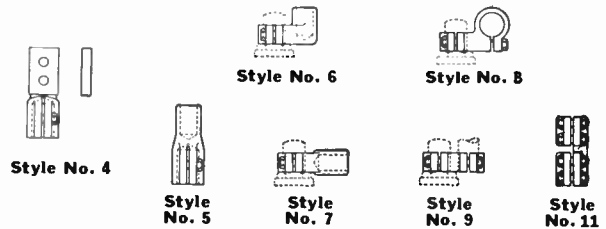

Style No. 6

Style No. 8

Style No. 4

Style No. 5

Style No. 7

Style No. 9

Style No. 11

Interchangeable Cable Entrances

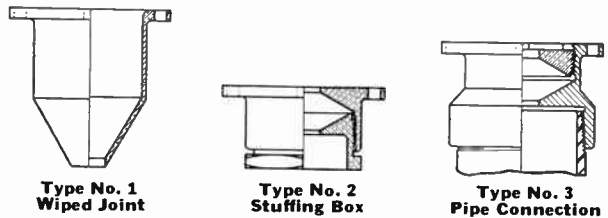

Type No. 1
 Wiped Joint

Type No. 2
 Stuffing Box

Type No. 3
 Pipe Connection

Joint Protecting Boxes



2-Way

3-Way

4-Way

Prices on application.

Natco Underground Clay Conduit

This conduit has many features that make it ideal for cable protection. Made of special high-grade clays, vitrified into a flint-like rock and glazed to smooth glass-like surfaces. It will not soften or swell, deform or disintegrate on exposure to heat, moisture, steam or chemical attack. Absolutely free from caustic alkalis, acids and organic compounds. Protects cable from corrosive soils or ground waters, from cinder fills or chemical wastes. Will safely carry all normal street loads and stand up under severe traffic vibration. Also permits immediate back-filling of trenches.

Natco Standard Single Duct Conduit



Adapted for high tension power lines, single cable terminals or for low tension laterals, as in telephone or signal lines.

When building up duct banks it provides two heavy insulating walls between adjacent cables, and permits breaking or staggering of all joints throughout duct bank.

Individual duct lines, in approaches to manholes, can be splayed and separated. The four outer sides are scarified lengthwise to provide anchorage for bedding mortar. Inner edges of duct entrances are beveled and smoothed to eliminate projections and make pulling of cables safe and easy.

Certain shapes of square bore single duct have through dowel holes in corners for use of steel dowel pins for assembling, centering and aligning duct lines.

*Nominal Bore, In.	Approx. Outside Size, In.	Standard Lengths In.		Short Lengths			Min. Carload, Duct Ft.
		No.	In.	6-in. No.	9-in. No.	12-in. No.	
3 1/4 Rd.	4 1/2 x 4 1/2	100	18	101	102	103	8700
3 1/2 Rd.	4 7/8 x 4 7/8	110	18	111	112	113	6900
4 1/4 Rd.	5 5/8 x 5 5/8	140	18	141	142	143	5700
5 1/4 Rd.	6 7/8 x 6 7/8	150	24	151	152	153	4000
†3 1/4 Sq.	4 3/4 x 4 3/4	160	24	161	162	163	6100
3 1/2 Sq.	5 x 5	170	18	171	172	173	5700
†4 1/4 Sq.	5 7/8 x 5 7/8	190	18	191	192	193	4800

†With dowel hole in each corner.

Natco Single Duct Bends

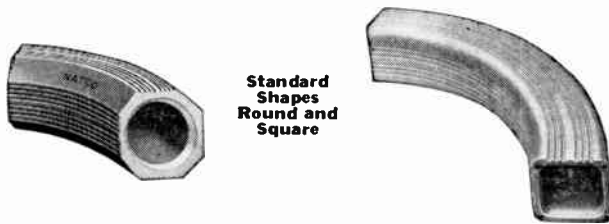

Standard Shapes Round and Square

Approx. Lgth., In. 19 9 1/2 28 1/2 14 1/4 38 19 57 28 1/2

*Nominal Bore In.	12-in. Radius		18-in. Radius		24-in. Radius		36-in. Radius	
	90° No.	45° No.	90° No.	45° No.	90° No.	45° No.	90° No.	45° No.
3 1/4 Rd.	500	600	501	601	502	602	504	604
3 1/2 Rd.	510	610	511	611	512	612	514	614
4 1/4 Rd.	540	640	541	641	542	642	544	644
3 1/4 Sq.	560	660	561	661	562	662	564	664
3 1/2 Sq.	570	670	571	671	572	672	574	674
4 1/4 Sq.	590	690	591	691	592	692	594	694

*Nominal Bore In.	36-in. Radius Length, In.		60-in. Radius Length, In.		72-in. Radius Length, In.		96-in. Radius Length, In.	
	18 No.	12 No.	18 No.	12 No.	18 No.	12 No.	18 No.	12 No.
3 1/4 Rd.	1000	1003	1200	1203	1300	1303	1400	1403
3 1/2 Rd.	1010	1013	1210	1213	1310	1313	1410	1413
4 1/4 Rd.	1040	1043	1240	1243	1340	1343	1440	1443
3 1/4 Sq.	1060	1063	1260	1263	1360	1363	1460	1463
4 1/4 Sq.	1090	1093	1290	1293	1390	1393	1490	1493

*Actual size of duct hole 1/8-inch larger than nominal.

Prices on application.

Natco Standard Multiple Duct Conduit

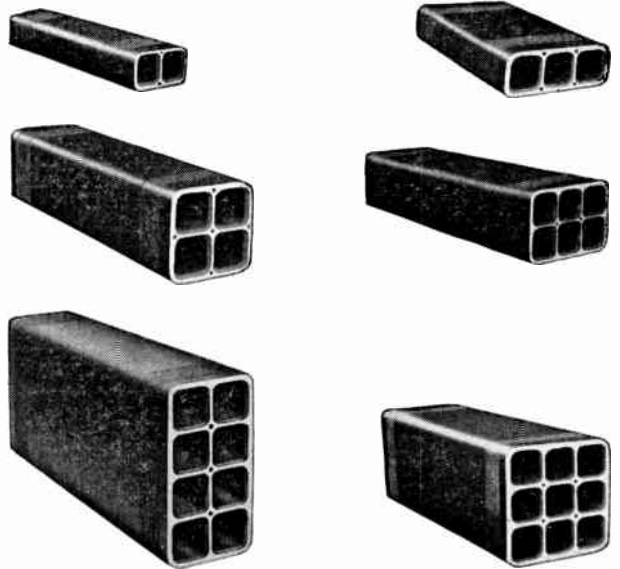

For telephone, telegraph, railway signal, fire alarm and low tension light and power service.

Provides longer lengths and multiplicity of duct holes — economical and quickly installed.

The 3 1/4 in. is the standard bore; 3 1/2 in. bore is for certain municipal installment; 4 1/4 in. bore is the over-size type for most telephone service and certain low tension power and lighting systems.

With Square Duct Holes

*Nominal Bore, In.	No. Duct Holes	Approx. Outside Size, In.	Standard Lengths, No. In.	Duct Feet per Piece	Short Lengths				Min. Carload Duct Ft.	
					6-in. No.	8-in. Long No.	9-in. Long No.	12-in. Long No.		
3 1/4	2	4 3/4 x 8 3/4	3000	24	4	3001	3006	3003	8200
3 1/4	3	4 3/4 x 12 3/4	3020	24	6	3021	3026	3023	8100
3 1/4	4	8 3/4 x 8 3/4	3040	36	12	3041	3042	3043	9600
3 1/4	6	8 3/4 x 12 3/4	3050	36	18	3051	3052	3053	10000
3 1/4	8	8 3/4 x 16 3/4	3080	36	24	3081	3082	3083	10000
3 1/2	9	12 3/4 x 12 3/4	3090	36	27	3091	3092	3093	10000
3 1/2	2	5 1/8 x 9 3/8	3100	24	4	3101	3106	3103	7000
3 1/2	3	5 1/8 x 13 3/8	3120	24	6	3121	3126	3123	7200
3 1/2	4	9 3/8 x 9 3/8	3140	36	12	3141	3142	3143	8200
3 1/2	6	9 3/8 x 13 3/8	3150	36	18	3151	3152	3153	8600
4 1/4	2	5 1/2 x 11	3400	24	4	3401	3406	3403	5600
4 1/4	3	5 1/2 x 16 1/2	3420	24	6	3421	3426	3423	6000
4 1/4	4	11 x 11	3440	36	12	3441	3442	3443	6600
4 1/4	6	11 x 16 1/2	3450	36	18	3451	3452	3453	6800
4 1/4	9	16 1/2 x 16 1/2	3490	24	18	3491	3496	3493	7300

All above have an adequate number of dowel holes for assembling and aligning duct holes.

Natco Socket Joint Single Duct Conduit



This duct is self-centering and provides positive alignment, lays up fast and can be installed by ordinary labor.

May be readily troweled or sealed with cement mortar. Especially adapted for single duct lateral lines and duct bank construction.

*Nominal Bore, In.	3 1/2 Round	4 Round	4 1/2 Round
Length, In.	18 & 24	24	24

*Actual size of duct hole 1/8-in. larger than nominal.

Prices on application.

Natco Scored or Split Conduit



These ducts can be split apart on the job and used for repairing or replacing duct lines without the necessity of removing cable. Split sections can also be used to enclose cable joints or splices instead of building manholes.

Single Duct

Nomina Bore In.	Standard Length 18-in. Long No.	6-in. Long No.	Short Lengths		
			9-in. Long No.	12-in. Long No.	
3 1/4 Rd.	200	201	202	203	
3 1/2 Rd.	210	211	212	213	
4 1/4 Rd.	240	241	242	243	
3 1/4 Sq.	260	261	262	263	
3 1/2 Sq.	270	271	272	273	
4 1/4 Sq.	290	291	292	293	

Multiple Duct

Nominal Bore In.	No. Duct Holes	Standard Lengths		Short Lengths		
		18-in. No.	36-in. No.	6-in. No.	9-in. No.	12-in. No.
3 1/4	2	3600	3601	3603
3 1/4	3	3620	3621	3623
3 1/4	4	3640	3649	3641	3642	3643
3 1/4	6	3650	3659	3651	3652	3653
3 1/4	8	3680	3681	3682	3683
3 1/4	9	3690	3691	3692	3693
3 1/2	2	3700	3701	3703
3 1/2	3	3720	3721	3723
3 1/2	4	3740	3749	3741	3742	3743
3 1/2	6	3750	3759	3751	3752	3753
4 1/4	2	4000	4001
4 1/4	3	4020	4021
4 1/4	4	4040	4041
4 1/4	6	4050	4051
4 1/4	9	4090	4091

Natco Factory Split Clay Conduit

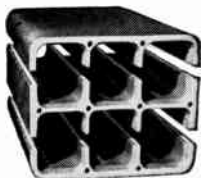

Before Reassembly

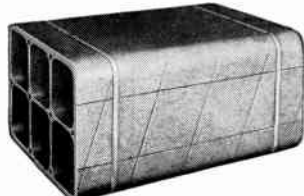

After Reassembly

This new split conduit is now available already split apart and reassembled at the factory and securely banded and held together in its original position by means of steel straps until ready for use. Has diagonal marking on one side of each piece to insure reassembly in their original position.

Saves labor and breakage and loss in splitting by inexperienced workmen. In convenient lengths for easy installation.

Single Duct

Nominal Bore In.	Approx. Outside Size In.	Standard Lengths 18-in. No.	Short Lengths	
			6-in. No.	F261
3 1/4 Rd.	4 1/2 x 4 1/2	F200	F201	
3 1/4 Sq.	4 3/4 x 4 3/4	F260	F261	

Multiple Duct With 3 1/4 In. Square Bore

No. Duct Holes	Approx. Outside Size, In.	18-in. No.	6-in. No.	
			F3601	F3611
2	4 3/4 x 8 3/4	F3600	F3601	
3	4 3/4 x 12 3/4	F3620	F3621	
4	8 3/4 x 8 3/4	F3640	F3641	
6 Type 6-3	8 3/4 x 12 3/4	F3650	F3651	
6 Type 6-4	8 3/4 x 12 3/4	F3660	F3661	
8	8 3/4 x 16 3/4	F3680	F3681	
9	12 3/4 x 12 3/4	F3690	F3691	

Note — Bore sizes 3 1/2 and 4 1/4 in. in 18 in. lengths made special to order only; 36 in. lengths made only scored to split. Prices on application.

Natco Mitered Conduit

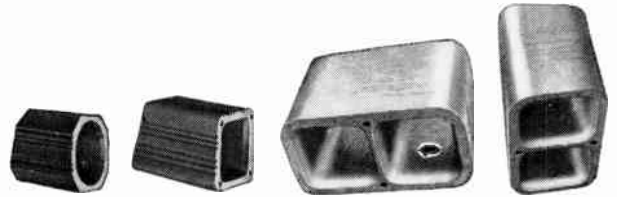

Single Rd. Single Sq. 2-Way Flat 2-Way Edge

This shape provides a simple and flexible means of constructing perfect curves in underground lines of clay conduit. It is made in one segmental form — in all single and multiple duct shapes and in either flat or edge positions.

Can be used to construct simple or reverse curves in either horizontal or vertical planes.

Only one mitered shape is required for any curve from 10-ft. radius up. The radius is varied simply by interposing straight short pieces between the mitered pieces. The arc or angle of the curve, from 3 degrees up, is governed by the total number of pieces used. Joints are all uniformly even and tight fitting and cables can be easily pulled through the true, easy curves thus formed.

Eliminates the need of manholes at bends or turns and especially at approaches to central offices from street or alley.

Minimum radius 10 ft. Angle of section 3°. Requires 30 pieces to a 90° curve. Approximate length 6 x 6 1/8 in.

Single Duct — Round and Square Bore

No. Duct Holes	Position of Conduit	Nominal Bore 3 1/4 In. No.	Nominal Bore 3 1/2 In. No.	Nominal Bore 4 1/4 In. No.
1	Round	300	310	340
1	Square	360	370	390

Multiple Duct — Square Bore Only

No. Duct Holes	Position of Conduit	Nominal Bore 3 1/4 In. No.	Nominal Bore 3 1/2 In. No.	Nominal Bore 4 1/4 In. No.
2	Flat	4800	4900	5200
2	Edge	4810	4910	5210
3	Flat	4820	4920	5220
3	Edge	4830	5230
4	4840	4940	5240
6	Flat	4850	4950	5250
6	Edge	4860	4960	5260
9	4890	5290

Note — Mitered conduit in smaller or larger radii made special to order.

Natco Branch Conduits



One end of this conduit is the same shape and size as standard conduit, while at the other end the individual ducts are more widely separated by means of double webs which permit alignment with abutting branch lines.

This conduit permits the division of multiple duct main lines into two or more branch lines, each having a smaller number of ducts than the main line.

Such a division is highly advantageous in splaying main duct lines for entrance to central office buildings or to manholes, or in straddling pipe lines or other underground obstructions, or for crossing viaducts or bridges where shallow duct lines are required.

Main duct lines may be splayed vertically so that duct will enter cable vault of a central office building approximately in line with the cable racks.

Correct alignment of duct openings and tight joints are provided — no cutting, fitting, or breaking into main lines, and all accomplished without the necessity of expensive manholes.

Length over all 24 in.

No. Duct Holes	Type	For Branching Into: Ducts	Nominal Bore In.		
			3 1/4 No.	3 1/2 No.	4 1/4 No.
2	1-1	2 single	5400	5500	5800
3	1-2	1 single and 1 2-way	5420	5520	5820
3	1-1-1	3 single	5425	5525	5825
4	2-2	2 2-way	5440	5540	5840
6	2-1	1 2-way and 1 4-way	5450	5550	5850
6	2-2-2	3 2-way	5455	5555	5855
6	3-3	2 3-way	5460	5560	5860
9	3-6	1 3-way and 1 6-way	5490	5890

Note — Also available scored for splitting apart. Prices on application.

Natco Transposition Conduit

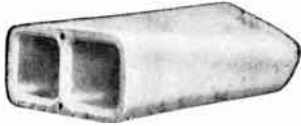

Transposition conduit solves construction problems presented by underground street obstructions and facilitates changing the position of cables on approaching manholes, cable vaults, viaducts, bridges or other crossings. Also provides a means of changing the overall height of conduit lines without interruption thereto and without the necessity of expensive manholes.

The position of ducts and cables in a multiple duct conduit line can be transposed either a quarter turn of 90° or a half turn of 180°. Direction of twist may be either right or left hand or a combination of both.

Nominal Bore In.	Degree of Twist	No. Pieces In ¼ turn
3¼	22½	4
3½	18	5
4¼	15	6

Length Over All 24 Inches

No. Duct Holes	Duct Feet Per Piece	Nominal Bore In.					
		¾ Twist		¼ Twist			
		R. H. No.	L. H. No.	R. H. No.	L. H. No.		
2	4	6600	6605	6700	6705	7000	7005
3	6	6620	6625	6720	6725	7020	7025
6	12	6650	6655	6750	6755	7050	7055

Natco Pipe Connectors



Single Duct



Two-Way



Three-Way

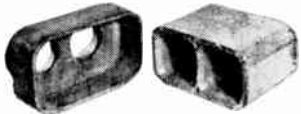

Rear View of Connector Ready to Receive Conduit.

For connecting clay conduit lines to cast iron or steel pipe lines as in pole risers, or to enter buildings.

They are made of cast iron.

One end shaped to receive the end of clay conduit line, the other end reamed to receive the cast iron or steel pipe lines.

When ordering—Specify whether pipes are cast iron or steel, and if steel, whether threaded or slip joint.

Type Connection	Single Duct	2-Way	3-Way
3¼-in. Bore to 3-in. Pipe	9020	9022	9023
4¼-in. Bore to 4-in. Pipe	9040	9042	9043

Prices on application.

Call Graybar FIRST For . . .

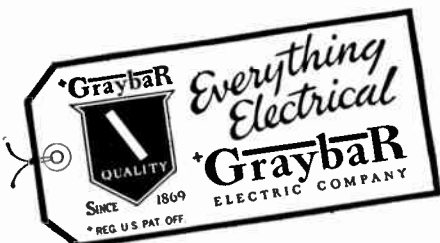

Natco Conduit No. 106



This illustration shows the conversion of a 4-way multiple duct line into two 2-way multiple duct in an edge position, one of which is flexed or curved

to one side in the direction of a pole and terminated in two riser iron pipe lines, ascending the pole, while the other 2-way line is transposed or twisted 90° from an edge to a flat position in a distance of 8 ft. and then continued straight on in the form of a standard 2-way multiple duct conduit — in a flat position.

(B) One-piece 4-way type 2-2 branch conduit 2 ft. long (for dividing the 4-way line onto two 2-way lines).

(E) Six pieces of 2-way mitered conduit — edge position — 3° 10-ft. radius, 6¼ in. long (for flexing or curving one of the 2-way lines to one side in the direction of the pole. The angle of flexure shown is 18°, but any angle of flexure divisible by three may be attained by varying the number of mitered pieces).

(H) One-piece 2-way standard conduit 2 ft. long (laid in edge position to extend the flexed 2-way line on toward the pole).

(R) One cast iron 2-way connector for 3-in. wrought iron pipe.

(P) Four pieces of 2-way left-hand transposition conduit 2 ft. long, 22½° (for transposing the other 2-way line 90° from an edge to a flat position).

Natco Dowel Pins

Generally used for joining and aligning individual sections of conduit.

All multiple duct and some single duct conduit is made with not less than two continuous dowel holes large enough to accommodate these pins. Two pins are used at each joint or for each piece of conduit, regardless of size.

Pressed steel pin, with integral center flange.

No. 9050 Size ½ x 3-in.

Natco Wrapping Tape



A special prepared tape which is frequently used for wrapping joints before applying the joint mortar.

It adheres closely and firmly to the conduit surfaces, and aids in waterproofing the joints.

Made of paper with a water-proof paraffin coating.

Especially valuable when installing conduit duct in trench, subway or masonry structures before pouring concrete encasement.

In Rolls of 100 Linear Yards

No. 9060 — Width 4 in. Weight per roll 8 lbs.

No. 9061 — Width 6 in. Weight per roll 12 lbs.

When ordering specify total number of yards required.

Prices on application.

Orangeburg Fibre Conduit

This Fibre Conduit has been used for many years for underground communications and power circuits, and has demonstrated its ability to give maximum, permanent, low-maintenance service under conditions that expose ducts to attack from ground waters and chemical wastes, both acid and alkaline.

Its first cost is low; it is light in weight, yet amply strong to resist breakage; can be transported to the job in large truck loads; one man can carry several lengths at one time.

The material is easy to cut and work. Angle couplings, bends and other useful fittings are available to make installation simple and economical.

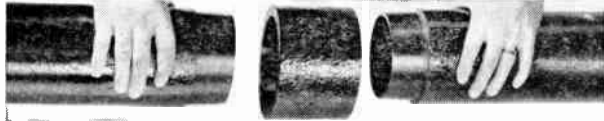

Taper Sleeve Joint

The uniformly long sections and readily assembled taper sleeve joints make for labor saving and low installed cost.

Protection from Cable Sheath Abrasion — The smooth bore and absence of any harsh materials in the composition of Orangeburg Fibre Conduit offers better protection against abrasion or scoring of cable sheath.

Protection from Pulling Tension — The coefficient of friction is lower in this conduit than in other types of duct material so that pulling tensions are kept at a minimum.

Published data made by one of the large utilities, reveal the following coefficients of friction for a large actual installation recently made in which oil-filled cable was used:

Size of Cable	Size of Duct	Coefficient
300,000CM 2¼-In. O.D.	3½-In.	.25— .30
650,000CM 2½-In. O.D.	4-In.	.25— .30

Protection from Cable Sheath Corrosion — The tight taper sleeve joint and the impermeable wall of Orangeburg Fibre Conduit protect the cable by preventing infiltration or otherwise ground waters through the duct structure.

General Properties — Composed of 25% wood fibre and 75% of coal tar pitch. Wall sections are homogeneous and impregnation is uniform throughout.

Specifications:

- Federal Specifications: WC-581,
- A. T. & T. (Bell Laboratories): AT-7047,
- U. S. Navy: 9YF,
- I. M. S. A.: 104-1942,
- Civil Aeronautics Authority: CAA-606,
- Association of American Railroads: XV111-A-21 1929,
- And many Public Utilities Specifications.

Orangeburg Standard Conduit — Type I

For Installation with Concrete Encasement

For main distribution, high tension, and downtown locations.

How to lay Type I Standard Conduit:

Tier-By-Tier Method—A foundation of concrete is first placed on the bottom of the trench which has been graded. The thickness of this base is gauged by grade stakes which have been placed in the center of the trench. On this concrete base the bottom tier of ducts is laid, the horizontal separation of ducts being maintained by wooden or metal combs placed 3 to 5 ft. apart. The space between the ducts of this first tier is then filled with concrete and the ducts covered to the top of the comb separators which are then removed and used on succeeding tiers.

Built-up or Monolithic Method: This method utilizes plastic or precast concrete separators which are used to erect a self-supporting structure with the conduit in position before the concrete is poured. For spacers (Bridge separators) see following pages. For more detailed information contact Graybar.

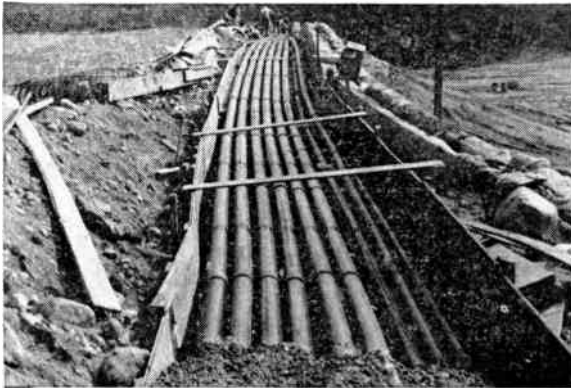

Orangeburg Nocrete Conduit — Type II

For Installation without Concrete Encasement

For house connections, laterals and extensions; airport, street and parkway lighting, fire alarm and signal systems; industrial and institutional grounds.

This conduit has three prime characteristics; (A) mechanical strength; (B) ability to endure permanently, and (C) give lasting cable protection. It is also immune to soil corrosion and electrolysis.

How to Lay Orangeburg NOCRETE Conduit:

Trenching:

Dig not less than 4-in. below desired grade. Use template to detect high spots and holes. Fill holes and depressions, tamping thoroughly.

Place about 4-in. selected backfill, free from stones, and tamp lightly.

Bed the Nocrete conduit in the selected backfill ¼ to ⅓ of the conduit diameter. Under no circumstances should bricks or other supports be used to bring conduit to grade.



After conduit is bedded and checked for grade, additional selected backfill is placed by shovel at sides of conduit and tamped. By careful tamping at this point, the conduit can support a much greater load, and is less likely to be subsequently disturbed or shifted. More selected backfill is now placed, and lightly compacted by tamping with shovel or walking over it, compacting the soil so that subsequent back-filling will not allow stones to damage conduit. (No large boulders should be put back into the trench.)

The trench may now be backfilled by any conventional means—bulldozer—loader—etc., and the Nocrete conduit is protected.

Prices on application.

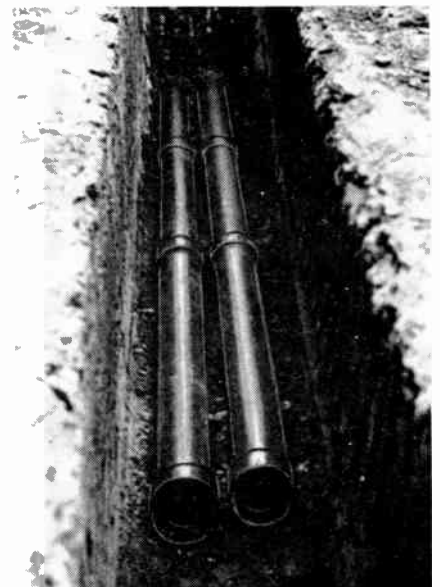

Orangeburg Fibre Conduit With Taper Joint Couplings

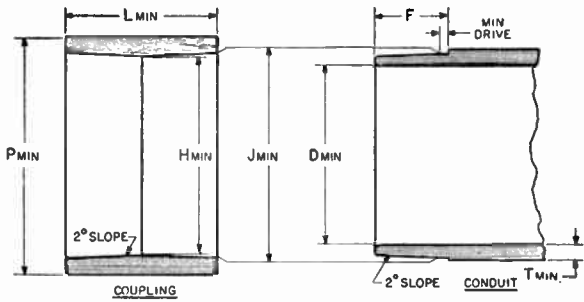

Standard — Type I
Dimensions, Inches

Size	2	3	4	4½	5	6
D Min.	2.00	3.00	4.00	4.50	5.00	6.00
F	1.00	1.20	1.60	1.80	1.95	1.95
H Min.	2.365	3.326	4.353	4.932	5.528	6.562
J Min.	2.438	3.113	4.168	5.061	5.668	6.702
L Min.	2.10	2.50	3.30	3.70	4.00	4.00
P Min.	2.97	3.99	5.12	5.73	6.66	7.72
T Min.	.20	.20	.20	.20	.25	.25
Min. Drive	.10	.10	.10	.15	.20	.20
Length, Ft.	5	8	8	8	8	8

Nocrete — Type II
Dimensions, Inches

Size	3	4
D Min.	3.00	4.00
F	1.45	1.85
H Min.	3.670	4.720
J Min.	3.775	4.853
L Min.	3.00	3.80
P Min.	4.49	5.60
T Min.	.39	.43
Min. Drive	.10	.10
Length, Ft.	8	8

Orangeburg 5° Angle Couplings

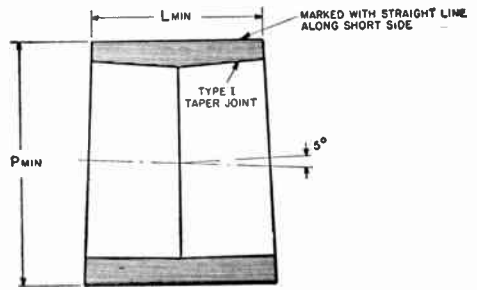

These couplings permit the laying of offsets, long radius bends, etc., to get around obstructions and other services which may be encountered.

The same taper joint is provided, and a mark on the coupling shows the direction in which the angle will point.

For Standard Conduit — Type I

Size	2	3	4	4½	5	6
P Min.	2.97	3.99	5.12	5.73	6.66	7.72
L Min.	2.10	2.50	3.30	3.70	4.00	4.00

For Nocrete Conduit — Type II

Size	3	4
P Min.	4.49	5.60
L Min.	3.00	3.80

Orangeburg Bends and Elbows

These fibre bends and elbows are made to the required radius and degree. Furnished with standard interchangeable Taper Sleeve Joint (coupling included). Stock bends and elbows are listed with dimensions. Split bends and bends of special radius and degree may be made to order.

Nominal Inside Diameter, Inches of 20-Inch Offset Bends

Standard Conduit (Type I) — or Nocrete Conduit (Type II).	2.	3.	4.	4.5	5.	6.
Type I Bend	2.	3.	4.	4.5	5.	6.
Type II Bend	..	3.	4.

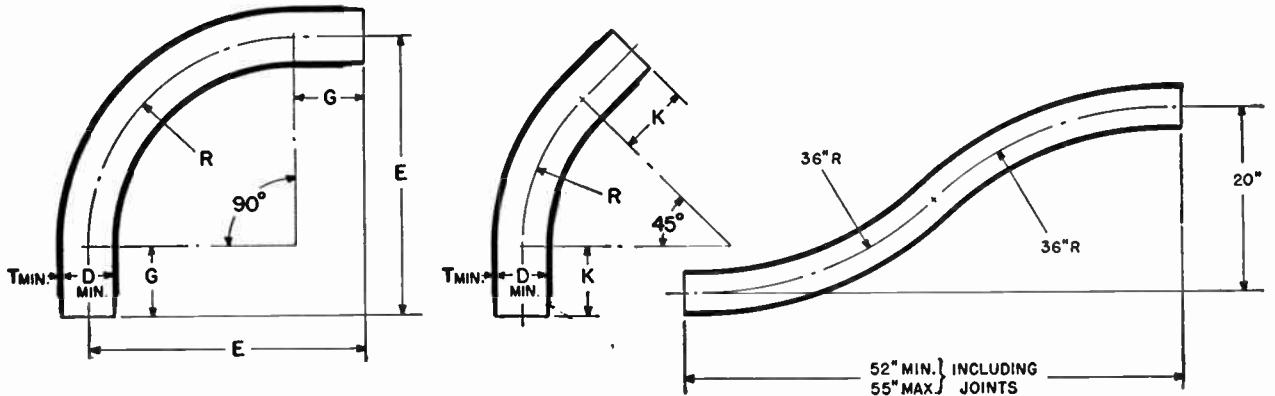

For Standard Conduit (Type I)
Dimensions, Inches

Size, D Min.	2.0		3.0		4.0		4.5		5.0		6.0	
T Min.	.23		.28		.32		.32		.41		.46	
R	9.5	18	24	36	13	24	36	16	36	18	36	36
E	17.5	26	32	38	21	32	38	24	38	26	36	36
G	8	8	8	2	8	8	2	8	0	8	0	0
K	8	8	8	2	8	8	8	8	8	8	8	8

For Nocrete Conduit (Type II)
Dimensions, Inches

Size, D Min.	3.0			4.0	
T Min.	.39			.43	
R	13	24	36	16	36
E	21	32	38	24	38
G	8	8	2	8	2
K	8	8	8	8	8

Prices on application.

Orangeburg Conduit Fittings
For STANDARD and NOCRETE Fibre Conduit

Orangeburg Bend Sections
5°—36 in. Radius

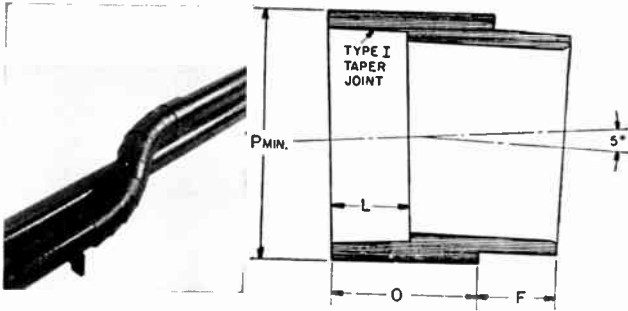

For special radius applications — cross-unders, transformations, obstructions. Offset male and female tapered joints tooled at an angle of 2 1/2°, resulting in a bend section of 5°. Various degrees and length bends, offsets and spirals can be assembled in the field.

For Orangeburg STANDARD conduit only
Dimensions, Inches.

Size	2	3	4	4 1/2	5
P Min.	2.97	3.80	5.12	5.60	6.40
O	3.00	2.97	2.94	2.90	2.85
L	1.05	1.25	1.65	1.85	2.00
F	1.00	1.20	1.60	1.80	1.95

Orangeburg Conduit Reducers

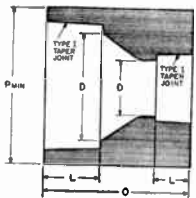

For reducing from one size fibre conduit to another. Available in all combinations from 2 to 6 in., inclusive. The standard reducer is taper sleeve joint at both ends.

When ordering specify whether for Standard or Nocrete conduit and sizes involved.

Orangeburg Conduit Adapters

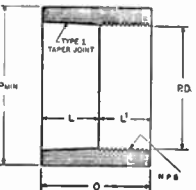

Adapters from metal pipe to fibre conduit are available in all combinations from 2 to 6 in., inclusive.

The standard adapter is taper sleeve joint at the fibre end and threaded for metal pipe size specified. Can be supplied straight bore for unthreaded metal pipe.

When ordering specify sizes and types.

Orangeburg Conduit Field Tooling Lathes

For 2 to 6 in. STANDARD AND NOCRETE Conduit

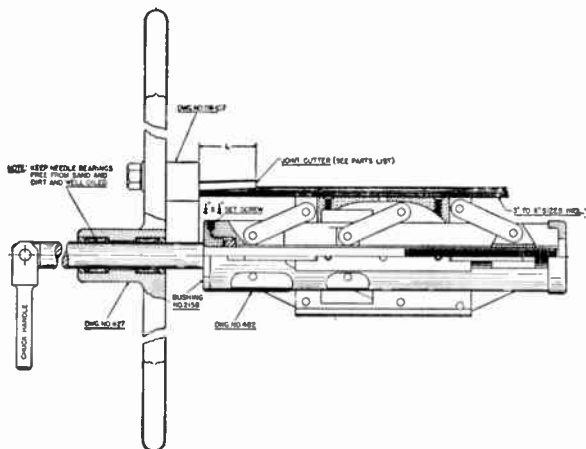

Orangeburg Conduit Bell Ends

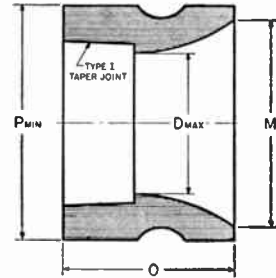

For use at conduit terminals in manholes, at substations, etc.

For Standard Conduit — Type I

Dimensions, Inches.

Size	2	3	4	4 1/2	5	6
P Min.	3.12	4.19	5.73	6.66	6.83	8.10
D Max.	2.15	3.15	4.15	4.65	5.15	6.20
M	3.10	4.15	5.40	6.30	6.50	7.75
O	2.55	3.00	3.65	4.50	4.50	4.50

For Nocrete Conduit — Type II

Dimensions, Inches.

Size	3	4
P Min.	4.19	5.60
D Max.	3.15	4.15
M	4.12	5.2
O	3.5	4.25

Fibre Conduit Plugs — For temporarily closing ends of ducts during concreting, etc. Available for 2 to 6 in. size conduits, inclusive.

Fibre Conduit Bushings — Solid and split bushings available for all conduit sizes 2 to 5 inches, inclusive.

Fibre Conduit Caps — For sealing spare ducts or exposed conduit ends, etc. Available for taper or plain end.

When ordering be sure to specify size and kind wanted.

Specially designed for tooling fibre conduit in the field easily and quickly.

Well constructed of fine material by expert mechanics; Made of hardened alloy steel, with needle bearings; With reasonable care and under normal conditions they will give years of accurate service.

Conduit Field Tooling Lathes

No.	Description
0904	For 2" STANDARD Conduit
0930	For 3" STANDARD Conduit only
0940	For 4" STANDARD Conduit only
0943	For 3" and 4" STANDARD Conduit only
0905	For 3" to 6" sizes, inclusive, both STANDARD and NOCRETE Conduit

All tapering tools are furnished with necessary cutter blades and packed in fibre carrying cases.

Cutter Blades for Conduit Field Tooling Lathes

No.	For Conduit Sizes
2820-2	2-In. and 3-In. Standard
2820-3	4-In. and 4 1/2-In. Standard and 4-In. Nocrete
2820-4	5-In. and 6-In. Standard
2820-6	3-In. Nocrete

Prices on application.

Orangeburg Spacers

For Orangeburg Standard Conduit (Type I) Only

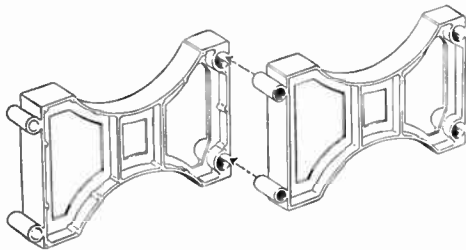

Plastic Spacers

For building duct formations, preparatory to concreting, lightweight interlocking plastic spacers are available.

Intermediate spacers provide vertical and horizontal separation of 1, 1½, 2 or 3 in. between outside walls of adjacent conduits. Base spacers provide a 3 in. separation between bottom row of ducts and trench bottom with 1, 1½, 2 or 3 in. horizontal separation.

Spacers are made as a one-way unit with interlocking lugs, as illustrated, which permit assembly to the desired combination in the field.

If specified, spacers will be shipped already assembled in 2, 3, or 4-way combinations.

These plastic spacers are molded at high pressures and temperatures to produce a tough, lightweight spacer which withstands rough handling in transportation and installation.

One-half to one-fifth the weight of other types, the skeletonized structure provides "locked-in" construction. The

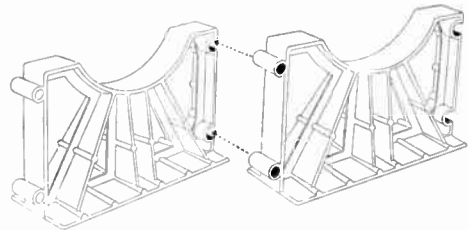

interlocking feature allows quick adaptation to field requirements and eliminates multiplicity of combinations in ordering.

Each spacer is marked to indicate conduit size and separation.

Spacer Links

A horizontal separation greater than 3 in. is occasionally required to separate ducts carrying power and communication cables. To provide this additional separation, 2 in. spacer links are available. They are inserted between base or intermediate spacers in multiples required to produce desired separation, and are assembled with interlocking lugs in the same manner as regular spacers.

Concrete Spacers

Where specifications require, concrete spacers for 2 to 5 in. conduit sizes, inclusive, may be supplied with 1, 1½, 2, or 3 in. separation. However, transportation costs may make it more practical for the large user to make his own spacers. Information as to mix employed will be furnished upon request.

Shipping Weights and Data

On Orangeburg Fibre Conduit

Economical Transportation

Orangeburg Conduit is transported most economically because it combines light weight with ample strength to resist breakage. The largest truck bodies can be loaded to maximum cubic carrying capacity, reducing trips and hourly costs to an almost negligible cost per foot.

Price Schedules

Orangeburg price schedules are based on total weight of material, including bends, elbows and items classified as fittings (both STANDARD and NOCRETE); excluding items classified as accessories, such as spacers, etc.

Shorts

The manufacturer reserves the right to include 15% lengths shorter than standard. Shorts are cut to even lengths—each piece is tooled and coupling is furnished. All are packed separately in any shipment to facilitate identification and easy count.

Class A Orders—30,000 lbs. (Minimum car) or over.

Class B Orders—10,000 to 29,999 lbs.

Class C Orders—9,999 lbs. or less.

Packaging and Bundling

There is an extra charge for bundling Class A and B orders, if so specified. Class C orders are usually packaged for less than carload handling.

The weights listed are used for pricing computations only (approx. shipping weights).

Approximate Shipping Weights

Orangeburg Standard Conduit

Conduit Size, In.	Wt. Per 100 Ft. Lbs.	Min. No. of Feet to 30,000 Lbs.	Min. No. of Feet to 10,000 Lbs.
2	115	26,100	8,700
3	140	21,430	7,144
4	200	15,000	5,000
4½	240	12,500	4,167
5	300	10,000	3,333
6	425	7,059	2,353

Orangeburg Nocrete Conduit

3	270	11,112	3,704
4	360	8,333	2,778

Weights of bends and other fibre items are included in figuring minimum weights — such items on an order will decrease footage in the conduit weight tables.

Call Graybar FIRST For . . .



Crouse-Hinds Traffic Signals

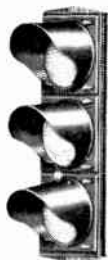

Front View

Design

The Crouse-Hinds Company is offering a complete new line of traffic signals incorporating a really dust-tight optical system. Reflector and lens assemblies will stay clean resulting in a more brilliant signal indication. This new optical system will retain its peak efficiency for the life of the signal.

Every detail in the design of these new signals has been carefully considered not only from an operational and maintenance standpoint but for appearance as well. Hinges and catches are concealed not only improving the appearance of the signal but eliminating protruding lugs which are easily broken.

Materials

The casing, door, and hood are made of special silicon aluminum alloy, cast in steel dies under great pressure. Such construction insures a uniform and homogeneous casting of great strength, capable of resisting corrosive atmospheres, including salt air. Castings are extremely accurate and similar parts are interchangeable on all signals.

The red, amber, and green lenses are selected especially for purity of color and high transmission. The outer surface of the lens is smooth, which makes cleaning easy, while on the inner surface there are prisms for distributing the light downward and to the sides.

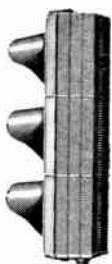

Rear View

Dust-Tight Optical System

Signals are equipped with a complete optical unit for each signal indication. Each optical unit consisting of a receptacle, reflector, lens and door, is kept free from dust by the use of specially designed gaskets between the component parts. Beam candle power is maintained at high levels indefinitely.

The reflector used is an extremely accurate parabolic reflector made of polished glass, silvered to form the reflecting surface. The silvering is protected by electrolytically deposited copper over which is placed a backing of baked enamel. High efficiency Alzak finished aluminum reflectors can be furnished when specified.

The reflector is mounted in an aluminum spider which also holds the lamp receptacle. The left side of the reflector support ring is hinged to the casing, and one catch on the right accurately positions the assembly behind the lens. In a normal position, the reflector assembly is rigidly fastened to the casing and does not have to be disturbed for relamping. When access to the rear is wanted, it is only necessary to loosen the single catch and swing the reflector outward on its hinges.

The optical system is designed to take the standard 60-watt traffic signal lamp mounted in an A-21 clear bulb. Traffic signal lamps of 25, 40, or 100-watt sizes may also be used.

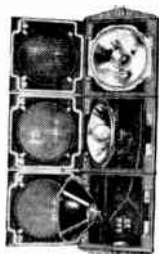

View Showing
Optical System

Body Construction

The bodies of the new Crouse-Hinds signals are of unit sectional construction, which features an individual body casting for each optional system. This insures a rigid, compact casing which is dust-tight and water-tight. Signals of two, three, four, or five sections may be built up as desired.

Unit construction, with complete interchangeability of parts, is of great benefit to cities using any quantity of signals, since any desired combination and arrangement of signal bodies can be made up locally.



Separated View of
Body Castings

Crouse-Hinds Adjustable Traffic Signals

‡With Red, Amber, and Green Unlettered I.T.E. Lenses



Type TSP-113DT
One-Way Signal
4-Inch Post
Mounting
Underground
Feed

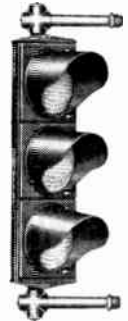

Type TSV-113DT
One-Way Signal
Vertical
Bracket-Arm
Mounting

***Three-Section, One-Way Signals**

Type	No.	Mounting	‡Each
TSO -113DT	50010	Without any Mounting Attachments . . .	\$130.50
TSW -113DT	50011	Span Wire	150.50
TSM -113DT	50012	Mast Arm	160.50
TSV -113DT	50013	Vertical-Bracket Arm, less Pole Clamps . .	‡147.00
TSH -113DT	50014	Horizontal-Bracket Arm, less Pole Clamps ‡	168.00
TSB -113DT	50015	Horizontal-Bracket with Fuse Compart- ment, less Pole Clamps	‡193.00
TSP -113DT UG	50016	4-Inch Post, Underground Feed	146.50
TSP -113DT OH	50017	4-Inch Post, Overhead Feed	161.50
TSU -113DT UG	50018	1½-Inch Nipple, Underground Feed	135.50
TSU -113DT OH	50019	1½-Inch Nipple, Overhead Feed	150.50

*For two-section signals, deduct \$43.50 from above prices. For four-section signals, add \$43.50 to above prices.

▲ Three-Section, Two-Way Adjustable Signals

Type	No.	Mounting	‡Each
TRW -223DT	50080	Span Wire	\$316.50
TRM -223DT	50081	Mast Arm	326.50
TRV -223DT	50082	Vertical-Bracket Arm, less Pole Clamps . .	‡315.50
TTV -223DT	50083	Tandem-Bracket Arm, less Pole Clamps . .	‡315.50
TRP -223DT UG	50084	4-Inch Post, Underground Feed	312.50
TRP -223DT OH	50085	4-Inch Post, Overhead Feed	330.00
TRU -223DT UG	50088	1½-Inch Nipple, Underground Feed	301.50
TRU -223DT OH	50089	1½-Inch Nipple, Overhead Feed	319.00

▲For two-section signals, deduct \$87.00 from above prices. For four-section signals add \$87.00 to above prices.

★ Three-Section, Three-Way Adjustable Signals

Type	No.	Mounting	‡Each
TRW -333DT	50092	Span Wire	\$466.00
TRM -333DT	50093	Mast Arm	476.00
TRV -333DT	50094	Vertical-Bracket Arm, less Pole Clamps . .	‡465.00
TRP -333DT UG	50095	4-Inch Post, Underground Feed	462.00
TRP -333DT OH	50096	4-Inch Post, Overhead Feed	479.50
TRU -333DT UG	50099	1½-Inch Nipple, Underground Feed	451.00
TRU -333DT OH	50100	1½-Inch Nipple, Overhead Feed	468.50

★For two-section signals, deduct \$130.50 from the above prices. For four-section signals, add \$130.50 to above prices.

‡ Three-Section, Four Way Adjustable Signals

Type	No.	Mounting	‡Each
TRW -443DT	50103	Span Wire	\$615.50
TRM -443DT	50104	Mast Arm	625.50
TRV -443DT	50105	Vertical-Bracket Arm, less Pole Clamps . .	‡614.50
TRP -443DT UG	50106	4-Inch Post, Underground Feed	611.50
TRP -443DT OH	50107	4-Inch Post, Overhead Feed	629.00
TRU -443DT UG	50110	1½-Inch Nipple, Underground Feed	600.50
TRU -443DT OH	50111	1½-Inch Nipple, Overhead Feed	618.00

‡For two-section signals, deduct \$174.00 from above prices. For four-section signals, add \$174.00 to above prices.

Also available in five-way and six-way adjustable signals.

Prices do not include incandescent lamps.

Special detachable hoods not exceeding 8 inches in length will be furnished without extra charge. Hoods exceeding 8 inches in length, add \$2.00 per hood.

‡Price does not include pole clamps.

‡Prices include unlettered lenses in all sections. For each unlettered lens changed to a lettered lens or to an arrow lens, add \$2.50 to the prices. For each lens omitted, deduct \$5.00 from the prices.

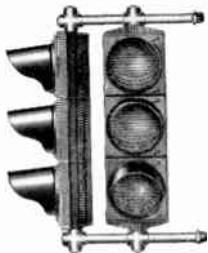

Type TTV-223DT
Two-Way Signal
Tandem
Bracket-Arm
Mounting

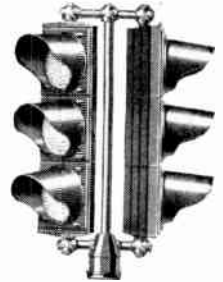

Type TRP-223DT
Two-Way Signal
4-Inch Post
Mounting
Underground
Feed

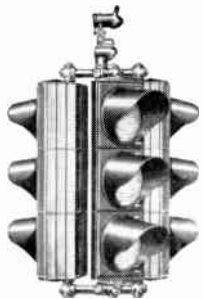

Type TRM-333DT
Three-Way Signal
Mast-Arm
Mounting

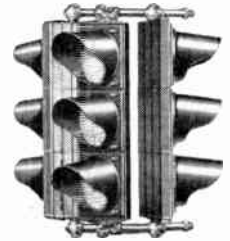

Type TRV-333DT
Three-Way Signal
Vertical
Bracket-Arm
Mounting

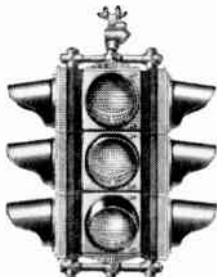

Type TRW-443DT
Four-Way Signal
Span-Wire
Mounting

Crouse-Hinds Non-Adjustable Square Traffic Signals

§ **With Red, Amber, and Green Unlettered I.T.E. Lenses**



**Type TIM-443DT
Four-Way Signal
with Base Light,
Mast-Arm
Mounting**

▲ Three-Section, Four-Way Non-Adjustable Signals

Type	No.	Mounting	§ Each
TSW-443DT	50283	Span wire.....	\$428.50
TIW-443DT	50284	Span Wire with Base Light.....	461.50
TSM-443DT	50285	Mast Arm.....	438.50
TIM-443DT	50286	Mast Arm with Base Light.....	471.50
TSV-443DT	50287	Vertical-Bracket Arm, less Pole Clamps.....	427.50
TSP-443DT UG	50288	4-Inch Post, Underground Feed.....	430.00
TSP-443DT OH	50289	4-Inch Post, Overhead Feed.....	445.00
TSU-443DT UG	50292	1½-Inch Nipple, Underground Feed.....	416.00
TSU-443DT OH	50293	1½-Inch Nipple, Overhead Feed.....	431.00

Type H and Type K Adjustable Highway Traffic Signals

The new Type H highway signals equipped with 12-in. lenses, in contrast to the 8-in. lenses used in conventional signals, meet the need for a more brilliant signal on major highways and other thoroughfares where the faster moving

traffic requires longer stopping distances. Type K signals combine the brilliant Type H 12-in. red section with the lower const. conventional 8-in. amber and green sections.

Type H Three-Section† One-Way and Adjustable Highway Traffic Signals With 12-inch Red, Amber and Green Lenses*

One-Way, Three-Section Signals

Type	No.	Mounting	Each
HSO-113	50800	Without Mounting Attachments.....	\$198.00
HSW-113	50801	Span Wire.....	218.00
HSM-113	50802	Mast Arm.....	228.00



**Type HSO-113
Without Mounting
Attachments**

Two-Way, Three-Section Adjustable Signals

HRW-223	50806	Span Wire.....	451.50
HRM-223	50807	Mast Arm.....	461.50

Three-Way, Three-Section Adjustable Signals

HRW-333	50811	Span Wire.....	668.50
HRM-333	50812	Mast Arm.....	678.50

Four-Way, Three-Section Adjustable Signals

HRW-443	50815	Span Wire.....	885.50
HRM-443	50816	Mast Arm.....	895.50

Type K Three-Section One-Way and Adjustable Highway Traffic Signals With 12-inch Red; 8-inch Amber and Green Lenses*

One-Way, Three-Section Signals

Type	No.	Mounting	Each
KSO-113	50817	Without Mounting Attachments.....	\$153.00
KSW-113	50818	Span Wire.....	173.00
KSM-113	50819	Mast Arm.....	183.00



**Type KSO-113
Without Mounting
Attachments**

Two-Way, Three-Section Adjustable Signals

KRW-223	50823	Span Wire.....	361.50
KRM-223	50824	Mast Arm.....	371.50

Three-Way, Three-Section Adjustable Signals

KRW-333	50828	Span Wire.....	533.50
KRM-333	50829	Mast Arm.....	543.50

Four-Way, Three-Section Adjustable Signals

KRW-443	50832	Span Wire.....	705.50
KRM-443	50833	Mast Arm.....	715.50

§Prices include unlettered lenses in all sections. For each unlettered lens changed to lettered or arrow lens, add \$2.50 to prices. For each lens omitted deduct \$5.00 from prices.

▲For two-section signals, deduct \$125.00 from above prices. For four-section signals, add \$125.00 to prices.

†Each additional 12-in. section, add \$66.00 per face. Each 12-in. section omitted, deduct \$66.00 per face. Each additional 8-in. section, add \$43.50 per face. Each 8-in. section omitted, deduct \$43.50 per face.

*For 12-in. lettered or arrow lenses, add \$5.00 per lens. For 8-in. lettered or arrow lenses, add \$2.50 per lens. Special hoods for 12-in. sections. TL2227 combination hood having shape similar to KL455, (no extra charge.) Special 12-in. hoods, add \$2.00 per hood.

Back plates for 3-section type K, add \$33.00 per face.

Incandescent lamps, and pole clamps, not included in cat. nos. and prices.

Crouse-Hinds One-Section Beacons

Without Motor Flashing Switch

†**With Amber Unlettered I.T.E. Lenses**

***One-Section, Four-Way Adjustable Beacons**



Adjustable

Type	No.	Mounting	Each
TRW -441DT	50435	Span Wire with Top Arm Assembly Only.....	\$239.50
TRM -441DT	50436	Mast Arm with Top Arm Assembly Only.....	249.50
TRV -441DT	50437	Vertical-Bracket Arm, less Pole Clamp.....	▲266.50
TRP -441DT UG	50438	4-Inch Post, Underground Feed.....	263.50
TRP -441DT OH	50439	4-Inch Post, Overhead Feed.....	281.00
TRU -441DT UG	50442	1½-Inch Nipple, Underground Feed.....	252.50
TRU -441DT OH	50443	1½-Inch Nipple, Overhead Feed.....	270.00

***One-Section, Four-Way Non-Adjustable Beacons**



Non-Adjustable

Type	No.	Mounting	Each
TSW -441DT	50378	Span Wire.....	\$178.50
TIW -441DT	50379	Span Wire with Base Light.....	211.50
TSM -441DT	50380	Mast Arm.....	188.50
TIM -441DT	50381	Mast Arm with Base Light.....	221.50
TSP -441DT UG	50382	4-Inch Post, Underground Feed.....	180.00
TSP -441DT OH	50383	4-Inch Post, Overhead Feed.....	195.00

*Contact Graybar for additional information on two, three, five, and six-way beacons.

Crouse-Hinds One Section, One-Way Beacons and Signals

Without Motor Flashing Switch

†**With Amber Unlettered I.T.E. or Special Lenses**



Crouse-Hinds one-way, one section beacons and signals are similar in all respects to standard traffic signals, except that they have only one section instead of the usual three.

All beacons except TSE-111DT are regularly equipped with amber, unlettered I.T.E. lenses.

Type TSE-111DT is equipped with WALK or ARROW lenses and is used for mounting beneath existing signals. They are furnished complete with 1¼ inch diameter pipe nipple, lead gasket, and check nuts.

Type TST-111DT beacons are equipped with an auxiliary reflector and receptacle for illuminating an information or warning sign mounted on the supporting standard immediately below. Auxiliary reflector is designed to take any lamp not exceeding 3⅛ inches in diameter or 6⅛ inches in length. A standard 100-watt lamp is recommended. On the bottom of the type TST-111DT beacon, there is a slip fitter for 2-inch pipe, cast as part of the beacon base. Set-screws are provided for fastening it to the 2-inch supporting pipe.



Type	No.	Mounting	Lens	Each
TSO -111DT	50463	Without any Mounting Attachments.....	Amber	\$43.50
TSW -111DT	50464	Span Wire.....	Amber	63.50
TSM -111DT	50465	Mast Arm.....	Amber	73.50
TSP -111DT UG	50466	4-Inch Post, Underground Feed.....	Amber	59.50
TSV -111DT	50470	Vertical-Bracket, with Top Arm Only, less Pole Clamps.....	Amber	▲54.25
TSE -111DT	50471	1¼-Inch Nipple in Top with Hood.....	WALK	51.00
TSE -111DT	50472	1¼-Inch Nipple in Top with Hood.....	Vertical Arrow	51.00
TSE -111DT	50473	1¼-Inch Nipple in Top with Hood.....	Right Arrow	51.00
TSE -111DT	50474	1¼-Inch Nipple in Top with Hood.....	Left Arrow	51.00
TST -111DT UG	50475	2-Inch Post with Sign Reflector and Glass Door.....	Amber	87.50



Prices do not include incandescent lamps, motor flashing switches, or radio interference suppressors.

Beacons are furnished with KL9 removable sheet aluminum hoods. There is no deduction in price for the omission of hoods.

†Lenses of any standard color can be obtained without extra charge. Lettered lenses can be furnished at an advance of \$2.50 per lens in the price. For each lens omitted, deduct \$2.50 from the prices.

▲Price does not include pole clamps.

Crouse-Hinds Automatic Synchronous Controllers

Jack Mounted—Weatherproof Cabinets

With Gear-Shift—Adjustable Time-Cycle, 40, 50, 60, 70, and 80 Seconds
10 Amperes, 115 Volts, 60 Cycles A.C.—6 to 15 Color Circuits, 16 Intervals

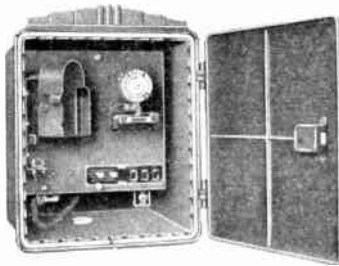

Type KS-2
Mounted in Size 16 Cabinet

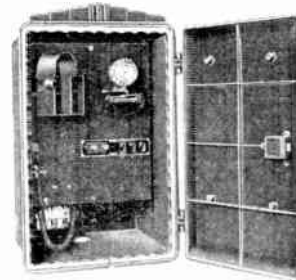

Type GS-5
Mounted in Size 22 Cabinet

Types KS-2 and GS-5 Non-Interconnected Synchronous

The non-interconnected type is for use at adjacent or isolated intersections. They will keep in step with each other and provide limited progressive traffic movement. They can run 24 hours a day, be shut down, or turned to flashing, by means of time switches. All are equipped with reset circuits. At time of installation of controllers, if there is the possibility of future interconnection, the future-interconnected type should be purchased as the small additional cost would easily be justified.

Type GS-5 Future-Interconnected Synchronous

This future-interconnected controller meets the immediate problem for cities desiring to install a signal system, but lacking sufficient money to purchase cable. The signals and controllers may be installed and the interconnecting cable purchased and installed later. These controllers are similar to the non-interconnected type except they are designed and wired for interconnection later.

The terminal board is designed for interconnection; fuse clips for the interconnecting cable are furnished and the remote-control relay subbases for signal shut-down and flashing are installed and wired complete. The automatic reset circuit is also added.

Remote-controlled relays are not supplied with future interconnected controllers. They may be purchased at time of interconnection and mounted on the relay subbases.

Type GS-5 Interconnected Synchronous

Type GS interconnected controller is the one generally used in congested portions of cities and on long thoroughfares. This system permits progressive signal operation and provides all of the necessary control features except control of the time-cycle from the master.

The following features may be incorporated in the system by running an interconnecting cable between the controllers, automatic reset, remote shut-down, remote flashing, and remote emergency all-red. One positive wire in the cable for each remote-control feature, in addition to the common wire.

Crouse-Hinds Automatic Synchronous Controllers

Jack Mounted—Weatherproof Cabinets

***With Gear Shift—Adjustable Time Cycle, 40, 50, 60, 70, and 80 Seconds
†10 Amperes, 115 Volts, 60 Cycles A.C.—6 to 15 Color Circuits, 16 Intervals**

Type KS-2 for Non-Interconnected Operation

With Hand Reset Switch

**With 2 vehicle movements. Minimum number of signal circuits, 6.
Not available in 3, 4, or 5 vehicle movements.**

No.....		Without Flashing Mechanism	With Flashing Mechanism
Type KS-2.....	Each	\$475.00	\$510.20

Type GS-5 for Non-Interconnected Operation

With Hand Reset Switch

	2 Vehicle Movements 6 Signal Circuits		3 Vehicle Movements 9 Signal Circuits		4 Vehicle Movements 12 Signal Circuits		5 Vehicle Movements 15 Signal Circuits	
	No.	Each	No.	Each	No.	Each	No.	Each
Type GS-5, without Flashing Mechanism....	46488	\$525.00	46490	\$543.00	46492	\$561.00	46494	\$579.00
Type GS-5, with Flashing Mechanism.....	46489	560.00	46491	578.00	46493	596.00	46495	614.00

Type GS-5 for Future-Interconnected Operation

With Hand Reset Switch, Automatic Reset Circuit, and Relay Subbases Wired Complete

Type GS-5 with Flashing Mechanism	Type GS-5 With Relay Subbases Wired For			2 Vehicle Movements 6 Signal Circuits		3 Vehicle Movements 9 Signal Circuits		4 Vehicle Movements 12 Signal Circuits		5 Vehicle Movements 15 Signal Circuits	
	Signal Shut-Down	Flashing	Emergency All-Red	No.	Each	No.	Each	No.	Each	No.	Each
X	X	X	..	46620	\$620.00	46624	\$648.00	46628	\$666.00	46632	\$684.00
..	X	..	X	46621	585.00	46625	613.00	46629	631.00	46633	649.00
X	..	X	X	46622	620.00	46626	658.00	46630	676.00	46634	694.00
X	X	X	X	46623	630.00	46627	668.00	46631	686.00	46635	704.00

Type GS-5 for Interconnected Operation

With Hand Reset Switch, Automatic Reset Circuit, and Jack Mounted Remote Control Relays Wired Complete

Type GS-5 with Flashing Mechanism	Type GS-5 With Remote Control Relays For			2 Vehicle Movements 6 Signal Circuits		3 Vehicle Movements 9 Signal Circuits		4 Vehicle Movements 12 Signal Circuits		5 Vehicle Movements 15 Signal Circuits	
	Signal Shut-Down	Flashing	Emergency All-Red	No.	Each	No.	Each	No.	Each	No.	Each
	No Relays Furnished			46636	\$585.00	46644	\$613.00	46652	\$631.00	46660	\$649.00
..	X	46637	615.00	46645	643.00	46653	661.00	46661	679.00
X	..	X	..	46638	660.00	46646	728.00	46654	746.00	46662	764.00
..	X	46639	625.00	46647	693.00	46655	711.00	46663	729.00
X	X	X	..	46640	690.00	46648	758.00	46656	776.00	46664	794.00
..	X	..	X	46641	655.00	46649	723.00	46657	741.00	46665	759.00
X	..	X	X	46642	700.00	46650	818.00	46658	836.00	46666	854.00
X	X	X	X	46643	740.00	46651	858.00	46659	876.00	46667	894.00

Prices include brackets for wood-pole mounting or adjustable pole bands for steel-pole mounting. Standard 4-inch pedestal adapter, \$25.00 additional.

*May be furnished with gears for other time-cycles.

†Controllers are furnished for 110 to 125-volt, 60 cycle operation. For any other frequency, add \$50.00, and for any other voltage, add \$50.00 to the above prices.

Type TSS-20 Crouse-Hinds Motor Flashing Switches

20 to 60 Flashes per Minute

***10 Amperes, 115 Volts, 60 Cycles A.C.**

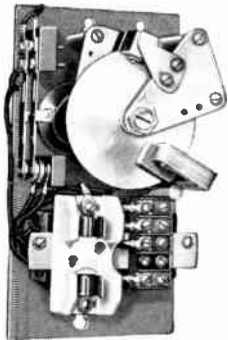

Switch Only

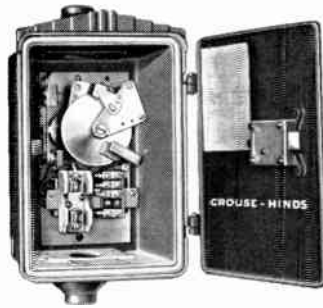

**Switch in Size 12 Cabinet
(Door Open)**

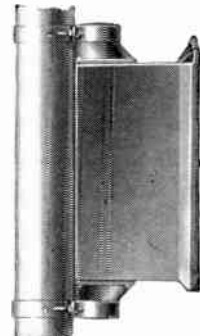

**Size 12 Cabinet
Steel-Pole Mounting
With
Adjustable Pole Bands**

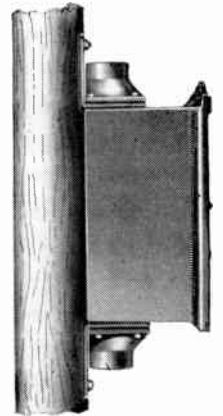

**Size 12 Cabinets
Wood-Pole Mounting
With Wood Pole Brackets**

Type TSS-20 has large diameter, widebreak, non-corrosive metal contacts and will handle an incandescent lamp load of 10 amperes. It is driven by a variable speed induction—disc motor, the magnetic circuit of which is laminated throughout, thus giving high torque at low wattage input.

The speed of flash may be varied between 20 times a minute and 60 times a minute.

In addition to the motor flashing switch itself, a terminal block with properly identified terminals for all field connections is provided. A set of fuse clips for the hot side of the power line is mounted on the terminal block.

The entire switch assembly may be removed as a unit from the cabinet to facilitate installation.

Cabinet: Type TSS-20 motor flashing switch is mounted in a cast aluminum, weatherproof cabinet, equipped with a heavy duty brass lock. The hinged door of the cabinet is equipped with a gasket to exclude dust and moisture.

Radio Interference Suppressor: Type TSS-20 motor flashing switches are listed below with and without radio interference suppressors.

	Single-Circuit No.	†Each		Two-Circuit No.	†Each
Type TSS-20, with Suppressor.....	46819	\$124.00		46820	\$139.10
Type TSS-20, without suppressor.....	46817	104.10		46818	115.10

Crouse-Hinds Traffic Signal Lenses

For All Types of Signals

8¾-Inch I.T.E. Lenses—Standard

(Meets Specifications of Institute of Traffic Engineers)

- No. KL3842, I. T. E. Red Lens..... each \$5.50
- No. KL3843, I. T. E. Amber Lens..... each 5.50
- No. KL3844, I. T. E. Green Lens..... each 5.50



**I.T.E. Lens
Green, Amber,
or Red**



**Clear WALK Lens
I.T.E. Standard**

8¾-Inch Lettered Prismatic Diffusing Lenses

- No. TL988, I. T. E. Arrow, Black Field, Green Arrow..... each \$8.00
- No. KL3825, Lettered WALK, Black Field, Clear Lettering..... each 8.00
- No. KL3829, Lettered WAIT, Black Field, Clear Lettering..... each 8.00



**Green Prismatic
Diffusing Lens
I.T.E. Arrow**



Clear WAIT Lens

*Can be furnished for 230-volt, 60 cycle operation without extra charge. Contact GRAYBAR for information on other voltages and frequencies.

†Prices include brackets for wood-pole mounting or adjustable pole bands for steel-pole mounting.

Crouse-Hinds Super-Trafflex Controllers Jack Mounted—Weatherproof Cabinets

*40 to 120 Seconds Time Cycle
†10 Amperes, 115 Volts, 60 Cycles A.C.—6 to 15 Color Circuits, 16 Intervals

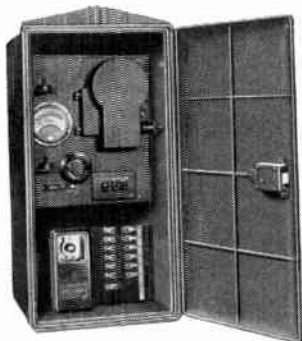

Type GFM-3 Super-Trafflex Master Controller
With Time Switch in Size 28 Cabinet

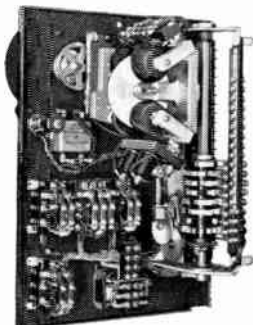

Type GF Super-Trafflex Secondary Controller

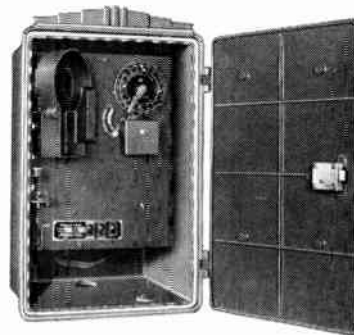

Type GF Super-Trafflex Secondary Controller in Size 22 Cabinet

Full Flexible—Progressive Control of Traffic

Crouse-Hinds Trafflex Control system provides for a full flexible-progressive movement of traffic, in which the operation of the signals is determined by the traffic requirements at individual intersections. The time relationship between adjacent controllers permits a smooth, uninterrupted flow of traffic in all directions at varying speeds.

Trafflex Control System

The Trafflex control system consists of a Super-Trafflex master controller located at control headquarters, within or near the control area, and a Super-Trafflex secondary at each of the controlled intersections.

The Type GF Super-Trafflex controller is driven by the Crouse-Hinds standard Trafflex motor which employs both driving and bucking coils and provides for remote control of the time-cycle.

The Super-Trafflex master, which controls the speed at which traffic may flow, acts upon the Super-Trafflex secondaries, slowing them down or speeding them up as may be required, and keeps the secondaries in their proper time relationship with respect to each other.

When the time-cycle regulator of the master is adjusted to give a different time-cycle, the secondaries respond instantly to any change in speed control, always keeping in step. No synchronization by the master is required when the time-cycle is changed.

This system provides for remote control of the time-cycle, shut-down, flashing, emergency all-red, control of the offset from zero time, division of the time-cycle into the correct number of intervals, and automatic supervision of all secondaries.

Crouse-Hinds Trafflex system places in the hands of the traffic engineer means for controlling all phases of vehicular and pedestrian traffic.

This flexible-progressive control of traffic is the only method of traffic control which is entirely satisfactory for large interlocked areas. The system is simple to install, easy to maintain, inexpensive to operate, requires little maintenance expense, and may be readily extended as traffic conditions warrant.

Type GFM-3 Super-Trafflex Master Controllers

40 to 120 Seconds Time Cycle
With Manually-Operated Switch for Shutdown or Flashing
★Capacity—50 Secondary Controllers

No.	Description	Dials	Cabinet Size	Each
46700	Single Master	(One)	22	\$ 706.20
46701	Dual Master with Manual Change-over	Two	40	1181.70
46702	Dual Master with Time Switch Change-over	Two	40	1381.70
With Time Switch for Shutdown or Flashing				
46703	Single Master	(One)	28	\$ 806.20
46704	Dual Master with Manual Change-over	Two	40	1281.70
46705	Dual Master with Time Switch Change-over	Two	40	1481.70

★ For 100 Secondary Capacity add \$120.00 to above prices for Single Masters add \$240.00 for Dual Masters.

Type GF-5 Super-Trafflex Secondary Controllers

40 to 120 Seconds Time Cycle

Number of Vehicle Movements		Two		Three		Four		Five		
Minimum Number of Signal Circuits		Six		Nine		Twelve		Fifteen		
Flashing Mechanism	With Remote Control Relays for Signal		No.	Each	No.	Each	No.	Each	No.	Each
	Shut-Down	Flashing								
	No Relays Furnished		46668	\$635.00	46676	\$663.00	46684	\$681.00	46692	\$699.00
..	x	..	46669	665.00	46677	693.00	46685	711.00	46693	729.00
x	..	x	46670	710.00	46678	778.00	46686	796.00	46694	814.00
..	46671	675.00	46679	743.00	46687	761.00	46695	779.00
x	x	x	46672	740.00	46680	808.00	46688	826.00	46696	844.00
..	x	..	46673	705.00	46681	773.00	46689	791.00	46697	809.00
x	..	x	46674	750.00	46682	808.00	46690	826.00	46698	844.00
x	x	x	46675	790.00	46683	868.00	46691	926.00	46699	944.00

Prices include brackets for wood-pole mounting or adjustable pole bands for steel-pole mounting.

Standard 4-inch pedestal adapter, \$25.00 additional.

*These controllers may be furnished with time-cycle ranges of 30-90 seconds or 20-60 seconds, without extra charge.

†Controllers are furnished for 110 to 125-volt, 60 cycle operation. For any other frequency, add \$50.00, and for any other voltage, add \$50.00 to the above prices.

Crouse-Hinds Synchronous Traffic Signal Controllers

Type LS

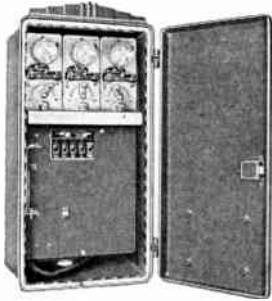

Type LS—Three-dial

Type LS Controllers can be supplied with one, two, or three dial-units. Each dial-unit can be set for a different time-cycle, a different timing-split and a different offset. All controllers are provided with jacks and wiring for three dial-units regardless of the number originally purchased. Therefore it is ideal for use where a single-dial controller is sufficient at the time of installation but where future needs may call for additional dials.

Type LS controllers have separate dial-units each complete in itself. A complete controller consists of from one to three dial-units mounted on a sliding shelf, a face plate, a rear panel and a cabinet housing the assembly.

These controllers are available for non-interconnected and interconnected operation. These types are essentially the same and differ only in the auxiliary features for interconnection.

Type LS1-SD Controller for Non-Interconnected Operation

With One Single-Reset Dial-Unit

With Hand Reset Switch

Standard Equipment	Two Vehicle Movements Six Signal Circuits		Three Vehicle Movements Nine Signal Circuits	
	No.	Each	No.	Each
Without Flasher	51000	\$704.00	51002	\$722.00
With Flasher and Filter	51001	754.00	51003	772.00

Types LS1-SD and LSM1-SD Controllers for Interconnected Operation

With One Single-Reset Dial-Unit

With Hand Reset Switch, Automatic Reset Circuits, Relay Subbases, and Remote Control Relays Wired Complete

Flasher and Filter (F)	With Relay Subbases (S) or Subbases and Relays (S-R) for			Type LS1-SD				Type LSM1-SD			
	Shutdown	Flashing	All-Red	Two Vehicle Movements Six Signal Circuits		Three Vehicle Movements Nine Signal Circuits		Two Vehicle Movements Six Signal Circuits		Three Vehicle Movements Nine Signal Circuits	
				No.	Each	No.	Each	No.	Each	No.	Each
...	S	S*		51012	\$764.00	51020	\$792.00	51028	\$774.00	51036	\$801.00
...	S-R	S*		51013	794.00	51021	822.00	51029	804.00	51037	832.00
F	S	S-R		51014	854.00	51022	922.00	51030	864.00	51038	932.00
...	S		S-R	51015	804.00	51023	872.00	51031	814.00	51039	882.00
F	S-R	S-R		51016	884.00	51024	952.00	51032	894.00	51040	962.00
...	S-R		S-R	51017	834.00	51025	902.00	51033	844.00	51041	912.00
F		S-R	S-R	51018	894.00	51026	1012.00	51034	904.00	51042	1022.00
F	S-R	S-R	S-R	51019	934.00	51027	1052.00	51035	944.00	51043	1062.00

Two-Dial and Three-Dial Controllers †

Order by Catalog Numbers Listed Above Using Type Letters from the Following Table

Number of Dials	Type Letters	Secondary	Add Each	Type Letters	Master & Secondary	Add Each
Two	LS1-DD		\$260.00	LSM1-DD		\$220.00
Three	LS1-TD		520.00	LSM1-TD		440.00

*All-Red Relay Subbase, substituted for flashing relay subbase without extra charge.

†Two-dial and three-dial controllers are furnished with ten time-cycle gears—two sets for 40, 50, 60, 70 and 80 seconds.

Extra Dial-Units and Accessories

No.	Description	Each
TL1462	Dial-Unit Only, less dial-transfer relay. For LS-1 controller	\$190.00
TL1495	Dial-Unit Only, less dial-transfer relay. For LSM-1 controller	190.00
KL9501A	Dial-Transfer Relay	40.00
KL461	Motor-Brake Relay	30.00

Crouse-Hinds Semi-Vehicle-Actuated Controllers

Type SVA

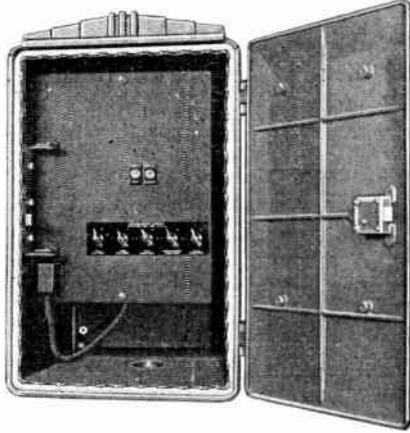

**Type SVA-2 Controller
in Size 22 Cabinet**

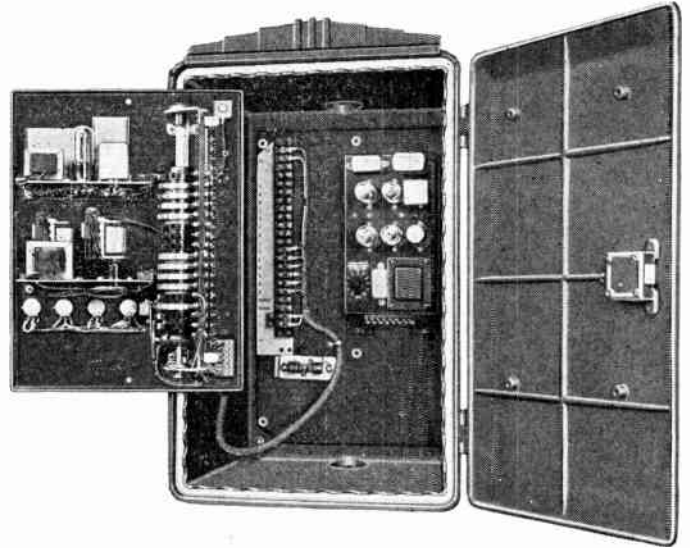

**Interior View, Type SVA-2 Controller
with MNA-1 Amplifier**

The intersections of heavily-traveled major streets with minor streets on which traffic is relatively light present a special traffic problem. Traffic signals are required at such intersections to interrupt main street traffic flow so that vehicles on the cross street may enter the intersection in safety. However, cross street traffic is usually intermittent at these intersections, and conventional fixed-time controllers do not always provide efficient operation.

Type SVA controller is especially designed for use at such intersections. It is of the semi-vehicle-actuated type and requires the use of vehicle detectors placed in the cross street. The controller is so designed that the signal indications are green to main street traffic until a detector is actuated. Such actuation causes the main street green indication.

Pedestrian Operation

In some instances there is considerable pedestrian traffic at intersections where SVA controllers are required. To provide protection for pedestrians wishing to cross the major street, the controller may be actuated by pedestrian pushbuttons.

Interconnected Operation

When provided with the proper auxiliary equipment, type SVA controllers may be installed in interconnected systems. Such controllers are equipped with automatic reset circuits so that the offset relationship of the actuated cycle may be coordinated with the operation of other controllers in the system for progressive traffic movement. Type SVA controllers can be furnished for installation in type GS or LS interconnected synchronous systems. They are also available for use in Super-Trafflex control systems.

For information and prices on type SVA controllers arranged for interconnected operation, contact GRAYBAR.

**Complete Jack-Mounted Controllers in Size 22 Weatherproof Cabinets
6 Color Circuits, 4 Intervals 10-Ampere, 115-Volt, 60 Cycle A. C.**

No.	Type	Description	Each
50798	SVA-2	Controller, Less Pedestrian Extension Timer	\$750.00
50799		Controller, With Pedestrian Extension Timer	816.00

Type PSN Non-Directional Pressure Sensitive Detectors

46972	PSN-6	6-ft. Non-Directional Pressure-Sensitive Detector with Frame	\$377.40
46973	PSN-8	8-ft. Non-Directional Pressure-Sensitive Detector with Frame	438.60
13893-N	PDR-1	Relay Unit for Directional Pressure-Sensitive Detector	33.00

Pedestrian Pushbutton and Sign



**Type
TL1731**

Pedestrian Pushbutton		Pedestrian Sign	
No.	Each	No.	Each
TL1731	\$22.00	15178-B	\$4.00

Crouse-Hinds Neon Traffic Signals and Signs



Fig. 1



Fig. 2



Fig. 3



Fig. 4



Fig. 5



Fig. 6



Fig. 7



Fig. 8



Fig. 9

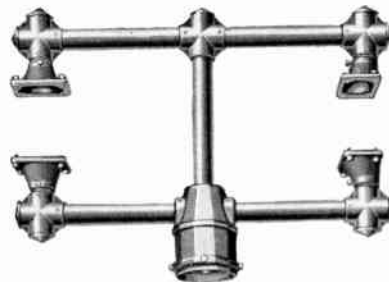

Fig. 10

Neon signals and signs are furnished less tubing. Tubing can be purchased locally and the Crouse-Hinds Company will furnish a drawing of the tubing.

One or two-line signals may be used in any arrangement—with slip-fitters or bracket arms.

Type	No.	Description	Recommended	Each
TNO-1	46835	Don't Walk (Fig. 1)	Red	\$200 00
	46840	Wait Walk	Red-Green	200 00
TNO-2	46842	Don't Walk	Red	200 00
	46847	Wait Walk (Fig. 2)	Red-Green	200 00
TNO-3	46955	Don't Walk—Walk (Fig. 3)	Red-Green	264 00
No.	Fig.	Mounting Attachments* Description		Each
TL241	4	4-in. Slip-Fitter with nipple and check nut		\$16 00
TL1752	5	Mast-Arm Hanger		35 70
TL1751	6	Span-Wire Hanger		25 70
TL246	7	1 1/4-in. Double Hub-Plate, for bracket-mounted signals		6 20
TL247	7	1 1/2-in. Double Hub-Plate, for span-wire, mast-arm and post-mounted signals		6 20
TL242	8	Upper or Lower Bracket Arm, for TNO-1 or TNO-3 signals†		10 85
TL245	8	Upper or Lower Bracket Arm, for TNO-2 signals†		10 85
TL248	9	Blank Plate, for unused openings		1 20
TL1257	10	4-in. Slip-Fitter Pipe-Arm Assembly, for two TNO-1 signals§		61 90
TL996	10	4-in. Slip-Fitter Pipe-Arm Assembly, for two TNO-2 signals§		61 90
TL1761	10	4-in. Slip-Fitter Pipe-Arm Assembly, for two TNO-3 signals§		61 90

*All mounting attachments are furnished complete with gaskets and screws.

†Signals should be supported by arms at both top and bottom. Pole clamps are not included in catalog numbers and prices.

§When signals are to be mounted one above the other, select proper mounting attachments from figures 4 to 10 above.

Crouse-Hinds Pedestals and Poles

Poles and pedestals on this page have an ornamental cast Feraloy base and a shaft of tubular steel.

The 34-inch pedestal has a shaft of either 3 or 4 inch diameter pipe, and is designed for mounting control cabinets. The longer poles, for mounting signals, have a tubular steel shaft of 4-inch pipe with an overall height of from 5 to 10 feet.

Poles and pedestals should be mounted on concrete foundations. They require four foundation bolts, 3/4 inch in diameter, 16 to 18 inches long. Foundation bolts are not included in the catalog numbers listed below.

There is a door in the ornamental base which is fastened to the base with machine screws. The opening of this door is 8 1/16 inches high, 2 1/2 inches wide at the top and 10 3/4 inches wide at the bottom. This large opening provides ample room for making splices.

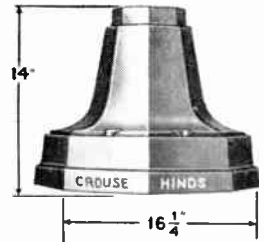

Ornamental Base For Pedestals and Poles

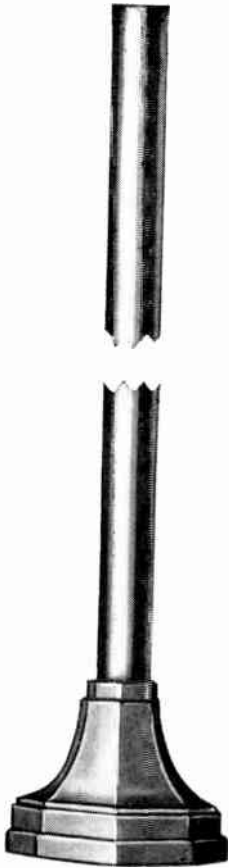

Pole with Ornamental Base and 4-Inch Pipe Shaft

4-Inch† Tenon Mounting		4-Inch† Tenon Mounting	
No.	Each	No.	Each
45670	\$72.00	45673	\$82.50
45671	75.50	45674	86.00
45672	79.00	45675	89.50

†Poles for 1 1/2 or 2-inch nipple mounting, add \$7.00 to the list prices.

Control Box Pedestals

No.	46391
Size Pipe Shaft	4
Height	34
Each	\$65.00

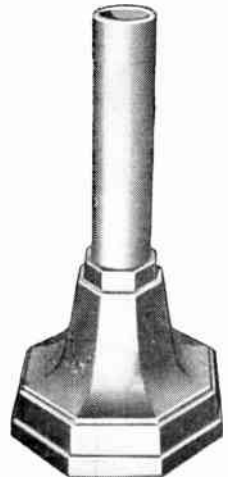

34-Inch Pedestal with 4-Inch Pipe Shaft

No. 45669 Ornamental Bases

No. 45669, Height, 14 inches. Each \$58.00

Crouse-Hinds Pole Clamps and Mounting Attachments

For Signals and Control Boxes

Pole Clamps for 1 1/2-Inch Bracket Arms with 1 1/4-Inch Downward Hub



Single Hub

Dimensions, Nominal Inside	Inches Actual Outside	Single Hub		Double Hub	
		No.	*Each	No.	*Each
3	3 1/2	KL.3134	\$10.00	KL.3161	\$15.00
4	4 1/2	KL.3135	12.50	KL.3162	17.50
5	5 9/16	KL.3136	15.00	KL.3163	20.00
6	6 5/8	KL.3137	17.50	KL.3164	22.50
7	7 5/8	KL.3138	20.00	KL.3165	25.00
8	8 5/8	KL.3139	22.50	KL.3166	27.50
9	9 5/8	KL.3140	25.00	KL.3167	30.00
10	10 3/4	KL.3141	27.50	KL.3168	32.50



Double Hub



No. KL2428, For 1 1/2-Inch Arms

Wood-Pole Plates

For All Wood Poles

No. KL.2428, 1 1/4-inch Downward Hub. Each \$5.70
 No. HL.9062. Each 5.70

*For intermediate sizes, use price of next size larger clamp.



No. HL9062, For 2-Inch Mast Arms

G-E Fluorescent Street Lighting Luminaiers

Form 202S



Form 202S (2880 lumens) is designed for lighting residential and suburban streets. The soft, diffused fluorescent source scatters light in broad IES Type I distribution pattern which illuminate streets, sidewalks, and adjacent bushes and trees. Long-life lamps with low power consumption provide the economical operation so necessary in suburban areas.

Application of units over roadway is now possible by means of slip-fitter mounting. Applied over the roadway, unit provides excellent pavement brightness and, hence, improved silhouette visibility.

Form 202S consists of aluminum hood; clear, acrylic-plastic side-hinged globe; hinged aluminum reflector, and integral-mounted ballast wired to terminal board. Unit operates two two-foot, rapid-start lamps that generate a total of 2880 lumens. Approximate projected area, 2 sq. ft.

Form 204S



Form 204S (7200 lumens) is designed for lighting residential and light-traffic streets. Elongated fluorescent source can be effectively mounted over the roadway to produce excellent pavement brightness and, hence, improved visibility. Luminaire produces broad IES Type I distribution pattern. Low luminaire brightness means minimum glare.

Where mounting heights are restricted by pole height or overlapping trees, Form 204S provides a convenient and attractive solution.

Form 204S consists of aluminum hood; clear, side-hinged, acrylic-plastic globe; hinged aluminum reflector, and integral-mounted ballast wired to terminal board. Unit operates two four-foot, rapid-start lamps which generate a total of 7200 lumens. Approximate projected area, 3.75 sq. ft.

Form 206S



Form 206S (11,500 lumens) is designed for lighting primary traffic areas. This versatile unit, however, is ideally suited for other applications, such as medium business and shopping areas.

Easy to install and maintain, Form 206S provides soft, diffused light with virtually no glare. Exceptional uniformity of pavement brightness, even under wet weather conditions, is afforded by this unit.

Form 206S consists of aluminum hood; clear, acrylic-plastic globe; hinged aluminum reflector, and integral-mounted ballast wired to terminal board. Unit operates two six-foot, rapid-start lamps which generate a total output of 11,500 lumens.

Luminaire is slip-fitter-mounted and globe is one-piece and side-hinged. Resilient gasketing material is used between hood and globe as weather seal. Recessed double-contact-base lamps are easily installed in spring-loaded sockets. Approximate projected area, 5.8 sq. ft.

For further information contact Graybar.

Form 406S



Form 406S (23,000 lumens) is designed for lighting highways and expressways, primary and secondary traffic and business streets, interchanges, parking lots, service areas, and other areas requiring a relatively high level of illumination.

This four-lamp unit provides soft, diffused light with virtually no glare and exceptional uniformity of pavement brightness which improves the overall appearance of street or area illuminated. Form 406S is slip-fitter-mounted luminaire with aluminum hood, side-hinged clear acrylic-plastic globe, and hinged aluminum reflector. Available with integral-mounted multiple or series ballasts wired to terminal board, or series external ballast for pole-base mounting. (For series circuits over 5000 volts OCV, external ballasts are required.)

Form 406S houses four six-foot, rapid-start, recessed double-contact-base lamps which generate a total of 23,000 lumens. Approximate projected area, 8 sq. ft.

Form 106U



Form 106U is a luminaire specially designed for use at the relatively low mounting heights of underpasses and tunnels. At such limited mounting heights, optimum visibility can be produced only by the combined low brightness factor (and high light output) of the Form 106U luminaire. Properly installed, the units minimize brightness contrast, thus reducing eye fatigue and increasing visual comfort.

Correct application of this luminaire assures uniform light distribution over the pavement and especially over side walls and ceiling of the tunnel or underpass. Designed primarily for mounting: (a) at the junction of ceiling and side walls; or (b) along the center of an arched ceiling. Where desired, a continuous line-of-light effect can be achieved with end-to-end positioning. Maintenance and operating costs are minimized by the long life and low energy consumption of the fluorescent lamp.

Consists of an aluminum hood, specular-finished aluminum reflector, and a scalloped acrylic-plastic globe for improved light diffusion. Easy servicing and relamping is assured by a side-hinged globe secured to the hood by three sturdy toggle-latches. To prevent entrance of moisture, dirt, and insects, globe is gasketed and firmly clamped to the hood. Adjustable mounting brackets permit adjustment of luminaire at various angles to the roadway.

An outstanding increase in performance of fluorescent street lighting is provided by luminaires utilizing the newest development in lighting—the Power Groove fluorescent lamp. Lumen output provided by the Power Groove lamp is shown in table.

With Power Groove Lamps

Luminaire	High Output Lamp Lumens	Power Groove Lamp Lumens	Percent Increase
Form 204S	7200	12000	67
Form 206S	11500	18600	62
Form 406S	23000	37200	62

G-E Filament Street Lighting Luminaires

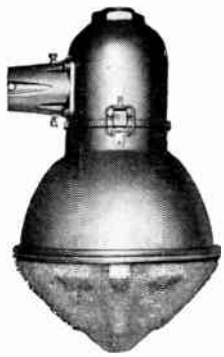

Form 101RV

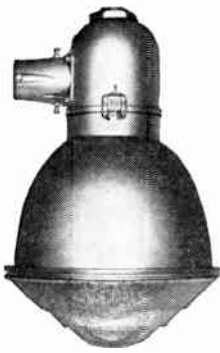

Form 101VR

Form 101R
101D
101S

Form 101FR

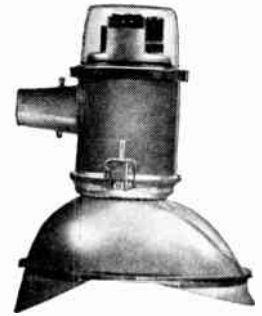

Form 110SO

Type I Light Distribution

Forms 101RV and 101VR

Type RV is a high-efficiency optical assembly producing a two-way light distribution (IES Type I) intended for center-of-street (or near-center) mounting. Most effective for lighting relatively narrow residential and light-traffic streets where the economy of 4000 and 6000-lumen filament lamps at longer spacings, is desired. Affords very good house-side and street-side shielding, and generally is recommended for illumination levels from 0.2 to 0.4 foot-candle.

The 101RV luminaire consists of a 1¼-in. slip-fitter, die-cast aluminum hood for internal wiring, an aluminum reflector, and a refractor. Available in spun-sealed, roller-latch, and clamp-band optical assemblies.

Type VR is a high-efficiency optical assembly producing two-way light distribution (IES Type I) and intended for center-of-street (or near-center) mounting. Designed for long spacing on residential and very light-traffic streets using from 4000 to 10,000-lumen filament lamps. Lamp is high in reflector providing excellent shielding on both house-side and street-side of luminaire. Recommended where illumination from 0.2 to 0.4 ft.-candle is required.

The 101VR luminaire consists of a 1¼-in. slip-fitter, die-cast aluminum hood for internal wiring, an aluminum reflector, and a refractor.

Types II and III Light Distributions

Forms 101R, 101FR, 110SO

The Type R optical assembly, utilizing a specially designed refractor, produces an IES Type II light distribution particularly suited for narrow streets, with luminaire mounted at side of roadway and overhanging pavement three to four ft. Filament lamps ranging from 2500 to 10,000 lumens can be used in this optical assembly which is also ideally suited for all applications requiring use of IES Type III distribution on medium-width light-to-heavy-traffic streets, arteries, and highways.

The 101R luminaire consists of a 1¼-in. slip-fitter, die-cast aluminum hood for internal wiring, an aluminum reflector, and a refractor. Available with spun-sealed, roller-latch, and clamp-band optical assemblies.

The Type SO is a modern, open reflector having an IES Type II light distribution. Specially designed for use with

2500-lumen lamps, at spacings normally used for residential streets (1000-lumen lamps may be used by changing socket position). Mounting should be near side of roadway with three to five-ft. overhang. Shields used in suburban areas to minimize objectional light toward residences. Shields redirect stray light into two major beams. The 110SO luminaire has die-cast aluminum hood with integrally cast 1¼-in. slip-fitter, internal wiring, plug-in photoelectric control unit, and an aluminum reflector. The 110 hood is available with all other optical assemblies.

Type FR is a high-frequency optical assembly which accommodates filament lamps up to 15,000 lumens and with appropriate reflectors can produce IES Type II or III distribution patterns. Luminaires with FR optical assembly provide excellent uniformity of pavement brightness and are effective where high illumination levels are desired. Mounting at or near side of street is recommended.

The 101FR luminaire consists of a 1¼-in. slip-fitter, die-cast aluminum hood with internal binding posts, an aluminum housing with internal aluminum reflector, hinged roller-latch holder and a refractor.

Type IV Light Distribution

Form 101D

Type D optical assembly produces an IES Type IV light distribution and is best-suited for wide pavements, intersections, and area lighting. Side-of-street mounting is recommended; and lamps from 2500 to 10,000 lumens can be used. Reduced luminaire brightness renders this unit advantageous for streets and areas having considerable pedestrian traffic.

The 101D luminaire consists of a 1¼-in. slip-fitter, die-cast aluminum hood for internal wiring, an aluminum reflector and deflector, and a rippled globe. Available with spun-sealed, roller-latch, and clamp-band optical assemblies.

Type V Light Distribution

Form 101S

Type S optical assembly produces symmetrical, or circular, light distribution (IES Type V). Accommodates filament lamps ranging from 2500 to 10,000 lumens; and has its main application at street intersections, auto parking lots, and in institutional or campus areas.

The 101S luminaire consists of a 1¼-in. slip-fitter, die-cast aluminum hood for internal wiring, an aluminum reflector and a globe. Available with spun-sealed, roller-latch, and clamp-band optical assemblies.

G-E Mercury Street Lighting Luminaires

Constructed with distinctive tilted design which is functional as well as attractive, improving optical performance and making the luminaire unusually easy to service.

Glassware, lamp, and reflector are tilted to put more light on the street and to provide greater accessibility for servicing. Hinged glassware swings open when the roller latch is lifted, making interior of luminaire completely accessible. Reflector and glassware can be detached from unit without using tools.

Can operate on either conventional circuits with ballasts, or in series on the new Ballastless Mercury circuit. Type 2 and Type 3 distribution patterns available to permit various spacing arrangements on different width streets.

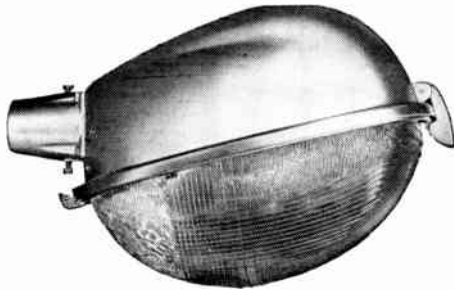

Form 400

A high-efficiency mercury luminaire producing either an IES Type II or Type III distribution with proper selection of reflector. The 100 uses H250-A5, H100-A1, or H100-E1 mercury lamps (or their color improved versions) and is designed for use where high level of illumination is required, as on high-speed expressways, heavily traveled main urban traffic areas, and downtown "whiteway" lighting.

Consists of an aluminum housing and slip-fitter with provision for internal wiring, hinged detachable glass reflector, and an aluminum snap-in reflector.

Two reflectors available: one for IES Type II and the other IES Type III light-distribution patterns.

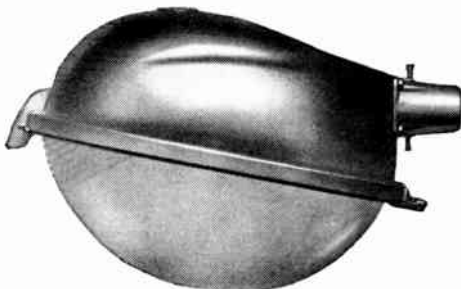

Form 402

Designed for use with the new 700 or 1000 watt mercury-vapor lamps. Principal application is in large-area lighting, primary retail-traffic streets, and expressways.

Has high level of illumination produced in IES Type IV pattern. Application of Form 102 may be either single- or twin-mounted, and both luminaire and lamp size may justify a mounting height in the 30-35 ft. range.

Designed for the 700 or 1000-watt mercury lamps. The luminaire consists of a roller-latch, hinged detachable glassware, aluminum internal reflector, and mogul multiple socket for use with either clear or color improved lamps.

G-E Constant-Current Transformers

Type RO-2 and ROC-2

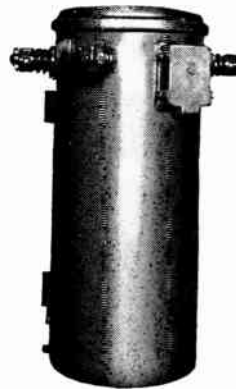

Type RO-2 Pole-Type

Type RO-2 constant-current transformer provides constant current to series street-lighting circuits with normal power factor.

Type ROC-2 is similar to the RO-2 but has outdoor-type capacitors for high-power-factor operation. The ROC-2 is recommended for long or heavily loaded distribution feeders where it is desirable to limit voltage drop and losses through minimum kva demand.

Mechanism designed with moving coil which automatically adjusts to various load factors. Provides a source of constant-current output which is necessary in series street-lighting circuits.

Designed to supply a variety of loads, regardless of whether they are incandescent, mercury, or fluorescent.

The weight of the Type RO-2 and ROC-2 transformers has been reduced. Less oil is used, and the internal mechanism weighs less than on previous models.

How the Constant-Current Transformer Operates

The moving-coil, constant-current transformer is a variable-impedance device for regulating output current to a constant value through a large range of load impedance and with limited variation in primary supply voltage.

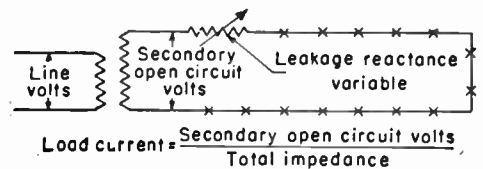

Its equivalent circuit may be considered as a conventional, low-reactance distribution transformer with external, self-adjusting variable series reactance.

This reactance is magnetic-leakage reactance and always adjusts itself to a value which, when added to the load impedance, permits constant current to flow. The amount of reactance is determined by the moving-coil position, which in turn is maintained by the force of repulsion between the coils.

The desired output current sets up a definite corresponding force of repulsion which floats the moving coil in the position that produces this current. For any given set of conditions, a state of mechanical equilibrium is attained whereby the force of repulsion exactly balances the weight of the moving coil.

Where the transformer is fully loaded and minimum series reactance is needed, the moving coil floats near the bottom of the core window. As load is removed and more reactance is required to regulate current, the coil floats higher.

Changes of load tend to unbalance the equilibrium of forces by increasing or decreasing the force of repulsion. In a freely moving, well-balanced mechanism, these are immediately counteracted by the movement of the floating coil to a new position, which restores the mechanical-electrical balance.

G-E Types IL and ILH Transformers
Pole-base and Aerial Types

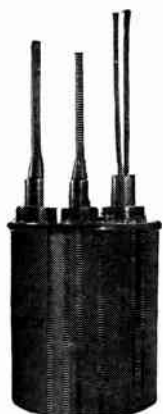

Type IL transformer with tapping sleeves for pole-base mounting



Type IL transformer with satchel handles for aerial mounting

Type IL is a series-to-series incandescent single-lamp transformer designed for use in constant-current series circuits. Provides a means of reducing high circuit voltage and permits the use of low-voltage cable from transformer to luminaire. Eliminates system outages otherwise caused by breakdowns between the main circuit and the luminaire. Adequate insulation is provided for luminaires mounted on metal poles, and high-current, high-efficiency, concentrated-filament series lamps may be used. Protects lamps from line surges.

Type ILH transformers are designed to provide the correct starting and operating voltage for mercury lamps. High-power-factor multiple lag-type ballasts have capacitance added so that more lamps and ballasts may be used on a circuit. Series transformers are designed to isolate series circuits from the luminaire and provide the necessary starting and running characteristics for mercury lamps.

Construction of aerial and pole-base units is the same, except for the addition of a satchel handle for mounting the aerial type. Leads are brought out through rubber tapping sleeves in the cover.

Core is made of carefully annealed, high-permeability, nonageing, cold-rolled silicon steel. High and low-voltage windings are wound and insulated separately, then impregnated under vacuum before assembling to the core. Entire casing is filled with high-quality insulating compound. Case is constructed of a cast-aluminum cover spun-sealed to a one-piece drawn-aluminum can.

G-E Film Cutouts

Rolled metal edge makes cutout strong and easy to install.

Smooth flat surfaces insure good electrical contact.

Stiff fiber insulation, securely clamped, makes cutout mechanically sturdy; it will not fall apart.

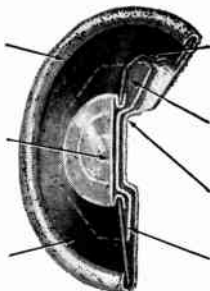

Enlarged View of Film Cutout

Fiber insulation excludes moisture; colored for identification of rating.

Oxidized copper disk gives excellent uniformity of dielectric value.

Indentation centers copper insert.

"All-round" contact makes cutout pressureproof.

An enclosed copper-oxide film cutout designed for use with individual lamps in series circuits to provide circuit continuity when the lamp fails. These cutouts are recognized for dependable operation and sturdy construction.

The dielectric value of copper oxide is carefully controlled for uniformity, and the film is not affected by heat or pressure. Oxidizing disk is securely enclosed in moistureproof aluminum and fiber casing which resists damage and will not separate.

G-E Electric Protectors



Type J-1A protector for multiple control circuit

Developed to operate in conjunction with a primary control switch, and its function is to open this primary switch as soon as an open circuit occurs.

Consists of two small transformers, a thermal switch, a relay, a set of disconnecting contacts, and a timing resistor. One of the two small transformers is energized by the control circuit and the other by the load circuit to be protected. Under normal operating conditions, the disconnecting contacts are closed on the multiple-control type, and open on the series-control type.

When an open circuit occurs in the load circuit, the relay becomes de-energized, closes, and completes circuit. Then the thermal switch will operate and open the disconnecting contacts on the multiple type (close on the series type) to de-energize the controller operating coil. This allows the controller contacts to open and de-energize the primary of the constant-current transformer.

After the open circuit in the load circuit has been repaired, the protector can be reset (reconnecting the transformer to the main system) by means of a reset lever conveniently located in the bottom of the casing.

This protector operates entirely in air and is housed in an attractive drawn-steel case. Operation is unaffected by changes in ambient temperature.

G-E Photoelectric Controls

Type P



Strap-Mounted



Meter-Socket-Mounted

Turns streetlights on when needed, regardless of the time of day. Provides sensitive, low cost control of either series or multiple circuits.

Automatically actuated by changes in daylight intensity, these controls provide either high-level or low-level illumination with six different units available. These simple-to-install, reliable, and easy-to-maintain units are particularly suited for outlying districts not served by series circuits. When applied in this manner, they effectively control individual luminaires from existing multiple circuits. Also used to control primary switch on series street-lighting circuits.

Call Graybar FIRST For . . .

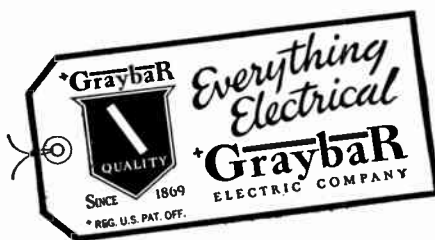

Jefferson Mercury Lamp Ballasts For Outdoor Lighting

Series Circuit Transformers



No. 340-702

Aerial and pole base type transformers are available for series circuit street lighting. Standard units are designed for a 6.6 amp. circuit, but can be furnished to operate on 7.5, 10, 15 or 20 amp. circuits. All units are completely weatherproofed, having a 300-minimum open circuit secondary voltage to insure starting in cold weather.

These transformers are insulated for series circuits up to 10,500 volts. A 22,000 volt test applied to every unit insures against failure in the field.



No. 340-706

No.	Lamp Wattage	Amperes Primary	Circuit Sec. Open	Wattage Input	Mounting	Wt. Lbs. Ship.	Each
340-701	1-400 Watt H-1	6.6	300	430	Pole Base-Aerial	30	\$106.70
340-702	1-400 Watt H-1	6.6	300	430	Pole Base	30	106.70
340-703	1-400 Watt H-1	6.6	300	430	Aerial-Satchel Handle	30	106.70
340-706	1-400 Watt H-1	6.6	300	430	With Pole Top Adapter	37	125.52
340-751	1-250 Watt H-5	6.6	275	300	Aerial-Pole Base	29	106.70
340-752	1-250 Watt H-5	6.6	275	300	Pole Base	29	106.70
340-753	1-250 Watt H-5	6.6	275	300	Aerial	29	106.70
340-756	1-250 Watt H-5	6.6	275	300	With Pole Top Adapter	36	125.52
340-761	1-175 Watt H-22	6.6	275	220	Aerial-Pole Base	28	86.90
340-771	1-100 Watt H-4	6.6	275	125	Aerial-Pole Base	24	79.20

Accessories

No.	Description	Wt. Lbs.	Each
232-005	Poletop Adaptor — 6 ³ / ₁₆ in. diameter Case	5	\$16.50
232-007	Poletop Adaptor — 7 ¹ / ₂ in. diameter Case	8	23.24
232-010	Poletop Adaptor for 6 ¹ / ₃₂ in. diameter Case	7	18.82
232-008	Fixture Arm Support for use with Poletop Adaptors	1 ¹ / ₂	6.82
232-011	Aerial Mounting Clamp for Steel Pole	3 ¹ / ₂	4.04
232-013	Aerial Mounting Bracket for Wood Pole 6 ³ / ₁₆ x 6 ¹ / ₃₂ in. diameter Cases	2 ¹ / ₂	5.02
232-014	Aerial Mounting Bracket for Steel Pole 6 ³ / ₁₆ x 6 ¹ / ₃₂ in. diameter Cases	8	8.80
232-015	Aerial Mounting Bracket for Wood Pole 7 ¹ / ₂ in. diameter Case	2 ³ / ₄	5.06
232-017	Aerial Mounting Bracket for Steel Pole 7 ¹ / ₂ in. diameter Case	8 ³ / ₄	8.80
232-018	Aerial Mounting Bracket for Wood Pole 5 ⁵ / ₈ in. diameter Case	2 ¹ / ₂	5.06
232-020	Aerial Mounting Bracket for Steel Pole 5 ⁵ / ₈ in. diameter Case	8	8.80
232-019	Pole Top Adaptor — 5 ⁵ / ₈ in. diameter Case	5 ¹ / ₂	16.50

Note: 232-013, 014, 015, 017, 018 and 020 — No charge if furnished with transformers.



No. 236-311

Made of special Core Steel with high silicon content. Heavy steel hot-dipped galvanized both inside and out prevents moisture damage—insures long, low cost maintenance-free performance.

Transformers are furnished for every type of Mercury lighting. There are standard multiple circuit types (normal or high power factor) for 115, 230 and 460 volt line operation (units can be furnished for other voltages.)



No. 232-411

No.	Wattage Lamp	Primary Voltage	Sec. Open Circuit	Input Wattage	Power Factor	Mounting	Ship. Wt. Lbs.	Each
232-121	1-1000 Watt H-15	105/115/125	460	1085	High	Pole Base	72	\$209.00
232-123	1-1000 Watt H-15	210/230/250	460	1085	High	Pole Base	72	209.00
232-128*	1-1000 Watt H-15	460	460	1030	High	Pole Base	40	125.40
232-131	1-1000 Watt H-15	105/115/125	460	1085	High	Aerial Wall	72	209.00
232-133	1-1000 Watt H-15	210/230/250	460	1085	High	Aerial Wall	72	209.00
232-138*	1-1000 Watt H-15	460	460	1030	High	Aerial Wall	40	125.40

Jefferson Mercury Lamp Ballasts

For Outdoor Lighting (Cont)

No.	Wattage Lamp	Primary Voltage	Sec. Open Circuit	Input Wattage	Power Factor	Mounting	Ship. Wt. Lbs.	Each
232-771	1-700 Watt H-18	105/115/125	460	780	High	Aerial Wall	47	187.00
232-773	1-700 Watt H-18	210/230/250	460	780	High	Aerial Wall	47	187.00
232-778*	1-700 Watt H-18	460	460	740	High	Aerial Wall	25	112.20
232-781	1-700 Watt H-18	105/115/125	460	780	High	Pole Base	47	187.00
232-783	1-700 Watt H-18	210/230/250	460	780	High	Pole Base	47	187.00
232-788*	1-700 Watt H-18	460	460	740	High	Pole Base	25	112.20
232-941	2-400 Watt H-1	110/120/220/240	300	900	High	Pole Base	74	187.00
232-944	2-400 Watt H-1	188/208/220/240	300	900	High	Pole Base	74	187.00
232-946	2-400 Watt H-1	250/265/277	300	900	High	Pole Base	74	205.70
232-948	2-400 Watt H-1	420/460/500	300	900	High	Pole Base	74	205.70
232-951	2-400 Watt H-1	110/120/220/240	300	900	High	Aerial Wall	74	187.00
232-954	2-400 Watt H-1	188/208/220/240	300	900	High	Aerial Wall	74	187.00
232-956	2-400 Watt H-1	250/265/277	300	900	High	Aerial Wall	74	205.70
232-958	2-400 Watt H-1	420/460/500	300	900	High	Aerial Wall	74	205.70
232-441	1-400 Watt H-1	110/120/220/240	300	450	High	Pole Base	38	111.10
232-444	1-400 Watt H-1	188/208/220/240	300	450	High	Pole Base	38	111.10
232-446	1-400 Watt H-1	250/265/277	300	450	High	Pole Base	38	122.20
232-448	1-400 Watt H-1	420/460/500	300	450	High	Pole Base	38	122.20
232-611	1-400 Watt H-1	105/115/125	220	450	Normal	Aerial Wall	27	70.96
232-613	1-400 Watt H-1	210/230/250	220	450	Normal	Aerial Wall	27	70.96
232-616	1-400 Watt H-1	250/265/277	220	450	Normal	Aerial Wall	27	78.10
232-618	1-400 Watt H-1	420/460/500	220	450	Normal	Aerial Wall	27	78.10
232-621	1-400 Watt H-1	105/115/125	220	450	High	Aerial Wall	28	81.40
232-623	1-400 Watt H-1	210/230/250	220	450	High	Aerial Wall	28	81.40
232-626	1-400 Watt H-1	250/265/277	220	450	High	Aerial Wall	28	89.54
232-628	1-400 Watt H-1	420/460/500	220	450	High	Aerial Wall	28	89.54
232-631	1-400 Watt H-1	105/115/125	220	450	Normal	Pole Base	27	70.96
232-633	1-400 Watt H-1	210/230/250	220	450	Normal	Pole Base	27	70.96
232-636	1-400 Watt H-1	250/265/277	220	450	Normal	Pole Base	27	78.10
232-638	1-400 Watt H-1	420/460/500	220	450	Normal	Pole Base	27	78.10
232-641	1-400 Watt H-1	105/115/125	220	450	High	Pole Base	28	81.40
232-643	1-400 Watt H-1	210/230/250	220	450	High	Pole Base	28	81.40
232-646	1-400 Watt H-1	250/265/277	220	450	High	Pole Base	28	89.54
232-648	1-400 Watt H-1	420/460/500	220	450	High	Pole Base	28	89.54
232-411	1-400 Watt H-1	105/115/125	300	450	Normal	Aerial Wall	27	93.50
232-413	1-400 Watt H-1	210/230/250	300	450	Normal	Aerial Wall	27	93.50
232-416	1-400 Watt H-1	250/265/277	300	450	Normal	Aerial Wall	27	102.86
232-418	1-400 Watt H-1	420/460/500	300	450	Normal	Aerial Wall	27	102.86
232-431	1-400 Watt H-1	105/115/125	300	450	Normal	Pole Base	25	93.50
232-433	1-400 Watt H-1	210/230/250	300	450	Normal	Pole Base	25	93.50
232-436	1-400 Watt H-1	250/265/277	300	450	Normal	Pole Base	25	102.86
232-438	1-400 Watt H-1	420/460/500	300	450	Normal	Pole Base	25	102.86
232-588*	1-425 Watt H-17	460	460	450	High	Aerial Wall	36	84.70
232-598*	1-425 Watt H-17	460	460	450	High	Pole Base	36	84.70
236-311†	1-400 Watt H-1	100-130/200-260	300	465	High	Pole Base	42	111.10
236-316†	1-400 Watt H-1	200-315	300	465	High	Pole Base	42	122.20
236-318†	1-400 Watt H-1	200-260/400-520	300	465	High	Pole Base	42	122.20

*Series Reactor Type

†Constant Wattage for use with all 400 Watt H-1 lamps.

Note: Mercury Lamp Ballasts available for 1-250 watt H-5 lamps, 1-175 watt H-22 lamps and 1-100 watt H-4 lamps in above listed voltages.

American Concrete Lighting Standards

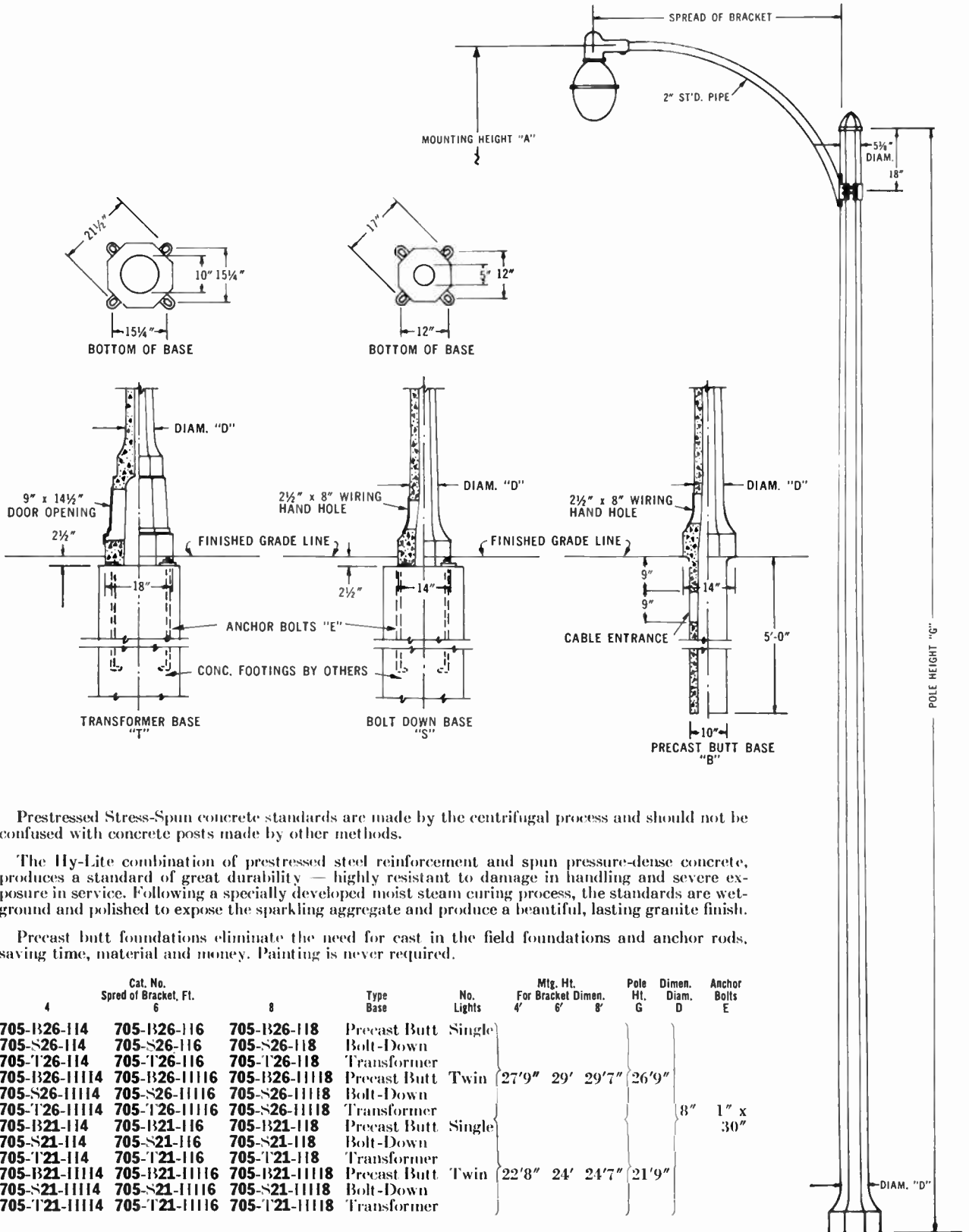

Prestressed Stress-Spun concrete standards are made by the centrifugal process and should not be confused with concrete posts made by other methods.

The Hy-Lite combination of prestressed steel reinforcement and spun pressure-dense concrete, produces a standard of great durability — highly resistant to damage in handling and severe exposure in service. Following a specially developed moist steam curing process, the standards are wet-ground and polished to expose the sparkling aggregate and produce a beautiful, lasting granite finish.

Precast butt foundations eliminate the need for cast in the field foundations and anchor rods, saving time, material and money. Painting is never required.

Cat. No.			Type Base	No. Lights	Mfg. Ht. For Bracket Dimen.			Pole Ht. G	Dimen. Diam. D	Anchor Bolts E
4	6	8			4'	6'	8'			
705-B26-114	705-B26-116	705-B26-118	Precast Butt	Single	27'9"	29'	29'7"	26'9"	8"	1" x 30"
705-S26-114	705-S26-116	705-S26-118	Bolt-Down	Transformer						
705-T26-114	705-T26-116	705-T26-118	Transformer							
705-B26-1114	705-B26-1116	705-B26-1118	Precast Butt	Twin						
705-S26-1114	705-S26-1116	705-S26-1118	Bolt-Down							
705-T26-1114	705-T26-1116	705-T26-1118	Transformer							
705-B21-114	705-B21-116	705-B21-118	Precast Butt	Single	22'8"	24'	24'7"	21'9"	8"	1" x 30"
705-S21-114	705-S21-116	705-S21-118	Bolt-Down	Transformer						
705-T21-114	705-T21-116	705-T21-118	Transformer							
705-B21-1114	705-B21-1116	705-B21-1118	Precast Butt	Twin						
705-S21-1114	705-S21-1116	705-S21-1118	Bolt-Down							
705-T21-1114	705-T21-1116	705-T21-1118	Transformer							

Ornamental end fitting with plumbing adjustment when specified, furnished at extra cost. Bolts and bolting data drawings for foundation template furnished for bolt down and transformer base type. Bracket ends are arranged to receive a 1 1/4-in. slip fitter. A 2-in. slip fitter is available on special order.

Hapco Aluminum Alloy Street Lighting Standards

Bracket Styles "S" and "B"—Pole Types 1 and 1-T

Bracket Style "S"

Bracket Style "B"

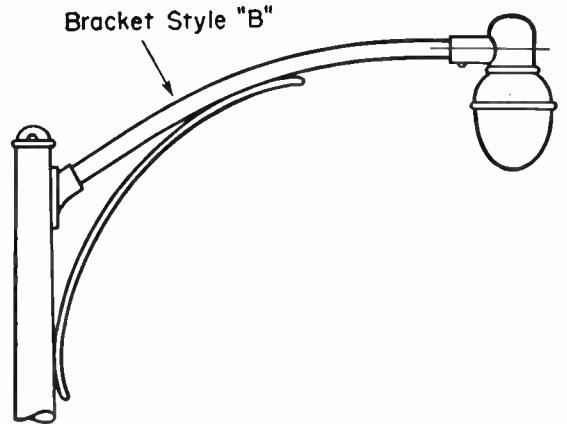
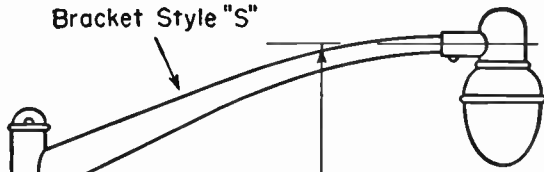

Pole Type 1—Bracket Style "S"

**Mtg. Hgt. for 6 Ft. Brkt.	Catalog Numbers			Bolt Circle	Nominal Pole Size
	4 Feet	6 Feet	8 Feet		
21'-0"	12820S4	12820S6	12820S8	10"	7" x 4" x 20'-0"
23'-6"	12822S4	12822S6	12822S8	10"	7" x 4" x 22'-6"
26'-0"	12825S4	12825S6	12825S8	10"	7" x 4" x 25'-0"
26'-0"	13225S4	13225S6	13225S8	11"	8" x 4 1/2" x 25'-0"
28'-6"	13227S4	13227S6	13227S8	11"	8" x 4 1/2" x 27'-6"
31'-0"	13230S4	13230S6	13230S8	11"	8" x 4 1/2" x 30'-0"
33'-6"	13232S4	13232S6	13232S8	11"	8" x 4 1/2" x 32'-6"
36'-0"	13235S4	13235S6	13235S8	11"	8" x 4 1/2" x 35'-0"

*Pole Type 1-T—Bracket Style "S"

21'-0"	1T2820S4	1T2820S6	1T2820S8	15"	7" x 4" x 20'-0"
23'-6"	1T2822S4	1T2822S6	1T2822S8	15"	7" x 4" x 22'-6"
26'-0"	1T2825S4	1T2825S6	1T2825S8	15"	7" x 4" x 25'-0"
26'-0"	1T3225S4	1T3225S6	1T3225S8	15"	8" x 4 1/2" x 25'-0"
28'-6"	1T3227S4	1T3227S6	1T3227S8	15"	8" x 4 1/2" x 27'-6"
31'-0"	1T3230S4	1T3230S6	1T3230S8	15"	8" x 4 1/2" x 30'-0"
33'-6"	1T3232S4	1T3232S6	1T3232S8	15"	8" x 4 1/2" x 32'-6"
35'-0"	1T3235S4	1T3235S6	1T3235S8	15"	8" x 4 1/2" x 35'-0"

Pole Type 1—Bracket Style "B"

21'-0"	12820B4	12820B6	12820B8	10"	7" x 4" x 20'-0"
23'-6"	12822B4	12822B6	12822B8	10"	7" x 4" x 22'-6"
26'-0"	12825B4	12825B6	12825B8	10"	7" x 4" x 25'-0"
26'-0"	13225B4	13225B6	13225B8	11"	8" x 4 1/2" x 25'-0"
28'-6"	13227B4	13227B6	13227B8	11"	8" x 4 1/2" x 27'-6"
31'-0"	13230B4	13230B6	13230B8	11"	8" x 4 1/2" x 30'-0"
33'-6"	13232B4	13232B6	13232B8	11"	8" x 4 1/2" x 32'-6"
36'-0"	13235B4	13235B6	13235B8	11"	8" x 4 1/2" x 35'-0"

*Pole Type 1-T—Bracket Style "B"

21'-0"	1T2820B4	1T2820B6	1T2820B8	15"	7" x 4" x 20'-0"
23'-6"	1T2822B4	1T2822B6	1T2822B8	15"	7" x 4" x 22'-6"
26'-0"	1T2825B4	1T2825B6	1T2825B8	15"	7" x 4" x 25'-0"
26'-0"	1T3225B4	1T3225B6	1T3225B8	15"	8" x 4 1/2" x 25'-0"
28'-6"	1T3227B4	1T3227B6	1T3227B8	15"	8" x 4 1/2" x 27'-6"
31'-0"	1T3230B4	1T3230B6	1T3230B8	15"	8" x 4 1/2" x 30'-0"
33'-6"	1T3232B4	1T3232B6	1T3232B8	15"	8" x 4 1/2" x 32'-6"
36'-0"	1T3235B4	1T3235B6	1T3235B8	15"	8" x 4 1/2" x 35'-0"

For Twin Brackets Specify Twin after Catalog Number.

4"x6" handhole with reinforcing frame and cover furnished extra upon request on Type No. 1 poles.

All poles furnished with nominal wall thickness of .188" unless otherwise requested.

All poles furnished complete with anchor bolts, nuts and washers.

Bracket arm supplied with 1 1/4" slipfitter end unless otherwise specified.

For bracket, arm and base details, see page 1027.

*For Type 1-T Poles—the mounting height includes 20" high transformer base.

Luminaires not included.

**Mounting heights are for poles with 6 ft. bracket. For 4 ft. brackets deduct 6 in. from mounting height and for 8 ft. brackets add 6 in.

Prices on application.

Mounting Height To Foundation Level

Pole Type No. 1 Standard Base



Pole Type No. 1-T Transformer Base

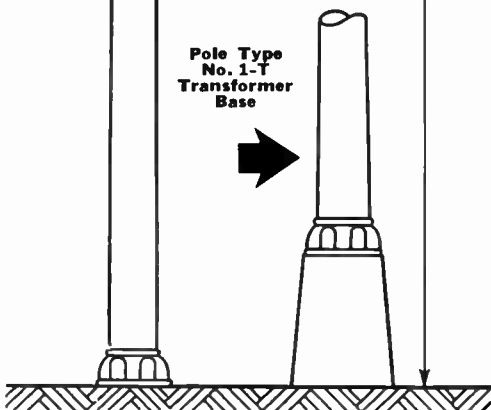

Hapco Aluminum Alloy Street Lighting Standards

Bracket Styles L and Y—Pole Types 1 and 1-T

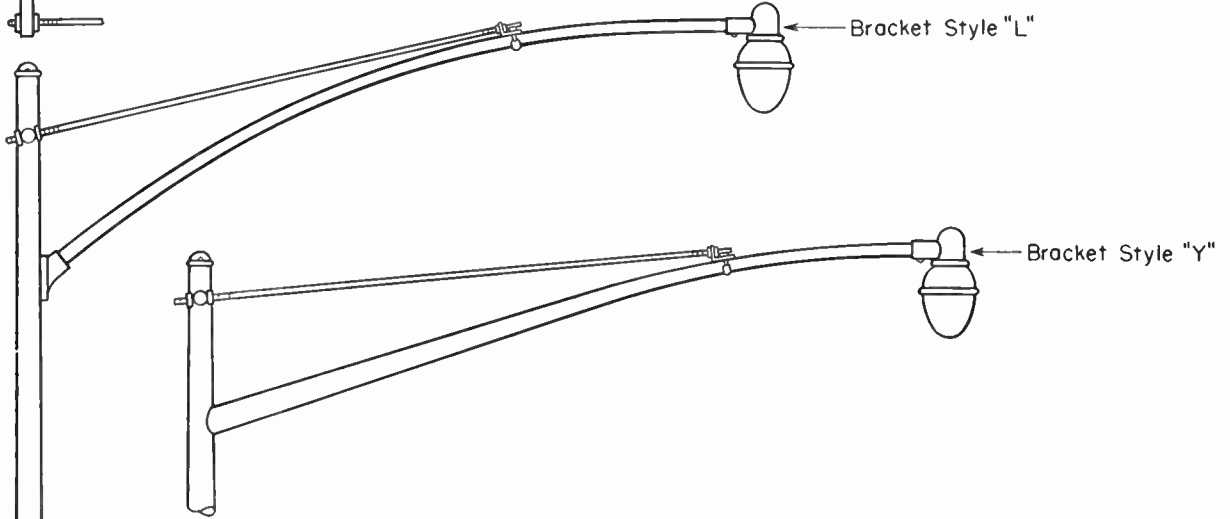
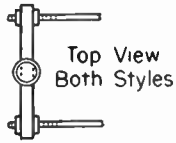

Pole Type 1—Bracket Style "L"

**Mtg. Hgt. for 15 Ft. Brkt.	Bracket Lengths In Feet			Bolt Circle	Nominal Pole Size
	10 Feet	Catalog Numbers 12 Feet	15 Feet		
26'-0"	132251.10	132251.12	132251.15	11"	8" x 4 1/2" x 25'-0"
28'-6"	132271.10	132271.12	132271.15	11"	8" x 4 1/2" x 27'-6"
31'-0"	132301.10	132301.12	132301.15	11"	8" x 4 1/2" x 30'-0"
33'-6"	132321.10	132321.12	132321.15	11"	8" x 4 1/2" x 32'-6"
36'-0"	132351.10	132351.12	132351.15	11"	8" x 4 1/2" x 35'-0"

*Pole Type 1-T—Bracket Style "L"

26'-0"	1T32251.10	1T32251.12	1T32251.15	15"	8" x 4 1/2" x 25'-0"
28'-6"	1T32271.10	1T32271.12	1T32271.15	15"	8" x 4 1/2" x 27'-6"
31'-0"	1T32301.10	1T32301.12	1T32301.15	15"	8" x 4 1/2" x 30'-0"
33'-6"	1T32321.10	1T32321.12	1T32321.15	15"	8" x 4 1/2" x 32'-6"
36'-0"	1T32351.10	1T32351.12	1T32351.15	15"	8" x 4 1/2" x 35'-0"

Pole Type 1—Bracket Style "Y"

26'-0"	13225Y.10	13225Y.12	13225Y.15	11"	8" x 4 1/2" x 25'-0"
28'-6"	13227Y.10	13227Y.12	13227Y.15	11"	8" x 4 1/2" x 27'-6"
31'-0"	13230Y.10	13230Y.12	13230Y.15	11"	8" x 4 1/2" x 30'-0"
33'-6"	13232Y.10	13232Y.12	13232Y.15	11"	8" x 4 1/2" x 32'-6"
36'-0"	13235Y.10	13235Y.12	13235Y.15	11"	8" x 4 1/2" x 35'-0"

*Pole Type 1-T—Bracket Style "Y"

26'-0"	1T3225Y.10	1T3225Y.12	1T3225Y.15	15"	8" x 4 1/2" x 25'-0"
28'-6"	1T3227Y.10	1T3227Y.12	1T3227Y.15	15"	8" x 4 1/2" x 27'-6"
31'-0"	1T3230Y.10	1T3230Y.12	1T3230Y.15	15"	8" x 4 1/2" x 30'-0"
33'-6"	1T3232Y.10	1T3232Y.12	1T3232Y.15	15"	8" x 4 1/2" x 32'-6"
36'-0"	1T3235Y.10	1T3235Y.12	1T3235Y.15	15"	8" x 4 1/2" x 35'-0"

Mounting Height—
Foundation Level
To Bracket Center-
Line At Outer End

Notes

- For Twin Brackets specify Twin after catalog number.
- All poles furnished with nominal wall thickness of .188" unless otherwise requested.
- All poles furnished complete with anchor bolts, nuts and washers.
- Bracket Arm supplied with 1 1/4" slipfitter unless otherwise specified.
- For Bracket, Arm and Base Details, see Page 1027.
- 1"x6" handhole with reinforcing frame and cover furnished extra upon request on Type No. 1 Poles.

*For Type 1-T Poles—Mounting height includes 20" high transformer base.

Luminaires not included.

**Mounting heights are for poles with 15 ft. brackets. Deduct 5 in. for 12 ft. brackets and 3 in. for 10 ft. brackets.

Prices on application.

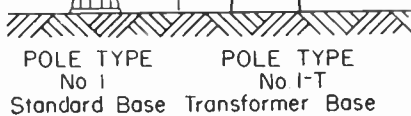

Hapco Bracket, Arm and Base Details

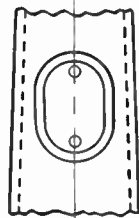
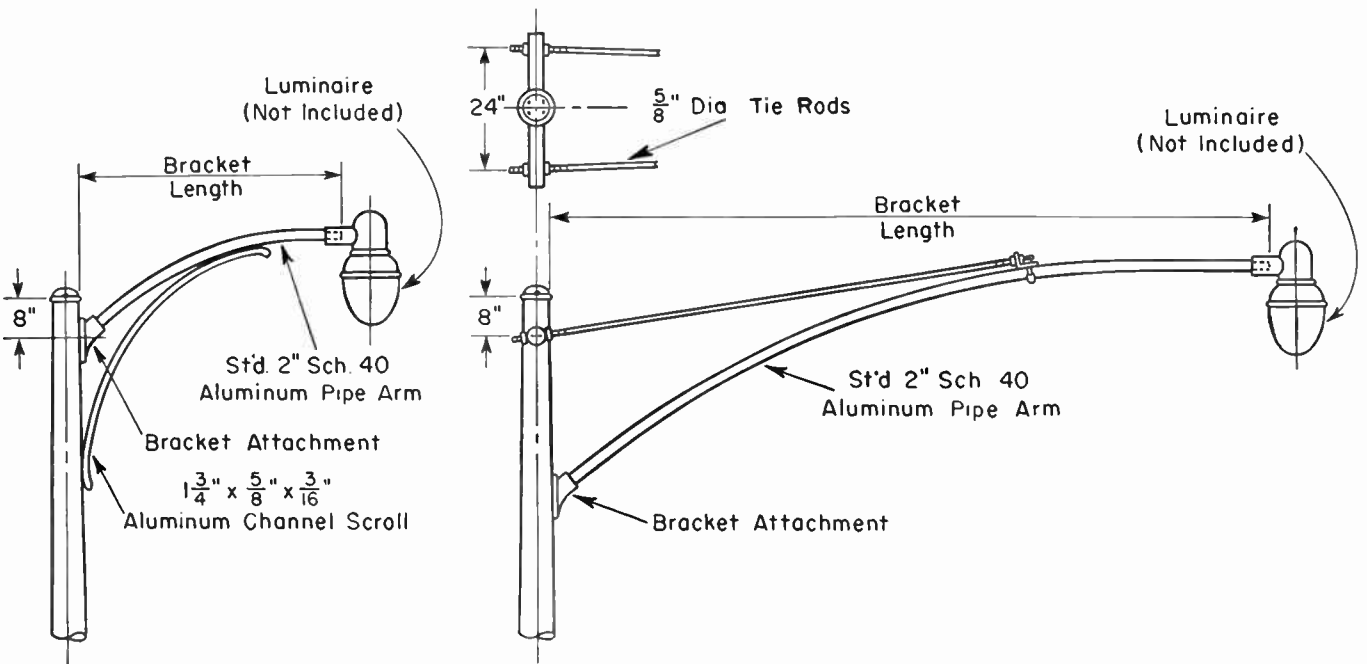

4" x 6" Reinforced Handhole

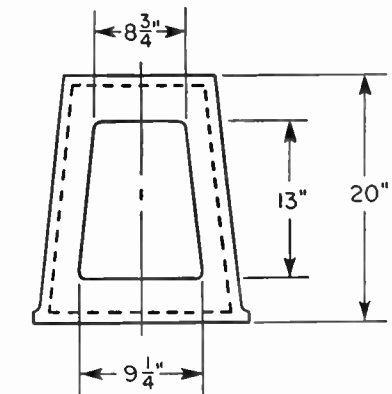
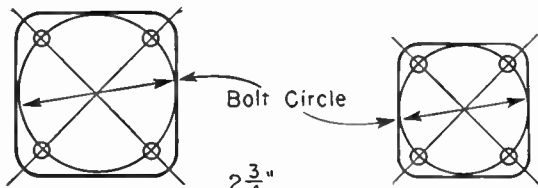
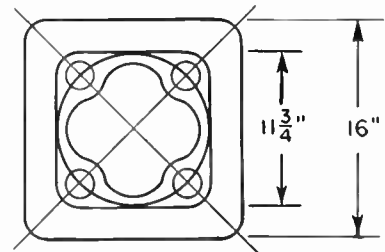

Cast Aluminum Alloy Transformer Base

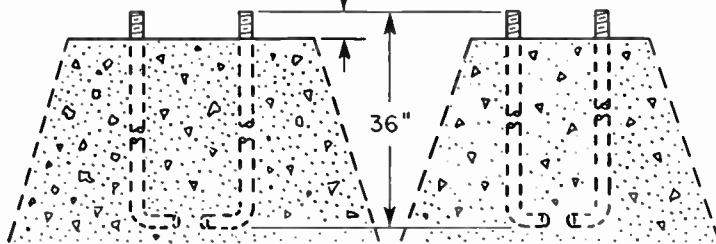

Anchorage For Transformer Base

Anchorage For Pole Base

For complete information and prices contact Graybar.

Union Metal Steel Monotube Poles

For Power Distribution

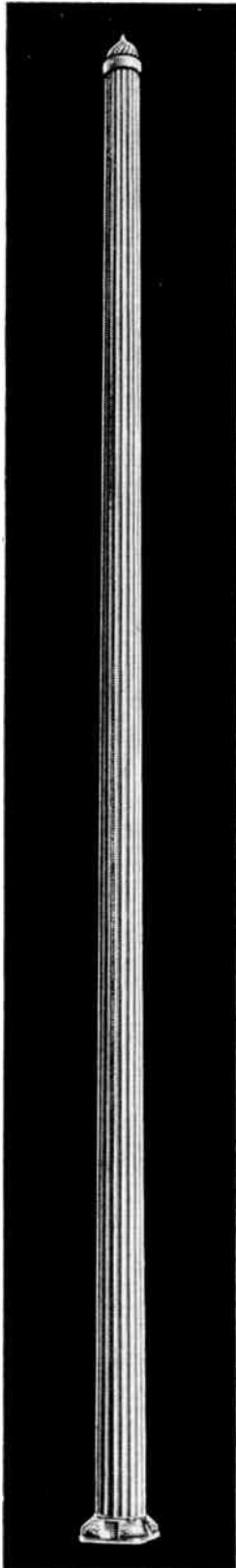

Fluted Pole

Monotube Power Distribution Poles are used for the same purpose as wood, structural steel, or sectional tubular poles. They are the product of more than 50 years of experience in manufacturing steel poles, and their construction is based on this practical experience plus sound engineering principles.

These poles taper uniformly from top to bottom, with the largest diameter at the ground line where the maximum strength is needed.

Monotube poles are of continuous one-piece construction made from the highest grade, open hearth steel. The exclusive cold-rolling process used in fabricating Union Metal Monotubes greatly increases the yield point and ultimate strength of the original metal. Monotubes combine great strength with flexibility. This feature of flexibility is doubly important in overhead wiring installations where ice, wind, and dead-end load conditions are present.

The Monotube pole achieves maximum ability to withstand shock and impact. Even when the yield strength has been exceeded, the pole bends rather than breaks.

Monotubes are made in two designs, round and fluted. A steel base, arranged to accommodate the foundation bolts, is securely welded to the lower end of the tube. The round design can also be furnished for embedment directly into concrete. Poles are available in 11 gage, 7 gage, 3 gage, and 0 gage steel, and ground line diameters range from 6 to 14 inches.

Monotube power distribution poles can also be used in combination with other municipal services, carrying combinations of two or more power and lighting circuits, street lighting circuits and luminaires, trolley span wire suspension, fire and police alarm circuits, etc.

No matter how specialized the requirements, Union Metal Monotube poles can be built to meet them, and with the added advantages of economy of installation and maintenance, great strength with light weight, attractive appearance with exceptional utility.

Contact your nearest Graybar Office or warehouse for complete information on prices and delivery.

Printed information on various types of Monotube poles is available.

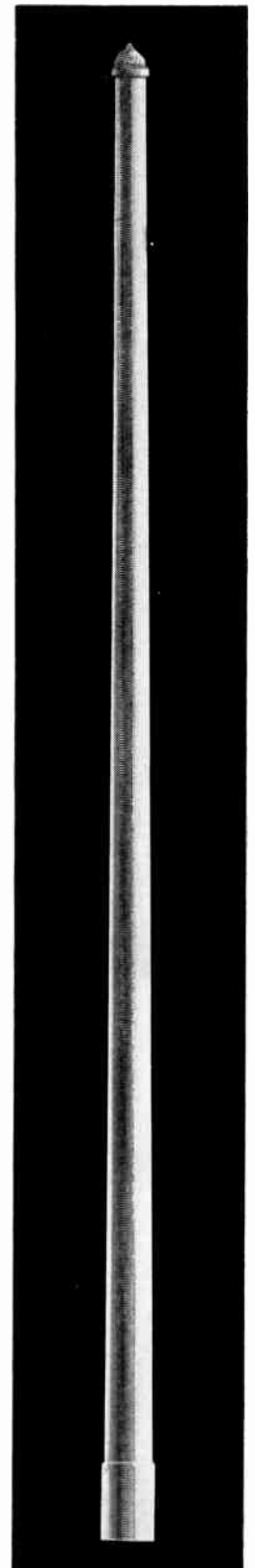

Round Pole

Union Metal Steel Poles

For Slip Fitter Type Fluorescent Luminaires

These poles are recommended for use with 2" slip fitter type luminaires, each having a maximum weight of 110# and a maximum projected area of 8.5 sq. ft., or an equivalent drag force of no more than 225#, at 100 m.p.h. (101.6) winds in accordance with the National Bureau of Standards Handbook II 43, dated 1949 (National Electrical Safety Code). In hurricane areas pole sizes will be increased to meet local conditions.

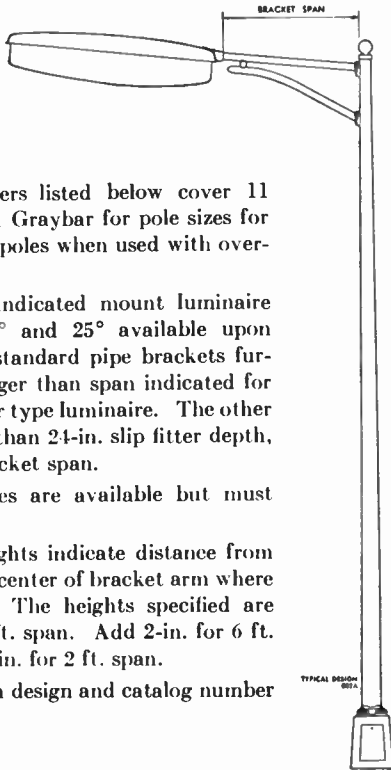

The catalog numbers listed below cover 11 gauge steel. Contact Graybar for pole sizes for corner and dead end poles when used with overhead wiring.

The brackets as indicated mount luminaire at 5°. Tilts of 15° and 25° available upon request. The 2-in. standard pipe brackets furnished are 24-in. longer than span indicated for mounting of slip fitter type luminaire. The other luminaires with less than 24-in. slip fitter depth, add difference to bracket span.

Twin bracket poles are available but must be specified.

The mounting heights indicate distance from top of foundation to center of bracket arm where luminaire attaches. The heights specified are for brackets with 4 ft. span. Add 2-in. for 6 ft. span and subtract 2-in. for 2 ft. span.

Please specify both design and catalog number when ordering.

No. 802-A

Steel—Round Anchor Base Type

Design No.	Catalog Numbers			Pole Size	Mfg. Ht.
	Bracket Span				
	2-0	4-0	6-0		
800A	F250-N2E	F250-A2E	F250-B2E	7 x 3.5 x 25-0	25-0
800A	H286-N2E	H286-A2E	H286-B2E	8 x 4 x 28-6	28-6
800A	H300-N2E	H300-A2E	H300-B2E	8 x 3.8 x 30-0	30-0

Steel—Round Transformer Base Type

802A	F250-N2E	F250-A2E	F250-B2E	7 x 3.5 x 25-0	26-8
802A	H286-N2E	H286-A2E	H286-B2E	8 x 4 x 28-6	30-2
802A	H300-N2E	H300-A2E	H300-B2E	8 x 3.8 x 30-0	31-8

Steel—Octaflute Anchor Base Type

801A	F250-N2E	F250-A2E	F250-B2E	7 x 3.5 x 25-0	25-0
801A	H286-N2E	H286-A2E	H286-B2E	8 x 4 x 28-6	28-6
801A	H300-N2E	H300-A2E	H300-B2E	8 x 3.8 x 30-0	30-0

Steel—Octaflute Transformer Base Type

803A	F250-N2E	F250-A2E	F250-B2E	7 x 3.5 x 25-0	26-8
803A	H286-N2E	H286-A2E	H286-B2E	8 x 4 x 28-6	30-2
803A	H300-N2E	H300-A2E	H300-B2E	8 x 3.8 x 30-0	31-8

Consult your nearby Graybar office for prices.

Union Metal Steel Davit Poles

For Slip Fitter Type Fluorescent Luminaires

These poles are recommended for use with 2" slip fitter type luminaires, each having a maximum weight of 110# and a maximum projected area of 8.5 sq. ft., or an equivalent drag force of no more than 225#, at 100 m.p.h. (101.6) winds, in accordance with the National Bureau of Standards Handbook II 43, dated 1949 (National Electrical Safety Code). In hurricane areas pole sizes will be increased to meet local conditions.

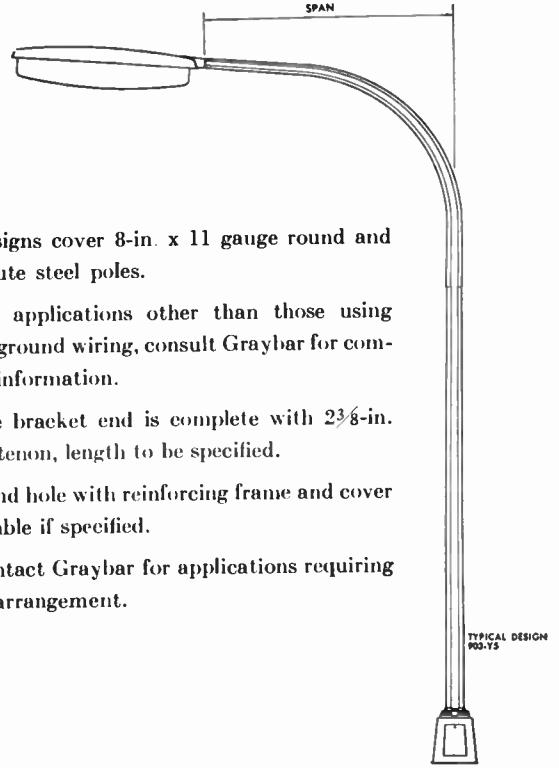

No. 903-Y5

Designs cover 8-in. x 11 gauge round and octaflute steel poles.

For applications other than those using underground wiring, consult Graybar for complete information.

The bracket end is complete with 2 3/8-in. O.D. tenon, length to be specified.

Hand hole with reinforcing frame and cover available if specified.

Contact Graybar for applications requiring twin arrangement.

Round Anchor Base Type

Span, Ft.	Design Number		Ft.	Nominal Mfg. Ht. In.
	Steel Tilt of Luminaire			
	5°	15°		
6	900-Y1	900-Y2	28	0
6	900-Y3	900-Y4	30	0
9	900-Y5	900-Y6	28	0
9	900-Y7	900-Y8	30	0

Round Transformer Base Type

6	902-Y1	902-Y2	29	8
6	902-Y3	902-Y4	31	8
9	902-Y5	902-Y6	29	8
9	902-Y7	902-Y8	31	8

Octaflute Anchor Base Type

6	901-Y1	901-Y2	28	0
6	901-Y3	901-Y4	30	0
9	901-Y5	901-Y6	28	0
9	901-Y7	901-Y8	30	0

Octaflute Transformer Base Type

6	903-Y1	903-Y2	29	8
6	903-Y3	903-Y4	31	8
9	903-Y5	903-Y6	29	8
9	903-Y7	903-Y8	31	8

Union Metal Steel Traffic Signal Standards

Upright Type

Tie Rod Construction

Pipe Construction

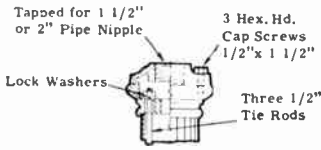

NIPPLE TYPE MOUNTING

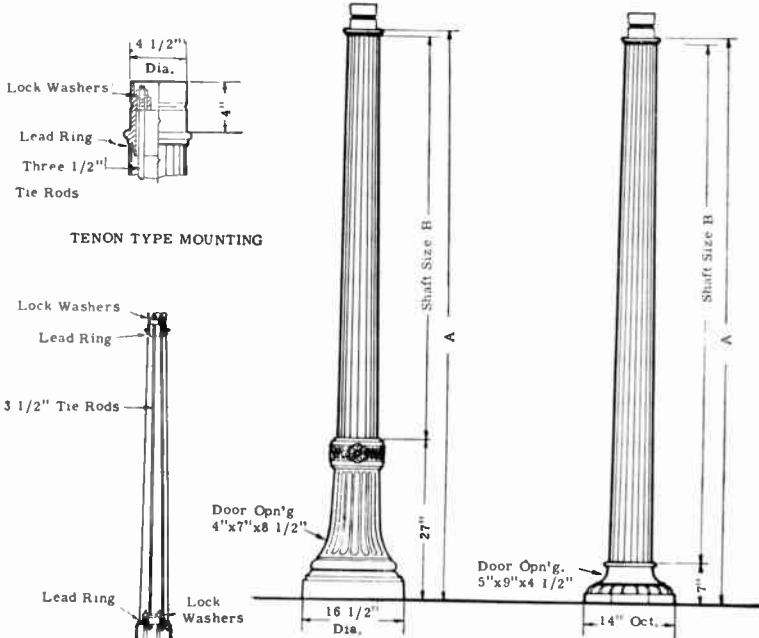

TENON TYPE MOUNTING

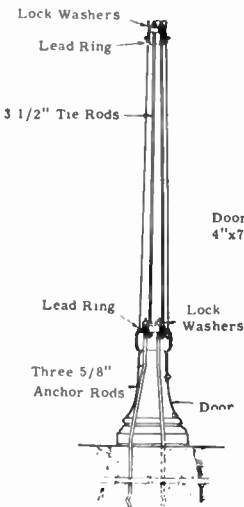

TYPICAL SECTIONAL VIEW Showing Tie Rod Construction

ANCHOR BOLT PLAN

ANCHOR BOLT PLAN

ANCHOR BOLT PLAN

DESIGN NO. 7504

DESIGN NO. 7505

DESIGN NO. 50201

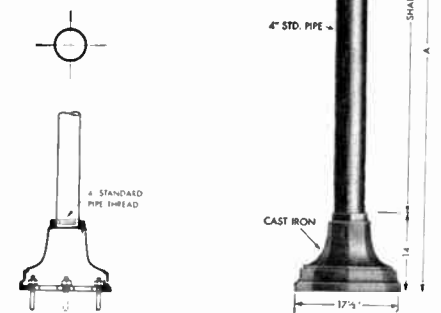

Height A	Type Mounting	Design Number	Shaft Size B*		Design Number	Shaft Size B*		Design Number Pipe Shaft	Shaft Lgh. 4 Std. Pipe B
			Bottom Dia. In.	Top Dia. Length In.		Bottom Dia. In.	Top Dia. Length In.		
4'-0"	Tenon	7504-Y5	6 1/2	x20	7505-Y4 7505-Y5 7505-Y6	6 1/2	x10 1/2	50201-Y4 50201-Y5 50201-Y6	2'-10"
	1 1/2" Pipe Tap	7504-Y6	6 1/2	x20		6 1/2	x10 1/2		2'-10"
	2" Pipe Tap	7504-Y7	6 1/2	x20		6 1/2	x10 1/2		2'-10"
6'-0"	Tenon	7504-Y8	6 1/2	x5 1/2 x44	7505-Y7 7505-Y8 7505-Y9	6 1/2	x5 1/2 x64	50201-Y7 50201-Y8 50201-Y9	1'-10"
	1 1/2" Pipe Tap	7504-Y9	6 1/2	x5 1/2 x44		6 1/2	x5 1/2 x64		1'-10"
	2" Pipe Tap	7504-Y10	6 1/2	x5 1/2 x44		6 1/2	x5 1/2 x64		4'-10"
8'-0"	Tenon	7504-Y11	6 1/2	x4 1/2 x68	7505-Y10 7505-Y11 7505-Y12	6 1/2	x4 1/2 x88	50201- 50201-Y10 50201-Y1	6'-10"
	1 1/2" Pipe Tap	7504-Y12	6 1/2	x4 1/2 x68		6 1/2	x4 1/2 x88		6'-10"
	2" Pipe Tap	7504-Y13	6 1/2	x4 1/2 x68		6 1/2	x4 1/2 x88		6'-10"
10'-0"	Tenon	7504-Y14	6 1/2	x4 1/2 x92	7505-Y13 7505-Y14 7505-Y15	6 1/2	x4 1/2 x112 1/2	50201-Y11 50201-Y12 50201-Y13	8'-10"
	1 1/2" Pipe Tap	7504-Y15	6 1/2	x4 1/2 x92		6 1/2	x4 1/2 x112 1/2		8'-10"
	2" Pipe Tap	7504-Y16	6 1/2	x4 1/2 x92		6 1/2	x4 1/2 x112 1/2		8'-10"

12' 0" Standards available upon request.

Prices on application.

Union Metal Steel Double Sign Posts

Span Type

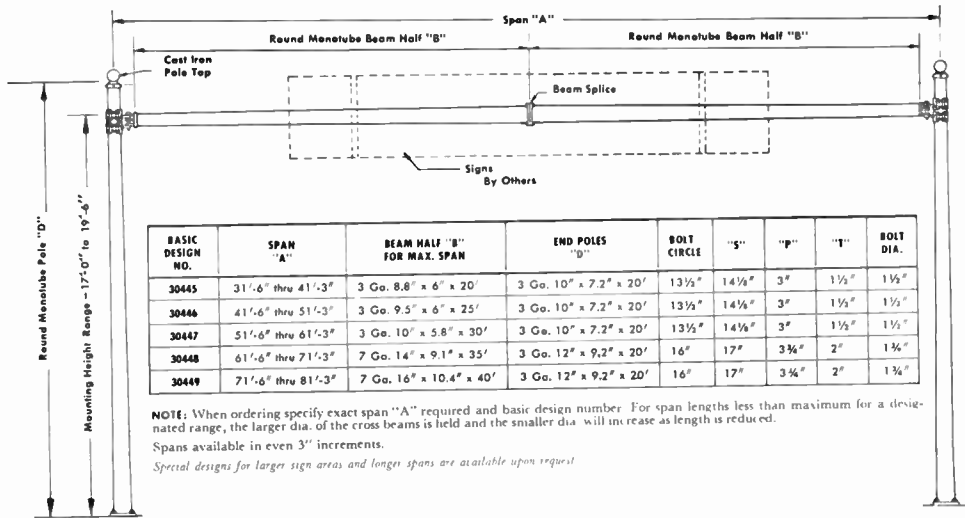

Full information available from Graybar on beam clamps, fittings, couplings, etc.

NOTES: Monotube Double Sign Post Supports are designed on the basis of a maximum sign area of 100 square feet composed of a sign 5 ft. high, and with end of sign at least 6 ft. from nearest upright support pole.

Contact GRAYBAR for prices.

Union Metal Steel Traffic Signal Poles

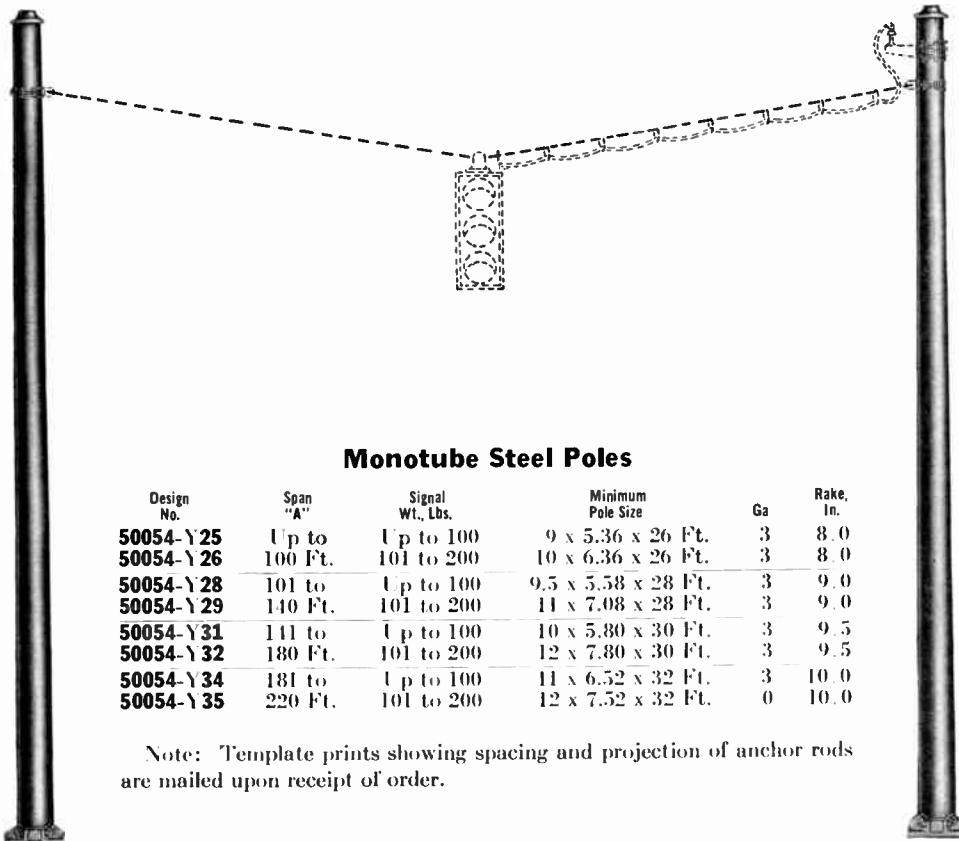

Poles are of such length as to allow for maximum clearance of 16 ft. with maximum signal height of 1 ft. and still maintain minimum sag of 5 per cent of span in span wire.

Poles chosen on basis of maximum total weight of span wire and control cable equal to 0.8 lbs. per ft. over entire span. Sag in span wire was assumed to be minimum of 5% of span in all cases.

Where signal is less than maximum allowed weight, pole rake may be cut down proportionally.

These poles are adequate to meet heavy loading district requirements.

Monotube Steel Poles

Design No.	Span "A"	Signal Wt., Lbs.	Minimum Pole Size	Ga	Rake, In.
50054-Y25	Up to 100 Ft.	Up to 100	9 x 5.36 x 26 Ft.	3	8.0
50054-Y26	101 to 200	101 to 200	10 x 6.36 x 26 Ft.	3	8.0
50054-Y28	101 to 140 Ft.	Up to 100	9.5 x 5.58 x 28 Ft.	3	9.0
50054-Y29	140 Ft.	101 to 200	11 x 7.08 x 28 Ft.	3	9.0
50054-Y31	111 to 180 Ft.	Up to 100	10 x 5.80 x 30 Ft.	3	9.5
50054-Y32	180 Ft.	101 to 200	12 x 7.80 x 30 Ft.	3	9.5
50054-Y34	181 to 220 Ft.	Up to 100	11 x 6.52 x 32 Ft.	3	10.0
50054-Y35	220 Ft.	101 to 200	12 x 7.52 x 32 Ft.	0	10.0

Note: Template prints showing spacing and projection of anchor rods are mailed upon receipt of order.

Contact GRAYBAR for additional information and prices.

Union Metal Steel Monotube Traffic Standards

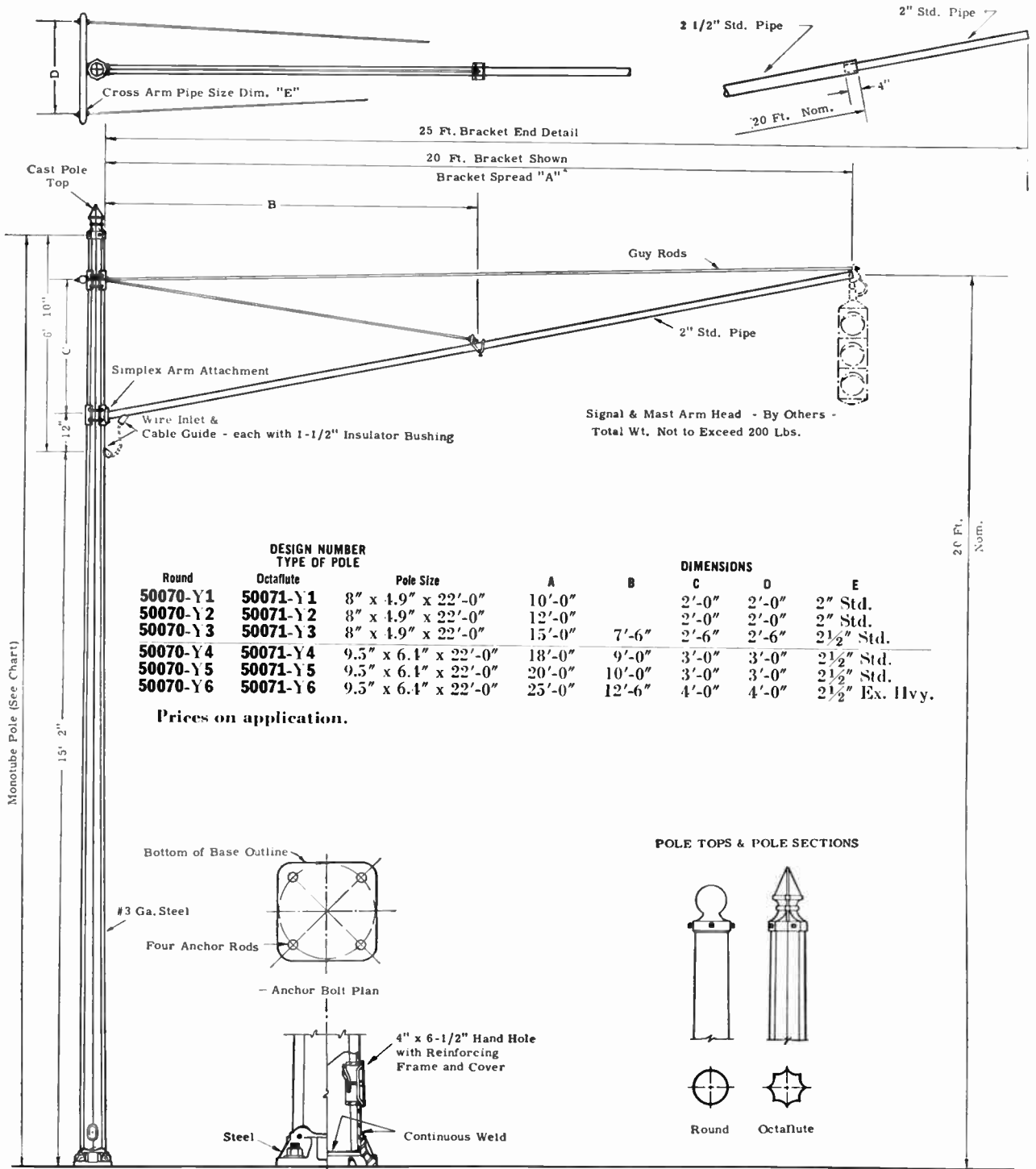

Design numbers include pole, pole shims, anchor rods, 4" x 6 1/2" hand hole frame and cover, pole top and complete mast arm, but do not include traffic signal and mast arm head.

The 10 ft. and 12 ft. mast arms do not have a center support.

**Union Metal Steel Monotube Pendant Lighting Poles
With Single Curved Bracket**

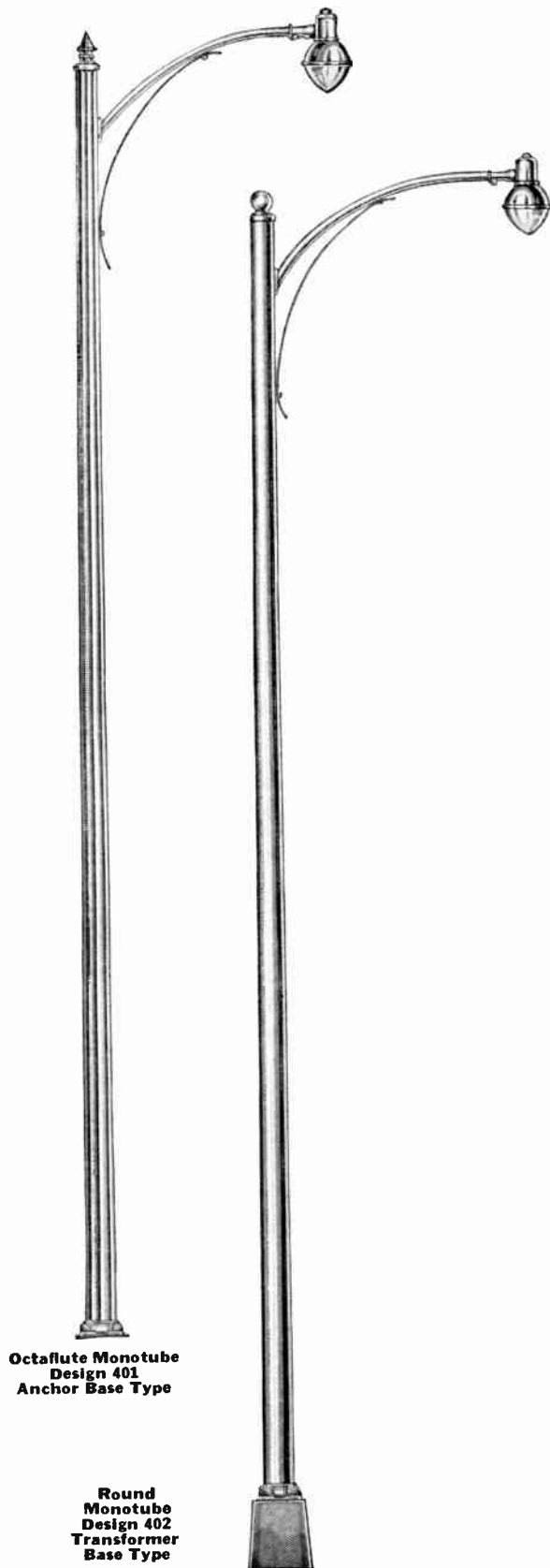

★Round Design 400 Anchor Base Type

Mfg. Height	Number and Bracket Spread			Pole Size
	4'-0"	6'-0"	8'-0"	
19' 0"	E186-A1	E186-B1	E186-C1	6.5 x 3.9 x 18' 6"
20' 6"	E200-A1	E200-B1	E200-C1	6.5 x 3.7 x 20' 0"
21' 0"	F236-A1	F236-B1	F236-C1	7 x 3.7 x 23' 6"
25' 6"	F250-A1	F250-B1	F250-C1	7 x 3.5 x 25' 0"
29' 0"	H286-A1	H286-B1	H286-C1	8 x 4 x 28' 6"
30' 6"	H300-A1	H300-B1	H300-C1	8 x 3.8 x 30' 0"
34' 0"	J336-A1	J336-B1	J336-C1	8.5 x 3.8 x 33' 6"
35' 6"	J350-A1	J350-B1	J350-C1	8.5 x 3.6 x 35' 0"

★Octaflute Design 401 Anchor Base Type

19' 0"	E186-A1	E186-B1	E186-C1	6.5 x 3.9 x 18' 6"
20' 6"	E200-A1	E200-B1	E200-C1	6.5 x 3.7 x 20' 0"
21' 0"	F236-A1	F236-B1	F236-C1	7 x 3.7 x 23' 6"
25' 6"	F250-A1	F250-B1	F250-C1	7 x 3.5 x 25' 0"
29' 0"	H286-A1	H286-B1	H286-C1	8 x 4 x 28' 6"
30' 6"	H300-A1	H300-B1	H300-C1	8 x 3.8 x 30' 0"
34' 0"	J336-A1	J336-B1	J336-C1	8.5 x 3.8 x 33' 6"
35' 6"	J350-A1	J350-B1	J350-C1	8.5 x 3.6 x 35' 0"

★Round Design 402 Transformer Base Type

20' 8"	E186-A1	E186-B1	E186-C1	6.5 x 3.9 x 18' 6"
22' 2"	E200-A1	E200-B1	E200-C1	6.5 x 3.7 x 20' 0"
25' 8"	F236-A1	F236-B1	F236-C1	7 x 3.7 x 23' 6"
27' 2"	F250-A1	F250-B1	F250-C1	7 x 3.5 x 25' 0"
30' 8"	H286-A1	H286-B1	H286-C1	8 x 4 x 28' 6"
32' 2"	H300-A1	H300-B1	H300-C1	8 x 3.8 x 30' 0"
35' 8"	J336-A1	J336-B1	J336-C1	8.5 x 3.8 x 33' 6"
37' 2"	J350-A1	J350-B1	J350-C1	8.5 x 3.6 x 35' 0"

★Octaflute Design 403 Transformer Base Type

20' 8"	E186-A1	E186-B1	E186-C1	6.5 x 3.9 x 18' 6"
22' 2"	E200-A1	E200-B1	E200-C1	6.5 x 3.7 x 20' 0"
25' 8"	F236-A1	F236-B1	F236-C1	7 x 3.7 x 23' 6"
27' 2"	F250-A1	F250-B1	F250-C1	7 x 3.5 x 25' 0"
30' 8"	H286-A1	H286-B1	H286-C1	8 x 4 x 28' 6"
32' 2"	H300-A1	H300-B1	H300-C1	8 x 3.8 x 30' 0"
35' 8"	J336-A1	J336-B1	J336-C1	8.5 x 3.8 x 33' 6"
37' 2"	J350-A1	J350-B1	J350-C1	8.5 x 3.6 x 35' 0"

Catalog numbers listed cover 11-ga. steel poles. Heavier gauges can be furnished, quotations on request.

Handhole with reinforcing frame and cover are not included as regular equipment. Must be specified if wanted.

Designs indicated include a Fabricated Steel Transformer Base. Ornamental transformer bases in cast iron or cast steel are available and will be quoted on request.

Bracket ends are arranged to accommodate a 1¼-inch Slip Fitter Type Luminaire. A 2-inch Slip Fitter arrangement or an End Knob with Plumbizer is also available.

Mounting heights given indicate distance from top of foundation to center of bracket arm where luminaire attaches. Heights specified are for brackets with 4-ft. spread. Add 7 inches for 6-ft. spread and 9 inches for 8-ft. spread.

Bracket Arm is 2-inch pipe.

★When ordering, specify both Design and Catalog Number.

Prices on application.

Union Metal Monotube Steel Pendant Lighting Poles
With Single Curved Bracket and Back Brace

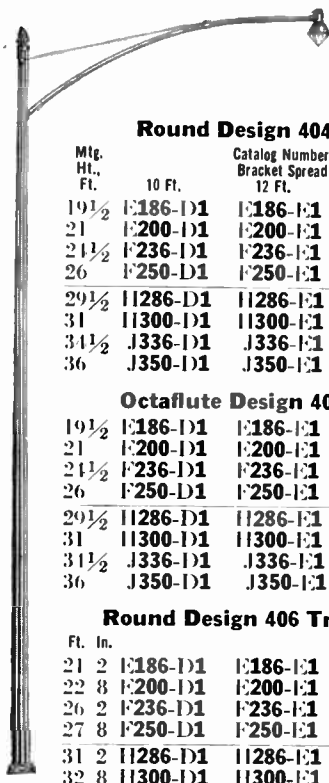

Round Design 404 Anchor Base Type

Mfg. Ht. Ft.	10 Ft.	Catalog Numbers Bracket Spread 12 Ft.	15 Ft.	Pole Size Ft.
19 1/2	E186-D1	E186-F1	E186-F1	6.5 x 3.9 x 18 1/2
21	E200-D1	E200-F1	E200-F1	6.5 x 3.7 x 20
24 1/2	F236-D1	F236-F1	F236-F1	7 x 3.7 x 23 1/2
26	F250-D1	F250-F1	F250-F1	7 x 3.5 x 25
29 1/2	H286-D1	H286-F1	H286-F1	8 x 4 x 28 1/2
31	H300-D1	H300-F1	H300-F1	8 x 3.8 x 30
34 1/2	J336-D1	J336-F1	J336-F1	8.5 x 3.8 x 33 1/2
36	J350-D1	J350-F1	J350-F1	8.5 x 3.6 x 35

Octaflute Design 405 Anchor Base Type

Mfg. Ht. Ft.	10 Ft.	Catalog Numbers Bracket Spread 12 Ft.	15 Ft.	Pole Size Ft.
19 1/2	E186-D1	E186-F1	E186-F1	6.5 x 3.9 x 18 1/2
21	E200-D1	E200-F1	E200-F1	6.5 x 3.7 x 20
24 1/2	F236-D1	F236-F1	F236-F1	7 x 3.7 x 23 1/2
26	F250-D1	F250-F1	F250-F1	7 x 3.5 x 25
29 1/2	H286-D1	H286-F1	H286-F1	8 x 4 x 28 1/2
31	H300-D1	H300-F1	H300-F1	8 x 3.8 x 30
34 1/2	J336-D1	J336-F1	J336-F1	8.5 x 3.8 x 33 1/2
36	J350-D1	J350-F1	J350-F1	8.5 x 3.6 x 35

Round Design 406 Transformer Base Type

Ft. In.	10 Ft.	Catalog Numbers Bracket Spread 12 Ft.	15 Ft.	Pole Size Ft.
21 2	E186-D1	E186-F1	E186-F1	6.5 x 3.9 x 18 1/2
22 8	E200-D1	E200-F1	E200-F1	6.5 x 3.7 x 20
26 2	F236-D1	F236-F1	F236-F1	7 x 3.7 x 23 1/2
27 8	F250-D1	F250-F1	F250-F1	7 x 3.5 x 25
31 2	H286-D1	H286-F1	H286-F1	8 x 4 x 28 1/2
32 8	H300-D1	H300-F1	H300-F1	8 x 3.8 x 30
36 2	J336-D1	J336-F1	J336-F1	8.5 x 3.8 x 33 1/2
37 8	J350-D1	J350-F1	J350-F1	8.5 x 3.6 x 35

No. 405

Octaflute Design 407 Transformer Base Type

Ft. In.	10 Ft.	Catalog Numbers Bracket Spread 12 Ft.	15 Ft.	Pole Size Ft.
21 2	E186-D1	E186-F1	E186-F1	6.5 x 3.9 x 18 1/2
22 8	E200-D1	E200-F1	E200-F1	6.5 x 3.7 x 20
26 2	F236-D1	F236-F1	F236-F1	7 x 3.7 x 23 1/2
27 8	F250-D1	F250-F1	F250-F1	7 x 3.5 x 25
31 2	H286-D1	H286-F1	H286-F1	8 x 4 x 28 1/2
32 8	H300-D1	H300-F1	H300-F1	8 x 3.8 x 30
36 2	J336-D1	J336-F1	J336-F1	8.5 x 3.8 x 33 1/2
37 8	J350-D1	J350-F1	J350-F1	8.5 x 3.6 x 35

Catalog numbers listed cover 11 gauge steel poles. Heavier gauges can be furnished, quotations on request. Handhole with reinforcing frame and cover are not included as regular equipment. Must be specified if wanted.

Designs indicated include a Fabricated Steel Transformer Base. Ornamental transformer bases in cast iron or cast steel are available and will be quoted on request.

Bracket ends are arranged to accommodate a 1 1/4-in. Slip Fitter Type Luminaire. A 2-in. Slip Fitter arrangement or an End Knob with Plumbizer is also available.

Mounting heights given indicate distance from top of foundation to center of bracket arm where luminaire attaches. Heights specified are for brackets with 10 ft. spread. Add 2-in. for 12 ft. spread and 6-in. for 15 ft. spread.

Bracket Arm is 2-in. pipe. When ordering, specify both Design and Catalog Number.

Prices on application.

No. 406

Hubbard Upsweep Street Lighting Brackets
Hot Galvanized

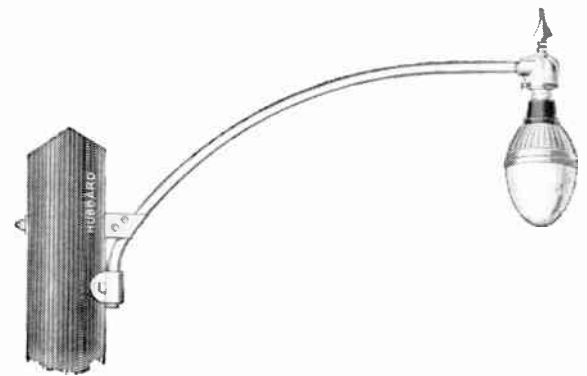

Municipal Type

Hubbard Upsweeps allow the maximum heights in luminaire mounting. There is no pole space "wasted" by under or overhead braces. They can be mounted at the pole top if desired. Actual mounting space on the pole is normally less than 10-inches.

Ease of installation, graceful design, one-piece construction, and the absence of attendant accessories which demand warehousing or handling, are a few of the advantages enjoyed by Hubbard Upsweep Brackets. All sizes more than meet the strength requirements demanded by the most severe conditions. Furnished with either threaded ends for Levelite attachment, or plain ends for slip-fitter attachment. Specify when ordering.



Round Brace Type

Both Municipal Type and Round Brace Brackets have the "Keyhole" features. These Brackets are similar except that the latter has a 3/4-inch round brace welded underneath for additional strength. The Round Brace Type requires no more mounting space than the Municipal type.

Municipal Type

Nominal Pipe Diameter 1 1/4 inches

Threaded End	No.	Plain End	Nominal Length of Arm, Feet	Rise - From Top of Lower Attachment Plate to Center of Pipe at Outer End - Approximate	Approx. Ship. Wt. Lbs., 100 Pcs.
23003	23003-P	3	16 inches	1200	
23004	23004-P	4	20 inches	1400	
23005	23005-P	5	24 inches	1600	
23006	23006-P	6	26 inches	2200	

Round Brace Type

Nominal Pipe Diameter 1 1/4 inches

23206	23206-P	6	26 inches	3150
23208	23208-P	8	29 inches	3500

Hapco Aluminum Alloy Street Lighting Brackets

**Hapco Tapered Type
Upsweep Bracket
Aluminum Alloy**

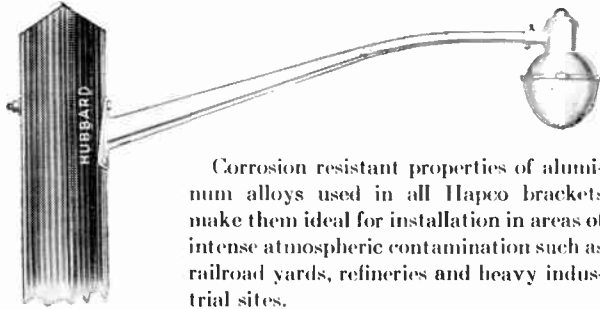

Corrosion resistant properties of aluminum alloys used in all Hapco brackets make them ideal for installation in areas of intense atmospheric contamination such as railroad yards, refineries and heavy industrial sites.

No.		Nominal Length, Ft.	Nominal Pipe Diam. Inches Tapered	Approx. Rise Inches	Approx. Ship. Wt. Lbs. Each
Threaded End	Plain End				
HAL 4224	HAL 4224P	1	1 to 2	18	7.0
HAL 4225	HAL 4225P	5	1 to 2	20	8.5
HAL 4226	HAL 4226P	6	1 to 2	24	10.0
HAL 4228	HAL 4228P	8	1 to 2	30	14.5

**Hapco Municipal Type
Upsweep Bracket
Aluminum Alloy**

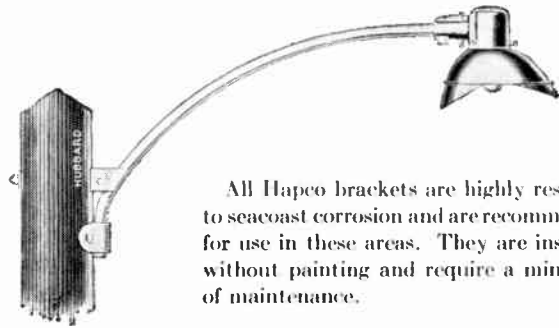

All Hapco brackets are highly resistant to seacoast corrosion and are recommended for use in these areas. They are installed without painting and require a minimum of maintenance.

No.		Nominal Length, Ft.	Nominal Pipe Diam. Inches	Approx. Rise Inches	Approx. Ship. Wt. Lbs. Each
Threaded End	Plain End				
HAL 143A	HAL 143AP	3	1 1/4	16	4.5
HAL 144A	HAL 144AP	4	1 1/4	20	5.5
HAL 145A	HAL 145AP	5	1 1/4	24	6.5
HAL 146A	HAL 146AP	6	1 1/4	26	8.5

**Hapco Round Brace Type
Upsweep Bracket
Aluminum Alloy**

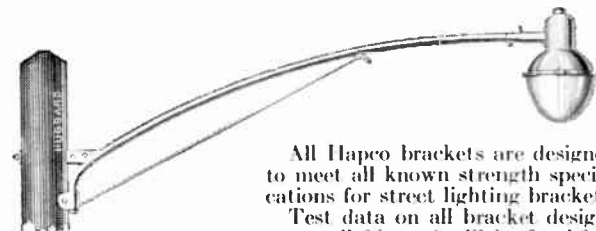

All Hapco brackets are designed to meet all known strength specifications for street lighting brackets. Test data on all bracket designs are available and will be furnished upon request.

No.		Nominal Length, Ft.	Nominal Pipe Diam. Inches	Approx. Rise Inches	Approx. Ship. Wt. Lbs. Each
Threaded End	Plain End				
HAL 1426	HAL 1426P	6	1 1/4	26	11
HAL 1428	HAL 1428P	8	1 1/4	29	14

Prices on application.

**Hapco Double Bend Upsweep Type
Street Hood Bracket
Aluminum Alloy**

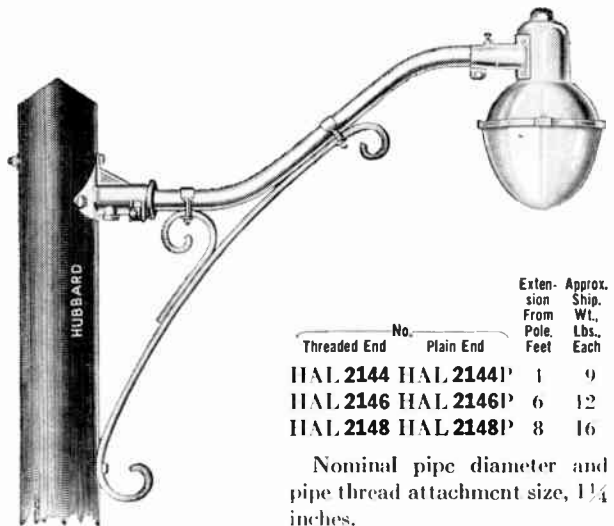

No.		Extension From Pole, Feet	Approx. Ship. Wt. Lbs. Each
Threaded End	Plain End		
HAL 2144	HAL 2144P	1	9
HAL 2146	HAL 2146P	6	12
HAL 2148	HAL 2148P	8	16

Nominal pipe diameter and pipe thread attachment size, 1 1/4 inches.

**Hapco Straight and Bent Arm Types
Street Hood Brackets
Aluminum Alloy**

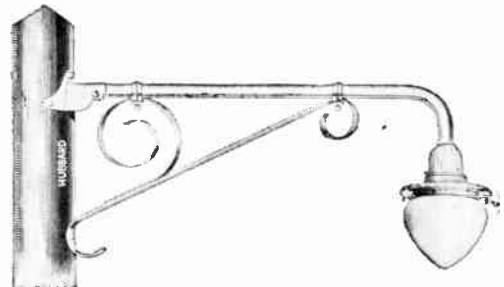

Bent Arm Type

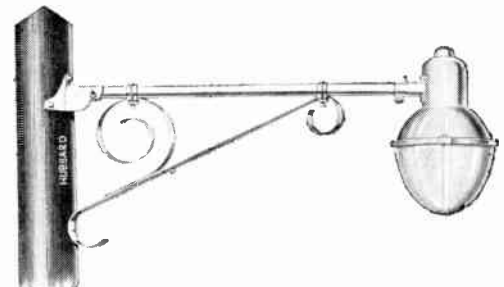

Straight Arm Type

**Bent Arm and Straight Arm Brackets
1 1/4-inch Nominal Diameter Pipe**

Bent Arm Type		Straight Arm Type		Extension Feet	Approx. Ship. Wt. Lbs. ea.
Threaded End	Plain End	Threaded End	Plain End		
HAL 414	HAL 414P	HAL 404	HAL 404P	4	9*
HAL 416	HAL 416P	HAL 406	HAL 406P	6	12*
HAL 418	HAL 418P	HAL 408	HAL 408P	8	16*

*Weights given are for Bent Arm Type Brackets. Subtract 0.5 lbs. for weights of Straight Arm Type Brackets.

Prices on application.

**Hapco Aluminum Alloy Tie Rod Type
Upsweep Brackets**

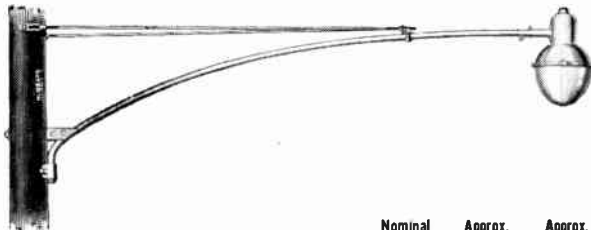

No.		Nominal Length, Ft.	Nominal Pipe Diam. Inches	Approx. Rise Inches	Approx. Ship. Wt. Lbs. Each
Threaded End	Plain End				
HAL 14108	HAL 14108P	8	1 1/4	28 5/8	15
HAL 14110	HAL 14110P	10	1 1/4	28 5/8	17
HAL 14112	HAL 14112P	12	1 1/4	28 5/8	19
HAL 14114	HAL 14114P	14	1 1/4	28 5/8	21
HAL 14116	HAL 14116P	16	1 1/4	28 5/8	23

Method of Mounting Hubbard Upsweep Brackets on

Wood Poles

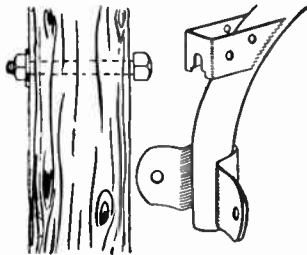

Simply "hang" the Bracket over the head of the bolt by means of the key-hole slot.

Then draw nut tight. Lag screws (1/2-inch) are used in the lower attachment holes.

Metal Poles

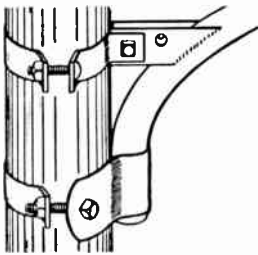

For metal pole attachment, there is no change in the design of the arm. The same arm may be mounted on either metal or wood poles. Bands are, as shown, constructed to attach to the top fastening of the arm and, utilizing two angle bolts, to attach to the bottom fastening.

**Hubbard Pole Bands
For Upsweep
Street Lighting Brackets**

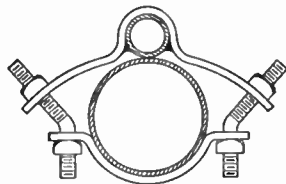
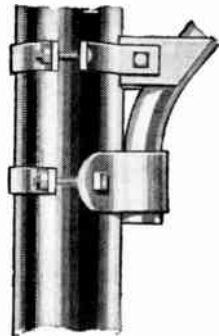

Detail of a Bracket Mounted on a 4-inch Pole—Lower Band

All bolts are included, consisting of two standard 1/2-inch machine bolts for the upper band, two special 1/2-inch stud bolts for the lower band and one 1/2 by 3 1/2-inch machine bolt with lock washer for attaching the bracket.

Hubbard Attachment Bands are designed exclusively for installation of Hubbard Upsweep Brackets on metal poles.

No.	Nom. Diam. Pole—In.	Actual O. O. Pole—In.	Steel Size—Inches	Approx. Wt. Lbs. 100 Sets (Inc. Bolts)
28264	4	4 1/2	1/4 x 1 1/2	470
28265	5	5 9/16	1/4 x 1 1/2	511
28266	6	6 5/8	1/4 x 1 1/2	567
28267	7	7 5/8	1/4 x 1 1/2	660
28268	8	8 5/8	1/4 x 1 1/2	671

Prices on application.

Hubbard Upsweep Street Lighting Brackets

**Hot Galvanized
Tie Rod Type**

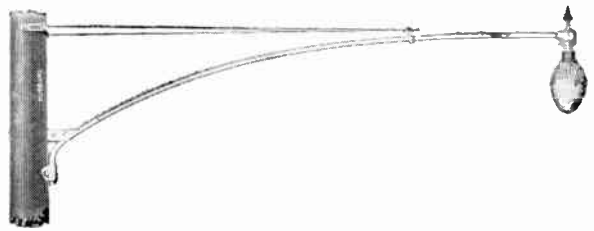

In the longer arms, more strength is needed to withstand both vertical and side loading. For this reason, Mast Arms of the No. 23108 series are installed with tie rods fastened to the side of the pole. These rods are an effective brace against side sway and, of course, make possible an extremely heavy vertical load. Conventional, key-hole type mounting is used as the lower attachment, similar to the Hubbard One-Piece type mounting.

The rise from the top of the lower attachment plate to the center of the pipe at its outer end is 28 5/8 inches. Nominal Pipe Diameter 1 1/4 inches. Also furnished in aluminum alloy.

Threaded End	Number	Plain End	Nominal Length of Arm—Feet	Approx. Ship. Wt. Lbs., 100 Pcs.
23108	23108-P		8	3300
23110	23110-P		10	3900
23112	23112-P		12	4500
23114	23114-P		14	5100
23116	23116-P		16	5700

Truss Type



Hubbard Truss Type Arms are designed to meet requirements for lengths beyond 8 feet, while at the same time embodying all the features of the Hubbard Line. This arm offers the same simplicity of design as the shorter arms. It rates much higher in all lengths than the strength requirements demanded by the most severe loading, either vertical or horizontal. It is easy to install and is adaptable to either internal or external wiring.

As the illustration shows, this Truss Type Arm is supported by two 5/8-inch double arming bolts (not included).

Rise, lower pole mounting bolt to pipe center at outer end, 37 inches. Nominal pipe diameter, 1 1/4 inches. Also furnished in aluminum alloy.

Threaded End	Number	Plain End	Nominal Length of Arm—Feet	Approx. Ship. Wt. Lbs., 100 Pcs.
3943	3943-P		8	3800
3944	3944-P		10	4600
3955	3955-P		12	5500
3956	3956-P		14	6300
3957	3957-P		16	7100
3958	3958-P		18	8000
3959	3959-P		20	9100

¶ Western zone prices; eastern prices lower.

Hubbard Street Lighting Brackets For Fluorescent Luminaires Galvanized Steel

Supporting the weight of a heavier fixture is only one of three important requirements for fluorescent luminaire brackets. The design must also be able to withstand 100-mile per hour wind velocities applied over a larger projected luminaire area as well as support the added seasonal weight of an increased snow-and-ice-loading area.

"Heavied-up" models of brackets designed for mercury vapor and filament type fixtures do not make satisfactory supports for fluorescent luminaires. As a result, a new design of brackets for fluorescent luminaires has been developed.

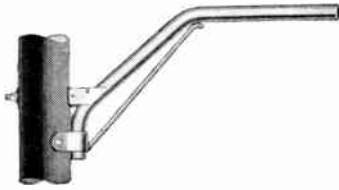

No. 23022 for use with luminaires with a maximum projected area not to exceed 4 square feet and total weight not to exceed 40 pounds.

No. 23032 for use with luminaires with a maximum projected area not to exceed 8 square feet and total weight not to exceed 110 pounds.

No.	Over-all Length In.	Nominal Length Ft.	Rise—From Top of Lower Attachment Plate To Center of Pipe at Outer End Approx. In.	Approx. Ship. Wt. Lbs.
23022	37	2	21	25
23032	48	2	21	28

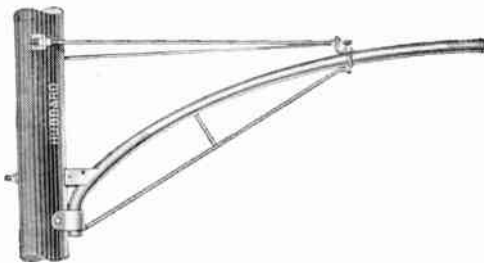

Nos. 23024 through 23028 for use with luminaires with a maximum projected area not to exceed 4 square feet and total weight not to exceed 40 pounds.

No.	Nominal Length Ft.	Nominal Pipe Diam. In.	Rise—From Top of Lower Attachment Plate To Center of Pipe at Outer End Approx. In.	Approx. Ship. Wt. Lbs.
23024	4	2	31	45
23026	6	2	31	57
23028	8	2	31	71



Nos. 23034 and 23036 for use with luminaires with a maximum projected area not to exceed 8 square feet and total weight not to exceed 110 pounds.

No.	Nominal Length Ft.	Nominal Pipe Diam. In.	Rise—From Top of Lower Attachment Plate To Center of Pipe at Outer End Approx. In.	Approx. Ship. Wt. Lbs.
23034	4	2	31	54
23036	6	2	31	69



Nos. 23010 through 23020 for use with luminaires with a maximum projected area not to exceed 4 square feet and total weight not to exceed 40 pounds.

No.	Nominal Length Ft.	Nominal Pipe Diam. In.	Rise—From Lower Pole Mounting Bolt To Center of Pipe at Outer End Approx. In.	Approx. Ship. Wt. Lbs.
23010	10	2	33	77
23012	12	2	33	92
23014	14	2	33	106
23016	16	2	33	120
23018	18	2	33	134
23020	20	2	33	148



Nos. 23908 through 23920 for use with luminaires with a maximum projected area not to exceed 8 square feet and total weight not to exceed 110 pounds.

No.	Nominal Length Ft.	Nominal Pipe Diam. In.	Rise—From Lower Pole Mounting Bolt To Center of Pipe at Outer End Approx. In.	Approx. Ship. Wt. Lbs.
23908	8	2	33	77
23910	10	2	33	95
23912	12	2	33	112
23914	14	2	33	130
23916	16	2	33	147
23918	18	2	33	165
23920	20	2	33	182

Hubbard Street Hood Brackets

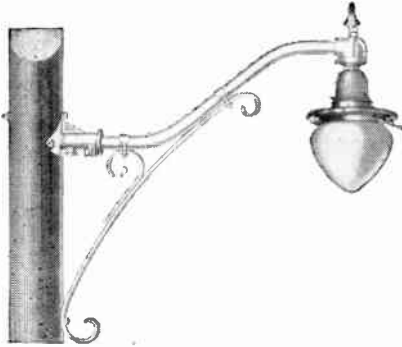

No. 22654

Double Bend Upsweep Type

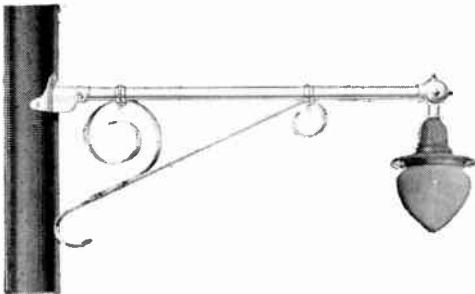

No. 3714

Straight Arm Type

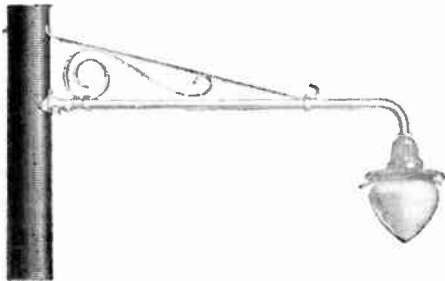

No. 3728

Top Scroll Type

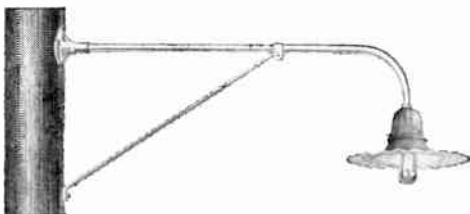

No. 23816

Rural Type

The brackets shown above are a few of the additional styles of brackets manufactured by Hubbard and Company. For many years, Hubbard and Company has offered an outstanding service in the design and manufacture of material made to the customers' specifications and requirements. We respectfully request that you allow us to be of service to you in any street lighting situation involving special material.

For complete information and prices contact your nearest Graybar Office.

**Hubbard Pole Plates
Standard Type**

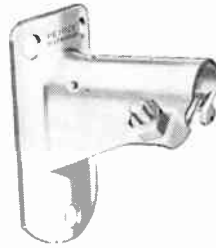

No. 3701

Standard Type Pole Plates are generally used on Brackets of 4 foot lengths. They are formed of pressed steel with a clamping arrangement which eliminates the necessity for threading on pipes.

For Wood Pole Mounting

No.	Pipe Size In.	Mtg. Hole Diam. In.	Ship. Wt. Lbs., 100
3701	3/4	9/16	225
3703	1 1/4	1 1/16	365

One Piece Type-Pressed Steel

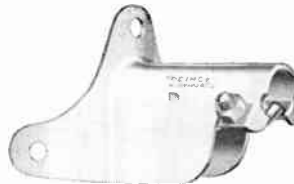

No. 3901

These plates, designed for 1 1/4-inch pipe Street Hood Brackets, are of one piece construction which insures the maximum strength of the No. 7 gauge steel from which they are formed. The 9 1/2-inch horizontal pole bearing surface is especially effective in eliminating side sway. No. 3933 is similar to No. 3901

except that the bracket pipe is held at a 45° angle to the pole.

Approx. weight lbs., 100.....480.

No. 3901.....

No. 3933—1 1/4" pipe—Wt.—450.....

**One Piece Type
With Porcelain
Bushing**



No. 3907

The No. 3907 Pole Plate is similar in appearance to the No. 3901 style shown above. The difference is that the No. 3907 plate is furnished with a No. 3751 porcelain

bushing for internal wiring. Clamping arrangement accommodates a 1 1/4-inch pipe arm.

Approx. Ship. wt., lbs., 100.....550.

No. 3907.....

Oval Back Type

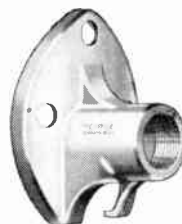

Oval back type Pole Plates are made from certified Malleable Iron. No. 4728, with a flat back, is threaded for 3/4-inch pipe. No. 4730, with back curved to fit the pole, is threaded for 1 1/4-inch pipe.

No. 4731 is similar to No. 4728 in that it has a flat back. It is, however, unthreaded and is furnished with a set screw for 1 1/4-inch pipe arm attachment.

All three sizes have a convenient opening at the base of the plate to permit internal wiring of the arm.

No.	Style of Back	Pipe Size	Dimensions — Inches			Approx. WL Lbs., 100 Pcs.
			Mtg. Top	Hole Diam.	Side	
4728	Flat	3/4	9/16	9/16	245	
4730	Curved	1 1/4	1 1/16	1 1/16	320	

Hubbard Levelite End Fittings

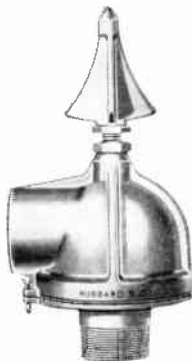

No. 3279

The Hubbard Levelite has been designed to provide a much needed flexibility on street lighting installations. Luminaires may be leveled or purposely tilted in any direction, and permanently locked in that position. Under special conditions such as building obstructions, landscaping consisting of trees which it is preferred not to trim, and instances where unforeseen changes occur after lines are in service, the lighting can be handled in a practical manner by Levelite flexibility.

No.	For Pipe Arm Nominal Size—Inches	Luminaire Attachment Thread—Inches	Approx. Ship. Wt. Lbs., 100 Pcs.
3279	1 1/4	1 1/4 (Pipe)	563
3281	2	1 1/4 (Pipe)	900
3282	2	2 (Pipe)	941

End Fittings For Pipe Brackets or Mast Arms



No. 3303



No. 3386



No. 3388



No. 3381-84

No.	Dimensions—Inches Size of Fittings— Nominal Pipe Arm First —Luminaire Second	Style Arm First Luminaire Second	Approx. Ship. Wt. Lbs., 100 pcs.
3291	1 1/4 to 1 1/4	Female and Male	100
3292	1 1/4 to 3/4	Female and Male	70
3303	1 1/4 to 1 1/4	Female and Male	300
3381	Standard Reducer 1 1/4 to 3/4	Female and Male	77
3384	Bushing—3/4 to 1 1/4	Female and Male	85
3386	1 1/4 to 1 1/4	Female and Male	275
3388	1 1/4 to 1 1/4	Female and Male	275

Hubbard Pole Plates

Wood Pole Bushing Type

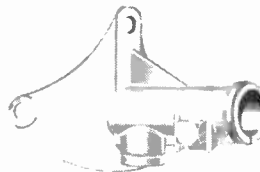

Nos. 4752-4755

These malleable iron clamp type Pole Plates are designed for 1 1/4 and 2-inch pipe, forged on the pole end to meet the insertion requirements of the clamping arrangement. Used for internal wiring. One 5/8-in. and two 1/2-in. mounting bolts are required for installation and must be ordered separately.

No.	Pipe Size	Dimensions—Inches		Approx. Wt. Lbs., 100 Pcs.
		Mtg. Hole Diam. Top	Side	
4752	1 1/4	1 1/16	9/16	585
4755	2	1 1/16	9/16	815

Pole Plate Bushings



No. 3751 is a porcelain bushing. It is recommended for use with Pole Plates Nos. 3907, 4752 and 4755.

Approx. Ship. Wt. Lbs., 100 Pcs. 16.

Hubbard Lamp Lead Brackets

Wood Pole Type



No. 1660

Used on pole or crossarm for running cables to the mast arm.

Diameter of wire hole, 1-inch.

No.	Dimensions—In. Diam. Wire Hole	Ext.	Attachment	Approx. Ship. Wt. Lbs., 100 Pcs
1660	1	5 1/2	Lag Screw	265

Hubbard One Bolt Lamp Lead Brackets

Split Insulator Type



No. 157

Split Insulator Type Lamp Lead Brackets may be opened for the insertion of lamp leads. The wire hole is adjustable from 5/16-in. by 1 1/8-in. to 1-in. by 1 1/8-in.

No.	For Pipe Size In.	Extension from base Inches	Approx. Ship. Wt. Lbs., 100 Pcs.
157	1 1/4	5	280

Solid Insulator Type



Hubbard Lamp Lead Brackets of the solid insulator type have a wire hole through which the cable must be threaded. The one-bolt attachment simplifies installation.

No.	For Pipe Size In.	Extension from c'tr. of Pipe Inches	Approx. Ship. Wt. Lbs., 100
180	1 1/4	5	200
181	2	5 1/2	230
182	Lagscrew 1/2" x 3"	6 1/8	220

Benjamin "General Line" Industrial Fluorescent Equipment

Listed By Underwriters' Laboratories, Inc.

"Twin-Flo SD-1", 25% Up Units
 For T-12, 48" 40-W R.S.; 48" and 96" Slimline
 and 800ma Rapid-Start Lamps

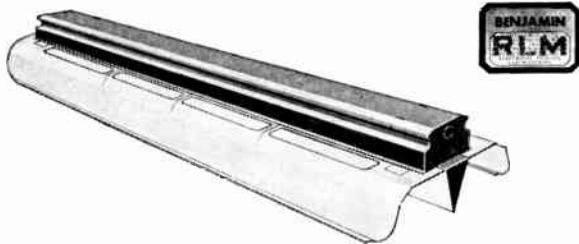

These individual units and continuous line systems are of heavy gauge steel construction with open end reflectors finished in "Lifetime" porcelain enamel; white inside and out. Reflectors have apertured tops directing 25% (nominal) of the light upward to reduce undesirable ceiling contrasts. Reflector and center shield are of one-piece construction. Reflectors for 8 ft. units are two-piece for easier handling. Reflector may be easily removed from channel by releasing two "Lok-Latch" fasteners. Lamps are held in place by a pair of Benjamin patented "Springlox" metal-clad lampholders.

Continuous lines are made by joining two or more channel-sections with a channel coupling. 8 ft. channel-sections are normally supplied with a 4 ft. section at end of line if necessary. Units may be installed using knockouts on top of channel or coupling. Sliding hangers are also available. Shielding angle is 27°; reflection factor is 85% or higher. All units listed, except 800ma, meet RLM standard SD-1. Units are wired with 6 in. leads; channel-sections are finished in baked gray paint enamel.

Individual Units and Continuous Line Systems Including Couplings and End Caps With Open-End, Apertured Top Reflectors

Effective Over-all Length	2-48" or 2-96" T-12 Slim-line Lamps: Series Ballast		2-48" or 2-96" 800ma T-12 Rapid-Start Lamp	
	No.	Each	No.	Each
4' 4 1/4"	48002	\$38.50	48052	\$48.95
8' 4 1/4"	96002	56.15	96052	66.60
12' 8 1/2"	96002-12	91.30	96052-12	115.55
16' 8 1/2"	96002-16	122.30	96052-16	133.20

For each additional 8 ft. section with coupling, add 8' 4 1/4" and \$56.15 to price of Slimline or \$66.60 to Rapid-Start.

2-40W, T-12 Rapid Start		Listings for 110-125v. 60 cycles; special voltages and frequencies available.
Effective Over-all Length	No.	
4' 6"	40052RS	\$35.15
9' 0"	40052RS-8	69.60
13' 6"	40052RS-12	104.75
18' 0"	40052RS-16	139.15

For each additional 8' section with coupling, add 9' 0" and \$69.60 to price.

Suspensions for "General Line" Equipment

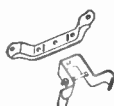

No.	Description	Each
5243	1 pr. hvy. duty 5' chain assemb.	\$1.35
C-100-24	24" sing. stem and canopy, rigid type	1.95
C-100-S-24	24" sing. stem and canopy, swivel type	3.04
18443	Sliding hanger w/offset ceil. strap for 1/2" conduit	1.35
18439	Sliding hanger w/offset ceil. strap for 3/8" rod	1.35
18449	Sliding chain suspension	.80
18472	Sliding hanger for messenger cable	1.20
18441	Offset ceiling strap for 1/2" conduit	.60
18431	Offset ceil. strap for 3/8" rod or 3/16" bolt (nut and bolt supplied)	.60
18432	Flat ceil. strap, 3/8" rod, 3/16" bolt	.60

Open-End, 10% and 15% Up Units*
 For T-12, 48" 40-W R.S.; 48" and 96" Slimline
 and 800ma Rapid-Start Lamps
 Also for T-17, 60" 90-100W Preheat Lamps



Reflectors are of one-piece construction, but without center shield as on "Twin-Flo SD-1" unit. Other specifications same as for "Twin-Flo SD-1" units except that either 10% or 15% (nominal) of the light directed upward and shielding angle is 13° except on 90-100W units it is 14°.

Individual Units and Continuous Line Systems Including Couplings and End Caps With Open-End, Apertured Top Reflectors

Over-all Length	40 Watt T-12 Rapid-Start Lamps (With 10% Upward Light)* "Twin-Flo"		"Triple-Flo"	
	No.	Each	No.	Each
4' 6"	44362RS	\$29.35	44163RS	\$40.25
9' 0"	44362RS-8	57.90	44163RS-8	71.60
13' 6"	44362RS-12	87.25	44163RS-12	111.90
18' 0"	44362RS-16	115.80	44163RS-16	143.30

For each additional 8' section with coupling, add 9' and \$57.90 to price for each twin-lamp and \$71.60 to 3-lamp.

Effective Over-all Length	48" and 96" T-12 Slimline Lamps With Series Ballast (10% Up Light)*	
	No.	Each
4' 4 1/4"	48122	\$32.75
8' 4 1/4"	96122	49.95
12' 8 1/2"	96122-12	82.70
16' 8 1/2"	96122-16	99.90

For each additional 8' section with coupling, add 8' 4 1/4" and \$49.95 to twin-lamp and \$70.30 to 3-lamp.

Effective Over-all Length	48" and 96" 800ma T-12 Rapid-Start Lamps (10% Upward Light)*	
	No.	Each
4' 4 1/4"	48922	\$43.20
8' 4 1/4"	96922	60.40
12' 8 1/2"	96922-12	103.60
16' 8 1/2"	96922-16	120.80

For each additional 8' section with coupling, add 8' 4 1/4" and \$60.80 to twin-lamp and \$82.05 to 3-lamp.

Effective Over-all Length	For 90-100W, T-17, 60" Preheat Lamps (With 15% Upward Light)	
	No.	Each
5' 5 1/2"	64162W	\$4.30
10' 11"	64162W-10	107.70
16' 4 1/2"	64162W-15	161.95
21' 10"	64162W-20	216.10

90-100 W units have FS-850 starters and "rotating-lock" lampholders.

*Suffix No. with -15% for 15% upward light reflectors.

▲Open-end, solid top reflectors and closed end, in either solid or aperture-top are available. Data on request.

Shields and Louvers for "General Line"

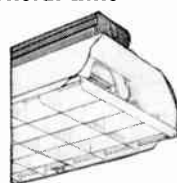
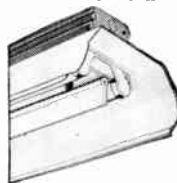

No.	Shield Description	Louver Description	Each
8482	Louver for 2-lamp Bipin Units w/13 1/8" Refl. †		\$7.60
8483	Louver for 3-lamp Bipin Units w/13 1/8" Refl. †		9.15
60902	Louver for 90/100 Watt Units		12.40
9632	Louver for 96" Slimline or 800ma 2 or 3 lamp Units		19.25
4832	Louver for 48" Slimline or 800ma 2 or 3 lamp Units		9.60
8446*	Longitudinal Shield for 40W Bipin Units		2.95
9634*	Longitudinal Shield for 96" Slimline Units		5.85
4834*	Longitudinal Shield for 48" Slimline Units		2.95

Lamps are not included with units on this page. *For 2-lamp units only. †Not for 15% up-light refl.

Benjamin Protected Fluorescent Units

General Specifications—Benjamin Protected lighting units are available in either the standard high quality construction or an unusually durable corrosion-resisting construction. All units have a one-piece steel housing finished in "lifetime" porcelain enamel; outside finish of housing is gray. Flat reflector plate in top of housing is removable for convenient access to control equipment; reflection factor is 85% or higher. All units have two weatherproof flanges on top of housing for suspension and entrance of wiring. Flanges are spaced on 47½ in. centers and tapped ½ in. I.P. size standard; ¾ in. when specified. Covers attach to one side of housing by three spring metal hinges. Three spring clamps securely and tightly lock other side of cover. TX units not available with covers.

Standard construction includes Benjamin SPRINGLOX steel body, lampholders and steel cover frames. Both are finished in baked paint enamel. Corrosion-resisting units are supplied with monel metal SPRINGLOX lampholders and a steel cover frame finished in porcelain enamel; with cover hardware of monel metal or stainless steel. Monel metal lampholders not available for starter type units with pre-heat ballasts. Units are supplied with 6 in. wire leads; metal-to-metal bonds ground unit to conduit system.

"Type II-G Sealed-Flo" Units

Listed By Underwriters' Laboratories, Inc.

For Class II, Groups F and G Hazardous Locations
Also Suitable for Class III Hazardous Locations

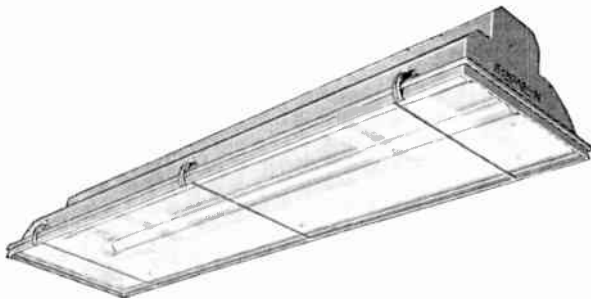

Completely enclosed unit. Asbestos gasket seals cover to housing. Double strength clear glass cover units listed; for wire reinforced glass, replace "CL" suffix with "WG" and add \$19.40 to price; for Tempered Plate Glass use suffix "TP" and add \$19.40. Standard construction units listed; for units with corrosion-resisting construction, prefix cat. no. with "CR-" and add \$10.65 for twin-lamp and \$12.85 for 3-lamp units. Length 53¾ in., width 13½ in., and depth 7¾ in.

"Sealed-Flo 40"

Clear Glass Cover No.*	No. & Type Lamps	Each
49462CL-RS	2-40W Rapid Start**	\$72.70
49463CL-RS	3-40W Rapid Start**	83.65
"Sealed-Flo 48"		
46462CL	2-48" Slimline (Series)†	81.20
46463CL	3-48" Slimline (Series)†	102.50
"Sealed-Flo 800"		
46492CL	2-48" 800ma Rapid Start	91.65
46493CL	3-48" 800ma Rapid Start	114.45

*Listed for 110-125 V. 60 cycles; special voltages and frequencies available.

**For 40W preheat unit with FS-40 non-blinking manual reset starters drop "RS" from no. and add suffix "W"; and \$0.65 per starter. For standard FS-4 starters drop "RS" and use 40-W R.S. price.

†For equipment with "lead-lag" ballast, suffix no. with "L" and add \$3.25 to price.

Lamps not included with units on this page.

"Vapor-Tite" Units

Listed As Vapor-Tight By Underwriters' Laboratories, Inc.

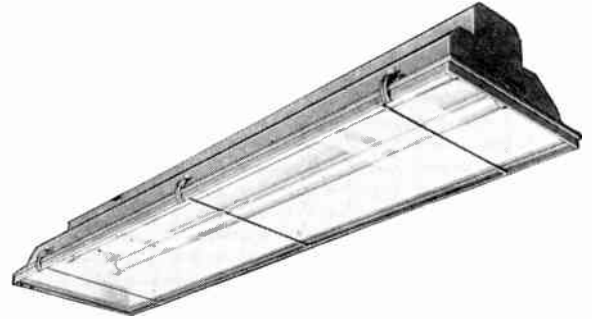

Completely enclosed unit for use in locations exposed to moisture or non-combustible dust. Rubber gasket seals cover to housing. Double strength clear glass cover units listed. For clear acrylic plastic, replace "CL" in no. with "PG"; for Tempered Plate Glass, replace "CL" with "TP"; for Wire-Reinforced Glass, replace "CL" with "WG"; and add \$19.40 to price. Standard Construction Units are listed; for Corrosion-Resisting Construction prefix no. with "CR-" and add \$10.65 for twin-lamp and \$12.85 for 3-lamp units. Length is 53¾ in., width 13½ in., depth 7¾ in.

"Vapor-Tite 40"

Clear Glass Cover No.*	No. & Type Lamps	Each
49562CL-RS	2-40W Rapid Start**	\$ 70.80
49563CL-RS	3-40W Rapid Start**	81.70
"Vapor-Tite 48"		
46562CL	2-48" Slimline (Series)†	79.30
46563CL	3-48" Slimline (Series)†	100.60
"Vapor-Tite 800"		
46592CL	2-800ma Rapid Start	89.75
46593CL	3-800ma Rapid Start	112.55

(*) (**) (†) See footnotes in column at left.

"TX" Textile Units

Listed By Underwriters' Laboratories, Inc.



Units without covers for use in textile mills and other locations with damp, humid atmospheres. Standard construction units with steel body SPRINGLOX lampholders are listed. For corrosion-resisting unit with monel metal lampholders, prefix number with "CR-" and add \$5.10 for twin-lamp and \$7.30 for 3-lamp units. Length 53¾ in., width 13½ in.

"TX-40"

No.*	No. & Type Lamps	Each
49262RS	2-40W Rapid Start**	\$45.75
49263RS	3-40W Rapid Start**	56.65
"TX-48"		
46262	2-48" Slimline (Series)†	55.90
46263	3-48" Slimline (Series)†	77.15
"TX-800"		
46292	2-800ma Rapid Start	66.35
46293	3-800ma Rapid Start	89.10

(*) (**) (†) See footnotes in column at left.

Smithcraft Industrial Units

Smithcraft A.L.S. Factory Lighting

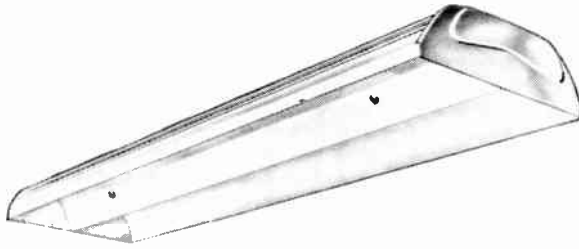

Wherever the Smithcraft A.L.S. is installed, many favorable production factors result: improved quality, greater accuracy, less fatigue, improved safety conditions, less employee turn-over and absenteeism. The following quality lighting characteristics explain why the A.L.S. is "Lighting for production" and why the unit provides today's most comfortable factory seeing.

High over-all efficiency.

30° crosswise shielding.

Transverse uplighting* . . . lights ceiling without "hot spots." (*Patent Reissue No. 23,485.) 19% of the fixture output is in uplighting.

The A.L.S. is more than 16-in. wide; lamps are spaced 8-in. apart . . . results in extremely comfortable low brightness.

Continuous lines of light . . . all light from end to end . . . no dark areas between fixtures—lampholders are back to back.

In addition to these outstanding lighting characteristics, the A.L.S. is easy and economical to install and maintain and has several important safety features.

Lamps are roofed over for protection against falling dust.

Stays clean longer. Airflow construction minimizes accumulation of dust.

Reflectors are removed simply by pressing conveniently located release buttons.

Reflectors cannot vibrate loose. Lamps are double-held . . . by lamp socket . . . by reflector.

Reflectors are rolled sections with box-like construction at both edges providing new strength and rigidity.

The A.L.S. is extremely easy and simple to install by any of the usual methods (rod, conduit, stem set, chain, messenger cable, etc.). The Smithcraft A.L.S. is finished in White Supercoat Baked Enamel with a reflectance of 86%.

For Slimline Lamps (430-MA)

No.	No. of Lamps	Type Lamps	Shp. Wt., Lbs.	Each
ALS2-96	2	F96T12	58	\$84.12
ALS2-72	2	F72T12	49	80.12

For Rapid-Start Bi-Pin Lamps

ALS2-40RS	2	F40T12RS	35	55.88
-----------	---	----------	----	-------

Available with 800-MA Rapid-Start for 8-ft. lamps.

Packed one complete unit to a carton.

Smithcraft Tech

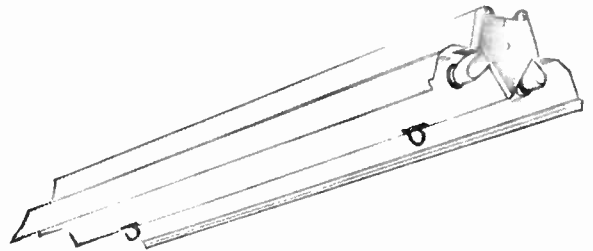

No. TEC2-40SRS

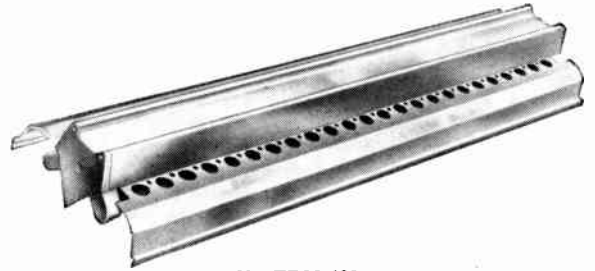

No. TEC2-48S

Engineered in accordance with today's most advanced factory lighting practice, the Smithcraft Tech provides approximately 10% uplighting through openings in the top of the reflectors. The smooth sides of the housing are constructed on an angle for maximum uplighting efficiency. Reflectors provide a shielding of 13° and have a V-center construction that results in comfortable low-brightness and a shallow, compact unit. Finish of the Tech is all white with reflectors of either porcelain or white baked enamel. Through an exclusive new Smithcraft mounting arrangement, hangers are simply slid into the flanged channel which is the top of the housing, saving hours of installation time. Rods, chain or messenger cable clamps are easily attached to the hangers. Large grip, spring-mounted loops are given a simple quarter turn to release the reflectors.

Supercoat Baked Enamel Reflectors For Rapid-Start Bi-Pin Lamps

No.	No. of Lamps	Type Lamps	Shp. Wt., Lbs.	Each
TEC2-40SRS	2	F40T12/RS	26	\$32.38
TEC2-42SRS	4	F40T12/RS	52	64.76

For Slimline Lamps

TEC2-48S	2	F48T12	28	38.26
TEC2-96S	2	F96T12	55	59.38

Continuous Mounting Unit

Includes necessary end caps to finish off rows. Includes connectors and reflector couplings (RC102) between 4-ft. reflectors and between fixtures. For continuous units, add C in front of catalog number. Prices are the same as those shown above.

Lifetime Porcelain Enamel Reflectors For Rapid-Start Bi-Pin Lamps

No.	No. of Lamps	Type Lamps	Shp. Wt., Lbs.	Each
TEC2-40PRS	2	F40T12/RS	27	\$35.26
TEC2-42PRS	4	F40T12/RS	54	70.50

For Slimline Lamps

TEC2-48P	2	F48T12	29	41.12
TEC2-96P	2	F96T12	57	65.12

Continuous Mounting Unit

Includes necessary end caps to finish off rows. Includes connectors and reflector couplings (RC102) between 4-ft. reflectors and between fixtures. For continuous units, add C in front of catalog number. Prices are the same as those shown above.

Tech units are packed one complete unit to a carton, if so specified. Drop shipments packed bulk.

**Smithcraft Industrial Units
Monitor Series**



Monitor 10



Monitor V-25

Strong, durable, beautifully constructed industrial fixtures designed for top value and very long-term use in today's factories.

The Monitor V-25 provides approximately 25% uplighting—the Monitor 10 provides approximately 10% uplighting—through scientifically designed apertures which are collared for extra strength. Reflectors are ribbed for strength and rigidity.

Monitor units may be mounted individually or in continuous rows by any conventional method—rod, chain, messenger cable, etc.

Reflectors are quickly released by easy-to-grasp, unobtrusive captive catches. Plastic inserts act as reflector couplings to prevent light leaks and align units. Housing is a flanged channel for added strength and to receive slideable hangers, substantially reducing installation costs. Newest type turret lamp holders provide trouble-free service and securely lock lamps in place.

Both the Monitor 10 and V-25 are available with Supercoat Baked Enamel or Lifetime Porcelain Enamel reflectors.

A louver assembly providing 30° x 30° shielding is available at extra cost. Louver releases by a simple swivel catch.

**Baked Enamel Reflectors
For Rapid-Start Bi-Pin Lamps**

No.	No. of Lamps	Type Lamps	Ship. Wt., Lbs.	Each
Individual Fixture with End Caps				
MFS2-40	2	F40T12RS	27	537.00
MFS3-40	3	F40T12RS	31	51.25
*Continuous Row				
CMFS2-40	2	F40T12RS	27	37.00
CMFS2-42 (8-ft. Housing)	4	F40T12RS	53	73.38
CMFS3-40	3	F40T12RS	31	51.25
CMFS3-42 (8-ft. Housing)	6	F40T12RS	63	92.38

For Slimline Lamps

†Individual Fixture with End Caps				
MFS2-96	2	F96T12	51	60.50
MFS3-96	3	F96T12	65	88.63
*Continuous Row				
CMFS2-96	2	F96T12	51	60.50
CMFS3-96	3	F96T12	65	88.63

**Porcelain Enamel Reflectors
For Rapid-Start Bi-Pin Lamps**

Individual Fixture with End Caps				
MFP2-40	2	F40T12RS	28	39.25
MFP3-40	3	F40T12RS	32	53.50
*Continuous Row				
CMFP2-40	2	F40T12RS	28	39.25
CMFP2-42 (8-ft. Housing)	4	F40T12RS	56	77.88
CMFP3-40	3	F40T12RS	32	53.50
CMFP3-42 (8-ft. Housing)	6	F40T12RS	65	96.88

For Slimline Lamps

†Individual Fixture with End Caps				
MFP2-96	2	F96T12	53	65.00
MFP3-96	3	F96T12	66	93.13
*Continuous Row				
CMFP2-96	2	F96T12	53	65.00
CMFP3-96	3	F96T12	66	93.13

*Fixture with housing connector and end caps. Includes plastic reflector couplings between 4-ft. reflectors and between fixtures.

†Includes plastic reflector couplings between 4-ft. reflectors.

**Baked Enamel Reflectors
For Rapid-Start Bi-Pin Lamps**

No.	No. of Lamps	Type Lamps	Ship. Wt., Lbs.	Each
Individual Fixture with End Caps				
MVS2-40	2	F40T12RS	27	45.00
*Continuous Row				
CMVS2-40	2	F40T12RS	27	45.00
CMVS2-42	4	F40T12RS	53	89.00

For Slimline Lamps

†Individual Fixture with End Caps				
MVS2-96	2	F96T12	51	70.00
CMVS2-96	2	F96T12	51	70.00

**Porcelain Enamel Reflectors
For Rapid-Start Bi-Pin Lamps**

No.	No. of Lamps	Type Lamps	Ship. Wt., Lbs.	Each
Individual Fixture with End Caps				
MVP2-40	2	F40T12RS	28	47.50
*Continuous Row				
CMVP2-40	2	F40T12RS	28	47.50
CMVP2-42 (8-ft. Housing)	4	F40T12RS	56	94.00

For Slimline Lamps

†Individual Fixture with End Caps				
MVP2-96	2	F96T12	53	75.00
CMVP2-96	2	F96T12	53	75.00

*Fixture with housing connector and end caps. Includes plastic reflector couplings between 4-ft. reflectors and between fixtures.

†Includes plastic reflector couplings between 4-ft. reflectors.

Note: When ordering please specify how units are to be hung, length of rows and number of rows. The correct quantity of accessories required can then be furnished.

Above reflectors available for 800-MA Rapid-Start Bi-Pin Lamps. Prices on request.

Day-Brite Industrial Fluorescent Lighting Fixtures

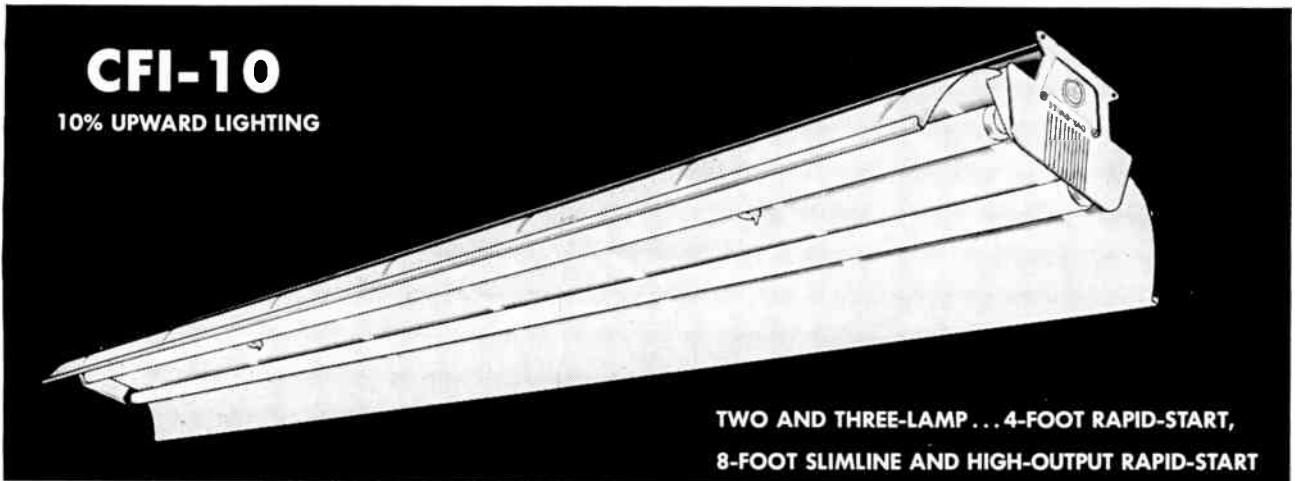

Smart looking and rugged, designed and built to deliver lifetime visual comfort for today's modern working areas. Two and three-lamp units for 4-ft. Rapid-Start and 8-ft. Slimline lamps, and for two-lamp 8-ft. High-Output Rapid-Start lamps. All steel, reinforced construction. Truss-type channel, finished in Hot-Bonded gray enamel, rust inhibited. Channel top designed to permit use of sliding clamp hanger. Plenty of knockouts for feed and mounting.

All-White Vitreous Porcelain Enamel one-piece open-end reflectors. Embossed reinforcing ribs add strength. Wiped edges eliminate chipping and crazing. Reflection factor 85% or more, with 13° lateral shielding.

Provides 10% upward lighting component through die-embossed apertures reduces contrast between fixture and surrounding ceiling area. Updraft action of air through apertures keeps dust from settling, reduces operating temperature and increases lamp efficiency. Reflectors fasten to channel studs by 2-in diameter captive wing-nuts. These large adhering surfaces assure rigid, fool-proof fastening. Can be taken off and put on in less than a minute with no tools required.

Push-type metal clad sockets for secure lamp support. Complete units ready to install, by chain, pipe or rod. HPF Certified CBM ballasts for 118 volt, 60 cycle a-c operation.

Approved by Underwriters' Laboratories

For Rapid-Start Lamps

No.	No. Lamps	FL	Overall Lgth. in.	Type Mounting	Approx. Ship. Wt. Lbs.	Each
40211-4	2	4	50	Suspended	30	\$23.70
40311-4	3	4	50	Suspended	35	32.28

For High-Output Rapid-Start Lamps

80211-8	2	8	96 1/4	Suspended	61	48.00
80311-8	3	8	96 1/4	Suspended	71	65.70

For Slimline Lamps

90211-8	2	8	96 1/4	Suspended	57	39.24
90311-8	2	8	96 1/4	Suspended	65	55.80

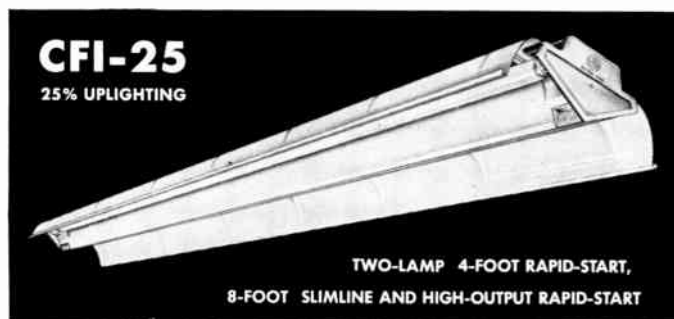

Two-lamp units for 4-ft. Rapid-Start, 8-ft. Slimline and 8-ft. High-Output Rapid-Start lamps. Same rugged construction features as above with deep center "V" louver, providing a 30° lateral shielding, and larger reflector apertures which provide 25% upward lighting.

All-White Vitreous Porcelain Enamel reflector, with embossed ribs for added strength. Has wiped edges. Updraft action of air through apertures increases lamp efficiency by lowering operating temperature.

Push-type reinforced sockets for positive spacing, alignment and secure lamp support.

HPF Certified CBM ballasts for 118 volt, 60 cycle a-c operation. Individually wired.

Approved by Underwriters' Laboratories

For Rapid-Start Lamps

No.	No. Lamps	FL	Overall Lgth. in.	Type Mounting	Approx. Ship. Wt. Lbs.	Each
41252-4	2	4	50	Suspended	34	\$28.80
41252-8	4	4 (Tandem)	99 3/4	Suspended	63	56.88

For Slimline Lamps

91252-8	2	8	96 1/4	Suspended	63	45.60
---------	---	---	--------	-----------	----	-------

For High-Output Rapid-Start Lamps

81252-8	2	8	96 1/4	Suspended	66	54.00
---------	---	---	--------	-----------	----	-------

Day-Brite Industrial Lighting Fixtures

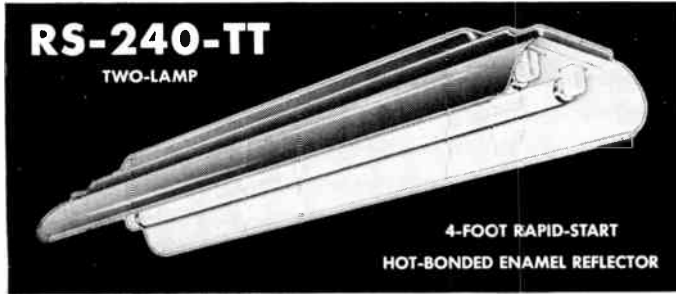

No.	No. Lamps	Ft.	Overall Lgth., In.
RS-240-TT	2	1	52 1/2

RS-240-TT Unit
 Complete single unit with open end reflector for 2 and 4-ft. Rapid-Start lamps. Designed and manufactured specifically for easy-to-install single unit installations. Die-drawn, one-piece, fixture housing of turret-type construction. Equipped with heavy duty push-type sockets engineered for a lifetime of dependable lighting.

Has Hot-Bonded finish with aluminum gray hood and reflector exterior. Reflector interior is Super-White.

HPF Certified CBM Rapid-Start ballasts, 118 volt, 60 cycle a-c Standard. Individually wired for single unit installation.

Approved by Underwriters' Laboratories

Type Mounting	Approx. Shp. Wt., Lbs.	Each
Suspension	22	\$19.08

All-Porcelain Industrial Units

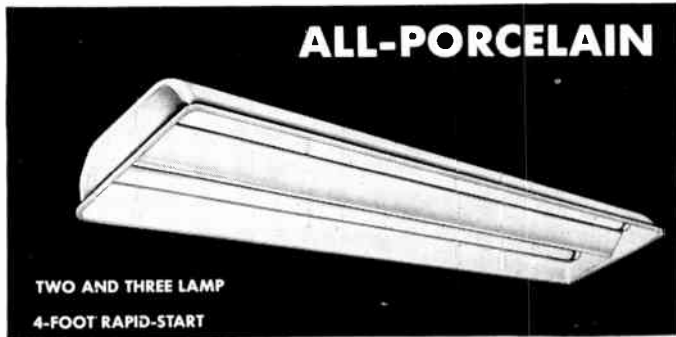

No.	No. Lamps	Ft.	Overall Lgth., In.
41215	2	4	52 1/2
41315	3	4	52 1/2

For two and three 4-ft. Rapid-Start lamps. Complete single units for use where fixtures are exposed to moisture or high humidity. Ideal for laundries, food plants, meat packing plants, bottling plants, textile mills where a completely enclosed fixture is not required.

All-steel one-piece body, die-drawn with smooth rounded edges—easy to clean. Extremely strong, cannot twist or warp. Body and interior in lifetime Vitreous porcelain with a reflection factor of 85% or more.

Pipe flanges in top accommodates 1/2-in. pipe hangers. Feed wires through one hanger. All screws and flanges gasketed. Chains support interior wire-way cover in lowered position for service.

HPF Certified CBM Rapid-Start ballasts for 118 volt, 60 cycle a-c operation. Individually wired units.

Approved by Underwriters' Laboratories

Type Mounting	Approx. Shp. Wt., Lbs.	Each
Suspension	30	\$33.00
Suspension	32	42.00

Vapor-Tight Units

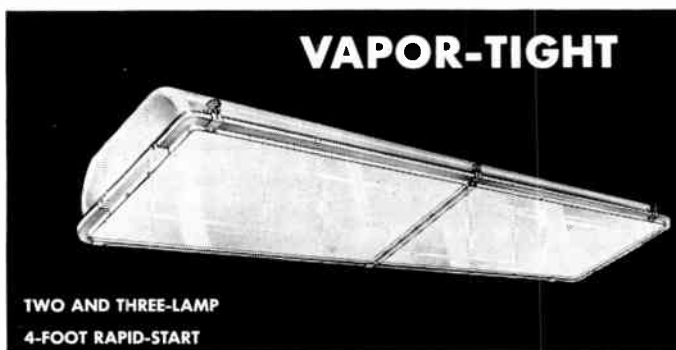

No.	No. Lamps	Ft.	Overall Lgth., In.
41217	2	4	53 7/16
41317	3	4	53 7/16
41219	2	4	53 7/16
41319	3	4	53 7/16
41218	2	4	53 7/16
41318	3	4	53 7/16

For two and three 4-ft. Rapid-Start lamps. Complete single units for use where fixtures are exposed to moisture or where non-combustible dust is present.

All-steel one-piece body, die-drawn with smooth rounded edges. Body and interior in lifetime Vitreous porcelain with reflection factor of 85%.

Hinged frame provided with separable hand-operated latching; hinges can be opened from either side for servicing. Extruded vinyl gasket in frame completely surrounds glass.

Vapor-tight units are available with two types of glass 1/8-in. clear and 1/4-in. tuf-flex or with clear acrylic plastic.

Flanges in top of units accommodate 1/2-in. pipe hangers. Feed wires through one hanger. All screws and flanges are gasketed.

HPF Certified CBM Rapid-Start ballasts for 118 volt, 60 cycle a-c operation. Individually wired for single unit installations. Safety fuse is provided to prevent overheating in event of ballast failure.

Approved by Underwriters' Laboratories

1/8-Inch Clear Glass			
Type Mounting	Approx. Shp. Wt., Lbs.	Each	
Suspension	46	\$56.40	
Suspension	51	65.40	
1/4-Inch Tuf-Flex Glass			
Suspension	47	72.60	
Suspension	52	81.60	
1/8-Inch Clear Plastic (Acrylic)			
Suspension	52	64.20	
Suspension	59	73.20	

Wheeler Industrial Fluorescent Lighting Fixtures

“D” Line Slimline—RLM Turret

“Industri-Line” Diffusers

For Slimline T-12 Single-Pin

Designed to provide an upward component of light (approximately 12%) to relieve the severe brightness contrast of an otherwise dark overhead, producing more light per foot of lamp length.

Has instant starting—no starters required.

Turreted lampholders permit quick and positive lamp insertion and removal. Depressable action holds lamps firmly and compensates for any variation in lamp length.

Listings below include ETL Certified Series Sequence Ballasts.

**38 Watt Fluorescent Lamps—48-In. Slimline
4-Ft. Single Length**

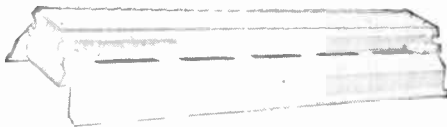

With Open End Diffuser Type Reflector

No.	Lamps	Length, In.	Width, In.	Depth, In.	Ship. Wt., Lbs.	Each
D8421-DIF-SER	2-38	47 ²³ / ₃₂	13	6 ⁵ / ₈	35	\$35.00
D8121-DIF-SER	3-38	47 ²³ / ₃₂	13	6 ⁵ / ₈	45	55.00

With Closed End Diffuser Type Reflector

D8425-DIF-SER	2-38	47 ²³ / ₃₂	13	6 ⁵ / ₈	35	\$39.70
D8125-DIF-SER	3-38	47 ²³ / ₃₂	13	6 ⁵ / ₈	45	59.70

**74 Watt Fluorescent Lamps—96-In. Slimline
8-Ft. Single Length**

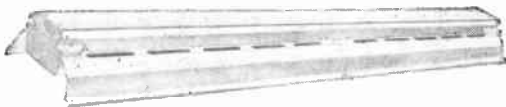

With Open End Diffuser Type Reflector

No.	Lamps	Length, In.	Width, In.	Depth, In.	Ship. Wt., Lbs.	Each
D8475-DIF-SER	2-74	95 ²³ / ₃₂	13	6 ⁵ / ₈	83	\$55.90
D8175-DIF-SER	3-74	95 ²³ / ₃₂	13	6 ⁵ / ₈	96	76.90

With Closed End Diffuser Type Reflector

D8485-DIF-SER	2-74	95 ²³ / ₃₂	13	6 ⁵ / ₈	83	\$67.90
D8185-DIF-SER	3-74	95 ²³ / ₃₂	13	6 ⁵ / ₈	96	89.00

Lead Lag Ballasts will be supplied on any of the above fixtures, in place of Series Sequence, at added costs. To order, drop letters “SER” from number and specify “with Lead Lag.”

Solid-Top Reflectors are available at same prices shown for fixtures with Diffuser Type Reflectors. To order, delete letters “DIF” from number. All white finish unless otherwise specified.

Porcelain Enameled Top Channels are available for any of the fixtures, listed with porcelain reflectors, at added costs. To order, insert in number the letters “CT,” “CT-1,” or “CT-2,” depending on number and arrangement of mounting flanges desired.

RLM “D 8000” Turret Line Diffusers

Rapid Start Ballasts are supplied as standard equipment, to provide instant operation of lamps at no increase in cost. Reflectors are porcelain enameled white. Channels are finished in baked white enamel. Fixtures provide approximately 12% uplight.

Turret Lampholders permit quick and positive lamp insertion and removal.

**40 Watt Fluorescent Lamps—48-In. Bi-Pin
4-Ft. Single Length**

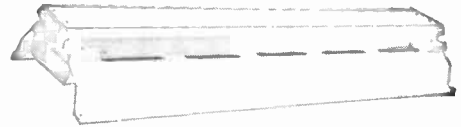

With Open End Diffuser Type Reflectors

No.	Lamps	Length, In.	Width, In.	Depth, In.	Ship. Wt., Lbs.	Each
D8021-DIF-RS	2-40	49 ⁷ / ₁₆	13	6 ⁵ / ₈	29	\$31.50
D8031-DIF-RS	3-40	49 ⁷ / ₁₆	13	6 ⁵ / ₈	33	43.40

With Closed End Diffuser Type Reflectors

D8221-DIF-RS	2-40	49 ⁷ / ₁₆	13	6 ⁵ / ₈	29	\$35.30
D8231-DIF-RS	3-40	49 ⁷ / ₁₆	13	6 ⁵ / ₈	33	47.10

**40 Watt Fluorescent Lamps—48-In. Bi-Pin
8-Ft. Double Length**

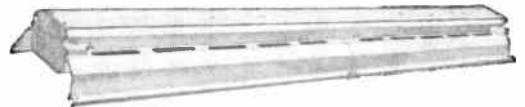

With Open End Diffuser Type Reflectors

No.	Lamps	Length, In.	Width, In.	Depth, In.	Ship. Wt., Lbs.	Each
D8041-DIF-RS	4-40	98 ¹³ / ₁₆	13	6 ⁵ / ₈	63	\$62.30
D8061-DIF-RS	6-40	98 ¹³ / ₁₆	13	6 ⁵ / ₈	67	77.60

With Closed End Diffuser Type Reflectors

D8241-DIF-RS	4-40	98 ¹³ / ₁₆	13	6 ⁵ / ₈	63	\$69.80
D8261-DIF-RS	6-40	98 ¹³ / ₁₆	13	6 ⁵ / ₈	67	84.80

**40 Watt Fluorescent Lamps—48-In. Bi-Pin
8-Ft. Skip Section**



With Open End Diffuser Type Reflector

No.	Lamps	Length, In.	Width, In.	Depth, In.	Ship. Wt., Lbs.	Each
D8064-DIF-RS	2-40	98 ¹³ / ₁₆	13	6 ⁵ / ₈	50	\$39.20
D8066-DIF-RS	3-40	98 ¹³ / ₁₆	13	6 ⁵ / ₈	54	51.00

With Closed End Diffuser Type Reflector

D8264-DIF-RS	2-40	98 ¹³ / ₁₆	13	6 ⁵ / ₈	50	\$42.80
D8266-DIF-RS	3-40	98 ¹³ / ₁₆	13	6 ⁵ / ₈	54	54.70

Preheat Ballasts with FS-4 Starters are available at same prices shown for fixtures with Rapid Start Ballasts. To order, drop RS suffix. FS-40 No-Blink Starters available at added cost.

Solid-Top Reflectors are available at same prices shown for fixtures with Diffuser Type Reflectors. To order, delete letters “DIF” from number. All white finish unless otherwise specified.

Porcelain Enameled Top Channels are available for any of the fixtures, listed with porcelain reflectors, at added costs. To order, insert in number the letters “CT,” “CT-1,” or “CT-2,” depending on number and arrangement of mounting flanges desired.

**Wheeler Industrial Fluorescent Fixtures
RLM Bi-Flo Upliter**

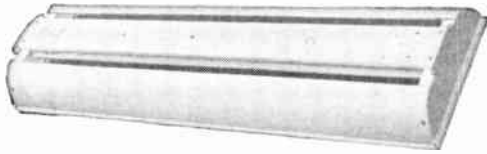

Unique Wheeler construction incorporates center V channel, deep shielding side reflectors, with continuous openings above lamps. Provides 28% upward component, 30° cross-wise shielding.

Design permits a constant flow of air to circulate through fixture, reducing dust accumulation.

Heavy ribbing at bottom, side panels are permanently fastened, one-piece center side panel support bridges entire fixture.

Improved spring-type latch, operated from either side with one hand, releases reflector quickly, positively, without use of tools.

Depressable type lampholders provide push-pull lamp insertion.

Lampholder supports are heavy gauge steel. Lampholder mounting plates have sloping skirt to pick up light and minimize dark ends.

All units interlock at ends for quick and easy continuous mounting and accurate fixture spacing.

38 Watt, 48-In. Slimline, Single Length, Series Sequence Ballasts

No.	Lamps	Length, In.	Width, In.	Depth, In.	Ship. Wt., Lbs.	Each
8300-SER	2-38	48	13 ³ / ₈	5 ¹ / ₁₆	32	\$35.10
8304-SER*	2-38	48	13 ³ / ₈	5 ¹ / ₁₆	31	31.30

74 Watt, 96-In. Slimline, Single Length, Series Sequence Ballasts

No.	Lamps	Length, In.	Width, In.	Depth, In.	Ship. Wt., Lbs.	Each
8301-SER	2-74	96	13 ³ / ₈	5 ¹ / ₁₆	60	\$55.10
8305-SER*	2-74	96	13 ³ / ₈	5 ¹ / ₁₆	58	52.10

40 Watt, 48-In. Bi-Pin, Single and Double Length, Rapid Start Ballasts

No.	Lamps	Length, In.	Width, In.	Depth, In.	Ship. Wt., Lbs.	Each
8306-RS	2-40	49 ³ / ₄	13 ³ / ₈	5 ¹ / ₁₆	33	\$31.50
8308-RS*	2-40	49 ³ / ₄	13 ³ / ₈	5 ¹ / ₁₆	32	29.60
8307-RS	4-40	99 ¹ / ₂	13 ³ / ₈	5 ¹ / ₁₆	62	62.30
8309-RS*	4-40	99 ¹ / ₂	13 ³ / ₈	5 ¹ / ₁₆	60	58.50

100 Watt, 96-In., 800 MA, Rapid Start

No.	Lamps	Length, In.	Width, In.	Depth, In.	Ship. Wt., Lbs.	Each
8315-RS†	2-100	96	13 ³ / ₈	5 ¹ / ₁₆	68	\$70.50
8316-RS*	2-100	96	13 ³ / ₈	5 ¹ / ₁₆	66	66.70

Note: Numbers are for units without End Caps or mounting equipment which must be ordered separately.

8325 End Caps (Pair of 2) required per fixture or ends of row..... \$1.50

* Painted Reflectors, high-temperature baked enamel, are NON RLM.

† No existing RLM standard.

"D-8500 Line" Diffusers

Single Length for Two 100 Watt, 96-In., T-12 Hi-Output Lamps



Designed for use with the 100-Watt rapid-start lamp. Provides more light per fixture, with a small component of light (approximately 12%).

Diffuser apertures also provide for necessary heat dissipation.

Ideally suited for medium to high mounting applications. Instant starting—no starters required.

Has special depressible individual sockets. Lampholders are constructed of white Urea. Reflectors are porcelain enameled white outside and inside. Channel is finished in white baked enamel.

100 Watt, 96-In., 800 MA, 8-Ft., Single Length With Open End Diffuser Type Reflector

No.	Lamps	Length, In.	Width, In.	Depth, In.	Ship. Wt., Lbs.	Each
D8575-DIF-RS	2-100	96 ⁵ / ₁₆	13	6 ⁵ / ₈	90	\$64.50

With Closed End Diffuser Type Reflector

No.	Lamps	Length, In.	Width, In.	Depth, In.	Ship. Wt., Lbs.	Each
D8585-DIF-RS	2-100	96 ⁵ / ₁₆	13	6 ⁵ / ₈	86	70.50

**Wheeler Industrial Fluorescent Fixtures
Power-Lume
For Use With Power-Groove Lamps**

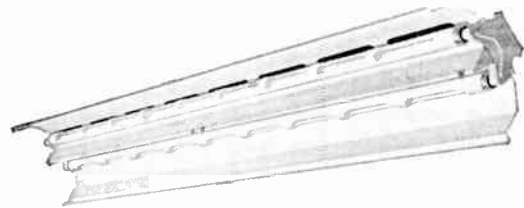

Two models available, the Power-Lume F (with standard porcelain reflectors) ideal where rough work is performed and shielding unimportant; and the Power-Lume V (with drawn one-piece V type porcelain reflectors) with increased shielding for areas where difficult seeing tasks are performed.

Power-Lume F

No.	Ref. Type	Length, In.	Width, In.	Ht., In.	Ship. Wt., Lbs.	Each
E8536-DIF	Porc. 14°	96 ¹¹ / ₃₂	16 ¹ / ₈	8	80	\$91.00
E8537-DIF	Porc. 14°	48 ¹¹ / ₃₂	16 ¹ / ₈	8	48	51.70
E8536-DIF-AL	Alum. 14°	96 ¹¹ / ₃₂	16 ¹ / ₈	8	62	111.00
E8537-DIF-AL	Alum. 14°	48 ¹¹ / ₃₂	16 ¹ / ₈	8	39	61.70
E8538	4-ft. Steel Louver for unit 27 x 27°				12	11.00
E8538-AL	4-ft. Alum. Louver for unit 27 x 27°				8	16.00

Power-Lume V

No.	Ref. Type	Length, In.	Width, In.	Ht., In.	Ship. Wt., Lbs.	Each
E8540-DIF	Porc. 27°	96 ¹¹ / ₃₂	16 ¹ / ₈	8	86	95.70
E8541-DIF	Porc. 27°	48 ¹¹ / ₃₂	16 ¹ / ₈	8	51	53.90
E8540-DIF-AL	Alum. 27°	96 ¹¹ / ₃₂	16 ¹ / ₈	8	64	115.70
E8541-DIF-AL	Alum. 27°	48 ¹¹ / ₃₂	16 ¹ / ₈	8	40	63.90

E8551	4-ft. Steel Louver for unit 27 x 27°				12	11.00
E8551-AL	4-ft. Alum. Louver for unit 27 x 27°				8	16.00

E8542 End Closures for 27° V-Reflectors: Order 2 per row or 2 per individual fixture No Charge

**Wheeler Commercial Fluorescent Lighting
Fixtures
"Flo-Liner"**

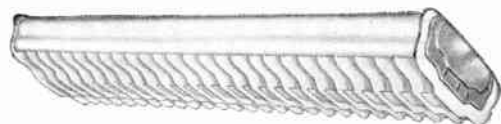

Combines high efficiency and smart styling with great maintenance ease and economy.

When detached, louver assembly is automatically suspended below channel by supporting chains for quick, easy access to operating equipment.

2 lamp and 4 lamp units available for both single pin and bi-pin lamps.

Translucent plastic side panels and center panel give 85% efficiency with low brightness.

For more seeing comfort, 51% of the light is directed above the horizontal and 34% below.

Slimline Units with Plastic Side Panels

No.	Lamps	Shielding	Length, In.	Width, In.	Ht., In.	Ship. Wt., Lbs.	Each
6570	2-38	45° x 25°	48 ³ / ₁₆	13	5	23	\$35.50
6571	2-38	45° x 15°	48 ³ / ₁₆	13	5	25	39.30
6572	4-38	45° x 25°	48 ³ / ₁₆	18 ¹ / ₈	5	40	59.90
6573	4-38	45° x 15°	48 ³ / ₁₆	18 ¹ / ₈	5	42	64.30
6574	2-74	45° x 25°	96 ⁹ / ₁₆	13	5	45	56.90
6575	2-74	45° x 15°	96 ⁹ / ₁₆	13	5	49	63.90
6576	4-74	45° x 25°	96 ⁹ / ₁₆	18 ¹ / ₈	5	68	94.30
6577	4-74	45° x 15°	96 ⁹ / ₁₆	18 ¹ / ₈	5	76	103.10

Bi-Pin Units with Plastic Side Panels

6560-RS	2-40	45° x 25°	48 ³ / ₁₆	13	5	21	\$30.50
6561-RS	2-40	45° x 15°	48 ³ / ₁₆	13	5	23	34.10
6562-RS	4-40	45° x 25°	48 ³ / ₁₆	18 ¹ / ₈	5	36	51.90
6563-RS	4-40	45° x 15°	48 ³ / ₁₆	18 ¹ / ₈	5	38	55.70

* Numbers are for units without end caps. For Two lamp units, order No. 6584 (pair of two)..... \$1.30 For Four lamp units, order No. 6585 (pair of two)..... \$1.70

Wheeler Specialized Fixtures
For Hazardous and Non-Hazardous Locations
Vapor-Tight and "Series II" Dust-Tight



All of these fixtures feature a one-piece body, rigidly formed and completely covered with two coats of vitreous porcelain enamel.

Flanges are gasketed to body to seal out dust and moisture. Lampholders are the depressible turret type for positive protection against falling lamps. All parts are adequately grounded.

Vapor-Tight—For Non-Hazardous Locations

Safety engineered units designed for use in locations where extreme dirt conditions, high moisture content, acid or alkaline atmosphere are prevalent.

38 Watt Fluorescent Lamps—48-In. Slimline
With Series Sequence Ballasts

No.	Lamps	Glass	Lgth., In.	Width, In.	Depth, In.	WT., Lbs.	Ship. Lbs.	Each
H-4628-SER	2-38	Temp.	53	11 ³ / ₄	7	81		\$106.90
4621-SER	2-38	Plain	53	11 ³ / ₄	7	65		85.90
H-4624-SER	3-38	Temp.	53	11 ³ / ₄	7	84		130.00
4625-SER	3-38	Plain	53	11 ³ / ₄	7	80		109.00

40 Watt Fluorescent Lamps—48-In. Bi-Pin
With Rapid Start Ballasts

H-4442-RS	2-10	Temp.	53	11 ³ / ₄	7	81		\$ 97.70
4443-RS	2-10	Plain	53	11 ³ / ₄	7	65		76.70
H-4446-RS	3-10	Temp.	53	11 ³ / ₄	7	84		109.50
4447-RS	3-10	Plain	53	11 ³ / ₄	7	80		88.50

90 Watt Fluorescent Lamps—60-In. Bi-Pin
With Preheat Ballasts FS-850 Starters

H-4481	2-90	Temp.	64	11 ³ / ₄	7	106		\$130.00
4481	2-90	Plain	64	11 ³ / ₄	7	92		108.00

"Series II" Dust-Tight—For Hazardous Dust Locations

Designed for **Class II, Group F and G**, and **Class III** hazardous locations.

38 Watt Fluorescent Lamps—48-In. Slimline
With Series Sequence Ballasts

H-4470-SER	2-38	Temp.	53	11 ³ / ₄	7	81		\$109.00
4471-SER	2-38	Plain	53	11 ³ / ₄	7	65		88.00
H-4474-SER	3-38	Temp.	53	11 ³ / ₄	7	84		132.10
4475-SER	3-38	Plain	53	11 ³ / ₄	7	80		111.10

40 Watt Fluorescent Lamps—48-In. Bi-Pin
With Rapid Start Ballasts

H-4490-RS	2-10	Temp.	53	11 ³ / ₄	7	81		\$ 99.80
4489-RS	2-10	Plain	53	11 ³ / ₄	7	65		78.80
H-4494-RS	3-10	Temp.	53	11 ³ / ₄	7	84		111.60
4493-RS	3-10	Plain	53	11 ³ / ₄	7	80		90.60

90 Watt Fluorescent Lamps—60-In. Bi-Pin
With Preheat Ballast FS-850 Starters

H-4480	2-90	Temp.	64	11 ³ / ₄	7	106		\$132.00
4480	2-90	Plain	64	11 ³ / ₄	7	92		110.00

RLM Textilume for Textile Mill Use



Specifically designed for maximum corrosion resistance when used in humid atmospheres such as those found in textile mills.

38 Watt Fluorescent Lamps—48-In. Slimline
With Series Sequence Ballasts

5690-SER	2-38	None	53	11 ³ / ₄	7	60		\$ 60.50
5692-SER	3-38	None	53	11 ³ / ₄	7	63		83.60

40 Watt Fluorescent Lamps—48-In. Bi-Pin
With Rapid Start Ballasts

5694-RS	2-10	None	53	11 ³ / ₄	7	60		\$ 49.50
5696-RS	3-10	None	53	11 ³ / ₄	7	63		61.30

90 Watt Fluorescent Lamps—60-In. Bi-Pin
With Preheat Ballasts FS-850 Starters

4482	2-90	None	64	11 ³ / ₄	7	60		\$ 75.20
------	------	------	----	--------------------------------	---	----	--	----------

Cover Assemblies for Textilume Fixtures

5685	With 3/16-in. Plain Clear Glass							\$ 21.50
5686	With 1/4-in. Tempered Clear Glass							42.50

Wheeler Industrial Incandescent Fixtures
Alzak Aluminum Deep Bowl Units for Incandescent
and Mercury Vapor Lamps



Designed to provide efficient quality lighting performance and a wide range of light distributions for all types of medium and high bay installations.

Reflectors

All reflectors in this listing are aluminum, with a hard oxide coating to preserve the reflecting surface and resist corrosive atmospheres. This superior finish

results in reflectance of between 80% and 90%. A shielding angle of 35° below the horizontal is provided in the incandescent types.

When mercury vapor lamps are used, the shielding angle varies with the lamp type.

To reduce the heat around socket and wiring, all reflectors are designed with ventilating slots, so arranged as to prevent any moisture and dirt from falling onto the lamp.

Steel necks are provided for additional strength, zinc plated for superior corrosion resistance.

Canopies

These reflectors are available in a variety of neck and canopy styles.

Wheeler's Duratach construction permits the removal of lamp and reflector as a unit, without disturbing the canopy or wiring.

Wheeler's Durex style permits the removal of the reflector, after the lamp has been taken out, without disturbing canopy or wiring.

Wheeler's Solid Neck style requires the wiring to be loosened from the socket before the reflector can be removed.

Duratach and Durex units are available with both pendent and outlet box style canopies.

Solid Neck units are equipped for pendant mounting, with an outlet box adaptor available as an accessory.

All pendent types are threaded for 1/2-in. pipe; threads for 3/4-in. pipe supplied when specified.

Accessories

A full line of accessories: wire guards, baffles, plaster and finish rings are available for such applications as store and gymnasium use.

For use with 300-500 watt Incandescent and 400 watt Mercury Vapor Lamps.

No.	Style	Type	Diam., In.	Ht., In.	Std. Pkg.	Ship. Lbs.	WT., Lbs.	Each
4131	Durex	Pendant	14	12 ⁷ / ₈	4	18		\$17.65
4131-OB	Durex	Outlet Box	14	12 ⁵ / ₈	4	19		17.65
BDP-14S	Duratach	Pendant	14	11 ³ / ₈	4	22		18.78
BDO-14S	Duratach	Outlet Box	14	11 ⁵ / ₈	4	23		18.78
BS-14S	Solid Neck	Pendant	11	12 ¹⁵ / ₁₆	4	18		17.22
4127	Durex	Pendant	16	14 ¹ / ₂	4	22		21.04
4127-OB	Durex	Outlet Box	16	11 ¹ / ₄	4	23		21.04
BDP-16C	Duratach	Pendant	16	16	4	26		22.24
BDO-16C	Duratach	Outlet Box	16	16 ¹ / ₄	4	27		22.24
BS-16C	Solid Neck	Pendant	16	14 ¹ / ₂	4	22		20.55

For use with 750-1500 watt Incandescent and 400 watt Mercury Vapor Lamps.

4132	Durex	Pendant	18	16 ¹ / ₂	4	20		\$25.27
4132-OB	Durex	Outlet Box	18	16 ¹ / ₄	4	21		25.27
BDP-18S	Duratach	Pendant	18	18 ¹ / ₈	4	24		26.47
BDO-18S	Duratach	Outlet Box	18	18 ³ / ₈	4	25		26.47
BS-18S	Solid Neck	Pendant	18	16 ⁵ / ₈	4	20		24.87

4128	Durex	Pendant	18	17 ¹ / ₂	4	23		25.27
4128-OB	Durex	Outlet Box	18	17 ¹ / ₄	4	24		25.27
BDP-18C	Duratach	Pendant	18	19 ¹ / ₈	4	27		26.47
BDO-18C	Duratach	Outlet Box	18	19 ³ / ₈	4	28		26.47
BS-18C	Solid Neck	Pendant	18	17 ⁵ / ₈	4	23		24.87

Combinations can be supplied as dual units for Incandescent-Mercury Vapor mixtures and for higher intensities. To order, specify numbers of both units desired and add "Dual."

Benjamin "Turnlox" Two-Piece Reflector Units

Listed By Underwriters' Laboratories, Inc.



Two-Piece Bayonet Lock Construction

Units are composed of two separable elements: a hood with a wiring terminal base, and a reflector-lamp holder assembly.

The hood and reflector assembly are locked together by a three point bayonet coupling. Electrical and mechanical connection is made simultaneously with the engagement of the coupling. The terminal base in the hood is backed by a spiral compression spring that maintains the contacts of the hood and reflector in positive electrical contact. Polarization is automatically assured by circular design of contacts which are kept clean by wiping action of engagement and disengagement.

Large, shallow wiring space in hoods allows ample room for easy wiring, no parts to be replaced after completing wiring.

Hoods with porcelain terminal base are available in three styles—pendent, ceiling and angle. Hoods take either a medium or mogul base reflector-lampholder assembly.

Lampholder assemblies consist of a porcelain holder and a steel bayonet attaching plate.

Hoods are cast metal. Reflectors are life-time porcelain enameled steel; finished green outside, reflecting white inside; except "Glassteel" reflectors are white outside.

Rigid, keyless lampholders standard; for optional shock-absorbing lampholder (except on Elliptical Angle) add suffix "SHB" and \$0.28 to price. Pendant and Angle Hood Units tapped 1/2" I.P.S. standard; except mogul base Elliptical Angle Units are tapped 3/4" standard. For 3/4" tapping add suffix "-3/4" to number. Ceiling Hood Units fit 3 1/4" or 4" octagon boxes.

Rigid, keyless lampholders standard; for optional shock-absorbing lampholder (except on Elliptical Angle) add suffix "SHB" and \$0.28 to price. Pendant and Angle Hood Units tapped 1/2" I.P.S. standard; except mogul base Elliptical Angle Units are tapped 3/4" standard. For 3/4" tapping add suffix "-3/4" to number. Ceiling Hood Units fit 3 1/4" or 4" octagon boxes.



No. 7643



No. 7425

RLM Dome Reflector Units

No. *	Lamp Size Watts	Diam., In.	Std. Pkg.	Shp. Wt., Lbs. Std. Pkg..	Each
7641	100	12	10	41	\$ 7.48
7642	150	14	10	48	8.13
7643	200	16	10	56	8.70
7644	300, 500	18	5	43	10.94
7645	750-1500	20	5	52	14.21

For RLM Dome with vented neck add prefix "V".

Shallow Dome Reflector Units

7421	100	12	10	40 1/2	7.48
7423	150	14	10	45 1/4	8.13
7425	200	16	10	54	8.70
7509	300, 500	18	5	41	10.94



No. 7403



No. 7169

RLM Bowl Reflector Units

7161	100	8	10	30	\$ 7.11
7169	200	10	10	44	7.85
7173	300, 500	12	5	31	10.66
7177	750-1500	16	5	43	12.90

Flat Cone Reflector Units

7411	100	14	10	43	7.48
7402	150	16	10	49	8.13
7403	200	18	10	57	8.79

*Nos. shown are for Pendent Hood. Specifications are the same for ceiling or angle hoods. In ordering ceiling hoods change the first digit of the cat. no. to "9"; for angle hoods, change the first digit to "3". Lamps are not included.

Benjamin Type RR Reflector Units Porcelain Enameled Steel

Listed By Underwriters' Laboratories, Inc.

Meets the lighting and service requirements of locations such as railroad yards, steel mills and industrial plants where equipment is constantly subjected to mechanical strain and the corrosive influences of smoke, fumes, grime, moisture and weather.

Type RR thread consists of a 3/4 in. diameter, rolled metal thread attached to the reflector neck. Any type RR threaded reflector will fit any type RR threaded hood.

The hoods have the lampholder included. Lower portion of the two piece lampholder may be removed for access to the heavy binding screws. Cast hoods are two piece, so the bottom half may be unscrewed for convenience in wiring.

Pendent steel units have a separable "X" type fitting which allows the hood to be slipped back over the conduit for access to the lampholder. Cast hoods have set screw to prevent loosening of reflector.

Cast hoods finished in green paint enamel; steel hoods in green porcelain enamel. Reflectors are finished in life-time porcelain enamel; green outside, reflectors white inside.

RR Type Threaded Hoods—With Rigid Lampholder



No. 26050



No. 26045



No. 26030



No. 26025

With Medium Base Lampholders

No.	Description	Std. Pkg.	Shp. Wt., Lbs. Std. Pkg.	Each
26050	Pendent Cast Hood	10	26	\$4.02
26045	Ceiling Cast Hood	10	24	4.21
26030	Pendent Steel Hood	10	15	3.09
26025	Ceiling Steel Hood	10	10 1/2	2.99

With Mogul Base Lampholders

26055	Pendent Cast Hood	5	16	4.77
26049	Ceiling Cast Hood	5	14	5.14
26035	Pendent Steel Hood	5	9	3.74
26029	Ceiling Steel Hood	5	7	3.74

Pendent hoods tapped 1/2" I.P.S. standard; for 3/4" tapping add suffix number with "-3/4".

Ceiling steel hoods fit 3 1/4" or 4" octagonal outlet boxes; ceiling cast hoods fit 4" octagonal outlet boxes. For units with shock-absorbing lampholder suffix number with "SHB" and add \$0.28 to price.



No. 26014



No. 26414

RLM Dome Reflectors

No.	Lamp Size Watts	Diam., In.	Std. Pkg.	Shp. Wt., Lbs. Std. Pkg.	Each
26012	100	12	10	19	\$3.83
26014	150	14	10	25	4.49
26016	200	16	10	33	5.24
26018	300, 500	18	5	26 3/4	6.36
26020	750-1500	20	5	35 1/4	9.72

Shallow Dome Reflectors

26414	100, 150	14	10	22	4.49
26416	200	16	10	25	5.33
26418	300, 500	18	5	20	6.36

Benjamin Type RR Reflector Units
Porcelain Enameled Steel (Cont.)



No. 26108



No. 26232

RLM Bowl Reflectors

No.	Lamp Size Watts	Diam., In.	Std. Pkg.	Shp. Wt., Lbs. Std. Pkg.	Each
26108	100	8	10	14	\$3.55
26110	200	10	10	19	4.21
26112	300, 500	12	5	16	6.26

RLM Symmetrical Angle Reflectors

26232	200	12	10	25	4.77
26234	300, 500	14	5	20	5.80
26236	750-1500	16	5	26	10.38

*No. 26236 is not RLM standard.

Benjamin Type N Shade Holder Reflectors

All type N shadeholder reflectors have a neck that fits any style of attachable "Snap-In" holder shown below or any standard 2 1/4 in. shade holder. Finished in Benjamin "lifetime" porcelain enamel; green outside, reflecting white inside.



No. 14200N



No. 11200N



No. 12200N



No. 15100N

No.	Lamp Size Watts	Diam. In.	Std. Pkg.	Shp. Wt., Lbs.	Each
14075-N	100	12	10	18	\$3.23
14100-N	150	14	10	23	3.82
14200-N	200	16	10	30 1/2	4.41
Shallow Dome Reflectors					
11075N	100	12	10	14	2.84
11100N	150	14	10	22	3.23
11200N	200	16	10	29	4.31

RLM Dome Reflectors

12075N	100	8	10	12 1/2	2.74
12200N	200	10	10	19	3.82

RLM Bowl Reflectors

15075N	100	8	10	11	2.45
15100N	150	10	10	19	3.33

RLM Angle Reflectors

15075N	100	8	10	11	2.45
15100N	150	10	10	19	3.33

Holders snap into reflector neck. Type B has copper finish, types P and S have bright metal finish.

"Snap-In" Shade Holders



No. 4384



No. 4385



No. 4383

4384	*Type B (Brass)	\$0.59
4385	†Type P (Porcelain)	.78
4383	φType S (Screw-Type)	.59

*Attachment to Standard Brass Shell Sockets with Uno thread.

†Attachment to Standard Porcelain or Composition Sockets.

φAttachment to Benjamin "Benco" Metal Clad Sockets and Fittings.

Benjamin "Socket-Reflector" Units
Porcelain Enameled Steel

Listed By Underwriters' Laboratories, Inc.



One-Piece Construction With "X" Type Fitting

Weatherproof units for indoor or outdoor use recommended for locations where interchangeability and removal of reflectors are not a prime consideration.

The "X" type separable fitting allows the porcelain enamel steel reflector to be slipped back over the conduit providing convenient access to the easily wired lampholder.

The fitting consists of a threaded lower flange, a threaded cap nut and two gaskets to protect the inside and outside of the reflector top. The lampholder is supported directly by the unit stem, while the reflector is held independently of the lampholder between the lower cast aluminum flange and the cast aluminum cap nut.

Rigid, keyless lampholders standard. For shock-absorbing lampholders (except on elliptical angle), add suffix "SHB" and \$0.28 to price. Units are tapped 1/2-in. I.P.S. standard, except mogul base elliptical angle tapped 3/4-in. standard. For 3/4-in. tapping, add suffix number with "3/4."

Reflectors are green outside, reflecting white inside; except Glassteel reflectors are white outside.



No. 5643



No. 5425

RLM Dome Reflector Units

No.	Lamp Size Watts	Diam., In.	Std. Pkg.	Shp. Wt., Lbs. Std. Pkg.	Each
5641	100	12	10	30	\$ 5.80
5642	150	14	10	36 1/2	6.45
5643	200	16	10	44 1/2	7.01
5644	300, 500	18	5	36	9.16
5645	750-1500	20	5	45	12.44

Shallow Dome Reflector Units

5421	100	12	10	29	5.80
5423	150	14	10	34	6.45
5425	200	16	10	42 1/2	7.01
5509	300, 500	18	5	34	9.16

Note: For RLM Dome with vented neck, add suffix "V" to catalog number.



No. 6169



No. 5403

RLM Bowl Reflector Units

No.	Lamp Size Watts	Diam., In.	Std. Pkg.	Shp. Wt., Lbs. Std. Pkg.	Each
6161	100	8	10	27	\$ 5.42
6169	200	10	10	32	6.17
6173	300, 500	12	5	24	8.88
6177	750-1500	16	5	30	11.13

Flat Cone Reflector Units

5401	100	14	10	31 1/2	5.80
5402	150	16	10	37	6.45
5403	200	18	10	45 1/2	7.11

Lamps are not included with above units.

Benjamin "Socket-Reflector" Units



No. 5526



No. 5546

Elliptical Angle Reflector Units

No.	Lamp Size Watts	Diam., In.	Std. Pkg.	Shp. Wt., Lbs. Std. Pkg.	Each
5522	100	12 ³ / ₄ x 9 ¹ / ₈	10	36	\$ 6.08
5525	150	12 ³ / ₄ x 9 ¹ / ₈	10	39	7.39
5526	200	16 ¹ / ₄ x 11 ¹ / ₂	10	49	8.32
5537	300, 500	20 x 14 ³ / ₄	5	37	15.05
5538	750-1500	22 x 15	2	26	16.73

RLM Symmetrical Angle Reflector Units

No.	Lamp Size Watts	Diam., In.	Std. Pkg.	Shp. Wt., Lbs. Std. Pkg.	Each
5541	100	8	10	23	5.24
5542	150	10	10	29 ¹ / ₂	6.08
5546	200	12	10	37 ¹ / ₂	6.92
5543	300, 500	14	5	29	8.51
5544 [^]	750-1500	16	5	37	13.18

RLM Glassteel Diffuser Units



No. 5202

One-piece construction. Removable lampholder assembly, separable "X" type fitting allows reflector to be slipped back over the conduit providing convenient access for wiring. Units meet RLM standard No. 18.

No.	Lamp Size Watts	Diam., In.	Std. Pkg.	Shp. Wt., Lbs. Std. Pkg.	Each
5201 [^]	200	18	4	41	\$15.71
5202	300, 500	20	4	53	21.60

[^]Not RLM Std.

Benjamin Shallow Dome Reflectors



No. H412

Have heel to fit standard 2¹/₄ in. shadeholders; can also be used with SNAP-IN reflector holders. Steel reflectors finished in porcelain enamel: green outside, reflecting white inside.

No.	Diam., In.	Std. Pkg.	Shp. Wt., Lbs. Std. Pkg.	Each
H410	10	10	8 ¹ / ₂	\$1.57
H412	12	10	12 ¹ / ₂	1.76
H414	14	10	16	2.25
HN416	16	10	25 ¹ / ₂	2.74

Call Graybar FIRST For . . .

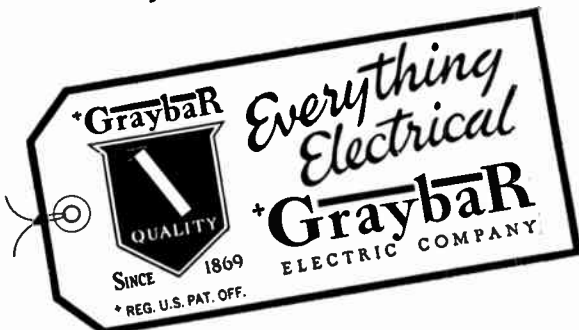

Benjamin "High-Bay" Reflector Units

Hoods, Lampholders and Fittings
Listed By Underwriters' Laboratories, Inc.

General Specifications—These units are for incandescent and mercury vapor lamps with either porcelain enameled steel or Alzak aluminum reflectors. Listings are for vented units. To order non-vented units at the same price drop the "V" from the number. In 400 watt mercury vapor, and all incandescent units, venting is accomplished thru elongated slots in the neck; 1000 watt mercury vapor units have spacers between the neck and reflector.

Socket-Reflector—with a standard separable "X" type fitting and mogul base lampholder. Unit tapped 1/2-in. I.P. size standard, 3/4-in. when specified. (Cat. no. beginning with 5.)

Turnlox—Weatherproof bayonet type construction permits removal of reflector and lamp from hood as a unit for easy maintenance. Includes mogul base lampholder. Cast aluminum hoods. Pendant hood units (Cat no. beginning with 7) tapped 1/2-in. I.P. size standard, 3/4-in. when specified. Ceiling hood units (Cat. no. beginning with 9) fits 3 1/4-in. or 4-in. octagonal outlet boxes.

Mercury vapor lamps will not operate on ordinary lighting circuits unless special transformer or reactor equipment is used. Lamp, wire, transformer, or reactor are not supplied.

Porcelain Enamel Units
Spread Distribution

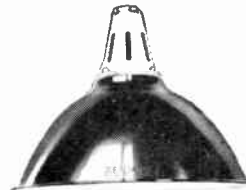

No. V5481

For general interior lighting. Spacing-to-mounting-height ratio is 1.0; distribution is spread with both incandescent and mercury vapor lamps. Steel reflectors finished in "lifetime" porcelain enamel: green outside, white inside, with a reflection factor of 85% or more. The spun steel neck bolts to the reflector. Std. Pkg. quantity is 4.

20" Porcelain—400 W. Mercury Vapor and 750-1500 W. Incandescent Lamps*

No.**	Lamp Type	Dia., In.	Ht., In.	Each
V5480	{ 750-1500, }	20	15 ¹ / ₂	\$15.05
V7480	{ H400-A1, }	20	17 ¹ / ₄	16.83
V9480	{ A11-1 }	20	16 ⁷ / ₈	16.83

20" Porcelain—400 W. Mercury Vapor Lamps

No.	Lamp Type	Dia., In.	Ht., In.	Each
V5481	{ H100-E1, E-111, }	20	15 ¹ / ₂	15.15
V7481	{ H100-J1, J-111, }	20	17 ¹ / ₄	16.83
V9481	{ H100-RC1 }	20	16 ⁷ / ₈	16.83

24" Porcelain—1000 W. Mercury Vapor Lamps

No.	Lamp Type	Dia., In.	Ht., In.	Each
V5317	{ H1000-A12, A-1112 }	24	20 ³ / ₄	22.63
V7317	{ H1000-A15, A-1115 }	24	22 ³ / ₄	24.31
V9317	{ H1000-C12, C-1112 }	24	22 ¹ / ₄	24.31

*Shock-absorbing lampholder, for use with incandescent lamps only, available in place of standard rigid type; to order add "S11B" to number and \$0.28 to price.

**For 3/4 in. tapped "Turnlox" pendant or "Socket-Reflector" units suffix number with 3/4.

Twin-Hanger Suspension



No. 5483

May be used with mercury or incandescent lamp units tapped 1/2 in. I.P. size; consists of Unistrut Channel with snap-in closure strip at bottom. Flange on top is tapped 1/2 in. standard, 3/4 in. when specified. Wiring not furnished; finish is baked aluminum paint over electro-plating.

No.	Description	Each
5483	For 18 in. or 20 in. Reflectors	\$8.82
5479	For 22 in. or 24 in. Reflectors	8.82

**Benjamin "High-Bay" Reflector Units
Aluminum Units
For Mercury Lamps**

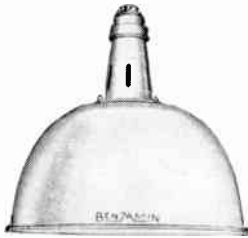

No. V7265

For general interior lighting where a greater degree of light concentration is desired than provided by porcelain enameled reflectors. Light distribution varies with the lamp used in the reflector. Spacing-to-mounting-height ratio for specific distribution is as follows: highly concentrating 0.2; concentrating 0.6; medium spread 0.8-1.0; spread 1.0. Made of heavy aluminum with either an etched or polished Alzak reflecting surface.

For 400 W. Mercury Vapor Lamps

No.*	Lamp Type	Distribution	Dia., In.	Ht., In.	Each
V5470	H400-A1, A-III	Medium Spread	18	17	\$25.15
V7470			18	18 3/4	26.93
V9470			18	18 3/8	26.93
V5471	H400-E1, E-III	Concentrating▲	18	17	25.25
V7471			18	18 3/4	26.93
V9471			18	18 3/8	26.93
V5264	H400-A1, A-III	Spread	18	16 1/8	25.15
V7264			18	17 1/8	26.93
V9264			18	17 1/2	26.93
V5265	H400-E1, E-III	Spread	18	16 1/8	25.25
V7265			18	17 1/8	26.93
V9265			18	17 1/2	26.93

For 1000 W. Mercury Vapor Lamps

V5457	H1000-A12, A-III2,	Concentrating†	24	20 5/8	40.49
V7457			24	22 3/8	42.26
V9457			24	22	42.26
V5276	H1000-C12, C-III2	Highly	24	20 5/8	52.64
V7276			24	22 3/8	54.32
V9276	H1000-C15, B-III5	Concentrating‡	24	22	54.32

▲Medium spread with J lamps; spread with RC1.

†Spread with H1000C-12, C-III2, H1000C-15, B-III5.

‡Med. spread with H1000C-12, C-III2, H1000C-15, B-III5.

For Incandescent Lamps



No. V4166

Same lighting applications and same spacing to mounting height ratio as mercury vapor units above of corresponding distribution. Reflector and neck are spun in one piece, from heavy gauge aluminum. Reflectors are finished by Alzak; both outer and inner surfaces are etched. Std. Pkg. quantity is 4.

No.*	Construction	Dia., In.	Ht., In.	Cut-Off to Light Center	Each
300, 500 W.—Medium Spread Units					
V4166	"Socket-Reflector"	16	13 7/8	30°	\$20.85
V7166	"Turnlox", Pendent	16	15 7/8	30°	22.63
V9166	"Turnlox", Ceiling	16	15 1/4	30°	22.63
300, 500 W.—Spread Units					
V4174	"Socket-Reflector"	14	13 7/8	35°	17.30
V7174	"Turnlox", Pendent	14	15 7/8	35°	19.07
V9174	"Turnlox", Ceiling	14	15 1/4	35°	19.07
750-1500 W.—Spread Units					
V4176S	"Socket-Reflector"	16	17 1/4	35°	20.85
V7176S	"Turnlox", Pendent	16	19 1/4	35°	22.63
V9176S	"Turnlox", Ceiling	16	18 3/8	35°	22.63
V4168	"Socket-Reflector"	18	19 1/4	40°	25.06
V7168	"Turnlox", Pendent	18	21 1/4	40°	26.83
V9168	"Turnlox", Ceiling	18	20 5/8	40°	26.83
V4178	"Socket-Reflector"	18	17 3/4	35°	25.06
V7178	"Turnlox", Pendent	18	19 3/4	35°	26.83
V9178	"Turnlox", Ceiling	18	19 1/8	35°	26.83

For shock-absorbing lampholder in place of standard rigid type add suffix "SIB" and \$0.28 to price.

*For 3/4-in. tapped "Turnlox" pendent or "Socket-Reflector" units suffix number with -3/4.

Benjamin 45° Outlet Box Cover Aligners

Listed By Underwriters' Laboratories, Inc.

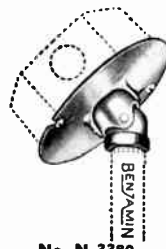

No. N-3380

Allows lighting unit to hang plumb when suspended from outlet boxes mounted on surfaces having up to 15° slope. Provides flexible suspension which gives under glancing blow of ladders and similar objects. Consists of steel pipe bushing, tapped 1/2 in. or 3/4 in. I.P. size, which swings forward or back on two pivot studs joining it to a steel cup. Cup is similarly hinged to steel cover of aligner. Finish is aluminum paint, applied over electroplating. Std. Pkg., 10.

No.	Description	Size Tap. In.	Shp. Wt. Lbs.	Each
N3380	Fits 3 1/4" and 4" Octagonal Box	1/2	4 1/4	\$1.08
N3381	Fits 3 1/4" and 4" Octagonal Box	3/4	5	1.08
N3385	Fits 4" Square Box	1/2	5	1.37
N3386	Fits 4" Square Box	3/4	5 1/2	1.37

Benjamin Reflector Locking Guards



No. 1393

Fit dome reflector units and many other reflectors having circular openings and beaded edges. Shallow type for use where globe or lamp does not project below bead; deep type for use where lamp does. Constructed of heavy gauge steel wire with welded joints. Guards are arranged for but do not include padlock. Finished bright tin, after welding. Standard package, 10.

Shallow Type

Deep Type

Diameter, In.	No.	Shp. Wt. Lbs.	Each	No.	Shp. Wt. Lbs.	Each
8	1380	6	\$2.94
10	1383	6	3.53
12	1387	7	\$4.61	1386	8	4.21
14	1389	11	5.29	1388	10	4.80
16	1393	11 1/2	5.78	1392	12 1/2	5.29
18	1395	14	6.27	1394	17	6.27
20	1397	16	6.96	1396	18	6.96

Benjamin Pit and Tunnel Lighting Units

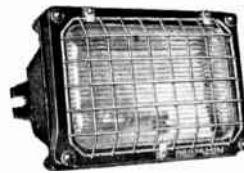

No. 5715

Available with either a plain or refractor glass cover which is protected by a guard. Units may be installed in walls, ceilings, floors or across wall corners. When installing units with refractor glass covers in pit side walls, the unit body need be tilted only 5 degrees from the vertical for satisfactory lighting results.

Where it is not possible to install the unit in the wall, ceiling or floor, it may be attached to supporting straps by means of two lugs on the back of the body casting.

Finished in Benjamin "lifetime" porcelain enamel. Reflecting surfaces are reflecting white, acid-resisting, porcelain enamel with a reflection factor of 85% or more. Sealed against dirt and water by neoprene gasket. Std. tapping -1/2" I.P.S. at both ends; other tappings available.

No.	Lamp Size, Watts	Diam., In.	Description	Each
5715	100, 150	12 5/8 x 8 3/8 x 6 1/2	Refractor Glass	\$33.75
5720	200	13 x 8 3/8 x 7 1/2	Refractor Glass	38.05
5710	100, 150	12 5/8 x 8 3/8 x 6 1/2	Plain Glass	33.75
5717	200	13 x 8 3/8 x 7 1/2	Plain Glass	38.05

Units listed as Vapor-tight by Underwriters' Laboratories. Where other than water vapors are present, installation is subject to rules of local inspection authorities having jurisdiction.

Wheeler Industrial Light Reflectors

Durex

Listed by Underwriters' Laboratories



RLM Standard Dome



Shallow Dome



RLM Deep Bowl



RLM 30° Angle Type

Recommended for industrial plant lighting, railroad lighting, garage lighting and wherever rugged, serviceable lighting fixtures are required.

Fixtures consist of a canopy, socket and porcelain enameled reflector.

Canopies have aluminum screw ring which provides a cushion grip on the porcelain enameled threaded neck of reflector. Canopies are short to allow exposure of socket for easy wiring when reflector is removed. Finished in baked green enamel.

All reflectors are interchangeable in all canopies and are designed to meet all mechanical and wiring requirements.

Finish: Porcelain Enamel Green outside, White inside.

The four types listed below will fill the needs of the most difficult and unusual lighting conditions.

RLM Standard — For general industrial lighting.

Shallow Dome — For platform, shed, warehouse and yard lighting.

RLM Deep Bowl — For work benches and other locations where concentrated light is desired.

RLM 30° Angle — For side lighting installations.

The high quality of material used in construction and the first grade porcelain enamel used in finishing assures long, uninterrupted service.

RLM Standard Dome

Reflector Only						Reflector and Durex Cast Canopy												
Lamp Watts	No.	Diam. In.	Ht. In.	Shlp. Wt. Lbs.	Each	Socket Base	Pendent *Tapped for 1/2-in. Pipe				Outlet Box For 4-in. Outlet Box				Side Outlet Tapped for 1/2-in. Pipe			
							No.	Diam. In.	Shlp. Wt. Lbs.	Each	No.	Diam. In.	Shlp. Wt. Lbs.	Each	No.	Diam. In.	Shlp. Wt. Lbs.	Each
75-100	1042	12	6	25	\$3.52	Medium	1212	12	39	\$5.79	1212-OB	12	43	\$5.79	1212-SO	12	42	\$5.79
150	1044	14	7 3/4	38	4.25	Medium	1214	14	52	6.32	1214-OB	14	56	6.32	1214-SO	14	55	6.32
200	1046	16	8 7/8	42	4.83	Medium	1216	16	56	7.11	1216-OB	16	60	7.11	1216-SO	16	59	7.11
300-500	1048	18	10 1/8	28	6.47	Mogul	1218	18	37	9.29	1218-OB	18	39	9.29	1218-SO	18	39	9.29
750-1000	1049	20	13	32	9.76	Mogul	1219	20	41	12.56	1219-OB	20	43	12.56	1219-SO	20	43	12.56
Shallow Dome Type																		
75-100	1053	12	5 1/2	23	\$3.46	Medium	1225	12	37	\$5.81	1225-OB	12	41	\$5.81	1225-SO	12	40	\$5.81
150	1054	14	6 7/8	30	4.27	Medium	1224	14	44	6.54	1224-OB	14	48	6.54	1224-SO	14	47	6.54
200	1056	16	8	38	4.87	Medium	1226	16	52	7.14	1226-OB	16	56	7.14	1226-SO	16	55	7.14
300-500	1058	18	9 1/4	22	6.67	Mogul	1228	18	31	9.48	1228-OB	18	33	9.48	1228-SO	18	33	9.48
RLM Deep Bowl Type																		
75-100	1060	8	6 3/8	18	\$3.80	Medium	1136	8	32	\$6.05	1136-OB	8	36	\$6.05	1136-SO	8	35	\$6.05
150	1061	10	8 3/4	25	4.47	Medium	1137	10	39	6.75	1137-OB	10	43	6.75	1137-SO	10	42	6.75
300	1062	10	9 1/4	27	5.11	Medium	1138	10	43	7.39	1138-OB	10	47	7.39	1138-SO	10	46	7.39
RLM 30° Angle Type																		
75-100	1070	8	8 1/4	18	\$2.27	Medium	1170	8	32	\$4.55	1170-OB	8	36	\$4.55
150	1079	10	10 1/8	25	2.58	Medium	1179	10	39	4.83	1179-OB	10	43	4.83
200	1071	12	11 7/8	32	4.68	Medium	1171	12	46	6.96	1171-OB	12	50	6.96

Wheeler Reflector Canopies

Durex Cast



Pendent



Outlet Box



Side Outlet

*Tapped for 1/2-in. Pipe
Height 1 1/8 in.

No.	Socket Att'd	Std. Pkg.	Shlp. Wt. Lbs.	Each
1022	Medium	10	14	\$2.27
1023	Mogul	5	9	2.80

For 4-in. Outlet Boxes
Height 1 1/4 in.

No.	Socket Att'd	Std. Pkg.	Shlp. Wt. Lbs.	Each
1026	Medium	10	18	\$2.27
1027	Mogul	5	11	2.80

For 1/2-in. Horizontal Pipe
Height 2 3/4 in.

No.	Socket Att'd	Std. Pkg.	Shlp. Wt. Lbs.	Each
1066	Medium	10	17	\$2.27
1067	Mogul	5	11	2.80

*Can be supplied tapped for 3/4-in. pipe when specified at no extra cost.

Wheeler Improved Industrial Reflectors

Duratach

Modern, rugged construction, incorporating many new features for amazingly easy, low-cost maintenance, plus complete interchangeability.

To mount reflector assembly, simply push up into canopy and twist slightly. All mechanical and electrical connections are made simultaneously by this one simple operation.

Any Duratach Reflector Assembly can be inserted into any Duratach Canopy without disturbing the wiring of the original installation.

Reflectors are durable porcelain enamel. Normally supplied green outside, white inside. They are also available white outside and inside on request.

Canopy and socket assemblies include die-cast aluminum canopy, porcelain socket cap and socket body, medium or mogul base, a steel coupling, and attaching nuts and screws.

Once in position, the reflector assembly is kept from loosening by downward pressure of a unique retainer ring backed by a large coil spring within the canopy.



RLM Standard Dome



RLM 30° Angle



RLM Deep Bowl



Elliptical Angle



Shallow Dome

RLM Standard Dome

No.	Lamp Watts	Socket Base	Diam., In.	Ht., In.	Std. Pkg.	Ship. Wt., Lbs.	Each
DP12H	100	Medium	12	9 ³ / ₁₆	10	39	\$7.37
DP14H	150	Medium	11	10 ⁵ / ₁₆	10	45	8.10
DP16H	200	Medium	16	12	10	53	8.70
DP18H	300-500	Mogul	18	13 ⁵ / ₁₆	10	67	10.80
DP20H	750-1500	Mogul	20	16 ³ / ₁₆	5	40	14.19

RLM Deep Bowl

DP8P	100	Medium	8	9 ¹ / ₁₆	10	34	\$7.05
DP10P	150	Medium	10	11 ¹ / ₁₆	10	40	7.78
DP11P	200	Medium	10	12 ³ / ₈	10	44	7.78
DP12P	300-500	Mogul	12	13 ⁷ / ₈	10	52	10.68

RLM 30° Angle Bowl

DP8N	100	Medium	8	11 ¹ / ₄	10	34	\$6.84
DP10N	150	Medium	10	13 ¹ / ₁₆	10	40	7.67
DP12N	200	Medium	12	15 ¹ / ₄	10	47	8.38
DP14N	300-500	Mogul	14	17	10	55	10.26

Shallow Dome

DP12D	100	Medium	12	8 ⁹ / ₁₆	10	37	\$7.37
DP14D	150	Medium	14	9 ¹ / ₂	10	43	8.10
DP16D	200	Medium	16	11 ¹ / ₈	10	51	8.70

Elliptical Angle

DP10E	150	Medium	10	13 ¹ / ₁₆	10	40	\$8.93
DP12E	200	Medium	12	15 ¹ / ₄	10	47	9.95
DP14E	300-500	Mogul	14	17	10	55	16.68

Wheeler Reflector Canopies



Reflector with Pendant Canopy



Reflector with Outlet Box Canopy



Reflector with Side Outlet Canopy

Canopy tapped 1/2-in. standard, 3/4-in. if specified, at no increase in price.

Canopy fits standard 4-in. Outlet Box.

Canopy tapped 1/2-in. standard.

Note: Provision is made to convert standard pendant units to outlet box and side outlet mounting as shown above. Simply specify with "Outlet Box" canopy or "Side Outlet" canopy.

Wheeler Vapor-Tight Pendent and Ceiling Fixtures

Designed to resist the deteriorating effects of vaporous and other adverse atmospheric conditions, for use where ordinary fixtures fail.

Units consist of a cast aluminum canopy cap and body, with choice of pendent or ceiling top, socket, vapor-proof glass globe, and an acid-resisting porcelain enameled steel reflector.

All reflectors are interchangeable throughout the medium base and mogul base range. Reflector is securely fastened to the canopy for added safety. Unique gasket between globe and canopy insures a tight, sealed unit.

Easy to wire and maintain. Simply remove the canopy cap from the canopy body to fully expose the socket. This

permits easy access to socket terminals for wiring and maintenance.

Canopy for ceiling or pendent mountings. All aluminum canopy bodies supplied with pendent caps for standard 1/2-in. conduit, or with ceiling caps drilled with two holes to fit any standard 4-in. outlet box. Conduit system is effectively sealed off from dirt, moisture or gases by stuffing gland built into fixtures.

Sockets furnished in medium base or mogul base. All sockets are heavy porcelain with large heads on contact screws for easy wiring to terminals. A Wheeler "shock absorber" can be supplied at extra cost when specified.



Standard Dome

Pendent Type
(Illustrated at left)
Standard Dome

Clear Globe		Heat Resisting Globe		Diam., In.	Ht., In.	Lamps, Watts	Socket Base	Std. Pkg.	Shp. Wt. Lbs.
No.	Each	No.	Each						
VP14H	\$12.14	VP14H-HR	\$14.31	13 3/4	11 1/8	150	Medium	10	88
VP16H	13.63	VP16H-HR	15.79	16	11 1/8	200	Medium	10	91
VP18H	18.56	VP18H-HR	21.32	18	12 1/16	300-500	Mogul	5	65



Standard Dome

Deep Bowl

VP9P	\$11.94	VP9P-HR	\$14.12	9 1/4	11 1/8	150	Medium	10	71
VP10P	12.14	VP10P-HR	14.31	10 1/4	11 1/8	200	Medium	10	77
VP12P	16.39	VP12P-HR	19.16	12 1/8	12 1/16	300-500	Mogul	5	60



Deep Bowl



Deep Bowl

30° Angle

VP12N	\$12.63	VP12N-HR	\$14.81	12 1/8	13 13/16	200	Medium	10	78
VP15N	17.77	VP15N-HR	20.53	15 3/8	16 1/4	300-500	Mogul	5	63

Shallow Dome

VP14D	\$12.54	VP14D-HR	\$14.70	14	11 1/8	150	Medium	10	81
VP18D	13.33	VP18D-HR	15.49	18	11 1/8	200	Medium	10	118

Without Reflector

VP-1	\$ 8.50	VP-1-HR	\$10.66	5 1/16	11 1/8	150-200	Medium	10	65
VP-2	12.05	VP-2-HR	14.81	8 1/2	12 1/16	300-500	Mogul	5	50



30° Angle



30° Angle

Ceiling Type
(Illustrated at right)
Standard Dome

Clear Globe		Heat Resisting Globe		Diam., In.	Ht., In.	Lamps, Watts	Socket Base	Std. Pkg.	Shp. Wt. Lbs.
No.	Each	No.	Each						
VO14H	\$12.73	VO14H-HR	\$14.91	13 3/4	11 1/8	150	Medium	10	89
VO16H	14.21	VO16H-HR	16.39	16	11 1/8	200	Medium	10	92
VO18H	19.16	VO18H-HR	21.92	18	12 1/16	300-500	Mogul	5	66

Deep Bowl

VO9P	\$12.59	VO9P-HR	\$14.70	9 1/4	11 1/8	150	Medium	10	72
VO10P	12.73	VO10P-HR	14.91	10 1/4	11 1/8	200	Medium	10	78
VO12P	16.98	VO12P-HR	19.74	12 1/8	12 1/16	300-500	Mogul	5	61

30° Angle

VO12N	\$13.23	VO12N-HR	\$15.40	12 1/8	13 13/16	200	Medium	10	79
VO15N	18.37	VO15N-HR	21.13	15 3/8	16 1/4	300-500	Mogul	5	64

Shallow Dome

VO14D	\$13.12	VO14D-HR	\$15.30	14	11 1/8	150	Medium	10	82
VO18D	13.91	VO18D-HR	16.09	18	11 1/8	200	Medium	10	119

Without Reflector

VO-1	\$ 9.08	VO-1-HR	\$11.26	5 1/16	11 1/8	150-200	Medium	10	66
VO-2	12.63	VO-2-HR	15.40	8 1/2	12 1/16	300-500	Mogul	5	51



Shallow Dome



Shallow Dome



Without Reflector



Without Reflector

Wire Guards available for all Vapor-Tight Fixtures with reflectors. For information contact Graybar.

Wheeler Industrial Reflectors

One-Piece Solid Neck



Time-proven line of sturdy, attractive one-piece reflectors. Expertly designed for quality illumination at low initial cost.

Incorporates the Wheeler standard two-piece socket which is attached to a die-cast aluminum yoke, keyed for positive engagement to the top of the reflector neck.

Reflectors are porcelain enameled green outside, white inside.

RLM Standard Dome

No.	Diam., In.	Ht., In.	Lamp, Watts	Socket Base	Std. Pkg.	Ship. Wt., Lbs.	Each
S12H	12	7 ¹ / ₁₆	100	Medium	10	31	\$5 70
S14H	14	8 ¹ / ₁₆	150	Medium	10	40	6 43
S16H	16	10 ¹ / ₈	200	Medium	10	48	7 05
S18H	18	11 ³ / ₁₆	300-500	Mogul	10	62	9 21
S20H	20	14 ¹ / ₁₆	750-1500	Mogul	5	38	12 45

RLM Deep Bowl

S8P	8	8 ³ / ₁₆	100	Medium	10	29	\$5 40
S10P	10	9 ⁹ / ₁₆	150	Medium	10	35	6 13
S11P	10	10 ⁷ / ₈	200	Medium	10	39	6 13
S12P	12	12 ³ / ₈	300-500	Mogul	10	44	9 02

RLM 30° Angle Bowl

S8N	8	9 ³ / ₄	100	Medium	10	29	\$5 19
S10N	10	11 ⁹ / ₁₆	150	Medium	10	35	6 02
S12N	12	13 ³ / ₄	200	Medium	10	42	6 73
S14N	14	15 ¹ / ₂	300-500	Mogul	10	47	8 61

Shallow Dome

S12D	12	7 ¹ / ₁₆	100	Medium	10	32	\$5 70
S14D	14	8	150	Medium	10	38	6 43
S16D	16	9 ⁵ / ₈	200	Medium	10	46	7 05

Elliptical Angle

S10E	10	11 ⁹ / ₁₆	150	Medium	10	35	\$7 26
S12E	12	13 ³ / ₄	200	Medium	10	42	8 29
S14E	14	15 ¹ / ₂	300-500	Mogul	10	47	15 02

Benjamin Lampholder Extensions and Reducers

Listed By Underwriters' Laboratories, Inc.

Medium Base Extension



No. 91

Permits use of 75, 100 and 150 watt lamps in reflectors designed for the next larger size lamp. It lowers filament of the lamps 7/8 in., bringing the filament close to the proper position in the reflector to obtain maximum light output and correct distribution.

No. 91 Each \$0.59

Mogul Base Extension



No. 4396

Allows lampholder to be extended 2 1/2 in. and the lamp filament to be lowered correspondingly. 750 and 1500 watt incandescent lamp units may be converted for use with 300 and 500 watt lamps by addition of this extension. Body is porcelain with brass and copper contact parts.

No. 4396 Each \$2.06

Mogul to Medium Reducer



No. 98

Adapts mogul screw base lampholders for use with medium screw base lamps. When attached, the center contact is lowered 13/16 in. Both threaded shells are made of copper.

No. 98 Each \$0.69

Benjamin Accessories For Reflector Equipment

Strain Relief Cord Grip



Attaches to any lampholder tapped for 1/2 in. I.P. size, and accommodates any cord from 3/8 in. to 1 1/2 in. diameter. Two steel straps attached by machine screws to aluminum bushing.

No. 1261 Each \$0.39

Strain Relief Watertight Cord Grip



Serves also as a watertight cord bushing for outdoor installations. Attaches to any reflector fitting tapped 1/2 in. I.P. size, and accommodates any cord from 3/8 in. to 9/16 in.

No. 1263 Each \$1.96

Benjamin Shock-Absorbing Suspension Fittings

Outlet Box Cover Aligners



Flexible joint allows unit to hang plumb from surfaces having up to 12 1/2° slope. Fitting supported by steel cover which fastens to outlet box. Tapped 1/2" I.P.S.

No. 3366 Each \$1.67

Canopy Type Aligners



Supported by a strap with slots to slip over the screws on the ears of 3 1/4 in. and 4 in. octagonal outlet boxes. Steel canopy is attached to the outer edge of the straps by a quarter turn to the right.

Finish is aluminum paint over electroplating. Tapped 1/2" I.P.S.

No. 3355 Each \$2.25

Looped-Top Suspension Fitting



Cast metal housing, steel stirrup and a shock-absorbing steel wire spring. Finished in aluminum paint applied over electroplating. Tapped 1/2" I.P.S. (Female).

No. 6030 Each \$1.57

Steberlites

Cast Aluminum For PAR-38, R-40 and PAR-56 Lamps

Listed by Underwriters' Laboratories, Inc.



S-300



S-350



S-400

No. S-300 medium base and S-350 mogul base Steberlites are furnished with Silicone lamp gaskets for a weatherproof seal between lamp and socket housing. Universally adjusted mounting arms are threaded 1/2-in. and have locknuts. Porcelain sockets have spring-loaded center contacts.

S-100 is for PAR-56 lamp. Has finned construction for cooler operation and longer lamp life. Supplied with clear heat-resisting protective lens.

No.	Description	Each
S-300	For PAR-38 or R-40 lamps	\$ 3 00
S-350	For R-40 Mogul lamps	6 00
S-400	For PAR-56 lamp	15 00
S-401	Same as above but without lens	12 90

Steberlite Cast Aluminum Fittings

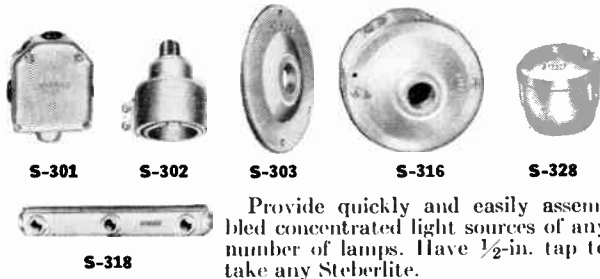

Provide quickly and easily assembled concentrated light sources of any number of lamps. Have 1/2-in. tap to take any Steberlite.

No.	Description	Each
S-301	Adapter box, 6 tapped openings, 3 plug closures.	\$ 3.00
S-302	Pole Slip Fitter, 1 1/2 to 2-in. pipe.	1.90
S-303	4-in. outlet box adapter, 1 tapped opening.	.60
S-316	4-in. adapter fitting box, 6 tapped openings.	2.90
S-328	Acorn adapter fitting, 4 tapped openings.	2.00
S-318	Trough, 12 1/2 x 1 1/2 x 1 1/2-in., 9 tapped openings.	4.25

Chrome Plated Steberlites

Fixtures listed include chrome plated S-500 Steberlite, packaged with special single, two or three lamp fittings for surface or outlet box mounting. Fittings are cast aluminum and finished in rich black.



Listed by Underwriters' Laboratories, Inc.

No. S-5011 Single Lamp

For wall or pole mounting. Flange equipped with 2-porcelain bushings. For open wiring, 2-screw holes.

No. S-5011.....Each \$2.50

S-5001 Single-Lamp

All purpose mounting flange fits 3 1/4 or 4-in. outlet box or may be mounted directly to wall or pole.

No. S-5001.....Each \$2.95

No. S-5002 Two-Lamp

Same as S-5001 but has two S-500 chrome plated Steberlites.

No. S-5002.....Each \$5.30

No. S-5003 Three-Lamp

Same as S-5001 and S-5002 but has three S-500 Steberlites.

No. S-5003.....Each \$7.80



S-5002



S-5003

Steber Coverlites and Extension Reflectors



C-112-PC



C-10-X

Coverlites have pull chain socket contained entirely in neck of reflector. Mtg. holes to fit 3 1/4 or 4-in. outlet box. 6-in. leads. Coverlites and socket extension reflectors finished in Gray-tone Ultramel, white inside. U/L Listed.

No.	Diam., In.	Watts	Each
C-112-PC	12	100	\$2.25
C-114-PC	14	150	2.55
C-116-PC	16	200	3.50
C-10-X	10	60	1.20
C-12-X	12	100	1.50

Benjamin Stock-Bin-Lite Reflector Units

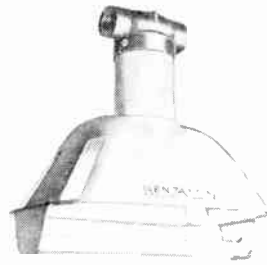

No. T-1878

Provides uniformity of illumination from top to bottom of the shelf or bin tiers in stock rooms, tool cribs and book stacks. Prevents direct glare from the filament when looking down the aisles.

Reflector may be removed from hood by loosening two adjusting screws on side of hood and pulling down on reflector.

Deep-trough shape, steel reflectors finished in "lifetime" porcelain enamel, reflecting white inside and outside with a reflection factor of 85% or more. A V-shaped deflector bar is suspended below reflector.

Reflectors available in four mounting styles: pendent, angle, outlet-box and feed-thru hoods.

No.*	Lamp Size, Watts	Diam., In.	Std. Pkg.	Shp. Wt., Lbs. Std. Pkg.	Each
1875	50, 75	11 3/8 x 7 1/4	10	29	\$5.48
1876	100	11 3/8 x 7 1/4	10	32 1/2	4.86
1877	150	11 3/8 x 7 1/4	10	34	5.14
1878	200	11 3/8 x 7 1/4	10	35	5.33

*Listings cover reflectors only. For complete unit with hood and lampholder add the following prefix: "E" for pendent; "L" for angle; "T" for "feed-thru"; "C" for ceiling hood type. Add \$1.97 to price; except on "feed-thru" add \$2.33.

Ceiling hoods fit 4" octagon boxes. All other styles tapped 1/2" I.P.S. Std.; 3/4" if specified, at same price.

Benjamin Shallow Dome Yardlights



No. 1914

Each unit consists of a shallow-dome reflector of porcelain-enamelled steel and a bracket assembly, which includes the following: detachable cast-iron hood, with a medium-base

porcelain lampholder; a 16 in. length of steel pipe; a malleable iron wall fitting; and two lag screws.

No.	Lamp Size, Watts	Diam., In.	Std. Pkg.	Shp. Wt., Lbs. Std. Pkg.	Each
1912	100	12	5	21 1/2	\$6.27
1914	150	14	5	25	6.86
1916	200	16	5	33	7.45

Lamps are not included with above units.

Steber Yardlites Porcelain or Ultramel



YRP-12

Heavy gauge metal reflectors in one piece. Substantial socket hood. 1/2-inch rigid pipe arm, cast aluminum flange with insulating bushings. Meet REA Specifications.

No.	Reflector Size, In.	Finish	Color Inside	Color Outside	Lamp Watts	Each
YRP-12	12	Porcelain	White	Green	100	\$4.85
YRP-14	14	Porcelain	White	Green	150	5.25
YRU-12	12	Ultramel	White	Graytone	100	4.00
YRU-14	14	Ultramel	White	Graytone	150	4.25

Benjamin Hinged Reflector Covers



No. N-6416

Attach to any Benjamin reflector having circular opening and beaded edges, where lamp does not project below reflector bead. Consists of a two-piece steel retaining band, circular asbestos gasket and disc.

Metal lever-controlled cams hold the lower and upper sections in positive engagement. Plastic cover also available for certain 16 in. diameter dome units. Std. Pkg. 5.

Reflector Diameter, In.	Plain Clear Glass			Impact Resisting Glass		
	No.	Ship. Wt., Lbs. Std. Pkg.	Each	No.	Ship. Wt., Lbs. Std. Pkg.	Each
8	N-6408	6 1/2	\$5.78			
10	N-6410	10	6.08			
12	N-6412	13	6.47	6381	23 1/2	\$9.41
14	N-6414	18 3/4	8.04	6384	27 3/4	13.13
16	N-6416	21 3/4	9.70	6386	33	16.95
18	N-6418	26	10.09	6388	41 1/2	19.70
20	N-6420	32	13.43	6390	50 1/2	24.50
22	N-6422	51	17.25			

Benjamin "Turnlox" Two-Piece Reflector Units

Porcelain Enameled Steel

Listed By Underwriters' Laboratories, Inc.



No. 7526



No. 7546

Elliptical Angle Reflector Units

No.*	Lamp Size Watts	Diam., In.	Std. Pkg.	Ship. Wt., Lbs. Std. Pkg.	Each
7522	100	12 3/4 x 9 1/8	10	18	\$ 7.76
7525	150	12 3/4 x 9 1/8	10	50 1/2	9.07
7526	200	16 1/4 x 11 1/2	10	60 3/2	10.00
7537	300, 500	20 x 14 3/4	5	15	16.83
7538	750-1500	22 x 15	2	29	18.51

RLM Symmetrical Angle Reflector Units

7541	100	8	10	34 1/2	6.92
7542	150	10	10	11	7.76
7546	200	12	10	13	8.51
7543	300, 500	14	5	35	10.29
7544	750-1500	16	5	44	14.96

*Nos. shown are for Pendent Hood. Specifications are the same for ceiling or angle hoods. In ordering ceiling hoods change the first digit of the cat. no. to "9"; for angle hoods, change the first digit to "3". Standard Angle Hood No. 3 provides 3 reflector positions — one facing directly towards stem; Optional Angle Hood No. 3-R provides 3 reflector positions — one facing directly away from stem. For No. 3-R Hood, suffix unit number with "R". All hood styles same price.

RLM Glassteel Diffuser Units

For general lighting. Provides soft, evenly diffused illumination through combined lighting characteristics of the opal glass diffusing globe and the apertured porcelain enamel steel reflector. Apertures direct 5% to 9% of light to ceiling areas. Reflection factor 85% or more.

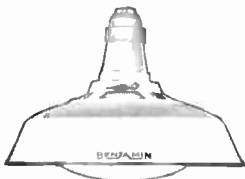

No. 7202

No.*	Lamp Size Watts	Diam., In.	Std. Pkg.	Ship. Wt., Lbs. Std. Pkg.	Each
7201*	200	18	4	17	\$17.39
7202	300, 500	20	4	60	23.38

*Not RLM Standard.

*Nos. shown are for Pendent Hood. In ordering ceiling hoods change the first digit of the cat. no. to "9".

Benjamin Pear-Shaped Half Shades



No. 365P

No. 365P attaches to standard brass shell or porcelain lampholders. No. 367 fits BENCO weatherproof lampholders. Beaded neck fits into and held by holder ring allowing shade to be rotated. Shades take 40-75 W. lamps.

No. 365P	Each	\$1.18
No. 367	Each	1.08

Multi Reflectors

Finish: porcelain enameled white inside, green outside.

Shallow Bowl

With Low Neck for 2 1/4-Inch Shade Holder.



No. 5610

No.	Diam., In.	Fitter Size, In.	Std. Pkg.	Each
5610	10	2 1/4	10	\$1.55
5612	12	2 1/4	10	1.76
5614	14	2 1/4	10	2.22
5616	16	2 1/4	10	2.69

Deep Cone

With Type A Neck for 2 1/4-Inch Holder Shade.



No. 6630

No.	Diam., In.	Height, In.	Std. Pkg.	Each
6630	7	4 1/2	10	\$2.10
6631	8	5	10	2.39
6632	10	5 1/2	10	2.87

Small Size

For Sewing Machine and Refrigerator with Holder for Threaded Brass Shell Socket.

Lamp size, 15 to 25 watts.



No. 6638

No.	Diam., In.	Height, In.	Finish	Std. Pkg.	Each
6638	3 1/2	3 1/8	Porcelain Enamel	10	\$1.70

Multi Thredlok Shallow Bowl Reflector

For general lighting of large open areas where glare from partially shielded lamp is not objectionable.

Cast aluminum hoods. Porcelain enameled steel reflectors. Green outside, white inside.

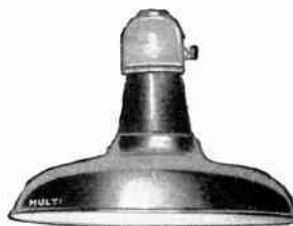

No. 5852

No.	Pendant O.A. Ht. In.	Each	No.	Outlet Box O.A. Ht. In.	Each	Lamp Size, Watts	Diam., In.
5852	10 1/8	\$7.33	5862	10	\$7.34	100	12
5853	11 3/8	7.98	5863	11 1/8	7.97	150	14
5854	12 1/4	8.53	5863	12	8.54	200	16
5855	12 7/8	10.73	5865	12 5/8	10.72	300-500	18

Multi Vaporproof Lights

For Swimming Pools

Vaporproof construction. Pendent holder cast aluminum. Reflector 18-in. diameter, lifetime porcelain enamel on steel. Threaded ball globe available in clear, opal or heat resisting.

Lamp size: 300-500 watts. Specify No. 3156 for mounting on 4 1/2-in. cast box.



No. 3276

No. 3276	Each	\$18.35
----------	------	---------

Benjamin Steelite Armor-Clad Units



No. 5281

For severe service locations exposed to moisture or non-combustible dust. Aluminum reflector is enclosed in a protective steel housing. Available with three styles of reflectors having basically concentrating, medium spread and spread distribution. Either incandescent or mercury vapor lamp.

Listed as "vapor tight" by Underwriters' Laboratories, Inc.

Unit tapped 1/2" I.P.S. Std.; tapped 3/4", if specified, at same price.

For 750-1500W. Incandescent Lamps

No.	Spacing-to-Mntg. Ht. Ratio	Distribution	Ht. In.	Diam. In.	Each
5280	0.5	Concentrating	18 3/4	20 3/4	\$59 75
5281	0.7	Medium Spread	18 3/4	20 3/4	56 47
5282	.1	Spread	18 3/4	20 3/4	56 47

For 400W. Mercury-Vapor Lamps

No.	Spacing-to-Mntg. Ht. Ratio	Size & Type Lamp	Ht. In.	Diam. In.	Each
5285	0.4	H100-A1, A-H11	18 3/4	20 3/4	\$59 75
5293	0.4	H100-E1, E-H11	18 3/4	20 3/4	59 75
5293	0.9	H100-J1, J-H11	18 3/4	20 3/4	59 75
5286	0.7	H100-A1, A-H11	18 3/4	20 3/4	56 47
5294	0.5	H100-E1, E-H11	18 3/4	20 3/4	56 47
5294	0.9	H100-J1, J-H11	18 3/4	20 3/4	56 47
5287	0.9	H100-A1, A-H11	18 3/4	20 3/4	56 47
5295	0.9	H100-E1, E-H11	18 3/4	20 3/4	56 47
5295	1.0	H100-J1, J-H11	18 3/4	20 3/4	56 47

Benjamin Master Sign Reflector Units



No. 5570



No. 5576

Used for lighting of standard and three sheet poster panels, store and highway bulletins, roof and wall signs. Available in one-piece socket-reflector construction or two-piece angle hood separable construction. Reflectors are porcelain enameled steel, green outside; also available white outside at same price.

Side outlet type of construction permits conduit to be led straight into reflector neck. Separable "X"-type fitting of Socket-Reflectors allows reflector to be slipped back out of the way for access to the lampholder. Regularly supplied with Underwriters' listed one-piece porcelain medium-base rigid lampholder, with lamp grip to retard loosening of lamps under vibration.

Two-piece angle hood arranged for base-up burning position making it possible to service from the ground. Reflector quickly removed by loosening two screws at top of the cast-iron hood. A set screw at conduit entrance locks reflector in position; also useful for attaching guy wire. All units tapped 1/2" I.P.S. Std.; for 3/4" tapping (same price) add suffix "3/4".

Socket-Reflector Units

No.	Lamp Size, Watts	Diam., In.	Std. Pkg.	Shp. Wt., Lbs. Std. Pkg.	Each
5569	100	11 1/8 x 7 7/8	9	27 1/2	\$6.17
5570	150-200	13 1/2 x 9 1/8	9	29 1/2	6.27
5571	300	13 1/2 x 9 1/8	9	30	7.35

300 W. lamp recommended above is medium base.

Angle Hood Reflector Units

No.	Lamp Size, Watts	Diam., In.	Std. Pkg.	Shp. Wt., Lbs. Std. Pkg.	Each
5575	100-150	9 1/8 x 13 1/2	9	40 1/2	7.35
5576	200	9 1/8 x 13 1/2	9	41	7.35

Benjamin Emblem Sign Reflector Units



No. L-1823

Designed for lighting circular emblem signs of the type used about gasoline filling stations, super-service stations, garages, etc. Removable reflector and no conduit bending necessary for installation. Hood is drilled for attaching guy wires, if needed.

Cast-iron hood finished in baked aluminum paint over electro-plating. Underwriters' listed, rigid porcelain lampholder. Steel reflectors finished in "lifetime" porcelain enamel; green outside, reflecting white inside. Hood tapped 1/2" I.P.S. Std.; for 3/4" tapping add suffix "3/4".

No.	Lamp Size, Watts	Diam., In.	Std. Pkg.	Shp. Wt., Lbs. Std. Pkg.	Each
L-1821	50-75	8	10	30	\$4.49
L-1822	100	8	10	30	4.49
L-1823	150	10	10	35	4.77

Benjamin Gymnasium Units

All white porcelain enameled dome reflector units, with steel wire guards, for use with silvered bowl lamps.



No. 5415

Separable "X"-type fitting, common to both pendant and ceiling units. Ceiling units include No. 3622 Adapter Cover for attachment to 4 in. octagonal outlet boxes. Cover fits between reflector neck and threaded cap nut of fitting. Lampholder is mogul base shock-absorbing type, with a finger-type lamp grip. Fittings tapped 1/2" I.P.S. Std.; for 3/4" tapping (same price) add suffix "3/4".

No.	Lamp Size, Watts	Diam., In.	Description	Each
5415	750-1000	22	Pendant Mounted	\$25.06
5416	750-1000	22	Ceiling Mounted	25.34

Multi Gymnasium Fixtures Complete With Mounting Ring

Listed by Underwriters' Laboratories, Inc.



No. 3088



No. 3089



No. 3088R

For flush mounting in ceiling, serviceable from above or below. Lamp size, 300 to 500 watts. Reflector diameter, 18 in.

No.	Description	Each
3083	Without Guard	\$27.00
3088	With Hinged Wire Guard	33.50
3089	With Cast Metal Guard	45.35
3088R	Plaster Ring and Saddle	15.90

Multi Shower Room Vapor Proof Fixtures



No. 3071

Vaporproof receptacle. Welded wire guard. Heavy spun steel white porcelain enameled canopy. Cast aluminum guard and socket holder. Designed for 150 watt lamp. Overall diameter, 9 1/4-inches. Overall height, 11 1/2-inches.

Standard package, 5.

No.	Each
3071	\$13.10

Multi Dust and Moisture-Proof Fixtures

Listed by Underwriters' Laboratories, Inc.

For use in damp locations or limited outdoor applications.



No. 3124

Construction: Threaded metal shell carries a porcelain socket, gasket, and enclosing globe. Pendant type tapped for 1/2-inch pipe. Box cover type mounted on steel plate adapter for attaching directly to 4-inch outlet box. Lamp vertical, receptacle at top.

Finish: Metal parts are rust-proofed.



No. 3132

4-Inch Box Cover Type

No.	Overall Height Inches	Lamp Size Watts	Std. Pkg.	Approx. Wt., Lbs. Std. Pkg.	Each
3124	7 3/4	40-100	10	18	\$3 55
3125	8 3/4	75-150	10	28	5 16

No. 3123 Rubber Gasket

For use between box and fixture.

3123					\$0.16
------	--	--	--	--	--------

Pendant Type

No.	Overall Height Inches	Lamp Size Watts	Std. Pkg.	Approx. Wt., Lbs. Std. Pkg.	Each
3131	9 1/2	40-100	10	20	\$3 57
3132	11	75-150	10	30	5 15

Multi Ile-Lite

For Stock Bins and Book Stacks

Gives wide spread of light downward and outward.

Available in the "MT" socket fittings—pendant, outlet box cover, bracket and feed through. All socket fittings are cast iron, rust-proofed and tapped for 1/2-inch pipe.

Finish: White Porcelain enamel inside and outside.



No. 6712

With Keyless Socket

No.	Pendant Type Each	Box Cover Type No.	Each	Diam., In.	Lamp Size, Watts	Std. Pkg.
6712	\$6 75	6722	\$6 74	12	100	10
6713	7 12	6723	7 12	14	150	10
6714	7 29	6724	7 30	16	200	10

For pull chain socket, suffix PC to catalog number and add \$1.00 to prices.

Hubbell Half Reflectors

With Adjustable Holder

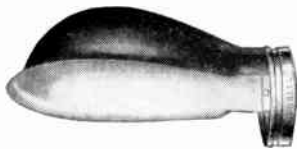

No. 5429

Adjustable holder can be securely screwed to threads on socket shell, and turned as much as one full turn to adjust.

Steel. Green and white finish. Takes 25, 40 or 60 watt lamps.

Packed 6 in a carton. 30 in a standard package. Package weight, 8 pounds.

For Brass Shell Sockets

No. 5429	per 100	\$133.00
----------	---------	----------

For Weatherproof Sockets

No. 5429-P	per 100	\$157.00
------------	---------	----------

Benjamin Explosion-Proof Units

Listed By Underwriters' Laboratories, Inc.

For Class I, Groups C and D Hazardous Locations



No. 7613



No. 7629

Units possess strength in every part to withstand the pressures of internal explosions without breaking down or permitting flame, hot gases or sparks to escape and ignite surrounding atmosphere.

Porcelain enamel steel reflectors attach to body of unit and are held in place by an aluminum retaining band. Inner auxiliary reflectors of aluminum, to prevent loss of light, are provided around neck of lamp. Hoods have removable inspection plug for access to wiring terminals. Wiring connections are made to conventional binder-screw terminals of lampholder, which can be slipped out of the removable hood for easy wiring. The one-piece lampholder provides a barrier between the globe and hood so that explosions originating in either space cannot be transmitted to the other.

Lampholder and enclosing-globe have metal gaskets formed on to them to seal effectively the unit at the hood and globe joints. All joints are close fitting, deep flanged and threaded to sufficient depth to prevent escape of flame.

Reflectors are porcelain enamel steel, reflecting white inside, green outside. Inner reflectors are aluminum, securely attached within unit bodies; polished reflecting surface on 100 w. units, oxidized on 150, 200, and 300 w. medium base units. Unit bodies are cast aluminum, threaded at top for hood and bottom for guard. Guards are cast aluminum.

Heat-resisting glass globes of clear glass, designed to withstand hydrostatic pressure of 380 lbs. per sq. in. minimum. Globe has formed-on metal gasket.

Less Reflector

No.*	Lamp Size, Watts	Dia., In.	Shp. Wt., Lbs.	Each
7601	100	..	8 1/2	\$31.60
7602	150	..	8 1/2	31.60
7603	200	..	14 1/2	45.25
7604	300	..	14 1/2	45.25

With Dome Reflector

No.	Lamp Size, Watts	Dia., In.	Shp. Wt., Lbs.	Each
7611	100	12	10	36.00
7612	150	14	10 1/2	36.65
7613	200	16	18	51.43
7614	300	16	18	51.43

With Shallow Dome Reflector

No.	Lamp Size, Watts	Dia., In.	Shp. Wt., Lbs.	Each
7615	100	12	9 3/4	36.00
7616	150	14	10 1/2	36.65
7617	200	16	17 1/2	51.05
7618	300	16	17 1/2	51.05

With Bowl Reflector

No.	Lamp Size, Watts	Dia., In.	Shp. Wt., Lbs.	Each
7629	100	10	10 1/4	36.09

With Symmetrical Angle Reflector

No.	Lamp Size, Watts	Dia., In.	Shp. Wt., Lbs.	Each
7633	100	10	10 1/4	36.47
7634	150	12	10 1/2	37.12
7635	200	16	18 1/2	52.08
7636	300	16	18 1/2	52.08

*Listings are for 1/2 in. tapped pendant units only. Units also available in 3/4 in. tapped as well as ceiling and angle units. In ordering ceiling units add "CX" to the Cat. No. and \$7.10 to the price; for angle units add "BX" to Cat. No. and \$10.38 to the price.

200 Watt A-25 lamps may be used in 150 W. fixtures. In such instances prefix 150 W. number with "N-"; special lampholder will be furnished at no extra cost.

Note: Units are listed for installation in Group C locations for vertical position (lamp base up); in Group D locations from vertical position (lamp base up) to horizontal.

Lamps are not included with above units. 300 W. lamps indicated are medium base.

R & S Lighting Fixtures

**Explosion-Proof and Dust-Tight
Class I, Groups C and D**



Type ELP Pendant Fixtures

Without Reflectors

Lamp Watts	Outlet Size	With Guard		Without Guard	
		No.	Each	No.	Each
100/150	3/4	4501	\$25 50	4504	\$24 25
*200/300	3/4	4503	37 00	4506	35 25
•300/500	3/4	4557	56 00	4557L.G	52 00

With Standard Dome Reflectors

100	3/4	4501R	\$29 00	4504R	\$27 75
150	3/4	4507	29 75	4510	28 50
*200/300	3/4	4509	42 00	4512	40 25
•300/500	3/4	4557R	65 50	4557RLG	61 50

With Shallow Dome Reflectors

100/150	3/4	4501S	\$28 75	4504S	\$27 50
*200/300	3/4	4503S	41 75	4506S	40 00
•300/500	3/4	4557S	65 25	4557SLG	61 25

With 30° Angle Reflectors

100	3/4	4501AR	\$29 75	4504AR	\$28 50
150	3/4	4513	30 25	4516	29 00
*200/300	3/4	4515	43 25	4518	41 50

Type ELJ Ceiling Fixtures

Without Reflectors

Lamp Watts	Outlet Size	With Guard		Without Guard	
		No.	Each	No.	Each
100/150	3/4	4521	\$31 50	4524	\$30 25
*200/300	3/4	4523	43 00	4526	41 25
•300/500	3/4	4558	62 00	4558L.G	58 00

With Standard Dome Reflectors

100	3/4	4521R	\$35 00	4524R	\$33 75
150	3/4	4527	35 75	4530	34 50
*200/300	3/4	4529	48 00	4532	46 25
•300/500	3/4	4558R	71 50	4558RLG	67 50

With Shallow Dome Reflectors

100/150	3/4	4521S	\$34 75	4524S	\$33 50
*200/300	3/4	4523S	47 75	4526S	46 00
•300/500	3/4	4558S	71 25	4558SLG	67 25

With 30° Angle Reflectors

100	3/4	4521AR	\$35 75	4524AR	\$34 50
150	3/4	4533	36 25	4536	35 00
*200/300	3/4	4535	49 25	4538	47 50

*Accommodates medium screw base lamp only.

•Accommodates 300/500 mogul screw base lamp.

†Outlets—Unless otherwise specified, furnished with one 3/4-inch outlet. Additional or larger outlets charged extra. Maximum conduit 3/4-inch on pendants, 1-inch, four way on ceiling type. Specify size and location.

Conduit Base—Standardized base permits interchanging reflector globe assemblies of all sizes.

Housings—Cast aluminum alloy, natural finish.

Guards—Steel, cadmium plated finish. Can be furnished in cast aluminum alloy at extra cost.

Reflectors—Porcelain enameled steel; green outside, white inside.

R & S Lighting Fixtures

**Explosion-Proof and Dust-Tight
Class I, Groups C and D**

Type ELB Bracket Fixtures



Without Reflectors

Lamp Watts	Outlet Size	With Guard		Without Guard	
		No.	Each	No.	Each
100/150	3/4	4541	\$34 00	4544	\$32 75
100/150	3/4	4598	45 00	4594	43 75
*200/300	3/4	4543	45 50	4546	43 75
*200/300	3/4	4593	56 50	4596	54 75

With 30° Angle Reflectors

Lamp Watts	Outlet Size	With Guard		Without Guard	
		No.	Each	No.	Each
100	3/4	4541AR	\$38 25	4544AR	\$37 00
100	3/4	4599	49 25	4554	48 00
150	3/4	4547	38 75	4550	37 50
150	3/4	4597	49 75	4555	48 50
*200/300	3/4	4549	62 75	4552	61 00

Furnished with 2-inch deep box. Available with 3-inch deep box. Prices on request.

*Accommodates medium screw base lamp only.

†Outlets—Unless otherwise specified, furnished with one 3/4-inch outlet. Additional outlets charged extra. Maximum conduit 3/4-inch, four way. Specify size and location.

■With long type arm. Will also accommodate dome type reflectors.

Bracket Arm—Standardized arm permits interchanging reflector globe assemblies of all sizes except 500 watt.

Housing—Cast aluminum alloy, natural finish.

Guards—Steel, cadmium plated finish. Can be furnished in cast aluminum alloy at extra cost.

Reflectors—Porcelain enameled steel; green outside, white inside.

R & S Type ELH Portable Hand Lamps

Bail Handle Type

Maximum Lamp Size 150 Watts

No.	Description	Cable Dia.	Each
4587	Complete Portable	.625"	\$55 00
4586	Half Shade Only		3 00

Hook Type

Maximum Lamp Size 150 Watts

4585	Complete Portable	.450"	\$55 00
4586	Half Shade Only		3 00



No. 4587

Enclosure—Non-sparking—Cast aluminum alloy, natural finish with clear globe.

Guard—Non-sparking—Cast aluminum alloy, natural finish.

Shade—Aluminum, anodized finish. Not included in portable price.

Wiring—Heat resisting wire leads, factory sealed, for connection to three conductor cord.

R & S Lighting Fixtures Vaportight—With Screw Globe

Type VLP Pendant Fixtures



With Standard Dome Steel Reflector



With Shallow Dome Steel Reflector

With Standard Dome Steel Reflector

Cast Aluminum Alloy

Max. Watts	Lamp Size Base	With Guard		Without Guard	
		No.	Each	No.	Each
†100	Med.	6361A	\$12.75	6360A	\$10.50
†150	Med.	6304A	16.50	6303A	13.00
†200	Med.	6306A	18.00	6305A	14.50
300	Med.	6108A	28.50	6107A	22.00
300	Mog.	6308A	29.75	6307A	23.25
500	Mog.	6144A	41.75	6143A	35.25

Cast Brass

†100	Med.	6202	14.50	6201	11.75
†150	Med.	6204	22.00	6203	17.00
†200	Med.	6206	23.50	6205	18.50
300	Med.	6008	38.50	6007	30.50
300	Mog.	6208	39.75	6207	31.75
500	Mog.	6134	58.25	6133	50.25

Cast Iron

†150	Med.	6304	16.50	6303	13.00
†200	Med.	6306	18.00	6305	14.50
300	Med.	6108	28.50	6107	22.00
300	Mog.	6308	29.75	6307	23.25
500	Mog.	6144	41.75	6143	35.25

With Shallow Dome Steel Reflector

Cast Aluminum Alloy

†100	Med.	6369A	\$11.00	6362A	\$8.75
†200	Med.	6364A	15.75	6363A	12.25
300	Med.	6196A	27.00	6195A	20.50
300	Mog.	6366A	28.25	6365A	21.75
500	Mog.	6146A	40.25	6145A	33.75

Cast Brass

†100	Med.	6252	12.75	6251	10.00
†200	Med.	6264	21.25	6263	16.25
300	Med.	6066	37.00	6065	29.00
300	Mog.	6266	38.25	6265	30.25
500	Mog.	6136	56.75	6135	48.75

Cast Iron

†200	Med.	6364	15.75	6363	12.25
300	Med.	6196	27.00	6195	20.50
300	Mog.	6366	28.25	6365	21.75
500	Mog.	6146	40.25	6145	33.75

Reflectors—Porcelain enameled steel, green outside and white inside.

Globes—Clear globes regularly furnished. Heat resisting and colored globes available. Prices on request.

Guards—Cast aluminum alloy with aluminum and iron fixtures. Cast brass with brass fixtures. If specified on order, iron fixtures will be furnished with cast brass guards at difference in list price of guards additional.

†**Lampholders**—Can be furnished with shock and vibration proof lampholder No. 116 at additional cost. When so required, add suffix "SV" to catalog number.

Finish—Cast iron, corrosion resisting baked enamel finish. Cast brass and aluminum, natural finish.

Outlets—Unless otherwise specified, furnished tapped for maximum conduit: 100—300 watt, 3/4-inch; 500 watt, 1-inch. Smaller sizes available if specified on order.

For Fixtures without reflectors but suitable for future attachment of reflector, add suffix "LR" to catalog number—same prices as non-reflector fixtures.

Type VLJ Junction Box Fixtures*



With Standard Dome Steel Reflector



With Shallow Dome Steel Reflector

With Standard Dome Steel Reflector

Cast Aluminum Alloy

Max. Watts	Lamp Size Base	With Guard		Without Guard	
		No.	Each	No.	Each
†100	Med.	6312A	\$13.25	6311A	\$11.00
†150	Med.	6314A	17.00	6313A	13.50
†200	Med.	6316A	18.50	6315A	15.00
300	Med.	6118A	29.25	6117A	22.75
300	Mog.	6318A	31.00	6317A	24.50
500	Mog.	6164A	42.75	6163A	36.25

Cast Brass

†100	Med.	6212	15.00	6211	12.75
†150	Med.	6214	22.50	6213	17.50
†200	Med.	6216	24.00	6215	19.00
300	Med.	6018	39.00	6017	31.00
300	Mog.	6218	40.75	6217	32.75
500	Mog.	6154	59.00	6153	51.00

Cast Iron

†150	Med.	6314	17.00	6313	13.50
†200	Med.	6316	18.50	6315	15.00
300	Med.	6118	29.25	6117	22.75
300	Mog.	6318	31.00	6317	24.50
500	Mog.	6164	42.75	6163	36.25

With Shallow Dome Steel Reflector

Cast Aluminum Alloy

†100	Med.	6330A	\$11.50	6329A	\$9.25
†200	Med.	6384A	16.25	6383A	12.75
300	Med.	6186A	27.75	6187A	21.25
300	Mog.	6386A	29.50	6385A	23.00
500	Mog.	6166A	41.25	6165A	34.75

Cast Brass

†100	Med.	6272	13.25	6271	11.00
†200	Med.	6284	21.75	6283	16.75
300	Med.	6086	37.50	6085	29.50
300	Mog.	6286	39.25	6285	31.25
500	Mog.	6156	57.50	6155	49.50

Cast Iron

†200	Med.	6384	16.25	6383	12.75
300	Med.	6186	27.75	6187	21.25
300	Mog.	6386	29.50	6385	23.00
500	Mog.	6166	41.25	6165	34.75

Reflectors—Same as on type VLP pendant fixtures.

Globes—Same as on type VLP pendant fixtures.

Guards—Same as on type VLP pendant fixtures.

†**Lampholders**—Same as on type VLP pendant fixtures.

Finish—Cast iron, corrosion resisting baked enamel finish. Cast brass and aluminum, natural finish.

Outlets—Unless otherwise specified, furnished with one 3/4-inch outlet. Additional or larger outlets charged extra. Maximum conduit: Medium base fixtures 3/4-inch, mogul base 1-inch, four way. Specify size and location. Deep boxes to permit larger outlets can be furnished at additional cost.

•**Junction Boxes**—Regularly furnished with cast iron junction boxes: No. 333 for medium base and No. 2401 for mogul base fixtures. Can be furnished with cast brass boxes: No. 332 for medium base fixtures, No. 2403 for mogul base fixtures, at additional cost, if specified on order.

For Fixtures without reflectors but suitable for future attachment of reflector, add suffix "LR" to catalog number—same price as non-reflector fixtures.

R & S Vaportight Lighting Fixtures With Screw Globe



Type VLP Pendant Fixtures

With 30° Angle Steel Reflector

Outlets—Unless otherwise specified, furnished tapped for maximum conduit: 100-300 watt, 3/4-inch; 500 watt, 1-inch. Smaller sizes available if specified on order.

Cast Aluminum Alloy

Max. Watts	Lamp Size Base	With Guard		Without Guard	
		No.	Each	No.	Each
†100	Med.	6388A	\$14.25	6387A	\$12.00
†200	Med.	6233A	19.75	6232A	16.25
300	Med.	6179A	29.75	6178A	23.25
300	Mog.	6239A	31.00	6238A	24.50
500	Mog.	6148A	43.00	6147A	36.50

Cast Brass

†100	Med.	6231	16.00	6230	13.25
†200	Med.	6235	25.25	6234	20.25
300	Med.	6037	39.75	6036	31.75
300	Mog.	6237	41.00	6236	33.00
500	Mog.	6138	59.50	6137	51.50

Cast Iron

†200	Med.	6233	19.75	6232	16.25
300	Med.	6179	29.75	6178	23.25
300	Mog.	6239	31.00	6238	24.50
500	Mog.	6148	43.00	6147	36.50

Type VLJ Junction Box Fixtures*

With 30° Angle Steel Reflector

*Regularly furnished with cast iron junction boxes: No. 333 for medium base and No. 2401 for mogul base fixtures. Can be furnished with cast brass boxes: No. 332 for medium base fixtures, No. 2403 for mogul base fixtures, at additional cost, if specified on order.



Cast Aluminum Alloy

Max. Watts	Lamp Size Base	With Guard		Without Guard	
		No.	Each	No.	Each
†100	Med.	6343A	\$14.75	6342A	\$12.50
†200	Med.	6243A	20.25	6242A	16.75
300	Med.	6189A	30.50	6188A	24.00
300	Mog.	6249A	32.25	6248A	25.75
500	Mog.	6168A	44.00	6167A	37.50

Cast Brass

†100	Med.	6241	16.50	6240	14.25
†200	Med.	6245	25.75	6244	20.75
300	Med.	6047	40.25	6046	32.25
300	Mog.	6247	42.00	6246	34.00
500	Mog.	6158	60.25	6157	52.25

Cast Iron

†200	Med.	6243	20.25	6242	16.75
300	Med.	6189	30.50	6188	24.00
300	Mog.	6249	32.25	6248	25.75
500	Mog.	6168	44.00	6167	37.50

Outlets—Unless otherwise specified, furnished with one 3/4-inch outlet. Additional or larger outlets charged extra. Maximum conduit: Medium base fixtures 3/4-inch, mogul base 1-inch, four way. Specify size and location. Deep boxes to permit larger outlets can be furnished at additional cost.

Reflectors—Porcelain enameled steel, green outside and white inside.

Globes—Same as on type VLB bracket fixtures.

Guards—Same as on type VLB bracket fixtures.

Lampholders—Same as on type VLB bracket fixtures.

Finish—Cast iron, corrosion resisting baked enamel finish. Cast brass and aluminum, natural finish.

For Fixtures without reflectors but suitable for future attachment of reflector, add suffix "LR" to catalog number—same price as non-reflector fixtures.

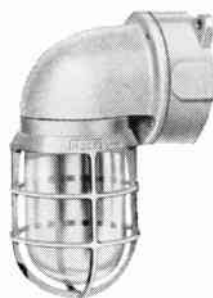

No. 6255

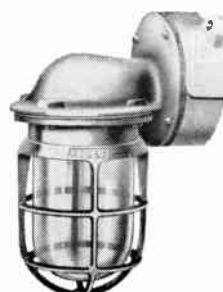

No. 4984

Type VLB Bracket Fixtures

**With No. 333 Cast Iron Junction Box*
No. 6255 Style**

Cast Aluminum Alloy

Max. Watts	Lamp Size Base	With Guard		Without Guard	
		No.	Each	No.	Each
† 60	Med.	^6253A	\$12.75	^5152A	\$10.50
†100	Med.	^ 449A	12.90	^5148A	10.65
†200	Med.	6254A	18.25	5153A	14.75

Cast Brass

† 60	Med.	^6250	16.50	^5149	13.75
†100	Med.	^6255	16.65	^5154	13.90
†200	Med.	1426	26.00	5125	21.00

Cast Iron

†* 60	Med.	^6253	12.75	^5152	10.50
†*100	Med.	^ 449	12.90	^5148	10.65
† 200	Med.	6254	18.25	5153	14.75

Type VLB Bracket Fixtures

**With No. 333 Cast Iron Junction Box*
No. 4984 Style**

Cast Aluminum Alloy

Max. Watts	Lamp Size Base	With Guard		Without Guard	
		No.	Each	No.	Each
† 60	Med.	^4909A	\$13.75	^4908A	\$11.50
†100	Med.	^4919A	13.90	^4918A	11.65

Cast Brass

† 60	Med.	^4924	17.25	^4923	14.50
†100	Med.	^4984	17.40	^4983	14.65

Cast Iron

†* 60	Med.	^4909	13.75	^4908	11.50
†*100	Med.	^4919	13.90	^4918	11.65

*Switch—Can be furnished with externally operated switch at additional cost—suffix "SW" to catalog number.

*Regularly furnished with cast aluminum alloy globe holder.

Globes—Clear globes regularly furnished. Heat resisting and colored globes available. Prices on request.

Guards—Cast aluminum alloy with aluminum and iron fixtures. Cast brass with brass fixtures. If specified on order, iron fixtures will be furnished with cast brass guards at difference in list price of guards additional.

Lampholders—Can be furnished with shock and vibration proof lampholder No. 116 at additional cost. When so required suffix "SV" to catalog number.

Finish—Cast iron, corrosion resisting baked enamel finish. Cast brass and aluminum, natural finish.

Outlets—Unless otherwise specified, furnished with one 3/4-inch outlet. Additional outlets charged extra. Maximum conduit 3/4-inch, four way. Specify size and location. Deep boxes to permit larger outlets can be furnished at slight additional cost.

*Can be furnished with cast brass junction box No. 332 at additional cost, or less box, if specified on order.

R & S Lighting Fixtures

Vaportight—With Screw Globe



**Pendent Style
No. 5000**



**Outlet Box Style
No. 5093**

Type VLP Pendent Fixtures

Cast Aluminum Alloy

Max. Watts	Lamp Size Base	With Guard		Without Guard	
		No.	Each	No.	Each
†100	Med.	†6345A	\$7.75	†6344A	\$5.50
†200	Med.	6324A	11.00	6346A	7.50
300	Med.	6128A	19.75	6127A	13.25
300	Mog.	6328A	21.00	6347A	14.50
500	Mog.	6142A	33.00	6141A	26.50

Cast Brass

†100	Med.	†5000	9.50	†5003	6.75
†200	Med.	5001	16.50	5004	11.50
300	Med.	6028	29.75	6027	21.75
300	Mog.	1413	31.00	1417	23.00
500	Mog.	6132	49.50	6131	41.50

Cast Iron

†200	Med.	6324	11.00	6346	7.50
300	Med.	6128	19.75	6127	13.25
300	Mog.	6328	21.00	6347	14.50
500	Mog.	6142	33.00	6141	26.50

Outlets—Unless otherwise specified, furnished tapped for maximum conduit: 100-300 watt, 3/4-inch; 500 watt, 1-inch. Smaller sizes available if specified on order.

Type VL Outlet Box Fixtures

For mounting to 1-inch stamped steel outlet boxes.

Cast Aluminum Alloy

†100	Med.	†6333A	\$7.75	†5132A	\$5.50
†200	Med.	6336A	11.00	5135A	7.50
300	Med.	6177A	19.75	5176A	13.25
300	Mog.	6397A	21.25	5196A	14.75
500	Mog.	6169A	33.00	6160A	26.50

Cast Brass

†100	Med.	†5093	9.00	†5192	6.25
†200	Med.	5094	16.00	5193	11.00
300	Med.	5097	29.25	5195	21.25
300	Mog.	5098	30.00	5197	22.00
500	Mog.	6159	48.50	6150	40.50

Cast Iron

†200	Med.	6336	11.00	5135	7.50
300	Med.	6177	19.75	5176	13.25
300	Mog.	6397	21.25	5196	14.75
500	Mog.	6169	33.00	6160	26.50

†Switch—Can be furnished with externally operated switch at additional cost—suffix “SW” to catalog number.

Globes—Clear globes regularly furnished. Heat resisting and colored globes are available. Prices on request.

Guards—Cast aluminum alloy with aluminum and iron fixtures. Cast brass with brass fixtures. If specified on order, iron fixtures will be furnished with cast brass guards at difference in list price of guards additional.

†Lampholders—Can be furnished with shock and vibration proof lampholder No. 116 at additional cost. When so required suffix “SV” to catalog number.

Finish—Cast iron, corrosion resisting baked enamel finish. Cast brass and aluminum, natural finish.

R & S Lighting Fixtures

**Vaportight—With Screw Globe
Type VLJ Junction Box Fixtures***



No. 5045

*Regularly furnished with cast iron junction boxes: No. 333 for medium base and No. 2401 for mogul base fixtures. Can be furnished with cast brass boxes: No. 332 for medium base fixtures, No. 2403 for mogul base fixtures at additional cost, if specified on order.

Finish—Cast iron, corrosion resisting baked enamel finish. Cast brass and aluminum, natural finish.

Cast Aluminum Alloy

Max. Watts	Lamp Size Base	With Guard		Without Guard	
		No.	Each	No.	Each
†100	Med.	†6321A	\$8.25	†5066A	\$6.00
†200	Med.	6334A	11.50	5067A	8.00
300	Med.	6198A	20.50	6197A	14.00
300	Mog.	6338A	22.25	5068A	15.75
500	Mog.	6162A	34.00	6161A	27.50

Cast Brass

†100	Med.	†5045	10.00	†5051	7.75
†200	Med.	5047	17.00	5052	12.00
300	Med.	6098	30.25	6097	22.25
300	Mog.	1414	32.00	5053	24.00
500	Mog.	6152	50.25	6151	42.25

Cast Iron

†200	Med.	6334	11.50	5067	8.00
300	Med.	6198	20.50	6197	14.00
300	Mog.	6338	12.25	5068	15.75
500	Mog.	6162	34.00	6161	27.50

Outlets—Unless otherwise specified, furnished with one 3/4-inch outlet. Additional or larger outlets charged extra. Maximum conduit: Medium base fixtures 3/4-inch, mogul base 1-inch, four way. Specify size and location. Deep boxes to permit larger outlets can be furnished at slight additional cost.

Type VL Ceiling Fixtures

Outlets—Unless otherwise specified, furnished with one 3/4-inch outlet. Additional outlets charged extra. Maximum conduit 3/4-inch, four way. Specify size and location.

Finish—Cast brass and aluminum, natural finish.



No. 4942

Cast Aluminum Alloy

Max. Watts	Lamp Size Base	With Guard		Without Guard	
		No.	Each	No.	Each
†60	Med.	†4930A	\$9.00	†4929A	\$6.75
†100	Med.	4940A	9.15	4939A	6.90

Cast Brass

†60	Med.	†4932	10.75	†4934	8.00
†100	Med.	4942	10.90	4944	8.15

†Switch—Can be furnished with externally operated switch at additional cost—suffix “SW” to catalog number.

Globes—Clear globes regularly furnished. Heat resisting and colored globes available. Prices on request.

Guards—Cast aluminum alloy with aluminum and iron fixtures. Cast brass with brass fixtures. If specified on order, iron fixtures will be furnished with cast brass guards at difference in list price of guards additional.

†Lampholders—Can be furnished with shock and vibration proof lampholder No. 116 at additional cost. When so required suffix “SV” to catalog number.

Benjamin Reflectors For Lighting "Vapolets"



Porcelain enamel steel of one-piece construction with closed bead and have a cast aluminum threaded attaching ring, equipped with a set screw. Finish is acid-resisting, porcelain enamel; green outside, reflecting white inside.

No.	Wattage	Dia., In.	Description	Each
No. 145				
145	100	12	Dome Reflectors	\$5.33
146	150	14	Dome Reflectors	6.36
147	200	16	Dome Reflectors	7.29
148	100	12	Shallow Dome Reflectors	4.39
149	150	14	Shallow Dome Reflectors	5.33
150	200	16	Shallow Dome Reflectors	6.36
152	40-75	10	Symmetrical Angle Reflectors	3.93
153	100	12	Symmetrical Angle Reflectors	5.61
154	150, 200	16	Symmetrical Angle Reflectors	7.20

Benjamin "II-G 600 Series" Dust-Tight Units

Listed by Underwriters' Laboratories, Inc. For Class II, Groups E, F and G Hazardous Locations Also Suitable for Class III Locations



No. 657

Dust-tight, weather- and moisture-proof and suitable for installation in exposed or damp locations.

Units have one-piece, weather-proof copper casing tapped for 1/2 in. conduit. Fitted with removable, one-piece, easily-wired, medium base porcelain lampholder with lamp grip. The glass globe threads into the copper casing and seats against an impregnated asbestos gasket. There is a choice of globes—plain clear, heat-resistant clear, and opal. Finish is natural copper. Guard-type units have removable heavy steel wire guards, welded and finished bright tin. Std. Pkg 10.

Units Without Globe Guards

No.	Lamp Size, Watts	Type of Globe	Dia., In.	Shp. Wt., Lbs. Std. Pkg.	Each
663	40-75	Plain, Clear	4 1/8	21	\$ 3.93
665	100, 150	Plain, Clear	6	33	5.05
665HTR	100, 150	Heat-Res. Clear	6 3/8	29 1/2	7.76
665OP	100, 150	Opal	6 3/8	35	9.44

Units with Wire Globe Guards

657	40-75	Plain, Clear	4 5/8	24	7.11
658	100, 150	Plain, Clear	7 1/2	35	10.75
658HTR	100, 150	Heat-Res. Clear	7 1/2	31	13.46
658OP	100, 150	Opal	7 1/2	35	15.15

Lamps are not included with above units.

Units are listed for installation in Class II, Groups E, F and G Hazardous locations. For vertical position (lamp base up).

Union Haymow Light

Schedule A

Dust and Vapor Proof Fits 3/4- or 4-Inch Box



No. 159

Designed and priced for those dusty and mildly corrosive locations where the cost of the conventional dust and vapor proof fixtures excludes their use.

Glass globe is a standard wide mouth quart canning jar for easy replacement.

No.	Description	Carton	Std. Pkg.	Wt. Lbs. Std. Pkg.	Per 100
159	Fixture & Globe	1	25	46	\$145.00
159-6	Globe only	12	12	15	42.00

Benjamin Type M Junction Vapolets

Listed By Underwriters' Laboratories, Inc.



No. 6701

Water-tight outlet boxes for use in marine and seaboard duty and in non-hazardous atmospheric industrial locations where acids, vapors, dust, smoke and/or moisture is present. Box is cast iron finished in baked aluminum paint over electroplating; tapped for four No. 10-24 brass screws furnished to fasten cover. Cover is plain type made of heavy gauge steel; finish is baked aluminum paint applied over surfaces treated to insure paint adhesion and inhibit corrosion. Outside diameter is 1 1/2".

Outside depth, including cover and rubber gasket is 2 9/16".

Vapolets without Lugs

No.	Size, Tap., In.	Description	Net Wt., Lbs.	Each
6701C-1/2	1/2	"C" Feed Thru	2 1/4	\$2.81
6701C-3/4	3/4	"C" Feed Thru	2 1/4	2.81
6701C-1	1	"C" Feed Thru	2 1/4	2.90
6701X-1/2	1/2	"X" Four Way	2 1/4	3.09
6701X-3/4	3/4	"X" Four Way	2 1/4	3.09
6701X-1	1	"X" Four Way	2 1/4	3.27
6701	...	No Tapping	2 1/4	2.52

Benjamin "6500 Series" Vapor-Tight Units

Listed As Vapor-Tight By Underwriters' Laboratories, Inc.



No. 6501

For use in locations where units are exposed to the deteriorating effects of non-combustible atmospheres containing corrosive fumes, vapors, dust, smoke and/or moisture. Lamp is enclosed in heavy glass screw globe. Single asbestos gasket between the hood and globe, and a gasket between the two sections of the hood assures a tight lamp closure. Plain clear, heat-resisting clear or opal glass globes are available.

Hoods are aluminum castings of two-piece construction designed to accommodate the non-corroding, threaded aluminum neck of the heavy gauge steel reflectors. Reflectors are finished in acid-resisting porcelain enamel, green outside and reflecting white inside. Std. Pkg. is ten on medium and five on mogul base units.

Dome Reflector Units

No.*	Lamp Size, Watts	Dia., In.	Shp. Wt., Lbs. Std. Pkg.	Each
6500	100	12	58	\$11.03
6501	150	14	64	11.87
6502	200	16	71	13.28
6503	300, 500	18	65 1/2	18.23

Bowl Reflector Units

6506	150	9	57	10.85
6507	200	10	60	11.03
6508	300, 500	12	54 1/2	15.33

Flat Cone Reflector Units

6513	100	14	61	10.94
6514	150	16	67	11.31
6515	200	18	69	12.34

Symmetrical Angle Reflector Units

6517	100	10	57	11.97
6518	150, 200	12	65	12.72
6519	300, 500	14	56	17.39

Units Less Reflector

6526	100	6	44	7.20
6527	150, 200	6	48	7.67
6528	300, 500	8 1/4	41 1/2	10.10

*Listings for plain clear globes; when ordering opal globes suffix the Cat. No. with "OP". Prices on request.

Pendent hoods tapped 1/2" I.P.S. std.; units also available with hoods for Benjamin "Type M" Junction Vapolet Boxes.

Benjamin Lighting "Vapolets"

Listed As Vapor-Tight By Underwriters' Laboratories, Inc.



No. 7113X

For use in indoor and outdoor atmospheric locations where the lighting equipment is subjected to rough handling and exposed to the deteriorating effects of non-combustible atmospheres containing corrosive fumes, vapors, dust, smoke and/or moisture.

Available in pendent, ceiling and angle-body styles with steel wire globe guards. Bodies are formed of cast iron alloy with built-in conduit stops; threaded on the outside and the inside; finished in baked aluminum paint over electroplating.

Ceiling Type Units

Lamp Size, Watts	Size Tap., In.	"C" Feed-Through Tapping With one pipe Plug		"X" Four-Way Tapping With two pipe Plug	
		No.	Each	No.	Each
40-75	1/2	7117-C	\$ 8.98	7117-X	\$ 9.44
10-75	3/4	7127-C	9.16	7127-X	9.82
10-75	1	7137-C	9.35	7137-X	10.19
100	1/2	7113-C	8.98	7113-X	9.44
100	3/4	7123-C	9.16	7123-X	9.82
100	1	7133-C	9.35	7133-X	10.19
150, 200	1/2	7114-C	10.66	7114-X	11.13
150, 200	3/4	7124-C	10.85	7124-X	11.50
150, 200	1	7134-C	10.94	7134-X	11.78

Pendent Type Units Angle Type Units

Lamp Size, Watts	Size Tap., In.	With "A" Top Tapping		"X" Four-Way Tapping With three pipe Plug	
		No.	Each	No.	Each
40-75	1/2	7110-A	8.79	7119-X	10.00
40-75	3/4	7120-A	8.88	7129-X	10.19
100	1/2	7111-A	8.79	7115-X	10.00
100	3/4	7121-A	8.88	7125-X	10.19
150, 200	1/2	7112-A	10.47	7116-X	11.50
150, 200	3/4	7122-A	10.57	7126-X	11.87

Units listed have plain, clear glass globes; special "Vapolet" globes also available. For Porcelain Enameled Reflectors see adjacent listings.

Lamps are not included with units.

Benjamin "II-G 8500 Series" Dust-Tight Units

▲Listed By Underwriters' Laboratories, Inc. For Class II, Groups E, F and G Hazardous Locations Also Suitable for Class III Hazardous Locations



No. 8500

Individually packaged, enclosed equipment for locations requiring dust-tight lighting equipment. Weather- and moisture-proof, and due to the protection of the lamp afforded by the glass screw globe, are valuable in food industries where there is danger of spoilage from breakage of uncovered lamps.

Acid-resisting, porcelain enamel steel reflector threads into the cast aluminum hood and is locked in place by a set screw. Inner auxiliary reflector of aluminum, to prevent loss of light, is provided around neck of lamp. Glass globe screws into the reflector and is sealed to the hood by an impregnated asbestos gasket. A spring device prevents the globe from loosening. Cast hood separable for easy access to lampholder. Wiring simple. Unit tapped 1/2" I.P.S. Std. Pkg. 10.

Dome Reflector Units

No.	Lamp Size, Watts	Dia., In.	Shp. Wt., Lbs. Std. Pkg.	Each
8500	100	12	87 1/2	\$19.64
8505	150	18	160	25.25
8503	200	18	157 1/2	25.25

Flat Cone Reflector Units

8513	100	14	90	19.17
8514	150	18	151	24.40
8515	200	18	151 1/2	24.40

Bowl Reflector Units

8506	100	9	87 1/2	21.13
8507	150	12	113	26.27
8508	200	12	110 1/2	26.27

*Nos. 8507 & 8508 for Class II, Group E, and Class III locations.

Symmetrical Angle Reflector Units

8517	100	10	85 1/2	19.92
8519	150	14	158	24.31
8518	200	14	155 1/2	24.31

Listings are for units with plain globes; when ordering units with heat resisting globes add the suffix IIR to the Cat. No. Listings are also for pendent type units only. Ceiling units are available complete with dust-tight outlet boxes. Lamps not included.

Holophane Industrial Lighting Units

Approved by Underwriters' Laboratories, Inc.

Holophane HIBAY* Units

Holophane HIBAY units are specifically designed to provide high level lighting from mounting heights of over 30-ft. and to mechanically meet the severe operating conditions in heavy industry, steel mills, engine repair shops, foundries, etc.

Holophane HIBAY* Incandescent Units



Prismatic reflector protected by a metal cover spun and sealed over the outside. Tripod support from below rigidly retains reflector. Glare eliminated by proper shielding angle.

Heavy-duty, plated steel parts and ventilated socket.

Porcelain mogul base socket can accommodate 750, 1000, and 1500 watt lamps.

3/4-in. male stem and loop termination.

No.	Max. Spacing Ratio	Diam., In.	Depth, In.	Each
690-AL-HS	0.6	21 3/4	28	\$41.60
691-AL-HS	1.0	19 3/4	26	41.60
692-AL-HS	2.0	19 3/4	26 1/2	41.60

*Holophane Trade Mark.

Holophane HIBAY* Mercury Vapor Units



For 100 watt mercury vapor lamps.

Ventilated socket in cast hood with 3/4-in. conduit tap. Can be wired and installed separate from reflector.

Spun on and sealed metal cover keeps reflecting glass prisms clean.

Reflector and socket assemblies held safely together

by heavy steel brackets hooked over and secured to two steel pins.

Upward draft action of open top and bottom fixture design keeps reflector surface clean. Drip covers available for damp locations.

Deep shielding protects against lamp glare. 3/4-in. female pipe tap termination. Diam.—21 1/2-in. Depth—17 1/4-in.

No. 640..... Each \$34.40

Holophane Industrial Lighting Units

Holophane LOBAY* Units

A virtual standard of industrial lighting because of their high sustained efficiency, mechanical construction, and proper light distribution. The AL numbers in both the incandescent and mercury vapor units denote a spun-on aluminum reflector.

Holophane Lobay Incandescent Units

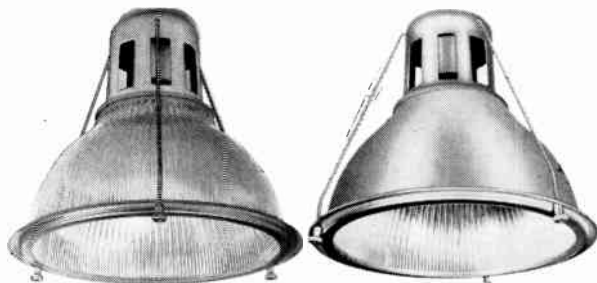

No.	Lamp Watt.	Max. Spacing Ratio	Dimensions, In.		Each
			Length	Depth	
682	300-500	2.0	13 ¹³ / ₁₆	12 ³ / ₈	\$11.30
682-AL	Same as above	Aluminum	Covered Reflector		13.50
682-B	750 W.- (Bipost)	2.0	13 ¹³ / ₁₆	12 ³ / ₈	12.90
682-B-AL	Same as above	Aluminum	Covered Reflector		15.10
684	200†-300‡	1.5	11 ⁷ / ₈	11 ¹ / ₂	8.55
684-AL	Same as above	Aluminum	Covered Reflector		10.60
685	300-500	1.5	13 ¹³ / ₁₆	12 ³ / ₈	11.30
685-AL	Same as above	Aluminum	Covered Reflector		13.50
685-B	750W Bipost	1.5	13 ¹³ / ₁₆	12 ³ / ₈	12.90
685-B-AL	Same as above	Aluminum	Covered Reflector		15.10
686	300-500	0.75	13 ¹³ / ₁₆	12 ³ / ₈	11.30
686-AL	Same as above	Aluminum	Covered Reflector		13.50
686-B	750W Bipost	0.75	13 ¹³ / ₁₆	12 ³ / ₈	12.90
686-B-AL	Same as above	Aluminum	Covered Reflector		15.10

685 Series, Intensive distribution, for mounting up to 15-ft.; 686 Series, Concentrating Distribution, for 15-20-ft. mountings.
682 Series, Extensive Distribution, for uniform low-level lighting.
†Medium base 6" l.c. lamp.



Holophane LOBAY* Mercury Vapor Unit—No. 635—AL

A newly designed prismatic reflector for achieving the highest output from 400 watt mercury lamps.

Consists of a ventilated socket yoke and a highly efficient prismatic reflector with spun-on aluminum cover. Two brackets with thumb screws hold the socket yoke and reflector.

Efficient—The prismatic reflector delivers over 62% of the E-H11 lamp lumens in the useful 0-15° zone. Over 51% of the J-H11 lamp output is directed into the same zone!

Spacing ratio—1.25. Diameter—15¹/₂-in., Depth—17⁷/₈-in. Terminates in 3/4-in. female pipe tap. Uses 400 Watt Mercury Lamp—E-H11 or J-H11 (Color corrected).

No. 635-AL.....Each \$25.85

Holophane All Purpose Industrial Luminaires

Vapor Tight and Dust Tight
For Indoor and Outdoor Use

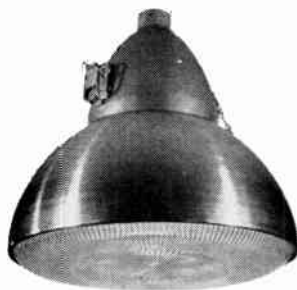

No. 02420

Use wherever high level illumination is needed, indoors or outdoors.

Has a pre-assembled prismatic reflector and refracting plate combination, permanently held together by means of a spun metal cover. A metal hood engages an asbestos gasket for an effective vapor tight and dust tight seal. Latches can not loosen under vibration.

Prismatic glass assembly held by chain to hood while relamping.

Lamp Wattage; 200-300 (Medium base—6-in. light center).

Distribution—Intensive. Maximum Spacing Ratio—1.5.

Dimensions—Diam. 14¹/₈, Depth 14-inches.

Terminates in 3/4-in. female pipe thread.

No. 02420.....Each \$34.85

*Holophane Trade Marks.

Vapor Tight
For Indoor Use

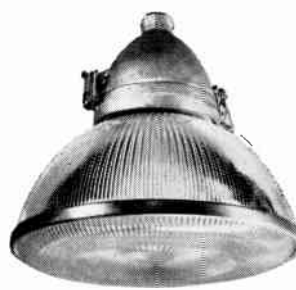

No. 02423

Essentially the same as No. 02120 in construction and performance except that the aluminum cover is omitted to provide an element of upward light. Prismatic glass is of special composition to assure safe operation under moist or severe conditions.

Total efficiency is over 80% or even in excess of typical open bottom industrial units without vapor-tight construction.

Prismatic glass assembly held by chain while relamping.

Lamp Wattage; 200-300 (Medium base—6-in. light center).

Distribution—Intensive. Maximum Spacing Ratio—1.5.

Dimensions—Diam. 14¹/₈, Depth 14-inches.

Terminates in a 3/4-in. female pipe thread.

No. 02423.....Each \$34.85

Holophane Industrial Lighting Units

Holophane Incandescent Vapor-Tight, Dust-Tight Lighting Units

Underwriters' Approved Vapor-Tight and Dust-Tight, Class II—Groups E, F, and G

These Holophane units not only meet vapor and dust tight operating requirements safely, but also direct the light to the work areas, producing higher levels of illumination with a reduction in high angle glare.



Nos. 02470, 02472, 02480



No. 02328-V



Nos. 02460-V, 02476-V

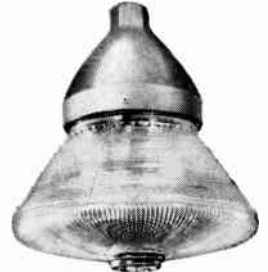

Nos. 02368, 02378

Units consist essentially of a threaded metal holder tapped for 3/4-in. conduit entry and a prismatic glass light director. Nos. 02368, 02378 are three-piece Reflector-Refractor* units. No. 832-D is a Wide-spread* refractor in a hinged, hooded, metal fitter.



No. 832-D

No.	Lamp Wattage	Distribution	Max. Spacing Ratio	Dimensions in In.		Each
				Diam.	Depth	
02328-V**	100-150	Extensive	2.25	8 5/8	11 3/8	\$11.30
02368	100-150	Extensive	2.0	10 1/2	12	16.30
02378	200 (A-25)	Extensive	2.0	12	13 1/4	18.00
02460-V**	100-150	Extensive	2.0	9 7/8	10 3/16	13.60
02470	100-150	Extensive	2.0	9 7/8	11 1/4	13.60
02472	100-150	Asymmetric	2.5	9 7/8	11 5/16	13.60
02476-V**	100-150	Asymmetric	1.0	9 7/8	10 1/2	13.60
02480	200 (A-25)	Extensive	2.0	12 1/4	13	23.35
832-D	200 (A-25)	Widespread	6.0	10 1/4	12 5/16	29.10

When using a 100 watt lamp in units with lamp wattage of 100-150, use a 5/8-in. socket extension. Wire not furnished with any of above units.

**Underwriters classify as vapor tight only.

Holophane Outdoor Lighting Units

Holophane No. 415 Wall Mounting Outdoor Unit



Ideal for residential, industrial and public area use. Prismatic glass assembly built to direct light downward and outward for wide coverage, produces uniformly lighted appearance.

Die cast hood made to stand all weather conditions, is dust and rust-proof.

Glass assembly hinged.

Wall projection 9 1/2-in.

Depth, 9 3/8-in.

100-150 Watt Lamp.

Flanged for 3 1/4-4-in. outlet box, recessed or exposed.

No. 415.....Each \$17.35

Holophane No. 420 Wall Mounting Outdoor Unit



Actual usage will prove that No. 420 is far better than other outdoor lighting fixtures with the same lamp wattage.

Prismatic construction sends more light over a larger area.

Glass assembly hinged.

Hood weatherproofed.

Wall projection 10 5/8-in.

Depth, 10 3/8-in.

200 A-25 Watt Lamp.

Flanged for 3 1/4-4-in. recessed or exposed outlet box.

No. 420.....Each \$24.75

Holophane Outdoor Lighting Units

Holophane Recessed or Surface Type REFRACTOLENS*

This family of units is designed for illuminating extensive horizontal areas from vertical mounting positions. Light distribution is mostly downward and fan-shaped. Ratio Spacing—4.0.

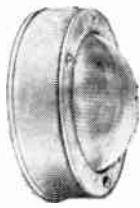

No. U-818



No. U-818-M

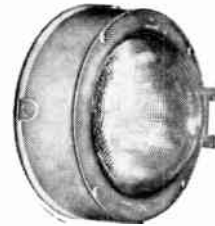

Nos. U-850, U-851

No.	Lamp Wattage	Recessing Depth, In.	Diam., In.	Depth, In.	Each
U-818	200A-25	3 1/2	16	6 3/4	\$ 57.40
U-818-M	300	5 3/4	16 1/8	9	73.90
U-818-S	6000 lumen Series	5 3/4	16 1/8	9	81.60
U-818-TC	200A-25	3 1/2	16	6 3/4	58.65
U-818-M-TC	300	5 3/4	16 1/8	9	74.15
U-826	100-150	3 1/2	12 5/8	5 3/4	40.35
U-850	500, 750, 1000	6 3/4	26	12 1/2	182.65
U-851	400 E-111 Merc.	6 3/4	26	12 1/2	182.65

Wire not furnished with these units.

U-850, U-851 have 5/8-in. tap mounting holes, all other units, 1/2-in.

For conduit entrance—all units, except U-826 have a 1" tapered pipe thread on top and two in back; U-826 has 3/4" thread on top and 2 1/8" slip fit in back. Entries at bottom or sides on special order.

Holophane Outdoor Sub-Station Lighting Units



Nos. 043386, 043776



No. 0871-T Mounting Bracket

For lighting outdoor sub-stations. Features two basic light distributions, symmetric or asymmetric. Provides effective illumination of vertical surfaces with an absence of glare.

Cast aluminum holder, 2-piece prismatic refractor, blown glass outer globe, mogul socket, and prismatic bottom diffuser. Main beam is adjustable.

Bracket (0871-T) is high strength cast aluminum with a span of 20 3/8-in. Terminates at fixture end with male thread of 1 1/2-in., opposite end 3/4-in. female pipe thread; for attaching Nos. 830, 832 for additional ground light.

No.	Lamp Wattage	Distribution	Diam.	Dimensions in In.	Height	Each
043386	300-500	Symmetric	14 3/4	20 3/8 Span	19 3/4 Max.	\$53.00
043776	300-500	Asymmetric	14 3/4		19 3/4 Max.	55.30
832	200	Symmetric	9	20 3/8 Span	12	15.35
830	100-150	Symmetric	8		10 5/8	13.35
0871-T	Mounting Bracket					17.60

Holophane A-WAY* POSTOP* Outdoor Lighting Unit

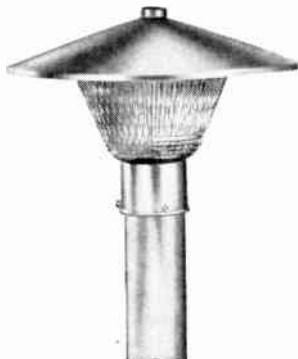

Ideal for driveways, campus grounds, gardens, motel approaches, drive-in theaters, garden apartments, etc. Many uses in the industrial field also.

Distributes light in an asymmetric pattern to provide even illumination on wide spacings, up to 3.5 times the mounting height above the ground (usually 8 to 10-ft.).

Unit consists of a 13 7/8-in. cover, a two-piece prismatic glass refractor and a slip fitter. A medium base porcelain socket is positioned for 150 watt lamp (use a 5/8-in. socket extension for 100 watt lamp). The anodized aluminum fitter for No. 04343 slips over any standard 3-in. post; the No. 04344 cast aluminum fitter slips over a 1-in. pipe.

Metal parts are weather-resistant and the glass assembly is gasketed at both top and bottom to retard the entry of moisture and insects. Relamping is accomplished simply by loosening the top nut and removing the cover.

No.	Description	Each
04343	With slip fitter for 3-in. diameter pole.....	\$20.50
04344	With slip fitter for 1-in. diameter pipe.....	22.90

*Holophane Trade Marks.

Woodward Heavy-Duty Adjustable Lighting Fixtures

Reflector Assemblies For Series 8RU, 8U and 9RU

Woodward Heavy-Duty Industrial Lighting Fixtures

Reflectors and shields are cast aluminum with high-temperature white interiors and black wrinkle exteriors. Reflectors equipped with McGill "Levolier" sockets.

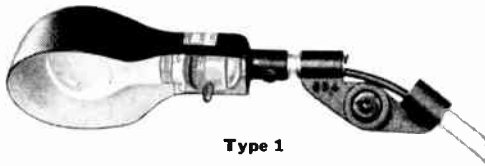

Type 1

50-100 watt, pear-shaped reflector. Clamp mounted socket.

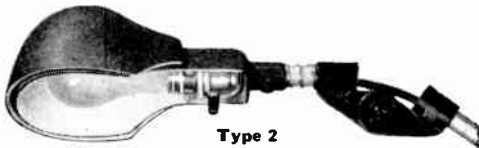

Type 2

Same as Type 1, but complete with THERMA-GUARD shield for safety and ease of handling. Will not burn operator.



Type 4



Type 5

Type 4 has 50-100 watt, vertical parabolic reflector. Reflector will accommodate 75 watt reflector-flood lamp.

Type 5 is the same as Type 4 but complete with THERMA-GUARD shield for safety and ease of handling. Will not burn operator.

One of a Series of Low-Cost, Versatile Localized Fixtures



Model B-33

Flex-arm type. For continuous rough duty service. Has overall reach of 26-in.; 32-in. model available.

Complete with 50-100 watt cast aluminum reflectors, 8-ft. oil-proof cord set and key socket.

Type FC clamp-on base optional at extra cost.

Underwriters' Laboratories approved.

Model B-33 Each **\$8.00**



FC Clamp

Additional printed information on these products and other items not listed—including Vapor-Proof, Fluorescent and Portable Units—is available on request to Graybar.

Rugged Adjustable Baskets

For Use with Reflector Assemblies

Swivels, bases and radial arms formed from specially alloyed, heat treated cast iron. Uprights and extension arms constructed of standard conduit tubing permitting "Customizing" where required. Castings finished in black baked enamel. Tubing and hardware heavily plated. Complete with 8-ft. oil-proof cord set and Universal Base for mounting in any position required. Underwriters' Laboratories approved.

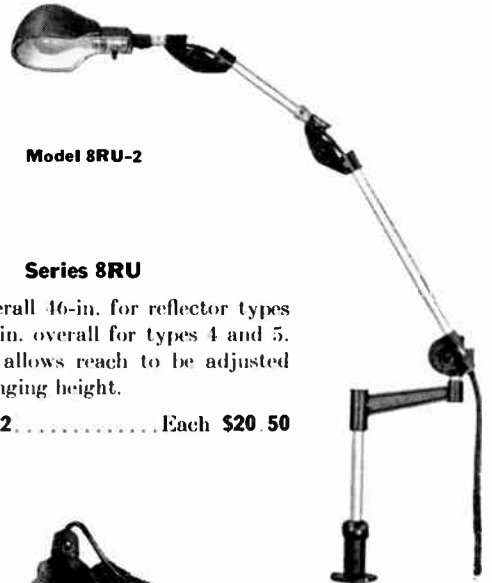

Model 8RU-2

Series 8RU

Reach overall 46-in. for reflector types 1 and 2, 40-in. overall for types 4 and 5. Radial arm allows reach to be adjusted without changing height.

Model 8RU-2 Each **\$20.50**



Model 8U-5

Series 8U

Reach overall of 34-in. for reflector types 1 and 2, 28-in. overall for types 4 and 5.

Model 8U-5 Each **\$18.50**



Model 9RU-1

Series 9RU

Reach of 31-in. for all reflector assemblies. Radial arm for adjusting reach without changing height.

Model 9RU-1 Each **\$16.00**

Model number is determined by suffixing the type number of the reflector assembly desired to the series number of the basket required.

White Adjustable Lighting Fixtures
A Complete Line for Every Working Requirement

Wall Mounting Type



Has three sets of Universal Joints and two 18-in. arms. Finished in gray and cadmium.

No.	Description	Each
R2LAW	Wired complete	\$12.15
2LAW	Less socket, shade and wiring	7.95

Other type mounting bases and shades available.

Office Type Desk Portable



Has telescoping arms. Universal Joint at 8-in. felted base, range 29-in. Finished in statuary bronze.

No.	Description	Each
R7P	Wired complete	\$18.50

Bench Mounting Type



Equipped with 8-in. Crank arm; 18-in. universally adjustable lamp arm, range 34-in. Height 24-in.

Finished in gray and cadmium.

Other type mounting bases and shades available.

No.	Description	Each
R3D	Wired complete	\$12.25
3D	Less socket, shade and wiring	7.65

Bench or Laboratory Portable

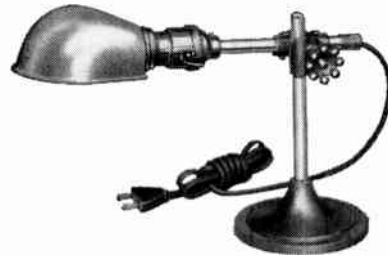

Equipped with heavy 1 3/4-in. felted iron base, range 12-in., height overall 8-in. Universal Joint supporting lamp arm. Easily removable as a hand examination lamp. Finished in gray and cadmium.

No.	Description	Each
R4BP	Wired complete	\$11.50

Spring-Balanced Type



Equipped with "Ultra-Flex" arms. Wired complete. Finished in gray or brown.

No.	Description	Each
2MC	Two arms with 40-in. range and clamp on base	\$18.75
2MW	Two arms with 40-in. range and side base...	17.50
2MD	Two arms with 40-in. range and top base...	17.50
3MW	Three arms with 60-in. range and side base...	23.50

Conduit Mounting Type



Equipped with 7-in. Crank arm and 18-in. universally adjustable lamp arm, range 29-in. Finished in gray and cadmium. Specify if for vertical or horizontal conduit and size.

No.	Description	Each
R1DC	Wired complete	\$12.20
1DC	Less socket, shade and wiring	7.80



Office Type Wall Fixture

Universally adjustable telescoping arms, range 32-in. Finished in statuary bronze.

No.	Description	Each
R8F	Wired complete	\$18.90

Dazor Floating-Arm Air-Cooled Incandescent Lamps

**Desk Model
With Yoke-Mounted Reflector**

For the desk occupant who prefers high-intensity incandescent lighting with unrestricted light placement. The air-cooled reflector is always safe to handle. A 60-watt bulb is recommended.

One per case. Approx. ship. wt., 11½ lbs.

Finish is frost - green baked enamel over bonderizing. Optional colors available at no extra charge: frost-tan, statuary-bronze, gray or ebony.

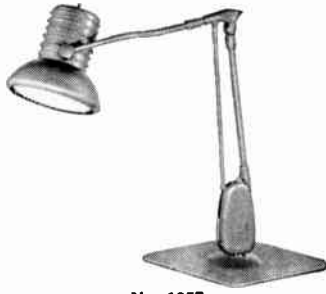

No. 1057

No.	Extension, In.	(West)	Each	(East)
1057	21	\$25.75		\$24.50

**Universal Model
With Side-Mounted Reflector
(Also available with top-mounted reflector)**

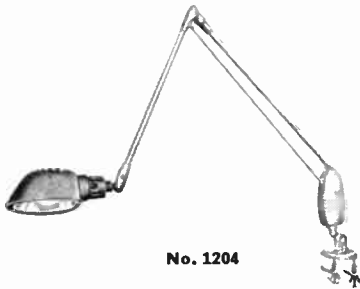

No. 1204

The Universal base may be clamped or screwed to any surface—horizontal, vertical, or sloping. Dual-clamp fittings are removable. Screws furnished. A 60-watt bulb is recommended for the air-cooled reflector.

One per case. Approx. ship. wt., 8 lbs.

Finish is statuary-bronze baked enamel over bonderizing. Optional color available at no extra charge: gray.

No.	Extension, In.	(West)	Each	(East)
1204	21	\$17.50		\$16.25
1206	34	17.50		16.25

**Pedestal Model
With Top-Mounted Reflector
(Also available with side-mounted reflector)**

A heavy iron base, 12 in. in diameter, gives stability to this portable, floor-type Dazor. Pedestal measures 39 in. from floor to arm hinge at top of pedestal. A 60-watt bulb is recommended for the air-cooled shade. Caster attachments are available.

One per case. Approx. ship. wt., 34 lbs.

Finish is statuary - bronze baked enamel over bonderizing. Optional colors at no extra charge: white or gray.



No. 604

No.	Extension, In.	(West)	Each	(East)
604	24	\$31.50		\$29.00
605	34	31.50		29.00

Dazor Adjustable-Arm Air-Cooled Incandescent Lamps

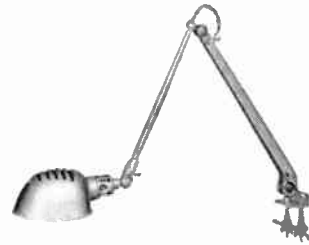

No. 1102

**Side-Mounted Reflector Model
(Also available with top-mounted reflector)**

These Dazor industrial lamps have the capacity to hold a position despite vibration or shock. Base is stamped steel, L-shaped with holes for bolting to horizontal or vertical surface. Dual-clamp fittings are removable.

One per case. Approx. ship. wt., 6 lbs.

Finish gray baked enamel over bonderizing.

No.	Extension, In.	(West)	Each	(East)
1102	31	\$13.00		\$11.75
1103	20	13.00		11.75

Dazor Air-Cooled Incandescent Desk And Table Lamps

Swing-Arm Desk Lamp



No. 1056

Executive-type lamp employing indirect lighting. The circular shade, 13 in. in diameter, casts diffused light in volume on the desk surface. A 100-watt bulb should be used.

One per case. Approx. ship. wt., 13½ lbs.

Finished frost-green baked enamel over bonderizing, combined with brass. Optional colors available at no extra charge: frost-tan, statuary-bronze, gray or ebony, combined with brass.

No.	Extension, In.	(West)	Each	(East)
1056	13	\$26.00		\$24.75

A decorative Dazor on its own account or as a companion to the Swing-Arm Lamp. Has same shade, providing diffused indirect light and dissipating heat from the recommended 100-watt bulb. Lamp stands 14½ in. over all.

One per case. Approx. ship. wt., 6 lbs.

Finishes are the same as for the Swing-Arm Lamp above.

No.	(West)	Each	(East)
1055	\$13.75		\$12.50



No. 1055

**Dazor Floating-Arm Fluorescent Lamps
For Operation on 110V-60C Alternating Current**

Model number with prefix "P" indicate high-power-factor units
For Two T8 15-Watt tubes



No. 2124

Universal Model

May be clamped or screwed to any surface — horizontal, vertical or sloping. Dual-clamp fittings are removable. Screws furnished.

One per carton; six cartons per case. Approx. ship. wt. per unit, 10 lbs.

No.	Extension, In.	(Western)	Each	(Eastern)
2124	24	\$25 00		\$23 75
2134	34	25 00		23 75
P-2124	24	29 00		27 75
P-2134	34	29 00		27 75

Finish statuary-bronze baked enamel over bonderizing. Optional colors available at no extra charge: gray, frost-green or frost-tan.

Desk Model

Has a weighted base that does not require fastening down. May be placed anywhere on a flat-top desk, table or horizontal surface.

One per case. Approx. ship. wt., 19 1/2 lbs.



No. 2324

No.	Extension, In.	(Western)	Each	(Eastern)
2324	24	\$34 25		\$31 75
P-2324	24	38 25		35 75

Finish statuary-bronze baked enamel over bonderizing. Optional colors available at no extra charge: gray, frost-green or frost-tan.

Pedestal Model

The pedestal model has a heavy iron base, 12 in. in diameter, which gives stability to this floor-type Dazor. Pedestal measures 39 in. from floor to arm hinge. Lamp may be conveniently moved. Caster attachments are available.

One per case. Approx. ship. wt., 37 lbs.

Finish statuary-bronze baked enamel over bonderizing. Optional colors available at no extra charge: gray, frost-green or frost-tan.

No.	Extension, In.	(West)	Each	(East)
2224	24	\$40 00		\$37 50
2234	34	40 00		37 50
P-2224	24	44 00		41 50
P-2234	34	44 00		41 50



No. 2224

Dazor Floating-Arm Fluorescent Lamps

Bracket Model

The gooseneck bracket base fastens to underside of drawing board, leaving upper edge clear for T square. Board cover drops into gooseneck.

One per carton; six cartons per case. Approx. ship. wt. per unit, 11 lbs.

Finish statuary-bronze baked enamel over bonderizing.



No. 2434

No.	Extension, In.	(West)	Each	(East)
2434	34	\$27 00		\$25 75
P-2434	34	31 00		29 75

Dazor Floating-Arm Magnifiers With Fluorescent Lighting

For Operation on 110V-60C Alternating Current
For Three T5 6-Watt Tubes

Universal Model

Two seeing aids, magnification and lighting, are combined in one head. The 5" double convex lens has a focal length of 13 in., a power of 3 diopters. This model clamps or screws to any surface — horizontal, vertical or sloping. Dual-clamp fittings are removable.

One per case. Approx. ship. wt., 13 1/2 lbs.

Finish is statuary-bronze baked enamel over bonderizing. Optional colors available at no extra charge: white or gray.



No. M-209

No.	Extension, In.	(West)	Each	(East)
M-209	24	\$38 75		\$37 50

Pedestal Model

A portable, floor-type Dazor for doctors, technicians, and artists. A heavy iron base, 12 in. in diameter, provides stability. Pedestal measures 39 in. from floor to arm hinge at top of pedestal. Caster attachments are available.

One per case. Approx. ship. wt., 39 lbs.

Finish statuary-bronze baked enamel over bonderizing. Optional colors available at no extra charge: white or gray.

No.	Extension, In.	(West)	Each	(East)
M-210	24	\$53 75		\$51 25



No. M-210

Dazor Floating-Arm Magnifiers With Fluorescent Lighting

Desk Model

The weighted base does not require fastening down. It may be placed anywhere on a flat-top desk, table or other horizontal surface.

One per case. Approx. ship. wt., 20½ lbs.

Finish is statuary-bronze baked enamel over bonderizing. Optional colors available at no extra charge: white or gray.



N . M-270

No.	Extension, In.	(West)	Each	(East)
M-270	18	\$48.00		\$45.50

Adjustable-Arm Magnifier

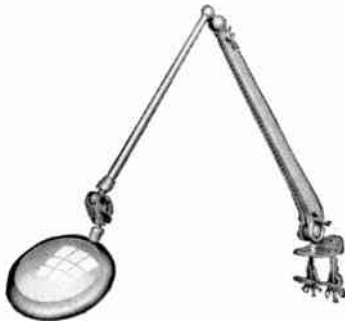

No. M-1106

This Dazor is for use when job lighting is supplied by another source. Its 5 in. double-convex lens has a focal length of 13 in. and a power of 3 diopters.

One per case. Approx. ship. wt., 6 lbs.

Finish gray baked enamel over bonderizing.

No.	Extension, In.	(West)	Each	(East)
M-1106	31	\$17.00		\$15.75
M-1107	20	17.00		15.75

Thompson Pulleys

For Disconnecting and Lowering Hangers

Pulleys are required for every installation of Thompson Hangers; the types and quantities required of each depends on installation conditions.

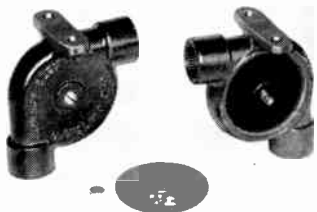

Sealttype—Corner

Used only with conduit enclosed horizontal cable runs. The vertical run from the corner pulley to terminal fitting may be open or conduit-enclosed.

Threaded for ¾-in. conduit, with bolt hole

spaced to take U-bolts for 1¼-in. pipe brackets. For use with Sealttype Hangers AL-2390 and AL-4590.

★No. AL-7080—Sealttype, fixed position, aluminum alloy, heat treated. Weight each 1.0 lbs. . . Each \$6.70

★Bolt hole spacing for either 1¼" or 1½" pipe size as specified.

Thompson Pulleys

**For Disconnecting and Lowering Hangers
Open Face, Straight Through or Corner**



No. AL-7110



No. AL-7130



No. AL-7150

For use at the wall, column or pole where the direction of the chain or cable from the hanger is changed from inclined or horizontal to vertical and at intermediate locations between hanger and corner locations, as required.

Housings are cast 220-T4 aluminum alloy. Composition wheels have excellent wearing qualities; are highly resistant to oils, acids, alkalis and corrosive gases. Bronze axles.

Pulley wheels have graphite-impregnated hubs to assure smooth operation and eliminate need for lubrication.

No.	Description	WL Ea., Lbs.	Each
AL-7110	Transverse Lugs, Fixed Position.....	1.1	\$2.80
AL-7130	Transverse Lugs, Hinged, Bolted Type	1.5	4.40
AL-7150	Transverse Lugs, *Hinged.....	1.6	4.80

*Hinge has ¾-in. male pipe thread stud with locknut for direct attachment to flange plates and beam clamps.

Thompson Combination Suspension Assemblies

These assemblies provide all of the advantages of the beam clamps and the adjustable angle fittings, and offer a solution for many suspension problems.

Beam clamp parts are malleable iron, hot-dip galvanized. Adjustable angle fittings and flange plates, aluminum alloy.

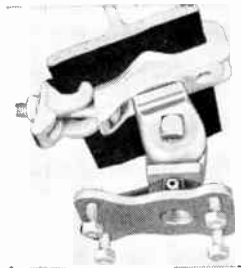

No. 7745

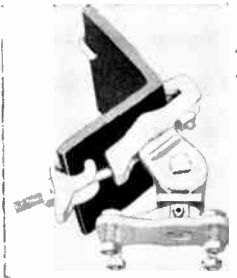

No. 7755

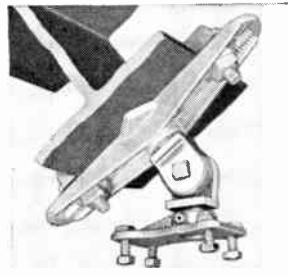

No. 7765

Light Duty

For hand-line operated hangers only, and for fixtures weighing 60 lbs and under.

All have ¾-in. adjustable angle fitting and hanger flange plate. Complete with attaching bolts and nuts.

No.	Description	Each
7745	With I Beam Clamp; Weight each 2.36 lbs...	\$ 8.70
7755	With L Beam Clamp; Weight each 2.45 lbs..	8.80
7765	With Wide Flange Beam Clamp; Weight each 3.92 lbs.....	11.20

Thompson Disconnecting and Lowering Hangers

These hangers provide the necessary accessibility to lighting equipment in all types of lighting installations. They bring the lighting fixture down to the man instead of sending the man up to the fixture.

When the fixture is lowered the electrical circuit is broken—there is no electrical hazard; when the fixture is raised after servicing it is returned to and locked in its original position and the electrical circuit is re-established.

Hanger consists of two members: the upper member carries a pair of contact assemblies to which the current feed wires attach (this member is firmly attached to supporting structure). The lower member carries the engaging lower contact assemblies, wired to the lighting fixture which it supports.

The entire operation of unlatching, disconnecting and lowering, raising, re-positioning, reconnecting and latching is a manual one, by means of the regulated pull and release on the small chain or cable used to lower or raise the fixture.

Thompson hangers are suitable for hand-operated installations only. For safety sake, 60 lbs. is the maximum recommended gross weight per unit.

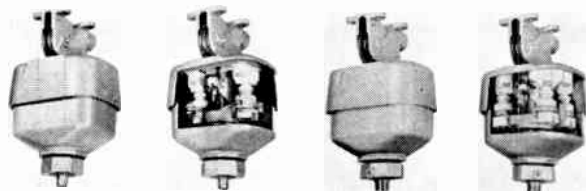

No. AL-2370

No. AL-4570

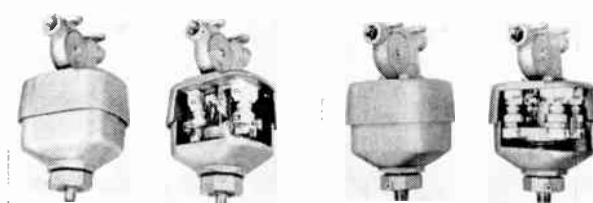

No. AL-2390

No. AL-4590

Open-Face Models Aluminum Alloy Construction 2-Pole Hangers

No.	Description	Each
AL-2370	Standard Hanger	\$32.00
AL-2375	With Stainless Steel Guide	43.00

Six in standard package. Approx. weight, 44 lbs.

4-Pole Hangers

AL-4570	Standard Hanger	\$38.00
AL-4575	With Stainless Steel Guide	49.00

Six in standard package. Approx. weight, 44 lbs.

Seal-Type Models Aluminum Alloy Construction 2-Pole Hangers

No.	Description	Each
AL-2390	Standard Hanger	\$35.00
AL-2395	With Stainless Steel Guide	46.00

Six in standard package. Approx. weight, 44 lbs.

4-Pole Hangers

AL-4590	Standard Hangers	\$41.00
AL-4595	With Stainless Steel Guide	52.00

Six in standard package. Approx. weight, 44 lbs.

Thompson Shock Absorbers



Showing Shock Absorber No. A-50M applied direct to a Thompson Hanger and supporting a standard RLM deep bowl reflector.

Designed to protect lamp filaments and entire lighting fixture from shocks and vibration frequently found in industrial applications. Also for use with other suspended devices, such as motors, fans, unit heaters and many other types of equipment.

In computing fixture weight, all attachments and connections to be supported must be included.

Junior Size

Bell shaped body, open spring plate and stem are 220-T4 aluminum alloy. Springs steel, cadmium plated and baked.

Rated Cap. Lbs.	Series 10		Series 20	
	No.	Each	No.	Each
1½-5	A-10L	\$4.20	A-20L	\$4.20
3-8	A-10M	4.20	A-20M	4.20
5-12	A-10II	4.20	A-20II	4.20

24 in Std. Pkg.: Weight 26 Lbs.

*Standard pipe thread—F-Female, M-Male.



Junior Size



Heavy Duty Size



Heavy Duty — Loop Top

Heavy Duty Size

Bell shaped body, open spring plate and stem are 220-T4 aluminum alloy. Springs are steel, cadmium plated and baked.

Rated Cap. Lbs.	Series 50		Series 60		Series 70	
	No.	Each	No.	Each	No.	Each
5-12	A-50L	\$5.30	A-60L	\$5.40	A-70L	\$5.00
9-25	A-50M	5.30	A-60M	5.40	A-70M	5.00
15-40	A-50II	5.50	A-60II	5.60	A-70II	5.20
30-75	A-50III	5.50	A-60III	5.60	A-70III	5.20

Series 50 and 60 — 12 in standard package; Weight 23 lbs. Series 70 — 10 in standard package; Weight 23 lbs.

Thompson Beam and Angle Clamps

For Disconnecting and Lowering Hangers

For quickly and easily attaching hangers and pulleys to structural members of buildings; also applicable to suspension of many other devices. All cast parts are malleable iron, hot-dip galvanized. Provided with $\frac{3}{4}$ -in. pipe connections.



No. 7700



No. 7705

For use with light I and \perp Beams, \square and \square . Width over flanges, $3\frac{1}{2}$ - to $4\frac{1}{2}$ -in. Flange thickness not over $\frac{3}{8}$ -in. Tapped $\frac{3}{4}$ -in. Pipe thread.

No. 7700—Beam Clamp Only; Wt. Each, 1.13 Lbs. Each **\$2.40**

No. 7705 Beam Clamp with Hanger Flange Plates; With $\frac{5}{16}$ x 1-in. attaching bolts and nuts; Wt. Each 1.76 Lbs. Each **\$4.80**



No. 7710



No. 7715

For use with light L's, flange width 3 to 4-in.. Flange thickness not over $\frac{3}{8}$ -in. Tapped $\frac{3}{4}$ -in. pipe thread.

No. 7710—Angle Beam Clamp Only; Wt. Each 1.22 Lbs. Each **\$2.50**

No. 7715—Angle Beam Clamp with Hanger Flange Plate; With $\frac{5}{16}$ x 1-in. attaching bolts and nuts; Wt. Each 1.85 Lbs. Each **\$4.90**



No. 7720



No. 7725

Adjustable; For Wide Heavy Beams. For use with I, \perp and H beams, trusses and girders of \square and \square .

No. 7720—Beam Clamp Only; Width over flanges 4- to 8-in. flange thickness from $\frac{3}{8}$ to $\frac{3}{4}$ -in.; tapped $\frac{3}{4}$ -in. pipe thread. Weight each 2.69 lbs. Each **\$4.90**

No. 7725 Beam Clamp with Hanger Flange Plate; With $\frac{5}{16}$ x 1-in. attaching bolts and nuts. Weight each 3.32 lbs. Each **7.40**

Thompson Terminal Fittings

Locking Hooks



For securing terminal links of operating cables or chains. Drilled for padlock with $\frac{1}{4}$ -in. bail or $\frac{3}{16}$ -in. rod (when mounted in groups).

Constructed of malleable iron, hot-dip galvanized. Mounting holes for $\frac{3}{16}$ -in. bolts.

No.	Description	Each
8135	Weight each .20 lb.	\$0.60

Lock Boxes

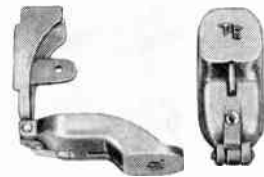

Open chain or cable type. For use with Terminal or Connecting Links, or Drawbar Tension Springs.

For bolting to pole, column or wall.

High strength aluminum alloy. Will take padlock with $\frac{1}{4}$ -in. shackle.

No. 8150—Weight each 1.18 lbs. Each **\$2.90**

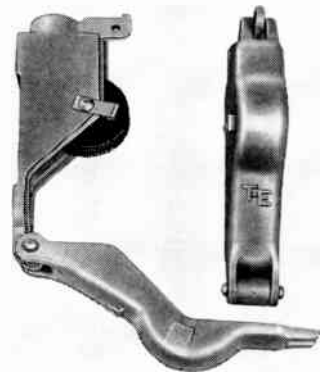

Conduit-connected, tapped for $\frac{3}{4}$ -in. pipe thread.

For use with terminal links or connecting links.

Aluminum alloy; contains composition pulley wheel so pull on hand line may be at desired angle to pole, column or wall. Will take padlock with $\frac{1}{4}$ -in. shackle.

No. AL-8181—Weight each 1.49 lbs. Each **\$11.80**

We can also furnish Chain, Chain Fittings, Cable and Cable Fittings for use with Thompson Hangers.

Day-Brite Commercial Fluorescent Lighting Fixtures

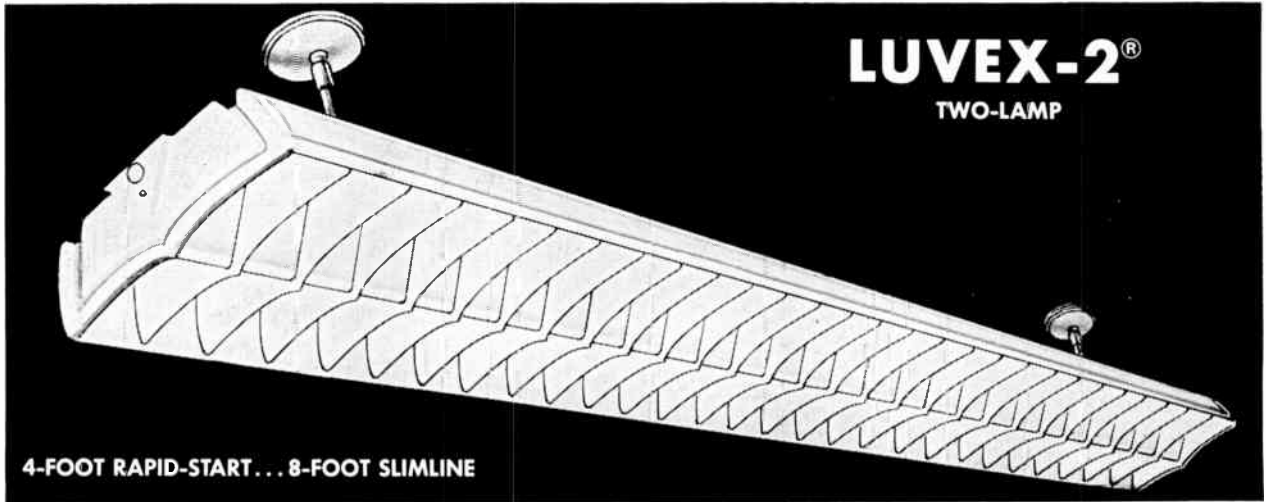

Semi-direct all-metal shielded fixtures for 3-ft. Slimline or 4-ft. Rapid-Start lamps. For either 8-in. or 24-in. suspension mountings. These fixtures are especially adapted to high-level school and office lighting. Efficiency is 83% or more.

Die-formed and welded construction throughout for uniformity and stability. Interlocking louver assembly—Center wireway cover, longitudinal louvers, supported to wireway by snap catches. One-piece enclosure. Ends, sides, center louver, and lateral louvers completely pre-assembled for maximum strength, forming a rigid one-piece unit that is easily installed. Shielding 35°-25°. Service Chains support enclosure in lowered position for maintenance.

Enclosures and 8-ft. chassis are supplied in double lamp lengths for 4-ft. Rapid-Start. Require less hangers and simplify installation and maintenance.

Plenty of knockouts and mounting holes for installation and feed. Enclosure, chassis and louver assembly finished in Hot-Bonded Super-White enamel, rust inhibited.

Simplified through wiring. Self-bushed holes in ends of chassis. Locknuts, nipples not required.

Twin-Stem Hangers supplied with 4-ft. single units.

“A-J” Adjustable Single Stem Hangers supplied for 3-ft. single units and continuous installations. All hangers have swivel fittings and all parts necessary for complete installation.

HPF certified CBM Rapid-Start or Slimline ballasts for 118-volt, 60-cycle, a-c operation. Individually wired for single unit or continuous suspension mounted runs (thru circuit wires not included).

Approved by Underwriters' Laboratories

		Lamps		Overall Length, In.	Width In.	Suspension Mtg. In.	Approx. Ship. Wt. Lbs.	Each
No.	No.	Ft.						
Rapid-Start								
46456-4	2	4		48 1/2	12 3/4	8	31	\$27.96
46457-4	2	4		48 1/2	12 3/4	24	32	28.68
Slimline								
96266-8	2	8		96 1/2	12 3/4	8	62	46.32
96267-8	2	8		96 1/2	12 3/4	24	63	47.04



Luvex-4 has same rugged construction features and finish as Luvex-2 above.

Twin-Stem Hangers supplied with 4-ft. individual units are finished in lustre aluminum enamel with swivel fittings and all parts necessary for complete installation.

“A-J” Adjustable Single Stem Hangers supplied for continuous installations provide over one inch vertical adjustment thru externally hand-operated fittings. Includes swivel fittings and all parts necessary for complete installation. Hangers finished in Hot-Bonded Lustre aluminum.

		Lamps		Overall Length, In.	Width In.	Suspension Mtg. In.	Approx. Ship. Wt. Lbs.	Each
No.	No.	Ft.						
Rapid-Start								
46448-4	4	4		48 1/2	21	8	60	\$46.80
46449-4	4	4		48 1/2	21	24	61	47.52
Slimline								
96468-8	4	8		96 1/2	21	8	94	77.28
96469-8	4	8		96 1/2	21	24	95	78.00

Day-Brite Commercial Fluorescent Lighting Fixtures

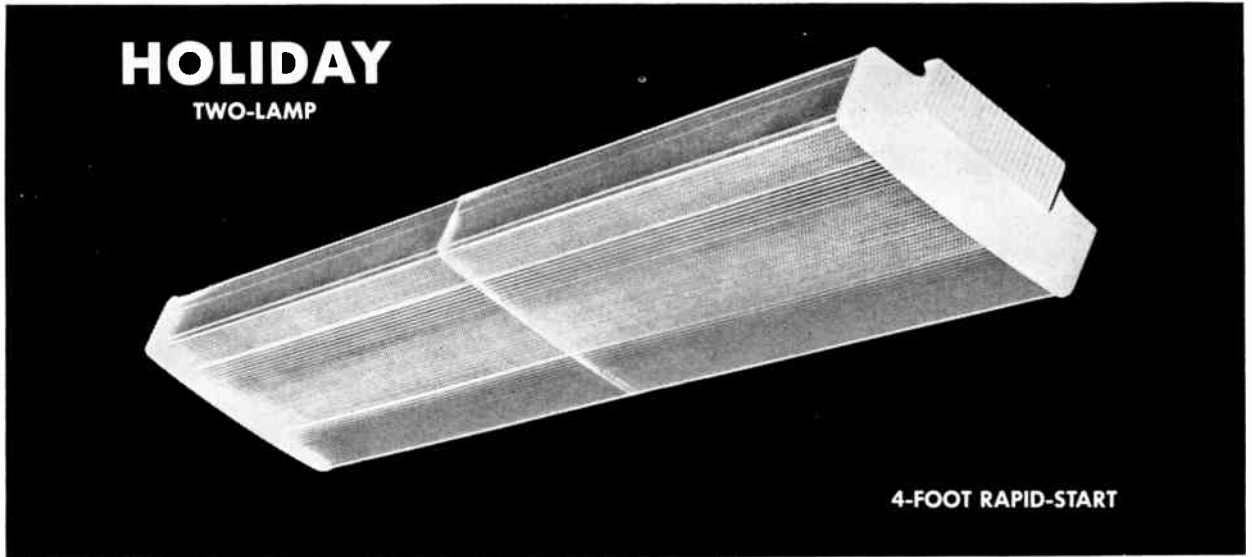

The Day-Brite Holiday brings the solution to many lighting problems. Designed specifically for low ceiling applications in modern interiors where recessing is not possible. Ideal for schools, offices, stores, under balconies and in modern industrial areas involving critical seeing tasks.

The enclosures are of molded acrylic plastic to assure positive consistency of color, transparency, and dimensional stability. Snap catches release enclosure which is supported by separable hinges in lowered position. Can be completely removed and hinged from either side.

The Holiday is available as 4-ft. and 8-ft. units and fill-in sections. . . all for 2 rows of 1-ft. Rapid-Start lamps.

They are recommended for surface mounting and include ceiling mounting straps.

Simplified servicing features include 2-ft. plastic enclosure sections mounted in 4-ft. concealed type metal frames equipped with separable hinges and snap latches. No tools required for servicing.

All metal parts are rust-inhibited and finished in Hot-Bonded Super-White enamel.

Fixtures are individually wired with CBM, HPF, Rapid-Start Ballasts for 118v. 60 cycle, A. C. operation. A fuse is included with each Ballast to prevent overheating in event of Ballast failure.

U. L. Approved. Surface Mounting Type.

No.	Lamps		Overall Lgth., In.	Width In.	Approx. Ship. Wt., Lbs.	Each
	No.	FL				
46500-4	2	4	49½	10⅝	30	\$48.24
46500-8	4	4 (tandem)	97½	10⅝	58	93.66

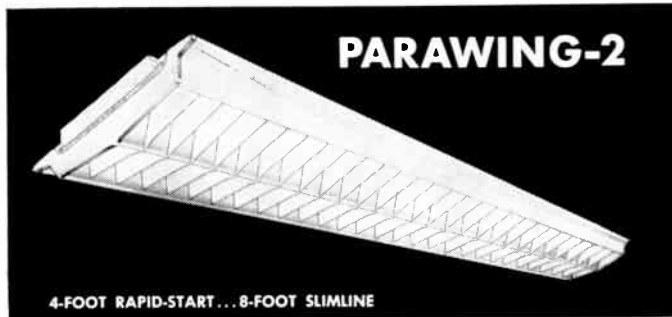

The Parawing-2, a two-lamp surface mounted fixture, is ideal for low ceiling application in schools, offices, and stores where a shallow surface mounted fixture is desired.

The Box-Wing plastic diffusers which form the fixture's sides neatly blend the light into surrounding ceiling areas. These plastic diffusing elements are double-walled and completely sealed to prevent deposits of foreign matter—stay clean longer.

Parabolic profile provides maximum efficiency and brightness control.

One-piece interlocked metal louver assembly. Rigidly formed steel chassis and ends are provided with adequate knockouts for easy installation.

Single units can be installed direct to ceiling or by means of mounting straps included with all fixtures. Can be suspended through use of standard stem hangers.

Continuous runs made up of multiple single units as required for complete run. Self-bushed holes in ends of chassis provided for through wiring. Locknuts, nipples not required. Mounting straps are used at ends and at each coupling point.

All metal parts are rust-inhibited and finished in Hot-Bonded Super-White enamel.

Fixtures are individually wired for single unit or continuous installations, with HPF certified CBM Ballasts for 118 volt, 60 cycle, A. C. operation (through circuit wires not included).

Approved by Underwriters' Laboratories

No.	No.	Lamps		Overall Length in.	Width In.	Approx. Ship. Wt. Lbs.	Each
		No.	FL				
47256-4	2	4	R. S.	48¾	16	29	\$30.00
47256-8	4	4	R. S. (Tandem)	96¾	16	58	57.60
97256-8	2	8	Slimline	96¾	16	58	53.40
Parawing-4							
47456-4	4	4	R. S.	48¾	24⅞	56	52.80

Day-Brite Commercial Rapid-Start Lighting Fixtures

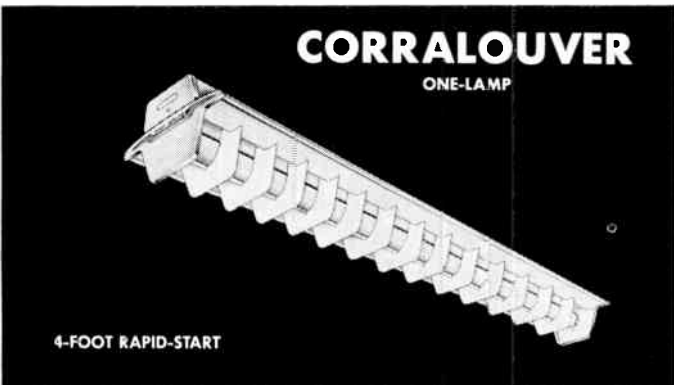
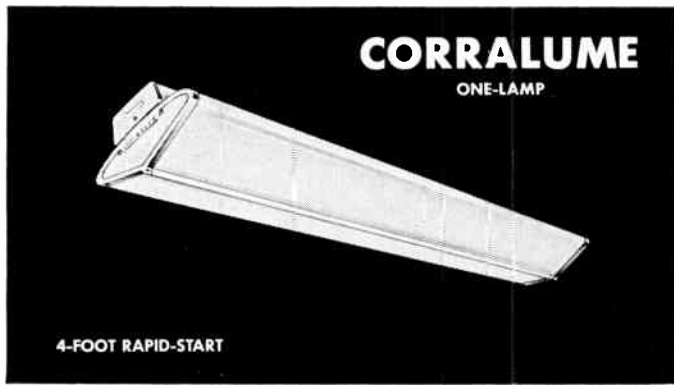

Corralume Corraline Corralouver

Smart and modern looking, these units are designed for lighting corridors, pedestrians' tunnels, book-stacks, bins and similar long narrow traffic areas. They are engineered to provide ceiling and side wall illumination, wiping out gloom and dark shadows normally found in these areas. Their extreme flexibility of application makes them ideally suited for use under balconies, in reception areas, wash rooms, and powder rooms. Louvered units are ideal for bin and stack lighting.

Designed primarily for surface mounting, all fixtures include mounting straps. They can be suspended by the addition of standard hangers.

Self-bushed holes behind knockouts at each end. Units can be mounted end to end for continuous runs as required. Hot-Bonded Super-White enamel finish on all metal parts.

All units have HPF certified CBM Rapid-Start ballasts for 118 volt, 60 cycle a-c operation. Individually wired for single unit or continuous installations. (through circuit wires not included). All three fixtures have enclosures which can be completely removed or hinged from either side.

Approved by Underwriters' Laboratories

Corralume

One-piece extruded polystyrene plastic enclosure with lamp in center—blending at outer edges to emphasize the modern shape. Snap catches release enclosure which is supported by separable hinges in lowered position. These 4-ft. plastic sections are supported at ends and top edges by die-formed steel end plates and rails.

Corraline

One-piece extruded polystyrene plastic enclosure has smart ribbed sides and diffused bottom to minimize extreme brightness. Also has separable hinges and snap catches. Four ft. enclosure sections are supported by die-formed steel end plates and rails.

Corralouver

All metal louver assembly and longitudinal reflectors on a new and unique design. They are completely interlocked for strength and stability. Has snap catches and separable hinges. Entire assembly is rust-inhibited and finished in Hot-Bonded Super-White Enamel.

No.	No.	Lamps	Fl.	Corralume		Type Mounting	Approx. Shp. Wt., Lbs	Each
				Overall Lgth., In.				
40140-4	1	4		49		Surface	21	\$21.60
40140-8	2	4 (Tandem)		98		Surface	33	35.52
				Corraline				
40150-4	1	4		49		Surface	19	21.60
40150-8	2	4 (Tandem)		98		Surface	31	35.52
				Corralouver				
40160-4	1	4		49		Surface	21	21.60
40160-8	2	4 (Tandem)		98		Surface	35	35.52

Day-Brite Plexoline Lighting Fixtures

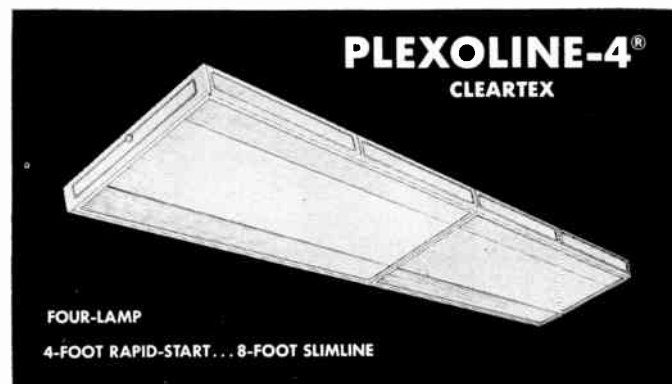
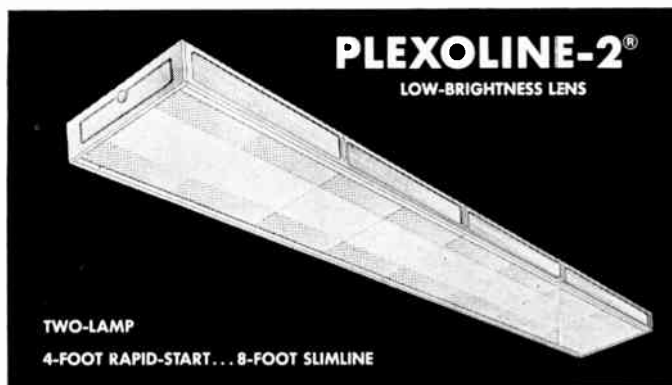
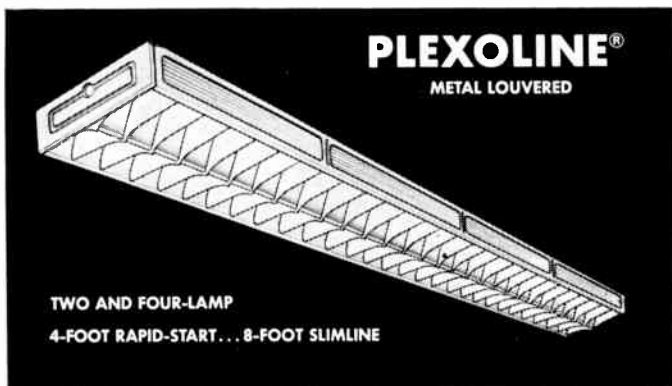

The Plexoline is a complete lighting system, simple to install and maintain, efficient, beautiful, engineered and constructed by master craftsmen—and absolutely unequalled in versatility. Used individually, each element is complete in itself.

This fixture's great adaptability makes it ideal for stores and showrooms, offices, schools, libraries, public buildings, banks, utilities, and institutions. Unlimited pattern arrangements can be worked out with the addition of Plexoline fixed or adjustable accent units designed especially for use in combination with these Plexoline series (listed on another page in this catalog).

The entire Plexoline system is quality built and engineered. Wherever the Plexoline can serve you, it delivers its unprecedented versatility with quality performance and economy second to none.

All metal parts finished in Hot-Bonded Super-White enamel. Plenty of knockouts and mounting holes. Self-bushed holes in ends of chassis. Locknuts, nipples not required. Ribbed plastic side panels have low surface brightness and high transmission. HPF Certified CBM ballasts for 118 volt, 60 cycle a-c operation. All glass and plastic enclosed units are wired with safety fuses to prevent overheating in the event of ballast failure.

Metal Louvered—All steel louver assembly is completely interlocked to prevent twisting or warping. Entire assembly supported by snap latches. Hot-Bonded Super-White enamel, rust inhibited.

Low Brightness Lens—Holophane Controlens designed primarily to give the maximum amount of light with the minimum amount of glare. In hinged frames with separable hinges.

Cleartex Plastic—Exclusive ribbed design in Cleartex provides both brightness control and distinctive appearance. In hinged frames with separable hinges—hinge from either side or completely remove—without tools.

No.	Type Bottom	No. Lamps	Ft.	Overall Lgth. In.	Type Mounting	Approx. Ship. Wt., Lbs.	Each
47410-4	Louvered	4	4	48 ⁷ / ₈	Surface	48	\$53.28
47210-4	Louvered	2	4	48 ⁷ / ₈	Surface	31	30.72
47210-8	Louvered	4	4 (tandem)	96 ⁷ / ₈	Surface	61	59.28
47230-4	L. Brightness	2	4	48 ⁷ / ₈	Surface	44	44.76
47230-8	L. Brightness	4	4 (tandem)	96 ⁷ / ₈	Surface	88	85.20
47495-4	Cleartex Plastic	4	4	48 ⁷ / ₈	Surface	44	57.96
Slimline							
97400-8	Louvered	4	8	96 ⁷ / ₈	Surface	96	91.92
97200-8	Louvered	2	8	96 ⁷ / ₈	Surface	62	54.18
97220-8	L. Brightness	2	8	96 ⁷ / ₈	Surface	88	81.90
97495-8	Cleartex Plastic	4	8	96 ⁷ / ₈	Surface	86	99.60

Day-Brite Recessed Mobilex Lighting Fixtures



Mobilex units 24-in wide for two, three and four 4-ft. Rapid-Start lamps.

Designed for flexibility of application, reduced in over-all weight and height. Even with the addition of suspension straps, the minimum overhead clearance required by these fixtures is a mere 5¾-in. Lightweight rigid fixed construction ideally suited for use in new lighter weight suspended ceilings.

Can be mounted singly, end-to-end, side-by-side, or in any combination. Provides unusual versatility in meeting architectural lighting requirements in offices, stores, and institutions.

These units are available with a choice of enclosing elements.

The metal Egg-crate louvers are completely interlocked and supported in rigid die-formed metal frames. Entire assembly is rust-inhibited and finished in Hot-Bonded Super-White enamel, provides 30°-30° shielding.

The new plastic enclosing elements—Cleartex and Daytex—are each an exclusive Day-Brite design, combining beauty of design, low brightness with high transmission, and a significant reduction in weight. Each is rigidly supported in a die-formed metal frame with separable hinges that can be hinged from either side.

Has removable wireway cover for access to control equipment and adequate knockouts for feed in ends and sides. Hot-Bonded Super-White enamel finish, rust-inhibited before painting. Continuous through wiring—locknuts, nipples not required.

High Power Factor certified CBM Rapid-Start ballasts for 118 volts, 60 cycle a-c operation. Individually wired for single unit or continuous installations (through circuit wires not included). Safety fuse is provided to prevent overheating in event of ballast failure.

Approved by Underwriters' Laboratories

Name	No.	No. Lamps	Ft.	Overall Lgth., In.	Type Mounting	Approx. Ship. Wt. Lbs.	Each
Egg-Crate Louvers	4F260-4	2	4	48	Recessed	60	\$50.40
	4G260-4	2	4	48	Recessed	57	45.60
	4F360-4	3	4	48	Recessed	64	59.76
	4G360-4	3	4	48	Recessed	60	54.96
	4F460-4	4	4	48	Recessed	63	62.16
	4G460-4	4	4	48	Recessed	60	58.92
Cleartex Plastic	4F295-4	2	4	48	Recessed	41	46.80
	4G295-4	2	4	48	Recessed	50	42.00
	4F395-4	3	4	48	Recessed	45	56.16
	4G395-4	3	4	48	Recessed	49	51.36
	4F495-4	4	4	48	Recessed	47	58.56
	4G495-4	4	4	48	Recessed	46	53.76
Daytex Plastic	4F299-4	2	4	48	Recessed	43	49.68
	4G299-4	2	4	48	Recessed	49	44.88
	4F399-4	3	4	48	Recessed	47	59.04
	4G399-4	3	4	48	Recessed	50	54.24
	4F499-4	4	4	48	Recessed	49	61.44
	4G499-4	4	4	48	Recessed	..	56.64

Due to space limitations only Flange and Grid Type Mobilex are listed here, but Day-Brite Mobilex for all other ceiling types are available.

Day-Brite Recessed Troffers
12-Inch Wide Shallow Troffers

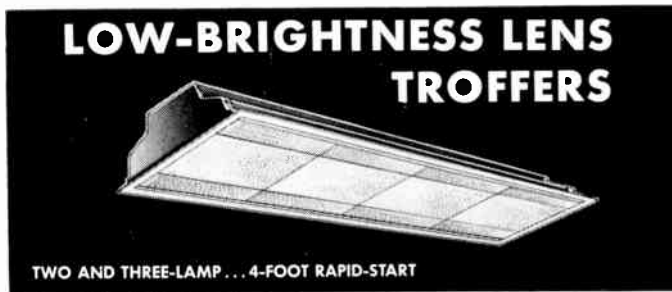

Right with today's trend to Modular planning—reduced in weight, shallower in design, more flexible in application and installation.

Two and three lamp units complete with all mounting accessories required for installation in either flange or grid type ceilings as listed in schedule below.

Die-formed construction throughout for uniformity and stability. Removable wireway cover for access to control equipment. All three enclosing elements illustrated here have die-formed steel frames with separable hinges which can be hinged from either side or completely removed for maintenance. Plenty of knockouts for feed in ends and sides. "No-sag" couplings assure in-line runs. Hot-Bonded Super-White enamel finish, rust inhibited.

HPF Certified CBM Rapid-Start Ballasts for 118 volt, 60 cycle a-c operation. Individually wired for single unit or continuous installations (thru circuit wires not included). Safety fuse provided to prevent overheating in case of ballasts failure.

Approved by Underwriters' Laboratories

Plastic Cleartex enclosing elements are an exclusive Day-Brite design. They provide low-brightness, high transmission and less weight.

White metal Egg-Crate louvers provide 30°-30° shielding.

Low-Brightness Holophane Controlens for super comfort and maximum control of illumination.

Aizak Paralouver Troffers

Exclusive patented Paralouvers for longitudinal shielding (shielding 42°-30°). Surface of each lateral louver is a series of Parabolas which direct light to the working plane. Interlocked louver assembly supported by easy-turn latches. Louvers on chains for service without tools. Diffuse Aizak body. Plenty of knockouts for feed; no-sag couplings.

HPF Certified CBM ballasts for 118 volt, 60 cycle, a-c operation. Individually wired.

Approved by Underwriters' Laboratories

All-White Parabolic Troffers

Die-formed steel construction throughout. Interlocked louver assembly with easy-turn latches and service chains. Shielding, 42°-22°. Entire fixture rust inhibited and finished in Hot-Bonded Super-White enamel HPF certified CBM ballasts. 118 volt, 60 cycle, a-c. Individually wired.

Approved by Underwriters' Laboratories

Name	No.	No. Lamps	Ft.	Overall Lgth., In.	Fixture Depth, In.	Type Mounting	Approx. Shp. Wt. Lbs.	Each
Egg-Crate Louvers	4F210-4	2	1	48	4 7/8	Recessed	36	\$33.48
	4G210-4	2	1	48	4 7/8	Recessed	34	33.48
	4F310-4	3	1	48	4 7/8	Recessed	40	42.84
	4G310-4	3	1	48	4 7/8	Recessed	38	42.84
Low-Brightness	4F230-4	2	1	48	4 7/8	Recessed	38	41.04
	4G230-4	2	1	48	4 7/8	Recessed	34	41.04
	4F330-4	3	1	48	4 7/8	Recessed	43	50.40
	4G330-4	3	1	48	4 7/8	Recessed	37	50.40
Plastic Cleartex	4F240-4	2	1	48	4 7/8	Recessed	30	31.68
	4G240-4	2	1	48	4 7/8	Recessed	28	31.68
	4F340-4	3	1	48	4 7/8	Recessed	34	41.04
	4G340-4	3	1	48	4 7/8	Recessed	33	41.04
Para-Louver All-White Parabolic	4F200-4	2	1	48	5 7/8	Recessed	28	44.76
	4G200-4	2	1	48	5 7/8	Recessed	28	44.76
	4F205-4	2	1	48	5 7/8	Recessed	36	31.08
	4G205-4	2	1	48	5 7/8	Recessed	34	31.08

Due to space limitations, only Flange and Grid Type Troffers are listed here, but Day-Brite Troffers for all other ceiling types are available.

Day-Brite Commercial and Industrial Hangers

Commercial Hangers

Twin-Stem Hangers

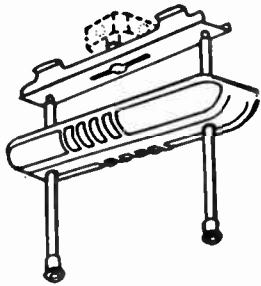

Can be mounted to fixture stud or direct to ceiling. Has slotted arrangement to accept top swivel fittings of hanger stems. No locknuts required for attachment of stems to strap.

Self-centering of two-hole ceiling canopy is assured thru offset knurled canopy rings. Cannot go up off centered.

Bottom stem fittings machine crimped to stems. Threaded for attachment thru top of fixture

channel. Locknut included. Rust-inhibited and finished in lustre aluminum enamel. Complete with all parts including sufficient fixture wire to reach outlet box connection.

No.	Length In.	Carton	Ship. Wt. Lbs.	Each
3328-A	8	1	4	\$3.36
3322-A	12	1	4	3.72
3324-A	24	1	5	4.08

"A-J" Adjustable Single Stem Hangers

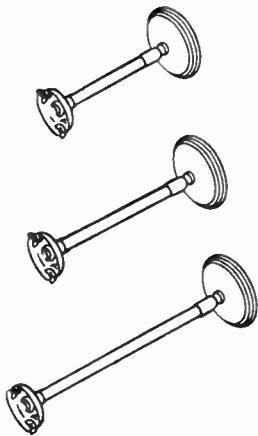

For 8-ft. single units and continuous installations. Provide over one inch vertical adjustment through externally hand operated fittings. All hangers have swivel fittings and all parts necessary for complete installation. Hot-Bonded lustre aluminum finish.

Packed two per carton.

No.	Length In.	Ship. Wt. Lbs.	Each
3318-A	8	3	\$1.86
3312-A	12	4	2.04
3314-A	24	4	2.22

Sliding Clamp



Replaces bottom fitting on "A-J" stem hangers. Sliding action allows positioning of hangers at any location along top of fixture channel when overhead obstructions do not permit standard hanger spacings.

Can be used with fixtures that are provided with acceptable channel formations.

Packed 10 per carton. Approx. wt. 1/2-lb.

No. 3425-A..... Each \$0.60

Industrial Hangers

Hydee Hanger

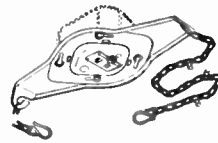

One-piece steel stamping construction provides receptacle support switch K. O. and all necessary mounting holes for 4-in. and 3 1/4-in. outlet box or plaster ring. Slots 4-in. box attachment allow 15° adjustment. More than adequate support. Self-grounding. Hanger plate

is finished in baked lustre aluminum enamel. "S" hooks and cord clips in rustproof finish. Easy and speedy to install. Simplifies fixture maintenance, in case of trouble the entire fixture can be easily and quickly removed. . . a replacement installed . . . and the defective unit repaired at leisure. Approved by Underwriters' Laboratories.

Approx. ship. wt. 15 lbs.

No. 9988 Hydee Hanger complete..... Each \$1.38

"A-J" Hangers

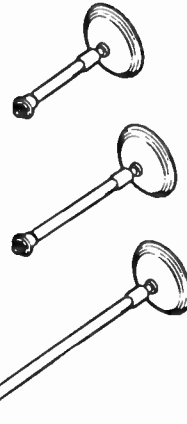

For 8-ft. single units and continuous installations. Provide over one inch vertical adjustment through externally hand operated fittings. All hangers have swivel fittings. Hot-Bonded lustre aluminum finish.

Fit 1/2-in. pipe K. O.

Approx. ship. wt. 2 lbs.

No.	Length In.	Each
7908-E	7 1/4	\$1.80
7912-E	11 1/4	1.98
7924-E	23 1/4	2.16

Ice Tong Hanger



Can be placed anywhere along channel for rod and pipe hangers. Approx. ship wt. 1/2 lb.

No.	Description	Each
9952-A	For 3/8-in. Rod or Mtg. Screws	\$0.72
9952-B	For 1/2-in. Conduit Pipe Hangers	.72
9952-C	For 3/8-in. Iron Pipe Hangers	.72

Cable Clamp



For use with messenger cable. Fits 1/2-in. pipe K. O. in top of channel. Approx. ship. wt. 1/2 lb.

No. 9953..... Each \$0.96

Chains with "S" Hooks



One pair 5-ft. long with "S" hooks. Approx. ship. wt. 1 lb.

No. 9963..... Pair \$0.84

Wakefield Luminaires

Grenadier

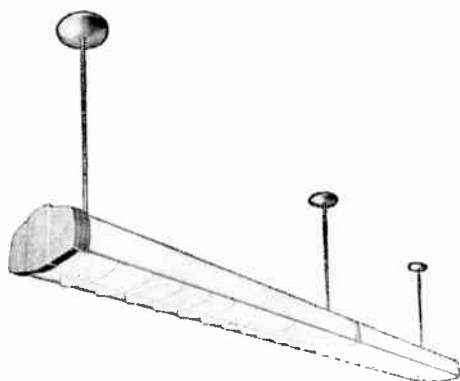

The Grenadier II is a louvered unit with metal-framed translucent white plastic side panels, equipped for use with either two 40-watt fluorescent lamps in each 4-ft. section or two Slimline lamps in each 8-ft. section. Available in three types: Stem, Canopy and On-Ceiling models. Units are interconnectable with standard parts.

The Grenadier IV is equipped for use with either four 40-watt fluorescent lamps in each 4-ft. section or four Slimline lamps in each 8-ft. section. Available in two styles, the Stem and On-Ceiling.

Grenadier II and IV are matched in design and may be used harmoniously in adjacent installations.

No.	No. of Lamps	Body Depth In.	Description	Std. Pkd. Wt. Lbs.	Std. Unpkd. Wt. Lbs.	Pkg. Quan.	Each
GRR-214-B	2-40W R.S.	5	Basic Unit Body w/ louvers and metal framed plastic side panels, rapid start ballast, end caps.....	43½	34½	2	\$30.58
GRR-214-E	2-40W R.S.	5	Extension Unit body w/ louvers and metal framed plastic side panels, rapid start ballast.....	41	32	2	28.07
GRR-218-BT	4-10W R.S.	5	Basic Unit 8' body w/ louvers and metal framed plastic side panels, 8' one-piece channel, 2 lamps in line w/ rapid start ballast, end caps.....	44½	34½	1	57.50
GRR-218-ET	4-10W R.S.	5	Extension Unit 8' body w/ louvers and metal framed plastic side panels, 8' one-piece channel, 2 lamps in line w/ rapid start ballast.....	42	32	1	54.99
GRS-214-B	2-38W Slimline	5	Basic Unit 4' body w/ louvers and metal framed plastic side panels, end caps.....	50½	44½	2	34.58
GRS-214-E	2-38W Slimline	5	Extension Unit 4' body w/ louvers and metal framed plastic side panels.....	48	42	2	32.07
GRS-218-B	2-74W Slimline	5	Basic Unit 8' body w/ louvers and metal framed plastic side panels w/ 8' one-piece channel, end caps.....	44½	34½	1	52.67
GRS-218-E	2-74W Slimline	5	Extension Unit 8' body w/ louvers and metal framed plastic side panels 1/ 8' one-piece channel.....	42	32	1	50.16
GRR-414-B	4-10W R.S.	5½	Basic Unit Body w/ louvers and metal framed plastic side panels, w/ rapid start ballast, end caps.....	31	23	1	51.75
GRR-414-E	4-10W R.S.	5½	Extension Unit Body w/ louvers and metal framed plastic side panels, w/ rapid start ballast.....	31	20	1	48.83
GRS-414-B	4-38W Slimline	5½	Basic Unit 4' body w/ louvers and metal framed plastic side panels, end caps.....	44	35	1	61.16
GRS-414-E	4-38W Slimline	5½	Extension Unit 4' body w/ louvers and metal framed plastic side panels.....	41	32	1	58.24
GRS-418-B	4-74W Slimline	5½	Basic Unit 8' body w/ louvers and metal framed plastic side panels (two 4' channels), end caps.....	72	52	1	91.40
GRS-418-E	4-74W Slimline	5½	Extension Unit 8' body w/ louvers and metal framed plastic side panels (two 4' channels).....	69	49	1	88.48
GRR-414-W†	4-10W R.S.	5½	Body, for individual mounting, w/ louvers and metal framed plastic side panels w/ rapid start ballast, end caps.....	32	21	1	49.91
41		1	On ceiling outlet box cover assembly.....	¾	½	*	0.53
43		4	Ceiling unit canopy assembly.....	2	2	1	1.92
34		6	Single stem and canopy assembly.....	1	¾	*	1.25
			With 35° swivel.....	1	¾	*	2.77
44		20	Single stem and canopy assembly.....	1¼	1	1	1.71
			With 35° swivel.....	1¼	1	1	3.17
12		20	Double stem and canopy assembly.....	3¼	2	1	3.59

Accessories for Grenadier II

29			Set of 2 solid top plate reflectors.....	2½	2	*	2.41
30			Set of 2 slotted top plate reflectors.....	2½	2	*	2.59

Accessories for Grenadier IV

49			Set of 2 solid top plate reflectors.....	3½	3	*	3.67
50			Set of 2 slotted top plate reflectors.....	3½	3	*	3.84

Extra lengthening per inch, per stem..... .05

*Direct shipment packaging.

†Indicates for single unit mounting only. Accessories for GRR-414-W are Nos. 12, 41, 49 and 50.

Wakefield Luminaires

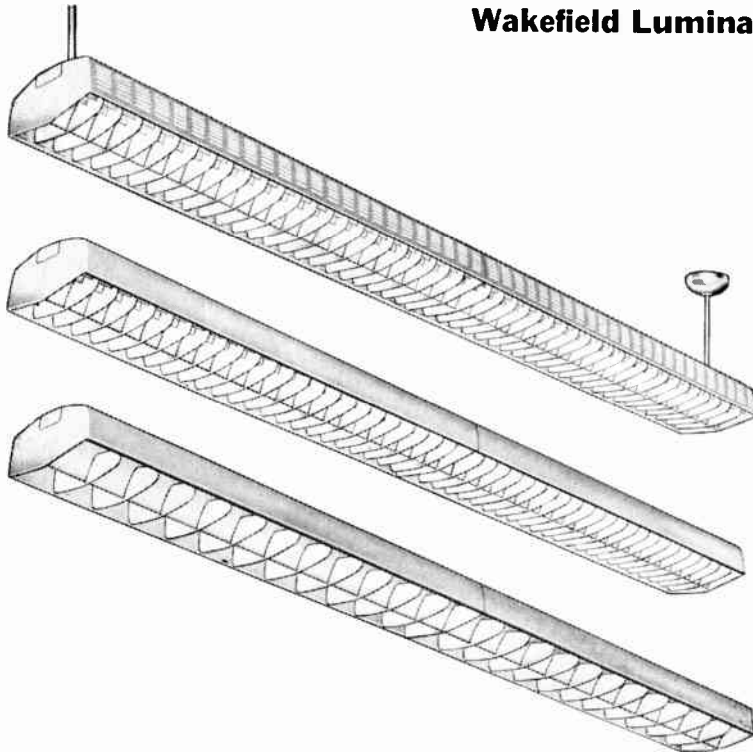

Pacemaker

The Pacemaker is a good example of how modern engineering and quality construction can be achieved at a moderate price. The heavy gauge steel construction, the excellent craftsmanship, the precision fitting of louvers and other parts make it outstanding in its price class. Its clean, simple, uncluttered design, its pure white infra-red baked enamel finish over a rust-preventive undercoating recommend it for schools, offices, drafting rooms, stores, restaurants and many other areas where a fine but low priced luminaire is desired.

There are three models as illustrated: with slotted side panels and 45° x 45° shielding; with solid side panels and 45° x 45° shielding; and with solid side panels and 25° x 35° shielding. Three mountings also: 6-in. stem, 20-in. stem and on-ceiling. Available in 8-ft. or 4-ft. lengths for continuous runs or as single units, for Rapid Start and Slimline lamps.

With Illuminated Steel Sides, 45° x 45° Shielding

No.	No. of Lamps	Body Depth In.	Description	Std. Pkd. Wt. Lbs.	Std. Unpkd. Wt. Lbs.	Pkg. Quan.	Each
PMR-214-HM	2-40W R.S.	5	Complete body with louvers for single or continuous mounting with rapid start ballast.	50	44	2	\$25.83
PMR-218-IIHT	4-40W R.S.	5	Complete 8-ft. channel with louvers for single or continuous mounting, 2 lamps in line with rapid start ballast.	48	41	2	50.65
PMS-214-IIH	2-38W Slimline	5	Complete 4-ft. body with louvers, for single or continuous mounting.	58	52	2	28.91
PMS-218-IH	2-74W Slimline	5	Complete 8-ft. channel with louvers, for single or continuous mounting.	50	43	1	46.66
With White Enamel Steel Sides, 45° x 45° Shielding							
PMR-214-II	2-40W R.S.	5	Complete body with louvers for single or continuous mounting with rapid start ballast.	50	44	2	25.25
PMR-218-IIT	4-40W R.S.	5	Complete 8-ft. channel with louvers for single or continuous mounting, 2 lamps in line with rapid start ballast.	48	41	2	49.49
PMS-214-II	2-38W Slimline	5	Complete 4-ft. body with louvers, for single or continuous mounting.	58	52	2	28.33
PMS-218-II	2-74W Slimline	5	Complete 8-ft. channel with louvers, for single or continuous mounting.	50	43	1	45.50
With White Enamel Steel sides, 35° Cross x 25° Lengthwise Shielding							
PMR-214	2-40W R.S.	5	Complete body with louvers for single or continuous mounting with rapid start ballast.	43	37	2	21.26
PMR-218-T	4-40W R.S.	5	Complete 8-ft. channel with louvers for single or continuous mounting, 2 lamps in line with rapid start ballast.	41	34	2	41.66
PMS-214	2-38W Slimline	5	Complete 4-ft. body with louvers, for single or continuous mounting.	51	45	2	24.41
PMS-218	2-74W Slimline	5	Complete 8-ft. channel with louvers, for single or continuous mounting.	43	36	1	37.66
Accessories For The Pacemaker							
34		6	Single stem and canopy assembly.	1	1	*	1.25
41		1	With 35° swivel.	1	1	*	2.77
44		20	On ceiling outlet box cover assembly.	3/4	1/2	*	.53
17			Single stem and canopy assembly.	1	1	*	1.71
12		20	With 35° swivel.	1	1	*	3.17
			Set of 2 end caps for Pacemaker.				.25
			Double stem and canopy assembly.	3 1/4	2	*	3.59
							.05
							.33

Extra lengthening per inch, per stem.

Extra for Single Pack.

*Direct Shipment Packaging.

Wakefield Luminaires

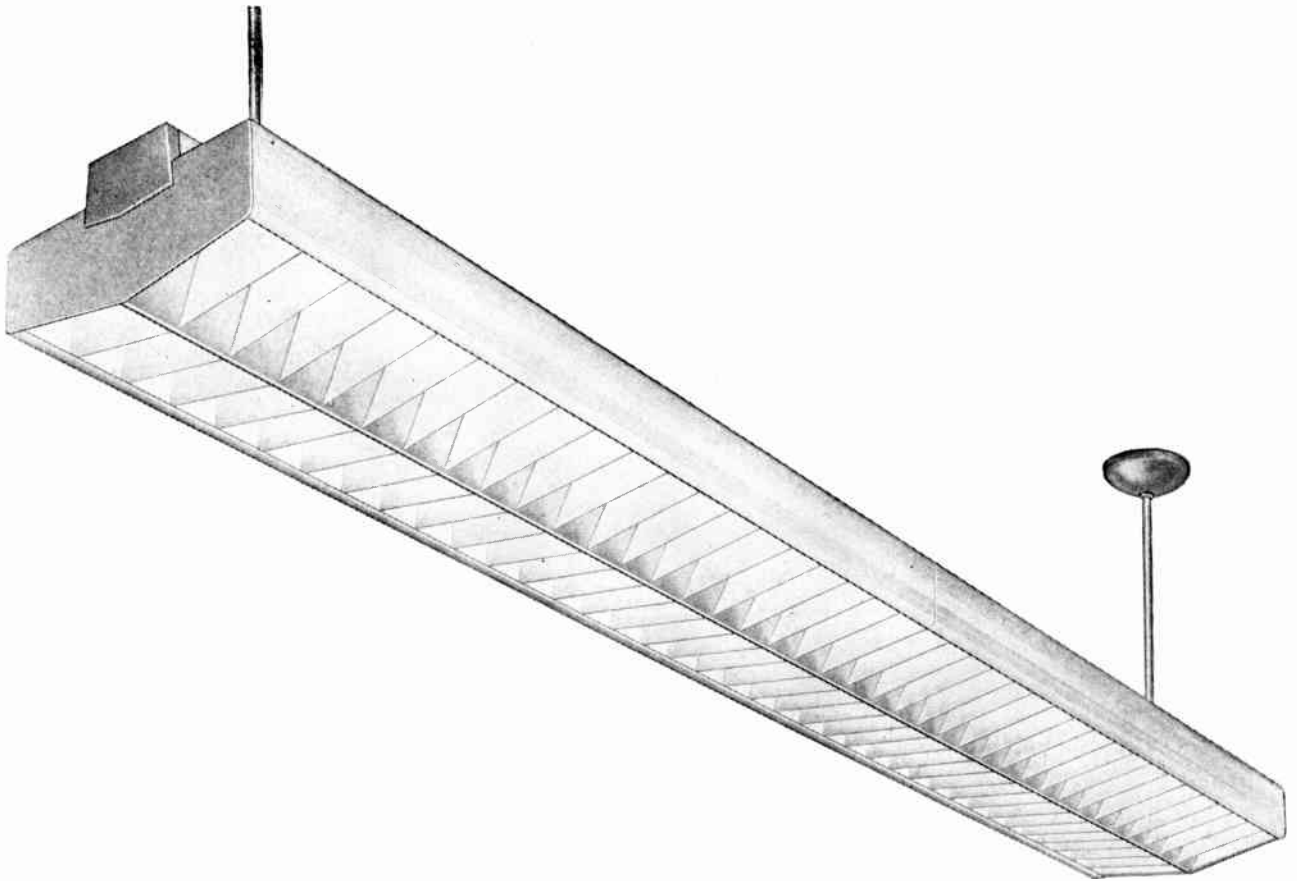

The Cavalier

A deluxe suspended luminaire with full length, unframed luminous plastic side panels supported internally by a steel frame. The steel frame is also the internal reflector, keeping side-panel brightness a pleasant 100 footlamberts.

Important feature is a sliding stem plate concealed in the top of the channel which can be moved to support the lu-

minaire at any point, eliminating problems of inline spacing of mounting points. If mounting hole or outlet box doesn't line up with the luminaire, adjustable ceiling straps line it up for you, providing up to 1-in. adjustment.

Special low brightness finish on louvers, side reflectors and channels. Louvers give 45° x 45° shielding. Rapid Start or Slimline lamps. Light distribution about half up, half down.

No.	No. of Lamps	Body Depth In.	Description	Std. Pkd. Wt. Lbs.	Std. Unpkd. Wt. Lbs.	Pkg. Quan.	Each
CA-248-B	2-40W Rapid Start	6 7/8	Complete body with louvers and end caps.	32	25	1	\$36.16
CA-248-B-4	4-40W Rapid Start	6 7/8	Complete body with louvers, end caps, and 8-in. channel, two in line.	63	58	1	72.65
CA-296-B	2-74W Slimline	6 7/8	Complete body with louvers, end caps, and 8-in. channel.	63	50	1	66.82
22		20	Double Stem and Canopy Assembly.	3 1/4	2	1	4.67
74		6	Single Stem and Canopy Assembly. With 35° Swivel.	1	3/4	1	1.67
84		20	Single Stem and Canopy Assembly. With 35° Swivel.	1 1/4	1	1	2.08
							3.51
							.05
							2.51

Extra lengthening, per inch, per stem.

Extra charge for sim. to CA-248-B except with Slimline ballast.

Wakefield Troffers

The new Wakefield Troffer is a standard packaged unit that offers many combinations. The overall depth of unit is 4 7/8-in. The body is one piece and is the standard Wakefield 20-gauge construction. All units are available for flange, snap-in and lay-in types of ceilings. Modular units do not grow in length when units are used in continuous rows. Seven

types of light control: No. 70 Corning low brightness lens—acrylic and styrene diffusing plastics—vinyl plastic—styrene lens—35 x 35 degree louvers and Alba-Lite diffusing glass.

For Troffer with 277 Volt Ballast (BV) add suffix letter "D" to catalog number.

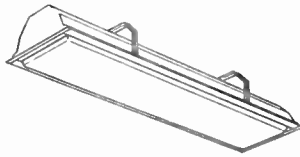

1-Ft. x 4-Ft.

No.	Troffers 1-ft. x 4-ft.						Styrene Lens	Alba-Lite No. 93
	.060 Styrene	35° x 35° Louver	#70 Corning	Acrylic	.020 Vinyl			
TRR-21451-B	\$34.99	\$31.66	\$38.32	\$40.50	\$29.99	\$33.33	\$34.32	
TRR-21451-E	34.50	31.17	37.83	39.99	29.50	32.83	33.83	
		Two Lamp, Rapid Start						
		Two Lamp, Slimline						
TRS-21451-B	38.32	34.99	41.83	43.99	33.33	36.66	37.83	
TRS-21451-E	37.83	34.50	41.32	43.50	32.83	36.16	37.32	

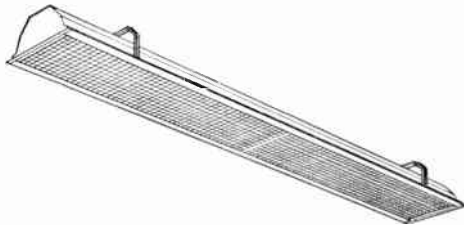

1-Ft. x 8-Ft.

No.	Troffers 1-ft. x 8-ft.						Styrene Lens	Alba-Lite No. 93
	.060 Styrene	35° x 35° Louver	#70 Corning	Acrylic	.020 Vinyl			
		Troffers 1-ft. x 8-ft.						
		Two Lamp, Rapid Start						
TRR-21851-BT	61.82	58.49	68.82	73.16	51.83	58.49	60.65	
TRR-21851-ET	61.32	57.99	68.32	72.65	51.32	57.99	60.16	
		Two Lamp, Slimline						
TRS-21851-B	65.32	58.65	72.16	76.65	55.32	61.98	64.16	
TRS-21851-E	64.82	58.16	71.65	76.15	54.83	61.48	63.65	

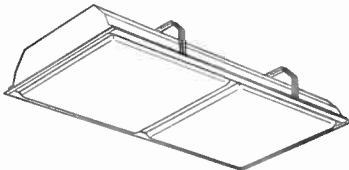

2-Ft. x 4-Ft.

No.	Troffers 2-ft. x 4-ft.						Styrene Lens	Alba-Lite No. 93
	.060 Styrene	35° x 35° Louver	#70 Corning	Acrylic	.020 Vinyl			
		Troffers 2-ft. x 4-ft.						
		Four Lamp, Rapid Start						
TRR-42451-B	56.65	53.32	66.65	71.65	49.99	56.99	61.16	
TRR-42451-E	55.83	52.49	65.82	70.82	49.16	56.16	60.32	

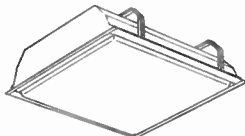

2-Ft. x 2-Ft.

No.	Troffers 2-ft. x 2-ft.						Styrene Lens	Alba-Lite No. 93
	.060 Styrene	35° x 35° Louver	#70 Corning	Acrylic	.020 Vinyl			
		Troffers 2-ft. x 2-ft.						
		Four Lamp						
TRT-42251-B	54.99	51.65	64.98	69.98	48.32	55.32	55.57	
TRT-42251-E	54.57	51.24	64.57	69.57	47.91	54.91	55.16	

Note: Flange Troffers listed above are for use with acoustical ceilings using concealed mechanical suspension, yokes included in carton and price, but packed in separate carton.

Change last two digits to the following for:

- 52—Flange Troffers for use with suspended plaster ceilings with plaster frames, yokes included in price, but packed in separate carton. To include plaster frame, add letter "S" and costs as shown at right.
- 53—Snap-In Troffers with safety yokes for use with metal pan acoustical ceilings using tee-bar suspension.
- 54—Hook-On Troffers for use with Acousti-Line and structural Acousti-Line ceilings, when mounted at right angles to Acousti-Line panels.
- 55—Grid Troffers or Lay-In Troffers for use with acoustical ceilings using exposed grid suspension. Use basic unit price above and deduct \$3.00 for Troffer sizes 1-ft. x 4-ft. and 1-ft. x 8-ft. Deduct \$4.17 for sizes 2-ft. x 4-ft. and 2-ft. x 2-ft.
- 57—Hook-On Troffers for use with Acousti-Line and Structural Acousti-Line Ceilings when mounted parallel to Structural Acousti-Line and Acousti-Line panels.

Plaster Frames for "52"

No.	Troffer Size, Ft.	Each
TR-14-B	1 x 4	\$4.00
TR-14-E	1 x 4	3.17
TR-18-B	1 x 8	7.08
TR-18-E	1 x 8	6.17
TR-24-B	2 x 4	4.84
TR-24-E	2 x 4	3.67
TR-22-B	2 x 2	3.59
TR-22-E	2 x 2	2.41

Troffer with 277 Volt Ballast (D)

Type	Troffer Size, Ft.	Each
Rapid Start	1 x 4	\$0.75
	1 x 8, 2 x 4	1.51
Slimline	1 x 4	.75
	1 x 8	.75
Trigger Start	2 x 2	2.84

Troffer Approximate Weight, Packed

	Louver or Glass	Plastic
2' x 2'	35	30
1' x 8'	38	33

Wakefield Luminaires

Geometrics—OMEGA—On-Surface Type

A complete unit ready for on-surface mounting on existing ceilings with no required structural changes. The ballasts and lampholders are in an individual metal housing that provides hook-on suspension points for the Wakefield Rigid-Arch diffuser.

The Rigid-Arch diffuser is molded with a sweeping arch, slightly higher in the center than at the edges to give greatly improved rigidity. It has a non-specular, matt finish that minimizes possible reflected glare from outside the building. Omega is also available with louvers.

Units may be used individually or combined in an unlimited variety of lighting designs. Width dimensions are to the exact inch module for precise co-ordination of various Omega sizes and with other building materials.

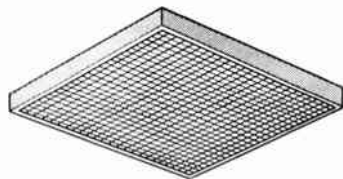
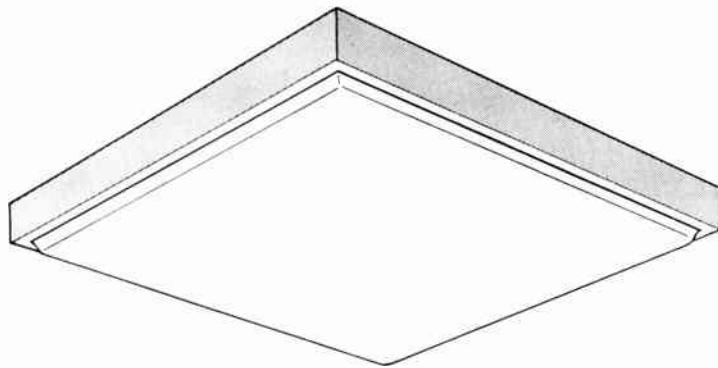

4-Ft. x 4-Ft.



1-Ft. x 4-Ft.

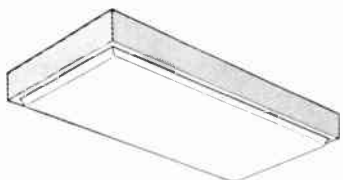

2-Ft. x 4-Ft.

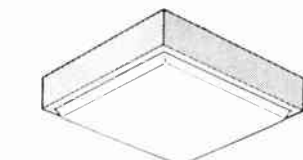

2-Ft. x 2-Ft.

4-ft. x 4-ft.

No.	No. of Lamps	Description	Std. Pkd. Wt., Lbs.	Std. Unpkd. Wt., Lbs.	Pkg. Quan.	Each
FFL-848-O	8-40W	4-ft. x 4-ft. On-Surface unit with louver and Rapid Start ballast for 48-in. Rapid Start lamps. . .	107	95	1	\$147.96
FF-648-O	6-40W	4-ft. x 4-ft. On-Surface unit with Rigid-Arch Diffuser and Rapid Start ballast for 48-in. Rapid Start lamps.	97	87	1	172.62
FFL-648-O	6-40W	Same with louver.	110	98	1	132.63

1-ft. x 4-ft.

OF-248-O	2-40W	1-ft. x 4-ft. On-Surface unit with Rigid-Arch Diffuser and Rapid Start ballast for 48-in. Rapid Start lamps.	31	26	1	46.66
OFL-248-O	2-40W	Same with louver.	34	28	1	39.50

2-ft. x 4-ft.

TF-448-O	4-40W	2-ft. x 4-ft. On-Surface unit with Rigid-Arch Diffuser and Rapid Start ballast for 48-in. Rapid Start lamps.	56	50	1	91.82
TFL-448-O	4-40W	Same with louver.	64	54	1	75.06

2-ft. x 2-ft.

TT-424-O	4-20W	2-ft. x 2-ft. On-Surface unit with Rigid-Arch Diffuser and trigger ballast for 24-in. General Line lamps. LPF Ballasts.	35	25	1	57.73
TTL-424-O	4-20W	Same with louver.	38	30	1	47.99
TT-324-O	3-20W	2-ft. x 2-ft. On-Surface unit with Rigid-Arch Diffuser and trigger ballast for 24-in. General Line lamps. LPF Ballast.	33	27	1	54.65

Wakefield Luminaires

Geometrics—BETA—Recessed Flanged Type

The Beta is a modular flanged unit for mounting in suspended ceilings. It comes with either a Rigid-Arch acrylic plastic diffuser or with 35° x 35° low brightness steel louvers, and uses Rapid Start lamps. Ballasts and lampholders are contained in an individual metal housing. Bodies are equipped with a self-leveling device and are constructed of 20 gauge steel. Infra-red baked white enamel provides an 85% reflectance factor. Flange and diffuser frame are finished in metallic satin. Diffuser frames are designed to eliminate light leaks. Unlighted, the Rigid-Arch plastic diffuser blends with and appears as part of the ceiling. Its matte finish (molded into the diffuser) eliminates reflected glare or brightness from exterior or interior light sources. Its concave arch provides structural strength. Touch-Latch and hinge frame assembly provide ease of maintenance.

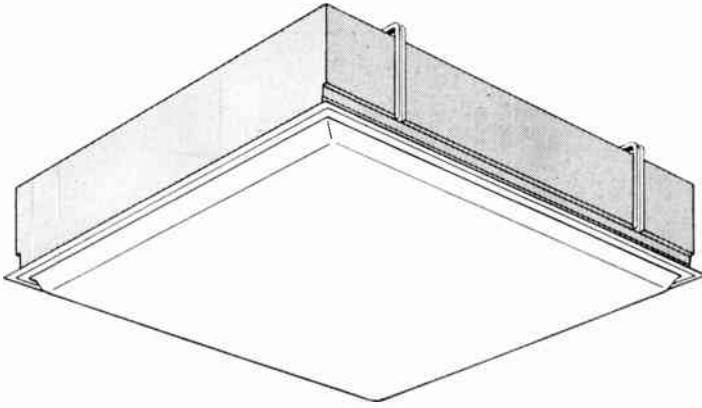

4-ft. x 4-ft. Recessed Unit



4-Ft. x 4-Ft.

No.	No. of Lamps	Description	Wt. Lb.	Pkg. Quan.	Each
FFL-848-I	8-10W	With louver, for 48-in. Rapid Start lamps for individual mounting.....	140	1	\$169.96
FF-648-I	6-10W	With Rigid-Arch Diffuser, for 48-in. Rapid Start lamps for individual mtg.....	113	1	196.62
FFL-648-I	6-10W	Same, with louver.....	135	1	156.63
FFI		Rough Plaster Frame for individual mtg..	10	*	7.25
FFE		Rough Plaster Frame for End unit.....	8	*	6.84
FFM		Rough Plaster Frame for Middle unit....	5½	*	5.51

1-ft. x 4-ft. Recessed Unit with Rigid-Arch Diffuser

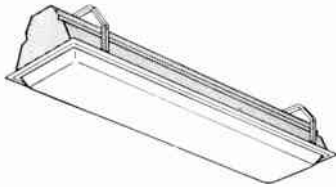

1-Ft. x 4-Ft.

OF-348-I	3-40W	For 48-in. Rapid Start lamps for individual mounting.....	31	1	60.16
OFL-348-I	3-10W	Same with louver.....	34	1	52.91
OF-248-I	2-10W	For 48-in. Rapid Start lamps for individual mounting.....	27	1	46.66
OFL-248-I	2-10W	Same, with louver.....	32	1	39.50
OFI		Rough Plaster Frame for individual mtg..	6	*	4.33
OFE		Rough Plaster Frame for End unit.....	6	*	4.41
OFM		Rough Plaster Frame for Middle unit....	5½	*	3.92

2-ft. x 4-ft. Recessed Unit with Rigid-Arch Diffuser

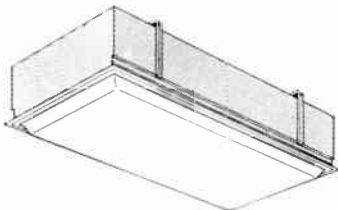

2-Ft. x 4-Ft.

TF-448-I	4-10W	For 48-in. Rapid Start lamps for individual mounting.....	64	1	109.81
TFL-448-I	4-10W	Same, with louver.....	81	1	93.31
TFI		Rough Plaster Frame for individual mtg..	7½	*	5.17
TFE		Rough Plaster Frame for End unit.....	7	*	4.92
TFM		Rough Plaster Frame for Middle unit....	7	*	4.17

2-ft. x 2-ft. Recessed Unit with Rigid-Arch Diffuser and Trigger Ballast

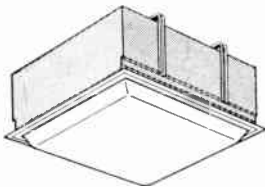

2-Ft. x 2-Ft.

TT-624-I	6-20W	For 24-in. General Line lamps. LPF Ballasts.....	47	1	83.31
TTL-624-I	6-20W	Same, with louver.....	49	1	72.65
TT-424-I	4-20W	For 24-in. General Line lamps. LPF Ballasts.....	44	1	73.73
TTL-424-I	4-20W	Same, with louver.....	41	1	63.16
TT-324-I	3-20W	For 24-in. General Line lamps for individual mounting. LPF Ballasts.....	42	1	70.24
TTI		Rough Plaster Frame for individual mtg... 2-ft. x 2-ft. for individual use only.	4	*	3.41

Suffix "I" identifies fixture designed for individual mounting.

Suffix "E" should be used in place of "I" if fixture is mounted as End unit in continuous mounting.

Suffix "M" should be used in place of "I" if fixture is mounted as Intermediate or Middle unit in continuous mounting.

Extra charge for Slimline ballast per pair of four-foot lamps \$2.51—1.88.

*Direct shipment packaging.

Wakefield Magic Ceiling Lighting



You can picture for yourself how easily and inexpensively this classroom was transformed by an 18-ft. x 28-ft. Magic Ceiling.

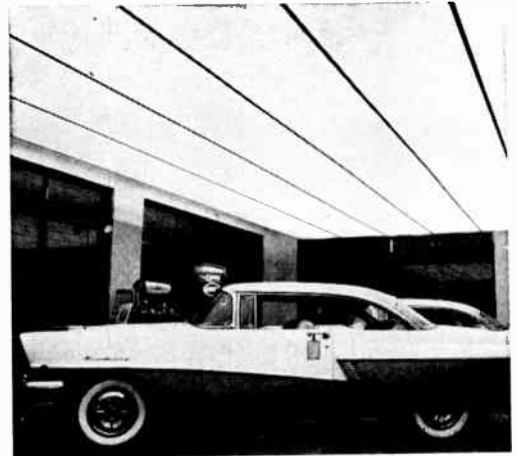

Auto showrooms are a natural for Magic Ceiling. Cars look their best under large area lighting. An 18-ft. x 24-ft. Magic Ceiling used here.



Two 18-ft. x 24-ft. Magic Ceilings give this restaurant a happy look. Heating and cooling grills are in walls above the ceiling.



You should have seen the old unsightly ceiling of this store before two 24-ft. x 28-ft. Magic Ceilings glamorized and transformed it.

The Magic Ceiling comes in 11 stock sizes which alone or in combination will fit practically any area without having to be attached to the side walls. Simply measure the room, order the proper size and the Magic Ceiling comes to the job as a complete package—straps, channels, grid Wakon diffuser, lamps.

Installation is quick and simple, no attaching to side walls,

perimeter obstacles like ducts, ventilators, etc., may be by-passed. No complicated computations; no ceiling construction work; no dirt, no plaster, no sawdust. Conceals everything above it—pipes, beams, ventilating ducts, sprinkler heads.

Gives shadow-free illumination throughout, transforms old dull interiors into new glamorous interiors.

Standard Sizes—18-in. Suspension

No.	Nominal Size FL	No. of 40W RS Lamps	Designed* for (FL-C)	No. of Cartons	Wt. Lbs.	Each
68-10	6 x 8	10	50	3	125	\$ 153.30
98-14	9 x 8	14	50	4	174	218.28
912-15	9 x 12	15	50	6	221	289.93
1216-20	12 x 16	20	50	8	296	374.91
1516-24	15 x 16	24	50	8	334	449.89
1820-25	18 x 20	25	50	10	397	583.19
1824-30	18 x 24	30	50	11	460	654.84
1828-35	18 x 28	35	50	15	550	791.47
1832-40	18 x 32	40	50	16	598	859.79
2424-42	24 x 24	42	50	14	635	884.78
2428-49	24 x 28	49	50	19	707	1069.73

Extra Magic Ceiling channels and channel clamps, 4-ft. Rapid Start (1 lamp) 14.41
8-ft. Rapid Start (2 lamps) 17.50

*Actually footcandles will be considerably higher if installed on reasonably white ceiling and floats free a few inches up to two feet from light side walls. Make sure bare lamps are not visible from all possible viewing angles (e.g. through clear glass partitions, partial partitions, etc.)

Smithcraft Commercial Fluorescent Lighting Fixtures

The Freeway

Plastic-Enclosed Luminaire



Clean, modern, plastic-enclosed luminaire for corridor-lighting in office buildings, schools, and other institutions, airports and rail and bus terminals.

Simple and modern, the Freeway is architecturally very pleasing lighting for corridors or for long narrow areas. Dark corridors and passageways are transformed into pleasantly lighted, comfortable areas with good lighting on walls, ceilings, and floors.

Shielding is a one-piece extruded polystyrene section with high impact strength, break resistance and light stability after prolonged use. It simply snaps in and out of place. Because unit is completely enclosed, maintenance is reduced to a minimum.

Installation, individually or in continuous rows is very simple. Knockouts in the end of each housing are provided for continuous wiring. Fixture end caps fasten together so that straight continuous rows are assured.

The Freeway is generally surface-mounted, but may be pendent-mounted with the SS102 or SS105 Stem Sets.

For Rapid-Start Bi-Pin Lamps

No.	No. of Lamps	Type Lamps	Shlp. Wt., Lbs.	Each
FRE1-40	1	F40T12RS	16	\$32.50
FRE1-42	2	F40T12RS	26	44.88

Note: Packed one complete unit to a carton.

Canopy and Stem Sets

No.	Description	Each
SS102	Canopy, single 15-in. steel stem (o.d. 1/2-in.), heavy canopy bar, fittings. Stem is adjustable after installation.....	\$2.36
SS105	Canopy, two 30-in. steel stems (o.d. 1/16-in.—8-in. on centers). Plate insert with screws. Size of canopy 13 1/2 x 6 1/4-in.....	5.86

The Federal

Louvered Unit with Steel or Plastic Sides

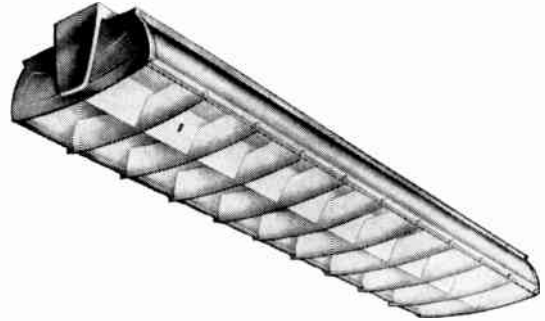

A very economical dependable 2-light louvered fixture of steel construction available with steel or plastic side reflectors for schools, stores, offices and similar installations. Steel parts are finished in Supercoat Baked Enamel. Federal may be mounted individually or in continuous rows, surface or pendent. Rigid louver provides shielding of 35° crosswise and 25° lengthwise. If desired, louvers providing additional shielding of 35° crosswise and 45° lengthwise or additional shielding of 45° crosswise and 45° lengthwise may be supplied at additional cost. Louver is released by simple finger action for re-lamping and cleaning and is suspended by chain at a convenient working distance from fixture. Or louver may be completely removed easily and quickly. Side reflectors are easily removed for cleaning.

For Rapid-Start Bi-Pin Lamps

No.	No. of Lamps	Type Lamps	Shlp. Wt., Lbs.	Each
Steel Reflectors				
FED2-40RS	2	F40T12RS	25	\$36.28
FED2-42RS	4	F40T12RS	48	72.56
(8-ft. Housing)				
Plastic Reflectors				
FED2-40PRS	2	F40T12RS	24	37.58
FED2-42PRS	4	F40T12RS	43	75.16
(8-ft. Housing)				

Available with 800-MA Rapid-Start for 8-ft. lamps.

For Slimline Lamps (430-MA)

No.	No. of Lamps	Type Lamps	Shlp. Wt., Lbs.	Each
Steel Reflectors				
FED2-96	2	F96T12	48	\$67.48
FED2-48	2	F48T12	26	43.80
Plastic Reflectors				
FED2-96P	2	F96T12	41	70.08
FED2-48P	2	F48T12	24	45.10

Packed one complete unit to a carton. For continuous row mounting, specify number and length of rows; necessary end caps and connectors will be supplied no charge.

Additional Cost for Shielding of 35° Crosswise, 45° Lengthwise

Specify on order when 35° crosswise, 45° lengthwise shielding is desired.

Add to price of 4-ft. fixture.....	Each \$3.26
Add to price of 8-ft. fixture.....	6.50

Additional Cost for Shielding of 45° Crosswise, 45° Lengthwise

Specify on order when 45° crosswise, 45° lengthwise shielding is desired.

Add to price of 4-ft. fixture.....	Each \$4.56
Add to price of 8-ft. fixture.....	9.10

Hanging accessories are exactly the same as those shown for the Eye-Q in the left-hand column.

Smithcraft Commercial Fluorescent Lighting Fixtures

The Civic
Aluminum-Framed Unit

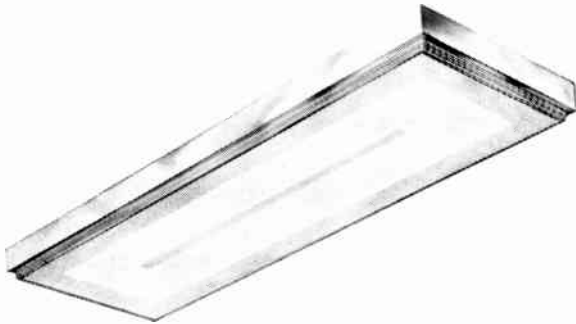

An attractive aluminum-framed unit providing a permanent luxury-look. Absolutely clean and architectural, it is an ideal lighting unit for executive offices, directors' rooms, reception rooms, governmental and institutional installations of all types.

Maintenance on this unit is simple. The shielding is contained in the frame, which is also the sides and ends of the unit. Unit is opened by a swinging, hinging action without tools or loose parts; relamping is easily accomplished, and access to the ballast and electrical components is provided.

The Civic is generally surface mounted and has a completely closed top for 100% downlighting. However, it may be pendent mounted, using the SS102 Stem Set. It may be also mounted in continuous rows with connector provided.

Shielding media available are Corning Pattern No. 70 glass and Acrylic Plastic sand-blasted with a modern architectural pattern.

For Rapid-Start Bi-Pin Lamps

No.	No. of Lamps	Type Lamps	Shp. Wt., Lbs.	Each
With Corning Pattern No. 70 Glass				
CVC2-40S	2	F40T12RS	35	\$ 80.62
CVC4-40S	4	F40T12RS	42	101.88
With Acrylic Plastic				
CVC2-40P	2	F40T12RS	30	90.62
CVC4-40P	4	F40T12RS	37	113.00

Note: Packed one complete unit to a carton with all fittings for normal continuous row mounting.

Canopy and Stem Set

Consists of canopy, single 15-in. steel stem (o.d. 1/2-in.), heavy canopy bar, and fittings. Stem is adjustable after installation. For use with 2-light and 4-light units.

No.	Description	Each
SS102	Canopy and Stem Set	\$2.36

The Executive
All-Steel Louvered Unit

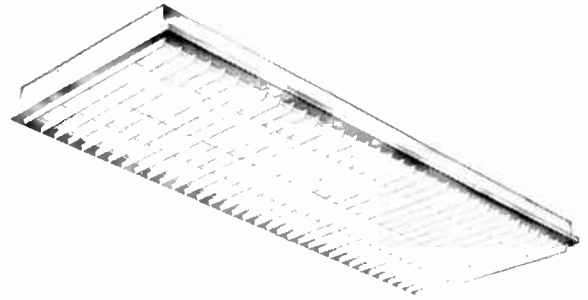

A very shallow, attractive all-steel louvered unit, ideal for use in schools, offices, stores, etc. Particularly suited because of its shallowness for use in today's low-ceilinged schoolrooms and offices.

The metal sides of the unit are illuminated by light from the fixture, reducing contrast. Egg-crate louvers provide a shielding of 30° crosswise and 45° lengthwise. May be purchased with an open top for uplighting or with a top reflector for 100% downlighting.

The unit may be mounted individually or in continuous rows, surface or pendent. The louver is quickly and easily released by gentle fingertip pressure, and replaced by simply placing back in position. When opened, the louver is suspended by chains at a convenient level for relamping and ballasts and electrical components are easily serviced.

For Rapid-Start Bi-Pin Lamps

No.	No. of Lamps	Type Lamps	Shp. Wt., Lbs.	Each
With Open Top For Uplighting				
EX2-40	2	F40T12RS	33	\$ 45.62
EX2-42	4	F40T12RS	58	90.76
(8-ft. Housing)				
EX4-40	4	F40T12RS	45	75.76
EX4-42	8	F40T12RS	78	150.62
(8-ft. Housing)				
With Top Reflectors For All Downlighting				
EX2-40TR	2	F10T12RS	36	47.88
EX2-42TR	4	F40T12RS	64	95.26
(8-ft. Housing)				
EX4-40TR	4	F40T12RS	49	80.62
EX4-42TR	8	F10T12RS	86	160.38
(8-ft. Housing)				

For Slimline Lamps

No.	No. of Lamps	Type Lamps	Shp. Wt., Lbs.	Each
With Open Top For Uplighting				
EX2-96	2	F96T12	61	\$ 82.26
EX2-48	2	F48T12	35	51.26
EX4-96	4	F96T12	85	137.12
EX4-48	4	F48T12	50	88.50
With Top Reflectors For All Downlighting				
EX2-96TR	2	F96T12	67	86.76
EX2-48TR	2	F48T12	38	53.50
EX4-96TR	4	F96T12	93	146.88
EX4-48TR	4	F48T12	54	93.38

Note: Packed one complete unit to a carton with all fittings for normal continuous row mounting.

Smithcraft Commercial Fluorescent Lighting Fixtures

All Steel Louvered Unit

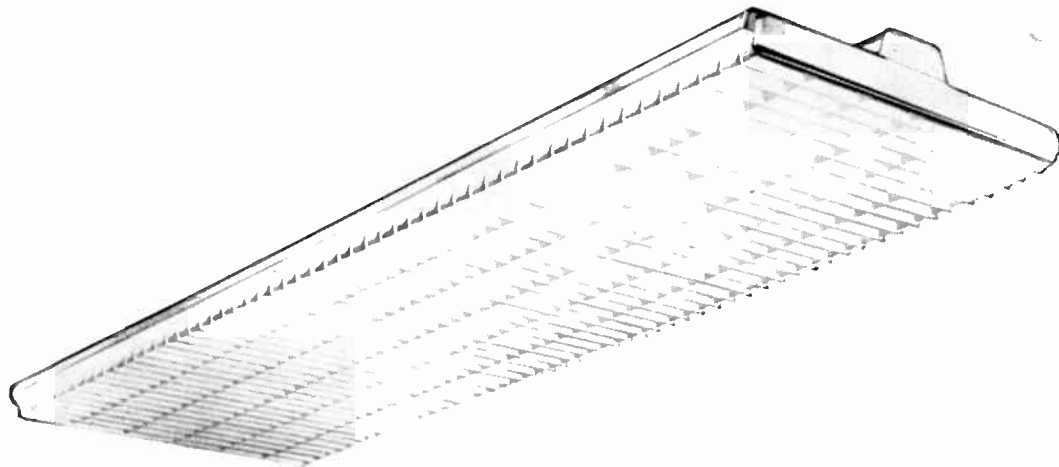

“The Director”

Through its distinctive appearance and outstanding lighting qualities the Director brings many “plus” values wherever it is installed. The Director is an all-steel, louvered unit finished in white Supercoat baked enamel with end sections in aluminum finish. It may be mounted individually or in continuous rows, surface or pendant. Rigid egg-crate louvers, supplied in the same length as the unit provides a shielding of 25° crosswise, and 35° lengthwise. If desired, a deluxe louver may be supplied to provide increased shielding to 40° crosswise; 35° lengthwise. For relamping or other maintenance the louver is released from either end and is “shelf-suspended.” Top reflectors may be supplied to direct all or part of uplighting downwards.

For Rapid-Start Bi-Pin Lamps

No.	No. of Lamps	Type Lamps	Ship. Wt., Lbs.	Each
DIR2-40RS	2	F40T12RS	35	\$ 55.90
DIR3-40RS	3	F40T12RS	42	82.42
DIR4-40RS	4	F40T12RS	51	100.50
DIR6-40RS	6	F40T12RS	69	137.40

Due to ballast interference with knockouts, for surface mounting (DIR6-40) two CC503 clamps will be furnished no charge. For pendant mounting, use SS117 at extra cost as listed below.

Available with 800-MA Rapid-Start for 8-ft. lamps.

DeLuxe Louvers

If desired, the Director may be supplied with a Deluxe louver to provide an increased shielding of 40° crosswise, 35° lengthwise. Add the prices shown below to the cost of the fixture.

No.	For Use With	Each
DL24	2-light 48-in. Director	\$ 4.02
DL28	2-light 96-in. Director	7.16
DL34	3-light 48-in. Director	4.80
DL38	3-light 96-in. Director	8.70
DL44	4-light 48-in. Director	5.60
DL48	4-light 96-in. Director	11.30
DL64	6-light 48-in. Director	7.92
DL68	6-light 96-in. Director	17.04

For Slimline Lamps (430-MA)

No.	No. of Lamps	Type Lamps	Ship. Wt., Lbs.	Each
DIR2-96	2	F96T12	62	\$104.78
DIR2-48	2	F48T12	35	67.20
DIR3-96	3	F96T12	85	152.76
DIR3-48	3	F48T12	46	110.90
DIR4-96	4	F96T12	90	159.66
DIR4-48	4	F48T12	52	115.18
DIR6-96	6	F96T12	131	259.22
DIR6-48	6	F48T12	72	160.80

Because of size limitations, series ballasts only can be furnished for DIR6-48. For surface mounting, (DIR6-48) two CC503 clamps will be furnished, no charge. For pendant mounting, use SS117 at extra cost.

Packed one complete housing to a carton; two louvers to a carton except that louvers for all Director 6-light units and the DIR4-96-430 are packed one louver to a carton. Fittings for normal continuous mounting included.

Hanging Accessories

No.	Description	Each
CC503	Ceiling Clamp for surface mounting.....	\$1.50
SS117	Stem Set. Fixture is inserted and clamps and bolts are tightened. Single 24-in. steel stem (O.D. 11/16-in.).....	4.50
SS110	Stem Set with leveling plate, single 24-in. steel stem (O.D. 11/16-in.).....	4.38

Top Reflectors

Top reflectors may be supplied at additional cost to direct all of the lighting downwards or they may be supplied for partial downlighting.

Prices on application.

Smithcraft Commercial Fluorescent Lighting Fixtures

The Sheraton

Plastic-Sided Steel Louvered Unit

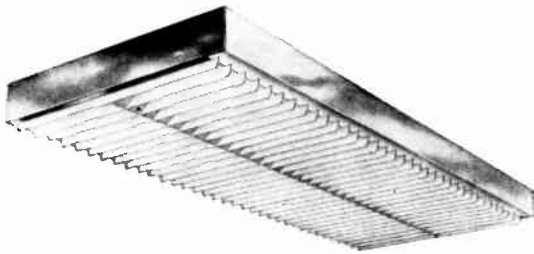

A very shallow (only 3¼-in. deep) louvered unit with translucent plastic sides. The Sheraton provides excellent illumination where low ceilings prevail and is ideally suited for many of today's 9-foot schoolrooms and offices. Sheraton may be mounted individually or in continuous rows, surface or pendent. Louver is quickly and easily released by gentle fingertip pressure and replaced by simply placing back in position. It is suspended by chain at a convenient level for relamping. Louvers provide a shielding of 30° crosswise and 45° lengthwise. Side panels are easily removed for cleaning. Top reflectors for 100% downlighting are available.

For Rapid-Start Bi-Pin Lamps

No.	No. of Lamps	Type Lamps	Shp. Wt., Lbs.	Each
SN2-40RS	2	F40T12RS	31	\$ 46.68
SN2-42RS	4	F40T12RS	62	93.36
(8-ft. Housing)				
SN4-40RS	4	F40T12RS	51	77.60
SN4-42RS	8	F40T12RS	100	155.22
(8-ft. Housing)				

Available with 800-MA Rapid-Start for 8-ft. lamps.

For Slimline Lamps (430-MA)

No.	No. of Lamps	Type Lamps	Shp. Wt., Lbs.	Each
SN2-96	2	F96T12	50	\$ 84.50
SN2-48	2	F48T12	32	53.30
SN4-96	4	F96T12	85	130.90
SN4-48	4	F48T12	53	89.06

Top reflectors are available for additional downlighting.

Prices on request.

Packed one complete unit to a carton with all fittings for normal continuous row mounting.

The Twosome
With 45° x 45° Compound Shielding

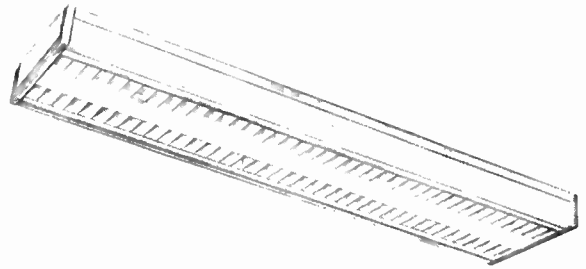

High quality, top value, economical unit, ideal for schools, offices, stores, etc. Has new compound shielding which because of a new design technique, provides 45° x 45° shielding in a very shallow unit (only 3½ in. deep). No. dark center streak. A light spill at end cap reduces contrast.

Bottom shielding is a combination of a strip of extruded polystyrene with white steel baffles on either side. The bottom shielding together with the side shields is a complete assembly which is hinged from either side or easily lifted from the unit.

The unit may be pendent or surface mounted individually or in continuous rows. Top reflectors for 100% downlighting are available.

For Rapid-Start Bi-Pin Lamps

No.	No. of Lamps	Type Lamps	Shp. Wt., Lbs.	Each
TWC2-40	2	F40T12RS	23	\$ 41.12
TWC2-42	4	F40T12RS	43	80.62
(8-ft. Housing)				
TWC4-40	4	F40T12RS	34	65.00
TWC4-42	8	F40T12RS	63	127.88
(8-ft. Housing)				

For Slimline Lamps (430-MA)

No.	No. of Lamps	Type Lamps	Shp. Wt., Lbs.	Each
TWC2-96	2	F96T12	46	75.00
TWC4-96	4	F96T12	67	116.50

Note: The twosome is also available with the following shieldings: Plastic louvers, flanged polystyrene, albalite glass, ribbed Skytex glass and corning pattern No. 70 glass.

Packed one complete unit to a carton with all fittings for normal continuous row mounting.

Smithcraft One-Foot Wide Gridex Troffers

Lay-In Troffers for use in inverted "T" grid type suspended ceilings



Units available in 4-ft. lengths for 2 and 3 lamps and provide flexible recessed lighting that integrates architecturally with any interior design.

Easily installed from below by tilting, inserting in ceiling opening and placing in position on ceiling rails.

Louvers are hinged; other shieldings are contained in hinged door frame.

For Rapid-Start Bi-Pin Lamps

No.	No. of Lamps	Type Lamps	Shp. Wt., Lbs.	Each
Steel Louvers—40°x40° Shielding				
GXL2-40	2	F40T12/RS	37	\$51.12
GXL3-40	4	F40T12/RS	42	69.38
Ribbed Glass Shielding				
GXR2-40	2	F40T12/RS	40	51.88
GXR3-40	3	F40T12/RS	44	71.26
Albalite "66" Glass Shielding				
GXA2-40	2	F40T12/RS	40	54.38
GXA3-40	3	F40T12/RS	44	72.50
Pattern No. 70 Shielding				
GXS2-40	2	F40T12/RS	40	62.50
GXS3-40	3	F40T12/RS	44	82.12
Plastic Lucite Refractors				
GXP2-40	3	F40T12/RS	38	66.26
GXP3-40	3	F40T12/RS	41	84.12
Holophane Controlens®				
No. 6014 Plastic Lucite Lens				
GXHP2-40	2	F40T12/RS	38	77.38
GXHP3-40	3	F40T12/RS	41	96.76

Smithcraft Troffers

Metro Troffers

For Use with Inverted "T" Grid Type Suspended Ceilings

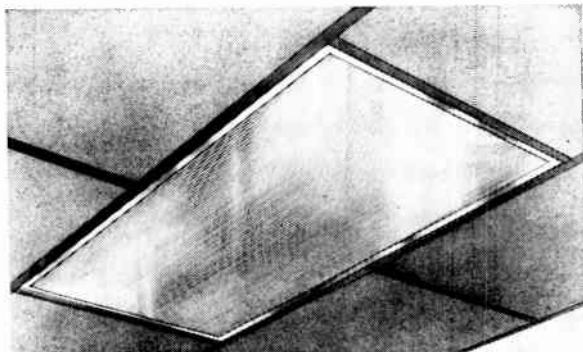

Smithcraft 2-ft. wide Metro troffers have been designed specifically for use with inverted "T" grid type suspended ceilings consisting of interlocked tees spaced 21-in. by 24-in., or 24-in. by 48-in.

Units are easily installed from below by tilting and placing in position or by squeezing the sides of the troffer to clear the ceiling rails, and the troffer is then locked in place.

Doors in door-framed units are instantly and positively contact-closed and instantly released without buttons, screws or other visible catches.

For Rapid-Start Bi-Pin Lamps
Steel Louvers

Providing 30° x 30° Shielding
2-ft. Wide x 4-ft. Long Troffers

No.	No. of Lamps	Type Lamps	Ship. Wt., Lbs.	Each
MET2-40L	2	F40T12/RS	55	\$ 70.98
MET3-40L	3	F40T12/RS	59	86.52
MET4-40L	4	F40T12/RS	60	91.26

Plastic Louvers in Hinged Door Frame

Providing 42° x 42° Shielding
2-ft. Wide x 4-ft. Long Troffers

MET2-40PL	2	F40T12/RS	38	87.62
MET3-40PL	3	F40T12/RS	43	106.06
MET4-40PL	4	F40T12/RS	45	108.16

Ribbed Glass

2-ft. Wide x 4-ft. Long Troffers

MET2-40R	2	F40T12/RS	50	72.62
MET3-40R	3	F40T12/RS	55	89.10
MET4-40R	4	F40T12/RS	62	93.42

Albalite Glass Shielding

2-ft. Wide x 4-ft. Long Troffers

MET2-40A	2	F40T12/RS	50	77.40
MET3-40A	3	F40T12/RS	55	83.78
MET4-40A	4	F40T12/RS	62	98.22

Corning Pattern No. 70 Glass Shielding

2-ft. Wide x 4-ft. Long Troffers

MET2-40S	2	F40T12/RS	50	96.68
MET3-40S	3	F40T12/RS	55	113.30
MET4-40S	4	F40T12/RS	62	116.68

Polystyrene Plastic Dish Shielding

2-ft. Wide x 4-ft. Long Troffers

MET2-40P	2	F40T12/RS	38	83.40
MET3-40P	3	F40T12/RS	43	101.28
MET4-40P	4	F40T12/RS	50	104.38

All 2-ft. wide troffers listed above are also available in 2-ft. long units.

Prices on application.

Templex Troffers

With Attached Hangers for Ceilings Supported by 1½-In. Steel Channel, T-Bars, Wood Framing, Plaster Frame, etc.

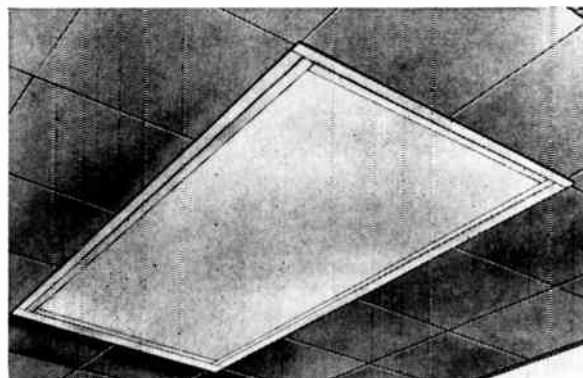

Templex 2-ft. wide troffers are similar to the Metro troffers, except they are furnished with hangers attached for automatic positioning on ceiling supporting members. Units are simply placed in the ceiling and hangers position automatically on ceiling supporting members. Leveling is from below by four easily accessible screws.

Troffers with catalog prefix TEM are flanged troffers for use in ceilings supported by 1½-in. steel channel, Pomeroy or other steel supporting members and for wood framed openings and plaster frames.

For Templex troffers without flange, substitute catalog prefix PAN for TEM shown below. The same prices apply.

For Rapid-Start Bi-Pin Lamps
Steel Louvers

Providing 30° x 30° Shielding
2-ft. Wide x 4-ft. Long Troffers

No.	No. of Lamps	Type Lamps	Ship. Wt., Lbs.	Each
TEM2-40L	2	F40T12/RS	56	\$ 65.18
TEM3-40L	3	F40T12/RS	60	91.26
TEM4-40L	4	F40T12/RS	62	94.50

Plastic Louvers in Hinged Door Frame

Providing 42° x 42° Shielding
2-ft. Wide x 4-ft. Long Troffers

TEM2-40PL	2	F40T12/RS	40	91.80
TEM3-40PL	3	F40T12/RS	45	109.50
TEM4-40PL	4	F40T12/RS	47	111.40

Ribbed Glass

2-ft. Wide x 4-ft. Long Troffers

TEM2-40R	2	F40T12/RS	52	76.80
TEM3-40R	3	F40T12/RS	57	93.30
TEM4-40R	4	F40T12/RS	64	97.36

Albalite "66" Glass Shielding

2-ft. Wide x 4-ft. Long Troffers

TEM2-40A	2	F40T12/RS	52	81.60
TEM3-40A	3	F40T12/RS	57	98.78
TEM4-40A	4	F40T12/RS	64	102.16

Corning Pattern No. 70 Glass Shielding

2-ft. Wide x 4-ft. Long Troffers

TEM2-40S	2	F40T12/RS	52	100.88
TEM3-40S	3	F40T12/RS	57	117.36
TEM4-40S	4	F40T12/RS	64	121.16

Polystyrene Plastic Dish Shielding

2-ft. Wide x 4-ft. Long Troffers

TEM2-40P	2	F40T12/RS	40	89.50
TEM3-40P	3	F40T12/RS	45	105.32
TEM4-40P	4	F40T12/RS	52	109.50

All Templex 2-ft. wide troffers are also available in units 2-ft. long.

Prices on application.

Smithcraft Architectural Troffers

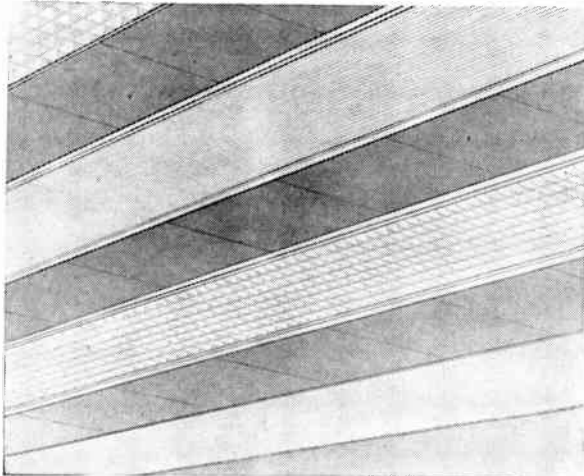

With Steel Louvers
Providing 40° x 40° Shielding

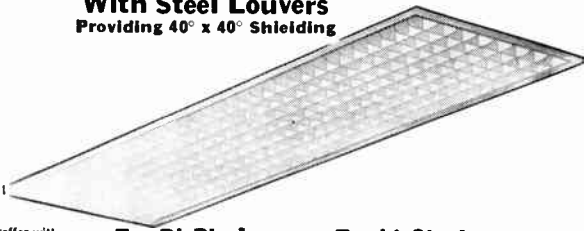

Troffer with Integral Trim Flange *No.	No. of Lamps	Type Lamps	Shp. Wt., Lbs.	Each
For Bi-Pin Lamps—Rapid-Start				
F T L2-20/TS	2	F20T12	22	\$ 48.90
F T L2-40	2	F40T12/RS	37	53.70
F T L3-40	3	F40T12/RS	42	71.78
F T L2-42 (8-ft. Housing)	4	F40T12/RS	73	105.32
F T L3-42 (8-ft. Housing)	6	F40T12/RS	81	128.86
For Slimline Lamps (430-MA)				
F T L2-96	2	F96T12	78	97.90
F T L2-72	2	F72T12	64	91.40
F T L2-48	2	F48T12	40	60.86
F T L3-96	3	F96T12	87	134.78
F T L3-72	3	F72T12	75	124.52
F T L3-48	3	F48T12	49	88.16

With Ribbed Glass

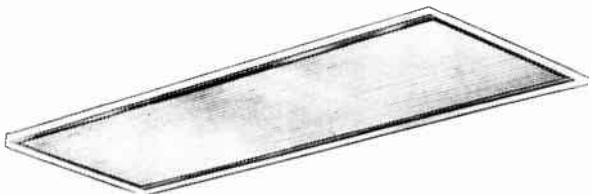

Troffer with Integral Trim Flange *No.	No. of Lamps	Type Lamps	Shp. Wt., Lbs.	Each
For Bi-Pin Lamps Rapid-Start				
F T R2-20/TS	2	F20T12	25	\$ 51.62
F T R2-40	2	F40T12/RS	43	55.30
F T R3-40	3	F40T12/RS	47	70.98
F T R2-42 (8-ft. Housing)	4	F40T12/RS	86	105.06
F T R3-42 (8-ft. Housing)	6	F40T12/RS	93	125.06
For Slimline Lamps (430-MA)				
F T R2-96	2	F96T12	90	100.72
F T R2-72	2	F72T12	64	92.36
F T R2-48	2	F48T12	44	61.52
F T R3-96	3	F96T12	98	136.56
F T R3-72	3	F72T12	76	126.16
F T R3-48	3	F40T12	53	88.30

*For Troffers without Flange, omit "F" as first letter of number prefix.

1. No visible catches, latches, hinges, bolts or screws.
2. Door frame contains glass, lens or plastic, opens or closes by simple pressure upwards with exclusive Smithcraft Pressure-Catch. To remove door frame, simply lift off without tools or loose parts.
3. In louvered units, louvers hinge from either side, close by simple pressure upwards and are removed without tools or loose parts.
4. Architecturally precise modules for exactly 12-in. openings—perfectly straight, trim, in-line rows, whether mounted individually or in continuous rows.
5. No light leaks.
6. Slimly-designed glass frame for better appearance.
7. Wide selection of shielding media, spot boxes, pattern lighting.
8. Troffers available with integral trim flange for finishing ceiling opening.
9. Simple clips adapt troffer to today's ceilings. Troffer-in-plaster frame assures perfectly square openings.
10. No exact positioning required; simple adjustability at every point with the Smithcraft Yoke-Aligner Hanger.

With Plastic Louvers
Providing 42° x 42° Shielding

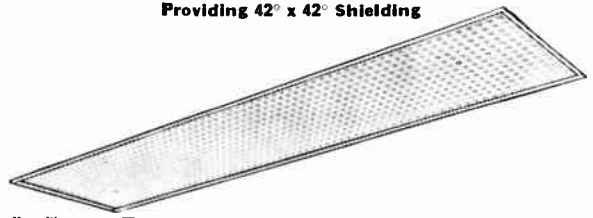

Troffer with Integral Trim Flange *No.	No. of Lamps	Type Lamps	Shp. Wt., Lbs.	Each
For Bi-Pin Lamps—Rapid-Start				
F T P L 2-20/TS	2	F20T12	20	\$ 58.12
F T P L 2-40	2	F40T12/RS	33	61.52
F T P L 3-40	3	F40T12/RS	38	79.78
F T P L 2-42 (8-ft. Housing)	4	F40T12/RS	70	120.08
F T P L 3-42 (8-ft. Housing)	6	F40T12/RS	77	148.46
For Slimline Lamps (430-MA)				
F T P L 2-96	2	F96T12	73	115.60
F T P L 2-72	2	F72T12	56	107.90
F T P L 2-48	2	F48T12	36	68.82
F T P L 3-96	3	F96T12	82	151.98
F T P L 3-72	3	F72T12	68	143.72
F T P L 3-48	3	F48T12	45	99.26

With Albalite "66" Glass

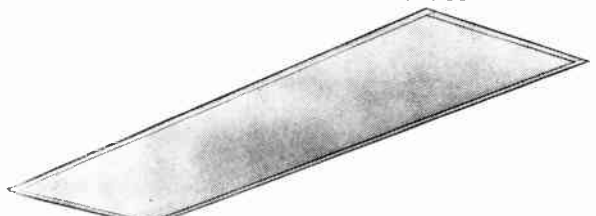

Troffer with Integral Trim Flange *No.	No. of Lamps	Type Lamps	Shp. Wt., Lbs.	Each
For Bi-Pin Lamps—Rapid-Start				
F T A2-20/TS	2	F20T12	25	\$ 52.12
F T A2-40	2	F40T12/RS	43	57.98
F T A3-40	3	F40T12/RS	47	74.06
F T A2-42 (8-ft. Housing)	4	F40T12/RS	86	110.00
F T A3-42 (8-ft. Housing)	6	F40T12/RS	93	131.90
For Slimline Lamps (430-MA)				
F T A2-96	2	F96T12	90	106.32
F T A2-72	2	F72T12	64	99.32
F T A2-48	2	F48T12	44	64.06
F T A3-96	3	F96T12	98	138.40
F T A3-72	3	F72T12	96	133.00
F T A3-48	3	F48T12	53	92.18

*For Troffers without Flange, omit "F" as first letter of number prefix.

Smithcraft Architectural Troffers

With Corning No. 70 Glass

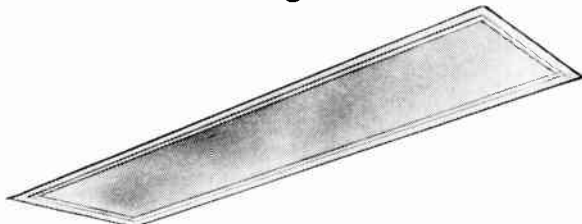

For Bi-Pin Lamps—Rapid-Start

Troffer with Integral Trim Flange *No.	No. of Lamps	Type Lamps	Ship. Wt., Lbs.	Each
FTCS2-20/TS	2	F20T12	25	\$ 58.32
FTCS2-40	2	F40T12/RS	43	68.10
FTCS3-40	3	F40T12/RS	47	84.46
FTCS2-42	4	F40T12/RS	86	129.68
(8-ft. Housing)				
FTCS3-42	6	F40T12/RS	93	151.02
(8-ft. Housing)				

For Slimline Lamps (430-MA)

FTCS2-96	2	F96T12	90	124.66
FTCS2-72	2	F72T12	64	113.08
FTCS2-48	2	F48T12	44	75.10
FTCS3-96	3	F96T12	98	159.68
FTCS3-72	3	F72T12	76	146.48
FTCS3-48	3	F48T12	53	100.92

With Plastic Lucite Refractors

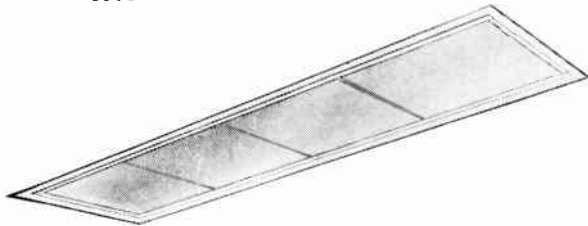

For Bi-Pin Lamps—Rapid-Start

Troffer with Integral Trim Flange *No.	No. of Lamps	Type Lamps	Ship. Wt., Lbs.	Each
FTP2-20/TS	2	F20T12	23	\$ 59.30
FTP2-40	2	F40T12/RS	36	69.76
FTP3-40	3	F40T12/RS	42	85.86
FTP2-42	4	F40T12/RS	82	133.98
(8-ft. Housing)				
FTP3-42	6	F40T12/RS	90	157.66
(8-ft. Housing)				

For Slimline Lamps (430-MA)

FTP2-96	2	F96T12	75	128.46
FTP2-72	2	F72T12	58	122.22
FTP2-48	2	F48T12	40	73.96
FTP3-96	3	F96T12	83	160.48
FTP3-72	3	F72T12	70	148.72
FTP3-48	3	F48T12	49	103.70

*For Troffers without Flange, omit "F" as first letter of number prefix.

Notes

Smithcraft Troffers are also available with the following shielding media: Holophane Dished Controlens No. 9033, 9034; Holophane Controlens No. 6014.

All Troffers are available with Integral Trim Flange or without Flange at the same price. Note catalog listing.

Troffer prices include necessary Yoke-Aligner Hanger Assemblies for hanging and necessary connectors and end caps.

20-watt Troffers are furnished with Trigger-Start ballasts.

Troffers are also available for single 40-watt Rapid-Start Lamps and for single T-12 Slimline Lamps.

With Holophane Controlens No. 9016

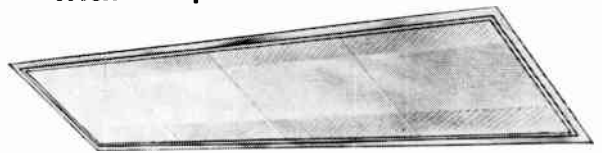

For Bi-Pin Lamps—Rapid-Start

Troffer with Integral Trim Flange *No.	No. of Lamps	Type Lamps	Ship. Wt., Lbs.	Each
FTIIV2-20/TS	2	F20T12	28	\$ 66.90
FTIIV2-40	2	F40T12/RS	47	72.32
FTIIV3-40	3	F40T12/RS	52	88.56
FTIIV2-42	4	F40T12/RS	97	138.58
(8-ft. Housing)				
FTIIV3-42	6	F40T12/RS	105	159.80
(8-ft. Housing)				

For Slimline Lamps (430-MA)

FTIIV2-96	2	F96T12	97	133.72
FTIIV2-72	2	F72T12	74	125.72
FTIIV2-48	2	F48T12	51	79.22
FTIIV3-96	3	F96T12	105	170.10
FTIIV3-72	3	F72T12	86	160.90
FTIIV3-48	3	F48T12	60	106.00

With Polycraft Plastic Dish

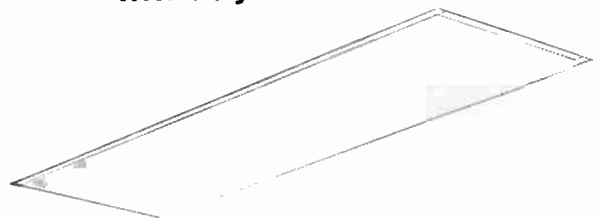

For Bi-Pin Lamps—Rapid-Start

Troffer with Integral Trim Flange *No.	No. of Lamps	Type Lamps	Ship. Wt., Lbs.	Each
FTP2D-40	2	F40T12/RS	32	\$ 66.96
FTP2D-40	3	F40T12/RS	38	83.72
FTP2D-42	4	F40T12/RS	66	128.96
(8-ft. Housing)				
FTP2D-42	6	F40T12/RS	75	148.98
(8-ft. Housing)				

For Slimline Lamps (430-MA)

FTP2D-96	2	F96T12	72	124.40
FTP2D-48	2	F48T12	37	73.06
FTP2D-96	3	F96T12	80	157.06
FTP2D-48	3	F48T12	44	104.90

*For Troffers without Flange, omit "F" as first letter of number prefix.

Plaster Frame

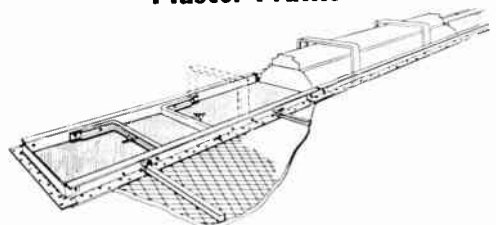

Plaster Frame (For plaster up to 5/8-in. thick)

No. A2006 Price Per Linear Foot of Troffer \$1.70

Plaster Frame (For plaster up to 1 1/4-in. thick)

No. A2009 Price Per Linear Foot of Troffer \$2.08

Pittsburgh Universal Troffers and Downlights

Basic Troffer



96-in. long, 72-in. on special order.

Complete with ends. Rigidly constructed to fit an opening 48-in. long and 12-in. wide. Slimline units available 48-in. or

Eggcrate Louver

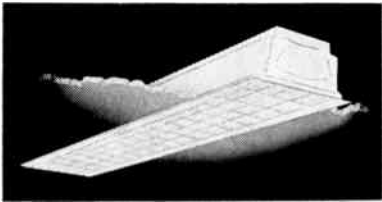

Provides 30° lengthwise and 45° crosswise shielding. Captive screw latches provide easy access for relamping. (HEC closure.) For eggcrate plastic closure, order PEC closure.

Alba-Lite Glass

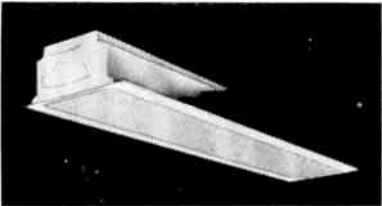

sure. Pattern #70 glass (CLB) may also be used.

A highly efficient closure and a decorative element ideal for seeing comfort and refined architectural harmony. (GE closure.)

For curved Alba-Lite order CGE closure.

Flat Controlens®

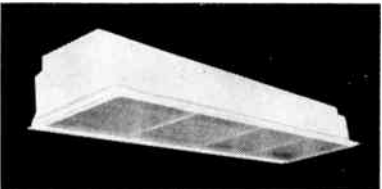

Low brightness closure. For glass order 9016-4 (M) or 9026-4 (M). For plastic order 6016-4 (M).

®Holophane Co., Inc. Registered Trade Mark.

Curved Controlens®

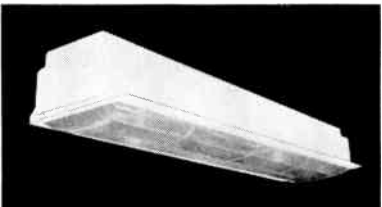

Curved, low-brightness closure. Order 9033-4-A

®Holophane Co., Inc. Registered Trade Mark.

Acrylic Closure

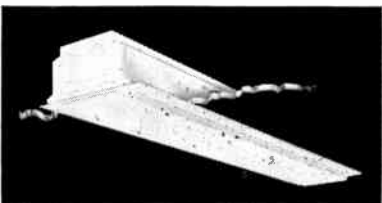

Curved acrylic plastic closure. DAC closure.

Three-foot closures are available on special order for use with 6-ft. troffer. (Use 2 per troffer.) Twinlens and Corning curved lens closures are also available.

Pittsburgh troffers provide complete flexibility in planning recessed lighting installations. Interchangeable closures provide an easy means to make changes in lighting to suit changes in layout.

Factory mitering of flanges on PF-type troffers is available on special order.

Troffers may be combined with Companion Recessed Downlights fitted in line, at corners, ends, "T" or cross-overs. Adjustable or fixed spots, or hinged closures with Alba-Lite glass or eggcrate louver are available. All are equipped with silvered-mirror glass Permafectors and use general service incandescent lamps.

For installation in metal pan "Clip and T-Bar" ceiling, substitute "AF" for "PF" in catalog number. Ask Graybar for information on troffers for other suspended ceilings.

Universal Troffer Chassis

No.	Lamps No.—Watts	Length In.	Recessing Width, in.	Recessing Depth, in.	Each
For Rapid Start Lamps					
PF-240-ES	2—40	48	12	6 1/2	\$27.42
PF-340-ES	3—40	48	12	6 1/2	36.83
PF-440-E	4—40	48	12	8 3/4	45.00
PF-4280-ES	4—40	96	12	6 1/2	52.00
PF-4380-ES	6—40	96	12	6 1/2	67.68
For Slimline Lamps					
PF-4248AS-4	2—48	48	12	6 1/2	32.92
PF-4348AS-4	3—18	48	12	6 1/2	51.00
PF-4296AS-4	2—96	96	12	6 1/2	47.08
PF-4396AS-4	3—96	96	12	6 1/2	63.92

Troffer Closure Assemblies

No.	Length, in.	Width, in.	Use	Each
HEC-12-40	47 7/8	11 5/8	One per 4-ft.	\$ 8.42
PEC-12-40 (M)	47 7/8	11 5/8	troffer. Two	11.50
GE-12-40 (M)	47 7/8	11 5/8	per 8-ft.	8.17
CLB-12-40 (M)	47 7/8	11 5/8	troffer	16.33
CGE-12-40 (M)	47 7/8	11 5/8		16.00
9016-4 (M)	47 7/8	11 5/8		19.17
9026-4 (M)	47 7/8	11 5/8		19.17
6016-4 (M)	47 7/8	11 5/8		24.92
9033-4-A	47 7/8	11 5/8		28.17
DAC-12-40 (M)	47 7/8	11 5/8		22.67

DL-150 and DL-300 Downlights

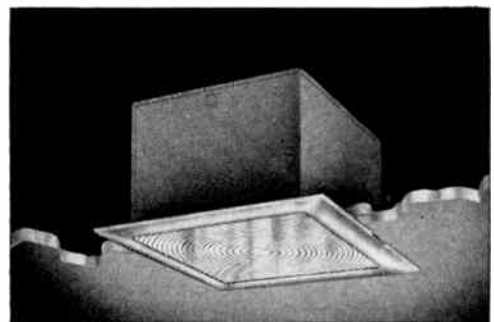

DL-300

The DL-150 and DL-300 series Downlights provide high efficiency and controlled brightness with optically mated Permaeffector, lamp and prismatic lens. Their high efficiency makes them outstandingly economical units to operate.

The frame is a one-piece aluminum die-casting of smart modern design and blends beautifully into the ceiling. There are no visible hinges or catches.

No.	Lens	Overall Dimensions			Each
		Length, In.*	Width, In.*	Depth, In.**	
DL-300-C	Concentrating	15 1/2	15 1/2	11 5/8	\$34.00
DL-300-E	Extensive	15 1/2	15 1/2	9 1/8	34.00
DL-300-B	Diffusing Bowl	15 1/2	15 1/2	9 1/8	30.33
DL-150-C	Concentrating	11 1/16	11 1/16	9	24.33
DL-150-E	Extensive	11 1/16	11 1/16	7 3/4	24.33
DL-150-B	Diffusing Bowl	11 1/16	11 1/16	7 3/4	22.50

*Outer frame dimension DL-300 unit recesses into 12-in. sq. opening. DL-150 unit recesses into 7 3/4 in. sq. opening.

**Recessed Depth

Pittsburgh Luma-Ceiling



Luma Ceiling No. 10

Luma-Ceiling No. 10 offers quality, plus simplicity of installation and maintenance in a luminous ceiling. A complete installation consists of translucent white vinyl plastic, corrugated for rigidity, supported on extruded aluminum channels, and standard strip fixtures.

Below are shown approximate prices per square foot of Luma-Ceiling No. 10 (not including fixtures) in standard installations, as follows: (1) The longitudinal channel is on 3-ft. centers, (2) The plenum depth is 2 ft. or under from lamp center to upper surface of plastic, (3) The area is one which is rectangular or square with 90° corners, (4) There are no obstructions such as columns or pillars within the wall or area boundaries.

For firm quotations or quotations on irregular rooms or on installations that are not standard, contact your Graybar representative.

Sq. Ft. to be Installed	Estimated Price Per Sq. Ft.
0-299 sq. ft.	\$1.08
300-599 sq. ft.	1.00
600-899 sq. ft.92
900 sq. ft. and over83

Where Pittsburgh strip is not used with Luma-Ceiling No. 10, add 20% to the above prices.

Every request for a quotation or any order on a Luma-Ceiling No. 10 job should be accompanied by as complete information as to dimensions and other installation factors as is possible.

Standard Luma-Ceiling is furnished with rolled corrugated vinyl plastic. For plastic eggcrate, Honeylite, 3x3-ft. vinyl plastic pans, or 3x3-ft. acrylic plastic pans, see Graybar.

Adjustable Downlights



DLC-101-8

Adjustable downlight for individual mounting, equipped with silver-mirrored Permalector.

No.	Wattage	Recessing	Dimensions	Each
DLC-101-8	200	10 ⁷ / ₈	10 ¹ / ₄	\$28.08
DLC-102-8	150	10 ⁷ / ₈	10 ¹ / ₄	27.92

Pittsburgh Presidential Luminaires

The Coolidge

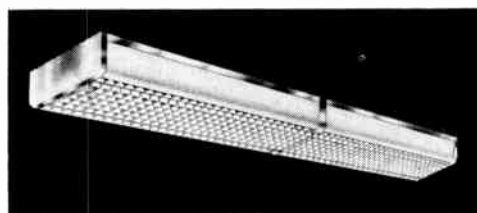

D-7240—(Coolidge)

The Coolidge D-7000 series and the Tyler A-7000 series combine sound lighting engineering with functional design. Side panels are curved Alba-Lite glass, while the bottom is eggcrate louver, hinged for easy maintenance. Louver on A-7000 series is flat, while louvers on the D-7000 series is dropped. Both are distinctive either individually or continuously mounted.

A-7000 series luminaires are available in 4-ft. units only, and they utilize Bipin lamps. D-7000 series models are made in 4-ft. lengths and 8-ft. lengths, and they utilize pairs of Rapid Start lamps mounted in tandem.

A-7000—Rapid Start Lamps

No.	Lamps No.—Watts	Length In.	Width In.	Depth In.	Each
A-7240	2—40	48 ¹ / ₈	10 ⁷ / ₁₆	5 ¹ / ₁₆	\$38.08
A-7340	3—40	48 ¹ / ₈	10 ⁷ / ₁₆	5 ¹ / ₁₆	48.75
A-7440	4—40	48 ¹ / ₈	14	5 ¹ / ₁₆	53.58

D-7000—Rapid Start Lamps

D-7240	2—40	48 ¹ / ₈	10 ⁷ / ₁₆	5 ¹⁵ / ₁₆	40.58
D-7340	3—40	48 ¹ / ₈	10 ⁷ / ₁₆	5 ¹⁵ / ₁₆	51.25
D-7440	4—40	48 ¹ / ₈	14	5 ¹⁵ / ₁₆	58.08
D-7280	4—40	96 ¹ / ₈	10 ⁷ / ₁₆	5 ¹⁵ / ₁₆	81.17
D-7380	6—40	96 ¹ / ₈	10 ⁷ / ₁₆	5 ¹⁵ / ₁₆	102.50
D-7480	8—40	96 ¹ / ₈	14	5 ¹⁵ / ₁₆	116.17

The Grant

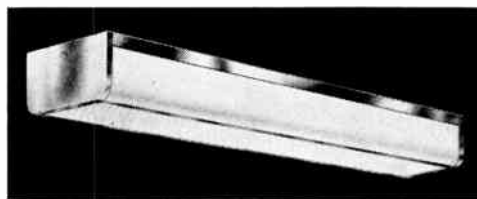

A-8240-A

The Grant series are completely glass-enclosed luminaires which are flexible and functional in design . . . outstanding in appearance and style.

Gracefully curved side panels and flat bottom panels are Alba-Lite glass. The metal frame enclosing the bottom panel is securely held in position by hinges and patented spring latches so that it may be opened or removed instantly if desired, without tools. Knockouts provide for service entrances, continuous wiring, pendant mounting, and the locking together of units for continuous runs.

No.	Rapid Start Lamps No.—Watts	Length In.	Width In.	Depth In.	Each
A-8240-A	2—40	48 ¹ / ₈	10 ⁷ / ₁₆	5 ¹ / ₁₆	\$42.67
A-8340-A	3—40	48 ¹ / ₈	10 ⁷ / ₁₆	5 ¹ / ₁₆	53.33
A-8440-A	4—40	48 ¹ / ₈	14	5 ¹ / ₁₆	58.17
A-8280-A	4—40	96 ¹ / ₈	10 ⁷ / ₁₆	5 ¹ / ₁₆	85.34
A-8380-A	6—40	96 ¹ / ₈	10 ⁷ / ₁₆	5 ¹ / ₁₆	106.67
A-8480-A	8—40	96 ¹ / ₈	14	5 ¹ / ₁₆	116.34

Litecontrol Lens Fixtures

2-Ft. x 4-Ft.

Series 7300 for 2, 4, or 6-40 W/RS Lamps—Surface Type
Series 8300 for 2, 3, 4, or 6-40 W/RS Lamps—Recessed Type

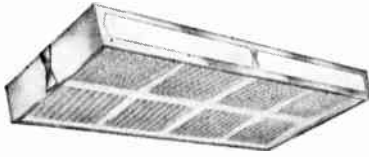

Surface (illustrated) and recessed fixtures, using Holophane No. 6024 acrylic low brightness, high efficiency lens in a hinged door. Door is opened and closed without tools by Trigger Catches.

Surface type has plastic side panels. All fixtures may be mounted singly or in rows.

Efficiency—7300 series 4 lamp, 65.9%. 8300 series 4 lamp, 61.7%. Finish, baked white enamel.

Surface—Individual or Continuous, With End Cap

For 40 Watt Rapid Start Lamps

No.	No. of Lamps	Each
7324RS	2	\$134.10
7344RS	4	153.30
7364RS	6	172.40

Recessed—Individual or Continuous, Less End Cap

For 40 Watt Rapid Start Lamps

No.	No. of Lamps	Each
8324RS	2	\$144.10
8334RS	3	162.50
8344RS	4	163.30
8364RS	6	182.40
8300-3	End Caps	3.30

Litecontrol Shallow Surface Fixtures

Series 3600 for 2-40 Watt/RS Lamps—Lens Type
Series 3800 for 2-Slimline Lamps—Lens Type
Series 1600 for 2-40 Watt/RS Lamps—Plastic Dish Type
Series 1800 for 2-Slimline Lamps—Plastic Dish Type

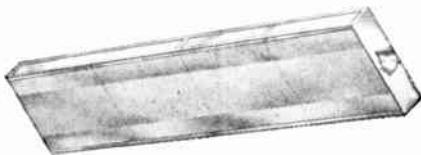

Hinged door holds Holophane No. 9022 low brightness lenses (series 3600 and 3700) or Plexiglas dish (series 1600 and 1700). Door is easily opened without tools by Trigger Catches. In continuous rows, fixtures show unbroken length of lenses without dividers. Also available with metal sides, or with Holophane No. 6016 acrylic lenses, plastic grid louver, or Honeylite louver bottom. Finish, baked white enamel.

Individual or Continuous, With End Cap

For 40 Watt Rapid Start Lamps

No.	No. of Lamps	Each
3624RS	2	\$71.80
3648RS	4 tandem	139.80
1624RS	2	68.50
1648RS	4 tandem	133.30

For Slimline Lamps

No.	No. of Lamps	Size, Ft.	Each
3724	2	4	\$78.50
3728	2	8	134.30
1724	2	4	75.30
1728	2	8	127.80

Litecontrol Shallow Baffle Fixtures

Series 7700 for 2-40 Watt/RS Lamps
Series 7800 for 2- Slimline Lamps
Series 7900 for 4-40 Watt/RS Lamps
Series 8000 for 4- Slimline Lamps

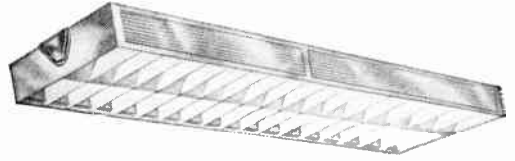

Shallow baffle fixture, with plastic sides, for single or row mounting, surface or pendant. Downlite reflectors available on special order. In rows, ornaments are discarded, and fixtures nipped together through ends.

For pendant mounting, use No. P2 pendants in rows, (1 per fixture in row plus 1) or No. P4 for individual mounting (1 per fixture).

Finish, baked white enamel.

Individual or Continuous, With End Cap

For 40 Watt Rapid Start Lamps

No.	No. of Lamps	Each
7724RS	2	\$48.00
7748RS	4 tandem	92.30
7944RS	4	84.80

For T-12 Slimline Lamps

No.	No. of Lamps	Size, Ft.	Each
7824	2	4	\$54.80
7828	2	8	87.30
8044	4	4	98.30
8048	4	8	139.00

Litecontrol Baffle Type Fixtures

Series 4600 for 2-40 Watt/RS Lamps
Series 6600 for 2 Slimline Lamps

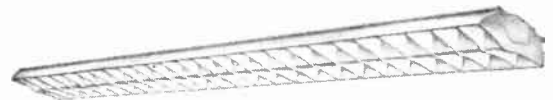

General diffuse, all metal, for pendant mounting, singly or in rows. Cutoff 15° crosswise, 25° lengthwise. Light distribution 42.5% upward, 39% downward. May be relamped from above without moving baffles. Baffles hinge from either side without tools.

Also available with extruded ribbed plastic sides in place of steel (Series 7600 Rapid Start, 8600 Slimline). May be had on special order, with 4 lamps side by side, and in 8 foot lengths with 2-800 m.a. high output lamps.

For mounting, use No. 6600-25 mounting brackets, No. P2 pendants for rows (1 per fixture in row plus 1), or No. P4 pendant for single mounting (1 per fixture).

Finish, baked white enamel.

Individual or Continuous, With End Cap

For 40 Watt Rapid Start Lamps

No.	No. of Lamps	Each
4624RS	2	\$40.80
4648RS	4 tandem	77.40

For T-12 Slimline Lamps

No.	No. of Lamps	Size, Ft.	Each
6624	2	4	\$47.50
6628	2	8	70.50

Litecontrol Surface Fixtures

2-Ft. x 4-Ft. and 4-Ft. x 4-Ft.

Series 4200 for 4, 6, or 8—40W/RS Lamps—4-ft. wide
Series 6200 for 2, 3, or 4—40W/RS Lamps—2-ft. wide

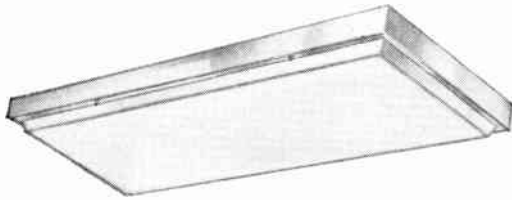

Shallow surface fixtures, having 4-ft. x 4-ft. acrylic plastic dish (Series 4200) or 2-ft. x 4-ft. Plexiglas dish (Series 6200), held in hinged door. Door is easily opened and closed without tools by Trigger Catches.

Series 6200 is also available, upon special order, in 2-ft. x 2-ft. size, using 20 Watt Trigger Start lamps, also with other diffusing materials: plastic grid louver, Corning No. 70 lens panel, Albalite No. 66 glass, or Honeylite louver. Finish, baked white enamel.

Individual or Continuous, With End Cap

For 40 Watt Rapid Start Lamps
4-Ft. x 4-Ft. Type

No.	No. of Lamps	Each
4244RS	4	\$201.80
4264RS	6	220.90
4284RS	8	240.00

2-Ft. x 4-Ft. Type

6224RS	2	\$105.00
6234RS	3	123.40
6244RS	4	124.10

Litecontrol Recessed Troffers

2-Ft. x 4-Ft.

Series 6000 for 2, 3, 4, or 6—40W/RS Lamps—Plaster Ceilings
Series 6100 for 2, 3, 4, or 6—40W/RS Lamps—Grid Type Ceilings

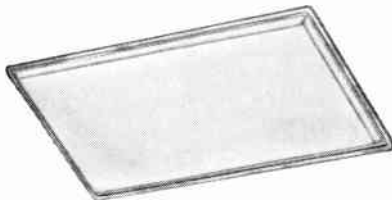

Hinged-door troffer, using Plexiglas dish, with finger-operated Trigger Catches. Series 6000 for mounting singly or in rows, in plaster or T-bar ceiling—will not snap in. Series 6100 for mounting singly or in rows in grid (inverted T-bar) ceilings only—fixture sides collapsible for mounting in shallow plenum areas.

Both series also available on special order in 2-ft. x 2-ft. size, using 20 Watt Trigger Start lamps, also with other diffusing materials: Corning No. 70 lens panel, Albalite No. 66 glass, plastic grid louver, or Honeylite louver. Finish, baked white enamel.

Individual or Continuous For Plastic Ceilings—Less End Cap

For 40 Watt Rapid Start Lamps

No.	No. of Lamps	Each
6024RS	2	\$93.00
6034RS	3	111.40
6044RS	4	112.10
6064RS	6	131.30
6000-3	End Cap	3.30

For Grid Ceilings, With End Cap

For 40 Watt Rapid Start Lamps

6124RS	2	\$96.80
6134RS	3	115.10
6144RS	4	115.90
6164RS	6	135.00

Litecontrol Hinged-Lens Troffer

Series 3300-X for 2 or 3—40W/RS Lamps—Stylux Plastic Panel
Series 3400-X for 2 or 3 Slimline Lamps—Stylux Plastic Panel
Series 3500 for 2 or 3—40W/RS Lamps—Lenses
Series 5100 for 2 or 3 Slimline Lamps—Lenses

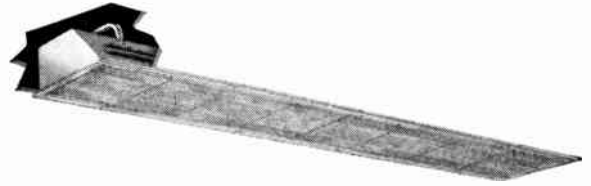

Hinged door holds Holophane No. 9022 low brightness lenses (Series 3500, 5100) or Stylux Plastic Panel (Series 3300, 3400). Door is fingertip operated, by Trigger Catches. For plaster or T-bar ceilings (not snap in). Available with Plexiglas diffusers (Series 6300, 6400), No. 9033 and 9034 curved lenses (Series 4700, 4800), or steel louvers (3500ML, 5100ML). Other diffusers available with Series 3300, 3400: Honeylite louver, plastic grid louver, Corning No. 70 lens panel. Finish, baked white enamel.

Individual or Continuous, Less End Caps

For 40 Watt Rapid Start Lamps

No.	No. of Lamps	Each
3324RS-X	2	\$51.80
3334RS-X	3	70.10
3348RS-X	4 tandem	97.50
3368RS-X	6 tandem	116.60
3524RS	2	65.50
3534RS	3	83.90
3548RS	4 tandem	129.50
3568RS	6 tandem	148.80

For T-12 Slimline Lamps

No.	No. of Lamps	Size, Ft.	Each
3424-X	2	4	\$58.50
3434-X	3	4	80.50
3428-X	2	8	91.30
3438-X	3	8	119.40
5124	2	4	72.30
5134	3	4	94.30
5128	2	8	123.00
5138	3	8	151.10

3300-3, 3400-3, 3500-3 or 5100-3 End Cap 1.60

Litecontrol Incandescent Lens Boxes

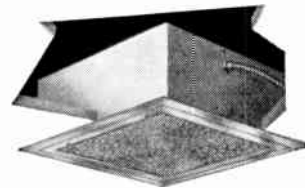

Single Flush Type

Boxes use 6-in., 8-in., or 12-in. Holophane lenses, with vertical or horizontal lamp positions. Doors have concealed hinges, open without marring ceiling. Many variations available: Multiple, psychiatric ward, gymnasium, (single or multiple, with ring catch for pole relamping), and corridor boxes.

No.	Spread	Lamp †Watts	Lgth., In.	Roughing Box Width, In.	Depth, In.	Each
6FV	Narrow	100	8 ⁵ / ₈	8 ⁵ / ₈	7 ¹ / ₄	\$28.80
6FH	Narrow	100	8 ⁵ / ₈	8 ⁵ / ₈	4 ¹ / ₂	23.80
8FV	Narrow	150	10 ⁵ / ₈	10 ⁵ / ₈	9 ¹ / ₂	32.50
*8FVS	Wide	150	10 ⁵ / ₈	10 ⁵ / ₈	9 ¹ / ₂	36.80
8FH	Wide	150	10 ⁵ / ₈	10 ⁵ / ₈	4 ³ / ₄	26.50
12FV	Narrow	300	14 ¹ / ₈	14 ¹ / ₈	11 ¹ / ₈	42.00
*12FVS	Wide	300	14 ¹ / ₈	14 ¹ / ₈	11 ¹ / ₈	47.50
*12FH	Wide	300	14 ¹ / ₈	14 ¹ / ₈	6 ³ / ₈	34.40

*Supplied with Holophane Square Reflector.

†Maximum Lamp Size.

Note: Position of Lamp: "V" Vertical; "H" Horizontal.

Curtis Sky-Lux Modular Luminaires

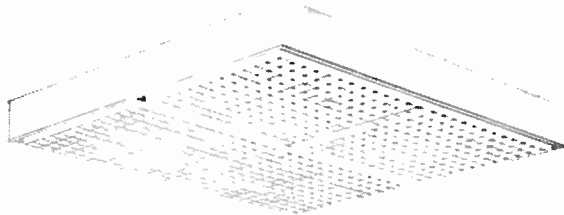

4x4 Surface Sky-Lux with Curticell louver-diffuser.

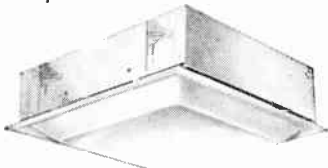
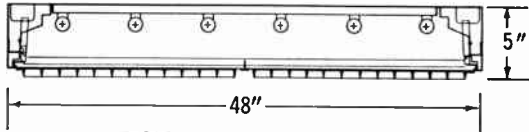

2 x 2 Recessed Sky-Lux with dished concave acrylic diffuser.

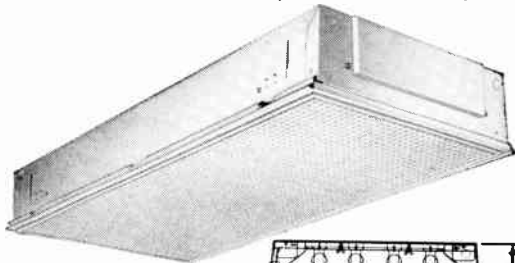
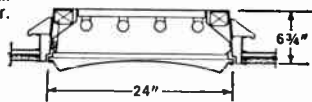

2 x 4 Contractible Sky-Lux with Plastic egg crate louver.

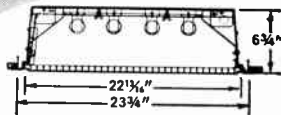

Curtis Sky-Lux® series are brand new modularly designed luminaires providing controlled high-level illumination. Designed for use in all ceiling types, Sky-Lux series luminaires make possible a lower, more dramatic ceiling effect for today's commercial interiors.

Sky-Lux series luminaires are available for surface or recessed (flange or flush) mounting or Inverted "T" grid ceilings in 2x2-ft., 2x4-ft., and 4x4-ft. sizes. Bottom closures include flat, concave and dished concave diffuse acrylic plastic panels, and the exclusive new CurtiCell louver-diffuser*.

Concealed latches and hinges provide instant accessibility for lamp replacement and maintenance, and a clean-swept ceiling plane with no distracting hinges, screw heads, nuts or latches. Door gaskets minimize maintenance by sealing the luminaire against dust and foreign particles.

Exclusive Rapidjust** hangers make installation faster and easier, and provide a quick, sure levelling device for final ceiling adjustment.

Construction

Units are fabricated of heavy gauge steel and finished in baked white Fluracite enamel. Sky-Lux 4x4-ft. luminaires have built-in tri-rib construction for extra strength and rigidity.

Hinged door frame is steel and is finished in baked white Fluracite enamel.

Wiring

Units are wired for 110-125 volt a-c circuits and equipped ETL listed components. Underwriters' Laboratories Approved. IBEW labels.

Dimensions—Recessed Units

	2 x 2-ft. Luminaires		2 x 4-ft. Luminaires		4 x 4-ft. Luminaires	
	Flush	Flange	Flush	Flange	Flush	Flange
Length, in.	24	25 1/4	48	49 1/4	48	49 1/4
Width, in.	24	25 1/4	24	25 1/4	48	49 1/4
Depth, in.	6 1/2	6 1/2	6 1/2	6 1/2	6 1/2	6 1/2

©Curtis Lighting, Inc.

*Pat. Pend.

**Trademark applied for

Recessed Sky-Lux

Closure	No. of Lamps	2 x 2-Ft.			2 x 4-Ft.			No. of Lamps	4 x 4-Ft.		
		Flange	Flush	Each	Flange	Flush	Each		Flange	Flush	Each
White Curticell	2	285231.22	295231.22	\$47.85	285221.24	295221.24	\$64.35	4	285421.44	295421.44	\$124.75
	3	285331.22	295331.22	52.85	285321.24	295321.24	74.00	6	285621.44	295621.44	136.95
	4	285431.22	295431.22	55.55	285421.24	295421.24	74.55	8	285821.44	295821.44	149.05
Dished Concave Acrylic	2	28923D22	29923D22	57.55	28922D24	29922D24	84.05	4	28942D44	29942D44	164.60
	3	28933D22	29933D22	62.35	28932D24	29942D24	93.75	6	28962D44	29962D44	176.75
	4	28943D22	29943D22	65.00	28942D24	29942D24	94.25	8	28982D44	29982D44	188.95
Plastic Louver	2	280231.22	290231.22	51.00	280221.24	290221.24	73.20	4	280421.44	290421.44	146.05
	3	280331.22	290331.22	55.95	280321.24	290321.24	82.85	6	280621.44	290621.44	158.25
	4	280431.22	290431.22	58.55	280421.24	290421.24	83.35	8	280821.44	290821.44	170.60

Note: Flush type units may be mounted in continuous rows. For continuous row mounting of Flange type units suffix catalog numbers: For end of row (-3) for middle of row (-2) for example: 28523L22-2.

Surface Sky-Lux

Closure	No. of Lamps	2 x 2-Ft.		2 x 4-Ft.		No. of Lamps	4 x 4-Ft.	
		No.	Each	No.	Each		No.	Each
White Curticell	2	275231.22	\$43.65	275221.24	\$54.00	4	275421.44	\$117.60
	3	275331.22	48.20	275321.24	66.00	6	275621.44	129.65
	4	275431.22	50.65	275421.24	67.25	8	275821.44	141.85
Dished Concave Acrylic	2	27923D22	57.65	27922D24	78.35	4	27942D44	157.40
	3	27933D22	62.05	27932D24	90.55	6	27962D44	169.60
	4	27943D22	64.55	27942D24	91.60	8	27982D44	181.75
Plastic Louver	2	270231.22	48.60	270221.24	61.05	4	270421.44	138.95
	3	270331.22	53.05	270321.24	73.20	6	270621.44	151.00
	4	270431.22	55.60	270421.24	74.35	8	270821.44	163.20

Contractible Sky-Lux

No. of Lamps	2 x 2-Ft.			2 x 4-Ft.			
	No.	Each	No.	Each	No.	Each	
2	265231.22	\$43.65	265221.24	\$54.00	4	265421.44	\$117.60
3	265331.22	48.20	265321.24	66.00	6	265621.44	129.65
4	265431.22	50.65	265421.24	67.25	8	265821.44	141.85
2	26923D22	57.65	26922D24	78.35	4	26942D44	157.40
3	26933D22	62.05	26932D24	90.55	6	26962D44	169.60
4	26943D22	64.55	26942D24	91.60	8	26982D44	181.75
2	260231.22	48.60	260221.24	61.05	4	260421.44	138.95
3	260331.22	53.05	260321.24	73.20	6	260621.44	151.00
4	260431.22	55.60	260421.24	74.35	8	260821.44	163.20

Note: Contractible Sky-Lux also available. 4 x 4-ft. Plaster Frames for above luminaires can be furnished. Sky-Lux also available with: Flat acrylic plastic diffuser, concave acrylic plastic diffuser, alba-lite glass, Hexcel Honeylite, and Corning #70 lens.

Curtis Strato-Lux Luminaires With CurtiCell Louver Diffuser

Approved by Underwriters' Laboratories, Inc.

A complete packaged lighting system, with CurtiCell louver-diffusers create a soft shadowless, glare-free illumination combining complete diffusion and 25° crosswise and lengthwise shielding of the diffusing medium.

Creates a sense of light airiness—the luminaire “floats” or is suspended entirely from the ceiling, with no juncture necessary between the luminaire and the side walls.

Made of two pieces of self-extinguishing vinyl plastic, a flat top sheet and a vacuum formed cellular bottom sheet. CurtiCell is available in 2 x 2 and 2 x 4-ft. panels.

No.	Lamps No.—Lgth.	Avg. Ft.—Candles**	Size, Ft.	Number Normal Support Points	Cost Per Sq. Ft. of Room Area	Per Unit
8 x 8-ft. Room Dimensions						
159281.00	3—72	20	6x6	4	\$2.69	\$172.00
159181.00	6—72	40***	6x6	4	3.23	206.65
8 x 10-ft. Room Dimensions						
159211.01	3—96	30	6x8	4	2.36	188.65
159111.01	6—96	60***	6x8	4	2.79	233.05
8 x 18-ft. Room Dimensions						
159211.02	6—96	40	6x16	6	2.32	333.85
10 x 10-ft. Room Dimensions						
159211.03	4—96	30	8x8	4	2.17	217.00
159111.03	8—96	60***	8x8	4	2.73	272.25
10 x 12-ft. Room Dimensions						
159211.04	5—96	40	8x10	4	2.20	264.60
10 x 18-ft. Room Dimensions						
159211.05	8—96	40	8x16	6	2.19	394.35
12 x 14-ft. Room Dimensions						
159281.06	10—72	40	10x12	12	2.92	490.90
14 x 14-ft. Room Dimensions						
159281.07	12—72	45	12x12	12	2.75	539.30
14 x 18-ft. Room Dimensions						
159211.08	12—96	55	12x16	12	2.52	634.30
18 x 18-ft. Room Dimensions						
159211.09	16—96	65	16x16	12	2.34	758.60

**Values shown are for Frosty CurtiCell elements, with lamps on 24-in. centers, except where noted. See note on white translucent CurtiCell elements below.

***Lamps on 12-in. centers.

Notes

1. Higher intensities can be obtained from the above assemblies by adding more lamps. Use the following adders, and specify the number of (total) lamps desired per unit.

For One Lamp, 72-in. or 96-in., add, \$20.80

For Two Lamps, or multiples thereof, add, \$25.00

2. CurtiCell louver-diffuser panels are available in two densities—Frosty (order from table above) and White. Strato-Lux assemblies with White CurtiCell louver-diffuser elements produce lower direct brightness and reflected glare, and approximately 20% less transmitted light.

To order White louver diffuser panels, substitute “5” for the third digit (9) in the catalog numbers listed in the table above.

3. Spacing between channels and plastic: Normal distance from the top of the wiring channels to the CurtiCell louver-diffuser elements in 21-in. for 24-in. lamp spacing.

With 12-in. lamp spacing, a distance of 13-in. is recommended.

4. Larger room areas can be calculated by combining two or more of the elements shown in column 4 of the table above.

Strato-Lux is available with a variety of diffusing and louvering media. Including Plastic Eggcrate louvers and Hexcel Honeylite in 2x4-ft. Modules; Holophane #6025 Con-trolens in 2x2-ft. Module.

*Trademark Applied For. #Patent Pending.
Contact Graybar for additional information.

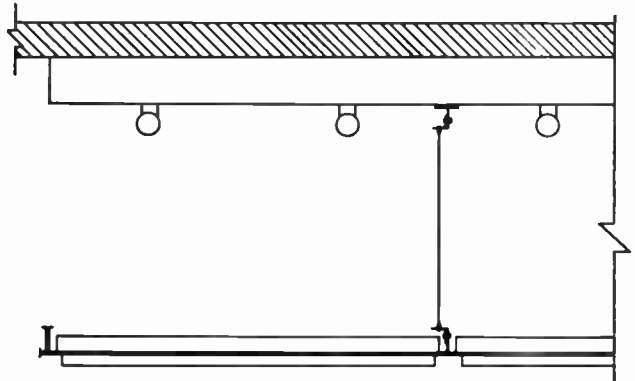
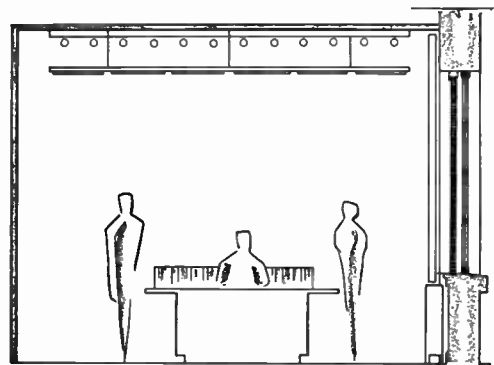

Curtis Fluorescent Troffers

Listed by Underwriters' Laboratories, Inc.

The new Curtis Eye Comfort® troffers feature low brightness quality and L.B.Q. aluminum louver fins for extra durability and brightness control in the critical viewing angles. Also available without louvers, these troffers install into virtually every type ceiling construction including Snap-in, "T" Bar, inverted "T" grid, Burgess-Manning, Acousti-Line and plaster ceilings. Total recessing depth required including Curtis U-Support Straps is less than 6½-in.

Side reflectors are of .040-in. aluminum for maximum efficiency and all aluminum parts are Alzak processed after fabrication for finish permanence. Cast ribs provide perfect reflector alignment in continuous rows without intervening end plates. Also available in steel finished white fluracite enamel.

Eye Comfort Steel Troffers with hinged doors available.

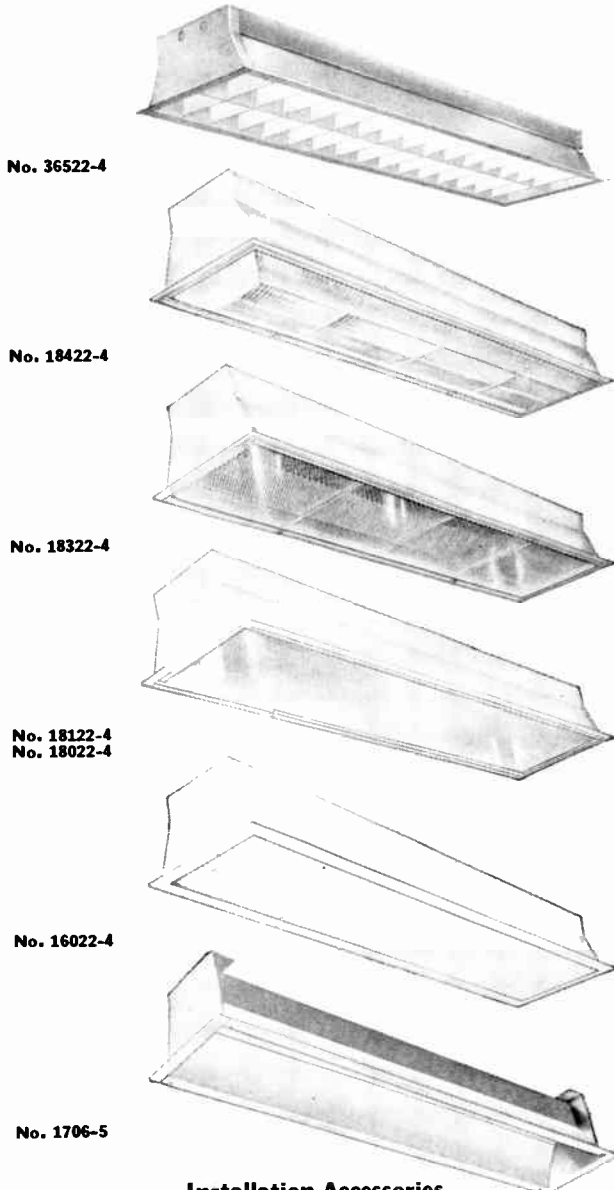

Installation Accessories

	4-ft. Section		5-ft. Section	
	No.	Price	No.	Price
Basic Plaster Frame	14148	\$4.45	14160	\$6.10
Extension Plaster Frame	14149	3.20	14161	5.10
1 "U" Support Strap; 2 End Finishing Flanges (Alzak)			14406	2.40
1 "U" Support Strap; 2 End Finishing Flanges (Steel)			14407	2.40
1 "U" Support Strap; 2 Leveling Screws for Flush Units			1440	1.35
Clips for fastening "U" Support Straps			14403	1.15

Two Lamp Eye Comfort Troffers

Recessing Type			Lamp Type	Lgth., In.	Each
No. Flange Type	No. Flush Type	Inverted "T"			
With Extruded LBQ Louvers					
36522-4	37522-4	39522-4	Rapid Start	48	\$49.35
36542-8	37542-8	39542-8	Rapid Start	96	96.85
36521-8	37521-8	39521-8	Slimline	96	96.85
36525-5	37525-5	39525-5	Low Brightness	60	62.45
With Flat Alzak Louvers					
36422-4	37422-4	39422-4	Rapid Start	48	43.85
36442-8	37442-8	39442-8	Rapid Start	96	86.75
36421-8	37421-8	39421-8	Slimline	96	86.75
36425-5	37425-5	39425-5	Low Brightness	60	55.35

Without Louvers					
36025-5	37025-5	39025-5	Low Brightness	60	45.85

No. Flange Type	No. Flush Type	Lamps			Type	Each
		No.	Watts	Lgth., In.		
Holophane Lo-Brite** Dished Crystal Controlens**						
18422-4	19422-4	2	40	48	T-12, Rapid Start	\$61.35
18421-8	19421-8	2	74	96	T-12, Slimline	115.35
18432-4	19432-4	3	40	48	T-12, Rapid Start	70.95
18431-8	19431-8	3	74	96	T-12, Slimline	134.75

Holophane Lo-Brite** Flat Crystal and Plastic* Controlens**						
18322-4	19322-4	2	40	48	T-12, Rapid Start	51.85
18321-8	19321-8	2	74	96	T-12, Slimline	97.55
18332-4	19332-4	3	40	48	T-12, Rapid Start	61.35
18331-8	19331-8	3	74	96	T-12, Slimline	116.25

*To Order with Plastic Controlens: Substitute "5" for third digit (3) in catalog numbers listed above.

Corning Alba-Lite Glass Panel						
18122-4	19122-4	2	40	48	T-12, Rapid Start	42.00
18121-8	19121-8	2	74	96	T-12, Slimline	82.05
18132-4	19132-4	3	40	48	T-12, Rapid Start	51.60
18131-8	19131-8	3	74	96	T-12, Slimline	100.85

Fine Cross-Rib Glass Panel						
18022-4	19022-4	2	40	48	T-12, Rapid Start	43.35
18021-8	19021-8	2	74	96	T-12, Slimline	80.55
18032-4	19032-4	3	40	48	T-12, Rapid Start	52.85
18031-8	19031-8	3	74	96	T-12, Slimline	99.25

Hexcel Honeylite***						
16822-4	17822-4	2	40	48	T-12, Rapid Start	48.85
16821-8	17821-8	2	74	96	T-12, Slimline	91.40
16832-4	17832-4	3	40	48	T-12, Rapid Start	58.35
16831-8	17831-8	3	74	96	T-12, Slimline	110.20

Egg Crate, Polystyrene Plastic*						
16022-4	17022-4	2	40	48	T-12, Rapid Start	41.95
16021-8	17021-8	2	74	96	T-12, Slimline	77.75
16032-4	17032-4	3	40	48	T-12, Rapid Start	51.55
16031-8	17031-8	3	74	96	T-12, Slimline	96.35

Single Lamp Low-Brightness, Alzak Aluminum Troffers

No.	Lamps			Type	Each
	No.	Watts	Lgth., In.		
1706-5	1	40	60	T-17, Low-Brightness	\$48.65
1706-10	2	40	60	T-17, Low-Brightness	77.85
1706-110	2	40	60	T-17, Low-Brightness	75.95

§Lamps not supplied. **Trade-mark Holophane Co., Inc. †Proprietary term of ALCOA. ***Trade-mark Hexcel Corp. ‡Trade-mark Curtis Lighting, Inc.

Curtis Fluorescent Luminaires

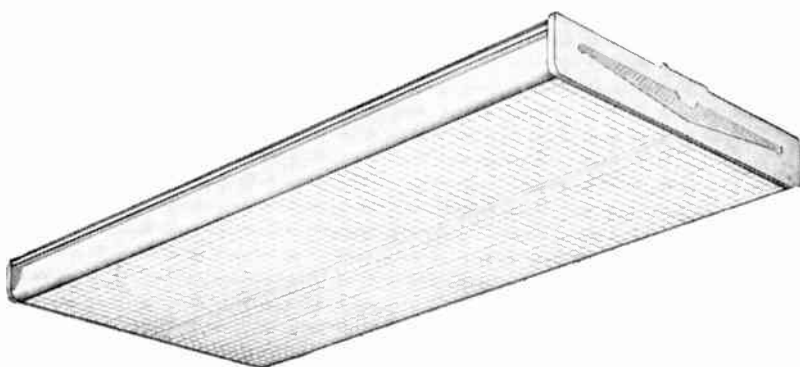

Edge-Glo

Curtis Edge-Glo luminaires combine high-fashion styling with high quality illumination. Long and shallow, Edge-Glo is just 3½ in. thin. Side panels, illuminated by reflected light, present a soft, glowing effect.

Edge-Glo is available in 2, 4 and 6-lamp sizes, in Alzak* Aluminum, Golden Alzak* Aluminum or baked white Fluracite enamel on aluminum, and a variety of bottom closures.

Dimensions

Curtis Edge-Glo units are 48⅞ in. long; 2-lamp units are 12¼ in. wide, 4 and 6-lamp units are 23¼ in. wide; and all units measure 3½ in. in depth.

Plastic Egg Crate Louver		Holograph Lo-Brite Plastic Controlens No. 6016		Flat Acrylic Plastic Diffuser		Hexcel Honeylight		Number and Type of Lamps
No.	Each	No.	Each	No.	Each	No.	Each	
Alzak Aluminum								
22022	\$39.60	22122	\$52.05	22222	\$45.40	22822	\$45.05	Two 40-watt, T-12, 48-in. Rapid Start
22042	63.20	22142	88.40	22242	75.20	22842	74.05	Four 40-watt, T-12, 48-in. Rapid Start
22062	78.25	22162	103.20	22262	90.20	22862	89.00	Six 40-watt, T-12, 48-in. Rapid Start
22028	78.35	22128	102.65	22228	89.55	22828	88.95	Two 40-watt, T-12, 96-in. Rapid Start

Golden Edge-Glo								
22022-G2	41.25	22122-G2	54.00	22222-G2	47.05	22822-G2	46.85	Two 40-watt, T-12, 48-in. Rapid Start
22042-G2	64.75	22142-G2	90.85	22242-G2	76.95	22842-G2	75.75	Four 40-watt, T-12, 48-in. Rapid Start
22062-G2	79.35	22162-G2	105.25	22262-G2	91.95	22862-G2	91.05	Six 40-watt, T-12, 48-in. Rapid Start
22028-G2	80.25	22128-G2	103.85	22228-G2	92.00	22828-G2	90.55	Two 40-watt, T-12, 96-in. Rapid Start

Baked White Fluracite Enamel on Aluminum								
21022	36.05	21122	49.75	21222	43.20	21822	42.85	Two 40-watt, T-12, 48-in. Rapid Start
21042	59.90	21142	85.00	21242	72.00	21842	71.25	Four 40-watt, T-12, 48-in. Rapid Start
21062	74.85	21162	100.35	21262	87.55	21862	87.55	Six 40-watt, T-12, 48-in. Rapid Start
21028	72.20	21128	98.20	21228	87.20	21828	84.60	Two 40-watt, T-12, 96-in. Rapid Start

Forty-Sixty Series

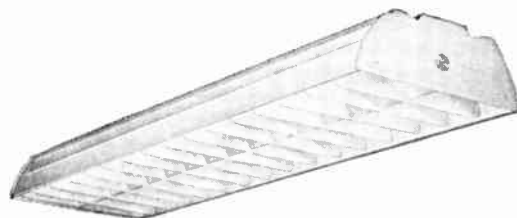

Curtis Forty-Sixty series luminaires provide excellent general illumination for interiors. Forty-Sixty series luminaires are available in shallow (1⅞ in.) and deep (5⅞ in.) units with a wide range of lengthwise shielding angles and lamp types as shown in the table below.

Units are available with reflectors and louver fins of Alzak Aluminum or baked white Fluracite enamel on steel; and also with Fine Ribbed Polystyrene Plastic Side Reflectors.

Alzak Aluminum Reflectors and Louver Fins

No.	35° Crosswise 25° Lengthwise	Shallow Series* (Choice of Shielding Angles)		35° Crosswise 45° Lengthwise	Each	Number, Size and Type of Lamps (Lamps Not Supplied)
		Each	No.			
N40602		\$30.40	N40632		\$33.20	Two 40-watt, T-12, 48-in. Rapid Start
N40802		60.65	N40832†		65.85	Four 40-watt, T-12, 48-in. Rapid Start
N40601		55.85	N40631		60.55	Two 74-watt, T-12, 96-in. Slimline

Steel Baked Enamel Reflectors and Louver Fins

N35252	24.75	N35452	20.75	Two 40-watt, T-12, 48-in. Rapid Start
N35282†	49.55	N35482†	52.55	Four 40-watt, T-12, 48-in. Rapid Start
N35251	38.75	N35451	38.75	Two 74-watt, T-12, 96-in. Slimline

*Also available in a Deep Series for greater shielding.

†To order with fine-ribbed plastic reflectors add "P" to catalog number; use same price.

Curtis Fluorescent Lightstrips



†NOTE: Reflector connector straps available for joining reflectors end-to-end in rows.

No.	Description	Each
No Reflectors—Single Lamp Units		
8000-4 ft.	38W, T-12, 48-in. Slimline, basic	\$20.35
8001-8 ft.	74W, T-12, 96-in. Slimline, basic	28.40
8005-5 ft.	90W, T-17, 60-in. Preheat, basic	35.00
8007-4 ft.	60W, T-12, 48-in. H. O. Rapid Start, basic	26.85
8003-8 ft.	74W, T-12, 96-in. Slimline, basic	35.95

No.	Description	Each
No Reflectors—Two Lamp Units, Lamps in-line		
8000-8 ft.	38W, T-12, 48-in. Slimline, basic	26.65
8000-E8 ft.	39W, T-12, 48-in. Slimline, exten.	26.25
8001-16 ft.	74 W, T-12, 96-in. Slimline, basic	40.40
8001-E16 ft.	74W, T-12, 96-in. Slimline, exten.	40.00
8005-10 ft.	90W, T-17, 60-in. Preheat, basic	45.00
8005-E10 ft.	90W, T-17, 60-in. Preheat, exten.	44.50
8007-8 ft.	60W, T-12, 48-in. H. O. Rapid Start, basic	40.00
8007-E8 ft.	60W, T-12, 48-in. H. O. Rapid Start, exten.	39.60
8003-16 ft.	105 W, T-12, 96-in. H. O. Rapid Start, basic	54.20
8003-E16 ft.	105W, T-12, 96-in. H. O. Rapid Start, exten.	53.75

Attachable Reflectors For Above—Single Side

Alzak Aluminum		
No.	Description	Each
120-4 ft.	Deep	\$ 3.60
130-5 ft.	Deep	4.60
121-4 ft.	Shallow	3.40
131-5 ft.	Shallow	1.60

Steel, White Fluracite		
No.	Description	Each
122-4 ft.	Deep	2.00
132-5 ft.	Deep	2.60
123-4 ft.	Shallow	1.60
133-5 ft.	Shallow	2.05

These reflectors attach to channels through keyhole slots with sheet metal screws provided. One deep and one shallow reflector provide asymmetric reflector. Order two of each number for symmetrical reflectors.



Twin Lamp Units—Lamps Parallel

No.	Type Lamps (2)	Each
1311-4 ft.	40W, T-12, 48-in. Rapid Start, basic	\$23.40
1311-E4 ft.	40W, T-12, 48-in. Rapid Start, exten.	22.95
1319-4 ft.	60W, T12, H.O. Rapid Start, basic	37.55
1319-E4 ft.	60W, T-12, H.O. Rapid Start, exten.	37.40
1318-8 ft.	105W, T-12, 96-in. H.O. Rapid Start basic	48.35
1318-E8 ft.	105W, T-12, 96-in. H.O. Rapid Start exten.	47.85
1314-5 ft.	90W, T-17, 60-in. Preheat, basic	42.55
1314-E5 ft.	90W, T-17, 60-in. Preheat, exten.	42.00
1313-4 ft.	38W, T-12, 48-in. Slimline, basic	27.75
1313-E4 ft.	38W, T-12, 48-in. Slimline, exten.	27.25
1316-6 ft.	55W, T-12, 72-in. Slimline, basic	38.75
1316-E6 ft.	55W, T-12, 72-in. Slimline, exten.	38.25
1317-8 ft.	74W, T-12, 96-in. Slimline, basic	40.55
1317-E8 ft.	74W, T-12, 96-in. Slimline, exten.	40.00

**Fluorescent Mogul Curtistrip
Twin Lamp Units—Lamps Staggered**

No.	Type Lamps (2)	Per Foot
1311X	20W, T-12, 24-in. Trigger Start, or 40W, T-12, 48-in. Rapid Start	\$8.60
1313X	38W, T-12, 48-in. Slimline, or 74W, T-12, 96-in. Slimline	9.25

Note: Prices apply to runs of 20 ft. or over. Specify number of lamps required for each staggered strip and method in which lamps are to be staggered.

Fluorescent Medium Curtistrip



Deep Open-End White Fluracite Enamel on Steel Reflectors*

No.	Number and Type of Lamps	Each
26422-2 ft.	One 20W, T-12, 24-in. Trigger Start, basic	\$11.60
26422-4 ft.	One 40W, T-12, 48-in. Rapid Start, basic	19.25
26422-8 ft.	Two 40W, T-12, 48-in. Rapid Start, basic	28.55
26422-E2 ft.	One 20W, T-12, 24-in. Trigger Start, exten.	11.60
26422-E8 ft.	Two 40W, T-12, 48-in. Rapid Start, exten.	28.55

Deep Open-End Alzak† Aluminum Reflectors*

No.	Number and Type of Lamps	Each
26742-4 ft.	One 40W, T-12, 48-in. Rapid Start, basic	22.65
26742-8 ft.	Two 40W, T-12, 48-in. Rapid Start, basic	35.20
26742-E8 ft.	Two 40W, T-12, 48-in. Rapid Start, exten.	35.20

Shallow Open-End White Fluracite Enamel on Steel Reflectors*

No.	Number and Type of Lamps	Each
26462-2 ft.	One 20W, T-12, 24-in. Trigger Start, basic	11.40
26462-4 ft.	One 40W, T-12, 48-in. Rapid Start, basic	18.65
26462-8 ft.	Two, 40W, T-12, 48-in. Rapid Start, basic	27.65
26462-E2 ft.	One 20W, T-12, 24-in. Trigger Start, exten.	11.40
26462-E8 ft.	Two 40W, T-12, 48-in. Rapid Start, exten.	27.65

Asymmetric Open-End White Fluracite Enamel on Steel Reflectors*

No.	Number and Type of Lamps	Each
26502-2 ft.	One 20W, T-12, 24-in. Trigger Start, basic	11.55
26502-4 ft.	One 40W, T-12, 48-in. Rapid Start, basic	18.25
26502-8 ft.	Two 40W, T-12, 48-in. Rapid Start, basic	26.05
26502-E2 ft.	One 20W, T-12, 24-in. Trigger Start, exten.	11.55
26502-E8 ft.	Two 40W, T-12, 48-in. Rapid Start, exten.	26.05

Shallow Open-End Alzak† Aluminum Reflectors*

No.	Number and Type of Lamps	Each
26762-4 ft.	One 40W, T-12, 48-in. Rapid Start, basic	\$20.25
26762-8 ft.	Two 40W, T-12, 48-in. Rapid Start, basic	30.05
26762-E8 ft.	Two 40W, T-12, 48-in. Rapid Start, exten.	30.05

Asymmetric Open-End Alzak† Aluminum Reflectors*

No.	Number and Type of Lamps	Each
26782-4 ft.	One 40W, T-12, 48-in. Rapid Start, basic	20.35
26782-8 ft.	Two 40W, T-12, 48-in. Rapid Start, basic	30.05
26782-E8 ft.	Two 40W, T-12, 48-in. Rapid Start, exten.	30.05

No Reflectors*

No.	Number and Type of Lamps	Each
26562-2 ft.	One 20W, T-12, 24-in. Trigger Start, basic	9.60
26562-4 ft.	One 40W, T-12, 48-in. Rapid Start, basic	15.65
26562-8 ft.	Two 40W, T-12, 48-in. Rapid Start, basic	21.65
26562-E2 ft.	One 20W, T-12, 24-in. Trigger Start, exten.	9.60
26562-E8 ft.	Two 40W, T-12, 48-in. Rapid Start, exten.	21.65

Accessories and Reflector End Plates

No.	Description	Each
522	Deep Reflector End Plate	\$1.65
523	Shallow Reflector End Plate	1.35
524	Asymmetric Reflector Plate—Right End	1.95
525	Asymmetric Reflector Plate—Left End	1.95

*Reflector End Plates not included; order separately
†A proprietary term of ALCOA.

Garcy "Adda-Strip" Lighting

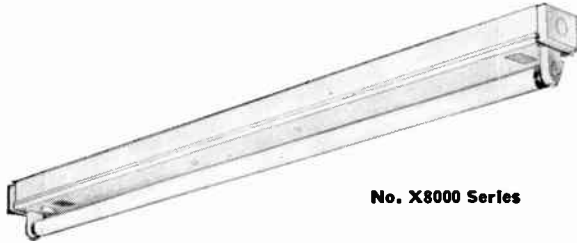

No. X8000 Series

High Power Factor

No.	Lgth. In.	No. and Size Lamps	Std. Pkg.	Wt. Lbs.	Each
X8000-18H**	19	1-18", 15W	12	46	\$ 8.75
X8000-24H**	25	1-24", 20W	12	60	8.91
X8000-36H**	37	1-36", 30W	6	47	10.84
X8000-48H***	49	1-48", 40W	6	55	11.10
X8000-96H***	96	2-48", 40W	4	72	17.04

*Length includes 1/2-in. box at each end on all except 96 in. units. 96 in. units include coupling.

**Trigger-Start low power factor available at same price on items marked only.

***Rapid-Start available at same price.

For Side Mounted Lamps



No. 9929 Series

No.	Lgth. In.	No. and Size Lamps	Std. Pkg.	Wt. Lbs.	Each
9929-18H*	18	1-15 Watt, H.P.F.	4	12	\$11.60
9929-24H*	24	1-20 Watt, H.P.F.	4	20	11.74
9929-36H*	36	1-30 Watt, H.P.F.	4	32	15.20
9929-48H**	48	1-40 Watt, H.P.F.	4	36	15.39
9929-96H**	96	2-40 Watt, H.P.F.	4	72	26.16
X9929-96H	96	2-40 Watt, H.P.F.	4	72	22.38

*Trigger-Start L.P.F. available at same price on items marked only.

**Rapid-Start available at same price.

X9929-96H does not include wire leads.

Slimline Strip

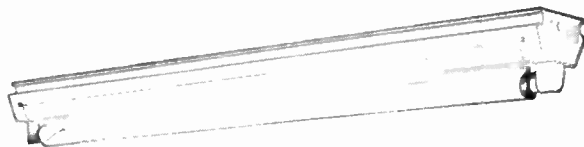

No. SL9811

For 430 Ma. Slimline Lamps

No.	Lgth. In.	No. and Size Lamps	Std. Pkg.	Wt. Lbs.	Each
SL9811-4	48	1-48" Slimline, 430ma.	4	76	\$23.75
RS9811-4	48	1-40W Rapid-Start	4	52	17.35
SL9811-6	72	1-72" Slimline, 430ma.	4	110	32.98
SL9811-8	96	1-96" Slimline, 430ma.	2	72	27.19

With Two Lamp Ballasts

Where two-lamp ballasts can be used in one unit, no ballasts in next unit — use these prices.

SL9811-4	\$19.25
SL9811-6	23.45
SL9811-8	20.00

Garcy "Vest-Pocket" Fluorescent Strip Lighting

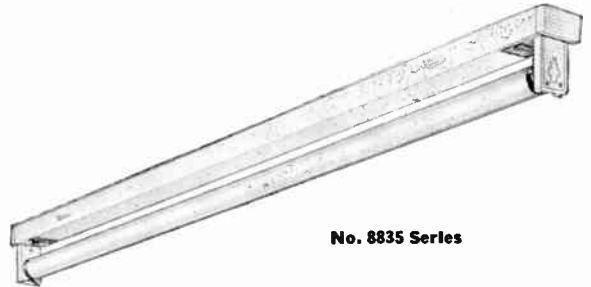

No. 8835 Series

No.	Lgth. In.	No. and Size Lamps	Each
8835-18II	18	1-15 Watt, H.P.F.	\$13.49
8835-24II	24	1-20 Watt, H.P.F.	13.95
8835-36II	36	1-30 Watt, H.P.F.	19.08
8835-48II	48	1-40 Watt, H.P.F.	19.16

End Boxes and Couplings For 8835 Series

8835-3	End Box	\$0.56
8835-4	Blank End Box	.48
8835-8	End Box with Starter Base	.94
8835-5	Blank Coupling	.41
8835-6	Coupling with Starter Base	.94

Slimline

No.	Lgth., In.	Lamp	Ship. Wt. Lbs.	Single Lamp Each	Two-Lamp* Each
8875	42"	200 ma.	15	\$33.88	\$25.70
8875	48"	430 ma.	20	32.01	23.70
8875	64"	200 ma.	17	35.41	29.20
8875	72"	200 ma.	18	37.66	32.11
8875	72"	430 ma.	22	42.14	31.95
8875	96"	200 ma.	20	40.23	31.66
8875	96"	430 ma.	24	40.23	31.20

*Use these prices where two strips can be furnished with one two lamp ballast and one ballast box. Prices are per fixture.

End Boxes and Couplings For No. 8875 Series

No.	Description	Each
8875-A	Splice End Box and Cover	\$0.73
8875-B	1/4" End Box	.55
8875-C	3/4" End Box with Sleeve	.73
8875-D	Coupling	.36
8875-E	Splice Box Coupling	.73

Garcy Ultra-Lux Fixtures

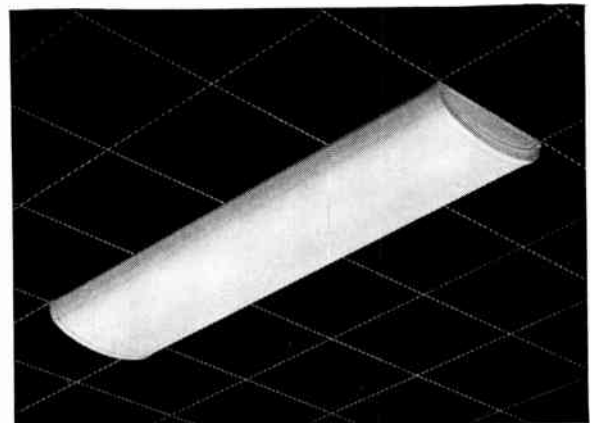

Exceptionally shallow fixture for 2-40 Watt Rapid-Start lamps. Ideal for surface mounting in low ceiling offices and stores. Only 3/4 in. deep. Chassis is steel, finished baked white enamel. Shield of translucent polystyrene plastic provides efficient light transmission and uniform distribution. Concealed hinges for cleaning and relamping.

No. 5022-P	Each \$29.00
------------	--------------

Garcy Recessed Fluorescent Troffers

5500 Series

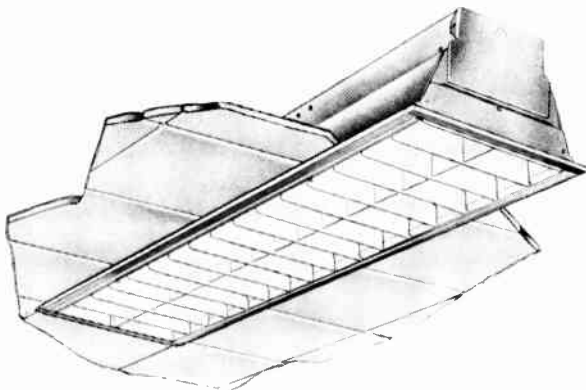

No. 5502—HL Series with Louver

**For 40-Watt, 48-In. T-12 Rapid Start Lamps
Two Lamp Rows**

No.	Lgth. Ft.	Louvered	Each Glass	Lens*
RS5502-4	4	\$36 30	\$37 50	\$43 80
RS5502-8	8	67 00	69 70	82 40
RS5502-12	12	100 80	104 70	123 60
RS5502-16	16	131 60	136 90	162 20
RS5502-20	20	165 30	171 90	203 40
RS5502-24	24	196 10	204 10	242 00
RS5502-28	28	229 90	239 10	283 30
RS5502-32	32	260 60	271 30	321 90

Three Lamp Rows

RS5503-4	4	\$44 20	\$45 50	\$52 80
RS5503-8	8	78 10	80 90	95 10
RS5503-12	12	119 90	123 90	145 40
RS5503-16	16	153 80	159 40	187 70
RS5503-20	20	195 50	202 40	238 00
RS5503-24	24	229 40	237 80	280 20
RS5503-28	28	271 10	280 80	330 60
RS5503-32	32	305 00	316 30	372 30

**For 430 Ma. Slimline Lamps (48-In., 72-In. and 96-In.)
Two Row Lamps**

No.	Lgth. Ft.	Louvered	Each Glass	Lens*
SL5502-4	4	\$42 00	\$46 60	\$48 10
SL5502-6	6	64 50	67 00	75 90
SL5502-8	8	61 40	63 90	77 80
SL5502-12	12	100 90	104 90	123 40
SL5502-14	14	123 40	128 40	151 30
SL5502-16	16	120 30	125 30	153 10
SL5502-20	20	159 90	166 30	198 80
SL5502-24	24	179 20	202 40	228 40
SL5502-28	28	218 80	243 30	274 10
SL5502-32	32	238 10	248 10	303 80

Three Lamp Rows

SL5503-4	4	\$66 30	\$63 00	\$67 40
SL5503-6	6	90 60	93 40	102 20
SL5503-8	8	86 70	87 70	104 20
SL5503-12	12	150 50	148 10	169 10
SL5503-14	14	174 90	178 60	203 90
SL5503-16	16	170 90	172 80	205 90
SL5503-20	20	234 70	233 30	270 80
SL5503-24	24	255 20	258 00	307 70
SL5503-28	28	318 90	318 40	372 50
SL5503-32	32	339 40	343 10	409 40

Note: Above prices are for complete runs, including necessary end sets and mounting brackets. Plaster frames are extra.

Plaster Frames

Pair of 4-ft. Side Rails	\$3 75
Pair of 6-ft. Side Rails	5 00
Pair of 8-ft. Side Rails	6 25
Pair of End Rails	1 25

*With Corning Lens No. 541350. Also available with Corning No. 70 Low Brightness Lens.

5600 Series

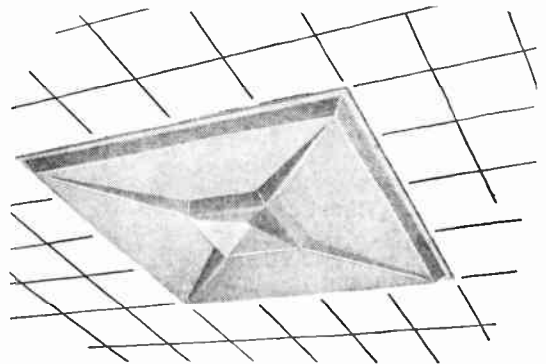

HP Series Hinged Plexiglas

Sturdily made fixtures with hinged egg-crate louver, plastic diffuser or glass-panel bottom. Die-formed chassis of 20-gauge steel. Finished baked white enamel. Separable end cover and flange. Two-ft. wide units can be joined in continuous runs.

Egg-crate louvers are completely framed for one-piece rigidity; provide 37° shielding crosswise and lengthwise. Plastic shield is die-formed to special concave no-sag contour. Glass-panel units utilize Corning Alba-Lite glass.

2-Ft. x 2-Ft., 2-Ft. x 4-Ft. and 2-Ft. x 8-Ft. Units

No.	Lgth. In.	No. and Size Lamps	Louvered	Each Plastic	Glass
5622	24	2-20W Fluorescent	\$34 90	\$43 10	\$36 30
RS5602-4	48	2-40W Rapid-Start	48 90	66 60	52 80
RS5602-8	96	*4-40 Rapid-Start	93 10	123 60	101 30
SL5602-8	96	2-96" Slimline, 430 ma.	90 20	124 90	99 70

5623	24	3-20W Fluorescent	43 40	51 90	44 90
RS5603-4	48	3-40W Rapid-Start	59 10	77 10	64 90
RS5603-8	96	*6-40W Rapid-Start	105 20	135 90	113 30
SL5603-8	96	3-96" Slimline, 430 ma.	117 70	147 40	125 50

5624	24	4-20W Fluorescent	48 80	57 10	50 00
RS5604-4	48	4-40W Rapid-Start	62 00	80 10	66 10
RS5604-8	96	*8-40W Rapid-Start	119 20	149 70	127 40
SL5604-8	96	4-96" Slimline, 430 ma.	113 40	143 30	104 10

4-Ft. x 4-Ft. Fixtures

No.	No. and Size Lamps	Louvered	Each Plastic	Glass
RS5606	6-40W Rapid-Start	\$139 10	\$153 00	\$146 10
RS5608	8-40W Rapid-Start	153 10	167 00	160 00
RS5610	10-40W Rapid-Start	167 00	180 80	173 90

*Tandem type (two lamps, end to end, in each row).

Note: With Plexiglas, add "HP" to number. With Egg-Crate Louver, add "HL" to number. With Alba-Lite Glass, add "HS" to number. With Corning Lens No. 541350, add "CL" to number.

Prices for "FG" Series (for use in aluminum T-Grid ceilings) will be furnished on request. State quantity.

Garcy Speed-Line Fluorescent Fixtures

Speed-Line fixtures have a specially formed wireway, designed for use with a special heavy duty joiner. The wireway and the joiner permit pre-assembly and pre-wiring of continuous runs of fixtures at convenient working level and make it possible to raise the entire run to the ceiling as unit.

Garcy's C12806 clamp-type, adjustable stem hangers add to the time savings. Attached to the continuous wireways at floor level, they hook easily into the pre-installed hickies when the assembly is carried to the ceiling. Spacing flexible.

"Visualier" Series

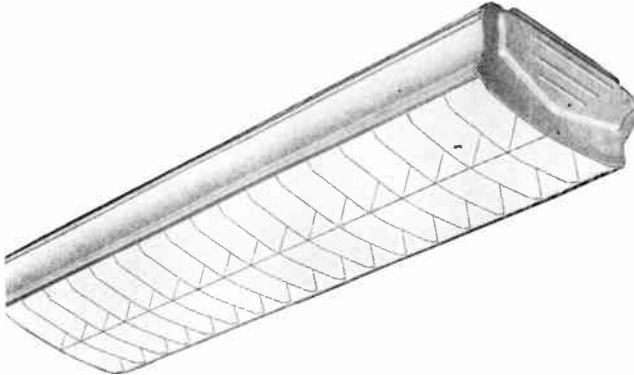

Two-lamprow units, ideal for school lighting. One-piece shield provides 45° x 45° shielding to prevent glare; illuminated sides for minimum contrast; hinges from either side for cleaning or relamping. Baked white enamel. Slimline or Rapid-Start lamps.

No.	Lgth. In.	No. and Size Lamps	Each
RS5350-4	48	2-40 Watt Rapid Start	\$29.38
RS5350-8	96	4-40 Watt Rapid Start	58.13
SL5350-4	48	2-48 In. Slimline, 430 ma.	35.84
SL5350-8	96	2-96 In. Slimline, 430 ma.	52.81

"Gar-See-Lite" Series

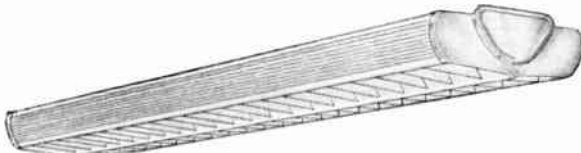

Moderately priced two-lamp units with opaque metal, plastic or illuminated metal side panels. Metal louver shield provides 35° crosswise, 27° lengthwise shielding (45° lengthwise also available); hinges from either end. Baked white enamel. Slimline or Rapid-Start lamps.

With Opaque Metal Sides

No.	Lgth. In.	Ship. Wt. Lbs.	No. and Size Lamps	Each
RS5382M-4	48 1/8	36	2-40 Watt Rapid Start	\$25.00
RS5382M-8	96 1/8	72	4-40 Watt Rapid Start*	48.91
SL5382M-8	96 1/8	67	2-96 In. Slimline, 430 ma.	45.63
SL5382P-4	48 1/8	35	2-48 In. Slimline, 430 ma.	32.04
5382M-4	48 1/8	36	2-40 Watt Fluorescent	25.79

*Tandem type (two lamps, end to end, in each row).

With Plastic Sides

RS5382P-4	48 1/8	36	2-40 Watt Rapid Start	\$25.94
RS5382P-8	96 1/8	72	4-40 Watt Rapid Start*	50.94
SL5382P-8	96 1/8	67	2-96 In. Slimline, 430 ma.	47.50
SL5382P-4	48 1/8	35	2-48 In. Slimline, 430 ma.	32.98
5382P-4	48 1/8	36	2-40 Watt Fluorescent	26.73

*Tandem type (two lamps, end to end, in each row).

With Illuminated Metal Sides

RS5382I-4	48 1/8	36	2-40 Watt Rapid Start	\$25.63
RS5382I-8	96 1/8	72	4-40 Watt Rapid Start*	50.16
SL5382I-8	96 1/8	67	2-96 In. Slimline, 430 ma.	46.88
SL5382I-4	48 1/8	35	2-48 In. Slimline, 430 ma.	32.66
5382I-4	48 1/8	36	2-40 Watt Fluorescent	26.41

*Tandem type (two lamps, end to end, in each row).

No. 5082-E Ornamental End plates.
Pair required per run. Each \$0.94

Garcy Speed-Line Accessories

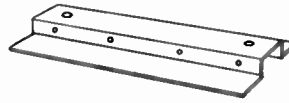

Speed-Line Joiner

One less than number of fixtures in run required.
No. 65350. Each \$1.41

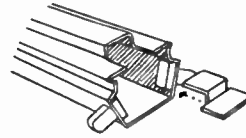

Top Channel End Closure

One pair required per run.
No. 5350-A. Each \$0.63



**Adjustable Stem Hanger
2 In. Adjustment**

No.	Lgth., In.	Each
C12806-10	10	\$2.19
C12806-14	14	2.38
C12806-18	18	2.50
C12806-22	22	2.69
C12806-30	30	2.88
C12806-36	36	3.13
C12806-48	48	3.50

Garcy Showcase Lighting Fixtures

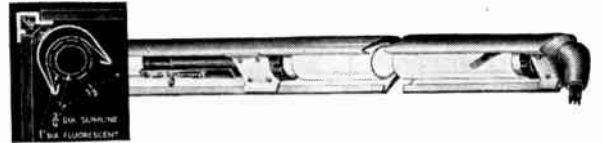

No. 4500 Series

Properly contoured reflectors concentrate the light inside the case where it is needed, also affording complete shielding of the lamps. Fixtures are available for standard case sizes, combining lamps as necessary. Garzal aluminum reflector; exterior in satin nickel, satin bronze and other finishes. Ballast in separate control box. All units available with clips for mounting to wood or glass.

Low Power Factor

No.	Fixture Lgth. In.	For Lamps (L.P.F.)**		Each
		Fluorescent No. Lgth., In.	Slimline, 200 ma. No. Lgth., In.	
4500A	33	1-18	\$24.69
4500B	45	1-36	30.16
SI4500C	45	1-42	38.75
4500R	69	1-36 & 1-18	44.06
4500D	69	1-18	1-42	54.23
SI4500E	69	1-64	45.79
4500G	84	1-36	1-42	61.25
4500J	106	1-36	1-64	63.75

High Power Factor

4501A	33	1-18	\$29.23
4501B	45	1-36	35.31
SI4501C	45	1-42	42.50
4501R	69	1-36 & 1-18	52.04
4501D	69	1-18	1-42	58.29
SI4501E	69	1-64	49.38
SI4501M	76	1-72	50.63
4501F	87	2-36	50.16
4501G	84	1-36	1-42	66.10
4501V	93	2-42	66.56
4501K	100	2-36 & 1-18	66.88
4501N	100	1-96	57.35
4501J	106	1-36	1-64	77.50
4501T	111	1-42 & 1-64	73.91
4501W	134	2-64	77.66

*Length includes end connection. 33 in., 45 in. and 69 in. length are carried in stock.

**Prices based on maximum use of two-lamp ballasts.

Gibson Fluorescent Lighting Fixtures



STANDARD UNI-RACE

Included in the cost of the fixture.



CANOPY UNI-RACE

For surface mounting and special applications. Supplied at small extra cost.

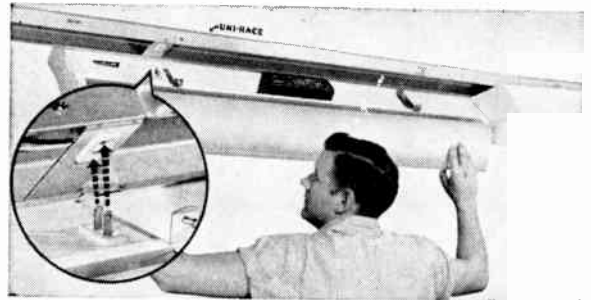

The Fixture That Just Plugs In

Uni-Race Fill-In Sections are available for spaced interval mounting to which fixture can be plugged in without additional electrical work.

Uni-Race, each Ortho-77 & 88 is supplied with a companion wireway known as Uni-Race. The Uni-Race has a built-in receptacle which receives plug built into the fixture.



Ortho-77 Commercial

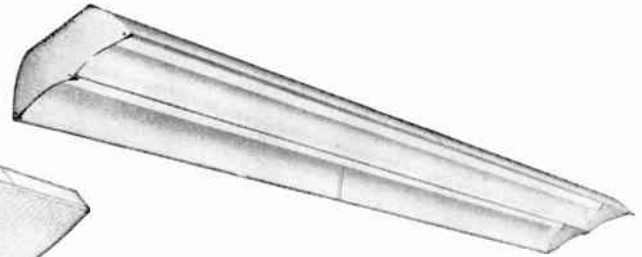

Ortho-88 Industrial

No.	No. & Size Lamp	Each
77-224X	2/40 WRS	\$32.86
77-244X	2/40 WS	35.88
77-284X	2/75 WS	58.38

No.	No. & Size Lamp	Each
77-424X	4/40 WRS	\$54.82
77-444X	4/40 WS	57.79
77-484X	4/40 WS	86.65

No.	No. & Size Lamp	Each
88-221X	2/40 WRS	\$30.80
88-241X	2/40 WS	33.05
88-281X	2/75 WS	47.15
88-291X	2/100 WRS	57.74

No.	No. & Size Lamp	Each
P88-221X	2/40 WRS	\$33.62
P88-241X	2/40 WS	36.04
P88-281X	2/75 WS	52.29
P88-291X	2/100 WRS	62.89

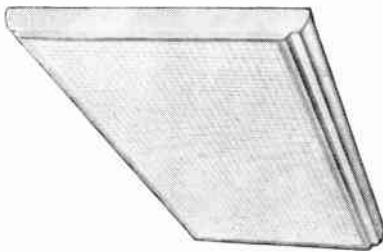

4-Light

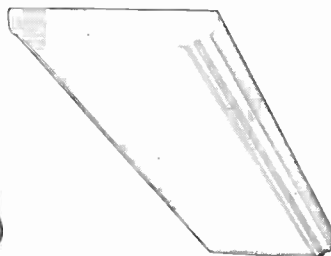

2-Light

Ceilo-35
2 3/4 In. Deep With No Dark Areas

No.	Type	No. & Size Lamp	Each
35-224X	Plastic Louver	2/40 WRS	\$41.30
35-424X	Plastic Louver	4/40 WRS	66.40
PY35-220X	P-1 Plexiglas	2/40 WRS	45.73
PY35-420X	P-1 Plexiglas	4/40 WRS	74.55
DR35-220X	Drop Plexiglas	2/40 WRS	47.47
DR35-420X	Drop Plexiglas	4/40 WRS	75.96

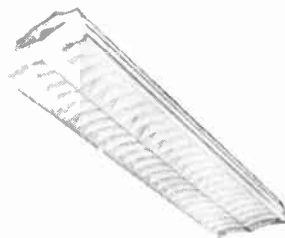

MP-45



MP-46

A new school fixture that equals or exceeds the American School Standard available in All Metal as the MP-45, and in Plastic Sides as the MP-46.

No.	Shielding	No. & Size Lamp	Mounting	Each
45-224X	45 x 45°	2/40 WRS	Surface	\$26.36
45-284X	45 x 45°	2/75 WS	Surface	48.50

For MP-46 with Plastic Sides (change prefix to MP-46) and add \$1.77 per 48 in. length.



PAR-42 Industrial

No.	No. & Size Lamp	Each	No.	No. & Size Lamp	Each
42-221X	2/40 WRS	\$26.00	P42-221X	2/40 WRS	\$28.21
42-241X	2/40 WS	27.23	P42-241X	2/40 WS	29.45
42-281X	2/75 WS	42.38	P42-281X	2/75 WS	46.81
42-291X	2/100 WRS	53.19	P42-291X	2/100 WRS	57.62

Holophane Fluorescent Lighting Units

Approved by Underwriters' Laboratories, Inc.

Holophane No. 9300 Series . . . Surface Attached HOLOFLUX*

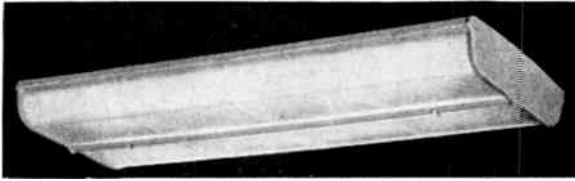

The surface attached Holoflux units afford the highest degree of seeing comfort with the most efficient performance. Their contour and unique prismatic construction are designed to produce the greatest useful output from the fluorescent sources. High levels of illumination are achieved with complete absence of cumulative glare.

Shallow depth. 4½-in. simulates recessed construction without the expense of roughing-in. Units take 2 or 4 lamps of conventional bipin starter type, instant-start single pin lamps and the 4-ft. rapid start lamps.

New, improved hinging and locking assures totally enclosed construction during operation yet allows easy access for relamping. Specified wherever high efficiency lighting with the greatest degree of comfort is desired.

Steel parts bonderized and finished with prime and white enamel coatings. Hinged doors. 18¼-in. wide, 4½-in. deep.

No.	Ft.	Length In.	Lamps	0-60° Output	Each	No.	Ft.	Length In.	Lamps	0-60° Output	Each
9302-4	4	2	2-F40T12	49.8	585.90	9322-8	8	2	2-F96T12	49.8	160.50
9304-4	4	2	4-F40T12	45.4	102.85	9324-8	8	2	4-F96T12	45.4	181.15
9312-4	4	2	2-F48T12	49.8	89.25	9332-4	4	2	2-F40T12/RS	49.8	85.90
9314-4	4	2	4-F48T12	45.4	105.65	9334-4	4	2	4-F40T12/RS	45.4	99.55

F40T12—starter type; F48T12 and F96T12—slimline; F40T12/RS—Rapid Start. All Holoflux units are wired.

Ballasts: 2 lamp units—1-2 lamp; 4 lamp units—2-2 lamp.

Note: Four ft. and eight ft. additional sections available for making continuous runs.

Holophane No. 9200 Series . . . Recessed HOLOFLUX*

Designed to produce the highest efficiency with complete absence of glare from any direction of view. Units have smooth modern lines, can be installed inexpensively and maintained at low cost. A wide choice of lamp styles is available. A hinged door variety holds lenses securely in a frame, provides an unbroken streamlined appearance, unit ends are integrated smoothly into the ceiling.

Engineered to be as wide as possible to produce maximum efficiency and lowest possible brightness at normal viewing angles. Fourteen-inch width permits installation in practically all types of ceilings including wood joists on 16-in. centers.

Units can be installed with ease in acoustic tile ceilings with a minimum amount of tile cutting. Maximum spacing, 1¼ times the mounting height.

Unhinged Units

No.	Length Rec. Portion, In.	Lamps	Ballasts	Each
9201-4	48½	2-F40T12	1-2 Lamp	73.55
9202-4	48½	3-F40T12	1-3 Lamp	86.75
9209-4	48½	3-F40T12	1 + 1-2	84.50
9222-8	96¾	2-F96T12	1-2 Lamp	134.70
9223-8	96¾	3-F96T12	1 + 1-2	154.80
9225-4	48½	2-F48T12	1-2 Lamp	76.65
9226-4	48½	3-F48T12	1 + 1-2	99.85
9235-4	48½	2-F40T12/RS	1-2 Lamp	73.55
9236-4	48½	3-F40T12/RS	1 + 1-2	84.50
9238-4	48½	3-F40T12/RS	1-3 Lamp	82.75

Hinged Units

No.	Length Rec. Portion, In.	Lamps	Ballasts	Each
9252-4	48¾	2-F40T12	1-2 Lamp	87.55
9253-4	48¾	3-F40T12	1-3 Lamp	100.85
9259-4	48¾	3-F40T12	1 + 1-2	97.95
9262-4	48¾	2-F48T12	1-2 Lamp	90.45
9263-4	48¾	3-F48T12	1 + 1-2	111.95
9272-8	96¾	2-F96T12	1-2 Lamp	154.85
9273-8	96¾	3-F96T12	1 + 1-2	177.05
9282-4	48¾	2-F40T12/RS	1-2 Lamp	87.55
9283-4	48¾	3-F40T12/RS	1 + 1-2	97.95
9285-4	48¾	3-F40T12/RS	1-3 Lamp	96.85

All units 13¾-in. wide at ceiling line. Need 6¾-in. min. recessing space.

Ceiling opening required 14¼-in. x 49-in. for first 4-ft. section, additional section 11¼ x 48-in.

Note: Four ft. and eight ft. additional sections available for making continuous runs.

New Holophane REALITE* With New PRISMALUME* Enclosure

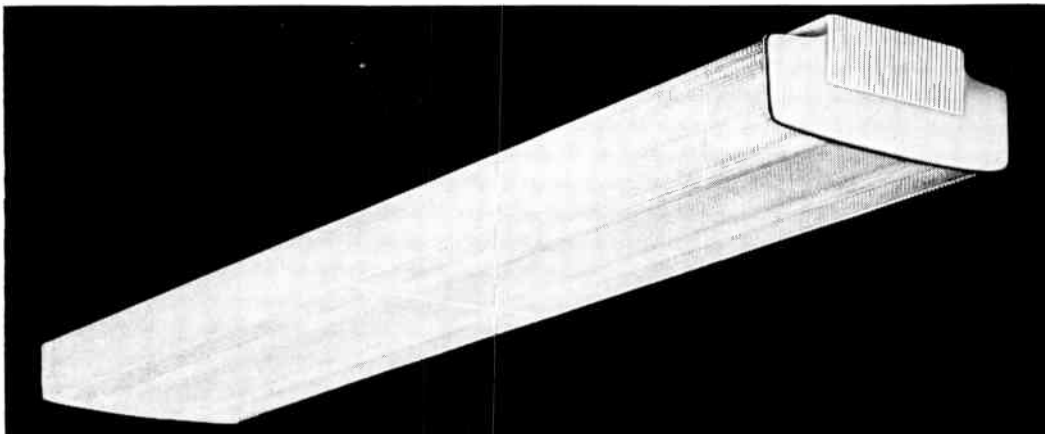

Realite . . . a compact shallow, ceiling attached luminaire offers exceptional light control with Prismalume acrylic plastic enclosure.

Prismalume is not a mere diffuser but a precisely designed optical element. Bends light rays away from direct viewing area.

An exceptional luminaire for low ceiling areas where recessing is not desirable or practicable.

10⅝-in. wide.
4¼-in. deep.
All units wired.

No. 6500-4 49½-in. Long Each \$49.95‡
(2-Lamp—Rapid Start)

No. 6500-8 97½-in. Long Each \$96.95‡
(4-Lamp—Rapid Start)

Units are fused for ballast protection.

*Holophane Trade Marks. ‡Prices slightly higher West of the Rockies.

Note: Eight ft. additional sections available for making continuous runs.

Benjamin Commercial Fluorescent Lighting Units

Listed By Underwriters' Laboratories, Inc.

"Catalina" Series (CT)

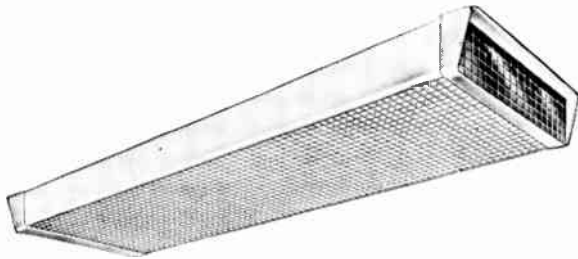

Shallow designed units for soft, well diffused illumination in offices, schools, stores and other commercial areas.

Louvers are injection molded, polystyrene with 1/2"x1/2"x1/2" cells which provide 45° shielding. The D-shaped side panels of semi-tubular, translucent extruded plastic are chemically welded to the louver to form the unit enclosure.

Units are supplied pre-wired; finish is white baked paint enamel. Over-all width of twin-lamp unit, 13 1/8"; 4-lamp unit 16 1/16". Over-all depth of unit is 4"; but apparent depth is 3 1/2".

Individually packaged units (less suspensions) are listed; complete lines are also available. For units with a 2 1/2" rigid stem canopy suspension add suffix "S" to unit number. Suspensions regularly supplied with "S" suffix units are: on 4' units, a twin-stem type at \$4.06 additional; on 8' units, two single-stem type (with sliding hanger and 2" leveling adjustments) at \$6.08 additional. Suspensions with swivel stems also available, as well as top reflectors for ceiling mounted units. Prices on request.

For 48-In. 40-Watt T-12 Rapid-Start Lamps*

Length	Twin-Lamp		4-Lamp	
	No.	Each	No.	Each
4' 2 5/8"	CT-240RS-4	\$30.81	CT-440RS-4	\$42.12
8' 3 1/2"	CT-240-RS-8	60.45	CT-440RS-8	82.68

For 96-In. T-12 Slimline Lamps*▲

8' 2 1/4"	CT-296-8	49.92	CT-496-8	67.86
-----------	----------	-------	----------	-------

Special sliding or non-sliding type canopy stem suspensions are available; as are "Top Reflectors" for use in surface mounted units; data on application.

"Officer" Series (VL)

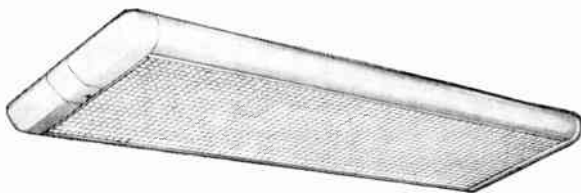

Units listed have one-piece injection molded plastic louver sections, with 1/2"x1/2"x1/2" cells, which provides 45° shielding.

Individual units below are listed with canopy stem suspensions; complete runs also available. Units supplied prewired; finish is white baked paint enamel. Over-all length is 4 ft. 5 3/8 in. for single length 40-W; 8 ft. 7 in. for double length units. Length of 96 in. Slimline unit is 8 ft. 5 1/4 in. Depth is 5 1/2 in. Over-all width is 10 1/4 in. for 2 and 3-lamp; 16 1/4 in. for 4-lamp unit.

For 48-In. 40-Watt T-12 Rapid-Start Lamps*†

No. (Twin Lamp)	Each	No. (3-Lamp)	Each	No. (4-Lamp)	Each
VL-240RS-4S	\$36.27	VL-340RS-4S	\$45.32	VL-440RS-4S	\$54.68
VL-240RS-8S	66.92	VL-340RS-8S	79.48	VL-440RS-8S	103.43

For 96-In. T-12 Slimline Lamps*▲

VL-296-8S	63.96	VL-396-8S	85.18	VL-496-8S	91.57
-----------	-------	-----------	-------	-----------	-------

Incandescent inserts for highlighting are available.

"Capri" Series (SC)

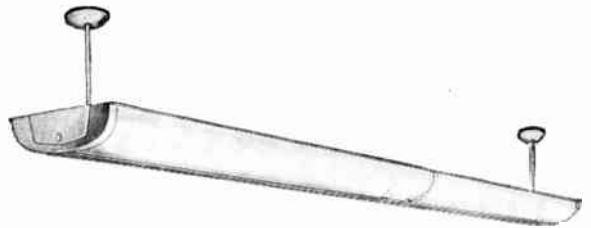

A luminous indirect, exceptionally shallow unit designed to meet present day school-lighting practice; also provides well diffused light for stores, offices, etc. Designed for pendent mounting. Translucent polystyrene plastic side panels are easily removable for cleaning; bottom is vented to minimize dirt accumulation. Individual units with canopy stem suspension are listed; complete runs also available. Units are supplied prewired; finish is white baked paint enamel.

For 48-In. 40-Watt T-12 Rapid-Start Lamps*†

No.	Over-all Dimensions (Twin-Lamp)			Each
	Length	Width	Depth	
SC-240RS-4S	4' 1/16"	10 1/2"	3 1/16"	\$29.80
SC-240RS-8S	8' 1/16"	10 1/2"	3 1/16"	50.93

For 96-In. T-12 Slimline Lamps*▲

SC-296-8S	8' 1/16"	10 1/2"	3 1/16"	46.88
-----------	----------	---------	---------	-------

"PTE" Series

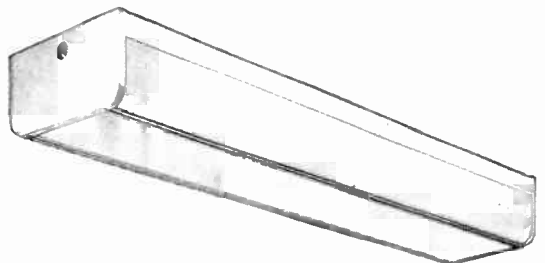

Designed to meet the problems encountered in modern store lighting. Units listed have Albalite glass sides and bottoms; No. 66 glass sides regularly supplied, with one side smooth, one side ribbed. Units designed for surface mounting—for use individually or in continuous runs. Supplied prewired; finish is white baked paint enamel. Over-all length is 4 ft. 1/4 in. for 48 in. lamp unit; 8 ft. 1/4 in. for 96 in. lamp units. Width is 14 1/16 in.; depth 6 1/4 in.

Units are also available with plastic side panels; with plastic 45°x45° louvers; or with special glass sides having one side pebbled—one side smooth; data on request.

For 48-In. 40-Watt T-12 Rapid-Start Lamps*†

No. (Twin-Lamp)	Each	No. (3-Lamp)	Each	No. (4-Lamp)	Each
PTE-240RS-4	\$47.42	PTE-340RS-4	\$57.80	PTE-440RS-4	\$60.29

For 96-In. T-12 Slimline Lamps*▲

PTE-296-8	95.94	PTE-396-8	116.69	PTE-496-8	118.40
-----------	-------	-----------	--------	-----------	--------

*Listed for 110-125V. 60 cycles; other voltages available.

†For 40-W preheat units with FS-40 non-blinking, manual reset starters, drop "RS" from number and add suffix "W"; also \$0.65 per starter. For preheat units with standard FS-4 starters, drop "RS" from number and use 40-W R.S. price.

▲Slimline units have "series-type" ballasts. To specify add "lead-lag" to number and \$5.75 to 2 or 3-lamp and \$11.50 to 4-lamp unit price.

Lamps are not included with units on this page. All 8', 40W. R.S. units are two units in tandem.

Benjamin 12-Inch Width Recessed "Trofferlites"

Listed By Underwriters' Laboratories, Inc.

A complete line of recessed troffers—outstanding for their versatility of surface brightness, high light values, efficiency of operation and low maintenance cost. A feature of the Benjamin line is "Multi-Vent" which provides both light and air conditioning from the same unit—see data below. Units may be mounted individually or in continuous rows to form almost any pattern. Individual units with end caps are listed. For continuous runs with necessary fittings change 4 or

8 in suffix (which indicates length of unit in feet) to desired line length in multiples of 4 feet. Price will vary somewhat as compared to equal footage in individual units. Steel housing, reflector, and end caps are finished white baked paint enamel. Reflector may be quickly removed for access to ballast and wiring. Benjamin adjustable or stationary incandescent downlights may be inserted in continuous lines for "high lighting." Lamps are not included with the units.

Standard "Trofferlites"—Louvered, Baffled, Enclosed and Open**

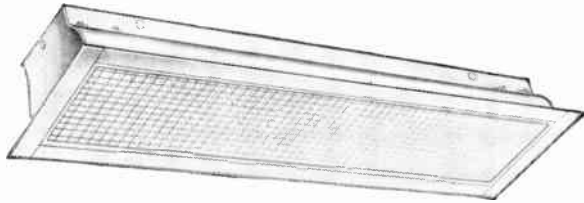

With 45° x 45° Plastic Louver

Units listed have flange trim and two hangers (No. T-102-B), for steel channel furring. Troffer depth is 6".

Open troffers have 15° x 15° polystyrene plastic louvers with 1/2" x 1/2" x 1/2" cells. For troffers with 31° x 31° steel louvers, drop "P" from number and deduct \$4.13 and \$8.27 from price of each 4 ft. and 8 ft. unit respectively. For troffers with steel baffles, replace "LP" in number with "B" and deduct \$8.35 and \$16.69 from price of each 4 ft. and 8 ft. unit respectively. For troffers with open housing, replace "LP" in number with

"O" and deduct \$10.30 and \$20.59 from price of 4 ft. and 8 ft. unit respectively.

Enclosed troffers have a deluxe hinge with a concealed depression latch; hinge may be installed on either side of housing. Units with "Reglex" glass covers listed; a wide variety of glass and plastic panels and specialized lenses also available.

With 45°x45° Plastic Louver (TLP)

No. of Lamps	40-Watt Rapid-Start*		Slimline	
	No.	Each	No.	Each
2	TLPE-240RS-4II	\$37.60	TLPE-296-8II	\$67.94
3	TLPE-340RS-4II	47.42	TLPE-396-8II	88.76
4	TLPE-240RS-8II	71.29
6	TLPE-340RS-8II	85.41

With "Reglex" Glass Cover (TG)▲

2	TGF-240RS-4II	35.96	TGF-296-8II	64.58
3	TGF-340RS-4II	45.79	TGF-396-8II	84.77
4	TGF-240RS-8II	68.02
6	TGF-340RS-8II	82.13

"Multi-Vent Trofferlites"—Louvered, Baffled, Enclosed and Open**

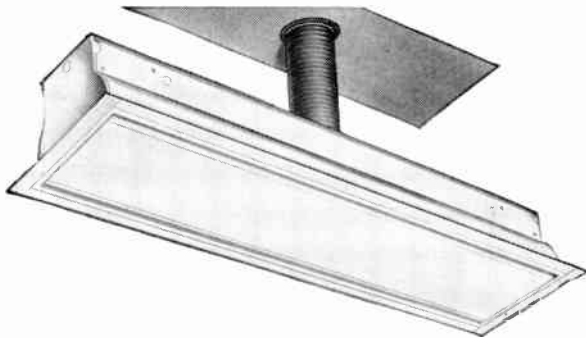

With "Reglex" Glass Cover

These troffers provide both light and air conditioning from the same unit. The air diffuser is completely built into and concealed within the fixture and air may be led from the ducts directly into the fixture thru "Multi-Vent" flexible tubing. Uniformity of temperature is assured since the "Multi-Vent" distributes air using the unique pressure displacement principle instead of high velocity injection.

"Multi-Vent" components for these units are supplied by Pyle National Co. and are as follows: Diffuser Pan (No. MVB); Collar (No. MVC-5); and Hose (No. MVII-5). Except for the air-conditioning feature, these troffers are similar in construction to standard Benjamin troffers. Depth is 7 1/16 in. Enclosed units have a vented cover frame for air passage.

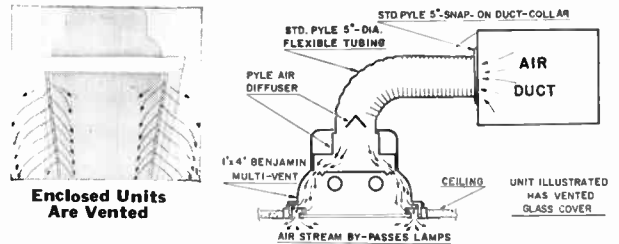

With 45°x45° Plastic Louver (MTLP)

No. of Lamps	40-Watt Rapid-Start*		Slimline	
	No.	Each	No.	Each
2	MTLPE-240RS-4II	\$41.89	MTLPE-296-8II	\$76.52
3	MTLPE-340RS-4II	51.71	MTLPE-396-8II	97.34
4	MTLPE-240RS-8II	79.87
6	MTLPE-340RS-8II	93.99

With "Reglex" Glass Cover (MTG)†

2	MTGF-240RS-4II	40.25	MTGF-296-8II	73.16
3	MTGF-340RS-4II	50.08	MTGF-396-8II	93.05
4	MTGF-240RS-8II	76.60	93.05
6	MTGF-340RS-8II	90.71

Listings for 110-125 v. 60 cycles; other voltages available. 8' 40-W. R.S. units are two units in tandem.

*For 40W. preheat unit with FS-10 non-blinking, manual reset starters, drop "RS" from number and add suffix "W"; and \$0.65 per starter. For standard FS-4 starters, drop "RS" and use 40W. R.S. price.

**Troffers listed include two hangers for steel channel furring; for wood furring hangers add letter "C" at end of number. For units without hangers drop "H" from number and deduct \$2.10 from unit price.

▲Other types of glass and plastic available.

†Also available with flat Albalite corning or flat low brightness corning No. 70 glass.

Benjamin 24" Width "Trofferlites"

Listed By Underwriters' Laboratories, Inc.

Louvered, Baffled, Enclosed and Open

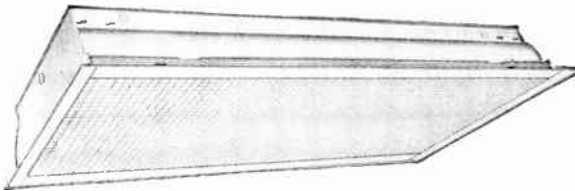

With 45° x 45° Plastic Louver

Complete individual units with end caps are listed. To order continuous runs with necessary fittings change 4 or 8 in suffix (which indicates length of unit in ft.) to desired line length in multiples of 4 ft.

Prices on lines will vary as compared to an equal footage in individual units. Listings cover troffers with 45°x45° polystyrene plastic louvers having 1/2"x1/2"x1/2" cells. Enclosed units with "Reglex" glass covers (equipped with a deluxe hinge and a concealed depression latch) are also listed. Other variations of louvers and covers are available.

Steel housing, reflectors and end caps are finished in white baked paint enamel. Ballasts are removable by loosening two screws; over-all troffer depth is 6 in. Troffers listed have flange trim and two hangers (No. TW-102-B) for steel channel furring. Lamps are not included.

With 45°x45° Plastic Louver (TWLP)*

40-Watt Rapid-Start			Slimline		
No. of Lamps	No.	Each	No.	Each	
2	TWLPE-240RS-4II	\$54.44	TWLPE-296-8II	\$96.56	
3	TWLPE-340RS-4II	62.87	TWLPE-396-8II	119.65	
4	TWLPE-440RS-4II	64.12	TWLPE-496-8II	124.41	
4	TWLPE-240RS-8II	103.27			
6	TWLPE-340RS-8II	114.66			
8	TWLPE-440RS-8II	122.62			

*For troffers with 31°x31° steel louvers change prefix to TWLF and deduct \$3.20 for each 4 ft. and \$6.40 for each 8 ft. unit. For troffers with steel baffles change prefix to TWBF and deduct \$12.48 for 4 ft. and \$24.96 for 8 ft. unit. For open troffers change prefix to TWOF and deduct \$12.95 for each 4 ft. and \$25.90 for each 8 ft. unit.

With "Reglex" Glass Cover (TWG)**

40-Watt Rapid-Start			Slimline		
No. of Lamps	No.	Each	No.	Each	
2	TWGF-240RS-4II	\$52.03	TWGF-296-8II	\$93.76	
3	TWGF-340RS-4II	61.93	TWGF-396-8II	112.55	
4	TWGF-440RS-4II	63.02	TWGF-496-8II	114.11	
4	TWGF-240RS-8II	98.44			
6	TWGF-340RS-8II	112.71			
8	TWGF-440RS-8II	120.43			

**For Flat Albalite Glass change prefix to TWGAF and add \$3.28 for each 4 ft. and \$6.55 for each 8 ft. unit. For Flat Low Brightness Corning No. 70 Glass change prefix to TWGSF and add \$13.26 for each 4 ft. and \$26.52 for each 8 ft. unit.

Note: 8 ft. 40-W R. S. units are two units in tandem.

Benjamin 24" Width "Trofferlites"

Listed by Underwriters' Laboratories, Inc.

With Plastic Panels



No. TWV2F (Rattan)



Crystal



Saxon



Safari

This type of luminous plastic cover assures soft, restful light diffusion. Units are provided with the same deluxe knuckle hinge and concealed depress-release latch as other enclosed troffers; cover hinges on either side. Units with Rattan-Vinyl panel listed; for Safari-Vinyl change prefix to "TWV1F"; for Crystal-Vinyl to "TWV1F"; for Saxon-Vinyl to "TWV3F"; for Saxon-Plexiglas to "TWV3F". Units with panels other than Rattan are same price; except Saxon-Plexiglas add \$12.17 for 4 ft. and \$24.34 for 8 ft. unit.

With 2' x 2' Plastic Panels (TWV2F)

40-Watt Rapid-Start			Slimline		
No. of Lamps	Panel Design and Material	No.	Each	No.	Each
2	Rattan-Vinyl	TWV2F-240RS-4II	\$45.40	TWV2F-296-8II	\$83.93
3	Rattan-Vinyl	TWV2F-340RS-4II	56.71	TWV2F-396-8II	98.44
4	Rattan-Vinyl	TWV2F-440RS-4II	58.19	TWV2F-496-8II	100.46
4	Rattan-Vinyl	TWV2F-240RS-8II	85.15		
6	Rattan-Vinyl	TWV2F-340RS-8II	102.34		
8	Rattan-Vinyl	TWV2F-440RS-8II	110.76		

Listings are for 110-125V. 60 cycles; other voltages available.

Note: 8 ft. 40-W. R. S. Units are two units in tandem.

Benjamin "Corri-Lite" Series (COR)

Listed By Underwriters' Laboratories, Inc.

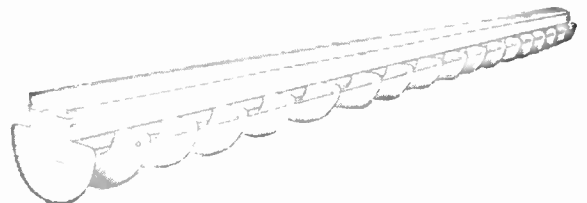

No. COR-196RS

For lighting corridors, narrow rooms, offices, stores, etc., efficiently and economically; baffle is hinged to simplify maintenance. Suitable for use individually or in continuous runs; for ceiling or stem suspension. Canopy and stem available but must be specified separately. Unit depth is 6 3/4 in. for 40W R.S.; 7 7/16 in. for Slimline and 800ma R.S. lamp units. Width is 6 7/8 in. Units are supplied prewired—ready to install; finish is white baked paint enamel.

With Type "S" Channel (2 1/2 in. x 2 in.)

For 48 in. 40 Watt T-12 Rapid-Start Lamps					
No.	Single Lamp Length	Each	No.	Twin-Lamp (In Tandem) Length	Each
COR-140RS	4' 1/8"	\$17.71	COR-2-140RS	8'	\$25.74

With Type "NHS" Channel (4 1/4 in. x 2 1/16 in.)

For 96 in. T-12 800ma Rapid-Start Lamps					
No.	Single Lamp Length	Each	No.	Twin-Lamp (In Tandem) Length	Each
COR-196RS	8' 3/32"	42.04	COR-2-196RS	16'	59.44
For 48 in., 72 in., 96 in. Slimline Lamps					
COR-148	4' 3/32"	24.88	COR-2-172	12' 3/32"	46.25
COR-172	6' 3/32"	31.20	COR-2-196	16' 3/32"	50.29
COR-196	8' 3/32"	33.23			

Listings are for 110-125V. 60 cycles; other voltages available.

Note: Order two end caps per fixture or run; No. CENDB for type "S"; No. CEND for type "NHS" at \$0.31 each.

Sliding Clamp Hangers for "NHS" channels: No. H-403 at \$0.65 each for general use; No. H-404 at \$1.05 each for messenger cable.

Benjamin Translucent Lighting Systems With or Without Acoustical Baffles

Listed By Underwriters' Laboratories & Approved By Factory Mutual Laboratories



Provides modern, attractive lighting for offices, stores and classrooms. Any room can be converted into a visual environment second to none with this wall to wall plastic diffuser. (3 ft. x 3 ft.) plastic sections supported by a framework of standard "V" shaped channels and finishing strips form the basis of the system. The framework is in turn suspended from the ceiling by rod assemblies which may be used with all common ceilings. Panels and louvers are interchangeable, or may be used in combination.

In rooms with dimensions that are not multiples of 3 ft., it is necessary to cut some of the louvers or panels and supporting channels to size. Louvers or panels are easily cut with scissors, and channels with a hacksaw. Finishing strip comes in 6 ft. lengths and is fastened to walls.

Material—Translucent, white vinylite which is odorless, non-toxic and will not distort or shrink due to water absorption. It is highly resistant to most common chemicals and does not support combustion—de-staticized, at the time of manufacture.

Panel-Glo Panels—Panels are either corrugated or Safari design. They are specially constructed for use in rooms using air conditioning and sprinkler systems so as not to affect their operation.

Sky-Glo Louvers—The 2 in. x 2 in. x 2 in. louver vanes provide 45° shielding.

Square-Foot Ordering—Systems with or without lighting equipment can be ordered under one catalog number for square or rectangular areas. The necessary panels, or louvers, lighting equipment (if ordered), and suspension parts are included. The quantity supplied is based upon an installation centered in the room.

Benjamin "Striplites" without reflectors are supplied with each complete system. Where conditions permit, continuous rows of 16 ft. strips spaced on 3 ft. centers are used. For this spacing, the distance from the bottom of the lamp to the top of the panel should be at least 22 in. with "Panel-Glo" and 28 in. with "Sky-Glo." The 16 ft. length is made up of two 8 ft. channels using 96 in. slimline lamps. Lamps operate from a twin lamp ballast located in one of the channels. Where space does not permit 16 ft. lengths, 4, 6, or 8 ft. strips will be supplied.

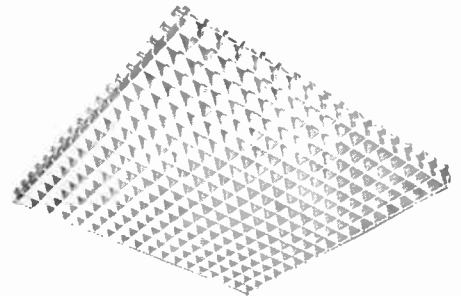

"Sky-Glo"

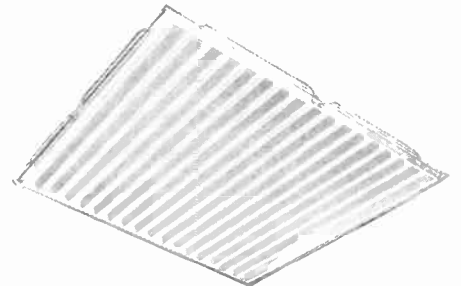

Corrugated "Panel-Glo"

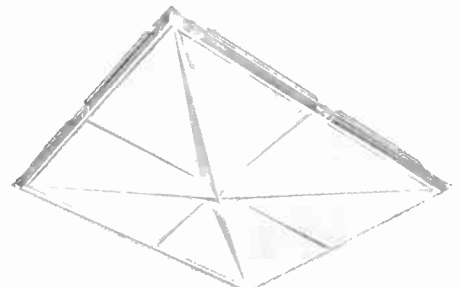

"Safari Panel-Glo"

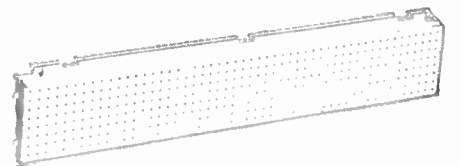

Acoustical Baffle

A perforated, metal housing filled with a sound-absorbent glass fiber for use with either the "Panel-Glo" or "Sky-Glo".

Price Per Square Foot*

	With Lighting	Less Lighting
"Sky-Glo" systems.....	\$2.96	\$2.18
"Panel-Glo" systems.....	1.72	.94

*Multiply adjusted length times width times the price per sq. ft.

**Ordering By The Square Foot
(For Rectangular and Square Rooms)**

This method is based on a 4-part catalog number that includes all necessary ordering information for an entire room-size system, either with or without lighting equipment. This catalog number is easily put together by the person estimating or laying out the installation:

1. First specify the type of ceiling desired by use of the following code letters: "L" for Sky-Glo louver, "P" for Panel-Glo corrugated panel, "P3" for Panel-Glo Safari panel, "FL" for Sky-Glo with Striplite, "FP" for Panel-Glo corrugated with Striplite, "FP3" for Panel-Glo Safari with Striplite.
2. Next give actual room length and width in feet if already multiples of 3 ft.; or actual room length and width raised to next larger multiples of 3 ft. ("adjusted" room dimensions).
3. Next indicate the type of rod support by use of the code letters: "S" for ceiling strap rod suspension, "T" for toggle head rod suspension.
4. Final digits of the number will be the length of the suspension rod required—in inches.

For irregularly shaped room systems or systems with Acoustical Baffles, write and state requirements.

All-Brite Fluorescent Fixtures

Aerolouve — Direct-Indirect

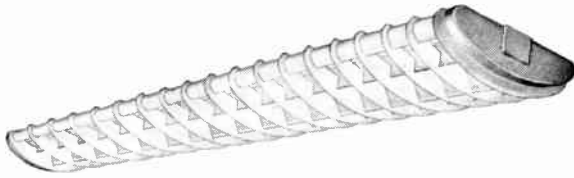

This new luminaire combines high efficiency with adequate shielding. Outer fins of smooth, translucent, extruded polystyrene plastic, are held by slots in lower blades.

Full-length louver provides 30° x 30° shielding, is held in place by self-aligning, captive catches and is secured to the case with chains for ease of servicing.

All parts are precision die formed from heavy cold-rolled steel, primed with All-Brite 57X rust-resistant Crycoast process, and electrostatically finished in high reflectance Formula 44X baked white enamel.

For end-to-end mounting use No. 31-31 wireway joiner.

No.	Lamps-In.	Lgth., In.	Width, In.	Wt. Lbs.	Each
22248SL	2-48	49 ¹ / ₁₆	15 ¹⁵ / ₁₆	26	\$32.62
22272	2-72	73 ¹ / ₁₆	15 ¹⁵ / ₁₆	46	53.40
22296	2-96	97 ¹ / ₁₆	15 ¹⁵ / ₁₆	52	53.56
22448SL	4-48	49 ¹ / ₁₆	15 ¹⁵ / ₁₆	36	46.31
22472	4-72	73 ¹ / ₁₆	15 ¹⁵ / ₁₆	56	77.03
22496	4-96	97 ¹ / ₁₆	15 ¹⁵ / ₁₆	62	77.17

California — Luminous-Indirect

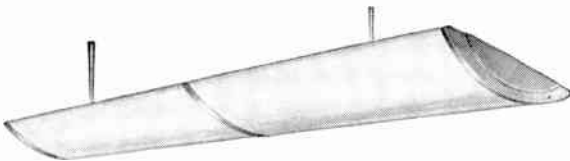

This luminous indirect fixture is a new contemporary design of singular beauty and high efficiency, yet with low brightness, which makes this unit ideal for highest quality illumination.

Destaticised 18-in. wide white plastic panels slide out for easy cleaning or relamping.

Crycoast rust-resistant prime and the electrostatically applied baked white enamel provide a finish that is durable and of the highest reflectance.

Use Joiner No. 31-31 for full wireway coupling.

Unit is designed for suspension mounting only. Standard suspension is 24-in.; minimum is 18-in.

Prices shown do not include hangers.

No.	Lamps-In.	Lgth., In.	Width, In.	Wt. Lbs.	Each
31248RS	2-48	49 ¹¹ / ₃₂	18	25	\$25.50
31248SL	2-48	49 ¹¹ / ₃₂	18	31	29.70
31272	2-72	73 ⁷ / ₃₂	18	56	47.10
31296	2-96	97 ⁷ / ₃₂	18	52	47.25
31448RS	4-48	49 ¹¹ / ₃₂	18	29	41.78
31448SL	4-48	49 ¹¹ / ₃₂	18	43	50.10
31472	4-72	73 ⁷ / ₃₂	18	66	74.10
31496	4-96	97 ⁷ / ₃₂	18	62	74.25

Corsair — Direct-Indirect

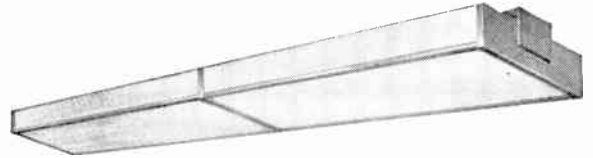

Series 74 (Albalite Bottom) and Series 84 (Louver Bottom)

The standard glass bottom and side panels are Corning Albalite. Bottom enclosures are hinged separately for easy maintenance.

Metal louver has 35° x 30° shielding. To order louvers change Series No. to 84 (i.e. 84248).

Use No. 84-31 joiner for full wireway coupling.

Matching spotlights are available for accent merchandising.

Units are available with 2, 3 or 4 lamps, in 4-, 6- and 8-ft. lengths, in fluorescent, rapid start or slimline.

No.	Lamps-In.	Lgth., In.	Width, In.	Wt. Lbs.	Each
74248RS	2-48	48 ⁷ / ₁₆	13 ⁷ / ₈	38	\$27.53
74248SL	2-48	48 ⁷ / ₁₆	13 ⁷ / ₈	40	33.45
74296	2-96	96 ¹ / ₃₂	13 ⁷ / ₈	60	51.23
74448RS	4-48	48 ⁷ / ₁₆	13 ⁷ / ₈	46	43.80
74448SL	4-48	48 ⁷ / ₁₆	13 ⁷ / ₈	50	52.13
74496	4-96	96 ¹ / ₃₂	13 ⁷ / ₈	75	78.23

Constellaire — Direct-Indirect

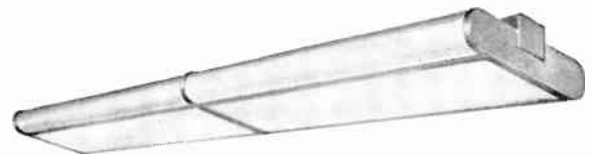

Series 35 (Albalite Bottom) and Series 45 (Louver Bottom)

Features extruded, internally ribbed, externally smooth, D-shaped, luminous polystyrene plastic side panels.

Metal parts are precision die formed of heavy cold-rolled steel, primed with All-Brite 57X rust-resistant Crycoast process, and electrostatically finished in high reflectance Formula 44X baked white enamel.

Standard glass bottom is Corning Albalite.

Plastic louvers 35° x 30° also available. To order louvers change Series No. to 45 (i.e. 45248).

No.	Lamps-In.	Lgth., In.	Width, In.	Wt. Lbs.	Each
35248RS	2-48	48 ⁷ / ₁₆	17 ¹¹ / ₁₆	34	\$26.03
35248SL	2-48	48 ⁷ / ₁₆	17 ¹¹ / ₁₆	40	30.15
35296	2-96	96 ¹ / ₃₂	17 ¹¹ / ₁₆	60	48.00
35448RS	4-48	48 ⁷ / ₁₆	17 ¹¹ / ₁₆	40	42.38
35448SL	4-48	48 ⁷ / ₁₆	17 ¹¹ / ₁₆	50	50.70
35496	4-96	96 ¹ / ₃₂	17 ¹¹ / ₁₆	75	76.35

All-Brite Fluorescent Fixtures

Bare Tube Fluorescent and Slimline Units

Channelite — Direct

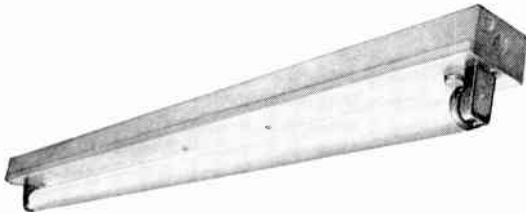

Inexpensive series ideally suited for cove, window, show-case valance or other types of strip lighting.

Incorporates many features of higher priced types of units, which result in simplified and more durable installations.

All metal parts are precision die formed of heavy cold-rolled steel, primed with All-Brite 57X Oakite Cryscocast rust resistant treatment and finished in Formula 41X electrostatically applied baked white enamel.

All single lamp units 37-in. and less have three 1/2-in. k.o.'s in the back of case. All other units have two 1/2-in. and two 3/8-in. k.o.'s in back, and a 3-in. k.o. in center of back.

Easily nipped together for continuous runs.

For rapid start operation on 48-in. units, add suffix RS.

No.	Lamps-In.	Lgth., In.	Width In.	Wt. Lbs.	Each
25118L.PF	1-18	19	2 7/8	3	\$ 3 30
25124L.PF	1-24	25	2 7/8	3	3 45
25136L.PF	1-36	37	2 7/8	5	5 75
25148L.PF	1-48	49	2 7/8	7	6 06
25148H.PF	1-48	49	2 7/8	7	11 03
25108H.PF	2-48*	48	2 7/8	9	19 20
25148SL	1-48	48 1/16	3 1/2	15	20 00
25196	1-96	96 1/16	3 1/2	25	21 90
25248SL	2-48	48 1/16	3 1/2	18	19 05
25296	2-96	96 1/16	3 1/2	30	26 25

*Two lamps end to end operated by one ballast.

Skipper — Direct-Indirect

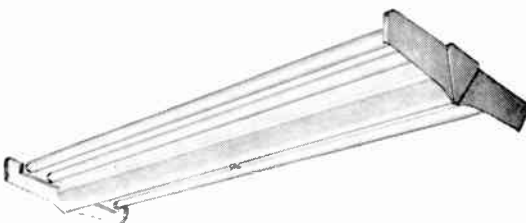

Sturdy, functional open-tube lighting unit. Embodies many of the features of higher priced units yet costs very little more than strip lighting.

Completely fabricated from heavy cold-rolled steel with 57X rust-resistant primer and high reflectance baked white enamel.

For continuous runs, use joiner #31-31.

Units may be directly surface mounted by means of 2 All-Brite "speed-easy" flush-mounting brackets #FM-205.

For pendant mounting use single stem hanger #105 or double stem hangers #290.

For rapid start operation on 48-in. units, add suffix RS.

No.	Lamps-In.	Lgth., In.	Width, In.	Wt. Lbs.	Each
41248H.PF	2-48	49 9/32	12 1/32	19	\$14 74
41448H.PF	4-48	49 9/32	12 1/32	25	24 49

Litemaster — Direct-Indirect



Slim, streamlined, has wide acceptance for general interior application. With lead-lag ballasts (slightly higher prices), may be used beneath service station canopies and similar semi-exposed installations.

Fabricated of heavy cold-rolled steel with rust-resistant primer and high reflectance baked white enamel.

Surface or pendant mounting.

Use All-Brite double stem #290 for 4-ft. units; single stem #105 for 6- and 8-ft. units.

Use joiner #59-31 for full wireway coupling of runs of units.

Single lamp spotlight (#59SP) available for Series 59, both single lamp (#69SP) and double lamp (#269SP) spotlites available for series 69.

No.	Lamps-In.	Lgth., In.	Width, In.	Wt. Lbs.	Each
59248SL	2-48	50 15/16	10 1/8	30	\$23 63
59272	2-72	74 15/16	10 1/8	34	31 80
59296	2-96	98 15/16	10 1/8	36	31 95
69448SL	4-48	50 15/16	20 1/4	50	43 35
69472	4-72	74 15/16	20 1/4	55	54 98
69496	4-96	98 15/16	20 1/4	62	55 13
69696	6-96	98 15/16	20 1/4	73	80 33

Aerolite — Direct-Indirect

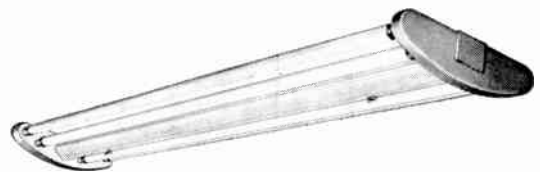

New, exceptionally slender design of the slimline open tube units. Features high efficiency and adaptability to a wide range of applications.

Die formed of heavy cold-rolled steel finished in All-Brite Formula 41X baked white enamel, electrostatically deposited over rust-resistant Cryscocast primer.

Joiner #31-31 provides an open wire-way for end-to-end mounting.

Spotlite #21SP, adjustable 30° vertical and 360° horizontal, for end or center of run (specify).

No.	Lamps-In.	Lgth., In.	Width, In.	Wt. Lbs.	Each
21248SL	2-48	49 1/16	1 15/16	20	\$19 05
21272	2-72	73 1/16	1 15/16	28	26 07
21296	2-96	97 1/16	1 15/16	33	26 25
21448SL	4-48	49 1/16	1 15/16	30	34 10
21472	4-72	73 1/16	1 15/16	38	45 53
21496	4-96	97 1/16	1 15/16	43	45 75
21SP	1-150 watt	14 1/4	14 1/4	5	15 75

All-Brite Fluorescent Fixtures

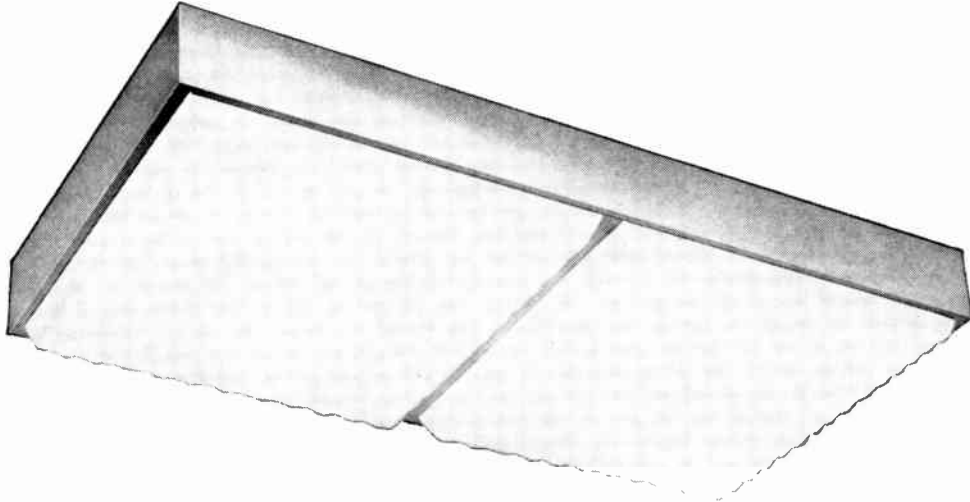

Area/Liter — Ceiling Mounted

Area/Liter follows latest trends in good lighting towards selected luminous areas . . . with new comfort, new beauty, and new versatility.

Low-bright luminous areas provide freedom from glare, wide distribution of light and relief from monotony.

Plastic diffusing panel of the Area/Liter is more than twice the usual area, greatly reducing brightness without cutting fixture light output.

Textured, feather-like plastic diffusing panel is matte-finished, does not pick up reflections.

Area/Liter is a self-contained, fully enclosed unit, completely wired, and can be mounted individually or easily joined end to end and side by side to form luminous areas, patterns, or rows.

Simple, rugged die-formed construction throughout, Area/Liter is a standardized fixture with custom-styled appearance.

Grid Modu/Liter

A New Concept in Grid Fixture Construction and Design

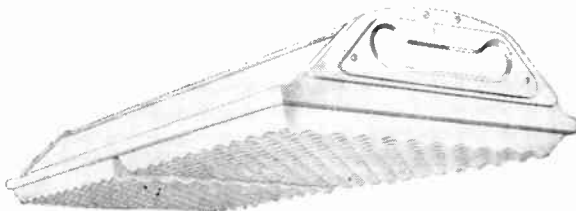

One piece roll formed body with clincher type back provides greater rigidity, more efficient distribution of light, less maintenance and greater ease of handling.

Exclusive built-in handles permit easy one man installation.

All fixtures treated with Crysoat rust inhibitive coating prior to painting.

All units approved by Underwriters Laboratories.

The Grid Modu/Liter is available with feather-like textured plastic diffusing panels, Corning Albalite, clear Skytex glass panels, or sturdy 30° x 30° steel louvers.

Basic units furnished in 2- or 4-ft. lengths in 2, 3 or 4 lamp models.

These fixtures are for use with grid type suspended ceiling with rail spacing of 24-in. x 24-in. or 24-in. x 48-in. center to center. Specify ceiling system being used when ordering.

Area/Liter Popular Numbers Readily Available

No.	Lamps In.	Lgth. In.	Width In.	Ht. In.	Wt. Lbs.	Each
10248RS	2-48	48	24	5 3/4	39	\$35 28
10448RS	4-48	48	24	5 3/4	50	48 52
10296	2-96	96	24	5 3/4	74	62 69
10496	4-96	96	24	5 3/4	87	91 36

Numbers Available On Factory Order

No.	Lamps In.	Lgth. In.	Width In.	Ht. In.	Wt. Lbs.	Each
10248SL	2-48	48	24	5 3/4	44	\$38 58
10448SL	4-48	48	24	5 3/4	54	57 07
10272	2-72	72	24	5 3/4	59	56 39
10472	4-72	72	24	5 3/4	70	86 94
10224TS	2-24	24	24	5 3/4	22	25 98
10424TS	4-24	24	24	5 3/4	27	34 66

Grid Modu/Liter Textured Plastic Panels

No.	Lamps In.	Start	Wt. Lbs.	Each
12224TS	2-24	trigger start	27	\$30 30
12324TS	3-24	trigger start	30	37 56
12424TS	4-24	trigger start	31	39 24
12248RS	2-48	rapid start	43	38 66
12348RS	3-48	rapid start	46	49 93
12448RS	4-48	rapid start	47	52 70

30° x 30° Steel Louvers

No.	Lamps In.	Start	Wt. Lbs.	Each
12224TS-ML	2-24	trigger start	31	\$30 30
12324TS-ML	3-24	trigger start	34	37 56
12424TS-ML	4-24	trigger start	35	39 24
12248RS-ML	2-48	rapid start	52	38 66
12348RS-ML	3-48	rapid start	55	49 93
12448RS-ML	4-48	rapid start	56	52 70

Corning Albalite Glass Panels

No.	Lamps In.	Start	Wt. Lbs.	Each
12224TS-CA	2-24	trigger start	34	\$33 30
12324TS-CA	3-24	trigger start	37	40 56
12424TS-CA	4-24	trigger start	38	42 84
12248RS-CA	2-48	rapid start	58	44 65
12348RS-CA	3-48	rapid start	61	55 93
12448RS-CA	4-48	rapid start	62	58 70

Skytex Glass Panels

No.	Lamps In.	Start	Wt. Lbs.	Each
12224TS-SKY	2-24	trigger start	34	\$31 06
12324TS-SKY	3-24	trigger start	37	38 32
12424TS-SKY	4-24	trigger start	38	40 60
12248RS-SKY	2-48	rapid start	58	40 15
12348RS-SKY	3-48	rapid start	61	49 93
12448RS-SKY	4-48	rapid start	62	52 70

All-Brite Fluorescent Fixtures

Astralouve — Direct-Indirect

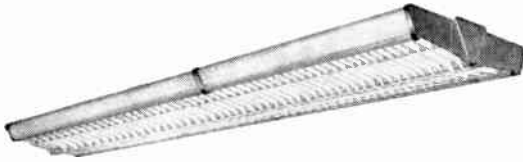

This exceptionally shallow fixture combines beauty and economy. Its smooth side panels of translucent polystyrene snap into rigid steel supports. (Metal sides available at same price, add suffix M.)

All parts precision die formed from heavy cold-rolled steel, primed with All-Brite 57X rust-resistant Crysocoat process, and electrostatically finished in high reflectance Formula 41X baked white enamel.

Louver provides 35 x 35 shielding, is held in place by a self-aligning, captive catch, and is suspended with safety chains for ease of relamping.

No.	Lamps-In.	Lgth., In.	Width, In.	Wt. Lbs.	Each
86248RS	2-48	49 ⁹ / ₃₂	12 ¹ / ₃₂	20	\$23.63
86248SL	2-48	49 ⁹ / ₃₂	12 ¹ / ₃₂	25	27.83
86272	2-72	73 ³ / ₃₂	12 ¹ / ₃₂	39	43.95
86296	2-96	97 ⁷ / ₃₂	12 ¹ / ₃₂	40	44.10
87448RS	4-48	19 ⁹ / ₃₂	16 ¹ / ₃₂	30	39.30
87448SL	4-48	19 ⁹ / ₃₂	16 ¹ / ₃₂	35	47.63
87472	4-72	73 ³ / ₃₂	16 ¹ / ₃₂	50	71.03
87496	4-96	97 ⁷ / ₃₂	16 ¹ / ₃₂	56	71.18

New Dean — Direct-Indirect



This slender luminaire features illuminated all-metal side panels, low brightness and high efficiency. Particularly adapted to installations requiring thin fixtures and all-metal construction for durability.

Louvers provide 35° x 35° shielding, and are held in place by self-aligning captive latches which are suspended on sturdy safety chains.

Units may be surface mounted directly or by means of FM-205. Use #290 double stem hanger for 4-ft. units, and #105 single stem hangers for 6- and 8-ft. units.

For end-to-end mounting use #31-31 wireway joiner to provide full wireway coupling.

For totally direct lighting, add suffix CT.

For rapid start operation, add suffix RS.

No.	Lamps-In.	Lgth., In.	Width, In.	Wt. Lbs.	Each
91248	2-48	49 ⁹ / ₃₂	12 ¹ / ₃₂	24	\$23.63
91248SL	2-48	49 ⁹ / ₃₂	12 ¹ / ₃₂	27	27.83
91272	2-72	73 ³ / ₃₂	12 ¹ / ₃₂	39	43.95
91296	2-96	97 ⁷ / ₃₂	12 ¹ / ₃₂	46	44.10
92448	4-48	49 ⁹ / ₃₂	16 ¹ / ₃₂	30	39.30
92448SL	4-48	49 ⁹ / ₃₂	16 ¹ / ₃₂	35	47.63
92472	4-72	73 ³ / ₃₂	16 ¹ / ₃₂	50	71.03
92496	4-96	97 ⁷ / ₃₂	16 ¹ / ₃₂	56	71.18

Silvray Fluorescent Lighting

Listed by Underwriters' Laboratories, Inc.

Visionaire

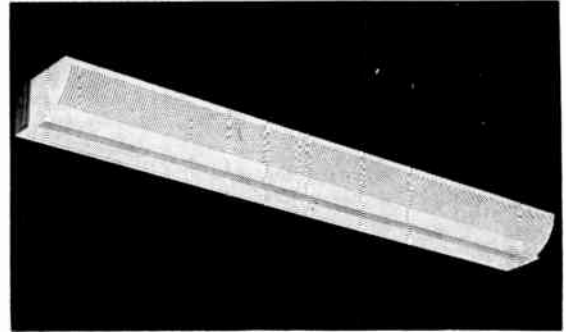

No. 41-L

A compact, precision-made fluorescent lighting unit designed for wall mounting, either individually or in continuous rows. Designed to be used either in normal or inverted position in portable or permanent installations. A new lighting concept with 1001 commercial and residential applications including cove lighting, supplementary overhead lighting, beam lighting, work counter lighting, and reception room lighting. Made in three sizes for either 20 watt, 25 watt or 40 watt fluorescent lamps. In its normal position, it provides a semi-indirect light distribution with 70% of the light directed upward and outward from the fixture, and the remainder directed downward through a louvered opening in the bottom of the reflector. Made of heavy gage steel channel containing ballast, lampholders and starter sockets. Units are finished in baked white enamel.

No.	Lamp Size	Length Inches	Width Inches	Height Inches	Each
21-L	20 W	24 ⁵ / ₁₆	6	3 ³ / ₈	\$19.25
21-O	20 W	24 ⁵ / ₁₆	6	3 ³ / ₈	18.15
31-L	25 W	33 ³ / ₁₆	6	3 ³ / ₈	13.90
31-O	25 W	33 ³ / ₁₆	6	3 ³ / ₈	14.65
41-L*	40 W	48 ³ / ₁₆	6	3 ³ / ₈	22.90
41-O*	40 W	48 ³ / ₁₆	6	3 ³ / ₈	21.50

L—Metal slot louvered side panel and furnished with plastic brightness modifier.

O—Opaque metal side panel.

*Rapid Start Ballast available. Designate by suffix "RS" and add \$1.80.

Call Graybar FIRST For . . .



Silvray Fluorescent Luminaires

ILC System

For High Output R.S. Rapid-Start Fluorescent Lamps

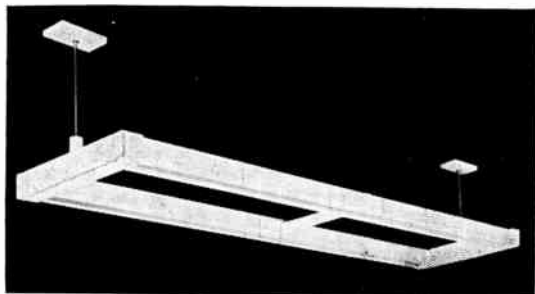

Uses two separate lampholder channels mounted parallel and joined at their ends by a lateral enclosure which houses the ballast and lampholders and provides connections for the supporting hangers.

Each lampholder channel consists of two roll formed hollow members which serve both as structural members and as a raceway for lampholder leads and line wires.

Provision is made for either individual or continuous row installation. Units have plastic panels.

Has baked white enamel finish.

No.	Lamps	Hanger Spacing In.	Shp. Wt. Lbs.	Each
*ILC288	2-F96T12HO	98 ⁷ / ₈	81	\$79.35
*ILC268	2-F72T12HO	71 ⁷ / ₈	77	76.25
*ILC248	2-F48T12HO	50 ⁷ / ₈	70	62.45
†ILCF288	2-F96T12HO	98 ⁷ / ₈	81	74.00
ILCF268	2-F72T12HO	71 ⁷ / ₈	74	69.70
ILCF248	2-F48T12HO	50 ⁷ / ₈	67	55.25

*Unit with 2 hangers and 2 end caps used for individual unit installation. One required as base unit for each continuous row.

†Unit with 1 hanger and no end caps for continuation section in continuous rows.

Note—ILC Luminaires with Plastic Eggcrate Louver are designated by suffix "L" after Catalog Number. Add \$3.75

Kirlin Built-In Fluorescent Troffers



No. 240B



No. 240TR-EC

Standard finish, white. Reflectors backed white synthetic enamel, removable for access to wiring. Wired with high power factor ballasts except on 20W.

Designed for wide distribution of light, lamps spaced 3 1/2-in. for maximum efficiency. The two and three-lamp units are proper width for 12-in. acoustic tile ceilings.

No.	Max. Watts	Size For Ceiling Opening In.	Depth In.	Frame Size In.	Each
Trigger-Start Albalite					
220B	2-20	11 3/4 x 24 3/4	6 1/4	13 7/8	\$47.80
Trigger-Start 10-In. Wide					
220-B10	2-20	10 1/4 x 24 1/2	5 1/4	10 7/8	\$43.20
Rapid Start Type Albalite					
240B-RS	2-40	11 3/4 x 48 3/4	6 1/4	13 1/8	\$59.33
340B-RS	3-40	11 3/4 x 48 3/4	6 1/4	13 7/8	76.47
440B-RS	4-40	16 3/8 x 48 3/4	6 1/4	17 5/8	95.33
Open Troffer With Egg-Crate Rapid Start Type					
240-TR-EC-RS	2-40	11 3/4 x 48 3/4	6 1/4	13 7/8	\$58.40
340-TR-EC-RS	3-40	11 3/4 x 48 3/4	6 1/4	13 7/8	71.20
440-TR-EC-RS	4-40	16 3/8 x 48 3/4	6 1/4	18 3/8	86.07

Bryant Fluorescent Lampholders



No. 4374

**Slimline
For T6 and T8 3/4-Inch and
1-Inch Diameter Lamps**

No. 4373 designed so that primary circuit is not complete until lamp pin is inserted. This prevents current in high voltage circuit from flowing to the No. 4374 high voltage lampholder until lamp is in place. Binding screws are located in recessed bases and covered by insulating plates.

Mounting holes for No. 8 screws are on 1 1/4-inch centers. Packed 10 in a carton. 100 in a standard package.

**For High Voltage Secondary—
Single Terminal Connection
600 Watts, 1000 Volts**

No.	Description	Wt. Lbs. Std. Pkg.	Per 100
4374	White	22	\$72.00

Spring supported contact provides push-pull principle of lamp insertion and removal.

**For Low Voltage Primary—
Two Terminal Connections
660 Watts, 250 Volts**

4373	White	22	\$72.00
------	-------	----	---------

Dimensional and mounting information on request.

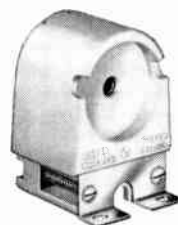

No. 4371

Slimline

For T-12 1 1/2-Inch Slimline Lamps

Surface, recessed, or butt-on mounting. White Plastic. Elongated mounting holes 1 1/4 to 1 1/2-inch centers. Supplied in matched pairs of high and low voltage. The lamp must be in place in both holders to complete the high voltage circuit.

Packed 10 in a carton. 100 in a standard package.

**Low Voltage Primary—Two
Terminal Connections
660 Watts, 250 Volts**

No.	Description	Wt. Lbs. Std. Pkg.	Per 100
4371	White	32	\$85.50

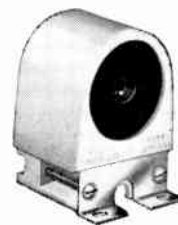

No. 4372

**High Voltage Secondary—
Single Terminal Connection
660 Watts, 1000 Volts**

4372	White	30	\$85.50
------	-------	----	---------

Bryant Fluorescent Lampholders and Starter Sockets

Listed as standard by Underwriters' Laboratories, Inc.

Standard Type



No. 4300

For 14, 15, 20, 25, 30, and 40-Watt Lamps.
660 Watts, 600 Volts

Packed 10 in a carton. 100 in a standard package.

**Twist Turn Contacting—
1 and 1½-Inch Lamps
Flush or Surface Mounting**

No.	Description	Wt. Lbs. Std. Pkg.	Per 100
4300	Black	7	\$14.50
4300-W	White	7	17.00



No. 4307

**With Starter Sockets
Twist Turn Contacting**

No.	Description	Wt. Lbs. Std. Pkg.	Per 100
4307	Black	13	\$29.00
*4307-W	White	13	32.00

*Lampholder only is white; starter socket is black.

Push Contact Lampholders

For Two and Three Lamps—660 Watts, 600 Volts



No. 4395

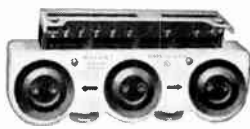

No. 4397

For standard bi-pin lamps, 14, 15, 20, 25, 30 and 40 watt. Plastic terminal blocks with binding screws at top. Easy to wire—strip conductors, insert in holes, tighten screws.

Packed 10 in a carton, 100 in a standard package. Package weight, 100 pounds. No. 4395, 96 pounds.

No.	Description	Per 100
4395	Two lamp, 5-inch center mounting	\$166.00
4396	Three lamp, 2½-inch center mounting, for one starter	193.00
4397	Three lamp, 2½-inch center mounting, for two starters	198.50

Starters not included with lampholders.

For Two Slimline Lamps—5-Inch Center Mounting T-12, 1½-Inch or Other Slimline Lamps

Baked white enamel finish steel covers. Black plates. Packed 10 in a carton. 100 in a standard package. Package weight, 84 pounds.



No. 4361

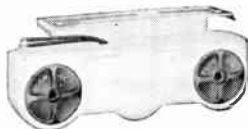

No. 4362

No.	Description	Per 100
4361	For low voltage primary, 660 Watts, 250 Volts	\$185.00
4362	For high voltage secondary, 660 Watts, 1000 Volts	185.00

Mogul Type Lampholders

660 Watts, 600 Volts
For 85, 90 and 100-Watt Lamps

Packed 10 in a carton. 50 in a standard package.

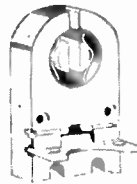

No. 4350-W

With Metal Bracket

No.	Description	Wt. Lbs. Std. Pkg.	Per 100
4350-W	White	9	\$71.00

Without Metal Bracket

4351-W	White	8	\$72.50
--------	-------	---	---------

**With Starter Sockets
For 2-Pin and 4-Pin Starters
With Metal Bracket**



No. 4367-W

Starter Socket 250 Volts take 2 pin and 4 pin starters except No. F564

4367-W	White	15	\$127.50
--------	-------	----	----------

Midget Size Lampholders

4-Watt, 6-Watt, and 8-Watt Lamps
75 Watts, 250 Volts



No. 4330

Packed 10 in a carton. 100 in a standard package.

No.	Description	Wt. Lbs. Std. Pkg.	Per 100
4330	Black	2	\$34.50
4330-W	White	2	36.50

Starter Sockets

**For Separate or Remote Mounting
660 Watts, 250 Volts**



No. 4309

Black Plastic.

**For 15, 20, 25, 30, and 40-Watt,
2-Pin Starters**

No.	Carton	Std. Pkg.	Wt. Lbs. Std. Pkg.	Per 100
4309	10	100	5	\$23.00

**For 85, 90, and 100-Watt,
2-Pin and 4-Pin Starters
Except No. FS64**



No. 4369

4369	10	50	4	\$53.00
------	----	----	---	---------

Dimensional and mounting information available upon request to GRAYBAR.

Bryant Universal Push Contact Lampholders

Listed as standard by Underwriters' Laboratories, Inc.

For All Sizes of Slimline Lamps

White Thermo-Setting Plastic. Mounting screws thread into metal back plates. Packed 10 in a carton. 100 in a standard package.

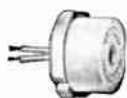

No. 4569



No. 4570

Butt-On Mounting

No.	Description	Wt. Lbs. Std. Pkg.	Per 100
4569	For low voltage primary, 660 Watts, 250 Volts, equipped with two 12-inch white leads of No. 18 stranded wire...	6	\$31.00
4570	For high voltage secondary, 660 Watts, 1000 Volts, equipped with one 12-inch red lead of No. 18 stranded wire....	10	46.50



No. 4571

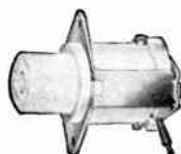

No. 4572

Flush Mounting With Bracket

4571	For low voltage primary, 660 Watts, 250 Volts, equipped with two 12-inch white leads of No. 18 stranded wire...	7	\$35.50
4572	For high voltage secondary, 660 Watts, 1000 Volts, equipped with one 12-inch red lead of No. 18 stranded wire....	12	53.00

For T-6, T-8, T-12 Slimline Lamps

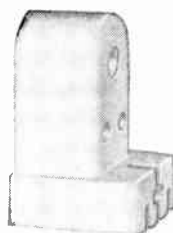

No. 4376

White Thermo-Setting Plastic. Designed to permit straight-in wiring. Single screw mounting. 8 - 32 x 1/2 inch mounting screw and nut furnished.

Packed 10 in a carton. 100 in a standard package. Package weight, No. 4376, 13 pounds. No. 4377, 14 pounds.

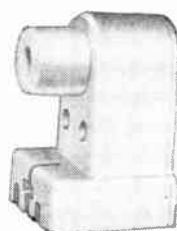

No. 4377

Flush or Surface Mounting

No.	Description	Per 100
Two Terminal Connection		
4376	Low voltage primary, 660 Watts, 250 Volts...	\$38.00
Single Terminal Connection		
4377	High voltage secondary, 660 Watts, 1000 Volts...	42.00

Bryant Fluorescent Lamp Starters

Listed as standard by Underwriters' Laboratories, Inc.



No. FS2 and FS4



No. FS85-NA



No. FS40

Standard Type

No.	No. of Pins	Lamp, Watts	Car-ton	Std. Pkg.	Wt. Lbs. Std. Pkg.	Per 100
FS2	2	15 and 20	10	100	3	\$25.00
FS4	2	30 and 40	10	100	3	25.00
FS85	2	85, 90, and 100	10	50	3	89.50
FS85-4	4	85, 90, and 100	10	50	3	89.50
FS5	2	4, 6, and 8	10	50	2	44.00

"No Blink" Starters

Prevent annoying blinking and flickering of lamps which have reached the end of normal life.

Automatic Reset

FS4-NA	2	40	10	100	3	\$ 75.50
FS85-NA	2	85, 90, and 100	10	50	3	105.00
FS85-NA4	4	85, 90, and 100	10	50	3	105.00

Manual Reset

FS20	2	15 and 20	10	100	3	\$ 84.00
FS30	2	30	10	100	3	92.50
FS40	2	40	10	100	3	75.50
FS850	4	85, 90 and 100	10	100	3	105.00

Bryant Show Case Lampholders

For 1-Inch Lamps Only
Straight Push Contacting
With Metal Bracket

660 Watts, 250 Volts



No. 4303

No.	Description	Pkg. Wt.	Per 100
4303	Black	5	\$28.50
4303-W	White	5	30.50



No. 4328

Surface Mounting—With Wire Leads
Twist Turn Contacting
660 Watts, 600 Volts

One 9-Inch and one 27-Inch Lead of No. 18, 90° Thermoplastic Stranded Wire.

4328	Black	4	\$21.00
4328-W	White	4	22.00

Hubbell Jackrabbit Fluorescent Starters



No. FS-4



No. FS-40



No. FS4-NA

New ceramic condensers — hard as a rock and just as indestructible — assures longer starter life and uniform top performance under all operating conditions.

Operation unaffected by high humidity at either high or low temperatures. Will not melt, burn, char, or disintegrate. Resists heat and cold. Gives greater uniformity, and is smaller in size.

The Neostart, Nos. FS-2 and FS-4, is a glow discharge type of starter particularly suited to withstand the continued punishment resulting from lamp failure.

The Autoset-Automatic Reset, No. FS-4NA, provides the time-saving economy of automatic reset operation, effective under conditions involving low line voltage, ungrounded fixtures, etc.

Neostart

No.	For Use With	Std. Pkg.	Per 100
FS-2	14, 15, & 20 Watt Lamps	100	\$ 25 00
FS-4	13, 30, & 40 Watt Lamps	100	25 00
FS-5	4, 6, 8, 22, & 25 Watt Lamps	100	44 00
FS-12	32 Watt Circline Lamps	100	26 50
FS-25	22 Watt Circline, 25 Watt Std. Lamps	100	29 50
FS-85	90, & 100 Watt Lamps	50	89 50
FS-85-4*	90, & 100 Watt Lamps	50	89 50

Manual Reset

FS-20	14, 15, & 20 Watt Lamps	100	\$ 84 00
FS-30	30 Watt Lamps	100	92 50
FS-40	40 Watt Lamps	100	75 50
FS-850-2	90 & 100 Watt Lamps	50	105 00
FS-850*	90 & 100 Watt Lamps	50	105 00

Autoset—Automatic Reset

FS2-NA	20 Watt Lamps	100	\$ 84 00
FS4-NA	40 Watt Lamps	100	75 50
FS-85-NA	90 & 100 Watt Lamps	50	105 00
FS-85-NA-4*	90 & 100 Watt Lamps	50	105 00

Thermostart

M-2	15 & 20 Watt Lamps For A-C & D-C Applications	100	\$ 71 50
-----	--	-----	----------

*(4-Contact Type)

Call Graybar **FIRST** For . . .

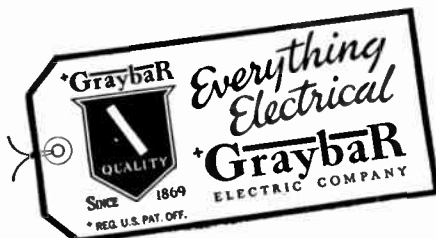

Hubbell Fluorescent Lampholders



No. 2937

**Twist Turn Contacting
Flush or Surface Mounting
660 Watts, 600 Volts**

For 1 and 1½-inch fluorescent lamps, flush or surface mounting. Insulation cover plate protects wiring.

Wiring grooves take conductors up to size 11, solid wire.

No.	Description	Car-ton	Std. Pkg.	Wt., Lbs. Std. Pkg.	Per 100
2936	Black Bakelite	10	100	8	\$19 00
2937	White Bakelite	10	100	8	21 00

Hubbell Fluorescent Lampholders

**Flush Mounting—For Narrow Channel Wiring
660 Watts, 600 Volts**



No. 2939

For 1-inch fluorescent lamps. Particularly suitable for narrow channel wiring work, showcase lighting and side-wall fixtures. Sheet insulation cover plate protects wiring. Quick and easy installation is provided by one screw mounting.

No.	Description	Car-ton	Std. Pkg.	Wt., Lbs. Std. Pkg.	Per 100
2938	Black Bakelite	10	100	6	\$28 50
2939	White Bakelite	10	100	6	30 50

**Hubbell Fluorescent Lampholders
and Sockets**

660 Watts, 250 Volts



No. 2943

Lampholders and Starter Sockets

No.	Description	Color	Car-ton	Std. Pkg.	Wt. Lbs.	Per 100
2942	Twist-Turn Contacting	Black	13	100	10	\$40 00
*2943	Twist-Turn Contacting	*White	13	100	10	42 00

*Only the lampholder is white. Starter socket is black.

G-E Fluorescent Light Starters

**Watch-Dog
For A-C Operation**

Glow-Switch Type—Manual Reset Button



No. FS-40

These starters automatically cut off failing lamps, eliminate blinking and protect ballasts and fixture wiring.

The manual reset button pops out when starter cuts off on dead lamp, but can be reset by pressing in when new lamp is inserted — no cooling period necessary.

No.	No. Terminals	Watts	Length Lamp, In.	Type Bulb	Per 100
FS-20	2	20	24	T-12	\$ 84.00
FS-30	2	30	36	T-8	92.50
FS-40	2	40	48	T-12	75.50
FS-400	2	40	48	T-12	84.00
FS-850	4	90, 100	60	T-17	105.00
FS-850S	4	90, 100	60	T-17	117.50

Ten in a carton; 200 in standard package.

Standard — Glow Switch Type



All-purpose starters, accurately timed to combine efficient starting with long lamp life.

Built to withstand shock and breakage. Have two terminals.

For A-C Operation

No.	Watts	Length Lamp, In.	Type Bulb	Per 100
FS-2	14, 15, 20	15, 18, 24	T-8, T-12	\$25.00
FS-4	13, 30, 40	21, 36, 48	T-5, T-8, T-12	25.00

Ten in a carton; 200 in standard package.

FS-5	4, 6, 8	6, 9, 12	T-5	44.00
FS-6	90, 100	60	T-17	89.50

Ten in a carton; 100 in standard package.

FS-12	32	12-in. Diam.	Circline	26.00
FS-25	22, 25	33, 8-in. Diam.	T-12	29.50

Ten in a carton; 200 in standard package.

FS-5 and FS-6; 100 in standard package.



For A-C or D-C Operation

No.	Watts	Length Lamp, In.	Type Bulb	Per 100
FS-4DC	13, 30, 40	36, 48	T-8, T-12	\$44.00

Ten in a carton; 200 in standard package.

**Thermal-Switch Type
For A-C or D-C Operation**



No. FS-44

All purpose starters, for use in conjunction with proper ballasts, inductance units and series resistance for d-c operation.

FS-64 can be used in all sequence starting circuits and in those applications where ambient temperature is below 40° F. FS-44 recommended for reliable starting down to ambient temp. of 0° F.

With Four Terminals

No.	Watts	Length Lamp, In.	Type Bulb	Per 100
FS-44	40	48	T-12	\$92.00
FS-64	90, 100	60	T-17	92.50

**G-E Miniature Bi-Pin Lampholders
Butt-on Type**

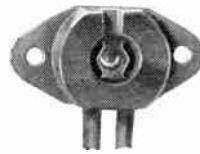

No. 95X276

For surface mounting. Fitted with two No. 18 A.W.G. thermoplastic-insulated wire leads 6-in. long, both black. Clearance holes for No. 4 Mounting screws (Screws not furnished).

For Lamps:

Watts—4, 6, 8, 13
Length—6, 9, 12, 21-in.
Diameter— $\frac{5}{8}$ -in.
Type Bulb—T-5

Rating: 660 Watts, 250 Volts

No. 95X276—Black Texolite..... Per 100 \$24.00
Ten in a carton; 100 in a standard package.

G-E Mogul Bi-Pin Lampholders

Standard and Combination Types

For flush or surface mounting.

Flush mounting requires No. 6-32 screws; surface mounting requires No. 6 screws (not furnished).

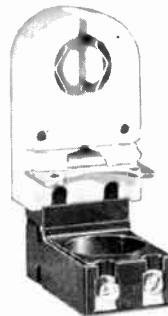

No. 95X123



No. 95X982

Wiring protected by plastic cover plate. Binding screws take wires up to No. 14 A.W.G. solid. Has bracket with two tapped holes for holding mounting bracket to channel or reflector.

Where separate starter socket is used, two No. 95X982 must be used for each lamp. Otherwise, use one standard and one combination type lampholder. Combination types have a four-contact starter socket that accommodates both 2-contact and 4-contact starters.

For Lamps:

Watts—90, 100
Length—60-in.
Diameter—2 $\frac{1}{8}$ -in.
Type Bulb—T-17

Rating: 660 Watts, 600 Volts—Standard Type

No.	Description	Per 100
95X982	White Plastic.....	\$ 71.00

660 Watts, 250 Volts Combination Type

95X123	White Plastic Lampholder; Black Plastic Starter Socket.....	127.50
--------	---	--------

**G-E Miniature Bi-Pin Lampholders
Standard Type**



No. 78X715

For flush mounting. No starter required as starter socket is integral part of ballast. Require one No. 6-32 mounting screw (Screw not furnished).

Use one each No. 78X715 and No. 78X723 for each lamp. Use two No. 95X132 for each lamp.



No. 95X432

For Lamps:

Watts—4, 6, 8, 13
Length—6, 9, 12, 21-in.
Diameter— $\frac{5}{8}$ -in.
Type Bulb—T-5

Rating: 660 Watts, 250 Volts

No.	Description	Per 100
78X715	Black Texolite.....	\$34.50
78X723	Black Texolite; Mounting Bracket the reverse of No. 78X715.....	37.50
95X432	Black Texolite, with two 6-in. No. 18 A.W.G. thermoplastic-insulated (1050C) wire leads.....	28.50

Ten in a carton; 100 in standard package.

G-E Medium Bi-Pin Lampholders

Standard and Combination Types



No. 78X354

For either flush or surface mounting. Wiring protected with plastic cover plate. Lampholder held to reflector or wiring channel with one screw and nut. Binding screws take conductors up to size 14 A. W. G. solid.



No. 78X729

Two No. 78X354 or No. 78X491 are required for each lamp where a separate starter socket is used. Conventional mounting requires one 78X354 with one 78X729 or one 78X491 with one 78X736 or 95X291. (Mounting screw and nut furnished with carton pack.)

For Lamps:

Watts—14, 15, 20, 25, 30, 40.
Length—15, 18, 24, 33, 36, 38-in.
Diameter—1, 1½-in.
Type Bulbs—T-8, T-12.

Standard—Rating 660 Watts, 600 Volts

No.	Description	Per 100
78X354	Black Texolite.....	\$19.00
78X491	White Plastic.....	21.00

Combination—Rating 660 Watts, 600 Volts

78X729	Black Texolite.....	\$40.00
78X736	White Plastic with Black Starter Socket.....	42.00
95X291	White Plastic Lampholder, Black Inverted Starter Socket.....	56.00

Ten in a carton; 100 in standard package.

Butt-On Type



No.	Description	Volts	Per 100
503X59	White Urea	600	\$29.00
503X60	White Urea	600	28.00

For surface mounting. 503X59 is threaded for No. 4-36 mounting screws. 503X60 is provided with clearance holes for No. 4-36 screws. (Screws not furnished.)

Both have two 18-in. thermoplastic-insulated leads approved for 105 C stripped ½-in.

Narrow-Channel Type



No. 78X464

For flush mounting; for narrow-channel wiring work, show-case lighting and side-wall fixtures. Wiring is protected by plastic cover plate. Requires one mounting screw No. 6-32 (Not furnished).

For Lamps:

Watts—15, 30.
Length—18, 36-in.
Diameter—1-in.
Type Bulb—T-8.

Rating 660 Watts, 250 Volts

No.	Description	Per 100
78X464	Black Texolite.....	\$28.50
78X492	White Plastic.....	30.50

Ten in a carton; 100 in standard package.

Ejector Type



No. 78X914

To be used in pairs for narrow-channel work, show-case lighting, and side-wall fixtures. Require No. 6-32 screws (Not furnished).



No. 78X915

For Lamps:

Watts—15, 30.
Length—18, 36-in.
Diameter—1-in.
Type Bulb—T-8.

Rating 660 Watts, 250 Volts

No.	Description	Per 100
78X914	Black Texolite Combination Lampholder and Starter Socket.....	\$106.00
78X915	Black Texolite—No Starter Socket.....	66.00

Ten in a carton; 100 in standard package.

Weather-Resistant Type



No. 95X178

For enclosed outdoor lighting equipment. Spring-mounting bracket. Two-hole mounting requires No. 6 screws (Screws not furnished). Has 12-in. No. 18/2 ½-in. SP-2 cord lead.

For Lamps:

Watts—14, 15, 20, 25, 30, 40.
Length—15, 18, 24, 33, 36, 48-in.
Diameter—1, 1½-in.
Type Bulb—T-8, T-12.

Rating 660 Watts, 250 Volts

No. 95X178.....	Per 100	\$97.00
-----------------	---------	---------

Ten in a carton; 100 in standard package.

Turret Type



No. 502X92

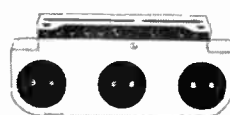

No. 95X936

These lampholders offer a wide scope for fluorescent applications in industrial or commercial lighting fixtures. Sturdy, all-metal construction. Have built-in starter sockets and holes for guiding leads to connection screws.

Easily mounted on any flat surface with two No. 8 mounting screws (Screws not furnished). Can also be mounted back-to-back for continuous lighting.

New lamps can be inserted and old lamps removed by depressing the face of either Turret lampholder with one end of the lamp until the other end clears the opposite face. Lamps are held securely and will withstand all normal jars, shocks and vibration.

For each twin lamp installation use two each of No. 502X92 or two No. 95X934 or one 95X935 w/one 95X936. For each triple-lamp installation use one 502X8 w/a 501X61 (which has one internal shunt) or use two 502X8 and make external shunt and use a two lamp ballast and a single lamp ballast.

For Lamps:

Watts—14, 15, 20, 25, 30, 40.
Length—15, 18, 24, 33, 36, 48-in.
Diameter—1, 1½-in.
Type Bulb—T-8, T-12.

Rating 660 Watts, 600 Volts

No.	Description	Per 100
502X92	3½-in. Center Spacing.....	\$154.00
95X934	5-in. Center Spacing.....	176.00

Triple Turret

95X936	2½-in. Center Spacing; for One Starter.....	209.00
95X935	2½-in. Center Spacing; for Two Starters.....	213.00

Five in a carton; 50 in standard package.

G-E Slimline Lampholders

For Fixture Mounting

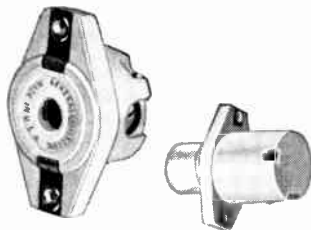

No. 502X21 No. 502X22

Butt-On Type

A small, sturdy and compact lampholder set. Designed to accommodate the T-6, T-8, or T-12 slimline lamps. Made of white urea. The protected, but easily accessible terminals permit quick and economical wiring. The sleeve nuts provide square, rigid mounting

not ordinarily found in bracket supported lampholders.

Internal telescoping of the cylinder in the high-voltage end provides additional security in relamping. Sleeve nuts for No. 6-32 screws are rigidly fixed to the sturdy ear mounting flange of the lampholder, to a spacing of 1 5/8 in. This spacing assures a square, permanent alignment on the fixture. Lampholders may be mounted to Lamp length—plus or minus 1/16 of an inch.

For Lamps:

Diameter—3/4, 1, 1 1/2-in.
Type Bulb—T-6, T-8, T-12

Rating: 660 Watts

No.	Description	For Lamp Length, In.	Voltage	Per 100
502X21	Low-Voltage End	42, 48, 64	250	\$56.50
502X22	High-Voltage End	72, 96	1000	79.00

Ten in a carton; 100 in standard package.

G-E Slimline Lampholders

For Fixture Mounting

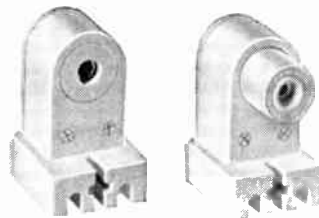

No. 502X63 No. 502X64

Plastic-Large Type

Accommodates all T-6, T-8 and T-12 slimline lamps.

Small and sturdy. Measurements from the lamp center to the bottom of the base are the same as those found on the conventional bi-bin fixture-type lampholder.

Lampholders can be spaced so that the center of one lamp to the center of adjoining lamp is slightly less than 1 1/2 inches.

All molded parts are white urea. Binding screws are located in underside—slots for standard No. 8 nuts are located in the front of the base.

For Lamps:

Length—42, 48, 64, 72, 96-in.
Diameter—3/4, 1, 1 1/2-in.
Type Bulb—T-6, T-8, T-12

Rating: 660 Watts

No.	Description	Volts	Per 100
502X63	Low-Voltage End	250	\$42.00
502X64	High-Voltage End	1000	46.00

Ten in a carton; 100 in standard package.

Twin Turret Type



No. 502X7



No. 502X6

This lampholder simplifies and speeds relamping. It eliminates the hazard of falling lamps; simplifies fixture design; provides 5-inch center spacing between lamps, and is built to withstand hard usage.

New lamps inserted and old lamps removed by depressing with lamp ends the movable molded parts in face of high-voltage Turret. Opposite end of lamp is then easily swung into position and held securely in place.

All-metal construction; white enamel finish.

Keyhole slots in mounting bracket provide easy mounting on any flat surface. Distance between centers of keyhole slots 4 3/4 inches.

Elongated wire holes guide leads to identified binding screws.

For Lamps:

Length—42, 48, 64, 72, 96-in.
Diameter—3/4, 1, 1 1/2-in.
Type Bulb—T-6, T-8, T-12

Rating: 660 Watts

No.	Description	Voltage	Per 100
502X7	Low-Voltage End	600	\$202.50
502X6	High-Voltage End	1000	226.00
*502X46	Low-Voltage End	600	202.00

*With 4 terminals. No internal shunt.
2 in a carton; 20 in standard package.

Triple Turret Type

No.	Description	Voltage	Per 100
502X47	Low-Voltage End	600	\$215.00
502X48	High-Voltage End	1000	271.00

G-E Fluorescent Lamp Starter Sockets
Medium Base Type



No. 78X769



No. 95X299

For use where starter is located at a distance from lampholder. Height of starter socket can be varied by using spacer No. 78 X 770. No. 95X299 is a companion device to "butt-on" type lampholders. No. 78X769 furnished with 1-in. mounting screws. No. 95X299 requires two No. 4 screws (Screws not furnished).

Made of black Texolite.

Rating: 660 Watts, 250 Volts

No.	Description	Per 100
78X769	For 2-Contact Starters.....	\$23.00
95X299	Butt-On Type; With Two 6-in. No. 18 A.W.G. thermo plastic insulated wire leads, stripped 3/4-in. For 2-Contact Starters.....	23.00

Ten in a carton; 100 in standard package.

G-E Fluorescent Lamp Starter Sockets



No. 95X180

Mogul Base Type

For use where starter is located at a distance from lampholder. Two No. 6-32 mounting screws 1 3/8-in. long furnished with each device.

Made of black Texolite.

Rating: 660 Watts, 250 Volts

No.	Description	Per 100
95X180	For 2- and 4-Contact Starters.....	\$39.50

Ten in a carton; 100 in standard package.

G-E Slimline Lampholders

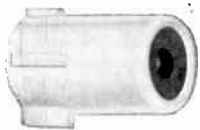

No. 95X671

Showcase Type

Especially adapted for narrow channel lighting.

Sturdy white plastic. Holds lamps securely in position. Has single mounting hole for No. 8 screw (Screw not furnished). Binding screws conveniently located under back cover.

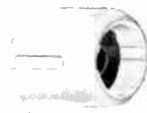

No. 95X683



No. 95X672

One 95X671 lampholder and one 95X672 or 95X683 should be used for each lamp. Also one 95X670 bracket for each lampholder.

No. 95X670 has trigger ejector for easy lamp removal or insertion, even in extremely narrow channels.

No. 95X670 bracket for mounting holder to reflector meets Underwriters' Laboratories requirements (One should be used with each lampholder).

For Lamps:

Length—42, 64 in.
Diameter— $\frac{3}{4}$ in.
Type Bulb—T-6

No.	Description	Volts	Per 100
95X671	High-Voltage End.....	1000	\$81.50
95X672	Low-Voltage End, With Lamp Ejector.....	250	110.00
95X683	Low-Voltage End.....	250	88.00
95X670	Bracket Only (one for each Holder).....	11.00

Rating: 660 Watts
Ten in a carton; 100 in standard package.

G-E Ballasts For Fluorescent Lamps

Cross-Section Dimensions

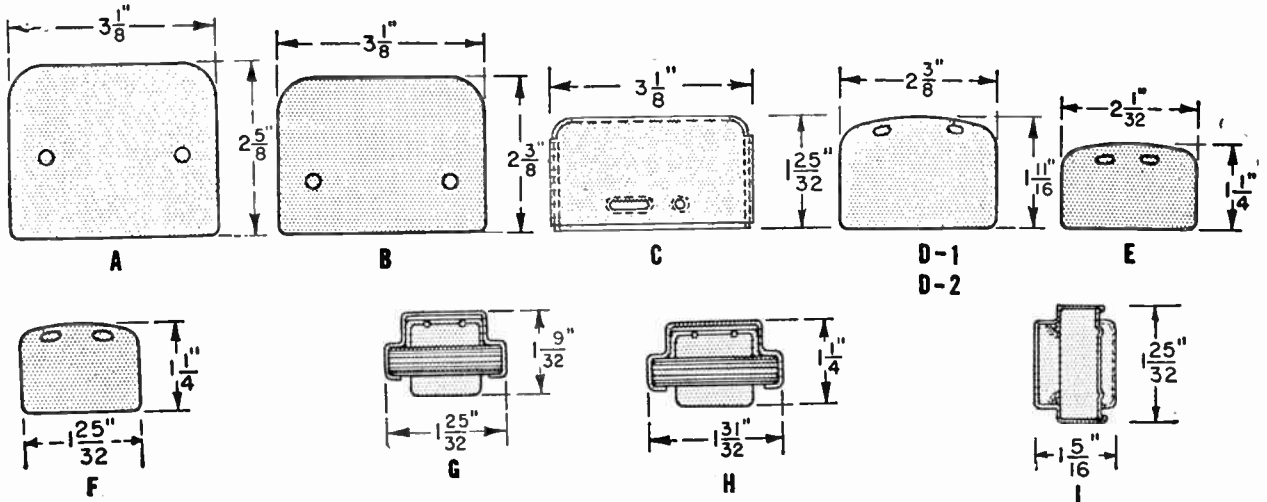

Mounting Dimensions in Inches for Above Cross Sections

	A	B	C	D-1	D-2	E	F	G	H	I	J	K
Corner Mounting Holes												
Dia., In.....	$\frac{7}{32}$	$\frac{7}{32}$	$\frac{7}{32}$									$\frac{7}{32}$
Width Between Centers, In.....	2	2	2				$\frac{3}{4}$	$1\frac{1}{16}$	$\frac{3}{4}$	$1\frac{11}{16}$		
Center Mounting-Slot												
Width, In.....	$\frac{3}{16}$	$\frac{3}{16}$	$\frac{3}{16}$	$\frac{3}{16}$	$\frac{3}{16}$	$\frac{3}{16}$	$\frac{3}{16}$	$\frac{3}{16}$	$\frac{3}{16}$	$\frac{5}{16}$	$\frac{3}{16}$	$\frac{3}{16}$

Equipment for Direct-Current Operation

Cat. No.	Lamp Watts	Circuit Voltage	Case Style	Length in Inches Overall	Length in Inches Mounting	Approx. Net Wt., Each, Lb.	Standard Package Quantity	Approx. Ship. Wt., Lbs.	List Price Each
58G690	6-8-14-15-20	110-125	F	4 1/4	3 7/8	3/4	20	18	\$1.60
58G690	13-30-32-40	220-250	F	4 1/4	3 7/8	3/4	20	18	1.60

Filters for Suppression of Radio Interference, 50/60 Cycles

Filter Cat. No.	Circuit Voltage	Approx. Watts Loss*	Case Size	Length in Inches Overall	Length in Inches Mounting	Approx. Net Wt., Each, Lb.	Standard Package Quantity	Approx. Ship. Wt., Lbs.	List Price Each
89G635	Max. 280	1 1/2	E	4 25/32	4 3/8	3/4	20	16	\$3.60

*Losses are given at maximum rated current.

†Maximum current rating, 3.5 amp.

G-E Ballasts For General-Line Fluorescent Lamps
110-125 Volts, 60 Cycles*

Uncorrected-power-factor—Single-lamp

Cat. No.	Nominal Lamp Watts	Line Current Amp.	Approx. Watts Loss†	Sound Rating	Length in Inches		Cross-Sect. Dimensions	No. of Units Per Std. Pkg.	Approx. Ship. Wt. Per Std. Pkg., Lb.	List Price Each
					Over-all	Mounting				
89G525	4	0.125	2	A	3 ¹ / ₁₆	2 ³ / ₄	I	50	34.5	\$1.20
89G435	6-8#	0.158	2	A	3 ¹ / ₁₆	2 ³ / ₄	G	50	33	.82
89G713	13 (T-5)	0.35	5	A	6 ¹ / ₂	6	K	10	24	2.60
89G381	14-15-20#	0.38	5	A	3 ¹ / ₁₆	2 ³ / ₄	G	50	34	.67
89G701‡	14-15 (T-12)	0.57	25φ	A	6 ¹ / ₂	6	K	20	37.5	2.35
89G702‡	15T8-20T12	0.68	29φ	A	6 ¹ / ₂	6	K	20	38	2.50
89G482	25	0.50	6	B	3 ³ / ₁₆	3 ¹³ / ₆₄	H	20	17.5	1.20
89G704	30	0.67	10	A	6 ¹ / ₂	6	K	20	38	1.75
89G707	40	0.67	9	A	6 ¹ / ₂	6	K	20	38	1.75

Uncorrected-power-factor—Two-lamp

89G440‡	(2) 14-15-20	1.0	15	A	8 ¹ / ₄	7 ¹³ / ₁₆	D-1	10	38	3.85
6G1000	2 (40)	.85	18	B	9 ¹ / ₂	8 ⁵⁷ / ₆₄	J	20	82.5	5.65

High-power-factor—Single-lamp

89G414	13 (T-5)	0.173	5	A	10	9 ⁹ / ₁₆	D-1	10	35	8.30
89G424	14	0.21	5.5	D	8 ¹ / ₄	7 ¹³ / ₁₆	D-1	10	21.5	4.90
89G422	15	0.17	4.5	D	8 ¹ / ₄	7 ¹³ / ₁₆	D-1	10	21.5	4.90
89G423	20	0.23	5	D	8 ¹ / ₄	7 ¹³ / ₁₆	D-1	10	21	4.90
89G706	30	0.35	10.5	A	9 ¹ / ₂	8 ⁵⁷ / ₆₄	J	20	77	4.90
89G711	40	0.45	11	A	9 ¹ / ₂	8 ⁵⁷ / ₆₄	J	20	77	4.90
89G603	90-100	1.00	21	D	11 ³ / ₄	11 ⁹ / ₆₄	B	6	60	14.80

Ballasts for Rapid-Start Lamps

All Two-Lamp and Three-Lamp Units Operating in Series

Uncorrected-power-factor

Cat. No.	Lamp Type	Nominal Lamp Watts	Line Current Amp.	Lamp Current Amp.	Input Watts	Min. Line Power Factor Percent	Sound Rating	Cross-section Dimensions	Length in Inches		Approx. Ship. Wt. Per Std. Pkg., Lb.	Each
									Over-all	Mounting		
89G325	{ F30T12/RS	30 or 40	.85	.425	48	50	A	D-1	6 ¹ / ₂	6	27.5	\$2.90
89G529	{ F40T12/RS											
89G327	{ F10T12/RS											
	{ FC16T10/RS	(2) 40	1.30	.425	93	50	A	D-1	8 ¹ / ₄	7 ¹³ / ₁₆	40	5.15
		40	.85	.420	48	50	A	D-1	6 ¹ / ₂	6	26.5	2.75

High-Power-Factor

89G708	{ F30T12/RS	30 or 40	0.50	.425	52	90	A	J	9 ¹ / ₂	8 ⁵⁷ / ₆₄	75	5.65
89G545	{ F40T12/RS											
89G836	{ F10T12/RS											
89G839	{ F96T12/HO	(2) 105	2.3	.824	264	90	F	A	16 ¹ / ₁₆	16 ¹ / ₈	95	15.75
89G839	{ F96T12/HO	(2) 105	1.0	.824	264	90	F	A	16 ¹ / ₁₆	16 ¹ / ₈	95	16.25
89G792	{ F72T12/HO	(2) 95	2.2	1.000	235	90	F	A	19 ¹ / ₄	18 ⁵ / ₈	67.5	17.30
89G555	{ F40T12/RS	(3) 40	1.3	.425	140	90	C	A	11 ³ / ₄	11 ⁹ / ₆₄	60.5	12.40
89G549	{ F40T12/RS	(3) 40	.550	.425	138	90	C	A	11 ³ / ₄	11 ⁹ / ₆₄	62.5	12.90
89G601	{ F96T12/RS	(2) 105	2.1	.800	246	90	F	A	19 ³ / ₁₆	18 ⁵ / ₈	67	16.80
89G817	{ F48T12/HO	(2) 60	1.2	.800	110	90	D	A	11 ³ / ₄	11 ⁹ / ₆₄	61	13.65
89G605	{ F48T12/RS	(2) 85	1.7	.800	200	90	F	A	14 ⁵ / ₁₆	13 ³ / ₄	78	14.70
	or F72T12/HO											

High-Power-Factor—Tulamp and 3-Lamp

Brick and Standard Cross Section

No.	Nominal Lamp Watts	Line Current Amp.	Approx. Watts Loss	†Cross-section Dimensions	Length in Inches		Sound Rating	No. of Units Per Std. Pkg.	Approx. Ship. Wt. Per Std. Pkg., Lb.	Each
					Over-all	Mounting				
89G776	(3) 40	1.3	29	C	14 ⁵ / ₁₆	13 ³ / ₄	B	6	55	\$10.50
89G562	(2) 90-100	1.95	31	A	19 ¹ / ₄	18 ⁵ / ₈	D	4	63	15.55

Brickette Cross Section

89G428	(2) 15	0.32	9	D-1	10	9 ⁹ / ₁₆	D	10	33.5	6.75
89G429	(2) 20	0.42	9	D-1	10	9 ⁹ / ₁₆	D	10	33.5	6.75
89G780	(2) 30	0.7	17	J	9 ¹ / ₂	8 ⁵⁷ / ₆₄	B	20	81	5.65
6G1000	(2) 40	0.85	18	J	9 ¹ / ₂	8 ⁵⁷ / ₆₄	B	20	82.5	5.65

*A complete line of standard 50-cycle ballasts is available. Special ballasts for certain other frequencies can be obtained.

†Losses and power factor are given at rated lamp watts input and nominal voltage rating of 118 volts.

‡Trigger-start ballast, no external starter required.

#Operation will vary slightly with different-sized lamps. This listing represents average values for both lamps.

φInput watts.

φReliable starting down to O F.

○For operating two lamps in series.

Refer to Bulletin GEC-983 for complete description and application data on ballasts for fluorescent lamps.

General Electric Ballasts For Slimline and 40-Watt Instant-Start Lamps

60 Cycles

No.	Lamp Type	Nominal Lamp Watts	Line Current Amp.	Lamp Current Amp.	Watt Loss	Circuit Voltage	Open Cir. Voltage	Min. Line Power Factor Percent	Sound Rating	Length in Inches Overall	Length in Inches Mounting	Cross Sect. Dimensions	No. of Units Per Std. Pkg.	Approx. Ship. Wt. Per Std. Pkg., Lb.	List Price, Each
89G580	42T6	25	.37	.200	13	110-125	450	90	B	9 1/2	8 3/4	C	12	60	\$12 10
89G584	◇	(2) 25	.65	.200	21	110-125	450	90	D	14 5/16	13 3/4	C	6	54	13 85
89G553	◇	(2) 32.5	.84	.300	32	110-125	450	90	D	14 3/8	13 3/4	C	6	56	18 20
89G693	48T12	38.5	.56	.425	20	110-125	450	90	D	9 1/2	8 3/4	C	12	74	7 50
89G628	◇	(2) 38.5	.95	.425	30	110-125	450	90	D	14 5/16	13 3/4	C	6	56.5	9 10
89G600	†	(2) 38.5	.85	.425	20	110-125	500	90	D	9 1/2	8 3/4	C	12	74	7 50
89G694	and	38.5	.28	.425	20	220-250	430	90	D	9 1/2	8 3/4	C	12	67	11 00
89G630	◇	(2) 38.5	.48	.425	28	220-250	450	90	D	14 5/16	13 3/4	C	6	56	15 45
89G695	◇	38.5	.25	.425	20	240-280	430	90	D	9 1/2	8 3/4	C	12	67	8 00
89G631	◇	(2) 38.5	.43	.425	28	240-280	450	90	D	14 5/16	13 3/4	C	6	56	9 60
89G710	†	(2) 38.5	.40	.425	20	240-280	575	90	E	9 1/2	8 3/4	C	12	74.5	8 00
89G585	◇	(2) 24.5	.70	.120	19	110-125	600	90	D	11 5/16	13 3/4	C	6	52	14 10
89G581	and	37	.53	.200	16	110-125	600	90	B	9 1/2	8 3/4	C	12	61	12 70
89G586	◇	(2) 37	.90	.200	25	110-125	600	90	D	11 3/8	13 3/4	C	6	56	15 00
89G582	◇	48.5	.625	.300	21	110-125	600	90	D	11 3/4	11 3/4	B	6	59.5	16 40
89G587	◇	(2) 48.5	1.15	.300	34	110-125	600	90	D	14 5/16	13 3/4	B	6	75	19 05
89G762	72T12	57	.90	.425	27	110-125	625	90	D	11 3/4	11 3/4	C	8	66	9 10
89G490	◇	(2) 57	1.6	.425	34	110-125	630	90	E	14 5/16	13 3/4	A	6	82.5	13 20
6G1010	†	(2) 57	1.45	.430	26	110-125	700	90	C	11 3/4	11 3/4	C	6	51.5	9 10
89G398	†	(2) 57	.80	.425	29	220-250	750	90	E	14 5/16	13 3/4	A	6	74.5	14 40
89G532	◇	(2) 57	.70	.425	34	240-280	660	90	D	14 5/16	13 3/4	A	6	83.5	13 70
89G460	†	(2) 57	.39	.425	30	440-480	750	90	E	14 5/16	13 3/4	A	6	74	14 40
89G588	◇	(2) 32	.78	.120	21	110-125	750	90	C	14 5/16	13 3/4	C	6	55	14 40
89G743	◇	19	.65	.200	26	110-125	750	90	D	9 1/2	8 3/4	C	12	70	10 00
89G589	◇	(2) 19	1.15	.200	28	110-125	750	90	D	14 3/8	13 3/4	B	6	74	15 00
89G590	◇	(2) 65	1.40	.300	35	110-125	750	90	D	14 5/16	13 3/4	A	6	82	19 05
89G762	96T12	73.5	.90	.425	27	110-125	625	90	D	11 3/4	11 3/4	C	8	66	9 10
89G490	◇	(2) 73.5	1.60	.425	34	110-125	630	90	E	14 5/16	13 3/4	A	6	82.5	13 20
6G1010	†	(2) 57	1.45	.430	26	110-125	700	90	C	11 3/4	11 3/4	C	6	51.5	9 10
89G493	†	(2) 73.5	.39	.425	25	240-280	625	85	D	14 5/16	13 3/4	A	6	58	9 60
89G899	†	(2) 73.5	.67	.430	26	260-290	700	90	C	11 3/4	11 3/4	C	6	51	9 60
89G532	◇	(2) 73.5	.70	.425	34	240-480	660	90	D	14 5/16	13 3/4	A	6	83.5	13 70
89G398	†	(2) 73.5	.8	.425	29	220-250	750	90	C	14 5/16	13 3/4	A	6	74.5	14 40
89G460	†	(2) 73.5	.39	.425	30	440-480	750	90	E	14 5/16	13 3/4	A	6	74	14 40

General Electric Ballasts For Circline Lamps

60 Cycles—110-125 Volts

No.	Type	Nominal Lamp Watts	Lamp Diam., In.	Line Current Amp.	Min. Line Power Factor Percent*	Approx. Watts Loss*	Sound Rating	Length in Inches Overall	Length in Inches Mounting	Cross Sect. Dimensions	Std. Pkgs. —	Ship. Wt., Lbs.	Each
89G700	Single-lamp	32	12	.56	55	10	A	6 1/2	6	K	20	37	\$1 70
89G332	# Single-lamp	32	12	1.00	40	14	A	6 1/2	6	D-1	10	28	2 75
89G319	#† Two-lamp	32 & 22	12 & 8 1/4	1.2	50	13	A	8 1/4	7 13/16	D-1	10	38	3 85
89G467	Two-lamp	22 & 32	8 1/4 & 12	1.00	58	10	A	6 1/2	6	D-1	10	26	2 55
89G481	† Series	32 & 40	12 & 16	1.35	50	15	A	8 1/4	7 13/16	D-1	10	38.5	4 20
89G499	Single-lamp	22	8 1/4	.38	55	6.5	A	3 1/16	2 3/4	I	50	33.5	82
89G322	# Single-lamp	22	8 1/4	.95	50	14	A	6 1/2	6	D-1	10	28	2 75
89G327	Two-lamp	32 or 40	12 or 16	.85	50	48	A	6 1/2	6	D-1	10	26.5	2 75

*Losses and power factor are given at rated lamp watts input and nominal voltage rating of 118 volts.

†This ballast is not suitable for portable-lamp applications, as the open-circuit voltage (151 volts) is in excess of that

permitted by the National Electric Code for portable devices. †Operates two lamps in series.

◇Lead-lag.

#Trigger-start ballast, no starter required.

General Electric Circle-Dot Ballasts

Lamp Type	Nominal Lamp Watts	Lamp Current in Amp.	Line Current in Amp.	Input Watts	Ballast Cat. No.	List Price, Each	No. Units Per Std. Pkg.	Approx. Ship. Wt. in Lbs. Per Std. Pkg.	Sound Rating	Length in Inches Overall	Length in Inches Mounting	Cross Section Dimensions
F40T12/SS	(2) 35.0	.385	.82	—	89G1800	\$3 90	20	82	B	9 1/2	8 3/4	J
F40T12/RS	(2) 35.0	.370	.70	85	89G825†	5.40	20	80	B	9 1/2	8 3/4	J
F96T12/S*	(2) 66.0	.370	1.40	—	89G850†	7.50	6	51	C	11 3/4	11 3/4	C

*Also operates two F72T12 lamps with reliable starting to O F.

†Series ballast for reliable starting down to 50 F.

Jefferson Fluorescent Lamp Ballasts
Rapid Start and Slimline—60 Cycle
Rapid Start—Normal Power Factor

No.	Lamp Type	Lamp Watts	Voltage Range	Lamp Current MA	Watts Loss	Length	Dimensions-In. Mtg. Centers	Width	Height	Each
254-111	40T12/RS	40	110-125	425	18	6 ⁹ / ₁₆	6	3 ³ / ₈	1 ³ / ₄	\$ 5.80
Rapid Start—High Power Factor										
254-761	40T12 RS	40	110-125	425	17	10	9 ³³ / ₆₄	2 ³ / ₈	1 ¹¹ / ₁₆	\$11.30
254-768	40T12/RS	40	260-290	425	17	10	9 ³³ / ₆₄	2 ³ / ₈	1 ¹¹ / ₁₆	12.30
254-701	2-40T12/RS	2-40	110-125	425	15	9 ³ / ₈	9 ³⁷ / ₆₄	2 ³ / ₈	1 ¹¹ / ₁₆	11.30
254-708	2-40T12/RS	2-40	260-290	425	15	9 ³ / ₈	9 ³⁷ / ₆₄	2 ³ / ₈	1 ¹¹ / ₁₆	12.30
254-721	2-96 (or 72) T12/RS	2-100	105(85) 110-125	800	38	14 ⁵ / ₁₆	13 ³ / ₄	3 ¹ / ₈	2 ⁵ / ₈	31.50
254-728	2-96 (or 72) T12/RS	2-100	105(85) 260-290	800	38	14 ⁵ / ₁₆	13 ³ / ₄	3 ¹ / ₈	2 ⁵ / ₈	32.50
Slimline—High Power Factor										
254-121	48T12	40	110-125	425	20	9 ⁷ / ₁₆	8 ⁷ / ₈	3 ¹ / ₈	2 ³ / ₈	\$15.00
254-128	48T12	40	260-290	425	20	9 ⁷ / ₁₆	8 ⁷ / ₈	3 ¹ / ₈	2 ³ / ₈	16.00
254-471	96T12	73.5	110-125	425	25	11 ¹⁵ / ₆₄	11 ⁹ / ₆₄	3 ¹ / ₈	2 ¹⁹ / ₃₂	18.20
254-478	96T12	73.5	260-290	425	20	11 ¹⁵ / ₆₄	11 ⁹ / ₆₄	3 ¹ / ₈	2 ¹⁹ / ₃₂	19.20
Leadlag										
234-191	2-48T12	2-40	110-125	425	23	14 ⁵ / ₁₆	13 ³ / ₄	3 ¹ / ₈	2 ³ / ₈	\$18.20
254-281	2-72T8 or 2-64T6	2-38 or 2-39	110-125	200	25	14 ⁵ / ₁₆	13 ³ / ₄	3 ¹ / ₈	2 ³ / ₈	30.00
254-401	2-96T8	2-51	110-125	200	25	14 ⁵ / ₁₆	13 ³ / ₄	3 ¹ / ₈	2 ³ / ₈	30.00
254-311	2-96T8	2-69	110-125	300	35	19 ³ / ₁₆	18 ⁵ / ₈	3 ¹ / ₈	2 ¹⁹ / ₃₂	38.10
254-411	2-96 (or 72) T12	2-73.5(2-57)	110-125	125	35	14 ⁵ / ₁₆	13 ³ / ₄	3 ¹ / ₈	2 ⁵ / ₈	26.40
Series Sequence										
254-521	2-48T12	2-40	110-125	425	21	11 ¹⁵ / ₆₄	11 ⁹ / ₆₄	3 ¹ / ₈	1 ³ / ₄	\$15.00
254-528	2-48T12	2-40	255-285	425	20	11 ¹⁵ / ₆₄	11 ⁹ / ₆₄	3 ¹ / ₈	1 ³ / ₄	16.00
254-516	2-96 (or 72) T12	2-73.5(2-57)	199-216	425	29	14 ⁵ / ₆₄	11 ⁹ / ₆₄	3 ¹ / ₈	2 ¹⁹ / ₃₂	30.50
254-731	2-96 (or 72) T12	2-73.5(2-57)	110-125	425	25	14 ⁵ / ₁₆	13 ³ / ₄	3 ¹ / ₈	1 ³ / ₄	18.20
254-738	2-96 (or 72) T12	2-73.5(2-57)	260-290	425	25	15 ⁵ / ₁₆	13 ³ / ₄	3 ¹ / ₈	1 ³ / ₄	19.20
Preheat—60 Cycle										
Single Lamp—Normal Power Factor										
234-521	14	110-125	...	5	4 ¹ / ₄	3 ¹ / ₂	1 ³ / ₄	1 ¹ / ₄	\$ 1.70
234-531	14-15	110-125	...	5	3	2 ³ / ₄	1 ¹¹ / ₁₆	1 ¹⁹ / ₃₂	1.34
234-501	15	110-125	...	5	4 ¹ / ₄	3 ¹ / ₂	1 ³ / ₄	1 ¹ / ₄	1.70
234-511	20	110-125	...	5	4 ¹ / ₄	3 ¹ / ₂	1 ³ / ₄	1 ¹ / ₄	1.70
234-551	20	110-125	...	5	3	2 ³ / ₄	1 ¹¹ / ₁₆	1 ¹⁹ / ₃₂	1.34
234-541	30	110-125	...	7	10 ¹ / ₂	9 ³ / ₄	1 ²⁷ / ₃₂	1 ¹⁹ / ₃₂	3.50
234-546	30	199-216	...	6.25	8	7 ¹ / ₄	1 ²⁷ / ₃₂	1 ¹⁹ / ₃₂	6.60
234-543	30	220-250	...	6.75	8	7 ¹ / ₄	1 ²⁷ / ₃₂	1 ¹⁹ / ₃₂	6.60
234-281	40	110-125	...	10	6 ¹ / ₂	6	2 ³ / ₈	1 ⁵ / ₈	3.50
234-286	40	199-216	...	10	6 ¹ / ₂	6	2 ³ / ₈	1 ⁵ / ₈	6.60
234-283	40	220-250	...	10	6 ¹ / ₂	6	2 ³ / ₈	1 ⁵ / ₈	6.60
Single Lamp—High Power Factor										
234-621	14	110-125	...	5	8 ¹³ / ₁₆	8 ³ / ₁₆	2 ⁹ / ₃₂	1 ⁹ / ₃₂	\$ 9.80
234-601	15	110-125	...	5	8 ¹³ / ₁₆	8 ³ / ₁₆	2 ⁹ / ₃₂	1 ⁹ / ₃₂	9.80
234-611	20	110-125	...	5	8 ¹³ / ₁₆	8 ³ / ₁₆	2 ⁹ / ₃₂	1 ⁹ / ₃₂	9.80
234-941	30	110-125	...	10	10	9 ¹ / ₂	2 ³ / ₈	1 ¹⁹ / ₁₆	9.80
234-946	30	199-216	...	10	10	9 ¹ / ₂	2 ³ / ₈	1 ¹⁹ / ₁₆	14.70
234-943	30	220-250	...	10	10	9 ¹ / ₂	2 ³ / ₈	1 ¹⁹ / ₁₆	14.70
234-781	40	110-125	...	10	10	9 ¹ / ₂	2 ³ / ₈	1 ⁵ / ₈	9.80
234-786	40	199-216	...	10	10	9 ¹ / ₂	2 ³ / ₈	1 ⁵ / ₈	14.70
234-783	40	220-250	...	10	10	9 ¹ / ₂	2 ³ / ₈	1 ⁵ / ₈	14.70
234-691	100	110-125	...	25	14 ⁵ / ₁₆	13 ³ / ₄	3 ¹ / ₈	2 ³ / ₈	29.60
234-693	100	220-250	...	27	14 ⁵ / ₁₆	13 ³ / ₄	3 ¹ / ₈	2 ³ / ₈	32.30
Two Lamp—Normal Power Factor										
234-985	2-15	110-125	...	10	6 ¹ / ₂	5 ³ / ₄	1 ²⁷ / ₆₄	1 ¹⁹ / ₆₄	\$ 3.20
234-986	2-20	110-125	...	10	6 ¹ / ₂	5 ³ / ₄	1 ²⁷ / ₆₄	1 ¹⁹ / ₆₄	3.20
Two & Three Lamp—High Power Factor										
234-701	2-15	110-125	...	8	14 ⁵ / ₁₆	13 ¹¹ / ₁₆	2 ⁹ / ₃₂	1 ⁹ / ₃₂	\$13.50
234-711	2-20	110-125	...	12	14 ⁵ / ₁₆	13 ¹¹ / ₁₆	2 ⁹ / ₃₂	1 ⁹ / ₃₂	13.50
234-441	2-30	110-125	...	15	16 ⁷ / ₁₆	15 ⁵ / ₈	2 ¹ / ₂	1 ⁹ / ₁₆	15.50
234-841	2-30	110-125	...	15	9 ⁷ / ₁₆	8 ⁷ / ₈	3 ¹ / ₈	2 ³ / ₈	15.50
234-446	2-30	199-216	...	12	16 ⁷ / ₁₆	15 ⁵ / ₈	2 ¹ / ₂	1 ⁹ / ₁₆	18.50
234-846	2-30	199-216	...	11	9 ⁷ / ₁₆	8 ⁷ / ₈	3 ¹ / ₈	2 ³ / ₈	18.50
234-443	2-30	220-250	...	13	16 ⁷ / ₁₆	15 ⁵ / ₈	2 ¹ / ₂	1 ⁹ / ₁₆	18.50
234-843	2-30	220-250	...	12	9 ⁷ / ₁₆	8 ⁷ / ₈	3 ¹ / ₈	2 ³ / ₈	18.50
234-481	2-40	110-125	...	18	16 ⁷ / ₁₆	15 ⁵ / ₈	2 ¹ / ₂	1 ⁹ / ₁₆	15.50
254-881	2-40	110-125	...	16	9 ⁷ / ₁₆	8 ⁷ / ₈	3 ¹ / ₈	1 ³ / ₄	11.30
234-486	2-40	199-216	...	14	16 ⁷ / ₁₆	15 ⁵ / ₈	2 ¹ / ₂	1 ⁹ / ₁₆	18.50
234-886	2-40	199-216	...	13	9 ⁷ / ₁₆	8 ⁷ / ₈	3 ¹ / ₈	2 ³ / ₈	18.50
234-483	2-40	220-250	...	15	16 ⁷ / ₁₆	15 ⁵ / ₈	2 ¹ / ₂	1 ⁹ / ₁₆	15.50
234-883	2-40	220-250	...	13	9 ⁷ / ₁₆	8 ⁷ / ₈	3 ¹ / ₈	2 ³ / ₈	15.50
234-131	2-40	255-285	...	16	9 ⁷ / ₁₆	8 ⁷ / ₈	3 ¹ / ₈	2 ³ / ₈	18.50
234-791	2-100	110-125	...	36	19 ³ / ₁₆	18 ⁵ / ₈	3 ¹ / ₈	2 ³ / ₈	31.10
234-796	2-100	199-216	...	36	19 ³ / ₁₆	18 ⁵ / ₈	3 ¹ / ₈	2 ³ / ₈	40.70
234-793	2-100	220-250	...	36	19 ³ / ₁₆	18 ⁵ / ₈	3 ¹ / ₈	2 ³ / ₈	40.70
234-983	3-40	110-125	...	26	14 ⁵ / ₁₆	13 ³ / ₄	3 ¹ / ₈	2 ³ / ₈	21.00
234-980	3-40	220-250	...	25	14 ⁵ / ₁₆	13 ³ / ₄	3 ¹ / ₈	2 ³ / ₈	25.20

Jefferson Indoor Mercury Lamp Ballasts 60 Cycle



No. 233-901



No. 233-761

Mercury lamps are being accepted as the modern way of lighting factories, warehouses, mills, offices, drafting rooms, exteriors, etc., as they give double the luminosity at the same power cost, or give equal intensity at one-half the power cost.

Available for 100, 250, 400, 700 and 1000 watt mercury lamps. Dual lines of transformers are available for 1000 watt mercury lamps. All transformers are equipped with knockouts, have color coded and tagged leads, sturdy mounting brackets and extra roomy wiring compartments which are readily accessible. Heavy gauge steel cases are finished in baked enamel.

No.	Lamp Wattage	Primary Voltage	Sec. Open Cir.	Input W.	Power Factor	Each
233-871	1-250 Watt H-5	105 / 115 / 125	250	275	High	\$ 52.44
233-901	2-400 Watt H-1	105 / 115 / 125	220	875	High	79.24
233-903	2-400 Watt H-1	210 / 230 / 250	220	875	High	79.24
233-906	2-400 Watt H-1	250 / 265 / 277	220	875	High	79.24
233-908	2-400 Watt H-1	420 / 460 / 500	220	875	High	90.06
233-421	1-400 Watt H-1	110 / 120 / 220 / 240	300	450	High	98.04
233-428	1-400 Watt H-1	420 / 460 / 500	300	450	High	114.00
233-811	1-400 Watt H-1	105 / 115 / 125	220	450	Normal	37.62
233-813	1-400 Watt H-1	210 / 230 / 250	220	450	Normal	37.62
233-821	1-400 Watt H-1	105 / 115 / 125	220	450	High	50.16
233-823	1-400 Watt H-1	210 / 230 / 250	220	450	High	50.16
233-826	1-400 Watt H-1	250 / 265 / 277	220	450	High	50.16
233-828	1-400 Watt H-1	420 / 460 / 500	220	450	High	50.16
233-513	1-400 Watt H-1	220 / 240 / 265 / 277	*	420	Normal	34.20
233-523	1-400 Watt H-1	220 / 240 / 265 / 277	*	420	High	47.32
233-761	1-700 Watt H-18	105 / 115 / 125	460	780	High	108.88
233-763	1-700 Watt H-18	210 / 230 / 250	460	780	High	108.88
233-768	1-700 Watt H-18	460	*	740	High	54.72
233-101	1-1000 Watt H-12	105 / 115 / 125	230	1085	High	131.68
233-103	1-1000 Watt H-12	210 / 230 / 250	230	1085	High	131.68
233-108	1-1000 Watt H-12	420 / 460 / 500	230	1085	High	141.94
233-106	1-1000 Watt H-12	220 / 240 / 265 / 277	*	1050	High	112.86
233-111	1-1000 Watt H-15	105 / 115 / 125	460	1085	High	135.66
233-113	1-1000 Watt H-15	210 / 230 / 250	460	1085	High	118.56
233-118	1-1000 Watt H-15	460	*	1050	High	66.12

*Same as Line Volts - Series Reactor Choke.

Skylike Incandescent Luminaires

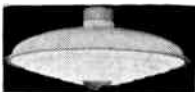

No. W5300



No. S5301
Pendant

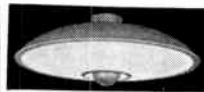

No. W5301

5300 Line

Designed for either recessed or pendant installation. Surface installations may be accomplished by use of a surface mounting enclosure.

All fixtures in this group employ a basic reflector designed to afford the most effective utilization of silvered bowl lamps. The difference between the three types lies in the shielding and diffusing devices.

The No. 5300 units are equipped with a delicately formed concentric ring louver of five 20 gauge narrow steel bands.

The No. 5301 units consist of a circular panel of bent glass approximately 18-in. in diam. Glass is lightly etched over-all and has superimposed design consisting of concentric enameled bands.

5300 Group—Recessed—Complete with Plaster Ring

No. Wired Assembly	Silvered Bowl Lamp Size	Recess Diam. In.	Flange Diam. In.	Recess Depth In.	Each
W 5300/1	150	21½	22⅞	5¾	\$23.20
W 5300/2	200	21½	22⅞	5¾	23.20
W 5300/3	300	21½	22⅞	7	23.20
W 5300/5	500	21½	22⅞	7	23.20

5301 Group—Recessed—Complete with Plaster Ring

W 5301/1	150	21½	22⅞	5¾	34.25
W 5301/2	200	21½	22⅞	5¾	34.25
W 5301/3	300	21½	22⅞	7	34.25

Note: For surface mounted unit drop prefix "W" and insert prefix "SM". Add.....\$7.70

5300 Group—Pendant

No.	Silvered Bowl Lamp Size	Overall Length In.	Flange Diam. In.	Stem Length In.	Each
S5300/1	150	27	21½	16	\$25.50
S5300/2	200	27	21½	16	25.50
S5300/3	300	28	21½	16	25.50
S5300/5	500	28	21½	16	25.50

Skylike Lighting Fixtures

Louvered Incandescent Lighting Systems—Prewired

50 Series With Metal Eggcrate Louver

**Type A
24-In. Square Units**

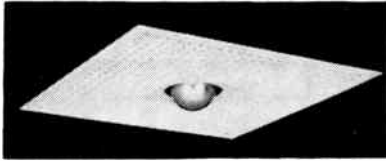

Skylike 50 Series louvered units are for general lighting requirements in stores, offices, classrooms, auditoriums, gymnasiums and all similar applications requiring soft, well diffused light with minimum fixture maintenance.

Standard 24-in. reflector and its accessories permit use of 150, 200, 300 or 500 watt silvered bowl lamps.

Installations may be fully recessed, semi-recessed, surface mounted or suspended.

Reflector is die-formed from 20 gauge electrolytically zinc coated steel. Louver formed from 22 gauge steel in 1-in. grid and enclosed in 20 gauge steel outer frame.

All units wired and include side-connection junction box as an integral part of the mounting yoke. Junction box is Underwriters' Laboratory approved for "feed-thru" connection of low temperature building wires for 150, 200 and 300 watt lamps. For 500 watt lamps, connections to junction box require wire rated at 75° C.

Available with aluminum bulb guard for gymnasium lighting and auxiliary medium base socket accommodating up to 25 watt lamp for night lighting.

Complete Wired Unit with Plaster Frame

No.	Silvered Bowl Lamp Size	Each
RP5001A	150	\$30.05
RP5002A	200	30.05
RP5003A	300	30.05
RP5005A	500	30.05

Note: For data on recessed acoustical, semi-recessed, or surface mounted assemblies contact GRAYBAR.

50 Series With Plastic Diffusers

**Type B and Type C
24-In. Square Units**

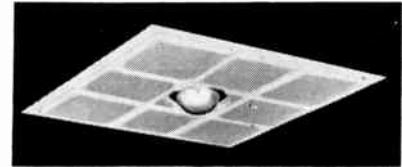

8 Panel Plastic Diffuser

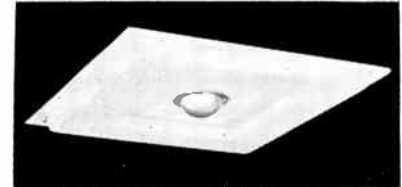

One Piece Plastic Diffuser

Available with two types of plastic diffusers. They are of approximately equivalent lighting characteristics as both are formed from the same material.

May be used with 150, 200 or 300 watt silvered bowl lamps. Reflector is die-formed from 20 gauge electrolytically zinc coated steel.

Type B plastic diffuser consists of 8 panels of injection molded styrene supported in a steel frame forming a grid of 8 panels.

Type C plastic diffusers consists of one piece styrene diffuser dropping slightly below reflector flange and having a concentric square pattern. A metal frame supports the panel.

Installations may be fully recessed, semi-recessed, surface mounted or suspended.

**Complete Wired Unit with Plaster Frame
With 8 Panel Plastic Diffuser**

No.	Silvered Bowl Lamp Size	Each
RP5001B	150	\$36.45
RP5002B	200	36.45
RP5003B	300	36.45

With One Piece Plastic Diffuser

RP5001C	150	32.80
RP5002C	200	32.80
RP5003C	300	32.80

Junior Skylike 70 Series

With Metal Eggcrate Louver or Glass Diffuser

14-In. Square Units

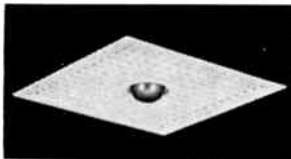

Metal Eggcrate Louver



Glass Diffuser

General purpose lighting unit having both commercial and residential application. Designed for 75, 100 or 150 watt silvered bowl lamps.

Reflector is die-formed from 20 gauge electrolytically zinc coated steel. Louver formed from 22 gauge steel in 1-in. by 1-in. grid and enclosed in 20 gauge steel outer frame.

Standard glass diffuser is lightly stippled high transmission tempered glass enclosed in sturdy steel frame.

Wired complete with 4-ft. flexible conduit and AF wire. Installations may be fully recessed, semi-recessed or surface mounted.

Available with medium base socket accommodating 7½ watt lamp for night lighting.

**Complete Wired Unit with Plaster Frame
Louvered Type**

No.	Silvered Bowl Lamp Size	Each
WRP70F/100	100	\$17.30
WRP70F/150	150	17.30

Glass Diffuser Type

WRPG70F/100	100	19.95
WRPG70F/150	150	19.95

Note: For data on semi-recessed or surface mounted assemblies contact GRAYBAR.

Litecraft Decorative Lighting

For new buildings, redecorating or remodeling, here are a few decorative lighting designs.

Available in a wide selection of designs to meet almost any requirement. Our custom design department is prepared to

submit drawings and suggestions for special applications.

Functional, fashionable, flexible—suited for almost every residential, commercial and institutional application—modern or traditional. They perform efficiently and relamp quickly.

Litecraft Concentric Rings

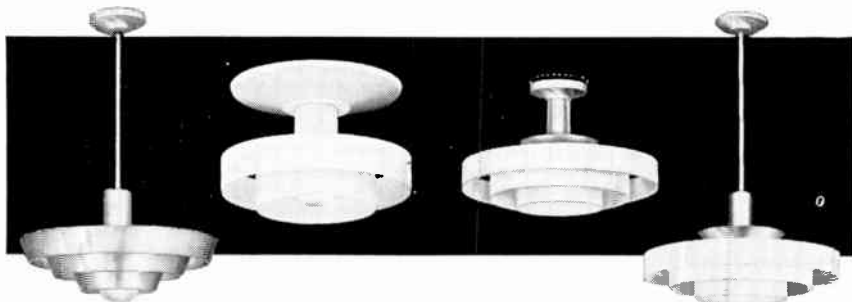

Designed for use with silvered-bowl lamps. Assures wide-spread glareless indirect light. Non-twist pendant units have earthquake-proof swivel aligner and stemlok socket cap that saves installation time. Finishes dual-sprayed and baked twice at 375° F. UL Approved. Made and wired by IBEW-AFL craftsmen.

No.	Type	Finish	Silvered Bowl Lamp Size	Diam. In.	Length In.	Ship. Wt., Lbs.	Each
*A105	Close-up	White	300/500	19	11	9	\$ 9.75
*A106	Pendant	White	300/500	19	30	9½	10.69
A113	Close-up	Colors	200	11	8¾	4	4.94
*A125	Close-up	Anodized	300/500	19	12	5½	10.94
*A126	Pendant	Anodized	300/500	19	28	6	11.88

All units listed are 3-ring except No. A113 which is 2-ring.

*Also available in 200SB. Colors: Flame, Blue, Oyster White, Matte White.

Chandeliers, Twinlites and Brackets

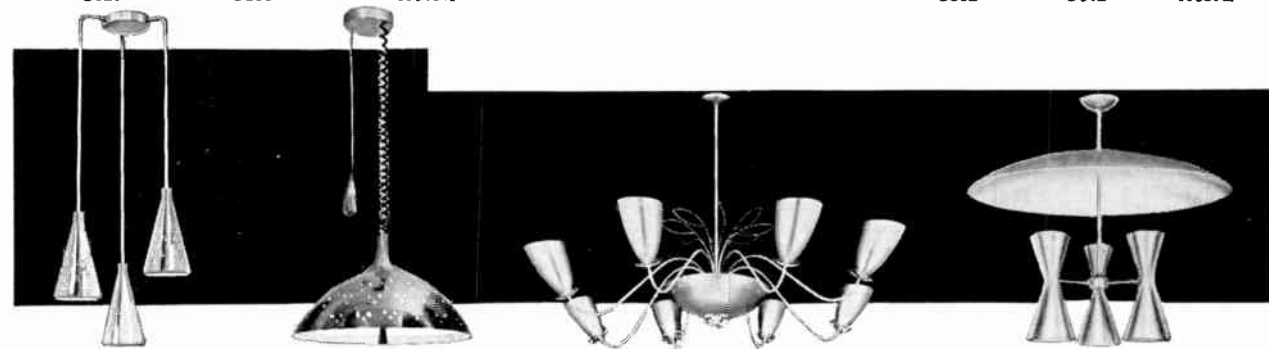
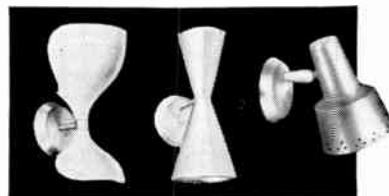

No.	Type	Finish	Lamps & Watts	Width In.	Extension In.	Length In.	Each
B158/36-3	Pendant Dome	Satin Brass	3-100W UP 3-150W Down	36	36	\$ 81.56
C214	Counterbalanced	Satin Brass	3-75W 1F	18	41 to 64	68.75
C288	Chandelier	Satin Brass	Bowl: 3-60W Ref.: 8-100W	60	36	237.50
C300	Ceil. Mobile	Polished Brass	3-150W 1F	50	35.19
C301	Wall Bracket	White & Brass	1-150W UP 1-40W Down	9	7¾	14	24.25
C303	Wall Bracket	Satin Brass	1-150W 1F	9½	10¾	5½	15.63
C317	Wall Bracket	White & Brass	1-150W 1F	14	16	5	19.56
C641	Wall Bracket	Satin Brass	1-100W UP 1-150W Down	6½	10	14	15.81
H637E	Wall Bracket	Satin Brass	1-100W 1F	5	7	7¼	* 8.63
H64011	Ceiling	Satin Brass	2-150W R40	17	13	*19.56

Above fixtures also available in standard Litecraft finishes and colors: Satin Brass, Satin Bronze, Satin Copper, Satin Aluminum—Green, Flame, White, Chartreuse, Terra Cotta, Blue, Black and Gray.

*Satin Aluminum price.

Litecraft Decorative Lighting

Domelites

Provide their own reflecting surface, assure efficient lighting regardless of ceiling height, color or condition.

Available in an infinite variety of sizes, wattages, finishes and decorative designs for surface, pendant or recessed mounting in homes and offices. Simple to install and service. UL approved. Union made by IBEW-AFL craftsmen. Wired ready to install. All pendant domelites are 36" over-all length.

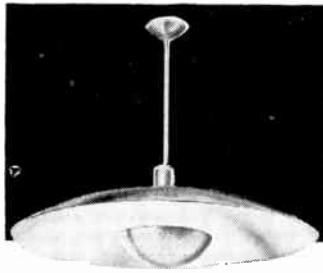

B150

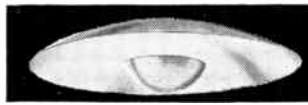

B180



B139
Fresnel
Lens

B141
Curved
Lens

B142
Louver

No.	Type	Reflector	Ship. Wt., Lbs.	Each
B150/24	Pendant	Perforated cup	10	\$24.50
B139/24	Pendant	Fresnel lens	10	25.69
B141/24	Pendant	Curved lens	10	28.44
B142/24	Pendant	Louver	10	26.06
B180/24	Recessed	Perforated cup	11	32.75

All Domelites illustrated are 24-in. in diameter and utilize 1-150W IF lamp. Available in a wide variety of diameters up to 6-ft.

Litecraft Incandescent Accent Lighting

Hi-Lites and Adjust-O-Lites feature the gyromatic non-slip swivel. 360° horizontal adjustment and 180° vertical control puts the light where it's needed. Fixtures furnished with AF leads and mounting hardware. Individually boxed.

and copper. Colors: green, flame, white, chartreuse, terra cotta, blue, black, gray. Flex-Arms available: 9-in., 12-in., 15-in., 18-in. and 24-in. Adjust-O-Lites mount on 3/4-in. or 4-in. outlet box. Finish: Chrometone.

H699 clip-on louver accommodates red, green, blue or amber color filters. Hi-Lite Satin finishes: Aluminum, brass

All Litecrafts dual-sprayed and baked twice at 375° F. Union made and wired by IBEW-AFL craftsmen. UL Approved.

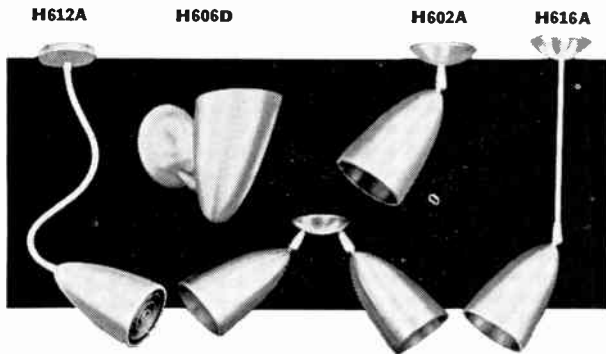

H607A

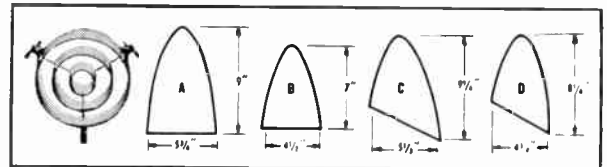

H751

H741

H742

H745

H748

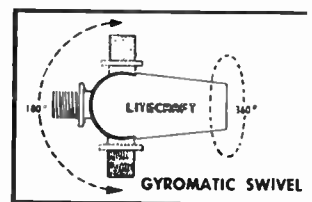



No.	Type	No. Lamps	Reflector See Above	Std. Ctn.	Wt., Lbs. Std. Ctn.	Each
Hi-Lites						
H1602A	Single Ceiling Mount.....	1	A	8	16	*\$ 5.88
H1606D	Single Wall Bracket.....	1	D	8	16	* 5.88
H1607A	Twin-Ceiling Mount.....	2	A	4	16	* 10.88
H1612A	24-in. Flex-Arm, 36-in. OA.....	1	A	4	13	* 7.19
H1616A	Swivel, Rigid Stem, 36-in. OA.....	1	A	8	27	* 7.38
H1699	For use with Type A reflectors.....	12	5	1.44
Adjust-O-Lites						
H1741	One-Lite Swivel Socket on Canopy.....	6	4	1.75
H1742	Two-Lite Swivel Socket on Canopy.....	8	10	3.00
H1745	One-Lite Screw-In with Swivel Socket.....	24	15	1.50
H1748	Clamp-On to 1 1/2-in. Pipe or 1 1/4-in. Flat, 6-ft. Cord..	12	10	2.81
H1751	One-Lite Swivel Socket on Box Cover.....	12	7	1.31

Be sure to specify reflector shape and finish or color.

*Price for Satin Aluminum finish—other finishes slightly higher.

MOE Residential Lighting Fixtures



		
No. M115	No. M116	No. M131
No.	Description	Each
M115	Bathrm. Bent glass shade. Perf. chrome band. 4" Wide. 12" Long. Ex. 3". w/Switch. CO. 2-60W.....	\$ 5.95
M116	Kitch./Bathrm. Frosted glass. Perf. chrome band. w/Switch. CO. 13" Long. 4" Wide. Ex. 4". 2-60W.....	9.95
M131	Bathrm. Wall. Canopy Switch. CO. 60W. 6" High. 4 1/2" C. Diam. 4 1/2" Ex. Chrome....	4.45



		
No. M214	No. M222	
No.	Description	Each
M214	Bedrm. Gold beaded squares & clear lines on wht. ceramic glass. 14" Sq. 4 7/8" Deep. 4-40W.....	\$10.95
M216	Same—17" Sq. 5 3/8" Deep. 4-60W.....	12.95
M222	Bedrm. Blk. design on linen-textured wht. glass. 11 1/2" Sq. 5 1/2" Deep. Adaptl. for p/sw. in cntr.....	6.95
M224	Same—13" Sq. 5" Deep. 2-60W.....	7.95
M226	Same—16 1/2" Sq. 5 1/2" Deep. 4-60W.....	8.95







	No. M263 Golden beading on white background. For living-dining room. 14" Diam. 6" Deep. 3-60W. Brass.	Each \$7.95
	No. M265. Same but 16" Diam. 6" Deep. 4-60W.	Each \$9.95

Bathroom Fixtures



	No.	Description	Each
	M311	4-40W. w/sw. CO. 25" Long. 4" Wide. 4 1/2" Ex.....	\$12.95
	M312	Same—20W Fluorescent.....	14.95
	M314	Same—40W Fluorescent. 49" Long. 15W. Fluor. Turn sw. CO. 1 1/2" Wide. 25" Long. 2 1/4" Ex. Box flange 3 1/2". 60 cycle AC only.....	11.95
	M326	Adj. chrome fltr. brkt. 15 1/4" Long. 2 1/8" Wide. Extends 3 3/4", installed on fixture.....	1.95
	M336	Same—18 1/4" Long.....	2.25
	M327	Snap-on glass shade only. 16" Long. 2 1/2" Wide.....	2.25
	M337	Same—18 1/2" Long.....	2.45
	M329	1-W Fluor. C. sw. 60 cycle AC. 18" Long. 2 1/4" Wide. Box flange 3 1/4". 3 1/2" Ex. Chrome.....	6.95
	M339	Same—15W Fluor. 21" Long.....	7.95
	M349	Same as M329—Trigger start.....	8.95
	M359	Same as M339—Trigger start.....	9.95

		
No. M1067	No. M1053	No. M1055
No.	Description	Each
M1067	Hallway-Lrm-Dnrm. Twin accents. Adj. fltrs. 100W or R30-75W. 3-way sw. Blk., Terra-Cotta, or White.....	8.95
	Brass.....	10.95
M1063	Same—1-light. Blk., Terra Cotta, White....	5.95
	Brass.....	6.95
M1053	Accent or outdoor light. Wall or Clg. Max. Ex. 11 1/2" O. D. Width 10 1/2". 150-WR-40. Al. or Brass.....	7.95
M1057	Same but twin. O. D. Width 21". Al. or Brass.	14.95
M1055	Tension-fit louvers for M1053-57. Blk.....	1.95

							
No. M406 To M416	No. M426 To M432	No. M458 To M462					
Drum type fixtures. Genuine white Opal glass. Easily converted to pull chain. No. M426 to M432 have louvered bottom. No. M458 to M462 have white glass with contrasting concentric ribbed design. All except Nos. M490 to M496 have chrome finish. Latter has satin aluminum finish.							
No.	Lamps	Watt.	Each	No.	Lamps	Watt.	Each
M406	1	60	\$ 4.45	M426	1	60	\$ 3.95
M408	2	60	6.45	M428	2	60	5.45
M410	2	75	8.45	M430	2	75	6.45
M412	3	60	10.95	M432	3	60	9.95
M414	2	100	14.45	M458	1	60	6.95
M416	3	100	19.95	M460	2	60	8.95
				M462	2	75	11.95

			
No. M478	No. M631	No. M700	No. M703
			
No. M716	No. M728	No. M738	

No.	Description	Each
M478	Hllwy. or kitch. Pol. copper pan w/brass gallery. Opal glass. 2-60W. 8 1/2" Diam. 5 1/2" Deep.....	\$ 9.45
M480	Same—2-75W. 10 1/2" Diam.....	11.45
M631	Bthrm. or kitch. Wht. glass, clear louvered bttm. 100 W. 7" Diam. 7 1/2" Deep. Chrome. 4 3/4" C.....	4.45
M641	Same—9" Diam. 8" Deep. 5 1/2" Canopy....	4.95
M700	Bthrm. or kitch. Wht. glass clear ribbed bttm. w/sw. CO. 4 3/4" C. Diam. & Wide. 7 1/2" Ex. 60 W.....	2.95
M702	Same—without switch.	
M703	Bthrm. or kitch. Wht. glass ribbed crystal bttm. w/sw. CO. 4 3/4" C. Diam. 6 1/2" Wide. 7 1/4" Ex. 60 W.....	4.95
M716	Hallway. Can convrt. to pull chain. 60W. 6 1/2" Diam. 5 1/4" Deep. Brass.....	5.95
M728	Hallway. Cut glass bowl. Can convrt. to pull chain. 8" Diam. 4 3/4" Deep. 60W. Brass.....	7.45
M730	Same—2-60W. 10" Diam. 5" Deep.....	9.95
M732	Same—2-75W. 12" Diam. 5 1/4" Deep.....	12.95
M738	Hallway. Opal glass. Can convrt. to pull chain. 60W. 8" Diam. 4 3/4" Deep. Brass.....	6.45
M740	Same—2-60W. 10" Diam. 5" Deep.....	8.45

		
No. M749	No. M761	
No. M749, Bthrm. Incandescent 4-light. Wht. glass shade. w/sw. CO. 25" Long. 4 1/2" Wide. 4 3/4" Ex. Chrome.		
No. M761, Wht. glass sconce. Crystal beadg. 11 1/2" High. 6" Ex. 5 1/2" Wide. w/sw. CO. 75W. Chrome.		
No.	Description	Each
M749	As described above.....	\$ 9.95
M769	Same—6-25W Fluor. 36" Long.....	12.95
M761	As described above.....	11.95
M1161	Same—Gold beading. Flared top. 2-60W.....	11.95

MOE Light Residential Lighting Fixtures



No. M840



No. M1026
Description



No. M1015
Each

No.	Description	Each
M840	Reel type lantern. Adj. 28" to 56". 16" Diam. 100W. Antique Copper.....	\$27.95
M839	Same, no reel, 36" Long overall. Chain Hang.....	22.95
M1011	Dnrm. Stippled glass & mobile. 19" Diam. 16" Long. 4-60W. Brushed brass & black....	19.95
M1026	Same, w/downlight. R-30 75W. Black louver.....	23.95
M1015	Gold beading on wht. glass. 15" Diam. 24" Long. 4-60W. Brass.....	11.95



No. M1021



No. M1022



No. M1029

No.	Description	Each
M1021	Hallway. 7½" High. 4" Wide. 3" Ex. Canopy 4" Wide, 6" High. Turn knob sw. 40W. Pol. Brass.....	\$ 4.95
M1022	Golden-headed sunburst on wht. glass. 22" Diam. 17" Long. 3-100W, 1-60W. Brass.....	29.95
M1029	Dnrm or Bdrm. Stippled glass w/blk. & crystal accent. 19" Diam. 7" Deep. 4-60W. Brushed Br. & Blk.....	17.95



No. M1031
No.



No. M1035
Description



No. M1050
Each

No.	Description	Each
M1031	Lrm. or Dnrm. 5" Canopy Diam. 8¾" High. 8" Ex. w/sw. 40W. Brass.....	\$ 5.95
M1041	Same, hanging lamp. 8" Spread. 9" Long....	5.95
M1035	Lrm.-Dnrm. Frosted chimneys, spiral-glass center-urn accent. 18" Spread. 36" Long. 5-10W.....	27.95
M1050	Lrm.-Dnrm. Reel light w/frost wht. fiber glass shade. Louvered lens. 2-75W. Adj. 20-52" Overall lgth. 21" Diam. Brushed brass.....	44.95



No. M1058

No.	Description	Each
M1058	Lrm.-Dnrm. Fiber glass. 21" Diam. 2-stems (12" & 18") for close-to-ceiling or suspended mtg. Adj. overall from 10-36". Swivel canopy. 4-60W. Black.....	\$24.95



No. M1066



No. M1072



No. M1073

No.	Description	Each
M1066	Lrm.-Bdrm.-Hallway. Wall. w/Canopy sw. 13" Diam. 15" High. OA. 60W Brass; Black	\$ 6.95
M1072	Dnrm. 2-stem sections (12 & 18") Adj. 19-37". 4-60W. 16½" Diam. Swivel Canopy. Brass.....	19.95
M1073	Lrm.-Dnrm. 1-Light. Swivel canopy. 100W. 16" Diam. 2-stem sections, adj. 21-39". Blk., Terra Cotta. Bottom lens.....	12.95
M1074	Same—20" Diam. 150W.....	14.95



No. M1075



No. M1082



No. M1089

No.	Description	Each
M1075	Lrm.-Dnrm. Bttm. lens. 100W. 9½" Long. 14" Diam. Terra Cotta; White.....	\$ 9.95
M1082	Bdrm. 14" Sq. 5" Deep. 2-60W. Brass.....	4.95
M1089	Bdrm. Silver leaf design on wht. glass. 16" Sq. 5½" Deep. 4-60W. Chrome.....	19.95



No. M1096

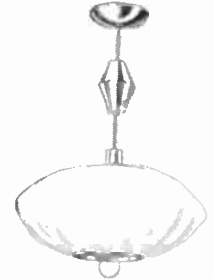

No. M1097

No.	Description	Each
M1096	Lrm.-Dnrm. Textured fabric shade. Wht. glass. Sw. above shade. Adj. 19-47". 18" Diam. 2-60W. Polished Brass.....	\$27.95
M1097	Reel light. Wht. vinylite on wire frame shade. Adj. 21-49". 18" Diam. 150W. Polished Brass.....	29.95
M1496	Same, 22" Diam. 150W. Brass.....	37.95



No. M1141



No. M1160



No. M1173

No.	Description	Each
M1141	Kitch.-Hallway. 8" Spread. 9" Long. 60W. Red and brass.....	\$ 7.95
M1160	Bdrm. Bent glass "pocket". 14" Wide. 7" High. 6" Ex. 2-10W. Turn-sw. Brass and Black.....	12.95
M1173	Bdrm.-Lrm.-Dnrm. Close-to-ceiling rfltr. fixture. Glass bttm. lens. 8" High. 16" Diam. 100W. Black; Terra Cotta.....	9.95

MOE Light Residential Lighting Fixtures



No. 1208



No. M1212

No.	Description	Each
M1175	Hallway, 7 1/2" Long. 6 3/4" Diam. 100W. Black; Terra Cotta.....	\$ 4.95

Instant Start Circline Fluorescent Kitchen Fixtures

M1201	32W. 12" Diam. 3 1/2" Deep. Polished Copper.....	14.45
M1211	Same—White only.....	12.25
M1231	Same—Chrome.....	13.25
M1202	1-32W & 1-22W. 12" Diam. 3 1/2" Deep. Pol. Copper.....	22.45
M1212	Same—White only.....	19.95
M1232	Same—Chrome.....	20.95
M1208	22W. 8 1/4" Diam. 4" Deep. Chrome.....	12.25
M1242	1-10W, 1-32W. 16" Diam. 3 1/2" Deep. Chrome.....	25.95
M1243	1-10W, 1-32W, 1-22W. 16" Diam. 4" Deep. Chrome.....	34.45



No. M1261



No. M1353



No. M1363

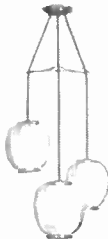

No. M1407



No. M1425



No. M1421



No. M1423

No.	Description	Each
M1261	Perf. Pol. Brass Cone w/glass bttm. lens. 7 1/2" Long. 5 1/2" Diam. 100W.....	\$ 9.95
M1353	Lrn-Drm. Accent. Textured raffia over fiber glass. 100W. Max. Ex. 10 1/2". Brass....	7.95
M1357	Same, twin accent. 3-Way canopy switch....	12.95
M1363	Brass or Copper accent. 100W. or 75W. R30. w/switch.....	9.95
M1367	Same but twin accents. 3-way Canopy switch.....	14.95
M1407	3-60W. Wht. vinylite bubbles. Ea. adj. to 42" max. OA length. Bubbles 10" Long. 8 1/2" Diam. Br.....	29.95
M1421	Cord tex. shade. Pol. Brass. 9 3/4" High. 75W. 7" Diam. Cordette Casual.....	12.95
M1423	Wall. Cord tex. shade. Pol. Br. Cordette casual. 12" High OA. 8 1/2" Ex. 75W.....	14.95
M1425	Close-to-ceiling. Cordette Casual. Canopy & swivel stem. 6 1/2" High, surface mtg.; 10" stem mtg. 16" Diam. 3-60W.....	21.95

Cordette Casual Cones

Brass cones are 7-in. in diameter by 12-in. high. All units are adjustable to 42-in. from ceiling. Available singly, or in clusters of 3 or 5.



No. M1417

No.	Description	Each
M1417	Single Cone, 75W.....	\$16.95
M1457	Five-75W cluster. Each Cone is adjustable.....	59.95
M1427	Three-75W cluster. Each Cone is adjustable.....	39.95



No. M1428



No. M1429

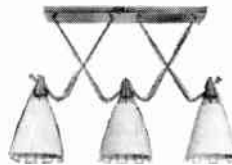

No. M1437



No. M1447

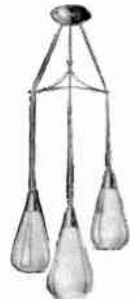

No. M1467

No.	Description	Each
M1428	Cordette Casual P/D fix. Reel adj. 26-51". Tapered chimney. 18" Diam. shade. 50-150W Lamp. 3-way switch. Brass.....	\$49.95
M1429	Cordette Casual reel P/D. Adj. 19-17". 20" Diam. 3-way switch. 3-60W.....	37.95
M1437	3-in-lin Cordette Casual. Interlaced rods 4 1/2" x 22 1/4". 21 1/2" Deep, OA. 31" Across. 75W. Brass.....	49.95
M1447	3-Light cluster, w/perf. shades. 9" Canopy Diam. 46" Max. Ex. Ea. Shade 5 1/2" Diam. 3-10W. Brass.....	39.95
M1467	Opal glass cluster w/brass wire supports. 6" Diam. Canopy. 48" Max. Ex. Ea. Shade 5 1/2" Diam. 3-10W. Polished Brass.....	34.95



No. M1484



No. M1490

No.	Description	Each
M1484	18" Chain hung lantern. 20" Diam. shade. Adj. 26-61". 3-way switch. 50-100-150W. Brass; Brass w/Copper shade.....	\$34.95
M1483	Same as M1484 but reel type.....	39.95
M1490	Reel light. 20" Diam. shade. Adj. 18-52". 3-60W. Polished Brass.....	29.95

MOE Outdoor Lighting Fixtures



No. M824



No. M825

No.	Description	Each
M824	Black post lamp. Frosted glass panels. 8 1/2" Sq. 12 1/2" H. 75W. Brass top ornament.	\$8.95
M825	Chg. light. 9 1/2" Deep. 8 1/2" Sq. 75W. Black.	8.95

Outdoor Ceiling Light

Overall diameter 6-in. Length 7 1/2-in. Uses, up to 60-watt lamp. In either Brass or Black.



No. M827

No. M827

Each	Black	Brass
	\$8.95	6.95

No. M843 Post Lantern

Black with Brass trim. Has frosted chimney and beveled glass panels. Uses up to 100W lamps. 9 1/2-in. square. 18 1/4-in. high.



No. M843

No. M843.....Each \$27.95



No. M845



No. M852



No. M853

No.	Description	Each
M845	Post lantern. 9 1/2" Sq. 19" High. 75W. Black.	\$16.95
M852	Expanded black metal around white opal glass. 16" Diam. 11 1/2" High. 100W. Black.	17.95
M853	Large contemporary post lantern. 20" Diam. 14 1/4" High. 150W. Black.	19.95



No. M865



No. M867



No. M868

No.	Description	Each
M865	Wall fixture. 6 3/4" Long. 8" Wide. Extends 5 1/2". 75W. Black	\$ 4.95
	Brass or Copper	5.95
M867	Black Ceiling Lantern. 8" Deep. 5 1/2" Sq. 75W.	8.95
M868	Simulated beveled-glass windows. 16 1/2" High. 5 1/2" Sq. 6 1/2" Ex. 75W. Black w/Brass t/O.	9.95

Lantern Posts And Name Brackets

Fit all Moe Light post lanterns. Top fittings all 3-in. outside diam. Nos. M900 and M903 drilled for name bracket. No. M906 and No. M901 drilled for No. M907 bracket.



No.	Description	Each
M900	Black on heavy gage steel. Adj. 63" to 88".	\$13.95
M901	Black wrought iron. 96" High overall.	14.95
M903	Black on aluminum. Adj. 72" to 84".	15.95



No. M877



No. M881



No. M882



No. M883

No.	Description	Each
M877	Ceiling. w/Sol. Brass trim rods. Frosted glass panels. 3 3/4" Deep. 8" Sq. 60W. Black	\$ 5.95
	Brass or Copper	7.45
M879	Larger than M877. 9 1/4" Sq. 2-60W. Black	7.95
	Brass or Copper	9.45
M880	Wall. 4 1/2" Diam. 7" High. 6" Ex. 75W. Black with solid copper holder.	3.25
M881	Same except black holder.	2.95
M882	Ceiling. Companion to M880. 5" Diam. 7" Deep. 75W. Brass.	2.50
M883	Wall. 7" High. 6" Ex. 4 1/2" C. Diam. 60W. Black	3.45
	Brass or Copper	3.95



No. M885



No. M887



No. M888



No. M894

No.	Description	Each
M885	Has white opal glass. 8 1/2" High. 8 3/4" Wide. 9 1/2" Ex. 100W. Black and Brass.	\$ 8.95
M887	Wall. 8 3/4" Sq. 4 1/2" Ex. 60W. Black	6.95
	Copper	7.95
M888	Wall. 7 1/2" High. 7" Wide. 5" Ex. Brass or Copper	9.95
M894	Tex. fiber glass w/blk. mesh screen. 18" High. 8 1/2" Sq. 4 1/2" Ex. 75W. Brass.	11.95



No. M898



No. M1804



No. M1806



No. M1812

No.	Description	Each
M898	Coach light bracket. Beveled glass. 18" High. 8 1/2" Sq. 9 1/4" Ex. 75W. Black w/Brass trim.	\$27.95
M1804	Crystal-clear globe in Brass mtg. 14" High. 6 1/2" Diam. 6 3/4" Ex. 75W.	17.95
M1806	Brandy sniffer glass set in brass. 13 3/4" High. 6" Diam. 7" Ex. 75W. Brass.	22.95
M1812	Post lantern w/blk. top, pol. br. uprights and top ornament. 12" Sq. 11 1/2" High. 100W.	17.95

Post Lantern

Has expanded metal cage, polished brass uprights and frosted chimney.

10-Inches square. 14 3/4-inches high. Uses up to 100 watt lamps.

No. M1814.....Each \$14.95



No. M1814

Post Lantern

Has beautifully textured glass panels framed in brass. Overall finish is black with brass trim.

12-Inches square. 12 1/4-inches high. Uses up to 150W lamps.

No. M1816.....Each \$24.95



No. M1816

MOE Light Recessed Prewired Lighting Fixtures

2-100 Watt Prewired Recessed Rectangular Units

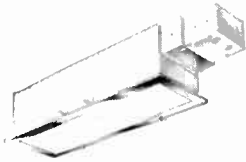

Can be had with Flat Alba-Lite or White Bent Glass.
Housing size: 2 1/4-in. x 6 3/4-in. Depth, 6 1/4-in. Outlet box extends 6 1/2-in. from housing. Overall dimensions, 25 3/8-in. x 7 7/8-in.
Chromium finish. Packaged complete.

No.	Description	Each
M5618	Flat Alba-Lite Glass.....	\$19.95
M5619	White Bent Glass.....	21.95

Housings Only

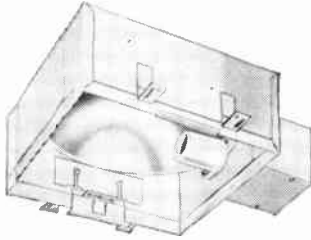

No.	Dimensions Sq. Dpth.	Lamps No.-W.	Each
M5606	8 1/8" x 4 1/4"	1-75	55.80
M5608	10 1/8" x 4 1/4"	1-100	6.20
M5611	12 1/8" x 4 1/4"	1-150	7.20
M5614	9 1/8" x 6 1/8" Rec.	1-60	5.80
M5613	12 5/8" x 7 1/2" Rec.	1-300	11.45
M5616	12 1/8" x 8 1/8" Rec.	1-100	6.20

Recessed Housings

Trim and Glass For Above Housings.

Trim Available in Brass; Chromium; Aluminum; Baked White.

Flat Alba-Lite Glass



No.	Fits Housing No.	O.D. Dimen. In.	Each
M16	M5606	9 1/4" Sq.	\$4.15
M18*	M5608	11 1/4" Sq.	4.55
M11	M5611	13 1/4" Sq.	5.25
M13	M5613	14 3/4" Sq.	8.50
M4	M5614	10 1/4" x 7 1/4"	4.15
M17	M5616	13 1/4" x 9 1/4"	4.75

Bent, White Glass



M16	M5606	9 1/4" Sq.	56.15
M18	M5608	11 1/4" Sq.	7.25
M11	M5611	13 1/4" Sq.	7.75
M13	M5613	14 3/4" Sq.	12.50
M17	M5616	13 1/4" x 9 1/4"	7.45

Fresnel Lens

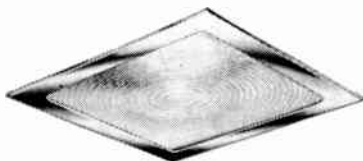

No.	Housing No.	Sq. In.	Each
M128	M5608	11 1/4"	\$7.55
M121	M5611	13 1/4"	9.25
M123	M5613	14 3/4"	15.50

Drop Opal Glass



Contact Graybar for listing of Drop Opal Glass and Trim for above housings.

Prewired Pinpoint Spot



No. M-5690



No. M91

*Available with a copper trim. Add \$2.35 to price shown.

No.	Description	Each
M5690	Uses R30-75W Rfltr. 8 1/8" Sq. Housing. 4" Box Ex. Finish opng. 6" Diam. 7 3/4" Deep.....	\$7.50
M91	Trim: 6 1/2" Diam. 1 1/2" Aperture. Chrome; Br. Wht.....	3.25
M92	Same, 2" Aperture.....	3.25
M93	Same, 3" Aperture.....	3.25

(150W, R-40) Prewired Baffle Units



No. M96

9 1/8-In. Sq. housing, 9 1/2-in. deep. Outlet box extends 4-in. from housing. Finish opening 8 1/4-in. diam. No. M5696..... Each \$9.95
Trim 9-in. diam. available in Chromium; Brass; White; Aluminum.

No. M96 Trim only... Each \$4.00

Shower Lites — Prewired



No. M-5675



No. M-5676

No.	Description	Each
M5675	1-60W incandescent. Drop Opal glass. 8 1/8" Sq. housing. 5 3/4" Deep. Overall trim sz., 7 3/4" diam. 4" Box Ex. Water tight gasket. Finish opening 6 1/2" Diam. Aluminum.....	\$9.95
M5676	Same but crystal lens.....	9.95

Recessed 2-20W Fluorescents



Trigger start. L.P.F. 60 cycle, AC only. Flat Alba-Lite or White Bent glass. Housing, 2 1/4 x 6 3/4-in. Depth 4 1/4-in. Trim, 25 3/8 x 7 7/8-in. O.D. Chrome. Packaged complete.

No. M5620 Alba-Lite Glass..... Each \$24.95
No. M5650 White Bent Glass..... \$26.95

75W, R-30 & 150W, R-40 Prewired Units



No. M-5694



No. M94



No. M-5695



No. M95

No.	Description	Each
M5694	8 1/8" Sq. Housing. 7 3/4" Deep. 4" Box Ex. Finish opening 6" Diam.....	\$7.50
M94	Trim: 6 1/2" Diam. OA. Blk. louver. Chrome; Brass; White; Aluminum.....	3.45
M5695	9 1/8" Sq. Housing. 7 3/4" Deep. 6 1/2" Box Ex. Finish opening 8 1/4" Diam.....	5.00
M95	Trim: 8 3/4" Diam. OA. Blk. Louver. Chrome; Brass; White; Aluminum.....	2.50

Moe Light Recessed Prewired Lighting Fixtures
Prewired Eyeball Units

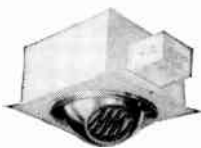

No. M-5699

No.	Description	Each
M5698	8 1/8" sq. housing. 5 3/4" deep. 9 1/4" trim diam. R30-75W. Brass; Aluminum.	\$18.95
M5699	12 5/8" sq. housing. 7 1/2" deep. 11 3/4" trim diam. R40-150W. Brass; Aluminum.	24.95

Light (25W) Aisle Lights



Aluminum face. Glass behind louvers. Housing 7 7/8-in. x 1 7/8-in. Depth 3 5/8-in. Trim: 8 5/8-in. x 5 5/8-in. diam. Aluminum.

M-5678		\$5.95
M-5679	Has switch and Co.	6.95

Star Light Lighting Fixtures



No. SL123



No. SL183

No.	Description	Each
All Are Two-Light Fixtures		
SL123	Stem-leaf design. 12" sq. 5 1/4" deep. Eggshell canopy. Brass trim. Rose, Blue or White.	\$1.98
SL143	Same. White only. 14" sq.	2.78
SL163	Same. White only. 16" sq.	4.88
SL182	Gold beaded design—white ceramic glass. 13" diam. 5 1/4" deep.	3.33
SL183	Same. Three-light. 15 1/4" diam. 5 1/2" deep.	5.22



No. SL210



No. SL245



No. SL310



No. SL300

No.	Description	Each
SL210	1-75W. 4 3/4" canopy. 7 1/2" deep. 4 3/4" wide. Chrome. White with crystal bottom. Keyless	\$1.89
SL211	Same except with Pull. Co.	2.44
SL212	Same except Co.	2.11
SL245	2-60W. 15" long. 4 1/2" wide and deep. Chrome. White etched glass. Keyless.	4.33
SL246	Same except with pull. Co.	4.77
SL247	Same except Co.	4.55
SL249	Same. With switch. 25" long. 4 3/4" deep.	8.77
SL310	Perf. Al. Cone. 7" long. 5 1/2" diam. Brass or Aluminum. 1-75W.	6.55
SL300	Simulated cut glass. 4 3/4" Canopy. 3 1/4" holder. 6 1/2" long. Brass, copper or black.	2.11



No. SL320



No. SL391



No. SL755



No. SL757

No.	Description	Each
SL320	Embossed grape design. 6" diam. and long. 4 3/4" Canopy. Brass. 1-75W.	\$2.44
SL391	White etched glass. 7 1/2" high. 4 1/2" wide and deep. Brass. 1-75W. With switch.	3.44
SL392	Same but without switch.	3.22
SL755	Aluminum and plastic. 1-60W. 5 1/2" high. 8 1/2" wide. Extends 4 1/2". Black and brass.	4.44
SL757	White frosted glass. Blk. 1-60W. 8" sq.	3.77

Star Light Lighting Fixtures



No. SL466



No. SL700

No.	Description	Each
SL466	White glass-clear pris. bottom. Chrome. 1-60W. 6 3/4" Canopy. 6 1/2" diam. 5 1/2" deep.	\$2.78
SL468	Same but 2-60W. 8 3/4" Canopy. 8 1/2" diam. 5 3/4" deep.	3.55
SL470	Same but 2-75W. 10 3/4" Canopy. 10 1/2" diam. 6" deep.	4.66
SL700	Simulated cut glass. 1-75W. Canopy 4 1/2". 8" long. Extends 5". Brass or copper.	2.33



No. SL775



No. SL770



No. SL780

No.	Description	Each
SL770	Post light. Clear glass chimney. 1-100W. 12 1/4" high. Shade diam. 16". Black and brass.	\$11.95
SL775	Post light. Frosted chimney. 1-100W. 10" sq. shade. 15" high. Black and brass.	11.95
SL780	Adj. Fluted Al. post. 3" diam. fit. 82" high.	13.94
SL781	Same but no-adjustable.	11.94



No. SL806



No. SL814



No. SL820

No.	Description	Each
SL806	1-75W. Chrome frame. Recessed box 6 3/4" sq. Frame 8 1/4" sq. 4 1/4" deep.	\$ 4.77
SL808	Same; 1-100W. Box 8 3/4" sq. Frame 10 1/4" sq.	5.77
SL811	Same; 1-100W. Box 10 3/4" sq. Frame 12 1/4" sq.	7.77
SL814	1-75W. Chrome. Box 7 3/4" x 4 3/4". Frame 9 1/4" x 6 1/4". 4 1/4" deep.	4.77
SL816	Same; 1-100W. Box 10 3/4" x 6 3/4". Frame 12 1/4" x 8 1/4". 4 1/4" deep.	5.77
SL820	2-20W Fluorescent. L.P.F. 60 cycle AC only. Box 2 1/2" x 6 3/4". Frame 25 3/4" x 8 1/4".	17.65



No. SL855



No. SL861



No. SL862

All are aluminum with bottom glass watertight gasket.

Plaster Ring Included

SL855	Box diam. 5 1/2". 6 5/8" deep. 7 1/2" trim diam.	\$5.11
SL861	Box diam. 4 1/2". 5 3/8" deep. 5 9/16" trim diam.	4.22
SL891	Box diam. 5 1/2". 6 5/8" deep. 7" trim diam.	4.33
SL862	Box diam. 4 1/2". 7" deep. 5 9/16" trim diam.	5.44
SL892	Box diam. 5 1/2". 8 1/2" deep. 7" trim diam.	5.66

Silvray Lighting Fixtures

Silvered Bowl Incandescent Lighting



No. 1500S/3R/2 and No. 1500/3R 2

Combines unique functional simplicity of design, high efficiency and great flexibility of application. When used with the silvered bowl lamp it is the ideal solution to the critical lighting requirements of schools, offices, libraries, drafting rooms and all other areas in which close visual work is performed. When used with silvered bowl lamps the light distribution is totally indirect.

"1500 Line" Specifications

Ring assembly is formed from 20 gauge steel with seamless weld; bonderized and finished in two coats baked white enamel. Pendant unit suspension has 15° non-twist swivel and threadless husk connection; bonderized and finished in baked Silclad process (satin aluminum). Ceiling units have satin white enamel canopy and Silclad husk. Standard Package — 1 unit.

No.	Type of Suspension	Silvered Bowl Lamp Size	Dimensions Height O.A. Inches	Dimensions Diam. O.A. In.	Shipping Weight	Each
3 Ring						
BT1500	Ceiling	150	7½	14	6	\$10.30
1500/3R/2	Ceiling	150-200	12½	14	6	10.45
1500/3R/5	Ceiling	300-500	15	19	9	10.70
1500S/3R/2	Pendent	150-200	24	14	6	10.60
1500S/3R/5	Pendent	300-500	30	19	10	10.90
1500S/3R/10	Pendent	750-1000	42½	21	12½	18.70
4 Ring						
1500S/4R/10		750-1000		24		26.00



"500 Line" Specifications

Rings are of 24 gauge and stamped in one piece; bonderized and finished in baked eggshell enamel. Pendant suspension has 15° non-twist swivel and threadless husk connection bonderized and finished baked Silclad process (satin aluminum). Ceiling units have canopy and husk finished Silclad. Standard Package — 5 units.

No.	Type of Suspension	Silvered Bowl Lamp Size	Dimensions Height O.A. Inches	Dimensions Diam. O.A. In.	Shipping Weight	Each
3 Ring						
525C	Ceiling	300-500	10¾	18	25*	\$ 9.40
550S	Pendent	300-500	28¾	18	28*	9.55
1500/525C	Ceiling	300-500	13¾	18	22*	10.25

Silvered Bowl Incandescent Lighting

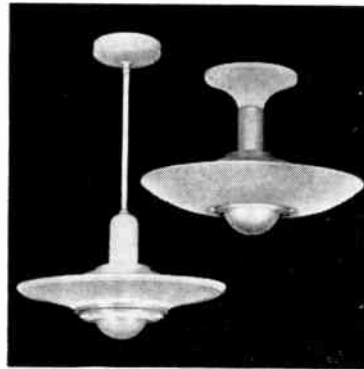

Nos. 207PL/5 and CPL/5

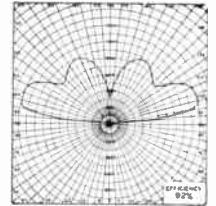

Distribution Curve No. 207PL

Indirect luminaires with translucent plastic basins designed for use with the silvered bowl lamp. The luminous plastic basin is approximately of the same order of brightness as the lighted ceiling. These fixtures combine high efficiency, balanced brightness and pleasing design. Recommended for schools, offices, libraries, drafting rooms and similar areas where critical and prolonged visual tasks are involved. Fixtures have a "non-twist" locking device which prevents twisting or rotation of stem and wires when inserting or removing lamps. Hangers are finished Silclad Satin Aluminum.

No.	Silvered Bowl Wattage	Type of Mounting	Dimensions Ht. O.A.	Dimensions Diam. O.A.	Finish Fixture Body	Shp. Wt. Lbs.	Each
207PL/5	300-500	Suspension	31	18	Luminous Plastic	7	\$17.00
207CPL/5	300-500	Ceiling	14	18	Luminous Plastic	7	16.15
210PL/5	300-500	Suspension	31	18	Luminous Plastic	7	17.00
210CPL/5	300-500	Ceiling	14	18	Luminous Plastic	7	16.15
210PL/10	750-1000	Suspension	42	25	Luminous Plastic	15	29.50

Silvered-Bowl—3500 Line

Totally Indirect or Direct-Indirect Lighting

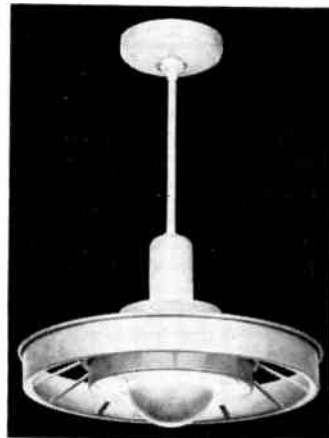

Two shielding rings are formed from one piece in this compact new design. Spoke-like members connect and join the two shielding rings. When used with silvered bowl lamp, the light distribution is totally indirect.

The addition of a specular aluminum reflector and concentric shielding louver, placed inside the inner ring of the fixture, changes light distribution to direct-indirect.

Both types available in the Silclad finish or in several decorator colors.

Totally Indirect Units

No.	Silvered Bowl Lamp Size	Type of Suspension	Overall Height In.	Overall Diam. In.	WL Lbs.	Each
3510S	300-500	Pendent	28¾	16¼	6½	\$14.40
3510C	300-500	Ceiling	13½	16¼	6½	14.25

Direct-Indirect Units

With Aluminum Reflector and Concentric Louver

No.	Silvered Bowl Lamp Size	Type of Suspension	Overall Height In.	Overall Diam. In.	WL Lbs.	Each
3500S	300-500	Pendent	28	16¼	7½	16.80
3500C	300-500	Ceiling	12¾	16¼	7½	16.65

Silvray Incandescent Luminaires

The Pendent Silverspot



Offers a means of providing supplementary or special effect lighting where structural conditions preclude recessed or close ceiling mounted lighting elements.

Color impregnated reflectors in red, blue or daylight blue, or gold may be substituted for the standard polished aluminum reflector.

The part of the pendent unit which encloses lighting element is formed in two parts from aluminum. The standard finish is satin aluminum, but the unit is available in enamel colors in blue, gold, red and black.

Pendent hanger furnished in two sections joined by specially designed coupling.

With Coupled Stem, Canopy and 45° Universtical Swivel Aligner Standard Aluminum Finish

No.	Silvered Bowl Lamp	Overall Height In.	Overall Diam. In.	Wt. Lbs.	Each
114	100A/1SB	65	8	6 1/2	\$23.20
115	100A/1SBIF	65	8	6 1/2	23.20

Note: 2-100W A-21 silvered bowl lamps included.

Coloray interchangeable reflectors in red, blue or gold when ordered with unit. Add. \$0.55

For exterior color finish, add. \$1.20

Wakefield Incandescent Luminaires

Commodores

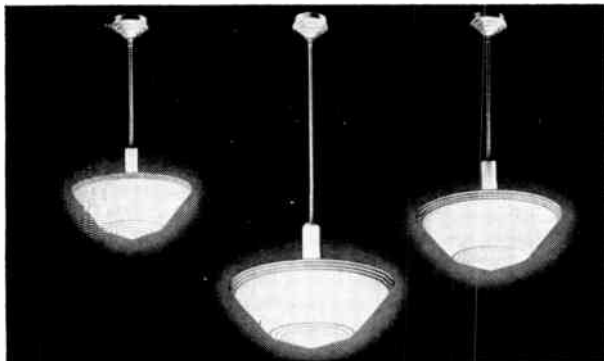

Manufactured in a complete series for wattages from 200 to 750 watts. Hangers and reflectors are similarly styled, so that an installation requiring units which utilize various sizes of lamps and reflectors will have complete uniformity of appearance.

Hangers are made of steel with metallic satin finish. Reflectors made in diameters from 15-in. to 23-in. varying in wall thickness to assure uniformity of brightness for various lamp sizes.

Provide excellent semi-indirect or luminous indirect illumination for offices, drafting rooms, classrooms and other interiors where quality incandescent lighting is desired.

No.	Wattage	Reflector Diam. In.	Socket	Overall Length In.	Std. Pkg.	Std. Pkg. Wt. Lbs.	Each
265	200-300	15	Med.	28	4	10	\$ 7.26
2653	200-300	15	Med.	14	4	10	6.59
3693	300-500	19	Mog.	16 1/2	12	54	9.65
3694	300-500	19	Mog.	24	6	23	10.59
369	300-500	19	Mog.	34	6	24	10.59
763	750	23	Mog.	44	4	29	22.45
3487	Lamp Shield for No. 369, 3693 or 3694						1.59

R & S Lighting Fixtures

Type VL Vaportight Ceiling Fixtures

Cast Brass—With 8-inch Straight Side Screw Bowl



No. 1470F



No. 1470FG

Non-Guarded

No.	Max. Size and No. of Lamps	*Outlet Location	Overall Dimens. In. Dia.	Dpth.	Each	Replacement Bowl No.
1470F	2-40	Top	8 3/8	3 5/8	\$22.50	2465
1370F	2-40	Side	8 3/8	4 7/8	27.50	2465

Finish—Natural brass, machined finish.

With Hinged Cast Brass Guard

1470FG	2-40	Top	10	5	50.00	2465
1370FG	2-40	Side	10	5 7/8	55.00	2465

Finish—Natural cast brass.

Cast Brass—With 6, 8 or 12-inch Screw Bowl



No. 370



No. 1370A

Non-Guarded

No.	Max. Size and No. of Lamps	*Outlet Location	Overall Dimens. In. Dia.	Dpth.	Each	Replacement Bowl No.
With 6-inch Bowl						
373	1-40	Top	6 1/8	3	\$15.00	2451
371	1-40	Side	6 7/8	4 3/8	17.50	2451
With 8-inch Bowl						
372	2-40	Top	8 3/8	3 3/4	22.50	2451
370	2-40	Side	8 3/8	5 1/4	27.50	2451
With 12-inch Bowl						
350	3-100	Top	12 1/2	8	70.00	2464
351	3-100	Side	12 1/2	8	70.00	2464

Finish—Natural brass, machined finish.

With Hinged Cast Brass Guard

With 6-inch Bowl						
1471A	1-40	Top	8	4 3/8	35.00	2451
1371A	1-40	Side	8	5 3/8	40.00	2451
With 8-inch Bowl						
1470A	2-40	Top	10	5 1/4	50.00	2454
1370A	2-40	Side	10	6 1/8	55.00	2454
With 12-inch Bowl						
1350	3-100	Top	14	8 3/4	95.00	2464
1351	3-100	Side	14	8 3/4	95.00	2464

Finish—Natural cast brass, 12" size has machined finish band.

Special finishes to order at extra cost.

*Top outlet fixtures are designed for mounting to No. 333 junction box set flush in ceiling. Can be furnished for mounting to standard stamped steel outlet boxes with stud, if specified on order. Boxes are not included.

Outlets—Unless otherwise specified, side outlet fixtures are furnished with one 3/4-inch outlet. Additional outlets charged extra. Maximum conduit 3/4-inch, four way. Specify size and location.

Bowls—Inside frosted bowls regularly furnished. Clear bowls available in 6-inch and 8-inch round type only.

Perfeclite Lighting Fixtures

Listed by Underwriters' Laboratories, Inc.

Safety Screwless Fixtures

"Onli"

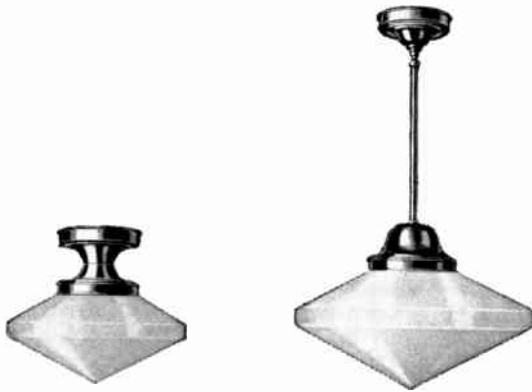

Complete with porcelain socket, strap and screws. Opal enclosing globe. Safety locking fitter. Made of steel. Standard finish, Statuary Bronze. Available in Satin Chrome.

Ceiling Type

No.	Watts	Socket	Glass, In.	Overall Length, In.	Std. Pkg. Wt., Lbs.	P.S.B. Each	S. Chr. Each
0310	60	Med.	10 x 4	10	4	\$6.08	\$6.83
0312	150	Med.	12 x 4	10½	5	7.13	7.88
0314	200	Med.	14 x 6	11½	7	8.40	9.15
0316	300	Med.	16 x 6	13½	10	10.55	11.30
0318	500	Mogul	18 x 6	16¼	14	16.43	17.18

Rod Pendant Type

No.	Watts	Socket	Glass, In.	Overall Length, In.	Std. Pkg. Wt., Lbs.	P.S.B. Each	S. Chr. Each
3710	60	Med.	10 x 4	35	4	9.00	10.60
3712	150	Med.	12 x 4	36	5	10.05	11.65
3714	200	Med.	14 x 6	38	7	11.33	12.93
3716	300	Med.	16 x 6	38½	10	13.48	15.08
3718	500	Mogul	18 x 6	41¼	14	19.28	20.88

Ceiling Fixtures



Safety Locking



Cast Aluminum Vapor proof

Complete with porcelain sockets. Opal glassware. Fixture No. III-6 has safety holder. Fixture No. 1515 is vapor-proof and moisture-proof.

No.	Watts	Glass Diam., In.	Overall Length, In.	Finish	Std. Pkg. Wt., Lbs.	Std. Pkg. Wt., Lbs.	Each
III-6	1-75	6½	5	Satin Chrome	12	40	\$6.08
1515	2-60	8¾		Alchrome	1	11	31.45

Ceiling Holders



Screw Type



Safety Type

Complete with porcelain receptacle, strap with screws. Knockout in canopy for switch.

Screw Type Ceiling Holders

Heavily Coppered 26-Gauge Steel

No.	Socket	Fitter, In.	Overall Length, In.	Std. Pkg. Wt., Lbs.	Std. Pkg. Wt., Lbs.	P.S.B. Each	S. Chr. Each
1174	Med.	4	4½	24	29	\$2.45	\$3.08
1176	Med.	6	5	24	33	2.45	3.08
1176M	Mogul	6	5	24	43	3.25	3.88

Standard finish; Plated Statuary Bronze. Also available in Satin Chrome.

18-Gauge Aluminum

No.	Socket	Fitter, In.	Overall Length, In.	Std. Pkg. Wt., Lbs.	Std. Pkg. Wt., Lbs.	Each
AL-1174	Med.	4	4½	24	15	\$3.20
AL-1176	Med.	6	5	24	17	3.20
AL-1176M	Mogul	6	5	24	22	4.00

Standard finish; Brushed Satin Aluminum.

Safety Clip Type Ceiling Holders

Made of Steel

No.	Socket	Fitter, In.	Overall Length, In.	Std. Pkg. Wt., Lbs.	Std. Pkg. Wt., Lbs.	P.S.B. Each	S. Chr. Each
9284	Med.	4	4½	24	30	\$2.63	\$3.38
9286	Med.	6	5	24	30	2.63	3.38
9286M	Mogul	6	5	24	46	3.50	4.25

Standard finish; Statuary Bronze. Available in Satin Bronze.

18-Gauge Aluminum

No.	Socket	Fitter, In.	Overall Length, In.	Std. Pkg. Wt., Lbs.	Std. Pkg. Wt., Lbs.	Each
AL-9284	Med.	4	4½	24	15	\$3.50
AL-9286	Med.	6	5	24	17	3.50
AL-9286M	Mogul	6	5	24	22	4.38

Standard finish; Brushed Satin Aluminum.

Safety Type Rod Swivel Pendants



Complete with canopy, swivel, and heavy wall tubing, and porcelain sockets. Length 24-in. Standard package 20.

Made of Steel

No.	Socket	Fitter, In.	Std. Pkg. Wt., Lbs.	P.S.B. Each	S. Chr. Each
2174	Med.	4	41	\$5.55	\$7.15
2176	Med.	6	46	5.55	7.15
2176M	Mogul	6	51	6.35	7.95

Standard finish; Plated Statuary Bronze. Available in Satin Chrome.

Made of Aluminum

No.	Socket	Fitter, In.	Std. Pkg. Wt., Lbs.	Each
AL-2174	Med.	4	30	\$7.25
AL-2176	Med.	6	33	7.25
AL-2176M	Mogul	6	39	8.05

Standard finish; Brushed Satin Aluminum.

Perfclite Screw Type Pendant Holders

Made of Steel



No.	Socket	Fitter, In.	Std. Pkg. Wt., Lbs.	P.S.B. Each	S. Chr. Each
2175	Med.	4	41	\$5 55	\$7 15
2177	Med.	6	44	5 55	7 15
2177M	Mogul	6	50	6 35	7 95

Standard finish; Plated Statuary Bronze. Also available in Satin Chrome.

18-Gauge Aluminum

No.	Socket	Fitter, In.	Std. Pkg. Wt., Lbs.	Each
AL-2175	Med.	4	30	\$7 25
AL-2177	Med.	6	33	7 25
AL-2177M	Mogul	6	39	8 05

Standard finish; Brushed Satin Aluminum.

Wakefield Globe Hangers



No. 1061AT

These "1000 Line" hangers are drawn from heavy gauge steel, and finished in metallic satin.

Canopies are 5-in. on semi-rigid types and 6-in. on ceiling units.

Semi-Rigid Unit

No.	Fitter, In.	Overall Lgth., In.	Socket	Std. Pkg.	Std. Pkg. Wt., Lbs.	Each
1044AT	4	24	Med.	24	44	\$2 91
1064AT	6	24	Med.	16	39	2 99
1064BT	6	24	Mog.	16	39	3 41

Ceiling Type

No.	Fitter, In.	Overall Lgth., In.	Socket	Std. Pkg.	Std. Pkg. Wt., Lbs.	Each
1041AT	4	5 1/2	Med.	12	19	\$2 01
1061AT	6	5 7/8	Med.	12	23	2 11
1061BT	6	5 7/8	Mog.	12	24	2 64

Graybar Lighting Fixture Glassware

Direct Lighting

Enclosing Units

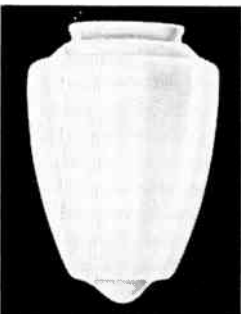

Series No. G-830

A well designed Stalactite shape, ideal for high bay, corridor or hallway lighting. Has an unusual lateral distribution of light.

Made of distinctive type of opal glass. Single layer homogeneous construction, with a mere suggestion of bluish pigment to avoid the monotony of a flat white glass.

No.	Depth, In.	Diam., In.	Fitter, In.	Wattage	Std. Pkg.	Approx. Wt. Std. Pkg. Lbs.	Each
G-830-8	8	6	4	75	12	30	\$ 2 58
G-830-10	10	7	4	75-100	12	30	4 38
G-830-12	12	8 3/8	6	150	4	23	6 87
G-830-14 1/2	14 1/2	10 3/8	6	200	1	10	8 61
G-830-16 1/2	16 1/2	11 3/8	6	300	1	15	12 66
G-830-18	18	12	6-8	300	1	18	19 98

†Specify either 6-in. or 8-in. when ordering.

Graybar Lighting Fixture Glassware

Direct Lighting

Enclosing Units

A well-balanced series of enclosing units for direct lighting. Made of an unusual type of opal glass — single layer homogeneous construction, with a mere suggestion of bluish pigment to relieve the monotony of a flat or "chalk-white" glass. Blown to proper weight for maximum transmission of light and elimination of excessive "hot spots".

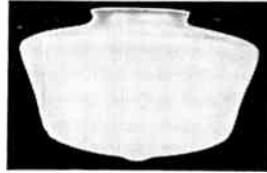

No. 92 Series



No. 66 Series

Series 92

No.	Diam., In.	Depth, In.	Fitter, In.	Wattage	Std. Pkg.	Approx. Wt. Std. Pkg. Lbs.	Each
9208	8 7/16	6	4	75-100	12	30	\$ 1 95
9209	9	6 1/2	4	75-100	8	17	2 70
9210	10	6 3/4	4	75-100	8	19	3 84
9212	12	7	*4-6	100-150	4	14	6 15
9214	14	8 1/2	6	200	2	10	7 35
9216	16	9	6	200-300	2	15	8 88
9218	18	10 7/8	6	300	1	12	14 46

Series 66

No.	Diam., In.	Depth, In.	Fitter, In.	Wattage	Std. Pkg.	Approx. Wt. Std. Pkg. Lbs.	Each
6675	9	5	4	75-100	8	17	\$2 70
6680	10	6	4	75-100	8	19	3 84
6610	12	7	*4-6	100-150	4	14	6 15
6620	14	8 1/2	6	200	2	10	7 35
6630	16	9 1/4	6	200-300	2	15	8 88

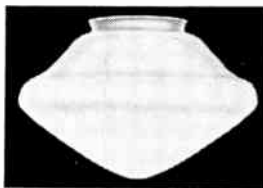

No. 88 Series



No. 99 Series

Series 88

No.	Diam., In.	Depth, In.	Fitter, In.	Wattage	Std. Pkg.	Approx. Wt. Std. Pkg. Lbs.	Each
8875	9	6 1/2	4	75-100	8	17	\$ 2 70
8880	10	6 1/2	4	75-100	8	19	3 84
8810	12	8 3/8	*4-6	100-150	4	14	6 15
8820	14	8 7/8	6	200	2	10	7 35
8830	16	10 3/8	6	200-300	2	15	8 88
8850	18	11	6-8	300-500	1	12	14 46

Can also be furnished "Neckless", without fitter, same sizes and prices; When wanted "neckless" affix "1/2" to number.

Series 99

No.	Diam., In.	Depth, In.	Fitter, In.	Wattage	Std. Pkg.	Approx. Wt. Std. Pkg. Lbs.	Each
9975	9	6 1/2	4	75-100	8	17	\$ 2 70
9980	10	6 1/2	4	75-100	8	19	3 84
9910	12	7 3/4	*4-6	100-150	4	14	6 15
9920	14	9	6	200	2	10	7 35
9930	16	10	6	200-300	2	15	8 88
9950	18	12	6-8	300-500	1	12	14 46

*4-in. size is standard; 6-in. size furnished on request.

†Specify either 6- or 8-in. when ordering.

Graybar Lighting Fixture Glassware

Designed for use with many types of wall brackets, ceiling fixtures, drop lights, etc. Also as replacements for fixtures having standard fittings.

Single layer homogeneous opal white glass of a density carefully selected for diffusing qualities. It is light in weight, warm in color and extremely refined in appearance.

Half Shades

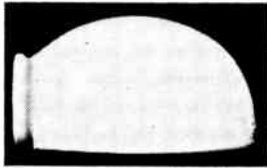

No. G9989

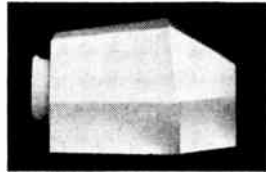

No. G9504

For 2 1/4 in. Fitter

No.	Length In.	Depth, In.	Std. Pkg.	Approx. Wt. Std. Pkg. Lbs.	Each
G9989	6	3 1/4	36	30	\$2.01
G9504	5	3 1/2	36	30	2.01

Reflector Shades



Nos. G747 and G975



Nos. G615, G699 and G700

For 2 1/4 in. Fitter

No.	Length In.	Depth, In.	Std. Pkg.	Approx. Wt. Std. Pkg. Lbs.	Each
G747	4 3/4	4 5/8	24	30	\$1.53
G975-6	6 1/8	5	27	25	1.80
G975-7	7	5 1/4	12	28	2.31
G615	6	4	36	27	1.80
G699	7	5	24	32	2.31
G700	8	5	24	32	3.15



Nos. G346 and G348



Nos. G340, G341 and G342

For 2 1/4 in. Fitter

No.	Length In.	Depth, In.	Std. Pkg.	Approx. Wt. Std. Pkg. Lbs.	Each
G346	7	2 3/4	24	33	\$2.31
G348	9	3 7/8	24	36	4.08
G340	6	4 1/2	24	30	1.80
G341	7	5 7/8	24	33	2.31
G342	8	5 7/8	24	34	3.15

Bowls

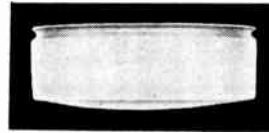

No. G91 Opolo



No. G91 1/2 Opolo

Series G91

No.	Diam. In.	Depth, In.	Fitter, In.	Std. Pkg.	Std. Pkg. Wt. Lbs.	Each
G91-8	6-8	3	6-8	24	35	\$ 3.81
G91-10	10	3 1/2	8-10	8	27	6.15
G91-12	12	4 1/2	10-12	3	15	8.43
G91-14	14	4 3/4	12-14	3	19	10.62
G91-16	14-16	5 1/4	14-16	2	18	14.55

**Series G91 1/2
Hole in Bottom**

No.	Diam. In.	Depth, In.	Fitter, In.	Std. Pkg.	Std. Pkg. Wt. Lbs.	Each
G91 1/2-8	8	3	8	24	30	\$ 3.81
G91 1/2-10	10	3	10	8	27	6.15
G91 1/2-12	12	4	12	3	15	8.43
G91 1/2-14	14	4	14	3	19	10.62
G91 1/2-16	16	4 1/2	16	2	18	14.55

When ordering, give number and specify size of fitter.

Bathroom Shades

No Fixtures



No. G9970/F273



No. G10074/271

No.	Diam. In.	Depth, In.	Fitter, In.	Std. Pkg.	Std. Pkg. Wt. Lbs.	Each
G9970/F273	5 1/2	3 1/8	2 1/4	24	25	\$2.76
G10074/271	6	4 1/2	3 1/4	24	25	2.76

Ball Globes



No.	Diam. In.	Fitter, In.	Std. Pkg.	Wt. Std. Pkg. Lbs.	Each
G608-5	5	3 1/4	27	30	\$ 2.01
G608-6	6	3 1/4	27	32	2.01
G608-7	7	3 1/4	12	29	2.40
G608-8	8	4	12	30	3.09
G608-9	9	4-6	8	28	4.62
G608-10	10	4-6	4	17	6.15
G608-12	12	4-5-6	2	12	8.85
G608-14	14	6-8	1	10	12.15
G608-16	16	6-8	1	15	15.15
G608-18	18	8-10	1	18	32.91
G608-20	20	8	1	25	60.72

Note — When ordering Standard G608 globes give number and specify size of fitter.

No. G608-6 and G608-8 available in plain ruby glass.

Alabax Porcelain Lighting Fixtures

Approved by Underwriters' Laboratories, Inc.

Popular for installations in private and public housing projects, hospitals, hotels, schools, residential and all types of buildings. Glistening white glaze. Available in pastel ivory glaze or rich jet black at a small extra cost. Glaze is fired permanently into porcelain, insuring lasting color.

Porcelain stays like new, will not rust, dull, peel, nor change color. Is as easily cleaned as a china plate. Fixtures are safe because porcelain is the best electrical insulation. Lamps are not supplied.



No. AL-3129



No. AL-3100

Wall Fixture

With glass as illustrated.
Width, 3½ in.; height 6¼ in.; extends 5 in.

- AL-3129 Keyless, white, with outlet.....\$6.83
- AL-3130 Keyless, white, no outlet..... 6.42
- AL-3131 "T" rated push switch, white, with outlet... 7.32
- AL-3134 Keyless, black, no outlet..... 6.80
- AL-3137 Keyless, ivory, no outlet..... 6.80
- AL-3133 Glass tube..... 2.11

Flame Lamp Fixture

Flame lamps not supplied.
Width, 4 in.; height, 6⅜; extends 3⅞ in.

- AL-3100 Pull, with outlet.....\$3.72
- AL-3101 Pull, no outlet..... 3.36
- AL-3102 Keyless, with outlet... 3.36
- AL-3103 Keyless, no outlet.... 3.02

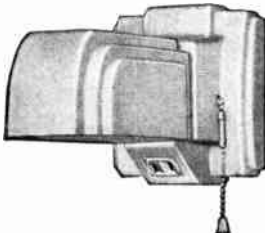

No. AL-2380

With glass as illustrated.
Width, 4½ in.; height, 5 in.; extends 7½ in.

- AL-2380 Pull, with outlet.....\$5.11
- AL-2381 Pull, no outlet..... 4.79
- AL-2382 Keyless, with outlet... 4.65
- AL-2383 Keyless, no outlet.... 4.32
- AL-2384 Glass only..... 1.85



No. AL-2390

With glass as illustrated.
Width, 5⅞ in.; height, 4⅝ in.; extends 7⅝ in.

- AL-2390 Pull, with outlet.....\$5.11
- AL-2391 Pull, no outlet..... 4.79
- AL-2392 Keyless, with outlet... 4.65
- AL-2393 Keyless, no outlet.... 4.32
- AL-2394 Glass only..... 1.85



AL-2604



AL-2690

With glass as illustrated.
Fitter size, 3¼ inches.
Diameter at base, 4¾ inches.
Extends out, 5¾ inches.

- AL-2604 Keyless, black glaze, no outlet.....\$5.83
- AL-2605 Keyless, brown glaze, no outlet..... 5.83
- AL-2690 Keyless, black glaze, no outlet..... 7.09



No. AL-2108-13

Keyless sockets.
Width, 4¾ in.; height, 7 in.; extends 3⅝ in.

- AL-2108-12 "T" S.P. Switch at bot., no outlet..\$5.01
- AL-2108-13 "T" S.P. Switch at bot., outlet right side..... 5.36
- AL-2108-16 "T" 3-Way Switch at bottom, outlet right side..... 5.75
- AL-2108-17 "T" 3-way Switch at bottom, no outlet..... 5.36
- AL-2108-18 "T" S. P. Switch at bottom, outlet left side..... 5.36
- AL-2108-20 Outlet at bottom.. 4.75



No. AL-2204

Fitter Size In.	Diam. In.	Depth In.
4	5½	1½
6	8⅞	3½

- AL-2204 Keyless, 6 In. Fitter..\$5.91
- AL-2073 Keyless, 4 In. Fitter.. 2.19

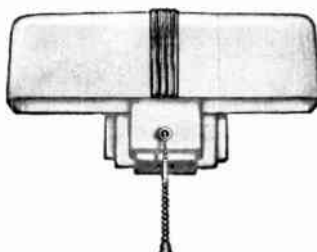

No. AL-2850

With glass as illustrated.
Width, 10¾ in.; height, 5½ in.; extends 5¼ in.

- AL-2850 Pull, with outlet....\$10.32
- AL-2851 Pull, no outlet..... 9.99
- AL-2852 Keyless, with outlet. 9.31
- AL-2853 Keyless, no outlet... 9.00
- AL-2854 Glass only..... 5.24



No. AL-2300

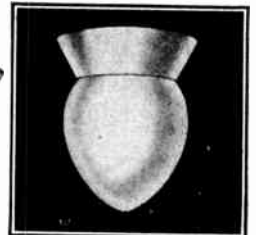

No. 2302

Moisture proof fixtures, with sockets and lead wires cemented into position, and two rubber gaskets.

- AL-2300 With 5" CRI glass...\$3.83
- AL-2301 With 6" CRI glass... 4.21
- AL-2303 With 5" opal glass... 4.22
- AL-2302 With CRO glass..... 5.28



No. AL-3140

No. AL-3140-1

With shade holder ring.
Diam., 5½ in.; extends 1¾ in.

- AL-3140 Keyless.....\$1.35
- AL-3140-LFT Keyless for lamp with left hand thread..... 1.58

No shade holder ring.
Diam., 5½ in.; extends 2⅜ in.

- AL-3140-1 Keyless..... 1.88

Perfelite Lighting Fixtures

Listed by Underwriters' Laboratories, Inc.

Utility Units



Equipped with strap and screws for concealed mounting to outlet box, and with eyelet for pull chain socket. Porcelain keyless socket. Medium base. Made of Aluminum. Standard finish; Brushed Satin Aluminum.

No.	Fitter In.	Canopy Diam., In.	Overall Depth, In.	Std. Pkg.	Std. Pkg. Wt., Lbs.	Each
903-Y	4	6 1/4	2 1/2	24	20	\$1.60



Equipped with strap and screws and keyless medium porcelain socket. Made of steel. Standard finish; Plated Statuary Bronze. Available also in Satin Chrome.

No.	Fitter, In.	Canopy Diam., In.	Overall Depth, In.	Std. Pkg.	Std. Pkg. Wt., Lbs.	P.S.B. Each	S. Chr. Each
1113	3 1/4	5 1/2	2 1/4	24	18	\$1.15	\$1.63



Complete with strap and screws for mounting medium keyless porcelain socket, and 6-in. diam. glass opal glass shade. Standard finish; Plated Statuary Bronze. Also available in Satin Chrome.

No.	Fitter, In.	Reflector Diam., In.	Std. Pkg.	Std. Pkg. Wt., Lbs.	P.S.B. Each	S. Chr. Each
1172-B	2 1/4	6	12	15	\$3.20	\$3.68



Made of steel. Opal glass reflector. Equipped with 5 1/4-in. x 3-in. deep canopy. Wired with medium base porcelain socket. Standard finish; Plated Statuary Bronze. Also available in Satin Chrome.

No.	Fitter, In.	Canopy Diam., In.	Std. Pkg.	Std. Pkg. Wt., Lbs.	P.S.B. Each	S. Chr. Each
PB-80	2 1/4	5 1/4	24	36	\$5.63	\$7.35

Wall Brackets



Prismatic, weatherproof, wall bracket. Made of aluminum. Gasketed. Suitable for use in vestibules, stairwells, entry-ways. Wired with medium base porcelain socket. Standard finish; Anodized Aluminum.

No.	Watts	Back Plate, In.	Extends, In.	Std. Pkg.	Std. Pkg. Wt., Lbs.	Each
VC-40	100	8 x 6	7	4	16	\$12.93

Flat Bottom Ceiling Pan Fixtures

Safety Locking



Safety-locking ceiling pan. Made of aluminum. Opal glass. Suitable for connection to any 60° C wire. Glass is chain-hinged and is secured by simply turning into holder engaging lugs. Standard finish; Satin Aluminum.

No.	Watts	Glass Diam., In.	Std. Pkg.	Std. Pkg. Wt., Lbs.	Each
IIII-9	2-40	8 1/4	12	46	\$10.35
IIII-11	2-60	9 7/8	12	48	12.08
IIII-13	2-75	11 7/8	6	32	15.28
IIII-15	2-100	13 3/4	4	30	19.25
IIII-17	3-100	16	1	13	26.95

Ceiling Pan Fixtures



Ceiling pan units with center-lock up assembly. Made of aluminum. Equipped with porcelain sockets. Opal glass. Standard finish; Satin Aluminum.

No.	Watts	Glass Diam., In.	Std. Pkg.	Std. Pkg. Wt., Lbs.	Each
130-UNS	2-40	8	12	40	\$6.75
131-UNS	2-75	10	6	28	8.90
132-UNS	3-60	12	4	23	11.90
133-UNS	3-100	14	4	31	15.23
134-UNS	4-100W	16	1	10	22.80

Moisture Proof Fixtures

Prismatic Glass



Cast aluminum body and globe holder. Porcelain socket, rubber gasket. Shock-resistant prismatic tempered glass. Finish of Marine grey.

No.	Watts	Std. Pkg.	Std. Pkg. Wt., Lbs.	Each
C-6	100	1	4 1/2	\$15.63
C-7	100	1	5 1/2	17.93

Pittsburgh High-Efficiency, Silver-Mirrored Permafectors

Where to use Pittsburgh Permafectors

Many lighting installations require a "controlled light source." The most practical and versatile light source which meets this requirement is the incandescent lamp. This is true because incandescent lamps are the closest to the ideal "single point" source.

To the desirable qualities of the lamp, add the absolute control of light direction and distribution possible with Pittsburgh silver-mirrored Permafectors and the application possibilities are almost limitless.

Key to Permafecter Catalog Numbers

The suffix numbers on each Permafecter catalog number indicate the use and equipment furnished with the Permafecter unit having that suffix.

The numbering system as illustrated below, is applied to every Pittsburgh Permafecter unit offered on this and the following page:

- Catalog Number only—for surface or pendent mounting.
- No. and suffix, 2 —for recessing with open bottom.
- No. and suffix, 4 —for recessing with hinged roundel.
- No. and suffix, 5 —for recessing with hinged louver.
- No. and suffix, 7 —for recessing with hinged roundel and housing.
- No. and suffix, 8 —for recessing with hinged louver and housing.



E-75

No. E-75 Permafecter

Application: The E-75 is a broadly distributing reflector for direct lighting service where a close spacing of low wattage lamps is employed for relatively low mounting. Combinations are available for various types of mounting and with louver or roundel bottoms.

Bottom Opening: 6 $\frac{3}{4}$ in. diameter. Lamp size: 60W, A-19 or 75W or 100W, A-21.

No.	Each	No.	Each
E-75-GO	\$ 5.17	E-75-5	\$12.92
E-75-2	8.50	E-75-7	17.75
E-75-4	12.67	E-75-8	18.00



E-150

No. E-150 Permafecter

Application: The E-150 series is a broadly distributing reflector with considerable center concentration for direct lighting where close spacing of lamps is required. Various combinations are available for either louver or roundel bottoms. The E-150 series is also suitable for exposed service.

Recommended Spacing:

Should not exceed distance between reflector bottom and work surface. Bottom Opening: 8 $\frac{1}{2}$ in. diameter. Lamp size: 150W, A-23.

No.	Each	No.	Each
E-150	\$ 7.00	E-150-5	\$14.92
E-150-2	9.25	E-150-7	21.00
E-150-4	14.67	E-150-8	21.25

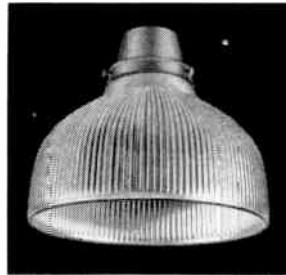

E-230

No. E-230 Permafecter

Application: Broad distribution with desirable center concentration. It is excellent for down-lighting in stores, gyms, badminton courts and other installations with low headroom.

Combinations are available with louver or roundel bottoms. May be equipped with wire guards for use in industrial plants, hangars, etc.

Recommended Spacing: Not exceeding distance between reflector bottom and working plane. Bottom Opening: 9 $\frac{1}{2}$ in. diameter. Lamp size: 300W, PS-30.

No.	Each	No.	Each
E-230	\$ 7.58	E-230-5	\$16.00
E-230-2	10.00	E-230-7	23.42
E-230-4	16.33	E-230-8	23.08



E-500

No. E-500 Permafecter

Application: A wide-utility reflector which may be ceiling recessed and equipped with concentric louver or hinged ceiling roundel.

This unit may also be enclosed in a metal housing or exposed for industrial and public space illumination. It is excellent for use above skylights.

Recommended Spacing: Should not exceed distance between reflector bottom and work surface. Bottom Opening: 11 $\frac{1}{8}$ in. diameter. Lamp size: 500W, PS-10 or 300W, PS-35.

No.	Each	No.	Each
E-500	\$16.17	E-500-5	\$24.92
E-500-2	18.25	E-500-7	34.67
E-500-4	27.75	E-500-8	31.83



No. C-201 Permafecter

Application: Excellent for ceiling recessing with flush mounting ring and concentric louver in show windows or interior displays.

Ideal for cove lighting where a narrow beam with a long "throw" is required; and for lighting through skylights in art galleries and similar public buildings. Recommended Spacing: Should not exceed $\frac{1}{3}$ the height of

the reflector bottom above the working plane. Bottom Opening: 10-in. diameter. Lamp size: 200W, A-25.

No.	Each	No.	Each
C-201-A	\$ 8.50	C-201-5	\$17.58
C-201-2	11.42	C-201-7	26.25
C-201-4	18.75	C-201-8	25.08

Pittsburgh High-Efficiency, Silver-Mirrored Permafectors



54

**No. 54
Permafecto**

Application: For shallow windows from 7-ft. to 10-ft. high. Also for rug racks, quotation boards, building fronts and entrances, church choirs and sanctuaries, indoor sports areas, art galleries, indirect cover lighting. This series may be external or recessed mounted and equipped with either louvers or roundels.

Recommended Spacing: 12-in. on centers. Bottom Opening: 9½ in. diameter. Lamp size: 200W, A-25.

No.	Each	No.	Each
54	\$ 7.58	54-5	\$16.33
54-2	10.00	54-7	23.42
54-4	16.33	54-8	23.42



55

**No. 55
Permafecto**

Application: This series is designed for shallow windows 4-ft. to 9-ft. high, medium trim and island windows. It may also be used in interiors for illuminating racks, quotation boards, walls, fronts, entrances, as well as indoor handball, squash and tennis courts. This series may be external or recessed mounted

and equipped with either louvers or roundels.

Recommended Spacing: 12-in. on centers. Bottom Opening: 8½ in. diameter. Lamp size: 150W, A-23.

No.	Each	No.	Each
55	\$ 6.67	55-5	\$14.67
55-2	8.92	55-7	20.67
55-4	14.33	55-8	21.00



56

**No. 56
Permafecto**

Application: For use in high and very shallow windows, where the height measures from 2 to 3 times the depth; or in windows in which display material is placed low. Also suitable for rug racks, building fronts, church choirs, museums, and similar applications. This series may be external or recessed mounted with either louvers or roundels.

Recommended Spacing: 12-in. on centers. Bottom Opening: 9½ in. diameter. Lamp size: 200W, A-25.

No.	Each	No.	Each
56	\$ 7.58	56-5	\$16.33
56-2	10.00	56-7	23.42
56-4	16.33	56-8	23.42



57

**No. 57
Permafecto**

Application: High and very shallow windows, where the height is from 2 to 3 times the depth, or in windows where display material is placed low. Also excellent for indoor sports areas, indirect cove lighting, and similar applications. This series may be external or recessed mounted and equipped with either louvers or roundels.

Recommended Spacing: 12-in. on centers. Bottom Opening: 8½ in. diameter. Lamp size: 150W, A-23.

No.	Each	No.	Each
57	\$ 6.67	57-5	\$14.67
57-2	8.92	57-7	20.67
57-4	14.33	57-8	21.00



85

**No. 85
Permafecto**

Application: Installed flush with ceiling, this permafecto illuminates full background height without sharp cut-off. Excellent for indirect lighting from wall urns, coves, columns, and similar mountings. This series may be external or recessed mounted and equipped with either louvers or roundels.

Recommended Spacing: 12-in. on centers. Bottom Opening: 8½ in. diameter. Lamp size: 150W, A-23.

No.	Each	No.	Each
85	\$ 7.42	85-5	\$15.42
85-2	9.67	85-7	21.42
85-4	15.08	85-8	21.75



99

**No. 99
Permafecto**

Application: The No. 99 Permafecto, when recessed mounted, illuminates the full height of the background without the sharp cut-off of the more concentrating Nos. 54, 55 and 57 Permafectors. It is also ideal for indirect lighting in wall urns, coves, columns and similar mountings. This series may be external or recessed mounted

and equipped with either louvers or roundels.
Recommended Spacing: 10½ in. on centers. Bottom Opening: 9½ in. diameter. Lamp size: 300W, PS-35.

No.	Each	No.	Each
99	\$ 8.25	99-5	\$17.00
99-2	10.67	99-7	24.08
99-4	17.00	99-8	24.08

Refer to Preceding Page for Information on Key to Permafecto Catalog Numbers.

Amplex Swivelites

Specify Amplex Swivelites for These 4 Sounds Reasons

1. Double Ball Swivel

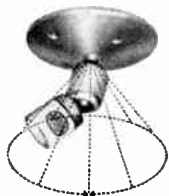

Exclusive free floating universal joint swivel. Positive finger-tip positioning to any angle. 360° hor., 170° vert.

2. Lustrous, Lasting Finish



Deluxe Satin Aluminum, infra-red baked. Will not chip, discolor or blister from heat even after long service.

3. Air Flow Ventilation



Eighty ventilating ports in base of Swivelite hoods carry off excess heat. Lamp burn cooler, last longer.

4. Adapt-a-Unit Construction

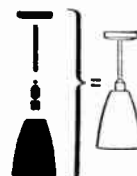

Hood easily added, removed, interchanged. Straight or curved pipe or flexible extensions installed as needed.

Screw In Units*

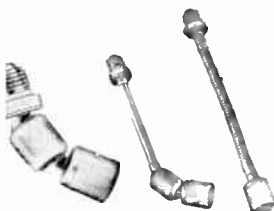

No.	Carton	Each
No. N10	1	\$1.93
No. N10-6	1	2.86
No. FS12	1	3.85
S12	1	2.42
S18	1	3.03

Box Plate Units*

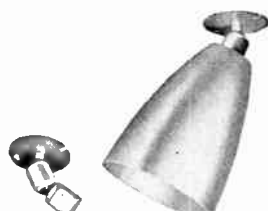

No.	Carton	Each
No. P3-4	1	\$2.31
No. P3-4SH	1	8.75

Portable Bases



No.	Carton	Each
No. B10JH	1	\$8.25
No. B44SH	1	10.23
No. B44	1	3.80

Clamp-On and Escutcheon Units*

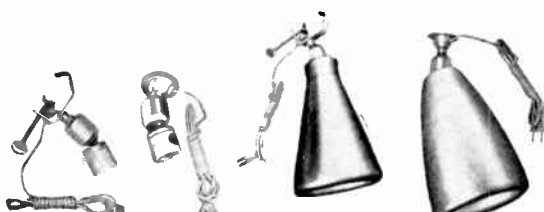

No.	Carton	Each
No. CO	1	\$3.30
No. E	1	9.74
No. COSH/S	1	2.42
No. ESH	1	8.86

*All fixtures available with either standard or Midget hoods in both Torpedo shape and Swedish styles. All units are packed individually.

Canopy Units*



No.	Carton	Each
No. C11SH	1	\$9.41
No. C12SH	1	16.89
No. C12SH-12	1	21.84

Fixtures are supplied with 72 in. wire leads. Single canopies, double, triple and quadruple cluster units available in stem lengths up to 60 inch.



No. C12SH-12

Recessed Hi-Hats

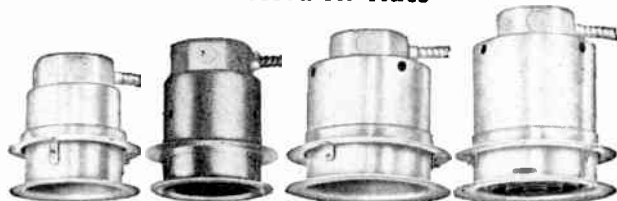

No.	Carton	Each
No. 605G	1	\$6.03
No. 615G	1	7.36
No. 711G	1	5.83
No. 715G	1	6.73

Units are available with or without Greenfield.

Focalites*

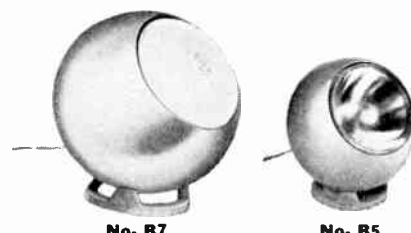

*B5 unit accommodates Par 38 reflector lamp. B7 unit accommodates R40 medium base, reflector lamp.

No.	Carton	Each
B-5	1	\$6.40
B-7	1	7.25

There's a complete line of Swivelite fixtures, Louver clips, Color clips, Color Filters for every accent and flood lighting need.

Contact GRAYBAR for complete details.

Holophane Commercial Lighting Units

Approved by Underwriters' Laboratories, Inc.

Holophane LO-BRITE* CONTROLENS* Units For In-Bilt Lighting

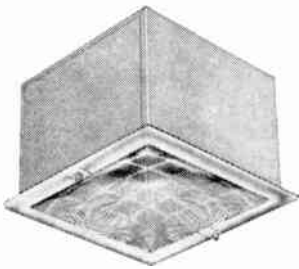

A recessed lighting unit used wherever uniform illumination of the work area is required. Intensive light distribution is achieved through an optical system consisting of a square reflector and a Lo-Brite Controlens with concave contour. The resulting distribution meets present-day practices of higher illumination levels and closer spacing ratios for uniformity on the work plane.

18-gauge steel housing with white enamel finish inside, baked gray enamel outside. 16-gauge steel, pearl gray finished, face plate.

No.	Lamp Wattage	Roughing Box, In. Square	Depth	Face Plate, In. Square	Framed Opening, In. Square	Each
F-1560	100-150	10 ³ / ₈	8 ¹ / ₈	11 ³ / ₄	10 ¹ / ₂	\$27.25
FA-1560	100-150	10 ³ / ₈	8 ¹ / ₈	12	10 ¹ / ₂	30.00
T-1560	100-150	10 ³ / ₈	8 ¹ / ₈	12	12	32.95
F-1570	300‡	13 ¹⁵ / ₁₆	10	15 ³ / ₈	14 ¹ / ₈	33.05
F-1570-TS	300‡	14 ³ / ₈	10 ¹ / ₁₆	15 ³ / ₈	14 ⁵ / ₈	40.40

No. F-1570-TS designed with lift-off top for above-ceiling servicing. FA-1560 for acoustic tile ceilings. T-1560 for JM metal tile ceilings. Units are not supplied wired.

‡Medium base 6" light center lamp.

Holophane PARADOME* Lighting Units



C-5400



S-5400

The Holophane PARADOME* represents the closest approach to achieving desirable natural lighting. Has a pleasing and attractive appearance and provides visual comfort and low brightness.

Optical assembly consists of a prismatic reflector 8¹/₂-in. deep and a concave bottom CONTROLENS* 15¹/₁₆-in. diam., with a removable disc 7³/₄-in. for relamping. The lower 7-in. of the reflector is enclosed in a specially designed fiber glass cover. These elements produce a semi-direct light distribution.

Ceiling-attached and suspension metal fitters are available; finished in satin chrome plate.

No.	Lamp Wattage	Max. Spacing Ratio	Dimensions, In.		Each
			Diameter	Depth	
C-5400	200‡ 300	1.0	15 ⁷ / ₁₆	12 ³ / ₄	\$28.80
S-5400	200‡ 300	1.0	15 ⁷ / ₁₆	33 ³ / ₄	33.15

Termination: C-5400—Outlet Box Strap.
S-5400—³/₈-in. hickey.

‡No socket extension required for 6-in. light center lamp. Size of top canopy—8-in. diam.

Units are not wired.

Holophane In-Bilt Counterlite

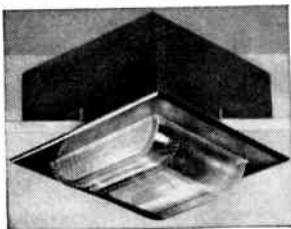

Provides an unusually efficient means of producing high levels of illumination on counters or along lines of display. Unique in that it projects an oval pattern of light—narrow and widespread along the counter. Concentrates light on the display for higher illumination and greater attraction. Spill light is sufficient to take care of traffic aisles and stock shelves. Unsurpassed for "Point-of-Sale" lighting.

Semi-flush construction for partial recessing in ceiling.

Optical components, housed in a heavy gauge steel box, are a square, compound, dished CONTROLENS* and a polished metal reflector. Depressed inner lens controls almost the entire 360° of the generated light. Finish: Box—gray baked enamel; hinged face plate—pearl gray enamel. Recessed depth—7-in. Overall depth 9⁷/₈-in. Face plate—15³/₈-in. sq. Roughing box—13³/₄-in. sq. Plaster opening 14-in. sq. Wire not furnished with units.

No. F-1814.....Each \$42.45

Holophane XTRAFICIENCY* Units

Provides "three-dimensional" controlled corridor lighting, so that this area will have high level comfortable, safe illumination conditions. Average brightness toward viewer is less than 1 candle power per square inch.

Enclosed prismatic glass refractor bowl with ceiling type fitter. Fitter consists of: a steel ceiling plate with mounting strap for a medium base socket, metal reflector, outlet box cover plate, and a steel housing 1³/₄-in. deep with spring wire clips to support the refractor bowl.

Exterior finish—pearl gray baked enamel.
Dimensions: Depth—6-in., width—9¹/₄-in., length—13¹/₄-in.
Maximum spacing ratio—1.5.
Lamp wattage—150 (A23).

No. C-824.....Each \$15.95



*Holophane Trade Marks.

Litecraft Deluxe Pre-Wired Recessed Incandescent Lighting

Litecraft deluxe recessed fixtures combine high efficiency with easy installation and servicing. Pre-wired so that supply connections may be made with 60° wire (Type R, T, TW, etc.), no asbestos wire required.

Mounting rails included with fixture make installation extremely simple, eliminates need for plaster frame. Door-within-door construction insures no light leak regardless of ceiling condition. Spring latched, hinged, stainless steel lens frame provides instant access and assures a lifetime of trouble-free operation. Litecraft finishes dual-sprayed and baked twice at 375° F. for permanence. Union made and wired by IBEW-AFL. Underwriters' Laboratories approved.

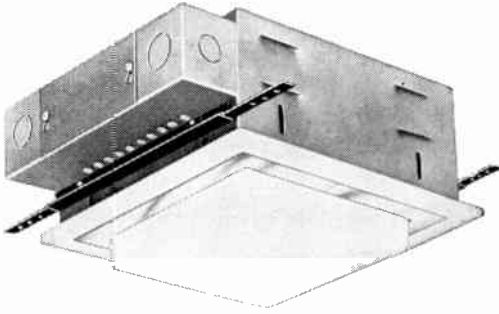

E301-21
100W IF with cast opal diffuser

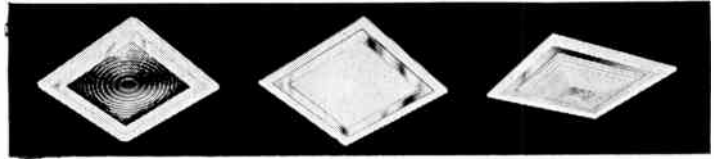

Fresnel Lens
E302-12 200W IF

Corning Alba-Lite
E302-32 200W IF

Semi-Flush Lens
E302-42 200W IF

Be sure to order both housing and lens and frame assembly by individual number.

Cast Opal Lens Diffuser

Housing No.	Lens & Frame	Watts	Housing Size Sq. In.	Recess Depth In.	Lens Size In.	Face Frame Sq. In.	Each
E301	-21	60/100	9½	4½	7⅞	10½	\$11.63
E302	-22	150/200	12½	6	10⅞	13½	12.44
E303	-23	300	13½	6⅝	11⅞	14½	21.13

Fresnel Lens

E301	-11	60/100	9½	4½	7⅞	10½	11.94
E302	-12	150/200	12½	6	10⅞	13½	13.31
E303	-13	300	13½	6⅝	11⅞	14½	21.44

Example: 300W housing with Fresnel lens E303-13 Includes: Housing, lens, frame and mounting bars.

Corning Alba-Lite Lens

Housing No.	Lens & Frame	Watts	Housing Size Sq. In.	Recess Depth In.	Lens Size In.	Face Frame Sq. In.	Each
E301	-31	60/100	9½	4½	7⅞	10½	\$10.19
E302	-32	150/200	12½	6	10⅞	13½	11.13
E303	-33	300	13½	6⅝	11⅞	14½	18.75

Semi-Flush Lens

E301	-41	60/100	9½	4½	7⅞	10½	11.57
E302	-42	150/200	12½	6	10⅞	13½	12.56
E303	-43	300	13½	6⅝	11⅞	14½	21.00

Note: Wiring compartment extends added 2¼-in. beyond housing.

Litecraft Pre-Wired Budget-Lites

Jumbo size connection box is removable from inside or outside fixture. Underwriters' Laboratories approved for connection with 60° wire (Type R, T, TW, etc.), no asbestos wire needed. Ever-Tite spring hinges attach frame to housing with a snap, making relamping easy, no tools needed. No exposed hardware. Built-in light-trap prevents light leaks. Indented frame edges assure finger grip. Litecraft finishes dual-sprayed and baked twice at 375° F. to assure lifetime protection of the fine finish. Union made by IBEW-AFL craftsmen.

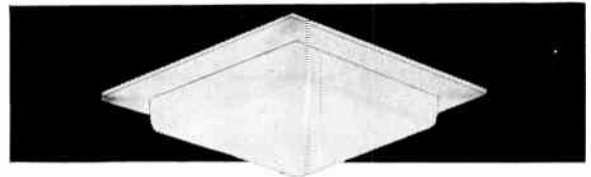

Opal Diffuser

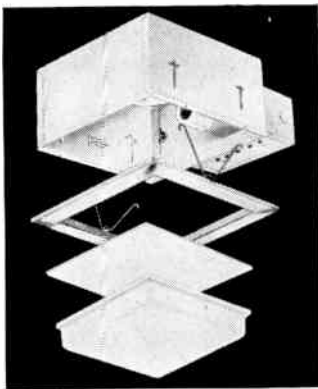

Exploded View

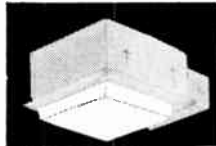

Opal Diffuser White Frame

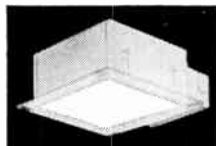

Alba-Lite Diffuser Chrome Frame

Lens and frame assemblies packaged separately. Standard packages are: 6 housings to master carton; 6 lens and frame assemblies to master carton. Be sure to order both housing and lens and frame assembly by individual number. Example: 200W housing with Alba-Lite diffuser and chrome frame—E522-58.

Cast Opal with White Frame

Housing No.	Lens & Frame	Watts	Housing Size Sq. In.	Recess Depth In.	Lens Size Sq. In.	Face Frame Sq. In.	Each
E521	-51	100	8½	4½	7⅞	9½	\$ 7.00
E522	-55	150/200	11½	5½	10⅞	12½	8.50

Cast Opal with Chrome Frame

E521	-52	100	8½	4½	7⅞	9½	10.19
E522	-56	150/200	11½	5½	10⅞	12½	9.31

Alba-Lite with White Frame

E521	-53	100	8½	4½	7⅞	9½	5.06
E522	-57	150/200	11½	5½	10⅞	12½	6.50

Alba-Lite with Chrome Frame

E521	-54	100	8½	4½	7⅞	9½	5.69
E522	-58	150/200	11½	5½	10⅞	12½	7.25

No. E531 Bar Hangers 1 pr. per fixture.....Per Pr. \$0.56
No. E532 Kwik-Mount clips 4 per fixture.....Per Pr. .31

Lowest cost pre-wired units for connection with 60° wire, no asbestos wire needed. Mounting rails or Kwik-Mount clips eliminate need for plaster frame.

Note: Wiring compartment extends an added 4-in. beyond housing. Polished brass frame available at same price as Chrome. Silvertone frame available at same price as white.

Kirlin Built-In Lighting Fixtures



No. 1212



No. 1208-SUR

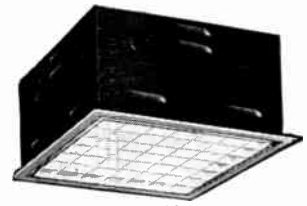

No. 1212L



No. 1511D



No. 1211C

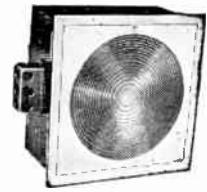

No. 1413

Recessed Square Models

Has Aluminum alloy, white, die-cast frame that may be painted color of ceiling. Equipped with hinged stainless-steel door (like auto trim), rustproof, suitable for bathroom, shower, porch, or marquee. No gasket needed.

Smooth side of lens is out, prisms on the inside, to aid in cleaning. Louvers are bent inward on boxes. Frames are adjustable for perfect fit against ceiling.

Fixtures may be installed in present ceiling.

Wide Lens

No.	Max. Watts	Size For Ceiling Opening In.	Depth In.	Frame Size In.	Each
1207	60-100	7 5/8 x 7 5/8	5 1/8	8 9/16 x 8 9/16	\$17.60
1208	60-150	9 1/4 x 9 1/4	5 1/2	10 1/4 x 10 1/4	19.07
1211	60-150	11 7/8 x 11 7/8	5 1/2	12 7/8 x 12 7/8	29.95
1212	100-300	13 1/4 x 13 1/4	7 5/8	12 7/8 x 12 7/8	32.53
1611*	100-300	11 7/8 x 11 7/8	7	12 7/8 x 12 7/8	33.73

Shallow Box

1511	60-150	11 7/8 x 11 7/8	4 1/4	12 7/8 x 12 7/8	29.80
------	--------	-----------------	-------	-----------------	-------

Egg-Crate Louver

1208-L	60-150	9 1/4 x 9 1/4	5 1/2	10 1/4 x 10 1/4	22.87
1212-L	100-300	13 1/4 x 13 1/4	7 5/8	14 1/8 x 14 1/8	37.13
1218-L	300-500	19 3/8 x 19 3/8	13	20 x 20	93.87

Egg-Crate Fotalite

1208-F	60-150	9 1/4 x 9 1/4	5 1/2	10 1/4 x 10 1/4	22.67
1212-F	100-300	13 1/4 x 13 1/4	7 5/8	14 1/8 x 14 1/8	37.00
1211-F	60-150	11 7/8 x 11 7/8	5 1/2	12 7/8 x 12 7/8	34.67

*Use 75° Feed Wire.

Incandescent Wide Angle

Has white enameled steel frame, satin chrome steel door. Plaster frame available for all models.

Wide Lens

No.	Max. Watts	Size For Ceiling Opening In.	Depth In.	Frame Size In.	Each
1218	300-500	19 3/8 x 19 3/8	13	20 x 20	\$88.27

Surface Mounted Models

Uses GlasSurfaced aluminum reflectors. Has baked white enamel finish. May be mounted in groups.

No.	Max. Watts	Size For Ceiling Opening In.	Depth In.	Frame Size In.	Each
1208-SUR	60-150	11 x 11	5 1/2	11 x 11	\$34.67
1212-SUR	100-300	15 x 15	7 1/2	15 x 15	49.27
1218-SUR†	2-300	21 x 21	9	21 x 21	107.40

†2 lamps.

Drop Lens Type

Standard finish, stainless Steel door, white die-cast frame. May be had with chrome frame on special order.

Drop Lens 1 1/4-In.

No.	Max. Watts	Size For Ceiling Opening In.	Depth In.	Frame Size In.	Each
1211-D	60-150	11 7/8 x 11 7/8	5 1/2	12 7/8 x 12 7/8	\$36.93
1511-D	60-150	11 7/8 x 11 7/8	4 1/4	12 7/8 x 12 7/8	36.80
1611-D*	100-300	11 7/8 x 11 7/8	7	12 7/8 x 12 7/8	40.73

Drop Lens 1 3/8-In.

1409-D-P	60-150	9 1/4 x 9 1/4	5 1/2	10 1/4 x 10 1/4	23.73
----------	--------	---------------	-------	-----------------	-------

Drop Lens 1 1/2-In.

1412-D-C	100-300	13 1/4 x 13 1/4	7 5/8	14 1/8 x 14 1/8	36.67
----------	---------	-----------------	-------	-----------------	-------

*Use 75° feed wire on 1611-D.

Square Concentrating Models

Used where ceilings are relatively high; most jobs require the standard wide-angle units.

Square box is more easily installed than round box, and door being square permits stronger hinging, always a weak point on round doors. Finished in white enamel.

Light distribution is semi-concentrating on 1408 and 1413.

Concentrating Lens

No.	Max. Watts	Size For Ceiling Opening In.	Depth In.	Frame Size In.	Each
1211-C	150	11 7/8 x 11 7/8	5 1/2	12 7/8 x 12 7/8	\$34.22
1409-C	150	9 1/4 x 9 1/4	5 1/2	10 1/4 x 10 1/4	24.33
1412-C	200-300	13 1/4 x 13 1/4	7 5/8	14 1/8 x 14 1/8	37.60

Semi-Concentrating Shallow

1511-C	150	11 7/8 x 11 7/8	4 1/4	12 7/8 x 12 7/8	\$34.07
--------	-----	-----------------	-------	-----------------	---------

Concentrating Corning Lens

1611-C*	150-300	11 7/8 x 11 7/8	7	12 7/8 x 12 7/8	38.00
---------	---------	-----------------	---	-----------------	-------

Round Lens Opening

1408	100-150	9 1/4 x 9 1/4	5 1/2	10 1/4 x 10 1/4	28.00
1413	200-300	13 1/4 x 13 1/4	7 5/8	14 1/8 x 14 1/8	42.00

*Use 75° Feed Wire on 1611-C.

Kirlin Built-In Lighting Fixtures

Rectangular Incandescents



No. 508



No. 614

Rectangular Distribution

Standard finish, stainless steel door; white enamelled frame—die-cast on 508 and 614, steel frame on 514: Die-cast fronts are rust-resistant. Reflectors of GlasSurfaced aluminum, permanently bright.

Albalite, Tubular

No.	Max. Watts	Size For Ceiling Opening In.	Depth In.	Frame Size In.	Each
514	2-40	1 1/8 x 3 3/4	4	15 1/4 x 5 1/4	\$19.80

Lens, Special Glass

508	60-100	8 1/2 x 5 1/2	5 7/8	9 5/16 x 6 1/2	16.47
614	100-150	13 1/8 x 7 5/8	5 3/4	14 1/8 x 8 1/2	24.27

25° Louver-Glass

514F-25-10	2-40	1 1/8 x 3 3/4	4	15 1/4 x 5 1/4	23.07
508F-25-10	60-100	8 1/2 x 5 1/2	5 7/8	9 5/16 x 6 1/2	18.80
614F-25-10	100-150	13 1/8 x 7 5/8	5 3/4	14 1/8 x 8 1/2	28.07

Hinged Night Light

508-NL	15-100	8 1/2 x 5 1/2	3 5/8	9 5/16 x 6 1/2	16.47
--------	--------	---------------	-------	----------------	-------

Hub Incandescent Controlens Elements

Flush Type With *Holophane Controlens



Single Lens Element



Two Lens Element



Three Lens Element

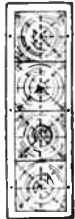

Four Lens Element

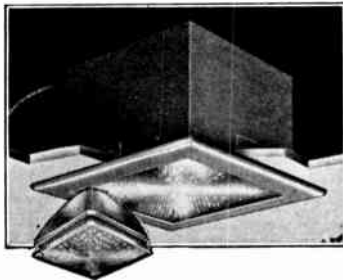

Pre-focused at factory to produce specific lighting distribution. Plaster frames available at additional cost.

Consists of steel recess box with wireway, medium base sockets and individual spun **Lume-Crome reflectors and Controlens in a steel frame, finished standard in silver gray lacquer — Other finishes at additional cost.

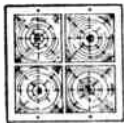

Square Four Lens Element

No.	Lenses No.	Lenses In.	Lamps No.	Max. Watts	HL Box	Dimens. In. Ceiling Opening	With Hinged Frame Each	With Removable Frame Each
6001	1	6 1/2	1	100	8 3/8	8 3/8 x 8 3/8	\$18.28	\$17.53
6002	2	6 1/2	2	100	8 3/8	†14 7/8 x 8 3/8	32.61	31.88
6003	3	6 1/2	3	100	8 3/8	†21 3/8 x 8 3/8	44.11	43.36
6004	4	6 1/2	4	100	8 3/8	†27 7/8 x 8 3/8
6091	4	6 1/2	4	100	8 3/8	†15 x 15
6031	1	8 1/2	1	150	11 3/8	10 3/8 x 10 3/8	22.93	22.20
6032	2	8 1/2	2	150	11 3/8	18 7/8 x 10 3/8	44.74	40.26
6033	3	8 1/2	3	150	11 3/8	27 3/8 x 10 3/8	64.65	63.89
6034	4	8 1/2	4	150	11 3/8	35 7/8 x 10 3/8
6092	4	8 1/2	4	150	11 3/8	19 x 19
6061	1	12	1	300	12 3/4	13 7/8 x 13 7/8	27.59	26.85
6062	2	12	2	300	12 3/4	25 7/8 x 13 7/8	54.08	53.33
6063	3	12	3	300	12 3/4	37 7/8 x 13 7/8	82.51	76.83
6064	4	12	4	300	12 3/4	49 7/8 x 13 7/8
6093	4	12	4	300	12 3/4	26 1/8 x 26 1/8	104.58	96.98

**Glass reflectors available at additional cost. Specify on order whether Lume-Crome or glass reflectors are wanted.

†Dimensions for elements with Lume-Crome reflectors. For glass reflector elements verify dimensions with Factory.

*©Holophane Co., Inc.

● Prices on application.

Silvray Lighting Fixtures

The Silver-Dot

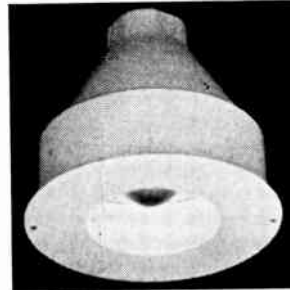

Available in two sizes for use with the 100W A-21 and 200W PS-30 silvered bowl lamps. Offers effective means of providing general or specific area downlighting.

Accurate die formed reflectors, designed for silvered bowl lamps; insures precise control of light and freedom from glare without costly louvers.

Recessed Units with Plaster Ring—Wired

No.	Silvered Bowl Size	Recess Depth In.	Ceiling Opening In.	Flange Diam. In.	Each
W110	100A/ISB*	7 1/4	6 1/2	7 1/4	\$11.55
W110	100A/ISBIF*	7 1/4	6 1/2	7 1/4	11.55
W113	200/SB	10 3/4	10 1/2	11 1/2	17.75

*Nos. W110 and W111 furnished with 2-100W A-21 silvered bowl lamps.

Coloray interchangeable reflectors in red, blue or gold when ordered with unit. Add.....\$0.55

The Silver-Spot

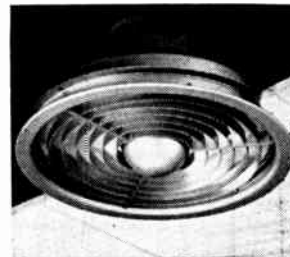

General purpose downlight providing a concentrating light distribution.

Recessed units furnished complete with plaster ring.

Interchangeable color impregnated aluminum reflectors available in red, blue and gold for colored effects.

Recessed Units with Plaster Ring—Wired

No.	Silvered Bowl Lamp	Recess Depth In.	Ceiling Opening In.	Flange Diam. In.	Each
W100R	100A/ISB	5 1/4	9 1/4	10 1/4	\$12.40
W101R	100A/ISBIF	5 1/4	9 1/4	10 1/4	12.40

Note: 2-100W A-21 silvered bowl lamps furnished with unit.

Coloray interchangeable reflectors in red, blue or gold when ordered with unit. Add.....\$0.55

Silvray Lighting Fixtures

Adjusto-Silverspot
Full 360° Rotation—70° Vertical Swivel



Permits light from unit to be aimed to any desired area.

Die-formed polished aluminum reflector and heavy duty louver give 180° shielding of lamp filament and 45° shielding of reflector.

Consists of a fixed external steel housing and a rotating and swiveling interior drum which contains receptacle, reflector and louver. Entire inside drum rotates in a spring loaded groove in the faceplate.

Recessed Type with Plaster Frame Included—Wired

No.	Silvered Bowl Lamp	Recess Depth In.	Ceiling Opening In.	Flange Diam. In.	Each
W116	100A/ISB	6 3/4	10 1/2	11 3/4	\$24.40
W117	100A/ISBIF	6 3/4	10 1/2	11 3/4	24.40

Note: 2—100W A-21 silvered bowl lamps furnished with unit.

Coloray interchangeable reflectors in red, blue or gold when ordered with unit. Add.....\$0.55

Garcy Incandescent Fixtures

Recessed Unit For 300-Watt Lamp



Elliptical reflector permits wide angle light distribution from an inconspicuous source. Reflector is specular processed aluminum. Aperture plate is steel, finished baked white enamel. Four-in. extension ring with removable cover facilitates installation. Also available with concentric ring louver. Height 14 1/2-in. Requires 11 7/8-in. ceiling opening.

No. 6811..... Each \$24.33

Recessed, Louvered Unit For R40 Spot Or Flood Lamp



Light beam adjustable 360° horizontally and up to 35° from vertical. Snap-in, parallel vane louver shields lamp from view and turns within housing for easy adjustment. Hinged for easy lamp replacement. Provides high level lighting for stores and other commercial interiors.

Drum housing and parallel-vane, cast louver are finished in matte black. Trim-flange is finished in baked white enamel.

No. 6815 1-R40 Spot or Flood, 150W..... Each \$27.04
 Plaster Frame for No. 6815..... Each 1.98

Recessed Adjustable Unit For R40 Spot Or Flood Lamp



Simple finger-tip direction control. No screws or nuts to tighten. Universally adjustable Gimbal rings permit wide positioning range. Plaster Ring No. 7581 must be ordered separately if required. Exposed surfaces are finished in Garlite baked white enamel. Height 6 3/4 in. Ceiling opening 8 1/4 in.

No. 7580 Open type for 150W R40 Spot or Flood. Each \$15.69

Garcy Incandescent Fixtures

Swivel Display Units



No. 6970

For spotlighting store and window displays, lighting maps, board displays, pictures in offices, reception rooms and lobbies. Universally adjustable with full 360° horizontal sweep (with safety stop) and 90° vertical sweep.

Surface or stem mounting to wall or ceiling. Mounting strap furnished for easy attachment to outlet box stud. Open neck design provides adequate ventilation.

Listed by Underwriters Laboratories, Inc. Measures 13 1/2 in. from ceiling to bottom of surface mounted unit. Bottom shade diameter is 6 3/4 in.

Shade canopy and swivel are aluminum. The collar is steel, finished dead black. No. L6970 Louver Ring is optional where shielding is required.

No.	Description	Ship. Wt. Lbs.	Each
6970	Surface Mounting type	3	\$10.79
P6970	Stem Mounting type	4	11.88
L6970	Snap-in Louver Ring	1	2.73

Note—Standard stem length is 24 in. Other lengths available.

Recessed Drum Unit For Par 38 Spot Or Flood Lamp

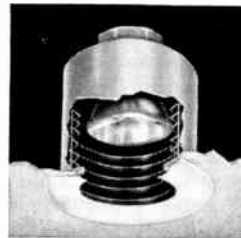

No. 6809

Flush recessed drum fixture designed for high level recessed lighting from low brightness ceiling areas. Uses Par 38 spot or flood type lamps. Continuous spiral baffle ring finished in dead black to provide effective shielding at normal viewing angles. Furnished complete with socket, separable knockout box at top and wire lead in 5 ft. Green field BX. Height 10 1/8 in. Fits 8 1/4 in. ceiling opening. Plaster ring extra.

No. 6809 Recessed Unit..... Each \$16.39
 No. 7581 Plaster Ring..... Each 1.64

Hub Aisle, Step and Night Lights



No. 9950



No. 9969



No. 9955



No. 9850 Mounts directly under Arm of Aisle Chair.

‡No. 9950 is same as No. 9969 except without toggle switch and convenience outlet.

Made of steel, lacquered finish, or brass or bronze metal.

No.	Max. Lamp, Watts	Cover, In. Wdth.	HL.	Wdth.	Recess Box, In. HL.	Depth	Lacquer Sprayed, Each	Brass or Bronze, Each
9950	40	5 1/2	8 3/8	4 1/2	6 7/8	3 1/4	\$5.37	\$ 8.05
9951	40	8 3/8	5 1/2	6 7/8	4 1/2	3 1/4	5.28	8.05
9969	40	8 3/8	5 1/2	6 7/8	4 1/2	3 1/4	7.51	10.21
9955	10	6	6	4 11/16	4 11/16	2	6.11	8.66
9850	10	6	3 1/2	6.11

For clear glass dust panels in flush units, add \$1.61.

Hub Flush Square Luminous Elements

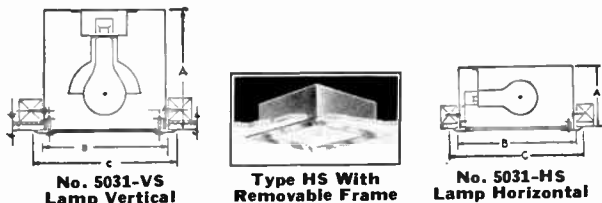

Steel recess box, with interior sprayed Lustralume lacquer. Steel frames, removable or concealed hinge types, standard finish in silver gray lacquer. VS type fitted with individual spun Lume-Crome reflectors.

Frosted clearlite glass panels are standard — Albalite available at same price (Please specify); flashed opal or other glass at additional cost.

Lamps Vertical

No.	Max. Lamp Wattage	Dimensions, Inches			With Hinged Frame, Each	With Removable Frame, Each
		Box HL	Ceiling Opening B	Frame Overall C		
5001-VS	100	8 ³ / ₈	8 ³ / ₈	10 ¹ / ₄	\$14.76	\$13.89
5031-VS	150	11 ³ / ₈	10 ³ / ₈	12 ¹ / ₄	17.99	17.10
5061-VS	300	12 ³ / ₄	13 ⁷ / ₈	15 ³ / ₄	22.38	21.98

Lamps Horizontal

5001-HS	60	4 ⁵ / ₈	8 ³ / ₈	10 ¹ / ₄	\$12.33	\$11.50
5031-HS	100	4 ⁵ / ₈	10 ³ / ₈	12 ¹ / ₄	15.21	14.33
5061-HS	200	7	13 ⁷ / ₈	15 ³ / ₄	19.24	18.35

Plaster frames available at additional cost.

Hub Directional Signs

Single or Double Face

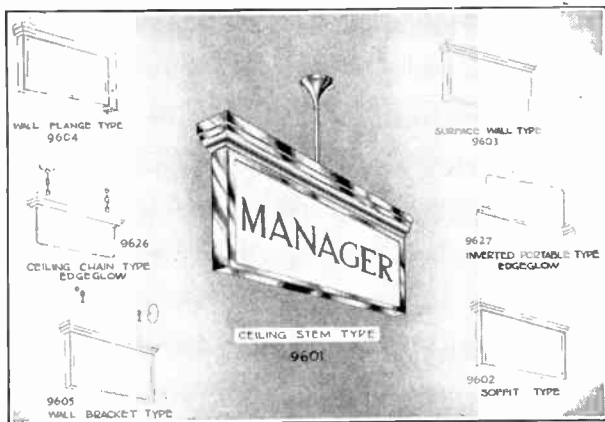

Available in various sizes to meet specifications. Made of heavy gauge steel moldings and finished in any standard lacquer color. Inscriptions may be any lettering or design; white or opaque bronze-tone background, embossed white on ruby or green background, or engraved in clear plate glass for edge-glow effect. Also furnished with white opal letters on polished black flashed background, metal stencil with opal glass back-plate or colored ceramic-filled letters on opal background at extra cost. Complete with disc lamp holders for 12 or 18-in. lumiline lamps or receptacles for T-10 tubular lamps.

15 x 6 1/2-in. Glass

21 x 8-in. Glass

No.	15 x 6 1/2-in. Glass		21 x 8-in. Glass	
	Single Face	Double Face	Single Face	Double Face
9601	\$55.00	\$67.50	\$70.00	\$85.00
9602	50.00	62.50	60.00	75.00
9603	50.00	60.00	60.00	75.00
9604	57.50	70.00	73.00	88.00
9605	60.00	72.50	75.00	90.00
9626	63.25	69.75	82.50	91.75
9627	50.00	62.50	60.00	75.00

Hub Flush or Suspended Reflector Elements

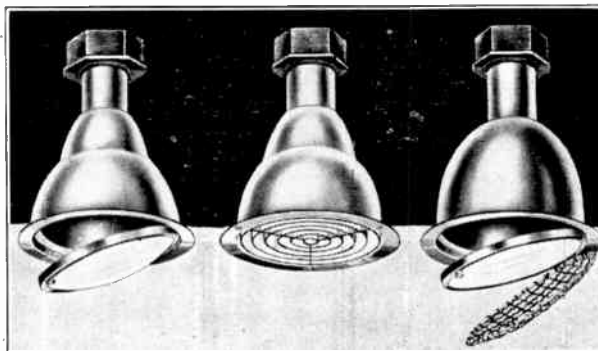

Concentrating Reflector With Hinged Ring Convex Roundel **Concentrating Reflector Removable Ring & Concentric Louver** **Distributing Reflector With Hinged Ring Diffusing Glass Wire Guard**

Flush Type: Available with hinged or removable ring of steel, finished in various colors of lacquer. Hinged type fastens edgewise through flange to ceiling or plaster ring. Removable type — ring screws to ceiling through face — reflector installed separately.

Suspended Type: For stem hanging (Stem not included). Furnished with "G" ring in place of ceiling ring.

Clear convex roundel or tempered diffusing glass. Other types are available at extra cost.

Reflectors, concentrating or distributing types of Lume-Crome.

Units with medium screw base receptacles have standard 4-in. outlet box cover. Larger sizes with mogul base receptacle have 1/2-in. i.p.t. cap.

Steel louvers, concentric or parallel, finished standard in aluminum gray. Heavy gauge wire guards with welded joints and rust-proofed finish.

Concentrating Reflector No.	1823	1930	1235	1540	1852
Distributing Reflector No.	3823	3930	3235	3540	3852
	Each	Each	Each	Each	Each
With Hinged Type Ceiling Ring.	\$10.45	\$11.73	\$15.30	\$20.40	\$27.54
With Removable Type Ceiling Ring.	8.41	9.44	13.00	16.33	21.43
With "G" Ring for Suspended Mounting.	2.55	3.06	3.83	9.18	12.75
Add for Convex Roundel Glass	2.55	3.06	3.83	9.18	12.75
Add for Tempered Diffusing Glass.	3.83	4.59	6.13	10.71	13.78
Add for Concentric Louvers.	4.08	4.59	5.10	6.63	8.68
Add for Parallel Louvers.	4.08	4.59	5.10	6.63	10.20
Add for Flat Wire Guard.	3.31	3.83	4.34	4.59	6.63
Add for Dished Wire Guard.	4.00	4.59	5.19	5.53	7.99
Add for Plaster Ring.	1.88	2.21	2.55	3.31	5.10
Lamp Receptacle.	Med.	Med.	Med.	Mog.	Mog.
Lamp Wattage.	100	150-200	300	300-500	750-1000
Height, Inches.	9 3/8	12 3/8	13 1/2	19	23
Plaster Ring I. D. Inches.	8 1/4	10 1/8	12	17 1/4	19 3/4
Ceiling Ring, O. D. Inches.	10	11 1/8	14	19	21 3/4

Hub Wall Mounting Bed Lights

With Holophane Controlens

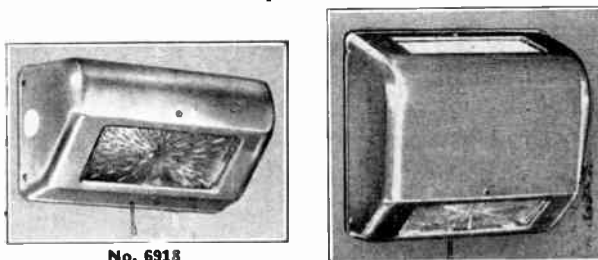

No. 6918

No. 6919

No. 6918—Cast aluminum housing. For 60-75-watt, A-19 lamp. Size 10 1/4-in. wide, 6-in. high. Each \$21.54

No. 6919—Cast aluminum housing. Two compartment type. Top for 150-watt lamp. Bottom 60-75-watt, A-19 lamp. Size 10 1/4-in. wide, 9 1/8-in. high. Each \$26.24

Day-Brite Incandescent Units

Recessed Canopy Units

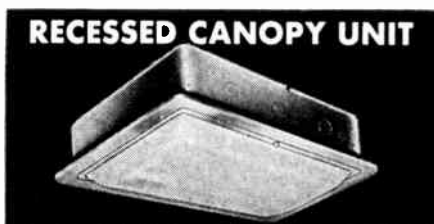

Ruggedly constructed 20-gauge steel recessing boxes, with porcelain sockets, anodized aluminum frames, and dished Albalite glass. Plenty of mounting holes are located in sides of the box for easy installation. Knockouts are located in the sides for line connections. U/L approved.

Length—13⁵/₁₆-in.

Width—8¹/₁₆-in.

Depth—3¹/₂-in.

Approx. ship. wt.—11-lbs.

No. **2501** Each **\$15.48**

Derby Downlights

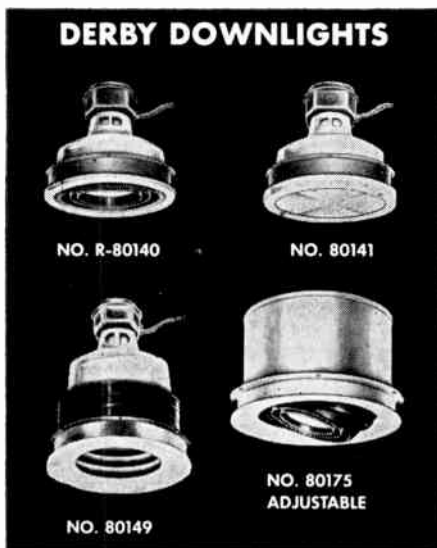

Derby Downlights are compact units with all the top quality of Day-Brite equipment. They are engineered to save time, trouble and expense on installation. All units feature one-piece die-drawn bodies—no seams, no raw edges. Lip flanges cover ceiling defects and prevent light leaks. All fixtures come supplied with flexible conduit, box connector and wire leads but are shipped unwired. Derby Downlights are especially suited for window displays, marquees, stores, lobbies, soda fountains, reception rooms, murals, restaurants, canopy lighting, escalators, foyers, churches, kitchens, rathskellers, etc.

Fixed Derby Downlights are available with louvers, 6³/₄-in. Holophane Controls and deep baffles. U/L Approved.

No.	Lamps No.	Size and Type	Depth In.	Ceiling Opng., in.	Approx. Ship. Wt., Lbs.	Each
R-80140	1	PAR-38, 150W	7	7	5	\$ 6.60
80141	1	A-21, 100W	7	7	6	9.00
80143	1	R-40 to 300W	7	7	6	7.20
80149	1	PAR-38, R-40 150W Spot	11 ¹ / ₄	9	10	11.76
80175	1	PAR-38, or 46 Side Prong	8	10	10	15.60

Duo-Frame Recessed Units

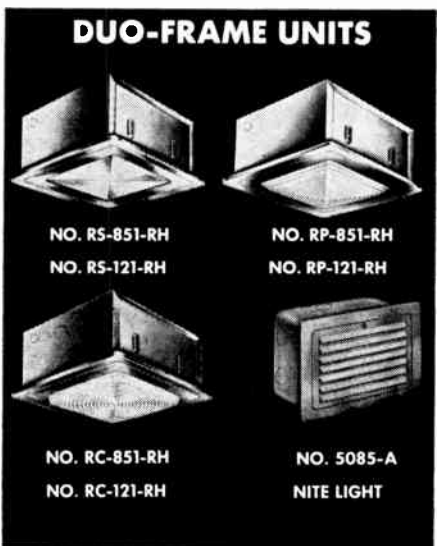

One-lamp units with 8¹/₂ and 12-in. lenses. Duo-Frame construction features outer frame that fastens to box after plastering and painting have been completed. Remains in position during servicing operations by means of drop hinges mounted to inner frame. Opens easily by means of knurled captive latch screw. No tools required.

Fixtures furnished complete with porcelain sockets mounted in removable wireways, specular Alzak reflectors and quality lenses for maximum efficiency. Fixtures are shipped unwired.

Frames and outsides finished in Hammerlord aluminum with Super-White inside. Rust inhibited before painting. Conveniently located mounting holes and knockouts for easy installation and electrical connections.

Corning lensed bowl and Phoenix square bowl lenses extend below ceiling line to provide splash light on ceiling area surrounding fixtures. Creates distinctive appearance while reducing brightness contrast. (Although not listed here, Duo-Frame units are also available with vertical lamp mounting and Holophane prismatic glass reflectors instead of specular Alzak.)

Hinged Louvered Nite Lite has die-drawn recessing box of heavy gauge steel. Duo-Frame construction porcelain socket is mounted to removable steel wireway and provides concealed wiring within the unit. Uses one 25W A-19 lamp.

Hinged Louvered Face Nite Light

No.	Hgt	Dimensions, Inches			Box Hgt	Width	Each
		Frame	Width	Depth			
5085-A	6 ⁷ / ₈		8 ¹ / ₄	3	5 ⁵ / ₁₆	7	\$4.68
5086	Same as above but stainless finish.						6.84

Duo-Frame Units

No.	Size	Lens Type	Size In., Sq.	Depth In.	Lamp Type	Approx. Ship Wt., Lbs.	Each
RS-851-RH	8 ¹ / ₂	Holophane	10 ⁷ / ₈	7	150W A-23	15	\$17.04
RS-121-RH	12	Holophane	14 ³ / ₈	9	200-300 PS-30	23	22.80
RC-851-RH	8 ¹ / ₂	Corning	10 ⁷ / ₈	7	150W A-23	15	15.12
RC-121-RH	12	Corning	14 ³ / ₈	9	200-300 PS-30	23	20.16
RP-851-RH	8 ¹ / ₂	Phoenix	10 ⁷ / ₈	7	150W A-23	23	15.36
RP-121-RH	12	Phoenix	14 ³ / ₈	9	200-300 PS-30	23	20.88

Litecraft Incandescent Downlights

Litecraft Hi-Hats, or downlights, are designed for installation wherever special lighting effects are desired as window displays in department stores, drug stores, reception rooms, or in homes. These fixtures are inexpensive, easy to install and take less space than ordinary fixtures.

Available in a wide variety of styles and sizes. The housings of Litecraft Hi-Hats are made of heavy-gauge metal. All finishes are dual-sprayed and baked twice at 375° F. to assure lifetime beauty of the fine finish.



D840
Shower-Lite

The heavy-duty porcelain sockets used are rated at 660 watts—250 volts. Litecrafts come wired with 4½-ft.—14G leads and are individually boxed. The gasketed D840 Shower-Lite (not wired) is ideal for weather-resistant installations. It's flashed opal lens gives widespread light distribution. All Litecrafts IBEW-AFL wired and labeled. Underwriters' Laboratories Approved. Heavy-gauge steel plaster rings available at modest cost. Specify when ordering.

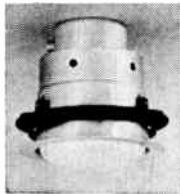

F340

No.	Type	Lamps Watts	Finish	Drum Diam. In.	Recess Depth In.	Plaster Ring In.	Face Plate In.	Std. Pkg.	Wt. Lbs. Pkg.	Each
F340	Open	*150W-R40	Satin Al.	5½	6¼	6⅛	7	18	35	\$ 3.06
F341	Louvered	*150W-R40	Satin Al.	5½	8⅛	6⅛	7	12	27	4.44
F343	Open	75W-R30	Satin Al.	4¼	5¼	4⅝	5¾	8	12	3.31
F344	Louvered	75W-R30	Satin Al.	4¼	6⅞	4⅝	5¾	8	14	4.44
F352	Skirted	*150W-R40	Silvertone	5½	6½	6⅛	7¼	6	14	7.38
F360	Semi-Recsd.	*150W-R40	Satin Al.	5¾	4½	6⅛	7	1	2½	2.63
F365	Ballled									
	5¼-in. Aperture	*150W-R40	White	8	10¾	8½	9½	4	28	15.38
F368	Surf. Louv.	*150W-R40	Satin Al.	5¾	7" long	1	2	7.13

Vapor-Resistant

**D840	Gasketed Opal Lens	75W IF	Satin Al.	4½	5	4⅝	7⅞	18	40	3.13
--------	--------------------	--------	-----------	----	---	----	----	----	----	------

*150 watt PAR38 may be used interchangeably with R40.

**Not wired.



F368

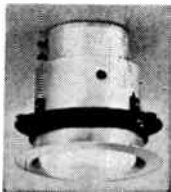

F343



F344



F352



F360



F365



F368

Litecraft Adjustable Recessed Lighting

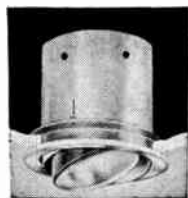

G502

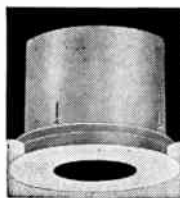

G509

Compact, versatile and modestly priced. . . . Ideal for use as store window, counter, display or accent lighting where lighting needs change. Litecraft units are among the most flexible ever developed. Their positive-action adjusting mechanisms and neat appearance make them useful for almost any commercial or residential application.

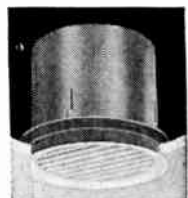

G510



G512

The ruggedly built housings are vented for extra cool operation. Equipped with 660 watts—250 volts heavy-duty porcelain sockets, wired with 4½-ft.—14G leads. Made by IBEW-AFL craftsmen and Underwriters' Laboratories approved. Standard finishes: Satin Aluminum or White. Litecrafts are dual-sprayed and baked twice at 375° F. to assure lifetime beauty of the fine finish.

Heavy gauge steel plaster-rings available at modest cost. Specify when ordering.

No.	Adjustability	Lamps Watts	Finish	Drum Diam. In.	Recess Depth In.	Plaster Ring In.	Face Plate In.	Std. Pkg.	Wt. Lbs. Std. Pkg.	Each
G502	27°	150W-PAR38	Satin Al.	5¾	6¼	6⅛	7¼	12	17	\$ 8.75
G509	Open 35°	150W-R40	White	10	9¾	10½	11½	1	8	15.50
G510	Louvered 35°	300W-R40	White	10	11¾	10½	11½	1	9	17.19
G512	41°	150W-PAR38	*	8	5¼	8½	10⅝	8	38	15.63

*Ball—Satin Aluminum. Face Plate—White.

Curtis Square Recessed Downlights

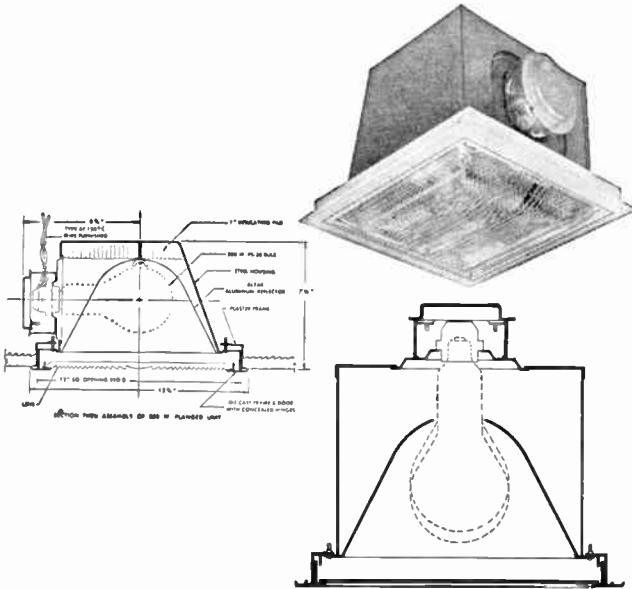

Curtis Square Recessed Series downlights have unlimited applications for all interiors. Units feature patented hinged steel door with no screws, nuts or hinges showing. Flush-type units mount at the ends or between sections of all Curtis Flush-type Eye-Comfort® Troffers.

Units with horizontal lamps (2400-2500 series) are supplied with socket positioned for 300-watt lamp. Units can be adapted to use 100, 150 and 200-watt lamps by repositioning the socket which automatically positions the lamp for maximum lumen output.

Units with vertical lamps (2800-2900 series) are for use with one 200 or 300-watt lamp only.

White Fluracite Enamel Frame and Door Finish

Horizontal Lamp		Vertical Lamp		Type of Lens	Each
Flange	Flush	Flange	Flush		
2400	2500	2800	2900	Corning Wide Angle Lens...	\$27.95
2401	2501	2801	2901	Corning Pebbled Glass...	23.25
2402	2502	2802	2902	Corning Corridor Lens...	30.95
2403	2503	2803	2903	Phoenix Dished Lens...	24.75
2404	2504	2804	2904	Luminex Glass 1/2 in. Heat-treated, etched...	24.95
2405	2505	2805	2905	Corning Concave...	28.75

Chrome Plated Frame and Door Finish

2420	2520	2820	2920	Corning Wide Angle Lens...	31.55
2421	2521	2821	2921	Corning Pebbled Glass...	26.85
2422	2522	2822	2922	Corning Corridor Lens...	34.55
2423	2523	2823	2923	Phoenix Dished Lens...	28.35
2424	2524	2824	2924	Luminex Glass 1/2 in. Heat-treated, etched...	28.55
2425	2525	2825	2925	Corning Concave...	32.35

Plaster Frames, Support Brackets and Accessories

No.	Description	Each
14000	Plaster Frame.....	\$3.85
14050	Extension Plaster Frame for ends of Curtis Eye-Comfort Troffers to accommodate Square Recessed Downlights listed above....	1.60
6430	Mounting Support Brackets for mounting units in other than plaster ceilings (4 per pkg.)....	.85
12029	White Fluracite enamel Patterned Louver for use with Corning Pebbled Glass lens.....	9.20
.....	Emergency light Circuit in downlights listed above. To Order: add -72 to catalog number of downlight wanted. Ex: 2400-72.....	7.35

Vari-Spot with Color-Ray Reflectors

Produce soft tones of colored light using a 100-watt silver bowl lamp. Units have 5 1/4-in. aperture, plain flange, require 10 3/4 in. recessing depth.

No.	Reflector	Each	No.	Reflector	Each
2257	Gold	\$17.65	2257-R	Red	\$17.65
2257-B	Blue	17.65	2257-P	Pink	17.65

Curtis Regressing Skirts

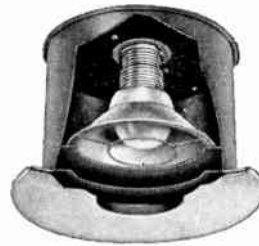

Vari-Spot with Ro-Tite**

The Curtis Vari-Spot features an adjustable Alzak* aluminum reflector that permits the diameter of the beam of light to be controlled and changed to meet specific lighting needs.

No.	Lamps No.—Watts	Aperture, In.	Flange	Recessing Depth, In.	Each
2245	1—100	3 1/2	Plain	8 3/16	\$16.20
2246	1—100	3 1/2	Decorative	8 3/16	16.20
2247	1—150	5 1/4	Plain	10 3/4	16.85



Punchy with Ro-Tite**

Curtis Punchy Units put concentrated, high-intensity light wherever accent is needed. Aluminum gimbal ring can be adjusted to any angle up to 0-35° from the vertical and 0-360° on the horizontal. Unit takes one 150W PAR-38 or R-40 screw base spot or flood lamp.

6-in. recessing depth.
No. 2250 Each \$15.95

Spotty with Ro-Tite**

Curtis Spotty is a fixed downlight using one PAR-38 or R-40 screw base spot or flood lamp. Three baffles reduce lamp brightness.

Unit takes one 150 watt lamp. Recessing depth 9 5/8 in. Fixed focus.

No.	Aperture In.	Each
2244	5 1/4	\$13.95
2248	3 1/2	13.95

Note: Plaster Ring for Spotlights above. No.—14011

**Ro-Tite is a ratchet fastening device that eliminates all screw heads, nuts and hinges on the flange surface. Easy access for maintenance.

©Curtis Lighting, Inc.

Call Graybar FIRST For . . .

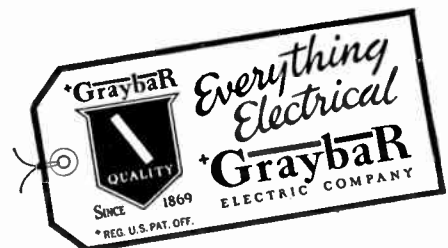

Day-Brite Accent and Exit Fixtures

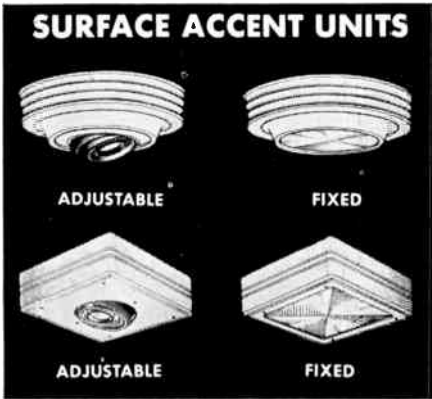

Designed for use in conjunction with Viz-Aid, Lennox, and Plexoline fixtures.

Boxes and trim finished in hot-bonded, super-white enamel with lamp housing on adjustable units in luster aluminum with interior of matt black. Adjustable units accommodate 150W PAR-38 or 200W PAR-16 side-prong lamps and include a two-prong connector with 18-in. asbestos covered leads. Fixed units include porcelain socket and 11 or 12-in. square or round Holophane Controlens with Alzak reflectors. Unwired.

For Plexoline 2

No.	Lamp Types	Depth In.	Outside Dimensions, In.	Shp. Wt.	Each
80160	PAR-38, 46 Side Prong	6 1/4	15-Diam.	16	\$27.48
80161	150W A-23	6 1/4	15-Diam.	11	18.72

For Plexoline 4

80165	PAR-38, 46 Side Prong	6 1/4	21-Diam.	25	35.94
80166	300W PS-30	6 1/4	21-Diam.	20	29.46

For Viz-Aid and Lennox 2

80112	PAR-38, 46 Side Prong	6	13 1/4-Sq.	12	15.00
80113	150W A-23	6	13 1/4-Sq.	15	20.64

For Viz-Aid and Lennox 4

80116	PAR-38, 46 Side Prong	6	16 1/2-Sq.	16	16.74
80117	300W PS-30	6	16 1/2-Sq.	20	23.10

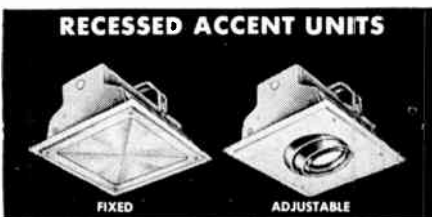

Square recessed accent units, adjustable or fixed, for use in conjunction with recessed troffers. Available with Holophane Controlens. Flange type individual unit with suspension strap. Unwired.

Fixed Recessed Unit

No.	Lamps Types	Depth In.	Outside Dimensions, In.	Shp. Wt., lbs.	Each
R80137	PAR-38, 46 Side Prong	6 7/8	12-Sq.	12	\$15.72

Adjustable Recessed Unit

R80127	150W A-23	6 7/8	12-Sq.	13	18.96
--------	-----------	-------	--------	----	-------



Day-Brite exit signs have been designed to blend with any interior. Smart modern appearance and size make these signs attractive as well as useful. A complete line of exit signs is available to fill any application: single face, double face, triangular, directional arrows, surface mounted, suspended, recessed . . . Exit signs for any room, corridor, lobby, auditorium, etc.

Years of research and engineering development have made this complete line of exit signs another "Decidedly Better" Day-Brite product.

Red glass with metal stencil. Hot-bonded luster aluminum finish. Two porcelain sockets for 25W A-19 lamps. Wired with 6-in. pigtailed.

Single Face—Surface Mounted

9 3/16-in. High, 13 9/16-in. Long, 4 3/16-in. Deep

No.	Letter Size, In.	Arrow	Approx. Shp. Wt., Lbs.	Each
3116	6	None	11	\$10.56
3115-R	5	Right	11	11.16
3115-L	5	Left	11	11.16
3115-D	5	Double	11	11.16

Double Face—Top or End Mounted

3126	6	None	12	15.60
3125-R & L	5	Right & Left	12	16.80
3125-D	5	Double	12	16.80

Recessed

7 7/8-in. High, 12 1/4-in. Long, 3 1/2-in. Deep

3106	6	None	8	9.36
3105-R	5	Right	8	9.96
3105-L	5	Left	8	9.96
3105-D	5	Double	8	9.96

Triangular

7 3/4-in. High, 11 3/4-in. Long, 10 1/2-in. Deep

3136	6	None	9	19.02
3135-R & L	5	Right & Left	9	20.22
3135-D	5	Double	9	20.22

Graybar Exit Light Globes



No. G10075—Side Bracket Type **No. G10075—Ceiling Type** **No. G608/434 Ceiling Type**

Size 8½ x 6 x 6 in.; Fitter 3¼-4 in.
Standard package 12; Weight Standard Package 30 lbs.
Letters 4½ in. high, ½ in. stroke.

Side Bracket

No.	Glass	Letters	Each
10075/429	Opolo	Black or Red	\$8.37
10075/432	Green Diffused	White or Black	9.21
10075/433	Ruby Diffused	White or Black	10.47

Ceiling Type

10075/434	Opolo	Black or Red	\$8.37
10075/435	Green Diffused	White or Black	9.21
10075/436	Ruby Diffused	White or Black	10.47

When ordering — Give number and specify color of letters and fitter size.

Ceiling Type — Ball Globe

Diameter, 8-in.; Fitter, 4-in. Letters are 3-in. high, ½-in. stroke. With Opollo white glass, black or red letters.

No.	*Description	Each
G608/434	Exit — 1 Side	\$8.34
	Exit — 2 Sides	9.63

*Specify on orders.

Standard package, 12; wt. per standard pkg., 30 lbs.

Kliegl Flush-Louver Ceiling Fixtures



No. 26 F 14

Directional reflector design with louvered ring light shields, that are efficient in performance, decorative in appearance and afford protection to lamp.

Suitable for gymnasium and other locations where this design is preferable and most practical.

Sturdy cast aluminum louvers, spun aluminum reflector with permanent Alzak finish. U/L approved.

Hinged louver permits easy access for relamping.

Completely wired with 5-ft. leads, ready for installation.

Surface mounted and suspension types of similar design also available to meet various structural conditions.

No.	Lens Diam., In.	Lamp Watts	Plaster Ring No.	Price Each	
				Unit	Plaster Ring
26F06	6	60	26F06/PR	\$24.80	\$3.75
26F06A	6	100	26F06A/PR	25.80	3.75
26F08	8	150	26F08/PR	29.00	4.00
26F12	12	200	26F12/PR	43.25	5.50
		300			
26F14	13½	300	26F14/PR	49.25	6.50
		500			
26F16	16	750	26F16/PR	68.50	7.50
26F16A*	16	1000	26F16A/PR	68.50	7.50

*For use in fire resistant structures only.

Kliegl Shovel Lights



Illuminates entire wall from ceiling to floor, evenly, without scallops. Unique reflector design projects the light through a small ceiling opening, 2½-in. x 2¼-in.

"Eyelid", projecting only ¾-in. below the ceiling line, shields opening, and light source is practically invisible under normal viewing conditions.

With units spaced 3½-ft. out from wall, on 3½-ft. centers, lighting will be uniformly graduated with an unnoticeable high value at eye level or normal picture height. U/L Approved.

Removal of interior baffle permits straight down lighting.

Uses standard long life flood lamps. Flush center plate is removable for relamping.

Plaster ring is furnished for framing.

Reflector has permanent Alzak aluminum finish. Mounting ring is machined cast aluminum.

No.	Lamp Watts	Lamp No.	Each
2175	150	150R/FL	\$55.00

Kliegl Baffled Downlights



No. 2510

Utilizes concentrated beam characteristics of standard reflector lamps for general illumination or accent lighting.

Cylindrical ring baffles trap the side spill rays and eliminate all glare or surface brightness. Lamp cannot be seen from normal viewing angle.

Units are easily relamped from below the ceiling through light opening.

Furnished fully wired with 5-ft. leads, ready for installation. U/L approved.

Made in cylindrical form for flush inbuilt or surface mounting. Also with square housing and face plate for recessed installations.

No.	Lamp Watts	Lamp No.	Each
2510	150	150R SP or /FL	\$21.80
2510E	150	150 PAR/SP or /FL	26.30
2510S	150		28.80
2511	300	300R/SP or /FL	32.00
2511E	300	300R/SP or /FL	38.00
2511S	300	300R/SP or /FL	41.00

E—surface mounted; S—square unit.

Kliegl Regressed Lens Ceiling Fixtures

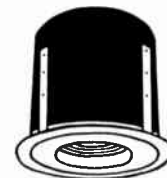

No. 2228

Designed for highest quality lighting. Provides direct illumination with efficiency of lens and reflector assembly, and visual effect of concealed downlight.

Gives comfortable lighting without side glare or surface brightness.

Cone supported regressed Fresnel heat resisting lens has coloured black riser.

Spun aluminum permanent Alzak-finish reflector. Sturdy cast aluminum combination plaster and finishing ring. U/L approved.

Mounting facilities adaptable to all types of building construction.

Completely wired with 5-ft. leads ready for connections.

Hinged face plate makes relamping easy operation.

No.	Lens Diam., In.	Lamp Watts	Plaster Ring No.	Price Each	
				Unit	Plaster Ring
2223	3	60	2223/PR	\$25.80	\$3.75
2224A	3	100	2224A/PR	25.80	3.75
2224	4½	100	2224/PR	28.80	3.75
2226A	6	100	2226A/PR	33.00	4.00
2226	6	150	2226/PR	33.00	4.00
2228	8	200	2228/PR	43.25	5.50
		300			
2232	12	300	2232/PR	71.50	6.50
		500			

Century Architectural Lighting

Elliptical Downlites

Alzak aluminum reflector for general service lamp—recessed.



No. 922



No. 962

Open downlite precision Alzak reflector, 45° cutoff, general service lamp, access through aperture.

Precision compound contour Alzak reflector for various sloped or flat high ceilings.

No.	Wattage	Aperture In.	Weight Lbs.	Each
902†	300	6 B	8	\$30.00
903	300	6 B	8	30.00
916*	1000	8 T	45	88.00
919*	1000	8 B	45	88.00
920	300	6 B	8	30.00
922†	150	5 1/4 B	5	19.00
923	150	5 1/4 B	5	21.50
926**	1000	8 T	45	90.00
929**	1000	8 B	45	88.00
930†	300	6 B	8	30.00
932†	100	5 1/4 B	5	19.00
933	300	6 T	8	32.00
936	1000	8 T	35	85.00
939	1000	8 B	35	82.00
960	500	7 T	12	66.00
961*	500	7 T	12	70.00
962**	500	7 T	12	72.00
963	500	7 B	12	70.00
964*	500	7 B	12	74.00
965**	500	7 B	12	75.00

Mounting frame included.

†Flush plaster ring construction. All other units for wet or dry ceiling.

*15° sloped ceiling units.

**30° sloped ceiling units.

No Greenfield included.

T—Top Access. B—Bottom Access.

Alzak Aluminum reflector for reflector type lamps—recessed.



No. 980

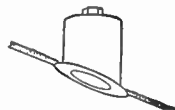

No. 982

82% efficiency which permits a minimum number of low brightness ceiling openings.

981—10' sloped ceiling
982—20' sloped ceiling.
983—30' sloped ceiling.

No.	Wattage	Aperture In.	Weight Lbs.	Each
980	500	9	15	\$47.00
981	500	9	15	51.00
982	500	9	15	54.00
983	500	9	15	57.00

Mounting frame included. No Greenfield included.

Project-O-Lites

Has optical lens systems; recessed. Provides precision beam cut-off.

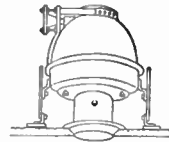

No. 1653

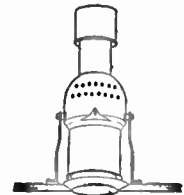

No. 1646

Compound contoured and stepped Alzak reflector, framing shutters and focusing objective lens system.

Powerful adjustable leko downlite employing precision optical train, projects beam through small ceiling aperture.

No.	Wattage	Aperture In.	Weight Lbs.	Each
1622*	60	1 1/2 T	16	\$ 49.50
1623*	60	1 1/2 B	16	56.10
1645	750	4 1/2 T	18	53.90
1646	750	6 T	23 1/2	58.30
1647	2000	8 T	30	106.70
1651	100	1 B	10	44.00
1653	400	3 1/2 B	18	75.00
1654	400	3 1/2 T	15	66.00
1655**	400	3 1/2 B	15	77.00
1656**	400	3 1/2 T	15	68.75

*15 volt transformer included. No Greenfield included. For installation in wet or dry ceiling—mounting frame included.

**Double Objective Lens.

T—Top Access. B—Bottom Access.

Straight Down Downlites

Recessed Reflector lamp type—soft edge beam.

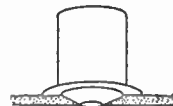

No. 1664

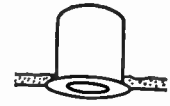

No. 299

30 Volt "Pinhole" downlite, self-contained transformer.

Vertical baffle downlite accommodates R30 lamp and color filter.



No. 338



No. 388

Concentric louvers use highly efficient reflector lamp.

Baffle downlite mounts flush and blends inconspicuously with ceiling.

No.	Wattage	Aperture In.	Weight Lbs.	Each
299	75	3 B	7	\$17.00
338	150	6 3/8 B	7	12.00
368*	150	5 1/4 TB	15	16.50
388	150	5 1/4 TB	15	16.00
398	300	7 TB	20	30.00
1664†	20	1 1/2 T	8	26.40
1665†	20	1 1/2 B	8	30.80

*Dropped ceiling plate for acoustical ceilings. Mounting frame included.

†30 volt. No Greenfield included.

T—Top Access. B—Bottom Access.

**Century Architectural Lighting
Angular Downlites**

Recessed reflector lamp type with adjustable socket device.

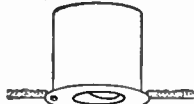

No. 352

Adjustable open type accentlite with 34° vertical and 360° horizontal adjustment using reflector lamps.



No. 396

Shallow adjustable accentlite requires only 8 in. above finished ceiling. Has 42° vertical and 360° horizontal adjustment.

No.	Wattage	Aperture Ins.	Weight Lbs.	Each
337	150	8 3/4	9	\$20.00
352	150	5 1/4	9	19.50
365	150	5 1/4	9	21.00
370*	150	5 1/4	9	23.00
395*	200	5 1/4	16	37.95
396*	200	5 1/4	15	36.30
399*	300	7 x 8	20	53.00

Mounting frame included. 55° spread lens included with 365, 370, 395. No Greenfield included.

*Flush plaster ring construction.

**Lekolites
Precision Beam—Built-In Control—Recessed**



No. 1680

Universally adjustable recessed lekolite, precision optical train includes 4-way shutters.



No. 1649

Powerful angled optical accentlite for beam angles between 30° and 60° employs precision optical train, includes framing shutters.

No.	Wattage	Aperture Ins.	Weight Lbs.	Each
1648	500	4 1/2	28	\$ 68.00
1649	750	6	33	73.00
1650	2000	8	60	126.00
1680	500	4 1/2	60	100.00
1681	750	6	60	106.50
1840*	500	4 1/2	85	171.00
1841*	500	4 1/2	110	236.00
1842*	500	4 1/2	130	306.00
1846*	750	6	85	177.00
1847*	750	6	110	251.50
1848*	750	6	130	322.00

*Multigang 2, 3 or 4 units with unistrut. No Greenfield included.

**Century Stage Lighting
Borderlights**

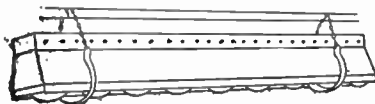

No. 450

Alzak reflectors, heat resisting colored glass roundels, chain hangers, scenery guards, splice box.

No.	Outlet Wattage	Outlet Centers Ins.	Weight Lbs. Per FL	Per Foot
411*	100	6	7	\$ 17.00
413*	300	8	8	20.33
414*	500	12	9	24.63
417*	150	6	7	17.00
450†	100	6	7	16.00
453†	150	6	8	16.00
455†	300	8	8	18.48
460†	500	12	9	23.63
412**	100	6	7	118.80

*Combination holder for roundels, gelatine or cinemoid.

**Sidearm clamp pigtail leads and 15 amp. connectors.

†Spring ring holders.

**Century Stage Lighting
Disappearing Footlites**

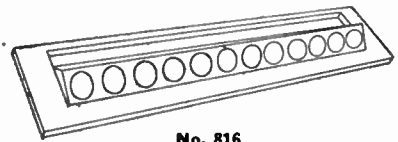

No. 816

Alzak reflectors, heat resisting colored glass roundels, kiln-dry maple trim, automatic mercury cutoff switch.

No.	Outlet Wattage	Outlets	Weight Lbs. Per FL	Each
815*	100	15	50	\$ 84.70
816	100	12	50	116.00
817	150	9	86	123.50

*Continuous Alzak reflector (no roundels).

"Paint with Light" Strips

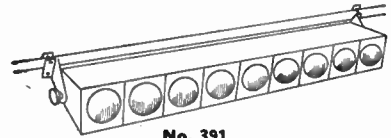

No. 391

Combination holders with 55° spread, heat resisting colored glass roundels, individual compartments wired for PAR or R type lamps.

No.	PAR and R Type Lamps	Outlets	Weight Lbs. Per FL	Each
391	300	12	39	\$103.00
394	300	9	29	79.50
397	300	15	47	130.00
431*	300	12	45	131.00
434*	300	9	35	107.00
437*	300	15	53	158.00
470†	300	12	80	} Price on application.
475†	300	9	90	

*Includes 6 pigtail leads and 15 amp. connectors.

†With stripped glass filters.

Incandescent Follow Spots



No. 998

Medium intensity sharp or soft edge follow spot with iris and horizontal cut-off shutters.

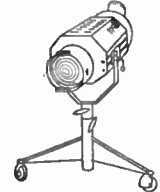

No. 1542

Alzak ellipsoidal reflector, heat resisting lens. Built-in parallel horizontal shutters and iris, flip in spread lens for wide beam, spring balanced stand, switch and cable, focusing handle and lock.

No.	Wattage	Lens Diam. Ins.	Beam Spread Degrees	Weight Lbs.	Each
998	1500	6	20-32	150	\$250.00
999	2100 (60V)	6	20-32	200	550.00
1542	3000	12	12 Max.	200	550.00
1545	5000	12	12 Max.	200	625.00

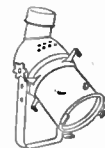

No. 1591

**Lekolites
Precision Beam—Built-In Control**

Alzak ellipsoidal reflector, heat resisting lenses, built-in 4-way adjustable shutters, yoke and C clamp, color frame, wire lead.

No.	Wattage	Lens Diam. Ins.	Beam Spread Degrees	Weight Lbs.	Each
1568	2000	8	22 Max.	97	\$133.25
1575	750	8	26 Max.	30	90.75
1581	500	4 1/2	50 Max.	13	65.00
1591	750	6	40 Max.	17	65.00
1566	2000	8	24 Max.	97	129.50
1579	750	8	19 Max.	30	88.00
1587	500	4 1/2	45 Max.	13	49.50
1597	750	6	24 Max.	17	49.50

Century Stage Lighting

Fresnelites

Soft edge beam—variable focus. Alzak spherical reflector, heat resisting Fresnelens, yoke and C clamp, color frame, wire lead, adjustable focus.

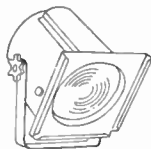

No. 500

No.	Wattage	Lens Diam. Ins.	Beam Spread Degrees	Weight Lbs.	Each
500	750	6	20-60	7	\$ 25.00
526	1500	8	15-45	18½	61.00
530	2000	10	25-60	24	82.50
534	5000	14	24-60	46	132.00

Fresnelite Jr.



No. 1211



No. 523

Alzak spherical reflector, heat resisting Fresnelens, yoke, base cord and Hubbell plug. Soft edge beam—variable focus.

523	150	3	15-40	3½	20.00
1211	150	3	16-40	3	18.00

Floodlights—Wide Spread

Wide angle floodlights for lighting large areas at close range. Standard equipment in wings and at foot of backdrop. Alzak reflector, have yoke and C clamp, wire lead.

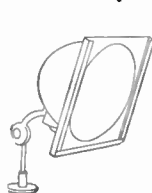

No. 2927



No. 1305

No.	Wattage	Lens Diam. Ins.	Beam Spread Degrees	Weight Lbs.	Each
2927*	400	10	130	4	\$ 15.00
1302	500	14	130	9	30.00
1305	2000	16	130	8	38.00
1318	2000	18	130	15	38.00

*Universal mounting bracket.

Floodlights—High Powered—Narrow Beam

Alzak parabolic reflector, built in baffle, yoke and C clamp, focusing adjustment, color frame, wire lead and 2 wire 2 pole connector.

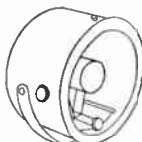

No. 1515

No.	Wattage	Lens Diam. Ins.	Beam Spread Degrees	Weight Lbs.	Each
1502	2000	16	18-24	22	\$ 60.50
1515	750	10	12-20	13	52.80

Cinemoid Color Mediums

Long life, heat resisting, weatherproof. Impervious to moisture. Pure uniform colors. Heavy gauge for long life. Now stocked in all colors in size 21 in. x 24½ in. Heat resistant, waterproof, for use on high or low wattage lamps, indoors or outdoors.

Send for sample book listing all colors. Each \$1.15.

Dimmers and Switchboards

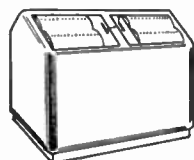

Permanent—Portable—Remote Control—Manuals
C—I All Tube Systems
Magnatrol—Magnetic Amplifiers
Auto Transformers

Century T-V Studio Lighting

Fresnelites

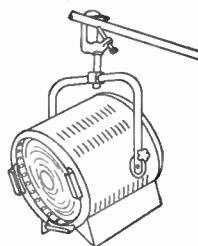

No. 572

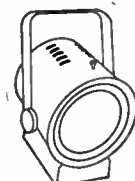

No. 520

Soft edge beam—Variable focus—Readily controllable. Include Alzak reflector, heat resisting pyrex Fresnelens, yoke and C clamp, wire lead and 2 wire 2 pole male connector.

Accessories available are barn door, high hat, diffuser frame.

No.	Wattage	Lens Diam. Ins.	Beam Spread Degrees	Weight Lbs.	Each
520	750	6	25-72	12½	\$ 30.50
523	150	3	15-40	3½	20.00
526	1500	8	15-45	18½	61.00
530	2000	10	16-45	24	82.50
534	5000	14	15-45	46	132.00
554	5000	14	16-46	21	230.00
560	10,000	20	16-46	85	490.00
571	2000	8	15-57	52	70.00
572	2000	12	30-70	65	115.00
576	5000	16	32-45	85	155.00

Scooplights (Floodlights)

Compact, flexible, mobile, lightweight.

Include Alzak reflector, yoke and C clamp, wire lead and 2 wire 2 pole connector.

Accessories available are diffuser frame.

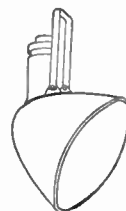

No. 1318

No.	Wattage	Lens Diam. Ins.	Beam Spread Degrees	Weight Lbs.	Each
1312	500	14	8	\$ 30.00
1315	1500	16	8	38.00
1318	2000	18	12	38.00

Striplites

May be placed behind ground rows or scenery on floor, near cyclorama, or overhead.

Include 6 Alzak reflectors, male end connectors wired for thru feed on two circuits, trunnion for pipe or floor mounting. Unitized diffuser frame available as accessory.

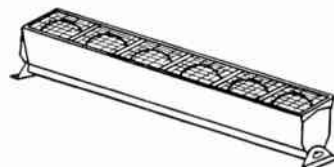

No. 440

No.	Wattage	Lamp Center Ins.	Length Ft.	Weight Lbs.	Each
440	200	8	4	40	\$98.00

Connector Troughs

These are wiring troughs made to required size—with outlet centers spaced as desired, with rating generally of 20 amp. per outlet. 50 amp. outlets can be furnished if required.

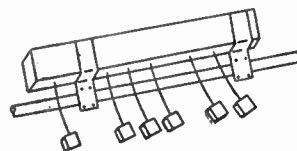

No. 6200

No. 6200	With 20 amp. outlets	}	Price on Application
6300	With 50 amp. outlets		

Hub Borderlights



Individual Reflector Type

With individual Lume-Chrome reflectors, fitted with clear and natural colored convex, heat-resisting glass roundels. Hinged retaining rings hold either roundels or metal frames for gelatin.

Wired for three or more colors and additional circuits as required for worklights, spotlights, etc.

Fitted with chain hangers, heavy scenery guards and splice box with terminal blocks.

No. 21625

Furnished in any length (Please specify length.)

No.	Outlet Wattage	*Outlet Spacing In.	Face, In.	Ht. In.	Shlp. Wt. Lbs. Per Ft.	Per Foot
21623	100	6	7 1/2	9	13	\$14.36
21625	150	6	7 1/2	10 1/4	13	14.36
21830	200	8	9 1/8	13 1/2	15	16.58
21235	300-500	12	14 1/4	17 1/2	20	26.39

Worklight Receptacles

Single outlet in top of borderlight to connect spotlights, worklights, etc. 15 ampere, 125 volts.

No. 526 Each \$8.05

Upper Worklight Units

To fit No. 526 Receptacle. Consists of reflector, glass roundel, retaining ring, attachment clamp, cable and plug.

No.	With Reflector	Each
WL-1625	For 100 or 150 Watt Lamps	\$12.79
WL-1830	For 200 Watt Lamps	14.54

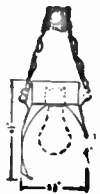

Type A, With Continuous Reflector

For colored-bulb lamps up to 100 watts. Fitted with chain hangers and splice box for feed cables.

Size: 5 1/2 in. wide, 8 1/2 in. high; length as required.

Wired standard for three colors; additional colors and required circuits. (Please specify).

No. 20804L

Matte White or Lustralume Aluminum Lacquered Reflecting Surface

No.	20804P	20806P	20808P
*Outlet Spacing, In.	4	6	8
Per Foot	\$7.95	\$7.65	\$7.28

Lume-Crome or Alzak Aluminum Reflector Lining

No.	20804L	20806L	20808L
*Outlet Spacing, In.	4	6	8
Per Foot	\$9.95	\$9.28	\$9.30

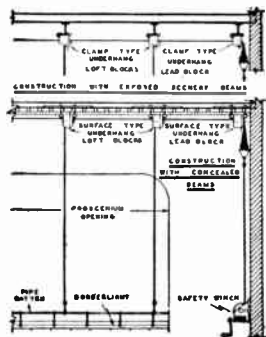

Hub Winch Rigging

For raising or lowering borderlights. Consists of wire cables running over ceiling blocks to a winch. Ceiling blocks and winches are furnished in varying capacities according to load.

When ordering, specify type of ceiling (exposed or concealed beams) dimensions of stage, including height and length, and type and weight of borderlights.

No. of Lines In Set	Max. Proscenium Opening, Ft.	Per Set
2	20	\$153.00
3	35	178.50
4	45	250.00

*Minimum center to center.

Hub Disappearing Footlights

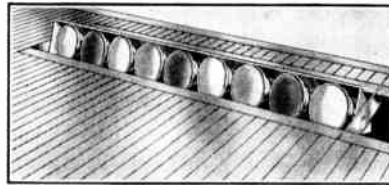

No. 41625

These footlights present a practically unbroken front, but project slightly above stage floor in use, fold flush when not in use,

and are locked both open and closed.

Cover and trim of kiln-dried maple. Lamp carriage secured to back of cover.

Furnished in 5-ft. sections with three Mercury cut-off switches, splice box and flexible armored conduit.

Wired standard for three colors. Additional colors and required circuits as specified.

Approved by Underwriters' Laboratories, Inc. and comply with N.E.C. Standards.

Type I—With individual spun reflectors and pivoting retaining rings for glass roundels or gelatin color frames.

Type L—With continuous LUME-CROME reflector.

Type P—With continuous matte white or Lustralume aluminum lacquer reflector.

No.	Type	No. Outlets	Lamp Wattage	Width Frame, In.	Shlp. Wt. Lbs.	Per 5-Ft. Section
41623	I	9	100	18	90	\$117.71
41625	I	9	150	18	95	117.71
43523	I	12	60-100	14	80	102.00
40004-L	L	15	40-100	14	75	89.25
40004-P	P	15	40-100	14	70	83.45

Hub Permanent Semi-Flush Footlights

Wired standard for three colors. Additional colors and required circuits as specified.

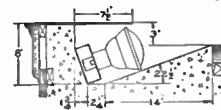

Open Type

With individual spun reflectors and glass roundels in pivoting retaining rings that also accommodate gelatin frames. Tread plate not included.

Can be furnished in any length. Center to center minimum spacing, 6-in.

No.	Lamp Wattage	Per Foot
61623	60-100	\$12.98
61625	150	12.98

Saffred Type

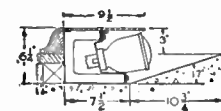

No. 63520

With individual spun reflectors and glass roundels in pivoting retaining rings that also accommodate gelatin frames.

Top is of 3/16-in. steel tread-plate supported on heavy channel brackets, angle iron reinforced. Furnished

in any length. Reflector outlets spaced 6-in. on center, minimum.

No.	Lamps, Watts	Per Foot
63520	60-100	\$23.26
63620	150	25.00

Hub Ceiling Bowl Element

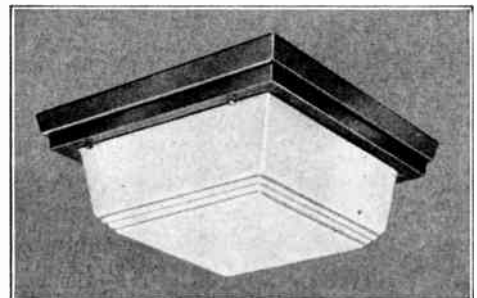

Has moulded white Monax diffusing bowl with three medium base sockets. Fixture is 15-in. square, 5 3/8-in. high.

No. 5715 Each \$39.10

Hub Portable Footlights



No. 73523

Can be furnished in multiple sections up to 10 ft. each, complete with connecting cables and separable connectors or twist-lock couplings; (Specify when ordering.)

Individual Reflector Type

With Lume-Crome reflectors and glass roundels for 60 to 100 watt lamps. Reflector outlets spaced 6 in. on center minimum. Size: 10 1/8-in. wide, 5 3/8-in. high.

No. 73523 Per Foot **\$13.33**

For each two-conductor cable lead and two-pole half connector, add **\$5.85**.

Continuous Reflector Type

With continuous reflector for colored bulb lamps. Sockets spaced 4 in. on center, minimum. Size: 8 1/4 in. wide, 3 1/2 in. high.

No. 70004P—Matte White or Lustralume Aluminum Lacquer Reflecting Surface. . . . Per Foot **\$7.95**

No. 70004L—With Lume-Crome or Alzak Aluminum Reflector Lining. Per Foot **9.95**

For each two-conductor cable lead and two-pole half connector, add **\$5.85**.

Hub Flush Floor Pockets

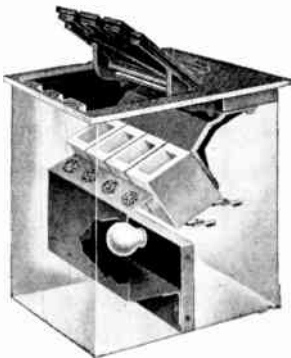

Heavy gauge metal construction with cast-iron, non-skid safety-tread top and self-closing flush door.

Pilot light and color identification jewel for each receptacle, automatically illuminated when door is opened.

Designation discs show service of each receptacle.

Recess box 12 1/2-in. deep, 10 3/4-in. long.

Two-Wire, 250 Volts, 50 Amperes

No.	With Pilot Light and Jewels, Each	With Pilot Light Only, Each	Without Pilot Light, Each	No. Receptacles	Wtd. Box, In.
10051		\$22.45	\$15.05	1	4 7/8
10052	\$36.24	29.09	21.48	2	4 7/8
10053	49.21	40.73	32.66	3	9 3/8
10054	62.18	51.45	43.37	4	9 3/8

Hub Wall Pockets

Can be furnished for flush or surface mounting, in open type or with spring-hinged door for each receptacle. (Specify when ordering). Box 7-in. high, 5 1/4-in. deep.

Two-Wire, 250 Volts, 50 Amperes

Flush Type			Surface Type			No.	Wtd. Box, In.
No.	Open, Each	With Doors, Each	No.	Open, Each	With Doors, Each	Receptacles	
11051	\$12.78	\$13.90	11051	\$12.78	\$13.90	1	6
11052	19.25	21.48	11052	19.25	21.48	2	7 3/4
11053	27.96	31.33	11503	27.96	31.33	3	9 7/8
11054	36.68	41.15	11504	36.68	41.15	4	12

For brass face plate add 15% to price of door type pocket. For lock-type door add **\$5.36** to price. Single door with lock and two keys supplied for multiple receptacles (not a door over each receptacle).

Extra Plugs and Receptacles

No.	Description	Each
476	50 Ampere Plug	\$3.40
480	50 Ampere Receptacle	2.80

Hub Directional and Exit Signs



Flush Type Concealed Hinge Front

Made of steel. Recess box has 1/2-in. knockouts and removable channel for concealed wiring including two receptacles for medium screw base lamps.



Surface Type Concealed Hinge Front

Exposed surfaces finished standard in silver gray lacquer; Interior sprayed Lustralume lacquer. Other finishes — Prices on application.

Exit — Ruby or green letters on white background; white letters on ruby or green background — standard.



Flush Type, Two-Piece Continuous Hinge Frame

Directional inscriptions — Ruby, green or black letters on white background; White letters on ruby, green, or black background — standard.

Opaque bronzetone, aluminum or opal background, or special glass, lettering and designs — prices on application.

With Concealed Hinge Front

No.	Depth	Box Size, In. Ht.	Wtd.	Exit		Directions	
				Letter Ht. in.	Each	1-Line Each	2-Line Each
9003	4	6	12	3	\$16.74	\$20.35	\$22.15
9005	4	8 3/4	13 3/4	4, 5, 6	17.71	23.50	25.95
9006	4	10 3/4	16 3/4	6, 8	21.15	27.51	31.54

Surface Type

9203	3 1/2	7 1/4	13 1/4	3	17.71	\$21.26	\$23.04
9205	3 1/2	10	15	4, 5, 6	18.70	24.61	26.85
9206	3 1/2	12	18	6, 8	22.63	29.09	33.10

If wanted with wire guard add **\$3.93** per sign.

With Two-Piece Continuous Hinge Frame

Flush Type							
No.	Depth	Box Size, In. Ht.	Wtd.	Letter Ht. in.	Each	1-Line Each	2-Line Each
9060	4	7 3/4	12 1/4	3, 4, 5	\$21.65	\$24.61	\$26.39
9061	4	8 3/4	13 3/4	6	23.13	27.48	29.79
9062	4	10 3/4	16 3/4	8	24.60	29.40	33.24

Surface Type

9260	4	9	13 1/2	3, 4, 5	23.13	25.95	27.74
9261	4	10	15	6	24.61	28.89	31.04
9262	4	12	18	8	30.25	35.50	40.00

If wanted with wire guard add **\$3.93** per sign.

Kliegl Pin Hole Downlights

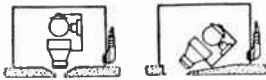

No. 2144 No. 2147
Top relamping

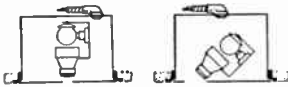

No. 2145 No. 2146
Bottom relamping

Small flush-type ceiling fixtures with an objective lens system and framing shutters for adjusting the beam spread and shape.

Used primarily for accent lighting. Light rays are projected through small aperture in ceiling.

Vertical models are used for lighting dining tables, game room equipment, and the like.

Angular models are generally used for lighting pictures, showpieces, and similar objects of art or decoration.

Beam may be patterned in square, circular or irregular forms to suit requirements. Easily relamped from above or below ceiling depending on design selected.

No.	Projection	Relamping	Lamp Watts	Lamp No.	Each
2144	Verticle	Top	75	75G16-1/2/DC	\$48.00
2147	Angular	Top	100	100G16-1/2/29DC	54.00
2150	Verticle	Top	100	100A21/FL	54.00
2151	Angular	Top	250*	250G/FL	64.00
2145†	Verticle	Bottom	75	75G16-1/2/DC	51.00
2146†	Angular	Bottom	100	100G16-1/2/29DC	51.00
2148†	Verticle	Bottom	100	100A21/FL	63.00
2149†	Angular	Bottom	250*	250G/FL	63.00

*Fire proof construction only
†Furnished with Plaster Ring

Kliegl Frontlights



No. 2170

Adjustable-beam downlight, mounted on circular frame with hinged front plate. Units may be rotated and tilted to direct light beam in required direction.

Designed for frontlighting a stage, floor show, spotlighting people or similar adaptations. May be focused to form a pattern with adjustable framing shutters.

Has highly efficient ellipsoidal reflector and focusable lens system.

Relamping can be done from above or below ceiling. U/L approved.

No.	Type Shutters	Beam Spread	Lamp Watts	Lamp No.	Each
2165	Drop-in	53°	500	500/T14/8	\$ 75.50
			750	750/T14	
2167	Drop-in	53°	1000	1M/T24/12	128.50
2170	Built-in	53°	500	500/T14/8	84.50
			750	750/T14	

Kliegl Picture-Lighting Projectors



No. 276AA

Fitted with an optical system and four-way adjustable cut-off shutters. Permits regulation of size and shape of light beam so that illumination may be confined to any desired area or object.

Flexibly mounted in a yoke, light beam can be projected in any direction. Units are portable with suitable supports and may be placed on a table or shelf, hung from ceiling or fastened on wall.

Furnished with 9-ft. extension cord and attachment plug.

No.	Hgt. In.	Width In.	Lgt. In.	Lamp Watts	Each
276	6½	4½	7½	75-100	\$35.00
276AA	8½	6	9	100-250	41.00

Kliegl Fresnel-Lens Spotlights



No. 43N8-E

General purpose type spotlights which project a high intensity circular spot or floor beam with even field of illumination and soft diffused outline.

Spread range approximately 10° to 55°.

Has simple focusing adjustment and unrestricted directional movement.

Fully equipped with lamp holder, spherical polished Alzak aluminum reflector, heat-resisting Fresnel lens, and light-tight ventilated housing. U/L approved.

Supplied with pipe clamp mounting. Other kinds and sizes of mountings from 100 to 10,000 watts available.

No.	Lamp Watts	Lens Diam. In.	Type Mounting	Each
43N6-E	500	6	Pipe Clamp	\$26.30
43N8-E	1000	8	Pipe Clamp	64.00

Kliegl Klieglights



No. 1365 No. 1366

Projects high intensity light beam which may be patterned to any desired shape.

Particularly serviceable where illumination of area with a well defined cut-off of light is required.

Consists essentially of an ellipsoidal reflector and lens system coordinated

with adjustable framing shutters.

Reflector is spun Alzak polished aluminum. Has stepped lens with black risers held in movable mount to permit focusing.

Four-way adjustable shutters are built in the unit. Slide grooves on front hold a color frame. U/L approved.

Units is supported in a swivel yoke and supplied with pipe clamp. Other sizes and mountings are available.

No.	Lamp Watts	Lens Diam. In.	Type Mounting	Each
1365	200/500	6	Pipe Clamp	\$ 55.25
1366	1000/2000	6	Pipe Clamp	119.00

Kliegl Booth Spotlights



No. 1174 No. 1178

Dyna-beam Klieglights

Produces an exceptionally powerful beam. Used to spot or floodlight the stage from distances of 75 to 200 feet.

Mounted on roller cast-er floor stand. Fitted with step (front) lens in sliding mount; auxiliary spread lens on hinged mount; inbuilt curtain and iris shutters; ellipsoidal polished Alzak aluminum reflector; forced air ventilating system.

No. 1179 is equipped with color boomerang attached to front of unit which permits quick color changes.

Super-Klieglights

Similar in design to Dyna-beams, except they accommodate lower wattage lamps; are not equipped with auxiliary spread lens. No. 1175 is equipped with color boomerang. Super-Klieglights are effective within their working range up to 100 feet.

No.	Description	Lamp Watts	Lens Diam. In.	Each
1178	Dyna-beam	3000	12	\$619.00
1179	Dyna-beam	3000	12	823.00
1174	Super-Klieglight	2000	12	396.00
1175	Super-Klieglight	2000	12	541.00

Kliegl Disappearing Footlights

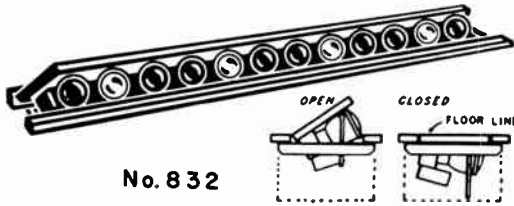

No. 832

Single row reflector type, 5-ft. section, with 12 receptacles for 75/100 watt A-21 lamps. Each reflector equipped with an Alzak aluminum reflector and 4-in. glass color roundel.

Wired for three colors. Supplied with white (clear), blue and red color glass roundels.

Continuous style flooring with floor panel hinged to back strip, and provided with swinging bracket for tilt adjustment.

Equipped with splice box, terminal block and automatic mercury cut-off switches. U/L approved.

No. 832. 5-ft. section, 12 outlets Each \$114.00

Kliegl Permanent Borderlights

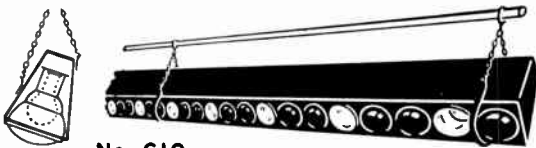

No. 610

Individual reflector type with receptacles for 100/150 watt A-21 medium screw base lamps, spaced 6-in. on centers.

Wired for three or four colors as specified, furnished with glass color roundels in hinged-ring holders. U/L approved.

No.	Lamp Watts
610	100
610A	150

Prices on application.

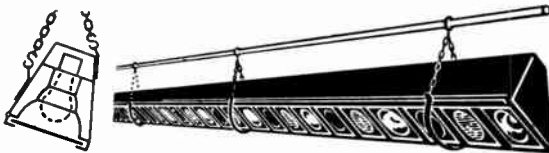

No. 610-C

Universal type for 100 watt A-21 medium screw base lamps, spaced 6 3/8-in. on centers.

Equipped with slide grooves on front of each reflector compartment. Furnished with removable frames for Cinemoid, gelatine or glass color mediums.

No. 610C. Universal borderlight. . . . Price on application

Crouse-Hinds Mercury Floodlights

Types MVE 12-14-16
250 to 1000 Watt
Heavy Duty



No.	Reflector	Max. Size Watts	Lamps Type	Each
Type MVE-12				
47021	Wide Beam	250	115	\$ 86.00
47022	Narrow Beam	250	115	86.00
Type MVE-14				
47023	Wide Beam	400	111	136.00
47024	Narrow Beam	400	111	136.00
Type MVE-16				
47025	Wide Beam	1000	1115	170.00
47026	Narrow Beam	1000	1115	170.00

Crouse-Hinds Mercury Floodlights

Types MVB-14 and MVB-16 400 to 1000 Watt

General Purpose



No.	Type	Reflector	Max. Size Watts	Lamps Type	Each
47027	MVB-14	Etched Alzak	400	111	\$67.00
47028		Polished Alzak			74.00
47029	MVB-16	Etched Alzak	1000	1115	84.00
47030		Polished Alzak			94.00

Types MVF and MVM 400 to 700 Watt

General Purpose

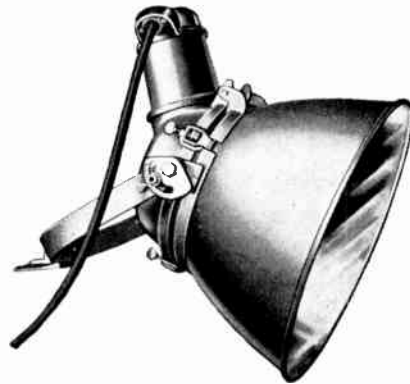

No.	Type	Reflector	Max. Size Watts	Lamp Type	Each
47034		Wide Beam-Etched Alzak			\$ 87.00
47035	MVF	Medium Beam-Polished Alzak	400	111	95.00
47036		Narrow Beam-Polished Alzak			108.00
47031		Wide Beam-Etched Alzak			78.00
47032	MVM*	Medium Beam-Polished Alzak	700	1118	88.00
47033		Narrow Beam-Polished Alzak			88.00

*Not illustrated.

Note: Catalog numbers do not include mercury lamps. Specify lamp to be used: "111," "1115," etc.

Accessories and Parts—Purchased with Floodlight

Description	Add Suffix	Description	Add Suffix	Each
*Diffusing lens, cl. (MVB-14, 16; MVE-12, 14, 16)	DF	SlipFitter Base 2" Pipe (MVB-14, 16; MVF & MVM)	6B	\$6.00
*Plain lens, cl. (MVB-14, 16; MVE-12, 14, 16)	PL	SlipFitter Base 2" Pipe (MVE-12, 14, 16)	6B	6.00
*Smooth Beam lens, cl. (MVB-14, 16; MVE-12, 14, 16)	SM	Flat Base (MVB-14, 16)	FB	2.00
*Pl. Heat Res. lens (MVM only)		Cross-Arm Base for Wood or CWSB Steel Arm (MVF & MVM)	*	
Pipe Top Ball. Mntg. w/2-2 1/2"		SlipFitter for 3 3/16" dia.	PTB	6.00

*No extra charge.

Crouse-Hinds Mercury Floodlights

Type	Reflector	Lens	W. & Type	Lamp	Photometric Data *			Beam Spread		
					Lumens	Lumens	Beam Efficiency	C. P.	Horizontal ¹	Vertical ²
MVE-12	Wide Beam	SM	250	10800	4880	45.2	23620	48.0	49.2	
		SP			4990	46.2	16170	57.2	48.4	
		SW	C-II5		5080	47.0	5340	138.5	62.0	
		DF			5210	48.3	7150	93.0	89.6	
	Narrow Beam	SM	250	10800	4374	40.5	41910	33.1	31.7	
		SP			4560	42.3	28280	42.0	30.0	
		SW	C-II5		4130	41.0	8125	124.2	34.6	
		DF			4905	45.4	13320	66.5	68.2	
	Wide Beam	SM	250	9600	4770	49.7	5590	93.2	90.6	
		SP			4815	50.2	5420	102.0	88.0	
		SW	D-II5		4860	50.7	2650	152.0	92.0	
		DF			4945	51.5	4210	108.2	100.4	
MVE-14	Wide Beam	SM	400	19400	9166	47.2	42620	43.4	50.0	
		SP			9230	47.6	38003	62.0	46.0	
		SW	E-III		10240	52.8	12736	136.0	54.8	
		DF			10578	54.4	17885	83.0	81.3	
	Narrow Beam	SM	400	20300	6946	34.2	100240	28.4	29.4	
		SP			19400	7724	39.8	62230	45.2	31.1
		SW	E-III		20300	8602	42.4	16240	126.0	44.5
		DF			20300	9192	45.3	21670	66.8	68.4
	Wide Beam	SM	400	19400	10574	54.5	12337	90.4	91.8	
		SP			9580	50.4	10320	102.4	86.2	
		SW	J-III		19000	9194	48.4	5042	160.4	90.3
		DF			19000	9566	50.3	8025	111.0	106.0
MVE-16	Wide Beam	SM	1000	52250	22710	43.5	43275	78.4	88.4	
		SP			25518	48.9	32175	104.0	99.1	
		SW	A-III5		24304	46.5	16428	154.0	93.4	
		DF			26334	50.4	23965	118.8	120.9	
	Narrow Beam	SM	1000	52250	19978	38.1	60945	59.8	73.2	
		SP			25358	48.5	45855	83.0	95.1	
		SW	A-III5		20838	39.9	17335	144.0	99.0	
		DF			23580	45.0	49110	78.1	82.2	
	Wide Beam	SM	1000	49400	25280	51.2	16988	114.0	113.6	
		SP			24856	50.3	18160	118.0	103.3	
		SW	B-III5		23410	47.4	10248	164.0	101.9	
		DF			25536	51.7	15935	128.0	126.0	
MVF	W.B. Etched M.B. Polished N.B. Polished	PL	400	20000	9864	49.4	11500	91.0	91.0	
		PL			8966	44.8	77000	36.5	41.0	
		PL	E-III		7378	36.9	154000	22.0	32.0	
	W.B. Etched M.B. Polished N.B. Polished	PL	400	19000	8124	42.8	7410	102.0	101.0	
		PL			10004	52.5	16580	73.0	75.0	
		PL	J-III		9922	52.2	20670	73.0	74.0	
MVM	W.B. Etched M.B. Polished M.B. Polished	PL	700	36000	18712	51.9	18723	105.0	100.1	
		PL			17144	47.6	61540	57.2	65.2	
		ST			18654	51.8	37085	80.6	80.3	
	M.B. Polished N.B. Polished	SW	A-III8		21152	58.8	18477	152.8	86.4	
		PL			13292	36.9	111780	37.2	48.8	
		PL	700	34000	14936	43.9	11682	110.0	106.9	
PL		18080	53.2		19028	98.6	97.2			
SW	B-III8	18674	54.9		9931	167.2	104.5			
MVB-14	Etched Polished Polished Polished	SM	400	20300	8022	39.5	8411	99.0	99.0	
		SM			6444	31.7	85950	30.0	30.4	
		SP			7060	34.8	55090	46.2	31.9	
		SW	E-III		8392	41.3	15400	125.8	45.3	
	Polished	DF			8038	39.6	24590	61.6	61.9	
		SM	400	19400	7542	38.9	6080	106.6	106.8	
		SM			9118	47.0	11843	92.0	90.7	
		SP			9190	47.4	11268	98.0	89.9	
	SW	J-III	9270		47.8	5437	159.2	95.7		
	Polished	DF			9312	48.0	9070	106.2	103.7	
		Etched & Polished Polished Polished	SM	1000	52250	24238	46.4	21445	102.6	102.0
			SM			28670	54.9	43950	92.8	95.5
SP				27912		53.4	45310	94.0	83.9	
SW	A-III5		27510	52.7		21105	155.0	83.2		
Polished	DF			29564	56.6	30700	105.2	109.4		
	Etched Polished Polished Polished	SM	1000	49400	21498	43.5	13695	116.60	116.50	
		SM			26516	53.7	19345	110.0	109.5	
		SP			25464	51.5	17930	122.0	108.2	
SW		B-III5	23366		47.3	9935	165.2	108.1		
Polished	DF			25698	52.0	15045	130.8	127.2		

*This information is approximate and given for estimating purposes only. Further information on application.

Crouse-Hinds General Purpose Floodlights

Type MDB-10 Floodlight

200-Watt
300-Watt



Std. Mounting

Light weight, weatherproof; for lighting residential yards, driveways.

Round flange base can be bolted to flat horizontal or vertical surface. Holes are spaced to fit holes in a 4-inch outlet box. Steel stake can be provided for temporary mounting on ground.

Net weight 1 1/4 lbs.; shipping weight 9 lbs.

No.	Description	Each
44711	100° Etched Alzak Reflector, Plain lens	\$30.00
44826	100° Etched Alzak Reflector, Plain lens Suspension Base	30.00
44702	35° Polished Alzak Reflector, Plain lens,	36.00
44825	35° Polished Alzak Reflector, Plain lens, Suspension Base	36.00

(Clear 50° spread, 100° spread, or diffusing lens will be furnished if specified.)

Colored Lenses, Plain*

No.	Color	With Floodlight	Separate
K1.507	Red	Add \$5.00	\$16.00
K1.508	Amber	Add 5.00	16.00
K1.509	Green	Add 5.00	16.00
K1.510	Blue	Add 5.00	16.00

*200 watt maximum when MDB-10 is equipped with colored lens.

Types MDB-14 and MDB-16 Floodlights

14-Inch, 500 Watts

16-Inch, 1000 Watts



Type MDB-14 and MCB-16 With Cross-Arm Base

Floodlight Complete With Hinged Door And Cross Arm Base*

No.	Type	Reflector	Each
44597A	MDB-14	70 Degree—Etched Alzak	\$67.00
44598A	MDB-14	20 Degree—Polished Alzak	74.00
44595A	MDB-16	70 Degree—Etched Alzak	84.00
44596A	MDB-16	20 Degree—Polished Alzak	94.00

*To obtain other bases, specify "MDB . . . except with . . . base."

(Furnished with smooth beam lens; clear plain, 50° spread, 100° spread or diffusing lens when specified.)

Bases and Brackets

No.	Description	Add Each
FI.5647	Slip fitter base for 1 1/2" pipe	\$6.50
FI.5650	Slip fitter base for 2" pipe	7.00
FI.5653	Slip fitter base for 2 1/2" pipe	8.50
K1.3070	U-bolt base for 1" to 2" pipe	6.00
K1.8844	Pole bracket	4.00
K1.2804	Flat base	2.00

Type MDR-14 Portable Floodlight

500-Watt



A light duty floodlight especially suitable for emergency portable lighting as a narrow beam spotlight for long range, or as a wide beam floodlight for medium or short range use.

Net weight: 17 1/4 lbs. Shipping weight: 25 lbs.

Wide Beam, Short Range

No.	Lens	Watts	Lamp	Blub	Each
44637	Diffusing	500		PS-40	\$96.00

Narrow Beam, Long Range

44636	Plain	500		PS-40	96.00
-------	-------	-----	--	-------	-------

KL9454 set of holding clamps, list price per set is \$18.00. Can be used with this floodlight. Heavy duty portable floodlights with cast aluminum housing can be furnished. See listings of types ADR-12, ADR-14, and ADR-16.

Type MDB-14 Service Station Floodlight

14-Inch, 500-Watt

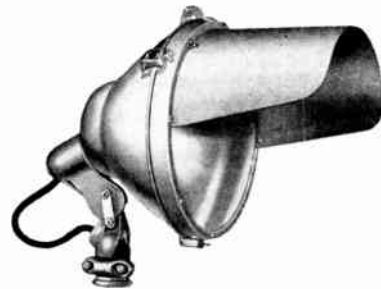

Type MDB-14 #44666A

Type MDB-14 #44666A floodlight has been specifically developed for efficient lighting of gasoline service stations. A wide selection of lenses is available to provide the exact beam spread required for each mounting location.

Floodlight With Slip-Fitter* Base and Hood

Type	Beam Spread†		Average‡ Max. CP	Each
	Hori.	Vert.		
MDB-14 #44666A-SM With smooth beam lens	16.0°	16.0°	142,200	\$83.00
MDB-14 #44666A-PL With plain lens	11.2°	11.3°	268,800	83.00
MDB-14 #44666A-SP With 50° spread lens	34.5°	13.5°	79,600	83.00
MDB-14 #44666A-SW With 100° spread lens	116.8°	18.0°	15,885	83.00
MDB-14 #44666A-DF With diffusing lens	46.4°	47.0°	24,580	83.00

*For 1/2-inch pipe.
†With 500-watt, 115-volt, G-40 bulb, floodlight service lamp.

Crouse-Hinds General Purpose Floodlights

The FLA and MUA line of general purpose floodlights were designed for lighting athletic fields of all types, parking areas, playgrounds, outdoor storage areas and service stations, suitable for 750, 1000 or 1500 watt, PS-52 bulb lamps. Can be arranged for 500 watt PS-10 bulb lamp if specified. Aluminum reflectors are Alzak finished.

Type FLA



The Type FLA floodlight was developed primarily for athletic field lighting. Because of its versatility, it is suitable for many general floodlighting applications.

The FLA floodlight can be furnished with five types of reflectors. A heat and impact resisting cover glass is sealed into the reflector.

A large hinged rear door makes relamping easy. A catch holds the door open.

Degree scales and a sight for aiming the floodlight are included.

Floodlight With FL1585 Cross-Arm Base for Wood Arm*

No.	Reflector	Dia., In.	Each
44429C	80 Degree—Etched Alzak	18	\$ 87.00
44428C	50 Degree—Etched Alzak	18	90.00
44427C	35 Degree—Polished Alzak	18	95.00
44426C	20 Degree—Polished Alzak	20	108.00
44559C†	14 Degree—Polished Alzak	20	108.00

†Use 1500 watt, G-18 bulb, floodlight service lamp.

Type MUA Elliptalux

With Porcelain Enameled Reflectors Models I and II Head



With Model II Head and Slip-Fitter Base

Wide beam auxiliary reflector is sheet aluminum with etched Alzak finish. Superimposes on the general distribution a wide beam of high intensity for lighting distant areas.

Narrow beam auxiliary reflector is sheet aluminum with polished Alzak finish. Supplies a narrow beam of high intensity having a spread of 40° horizontally by 27° vertically.

Floodlight with Cross-Arm Base*

Description	Mod. I No.	Mod. II No.	Each
Without Auxiliary Reflector	42173	44219B	\$40.00
With Narrow Beam Auxiliary Reflector	42187	44222B	47.00
With Narrow Beam Auxiliary Reflector	42179	44225B	51.00

The MUA line has two models of heads and eight different reflectors. Model II heads are especially suitable for athletic field installations. Alzak aluminum reflectors available with or without, hinged front door. All floodlights are furnished with four ft. of 2-conductor cable, except Model I heads which have pigtail leads.

Type MUA Alupalux

With Aluminum Reflector—Model II Head



Cross Arm Mounting With Model II Head

Mounting provides both horizontal and vertical degree scales for accurate setting of the floodlight during installation.

Either open style or with enclosing lens. Hinged door and lens recommended for keeping the reflecting surface free from dirt and dust, and preventing lamp breakages. Standard lens is plain; a stippled or 100° lens will be furnished if specified.

Reflector	Open Type		With Hinged Door	
	No.	Each	No.	Each
90 Degree—Etched Alzak	43909B	\$50.00	43951B	\$78.00
70 Degree—Etched Alzak	44417B	50.00	44404B	78.00
30 Degree—Polished Alzak	43910B	60.00	43952B	88.00
20 Degree—Polished Alzak	44419B	60.00	44407B	88.00

Note.—Model I Head will be furnished at same price when specified.

Type MUA Multalux

With Porcelain Enameled Reflector

Models I and II Heads



With Model I Head and Slip-Fitter Base

Designed for lighting service stations.

Wide beam auxiliary reflector is sheet aluminum with etched Alzak finish. Superimposes on the general distribution a wide beam of high intensity for lighting buildings and pumps.

Narrow beam auxiliary reflector is sheet aluminum with polished Alzak finish.

Floodlight With Cross-Arm Base*

Description	Model I No.	Model II No.	Each
Without Aux. Reflector	42207	44641B	\$54.00
With Wide Beam Aux. Reflector	42210	44642B	61.00
With Narrow Beam Aux. Reflector	42213	44643B	65.00

Bases* and Brackets for FLA and MUA

Description	MUA No. Mod. I	FLA, MUA No. Mod. II	Each
Cross Arm	**	FL1585	\$3.00
For Wood cross arm	**	FL1824	3.00
For Steel cross arm	**	FL2019	3.00

*To obtain another type of base, select catalog no. from above table and include in ordering description.

Description	MUA No. Mod. I	FLA, MUA No. Mod. II	Each
Slip-Fitter Base For 1½" pipe	HL5887	FL5646	\$6.00
For 2" pipe	FL5649	6.00
For 2½" pipe	FL5652	6.00
Bracket Base For 1-2" pipe or vert. surface	KL2076	KL2076	6.00
Base for Thompson Hanger	Suffix TH	

**Model I head has integral cross-arm base with a single hole; clearance for ¼" bolt.

Crouse-Hinds Heavy Duty Floodlights

Heavy duty floodlights are efficient, rugged and weather-proof projectors. They are made of corrosion-resistant cast aluminum and have internal reflectors of polished Alzak aluminum.

Heavy duty floodlights are recommended for the illumination of industrial areas, railroad yards, buildings, smoke stacks, large signs and other areas.

Types ADE-12, ADE-14 and ADE-16

Medium and Long Range

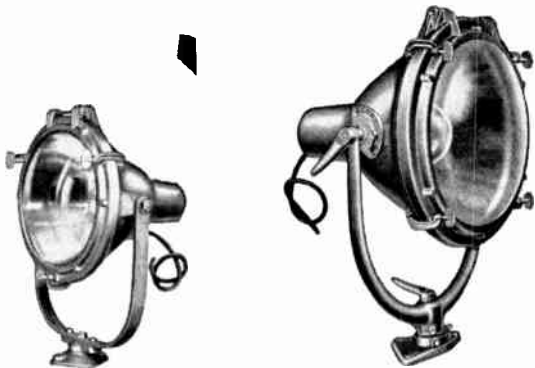

Type ADE-12

Type ADE-14 and ADE-16

A clear, smooth beam lens is furnished on floodlights for PS bulb lamp unless otherwise specified. A clear, diffusing lens, plain lens and two types of spread lens, 50° and 100°, can be furnished without additional charge, if specified on the order.

Catalog numbers 44492, 42921A and 42743A cover floodlights with a special housing which provides the proper burning position for G-bulb lamps.

No.	Type	Reflector	Watts	Lamps Bulb	Each
42428A	ADE-12	Wide Beam	200	PS-30	\$86.00
42429A	ADE-12	Narrow Beam	250	G-30	86.00
44492	ADE-12	Narrow Beam	250	G-30	86.00
42740	ADE-14	Wide Beam	500	PS-40	136.00
42739	ADE-14	Narrow Beam	500	PS-40	136.00
42921A	ADE-14	Narrow Beam	500	G-40	136.00
42741	ADE-16	Wide Beam	1000	PS-40	170.00
42932	ADE-16	Narrow Beam	1000	PS-40	170.00
42743A	ADE-16	Narrow Beam	1000	G-40	170.00

Slip fitter bases for 1¼ (except ADE-12), 1½, 2 and 2½-in. pipe available at same price. Other bases and brackets available.

Type LCE-1120

Medium and Long Range



An efficient floodlight for illumination of large areas. A clear, smooth beam lens is furnished on floodlights for PS-bulb lamp unless another type is specified. Plain, 50° spread, 100° spread and diffusing types are available without extra charge. When G-bulb lamp is used, the housing is inverted to provide the proper burning position. The standard base is flat. Other bases and brackets available.

No.	Reflector	Watts	Lamp Bulb	Each
42745	Wide Beam	1500	PS-52	\$280.00
42953	Narrow Beam	1500	PS-52	280.00
42746	Narrow Beam	1500	G-48	280.00

Color screens are available.

Types ADE-12, ADE-14 and ADE-16 are suitable for marine service on shipboard. To obtain these units carrying the U. S. Coast Guard approval, add suffix "M" to the catalog when ordering.

Types ADR-12, ADR-14 and ADR-16

Portable

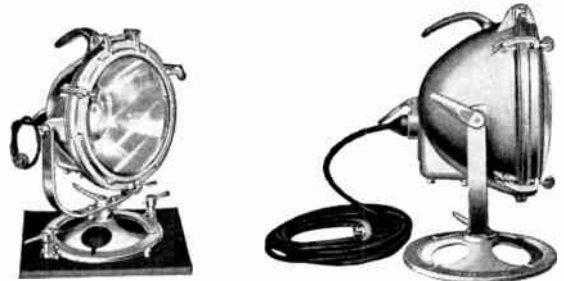

Type ADR-12 With Holding Clamps

Type ADR-14 With Cable Assembly Connected

Types ADR-12, ADR-14 and ADR-16 floodlights are rugged units especially adaptable for portable use, either when a narrow beam spotlight or a wide evenly distributed beam of light is required.

Wiring Connections: Built-in weatherproof twistlock plug at rear of housing has spring door with gasket. No external cable is included with floodlights, but available as accessory.

No.	Type	Lens*	Watts	Lamp Bulb	Each
42950C	ADR-12	Diffusing	250	G-30	\$100.00
42023C	ADR-12	Plain	250	G-30	100.00
44176C	ADR-14	Diffusing	500	G-40	142.00
42783C	ADR-14	Plain	500	G-40	142.00
44672	ADR-16	Diffusing	1000	G-40	176.00
44102A	ADR-16	Plain	1000	G-40	176.00

Accessories

No.	Description	Each
KL9138	25 ft. cable assembly †	\$20.00
KL9139	50 ft. cable assembly †	34.00
KL9140	100 ft. cable assembly †	62.00
KL9454	Set of holding clamps complete with guide posts, screws and template	22.00

*Diffusing lens provides wide beam; plain lens provides narrow beam for long range.

†Consists of weatherproof connector to fit floodlight, 2-conductor No. 14 type SO cable, and twistlock plug.

Type LCE-24

Long Range



Especially designed for long range lighting with high wattage lamps. Furnished with a clear, plain lens unless another type is specified. Spread lenses are available without extra charge. Standard base is flat. Other bases and brackets available.

No.	Reflector	Watts	Lamp Bulb	Each
42781A	Narrow Beam	1500 or 2000	PS-52	\$380.00
42841A	Narrow Beam	1500	G-48	380.00

Crouse-Hinds Explosion-Proof Floodlights

Type RLEE-14
Class I, Group D—500-Watt

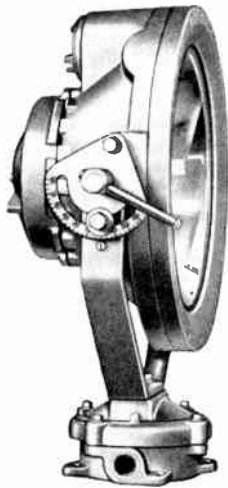

An explosion-proof outdoor floodlight designed for use in hazardous areas. The housing and door is made of cast aluminum alloy.

It is designed for conduit wiring into the base, which is also an explosion-proof junction box with a terminal block. Re-lamping is accomplished by unscrewing the rear door. This type is also available with carrying handles and wheel base for portable uses (RLER-14). Information on request.

No.	Description	Watts	Lamp Bulb	Each
44695	With Narrow Beam Polished Alzak Reflector	500	PS-40	\$415.00
44696	With Narrow Beam Polished Alzak Reflector	500	G-40	415.00
44697	With Wide Beam Etched Alzak Reflector	500	PS-40	410.00

Spread screen or diffusing lens can be furnished with RLEE-14 or RLER-14. Add \$20.00 list to price of floodlight.

Types RCDE-6 and RCDE-6

Class I, Group C and D



Type RCDE-6
With Wheel Base

RCDE-6 is designed for permanent installation at fixed locations.

The RCDE-6 is explosion-proof cast aluminum floodlight designed for aircraft maintenance, refueling operations and other locations where a portable floodlight is needed for use in class I, Groups C and D atmospheres. It is furnished with either a tripod or wheel base mounting.

The aluminum tubing tripod mounts the floodlight 5½ ft. above the ground when retracted and 10 ft. when extended.

When mounted on a wheel base, the floodlight is easy to handle because of its compact design and convenient carrying handle.

The RCDE-6 with tripod can be furnished to meet the requirements of Air Force-Navy Aeronautical Standard Drawing AN2580, specification MIL-F-6139. Information will be furnished upon request.

No.	Description	Each
44719	With explosion-proof junction box for permanent installation, for 150W, PAR-38 & R-40.	\$130.00
44655	With wheel base mounting, for 150W, PAR-38 and R-40 lamp	120.00
44599	With tripod mounting, for 150W, PAR-38 and R-40 lamp.	260.00

Crouse-Hinds Explosion-Proof Floodlights

Type RCDE-8
Class I, Group 200-300-Watt



Type RCDE-8
Pit Light

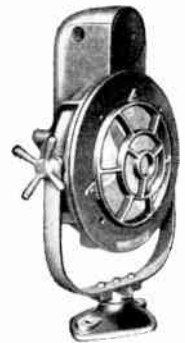

With Trunnion
Mounting

Designed to meet the requirements of an explosion-proof floodlight.

The RCDE-8 pit light is recommended for lighting automobile greasing pits and lifts and for general use in hazardous locations.

Pit Light—Without Brackets

Housing	Door	Narrow Beam Polished Ref.		Wide Beam Etched Ref.	
		No.	Each	No.	Each
Feraloy	Aluminum	41704B	\$135.00	41702B	\$130.00
Feraloy	Brass	41705B	170.00	41706B	165.00
Aluminum	Aluminum	41707B	135.00	41708B	130.00
Brass	Brass	41709B	225.00	41710B	220.00

Pit Light—With Three "Z" Brackets*

Feraloy	Aluminum	41711B	140.00	41712B	135.00
Feraloy	Brass	41713B	175.00	41714B	170.00
Aluminum	Aluminum	41715B	140.00	41716B	135.00
Brass	Brass	41717B	230.00	41718B	225.00

With Trunnion and Flat Base Mounting

Feraloy	Aluminum	41719B	140.00	41720B	135.00
Feraloy	Brass	41721B	175.00	41722B	170.00
Aluminum	Aluminum	41723B	140.00	41724B	135.00
Brass	Brass	41725B	230.00	41726B	225.00

With Suspension Mounting

Aluminum	Aluminum	41989B	140.00	41990B	135.00
Feraloy	Aluminum	41991B	140.00	41992B	135.00
Brass	Brass	41993B	230.00	41994B	225.00

*A 25° refracting screen can be furnished; FL4408, add \$10.00 each.

Crouse-Hinds Type HLG Fluorescent Fixtures

For Tunnel, Underpass and Area Lighting



An efficient fluorescent fixture designed for outdoor and indoor use. Suitable for lighting tunnels, underpasses, loading docks and other outdoor locations, it is also used in indoor locations where a rugged weatherproof enclosed fixture is needed. Can be mounted in continuous rows.

No.*	Lamps Per Fixture	Ballast Equipment	Each
44970	1	None	\$220.00
44971	1	1—1 lamp	260.00
44973	1	1—2 lamp	270.00
44972	2	2—1 lamp	330.00
44974	2	1—2 lamp	280.00

*Add suffix for line voltage when ordering: 115-125V—118; 199-216V—208; 220-250V—236; 240-280V—265; 440-480V—460.

Crouse-Hinds Floodlights
For Pits, Tunnels, Underpasses

Type RCD-8
100—150—200 Watt
Form F for Floor Mounting



Watertight, door overlaps case; projects above concrete about 3/16 in. Door has rough pebbled surface. Has flat glass lens; heavy enough to allow it to be stepped on, impact-resisting. Available only in plain type.

No. 41427B..... Each \$60.00

Form W for Wall Mounting



Similar to Form F, except it is provided with a hinged and flush door, so that it can be set absolutely flush with concrete wall. Can also be mounted on a ceiling or wall by using brackets. Refracting lenses can be set to refract light up or down. Baked enamel finish.

	With Plain Lens		With Refracting Lens	
	No.	Each	No.	Each
With Grid	41409	\$54.00	41410	\$54.00
Without Grid	41332	50.00	41334	50.00

Type RCD-12

200-300 Watt Multiple
1000-6000 Lumen Series



The RCD-12 was designed for multiple or series lamps. It is suitable for surface mounting or for flush mounting in concrete or stone. Tunnels and underpasses can be efficiently lighted from fixtures mounted overhead or along the sidewall. It is also suitable for lighting drives, walkways, and loading areas around industrial and public buildings, with sidewall mounted fixtures equipped with the deflecting spread lens.

The large wiring chamber is provided with four 1 1/2 in. conduit hubs. Two external hubs on sides, one internal hub on top and one internal hub on back.

1000 Lumen

Series	Ceiling Mounting With Diffusing Lens		Sidewall Mounting With Deflecting Spread Lens	
	No.	Each	No.	Each
	44450	\$140.00	44451A	\$155.00

2500 to 6000 Lumen

Series	44450	140.00	44453A	155.00
--------	-------	--------	--------	--------

200 Watt Medium Base

Multiple	44489	118.00	44487A	130.00
----------	-------	--------	--------	--------

300 Watt Mogul Base

Multiple	44490	120.00	44488A	132.00
----------	-------	--------	--------	--------

Crouse-Hinds Underwater Swimming Pool Floodlights

Type SPS
For Dry Niche Mounting—500-1500 Watt



This unit is intended for pools which have a passage around the outside wall, or for installation in a manhole. The design is such that a very small manhole can be used, since it is unnecessary to enter the manhole for servicing. A 3-conductor cable is furnished with the floodlight.

In a pool with tile facing, a square bronze mask, with satin chromium plate finish, is used for covering the edge of the tile.

When concrete wall exceeds 5 3/8-in. thickness, use an extension ring listed below to provide an opening for the floodlight.

No.	Material	Description	Each
44124C	Bronze	Complete with porthole ring, door and floodlight for concrete pools.	\$270.00
44575B	Bronze	Complete with porthole ring, door, floodlight and tile mask for tile pool.	350.00
FL2633*	Sheet Steel	Extension ring, up to 16-in.	15.00
FL3265*	Sheet Steel	Extension ring, 16-in. to 24-in.	20.00

*Specify thickness of concrete wall when ordering.

Crouse-Hinds Underwater Swimming Pool Floodlights

Type RPS
500-750-1000 Watt

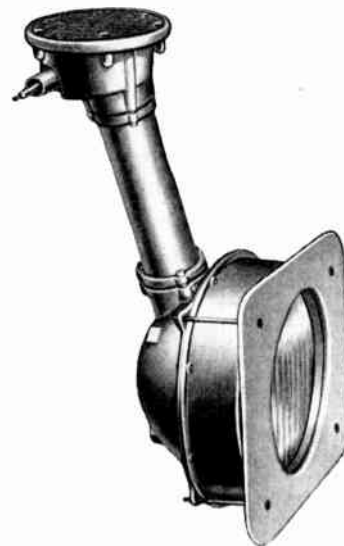

Underwater floodlight designed to be set in the wall of a swimming pool. It includes a flush floor box which is connected to the floodlight by a large tube. Combines the low installation cost feature of wet niche floodlights with the safety, convenience, and ease of servicing of the dry niche.

The lamp and lamp receptacle can be withdrawn from the floodlight through the tube and floor box. To assure safety in relamping, the unit is so constructed that the cord plug must be disconnected before the lamp receptacle assembly can be withdrawn.

No.	Description	Material	Each
44133C	Swimming Pool Floodlight for concrete pools	Bronze	\$560.00
44572D	Swimming Pool Floodlight complete with tile mask, for tile pools.	Bronze	650.00

Crouse-Hinds Lantern Floodlights

Type GCP-14
300-1500-Watt Incandescent
400-700-Watt Mercury Vapor



An ornamental lantern type floodlight designed for the illumination of buildings, gasoline service stations, and other places where the appearance of the lighting unit is important. The daytime appearance is that of an ornamental street lantern. At night the large, efficient reflector on the inside transforms it into a powerful floodlight. Frame is cast aluminum.

With Floodlight Reflector Slip Fitter

Reflector	4-in. No.	7-in. No.	Each
Wide Beam	41322B	41323B	\$300.00
Narrow Beam	41402B	41401B	300.00

Without Reflector Slip Fitter

Receptacle Type	4-in. No.	7-in. No.	Each
Mogul Multiple	41337	41338	\$165.00
Series Film Cutout	41320	41321	170.00

Note.—Can be arranged for mercury vapor lamp without extra charge if specified. Add suffix H11 for 400-watt, H118 for 700-watt.

Crouse-Hinds Type FS Lighting Fixtures



6-Watt—Dead End

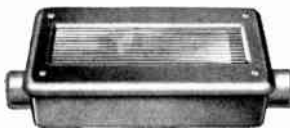

25-Watt—Through Feed

Small lighting units made to mount flush in concrete, stone, or plastered walls; to light steps, walks, floors and gardens. Also used in hospitals, mounted low in the wall for lighting the floor without disturbing patients.

Cover is equipped with louvered glass, which is normally set to direct light downwards. The 6-Watt uses an FS single-gang body, and the 25-Watt uses an FS four-gang body.

With Aluminum Cover

Size In.	6 Watts				25 Watts			
	(Through)		(Dead End)		(Through)		(Dead End)	
	No.	Each	No.	Each	No.	Each	No.	Each
1/2	42877	\$ 9.70	42879	\$9.45				
3/4	42916	9.85	42908	9.55	42912	\$19.00	42904	17.25
1	42917	10.35	42909	9.75	42913	19.50	42905	17.50

With Chromium Plated Bronze Cover

1/2	42878	21.05	42880	20.80				
3/4	42918	21.20	42910	20.90	42914	37.25	42906	35.50
1	42919	21.70	42911	21.10	42915	37.75	42907	35.75

Covers Complete With Lens and Gasket

Description	6 Watts		25 Watts	
	No.	Each	No.	Each
Aluminum	KL316	\$ 5.85	KL326	\$ 9.10
Chromium Plated	KL318	17.20	KL328	27.35

Crouse-Hinds Type VCD-6 Lighting Fixtures

For Walkway and Roadway Lighting



With Aluminum Housing and Door			
No.	Lamp		Each
43394	100 Watts—GS		\$70.00
43471	60-100 Watts—T		70.00

With Bronze Housing and Door			
No.	Lamp		Each
44465	100 Watts—GS		\$115.00
44466	60-100 Watts—T		115.00

**GS—General lighting service lamp; T—Traffic Signal lamp.

Note.—Hub size, as specified.

General Electric Fluorescent Floodlights



Floodlight Fixture, Type L-108

A lightweight, easy-to-install, extruded aluminum, fluorescent floodlight. Standard Fluoroflood Fixture length is 8-ft. Double Fixture is 16-ft. in length and adaptable to standard outdoor advertising panels. Extension unit can be used with either the single or double fixtures for extending light source length.

May be equipped with clear-plastic cover, protecting fluorescent lamp and enameled reflector. Equipped with built-in device for easy, accurate aiming, and swivel-in feature of conduit mounting making installation and maintenance easy.

Has spring-loaded telescopic lamp holders for recessed double-contact, rapid-start lamps.

Open Units

Cat. No.	Description	Approx. Wt., Lbs.		Each
		Ship.	Net	
21L108C1	*Single Fluoroflood Fixture (8-ft.—1 lamp)...	11	9	\$29.00
21L108C2	*Double Fluoroflood Fixture (16-ft.—2 lamps)...	20	18	\$56.00
21L108C3	*†Single Extension Fixture (8-ft.—1 lamp)...	11	9	25.50

Cover Kit

108A4201G3	‡Cover kit (for single fixture).....	3	1	7.50
------------	--------------------------------------	---	---	------

*Lamps, ballast, and conduit are not included. Lamp used: 96T12/CW/RS.

†For use with standard single or double fixtures for extending source length for applications, such as larger poster panels, loading docks, and other similar uses.

‡Transparent-plastic door and fasteners for enclosing a single open Fluoroflood Fixture.

§Per double fixture (Shipped one double per carton).

General Electric Handy Floodlights

Type L-66



For work-lighting or protective lighting around substations, home and farm buildings, construction jobs—either temporary or permanent.

Powerful wide-angle beam illuminates a large area. Inexpensive, durable, lightweight, thoroughly practical for general use.

Cat. No.	Type of Reflector	Approx. Std. Pkg. Wt., Lbs.		List Price Each
		Net	Ship.	
A175G7	Wide-beam etched-surface aluminum.....	4	7	\$15.50

General Electric Sports and Area Floodlights

Type L-45A

For close-range illumination of filling stations, and work, storage, parking and sports areas.

Durable open floodlights, with porcelain-enameled reflector. Die-cast aluminum socket housing, with porcelain-shell mogul socket.

The auxiliary processed aluminum reflectors provide increased illumination of areas or buildings that require special emphasis.

Supplied only with crossarm mounting which will fit all other mountings.

Type L-45A Floodlight for Crossarm Mounting for 300/1500 Watts

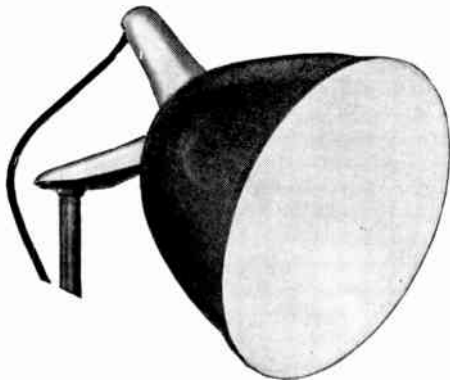

Approx. weight: Shipping, 13 lbs.; Net, 9½ lbs.
Reflector: Porcelain enamel.

Cat. No. A70G1. Each **\$21.00**
Lamps are not included.

Type L-46A Floodlight for Crossarm Mounting for 300/1500 Watts

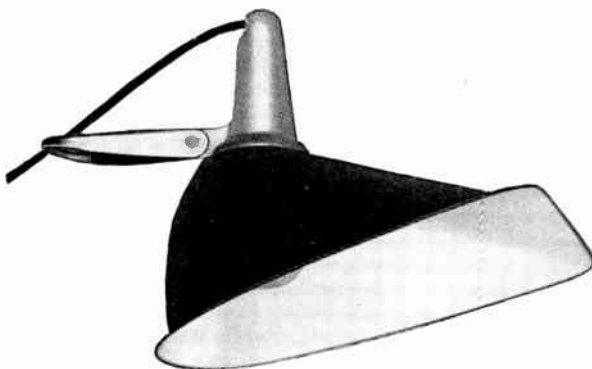

Approx. weight: Shipping, 19 lbs.; Net, 13½ lbs.

Type of Auxiliary reflector included: Porcelain-enameled steel.

Cat. No. A71G1. Each **\$31.50**

For use with 300 or 500 watt lamp, order similar to above Cat. No., and specify lamp wattage.

Lamps are not included.

General Electric Sports and Area Floodlights

Type L-69A Floodlight for Crossarm Mounting



Aluminum floodlight available with either spun-sealed or clamp-band impact-resisting, tempered door-glass. Outstanding light control and beam efficiency is provided by anodized reflector designs available in very-narrow, narrow, medium and wide beam patterns.

Features V-notch aiming; rear relamping; handy terminal-box design for easy, low-cost installation and faceted rear reflector for improved candlepower.

Reflector Description	Spun-Sealed Design No.	Each	Clamp-Band Design No.	Each
Very-narrow beam*	21.69A3AF	\$74.00	21.69A3AH	\$78.00
Narrow beam†	21.69A3	68.00	21.69A3AE	72.00
Medium beam†	21.69A1	57.00	21.69A1AE	61.00
Wide beam†	21.69A2	53.00	21.69A2AE	57.00

*Includes four-foot cable.

†Does not include cable.

Steber Utilites—Outdoors & Indoors

For PAR-38 and R-40 Lamps

Designed for counter, ceiling, wall or outlet box mounting.

Drawn steel with weatherproof gasket between lamp and socket.

Furnished with various mounting provisions as noted below. U/L Listed.



No. 2



No. 4

No.	Mtg. Provision	Each
2	Base plate for surface or outlet box — 6-ft. cord set.	\$2.05
2-O	Same but has no cord set. Has leads.	1.45
2-SO	Base plate & ground spike — 6-ft. cord set.	2.20
2-S	Same, but no baseplate.	2.05
4	Pin-up, stand-up holder. Black mtg. stand with gold finished socket housing. Approved cord & plug and weatherproof socket.	2.00

Steber Utilite Color Equipment



U-40

U-45

Lensholder has sturdy spring clip. Attach to either PAR-38 or R-40 lamps.

Lenses available in amber, blue, green or red. Specify when ordering.

No.	Description	Each
U-40	Lensholder	\$.70
U-45	Lens (Specify color)	1.05
U-46	Lensholder & one lens (Specify color)	1.70

Revere Enclosed Type Floodlights

Listed by Underwriters' Laboratories, Inc.



Constructed of spun sheet aluminum, with cast neck and socket mounting.

The unit is strong and sturdy, sealed by an impregnated asbestos gasket. Weatherproof and dust-tight in all positions. Available with clamp-type or hinged lens cover. The hinged type is advantageous from the standpoint of servicing.

Lenses are heat-resisting glass.

Focusing mechanism is furnished as standard on narrow beam floods only. Fixed focus furnished if desired.

150-200 Watt

12-In. Heat-resisting Lens With Clamp Cover Glass

Mounting	Wide Beam Plain Lens		Narrow Beam Plain Lens	
	No.	Each	No.	Each
Yoke Only	7110WP	\$55.00	7120NP	\$62.30
Cross Arm	7111WP	57.10	7121NP	64.45
1½-In. Slip Fitter	7112WP	59.70	7122NP	67.00
2-In. Slip Fitter	7113WP	61.10	7123NP	68.40
Clamp-1 & 2-In. Pipe	7114WP	58.70	7124NP	66.05
Standard Base	7115WP	57.15	7125NP	64.45
Wall Mounting	7118WP	64.25	7128NP	71.55

With Hinged Cover Glass

Yoke Only	7110WPH	\$63.85	7120NPH	\$71.15
Cross Arm	7111WPH	65.95	7121NPH	73.30
1½-In. Slip Fitter	7112WPH	68.55	7122NPH	75.85
2-In. Slip Fitter	7113WPH	69.95	7123NPH	77.30
Clamp-1 & 2-In. Pipe	7114WPH	67.50	7124NPH	74.85
Standard Base	7115WPH	66.05	7125NPH	73.35
Wall Mounting	7118WPH	73.10	7128NPH	80.45

300-500 Watt

14-In. Heat-resisting Glass Lens With Clamp Cover Glass

Yoke Only	7140WP	\$52.45	7150NP	\$59.45
Cross Arm	7141WP	54.55	7151NP	61.60
1½-In. Slip Fitter	7142WP	57.10	7152NP	64.10
2-In. Slip Fitter	7143WP	58.55	7153NP	65.50
Clamp-1 & 2-In. Pipe	7144WP	56.10	7154NP	63.15
Standard Base	7145WP	54.60	7155NP	61.60
Wall Mounting	7148WP	61.70	7158NP	68.65

With Hinged Cover Glass

Yoke Only	7140WPH	\$56.80	7150NPH	\$69.75
Cross Arm	7141WPH	58.95	7151NPH	71.95
1½-In. Slip Fitter	7142WPH	61.55	7152NPH	74.50
2-In. Slip Fitter	7143WPH	62.90	7153NPH	75.85
Clamp-1 & 2-In. Pipe	7144WPH	60.55	7154NPH	73.50
Standard Base	7145WPH	59.00	7155NPH	72.00
Wall Mounting	7148WPH	66.05	7158NPH	79.05

750-1000 Watt

16½-In. Heat-resisting Glass Lens With Clamp Cover Glass

Yoke Only	7190WP	\$56.60	7190NP	\$64.90
Cross Arm	7191WP	58.55	7191NP	67.20
1½-In. Slip Fitter	7192WP	61.30	7192NP	69.60
2-In. Slip Fitter	7193WP	62.75	7193NP	71.05
Clamp-1 & 2-In. Pipe	7194WP	60.30	7194NP	68.70
Standard Base	7195WP	58.80	7195NP	67.10
Wall Mounting	7198WP	65.75	7198NP	74.10

With Hinged Cover Glass

Yoke Only	7190WPH	\$66.40	7190NPH	\$74.15
Cross Arm	7191WPH	68.65	7191NPH	76.40
1½-In. Slip Fitter	7192WPH	69.00	7192NPH	78.25
2-In. Slip Fitter	7193WPH	70.05	7193NPH	81.20
Clamp-1 & 2-In. Pipe	7194WPH	70.15	7194NPH	77.80
Standard Base	7195WPH	68.85	7195NPH	76.50
Wall Mounting	7198WPH	74.00	7198NPH	82.65

Above floodlights can be furnished without lenses. If stippled lens is wanted, in either case, substitute letter "S" for "P" on above numbers. If ribbed lens is wanted substitute letter "R" for "P". No extra charge for change in lenses.

Revere Enclosed Floodlights

Listed by Underwriters' Laboratories, Inc.

**Dust-Tight and Weatherproof
750-1000-1500 Watts**

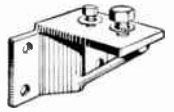
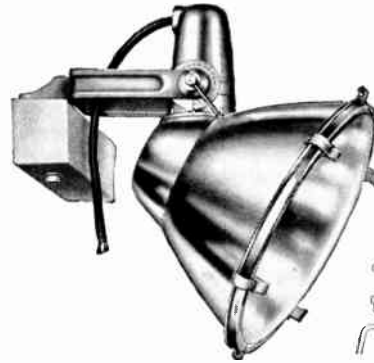

Wall or Wood Pole Mounting



Clamp Mounting

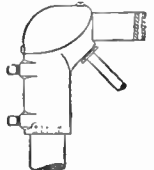

Slip Fitter

Can be used for any long range lighting requirements, such as playgrounds, billboards, railroad lighting yards, refineries, tank farms, baseball, football, aeronautical obstructions, etc.

The double parabola Alzak aluminum reflector design provides maximum light output with vertical burning lamps. Wide choice in beam control. Hinged lens ring for easy access, rotation stop with degree markings, sealed top for easy access to socket terminals, and sturdy construction. Parts are of non-ferrous metal, stainless steel, or hot dip galvanized.

Mounting	Narrow Beam		Wide Beam	
	No.	Each	No.	Each
Yoke Only	4215-P	\$78.65	4210-P	\$67.80
Cross Arm	4216-P	80.20	4211-P	69.30
1½-In. Slip Fitter	4217-P	83.30	4212-P	72.40
2-In. Slip Fitter	4218-P	84.65	4213-P	73.70
Clamp-1 and 2-In. Pipe	4219-P	81.80	4214-P	70.90
	4221-P	83.15	4220-P	72.25

Above prices are for plain lens; if stippled lens is wanted, substitute letter "S" for "P"; for ribbed lens substitute letter "R" for "P". Add letter "M" to Cat. No's. if for use with mercury lamps.

Rear Service Floodlights

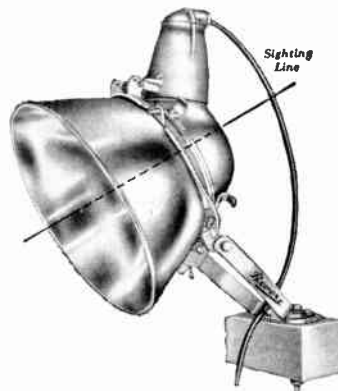

This floodlight consists of two accurately shaped aluminum reflectors, the purpose of which is to permit servicing from the rear and not disturb the front setting or section.

The front section is provided with a plain clear impact-resisting glass cover which is rolled in place with a non-hardening cement to provide a permanent water-tight seal.

The all-aluminum construction assures light weight. There are no loose parts to drop or dangle in the wind. Maintenance is safe and easy. Parts are of non-ferrous metal, stainless steel or galvanized. Front and rear built-in sights enable accurate aiming.

Designed for use with a 750, 1000 or 1500-watt PS-52 clear bulb general service lamp with mogul screw base.

Mounting	Diameter 20¾ In.				Diameter 18 In.			
	20° Spread		50° Spread		35° Spread		75° Spread	
	Nema Type 2 Group B		Nema Type 4 Group B		Nema Type 3 Group B		Nema Type 5 Group B	
	No.	Each	No.	Each	No.	Each	No.	Each
Yoke Only	2000	\$98.00	2010	\$87.40	2030	\$86.30	2040	\$74.05
Cross Arm	2001	99.85	2011	89.00	2031	88.20	2041	75.60
1½-In. Slip Fitter	2002	102.60	2012	92.10	2032	92.65	2042	78.65
2-In. Slip Fitter	2003	102.60	2013	92.10	2033	94.35	2043	79.65
Clamp-1 to 2-In. Pipe	2004	101.70	2014	90.55	2034	90.10	2044	77.20
Wall Mounting	2008	101.70	2018	90.55	2038	2048	77.20

Revere Eliptor Floodlights

300 to 1500 Watts

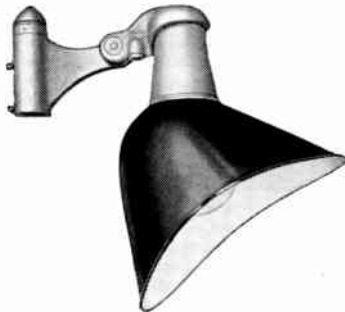

No. 3800

Porcelain Enameled
All adjustments are easily made from one position on side of the housing.

Porcelain enameled steel reflector, white inside — red, green, cream or blue outside. Other colors available.

Inner reflector is aluminum, semi-specular finish, giving maximum projection and control.

Any of the 500-watt floodlights can be used with the 400-watt type base-up burning mercury

lamps. When using Mercury Lamps keep lamp within 10° of vertical.

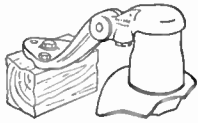

Cross Arm Mounting for Wood or Angle Iron

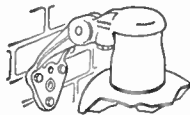

Wall Mounting

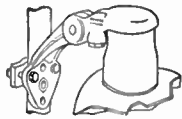

Clamps Around 1½ or 2-In. Vertical Pipe

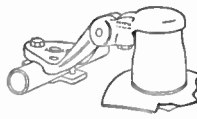

Clamps Around 1½ or 2-In. Horizontal Pipe

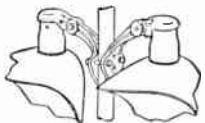

Wall Type, Clamped Back to Back for Pole Mounting. Sets of (2) bolts and Nuts Furnished extra.

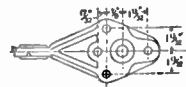

Hole Spacing on Cross Arm or Wall Mounting

Mounting	Size Lamps, Watts	Without Inner Reflector		With Inner Reflector	
		No.	Each	No.	Each
1½-In. Pipe Slip Fitter	300-500	3800	\$31.00	3820	\$35.75
	750-1000-1500	3801	32.55	3821	37.55
	750-1000 Bi-Post	†38001	41.90	†38201	45.70
2-In. Pipe Slip Fitter	300-500	3802	31.00	3822	35.75
	750-1000-1500	3803	32.55	3823	37.30
	750-1000 Bi-Post	†38021	41.90	†38221	45.70
Pipe Clamp Bracket	300-500	3804	29.40	3824	34.20
	750-1000-1500	3805	31.00	3825	35.75
	750-1000 Bi-Post	†38041	39.35	†38241	44.10
Cross Arm and Wall Bracket	300-500	3806	27.85	3826	32.60
	750-1000-1500	3807	29.40	3827	34.20
	750-1000 Bi-Post	†38061	37.75	†38261	42.55
*Pendant Mtg. for ¾-In. Pipe	300-500	3808	24.75	3828	29.45
	750-1000-1500	3809	25.90	3829	31.05
	750-1000 Bi-Post	†38081	34.65	†38281	39.40
†Snap on Wire Guard		3817	4.35		

Weights: Pendant Mounting, 19 lbs.; All others 21 lbs.

Aluminum

Without Inner Reflector

Mounting	300-500 Watt		750-1500 Watt		750-1000 Watt Bi-Post	
	No.	Each	No.	Each	No.	Each
Cross Arm and Wall Bracket	3851	\$31.00	3861	\$32.55	†3871	\$40.90
1½-In. Slip Fitter	3852	34.15	3862	35.70	†3872	44.05
2-In. Slip Fitter	3853	34.15	3863	35.70	†3873	44.05
Pipe Clamp Bracket	3854	32.55	3864	34.15	†3874	42.50
*Pendant Mtg. for ¾-In. Pipe	3859	27.85	3869	29.40	†3879	37.80
†Snap on Wire Guard	3817	4.35				

*Can be furnished for ½ or 1 in. pipe at no extra cost.

No. **3819** — One set (2 bolts and nuts) at **\$0.65** per set to mount two wall brackets back to back on 1½- or 2-in. pipe.

†Two lengths of Firezone wire furnished with each Bi-post socket.

Revere Alzak Open And Enclosed Type Floodlights

300 to 1000 Watt Lamps

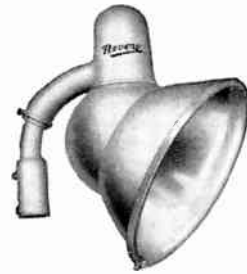

Clamp Ring Cover Type

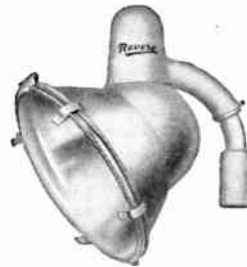

Hinged Cover Type

This series of floodlights furnished for individual or Mercury and Incandescent Lighting jobs. Open-type reflector is 17¾-in. diam. Formed reflector is 17¾-in. Closed types—16½-in. diam. Reflectors are made of Alzak Aluminum. All castings are Aluminum.

Telescopic arm provides vertical adjustment of 37°. Horizontal 360°. Arm operates within a one-piece casting comprising socket dome enclosure. Wiring is enclosed, protected from heat of lamp or moisture.

When Mercury Lamps are to be used, enclosed floods recommended for better lamp performance.

300-500 Watt Incandescent Mogul Screw Base or 400 Watt Mercury Lamps*

Clamp Ring Cover Type

Mounting	— NEMA Classification —			
	Group A Type 3	Group A Type 4	Group A Type 5	Group A Type 6
	Plain	†Stippled	Plain	†Stippled
	Narrow Beam Flood		Wide Beam Flood	
Crossarm	3350-NP	3350-NS	3350-WP	3350-WS
1½-in. Slip	3351-NP	3351-NS	3351-WP	3351-WS
2-in. Slip	3352-NP	3352-NS	3352-WP	3352-WS
Clamp	3353-NP	3353-NS	3353-WP	3353-WS
Wall	3354-NP	3354-NS	3354-WP	3354-WS

750-1000 Watt Incandescent Mogul Screw Base

Crossarm	3360-NP	3360-NS	3360-WP	3360-WS
1½-in. Slip	3361-NP	3361-NS	3361-WP	3361-WS
2-in. Slip	3362-NP	3362-NS	3362-WP	3362-WS
Clamp	3363-NP	3363-NS	3363-WP	3363-WS
Wall	3364-NP	3364-NS	3364-WP	3364-WS

Hinged Cover Type

Crossarm	3350-NPH	3350-NSH	3350-WPH	3350-WSH
1½-in. Slip	3351-NPH	3351-NSH	3351-WPH	3351-WSH
2-in. Slip	3352-NPH	3352-NSH	3352-WPH	3352-WSH
Clamp	3353-NPH	3353-NSH	3353-WPH	3353-WSH
Wall	3354-NPH	3354-NSH	3354-WPH	3354-WSH

750-1000 Watt Incandescent Mogul Screw Base

Crossarm	3360-NPH	3360-NSH	3360-WPH	3360-WSH
1½-in. Slip	3361-NPH	3361-NSH	3361-WPH	3361-WSH
2-in. Slip	3362-NPH	3362-NSH	3362-WPH	3362-WSH
Clamp	3363-NPH	3363-NSH	3363-WPH	3363-WSH
Wall	3364-NPH	3364-NSH	3364-WPH	3364-WSH

*A transformer is required for each Mercury lamp.

†If Stippled Clamp Ring Cover Type is desired with Ribbed Lens, use letters "NR" with catalog numbers instead of "NS". If Stippled Hinged Cover Type is desired with Ribbed Lens, use letters "NRH" with catalog numbers instead of "NSH".

For information concerning Open Type Floodlights contact Graybar.

Revere Underneath Lighting
For Efficient Lighting of Vertical Surfaces

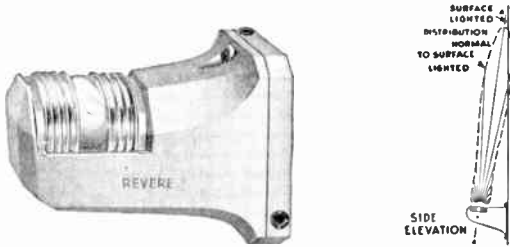

Beam of flood illuminates surfaces without creating a hot spot or glare.

Has an Alzak Aluminum Reflector with special prismatic lens and is completely weatherproof.

Uses medium screwbase socket. Clear PS-30, 6-in. L.C.L. Lamp.

No.	Lamp Size	Lens Type	Each
3151	200-300 W.	120° Pris.	\$65.20
3151-A	200-300 W.	180° Pris.	62.30

R & S Underwater Lighting
For Swimming Pools
Type SL

Cast bronze, each floodlight equipped with an Alzak finished reflector and clear spreadlight Pyrex lens. To insure against shock due to accidental grounds or short circuit, means are provided for effectively grounding all metal parts.

Front Relamp Type



No. 2360

Used in pools which are drained at frequent intervals. To relamp, drain the pool to a point below the floodlight and remove the lens retaining frame.

No.	Description	Each
2360	250-Watt Floodlight only.....	\$120.00

Back Relamp Type



No. 2365

These floodlights are for pools having a passageway or tunnel behind the pool walls. To relamp, remove wing nuts and back cover plate.

No.	Description	Each
2364	*250-Watt Floodlight only.....	\$150.00
2365	*400-Watt Floodlight only.....	175.00
2422	*1000/1500 Floodlight only.....	562.50

R&S Underwater Lighting
For Swimming Pools
Type SL
Removable Water-Cooled Type



No. 2362

For pools where it is either inconvenient or uneconomical to drain the water for relamping.

To relamp, release surplus cable in cable box and remove floodlight from housing. Relamp above surface of water.

No.	Description	Each
2362	*400-Watt Floodlight only.....	\$140.00
2398	*1000/1500 Floodlight only.....	300.00
2362II	Support Housing for No. 2362.....	65.00
2362SII	Support Housing for No. 2362.....	90.00
2398II	Support Housing for No. 2398.....	155.00
2363	Cable Box for Nos. 2362, 2398.....	50.00
2362TP	Trunnion Plate for No. 2362.....	8.75
2362B	Support Bracket for No. 2362.....	3.75

*Equipped with three-conductor rubber covered cable: Back relamp type 10 ft. Removable type 16 ft.—No. 16 for 250 and 400 watt fixtures; No. 14 for 1000/1500 watt fixtures.

Lamps are not furnished with fixtures. Type G "Floodlight Service" lamps should be used.

R & S Watertight Fixtures
Type SL
Reflector Type Fountain Light*



No. 2303

No. 2303 and 2417 for fountains, small pools and lily ponds. No. 2096 is similar to No. 2303 but made of aluminum for fish ponds.

*Clear lenses and globes are standard. Colored lenses and globes are available at additional cost, prices on application. Specify color when ordering.

No.	Max. Lamp Watts	Material	Over-all Hght., In.	Each
2303	100	Cast Bronze	7 1/4	\$40.00
2096	100	Cast Aluminum	7 1/4	40.00
2417	150	Cast Bronze	9 1/2	60.00

**R&S Watertight Fixtures
Type SL**

Globe Type Fountain Light*



No. 2366

These flared lip globe type fountain lights are of cast bronze for installation in small pools and fountains for the general illumination of water.

No.	Max. Lamp Watts	Over-all Hght., In.	Each
2366	25	5 3/4	\$14 00
2367	100	7 3/4	17 00
2368	150	8 5/8	22 00
2369	200	10 1/4	27 00

Outlets—Maximum conduit 3/4-inch except No. 2369—1-inch. Specify size and locations.

*Clear lenses and globes are standard. Colored lenses and globes are available at additional cost, prices on application. Specify color when ordering.

R & S Step Light

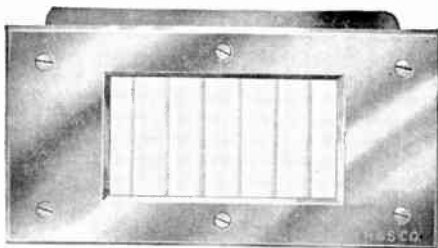

Designed to illuminate steps, terraces, entrance gates, patios, etc. Bronze construction eliminates corrosion. Arranged for flush mounting and supplied with diffusing glass panels. Brush natural bronze finish. Other finishes available.

No.	Each
2090 (Max. size lamp, 100-watt)	\$31.25

Outlets—Furnished with two 3/4-inch maximum conduits on one end. Special outlets available.

R & S Curb Light



No. 2092

Used in illuminating driveways, catwalks and terraces. Furnished with internal half shade. The clear fresnel lens provides a wide horizontal beam of light, eliminating any tendency of light being thrown upwards on the surrounding landscape.

Constructed of cast bronze with all external parts brush natural bronze finish. Other finishes available on application.

No.	Each
No. 2092 (Max. size lamp, 60-watt)	\$28.00

Outlets—Maximum conduit two 3/4-inch on bottom. Specify sizes and location.

Lamps are not furnished with fixtures.

Hope Threaded Pole Bases

**With Junction Chamber
Malleable Iron**

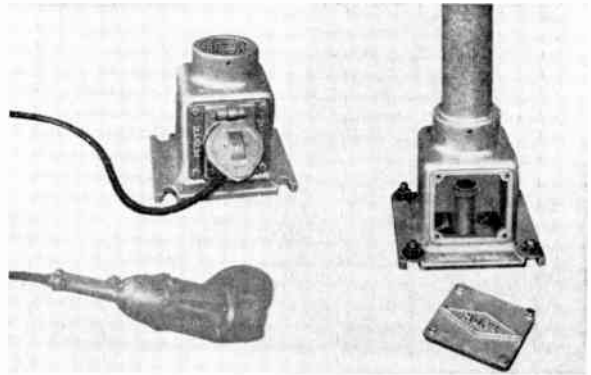

Lighting poles easily fabricated by combining threaded pole bases with single or coupled lengths of galvanized conduit or pressure pipe. Limitless variety of custom-made uprights can be erected below usual costs. Adapted to small or large quantities. Hub is tapped deep for full locking engagement with all threads on pipe, with recess at top for field packing with lead. Headless setscrew prevents turning. Ample junction chamber, open through bottom, for stubbing up conduit run and for splicing and grounding. Attractive design of tough malleable iron. Available with standard plain gasketed cover or new NEMA 3 pole weatherproof receptacle cover for use of service tools. Standard finish hot dip galvanize. Sidewall tapped for 1/4 in.-20 ground stud.

Lighting Applications: Parking areas, service stations, car lots, piers and docks, railway station platforms, parks and playgrounds, schools, sewerage disposal and waterworks plants. Other applications: Mounting for signs, signals, police and fire boxes, yard speakers, electrical enclosures.

With Plain Cover

No.	Pipe Size IPS In.	Ht. In.	Bolt Centers In.	Bolt Size In.*	Bottom Opening In.	Approx. Shp. Wt. Lb.	Each
1142200	2	7	6 1/2 x 6 1/2	1/2	4 1/2 x 1 1/2	25	\$40.00
1142250	2 1/2	7 3/4	6 1/2 x 6 1/2	1/2	4 1/2 x 1 1/2	30	46.00
1142300	3	7 3/4	6 1/2 x 6 1/2	1/2	4 1/2 x 1 1/2	35	50.00
1142400	4	10	7 3/4 x 7 3/4	3/4	5 1/2 x 5 1/2	48	70.00

With 3 Pole Receptacle Cover

No.	Pipe Size IPS In.	Each	No.	Pipe Size IPS In.	Each
1142200RC3	2	\$53.00	1142300RC3	3	\$63.00
1142250RC3	2 1/2	59.00	1142400RC3	4	85.00

*Anchor bolts not included in list prices.

Call Graybar FIRST For . . .

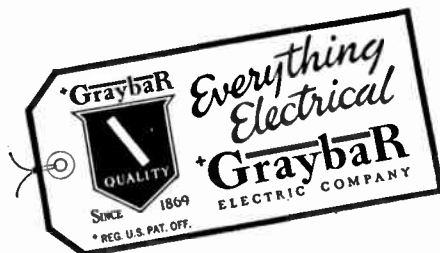

Hapco Aluminum Floodlighting Standards

For Shopping Centers, Parking Lots and Playing Fields

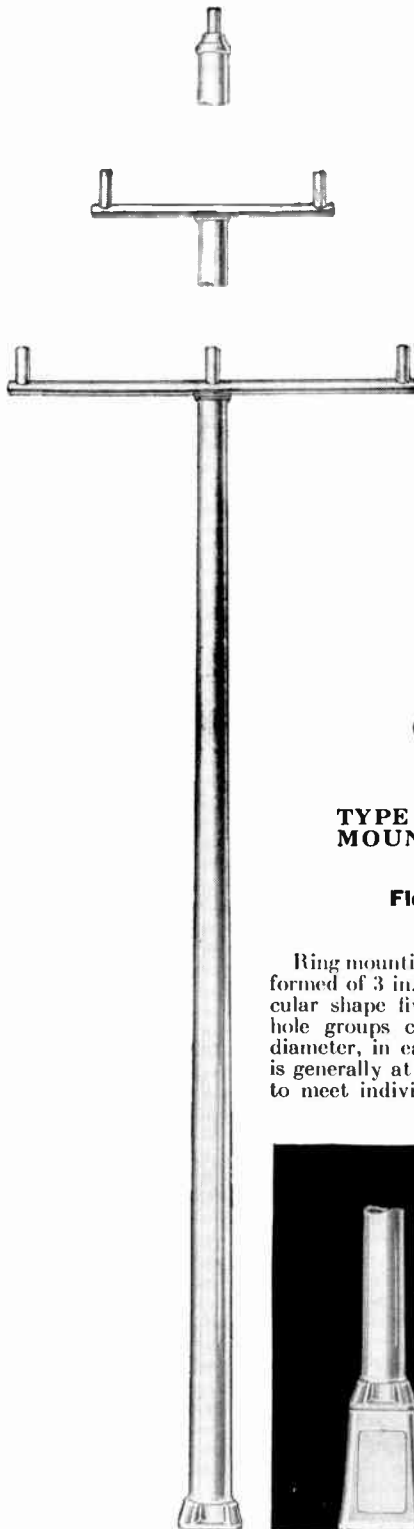

**Pole Type 1
Plain Base**

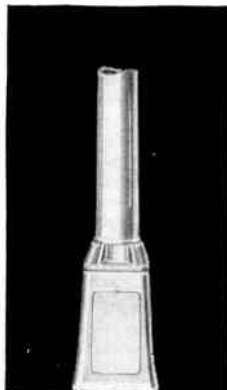

**Pole Type 1T
Transformer Base**

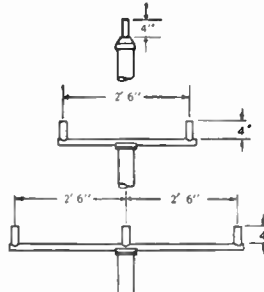

**Diagram of Dimensions
of Mounting Types**



Aluminum Floodlighting Standards

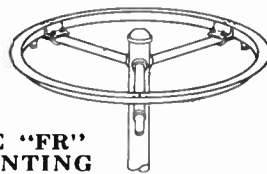

**TYPE "FR"
MOUNTING**

**Flood Ring Mounting
Type "FR"**

Ring mounting can be furnished, as illustrated, formed of 3 in. by 3 in. by 1/4 in. angle to a circular shape five ft. in diameter. Attachment hole groups consist of four holes, 1/16 in. in diameter, in each group. Placement of groups is generally at 90° around the ring. Variations to meet individual specifications are available.

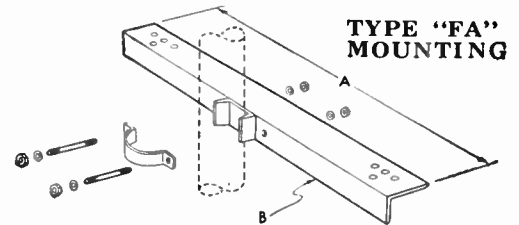

**Flood Arm Mounting
Type "FA"**

A variation in floodlight mounting methods is available in the form of 3 in. by 3 in. by 1/4 in. angle (B) crossarms which may be mounted as single or double arms for any desired floodlight grouping. Mounting studs and strap are furnished for single arm mounting, studs only for double arm mounting. Special arrangements on request. "A" = 29 in.

Pole Type 1—Plain Base

Single Mtg.		Double Mtg.		Triple Mtg.		Mtg. Ft.	Wt. of Pole	Actual Pole Size
1 1/2" Pipe	2" Pipe	1 1/2" Pipe	2" Pipe	1 1/2" Pipe	2" Pipe			
12820F11	12820F21	12820F12	12820F22	12820F13	12820F23	21	97	7" x 4" x 19' 8"
12825F11	12825F21	12825F12	12825F22	12825F13	12825F23	26	120	7" x 4" x 21' 8"
13225F11	13225F21	13225F12	13225F22	13225F13	13225F23	26	131	8" x 4 1/2" x 21' 8"
13230F11	13230F21	13230F12	13230F22	13230F13	13230F23	31	153	8" x 4 1/2" x 20' 8"
16030F11	16030F21	16030F12	16030F22	16030F13	16030F23	31	214	10" x 6" x 29' 8"
13235F11	13235F21	13235F12	13235F22	13235F13	13235F23	36	179	8" x 4 1/2" x 34' 8"
16035F11	16035F21	16035F12	16035F22	16035F13	16035F23	36	240	10" x 6" x 31' 8"
16040F11	16040F21	16040F12	16040F22	16040F13	16040F23	41	275	10" x 6" x 39' 8"

Pole Type 1T—Transformer Base

1T2820F11	1T2820F21	1T2820F12	1T2820F22	1T2820F13	1T2820F23	21	130	7" x 4" x 18'
1T2825F11	1T2825F21	1T2825F12	1T2825F22	1T2825F13	1T2825F23	26	151	7" x 4" x 23'
1T3225F11	1T3225F21	1T3225F12	1T3225F22	1T3225F13	1T3225F23	26	162	8" x 4 1/2" x 23'
1T3230F11	1T3230F21	1T3230F12	1T3230F22	1T3230F13	1T3230F23	31	185	8" x 4 1/2" x 28'
1T3235F11	1T3235F21	1T3235F12	1T3235F22	1T3235F13	1T3235F23	36	210	8" x 4 1/2" x 33'

Bracket Arms—Approximate Weights Each

Single		Double		Triple	
1 1/2" Pipe	0 4 lbs.	1 1/2" Pipe	8 1/2 lbs.	1 1/2" Pipe	11 lbs.
2" Pipe	0 5 lbs.	2" Pipe	12 lbs.	2" Pipe	16 lbs.

Revere Hinged Floodlight Poles

These poles were created and developed by the Revere Electric Mfg. Co. Many years of service have proved this type of pole most efficient and practical for floodlighting. The hinged construction makes it possible to obtain full benefit of light from any lamps used, because reflectors can be kept clean at all times. The poles also eliminate risky climbing and expensive maintenance—servicing can be done at ground level.

Poles are available in Square Type in 18-ft., 20-ft. and 24-ft. mounting heights, and Round Type in 20 and 24-ft. mounting height. Poles are available for base and bolt mounting, also for concrete mounting. The Square and Round Types accommodate one or two floodlights. The Heavy-Duty Square Tapered Type, 199-E Series, will accommodate 1, 2, or 3 floodlights as well as one or two sign arms. The pole is also available in 30-ft. mounting height listed as 199-D30.

Brackets can be furnished for mounting extra area lighters (3018) or identification signs and other advertising on the regular and Heavy-Duty square types.

Base and Bolt Mounting

For 18, 20 and 24-ft. mounting heights. Lower section is 3-in., upper is 2½-in. square seamless steel tubing, with 2-in. short threaded top nipple. Counter-balance arm is made of two ¾x2½-in. side bars bridged and proportioned to balance. Four ¾x2½-in. anchor bolts with nuts and washers are provided. Ornamental base securely welded to shaft. Wiring opening 10-in. from base bottom.

No.	Mtg. Ht. Ft.	Capacity	Wt. Lbs.
199-G18	18	1 or 2 Floods	138
199-G20	20	1 or 2 Floods	157
199-G24	24	1 or 2 Floods	193
199-E20	20	1, 2 or 3 Floods	217
199-E24	24	1, 2 or 3 Floods	248
199-D30	30	1, 2 or 3 Floods	324
199-DB30	30	180 lbs. Maximum	440

Lowering chains are listed as extras.

Concrete Mounting Type

Does not have an ornamental base and is therefore longer than the base and bolt mounting type. The extra length of 3-ft. is embedded in concrete foundation. Tapped 10-in. above ground for ½-in. pipe.

No.	Mounting Height Ft.	Capacity Floods	Wt. Lbs.
199-18	18	1 or 2	157
199-20	20	1 or 2	174
199-24	24	1 or 2	196

Floodlight Brackets

For One Floodlight			For Two Floodlights		
No.	Terminal	Wt. Lbs.	No.	Terminal	Wt. Lbs.
199-II	1½ in.	3	199-J	1½ in.	11
199-I	2 in.	3	199-K	2 in.	15

For Three Floodlights		
No.	Terminal	Wt. Lbs.
199-L	1½ in.	14
199-M	2 in.	18

Round Type Hinged Poles

Well-proportioned: Can be furnished for base and bolt, concrete mounting, replacement and concrete sleeve inserting type. Top of pole threaded, 2-in., for mounting brackets. Drilled and tapped 10-in. from grade for 1-in. pipe.

For One or Two Floodlights					
Base and Bolt Mounting		Concrete Mountings			
No.	Mtg. Ht., Ft.	Wt. Lbs.	No.	Mtg. Ht., Ft.	Wt. Lbs.
300-L-20	20	167	300-C1-20	20	190
300-L-24	24	192	300-C1-24	24	212

Low-Mounting Light Standards

Developed to provide adequate illumination at gas station pump islands; also for any type of yard area lighting, factory gate entrances, outdoor theater entrances as well as for airport use. No. 204 has air and water dispensing facilities. Switches and receptacles extra.

No.	Description	Ht., Ft.	Wt., Lbs.
203-B	Similar to No. 203-M standard except upper section is corrugated instead of round.	12	53
204	5-in. Tubing with Reducer for 2-in. Upper Shaft with Air and Water Service	12	68
203-M	Same as No. 204 except Less Air and Water.	12	53

New "Cor-Ten" Heavy-Duty Hinged Pole

No. 199-DB30 carries luminaires or floods up to 180 lbs. combined weight. Made of new type low alloy, high strength steel, offering weight reduction and corrosion resistance.

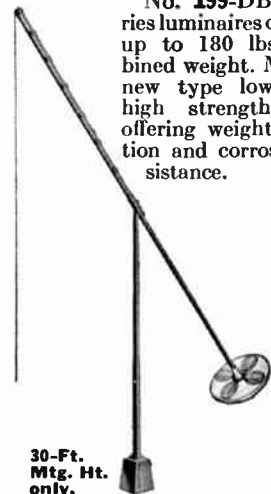

30-Ft. Mtg. Ht. only.

Available with Transformer Base for Use with Mercury Lamps.

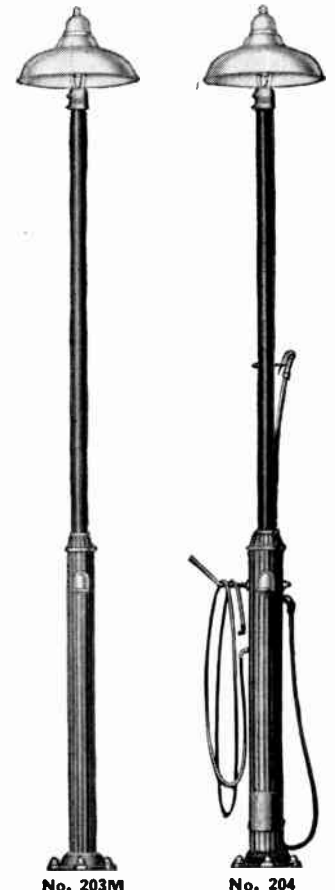

No. 203M

No. 204

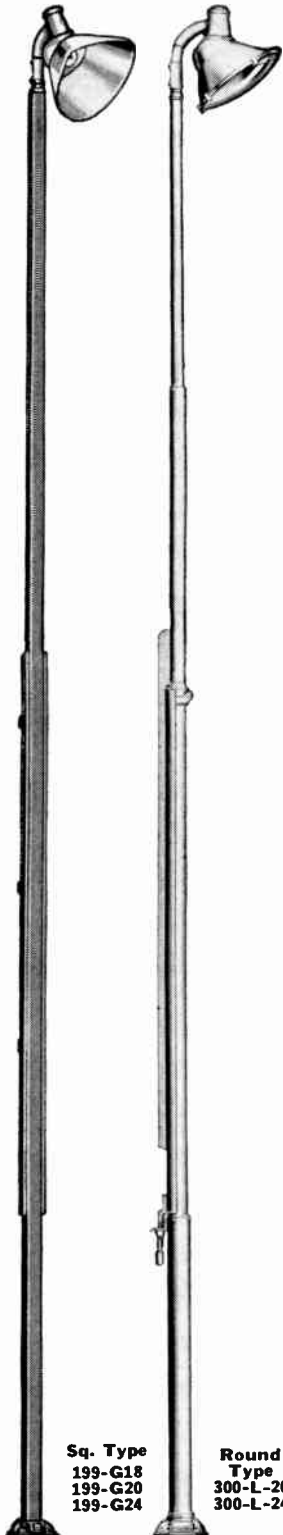

Sq. Type
199-G18
199-G20
199-G24

Round Type
300-L-20
300-L-24

Revere Floodlights and Cluster Lights

Low-Mounting Type

Holders available in red, blue, green, cream or white—or all aluminum finish.
Listed by Underwriters' Laboratories, Inc.



No. 3281

Precision diecast aluminum holder for PAR-38, medium base lamps. Hi-temp gasket.

No.	Mounting	Each
3280	3/8 in. female	\$3.80
3281	1/2 in. male	3.70



No. 3286

Cast aluminum holder, for PAR-38-150W or R-10-200-300W medium base lamps. Silicone gasketed.

No.	Mounting	Each
3286	1/2 in. male	\$3.30



No. 3288

Smallest, die cast aluminum holder for PAR-38, 150W or R-10-200-300W medium base lamps. Hi-temp gasket.

No.	Mounting	Each
3288	1/2 in. male	\$2.10



No. 3291
No. 3294

Open type holder for R-10 outdoor 300-500 W. mogul base lamps. Steel or alum. housings.

Aluminum		Porcelain	
1/2-in. Fem.	1/2-in. Male	1/2-in. Fem.	1/2-in. Male
3291 \$15.55	3291-M \$15.80	3294 16.30	3294-M 16.55



No. 3160
No. 3180 Medium Base Lamps

Attractive, quality made, enclosed holder for PAR-38 or indoor R-10 lamps.

Aluminum		Porcelain	
1/2-in. Fem.	1/2-in. Male	1/2-in. Fem.	1/2-in. Male
3160 \$17.85	3160-M \$17.95	3180 17.50	3180-M 17.60

For Mogul Base Lamps



No. 3271

Rugged cast aluminum. Floating socket holder, allows for variance in lamp lengths. Woven asbestos gasketed.

No.	Mounting	Each
3271	1/2-in. female	\$8.60

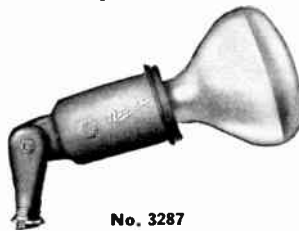

No. 3287

Cast aluminum holder for mounting to walls. For R-10 Mogul Base lamps.

No.	Mounting	Each
3287	1/2-in. male	\$7.40



No. 3510-A

No. 3520-A

Lamp

200W

300W

Each

\$12.00

13.75

Heavy-Duty Types

Sturdy, cast aluminum holder for PAR-46-200W or PAR-56-300W lamps. Gasketed 1/2-in. female. Hinged door.

No.	Lamp	Each
3510-A	200W	\$12.00
3520-A	300W	13.75

Can also be furnished with lens.

Heavy-Duty Holder

For PAR-56-300W or PAR-64-500W lamps. Merely change lamp retaining rings.

Can also be had with male fitters.

No.	Mounting	Each
3530	1/2-in. female	\$25.20
3540	For PAR-64 1/2-in. female	25.20

Cluster Lights

Showing combinations available with above lamp holders using splice boxes and accessories.



No. 3343-S



No. 3244-S



No. 3255-S—Aluminum
No. 3265-S—Porcelain



No. 3222-S—Aluminum
No. 3232-S—Porcelain

No. 3225-S furnished with 1 to 5 No. 3291 or 3294 lamp holders. No. 3244-S furnished with 1 to 5 No. 3281 lamp holders. No. 3343-S furnished with 1 to 5 No. 3271 lamp holders. No. 3222-S and 3232-S furnished with 1 to 5 No. 3160-M or 3180-M lamp holders.

Splice Boxes and Accessories

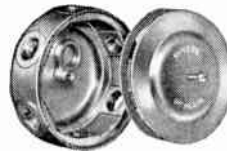

No. 3246

Precision cast aluminum splice box with six 1/2-in. thr. hubs.

No.	Each
3246	\$2.80



No. 3247

No.	Description	Each
3247	2" Slip Fitter	\$2.00
3248	1/2" Close Nipple	.15
3250	1/2" Pipe Plug	.15



No. 3248



"T" Bar Splice

Neat splice boxes. Cast aluminum, gasketed, with plugs.

No.	Description	Each
3238	7 Outlet	\$ 8.40
3239	13 Outlet	12.50
2412	9 Outlet	4.85

Table on Cluster Lights

Description	(With 3281 Holders)		(With 3271 Holders)		(With 3291 or 3294 Holders)		(With 3160 or 3180 Holders)	
	1/2-in. Pipe Mtg. No.	Each	1/2-in. Pipe Mtg. No.	Each	Aluminum No.	Each	Aluminum No.	Each
2 Light Assembly	3242	\$10.20	3342	\$20.00	3252	\$34.85	3222	\$39.15
3 Light Assembly	3243	13.90	3343	28.60	3253	50.65	3223	57.10
4 Light Assembly	3244	17.60	3344	37.20	3254	66.45	3224	75.10
5 Light Assembly	3245	21.30	3345	45.80	3255	82.25	3225	93.05
					3262	\$36.35	3233	\$38.45
					3263	52.85	3234	56.00
					3264	69.40	3235	73.60
					3265	85.95		91.20

Revere Area Lights

Convertible area lighter (left) accommodates 1 to 5 top floods with 1/2-in. male fitters in its dome. No load stress on reflector. Lamps changed without disassembling. Wire raceway in arms. Lamp mounted base up for high efficiency. Porcelain reflectors come in red, green, blue, cream or white porcelain enamel. Green is standard. Fitter slips 2-in. pipe.

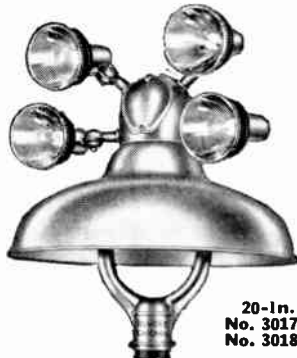

20-In. Reflector
No. 3017—Alzak
No. 3018—Porcelain

No.	Description	Each
3017	Alzak, for 300-500 Watt Lamps	\$28.40
3018	Porcelain, for 300-500 Watt Lamps	23.55
3480	Alzak, for 750-1000 Watt Bi-Post Lamps	33.65
3481	Porcelain, for 750-1000 Watt Bi-Post Lamps	28.80
3033	Alzak, for 200 Watt Lamps	32.50
3032	Porcelain, for 200 Watt Lamps	21.35



Economy Type Area Lighter
No. 3032—Porcelain
No. 3033—Alzak
16-In. Reflector for 200 Watt Lamps

Revere "Ultra-Lite" Luminaires

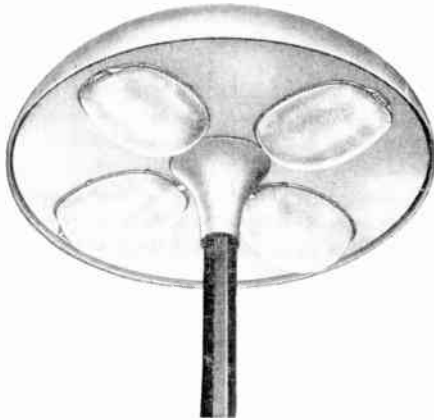

A "1 in 1" spectacular for Shopping Center Parking Areas, Swimming Pools, Playgrounds, Amusement Centers, etc.

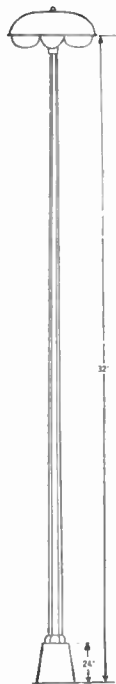
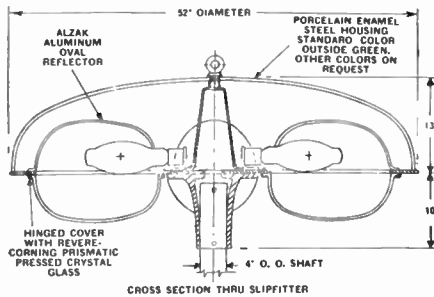

A scientific application of 4 Revere Mercury Luminaires mounted into a spun parabolic dome. Produces a square light pattern covering 40,000 sq. ft. at 32-ft. mtg. ht. Provides more light with fewer poles. Gives lighted area new impetus and reduces maintenance costs. Fitter slips 4-in. O.D. Pole Top. 52-in. unit of spun steel in standard green or other colors. 72-in. unit is of spun aluminum (natural finish), for use with rigid or hinged poles.

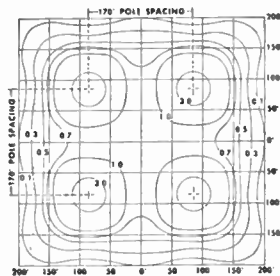

Composite Isolux Curve showing horizontal distribution in foot candles at grade. Poles spaced 170-ft. at 32-ft. mounting.

No. 560-30-3 Pole with No. 635 Sub-Base

No.	Description	WL Lbs.
5440	52-In. Ultra-Lite complete w/4 Luminaires	280
5441	72-In. Ultra-Lite complete w/4 Luminaires	280
199-DB-30	Hinged Cor-Ten Pole	440
199-CH-35	Lowering Chain for Pole	6
560-30-3	30-ft. Octagonal tapered steel pole	295
635	Sub-base for 4 transformers	280

Revere Roof and Wall Brackets

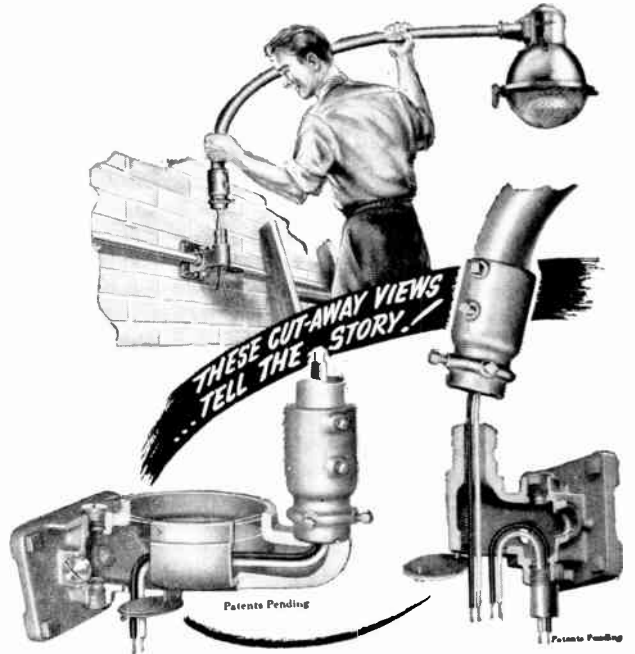

Roof Type has "L" sleeve to accommodate 3-ft. x 6-ft. 90° straight arms to run over parapet. Wall Type has straight sleeve for 90°-1 1/4-in. bent arms or upsweep arms. Either bracket can be used for Mercury Lighting (by mounting transformers at a remote point) or for Incandescent Lighting. Brackets made to rigid standards, light in weight, strong. Wiring spliced at each bracket, no extra fittings required. Brackets for Mercury only designed to accommodate transformers and to mount on walls or roofs. Same type arms as above are provided.

Wall and Roof Type—No Provision for Transformers

No.	Description
860	Wall Bracket w/Aluminum sleeve.
*860-4A	Wall Bracket w/4-ft. upsweep Aluminum arm.
*860-904A	Wall Bracket w/4-ft. 90° Aluminum arm.
864	Roof Bracket w/90° sleeve.
864-36G	Roof Bracket w/3-ft. x 6-ft.—90° Galv. arm.

Wall and Roof Type With Provisions for Mercury

861	Wall Bracket for Transformer w/sleeve.
861-4A	Wall Bracket for Transformer w/4-ft. upsweep Alum. arm.
861-904A	Wall Bracket for Transformer w/4-ft. 90° Alum. arm.
865	Roof Bracket for Transformer w/90° sleeve.
865-36G	Roof Bracket for Transformer w/3-ft. x 6-ft. 90° Galv. arm.

*Available with Hot Dip Galvanized Arm.

Revere Fluorescent Pylon-Lites

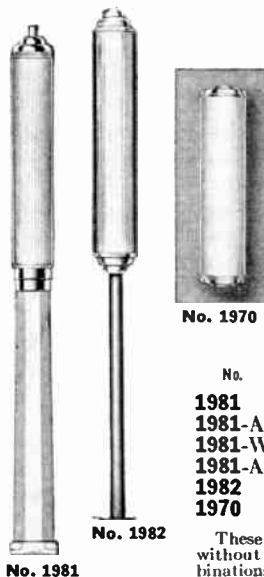

No. 1981 consists of a cast steel base and octagonal shaft with cylindrical glass enclosure housing 6-IS Fluor. Lamps. No starters needed. Ht. to top cap 9-ft. 6-in. Strong, rigid frame assures upright installation unaffected by vibration.

No. 1982 mounts on pipe of 2, 2 1/2, 3, 3 1/2, 4, 4 1/2 and 5-in. diam.

No. 1970 is a Half Pylon-Lite for wall mtg. and houses 4 lamps.

No.	Description
1981	Unit with 2-in. pipe stub.
1981-A	As above and with air conn.
1981-W	As above and with water conn.
1981-AW	Same with air and water conn.
1982	Pylon-Lite for 2-in. pipe.
1970	Half Round Wall Type.

These units available with lettering in glass, without pipe stubs at top, and in many other combinations.

**Wide-Light Area Lights
Indoor Luminaires**



Aisle

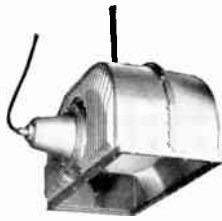

Area

Indoor fixtures that bathe your aisles, bins assembly lines and work areas in "daylight". Each fixture gives light spread 40-ft. each way of aisle.

For shops, warehouses, terminals, sheds, machine shops, papermills, supply stores and for general industrial service.

Can be mounted directly on ceiling, or can be run on overhead universal trolley duct to provide the utmost flexibility and reduce the number of lights needed. Rearrangement of shop areas and warehouse aisling can be done with no need for lighting fixture relocation or wiring disturbance.

Description	Each
Aisle (100 watt)	\$ 40.00
Area (1000 watt Hi-bay)	112.00

Weatherproof Floodlights

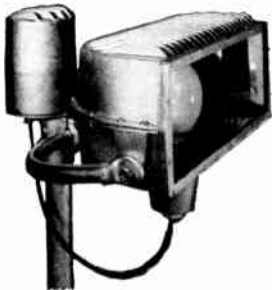

Weatherproof 400-watt floodlights with built-in ballast meet most outdoor requirements for broad area lighting with maximum operating economy. For loading docks, parking areas, refineries, shipyards, billboards, used car lots, and other outdoor applications.

Available with Type "B" reflector designed for extra depth as well as breadth of beam.

Type "A" reflectors, giving broader, less concentrated beam, supplied on order at no extra charge. Specify Type "A" when floodlight must be mounted unusually close, up to within 6-ft. of surface to be lighted. Each **\$144.00**

1000 Watt "Big Bertha"

This extra high output floodlight available for use with new 1000 watt color-corrected mercury vapor lamp or 1500 watt inside frosted incandescent lamp. Performance outstanding when used for large areas. Each **\$148.00**

Wide-Lite Vapor-Tight Floodlights

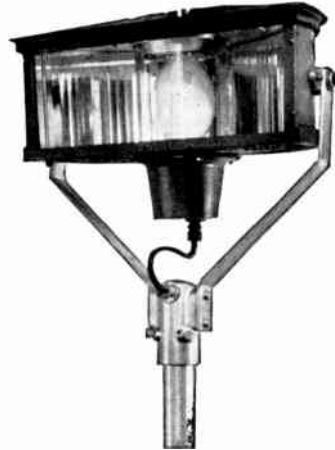

Particularly valuable for hangers and outdoor aircraft maintenance, for oil rigs, tank farms, pump houses, bulk oil stations.

Double protection by use of protective glass cylinder surrounding lamp. No breather required.

Supplied with Type "A" reflector, designed to give extra breadth of beam so floodlight may be mounted close up, to within 6-ft. of surface to be lighted.

Each **\$136.00**

**Wide-Lite Floodlight Accessories
Mounting Brackets**



Trunion



Wall



Pole X-Arm

May be used with any outdoor type of Wide-Lite flood light. Heavy cast aluminum alloy construction.

Description	Each
Trunion	\$ 8.00
Wall	18.75
Pole X-Arm	16.00

Tripod Portable Bases

Designed for using Wide-Lites in construction or salvage work; for temporary or semi-permanent installations.

. Each **\$52.00**

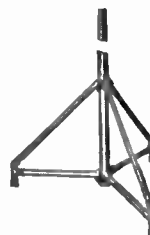

**Adapter Kit For Duct
Mounting**

Adapts indoor Wide-Lite and ballast for suspension and feed from universal trolley duct.

. Each **\$16.00**



**Benjamin "Duo-Service" Floodlights
For Stationary Mounting or with "Saflox" Lowering Attachment**

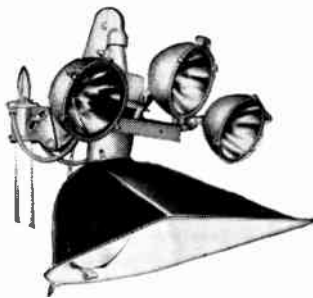

No. 27564-P-3

Combines in the same unit a large porcelain enamel diffusing reflector, with a beam-producing, aluminum, inner flood-lighting reflector. For use in gasoline service stations, super-service stations, roadside inns, etc.

Inner reflector intercepts a portion of the light from the lamp and concentrates this light on the object to be emphasized. Balance of the light is utilized by the diffusing porcelain reflector for general illumination.

Hood and bracket are aluminum castings, the porcelain enamel finish of the diffusing reflector resists deterioration from smoke, dirt and unfavorable atmospheric conditions. Reflecting surface of the porcelain enamel never requires painting or refinishing.

Available with three types of brackets: closed-wiring slip-fitter, open-wiring cross-arm and cross-arm with pipe clamp. Also available with "Saflox" lowering attachment. Inner reflector can be adjusted from side to side to locate floodlighting beam on building independently. Units listed have slip-fitter to fit 1 1/2" pipe; for 2" pipe size, same price, add suffix "A".

With "Saflox" Lowering Attachment

Reflector Description	Without Clusterette		With 3 PAR 56	
	No.	Each	No.	Each
Concentrating	27563	\$92.19	27563P3	\$144.08
Medium Spread	27564	87.98	27564P3	139.87
Wide Spread	27566	90.04	27566P3	141.93
Less Inner Ref.	27565	83.78	27565P3	135.67

For Stationary Attachment

Concentrating	5763	50.21	5763P3	96.02
Medium Spread	5764	46.00	5764P3	91.81
Wide Spread	5766	48.06	5766P3	93.87
Less Inner Ref.	5765	41.79	5765P3	87.60

Units are for 750-1500W incandescent lamps. Also available for 400-watt mercury vapor lamps.

Benjamin "Variety-Lite" Floodlights



No. 1936

For use about the home and business establishments. The steel reflector is finished in porcelain enamel. The one-piece, medium base, porcelain lamp-holder is Underwriters' listed.

Supplied wire with 6 ft. of rubber service cord and rubber plug. Reflector is finished in porcelain enamel. Inner reflecting surface is special diffusing white.

No.	Lamp Size Watts	Description	Shp. Wt., Lbs.	Each
1934	75, 100	8" Diameter	3½	\$6.55
1936	200, 300	10" Diameter	4½	7.01

300W. lamp recommended above is medium base.

Benjamin "Olympia" Floodlights



No. 6274

For use in sport and recreational fields and areas as well as industrial and railroad yards. All exposed metal parts are aluminum or other non-ferrous material except for the steel trunnion bracket. Reduces tendency of movable parts to "freeze" and prevents rust streaks. Heat and impact-resisting cover glass is spun into the edge of the reflector as permanent protection for the lamp against rain, dirt and insects.

Detachable hood has a bead-like overhang at the reflector joint to keep out rain; a silicone-rubber gasket seals this joint. Lead wire has weather-proof gland at entrance to neck. Polished or etched, alzak aluminum reflectors.

No.	Lamp Size Watts	Description	Shp. Wt., Lbs.	Each
6270	750-1500	20" Dia. Narrow Beam	35	\$87.52
6272	750-1500	18" Dia. Medium Beam	32¼	73.87
6274	750-1500	18" Dia. Wide Beam	32¼	69.10

Benjamin 300 To 1000 W. Utility Floodlights



No. P6032M

One-piece, sheet aluminum housings with Alzak finish. Wire entrance to housing is weatherproof. Impregnated asbestos gasket seals the joint between heat-resisting cover glass and housing. Aluminum channel band, operated by single shoe-buckle type clamp, holds glass and gasket in place. Three styles of cover glasses available: clear, stippled and ribbed. Six types of brackets available.

With Type "B" Swivel and Stand Mounting Bracket

Lamp Size Watts	Shp. Wt., Lbs.	Spread Type		Concentrating Type	
		No.	Each	No.	Each
300, 500	16	P-6022-B	\$36.28	P-6023-B	\$43.20
750, 1000	20	P-6032-B	47.40	P-6033-B	55.73

With Type "D" Pipe Clamp Mounting Bracket

300, 500	17	P-6022-D	36.28	P-6023-D	43.20
750, 1000	22	P-6032-D	47.40	P-6033-D	55.73

With Type "E" Wall Mounting

300, 500	20	P-6022-E	37.59	P-6023-E	44.60
750, 1000	23	P-6032-E	48.81	P-6033-E	57.13

With Type "H" 1½" Slip Fitter Mounting Bracket

300, 500	18½	P-6022-H	37.59	P-6023-H	44.60
750, 1000	22	P-6032-H	48.81	P-6033-H	57.13

With Type "K" ½" Pipe Bracket

300, 500	18	P-6022-K	37.59	P-6023-K	44.60
750, 1000	21	P-6032-K	48.81	P-6033-K	57.13

With Type "M" Cross Arm Bracket

300, 500	15½	P-6022-M	34.88	P-6023-M	41.89
750, 1000	19	P-6032-M	46.00	P-6033-M	54.32

Listings are for clear glass covers; when ordering stippled glass substitute "S" for "P", for ribbed glass "R" for "P".

Benjamin "Type RD" Floodlighting Projectors



Model RD-14

A one-piece, seamless floodlight housing of heavy gauge aluminum provides strength with light weight. Housing, cover frame, cover clamps and mounting straps are of aluminum and will not rust or corrode. Housing interior is sealed by a special gasket (which is held firmly in place by a metal expanding band) against the passage of dirt, smoke and moisture.

Cover is held firmly and with equalized pressure against the housing by means of easily operated, adjustable, lever type clamps.

Mounting base is equipped with horizontal and vertical stops for automatic resetting of floodlights after lamp replacement or for floodlight cleaning.

Width of beam regulated by focusing device, operated by aluminum knob at rear of housing. Mirrored glass reflector is designed to intercept as much light as possible.

Model RD11 (11" Diameter)

No.	Lamp Size Watts	Description	Shp. Wt., Lbs.	Each
5825	200, 250	Plain Glass Cover	18	\$74.80
5826	200, 250	Stippled Glass Cover	18	74.80
5827	200, 250	Ribbed Glass Cover	18	74.80

Model RD14 (14¼" Diameter)

5850	300, 500	Plain Glass Cover	26	93.50
5851	300, 500	Stippled Glass Cover	27	93.50
5852	300, 500	Ribbed Glass Cover	28	93.50

Model RD18 (18" Diameter)

5875	750-1000	Plain Glass Cover	57	123.42
5876	750-1000	Stippled Glass Cover	58	123.42
5877	750-1000	Ribbed Glass Cover	59	123.42

Units take General Service or Floodlighting lamps.

Benjamin "Ellipto-Lite Play-Area" Floodlights



No. S977

Wide-angle, open reflector type floodlights designed to provide illumination for outdoor sport and recreational areas. Combines a large, open type, diffusing, porcelain enamel, steel reflector with an inner reflector of processed aluminum.

Provides uniform and strong illumination on the ground to the front and sides of the unit. Directs adequate light on vertical surfaces to be illuminated.

Directs part of the reflected light to the upper areas permitting players and spectators to follow an object in flight. A sighting bar provided as part of cast neck, except for "Saflox" units.

With Pendant Hoods—Tapped ¼" I.P.S.

Lamp Size Watts	With Inner Reflector		Less Inner Reflector	
	No.	Each	No.	Each
300, 500	5770	\$26.37	5772	\$21.79
750-1500	5970	27.86	5973	23.19

With Stationary Slip-Fitter*

300, 500	5774	32.63	5775	28.05
750-1500	5975	34.13	5976	29.45

With "Saflox"*—Lowering Attachment

750-1500	25975	83.50	25976	78.82
----------	-------	-------	-------	-------

With Cross Arm Bracket

300, 500	5771	29.55	5773	24.96
750-1500	5971	31.04	5974	26.37

With Cross Arm Bracket and Pipe Clamp

300, 500	5777	30.94	5779	26.36
750-1500	5977	32.44	5978	27.76

*Listings are for 1½" Slip-Fitter Bracket; also available in 2" size at no extra cost, when ordering add "A" to cat. no.

Crouse-Hinds Aviation Lighting

High Intensity Runway Lighting



The Crouse-Hinds Company offers all three types of high intensity fixtures, as illustrated above, to meet the three CAA Specifications (L-818, L-819 and L-820). All are approved by CAA, and all provide the basic high intensity candlepower required. They have many construction features in common such as: cast aluminum housing, Pyrex glassware, disconnecting cable connector, same breakable coupling and standard steel base with base plate. All units provide the necessary top light and side light needed for planes not on the approach path; and use a 5-stage brightness control.

Type HRC utilizes a double prismatic lens system on a cast aluminum base, with a 500-watt, 115-volt lamp mounted on a movable socket. The main beams are automatically "toed in" or "toed out" by a thermal control working in step with the applied voltage. The brightness setting selected by the operator produces automatically the most efficient aiming of the beams for any weather condition.

Type HRL fixture has a fixed focus double beam optical system. Each fixture uses a 200-watt lamp and is provided with a series to series insulating transformer installed underground in the base housing.

Type HSL fixture has a cast aluminum housing with two 95-watt sealed beam high intensity lamps inside and a 45-watt medium intensity light on top. Three insulating transformers are installed underground in the base. Each of the three lamps may be switched separately from the tower.

No.	Type	Description	Each
44919		Complete fixture with clear glass and base.	\$482.00
FI1877	HRC	180-degree yellow color screen with bracket.	18.00
FI1878		360-degree green color screen with bracket.	36.00
44607		Complete fixture with base plate, & clear glass, less base.	92.00
44609		Complete fixture as above, except clear/yellow.	105.00
44608	HRL	Complete fixture as above, except green (threshold light).	108.00
FI1818		Base only, steel type, Spec. L-809.	60.00
FI4605		200-watt, series-to-series transformer.	72.00
44543B		Complete fixture with clear glass, base, & 3 transformers.	*
44544B	HSL	Complete fixture as above, except clear/yellow, left-hand.	*
44545B		Complete fixture as above, except clear/yellow, right-hand.	*
44546B		Complete fixture as above, except green (threshold light).	*

*Price on request.

Type ERL Marker Lights



Type ERL elevated marker lights are constructed in accordance with CAA Specifications L-802 (runway and threshold lights) and L-822 (taxi lights). They are used on both large and small airports. On large airports type ERL fixtures are normally used on non-instrument runways, and high intensity fixtures (type HRL, HRC, or HSL) on instrument runways.

Series runway fixtures normally use the 30-watt, 6.6-ampere, T-10 bulb lamp. The 45-watt, 6.6-ampere lamp is used for series threshold lights and taxi lights and can be used for runway lights where a higher intensity is desired. Multiple 115-volt units use the 40-watt, 115-volt lamp.

Style A mounting includes a 30 in. anchor stake, surface flange, and a direct burial insulating transformer. Style B includes a base plate for mounting on the FL1818 base (specify transformer separately). Style C consists of a junction box and 30 in. anchor stake.

The recommended system for new installations utilizes a series circuit and fixtures with Style B mounting, FL1818 steel base housing and FL4603 insulating transformer. The FL1818 base is large enough to take care of future conversion to type HRL high intensity fixtures. For a more economical installation, as for small airports, Style A mounting with direct burial transformers and series circuit can be used.

Type ERL with Style B mounting is used for converting existing flush fixtures to elevated fixtures. Practically any existing flush contact lights can be converted to ERL type, by adding a series-to-series insulating transformer in each base, and adding the elevated light with the necessary adapter base plate. Information will be furnished on request regarding conversion of any particular style flush light.

Mounting	Circuit	Runway Lights	Each	Threshold Lights	Taxi Lights		Each	
		Clear Asym.		Green Asym.	Blue Asym.	Blue Sym.		
A	6.6 Amp.	44376B	\$120.00	44377B	44378B	44386B	\$122.00	
A	600 V.	44501B	161.00	44502B	44503B	44504B	163.00	
B	6.6 Amp.	44379	77.00	44380	44381	44387	163.00	
C	115/230 V.	44370A	117.00	44371A	44372A	44384A	163.00	
Series Transformer, 45-watt, 6.6 Amp.....							FL4603	49.00
Base Housing, for Style B Units.....							FL1818	60.00

Photoelectric Control

For Aviation and General Service



Provides automatic operation of lighting circuits at dusk and dawn. The control employs a light sensitive photo-tube, amplifier circuit, sensitive relay, and 2-pole load relay, assembled within a weatherproof cast aluminum cabinet.

The sensitivity of the photoelectric control is adjustable within the light ranges listed below.

The contacts of the load relay are rated 25 amp. per pole, at 120 volts a-c. Separate load contactors for higher current ratings are listed.

No.	Description	Each
44870	Photoelectric Control, 10-60 FC	\$130.00
44871	Photoelectric Control, 1-6 FC	130.00
44414A	Contactors, 2-P, 50-A, Non-Weatherproof	106.00
44415A	Contactors, 2-P, 50-A, Weatherproof	146.00

Crouse-Hinds Aviation Lighting

Type FCB-12 Fresnel Beacons

For Airport Identification and Hazard Marking
Uses Two 500 Watt or 620 Watt Lamps



Designed for use as an auxiliary green code flashing beacon at airports, and as a red marker light for major obstructions to air navigation.

When used at airports, it is usually equipped with green color screens, and connected to a special code flasher to produce a Morse code signal, designating the airport. Code signal consists of from one to three letters, and must be approved by the CAA. Should be mounted high enough to allow its beam to clear surrounding obstacles. Housing is cast aluminum alloy.

Lamps: 500-watt, 115-volt, PS-40 bulb, mogul prefocus base, 100 hour life, or 620-watt, 115-volt, PS-40 bulb, mogul prefocus base, 3000 hour life.

No.	Type	Description	Each
41257D	FCB-12	Red Hazard Beacon	\$450.00
41258D	FCB-12	Green Code Beacon	450.00

Type VAW Obstruction Lights



Disconnecting Fixture with Thompson Hanger



Single Fixture



Transfer Relay



Double Fixture

Made in accordance with Specification MIL-L-7830 to meet requirements of the Air Forces, Navy, and CAA. Particularly used as obstruction lights. Meets FCC requirements for tower lighting.

When used as obstruction lights, VAW fixtures are equipped with red globes. Globes in other colors, for other applications, can be furnished.

Constructed of cast aluminum with 1-inch bottom hub. Available in two styles: multiple units for use on standard 115-volt circuits, and series units for use on 6.6-ampere series circuits.

The transfer relay is designed to complete the circuit to the spare lamp upon failure of the operating lamp. Relay is mounted in weatherproof housing.

The double disconnecting fixtures are used to mark obstructions to air navigation such as poles, towers, smokestacks, and water tanks, where it is desirable to lower the fixture for cleaning and relamping. Thompson Hanger is not included.

For 115-Volt Multiple Circuits

No.	Description	Each
43958	Single Fixture with Red Globe	\$32.00
43961	Double Fixture with Red Globes	64.00
43902	Transfer Relay, for Double Fixture	35.00
43950A	Disconnecting Double Multiple Fixture with Red Globes, for Thompson Hanger	82.00

For Series Circuits

43623	Single Fixture with Red Globe	65.00
43624	Double Fixture with Red Globes	130.00

Type TSS Flashers

120 Volts, 50/60 Cycles

Used to flash "on-off" signals as required for type FCB-12 red hazard beacons, and to flash code signals as required for type FCB-12 green airport identification beacons.

All type TSS standard flashers are arranged to flash "on-off" in accordance with CAA requirements for hazard beacons. Type TSS-18 (No. 46397) code flasher is furnished with the cam made to order to flash the code assigned to the airport by the CAA. The code flasher will flash most two-letter codes and some three-letter codes.

No.	No. of Circuits	Type of Flasher	Each
46993	1	TSS-22	\$135.00
46994	2	TSS-22	155.00
46995	3	TSS-22	175.00
46441	4	TSS-18	228.00
46442	5	TSS-18	258.00
46397	1 (Code)	TSS-18	230.00

Contacts of TSS-22 are mercury tube, rated 25 amperes.

Contacts of TSS-18 are metal, rated 10 amperes.

Type TGS Taxi Guidance Signs



Type TGS 3-Section Sign With Base Plate

The need for taxi guidance signs on airports has been emphasized more and more each year with ever-increasing ground traffic, larger fields, and increased activity under reduced visibility conditions.

The use of Type TGS signs provides a system of taxiway guidance such as is commonly used on highways, showing the pilot his location at each intersection and telling him how to reach his designation.

The sign housing is lightweight, aluminum, box-type construction mounted on one or more breakable couplings, all in accordance with CAA Specification L-829. Each number, letter, or symbol (arrow, dot, dash) is contained in a standard 14" square removable and interchangeable cast aluminum panel. Signs can be either one-way type or two-way type (with letters both front and back). The letters are made with an orange-yellow plastic on a black background, providing excellent legibility for both day and night.

Signs vary in length from one to six sections. Each unit section base is detachable so that signs are easily converted from one size to another.

The signs may be mounted on either standard base housings or on standard anchor stakes as commonly used for medium intensity marker lights. A series circuit with series insulation transformers is generally used. A 115-volt or 230/115-volt system may be advantageous for short run or lightly loaded circuits. Insulating transformers are not required for these units.

Description	Complete With Stake Mounting and Series Transformer		Complete With FL1818 Base and Series Transformer	
	No.	Each	No.	Each
Single Section	44746	\$215.00	44745	\$260.00
2-Section	44748	300.00	44747	345.00
3-Section	44750	455.00	44749	490.00
4-Section	44752	550.00	44751	585.00
5-Section	44754	670.00	44753	695.00
6-Section	44745	760.00	44755	780.00

Crouse-Hinds Aviation Lighting

Type DCB-36 Rotating Beacons

36-Inch Diameter—1000 Watt



A rotating beacon of high efficiency which projects beams of light in two directions, 180° apart. The optical system consists of a lens combination in each end of the housing, with a single lamp in the center. Each combination consists of an 18-in. inner doublet lens and a 36-in. outer lens. The outer lens is made of a one-piece bull's-eye lens 20-in. in diameter, surrounded by twelve 30° sectors of an annular ring.

When color is required in either or both ends of the beacon, the inner doublet lens is furnished in red, green, or yellow. Standard airport beacon listed below has one beam clear, one beam green.

No. 41281B 115 volts, 60 cycles A.C. Each **\$3600.00**

Type DCB-24R Rotating Beacon

24-Inch Diameter—500 or 1000 Watt



A drum type beacon with drum rigidly mounted on rotating shaft. Beam can be raised and lowered by raising lowering lamp table on lamp-changer. Lamp-changer shaft is calibrated in degrees. Normal factory setting with beam 1.5° above horizontal.

Beacons for advertising purposes can be furnished but must be approved by the CAA before installation. Speed of rotation required is 2 R.P.M., and beacon must be red.

In addition to beacon, it is necessary to install a 24-inch fixed directional searchlight with automatic lamp-changer, the white beam pointing towards the nearest airport. Crouse-Hinds type DCE-24 searchlights meet this requirement.

One or more of these beacons with red lenses rotating at 12 R.P.M. can be effectively installed for marking hazardous areas.

No.	Description	Each
44779	12 R.P.M., Red Beam, 1000-watt	\$2600.00
43357	2 R.P.M., Red Beam, 1000-watt	2780.00

Type DCB-10 Rotating Beacon

For Small Airports—500 Watt



Designed to meet requirements of small airports with no regular scheduled air transport activities. Provides alternate clear and green flashes from an optical system rotating at 6 R.P.M., thus indicating the location of a lighted airport with the same beam characteristics as the standard type DCB-36 airport beacon.

Constructed with a large Pyrex glass dome which completely encloses the rotating optical system. A magnetic lamp-changer provides a spare lamp which is automatically moved to the correct focal position and switched on when the first operating lamp fails. An indicating circuit is included.

No. 44035 115 volts, 60 cycles A.C. Each **\$990.00**

Type WC Illuminated Wind Cone Fixtures

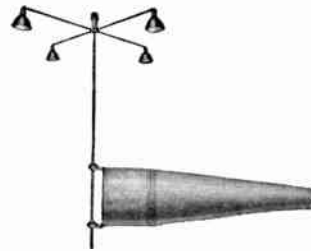

Type WC-36 is a heavy duty fixture equipped with a 36-inch diameter, 12-ft. fabric wind sock.

Type WC-18 wind cone is designed particularly for use at small airports. It is also recommended as an auxiliary wind cone at larger airports.

Both the WC-36 and WC-18 fixtures include ball bearings for the wind cone swivel support and four lighting reflectors, which are 200-watt for type WC-36 and 150-watt for type WC-18.

No.	Description	Each
44622	WC-36 for Beacon Tower Mounting	\$570.00
44621	WC-36 for Roof or Ground Mounting	590.00
FL624	Hinged Standard for 44621	800.00
FL2446	Set of Lead Counterweights for FL624	520.00
44036	WC-18 for 2-inch Pipe Mounting	300.00
FL1123	Hinged Standard for 44036	250.00

Type WT Illuminated Wind Tees

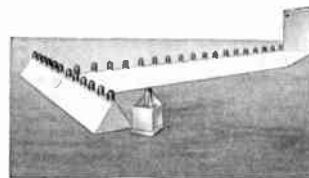

Serves as a continuous day and night indication of the true wind direction. Gives the appearance of a single green "T" when viewed from above at night and a single stroke chrome yellow "T" when viewed from above in the daytime.

Can be furnished either as a standard wind tee responsive to and affected by the wind only, or can be furnished with any of several different combinations of accessories to make it completely automatic or controlled by a remote operator.

No.	Description	Each
43339C	Free Floating Wind Tee	\$ 3600.00
43338C	Free Floating Wind Tee with Position Trans.	3900.00
44592B	Automatic Wind Tee with Operator Control and Position Transmitter	11,500.00
KL3301	Indicating Panel for 43338C Tee	300.00
TL982	Indicating Panel with Switches for 44592B Tee	360.00

**Type PTS Signal Projectors
For Airport Traffic Control**



Type PTS signal lights are designed for projecting a high intensity beam of light for clear, green or red signals to planes in the air and on the ground.

New compact Type PTS #47014 portable traffic signal can be operated with one hand. This lightweight signal for airport control towers is supplied with an overhead trunnion and yoke support. It weighs only 6 lbs., 9 ozs.

A single pistol grip contains all signal controls: an index finger trigger for selecting red or green color screens, a middle finger trigger for flashing the lamp, a thumb-operated lever for selecting a clear signal. Morse code signals can be flashed.

No. 47014 Portable traffic signal complete with transformer, cable, & two lamps Each **\$260.00**

**Modern Metal Naval Marine Equipment
Lighting Fixtures, Parts, and Accessories**

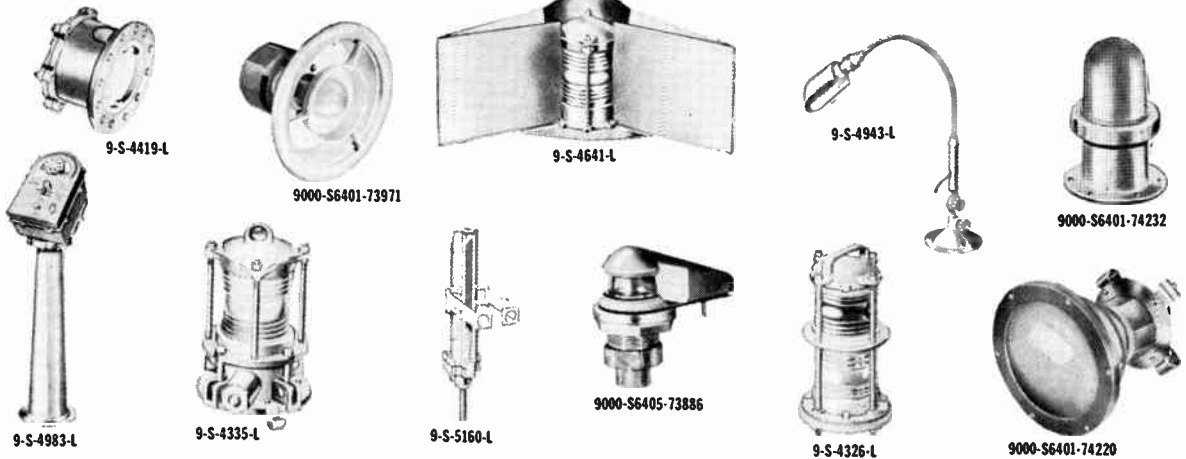

All Units In Strict Accordance with U. S. Navy Bureau of Ships Specifications

BuShips Drawing No.	Type *	Description
9-S-2034-L	AT	Diffusing Globes
2036	II-1A	Lampholder, Candelabra Screw
2057	R-20	Steering Light, Jackstaff
2176	Shield Reflector
3136	P	Diffusing Globe, threaded
4072	AT	Fresnel Lenses
4237	AT	Portable Light, wire guard, NWT
4298	2-B	Wake Light, WT
4326	C-B	Speed Light, 9 light
4335	AT	Navigational Lights, 6 & 3 lights
4341	J-8E	Overhead Light, with baffle, NWT, 50W
4374	IXS	Guard, Wire
4419	L-3A	Magazine Hoist Light, EP
4535	AT	Overhead Light, with globe, WT
4537	AT	Bulkhead Light, with globe, WT
4588	B-1A	Indicator Light, single, WT
4592	AT	Berth Light, with shade
4596	Gangway Flood Light, WT, 100W
4598	Gangway Flood Light, WT, 200W
4609	B-2A	Indicator Light, 2 dial, WT
4610	B-3A	Indicator Light, 3 dial, WT
4611	B-4A	Indicator Light, 4 dial, WT
4634	N	Lampholder, bayonet candelabra
4639	RSP-S	Side Light, Port, Red, WT
4639	RSS-S	Side Light, Starboard, Green, WT
4640	AT	Towing & Range Light, WT
4641	AT	Stern Lights, Blue or Clear, WT
4644	AT	Portable Light, WT, 100W
4666	Shield Reflector
4710	L-4A	Berth Light, with plastic shade
4778	II-9A	Lampholder, Med. Screw, weatherproof, rubber
4779	14	Lampholder, Mogul Screw, 3 contact
4836	II-4A	Lampholder, Med. Screw, Base mounted
4856	15	Lampholder, Mogul Screw, Base mounted
4866	J-8E	Reflector, porcelain enamel
4889	AT	Anchor and Boom Lights
4931	II-7A	Lampholder, Min. Bayonet
4943	AT	Desk and Workbench Flexible Light
4944	J-14A	Angle Light, 45°, with Reflector
4951	AT	Chart table Light
4971	N-7A	Diffusing Globe, threaded
4983	AT	Controller, for Speed Lights
5021	AT	Overhead Light, Explosion Proof, 100W
5023	N-8A	Globe, diffusing, Explosion Proof
5038	5-7	Lampholder, Candelabra Screw, Panel Mtg.
5079	L-6A	Chartboard Light, flexible arm, NWT
5092	AT	Desk Light, NWT
5123	AT	Globe, diffusing, small boats
5160	AT	Boiler gauge lights, NWT
5173	AT	Desk Light, with Switch, WT
5186	AT	Bulkhead Light, with Switch, WT
5279	B-8	Indicator Light, Single, Panel Mtd, WT
5280	B-9	Indicator Light, 2 dial, Panel Mtd, WT
5281	B-10	Indicator Light, 3 dial, Panel Mtd, WT
5282	B-12	Indicator Light, 4 dial, Panel Mtd, WT
5293	AT	Hand Lantern, emergency, WT
5295	AT	Pulsator, for speed lights, NWT
5299	AT	Polarity Signal Lights, WT
5300	A	Station Keeping Lights, WT

BuShips Drawing No.	Type *	Description
5381	Aircraft Warning Light, 6 light
5441	AT	Pendant Light, with brace, NWT
5442	II	Lampholder, pendant type, NWT
5452	K-15B	Floodlights, 500W, SP
5490	AT	Well Lights, Bulkhead, WT, Small Boats
5491	AT	Well Lights, Deck, WT, Small Boats
5613	C	Chartboard Light, Flexible, NWT

"9000" Series

S6405-73141	AT	Minesweeping & Inland Range Light
S6401-73271	K-16D	Portable Light, NWT, Small Boats
S6401-73420	J-24A	Psychiatric Ward Light, Shockproof
S6405-73455	II-12A	Lampholder, Candelabra Screw, 2 light
S6405-73456	II-13A	Lampholder, Candelabra Screw, 3, 6, & 9 light
S6405-73499	R-54A	Ultra-violet Light, night light
S6401-73676	J-23A	Dental Light, General Illumination
S6202-73772	AT	Shockmounts for Lighting Fixtures
S6401-73784	H-15A	Socket for Ultra-violet Light
S6401-73820	AT	Spotlight, Panel, NWT
S6401-73842	J-36D	Overhead light, cast alum. baffle, NWT
S6202-73860	C-71D	Terminal Box for Ltg. Fixtures
S6202-73860	C-71E	Terminal reactor box for Fluorescent Fixtures
S6405-73885	AT	Port & Starboard side lights, Small Boats
S6405-73886	R-3B	Bow Light, small boats
S6405-73887	R-16B	Masthead & Range Light, Small boats, WT
S6405-73897	R-18A	Anchor Light, PP, for submarines
S6405-73900	AT	Running Light for submarines, PP
S6401-73938	J-32B	Aircraft Carrier Hanger Light
S6401-73971	AT	Overhead Lights, W/Guard, Shield or Reflector, NWT
S6401-73989	M-20A	Boiler Casing Light, EP
S6401-73997	J-39D	Overhead Light, W/Cast Baffle, NWT, 200W
S6202-74056	AT	Relays, for Hand Lanterns, 115V, A-C or D-C
S6401-74070	AT	Berth Lights, incandescent, NWT
S6405-74100	R-34A	Stern Light, WT, Small Boats
S6405-74102	R-27A	Polarity Signal Lights
S6405-74103	AT	Polarity Lights, Small Boats
S6501-74104	Traffic Light, for Carriers
S6401-74218	AT	Deck or Bulkhead Lights, WT, 50W
S6401-74219	AT	Deck Light, 100W, WT
S6401-74220	AT	Flood Light, general purpose, WT
S6401-74231	R-56B	Aircraft Warning Light, 6 light, WT
S6401-74232	AT	Anchor or Boom Light, WT
S6405-74240	R-19A	Station Keeping Light, Minesweepers
S6405-74245	Instrument Panel Light, NWT, Small Boats
S6504-74246	A-55A	Flight Control Variable Dimmer
S6405-74250	Navigational Light Kit, portable, Small Boats
S6405-74251	Navigational Light Kit, portable, Small Boats
S6405-74277	R-29B	Minesweeping Light, Small Boats
S6405-74278	R-4A	Anchor Light
S6405-74279	R-13A	Bow Light, WT, Small Boats, WT
S6405-74355	AT	Side Lights, Hull Contour type
S6405-74392	C-84A	Deck Edge Light, Carriers, WT
S6405-74396	Combination Light, Small Boats
S6401-74404	AT	Adjustable Stands, for Hand Lanterns
S6401-74426	K-39A	Flood Lantern, battery type, Non-Mag.
S6401-74493	M-27A	Panel Light, PP, for Submarines
815-F-1197017	AT	Sight Light, for Submarines
815-F-1197117	AT	Navigational Light
Multi-purpose Light	A	Signalling Light Kit

*AT Designates "All Types"

Modern Metal Fuse & Distribution Boxes & Panels

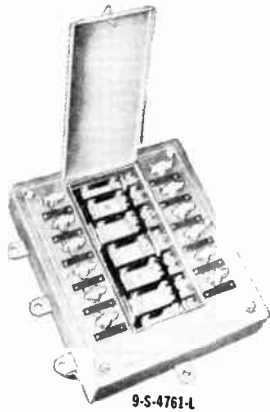

9-S-4761-L

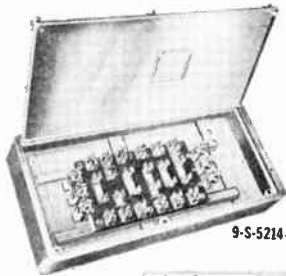

9-S-5214-L



9000-S6202-74071



9-S-4831-L

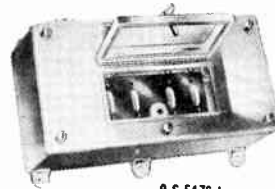

9-S-5476-L



9-S-5170-L

All Units in Strict Accordance with U. S. Navy Bureau of Ships Specifications

BuShip Drawing No.	Type*	Description
9-S-4228-L	F-S	Feeder Dist. Fuse Box, 4 Ckt., 2 wire, WT
4229	F-S	Feeder Dist. Fuse Box, 6 Ckt., 2 wire, WT
4230	H-S	Feeder Dist. Fuse Box, 8 Ckt., 2 wire, WT
4232	F-S	Feeder Dist. Fuse Box, 2 Ckt., 2 wire, WT
4234	G-S	Feeder Junction Box, 2 wire, 0-30A, WT
4260	F-S	Connection Box, 4 Terminal, NWT
4262	C-3A	Connection Box, 20 Terminal, WT
4302	AT	Connection Box, 40 Terminal, WT
4303	AT	Connection Box, 40 Terminal, WT
4540	J-S	Dist. Panel, 12 Ckt., WT
4550	16-S	Dist. Panel, with interlocking main Switch, 4 Ckt., WT
4735	GGG-S	250V, Feeder Junction Box, 3 wire, 30A fuse, WT
4740	LLL-S	Feeder Junction Box, 3 wire, 31-60A, 250V, NWT
4750	17-S	Branch Distrib. Box, 3 wire, 4 Ckt., 125V, WT
4753	18-S	Branch Distrib. Box, 3 wire, 4 Ckt., 125V, NWT
4755	18-S	Branch Distrib. Box, 3 wire, 12 Ckt., 125V, NWT
4758	22-S	Distrib. Panel, 12 Ckt., 3 wire, WT with Switches
4759	24-S	Distrib. Panel, 4 Ckt., 3 wire, NWT with Switches
4761	24-S	Distrib. Panel, 12 Ckt., 3 wire, NWT with Switches
4831	DD1-S	Shore Connection Box, 800A
4875	HHH-S	Feeder Dist., 3 wire, 2 Ckt., 250V, NWT
4876	111-S	Feeder Dist., 3 wire, 4 Ckt., 250V, NWT
4877	JJJ-S	Feeder Dist., 3 wire, 6 Ckt., 250V, NWT
4916	A-1S	Dist. Panel, for Navigational Lights, 14 Ckt., WT
4995	AT	Feeder Dist., W/Fuse Pullers, 500V, 2 Ckt., WT
4996	AT	Feeder Dist., W/Fuse Pullers, 500V, 4 Ckt., WT
4997	AT	Feeder Dist., W/Fuse Pullers, 500V, 6 Ckt., WT
5011	AT	Feeder Dist., W/Fuse Pullers, 500V, 4 Ckt., WT
5076	32-S	Power Distribution Panel, 4 Ckt., WT
5078	34-S	Power Distribution Panel, 6 Ckt., WT
5080	DD-S	Dist. Panel, for Navigational Lights, 8 Ckt., NWT
5081	BB-S	Dist. Panel, for Navigational Lights, 8 Ckt., WT
5161	AT	Connection Box, 8 & 10 Terminal, WT
5170	AT	Control Panel, for Running Lights
5174	AT	Connection Box, 4 & 5 Terminal, WT
5195	22-S	Distrib. Panel, 8 Ckt., 3 wire, WT, W/Switch
5214	18-S	Branch Dist. Box, 3 wire, 125V, 8 Ckt., NWT
5304	35-S	Branch Dist. Box, 2 wire, 125V, 4 Ckt., WT
5305	35-S	Branch Dist. Box, 2 wire, 125V, 8 Ckt., WT
5333	AT	Steel Enclosure, nominal 3-in., WT & NWT

BuShip Drawing No.	Type*	Description
5334	AT	Steel Enclosure, nominal 4-in., WT & NWT
5335	AT	Steel Enclosure, nominal 5-in., WT & NWT
5348	D-27A	Branch Dist. Box, 2 wire, 125V, 4 Ckt., NWT
5349	D-29A	Branch Dist. Box, 2 wire, 125V, 8 Ckt., NWT
5459	D-31B	Dist. Panel, 4 Ckt., NWT
5460	D-61B	Dist. Panel, 8 Ckt., NWT
5461	37-S	Dist. Panel, 12 Ckt., NWT
5476	D-36A	Dist. Panel, Ckt. Breaker, 4 Ckt., SPT
5477	D-38A	Dist. Panel, Ckt. Breaker, 6 Ckt., SPT
5525	A-5A	Shore Connection Box
"9000" Series		
S6405-73043	AT	Dist. Panel, W/Main Switch, 8 Ckt., WT
S6202-73111	AT	Shore Connection Box, WT
S8106-73142	C74A	Conn. Box, Degaussing, 20 Term., WT
S8106-73143	C76A	Conn. Box, Degaussing, 40 Term., WT
S8106-73144	C78A	Conn. Box, Degaussing, 60 Term., WT
S8106-73145	C80A	Conn. Box, Degaussing, 80 Term., WT
S6202-73159	KKS	Feeder Dist. Box, 6 Ckt., NWT
S6202-73215	SSS-S	Feeder Dist. Box, 2 Ckt., NWT
S6202-73216	TTT-S	Feeder Dist. Box, 4 Ckt., NWT
S6202-73351	...	Ckt. Breaker, WT
S6202-73771	...	Dist. Panel, W/Circuit Breakers
S6201-73823	ALB-5	Ckt. Breaker Panels, all Ckts.
S6201-73988	AQB	Encl., NWT & SBM, Nominal 3-in., Brass
S6202-74013	AT	Encl., NWT & SBM, Nominal 4-in., Brass
S6202-74014	AT	Encl., NWT & SBM, Nominal 5-in., Brass
S6202-74015	AT	Encl., NWT & SBM, Nominal 5-in., Brass
S6202-74016	C59A	Connection Box, 8 Term., SBM
S6501-74017	6TB6C	Connection Box, 6 Term., SBM
S6202-74018	C60C	Connection Box, 10 Term., SBM
S6202-74027	AT	Connection Box, 4 Term., SBM
S6202-74028	C24B	Branch Junction Box for fuses, SBM
S6202-74071	A15A	Dist. Panel, Flush Mtg. for small boats
S6202-74300	A60A	Control & Dist. Panel, small boats
S6202-74305	A31A	Control Panel, small boats
S6202-74306	A33A	Control Panel, small boats
S6401-74420	A65A	Dimmer Control Panel
S6202-74440	D58A	Dist. Box, 4 Ckt., 3 Phase, NWT
S6405-74486	A-59A	Nav. Light Control Panel

*AT Designates "All Types"

Naval Contact Makers

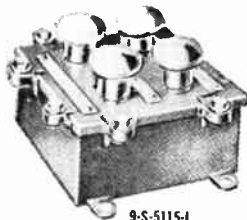

9-S-5115-L

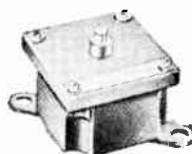

9-S-4524-L



9000-S6405-73065

All Units in Strict Accordance with U. S. Navy Bureau of Ships Specifications

BuShips Drawing No.	Type*	Description
9-S-2972-L	L	Contact Maker, Normally Open
4524	AS	Contact Maker, Normally Closed, NWT
4812	AT	Contact Maker
4835	M-16	Contact Maker, Portable
5114	Contact Maker, 6 gang, WT
5115	Contact Maker, 4 gang, WT

BuShips Drawing No.	Type*	Description
"9000" Series		
S6405-73065	AT	Contact Makers
S6501-73353	S-166A	Contact Maker, Single
S6501-73466	S-218A	Contact Maker, 4 gang, WT
S6501-73467	S-169A	Contact Maker, 6 gang, WT
S6504-74055	AT	Contact Makers, Locking & Non-Locking, SBM

*AT Designates "All Types"

Modern Metal Naval Cable Connectors, Boxes and Lugs

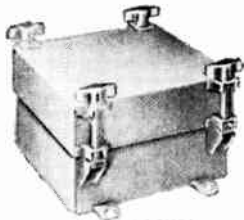

9-S-5407-L

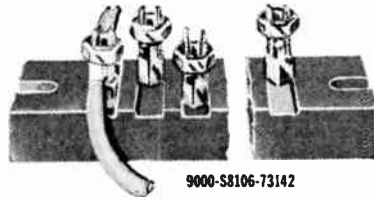

9000-S8106-73142

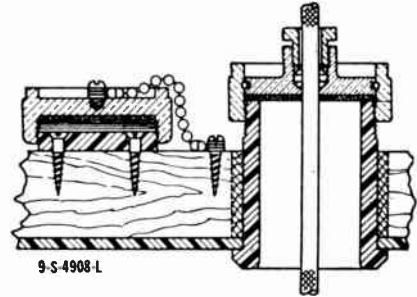

9-S-4908-L

All Units in Strict Accordance with U. S. Navy Bureau of Ships Specifications

BuShips Drawing No.	Type*	Description
9-S-4112-L	1	Thru-Deck Outlet
4441	AT	Cable Straps
4442	AT	Cable Straps
4525	2	Thru-Deck Outlet, WT
4799	II-37A	Thru-Deck Outlet
4908	II-18A	Thru-Deck Outlet
5058	A	Cable Coupling

BuShips Drawing No.	Type*	Description
5289	Cable Stowage Rack
5407	Riser Terminal Enclosure, WT
"9000" Series		
S6202-73286	AT	Packing, Prefabricated, for tubes
S6505-74249	1C/TCR	Cable Stowage Reel, Casualty Power

*AT Designates "All Types"

Naval Telephone & Intercommunication Equipment

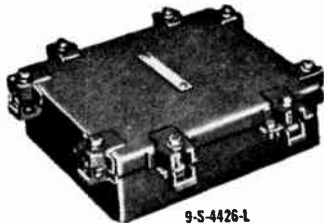

9-S-4426-L



S6501-590485



9000-S6501-73495



9000-S6501-73819

All Units in Strict Accordance with U. S. Navy Bureau of Ships Specifications

BuShips Drawing No.	Type*	Description
9-S-4426-L	C30A	Terminal Connection Box, 80 pr., telephone, WT
4427	G32A	Terminal Connection Box, 160 pr., telephone, WT
4428	C31A	Terminal Connection Box, 240 pr., telephone, WT
4478	G40A	Terminal Connection Box, 40 pr., telephone, WT
5406	T-1S	Telephone Jack Box, single, WT

BuShip Drawing No.	Type*	Description
"9000" Series		
S6501-73495	1-6	Telephone Headset Stowage Box
S6501-73801	1C/D	Call Signal Station
S6501-73819	SPF	Telephone Holder, with Jack, Aluminum
S6501-73892	G29A	Jack Box, PP, for Subs
S6501-74295	A-26A	Selector Switch
S6501-74464	AT	Telephone Handset Holder, Shockproof.
S6501-590485	Telephone Handset Holder, Shockproof

*AT Designates "All Types"

Naval Plugs and Receptacles



9000-S6202-73448



9000-S6202-73002



9-S-4797-L



9000-S6202-73028

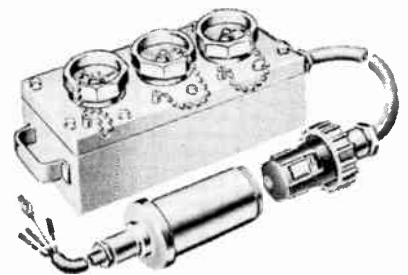

9-S-5544-L

All Units in Strict Accordance with U. S. Navy Bureau of Ships Specifications

BuShips Drawing No.	Type*	Description
9-S-4440-L	D2G	Plug Connector, Grounded, WT
4861	AT	Plug Connector, Grounded, WT, High Voltage
4862	AT	Receptacle, 3 Phase, Grounded
4863	FF-S	Receptacle, 1 Phase, Grounded
4864	AT	Switch & Receptacle, 30A, 3 Phase, Grounded
4865	BB-S1	Switch & Receptacle, Single Phase, Grounded
5058	A	Cable Coupling, 6PT, WT
"9000" Series		
S6202-73002	Receptacle, Connector, Flush Mtg., WT
S6202-73028	Battery Charging Outlet, Single Ckt., WT
S6202-73213	Receptacle, Polarized, Mod. Brass Enclosed
S6202-73274	C-SG2	Convenience Outlet, Duplex, NWT
S6202-73310	G48A	Connector Receptacle, Single, Grounded, WT

BuShip Drawing No.	Type*	Description
S6202-73448	G55A	Receptacle, Single, Portable, Grounded, WT
S6202-73861	A47B	Test Bench Receptacle, 8 Outlet
S6501-73892	G29A	Plug, PP, for Jack Box
S6202-74026	G48B	Receptacle, Single, Grounded, WT
S6202-74068	G80A	Switch & Receptacle, 10A, 20V, SBM
S6202-74159	G30A	Receptacle
S6202-74160	G32A	Receptacle, Single, 25A, DP
S6202-74161	G31A	Receptacle, 3 Phase, 25A
S6202-74162	G36A	Receptacle
S6202-74163	G28A	Receptacle, 6 outlet, portable, SBM
S6202-74214	G60A	Switch & Receptacle, 500V, 3PH., GND, SBM
S6202-74215	AT	Switch & Receptacle, 25A, GND, SBM
S6202-74372	G45A	Receptacle, for small boats

*AT Designates "All Types"

Modern Metal Naval Switches, Parts and Accessories



9000-S6202-74276

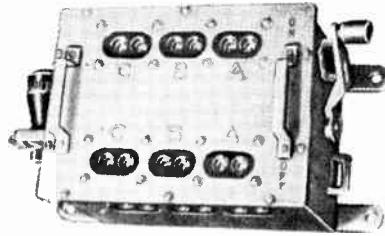

9000-S6201-73177

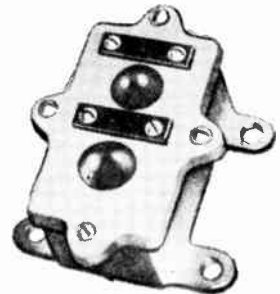

9-S-4488-L

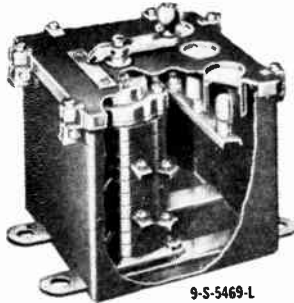

9-S-5469-L

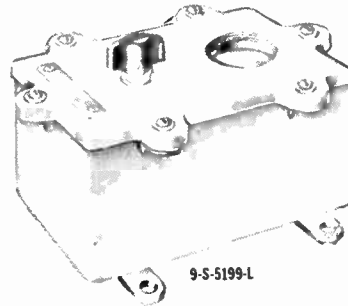

9-S-5199-L

All Units in Strict Accordance with U. S. Navy Bureau of Ships specifications

BuShips Drawing No.	Type*	Description
9-S-2524-L	B	Push Switch, Hand type
4488	A-S	Pushbutton, 2 gang, WT
4489	A-S	Pushbutton, 3 gang, WT
4490	A-S	Pushbutton, 4 gang, WT
4581	AT	Pushbutton, single, WT
4629	A-S	Pushbutton, 5 gang, WT
4708	Pushbutton, NWT, N. M.
4718	S-1B	Rotary Switch, 10A, 120V, DPST
4719	S-2	Rotary Switch, 10A, 120V, TPST
4721	S-4B	Rotary Switch, 10A, 120V, SPDT
4772	DB-S	Toggle Switch, Stateroom, NWT
4838	AA	Pushbutton, NE
5194	32-1S	Rotary Switch, 30A, DPDT, WT
5199	A-S	Switch & Indicator Light, WT
5378	WWS	Rotary Switch, 10A, 120V, DPDT, WT
5393	8-3S	Door Switch, 3 pole, WT
5394	8-6S	Door Switch, 6 pole WT
5468	AT	Transfer Switch, with Indicator Lights, 30A, WT

BuShips Drawing No.	Type*	Description
5469	AT	Transfer Switch, with Indicator Lights, 60A, WT
5478	USI	Pushbutton, heavy duty, WT
5514	15-1S	Rotary Switch, 30A, DPDT, WT
"9000" Series		
S6202-73075	AT	Multipole Rotary Selector Switch, NE
S6202-73127	AT	Multipole Rotary Selector Switch, NE
S6202-73136	AT	Multipole Rotary Selector Switch, NE
S6201-73177	Casualty Power Supply Switch, Port., NWT
S6202-73295	AT	Multipole Rotary Selector Switch, NE
S6202-73319	IIIIII-S	Transfer Switch, W/Indicators, 200A, WT
S6202-73691	Motor Starter, Across Line, 10 hp.
S6202-73826	S2JR5	Multipole Rotary Selector Switch, NE
S6202-73888	Pushbutton, for Horn, WT, Panel Mtg.
S6202-74085	AT	10A, Rotary Snap Switches, NE
S6202-74090	AT	30A, Rotary Snap Switches, NE
S6202-74207	AT	Rotary Snap Switches 10A, ABM
S6202-74276	AT	Rotary Snap Switch, 30A, SBM
S6202-74294	E-17A	Pushbutton, 2 gang, flush mounted
*AT Designates "All Types"		

Naval Rheostats

All Units in Strict Accordance with U. S. Navy Bureau of Ships Specifications

BuShips Drawing No.	Type*	Description
9-S-5262	Dimmer Switch
S6504-74246	A-55A	Dimmer, Flight Control, 150W, SBM
S6202-74292	Z-17A	Rheostats, for Windshield Wipers, WT
*AT Designates "All Types"		

Abbreviations:	Ckt.	—Circuit	NWT	—Non-Watertight
	Encl.	—Enclosed	PP	—Pressure-Proof
	EP	—Explosion-Proof	SBM	—Submersible
	NE	—Non-Enclosed	SPT	—Spraytight
			WT	—Watertight

How to Order G-E Lamps

To expedite service and to assure best discount, order in standard package quantities whenever possible. Specify quantity desired of each type of lamp and order by Lamp Ordering

Abbreviations. These consist of watts, bulb shape and diameter in eighths of an inch, color or other description. See illustrations below.

FLUORESCENT

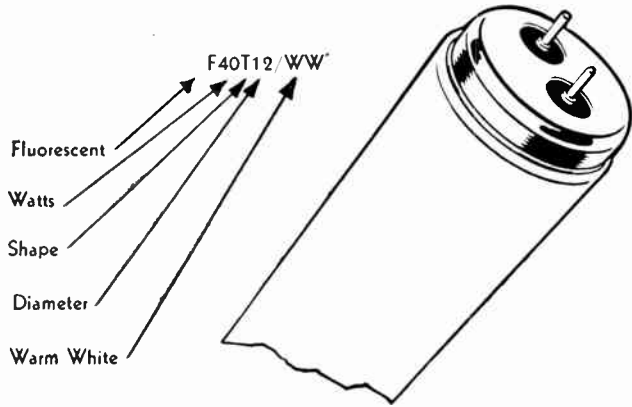

FILAMENT

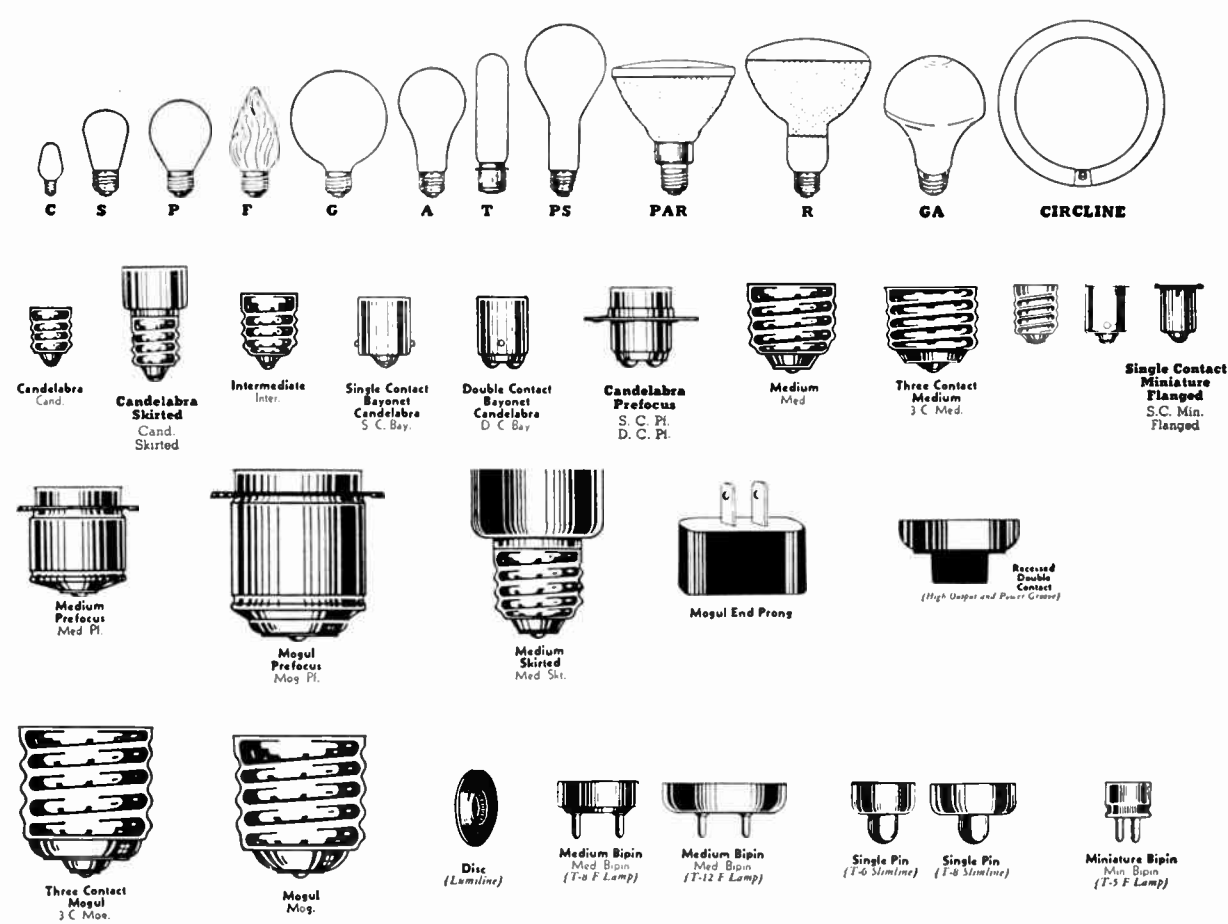
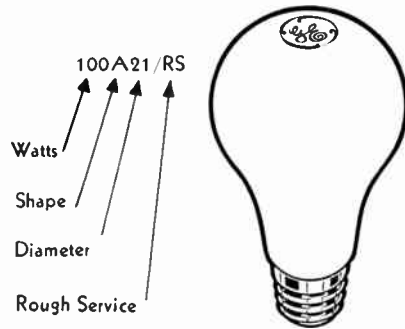

G-E Fluorescent Lamps

The life and light output ratings of fluorescent lamps are based on their use with ballasts providing proper operating characteristics. Ballasts that do not provide proper electrical values may substantially reduce either lamp life or light output, or both.

Ballasts certified as built to the specifications adopted by the Certified Ballasts Manufacturers (CBM) do provide values that meet or exceed minimum requirements. This certification assures the user, without individual testing, that lamps will operate at values close to their ratings.

Life Ratings—based on 3 burning hours per start: 7500 hrs.—T6, T8, and T12 preheat, rapid start, and slimline; T12 instant start; T17 preheat; all circlines. Exceptions: F100T12/RS rapid start (7500 hrs. for 10 hrs./start); 14 watt T12 preheat. 6000 hrs.—T17 instant start, 6, 8, and 13 watt T5 preheat; 14 watt T12 preheat. 4000 hrs.—4 watt T5. Life Multiplying Factors—for 6 hrs. per start: 1.25; for 12 hrs. per start: 1.6; for continuous operation: 2.5. Lamp lengths include lamp and two standard lamp-holders.

General Line Fluorescent Lamps



F40T12
F40T17 F90T17

Medium Bipin Bases

Nom. Lamp Watts	Length, In.	Bulb Size	Diam., In.	Color	Lamp Ordering Abbrev.	Std. Pkg. Qty.	Each
14	15	T-12	1½	Cool White	F14T12/CW	24	\$1.00
14	15	T-12	1½	Warm White	F14T12/WW	24	1.05
14	15	T-12	1½	Deluxe Cool White	F14T12/CWX	24	1.05
14	15	T-12	1½	Home-line	F14T12/WWX	24	1.05
15	18	T-8	1	Cool White	F15T8/CW	24	1.00
15	18	T-8	1	Warm White	F15T8/WW	24	1.05
15	18	T-8	1	Deluxe Cool White	F15T8/CWX	24	1.05
15	18	T-8	1	Home-line	F15T8/WWX	24	1.05
15	18	T-12	1½	Cool White	F15T12/CW	24	1.00
15	18	T-12	1½	Warm White	F15T12/WW	24	1.05
15	18	T-12	1½	Deluxe Cool White	F15T12/CWX	24	1.05
15	18	T-12	1½	Home-line	F15T12/WWX	24	1.05
20	24	T-12	1½	Cool White	F20T12/CW	24	1.00
20	24	T-12	1½	Warm White	F20T12/WW	24	1.05
20	24	T-12	1½	Deluxe Cool White	F20T12/CWX	24	1.05
20	24	T-12	1½	Home-line	F20T12/WWX	24	1.05
25	33	T-12	1½	Cool White	F25T12/CW/33	24	1.40
25	33	T-12	1½	Warm White	F25T12/WW/33	24	1.45
25	33	T-12	1½	Deluxe Cool White	F25T12/CWX/33	24	1.45
25	33	T-12	1½	Home-line	F25T12/WWX/33	24	1.45
30	36	T-8	1	Cool White	F30T8/CW	24	1.20
30	36	T-8	1	Warm White	F30T8/WW	24	1.25
30	36	T-8	1	Deluxe Cool White	F30T8/CWX	24	1.25
30	36	T-8	1	Home-line	F30T8/WWX	24	1.25
40	48	T-12	1½	Cool White	F40T12/CW	24	1.20
40	48	T-12	1½	Warm White	F40T12/WW	24	1.25
40	48	T-12	1½	Deluxe Cool White	F40T12/CWX	24	1.25
40	48	T-12	1½	Home-line	F40T12/WWX	24	1.25
40	48	T-12	1½	White	F40T12/W	24	1.25
40	48	T-12	1½	Daylight	F40T12/D	24	1.25
40	48	T-12	1½	Soft White	F40T12/SW	24	1.55

Medium Bipin Bases (Cont.)

Nom. Lamp Watts	Length, In.	Bulb Size	Diam., In.	Color	Lamp Ordering Abbrev.	Std. Pkg. Qty.	Each
40	48	T-12	1½	*Cool White	F40T12/CW/IS	24	\$1.50
40	48	T-12	1½	*Warm White	F40T12/WW/IS	24	1.55
40	48	T-12	1½	*Deluxe Cool White	F40T12/CWX/IS	24	1.55
40	48	T-12	1½	*Home-line	F40T12/WWX/IS	24	1.55
40	48	T-12	1½	White	F40T12/W/IS	24	1.55
40	48	T-12	1½	Daylight	F40T12/D/IS	24	1.55
40	48	T-12	1½	Soft White	F40T12/SW/IS	24	1.85

*For instant start service. No starters required.
Most lamps available in white and daylight at price of Deluxe Lamps and in soft white, green, pink, blue, gold, red at added cost.

Mogul Bipin Bases

Nom. Lamp Watts	Length, In.	Bulb Size	Diam., In.	Color	Lamp Ordering Abbrev.	Std. Pkg. Qty.	Each
40	60	T-17	2½	*Cool White	F40T17/CW/IS	12	\$3.40
40	60	T-17	2½	*Warm White	F40T17/WW/IS	12	3.50
40	60	T-17	2½	*Deluxe Cool White	F40T17/CWX/IS	12	3.50
40	60	T-17	2½	*Home-line	F40T17/WWX/IS	12	3.50
90	60	T-17	2½	Cool White	F90T17/CW	12	2.90
90	60	T-17	2½	Warm White	F90T17/WW	12	3.00
90	60	T-17	2½	Deluxe Cool White	F90T17/CWX	12	3.00
90	60	T-17	2½	Home-line	F90T17/WWX	12	3.00

Most of these lamps available in white and Daylight at price of Deluxe Lamps and in Soft white, green, pink, blue, gold, and red at added cost.
*For instant start service. No starters required.

Miniature Bipin Bases

Nom. Lamp Watts	Length, In.	Bulb Size	Diam., In.	Color	Lamp Ordering Abbrev.	Std. Pkg. Qty.	Each
4	6	T-5	⅝	Cool White	F4T5/CW	24	\$1.30
4	6	T-5	⅝	Warm White	F4T5/WW	24	1.35
4	6	T-5	⅝	Deluxe Cool White	F4T5/CWX	24	1.35
4	6	T-5	⅝	Home-line	F4T5/WWX	24	1.35
6	9	T-5	⅝	Cool White	F6T5/CW	24	1.30
6	9	T-5	⅝	Warm White	F6T5/WW	24	1.35
6	9	T-5	⅝	Deluxe Cool White	F6T5/CWX	24	1.35
6	9	T-5	⅝	Home-line	F6T5/WWX	24	1.35
8	12	T-5	⅝	Cool White	F8T5/CW	24	1.30
8	12	T-5	⅝	Warm White	F8T5/WW	24	1.35
8	12	T-5	⅝	Deluxe Cool White	F8T5/CWX	24	1.35
8	12	T-5	⅝	Home-line	F8T5/WWX	24	1.35
13	21	T-5	⅝	Cool White	F13T5/CW	24	1.45
13	21	T-5	⅝	Warm White	F13T5/WW	24	1.50

G-E Fluorescent Lamps

Slimline Fluorescent Lamps

Instant Start—No Starters Used—Single Pin Base

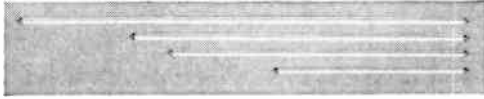

Nom. Lamp Watts	Length, In.	Bulb		Color	Lamp Ordering Abbrev.	Std. Pkg Qty.	Each
		Size	Diam., In.				
F64T6							
74	96	T-12	1½	Cool White	F96T12/CW	12	\$3.30
74	96	T-12	1½	Warm White	F96T12/WW	12	3.40
74	96	T-12	1½	Deluxe Cool White	F96T12/CWX	12	3.40
74	96	T-12	1½	Home-line	F96T12/WWX	12	3.40
F12T8							
55	72	T-12	1½	Cool White	F72T12/CW	12	3.20
55	72	T-12	1½	Warm White	F72T12/WW	12	3.30
55	72	T-12	1½	Deluxe Cool White	F72T12/CWX	12	3.30
55	72	T-12	1½	Home-line	F72T12/WWX	12	3.30
38	48	T-12	1½	Cool White	F48T12/CW	24	1.90
38	48	T-12	1½	Warm White	F48T12/WW	24	1.95
38	48	T-12	1½	Deluxe Cool White	F48T12/CWX	24	1.95
38	48	T-12	1½	Home-line	F48T12/WWX	24	1.95
32-65	96	T-8	1	Cool White	F96T8/CW	24	3.00
32-65	96	T-8	1	Warm White	F96T8/WW	24	3.10
32-65	96	T-8	1	Deluxe Cool White	F96T8/CWX	24	3.10
32-65	96	T-8	1	Home-line	F96T8/WWX	24	3.10
24-48	72	T-8	1	Cool White	F72T8/CW	24	2.80
24-48	72	T-8	1	Warm White	F72T8/WW	24	2.90
24-48	72	T-8	1	Deluxe Cool White	F72T8/CWX	24	2.90
24-48	72	T-8	1	Home-line	F72T8/WWX	24	2.90
25-48	64	T-6	¾	Cool White	F64T6/CW	24	2.70
25-48	64	T-6	¾	Warm White	F64T6/WW	24	2.80
25-48	64	T-6	¾	Deluxe Cool White	F64T6/CWX	24	2.80
25-48	64	T-6	¾	Home-line	F64T6/WWX	24	2.80
17-32	42	T-6	¾	Cool White	F42T6/CW	24	2.50
17-32	42	T-6	¾	Warm White	F42T6/WW	24	2.60
17-32	42	T-6	¾	Deluxe Cool White	F42T6/CWX	24	2.60
17-32	42	T-6	¾	Home-line	F42T6/WWX	24	2.60

All these lamps available in daylight, soft white, green, pink, blue, gold, and red. Some lamps available in special colors for special applications such as signs.

Rapid Start Fluorescent Lamps

(No Starters Used)

Medium Bipin Bases

Nom. Lamp Watts	Length, In.	Bulb		Color	Lamp Ordering Abbrev.	Std. Pkg Qty.	Each
		Size	Diam., In.				
40	48	T-12	1½	Cool White	F40T12/CW/RS	24	\$1.30
40	48	T-12	1½	Warm White	F40T12/WW/RS	24	1.35
40	48	T-12	1½	Deluxe Cool White	F40T12/CWX/RS	24	1.35
40	48	T-12	1½	Home-line	F40T12/WWX/RS	24	1.35

High Output Fluorescent Lamps

Nom. Lamp Watts	Length, In.	Bulb		Color	Lamp Ordering Abbrev.	Std. Pkg Qty.	Each
		Size	Diam., In.				

Recessed Double Contact Base

105	96	T-12	1½	Cool White	F96T12/CW/HO	12	\$3.85
105	96	T-12	1½	Warm White	F96T12/WW/HO	12	3.95
105	96	T-12	1½	Deluxe Cool White	F96T12/CWX/HO	12	3.95
105	96	T-12	1½	Home-line	F96T12/WWX/HO	12	3.95
85	72	T-12	1½	Cool White	F72T12/CW/HO	12	3.75
85	72	T-12	1½	Warm White	F72T12/WW/HO	12	3.85
60	48	T-12	1½	Cool White	F48T12/CW/HO	24	2.45
60	48	T-12	1½	Warm White	F48T12/WW/HO	24	2.50

Mogul Bipin Base

100	72	T-12	1½	Cool White	F100T12/CW/HO	12	4.50
100	72	T-12	1½	Warm White	F100T12/WW/HO	12	4.70

Available in green, pink, blue, gold, and red.

Power Groove Fluorescent Lamps

Nom. Lamp Watts	Length, In.	Bulb		Color	Lamp Ordering Abbrev.	Std. Pkg Qty.	Each
		Size	Diam., In.				
200	96	PG-17	2½	Cool White	F96PG17/CW	8	\$6.50
155	72	PG-17	2½	Cool White	F72PG17/CW	8	6.25
107	48	PG-17	2½	Cool White	F48PG17/CW	12	4.95

RF Fluorescent Lamps

2 and 3 Prong Base

Nom. Lamp Watts	Length, In.	Bulb		Color	Lamp Ordering Abbrev.	Std. Pkg Qty.	Each
		Size	Diam., In.				
85	58	T-10	1½	Industrial White	F85T10/IW	24	\$3.75
85	58	T-10	1½	Blue White	F85T10/BW	24	3.75

G-E Circline Fluorescent Lamps

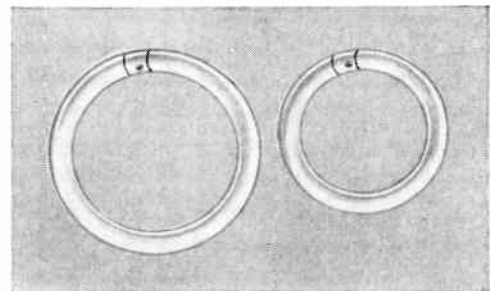

FC12T10

FC8T9

Circline lamps have wide use in residential lighting fixtures, floor and table lamps and many commercial and industrial applications.

Home-line color should be used in residential installations.

Nom. Lamp Watts	Length, In.	Bulb		Color	Lamp Ordering Abbrev.	Std. Pkg Qty.	Each
		Size	Diam., In.				
22	8	1⅛		Cool White	FC8T9/CW	12	\$3.50
22	8	1⅛		Home-line	FC8T9/WWX	12	3.60
32	12	1¼		Cool White	FC12T10/CW	12	3.50
32	12	1¼		Home-line	FC12T10/WWX	12	3.60
40	16	1¼		Cool White	FC16T10/CW/RS	12	4.50
40	16	1¼		Home-line	FC16T10/WWX/RS	12	4.70

G-E General Service Lamps

115, 120 and 125 Volts

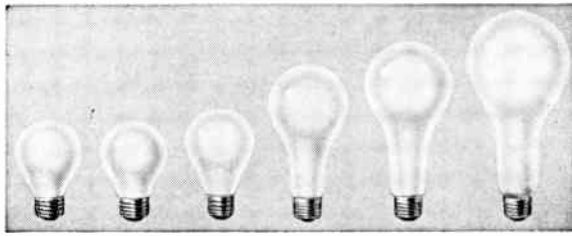

15W 25W 40W 50, 60
75W 100W 150W

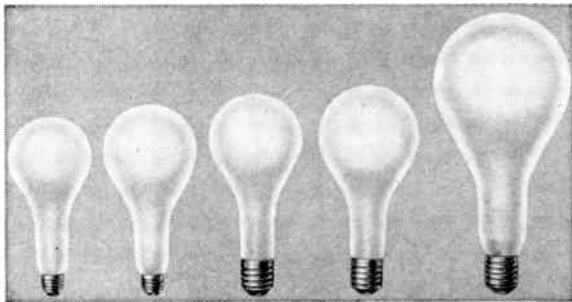

200/IF 300M/IF 300/IF 500/IF 750/IF
1000/IF
1500/IF

Inside Frosted

For most general lighting purposes. Inside frosting diffuses the light and helps eliminate shadows and glare. Light output is practically the same as for clear lamps. Outside surface is smooth and easily cleaned.

Watts	Bulb	Base	Max. Overall Length Inches	Lamp Ordering Abbrev.	Std. Pkg. Qty.	Each
15	A-15	Med.	3 1/2	15A15	120	\$0.21
25	A-19	Med.	3 15/16	25A	120	.21
40	A-19	Med.	4 1/4	40A	120	.21
50	A-19	Med.	4 7/16	50A	120	.21
60	A-19	Med.	4 7/16	60A	120	.21
75	A-19	Med.	4 7/16	75A	120	.21
100	A-21	Med.	5 5/16	100A	120	.23
150	A-23	Med.	6 3/16	150A	60	.27
200	A-25	Med.	6 15/16	200/IF	60	.40
300	PS-30	Med.	8 1/16	300M/IF	60	.48
300	PS-35	Mog.	9 3/8	300/IF	24	.67
500	PS-40	Mog.	9 3/4	500/IF	24	1.50
750	PS-52	Mog.	13 1/16	750/IF	6	2.95
1000	PS-52	Mog.	13 1/16	1000/IF	6	3.15
1500	PS-52	Mog.	13 1/16	1500/IF	6	4.65

Clear Lamps

Used in enclosed diffusing equipment or shielded reflectors which protect the eyes from glare.

150	A-23	Med.	6 5/16	150A/CL	60	\$0.29
200	A-25	Med.	6 15/16	200A/CL	60	.38
300	PS-30	Med.	8 1/16	300M	60	.48
300	PS-35	Mog.	9 3/8	300	24	.67
500	PS-40	Mog.	9 3/4	500	24	1.00
750	PS-52	Mog.	13 1/16	750	6	2.80
1000	PS-52	Mog.	13 1/16	1000	6	3.00
1500	PS-52	Mog.	13 1/16	1500	6	4.50

G-E Daylight Lamps

115-125 Volts

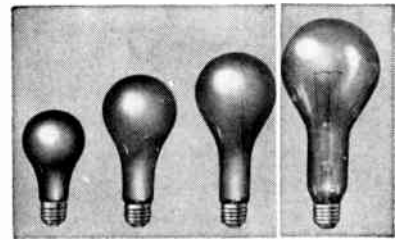

60A/D 100A/D 150A/D 200/D

Produce light approximating daylight. Used where color discernment is important.

Watts	Bulb	Base	Max. Overall Length Inches	Lamp Ordering Abbrev. (Exc. Volts)	Std. Pkg. Qty.	Each
60	A-19 I.F.	Med.	1 7/16	60A/D	120	\$0.35
100	A-23 I.F.	Med.	6 1/16	100A/D	120	.47
150	PS-25 I.F.	Med.	6 15/16	150/D	60	.60
200	PS-30 Cl.	Med.	8 1/16	200/D	60	.85

G-E Silvered Bowl Lamps

120 Volts

Used with indirect lighting equipment. Have inside frosted bulb with coating of mirrored silver on the bowl.

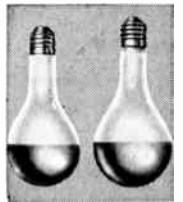

300/SB1F 200/SB1F

60	A-19	Med.	4 7/16	60A/SB	120	\$0.41
100	A-21	Med.	5 5/16	100A/SB	120	.43
150	PS-25	Med.	6 15/16	150/SB	60	.62
200	PS-30	Med.	8 1/16	200/SB1F	60	.88
300	PS-35	Mog.	9 3/8	300/SB1F	24	1.40
500	PS-40	Mog.	9 3/4	500/SB1F	24	2.00
750	PS-52	Mog.	13 1/16	750/SB1F	6	5.00
1000	PS-52	Mog.	13 1/16	1000/SB1F	6	5.20

G-E Lumiline Lamps

Disc Base—115 and 125 Volts

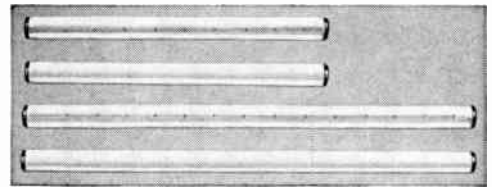

L40 L30, L60
L40IF L30IF, L60IF

For showcase or window display, mirrors, etc. or wherever continuous lines of clear or colored light of low brightness is desired. Many artistic decorative effects are possible.

Watts	Bulb	Lamp Ordering Abbrev. (Exc. Volts)	Overall Length In.	Std. Pkg. Qty.	Each
30	T-8, Clear	L30	17 3/4	24	\$1.90
30	T-8, Inside Frosted	L30/IF	17 3/4	24	1.90
30	T-8, White	L30/W	17 3/4	24	1.90
40	T-8, Clear	L40	11 3/4	24	1.60
40	T-8, Inside Frosted	L40/IF	11 3/4	24	1.60
40	T-8, White	L40/W	11 3/4	24	1.60
60	T-8, Clear	L60	17 3/4	24	1.80
60	T-8, Inside Frosted	L60/IF	17 3/4	24	1.80
60	T-8, White	L60/W	17 3/4	24	1.80

G-E Reflector Lamps

For General Lighting



R52

R-52 reflector lamps are designed for general lighting applications, particularly where dirt conditions are severe. Dust and dirt collection on the sides of the bulb do not affect light output since the metallic reflector coating is inside the lamp.

The 1M/RB52 has a double contour reflector design which permits using 1000 watts in the R52 bulb size. All R52 lamps require a shield to protect lamps from moisture or physical contact.

Lamp Ordering Abbrev.	Watts	Bulb	Volts	Std. Pkg. Qty.	Life Hrs.	Each
500R52	500	R52	115, 120, 125	6	2000	\$4.00
500R52	500	R52	230, 250	6	2000	4.90
750R52	750	R52	115, 120, 125	6	2000	4.90
750R52	750	R52	230, 250, 260	6	2000	5.25
1M/R52	1000	R52	115, 120, 125	6	2000	9.75
1M/RB52	1000	RB52	115, 120, 125	6	2000	5.90

G-E Reflector Lamps

120 Volts

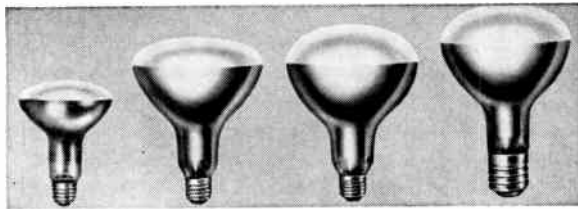

75R30/SP

150R/SP

300R/FL/1

300R/3FL

Reflector Lamps are self-contained spot and flood lamps employing a silver reflecting surface. Some are made of ordinary soft glass, others of heat-resistant glass for better performance with high wattage filaments and for out-door use. Even heat resistant bulbs should be protected from falling moisture when used outdoors.

Watts	Bulb	Base	Description	Lamp Ordering Abbrev.	Std. Pkg. Qty.	Each
75	R30	Med.	Spot-Light I.F.	75R30/SP	60	\$1.25
75	R30	Med.	Flood I.F.	75R30/FL	60	1.25
150	R40	Med.	Spot-Light I.F.	150R/SP	24	1.25
150	R40	Med.	Flood I.F.	150R/FL	24	1.25
300	R40	Med.	Spot-Light I.F.	300R/SP	24	1.65
300	R40	Med.	Flood I.F.	300R/FL	24	1.65
300	R40	Med.	Spot-Heat Resistant Glass	300R/SP/1	24	3.30
300	R40	Med.	Flood-Heat Resistant Glass	300R/FL/1	24	3.30
300	R40	Mog.	Spot-Heat Resistant Glass	300R/3SP	24	3.60
300	R40	Mog.	Flood-Heat Resistant Glass	300R/3FL	24	3.60
500	R40	Mog.	Spot-Heat Resistant Glass	500R/3SP	24	4.20
500	R40	Mog.	Flood-Heat Resistant Glass	500R/3FL	24	4.20

Reflector Color Lamps

115-125 Volts

150	R40	Med.	Blue White	150R/BW	12	\$2.25
150	R40	Med.	Blue	150R/B	12	2.25
150	R40	Med.	Green	150R/G	12	2.25
150	R40	Med.	Pink	150R/PK	12	2.25
150	R40	Med.	Red	150R/R	12	2.25
150	R40	Med.	Yellow	150R/Y	12	2.25

G-E Decorative Lamps

115-120-125 Volts

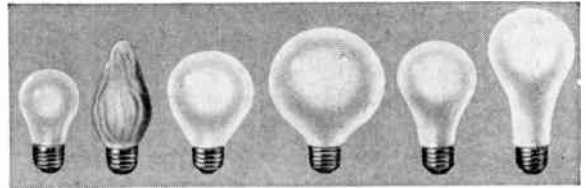

For interior applications in theaters, homes, restaurants, public buildings. Outside coated lamps are not recommended for outdoor use.

Watts	Bulb and Finish	Base	Lamp Ordering Abbrev.	Std. Pkg. Qty.	Each
15	F-10 Clear	Cand.	15FC	60	\$.35
15	F-10 O.C.*	Cand.	15FC*	60	.35
25	F-15 Clear	Med.	25F	120	.30
25	F-15 O.C.*	Med.	25F*	120	.30
25	G-18-1/2 O.C.*	Med.	25G18 1/2*	120	.40
40	G-25 O.C.*	Med.	40G*	60	.47
60	A-21 O.C.†	Med.	60A21†	120	.47
100	A-23 O.C.†	Med.	100A23†	120	.50

Colors: Flame tint (FT), white (W), ivory (V). Substitute color symbol in place of () in ordering.

†Colors: Blue (B), flame tint (FT), green (G), ivory (V), amber-orange (AO), red (R), old Rose (RO) and Yellow (Y). Substitute color symbol in place of (†) in ordering.

G-E Coloramic Lamps

115-125 Volts

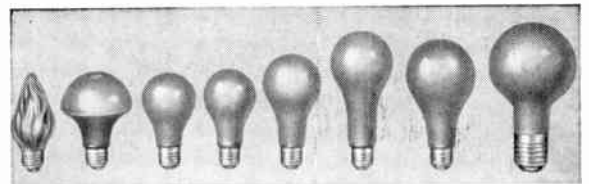

25W

50W

60W

75W

100W

150W

50/150W

100/300W

These lamps have colored ceramic coatings baked permanently on the bulb. The colors are Sky Blue (SKY), Spring Green (SPG), Sun Gold (SUN), and Dawn Pink (DPK), which can be used to accent certain colors in the decorative schemes of homes and other areas.

Use higher wattage lamp than normally employed if used in reading lamp since coating absorbs some light.

Watts	Bulb	Base	Max. Overall Length In.	Lamp Ordering Abbrev.	Std. Pkg. Qty.	Each
25	F-15	Med.	4 1/2	25F/DPK	120	\$.30
50	GA-25	Med.	4 7/16	50GA/DPK	60	.55
60	A-19	Med.	4 7/16	60A/DPK	120	.27
75	A-19	Med.	4 7/16	75A/SKY	120	.29
75	A-19	Med.	4 7/16	75A/SPG	120	.29
75	A-19	Med.	4 7/16	75A/SUN	120	.29
75	A-19	Med.	4 7/16	75A/DPK	120	.29
100	A-21	Med.	5 3/16	100A/SKY	120	.29
100	A-21	Med.	5 3/16	100A/SPG	120	.29
100	A-21	Med.	5 3/16	100A/SUN	120	.29
100	A-21	Med.	5 3/16	100A/DPK	120	.29
150	A-23	Med.	6 3/16	150A/SKY	60	.32
150	A-23	Med.	6 3/16	150A/SPG	60	.32
150	A-23	Med.	6 3/16	150A/SUN	60	.32
150	A-23	Med.	6 3/16	150A/DPK	60	.32
50	PS-25	3C. Med.	5 13/16	50/150M/DPK	60	.69
100	PS-25	3C. Med.	5 13/16	50/150M/SKY	60	.69
150	PS-25	3C. Med.	5 13/16	50/150M/SPG	60	.69
150	PS-25	3C. Med.	5 13/16	50/150M/SUN	60	.69
100	G-30	3C. Mog.	6 3/4	100/300/DPK	60	.99

G-E Sign and Decorative Lamps

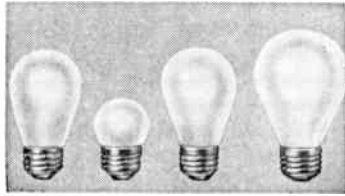

6S14 7 1/2 S11 10S14 15A17

These lamps are used for outdoor signs, decorations and many interior applications. The color is a fired-on, glass-like material that will not scratch, chip, peel or come off when exposed to the weather.

Watts	Bulb and Finish	Base	Lamp Ordering Abbrev.	Std. Pkg. Qty.	Each
6	S-14 Clear	Med.	6S/14	120	\$0.25
6	S-14 I.F.	Med.	6S14/IF	120	.25
6	S-14 *Colored	6S14/*	120	.32
7 1/2	S-11 Clear	7 1/2 S	120	.22
7 1/2	S-11 *Colored	7 1/2 S	120	.25
7 1/2	S-11 White	Med.	7 1/2 S/CW	120	.25
7 1/2	S-11 Red	Med.	7 1/2 S/CR	120	.25
10	S-11 Clear	Inter.	10S11N	120	.23
10	S-11 *Colored	Inter.	10S11N/C*	120	.30
10	S-14 Clear	Med.	10S14	120	.23
10	S-14 I.F.	Med.	10S14/IF	120	.23
10	S-14 *Colored	Med.	10S14/C*	120	.30
11	S-14 Clear	Med.	11S14	120	.28
11	S-14 I.F.	Med.	11S14/IF	120	.28
11	S-14 *Colored	Med.	11S14/C*	120	.35
15	A-17 *Colored	Med.	15A/*	120	.32
25	A-19 *Colored	Med.	25A/*	120	.30
40	A-21 *Colored	Med.	40A/*	120	.37
20	A-17 Clear Flashing Sign	Med.	20A17/5	120	.30

*Colors: White (W); blue (B); flame tint (FT); green (G); orange (O); red (R); rose (R₂); and yellow (Y).

Substitute color symbol in place of (*) in ordering abbreviation thus: 10S11u.c."N"/CB.

G-E Natural Colored Lamps

Medium Screw Base
115 and 125 Volts

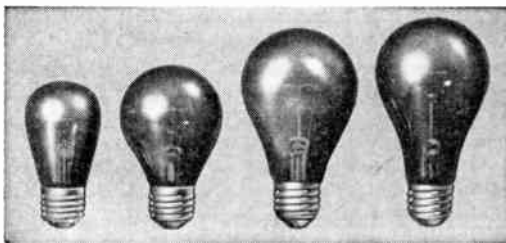

10S14/NA 25A/NA 40A/NA 60A/NA

The four lamps in natural colored, clear glass bulbs cover a large percentage of present demands. Prices are for the manufacturer's standard glass only.

Watts	Bulb	Order Abbrev. (Ex. Volts)	Std. Pkg. Qty.	Each
10	S-14 Amber Green, Blue or Ruby	10S14/N*	120	\$1.75
25	A-19 Amber Green, Blue or Ruby	25A/N*	120	1.90
40	A-21 Amber Green, Blue or Ruby	40A/N*	120	2.00
60	A-21 Amber Green, Blue or Ruby	60A21/N*	120	2.00

*Substitute color symbol in place of * in ordering abbreviation. Thus: 10S14/NR is the ruby color.

G-E Tubular Lamps

120 Volts

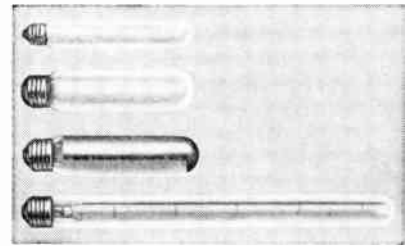

25T6 1/2 IF
25T10/IF

25T10/RFL
40T8

These low-wattage tubular lamps are for showcase lighting, in shallow-depth displays, and in small trough-like reflectors. The SHOWCASE REFLECTOR lamps have a built-in reflecting surface and a spring contact base for positioning. Those listed in clear glass also available in inside frost.

Watts	Bulb	Base	Lamp Ordering Abbrev.	Std. Pkg. Qty.	Each
25	T-6 1/2 Clear	Inter.	25T6 1/2	60	\$0.55
25	T-10 Clear	Med.	25T10	60	.32
25	T-10 I.F.	Med.	25T10/IF	60	.34
25	T-10 Refl. (Lt.I.F.)	Med.	25T10/RFL	60	1.40
40	T-10 Refl. (Lt.I.F.)	Med.	40T10/RFL	60	1.40
40	T-8 Clear	Med.	40T8	24	1.20
40	T-10 Clear	Med.	40T10	60	.32

G-E Floodlight Lamps

120 Volts

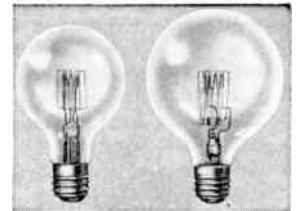

G-40

G-48

G-E Floodlight lamps are made with the filament concentrated into a small space and accurately positioned with respect to the base. They may be burned in any position from vertically base down to horizontal. Similar Spotlight Lamps available.

Floodlight Lamps

Watts	Lamp Ordering Abbrev.	Bulb	Base	Light Center Length, In.	Std. Pkg. Qty.	Each
250	250G/FL	G30	Med.	3	60	\$1.80
400	400G/FL	G30	Med.	3	60	1.90
500	500G/FL	G40	Mog.	4 1/4	24	3.10
750	750G/FL	G10	Mog.	4 1/4	24	10.50
1000	1M/G40/FL	G10	Mog.	5 1/4	24	8.50
1500	1500G48/6	G48	Mog.	5 1/4	6	16.00
2000	2M/G48/17	G48	Mog.	5 1/4	6	14.00

G-E Ozone Lamps



G-E Ozone Lamps emit ultraviolet energy through the special glass bulb which changes some of the oxygen of the air to ozone. This masks odors in many areas such as kitchens, rest rooms, closets, offices, stores, elevators, basements, etc. Use one lamp for each 1000 cubic ft. of space.

Lamps require a ballast to limit current during operation. This can be a choke-coil, a 40-watt light bulb or a resistance of the correct size.

Watts	Bulb and Finish	Lamp Ordering Abbrev.	Std. Pkg. Qty.	Each
4	S-11, Clear	OZ4S11	120	\$1.25

G-E Projection Lamps†
115, 120 and 125 Volts

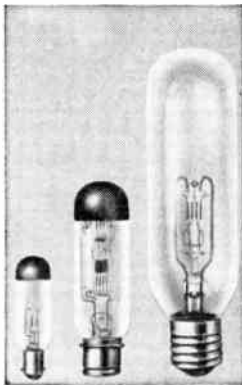

T-8 T-12 T-20

G-E Projection lamps are characterized by extreme concentration of light source, made possible by a highly developed technique in the forming, treating and mounting of filaments.

These lamps are for use only in equipment specially designed to maintain bulb and base temperatures within safe limits.

Single-Contact Bayonet Base

Watts	Bulb and Finish	Lamp Ordering Abbrev.	Rated Life (Hrs.)	Max. Over-all Length, Inches	Avg. Light Center Length, Inches	Std. Pkg. Qty.	Each
75	T-8	Cl. PH/75T8/72	50	3 1/8	1 3/8	24	\$1.70
100	T-8	Cl. PH/100T8/108SC	50	3 1/8	1 3/8	24	1.40
150	T-8	Cl. PH/150T8/70	25	3 5/8	1 3/8	24	2.00
300	T-8 1/2	Cl. PH/300T8 1/2/10	25	4 1/8	1 3/8	24	3.10

Medium Prefocus Base

300	T-10 †	PH/300T10P	25	5 3/4	2 3/16	24	4.20
500	T-10	PH/500T10P	25	5 3/4	2 3/16	24	4.60
500	T-20	PH/500T20P	50	5 3/4	2 3/16	24	4.90
750	T-12 †	PH/750T12P	25	5 3/4	2 3/16	24	4.95
1000	T-12 †	PH/1M/T12P	10	5 3/4	2 3/16	24	5.75
1000	T-20	PH/1M/T20MP	25	5 3/4	2 3/16	24	6.15

Mogul Prefocus Base

1000	T-20	PH/1M/T20P	50	9 1/2	3 7/16	12	7.90
------	------	------------	----	-------	--------	----	------

†Opaque end.

G-E Reflector Infrared Heat Lamps



Medium Base
115-125 Volts (Design Volts 115)

Heat lamps help relieve muscular aches and pains, and have many other uses for quick drying and heating. The R10/10 has built-in red filter to reduce brightness; is more rugged and has special glass providing protection against breakage by splashing water.

Watts	Bulb	Ordering Abbreviation	Std. Pkg. Qty.	Each
250	R-40 Light Inside Frosted	250R40/1	24	\$1.10
250	R-40 Red Bowl	250R40/10	24	2.95

G-E Projector Lamps
120 Volts

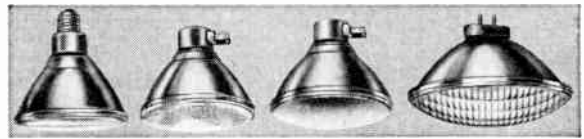

Par 38 Par 38 Side Prong Par 46 Side Prong Par 56 Side Prong

Self-contained spot and flood lamps made of pressed heat-resistant glass. They may be used outdoors, though the higher wattage lamps should be protected from moisture. With their excellent control of light they are also used in many indoor applications such as display lighting.

Watts	Bulb	Base	Description	Lamp Ordering Abbrev.	Std. Pkg. Qty.	Each
150	PAR 38	Med. Skt.	Spot	150PAR/SP	12	\$2.20
150	PAR 38	Med. Skt.	Flood	150PAR/FL	12	2.20
150	PAR 38	Side Prong	Spot	150PAR/3SP	12	2.50
150	PAR 38	Side Prong	Flood	150PAR/3FL	12	2.50
200	PAR 46	Side Prong	Narrow Spot	200PAR46/3NSP	8	4.50
200	PAR 46	Side Prong	Medium Flood	200PAR46/3MFL	8	4.50
300	PAR 56	Mog. End Prong	Narrow Spot	300PAR56/NSP	8	5.20
300	PAR 56	Mog. End Prong	Medium Flood	300PAR56/MFL	8	5.20
300	PAR 56	Mog. End Prong	Wide Flood	300PAR56/WFL	8	5.20
500	PAR 64	Mog. End Prong	Narrow Spot	500PAR64/NSP	8	10.75
500	PAR 64	Mog. End Prong	Medium Flood	500PAR64/MFL	8	10.75
500	PAR 64	Mog. End Prong	Wide Flood	500PAR64/WFL	8	10.75

Projector Color Lamps
115-125 Volts

150	PAR-38	Med. Skt.	Blue White	150PAR/BW	12	2.95
150	PAR-38	Med. Skt.	Blue	150PAR/B	12	2.95
150	PAR 38	Med. Skt.	Green	150PAR/G	12	2.95
150	PAR 38	Med. Skt.	Pink	150PAR/PK	12	2.95
150	PAR-38	Med. Skt.	Red	150PAR/R	12	2.95
150	PAR-38	Med. Skt.	Yellow	150PAR/Y	12	2.95

G-E Three-Lite Lamps
115, 120 and 125 Volts

Give three levels of lighting. Used generally in table and floor lamps. Three contact bases.

Watts	Bulb	Base	Ordering Abbreviation (Exc. Volts)	Std. Pkg. Qty.	Price
30	A-21 I.F.	Med.	30/100	120	\$0.49
70					
100					
50	PS-25 I.F.	Med.	50/150M	60	.55
100					
150					
50	PS-25 I.F.	Mog.	50/150	60	.69
100					
150					
30	PS-25 White	Med	30/230M/1W	60	.65
200					
230					
50	R-40 White	Med.	50/150 R/W	24	1.19
100					
150					
100	G-30 White	Mog.	100/300	60	.89
200					
300					



50/150

G-E Photoflash Lamps

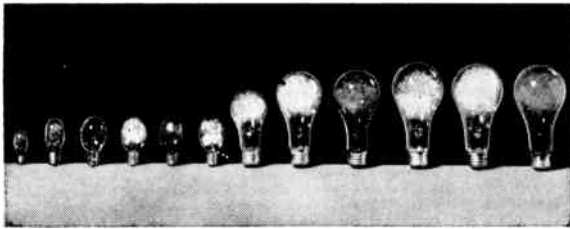

M2 8 SM 5 5B 6 11 22 22B 31 50 50B

PowerMite M2—Tiniest Flashbulb made. 66% more light than older type M2 bulbs. Plenty of light for the casual amateur or professional. Makes exceptional pictures with either black and white or color films.

PowerMite M2B—First miniature blue flashbulb. Same characteristics as the PowerMite M2 but has blue filter coating for use with daylight color films.

No. 8—Second smallest flashbulb in the G-E line. In light output and size it is between the PowerMite and the No. 5.

SM—Gas filled no. 1 flashbulb. Flash duration about 1/200 second. Ideal for simple cameras because it lessens subject and camera movement.

No. 5—The standard bulb used by professionals and amateurs with larger cameras. Precise, uniform, split-second flash for between the lens shutter synchronization.

No. 5B—Same characteristics as the No. 5 but with blue filter coating for use with daylight color films.

No. 6—For high shutter speed synchronization with most focal plane shutter cameras up to 2 1/4 x 2 1/4-in. negative size.

No. 11—Larger size screw base bulb for synchronization with many between the lens shutters.

No. 11B—Same as No. 11 but with blue filter coating for use with daylight color films.

No. 22—For use with front shutter cameras, this bulb provides plenty of peak light for extra coverage and high speed shots.

No. 22B—Same as No. 22 but with blue filter coating for use with daylight color films.

No. 31—For high shutter speed synchronization with large focal plane shutter cameras. Over 4 times as much light as the No. 6 flashbulb.

No. 31B—Same as No. 31 but with blue filter coating for use with daylight color films.

No. 50—Most powerful flashbulb in the G-E line. Great light intensity in a compact bulb size to cover large areas or for exposure at small apertures.

No. 50B—Same as No. 50 but with blue filter coating for use with daylight color films.

Order No.	Flash With Voltage	Aprox. Lumen Seconds	Bulb	Case Qty.	Ctn. Qty.	Each
PowerMite M2	3-V.	7000	B6 1/4 Cl.	120	12	\$0.11
PowerMite M2B	3-V.	5500	B6 1/4 Blue	120	12	.13
PH/8	3-V.	9000	BT-8 Cl.	120	12	.13
PH/SM	3-V.	4800	B-11 Cl.	120	12	.16
PH/5	3-V.	18500	B-11 C.	120	12	.14
PH/5B	3-V.	8800	B-11 Blue	120	12	.17
PH/6	3-V.	17500	B-11 Cl.	120	12	.16
PH/6B	3-V.	8000	B-11 Blue	120	12	.20
PH/11	3-V.	32000	A-15 Cl.	120	8	.19
PH/11B	3-V.	14500	A-15 Blue	120	8	.23
PH/22	3-125V.	70000	A-19 Cl.	120	6	.21
PH/22B	3-125V.	32000	A-19 Blue	120	6	.27
PH/31	3-V.	81000	A-21 Cl.	60	6	.28
PH/31B	3-V.	37000	A-21 Blue	60	6	.34
PH/50	3-125V.	100000	A-21 Cl.	60	6	.26
PH/50B	3-125V.	45000	A-21 Blue	60	6	.32

G-E Photographic Enlarger Lamps

Medium Base—115-125 Volts

Lamp No.	Watts	Bulb and Finish	Base	Life (Hrs.)	Case Qty.	Car-ton Qty.	Each
PH/111	75	S-11 White	S.C. Bay.	25	120	6	\$0.80
PH/211	75	A-21 White	Med. Soc.	100	60	6	.55
PH/212	150	A-21 White	Med. Soc.	100	60	6	.60
PH/213	250	A-21 White	Med. Soc.	3	60	6	.60
PH/302	500	PS-30 White	Med. Soc.	100	60	1	1.50

Discounts on G-E Photo Lamps obtainable upon request.

G-E Photoflood Lamps
105-120 Volts

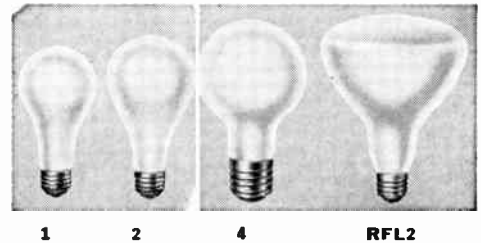

3400°K Photoflood Lamps give maximum light for the amount of current used. Designed for use with Type A color materials, but are also ideally suited for black and white photography.

3200°K Lamps are for general studio use with either black and white film or professional types of indoor color materials.

Reflector Photo Lamps have built-in reflectors. Beam spreads of these lamps vary from 20° for the PH/RSP2, to 90° for the PH/RF12.

3400° Lamps for Photography
115-120 Volts

Order Abbrev. and Code	Watts	Rated Lumens at 115V.	Beam Spread to Half Intensity	Base	Rated Life (Hrs.)	Case Qty.	Each
PH/1	250	8500	—	Med.	3	60	\$0.28
PH/2	500	17000	—	Med.	6	60	.47
PH/4	1000	31000	—	Mog.	10	24	1.45
PH375/34R4	375	16000	40°	Med.	4	4	1.50
PH/RFL2	500	6500*	90°	Med.	6	24	1.50
PH/RSP2	500	50000†	20°	Med.	6	24	1.65

*Flood. †Spot.

3200°K Lamps for Photography
115-125 Volts

Order Abbrev. and Code	Watts	Rated Lumens at 115V.	Base	Rated Life (Hrs.)	Case Qty.	Each
PH/500PS25/5 (ECT)	500	13650	Med.	60	60	\$0.70
PH/500/32R7 (EAL)	500	8200	Med.	6	24	1.85
PH/500T20 (DMS)	500	13200	Med.	50	24	4.90
PH/1M/PS40/1 (ECV)	1000	26500	Mog.	60	24	3.00
PH/1M/T20 (DPT)	1000	28000	Mog.	50	12	7.90

G-E Deluxe White Lamps

Has an inside silica coating which gives almost perfect light diffusion, are clean and white in appearance—ideal for reading lamps.

Also furnished in Three-lite types.



Watts	Bulb	Base	Max. Over-all Length	Ordering Abbreviation	Std. Pkg. Qty.	Each
60	A-19	Med.	4 7/16	60A/W	120	\$0.25
100	A-21	Med.	5 5/16	100A/W	120	.28

G-E Country Home Lamps

30-60 Volts

For battery-generator sets as used on farms.

Watts	Bulb	Base	Ordering Abbreviation (Exc. Volts)	Std. Pkg. Qty.	Price
15	A-17 I.F.	Med.	15A	120	\$0.27
25	A-19 I.F.	Med.	25A	120	.27
50	A-21 I.F.	Med.	50A21	120	.27
100	A-23 I.F.	Med.	100A	120	.40

G-E Appliance Night Light and Home Indicator Lamps

120-115-125 Volts

Candelabra Screw Base

Watts	Bulb and Finish	M.O.L. Inches	Ordering Abbreviation	Std. Pkg. Qty.	Each
6	S-6 Clear	1 7/8	6S6	240	\$0.22
7	C-7 Night Lt.	2 1/8	7C7/W	240	.20
10	C-7 Clear	2 1/8	10C7	240	.23

D-C Bayonet Candelabra Base

10	C-7 Clear	2 3/8	10C7DC	120	.26
15	T-7 Clear	2 5/8	15T7DC	60	.35
25	T-8 Clear	2 5/8	25T8DC	60	.35

Medium Screw Base

40	A-15 I.F.	3 3/4	40A15/1	120	.21
40	A-15 Clear	4	40A15/22	120	.25



40A15/1 40A15/22

G-E Semi-indirect Home Lighting Lamp

120 Volts

This lamp has a decorated enamel bowl which gives pleasing semi-indirect lighting. For single and multi-lamp rosette-type sockets in homes. Burn base up.



Watts	Bulb	Base	Ordering Abbreviation	Std. Pkg. Qty.	Each
50	GA-25 (Yellow)	Med.	50GA	60	\$0.55
50	GA-25 (Pink)	Med.	50GA/DPR	60	.55
100	GA-30 (Yellow)	Med.	100GA	60	.75

G-E Traffic Signal Lamps

**Medium Screw Base
120 Volts**

Clear bulb. Has short light-center length, produces adequate light to assure signal indication of proper brightness.

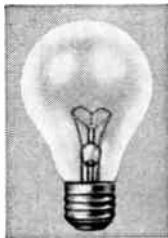

Lamp Ordering Abbrev.	Watts	Rated Avg. Life	Approx. Initial Lumens	Std. Pkg. Qty.	Each
60A21/TS	60	2000	665	120	\$0.25
64A21/TS	64	3000	665	120	.29
69A21/TS	69	6000	665	120	.32
100A21/TS	100	2000	1260	120	.37
107A21/TS	107	3000	1260	120	.42
116A21/TS	116	6000	1260	120	.47

**G-E Series Street Lighting Lamps
Mogul Screw Base**

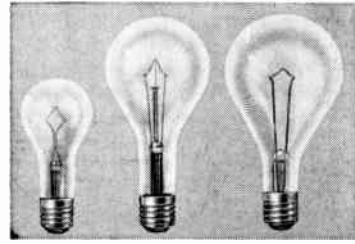

PS-25 PS-35 PS-40

Designed to meet the special requirements of street lighting service. Filaments formed to produce favorable light distribution. On constant current operation, bulb blackening is compensated for by a slow increase in wattage and filament temperature. Lamps shown designed for 2000 hr. life.

No. of Am-peres	No. of Lumens	No. of Volts	Bulb	Lamp Ordering Abbrev. (Ex. Volts)	No. in Std. Pkg.	Each
6.6	1000	9.5	PS-25, Clear	1M/66	60	\$0.55
6.6	2500	21.6	PS-35, Clear	2500/66	24	.80
6.6	4000	32.8	PS-35, Clear	4M/66	24	1.00
6.6	6000	48.4	PS-40, Clear	6M/66	24	1.30
15	4000	13.8*	PS-35, Clear	4M/15BU	24	1.50
15	4000	13.8†	PS-35, Clear	4M/15BD	24	1.50
20	6000	11.9*	PS-40, Clear	6M/20BU	24	1.65
20	6000	11.9†	PS-40, Clear	6M/20BD	24	1.65
20	10000	21.4*	PS-40, Clear	10M/20BU	24	2.50
20	10000	21.4†	PS-40, Clear	10M/20BD	24	2.50
20	15000	35.9*	PS-40, Clear	15M/20BU	24	3.00
20	15000	35.9†	PS-40, Clear	15M/20BD	24	3.00

*Base up.

†Base down.

G-E Street Railway Lamps

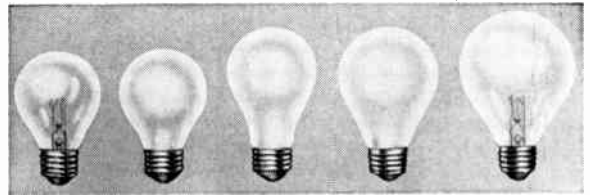

36A19 1A/A19 1.6A/A21 36A21 P-25

Headlights

Designed for operation in series with four lamps of corresponding wattage and voltage used elsewhere in the car.

Lamp Ordering Abbrev.	Watts	Bulb	Base	Each
36A/RYY	36	A-19	Med. Std.	\$0.70
56P25	56	P-25	Med. Std.	1.00

Car Lighting—5-in-Series

Lamps are of the vacuum type. The 36-watt and 56-watt lamps provide more satisfactory performance when operated in the vertical base-up position.

Lamp Ordering Abbrev.	Watts	Bulb	Base	Each
36A/R Y	36	A-21	Med. Std.	\$0.30
56A21	56	A-21	Med. Std.	.31

Car Lighting—Cutout Lamps, 30-Volt

Lamps are of the gas-filled type and are provided with a cut-out feature which short circuits the individual lamp upon burnout.

Lamp Ordering Abbrev.	Watts	Bulb	Base	Each
1A/A19	1 amp.	A-19	Med. 30	\$0.50
1.6A/A21	1.6 amp.	A-21	Med. 30	.55

G-E Clear Neon Glow Lamps

105-125 Volts

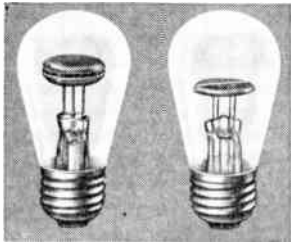

NE-40 NE-34



NE-30 NE-45

Screw Base Lamps. Series resistor mounted within base. See values marked "IN" in column "Series Resistance." Lamps suitable for use on higher voltages with addition of proper external resistance. Information on request.

Bayonet Base Lamps. External resistance required to limit current to normal amount. External resistors, supplied by user, should have values marked "EX" in column "Series Resistance," for use at rated voltage.

Packed 10 in unit package, except No. NE-2 which is packed 100 in unit package.

Nom. Watts	Bulb	Base	Order Designation	Maxim Overall Length Inches	New Lamp *Starting Voltage A.C.D.C.	Approximate Series Resistance Ohms	Each
3	S-14	Medium Screw	NE-40	3 1/2	60 85	2200 IN	\$2.70
2	S-14	Medium Screw	NE-34	3 1/2	60 85	3500 IN	1.85
1	S-11	Medium Screw	NE-30	2 1/4	60 85	7500 IN	1.20
1	G-10	D-C Bay. Cand.	NE-32	2 1/4	60 85	7500 EX	1.20
†1	S-11	Medium Screw	NE-56	2 1/4	60 85	33000 IN	1.25
†1/2	T-4 1/2	Cand. Screw	NE-58	1 1/2	65 90	100000 IN	.95
‡1/4	T-4 1/2	D-C Bay. Cand.	NE-16	1 1/2	DC 67		.63
1/4	T-4 1/2	Cand. Screw	NE-45	1 1/2	65 90	30000 IN	.85
1/4	T-4 1/2	D-C Bay. Cand.	NE-48	1 1/2	65 90	30000 EX	.70
1/25	T-2	Unbased (Wire Term)	NE-2	1 1/16	65 90	200000 EX	.10
1/25	T-3 1/4	S. C. Bay. Min.	NE-51	1 1/8	65 90	200000 EX	.21
1/4	T-4 1/2	D-C Bay. Cand.	NE-17	1 1/2	55 70	30000 EX	.90
1/4	T-4 1/2	Cand. Screw	NE-57	1 1/2	55 75	30000 IN	.99

Outside colored orange or red available on G-10 or S-14 lamps at additional charge of 5 cents each.

*Applies to new lamp.

†210-250 Volts.

‡Dimension for glass parts only. Wire terminals extend 1 inch.

|| Designed for 67-87 volts, d-c (operating voltage at 1.5 milliamperes, 53-65 volts, d-c.).

G-E Train and Locomotive Lamps

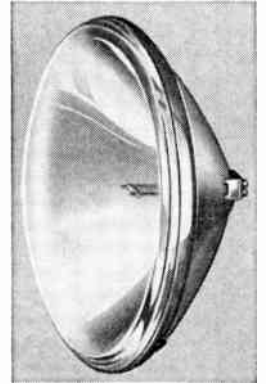

200 PAR

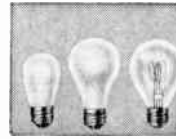

15S14/IF 100A21/3 40A19



200P-25

Trainlighting: Voltage regulating devices should be adjusted to maintain rated lamp voltage at the socket. 30 and 60-volt are best adapted to the voltage conditions normally encountered in trainlighting service.

Locomotive Headlight: Should be operated at rated voltage in headlight equipment protecting it from excessive vibration. The bulb must be protected from water which might strike it while hot, except in the case of the 200-watt PAR-56, lamp, which is of heat-resistant glass. Two sealed-beam type lamps are used on road locomotives, one on switchers. The 250-watt lamp is designed for road locomotives equipped with reflectors. The 100-watt is recommended for switching locomotives.

Locomotive Cab: For all-steam locomotive lighting purposes except headlighting.

Train—30 and 60 Volts

Watts	Bulb and Finish	Base	Lamp Ordering Abbrev. (Exc. Volts)	Std. Pkg. Qty.	Each
15	A-17 I.F.	Med.	15A	120	\$0.27
25	A-19 I.F.	Med.	25A	120	.27
40	A-19 I.F.	Med.	40A	120	.35
50	A-21 I.F.	Med.	50A21	120	.27
100	A-23 I.F.	Med.	100A	120	.40

Train—Rough Service—75 Volts

25	A-17 I.F.	Med.	25A17/RS	120	.40
50	A-19 I.F.	Med.	50A19/RS	120	.40

Train—34 Volts

15	S-14 I.F.	Med.	15S14/IF	120	.27
----	-----------	------	----------	-----	-----

Headlight—32 Volts

100	A-21 Clear	Med.	100A21/3	120	1.50
200*	PAR-56 Clear	Sc. Term.	200PAR	8	4.50
250	P-25 Clear	Med.	250P25	60	2.20

*30 volt only.

G-E Aviation Lamps



40T10P

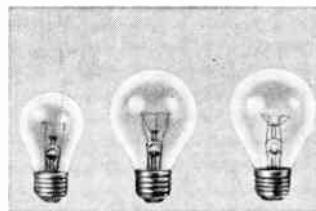

15A15/CL 25A/CL 50A/CL/VS



6.6A/T10P

Aircraft Marker Lamps (Clear)

Watts	Bulb	Base	Volts	Lamp Ordering Abbrev.	Each
† 45	T-10	Med. Pf.	6.6A	6.6A/T10P	\$1.20
† 200	T-14	Med. Pf.	6.6A	6.6A/T14P	3.30
* 15	A-15	Med.	Std.	15A15/CL	.26
† 25	A-19	Med.	Std.	25A/CL	.26
† 40	T-10	Med. Pf.	Std.	40T10P	1.55
o 50	A-19	Med.	Std.	50A/CL/VS	.26

†Marker.

*Wind Direction.

‡Boundary Marker.

o Obs. Marker.

Note: For low intensity, semi-flush Airport Runway Marker lights, about 2-in. high, use A-21 lamps. For medium intensity elevated lights, about 2-ft. high, use T-10 lamps. For higher intensity elevated lights, on runways where instrument landings are made, use 6.6A/T14P lamps.

G-E Black Light Lamps

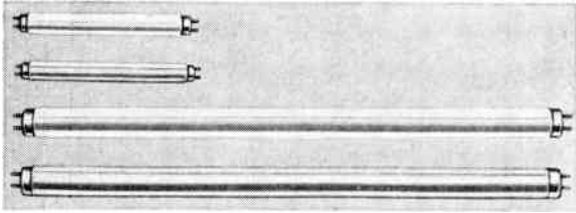

Mercury Lamps. Four types of mercury lamps are commonly used for black light effects: the BL1 uses a red-purple glass filter for the outer bulb and the H100-SP4 Spot (H100-FL4 flood), H250-A5 and H100-E1 require separate filters.

Filament Lamp. A 250-watt filament lamp in a red-purple bulb is available for black light effects. Known as the Purple X lamp, it is designed for intermittent service only.

Fluorescent Lamps. Black light fluorescent lamps contain a special phosphor whose radiation peaks in the near-ultraviolet region of the spectrum. Lamps often used with filters to reduce visible light. Available with BLB glass for use without filters.

Mercury

Watts	Bulb	Base	Ordering Abbrev.	Std. Pkg. Qty.	Each
100	T-16	Admed.	H100-BL4	6	\$14.50
100	PAR-38	Admed. Skirted	H100-SP4 (spot)	12	15.50
100	PAR-38		H100-FL4 (flood)	12	15.50
250	BT-28	Mogul	H250-A5	6	18.00
400	BT-37	Mogul	H400-E1	6	20.00

Filament (115-125 Volts)

250	A-21	Medium	250A21/60	120	2.20
-----	------	--------	-----------	-----	------

Fluorescent

Watts	Bulb	Base	Lamp Ordering Abbrev.	Std. Pkg. Qty.	Each
15	T-8	Med. Bipin	F15T8/BL	24	\$1.35
30	T-8	Med. Bipin	F30T8/BL	24	1.55
40	T-12	Med. Bipin	F40T12/BL	24	1.55
40	T-12	Med. Bipin	F40T12/BLB	24	7.75
40	T-12	Med. Bipin	F40T12/BL/RS*	24	1.65
17.5-32.5	T-6	Single Pin	F42T6/BL	24	3.20
25.5-48	T-6	Single Pin	F64T6/BL	24	3.40
32-65	T-8	Single Pin	F96T8/BL	24	4.00

*Rapid Start Lamp.

**G-E Rough Service and Vibration Lamps
120 Volts**

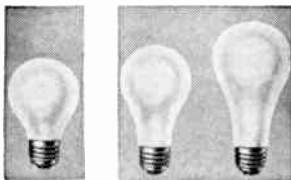

50A/RS 100A/RS 150/RS

Rough Service lamp withstands shock and bumps, such as received when used as a portable light on extension cord. Some Rough Service Lamps available in 230 and 250 volts.

Watts	Bulb and Finish	Base	Max. Overall Length, In.	Lamp Ordering Abbrev. (Ex. Volts)	Std. Pkg. Qty.	Each
50	A-19 I.F.	Med.	3 ¹⁵ / ₁₆	50A/RS	120	\$0.40
100	A-21 I.F.	Med.	6 ¹ / ₁₆	100A/RS	120	.43
150	PS-25 I.F.	Med.	6 ¹⁵ / ₁₆	150/RS	60	.60
300	PS-35	Mog.	9 ³ / ₈	300/RS	24	1.40

The Vibration lamp is designed to withstand high frequency vibration, as from high-speed machinery.

50	A-19 I.F.	Med.	3 ¹⁵ / ₁₆	50A/VS	120	\$0.26
100	A-23 I.F.	Med.	6 ¹ / ₁₆	100A23/28	120	.60
150	PS-25 I.F.	Med.	6 ¹⁵ / ₁₆	150/VS	60	.75

G-E Mercury Lamps

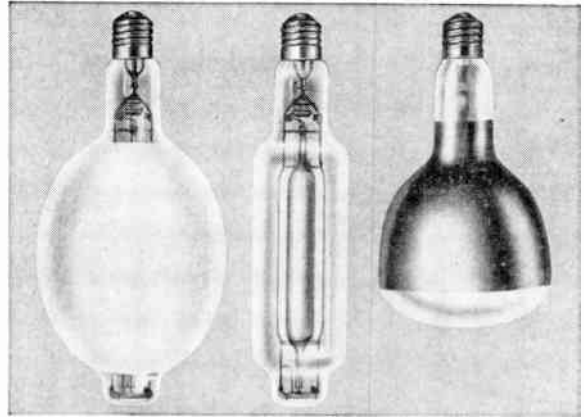

G-E Mercury lamps have high efficiency and long life and are applicable for general lighting in many industrial areas and for street and flood lighting. The reflector mercury lamps listed below provide good maintenance of light output even in dirty areas. They are intended for use in conventional high bay lighting units. Auxiliary equipment required to operate.

Watts	Bulb	Base	Description	Lamp Ordering Abbrev.	Std. Pkg. Qty.	Each
100	PS-25	Mog.	Street Lighting	H1100-1A	24	\$11.25
175	BT-28	Mog.	General and Street Lighting	H1175-A22	12	15.00
250	BT-28	Mog.	General Street Lighting	H1250-A5	12	18.00
400	BT-37	Mog.	General and Street Lighting	H1400-E1	6	20.00
400	BT-37	Mog.	*General and Street Lighting	H1400-J1	6	23.00
400	R 52	Mog.	*Reflector High Bay Color Improved	H1400-RC1	6	25.50
400	R 52	Mog.	Reflector High Bay	H1400-R1	6	25.50
400	T-16	Mog.	General and Street Lighting	H1400-A1	12	14.50
1000	BT-56	Mog.	General and Street Lighting	H11000-A15	6	49.00
1000	BT-56	Mog.	*General Lighting Color Improved	H11000-C15	6	54.50
1000	BT-56	Mog.	*Semi-Reflector High Bay	H11000 RC15	6	53.50
1000	BT-56	Mog.	General Color Improved	H11000 A12	6	49.00
1000	BT-56	Mog.	*General Lighting Color Improved	H11000-C12	6	54.50
1000	BT-56	Mog.	*Semi-Reflector High Bay	H11000 RC12	6	53.50
3000	T-9 1/2	S.C. Term	High Bay Industrial Lighting	H13000-A9	1	59.00

*Color Improved lamps contain a red producing inside coating that provides color balance more like incandescent lamps.

G-E High Voltage Lamps

Durability and efficiency are less than with 110-125 volt lamps, but are lamps designed for use in the few locations where only the higher voltage is available. Some rough service lamps and R-52 and R-40 lamps also are available in 230 and 250-volt designs. Lamps listed below also available in clear bulbs.

Medium Screw Base

No. of Watts	Bulb	Lamp Ordering Abbrev. (Ex. Volts)	Std. Pkg. Qty.	Each
25	A-19 Inside Frosted	25A	120	\$0.29
50	A-19 Inside Frosted	50A	120	.29
100	A-21 Inside Frosted	100A	120	.33
200	PS-30 Inside Frosted	200/1F	60	.56

Mogul Screw Base

300	PS-35 Inside Frosted	300	24	1.00
500	PS-40 Inside Frosted	500	24	1.40
750	PS-52 Inside Frosted	750	6	3.40
1000	PS-52 Inside Frosted	1000	6	3.55

General Electric Miniature Lamps

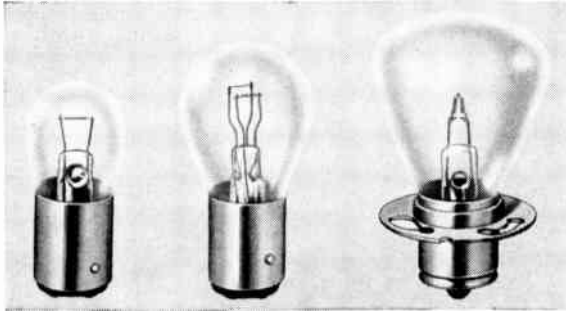

G-6 D.C. Index S-8 RP-11 Prefocus

6-8 Volt—Automotive Service					
G-E Lamp Number	C.P.	Bulb	Base	Each	
51	1	G-3 1/2	Min. Bay.	\$0.15	
55	2	G-4 1/2	Min. Bay.	.15	
63	3	G-6	S. C. Bay.	.20	
64	3	G-6	D. C. Bay.	.20	
81	6	G-6	S. C. Bay.	.20	
82	6	G-6	D. C. Bay.	.25	
87	15	S-8	S. C. Bay.	.35	
88	15	S-8	D. C. Bay.	.35	
209	15	B-6	S. C. Bay.	.35	
210	15	B-6	D. C. Bay.	.35	
1129	21	S-8	S. C. Bay.	.35	
1130	21	S-8	D. C. Bay.	.40	
1133	32	RP-11	S. C. Bay.	.40	
1154	21-3	S-8	D. C. Index	.45	
1158	21-3	S-8	D. C. Bay.	.45	
1183	50	RP-11	S. C. Bay.	.50	
1323	32	RP-11	S. C. Pref.	1.00	
2330	32-32	RP-11	D. C. Pref.	1.00	
2331	32-32	RP-11	D. C. Pref.	1.00	
12-Volt Automotive Service					
53	1	G-3 1/2	Min. Bay.	.15	
57	2	G-4 1/2	Min. Bay.	.15	
67	4	G-6	S. C. Bay.	.20	
68	4	G-6	D. C. Bay.	.20	
89	6	G-6	S. C. Bay.	.20	
90	6	G-6	D. C. Bay.	.25	
93	15	S-8	S. C. Bay.	.35	
94	15	S-8	D. C. Bay.	.35	
1003	15	B-6	S. C. Bay.	.35	
1004	15	B-6	D. C. Bay.	.35	
1016	21-6	S-8	D. C. Index	.55	
1034	32-4	S-8	D. C. Index	.40	
1073	32	S-8	S. C. Bay.	.35	
1141	21	S-8	S. C. Bay.	.35	
1142	21	S-8	D. C. Bay.	.35	
1143	32	RP-11	S. C. Bay.	.45	
1176	21-6	S-8	D. C. Bay.	.45	
1327	32	RP-11	S. C. Pref.	1.00	
Radio Panel, Indicators, Miscellaneous					
G-E Lamp Number	Bulb	Rated Volts	Amps.	Base	Each
41	T-3 1/4	2.5	0.50	Min. Screw	\$0.15
40	T-3 1/4	6.3	0.15	Min. Screw	.15
46	T-3 1/4	6.3	0.25	Min. Screw	.15
47	T-3 1/4	6.3	0.15	Min. Bay.	.15
44	T-3 1/4	6.3	0.25	Min. Bay.	.15
1458	G-5	20	0.25	Min. Bay.	.17
1490	T-3 1/4	3.2	0.16	Min. Bay.	.15
Toy Train					
363	G-3 1/2	14	0.20	Min. Bay.	.17
428	G-4 1/2	12.5	0.25	Min. Screw	.17
432	G-4 1/2	18	0.25	Min. Screw	.17
1445	G-3 1/2	18	0.15	Min. Bay.	.20
1447	G-3 1/2	18	0.15	Min. Screw	.20
1449	G-3 1/2	14	0.20	Min. Screw	.17

A unit package of sealed beam lamps consists of 1 lamp. A standard shipping package of sealed beam lamps consists of 8 lamps of the same G-E lamp number. A unit package of other than sealed beam lamps consists of 10 lamps of the same G-E lamp number.

G-E Sealed Beam Lamps

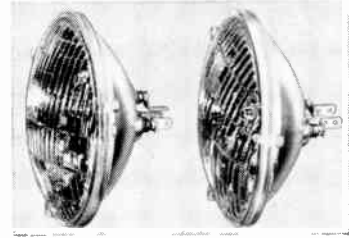

General Electric Sealed beam headlamps are of rugged, all-glass construction—they do not grow dim! Same construction used in General Electric fog lamps.

3 Cont. Lugs

G-E Lamp No.	Watts	Volts	Bulb	Service	Per Unit Pkg.
5440	50-40	12	PAR-56	Headlamp H.D.	\$2.65
5040S	50-40	6	PAR-56	Aimer Headlamp	2.50
5400S	50-40	12	PAR-56	Aimer Headlamp	2.50
Screw Terminal					
4012	35	6	PAR-46	Clear Fog	2.65
4012A	35	6	PAR-46	Amber Fog	3.10
4013	25	6	PAR-46	Tractor	2.75
4015	35	6	PAR-36	Clear Fog	2.50
4015A	35	6	PAR-36	Amber Fog	2.75
4412	35	12	PAR-46	Clear Fog	2.60
4412A	35	12	PAR-46	Amber Fog	3.00
4435	30	12	PAR-46	Clear Spot	3.75
4510	25	6	PAR-36	Clear Utility	2.50
4515	30	6	PAR-36	Clear Spot	2.60
4516	30	6	PAR-36	Clear Hand Spot	2.50
4535	30	6	PAR-46	Clear Spot	2.85

Flashlights, Hand-Lanterns, Bicycles and Miscellaneous



Miniature Screw Base

G-E Lamp Number	Bulb	Rated Volts	Design Amps.	Service Used With	Each
112	TL-3	1.20	0.22	1-AA cell	\$0.17
123	G-3 1/2	1.25	0.30	1-C or D	.17
131	G-3 1/2	1.30	0.10	1-D	.17
222	TL-3	2.25	0.25	2-AA	.17
223	FE-3 3/4	2.25	0.25	2-AA	.17
233	G-3 1/2	2.33	0.27	2-C	.17
14	G-3 1/2	2.47	0.30	2-D	.17
13	G-3 1/2	3.70	0.30	3-D	.17
27	G-4 1/2	4.90	0.30	4-F	.17
425	G-4 1/2	5.00	0.50	4-F	.17
502	G-4 1/2	5.10	0.15	4-F	.17
605	G-4 1/2	6.15	0.50	5-D	.17
965	T-4 1/2	9.84	0.50	8-D or F	.25

Single Contact Miniature Flange Base

PR	Bulb	Rated Volts	Design Amps.	Service	Each
PR4	B-3 1/2	2.33	0.27	2-C	.20
PR2	B-3 1/2	2.38	0.50	2-D	.20
PR6	B-3 1/2	2.47	0.30	2-D	.20
PR3	B-3 1/2	3.57	0.50	3-D	.20
PR7	B-3 1/2	3.70	0.30	3-D	.20
PR12	B-3 1/2	5.95	0.50	5-D	.20
PR13	B-3 1/2	4.75	0.50	4-F	.20
PR16	B-3 1/2	12.0	0.25	—	.22

AA-cells 1/2" dia., 1 1/8" high.
 C-cell 1 1/16" dia., 1 13/16" high.
 D-cell 1 1/4" dia., 2 1/4" high.
 F-cell 1 1/4" dia., 3 1/16" high.
 No. 6 cell 2 1/2" dia., 6" high.

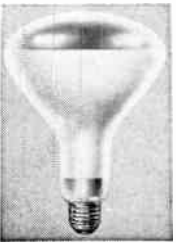

G-E Sunlamps

Used in homes, offices and solaria.

●RS—Medium Screw Base. 275 watts. Is in a bulb with self-contained reflector and operates directly from 50-60 cycle, 110-125 volt a-c current with no auxiliary ballast required.

R-40, Inside Frosted bulb. Standard package, 6. Each **\$9.95**

RS

G-E Infrared Industrial Lamps
115-125 Volts (Design Volts 115)

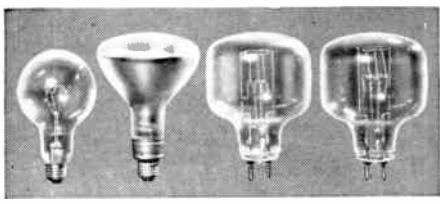

G-30 R-40 T-40 T-40

For service other than illumination. Speeds up drying and surface heating processes, by radiation. Used in drying photographic prints, industrial and automotive finishes, food products, localized heating, surface moisture, motor and transformer windings, blueprints, pottery, etc.

The reflector drying lamp fits into many specialty jobs not otherwise readily equipped.

Reflector Lamps

Watts	Lamp Ordering Abbrev.	Bulb	Base	Design Volts	Light Center Length, In.	Max. Overall Length, In.	Each
125	125R40	R-40	Med. Skt.	115	—	7 1/4	\$1.45
250	250R40/1	R-40	Med. Screw	115	—	6 1/2	1.10
250	250R40/4	R-40	Med. Skt.	115	—	7 1/4	1.50
375	375R40	R-40	Med. Skt.	115	—	7 1/4	1.65

Lamps Requiring Auxiliary Reflectors

125	125G30	G-30	Med. Skt.	115	5	7 1/8	.95
250	250G30	G-30	Med. Skt.	115	5	7 1/8	1.00
375	375G30	G-30	Med. Skt.	115	5	7 1/8	1.50
500	500T40/3	T-40	Med. Bipost	115	3 1/6	7 1/4	10.50
1000	1MT40/3	T-40	Med. Bipost	115	3 1/6	7 1/4	11.00

Tubular Quartz Lamps

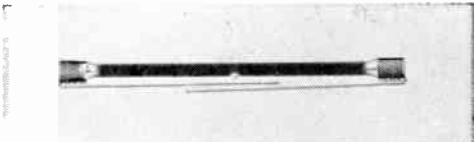

Tubular quartz lamps deliver many times the energy concentration provided by R-40 lamps. They may be used in compact trough reflectors for concentrated radiation.

Watts	Lamp Ordering Abbrev.	Bulb	Base	Design Volts	Lighted Length, In.	Max. Overall Length, In.	Each
500	500T3	T-3	Sleeve	120	5	8 13/16	\$7.00
1000	1000T3	T-3	Sleeve	240	10	13 13/16	8.50
2500	2500T3	T-3	Sleeve	480	25	28 13/16	16.00
5000	5M/T3	T-3	Sleeve	960	50	53 13/16	29.00

G-E Germicidal Lamps

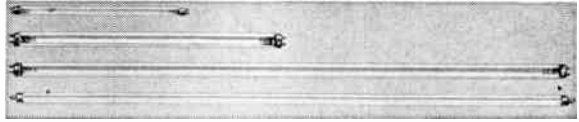

Special ultraviolet-transmitting glass tubes for use in sterilizing the air in hospital operating rooms, nurseries, air conditioning systems, and for preventing growth of mold on meats stored in refrigerators.

Special fixtures designed for these lamps should be used, and installed properly to shield eyes and skin from direct exposure.

Medium Bipin Base

Watts	Bulb	Ultra-Violet Output Watts	Lamp Ordering Abbrev.	Std. Pkg. Qty.	Each
15	T-8, Clear	3.6	G15T8	24	\$3.25
30	T-8, Clear	8.3	G30T8	24	4.95

Miniature Bipin Base

8	T-5, Clear	1.3	G8T5	24	3.50
---	------------	-----	------	----	------

Cory Commercial Electric Coffee Brewers



No. C500-H Electronic Automatic Stainless Steel Coffee Brewer

Brews 12-cup capacity decanter in approximately three minutes — entire operation takes only 11 seconds of operators' time.

Affords automatic control of the four essentials to perfect coffee — correct amount of coffee, water measurement, temperature and infusion time.

No. C500-H — One burner III-lo, three burners low-medium. 115/230 volts a-c or 120/208 volts a-c. 5-CDA decanters, 1-CAL replacement bowl, two extra cartridges with filters and cartridge racks. Size: 21 in. deep, 27 in. wide, 22 in. high. Approximate weight 83 lbs.

No. C500-H Each **\$495.00**

Stainless Superama Stoves

No.	Burners	Volts AC Only	Max. Watts	Size	No. Cartons	Ship. Wt.	Each
CH2W	2	115	320	8 7/8 x 14 15/16 x 4 3/8	1	7	\$39.50
CH2	2	115	1070	8 7/8 x 14 15/16 x 4 3/8	1	6 3/4	49.00
CH3	3	115	1605	8 7/8 x 22 5/16 x 4 3/8	1	9 3/4	69.00
CH4	4	115/230	2140	18 1/2 x 14 15/16 x 6 1/16	1	14 3/4	99.00
CH4T	4	115	2140	18 1/2 x 14 15/16 x 6 1/16	1	14 3/4	99.00

Commercial Fans

For Offices, Banks, Stores and Institutions

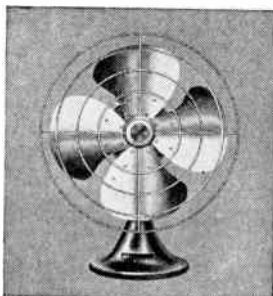

Desk Type

Can be Furnished in Various Sizes and Types, in both Oscillating and Non-Oscillating

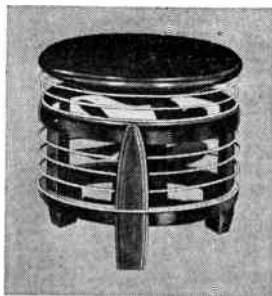

Floor Circulator Type

For Home or Office use. In various sizes and colors

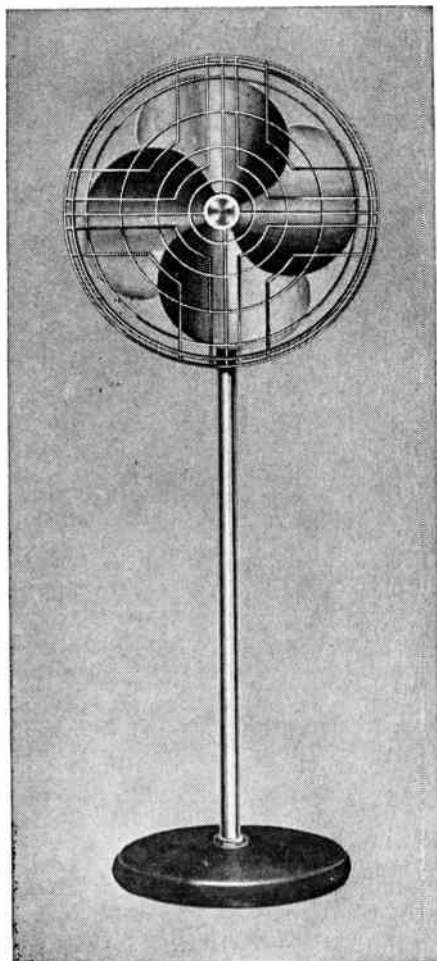

Pedestal Type

Available in Several Sizes

While we show only three typical fans of current style — desk, floor circulator, and pedestal — may we suggest that you call or write our nearest office or warehouse (see list at back of catalog) when you need technical help, prices, and delivery information.

For the latest fan information, be sure to contact your nearest Graybar office or warehouse

Fresh'nd-Aire Air Circulators

For Commercial and Industrial Use

Designed and built to deliver quiet, efficient, draft-free over all air circulation economically.

There is a model to cover almost every requirement, from the smallest office or store to the largest industrial plant.

Made of the finest and best material available for the purpose, by expert workmen. All are very attractive and their performance outstanding.

Heavy duty custom-built motor, with extra length sleeve bearings — floats on a cushion of rubber. Motor housing is air-cooled, assuring a constant flow of air in and around the motor; durable chrome finish. Patented plastic propeller, electrically, dynamically and permanently balanced to prevent motor wear and to deliver maximum air flow. Pull-chain speed control — shows each operating speed at a glance. Heavy steel wire safety guard, plated finish.

Complete with 8-ft. rubber covered cord and attachment plug cap.



Low Stand Model

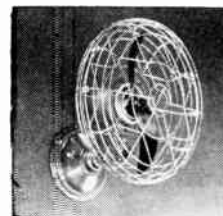

Wall Mounted

Low stand or wall models are designed to be used basically as low stand table or wall circulators. Can be converted from low stand type to wall model by simply turning base as shown in "Wall mounted".

For Operation on 115 Volts, 60 Cycles A-C

Model	Propeller, In.	CFM	Speeds	Watts	Shp. Wt. Lbs.	Each
1700L	17	4000	3	100	24	\$ 74.95
2000L	20	6000	3	130	30	84.95
2300L	23	8000	3	175	32	99.95
2600L	26	12000	5	200	57	129.95

One in a Carton.

Note — Low stand or wall models can be converted into high stand models by using a Conversion Kit — Contact Graybar for further information.

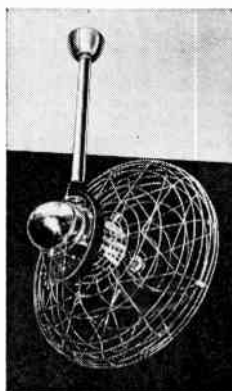

Fresh'nd-Aire Ceiling Brackets

This ceiling bracket reduces ceiling installation to a one man job. Will mount any of the fans listed above in an upright position — adjustable for 360° turn. Comes complete with chromed ceiling canopy and black malleable iron mounting ring.

Model	*Extension from Ceiling, In.	Each
UCM20	20	\$25.45
UCM48	48	27.45

*Distance from ceiling to fan center.

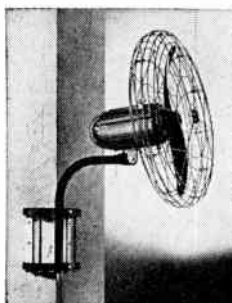

Fresh'nd-Aire Post and Corner Brackets

Makes it possible to mount any Fresh'nd-Aire air circulator into corners or other irregular surface. Fits any angle or rounded surface and works equally well on flat surfaces. Screw adjustment permits air circulator to swivel freely in any direction. Tubular steel, black crackle finish. Ship. wt., 12 lbs.

Model 3019 Ea. \$22.50

Michael Electric Hand Dryers

Ozo Hurricane

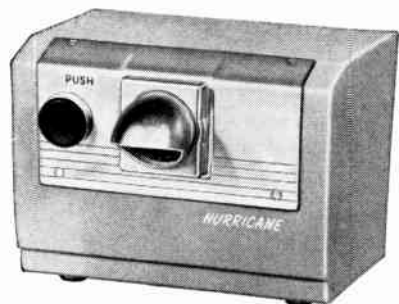

Simple, fool-proof, push button timer responds to fingertip or elbow pressure releasing quick-drying air current. Dries hands in about 20 seconds, shuts off automatically in 30 seconds.

This 20 amp. dryer can be directly wired to 110 a-c line. Heating element constructed of high quality nichrome wire. Heater protected by special fuse. Has grey metallic finish with other parts galvanized to prevent rust.

No.	Dimensions In.	Wt. Lbs.	Each
OHD-50C	9½ x 7 x 6¾	15	\$79.95

Wesix Bathroom Heaters

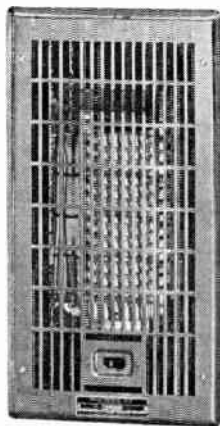

"Built-In"

A compact heater for bathrooms of average size. Features an "electric chimney" similar to those in major WESIX models. Easy to place in the smallest bathrooms, it will fit into standard walls under windows or in almost any location.

Standard voltage 120 a-c. (Can be furnished for 240 volts). Over all dimensions 10½ x 20 in.

No.	Wattage	Each
10FC	1000	\$22.00
12FC	1250	22.00
15FC	1500	22.00

Ship. weight 11 lbs.

Wesix Bathroom Heaters

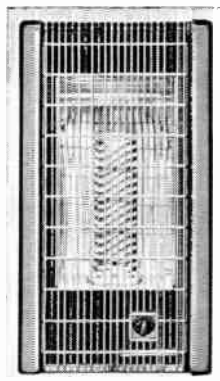

"Automatic"

Where automatic heat is desired, for cold climates or where the bathroom has a large outside wall area, we highly recommend this regular major air heater with its sparkling nickel finish.

It features the famous WESIX Thermostat which automatically regulates room temperature yet can be instantly and easily adjusted to any desired temperature.

Standard voltage 120 volts a-c. (Can be furnished for 240 volts.)

No.	Wattage	Each
10WFN	1000	\$59.00
12WFN	1250	59.00
15WFN	1500	59.00

Ship. weight 17 lbs.

"Competitor"

In the lowest price field, the "Competitor" bathroom heater is a durable, high quality unit that is built to the same exacting standards as regular Wesix bathroom models. Shipping wt. is 11 lbs., standard voltage is 120 v.

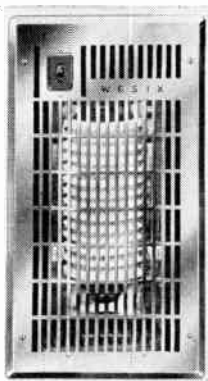

No.	Wattage	Each
10BH-1	1000	\$16.00
12BH-1	1250	16.00
15BH-1	1500	18.00
15BH-2 (240 v.)	1500	19.00

"Time Switch Control"

An integral 60 minute time switch prevents wasted power in bathrooms in home, or in apartments, offices or motels. Mechanical time switch may be set for any period up to one hour. Chromium finish. Easily installed between studs. Over-all dimensions, 10½ in. by 20 in. 120 v., 1500 watts.

No. 15TH—Shipping Wt., 12 Lbs. Each \$29.50

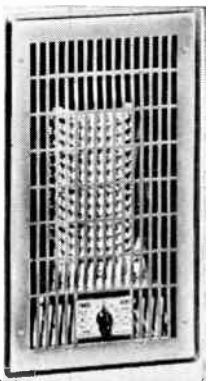

Framing Details and Dimensions:

Heaters should not be located behind or in the way of hinged doors, under towel racks, tables or cabinets.

Wall Opening Dimensions:

No.	Width, In.	Height, In.	Heater Depth, In.
10FC, 12FC, 15FC	8⅝	17¾	3⅞
10WFN, 12WFN, 15WFN	9⅞	20¼	4

Installation:

Heater rests on bottom strip that is set flush with studs, 6 in. above finished floor. Heater is fastened with screws through side flange and wall finish, into studs. Interior wall finish should run even with wall opening on top, bottom and sides. For plaster finish a lath edging or ground strip around opening prevents crumbling. Heater grille overlaps wall opening about 1 in.

Wesix Automatic Fan Type Heaters

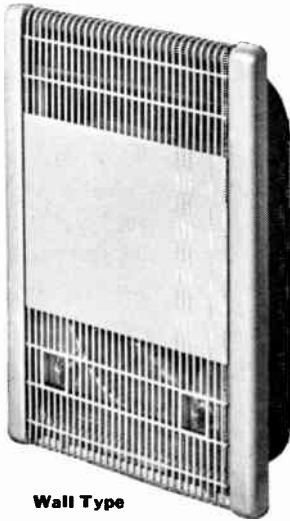

Wall Type

Built for dependable quiet operation with sealed motor that requires no oiling, vibration-free floating grille and low velocity air movement, the fan-type heaters are equipped with Wesix thermostat, separate fan control and full over-temperature protection.

Available in portable, flush wall or bracket mounted models. Wall opening of all flush wall models, width 14 1/4 in., height 20 1/4 in., depth 4 in. Shipping wt. 25 lbs. Standard finish, hammer-tone bronze. Available in polished nickel on special order. 240 v. operation.

Bracket type: 15 5/8 in. wide, 16 1/2 in. high, 8 1/2 in. deep.

Wall Type No.	Each	Port-able No.	Each	Bracket No.	Each	Watts	Shp. Wt. Lbs.
20WD	\$85.00	20PD	\$ 96.50	20PDB	\$ 96.50	2000	27
30WD	87.00	30PD	98.50	30PDB	98.50	3000	27
40WD	90.00	40PD	100.50	40PDB	100.50	4000	27
50WD	95.50	50PD	102.50	50PDB	102.50	5000	27

Wesix Automatic Floor Furnaces

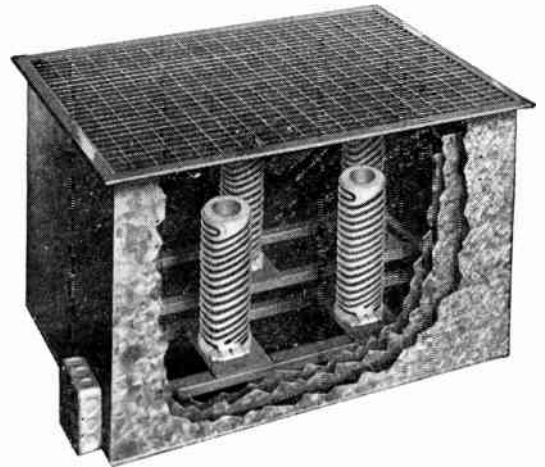

Designed to give safe and clean heating at a minimum cost including installation. They feature the same basic construction as other WESIX automatic electric heaters such as the "electric chimney" for high velocity natural circulation and the built-in WESIX thermostat for comfort and economy.

Equipped with two double-pole switches.

Operate on 240 volts a-c.

Guaranteed by maker against defects. Listed by Underwriters' Laboratories, Inc.

No.	Watts	Floor Opening In.	Grille Overall, In.	Shp. Wt. Lbs.	Each
30FFE	3000	14 1/4 x 24 1/4	16 x 26	79	\$ 96.50
50FFE	5000	14 1/4 x 30 1/4	16 x 32	105	128.50
80FFE	8000	20 1/4 x 30 1/4	22 x 32	126	156.00

Wesix Automatic Electric Wall Furnaces

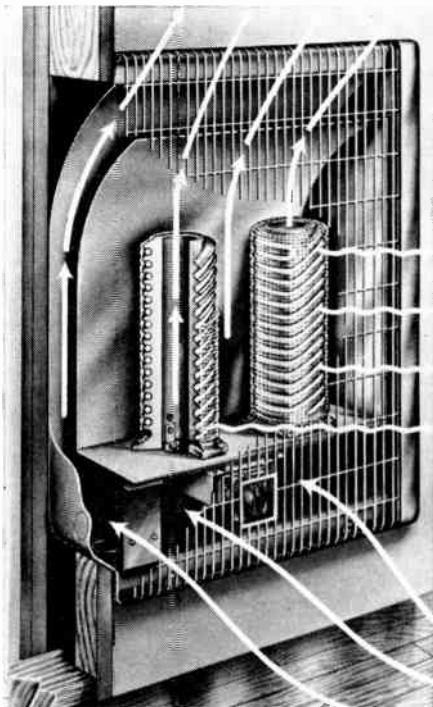

The radiant plus circulating heat of these wall furnaces provide maximum room comfort — air is neither too hot nor too cold and neither stuffy nor drafty. Radiant heat gives quick, penetrating warmth. Wesix "electric chimneys" provide controlled natural circulation of warm air throughout the room. Without fans, blowers or other moving parts this circulation is gentle and silent. It provides even distribution of warmth from floor to ceiling in every corner of the room.

Standard voltage, 240 a-c, unless otherwise specified.

Standard finish hammer-tone bronze.

Depth of opening 4 in.

No.	Watts	Wall Opening In. Width	Wall Opening In. Height	Shp. Wt. Lbs.	Each
*12WF	1250	9 7/8	20 1/4	17	\$ 53.50
*16WF	1666	14 1/4	20 1/4	22	69.00
20WF	2000	14 1/4	20 1/4	22	69.00
25WF	2500	19 1/2	20 1/4	29	74.50
30WF	3000	22 3/4	20 1/4	30	79.50
40WF	4000	29	20 1/4	38	93.00
50WF	5000	35 3/8	20 1/4	46	114.00

Ionix Control available on all Units. Prices on request.

*Also available in 120 volts a-c.

Guaranteed by maker against defects. Listed by Underwriters' Laboratories, Inc.

Installation

These instructions should be followed exactly as to location and method of framing in: heaters are set 6 in. above finish floor, preferably on outside wall; heaters are supplied in one unit and should be so installed AFTER plastering or other wall-finishing operations are completed.

Wesix Automatic Electric Wall Furnaces



Ionix Wall Convectore

Heating by controlled radiation and convection, the low temperature on the grille panel of the Ionix Wall Convectore permits greater freedom in furniture placement and is ideal for use in schools, offices, theaters or in other locations near work or play areas.

Exclusive with Wesix, the Ionix wall convectore features ionization and air purification to destroy airborne bacteria, mold and pollen and make indoor air like outdoor air at its best. "Air sterilization" which is also found on Ionix wall furnaces is enhanced by the system of baffles found on the Ionix wall convectore.

No.	Watts	Wall Opening, In.		Shipping Wt., Lbs.	Each
		Width	Height		
15CW-IX	1500	9 $\frac{1}{8}$	20 $\frac{1}{4}$	22	\$ 67.00
20CW-IX	2000	14 $\frac{1}{4}$	20 $\frac{1}{4}$	27	86.50
25CW-IX	2500	19 $\frac{1}{2}$	20 $\frac{1}{4}$	30	93.00
30CW-IX	3000	22 $\frac{3}{4}$	20 $\frac{1}{4}$	35	100.50
40CW-IX	4000	29	20 $\frac{1}{4}$	45	117.00
50CW-IX	5000	35 $\frac{3}{8}$	20 $\frac{1}{4}$	55	159.50

Standard voltage 240 v., unless otherwise specified.

Standard finish: hammertone bronze, special finishes available on order.

Depth of opening is 4 in.

Underwriters' Laboratories listed and approved.

Wesix Centramatic Controls

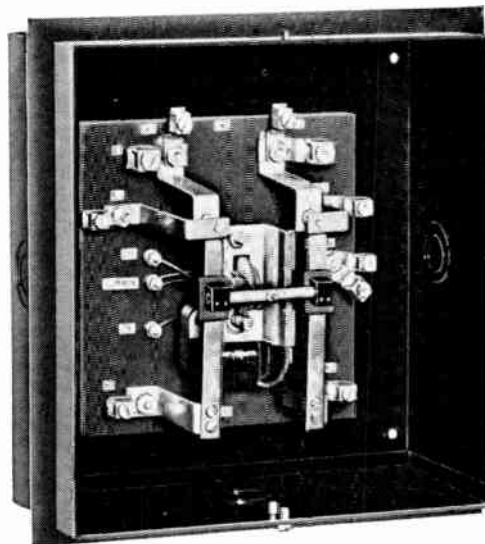

With this complete, packaged kit, central control and automatic capacity control can be added to the already "multiple zone controlled" electric heating system. Basic unit is 100 amp. switch which turns heating equipment throughout the home to high, low or off position automatically. Capacity and indoor-outdoor control is by the easily installed "Climatwins" a sensitive outdoor and indoor thermostat combination.

When outdoor temperature rises above a pre-set level, all automatic heating units are switched to 120 v. operation. In addition, house temperature is controlled by overriding central thermostat whenever temperature setting is lower than setting of individual room thermostats. Shipping wt. 55 lbs. UL approved. Each.....\$95.00

No.	Components	Amps.	Volts
CLR	Controller.....	100	240
	Indoor Thermostat.....	25	240
	Outdoor Thermostat.....	30	240

Wesix Heavy Duty Unit Heaters



Available in a wide range of sizes for commercial and industrial installations.

They have "Dust-free" enclosed elements for even heat distribution without danger of clogging with dust or other airborn material.

Commercial Type (Axial Fan)

†230 Volts, A-C

No.	Watts	*Std. Phase	Dimensions, In.			Ship. Wt., Lbs.	Each
			Depth	Width	HT.		
3CU8	3000	1	11	12	12	35	\$ 78.00
4CU8	4000	1	11	12	12	40	92.50
5CU8	5000	1	14	12	12	45	99.50
6CU8	6000	1	14	12	12	45	117.00
6CU12	6000	3	13	16	16	61	143.00
7 $\frac{1}{2}$ CU12	7500	3	13	16	16	71	148.00
10CU12	10,000	3	16	16	16	110	217.00
12CU12	12,000	3	16	16	16	110	189.50
12CU14	12,000	3	17	18	18	75	249.00
15CU14	15,000	3	17	18	18	80	260.00
18CU14	18,000	3	17	22	22	110	285.00
20CU14	20,000	3	17	22	22	115	311.00

Wesix Automatic Portable Heaters

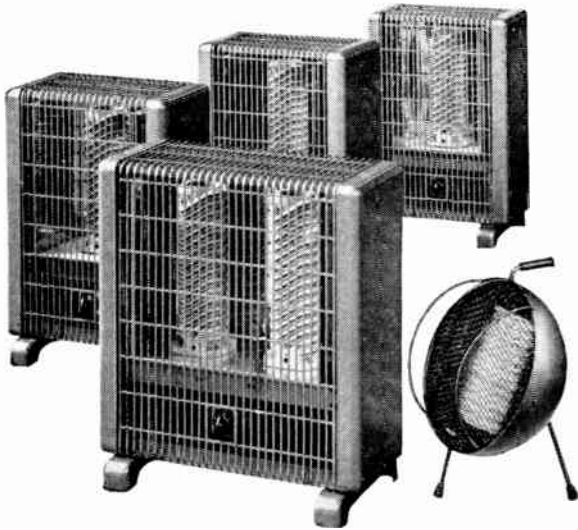

For completely automatic electric heating in one or more rooms or for general auxiliary heating, these Wesix portables provide the same balanced radiant plus circulating heat as Wesix wall furnaces. Strong, safe construction with over-temperature protection in case of tipover and ten year element guarantee insures years of silent, maintenance-free service. Grille easily removed for cleaning. Adjustable thermostat in incoming airstream for accurate temperature control; standard finish Hammer-tone Bronze. Standard or Ionix models available. All models except 50CR are complete with 5 ft. cord and polarized cap. (Regular cap on 120 v. models). Guaranteed by maker against defects.

No.	Watts	Appr. Width In.	Shp. Wt. Lbs.	Each
*15CR	1500	11	20	\$44.50
20CR	2000	15 3/4	30	56.00
30CR	3000	20 3/4	35	67.00
40CR	4000	25	45	78.50
50CR	5000	33 1/2	55	99.50

*Can be supplied for 120 volts a-c, 1500 watts or less.

"Fireball"

Small portable in attractive modern design. Heat is by radiation and convection. Heater stands on three rubber tipped legs with cool handle balanced for easy carrying. Five year guarantee against burnout. Complete with cap and cord. Sizes 1250 watts and 1500 watts, 120 v. Finish, Antique black.

Wesix Bracket Type Heaters

These heaters feature the same construction as Portable Heaters, except that the feet and handles are replaced by brackets which fasten to walls by screws and bolts. When mounted on the wall just above the baseboard, they give the same dependable service as the Wall Furnaces, with the floor surface left clear for easy cleaning. Ideal where masonry walls or other existing construction prohibits cutting wall openings.

Standard voltage, 240 volts, a-c. Specify finish and voltage. All sizes approximately 9 in. deep, 16 3/4 in. high; (Overall width—see table).

No.	Watts	Approx. Width In.	Shp. Wt. Lbs.	Each
*15CRB	1500	11	20	\$43.00
20CRB	2000	15 3/4	30	53.50
30CRB	3000	20 3/4	35	64.50
40CRB	4000	25	45	75.50
50CRB	5000	33 1/2	55	97.00

*Can be supplied for 120 volts a-c, 1500 watts or less.

Wesix Electric Baseboard Panels

Here is a vastly superior perimeter heating system designed for maximum comfort and perfect compatibility with modern interior design. It employs the same principle of radiative and convection heating that has been used by Wesix successfully for many years. Unlike so-called "panel" heat or "radiant" heating in floors or ceilings, these Baseboards are fully automatic and there is no time-lag or excess residual heat to bring waste and discomfort.

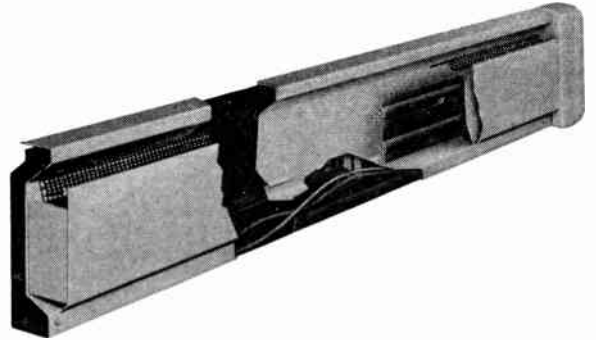

Installed beneath picture windows, the panels keep glass free of fog and counteract downdraft caused by high heat loss.

No metal fitting on the job. Two standard lengths are designed to fit any size room with sufficient capacity for design temperature difference up to 70 degrees F.

Controls are simple, assuring low installation costs. No expensive wiring or pipes to lay in concrete or plaster. No condensation, no furnace, no flues.

Engineered for a maximum surface temperature of 150° F., these units are rated at 250 watts per linear foot and operate on 240 volts a-c.

Baseboard

No.	Watts	Length, In.		Shp. Wt. Lbs.	Each
7CBB-32	667	2	8	20	\$27.00
10CBB-48	1000	4	0	25	38.30

Controls

No. CBBLDP — Thermostat and Switch; Length 6 in.; Ship. weight 5 lbs..... Each **\$25.00**

Accessories

No. CBBCS Corner Piece, length 2 3/4 in.; Ship. wt. 1 lb..... Each **\$3.50**

No. CBBDR Receptacle Section, lgth. 6 in.; Ship. wt. 2 lbs..... Each **\$9.50**

No. CBBES End Pieces, length 2 7/8 in., wt. 1 lb..... Each **\$3.50**

Note: For control by Wall Thermostat, specify Wesix No. DLV.

Standard Finish: Sea Grey.

Installation

Baseboard panels are surface mounted on the wall above finished floor. Baffle alignment plates assure even alignment of panels and control section.

Thermostatic controls should be carefully adjusted in each room for maximum comfort. In a well engineered installation in a properly constructed, well-insulated house, the temperature difference from corner to corner, floor to ceiling will be less than 2° F.

Big Beam Combination Portable Electric Hand Lamp and Flashing Red Signal Beacon

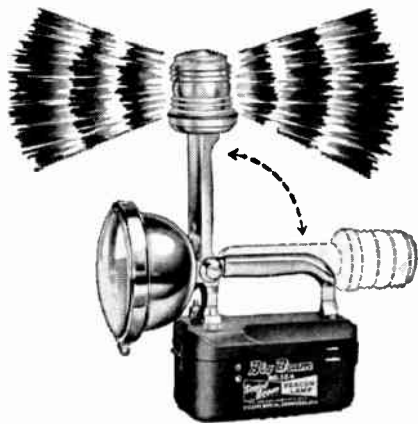

This combination portable electric hand lamp and flashing beacon No. 164 and incandescent bulb type No. 104 is the most popular of its kind on the market today. With beacon arm folded down over handle the beacon serves as a tail light. When beacon is raised to upright position, unob-

structed vision is assured. When placed on ground or top of car, it serves as a warning or signal light. Two switches—one for head light—the other for tail light. Powered by one #200, 6 volt lantern battery.

No.	Description	Each
164	Big Beam Beacon, less battery.....	\$10 50
104	Big Beam Beacon, less battery.....	9 95
200	6-volt lantern battery.....	1 00

Big Beam Flashing Flare Beacons



Gives safety in every conceivable emergency. Designed and created to fill a popular demand for a flasher of this type that is sturdy and dependable, compact and light weight and inexpensive to give long-lasting service.

Simple to operate push button starts and stops the flasher. The one 6-volt standard lantern battery can be replaced in seconds.

Flashes approximately 60 to 65 times per minute and gives about 65 hours of continuous use on one battery. Battery container 20 gauge steel, rustproof and weatherproof, painted with red baked enamel.

No.	Description	Each
108F	Flashing Flare Beacon, less battery.....	\$4 95
200	6-volt lantern battery.....	1 00

Big Beam Electric Hand Lanterns

Explosion-Proof



Approved by Underwriters' Laboratories for Class 1, Group D hazardous locations. Bulb is held in its socket by a compressed high-tension spring clamped over the glass envelope of the bulb. If bulb cracks or breaks, the spring crushes the bulb and simultaneously ejects bulb base from contact socket, thus eliminating filament after-glow.

Sparkproof case and head are of drawn brass. Handle die cast zinc. Lead seals to prevent tampering and container latch which can be padlocked. Ideal lamp for any hazardous area. Uses two 6-volt standard lantern batteries.

No.	Description	Each
287EX	Explosion Proof Hand Lamp, less batteries.....	\$33 75
200	6-volt lantern battery.....	1 00

Big Beam Hand Lamps



Projects a beam for a distance of 2500 ft.

Powered by a 6-volt heavy-duty, 26 amp.-hr., rechargeable storage battery. Pressure type battery-to-lamp contacts eliminate broken and corroded wire. Has two bulbs—main and auxiliary. Lamp head adjustable in a 180° vertical arc.

Reflector, 7-in. triple-silver plated.

Lamp head and handle finished with durable black enamel. Case finished with acid-resistant coating. Shipping weight, 19 lbs.

No. 411	Complete with Battery.....	Each	\$41 00
No. 1280	Charger.....	Each	22 50

Big Beam Transista Lamps



Transistor circuit assures minimum of 1500 continuous flashing hrs. on two standard 6-volt lantern batteries.

Equipped with big, 4½-in. double-faced lens and filament type bulb clearly visible from both directions.

Has tamper-proof concealed switch and locking device for attaching to barricade.

Case constructed of 20-gauge steel and finished in red baked enamel. Telescoping cover weatherproofs entire unit.

Has no moving parts to get out of order.

No. 410T	Transista Flash, less batteries. Specify red or amber lens.....	Each	\$22 95
----------	---	------	---------

No. 408F Hand Lamps

Flash or Steady. Uses one or two standard 6-volt lantern batteries. Has two operating bulbs with spare in dummy socket for added protection. Equipped with Dome type fresnel lens. Specify red, green, amber, clear or blue.

No. 408F	Flashing Flare, less batteries.....	Each	\$11 50
----------	-------------------------------------	------	---------

Note: Prices slightly higher in 11 western states.

Justrite Safety Flashlights

Yellow Jacket

Approved for use in Class 1, Group D hazardous locations by the Underwriters' Laboratories, Inc., and by the U.S. Bureau of Mines, Approval No. 608, for use in methane gas and air mixtures.



A completely redesigned 3-cell flashlight, light in weight, small and powerful.

Case is high-visibility yellow in color, made of unbreakable cellulose butyrate acetate, that resists shock and withstands a wide range of temperatures. Completely insulated to permit its use around electrical circuits without danger.

Case fits the hand or pocket easily. Will stand steadily and throw a beam diagonally upward.

Highly polished silver plated reflector 2½-in. diameter. Protected with neoprene ring. Simple operating switch. Has finger ring on bottom and belt clip on side of case. Case is guaranteed unconditionally by the maker against breakage in normal use.

Complete with No. 365 bulb and clear lens. Throws a beam of light 1500 feet. Requires 3 standard flashlight batteries (Batteries not included).

Size: 2⅝ x 3⅝ x 6-in. Individually boxed, 12 in a standard package; weight of standard package, 7 lbs.

No. 1717-8.....	Each	\$5 35
-----------------	------	--------

Big Beam Jr. Electric Hand Lamps

Portable



No. 111

Gives a big, powerful light for unlimited sports, utility and emergency uses.

Designed for those who want a bright, portable light for work or play.

Battery case and hinged cover heavy drawn steel, with snap catch. One-piece handfit handle 4-in. long.

Lamp head 4½-in. diameter with highly polished reflector. Push button switch mounted on top of case.

Lamp-to-battery pressure type contacts—no wires to connect, weatherproof and rust-proof. Can be focused for wide or narrow beam.

Over all size: 8½-in. long, 4½-in. wide, 6¾-in. high.

Finish: Head lamp and handle assembly, nickel-chrome plated. Case and cover durable baked red enamel. Complete with Bulb No. 160.

Requires one 6-volt lantern type battery. (Battery not included.)

Packed individually; 12 in a shipping case

Weight Per Case 38 lbs.

No. 111 — Net Wt. 2 lbs..... Ea. **\$6.95**
 No. 166—With Sealed Beam, Net Wt., 2¼ lbs... Ea. **\$7.50**

Big Beam Electric Hand Lamps

Portable



No. 211

Throws a powerful 1500-foot brilliant beam, or spread light.

For unlimited utility, emergency or sports use.

Battery case and hinged cover heavy drawn steel, with snap catch. One-piece hand-fit handle.

Lamp head 5-in. diameter, with highly polished reflector. Heavy convex glass lens. Double throw control switch

lights either the main bulb or a small auxiliary bulb for dim light.

Simple focus adjustment permits choice of powerful 1500-foot beam or bright spread light. Lamp-to-battery pressure type contacts — no wires to connect, weather-proof and rust-proof.

Finish: Head lamp and handle assembly, polished nickel-chrome plated. Case and cover durable baked red enamel.

Overall size: 10-in. long, 5¼-in. wide, 9¾-in. high.

Requires two standard 6-volt lantern batteries. (Batteries not included.)

Packed individually; 12 in a shipping case

Weight of case 64 lbs.

No. 211 - Complete with Main Bulb No. 260 and Auxiliary Bulb No. 255..... Each **\$12.95**

No. 212 — An Excellent Lamp for Motorists, Road Crews, Railroad Men, etc. Complete with Main Bulb No. 260, and Red Auxiliary Bulb No. 255. Equipped with a Flashing Unit to operate Red Signal or Warning Light..... Each **\$17.95**

Prices slightly higher in 11 western states.

Big Beam Electric Hand Lamps

Portable

An all-purpose lamp for use by utilities, railroads, fire and police departments, and others who require a powerful working light.

Throws a brilliant beam 2500 feet and is unexcelled for all night emergency jobs.



No. 1000

Battery case and cover, heavy steel, with lever catches. One-piece hand-fit handle.

Lamp head 7-in. diameter, with silver plated brass reflector and crystal clear glass lens ¾-in. thick; two toggle switches, single pole, single throw, on top of lamp head. Lamp to battery pressure-type contacts — no wires to connect.

Finish: Head lamp and handle assembly chrome plated; Case and cover heavy baked red enamel.

Requires one 9-volt Dry battery. (Battery not included.)

Complete with No. 900 main bulb and No. 955 auxiliary bulb.

Over all size: 14-in. long, 7-in. wide, 13-in. high.

Packed Individually

No. 1000—Shipping Weight 9 Lbs..... Each **\$24.95**

With 100% Spillproof Rechargeable Battery

For all industrial purposes, public utilities, railroads, police and fire departments, hospitals and many other purposes.

Each cell of battery has a transparent window with three built-in specific gravity ball indicators, which indicate the condition of battery by their position in cells.

Container is 18 gauge welded steel, durable baked red enamel finish. Chrome plated carrying handle, with D rings for shoulder strap.



No. 312

Lamphead 6¼-in. diameter, chrome plated. Highly Polished reflector. Heavy convex glass lens. Double-throw switch, single pole, toggle type. Button on head for fastening snap-on lens.

Lamp head can be adjusted to 170° vertical arc.

Lamp-to-battery pressure type contacts — no wires to connect.

Overall size: 13½-in. long, 6¼-in. wide, 10½-in. high.

Storage battery for No. 311 — 6-volt, 20 ampere hour capacity, built-in specific gravity indicators. Complete with 6-volt pre-focused main bulb No. 900, 2.35 amperes, and standard G-E 6-volt auxiliary bulb No. 55.

No.	Description	Each
311	With Battery, without Charger; Shipping Weight 17½ Lbs.....	\$45.00

Storage battery for No. 312 — 4-volt, 20 ampere hour capacity, with specific gravity indicators. Complete with 4-volt pre-focused main bulb No. 360, 1.5 amperes, and standard G-E No. 502 special miniature base auxiliary bulb.

Built-in charger recharges battery by connecting to 110-volt a-c circuit by removing charge cord from inside of lamp container and following instructions furnished with lamp.

Packed Individually

No.	Description	Each
312	With Battery and Built-in Battery Charger; Ship. Wt. 17 Lbs.....	\$49.50

Big Beam Automatic Emergency Lighting Units

With Glass Jar Batteries

Model 2ATW

Automatic emergency lighting units with 2 heads, glass jar storage battery, trickle charger, fast charger and 12 hour time switch.

Wherever storms, fire, floods, accidents or a blown fuse disrupt lighting service, a Big Beam automatic emergency light will provide illumination for hours. No special wiring is needed—just place the unit for most effective illumination and plug into any convenient lighting outlet.

Battery charged to capacity at all times by enclosed automatic trickle charger. Actual test assure minimum



of 8½ full hours of operation when fully charged. Enclosed relay automatically turns lights ON when regular current fails and OFF when current is restored. 12-hr. time switch for fast charging run-down battery—automatically reverts to trickle charge at end of desired length of fast charging—up to 12 hours on one turn of switch. Has built-in specific gravity discs. Power furnished by 3 cell, 25, 30, 40, 80 or 100 ampere hour glass jar battery. Complete unit 16-in. long; 8½-in. wide; 19¼-in. high overall. Complete unit with heads, but without battery, weight 20 lbs.

No.	Description	Each
2ATW/25	With 25 Amp. Hr. Glass Battery.....	\$120.00
2ATW/30	With 30 Amp. Hr. Glass Battery.....	120.00
2ATW/40	With 40 Amp. Hr. Glass Battery.....	117.00
2ATW/80	With 80 Amp. Hr. Glass Battery.....	124.00
2ATW/100	With 100 Amp. Hr. Glass Battery.....	122.50

Big Beam Automatic Emergency Lights

Electric, Portable

These lamps are fitted with an extension cord and plug, and relay unit. When cord is plugged into an electrical outlet served by the same circuit, the auxiliary lamp goes on automatically the instant current fails and regular lights go out.



Single Head Model No. 801

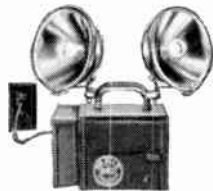

Dual Head Model No. 802

For theaters, hospitals, hotels, institutions, public buildings, amusement buildings and department stores. Also where local building laws require auxiliary emergency lighting.

Projects a powerful light — adjustable to any direction. Equipped with floodlight lens for diffusing light over a wide area. Can be used as a regular portable hand lamp.

Lamp heads 6½-in. diameter, with highly polished reflectors. Heavy convex glass lens. Trouble-free toggle switch on top of lamp heads. Heads, handle and heavy steel case with snap catch, all finished in green hammerloid enamel.

Swivel lamp heads may be turned a full 360° horizontally and 230° in vertical direction.

Require four No. 6, 6-in. dry batteries. (Batteries not included.) Pre-focused Bulbs No. 760, 4½ volts.

No.	Type	Lgth.	Overall Size, In.		Hgt.	Ship. Wt., Lbs.	Each
801	Single Head	12	6½	13	9	\$32.95	
802	Dual Head	14½	6¼	13	11	39.95	

Big Beam Automatic Emergency Lights
Electric, Portable

Approved by Underwriters' Laboratories, Inc.

For providing instant, automatic emergency lighting whenever any interruption in electric service causes the regular lighting to fail. Avoids confusion and prevents panic and disaster in crowded buildings when a fire or storm causes the lights to go out.

The two powerful floodlights provide ample lighting over a large area minimizing property damage and guarding merchandise theft when lights fail.

The general operation and installation is the same as Nos. 801 and 802. Complete with an 8-ft. rubber cord and attachment plug cap.



No. 2AD-S

Attractively designed container of heavy steel, with full length piano hinge and two lever-type latches for cover. Heads, handle and container finished in soft green hammerloid.

Two floodlight heads 6¼-in. diameter with highly polished reflectors. Convex glass lenses. Brass, friction-type corrosion-proof swivel joints hold adjustable heads in any

position. Thoroughly dependable automatic switch over relay.

Complete with General Electric heavy duty pre-focused bulbs (one spare bulb (No. 900) included in battery case).

Requires one 9-volt standard dry battery that is easily replaced. (Battery not included.)

Over all size: 15-in. long, 6¼-in. wide, 15½-in. high.

No. 2AD-S—Shipping Weight 15 lbs Each \$57.95

Big Beam Electric Hand Lamps

Portable With Weather Proof Battery Case



No. 700A

A powerful heavy duty lamp for use in industrial plants, R. R. contractors, public utilities and all night service jobs. Throws a powerful beam 2000 feet.

Battery case and hinged cover heavy drawn steel, with snap catches. One - piece hand-fit handle.

Adjustable lamp head 6¼-in. diameter, with highly polished reflector. Convex glass lens. Cutler-Hammer toggle switch on lamp head.

Simplified battery-

connecting plate assures correct battery replacement.

Finish: Case and cover finished in acidproof red enamel. Base waterproof.

Over all size: 11¼-in. long, 6¼-in. wide, 10¾-in. high.

Requires four No. 6, 6-in. dry batteries. (Batteries not included.) Net Weight 5 lbs. Shipping Weight 7 lbs.

No.	Description	Each
700	Black Japanned Lamp Head and Handle; With Main Bulb No. 760 only	\$18.95
700A	Chrome Plated Lamp Head and Handle; With Main Bulb No. 760 and Auxiliary Bulb No. 755	20.95
712	Same as No. 700 except with Flashing Main Bulb; can be used with Snap-On Colored Lens for Signaling.	23.75

Prices slightly higher in 11 western states.

Justrite "Light-Stick" Flashlights



The new "money-saving" design in flashlights for maintenance work in telephone companies and other utilities. Has 6 volt circuit. Gives 2 2/3 times more light than conventional flashlights and batteries last up to 2 1/2 times as long to secure a savings of 20% in cost of operation.

Flat-sided battery case holds 1 regular (size D) flashlight batteries, has belt hook on back, carrying ring on bottom. Headpiece adjusts to any angle, has rubber protector, highly polished 2 1/2 in. reflector, No. 27 bulb.

Overall size 2 1/2 x 3 x 8 1/2 in. Made of rust-proofed steel, finished in chip-proof gray enamel. Packed in unit carton, less batteries.

No. 2105-4 "Light-Stick" Flashlight. Each \$5.40

Justrite "Yellow-Flash" Lights

Powerful—Compact—Convertible

Lights designed for operation on 8 standard flashlight batteries (size D) and a No. 965—8 volt bulb for a far reaching, powerful light—where less light volume and battery economy is desired a standard lantern battery and a No. 27 or PR-13 5-volt bulb can be used.

Flashlights



A good, handy flashlight for hunters, fishermen, householders, inspectors, farmers, campers, guards, peace officers and watchmen. Small size makes it possible to carry in tool kit, tackle box or glove compartment.

Rust-resisting coated steel case, finished in chip-proof enamel. Folding wire handles. Head piece can be tilted so that light may be directed at any angle. Headlamp with 2 1/2 in. highly polished reflector and glass lens is chromium finished, mounted on swivel assembly.

Complete with one No. 965—8 volt bulb for operation on 8 flashlight batteries. (Batteries not included.)

Overall size: 8 x 3 x 3-in. One in a carton; 12 in a case.

No. 2109-1 Weight each, 1 3/4 lbs. Each \$4.95

Head Lights



For all purposes requiring both hands free. Ideal for camp chores, night loading, farm or guard duty.

Metal battery case, yellow baked-on enamel finish, with gray baked-on enamel end caps and trimmings. Has belt loop for fastening to ordinary belt.

Metal headlight assembly, polished heavy chrome finish, with 2 1/2-in. highly polished reflector and glass lens, mounted on swivel assembly with adjustable head band, padded with sponge rubber for comfort. Switch on

head lamp. Weatherproof plastic connecting cord attaches to head piece.

Complete with one No. 965—8-volt bulb for operation on 8 flashlight batteries (Batteries not included).

Battery case 5x3x3-in. One in a carton; 12 in a case.

No. 1903-6—Weight each, 1 1/2 Lbs. Each \$5.45

Justrite Head-Light

A four-cell general utility head-light for work requiring both hands free. Produces a splendid working light that will carry 1500 ft.



The battery case is small enough to slip easily into a pocket. Has clip on case to fasten securely to any belt.

Rust-resistant metal battery case, finished in attractive baked-on gray enamel, with cadmium plated trim.

Metal head-light assembly, baked-on gray enamel finish, with 2 1/2-in. polished reflector. Mounted on swivel assembly, with adjustable head-band, padded with sponge

rubber for comfort. 48-in. weatherproof plastic connecting cord attaches to headpiece.

Operates on four standard flashlight batteries, Size D (Batteries not included). Complete with No. 425 Bulb.

In shipping carton of 12; Weight 12 lbs.

No.	Description	Each
1904-4	General Utility.	\$4.60
*1704-8	For Class 1, Group D Hazardous Locations.	9.50

*With Heavy Cord and Kickout Bulb Socket; Approved by Underwriters' Laboratories, Inc.

Justrite Safety Extension Lights

Approved by Underwriters' Laboratories, Inc. For Use in Class 1, Group D Hazardous Locations



For inspection of barrels, storage tanks, gasoline drums, etc. The flexible extension is a core of tough flexible spring steel, entirely covered with flexible brass tubing—rust-resistant for long duty service.

It is sparkproof and can be bent and inserted into a 3/4 in. or larger opening, and will retain its curvature as set. Light head equipped with a clear plastic globe and No. 365 bulb.

Battery case is high visibility yellow in color, made of unbreakable cellulose acetate butyrate that resists shock and withstands a wide range of temperature.

Requires 3 standard flashlight batteries. (Batteries not included).

Size 2 5/8 x 3 5/8 x 6 in. In individual corrugated shipping carton. Approximate shipping weight 1 lb.

No.	Description	Each
1729-15	With 15 In. Extension.	\$12.00
1729-30	With 30 In. Extension.	14.00

Justrite "Pendragon" Industrial Lantern



A new, more powerful, more sturdy lantern for utility companies and industrial construction and maintenance work.

Combines maximum power and maximum efficiency: beam candle power averages 20,000; overall size only 5 1/4 x 8 x 9 in. Holds 3 standard lantern batteries, will operate for short periods on two batteries or on one battery.

Made of heavy-gauge rust-proofed steel finished in chip-proof enamel. Chrome plated trim.

Rubber covered carrying handle. Available with the new high power sealed beam lamp No. 4517 or with double filament bulb in 1 1/2 in. aluminized reflector.

No.	Description	Each
2401-4	With 1.25 amp. sealed beam lamp No. 4517.	\$19.95
2404-3	With double filament lamp No. 508 (1.0 amp. filament for powerful beam; 0.3 amp. for long hours of burning)	19.95

Note: Batteries not included.

Justrite Railroad Car Inspectors' Lanterns

These lanterns are constructed of rust-resisting steel, chip-proof, baked enamel finish. Sturdy hardwood handle riveted to case. Adjustable guard, fully reinforced. Nickel plated focusing head.



Equipped with two independent lens housings, one having a spread beam honeycomb lens and a No. 27 bulb for spread light, the other with a clear lens and a No. 502 bulb for spot beam. Two independent switches make the lights adaptable for all inspection uses.

Finish: Baked-on yellow enamel.

Complete with one No. 502 clear bulb and clear lens, and one No. 27 bulb and honeycomb lens for use with standard 6-volt lantern battery (Battery not included).

No. 2121-1 In ship. carton of 12; Wt. 22 lbs. . . . Each \$9.95

This model is equipped with a spread-beam honeycomb lens which gives efficient wide spread illumination—a clear even pattern of light three times larger in diameter than the beam of ordinary flashlights or lanterns. There are no dark rings or spots in the light beam.

Complete with one No. 27 bulb for use with standard 6-volt lantern battery (Battery not included).

In shipping carton of 12; weight 22 lbs.

No. 2131-1 Each \$7.50

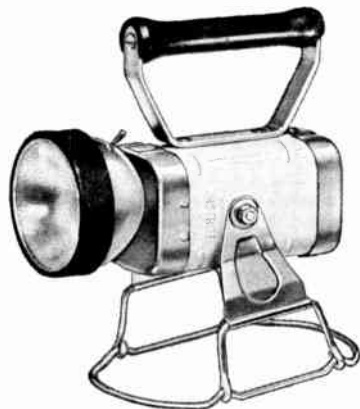

Justrite Portable Hand Lanterns

All-Purpose Safety Type

Approved by Underwriters' Laboratories, Inc., the U. S. Bureau of Mines, and the U. S. Coast Guard Merchant Marine Technical Division

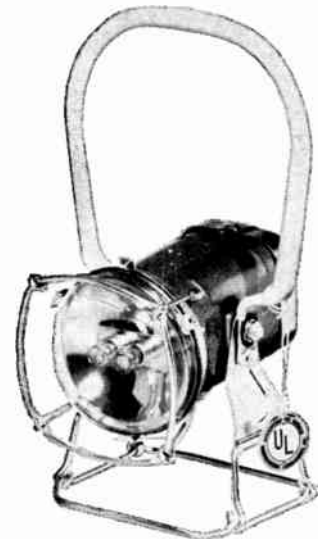

Produces a powerful bright forward beam, plus light to all sides, or a more subdued light as desired.

Battery case is rust-resisting coated steel. Cadmium plated fittings. Globe covers 3 3/4 in. chrome reflector and two sliding bulbs which are put in operation by sliding switch. Aluminum tubing handle, covered with plastic insulating jacket.

Protruding parts are brass, or otherwise sparkproof. Light pivots on base and can be moved to any angle.

Complete with two bulbs, one No. 425 for bright light, and one No. 27 for more subdued light. Requires one standard lantern battery (battery not included). In shipping carton of 12; weight 33 lbs.

No. 1744-8. Each \$8.60

Justrite Flagman's Lanterns

Fully approved by the Association of American Railroads for use by Flagmen.

Has the twin-bulb feature that creates a bright light through 360° in a horizontal plane and a vertical pencil of light visible at a great distance. The twin-bulb feature guarantees against light failure; if one bulb burns out, light can be restored instantly by moving switch.

Battery case is rust-resistant with chip-proof gray enamel finish. Fittings on case and guard cadmium plated. Weatherproof 3 1/2-in. chrome plated reflector provides a powerful spot beam. Aluminum handle, steel reinforced, clears top of case by 4-in. Strong guard of steel, securely welded and reinforced.

The switch moves the bulb to the center of reflector where contact is made.

Fresnel globe produces an intense light with high optical fidelity.

Complete with two No. 27 bulbs. Requires one standard 6-volt lantern battery (Battery Not included).

In shipping carton of 12; Weight 32 lbs.

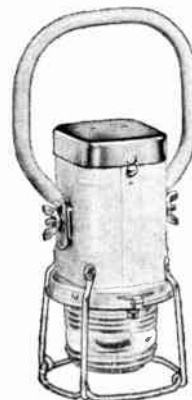

No. 2172-2—With Red Fresnel Globe. Each \$9.35

Justrite Railroad Trainman's Lanterns

Has the twin-bulb feature, with one bulb socket extended for general lighting purposes, the other focused to provide a powerful forward beam for reading car numbers at a distance, for gnawing through smoke, fog, etc.



Battery case is rust-resistant steel with chip-proof gray enamel finish. Fittings on case and guard cadmium plated. Chrome plated brass reflector 3 1/2-in. diameter. Aluminum tubing handle, steel reinforced, clears top of case by 4-in. Strong stationary guard, with welded ring.

The switch moves the bulb to the center of reflector where contact is made.

Requires a standard 6-volt lantern battery and one each bulb No. 502 or 27 (Batteries and bulbs not included).

In ship, carton of 12; Wt. 24 lbs.

No. **2140-1**—Without Glass Globe over Reflector, Each **\$5.80**
 No. **2140-3**—With Glass Globe over Reflector, . . . Each **6.40**

Exide Auxiliary Lights

Approved by Underwriters' Laboratories, Inc.



Model M



Model T

"Lightguards"

Gray hammerstone 20 gauge steel containers, equipped with 3-COE-7 battery and adjustable sealed beam lamps. Operates on 115 volts 60-cy. a-c. has relay which automatically connects lamp to battery on failure of power service. Units equipped with 6 ft. #18-2 cord set.

Model M Lightguard: Designed for 2 rate charging. High rate of 1 1/2 amps. recharge battery in 12 hours; trickle rate of 55 milliamperes maintain battery in a state of full charge.

Model T Lightguard: Designed with a single rate of charge—175 milliamperes.

Model A Lightguard: Designed for fully automatic high and low rate charging.

No.	Model	Lamp	Width, In.	Depth, In.	O.A. Hgt. In.	Wt., Lbs.
48263	M	1	9 1/8	7 7/8	15 1/2	36 1/2
48255	T	1	9 1/8	7 7/8	15 1/2	35 1/2
54657	A	1	9 1/8	7 7/8	15 1/2	37

Exide Auxiliary Lights

Emergency Lights

Approved by Underwriter's Laboratories, Inc.

"Lightguards"

Gray hammerstone 20 gauge steel container equipped with 3-COE-7 battery and adjustable sealed beam lamp on cover.

Operates on 115 volts 60 cy. a-c, equipped with heavy duty relay which automatically connects lamps to battery on failure of power service.

MODEL ME Lightguard: Designed for 2 rate charging. The 1 1/2 amperes will recharge battery in 12 hours. Trickle rate of 55 milliamperes maintains battery in a state of full charge.

MODEL TE Lightguard: Designed for one rate of charge, 175 milliamperes.

MODEL AE Lightguard: Designed for fully automatic high and low rate charging.

No.	Model	Lamp	Width, In.	Depth, In.	O.A. Ht. In.	Wt. Lbs.
48762	ME	1	9 1/8	7 7/8	15 1/2	36 1/2
51582	ME	2	9 1/8	7 7/8	15 1/2	37 3/4
48761	TE	1	9 1/8	7 7/8	15 1/2	35 1/2
51582	TE	2	9 1/8	7 7/8	15 1/2	36 3/4
54660	AE	1	9 1/8	7 7/8	15 1/2	37

Models ME, TE and AE are conduit connected (no cord supplied).

Exide Lightguard Mounting Brackets

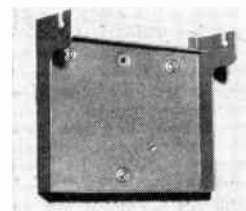

Constructed of 16-gauge cold rolled steel.

Designed for wood, tile or masonry walls, using wood screws, toggle bolts or lag screws. Gives full view of both sets of pilot balls.

Adaptable to Lightguard models equipped with studs and wing nuts.

Easy to install. Finished in gray hammertone.

No.	Length In.	Width In.	Ht. In.	Approx. Net Wt. Lbs.
57691	9 1/16	3	9	2

"Eveready" Heavy-Duty Flashlights

Particularly suitable for Industrial Applications



No. 1251A



No. 1259A

Heavy Duty Flashlights: Heavy-duty insulated case will not shatter, crack or dent and it's resistant to temperature extremes. Withstands deterioration from water, oils, grease, gasoline, alcohols and acids. Equipped with unbreakable polyethylene safety-glow lens-guard and ring hanger.

Permissible Safety Flashlights: Same as heavy duty flashlights plus special safety features and extra lamp in bottom cap. Approved by U. S. Bureau of Mines for use in Methane and Air Mixtures and listed by UL for use in gas air mixtures of Class 1, Groups C and D.

No.	Type	No. of Cells	Lamp No.	Uses Batteries	*Each
1251A	Heavy Duty	2	PR6	950	\$2.50
1351A	Heavy Duty	3	PR7	950	2.75
1259A	Safety	2	PR6	950	4.15
1359A	Safety	3	PR7	950	4.35

*Without batteries.

"Eveready" Flashlights

Individually Packed In Attractive Boxes



No. 8251

Automatic Spotlight

All chrome finish. Removable bottom cap. Ring hanger.



No. 2251

Standard Automatic Spotlight

Two - cell. Chrome finish with black decoration. America's best seller.



No. 2351

Automatic Spotlight

Three - cell flashlight. Same features as the No. 2251.



No. 212

Small Penlite

Black and chrome finish. Use two No. 912 batteries.

No.	Description	Std. Pkg.	*Each
8251	Automatic spotlight 2 cell	24	\$1.59
2251	Automatic spotlight 2 cell	24	1.85
2351	Automatic spotlight 3 cell	24	2.20
212	Penlite 2 cell	50	.89

*Batteries are not included.

"Eveready" Flashlight Lens Assortments



This assortment contains a good quantity of lenses for all popular flashlights.

Contains:

30 No. 53419 (Diam. 1.76") standard spotlight lenses. 6 No. 53123 (Diam. 1.64") small spotlight lenses.

4 No. 53390 (Diam. 3.109") large searchlight lenses.

For replacement quantities each of the 3 lens type can be ordered in separate packages.

No. 102..... Per Assortment \$1.84

"Eveready" Lantern Batteries



No. 409



No. 509

For electric lanterns requiring this type battery.

Size battery—2 5/8 x 2 5/8 x 3 7/8-in.

No.	Type	Std. Pkg.	Std. Pkg. Wt. Lbs.	Each
509	General Purpose	12	16	\$0.98
731	General Purpose	6	19 1/2	2.45
409	Railroad and Industrial	25	33 1/2	.98

"Eveready" Emergency Lighting Batteries



No. 915



No. 916

For exit and searchlights, used in emergency lighting, etc. Strong metal case, web-strap handle.

No.	Volts	Each
715	7 1/2	\$5.50
716	9	6.45

"Eveready Ignitor" Dry Batteries



For all applications requiring long life and heavy service. Their exceptionally high quality and recuperative powers makes them ideal for ignition, radio, bells, buzzers, electric games, toys, lanterns and other battery-operated devices.

Round jackets.

Screw terminals will be furnished unless Fahnestock spring terminals are specified.

Size: diameter, 2 5/8 inches; height, 6 5/8 inches.

In standard package of 12.

Weight per standard package, 27 lbs.

No. 6—"Ignitor"; 1 1/2 volts..... Each \$1.05

"Eveready" Dry Batteries

Railroad and Industrial



Especially designed for Railroad and Industrial uses where a wide range of service conditions, from extremely heavy to extremely light, are encountered.

Screw terminals will be furnished unless otherwise specified.

Round jackets only.

Size: diameter, 2 5/8 inches; height, 6 5/8 inches.

In standard package of 12.

Weight of standard package 27 1/2 lbs.

No. 6—Special Railroad and Industrial; 1 1/2 volts.... Each \$1.15

"Eveready Columbia" Dry Batteries

Telephone, "Gray Label"



These batteries are noted for their long life on light drain service and are recommended especially for telephone service.

Round jackets only.

Fahnestock spring terminals are furnished unless screw terminals are specified.

Size: diameter, 2 5/8 inches; height, 6 5/8 inches.

In standard package of 12.

Weight standard package 26 1/4 lbs.

No. 6—"Columbia," Telephone; 1 1/2 Volts.... Each \$1.05

"Eveready" Air Cell Batteries
For Telephone, Railroad and Industrial Use



No. T-1600



No. T-2600

The sustained voltage, long life and low ampere hour cost make these batteries desirable for railroad, telephone and industrial use.

Available in single cell units and in batteries consisting of two cells in series. Average voltage per cell is 1.25 volts, falling to 1.0 volts per cell at the end of their capacity.

They are shipped dry, but use a liquid electrolyte. This prevents shelf depreciation.

No.	Voltage	Amp. Hr. Cap.	Lgth.	Size, Inches Wdth.	Ht.	WT., Dry Lbs.	Each
T-2300	2 1/2	300	8 3/4	5 5/8	8 5/8	11	\$13.45
T-1600	1 1/4	600	5 3/4	6 5/8	21	11 1/2	9.85
T-2600	2 1/2	600	10	6 5/8	11 1/4	21	17.05

"Eveready Hot Shot" Batteries

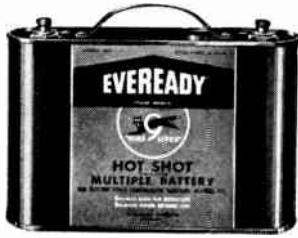

No. 1461

For all purposes requiring four or more dry cells in series. Particularly adapted for electric fences, gas engines (tractors, motor boats, etc.), blasting, fire and burglar alarms, gongs, bells, annunciators, signals, lights for closets, outhouses, camps, boats, search-lights, etc.

These batteries are composed of specially selected cells. Internal connections are securely soldered and the cells are completely insulated against accidental short circuits. Terminals are insulated.

No.	Voltage	Lgth.	Overall Size, In. Wdth.	Ht.	Std. Pkg.	WT., Std. Pkg., Lbs.	Each
1461	6	10 3/8	2 3/4	7 1/4	6	58 1/4	\$4.35
1462	6	5 5/16	5 5/16	7 1/4	4	39 1/4	4.35
1562	7 1/2	7 7/8	5	7 1/4	4	50 1/2	5.50
1662	9	7 13/16	5 1/4	7 1/4	4	60 1/4	6.45

"Eveready" Batteries

These batteries have an unusually long life and rapid recuperative power after use. All materials used are the best procurable for the purpose and each operation is carefully supervised and rigidly inspected.



No. 1050..... Prices on application.

Industrial Type

Revolutionary "inside-out" construction. Gives more bright white light, especially for sustained heavy duty use. Leak-proof, will not swell, stick or jam in flashlight case.

Height, 2 27/64-inches; diameter, 1 21/64-inches.

Cell size D.

Standard package of 192.

Weight per standard package, 42 1/2 pounds.

"Eveready" Batteries
Unit Cells — All 1 1/2 Volts



No. 912



No. 915

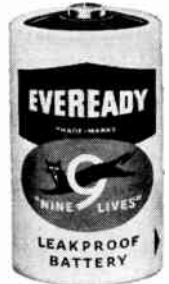

Nos. 935 and 950

No.	Type	Cell Size	Size In.	Unit Pkg.	Unit Pkg. Wt. Lbs.	Each
912	Penlite	AAA	1 3/4 x 0.4	12	1/4	\$0.125
915	Baby Tubular	AA	1 31/32 x 35/64	12	1/2	.125
935	Regular	C	2 x 1 1/64	12	1 1/8	.20
*950	Leakproof	D	2 27/64 x 1 21/64	*48	9 1/2	.20
D99	Leakproof	D	2 13/32 x 1 21/64	*48	10	.25

*In Display Package.

Ray-O-Vac Batteries



No. 1LP



No. 2LP

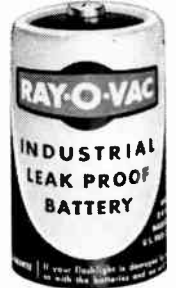

No. 3LP

Leak proof flashlight batteries. Fully sealed-in-Steel, stays fresh for years. Guaranteed against corrosion damage to the flashlight case. No. 3LP especially designed for industrial use.

No.	Size	Std. Pkg.	Unit Pkg.	Each
1LP	C	210	24	\$.20
2LP	D	192	48	.20
3LP	D	192	48	.25



No. 6



No. 941



No. 941RR

No. 6 Ignition battery. Service surpasses Bureau of Standards specifications. Available in standard packages of 25 or 12 or individually in screw or clip terminals. Each \$1.15

No. 941 and 941RR. 6-Volt lantern battery. Raysol additive increases life, reduces corrosion. 941RR heavy duty used for railroads and industry. Each \$0.98

Ray-O-Vac Batteries



No. 7LP



No. 7R



No. 400

Penlight batteries. No. 7LP Leak-proof-sealed in steel.

No.	Description	Std. Pkg.	Each
7LP	Regular size	120	\$0.15
7R	Standard size	120	.125
400	Actual pen-size	60	.125

Ray-O-Vac Lanterns



No. 303

Powerful lantern has a sealed beam spotlight mounted in 180° adjustable head, red swivel flasher with shatter-proof lens and dual switches on handle. Uses 918 6-volt lantern battery. Lantern, complete with battery, packed in individual display cartons.

No. 303 Sportsman® Lantern Each \$12.40



No. 301

Same features as the No. 303 lantern, but without the flasher. A powerful lantern for outdoor use. Lantern, complete with battery, packed in individual display cartons.

No. 301 Sportsman® Lantern Each \$9.95

Ray-O-Vac Lanterns

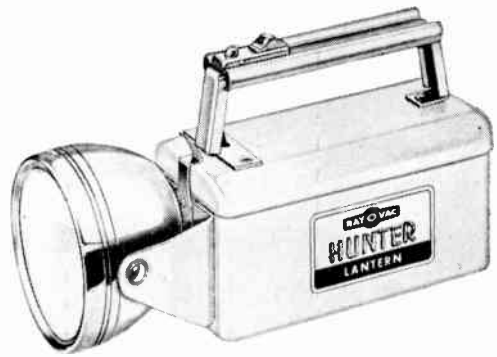

No. 398

Versatile lantern has a 3-inch reflector, 3-position switch with flasher button and 180° swivel head. Uses bulb PR12 or PR15. Uses either 8 No. 2LP or 5LP flashlight batteries, or one No. 941 spiral spring terminal 6-volt lantern battery with no bulb changing. Available in individual cartons.

No. 398 Hunter® Lantern Each \$4.95



No. 298

Weights only 3 oz. Has a 3-inch reflector, lucite lens, battery pouch, adjustable headband. Uses 6-volt lantern battery No. 941 and bulb PR13. Available in individual cartons or 3 on display card No. M-329.

No. 298 Nite-Hawk® Headlite Each \$3.29

Ray-O-Vac Flashlights



No. N22

Highly resistant to breakage, chemical action, temperature extremes. Features removable end cap with spare bulb holder, plus replaceable lock-type switch. Available in individual cartons. Two-cell uses two No. 3LP or 2LP and bulb PR6.

No. N22 Workman® Flashlight Each \$3.25

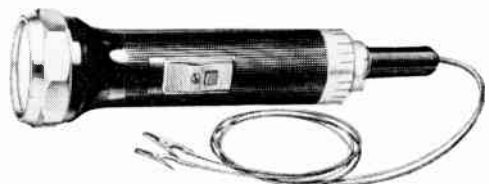

No. N22T

A combination Workman flashlight and continuity tester which mounts into the end cap and is removable. Uses two No. 3LP or 2LP and bulb No. PR6. Available in individual boxes.

No. N22T Workman® Flashlight and Continuity Tester Each \$6.75

Ray-O-Vac Flashlights



G22

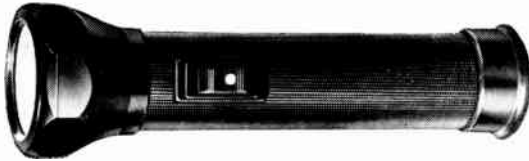

G32

Rubber end caps and fibre barrel. Replaceable switch with positive lock button. Available in individual cartons. G22 uses two No. 3LP or 2LP batteries and bulb PR6. G32 uses three No. 3LP or 2LP batteries and bulb PR7.

G22 Heavy duty flashlight Each \$2.60
G32 Heavy duty flashlight 2.67



No. AN22

Safety lights approved for use in explosive atmosphere by Underwriters Laboratories and Bureau of Mines. Available in individual boxes. Two cell, uses two No. 3LP or 2LP and bulb PR6.

No. AN22 Workman Flashlight Each \$3.98

Ray-O-Vac Penlights



No. PAA2. Regular size. Uses two No. 7R or 7LP and bulb 222. Available in individual cartons or on display card M-260. Each \$0.89

No. PK2. Deluxe pen size. Uses two No. 400 batteries and bulb No. 224. Available in individual cartons or on display card M-130; Each \$0.89

No. PAA2 No. PK2

Ray-O-Vac Signal Wands



No. W2



No. W4



No. W8

Unbreakable red polyethylene signal wands to fit all standard Ray-O-Vac flashlights. Snap-in cap gives choice of red warning glow or piercing white beam. Available in individual cartons.

No.	Length In.	Each
W2	2	\$0.65
W4	4	.98
W8	8	1.59

Sterling Pocket Meters

These direct current meters can be used for battery testing of any kind (as stated with each meter), in railroad signal work, for photo flash purposes and in telephone and low-voltage electrical work generally. They are polarity indicators. Metal case 2 1/4-in. diameter, 5/8-in. thick, nicely nickel plated.

All are packed in individual boxes, in standard package of 10; shipping weight 4 lbs.

Pocket Ammeters

For testing No. 6—6-in. dry cells. 0—35 ampere scale, 1 ampere divisions. Has one flexible terminal.

No. 24.....Each \$2.75



Pocket Voltammeters

No. 44: For testing "Hot Shot," radio "A" batteries and No. 6—6-in. dry cells. 0-35 ampere scale, 1 ampere divisions; 0-10 volt scale, 1/5 volt divisions. Has one flexible terminal.

No. 44.....Each \$3.25



No. 45: For testing No. 6—6-in. dry cells and ordinary 45 volt radio "B" batteries. 0-35 ampere scale, 1 ampere divisions; 0-50 volt scale, 1 volt divisions.

No. 45.....Each \$4.25

Pocket Voltmeters

For testing 45 volt and 90 volt "B" batteries and 1 1/2 volts radio "A" batteries. Has flexible terminals which will fit any type of socket hole, prevent shorts and permit inclining meter for easy reading.

Scales: 0-100 volts, 5 volt divisions; 0-2 volts, 1/10 volt divisions.

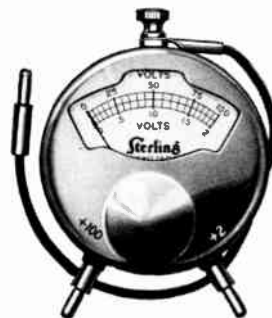

No. 38A.....Each \$4.00

Pocket Voltmeters

Graphic General Testers

A single tester for dealers and servicemen for testing all portable "A" and "B" batteries.

Has red and green color chart for all standard batteries, including 45 volt and 90 volt "B" batteries and 1.5, 4.5 and 7.5 volt "A" batteries. Has flexible terminals for battery protection and easy reading.

Scale: 0-100 volt for special size "B" batteries, 5 volt divisions.

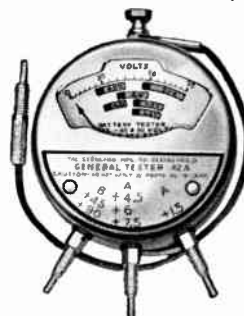

No. 42A.....Each \$6.25

Pyrene Fire Extinguishers

Approved by Underwriters' Laboratories, Inc., and Factory Mutuals.

Vaporizing Liquid, Small Pump Type



Light, compact and easily operated. Smothers all classes of incipient fires, particularly those in flammable liquid and electrical equipment. Double-acting hand operated pump. Discharges a steady stream 25 to 30 feet from any position in any direction.

For motorcycles, airplanes and heavy vehicles, "shock absorber" construction; clamp type brackets for wall or steering post guard against wear from excessive vibration. Complete with charge and bracket.

No. C21

Brass, Polished Finish

No.	Cap. Qts.	Bracket	Unit Pkg.	Wt. Pkg. Lbs.	Each
C21	1	Wall	12	87	\$20.60
C21T	1	Vehicle, Clamp	12	91	21.75
C31	1 1/2	Clamp	6	63	25.00
C31T	1 1/2	Vehicle, Clamp	6	63	25.00

Vaporizing Liquid, Pressure Type



Type C105P and C105PM: Two quart dual cylinder pressure type for flammable liquid and electrical fires and incipient fires in ordinary combustibles.

Type C45P and C45PA: One gallon VL stored pressure type. Heavy duty unit for industrial, electrical and vehicular protection against all classes of incipient fire. Flexible metal, rubber-covered hose, adjustable shut-off nozzle, pressure gauge.



C105PM

C45P

No.	Description	Each
C105P	2 Qt. Brass, without Pump	\$71.00
C105PM	2 Qt. Brass, with Pump	83.00
C45P	1 Gal. Stainless Steel, with Pump	118.00
C45PA	1 Gal. Stainless Steel, without Pump	113.00

Pyrene Foam Type

**Polished Copper
2 1/2 Gallon Type**

Discharges a foam that floats on liquids, clings to ordinary combustibles, forms a fire-resistive, insulating blanket that smothers the fire by depriving it of air.

Protects against re-flash. Must be discharged annually and recharged with Pyrene Foam.

Seamless drawn one-piece copper shell and dome—no rivets or seams—tested to 500 lbs. Discharges about 22 gallons of foam.



No. P13



No. PD2PN

No. P13—Shipping weight 23 lbs. **\$56.85**
If wanted with pressure relief valve No. PVI to meet U.S.C.G. requirements add \$5.00 to price.

Extinguishers on Wheels (Engines)

Large-capacity units for larger fire hazards, indoor and outdoor. Sturdily constructed of heavy sheet steel. Inner cylinder of cold rolled copper. Enamel finish. Manually-operated stopple prevents splashing and premature operation.

Outdoor and Airport Types are equipped with 50-ft. drag rope, reel and hose basket.

Forty-Gallon Capacity

No.	Type	Ship. Wt.	Each, Lbs.	Each
PD2PN	Indoor	55.1		\$860.00
PD3PN	Outdoor	630		912.50
PD4PN	Airport, with 8-in. Tires	855		992.50

Soda-Acid Type



No. S13

Discharges a stream of liquid effective on incipient fires in ordinary combustibles, such as wood, paper, textiles, etc.

Insurance authorities recommend that wet, chemical soda-acid type extinguishers be discharged and recharged annually.

**Polished Copper
2 1/2 Gallon Type**

Seamless drawn one-piece Copper alloy shell and dome, tested to 500 lbs. Tough plastic nozzle, resists damage and discloses clogging. Operated by inverting tank.



No. SD2L

No. S13—Shipping Weight 18 lbs. **\$51.60**
If wanted with pressure relief valve No. PVI to meet U.S.C.G. requirements add \$5.00 to price.

Extinguishers on Wheels (Engines)

Large-capacity protection for property consisting of ordinary free-burning material, such as lumber yards, camps, textile factories, heated warehouses and small communities.

Steel tank, with drawn steel bottom and dome. Seams welded and brazed. Entire tank coated with hot dipped galvanizing. Equipped with 3/4 in. chemical engine hose and brass shut-off nozzle. Operated by lowering handle to ground. Indoor types are narrow enough to permit passage through doors and aisles. Outdoor type has 50-ft. drag rope and reel and hose basket.

No.	Type	Ship. Wt. Each, Lbs.	Each
SD2M	Indoor, Manual Operation	536	\$795.00
SD3M	Outdoor, Manual Operation	620	845.00

Pyrene Gas Cartridge Type



No. W13

Operated by inverting and striking head on floor. Seamless drawn one-piece copper shell and dome, no seams or rivets, tested to 500 lbs. Discharges a 40 ft. stream by pressure from carbon dioxide gas cartridge. Tough plastic nozzle discloses clogging. Requires no annual recharging.

Water Type—2 1/2 Gallons

Effective on fires in ordinary combustibles.

No. 1113—Polished; Wgt. 18 lbs.	Each	\$61.85
No. HWC1—Extra Cartridge (New); Weight Unit of 6, 14 lbs.	Each	4.95

Anti-Freeze Type—2 1/2 Gallons

For protection of unheated warehouses, docks, bridges, and other locations subject to freezing temperatures, and where the hazard consists of ordinary combustible material.

No. W13—Polished; Weight 27 lbs.	Each	\$66.85
No. WR1—Extra Anti-Freeze Charge and Cartridge, Weight each 14 lbs.	Each	9.95

Pyrene Fire Extinguisher Recharges

Pyrene Vaporizing Liquid. Non-conductor of electricity, Non-corrosive and anti-freezing to 50° below zero.

No.	Unit Pkg.	Wt. Pkg. Lbs.	Each
CR2—1-Qt. Can	20	78	\$2.35
CR4—4-Qt. Can	4	58	7.65

Foam Type—Specially compounded, accurately proportioned.

PXR1—2 1/2 Gallon Size	12	65	\$2.45
PR5—20 Gallon Size	1	40	16.50
PR6—40 Gallon Size	1	72	24.75

Soda-Acid Type. High grade ingredients, full weight and accurately proportioned.

SXR1—2 1/2 Gallon Size	24	68	\$ 1.20
SR3—40 Gallon Size	1	30	14.35

C-O-Two-Fire Extinguishers

Kills fire with Carbon Dioxide, a clean, pure, dry, odorless, non-damaging and non-deteriorating, inert gas.

The extinguishers smother fire instantly under a heavy, dense, blanket of cold Carbon Dioxide gas, which is the fastest extinguishing agent known. It is stored in steel cylinders under high pressure, and when liberated, the gas is discharged by its own pressure, without pumping, and snuffs out fire in seconds. It will not freeze in temperatures as low as 10° F. below zero, and is just as effective indoors as out, in high or low climatic temperatures.

Highly recommended for the speedy extinguishment of highly inflammable liquids, such as gasoline, oil, grease, paints, lacquer solvents; will not damage electrical equipment. Leaves no odor or stain and does not damage or injure machinery, woodwork, finishes, fabrics or other materials with which it comes in contact.

Carbon Dioxide is non-corrosive, a non-conductor of electricity and does not deteriorate. A periodic weight check of the extinguisher is the only maintenance required. Recharging stations are conveniently located in all principal cities.

Superior in design and construction, excellent quality material and workmanship.



PSA-5



No. PSH-15

Flexible discharge hose, wire, braid reinforced, with die-pressed couplings. Non-metallic discharge horns are shatter-proof, and non-conductors of electricity, resist corrosion and moisture. Special rubber handle covers all metal parts of horn, couplings of discharge hose and swivel connections.

Hand Portables

With Squeeze-Grip valves, easily opened or closed while carrying.

No.	Size Lbs.	With Swivel			App. Wt. Lbs.	Each
		Ht.	Overall Size, In. Wdth.	Oph.		
PSA-2½	2½	17¼	8¾	3½	11½	\$35.25
PSA-5	5	16¾	8¾	5¼	19½	40.70
With 36-Inch Hose						
PSH-10	10	27½	10½	6¾	41	64.65
PSH-15	15	31	11	6¾	50	72.90
PSH-20	20	32¾	11½	7	64½	83.75

Wheeled Portables

The 50 and 75 lb. size are available with Type B valves, permitting partial discharge, or Type VF valves for complete discharge of cylinder. The 100 lb. size is available only with Type VF valves. All valves are "pressure-seat" type. Complete with hose as specified with each unit.



No. WB-50

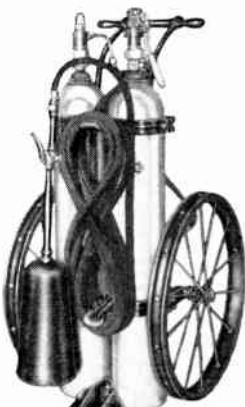

No. WV-100

No.	Size Lbs.	Ht.	Overall Size, In. Wdth.	Oph.	Hose, Feet	App. Wt. Lbs.	Each
WB-50	50	64	18½	38	15	285	\$259.00
WB-75	75	60	21½	43	25	377	333.00
WV-100	100	61	29	46	40	610	519.00

Kidde Fire Extinguishers

CO₂ Portables (Trigger Type)

A pull on the trigger of a Kidde carbon dioxide extinguisher releases a fog of fire smothering gas which stops electrical and flammable liquid fires in their tracks!

This clean dry gas is harmless to foods, fabrics, and finishes. It's safe to handle, and will not damage machinery, electrical equipment or insulation. It disappears without a trace following discharge.

A jam proof locking pin prevents accidental or premature discharge.



Model No.	Cap. Lbs.	Average Charged Wt., Lbs.	Aver. Ht. Valve & Cyl. In.	Cyl. Diam. In.	Each
2½T-1	2½	9	16⅝	3⅞	\$36.65
5T-1	5	14½	15½	5⅞	43.20
10T-1	10	34	21⅞	6¾	68.50
15T-1	15	41	26⅞	6¾	77.35
20T-1	20	56	26¾	7¾	88.90

CO₂ Portables (Squeeze Type)

This type of carbon dioxide portable is manufactured for those who prefer extinguishers with squeeze valve operation. When operated they discharge a fog of fire smothering gas that smothers electrical or flammable liquid fires instantly.

This clean dry gas is harmless to foods, fabrics, and finishes. It's safe to handle, and will not damage machinery or contaminate chemical mixtures. It disappears without a trace following discharge.

Jam proof locking pin prevents accidental or premature discharge.



Model No.	Cap. Lbs.	Average Charged Wt., Lbs.	Aver. Ht. Valve & Cyl. In.	Cyl. Diam. In.	Each
2½F	2½	8¾	17⅞	3⅞	\$35.20
5F	5	15½	16⅞	5¼	40.60
10F	10	32	21¾	6¾	64.60
15F	15	42	26	6¾	72.90
20F	20	50	26¼	7¾	83.70

Cartridge Operated—Dry Chemical Portables

This cartridge-operated dry chemical portable comes in larger capacities and is your best weapon against larger fires, inflammable liquid, live electrical equipment, or textiles where dust and residue are not a problem.

Has single trigger control of the dry chemical and CO₂ valves, automatic fluffing assures instant action and thorough expulsion of the dry chemical.

Exclusive diffuser horn covers wider area, gives more effective fire extinguishment.



Model No.	Cap. Lbs.	Average Charged Wt., Lbs.	Aver. Ht. Valve & Cyl. In.	Cyl. Diam. In.	Each
20DC	20	37	21½	6¾	\$73.60
30DC	30	50	29	6¾	91.50

Wet Chemical Portables

Wet chemical portables are available in a wide variety of container metals, construction, operation and capacities. Interiors are treated against corrosion and shells pass 500 psi pressure tests. Kidde foam, soda acid and cartridge operated water extinguishers are available in 2½ gallon bronze or stainless steel models. Pressurized water or water anti-freeze units are bronze.

Vaporizing liquid extinguishers with CTC come in pump capacities of 1 and 1½ quarts, pressurized in 1 and 1½ quarts and 1 gallon. Water pump tank extinguishers, in steel or copper cases, available in 2½ and 5 gallon sizes.



Kidde Fire Extinguishers

Pressurized Dry Chemical Portables



This pressurized dry chemical portable combines tremendous fire-killing power with quick, simple recharging that permits you to put the unit back into service.

Extinguisher pressurization with dry air or nitrogen varies with the size: Model 5DCP, 150 lbs.; Model 10DCP, 150 to 250 lbs.; Models 20 DCP and 30DCP, 225 to 250 lbs. While the range is greater at the higher pressure, complete discharge of dry chemical is obtained also at the lower pressure.

Easy-to-read gauge tells if unit is pressurized.

New 20 and 30 lb. units have easier, faster trigger operation, automatic trigger-lock, fully enclosed mechanism.

Model No.	Cap. Lbs.	Average Charged Wt., Lbs.	Aver. Hgt. Valve & Cyl. In.	Cyl. Diam. In.	Each
5DCP	5	10	15 ⁵ / ₁₆	4 ³ / ₈	\$40.75
10DCP	10	21	17 ³ / ₄	5 ¹ / ₄	60.40
20DCP	20	35 ¹ / ₂	21	9 ⁵ / ₁₆	75.50
30DCP	30	49	28	9 ⁵ / ₁₆	93.50

Bean Power Sprayers

Model 70-MTBT

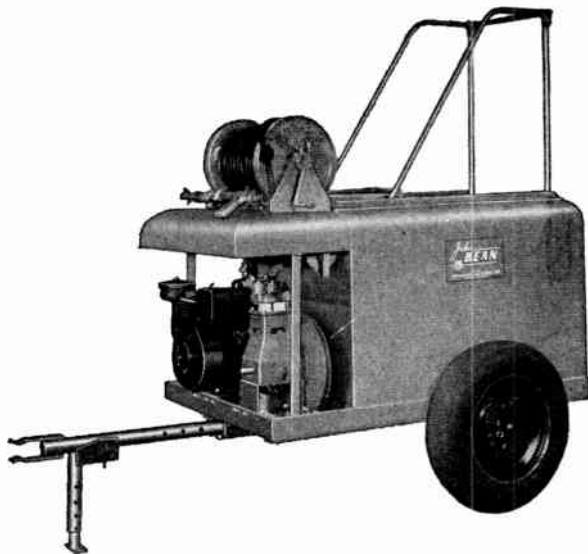

Especially adapted for right-of-way brush killing; can be drawn by Jeep, passenger model car, light truck or tractor.

Pump delivers 7 gallons per minute at 400 lbs. pressure; driven by a 5-h.p. Briggs & Stratton air-cooled gasoline engine. Plunger-type pump, fully enclosed and constantly lubricated by oil bath; has positive-action disc-type valves and quick-acting pressure-relief valve. "V" belt drives to pump and agitator.

With 150-gallon leak-proof and corrosion-resistant Bean-Bond tank. 200 or 300-gallon tank available at extra cost. Spray liquid strained as it goes to tank, then filtered between tank and pump. Constant agitation by propeller-type paddles.

Tapered roller-bearing disc wheels for 15-in. rubber tires; tires not furnished but can be supplied at extra cost.

Complete with Spraymaster Deluxe spray gun with quick-acting shut-off and easy adjustment for close or distant spraying; 100-ft. of 1/2-in. high-pressure hose on re-wind reel; removable refiller with 20-ft. suction hose for lifting water from ponds or other common refilling points.

Length less drawbar, 61-in.; height to top of tank 44-in. to top of reel 58 1/2-in. to top of rail 77-in.; width 53-in.; clearance 11-in.; tread 45-in.

No.	Capacity Gal.	Delivery	Net Wt., Lbs.	Each
70-MTBT	150	7 g.p.m. @ 400 lbs.	985	\$1148.00

Bean Power Sprayers

Spartan Model 33-LC

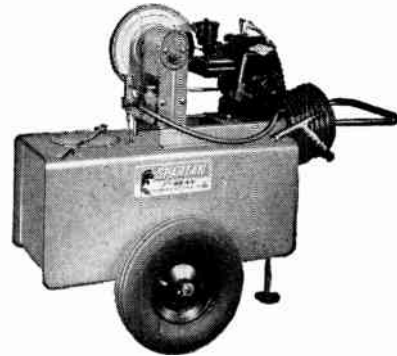

Equipped with 30 gal. all-steel tank with Bean-Bond anti-corrosive coating protection. Has 8-in. opening with snap on filler lid for easy cleaning and filling. Pump feeds from tank directly through valve chamber equipped with removable screened cleanout. Provided with removable drain plug.

Mechanical, paddle-type agitator plus jet stream from pump keeps materials thoroughly mixed.

Adjustable relief valve gives desired pressure for spraying. Complete turn changes pressure 35 lbs.

John Bean "45" Spray Gun easily adjusts from fine mist to solid stream. Comfortable pistol grip permits tireless operation with positive control. Furnished with 25-ft. of high pressure, heavy-duty hose, 1700 lb. burst proof tested.

Equipped with Briggs & Stratton 1 1/2-h.p. air cooled gas engine with spring recoil starter. V-belt drive to pump.

Provided with Model 61 pump, semi-enclosed with lifetime ceramic cylinders. Cold-forged crankshaft, full-stroke guided plungers, chemical resistant, wear compensating plunger cups, self-aligning ball bearings and heavy duty, cast iron manifold with built-in suction screen.

Has ball bearing disc wheels. 4.00 x 8 pneumatic tires. Length 36-in.; width 25-in.; height 40-in.

No.	Capacity Gal.	Delivery	Net Wt., Lbs.	Each
33-LC	30	3 g.p.m. @ 300 lbs.	160	\$312.00

Spartan Model 33-C

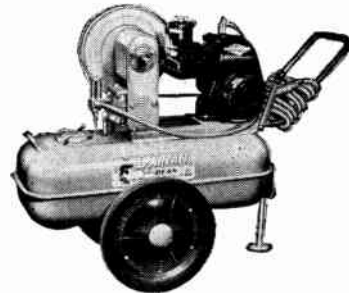

Provided with 15 gal. all-steel tank with Bean-Bond anti-corrosive coating protection. Tank easily filled or cleaned through large opening. Pump feeds from tank through valve chamber equipped with removable filter screen.

Material kept in constant circulation by overflow jet agitation by-pass.

Relief Valve is adjustable to desired spraying pressure. Complete turn regulates pressure 35 lbs.

John Bean "45" spray gun adjusts easily from fine mist to solid stream. Has comfortable pistol grip. Furnished with 25-ft. of high pressure (1700 lb. burst proof) hose.

Equipped with Briggs & Stratton 1 1/2-h.p. air cooled gas engine with recoil starter. V-belt drive to pump.

Has Model 61 pump with lifetime ceramic cylinders. Furnished with stamped steel wheels with sleeve bearings. Length 35 1/2-in.; width 19 1/2-in.; height 34-in.

No.	Capacity Gal.	Delivery	Net Wt., Lbs.	Each
33-C	15	3 g.p.m. @ 300 lbs.	140	\$265.00

Edwards Industrial Fire Alarm Systems

These alarm systems are made to meet almost any requirement. The more popular and standard ones are listed below. Many details have been omitted because of space.

Complete details concerning variations from any of these systems will be given promptly on request. Also detailed specifications for d-c and special systems will be supplied to meet specific requirements. For further information contact Graybar.

As fire alarm systems are protective in nature, conduit should always be used irrespective of the voltage or the type of system. The simplest and lowest-priced systems are open-circuit types which do not provide automatic detection of defects in wiring or connections, and are not listed by Underwriters. Open-circuit systems, however, are preferable to no system at all and afford valuable protection if properly inspected and tested at regular intervals.

All closed-circuit systems are fully supervised and have a control panel placing each unit of the system under constant electrical supervision. Open circuits or grounds in the wiring or in any device causes trouble bell alarm only. From the standpoint of safety and dependability they are the most satisfactory for the majority of buildings.

The installation of standard closed-circuit systems (SSA) is relatively simple since all stations are wired in series and are connected on one loop and the signals in series on another loop—all centralized at the control panel.

Many code authorities limit the number of stations on one circuit to 20 and the number of signals on one circuit to 10 for a-c and 14 for d-c.

Keys are provided for "break glass" type stations to operate any station without breaking glass when fire drill is held.

Information Chart

This chart presents the different systems at a glance and enables one to see the salient points of each system and the apparatus used. It has been arranged with as great a degree of accuracy as the subject of such diversity will permit. The (*) at left of Catalog Designation indicates that the system is listed by Underwriters' Laboratories and meets all requirements of NBFU Pamphlet 72.

Systems listed below are for operation from current supplied direct from a reliable light or power service. 3-Wire a-c single phase, with grounded neutral (one side to operate the signaling system and the other to operate the trouble bell) as recommended in Standards of the National Board of Fire Underwriters' Pamphlet No. 72. Some systems may be operated from d-c (Details furnished by Graybar on request).

Class of System	Catalog Designation	Operating Supply	Alarm Indication	Signals Used	Stations Used
Open Circuit	†VOA	120 Volts A-C or less	Vibrating Bells or Horns Continuous	Nos. 340 Bells, 380 Flush, 382 Projector, 384 Grille Horns	Nos. 270-SPO, 271-SPO 241, 242
Closed Circuit	*CCVA	120 Volts A-C	Vibrating Bells or Horns Continuous	Nos. 325 Bells, 360 Flush, 362 Projector, 364 Grille Horns	
Master Coding Closed Circuit	*SSAMR	120 Volts A-C	‡Code Ringing on Single Stroke Bells or Horns	Nos. 24 Bells, 360 Flush, 362 Projector, 364 Grille, 364, Horns, 18F Chime	Nos. 1250, 1251
Closed Circuit	*SSA	120 Volts A-C	Code Ringing on Single Stroke Bells or Horns	Nos. 24 Bells, 360, 362, 364, Horns, 18F Chime	Nos. 1252, 1253
Pre-Signal Closed Circuit	*PSSA	120 Volts A-C	Code Ringing on Single Stroke Bells or Horns	Nos. 24 Bells, 360, 362, 364, Horns, 18F Chime	No. 1351
City Connected Closed Circuit	SSAMS	120 Volts A-C	Code Ringing on Single Stroke Bells or Horns	Nos. 24 Bells, 360, 362, 364, Horns, 18F Chime	No. 1352
	*SSAMT	120 Volts A-C	Code Ringing on Single Stroke Bells or Horns	Nos. 24 Bells, 360, 362, 364, Horns, 18F Chime	No. 1353

†All systems except VOA have control panels and are supervised.
‡Common Code Type.

Edwards Fire Alarm Stations

Single Action, Non-Code

No. 270 (Breakglass) and No. 271 (Non-Breakglass)



No. 270

Designed for use in installations where a coded alarm is not necessary.

A Zinc Die Cast Station (3 1/8 x 4 5/8 x 1 in.). Single pole switch is standard. Double pole normally open or closed and for city shunt or tripper connection available on request.

Simple to test, red finish. Rating is 4 amps. at 125 v. AC. Mounts on 4 or 1 1/8 in. square box with single gang plaster cover, overall depth of 2 1/4 in.

No.	Description	Each
270-SPO	Single Pole, Open circuit	\$15 00
270-SPC	Single Pole, Closed circuit	15 00
270-DPO	Double Pole, Open circuit	19 00
270-DPC	Double Pole, Closed circuit	19 00
270-DOC	Double Pole, Open & Closed	20 00
270-TC	Tripper Connected	25 00
270-SC	Shunt Connected	25 00
For surface mounting specify PP27193 back box		4 50
Additional glass rods specify PP27165		50
271-SPO	Single Pole, Open circuit	15 00
271-SPC	Single Pole, Closed circuit	15 00
271-DPO	Double Pole, Open circuit	18 00
271-DPC	Double Pole, Closed circuit	18 00
271-DOC	Double Pole, Open & Closed	20 00
For surface mounting specify PP27193 back box		4 50

Edwards Streamlined Fire Alarm Stations

Closed Circuit, Code Ringing

For use with Fire Alarm Systems operating on voltages up to 120 Volts a-c or d-c.



No. 1250



No. 1253

Pull-Lever Type—Local Non-Interfering

For Systems Nos. SS and SSA

Positive, fool-proof action—just a pull, release, and alarm is in. Adaptable to any circuit arrangement ever specified. "Hug-the-wall" appearance. Diecast case, lustrous baked enamel finished, with polished metal bands. Transparent plastic protective cover over mechanism. Front-connected terminal block for easy installation—saves up to 30% installation time over old stations. Elimination of special keys makes testing easier.

Size—7½ in. high, 5½ in. wide, depth 1⅞ in. Flush model protrudes 1⅞ in. from wall. Cast box available for surface mounting.

Pull Lever Type

No.	Each
1250	Approximate shipping weight, 4 lbs. \$77.00

Pull-Lever Break Glass Type

Has glass rod across pull-lever which is broken when alarm is turned in. Glass rod is easily and economically replaced.

No.	Each
1251	Approximate shipping weight, 4 lbs. \$90.00

Closed Circuit Pre-Signal Ringing Station Open Door

For Systems Nos. PSS and PSSA

Same as stations described above, except that presignal alarm is sounded at pre-determined places only. If it is found desirable, upon investigation, to sound a general alarm, that may be done by inserting key in lock on right side of box and pulling lever.

No.	Each
1252	Approximate shipping weight, 4 lbs. \$90.00

Pre-Signal Break Glass Station

Combines special features of Pre-Signal and Break Glass types, with all features of standard station.

No.	Each
1253	Approximate shipping weight, 4 lbs. \$103.00

City Controlled Systems

Shunt Trip, Break-Glass, Local Non-interfering; for Systems Nos. SSMS and SSAMS.

No.	Each
1351 \$121.00

Tripper Type, Break-glass, Local non-interfering; for Systems Nos. SSMT or SSAMT.

No.	Each
1353 \$121.00

When ordering specify P.P. No. 24901 Wall Box for surface mounting and P.P. No. 24900 Wall Box for flush mounting. This applies to all above stations.

Edwards Home Fire Alarm

Underwriters' Approved thermostatic detectors set off alarm when heat becomes excessive. Each detector offers 400 sq. ft. of coverage. Self-restoring, they may be tested for sensitivity by applying heat.

Two thermostatic detectors are provided with each system (which operates on house current), but additional detectors may be added to the system at any time.



No. 243



No. F-100

This low-cost, easily installed system assures effective and dependable protection against fire hazards. Central signal unit (either surface or flush mounted) is always ready to sound alarm. Test feature to check operation is included.

No.	Description	Each
F-100	Home Fire Alarm for Flush Installation	\$24.95
F-200	Home Fire Alarm for Surface Installation	24.95
243	Thermal Detector—140° F.	3.50
244	Thermal Detector—190° F.	3.50

Federal Sirens and Accessories

Industrial Sirens



Type A Siren

All purpose siren which has quick pick-up to high maximum pitch for contrast with industrial and traffic noises.

Weatherproof housing, adjustable bracket. Has 1/3 hp. sound output at 150 watts.

Choice of voltages includes 6, 12, 24, 48 and 110, for 25 to 60 cycles a-c or d-c.

Model	Length, In. Excluding Bracket	Diam. In.	Net Wt. Lbs.	Ship. Wt. Lbs.	Each
Type A	11 1/2	10 1/2	13	15	\$65.00



Type J Siren

This siren is similar to type A, however it has a heavy duty motor for severe services on cranes and other heavy industrial equipment.

Available in 110, 220 or 250 volts, 25 to 60 cycles a-c or d-c.

Model	Length In.	Diam. In.	Net Wt. Lbs.	Ship. Wt. Lbs.	Each
Type J	12	11 1/2	15 1/2	18	\$75.00

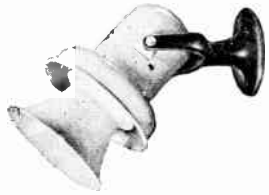

Type D Siren

Similar to types A and J but with a more powerful motor.

Produces 1/2 hp. sound output on 215 watts. Its deeper tone carries farther and provides a better contrast where ambient noises are high pitched.

Equipped with adjustable bracket. Weatherproof housing. Available in 6, 12, 24, 48 or 110 volts, 25 to 60 cycle a-c or d-c.

Model	Length In.	Diam. In.	Net Wt. Lbs.	Ship. Wt. Lbs.	Each
Type D	12	9 1/2	14	17	\$70.00

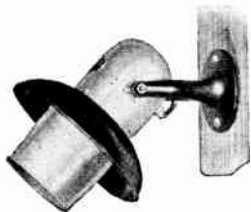

Type L Siren

Heavy duty version of type D siren, for heavy industrial use and higher voltages.

Available in 110, 220 or 250 volts, 25 to 60 cycle a-c or d-c.

Model	Length In.	Diam. In.	Net Wt. Lbs.	Ship. Wt. Lbs.	Each
Type L	11 1/2	11 1/2	16 1/2	19	\$80.00

Model AX Explosion Proof Siren



This model is similar in sound output to the models A and J siren.

Meets rigid Underwriters specifications for use in Class I group D and Class II groups F & G hazardous locations. 110 volts only a-c or d-c.

Model	Length In.	Diam. In.	Net Wt. Lbs.	Ship. Wt. Lbs.	Each
Type AX	10	7	16	19	\$186.00

Vertical Sirens



Inexpensive signal for fire, air raid and other alarm purposes in industry or municipality.

Vertical design distributes sound waves radially over distances averaging 1/2 to 2 miles. Specially designed ball bearing motors assure quick pickup and high output. Weatherproof housing.

The two hp. universal motor will also operate on d-c; all others are for 60 cycle a-c operation with choice of voltage.

Model STII-10 differs radically in design and appearance with sound output proportionately higher than hp. indicates.

Model	H.P.	Phase	Voltages	Ship. Wt. Lbs.	Each
2	2	1	110 or 220	70	\$275.00
5	5	3	220/440	300	500.00
5	5	1	220	325	650.00
7	7 1/2	3	220/440	440	550.00
7	7 1/2	1	220	460	700.00
STII-10	10	3	220/440	450	750.00
STH-10	10	1	220	470	900.00

Remote Control Relays

The remote control relays must be used with all large sirens to allow remote operation by push button, timers, alarm boxes or program clocks.

Remote Control for #2 siren \$35.00.

Remote Control for #5, 7 or STII-10 sirens. 3 phase \$60.00. Single Phase \$80.00.

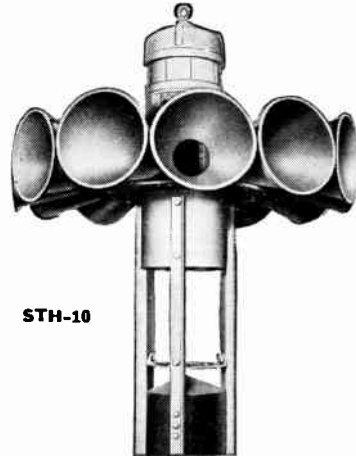

STH-10

Predetermined General Alarm Control

This accessory operates the siren up and down scale for 2 1/2 minutes but can be actuated by one or more remotely located start only push buttons.

Choice of 110 or 220 volts.

Fire Alarm Pull Box



Pull Lever Box

A pull of the handle winds the clockwork actuated contacts to sound siren up and down scale for 2 minutes and then stop. No voltage limitations.

Program Clock



The program clock can be set to blow the siren one blast for a time or test signal at any five minute interval in a 24 hour day.

Has self-starting motor. Available in 110 or 220 volts, 60 cycle a-c.

Model	Each
Pull Lever Box as illustrated	\$ 70.00
Pull Lever Box weatherproof	100.00
Predetermined General Alarm Control	75.00
Push button for above	6.00
Push button in weatherproof break glass box	21.00
Model 75 Program and Test Clock	85.00

Federal Paging Devices

Push-Button Signakall



The Signakalls work with any existing horn, bell or light system or may be the nucleus of a new expanding system.

They relieve congested switchboard traffic; free held telephone lines; and speed location of key personnel.

Signakall actuated systems prove indispensable in busy offices, stores, factories and institutions.

Operates on 110 volt, 60 cycle a-c. Use of 110 volt line relay allows operation of low or high voltage signal circuits. Dimensions: 12½ x 6⅞ x 6¼ inches.

Model SK2: Initiates 20 different code signals. The selector knob in one position limits calls to 3 rounds but in second position permits call to repeat until shut off.

Model SK4: A 40 button model. Available in the same size case.

No.	Button	Net Wt. Lbs.	Ship. Wt. Lbs.	Each
SK2	Twenty	6	15¼	\$175.00
SK4	Forty	8½	17½	\$330.00
Line Relay, 110 volt (up to 10 amp. capacity)				20.00

Industrial Bells

Vibrating, Single Stroke And Chimes



Superior bells for all purposes. Strong impulses and special drawn steel gongs assure maximum sound output.

The standard model bells are weatherproof construction and will be so furnished unless otherwise specified.

Models with plug-in feature for surface or concealed conduit mounting on any standard outlet box are available at no additional cost;

please specify. Standard construction on the chime, which is primarily for interior use in quiet areas such as offices, etc.

Industrial bells available for d-c as well as a-c 60 cycle. No extra charge for 25 cycle if specified. Special voltages also available up to 250 volts.

A-C Models

Vibrating Bells

No.	Diam. In.	Ship. Wt. Lbs.	List Price Each			
			6 or 12 V.	24 V.	115 V.	Other
306	6	6¼	\$31.00	\$37.00	\$41.00
310	10	8½	41.00	44.00	55.00

Single Stroke Bells

106	6	6¼	\$31.00	\$37.00	\$41.00
110	10	8½	41.00	44.00	55.00

Chimes

101	Bar	7	\$29.00	\$33.00	\$37.00
-----	-----	---	-------	----------------	----------------	----------------

D-C Models

Vibrating Bells

No.	Diam. In.	Ship. Wt. Lbs.	List Price Each			
			6 or 12 V.	24 V.	115 V.	Other
406	6	6¼	\$31.00	\$33.00	\$37.00	\$41.00
410	10	8½	41.00	41.00	44.00	55.00

Single Stroke Bells

206	6	6¼	\$31.00	\$33.00	\$37.00	\$41.00
210	10	8½	41.00	41.00	44.00	55.00

Chimes

201	Bar	7	\$29.00	\$33.00	\$37.00
-----	-----	---	-------	----------------	----------------	----------------

Compressed Air Horns



Air horns for industries and municipalities or wherever a loud distinctive general alarm or code signal is desirable.

These air horns are ideal for short codes or prolonged alarms.

Each successively larger whistle has a deeper and more powerful tone. Projectors are specially machined cast bell bronze. Horns are available for specific pressures ranging from 15 pounds upward.

Diaphragms of special metal will last almost indefinitely at proper working pressure. Electric valves or hand valves available at prices depending on current and pressure characteristics required.

The numerals in Catalog Nos. indicate diameter of diaphragm. The letters H, M or L indicate high, medium or low pitch.

Valves are available for any common voltage in d-c from 6 to 250 volts; for 60 cycles a-c in 24, 110, 208, 220 and 240 volts; and for 25 cycle a-c on 110, 220 and 440 volts.

Screw Type Connection

No.	Frequency in CPS	Lgh. O.A. In.	Pipe Size In.	Ship. Wt. Lbs.	Price Each		
					Horn	Hand Valve	Elec. Valve
3-H	725	4¾	¾	4	\$37.50	\$12.00	\$20.00
3-M	420	6½	¾	5	45.00	12.00	20.00
3-L	350	12½	¾	6	52.50	12.00	20.00
4-H	470	7½	½	7	55.00	15.00	35.00
4-M	380	11	½	12	85.00	15.00	35.00
4-L	290	14½	½	14	100.00	15.00	35.00
6-H	310	11½	¾	20	150.00	18.00	55.00
6-M	255	15	¾	22	170.00	18.00	55.00
6-L	190	18½	¾	25	200.00	18.00	55.00

Flange Type Connection

8-H	210	14½	¾	50	225.00	20.00	60.00
8-L	170	21½	¾	60	325.00	20.00	60.00
10-H	200	16	1	60	300.00	23.00	75.00
10-L	125	32	1	120	400.00	23.00	75.00

Beacon-Ray Lights

The beacon-ray light is the finest general alarm warning device by itself or to supplement audible signals in extremely noisy areas.

It's an excellent signal in any danger spot such as drawbridges and other navigational or industrial hazards; also an exceptional attention getter on electric signs, drive-ins, etc.

The standard model is for 110 volt 60 cycle a-c. Available in a choice of red, green, blue, amber or clear white lenses.

Equipped with ½-in. pipe flange and two wire leads for simple and easy mounting. No rectifiers or transformers required.

Finished in hammertone gray enamel. Special models for other electric requirements available.



No.	Volts	Hgt. In.	Diam. In.	Ship. Wt. Lbs.	Price Each
27-S	110 a-c	14	6¼	6	\$65.00

For all your paging device requirements be sure to contact GRAYBAR first.

Federal Electric Horns

Excellent signals for coding as well as alarm. A variety of models available. The standard horns are the familiar industrial type. The Hi-Power horns are twice as loud as the standard and are used for larger or noisier areas. The resonating horns are twice as loud as the Hi-Power, also have distinctive trumpet tone. The motor driven horns are less powerful than the resonating and have another distinctive sound; are not satisfactory for fast code signals.

Horns are pearl gray baked enamel unless otherwise noted. All horns are tapped for 1/2-in. conduit. The a-c models are 60 cycles but 25 cycles are optional. D-C models are available as listed below.

Vibratory Horns

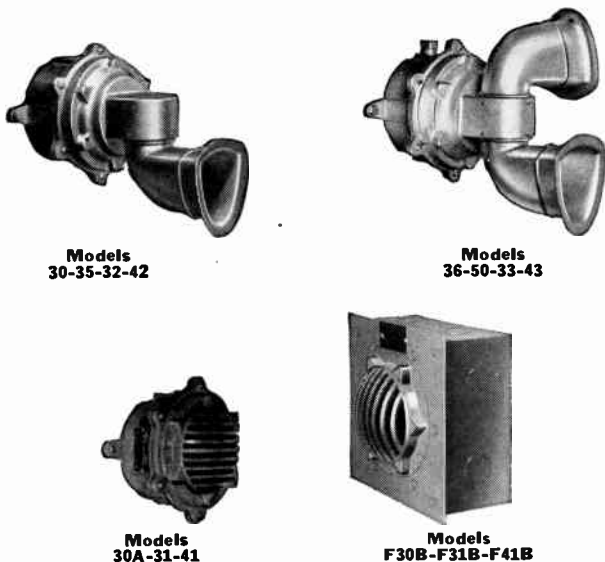

Two major classes, standard and hi-power, with choice of grille, single or double projector. Projectors may be rotated 180° to direct sound. Concealed conduit mounting optional if specified. Flush type also available. Horns constructed from material that will not corrode.

Standard Horns

Weatherproof Models

No.	Voltage A-C	Description	Ship. Wt. Lbs.	Each
30A	6-250	Grille	4 1/4	\$19.50
30	6-250	Single Projector	6 1/2	26.50
50	6-250	Double Projector	7 1/4	35.00

Interior Type

35	6-250	Single Projector, red	6 1/4	22.00
36	6-250	Double Projector, red	7 1/4	30.50
F30B	6-250	Flush Type, Prime Finish	6 1/2	29.00

Hi- Power Horns

The Hi-Power horns are identical in appearance and dimensions with respective standard models. Also available in d-c.

A-C Models

No.	Voltage	Description	Ship. Wt. Lbs.	Each
31	6-250	Grille	4 1/2	\$20.50
32	6-250	Single Projector	6 3/4	27.50
33	6-250	Double Projector	7 1/2	36.00
F31B	6-250	Flush Type	6 3/4	30.00

D-C Models

41	6-250	Grille	4 1/2	\$30.00
42	6-250	Single Projector	6 3/4	36.50
43	6-250	Double Projector	7 1/2	44.50
F41B	6-250	Flush Type	6 3/4	36.50

Resonating Horns

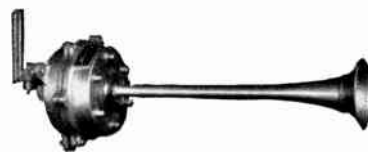

Models 55-56

The loudest electric horns. The weatherproof models have swivel bracket, straight projector and pearl gray finish. The interior types have coiled projector, plug-in mounting and red finish.

No.	Voltages	Description	Ship. Wt. Lbs.	Each
55	24-250 AC	Weatherproof	11	\$65.00
56	6-250 DC	Weatherproof	11	65.00
53	24-250 AC	Interior	10	60.00
54	6-250 DC	Interior	10	60.00

Motor Driven Horns



Models 20-21

Models 60-61

A-C Models

No.	Voltages	Description	Ship. Wt. Lbs.	Each
20	110-220-250	Sgl. Projector	12	\$78.50
60	110-220-250	Dbl. Projector	15	87.50

D-C Models

21	110-220-250	Sgl. Projector	12	\$78.50
61	110-220-250	Dbl. Projector	15	87.50

Explosion Proof Horns

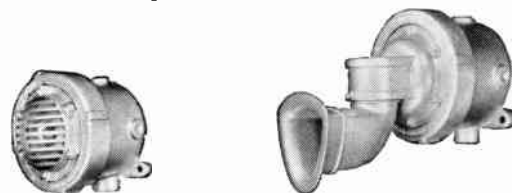

Models 31X-41X

Models 30X-32X-42X

A number of electric horns available in explosion proof construction meeting class I group D requirements. Model numbers similar to corresponding non-explosion proof units but have an X appended.

Resonating and all d-c explosion proof horns are furnished complete with an explosion proof splicing conduit which is not required in other models.

A-C Models

No.	Voltages	Description	Ship. Wt. Lbs.	Each
30X	110-220	Standard	11 1/2	\$55.00
31X	6-250	Hi-Power	11 1/2	60.00
32X	6-250	Hi-Power	13	63.50
33X	6-250	Hi-Power	14	67.00
55X	110-220	Resonating	23	100.00

D-C Models

41X	6-250	Hi-Power	11 1/2	73.00
42X	6-250	Hi-Power	13	76.50
43X	6-250	Hi-Power	14	80.00
56X	110-220-250	Resonating	23	100.00

Faraday Air Trumpets

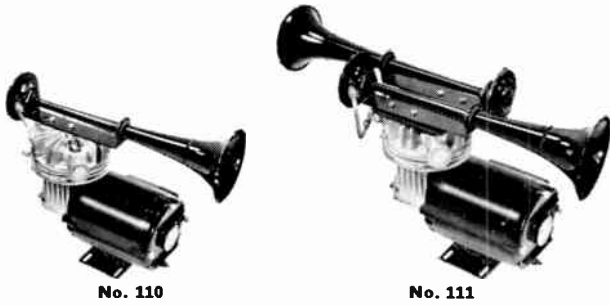

Gives an extremely loud alarm signal that will overcome very high noise levels and cover wide areas. It is an air-pressure horn ready to connect to existing circuits—no auxiliary equipment needed. Fitted with standard speed 1/4 hp motor. The powerful blast of the air trumpet is instantaneous when current is applied.

Hammertone gray enamel finish. (Red can be furnished if specified.)
One in a standard package. Approximate weight: single projector 68 lbs. Two-Way Projector, 85 lbs.

Single Projector Type

Nos.	Current and Voltage	Each
110	A-C, 115 and 230 volts.....	\$185 50
109	D-C, 24, 115, 250 volts.....	265 00

Two-Way Projector Type

111	A-C, 115 and 230 volts.....	\$237 50
112	D-C, 24, 115, 250 volts.....	295 00

When ordering specify current and voltage.

Faraday Industrial Horns

Listed by Underwriters' Laboratories, Inc.

For Coding and General Alarm—Heavy Duty



No. 121-U

No. 123-U

These horns give maximum signal strength, loud, commanding, clean-cut tone and positive instantaneous performance. Ideal for medium noise-level signaling.

The a-c vibrating electro-magnet mechanism operates without contacts. The d-c mechanism has heavy tungsten contact points.

Hammertone gray enamel finish. (Red enamel finish can be furnished when specified).

Uni-Pact—The adapter plate fits any standard 4 in. square or octagon outlet box, conduit or Wiremold fitting. All wiring is made to the plate installation to simplify maintenance.

Standard—Horns are same as Uni-Pact except for wall mounting with connection to 1/2 in. conduit directly to the housing or for mounting to an outlet box when used with the hanger plate that is furnished at no extra cost if specified.

One in a standard package. Approx. shipping weight: Drum type 4 1/2 lbs. Short and Megaphone type 5 1/2 lbs. Two-way type 9 1/2 lbs.

For A-C Operation

Uni-Pact Nos.	Standard Nos.	Projector Style	Voltages		Series Operation Each
			24-115 Each	Up to 230 Each	
121-U	121-S	Megaphone	\$23 00	\$27 00	\$23 00
123-U	123-S	Two-Way	32 50	37 00	32 50
127-U	127-S	Drum	20 00	25 00	20 00
128-U	128-S	Short	23 00	27 00	23 00

For D-C Operation

Nos.	Style	Voltages		Series Operation Each
		9V, 24V, 115V, 250V	Each	
146-U	146-S	Megaphone	\$29 50	
148-U	148-S	Two-Way	37 00	
144-U	144-S	Drum	27 50	
145-U	145-S	Short	30 50	

Faraday Weatherproof Industrial Horns

These horns are same as the Uni-Pact, except that they have a heavy cast housing and are gasketed for weatherproof installations. Tapped for 1/2 in. conduit.

One in a standard package. Approx. shipping weight: Megaphone type, 7 lbs. Two-Way Type, 11 lbs.

For A-C Operation

Nos.	Projector Style	Voltages		Series Operation Each
		24-115 Each	Up to 230 Each	
122	Megaphone	\$27 50	\$32 00	\$27 50
124	Two-Way	35 00	40 50	37 00

For D-C Operation

Nos.	Projector Style	Voltages		Series Operation Each
		9V, 24V, 115V, 250V	Each	
147	Megaphone		\$34 00	
149	Two-Way		41 50	

Faraday Air-Blast Signal Horns

Uni-Pact Kodaik

Listed by Underwriters' Laboratories, Inc.



No. 133-S



No. 133-L

A high powered signal horn with loud, powerful trumpet tone that can be heard above the usual noise level. Its positive instantaneous action makes it ideal for high-noise level coding or general signaling.

With adapter plate mounting.

Hammertone gray enamel finish. (Red enamel finish furnished if specified).

Dimensions: Loop type, 7 1/8-in. high, 7 1/8-in. wide, 12 3/4-in. long. Straight type, 6 1/2-in. high, 6 1/2-in. wide, 21 3/8-in. long.

One in a standard package. Approx. shipping weight 6 lbs.

For A-C Operation

Nos.	Style Projector	115 Volts Each		230 Volts Each	
		Each	Each	Each	Each
133-L	Loop	\$61 00		\$61 00	
133-S	Straight	61 00		61 00	

For D-C Operation

Nos.	Style Projector	115 Volts Each		250 Volts Each	
		Each	Each	Each	Each
132-L	Loop	\$61 00		\$61 00	
132-S	Straight	61 00		61 00	

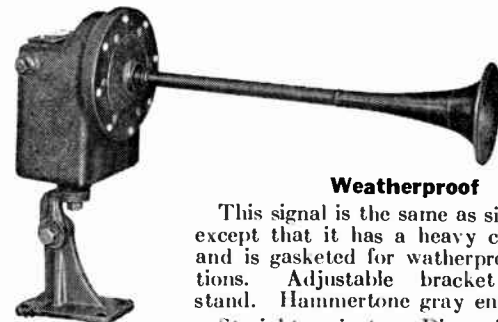

No. 136

Weatherproof

This signal is the same as signal above, except that it has a heavy cast housing and is gasketed for watherproof installations. Adjustable bracket mounting stand. Hammertone gray enamel finish.

Straight projector. Dimensions: 13 1/2-in. high, 6 1/2-in. wide, 21 1/2-in long.

One in a standard package. Approx. shipping weight 30 lbs.

Nos.	For	115 Volts Each		230 Volts Each		256 Volts Each	
		Each	Each	Each	Each	Each	Each
136	A-C	\$66 00		\$66 00			
134	D-C	66 00					\$66 00

Benjamin Type SNP Non-Weatherproof Howlers and Buzzers

Listed By Underwriters' Laboratories, Inc.

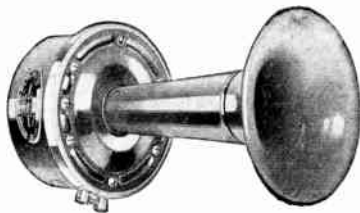

No. N-8755-115V



No. 8797-115V

Designed for use indoors where low current consumption, easy wiring and a sealed construction to keep out dirt are required. AC howlers operate on series or parallel circuits. DC howlers operate on parallel circuits only. DC howlers have interrupters with tungsten contacts protected from arcing by condensers.

Power consumption is 18 watts. Diaphragm is spring steel, 4³/₈ in. diameter. Finish baked gray hammered enamel. Baked red enamel finish available when specified.

SNP Buzzers recommended where competing noise is not excessive. Construction is same as Howlers except that a steel cover is used in place of the projector or grille.

Howler With Single Bell Projector

No. (AC)	Each	No. (AC)	Each	No. (DC)	Each
N-8755-12V	\$16.45	N-8755-115V	\$16.45	8726-6V	\$19.55
N-8755-24V	16.45	N-8755-230V	16.45	8726-115V	19.55
				8726-250V	19.55

Howler with Double Projector

N-8795-12V	22.85	N-8795-115V	22.85	8794-6V	26.05
N-8795-24V	22.85	N-8795-230V	22.85	8794-115V	26.05
				8794-250V	26.05

Projector-Less Howler with Grille Front

N-8741-12V	14.80	N-8741-115V	14.80	8740-6V	17.90
N-8741-24V	14.80	N-8741-230V	14.80	8740-115V	17.90
				8740-250V	17.90

Type SNP Buzzer

8797-12V	9.55	8797-115V	9.55	8796-6V	12.70
8797-24V	9.55	8797-230V	9.55	8796-115V	12.70
				8796-250V	12.70

Housings have 1/2" I.P.S. knockouts at back and side. Also holes for mountings to a flat surface or 3 1/4" or 4" octagonal boxes. No. 8731 Adapter Plate is required for alignment of Double-Bell Howlers when mounted on an outlet box and for mounting all Howlers on switch or 4" square outlet boxes. No. 8731 included with Howlers, when specified.

A.C. devices are 60 cycles std.; 25 cycles optional at same price. Special voltage also available. 250 V. D.C. devices are also for use on 230 V. systems. Bell ringing transformers are not suitable for 12 and 24 V. A.C. devices; signaling type required.

Benjamin Type SWP Weatherproof Buzzers

Listed By Underwriters' Laboratories, Inc.



No. 8699-115V

Recommended where competing noise is not excessive. Same construction as type SWP weatherproof howlers except that a steel cover is used in place of the projector. Sound is produced by hammer action of a vibrating armature striking cover. Buzzers do not have a muting mechanism. Power consumption is 18 watts.

No. (AC)	Each	No. (AC)	Each	No. (DC)	Each
8699-12V	\$16.45	8699-115V	\$16.45	8698-6V	\$19.55
8699-24V	16.45	8699-230V	16.45	8698-115V	19.55
				8698-250V	19.55

Benjamin Type SWP Weatherproof Howlers

Listed By Underwriters' Laboratories, Inc.



No. N-8546-115V

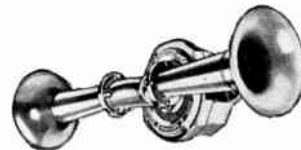

No. N-8590-115V

Sound-producing mechanism starts and stops instantly with the current impulse, making it ideal for code-calling. AC howlers operate on series or parallel circuits. DC howlers operate on parallel circuits only. DC howlers have interrupters with tungsten contacts which are protected against arcing by condensers.

Power consumption is 18 watts. Spring steel diaphragm, 4³/₈-in. diameter. Interchangeable projectors, 7-in. seamless single, or double bell-type projector assembly plugs into housing.

Heavy cast iron outlet box attached to seamless steel projector assembly by a cast aluminum threaded ring. Assembly joint is sealed by rubber gasket. Two lugs provided for wall mounting.

Finish baked gray hammered enamel.

Construction of type SWP fire alarm howlers, designed for fire alarm system operation, is same as for heavy-duty weatherproof howlers, except finish is baked red enamel.

The SWPE corrosion-resisting howler is designed to withstand atmospheres containing highly corrosive forces. It is similar in construction to the regular weatherproof howler except that the diaphragm is made of corrosion-resisting metal, 4³/₈-in. diameter; threaded union housing ring is cast brass; projector is finished in gray porcelain enamel. Other parts of the howler are baked gray hammered enamel. A muting mechanism is not provided as on the regular howler.

With Single Bell Projector

No. (AC)	Each	No. (AC)	Each	No. (DC)	Each
N-8546-12V	\$19.80	N-8546-115V	\$19.80	8526-6V	\$22.90
N-8546-24V	19.80	N-8546-230V	19.80	8526-115V	22.90
				8526-250V	22.90

With Double Bell Projector

N-8590-12V	26.35	N-8590-115V	26.35	8599-6V	29.45
N-8590-24V	26.35	N-8590-230V	26.35	8599-115V	29.45
				8599-250V	29.45

Corrosion Resisting Howler with Single Bell Projector

8547-12V	27.95	8547-115V	27.95	8527-6V	31.70
8547-24V	27.95	8547-230V	27.95	8527-115V	31.70
				8527-250V	31.70

Fire Alarm Howlers with Single Bell Projector

N-8564	19.80	N-8566-115V	19.80	8560-115V	22.90
N-8565	19.80	N-8566-230V	19.80	8560-250V	22.90

A.C. devices are 60 cycles, std.; 25 cycles optional at same price. Special Voltages also available. 250 V. D.C. devices are also for use on 230 V. systems. Bell ringing transformers are not suitable for 12 and 24 V. A.C. devices, signaling type required. No. N-8564 is rated 8 V.; No. N-8565 is rated 14 V. Boxes are tapped 1/2" I.P.S. std. — one side. Can be tapped 3/4" I.P.S. — one side, at same price; or 1/2" or 3/4" straight-thru at \$0.28 advance in price.

Benjamin Type SNP Moisture-Proof Howlers and Buzzers

Listed by Underwriters' Laboratories, Inc.

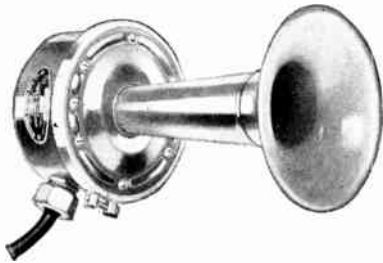

No. N-8652-115V

Effectively sealed against dirt and moisture for use in damp or dirty non-hazardous atmospheric areas in mines, factories, tunnels and subways. Same construction as Non-Weatherproof Howler except that 8 in. insulated wire leads enter housing through a watertight bushing.

Howler with Single Bell Projector

No. (AC)	Each	No. (AC)	Each	No. (DC)	Each
N-8652-12V	\$19.80	N-8652-115V	\$19.80	8651-6V	\$22.90
N-8652-24V	19.80	N-8652-230V	19.80	8651-115V	22.90
				8651-250V	22.90

SNP Moisture-Proof Buzzer

8679-12V	11.90	8679-115V	11.90	8678-6V	15.00
8679-24V	11.90	8679-230V	11.90	8678-115V	15.00
				8678-250V	15.00

Benjamin Type EXH Explosion-Proof Howlers and Buzzers

Listed By Underwriters' Laboratories, Inc. For Use In:

- Class I, Groups C and D Hazardous Locations
- Class II, Groups E, F and G Hazardous Locations
- Also Suitable for Class III Hazardous Locations



No. 8130-115V

Has ample strength in every part to withstand the pressures of internal explosions without breaking down or permitting flame, hot gases or sparks to escape and ignite surrounding atmosphere—and are of such design as to prevent the development of temperatures on outside surfaces sufficient to cause overheating or ignition of dust.

Power consumption is 30 watts. Spring steel diaphragm 5 in. diameter, rigidly supported. 5½ in. seamless steel projector assembly plugs into housing. Finish baked gray hammered enamel. Baked red enamel finish available. EXB Buzzers same general design, not as loud as Howlers.

Prices on application

Benjamin Motor-Driven Weatherproof Howler

Listed By Underwriters' Laboratories, Inc.

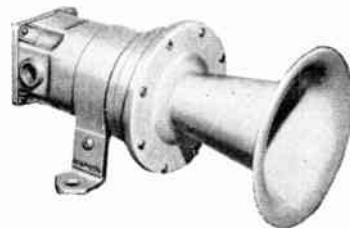

No. 8170-115V

Distinctive tone obtained through use of a high torque motor that starts and stops with practically no lag or "coasting."

High torque motor, series wound, Universal type for DC to 60 cycle AC operation; 115, 230 and 250 v.; power consumption 80 watts; permanently aligned armature shaft bearings lubricated by large capacity wick-feed oil cups.

Diaphragm 5½-in. diameter, sealed by gaskets and rigidly supported. 18 gauge steel housing, sealed with rubber gaskets, weatherproof. Finish baked gray hammered enamel over electroplating on steel housing, mounting bracket and projector. Housing tapped ½" I.P.S.

With 2-in. Single Bell Projector

No.	Each	No.	Each	No.	Each
8178-115V	\$58.95	8178-230V	\$58.95	8178-250V	\$58.95

With 5½-in. Single Bell Projector

8170-115V	58.95	8170-230V	58.95	8170-250V	58.95
-----------	-------	-----------	-------	-----------	-------

With Double Bell Projector

8182-115V	65.35	8182-230V	65.35	8182-250V	65.35
-----------	-------	-----------	-------	-----------	-------

Benjamin Motor-Driven Siren

Listed By Underwriters' Laboratories, Inc.



No. 8199-115V

Recommended for fire alarm systems, other warning systems where distinctive tone is essential and similar, non-coding uses.

High torque motor, series wound. Universal type for DC to 60 cycle AC operation; 115 and 230 v.; power consumption is approx. 180 watts; ½ hp. Ball bearings lubricated for life. Rotor fan is cast aluminum alloy.

18 gauge steel housing; rubber gasketed. Grille is 20 gauge steel. Heavy steel mounting bracket, strap-type that rotates around siren housing to any position. Finish baked gray hammered enamel over electroplating on housing, bracket and grille. Housing tapped ½" I.P.S.

No.	Each	No.	Each
8199-115V	\$57.05	8199-230V	\$57.05

Edwards Single Stroke Bells

For Approved Coded Fire Alarm Systems



Sturdy, compact signals. Mechanism completely enclosed in a metal housing for protection against dirt, dust or bugs. Gongs are Parkerized.

Solenoid construction—Approved by State, Insurance and Underwriters' Boards for series supervised circuits.

For mounting on wall or 4-in. square box, or standard switch box, or any outlet box with single gang conduit or Wiremold type fitting. For series operation on 115 volts from control panel.

No. 24

For 115 Volts A-C

Size, In.	Approximate Weight, Lbs.	Each
4	2	\$28 00
6	4 3/4	39 00
10	9	44 00

No. 23

For 115 Volts D-C

Size, In.	Approximate Weight, Lbs.	Each
4	2	\$28 00
6	4 3/4	39 00
10	9	44 00

Edwards Adaptabels

Listed for indoor uses by Underwriters' Laboratories, Inc.

Designed for average interior or protected exterior conditions in factories, offices and schools. Bells have a clear loud tone which carries great distances.

Electrical connections are made to the mounting plate only—the whole electrical installation can be made, tested and completed before painting and finishing walls. Large convenient binding posts for easy wiring.



Installation:

A-c Type—Mount separable plate on wall or any switch box, outlet box, conduit or wiremold type fitting. No nuts or screws required.

A-c Type—All 6-in. and 10-in. mount directly on wall, 4-in. square box, standard switch box, or any outlet box with single gang conduit or wiremold type fitting. 4-in. size has separable plate for mounting as above, except the 4-in. square box.

For A-C., 60 Cycles

Size, In.	No. 340		No. 562	
	Vibrating Each		Single Stroke Each	
24 Volts				
4	\$22 00	\$22 00		
6	31 00	31 00		
10	41 00	41 00		
115 Volts				
4	\$27 50	\$27 50		
6	37 00	37 00		
10	44 00	44 00		

Other Voltages up to 250

4	\$33 00	\$33 00
6	41 00	41 00
10	55 00	55 00

For D-C.

Size, In.	No. 561		No. 563	
	Vibrating Each		Single Stroke Each	
6 Volts				
4	\$22 00	\$22 00		
6	\$31 00	31 00		
10	41 00	41 00		
24 Volts				
4	\$25 50	\$25 50		
6	\$33 00	33 00		
10	41 00	41 00		

115 Volts

4	\$27 50	\$27 50
6	\$37 00	37 00
10	44 00	44 00

For other voltages up to 250

4	\$33 00	\$33 00
6	\$41 00	41 00
10	55 00	55 00

No. 341 4-in. Size Vibrating D.C. Adaptabel
 6 V.D.C. \$22 00
 24 V.D.C. 25 30
 120 V.D.C. 27 50
 Special Voltages to 120 V.D.C. 33 00

Edwards A-C Adaptahorns

These extra loud horns are especially designed for use in schools, industrial plants and institutions, and particularly where louder results from less current are desired.

They have specially sealed in mechanism, front connection feature and special mounting plate, which can be mounted on 3 1/4, 3 1/2, 4-in. octagon, 4-in. square boxes or any box with a single gang plaster cover for indoor uses, on wall or Conduit or Wiremold fitting. Wires can be easily connected to large, convenient binding posts on mounting plate. When wiring is completed it is only necessary to slip Adaptahorn on sturdy hanger and plug feature automatically makes connection.

Light gray finish.

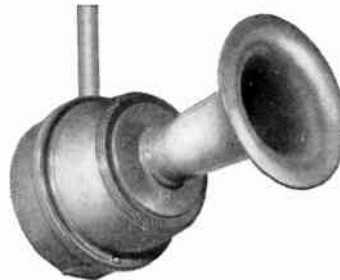

No. 372
Projector Type



No. 374
Grille Type

No.	Diam. In.	Lgh. In.	Ship. Wt. Lbs.	A-C 60 Cycles		25 Cycles or Other A-C Voltages to 250 V.
				24 Volts	115 Volts	
372	7	10 1/8	6 3/4	\$26 50	\$26 50	\$31 00
374	7	4	5 3/4	20 50	20 50	25 00

For Weatherproof Installations

Nos. 372 and 374 Adaptahorns can also be used for outdoor installations by using this cast back box and gasket for Underwriters' Listed Weatherproof Installation.

The box is drilled and tapped on top to take 1/2-in. conduit. Bosses are also provided in the back and on the bottom which can be drilled for unusual mounting requirements. Adds 1 7/8 in. to depth of Horns.

Cast Back Box and Gasket

No. 349 — Shipping Weight 2 lbs. Each \$6.60

Edwards Flush Horns

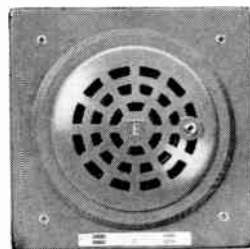

This Flush Type horn has the same characteristics and mechanism as Nos. 372 and 374 Adaptahorns, except for flush installations.

Particularly suitable in buildings such as schools and other public institutions.

Die-cast face, gray finish. Face plate 6 1/2 x 6 1/2 in. Wallcut size 5 5/8 x 5 5/8 in. x 3 in. deep.

Shipping weight 3 3/4 lbs. Furnished with No. 24687 wall box.

No.	A-C 60 Cycles		25 Cycles or Other A-C Voltages to 250 V.
	24 Volts	115 Volts	
370	\$33 00	\$33 00	\$37 50

Edwards Industrial Horns

Resonating Type

Listed by Underwriters' Laboratories, Inc.



No. 5420

For mills, mines, yards and wherever a powerful, distinctive signal is required. It is entirely electric in operation, eliminating expensive auxiliary equipment required for signals of equal tone and capacity. Weatherproof.

Housing is tapped for 1/2 in. conduit. Red lacquer finish. Swivel mounting bracket permits horn to be swung or tilted to any desired angle.

For voltage up to 250 A-C. (Specify voltage wanted.)

No. Each
5420—Approximate shipping weight, 9 lbs. \$72.00

Benjamin Telecode Relays

Listed by Underwriters' Laboratories, Inc.



For Panel Mounting

normally closed, "NC," until the relay coil is energized), or with locking armatures.

Locking relays have two independent coils; a pull-up and locking coil. The locking coil, usually connected in parallel with the signal, locks the contacts, when operated, to provide continuous operation of the signal until the circuit is broken by a release switch.

The pull-up coil is connected to the telephone line or actuating circuit and the locking coil is connected in parallel with the howler or other device operated from the contacts of the relay.

Contacts are tungsten. Coils are form wound with moisture-proof coverings and carefully impregnated.

Contacts are rated .8 ampere at 110 volts (will operate five vibrating-type howlers).

Standard coil windings are 1000 ohms. These will operate on a voltage range of 80 to 110 volts 20 to 60 cycles and also on 18 volts D.C. For use on telephone ringers with other than 1000 Ohms resistance specify resistance of ringer and voltage and frequency of ringing system. Not for use on harmonic ringing systems.

For Panel Mounting

No.	Description	Each	No.	Description	Each
	Less Condenser			With Condenser	
8313-P	Open Circuit	\$15.80
8313-C	Closed Circuit	15.80
8313-L	Locking Armature	17.80			

With Pressed Steel Box

8315-P	Open Circuit	15.80	8316-P	Open Circuit	\$21.00
8315-C	Closed Circuit	15.80	8316-L	Locking Armature	23.15
8315-L	Locking Armature	17.80			

With Explosion-Proof Box

8319-P	Open Circuit	21.00	8320-P	Open Circuit	26.35
8319-C	Closed Circuit	21.00	8320-L	Locking Armature	28.30
8319-L	Locking Armature	23.15			

With Watertight Box

8322-P	Open Circuit	19.00	8323-P	Open Circuit	24.30
8322-C	Closed Circuit	19.00	8323-L	Locking Armature	26.35
8322-L	Locking Armature	21.00			

Condenser capacity is 1 mfd. Pressed steel box is 6"x6"x3". Explosion-proof and Watertight Boxes are tapped "straight-thru" 1/2" I.P.S. std.; 3/4" if specified, at same price. Explosion-proof Relays are listed by Underwriters' Laboratories, Inc., for Class II, Groups F and G hazardous atmospheric locations. Also suitable for Class III hazardous locations.

Faraday Kodemasters

Portable Desk Type

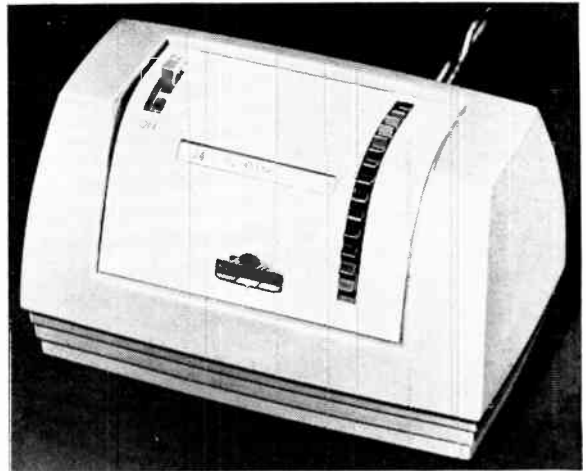

Consists of a synchronous motor-driven contact interrupter on which the desired code is manually set up and automatically transmitted to the system of audible signals connected to it.

Thirty separate and distinct codes are provided each of which is automatically set for the name that appears on index card when viewed through the cover slot. A code is set up by rotating the index wheel on right side of unit to number desired. Operating the switch lever on left so that the word "ON" appears in slot lights the pilot light and energizes the driving motor which causes unit to transmit the code. Code is continuously transmitted until switch lever is turned back of the "OFF" position.

If Kodemaster is shut off while a code is being transmitted it will continue to complete the code and then stop itself. An automatic interlocking feature prevents code being changed while the Kodemaster is in operation. Completes code even after it is manually shut off, therefore the code cannot be changed during this time as the mechanism must first stop and the pilot light goes out.

In addition to calling individuals, may be used for general signals, such as: Start Work, Dismissal, Rest Period, etc.

Contact rating 3 amp. 120 volt a-c; Code signal load 1 amp. 120 volt d-c. Voltage 120 volts, 60 cycle a-c. Finish: Hammetone Gray Enamel. Front cover satin stainless steel.

No.	Signals	Type	Size, In.	Each
805	30	Portable Desk	6 3/8 x 3 3/4 x 3 5/8	\$99.50

Call Graybar FIRST For . . .

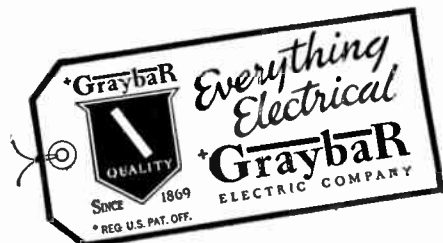

Edwards Lokator Systems

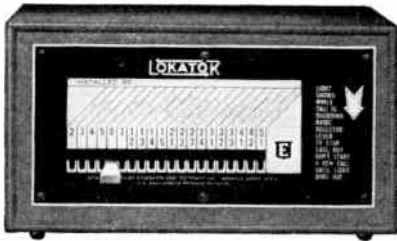

These systems use a predetermined code on audible and visual signal devices to call or "lokate" individuals in offices, stores, factories, etc. They are amazingly inexpensive, having been specifically designed and engineered to meet the diversified requirements of business and industry. Their versatility, dependability and low cost make them outstanding.

They are operated entirely by low voltage, irrespective of the voltage used to operate the signals. Mechanism is driven by sturdy, noiseless, synchronous motor.

Furnished in 20, 40 or 60 call units. All names can be typed on a printed form protected by a clear plastic strip. To locate an individual, operator need only slide the selector lever to desired name, apply a slight pressure and immediately the code of that person is sounded on all signal devices.

Wrinkle gray finish, with black panel and chromium relief.



Power Supply Units

When connected to standard lighting circuits they distribute 24 or 115 volts a-c to the signals, but permit only low voltage to enter the selector unit. They provide correct current, protect the Lokator from excessive line loads and provide a terminal box for centralizing all units in the system.

Lokator Signals



**No. 5024
Bell Signal**



**No. 5005
Chime Signal**



**No. 5031
Light Signal**

Designed especially for use on Lokator Systems.

Signal stroke bells sound a clear, crisp tone, audible over long distances and normal noise disturbances. Well built and will stand many years of hard service. Light gray finish.

Chime signals are the most commonly used. Emits a pleasant, musical tone, penetrating and clear, yet not annoying or harsh. Light gray finish.

Light signals—Ideal for locations where no noise whatsoever is desired. Call is shown by flashing light. Protruding glass dome enables it to be seen from all directions. Light gray finish.

Above signals are designed, rated and standardized for operation together.

Prices on application.

**Edwards Return Call Annunciators
Electro-manual Reset**

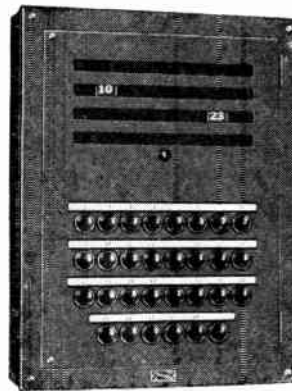

For return call systems. All indicated drops reset at once—individual resetting not possible. Also manual, mechanical reset in case of emergency. Rooms may be called from the office or central station, or vice-versa, and the call may be acknowledged.

Can be furnished in the following finishes — light gray, mahogany, walnut, oak, or any solid spray finish, if specified.

For other finishes, features, etc., and complete installation data contact Graybar.

No. 410—Surface Type, with Metal Case.

No. 412—Flush Type, with metal face plate and wall box.

No. 410—Surface Type

Depth 3 1/4 inches

No.	No. of Drops	Arrangement Across	Arrangement Down	Height in.	Width in.	App. Wt. Each, lbs.	Each
410	27	9	3	14 1/2	13 1/2	12 1/2	\$436.00
410	32	8	4	16 3/4	12 1/2	14 1/4	496.00
410	36	9	4	16 3/4	13 1/2	16	563.00
410	44	11	4	16 3/4	15 1/2	16 3/4	655.00

Larger sizes, add per drop \$15.00

No. 412—Flush Type

Depth 3 inches

No.	No. of Drops	Arrangement Across	Arrangement Down	Height in.	Width in.	App. Wt. Each, lbs.	Each
412	27	9	3	12 3/8	12	12 1/2	\$480.00
412	32	8	4	11 5/8	11	14 1/4	540.00
412	36	9	4	11 5/8	12	16	607.00
412	44	11	4	11 5/8	14	16 3/4	699.00

Larger sizes, add per drop \$15.00

For overall trim add 2 in. to height and width.

Larger sizes, prices on application.

For other finishes, features, etc., and complete installation data contact Graybar.

Edwards Surface Annunciettes

Manual Reset Type



A small, neat annunciator designed for momentary operation only. The operating and reset mechanism are thoroughly reliable and will stand up under severe service.

Standard audible signal is a buzzer. Marked connectors are furnished for adding extension signals if desired.

Complete with 100 assorted name and number cards for the drops.

Standard finish is light gray. All sizes 2 1/2 in. deep.

For 12 Volts, A-C

No.	No. of Drops	Arrangement Across	Arrangement Down	Height in.	Width in.	App. Wt. Each, lbs.	Each
82/4	4	4	1	4 3/8	5 1/4	1 1/2	\$ 26.40
82/8	8	4	2	4 3/8	5 1/4	1 3/4	40.70
82/12	12	6	2	5	7 3/16	2 3/4	60.50
82/16	16	4	4	7 3/16	7 3/16	3 1/2	79.20
82/20	20	5	4	7 3/16	7 7/8	4	101.20
82/24	24	6	4	7 3/16	8 3/8	6	121.00

For each additional 6 drops add \$49.50.

Special finishes, features, etc., and complete installation data contact Graybar.

Edwards Flush Annunciettes

Manual Reset Type

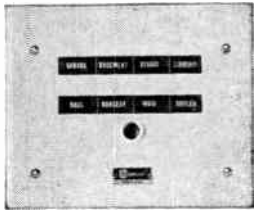

A small, neat annunciator designed for momentary operation only for flush mounting—complete with wall box. The operating and reset mechanisms are thoroughly reliable and will stand up under severe service.

Standard audible signal is a buzzer. Marked connectors are furnished for adding extension signals if desired.

Complete with 100 assorted name and number cards for drops.

Standard finish is light gray. All sizes 3 in. deep. Add 1/8 in. to height and width for over-all size trim.

**For 12 Volts A-C
Wall Cut**

No.	No. of Drops	Arrangement Across	Arrangement Down	Height in.	Width in.	App. Wt. Each, lbs.	Each
672/4	4	4	1	1 5/8	5 7/8	3 1/2	\$ 33.00
672/8	8	4	2	4 5/8	5 7/8	4	47.30
672/12	12	6	2	4 5/8	7 7/8	5 1/4	68.20
672/16	16	6	3	6 1/4	7 7/8	7	88.00
672/20	20	5	4	7 7/8	7 7/8	8	110.00
672/24	24	6	4	7 7/8	7 7/8	8 1/4	132.00

For each additional 6 drops add \$50.60.

For any solid spray finish add 25%.

For special voltages up to 48 V. or 25 cycles add 25%.

Special finishes, features, etc., and complete installation data contact Graybar.

Wall Boxes Only for No. 672 Annunciettes

For satisfactory installation wall boxes should be used.

No.	For Annunciettes	Each
671A	4 to 8 drops	\$2.20
671B	12 drops	2.20
671C	16 drops	11.00
671X	For larger sizes (specify size)	13.75

Edwards Desk-Type Annunciators

Manual Reset Type



Ideal for offices where it is desirable to keep wall space free from apparatus and where calls originating from several points receive attention from one individual.

Designed for momentary operation only. The operating and reset mechanism are thoroughly reliable and will stand severe services.

The standard audible signal is a buzzer. Marked connectors are furnished for adding extension signals if desired. Complete with 100 name and number cards for the drops.

Standard finishes—mahogany, walnut or oak (specify finish desired.) Depth 2 5/8 in. for all sizes.

For 12 Volts A-C, 60 Cycles

No.	No. of Drops	Arrangement Across	Arrangement Down	Height in.	Width in.	App. Wt. Each, lbs.	Each
673/2	2	2	1	2 1/2	4	2 1/4	\$ 55.00
673/4	4	4	1	2 1/2	5	2 3/4	79.20
673/6	6	6	1	2 1/2	7	3 3/4	99.00
673/8	8	8	1	2 1/2	9	5	121.00

For each additional 6 drops add \$71.50.

Special finishes, features, etc., and complete installation data contact Graybar.

Edwards Surface Annunciators

No. 808 and 809 Industrial Annunciators



No. 808

When indication is caused, bell rings until "bell drop" is reset, but indicator can't be restored until source of trouble is corrected. Resetting bell drop still permits subsequent operation by another indicator. Standard features: Heavy steel case, black finish; bakelite insulation throughout; 115v. AC or DC (up to 250v., AC or DC on specification) 4 in. bell for separate mounting provided (6 in. for 250 v.); surface wall mounting case with screwed on front cover.

No. 808 cannot be operated in multiple with other devices though the No. 809 may be. Dimensions and drop arrangements on application. Also available; for flush mounting and with hinged front and back panels for accessibility for terminals or open back switch board mounting; closed circuit operation remote reset of audible and indicating coils.

No.	No. of Drops	Each
808 and *809	4	\$193.00
	6	242.00
	8	264.00
	10	308.00
	12	352.00
	Larger sizes, per drop, add	22.00

*Add \$4.50 per drop to price of No. 808.

Edwards Surface Annunciators

Electric Reset

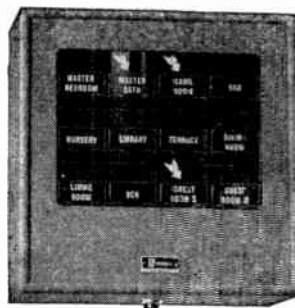

A high quality annunciator that will give outstanding service.

Uses the No. 4 drop for indicating and resetting.

The audible signal is a buzzer.

One reset button is furnished on case for each 16 drops—button will reset all 16 drops at one time.

Provision is made on each annunciator for common remote control resetting as well as extension signals.

Standard finish is light gray. Depth 3 in. on all sizes.

For 24 Volts, 60 Cyc. or 16 Volts D.C.

No.	No. of Drops	Arrangement Across	Arrangement Down	Height in.	Width in.	App. Wt. Each, lbs.	Each
403/4	4	2	2	6 1/8	5 1/8	3 3/4	\$ 47.50
403/8	8	4	2	6 1/8	8 1/8	5 1/2	69.50
403/12	12	4	3	8 1/8	8 1/8	7	91.50
403/16	16	6	3	8 1/8	11 1/8	8 1/4	121.00
403/20	20	5	4	10 1/4	9 5/8	10	160.50
403/24	24	6	4	10 1/4	11 1/8	12	181.50

For each additional 6 drops add \$60.50.

For special finishes, features, etc., and complete installation data contact Graybar.

Edwards Annunciator Drops

Note—When ordering drops for annunciators, give voltage, whether a-c or d-c (exact frequency if a-c., i.e., cycles, etc.). State whether annunciator requiring replacement drops has buzzer or extension signal and give catalog and serial number of annunciator.

No. 8—Manual Reset



An efficient drop used in all annunciator-drops. Its compact design gives a clear indication, but allows small, neat annunciators. Positive locking.

Approx. weight, ¼ lb.

No. 8 Each **\$7.70**

No. 80—Manual Reset



A heavy duty drop for high or low voltage as specified. It is used on Nos. 81 and 807 annunciators.

Its action is positive and the locking feature foolproof. Large indications are possible. Tag is 1 in. high, 1¼ in. wide.

No. 80 Each **\$8.50**

Add **\$4.50** for each set of contact clips.

No. 4—Electric Reset



Used in all electric reset annunciators. The indication is a white arrow which points directly at the name card. When reset the arrow drops out of sight behind the name card. The arrow can be seen from any angle. Has no springs or contacts and cannot shake or jar out of adjustment.

Locks in either position and cannot indicate until current is passed through magnets. Indication card is 1⅜x5⅝ in.

No. 4 Each **\$11.00**

Edwards Clock System Controls

Manual Dual-Motor Resetting Unit



For operating units of 80 clocks.

For use with multi-circuit program instruments without clocks as a power-interruption indicator.

Standard 115 volts, 60 cycles (can be supplied for other voltages and frequencies when specified. Contact Graybar for details.)

This unit consists of a special switch plate, with key type switches (to prevent tampering), power interruption pilot light and fits a 2-gang wall box with 2-gang cover, having a minimum depth of 2½ in. (Wall box not included with unit.) Switch plate is brushed nickel finish, marked to indicate switch positions. The power interruption pilot light, located to the left of the switches, is a red jewel and lights only when power is restored.

When power returns after an interruption, clocks automatically start again, but are slow to the extent of the interruption, and the pilot light continues to show red. To return clocks to the correct time it is only necessary to throw the reset switch to "advance" position with the key provided. This causes all clocks to operate at an accelerated rate. When all clocks are again on correct time, the advance switch is thrown to normal position, the pilot light is set to normal and the system continues to keep time.

Approx. shipping weight 2 lbs.

No. 1900A Each **\$40.00**

Edwards Centrally-Controlled Program Clock System

These systems are designed to meet the rigorous standards set by modern timing requirements.

They are built around the famous dual-motored Telechron movement, and eliminate contacts, rectifier, master clock, relays and pendulum. The motor is bi-polar, self-starting and synchronous, with the motor for accelerated resetting geared directly to the shaft on which the clock hands revolve.

Of the two motors, one is for normal time-keeping and the other for accelerated resetting. The time-keeping motor has the advantage of uniform torque from standstill to synchronous speed, is virtually noiseless in operation and instantaneous in starting and stopping, which minimizes scattering of clocks upon power stoppage.

These clock systems are in perfect synchronization with the incoming alternating current—there is no central control clock to be serviced or regulated.

All program instruments, clocks and signals described are listed by the Underwriters' Laboratories and are designed for operation on 115 volt, 60 cycle alternating current. (When so specified, units will be specially wound to operate on other voltages and frequencies.)

All devices are unqualifiedly guaranteed for perfection in material and workmanship.

The clock systems described have unlimited installation range. They will give dependable and faithful service in schools, colleges, hospitals, institutions, offices, industrial plants, stores, apartments and residences.

The systems described are clock and program systems. There is no economy in trying to make one system do the work of three instead of doing one job well. For example, program bells are not designed to call teachers to the phone or warn of fire.

Audible Signals

They include bells of excellent tone quality for use in corridors, playrooms, vocational rooms, etc.

Classroom buzzers may be housed in the clock outlet box or mounted separate from the clock.

Chimes for classrooms have a more penetrating tone than a bell without objectional shrillness.

There are also horns for outdoor use where a bell is not desirable.

Edwards Multiple Circuit Program Instruments

Four-Circuit Type

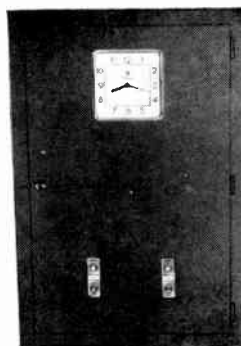

For automatically controlling the operation of signals according to predetermined schedules. Can be installed as individual units or as parts of an Edwards centrally-controlled clock system.

Particularly suitable for large schools, institutions or industrial plants where classes or shifts are on different schedules.

Standard 115 volts, 60 cycles.

The program element consists of two perforated metal cylinders mounted vertically and revolving about their respective vertical axes.

By inserting metal pins (provided with each instrument) into proper holes in each of the two cylinders, signals may be operated at one minute intervals, 24 hours per day, seven days per week.

The timing unit is a dual Telechron motored movement geared to the program instrument. The timing unit also controls the operation of contacts which close every minute for a period of 2 to 6 seconds, thus controlling signal duration through a relay having 6 ampere contacts at 115 volts a-c.

Size — 31½ in. high, 16 in. wide, 7 in. deep.

No. 1834 Each **\$666.00**

Edwards Signal Control Boards

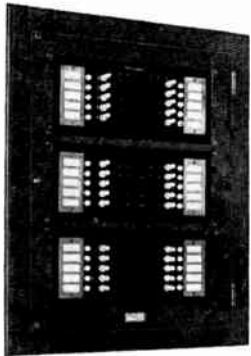

For use in schools having multiple circuit program instrument to transfer any room from one schedule or program to another. Has as many vertical conductor bars as there are program instrument circuits and as many connecting horizontal bars as there are signals. Push buttons are furnished to manually sound signals in any room.

Standard 115 volts, 60 cycles. Available for four circuit program systems in 20, 30 or 40 buttons; for six circuit systems from 40 to 120 buttons in multiples of 10 buttons. (Specify exact number of buttons.) For flush mounting unless otherwise specified.

No. 1940—Four-circuit, 20 buttons..... **\$175.00**
 Add for each additional 10 buttons..... **75.00**

Edwards Electric Clocks

Indoor Flush Wall Type

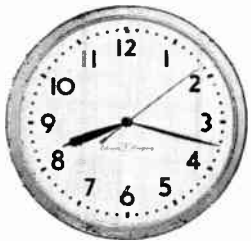

Satin aluminum finish metal case. Graceful hands, red sweep second hand.

Clear white dial, convex crystal glass and black arabic numerals for easy visibility from a distance.

Powered by Telechron synchronous, noiseless dual-motored movement. (For use with No. 1900A Manual reset or No. 1902A automatic reset control units.)

Hanger on back engages with special galvanized steel wall box and assures snug mounting to wall.

Wall box of ample size to accommodate clock movement and connecting wires. Also provides for mounting a program buzzer when desired. Wall box 7 5/8 in. high, 4 1/8 in. wide, 4 in. deep.

Dial 12 in. diameter. Outside diameter 13 1/4 in. Projects 1 1/4 in. from wall.

Approximate shipping weight 9 lbs.

*No. Each
1962—For 115 volts, 60 cycles A-C..... **\$40.00**



Indoor Surface Type

This clock is of the same general construction as the No. 1962 except for surface mounting.

Complete with concealed hanger with special wall fitting for "solid" mounting on wall over standard outlet box cover.

For concealed conduit only. (For new installation where a new

box is required use 4x4x1 1/2 in. deep box with 3/4 in. plaster cover.)

Dial 12 in. diameter. Outside diameter 14 3/8 in. Projects 3 3/16 in. from wall.

Approximate shipping weight 9 lbs.

*No. Each
1972—For 115 volts, 60 cycles A-C..... **\$40.00**

Edwards Electric Clocks

Indoor Suspended Type—Double Face



Designed especially for wall or ceiling mounting in corridors or places where it is desirable to have time visible from opposite directions.

The unit consists of two round surface type clocks (No. 1972 see above) mounted by standard hangers to a center suspension unit, which attaches directly to a special flush outlet box (1 1/4 x 1 1/4 x 2 1/2 in.) by a concealed bolt which is furnished with clock. Where lighting fixtures extend from ceiling, side wall mounting clocks are recommended.

Dials 12 in. diameter. Outside diameter 14 5/8 in.; Depth 8 in.; Height 17 5/16 in.

Approximate shipping weight 25 lbs.

*No. Each
1978—For 115 volts, 60 cycles A-C..... **\$132.00**

*For voltages and/or cycles other than 24V. 60 cycle or 115V. 60 cycle add **\$20.00**

General Electric Telechron Commercial Electric Clocks

Handsomely styled for offices, schools, stores and professional use. Has sturdy plastic case, black numerals and hands with red sweep second hand.

The Synchro-Scaled General Electric-Telechron motor in these electric clocks has an oil supply sealed against dirt. It is synchronized with local power plant master clocks and will give accurate, dependable time.

Available in rich brown or gleaming chrome color.

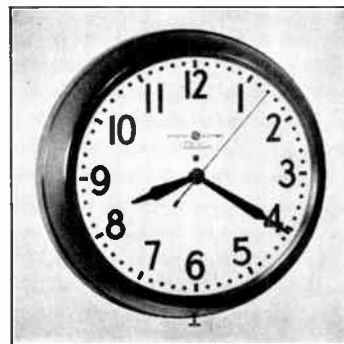

No.	Case	Dial, In.	Depth, In.	Diam., In.	Each
1H1608	Brown	8	3	11	\$11.95
1H1608-C	Chrome	8	3	11	13.95
1H1612	Brown	12	3 1/8	14 1/2	13.95
1H1612-C	Chrome	12	3 1/8	14 1/2	15.95
1H1615	Brown	15	3 1/4	17	19.95

Faraday Synchronous Electric Clocks

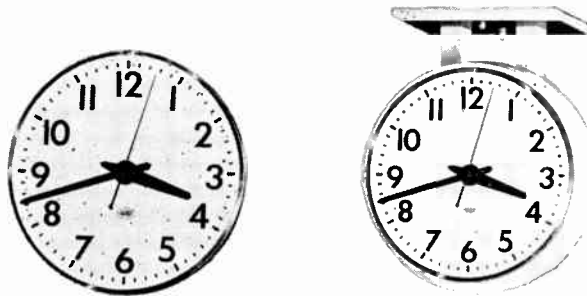

No. 6011

No. 6032

**120 Volts, 60 Cycles A-C
Flush Clocks**

Polished Aluminum Rim—White Dial, Black Numerals
Black Minute and Hour Hand, Red Sweep Second Hand

No.	Size, In.	Backbox	Shp. Wt., Lb.	Each
6011	8	With	4 $\frac{1}{4}$	\$23.75
6012	10	With	6 $\frac{1}{2}$	25.75
6013	12	With	7	28.50
6014	15	With	8	39.50

Surface Clocks

Hammertone Gray Enamel Case—Bezel Polished Aluminum
White Enamel Dial with Clear-Cut Black Numerals

No.	Size, In.	Without	Shp. Wt., Lb.	Each
6022	10	Without	4 $\frac{1}{2}$	\$25.75
6023	12	Without	5	28.50
6024	15	Without	6	39.50

Double Dial Clocks

White Enamel Dial, Black Numerals—Black Minute and Hour
Hands—Red Sweep Second Hand—Bezel Polished Aluminum
Gray Hammertone Enamel Case and Bracket

No.	Size, In.	Mounting	Shp. Wt., Lbs.	Each
6032	10	Side	12	\$105.00
6033	12	Side	13 $\frac{1}{2}$	110.00
6034	15	Side	16	131.00
6042	10	Ceiling	12	105.00
6043	12	Ceiling	13 $\frac{1}{2}$	110.00
6044	15	Ceiling	16	131.00

Faraday Synchronous Clocks

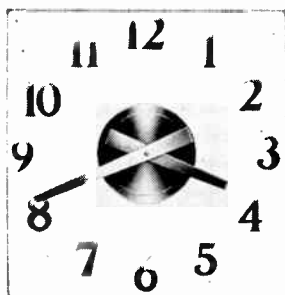

No. 6064-A

Skeleton Clocks

Modern design. Operated by a high quality synchronous motor, slow speed (150 rpm). Supplied with back box designed for easy installation.

Standard clocks available with hands, center plate and markers in satin or polished bronze or aluminum. Please specify.

No mounting rings.

120 Volts, 60 Cycles A-C

No.	Size, In.	Description	Design and Finish	Appr. Shp. Wt., Lbs.	Each
6064	16	Modern Marker	Standard	7 $\frac{1}{2}$	\$220.00
6064-A	16	Arabic Numerals	Standard	7 $\frac{1}{2}$	220.00
6066	24	Modern Marker	Standard	11 $\frac{1}{2}$	275.00
6066-A	24	Arabic Numerals	Standard	11 $\frac{1}{2}$	275.00

Edwards Flushcall Signaling Devices

Modernized signaling and calling devices for replacement of old-type bells, buzzers, transformers and pushes in residences, apartment houses, etc.

Each device fits standard gang boxes and takes standard switch or receptacle plates. Can be ganged together with 115 volt receptacles, etc., in standard box and finished with standard plates.

All are designed for a-c operation only, with absolutely no adjustment at any time.

Construction Details — Mechanism completely insulated from frame. Rust-resisting metals or finish throughout. Frame and louver front plate completely surround and protect gong and mechanism from wires in box. Large, accessible binding posts. Inclined construction of frame and shallow design leaves ample space for lock nuts and wires.



No. 660



No. 661



No. 664

All devices operate on 60 cycles. No extra charge for 25 cycles if specified.

The Ringcall

For replacing old-style small door bells. Has a pleasing tone and great carrying power.

No.	Schedule	A-C Volts	Std. Pkg.	Appr. Wt. Std. Pkg.	Each
660	S	8-10	6	2	\$2.09
760	S	24	3	3 $\frac{3}{4}$	2.59

The Buzacall

For replacing old-style buzzers. Has good tone and more carrying power.

No.	Schedule	A-C Volts	Std. Pkg.	Appr. Wt. Std. Pkg.	Each
661	S	8-10	6	1 $\frac{1}{4}$	\$2.04
761	S	24	3	1 $\frac{1}{2}$	2.48

The Melocall

Sounds a soft, mellow, momentary "ding" — an entirely different "third" call that is not annoying.

No.	Schedule	A-C Volts	Std. Pkg.	Appr. Wt. Std. Pkg.	Each
663	S	8-10	3	1 $\frac{1}{4}$	\$2.86
763	S	24	3	3 $\frac{3}{4}$	3.30

The Togelpush

Generally used to operate door openers.

No.	Schedule	A-C Volts	Std. Pkg.	Appr. Wt. Std. Pkg.	Each
664	S	Low	6	1 $\frac{1}{2}$	\$.57

The Tucall

A distinct improvement from the old-style combination surface-type bell and buzzer. Both signals are combined in a single unit occupying only one gang.

No.	Schedule	A-C Volts	Std. Pkg.	Appr. Wt. Std. Pkg.	Each
662	S	8-10	6	1 $\frac{1}{2}$	\$3.30
762	C	24	3	1	3.30

The Powacall

Listed by Underwriters' Laboratories, Inc.

Fits most standard boxes, or outlet boxes with cover 2 $\frac{3}{8}$ in. deep if placed in second gang of any combination, taking 115 volts from same line as receptacle, switch, etc., in first gang. Binding posts for easy installation.

No.	Schedule	A-C Volts	Std. Pkg.	Appr. Wt. Std. Pkg.	Each
666	S	10V-5W	3	3	\$4.13

Edwards Audible Signals

Classroom Chimes



Have a pleasant musical note, very penetrating but not objectionable. Two-note sequence. A simple neutral design to harmonize with the interior of the classroom. Grey finish.

Surface Type

Operates on 115 volts, 60 cycles.
 Size—5 in. wide, 7¼ in. high, 2¼ in. deep.
 Approx. shipping weight 2½ lbs.

No. 1984.....Each **\$12.00**

Note—Classroom chimes can also be furnished in flush type.

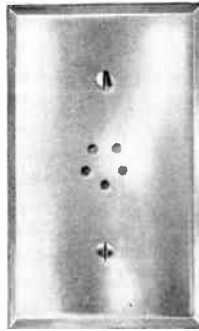

Classroom Buzzers

Can be housed in the clock outlet box—takes no room or wall space, saves an additional outlet. If desirable to mount away from the clock a single gang box for flush mounting, or Wiremold fitting for surface use.

Plate is not supplied.

Operates on 115 volts, 60 cycles.

Approx. shipping weight ¾ lb.

No. 1983.....Each **\$6.00**

Note—Contact Graybar for special voltages and frequencies.

Edwards Hospital Signaling Systems and Equipment

A dependable signaling system is an absolute necessity in every modern hospital.

Nurses' Calling System

May be either one of the following two types:

Locking-Button Type—in which the locking push button contains all the mechanism to actuate the audible and visible signals and to reset them when call has been answered, is suspended from a flexible neoprene-covered cord.

Pull-Cord-Switch Type—consists of a special toggle-type switch installed in the wall and operated by a pull cord. It is for use in those hospitals where low initial cost is the deciding factor. As the operation of the pull-cord switch requires more effort on the part of the patient, it is sometimes not favored.

Psychopathic Alarm Systems

A tamper-proof system that the deranged patient cannot operate. By means of a switch outside the corridor the attendants can make the calling station in each room operative before they enter the room. Then, in the event of an unruly patient, assistance can be called for.

Doctors' Paging System

As the services of the permanent staff and of visiting physicians are in constant demand in all hospitals, it is important that a doctor be reached as soon as possible. When visiting in a hospital, the doctor may have several patients requiring his attention, during which time a demand for his services may arise elsewhere.

These paging systems meet such conditions, as it permits calling three doctors to be paged at one time on any number of annunciators without disturbing the patients.

Doctors' In and Out Systems

In both large and small hospitals where the visiting doctors are likely to arrive at any hour of the day or night, it is important to know when a certain doctor is in or out of the building. This is accomplished with an electrical reset annunciator, with the required number of indications, located in view of the telephone operator. In the main entrance or doctors' cloak room is located a similar annunciator with switches. The doctor, by throwing the switch opposite his name lights the indicator showing his name on both annunciators. Throwing the switch in the opposite direction extinguishes the lights opposite his name in both instruments.

Ambulance and Entrance Signaling System

This is chiefly a push button located at doors leading out of the building and a lamp-annunciator having a lamp signal for each location, with buzzer as an audible signal. Very useful for night service.

Nurses' Home-Calling Systems

Provides communication between office and nurses' and attendants' rooms at their homes.

Two types of systems can be used, viz:

Return-Call Annunciator Type.

Intercommunicating Telephone Type.

A combination buzzer and push-button station is provided with the return-call annunciator system in the nurses' and attendants' rooms, and a combination annunciator and push button is installed at building office. This system permits the office to call the nurse and the nurse may answer the call by operating the corresponding push button.

Room stations can be provided with indicating drops which in a nurse's absence remain visible until reset, indicating that a call has been made.

In the intercommunicating telephone system a combination annunciator and push button board is provided with an operator's telephone and the room stations are replaced by telephones. Room telephones can be provided with indicating drops for the same purpose as stated above.

Hospital signaling equipment is approved by the War Department for Army Hospitals, Bureau of Yards and Docks of Navy Hospitals, and Department of Interior for Indian Hospitals.

Engineering Advice

We will gladly cooperate with architects, engineers, hospital superintendents, etc., in charge of operation to lay out systems and make recommendations.

There is no charge for this service. For information, contact Graybar.

Faraday Conventional and Uni-Pact Bells and Chimes

Listed by Underwriters' Laboratories, Inc.

All Uni-Pact units are furnished with the same size and type, easy-to-install adapter plate so that the various signaling units may be interchanged quickly and easily without rewiring.

The adapter plate mounting fits any standard 4 in. square or octagon outlet box, conduit or Wiremold fitting.

All connections are made to the adapter plate and the electrical installation and testing can be completed before painting building.



**Bells
Heavy Duty—Underdome
Type**

Compact signals, with loud, clear tones necessary for good signaling. Heavy duty solenoid plunger type mechanism. Hardened alloy steel gong, parkerized finish. Hammertone gray enamel frame (Red enamel can be furnished if specified).

One in standard package. Approximate shipping weight: 4-in., 2 lbs.; 6-in., 5 lbs.; 10-in., 10 lbs.

For A-C, 60 Cycles		
24 Volts		
Size Gong, In.	No. 2000 Vibrating Each	No. 2005 Single Stroke Each
4	\$22.00	\$22.00
6	31.00	31.00
10	41.00	41.00
115 Volts		
4	27.00	27.50
6	37.00	37.00
10	44.00	44.00
Other Voltages to 230		
4	\$33.00	\$33.00
6	41.00	41.00
10	55.00	55.00
For Series Operation		
4	\$27.50	\$27.50
6	37.00	37.00
10	44.00	44.00

For D-C		
9 Volts (No 4-In. Size)		
Size Gong, In.	No. 2020 Vibrating Each	No. 2010 Single Stroke Each
6	\$31.00	\$31.00
10	41.00	41.00
24 Volts		
6	\$33.00	\$31.00
10	41.00	41.00
115 Volts		
6	\$37.00	\$37.00
10	44.00	44.00
Other Voltages to 250		
6	\$41.00	\$41.00
10	55.00	55.00

Uni-Pact Chimes

Produce a clear tone that is pleasing and effective.

Heavy duty solenoid plunger type mechanism, with close-fitting cover.

Housing is hammertone gray enamel finish. Chime bar and resonator polished chromium finish. (Red enamel housing can be furnished if specified).

With Uni-Pact adapter mounting plate. Plate 6½-in. diameter. Height 8¾-in. Depth, 3-in.

One in a standard package. Approx. shipping weight 4½ lbs.

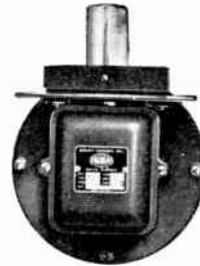

Nos.	For	24 Each	115 Each	Voltage Up to 230 Each	Up to 250 Each	Series Operation Each
228	A-C	\$29.00	\$33.00	\$37.00		\$33.00
208	D-C	29.00	33.00		\$37.00	33.00

Conventional Chimes

These chimes are the same as the Uni-Pact except that the heavy cast housing is designed for wall mounting with connection to ½-in. conduit, or for mounting to an outlet box when used with the hanger plate which is furnished at no extra cost if specified.

Housing is hammertone gray finish. Chime and resonator, polished chromium finish. (Red enamel housing can be furnished if specified).

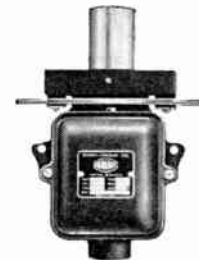

Frame 6-in. wide. Height 8-in. Depth 2½-in. One in a standard package. Approx. shipping weight, 3 lbs.

Nos.	For	24 Each	115 Each	Voltage Up to 230 Each	Up to 250 Each	Series Operation Each
227	A-C	\$29.00	\$33.00	\$37.00		\$33.00
207	D-C	29.00	33.00		\$37.00	33.00

Vibrating Bells

Heavy Duty—Neck Type

These bells have a full clear tone.

Designed for wall mounting, with connection to ½-in. conduit or to an outlet box when used with hanger plate which is furnished at no extra cost.

Heavy cast frame with close-fitting cover. Heavy duty solenoid plunger type mechanism. (Only d-c mechanism has contacts). Hardened steel gong, Parkerized finish. Frame hammertone gray enamel finish. (Red enamel finish furnished if specified).

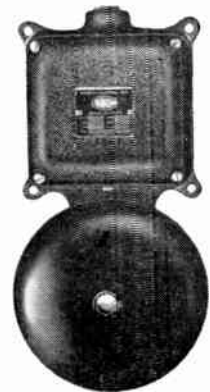

One in a standard package. Approx. shipping weight: 4-in., 2¾ lbs.; 6-in., 5 lbs.; 10-in., 9½ lbs.

No. ATL-700—For A-C				
Gong Size, In.	24 Volts Each	115 Volts Each	Other Voltages Up to 230 Each	Series Operation Each
4	\$21.00	\$26.25	\$31.50	\$26.25
6	29.90	35.15	40.50	35.15
10	39.35	42.00	52.00	42.00

No. 164—For D-C				
Gong Size, In.	9 Volts Each	24 Volts Each	115 Volts Each	Other Voltages Up to 250 Each
4	\$22.00	\$22.00	\$27.50	\$33.00
6	31.50	33.00	37.00	42.50
10	41.00	41.00	44.00	55.00

"A" Bells

Heavy Duty—Vibrating Armature

A rugged, heavy duty unit, with a two-coil vibrating armature type mechanism, coil silver contacts and heavy magnet coils. Heavy cast frame and cover with hardened alloy steel gong.

Hammertone gray enamel finish frame. Parkerized gong.

For wall or outlet box mounting. Hanger plate furnished at no extra cost when specified.



One in a standard package. Approx. shipping weight: 4-in., 5 lbs.; 6-in., 9 lbs.; 10-in., 15 lbs.

No. A—For D-C Operation Only				
Gong Size, In.	9 Volts Each	24 Volts Each	115 Volts Each	250 Volts Each
4	\$22.00	\$25.00	\$27.00	\$33.00
6	31.00	33.00	37.00	41.00
10	41.00	41.00	44.00	55.00

Edwards Industrial Chimes

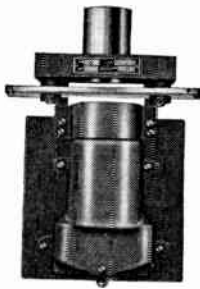

Recommended for executives' calls in department stores, for fire alarm signals in hospitals, or wherever a pleasing but penetrating gong tone is desired.

Complete with special plate for mounting on wall, on 4-in. square box, on standard switch box or on outlet with switch cover, 3 1/4-in. octagon box, or single gang.

Standard voltage — 24 volts, 60 cycles a-c and 24 volts d-c. Can be supplied for a-c and d-c in voltages up to 250 volts.

Approx. shipping weight 4 3/4 lbs.

No.	Description	Each
18	24V. D.C. or 60 Cycles	\$29.00
18	115V. D.C. or 60 Cycles	33.00
18	Other Voltages to 250 Volts	37.00

Edwards Return Call Stations

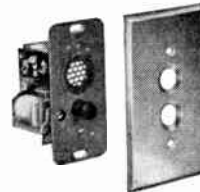

No. 139

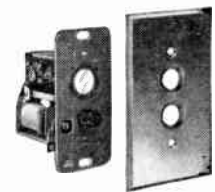

No. 140

Answercalls

Will fit any standard single gang switch box 2 3/8-in. deep and requires any standard push button switch plate (switch box and switch plate not included).

No. 139—Buzzer audible signal has no contacts or pivots and requires no adjustment. Standard 24 volts, 60 cycles. Can be supplied for voltages up to 48 volts a-c if specified.

No. 140—Recommended where it is desirable to leave indication of call to room during occupant's absence. Has annunciette type drop for visual signal. Operation of push button, when call is answered, automatically resets drop. Standard 24 volts, 60 cycles a-c.

Approximate weight, 1 lb.

No.	Description	Each
139	Flush Non-indicating	\$ 9.00
140	Flush Indicating	18.00

These stations are completely wired for installation and include a No. 255 return call push. For operation with any Edwards Return Call Annunciator.

Standard 24 volts, 60 cycles. Minimum voltage—8 volts d-c or 12 volts a-c. Other a-c or d-c voltages up to 48 volts can be furnished when specified.

Edwards Door Chimes

3-Signal Vibrechord Chimes

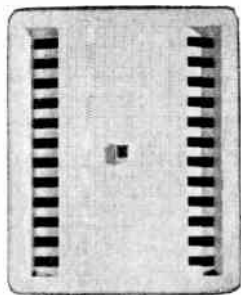

No. C-32

**Hideaway
No. C-32**

Recessed chime idea for new homes. 2 in. deep, 8 in. high, 6 3/4 in. wide (wall box 1/2 in. less). Vibrechord, two note and one note.

No. C-32 White grille..... Each \$9.95



No. C-28

**Bolero III
No. C-28**

Features one note, two note and Vibrechord calls with removable center section for decorative use. 4 3/4 in. wide, 7 1/2 in. high.

No. C-28 Ivory and brass Each \$8.95

Minuet

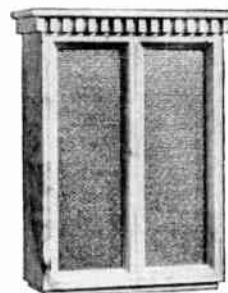

No. C-22

Bolero

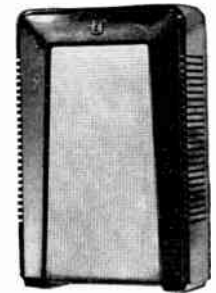

No. C-21

These chimes offer unique Vibrechord plus two note calls. Minuet is 5 3/8 in. x 7 3/8 in. Bolero is 4 3/4 in. x 7 1/2 in.

No.	Description	Each
C-22	White marble	\$8.95
C-23	Mahogany	8.95
C-21	Ebony, brass	7.95
C-20	White, chrome	7.95

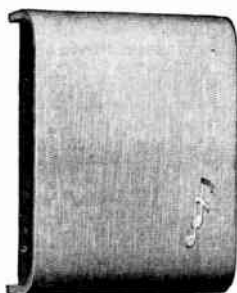

No. C-25

**Sylvan
No. C-25 and C-26**

3-signal chime in natural-grain limed oak or frosted walnut case. Gold finished side grilles. 2 1/2 in. deep, 7 1/2 in. high, 5 1/2 in. wide. One note, two note and Vibrechord.

No.	Description	Each
C-25	Limed oak	\$11.95
C-26	Frosted walnut	11.95

Edwards Door Chimes

Designed by Francesco Collura, these chimes offer the most pleasing, joyful call of any door chime. Precision tested by the exacting sonoscope to eliminate any discordant note. Easy to mount with a screwdriver.

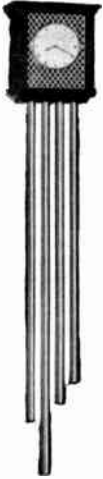

No. C-62

Canterbury

Eight note Westminster chime melody plus one and two note signals. Gold highlighted mahogany case with imported clock face and accurate Telechron movement. 11 3/8 in. wide, 6 in. deep, over-all length 62 1/2 in.

No. C-62 with transformer. . . . Each \$89.95



No. C-60

No. C-50, C-51 Claridge

No. C-60, C-61 Clarendon

Walnut or limed oak cabinets. Eight note Westminster melody, two note and single note. 10 1/4 in. wide, 5 1/2 in. deep, over-all length 57 1/2 in. Transformer included.

Claridge (Without Clock)

No.	Description	Each
C-50	Walnut	\$49.95
C-51	Limed Oak	49.95

Clarendon (With Clock)

No.	Description	Each
C-60	Walnut	\$79.95
C-61	Limed Oak	79.95

Brass tubes . . . at low cost! 44 in. long. Two note and single note. Two tube models in white or ebony cases (both with gold). Three tube model has limed oak case.

**Montclair
C-44 and C-45**

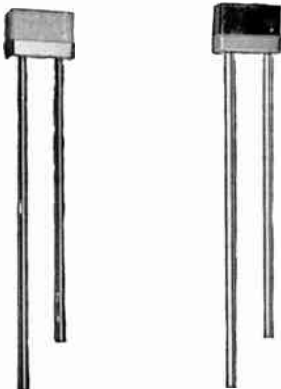

No. C-44

No. C-45

**Sherwood
C-47**



No. C-47

No.	Description	Each
C-44	Oyster white & gold, 7 5/8 in. wide, 2 5/8 in. deep.	\$10.95
C-45	Gold-flecked ebony & gold, 7 5/8 in. wide, 2 5/8 in. deep.	10.95
C-47	Limed oak, 7 1/2 in. wide, 2 1/2 in. deep.	16.95

Edwards Door Chimes

Mechanical Chimes



No. C-101
Twist, Brass

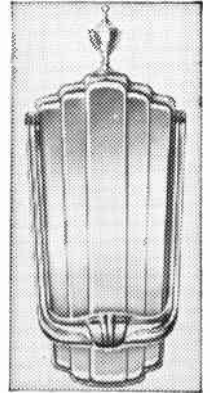

No. C-105

Low cost, easy to install. No wires. Drill 5/8 in. hole in door or frame to mount. Order extension shaft for doors thicker than 2 1/8 in. Two notes.

No.	Description	Each
C-101	Twist, Brass	\$4.95
C-102	Twist, Chrome	4.95
C-105	Fairfax, Brass	7.75
1600L	Extension shaft	1.00

Nutone Non-Electric 2 Note Chimes

Need No Wiring

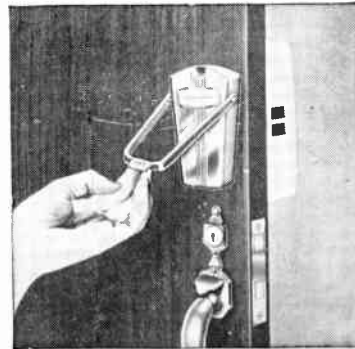

No. DK-308. Each \$8.45

Caroleer

“Door Knocker Chime”—gold anodized nameplate outside. Inside cover is oyster white, or walnut finish.

Adjustable, fits metal or wood doors 7/8-in. to 2 1/4-in. (For doors thicker or for installation in walls, up to 9-in. ask for shaft extension EX-310).

Packed 6 of 1 color to carton. Ship. wt. 11 lbs.

Greeter

Solid brass nameplate outside, oyster white or walnut finish cover on inside.

Adjustable, fits metal or wood doors, 7/8-in. to 2 1/4-in. (For doors thicker or for installation in walls, up to 9-in. ask for shaft extension EX-310).

Packed 6 of 1 color to carton. Ship. wt. 8 lbs.

No. MC-302. Each \$4.95

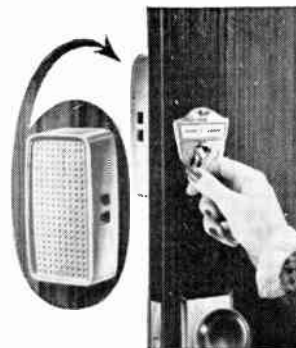

**Nutone Door Chimes
"Built-In"**



"Built-In" chime with cover flush against wall. May be painted to match walls.

Has 2 notes for front door, 1 note for rear door.

Cover finished in ivory.

Dimensions: 5 5/8-in. x 7 3/16-in. x 1 3/4-in. deep. Cut out measures 4 1/2-in. x 6 1/8-in.

Packed 6 to carton. Ship. wt. 16 lbs.

No. L-14..... Each **\$5.95**

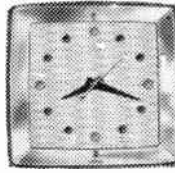

Chime and clock. Smart colorful dots for numerals, sweep second hand. Operates on 16 v. Flush Bezel finished in silver anodized aluminum and white grille, copper or gold anodized and ivory grille. Has 2 notes for front door, 1 note for rear.

Dimensions: 8-in. sq. x 2-in. deep. Fits 6 3/4-in. sq. cut out. Packed 3 to carton. Ship. wt. 12 lbs.

No. L-35..... Each **\$19.95**

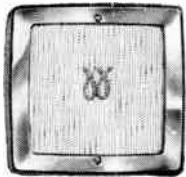

"Built-In" chime finished in silver anodized and white, or gold anodized and ivory.

Has 2 notes for front door, 1 note for rear door.

Dimensions: 8-in. sq. x 2-in. deep. Cut out measures 6 3/4-in. sq.

Packed 6 of 1 color to carton. Ship. wt. 19 lbs.

No. L-15..... Each **\$9.95**

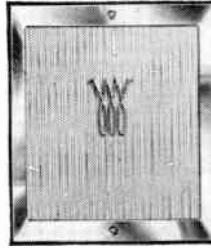

"Built-In" chime flush Bezel finished in gold anodized and ivory grille.

Has 8 or 4 notes for front door, 2 notes for rear door, 1 note for third door.

Dimensions: 9 1/8-in. x 11-in. x 2-in. deep. Fits 7 3/4-in. x 10-in. cut out.

Transformer included. Packed 3 to carton. Ship. wt. 19 lbs.

No. L-50..... Each **\$29.95**

Long Tube and 8 or 4 Note Westminster Chimes

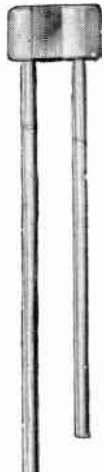

"Regal"
No. L-26



"Coronet"
No. L-33

Regal

Desert sand finish cover with fluted gold center. Satin brass tubes. Has 2 notes front door, 1 note rear door.

Dimensions: 2 7/8-in. x 7 1/2-in. x 39 1/4-in.

Packed 6 to carton. Ship. wt. 29 lbs.

No. L-26..... Each **\$10.95**



"Supreme"
No. L-42

Walnut or lime oak finish cover, 3 satin brass tubes. Has 2 notes for front door, 1 note for rear door.

Dimensions: 8 1/2-in. x 2 7/8-in. x 39 3/4-in.

Packed 6 of 1 color to carton. Ship. wt. 38 lbs.

No. L-33..... Each **\$16.95**

Patent pending.

Supreme

Westminster chimes, 8 or 4 notes front door, 2 notes rear door, 1 note third door. Operates on motor selector switch.

Lime oak or ebony cover, 4 long brass tubes.

Transformer included. Dimensions: 10-in. x 5-in. x 48 1/2-in.

Packed singly. Ship. wt. 11 lbs.

No. L-42..... Each **\$49.95**

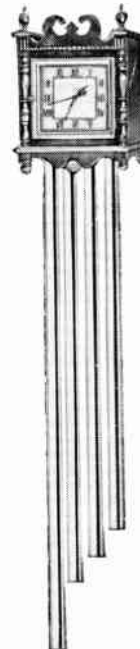

"Jefferson"
No. L-46

Jefferson

Westminster chimes and colonial wall clock. Mahogany cabinet, 4 brass tubes. Has 8 or 4 note chime front door, 2 notes rear door, 1 note third door.

Transformer included. Dimensions: 11-in. x 6-in. x 58-in.

Packed singly. Ship. wt. 16 1/2 lbs.

No. L-46..... Each **\$89.95**



"Century"
No. L-47

Century

Westminster chimes and wall clock. Lime oak or ebony finish with satin brass tubes.

Has 8 or 4 note chime front door, 2 notes rear door, 1 note third door.

Transformer included. Dimensions: 10-in. x 5-in. x 52 3/4-in.

Packed singly. Ship. wt. 13 lbs.

No. L-47..... Each **\$79.95**

Nutone Door Chimes

These door chimes are styled to harmonize artistically, yet unobtrusively, with the new "crisp look" of contemporary decor.

The tones produced are soft and melodious, yet can be heard throughout the house. Absolute pitch is guaranteed on all models.

Champion



Plastic cover finished in white and silver, or ivory and gold. Has 2 notes for front door, 1 note for rear door.

Dimensions: 7½-in. long, 4⅝-in. wide, 2-in. deep.

Packed 12 of 1 color to carton. Ship. wt. 15 lbs.

No. L-12.....Each \$4.95

Patent pending.

Harmony

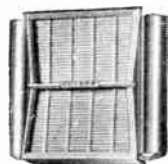

Plastic cover finished in ivory and gold, or white and silver. Has 2 notes for front door, 1 note for rear door.

Dimensions: 7-in. long, 7⅛-in. wide, 2¾-in. deep.

Packed 6 of 1 color to carton. Ship. wt. 15 lbs.

No. L-16.....Each \$7.95

Patent pending.

Victory

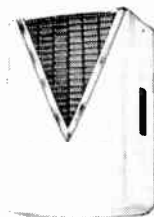

Finished in copper enamel and black. Has 2 notes for front door, 1 note for rear door.

Dimensions: 7-in. high, 4½-in. wide, 2-in. deep.

Packed 6 to carton. Ship. wt. 9 lbs.

No. L-17.....Each \$5.95

Mt. Vernon

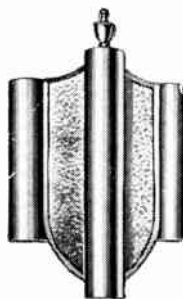

Graceful colonial design, finished in hammered brass. Has 2 notes for front door, 1 note for rear door.

Dimensions: 11¾-in. high, 7-in. wide.

Packed 6 to carton. Ship. wt. 20 lbs.

No. L-20.....Each \$11.95

Mayfair



Modified tube model. Cover finished in walnut or lime oak, with goldtone tubes. Has 2 notes for front door, 1 note for rear door.

Dimensions: 11⅝-in. high, 7⅞-in. wide, 3-in. deep.

Packed 6 of 1 color to carton. Ship. wt. 16 lbs., 4 oz.

No. L-23.....Each \$8.95

Patent pending.

Premiere

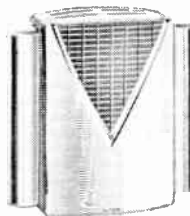

Cover attractively finished in the popular black and brass combination. Has 2 notes for front door, 1 note for rear door.

Dimensions: 7-in. x 8-in. x 2¼-in. deep.

Packed 6 to carton. Ship. wt. 17 lbs.

No. L-19.....Each \$9.95

Jewel



Cover finished in walnut or lime oak, with goldtone tube on each side. Has 2 notes for front door, 1 note for rear door.

Dimensions: 7-in x 9-in. x 3-in. deep.

Packed 6 of 1 color to carton. Ship. wt. 23 lbs.

No. L-22.....Each \$11.95

Repeat-A-Matic

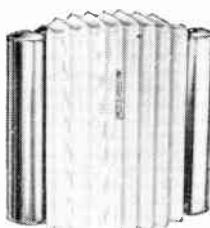

Three door chime. Has repeating chime for front door, 2 notes for rear door, 1 note for third door.

Finished in ivory and gold, or white and silver.

Dimensions: 7-in. x 7¾-in. x 2½-in. deep.

Packed 6 of 1 color to carton. Ship. wt. 15 lbs., 8 oz.

No. L-18.....each \$8.95

**The New "Chord Tone" Chimes
Desert Sand**

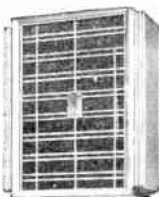

Provides two chords for front door, 2 notes for rear door.

Desert sand cover. Smart grille pattern. Gold flecked grille cloth.

Dimensions: 7⅞-in. x 9-in. x 2⅞-in. deep.

Packed 6 to carton. Ship. wt. 23 lbs.

No. L-30.....Each \$12.95

Patent pending.

Symphonic



Provides 8 or 4 chord tone chimes, plus 2 chords for rear door, 1 chord for third door.

Cover finished in walnut or lime oak with brass tubes and trim.

Transformer included.

Dimensions: 8-in. x 14-in. x 3¼-in. deep.

Packed 3 to carton. Ship. wt. 24 lbs.

No. L-41.....Each \$36.95

Nutone Pushbuttons



No. PB-1 Round



No. BP-2 Mt. Vernon



No. PB-3 Modern



No. PB-4 Jewel

No.	Description	Size, In.	Each
PB-1	Gold or Silver Anodized	3/4-in. diam.	\$0.44
PB-2	Gold Anodized	3 1/4 x 1 1/2	1.25
PB-3	Silver Anodized and Black	3 x 7/8	1.25
PB-4	Gold Anodized	3 x 1 3/8	1.25



No. PB-5 Concord



No. BP-6 Economy



No. PB-7 Aristocrat



No. PB-11 Pacesetter

No.	Description	Size, In.	Each
PB-5	Solid Brass	5 x 2	\$3.25
PB-6	Gold or Silver Anodized	2 1/2 x 1 3/8	1.25
PB-7	Gold Anodized	2 1/8 x 3/4	1.00
PB-11	Gold Anodized	2 1/16 x 3/4	.54



No. PB-12 Project



No. PB-14 Classic



No. PB-15 Kimberly



No. PB-16 Windsor

No.	Description	Size, In.	Each
PB-12	Walnut and Ivory	2 1/16 x 3/4	\$0.33
PB-14	Gold Anodized	1 7/8 x 1 7/8	1.25
PB-15	Bronze	1 1/16 sq.	1.25
PB-16	Antique Hammered Finish	3 7/8 x 1 3/8	1.50

Electrically Lighted Pushbuttons



PB-8, PB-9



PB-10

No.	Description	Size, In.	Each
PB-8	Gold. For all 16 v. chime circuits including Westminster chimes.	3 x 1 1/2	\$2.50
PB-9	Gold. For 24 v. chime circuits only.	3 x 1 1/2	2.50
PB-10	Gold or Silver and Black. For all 16 v. chime circuits including Westminster chimes.	2 5/8 x 3/8	1.50

Nutone Transformers

10 Volt



For bells or buzzers, and powerful enough for chimes in small homes. Mounts any place. Mounting feet for open wiring. Fits any 7/8-in. "knockout." Packed 48 to carton. Ship. wt. 33 lbs.

No.	Output: Watts	Each
Single screw bracket for quick mounting	510	\$2.42

16 Volts (10 VA)



Can take substantial surge loads. Mounts any place. 16 volts for 2 note chimes. Also for oil and gas heating systems or air conditioning units. Has thermal cut-out protective feature. Packed 48 to carton. Ship. wt. 36 lbs. U.L. listed and C.S.A. approved.

No.	Output: Watts	Each
101-OB	10	\$2.95

8-16-24 Volt Trivolt



All purpose, low voltage transformer with thermal cut-out. Guaranteed against burn out. Packed 12 to carton. Ship wt. 19 lbs., 8 oz. U.L. listed and C.S.A. approved.

No.	Output: Watts	Each
320	20	\$4.00

24 Volts (20 VA)



For higher loads, 24 volts for 8 note chimes. Mounts any place. Also used for oil and gas heating systems or air conditioning units. Has thermal cut-out protective feature. Packed 12 to carton. Ship. wt. 18 lbs., 8 oz. U.L. listed and C.S.A. approved.

No.	Output: Watts	Each
210-OB	20	\$3.75

16 Volts (30 VA)



For use on multiple chime installations. Can also be used for oil and gas heating systems, or air conditioning units. Mounts any place. Has thermal cut-out protective feature. Packed 12 to carton. Ship. wt. 18 lbs., 8 oz. U.L. listed and C.S.A. approved.

No.	Output: Watts	Each
301-OB	30	\$4.25

NuTone Relays



For use where hook-up of 2 or more motor driven chimes are operating from one set of push buttons. Also has special applications. Wires color coded at factory for easy identification. Packed 6 to carton. Ship. wt. 1 lb.

No.	Each
REL100	\$2.95

Edward Bells and Buzzers

The Lungen Line

For use in modern offices, residences, hospitals and production equipment where quality and neatness is desired. Are very durable and will stand hard service. Covers fit tightly making them bug and dust proof.

Available in four sizes giving a wide variation in volume and tone to meet all conditions.



No. 13—Bells

Durable silver alloy contacts. Polished chrome cover; base and gong cadmium finish. External insulated binding posts, grounded frame. Has double adjustment feature.

Three in a standard package.

Size Gong, In.	A-C, 60 Cycles 8-10 V. Each	A-C, 60 Cycles 24 V. Each	D-C 6-8 V. Each	D-C 24 V. Each	Other Voltages up to 48V., 25 or 60 cyc. Each	App. Wt. Std. Pkg. lbs.
1	\$4.51	\$5.06	\$4.51	\$5.06	\$8.03	1/4
1 3/4	4.18	4.73	4.18	4.73	7.70	3/4
3	4.51	5.06	4.51	5.06	8.03	1 3/4

When ordering specify voltage wanted.

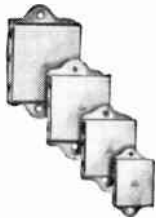

No. 115—Buzzers

For A-C Only

Fully insulated, no-contact type. Wire entrances provide for surface or concealed wiring. Adjustable from low, pleasant buzzer sound to near raucous clatter of a horn.

Polished chrome cover, cadmium finish base.

Three in a standard package.

Size, Nos.	Size Case, In.	A-C, 60 Cycles 8-12 V. Each	A-C, 60 Cycles 24 Each	Other volt-ages to 48, 25 or 60 Cycles Each	App. Wt. Std. Pkg. lbs.
1	2 1/8 x 1 5/16	\$3.19	\$3.41	\$5.72	1/2
2	2 5/8 x 1 3/4	3.41	3.63	6.05	3/4
4	3 1/2 x 2 1/4	4.95	5.23	7.70	1 1/2

When ordering specify voltage wanted.

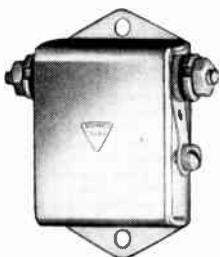

No. 15—Buzzers

Durable silver alloy contacts. Polished chrome cover, cadmium finish base. External insulated binding posts, grounded frame. Has double adjustment feature.

Three in a standard package.

Size No.	Size Gong, In.	A-C, 60 Cycles 8-10 V. Each	A-C, 60 Cycles 24 V. Each	D-C 6-8 V. Each	D-C 24 V. Each	Other Volt-ages up to 48, 25 or 60 cyc. Each	App. Wt. Std. Pkg. lbs.
0	1 5/8 x 1 1/2	\$3.63	\$4.29	\$3.63	\$4.29	\$6.93	1/4
1	2 1/8 x 1 7/8	3.41	3.96	3.41	3.96	6.60	1/2
2	2 5/8 x 2 1/8	3.63	4.29	3.63	4.29	6.93	3/4
3	3 x 2 1/2	3.85	4.40	3.85	4.40	7.37	1 1/4

When ordering specify voltage wanted.

Edwards Specialty Bells



Double-Magnet bell, non-weatherproof. For burglar alarm and other similar work. Adjustable tone control. Dependable and powerful signal.

One terminal grounded to base. Light gray finish.

Approximate shipping weight—4-in. 1 1/2 lbs. 6-in. 2 3/4 lbs.

No. 17

Size, In.	A-C, 60 Cycles 8 to 10 volts Each	D-C 6 to 8 Volts Each	Other voltages to 48 V. or 25 cycles Each
4	\$10.45	\$10.45	\$15.13
6	12.76	12.76	18.15



Single-Magnet bell, good quality, low cost. Adjustable for tone volume. Non-weatherproof. One terminal grounded to base.

Light gray finish, with nickel gong.

Approximate shipping weight—4-in. 1 1/4 lbs. 6-in. 2 1/2 lbs.

No. 55

Size, In.	A-C, 60 Cycles 8 to 10 volts Each	D-C 6 to 8 volts Each	Other voltages to 48 V. or 25 cycles Each
4	\$4.95	\$4.95	\$7.43
6	6.05	6.05	8.80



Monitor Bell — An entirely self-contained bell that presents a very neat appearance.

The hammer rod travels in a straight line, striking the inside of the gong, making the bell virtually bug and dust proof.

Finish—Light gray base, cadmium finish gong.

Approximate shipping weight 1 1/2 lbs.

No. 156

Standard 8-10 Volts A-C., 6-8 Volts D-C.....	Each \$3.63
24 Volts A-C or D-C.....	5.45
Other Voltages to 48 Volts (specify voltage).....	8.47

Edwards Door Bells and Buzzers



No. 730

Streamlined design. Satin aluminum finish, with gray finish base. Will harmonize with almost any wall color scheme. Being only 2 inches deep they can be mounted in out-of-the way places.

Will give efficient and trouble free service on either battery or transformer. Circuit is grounded to frame.

Nos. 720, 725 and 730 are completely enclosed—cover snaps on with a slight pressure. Nos. 710 and 744 have exposed gongs, but with snap-on cover over mechanism and binding posts.

Non-Adjustable

Standard 8-10 Volts, 60 Cycles, A-C and 6-8 Volts, D-C.

Nos.	Description	Std. Pkg.	Approx. Wt. Std. Pkg. lbs.	Each
720	Dixie Bell, covered.....	12	6	\$1.35
725	Dixie Buzzer, covered.....	12	2 1/4	1.16
730	Buzabel, combination bell and buzzer, covered.....	12	6	2.07
740	Nubel, 2 1/2-in. Gong.....	12	4 1/4	1.21
744	Exposed 4-in. Gong.....	3	2	2.07

Faraday Monitor Bells



A compact effective signal especially adapted to those applications where space is at a premium and where a reliable signal is required. The solenoid mechanism is completely concealed.

The vibrating bell operates smoothly, with powerful loud signal. The single stroke bell gives a clear sharp signal of distinct tone.

Hanger plate furnished without charge, if specified on order.

Hammertone gray enameled gong and frame.

One in a standard package. Approximate shipping weight 1 lb.

**Vibrating Bells
No. 346—For A-C Operation**

Gong Size, In.	Voltages			Up to 230 Each
	24 Each	115 Each		
3	\$5 00	\$6 60		\$7 70
4	6 00	8 50		9 50

No. 347—For D-C Operation

Gong Size, In.	Voltages			Up to 250 Each
	9 Each	24 Each	115 Each	
3	\$3 30	\$5 00	\$8 50	\$9 50
4	4 75	6 00	8 50	9 50

Single Stroke Bells

No. 336—For A-C Operation

Gong Size, In.	Voltages			Up to 230 Each
	24 Each	115 Each		
3	\$5 00	\$6 60		\$7 70
4	6 00	8 50		9 50

No. 337—For D-C Operation

Gong Size, In.	Voltages			Up to 250 Each
	9 Each	24 Each	115 Each	
3	\$3 30	\$5 00	\$6 60	\$7 70
4	4 75	6 00	8 50	9 60

Edwards Multiple Contact Push Buttons

For 50 Volts or Less A-C or D-C

Particularly suitable for use on electronic applications, special machinery, instruments, etc. Can be used on any applications requiring simultaneous operation of two or three devices, such as chime and buzzer, buzzer and annunciator drop, etc.



Nickel finish rim. Large terminals imbedded in tough plastic. Spring clips permit forced fit. Silver plated self-cleaning contacts.

Will fit 3/4-in. hole.

Standard package of 1.

Weight 1/4 lb.

No. 250—Depressing plunger closes 4 points together as a common circuit. Usually one point is connected to current

supply and the three other points are each connected to its associated device. Can also be used as a single pole, normally open circuit push of increased contact rating by connecting two points to current supply and the other two points to the signal device or instrument.

No. 251—Depressing plunger opens circuit.

No. 255—Depressing plunger breaks one circuit and makes another. Designed for three-wire return call systems and where a number of pushes are installed, one for each bell, with one push to ring all bells.

No.	Description	Each
250	Four Point, normally open	\$2 31
251	Two Point, closed circuit	3 41
255	Three Point "Return Call"	3 19

Edwards Weatherproof Push Buttons

For 50 Volts or Less

Surface Type

Thoroughly reliable for use outside of buildings, industrials, residences, for marine work, ice plants, chemical plants and where ever dampness, exposure or fumes would corrode or destroy the mechanism of ordinary push buttons.

Brass housing, polished finish. Weatherproof leather diaphragm under brass button center protects entire mechanism. Phosphor-bronze contact springs. Brass plate threaded for 1/2-in conduit. Diameter 2 3/8 in.

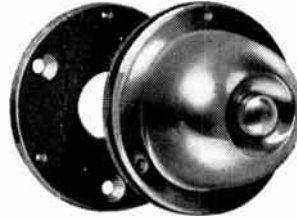

Standard package, 1; Approximate weight 1/2 lb.

No.	Description	Each
1786	—Without conduit plate	\$6 60
1786-C	—With threaded conduit plate	9 35

Edwards Entrance Push Buttons

Stamped Brass

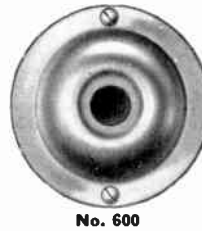

No. 600

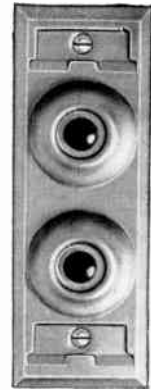

No. 602



No. 607



No. 603

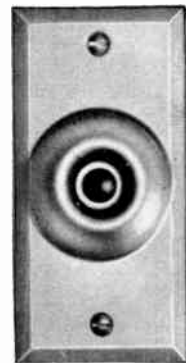

No. 611

Surface Push Buttons

These one-piece push buttons cover all general needs. Sturdy mechanism is fully insulated. Easy to reach terminals accommodate up to No. 14 wire.

No.	Size In.	Std. Pkg.	Approx. Wt., Lbs.	Each
600	2 5/16	12	1	\$0.30
602	2 x 1 9/16	6	3/4	.67
603	1 3/4	12	3/4	.30
607	2 1/16 x 2 5/8	6	1	.48
611	2 x 1	3	1/2	.70

Edwards Entrance Push Buttons

**Quality Bronze Push
No. 654 and 655**

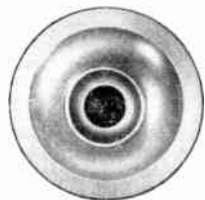

Round, well-built forged bronze push. Threaded cap for easy wiring and screw concealment.
Standard package 1; wt. 1/8 lb.

No.	Dimensions, In.	Each
654	1 3/4	\$2.16
655	2 3/8	2.38

**The Keynote
No. 634, 635, 636 and 637**

Thin design for narrow door trims. Blends with any style architecture. Durable plastic, cannot rust, in four colors—brass, chrome, ivory and brown. Light center action. One minute installation. Replaces all style push buttons.

No.	Style	Dimensions In.	Each
634	Brown, ivory center	3/4 x 2 5/8	\$0.33
635	Ivory, black center	3/4 x 2 5/8	.33
636	Brass, ivory center	3/4 x 2 5/8	.54
637	Chrome, black center	3/4 x 2 5/8	.65



No. 634

Deluxe Push Buttons



No. 644



No. 643



No. 656

Nos. 643 and 644 piano-key action is newest in push button design. Mechanism guaranteed against sticking. Hidden mounting screws. Forged of solid brass. Std. pkg. 3, wt. 1/2 lb. 5/8 x 2 3/4 in. Each **\$2.11**

No. 656 lighted push button with easily replaceable bulb. Operates from any transformer with maximum 16v. output. Also available for 24v. operation.

No.	Style	Dimensions, In.	Each
656-1	Brass, lighted 6-16v.	1 5/16 x 2 11/16	\$1.51
656-2	Chrome, lighted 6-16v.	1 5/16 x 2 11/16	1.62
656-3	Brass, lighted 24v.	1 5/16 x 2 11/16	1.89
656-4	Chrome, lighted 24v.	1 5/16 x 2 11/16	2.00

Miniature Push Buttons



No. 620-1



No. 620-3



No. 620-5

Small, neat, in good taste. Features Edwards No. 620 insulated push. Snaps into place after plate is attached. Std. pkg. 3, wt. 1/4 lb.

No.	Style	Dimensions, In.	Each
620-1	Brass, round	1 1/2 (1 1/8 ctr.)	\$1.08
620-2	Chrome, round	1 1/2 (1 1/8 ctr.)	1.24
620-3	Brass, diamond	1 1/2 x 2 1/4 (1 3/8 ctr.)	1.08
620-4	Chrome, diamond	1 1/2 x 2 1/4 (1 3/8 ctr.)	1.24
620-5	Brass, rectangular	1 1/8 x 2 3/16 (1 1/16 ctr.)	1.08
620-6	Chrome, rectangular	1 1/8 x 2 3/16 (1 1/16 ctr.)	1.24

Edwards Push Buttons

For 50 Volts or Less A-C or D-C

Raised Center

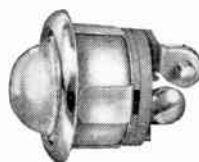

This push is of the same fine construction as the No. 620, except that it has a raised, rounded center push with white button 3/16-in. above the level of rim. Thoroughly insulated.

Standard finish, Nickel.
Standard package of 6; Weight of standard package 1/4 lb.
Will fit 5/8-in. hole.

No.	Each
625	\$0.88

Protruding Center Type



No. 621



No. 623



No. 622

Solid turned brass shell. Phosphor-bronze springs. Self-cleaning contacts. Large screw terminals. Round black center protrudes approximately 1/8-in. above rim. Standard finish, Nickel.

No. 621 has spring clips to hold push firmly in mounting hole.

No. 622 has escutcheon for wood screw mounting.

No. 623 with lock nut mounting.

No. 116 forced fit mounting.

Approximate weight standard package 1/4 lb.

No.	For Hole, In.	Standard Package	Each
621	5/8	6	\$1.05
622	1/2	6	1.54
623	5/8	6	1.32
116	1/2	1	1.95

Edwards High-Voltage Push Buttons

For voltages up to 250 volts.

Momentary Contact—Quick Make and Break Type



Sturdy mechanism, built to withstand heavy shock, vibration and constant use. Has large size button and is recommended for use on panels, for machinery and tools.

Bakelite body, with insulating protective sleeve. Solid brass shell. Large phosphor-bronze contacts. Threaded for 1/2-in. conduit locknut. Requires hole at least 7/8-in. diameter. Can be used on panels up to 1/4-in. thick. Fitted with 3-inch No. 16 gauge Type AF standard flexible wire leads.

Ratings—A-C: 6 amperes 125 volts, 3 amperes 250 volts. D-C: 3 amperes 125 volts, 1 ampere 250 volts.

Low voltage ratings by test—10 amperes at 48 and 32 volts a-c, 24 volts a-e and d-e, 12 volts a-c and d-c; 8 amperes at 32 volts d-e; 7 amperes at 48 volts d-e.

Standard finish, Nickel.

Standard package of 1; Weight Standard package 1/4 lb.

No.	Description	Each
850	Contacts stay closed as long as push button center is depressed.	\$4.84
854	Closed Circuit Type. Contacts are normally closed—pushing plunger opens the circuit.	6.60

Edwards Flush Push Buttons



No. 612



No. 652



No. 653

Easy to install pushes feature Edwards No. 620 insulated 5/8 in. push button which snaps into place after plate is attached.

No.	Style	Dimensions, In.	Each
612	Brass, rectangular	1 5/8 x 4 (3/16 ctr.)	\$1.40
652	Chrome, rectangular	1 3/4 x 4 (2 13/16 ctr.)	2.16
653	Old Iron, rectangular	1 1/4 x 3 3/4 (2 1/8 ctr.)	1.62

Edwards Flush Push Buttons

For 50 Volts or Less A-C or D-C



No. 620

For general utility purposes. New improved plastic back, not affected by moisture. Long-life molded center in heavy nickel trim. Heavy brass springs and plunger, easy floating push action—positive self-cleaning contacts.

Large strong terminals embedded in composition body.

Standard package of 12; Weight, standard package, 2 1/2 lbs. Will fit 5/8-in. hole.

No.	Description	Each
620	Standard, Not Luminous	\$0.44

Flat Pearl Center Type



No. 59.....Each \$1.10

Composition body, with heavy brass springs and plunger. Large terminals.

Spring clips for mounting.

Will fit 3/4-in. hole. Rim is 1/8-in. wide, 1/16-in. from back of rim to end of terminals. Thoroughly insulated.

Standard package of 6; Weight standard package 1/4 lb.

Edwards Pendant Pushes

High Voltage — Quick Make and Break Type



Sturdy mechanism, built to withstand heavy shock, vibration and constant use. Quick make and break is assured irrespective of the amount of pressure or the speed with which it is applied. Contacts stay closed as long as push button center is depressed.

Gray plastic case with end removable for connection — ample space for taping and knotting.

Has 1/2-in. entrance hole for flexible cord. Plastic collar surrounding push button is luminous, making it ideal for use with slide films, electronic equipment, x-ray, etc.

Standard package of 1; weight standard package 1/4 lb.

No. 851 Luminous.....Each \$8.80

Edwards Hospital Locking Pushes



Has locking mechanism that keeps attendants' light on until call has been answered. Button is released and contacts open when small reset pin is operated.

Newly designed shell of attractive grey composition is easy to handle and is practically unbreakable. The collar is luminous and can be seen in darkened areas. Has five contacts which are closed (one momentarily) when button is depressed.

Standard package 1; approximate weight 1/2 lb.

For 24 Volts

No. 7620.....Each \$6.50

Edwards Pendant Pushes



Suitable for residence or hospital work. Light in weight, but exceedingly strong. Designed for fingertip grasp—no chance of slipping out of hand.

Bakelite casing. Push button has plastic back, not affected by moisture, with long-life molded center in heavy nickel rim. Heavy brass springs and plunger, self-cleaning contacts. Large strong terminals embedded in composition body.

Standard package of 3; weight of standard package 1/8 lb.

No. 71.....Each \$1.23

Edwards Push Button Blocks

With Numbered Pushes



No. 146

Molded black Bakelite, with removable weighted base and composition pad.

Numbered flush midget pushes. Can be mounted on side of desk by using a concealed mounting hole provided for that purpose. The lustrous permanent finish will not scratch, mar or deteriorate.

Standard finish, black.

Standard package of 3; weight standard package 1/4 lb.

Without Cord

No. of Buttons.....	1	2	4	6
Each.....	\$3.96	\$4.73	\$6.93	\$10.00

With Cord

Each.....	\$5.78	\$7.43	\$11.39	\$16.23
-----------	--------	--------	---------	---------

Edwards Executive Push Buttons



**No. 200
Two Buttons**



**No. 200
Six Buttons**

Molded of sturdy french grey Styrene, with wide push button bars spaced for easy selection (yet two button model only 2¼ in. by 2½ in.)

Names magnified for quick attention. Positive action guaranteed by long-life silver overlay contacts. 48 standard titles included. Wide range of sizes and accessories. Where eight or more buttons are required, No. 300 series should be specified.

No.	No. of Buttons	Description	Each
146	1	Set Without Cord	\$ 3.96
146	2		4.73
146	4		6.93
146	6		10.00
146S	1	Set With Cord	5.78
146S	2		7.43
146S	4		11.39
146S	6		16.23
200	1	Set Without Cord	4.73
200	2		5.72
200	4		8.25
200	6		13.75
200C	1	Set With Cord and Connector Block	8.58
200C	2		10.56
200C	4		15.13
200C	6		23.10
200CB	1	Set With Cord, Connector, Buzzer	18.15
200CB	2		20.08
200CB	4		28.88
200CB*	6		41.80
300	8	Set Without Cord	28.60
300	10		33.55
300	12		46.20
	Add'l. Buttons	Per 4 Buttons	17.20
300C	8	Set With Cord and Connector Block	42.90
300C	10		47.30
300C	12		61.60
	Add'l. Buttons	Per 4 Buttons	22.00

*Special Voltages, add \$6.00

Edwards Floor Treads



For use in dining rooms for calling servants, and other places requiring foot contact signaling.

Has non-sliding rubber base. Firm, reliable connectors. Designed for quick and easy installation.

Can be used under carpet with negligible bulge.

Standard finish, brass. Diameter 3⅝-in. Projects only ½-in.

Standard package of 3; Weight standard package, 1 lb.

No. 290..... Each \$2.48

Edwards Push Button Panels

No. 107

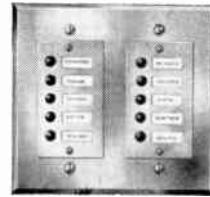

10 Button

A compact, sturdy push button panel for use in schools, public buildings, offices, etc., where no "All" or "Master" push button is required.

They are ideal where space is limited and where economy is a factor.

For example—3 to 5 buttons inclusive are mounted on a plate to fit a standard single gang switch box. 6 to 10 buttons inclusive are mounted on a plate which fits a standard two gang switch box. 11 to 15 buttons are mounted on a plate that will fit a standard three gang switch box, etc.

Larger than 25 button panels are provided with a steel wall box for flush mounting. Terminal board is provided suitable for mounting in back box and is wired to panel on 28 button panels and larger.

When ordering specify number of buttons wanted.

No.	No. of Buttons	Each
107	5 Buttons.....	\$22.00
	10 Buttons.....	44.00
	15 Buttons.....	66.00
	20 Buttons.....	88.00
	25 Buttons.....	110.00

Larger sizes (multiples of 5 buttons only) per button \$8.25

Benjamin Heavy-Duty Watertight Push Buttons

Listed by Underwriters' Laboratories, Inc.



Single Button

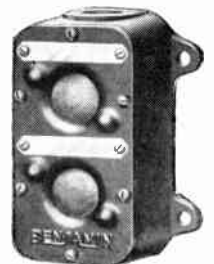

Two-Gang Button

Rated at 5 amps. for 125 v. circuits with either inductive or resistance loads. This type of button is suitable for use with any Benjamin signal or any electrical device with a similar rating. Button proper (plunger) is normally below the surface of the cap so the button cannot be accidentally operated. A waterproof neoprene gasket seals the plunger opening. All joints are watertight. Std. Tapping: ½" I.P.S. at top.

No.	Description	Each
8493	Single Button—Open circuit	\$ 5.50
8874	Single Button—Closed circuit	5.50
8495	Two-Gang Button—Open circuit both buttons	9.40
8884	Two-Gang Button—Open circuit one button, closed circuit one button	9.40

Edwards Door Openers

Compact and rugged. For use under varying conditions. Can be used on either right or left hand doors. Door may be opened with the key in the usual way according to the type of latch used. Electric operation of the door opener allows nosing to pass without use of key.

Has release check feature which keeps door openers in unlocked position after button is pushed, until door opener is tripped to its normal locking position when door is pushed open.

Mortise Type

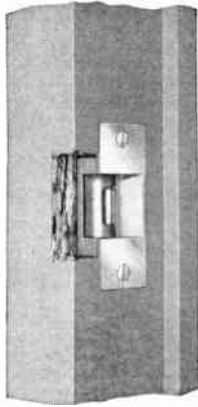

For better grade jobs and smaller mortise.

Has die-cast body. Forged brass roller and nosing. Will stand up under most severe operating conditions. Face plate beveled for perfect fit.

Body Size—2-in. high, 2⁷/₈-in. deep, 1¹/₄-in. thick. Nosing opening 1¹/₄-in. Face plate 3³/₈x1¹/₄-in.

Standard package of 1; Weight of standard package 3/4 lb.

Voltage: 4.5-6 d-c or 12-16 volts, 60 cycles a-c.

No. 154..... Each **\$9.90**

For special voltages up to 48 volts, add to list. Specify A.C. or D.C. **\$5.50**.

Mortise Type

For use where economy is desired—especially for low cost apartment jobs.

Has solid brass face plate, forged brass nosing. Entire mechanism enclosed in rust-proof case with easily removable cover. Fits same size mortise as same shape openers of other manufacturers.

Body size—3⁵/₈-in. high, 2¹/₂-in. deep, 1-in. thick. Nosing opening 1³/₈-in. Face plate 5⁷/₈x1¹/₄-in. Complete with brass mounting screws.

Standard package of 6; Weight standard package 5 lbs.

Voltage: 4.5-6 d-c or 8-12 volts, 60 cycles a-c.

No. 9..... Each **\$5.78**

Rim Type

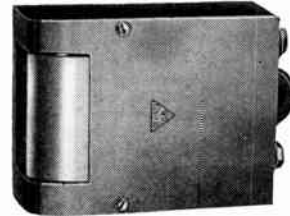

For operation with surface type locks, bolted to door.

For surface locks, thin frames, office gates, etc. Has few moving parts to be affected by constant use.

Forged brass nose and cast frame, brass finish face plate. Easily installed, with readily accessible terminals. Complete with mounting screws.

Body size—2-in. high, 3¹/₈-in. deep, 1¹/₈-in. thick. Nosing opening 1¹/₄-in.

Voltages: 3-6 volts d-c or 6-8 volts, 60 cycles a-c. Can be supplied for special voltages up to 48 volts.

Standard package of 1; Weight standard package 1 lb.

No. 152..... Each **\$8.25**

For special voltages up to 48 volts, add to list. Specify A.C. or D.C. **\$5.50**.

Edwards High-Voltage Push Buttons

**For Voltages up to 250 Volts
Momentary Contact — Quick Break Type**

Listed by Underwriters' Laboratories, Inc.



No. 820



No. 821

For heavy work. Sturdy, dependable mechanism requires a minimum of pressure to make contact and breaks fast regardless of how the pressure is released. Especially suitable on a-c where quick make is not a factor. Also used on d-c operation at lower current ratings.

Heavy brass chrome plated shell. Extra strong spring contacts. Terminals are large and easily accessible.

Standard finish, chrome.

Standard package of 1; weight standard package 1/4 lb.

Distance from back of rim to end of terminals 1¹/₂-in.

No.	Description	Each
820	Forced Fit, for 3/4-In. hole.....	\$4.40
821	Locknut Type, for 7/8-In. hole. Threaded for special modified 1/2-in. conduit locknut.....	4.84

Edwards Light Switches

For Bus Door Steps

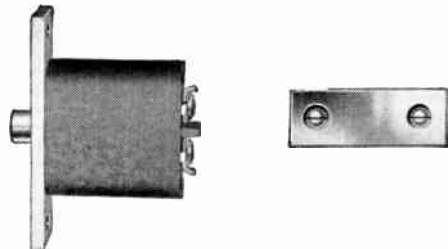

A well constructed switch built to stand up under the constant operation of bus doors.

Heavy brass face plate 2¹/₂x1-in., polished nickel finish. Stainless steel plunger head. Contacts enclosed in bakelite base. Bumper plate 1⁵/₈x⁵/₈-in.

Complete with screws for mounting.

Approximate weight 1/4 lb.

Operates on battery voltage.

Open circuit—depress plunger to open.

No. 504..... Each **\$5.50**

Edwards Door Trip



No. 236 Door Trip

Not Insulated Door Trip

For use where external mounting is desirable or not objectionable. Makes and breaks contact when door is opened and repeats operation when door is closed. Will not contact when door is closed. Standard package is 3. Weight per standard package 1/2 lb.

No. 236—Open Circuit.....Each \$2.48

Edwards Constant-Ringing Drops



For use on open or closed circuit burglar alarm systems.

When coils are energized by operation of any contact device on an open circuit system or through a relay on a closed circuit system the mechanism of the No. 26 drop closes a circuit and keeps it closed until reset by hand, thus causing a continuous alarm on bells, horns, etc., until reset.

The common terminal between coil and contact is grounded to case. In operation it also cuts its own magnets out of the circuit which reduces battery drain where d-c systems are used and protects the magnet coils where considerable time may elapse before resetting.

Standard operation: 6-8 volts d-c or 8-12 volts a-c. Special voltages to 48 volts a-c or d-c.

Exact voltage must be specified.

Standard package of 1; Weight standard package 1/2 lb.

No. 26.....Each \$6.49

For special voltages, add to list \$3.85.

Edwards All-Purpose Contactors

A universal device for doors, windows, transoms, etc. Easily and quickly installed. Fully insulated for use in wood or metal.

Designed for hard service, with pure phosphor-bronze scraping contacts, laminated phenolic insulation and heavy brass casing and moving parts.



So constructed that a pressure from any direction will depress the nosing, which requires slight pressure and may be installed in any position. It need not be mortised except where door or window is a very tight fit. Shallow enough for all standard frames and casings. Requires 3/4 in. hole. Complete with flat head brass screws.

Can also be used as a foot push, or on machinery where mechanical action of any kind must energize a low voltage electrical circuit.

Standard package of 6; Weight standard package 1/2 lb.

No.	Each
44—Pressure on nosing opens circuit.....	\$1.10
45—Pressure on nosing closes circuit.....	1.10
46—Momentary contact; pressure on nosing makes, then breaks the circuit and repeats the operation in returning to normal.....	1.10

Edwards Door Bell Transformers

Tri-Volt—25 Watts



Provides a greater selection of secondary voltages. Primarily adapted to applications where an unusually long wire run exists.

Finish: Gray.

Size: 4 3/8-in. high, 3-in. wide, 2 1/6-in. deep.

Standard package of 1; Weight of standard package 2 1/4 lbs.

Primary 115 volts, 50-60 cycles; secondary 8-16-24-volts, 25 watts.

No. 872.....Each \$6.05

Note—Special primaries, secondaries, and 25-cycle transformers can be supplied. Contact Graybar.

Edwards Signaling Transformers



Completely enclosed in sturdy stamped metal housings designed to form their own barriers between high and low voltages.

They have large, convenient binding posts on both primary and secondary to eliminate splicing, soldering and taping. Knockouts into both compartments permit entrance with BX, conduit or open wiring.

No. 88-50 and 88-100 listed by Underwriters' Laboratories, Inc.

Primary: 115 volts, 60 cycles. Can be used on up to 130 volts.

Secondary: 4-8-12-16-20-24 Volts.

No.	Watts	Height	Size, inches Width	Length	Wt. Std. Pkg., lbs.	Each
88-50	50	4 1/4	3 5/8	7 7/8	5 1/8	\$11.77
88-100	100	4 7/16	4 5/8	8 5/8	8 3/4	19.00
88-250	250	6	5 1/8	9 1/2	16 1/8	48.40
88-500	500	6 1/2	6 1/2	12 1/8	34 1/8	74.80
7194	750	6 1/2	7 1/2	14 1/2	42	88.00
7195	1000	6 1/2	9 3/4	14 1/2	58 1/4	111.00

Note—Special primary voltages up to 230 volts, special primary voltages 230 to 400 Volts, special secondary voltages and 25-cycle transformers can be furnished. For further information contact Graybar.

Edwards Door Bell and Chime Transformers

Easi-Mount



Can be mounted on any outlet box or cabinet with 1/2-in. knockouts or alone on any surface without box. No plates needed for any type mounting. No screws or parts to take out or lose. Has expandable nipple for box or cabinet mounting and integral mounting flanges for surface mounting to wall or ceiling.

Light gray finish. Size: 2 5/8-in. high, 2 5/8-in. wide, 1 1/8-in. deep.

Primary 115 Volts, 50-60 Cycles

No.	Description	Secondary Volts	Watts	Std. Pkg.	Wt. Std. Pkg., lbs.	Each
*890	Door Bell	10	5	6	6	\$2.42
*892	Chime	14	10	3	3	3.52
894	Chime	14	10	3	3	3.03
896	Tri-Volt	6-12-18	5	6	6	3.06

*Listed by Underwriters' Laboratories, Inc.

Kirkland Indicating Lamps and Annunciator Components

All lamps on this page for 120-volt bulbs. Prices do not include the bulb. Lamp bulbs serviced from panel front.

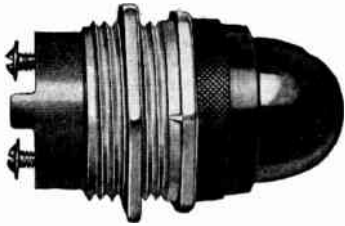

A most rugged lamp. Unusually shallow depth—only 1 1/4-in. behind front of panel. Single 13/8-in. hole mount. Heavy deeply cupped glass lens (all colors). Threaded lens cap. Brilliant signal produced from all angles. Heavy duty socket with 5/32 terminal screws. Hex holding lip in chrome finish. U/L listed. Uses S6 or T4 bulbs.

No. 659 D/E.....Each \$3.20



Lamp with flat surface lens. Illuminates engraved designation on lens. All

color effects. Saves a separate nameplate. 1-in. engraving area. 2 3/4-in. OA depth behind front of panel. Mount in 1 1/16-in. diam. hole. Uses S6 or T4 bulbs. U/L Listed.

Each \$1.80
150.....
150 Engraved lens.....*



Brilliant side visibility. Deep cupped heavy glass lens. All colors. Chrome

lens cap. Overall depth behind front of panel 2 3/4-in. Overall diam. 1 1/4-in. Mounting hole 1 1/16-in. Uses S6 and T4 bulbs.

No. 160.....Each \$1.80



185W



170SW

The 180SW unit has a No. 180 lamp mounted on a chrome finished single-gang switchplate. Ideal overdoor or exit light. The 170SW unit has a No. 170 lamp mounted as above.

Each \$4.25
No. 180SW.....
No. 170SW.....
No. 170SW Engraved Lens.....*

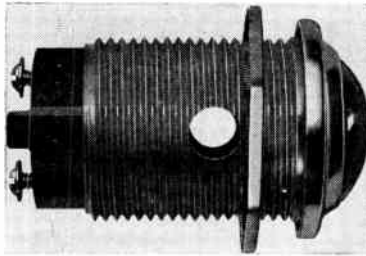

Rugged, heavy duty lamp with smooth curved surface lens (all colors). Chrome plated lens cap. Slip-fit lens cap. 2 1/4-in. OA depth behind front of panel. 13/8-in. mounting hole. U/L listed. 5/32 terminal screws.

Each \$2.40
No. 600.....



Square lamp designed for engraved lens. 13/8-in. diam. hole mount. All molded unit. Snap-on lens cap. All colors. 2 1/4-in. overall depth behind panel.

No.	Description	Each*
2SQS	screw type S6 bulb.....	\$3.20
2SQB	S6 bayonet base.....	3.20
2SQT	T3 1/4 bayonet base.....	2.80



Recessed lamp receptacles. Bulb acts as lens. Exposed bulb tip effects long lamp life. Chrome finish.

Bulbs not included in price.

No.	Description	Each
S11	For tungsten bulb.....	\$4.25
G10	For neon bulb.....	4.25
G11	For tungsten & neon bulbs.....	4.25
S14	For tungsten & neon.....	4.25

Lamp Bulbs and Resistors

For signal applications use a higher rating bulb than application.

No.	Description	Each
S6	150V for 120V service.....	\$0.65*
S6	all other low voltage.....	.85*
T-4	150V for 120V service....	.95*
T4	all other low voltage.....	.95*

Use a series resistor with 120-150V S6 or T4 bulb for 220-250V and 440V service.

Resistor	Each
220-250V.....	\$1.05
440V.....	1.50

*Plus Federal Tax.

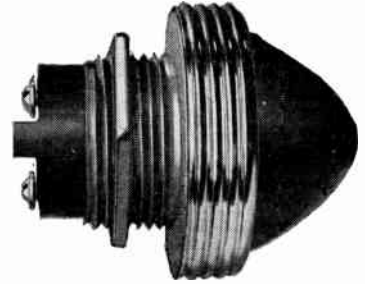

Two-inch beehive glass lens. Chrome, threaded lens cap. All colors. Desired on large panels. All angle illumination. Molded superior socket, 5/32 terminals. 13/8-in. diam. mounting hole. 1 1/4-in. overall depth behind front of panel. U/L listed.

Each \$3.20
No. 180.....



One lamp Annunciator. Large area illuminates message (1 1/8-in. diam.). All colors. 13/8-in. diam. mounting hole. 2 1/8-in. overall depth behind front of panel. Molded socket, 5/32-in. terminal screws. U/L listed. Overall dia. 2 1/8".

Each \$3.20
No. 170.....
170 Engraved lens.....*



Light barriers remove easily from molded slots. All colors. Up to four bulbs and messages, together horizontally and vertically. Overall size 3 3/4-in. by 1 1/2-in. Light chamber 3-in. by 1-in. Overall depth behind panel 2 3/4-in. Light barriers produce four 3/4-in. chambers,

three 1-in. sections, two 1 1/2-in., etc. U/L listed. Uses S6 or T4 bulbs.

No.	Sockets	Each
ML-1	1	\$3.30
ML-2	2	3.80
ML-3	3	4.30
ML-4	4	4.80
ML	engraved plate.....	*
ML	blank plate.....	\$.65
Frame	(black or gray finish)....	.90

*ENGRAVING COSTS A Set-up charge of \$1.50 net (no discount) is made for engraving on one or more of same type on the order.

List price per engraved character.....\$.12. The number of engraved characters on order constitutes the basis for discount.

Kirkland Indicating Lamps and Annunciator Components

All lamps on this page for low voltage bulbs, used on 120/220 volts with a series resistor. Prices do not include bulbs. Lamps are serviced from the front of the panel. Exception: DR Multiple Lamp Boxes also for 120 V.



A superfine unit appreciated by Engineers. Uses low current T2 slide base bulb, current as low as 0.038 on low voltages. Curved glass lens or flat for engraving. All colors. Mounts in 1/32-in. diam. hole. Overall depth behind front of panel 2 1/8-in. Use on 120/220V with series resistor. Friction held lens cap. Black finish (Gray on special orders). Solder terminals.

No. **T2MC** (Less Bulb & Resistor) **\$1.50** Each
T2MC Engraved flat lens *

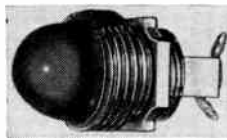

Deeply cupped heavy glass lens permits excellent side visibility. Chrome threaded lens cap. 1 1/4-in. overall diam., mounts 1/16-in. hole. Overall depth behind panel 1 1/8-in. SC bayonet socket for T3 1/4 LV bulb or socket with internal resistor for NE-51 neon bulb on 120/220V. All color lenses. Solder terminals.

No. **160SC** **\$1.80** Each
160SC/NEON, with resistor **2.30**

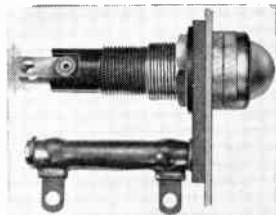

An inexpensive bracket to hold resistor required for 120/220 operation of T2-24V and T3 1/4-28V bulbs. Used with T2MC, T2SLC (Illustrated), T2SLC-P, 2026-F, 2025-P, 2026-P, 2025-F, and 2213. The lamp unit holds the bracket.

Bracket **\$0.30** Each

Lamp Bulbs

No. **T2-24V** (0.038 amp.) **\$0.85** Each*
T2 Std. voltages to 55V **.90**
T3 1/4 SC bayonet, 28V **.50**
 *Plus Federal Tax.

Resistors for Above Bulbs

Description Each
 For 120V service **\$1.35**
 For 220V service **1.60**
 Brackets furnished for above resistors.



T-2 slide base socket, metal body, threaded lens - cap of metal with smooth curved lens. Black finish. T2 low current bulb, all low voltages. Use with resistor on 120/220V. Overall diameter 7/8-in. Mounting hole 1/16-in. Overall depth behind front of panel 2 1/8-in. Also available with flat lens for engraved message. Solder terminals. All colors.

No. **T2SLC** (Less Bulb & Resistor) **\$2.75** Each
T2SLC Flat lens engraved *

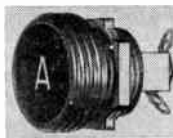

Flat lens for engraved message. All color effects. Threaded lens-cap in polished chrome. Overall depth behind front panel 1 1/2-in. Mounting hole 1/16-in. Area to engrave 1-in. Overall diameter 1 1/4-in. Uses T3 1/4 SC miniature bulbs, all low voltages. With series resistor on 120/220V. Solder terminals.

No. **150 SC** **\$1.80** Each
150 SC Engraved *

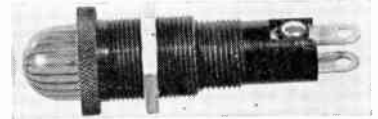

Brilliant side visibility obtained with low current T2 slide base bulb (0.038 amp.). Plastic lens, deeply cupped, in all colors and clear. Used with resistor on 120/220V. Black finish. Overall diameter 7/8-in. Depth behind front of panel 2 1/8-in. Mounting hole 1/16-in. Solder terminals.

No. **T2SLC-P** (Less Bulb & Resistor) **\$2.45** Each

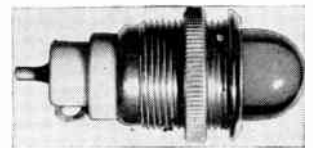

This superior heavy duty unit will withstand an extremely high potential test. A ceramic casting guards against insulation breakdown. Threaded plastic lens-cap permits full side visibility. Mounts in 3/4-in. diam. hole. Overall depth behind front of panel 1 1/2-in. Uses T3 1/4 bulb on LV. Used with resistor for 120/220V. Solder terminals.

No. **2213** (Less Bulb & Resistor) **\$1.60** Each

Type DR Multiple Lamp Box

Illuminated Engraved Designations: One to Six Indications; One to Six Bulbs Uses T3 1/4 Bayonet Base Bulbs; Voltages Up to 28 Volts.

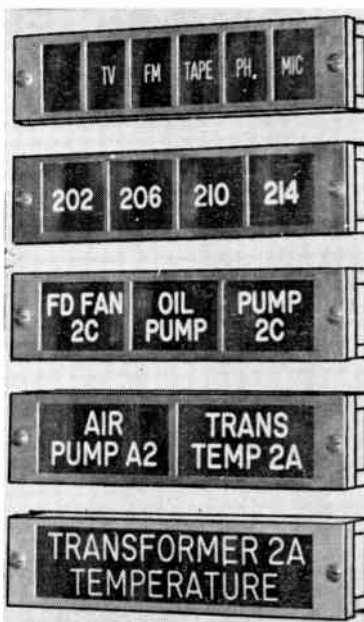

The engraved white designation on black background shows brilliantly when lighted. Also white plates.

Slots contain removable light barriers to produce 1, 2, 3, 4, or 6 individual light chambers.

DR boxes used in multiple can be stacked in vertical or horizontal rows producing a modern Annunciator. See Catalog.

Dimensions

Overall—5-in. wide x 1 1/8-in. high.
 Panel Opening: 4 1/16-in. x 1 1/8-in.

No.	Plate Area to Engraved Sections	Dimen. In.
*DR-HM-1	1	1 3/16 x 7/8
*DR-HM-2	2	2 1/16 x 7/8
*DR-HM-3	3	1 3/4 x 7/8
*DR-HM-4	4	3 1/34 x 7/8
*DR-HM-6	6	5/8 x 7/8

*Also for 120 V. S6 Lamp Bulbs.

***ENGRAVING COSTS** A Set-up charge of **\$1.50** net (no discount) is made for engraving on one or more units of same type on the order.

List price per engraved character **\$.12**. The number of engraved characters on order constitutes the basis for discount.

Kirkland Indicator Lamps and Annunciator Components

Rectangular Indicating Lamps

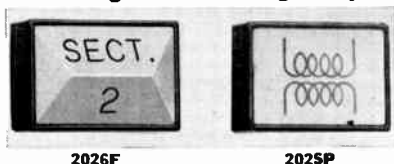

Ideal to engrave. Low voltage T3 $\frac{1}{4}$ bulbs. Two sizes. Black frame. All colors.

No.	Frame Size, In.	Mount Hole	Depth Behind Panel	Each
2025-P	3 $\frac{1}{32}$ x 1 $\frac{1}{16}$	1 $\frac{1}{32}$	1 $\frac{1}{16}$	\$1.15*
2025-F	Same as above with flat lens to engrave.			1.15
2025-P—Neon	Same as 2025-P but with NE-51 resistor.			1.40*
2026-P	1 $\frac{1}{32}$ x 3 $\frac{1}{32}$	3 $\frac{1}{4}$	1 $\frac{5}{8}$	1.35*
2026-F	Same as above with flat lens to engrave (1 $\frac{1}{16}$ x 3 $\frac{1}{4}$)			1.35
2026-P—Neon	Same as 2026-P but with NE-51 resistor.			1.50*

*Add for resistor 120/220V.

Rectangular Push Buttons



Match with lamps. Engraved designation. Two sizes. Black frame. Button colors: Red, Green, Black, White. Momentary contact type. Solder and screw terminals.

Small Models: (0.5 amps/250 VAC)

No.	Contacts	Each
1025-NO	Normally open	\$1.30
1025-NC	Normally closed	1.30

Large Models: (2.0 amps/250 VAC)

No.	Contacts, Sets	Each
1126-2O	2 open	\$2.00
1126-2C	2 closed	2.00
1126-0C	1 open, 1 closed	2.00



Multiple Lamp and Button Panels

Mounted on standard switchplates or special cabinets.

Prices on application.

Circular Push Buttons



Black frame. Button colors: Red, Green, Black, White. Single $\frac{3}{4}$ -in. hole mount. Rated 2 amp. per set, 250 VAC.

No.	Contacts	Each
1101-2O	2 open	\$1.70
1101-2C	2 closed	1.70
1101-0C	1 open, 1 closed	1.70

Solder and screw terminals. Other single contact buttons available.

Combination Lamp and Relay Assembly



Type RBE-170 individual lamp Annunciator. Prewired, complete with cable ready to install. Single 1 $\frac{3}{8}$ -in. hole mount. Up to 3 DPDT relays. Uses S6 bulb. Engraving diam. 1 $\frac{7}{8}$ -in. All modern alarm services possible on existing panels with economy. Alarm services arranged so that a new audible alarm signal will never be lost. RBE unit also available with beehive type lens (Type RBE-180).

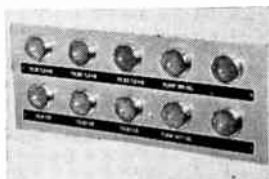

Typical Installation of RBE-180 Units

Mounted on existing panel. Present panels can be readily equipped with modern alarm service without the need for added cabinets. Just install RBE units and connect incoming wiring.

Type MLP Individual Alarm Units



Panel mount. 3-in. by 1-in. area for illuminated message. Box contains: Relays, S6 lamp bulbs and terminal block on rear. Cabinet size—4 $\frac{1}{8}$ -in. x 1 $\frac{3}{4}$ -in. Face plate—5-in. x 2 $\frac{1}{4}$ -in. Depth from front panel 7 $\frac{1}{4}$ -in. All standard alarm services. Ideal for group use. With or without toggle switch or push button.

Type VIG Individual Alarm Units

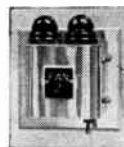

A wiring device. Mounts on standard 2-gang outlet. Contains two lamps, one DPDT relay, and toggle switch. Interesting alarm services possible. Ideal for industrial applications.



Type CFA Flasher Assembly

For alarm service. Anti-dust container houses thermal unit, resistor and relay. 100 flashes prox. per minute. 8-point octal plug fits standard receptacle.

Kirkland Custom Annunciators For Power Plants and Industry



Typical Message Plate

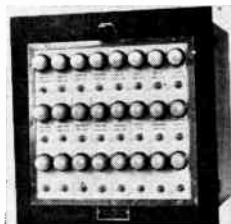

Bulls-Eye Annunciator



Window Annunciator

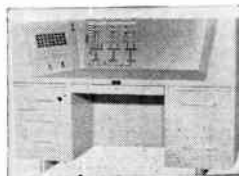

Desk Annunciator

All Modern Alarm Services

Supervise liquid levels, motors, transformers, pumps, doors, vaults, sprinklers, production factors, pressure, valves, switches, etc.

Standard anti-dust container, with plug, contains relays completely wired for intended service. The relay containers mount in plug receptacles mounted on ebony asbestos panels that are wired to the terminal block. Wires from the panel go to the lamp bulbs, power, and audible signal.

A wide variety of standard size windows are available for illuminated messages. Examples: 1-in. x 1-in., 1-in. x 2-in., 1-in. x 3-in., 2 $\frac{1}{4}$ -in. x 2 $\frac{1}{4}$ -in., 4-in. x 1-in., 2-in. x 2-in., 2-in. x 4-in.

Other sizes are also available along with a wide variety of indicating lamps (See catalog data) Plus Graphic Annunciators.

Typical wiring diagrams and suggested services available on request.

ENGRAVING COSTS A Set-up charge of \$1.50 net (no discount) is made for engraving on one or more units of same type on the order.

List price per engraved character \$.12. The number of engraved characters on order constitutes the basis for discount.

R & S Unilarm
Factory Built Unit Alarm System—Ready to Install
Explosion-Proof and Dust-Tight—Class I, Groups C and D

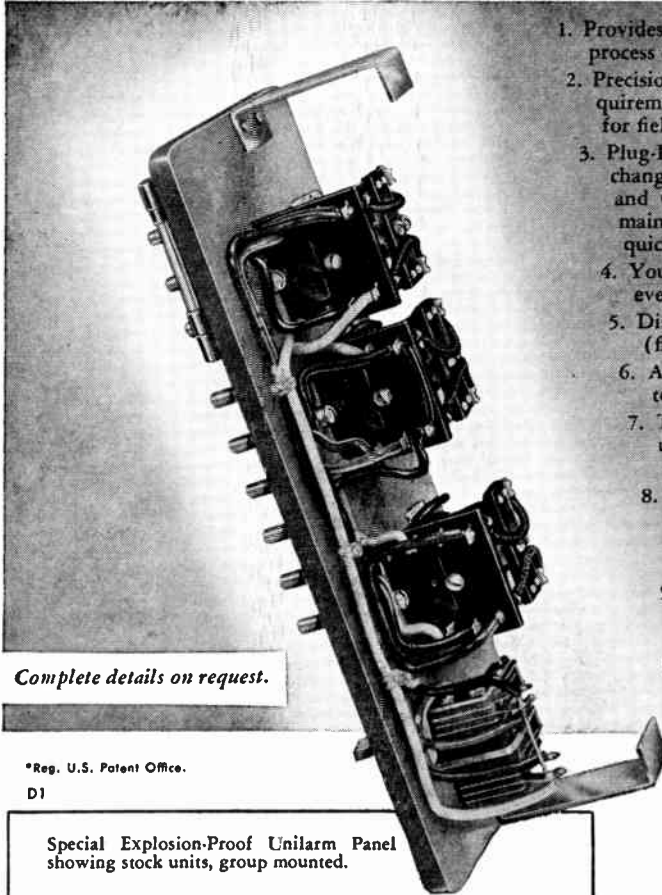

1. Provides unfailing supervision of equipment and process operations.
2. Precision-built to Underwriters' Laboratories requirements. Completely wired and tested . . . ready for field connections.
3. Plug-In Panel (large illustration), fits interchangeably into Explosion-Proof, Vaportight and General Purpose enclosed units. Reduces maintenance to a minimum . . . easily and quickly replaced with a spare unit.
4. Your choice of 100 standard circuits to suit every conceivable application.
5. Distinctive visual signal for each condition (flashing light) insures immediate attention.
6. Any number of Unilarms may be connected to one audible signal.
7. Tried and tested in the field. Thousands in use giving trouble-free protection. Accepted as standard by leading industries.
8. Available as individual unit or in multi-unit Panels. Also time delay types for applications subject to high surge or excessive vibration.
9. Saves space, engineering costs, installation and maintenance over other alarm systems.
10. Acknowledgement-test switch permits periodic testing of each Unilarm circuit.

*Reg. U.S. Patent Office.
 D1

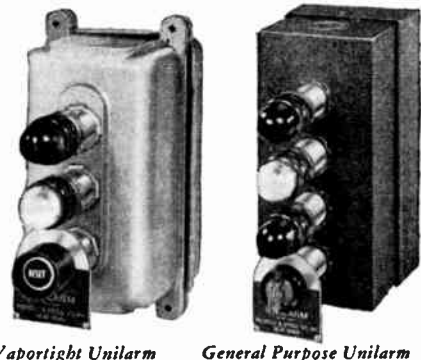
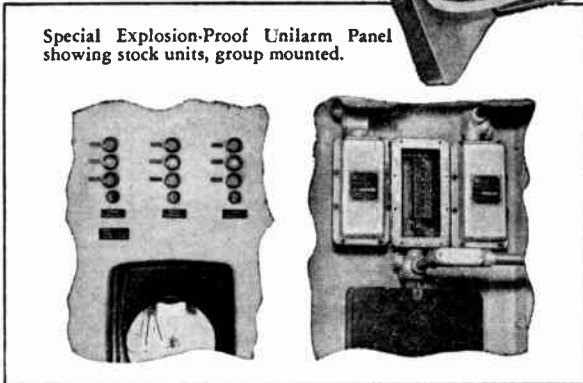

R&S Unilarm is also available in a complete line of Surface Mounted Types — Explosion-Proof, Vaportight and General Purpose.

Unilarms for Panel Mounting

Description	Standard		Three Stage		Five Stage		Vital Motor Alarm	
	No.	Price	No.	Price	No.	Price	No.	Price
Complete Unilarm	Explosion-proof	AEP2 \$143.00	AEP3 \$177.00	AEP23 \$176.00	AEP35 \$195.00	MAEP34 \$195.00		
	Vaportight	AVT2 120.00	AVT3 150.00	AVT23 152.00	AVT35 168.00	MAVT34 168.00		
	General Purpose	AU2 117.00	AU3 147.00	AU23 149.00	AU35 165.00	MAU34 165.00		
Replacement Parts	Plug-in Unit	PU2 67.00	PU3 82.00	PU23 90.00	PU35 100.00	MPU34 100.00		
	Lens Assembly							
	—Explosion-proof	ELA 3.75						
	—Vaportight	VLA 2.75						
	—General Purpose	LA 2.75						

Standard lens colors are White (normal), Green (low alarm), Red (high alarm). Other colored lenses will be supplied if specified.

Lamp—S6-6 watt, 120 volt bulbs regularly furnished.

Unilarm can be supplied for surface mounting. Information and prices on request to Graybar.

Crouse-Hinds Type EKP Visularm

Explosion-Proof and Dust-Tight

Class I, Group D (NEMA Type VII); Class II, Groups E, F, and G; and Class III (NEMA Types IX, V and III)

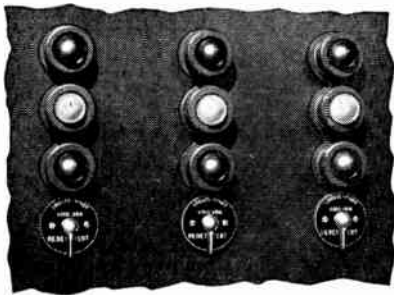

Three Horizontally Mounted VISULARMS
Front View of Panel

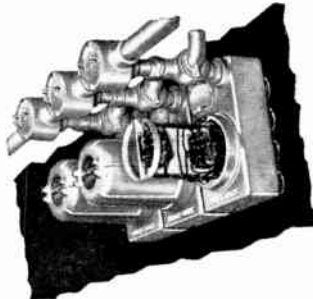

Three Horizontally Mounted VISULARMS. Back Feed Conduit Arrangement. Rear View of Panel

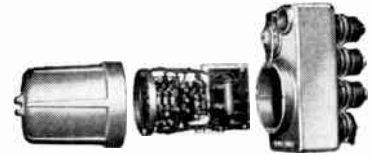

Separated View

Type EKP VISULARM is a complete compact unit used to supervise and control manufacturing processes in chemical plants, oil refineries, synthetic rubber plants and in other locations where constant control is necessary. The VISULARM will indicate, by means of pilot lights, normal and abnormal temperature, liquid level, speed, load or any other condition which can be electrically coupled to the circuit. It is desirable to provide an audible indication of abnormal conditions and therefore the units listed are arranged to operate horns, sirens, and bells listed elsewhere in this catalog. Auxiliary circuits can be furnished to actuate with other devices or control process equipment.

The VISULARM includes the following electrical features as standard: 1. Jack-mounted plate completely factory wired and tested. 2. High speed flasher on alarm light. 3. Independent horn circuit. 4. Reset switch. Silences horn and changes alarm light from flashing to steady until fault is corrected. 5. Test switch. Permits periodic check of every device in the VISULARM insuring proper operation under abnormal conditions.

Two-Light Two-Position Visularm

For Normal and Abnormal Indications

Signal Indications:

1. Normal—Bottom Green light on. Top Red light off.
2. Abnormal—Red light flashing. Horn on. Green light off.
3. Reset—Horn silenced. Red light on steady until conditions return to normal.

Description*	Initiating Device Contacts Maintained		Each
	†Normally Open	Normally Closed	
Complete VISULARM	EKP32-1-J1-3	EKP32-6-J1-3	\$195.00
Jack-mounted Plate	EKPU32-1	EKPU32-6	102.00

Two-Light Three-Position Visularm

For Normal, Intermediate, and Abnormal Indications

Signal Indications:

1. Normal—Bottom white light on. Top red light off.
2. Intermediate—White and red lights on.
3. Abnormal—Red light flashing. Horn on. White light off.
4. Reset—Horn silenced and red light on steady until conditions return to normal.

Description*	Initiating Device Contact Maintained		Each
	Normally Open	Normally Closed	
Complete VISULARM†	EKP32-2-J1-8	EKP32-8-J1-8	\$231.00
Jack-mounted Plate	EKPU32-2	EKPU32-8	115.50

Two-Light Four-Position Visularm

For Essential Motor Alarm

Signal Indications:

1. Motor Off—Bottom green light on. Top red light off.
2. Motor On—Red light on. Green light off.
3. Thermostat on motor indicates high temperature—Red light flashing. Horn on. Green light off. Motor continues to run.
4. Reset—Horn silenced. Red light on steady. Motor running.
5. If motor temperature continues to rise—Magnetic starter trips. Green light flashing. Horn on. Red light off. Motor stopped.
6. Reset—Horn silenced. Green light on steady. Motor stationary until restarted.
7. Motor stopped intentionally—Green light on. Red light off. Horn silent.

Two-Light Four-Position Visularm—Continued

Initiating Device Contact—Continued

N. O. Contacts on Thermostat

Extra N.C. Interlock Contact on Starter

Description*	Each
Complete VISULARM†	\$277.50
Jack-mounted Plate	\$138.00

Three-Light Three-Position Visularm

For Normal and High-Low Abnormal Indications

Signal Indications:

1. Normal—Center green light on. Both red lights off.
2. Abnormal Low—Bottom red light flashing. Horn on. Green and top red lights off.
3. Reset—Horn silenced. Bottom red light on steady until conditions return to normal.
4. Abnormal High—Top red light flashing. Horn on. Green and bottom red lights off.
5. Reset—Horn silenced. Top red light on steady until conditions return to normal.

*Description	Initiating Device Contact Maintained		Each
	Normally Open	Normally Closed	
Complete VISULARM†	EKP43-3-J1-3-1	EKP43-7-J1-3-1	\$231.00
Jack-mounted Plate	EKPU43-3	EKPU43-7	115.50

Three-Light Five-Position Visularm

For Normal, High-Low Intermediate, and High-Low

Abnormal Indications

Signal Indications:

1. Normal—Center white light on. Both red lights off.
2. Intermediate low—White and bottom red lights on steady. Top red light off.
3. Minimum Low—Bottom red light flashing. Horn on. White and top red lights off.
4. Reset—Horn silenced. Bottom red light on steady until conditions return to normal.
5. Intermediate high—White and top red lights on steady. Bottom red light off.
6. Maximum High—Top red light flashing. Horn on. White and bottom red lights off.
7. Reset—Horn silenced. Top red light on steady until conditions return to normal.

Description*	Initiating Device Contact Maintained		Each
	Normally Open	Normally Closed	
Complete VISULARM†	EKP43-4-J1-8-1	EKP43-9-J1-8-1	\$255.00
Jack-mounted Plate	EKPU43-4	EKPU43-9	137.00

†Visularm does not include howler. Refer to types ETH or WH horns listed elsewhere in this catalog. Pilot light jewels of colors other than those listed can be supplied. Information on request to GRAYBAR.

*Standard unit arranged for 115 volts a-c, 60 cycles. Visularm can be supplied for other voltages and frequencies or other circuit arrangements. Prices on application to Graybar.

Crouse-Hinds Type KP Visularm

Dust-Tight and Weather Resistant (Raintight)★

**Class II, Groups E, F, and F;
and Class III (NEMA Types IX, V, and III)**

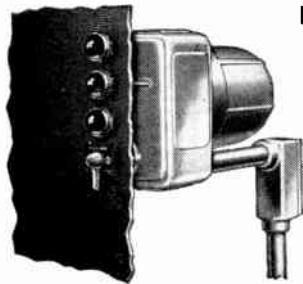

**Type KP
Visularm
Mounted on
Steel Panel**

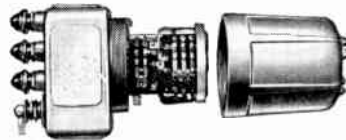

**Three-Light
Visularm
Cover
Removed**

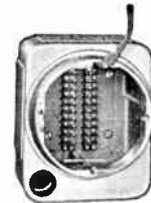

**Visularm Cover
and Interior
Removed
Showing
Terminal Block**

Type KP Visularm performs the same functions as type EKP explosion-proof Visularm which is designed primarily for Class I hazardous locations. The Type KP is ideal for use in boiler rooms, chemical plants, grain handling and food processing plants and similar moist or corrosive locations.

Electrically, types KP and EKP are identical. The jack-mounted relay plates are also identical and interchangeable which allows stocking common spare plates for both types of Visularm.

A 1" back hub is provided and all sides may be drilled and tapped for additional conduit entrances. Type KP Visularms may also be bolted together with a suitable gasket between and with clearance holes to allow passage of wires between units. Information on request to Graybar.

Two-Light, Two Position Visularm†

For Normal and Abnormal Indications

Signal Indications:

1. Normal—Bottom green light on. Top red light off.
2. Abnormal—Red light flashing. Horn on. Green light off.
3. Reset—Horn silenced. Red light on steady until conditions return to normal.

Description*	Initiating Device Contacts (Maintained)		Each
	Normally Open	Normally Closed	
Complete Jack-mounted Plate	KP32-1-J1-3†	KP32-6-J1-3†	\$160.00
	EKPU32-1	EKPU32-6	102.00

Two-Light, Three-Position Visularm†

For Normal, Intermediate, and Abnormal Indications

Signal Indications:

1. Normal—Bottom white light on. Top red light off.
2. Intermediate—White and red lights on.
3. Abnormal—Red light flashing. Horn on. White light off.
4. Reset—Horn silenced. Red light on steady until conditions return to normal.

Description*	Initiating Device Contacts (Maintained)		Each
	Normally Open	Normally Closed	
Complete Jack-mounted Plate	KP32-2-J1-8†	KP32-8-J1-8†	\$196.00
	EKPU32-2	EKPU32-8	115.50

Three-Light, Three-Position Visularm†

For Normal, Intermediate, and Abnormal Indications

Signal Indications:

1. Normal—Bottom green light on. Center amber and top red lights off.
2. Intermediate—Amber light flashing. Horn on. Green and red lights off.
3. Reset—Horn silenced. Amber light on steady until conditions become abnormal or return to normal.
4. Abnormal—Red light flashing. Horn on. Green and amber lights off.
5. Reset—Horn silenced. Red light on steady until conditions return to intermediate (steady amber light shows) or normal.

Description*	Initiating Device Contacts (Maintained)		Each
	Normally Open	Normally Closed	
Complete Jack-mounted Plate	KP33-11-J1-6-3†	KP33-12-J1-6-3†	\$205.00
	EKPU43-11	EKPU43-12	137.00

Three-Light, Three-Position Visularm†

For Normal and High-Low Abnormal Indications

Signal Indications:

1. Normal—Center green light on. Both red lights off.
2. Abnormal Low—Bottom red light flashing. Horn on. Green and top red lights off.
3. Reset—Horn silenced. Bottom red light on steady until conditions return to normal.
4. Abnormal High—Top red light flashing. Horn on. Green and bottom red lights off.
5. Reset—Horn silenced. Top red light on steady until conditions return to normal.

Description*	Initiating Device Contacts (Maintained)		Each
	Normally Open	Normally Closed	
Complete Jack-mounted Plate	KP33-3-J1-3-1†	KP33-7-J1-3-1†	\$181.00
	EKPU43-3	EKPU43-7	115.50

Three-Light, Five-Position Visularm†

For Normal, High-Low Intermediate, and High-Low Abnormal Indications

Signal Indications:

1. Normal—Center white light on. Top and bottom red lights off.
2. Intermediate Low—White and bottom red lights on steady. Top red light off.
3. Minimum Low—Bottom red light flashing. Horn on. White and top red lights off.
4. Reset—Horn silenced. Bottom red light on steady until conditions return to normal.
5. Intermediate High—White and top red lights on steady. Bottom red light off.
6. Maximum High—Top red light flashing. Horn on. White and bottom red lights off.
7. Reset—Horn silenced. Top red light on steady until conditions return to normal.

Description*	Initiating Device Contacts (Maintained)		Each
	Normally Open	Normally Closed	
Complete Jack-mounted Plate	KP33-4-J1-8-1†	KP33-9-J1-8-1†	\$205.00
	EKPU43-4	EKPU43-9	137.00

†Visularm does not include horn. Refer to listings of types ETH or WH horns elsewhere in this catalog. Pilot light jewels of colors other than those listed can be supplied. Information on request.

*Standard unit arranged for 115 volts A-C, 60 cycles. Visularm can be supplied for other voltages and frequencies or other circuit arrangements. Prices on application.

†For panel 1/8" to 1/4" thick. Specify type KPA for panel 1/4" to 5/8" thick or type KPB for panel 5/8" to 1" thick.

*To maintain raintightness, cover threads must be kept liberally coated with a lubricant which will not flow at the operating temperature encountered. Crouse-Hinds type STL thread lubricant is recommended.

Minneapolis-Honeywell Thermostats

Line Voltage Thermostats

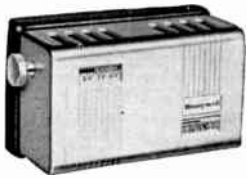

Designed to permit frequent cycling of low mass, quick-heating, quick-cooling electric resistance heating equipment.

Cycles 15 to 20 times per hr. under normal 50% heating load to assure close temperature control and long equipment life.

Cover amply vented for accurate air sampling.

Non-adjustable Differential, approximately 1/4 F.

Electrical Rating (a-c only): Resistance load, 4000 watts at 230 volts; 2000 watts at 115 volts. Pilot duty rating, 125 watt amps. at 115 or 230 volts.

Available with the following special features: Model with "Auto-Nite" switch to prevent automatic operation. Model with temperature range stops and locking cover. Wall plate for mounting thermostat on vertical switch box.

Finished in Silver bronze.

No.	Switching Action	Range	Height In.	Width In.	Depth In.	Wt. Lbs.	Each
T40A	S.P.S.T.	56 to 84 F	2 7/8	5	2 1/4	1	\$15.25

Specify Model number and special features required.



Designed for ceiling cable type electric resistance heating. Slower cycling, 3 to 6 times per hour, makes it ideal for high mass, slow heating, slow cooling installations. Cover amply vented for accurate air sampling.

Electrical Rating (a-c only): Resistance load — 1000 watts at 230 v; 2000 watts at 115 v. Pilot duty rating — 125 v. amps. at 115 or 230 v.

Differential: Non-adjustable, approximately 1 F.

Dimensions: Height (including knob) 5-in., width 2 7/8-in., depth 2 1/4-in.

Finish: Silver bronze.

Available with the following special features: Model with "Auto-Nite" switch to prevent automatic operation; Model with temperature range stops and locking cover; Wall plate No. 33410C for mounting thermostat on horizontal switch box.

No.	Switch	Range	Wt. Lbs.	Each
T41A	S.P.S.T.	56 to 84 F	1	\$15.25

Specify Model number and Special features required.

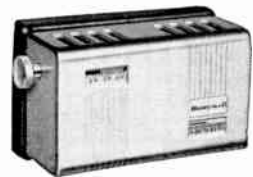

This heavy duty thermostat makes contact on temperature drop.

Designed for accurate and dependable control of line voltage heating equipment. Capable of directly handling motor driven units, blowers, and other line voltage loads.

Horizontally mounted allowing maximum circulation of air over the temperature sensing bellows.

Non-adjustable differential, approximately 2 F.

Electrical Capacity — a-c, 115 volts, 10.2 amp., 230 volts, 6.5 amp., d-c 115 volts, 0.2 amp., 230 volts, 0.1 amp.

Available with the following special features: Adaptor plate for mounting on vertical switch box and Conduit Adaptor for hanging thermostat in space.

Finished in Silver bronze.

No.	Switching Action	Range	Height In.	Width In.	Depth In.	Wt. Lbs.	Each
TA42A	S.P.S.T.	42 to 75F 56 to 84F	2 7/8	5	2 1/16	1	\$21.70

Specify Model number, Range and Special features required.

Light Duty Thermostats



This snap-acting, bimetal actuated line voltage room thermostat makes contact on temperature drop.

Suitable for either line or low voltage applications.

Used for direct control of small motors, unit heaters, coal blowers, automatic burners, relays, motor starters, and similar equipment.

Differential: Adjustable, 1 1/2 to 6 F.

Available with the following special features: Locking cover, Manual night shut-down. Special ranges 64 to 96 F., 34 to 66 F or their Centigrade equivalents, Special finishes and Q18A sub-base.

Finished in Silver bronze.

Electrical Capacity — a-c, 115 volts, 4.6 amp., 230 volts, 2.3 amp., d-c, 115 volts, 0.13 amp., 230 volts, 0.07 amp.

No.	Switching Action	Range	Height In.	Width In.	Depth In.	Wt. Lbs.	Each
T44A	S.P.S.T.	44 to 76 F. 54 to 86 F.	5	2	1 7/8	0.5	\$15.70

Specify Model number and Special features required.

Heavy Duty Thermostats

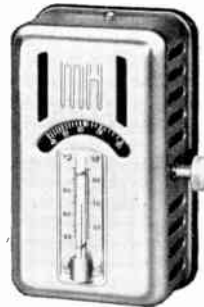

Makes contact on temperature drop. Used in either line or low voltage circuits to control heating systems.

Provided with proven, dependable mercury switch, this thermostat directly handles line voltage loads.

Differential: Non-adjustable 2 to 3 F.

Available with the following special features: Locking cover; Centigrade scale equivalent to standard Fahrenheit range and Special finishes.

Electrical Capacity — a-c, 115 volts, 7.4 amp., 230 volts, 3.7 amp., d-c 115 volts, 2.5 amp., 230 volts, 1.3 amp.

Finished in Silver bronze.

No.	Switching Action	Range	Height In.	Width In.	Depth In.	Wt. Lbs.	Each
T42A	S.P.S.T.	40 to 80F 60 to 100F	5 1/16	3 3/8	2 1/4	1 1/4	\$21.70

Specify Model number, Range and special features required.

Electric Clock Thermostats



Suitable for replacement of Series 10 or Series 80 thermostats. Standard voltage 115 volts, 60 cycles.

The Comfort Chronotherm automatically lowers room temperature at night for desired period of time (minimum six hours) and raises temperature in the morning to provide both day and night comfort.

Two handy fingertip levers allow convenient changing of day and night settings. Easy to read clock set in silver bronze case.

Universal heater element eliminates need for changing heaters to match the various applications, yet provides the short, frequent burner operations which are necessary for maintaining accurate temperature control.

May be used with the CS82 Powerpile in the self-energized systems.

Has adjustable Differential and Clock Transformer AT75A.

Available with the following special features: Night shutoff. Locking cover, Centigrade scale 10 to 26 C., Special voltages of 115 volts 25 or 50 cycles; 230 volts, 25, 50 or 60 cycles, Special finishes.

No.	Switching Action	Range	Height In.	Width In.	Depth In.	Wt. Lbs.	Each
T852A	2 or 3 wire snap-acting	50 to 80 F.	2 7/8	5	2 1/2	3.6	\$45.20

Minneapolis-Honeywell Thermostats

Double-Setting

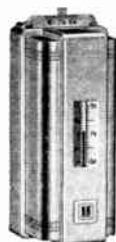

Ideal for motels or offices, where heat can be lowered in unoccupied units and restored to comfort temperatures in occupied units from a central panel.

Has double-setting, low voltage thermostat (Series 80). Heat leveling element in comfort stage. 2 S.P.S.T. switches. Range: 56°F. to 81°F. A 77°F. range stop and a locking cover are standard.

Switching: Panel switch in "Hi" position — Comfort stage circuit completed on drop to temperature setting. Panel switch in "Lo" position — Anti-freeze stage circuit completed on drop to 20° below setting.

Electrical Rating: 2 amps at 25 v. a-c. Rating for heater plug in comfort stage 0.135 to 1.4 amps.

Finish: Silver bronze. Special finishes available.

Temperature Sensing: Two bimetal elements.

No.	Ht. In.	Width In.	Depth In.	Each
TA802D	5	2	1 7/8	\$26.00

Note — When ordering specify Model number, voltage and frequency of M-H device to be controlled.

Round Thermostat



Designed for use with electric resistance heating. Recommended for use with R879A, R879B or other two-wire, low voltage electric heating relays. Adjustable heater provides means of regulating ON-OFF operating cycles of electric heating equipment.

Temperature selector and thermometer scale are combined in one easy-to-read dial.

Mercury switch assures positive, dust-free contact operation.

The T86A29 is the standard model for use with electric heating equipment.

The T86A31 is the same as the T86A29 except it has provision for night shutdown.

Operating Differential: Approximately 1/2 F., non-adjustable.

Electrical Rating: .5 amps. at 25 v. a-c.

Dimensions: Diameter 3 1/4-in., depth 1 1/2-in., diameter of adaptor plate 5-in.

Heater: Adjustable for currents from 0.35 to 0.8 amps. standard.

Available with the following special features: Centigrade scale 7 to 23 C; Locking cover; No. 104528B plate for mounting on outlet box; Ranges 35 to 65 F. and 45 to 75 F.

No.	Switch	Range	Wt. Lbs.	Each
T86A29	S.P.S.T.	55 to 85 F.	0.5	\$12.95
T86A31	S.P.S.T.	55 to 85 F.	0.5	12.95

Note — When ordering specify Model number and Special features required.

Pulsatherm*



Fast-cycling thermostat designed for use with the R879 Mercury Switch Relay to control electric resistance heating within a narrow temperature range.

Has non-adjustable thermostat heater which provides proper cycling rate when operating an R879 relay only.

Equipped with mercury switch that assures positive, dust-free contact operation for the life of thermostat.

Temperature selector and thermometer scale are combined in one dial.

Electrical Rating: .5 amps. at 25 v. a-c.

Operating Differential: Approximately 1/2 F. non-adjustable.

Dimensions: Diameter 3 1/4-in., depth 1 1/2-in.

Available with the following special features: Locking cover; No. 104528B plate for mounting on an outlet box.

No.	Switch	Range	Wt. Lbs.	Each
T86C	S.P.S.T.	55 to 85 F.	0.5	\$12.95

Note — When ordering specify Model number and Special features required.

*Trade Mark, Minneapolis-Honeywell.

Heating-Cooling Thermostats and Subbase



A Series 80, double-acting, three-wire, low voltage thermostat, designed for heating-cooling applications. When used with Q405 Subbase it provides complete control of heating cooling equipment.

Adjustable heat leveling provided in the heating position and "Cooling Anticipation" in the cooling position.

Features dustproof mercury switch. Thermostat closes one contact on temperature rise and another on temperature fall.

Range 55 to 85° F.; Differential, Adjustable, factory set at 1.5° F.; Electrical Rating, low voltage a-c only (1.5 amperes at 25 volts maximum); Heater adjustable for currents 0.1 to 0.8, 0.8 to 1.2, 0.16 to 0.32 amperes; Cooling Anticipation Non-adjustable, 0.65 amperes is standard. Adjustable from 0 to 0.8, 0.7 to 1.2, 1.1 to 1.5.

No.	Description	Diam. In.	Each
T87A	Heating Cooling Thermostat	3 1/4	\$13.45

Q405 Subbases

No.	Description	Each
Q405A	Provides system changeover switch with positions for Cool, Off, and Heat. Provides fan switch with positions for Auto and On.....	\$ 7.70
Q405B	Provides system changeover switch with positions for Cool and Heat. Provides fan switch with positions for Auto and On....	7.20
Q405C	Provides system changeover switch with positions for Cool, Off, and Heat.....	7.20
Q405D	Provides system changeover switch with positions for Cool and Heat.....	6.70

When ordering specify Model number of thermostat, Model number of subbase and special features required.

Minneapolis-Honeywell Electric Heating Sets

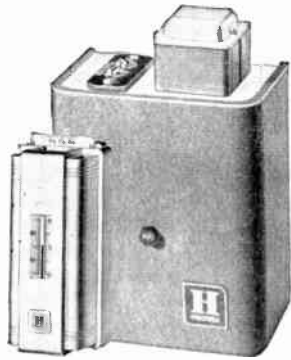

The Y362A and Y362B Electric Resistance Heating Packages contain the TA802D Double-Setting Thermostat and the R879 Mercury Switch Relay. The TA802D is designed for installations such as motels or offices where temperatures are desired to be lowered approximately 20° from a central panel in unoccupied units or offices, and restored to the "comfort" temperature setting during occupied periods.

The Y362A contains the R879A Relay capable of handling a single circuit up to 4600 watts resistance load at 230 volts a-c.

The Y362B contains the R879B Relay capable of handling two circuits up to 4600 watts resistance load each at 230 volts a-c total 9200 watts. A transformer in the R879 provides low voltage power to the control system.

Mercury switches in these relays are operated by a plunger-type solenoid having no metal-to-metal contact, insuring quiet operation.

Voltage and Frequency: 230 volts, 60 cycle standard.

Available with the following special features: Voltage and frequency of 208 or 115 volts, 60 cycle; 230 volts, 50 cycle.

No.	Description	Wt. Lbs.	Each
Y362A	Electric Heating Set	5	\$40.65
Y362B	Electric Heating Set	5	51.00

Note — When ordering specify Package set number, voltage and frequency.

Minneapolis-Honeywell A & B Electric Heating Sets

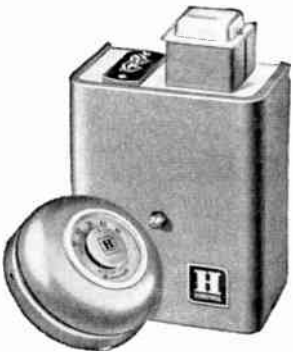

The Y321 Electric Heating Sets contain the T86A Round Thermostat and R879 Mercury Switch Relay. The Y321A contains an R879A Relay capable of handling a single circuit up to 4600 watts resistance load at 230 volts a-c. The Y321B contains an R879B Relay capable of handling two circuits up to 4600 watts resistance load each at 230 volts a-c total 9200 watts.

A built-in transformer in the R879 provides low voltage power to the control system. Both thermostat and relay have quiet switching mercury switches.

Voltage and Frequency: 230 volts, 60 cycles, standard.

Available with the following special features: Night shut-down thermostat; 104528B wall plate for mounting on an outlet box; voltage and frequency of 208 or 115 volts, 60 cycles.

No.	Description	Wt. Lbs.	Each
Y321A	Electric Heating Set with wall plate	5	\$28.20
Y321A	Electric Heating Set less wall plate	-	27.60
Y321B	Electric Heating Set with wall plate	5	38.55
Y321B	Electric Heating Set less wall plate	-	37.95

Note — When ordering specify Model number and special features.

Minneapolis-Honeywell C and D Electric Heating Sets

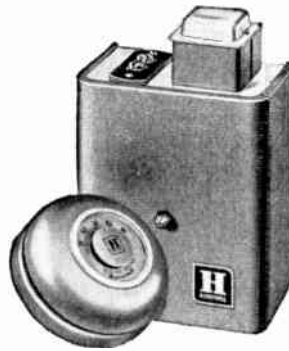

These sets contain the fast cycling T86C Round Thermostat and the R879 Mercury Switch Relay. The fast cycling T86C has a narrow differential which provides 8 to 10 cycles per hour at 50% load conditions, prevents wide temperature variations.

The Y321C contains an R879A Relay capable of handling a single circuit up to 4600 watts resistance load at 230 volts a-c. The Y321D contains an R879B Relay capable of handling two circuits of 4600 watts resistance load each at 230 volts a-c. The R879 has a built-in transformer. Thermostat and relay have mercury switches.

Voltage and Frequency: 230 volts, 60 cycle standard.

Available with the following special features: Voltage and frequency of 208 or 115 volts, 60 cycle; 104528B wallplate for mounting thermostat on an outlet box.

No.	Description	Wt. Lbs.	Each
Y321C	Electric Heating Set	5	\$27.60
Y321D	Electric Heating Set	5	37.95

Specify Package set number and special features required.

Minneapolis-Honeywell Mercury Switch Relays



Designed to carry a high amperage, line voltage, resistance load, when controlled with a two-wire low voltage thermostat.

Specially suitable for electric panel heating control application. Heavy duty sealed-in mercury switch, built to provide trouble-free operation, is actuated by plunger-type solenoid having no metal-to-metal contact. Designed to carry a single circuit, up to 4600 watts at 230 volts a-c.

Finish: Gray wrinkle.

Dimensions: Height 6 5/8-in., width 4 1/4-in. depth 3-in.

Voltages and Frequency: 230 volts, 60 cycles is standard. 208 or 115 volts, 60 cycles available.

Rating in Amperes (a-c Resistance load only): 20 amps. at 230, 208 or 115 volts, a-c.

No.	Switch	Resistive Load Rating in Amperes 115, 208, or 230 V. A-C	Wt. Lbs.	Each
R879A	S.P.S.T.	20 amps	4.3	\$14.65



Designed to carry two high amperage, line voltage, resistance loads, when controlled with a two-wire low voltage thermostat. Provided with heavy duty sealed-in mercury switches actuated by plunger-type solenoid having no metal-to-metal contact.

Designed to carry two resistance load circuits, up to 4600 watts each at 230 volts a-c, total for two circuits 9200 watts at 230 volts a-c.

Finish, Dimensions, Voltage and Frequency same as Model 879A.

No.	Switch	Resistance Rating in Amperes 115, 208, or 230 V. A-C	Wt. Lbs.	Each
R879B	D.P.S.T.	20 amps per switch	4.3	\$25.00

Specify Model Number, voltage and frequency.

Minneapolis-Honeywell Intermediate Relays

No. R882

Used for switching line-voltage loads under the control of two-wire low-voltage controllers.

Has two-wire relay coil operated from an external low-voltage supply. An external transformer can be ordered with the relay.

Controllers used to operate these relays must be either snap-acting or mercury switch type devices.

Voltage and frequency 20-24 volt, 50 or 60 cycle without transformer standard.

Weight 2 3/4 lbs.



No.	Switching Action	Rating in Amperes* (Full Load)		Each
		115 volts A-C	230 volts A-C	
R882A	S.P.S.T.			\$16.05
R882B	S.P.D.T.	10.2	6.5	17.65
R882C	D.P.S.T.			18.20

*Rating for each circuit.

When ordering specify Model number, voltage and frequency and transformer, if desired.

No. R482

Used for switching line-voltage loads under the control of line-voltage controllers.

Has two-wire relay coil which is operated directly from a line-voltage supply.

Controllers used to operate these relays must be either snap-action or mercury switch type devices. Can also be controlled by a manual switch in the line to the relay coil.

Voltage and frequency 115 volts, 50 or 60 cycle standard.

Weight 1 lb.



No.	Switching Action	Rating in Amperes* (Full Load)		Each
		115 volts A-C	230 volts A-C	
R482A	S.P.S.T.			\$16.05
R482B	S.P.D.T.	7.4	3.7	17.65
R482C	D.P.D.T.			18.20

*Rating of each circuit.

When ordering specify Model number, voltage, frequency.

No. RA89A

Used in low-voltage control circuits to provide S.P.S.T. switching of a-c line-voltage loads. Low-voltage for control circuit is provided by built-in transformer. Open contact switch closes the load circuit when relay coil is energized.

Relay can be operated by thermostat or other controller of the S.P.S.T. two-wire snap-action or mercury switch type.

Voltage and frequency 115 or 230 volts, 50 or 60 cycle standard.

The RA89A is a replacement for the R19A switching relay.

Weight 2 3/4 lb.



No.	Switching Action	Rating in Amperes (Full Load)		Each
		115 Volts A-C	230 Volts A-C	
RA89A	S.P.S.T.	10.2	5.1	\$15.40

When ordering specify Model number, voltage, frequency.

Minneapolis-Honeywell Switching Relays

Designed for control of heavy duty loads such as cooling compressors.

Makes possible the control of relatively high current by a low-amperage thermostat. Relay has optional switching, D.P.S.T. or S.P.S.T.

Model R847A with voltage and frequency of 230, 208 or 115 volts, 60 cycles, is used as control of cooling compressor with low voltage thermostat.



Model R847B with voltage and frequency of 24 volts, 60 cycles, is used as a control of cooling compressor with low voltage control circuit.

No.	Description	Height In.	Width In.	Depth In.	Each
R847A	With Transformer	5 1/4	4 1/4	2 3/4	\$18.45
R847B	Without Transformer	5 1/4	4 1/4	2 3/4	16.00

When ordering specify Model number, voltage, frequency.

Minneapolis-Honeywell Relays

Small, compact switching relays designed for mounting in panel boxes or similar locations where relay will be covered.

May be operated by two-wire line or low-voltage snap-acting thermostats or controllers to switch line or low-voltage loads.

The R488 operates directly on line voltage. The R888 operates on low voltage (24 volts). An external transformer must be used with R888 Relay.

Voltage and Frequency: R488 115 volts, 50 or 60 cycles standard. R888 24 volts, 50 or 60 cycles standard. Weight 3/4 lb.



No.	Relay Description	Each
R488A	115, 230/50, 60	\$12.40
R488B	115, 230/50, 60	15.95
R488C	115, 230/50, 60	16.05
R488D	115, 230/50, 60	16.05
R488E	Relay	11.25
R888A	115, 230/50, 60 w/Transformer	14.90
R888B	115, 230/50, 60 w/Transformer	18.45
R888C	115, 230/50, 60 w/Transformer	18.55
R888D	115, 230/50, 60 w/Transformer	18.55
R888E	115, 230/50, 60 w/Transformer	13.75

Special Features available: No. R488 in other voltages and frequencies. No. R888 in 25 cycle low voltage or with 115 or 230 volt transformer.

When ordering specify Model number, voltage, frequency.

Minneapolis-Honeywell Time-O-Switches

A line voltage timer designed to control operation of attic fans, store lights, or similar electrical equipment, which is to be shut off after a predetermined interval.

Timer may be set for "on" periods of from one-half to eleven hours.

Mercury switch controls the line-voltage circuit.

The S403B Time-O-Switch is similar to the S403A except that it is used in applications requiring timed "off" periods from one-half to eleven hours. The controlled equipment is turned "on" after the timed interval. "Manual-Automatic" switch permits by-passing timer on both Models.



No.	Rating in Amperes (Full Load)			Wt. Lbs.	Each
	115 volts A-C	230 volts A-C	D-C		
S403A	7.4	5.1		1 1/2	\$13.10
S403B		2.4	1.2	1 1/2	13.10

When ordering specify Model number.

Minneapolis-Honeywell Farm-O-Stat Thermostats

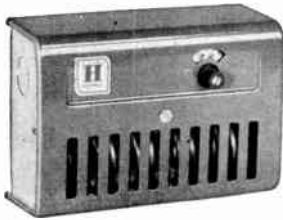

Ruggedly constructed line-voltage thermostat designed for high humidity applications.

Has 1/2 hp. Micro Switch totally enclosed and not affected by dust.

Durable red cover has slots in front and bottom to allow maximum circulation of air over the protected element.

Three mounting holes in base provide easy means of surface mounting. Has easy to read dial and external adjustment knob.

Differential: Non-adjustable, 2 F.

Electrical Capacity — a-c, 24 volts, 2.0 amp., 115 volts, 7.4 amp., 230 volts, 3.7 amp.

Special features available: No. 7640 HIF Bag assembly for post mounting.

No.	Switching Action	Range	Height In.	Width In.	Depth In.	Wt. Lbs.	Each
T631A	S.P.D.T.	35 to 100F 70 to 140F	4 1/4	6	2 1/4	2.5	\$20.60

Specify Model number and Special features required.

Minneapolis-Honeywell Dehumidifier Controllers



Operates dehumidifying equipment automatically.

Whenever relative humidity rises above setting selected controller turns dehumidifier ON. When humidity is reduced to setting selected controller turns dehumidifier OFF.

Equipped with 6-ft. cord and an interrupter plug.

Operating Differential 5% R.H. (approx.) non-adjustable.

Electrical Rating 115 v. a-c full load, 3.2 amp.; 115 v. a-c locked rotor, 19.2 amp.;

230 v. a-c full load, 1.6 amp.; 230 v. a-c locked rotor, 9.6 ampere. Gray Finish.

No.	Switching Action	Range	Height In.	Width In.	Depth In.	Each
H45A	S.P.S.T.	20 to 80% R.H.	5 3/4	2 5/8	1 1/8	\$11.95

Minneapolis-Honeywell Humidity Controllers



Operates dehumidifying equipment automatically. When relative humidity in room rises above setting selected, dehumidifier controller will turn dehumidifier ON. When relative humidity in area is reduced to setting controller will turn dehumidifier OFF.

Has permanent wiring terminals. May be used in line or low voltage circuits.

Operating Differential 5% R.H. (approx.) non-adjustable.

Electrical Rating 115 v. a-c full load, 3.2 amp.; 115 v. a-c locked rotor, 19.2 amp.; 230 v. a-c full load, 1.6 amp.; 230 v. a-c locked rotor, 9.6 amp.

Provided with backplate for mounting on vertical conduit box. Finished in Gray. Weight 1 lb.

No.	Switching Action	Range	Height In.	Width In.	Depth In.	Each
H45C	S.P.S.T.	20 to 80% R.H.	5 3/4	2 5/8	1 1/8	

Minneapolis-Honeywell Cutout Switches



Used to prevent possibility of reverse circulation in counterflow furnaces, and for attic fan control.

In attic fan installation it serves as a safety shut-off switch to guard against fire hazards by shutting off fan when temperature of air indicates presence of fire. After it opens circuit it must be manually reset.

Cutout temperature is factory set at 125° F., 135° F., 165° F., 200° F., or 240° F., Non-adjustable.

No.	Rating in Amperes (Full Load)	Wt. Lbs.	Each
L477A	115 volts A-C 10.2 230 volts A-C 5.1	1	\$ 9.70

When ordering specify Model number, and Cutout setting.

Minneapolis-Honeywell Pressure Controls Pressuretrol



The L404A breaks the circuit on pressure rise, and the L404B breaks circuit on pressure fall.

Used primarily as limit controls on steam heating systems. Bellows-actuated mercury switch provides S.P.D.T. switching. May be used with air, liquids, and non-combustible gases that will not injure the bellows.

The L404A and L404B are two-wire line voltage controls. Available with the following special features: External hand adjusting knob (standard on 10 to 300 lb. range); Special Range: 10 to 300 lbs.; Siphon 14026 (standard on 10 to 300 lb. range).

Finished in Gray wrinkle. Differential is Adjustable.

Electrical Capacity — a-c, 115 volts, 7.4 amp., 230 volts, 5.1 amp., d-c, 115 volts, 2.4 amp., 230 volts, 1.2 amp.

No.	Height In.	Width In.	Depth In.	Wt. Lbs.	Each
L404A	3 7/8	3 1/2	2 1/2	2.5	\$24.10
L404B	3 7/8	3 1/2	2 1/2	2.5	24.10

Specify Model number, Range and Special features required.

Minneapolis-Honeywell Remote Bulb Thermostats



To control temperature in ducts, tanks, boilers, and similar applications.

The T415 Models are used in two-wire line or low-voltage circuits and have an S.P.S.T. mercury switch.

No. T415A closes circuit on temperature fall. No. T415B opens circuit on temperature fall. No. 615A used in line or low-voltage circuits and has an S.P.D.T. mercury switch which opens one circuit and closes another on temperature fall.

Can be used to operate the K200B motorized valve assembly or M204A and M604B Modutrol motors.

Bulb Size: CA fill 1 1/2-in. x 1/16-in.; IIT fill 4-in. x 1/2-in. Element: 5-ft. (including bulb) copper standard.

Special Features Available: Knurled adjusting knob, A11A; Models with narrow differential; Low temperature fill in place of cross-ambient fill; Special element lengths and materials: 10, 20, 30-ft. copper; 5, 10, 20, 30-ft. mild steel or monel; Separable wells; Pressure fittings for liquid installations.

No.		At Ranges except 40 to 80F.				Each
		115 volts	230 volts	115 volts	230 volts	
T415A or B	a-c	7.4	5.1	1.0	0.5	\$33.00
	d-c	2.5*	1.3*	1.0	0.5	

*On 0-70 and 60-100 ranges this rating is 0-1 amp lower.

No.		115 volts	230 volts	Each
T615A	a-c	1.0	0.5	\$34.00
	d-c	1.0	0.5	

Specify Model number, Range and Special features required.

Mercoid Temperature Controls



These remote stem temperature controls have many industrial applications controlling temperatures of liquids and gases.

Furnished standard with 6-ft. copper stem and bulb, but are available in stainless steel or other materials, and length of stem. Have easy outside adjustments for setting cut-in and cut-out temperatures. Visible calibrated dial. Mercury switch contacts.

Electrical capacity—10 amp. 115 volts, 5 amp. 230 volts, and on order 3 amp. 440 volts.

Type DA-35

For Refrigeration and Air Conditioning

Range No.	Adj. Range, Degrees	Min. Differential Degrees		Each
		High	Low	
1	-30 to +60	3	12	\$30 00
1A	-60 to +30	5	15	35 00
2	0 to 75	1½	8	30 00
3**	25 to 100	1	5	32 00

For Industrial Applications

4**	50 to 150	2	12	\$32 00
5	100 to 200	2	9	30 00
6	135 to 235	3	10	30 00
7	150 to 270	3	12	30 00
7A	200 to 300	3	10	30 00
8	250 to 380	3	12	30 00
9*	370 to 530	4	14	53 00

*Standard with styles 1 or 2—stainless steel bulb 5¼ in. long.

**Standard with styles 1A or 2A—ambient bulb 12 in. long.

Above types are single pole, single throw to OPEN circuit as temperature increases. To CLOSE circuit as temperature increases add suffix (-3) such as DA-35-3, etc. Other circuits available on request. Available with other features on order: Galvanized armor on stem, vinylite plastic on bulb and stem, separable sockets, etc.

Standard Bulb Styles

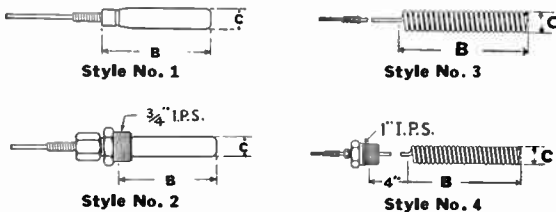

Description Extra Each

Explosion-Proof Case Type DAE, with above..... \$80 00
Weatherproof Case DAW, with above..... 26 00

Mercoid Clamp-On Risertherms



Temperature limit controls which operate from surface temperature of pipe to which it is strapped. Electrical capacity: 10 amp. 115 volts, 5 amp. 230 volts; on order 3 amp. 440 volts.

Each

Type 35-3—Range 140-230°F; For Unit Heaters. Circuit closes on temperature rises... \$12 00

Type 35—Range 110-200°F; For Unit Heaters. Circuit opens on temperature rises..... 12 00

**Mercoid Thermostats
Line Voltage Type**



For use with unit heaters and other line voltage applications.

Standard Ranges: 56-80°F, 38-70°F, 65-90°F and 25-60°F.

No.	Description	Each
855	Without Thermometer...	\$17.95
855T	With Thermometer.....	19.00

For Cooling

855R	Without Thermometer...	17.95
855RT	With Thermometer.....	19.00

For Heating—Explosion-Proof

No.	Description	Each
855EH	Without Thermometer.....	\$48.25
855EHT	With Thermometer.....	49.25

**Mercoid Sensatherms
(Low Voltage Thermostats)**



Extremely sensitive and accurate. Follow room temperature changes exactly and without lag or artificial heat acceleration. Mercury switch contacts. Differential plus or minus ½°. Finish—Champagne aluminite. Electrical capacity 0.9 ampere, 24 volts.

Type	Range	Each
Type H—For Heating	55-85°F.....	\$12.00
Type R—For Cooling	55-85°F or 65-95°F.....	12.00

Other ranges and types available at extra cost.

Mercoid Mercury Switches

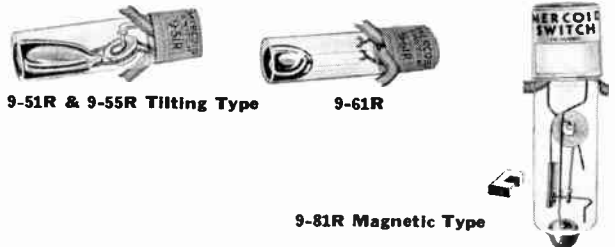

These switches have ample capacity for the normal over loading necessary in starting motors, lamploads, solenoids, etc. Unaffected by dust, dirt or corrosion, oxidation, open arcing-pitting or sticking of contacts. They are positive in operation, absolutely accurate and will give long, satisfactory service.

Type No.	115V	Amperage Rating (AC) 230V	440V	Mounting Clip Required	Each Tubes	Each Clips
9-51R	10	5	3	PP7-59	\$3.00	\$0.10
9-55R	25	12½	6	PP7-191	5.70	.50
9-61R	4	2	1	PP7-57	1.75	.10
*9-81R	0.3	0.15	..	PP7-57	3.95	.10

*Use Alnico Magnet PP93-87 with 9-81R, Each \$1.25.

Many other types are available. Standard length of lead wires 7 inches with No. 8 terminal.

Call Graybar FIRST For ...

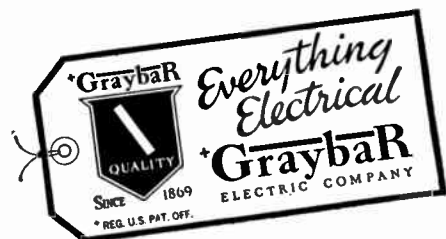

Cordley Electric Water Coolers

Five Year Guaranty

Entire cooler replaced and freight paid both ways if defect occurs in hermetic refrigeration system or cooling tank.

New Compact Line



G-2S



H-3S

Model G-2S: In Gray or White finish. 36-in. high. Uses 1 to 5 gallon bottle. Also available with cover for use without bottle.

Model H-3S Bubbler: Gray finish. 41½-in. high. Connects to municipal water supply and drain lines. Feather-touch "Accelerator-Pedal" handle for convenient operation. Adjustable automatic stream regulator.

The Standard Line

Completely vermin-proof. Fully sealed hermetic refrigeration systems. Meet and exceed U. S. sanitary codes. Comply with Bureau of Standards CS127-45. Tested and listed by U. L. and Canadian Standards Assn. For operation on 115 volts a-c 50 or 60 cycles.

Practical, extremely popular for commercial and industrial use. Bubbler models have connection on top for glass filler. Also extra connection on back for remote bubbler fountain (except H-3S). All standard models have stainless steel top, infra-red baked gray cabinet with black base.

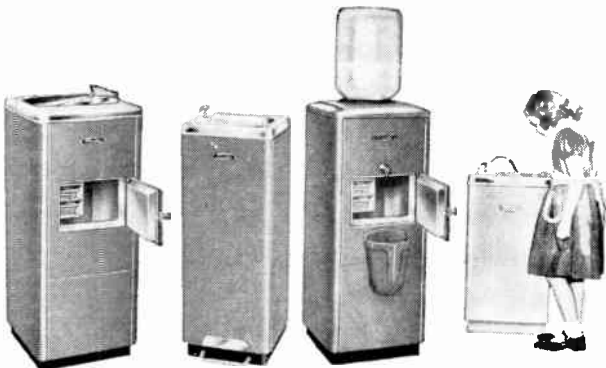

Refrigerator Models: Compartments with 1 cu. foot of storage space plus two ice trays. Useful for storing lunches, beverages, doctors' vaccines, etc. Compartments may be locked.

Low Height Model J-8: Only 33½-in. high. Ideal for schools with small children, hospitals with wheel chair patients, etc.

The Remote Line

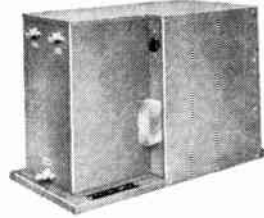

For hook-up to fixed fountains, faucets, etc. Four models meet a wide range of requirements . . . in soda fountains, laboratories, restaurants, institutions, etc.

Glass Fillers

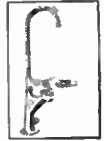

Remote Wall Fountains



Model	Type	*GPH	Hp.	Net Wgt. Lbs.	Ship. Wgt. Lbs.	Each
G-2S	Bottle	2.1	1/6	70	82	\$166.00
H-3S	Bubbler	2.9	1/6	76	88	197.00
CS-8	Bubbler	8.0	1/6	99	118	270.00
C-13	Bubbler	12.9	1/5	110	129	289.00
C-22	Bubbler	22.6	1/3	139	158	369.00
C-15W	Bubbler	15.0	1/5	114	133	335.00
C-27W	Bubbler	27.0	1/3	143	162	438.00
F-10WE	Bubbler Exp. Pr.	11.0	1/8	139	158	384.00
J-8	Bubbler	8.8	1/6	93	110	281.00
HC-5	Bubbler Comp.	5.0	1/6	141	160	373.00
GC	Bottle Comp.	1.0	1/6	141	160	335.00
SR-6	Remote	6.4	1/5	75	88	262.00
SR-14	Remote	13.7	1/3	125	146	326.00
SR-17W	Remote	16.5	1/3	104	125	346.00
SR-24W	Remote	23.3	1/2	113	134	377.00

Accessories

No.	Description	Each
GF-500	Push-button type glass filler	\$11.50
GF-700	Push-down type glass filler	14.50
F-610	Glass filler, restaurant type	12.75
9-12	Remote Fountain	49.50
9-20	Remote Fountain	42.50

*Ratings based on 80° inlet water cooled to 50° in 90° room. Other models available for d-c or 25 cycle a-c.

Wesix Wall Thermostats

Listed by Underwriters' Laboratories, Inc.



No. DLV

Sensitive to a temperature change of plus or minus one degree, Wesix model DLV combined thermostat and two-pole switch provides the finest control available for electric heating applications. Rated at 25 amps., 240 v., this unit features solid silver contacts and quick make and break action for long life under heavy load. Case color is ivory. Range, 55-85 degrees F.

No. DLV—Shipping Wt.,
1 Lb. Each **\$14.00**

For 240 Volts A-C, 30 Amp.



No. DB-30

No.	Description	Each
DB-30	Single Pole, Single Throw; for Standard Switch or Conduit Box	\$12.50
DBDT	Single Pole, Double Throw	14.00
DBDT-O	Single Pole, Double Throw; for Location Outdoors; Has Weatherproof Cover	16.00

Nutone Ventilating Fans

**Ceiling Fans for Vertical Discharge
Wall Switch Operated**

8-In. Ceiling Fan

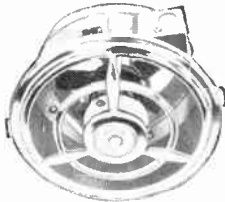

For ventilating directly through roof. Fan has 8-in. intake, 7-in. discharge without damper section.

Has one-piece removable grille 10½-in. diameter. Fits 9½-in. diameter opening.

Housing 5½-in. long, fits 7-in. diameter duct. Supplies 725 cfm free air.

Complete fan in one carton.

Anodized Aluminum Grille

Model		Ship. Wt. Lbs.	Each
820-JF		8	\$22.95
821-JF	With damper	10	25.50

10-In. Ceiling Fan



For ventilating directly through roof. 10-in. fan without reducer.

One-piece removable grille, 13-in. diameter.

Has snap-in motor and blade assembly. Fits into 11-in. diameter opening. Housing 5½-in. long. Supplies 1100 cfm free air.

Complete fan in one carton.

Anodized Aluminum Grille

Model	Description	Ship. Wt. Lbs.	Each
848	Without Reducer	9	\$29.75
849	With Reducer	11	32.75

Nutone Twin Blower Fans

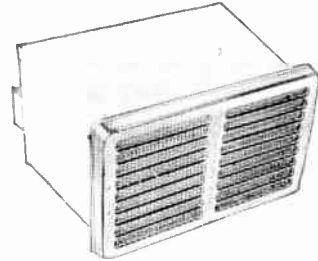

For installation in kitchen cabinets, on inside or outside wall.

Has 2 powerful centrifugal blowers for tremendous air delivery. Remarkably quiet.

Adjustable for vertical or horizontal discharge. Snap-in grille.

Compact housing fits inside cabinet. Anodized aluminum finish.

Model	Description	Housing Size, In.	Grille Size, In.	Ship. Wt. Lbs.	Each
870	Aluminum	8x8x14	9 ³ / ₁₆ x15 ¹³ / ₁₆	18	\$37.50
871	Copper	8x8x14	9 ³ / ₁₆ x15 ¹³ / ₁₆	18	37.50

Nutone Bathroom Blower Fans

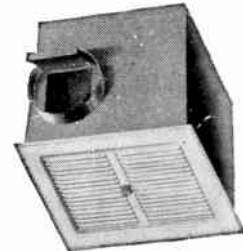

Designed especially for bathroom use where closed doors require a fan with high static pull.

Waterproof motor resists constant bathroom moisture.

Louver grille permits free flow of air, yet conceals inside. Center thumb screw holds grille tight.

Convenient handle for snap-in installation.

Removable flange allows smaller ceiling opening.

Adjustable bracket prevents sagging.

Anodized aluminum grille.

Fan can be discharged into attic space of a single floor plan, or between joists in a two-floor plan. Air can be carried with a standard 4-in. round duct to the outside.

Model	Housing Size, In.	Grille Size, In.	Ship. Wt. Lbs.	Each
881	8 ³ / ₈ x6 ³ / ₄ x7 ⁷ / ₈	7 ⁵ / ₈ x9 ¹ / ₄	9	\$25.95

Call Graybar FIRST For . . .

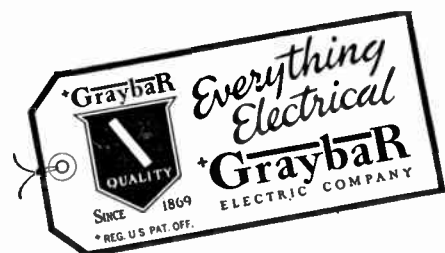

Nutone Ventilating Fans

**8-Inch Wall Fan
Pull Chain Operated**

Compact one piece grille, easily and quickly installed by a single thumb screw.

Has 10½ in. square grille, 13¾-in. square outside wall plate, and fits into 9½-in. diam. wall opening. Has 8-in. fan blade.

Housing, motor assembly, and grille packed in one carton.

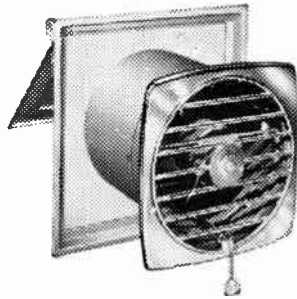

White Enamel Grille

Model	Wall Thickness In.	CFM Free Air	Shp. Wt. Lbs.	Each
800	5 to 10½	600	13	\$26.95
802	9 to 11½	600	14	26.95
804	3½ to 6½	600	13	26.95

Anodized Aluminum Grille

801	5 to 10½	600	12	27.95
803	9 to 11½	600	14	27.95
805	3½ to 6½	600	12	27.95

**10-Inch Wall Fan
Pull Chain Operated**

For medium or larger rooms. Removable center grille.

Housing fits into 11½-in. diameter wall opening, 13-in. square inside wall plate with center grille, and 13¾-in. square outside wall plate. Has 10-in. fan blade.

Housing, motor assembly, and grille packed in one carton.

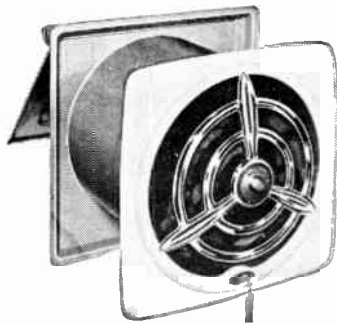

Anodized Aluminum Grille

Model	Wall Thickness In.	CFM Free Air	Shp. Wt. Lbs.	Each
811	5 to 10½	1100	14	\$36.25
813	9 to 14½	1100	17	36.25

**8-Inch Automatic Wall Fan
Wall Switch Operated**

One piece removable grille, automatic flutter-proof shutter and weather protected hood.

Has 10½-in. square grille, 13¾-in. square outside wall plate, and fits into 9½-in. diameter wall opening. Has pressure type 8-in. fan blade.

Housing, motor assembly, and grille packed in one carton.

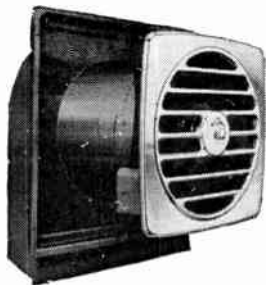

White Enamel Grille

Model	Wall Thickness In.	CFM Free Air	Shp. Wt. Lbs.	Each
806	5 to 10	500	15	\$26.95
808	9 to 14	500	17	26.95

Anodized Aluminum Grille

807	5 to 10	500	15	27.95
809	9 to 14	500	16	27.95

**10-Inch Automatic Wall Fan
Wall Switch Operated**

Single thumb screw grille installation, automatic flutter proof shutter and weather protected hood.

Has 13-in. square wall plate, 13¾-in. square outside wall plate, and fits into 11½-in. diameter wall opening. Has pressure type 10-in. fan blade.

Housing, motor assembly and grille are packed in one carton.

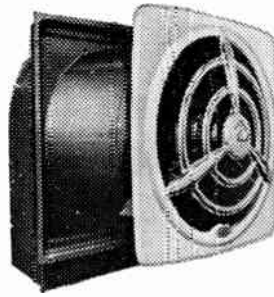

Anodized Aluminum Grille

Model	Wall Thickness In.	CFM Free Air	Shp. Wt. Lbs.	Each
817	5 to 10	900	17	\$36.25
819	9 to 14	900	19	36.25

**8-Inch Ceiling Fans
Wall Switch Operated**

For smaller rooms. Grille 10½-in. diameter. Has 8-in. pressure type blade. Hanger bar type mounting.

Has snap-in motor and blade assembly, one-piece removable round grille and adjustable sleeve.

Housing is 3½-in. deep. Fits 2x4-in. construction. Adjustable for standard 3¼x10-in. furnace duct. This fan also used for inside walls.

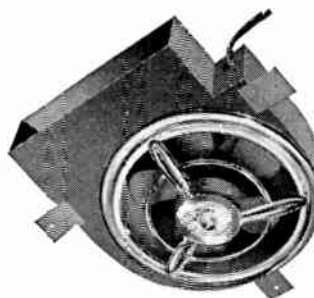

Complete fan in one carton.

Anodized Aluminum Grille

Model	CFM Free Air	Shp. Wt. Lbs.	Each
831	700	10	\$27.95

10-Inch Ceiling Fans, Wall Switch Operated

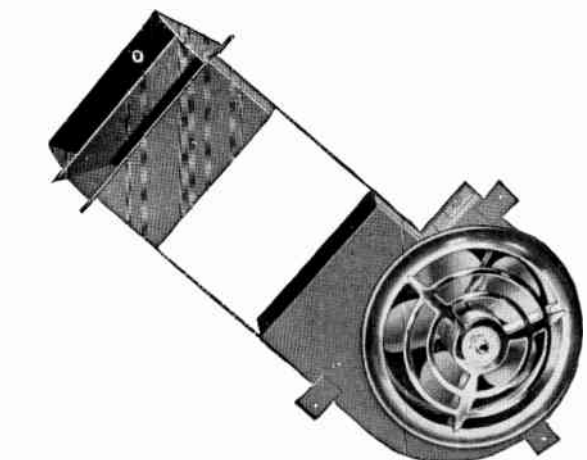

For medium or large rooms. Grille 13-in. diameter. Has 10-in. pressure type blade.

Has snap-in motor and blade assembly, one-piece removable round grille and adjustable sleeve.

Housing is 3½-in. deep. Fits 2x4-in. construction. Adjustable for standard 3¼x10-in. furnace duct. Fan used also for inside walls.

Complete fan in one carton.

Anodized Aluminum Grille

Model	CFM Free Air	Shp. Wt. Lbs.	Each
851	900	13	\$36.95

ILG Home Cooling Fans

Designed for top performance and utmost convenience these fans are ideal for ventilating homes, offices, stores or apartments. Provide top cooling comfort without installation costs. Simply place in desired spot and plug in. Easy to move—these portable fans can be quickly rotated from room to room.

Using the type Q fan wheel the home cooling fans give you super quiet performance even when operating at the highest

of their three speeds—they are a sleeper's delight. Equipped with a totally enclosed motor direct-connected to the fan blade. Each moving part is precision balanced. This superior design assures you of top performance at all times. All fans come equipped with six foot rubber covered cord.

All home cooling fans are covered by Ilg's famous "One-Name-Plate" guarantee which includes motor as well as fan.

Ilgwindowaire

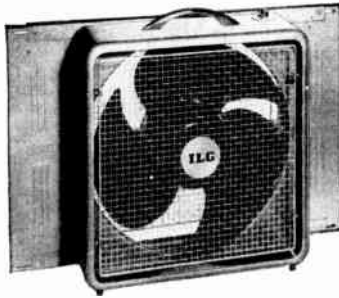

No. 7062: 115 volts, 1 phase, 60 cycles used as an exhaust fan or as an intake fan. Includes adjustable window panel No. 261-381-A which will fit any double hung window from 28 to 36 inches wide.

Portable, easy to carry about. Four rubber feet. 3-speed control, 6 ft. cord. Finish—Eye Rest Green.

No.	Fan Diam., In.	RPM	†CFM	Decible Rating	Ship. Wt. Lbs.	*List Each
7062	18	1000	3920	58	40	\$72.95
7063	Panel	8	6.45

*Prices include Federal Excise Tax.

†NEMA Rating including induced air.

Ilgrollaire



No. 7055: 115 volts, 1 phase. 60 cycles. The utmost in portability for a home fan.

Two rubber wheels make it easy to move Rollaire from room to room. The height of fan can be adjusted from 42-in. to 60 inches. 360 degree pivot. 3-speed control, 6 foot cord.

Eye-rest green finish of baked enamel. Chromium guards and stand.

No.	Fan Diam., In.	RPM	†CFM	Decible Rating	Ship. Wt. Lbs.	*List Each
7055	18	1000	3920	58	54	\$87.95

†NEMA Rating including induced air.

*Prices include Federal Excise Tax.

Ilgdualaire

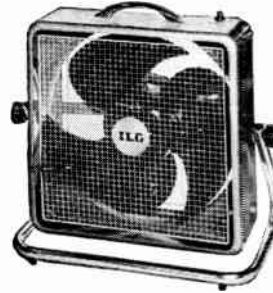

No. 7171: 115 volts, 1 phase, 60 cycles, an all-around good fan for the home because it can be used in so many ways. For blowing up or down; as a circulating fan or as an intake or exhaust fan. Can also be used as a window fan with No. 261-318-A panel.

Portable, 360 degree pivot. 3 speed control, 6 ft. cord.

No.	Fan Diam., In.	RPM	†CFM	Decible Rating	Ship. Wt. Lbs.	*List Each
7171	18	1000	3920	58	40	\$72.95

†NEMA Rating including induced air.

*Prices include Federal Excise Tax.

Ilgjets

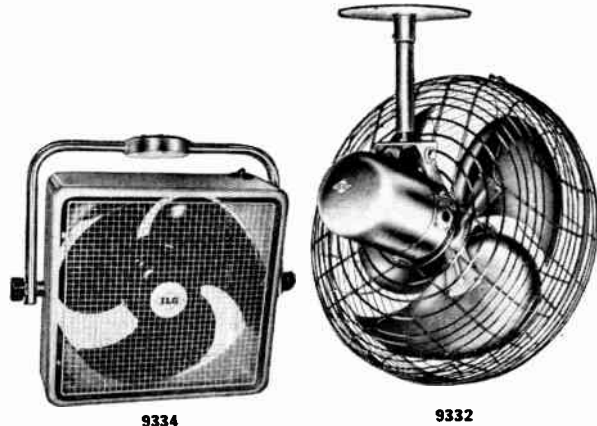

For extra quiet, extra efficient air circulation. Models with easily adjustable weighted pedestal base for floor use or models for mounting on wall, ceiling or table.

The No. 1275 and No. 1335 units are equipped with 20 ft. cord and plug. No. UA-205 fly fan provides an air curtain for open doors. The deflector No. 9331 is an optional accessory for No. UA-205.

115 Volts, 1 Phase, 60 Cycle

Size	No.	RPM	**CFM	Wheel Dia., In.	Decibels	Ship. Wt. Lbs.	List Each
1275	9332†	1140	7380	24	60	155	\$312.00
		800	5160		54		
1335	9333†	855	8520	30	58	245	388.00
		600	5540		48		
UA205	9334*	1000	3920	18	58	40	123.00
1275U	9335†	1140	7380	24	60	135	358.00
		800	5180		54		
1275U	9336*	1750	9260	24	72	135	358.00

**Rating at 3 feet including induced air.

*One speed. †Two speed. ‡Three Speed.

Deflector Cat. No. 9331 Retail \$33.00.

ILG Electric Kitchen Ventilators

115 Volts, Single Phase, 60 Cycle

Built-In Models For Wall Installation

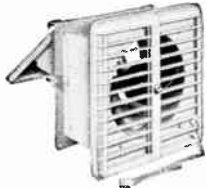

LC8 Built-In Ilgvent

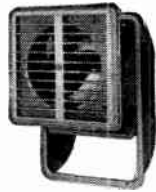

LC8 Automatic Built-In Ilgvent

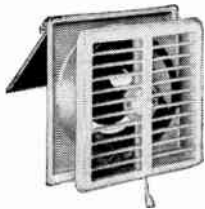

LC10 Ilgvent

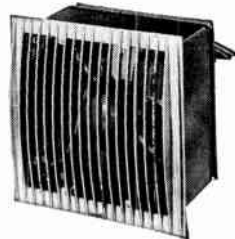

LC10 Automatic Ilgvent

LC-8 Built-In Ilgvent: Provides the moderate cost, high efficiency answer to small home ventilators. Totally enclosed motor with neoprene grease-proof connections, 18 gauge telescopic sleeves to fit various wall thicknesses. Pull chain operation, attractive grille furnished in chrome, cabinet French Gray.

LC-8 Automatic Built-In Ilgvent: Budget priced kitchen ventilator for wall switch operation . . . no television or radio interference. Neoprene covered grease-proof connections, attractive low air-resistor grille. Counter-balanced easy acting automatic back draft damper.

LC-10 Built-In Ilgvent: Suitable for larger kitchens, incorporates every wanted feature for the modern kitchen. Easy to clean, patented type Q Ilg fan provides whisper quiet performance. Totally enclosed motor with neoprene grease-proof connections, pull chain operation. Grille and cabinet furnished in attractive gray tones.

LC-10 Automatic Built-In Ilgvent: Full automatic operation, mirror finish aluminum grille, 16 gauge telescopic sleeves adjust to fit various wall thicknesses. Ilg "Q" fan wheel provides super quiet operation. Grille and cabinet furnished in French Gray.

No.	Sleeve Adjustment, In.	†CFM Air Capacity	Ship. Wgt. Lbs.	*Retail Price Each
Type LC-8 Built-In Ilgvent				
8070	5¼ to 10¾	375	21	\$39.00
8072	10½ to 16	375	26	41.05
Type LC-8 Automatic Built-In Ilgvent				
8074	5¼ to 10¾	300	22	42.08
8076	10½ to 16	300	27	43.11
Type LC-10 Built-In Ilgvent				
8151	4¼ to 6	530	23	56.45
8153	6¾ to 10	530	23	56.45
10-In. Automatic Built-In Ilgvent				
8091	8½ to 13	500	34	103.66

*Federal Excise Tax included in price.

†Ratings are certified according to test codes set up by the VAPM and ASHVE.

ILG Ceiling Type Electric Ventilators

115 Volt—60 Cycle—Single Phase

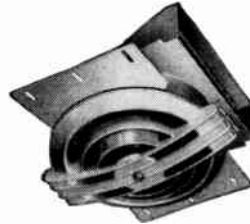

8132

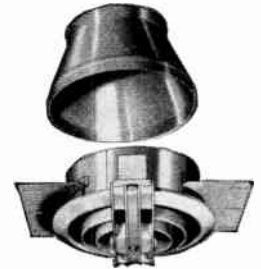

8136

No. 8132: New ceiling Ilgette Kitchen Ventilator has full capacity for thorough ventilation without sacrificing quiet operation. Easy to open for cleaning. Shaded pole, rubber mounted permanently lubricated motor, automatic operation of fan and discharge damper is controlled by standard wall switch.

No. 8136: Vertical ceiling Ilgette incorporates all the features of the No. 8132 ceiling Ilgette but is designed specifically for vertical discharge straight through roof using the No. 261-210-A damper.

No.	CFM Air Capacity	Ship. Wgt. Lbs.	Retail Price F.E.T. Included
10-Inch Ceiling Ilgette			
8132	350	20	\$62.61
Three Speed Switch			
900	...	2	*10.00
Wall Unit Only			
8139	...	7	*15.00
10-Inch Vertical Ceiling Ilgette			
8136	500	20	43.11
Damper For 10-Inch Vertical			
261-210-A	...	3	* 4.50

*Federal Excise Tax Not applicable.

ILG Portable Type Electric Ventilators

115 Volt—60 Cycles—Single Phase

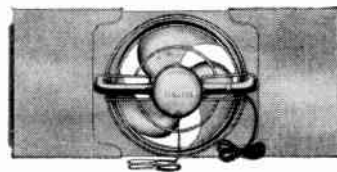

8104 & 8106

Portable Ilg Electric ventilators are ideal for use in homes or apartments where wall space or room arrangement does not permit use of the Built-In type.

Easy to install, fits ordinary window. All steel ivory finish adjustable panel.

10-Inch Portable Ilgette

No.	Panel Adjustment In.	†CFM Air Capacity	Ship. Wgt. Lbs.	Retail Price F.E.T. Included
8104	26 to 36	500	20	\$48.24
8106	36 to 46	500	24	48.24

†Ratings are certified according to test codes set up by the NAFM and ASHVE.

ILG Electric Window Ventilators

Package Type

115 Volt, 60 Cycle, Single Phase



No. 8102

10-in. package Ilgette easy to install in any window.

Pull chain operation starts and stops fan. Equipped with whisper quiet type "Q" fan wheel and a continuous duty motor . . . no radio or television interference.

Uses only 40 watts of electricity per hour.

**10 Inch Package Ilgette
115 Volts, 60 Cycles, Single Phase**

No.	†CFM Air Capacity	Ship. Wgt. Lbs.	Retail Price F.E.T. Included
8102	500	14	\$62.61

†Ratings are certified according to test codes set up by NAFM and ASHVE.

**ILG Portable Floor Fans
For Cooling Air in Industrial Plants**



These fans discharge a large volume of air at high velocity and afford a practical and economical means of heat relief to the workmen in large industrial plants. They run at exceedingly high speeds and are intended for use in places where their air noise is not a consideration.

The cast aluminum propeller has four blades, adequately protected by heavy wire guards.

Cast iron weight of sufficient weight to prevent overturning of fan.

The 12 in. fan is equipped with 20 ft. cord and plug; larger sizes have standard enclosed switch. Finish, attractive Green.

3-Phase, 60 Cycle, 220 Volts A.C.

No.	Size In.	RPM	*CFM	Hp. Motor	Ship. Wgt. Lbs.	Retail Price F.E.T. Included
9106	30	1140	16000	3/4	375	\$837.00
9108	36	1140	24000	1 1/4	460	975.00

3 Phase, 60 Cycle, 440 Volts A.C.

9107	30	1140	16000	3/4	375	\$837.00
9109	36	1140	24000	1 1/4	460	975.00

Single Phase, 60 Cycle, 115 Volts A.C.

9100	12	3400	3200	1/2	140	\$ 260.00
9185	30	1140	16000	3/4	375	1041.00

Single Phase, 60 Cycle, 230 Volts A.C.

9101	12	3400	3200	1/2	140	\$ 260.00
9186	30	1140	16000	3/4	375	1041.00

*Capacities include induced air volume.

For 115 or 230 volt d-c contact GRAYBAR.

ILG Electric Propeller Fans

Air conditions in a given type of building are fairly uniform and it is possible to generalize on the rate of air change advocated for various classes of buildings. The air change required in a room differs with the conditions found therein. The worse the air conditions the faster should be the air change. More rapid air changes are necessary in restaurants than in offices, etc.

To make it possible to select the correct size Propeller Fan, we give you the following:

Air Change Table

Class of Building	*Recommended Air Change	
	For Adequate Ventilation and Cooling	For Thorough Ventilation
Attic Cooling and Ventilation	2 min. on floor below attic space.
Churches	2 min.	5 min.
Factories (Gen. Ventilation)	3 min.	6 min.
Garages	3 min.	6 min.
Home kitchens	1 min.	2 min.
Halls (meeting)	2 min.	5 min.
Laundries	1 min.	3 min.
Offices	2 min.	5 min.
Restaurants and hotel kitchens	1 min.	2 min.
Stores	2 min.	5 min.
Theaters	2 min.	5 min.
Farm barns	100cfm per cow
Poultry houses	30cfm per horse
		2cfm per chicken.

***Definitions:** "Adequate Ventilation and Cooling": The use of rapid air change for the dual purpose of providing good ventilation and, in addition, effective cooling by (1) air movement (2) quick removal of heat caused by the sun, lights, equipment, processes, human occupants, etc. "Thorough Ventilation": The use of air change carefully established by thousands of installations as sufficient for health and comfort required by the nature of the space.

Example: If it is desirable to change the air in a room each five minutes, figure the cubical contents of the room by multiplying the length, width and height. Divide this figure by the rate of change, 5 in this case, which will give the amount of air the fan should handle each minute. Fans are rated in this manner.

Self-Cooled Motor

Ilg propeller fans have the patented enclosed self-cooled motor which affords low operating cost of the open motor with the protection of the fully enclosed motor. The fan action draws clean air through the vent pipe in the bottom of the fan from the outside, circulates it through the motor and exhausts it. The motor stays cool and clean always.

One Nameplate Construction

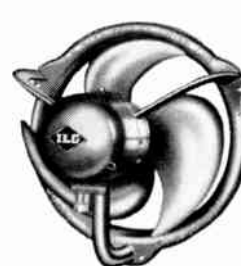

The entire fan, including the motor, is made by Ilg. Fan wheels are dynamically balanced to assure freedom from vibration, quiet operation and long bearing life. Sizes 63 to 123 have permanently oiled bearings—sizes 163 to 483 inclusive have permanently lubricated ball bearings. Size 72, type "W" fan is equipped with ball bearings and grease cup. Ilg frames are rugged and wrap-free. Sizes 63 to 243 inclusive are cast aluminum.

Size 303 and larger are steel. Finished in attractive and durable green enamel.

ILG Type "LQ" Propeller Fans

Propeller fans are designed for free air delivery and should not be used with extensive duct systems, flues or pipes, or to deliver air against greater than 1/8-in. static pressure.

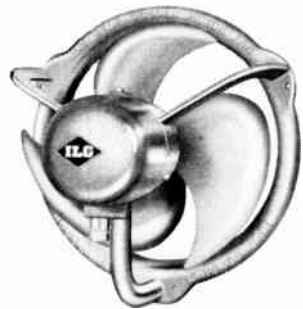

**Type LQ Alternating Current—
Constant Speed, One Phase, 60 Cycle**

Size	RPM	C.F.M. at Static 0"	Nom. Wheel		Motor Hp.	Decibel Rating	Approx. Weight, Lbs.		Catalog Numbers			Price
			.10" Dia. In.	Motor Hp.			Net	Shpg.	115 Volts	230 Volts	208 Volts	
63SH	2750	250	200	6	1/80	50	4	6	48078	48079	\$ 46.00
83SH†	1550	370	245	8	1/80	52	5	8	48080	48081	48082	50.00
103SH†	1550	550	425	10	1/80	46	7	11	48090	48091	48092	59.00
123SH†	1550	1000	800	12	1/20	53	12	16	48095	48096	48097	94.00
163SH	1140	1700	1410	16	1/16	54	28	32	48106*	48107	48163	157.00
183SH	1140	2600	2380	18	1/16	55	43	80	48108*	48109	48164	221.00
213SH	1140	3600	3260	21	1/5	61	59	100	48110*	48111	48165	271.00
243SH	855	4700	3900	24	1/4	57	94	150	48112*	48113	48166	361.00
303SH	685	7800	6750	30	3/8	56	150	240	48114*	48115	48167	541.00
363SH	570	11000	9950	36	5/8	63	217	350	48116*	48117	48168	778.00
423SH	490	15500	13650	42	7/8	60	400	590	48119	48169	1001.00
483SH	490	23300	22000	48	1 1/2	62	385	765	48121	48170	1239.00

*Motors are Dual Voltage 115 and 230 Volts.

†A three-speed switch for use with size 83 and 103 fans is available as optional accessory as follows: size 83 at 115 volts, Cat. No. 822 \$16.00 list; size 83 at 230 volts; Cat. No. 823 \$16.00 list; size 103 at 115 volts, Cat. No. 825 \$16.00 list; size 103 at 230 volts, Cat. No. 826 \$16.00 list. Size 123 at 115 volts, Cat. No. 828 \$18.00 list; size 123 at 230 volts, Cat. No. 829, \$18.00 list.

Type LQ Alternating Current—Two Speed, One Phase, 60 Cycle

Size	RPM	C.F.M.	Nom. Wheel		Motor Hp.	Decibel Rating	Approx. Weight, Lbs.		Catalog Numbers			Price
			.10" Dia. In.	Motor Hp.			Net	Shpg.	115 Volts	230 Volts	208 Volts	
163S	1140	1700	16	1/16	54	28	45	48200	48201	48240	\$188.00	
	855	1280										48
183S	1140	2600	18	1/8	55	54	90	48202	48203	48241	257.00	
	855	1950										49
213S	1140	3600	21	1/5	61	59	115	48204	48205	48242	306.00	
	855	2700										55
243S	855	4700	24	1/4	57	100	165	48206	48207	48243	432.00	
	600	3300										50
303S	685	7800	30	3/8	56	165	245	48208	48209	48244	622.00	
	500	5700										49
363S	570	11000	36	5/8	63	217	340	48210	48211	48245	858.00	
	400	7550										55
423S	490	15500	42	7/8	60	495	570	48213	48246	1097.00	
	380	12000										54

Note: Two speed fans are equipped with two speed remote flush mounted switch, having high, low, and off positions. Low speeds are approximate.

Type LQ Alternating Current—Constant Speed, Three Phase, 60 Cycle

Size	RPM	C.F.M. at Static 0"	Wheel		Motor Hp.	Decibel Rating	Approx. Weight, Lbs.		Catalog Numbers			List Price	
			.10" Dia. In.	Motor Hp.			Net	Shpg.	220/440 Volt	208 Volts	550 Volts	208/220 V. or 440 V.	550 V.
183M	1140	2600	18	1/8	55	54	80	49100	49200	49102	\$300.00	\$330.00	
213M	1140	3600	21	1/5	61	59	100	49103	49201	49105	337.00	367.00	
243M	855	4700	24	1/4	57	100	160	49106	49202	49108	387.00	417.00	
303M	685	7800	30	3/8	56	165	240	49109	49203	49111	469.00	499.00	
303M	855	9400	30	3/4	63	190	275	49215	49204	49218	610.00	641.00	
363M	570	11000	36	5/8	63	205	340	49115	49205	49117	681.00	716.00	
423M	490	15500	42	7/8	60	320	560	49118	49206	49120	905.00	951.00	
483M	490	23300	48	1 1/2	62	385	740	49121	49207	49123	1057.00	1110.00	
72" M	310	40500	72†	2 1/2	73	980	1600	2130	2210	2132	2556.00	2680.00	

†Type "W".

Type LQ Direct Current

Size	RPM	C.F.M.	Nom. Wheel		Motor Hp.	Decibel Rating	Approx. Weight, Lbs.		Catalog Numbers			List Price	
			.10" Dia. In.	Motor Hp.			Net	Shpg.	115 Volts	230 Volts	550 Volts	115 Volt or 130 V.	550 V.
123C*	1725	1100	12	1/12	57	12	19	52220*	52221	
163C*	1140	1700	16	1/16	54	28	35	52223*	52224	
183B*	1140	2600	18	1/8	57	43	78	52259*	52260	
243A	855	4700	24	1/4	57	94	170	52262	52263	52264	Price On Application	
303A	685	7800	30	3/8	56	150	235	52265	52266	52267		
363A	570	11000	36	5/8	63	205	305	52268	52269	52270		
423B	490	15500	42	7/8	60	320	495	52271	52272	52273		
483B	490	23300	48	1 1/2	62	385	585	52274	52275	52276		
72" B	310	40500	72†	2 1/2	73	1100	1700	2283	2284	2285		

Fans Size 123" and larger equipped with speed regulator. *Dimensions same as for type "XQ" fans. †Type "W".

ILG Types "PQ" and "XQ" Propeller Fans

High Speed

Explosion-Proof Fans

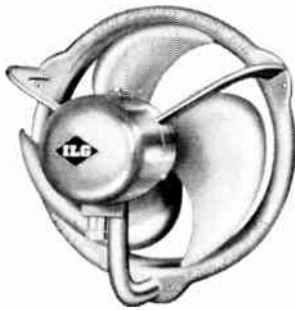

Type PQ

Particularly suitable for industrial applications where low decibel sound ratings are not of primary importance.

They combine the remarkable Type "Q" wheel with high-speed self-cooled motor and has greater air moving capacity with minimum physical dimensions.

The complete unit has all the fine features of the LQ fan.

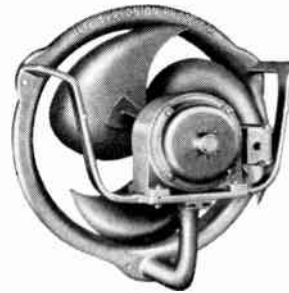

Type XQ

These fans have all the performance features of the Type Q propeller fans combined with the use of a ball bearing explosion-proof motor carrying the Underwriters' Laboratories label, suitable for all Class 1, Group D hazardous applications.

Type PQ High Speed Fans

115, 230 and 208 Volts 1 Phase 60 Cycle

Size	RPM	C.F.M. at Static Pressure				Motor Hp.	Decibel Rating	Approx. Weight, Lbs.		Catalog Numbers		List Price		
		0	¼	½	¾			Net	Shpg.	115 Volts	208 Volts			
163PS	1725	2640	2410	2080	1870	1720	1600	1/3	63	49	86	51100*	51102	\$208.00
183PS	1725	3670	3470	3250	3010	2620	2240	1/2	64	60	100	51105*	51107	254.00
213PS	1725	4800	4540	4290	4030	3740	5/8	63	109	150	51110*	51112	402.00
243PS	1140	6200	5640	5060	4500	3910	3220	3/4	64	115	163	51115*	51117	535.00
303PS	1140	12000	11500	10400	9400	8800	8400	2	69	179	235	51120*	51122	760.00

*Motors are Dual Voltage 115 and 230 Volts.

220/440, 208 or 550 Volts 3 Phase 60 Cycles

Size	RPM	C.F.M. at Static Pressure				Motor Hp.	Dec. Rating	Wt. Net	Approx. Shpg.	Catalog Numbers			Price			
		0	¼	½	¾					220/440 V.	208 V.	550 V.	220/440 V.	550 V.		
163PM	1725	2640	2410	2080	1870	1720	1600	1/3	63	49	56	51240	51242	51243	\$230.00	\$262.00
183PM	1725	3670	3470	3250	3010	2620	2240	1/2	64	60	90	51247	51249	51250	254.00	284.00
213PM	1725	4800	4540	4290	4030	3740	5/8	63	105	139	51254	51256	51257	377.00	407.00
243PM	1140	6200	5640	5060	4500	3910	3220	3/4	64	105	156	51261	51263	51264	432.00	462.00
303PM	1140	12000	11500	10400	9400	8800	8400	2	69	154	270	51268	51270	51271	633.00	666.00
363PM	855	16800	16300	15400	14300	13100	11700	2 1/2	76	230	452	51275	51277	51278	941.00	987.00

Note: Direct current prices on Type "PQ" fans available on request.

Type XQ Explosion-Proof Fans

115 or 230 Volts 1 Phase 60 Cycles

Size	RPM	C.F.M. at Static Pressure				Motor Hp.	Dec. Rating	Approx. Weight, Lbs. Net	Approx. Shpg.	Catalog Numbers		Price		
		0	¼	½	¾					115 V.	230 V.			
123XS	1725	1110	860	720	1/12	56	17	30	53125	53126	\$195.00
163XS	1140	1700	1330	1/8	54	39	66	53127	53128	252.00
163XS	1725	2640	2410	2080	1870	1720	1600	1/3	63	39	66	53129*		274.00
183XS	1140	2600	2310	1/8	55	43	84	53131	53132	281.00
183XS	1725	3670	3470	3250	3010	2620	2240	1/2	64	78	84	53133*		350.00
213XS	1140	3600	3190	2720	1/4	61	65	150	53135	53136	402.00
213XS	1725	4800	4540	4290	4030	3740	3430	3/4	63	105	154	53137*		420.00

*Motors are Dual Voltage 115 and 230 Volts.

220 or 440 Volts 3 Phase 60 Cycle

Size	RPM	C.F.M. at Static Pressure				Motor Hp.	Dec. Rating	Approx. Weight, Lbs. Net	Approx. Shpg.	Catalog Numbers		List Price	
		0	¼	½	¾					220 V.	440 V.		
163XM	1725	2640	2410	2080	1870	1720	1600	1/3	63	39	50	53250*	\$292.00
183XM	1140	2600	2310	1/8	55	43	86	53252*	360.00
183XM	1725	3670	3470	3250	3010	2620	2240	1/2	64	70	86	53254*	340.00
213XM	1140	3600	3190	2720	1/4	61	65	125	53256	420.00
213XM	1725	4800	4540	4290	4030	3740	3430	3/4	63	90	150	53258*	400.00
243XM	855	4700	3690	2980	1/2	57	105	165	53262*	570.00
243XM	1140	6200	5640	5060	4500	3910	3220	3/4	64	117	205	53260*	590.00
303XM	1140	12000	11500	10400	9400	8800	8400	2	69	154	235	53264*	880.00
363XM	855	16800	16300	15400	14300	13100	11700	3	76	300	400	53282*	1451.00

*Motors are Dual Voltage 220 and 440 Volts.

ILG Propeller Fan Guards

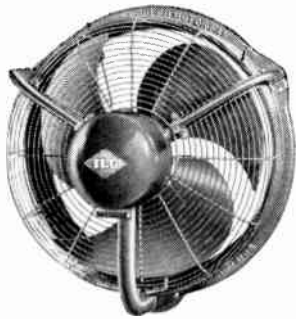

Heavy guage steel wire, close set, meeting all safety codes. Fan guards are recommended for protective purposes for fan installations 7 ft. or less from floor. Sizes 63, 83, and 103 are one piece type. All sizes for Type XQ propeller fans are one piece type. All other types and sizes consist of three sections. Guard may be attached to fan already installed and in use. Attached directly on fan frame.

No.	For Fan Size	Type	Ship. Wgt. Lbs.	Per Section	List Price	Complete
61747	63	LQ	4		\$ 5.00
61748	83	LQ	4		8.00
61749	103	LQ	4		11.00
61750	123	LQ	6	\$10.00		26.00
61776	123	XQ	7		31.00
61751	163	LQ	8	13.00		34.00
61770	163	PQ	8	14.00		41.00
61777	163	XQ	12		43.00
61752	183	LQ & PQ	10	15.00		40.00
61778	183	XQ	15		50.00
61753	213	LQ & PQ	15	17.00		44.00
61779	213	XQ	18		57.00
61754	243	LQ & PQ	20	19.00		47.00
61780	243	XQ	22		74.00
61755	303	LQ	25	23.00		65.00
61773	303	PQ	25	28.00		79.00
61781	303	XQ	30		91.00
61756	363	LQ	30	28.00		77.00
61775	363	PQ	30	33.00		94.00
61782	363	XQ	45		113.00
61757	423	LQ	38	34.00		97.00
61758	423	LQ	50	39.00		109.00
761	72	W	160	86.00		252.00

ILG Automatic Shutters

Automatic Shutters should always be installed on the outside of propeller fans to protect the fan and the interior of the building against rain or snow; also to prevent wind pressure against fan from overloading the motor, blowing out fuses or burning out the motor.

When fan is operating, shutter blades are held open by the air current; when fan is not operating the shutter closes automatically by gravity.

Rugged steel frame, with durable aluminum blades pressed on heavy duty rods. All parts are completely weather-resistant.

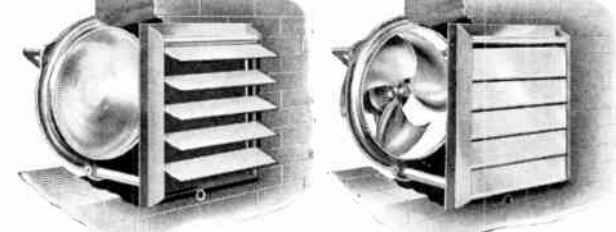

Fan in operation

Fan not operating

No.	Size In.	For Fan Size	List Price	No.	Size In.	For Fan Size	List Each
638	8	83	\$19.00	644	24	243	\$56.00
639	10	103	22.00	645	30	303	85.00
640	12	123	23.00	646	36	363	121.00
641	16	163	26.00	647	42	423	176.00
642	18	183	34.00	648	48	483	234.00
643	21	213	47.00	651	72	300	447.00

Note—Size of shutter corresponds to size of fan—e.g. 36-in. shutter for 36 in. fan.

Shutters 48-in. and larger are in two sections built in one frame.

Motor-Operated Shutters—For full information and prices contact Graybar.

ILG Power Roof Ventilators

Type "PRV-L & PRV"

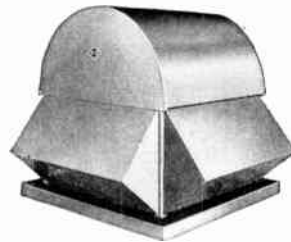

Type PRV-L

Provide positive controlled ventilation independent of wind or weather conditions in sizes providing air deliveries over the unusually large range of pressure from free air to 1½ inch static pressure.

Sturdy weather-tight welded steel frame and heavy gauge galvanized housing. Type PRV has 16-inch high base eliminating the need of expensive high-profile curbing

and fitting of air control accessories into the roof or curbing section. Easily and quickly installed, wired and serviced.

The top, hinged on two sides, can be removed without tools for access to the direct-connected motor. Has four screened louvers which are instantly removable.

Standard features include self-cooled, direct-connected motor, self cooled motor compartment, floated-drive sound isolation, non-overloading, backward curved type wheel. Ilg Green finish.

For 208 & 220/440 Volts, 3-Phase, 60 Cycle

Size*	RPM	Hp.	Base Sq. In.	Wdth. In.	Hgt. In.	Ship. Wgt. Lbs.	List Price	Gravity Shutter Price
PRV35L	685	1/8	31 1/4	34 1/2	26 1/8	300	\$561.00	\$35.00
	855	1/2				300	596.00	35.00
	1140	3/4				300	620.00	35.00
	1750	2 1/2				350	781.00	35.00
PRV40L	685	1/8	34 1/2	40 1/8	30 5/8	365	667.00	48.00
	855	5/8				365	686.00	48.00
	1140	1 1/2				365	737.00	48.00
	1750	5 1/2				515	859.00	38.00
PRV45L	570	3/8	37 3/4	45 1/8	32 1/2	520	832.00	58.00
	685	5/8				520	866.00	58.00
	855	1 1/4				520	892.00	58.00
	1140	3				565	983.00	58.00
PRV50L	570	5/8	41	50 5/8	36 3/8	540	994.00	89.00
	685	1 1/8				540	1027.00	89.00
	855	2				600	1095.00	89.00
	1140	5				630	1185.00	89.00
PRV55L	490	5/8	44 1/4	55 3/8	40	685	1059.00	92.00
	570	1				695	978.00	92.00
	685	1 3/4				695	1010.00	92.00
	855	3 1/2				695	1090.00	92.00
PRV60L	490	1	47 1/2	60 1/2	43	750	1224.00	113.00
	570	1 1/2				750	1121.00	113.00
	685	2 3/4				800	1111.00	113.00
	855	5 1/4				830	1243.00	113.00
PRV65L	490	2	50 3/4	65 1/2	46 1/2	1025	1432.00	128.00
	570	3				1025	1386.00	128.00
	685	5 1/4				1075	1623.00	128.00
	855	10				1175	1770.00	128.00
PRV70L	490	2 1/4	54	71 1/4	50 1/2	1175	1608.00	165.00
	570	3 1/2				1175	1519.00	165.00
	685	6				1225	1759.00	165.00
	855	11 1/2				1325	2059.00	165.00

Also available for 115 volts, 1-phase, 60 cycles and 230 volts, 1-phase, 60 cycles.

PRV Power Roof Ventilators also available for 115 volts-230 volts, 1 phase, 60 cycles and 208, 220/440 volts, 3 phase, 60 cycles—for full information and prices contact Graybar.

An optional feature is sprayed-on insulation to prevent condensation forming on inside of housing in the handling of steam, etc. in cold weather. Other accessories can be furnished, such as gravity or motor-operated shutters, manual or motor operated variable air controllers.

For exact construction information and other specifications, contact Graybar.

*The lowest speed in each size provides the most quiet operation.

ILG Power Roof Ventilators

New Type "L-LSQ"



Meets all modern institutional, commercial and industrial architectural requirements.

The three new sizes in the LSQ series are 83, 103, 123. They incorporate the super quiet, high efficiency,

low silhouette characteristics of the larger units.

The propeller fan is directly connected to the motor . . . no belts or pulleys . . . literally no maintenance. Optional gravity type or motor operated shutters for easy curbing.

Large Size LSQ, L-LSQ (Exhaust) and SRQ, L-SRQ

(Supply) Series



Larger sizes feature the "Q" propeller, connected directly to motor. Recommended for large area roof ventilation.

All-Aluminum housing provides year round protection for fan and motor. Type LSQ and SRQ have

self-contained base sufficient to house various optional air control accessories. Eliminates the need of expensive curbing, and the cost of installing air control accessories on the job. Optional automatic or operated shutters.

Constant Speed, 1 Phase, 60 Cycles

Exhaust Type Size	Supply Type Size	RPM	Approx. Ship. Wt. Lbs.	List Prices		
				115 Volt	230 Volt	208 Volt
L-LSQ-83SH†	..	1550	15	\$105.00	\$105.00
L-LSQ-103SH†	..	1550	19	140.00	140.00
L-LSQ-123SH†	..	1550	29	162.00	162.00
LSQ 163SH	SRQ 163SH	1140	115	\$340.00*	\$340.00
L-LSQ-163SH	L-SRQ-163SH	1140	81	296.00*	296.00
LSQ 163PS	SRQ 163PS	1725	126	399.00*	399.00
L-LSQ-163PS	L-SRQ-163PS	1725	92	355.00*	355.00
LSQ 183SH	SRQ 183SH	1140	129	353.00*	353.00
L-LSQ-183SH	L-SRQ-183SH	1140	87	353.00*	353.00
LSQ 183PS	SRQ 183PS	1725	130	447.00*	447.00
L-LSQ-183PS	L-SRQ-183PS	1725	88	403.00*	403.00
LSQ 213SH	SRQ 213SH	1140	163	447.00*	447.00
L-LSQ-213SH	L-SRQ-213SH	1140	100	393.00*	393.00
LSQ 213PS	SRQ 213PS	1725	163	524.00*	524.00
L-LSQ-213PS	L-SRQ-213PS	1725	100	470.00*	470.00
LSQ 243SH	SRQ 243SH	855	130	552.00*	552.00
L-LSQ-243SH	L-SRQ-243SH	855	130	498.00*	498.00
LSQ 243PS	SRQ 243PS	1140	210	622.00*	622.00
L-LSQ-243PS	L-SRQ-243PS	1140	130	568.00*	568.00
LSQ 303SH	SRQ 303SH	685	301	803.00*	803.00
L-LSQ-303SH	L-SRQ-303SH	685	210	736.00*	736.00
LSQ 303HS	SRQ 303HS	855	309	957.00	957.00
L-LSQ-303HS	L-SRQ-303HS	855	19	890.00	890.00
LSQ 303PS	SRQ 303PS	1140	351	979.00	979.00
L-LSQ-303PS	L-SRQ-303PS	1140	261	912.00*	912.00
L-LSQ-363SH	L-SRQ-363SH	570	345	1052.00*	1052.00

*Dual Voltage.

†A three speed switch for use with sizes 83 to 123 L-LSQ Roof ventilators is available as an accessory as follows: Size 83 at 115 volts, Cat. No. 825 \$16.00 list, size 83 at 230 volts, Cat. No. 826 \$16.00 list; size 103 at 115 volts, Cat. No. 835, \$16.00 list; size 103 at 230 volts, Cat. No. 836, on application; size 123 at 115 volts, Cat. No. 838, \$22.00 list, size 123 at 230 volts, Cat. No. 839 on application.

Note: Also available for two speed, 1 phase operation and constant speed, 3 phase operation — for full information and prices contact Graybar.

ILG Penthouses For Power Roof Ventilators

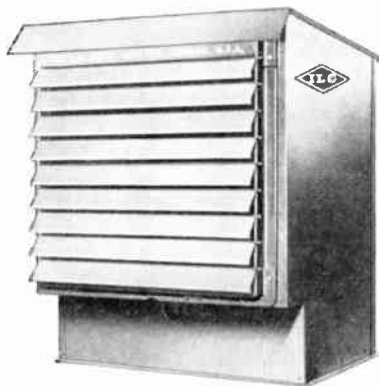

These Penthouses are for use with 1lg self-cooled motor propeller fans. They are solidly constructed of rust-resisting steel and are thoroughly weather proof.

Gauge Metal — 10- to 16-in., 20 gauge; 18- to 18-in., 18 gauge; 72-in., 16 gauge.

Equipped with an 1lg automatic shutter to protect the fan from the weather when it is not in operation.

Hinged top on back of penthouse furnishes easy access to fan for periodic lubrication. (Top has provision for lock.)

Also available with insulated lining for use where condensation of moisture during cold weather is a problem.

Fan Size	Metal Gauge	Dimensions in Inches			Ship. Wt. Lbs.	*List Prices	
		O.A. Hgt.	Roof Opening Lgth.	Roof Opening Wdth.		Standard	Insulated
103	20	19 1/4	14 1/16	12 5/16	40	\$102.00	\$149.00
123	20	22 1/8	16 3/16	14 1/16	50	114.00	183.00
163	20	28 1/4	21 1/4	16 1/4	75	122.00	195.00
183	18	32	21 1/4	18 1/4	120	146.00	243.00
213	18	36	27	20	135	162.00	270.00
243	18	41 1/2	31 1/8	22	175	194.00	301.00
303	18	46 7/8	39	26	260	249.00	384.00
363	18	60 1/4	48	30	425	325.00	466.00
423	18	66	57	35	500	479.00	645.00
483	18	72 1/4	66	40	700	609.00	820.00
72	16	102 1/4	81 1/2	47 1/2	1000	*1436.00	*1805.00

*Shipped knocked-down.



ILG Volume Centrifugal Fan

Type 6S—Motor Driven

A compact, direct-connected unit particularly suitable for building into apparatus which require ventilation or air movement. Widely used for electronic tube cooling.

Die-stamped steel housing, stand and flanges. Die-cast zinc wheel, dynamically balanced for quiet, highly efficient operation.

Direct connection of motor and wheel saves space, weight, time and cost and provides permanent alignment. Permanently-lubricated bearing type motor—3200 rpm, shaded pole; or 5000 rpm, series permanently-lubricated ball-bearing motor. Complete with 24-in. leads brought out of motor for making connections. Approx. Ship. Wt. 1 1/2 lbs.

Capacities in Cfm at Various Static Pressures

RPM	Free Air	Capacities in Cfm at Various Static Pressures													
		1/4"	1/2"	3/4"	1"	1 1/2"	2"	3"	4"	5"	6"				
3200	63	58	52	44	32	10	
5000	105	103	101	99	97	95	93	89	80	70	
Size		(3200 RPM Each) (230 V. Each) (5000 RPM 115 V. Each)													
6S	Fan Only (Housing, Wheel and Motor).....	\$46.00	\$50.00	\$86.00											
6SS	Fan and Stand Only.....	48.00	53.00											
6S1	Fan and Inlet Flange Only.....	48.00	53.00	89.00											
6SD	Fan and Discharge Flange.....	48.00	53.00	89.00											
6S1D	Fan, Inlet and Discharge Flanges only.....	52.00	55.00	91.00											
6SS1	Fan, Stand, Inlet Flange	52.00	55.00											
6SSD	Fan, Stand and Discharge Flange only.....	52.00	55.00											
6SS1D	Fan, Stand, Inlet and Discharge Flanges.....	55.00	59.00											

ILG Volume Centrifugal Fans

Type B



Combines high efficiency and low power consumption and is suitable for small volume, low pressure installations of any kind. Quiet and smooth running.

Die-cut steel housing and multi-blade wheel. Wheel is carefully balanced. Cast iron base and inlet flange bears both the housing and direct-connected motor. Universal discharge.

Type B Volume Centrifugal Fans, 60 Cycle

Size	RPM	Hp.	Ship. Wt. Lbs.	115 Volts		60 Cycle Single Phase 230 V.		208 Volts		60 Cycle Three Phase		Price
				No.	Price	No.	No.	Price	208 Volts Catalog No.	220/440 Volts* Catalog No.		
B9	1140	1/80	35	3B00†	\$114.00	3B01†	3B10†	\$114.00	
	1650	1/25	35	3B02†	103.00	3B03†	3B11†	103.00	
	1725	1/20	35	3B08*	143.00	3B08*	3B18	143.00	
B12	1140	1/16	60	3B16*	164.00	3B16*	3B19	164.00	
	1725	1/5	55	3B24*	162.00	3B24*	3B26	162.00	
B15	855	1/12	90	3B32*	224.00	3B32*	3B27	224.00	
	1140	1/5	90	3B40*	216.00	3B40*	3B34	216.00	
	1725	5/8	100	3B48*	276.00	3B48*	3B35	276.00	3B99	3B50	\$276.00	
B18	855	1/7	140	3B56*	336.00	3B56*	3B42	336.00	4B01	3B58	354.00	
	1140	3/4	140	3B64*	373.00	3B64*	3B43	373.00	4B02	3B66	422.00	
	1725	1-1/8	200	3B72	565.00	3B72	3B96	565.00	4B03	3B74	515.00	
B21	855	3/4	210	3B80*	497.00	3B80*	3B97	497.00	4B04	3B82	403.00	
	1140	3/4	210	3B88*	564.00	3B88*	3B98	564.00	4B05	3B90	485.00	

*Dual voltage 115/220 volt motors.

†Equipped with shaded pole type motors, all other single phase fans have split-capacitor type motors.

60 Cycle Performance Data

Size	RPM	Wheel Dia.	Performance Data											
			1/8	1/4	3/8	1/2	5/8	3/4	7/8	1	1 1/4	1 1/2	1 3/4	
B9	1140	4 3/4	136
	1650	223	201	170
	1725	235	214	186	144
B12	1140	6 1/4	371	312	236
	1725	573	535	495	457	411	345
B15	855	7 3/4	570	460	300
	1140	820	740	670	570	450
	1725	1160	1110	1050	1000	940	800
B18	855	9 1/4	880	760	620
	1140	1220	1140	1050	950	810
	1725	1960	1900	1850	1790	1670	1540	1410	1270
B21	855	10 3/4	1540	1400	1280	1190	1040
	1140	1920	1820	1730	1670	1600	1510	1180

Note: Contact GRAYBAR for information and prices on 25 cycle blowers.

Type B—Gasoline Engine Driven



This portable volume blower is entirely self-contained and is recommended for ventilating manholes, vats, tanks and other spaces where electricity is not available.

It is driven by a direct-connected 4-cycle gasoline engine. Blower inlet is screened to prevent paper, leaves and other litter from entering. Outlet has flange for attaching canvas hose (hose not included). Batteries or other connections are not required.

Gasoline consumption per hour: No. B12, 1/3 pint; No. 15, 1 pint. Capacity of tank; No. B12, 1 quart; No. B15, 1 gallon. Speed 1750 rpm.

Cat. No.	Size	Rating CFM	Hp.	Ht. In.	Wdth. In.	Depth In.	Ship. Wt. Lbs.	Each	Hose Price
B601	B126	630	1/6	16 3/4	26	17 3/4	95	\$388.00	\$95.00
3B99	B156	1200	1/2	16 3/4	26	19 3/4	125	451.00	95.00

ILG Centrifugal Fans

Type BC Direct-Connected—Constant Speed, 1 and 3 Phase, 60 Cycle

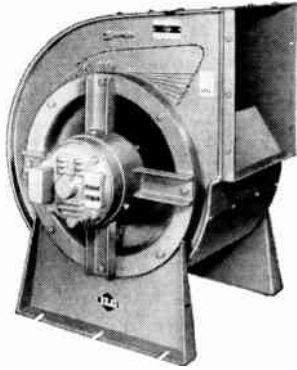

Type BC

New line of Ilg Type BC centrifugal fans sizes 122—200, in both direct-connected and belted models is the latest development of Ilg Research Laboratory. Checked feature by feature, the new Ilg fans with aluminum sides and scroll will be found to embody the characteristics accented in today's ventilation, air conditioning and air handling installation.

A backward-curved type wheel of all aluminum, spark-proof construction with non-overloading characteristics, features airfoil blades. New design fan wheel is highly efficient and provides quieter operation.

With wheel overhung on shaft, inlet is free of all obstructions. Every model suitable for both Class I and Class II duty. Sizes 45 through 70 cover the standard type BC fan with flat-bladed wheel.

Direct-connected data shown. For belted data contact GRAYBAR.

Size	RPM	Hp.	Ship- ping Wt.	60 CYCLE SINGLE PHASE			60 CYCLE 3 PHASE	
				Price 115 Volts	Price 208 Volts	Price 230 Volts	Price 220/440 & 208 Volts	Price 550 Volts
BC122	1140	1/8	105	\$ 558.00*	\$ 558.00	\$ 558.00*	\$ 515.00	\$ 546.00
	1725	3/8	110	573.00*	573.00	573.00*	528.00	559.00
BC135	1140	1/4	170	581.00*	581.00	581.00*	535.00	566.00
	1725	3/4	170	673.00	607.00	607.00	548.00	579.00
BC150	1140	1/2	200	612.00*	612.00	612.00*	564.00	595.00
	1725	1 1/4	200	759.00	656.00	656.00	578.00	609.00
BC165	855	1/4	220	675.00*	674.00	675.00*	613.00	644.00
	1140	1/2	220	792.00*	702.00	702.00*	631.00	663.00
	1750	2	280	1044.00	1097.00
BC182	855	3/8	275	814.00*	814.00	814.00*	719.00	755.00
	1140	3/4	275	861.00*	861.00	861.00*	772.00	811.00
	1750	3	340	1221.00	1270.00
BC200	855	5/8	345	949.00*	949.00	949.00*	828.00	869.00
	1140	1 1/2	375	1025.00*	1025.00	1025.00*	911.00	957.00
	1750	5	430	1462.00	1520.00
BC222	685	1/2	445	1040.00	961.00	1013.00
	855	1	445	1070.00	977.00	1027.00
	1140	2 1/2	445	1184.00	1230.00
BC245	685	3/4	520	1307.00	1200.00	1250.00
	855	1 3/4	520	1373.00	1242.00	1293.00
	1140	4	560	1449.00	1502.00
BC270	570	3/4	690	1415.00	1471.00
	685	1 1/4	690	1466.00	1523.00
	855	2 1/2	690	1510.00	1570.00
	1140	6	730	1554.00	1616.00
BC300	570	1 1/4	765	1578.00	1640.00
	685	2 1/4	790	1715.00	1783.00
	855	4 1/2	790	1779.00	1850.00
	1140	10	830	1819.00	1891.00
BC330	570	2 1/4	910	1920.00	1997.00
	685	3 1/2	910	2100.00	2161.00
	855	7	990	2351.00	2420.00
BC365	570	3 1/2	1100	2302.00	2370.00
	685	6	1140	2527.00	2605.00
	855	12	1210	3027.00	3118.00

*Dual voltage motors.

†Motors are single voltage specify either 220 or 410 volts.

Ilg Type BC Direct-Connected Centrifugal Fan Capacities

RPM	Hp.	Static Pressure In Inches															
		1/8 in.	1/4 in.	3/8 in.	1/2 in.	5/8 in.	3/4 in.	7/8 in.	1 in.	1 1/4 in.	1 1/2 in.	1 3/4 in.	2 in.	2 1/4 in.	3 in.	4 in.	
Size BC-122—Wheel Diameter 12 1/4 In.																	
1140	1/8	1190	1110	1020	910	800	700	600	500	400	300	200	150	100	75	50	25
1725	3/8	1850	1810	1760	1710	1660	1600	1530	1460	1310	1140	580
Size BC-135—Wheel Diameter 13 1/2 In.																	
1140	1/4	1650	1580	1490	1400	1270	1150	960
1725	3/4	2560	2520	2470	2430	2380	2320	2250	2190	2050	1890	1700	1450
Size BC-150—Wheel Diameter 15 In.																	
1140	1/2	2300	2220	2130	2030	1920	1790	1650	1470
1725	1 1/4	3530	3490	3440	3390	3330	3270	3200	3140	2990	2810	2680	2480	1950
Size BC-165—Wheel Diameter 16 1/2 In.																	
855	3/4	2250	2140	1980	1800	1580	1220
1140	1 1/2	3070	2990	2900	2800	2670	2510	2400	2250	1850
1750	2	4770	4740	4690	4630	4570	4500	4440	4370	4240	4090	3920	3750	3340	2800
Size BC-182—Wheel Diameter 18 1/4 In.																	
855	5/8	3180	3030	2870	2690	2470	2220	1920	500
1140	1 3/8	4320	4220	4110	4000	3870	3750	3600	3440	3100	2660
1750	2	6750	6690	6620	6550	6480	6410	6340	6250	6090	5920	5740	5560	5180	4730	3080
Size BC-200—Wheel Diameter 20 In.																	
855	5/8	4180	4040	3870	3680	3470	3230	2930	2570
1140	1 1/2	5640	5550	5440	5320	5190	5060	4920	4760	4430	4000	3480	2770
1750	5	8740	8680	8620	8550	8490	8420	8350	8280	8120	7960	7790	7600	7200	6750	5510
Size BC-222—Wheel Diameter 22 1/4 In.																	
685	1 1/2	4450	4250	4010	3750	3410	3020	2500
855	1	5650	5500	5340	5150	4960	4750	4520	4240	3530
1140	2 1/2	7600	7500	7390	7270	7140	7010	6870	6740	6450	6110	5700	5210	3600
Size BC-245—Wheel Diameter 24 1/2 In.																	
685	3/8	6090	5850	5590	5350	5090	4700	4210	3450
855	1 5/8	7720	7520	7330	7120	6920	6720	6520	6290	5650	4650	2200
1140	4	10400	10270	10120	9970	9820	9680	9530	9380	9080	8780	8400	7950	6750	4250
Size BC-270—Wheel Diameter 27 In.																	
570	1 1/4	6700	6400	6050	5720	5250	4650	3400
685	1 3/8	8220	7950	7650	7400	7100	6780	6400	5950	4350
855	2 1/2	10350	10180	9950	9720	9520	9300	9050	8820	8300	7620	6700	4700
1140	6	13950	13800	13650	13480	13320	13150	13000	12820	12500	12180	11850	11450	10500	9200
Size BC-300—Wheel Diameter 30 In.																	
570	1 3/4	9350	8980	8600	8200	7800	7300	6600	5700
685	2 1/4	11320	11020	10750	10450	10150	9820	9480	9100	8080	6300
855	4 1/2	14320	14080	13850	13600	13350	13100	12850	12600	12080	11500	10820	9900	6250
1140	10	19200	19020	18850	18650	18480	18300	18120	17920	17580	17220	16880	16500	15650	14650	11450
Size BC-330—Wheel Diameter 33 In.																	
570	2 1/4	12500	12100	11750	11300	10900	10450	9950	9280	7150
685	3 1/2	15180	14850	14520	14200	13880	13520	13180	12820	11980	10800	9100	5200
855	7	19050	18800	18550	18280	18000	17750	17500	17220	16700	16120	15500	14780	12700	8600
Size BC-365—Wheel Diameter 36 In.																	
570	3 1/2	17000	16600	16100	15700	15200	14800	14300	13700	12300	10000
685	6	20600	20200	19900	19500	19100	18800	18500	18000	17200	16200	15100	13500	5800
855	12	25900	25600	25300	25000	24700	24400	24100	23800	23200	22600	22000	21300	19700	17500

ILG Centrifugal Fans

"PE" Pressure Type

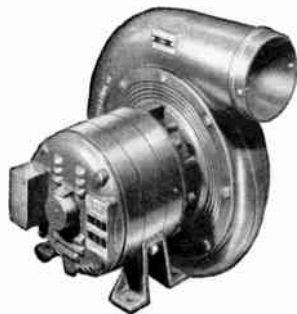

Especially designed for high pressure dust removal, waste conveyance, gas exhaust, supply blast, a rapid cooling. Dynamically balanced, Ilgprex universal wheel. Base furnished as standard equipment on belt-driven models. Furnished as an accessory on all direct-connected units.

For belted data contact Graybar.

Volume Centrifugal Fan Type "P"

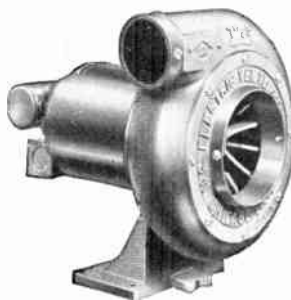

For exhausting fumes from chemical laboratories; handling light dust from polishing wheels and grinders; or any small exhaust purpose where considerable resistance is caused by long run of ducts.

Can be built into other machines such as automatic doughnut machines, lable making machines, heat treatment cabinets, etc.

Cast Iron Type "PE" Centrifugal Fan 60 Cycles

Size	RPM	Hp.	Ship. Wt. Lbs.	60 Cycle Single Phase		208 Volt		60 Cycle Three Phase		Optional Base		
				115/230 Volt	Price	Catalog No.	Price	208 Volt Catalog No.	220/440 Volt Catalog No.	Price	Catalog No.	Price
PE4	3400	1/4	70	22415	\$200.00	22416	\$200.00	22431	22432	\$ 210.00	22441	\$37.00
PE6	3400	1 1/2	170	22433	22434	524.00	22442	47.00
PE9	1750	1 3/4	300	22435	22436	855.00	22443	72.00
PE11	1750	5.0	500	22437	22438	1316.00	22444	94.00

Cast Aluminum Type "PE" Centrifugal Fan 60 Cycles

Size	RPM	Hp.	Ship. Wt. Lbs.	60 Cycle Single Phase		208 Volt		60 Cycle Three Phase		Optional Base		
				115/230 Volt	Price	Catalog No.	Price	208 Volt Catalog No.	220/440 Volt Catalog No.	Price	Catalog No.	Price
PE4	3400	1/4	50	22410	\$200.00	22409	\$200.00	22420	22412	\$ 210.00	22441	37.00
PE6	3400	1 1/2	120	22421	22417	524.00	22442	47.00
PE9	1750	1 3/4	150	22425	22422	855.00	22443	72.00
PE11	1750	5.0	256	22426	22427	1316.00	22444	94.00

Performance Data

Size	RPM	1/2 CFM	1 CFM	1 1/2 CFM	Capacity Table for "PE" Direct-Connected Fans											
					2 CFM	2 1/2 CFM	3 CFM	3 1/2 CFM	4 CFM	4 1/2 CFM	5 CFM	5 1/2 CFM	6 CFM	7 CFM	7 1/2 CFM	
PE4	3400	313	292	266	237	209	176	110
PE6	3400	950	915	875	840	800	760	710	660	545
PE9	1750	2010	1920	1820	1700	1560	1420	1290	1170	1010	670
PE11	1750	3690	3530	3380	3230	3070	2920	2760	2590	2400	2190	1720	1390

Type P Centrifugal Fans 60 Cycles

Size	RPM	Hp.	Ship. Wt. Lbs.	60 Cycle Single Phase				60 Cycle Three Phase					
				115 Volts	Price	230 Volts	Price	208 Volts	Price	208 Volts	Price	220/440 Volts	Price
7 1/2 P	1650	1/25	53	P602	\$ 98.00	P603	\$110.00
	3400	1/4	56	P600*	168.00	P600*	168.00	P612	\$168.00	P630	\$202.00	P604	\$202.00
	1650	1/25	73	P608	120.00	P609	131.00	P613	131.00
10P	1725	1/20	78	P616*	191.00	P616*	191.00	P614	191.00	P631	205.00	P620	205.00
	3400	1/2	85	P624*	223.00	P624*	223.00	P615	223.00	P632	237.00	P628	237.00
	1725	1/5	100	P640*	245.00	P640*	245.00	P618	245.00	P633	265.00	P644	265.00
15P	3400	1	125	P648*	476.00	P648*	476.00	P619	476.00	P636	414.00	P652	414.00
	3400	1-1/2	140	P656*	527.00	P656*	527.00	P626	527.00	P637	468.00	P660	468.00
20P	1725	7/8	240	P672	635.00	P673	635.00	P627	635.00	P638	548.00	P676	548.00

*For 115 Volts only.

60 Cycle Performance Data

Size	RPM	Hp.	Wheel Dia. In.	1/4 CFM	1/2 CFM	3/4 CFM	Static Pressure									
							1 CFM	1 1/2 CFM	2 CFM	2 1/2 CFM	3 CFM	3 1/2 CFM	4 CFM	4 1/2 CFM	5 CFM	6 CFM
7 1/2 P	3400	1/4	6-3/4	222	212	202	192	169	142	115	76
10P	1725	1/20	8-5/16	202	169	133	91
	3400	1/3	393	360	328	293	257	215	170
15P	1725	1/5	9-7/8	380	345	310	275	175
	3400	1-1/2*	800	780	760	745	710	670	635	600	560	525	485	435	330
20P	1725	7/8	14	1160	1120	1080	1030	930	820	690	550	340

*Above 1-1/2-in. pressure 15P 1 Hp. can be used.

ILG Gas-Fired Unit Heaters

For Use with Natural, Manufactured, Mixed (Combination of Natural and Manufactured), Propane or Butane Gases



Model N	City Gases		LP Gases and LP Gas-Air Mixture		Hp.	RPM	C.F.M. at 70°	Approx. Ship. Wt. Lbs.	Price
	Input	Output	Input	Output					
25-N	25,000	20,000	25,000	20,000	1/40	1050	400	150	\$244.00
50-N	50,000	40,000	50,000	40,000	1/25	1050	650	197	270.00
75-N	75,000	60,000	70,000	56,000	1/25	1050	1000	210	313.00
100-N	100,000	80,000	100,000	80,000	1/15	1050	1200	255	349.00
130-N	130,000	104,000	130,000	104,000	1/12	1140	1560	350	405.00
170-N	170,000	136,000	170,000	136,000	1/8	1140	2000	455	470.00
200-N	200,000	160,000	200,000	160,000	1/6	1140	2700	485	523.00

*Prices include all controls except Room Thermostat or Manual Cut-Off Switch. Prices are for 115 volt, 60 cycle, single-phase electric service. Light duty thermostat optional. Price \$24.00.

Input and output ratings are given in Btu per hour. Output rating includes allowance for recoverable heat due to jacket losses, etc., not concerned in determining efficiency. Ratings shown are for elevations up to 2000 ft. For elevations above 2000 ft., ratings should be reduced at the rate of 4% for each 1000 ft. above sea level.

ILG Electric Unit Heaters



Ilg has developed a new line of small electric heaters, sizes 1½ K.W. to 7½ K.W.

Steel and spiral design are protected against overheating by a built-in thermal cut-out.

Safety design eliminates bare live wires or terminals in air stream.

The entire unit covered by Ilg's one-name plate guarantee. An electric heater equal to every job.

For extra heat capacity sizes 9 KW to 15 KW are available. This unit is designed for heavy duty, continuous or automatically controlled operation in industrial and commercial applications.

Steel hanger bracket accessories that make it easy and convenient to mount 1½ KW to 5 KW sizes on wall or ceiling, or to mount 6 KW and 7½ KW sizes on ceiling are available at an additional charge of List Each \$6.00.

1½ KW to 15 KW Ilg Electric Unit Heaters and Controls
Controls Shown Below Are Those Needed in Addition to a Line Switch or Other Disconnecting Means

Size and Capacities	Dimensions In.	Volts	Rating Phase	Amps.	Motor Volts	Shpg. Wt. Lbs.	R.P.M.	Heater Price	Manual Control		Automatic Control		Price	
									Catalog No.	Price	Contractor Catalog No.	Thermo. Cat. No.		
1½ KW 5118 Btu 180 CFM	12½ width 15¾ height 10¼ depth	120	1	13.2	115	21	1550	\$124.00					196-2	\$35.00
		208	1	7.6	230	21	1550	131.00					196-2	35.00
		240	1	6.6	230	21	1550	131.00					196-2	35.00
2 KW 6824 Btu 180 CFM	12½ width 15¾ height 10¼ depth	120	1	17.4	115	21	1550	126.00					196-2	35.00
		208	1	10.0	230	21	1550	135.00					196-2	35.00
		240	1	8.7	230	21	1550	135.00					196-2	35.00
3 KW 10236 Btu 250 CFM	12½ width 15¾ height 10¼ depth	120	1	25.7	115	21	1550	135.00			957511836	180-2	64.00	
		208	1	14.8	230	21	1550	143.00					196-2	35.00
		210	1	12.9	230	21	1550	143.00					196-2	35.00
4 KW 13648 Btu 250 CFM	12½ width 15¾ height 10¼ depth	208	3	12.9	230	21	1550	143.00	957511756	\$33.00	957511756	180-2	58.00	
		240	3	11.2	230	21	1550	143.00	957511756	33.00	957511756	180-2	58.00	
		120	1	31.0	115	21	1550	142.00			95601154	144.00	95601154	180-2
5 KW 17060 Btu 320 CFM	12½ width 15¾ height 10¼ depth	208	1	19.6	230	21	1550	150.00					196-2	35.00
		240	1	17.1	230	21	1550	150.00					196-2	35.00
		208	3	17.0	230	21	1550	150.00	957511756	33.00	957511756	180-2	58.00	
6 KW 20172 Btu 380 CFM	12½ width 15¾ height 13¼ depth	240	3	14.8	230	21	1550	150.00	957511756	33.00	957511756	180-2	58.00	
		480	3	7.3	115	21	1550	194.00	957511869	43.00	957511869	180-2	68.00	
		600	3	5.8	115	21	1550	196.00	957511869	43.00	957511869	180-2	68.00	
7½ KW 25590 Btu 380 CFM	12½ width 15¾ height 13¼ depth	208	1	24.4	230	21	1550	189.00			956011393	180-2	69.00	
		240	1	21.2	230	21	1550	189.00	956011393	44.00	956011393	180-2	69.00	
		208	3	21.2	230	21	1550	189.00	956011393	44.00	956011393	180-2	69.00	
9 KW 30708 Btu 600 CFM	15½ width 21 height 18½ depth	240	3	18.4	230	21	1550	189.00	956011393	44.00	956011393	180-2	69.00	
		480	3	9.0	115	21	1550	223.00	957511869	43.00	957511869	180-2	68.00	
		600	3	7.3	115	21	1550	226.00	957511869	43.00	957511869	180-2	68.00	
12 KW 40944 Btu 800 CFM	15½ width 21 height 18½ depth	208	1	29.4	230	31	1550	200.00			956011393	180-2	69.00	
		240	1	25.6	230	31	1550	200.00			956011393	180-2	69.00	
		208	3	17.3	230	31	1550	200.00	956011393	44.00	956011393	180-2	69.00	
15 KW 51180 Btu 1000 CFM	18½ width 24¾ height 19¼ depth	240	3	15.0	230	31	1550	200.00	956011393	44.00	956011393	180-2	69.00	
		480	3	7.2	115	31	1550	252.00	957511869	43.00	957511869	180-2	68.00	
		600	3	5.8	115	31	1550	254.00	957511869	43.00	957511869	180-2	68.00	
9 KW 30708 Btu 600 CFM	15½ width 21 height 18½ depth	208	1	36.6	230	31	1550	229.00	95601154	144.00	95601154	180-2	169.00	
		240	1	31.8	230	31	1550	229.00	95601154	144.00	95601154	180-2	169.00	
		208	3	21.4	230	31	1550	229.00	95601393	45.00	95601393	180-2	69.00	
12 KW 40944 Btu 800 CFM	18½ width 24¾ height 19¼ depth	240	3	18.6	230	31	1550	229.00	95601393	44.00	95601387	180-2	69.00	
		480	3	9.0	115	31	1550	270.00	957511869	43.00	957511869	180-2	68.00	
		600	3	7.2	115	31	1550	272.00	957511869	43.00	957511869	180-2	68.00	
15 KW 51180 Btu 1000 CFM	15½ width 21 height 18½ depth	120	1	76.4	115	80	1140	458.00	95601179	229.00	95601179	180-2	254.00	
		208	1	41.0	230	80	1140	481.00	95601154	144.00	95601154	180-2	169.00	
		210	1	38.2	230	80	1140	458.00	95601154	144.00	95601154	180-2	169.00	
15 KW 51180 Btu 1000 CFM	18½ width 24¾ height 19¼ depth	208	3	25.7	230	80	1140	481.00	95601393	44.00	95601393	180-2	69.00	
		240	3	22.3	230	80	1140	458.00	95601393	44.00	95601393	180-2	69.00	
		440	3	12.5	230	80	1140	520.00	9560115	73.00	9560115	180-2	98.00	
15 KW 51180 Btu 1000 CFM	18½ width 24¾ height 19¼ depth	550	3	10.2	230	80	1140	520.00	9560115	73.00	9560115	180-2	98.00	
		440	3	16.3	230	85	1140	628.00	95601130	83.00	95601130	180-2	108.00	
		550	3	13.4	230	85	1140	628.00	95601130	83.00	95601130	180-2	108.00	
15 KW 51180 Btu 1000 CFM	18½ width 24¾ height 19¼ depth	240	1	50.7	230	125	1140	583.00	95601179	229.00	95601179	180-2	254.00	
		208	3	34.0	230	125	1140	613.00	95601155	152.00	95601155	180-2	177.00	
		240	3	29.5	230	125	1140	583.00	95601393	44.00	95601393	180-2	69.00	
15 KW 51180 Btu 1000 CFM	15½ width 21 height 18½ depth	440	3	20.2	230	90	1140	708.00	95601130	83.00	95601130	180-2	108.00	
		550	3	16.7	230	90	1140	708.00	95601130	83.00	95601130	180-2	108.00	
		18½ width 24¾ height 19¼ depth	240	1	63.2	230	125	1140	662.00	95601179	229.00	95601179	180-2	254.00
15 KW 51180 Btu 1000 CFM	18½ width 24¾ height 19¼ depth	208	3	42.3	230	125	1140	695.00	95601155	152.00	95601155	180-2	177.00	
		240	3	36.8	230	125	1140	662.00	95601155	152.00	95601155	180-2	177.00	

Note—For 440 volts and up, heater control, requires a 120 control circuit. If this circuit is not available, specify 480/120 volt No. 9T51Y6426 transformer at \$25.00 list or 600/120 volt No. 9T51Y6806 transformer at \$26.00 list.

ILG Steam Unit Heaters

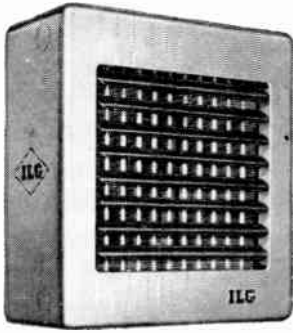

The new design and advanced engineering are reflected in every detail. The heaters are easily attached to the steam or hot water system in factory, store or office.

Heaters provide maximum heat where it is needed.

Clean, attractive lines, quiet, hushed operation, rugged construction . . . freedom from maintenance attention.

Nineteen capacity sizes are available.

Horizontal Type—Capacity Data and Price

Size	RPM	BTU 2 Lbs. Steam 60° F. Ent. Air	†CFM	Hp.	Approx. Ship. Wgt. Lbs.	Constant Speed 115-230 V. 60 Cy. Each	Two Speed 115-230 V. 60 Cy. Each
10418	1550	21000	318	1/100	55	\$122.00	\$147.00
10422	1550	23100	385	1/100	68	122.00	147.00
10427	1550	25100	466	1/70	65	128.00	153.00
12418	1550	38400	555	1/40	70	154.00	183.00
12423	1550	42900	690	1/30	95	154.00	183.00
12427	1550	46250	807	1/30	100	155.00	184.00
16418	1050	68500	919	1/40	100	206.00	240.00
16427	1050	82500	1362	1/20	115	231.00	267.00
16433	1050	90000	1600	1/10	120	242.00	286.00
21418	1050	115000	1631	1/10	160	293.00	333.00
21427	1140	138500	2420	1/6	170	337.00	384.00
21423E	1140	151500	3000	1/6	190	345.00	418.00
24416	1140	177000	2780	1/6	200	377.00	442.00
24416E	1140	191500	3330	1/6	210	418.00	468.00
24420	1140	205000	3800	1/3	230	436.00	479.00
24420E	1140	216000	4350	1/3	230	460.00	491.00
251D6	855	229000	3190	1/4	450	558.00	605.00
251E6	855	268200	4080	1/3	450	570.00	617.00
251F6	1140	286000	4676	1/2	490	584.00	652.00

Note: 3 Phase, 220/440 volt, 60 cycles also available.

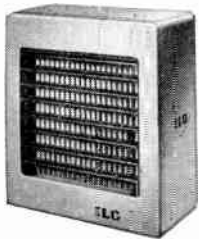

Textile Type

Has all horizontal type features and dimensions but more seamless copper tubes to increase heating surface.

The fins which would ordinarily pick up lint are eliminated.

Ten sizes are available.

Textile Type—Capacity Data and Price

Size	RPM	BTU 2 Lbs. Steam 60° F. Ent. Air	†CFM	Hp.	Approx. Ship. Wgt. Lbs.	Constant Speed 115-230 V. 60 Cy. Each	Two Speed 115-230 V. 60 Cy. Each
16418T	1050	44000	919	1/40	110	\$279.00	\$298.00
16427T	1140	56000	1480	1/12	115	327.00	378.00
16433T	1140	59500	1740	1/12	120	336.00	391.00
21418T	1140	76900	1770	1/12	190	430.00	487.00
21427T	1140	90000	2420	1/6	200	482.00	500.00
21423ET	1140	100000	3000	1/6	210	492.00	510.00
24416T	1140	118200	2780	1/6	250	542.00	557.00
24416ET	1140	126000	3330	1/6	255	553.00	568.00
24420T	1140	136000	3800	1/3	270	567.00	608.00
24420ET	1140	145000	4350	1/3	270	578.00	632.00

Note: 3 Phase, 220/440 volt, 60 cycles also available.

†CFM is cubic feet per minute of standard air at 70°F. and standard basis of rating 12 lbs. steam pressure 60°F. entering air.

ILG Steam Unit Heaters Vertical Type



ILG paces the field with this new heater that throws a powerful current of air downward to provide better heating in buildings with high ceilings. Coil construction similar to the horizontal type. Ball bearing motors are shielded from radiant heat. Available in eighteen capacity sizes and two types. Type V for standard outlet air temperature and Type VL for low outlet air temperature.

Optional adjustable directional vanes, diffuser cones and anenostats. For price on accessories contact Graybar.

Vertical Type U—Capacity Data and Price

Size	RPM	BTU 2 Lbs. Steam 60° F. Ent. Air	†CFM	Hp.	Approx. Ship. Wgt. Lbs.	Constant Speed 115-230 V. 60 Cy. Each	Two Speed 115-230 V. 60 Cy. Each
124V1	1550	45500	590	1/30	80	\$264.00	\$284.00
124V2	1550	53100	730	1/30	80	281.00	300.00
124V3	1550	60500	900	1/15	90	297.00	317.00
164V1	1140	114000	1500	1/12	165	374.00	395.00
164V2	1140	131000	1835	1/8	175	382.00	402.00
164V3	1725	170000	2820	1/3	185	413.00	433.00
214V1	1140	197500	2800	1/4	175	442.00	462.00
214V2	1140	227000	3270	1/4	180	494.00	515.00
214V3	1725	294000	4670	1/2	200	545.00	565.00
244V1	855	354000	4730	1/3	250	649.00	670.00
244V2	1140	392000	5560	1/2	265	706.00	728.00
304V1	855	440000	5790	3/8	375	837.00	860.00
3-Phase, 220/440 Volts 60 Cycles							
164V1	1140	114000	1500	1/12	165	Each \$387.00	406.00
164V2	1140	131000	1835	1/8	175	406.00	429.00
164V3	1725	170000	2820	1/3	185	449.00	468.00
214V1	1140	197500	2800	1/4	175	436.00	456.00
214V2	1140	227000	3270	1/4	180	505.00	525.00
214V3	1725	294000	4670	1/2	200	576.00	596.00
244V1	855	354000	4730	1/3	250	653.00	673.00
244V2	1140	392000	5560	1/2	265	740.00	760.00
244V3	1140	440000	6750	1	300	810.00	830.00
304V1	855	440000	5790	3/8	375	823.00	843.00
304V2	1140	535000	7700	1	400	892.00	912.00
304V3	1140	596000	9300	1-1/4	435	958.00	978.00

Vertical Type UL—Capacity Data and Price

Size	RPM	BTU 2 Lbs. Steam 60° F. Ent. Air	†CFM	Hp.	Approx. Ship. Wgt. Lbs.	Constant Speed 115-230 V. 60 Cy. Each	Two Speed 115-230 V. 60 Cy. Each
124V1L	1550	34200	590	1/30	80	\$224.00	\$244.00
124V2L	1550	36800	730	1/25	80	241.00	261.00
124V3L	1550	40000	900	1/15	90	257.00	277.00
164V1L	1050	84600	1140	1/20	115	301.00	322.00
164V2L	1140	89500	1735	1/8	120	307.00	328.00
164V3L	1725	101000	2820	1/3	135	301.00	322.00
214V1L	1050	127000	2300	1/12	170	329.00	350.00
214V2L	1140	142000	3270	1/4	180	373.00	394.00
214V3L	1725	162000	4670	1/2	200	410.00	431.00
244V1L	855	216000	4730	1/3	250	532.00	554.00
244V2L	1140	236000	5560	1/2	265	583.00	605.00
304V1L	855	298000	5500	3/8	375	619.00	642.00
3 Phase, 220/440 Volts 60 Cycles							
164V1L	1050	84600	1140	1/20	115	Each \$330.00	340.00
164V2L	1140	89500	1735	1/8	120	340.00	353.00
164V3L	1725	104000	2820	1/3	135	333.00	346.00
214V1L	1050	127000	2300	1/12	170	341.00	354.00
214V2L	1140	142000	3270	1/4	180	370.00	383.00
214V3L	1725	162000	4670	1/2	200	399.00	412.00
244V1L	855	216000	4730	1/3	250	525.00	538.00
244V2L	1140	236000	5560	1/2	265	572.00	585.00
244V3L	1140	256000	6750	1	300	581.00	594.00
304V1L	855	298000	5500	3/8	375	608.00	621.00
304V2L	1140	318000	7700	1	400	674.00	687.00
304V3L	1140	344000	9300	1-1/4	435	743.00	756.00

†CFM is cubic feet per minute of standard air at 70°F. and standard basis of rating 12 lbs. steam pressure 60°F. entering air.

G-E Natural-Convection-Type Horizontal Unit Heaters

For heating out-of-the-way places. Easily installed and very convenient.

Consist of a number of G-E strip heaters mounted in a perforated, pressed steel case, with heat-resisting painted finish.

Free air circulation provides maximum heat. Are easily installed and connected to power line and quickly moved from one location to another.

Common typical applications—Substations, valve houses, pump houses, warehouses, crane cabs, airplane hangars, electric locomotives, blower rooms, repair shops, service stations, laboratories, garages, scale rooms, watchmen's houses, elevators, drying rooms, waiting stations and ticket booth.

The Wall-Mounted Style can be furnished with and without switches (as below). Heaters with 3-heat snap switches make regulation of temperature simple and very economical.

Wall-Mounted Style

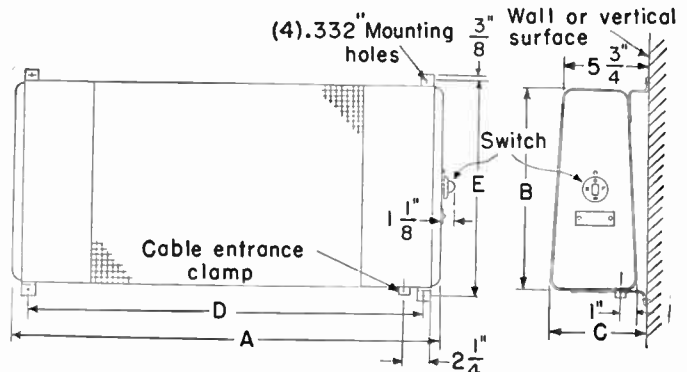

Equipped with heat baffles to prevent overheating and scorching of wall surfaces.

For mounting directly on wall, with main axis horizontal. Can be mounted with the cable emerging from either right or left.

With 3-heat Snap Switch						Without Switches						Dimensions, Inches					Approx. Ship. Wt., Lbs.
Cat. Nos.		Each	Cat. Nos.		Each	Cat. Nos.		Each	Watts	A	B	C	D	E			
120 Volts A-C	240 Volts A-C		120 Volts A-C/D-C	240 Volts A-C/O-C		480 Volts A-C/O-C	120 Volts A-C/D-C								240 Volts A-C/O-C	480 Volts A-C/O-C	
2A373G1	2A373G2	\$34.50	2A373G32	\$40.55	2A373G21	2A373G22	2A373G23	\$30.25	1000	30 9/16	7 1/4	6 1/8	28 9/16	8 1/8	22		
2A374G1	2A374G2	46.60	2A374G32	48.40	2A374G21	2A374G22	2A374G23	40.55	2000	30 9/16	10 1/2	6 5/16	28 9/16	11 3/8	32		
.....	2A375G2	56.85	2A375G32	61.70	2A375G22	2A375G23	52.65	3000	30 9/16	11 1/4	6 1/2	28 9/16	15 1/8	40		
.....	2A376G2	69.60	2A376G32	71.40	2A376G22	2A376G23	59.90	4500	37 1/8	14 1/4	6 1/2	35 1/8	15 1/8	50		

Floor-Mounted Style

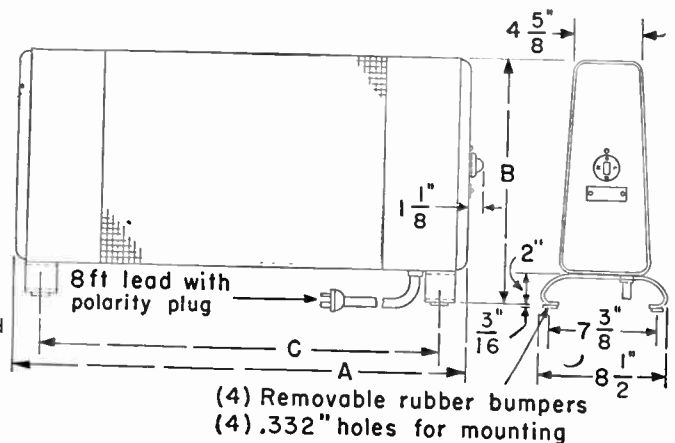

Each heater is equipped with a 3-heat snap switch mounted on one end and a 18-foot rubber-covered heater cord.

Cat. Nos.			Each	Cat. No.	Each	Watts	Dimensions, Inches			Approx. Ship. Weight, Lbs.
120 Volts A-C	240 Volts A-C	480 Volts A-C					A	B	C	
2A377G1	2A377G2		\$28.70	2A377G32	\$35.75	1000	30 9/16	9 1/4	27 15/16	18
2A378G1	2A378G2		36.85	2A378G32	45.10	2000	30 9/16	12 1/2	27 15/16	24
.....	2A379G2		47.30	2A379G32	52.80	3000	30 9/16	16 1/4	27 15/16	29
.....	2A380G2		60.50	2A380G32	68.20	4500	37 1/8	16 1/4	3-1 1/2	34

Suitable G-E control is available for these heaters. Contact Graybar for complete details.

G-E Forced-Convection-Type Unit Heaters

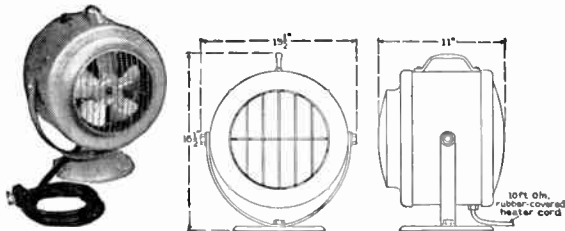

Fig. 1. Portable Style (2, 3 and 4 Kw.)

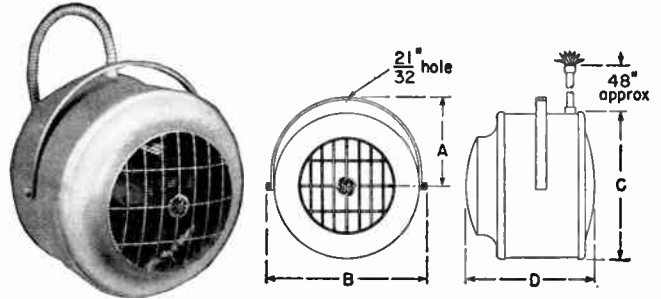

Fig. 2. Suspension Style (5, 7.5, 10, 12.5 and 15 Kw.)

Heaters—Equipped with G-E tubular heater, with strong radiating fins that multiply its radiating surface. Fins are electric-furnace brazed to the heater and provide maximum heat-transfer efficiency.

Motor—A G-E totally enclosed motor with sleeve bearings, protected against direct radiation from heating units by ingenious baffle. Cool air is drawn over the motor frame at all times through the space between motor and baffle.

Fan—G-E aphonic pressure-type, with matching outlet orifice. Efficient and quiet in operation.

Wide Utility—The smaller sizes of heaters are designed so that they can be used as hot weather fans.

Automatic Protection against Overheating—Heaters rated under 10 kilowatts have a convenient reset button located on outside of case. On heaters rated 10 kilowatts and higher a remote push-button control provides necessary reset feature.

Heater may be directed upward or downward as much as 30 degrees from horizontal to serve required area. There are no louvres to retard free flow of air.

Motor and fan can be operated independently on heaters of 2-, 3- and 4-kw by tumbler switch mounted on casing. On 5- and 7-5-kw heaters, fan-motor leads are brought out so fan can be connected to manual switch.

Portable Style—Primarily for Floor Mounting, But Easily Adaptable for Wall or Ceiling Mounting

No. Single-phase, 50-60 Cycles, A-C			Kw	Dimensions See Fig.	Btu Per Hr.	Equivalent Direct Radiation at 240 Btu Per Sq. Ft.	Average Velocity of Air, Ft. Per Min.	Volume of Air, Cu. Ft. Per Min. at Outlet Temp.	Temp. Deg. F.		Approx. Ship. Wt. Lbs.	Each
120 Volts	240 Volts	480							Inlet	Outlet (Avg.)		
2A381G4	2A381G5		2	1	6,824	28.4	390	127	70	125	29	\$75.90
2A382G4	2A382G5		3	1	10,236	42.7	730	206	70	117	29	86.90
	2A383G5	2A383G3	4	1	13,648	56.9	750	212	70	123	33	97.90

Suspension Style—For Wall or Ceiling Mounting

No.				Approx. Conditions under Normal Operation												
240 Volts		*480 Volts		Kw	Btu Per Hr.	Equivalent Direct Radiation at 240 Btu Per Hr.	Average Velocity of Air (Ft. Per Min.)	Volume of Air Cu. Ft. Per Min. at Outlet Temp.	Temp. Deg. F. Inlet	Outlet (Avg.)	Dimensions in In. (See Fig. 2)				Ship. Wt. Lbs.	Each†
Single-phase 60 Cycles, A-C	Three-phase 60 Cycles, A-C (Single-phase Motor)	Single-phase 60 Cycles, A-C (With 115-volt Motor)	Three-phase 60 Cycles, A-C (With 115-volt Single phase Motor)								A	B	C	D		
2A177G68	2A177G66	2A177G66	2A178G66	5	17,060	71.1	850	510	70	99	9 1/2	16 3/4	15	14 3/4	48	\$108.90
2A178G68	2A201G48	2A178G66	2A201G49	7.5	25,590	106.4	865	520	70	113					50	137.50
	2A202G48		2A202G49	10	34,120	142	1225	1510	70	90					109	234.30
	2A203G48		2A203G49	12.5	42,650	178	1753	1565	70	95	12 13/16	24	22	19 1/2	109	242.00
				15	51,180	213	1782	1590	70	100					114	253.00

*All 480-volt heaters have 115-volt motors. These motors have separate thermal control, and heater lead brought out through conduit.

†Price includes 4-ft. of armored connecting cable as shown in Fig. 2.

Chromalox Electric Unit Heaters

Listed by Underwriters' Laboratories, Inc.

Type CHF Hi-Flow Portable



Compact, functional design that packs tremendous heating capacity into a small, space-saving unit—ideal for shops, homes and stores. Rugged, tubular chrome support stand allows it to be mounted on walls or ceilings or to operate free-standing on floors, counters or shelves.

All metal Chromalox finned Microtube heating element provides rapid heat-up. Smooth running motor gently forces warmed air throughout the room. Controlled by a manual on-off switch and protected against overheat by a built-in thermal cutout switch.

All metal housing painted with durable, baked-on Mediterranean-Blue finish.

Overall size 15-in. high x 14½-in. wide and 9-in. deep.

No.	Volts	Rating	Watts	Output B.T.U. Per Hr.	Approx. Wt., Lbs.	Each
CHF-120	120 A.C.		2000	6824	17½	\$53.50
CHF-220	240 A.C.		2000	6824	18	53.50
CHF-230	240 A.C.		3000	10236	18	59.50
CHF-240	240 A.C.		4000	13648	22	69.50

All models supplied with 5½-ft. UL listed cord and polarized plug.

Separate polarized wall outlet recommended.

Chromalox Electric Convection Heaters

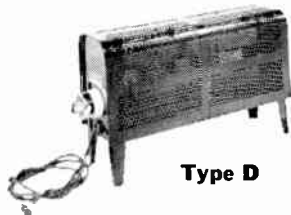

Type D

Small, efficient, portable heaters which can be easily picked up and moved from one place to another.

For use in industry for auxiliary heating in many locations and also for sole heat source in locations too remote for central heating plants.

Heating elements are the efficient, long-life, enclosed-type Chromalox strip heating elements.

Rugged construction throughout. Black enamel finish.

No. EH-810 and EH-815 have 6-ft. heater cord and attachment plug. Larger sizes with 6-ft. cord for connection to power lines.

All are equipped with 3-heat switch.

For 115, 230, 250 and 460 Volts, 25 or 60 Cycles A-C, or D-C

No.	Kw.	Length	Overall Size, in.	Height	Ship. Wt., Lbs.	Each
			Width			
EH-810	1.0	22	6	13	33	\$26.20
EH-815	1.5	22	6	13	33	30.25
EH-420	2.0	28	6	13	38	34.20
EH-430	3.0	28	6	13	38	41.50

Chromalox Electric Unit Heaters

Listed under Underwriters' Laboratories, Inc.

Re-Examination Service—Reference No. E-7061

Type H



Designed for wall mounting to concentrate heat near the floor. Ideal for installation in crane cabs and beneath windows.

They discharge heated air horizontally and can be

safely fastened to walls or wooden partitions.

The heating elements are efficient, long-life, enclosed type Chromalox strip heaters.

Sturdily constructed throughout to resist hard usage.

For 115 and 230 Volts, A-C or D-C

No.	Kw.	Length	Overall Sizes, in.	Height	Ship. Wt., Lbs.	Price Complete	Price Less Switch & Cable
			Width				
EH-1801	1.0	20¾	4½	7½	28	\$32.80	\$27.80
EH-2405	1.5	26¾	4½	7½	38	38.50	33.60
†EH-2406	2.0	26¾	4½	11¼	49	44.20	37.45
†EH-2407	3.0	26¾	4½	11¼	49	55.70	47.60

†Also available in 460 volts.

Dillon Thermometers

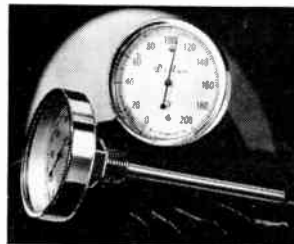

For indicating the temperature of liquids and gases. Can be permanently installed in pipes, furnace flues, tanks, cookers, etc. Should be immersed 2 in. in liquids and 4 in. in gases.

They are accurate to 1% of the range over the entire scale. Accuracy is unaffected by overload up to 50% 500°F. range; 10% above 750°F. range.

Standard mounting nut for Models S and R is ½ in. N.P.T. Models H and Q are furnished with plain bushing .406 in. dia. by ⅜ in. long, but these last two are also available with ¼ in. N.P.T. or ⅜-24 x ½ in. N.F. nut if specified. Nuts are welded to stem for high pressure use.

Anti-corrosion and acid resistant. Models H and Q are fully stainless except for dial. Models S and R are likewise stainless except for dial and bezel. All have pressure proof welded construction. Dials are of heat resistant aluminum with large black figures on silver background.

Scaled against moisture. Pointer is permanently fixed onto shaft. Direct drive from bi-metal coil assures accuracy of 1% of full scale. Stem is ⅝ in. diameter.

Standard stem lengths are 5 in. and 9 in.; any intermediate length from 2½ in. to 72 in. available at extra charge. When ordering, state desired length from top thread of mounting nut to tip of stem.

Prices below are based upon standard stem length of 5 in.

Note: Special ranges are procurable on order.

Fahrenheit Scale

Range	Model "S" 5 In. Dial Each	Model "R" 3 In. Dial Each	Model "H" 2½ In. Dial Each	Model "Q" 1 In. Dial Each
40- 160°F.	\$18.70	\$12.10	\$10.85	\$8.80
0- 200°F.	16.90	10.85	9.65	7.70
50- 300°F.	16.90	10.85	9.65	7.70
50- 500°F.	16.90	10.85	9.65	7.70
150- 750°F.	18.70	12.10	10.85	8.80
200-1000°F.	18.70	12.10	10.85	8.80

Centigrade Scale

Range	Model "S" 5 In. Dial Each	Model "R" 3 In. Dial Each	Model "H" 2½ In. Dial Each	Model "Q" 1 In. Dial Each
0-100°C.	\$16.90	\$10.85	\$9.65	\$7.70
-10-110°C.	16.90	10.85	9.65	7.70
0-150°C.	16.90	10.85	9.65	7.70
0-300°C.	16.90	10.85	9.65	7.70
Weight, ozs.	14	8½	2	1

Weston Thermometers

Stainless steel construction except scale glass. Metal scale plate with black figures and markings. Immersion should be

2-in. in liquids and 1-in. in gas. If subjected to temperatures in excess in 300° F., state temperature when ordering.

Testing Thermometers



Model 2261

Head diameter 1 3/4 - in. Scale Length 3.19-in. Stem .112-in. diameter. Standard stem length 8 - in.; other lengths to 18-in. on special order.

It is accurate within 1/2 of 1% of the thermometer range.

Range	Div.	Each
10 to 160°F.	2	\$8.50
0 to 180°F.	2	8.50
0 to 220°F.	2	8.50
50 to 300°F.	2	8.00
50 to 500°F.	2	8.00
50 to 100°C.	2	8.50
0 to 100°C.	1	8.50
0 to 150°C.	2	8.00
0 to 250°C.	2	8.00

Standard Industrial Thermometers



Model 2211

Head diameter 3-in. Scale Length 6-in. Connection Nut 1/2 N.P.T.; 3/4 N.P.T. at a surcharge. Stem diameter 1/4-in. Stem length 2 1/2-in., 4-in., 6-in., 9-in., 12-in., 18-in., 24-in. Stem lengths up to 72-in. in most ranges on special order.

It is accurate within 1% of range within entire scale.

Range	% Div.	Stem Length Including Threads				
		2 1/2 -in.	4 -in. or 6 -in.	9 -in. or 12 -in.	18 -in.	24 -in.
0 to 200°F.	2	\$18.00	\$17.50	\$19.25	\$21.00	\$22.75
50 to 300°F.	2	18.00	17.50	19.25	21.00	22.75
50 to 500°F.	5	18.00	17.50	19.25	21.00	22.75
150 to 750°F.	10	19.50	19.00	20.75	22.50	24.25
200 to 1000°F.	10	19.50	19.00	20.75	22.50	24.25
0 to 100°C.	1	18.00	17.50	19.25	21.00	22.75
10 to 110°C.	1	18.00	17.50	19.25	21.00	22.75
0 to 150°C.	1	18.00	17.50	19.25	21.00	22.75
0 to 300°C.	5	19.50	19.00	20.75	22.50	24.25

Note: Other sizes and ranges available.

G-E Flanged Water Immersion Heaters

These units were designed primarily for use in domestic water heaters, either in the original equipment or as replacement units for existing equipments. However, they can be applied successfully to almost any application where a flanged

immersion heater is required. These heaters feature a copper sheath, with a steel, brass face plate flange. Sizes and ratings are available from stock.

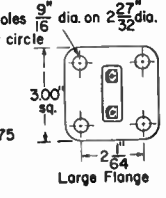
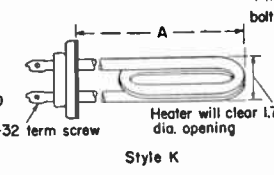
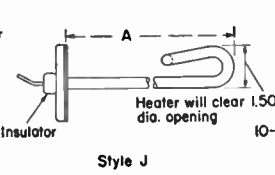
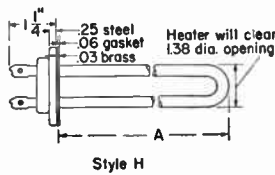
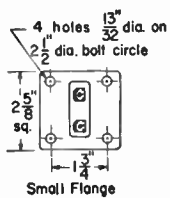

Small Flange

Cat. No.		Watts	Style	Max. A (In.)	List Price, Each
118 Volts	236 Volts				
2D319	2D319G2	600	II	5.78	\$4.25
2D320	2D320G2	750	II	6.84	4.40
2D321	2D321G2	1000	II	8.84	4.70
2D322	2D322G2	1250	II	10.00	4.90
2D323	2D323G2	1500	J	7.06	5.10
2D324	2D324G2	2000	J	10.00	5.70
2D325	2D325G2	2500	J	11.06	5.90
2D326	2D326G2	3000	J	13.81	6.30
2D329	3D329G2	4000	K	13.81	7.90
2D330	3D330G2	4500	K	15.31	8.40
2D331	3D331G2	5000	K	15.31	9.40

Large Flange

Cat. No.		Watts	Style	Max. A (In.)	List Price, Each
118 Volts	236 Volts				
2D319G3	2D319G4	600	II	5.78	\$6.50
2D320G3	2D320G4	750	II	6.84	7.00
2D321G3	2D321G4	1000	II	8.84	7.50
2D322G3	2D322G4	1250	II	10.00	7.50
2D323G3	2D323G4	1500	J	7.06	8.00
2D324G3	2D324G4	2000	J	10.00	8.50
2D325G3	2D325G4	2500	J	11.06	9.00
2D326G3	2D326G4	3000	J	13.81	9.50
2D329G3	2D329G4	4000	K	13.81	10.50
2D330G3	2D330G4	4500	K	15.31	11.00
2D331G3	2D331G4	5000	K	15.31	11.40

G-E Immersion Heaters For Water—Copper-Sheathed

These heaters have a high heat density. A few of their applications are—water baths, cleaning tanks, water-jacketed containers, humidifiers, load resistors, industrial water heaters,

quench tanks, electric steam radiators, stills and sterilizers, steam generators, and many others.

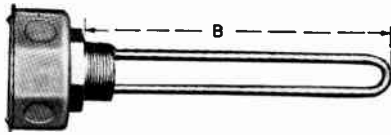

Fig. 1

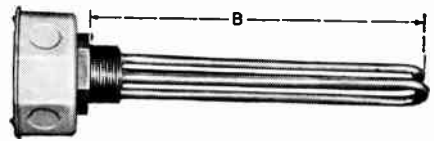

Fig. 2

Cat. Number †		Heaters		Kw. Rating	No. of Heats	Approx. Ship. Wt. Lbs.	Fig.	Approx. Dimensions, Inches—			List Price Each
115 Volts 1-heat	115 Volts 3-heat or 230 Volts 1-heat	230 Volts 1-heat	230 Volts 3-heat					Approx. Dimen.	Header Size ‡	Overall Length	
2D170	2D269	2D170G2		0.65	3-1	1 1/2	2	4 1/2	1 1/4	6 5/8	\$
	2D171		2D171G2	1.0	1	1 1/2	1	10 3/4	1 1/4	12 7/8	
	2D172		2D172G2	1.3	3	2 1/2	2	7 1/2	1 1/4	9 5/8
	2D173		2D173G2	2.0	3	3	2	10 3/4	1 1/4	12 7/8	
	2D174		2D174G2	3.0	3	4 1/2	2	10 1/2	2	12 3/4
	2D175		2D175G2	4.0	3	5 1/2	2	13 1/2	2	15 1/2	
			2D177G2	5.0	3	6 1/2	2	16 1/2	2	18 1/2
			2D179G2	7.5	3	9 1/2	2	23 3/4	2	26 5/8	
				10.0	3	12 1/2	2	31	2	33 5/8

250 Volt *Switches for Manual Control	
Cat. No.	Description
278608	3-heat
278608	3-heat
296569	3-heat
296569	3-heat
278610	3-heat

†Terminal covers furnished with all heaters.
‡Nominal pipe-thread diameter.
*All switches listed are suitable for circuits of 250 volts, a-c or d-c.
¶Over-all length of No. 2D174 is 16 5/8-in.; No. 2D174G2 is 15 3/4-in.
⊕Over-all length of No. 2D175 is 19 5/8-in.; No. 2D175G2 is 18 3/4-in.

For Water—Nickel-Silver Sheathed—Self-Protecting Type

Made only by General Electric—designed for applications in which the heaters are at times accidentally exposed to the atmosphere. Some of the applications of these heaters are—water baths, stills, sterilizers and others where the liquid is likely to be boiled away or drawn off.

Self-protecting—the special alloy resistance wire which has a high temperature coefficient of resistance reduces the watt input as the temperature is increased, thereby limiting the sheath temperature.

Number		Heaters		Kw. Rating	No. of Heads	Approx. Ship. Wt. Lbs.	Fig.	Approx. Dimensions, Inches—			List Price Each
115 Volts	230 Volts	Approx. Dimen.	Header Size ‡					Overall Length			
2D140		8 1/2	1 1/4	0.75	1	3	1	10 1/2		\$26.40	
2D141		8 1/2	1 1/4	1.5	3	3 1/2	2	10 1/2		38.10	
	2D142G2 †	9 1/2	2	2.5	3	6	2	11 1/2		44.15	
	2D143G2 †	12 1/2	2	3.5	3	7	2	14 1/2		53.25	
	2D144G2 †	15 1/2	2	4.5	3	8	2	17 1/2		59.30	

*250 Volt Switches for Manual Control	
No.	Description
278608	3-heat
GE987	Single-heat

*All switches listed are suitable for circuits of 250 volts, a-c or d-c.
†To maintain the self-protecting feature, the two elements must be wired in parallel when operating at rated voltage.
‡Nominal pipe-thread diameter.

For Noncirculating Oils—Steel-Sheathed

These heaters have steel headers and are particularly suitable for:
Oil heating
Oil sterilizing
Fuel-oil preheating
Impregnating waxes
Alkaline baths
Oil-jacket containers and many similar applications.

They have also been successfully applied to alkaline cleaning solutions and cyanide plating solutions. They can be used in such alkalies as sodium carbonate, sodium cyanide, etc., which will not attack steel. Some of the plating-bath solutions which utilize cyanides are brass, bronze, cadmium, gold and copper.

Cat. Number †		Heaters		Kw. Rating	Approx. Ship. Wt. Lbs.	Zig.	"B" Dimension	Approx. Dimensions, Inches—		List Price, Each
115 Volts 3-heat or 230 Volts 1-heat	230 Volts 3-heat or 460 Volts 1-heat	Header Size	Overall Length							
2D280	*2D280G2	1 1/4	13 5/8	1.0 †	5	2	11 1/2	1 1/4	13 5/8	\$22.65
2D181	2D281G2	2	15 3/4	1.5 †	6	2	13 1/2	2	15 3/4	26.75
2D182	2D182G2	2	20	2.0	7	2	17 3/4	2	20	30.95
2D183	2D183G2	2	24	2.5	8	2	21 3/4	2	24	35.10
2D184	2D184G2	2	28 1/4	3.0	10	2	26	2	28 1/4	39.35
2D185	2D185G2	2	Δ	4.0	12	2	34	2	Δ	47.80
2D186	2D186G2	2	□	5.0	14	2	41	2	□	54.45

3-Heat 250 Volt Switches ⊕ for Manual Control	
No.	Description
278608	3-heat
296569	3-heat
296569	3-heat
296569	3-heat
296569	3-heat
278610	3-heat
278610	3-heat

*3-heat only on 230 volts, cannot be run 1-heat on 460 volts.
†Terminal covers furnished with all heaters.
‡These heaters rated 25 watts per sq. in. All others rated 20 watts per sq. in.
¶Nominal pipe-thread diameter.
⊕All switches listed are suitable for 250 volts, a-c or d-c.
ΔOver-all length of No. 2D185 is 36 1/2-in.; No. 2D185G2 is 36 1/4-in.
□Over-all length of No. 2D186 is 43 5/8-in.; No. 2D186G2 is 43 1/4-in.

G-E Strip Heaters

For use as air and clamp-on heaters. Here are a few of the many applications—Process machinery, drying ovens, warming tables, glue tables, water baths, drying cabinets, pipe lines, incubators, valve and pump houses, etc.

They are rigidly constructed to withstand vibration, give uniform heat distribution. Compressed insulation.

With Offset Terminals At One End

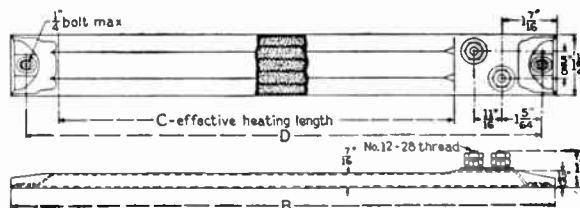

Cat. No.	Steel Sheath		Each
	Maximum Allowable Sheath Temperature, 750° F.	Watts	
2A430G2	1000	120	\$5.65
2A430	1000	240	5.65
2A429G3	750	120	5.05
2A429	750	240	5.05
2A428	500	120	4.75
2A428G2	500	240	4.75
2A428G5	500	275	4.75
2A427	350	120	4.35
2A427G2	350	240	4.35
2A426	250	120	3.80
2A426G2	250	240	3.80
2A425	150	120	3.50

Cat. No.	Chromized Sheath		Each
	Maximum Allowable Sheath Temperature, 1200° F	Watts	
2A409	1500	120	\$9.90
2A409G2	1500	240	9.90
2A408G2	1000	240	9.90
2A407	1000	120	8.85
2A407G2	1000	240	8.85
2A406G2	750	240	8.85
2A405	750	120	7.35
2A405G2	750	240	7.35
2A404	500	120	7.35
2A404G2	500	240	7.35
2A403	500	120	6.40
2A403G2	500	240	6.40
2A402	350	120	6.40
2A402G2	350	240	6.40
2A401	350	120	4.95
2A401G2	350	240	4.95
2A400	200	120	4.25

Dimensions, Inches			Approx. Ship. Wt. Lbs.
B	C	D	
35 1/2	31 1/2	34 3/4	4
35 1/2	31 1/2	34 3/4	4
35 1/2	31 1/2	34 3/4	4
30 1/8	26 1/8	29 3/8	3
30 1/8	26 1/8	29 3/8	3
30 1/8	26 1/8	29 3/8	3
23 1/2	19 1/2	22 3/4	3
23	19 1/2	22 3/4	3
23 1/2	19 1/2	22 3/4	3
23 1/2	19 1/2	22 3/4	3
17 5/8	13 5/8	16 7/8	2
17 5/8	13 5/8	16 7/8	2
17 5/8	13 5/8	16 7/8	2
11 3/4	7 3/4	11	2
11 3/4	7 3/4	11	2
7	3	6 1/4	2

*Can be connected in series for 480- or 550-volt circuits. For these voltages, secondary insulation is required.

With Terminals on Both Ends

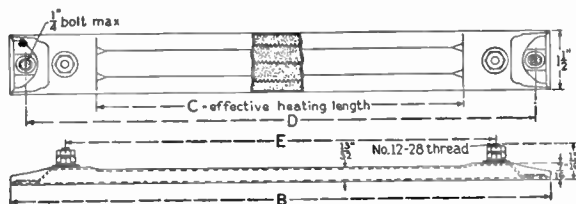

Cat. No.	Steel Sheath		Each
	Maximum Allowable Sheath Temperature, 1000° F.	Watts	
2A434	500	120	\$4.55
2A434G2	500	240	4.55
2A434G3	500	250	4.55
2A433	350	120	4.45
2A433G2	350	240	4.45
2A432	250	120	3.85
2A432G2	250	240	3.85
2A431	150	120	3.50

Cat. No.	Chromized Sheath		Each
	Maximum Allowable Steel Sheath Temperature, 1200° F	Watts	
2A414	750	120	\$7.10
2A414G2	750	240	7.10
2A413G2	500	240	7.10
2A413G3	500	250	7.10
2A412	500	120	6.05
2A412G2	500	240	6.05
2A411	350	120	4.85
2A411G2	350	240	4.85
2A410	200	120	4.25

Dimensions, Inches				Approx. Ship. Wt. Lbs.
B	C	D	E	
23 1/2	19	22 3/4	20 3/4	3
23 1/2	19	22 3/4	20 3/4	3
23 1/2	19	22 3/4	20 3/4	3
23 1/2	19	22 3/4	20 3/4	3
17 5/8	13 1/8	16 7/8	14 7/8	2
17 5/8	13 1/8	16 7/8	14 7/8	2
11 3/4	7 1/4	11	9	2
11 3/4	7 1/4	11	9	2
7	2 1/2	6 1/4	4 1/4	2

*Can be connected in series for 440- or 550-volt circuits. For these voltages, secondary insulation is required.

Chromalox Electric Strip Heaters

Width 1/2 Inches



Type "S"



Type "SE"

For use in heating platens, dies, hot plates, melting pots, kettles and tanks, air ducts, in plastic forming, plastic molding, drying operations, etc.

Type "S" has One Bolt Terminal at each end.

Type "SE" has Two Bolt Terminals at one end; can be bent lengthwise or curved in cross section for clamping to curved surfaces.

For 115 or 230 Volts

Note—Where line voltage is above 460 volts, strip heaters can be connected in series provided they are mounted on insulating bushings. Contact Graybar for prices.

**Maximum Sheath Temperature 750° F.
Heat Resisting Iron Sheath**

Type "S" No.	Type "SE" No.	Watts	Overall Lgth.	Mtg. Hole Center	Lgth. W/O Mtg. Tabs	Approx. Net WL. Lbs.	Each
S- 815	SE- 815	150	8	7	6 1/2	.6	\$3 20
S- 920	200	9 1/2	8 1/2	8	.7	3 40
.....	SE-1025	250	10 1/2	9 1/2	9	.9	3 40
S-1225	SE-1225	250	12	11	10 1/2	.9	3 40
S-1430	SE-1430	300	11	13	12 1/2	1.1	3 65
S-1532	SE-1532	325	15 1/4	14 1/4	13 3/4	1.2	3 75
S-1837	SE-1837	375	17 7/8	16 7/8	16 3/8	1.4	3 80
S-1850	SE-1850	500	17 7/8	16 7/8	16 3/8	1.4	3 80
.....	SE-1935	350	19 1/2	18 1/2	18	1.5	3 85
S-1950	SE-1950	500	19 1/2	18 1/2	18	1.5	3 85
S-2050	SE-2050	500	21	20	19 1/2	1.7	3 90
S-2425	250	23 3/4	22 3/4	22 1/4	1.8	4 00
S-2450	SE-2450	500	23 3/4	22 3/4	22 1/4	1.9	4 00
.....	SE-2475	750	23 3/4	22 3/4	22 1/4	1.9	4 25
.....	SE-2550	500	25 1/2	24 1/2	24	2	4 30
S-2575	SE-2575	750	25 1/2	24 1/2	24	2	4 40
S-2670	SE-2670	700	26 3/4	25 3/4	25 1/4	2.2	4 45
S-3075	SE-3075	750	30 1/2	29 3/8	28	2.5	5 10
S-3375	SE-3375	750	33 1/2	32 3/8	31	2.6	5 50
S-3610	SE-3610	1000	35 7/8	34 3/4	33 3/8	2.9	5 85
.....	SE-3880	800	38 1/2	37 3/8	36	3.1	6 25
S-3810	SE-3810	1000	38 1/2	37 3/8	36	3.1	6 35
S-4312	SE-4312	1250	42 1/2	41 3/8	40	3.5	7 00

Standard strip has mounting tabs at each end with slotted holes 5/16-in. wide, 1/2-in. long for bolting to supports. If wanted without mounting tabs, please specify, no additional charge.

Standard package is 12, 25 or 50 elements.

When ordering specify number and voltage wanted.

**Maximum Sheath Temperature 1200° F.
High Temperature Chrome Steel Sheath**

Type "S" No.	Type "SE" No.	Watts	Overall Lgth.	Mtg. Hole Center	Lgth. W/O Mtg. Tabs	Approx. Net WL. Lbs.	Each
S- 802	SE- 802	250	8	7	6 1/2	.6	\$4 70
S- 903	300	9 1/2	8 1/2	8	.7	4 90
.....	SE-1003	350	10 1/2	9 1/2	9	.9	5 10
S-1202	SE-1202	250	12	11	10 1/2	.9	5 25
S-1205	SE-1205	500	12	11	10 1/2	.9	5 25
S-1405	SE-1405	500	11	13	12 1/2	1.1	5 50
S-1505	SE-1505	500	15 1/4	14 1/4	13 3/4	1.2	5 55
S-1805	SE-1805	500	17 7/8	16 7/8	16 3/8	1.4	5 95
S-1807	SE-1807	750	17 7/8	16 7/8	16 3/8	1.4	6 00
S-1801	SE-1801	1000	17 7/8	16 7/8	16 3/8	1.4	6 05
S-1905	SE-1905	500	19 1/2	18 1/2	18	1.5	6 05
S-1907	750	19 1/2	18 1/2	18	1.5	6 35
S-1901	SE-1901	1000	19 1/2	18 1/2	18	1.5	6 35
.....	SE-2007	750	21	20	19 1/2	1.7	6 35
S-2005	500	21	20	19 1/2	1.7	6 35
S-2405	SE-2405	500	23 3/4	22 3/4	22 1/4	1.8	6 60
S-2407	SE-2407	750	23 3/4	22 3/4	22 1/4	1.8	6 60
S-2401	SE-2401	1000	23 3/4	22 3/4	22 1/4	1.8	6 95
S-2415	1500	23 3/4	22 3/4	22 1/4	1.8	6 95
.....	SE-2507	750	25 1/2	24 1/2	24	2.1	7 05
S-2501	SE-2501	1000	25 1/2	24 1/2	24	2	7 05
S-2607	750	26 3/4	25 3/4	25 1/4	2.1	7 15
.....	SE-2601	1000	26 3/4	25 3/4	25 1/4	2.2	7 15
S-3007	SE-3007	750	30 1/2	29 3/8	28	2.4	7 80
.....	SE-3001	1000	30 1/2	29 3/8	28	2.4	7 80
.....	SE-3307	750	33 1/2	32 3/8	31	2.6	8 55
S-3301	1000	33 1/2	32 3/8	31	2.6	8 55
S-3601	1000	35 7/8	34 3/4	33 3/8	2.9	9 10
.....	SE-3601	1500	35 7/8	34 3/4	33 3/8	2.9	9 10
S-3801	SE-3801	1000	38 1/2	37 3/8	36	3.1	9 40
S-4301	SE-4301	1500	42 1/2	41 3/8	40	3.4	10 30

Chromalox Immersion Heaters

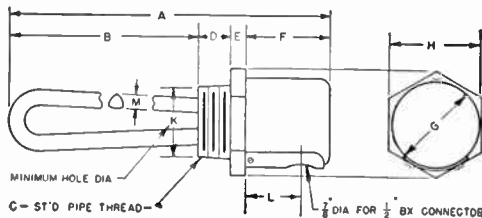

Type	°C	D	E	F	Dimensions, Inches			K	L	M
MT-1	1 1/4	3/4	3/8	2 7/8	2 1/2	2 3/8	1 5/8	2 3/8	1 1/32	
MTO-1	1 1/4	3/4	3/8	1 3/4	3 1/2	2 3/8	1 5/8	3/4	1 1/32	
MT-2 & MTO-2	2	1 1/2	2 1/16	2 7/8	2 15/16	2 11/32	1 13/16	1/2		

These heaters have standard pipe-threaded screw plug for mounting through walls of tanks, in pipe, etc. The heating section must be completely immersed in the material to be heated.

Type MT—For heating water and solutions that readily absorb heat. Watt density from 35 to 45 watts per square inch of heating surface. Copper sheath, bronze screw-plug and brazed joints are standard. (For Oakite solution cleaning tanks, where copper is attacked, specify steel sheath, forged steel screw-plug with welded joints).

Type MTO—For heating mineral oils, paraffin, etc. Watt density from 18 to 20 watts per square inch of heating surface. Steel sheath, forged steel screw-plug and welded joints are standard.

Type MT

No.	Volts	Watts	Heats	Pipe Thrd. In.	Lgth. Overall, In.	Heater Lgth. In.	Each
MT-175	118 or 236	750	1	1 1/4	11 1/2	7 3/8	\$13 80
MT-110	118 or 236	1000	1	1 1/4	13 1/2	9 3/8	15 30
MT-220-3	120 or 240	2000	3	2	12 1/4	8 1/8	22 20
MT-230	120 or 240	3000	3	2	16 1/4	12 1/8	26 20

Type MTO

MTO-110	120 or 240	1000	3	1 1/4	15 1/8	12 3/16	\$22 25
MTO-220	120 or 240	2000	3	2	22 1/8	17 7/8	30 15
MTO-230	120 or 240	3000	3	2	29 1/4	25 1/8	37 65

G-E Heating Cable

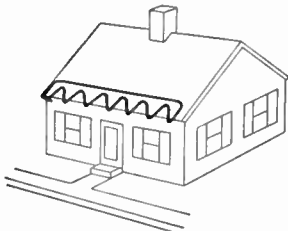

Roof De-icing



Pipe Heating

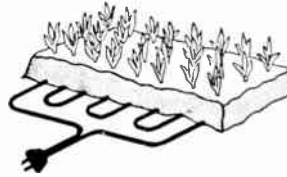

Soil Heating

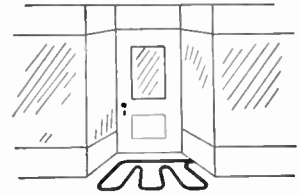

Freeing Sidewalks from Ice

New G-E vinyl-jacketed heating cable sets are designed for general purpose applications involving sheath temperatures up to 200° F. and offer special features of durability, long life, and safety. Very flexible, easy to install and clean handling. Minimum bending radius ¼-in.

The cable is constructed of a resistance-type conductor with nylon covering, a layer of thermoplastic vinyl insulation, a 16 carrier tinned-copper grounding braid, and an extruded vinyl jacket. This gives great resistance to abrasion and the action of oils, chemicals, and water.

Copper braid imbedded in jacketing provides both full electrical grounding protection, so external grounding connections are unnecessary, and additional mechanical strength.

Provides efficient, low cost heat in a wide range of applications. Used for soil heating—roof de-icing—protecting pipes, valves, and pumps from freezing—warming pipelines that carry liquids—brooder and kennel heating—poultry water warming—protecting sprinkler systems—floor heating—miscellaneous air heating.

Pipe Heating — Protects against freezing; Keeps viscous liquids warm for increased flow. For still air (pipe heating, etc.), install approximately 0.8 watts per sq. ft. of un-insulated surface per degree F temperature difference between pipe and surrounding air. If insulated with 1 inch of insulating material, use 30% of this value.

Surface Heating — Melts snow and ice. Install 3 to 6 feet of cable per square foot of iced surface, depending on temperature, time allowed, etc. For heating kennel floors, brooders, etc., install approximately 1 foot of cable for each square foot of floor area.

Roof De-icing—To keep eave gutters and downspouts free of ice (roof-de-icing) install 1 or 2 feet of cable per foot length of gutter, depending on temperature, time allowed, etc. This method forms channels through ice dams on eaves and in gutters and downspouts, allowing water to drain off instead of backing up underneath shingles, causing interior water damage.

Soil Heating — Reliable, automatic temperature control makes it possible to maintain ideal temperatures for plants —this provides strong, healthy plants that grow faster and are ready for market when prices are highest. Cost of operation compared with manure bed heating is decreased since this type of bed necessitates expensive preparation and loss of time.



No.	Description Ft.	115 Volt Rating		Std. Pkg.	Each	Construction Data			Resistance Ohms Ft.	
		Watts*	Amps*			Type	Avg.	Nylon		O.D.
HS26	26 (13-ft. loop)	130	1.12	4	\$5.75	Ni-Cr	27	.019	.198	3.967
HS40	40 (20-ft. loop)	200	1.72	4	7.50	Ni-Cr-Fe	24	.016	.198	1.671
HS60	60 (30-ft. loop)	300	2.63	4	10.00	Cu-Ni	24	.016	.198	.7280
HS100	100 (50-ft. loop)	500	4.35	4	14.50	Cu-Ni	22	.014	.198	.2812

*Nominal.

Wall Thicknesses on all sets: 1st vinyl insulation .034-in.; braid .0063-in. strand dia.; vinyl jacket .020-in.

Heating Wire Sets

Designed specifically for low-cost heating installations involving temperatures of 110° F. or below. Heating wire is lighter in weight than heating cable and possesses greater flexibility.

Diameter of conductor is approx. .0027-in.; insulation is 3/64-in. thick. Resistance wire on HW12020 is color coded with dark green stripes; other sets have tan stripe. Non-heating power



leads of 120 volt sets are yellow colored, 240 volt power leads are red.

No.	Description Ft.	Rating*	Amps*	Std. Pkg.	Each
HW12020	78	200W-120V	1.67	4	\$7.74
HW12040	156	400W-120V	3.33	4	11.55
HW24080	312	800W-240V	3.33	4	8.30

*Nominal.

Controls for Heating Cable



Thermostat No. HSC3 Rating 10A-115V A-C Each \$8.58



Control Assembly No. HSC4 Rating 10A-115V A-C Each \$10.10



Thermostat No. HSC5 Rating 25A-250V A-C Each \$15.00



Thermostat w/grounding outlet No. HSC7 Rating 15A-125V A-C Each \$17.00



Control Assembly No. HSC6 Rating 15A-125V A-C Each \$20.00

Triangle Infrared Batch and Conveyor Ovens For Baking, Drying, Preheating, Dehydrating

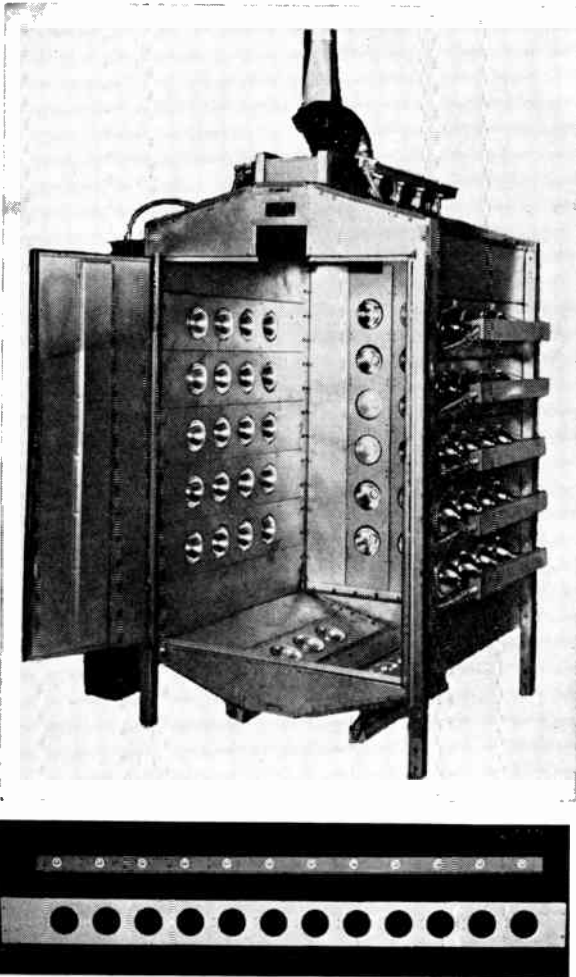

These ovens incorporate the time-saving benefits of instant heat through radiant energy and the by-product, recirculated heated air—the combination of which produces greater over-all thermal efficiency.

They have many excellent features which make for increased production, lower equipment installation and maintenance costs, great flexibility and ease of control, reduced space requirements, cleanliness and safety.

Being entirely enclosed, they make fullest use of both radiant and derived convected heat. This improved temperature control insures faster, better drying and baking and cuts power consumption and operating costs.

The standardized prefabricated panel construction makes for low-cost installation and a minimum of maintenance. Can be fabricated to either supplement or complement other heating facilities and are adaptable to processing a wide range of work.

All wiring, lamp bases and sockets are enclosed in covered channels. Automatic or manual switching devices can be used to vary working temperatures—maintain different baking cycles. Accessibility to all vital parts permits fast, easy, safe servicing without interrupting oven operation.

The positive ventilation control removes all fumes and moisture from the system and speeds drying. The equalized, uniform over-all oven temperatures insure uniform, high quality baking results.

They are designed and engineered to meet individual requirements. Laboratory tests, which give the time and temperature required to accomplish desired results will be made by the manufacturer at no extra cost.

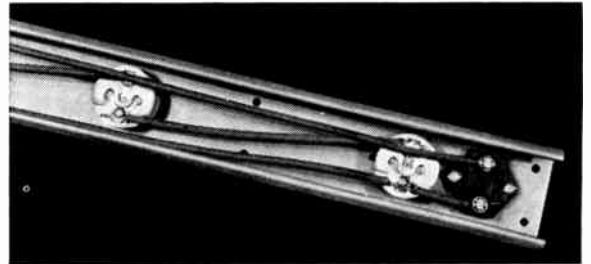

Standard Prefabricated Panels and Channels available for Construction of Infrared Banks.

Prefabricated Pierced Panels 8 5/8 In. Wide

Part. Nos.	Openings	Centers, In.	Length, In.	Each
II-613	12	8	108	\$12.00
II-802	10	8	92	11.00
II-795	8	8	76	9.50
II-616	6	8	60	8.00
II-796	4	8	44	5.80
II-800	2	8	28	4.70
II-798	16	6	108	12.90
II-785	14	6	98	12.00
II-801	12	6	86	11.00
II-788	10	6	76	10.00
II-799	8	6	60	8.30
II-789	6	6	50	6.80
II-790	4	6	38	5.80
II-791	2	6	28	4.70
II-792	8	12	108	12.90
II-793	6	12	76	9.30
II-794	4	12	60	8.00
II-930	2	12	28	5.50

Blank Panels 8 5/8 In. Wide

Part Nos.	Length, In.	Each	Part Nos.	Length, In.	Each
II-614	108	\$11.60	II-806	92	\$10.50
II-810	86	10.20	II-803	76	9.00
II-629	60	7.70	II-809	50	6.50
II-804	44	5.50	II-807	38	5.40

No. II-769—Raceway Bracket with Bolts. Each \$0.70

Pre-Wired Channels (Covers and End Caps Included) (Part Nos. Indicated Under Voltage)

Wired for Voltage			No. Sockets	Length In.	Each
110	230	440			
II-735	II-736	II-733	12	96	\$49.80
II-832	II-833	10	80	42.50
II-817	II-818	II-819	8	64	36.60
II-737	II-734	6	48	26.50
II-820	II-821	II-822	4	32	19.00
II-834	II-835	2	16	13.00
II-826	II-827	II-828	16	96	59.50
II-858	II-859	14	86	52.00
II-836	II-837	II-838	12	74	45.50
II-839	II-840	10	62	39.50
II-829	II-830	II-831	8	50	32.50
II-841	II-842	6	38	24.50
II-843	II-844	II-845	4	26	20.50
II-846	II-847	2	14	12.00
II-848	II-849	II-850	8	92	41.00
II-851	II-852	6	68	31.00
II-853	II-854	II-855	4	44	22.80
II-856	II-857	2	20	13.50

Panel-channel combinations from 86 to 108 in. long require 3 raceway brackets. Combinations under 86 in. long require 2 raceway brackets.

Always mention voltage when ordering.

G-E Metallic-Rectifier Power-Conversion Units

General Electric metallic-rectifier power supplies are designed for Industrial applications, such as the excitation of synchronous motors; electrochemical and electrometallurgical process power supplies; computer power supplies; various military and airborne applications; and as constant-voltage power supplies for d-c motors. Users of d-c power supplies include electric utilities and commercial buildings changing over from d-c to a-c service, as well as industrials and others who find that purchasing a-c power from their electric utility is cheaper than generating their own d-c power but have no simple and inexpensive way to convert their present d-c equipment. In addition, users of machine

tools and magnetic chucks will find these power supplies a reliable source of d-c power.

Ratings and prices are available on request.



G-E General-Purpose Chargers

General Electric general-purpose selenium battery chargers are designed for charging and floating batteries of all types. Control, signal, and communication batteries are especially well serviced by these chargers. Automatic control and output filters are available as accessories. Resistive and inductive loads can also be supplied by these units.

Prices and ratings are available on application.



Walker Silicon and Selenium Power Rectifiers

Heavy Duty

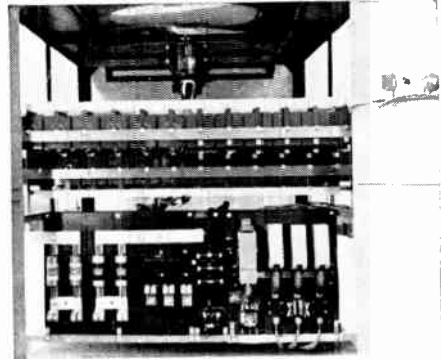

For elevator cranes, coal mine hoists, magnetic separators, synchronous motor excitation, speed controls, electro-chemical plants, cathodic protection of pipe lines and other underground metal structures and wherever D-C power is required. Natural convection or fan cooling is available.

Efficiency and power factor is approximately 82 to 90% and 95% respectively. May be connected to any three-phase system—two or three wire output. Cubicles containing as much as 350KW of rectification are made in single units.

No maintenance required. Contains no moving parts except a fan in fan cooled models; no sliding contacts and a minimum of relays. Variable voltages required for synchronous motor field excitation are obtained by saturable reactor controls which eliminate current interruption and sparking, permitting explosion proof installations. Generally, single tap switches accomplish field excitation.

Selenium power rectifiers have lower efficiency than the silicon. Selenium types have been used widely in the low voltage-high current metal finishing industry. Silicon though, is more economical for D-C voltages from 120 to 140-volts.

Voltage regulation is approximately 3% for silicon and 7% for selenium. Automatic controls allow 1% regulation for either silicon or selenium with A-C line voltage variations as much as 10% from no load to full load.

Walker Selenium, Germanium and Silicon Rectifiers

Metal Finishing Rectifying Service

These heavy duty metal finishing rectifiers whether used for electroplating, electrocleaning, electroforming, or anodizing are rugged and dependable. They are highly efficient and operate at lowest cost.

Germanium and Silicon rectifiers evidence no aging with continued use. They may be operated at full load 24 hours a day, seven days a week in high ambient temperatures and in corrosive atmospheres. The equipment has long life and requires little or no maintenance. Easily installed requiring no special concrete or steel flooring as do large motor generator sets. May be placed in close proximity to plating tanks.

Cabinets are finished in acid resistant grey paint.



Three models are available: (1) Without voltage control; (2) An integral control unit with built-in voltage control; (3) A separately controlled type with a control at a remote location from the rectifier.

Voltage controls of various types are available, the above illustration shows the common three dial tap switch arrangement. A single dial tap switch rectifier is available as is a stepless voltage control using either variable transformers or

saturable reactors. All controls may be either manually or automatically operated. The efficiency of germanium and silicon plating equipment is from 80 to 90 per cent while that of selenium is from 70 to 80 per cent.

Sizes range from six volt, fifty ampere, metal finishing rectifiers to large single package fan or water cooled ten thousand ampere, forty volt, reactor controlled plating units.

Equipment is designed for a low ripple of approximately 4.5% by use of three phase to six transformation. The use of interphase transformers assures uniform heating of all circuit elements. Protective circuits include A-C starter overload elements, thermal protection in the event of overload or fan mal-function, and protection against single-phase operation of the rectifier.

A unique protection circuit on all automatically controlled saturable reactor, constant current or voltage stabilized rectifiers is provided. In the event of elevated temperatures a visible and audible warning is evidenced. If after two minutes the source of trouble is not removed the rectifier load current is automatically reduced to a safe operating limit. The plating work is thus unharmed while the plating process continues at a lower rate. This feature is particularly important if chrome is being plated. This protective work saver feature of Walker rectifiers alone may save costly down-time and useless, expensive labor charges.

Most metal finishing applications are especially designed as to A-C voltage, ambient temperatures, method of control, and cycle of operation. Equipment calling for special as well as standard requirements can be supplied.

Periodic reverse equipment for the electroplater is supplied up to 1500 amperes and 18 volts.

Note: Consult Graybar for complete specifications.

Walker Selenium—Germanium—Silicon Battery Chargers

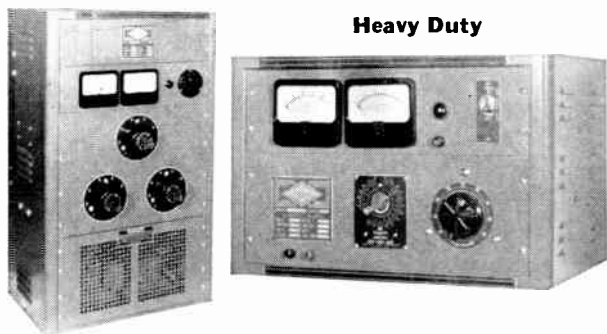

Heavy Duty

For telephone and railway communication service, materials handling equipment, or unattended substation Battery Chargers.

Full wave, low ripple output for, float, two rate, taper and automatic voltage control. Require no adjustment beyond initial setting.

Range: 6 V at 1 A. to 250 V at 70 A. Specify use, input and output volts and amps, and any special features required.

G-E Battery Chargers Farm and Home Type



No. 6RS937A2 "Overnight" Charger for 3 cells, 6 volts, 12 amperes

Selenium-rectifier chargers—small and lightweight. Can be mounted on shelf or wall, or placed on garage or car floor. Will charge battery without removing it from car, truck or tractor.

The No. 6RS937A1 (One-day Model) will charge the normally run-down battery in 24 hours or less.

The No. 6RS937A2 (Overnite Model) will charge the average discharged battery in 12 hours or less.

Model No.	Capacity	A-C Volts	Cycles	D-C Amp.	Each
6RS937A1	3 cells	115	60	7-4	\$23.00
6RS937A2	3 cells	115	60	12-7	33.00

G-E Tungar* Battery Chargers Half-Wave

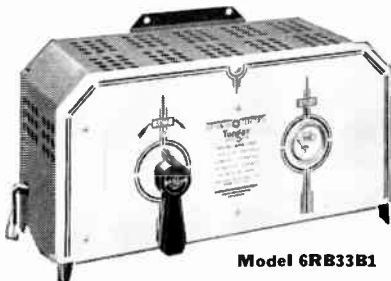

Model 6RB33B1

Autotransformer

Operates on 105/125 Volts, 60 Cycles A-C

Suitable for use in repair shops, garages, service stations, by car dealers, tire dealers, at airports, etc.

They are very efficient and have an adjustable charging—rate of from 2 to 6 amperes.

Model No.	Battery Capacity		Each
	Quantity of 3-cell 6-volt	Quantity of 6-cell 12-volt	
6RB33B1	1 to 6	1 to 3	\$67.00
6RB33B2	1 to 12	1 to 6	74.00

*Registered trade-mark of General Electric Co.

G-E Tungar* Chargers Full-Wave

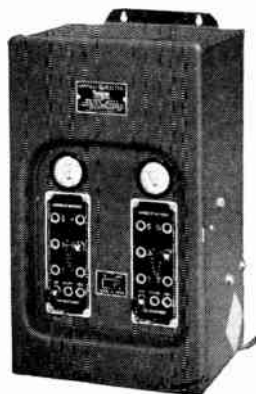

Model No. 6RB6B1 "6-12" Charger

"6-12" Charger

A medium-capacity charger, fast and economical in operation, that will handle—

Six 6-volt batteries at 12 amperes, or

Twelve 6-volt batteries at 6 amperes, or the equivalent.

Charging rate is adjustable from 2 to 12 amperes for 3 to 18 cells, and from 2 to 6 amperes for 3 to 36 cells.

"12-24" Charger

A heavy-duty charger that will do fast, one-day charging to meet all requirements of the busiest battery departments.

Will handle—

Twenty-four 6-volt batteries at 6 amperes, or

Twelve 6-volt batteries at 12 amperes, or the equivalent.

Charging rate is adjustable from 2 to 6 amperes for 3 to 72 cells and from 2 to 12 amperes for 3 to 36 cells.

Autotransformer

Operate on 105/125 volts, 50/60 Cycles A-C

Model No.	Charger	Each
6RB6B1	"6-12"	\$146.00
6RB6B5	"12-24"	162.00

*Registered trade-mark of General Electric Co.

G-E Tungar* Rectifier Bulbs

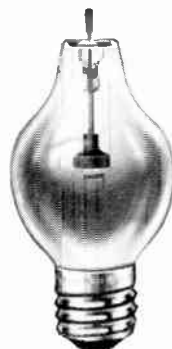

Nos. 189048-49 and 99X44

Manufactured of the finest material available and are laboratory-tested before being used. These bulbs were first developed over thirty years ago, and constant research has improved their design, increased their efficiency, and trebled their operating life.

Tungar bulbs make possible an excellent d-c power supply, free from noise and vibration. They operate with a very low voltage drop and consequent high over-all efficiency of the equipment with which they are used. Tungar bulbs are ideal for battery chargers ranging in size from the small home type to the large garage type which handles several batteries.

Argon, Half-Wave

No.	Dimensions Inches		Socket No.	Recommended Max. Output		Each
	Max. Length	Max. Diam.		D-C Amp.	D-C Volts	
12X825	4 1/4	2 3/16	1610-1†	2.0	75	\$ 6.00
189048	7	3 3/16	217967	6.0	60	6.50
189049	7	3 3/16	217967	6.0	90	6.50
206501	4 1/4	2 3/16	Std. Edison	2.0	75	6.00
217283	8 3/4	3 7/8	217967	15.0	60	12.50

Mercury-argon, Full-Wave

20X672	4 5/8	2 3/16	1610-1†	5.0	20	7.50
76X13	9 1/2	3 5/8	217967	20.0	75	19.50
99X44	7	3 3/16	217967	10.0	25	7.50
99X45	9 1/2	3 5/8	217967	20.0	25	19.50

Mercury-argon, Half-Wave

16X897	6	2 3/16	5556072G1	2.0	250	16.50
45X674	7 1/2	3 3/16	5556072G1	6.0	250	20.00

*Registered trade-mark of General Electric Company.

†Also order anode clamp 3200A1161G2.

‡Also order anode clamp 3200A1161G1.

Graybar Gasoline Electric Plants

400 Watts to 15000 Watts

Air Cooled Models

Power and Light for Every Purpose—A Size for Every Need

These Electric Plants have unlimited uses the world over for constant or standby service. The rugged, heavy-duty generators are backed by 32 years of manufacturing experience . . . powered by the finest engines in the world . . . at prices below competitive makes. These Electric Plants will enable you to electrify your home, farm, ranch, resort, store, service station or cabin at surprisingly low cost.

Each Electric Plant is compactly designed and precision built to give years of satisfactory service. They cost less to own and operate and are easy to start and service. All features not essential for dependable operation have been eliminated.

Available in 60 cycles, 115 or 230 volt, making it possible for you to use standard wiring and low cost A-C lights, radios, appliances and tools.

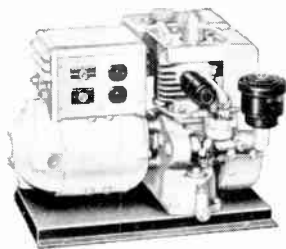

No. G600AR

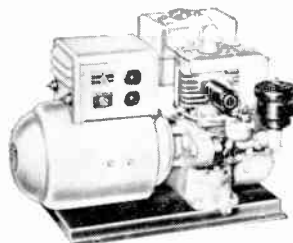

No. G3036AR

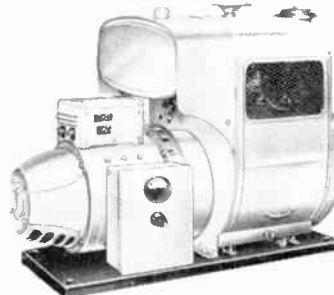

No. G10000AR

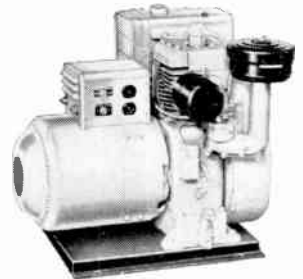

No. G1200AR

60 Cycle—Lightweight—3600 RPM—115 or 230 Volts—1-phase, 2-wire—Remote or Manual Start*

No.	Gen. Cap. Watts	Eng. Model No.	H.P.	Approx. Shp. Wt. Lb.	Each	No.	Gen. Cap. Watts	Eng. Model No.	H.P.	Approx. Shp. Wt. Lb.	Each
G800A	800	B&S 6BFB	2.25	114	\$ 246.00	G2500A	2500	WIS. ACN	5.6	236	\$ 448.00
G800AR	800	B&S 6BFB	2.25	128	300.00	G3036A	3000	B&S 23FB	8.4	250	530.00
G1200A	1200	B&S 8BFB	2.75	127	295.00	G3036AR	3000	B&S 23FB	8.4	210	613.00
G1200AR	1200	B&S 8BFB	2.75	134	360.00	†G3036A3	3000	B&S 23FB	8.4	255	558.00
G2200A	2250	B&S 14FB	5.3	236	428.00	†G3036AR3	3000	B&S 23FB	8.4	265	636.00
G2200AR	2250	B&S 14FB	5.3	281	493.00						

60 Cycle—Standard Weight—1800 RPM—115 or 230 Volts—1-phase, 2 to 4 wires—Remote or Manual Start*

G400A	400	B&S 6BFB	1.0	106	241.00	G2000AR	2000	B&S 23FB	5.2	250	613.00
G400AR	400	B&S 6BFB	1.0	115	295.00	G3000A	3000	WIS. AGN	9.2	527	716.00
G600A	600	B&S 8BFB	1.3	106	251.00	G3000AR	3000	WIS. AGN	9.2	574	793.00
G600AR	600	B&S 8BFB	1.3	115	307.00	‡G3000A3	3000	WIS. AGN	9.2	527	728.00
G750A	750	B&S 9BFB	1.7	170	333.00	‡G3000AR3	3000	WIS. AGN	9.2	574	804.00
G750AR	750	B&S 9BFB	1.7	177	389.00	†G5000A4	5000	WIS. TH	11.7	676	858.00
G1500A	1500	B&S 14FB	2.6	210	416.00	†G5000AR4	5000	WIS. TH	11.7	733	925.00
G1500AR	1500	B&S 14FB	2.6	218	482.00	†G10000AR4	10000	WIS. VF4	19.5	1060	1525.00
G2000A	2000	B&S 23FB	5.2	247	536.00	†G15000AR4	15000	WIS. VG4D	32.0	1550	2400.00

60 Cycle—Standard Weight—1800 RPM—3-phase, 3 and 4 Wire—Remote Start Only—230 and 120/208 Volts

‡G3003AR3	3000	WIS. AGN	9.2	574	804.00	†G10003AR3	10000	WIS. VF4	19.5	1060	1525.00
†G3003AR4	3000	WIS. AGN	9.2	574	815.00	†G10003AR4	10000	WIS. VF4	19.5	1060	1525.00
‡G5003AR3	5000	WIS. TH	11.7	733	942.00	§G15003AR4	15000	WIS. VG4D	32.0	1550	2400.00
†G5003AR4	5000	WIS. TH	11.7	773	942.00						

*—"R" at end of Number denotes Remote control. †—3-wire, 115/230 V. models. ‡—4-wire, 120/208 V. models.
 §—4-wire, 120/208 V. Revolving Field—Separately excited generators with voltage regulator, 0.8 power factor.
 ¶—Revolving Field—Separately excited generators with voltage regulator, 1.0 power factor.
 ¶—3-wire, 230 V. models. ‡—4-wire, 115/230 V. models.

Dollies and Carrying Handles for Above Models



Cradle Type Carrying Handles

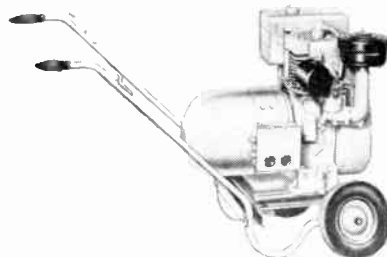

Portable Two Wheel Dolly

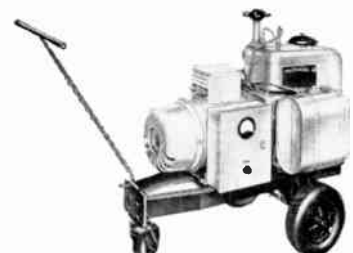

Portable Three Wheel Dolly

Description
 Cradle Type Carrying Handles
 Two Wheel Dolly
 Three Wheel Dolly

Takes Engine Make
 Briggs & Stratton and Wisconsin ACN Models only
 Briggs & Stratton and Wisconsin ACN Models only
 For AFH and TF Wisconsin Engine Models only

Each
\$10.00
25.00
88.40

IMPORTANT: Specify Engine when ordering.

Graybar Water-Cooled Gasoline Electric Plants 5000 Watts to 100,000 Watts

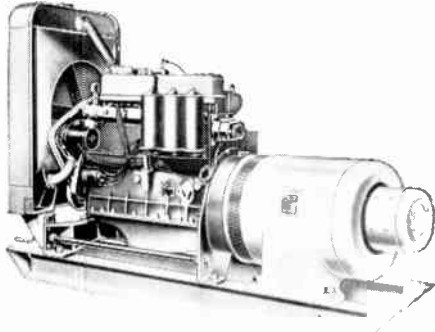

No. G10C18C

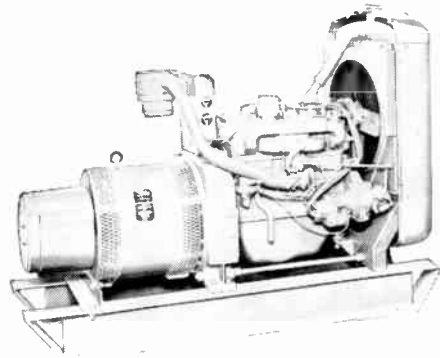

No. G15C18C

Rugged, dependable, and ideal water-cooled gasoline Electric Plants for a wide variety of uses, ranging from permanent power plants for lumber camps, oil fields, mines, manufacturing plants to emergency standby hospital, airport, contracting, amusement centers and small factory service.

In selecting the proper size be sure the unit you select is large enough to take care of your total present requirements and anticipated needs. The cost of additional capacity is small compared to the inconvenience of having insufficient current to meet all demands instantly, or the cost of changing models at a later date.

All capacity and horsepower ratings are in accordance with S. A. E. and I.C.E.I. test codes, corrected to sea level and 60° F. Deduct 3% for each 1000 feet above sea level and 1% for each 10° F. rise above 60° F.

No.	KW	Capacity KVA	P.F.	Volts	Electrical Details*			Engine Details	H.P.	RPM	Approx. Wt. Lbs. Crated	Each
					Cycles	Phase	Make	Model				
G5118C	5.0	5.0	1.0	115/230	60	1	III C	U-1	13.1	1800	950	\$1310.00
G5118D	5.0	5.0	1.0	120/208	60	3	III C	U-1	13.1	1800	950	1310.00
G10C18C	10.0	12.5	.8	115/230	60	1	Cont.	Y-112	27.0	1800	1370	1965.00
G10C18D	10.0	12.5	.8	120/208	60	3	Cont.	Y-112	27.0	1800	1370	1965.00
G15C18C	15.0	15.0	1.0	115/230	60	1	Cont.	F-162	40.8	1800	1570	2010.00
G15C18D	15.0	18.75	.8	120/208	60	3	Cont.	F-162	40.8	1800	1570	2010.00
G25C18C	25.0	31.25	.8	115/230	60	1	Cont.	F-226	59.4	1800	1800	2850.00
G25C18D	25.0	31.25	.8	120/208	60	3	Cont.	F-226	59.4	1800	1800	2650.00
G50C18C	50.0	62.5	.8	115/230	60	1	Cont.	M-363	100.0	1800	3150	4835.00
G50C18D	50.0	62.5	.8	120/208	60	3	Cont.	M-363	100.0	1800	3150	4580.00
G75C18C	75.0	93.8	.8	115/230	60	1	Cont.	R-602	155.0	1800	4760	7695.00
G75C18D	75.0	93.8	.8	120/208	60	3	Cont.	R-602	155.0	1800	4760	7310.00
G100C18C	100.0	125.0	.8	115/230	60	1	Cont.	S-820	205.5	1800	5730	9980.00
G100C18D	100.0	125.0	.8	120/208	60	3	Cont.	S-820	205.5	1800	5730	9565.00

*Listings cover popular types only. Standard commercial voltages up to 600 volts on sizes above 10KW can be supplied. Other types can be supplied at extra cost.

Graybar Portable Floodlight and Power Units

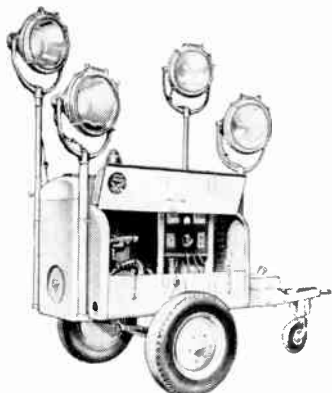

No. NH5-W2



No. NH10

Dependably powered by air- or water-cooled engines. 115, 115/230 or 120/208 volt, 60 cycle, single or 3-phase A-C or D-C generator unit.

Large lighted steel control panel, complete with voltmeter, ammeter, and rheostat to control voltage. Standard electric starter. All these features add up to make these units among the easiest to operate.

The panel is equipped with two plug-in duplex receptacles and outlets, for power tools and other auxiliary power needs or for use of portable floodlights away from unit itself. Side mounted tool box locks. A portable power plant for any emergency.

Ball-bearing wheels for high-speed transport. Front caster wheel retracts to transport position, let down for parking. Multiple leaf springs. Shipped complete with 6:00 X 16 auto wheels and tires. Painted highway yellow.

Heavy structural steel chassis. Waterproof steel housing with folding doors. Alloy axle.

No.	Capacity Watts	Electrical Details			Engine Details			Floodlight Details			Approx. Wt. Lbs. Crated	Each	
		Volts	Cycles	Phase	Make	Model	H. P.	RPM	No.	Candlepower Each	Watts Each		
NH5-W1	5000	115	60	1	Wis.	VF-4	19.5	1800	4	80,000	1000	2540	\$2495.00
NH5-W2	5000	115/230	60	1	Wis.	VF-4	19.5	1800	4	80,000	1000	2540	2495.00
NH10-W2	10000	115/230	60	1	Wis.	VF-4	19.5	1800	4	80,000	1000	2619	2795.00

Deduct for Deletion of Floodlights and Supports..... 670.00

**Graybar Diesel Electric Plants—Air Cooled and Water Cooled
1500 Watts to 6500 Watts**

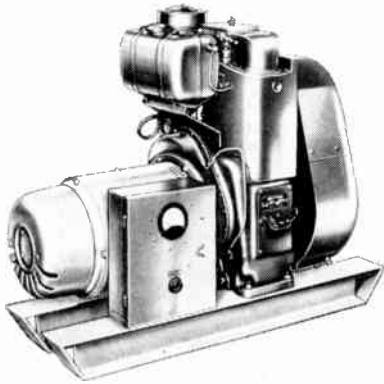

No. DA3P18B

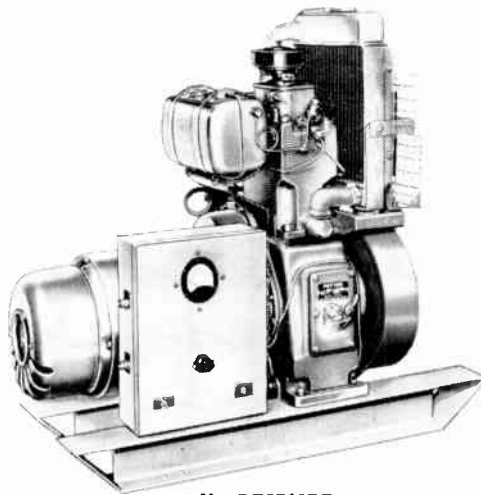

No. DR3P18BE

For more than 35 years large users of power have been using Diesel engines because they have proven to be the most dependable and economical source of power.

Now, all of the recognized advantages of diesel engines are brought to the small user of power. These Diesel Electric Plants are built in a range of sizes to meet the electric light and power needs of every farm, ranch, garage, hotel, theatre, hospital, school, small town, shop, mine, mill and factory.

All unnecessary parts have been eliminated from these plants in that all are designed especially for the service for which they have been sold.

Start easily even in the coldest weather.

Highest grade materials obtainable machined and finished to the closest tolerances give the plants an exceptionally long service life.

Available in a wide range of Diesel Engines, voltage output, phases, etc. Only a few of the most popular numbers are listed here. Consult Graybar for a complete listing. Electric start models only are listed, manual start models are available.

60 Cycle—1800 RPM—Electric Start							
No.	KW@100% P.F.	Generator Volts	Phase	Engine Model	H. P.	Ship. WL Lbs.	Each
DA105P18AE	1.5	115	1	PAZ1	3.0	560	\$ 830.00
DA105P18BE	1.5	115/230	1	PAZ1	3.0	560	830.00
DA3P18BE	3.0	115/230	1	AVA1	7.5	830	1185.00
DA3P18DE	3.0	120/208	3	AVA1	7.5	830	1206.00
DR3P18BE	3.0	115/230	1	AV1	7.5	895	1299.00

No.	KW@100% P.F.	Generator Volts	Phase	Engine Model	H. P.	Ship. WL Lbs.	Each
DR3P18DE	3.0	120/208	3	AV1	7.5	895	\$1325.00
DA605P18BE	6.5	115/230	1	AVA2	15.0	1210	1598.00
DA605P18DE	6.5	120/208	3	AVA2	15.0	1210	1624.00
DR605P18BE	6.5	115/230	1	AV2	15.0	1310	1722.00
DR605P18DE	6.5	120/208	3	AV2	15.0	1310	1742.00

Note: AVA1 or 2—Air-cooled. AV1 or 2—Water-cooled. All of above are powered by Peter Engines. Available with other makes engines, consult Graybar for complete details.

10 KW to 100 KW

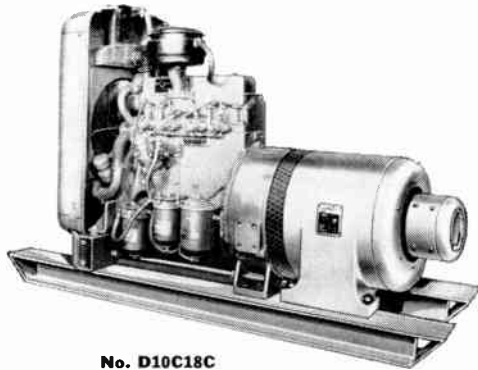

No. D10C18C

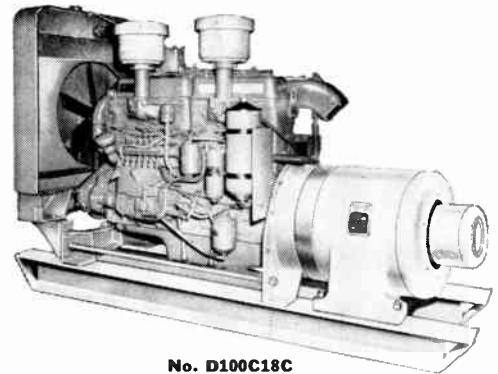

No. D100C18C

Powered by Continental Engines

No.	KW	Capacity KVA	P.F.	Volts	Electrical Details* Cycles	Phase	Model	Engine Details H.P.	RPM	Approx. Ship. WL Lbs.	Each
D10C18D	10	12.5	.8	120/208	60	3	ZD-129	28.0	1800	1650	\$ 2785.00
D10C18C	10	12.5	.8	115/230	60	1	ZD-129	28.0	1800	1650	2785.00
D20C18D	20	25	.8	120/208	60	3	ED-201	44.4	1800	2675	3775.00
D20C18C	20	25	.8	115/230	60	1	ED-201	44.4	1800	2675	3975.00
D25C18D	25	31.25	.8	120/208	60	3	HD-260	57.4	1800	2780	4195.00
D25C18C	25	31.25	.8	115/230	60	1	HD-260	57.4	1800	2780	4575.00
D30C18D	30	37.5	.8	120/208	60	3	HD-260	57.4	1800	3095	4370.00
D30C18C	30	37.5	.8	115/230	60	1	HD-260	57.4	1800	3095	4789.00
D50C18D	50	62.5	.8	120/208	60	3	TD-427	100.0	1800	4000	6450.00
D50C18C	50	62.5	.8	115/230	60	1	TD-427	100.0	1800	4000	6730.00
D60C18D	60	75	.8	120/208	60	3	RD-572	142.00	1800	4850	8410.00
D60C18C	60	75	.8	115/230	60	1	RD-572	142.00	1800	4850	8675.00
D75C18D	75	93.7	.8	120/208	60	3	RD-572	182.0	1800	4950	8850.00
D75C18C	75	93.7	.8	115/230	60	1	RD-572	182.0	1800	4950	9280.00
D100C18D	100	125.0	.8	120/208	60	3	SD-802	202.0	1800	6130	11150.00
D100C18C	100	125.0	.8	115/230	60	1	SD-802	202.0	1800	6130	11600.00

*Listings cover popular types only. Standard commercial voltages up to 600 volts on sizes above 10 kw can be supplied.

Graybar Belt or Direct Drive Generators 400 Watts to 100 Kw.

All Voltages, Phases and Cycles

A Size for Every Need—Belt or Direct Drive

Efficient, sturdy, rugged construction and long-life performance.

Each Generator is thoroughly inspected and tested before shipment and warranted to be free from defective material and workmanship.

All 600 to 10,000 watt models are self-excited and have an ingenious voltage regulation of + or - 5% at unity power factor when operated at constant speed. All revolving fields 10KW to 100KW Generators are separately excited, automatic voltage regulated and have a regulation of + or - 2% at 0.8 power factor when engine speed does not vary more than 5%. All models are cooled by forced air from centrifugal blowers with a maximum temperature rise of 50° C.

All Models, unless otherwise specified, operate at 1800 RPM, 60 Cycle. 3KW to 1000KW A-C sizes are built in 115, 230, 115/230, 220, 440 Volts, Single-phase or 120/208, 220/380 Volts, 3-phase. Also available in other voltages, cycles and phases. Direct current Generators, 600 W to 3000 W, available in 6, 12, or 32 volt battery charging. 3 KW to 10 KW Generators are built for 120 or 240 V non-battery charging

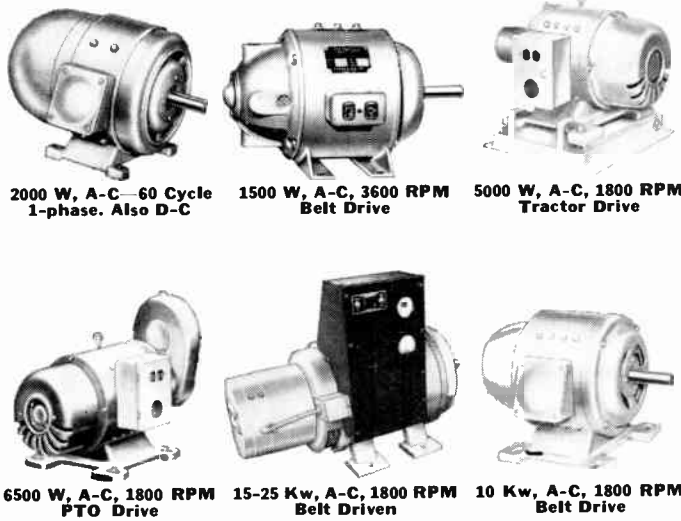

**2000 W, A-C—60 Cycle
1-phase. Also D-C**

**1500 W, A-C, 3600 RPM
Belt Drive**

**5000 W, A-C, 1800 RPM
Tractor Drive**

**6500 W, A-C, 1800 RPM
PTO Drive**

**15-25 Kw, A-C, 1800 RPM
Belt Driven**

**10 Kw, A-C, 1800 RPM
Belt Drive**

Belt Driven, Self-Excited, Unity Power Factor Generators

Model Nos. listed supply information as to watts, phase, wire, RPM, and whether A-C or D-C for example: Model No. 10018A43 breaks down thus:

**100—10 KW 18—1800 RPM A—A-C, 60 Cycle 4—4-wire 3—3-phase
600 W to 10 KW**

Model No.	Watts	Volts	Approx. Ship. Wt. Lbs.	Each	Model No.	Watts	Volts	Approx. Ship. Wt. Lb.	Each	Model No.	Watts	Volts	Approx. Ship. Wt. Lb.	Each
*1536 A	1500	115 or 230	85	\$195.00	3018 A	3000	115 or 230	218	\$293.00	6518 A43	6500	120/208	295	\$423.00
*2236 A	2200	115 or 230	170	250.00	3018 A3	3000	115/230	218	298.00	10018 A4	10000	115/230	370	575.00
*2236 A3	2200	115 or 230	170	250.00	3018 A4	3000	115/230	218	305.00	10018 A43	10000	120/208	370	575.00
*4036 A	4000	115 or 230	190	293.00	3018 A43	3000	120/208	218	305.00	*3012 A	3000	115 or 230	228	433.00
*4036 A3	4000	115/230	190	298.00	5018 A	5000	230	295	368.00	*3012 A3	3000	115/230	228	433.00
618 A	600	115 or 230	67	150.00	5018 A3	5000	115/230	295	379.00	*3012 A4	3000	115/230	228	444.00
1018 A	1000	115 or 230	72	162.00	5018 A43	5000	120/208	295	379.00	*3012 A43	3000	120/208	228	444.00
1518 A	1500	115 or 230	145	238.00	5018 A4	5000	115/230	295	379.00	*7512 A4	7500	115/230	370	575.00
2018 A	2000	115 or 230	170	260.00	6518 A3	6500	115/230	295	400.00	*7512 A43	7500	120/208	370	575.00
2018 A3	2000	115/230	170	270.00	6518 A4	6500	115/230	295	410.00					

Direct Current—600 W to 10 KW

*5036	5000	125	295	368.00	2518	2500	125	145	305.00	7518	7500	125 or 250	440	702.00
618D	600	32	67	150.00	3018D	3000	32	295	375.00	10018	10000	125 or 250	440	742.00
1018D	1000	32	67	173.00	3518	3500	125	218	357.00	*2012	2000	125	200	357.00
2018D	2000	32	145	305.00	5018	5000	125	295	389.00	*6012	6000	125	354	618.00

*1200 RPM.

Revolving Field Separately Excited A-C Belt Drive Generators 1800 RPM Revolving Field—60 Cycle—Direct Connected Exciter

Model No.	KW at .8 PF	KVA	Phase	Approx. Ship. Wt. Lb.	Each	Model No.	KW at .8 PF	KVA	Phase	Approx. Ship. Wt. Lb.	Each	Model No.	KW at .8 PF	KVA	Phase	Approx. Ship. Wt. Lb.	Each
B13T18	10	12.5	3	635	\$ 735.00	B25T18	20	25	3	1010	\$1145.00	B363T18	50	62.5	3	1450	\$1930.00
B13S18	10	12.5	1	635	740.00	B30T18	25	30	3	1030	1240.00	B75T18	60	75	3	1175	2125.00
B19T18	15	18.75	3	970	860.00	B38T18	30	37.5	3	1300	1360.00	B94T18	75	93.8	3	1625	2485.00
B19S18	15	18.75	1	970	930.00	B50T18	40	50	3	1400	1805.00	B125T18	100	125	3	1825	2910.00

1200 RPM Revolving Field—60 Cycle—Direct Connected Exciter

B13T12	10	12.5	3	905	913.00	B25T12	20	25	3	1300	1510.00	B63T12	50	62.5	3	1550	2055.00
B13S12	10	12.5	1	905	913.00	B30T12	25	30	3	1300	1680.00	B75T12	60	75	3	1625	2335.00
B19T12	15	18.75	3	1000	1160.00	B38T12	30	37.5	3	1450	1733.00	B94T12	75	93.8	3	1825	2655.00
B19S12	15	18.75	1	1000	1160.00	B50T12	40	50	3	1450	1900.00	B125T12	100	125	3	2275	3042.00

Tractor Driven Generators A-C—1800 RPM

Watts	Volts	Phase	Wire	Belt Driven		Power Take-Off Driven			
				Model No.	Approx. Ship. Wt. Lbs.	Model No.	Approx. Ship. Wt. Lbs.		
3000	115	1	2	3T1	197	\$350.00	3PT1	247	\$456.00
3000	115/230	1	3	3T2	197	350.00	3PT2	247	456.00
5000	115	1	2	5T1	273	478.00	5PT1	323	584.00
5000	115/230	1	3	5T2	273	446.00	5PT2	323	552.00
6500	115	1	2	6T1	319	530.00	6PT1	369	638.00
6500	115/230	1	3	6T2	319	489.00	6PT2	369	638.00
6500	120/208	3	4	6T3	319	510.00	6PT3	369	615.00
12000	115/230	1	4	12T2	439	638.00	12PT2	489	775.00
12000	120/208	3	4	12T3	439	657.00	12PT3	489	795.00

Listings on this page are only a partial list of the most popular Generators. For a complete listing of all Generators available, as well as accessory items and component parts consult Graybar.

White Diesel Generating Equipment

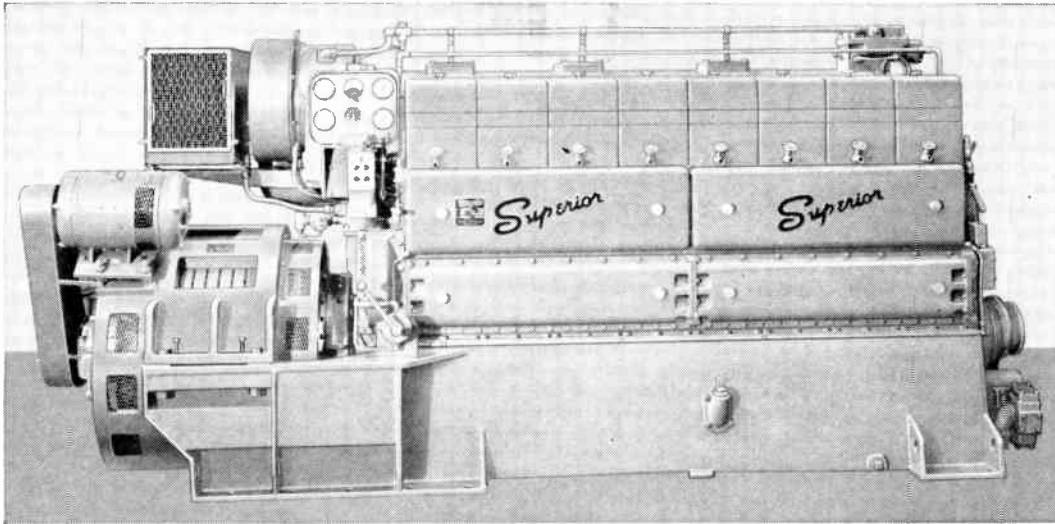

Diesel Generator Set, 150 to 500 Kw.

Used by telephone companies, industrial firms, gas, water, and electric utilities for continuous or standby power. Reliable Superior engines achieve low fuel consumption on non-premium fuels because of highly developed combustion system. Simple design permits easy maintenance. High quality construction, minimum of parts means reliable service and low upkeep.

Generators are 3 phase, 60 cycle, 2-bearing ac rated at .80 P.F. 50°C. temperature rise continuous duty with loft mounted exciters. Mounted with engine and cooling equipment of diesel, on steel sub-base. Standard generator voltages may be 120/208, 127/220, 240, 480 or 600 as customer may specify. Special generator sets quoted on request. Controls mounted on generator frame on standard units. Gas, diesel or dual fuel engines available. Automatic starting system available.

Kw.	RPM	BHP	Wt. Lbs.
150	600	225	23650
200	720	290	24050
250	900	360	23525
300	900	430	25975
350	900	505	27200
400	900	600	Variable with requirements
500	900	715	

Order by kw size. Specify Voltage.

Mobile Generating Plants, 350 Kw. and 500 Kw.



Useful to electric utilities or telephone companies needing mobile power the completely self-contained plants are available in 350 kw. and 500 kw. sizes. Superior diesel engines operate approximately 12 hours on non-premium fuel from tank below trailer. Heavy duty 6 or 8 cylinder Superior Model 40 diesel designed for continuous duty at 900 RPM.

A thirty-two foot trailer houses switchboard, 500 Kw. generator, muffler, starting equipment, engine, and radiator. Jacks provided to level trailer when in use. Can be operated by one man. All components are standard production items engineered for mobile power plant by WHITE DIESEL ENGINE DIVISION. The White Motor Company, Springfield, Ohio. Weight of 500 Kw. unit including White 3000 Series tractor approximately 53,000 lbs.

Prices on application.

Advantages of Purchasing General Electric Motors

These motors are manufactured in a wide variety of types and ratings. The most widely used motors—those fulfilling the requirements of the great majority of industrial applications—are listed in this catalog. Motors of large size, non-standard rating, or special construction are described in other publications, available on request from Graybar.

General Electric motors possess the exacting characteristics needed to power modern industrial machinery. They are mechanically sturdy, incorporate the latest developments in electrical design and provide the essential benefits of long life and unusually trouble-free service. Specified values of current torque, and speed can be depended upon in every unit.

Electric motors form a most versatile type of drive. They permit the application of power directly to the job. They frequently eliminate gearing and belting requirements altogether. They make it possible to bring processing operations directly into a production line.

The wide choice available in G-E motors permits the efficient application of motors in widely varying types of drives. The different enclosures offered permit the selection of motors that will stand up under the most severe conditions and that can be safely operated in the most hazardous locations. Enclosures can be obtained for installation in the presence of explosive and corrosive fumes, magnetic and abrasive dusts, splashing liquids, outdoor weather, and other adverse conditions.

General Electric motors are backed up by renewal-parts and exchange-plan services that mean economy and long life to any motor installation. G-E renewal parts are built of the same materials and to the same specifications as the original equipment. G-E exchange-plan motors eliminate long delays in repair or replacement of motors in fractional-hp. sizes and some integral-hp. sizes up through 15 hp.

Selection of Motors and Control

The selection of an electric motor and control for a given application depends upon the following factors.

Available Power

Whether a-c or d-c; the voltage; and, if a-c, the number of phases and frequency.

Selection of Motor Enclosure

The purpose of a motor enclosure is to protect vital motor parts, such as windings, from dust, fumes, water, and chemicals, and in some cases to prevent the possibility of an explosion due to over-heating or sparking of the motor when the atmosphere is laden with inflammable gases or combustible dust. Open motors, especially of the drip-proof type, provide sufficient protection for all normal conditions and are the most economical from an initial-cost standpoint. Open motors should not be installed where more complete enclosures are required to provide low maintenance and long life. The following can be used as a guide in selecting the enclosure required.

Open (Dripproof)—For ordinary industrial conditions—all conditions not requiring the more complete enclosures identified below.

Totally Enclosed—For extremely moist, dirty, or dusty locations, outdoor operation, or corrosive atmospheres.

Explosion-proof and Dust-explosion-proof—For hazardous-gas and hazardous-dust conditions as defined by the National Electrical Code. These motors carry a special Underwriters Label.

How to Select Polyphase Induction Motors

Determining Type of Motor Required—The type of motor required for a particular application is determined basically by the character of the driven machine and frequently also by the kind of operation desired of it.

Consideration must be given, for example, to the number of speeds required, to starting and accelerating requirements, to character of the load and to required speed regulation. In Table I are shown the types of motors commonly available to meet driven-machine requirements. While the large majority of machine requirements are met by general-purpose squirrel-cage motors, the exceptional requirements are tabulated as an aid in preventing misapplication of general-purpose types.

Service Factor

The service factor is a multiplier, which, applied to the normal horsepower rating, indicates a permissible loading within the accepted safe limits of temperature rise for the insulation.

Service factors apply only to 40° C. rise motors and range from 1.4 for the smaller fractional-horsepower a-c motors to 1.15 for integral-horsepower motors above 2 hp. 50° C. and 55° C. rise motors do not have a service factor.

Voltage and Frequency Range

Motors will operate successfully under the following conditions of voltage and frequency variations, but not necessarily in accordance with the standards established for operation at normal rating:

Where the variation in voltage does not exceed 10 per cent above or below normal.

Where the frequency variation does not exceed 5 per cent above or below normal.

Where the sum of the voltage and frequency variation does not exceed 10 per cent (provided the variation in frequency does not exceed 5 per cent) above or below normal rating as stamped on motor nameplate.

The starting and maximum running torque of a-c induction motors will vary as the square of the voltage, the speed varying directly with the frequency.

Selection of Motors and Control

(Continued)

Table I—Meeting Requirements of Driven Machine

Requirements of Driven Machine			Examples	Available Motors			Remarks
Type of Drive	Permissible Running Characteristics	Starting Load		Description	NEMA Classification	G-E Type	
Single-speed	Constant-speed	Normal	Fans, Saws, Lathes, Centrifugal Pumps, Centrifugal Compressors	Squirrel-cage, Normal-starting-torque, Low-slip	Designs A and B	Type K	See Table II for Locked-rotor Torque. See Fig. 1 for Speed-torque curve.
		High Break-away	Reciprocating Pumps, Loaded Conveyors	Squirrel-cage, High-Starting-torque, Low-slip	Design C	Type KG	See Table III for Locked-rotor Torque. See Fig. 1 for Speed-torque curve.
			Reciprocating Pumps and Compressors, Loaded Conveyors	Squirrel-cage, High-starting-torque, High-slip	Design D	Type KR	Locked-rotor Torque 275 percent of full-load torque. See Fig. 1 for speed-torque curve.
		High Inertia	Laundry Extractors, Punch Presses, Large Flywheel Loads	Squirrel-cage, Normal-starting-torque, Low-slip	Designs A and B	Type K	Advantageous where torque requirements increase with accelerating speed. (See Fig. 1). See Table II for Locked-rotor torque.
				Squirrel-cage, High-starting torques, High-slip	Design D	Type KR	Use for fluctuating fly-wheel loads.
				Wound-rotor	Type M	Smooth acceleration possible by use of starting rheostats in secondary circuit.
Rapid Reversing	Laundry Machines, some Machine Tools	Squirrel-cage, High-starting-torque, High-slip	Design D	Type KR	High-slip characteristics essential in rapid reversing service.		
Multi-Speed	Constant-Speed	Normal	Stokers, Printing Presses, Conveyors	Squirrel-cage, Normal-starting-torque, Low-slip	Type K	Available with two, three, or four speeds in constant-torque, constant-hp., and variable torque designs.
Adjustable Speed	Varying-Speed	Normal or High	Conveyors, Printing Presses, Rotary Kilns	Wound-rotor	Type M	Has constant-speed characteristics at full speed. Best speed range 2:1.
	Constant-Speed	Normal or High	Conveyors, Printing Presses, Paper Machines, Calenders, Rotary Kilns, Reels, Winches	Packaged Adjustable-Speed Drives	Speed Variator	M-G set conversion. Wide speed ranges. Automatic controls.
						Thy-mo-trol	Electric conversion. Wide speed ranges. Automatic controls.

Selection of Motors and Control

(Continued)

Control

The starting and maximum running torque of a-c induction motors will vary approximately as the square of the voltage, the speed varying directly with the frequency.

Table II Locked-rotor Torque of Normal-starting-torque Squirrel-cage Motors—NEMA Design A or B (G-E Type K)

Hp. 60-Cycle, 3- and 2-Phase, Single-Speed Motors, Continuous-Rated	Locked-Rotor Torque Expressed in Per Cent of Full-Load Torque			
	3600 RPM	1800 RPM	1200 RPM	900 RPM
1.....	...	275	175	150
1½.....	175	265	175	150
2.....	175	250	175	150
3.....	175	250	175	150
<hr/>				
5.....	150	185	160	130
7½.....	150	175	150	125
10.....	150	175	150	125
15.....	150	165	140	125
20.....	150	150	135	125
<hr/>				
25.....	150	150	135	125
30.....	150	150	135	125
40.....	135	150	135	125
50.....	125	150	135	125
60.....	125	150	135	125
<hr/>				
75.....	110	150	135	125
100.....	110	125	125	125
125.....	100	110	125	125
150.....	100	110	125	125
200.....	100	100	125	125

Table III Locked-rotor Torque of High-starting-torque Squirrel-cage Motors—NEMA Design C (G-E Type KG)

Hp. Continuous 60-Cycle, 3- and 2-Phase, Single-Speed Motors, Continuous-Rated	Locked-Rotor Torque Expressed in Per Cent of Full-Load Torque		
	1800 RPM	1200 RPM	900 RPM
3.....	...	250	225
5.....	250	250	225
7½.....	250	225	200
<hr/>			
10.....	250	225	200
15.....	225	200	200
20.....	200	200	200
25 to 200 max.....	200	200	200

Fig. 1 Typical Speed-torque Curves of Squirrel-cage Motors

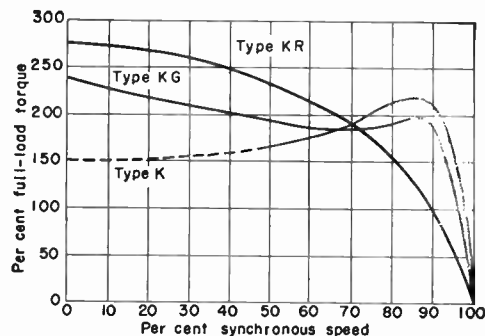

Type K—Normal-starting-torque, low-slip. NEMA design A or B.

Type KG—High-starting-torque, low-slip. NEMA design C.

Type KR—High-slip, high-starting-torque. NEMA design D.

Fig. 2 Typical Speed-torque Curves of Wound-rotor Motor, with Different Secondary Resistances

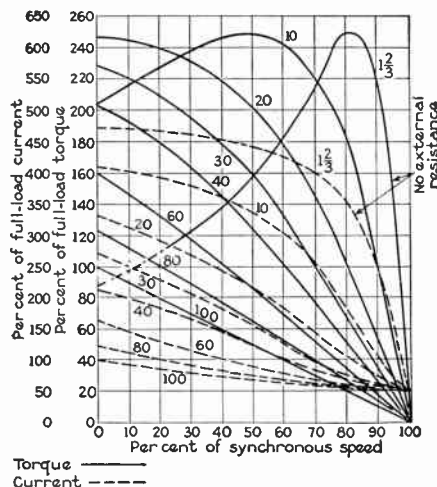

Various speed-torque and corresponding speed-current curves can be obtained by using different values of external secondary resistance. Numbers on the curves indicate the secondary (rotor) circuit resistance in per cent of value required to give full-load torque at standstill. Other values can be obtained by varying the secondary resistance to meet specific requirements.

The curves for "no external resistance" are merely reference curves, as appreciable resistance is necessary to obtain positive values of initial starting torque.

For Additional Information on

G-E Motor Controls

and

Other Control Equipment

See Pages 1335-1344

G-E Tri-Clad* "55" Squirrel-Cage Induction Motors

Type K, Normal Starting Torque; Type KG, High Starting Torque; Type KR, High Slip

1 to 125 Hp, 3 and 2-Phase, 60 Cycles

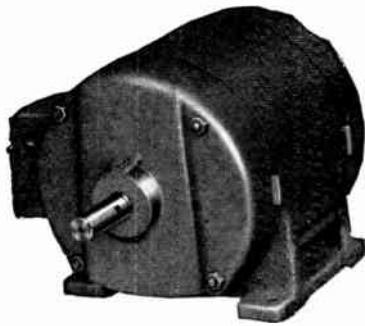

Dripproof

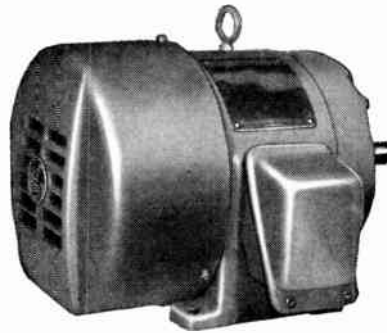

Totally enclosed, fan-cooled

A complete line of G-E motors—from 1 to 125 hp—with increased operating efficiency packed into the new NEMA frame dimensions. The line includes the general-purpose models, plus a variety of gear-motors, including the right-angle shaft gear motor. Available in most ratings are vertical, single-phase, wound-rotor, and multispeed motors, as well as NEMA Types C and D face- and flange-mounted types.

Because these Tri-Clad "55" motors are the result of extensive engineering research, their dimensions, operating characteristics, and appearance bear no resemblance to the former Tri-Clad line. Their lighter weight and smaller over-all size save money on shipping, handling, storing, and installing. Yet they retain the full power rating and service factor of previous models.

Features include: Greater rigidity, because of cast-iron construction. Increased protection from dripping liquids. Water-shedding motor assembly—the result of silicone Dri-Film* coating. Nonwicking leads protect internal connections. Formex* wire windings retard heat aging. New polyester-film slot and phase insulation is eight times stronger than ordinary electrical insulations. Attractive finish is easy to clean or repaint. Sealed bearing housing prevents lubricant leakage or entrance of dirt. Grease can be added during motor operation. Maintenance is easy with large knockoff lugs, stainless-steel nameplate, and oversize conduit box.

Type K—Normal Starting Torque NEMA Classification Design B

The Type K is suitable for either full-voltage or reduced voltage starting, depending upon the permissible starting current of the particular application. It has the highest efficiency and power factor of all the standard lines of induction motors, and is well fitted for driving pumps, fans, blowers, line shafting, and similar equipment requiring continuous operation with fairly constant load.

In general this motor can be used for any application where continuous operation and constant speed are required, together with a fairly constant load.

Type KG—High Starting Torque NEMA Classification Design C

The Type KG motor has high starting torque and low starting current and is intended to supply the need for motors having a higher starting torque than can be obtained from the Type K motors with full voltage applied.

Recommended for such drives as compressors without unloading valves, conveyors which must be started loaded, and other applications requiring high starting torque.

Type KG motors starting at full voltage should be applied only where high torque at start is actually required and only when the driven mechanism will not be injured by the sudden application of this torque. This latter caution applies especially to drives or driven machines utilizing belts, either of the flat or V type, chains or other flexible or flat elements.

Type K, Normal Starting Torque—General-purpose, Dripproof, Horizontal 60 Cycles, 3 and 2-Phase—208, 220, 440 and 550 Volts

Model Nos. 3-Phase, 208 220/440 Volts†	Hp. ConL 40° C Rise	Speed, RPM		Frame	Current (Max.)‡		Code Letter	Torque		Breakdown % Full-load	▲Book Price Motor Only
		Sync.	Full-load (Min.)		Full-load	Locked Rotor Full-Voltage		Full-load at Full-load Speed, Lb.-Ft.	Starting Full-voltage % Full-load		
5K182AG801	1/2	900	860	182	2.80	12	L	3.05	150	250	\$145.00
5K182AG601	3/4	1200	1140	182	3.10	18	L	3.45	175	275	130.00
5K184AG801	3/4	900	860	184	3.55	18	L	4.58	150	250	168.00
5K182AG201	1	1800	1730	182	3.52	24	L	3.03	275	300	117.00
5K184AG601	1	1200	1145	184	3.74	24	L	4.58	175	275	138.00
5K213AG801	1	900	865	213	4.38	24	L	6.07	150	250	187.00
5K182AG1	1 1/2	3600	3495	182	4.56	35	K	2.25	175	275	124.00
5K184AG201	1 1/2	1800	1730	184	4.87	35	K	4.55	265	300	138.00
5K184AG611	1 1/2	1200	1145	184	5.30	35	K	6.88	175	275	160.00
5K213AG811	1 1/2	900	865	213	6.33	35	K	9.1	150	250	223.00
5K184AG1	2	3600	3500	184	5.68	45	K	3.01	175	250	152.00
5K184AG211	2	1800	1730	184	5.98	45	K	6.07	250	275	160.00
5K213AG601	2	1200	1160	213	7.00	45	K	9.04	175	250	178.00
5K215AG801	2	900	860	215	8.21	45	K	12.2	150	225	258.00
5K184AG11	3	3600	3500	184	8.04	60	J	4.49	175	250	176.00
5K213AG201	3	1800	1750	213	8.9	60	J	9.00	250	275	178.00
5K213AG601	3	1200	1155	215	9.75	60	J	13.6	175	250	212.00
5K215AG601	3	900	870	254U	10.8	60	J	18.1	150	225	292.00
5K213AG1	5	3600	3525	213	14.1	90	H	7.45	150	225	196.00
5K215AG201	5	1800	1750	215	13.9	90	H	15.0	185	225	212.00
	5	1200	1170	254U	15.2	90	H	22.4	160	225	278.00
	5	900	870	256U	16.2	90	H	30.2	130	225	370.00
5K215AG1	7 1/2	3600	3525	215	19.5	120	G	11.2	150	215	233.00
	7 1/2	1800	1760	254U	20.6	120	G	22.3	175	215	278.00
	7 1/2	1200	1170	256U	21.6	120	G	33.7	150	215	352.00
	7 1/2	900	875	284U	23.8	120	G	45.00	125	215	443.00
	10	3600	3530	254U	26.2	150	G	14.9	150	200	306.00
	10	1800	1760	256U	26.8	150	G	29.9	175	200	352.00
	10	1200	1175	284U	28.2	150	G	44.7	150	200	422.00
	10	900	875	286U	31.2	150	G	60.00	125	200	556.00
	15	3600	3530	254U	38.2	220	F	22.3	150	200	405.00
	15	1800	1760	284U	39.4	220	F	44.8	165	200	422.00
	15	1200	1175	324U	41.0	220	F	67.0	140	200	556.00
	15	900	875	326U	43.2	220	F	90.0	125	200	682.00
	20	3600	3540	284U	50.4	290	F	29.6	150	200	485.00
	20	1800	1760	286U	51.6	290	F	59.7	150	200	556.00
	20	1200	1175	326U	53.8	290	F	89.5	135	200	682.00
	20	900	875	364U	56.4	290	F	120.00	125	200	848.00
	25	3600	3540	286U	62.0	365	F	37.2	150	200	667.00
	25	1800	1770	324U	63.6	365	F	74.1	150	200	653.00
	25	1200	1175	364U	63.9	365	F	112.00	135	200	848.00
	25	900	875	365U	70.3	365	F	150.00	125	200	972.00
	30	3600	3550	324S	73.8	435	F	44.4	150	200	743.00
	30	1800	1770	326U	74.4	435	F	89.0	150	200	750.00
	30	1200	1175	365U	76.3	435	F	134.00	135	200	972.00
	30	900	875	404U	82.1	435	F	180.00	125	200	1214.00

‡220-volt value only. †For 3-phase, 550 volts, and 2-phase, 220/440 volts consult Graybar.
*Reg. trade-mark of General Electric Co.
▲This page includes "Book" prices subject to discount. For the correct discount, consult Graybar.

G-E Tri-Clad "55" and Tri-Clad Squirrel-Cage Induction Motors
General-Purpose, Drip-proof, Horizontal

Type K, Normal-starting-torque, 60 Cycles, 2- and 3-phase

Horsepower Continuous 40° C Rise	Speed, RPM		Current, Full-load at 220V Amperes	Code Letter	208*, 220, 440 and 550 Volts			2300 Volts		
	Sync.	Full-load (Min.)			Frame	▲Book Price, Motor Only Sleeve-Bearing	Ball-Bearing	Frame	▲Book Price, Motor Only, Sleeve-Bearing	Ball-Bearing
40	3600	3550	96.6	F	326S	\$ 818.00	\$ 818.00
40	1800	1770	99.4	F	364U	933.00	933.00
40	1200	1175	103	F	404U	1214.00	1214.00	445	\$1740.00	\$1740.00
40	900	875	108	F	405U	1456.00	1456.00	504U	1982.00	1982.00
50	3600	3550	120	F	364US	1102.00	1102.00
50	1800	1770	123	F	365U	1118.00	1118.00	445S	1748.00	1748.00
50	1200	1175	126	F	405U	1456.00	1456.00	504U	1982.00	1982.00
50	900	875	131	F	444U	1788.00	1788.00	505	2314.00	2314.00
60	3600	3550	143	F	365US	1264.00	1264.00
60	1800	1770	146	F	404U	1396.00	1396.00	455S	1922.00	1922.00
60	1200	1175	151	F	444U	1788.00	1788.00	505	2314.00	2314.00
60	900	875	153	F	445U	2150.00	2150.00	505	2676.00	2810.00
75	3600	3560	180	F	404US	1700.00	1700.00	445S	2226.00	2226.00
75	1800	1770	181	F	405U	1674.00	1674.00	504S	2200.00	2200.00
75	1200	1175	187	F	445U	2150.00	2150.00	505	2622.00	2622.00
75	900	875	190	F	505	2552.00	2680.00	6323	3024.00	3175.00
100	3600	3560	235	F	405US	2184.00	2184.00	504S	2710.00	2710.00
100	1800	1770	243	F	444U	2146.00	2146.00	505S	2672.00	2672.00
100	1200	1180	249	F	505	2752.00	2890.00	505	3224.00	3385.00
100	900	875	252	F	6323	3190.00	3350.00	6324	3662.00	3845.00
125	3600	3560	294	F	444US	2861.00	2861.00	504S	3387.00	3387.00
125	1800	1770	297	F	445U	2580.00	2580.00	505S	3106.00	3261.00
125	1200	1180	306	F	6323S	3354.00	3522.00	6323S	3826.00	4017.00
125	900	875	311	F	6324	3758.00	3946.00	6325	4114.00	4320.00
150	3600	3560	349	F	445US	3655.00	3655.00	505S	4101.00	4101.00
150	1800	1770	356	F	6323S	3110.00	3266.00	6323S	3556.00	3734.00
150	1200	1180	363	F	6324S	3922.00	4118.00	6324S	4278.00	4492.00
150	900	875	367	F	6325	4312.00	4528.00	6333	4548.00	4775.00
200	3600	3565	471	F	505S	5164.00	5422.00	505S	5400.00	5400.00
200	1800	1770	470	F	6324S	3972.00	4171.00	6324S	4208.00	4418.00
200	1200	1180	484	F	6325S	4854.00	5097.00	6325SU	5080.00	5334.00
200	900	875	487	F	6333	5376.00	5645.00	6334	5554.00	5832.00

Type KG, High-starting-torque, 60 Cycles, 2- and 3-phase

3x	1200	1160	10.4	J	215	\$ 212.00
3	900	865	J	254U	307.00
5x	1800	1750	15.2	II	215	212.00
5	1200	1165	15.2	II	254U	292.00
5	900	865	16.2	II	256U	389.00
7 1/2	1800	1740	21.2	G	254U	292.00
7 1/2	1200	1165	21.8	G	256U	370.00
7 1/2	900	865	24.0	G	284U	465.00
10	1800	1745	27.4	G	256U	370.00
10	1200	1165	28.6	G	284U	584.00
10	900	865	31.4	G	286U	598.00
15	1800	1755	40.4	F	284U	443.00
15	1200	1170	41.2	F	324U	598.00
15	900	875	46.2	F	326U	733.00
20	1800	1755	53.8	F	286U	584.00
20	1200	1170	54.0	F	326U	733.00
20	900	875	60.2	F	364U	\$ 912.00	912.00
25	1800	1760	64.4	F	324U	702.00
25	1200	1175	66.3	F	364U	912.00	912.00
25	900	875	73.8	F	365U	1045.00	1045.00
30	1800	1765	77.4	F	326U	806.00
30	1200	1175	78.6	F	365U	1045.00	1045.00
30	900	875	85.3	F	404U	1396.00	1396.00
40	1800	1755	104.0	F	364U	1003.00	1003.00
40	1200	1175	101.2	F	404U	1396.00	1396.00
40	900	875	108.0	F	405U	1674.00	1674.00
50	1800	1760	128.0	F	365U	1202.00	1202.00
50	1200	1175	125.0	F	405U	1674.00	1674.00
50	900	875	134.0	F	444U	2056.00	2056.00
60	1800	1770	154	F	404U	1605.00	1605.00	444U	\$2210.00	\$2210.00
60	1200	1175	150	F	444U	2056.00	2056.00	445U	2661.00	2661.00
60	900	875	160	F	445U	2473.00	2473.00	505	3077.00	3231.00
75	1800	1770	190	F	405U	1925.00	1925.00	444U	2530.00	2530.00
75	1200	1175	186	F	445U	2473.00	2473.00	505	3015.00	3015.00
75	900	505	2935.00	3082.00	6323	3478.00	3652.00
100	1800	1775	254	F	444U	2468.00	2468.00	445U	3073.00	3073.00
100	1200	505	3165.00	3323.00	505	3708.00	3893.00
100	900	6323	3669.00	3852.00	6324	4211.00	4422.00
125	1800	1775	313	F	445U	2967.00	2976.00	505S	3572.00	3751.00
125	1200	6323S	3857.00	4050.00	6323S	4400.00	4620.00
125	900	6324	4322.00	4538.00	6325	4731.00	4968.00
150	1800	6323S	3577.00	3756.00	6323S	4089.00	4293.00
150	1200	6324S	4510.00	4736.00	6324S	4920.00	5166.00
150	900	6325S	4959.00	5207.00	6333S	5230.00	5492.00
200	1800	6324S	4568.00	4796.00	6324S	4839.00	5081.00
200	1200	6325S	5582.00	5861.00	6325S	5842.00	6134.00
200	900	6333S	6182.00	6491.00	6334	6389.00	6706.00

DIRECTION OF ROTATION. For motors in frames 444S and larger at 3600 rpm, the direction of rotation must be specified (as viewed from end opposite driving end) so that fan can be properly arranged for ventilation.

***208 VOLTS.** Listed Type K motors in frames 445 and smaller are rated 208-220/440 volts. Motor warranties covering voltage and frequency variation apply to the 220- and 440-volt ratings.

220-volt, 60 cycle ratings in frames 504 and above are usable on 208-volt network systems.

Torques are reduced by approximately 11 per cent, and other characteristics are modified slightly when motors are operated on 208 volts.

x—Model Nos. 3x—5KG215AG601. 5x—5KG215AG201.

▲This page includes "Book" prices subject to discount. For the correct discount, consult Graybar.

G-E Tri-Clad "55" Squirrel-Cage Induction Motors

Totally Enclosed, Fan-Cooled Horizontal

Type K—Normal Starting Torque

**Standard and Explosion-proof—1 to 30 H.P.
2 and 3-Phase, 60 Cycles, Continuous Duty, 55°C Rise
208, 220/440, or 550 Volts**

Enclosed motors are built in either nonventilated or fan-cooled construction. Motors in the smaller ratings are non-ventilated.

In the larger ratings, the totally enclosed, fan-cooled design is standard. This latter construction draws air into the end of the fan cover and directs it over the motor frame toward the pulley end. The integrally cast blades on the rotor agitate the air inside the motor, thus dissipating heat from the frame.

General Electric also has a complete line of totally enclosed motors which have been tested and listed by Underwriters' Laboratories for Class I, Group D (specified gases and vapors); Class II, Group E (magnesium or aluminum dust); Class II, Group F (coal or coke dust); and Class II, Group G (grain dust) service. Motors must be specified for the particular application in order that they may bear the proper Underwriters' label indicating suitability for the conditions applied.

Model Nos. Standard Duty 208-220/440 Volts#	Horsepower Continuous 55°C Rise	Speed, Rpm		Frame	Current (Max.)†		Code Letter	Full-load at Full- load Speed Lb.-Ft.	Torque Starting Full-V. % Full-load	Breakdown % Full-load Lb.-Ft.	▲ Book Price Motor Only
		Sync.	Full-load (Min.)		Full- load Amperes	Locked Rotor Full-V.					
5K1821IG821	1/2	900*	860	182	2.84	12	L	3.05	150	250	\$ 157.00
5K1821IG629	3/4	1200*	1150	182	2.87	18	L	3.45	175	275	142.00
5K1841IG823	3/4	900*	860	184	3.92	18	L	4.58	150	250	180.00
5K1821IG268	1	1800*	1730	182	3.16	24	L	3.03	275	300	150.00
5K1841IG659	1	1200*	1145	184	3.61	24	L	4.58	175	275	172.00
5K213BG831	1	900	865	213	4.38	24	L	6.07	150	250	203.00
5K182BG22	1 1/2	3600	3495	182	4.71	35	K	2.25	175	275	164.00
5K1841IG311	1 1/2	1800*	1730	184	4.43	35	K	4.55	265	300	172.00
5K184BG644	1 1/2	1200	1140	184	5.33	35	K	6.91	175	275	188.00
5K213BG832	1 1/2	900	865	213	6.33	35	K	9.1	150	250	239.00
5K184BG43	2	3600	3495	184	5.86	45	K	3.01	175	250	204.00
5K184BG254	2	1800	1730	184	6.05	45	K	6.07	250	275	212.00
5K213BG624	2	1200	1160	213	7.00	45	K	9.04	175	250	230.00
5K215BG816	2	900	860	215	8.21	45	K	12.2	150	225	326.00
5K184BG44	3	3600	3495	184	8.23	60	J	4.5	175	250	228.00
5K213BG228	3	1800	1745	213	9.02	60	J	9.03	250	275	248.00
5K215BG625	3	1200	1155	215	9.75	60	J	13.6	175	250	282.00
	3	900	870	254U	10.8	60	J	18.1	150	225	410.00
5K213BG21	5	3600	3520	213	14.6	90	II	7.45	150	225	266.00
5K215BG229	5	1800	1745	215	14.2	90	II	15.04	185	225	282.00
	5	1200	1170	254U	15.2	90	II	22.4	160	225	396.00
	5	900	870	256U	16.2	90	II	30.2	130	225	488.00
5K215BG20	7 1/2	3600	3525	215	20	120	G	11.2	150	215	303.00
	7 1/2	1800	1760	254U	21.2	120	G	22.3	175	215	396.00
	7 1/2	1200	1170	256U	21.8	120	G	33.7	150	215	470.00
	7 1/2	900	875	284U	23.6	120	G	45	125	215	605.00
	10	3600	3530	254U	27.0	150	G	14.9	150	200	424.00
	10	1800	1760	256U	27.0	150	G	29.9	175	200	470.00
	10	1200	1175	284U	28.2	150	G	44.7	150	200	584.00
	10	900	875	286U	31.2	150	G	60	125	200	718.00
	15	3600	3530	256U	38.8	220	F	22.3	150	200	523.00
	15	1800	1760	284U	39.8	220	F	41.8	165	200	584.00
	15	1200	1175	324U	41.0	220	F	67	140	200	790.00
	15	900	875	326U	43.6	220	F	90	125	200	916.00
	20	3600	3540	286U	50.6	290	F	29.7	150	200	647.00
	20	1800	1760	286U	52.2	290	F	59.7	150	200	718.00
	20	1200	1175	326U	53.8	290	F	89.5	135	200	916.00
	20	900	875	364U	57.7	290	F	120	125	200	1184.00
	25	3600	3550	324U	61.2	365	F	37	150	200	1001.00
	25	1800	1770	324U	64.0	365	F	74.1	150	200	937.00
	25	1200	1175	364U	63.9	365	F	112	135	200	1184.00
	25	900	875	365U	70.3	365	F	150	125	200	1388.00
	30	3600	3545	324S	78.1	435	F	44.5	150	200	1088.00
	30	1800	1770	326U	74.4	435	F	89	150	200	1040.00
	30	1200	1175	365U	76.3	435	F	134	135	200	1388.00
	30	900	875	404U	82.1	435	F	180	125	200	1734.00

*Nonventilated.

†220 Volt value only.

#For other voltages, 2-phase, severe-duty, and explosion-proof, consult Graybar.

▲This page includes "Book" prices subject to discount. For the correct discount, consult Graybar.

**G-E Tri-Clad and Tri-Clad "55" Squirrel-Cage Induction Motors
Totally Enclosed, Horizontal**

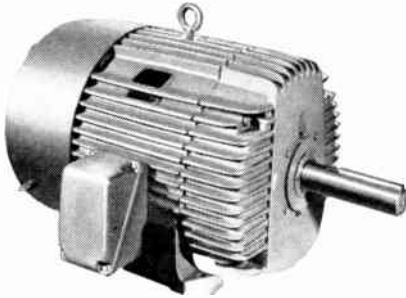

Typical of Frames 364 thru 445

Type K, Normal-starting-torque

60 Cycles, 3- and 2-phase

Horsepower Continuous 55° C. Rise	Speed, Rpm		Current Full- load at 220 V. Amperes	Code Letter	Frame	208*, 220, 440, 550 V. (All Frames)			2300 Volts		
	Sync.	Full-load (Min.)				▲Book Price, Motor Only Ball-bearing		Frame	▲Book Price, Motor Only Ball-bearing		
						Standard	Class I, Group D; Groups E, F, G†		Standard	Class I, Group D; Groups E, F, G†	
10	3600	3555	98	G	304US	\$ 1316.00	\$ 1516.00				
10	1800	1770	102	F	364U	1349.00	1549.00	445	\$ 2085.00	\$ 2285.00	
10	1200	1175	102	F	404U	1734.00	2008.00	504U	2260.00	2534.00	
10	900	875	104	F	405U	2090.00	2364.00	504U	2616.00	2890.00	
50	3600	3560	122	G	365US	1842.00	2116.00				
50	1800	1770	127	G	365U	1750.00	2024.00	504S	2380.00	2654.00	
50	1200	1175	127	F	405U	2090.00	2364.00	504U	2616.00	2890.00	
50	900	875	127	G	444U	2498.00	2788.00	505	3024.00	3314.00	
60	3600	3560	118	H	365US	2151.00	2425.00	504S#	2677.00	2951.00	
60	1800	1770	151	G	404U	2170.00	2444.00	504S	2696.00	2970.00	
60	1200	1180	150	G	444U	2498.00	2788.00	505	3024.00	3314.00	
60	900	875	151	G	445U	3350.00	3640.00	505	3876.00	4166.00	
75	3600	3570	182	H	444US	2996.00	3286.00	504S#	3522.00	3812.00	
75	1800	1770	188	G	444U	2726.00	3016.00	505S	3252.00	3542.00	
75	1200	1180	186	G	445U	3350.00	3640.00	505	3822.00	4112.00	
75	900	885	192	G	6324	4140.00	4554.00	6324	4612.00	5026.00	
100	3600	3570	237	H	445US	4040.00	4330.00	505S#	4566.00	4856.00	
100	1800	1775	248	G	445U	3668.00	3958.00	505S	4194.00	4484.00	
100	1200	1180	249	G	6324	4340.00	4774.00	6324	4812.00	5246.00	
100	900	885	255	G	6325	5902.00	6492.00	6325	6374.00	6964.00	
125	3600	3570	294	H	6325S#	5722.00	6294.00	6325S#	6248.00	6820.00	
125	1800	1780	304	H	6324S	4954.00	5449.00	6324S	5480.00	5975.00	
125	1200	1180	310	H	6325S	6373.00	7010.00	6325S	6845.00	7482.00	
125	900	885	319	H	6326	7140.00	7854.00	6326	7496.00	8210.00	
150	3600	3570	354	H	6326S#	7018.00	7720.00	6326S#	7464.00	8166.00	
150	1800	1780	360	H	6325S	5909.00	6500.00	6325S	6355.00	6946.00	
150	1200	1185	372	H	6326S	7452.00	8197.00	6326S	7808.00	8553.00	
150	900	885	376	H	6335S	8193.00	9012.00	6335S	8429.00	9248.00	
200	3600	3580	468	G	6328S	9295.00	10225.00	6328S#	9531.00	10461.00	
200	1800	1780	478	J	6328S	7547.00	8302.00	6328S	7783.00	8538.00	
200	1200	1185	493	II	6326S	9223.00	10145.00	6326S	9449.00	10371.00	
200	900	6342	10214.00	11235.00	6342	10392.00	11413.00	

†These motors are for hazardous conditions—tested and listed by Underwriters' Laboratories—as follows:

Class I, Group D—All frames.

Class II, Group E—Frames 505 and smaller, except 3600 rpm motors in frames 504S and 505S.

Class II, Groups F and G—All frames except 3600 rpm motors in frames 504S and larger.

#Sleeve bearings.

DIRECTION OF ROTATION. For motors in frames 504 and larger at 3600 rpm, the direction of rotation must be specified (as viewed from end opposite driving end), so that fan can be properly arranged for ventilation.

*208 VOLTS. Listed Type K motors in frames 445 and smaller are rated 208-220/440 volts. Motor warranties covering voltage and frequency variation apply to the 220- and 440-volt ratings.

220-volt, 60 cycle ratings in frames 504 and above are usable on 208-volt network systems.

Torques are reduced by approximately 11 per cent, and other characteristics are modified slightly when motors are operated on 208 volts.

▲This page includes "Book" prices subject to discount. For the correct discount, consult Graybar.

G-E Tri-Clad "55" Wound-Rotor Induction Motors

General-Purpose, Dripproof

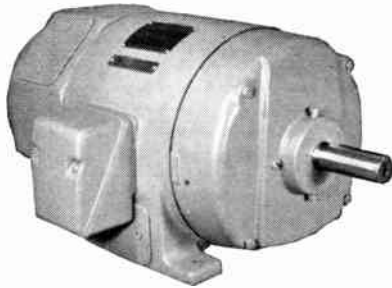

Type M—Tri-Clad wound-rotor motor

Type M—Constant-Speed and Adjustable-Varying-Speed 1-200 H.P., 2 and 3-Phase, 60 Cycles, Continuous Duty, 40°C Rise

Type M wound-rotor induction motors have both constant- and adjustable-varying-speed characteristics, the desired speed characteristics being obtained by selecting controllers of the proper types. This type of motor is suitable for constant-speed applications requiring frequent starting or reversing under heavy load, or where exceptionally high starting torque is encountered. It can also be used on applications requiring adjustable-varying-speed characteristics. For this type of service, the speed can be adjusted to any value over a considerable range but, once adjusted, will vary with change in load.

Type M Wound-rotor 60 Cycles, 3 and 2-Phase

Horsepower Continuous 40° C. Rise	Speed, RPM		Current, Full-Load At 220V.		110 V. (2-Hp & Smaller) 208, 220, 440 & 550 V. (All Ratings) ▲Book Price Sleeve- Bearing			2300 Volts ▲Book Price Sleeve- Bearing		
	Sync.	Full-Load (Min.)	Primary Amperes	Secondary Per Lead	Frame	Motor Only Ball- Bearing	Frame	Motor Only Ball- Bearing		
3	1200	1155	10.4	10.0	254U	\$ 580.00				
3	900	855	11.8	10.0	256U	739.00				
5	1800	1720	16.4	19.0	254U	580.00				
5	1200	1160	17.2	19.0	256U	704.00				
5	900	855	16.8	19.0	284U	888.00				
7 1/2	1800	1715	21.0	23.0	256U	704.00				
7 1/2	1200	1155	24.0	23.0	284U	846.00				
7 1/2	900	855	24.6	23.0	324U	1016.00				
10	1800	1740	28.6	26.5	284U	846.00				
10	1200	1155	31.4	26.5	324U	968.00				
10	900	860	32.2	26.5	326U	1216.00				
15	1800	1740	41.8	32.5	324U	1065.00				
15	1200	1150	45.2	32.5	326U	1216.00				
15	900	865	46.0	43.5	404	\$1474.00				
20	1800	1735	51.8	38.0	326U	1232.00				
20	1200	1160	54.0	38.0	404	1474.00				
20	900	865	59.0	47.5	405	1672.00				
25	3600				404S	2358.00				
25	1800	1735	66.0	77.0	365	1398.00				
25	1200	1160	66.0	40.0	405	1672.00				
25	900	865	68.0	106.0	444	1844.00				
30	3600				405S	2675.00				
30	1800	1740	78.0	87.0	404	1695.00				
30	1200	1165	79.0	99.5	444	1844.00				
30	900	870	83.5	89.0	445	2163.00				
40	3600				444S	2950.00				
40	1800	1740	101	90	405	2006.00				
40	1200	1165	104	100	445	2163.00	445*	\$2631.00		
40	900	870	106.4	75	504U	2537.00	504U*	3018.00		
50	3600				445S	3461.00				
50	1800	1740	127	92	444S	2213.00	445S	2681.00		
50	1200	1170	128	75	504U	2537.00	504U	3005.00		
50	900	870	134.4	75	505	2854.00	505	3322.00		
60	3600				504S	4059.00	504S*	4632.00		
60	1800	1755	149	85	445S	2596.00	504S	3006.00		
60	1200	1170	151	100	505	2854.00	505	3264.00		
60	900	870	163.4	100	505	3102.00	632S	3512.00		
75	3600				505S	4566.00	505S	5139.00		
75	1800	1755	183	145	504S	3044.00	505S	3418.00		
75	1200	1170	188	120	505	3226.00	505	3600.00		
75	900	870	195.4	150	632S	3597.00	632S	3971.00		
100	3600				6326S	5352.00	6326S	5848.00		
100	1800	1760	244	142	505S	3568.00	505S	3942.00		
100	1200	1170	248	150	505S	3904.00	6323S	4278.00		
100	900	870	257	165	6324	4316.00	6324	4690.00		
125	3600				6328S	6123.00	6328S	6558.00		
125	1800	1755	300	159	6323S	4082.00	6323S	4330.00		
125	1200	1170	309	211	6324S	4555.00	6324S	4803.00		
125	900	870	321	168	6325S	4988.00	6325S	5236.00		
150	3600				6338S	6927.00	6328S	7301.00		
150	1800	1755	358	163	6324S	4618.00	6324S	4866.00		
150	1200	1170	370	220	6325S	5237.00	6325S	5424.00		
150	900	870	374	230	6333S	5607.00	6333S	5794.00		
200	3600				6323S	8474.00	6338S	8661.00		
200	1800	1755	478	191	6325S	5649.00	6325S	5836.00		
200	1200	1170	504	198	6333S	6092.00	6333S	6279.00		
200	900	870	496	260	6334S	6823.00	6334S	6999.00		

*Three-phase motors only.

208 Volts. Listed Type M open 220-volt, 60-cycle motors are usable on 208-volt network systems with an 11 per cent torque reduction and other modified characteristics.

Dual Voltage. Motors for 220 and 440 volts in frames 445 and smaller are dual-voltage, 220/440 volts except those two-phase ratings identified as single-voltage.

Temperature Rise. The temperature rise of 3600-rpm motors in frames 504S and larger is 40° C rise on stator and 75° C rise with Class B insulation on rotor.

Horsepower Output. The horsepower output at 50 per cent below normal speed will be approximately 40 per cent of nameplate horsepower for 60-cycle motors and 30 per cent of nameplate horsepower for 60-cycle motors operating at 50-cycles, where 50-cycle operation is authorized. The temperature rise at reduced speed is on a 50° C basis. For constant torque loads, requiring 50 per cent horsepower at 50 per cent speed, consult Graybar.

▲This page includes "Book" prices subject to discount. For the correct discount, consult GRAYBAR.

G-E Tri-Clad "55" Integral-HP Single-Phase Induction Motors

Dripproof, Horizontal 60-Cycle Capacitor-Motors

Type KC—General-Purpose, Capacitor-Motor

Type KCJ—High-Torque, Capacitor-Motor

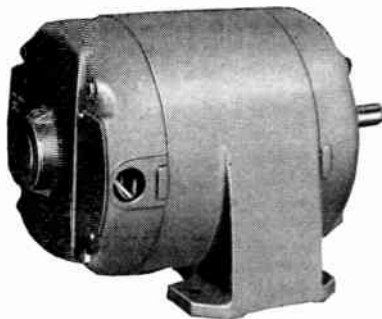

Typical Type KC Tri-Clad "55" Capacitor-Motor

Type KC Tri-Clad "55" capacitor-motors may be used for air compressors, pumps, fans, conveyors, and other general-purpose applications. These motors are rated in accordance with NEMA standards—breakdown torques meet NEMA standards for general-purpose motors—starting currents are of NEMA Classification Design L.

The Tri-Clad "55" design meets the advanced demands of industry. This modern, more enclosed design incorporates the latest developments in the art of motor manufacturing.

Type KCJ Tri-Clad "55" motors are designed for applications requiring high breakdown torque, such as compressors, saws and some farm applications. In general, Type KCJ motors should be selected when application requirements call for high breakdown torque. Contact Graybar for application recommendations.

Horsepower Continuous 40° C Rise	Speed Rpm Sync.	Frame	Volts	Without Thermal Protection		With Thermal Protection Built-in* (Automatic Reset)	
				Model No.	▲Book Price Each	Model No.	▲Book Price, Each
Type KC—General-Purpose							
3/4	1200	184	115/230	5KC184AG601	\$204.00
1	1800	182	115/230	5KC182AG201	131.00
1	1200	213	115/230	5KC213AG601	264.00
1 1/2	3600	182	115/230	5KC182AG1	134.00
1 1/2	1800	184	115/230	5KC184AG201	172.00
1 1/2	1200	215	115/230	5KC215AG601	333.00
2	3600	184	115/230	5KC184AG1	187.00
2	1800	213	115/230	5KC213AG201	231.00
3	3600	213	115/230	5KC213AG1	274.00
3	1800	215	115/230	5KC215AG201	292.00
5	3600	215	230	5KC215AG1	378.00

Type KCJ—High-Torque

1	1800	182	115/230	5KCJ182AG201	131.00	5KCJ182AG201X	\$135.00
1 1/2	1800	184	115/230	5KCJ184AG201	172.00	5KCJ184AG201X	179.00
2	1800	213	115/230	5KCJ213AG201	231.00	5KCJ213AG201T	237.00
3	1800	215	115/230	5KCJ215AG201	292.00

*Automatic-reset thermal protective devices are for use where equipment should be restarted automatically after interruption. Such devices should not be used where automatic restarting would endanger personnel or machines.

Type KCR—Capacitor-Motors

The Type KCR Tri-Clad dripproof motor is built in four frame styles for various applications: horizontal for heavier jobs from single-phase current (all farm applications, plus compressors, blowers, etc.); horizontal end-shield-mounted (for pump, blower, and hoist equipment which are mounted directly on the driving motor); horizontal close-coupled pump (for driving centrifugal pumps); and vertical solid-shaft (for jet pumps, machine tools, and wherever a vertical mounting offers advantages).

Horsepower Continuous 40° C Rise	Speed RPM Sync.	Frame	Volts	▲Book Price Each	Horsepower Continuous 40° C Rise	Speed RPM Sync.	Frame	Volts	▲Book Price Each
3	1200	254	230	590.00	7 1/2	3600	254CZ	230	753.00
5	1800	254	230	487.00	7 1/2	1800	254CZ	230	750.00
7 1/2	3600	254	230	707.00	5	1800	254P	230	531.00
7 1/2	1800	254	230	689.00	7 1/2	3600	254P	230	751.00
5	1800	254C	230	517.00	7 1/2	1800	254P	230	758.00
7 1/2	3600	254C	230	737.00					
7 1/2	1800	254C	230	725.00					

▲This page includes "Book" prices subject to discount. For the correct discount, consult GRAYBAR.

General Electric General-Purpose Synchronous Motors

High-Speed—Open (Drip-Proof)—Horizontal—Two-Bearing

Type TS Tri-Clad—3-Phase, 60 Cycles

Type QS Tri-Clad—2-Phase, 60 Cycles

These motors make complete, compact power units which simply require connection to an a-c power supply for operation. They are especially advantageous where (1) good power factor is desired, (2) where power factor improvement is needed, (3) where high efficiency is wanted (in the case of steady, continuous loads of 75 hp. and larger), or (4) where exact speeds must be maintained.

They have a mechanical simplicity comparable to that of squirrel-cage motors. Where direct-connected exciters are used, the exciter forms an integral part of the motor structure and saves both space and installation cost over other types.

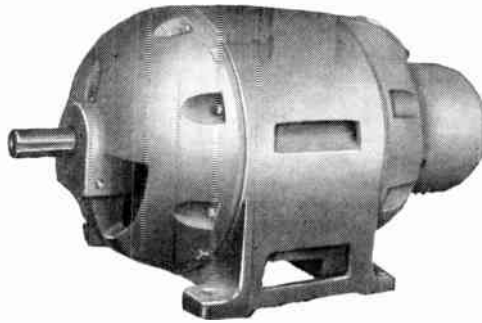

Tri-Clad Synchronous Motor with Direct-Connected Exciter

Tri-Clad construction offers the benefits of smooth contours, attractive appearance, and extra operating life.

Cast iron frame and end shields provide the best possible protection against physical damage.

G-E synchronous motors are particularly suited for driving centrifugal pumps, centrifugal compressors, belt-driven reciprocating compressors, fans, blowers, line shafts, d-e generators, rubber and paper mills, and the like.

Leading-power-factor motors are especially advantageous where other loads are of induction-motor and similar lagging power-factor types.

1.0 Power Factor

Hp. Continuous 40° C.	Speed RPM	Frame	▲Book Price Motor Only		▲Book Price Addition for *Direct- Connected Exciter	Exciter Size Kw.
			220, 440, 550 Volts	2300 Volts		
20	1200	934S	\$1782		\$ 462	.75
25	1200	934	1876	\$1970	462	.75
30	1800	934S	3202	3362	400	.75
	1200	934	1958	2056	462	.75
	900	944	2132	2238	802	1
40	1800	934S	3248	3410	400	.75
	1200	935	2100	2206	522	1
	900	944	2310	2426	802	1
	720	953	2740	2878	926	1
50	1800	934S	3392	3562	400	.75
	1200	944	2260	2374	522	1
	900	945	2516	2642	802	1
	720	953	2944	3092	1012	1.5
	600	954	3470	3644	1160	1.5
60	1800	935S	3790	3980	400	.75
	1200	945	2568	2696	522	1
	900	953	2838	2980	888	1.5
	720	954	3346	3514	1012	1.5
	600	954	3886	4080	1160	1.5
			220, 440, 550 or 2300 Volts			
75	1800	944S	\$4036		\$ 400	.75
	1200	945	2788		522	1
	900	954	3126		888	1.5
	720	955	3616		1012	1.5
	600	963	4224		1274	2
100	1800	945S	4448		448	1
	1200	953S	3162		610	1.5
	900	954	3532		888	1.5
	720	963	4072		1012	1.5
	600	963	4662		1274	2
	514	964	5324		1448	2
125	1800	953S	4838		448	1
	1200	954S	3532		610	1.5
	900	955	3954		888	1.5
	720	963	4478		1132	2
	600	964	5068		1274	2
	514	972	5744		1458	2
150	1800	954S	5234		448	1
	1200	955S	3920		610	1.5
	900	963S	4324		1014	2
	720	964	4864		1132	2
	600	965	5458		1274	2
	514	973	6134		1786	3
200	1800	955S	5888		514	1.5
	1200	963S	4662		610	1.5
	900	964S	5052		1014	2
	720	965	5592		1346	3
	600	972	6184		1496	3
	514	974S	6842		1786	3

0.8 Power Factor

Hp. Continuous 40° C.	Speed RPM	Frame	▲Book Price Motor Only		▲Book Price Addition for *Direct- Connected Exciter	Exciter Size Kw.
			220, 440, 550 Volts	2300 Volts		
20	1200	934	\$1876	\$1970	\$ 522	1
25	1200	934	1958	2056	522	1
	900	944	2132	2238	888	1.5
30	1800	934S	3248	3410	400	.75
	1200	935	2100	2206	522	1
	900	944	2310	2426	888	1.5
	720	953	2470	2878	1012	1.5
40	1800	934S	3392	3436	400	.75
	1200	944	2260	2374	610	1.5
	900	945	2516	2642	888	1.5
	720	953	2944	3092	1012	1.5
	600	954	3470	3644	1274	2
50	1800	935S	3790	3980	448	1
	1200	945	2568	2696	610	1.5
	900	953	2838	2980	888	1.5
	720	954	3346	3514	1132	2
	600	955	3886	4080	1274	2
			220, 440, 550 or 2300 Volts			
60	1800	944S	\$4036		\$ 448	1
	1200	945	2788		610	1.5
	900	954	3126		1014	2
	720	955	3616		1132	2
	600	963	4224		1274	2
75	1800	945S	4448		448	1
	1200	953	3162		610	1.5
	900	954	3532		888	1.5
	720	963	4072		1132	2
	600	963	4662		1496	3
	514	964	5324		1786	3
100	1800	953S	4838		448	1
	1200	954S	3532		610	1.5
	900	955	3954		888	1.5
	720	963	4478		1132	2
	600	964	5068		1496	3
	514	972	5744		1786	3
125	1800	954S	5234		514	1.5
	1200	955S	3920		610	1.5
	900	963	4324		1156	3
	720	964	4864		1346	3
	600	965	5458		1496	3
	514	973	6134		2152	5
150	1800	955S	5888		514	1.5
	1200	963S	4662		610	1.5
	900	964S	5052		1156	3
	720	965	5592		1346	3
	600	972	6184		1496	3
	514	974	6842		2152	5

*Price of direct-connected exciter includes suitable field rheostat.

▲This page includes "Book" prices subject to discount. For correct discount, contact Graybar.

G-E Fractional-HP Industrial Motors

Notice: These fractional-horsepower motors are for industrial service and are available to users, resale purchasers, and distributing manufacturers. They are not to be confused with the fractional-horsepower Utility motors distributed to dealers for farm, home-workshop, and incidental use.

A Complete Line of Advanced-Design Form G Motors



Developed over many years by General Electric, these motors have many outstanding, exclusive electrical and mechanical design features. Available for general or special duty in open and enclosed frames, there is a model suited for nearly any fractional-horsepower application. Up to 10 percent smaller and 50 percent lighter, these motors are easier to handle, mount, and connect.

New Flexibility—new bearing design makes possible all-angle operation. You can use G.E.'s quiet, all-angle sleeve-bearing motors with shaft up, down, or in any position—and with no loss of lubrication. Direction of shaft rotation on all models is easily reversed.

Easy Mounting—easily detachable cradle base means you can mount the base quickly wherever you want the motor, then simply attach the motor to the base with special clamps—which permit the motor rotation within the base.

Long Life—results from new insulation that resists moisture, corrosion, and electrical breakdown. You get the most advanced type of motor insulation in G-E fractional-horsepower motors, with famous G-E Formex* wire and insulating varnish stator protection, neoprene leads, and Mylar† polyester film, made available for the first time in this motor.

Full NEMA Performance—all models meet or exceed AIEE and NEMA requirements.

Quiet, Smooth Running—made possible by completely new design of rotor, including unitized rotor-fan casting, precise rotor balancing, and advanced magnetic design.

Slot and between-phase insulation of "Mylar" polyester film, Formex wire, and insulating varnish treatment make the stator winding strongly resistant to heat, aging, moisture, electrical stresses, and other hazards. Compact, dielectrically strong capacitor helps start heavy loads, reduces starting current.

Unique locking device and thrust washer assembly maintains correct end-play adjustments, absorbs moderate thrust loads, needs no maintenance.

Advanced magnetic design and unified rotor-fan casting provide quiet operation.

Ventilating openings and large fan combine to make a quiet, effective cooling system, providing cool running and long motor life.

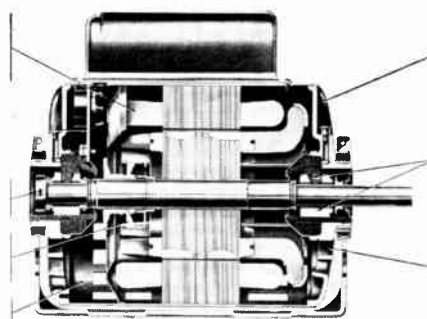

Reinforced, lightweight end shields improve appearance. Flat disk-type design increases strength, promotes free running, lengthens bearing life.

Lubrication system, with extra-large oil reservoir and specially compounded wicking materials, floats bearing surfaces in oil, prevents leakage, permits operation in any position.

Steel cradle base and latches strongly support all-position mounting, permit rotation of motor in base when required, make motor installation easy.

*Reg. trade-mark of General Electric Company.
†Du Pont trade-mark.

G-E Fractional-HP Industrial Motors Open Split-Phase, Type KH, 60 Cycles

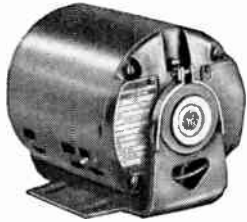

Type KH Motor—Resilient Base

Open (dripproof) construction, continuous duty, quiet all-angle sleeve-bearings, attractive blue-gray enamel finish, detachable base.

Where to Use

40 C Rise Motors—Specially suited for loads which need moderate starting torque (approx. 150% of running torque). Starting current is normal and meets all electrical codes for automatically controlled devices. A 1.35 service factor permits motors to handle loads 35% above nameplate rating. This is advantageous if maximum load is doubtful. Typical applications are furnace and air-conditioning fans and blowers, office machines and similar devices.

50 C Rise Motors—Can be used on loads requiring moderately high starting torque (approx. 200% of running torque). They have high starting currents and should be used only on applications where starting is infrequent. Since service factor is 1.0, motors should be used only when maximum load is known. Typical applications are summer cooling fans, evaporative coolers, small drill presses, jig saws, grinders, etc.

Hp	Rpm	Volts **	NEMA Frame	Standard 40 C. Rise		Special-service 50 C. Rise	
				Model No.	▲Book Price, Each	Model No.	▲Book Price, Each
1/6	1725	115	48	5KH133GG112	\$26.80	5KH132EG116	\$25.90
1/4	1725	115	48	5KH135KG104	28.30	5KH133GG102	26.50
1/3	1725	115	48	5KH135KG111	28.00
1/2	1725	115	56	5KH42JG3#	39.80
						5KH132EG115	\$26.90
						5KH133GG106	27.50
						5KH135KG113	29.00
						5KH42JG5	39.30

**230-volt ratings also available. #This model has double shaft extension (1 7/8-in. by 5/8-in. each end).

Open, Capacitor-Start, Type KC, 60 Cycles



Type KC Motor—Solid Base

Open (dripproof) construction, continuous duty, quiet all-angle sleeve-bearings, attractive blue-gray enamel finish, detachable base.

Where to Use

40 C Rise Motors—Specially designed for applications requiring exceptionally high starting torque (approx. 400% of running torque). Starting current is normal. Service factors of 1.25 to 1.35 provide load-carrying ability above nameplate rating. These extra-heavy-duty motors are ideal when maximum load is doubtful. Typical applications are pumps, air-conditioning compressors, conveyors, industrial equipment, etc.

50 C Rise Motors—Recommended for use on hard-to-start loads (starting torque 250% of running torque). Starting current is normal. Service factor is 1.0 and motors should be used only when maximum load is known. Typical applications are evaporative coolers, milking machines, attic fans, saws, jointers, etc.

Hp	Rpm	Volts **	NEMA Frame	Standard 40 C. Rise		Special-service 50 C. Rise	
				Model No.	▲Book Price, Each	Model No.	▲Book Price, Each
1/4	1725	115	48	5KC36MG105	\$37.40	5KC33GG202	\$34.10
1/3	1725	115/230	56	5KC42JG1	48.90	5KC42JG2	49.90
1/2	3150	115/230	48	5KC37JG150	43.40	5KC381G107	44.40
1/2	1725	115/230	56	5KC43MG1	59.20	5KC42JG4	48.90
1/2	1725	115	56	5KC43JG118††	49.80
3/4	3150	115/230	56	5KC43HG220	59.50	5KC38NG142*††	47.10
3/4	1725	115/230	56	5KC45PG1	74.50	5KC43MG44	59.20
1	3450	115/230	56	5KC47KG119	68.60	5KC45KG47††	65.00
						5KC43MG40	60.20

*These models rated 115 volts and are NEMA 48 frame. †These models have double shaft extension (1 1/2-in. by 1/2-in. each end). ††Have 1 7/8-in. by 5/8-in. double shaft extension.

Totally Enclosed, Fan-Cooled; Split-Phase, Type KH; Capacitor-Start, Type KC; 60 Cycles



Type KC Totally Enclosed Motor

Hp	Rpm	Volts	NEMA Frame	Capacitor-Start		Split-Phase	
				Model No.	▲Book Price, Each	Model No.	▲Book Price, Each
1/6	1725	115	48	5KC36GG113	\$44.10	5KH36GG105	\$36.50
1/4	1725	115	48	5KC38MG201	47.40	5KH37KG102	38.00
1/3	1725	115/230	56	5KC43JG5	58.90
1/2	3150	115/230	48	5KC381G114	53.40
1/2	1725	115/230	56	5KC45MG6	69.20
3/4	3150	115/230	56	5KC47MG18	69.50
3/4	1725	115/230	56	5KC47PG2	84.50
1	3450	115/230	56	5KC47NG4	78.70

Features

Continuous duty, 55 C rise, ball-bearings, lubricated for 10 years, solid detachable cradle base, attractive blue-gray enamel finish.

Where to Use

Same starting torque as 40 C rise open motors. Starting current is normal, and service factor is 1.0. Specially designed for operation in dirty or unfavorable atmospheric conditions.

▲This page includes "Book" prices subject to discount. For the correct discount, consult Graybar.

G-E Fractional-HP Industrial Motors
Type K, Three-phase, 60/50 Cycles



Type K Open Motor

Features

Continuous-duty, all-angle sleeve-bearings for moderate thrust or heavy-duty ball bearings with 10-year lubrication for heavy thrust, attractive blue-gray enamel finish.

Where to Use

For continuous-duty application where power supply is three-phase. Normal torque for starting, high pull-up torque for inertia loads, and high breakdown torque for peak-load conditions.

Hp	Rpm	NEMA Frame	208-220/440 Volts				Totally Enclosed, Fan-Cooled	
			Open (Dripproof), 40 C. Rise		Ball-bearing		55 C. Rise	
			Sleeve-bearing	▲Book Price, Each	Model No.	▲Book Price, Each	Model No.	▲Book Price, Each
1/4	1725/1425	48	5K33GG102	\$45.00	5K33GG202	\$49.00	5K36GG111	\$55.00
1/4	1140/950	56	5K42FG4	68.80	5K42FG85	72.80	5K43FG13	78.80
1/3	3450/2850	48	5K36FG115	40.80	5K36FG205	44.80	5K36FG117	50.80
1/3	1725/1425	56	5K42FG7	53.70	5K42FG36	57.70	5K43FG1	63.70
1/2	1725/1425	56	5K42JG2	59.20	5K42JG50	63.20	5K43JG2	69.20
1/2	1140/950	56	5K43MG4	97.10	5K43MG64	101.10	5K47PG18	107.10
3/4	3450/2850	56	5K43HG136	59.50	5K43HG148	63.50	5K45HG83	69.50
3/4	1725/1425	56	5K43MG3	74.50	5K43MG52	78.50	5K45MG1	84.50
1	3450/2850	56	5K45MG7	68.70	5K45MG93	72.70	5K47MG2	78.70

Thermal Protection

A built-in, automatic-reset thermal protective device is available for single-phase motors. Add to price of motor.

Motor Type	▲Book Price
Single-voltage.....	\$2.70
Dual-voltage.....	3.00

Type BC—Direct-Current, Compound-Wound Motors

For applications where direct-current motors with characteristics similar to those of alternating-current motors are required.



Type BC Open Motor, 40 Frame

Characteristics:

Case Temperature Rise—

Open Motors—40 C.
 Enclosed Motors—55 C.

Time Rating—

Continuous.

RPM—

1/6 to 3/4 Hp—1725.
 1 Hp—3450.

Hp	Volts	Open (Dripproof)		Totally Enclosed		Hp	Volts	Open (Dripproof)		Totally Enclosed	
		Sleeve-bearing	▲Book Price, Each	Ball-bearing	▲Book Price, Each			Sleeve-bearing	▲Book Price, Each	Ball-bearing	▲Book Price, Each
1/6	115	5BC42AB81	\$ 95.97	5BC42AB1285	\$115.55	1/2	115	5BC48AB86	\$159.34	5BC66AB1893	\$188.42
1/6	230	5BC42AB82	99.91	5BC42AB1196	120.07	1/2	230	5BC48AB87	164.59	5BC66AB1894	194.46
1/4	115	5BC44AB1	98.02	5BC44AB593	117.92	3/4	115	5BC68AB125†	187.32	5BC74AB1596	214.62
1/4	230	5BC44AB49	101.96	5BC44AB117	122.43	3/4	230	5BC66AB126†	192.57	5BC74AB1597	220.66
1/3	115	5BC46AB29	108.31	5BC46AB408	129.73	1	115	5BC48AB96	218.30	5BC74AB1592	256.25
1/3	230	5BC46AB30	112.25	5BC46AB89	134.30	1	230	5BC48AB97	223.55	5BC74AB1593	262.29

†Motor has ball-bearings.

▲This page includes "Book" prices subject to discount. For the correct discount, consult Graybar.

G-E Fractional-HP Industrial Motors

Ordering Directions

In placing order, specify:

- | | |
|---|--|
| (1) Complete model number if listed, type (First letters in model number, such as KH, KC, K, etc. | (4) Direction of rotation as viewed from end opposite the shaft-extension end. |
| (2) Horsepower, full-load speed, voltage, and frequency. | (5) Overload protection, if desired. |
| (3) Type of base (solid or resilient). | (6) Enclosure and bearing construction. |
| | (7) Standard control, if desired. |

Mounting Dimensions (For Estimating Only)

Types KC, K, and KH

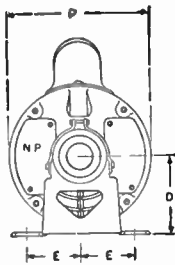

Type KC

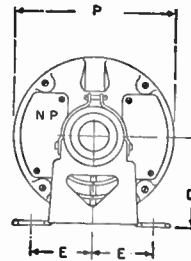
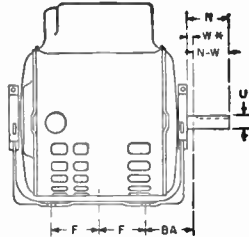

Type K and KH

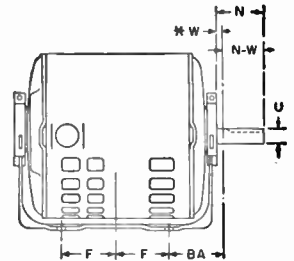

Dimensions In Inches

NEMA Frame	Motor Ratings	Keyway		Length of Flat or Key	U Max.	N Min.	D Max.	E Max.	F Max.	P Max.	BA Max.	N-NW† Max.
		Width	Depth									
48	All	Flat	0.05	1.16	.500	1.50	3.00	2.12	1.380	5.61	2.50	1.63
56	All	0.188	0.094	1.38	.625	1.88	3.50	2.44	1.505	6.42	2.75	2.02

Type BC

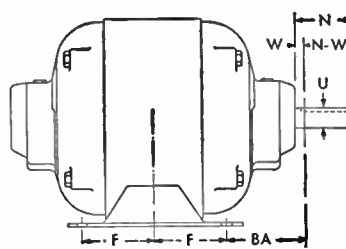
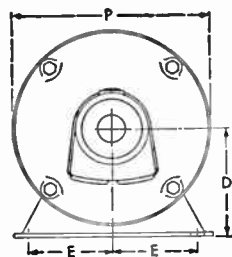

Dimensions In Inches

Motor Frame Group	Motor Ratings	Keyway		Length of Flat or Key	U	N	D	E	F	P	BA	N-NW†
		Width	Depth									
....	1/6 hp, 1725 Rpm & Smaller ¹	Flat	3/64	1 1/8	1/2	1 9/16	3 1/2	2 7/16	1 1/2	6 5/16	2 3/4	1 1/2
40	1/4 hp, 1725 Rpm & Larger ²	3/16	3/32	1 1/2	5/8	1 5/16	3 1/2	2 7/16	1 1/2	6 5/16	2 3/4	1 7/8
60	All	3/16	3/32	1 7/8	3/4	2 5/16	4 1/8	2 15/16	2 1/2	7 1/2	3 1/8	2 1/4
70	All	3/16	3/32	1 7/8	3/4	2 5/16	4 5/8	3 1/4	2 3/4	8 7/16	3 1/8	2 1/4

¹Includes 1/4 hp, 3450 rpm; 1/6 hp, 1725 rpm; 1/8 hp, 1140 rpm; 1/20 hp, 860 rpm; 60 cycle and all smaller ratings built in this frame group.

²Includes 1/3 hp, 3450 rpm; 1/4 hp, 1725 rpm; 1/6 hp, 1140 rpm; 1/2 hp, 860 rpm; 60 cycle and all larger ratings built in this frame group.

†-W = Allowance for variation in castings after final assembly.

G-E Fractional-HP Replacement Motors

This listing represents those models of General Electric motors most commonly used for oil burners, fans, blowers, pumps, and compressors.

Heating and Ventilation Motors

Oil-Burner Motors

Split-phase, sleeve-bearing, 50 C rise, continuous. Enclosure meets Underwriters' Laboratories requirements for totally enclosed oil-burner motors. NEMA standard flange mounted (6 $\frac{3}{8}$ -in. dia. rabbit); built-in manual-reset overload protection; lightweight, compact design, clockwise rotation easily reversed at terminal board; shaft diameter, $\frac{1}{2}$ -inch.



Hp	Volts
$\frac{1}{8}$	115
$\frac{1}{6}$	115
$\frac{1}{6}$	230
$\frac{1}{4}$	115

1725 Rpm—60 Cycles

Model Numbers		Book Price, Each
Two 20-in. Leads Out 3 O'clock*	9.5-in. of 2-conductor Cord. Out 5 O'clock*	
5KH39CG103Y	5KH39CG105Y	\$31.00
5KH32EG108Y	5KH32EG110Y	33.50
5KH32RG109Y	37.10
5KH35KG134Y	43.60

*Lead location described facing end opposite shaft. Standard rotation is clockwise viewing the end opposite shaft. Motors with this rotation will be furnished unless order specifies counter-clockwise.

Small Fan and Blower Motors

Type KSP, 51-frame unit-bearing shaded-pole motors are totally enclosed and have a large sealed-in oil capacity sufficient for years of dependable operation. Equipped with 20 inches of two-conductor cord with eyelets, threaded shaft $\frac{3}{16}$ -in. long with $\frac{1}{4}$ -in.-20 thread and special fan mounting with speed nut, they may be supplied for either horizontal or all-angle operation.

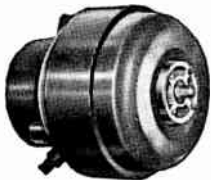

1550 Rpm—115 Volts—60/50 Cycles—Air Over Motor

Horizontal Mounting			All-Angle Mounting		
Watts	Model Numbers	Book Price, Lots 1-99 Each	Watts	Model Numbers	Book Price, Lots 1-99 Each
1.5	5KSP51AL24 (CCW), 5KSP51AL23 (CW)	\$14.35	4	5KSP51AL90 (CCW), 5KSP51AL84 (CW)	\$15.25
4	5KSP51AL56 (CCW), 5KSP51AL55 (CW)	14.35	6	5KSP51CL13 (CCW), 5KSP51CL14 (CW)	17.40
6	5KSP51CL4 (CCW), 5KSP51CL2 (CW)	16.75	9	5KSP51EL80 (CCW), 5KSP51EL115 (CW)	17.85
9	5KSP51EL12 (CCW), 5KSP51EL5 (CW)	17.20			

Accessories (Shipped Separately)

Mounting Brackets			Fan Blades		
Type	Inches High C/L	Book Price, Each	Size, In.	No. Blades	Book Price, Each
Triangular Mounting Plate	1	\$0.60	7 $\frac{3}{4}$	2	\$0.60
Foot Mounting	4 $\frac{1}{8}$.75	8 $\frac{3}{4}$	4	1.15
Foot Mounting	5 $\frac{3}{8}$.75	10	4	1.40

Type KSP 11- and 21-frame motors are specifically designed for all types of fans and blowers, such as room air conditioners, window fans, unit heaters and coolers, furnace blowers, exhaust and circulating fans, and many others that have moderate radial- and axial-thrust loads. Most applications require air over motor. Open construction, all-angle operation, sealed-in oil supply, attractive gray enamel finish, 2 18-in. long leads. Shaft diameter, 11-frame— $\frac{5}{16}$ -in., 21-frame— $\frac{1}{2}$ -in.

A type KSP39 (5 $\frac{1}{2}$ -in. diam.) is also available in a 115-volt motor in $\frac{1}{10}$ -, $\frac{1}{8}$ -, $\frac{1}{6}$ -, and $\frac{1}{4}$ -hp ratings, 1550 and 1050 rpm. Consult Graybar for complete information on this motor.



End Mounted

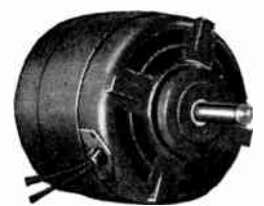

Resilient Ring

115-Volt Motor with Solid Base, Four Tapped Holes for End Mounting

Mini-Hp	Speed, Rpm	Model Nos.		Book Price, Lots 1-99 Each
		CCW Rotation	CW Rotation	
25	1550	5KSP11DG3	5KSP11DG6	\$20.95
25	1050	5KSP21DG933	5KSP21DG935	25.10
35	1550	5KSP11FG4	5KSP11FG7	22.80
35	1050	5KSP21DG937	5KSP21DG939	25.10
Hp				
$\frac{1}{20}$	1550	5KSP21DG941	5KSP21DG943	23.30
$\frac{1}{20}$	1050	5KSP21DG887	5KSP21DG945	27.45
$\frac{1}{16}$	1550	5KSP21FG947	5KSP21FG949	24.35
$\frac{1}{16}$	1050	5KSP21FG950	5KSP21FG952	29.30
$\frac{1}{12}$	1550	5KSP21HG953	5KSP21HG955	29.30
$\frac{1}{12}$	1050	5KSP21HG956	5KSP21HG958	30.30

115-Volt Motor with Rings for Base Mounting*

Mini-Hp	Speed, Rpm	Model Nos.		Book Price, Lots 1-99 Each
		CCW Rotation	CW Rotation	
25	1550	5KSP11DG352	5KSP11DG354	\$21.95
25	1050	5KSP21DG900	5KSP21DG902	26.10
35	1550	5KSP11FG356	5KSP11FG358	23.80
35	1050	5KSP21DG903	5KSP21DG904	26.10
Hp				
$\frac{1}{20}$	1550	5KSP21DG906	5KSP21DG908	24.30
$\frac{1}{20}$	1050	5KSP21DG910	5KSP21DG912	28.45
$\frac{1}{16}$	1550	5KSP21FG914	5KSP21FG916	25.35
$\frac{1}{16}$	1050	5KSP21FG918	5KSP21FG920	30.30
$\frac{1}{12}$	1550	5KSP21HG921	5KSP21HG923	30.30
$\frac{1}{12}$	1050	5KSP21HG925	5KSP21HG927	31.30

*Resilient base and latches for these motors ordered and shipped separately. Book price addition \$1.42.

▲ This page includes "Book" prices subject to discount. For the correct discount, consult Graybar.

G-E Fractional-HP Replacement Motors
Heating and Ventilation Motors (Continued)

Belted Fan and Blower Motors

Single-phase, open, quiet all-angle sleeve-bearings, resilient base; continuous-duty 40 C rise; built-in automatic-reset thermal protection. NEMA std.; moderate starting torque. Split-phase— $\frac{1}{8}$, $\frac{1}{6}$, $\frac{1}{4}$, $\frac{1}{3}$ hp. Capacitor-start— $\frac{1}{2}$, $\frac{3}{4}$ hp.

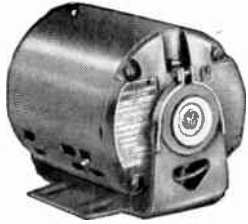

1725 RPM—60 Cycles				
Hp	Volts	Shaft Diam., In.	Model No.	▲Book Price, Each
$\frac{1}{8}$	115	$\frac{1}{2}$	5K1132FG117X	\$29.90†
$\frac{1}{6}$	115	$\frac{1}{2}$	5K1133GG111X	30.50†
$\frac{1}{4}$	115	$\frac{1}{2}$	5K1135KG103X	32.00†
$\frac{1}{3}$	115	$\frac{1}{2}$	5K1138NG201X	40.10†
$\frac{1}{2}$	115/230	$\frac{5}{8}$	5K1143MG24X	69.10†
$\frac{3}{4}$	115/230	$\frac{3}{4}$	5K1145PG8X	86.80†

†Includes thermal protection (automatic-reset).

Pump and Water-System Motors

Jet-Pump Motors

Type KC capacitor-start; open 40 C rise; continuous-duty; flat face-mounting; NEMA standard dimensions; ball-bearing; built-in automatic-reset overload protector; clockwise rotation.



Hp	3450 Rpm—115/230 Volts—60 Cycles		▲Book Price, Each
	With NEMA Std. Shaft with Keyway Shaft Diam. $\frac{5}{8}$ -in.	With NEMA Std. Shaft with $\frac{11}{16}$ -in. Thread. Shaft Diam. $\frac{5}{8}$ -in.	
	Model No.	Model No.	
$\frac{1}{8}$	5KC36FG102X	5KC36FG104X	\$51.10
$\frac{1}{2}$	5KC38JG155X	5KC38JG164X	49.30
$\frac{3}{4}$	5KC43HG12X	5KC43HG14X	58.40
1	5KC47KG7X	5KC47KG9X	68.40

Sump-Pump Motors

Type KH split-phase; vertical flange-mounted; drip-proof; continuous-duty 50 C rise; NEMA std. dimensions; built-in sump switch; built-in automatic-reset overload protector; 8-ft. rubber-covered cord and plug; coupling on shaft; ball-bearing both ends.



Hp	1725 Rpm—115 Volts—60 Cycles		▲Book Price, Each
	Model Numbers	Model Numbers	
	Float Type	Weight Type*	
$\frac{1}{8}$	5K1135KG136X	5K1135KG137X	\$48.75

*Model number includes the General Electric single-pole weight-controlled sump switch (less weights and cable). Weights and cable, where required, should be ordered separately. Consult Graybar for details.

Belt-Driven or Coupled Pump Motors

Type KC capacitor-start, open, quiet all-angle sleeve-bearings; solid base; continuous-duty 40 C rise; built-in automatic-reset thermal protector.



1725 Rpm—60 Cycles			
Hp	Volts	Model No.	▲Book Price, Each
$\frac{1}{4}$	115	5KC36MG105X	\$44.10
$\frac{1}{3}$	115/230	5KC42JG1X	56.20
$\frac{1}{2}$	115/230	5KC43MG1X	68.10
$\frac{3}{4}$	115/230	5KC45PG1X	85.80

▲This page includes "Book" prices subject to discount. For the correct discount, consult Graybar.

G-E Fractional-HP Utility Motors

Notice: General Electric Utility motors are built for farm, home-workshop, and incidental use. Their distribution is limited to dealers handling them as items of stock for retail sale.



Typical 1/2-HP Type KC Utility Motor

New Form G Open (Dripproof), Split-Phase, and Capacitor-Start Solid Base, All-Angle Sleeve-Bearing, 60 Cycles

G-E Utility motors are especially designed for the large variety of general applications in the shop, farm, and home. Their attractive appearance, sturdy construction, dependable low-cost operation, and simple connections make these motors ideal as a high-quality source of power for incidental use.

Outstanding features are—

Continuous duty—50 C rise.

Open (dripproof) construction.*

Motors designed to operate in any position—quiet all-angle sleeve-bearings absorb moderate thrust load.

Attractive finish of durable blue-gray enamel with red and silver label.

Large built-in terminal board—easy to connect.

Strong steel base rigidly clamped to bearing housing.

Split-Phase

Hp	Speed, Rpm	Rating		Full-load, Amp.	Extension	Shaft Features— Dimensions In Inches	Utility Motor Model Number	▲Book Price, Each
		Volts						
1/4	1725	115		5.6	Single	1 1/2 x 1/2 with Flat	5KH33GG102	\$26.50
1/3	1725	115		6.4	Single	1 1/2 x 1/2 with Flat	5KH35KG111	28.00
1/3	1725	115		7.4	Double	1 1/2 x 1/2 with Flat	5KH35KG122	29.50
1/2	1725	115		8.4	Double	1 7/8 x 5/8 with Keyway	5KH42JG3	39.80

Capacitor-Start

1/4	1725	115		5.6	Single	1 1/2 x 1/2 with Flat	5KC33GG202	34.10
1/3	1725	115		6.4	Single	1 1/2 x 1/2 with Flat	5KC35KG101	37.40
1/2	3450	115		8.4	Double	1 1/2 x 1/2 with Flat	5KC37JG115†	42.30
1/2	1725	115/230		8.4/4.2	Single	1 7/8 x 5/8 with Keyway	5KC42JG4	48.90
1/2	1725	115		8.4	Double	1 7/8 x 5/8 with Keyway	5KC43JG118†	49.80
3/4	3450	115		11.2	Double	1 1/2 x 1/2 with Flat	5KC38NG142†	47.10
3/4	1725	115/230		10.6/5.3	Single	1 7/8 x 5/8 with Keyway	5KC43MG44	59.20
1	3450	115/230		13.2/6.6	Double	1 7/8 x 5/8 with Keyway	5KC45KG47	65.00
1	1725	115/230		13/6.5	Single	1 7/8 x 5/8 with Keyway	5KC47SG182	95.10

Shaded-pole—Totally Enclosed (All-angle-operation Fan Kit)

Hp	Speed, Rpm	Rating	Volts	Full-load, Amp.	Extension	Features	Fan Kit Model No.	▲Book Price, Each
9 watts	1550		115	...	Single	Includes motor, 10 in. 2-blade fan, cord & plug, mtg. brackets, and screws.	1E180	\$21.85†

Accessories—Shipped Separately

No.	Description	For G-E Motor Size	▲Book Price, Each
114A421AAG1	8-ft. 2-conductor gray cord, incl. molded plug & cord thru switch.	All 1/4 to 3/4 Hp, incl.	\$3.00
112A515ADG1	8-ft. 2-cond. cord, incl. molded plug & motor mtg. on-off switch.	Frames 33-35-38	4.70
112A515ACG1	Same as above but for frames as listed.	Frames 42-43-45	4.70

*Motors mounted in horizontal position meet NEMA specifications for dripproof construction.

†These motors are ideally suited for home workshop applications because the internal starting switch is protected against saw-dust accumulations.

‡Includes Federal Excise Tax.

Warranty and Service Plan

These motors are backed by dependable 1-year G-E warranty. To aid the purchaser in obtaining prompt in-warranty service, inoperative motors will be repaired by a G-E authorized service station at no charge.

Out-of-warranty failures should be referred to the nearest General Electric authorized service station. For further information consult Graybar.

▲This page includes "Book" prices subject to discount. For the correct discount, consult Graybar.

G-E Fractional-HP Gear Motors

Horizontal, Floor-mounted, 60 Cycles

Open, and Totally Enclosed, Fan-cooled, Types KC Single-phase, and K, Polyphase

Concentric-Shaft, A-C

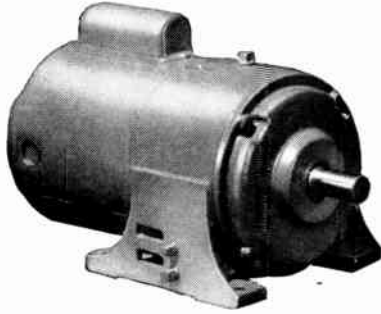

Proved by successful performance on industry's toughest jobs . . . a balanced combination of motor and gear in a single package.

Precision-machined, accurately assembled, helical gearing delivers maximum power at the output shaft.

Where to Use

Fractional-horsepower gear motors are especially applicable where dependable low output speeds are required.

Typical applications include all types of conveyors, mixers, agitators, pumps, materials-handling devices, and machine tools.

1/4 Horsepower

Output Speed RPM	Type KC			Type K		
	Gear Motor Frame Number		▲ Book Price, Each	Gear Motor Frame Number		▲ Book Price, Each
	Open	TEFC		Open	TEFC	
520	042120	043120	\$138.75	042120	043120	\$143.15
420	042120	043120	143.80	042120	043120	148.20
350	042120	043120	148.90	042120	043120	153.30
280	042120	043120	156.60	042120	043120	161.00
230	042120	043120	164.25	042120	043120	168.65
190	042120	043120	171.95	042120	043120	176.35
155	042120	043120	179.60	042120	043120	184.00
125	042220	043220	187.30	042220	043220	191.70
100	042220	043220	197.50	042220	043220	201.90
84	042220	043220	207.70	042220	043220	212.10
68	042220	043220	220.50	042220	043220	224.90
56	042320	043320	230.70	042320	043320	235.10
45	042320	043320	248.65	042320	043320	253.05
37	042320	043320	266.55	042320	043320	270.95
30	042320	043320	287.00	042320	043320	291.40
25	042320	043320	307.40	042320	043320	311.80
20	042320	043320	338.10	042320	043320	342.50
16.5	042328	043328	366.20	042328	043328	370.60
13.5	042328	043328	399.45	042328	043328	403.85

1/3 Horsepower

520	042120	043120	152.05	042120	043120	157.25
420	042120	043120	159.70	042120	043120	164.90
350	042120	043120	164.85	042120	043120	170.05
280	042120	043120	175.05	042120	043120	180.25
230	042120	043120	182.75	042120	043120	187.95
190	042120	043120	190.40	042120	043120	195.60
155	042120	043120	198.10	042120	043120	203.30
125	042220	043220	208.30	042220	043220	213.50
100	042220	043220	218.50	042220	043220	223.70
84	042220	043220	228.75	042220	043220	233.95
68	042220	043220	241.55	042220	043220	246.75
56	042320	043320	256.90	042320	043320	262.10
45	042320	043320	274.75	042320	043320	279.95
37	042320	043320	295.20	042320	043320	300.40
30	042320	043320	318.20	042320	043320	323.40
25	042328	043328	338.70	042328	043328	343.90
20	042328	043328	369.35	042328	043328	374.55
16.5	042332	043332	394.90	042332	043332	400.10
13.5	042332	043332	425.60	042332	043332	430.80

1/2 Horsepower

Output Speed RPM	Type KC			Type K		
	Gear Motor Frame Number		▲ Book Price, Each	Gear Motor Frame Number		▲ Book Price, Each
	Open	TEFC		Open	TEFC	
520	043120	045120	\$177.60	042120	043120	\$177.60
420	043120	045120	185.30	042120	043120	185.30
350	043120	045120	192.95	042120	043120	192.95
280	043120	045120	200.60	042120	043120	200.60
230	043120	045120	210.80	042120	043120	210.80
190	043120	045120	218.50	042120	043120	218.50
155	043120	045120	228.70	042120	043120	228.70
125	043220	045220	238.95	042220	043220	238.95
100	043220	045220	251.75	042220	043220	251.75
84	043220	045220	261.90	042220	043220	261.90
68	043220	045220	274.70	042220	043220	274.70
56	043320	045320	290.05	042320	043320	290.05
45	043320	045320	310.55	042320	043320	310.55
37	043328	045328	331.00	042328	043328	331.00
30	043328	045328	356.50	042328	043328	356.50
25	043328	045328	379.55	042328	043328	379.55
20	043328	045328	415.35	042328	043328	415.35
16.5	043332	045332	446.05	042332	043332	446.05
13.5	043336	045336	479.25	042336	043336	479.25

3/4 Horsepower

520	045120	047120	217.80	043120	045120	217.80
420	045120	047120	228.05	043120	045120	228.05
350	045120	047120	235.70	043120	045120	235.70
280	045120	047120	245.95	043120	045120	245.95
230	045120	047120	253.65	043120	045120	253.65
190	045120	047120	263.80	043120	045120	263.80
155	045120	047120	274.05	043120	045120	274.05
125	045220	047220	286.85	043220	045220	286.85
100	045220	047220	302.20	043220	045220	302.20
84	045220	047220	315.00	043220	045220	315.00
68	045220	047220	332.90	043220	045220	332.90
56	045328	047328	350.75	043228	045228	350.75
45	045328	047328	376.30	043228	045228	376.30
37	045328	047328	401.90	043228	045228	401.90
30	045328	047328	430.05	043228	045228	430.05
25	045332	047332	458.15	043332	045332	458.15
20	045336	047336	493.95	043336	045336	493.95
16.5	045340	047340	527.15	043340	045340	527.15
13.5	045340	047340	562.95	043340	045340	562.95

Rotation: Standard rotation is counterclockwise, facing end opposite shaft. Motors can be reconnected externally for opposite rotation.

▲ This page includes "Book" prices subject to discount. For the correct discount, consult Graybar. Prices are for OPEN style frame only. TEFC style frame is slightly higher.

G-E Fractional-HP Gear Motors

Horizontal, Floor-mounted, 60 Cycles

Open, and Totally Enclosed, Fan-cooled, Type KC Single-phase, and K, Polyphase

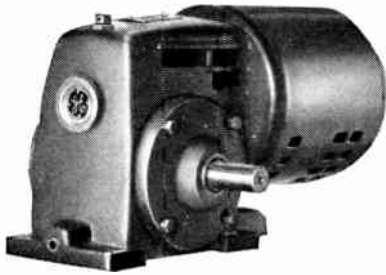

Right-angle-shaft units are particularly useful where space is at a premium, or mounting space is confined. Units are convenient to handle, easy to install.

General Electric right-angle-shaft gear motors are available in both single-reduction and combination worm and planetary designs. By the use of the combination design, maximum efficiency is provided in the lower range of output speeds.

Speed RPM	1/4 Horsepower					
	Type KC			Type K		
	Gear Motor Frame Number	TEFC	▲ Book Price, Each	Gear Motor Frame Number	TEFC	▲ Book Price, Each
197	042712	043712	\$151.40	042712	043712	\$155.80
148	042712	043712	151.40	042712	043712	155.80
99	042712	043712	151.40	042712	043712	155.80
74	042712	043712	151.40	042712	043712	155.80
58	042712	043712	151.40	042712	043712	155.80
48	042712	043712	151.40	042712	043712	155.80
41	042712	043712	151.40	042712	043712	155.80
36	042712	043712	151.40	042712	043712	155.80
32.9	042812	043812	192.55	042812	043812	196.95
29	042712	043712	151.40	042712	043712	155.80
24.6	042812	043812	192.55	042812	043812	196.95
24	042712	043712	210.30	042712	043712	214.70
16.4	042812	043812	192.55	042812	043812	196.95
12.2	042812	043812	192.55	042812	043812	196.95
9.6	042822	043822	221.95	042822	043822	226.35
8	042822	043822	261.85	042822	043822	266.25
6.8	042822	043822	261.85	042822	043822	266.25
6	042822	043822	261.85	042822	043822	266.25
1/3 Horsepower						
197	042712	043712	166.60	042712	043712	171.80
148	042712	043712	166.60	042712	043712	171.80
99	042712	043712	166.60	042712	043712	171.80
74	042712	043712	166.60	042712	043712	171.80
58	042712	043712	166.60	042712	043712	171.80
48	042712	043712	166.60	042712	043712	171.80
41	042712	043712	166.60	042712	043712	171.80
36	042712	043712	166.60	042712	043712	171.80
32.9	042812	043812	209.10	042812	043812	214.30
29	042713	043713	194.55	042713	043713	199.75
24.6	042812	043812	209.10	042812	043812	214.30
24	042713	043713	194.55	042713	043713	199.75
16.4	042822	043822	235.85	042822	043822	241.05
12.2	042822	043822	235.85	042822	043822	241.05
9.6	042822	043822	235.85	042822	043822	241.05
8	042822	043822	291.90	042822	043822	297.10
6.8	042822	043822	291.90	042822	043822	297.10
6	042822	043822	291.90	042822	043822	297.10

Speed RPM	1/2 Horsepower					
	Type KC			Type K		
	Gear Motor Frame Number	TEFC	▲ Book Price, Each	Gear Motor Frame Number	TEFC	▲ Book Price, Each
197	043712	045712	\$197.90	042712	043712	\$197.90
148	043712	045712	197.90	042712	043712	197.90
99	043712	045712	197.90	042712	043712	197.90
74	043712	045712	197.90	042712	043712	197.90
58	043712	045712	197.90	042712	043712	197.90
48	043712	045712	197.90	042712	043712	197.90
41	043712	045713	197.90	042713	043713	197.90
36	043713	045713	197.90	042713	043713	197.90
32.9	043812	045813	249.45	042812	043812	249.45
29	043713	045713	197.90	042713	043713	197.90
24.6	043822	045822	249.45	042822	043822	249.45
24	043713	045713	197.90	042713	043713	197.90
16.4	043822	045822	249.45	042822	043822	249.45
12.2	043822	045822	249.45	042822	043822	249.45
9.6	043822	045822	249.45	042822	043822	249.45
3/4 Horsepower						
197	045712	047712	225.40	043712	045712	225.40
148	045712	047712	225.40	043712	045712	225.40
99	045712	047712	225.40	043712	045712	225.40
74	045712	047712	225.40	043712	045712	225.40
58	045713	047713	225.40	043713	045713	225.40
48	045713	047713	225.40	043713	045713	225.40
41	045713	047713	225.40	043713	045713	225.40
32.9	045822	047822	285.50	043822	045822	285.50
24.6	045822	047822	285.50	043822	045822	285.50
16.4	045822	047822	285.50	043822	045822	285.50

Rotation: Standard rotation is counterclockwise facing end opposite shaft. Motors can be reconnected externally for opposite rotation.

▲ This page includes "Book" prices subject to discount. For the correct discount, consult Graybar.

Prices are for OPEN style frame only. TEFC style frame is slightly higher.

G-E Integral-HP Gear-Motors

*Tri-Clad "55"

Horizontal Floor-mounted

1-3 Hp. A-C

Drip-proof and Totally Enclosed

60 Cycles, Polyphase, 220/440 or 550 Volts

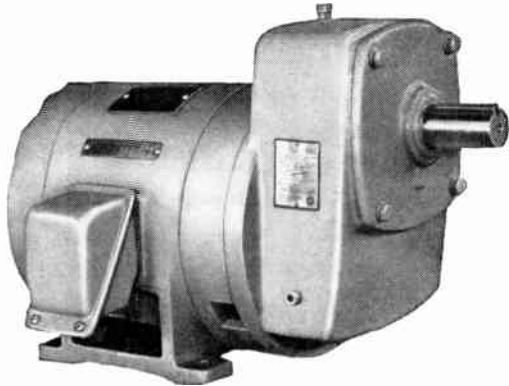

Integral Type Unit

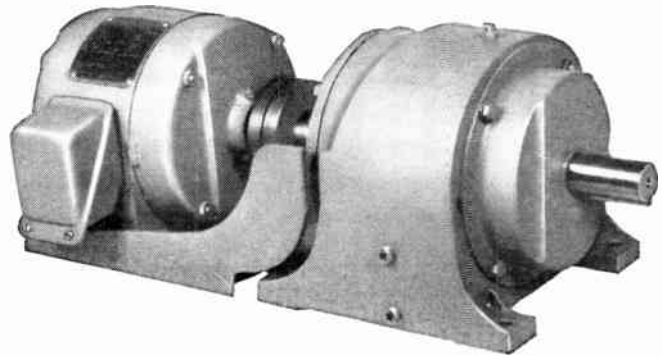

All-Motor Type Unit

Gear-motors provide flexibility and reliability in an easily maintained package for low-speed drives such as conveyors, mixers, fans, and roll drives.

gear unit for compact, one-piece service. With the all-motor type gear-motor, any footed motor may be mounted on a supporting base and coupled to the high-speed shaft of the gear unit.

Consists of a round-frame motor, flange-mounted to the

Integral-Type Unit, Drip-proof Construction

Nominal Output Speed RPM	1 Hp Continuous						2 Hp Continuous					
	Class 1		Class 2		Class 3		Class 1		Class 2		Class 3	
	Gear-motor Frame No.	▲Book Price Each	Gear-motor Frame No.	▲Book Price Each	Gear-motor Frame No.	▲Book Price Each	Gear-motor Frame No.	▲Book Price Each	Gear-motor Frame No.	▲Book Price Each	Gear-motor Frame No.	▲Book Price Each
780	182A129	\$292.00	182B129	\$328.00	182C129	\$370.00	184A129	\$401.00	184B129	\$452.00	184C129	\$510.00
640	182A129	297.00	182B129	335.00	182C129	379.00	184A129	403.00	184B129	454.00	184C129	513.00
520	182A129	301.00	182B129	340.00	182C129	384.00	184A129	407.00	184B129	459.00	184C129	518.00
420	182A129	307.00	182B129	347.00	182C129	393.00	184A129	421.00	184B129	476.00	184C129	538.00
350	182A129	311.00	182B129	352.00	182C129	398.00	184A129	433.00	184B129	490.00	184C229	555.00
280	182A129	321.00	182B229	364.00	182C229	413.00	184A229	446.00	184B229	506.00	184C229	575.00
230	182A229	337.00	182B229	383.00	182C229	435.00	184A229	468.00	184B229	532.00	184C239	606.00
190	182A229	350.00	182B229	399.00	182C229	455.00	184A229	491.00	184B229	561.00	184C239	639.00
155	182A229	368.00	182B229	421.00	182C229	481.00	184A229	513.00	184B239	587.00	184C239	672.00
125	182A229	390.00	182B229	447.00	182C229	512.00	184A229	542.00	184B239	623.00	184C239	714.00
100	182A229	409.00	182B229	471.00	182C239	541.00	184A239	574.00	184B239	661.00	184C249	760.00
84	182A229	425.00	182B229	489.00	182C239	563.00	184A239	599.00	184B239	691.00	184C249	797.00
68	182A229	452.00	182B239	523.00	182C239	603.00	184A239	635.00	184B249	734.00	184C249	848.00
56	182A239	478.00	182B239	554.00	182C239	640.00	184A239	674.00	184B249	782.00	184C249	905.00
45	182A239	509.00	182B239	592.00	182C249	686.00	184A249	711.00	184B249	827.00	184C359	959.00
37	182A239	539.00	182B239	627.00	182C249	728.00	184A249	758.00	184B249	884.00	184C359	1027.00
30	182A349	576.00	182B349	672.00	182C349	782.00	184A349	817.00	184B359	955.00	184C359	1112.00
25	182A349	607.00	182B349	710.00	182C349	828.00	184A349	868.00	184B359	1016.00	184C359	1186.00
20	182A349	656.00	182B349	769.00	182C359	899.00	184A349	940.00	184B359	1104.00	184C369	1292.00
16.5	182A349	705.00	182B349	829.00	182C359	970.00	184A359	1019.00	184B359	1199.00	184C369	1405.00
13.5	182A349	756.00	182B359	890.00	182C359	1044.00	184A359	1080.00	184B369	1273.00	184C369	1493.00
	1 1/2 Hp Continuous						3 Hp Continuous					
780	184A129	344.00	184B129	387.00	184C129	437.00	213A139	462.00	213B139	522.00	213C139	590.00
640	184A129	348.00	184B129	392.00	184C129	442.00	213A139	464.00	213B139	524.00	213C139	593.00
520	184A129	354.00	184B129	399.00	184C129	452.00	213A139	472.00	213B139	534.00	213C139	604.00
420	184A129	362.00	184B129	408.00	184C129	462.00	213A139	484.00	213B139	548.00	213C139	622.00
350	184A129	373.00	184B129	423.00	184C129	479.00	213A139	496.00	213B139	562.00	213C139	639.00
280	184A229	385.00	184B229	437.00	184C229	496.00	213A239	521.00	213B239	593.00	213C239	676.00
230	184A229	405.00	184B229	461.00	184C229	525.00	213A239	541.00	213B239	617.00	213C239	704.00
190	184A229	424.00	184B229	484.00	184C229	553.00	213A239	570.00	213B239	653.00	213C239	747.00
155	184A229	442.00	184B229	506.00	184C239	579.00	213A239	600.00	213B239	688.00	213C249	789.00
125	184A229	463.00	184B229	532.00	184C239	610.00	213A239	633.00	213B239	728.00	213C249	838.00
100	184A229	493.00	184B239	567.00	184C239	653.00	213A239	672.00	213B249	776.00	213C249	894.00
84	184A229	513.00	184B239	591.00	184C239	681.00	213A239	705.00	213B249	816.00	213C249	943.00
68	184A239	542.00	184B239	627.00	184C249	724.00	213A249	749.00	213B249	868.00	213C259	1005.00
56	184A239	573.00	184B239	662.00	184C249	766.00	213A249	796.00	213B249	925.00	213C259	1074.00
45	184A239	613.00	184B249	712.00	184C249	826.00	213A249	849.00	213B259	989.00	213C359	1150.00
37	184A239	654.00	184B249	762.00	184C249	886.00	213A249	907.00	213B259	1061.00	213C359	1236.00
30	184A349	697.00	184B349	814.00	184C359	948.00	213A359	968.00	213B359	1134.00	213C369	1324.00
25	184A349	738.00	184B349	864.00	184C359	1008.00	213A359	1037.00	213B359	1217.00	213C369	1423.00
20	184A349	799.00	184B359	938.00	184C359	1096.00	213A359	1129.00	213B369	1329.00	213C369	1557.00
16.5	184A349	856.00	184B359	1006.00	184C359	1179.00	213A359	1211.00	213B369	1428.00	213C369	1676.00
13.5	184A359	926.00	184B359	1092.00	184C369	1281.00	213A369	1313.00	213B369	1552.00	213C379	1824.00

*Reg. trade-mark of General Electric Co.

▲This page includes "Book" prices subject to discount. For the correct discount, contact Graybar.

G-E Integral-HP Gear-Motors

*Tri-Clad "55"—Horizontal, Floor-Mounted—5-15 H.P.

Dripproof and Totally Enclosed—60 Cycles, Polyphase, 220/440 or 550 Volts

Integral-Type Unit

Nomina Output Speed RPM	5 Hp Continuous						10 Hp Continuous					
	Class I		Class II		Class III		Class I		Class II		Class III	
	Gear-motor Frame No.	▲Book Price Each	Gear-motor Frame No.	▲Book Price Each	Gear-motor Frame No.	▲Book Price Each	Gear-motor Frame No.	▲Book Price Each	Gear-motor Frame No.	▲Book Price Each	Gear-motor Frame No.	▲Book Price Each
780	215A139	\$ 559.00	215B139	\$ 632.00	215C139	\$ 715.00	256A149	\$ 762.00	256B149	\$ 848.00	256C149	\$ 947.00
640	215A139	565.00	215B139	639.00	215C139	724.00	256A149	766.00	256B149	852.00	256C149	952.00
520	215A139	577.00	215B139	653.00	215C139	741.00	256A149	783.00	256B149	873.00	256C149	976.00
420	215A139	590.00	215B139	668.00	215C139	757.00	256A149	801.00	256B149	895.00	256C149	1003.00
350	215A139	610.00	215B139	694.00	215C239	789.00	256A149	825.00	256B149	924.00	256C249	1038.00
280	215A239	636.00	215B239	724.00	215C239	826.00	256A249	860.00	256B249	967.00	256C249	1089.00
230	215A239	665.00	215B239	760.00	215C249	869.00	256A249	894.00	256B249	1008.00	256C259	1138.00
190	215A239	700.00	215B239	803.00	215C249	920.00	256A249	937.00	256B249	1060.00	256C259	1200.00
155	215A239	737.00	215B249	848.00	215C249	974.00	256A249	983.00	256B259	1115.00	256C259	1266.00
125	215A239	781.00	215B249	900.00	215C249	1036.00	256A249	1037.00	256B259	1181.00	256C259	1345.00
100	215A249	830.00	215B249	959.00	215C249	1108.00	256A259	1099.00	256B259	1256.00	256C269	1436.00
84	215A249	871.00	215B249	1009.00	215C259	1167.00	256A259	1152.00	256B259	1320.00	256C269	1512.00
68	215A249	928.00	215B259	1078.00	215C259	1250.00	256A259	1222.00	256B269	1402.00	256C269	1611.00
56	215A249	983.00	215B259	1144.00	215C259	1329.00	256A259	1296.00	256B269	1494.00	256C269	1721.00
45	215A259	1053.00	215B259	1230.00	215C369	1432.00	256A269	1388.00	256B269	1605.00	256C369	1854.00
37	215A259	1126.00	215B259	1318.00	215C369	1537.00	256A269	1476.00	256B269	1712.00	256C379	1981.00
30	215A359	1212.00	215B369	1422.00	215C369	1662.00	256A369	1586.00	256B379	1845.00	256C379	2141.00
25	215A359	1294.00	215B369	1522.00	215C369	1781.00	256A369	1694.00	256B379	1976.00	256C379	2298.00
20	215A369	1406.00	215B369	1657.00	215C379	1943.00	256A379	1840.00	256B379	2153.00
16.5	215A369	1510.00	215B369	1783.00	215C379	2094.00	256A379	1979.00	256B379	2321.00
13.5	215A369	1647.00	215B379	1949.00	215C379	2293.00	256A379	2145.00
7½ Hp Continuous												
780	254A149	\$ 634.00	254B149	\$ 709.00	254C149	\$ 794.00	284A159	\$ 898.00	284B159	\$ 998.00	284C159	\$1113.00
640	254A149	639.00	254B149	715.00	254C149	801.00	284A159	912.00	284B159	1015.00	284C159	1132.00
520	254A149	653.00	254B149	731.00	254C149	821.00	284A159	927.00	284B159	1033.00	284C159	1154.00
420	254A149	666.00	254B149	748.00	254C149	841.00	284A159	948.00	284B159	1056.00	284C159	1182.00
350	254A149	688.00	254B149	774.00	254C149	873.00	284A159	976.00	284B159	1093.00	284C159	1226.00
280	254A249	714.00	254B249	805.00	254C249	910.00	284A259	1019.00	284B259	1144.00	284C259	1287.00
230	254A249	744.00	254B249	842.00	254C249	954.00	284A259	1063.00	284B259	1197.00	284C259	1351.00
190	254A249	783.00	254B249	889.00	254C249	1010.00	284A259	1115.00	284B259	1261.00	284C259	1427.00
155	254A249	820.00	254B249	934.00	254C259	1064.00	284A259	1173.00	284B259	1331.00	284C269	1511.00
125	254A249	864.00	254B249	988.00	254C259	1128.00	284A259	1239.00	284B259	1410.00	284C269	1607.00
100	254A249	920.00	254B249	1055.00	254C259	1209.00	284A259	1315.00	284B269	1503.00	284C269	1717.00
84	254A249	961.00	254B259	1104.00	254C259	1268.00	284A259	1383.00	284B269	1585.00	284C269	1815.00
68	254A259	1024.00	254B259	1180.00	254C269	1359.00	284A269	1471.00	284B269	1691.00	284C279	1943.00
56	254A259	1085.00	254B259	1254.00	254C269	1448.00	284A269	1558.00	284B269	1796.00	284C279	2069.00
45	254A259	1161.00	254B269	1346.00	254C369	1558.00	284A269	1673.00	284B279	1935.00	284C279	2236.00
37	254A259	1241.00	254B269	1443.00	254C369	1674.00	284A269	1781.00	284B279	2067.00	284C379	2393.00
30	254A369	1329.00	254B369	1549.00	254C379	1802.00	284A379	1914.00	284B379	2227.00
25	254A369	1417.00	254B369	1656.00	254C379	1930.00	284A379	2044.00	284B379	2385.00
20	254A369	1539.00	254B379	1804.00	254C379	2106.00	284A379	2219.00
16.5	254A369	1647.00	254B379	1935.00	254C379	2264.00	284A379	2490.00
13.5	254A379	1798.00	254B379	2118.00

*Reg. trade-mark of General Electric Co.

▲This page includes "Book" prices subject to discount. For the correct discount, consult Graybar.

G-E Integral-HP Gear-Motors

*Tri-Clad "55"—Horizontal, Floor-Mounted

Dripproof and Totally Enclosed—60 Cycles, Polyphase, 220/440 or 550 Volts

Integral-Type Unit 20-30 Hp., A-C

20 Hp Continuous

Nominal Output Speed RPM	Class I		Class II		Class III	
	Gear-motor Frame No.	▲Book Price Each	Gear-motor Frame No.	▲Book Price Each	Gear-motor Frame No.	▲Book Price Each
780	286A159	\$1102.00	286B159	\$1216.00	286C159	\$1347.00
640	286A159	1117.00	286B159	1235.00	286C159	1369.00
520	286A159	1136.00	286B159	1257.00	286C159	1396.00
420	286A159	1163.00	286B159	1290.00	286C159	1436.00
350	286A159	1197.00	286B159	1331.00	286C159	1485.00
280	286A259	1239.00	286B259	1382.00	286C259	1546.00
230	286A259	1295.00	286B259	1450.00	286C259	1628.00
190	286A259	1354.00	286B259	1522.00	286C259	1714.00
155	286A259	1422.00	286B259	1604.00	286C259	1812.00
125	286A259	1495.00	286B259	1692.00	286C259	1918.00
100	286A269	1588.00	286B269	1805.00	286C269	2053.00
84	286A269	1671.00	286B269	1905.00	286C279	2173.00
68	286A269	1771.00	286B279	2026.00	286C279	2318.00
56	286A269	1880.00	286B279	2158.00	286C279	2475.00
45	286A279	2010.00	286B279	2316.00
37	286A279	2142.00	286B279	2476.00
30	286A379	2305.00
25	286A379	2471.00
20
16.5
13.5

25 Hp Continuous

780	324A159	1277.00	324B159	1408.00	324C159	1557.00
640	324A159	1292.00	324B159	1426.00	324C159	1580.00
520	324A159	1312.00	324B159	1451.00	**	**
420	324A159	1346.00	324B159	1492.00	**	**
350	324A159	1378.00	324B269	1531.00	324C269	1709.00
280	324A269	1438.00	324B269	1603.00	324C269	1791.00
230	324A269	1500.00	324B269	1678.00	324C269	1882.00
190	324A269	1567.00	324B269	1758.00	324C269	1978.00
155	324A269	1641.00	324B269	1849.00	324C269	2086.00
125	324A269	1739.00	324B269	1968.00	324C269	2228.00
100	324A269	1846.00	324B269	2097.00	324C279	2383.00
84	324A269	1933.00	324B279	2201.00	324C279	2508.00
68	324A269	2056.00	324B279	2351.00	324C279	2688.00
56	324A279	2184.00	324B279	2505.00
45	324A279	2350.00
37	324A279	2490.00
30	324A379	2677.00
25
20
16.5
13.5

30 Hp Continuous

780	326A159	1433.00	326B159	1576.00	326C159	1740.00
640	326A159	1443.00	326B159	1601.00	326C159	1770.00
520	326A159	1477.00	326B159	1630.00	**	**
420	326A159	1519.00	**	**	**	**
350	326A159	1564.00	326B269	1734.00	326C269	1930.00
280	326A269	1625.00	326B269	1808.00	326C269	2018.00
230	326A269	1703.00	326B269	1903.00	326C269	2131.00
190	326A269	1777.00	326B269	1993.00	326C269	2239.00
155	326A269	1870.00	326B269	2106.00	326C279	2374.00
125	326A269	1975.00	326B269	2233.00	326C279	2527.00
100	326A269	2096.00	326B279	2378.00	326C279	2701.00
84	326A269	2197.00	326B279	2501.00	326C279	2849.00
68	326A279	2347.00	326B279	2682.00
56	326A279	2477.00
45	326A279	2675.00
37	326A279	2850.00
30
25
20
16.5
13.5

**Refer to Graybar

*Reg. trade-mark of General Electric Co.

▲This page includes "Book" prices subject to discount. For the correct discount, please contact GRAYBAR.

For d-c prices on all-motor type units, contact GRAYBAR.

All Motor-Type Unit 1 to 3 Hp., A-C

1 Hp Continuous

Nominal Output Speed RPM	Class 1		Class 2		Class 3	
	Gear-motor Frame No.	▲Book Price Each	Gear-motor Frame No.	▲Book Price Each	Gear-motor Frame No.	▲Book Price Each
350	182A229	\$ 330.00	182B229	\$ 376.00	182C229	\$ 426.00
280	182A229	341.00	182B229	389.00	182C229	443.00
230	182A229	359.00	182B229	410.00	182C229	467.00
190	182A229	373.00	182B229	427.00	182C229	489.00
155	182A229	393.00	182B229	451.00	182C229	517.00
125	182A229	417.00	182B229	480.00	182C229	552.00
100	182A229	438.00	182B229	506.00	182C229	583.00
84	182A229	456.00	182B229	526.00	182C229	608.00
68	182A229	486.00	182B229	564.00	182C229	652.00
56	182A239	514.00	182B239	598.00	182C239	692.00
45	182A239	548.00	182B239	640.00	182C249	742.00
37	182A239	581.00	182B239	678.00	182C249	789.00
30	182A349	622.00	182B349	728.00	182C349	849.00
25	182A349	656.00	182B349	769.00	182C349	899.00
20	182A349	710.00	182B349	834.00	182C359	977.00
16.5	182A349	764.00	182B349	900.00	182C359	1055.00
13.5	182A349	820.00	182B359	967.00	182C359	1137.00

1½ Hp Continuous

350	184A229	397.00	184B229	452.00	184C229	513.00
280	184A229	410.00	184B229	467.00	184C229	532.00
230	184A229	432.00	184B229	493.00	184C229	564.00
190	184A229	453.00	184B229	519.00	184C229	595.00
155	184A229	472.00	184B229	543.00	184C239	623.00
125	184A229	496.00	184B229	571.00	184C239	657.00
100	184A229	529.00	184B239	610.00	184C239	705.00
84	184A229	551.00	184B239	636.00	184C239	735.00
68	184A239	582.00	184B239	676.00	184C249	783.00
56	184A239	617.00	184B239	725.00	184C249	829.00
45	184A239	661.00	184B249	769.00	184C249	895.00
37	184A239	706.00	184B249	824.00	184C249	961.00
30	184A349	753.00	184B349	882.00	184C359	1029.00
25	184A349	798.00	184B349	937.00	184C359	1095.00
20	184A349	865.00	184B359	1018.00	184C359	1192.00
16.5	184A349	928.00	184B359	1093.00	184C359	1283.00
13.5	184A359	1005.00	184B359	1187.00	184C369	1395.00

2 Hp Continuous

350	184A229	460.00	184B229	523.00	184C229	595.00
280	184A229	475.00	184B229	541.00	184C229	617.00
230	184A229	499.00	184B229	569.00	184C239	651.00
190	184A229	524.00	184B229	601.00	184C239	688.00
155	184A229	548.00	184B239	630.00	184C239	723.00
125	184A229	580.00	184B239	669.00	184C239	769.00
100	184A239	615.00	184B239	711.00	184C249	820.00
84	184A239	643.00	184B239	744.00	184C249	861.00
68	184A239	683.00	184B249	791.00	184C249	917.00
56	184A239	725.00	184B249	844.00	184C249	980.00
45	184A249	766.00	184B249	894.00	184C359	1039.00
37	184A249	818.00	184B249	956.00	184C359	1114.00
30	184A349	883.00	184B359	1035.00	184C359	1207.00
25	184A349	939.00	184B359	1102.00	184C359	1289.00
20	184A359	1018.00	184B359	1198.00	184C369	1405.00
16.5	184A359	1105.00	184B359	1303.00	184C369	1530.00
13.5	184A359	1172.00	184B369	1384.00	184C369	1626.00

3 Hp Continuous

350	213A239	528.00	213B239	600.00	213C239	685.00
280	213A239	555.00	213B239	635.00	213C239	726.00
230	213A239	577.00	213B239	666.00	213C239	757.00
190	213A239	609.00	213B239	701.00	213C239	804.00
155	213A239	642.00	213B239	739.00	213C249	850.00
125	213A239	679.00	213B239	783.00	213C249	904.00
100	213A239	721.00	213B249	836.00	213C249	966.00
84	213A239	758.00	213B249	880.00	213C249	1020.00
68	213A249	806.00	213B249	937.00	213C259	1088.00
56	213A249	858.00	213B249	1000.00	213C259	1164.00
45	213A249	916.00	213B259	1070.00	213C359	1247.00
37	213A249	980.00	213B259	1149.00	213C359	1342.00
30	213A359	1047.00	213B359	1230.00	213C369	1439.00
25	213A359	1123.00	213B359	1321.00	213C369	1548.00
20	213A359	1224.00	213B369	1444.00	213C369	1695.00
16.5	213A359	1314.00	213B369	1553.00	213C369	1826.00
13.5	213A369	1427.00	213B369	1689.00	213C379	1989.00

G-E Integral-HP Gear-Motors

*Tri-Clad "55"—Horizontal, Floor-Mounted

Drip-proof and Totally Enclosed—60 Cycles, Polyphase, 220/440 or 550 Volts

All-Motor Type Unit

5—15 Hp., A-C

5 Hp Continuous

Nominal Output Speed RPM	Class 1			Class 2			Class 3		
	Gear-motor Frame No.	▲ Book Price Each		Gear-motor Frame No.	▲ Book Price Each		Gear-motor Frame No.	▲ Book Price Each	
350	215A239	\$ 650.00		215H239	\$ 742.00		215C239	\$ 847.00	
280	215A239	678.00		215H239	775.00		215C239	887.00	
230	215A239	710.00		215H239	815.00		215C249	935.00	
190	215A239	749.00		215H239	862.00		215C249	991.00	
155	215A239	790.00		215H249	912.00		215C249	1050.00	
125	215A239	838.00		215H249	969.00		215C249	1118.00	
100	215A249	892.00		215H249	1034.00		215C259	1198.00	
84	215A249	937.00		215H249	1089.00		215C259	1263.00	
68	215A249	1000.00		215H259	1165.00		215C259	1354.00	

56	215A249	1060.00		215H259	1237.00		215C259	1441.00	
45	215A259	1137.00		215H259	1332.00		215C369	1554.00	
37	215A259	1217.00		215H259	1429.00		215C369	1670.00	
30	215A359	1312.00		215H369	1543.00		215C369	1807.00	
25	215A359	1402.00		215H369	1653.00		215C369	1938.00	
20	215A369	1525.00		215H369	1802.00		215C379	2116.00	
16.5	215A369	1640.00		215H369	1940.00		215C379	2282.00	
13.5	215A369	1791.00		215H379	2123.00		215C379	2501.00	

7½ Hp. Continuous

350	254A249	729.00		254H249	824.00		254C249	933.00	
280	254A249	758.00		254H249	858.00		254C249	973.00	
230	254A249	791.00		254H249	898.00		254C249	1022.00	
190	254A249	834.00		254H249	950.00		254C249	1083.00	
155	254A249	874.00		254H249	1000.00		254C259	1143.00	
125	254A249	923.00		254H249	1059.00		254C259	1213.00	
100	254A249	984.00		254H259	1133.00		254C259	1302.00	
84	254A249	1029.00		254H259	1187.00		254C259	1367.00	
68	254A259	1099.00		254H259	1270.00		254C269	1467.00	

56	254A259	1166.00		254H259	1352.00		254C269	1565.00	
45	254A259	1249.00		254H269	1453.00		254C369	1686.00	
37	254A259	1337.00		254H269	1560.00		254C369	1814.00	
30	254A369	1434.00		254H369	1676.00		254C379	1954.00	
25	254A369	1531.00		254H369	1794.00		254C379	2095.00	
20	254A369	1665.00		254H379	1957.00		254C379	2289.00	
16.5	254A369	1784.00		254H379	2101.00		254C379	2463.00	
13.5	254A379	1950.00		254H379	2302.00		254C389	2702.00	

10 Hp Continuous

350	256A249	872.00		256H249	981.00		256C249	1107.00	
280	256A249	911.00		256H249	1029.00		256C249	1163.00	
230	256A249	948.00		256H249	1074.00		256C259	1217.00	
190	256A249	996.00		256H249	1131.00		256C259	1285.00	
155	256A249	1046.00		256H259	1191.00		256C259	1357.00	
125	256A249	1106.00		256H259	1264.00		256C259	1444.00	
100	256A259	1174.00		256H259	1347.00		256C269	1544.00	
84	256A259	1232.00		256H259	1417.00		256C269	1628.00	
68	256A259	1309.00		256H269	1507.00		256C269	1737.00	

56	256A259	1390.00		256H269	1608.00		256C269	1858.00	
45	256A269	1492.00		256H269	1730.00		256C369	2004.00	
37	256A269	1588.00		256H269	1848.00		256C379	2144.00	
30	256A369	1709.00		256H379	1994.00		256C379	2320.00	
25	256A369	1828.00		256H379	2138.00		256C379	2493.00	
20	256A379	1989.00		256H379	2333.00		256C389	2726.00	
16.5	256A379	2142.00		256H379	2518.00		256C389	2947.00	
13.5	256A379	2324.00		256H389	2739.00		256C389	3212.00	

15 Hp Continuous

350	284A259	1031.00		284H259	1160.00		284C259	1306.00	
280	284A259	1079.00		284H259	1216.00		284C259	1374.00	
230	284A259	1127.00		284H259	1275.00		284C259	1444.00	
190	284A259	1184.00		284H259	1345.00		284C259	1528.00	
155	284A259	1248.00		284H259	1422.00		284C269	1620.00	
125	284A259	1321.00		284H259	1509.00		284C269	1726.00	
100	284A259	1404.00		284H269	1611.00		284C269	1847.00	
84	284A259	1479.00		284H269	1701.00		284C269	1954.00	
68	284A269	1576.00		284H269	1818.00		284C279	2095.00	

56	284A269	1672.00		284H269	1933.00		284C279	2234.00	
45	284A269	1798.00		284H279	2086.00		284C279	2417.00	
37	284A269	1917.00		284H279	2232.00		284C379	2590.00	
30	284A379	2063.00		284H379	2408.00		284C389	2801.00	
25	284A379	2206.00		284H379	2581.00		284C389	3009.00	
20	284A379	2399.00		284H389	2813.00		284C389	3288.00	
16.5	284A379	2697.00		284H389	3174.00		284C389	3720.00	
13.5	284A389	2833.00		284H389	3339.00		

20—40 Hp., A-C

20 Hp Continuous

Nominal Output Speed RPM	Class I			Class II			Class III		
	Gear-motor Frame No.	▲ Book Price Each		Gear-motor Frame No.	▲ Book Price Each		Gear-motor Frame No.	▲ Book Price Each	
350	286A259	\$1261.00		286H259	\$1409.00		286C259	\$1578.00	
280	286A259	1307.00		286H259	1465.00		286C259	1645.00	
230	286A259	1369.00		286H259	1539.00		286C269	1735.00	
190	286A259	1434.00		286H259	1619.00		286C269	1830.00	
155	286A259	1509.00		286H269	1709.00		286C269	1938.00	
125	286A259	1589.00		286H269	1806.00		286C269	2054.00	
100	286A269	1691.00		286H269	1930.00		286C269	2203.00	
84	286A269	1783.00		286H269	2040.00		286C279	2335.00	
68	286A269	1893.00		286H279	2173.00		286C279	2494.00	

56	286A269	2012.00		286H279	2318.00		286C279	2667.00	
45	286A279	2155.00		286H279	2492.00		286C289	2876.00	
37	286A279	2301.00		286H279	2668.00		286C389	3086.00	
30	286A379	2480.00		286H389	2884.00		286C389	3346.00	
25	286A379	2663.00		286H389	3105.00		286C389	3611.00	
20	286A389	2903.00		286H389	3396.00		286C389	3959.00	
16.5	286A389	3129.00		286H389	3669.00		
13.5	286A389	3395.00		

25 Hp Continuous

350	324A269	1451.00		324H269	1619.00		324C269	1810.00	
280	324A269	1517.00		324H269	1698.00		324C269	1905.00	
230	324A269	1585.00		324H269	1781.00		324C269	2005.00	
190	324A269	1658.00		324H269	1869.00		324C269	2111.00	
155	324A269	1740.00		324H269	1969.00		324C269	2229.00	
125	324A269	1848.00		324H269	2100.00		324C269	2386.00	
100	324A269	1965.00		324H269	2241.00		324C279	2566.00	
84	324A269	2061.00		324H279	2356.00		324C279	2694.00	
68	324A269	2196.00		324H279	2521.00		324C279	2892.00	

56	324A279	2337.00		324H279	2690.00		324C289	3094.00	
45	324A279	2520.00		324H289	2911.00		324C289	3359.00	
37	324A279	2674.00		324H289	3098.00		324C389	3583.00	
30	324A389	2879.00		324H389	3347.00		324C389	3880.00	
25	324A389	3097.00		324H389	3611.00		324C389	4197.00	
20	324A389	3371.00		324H389	3942.00		
16.5	324A389	3660.00		

G-E Integral-HP Gear-Motors

Tri-Clad "55"—Horizontal, Floor-Mounted—Class I, 1 to 5 H.P.
 Dripproof and Totally Enclosed—60 Cycles, Polyphase, 220/440 or 550 Volts
Right-Angle Shaft

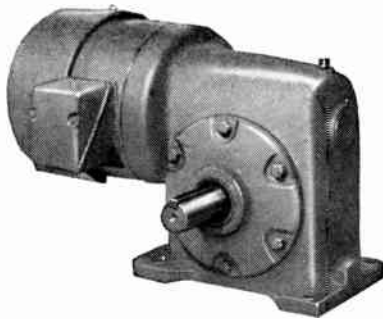

Where To Use

Right-angle shaft worm gear-motors are normally used when mounting configuration does not permit the use of either the concentric- or offset-shaft ratings. Examples of typical right-angle shaft applications are conveyors, door operators, and confined mounting positions on some machine tools.

1 Horsepower

Nominal Output Speed, RPM*	Gear-motor Frame No.	▲ Book Price, Each		
		Drip-proof	Totally Enclosed Non-ventilated	Explosion-proof
190	182A713	\$264.00	\$297.00	\$349.00
155	182A713	276.00	309.00	361.00
125	182A713	290.00	323.00	375.00
100	182A713	302.00	335.00	387.00
84	182A713	312.00	345.00	397.00
68	182A713	329.00	362.00	414.00
56	182A713	345.00	378.00	430.00
45	182A714	365.00	398.00	450.00
37	182A813	384.00	417.00	469.00

1½ Horsepower

190	184A713	319.00	353.00	405.00
155	184A713	330.00	364.00	416.00
125	184A713	344.00	378.00	430.00
100	184A713	363.00	397.00	449.00
84	184A713	375.00	409.00	461.00
68	184A714	394.00	428.00	480.00
56	184A714	413.00	447.00	499.00
45	184A714	438.00	472.00	524.00
37	184A813	464.00	498.00	550.00

2 Horsepower

Nominal Output Speed, RPM*	Gear-motor Frame No.	▲ Book Price, Each		
		Drip-proof	Totally Enclosed Fan-† Cooled	Explosion-proof
190	184A713	\$369.00	\$421.00	\$473.00
155	184A713	383.00	435.00	487.00
125	184A713	402.00	454.00	506.00
100	184A714	422.00	474.00	526.00
84	184A714	438.00	490.00	542.00
68	184A714	460.00	512.00	564.00
56	184A715	485.00	537.00	589.00
45	184A715	509.00	561.00	613.00
37	184A813	538.00	590.00	642.00

3 Horsepower

190	213A714	426.00	496.00
155	213A714	445.00	515.00
125	213A714	466.00	536.00
100	213A714	491.00	561.00
84	213A715	511.00	581.00
68	213A715	539.00	609.00
56	213A715	569.00	639.00
45	213A716	602.00	672.00
37	213A814	639.00	709.00

5 Horsepower

190	215A714	521.00	591.00
155	215A715	544.00	614.00
125	215A715	572.00	642.00
100	215A715	603.00	673.00
84	215A716	629.00	699.00
68	215A716	665.00	735.00

*Nominal speeds are full-load speeds and are based on 1750-rpm full-load motor speed. If motor full-load speeds vary slightly, output-shaft speed will change.

†Totally enclosed, nonventilated in 2-hp ratings.

For Class II and Class III right-angle shaft gear-motors, and for single-phase right-angle shaft gear-motors, contact Graybar.

Nominal Output Speed Rpm*	1 Hp.		1½ Hp.		2 Hp.		3 Hp.		5 Hp.	
	Gear Frame	Nominal Output Torque In-Lb. Minimum Sprocket Dia., In.	Gear Frame	Nominal Output Torque In-Lb. Minimum Sprocket Dia., In.	Gear Frame	Nominal Output Torque In-Lb. Minimum Sprocket Dia., In.	Gear Frame	Nominal Output Torque In-Lb. Minimum Sprocket Dia., In.	Gear Frame	Nominal Output Torque In-Lb. Minimum Sprocket Dia., In.
190	713	275 2¼	713	410 2¼	713	550 2¼	714	825 3	714	1375 3
155	713	340 2¼	713	510 2¼	713	680 2¼	714	1020 3	715	1700 3¾
125	713	400 2¼	713	600 2¼	713	800 2¼	714	1200 3	715	2000 3¾
100	713	480 2¼	713	720 2¼	714	960 3	714	1140 3	715	2400 3¾
84	713	560 2¼	713	840 2¼	714	1120 3	715	1680 3¾	716	2800 4½
68	713	660 2¼	714	990 3	714	1320 3	715	1980 3¾	716	3300 4½
56	713	765 2¼	714	1147 3	715	1530 3¾	715	2295 3¾
45	714	870 3	714	1305 3	715	1740 3¾	716	2610 4½
37	813	960 2¼	813	1440 3½	813	1920 †	814	2890 3½

▲ This page includes "Book" prices subject to discount. For the correct discount, consult Graybar.

G-E Direct-Current Motors

Dripproof—Industrial—Kinamatic*

Type CD (Frames 186A-505A) 150 HP and Smaller

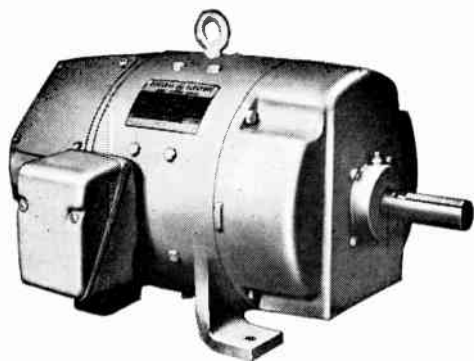

Type CD Kinamatic motors in frames 186 to 505 conform to new NEMA Standards for industrial direct-current motors. Designed to supersede the "constant-speed" and "adjustable-speed" general-purpose direct-current motors. All motors are suitable for operation over wide speed ranges by a combination of field control and armature-voltage control. Equipped throughout with Class B insulation and rated 60 C. rise for continuous operation at base speed. Especially suitable for use in adjustable-voltage systems where precise, stepless

speed control with constant torque output may be obtained in a relatively simple manner. Additional speed range with gradually increasing available horsepower output may be obtained by using a rheostat to weaken the motor shunt-field excitation.

The completely integrated design of General Electric Kinamatic d-c motors permits application flexibility. Low armature inertia and high transient commutating ability make them ideal for systems involving quick starting, stopping, and reversing duty. The greater protection offered by the dripproof enclosure and Class B insulation permits application of the standard motor in much more severe environmental conditions than is possible with general-purpose motors. Rugged ball bearings permit mounting at any angle—horizontal to vertical, shaft up or down.

Typical applications include drives for machine tools, such as lathes, milling machines, boring machines, and grinding wheels. Can be used in the paper, textile, steel, printing, rubber, and plastic industries for driving reels, rollers, conveyors, and other continuous-processing machinery where speed flexibility is required.

Standard voltage rating 210 volts.

Ratings

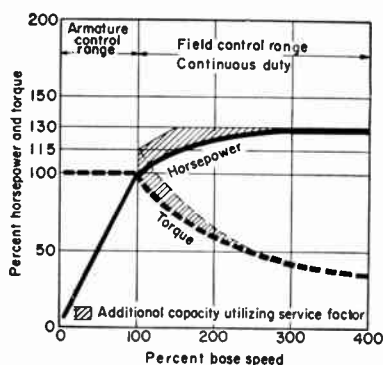

Graphical Representation of Ratings

Continuous Ratings

1. Continuous 60 C. Operation:

- The standard hp rating is the continuous 60 C. rating at base speed.
- At 300 per cent base speed and above, the continuous 60 C. rating is 130-133 per cent of the standard hp. rating.

2. Service-factor Operation:

- At base speed, the service-factor rating is 115 per cent of the standard hp. rating.
- Between 150 per cent and 300 per cent base speed, the service-factor rating is 130 per cent of the standard hp. rating.
- Above 300 per cent base speed, there is no service factor. For continuous 60 C. rating above 300 per cent base speed, see 1 (b).

Short-time Ratings

Standard Kinamatic dripproof industrial direct-current motors are suitable for operation at the next-higher standard horsepower rating without service factor for intermittent-duty application, such as cranes and machine tools.

Adjustable-Voltage Operation

Suitable for reduced-speed operation by adjustable armature voltage. Some derating may be necessary for applications requiring extended periods of low speed operation at full-load torque.

Ambient Conditions

Designed for operation in a 40 C. ambient temperature and at altitudes up to 3300-ft. above sea level. These motors can be operated in ambient temperatures up to 50 C. or altitudes up to 8800-ft. without service factor.

Enclosure

The standard enclosure for Kinamatic direct-current motors is dripproof. These motors are so constructed that drops of liquid or solid particles falling at any angle not greater than 15 degrees from the vertical cannot enter the motor, either directly or by sticking and running along a horizontal or inwardly inclined surface.

*Trade-mark of General Electric Company.

G-E Direct-Current Motors
Dripproof—Industrial—Kinematic
Type CD (Frames 186A-505A) 150 HP and Smaller

Horsepower Cont. 60 C.		Speed, Rpm		†Frame	▲Book Price, Each
At Base Speed	At 300% Base Speed	Base Speed	Rated Top Speed		
½	.65	850	3000	187A	\$ 328.00
	.65	650	2600	215A	380.00
	.65	500	2000	216A	440.00
	.65	400	1600	216A	500.00
¾	1.0	1150	3200	187A	304.00
	1.0	850	3000	215A	360.00
	1.0	650	2600	216A	415.00
	1.0	500	2000	254A	768.00
	1.0	400	1600	254A	860.00
1	1.3	1750	3500	186A	292.00
	1.3	1150	3200	187A	333.00
	1.3	850	2800	216A	396.00
	1.3	650	2600	254A	725.00
	1.3	500	2000	254A	812.00
	1.3	400	1600	256A	932.00
	1.3	400	1600	256A	932.00
1½	2.0	3500	4000	186A	315.00
	2.0	2500	4000	186A	324.00
	2.0	1750	3500	187A	332.00
	2.0	1150	3000	215A	396.00
	2.0	850	2800	254A	676.00
	2.0	650	2600	254A	792.00
	2.0	500	2000	256A	915.00
2	2.6	3500	4000	186A	351.00
	2.6	2500	4000	187A	361.00
	2.6	1750	3300	215A	370.00
	2.6	1150	3000	216A	462.00
	2.6	850	2600	254A	718.00
	2.6	650	2600	256A	852.00
	2.6	500	2000	284A	1022.00
	2.6	400	1600	286A	1196.00
3	4.0	3500	4000	186A	433.00
	4.0	2500	3700	215A	445.00
	4.0	1750	3300	216A	456.00
	4.0	1150	2800	254A	702.00
	4.0	850	2600	256A	856.00
	4.0	650	2600	284A	1010.00
	4.0	500	2000	286A	1218.00
	4.0	400	1600	326A	1432.00
5	6.5	3500	3700	216A	570.00
	6.5	2500	3700	216A	586.00
	6.5	1750	3000	254A	728.00
	6.5	1150	2800	256A	898.00
	6.5	850	2600	286A	1076.00
	6.5	650	2400	324A	1295.00
	6.5	500	2000	326A	1541.00
	6.5	400	1600	366A	1826.00
7½	10.0	3500	3500	254A	844.00
	10.0	2500	3500	254A	866.00
	10.0	1750	3000	256A	888.00
	10.0	1150	2800	286A	1084.00
	10.0	850	2600	324A	1286.00
	10.0	650	2400	326A	1555.00
	10.0	500	2000	366A	1860.00
	10.0	400	1600	404A	2279.00
10.0	300	1200	444A	2722.00	

Horsepower Cont. 60 C.		Speed, Rpm		†Frame	▲Book Price, Each
At Base Speed	At 300% Base Speed	Base Speed	Rated Top Speed		
10	13.0	3500	3500	256A	\$ 967.00
	13.0	2500	3500	256A	993.00
	13.0	1750	3000	284A	1018.00
	13.0	1150	2800	286A	1238.00
	13.0	850	2500	326A	1480.00
	13.0	650	2200	366A	1820.00
15	20.0	3500	3500	284A	1172.00
	20.0	2500	3300	284A	1203.00
	20.0	1750	3000	286A	1234.00
	20.0	1150	2600	326A	1518.00
	20.0	850	2500	366A	1810.00
	20.0	650	2200	404A	2250.00
20	26.0	3500	3500	286A	1351.00
	26.0	2500	3300	286A	1386.00
	26.0	1750	3000	324A	1422.00
	26.0	1150	2600	366A	1764.00
	26.0	850	2400	404A	2164.00
	26.0	650	2200	405A	2680.00
25	33	3500	3500	286A	1386.00
	33	2500	3000	324A	1422.00
	33	1750	2600	366A	1764.00
	33	1150	2400	405A	2470.00
	33	850	2000	445A	3070.00
	33	650	1800	504A	3652.00
30	40	3500	3500	286A	1351.00
	40	2500	3100	324A	1566.00
	40	1750	3000	326A	1606.00
	40	1150	2600	366A	2030.00
	40	850	2400	405A	2470.00
	40	650	2000	445A	3070.00
40	52	3500	3500	286A	1351.00
	52	2500	3100	324A	1422.00
	52	1750	3000	326A	1606.00
	52	1150	2600	366A	2030.00
	52	850	2400	405A	2470.00
	52	650	2000	445A	3070.00
50	65	3500	3500	286A	1351.00
	65	2500	3000	324A	1422.00
	65	1750	2700	366A	2092.00
	65	1150	2400	405A	2676.00
	65	850	2200	445A	3270.00
	65	650	2000	504A	4000.00
60	85	3500	3500	286A	1351.00
	85	2500	2400	404A	2395.00
	85	1750	2100	445A	3088.00
	85	1150	2200	504A	3796.00
	85	850	2200	504A	4600.00
	85	650	1800	505A	4600.00
75*	115	3500	3500	286A	1351.00
	115	2500	2400	404A	2395.00
	115	1750	2100	445A	3088.00
	115	1150	2200	504A	3796.00
	115	850	2200	504A	4600.00
	115	650	1800	505A	4600.00
100*	155	3500	3500	286A	1351.00
	155	2500	2400	404A	2395.00
	155	1750	2100	445A	3088.00
	155	1150	2200	504A	3796.00
	155	850	2200	504A	4600.00
	155	650	1800	505A	4600.00
125*	200	3500	3500	286A	1351.00
	200	2500	2400	404A	2395.00
	200	1750	2100	445A	3088.00
	200	1150	2200	504A	3796.00
	200	850	2200	504A	4600.00
	200	650	1800	505A	4600.00
150*	260	3500	3500	286A	1351.00
	260	2500	2400	404A	2395.00
	260	1750	2100	445A	3088.00
	260	1150	2200	504A	3796.00
	260	850	2200	504A	4600.00
	260	650	1800	505A	4600.00

†Standard shaft is suitable for either belt or gear drive, or for direct connection.

*Stabilized shunt-wound.

▲This page includes "Book" prices subject to discount. For the correct discount, consult Graybar.

G-E Industrial Motor-Generator Sets

Tri-Clad* Induction Motor—Kinematic* Direct-Current Generator

Generator KW Ratings Continuous 60 C. and Approximate HP of A-C Driving Motor
Required for Indicated D-C Drive

MG Set

Generator Kw	¾	1	1½	2	3	4½	6½	9	13	17	21	25	33	40	50	65	85	100
A-C Driving-motor Hp	1½	2	3	3	5	7½	10	15	20	25	30	40	50	60	75	100	125	150
D-C Motor Hp	¾	1	1½	2	3	5	7½	10	15	20	25	30	40	50	60	75	100	125

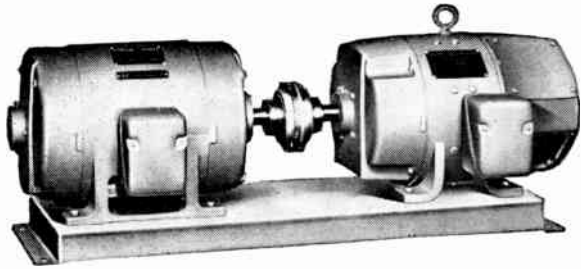

The Standard General Electric industrial motor-generator set has been designed to provide a maximum source of d-c power in minimum space. The new matched ratings utilize full power capacity of both motor and generator to provide a small, more compact set—one that will mean important savings in initial cost and space.

Four-bearing construction of standard two-unit motor-

generator sets permits faster, more economical replacement of units. By utilizing standard Kinematic d-c generators and Tri-Clad induction motors, alignment problems are minimized and low inventories of spare units and parts can be maintained.

Flexible steel couplings allow free end float of shafts without imposing thrust load on either motor or generator bearings. Easily disconnected couplings simplify alignment, and help assure smooth operation of motor-generator set.

Modern-design base is constructed of solid steel-plate bed with rigid cross bracing. Extra strength of base simplifies mounting and facilitates installation.

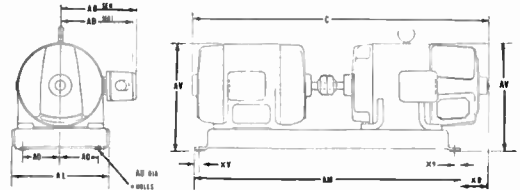

Dimensions and Ratings, 3-Phase, 60 Cycles, 1800 RPM

Type CD Generator			Type K Motor															
Kw.	60 C. Rise, Cont. Frame		Hp.	40 C. Rise, Cont. Frame		Wt. Lb.	AL	AM	XV	AO	AU	C	AV		AB		250-V Gen.	
	Volts	Frame		Volts	Frame								Motor	Gen.	Motor	125-V Gen.		
¾	125	187A	½	208	184	190	10 5/8	30	1 1/16	4 5/16	9/16	32 1/16	2 13/32	11 1/8	11 1/8	7 5/16	8	8
1	or	187A	2	220/440	184	190	10 5/8	30	1 1/16	4 5/16	9/16	32 1/16	2 13/32	11 1/8	11 1/8	7 5/16	8	8
1½	250	215A	3	or 550	213	260	12	33 3/8	1 1/16	5	9/16	35 3/4	1 31/32	12 3/4	12 5/8	8 3/16	8 3/4	8 3/4
2	125	216A	3	208	213	280	12	33 3/8	1 1/16	5	9/16	36 3/4	2 31/32	12 3/4	12 5/8	8 3/16	8 3/4	8 3/4
3	or	254A	5	220/440	215	380	14 1/8	38 1/4	1 1/8	5 5/8	1 3/16	40 7/8	3 1/4	14 3/4	15 5/8	8 3/16	10 9/16	10 9/16
4½	250	256A	7½	or 550	254	470	11 1/8	42 5/8	1 1/8	5 5/8	1 3/16	45 13/16	3 1/4	15 5/8	15 5/8	10 1/16	10 9/16	10 9/16
6½	125	284A	10	208	256	610	15 1/2	45 7/8	1 1/8	6 5/16	1 3/16	49 13/16	4 1/2	16 17/32	17 1/8	10 1/16	11 5/16	11 5/16
9	or	286A	15	220/440	284	720	15 5/8	48 1/2	1 1/8	6 3/8	1 3/16	53 1/16	4 5/16	17 7/32	17 1/8	10 13/16	12 7/16	11 5/16
13	250	324A	20	or 550	286	885	17 5/8	48 1/2	1 1/8	7 3/8	1 3/16	54 1/4	5 5/8	18 23/32	19 19/32	10 13/16	13 3/8	13 3/8
17	125	326A	25	208	324	975	17 5/8	48 1/2	1 1/8	7 3/8	1 3/16	54 5/8	5 1/2	19 23/32	19 19/32	12 13/16	15 1/16	13 3/8
21	or	365A	30	220/440	326	1260	20	51 1/4	1 1/2	7 1/2	1 1/8	57 1/2	5 9/16	23 3/8	24 1/4	12 13/16	16 1/16	14 3/8
25	250	366A	40	or 550	404	1670	21 1/4	56 1/2	1 1/2	8 3/8	1 1/8	62 5/8	5 13/16	25 7/8	25 1/4	16 1/8	16 1/16	14 3/8
33	125	404A	50	208	405	1870	22	56 3/8	1 1/2	8 1/2	1 1/8	65 3/16	7 1/16	25 7/8	26 1/4	16 1/8	18 13/16	17 1/16
40	or	405A	60	220/440	444	2195	23 1/2	60	1 1/2	9 1/4	1 1/8	69 13/16	7 1/16	28	27 1/4	17 1/8	18 13/16	17 1/16
50	250	444A †	75	or 550	445	2520	24	64 3/8	1 1/2	9 1/2	1 1/8	73 7/16	6 1/2	28	28 7/32	17 1/8	19 13/16	18 1/16
65	125	445A †	100	208 220 440 550	504	3040	26 1/2	66 7/8	1 1/2	10 3/4	1 1/8	76 15/16	6 5/8	31	29 23/32	18 5/8	19 13/16	19 13/16
85	or	504A †	125		505	3660	27	69 3/4	1 1/2	11	1 1/8	81 3/8	8 3/16	31	31 7/32	18 5/8	21 5/16	21 5/16
100	250	505A † ‡	150		6323	3970	30 1/2	72 1/4	1 1/2	12 3/4	1 1/8	84 7/8	7 15/16	35	33 7/32	20 5/8	21 5/16 †	21 5/16

†Generators for 125-volt ratings will have extended frames.

*Registered trade-marks of General Electric Company.

‡Two conduit boxes required for this rating—one on either side of frame.

Prices on application

G-E Speed Variators

**Packaged, Adjustable-voltage D-C Drives
Operates from A-C Power—1-500 HP**

Packaged, all-electric, adjustable-speed drive which operates from a-c power. The power unit converts incoming a-c power to d-c power and supplies it to a d-c drive motor. Speed of the d-c motor can be adjusted over a wide range by controlling its armature voltage and field current. Speed ranges of 200 to 1 and higher are available.

The basic model, with an 8 to 1 speed range, forms the foundation for the speed variator line. However, such a wide variety of modifications are available for these drives that applications for the speed variator are practically unlimited wherever an adjustable-voltage d-c drive is required.

For the large majority of industrial applications where reliable adjustable-speed power is required the general industrial speed variator drive may be used. Typical applications are drives for cement, chemical, food, glass, lumber, machine-tool, materials handling, metal-working, paper, paper converting, plastic, printing, rubber, steel, textile and wire drawing industries.

Power Unit

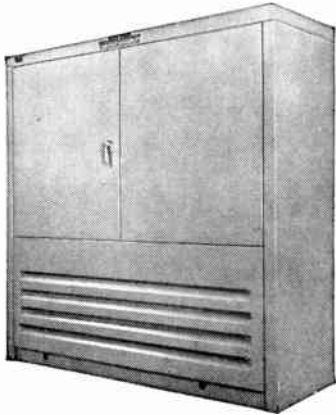

**Speed Variator Power Unit
(Typical of 15-30 HP)**

The basic power unit consists of a motor-generator set, full voltage starter for the induction motor of the M-G set, and the necessary d-c control for simple nonreversing operation of the d-c drive motor, all packaged together in an attractive, ventilated cabinet.

Since the power unit is factory assembled, wired, and tested, the cost of installation is extremely low.

Operator's Control



The basic operator's control devices are: an oiltight push-button station for starting and stopping the d-c drive motor and a small rheostat which adjusts the field current of the d-c generator in the power unit.

The adjustment of the generator field current controls the voltage applied to the d-c motor armature which, in turn, controls the speed of the d-c motor over an eight-to-one range.

The push-button station is for surface mounting, and the rheostat is for front-of-board mounting.

D-C Drive Motor



**Kinamatic* Dripproof
D-C Motor**

The d-c motor included in the basic Speed Variator drive is suitable for constant torque operation over an eight-to-one speed range. It is rated 210 volts d-c, 60 C. rise, Class B insulated in frames up through 505, and is rated 230 volts d-c, 50 C. rise in larger frames. Has dripproof enclosure, ball bearings, and is shuntwound.

These motors make it possible to obtain rapid acceleration and deceleration with low-energy demand.

*Trade-mark of General Electric Company.

Prices and information on other readily available modifications on application.

G-E Control Centers

**1 to 100 HP, 220 Volts, 3 Phase
1 to 200 HP, 440/600 Volts, 3 Phase
Interrupting Ratings: 15,000 to 25,000 Amperes**



Type DA7093

This pre-engineered control center permits the grouping of all switching and control operations at one convenient location. Compact design results in 50 percent saving of floor area.

Complete installation composed of standardized vertical sections, fusible or circuit-breaker-type control units, and accessories as required. Easy to plan, install and maintain and can be used for all types of industrial and commercial applications. Easily expanded to meet changing control requirements.

This space-saving design permits use of nine NEMA Size 1 units or six NEMA Size 2 units in one 90-in.-high vertical section. These starter units can be either of the fusible or circuit breaker type and are readily interchangeable. Main circuit breakers and fusible switches are available.

Control sections can be supplied in either factory assembled NEMA Types A, B, or C construction or as units for field assembly. Where switching sections only are required, these can be furnished as complete equipments or as units for field assembly.

With the broad line of standardized sections and control units available, it is easy to select combinations to meet exacting motor control requirements, whether for a single machine, a department, or an entire plant.

This packaged control center comes fully equipped with starters prewired to customer specifications. Load and control wiring on job is minimized and can be done with units in place.

Maximum safety protection for operating personnel built into this design. Handle must be moved to OFF position before door can be opened and unit removed from section. Handle can be padlocked in either of three positions. Aluminum barriers provide isolation from unit below when unit atop barrier is removed. Interlocked handle on control unit has "by-passing" interlock release to permit inspection.

Wide-opening door permits easy access to section interior. Unit easily released from section by turning latching screw. Unit can be locked during inspection in safe position clear of buses by latch on horizontal barrier. All components are mounted on unit frame for easy inspection or removal. Use of three separate stabs makes replacement easy. Individual bus-bar insulators assure complete electrical and mechanical protection.

Space saving unit size permits nine NEMA Size 1 units in one section without reduction in pull-box size. Flexible design permits 13 5/8 in. sections to be installed back to back with combined depth of only 27 1/4 in. or single back to back arrangement in one structure with 24 in. depth.

Note:—Two speed Control Centers available. For further information contact Graybar.

G-E IC7092 Motor Control Centers

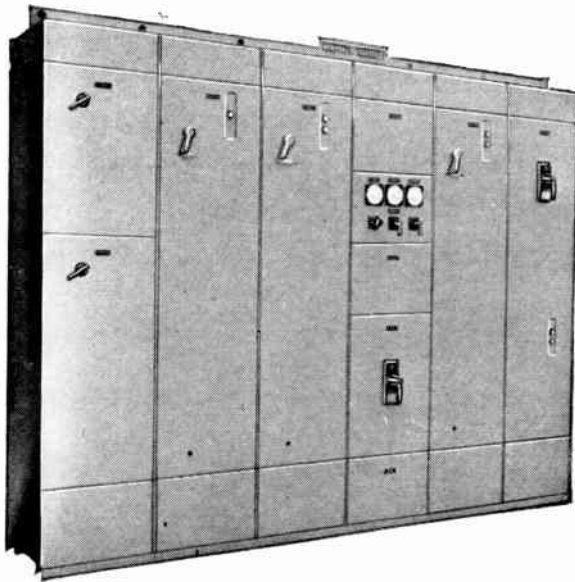

Offers the answer to simplified installation and maintenance of a-c combination starters, lighting panels, lighting transformers, and feeder circuit breakers, as well as other associated equipment for a group of motors in a central location.

Adapted for all starters in one factory area, or on a particular process—starters can be grouped and connected with one continuous power bus.

Features of the IC7092 control center include:

Standard Dimensions—all starter units are constructed in even multiples of 14 in. high; Extra-large wiring trough 4 in. wide (full height) continuous vertical wiring trough with cable supports for unit wiring; Vertical bus barrier separates starter components from vertical bus; Front Connection—all connections and terminals easily accessible from the front; Removable Starter Units; Flange-formed Doors; Free-floating stab-on Connector providing positive silver-to-silver contact on both sides of the vertical bus; Back-to-back mounting affords maximum space saving; I-beam construction provides strong, rigid structure; Safety Interlock prevents opening starter door when circuit breaker or fused switch are in ON position.

Normally furnished with bus work braced to withstand 25,000 rms amp. short-circuit current.

In cases where 50,000 rms amp. interrupting capacity is required, all fusible-type combination starters are supplied with current-limiting fuses. In addition, the bus is braced for 50,000 amp. A current-limiting reactor of proper rating, connected ahead of the motor control center, or a hook-stick-operated incoming-line Amp-trap current limiter may be connected on the incoming bus—to provide the required higher interrupting capacity.

Motor control centers are available in three types:

NEMA Type A construction—motor and control leads connected directly to contactor and interlocks at installation.

NEMA Type B construction—motor and control leads connected to individual terminal boards located in the individual starter compartment at installation.

NEMA Type C construction—motor and control leads connected at installation to master terminal board located in either top or bottom cable compartment of control center. All interconnecting wiring is done at the factory and an over-all interconnection diagram is furnished.

Control-center Air-circuit-breaker Combination Starters for Induction Motors

**Single-speed, Full-voltage
3-Phase, 60 Cycles**

Max. Hp				NEMA Size	Circuit-breaker Frame Size	Starter Interrupting Rating, Amperes	▲ Book Price: \$200.00 * Plus		
208 Volts	220 Volts	440 Volts	550 Volts				NEMA Type A	NEMA Type B	NEMA Type C
Nonreversing									
5	5	7½	7½	1	F	15,000	\$ 222.00	\$ 253.00	\$ 311.00
10	10	20	20	2	F	15,000	279.00	312.00	773.00
15	15	25	25	2	F	15,000	295.00	328.00	393.00
20	25	50	50	3	F	15,000	432.00	470.00	546.00
30	30	3	J	15,000	610.00	648.00	724.00
50	50	100	100	4	J	15,000	822.00	891.00	1021.00
50	50	100	100	4	K	15,000	942.00	1011.00	1141.00
50	50	100	100	4	AK-1-25	25,000	2232.00	2301.00	2431.00
...	60	200	200	5	L	25,000	1719.00	1791.00	1949.00
100	100	5	L	25,000	1719.00	1791.00	1949.00
100	100	200	200	5	AK-1-25	25,000	2365.00	2437.00	2595.00
Reversing									
5	5	7½	7½	1	F	15,000	352.00	391.00	458.00
10	10	20	20	2	F	15,000	455.00	496.00	572.00
15	15	25	25	2	F	15,000	471.00	512.00	588.00
20	25	50	50	3	F	15,000	671.00	718.00	803.00
30	30	3	J	15,000	849.00	896.00	981.00
50	50	100	100	4	J	15,000	1289.00	1367.00	1506.00
50	50	100	100	4	K	15,000	1409.00	1487.00	1626.00
50	50	100	100	4	AK-1-25	25,000	2626.00	2704.00	2843.00

*\$200.00 for each control center, totaling \$1999.00 or less; \$136.00 for each control center, totaling \$2000.00 to \$2999.00. No addition for control centers totaling \$3000.00 or more.

▲ This page includes "Book" prices subject to discount. For the correct discount, consult Graybar.

G-E IC702 Motor Control Centers (Con't.)
Control-center Fusible-switch Combination Starters for Induction Motors

Single-speed, Full-voltage

Nonreversing

Max. Hp	Volts	NEMA Size	Starter Interrupting Rating †Amperes	▲ Book Price: \$200.00 * Plus			Price Addition for †Fuses
				NEMA Type A	NEMA Type B	NEMA Type C	
3	208,220	1	25,000	\$ 182.00	\$ 213.00	\$ 271.00	\$ 15.00
5	208,220	1	25,000	192.00	223.00	281.00	23.00
7½	208,220	2	25,000	266.00	299.00	364.00	37.00
	440,550	1	25,000	194.00	225.00	283.00	26.00
15	208,220	2	25,000	291.00	324.00	389.00	58.00
	440,550	2	25,000	254.00	287.00	352.00	31.00
25	208,220	3	25,000	430.00	468.00	544.00	58.00
	440,550	2	25,000	273.00	306.00	371.00	56.00
30	208,220	3	25,000	518.00	556.00	632.00	121.00
	440,550	3	25,000	412.00	450.00	526.00	87.00
50	208,220	4	25,000	813.00	882.00	1012.00	126.00
	440,550	3	25,000	448.00	486.00	562.00	87.00
60	208,220	5	25,000	1473.00	1545.00	1703.00	156.00
	440	4	25,000	840.00	909.00	1039.00	141.00
	550	4	25,000	743.00	812.00	942.00	87.00
100	208,220	5	25,000	1473.00	1545.00	1703.00	156.00
	440,550	4	25,000	840.00	909.00	1039.00	141.00
125	440	5	25,000	1511.00	1583.00	1741.00	177.00
	550	5	25,000	1484.00	1556.00	1714.00	141.00
200	440,550	5	25,000	1511.00	1583.00	1741.00	177.00

Reversing

3	208,220	1	25,000	\$ 312.00	\$ 351.00	\$ 418.00	\$ 15.00
5	208,220	1	25,000	322.00	361.00	428.00	23.00
7½	208,220	2	25,000	442.00	483.00	559.00	37.00
	440,550	1	25,000	324.00	363.00	430.00	26.00
15	208,220	2	25,000	467.00	508.00	584.00	58.00
	440,550	2	25,000	430.00	471.00	547.00	31.00
25	208,220	3	25,000	669.00	716.00	801.00	58.00
	440,550	2	25,000	449.00	490.00	566.00	56.00
30	208,220	3	25,000	757.00	804.00	889.00	126.00
	440,550	3	25,000	651.00	698.00	783.00	87.00
50	208,220	4	25,000	1280.00	1358.00	1497.00	126.00
	440,550	3	25,000	687.00	734.00	819.00	87.00
60	440	4	25,000	1307.00	1385.00	1524.00	141.00
	550	4	25,000	1210.00	1288.00	1427.00	87.00
100	440,550	4	25,000	1307.00	1385.00	1524.00	141.00

*\$200.00 for each control center, totaling \$1999.00 or less; \$136.00 for each control center, totaling \$2000.00 to \$2999.00. No addition for control centers totaling \$3000.00 or more.

†Interrupting ratings and fuse prices are for current-limiting-type fuses.

▲ This page includes "Book" prices subject to discount. For the correct discount, consult Graybar.

G-E Limitamp* Controls

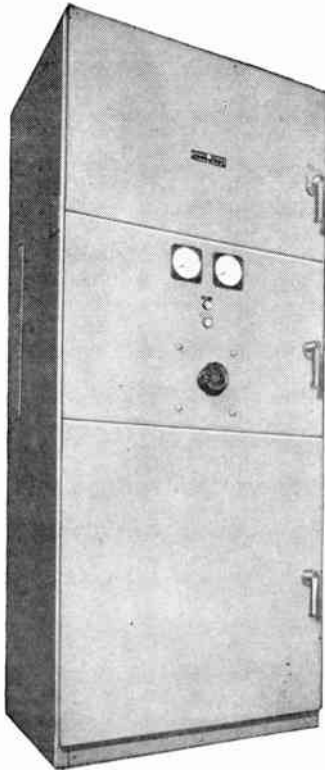

The Limitamp* Control with IC7160 starter with air-break contactor is designed to operate and protect squirrel-cage, wound-rotor, and synchronous motors; transformer feeders; and other equipment used in special applications. Can include control for auxiliary and accessory equipment, such as incoming-line panels, lighting panels, small low-voltage a-c and d-c motor starters, relaying and metering equipment.

Meets NEMA Class E2 Standards; and furnished completely assembled and wired in NEMA Type 1 free-standing, 30-in.-deep enclosures.

Equipped with gang-operated disconnect switch which will not allow access to the high-voltage compartment unless contactor and isolating switch are in OFF position.

Type EJ-2 current-limiting fuses provide short-circuit protection.

Ambient-compensated thermal overload relays protect motor against damaging overloads. Time-delay undervoltage protection is also provided.

The IC2812 air-break improved contactor is designed for reliable service and easy maintenance. Its principal parts—

arc chute, phase barriers, contact tips, interlock, and coil—are designed for repetitive service.

Has 30-in. deep enclosures with front connections requiring no rear-aisle space. All connections made from front, and line contactor rolls out for free working space.

In synchronous-motor control panels, load-angle field removal provides fastest field removal possible within the first half-slip cycle out of synchronism; motor field-loss relay is not required. Precision-angle switching is provided for utmost use of motor synchronizing ability. Graduated squirrel-cage protection is included to obtain maximum advantage of motor's accelerating ability, protecting time-rated squirrel-cage winding, yet allowing more time as the speed increases.

Limitamp interrupting capacity at 50 or 60 cycle power for 2300 volts, a-c is 150,000 kva; 4000 volts, a-c, 250,000 kva; and 4600 volts, a-c, 250,000 kva.

Full-voltage, Nonreversing, Squirrel-Cage-Motor Control (Three-phase, 60-Cycle)

Max. Hp.	▲Book Price, Each	
	2300 Volts, IC7160-A217	4000 Volts, IC7160-A218 4600 Volts, IC7160-A219
700	\$4944.00	\$5592.00
1000	5564.00	5592.00
1250	6244.00	5592.00
1500	6244.00	7009.00
2500	7009.00

Full-Voltage, Nonreversing Synchronous-Motor Control (Three-Phase, 60-Cycle)

250	\$7014.00	\$7662.00
700	7109.00	7757.00
1000	7729.00	7757.00
1250	8409.00	7757.00
1500	8706.00	9491.00
2500	9614.00

*Registered trade-mark of General Electric Company.

▲“Book” prices subject to discount. For correct discount, consult Graybar.

G-E IC8070 Plate-Type Field Rheostats

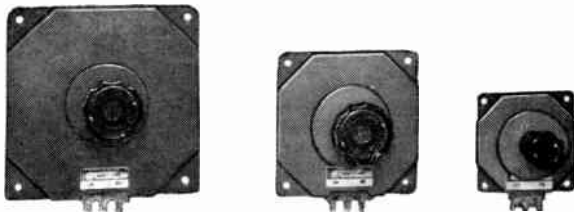

These G-E plate-type field rheostats are field-control devices for all types of direct current rotating equipment. They can be used to adjust the output voltage of a-c or d-c generators, and the speed of d-c motors.

Suitable for use in textile mills, paper mills, machinery manufacturing, steel mills, switchboard building, educational institutions, laboratories, etc. They are available for open-type, totally enclosed, open-type concentric, totally enclosed concentric, open-type sequence operation—all for front- or back-of-board mounting.

Features include: (1) Constant resistance—maintained by using resistance material affected only slightly by temperature; (2) Long mechanical life—since contact segments and brushes are made of special alloy material with long-wearing qualities; (3) Versatility—employing two adjustable stops, one at each end.

When ordering include ohms resistance, maximum ampere, and voltage for rheostat required. If for use with d-c motor, include information on motor rating (Model or Serial No.), together with speed increase desired. If rheostat is to be used

with other than G-E motor, the order should state maximum shunt-field current and ohms resistance necessary to insert in the field current to give maximum speed increase.

IC8070 Field Rheostats for Use with D-C Motors on General-Purpose Applications*

Max. Hp. of Motor	Motor Speed Range Ratio				
	1.25:1	1.5:1	2:1	3:1	4:1
2	\$30.00	\$30.00	\$30.00	\$30.00	\$43.00
3	30.00	30.00	30.00	30.00	43.00
5	30.00	30.00	30.00	43.00	43.00
7½	30.00	43.00	43.00	43.00	43.00
10	43.00	43.00	43.00	43.00	62.00
15	43.00	43.00	43.00	43.00	62.00
20	43.00	43.00	43.00	43.00	62.00
25	43.00	43.00	43.00	43.00	62.00
30	43.00	43.00	43.00	43.00	124.00
40	43.00	43.00	43.00	43.00	124.00
50	43.00	43.00	43.00	43.00	124.00
60	43.00	43.00	43.00	43.00	124.00
75	43.00	43.00	62.00	124.00	124.00
100	43.00	62.00	62.00	124.00	124.00
125	62.00	62.00	62.00	124.00	156.00
150	62.00	62.00	62.00	124.00	156.00
200	62.00	62.00	62.00	124.00	156.00

*For use with G-E d-c motors with basic speeds not less than 300 rpm. For rheostats to be used with other than G-E motors, or motors having basic speeds lower than 300 rpm, consult Graybar.

▲This page includes “Book” prices subject to discount. For the correct discount, consult GRAYBAR.

G-E IC2820 D-C General-Purpose Relays

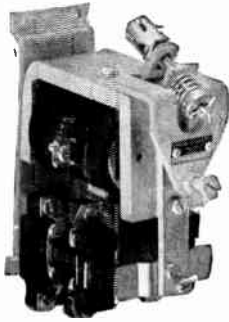

Four-circuit relay

Used for general-purpose switching, undervoltage protection, field protection, plugging, and similar applications. The relays are front connected and can be mounted on either steel or insulating panels.

Number of Circuits	Contact Arrangement		IC2820 Form		▲ Book Price, Each
	NO	NC	115 Volts	230 Volts	
1	0	1	A100AB3B	A100AB2B	\$ 49.00
	1	0	A100AB3C	A100AB2B	
2	0	2	A100AB3D	A100AB2D	52.00
	1	1	A100AB3E	A100AB2E	52.00
	2	0	A100AB3F	A100AB2F	52.00
4	0	4	A100BB3G	A100BB2G	84.00
	1	3	A100BB3H	A100BB2H	84.00
	2	2	A100BB3J	A100BB2J	84.00
	3	0	A100BB3K	A100BB2K	84.00
6	4	1	A100BB3L	A100BB2L	84.00
	0	6	A100BB3AB	A100BB2AB	96.00
	1	5	A100BB3AD	A100BB2AD	96.00
	2	4	A100BB3AE	A100BB2AE	96.00
	3	3	A100BB3AF	A100BB2AF	96.00
	4	2	A100BB3AG	A100BB2AG	96.00
8	5	1	A100BB3AH	A100BB2AH	96.00
	6	0	A100BB3AJ	A100BB2AJ	96.00
	2	6	A100BB3BB	A100BB2BB	108.00
	3	5	A100BB3BC	A100BB2BC	108.00
	4	4	A100BB3BD	A100BB2BD	108.00
	5	3	A100BB3BE	A100BB2BE	108.00
	6	2	A100BB3BF	A100BB2BF	108.00
	7	1	A100BB3BG	A100BB2BG	108.00
10	8	0	A100BB3BH	A100BB2BH	108.00
	4	6	A100BB3CB	A100BB2CB	120.00
	5	5	A100BB3CC	A100BB2CC	120.00
	6	4	A100BB3CD	A100BB2CD	120.00
	7	3	A100BB3CE	A100BB2CE	120.00
	8	2	A100BB3CF	A100BB2CF	120.00
	9	1	A100BB3CG	A100BB2CG	120.00
	10	0	A100BB3CH	A100BB2CH	120.00
	6	6	A100BB3CJ	A100BB2CJ	132.00
	7	5	A100BB3CK	A100BB2CK	132.00
12	8	4	A100BB3CL	A100BB2CL	132.00
	9	3	A100BB3CM	A100BB2CM	132.00
	10	2	A100BB3CN	A100BB2CN	132.00
	11	1	A100BB3CP	A100BB2CP	132.00
	12	0	A100BB3CQ	A100BB2CQ	132.00

G-E IC2800 D-C Contactors

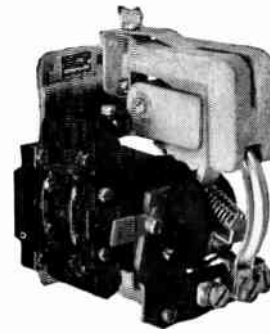

IC 1617 Contactor

Heavy duty and accessibility are the two special features of this line of d-c contactors, as regards their use by switchboard builders and panel assemblers for industrial service with machine tools, textile machinery, and the like.

IC2800 contactors are rated at 25-100 amp., 600 volts, maximum.

Both single-pole and multipole contactors in all forms are unit-mounted, supplied already assembled in a sturdy steel base drilled for surface mounting. All connections are made from the front.

Unit-style interlocks are available, factory-mounted or separately for field mounting. These can be easily changed from normally open to normally closed; or from normally closed to normally open.

Contactors Less Interlocks

Rating, Amp.	250 Volts Open	600 Volts Open	Contacts	Blowout Coil, Amp.		IC2800 Form	▲ Book Price Each Contactor with Coils but less Interlocks		
				NO Pole	NC Pole				
25	10	1 NO	{	0	...	1607A	\$ 42.00		
				1	...	1607B	45.00		
				2	...	1607C	45.00		
				5	...	1607D	45.00		
				10	...	1607E	45.00		
				25	...	1607F	45.00		
		1 NC	{	2	...	1608F	65.00		
				10	...	1608K	65.00		
				1	1	1609D	90.00		
				2	2	1609F	90.00		
				5	5	1609H	90.00		
				10	10	1609K	90.00		
1 NO, 1 NC	{	25	25	1609M	90.00				
		1 NO	{	0	...	1617A	49.00		
				25	...	1617C	53.00		
				50	...	1617B	53.00		
				1 NC	{	0	...	1618B	82.00
						50	...	1618F	86.00
1 NO, 1 NC	{			25	25	1619D	116.00		
		50	50	1619F	116.00				
100	50	1 NO	{	0	...	1621N	78.00		
				100	...	1621M	83.00		
				5	...	1620Q	113.00		
		1 NC	{	100	...	1620P	113.00		
				2 NO	{	0	...	1622N	113.00
						100	...	1622M	123.00
		1 NO, 1 NC	{	100	10	1625Q	153.00		
				100	100	1623Q	193.00		

Interlocks

Contacts	▲ Book Price Addition	
	Factory Installed	Furn. Separately
1 NO	\$ 9.00	\$6.00
1 NC	9.00	6.00
2 NO	12.00	9.00
2 NC	12.00	9.00
1 NO, 1 NC	12.00	9.00

▲ This page includes "Book" prices subject to discount. For the correct discount, please consult GRAYBAR.

G-E IC9516 A-C Brakes

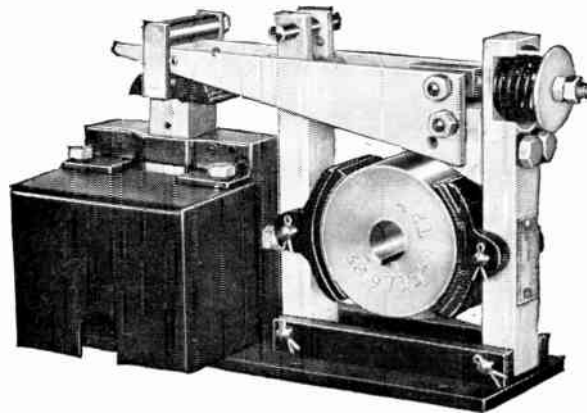

The IC9516 a-c brake is a long-wearing device used primarily to hold rotating apparatus or machinery in a fixed position while it is not in use. The brake is especially designed for shops with small a-c cranes; for spinning equipment in textile mills; and for use in laundries, bakeries, food processing plants, small assembly plants, and metal-working plants.

Features of the IC9516 brake include: (1) Long mechanical life—balanced molybdenum-alloy wheel, highly resistant to wear; (2) Easy torque adjustment—achieved by adjusting nuts at end of spring which sets brake; (3) Solenoid-coil connectors protected—metal connectors and conduit box mounted adjacent to solenoid.

The brake may also be used for stopping duty, if proper application rules are followed.

Brake shoes are lined with woven asbestos. Because the shoes operate at low unit pressure, lining wear is reduced, and normal time between relinings is lengthened.

Type B construction with drip-proof and splash-proof enclosures is available for outdoor applications; and Type C construction in dust-tight and watertight enclosures is available for severe atmospheric operation.

Hand-release mechanism also available.

Torque Rating Lb.-Fl.		CR9516 Brake Form	▲Book Price, Each Floor-Mounted Brake with Wheel	Type B Enclosure Drip- proof		Type C Enclosure Dust and Watertight		▲Book Price Additions		Hand Release †	Corrosion- resisting Fittings	Add for Type B Insulation on Solenoid	Omission or Separate ▲Book Price of Wheel	WR ² of Wheel Lb.-Fl ²
Con- tinu- ous	60 Min. Inter- mittent					Add for 1-shaft Seal	Add for 2-shaft Seal							
Solenoid-Operated														
3	3	458D	\$ 78.00	\$ 64.00	\$100.00	\$ 46.00	\$ 9.00	\$ 6.00	\$ 18.50		0.015	
10	15	460H	86.00	64.00	100.00	46.00	12.00	7.00	18.50		0.037	
25	35	461E	148.00	74.00	120.00	46.00	19.00	12.00	30.00		0.237	
50	75	462L	238.00	74.00	120.00	46.00	40.00	19.00	50.00		0.37	
125	160	463A	806.00	96.00	282.00	\$187.00	\$374.00	138.00	88.00	35.00	100.00		1.4	
3-Phase Thrustor* Operated#														
125	160	463C‡	806.00	96.00	282.00	187.00	374.00	138.00	88.00	100.00		1.4	
325	400	464S	1421.00	191.00	468.00	245.00	490.00	288.00	182.00	191.00		5.9	
600	800	465N	1911.00	218.00	558.00	273.00	546.00	288.00	250.00	276.00		17.5	
1200	1600	466N	2558.00	326.00	820.00	303.00	606.00	358.00	388.00	498.00		62.0	
2400	3600	467E	4262.00	426.00	640.00	904.00		189.0	

*Registered trade-mark of General Electric Co.

†For hand release used with Type B or C enclosures contact Graybar for price. For interlocking limit switch, add \$35.00 "Book" Price.

‡For single-phase, any voltage; or 25-cycle, any voltage, use solenoid-operated brake; for 3-phase, 550-volt, 60 and 50-cycle operation, brake is priced at \$952.00 "Book" Price, including auxiliary transformer and wheel.

#Brake for single-phase Thrustor motor can be furnished when specified, at same price on all brake forms, except Forms 463C and 465N. Time-delay setting is included on up and down stroke on all forms of Thrustor operated brakes except Form 463C.

▲This page includes "Book" prices subject to discount. For the correct discount, consult Graybar.

G-E CR101 Manual Motor-Starting Switches

For Fractional-Hp. Motors



Maximum Ratings, A-C

60-25 Cycles
Single-pole and double-pole, 1 Hp.,
115 to 230 Volts

Maximum Ratings, D-C

Single-pole, 1 Hp., 115 Volts
1/4 Hp., 230 Volts or
Double-pole, 1 Hp., 115 and 230 Volts

For surface or flush mounting

This small, compact, hand-operated starting switch incorporates positive overload protection. It is designed for use with fractional-horsepower motors. Order a switch by CR and Form number. Order a heater for overload device by catalog number selected from the table below.

Open Type—For Flush Mounting and Replacement in Enclosed Type

Form No.	No. of Poles	Approx. Dimensions, Inches			Approx. Ship. Wt. Lbs.	▲*Book Price Each
		High	Wide	Deep		
Y	1	3 1/16	1 3/4	1 9/16	1	\$ 6.50
H	2	3 1/16	1 3/4	1 9/16	1	7.50

Enclosed—For Surface Wall Mounting

Y1	1	4 5/32	2 13/32	2	2	7.50
H11	2	4 5/32	2 13/32	2	2	8.50

Dust-tight and Weather-resisting

Y400H	1	6 1/16	3	3 15/16	10	24.00
H400H	2	6 1/16	3	3 15/16	10	25.00

Explosion-proof—For Class I, Group D, Hazardous Locations

Y700H	1	6 3/4	3 1/2	4 9/16	11	24.00
H700H	2	6 3/4	3 1/2	4 9/16	11	25.00

Combination Device—Includes HAND-OFF-AUTO Selector Switch

H112	2	4 7/8	4 7/8	2 7/8	3	18.00
------	---	-------	-------	-------	---	-------

*Prices include one overload-device heater which must be ordered separately. Heater may be omitted, or additional heaters may be ordered, at \$1.00 each.

Heaters for Thermal Overload Devices

Interchangeable heaters are available for a variety of motor current ranges as shown in the accompanying table.

The table below gives the proper size heater to trip the switch on approximately 125 per cent motor current.

Listed values are for motors rated 40° C. continuous. For motors rated 50° C. or 55° C. continuous, multiply full-load current of motor by 0.9 and use this value to select heater.

Maximum Motor Full-load Amp.	Heater Cat. No. CR123H	Maximum Motor Full-load Amp.	Heater Cat. No. CR123H	Maximum Motor Full-load Amp.	Heater Cat. No. CR123H
.48	0 55A	1.78	2 05A	5.90	6 80A
.53	0 61A	1.95	2 24A	6.11	7 39A
.58	0 67A	2.13	2 45A	6.98	8 02A
.65	0 74A	2.32	2 67A	7.60	8 73A
.71	0 82A	2.53	2 91A	8.25	9 50A
.78	0 90A	2.76	3 17A	8.95	10 3B
.86	0 99A	3.01	3 46A	9.75	11 2B
.95	1 08A	3.27	3 77A	10.60	12 2B
1.04	1 20A	3.56	4 10A	11.40	13 2B
1.14	1 32A	3.88	4 46A	12.50	14 4B
1.25	1 44A	4.22	4 86A	13.60	15 7B
1.37	1 58A	4.60	5 29A	14.80	17 1B
1.49	1 72A	5.00	5 75A	16.00	18 6B
1.63	1 88A	5.43	6 25A		

Note: Refer to nearest General Electric office for recommendations for heaters to be used with definite-purpose motors.

▲This page includes "Book" prices subject to discount. For the correct discount, contact Graybar.

G-E CR106 and CR7006 A-C Magnetic Starters

For Connecting Single-, 2-, or 3-Phase Induction Motors Directly on the Line

Undervoltage Protection
Thermal Overload Protection
1-100 Hp. for 600 Volts, 60-25 Cycles

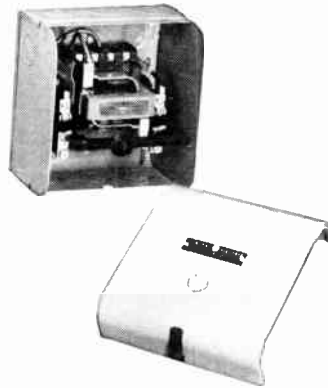

The CR106 and CR7006 magnetic motor starter is used for full voltage starting of squirrel cage induction motors. These starters consist of a 2- or 3-pole magnetically operated contactor with overload relays, mounted on a base and enclosed in a suitable case. Provide undervoltage protection or release. May be operated by means of a push-button station, float switch, or other pilot device.

CR7006, Size 0, with cover removed

Prices will be quoted on request for starters with push buttons mounted in cover.

Order by CR number and specify rating of motor with which to be used and heater units required for overload protection.

110 V.	Max. Horsepower 2- and 3-phase		NEMA Sizes	No. Poles	Approx. Ship. Wt. Lbs.	▲*Book Price Each
	208/230 V.	440 V.				
*1	2	3	0	2	6	\$ 32.00
2	3	5	0	3	6	37.00
*2	3	5	1	2	6	37.00
3	7 1/2	10	1	3	6	42.00
*3	7 1/2	10	2	3	16	74.00
7 1/2	15	25	3	3	29	118.00
*7 1/2	15	25				
15	30	50	4	3	31	266.00
25	50	100				

Enclosed

Max. Horsepower 2- and 3-phase	Type 1 General-purpose		Type 4 Water-tight		Type 12 Industrial use	
	Approx. Ship. Wt. Lbs.	▲*Book Price Each	Approx. Ship. Wt. Lbs.	▲*Book Price Each	Approx. Ship. Wt. Lbs.	▲*Book Price Each
*1	2	3	0	2	8	\$ 34.00
2	3	5	0	3	8	50
*2	3	5	1	2	8	50
3	7 1/2	10	1	3	8	50
*3	7 1/2	10	2	3	20	80
7 1/2	15	25	3	3	50	138.00
*7 1/2	15	25				
15	30	50	4	3	75	308.00
25	50	100				

*Single-phase rating.

Note: All starters listed above are for separate push-button connection. Price does not include push-button station, but includes overload-relay heater units.

Call Graybar FIRST for . . .

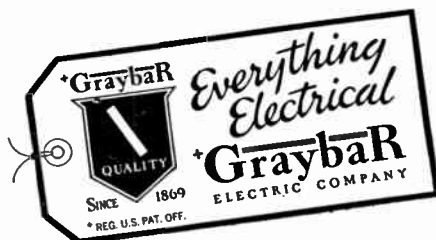

G-E CR1062 Manual Motor-Starting Switches

For 1- to 7½-HP A-C Motors

600 Volts, Maximum, 60-25 Cycles, Single-phase and Three-phase



Push-button, Size 1, and toggle-operated, Size 0, manual motor starter for wall or machine mounting.



CR1062 toggle-operated Size 1. Wall, machine, or pedestal mounting.

for push-button or toggle operation in 2-, 3-, or 4-pole forms, Sizes 0 and 1. Toggle switches in the above forms are also available in cast-iron enclosures suitable for installation in moisture, dust-laden, and hazardous locations. A specially designed form for textile loom service is included in the line.

Bimetallic overload device and a wide range of heaters give accurate response to overloads and provide complete motor protection. When the relay trips, the toggle or push button assumes a neutral position, giving positive indication of overload trip.

Guards around push button and toggle prevent accidental operation. Holes in guards on toggle forms permit padlocking in On or Off position. All general-purpose cases may be padlocked closed to prevent tampering.

General Electric now offers a complete line of manual starters for application on blowers, grinders, pumps, farm machinery, laundry and textile applications, and small machine tools. Available in open and general-purpose enclosures

Lift-off covers, retained by screws top and bottom, are provided to minimize space requirements. Combination knockouts conveniently located are provided. All starters conform to NEMA ratings and have Underwriters' approval. Renewal parts are available for all sizes and forms.

Open Switches

Toggle-operated

Push-button-operated

Maximum Horsepower Rating						No. of Poles	CR 1062 Form No.	Approx. Dimensions, In.			Approx. Ship. Wt. Lbs.	▲ Book Price Each	CR 1062 Form No.	Approx. Dimensions, In.			Approx. Ship. Wt. Lbs.	▲ Book Price Each
Single Phase			Polyphase					HL	Width	Depth				HL	Width	Depth		
110 V.	220 V.	440 to 600 V.	110 V.	220 V.	440 to 600 V.	*2	M13A	5 7/16	3 9/16	3 7/8	4	\$18 00	M12A	5 7/16	3 9/16	4 1/4	4	\$18 00
1	1 1/2	2	1 1/2	2	3	3	M19A	5 7/16	3 9/16	3 7/8	4	23 00	M8A	5 7/16	3 9/16	4 1/4	4	23 00
...	1 1/2	2	3	4	M11A	5 7/16	3 9/16	3 7/8	4	33 00	M10A	5 7/16	3 9/16	4 1/4	4	33 00
1 1/2	3	5	2	N13A	7 1/16	4 1/8	4 1/2	5	23 00	N12A	7 1/16	4 1/8	5 1/16	5	23 00
...	3	5	7 1/2	3	N9A	7 1/16	4 1/8	4 1/2	5	28 00	N8A	7 1/16	4 1/8	5 1/16	5	28 00
...	3	5	7 1/2	4	N11A	7 1/16	4 1/8	4 1/2	5	40 00	N10A	7 1/16	4 1/8	5 1/16	5	40 00

Switches in General-purpose, Type 1 Cases

Toggle-operated

Push-button-operated

						No. of Poles	CR 1062 Form No.	Approx. Dimensions, In.			Approx. Ship. Wt. Lbs.	▲ Book Price Each	CR 1062 Form No.	Approx. Dimensions, In.			Approx. Ship. Wt. Lbs.	▲ Book Price Each
Single Phase			Polyphase					HL	Width	Depth				HL	Width	Depth		
1	1 1/2	2	1 1/2	2	3	2	M5A	6 3/4	5	4 1/8	5	\$20 00	M6A	6 3/4	5	4 1/2	5	\$20 00
...	1 1/2	2	3	3	M1A	6 3/4	5	4 1/8	5	25 00	M2A	6 3/4	5	4 1/2	5	25 00
...	1 1/2	2	3	4	M3A	6 3/4	5	4 1/8	5	35 00	M4A	6 3/4	5	4 1/2	5	35 00
1 1/2	3	5	2	N5A	9 3/4	5	4 7/8	6	25 00	N6A	9 3/4	5	5 1/4	6	25 00
...	3	5	7 1/2	3	N1A	9 3/4	5	4 7/8	6	30 00	N2A	9 3/4	5	5 1/4	6	30 00
...	3	5	7 1/2	4	N3A	9 3/4	5	4 7/8	6	42 00	N4A	9 3/4	5	5 1/4	6	42 00

Switches in Watertight and Dust-tight Type 3, 4, or 5 Cases

Switches in Explosion-proof, Class I, Group D Type 7 and Class II, Group G, Type 9 Cases

						No. of Poles	CR 1062 Form No.	Approx. Dimensions, In.			Approx. Ship. Wt. Lbs.	▲ Book Price Each	CR 1062 Form No.	Approx. Dimensions, In.			Approx. Ship. Wt. Lbs.	▲ Book Price Each
Single Phase			Polyphase					HL	Width	Depth				HL	Width	Depth		
1	1 1/2	2	1 1/2	2	3	2	M16A	11 3/8	7 5/8	5 1/2	35	\$52 00	M19A	11 3/8	7 5/8	5 1/2	35	\$66 00
...	1 1/2	2	3	3	M14A	11 3/8	7 5/8	5 1/2	35	57 00	M17A	11 3/8	7 5/8	5 1/2	35	71 00
...	1 1/2	2	3	4	M15A	11 3/8	7 5/8	5 1/2	35	72 00	M18A	11 3/8	7 5/8	5 1/2	35	86 00
1 1/2	3	5	2	N16A	11 3/8	7 5/8	5 1/2	36	64 00	N19A	11 3/8	7 5/8	5 1/2	36	78 00
...	3	5	7 1/2	3	N14A	11 3/8	7 5/8	5 1/2	36	69 00	N17A	11 3/8	7 5/8	5 1/2	36	83 00
...	3	5	7 1/2	4	N15A	11 3/8	7 5/8	5 1/2	36	90 00	N18A	11 3/8	7 5/8	5 1/2	36	104 00

*Push-button operated only.

Heater Selection

Size 0, CR1062-M and Size 1, CR1062-N

Size 1, CR1062-N Only

Cat. No.	Full-Load Motor Current, Amps.		Cat. No.	Full-Load Motor Current, Amps.		Cat. No.	Full-Load Motor Current, Amps.		Cat. No.	Full-Load Motor Current, Amps.	
	2 Pole Forms	3- and 4-Pole Forms		2 Pole Forms	3- and 4-Pole Forms		2 Pole Forms	3- and 4-Pole Forms		2 Pole Forms	3- and 4-Pole Forms
81D228	0.35-0.38	0.34-0.36	81D238	1.37-1.52	1.30-1.43	81D545	5.13-5.61	4.86-5.30	81D267	16.8-18.3	15.85-17.14
81D224	0.39-0.43	0.37-0.39	81D532	1.53-1.66	1.44-1.60	81D546	5.62-6.15	5.31-5.80	81D256	18.4-19.8	17.15-18.69
81D225	0.44-0.46	0.40-0.43	81D533	1.67-1.84	1.61-1.74	81D547	6.16-6.76	5.81-6.44	81D558	19.9-21.6	18.70-20.20
81D230	0.47-0.50	0.44-0.48	81D534	1.85-2.02	1.75-1.91	81D548	6.77-7.43	6.45-7.00	81D559	21.7-22.2	20.21-21.70
81D525	0.51-0.57	0.49-0.53	81D535	2.03-2.20	1.92-2.08	81D549	7.44-8.13	7.01-7.65			
81D231	0.58-0.63	0.54-0.59	81D536	2.21-2.42	2.09-2.28	81D550	8.14-8.98	7.66-8.40			
81D526	0.64-0.70	0.60-0.65	81D537	2.43-2.68	2.29-2.52	81D551	8.99-9.73	8.41-9.20			
81D527	0.71-0.76	0.66-0.71	81D538	2.69-2.96	2.53-2.79	81D552	9.74-10.79	9.21-10.19			
81D233	0.77-0.83	0.72-0.78	81D539	2.97-3.24	2.80-3.05						
81D528	0.84-0.92	0.79-0.88	81D540	3.25-3.53	3.06-3.32						
81D235	0.93-1.06	0.89-1.00	81D541	3.51-3.86	3.33-3.64						
81D529	1.07-1.12	1.01-1.06	81D542	3.87-4.25	3.65-4.00						
81D530	1.13-1.24	1.07-1.17	81D543	4.26-4.65	4.01-4.39						
81D531	1.25-1.36	1.18-1.29	81D544	4.66-5.12	4.40-4.85						

*Listed values are for motors rated 40 C continuous. For motors rated 50 C or 55 C continuous, multiply full-load current of motor by 0.9 and use value to select heater.

▲This page includes "Book" prices subject to discount. For the correct discount, contact Graybar.

G-E CR7051 A-C Reduced-Voltage Magnetic Starters

For Squirrel-Cage Induction Motors

2- or 3-Phase, 3-Wire, 60 Cycles

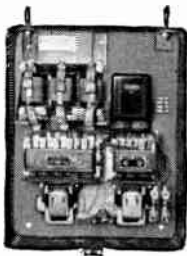

No. CR7051-A1G

Provides remote control for constant-speed squirrel-cage induction motors on compressors, blowers, and any application that does not require longer than 15 seconds to attain full speed, once every 4 minutes for an hour.

Consists chiefly of an autotransformer for supplying reduced voltage to motor during acceleration, accelerating contactor which connects autotransformer to line and motor to low-voltage taps, line contactor, temperature overload relay, a definite-time relay which causes accelerating contactor to open and line contactor to close after a predetermined time.

Dimensions and Weights (Air-Break)

CR7051 Form	Height In.	Width In.	Depth In.	Approx. Ship. Wt. Lb.
A1G	28	22	9.25	170
B1G	32	26	9.75	225
F100A	36	28	10.25	295

Nomenclature		Rating of Starter			▲Book Price Each*
No.	CR7051 Form	Hp.	Voltage Range	NEMA Size	
125L618G3	A1G		208	2	\$ 570
125L618G3	A1G		220	2	570
125L618G4	A1G	5-15	380	2	570
125L618G5	A1G		440	2	570
125L618G5	A1G		550	2	570
125L619G3	B1G		208	3	670
125L619G3	B1G		220	3	670
.....	...	20-25	380	2
125L618G6	A1G		440	2	570
125L618G7	A1G		550	2	570
125L619G26	B1G		208	3	698
125L619G26	B1G		220	3	698
.....	B1G	30	380	3
125L619G4	B1G		440	3	698
125L619G5	B1G		550	3	698
.....	F100A3		208	4	1296
.....	F100A3		220	4	1296
.....	...	40-50	380	3
125L619G6	B1G		440	3	722
125L619G7	B1G		550	3	722

*Book Price includes NEMA Type 1 enclosed control panel with overload relay, heaters, and starting autotransformer mounted, wired. Prices do not include push-button stations.

G-E CR1034 A-C Reduced-Voltage Manual Starters

For Squirrel-Cage Induction Motors

220-2200 Volts
60-50 Cycles

5-200 Hp.

3-Phase—3-Wire
2-Phase—3-Wire



CR1043-K1 low-voltage starter with ammeter attachment



A typical CR1034 starter

These starters are suitable for two- and three-phase motors, driving pumps, conveyors, compressors, blowers, or for other applications where reduced-voltage starting torques and currents are satisfactory for the load and power requirements. They afford high-torque efficiency, flexibility, protection to operator, protection to motor and driven machine, and time-delay undervoltage protection.

Each starter includes an autotransformer provided with several sets of starting taps, which facilitates adjustment of the motor starting torque and current to suit the particular load conditions. An autotransformer, switching device, instantaneous undervoltage device, and a hand-reset overload relay are all self-contained within a sheet-metal enclosure.

To order, specify CR and Form number, giving the complete motor rating, including horsepower, voltage, phase, and frequency. Order ammeter attachment, if desired. Book price, \$198.

CR1034 Form	Rating Hp.	Approx. Ship. Wt. Lbs.	▲Book Price Each
D100	5-15	150	\$ 375
D100		150	375
E100	20-25	165	393
D100		150	393
E100	30	165	407
E100		165	407
F100	40-50	310	710
E100		165	429
G100	60-75	360	765
F100		310	765
G150	100	700	1155
F100		310	765
G150	125	700	1155
G100		360	831
G100	150	360	831
G150		700	1265

*Use magnetic control.

▲"Book" prices subject to discount. For correct discount, consult Graybar.

General Electric CR7008 A-C Combination Magnetic Starters

Full-Voltage Starters for Induction Motors

Fusible, Nonfusible, or Circuit Breaker—Undervoltage Protection or Release

Thermal Overload Protection

1½-100 Hp., for 600 Volts, 60-25 Cycles, 2- and 3-phase



Size 1 combination magnetic starter with fusible disconnect switch in general-purpose enclosure

This combination magnetic starter is available in three basic forms consisting of a full-voltage starter in combination with a nonfusible disconnect switch, a fused disconnect switch, or a circuit breaker. Short-circuit protection is provided by the circuit breaker and fuse. Undervoltage protection or release, depending on the type of pilot device, is included.

A simple and reliable equipment for starting a small a-c motor is provided by a CR7008 combination magnetic starter and a CR107, CR108 and momentary-contact Start-Stop push-button station, limit switch, pressure governor, float switch, or other pilot device. The combination provides complete protection to both the motor and operator. Starters and pilot devices are completely enclosed, preventing accidental contact with any live parts.

These starters are available in general-purpose, water-tight, industrial use and automotive JIC cases, as well as in enclosures for hazardous and corrosive locations. The doors of all starters can be padlocked closed, and the switch can be padlocked in either the open or closed position. Positive interlocking between the switch, or breaker operating handle, and the case, prevent opening of the door with the handle in the On position, providing increased safety.

Advantages

Over-all Protection.—For complete, all-around protection to a-c motors, select a G-E combination magnetic starter. With fuses or circuit breakers to open the circuit the instant a short-circuit occurs, these units protect motor, wiring and the starter itself. In one compact low-cost unit, G-E com-

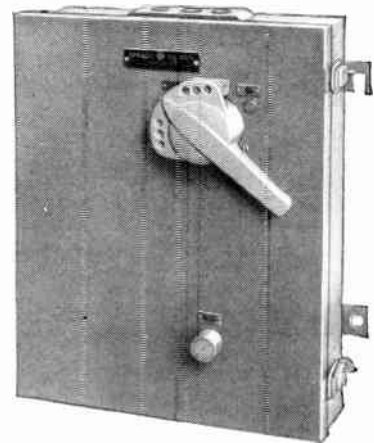

Size 4 combination starter with circuit breaker in watertight enclosure

bination starters give full protection where you need it most. Non-renewable fuses or completely enclosed circuit breakers give the tamperproof short-circuit protection that modern distribution demands—the magnetic starter and overload relays give the instant response you need for protecting the motor from overloads.

Protection of Personnel.—The new rotary-action disconnect switch on the G-E combination starter makes it impossible to open the cover without opening the circuit. The rotary action is positive and easy. Circuit-breaker forms have similar features.

Single-Unit Control.—The G-E combination magnetic starter saves space, speeds installation, because it's a single, compact unit that meets all National Electric Code requirements for circuit isolation and short-circuit protection. The combination starter provides complete protection to the equipment to which it is connected, and insures continuity of electric service to adjacent machines.

			Type I General Purpose						Type 4 Watertight						Type 12 Dust-tight					
Max. Horsepower 2- and 3-phase			Nonfusible		†Fusible		Circuit Breaker		Nonfusible		†Fusible		Circuit Breaker		Nonfusible		†Fusible		Circuit Breaker	
110 V.	220 V.	440 V.	Approx. Price	*▲Book Price	Approx. Price	*▲Book Price	Approx. Price	*▲Book Price	Approx. Price	*▲Book Price	Approx. Price	*▲Book Price	Approx. Price	*▲Book Price	Approx. Price	*▲Book Price	Approx. Price	*▲Book Price	Approx. Price	*▲Book Price
NEMA Size			Shp. Wt. Lbs.	Each	Shp. Wt. Lbs.	Each	Shp. Wt. Lbs.	Each	Shp. Wt. Lbs.	Each	Shp. Wt. Lbs.	Each	Shp. Wt. Lbs.	Each	Shp. Wt. Lbs.	Each	Shp. Wt. Lbs.	Each	Shp. Wt. Lbs.	Each
2	3	..	0 25	\$ 94	25	\$ 97	30	\$101	80	\$195	80	\$198	80	\$202	30	\$118	30	\$121	38	\$130
..	..	5	0 25	94	25	99	30	130	80	195	80	200	80	231	30	118	30	123	38	159
3	7½	..	1 25	99	25	102	30	106	80	195	80	200	80	202	30	123	30	128	36	130
..	..	10	1 25	99	25	106	30	135	80	195	80	202	80	231	30	123	30	130	36	159
7½	15	..	2 55	155	55	183	55	206	130	303	130	331	130	354	60	189	60	217	60	240
..	..	25	2 55	155	55	173	55	206	130	303	130	321	130	354	60	189	60	207	64	240
15	30	..	3 105	260	105	334	200	380	190	518	190	592	190	638	120	304	120	378	226	424
..	..	50	3 105	260	105	292	200	275	190	518	190	550	190	533	120	304	120	336	130	319
25	50	..	4 200	491	200	557	250	600	270	821	270	887	270	930	270	613	270	679	310	722
..	..	100	4 200	491	200	565	200	600	270	821	270	895	270	930	270	613	270	687	310	722

*Pilot device not included in above price and must be ordered separately. Price includes overload-relay heater units.

†Price includes starter complete with fuse clips; fuses must be ordered separately.

Note: Order by CR number and specify fusible, nonfusible, or circuit breaker starter as well as complete motor rating.

▲This page includes "Book" prices subject to discount. For the correct discount, contact Graybar.

**G-E CR109 and CR7009 A-C
Magnetic Reversing Controllers**

**Full-Voltage Reversing Controllers For Squirrel-Cage
Motors, Single-, 2-, or 3-Phase**

**Air-break — Undervoltage Protection and Thermal
Overload Protection
For 440 Volts, 60-25 Cycles**

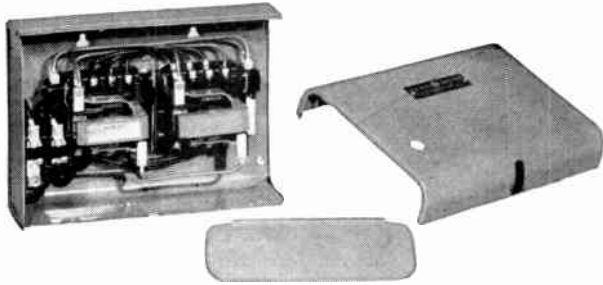

Size 1 magnetic reversing controller with cover removed

G-E CR109 or CR7009 magnetic controllers are suitable for use with reversing motors which are connected directly across the line. Each controller consists of two mechanically interlocked, magnetically operated, three-pole contactors with overload relay. The controllers may be controlled remotely through push-button station, limit switch, float switch, or other pilot device.

Undervoltage Protection or Release—These controllers are ordinarily operated by a momentary-contact Forward-Reverse-Stop push-button station. A normally open interlock is furnished on both the forward and reverse contactors of all controllers to complete the holding circuit. Undervoltage release is provided when maintained-contact pilot device is used.

Overload Protection—Sizes 0 through 4 include thermal overload relays that can be set for hand or automatic reset. Size 4 relays are hand-reset only. All use two relays externally reset from the front of the enclosure.

Enclosures—Controllers are enclosed in wall-mounted cases. Knockouts are conveniently located for conduit connections and for easy mounting.

Mechanical Interlock—The interference-type interlock is positive in action. Electrical interlocking is unnecessary.

110 Volt	Max. Horsepower 208 V. 440 Volt	NEMA Size	Open		Type 1 General Purpose		Type 4 Water tight		Type 12 Industrial Use	
			Wt. Lbs.	Book Price Each	Wt. Lbs.	Book Price Each	Wt. Lbs.	Book Price Each	Wt. Lbs.	Book Price Each
*1	2 3 5	0	16	\$ 80	18	\$ 84	30	\$130	26	\$102
*2	3 5 10	1	16	90	18	96	30	160	26	114
*3	7½ 10 25	2	40	168	54	184	67	288	60	214
*7½	15 25 50	3	60	277	96	305	110	459	102	371
25	50 100	4	60	672	125	724	150	996	136	826

*Single-phase rating.

†All forms 3 pole.

Note: All controllers listed above are for separate push-button connection. Price does not include push button. Above controllers Sizes 0 and 1 are also available in 2- and 4-pole forms. Sizes 2, 3, and 4 are also available in 4-pole form. Order by CR number and description, giving complete motor ratings.

G-E CR2940 and CR2943 Push-Button Stations



**Typical 3-button station
for front-of-panel or
wall mounting**



CR2943-NA 102A



**Typical watertight
station, CR2940-NJ102A**

CR2940 push-button stations are for use in the control circuits of various magnetic controllers. The large contacts and substantial construction of these heavy-duty stations make them well able to withstand the frequent operation and rough usage of machine-tool and similar applications.

The stations listed are divided into two general classes: momentary-contact and maintaining-contact. With a momentary contact, the circuit is completed or interrupted only as long as the operator's finger depresses the button. This feature is required when the station is used with a controller that must provide undervoltage protection. A maintaining contact holds the circuit open or closed. Stations with a combination of momentary and maintaining contacts are available. Information on request.

Push-button stations come in two sizes: standard-duty, suitable for use with contactors up to and including 150 amperes, and heavy-duty, for use with any-size contactor.

General-purpose, Momentary-contact

Single Button

Nomenclature	Nameplate Markings	Approx. Shp. Wt., Lbs.	Duty	Book Price, Each
CR2943-NA101F	Stop.....	2	Standard	\$ 6.00
CR2943-NA101E	Start.....	2	Standard	6.00
CR2940-NA101B	Start.....	4	Heavy	11.00
CR2940-NA101A	Stop.....	4	Heavy	11.00
CR2940-AA101A*	Reset.....	4	Heavy	11.00

Two Buttons

CR2943-NA102B	Raise—Lower.....	2	Standard	\$ 7.50
CR2943-NA102A	Start—Stop.....	2	Standard	6.00
CR2943-NA102E	Up—Down.....	2	Standard	7.50
CR2940-NA102A	Start—Stop.....	5	Heavy	17.00
CR2940-AA102A*	Raise—Lower.....	5	Heavy	17.00
CR2940-AA102M*	Up—Down.....	5	Heavy	17.00

Three Buttons

CR2943-NA103J	Forward—Reverse—Stop.....	4	Standard	\$12.00
CR2943-NA103K	Open—Close—Stop.....	4	Standard	12.00
CR2940-NA103A	Forward—Reverse—Stop.....	6	Heavy	22.00

Four Buttons

CR2940-AA104A*	Forward—Jog Forward—Reverse—Stop.....	10	Heavy	\$36.00
----------------	---------------------------------------	----	-------	---------

Five Buttons

CR2940-AA105A*	Forward—Jog Forward—Reverse—Jog—Reverse—Stop.....	10	Heavy	\$44.00
----------------	---	----	-------	---------

Maintaining-Contact — One Selector Switch

CR2940-NA101E	Safe Stop—Run.....	5	Heavy	\$14.00
CR2940-NA101C	Stop—Run.....	5	Heavy	14.00
CR2940-NA101D	Hand—Off—Auto.....	5	Heavy	14.00
CR2940-AA101E*	Fast—Slow.....	5	Heavy	14.00
CR2940-AA101E*	Creep—Normal.....	5	Heavy	14.00
CR2940-AA101D*	Open—Close.....	5	Heavy	14.00
CR2940-NA101F	Off—On.....	5	Heavy	14.00
CR2940-AA101D	Stop—Start.....	5	Heavy	14.00
CR2940-AA101E	Raise—Lower.....	5	Heavy	14.00

Stations for Special Applications

CR2943-NJ102A	Start—Stop (Watertight)	8	Heavy	\$19.00
CR2940-NJ102A	Start—Stop (Watertight)	8	Standard	26.00

*Specify nameplate marking on order.

▲This page includes "Book" prices subject to discount. For the correct discount, contact Graybar.

G-E CR2931 Enclosed Float Switches

For A-C or D-C Motors

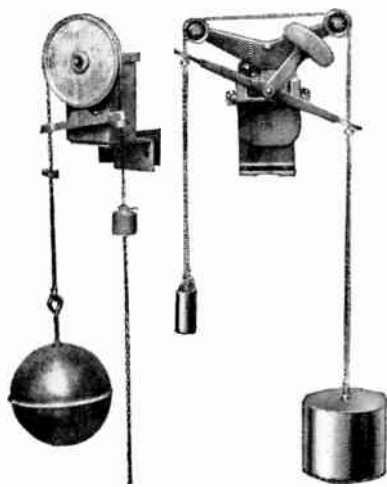

Form P

Form D

Suitable for use in the control circuit of a-c or d-c automatic starters, and, except for the Form P, can directly handle the circuits of small motors.

Arranged as furnished for tank operation — switch closes as lower liquid level is reached, and opens as top level is reached. Can be easily changed for sump pump operation by interchanging float and counterweight. Standard floats should not be subjected to pressure. Quotation on special floats will be furnished on request.

All switches are drip-proof and splash-proof, and are suitable for outdoor installation where they are not subjected to snow or sleet. Where the liquid whose level is to be controlled is subject to freezing, a float switch should not be used.

All switches are quick-acting when closing and opening, insuring minimum arcing and burning of contacts.

All switches are quick-acting when closing and opening, insuring minimum arcing and burning of contacts.

Form	No. of Poles	Description	Ship. Wt. Approx. Lbs.	Book Price Each
A	D-p	Rod-operated for clamping to inside top edge of tank; operated by rod and float; range, 10-in. to 5-ft.	85	\$ ^o 101.00
A	4-p	Same, except 4-pole	95	\$ ^o 112.00
B	D-p	Rod-operated for bolting to tank cover; requires guide in cover for operating rod; range 10-in. to 3½-ft.	95	\$ ^o 108.00
B	4-p	Same, except 4-pole.	105	\$ ^o 118.00
C	D-p	Rod-operated for bolting to tank cover; range, 10-in. to 3½-ft.	95	\$ ^o 112.00
C	4-p	Same, except 4-pole.	100	\$ ^o 124.00
D	D-p	Chain-operated for bolting to tank cover; operated by chain and float; suitable for any depth of tank or any variation in water level not less than 10-in.	110	\$ ^o 112.00
D	4-p	Same, except 4-pole.	120	\$ ^o 124.00
L	D-p	Chain-operated by chain and float; for any variation in water level not less than 5-in.	40	\$ ^o 80.00
M	D-p	Rod-operated; range, 2½-in. to 4½-ft.	70	\$ ^o 80.00
P	S-p	Operated by chain and float; for any variation in water level not less than 2-in.	10	\$ [†] 44.00
AW	S-p	Same as Form P, except with mercury-tube, heavy-duty "Konnectors".	10	\$ [†] 50.60

*Price includes 15-ft. of bronze chain. If more is needed, add \$0.40 for each additional foot.

†Price includes 15-ft. of brass chain. If more is required, add \$0.10 for each additional foot.

‡To obtain maximum operating range; deduct 3½-ft. from length of chain.

§To obtain maximum operating range; deduct 1½-ft. from length of chain.

¶Two standard lengths (each 3-ft.) of 3/8-in. brass rod are furnished. 3-ft. lengths can be furnished at \$1.20 per length.

G-E CR2927 Pressure and Vacuum Switches

Diaphragm Type — For Starting Small Motors or For Pilot-Circuit Control

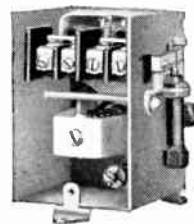

Pressure switch (cover removed) with unloader valve and differential-adjusting attachment mounted in place

These switches are designed to open or close contacts upon changes of pressure or vacuum of any gas or liquid which will not affect synthetic-rubber or brass or steel parts.

When larger motors than above ratings are used, these switches can be used in connection with automatic starters which will also provide overload protection.

Maximum Horsepower Ratings

A-C Polyphase		A-C Single-Phase		D-C	
Volts	Hp.	Volts	Hp.	Volts	Hp.
110	2	110	1½	115-550	½
220-550	5	220	3		

Order by CR number and Form No., and specify adjustment if other than factory adjustment is required.

Pressure Switches

*Standard Operation

Nom-enclosure	Max. Pressure Lbs. per Sq. In.		Factory Adjustment, Lbs. per Sq. In.		Min. Adjustment, Lbs. per Sq. In.		Max. Adjustment, Lbs. per Sq. In.		Approx. Ship. Wt. Lbs.	Book Price, Each
	Close	Open	Close	Open	Close	Open	Close	Open		
M14	5000	3200	4500	250	1300	3650	5000	5	\$46.00	
M 8	300	200	250	15	38½	245	300	5	\$21.60	
M 9	160	130	150	8	27	110	160	5	\$18.50	
M10	80	70	80	4	15	70	80	6	\$43.10	
M29	80	52	70	8	27	62	80	5	\$15.40	
M11	40	36	40	3	8	36	40	6	\$43.10	
M13	13	9	10	½	1½	12	13	8	\$49.30	

†Reversing Operation

M15	300	250	200	38½	15	300	245	5	\$21.60
M16	160	150	130	27	8	160	140	5	\$18.50
M17	80	80	70	15	4	80	70	6	\$43.10
M18	40	40	36	8	3	40	36	6	\$43.10
M20	13	10	9	1½	½	13	12	8	\$49.30

Vacuum Switches

Nom-enclosure	Operation	Max. Vacuum, inches of Mercury	Factory Adjustment, of Mercury, Inches		Min. Adjustment, of Mercury, Inches		Max. Adjustment, of Mercury, Inches		Approx. Ship. Wt. Lbs.	Book Price, Each
			Close	Open	Close	Open	Close	Open		
M12	*St'd	28	5	8	1	4½	23	28	8	\$40.00
M19	†Rev	28	8	5	4½	1	28	23	8	\$40.00

Attachments

Cat. No.	Description	Each
2244498G2	Unloader, 2-Way.....	\$6.20
2246093G1	Differential-adjusting Attachment for Standard-Operation Switch.....	3.10
2246900G1	Differential-adjusting Attachment for Reversing-Operation Switch.....	3.10
2246094G1	Hand-operation Lock-out Lever.....	4.60

*Standard operation: open at high vacuum, close(d) at low vacuum.

†Reverse operation: open at low vacuum, close(d) at high vacuum.

This page includes "Book" prices subject to discount. For the correct discount, contact Graybar.

G-E CR9440 Lever-Type Limit Switches

CR9440-J1C1 and J1D1

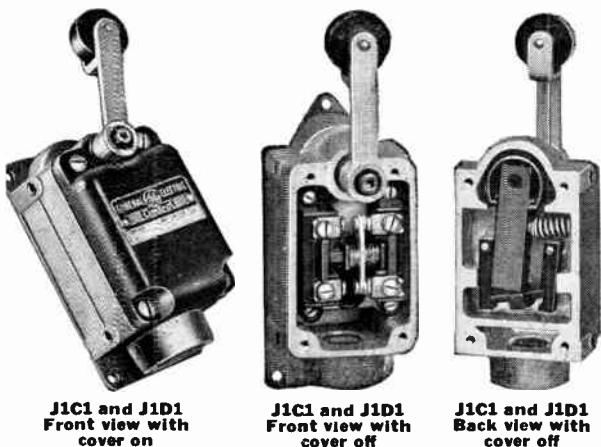

J1C1 and J1D1
Front view with cover on

J1C1 and J1D1
Front view with cover off

J1C1 and J1D1
Back view with cover off

The CR9440-J1C1 and J1D1 are sturdy, lever-operated limit switches enclosed in strong die-cast cases and molded phenolic covers. Their oilproof construction and single-pole, double-throw, double-break silver contacts of snap-action design make them very suitable for machine-tool and miscellaneous service.

Complete operation of the switches is obtained by a 12-degree travel of the lever with an overtravel of 24 degrees in either the clockwise or counterclockwise directions of rotation.

As supplied by the factory, these switches are arranged for clockwise operation, looking at the cover side. The direction of operation can be reversed by removing the base plate and transferring the return spring to the opposite side of the swing bar.

CR9440-B1B

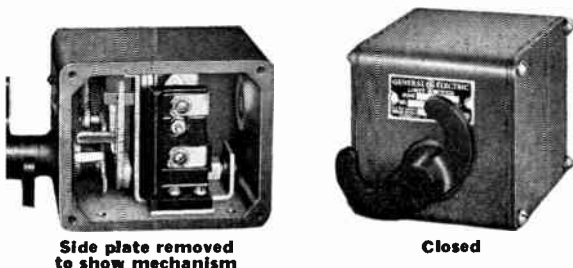

Side plate removed to show mechanism

Closed

A heavy-duty, snap-action, single-pole, double-throw switch with two independent circuits. This limit switch should be used whenever a small, compact, heavy-duty reversing limit switch is required to open or close a control circuit and where maintained accuracy of operation is of primary importance. Its field of application includes tapping machines, heading machines, grinder tables, welding machines, and other reciprocating machines where a reversing limit switch is applicable.

The contacts are double-break, and both stationary and movable tips are of fine silver to insure long life and dependable operation.

The movable contacts are held in either position by a small alnico magnet acting on an iron yoke. When the yoke is broken away from the magnet face, by direct mechanical action of the operating lever a sturdy spring snaps the contact assembly to the opposite position, where it is held in by the same alnico magnet until the yoke is broken away in the opposite direction. For this reason, the operating point is determined entirely by the position of the operating lever and is independent of tension in the spring. This construction insures maintained accuracy of operation in spite of changes in spring tension caused by aging under repeated operation.

Switch is enclosed in an oiltight steel enclosing case with two gasketed side plates and an opening in the rear for 1/2-inch conduit connection. With the side plates removed, the terminals are easily accessible, and large working clearances make the switch easy to wire and install.

CR9440-D2

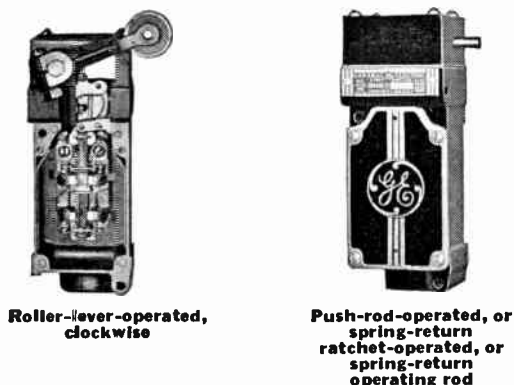

Roller-lever-operated, clockwise

Push-rod-operated, or spring-return ratchet-operated, or spring-return operating rod

open to normally closed operation, or vice versa. The operating heads can be interchanged, or turned 180 degrees. Holes are provided for mounting the switch on either its back or its side. These features allow maximum flexibility in application.

The switches are available in both open and enclosed forms. The open switches are particularly adapted to built-in applications where space is limited. Frames and plungers are constructed of molded *Textolite. The contacts are solid silver and are designed to close with a rolling action. All switches are equipped with flag terminals to accommodate two wires on each terminal. The construction is extremely compact and flexible. The enclosed form has a die-cast case, and is provided with velumoid gaskets and grease seals at shaft journals to make the switch oilproof for machine-tool use.

Application extends to virtually any automatic equipment where a traverse motion must be converted into control of an electric circuit, particularly where the motion is slow and snap-action contacts are necessary to prevent burning of the contact tips.

A lever-operated, push-rod-operated, or plunger-operated limit switch. All except the plunger-operated form have snap-action contacts. A variety of contact arrangements is available, which can be changed in the field from normally

*Registered trade-mark of General Electric Co.
See following page for ratings and prices.

G-E CR9440 Lever-Type Limit Switches
Continued

Development Figures

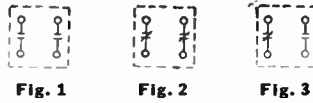

For Miscellaneous and Machine-Tool Service — Track-Type

Roller Lever, Spring-Return Operation

Form No.	Description	De-velop-ment Fig. No.	No. of Circuits Norm. Open	No. of Circuits Norm. Closed	Contact Rating, Inductive Load Carrying and Breaking, Maximum Amperes						Approx. Ship. Wt. Lbs.	▲ Book Price Each	
					D-C Circuits			A-C Circuits					
					115 Volts	230 Volts	550 Volts	110 Volts	220 Volts	440 Volts	550 Volts		
J1C	Oilproof, Snap-action, CW or CCW Rotation; 2 1/8-in. Lever adjustable through 160°; 3/4-in. Conduit.	3	†1	1	2.5	.8	.25	30	15	7	5	4	\$22.00
J1D	1/2-Inch Conduit.....	3	†1	1	2.5	.8	.25	30	15	7	5	4	22.00
D2AA	Snap-action Silver Contacts; Oilproof Case; CW Rotation.	1	2	..	1.5	.5	.15	30	15	7	5	3	22.00
D2BA		2	..	2	1.5	.5	.15	30	15	7	5	3	22.00
D2CA		3	†1	1	1.5	.5	.15	30	15	7	5	3	22.00
D2DA		3	†1	1	1.5	.5	.15	30	15	7	5	3	22.00
D2AB	Snap-action Silver Contacts; Oilproof Case; CCW Rotation.	1	2	..	1.5	.5	.15	30	15	7	5	3	22.00
D2BB		2	..	2	1.5	.5	.15	30	15	7	5	3	22.00
D2CB		3	†1	1	1.5	.5	.15	30	15	7	5	3	22.00
D2DB		3	†1	1	1.5	.5	.15	30	15	7	5	3	22.00

Reversing Motion, Maintained Contact

B1B	Alnico; Snap-action; Oilproof Case; Forked Lever (Offset); 1/2-In. Conduit.....	3	†1	1	4.0	1.2	.4	30	15	7	5	5	\$36.00
-----	---	---	----	---	-----	-----	----	----	----	---	---	---	---------

Plunger Operated

D2AF	Silver Contacts; Oilproof Spring Return; 3/4-In. Conduit.	1	2	..	1.5	.5	.15	30	15	7	5	3	\$14.00
D2BF		2	..	2	1.5	.5	.15	30	15	7	5	3	14.00
D2CF		3	†1	1	1.5	.5	.15	30	15	7	5	3	14.00
D2DF		3	†1	1	1.5	.5	.15	30	15	7	5	3	14.00

Push-Rod Operated

D2AC	Snap-action Silver Contacts; Oilproof case; 3/4-in. Conduit; Maintained contact.	1	2	..	1.5	.5	.15	30	15	7	5	3	\$22.00
D2BC		2	..	2	1.5	.5	.15	30	15	7	5	3	22.00
D2CC		3	†1	1	1.5	.5	.15	30	15	7	5	3	22.00
D2DC		3	†1	1	1.5	.5	.15	30	15	7	5	3	22.00
D2AD	Snap-action Silver Contacts; Oilproof Case; 3/4-In. Conduit; Spring Return.	1	2	..	1.5	.5	.15	30	15	7	5	3	22.00
D2BD		2	..	2	1.5	.5	.15	30	15	7	5	3	22.00
D2CD		3	†1	1	1.5	.5	.15	30	15	7	5	3	22.00
D2DD		3	†1	1	1.5	.5	.15	30	15	7	5	3	22.00

†Nonoverlapping contacts; one circuit is broken before the other is closed.

‡Overlapping contacts; one circuit is broken after the other is closed.

▲This page includes "Book" prices subject to discount. For the correct discount, contact Graybar.

Hoffman Oil Tight Pushbutton Enclosures

Standard

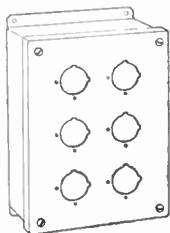

Designed for use with all standard makes of oil tight pushbuttons, switches and pilot lights. Oil tight construction seals out foreign materials making units suitable for use where liquids and dirt are a problem.

Constructed of 14 gauge steel. All seams gas welded. No conduit holes or hubs in the box. Flanged cover is gasketed with cellular neoprene and readily removable from box.

Standard finish is baked gray hammertone enamel over a phosphatized surface.

Standard enclosures are available for 1, 2, 3, 4, 6, 9, 12, 16, 20 and 25 control units. Special sizes and hole arrangements can be promptly furnished.

No.	No. of Units	Enclosure Size, In.	Std. Pkg.	Ship. Wt. Lbs.	Each
1PB	1	4 x 4 x 3	24	53	\$7.00
2PB	2	6 x 4 x 3	20	57	8.00
3PB	3	8 x 4 x 3	12	43	9.20
4PB	4	10 x 4 x 3	12	47	11.08
6PB	6	8 x 6 x 3	10	50	13.20
9PB	9	8 x 8 x 3	8	45	16.50
12PB	12	10 x 8 x 3	8	52	20.90
16PB	16	12 x 10 x 3	4	38	26.40
20PB	20	14 x 10 x 3	4	42	30.80
25PB	25	14 x 12 x 3	4	49	35.20

Note—EXTRA DEEP (4 3/4 inch) enclosures, SLIM and PENDENT enclosures are also available.

Mercoid Liquid Level Controls

For use on boilers as low water cut-off, feed water pump control and alarm purposes, and for many industrial applications where control is desired from change of liquid level of water, oil, gasoline, ammonia and other fluids.

Electrical capacity: 10 amp. 115 volts, 5 amp. 230 volts, and on order 3 amp. 440 volts. Bodies on all types are cast iron.

Low Water Controls

Standard with copper float and brass trim. Available semi-automatic, with hand reset. Also available weatherproof at extra cost.

Pressure Rating 150 lbs. Max.



Type 123

Type	Description	Each
123	Cuts in as level rises	\$32.00
123-3	Cuts in as level falls	32.00

Standard with nickel plated steel float and brass trim. Available semi-automatic, with hand reset.

Pressure Rating 300 lbs. Max.



Type 72

Type	Description	Each
72	Cuts in as level rises	\$56.00
72-3	Cuts in as level falls	56.00

Type 75 Feed Water Pump Control



Type 75

Spec.	Max. Pressure Rating, Lbs.	Each
2120	300	\$55.00

Type 75 Combination Feed Water Pump Control and Low Water Cutoff

Spec.	Max. Pressure Rating, Lbs.	Each
2123	300	\$60.00

Type 75 Liquid Level Controls
Max. Pressure 300 lbs.; Max. Temperature 425°F.

With Nickel Plated Steel Float and Brass Trim

Spec.	Description	Each
7500	Circuit Opens as Liquid Level Rises	\$59.00
7501	Circuit Opens as Liquid Level Lowers	59.00

With Nickel Plated Steel Float and Stainless Steel and Monel Trim

7525	Circuit Opens as Liquid Level Rises	\$70.00
7526	Circuit Opens as Liquid Level Lowers	70.00

Stainless Steel Float and Trim

7550	Circuit Opens as Liquid Level Rises	\$80.00
7551	Circuit Opens as Liquid Level Lowers	80.00



Type 76EH
Explosion-Proof
Liquid Level
Controls

*With Nickel Plated Steel Float and Brass Trim

Spec.	Description	Each
7600	Circuit Opens as Liquid Level Rises	\$85.00
7601	Circuit Opens as Liquid Level Lowers	85.00

†With Nickel Plated Steel Float and Stainless Steel and Monel Trim

7645	Circuit Opens as Liquid Level Rises	\$110.00
7646	Circuit Opens as Liquid Level Lowers	110.00

‡Stainless Steel Float and Trim

7660	Circuit Opens as Liquid Level Rises	\$121.00
7661	Circuit Opens as Liquid Level Lowers	121.00

*Max. pressure 150 lbs.; max. temperature 365° F.

†Max. pressure 300 lbs.; max. temperature 425° F.

Mercoid Pressure Controls



DA-31 & DA-21



DA-531 & DA-521



DS-231 & DS-221

Have easy outside adjustments for setting cut-in and cut-out pressures. Mercury switch contacts. Visible direct-reading dial. Bourdon tube pressure element.

Types DA-31, DA-531, DS-231 have light gauge Bourdon tube for applications where pressures change slowly and without surge.

Types DA-21, DA-521, DS-221 have heavier gauge Bourdon tubes and check valve for pressures which surge or pulsate.

Types DA-31, DA-21 have minimum differentials as indicated and electrical capacity: 10 amp. 115 volts, 5 amp. 230 volts, and on order 3 amp. 440 volts.

Types DA-531, DA-521 have closer, minimum differentials: electrical capacity: 115 volts — 5 amp. ac. 2½ amp. dc; 230 volts — 2 amp. ac, 1 amp. dc.

Types DS-231, DS-221 are single adjustment type with very close operating differential. Electrical capacity: 115 volts — 0.3 amp. ac, 0.15 amp. dc; 230 volts — 0.15 amp. ac, 0.07 amp. dc.

All are single pole, single throw to OPEN circuit as pressure increases. If desired to CLOSE circuit as pressure increases add suffix (-3), such as DA-31-3, etc. Double pole and other circuits available on request. Also available semi-automatic with hand reset.

Brass Bourdon Tubes (Except *)

Type DA-31			Type DA-531			Type DS-231		
Range In. Vac.	Min. Differential In. Vac.	Each	Min. Differential In. Vac.	Each	Min. Differential In. Vac.	Each	Min. Differential In. Vac.	Each
0-30	2	\$20.00	1	\$29.00	2/10	\$40.00		
Range Lbs.	Min. Differential Lbs.	Each	Min. Differential Lbs.	Each	Min. Differential Lbs.	Each		
0-14	1	\$15.00	1/2	\$24.00	1/8	\$33.50		
0-20	1	15.50	1/2	25.00	1/8	34.00		
0-35	1 3/4	16.50	3/4	26.00	1/4	35.50		
0-60	2 1/2	17.00	1	32.00	3/8	40.00		
0-100	3 3/4	18.00	2	33.00	7/16	41.00		
0-150	7	20.00	3	34.00	1/2	42.00		
0-200	8	24.00	3 1/2	38.00	3/4	44.00		
0-300	12	25.00	6	41.00	1	47.00		
Type DA-21			Type DA-521			Type DS-221		
0-14	1	\$15.50
0-35	2	17.00
0-60	3	18.00
0-60*	6	26.00	2	\$35.00	7/16	\$45.00		
0-100	6	20.00
0-100*	6	27.00	3	36.00	3/4	46.00		
0-150	8	22.00
0-150*	8	28.00	4	37.00	3/4	47.00		
0-200*	8	30.00	4	39.00	3/4	49.00		
0-300	12	26.00
0-300*	14	31.50	7	42.00	1	51.00		
0-600*	50	45.00	25	58.00	4	63.00		
0-1000*	75	60.00	40	74.00	10	79.00		
0-1500*	100	68.00	50	84.00	12	90.00		
300-2500*	150	79.00	100	95.00	15	100.00		

*Bourdon Tube Chrome Molybdenum Steel.

Explosion-proof case Type DAE with any of above \$80.00 extra.

Weather-proof case Type DAW with any of above \$26.00 extra.

Diaphragm seals of stainless, monel, etc. also available.

Struthers-Dunn Relays

The ratings of all relays are conservatively based on non-inductive loads. Contacts will break 150% and carry rated load without overheating. Motor and lamp loads require special consideration because of high inrush (5 to 12 times normal).

Fine quality material is used throughout and each one is individually adjusted for correct wipe and pressure to assure maximum life. They are also adjusted for satisfactory operation at 15% under-voltage on a-c and 20% on d-c. Fine silver button contacts. Most relays can be furnished with any contact combination desired. Housings of various types are available if specified.

Midget Relays

These are small size, plain magnetic relays for general control applications.



Type B1XBX

Coils—Shunt: Up to 230 volts a-c., 60 cycles and up to 115 volts d-c. (Up to 230 volts d-c with resistor.)

Series up to 30 amperes a-c or d-c.

Contact ratings: A-c, 115 volts 6 amperes; 230 volts 3 amperes. D-c, 24 volts 6 amperes; 115 volts 0.5 ampere. Non-inductive loads.

Size base 2 3/4 x 1 7/8-in.

Single Pole, Double Break

Type	Each
B1HXX Front Contact.....	\$5.90
B1XHX Double Throw.....	6.80
B1XXH Back Contact.....	5.90

Double Pole, Single Break

B1BXX Front Contact.....	\$7.70
B1XBX Double Throw.....	8.30
B1XXB Back Contact.....	7.70

Standard Industrial Relays

Plain magnetic type for general control applications.

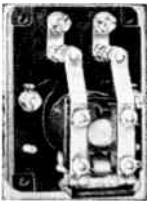

Type A8HXX

Coils—Shunt: Up to 550 volts, 60 cycles, a-c, up to 230 volts, d-c.

Series: Up to 30 amperes a-c or d-c.

Contact ratings—A-c, 115 and 230 volts, 30 amperes. D-c, Single break 115 volts 3 amperes; 230 volts 0.75 amperes. Double break, 115 volts 6 amperes; 230 volts, 3 amperes. Non-inductive loads.

Single Pole, Single Break

Type	Size Base, In.	Each
8AXA Double Throw, Separate Circ...	4 1/4 x 3	\$13.60

Single Pole, Double Break

A8HXX Front Contact.....	4 1/4 x 3	\$10.40
84XXH Back Contact.....	5 x 3	13.20

Double Pole, Single Break

8BXX Front Contact.....	4 1/4 x 3	13.60
84XXB Back Contact.....	5 x 3	15.10
84XB Double Throw.....	6 1/4 x 3	17.60
84BXB Double Throw, Separate Circ...	6 1/4 x 3	19.20

Three Pole, Single Break

A8CXX Front Contact.....	4 1/4 x 3	15.50
84XC Back Contact.....	5 x 3	17.20

Instrument-Controlled Relays

For Two-Wire Instruments

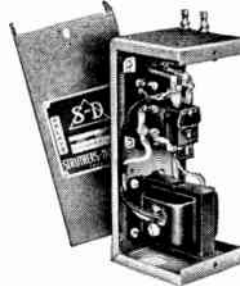

Type BRS239

Recommended when a high voltage load circuit is the sole source of supply and the instrument is for low voltage. Thermostat should be of the quick make-and-break type.

Underwriters' approved.

Consists of relay and transformer mounted in sheet metal housing, with external binding posts for connecting to thermostat.

Type	A-C Rating, Amps. 115 V.	230 V.	Hp. Rating	Each
ARS71	20	20	1	\$19.80
BRS239	6	3	1/3	13.90

For Three-Wire Instruments



Type 8BXX50

Separate Circuit

Recommended for use where low voltage control is available. Load and control circuits are isolated.

Type	Contact Rating, Amps.				Size, Base, In.	Each
	115 V.	D-C	A-C 230 V.	D-C		
8BXX50	30	6	20	3	4 1/4 x 3	\$15.10
B1BXX50	6	0.5	3	..	2 3/4 x 1 7/8	9.20

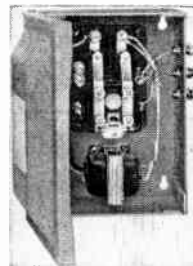

Type RS73

For supplying low voltage to instrument contacts and relay coil where sole power supply exceeds voltage rating of instrument contacts.

Mounted in sheet metal housing, with transformer. External binding posts for connecting to thermostat.

Type	A-C Contact Rating, Amps. 115 V.	230 V.	*Hp. Rating	Each
RS73	20	20	1	\$23.00
BRS240	6	3	1/3	15.40

*Approved by Underwriters' Laboratories for motor loads specified.

For Three-Wire Instruments



Type B1MXX50

For controlling heaters, refrigerator units, pressure devices, etc.

For use where control circuit and load are fed by the same line and where instrument contacts can handle the load circuit voltage. Instrument contacts make but do not break current.

Type	Contact Rating, Amps.				Size, Base, In.	Each
	115 V.	D-C	A-C 230 V.	D-C		
A8MXX50	30	6	20	3	4 1/4 x 3	\$13.20
B1MXX50	6	..	3	1	2 3/4 x 1 7/8	8.00

Struthers Dunn Relays

Mechanical Latch-in and Electrical Release Relays



Ideal for 3-wire or separate circuit control. Two-coil type, with mechanical latch for locking contacts in "operated" position until electrically released.

Coils: Continuous Duty.

Shunt—Up to 550 volts, 60 cycles a-c, up to 230 volts d-c. Series—Up to 30 amperes a-c or d-c.

Size base 1½ x 3¼ in.

Type	Description	Each
5HX46	S.P., S.T., D-B.	\$14.00
5BX46	D.P., S.T., S.B.	16.00
5AX46	S.P., D.T., S.B.	16.00

Ratchet Type Sequence Relays

Repeating Type (Round and Round)



These relays continuously repeat a pre-determined contact sequence.

Contact ratings: a-c, 115 volts, 20 amperes, 230 volts, 10 amperes, d-c, 115 volts, 1 ampere, 230 volts, 0.25 amperes, non-inductive.

Coils: Intermittent duty.

Shunt—Up to 550 volts, 60 cycle, a-c; Up to 230 volts, d-c. Series: Up to 30 amperes a-c or d-c.

Size base 5x3 in.

Sequence—"O" open contact, "X" closed contact.

Position	1	2	3	4	
1XX—Contact	O—O	X—X	O—O	X—X	Then
2XA—Contact	O—X	X—O	O—X	X—O	Repeat

Type	Description	Each
38BXX	Double Pole, Single Throw	\$25.40
38AXA	Single Pole, Double Throw	25.40

Midget Sequence Type

Coils—Shunt: Up to 230 volts a-c, 60-cycles and up to 115 volts d-c. (Up to 230 volts d-c with resistor.)

Series: Up to 30 amps a-c or d-c.

Type	Non-Inductive Contact Rating, Amps.				Each
	A-C		D-C		
	115 Volts	230 Volts	24 Volts	115 Volts	
31BXX	6	3	6	.5	\$16.00
31AXA	6	3	6	.5	16.00

Emergency Lamp Control Relays

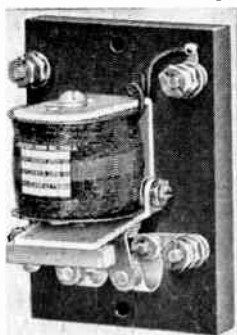

Type 20XXH5

For automatically cutting in an emergency or standby lamp when main lamp burns out.

These common circuit relays are single pole with series coil and normally-closed contacts on weighted armature for gravity return to normal position.

Relay can also be connected to an auxiliary source of power (as storage battery) to switch the emergency lamp into the auxiliary circuit should the main line voltage fail or the main lamp burn out.

The voltage drop at contacts is practically eliminated by low resistance fine silver contacts.

Contact ratings: Emergency lamps, maximum watts—115-230 volts, a-c, 800 watts; d-c, 100 watts.

Size of base, front connected, 4x2¾ in.

Single Pole, Single Throw.

Type	Description	Each
20XXA5	Single Break	\$8.60
20XXH5	Double Break	8.60

Telephone Auxiliary Signaling Relays

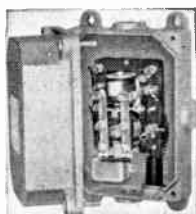

Type A5XXH501W6

For sustained signaling from telephone ringing circuit. Auxiliary signal remains on until relay is manually reset by pushing button in bottom of housing. For police and taxicab signals, etc.

Mechanical latch relay, ¾ Mf. condenser and push button mounted in cast iron housing and wired. Operates on 10 ma. at 90 volts, 60 cycles, with 7500 ohms impedance.

Contact ratings: 10 amperes at 115 volts a-c, 2 amperes at 115 volts d-c. Non-inductive.

When ordering specify type reset coil voltage and frequency (or d-e) and contact rating.

Type	Description	Each
A5XXH501W6	In Cast Iron Weatherproof Housing	\$49.60

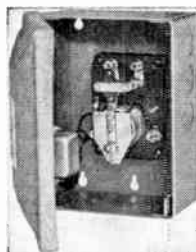

Type 4HXX56H3

For operating audible or visible auxiliary signals from telephone ringing current.

Relay and ¾ Mfd. condenser mounted in metal housing. Operates on 8 ma. at 90 volts, 20 cycles, with 9500 ohms impedance.

Contact ratings: 10 amperes at 115 volts a-c, 3 amperes at 115 volts, d-c. Non-inductive.

When ordering specify type and contact rating.

Type	Description	Each
411XX56H3	In Sheet Metal Knockout Box	\$20.20
411XX56W6	In Cast Iron Weatherproof Housing	36.00

Mercury Contact Relays

Solenoid Type

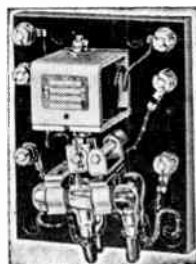

Type 48 BXX39

Recommended for high inrush loads (Motor-lamp, etc.) or dirt-laden atmosphere. Solenoid magnet assembly tilts mercury tube.

Contact ratings: a-c, 115 volts, 25 amperes, 230 volts, 20 amperes. d-c, 115 volts, 20 amperes, 230 volts, 10 amperes.

Coils—Shunt: Up to 550 volts, 60 cycles a-c. Up to 230 volts d-c. Series: Up to 30 amperes a-c or d-c.

Type	No. of Cont.	Normal Contact Position	Each
48AXX39	1	Open	\$29.50
48BXX39	2	Open	46.00
48XXA39	1	Closed	29.50
48XXB39	2	Closed	46.00

Sensitive Relays

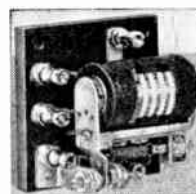

Type 112XAX

Long life, fast operation and vibration resistant relays with low inertia and balanced moving parts result in high sensitivity.

Sensitivity, 0.015 watts, d-c, 0.19 volt-amperes at 60 cycles.

Can be furnished with interconnected coil and contact circuits for use with thermoregulators.

Single pole, double throw contacts on non-inductive loads rated 2 amperes, 115 volts a-c; 1 ampere, 230 volts and 0.25 ampere 115 volts d-c.

Base size, front connected, 2½x2¾-in.

Coils wound with wire up to 44 gauge—prices varying with wire gauge.

Type 112XAX—Single Pole, Double Throw. Available with double pole, double throw contacts.

For more complete information and prices contact Graybar for bulletin.

Struthers-Dunn Time Delay Relays

**Repeating Type
(Round and Round)**



Type APSY1

These timers continue to repeat the contact cycle as long as the motor remains energized. The single pole, double throw snap action contacts are individually operated by fibre cams mounted on a shaft. The cam shaft assembly is rotated by a single wound synchronous motor.

Contacts rated: For a-c—10 amperes, 115 volts; 5 amperes, 230 volts; 3 amperes, 460 volts—non-inductive, or 1/2 hp. on 115, 230 or 450 volt d-c motor load.

Size base 3 3/4 x 2 1/4 x 2 1/8 in.

Type	Description	Each
APSY1	One contact; Speed 1 rpm.....	\$16.00

We can also furnish other type timers, such as single cycle repeating, immediate recycling, etc.

Edwards General Purpose Relays

**Single Pole
Contact Ratings**

No.	Coil Volts 12 V. A-C	Coil Volts 24 V. A-C	Coil Volts 115 V. A-C	Coil Volts Up to 250 V. D-C or 60 Cyc. A-C	Each
941-F	\$12.50	\$12.50	\$13.50	\$20.00	
941-B	12.50	12.50	13.50	20.00	
941-FB	15.50	15.50	16.50	20.00	

For Type A Surface Box on all 941 Relays, add to list \$8.25.

When ordering any of the above relays be sure to specify correct voltage for operation of relay coils—a-c or d-c (give cycles); contact arrangement—Front, Back or Front and Back; number of circuits contacts are required to open or close. Voltage and amperage contacts must handle. Is load inductive or non-inductive? Is relay to operate in series with any other device? Give any other information (or a sketch) of its intended use.

“Diamond H” Momentary Contact Toggle Switches

For Manual Control of Magnetic Switches, Relays, Etc.

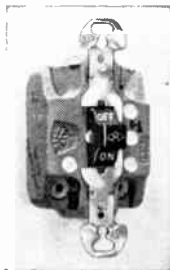

No. 15009

A special switch for use with magnetic switches. Contacts are made of pure silver. Will fit all standard conduit boxes and takes a standard switch plate.

Packed 10 in a carton. 100 in a standard package. Package weight, 38 pounds.

No.	Description	Each
15009	Single Pole Double Throw Toggle Switch Normally Open.....	\$3.68
15010	Lock Type Switch with Key.....	4.55
15010-2	Key.....	.25

H-B Mercury Plunger Relays

Approved by Underwriters' Laboratory Inc.



Fig. 1



Fig. 2

Fig. 1. This consists of a mercury-plunger tube and coil mounted on a heavy bakelite base, 2 1/2-in. x 5-in. x 3/8-in., which has 2 mounting holes. Through terminal bridges for one side of both the load and coil circuits are provided for convenience in wiring.

Fig. 2. This model is supplied for “switchboard” or other mounting. It consists of the tube, coil and mounting bracket.

No.	Mounting	Load Circuit*	Load Rating in Amps. AC		Coil Voltage	Each
			110	220		
7020	Fig. 1	N/O	30	20	110/60	\$10.45
7030	Fig. 1	N/O	30	20	220/60	10.45
7080	Fig. 2	N/O	30	20	110/60	9.10
7090	Fig. 2	N/O	30	20	220/60	9.10
7250	Fig. 1	N/C	30	20	110/60	11.20
7260	Fig. 1	N/C	30	20	220/60	11.20
7310	Fig. 2	N/C	30	20	110/60	9.70
7320	Fig. 2	N/C	30	20	220/60	9.70

*N/O: normally open. N/C: normally closed.

H-B Mercury Plunger Relays in Housings

Approved by Underwriters' Laboratory Inc.

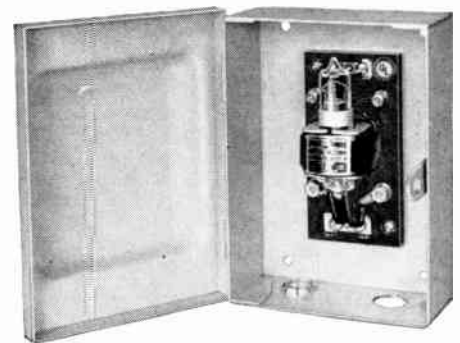

A hinged-cover steel housing, with knockouts on four sides, finished in gray enamel and complete with relay mounted. Special housings to meet individual needs can be supplied.

In listing below. No. designates housing and relay.

No.	Load Circuit	Load Rating in Amps. AC		Coil Voltage	Each
		110	220		
7370	N/O	30	20	110/60	\$13.85
7380	N/O	30	20	220/60	13.85
7430	N/C	30	20	110/60	14.65
7440	N/C	30	20	220/60	14.65

H-B Mercury Plunger Relays
For Street Lighting Control

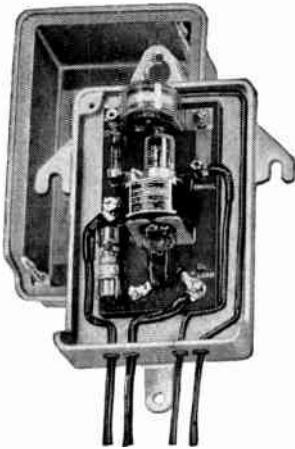

Hermetically-sealed Relay mounted in a weather-proof housing of new and simplified design. Coil and load fuses and lightning arrestor, singly or in combination as desired, are optional and are mounted on heavy bakelite base measuring 3 3/8-in. x 6-in. x 3/8-in.

Complete unit is made in both normally open and normally closed types, and for either open or closed pilot circuits used in remote control of cascade lighting. Load fuses are 30 amperes, coil fuses 2 amperes. The lightning arrestor is in coil circuit.

Assemblies also furnished with wired leads, when specified, extending

12-in. below bottom of housing at slight extra cost. Flexible stranded copper leads with moisture-proof (Type TW or equivalent) insulation are used. No. 8 wire used for load circuit. No. 10 for coil (control) circuit. Mounted in cast aluminum housing.

Fuse on Load and Coil Circuits with Lightning Arrestor

No.	Load Circuit*	Induction Load Rating in Amperes AC		Coil Voltage	Wt. Lbs.	Each
		110	220			
C-7496	N/O	30	20	110/60	4 1/2	\$22.75
C-7516	N/C	30	20	110/60	4 1/2	23.55

*N/O: Normally Open. N/C: Normally Closed.

If flexible stranded wire leads, which extend 12-in. below box, are desired, add suffix "A" to catalog number and add \$2.00.

Mossman Switches

BASIC CONTACT FORMS

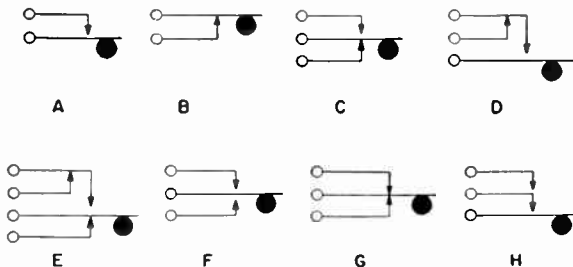

All contact forms are shown unoperated. Almost any combination may be made of these contacts up to a maximum of 15 spring in each spring stack.

When ordering a lever turn or push button switch, please specify: Series Number, giving switch Series number to identify the basic construction; the contacts required, using the basic form letters illustrated; the location of each contact by the switch position (or station) number; the ampere rating (standard ratings are at 110 volts, a-c non inductive); and the type of action desired whether locking or non-locking. For Interlocking Push Button Switches, give the desired type of operation.

Mossman Switches

Custom Built Multiple Contact Leaf-Spring Lever, Push and Turn Switches

Action of Lever Switches

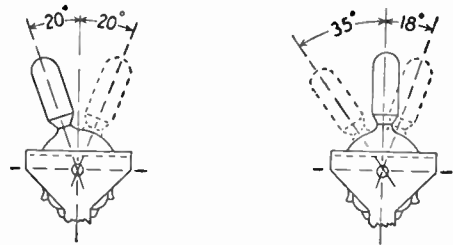

Two Position—Without Neutral or (O) Position

Three Position, Locking or Non-Locking

These switches are ruggedly constructed for reliable service. They are furnished with silver or other precious metal contacts in almost any combination of contact arrangement and mechanical action. They are regularly constructed for long life applications in radio transmitters, signal systems, fire alarm systems, test sets, industrial process controls, etc.

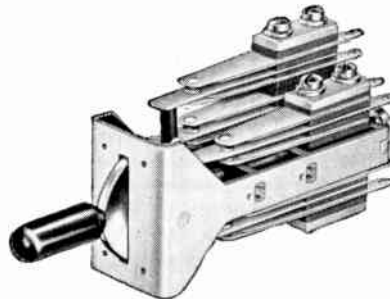

Series 4100 Heavy Duty Lever Switch

Affords great flexibility of circuit arrangement. Available in an almost unlimited series of combinations of contact assemblies and may be built up to suit specific requirements.

Contact Ratings:

Standard Heavy Duty—Fine silver contacts 3/16 in. diameter. Rated 10 amperes, 110 volts a-c, non-inductive.
Extra Heavy Duty—Silver alloy contacts 5/16 in. diameter. Rated 20 amperes, 110 volts a-c, non-inductive.
Phosphor bronze springs with solder-lug terminals. Frame tapped for 4 No. 4-40 machine screws, 5/8 x 1 1/4" centers.

Series 4103—Three Position: Locking or Non-Locking in active positions (Always locking in neutral position).

Series 4102—Two Position: Always locking in active position—has no neutral position.

Prices on application.

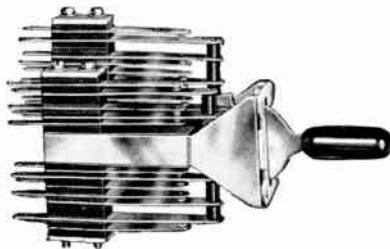

Series 4200 Lever Switch

Has many of the outstanding qualities of the Series 4100, but is lighter in weight and smaller in size.

Any combination can be made of the Basic Contact Forms.

Contact Ratings:

Standard Duty—Fine silver contacts 1/8 in. diameter. Rated 5 amperes, 110 volts a-c, non-inductive.
Extra Heavy Duty—Fine silver contacts 3/16 in. diameter. Rated 10 amperes, 110 volts a-c, non-inductive.
Phosphor bronze springs with solder-lug terminals. Frame tapped for No. 4-40 flat head screws, 13/16 x 1 1/8" centers.

Series 4203—Three Position: Locking or Non-Locking in active positions (Always locking in neutral position).

Series 4202—Two Position: Always locking in active position—has no neutral position.

Mossman Switches

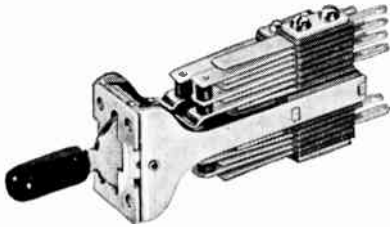

Series 4803 Telephone Lever Key Switch

A high grade switch, more rugged than the average Telephone Key, designed for exacting applications in switching electronic, communication, signalling and control circuits and for other purposes requiring more positive action.

Available with all Basic Contact Forms except F and G. Has detent or arresting spring to eliminate "bounce" or false operation of the contacts when key is restored to neutral position.

Contact Rating:

Standard Duty—Code 4, 18 gauge welded Palladium; Rated 3 amperes, 110 volts a-c, non-inductive.

Nickel silver leaf springs, with tinned solder type terminals.

Polished black phenolic handles are standard. Mounts with 4—#3-18 oval head screws on 17/32" x 13/16" centers.

Series 4803—Normally three positions; locking or non-locking action available in the active positions. Locking always in neutral position.

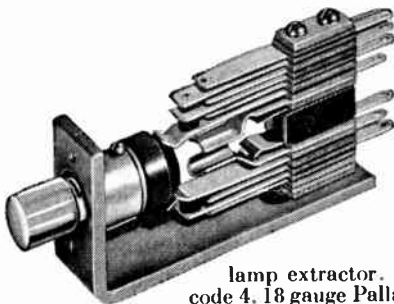

Series 536 Illuminated Push Switches

Designed for use on illuminated panels. Standard 24 or 48 volt telephone switchboard lamps are used to illuminate push button; lamps are removable from front by

lamp extractor. Standard contacts are code 4, 18 gauge Palladium, welded on nickel silver springs in combination of all Basic Forms except F and G. Buttons available in red, green, blue, amber and yellow and clear, all snap fitted. Buttons may be engraved with desired characters.



4400 Push Type



4400 Turn Type

Series 4400 Short Frame Push and Turn Switches

These switches are more ruggedly constructed than the conventional

jack switch of this type. Fine silver contacts 1/8 in. diameter; Rated 3 amperes, 110 volts a-c, non-inductive.

Contact Forms A, B and C available in any combination.

Black plastic push buttons and pointer knobs. Complete with mounting hardware.

Push Switches

Series	Description
4400PNL.....	Push, Non-Locking
4400PL.....	Push Locking
4400PNL-TL.....	Push, Non Locking, -Turn, Locking

Turn Switches—Two Position

	Position 1	Position 2
4402TL-NT.....	Turn, Locking	No Throw
4402TNL-NT.....	Turn, Non-Locking	No Throw

Turn Switches—Three Position

4403TL-L.....	Turn, Locking	Locking
4403TL-NL.....	Turn, Locking	Non-Locking
4403TNL-L.....	Turn, Non-Locking	Locking
4403TNL-NL.....	Turn, Non-Locking	Non-Locking

Series 5600 Push and Turn Switches

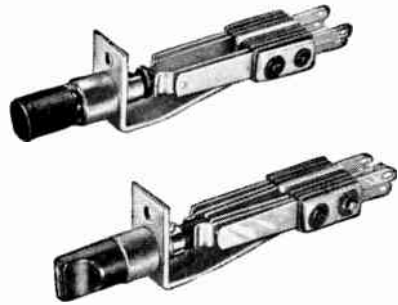

For a variety of applications where panel space is limited in communication, signalling and instrument apparatus. Contacts are 3 ampere, 110 Volts A-C (non-inductive). All basic forms except F and G may be used.

Push Switches

Series 5600PL—Locking Series 5600PNL—Non-Locking

Two Position

Series	Position 1	Position 2
5602TL-NT	Locking	No Throw
5602TNL-NT	Non-Locking	No Throw
Three Position		
5603TL-L	Locking	Locking
5603TL-NL	Locking	Non-Locking
5603TNL-L	Non-Locking	Locking

Series 7700 and 7600 Switches



Provide for easy push button selection of multiple circuits in almost any combination. Molded nylon plungers mounted on phenolic rollers result in extremely smooth, easy operation. Each button depressed releases any previously operated station. Contacts of released station restore to normal before contacts of a newly operated station are actuated. Series 7600 has 5/8 in. plunger centers, series 7700 3/4 in. centers.

Furnished in standard construction with from 4 to 12 stations. Up to 24 stations in a single row on special order. Optional features available include Lock-out or "No-two-operate feature" to prevent operation of more than one station at a time; non-locking stations; accumulative locking stations and illuminated buttons.

Contact Rating—3 amp., 110 v. a-c (non-inductive). Basic contact forms A, B, C and D may be used in any combination to a maximum of approximately 10 springs per pile-up. Twin pile-ups may be mounted on each station to provide up to 20 springs per station. (Requires 3/4-in. plunger centers).

Give complete Series number, state the type of operation desired and the required contacts for each station. Stations are numbered from left to right viewing from the terminal end with contact springs on the upper side of frame.

G-E Photoelectric Devices

CR7505-K100 Photoelectric Relay



**CR7505-K100G3
General-Purpose
Relay**

The CR7505-K100 photoelectric relay and accessories provide a complete line of inexpensive but thoroughly reliable apparatus for general-purpose indoor photoelectric application. Some of the possible applications are counting, signalling, limiting, and protecting.

The CR7505-K100G3 includes a double-throw magnetic relay, with contacts rated 10 amperes, a-c. This relay is energized by an amplifier circuit which includes a GL-923 phototube and a GL-2050 thyratron tube. Power supply is 115 volts, 50/60 cycles.

The relay will operate, without any lens in front of the phototube, on a minimum of 40 foot-candles at the aperture, and will reset when the light intensity is reduced to 30 foot candles or less.

CR7505-K100 Accessories



**Phototube Holder
CR7505-P211**



**Light Source
Transformer**

Light source CR7505-C201G1 can be mounted on transformer Cat. No. 9T53Y8025 or on any standard 1/2-inch conduit. Light source CR7505-C203G1 may be used where operating distances are greater than nine-feet. CR7505-K100 power requirements are 10 volt-amperes.

Phototube holder CR7505-P211G1 is similar in appearance to the -C201 light source. The P211G1 is furnished with six feet of special phototube cable and a plug for connecting the tube socket in the relay. CR7505-P212G1 is similar in appearance to the -C203 light source. Because of its 3-inch lens it is used where greater operating distances are required. Like the -P211, it is furnished with special cable and plug but no phototube, since a phototube is included in the K-100 relay.

CR7505-K100 Photoelectric Relay

Com- bina- tion	Description	Operating Distance Ft.	Approx. Ship. Wt. Lbs.	List Price Each
II	Including photoelectric relay, light source C7505-C201G1, & transformer Cat. No. 9T53Y8025	9	17	\$61.00
J	Same as H, plus extended phototube holder, CR7505-P211G1....	12	21	75.00
K	Including photoelectric relay, light source CR7505-C203G1, transformer Cat. No. 9T54Y8025, and lens barrel CR7505-B207G1..	30	19	72.00
L	Same as K, except including phototube holder CR7505-P212G1 instead of lens barrel.....	30	22	85.00
M	Same as L, except no light source or transformer.....	..	13	56.00
N	Same as M, except CR7505-P212G1 large lens instead of P211G1.....	..	14	61.00
P	Including photoelectric relay CR7505-K100G3 and lens barrel CR7505-B207G1.....	..	12	48.00

**CR7505-K201G2, CR7505-K202G2
Photoelectric Relays**

These photoelectric relays are suitable where higher sensitivity to light changes and/or higher operating speed is needed. The -K201G2 has a dust-tight/weather resistant enclosure and the -K202G2 has an explosion-proof/watertight enclosure.

They operate on either light increase or decrease, depending on the connections. A time delay may be added to make the relay insensitive to light change of short durations. They will operate from light flashes on interruption of 1/15 second between impulses, with not less than 1/15 second between flashes. They also have a maximum rate of 450 operations per minute. The d-c phototube circuit permits remote location of the phototube with no loss in sensitivity. Will operate from a 115/230-volt, 50/60 cycle power source with 10 volt-amperes power requirements.

The -K201G3 is the same as the -K201G2, except that it has a solid front cover for use with a remotely located phototube holder.

CR7505-K108G15 Photoelectric Relay

This device operates from a 115-volt d-c. or 25-cycle supply with a power requirement of 20-volt-amperes. The unit is mounted in a dust-tight and weather-resistant enclosing case for outdoor use. The cover of the enclosing case is fitted with a 3-in. lens and aperture for admission of light to the phototube. A metal visor is mounted over the lens to assist further in minimizing the effect of slanting sun rays. The relation of the lens and aperture is such that the operating light beam must be accurately aligned with the center of the lens and aperture behind it. Otherwise, the beam will not pass through the small aperture and will not reach the phototube. This system minimizes the effect of general daylight illumination, but the device must be so mounted that direct sunlight does not reach the lens.

The light source can be placed at a maximum distance of 35 feet from the phototube. A minimum illumination of 3-foot-candles is necessary to operate this relay.

115/230 Volts, 50/60 Cycles

Cat. No.	Dimensions of Panel Enclosing Case, In.			Approx. Ship. Wt. Lbs.	Each With Tubes
	High	Wide	Deep		
CR7505-K201G2	10 ¹ / ₃₂	6 ³ / ₃₂	4 ¹³ / ₁₆	8	\$85.00
CR7505-K202G2	12 ⁵ / ₈	12 ¹ / ₃₂	11 ³ / ₄	85	240.00

115 Volts, 25 Cycles

CR7505-K108G15	10 ¹ / ₁₆	5 ³ / ₈	7 ³ / ₈	9	82.00
----------------	---------------------------------	-------------------------------	-------------------------------	---	-------

G-E Photoelectric Devices

High-Speed Relays

- CR7505-N210G2 (Weather-resistant or Dust-tight)**
- CR7505-N211G2 (Explosion-proof or Watertight)**
- CR7505-N212G2 (Weather-resistant or Dust-tight)**



CR7505-N210G2
Photoelectric Relay
(Cover Removed)

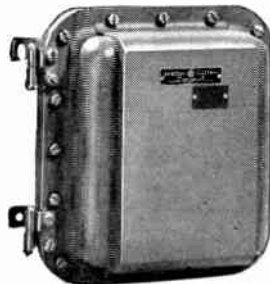

CR7505-N211G2
Explosion-proof
Photoelectric Relay

These three photoelectric relays are identical in circuit design. They are especially adapted for photoelectric applications where a device must respond to rapid light changes or short pulses of light or darkness. The relays can operate as rapidly as 600 times per minute. Since the magnetic

relay would be energized for such a short duration, the time might not be sufficient to perform the external control operation desired (to flash a warning light, for example). A time-delay feature is provided to delay the dropout of the magnetic relay. This time is adjustable up to one-half second by means of a potentiometer dial.

While the photoelectric relay may be operated on either light increase or decrease, it may at the same time be used in either two ways, depending on the need. It may be resistant-coupled, allowing the relay to energize with a signal without de-energizing the relay until after the original light level at the phototube is restored. Or, it may be capacitive-coupled, allowing the relay to respond to rapid changes in light by energizing the relay and then de-energizing it, regardless of the value of the light level. The time-delay reset alone determines when the relay will de-energize. The relays will respond to light changes as small as 1/2 a foot-candle, providing there is sufficient light on the phototube.

Power Requirements are 60 Volt-amperes

No.	Volts	Cycles	Approx. Ship. Wt. Lbs.	Each With Tubes
CR7505-N210G2	115/230	50/60	17	\$165
CR7505-N211G2	115/230	25/50/50	135	300
CR7505-N212G2	115/230	25	17	275

G-E CR7505 Photoelectric Accessories

Light Sources

CR7505-C201



CR7505-C201
Light Source

The CR7505-C201G1 light source has a die-cast aluminum enclosure. The back cover is spring-clipped in place so that it is easily removable for accessibility to the socket. An adjustable mounting bracket permits mounting in almost any position. The unit can be mounted directly on 1/2-inch conduit. The CR7505-C201G2 is identical except that it is weather-resistant and dust-tight.

The CR8505-C201 light source can be mounted directly on top of the Cat. No. 9T53Y8025 transformer so that a completely assembled light source with transformer results. This eliminates the use of protected leads to the light source,

as connections can be made directly within the light-source enclosure.

CR7505-C203



CR7505-C203
Light Source

The CR7505-C203 is similar to the CR7505-C201G1, except that the lens is 3-in. in diameter and has a 4 1/2-inch focal length. CR7505-C203G2 is of weather-resistant and dustproof construction in accordance with NEMA specifications. It may be used on machines which must be washed down, provided that the unit is not directly subjected to the hose stream.

CR7505-C202

This light source is for indoor service. It is similar to CR7505-C201, except that an additional lens is added to provide a short-focus, concentrated beam of light. This unit will concentrate an intense spot of light approximately 1/4-inch in diameter at a distance of 2 1/2 to 4-inches in front of the lens. The appearance and dimensions are the same as the CR7505-C201.

CR7505-C208



CR7505-C208 Light Source

This light source is explosion-proof and can be made watertight by applying a rubber gasket, which is furnished. This unit has a self-contained step-down transformer for the automobile type No. 1323 pre-focused lamp which has a 25/50/60-cycle, 115/230-volt rating. It has a 3-in.-diam. lens which will accommodate the infrared filter CR7505-B201G1.

Order light sources by CR number. Light-source power requirements are 20 volt-Amp.

No.	Height	Width	Depth	Approx. Ship. Wt. Lbs.	Each w/Lamp, but w/Transformer
CR7505-C200G1	4 9/16	2 3/4	3 7/16	6	\$ 9.00
CR7505-C201G1	6 1/16	2 7/16	6 1/2	6	10.00
CR7505-C201G2	6 1/16	2 7/16	6 1/2	6	12.00
CR7505-C202G1	6 1/16	2 7/16	6 1/2	6	11.00
CR7505-C203G1	6 1/16	2 7/16	8 1/2	6	15.00
CR7505-C203G2	6 1/16	2 7/16	8 1/2	6	17.00
CR7505-C208G1	12 5/8	12 3/4	11 3/4	90	182.00

G-E Photoelectric Devices

Electronic Timers

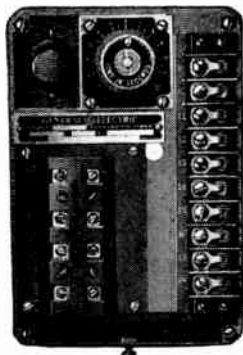

These timers are electronic devices which provide either a time delay or timed interval after an external switch, contact, or interlock is operated.

Among their many applications are:

Immediate-start Timing

Accurate control of the time duration of operations such as paint spraying, electroplating, car washing, heat-treating, preliminary bag filling, photographic printing, delaying heat-treating or painted parts until paint fumes are exhausted, prolonging fire siren operation after switch is turned off, etc.

Delayed-start Timing

Accurate limiting of the time duration of a delay required for: shutting down belt conveyors if material-removal lag becomes excessive, preventing too frequent starting and stopping of a thermostatically controlled motor, etc.

Sequence Timing

Two or more timers in combination will accurately control the time durations of operations in a sequence such as: cutting time, drift time, or oscillations on bearing-grinding machines, several operations required in sequence on rod-coiling machines; steam scalding, hydraulic flushing on commercial potato-peeling machines; low speed, medium speed, high speed on centrifuges, etc. This sequence may be manually or automatically reinitiated (repeat sequencing).

All models have a contact rating at 115 or 230 volts, a-c: 30 amp. inrush; 10 amp. carry; 10 amp. break.

Approximate shipping weight is 13-pounds.

No.	Timing Range Seconds		Contact Rating, Amp Break		Approx. Reset Time, Seconds		Each w/Tube
	Min.	Max.	125V, D-c	250V, D-c	Imme- diate Start	Delayed Start	
CR7504A142G1	0.06*	120.0	0.2 NO	0.1 NO	0.2	0.1	\$66.00
CR7504A142G2	0.6	12.0			2	1	\$67.00
CR7504A142G3	6.0	120.0	0.1 NC	0.05 NC	6	3	\$68.00
CR7504A142G4	3.0†	50.0+			4	2	\$68.00

Note: Special ranges available on request.

*0.03 second minimum to 1.2 seconds maximum time ranged when used for immediate start operation.

†Has 0-100% time scale.

Infrared Filter Cap

This unit is a small cap which fits over the end of the lens barrel of the CR7505-C201, -C203 or -C208 light source to provide a practically invisible beam. The cap contains a filter glass which absorbs practically all of the visible energy radiated by the lamp, but permits the infrared energy to pass. The photoelectric relays are sensitive to this infrared energy. The sensitivity is reduced somewhat by adding a filter.

The CR7505-B200G1 is for 1½-in. lens; the CR7505-B201G1 is for 3-in. lens.

Phototube Holders and Infrared Filters

No.	Description	Use With CR7505-	Approx. Ship. Wt. Lbs.	Each
CR7505-P202G2	Phototube holder & cable w/spade terminals 1½-in. lens.	K201, K202, N210, N211, N212	6	\$13.00
CR7505-P203G2	Same, 3-in. lens.		7	18.00
CR7505-B200G1	Infrared filter, 1½-in. lens.	C201, C202	1	9.00
CR7505-B201G1	Same, 3-in. lens.	C203, C208	2	22.00

Electronic Relay

CR7511-A126G2



The CR7511-A126G2 electronic relay is used to obtain a reliable contact from the touch of two conductors through which only a small current can flow. It may be used as a floatless liquid-level control in water, acids, salts, beer, etc. to operate motors, lights, solenoids, and contactors whenever there is sufficient change in the resistance of a circuit.

The electronic relay is basically an electronic-tube amplifier, which consists of an electromagnetic relay, an electronic tube, and a supply transformer. The components are mounted on a metal chassis, which fits into a standard weather-resistant and dust-tight enclosing case. Conduit knockouts in the case, with conveniently located large terminals on the chassis, greatly simplify installation.

The amplifier consists of an input or actuating circuit (the circuit which is to initiate the relay) and an output circuit which operates the electromagnetic relay. This relay is referred to as the anode relay, because it is in the anode circuit of the electronic tube. With the electronic relay connected for normal operation, the anode relay is circuit is closed as long as the contacts connected to the input circuit remain open. At the instant the input contacts are closed by a body having a resistance within the range of the input sensitivity for which the potentiometer is set, the anode relay opens.

When the electronic relay is connected for normal operation, a time delay is provided before the electromagnetic relay closes. This time delay depends on the external or actuating resistance. If the external resistance decreases greatly in value, the time delay is relatively short.

When the relay closes on an increase in the external resistance, the time delay depends essentially on the potentiometer setting. This time delay may be appreciable at high dial settings—particularly if the external resistance increased from a very low value.

The time-delay characteristics for reversed operation are similar. When the external resistance changes abruptly from a high value to a low one, the time delay will be quite short (Minimum 0.005 second); when the external resistance varies from low to high, the time delay may be much longer, depending essentially on the setting of the potentiometer.

115/230 Volts.

Frequency—50/60-cycles.

2 spdt output-relay contacts.

Price Includes Tubes.

No. CR7511A126G2..... Each \$80.00

Indoor Light-Source Transformer

These transformers may be used to supply low-voltage a-c to a 21- or 32-cp lamp in any one of the indoor light sources. They are rated 115/230 volts primary with a secondary voltage to provide approximately 1000 hours' life from either a 21- or 32-cp, 6-8 volt automobile lamp. A tap is also provided on the secondary to give approximately 3000 Hours' life from either a 21- or 32-cp, 6-8 volt lamp (with reduced illumination).

115/230 Volts

No.	Type	Cycles	Approx. Ship. Wt. Lbs.	Each
9T53Y8026	Open	50/60	2	\$11.00
9T53Y8047	Enclosed	50/60	2	12.00
9T53Y8058	Weatherproof	25/50/60	5	17.00

G-E Timing Devices

General Electric Timing Devices include 3 distinct product groupings: (1) Time Switches; (2) Interval Timers; (3) Time Meters.

The following table will be of assistance in selecting the proper type of timing device for the desired operation.

Time Switches

Use Time Switch Type	For Uses Requiring
TSA-47 and TSA-471	Regular-duty operation, related to hour of day, indoor use.
TSA-41	Regular-duty operation, related to hour of day, outdoor use.
TSA-40	Heavy-duty operation, related to hour of day, outdoor and indoor installation.

Percentage Timers

TSA-14, Percentage Timer	Repeating operation cycle, not related to hour of day (indoor).
--------------------------	---

Time Meters

KT-11, -12, -13, -14	Counting units of time-operating time of machines or electronic equipment.
----------------------	--

Complete Line of New Time Switches

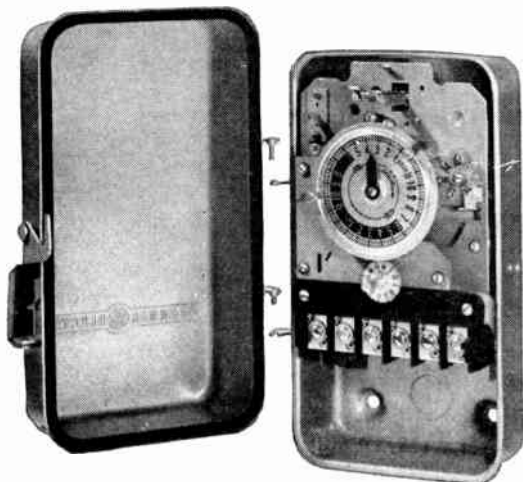

Type TSA-40 Time Switch

No matter what the particular application, there is the right General Electric time switch to handle it. Now industry's only manufacturers of a complete line of general purpose time switches, General Electric's line can handle both indoor and outdoor jobs—regular—or heavy-duty—with up to 16 ON-OFF operations in a day.

Regular-Duty Indoor Time Switches

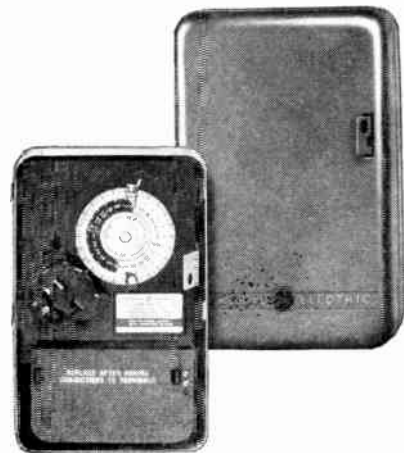

Type TSA-47 Time Switch

Used for a variety of timing jobs such as advertising signs, store windows, floodlighting, heating, air-conditioning, refrigeration and motor starting. Newest addition to General Electric's complete line, the TSA-47 is specially designed for flexibility on general purpose indoor timing jobs. For example, both double-pole and single-pole models are available. In addition, operations can be set as close as one hour apart with the TSA-47. You can get as many as 12 ON-OFF operations in a single day.

Gives heavy-duty protection, too. Contacts are rated at 35 amps., 240 volts per pole under tungsten—important for lighting loads. The TSA-47 will withstand 350 amps. of inrush current. This built-in protection is in both the 120-volt and 240-volt models.

Adjustable trippers are attached to the easy-to-read dial with thumb screws, actuate ON-OFF levers. Trippers for as many as 12 ON-OFF cycles may be placed on dial.

**Contact Rating Per Pole:
Spst: 35 Amps., Tungsten Load, 240 Volts A-C**

Motor Volts	Poles	Throw	†60-Cycle Cat. No.	List Price, Each	†60-Cycle Cat. No.	List Price, Each
120	1	1	699X1	\$11.00	699X7	\$15.00
240	1	1	699X2	12.00	699X8	16.00
120	2	1	699X3	13.00	699X9	17.00
240	2	1	699X4	14.00	699X10	18.00
120	1	2	699X5	13.00	699X11	17.00
240	1	2	699X6	14.00	699X12	18.00
With Case, Cord and Plug						
120	1	1	699X25	13.00	699X26	17.00

†Plain Dial.

‡Plain Dial with Omitting Device.

Order by catalog number and rating.

For 50 or 25-cycle operation add \$1.00.

For omitting device, catalog number 699X83, for installation in the field \$3.00.

Extra trippers—standard "ON" tripper, standard "OFF" tripper or special "OFF" tripper for omitting device actuation . . . \$0.25 each.

Switches can be supplied without case and cover, and with special mounting brackets, for convenient mounting in equipment.

G-E Regular-Duty Outdoor Time Switches

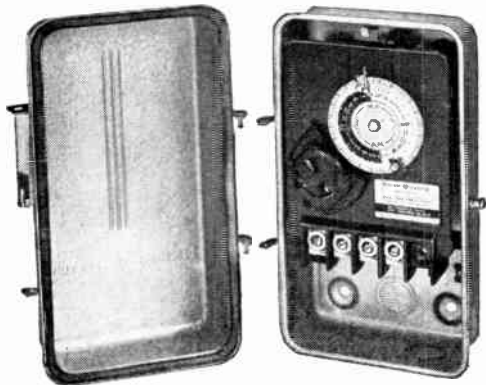

**Type TSA-41
Time Switch**

Ideal time switch for such jobs as street lighting, sign, store, floodlighting, irrigation and pump control, motor control, plus many other outdoor applications.

Has raintight case offering better protection against all types of weather. It has heavy-duty contact ratings of 35 amps., 240 volts per pole under tungsten load, in both 120-volt and 240-volt models.

As many as 12 ON-OFF operations per day can be set up on the easy-to-read dial. As on all other General Electric time switch, trippers can be set one hour apart.

**Contact Rating—35 Amps. Tungsten Load
240 Volts A-C**

Motor Volts	Switch Pole	Switch Throw	†60-Cycle Cat. No.	List Price Each	†60-Cycle Cat. No.	List Price Each
120	1	1	698X85	\$20 00	698X91	\$24 00
240	1	1	698X86	21 00	698X92	25 00
120	2	1	698X87	22 00	698X93	26 00
240	2	1	698X88	23 00	698X94	27 00
120	1	2	698X89	22 00	698X95	26 00
240	1	2	698X90	23 00	698X96	27 00

†Plain Dial.

‡Plain Dial with Omitting Device.

Note: Order by catalog number and rating.

For 50 or 25-cycle operation, add \$1.00

For omitting device, catalog number 699X83, for installation in the field \$3.00

Extra trippers—standard "ON" tripper, standard "OFF" tripper or special "OFF" tripper for omitting device actuation . . . \$0.25.

G-E KT Time Meters



An ideal indicator for compiling operating time and shut-down time for plant utilization records, to provide proper servicing and preventive maintenance on machinery and electronic equipment.

A complete line of KT time meters for every time-measuring application—includes 2½-in. and 3½-in. sizes in either round or square case for panel mounting, conduit-type case, portable stand and also military sealed model.

Has 6-digit register—extra large counter numbers. Counter digits are 2½-times the size of those found in any other meter. White numbers on a black background to provide unexcelled readability. Last digit in contrasting colors to indicate tenths.

Die-cast zinc bezel and plastic case completely enclose the mechanism, providing a dust-resistant enclosure.

Panel models meet ASA panel mounting specifications.

Time meter has wide temperature operating range.

G-E KT Time Meters (Cont.)

Panel-mounted Case

Time meters for slush mounting on a panel board or in an equipment case. Die-cast zinc bezel with aluminized dial face. Available in 2½-in. and 3½-in. sizes, round or square cases; all models with or without reset knob.

60-Cycle

Volts	Non-reset Type		List Price Each	With Reset Knob		List Price Each
	Register Minutes	Hours		Register Minutes	Hours	
120	909X48	909X49	\$17 00	909X54	909X55	\$19 00
240	909X50	909X51	18 00	909X56	909X57	20 00
480	909X52	909X53	19 00	909X58	909X59	21 00

2½-Inch Round Case

120	909X60	909X61	\$17 00	909X66	909X67	\$19 00
240	909X62	909X63	18 00	909X68	909X69	20 00
480	909X64	909X65	19 00	909X70	909X71	21 00

2½-Inch Square Case

120	909X72	909X73	\$17 00	909X78	909X79	\$19 00
240	909X74	909X75	18 00	909X80	909X81	20 00
480	909X76	909X77	19 00	909X82	909X83	21 00

3½-Inch Round Case

120	909X84	909X85	\$17 00	909X90	909X91	\$19 00
240	909X86	909X87	18 00	909X92	909X93	20 00
480	909X88	909X89	19 00	909X94	909X95	21 00

3½-Inch Square Case

120	909X84	909X85	\$17 00	909X90	909X91	\$19 00
240	909X86	909X87	18 00	909X92	909X93	20 00
480	909X88	909X89	19 00	909X94	909X95	21 00

Conduit-mounted Case

Panel model, 3½-inch square time meter, mounted in a die-cast zinc case with durable glass cover. Available with or without reset knob.

60-Cycle

Volts	Non-Reset Type		List Price Each	With Reset Knob		List Price Each
	Register Minutes	Hours		Register Minutes	Hours	
120	699X96	699X97	\$18 00	699X37	699X38	\$20 00
240	699X98	699X99	19 00	699X39	699X40	21 00
480	698X99	699X36	20 00	699X41	699X42	22 00

Portable Case

Panel model, 3½-inch square time meter, mounted in attractive portable steel case finished with hammertone gray paint. Available with or without reset knob.

60-Cycle

Volts	Non-reset Type		List Price Each	With Reset Knob		List Price Each
	Register Minutes	Hours		Register Minutes	Hours	
120	699X43	699X44	\$20 00	699X49	699X50	\$22 00
240	699X45	699X46	21 00	699X51	699X52	23 00
480	699X47	699X49	22 00	699X53	699X54	24 00

Note: Order by Catalog Number.

For 50-cycle service, add \$1.00. Order by Catalog Number "except 50 cycles." For 208-volt service, add \$1.50 to price of 240-volt model. Order by 240-volt Catalog Number "except 208 volts."

Call Graybar FIRST For . . .

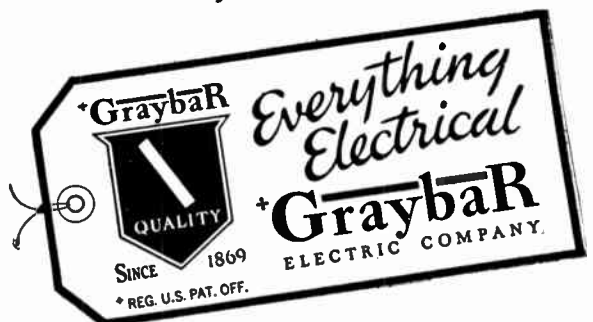

Paragon Interval Timers

(Series 2900)

Self-Starting, Synchronous



A manually preset interval timer for industrial control of plastic moulding, batch mixing, rubber curing, conveyor operations and other applications. The timer mechanism is mounted to cover, with inner terminal block for easy installation.

All models are single pole, double throw.

Can be equipped with bull's eye, signal buzzer, stop-start switch, etc. at a slight additional charge.

Write us for prices.

Surface mount case 8 x 5 x 3⁵/₁₆ inches.

Shipping weight 5 lbs.

120 Volt, 60-Cycle Motor

Capacity: 10 Amps., 1000 Watts, Non-inductive Load

No.	Range of Adjustability	Dial Grads.	Each
2904	0 to 5 min.	5 sec.	\$21.50
2905	0 to 15 min.	15 sec.	21.50
2906	0 to 30 min.	30 sec.	21.50
2907	0 to 60 min.	1 min.	21.50
2908	0 to 5 hours	5 min.	21.50
2909	0 to 10 hours	15 min.	21.50
2910	0 to 20 hours	30 min.	25.00

Note — For 240 volt, 50- or 60-cycle; 24 volt, 50- or 60-cycle; or 120 volt, 25- or 50-cycle motors add \$1.00 to list prices

Paragon Time Switches

(Series 700)

Seven-Day Calendar Dial

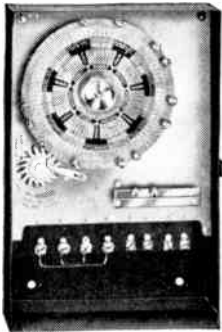

Provides individual settings for each day in the week. An entire week's program can be set in advance, with Sunday and holiday cutout.

For automatic control of heating, ventilating and air-conditioning systems in public buildings, schools, churches, factories, etc. Also for control of machine tool warmup glue pots, linotype machines, etc., on weekly schedule in accordance with daily operating or working schedules.

The 7-day dial is large and easy to set. Operations can be set to occur as close as 3 hours apart.

Surface-mounting case — 12⁵/₁₆ x 6¹/₈ x 3⁵/₁₆ in. Shipping weight 10 lbs.

115 Volts, 60 Cycles A-C

No.	Amps. per Pole	Watts per Pole	Switch	Each
702-40	35	4000	DPS1T	\$36.50
703-10	10	1000	SPDT	29.50
703-40	35	4000	SPDT	36.50
704-10	10	1000	DPDT	33.50

Note — For 115 volt, 25- or 50-cycle; 230 volt, 50- or 60-cycle; 24 volt, 50- or 60-cycle motors add \$1.00 to list prices. For 230 volt, 25-cycle motors add \$2.50 to list prices. 14 dial riders furnished as standard. Extra dial riders \$0.25 each net.

Paragon Time Switches

"Memory Master"—Indoor Type 3000 Series



Accurate and dependable for controlling signs, commercial lights, show window lights, stokers, valves, motors and other equipment where up to 7 "On-Off" operations per day are required.

Steel case with hasp for padlock. Size: 7¹/₂-in. x 4³/₄-in. x 3³/₈-in. Shipping weight 3 lbs. 6 oz.

No.	Voltage 60 Cy.	Switch	Amps.	Each
3001	120	S.P.S.T.	30	\$10.95
3002	240	S.P.S.T.	30	11.95
3003	120	D.P.S.T.	30	12.95
3004	240	D.P.S.T.	30	13.95
3005	120	S.P.D.T.	30	12.95
3006	240	S.P.D.T.	30	13.95
3007	24	S.P.D.T.	30	14.95

Note: For 25 or 50 cycle motors add \$1.00 to list price. One extra set of trippers furnished at no charge on request. Additional trippers \$0.25 per set of two.

Paragon Time Switches

3300 Series—Heavy Duty Outdoor Type

For Surface Mounting And Conduit Connections



Accurate, dependable time switch for countless outdoor applications. Designed for tough outdoor operations under extreme temperature variations.

Removable trippers on the 24 hour dial. Up to 7 "On-Off" operations per day are possible, with operations set as close as 90 minutes apart.

Motor sealed and lubricated for life.

Single-pole and double pole types available.

Dimensions: 9⁵/₈-in. high, 5³/₈-in. wide and 4¹/₂-in. deep.

No.	Voltage 60 Cy.	Switch	Amps.	Each
3301	120	S.P.S.T.	30	\$20.95
3302	240	S.P.S.T.	30	21.95
3303	120	D.P.S.T.	30	22.95
3304	240	D.P.S.T.	30	23.95

Tork Time Switches

Economical Torkmaster



Turns any electrical circuit ON and OFF automatically.

30 Amperes, 3000 Watt per pole Incandescent Lamp Load Rating.

Twenty-four hour dial, 2 hour minimum setting, 15 minute adjustments.

Guaranteed 3 years.
120 Volt—60 Cycles.

No.	Switch	Each	No.	Switch	Each
948	SPST	\$10.95	954	DPST	\$12.95

Astronomical Dial Type



By automatically changing the ON and OFF operations to follow the daily changes of sun time, these time switches save their cost many times each year. ON time occurs at sunset—may be set to turn off between 10:30 P.M. and 1:30 A.M.—or at sunrise. Insures ON time occurring when needed with a maximum saving of kilowatt hours.

Completely mechanical—may be installed wherever convenient.

Extreme accuracy is obtained by providing different operating cams

for each 110 miles or 2° of North Latitude. Simple to set. Extra heavy duty motor. **Fully rated for incandescent lamp loads.** 120 Volt—60 Cycles. Specify city of use.

No.	Switch	Amps. Per Pole	Each
1191Z	SPST	35	\$28.95
1962Z	DPST	35	30.95
1963Z	3PST	25	39.95
1197Z	SPDT	15	31.95

Astronomical Skip-A-Day Types

Parking Lot lighting, yard and school protective lighting and similar applications require skipping Saturdays, Sundays and Holidays as well as the astronomic feature. 120 Volt—60 Cycles. Specify city of use.

No.	Switch	Amps. Per Pole	Each
1191ZSK	SPST	35	\$33.95
1962ZSK	DPST	35	35.95
1963ZSK	3PST	25	44.95
1197ZSK	SPDT	15	36.95

Program Dial Type

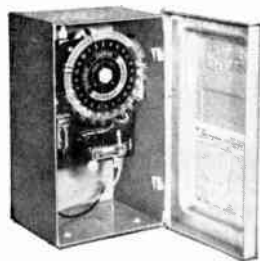

Provides multiple ON-OFF operations by means of trip tabs. Each tab provides ON operation for 15 minutes—adjoining tabs keep operation ON continuously. Many and varied ON and OFF times can be programmed to suit.

Special models available with dial speeds from one minute to one week.

Contracts rated 10 Amperes. 120 Volt—60 Cycles.

No.	Switch	Dial	Each
801	SPST	24-Hour	\$19.95
801SK	SPST	Skip-A-Day	24.95

Optional Features

Any Tork Time Switch can be equipped with optional features listed below, except as otherwise noted.
210-volt operation, add prefix "2-" and \$2.00.
20-Hour Reserve Power Unit to provide accurate timing during power outage, (all 24 hour models except Torkmaster), and suffix "-L," and \$35.00.

Standard Line Time Switches



This "High Quality" line features solderless lug terminals taking wire size down to No. 6 without bending and knockouts at top of case as well as sides, bottom and back for easy installation.

Separate manual On-Off levers. Heavy Duty all brass gears.

Twenty-four-hour dial, 45 minute minimum, 15 minute adjustments.

120 Volt—60 Cycles.

No.	Switch	Amps. Per Pole	Each
1191	SPST	35	\$13.95
1962	DPST	35	15.95
1963	3PST	25	24.95
1197	SPDT	15	16.95

Skip-A-Day Dial Type



Designed for commercial lighting, heating, air conditioning and other applications where working hours are regular five or six days a week and it is desired to "skip" operation on Saturdays, Sundays or Holidays.

Equipped with a seven-spoke calendar wheel in addition to the 24-hour dial, which rotates one revolution per week. Selection of the day or days of the week on which operation is to be omitted is made by simply inserting by

hand knurled knob screws into the tapped hole of the appropriate spoke.

Fully rated for incandescent lamp loads.

Twenty-four-hour dial, 45-minute minimum, 15-minute adjustment. 120 Volt—60 Cycles.

No.	Switch	Amps. Per Pole	Each
1191SK	SPST	35	\$16.95
1962SK	DPST	35	18.95
1963SK	3PST	25	27.95
1197SK	SPDT	15	19.95

Seven Day Dial Type



Permits individual ON-OFF times for each day of the week as well as omitting any day. This is necessary in all commercial installations where working hours vary such as stores and shopping centers.

Minimum setting 2 hours.

Fully rated for incandescent lamp loads.

120 Volt—60 Cycles.

No.	Switch	Amps. Per Pole	Each
7D1191	SPST	35	\$21.95
7D1962	DPST	35	23.95
7D1963	3PST	25	32.95
7D1197	SPDT	15	24.95

Flush enclosure, add suffix "-FL" and \$15.00.

Waterproof outdoor enclosure, add suffix "O" and \$15.00.

Raintight enclosure, (all models except 3 pole) add suffix "-R" and \$10.00.

Sangamo Time Switches

All Sangamo time switches are powered by a Sangamo Synchronous, high-torque, self-starting, low-speed 450 rpm. motor, unaffected by extreme high temperatures. Fine quality, carefully machined and inspected parts, with all metal parts corrosion resistant. Manual operation of switch does not affect subsequent automatic operation.

Types L and W

For heavy duty, and continuous service under widely varying installation requirements. The basic time switch units can be adapted to a wide range of applications by addition of special features available.

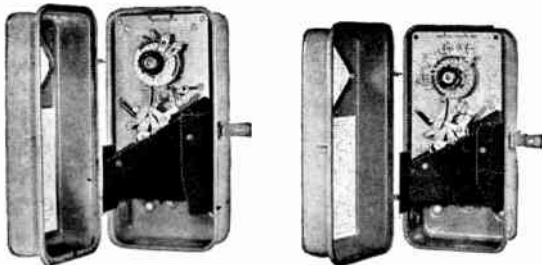

Type L

Type W

Case: Pressed steel, gasket sealed against dust, gray enamel finish. Size: 10¼ in. high, 5¼ in. wide, 4 in. deep. Four multiple knockouts, with ample wiring space.

Operation: Two pairs of time-setting levers. Minimum ON period 30 minutes; minimum OFF period 90 minutes.

Standard Motor Voltage 120 or 240 Volts, 60 Cycles, A-C.

Poles	Throw	A-C Amp. Per Circuit	Type L		Type W	
			No.	Each	No.	Each
Single	Single	35	1.11	\$31.70	W11	\$55.70
Double	Single	35	1.21	35.00	W21	59.00
Triple	Single	6	1.31	42.00	W31	66.00
Single	Double	35	1.12	35.00	W12	59.00
Double	Double	6	1.22	39.00	W22	63.00
Triple	Double	6	1.32	45.00	W32	69.00

Approximate shipping weight 7 lbs.

Type L—Synchronous

Synchronous motor drive, accuracy depends entirely upon frequency and continuity of power supply.

Type W—Synchronous-Carryover

Combines synchronous timing with reserve spring clock operation, providing accurate timing during power outage up to 10 hours duration, and eliminates resetting the dial.

Types LY and WY—Two Circuit



Type LY

The timing mechanism, general construction and other features are identical to that of Types L and W standard switches, but made to control independently two separate circuits. Minimum ON period 30 minutes; Minimum OFF period 2½ hours.

When furnished with omitting device or astronomic dial, both ON operations occur together, while OFF operations are separate.

Poles	Throw	A-C Amp. Per Circ.	Type LY		Type WY	
			No.	Each	No.	Each
Single	Single	35	LY-11	\$43.00	WY-11	\$67.00

Type B Time Switch



Powered by low-speed, hysteresis motor same as used in heavy duty switches. Single - pole, single throw construction. Equipped with silver contacts and a service-tested timing mechanism that runs quietly and efficiently, needs no maintenance.

Dead front safety construction, housed in all-steel case with hinged cover and sealable hasp; no glass to break. Overall dimensions: height, 7¼ - in., width 4¼ - in.,

depth 3⅞-in. Shipping weight 2 lbs., 3 oz.

Type SR and SJ Time Switches

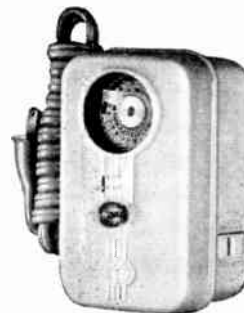

Type SJ

Synchronous, self-starting, low speed 450 rpm. motor. Precision made gears. Single pole, single throw contacts operated by lever action.

Type SR provides conduit k.o. on bottom, pryout on back, mounts on wall or switchbox.

Type SJ supplied with 6 foot plug-in cord and built-in receptacle for portable use. For operation in upright position.

Height 5⅝-in. high, 3⅞-in. wide, 3⅞-in. deep. Type SR weight 2 lbs. Type SJ 2¼ lbs.

No.	No. of Operations	A-C Rating at 120 V.	A-C Rating at 240 V.	Each
B	2 ON and 2 OFF	30 Amp.	15 Amp.	\$13.50
SR	2 ON and 2 OFF	15 Amp.	15 Amp.	13.50
SJ	1 ON and 1 OFF	10A. or ¼ HP	15.75

Type T—Interval Timers

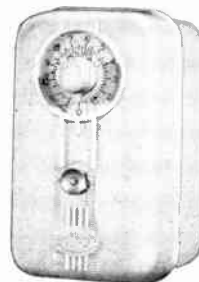

Type T

These timers are for controlling attic fans, unit heaters, air conditioners and appliances.

Provide an automatic OFF operation following a manually-set ON period.

For operation in upright position. Contacts are single pole, single throw, normally open.

For 120 Volts, 60 Cycles, A-C.

Type T for switchbox or wall installation.

Type TJ has 6-ft. plug-in cord and built-in receptacle for portable use.

Base: Pressed steel, ivory finish; Plaskon cover. Size: 5⅝ in. high, 3 in. wide, 3⅞ in. deep. Shipping weight 2 lbs.

No.	Interval	A-C Rating	Ship. Wt. Lbs.	Each
T-12H	15 min. to 12 hrs.	15 amp.	2	\$13.50
T-30M	1 min. to 30 min.	15 amp.	2	13.50
TJ-12H	15 min. to 12 hrs.	10 amp. or ¼ Hp.	2¼	15.75

Astronomic Dials

Automatically turns lights on at sunset and off at sunrise, compensating progressively day by day for the change in the seasons. Off operation can also be set at any time between 9:30 P.M. and 2:15 A.M. Reversed On and Off switch operations available.

Dials furnished as original equipment on Types L, LD, LY, W, WY and TC time switches. Space limitations prevent its use on Types B, SJ and SR time switches.

Astronomic Dials for latitudes 20°, 27½°, 30°, 32½°, 35°, 37½°, 40°, 42½°, 45°, 50°, 52°, add \$14.00.

G-E Dry-Type General-Purpose Transformers

Type M—For Indoor and Outdoor Service
Type D— For Indoor Service Only



Type M Single-Phase transformer For Indoor and Outdoor Application

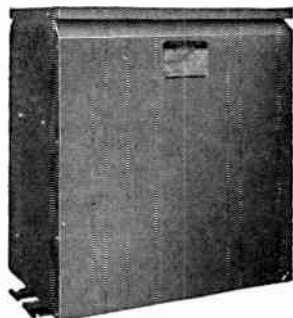

Small Type D Single-Phase Transformer for Indoor Application only

Type M transformers are totally enclosed, making them suitable for installation outdoors or where protection from dust and moisture is needed. Type D transformers are enclosed by louvered case and are suitable for indoor installation only.

Types M and D utilize Class B insulation and are designed for continuous operation in a 40 C. ambient with a temperature rise of 80 C.

The following table shows the NEMA standards and levels which Type M quiet transformers are designed to meet.

KVA	NEMA Standard, Decibels	Quiet Type M, Decibels
3-7.5	50	40
9-30	55	45
37.5-112.5	60	45
150	65	45

Widely used in commercial and industrial applications for supplying appliance, lighting, and power loads from 240, 480 and 600 volt distribution circuits. No vaults required, transformers can be located right at the load to provide correct voltage for the application.

Type M dry-type transformers 600 volts or below, single-phase and three-phase, 10 kva or less, 25 to 60 cycles, are listed by Underwriters' Laboratories Re-examination Service in the classification of Power Transformers.

For General Light and Power Service Indoor or Outdoor, Type M—3 to 500 Kva.—600 Volts and Below Indoor Only, Type D—Single-Phase—60 Cycles

Used to reduce the voltage of 240, 480 or 600-volt distribution circuits to supply 120 or 240 volt loads.

Primary 120/120 Volts—Secondary 120/240-Volts

Kva Output Cont. 80 C Rise	Model No. 9T-	Approx. Ship. Wt. Lbs.	Type	Approx. Dimensions In.			List Price Each
				Height	Width	Depth	
3	51Y6237	59	M	14	6 ³ / ₈	5 ¹ / ₂	\$100
5	21Y4	107	M	15 ¹ / ₄	8 ⁵ / ₈	7 ³ / ₄	145
7.5	5	140	M	17 ¹ / ₄	8 ⁵ / ₈	7 ³ / ₄	200
10	6	210	M	17 ¹ / ₄	11 ¹ / ₄	9 ⁷ / ₈	250
15*	1750	280	M	20 ¹ / ₈	11 ¹ / ₄	9 ⁷ / ₈	348
25*	23Y41	295	D	30 ¹ / ₈	22 ³ / ₈	18 ³ / ₈	536
37.5*	42	395	D	34 ¹ / ₈	25 ⁷ / ₈	20 ³ / ₈	685
50*	43	540	D	36 ¹ / ₈	30 ³ / ₈	22 ³ / ₈	825

Primary 600 Volts—Secondary 120/240 Volts

Kva Output Cont. 80 C Rise	Model No. 9T-	Approx. Ship. Wt. Lbs.	Type	Approx. Dimensions In.			List Price Each
				Height	Width	Depth	
3	51Y6817	59	M	14	6 ³ / ₈	5 ¹ / ₂	\$104
5	21Y16	107	M	15 ¹ / ₄	8 ⁵ / ₈	7 ³ / ₄	152
7.5	17	140	M	17 ¹ / ₄	8 ⁵ / ₈	7 ³ / ₄	210
10	18	210	M	17 ⁵ / ₈	11 ¹ / ₄	9 ⁷ / ₈	262
15	1754	280	M	20 ¹ / ₈	11 ¹ / ₄	9 ⁷ / ₈	364
25	23Y51	295	D	30 ¹ / ₈	22 ³ / ₈	18 ³ / ₈	562
37.5	52	395	D	34 ¹ / ₈	25 ⁷ / ₈	20 ³ / ₈	717
50	53	540	D	36 ¹ / ₈	30 ¹ / ₈	22 ³ / ₈	864

Primary 240/480 Volts—Secondary 120/240 Volts

Kva Output Cont. 80 C Rise	Model No. 9T-	Approx. Ship. Wt. Lbs.	Type	Approx. Dimensions In.			List Price Each
				Height	Width	Depth	
3	51Y6437	59	M	14	6 ³ / ₈	5 ¹ / ₂	\$100
5	21Y10	107	M	15 ¹ / ₄	8 ⁵ / ₈	7 ³ / ₄	145
7.5	11	140	M	17 ¹ / ₄	8 ⁵ / ₈	7 ³ / ₄	200
10	12	210	M	17 ⁵ / ₈	11 ¹ / ₄	9 ⁷ / ₈	250
15	1752	280	M	20 ¹ / ₈	11 ¹ / ₄	9 ⁷ / ₈	348
25	23Y1	295	D	30 ¹ / ₈	22 ³ / ₈	18 ³ / ₈	536
37.5	2	395	D	34 ¹ / ₈	25 ⁷ / ₈	20 ³ / ₈	685
50	3	540	D	36 ¹ / ₈	30 ³ / ₈	22 ³ / ₈	825
75†	24	640	D	36 ¹ / ₈	30 ³ / ₈	22 ³ / ₈	1108
100†	25	1110	D	40 ¹ / ₈	36 ¹ / ₈	25 ³ / ₈	1312
167†	26	1580	D	46 ⁷ / ₈	38 ³ / ₄	25 ¹ / ₂	2336

75†	74	640	D	36 ¹ / ₈	30 ¹ / ₈	22 ³ / ₈	1157
100†	75	1110	D	40 ¹ / ₈	36 ¹ / ₈	25 ³ / ₈	1370
167†	76	1580	D	46 ⁷ / ₈	38 ³ / ₄	25 ¹ / ₂	2438

Primary 600 Volts with (2) 5% Taps Below Normal—Secondary 120/240 Volts

Kva Output Cont. 80 C Rise	Model No. 9T-	Approx. Ship. Wt. Lbs.	Type	Approx. Dimensions In.			List Price Each
				Height	Width	Depth	
3	51Y6837	59	M	14	6 ³ / ₈	5 ¹ / ₂	\$108
5	21Y28	107	M	15 ¹ / ₄	8 ⁵ / ₈	7 ³ / ₄	158
7.5	29	140	M	17 ¹ / ₄	8 ⁵ / ₈	7 ³ / ₄	217
10	30	210	M	17 ⁵ / ₈	11 ¹ / ₄	9 ⁷ / ₈	271
15	1758	280	M	20 ¹ / ₈	11 ¹ / ₄	9 ⁷ / ₈	377
25	23Y61	295	D	30 ¹ / ₈	22 ³ / ₈	18 ³ / ₈	582
37.5	62	395	D	34 ¹ / ₈	25 ⁷ / ₈	20 ³ / ₈	743
50	63	540	D	36 ¹ / ₈	30 ¹ / ₈	22 ³ / ₈	895

Primary 480 Volts with (2) 5% Taps Below Normal—Secondary 120/240 Volts

Kva Output Cont. 80 C Rise	Model No. 9T-	Approx. Ship. Wt. Lbs.	Type	Approx. Dimensions In.			List Price Each
				Height	Width	Depth	
3	51Y6677	59	M	14	6 ³ / ₈	5 ¹ / ₂	\$100
5	21Y22	107	M	15 ¹ / ₄	8 ⁵ / ₈	7 ³ / ₄	145
7.5	23	140	M	17 ¹ / ₄	8 ⁵ / ₈	7 ³ / ₄	200
10	24	210	M	17 ⁵ / ₈	11 ¹ / ₄	9 ⁷ / ₈	250
15	1756	280	M	20 ¹ / ₈	11 ¹ / ₄	9 ⁷ / ₈	348
25	23Y11	295	D	30 ¹ / ₈	22 ³ / ₈	18 ³ / ₈	536
37.5	12	395	D	34 ¹ / ₈	25 ⁷ / ₈	20 ³ / ₈	685
50	13	540	D	36 ¹ / ₈	30 ¹ / ₈	22 ³ / ₈	825

*Wherever possible, 240/480—120/240 volt transformers should be ordered in preference to these units, to obtain stock shipment.

†These transformers are provided with (4) 2¹/₂% rated kva taps below normal. 25, 37.5, and 50-kva Type D transformers can be wall-mounted by the use of hangers.

G-E Transformers for General Light and Power Service

**Indoor or Outdoor, Type M—3 to 500 Kva—600 Volts and Below
Indoor Only, Type D—Three-Phase—60 Cycles**



Type M Three-Phase Transformer For Indoor and Outdoor Application

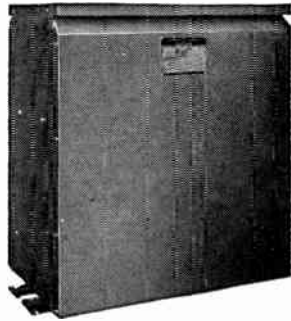

Small Type D Three-Phase transformer for Indoor Application only

Used for general light and power applications to supply and insulate 208Y/120 volts from 480 or 600-volt circuits.

These Type M three-phase transformers consist of main and teaser connected and sleeved together to form a single unit. Designed for wall mounting.

Type D three-phase transformers, because of their size and weight, are recommended for platform or floor mounting. However, units rated 75 kva and below can be wall-mounted by use of the hangers.

Three-phase voltage transformation is often made with three single-phase transformers connected as a three-phase bank. Each single-phase unit is one-third the bank kva rating. For example, three 50-kva single-phase, 480 to 240-volt transformers can be connected as a 150-kva, three-phase bank, 480 volts delta to 240 volts delta.

Primary 480 Volts—Secondary 208Y/120 Volts

Kva Output Cont. 80 C Rise	Model No. 9T-	Type	Approx. Dimensions			Approx. Ship. Wt. Lbs.	List Price Each
			Height	In. Width	Depth		
3	21Y 6250	M	19 1/4	7	6 1/4	85	\$ 141
6	6251	M	24	9	7 3/4	175	210
9	6252	M	26 1/2	9	7 3/4	225	282
15	6253	M	27 3/4	11 1/4	9 7/8	360	411
30	23Y 3002	D	34 1/8	33 1/4	20 3/8	540	708
45	3003	D	34 1/8	33 1/4	20 3/8	660	984
75	3004	D	36 1/8	41 1/8	22 3/8	940	1518
112.5	3005	D	40 1/8	45 7/8	25 3/4	1300	1938
150	3006	D	40 1/8	50 7/8	25 3/4	1650	2334
225	3007	D	58 3/4	62 1/4	35	2830	2916
300	3008	D	58 3/4	62 1/4	35	3300	3453
500	3009	D	70 1/2	69	39 1/4	4300	6147

Primary 480 Volts with (2) 5% Taps Below Normal—Secondary 208Y/120 Volts

Kva Output Cont. 80 C Rise	Model No. 9T-	Type	Height	In. Width	Depth	Approx. Ship. Wt. Lbs.	List Price Each
3	21Y 6258	M	19 1/4	7	6 1/4	85	\$ 147
6	6259	M	24	9	7 3/4	175	218
9	6260	M	26 1/2	9	7 3/4	225	293
15	6261	M	27 3/4	11 1/4	9 7/8	360	427
30	23Y 3102	D	34 1/8	33 1/4	20 3/8	540	736

Primary 480 Volts with (4) 2 1/2% Taps Below Normal—Secondary 208Y/120 Volts

Kva Output Cont. 80 C Rise	Model No. 9T-	Type	Height	In. Width	Depth	Approx. Ship. Wt. Lbs.	List Price Each
45	23Y 3103	D	34 1/8	33 1/4	20 3/8	660	\$1063
75	3104	D	36 1/8	41 1/8	22 3/8	940	1639
112.5	3105	D	40 1/8	45 7/8	25 3/4	1300	2093
150	3106	D	40 1/8	50 7/8	25 3/4	1650	2521
225	3107	D	58 3/4	62 1/4	35	2830	3149
300	3108	D	58 3/4	62 1/4	35	3300	3729
500	3109	D	70 1/2	69	39 1/4	4300	6639

Primary 600 Volts—Secondary 208Y/120 Volts

Kva Output Cont. 80 C Rise	Model No. 9T-	Type	Approx. Dimensions			Approx. Ship. Wt. Lbs.	List Price Each
			Height	In. Width	Depth		
3	21Y 6254	M	19 1/4	7	6 1/4	85	\$ 152
6	6255	M	24	9	7 3/4	175	227
9	6256	M	26 1/2	9	7 3/4	225	305
15	6257	M	27 3/4	11 1/4	9 7/8	360	444
30	23Y 3012	D	34 1/8	33 1/4	20 3/8	540	765
45	3013	D	34 1/8	33 1/4	20 3/8	660	1063
75	3014	D	36 1/8	41 1/8	22 3/8	940	1639
112.5	3015	D	40 1/8	45 7/8	25 3/4	1300	2093
150	3016	D	40 1/8	50 7/8	25 3/4	1650	2521
225	3017	D	58 3/4	62 1/4	35	2830	3149
300	3018	D	58 3/4	62 1/4	35	3300	3729
500	3019	D	70 1/2	69	39 1/4	4300	6639

Primary 600 Volts with (2) 5% Taps Below Normal—Secondary 208Y/120 Volts

Kva Output Cont. 80 C Rise	Model No. 9T-	Type	Height	In. Width	Depth	Approx. Ship. Wt. Lbs.	List Price Each
3	21Y 6262	M	19 1/4	7	6 1/4	85	\$ 158
6	6263	M	24	9	7 3/4	175	235
9	6264	M	26 1/2	9	7 3/4	225	316
15	6265	M	27 3/4	11 1/4	9 7/8	360	460
30	23Y 3112	D	34 1/8	33 1/4	20 3/8	540	793

Primary 600 Volts with (4) 2 1/2% Taps Below Normal—Secondary 208Y/120 Volts

Kva Output Cont. 80 C Rise	Model No. 9T-	Type	Height	In. Width	Depth	Approx. Ship. Wt. Lbs.	List Price Each
45	23Y 3113	D	34 1/8	33 1/4	20 3/8	660	\$1141
75	3114	D	36 1/8	41 1/8	22 3/8	940	1761
112.5	3115	D	40 1/8	45 7/8	25 3/4	1300	2248
150	3116	D	40 1/8	50 7/8	25 3/4	1650	2706
225	3117	D	58 3/4	62 1/4	35	2830	3383
300	3118	D	58 3/4	62 1/4	35	3300	4005
500	3119	D	70 1/2	69	39 1/4	4300	7131

G-E Autotransformers for General Light and Power Service

Indoor or Outdoor, Type M—Three-Phase—60 Cycles—5 to 25 Kva



Type M Autotransformer For Indoor and Outdoor Application

More economical and smaller than transformers designed to carry the same load. Within their voltage limitations, they will perform the same function as transformers, with the exception of insulating two circuits.

These autotransformers can be used to obtain 120 volts from a 240-volt circuit, to derive a neutral on a 240-volt, 2-wire circuit, or to balance a 120/240*-volt, 3-wire circuit.

May also be used in banks on poly-phase circuits.

Input 120 or 240 Volts, Output 120 or 240 or 240/120 Volts, 3-wire, 60 Cycles

Kva Output Cont. 80 C Rise	Model No. 9T-	Type	Approx. Dimensions			Approx. Ship. Wt. Lbs.	List Price Each
			Height	In. Width	Depth		
5	51Y 5682	M	13	6 3/8	5 1/2	50	\$ 82
7.5	21Y 3501	M	13 1/4	6 3/4	6 1/4	63	110
10	3502	M	14 3/4	8 5/8	7 3/4	100	137
15	4500	M	16 3/4	8 5/8	7 3/4	130	189
25	4501	M	18 1/8	11 1/4	9 7/8	220	282

*Kva output at 120 volts, 2-wire, or allowable unbalance at 240/120 volts, 3-wire.

G-E Quiet Transformers for Commercial Buildings

600 Volts and Below—Single-Phase and Three-Phase—60 Cycles

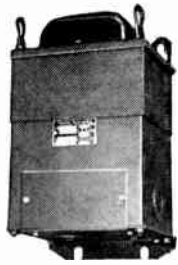

Type M Single-phase transformer for commercial building Applications

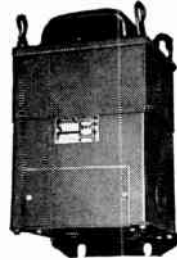

Type M single-phase transformer for indoor and outdoor Application



Small Type M three-phase transformer for commercial building Application



Large Type M three-phase transformer for commercial building Application

These transformers are designed for a noise level of 45 decibels or below, making them suitable for installation in commercial buildings, such as hospitals, libraries, offices, hotels, and other locations where population is dense. Some of the single and three-phase units, 15 kva and below, are also listed as part of the standard line dry-type transformers for

general light and power service.

The basic noise level of a transformer does not necessarily determine the noise in a given installation. Noise is transmitted through the air and the structural parts of the building, so care must be exercised when mounting the transformer.

Single-phase Ratings

Kva Output Cont. 80 C Rise	Model No. ST-	Type	Approx. Dimensions			Approx. Ship. Wt. Lbs.	List Price Each
			Height	Width	Depth		
3	51Y6437	M	14	6 ³ / ₈	5 ¹ / ₂	59	\$100
5	21Y10	M	15 ¹ / ₄	8 ⁵ / ₈	7 ³ / ₄	107	145
7.5	11	M	17 ¹ / ₄	8 ⁵ / ₈	7 ³ / ₄	140	200
10	12	M	17 ⁵ / ₈	11 ¹ / ₄	9 ⁷ / ₈	210	250
15	1752	M	20 ¹ / ₈	11 ¹ / ₄	9 ⁷ / ₈	280	348
25	1753	M	25 ¹ / ₈	11 ¹ / ₄	9 ⁷ / ₈	430	536
37.5	1802	M	30	14 ⁵ / ₈	12 ¹ / ₂	640	685
50	1803	M	33	14 ⁵ / ₈	12 ¹ / ₂	760	825

Primary 480 Volts with (2) 5% Taps Below Normal—Secondary 120/240 Volts

3	51Y6677	M	14	6 ³ / ₈	5 ¹ / ₂	59	\$100
5	21Y22	M	15 ¹ / ₄	8 ⁵ / ₈	7 ³ / ₄	107	145
7.5	23	M	17 ¹ / ₄	8 ⁵ / ₈	7 ³ / ₄	140	200
10	24	M	17 ⁵ / ₈	11 ¹ / ₄	9 ⁷ / ₈	210	250
15	1756	M	20 ¹ / ₈	11 ¹ / ₄	9 ⁷ / ₈	280	348
25	1757	M	25 ¹ / ₈	11 ¹ / ₄	9 ⁷ / ₈	430	536
37.5	1806	M	30	14 ⁵ / ₈	12 ¹ / ₂	640	685
50	1807	M	33	14 ⁵ / ₈	12 ¹ / ₂	760	825

Primary 480 Volts with (2) 2 1/2% Taps Above and Below Normal—Secondary 120/240 Volts

3	51Y6900	M	14	6 ³ / ₈	5 ¹ / ₂	59	\$104
5	21Y34	M	15 ³ / ₄	8 ⁵ / ₈	7 ³ / ₄	115	152
7.5	35	M	17 ³ / ₄	8 ⁵ / ₈	7 ³ / ₄	150	210
10	36	M	17 ⁵ / ₈	11 ¹ / ₄	9 ⁷ / ₈	210	262
15	1760	M	20 ¹ / ₈	11 ¹ / ₄	9 ⁷ / ₈	280	364
25	1761	M	25 ¹ / ₈	11 ¹ / ₄	9 ⁷ / ₈	430	562
37.5	1810	M	30	14 ⁵ / ₈	12 ¹ / ₂	640	717
50	1811	M	33	14 ⁵ / ₈	12 ¹ / ₂	760	864

Primary 600 Volts—Secondary 120/240 Volts

3	51Y6817	M	14	6 ³ / ₈	5 ¹ / ₂	59	\$104
5	21Y16	M	15 ¹ / ₄	8 ⁵ / ₈	7 ³ / ₄	107	152
7.5	17	M	17 ¹ / ₄	8 ⁵ / ₈	7 ³ / ₄	140	210
10	18	M	17 ⁵ / ₈	11 ¹ / ₄	9 ⁷ / ₈	210	262
15	1754	M	20 ¹ / ₈	11 ¹ / ₄	9 ⁷ / ₈	280	364
25	1755	M	25 ¹ / ₈	11 ¹ / ₄	9 ⁷ / ₈	430	562
37.5	1804	M	30	14 ⁵ / ₈	12 ¹ / ₂	640	717
50	1805	M	33	14 ⁵ / ₈	12 ¹ / ₂	760	864

Primary 600 Volts with (2) 5% Taps Below Normal—Secondary 120/240 Volts

3	51Y6837	M	14	6 ³ / ₈	5 ¹ / ₂	59	\$108
5	21Y28	M	15 ¹ / ₄	8 ⁵ / ₈	7 ³ / ₄	107	158
7.5	29	M	17 ¹ / ₄	8 ⁵ / ₈	7 ³ / ₄	140	217
10	30	M	17 ⁵ / ₈	11 ¹ / ₄	9 ⁷ / ₈	210	271
15	1758	M	20 ¹ / ₈	11 ¹ / ₄	9 ⁷ / ₈	280	377
25	1759	M	25 ¹ / ₈	11 ¹ / ₄	9 ⁷ / ₈	430	582
37.5	1808	M	30	14 ⁵ / ₈	12 ¹ / ₂	640	743
50	1809	M	33	14 ⁵ / ₈	12 ¹ / ₂	760	895

Three-phase Ratings

Primary 480 Volts—Secondary 208Y/120 Volts

Kva Output Cont. 80 C Rise	Model No. ST-	Type	Approx. Dimensions			Approx. Ship. Wt. Lbs.	List Price Each
			Height	Width	Depth		
3	21Y6250	Sm.M	19 ¹ / ₄	7	6 ¹ / ₄	85	\$141
6	6251	Sm.M	24	9	7 ³ / ₄	175	210
9	6252	Sm.M	26 ¹ / ₂	9	7 ³ / ₄	225	282
15	6253	Sm.M	27 ³ / ₄	11 ¹ / ₄	9 ⁷ / ₈	360	411
30	6405	Lg.M	25 ¹ / ₂	28 ¹ / ₂	13	620	708
45	6406	Lg.M	34 ¹ / ₈	28 ³ / ₄	15 ³ / ₈	940	984
75	6407	Lg.M	34 ¹ / ₈	32 ³ / ₄	15 ³ / ₈	1375	1518
112.5	6408	Lg.M	34 ¹ / ₈	34 ¹ / ₂	15 ³ / ₈	2025	1938
150	6409	Lg.M	34 ¹ / ₈	36 ¹ / ₂	15 ³ / ₈	2385	2334

Primary 480 Volts with (2) 5% Taps Below Normal—Secondary 208Y/120 Volts

3	21Y6258	Sm.M	19 ¹ / ₄	7	6 ¹ / ₄	85	\$147
6	6259	Sm.M	24	9	7 ³ / ₄	175	218
9	6260	Sm.M	26 ¹ / ₂	9	7 ³ / ₄	225	293
15	6261	Sm.M	27 ³ / ₄	11 ¹ / ₄	9 ⁷ / ₈	360	427
30	6423	Lg.M	25 ¹ / ₂	28 ¹ / ₂	13	620	736

Primary 480 Volts with (4) 2 1/2% Taps Below Normal—Secondary 208Y/120 Volts

45	21Y6442	Lg.M	34 ¹ / ₈	28 ³ / ₄	15 ³ / ₈	940	\$1063
75	6443	Lg.M	34 ¹ / ₈	32 ³ / ₄	15 ³ / ₈	1375	1639
112.5	6444	Lg.M	34 ¹ / ₈	34 ¹ / ₂	15 ³ / ₈	2025	2093
150	6445	Lg.M	34 ¹ / ₈	36 ¹ / ₂	15 ³ / ₈	2385	2521

Primary 480 Volts with (2) 2 1/2% Taps Above and Below Normal—Secondary 208Y/120 Volts

3	21Y6274	Sm.M	19 ¹ / ₄	7	6 ¹ / ₄	85	\$152
6	6275	Sm.M	24	9	7 ³ / ₄	175	227
9	6276	Sm.M	26 ¹ / ₂	9	7 ³ / ₄	225	305
15	6277	Sm.M	27 ³ / ₄	11 ¹ / ₄	9 ⁷ / ₈	360	444
30	6459	Lg.M	25 ¹ / ₂	28 ¹ / ₂	13	620	765
45	6460	Lg.M	34 ¹ / ₈	28 ³ / ₄	15 ³ / ₈	940	1063
75	6461	Lg.M	34 ¹ / ₈	32 ³ / ₄	15 ³ / ₈	1375	1639
112.5	6462	Lg.M	34 ¹ / ₈	34 ¹ / ₂	15 ³ / ₈	2025	2093
150	6463	Lg.M	34 ¹ / ₈	36 ¹ / ₂	15 ³ / ₈	2385	2521

Primary 480 Volts—Secondary 240 Volts

3	21Y6344	Sm.M	19 ¹ / ₄	7	6 ¹ / ₄	85	\$141
6	6345	Sm.M	24	9	7 ³ / ₄	175	210
9	6346	Sm.M	26 ¹ / ₂	9	7 ³ / ₄	225	282
15	6347	Sm.M	27 ³ / ₄	11 ¹ / ₄	9 ⁷ / ₈	360	411
30	6369	Lg.M	25 ¹ / ₂	28 ¹ / ₂	13	620	708
45	6370	Lg.M	34 ¹ / ₈	28 ³ / ₄	15 ³ / ₈	940	984
75	6371	Lg.M	34 ¹ / ₈	32 ³ / ₄	15 ³ / ₈	1375	1518
112.5	6372	Lg.M	34 ¹ / ₈	34 ¹ / ₂	15 ³ / ₈	2025	1938
150	6373	Lg.M	34 ¹ / ₈	36 ¹ / ₂	15 ³ / ₈	2385	2334

G-E Quiet Transformers for Commercial Buildings

600 Volts and Below—Single-phase and Three-phase— 60 Cycles

Three Phase Rating (Con.t)

Primary 480 Volts with (2) 5% Taps Below Normal—Secondary 240 Volts

Kva Output Cont. 80 C Rise	Model No. 9T-	Type	Approx. Dimensions			Approx. Ship. Wt. Lbs.	List Price Each
			Height	In. Width	Depth		
3	21Y6348	Sm.M	19 1/4	7	6 1/4	85	\$147
6	6349	Sm.M	21	9	7 3/4	175	218
9	6350	Sm.M	26 1/2	9	7 3/4	225	293
15	6351	Sm.M	27 3/4	11 1/4	9 7/8	360	427
30	6378	Lg.M	25 1/2	28 1/2	13	620	736

Primary 480 Volts with (4) 2 1/2% Taps Below Normal—Secondary 240 Volts

45	21Y6388	Lg.M	34 1/8	28 3/4	15 3/8	940	\$1063
75	6389	Lg.M	34 1/8	32 3/4	15 3/8	1375	1639
112.5	6390	Lg.M	34 1/8	34 1/2	15 3/8	2025	2093
150	6391	Lg.M	34 1/8	36 1/2	15 3/8	2385	2521

Primary 480 Volts with (2) 2 1/2% Taps Above and Below Normal—Secondary 240 Volts

3	21Y6356	Sm.M	19 1/4	7	6 1/4	85	\$152
6	6357	Sm.M	21	9	7 3/4	175	227
9	6358	Sm.M	26 1/2	9	7 3/4	225	305
15	6359	Sm.M	27 3/4	11 1/4	9 7/8	360	444
30	6396	Lg.M	25 1/4	28 1/2	13	620	765
45	6397	Lg.M	34 1/8	28 3/4	15 3/8	940	1063
75	6398	Lg.M	34 1/8	32 3/4	15 3/8	1375	1639
112.5	6399	Lg.M	34 1/8	34 1/2	15 3/8	2025	2093
150	6400	Lg.M	34 1/8	36 1/2	15 3/8	2385	2521

Primary 600 Volts—Secondary 208Y/120 Volts

Kva Output Cont. 80 C Rise	Model No. 9T-	Type	Approx. Dimensions			Approx. Ship. Wt. Lbs.	List Price Each
			Height	In. Width	Depth		
3	21Y6254	Sm.M	19 1/4	7	6 1/4	85	\$152
6	6255	Sm.M	21	9	7 3/4	175	227
9	6256	Sm.M	26 1/2	9	7 3/4	225	305
15	6257	Sm.M	27 3/4	11 1/4	9 7/8	360	444
30	6414	Lg.M	25 1/2	28 1/2	13	620	765
45	6415	Lg.M	34 1/8	28 3/4	15 3/8	940	1063
75	6416	Lg.M	34 1/8	32 3/4	15 3/8	1375	1639
112.5	6417	Lg.M	34 1/8	34 1/2	15 3/8	2025	2093
150	6418	Lg.M	34 1/8	36 1/2	15 3/8	2385	2521

Primary 600 Volts with (2) 5% Taps Below Normal—Secondary 208Y/120 Volts

3	21Y6262	Sm.M	19 1/4	7	6 1/4	85	\$158
6	6263	Sm.M	21	9	7 3/4	175	235
9	2664	Sm.M	26 1/2	9	7 3/4	225	316
15	6265	Sm.M	27 3/4	11 1/4	9 7/8	360	460
30	6432	Lg.M	25 1/2	28 1/2	13	620	793

Primary 600 Volts with (4) 2 1/2% Taps Below Normal—Secondary 108Y/120 Volts

45	6451	Lg.M	34 1/8	28 3/4	15 3/8	940	\$1141
75	6452	Lg.M	34 1/8	32 3/4	15 3/8	1375	1761
112.5	6453	Lg.M	34 1/8	34 1/2	15 3/8	2025	2248
150	6454	Lg.M	34 1/8	36 1/2	15 3/8	2385	2706

G-E B-B Transformers for Boosting and Bucking Applications

Single-phase and Three-phase—50 and 60 Cycles



B-B transformer for indoor or outdoor service

Provide an economical and convenient means for boosting or bucking voltage on single and three-phase circuits. They are compact, light in weight, and can be easily installed for indoor or outdoor service.

Employed primarily for boosting single-and three-phase circuits by connecting them as autotransformers. When used as autotransformers, the voltage change is small and the kva load they can handle is large in comparison to their physical size.

The transformers with series-multiple 12/24-volt secondary windings are suitable for a wide variety of applications. In addition to boosting low circuit voltages to rated voltage, they can be used as transformers to supply 12 or 24 volts, 2-wire or 24/12 volts, 3-wire; also as autotransformers to supply 132 or 144 volts from a 120-volt supply, or 252 or 264 volts from a 240-volt supply. Two or more units can be used in various combinations to obtain many other special voltages.

Kva Output Cont. 80 C Rise	Model No. 9T-	Type	Approx. Dimensions			Approx. Ship. Wt. Lbs.	List Price Each
			Height	Width	Depth		
3	51Y6177	M	14	6 3/8	5 1/2	59	\$106.00
5	21Y64	M	15 1/4	8 5/8	7 3/4	107	155.00
25	51Y6164	M	6 3/8	3 3/16	3	2 3/4	14.90
50	6166	M	6 3/8	3 3/16	3	2 3/4	17.05
75	6167	M	6 7/8	3 3/16	3	3 3/4	20.00
100	6168	M	7 1/8	3 3/16	3	4 1/4	21.85
150	6169	M	7 1/4	3 7/8	3 5/8	6	25.70
200	6170	M	7 1/2	3 7/8	3 5/8	6 3/4	28.30
250	6171	M	7 3/4	3 7/8	3 5/8	7 1/2	32.00
500	6172	M	8 7/8	4 3/4	4 5/16	13 1/4	43.45
750	6173	M	10 3/8	4 3/4	4 5/16	19 3/4	54.60
1000	6174	M	10 1/8	5 1/16	4 7/8	23	70.00
1500	6175	M	12 1/8	5 1/16	4 7/8	31	85.50
2000	6176	M	14 1/8	5 1/16	4 7/8	43 1/2	104.00

Call Graybar FIRST For . . .

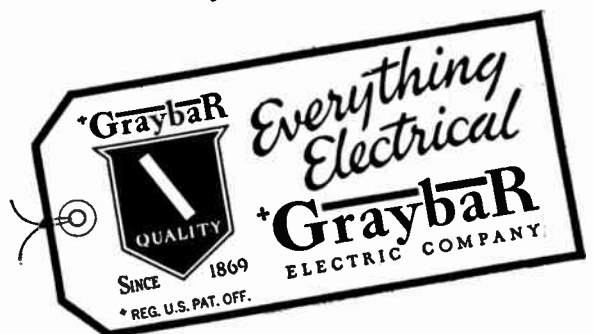

G-E Standard Control Transformers**Indoor or Outdoor Type****0.025 to 2 Kva—Single-phase—60/50 Cycles****Features**

Lighter Weight

Smaller Size

All-Welded Construction

New Frame-size Concept

Better Lamination Protection with
"Inset Core" Construction

Diagrammatic Name Plate

Numbered Leads and Terminals

Class B Insulation Throughout

Ample Wiring Space

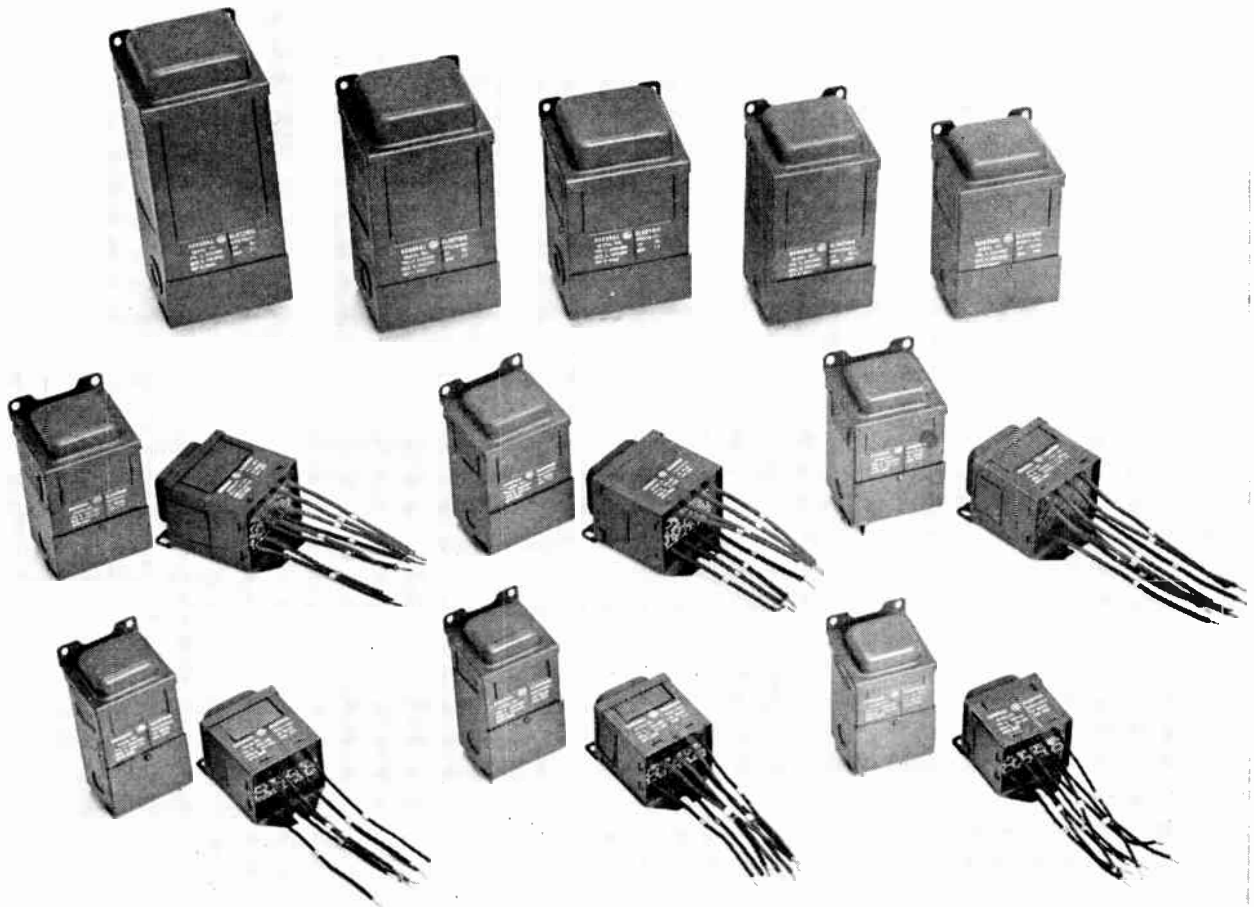
Pressure-vacuum-impregnated Core
and Coil**New standard control-transformer line. Open and enclosed units**

Many of these G-E control transformers (particularly those with 12/24 and 16/32 volt secondaries) provide an economical and convenient means of boosting or bucking voltage on single-phase or three-phase circuits. They are compact, light in weight, and can be easily installed. These transformers have both the primary and secondary windings

arranged for series-multiple connections.

With B-B transformers connected in series or in multiple, a 5, 10 or 20 per cent boost is possible. Because of the small voltage change required in such applications, the output of these small transformers is exceedingly large in comparison with their physical size.

G-E Standard Control Transformers

0.025 to 2 Kva—Single-phase—60/50 Cycles

Ordering Information

Listed below are model numbers for the G-E standard control-transformer line. Select from either of the first two tables the volt-ampere rating you need and match it with the voltage rating you require. This will give you the transformer frame size. Model numbers within a given frame size and construction type have the same mounting and overall dimensions. Model numbers, together with their prices and other pertinent selection data, are listed in the last table on this page.

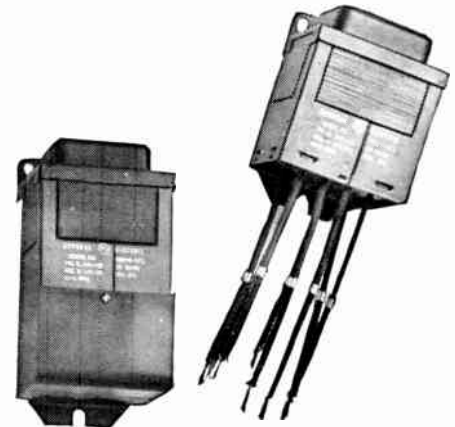

Fig. 1

Fig. 2

With Wiring Compartment (Fig. 1)

Volts		Volt-ampere Rating											
		25	50	75	100	150	200	250	500	750	1000	1500	2000
Primary	Secondary	Frame Size											
		609	609	612	613	813	814	815	1017	1021	1219	1223	1227
240/480	120/240	9T51Y6424	9T51Y6426	9T51Y6427	9T51Y6428	9T51Y6429	9T51Y6430	9T51Y6431	9T51Y6432	9T51Y6433	9T51Y6434	9T51Y6435	9T51Y6436
120/240	120/240	9T51Y6224	9T51Y6226	9T51Y6227	9T51Y6228	9T51Y6229	9T51Y6230	9T51Y6231	9T51Y6232	9T51Y6233	9T51Y6234	9T51Y6235	9T51Y6236
600	120/240	9T51Y6804	9T51Y6806	9T51Y6807	9T51Y6808	9T51Y6809	9T51Y6810	9T51Y6811	9T51Y6812	9T51Y6813	9T51Y6814	9T51Y6815	9T51Y6816
480*	120/240												9T51Y6674
600*	120/240												9T51Y6676
													9T51Y6834
													9T51Y6835
													9T51Y6836
120/240	12/24†	9T51Y6164	9T51Y6166	9T51Y6167	9T51Y6168	9T51Y6169	9T51Y6170	9T51Y6171	9T51Y6172	9T51Y6173	9T51Y6174	9T51Y6175	9T51Y6176
120/240	16/32†	9T51Y6184	9T51Y6186	9T51Y6187	9T51Y6188	9T51Y6189	9T51Y6190	9T51Y6191	9T51Y6192	9T51Y6193	9T51Y6194	9T51Y6195	9T51Y6196

*Two 5% FCBN taps in primary.

†See paragraph entitled "Transformers for Bucking and Boosting Applications."

With Open Wiring (Fig. 2)

Volts		Volt-ampere Rating						
		25	50	75	100	150	200	250
Primary	Secondary	Frame Size						
		609	609	612	613	813	814	815
240/480	120/240	9T51Y1424	9T51Y1426	9T51Y1427	9T51Y1428	9T51Y1429	9T51Y1430	9T51Y1431
120/240	120/240	9T51Y1224	9T51Y1226	9T51Y1227	9T51Y1228	9T51Y1229	9T51Y1230	9T51Y1231
600	120/240	9T51Y1804	9T51Y1806	9T51Y1807	9T51Y1808	9T51Y1809	9T51Y1810	9T51Y1811
120/240	6	9T51Y1104	9T51Y1106	9T51Y1107	9T51Y1108	9T51Y1109	9T51Y1110	9T51Y1111
120/240	12	9T51Y1244	9T51Y1246	9T51Y1247	9T51Y1248	9T51Y1249	9T51Y1250	9T51Y1251
120/240	24	9T51Y1264	9T51Y1266	9T51Y1267	9T51Y1268	9T51Y1269	9T51Y1270	9T51Y1271
120/240	32	9T51Y1204	9T51Y1206	9T51Y1207	9T51Y1208	9T51Y1209	9T51Y1210	9T51Y1211

Prices

Model No.	Va	Ship. Wt. Lbs.	List Price Each	Model No.	Va	Ship. Wt. Lbs.	List Price Each	Model No.	Va	Ship. Wt. Lbs.	List Price Each	Model No.	Va	Ship. Wt. Lbs.	List Price Each
9T51Y1106	50	2 3/4	16.20	9T51Y1267	75	3 3/4	18.95	9T51Y6175	1500	31	85.50	9T51Y6428	100	4 1/4	20.55
9T51Y1107	75	3 3/4	18.95	9T51Y1268	100	4 1/4	20.70	9T51Y6176	2000	43 1/2	104.00	9T51Y6429	150	6	24.20
9T51Y1108	100	4 1/4	20.70	9T51Y1269	150	6	24.40	9T51Y6184	25	2 3/4	14.90	9T51Y6430	200	6 3/4	26.70
9T51Y1109	150	6	24.40	9T51Y1270	200	6 3/4	26.90	9T51Y6186	50	2 3/4	17.05	9T51Y6431	250	7 1/2	29.00
9T51Y1110	200	6 3/4	26.90	9T51Y1271	250	7 1/2	30.40	9T51Y6187	75	3 3/4	20.00	9T51Y6432	500	13 1/4	40.90
9T51Y1111	250	7 1/2	30.40	9T51Y1424	25	2 3/4	14.05	9T51Y6188	100	4 1/4	21.85	9T51Y6433	750	19 3/4	51.45
9T51Y1204	25	2 3/4	14.10	9T51Y1426	50	2 3/4	16.10	9T51Y6189	150	6	25.70	9T51Y6434	1000	23	66.00
9T51Y1206	50	2 3/4	16.20	9T51Y1427	75	3 3/4	18.80	9T51Y6190	200	6 3/4	28.30	9T51Y6435	1500	31	80.50
9T51Y1207	75	3 3/4	18.95	9T51Y1428	100	4 1/4	20.55	9T51Y6191	250	7 1/2	32.00	9T51Y6436	2000	43 1/2	97.65
9T51Y1208	100	4 1/4	20.70	9T51Y1429	150	6	24.20	9T51Y6192	500	13 1/4	43.45	9T51Y6674	1000	23	66.00
9T51Y1209	150	6	24.40	9T51Y1430	200	6 3/4	26.70	9T51Y6193	750	19 3/4	54.60	9T51Y6675	1500	31	80.50
9T51Y1210	200	6 3/4	26.90	9T51Y1431	250	7 1/2	29.00	9T51Y6194	1000	23	70.00	9T51Y6676	2000	43 1/2	97.65
9T51Y1211	250	7 1/2	30.40	9T51Y1804	25	2 3/4	14.60	9T51Y6195	1500	31	85.50	9T51Y6804	25	2 3/4	14.60
9T51Y1224	25	2 3/4	14.05	9T51Y1806	50	2 3/4	16.80	9T51Y6196	2000	43 1/2	104.00	9T51Y6806	50	2 3/4	16.80
9T51Y1226	50	2 3/4	16.10	9T51Y1807	75	3 3/4	19.65	9T51Y6224	25	2 3/4	14.05	9T51Y6807	75	3 3/4	19.65
9T51Y1227	75	3 3/4	18.80	9T51Y1808	100	4 1/4	21.45	9T51Y6226	50	2 3/4	16.10	9T51Y6808	100	4 1/4	21.45
9T51Y1228	100	4 1/4	20.55	9T51Y1809	150	6	25.25	9T51Y6227	75	3 3/4	18.80	9T51Y6809	150	6	25.25
9T51Y1229	150	6	24.20	9T51Y1810	200	6 3/4	27.85	9T51Y6228	100	4 1/4	20.55	9T51Y6810	200	6 3/4	27.85
9T51Y1230	200	6 3/4	26.70	9T51Y1811	250	7 1/2	31.50	9T51Y6229	150	6	24.20	9T51Y6811	250	7 1/2	31.50
9T51Y1231	250	7 1/2	29.00	9T51Y6164	25	2 3/4	14.90	9T51Y6230	200	6 3/4	26.70	9T51Y6812	500	13 1/4	42.65
9T51Y1244	25	2 3/4	14.10	9T51Y6166	50	2 3/4	17.05	9T51Y6231	250	7 1/2	29.00	9T51Y6813	750	19 3/4	53.70
9T51Y1246	50	2 3/4	16.20	9T51Y6167	75	3 3/4	20.00	9T51Y6232	500	13 1/4	40.90	9T51Y6814	1000	23	68.60
9T51Y1247	75	3 3/4	18.95	9T51Y6168	100	4 1/4	21.85	9T51Y6233	750	19 3/4	51.45	9T51Y6815	1500	31	84.00
9T51Y1248	100	4 1/4	20.70	9T51Y6169	150	6	25.70	9T51Y6234	1000	23	66.00	9T51Y6816	2000	43 1/2	102.00
9T51Y1249	150	6	24.40	9T51Y6170	200	6 3/4	28.30	9T51Y6235	1500	31	80.50	9T51Y6834	1000	23	72.50
9T51Y1250	200	6 3/4	26.90	9T51Y6171	250	7 1/2	32.00	9T51Y6236	2000	43 1/2	97.65	9T51Y6835	1500	31	88.25
9T51Y1251	250	7 1/2	30.40	9T51Y6172	500	13 1/4	43.45	9T51Y6424	25	2 3/4	54.05	9T51Y6836	2000	43 1/2	107.00
9T51Y1264	25	2 3/4	14.10	9T51Y6173	750	19 3/4	54.60	9T51Y6426	50	2 3/4	16.10				

G-E Standard Control Transformers

0.025 to 2 Kva—Single-phase—60/50 Cycles

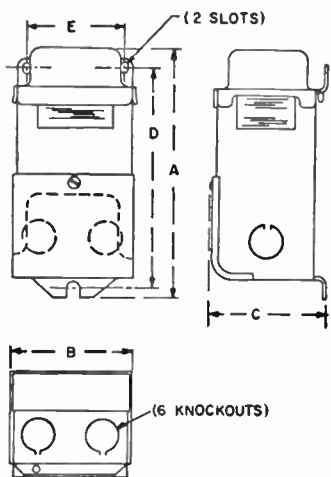

Fig. 1

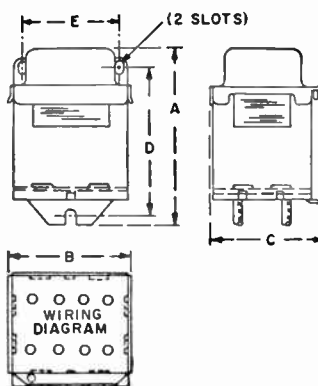

Fig. 2

With Wiring Compartment (Fig. 1)

Model No.	Approx. Dimensions In.				
	A	B	C	D	E
9T51Y6164	6 ³ / ₈	3 ³ / ₁₆	3	5 ⁵ / ₈	2 ¹ / ₂
9T51Y6166	6 ³ / ₈	3 ³ / ₁₆	3	5 ⁵ / ₈	2 ¹ / ₂
9T51Y6167	6 ⁷ / ₈	3 ³ / ₁₆	3	6 ¹ / ₄	2 ¹ / ₂
9T51Y6168	7 ¹ / ₈	3 ³ / ₁₆	3	6 ³ / ₈	2 ¹ / ₂
9T51Y6169	7 ¹ / ₄	3 ³ / ₁₆	3 ³ / ₈	6 ³ / ₈	3 ¹ / ₂
9T51Y6170	7 ¹ / ₂	3 ³ / ₈	3 ⁵ / ₈	6 ⁵ / ₈	3 ¹ / ₂
9T51Y6171	7 ³ / ₄	3 ³ / ₈	3 ⁵ / ₈	6 ⁷ / ₈	3 ¹ / ₂
9T51Y6172	8 ³ / ₈	4 ³ / ₈	4 ⁵ / ₈	7 ¹¹ / ₁₆	3 ³ / ₈
9T51Y6173	10 ³ / ₈	4 ³ / ₈	4 ⁵ / ₈	9 ⁵ / ₈	3 ³ / ₈
9T51Y6174	10 ⁷ / ₈	5 ¹ / ₁₆	4 ⁵ / ₈	9 ⁵ / ₈	4 ¹ / ₂
9T51Y6175	12 ¹ / ₈	5 ¹ / ₁₆	4 ⁵ / ₈	10 ⁹ / ₁₆	4 ¹ / ₂
9T51Y6176	11 ¹ / ₈	5 ¹ / ₁₆	4 ⁵ / ₈	12 ⁹ / ₁₆	4 ¹ / ₂
9T51Y6184	6 ⁵ / ₈	3 ³ / ₁₆	3	5 ⁵ / ₈	2 ¹ / ₂
9T51Y6186	6 ⁵ / ₈	3 ³ / ₁₆	3	5 ⁵ / ₈	2 ¹ / ₂
9T51Y6187	6 ⁵ / ₈	3 ³ / ₁₆	3	6 ¹ / ₈	2 ¹ / ₂
9T51Y6188	7 ¹ / ₈	3 ³ / ₁₆	3	6 ³ / ₈	2 ¹ / ₂
9T51Y6189	7 ¹ / ₄	3 ³ / ₈	3 ³ / ₈	6 ³ / ₈	3 ¹ / ₂
9T51Y6190	7 ¹ / ₂	3 ³ / ₈	3 ³ / ₈	6 ³ / ₈	3 ¹ / ₂
9T51Y6191	7 ³ / ₄	3 ³ / ₈	3 ³ / ₈	6 ³ / ₈	3 ¹ / ₂
9T51Y6192	8 ³ / ₈	4 ³ / ₈	4 ⁵ / ₈	7 ¹ / ₁₆	3 ³ / ₈
9T51Y6193	10 ³ / ₈	4 ³ / ₈	4 ⁵ / ₈	9 ⁵ / ₈	3 ³ / ₈
9T51Y6194	10 ¹ / ₈	5 ¹ / ₁₆	4 ⁵ / ₈	9 ⁵ / ₈	4 ¹ / ₂
9T51Y6195	12 ¹ / ₈	5 ¹ / ₁₆	4 ⁵ / ₈	10 ⁹ / ₁₆	4 ¹ / ₂
9T51Y6196	14 ¹ / ₈	5 ¹ / ₁₆	4 ⁵ / ₈	12 ⁹ / ₁₆	4 ¹ / ₂
9T51Y6224	6 ⁵ / ₈	3 ³ / ₁₆	3	5 ⁵ / ₈	2 ¹ / ₂
9T51Y6226	6 ⁵ / ₈	3 ³ / ₁₆	3	5 ⁵ / ₈	2 ¹ / ₂
9T51Y6227	6 ⁵ / ₈	3 ³ / ₁₆	3	6 ¹ / ₈	2 ¹ / ₂
9T51Y6228	7 ¹ / ₈	3 ³ / ₁₆	3	6 ³ / ₈	2 ¹ / ₂
9T51Y6229	7 ¹ / ₄	3 ³ / ₈	3 ³ / ₈	6 ³ / ₈	3 ¹ / ₂
9T51Y6230	7 ¹ / ₂	3 ³ / ₈	3 ³ / ₈	6 ³ / ₈	3 ¹ / ₂
9T51Y6231	7 ³ / ₄	3 ³ / ₈	3 ³ / ₈	6 ⁷ / ₈	3 ¹ / ₂
9T51Y6232	8 ³ / ₈	4 ³ / ₈	4 ⁵ / ₈	7 ¹ / ₁₆	3 ³ / ₈
9T51Y6233	10 ³ / ₈	4 ³ / ₈	4 ⁵ / ₈	9 ⁵ / ₈	3 ³ / ₈

Model No.	Approx. Dimensions In.				
	A	B	C	D	E
9T51Y6234	10 ¹ / ₈	5 ¹ / ₁₆	4 ⁷ / ₈	8 ⁷ / ₁₆	4 ¹ / ₂
9T51Y6235	12 ¹ / ₈	5 ¹ / ₁₆	4 ⁷ / ₈	10 ⁷ / ₁₆	4 ¹ / ₂
9T51Y6236	14 ¹ / ₈	5 ¹ / ₁₆	4 ⁷ / ₈	12 ⁷ / ₁₆	4 ¹ / ₂
9T51Y6424	6 ⁵ / ₈	3 ³ / ₁₆	3	5 ⁵ / ₈	2 ¹ / ₂
9T51Y6426	6 ⁵ / ₈	3 ³ / ₁₆	3	5 ⁵ / ₈	2 ¹ / ₂
9T51Y6427	6 ⁷ / ₈	3 ³ / ₁₆	3	6 ¹ / ₈	2 ¹ / ₂
9T51Y6428	7 ¹ / ₈	3 ³ / ₁₆	3	6 ³ / ₈	2 ¹ / ₂
9T51Y6429	7 ¹ / ₄	3 ³ / ₈	3 ³ / ₈	6 ³ / ₈	3 ¹ / ₂
9T51Y6430	7 ¹ / ₂	3 ³ / ₈	3 ³ / ₈	6 ³ / ₈	3 ¹ / ₂
9T51Y6431	7 ³ / ₄	3 ³ / ₈	3 ³ / ₈	6 ⁷ / ₈	3 ¹ / ₂
9T51Y6432	8 ³ / ₈	4 ³ / ₈	4 ⁵ / ₈	7 ¹¹ / ₁₆	3 ³ / ₈
9T51Y6433	10 ³ / ₈	4 ³ / ₈	4 ⁵ / ₈	9 ⁵ / ₈	3 ³ / ₈
9T51Y6434	10 ³ / ₈	5 ¹ / ₁₆	4 ⁵ / ₈	8 ⁷ / ₁₆	4 ¹ / ₂
9T51Y6435	12 ¹ / ₈	5 ¹ / ₁₆	4 ⁵ / ₈	10 ⁹ / ₁₆	4 ¹ / ₂
9T51Y6436	14 ¹ / ₈	5 ¹ / ₁₆	4 ⁵ / ₈	12 ⁹ / ₁₆	4 ¹ / ₂
9T51Y6674	10 ¹ / ₈	5 ¹ / ₁₆	4 ⁷ / ₈	8 ⁷ / ₁₆	4 ¹ / ₂
9T51Y6675	12 ¹ / ₈	5 ¹ / ₁₆	4 ⁷ / ₈	10 ⁷ / ₁₆	4 ¹ / ₂
9T51Y6676	14 ¹ / ₈	5 ¹ / ₁₆	4 ⁷ / ₈	12 ⁷ / ₁₆	4 ¹ / ₂
9T51Y6804	6 ⁵ / ₈	3 ³ / ₁₆	3	5 ⁵ / ₈	2 ¹ / ₂
9T51Y6806	6 ⁵ / ₈	3 ³ / ₁₆	3	5 ⁵ / ₈	2 ¹ / ₂
9T51Y6807	6 ⁵ / ₈	3 ³ / ₁₆	3	6 ¹ / ₈	2 ¹ / ₂
9T51Y6808	7 ¹ / ₈	3 ³ / ₁₆	3	6 ³ / ₈	2 ¹ / ₂
9T51Y6809	7 ¹ / ₄	3 ³ / ₈	3 ³ / ₈	6 ³ / ₈	3 ¹ / ₂
9T51Y6810	7 ¹ / ₂	3 ³ / ₈	3 ³ / ₈	6 ³ / ₈	3 ¹ / ₂
9T51Y6811	7 ³ / ₄	3 ³ / ₈	3 ³ / ₈	6 ⁷ / ₈	3 ¹ / ₂
9T51Y6812	8 ³ / ₈	4 ³ / ₈	4 ⁵ / ₈	7 ¹¹ / ₁₆	3 ³ / ₈
9T51Y6813	10 ³ / ₈	4 ³ / ₈	4 ⁵ / ₈	9 ⁵ / ₈	3 ³ / ₈
9T51Y6814	10 ³ / ₈	5 ¹ / ₁₆	4 ⁵ / ₈	8 ⁷ / ₁₆	4 ¹ / ₂
9T51Y6815	12 ¹ / ₈	5 ¹ / ₁₆	4 ⁵ / ₈	10 ⁹ / ₁₆	4 ¹ / ₂
9T51Y6816	14 ¹ / ₈	5 ¹ / ₁₆	4 ⁵ / ₈	12 ⁹ / ₁₆	4 ¹ / ₂
9T51Y6834	10 ¹ / ₈	5 ¹ / ₁₆	4 ⁷ / ₈	8 ⁷ / ₁₆	4 ¹ / ₂
9T51Y6835	12 ¹ / ₈	5 ¹ / ₁₆	4 ⁷ / ₈	10 ⁷ / ₁₆	4 ¹ / ₂
9T51Y6836	14 ¹ / ₈	5 ¹ / ₁₆	4 ⁷ / ₈	12 ⁷ / ₁₆	4 ¹ / ₂

With Open Wiring (Fig. 2)

9T51Y1104	4 ¹ / ₈	3 ³ / ₁₆	2 ¹⁵ / ₁₆	3 ⁷ / ₁₆	2 ¹ / ₂
9T51Y1106	4 ¹ / ₈	3 ³ / ₁₆	2 ¹⁵ / ₁₆	3 ⁷ / ₁₆	2 ¹ / ₂
9T51Y1107	4 ³ / ₈	3 ³ / ₁₆	2 ¹⁵ / ₁₆	3 ¹⁵ / ₁₆	2 ¹ / ₂
9T51Y1108	4 ³ / ₈	3 ³ / ₁₆	2 ¹⁵ / ₁₆	4 ¹ / ₁₆	2 ¹ / ₂
9T51Y1109	5	3 ³ / ₈	3 ¹ / ₂	4 ¹ / ₁₆	3 ¹ / ₈
9T51Y1110	5 ¹ / ₄	3 ³ / ₈	3 ¹ / ₂	4 ¹ / ₁₆	3 ¹ / ₈
9T51Y1111	5 ¹ / ₂	3 ³ / ₈	3 ¹ / ₂	4 ¹¹ / ₁₆	3 ¹ / ₈
9T51Y1204	4 ³ / ₈	3 ³ / ₁₆	2 ¹⁵ / ₁₆	3 ⁷ / ₁₆	2 ¹ / ₂
9T51Y1206	4 ³ / ₈	3 ³ / ₁₆	2 ¹⁵ / ₁₆	3 ⁷ / ₁₆	2 ¹ / ₂
9T51Y1207	4 ³ / ₈	3 ³ / ₁₆	2 ¹⁵ / ₁₆	3 ¹⁵ / ₁₆	2 ¹ / ₂
9T51Y1208	4 ³ / ₈	3 ³ / ₁₆	2 ¹⁵ / ₁₆	4 ¹ / ₁₆	2 ¹ / ₂
9T51Y1209	5	3 ³ / ₈	3 ¹ / ₂	4 ¹ / ₁₆	3 ¹ / ₈
9T51Y1210	5 ¹ / ₄	3 ³ / ₈	3 ¹ / ₂	4 ¹ / ₁₆	3 ¹ / ₈
9T51Y1211	5 ¹ / ₂	3 ³ / ₈	3 ¹ / ₂	4 ¹¹ / ₁₆	3 ¹ / ₈
9T51Y1224	4 ³ / ₈	3 ³ / ₁₆	2 ¹⁵ / ₁₆	3 ⁷ / ₁₆	2 ¹ / ₂
9T51Y1226	4 ³ / ₈	3 ³ / ₁₆	2 ¹⁵ / ₁₆	3 ⁷ / ₁₆	2 ¹ / ₂
9T51Y1227	4 ³ / ₈	3 ³ / ₁₆	2 ¹⁵ / ₁₆	3 ¹⁵ / ₁₆	2 ¹ / ₂
9T51Y1228	4 ³ / ₈	3 ³ / ₁₆	2 ¹⁵ / ₁₆	4 ³ / ₁₆	2 ¹ / ₂
9T51Y1229	5	3 ³ / ₈	3 ¹ / ₂	4 ³ / ₁₆	3 ¹ / ₈
9T51Y1230	5 ¹ / ₄	3 ³ / ₈	3 ¹ / ₂	4 ³ / ₁₆	3 ¹ / ₈
9T51Y1231	5 ¹ / ₂	3 ³ / ₈	3 ¹ / ₂	4 ¹¹ / ₁₆	3 ¹ / ₈
9T51Y1244	4 ³ / ₈	3 ³ / ₁₆	2 ¹⁵ / ₁₆	3 ⁷ / ₁₆	2 ¹ / ₂
9T51Y1246	4 ³ / ₈	3 ³ / ₁₆	2 ¹⁵ / ₁₆	3 ⁷ / ₁₆	2 ¹ / ₂
9T51Y1247	4 ³ / ₈	3 ³ / ₁₆	2 ¹⁵ / ₁₆	3 ¹⁵ / ₁₆	2 ¹ / ₂
9T51Y1248	4 ³ / ₈	3 ³ / ₁₆	2 ¹⁵ / ₁₆	4 ³ / ₁₆	2 ¹ / ₂

9T51Y1249	5	3 ³ / ₈	3 ¹ / ₂	4 ³ / ₁₆	3 ¹ / ₈
9T51Y1250	5 ¹ / ₄	3 ³ / ₈	3 ¹ / ₂	4 ³ / ₁₆	3 ¹ / ₈
9T51Y1251	5 ¹ / ₂	3 ³ / ₈	3 ¹ / ₂	4 ¹¹ / ₁₆	3 ¹ / ₈
9T51Y1264	4 ³ / ₈	3 ³ / ₁₆	2 ¹⁵ / ₁₆	3 ⁷ / ₁₆	2 ¹ / ₂
9T51Y1266	4 ³ / ₈	3 ³ / ₁₆	2 ¹⁵ / ₁₆	3 ⁷ / ₁₆	2 ¹ / ₂
9T51Y1269	5	3 ³ / ₈	3 ¹ / ₂	4 ³ / ₁₆	3 ¹ / ₈
9T51Y1270	5 ¹ / ₄	3 ³ / ₈	3 ¹ / ₂	4 ³ / ₁₆	3 ¹ / ₈
9T51Y1271	5 ¹ / ₂	3 ³ / ₈	3 ¹ / ₂	4 ¹¹ / ₁₆	3 ¹ / ₈
9T51Y1424	4 ³ / ₈	3 ³ / ₁₆	2 ¹⁵ / ₁₆	3 ⁷ / ₁₆	2 ¹ / ₂
9T51Y1426	4 ³ / ₈	3 ³ / ₁₆	2 ¹⁵ / ₁₆	3 ⁷ / ₁₆	2 ¹ / ₂
9T51Y1427	4 ³ / ₈	3 ³ / ₁₆	2 ¹⁵ / ₁₆	3 ¹⁵ / ₁₆	2 ¹ / ₂
9T51Y1428	4 ³ / ₈	3 ³ / ₁₆	2 ¹⁵ / ₁₆	4 ³ / ₁₆	2 ¹ / ₂
9T51Y1429	5	3 ³ / ₈	3 ¹ / ₂	4 ³ / ₁₆	3 ¹ / ₈
9T51Y1430	5 ¹ / ₄	3 ³ / ₈	3 ¹ / ₂	4 ³ / ₁₆	3 ¹ / ₈
9T51Y1431	5 ¹ / ₂	3 ³ / ₈	3 ¹ / ₂	4 ¹¹ / ₁₆	3 ¹ / ₈
9T51Y1804	4 ³ / ₈				

G-E Autotransformers for General Light and Power Service
Indoor or Outdoor Type
0.5 to 3 Kva—Single-phase—50/60 Cycles

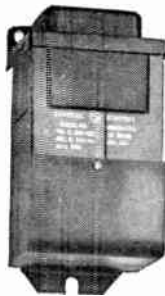

Small Control Autotransformer

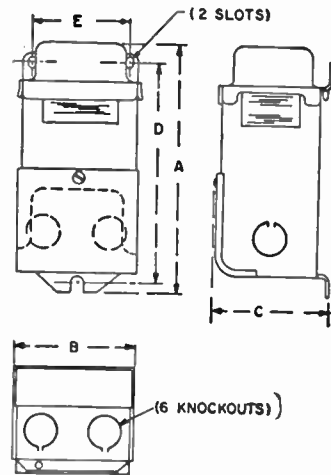

Fig. 1

These autotransformers can be used to obtain 120 volts from a 240 volt circuit, to derive a neutral on a 240 volt, 2-wire circuit, or to balance a 120/240* volt, 3-wire circuit. They also may be used in banks on polyphase circuits.

Model No.	Voltage Rating		Va Output	Frame Size	Approx. Dimensions In. (See Fig. 1)					Approx. Ship. Wt. Lbs.	List Price Each
	Input	Output			A	B	C	D	E		
9T51Y5600	120 or 240	120 or	500	815	7 3/4	3 7/8	3 5/8	6 7/8	3 1/8	7 1/2	\$26.90
9T51Y5601		240	750	1014	8 1/8	4 3/4	4 5/16	6 15/16	3 7/8	9 3/4	31.70
9T51Y5602		2-wire	1000	1017	8 7/8	4 3/4	4 5/16	7 11/16	3 7/8	13 1/4	36.50
9T51Y5603		or	1500	1021	10 3/8	4 3/4	4 5/16	9 3/16	3 7/8	19 3/4	45.90
9T51Y5604		240/120	2000	1219	10 1/8	5 1/16	4 7/8	8 9/16	4 1/2	23	58.90
9T51Y5605		3-wire	3000	1223	12 1/8	5 7/16	4 7/8	10 9/16	4 1/2	31	71.85

*Kva output at 120-volt, 2-wire, or allowable unbalance at 220/120 volt, 3-wire.

G-E Autotransformers for Boosting Voltage of Grounded Circuits
5 to 45 Kva—Three-Phase—60 Cycles



Three Control Autotransformers make One three-phase bank

The autotransformers listed below are designed primarily to boost the voltage of a three-phase secondary network system where the neutral is available and solidly grounded. They give the desired voltage at the minimum cost. Because of their small physical size as compared with the kva output of the bank, a very compact installation neat in appearance can be obtained.

Autotransformers of the bank ratings listed consist of three units with three leads brought out of each unit. Each bank of transformers consists of three separate units to be individually mounted.

3 Separate Units Per Bank—Dimensions and Weights are Per Unit
208Y volt 3-phase Transformation

Model No.	Voltage Rating		Single-phase Kva Output	Three-phase Bank Kva Output Cont.	Frame Size	Approx. Dimensions In. (See Fig. 1)					Approx. Ship. Wt. Lbs.	List Price (3 Units)
	Input	Output				A	B	C	D	E		
9T51Y5606	120	133	1 2/3	5	813	7 1/4	3 7/8	3 5/8	6 3/8	3 1/8	6	\$ 71.40
9T51Y5607			2 1/2	7 1/2	814	7 1/2	3 7/8	3 5/8	6 5/8	3 1/8	6 3/4	85.35
9T51Y5608			3 1/3	10	1014	8 1/8	4 3/4	4 5/16	6 15/16	3 7/8	9 3/4	96.00
9T51Y5609			5	15	1017	8 7/8	4 3/4	4 5/16	7 11/16	3 7/8	13 1/4	115.95
9T51Y5610			10	30	1219	10 1/8	5 1/16	4 7/8	8 9/16	4 1/2	23	185.70
9T51Y5611			15	45	1223	12 1/8	5 7/16	4 7/8	10 9/16	4 1/2	31	228.30

208Y to 240Y volt 3-phase Transformation

9T51Y5612	120	139	1 2/3	5	814	7 1/2	3 7/8	3 5/8	6 5/8	3 1/8	6 3/4	\$ 82.05
9T51Y5613			2 1/2	7 1/2	1014	8 1/8	4 3/4	4 5/16	6 15/16	3 7/8	9 3/4	97.65
9T51Y5614			3 1/3	10	1017	8 7/8	4 3/4	4 5/16	7 11/16	3 7/8	13 1/4	111.60
9T51Y5615			5	15	1021	10 1/8	5 1/16	4 7/8	8 9/16	4 1/2	23	139.50
9T51Y5616			10	30	1223	12 1/8	5 7/16	4 7/8	10 9/16	4 1/2	31	219.90
9T51Y5617			15	45	1227	14 1/8	5 7/16	4 7/8	12 9/16	4 1/2	43 1/2	284.85

Note: When ordering autotransformers, care should be exercised that the installation will meet local electrical inspector's requirements.

G-E Control-Panel and Machine-Tool Transformers

230/460 and 230/460/575 volt Primaries—0.050-1.5 Kva
115 and 115/95 volt Secondaries—60, 50/60 Cycles

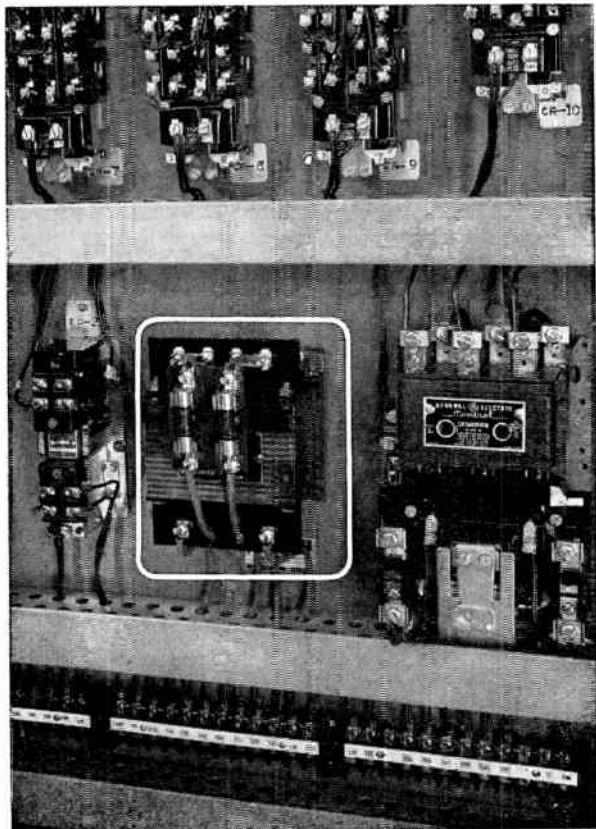

Panel mounted machine-tool transformer (G1)

These transformers have been designed for use by panel manufacturers, as well as those machine tool manufacturers who fabricate their own panels.

Features

Full compliance with all electrical requirements of NEMA and JIC standards.

Low regulation.

Compact design saves panel space.

Rugged construction—built specifically for machine-tool operation.

Ease of mounting helps reduce installation costs.

Low price helps you keep overall equipment costs down.

Wide Range of Ratings

More than one hundred different machine-tool transformers.

Eleven volt-ampere ratings: 50 to 5000 va.

Two frequency and primary-voltage combinations:
60 cycles, 115 volts—for domestic use.
50/60 cycles, 115/95 volts—for domestic or export use.

Five construction combinations: 50 to 150 va.

Seven construction combinations: 300 to 1500 va.

“Customer-specified” Accessory Groups

Machine-tool and panel transformer accessories available in seven different groups. The basic standard transformer ratings are available with fuses, circuit breakers, or leads.

The selection of one of these accessory groups gives the panel-board or machine-tool purchaser exactly the transformer he requires.

Group 1 (Model No. Suffix G1)

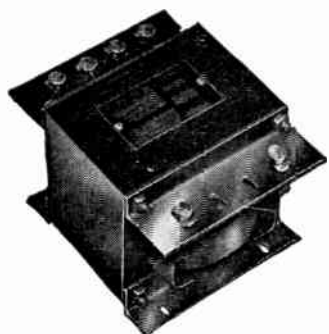

Basic transformer equipped with terminal boards. Primary and secondary terminal boards of Textolite* material. Top quality copper terminals suitable for spade, closed, or open terminal ends, as well as stripped leads. No wrapping necessary. Leads held firm in contact with terminals as screw is turned down. Boards mounted as integral part of core-and-coil assembly.

Entire unit is compact, yet terminal arrangement allows ample connection space.

Series-multiple ratings include brass terminal links on primary board for simple changes from series to parallel connections.

Note—Units in this group may be ordered without “G1” as a suffix to the basic model number.

*Registered trade-mark of General Electric Co.

G-E Control-Panel and Machine-Tool Transformers

**230/460 and 230/460/575 volt Primaries—0.050-1.5 Kva
115 and 115/95 volt Secondaries—60, 50/60 Cycles**

“Customer Specified” Accessory Groups (Con’t)

Group 2 (Model No. Suffix G2)



Basic transformer equipped with terminal boards; fused secondary.

Primary and secondary terminal-board arrangement of Textolite material as in Group 1, with the addition of a fuse* on the secondary board.

Sturdy fuse clips provide firm, vibration-free contact.

Group 3 (Model No. Suffix G3)

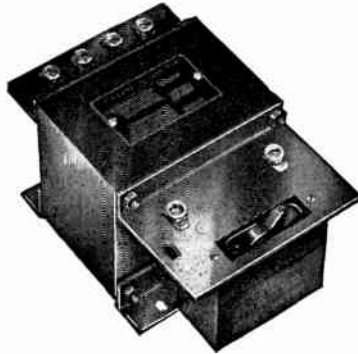

Basic transformer equipped with terminal boards; circuit breaker in secondary.

Primary and secondary terminal-board arrangement of Textolite material as in Group 1, with the addition of a high-shock circuit breaker mounted on the secondary board. Fully accessible for quick resetting.

Group 4 (Model No. Suffix G4)

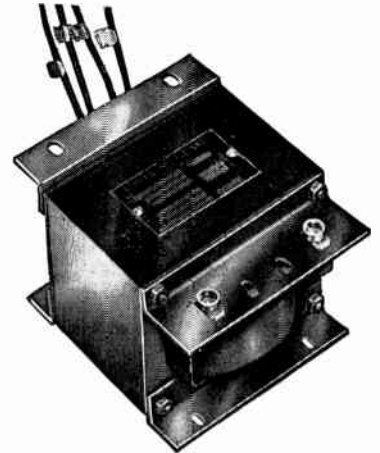

Basic transformer equipped with secondary terminal board; primary leads out.

Secondary terminal boards as described in Group 1. Eight-inch, stranded primary leads are stripped 1/2-in. for easy connection.

Group 5 (Model No. Suffix G5)

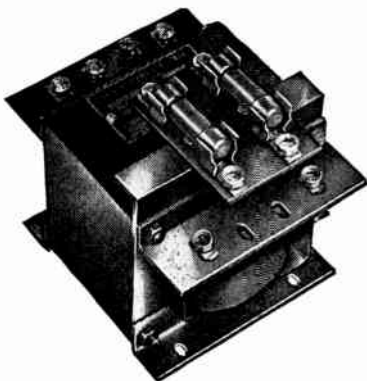

Basic transformer equipped with terminal boards and 2-fuse board.

Primary and secondary terminal-board arrangement of Textolite material as in Group 1.

In addition, a 2-fuse* Textolite board is mounted on top of the transformer for easy access to fuses.

*Fuses not included with these transformers.

Group 6 (Model No. Suffix G6)

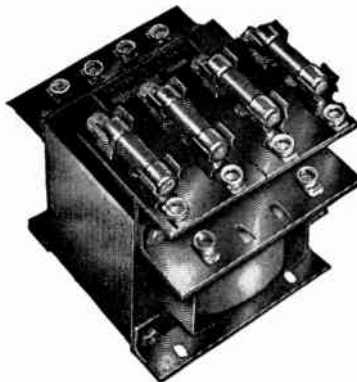

Basic transformer equipped with terminal board and 4-fuse board.

Primary and secondary terminal-board arrangement of Textolite material as in Group 1.

In addition, a 4-fuse* board of Textolite material is mounted on top of the transformer for easy access to fuses.

Group 7 (Model No. Suffix G7)

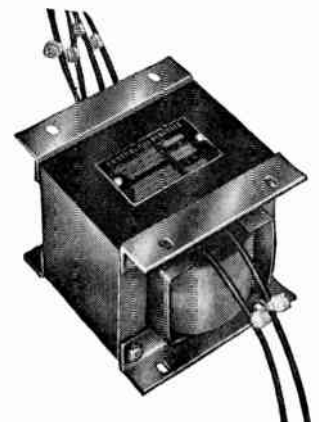

Basic transformer (leads out). Basic core-and-coil transformer with 8-in. stranded leads out. Leads are stripped 1/2-in. for easy connection.

G-E Control-Panel and Machine-Tool Transformers
230/460- and 230/460/575-Volt Primaries—0.050-1.5 Kva
115- and 115/95-Volt Secondaries—60, 50/60 Cycles

Model No.	* Kva	Group No. (See Preceding Pages)	Approximate Dimensions in Inches					Outline Fig. (See Following Pages)	List Price Each				
			Approximate Wt. in Lbs.		Overall								
			Net	Ship.	A	B	C			Mounting D	E		
230/460-volt Primary: 115-volt Secondary: 60 Cycles													
9T55Y2	0.050	G1	2 ³ / ₄	3 ³ / ₄	2 ³ / ₄	4 ¹ / ₈	3 ¹ / ₃₂	2 ¹ / ₈	1 ⁷ / ₈	1	\$ 12 10		
		G2†	2 ³ / ₄	3 ³ / ₄	3 ¹ / ₄	4 ⁵ / ₈	3 ¹ / ₃₂	2 ¹ / ₈	1 ⁷ / ₈	2	13 25		
		G4	2 ³ / ₄	3 ³ / ₄	2 ³ / ₄	3 ⁹ / ₁₆	3 ¹ / ₃₂	2 ¹ / ₈	1 ⁷ / ₈	3	10 20		
		G5†	2 ³ / ₄	3 ³ / ₄	4 ³ / ₈	4 ⁵ / ₁₆	3 ¹ / ₃₂	2 ¹ / ₈	1 ⁷ / ₈	4	17 10		
		G7	2 ³ / ₄	3 ³ / ₄	2 ³ / ₄	2 ⁷ / ₈	3 ¹ / ₃₂	2 ¹ / ₈	1 ⁷ / ₈	5	8 25		
		9T55Y3	0.075	G1	3 ¹ / ₂	4 ¹ / ₂	3 ¹ / ₄	4 ¹ / ₈	3 ³ / ₄	2 ¹ / ₈	2 ³ / ₄	1	13 90
				G2†	3 ³ / ₄	4 ³ / ₄	3 ³ / ₄	5 ⁵ / ₈	3 ³ / ₄	2 ¹ / ₈	2 ³ / ₄	2	15 05
G4	3 ¹ / ₂			4 ¹ / ₂	3 ¹ / ₄	3 ¹ / ₂	3 ³ / ₄	2 ¹ / ₈	2 ³ / ₄	3	12 00		
G5†	3 ¹ / ₂			4 ¹ / ₂	5 ¹ / ₄	4 ³ / ₈	3 ³ / ₄	2 ¹ / ₈	2 ³ / ₄	4	18 90		
G7	3 ¹ / ₂			4 ¹ / ₂	3 ⁹ / ₁₆	2 ⁷ / ₈	3 ³ / ₄	2 ¹ / ₈	2 ³ / ₄	5	10 05		
9T55Y5	0.150			G1	5 ¹ / ₄	6 ¹ / ₄	3 ¹ / ₄	5 ⁵ / ₈	3 ³ / ₄	2 ⁵ / ₈	2 ³ / ₄	1	16 15
				G2†	5 ¹ / ₂	6 ¹ / ₂	3 ³ / ₄	5 ¹ / ₈	3 ³ / ₄	2 ⁵ / ₈	2 ³ / ₄	2	17 30
		G4	5 ¹ / ₄	6 ¹ / ₄	3 ¹ / ₄	4	3 ³ / ₄	2 ⁵ / ₈	2 ³ / ₄	3	14 25		
		G5†	5 ¹ / ₄	6 ¹ / ₄	5 ¹ / ₄	4 ⁷ / ₈	3 ³ / ₄	2 ⁵ / ₈	2 ³ / ₄	4	21 15		
		G7	5 ¹ / ₄	6 ¹ / ₄	3 ⁵ / ₁₆	3 ¹ / ₄	3 ³ / ₄	2 ⁵ / ₈	2 ³ / ₄	5	12 30		
		9T55Y8	0.300	G1	11	16	4 ³ / ₈	5 ¹ / ₂	4 ⁷ / ₈	3 ¹ / ₄	3 ¹ / ₈	6	25 00
				G2†	11	16	4 ⁹ / ₁₆	5 ¹ / ₂	4 ⁷ / ₈	3 ¹ / ₄	3 ¹ / ₈	7	26 15
G3	11 ¹ / ₂			16 ¹ / ₂	4 ³ / ₈	6 ¹ / ₂	4 ⁷ / ₈	3 ¹ / ₄	3 ¹ / ₈	8	40 00		
G4	11			16	4 ³ / ₈	4 ³ / ₄	4 ⁷ / ₈	3 ¹ / ₄	3 ¹ / ₈	9	23 10		
G5†	11 ¹ / ₂			16 ¹ / ₂	6 ¹ / ₈	5 ³ / ₄	4 ⁷ / ₈	3 ¹ / ₄	3 ¹ / ₈	10	30 00		
G6†	11 ¹ / ₂			16 ¹ / ₂	6 ¹ / ₈	5 ³ / ₄	4 ⁷ / ₈	3 ¹ / ₄	3 ¹ / ₈	11	31 75		
G7	11			16	4 ³ / ₈	4 ¹ / ₄	4 ⁷ / ₈	3 ¹ / ₄	3 ¹ / ₈	12	21 15		
9T55Y10	0.500	G1	19	21	4 ³ / ₈	6 ³ / ₄	4 ⁷ / ₈	4 ¹ / ₂	3 ¹ / ₈	6	33 10		
		G2†	19	21	4 ⁹ / ₁₆	6 ³ / ₄	4 ⁷ / ₈	4 ¹ / ₂	3 ¹ / ₈	7	34 25		
		G3	19 ¹ / ₂	21 ¹ / ₂	4 ³ / ₈	7 ⁷ / ₈	4 ⁷ / ₈	4 ¹ / ₂	3 ¹ / ₈	8	48 10		
		G4	19	21	4 ³ / ₈	6	4 ⁷ / ₈	4 ¹ / ₂	3 ¹ / ₈	9	31 20		
		G5†	19 ¹ / ₂	21 ¹ / ₂	6 ¹ / ₈	4 ⁷ / ₈	4 ⁷ / ₈	4 ¹ / ₂	3 ¹ / ₈	10	38 10		
		G6†	19 ¹ / ₂	21 ¹ / ₂	6 ¹ / ₈	6 ⁷ / ₈	4 ⁷ / ₈	4 ¹ / ₂	3 ¹ / ₈	11	39 85		
		G7	19	21	4 ³ / ₈	5 ¹ / ₂	4 ⁷ / ₈	4 ¹ / ₂	3 ¹ / ₈	12	29 25		
9T55Y11	0.750	G1	25	27	4 ³ / ₈	8	4 ⁷ / ₈	5 ³ / ₄	3 ¹ / ₈	6	45 50		
		G2†	25	27	4 ⁹ / ₁₆	8	4 ⁷ / ₈	5 ³ / ₄	3 ¹ / ₈	7	46 65		
		G3	25 ¹ / ₂	27 ¹ / ₂	4 ³ / ₈	9 ¹ / ₈	4 ⁷ / ₈	5 ³ / ₄	3 ¹ / ₈	8	60 50		
		G4	25	27	4 ³ / ₈	7 ¹ / ₄	4 ⁷ / ₈	5 ³ / ₄	3 ¹ / ₈	9	43 60		
		G5†	25 ¹ / ₂	27 ¹ / ₂	6 ¹ / ₈	8 ¹ / ₈	4 ⁷ / ₈	5 ³ / ₄	3 ¹ / ₈	10	50 50		
		G6†	25 ¹ / ₂	27 ¹ / ₂	6 ¹ / ₈	8 ¹ / ₈	4 ⁷ / ₈	5 ³ / ₄	3 ¹ / ₈	11	52 25		
		G7	25	27	4 ³ / ₈	6 ³ / ₄	4 ⁷ / ₈	5 ³ / ₄	3 ¹ / ₈	12	41 65		
9T55Y12	1 0	G1	27	30	5 ⁷ / ₈	6	6 ³ / ₄	3 ¹ / ₂	4 ¹ / ₂	6	54 75		
		G2†	27	30	6 ¹ / ₄	6	6 ³ / ₄	3 ¹ / ₂	4 ¹ / ₂	7	55 90		
		G3	27 ¹ / ₂	30 ¹ / ₂	5 ⁷ / ₈	6 ⁷ / ₈	6 ³ / ₄	3 ¹ / ₂	4 ¹ / ₂	8	69 75		
		G4	27	30	5 ⁷ / ₈	5 ¹ / ₄	6 ³ / ₄	3 ¹ / ₂	4 ¹ / ₂	9	52 85		
		G5†	27 ¹ / ₂	30 ¹ / ₂	7 ⁵ / ₈	6 ¹ / ₈	6 ³ / ₄	3 ¹ / ₂	4 ¹ / ₂	10	59 75		
		G6†	27 ¹ / ₂	30 ¹ / ₂	7 ⁵ / ₈	6 ¹ / ₈	6 ³ / ₄	3 ¹ / ₂	4 ¹ / ₂	11	61 50		
		G7	27	30	5 ⁷ / ₈	4 ¹ / ₂	6 ³ / ₄	3 ¹ / ₂	4 ¹ / ₂	12	50 90		
9T55Y13	1.5	G1	34	37	5 ⁷ / ₈	7	6 ³ / ₄	4 ¹ / ₂	4 ¹ / ₂	6	78 00		
		G2†	34	37	6 ¹ / ₄	7	6 ³ / ₄	4 ¹ / ₂	4 ¹ / ₂	7	79 15		
		G3	34 ¹ / ₂	37 ¹ / ₂	5 ⁷ / ₈	7 ⁷ / ₈	6 ³ / ₄	4 ¹ / ₂	4 ¹ / ₂	8	93 00		
		G4	34	37	5 ⁷ / ₈	6 ¹ / ₄	6 ³ / ₄	4 ¹ / ₂	4 ¹ / ₂	9	76 10		
		G5†	34 ¹ / ₂	37 ¹ / ₂	7 ⁵ / ₈	7 ¹ / ₈	6 ³ / ₄	4 ¹ / ₂	4 ¹ / ₂	10	83 00		
		G6†	34 ¹ / ₂	37 ¹ / ₂	7 ⁵ / ₈	7 ¹ / ₈	6 ³ / ₄	4 ¹ / ₂	4 ¹ / ₂	11	84 75		
		G7	34	37	5 ⁷ / ₈	5 ¹ / ₂	6 ³ / ₄	4 ¹ / ₂	4 ¹ / ₂	12	74 15		
9T55Y14	2.0	G1	39 ¹ / ₂	40 ¹ / ₂	6 ¹ / ₁₆	7 ⁵ / ₈	6 ⁷ / ₈	4 ⁷ / ₈	4 ¹ / ₂	6	93 45		
		G2†	39 ¹ / ₂	40 ¹ / ₂	6 ¹ / ₄	7 ⁵ / ₈	6 ⁷ / ₈	4 ⁷ / ₈	4 ¹ / ₂	7	94 60		
		G3	40	41 ¹ / ₂	6 ¹ / ₁₆	8 ¹⁵ / ₁₆	6 ⁷ / ₈	4 ⁷ / ₈	4 ¹ / ₂	8	108 45		
		G4	39 ¹ / ₂	40 ¹ / ₂	6 ¹ / ₁₆	6 ¹⁵ / ₁₆	6 ⁷ / ₈	4 ⁷ / ₈	4 ¹ / ₂	9	91 55		
		G5†	39 ¹ / ₂	40 ¹ / ₂	7 ³ / ₄	7 ³ / ₄	6 ⁷ / ₈	4 ⁷ / ₈	4 ¹ / ₂	10	98 45		
		G6†	40	41 ¹ / ₂	7 ³ / ₄	7 ³ / ₄	6 ⁷ / ₈	4 ⁷ / ₈	4 ¹ / ₂	11	100 20		
		G7	39	40	6 ¹ / ₁₆	6 ¹ / ₈	6 ⁷ / ₈	4 ⁷ / ₈	4 ¹ / ₂	12	89 60		
9T55Y15	3.0	G1	53 ¹ / ₂	57	6 ¹ / ₁₆	9 ¹ / ₁₆	6 ⁷ / ₈	6 ¹⁵ / ₁₆	4 ¹ / ₂	6	125 00		
		G2†	53 ¹ / ₂	57	6 ¹ / ₄	9 ¹ / ₁₆	6 ⁷ / ₈	6 ¹⁵ / ₁₆	4 ¹ / ₂	7	126 15		
		G3	56	57 ¹ / ₂	6 ¹ / ₁₆	10 ¹⁵ / ₁₆	6 ⁷ / ₈	6 ¹⁵ / ₁₆	4 ¹ / ₂	8	140 00		
		G4	53 ¹ / ₂	57	6 ¹ / ₁₆	8 ¹⁵ / ₁₆	6 ⁷ / ₈	6 ¹⁵ / ₁₆	4 ¹ / ₂	9	123 10		
		G5†	53 ¹ / ₂	57	7 ³ / ₄	9 ¹³ / ₁₆	6 ⁷ / ₈	6 ¹⁵ / ₁₆	4 ¹ / ₂	10	130 00		
		G6†	56	57 ¹ / ₂	7 ³ / ₄	9 ¹³ / ₁₆	6 ⁷ / ₈	6 ¹⁵ / ₁₆	4 ¹ / ₂	11	131 75		
		G7	55	56 ¹ / ₂	6 ¹ / ₁₆	8 ³ / ₁₆	6 ⁷ / ₈	6 ¹⁵ / ₁₆	4 ¹ / ₂	12	121 15		
9T55Y16	5.0	G1	77	78 ¹ / ₂	7 ³ / ₄	10 ¹³ / ₁₆	11	5 ⁷ / ₈	6 ¹ / ₄	13	183 00		
		G2†	77	78 ¹ / ₂	7 ³ / ₄	10 ¹³ / ₁₆	11	5 ⁷ / ₈	6 ¹ / ₄	14	184 15		
		G3	77 ¹ / ₂	79	7 ³ / ₄	10 ¹³ / ₁₆	11	5 ⁷ / ₈	6 ¹ / ₄	15	198 00		
		G4	77	78 ¹ / ₂	7 ³ / ₄	10 ¹ / ₈	11	5 ⁷ / ₈	6 ¹ / ₄	16	181 10		
		G5†	77	78 ¹ / ₂	10 ¹ / ₈	10 ¹⁵ / ₁₆	11	5 ⁷ / ₈	6 ¹ / ₄	17	188 00		
		G6†	77 ¹ / ₂	79	10 ¹ / ₈	10 ¹⁵ / ₁₆	11	5 ⁷ / ₈	6 ¹ / ₄	18	198 75		
		G7	76 ¹ / ₂	78	7 ³ / ₄	9 ¹ / ₁₆	11	5 ⁷ / ₈	6 ¹ / ₄	12	179 15		

*On sizes 3 kva and above, mounting brackets also provided with end slots.
 †Fuses not included with these transformers.

G-E Control-Panel and Machine-Tool Transformers
230/460—and 230/460/575-volt Primaries—0.050-1.5 Kva
115- and 115/95-volt Secondaries—60, 50/60 Cycles

Model No.	* Kva	Group No. (See Preceding Pages)	Approximate Wt. in Lbs.		Approximate Dimensions in Inches				Outline Fig. (See Following Pages)	List Price Each	
			Net	Ship.	Overall		Mounting				
			230/460/575-volt Primary:		115/95-volt Secondary:		50/60 Cycles				
			A	B	C	D	E				
9T55Y22	0.050	G1	3 3/4	4 3/4	2 3/4	4 7/8	3 1/2	2 7/8	1 7/8	1	\$ 13.35
		G2†	4	5	3 3/4	5 3/8	3 1/2	2 7/8	1 7/8	2	14.50
		G4	3 3/4	4 3/4	2 3/4	4 15/16	3 1/2	2 7/8	1 7/8	3	11.45
		G5†	3 3/4	4 3/4	4 3/8	5 1/16	3 1/2	2 7/8	1 7/8	4	18.35
		G7	3 3/4	4 3/4	2 3/4	3 5/8	3 1/2	2 7/8	1 7/8	5	9.50
		G1	4 1/4	5 1/4	3 1/4	4 3/8	3 3/4	2 3/8	2 3/4	1	17.40
		G2†	4 1/2	5 1/2	3 3/4	4 7/8	3 3/4	2 3/8	2 3/4	2	18.55
9T55Y23	0.075	G4	4 1/4	5 1/4	3 1/4	3 3/4	3 3/4	2 3/8	2 3/4	3	15.50
		G5†	4 1/4	5 1/4	5 1/4	4 5/8	3 3/4	2 3/8	2 3/4	4	22.40
		G7	4 1/4	5 1/4	3 3/16	3 1/8	3 3/4	2 3/8	2 3/4	5	13.55
		G1	7 1/4	8 1/4	3 1/4	5 3/8	3 3/4	3 3/8	2 3/4	1	22.25
		G2†	7 1/2	8 1/2	3 3/4	5 7/8	3 3/4	3 3/8	2 3/4	2	23.40
		G4	7 1/4	8 1/4	3 1/4	4 3/4	3 3/4	3 3/8	2 3/4	3	20.35
		G5†	7 1/4	8 1/4	5 1/4	5 5/8	3 3/4	3 3/8	2 3/4	4	27.25
9T55Y25	0.150	G7	7 1/4	8 1/4	3 5/16	4 1/8	3 3/4	3 3/8	2 3/4	5	18.40
		G1	17	19	4 3/8	6 1/2	4 7/8	4 1/4	3 1/8	6	34.20
		G2†	17	19	4 9/16	6 1/2	4 7/8	4 1/4	3 1/8	7	35.35
		G3	17 1/2	19 1/2	4 3/8	7 5/8	4 7/8	4 1/4	3 1/8	8	49.20
		G4	17	19	4 3/8	5 3/4	4 7/8	4 1/4	3 1/8	9	32.30
		G5†	17 1/2	19 1/2	6 1/8	6 5/8	4 7/8	4 1/4	3 1/8	10	39.20
		G6†	17 1/2	19 1/2	6 1/8	6 5/8	4 7/8	4 1/4	3 1/8	11	40.95
9T55Y28	0.300	G7	17	19	4 3/8	5 1/4	4 7/8	4 1/4	3 1/8	12	30.35
		G1	22	24	4 3/8	7 1/2	4 7/8	5 1/4	3 1/8	6	44.70
		G2†	22	24	4 9/16	7 1/2	4 7/8	5 1/4	3 1/8	7	45.85
		G3	22 1/2	24 1/2	4 3/8	8 5/8	4 7/8	5 1/4	3 1/8	8	59.70
		G4	22	24	4 3/8	6 3/4	4 7/8	5 1/4	3 1/8	9	42.80
		G5†	22 1/2	24 1/2	6 1/8	7 5/8	4 7/8	5 1/4	3 1/8	10	49.70
		G6†	22 1/2	24 1/2	6 1/8	7 5/8	4 7/8	5 1/4	3 1/8	11	51.45
9T55Y30	0.500	G7	22	24	4 3/8	6 1/4	4 7/8	5 1/4	3 1/8	12	40.85
		G1	27	29	5 7/8	6 1/4	6 3/4	3 1/4	4 1/2	6	60.50
		G2†	27	29	6 1/4	6 1/4	6 3/4	3 1/4	4 1/2	7	61.65
		G3	27 1/2	29 1/2	5 7/8	7 1/8	6 3/4	3 1/4	4 1/2	8	75.50
		G4	27	29	5 7/8	5 1/2	6 3/4	3 1/4	4 1/2	9	58.60
		G5†	27 1/2	29 1/2	7 5/8	6 3/8	6 3/4	3 1/4	4 1/2	10	65.50
		G6†	27 1/2	29 1/2	7 5/8	6 3/8	6 3/4	3 1/4	4 1/2	11	67.25
9T55Y31	0.750	G7	27	29	5 7/8	4 3/4	6 3/4	3 1/4	4 1/2	12	56.65
		G1	32	34	5 7/8	6 3/4	6 3/4	4 1/4	4 1/2	6	73.00
		G2†	32	34	6 1/4	6 3/4	6 3/4	4 1/4	4 1/2	7	74.15
		G3	32 1/2	34 1/2	5 7/8	7 5/8	6 3/4	4 1/4	4 1/2	8	88.00
		G4	32	34	5 7/8	6	6 3/4	4 1/4	4 1/2	9	71.10
		G5†	32 1/2	34 1/2	7 5/8	6 7/8	6 3/4	4 1/4	4 1/2	10	78.00
		G6†	32 1/2	34 1/2	7 5/8	6 7/8	6 3/4	4 1/4	4 1/2	11	79.75
9T55Y32	1.0	G7	32	34	5 7/8	5 1/4	6 3/4	4 1/4	4 1/2	12	69.15
		G1	43	46	5 7/8	8	6 3/4	5 1/2	4 1/2	6	104.00
		G2†	43	46	6 1/4	8	6 3/4	5 1/2	4 1/2	7	105.15
		G3	43 1/2	46 1/2	5 7/8	8 7/8	6 3/4	5 1/2	4 1/2	8	119.00
		G4	43	46	5 7/8	7 1/4	6 3/4	5 1/2	4 1/2	9	102.10
		G5†	43 1/2	46 1/2	7 5/8	8 1/8	6 3/4	5 1/2	4 1/2	10	109.00
		G6†	43 1/2	46 1/2	7 5/8	8 1/8	6 3/4	5 1/2	4 1/2	11	110.75
9T55Y33	1.5	G7	43	46	5 7/8	6 1/2	6 3/4	5 1/2	4 1/2	12	100.15
		G1	46	47 1/2	6 1/16	8 1/16	6 7/8	5 15/16	4 1/2	6	124.50
		G2†	46	47 1/2	6 1/4	8 1/16	6 7/8	5 15/16	4 1/2	7	125.65
		G3	46 1/2	48	6 1/16	9 15/16	6 7/8	5 15/16	4 1/2	8	139.50
		G4	46	47 1/2	6 1/16	7 15/16	6 7/8	5 15/16	4 1/2	9	122.60
		G5†	46	47 1/2	7 3/4	8 13/16	6 7/8	5 15/16	4 1/2	10	129.50
		G6†	46 1/2	48	7 3/4	8 13/16	6 7/8	5 15/16	4 1/2	11	131.25
9T55Y34	2.0	G7	45 1/2	47	6 1/16	7 3/16	6 7/8	5 15/16	4 1/2	12	120.65
		G1	67	68 1/2	6 1/16	10 11/16	6 7/8	7 15/16	4 1/2	6	167.00
		G2†	67	68 1/2	6 3/4	10 11/16	6 7/8	7 15/16	4 1/2	7	168.15
		G3	67 1/2	69	6 1/16	11 15/16	6 7/8	7 15/16	4 1/2	8	182.00
		G4	67	68 1/2	6 1/16	9 15/16	6 7/8	7 15/16	4 1/2	9	165.10
		G5†	67	68 1/2	7 3/4	10 13/16	6 7/8	7 15/16	4 1/2	10	172.00
		G6†	67 1/2	69	7 3/4	10 13/16	6 7/8	7 15/16	4 1/2	11	173.75
9T55Y35	3.0	G7	66 1/2	68	6 1/16	9 3/16	6 7/8	7 15/16	4 1/2	12	163.15
		G1	110	111 1/2	7 3/4	12 7/8	11	7 7/8	6 1/4	13	244.00
		G2†	110	111 1/2	7 3/4	12 7/8	11	7 7/8	6 1/4	14	245.15
		G3	110 1/2	112	7 3/4	13 7/8	11	7 7/8	6 1/4	15	259.00
		G4	110	111 1/2	7 3/4	12 5/16	11	7 7/8	6 1/4	16	242.10
		G5†	110	111 1/2	10 1/8	12 15/16	11	7 7/8	6 1/4	17	249.00
		G6†	110 1/2	112	10 1/8	12 15/16	11	7 7/8	6 1/4	18	250.75
9T55Y36	5.0	G7	109 1/2	111	7 3/4	11 1/16	11	7 7/8	6 1/4	12	177.20

*On sizes 3 kva and above, mounting brackets are also provided with end slots.
 †Fuses not included with these transformers.

G-E Control-Panel and Machine-Tool Transformers

**230 / 460 and 230 / 460 / 575 Volt Primaries—0.050-1.5 Kva
115 and 115-95 Volt Secondaries—60, 50/60 Cycles**

Outline Dimensions

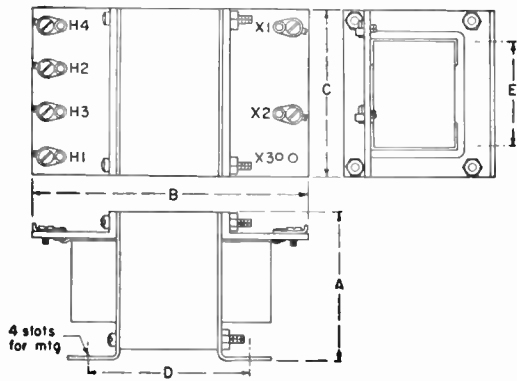

Fig. 1

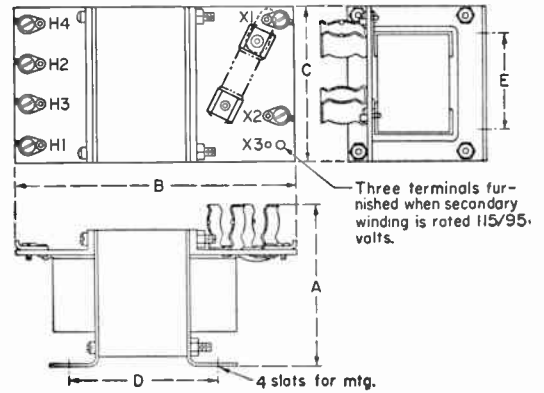

Fig. 2

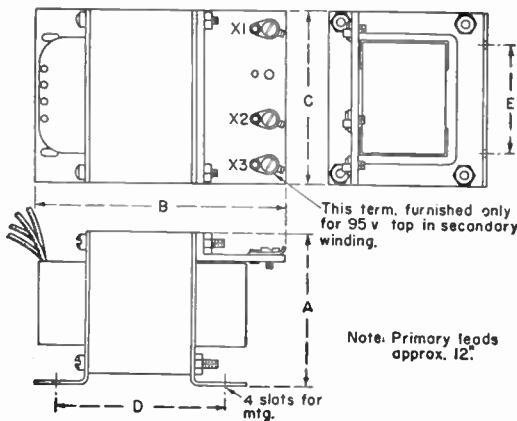

Fig. 3

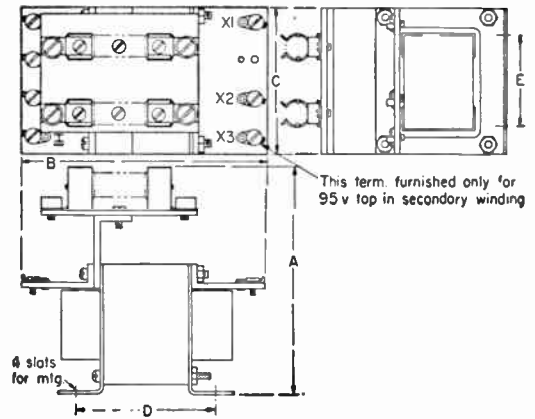

Fig. 4

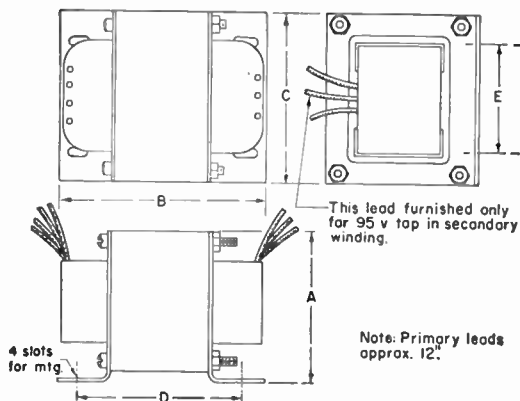

Fig. 5

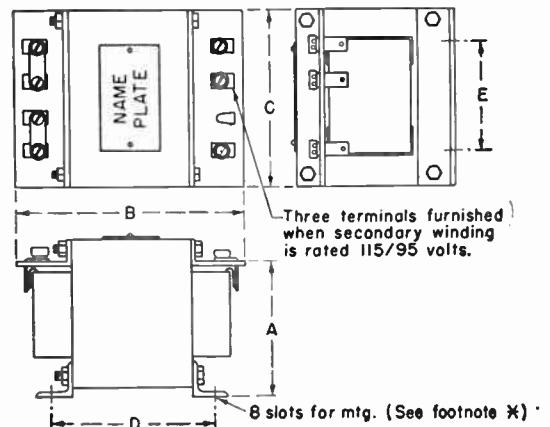

Fig. 6

*See Fig. 19.

G-E Control-Panel and Machine-Tool Transformers

**230/460 and 230/460/575 Volt Primaries—0.050-1.5 Kva
115 and 115/95 Volt Secondaries—60, 50/60 Cycles**

Outline Dimensions (Con't)

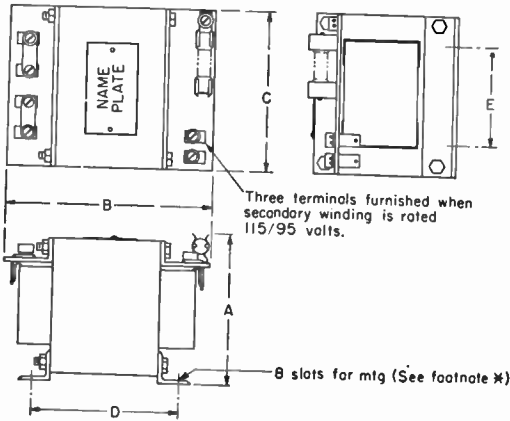

Fig. 7

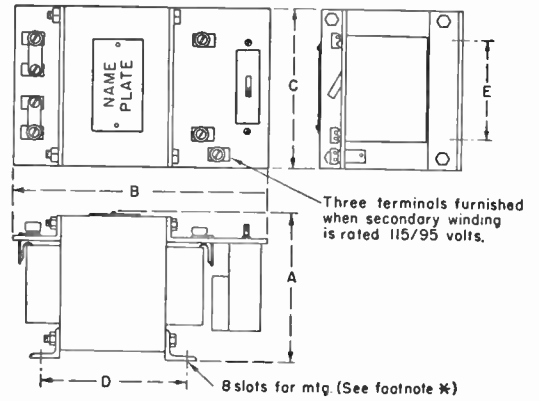

Fig. 8

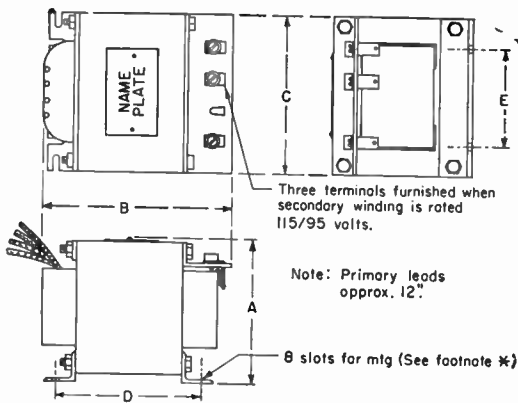

Fig. 9

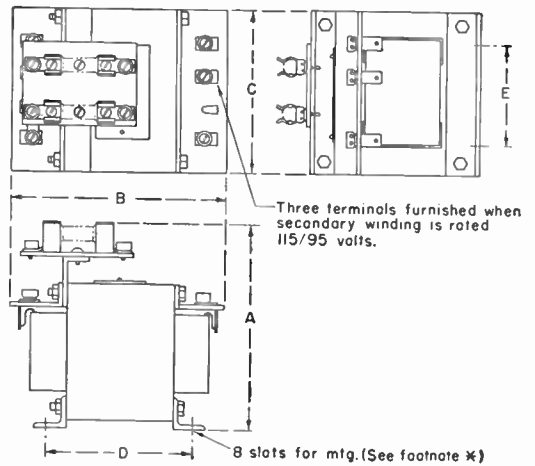

Fig. 10

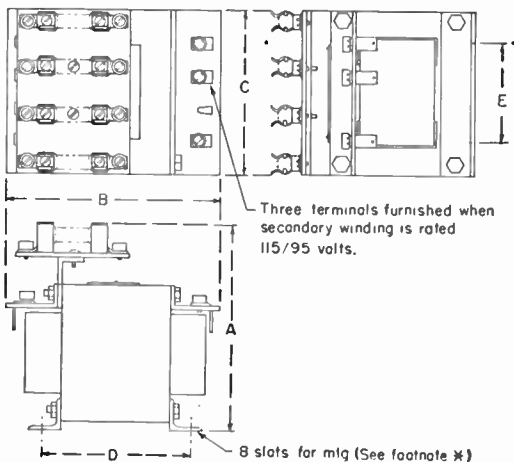

Fig. 11

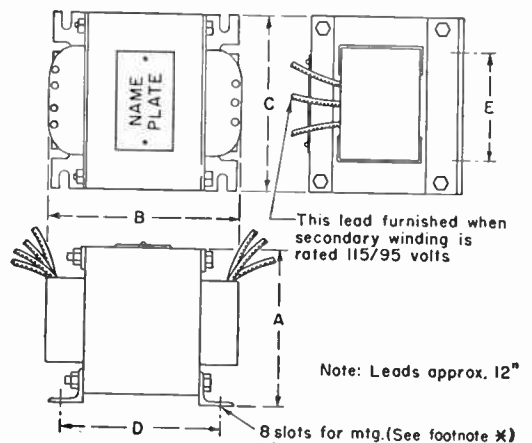

Fig. 12

*See Fig. 19.

G-E Control-Panel and Machine-Tool Transformers

**230/460 and 230/460/575 Volt Primaries—0.050-1.5 Kva
115 and 115/95 Volt Secondaries—60 50/60 Cycles**

Outline Dimensions (Con't)

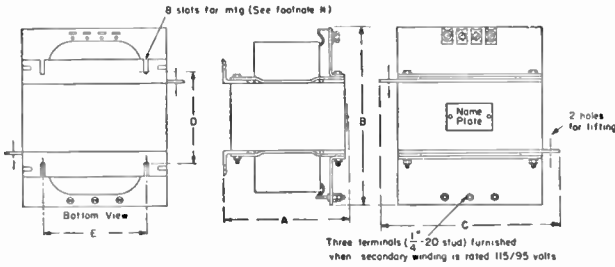

Fig. 13

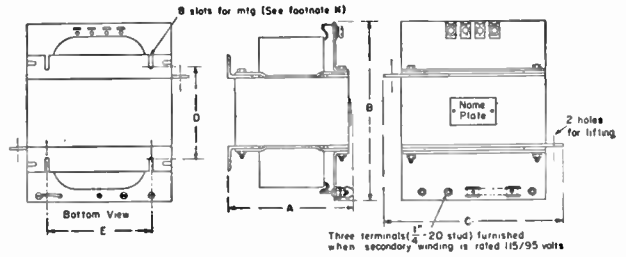

Fig. 14

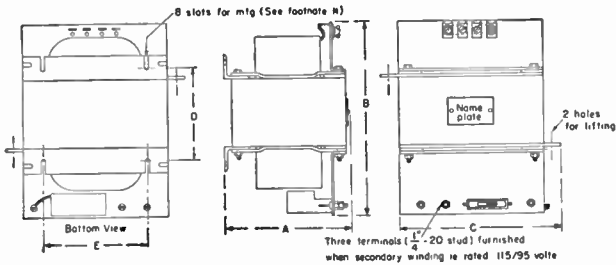

Fig. 15

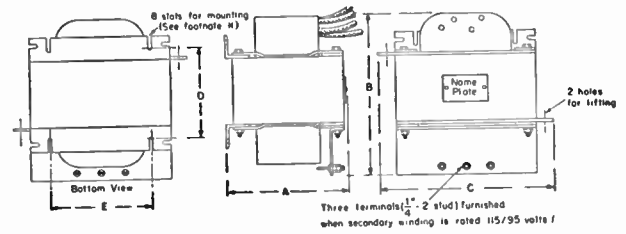

Fig. 16

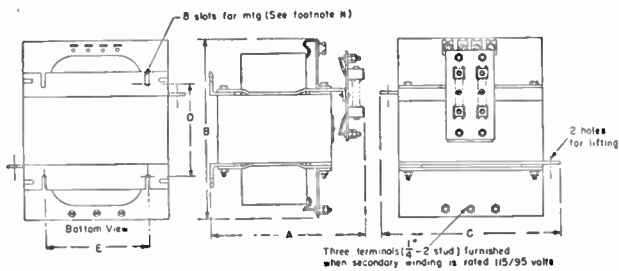

Fig. 17

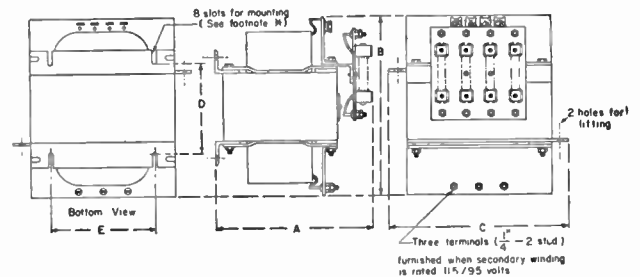
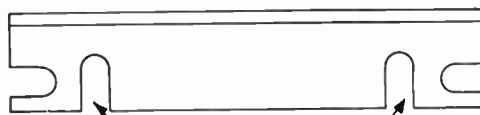

Fig. 18



Note: Dimension D and E taken from these slots only

Fig. 19

Note: For mounting dimensions from slots at end of brackets, consult Graybar.

G-E Voltage-Stabilizing Transformers

For Indoor Service

Dry-Type—Single-Phase—60 Cycles

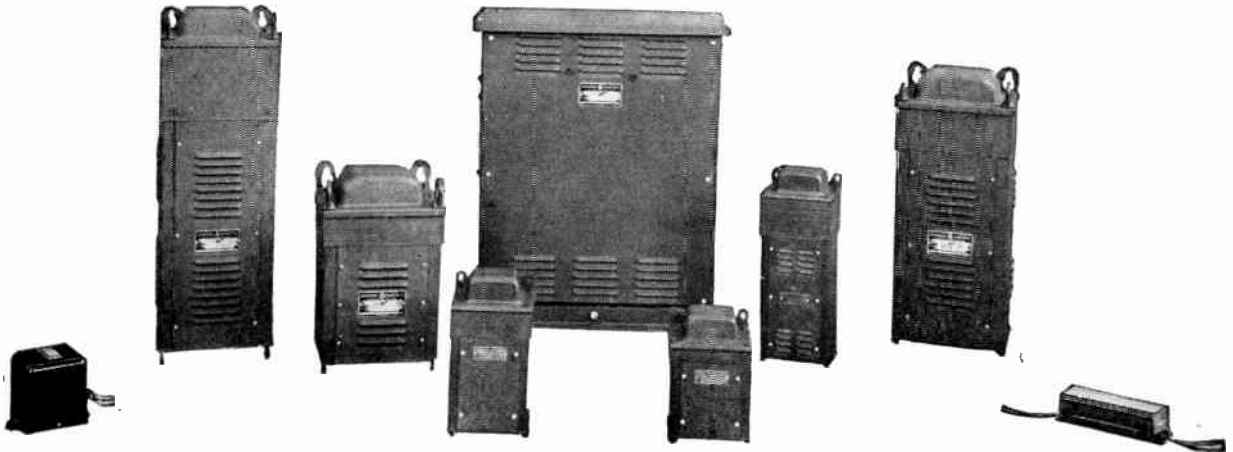

Standard line of G-E Voltage-Stabilizing Transformers, rated from 15 VA to 10,000 VA.

These transformers give stabilized output voltage within $\pm 1\%$ with input voltage variations of $\pm 15\%$ when operating at rated load and 1.0 power factor. They provide a dependable source of constant output voltage for applications such as radio transmitters, laboratory testing equipment, precision electrical processes, or wherever voltage must be held within close tolerances despite wide fluctuations in the supply voltage. These transformers are totally insulated and are for indoor service only.

Limitations

When considering voltage-stabilizing transformers for applications involving three-phase supplies, varying frequency sources, half-wave rectifiers, high starting currents (motors, relays, etc.), or where there is a need for nearly sinusoidal voltage wave shape, consult Graybar.

Volt-Amp Output Capacity	Voltages		Mode No.	Approx. Wt., Lb.		Net Price Each
	Input Range	Stabilized Output		Net	Ship	
15	95-130	115	9T91Y70	5	6	\$15.15
25	95-130	115	9T91Y80	5	6	16.40
50	95-130	115	9T91Y100	6	7	20.45
100	95-130	115	9T91Y120	15	16	29.00
250	95-130	115	9T91Y140	26	27	51.00
250	190-260	115	9T91Y142	26	27	51.00
500	95-130	115	9T91Y150	40	42	79.50
500	190-260	115	9T91Y152	40	42	79.50
1000	95-130	115	9T91Y170	60	65	132.50
1000	190-260	115	9T91Y172	60	65	132.50
2000	95-130/190-260*	115/230*	9T91Y181	150	159	240.50
3000	95-130/190-260*	115/230*	9T91Y191	200	225	340.00
5000	95-130/190-260*	115/230*	9T91Y201	300	335	505.00
10000	95-130/190-260*	115/230*	9T91Y221	600	648	990.00

*These can be connected for either 115- or 230-volt operation, but they cannot be connected 3-wire.

Jefferson Signaling Transformers

Listed as Standard by Underwriters' Laboratories, Inc.

For operating alternating current bells, horns, gongs and signaling systems.

Enclosed in a heavy metal case with primary and secondary wiring compartments having knockouts on sides and end. Screw terminals for quick and easy installation. All have secondary voltages: 4-8-12-16-20 and 24.

Primary 115 Volts, 50/60 Cycles.



No. 231-101

No.	Cap. V.A.	Max. Sec. Current at Any Volt.	Length In.	Width In.	Depth In.	Wt. Lbs.	Each
231-101	50	2 amp.	7 ¹¹ / ₁₆	4 ¹¹ / ₃₂	4	8	\$14.12
231-111	100	4 amp.	7 ¹¹ / ₁₆	4 ¹¹ / ₃₂	4	9	22.80

Jefferson Door Bell & Chime Transformers

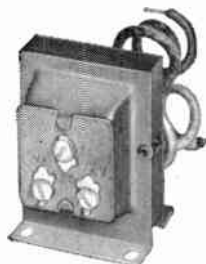

No. 230-201

Each Transformer listed has a Universal Mounting. By a simple "one-two" method, they will lock firmly into any outlet box or cover plate and are equipped with mounting feet for open wiring installation on post, wall or ceiling.

Primary - 115 Volts - 50/60 Cycles. Dimensions - (In.) 2¹/₂ x 1⁷/₈ x 2¹/₈. Weight - 3/4 lb.

No.	Model	Wattage	Secondary Voltage	Each
230-201	Wizard	5	10	\$3.38
230-221	Tri-Volt	10	6-12-18	4.28
230-341	Chime	10	16	4.14

Jefferson Machine Tool Control Transformers



No. 636-101

Window frame type construction, with use of heavy clamping bolts, assure quiet operation under normal operation. Exposed core type construction affords efficient heat dissipation.

No. 10 screw terminals accommodate Nos. 12 or 14 wire. Terminals securely fastened to coil withstand heavy screwdriver pressure. All terminals accessible from front.

60 Cycle

Primary 230/460 Volts — Secondary 115 Volts

No.	Cap. VA	Each	No.	Cap. VA	Each
636-101	50	\$22.14	636-141	500	\$47.34
636-111	75	23.98	636-151	750	66.74
636-121	150	28.28	636-161	1000	74.38
636-131	300	37.52	636-171	1500	94.88

50/60 Cycle

Primary 230/460/575 Volts — Secondary 115/95 Volts

No.	Cap. VA	Each	No.	Cap. VA	Each
636-201	50	27.66	636-241	500	59.18
636-211	75	31.90	636-251	750	83.58
636-221	150	35.32	636-261	1000	93.64
636-231	300	47.32	636-271	1500	114.76

60 Cycle

Primary 575 Volts — Secondary 115 Volts

No.	Cap. VA	Each	No.	Cap. VA	Each
636-301	50	28.02	636-341	500	58.82
636-311	75	28.76	636-351	750	80.10
636-321	150	34.26	636-361	1000	90.84
636-331	300	43.58	636-371	1500	113.88

Jefferson Power Circuit Transformers

Dry Type — Double Wound



No. 240-201



No. 244-411

All transformers are provided with brackets for quick installation at points convenient to the load to be serviced. Also possesses suitable large knockouts for conduit on both sides, bottom and back.

Transformer core is securely clamped on all four sides by a continuous window frame type of bracket. Exposed core type of construction affords efficient heat dissipation while permitting a substantial reduction in overall transformer dimensions.

Doubly impregnated with highest quality polymerizing varnish. Varnish is highly resistant to moisture, never softening under operating heat conditions nor ever tending to become brittle.

50/60 Cycles

*Primary 230/460 **Secondary 115/230				*Primary 575 **Secondary 115/230			
No.	Voltampere Capacity	Each	No.	Voltampere Capacity	Each		
240-201	50	\$14.50	240-701	50	\$15.12		
240-211	75	16.92	240-711	75	17.68		
**Primary 240/480 **Secondary 120/240				**Primary 600 **Secondary 120/240			
244-221	100	\$ 18.50	244-721	100	\$ 19.30		
244-231	150	21.78	244-731	150	22.72		
244-241	250	26.10	244-741	250	28.36		
244-251	500	36.82	244-751	500	38.38		
244-261	750	46.30	244-761	750	48.34		
244-401	1000	59.40	244-601	1000	61.74		
244-411	1500	72.46	244-611	1500	75.60		
244-421	2000	87.88	244-621	2000	91.80		
244-431	3000	146.00	244-631	3000	151.84		
244-441	5000	211.70	244-641	5000	221.92		
244-451	7500	292.00	244-651	7500	306.60		
244-461	10000	365.00	244-661	10000	382.52		
244-471	15000	508.08	244-671	15000	531.44		

60 Cycles

**Primary 240/480 **Secondary 120/240				**Primary 600 **Secondary 120/240			
No.	Voltampere Capacity	Each	No.	Voltampere Capacity	Each		
244-481	25	\$ 782.56	244-681	25	\$ 820.52		
244-491	37 ¹ / ₂	1000.10	244-691	37 ¹ / ₂	1046.82		
244-501	50	1204.50	244-701	50	1261.44		

Taps—None

Taps 4-2¹/₂%

244-481-200	25	\$ 842.44	244-681-200	25	\$ 878.96
244-491-200	37 ¹ / ₂	1074.60	244-691-200	37 ¹ / ₂	1122.78
244-501-200	50	1293.06	244-701-200	50	1352.00

Taps 2-5%

Primary 480 Only					
No.	Voltampere Capacity	Each	No.	Voltampere Capacity	Each
244-481-100	25	\$ 782.56	244-681-100	25	\$ 820.52
244-491-100	37 ¹ / ₂	1000.10	244-691-100	37 ¹ / ₂	1046.82
244-501-100	50	1204.50	244-701-100	50	1261.44

*55°C Temperature Rise Insulation.

**80°C Temperature Rise Insulation.

Jefferson Control Transformers



No. 637-201



No. 631-621

Recommended for service wherever low voltage a-c current is necessary, as in the operation of electrically controlled thermostats, magnetic relays, valves, etc.

Normal Reactance Type

Primary 115 Volts, 50/60 Cycles, Secondary 6 Volts

No.	Cap., VA	Each	No.	Cap., VA	Each
637-701	10	\$13 06	637-731	100	\$27 46
637-711	25	18 00	637-741	150	29 92
637-721	50	22 52			

*Primary 115 Volts, 50/60 Cycles, Secondary 24 Volts

637-201	25	20 20	637-261	100	29 66
637-221	50	24 72	637-271	150	32 12
637-231	75	27 70	637-291	250	35 86

*Primary 115 Volts, 50/60 Cycles, Secondary 32 Volts

637-601	50	24 72	637-621	150	32 12
637-611	100	29 66	637-631	250	35 86

†Primary 230/460 Volts, 50/60 Cycles, Secondary 115 Volts

637-531**	25	19 04	637-571	100	30 18
637-551	50	25 16	637-581	150	32 70
637-561	75	28 20	637-591	250	36 52

Loom Warp Stop Type

*Primary 115/230/460/575 Volts, 50/60 Cycles, Secondary 12 Volts

637-441	25	23 04	637-451	50	28 84
---------	----	-------	---------	----	-------

High Reactance Type

Primary 115 Volts, 60 Cycles, Secondary Open Circuit 25 Volts
Standard Mounting Ft. Mounted on Outlet Box Plate

631-501	15	18 82	631-621	15	22 12
631-511	20	20 58	631-631	20	23 88
631-521	25	23 44	631-641	25	26 74
631-531	35	25 74	631-651	35	29 04

*Primary Leads brought out through a Threaded Pipe Nipple.

†Primary and Secondary Leads brought out through a Threaded Pipe Nipple.

**Transformer designed with 230 Volt Primary only.

System Analyzer Add-a-Phase Power Converters



Operates 3 phase motors from single phase lines at 100% rated load and with balanced currents.

This power converter is an autotransformer type phase converter, designed to efficiently operate 3 phase motors on single phase 208-220 volt lines. Balanced currents can be maintained for specified loads up to 125% of rated horsepower.

Manufactured in ratings of 1 to 30 horsepower, the Add-A-Phase is matched in horsepower for the individual motor. Can be used in conjunction with several motors if two-thirds of the connected load is started, maintained and stopped simultaneously and the name plate rating is not exceeded. Autotransformer phase converter can be adjusted for smaller motors than its rating.

Available with built-in magnetic starter. Add MC to model number. Available in several types with modifications. Contact Graybar for full information.

HP	Type 2S	Type 2SA	Type 2SAC	Type HD	Type 2S-MC	Type 2SA-MC	Type 2SAC-MC	Type 2HD-MC
1	\$200.00	\$208.00	\$231.00	\$275.00	\$265.00	\$273.00	\$296.00	\$342.00
1½	229.00	237.00	259.00	292.00	286.00	304.00	323.00	355.00
2	257.00	267.00	273.00	341.00	320.00	330.00	341.00	404.00
3	270.00	280.00	346.00	403.00	335.00	345.00	402.00	468.00
5	341.00	353.00	429.00	544.00	398.00	409.00	501.00	595.00
7½	426.00	446.00	537.00	682.00	495.00	518.00	606.00	748.00
10	533.00	559.00	660.00	1007.00	599.00	628.00	759.00	1065.00
15	657.00	697.00	836.00	1148.00	754.00	796.00	962.00	1238.00
20	832.00	883.00	1012.00	958.00	1007.00	1164.00
25	1001.00	1063.00	1153.00	1214.00
30	1185.00	1263.00	1333.00	1409.00

T-P Phasing Units

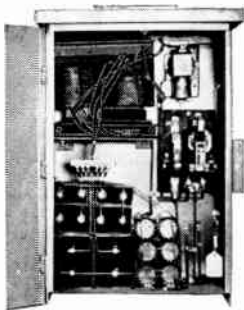

T-P Special

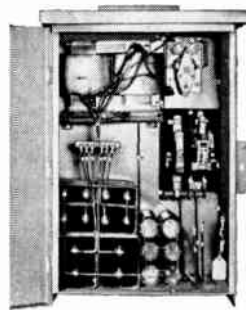

T-P Super

All advantages of a three phase motor can be available by incorporating a T-P Phasing Unit with a three-phase motor and standard fusible motor control. Utilizes all protective devices of a controller.

The Standard Unit is approximately 85% of rated nameplate horsepower. The Special and Super Units allow full 100% of nameplate.

Available in two models that can be adjusted to produce accurately balanced current in three phases by simple adjustment of transformer output and capacitance.

The SPECIAL Unit is suited for variable load equipment which does not have to be started under full load. External transformer taps and capacitor terminal board make it easy to balance phase currents for desired installation.

The SUPER Unit is similar to the Special except is designed where heavy duty operation is required. Particularly adaptable for use with air conditioners, irrigation pumps and similar equipment.

No. T-P 200 Special

Hp.	Voltage	Each	Hp.	Voltage	Each
2	220	\$235.00	10	220	\$587.00
3	220	255.00	15	220	717.00
5	220	320.00	20	220	867.00
7½	220	477.00	25	220	1017.00
			30	220	1187.00

No. T-P 200 Super

2	220	\$245.00	7½	220	\$520.00
3	220	295.00	10	220	650.00
5	220	385.00	15	220	777.00

No. T-P 200 Standard

1	220	\$ 77.00	10	220	\$385.00
1½	220	105.60	10	410	370.00
2	220	112.20	15	220	544.00
3	220	138.60	15	410	534.00
3	410	127.60	20	220	647.00
5	220	184.80	20	410	640.00
5	410	167.20	25	220	760.00
7½	220	245.00	25	410	745.00
7½	410	230.00	30	410	795.00

The Standard Units listed are built for 1200 rpm and 1800 rpm. Standard Units are available on special order to operate on other speeds.

Prices for specially designed units available.

G-E Inductrol* Voltage Regulators
Dry-type Induction Voltage Regulators
Hand-operated, Motor-driven and Automatic



Hand-operated



Motor-driven

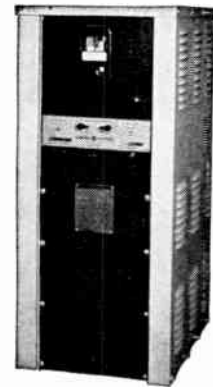

Automatic

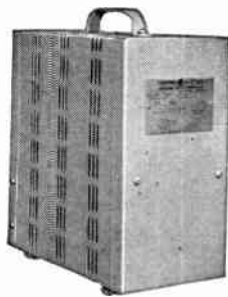

Automatic Inductrol with separately mounted control panel



Poor Voltage Drags Down Plant Efficiency

Type of Equipment	Effect of Undervoltage	Effect of Overvoltage
Incandescent Lamps	10% undervoltage cuts light output 30%—slows production.	10% overvoltage cuts lamp life 70% —triples replacements.
Fluorescent Lamps	10% undervoltage cuts light output 10%—may fail to start.	Life unpredictably and drastically shortened, depends on starts, ballasts, etc.
Mercury Vapor Lamps	10% undervoltage cuts light output 15 to 25%—lamps may go out.	Even 5% overvoltage overheats lamp —shortens life. May damage lamp transformer.
A-C Motors	Causes overheating—increases maintenance costs.	Decreases power factor—increases power costs.
Resistance Heaters	10% undervoltage cuts heat output 19%—slows production.	Causes severe overheating—high replacement costs.
Electronic Devices	Drastically cuts tube life. May destroy gas-filled tubes.	5% overvoltage cuts tube life 50% —high replacement costs.
Infrared Processes	Lengthens process time—slows production.	Causes blistering or scorching—increases manufacturing costs.

*Registered trade-mark of General Electric Co.

G-E Inductrol* Voltage Regulators

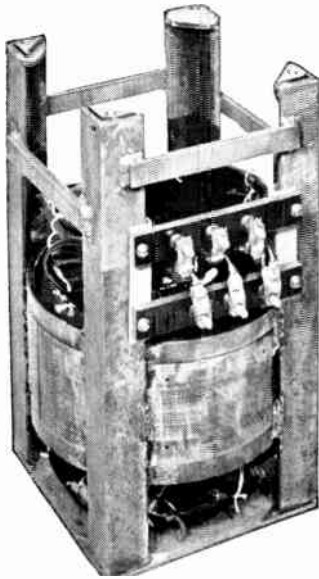

Typical
Inductrol Stator

An induction voltage regulator designed for industrial use. Can be used to accurately hold constant load voltage when supplied from fluctuating supply voltage or, can be used to provide a variable load or utilization voltage from a relatively constant supply voltage. Either of these functions can be automatically controlled, or can be manually controlled by means of motor drive or hand crank.

Consists basically of a laminated steel stator, on which is wound the regulating (series) winding, and a laminated steel rotor on which is wound an exciting (shunt) winding. By changing the position of the rotor, the magnitude of the voltage induced in the series winding is controlled, adding or subtracting from the supply voltage to produce the required output voltage.

Features

Higher reliability because there are no brushes to wear out or to cause maintenance trouble. Simple and rugged, the induction principle of operation provides an infinite number of voltage steps.

The Inductrol voltage regulator does not introduce harmful wave-form distortion.

Has no effect on the output voltage of Inductrol voltage regulators.

Voltage automatically held to within $\pm 10\%$ band width. Compensating controls on the Inductrol voltage regulator make it unnecessary to continually reset voltage level.

Electrically, the Inductrol voltage regulator will withstand up to 25 times normal currents.

Will withstand a 100% overload for one hour, while maintaining excellent long-life operating characteristics.

Typical Applications For Inductrol Voltage Regulators

TV Transmitters	Air Conditioning
Radio and Radar	Simulated Flight Trainers
Equipment	Calculators
Induction Heaters	Office Machines
Lighting	X-Ray Equipment
Radar	Laboratory Equipment
Resistance Heaters	Welders
Rectifiers	Film Processing
Crane Control	Wire Enameling
Heat Treating	Equipment Testing
Electrolytic Processes	Instrument Calibration
Blueprinting	Carrier Telephone
Spectographs	Equipment
Corona Detection	Motor Speed Controller
Photoengraving	

*Registered trade-mark of General Electric Co.

Note: Information on Inductrol voltage regulators for other ranges of regulation are available on request.

Automatically Operated Inductrol Voltage Regulators

Ideally suited for maintaining constant voltage on long secondary runs, supply lighting or power, especially where wide variations in load occur on various circuits, as in mills and factories, large office and apartment buildings. Where lighting and power are both supplied from the same bus, these Inductrols will compensate for change in power load, maintaining illumination at normal level.

Standard automatic Inductrol regulators are adjusted at the factory to hold output voltage within band width of $\pm 1\%$. Within $\frac{1}{2}$ second after voltage goes outside this band width, correction is initiated by the Inductrol regulator. Since the time of operation from the maximum lower position to the maximum raise position is 45 seconds, the time required to make a correction depends on the magnitude of the voltage deviation. On the average feeder, the majority of corrections are completed in approximately one second.

Automatically operated Inductrol voltage regulators can also be used for the following: a-c voltage control; a-c current control; rectifier control for d-c output voltage; rectifier control for d-c output current; temperature control; electronic control for mobile applications; vernier control for wide-range induction regulators; process control for cyclic industrial processes.

Hand-operated and Motor-operated Inductrol Voltage Regulators

Provide a convenient source of variable voltage for the calibration of meters, relays, and other instruments, also for testing vacuum tubes.

When used in circuits supplying high-voltage transformers, they facilitate the control of the applied voltage while tests on insulating materials are being made.

Offers smooth control of light for such applications as theater ceilings, photoprinting, blueprinting, etc.

Current-transformer and Oil-circuit-breaker Testing combined with high-current transformers provide variable current for testing current transformers, tripping mechanisms of oil circuit breakers, and the current-carrying capacity of contacts.

Particularly valuable for industrial processes, such as the control of resistance furnaces and induction furnaces.

May be used wherever a smoothly variable voltage source is needed. Inductrol regulators for these applications are usually arranged for 100% raise and 100% lower regulation; that is, they vary the supply voltage uniformly over a range from 0 to 200% of normal.

Inductrol Power Pack

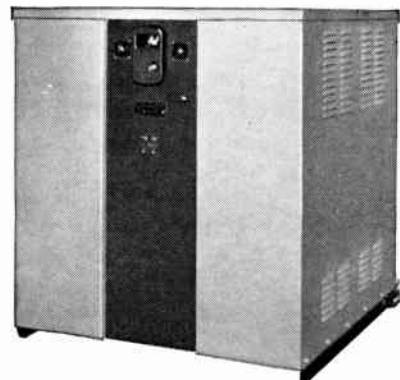

Inductrol Power Pack, including a lighting transformer (Type D), and Inductrol (dry-type induction Voltage Regulator), and a distribution panel board.

General Electric also builds an Inductrol Power Pack (combining a regulator, a transformer and circuit breakers) for circuit regulation where lighting and power voltages are different.

G-E Switchgear

The General Electric Company produces a complete line of switchgear equipments and component devices consisting of hundreds of items. A number of these items are listed in this catalog with complete information. Following is a list of many other standard items and the publications describing their

applications and characteristics. Upon receipt of a request, accompanied by a statement of your application requirements, a quotation and necessary descriptive matter on any of these items will be gladly supplied.

Apparatus	Descriptive Publication
Air Circuit Breakers	
Selection and Application	GEA-5915
Disconnecting Switches, Group-Operated, Outdoor	
Rotating Insulator, Horizontal Break, Type RB	GEA-5706
Disconnecting Switches, Hook-Operated, Outdoor	GEA-6716
Light-duty, for Rural Lines, Type FD	GEA-4911
Equipments	
Bus Runs, Isolated-phase	GEA-5460
Cubicles, Station-type	GEA-3658
Load Center Unit Substations	GEA-3592
Mercury-arc Rectifiers (Sealed Ignitron) 40-1000 Kw	GEA-5539
Mercury-arc Rectifiers (Pumpless) 750 Kw & up at 250 Volts, 1500 Kw & up at 600 Volts	GEA-5689
Metal-clad Switchgear, with Magne-blast Air Circuit Breakers	GEA-5664
Package Substations	GEA-4500
Package Substations, Rural	GEA-5276
Sectionalizing Units, Inside of Mine	GEA-5436
Switchboards, Control	GEA-4127
Power Circuit Breakers, Indoor Oil-Blast	
Motor-starting combinations	GEA-6202
Power Circuit Breakers, Outdoor Oil-Blast	
Base-mounted, 138-330 Kv	GEA-6157
Base-mounted, 115 to 230 Kv, Type FK-439	GEA-4407
Framework-mounted, 14.4 to 69 Kv, Type FK-439	GEA-5793
Framework-mounted, 7.2 Kv, Type FK-227	GEA-6583
Reclosers, 14.4 Kv	GEA-5961
Power Fuses and Supports	
Current-limiting Fuse Supports, Types EK and EKO	GEA-5501
Current-limiting Fuse Units, Type CLF	GEA-6319
Expulsion-fuse Disconnecting Switches, Type EF-1	GEA-5502
Selection and Application	GET-1843

Apparatus	Descriptive Publication
Relays	
A-c Wire-pilot, Type CPD	GEA-3004
Art of Protective Relaying	GET-1768
Auxiliary, Types HHA, HFA, HGA, and HMA	GEA-5457
Current-balance, Machines and Lines, Type IJC51B	GEA-4695
Current-balance, Regulating Transformers, Type IJC52A	GEA-4694
Differential, Percentage, Machines, Type IJD52A	GEA-3235
Differential, Product-restraint, Machines, Type CFD	GEA-4716
Differential-voltage, Switchgear, Type PVD	GEA-5449
Directional-distance, Reactance, Lines Type GCX	GEA-2170
Directional-ground, Types ICC and ICP	GEA-2009
Directional-overcurrent, Types IBC, IBCC, IBCP, and IBCV	GEA-3206
Directional, D-C, Types RAV, RBV, RBP, RBC, RCP, and RCV	GEA-3246
Drawout Relays, Switchgear (construction)	GEA-5578
Frequency, Type IJF	GEA-2013
Loss-of-excitation, Type CEH11A	GER-300
Overcurrent, Instantaneous, Type PJC	GEA-4880
Overcurrent, Instantaneous, Type PJC31C	GEA-5330
Overcurrent, Inverse-and Very-inverse-time, Type IAC	GEA-3553
Overpower, Type ICW	GEA-3417
Phase-sequence and Undervoltage, Type ICR	GEA-2524
Plunger-operated, Types PAA, PAC, PAV, PBA, PBC, and PCV	GEA-1811
Reclosing, Automatic, Multi-reclosure, Type ACR	GEA-5593
Reclosing, Automatic, Single-reclosure, Type HGA18	GEA-3340
Synchronism-check, Type IJS	GEA-3537
Synchronizing	GEA-5758
Temperature, Bearings, Type TBB	GEA-2209
Temperature, Windings, Type CFT	GEA-3734
Test Plug, for Drawout Relays and Meters, Type XLA	GEA-4984
Thermal, Type TMC	GEA-5525
Undervoltage and Overvoltage, Time, Type IAV	GEA-3552
Undervoltage and Overvoltage, Instantaneous, Type PJV	GEA-4880
Switches, Control	
Control and Transfer, Type SB-1	GEA-4746

G-E Low-Voltage Drawout Switchgear

With Type AK-1 Air Circuit Breakers

Interrupting Ratings—15,000 to 150,000 Amperes

600 Volts Maximum—3-phase, 3-wire, 60 Cycles



Installation view of a metal-enclosed, low-voltage, drawout air-circuit breaker switchboard.

Application

These equipments are available for indoor or outdoor service, for 600 volts maximum, in interrupting ratings of 15,000 to 150,000 amperes, for a-c 2-phase or 3-phase or d-c 2- or 3-wire circuits.

Features

- Completely metal enclosed.....
- Easily removed breaker, drawout relays and meters.....
- Co-ordinated switchgear components.....
- Complete primary and secondary control assembly; factory built.....
- Standard unit construction.....

Advantages

- Maximum protection to personnel; fire hazard minimized; long life.
- Easy to maintain; short outage time; lightweight installation.
- Balanced engineering and design. Interchangeability of breakers reduces outage time for maintenance.
- Lower over-all installation cost and purchasing expense; a finished tested job.
- Low initial cost; flexibility in application; easy future expansion; simplifies station planning; high salvage value. Saves system investment.

G-E Service Protectors

Type LB-1

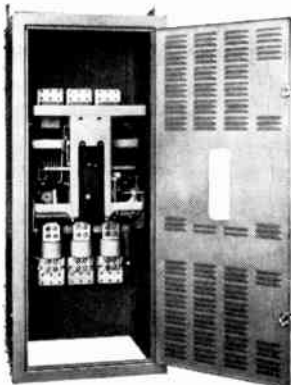

Combines a high-capacity switch with current-limiting fuses for service-entrance and feeder applications in buildings by using power from networks or high-capacity 120/208 or 277/480-volt systems.

It is a properly co-ordinated combination of interruptor-switch and current-limiting silver-sand fuses, possessing many outstanding features, including a quick-make, quick-break operating mechanism.

Economical and practical circuit-protective and switching device for circuits capable of 200,000 amperes RMS symmetrical short-circuit current.

Ratings with G-E Type CLF Fuses

Ampere Rating	Fuse Size	A-C Voltage Rating	Interrupting Rating Symmetrical Amperes	Contact Load-break Ability Amperes
1400	1600	480	200,000	12X Rating
2300	3000	480	200,000	12X Rating
3000	3000	480	200,000	12X Rating
3500	4000	480	200,000	12X Rating

G-E Low-Voltage Drawout Switchgear With Type AK-L Circuit Breakers

A Complete Line of Air Circuit Breakers with the Newest Features

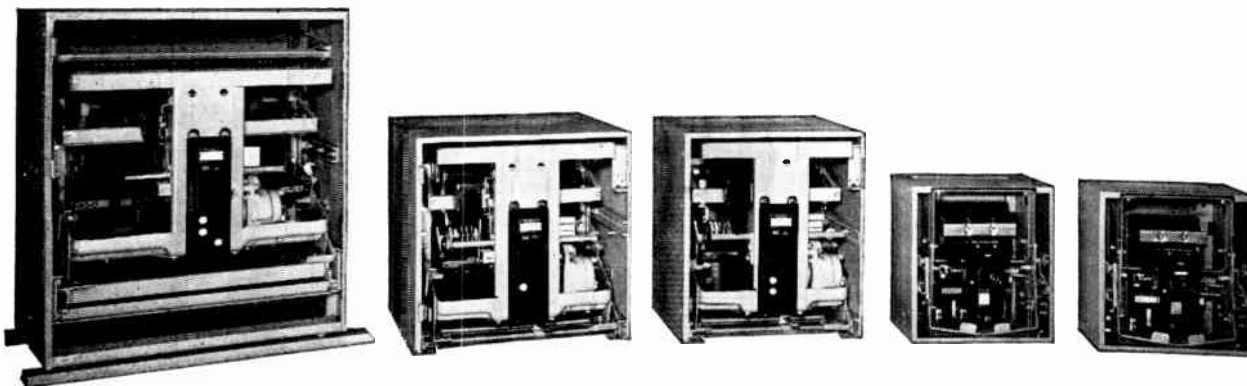

Type AK1-100
100,000-amp interrupting rating. Electrical closing only.

Type AK1-75
75,000-amp interrupting rating. Electrical closing only.

Type AK1-50, 50,000 amp interrupting rating. Electrical or manual closing available.

Type AK1-25, 25,000 amp interrupting rating. Electrical or mechanical closing.

Type AK1-15, 15,000-amp interrupting rating. Electrical or manual closing.

These basic breakers in their respective compartments are mounted in an all-welded frame, and are bus-connected to form a complete switchboard.

Indoor Drawout Switchgear Equipment

Outdoor Drawout Switchgear Equipment

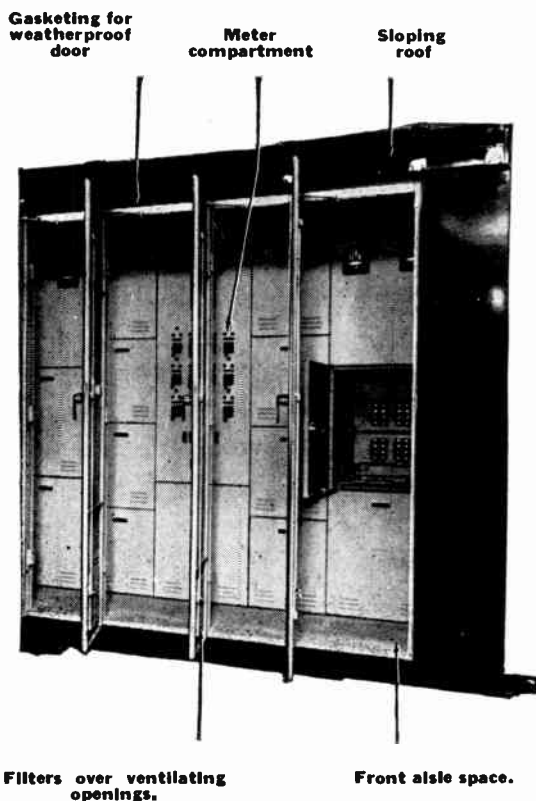
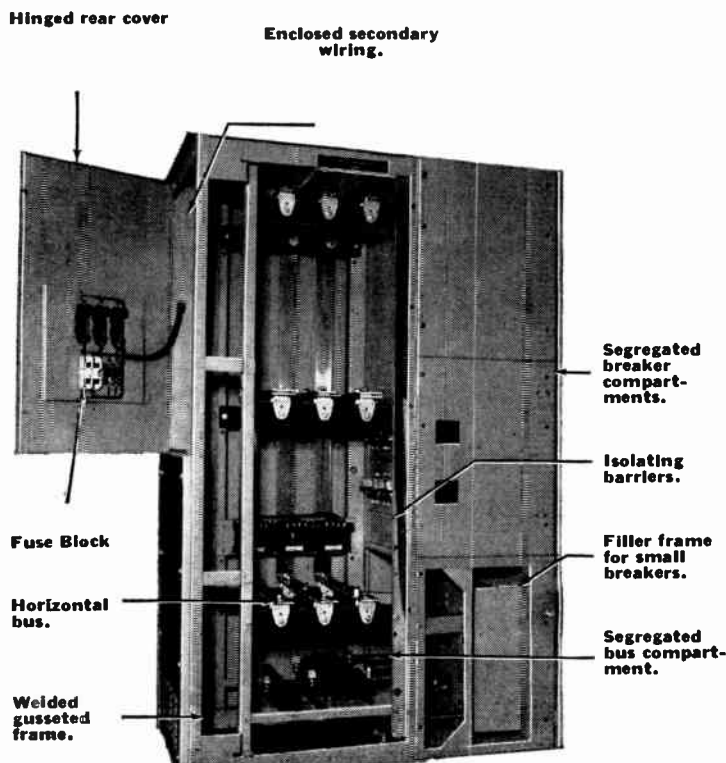

G-E Standard Metal-Enclosed A-C Switchboards

Feeder-Section Units (Drawout or Stationary)

For Incoming Line, Power Transformer, Feeder, and Motor-branch Circuit Application

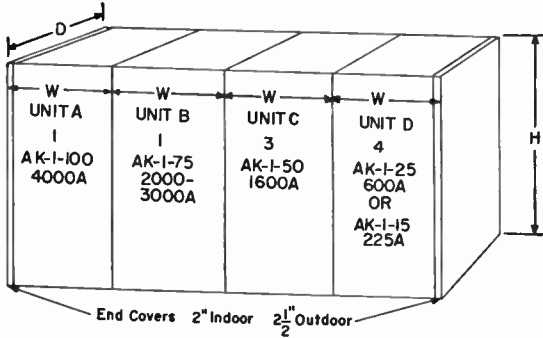

Fig. 1

Top compartment may be used for instrumentation in place of circuit-breaker position.

Weights and Dimensions

Air Circuit Breaker Type	Unit See Fig. 1	Indoor Equipment			Outdoor Equipment		
		Dimensions inches			Dimensions inches		
		H	W	D	H	W	D
Electrical and Manual Closing							
AK1-15	D	90	20	49	112	20	73
AK1-25	D	90	20	49	112	20	73
AK1-50	C	90	26	59	2200 ^①	112	26
					2600 ^②		
AK1-75	B	90	30	63	2800 ^③	112	34
					3100 ^④		
AK1-100	A	90	38	63	3600	112	42

*One complete vertical unit with maximum number of circuit breakers indicated in Fig. 1.

① Manual Closing. ② Electrical Closing. ③ 2000-amp. model. ④ 3000-amp. model.

Installation Data

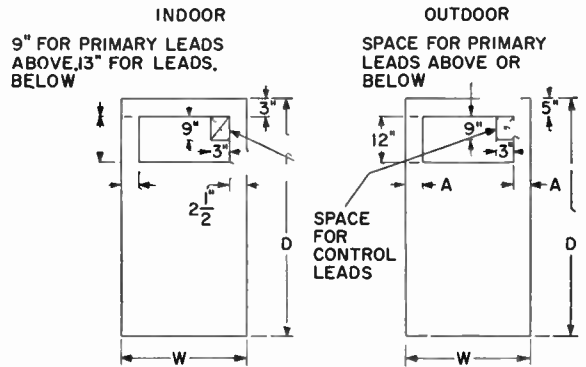
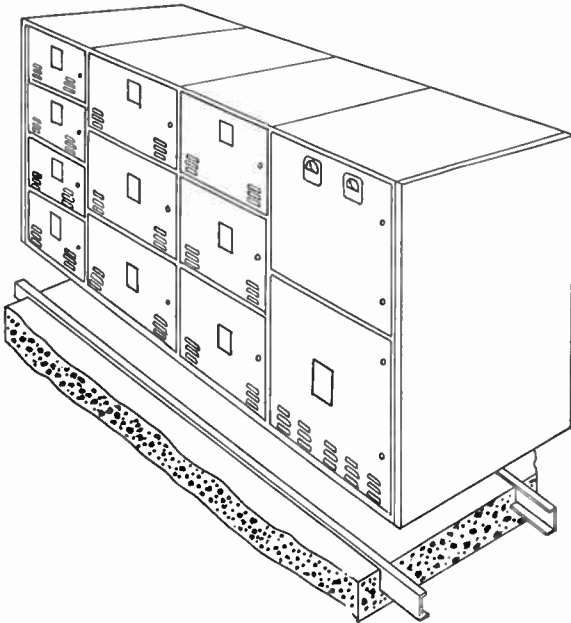

See table above for W and D dimensions. A = 2 3/4 for 20- and 26-in. wide units. A = 4 3/4 for 34- and 42-in. wide units.

Floor steel furnished by purchaser, unless otherwise indicated on floor plan.

Channels should be set level with each other and should be level over the full length.

Recommended 4-in. x 5.4#/ft. channels to be used for leveling purposes only.

Finished floor should have slight pitch away from the mounting channels, and in no case should the finish floor be higher than the mounting channels.

Recommended Aisle Space

Position	Indoor	Outdoor
Front	48-in.	48-in.
Rear	Width of unit	48-in.

G-E Air Circuit Breakers

Type AK-1

AK-1-15: 15-225 Amp Continuous
AK-1-25: 35-600 Amp Continuous

AK-1-50: 200-1600 Amp Continuous
AK-1-75: 2000-3000 Amp Continuous

AK-1-100: 4000 Amp Continuous
240, 480, 600 Volts A-C, or 250 Volts D-C

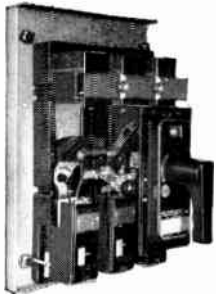

Type AK-1-25 Dead-front Switchboard Mounting

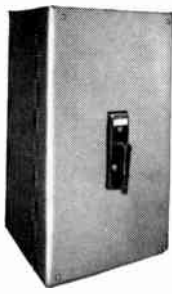

Type AK-1-50 General-purpose Enclosure, for Indoor Wall Mounting

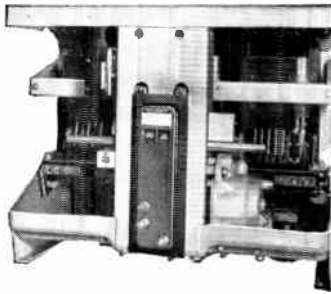

Type AK-1-100, Dead-front Switchboard Mounting

Application

Recommended for use in general industrial and switchgear applications. Suitable for severe service, where numerous opening and closing operations are required for general power and lighting circuits, and motor-starting service.

Features

- Small size, compact arrangement.
- Short-time rating equal to interrupting rating.
- Improved multislot contact design.
- Individual unit-pole construction simplifies maintenance.
- Pole units are mounted on metal plate, providing maximum fire resistance between front and back of breaker.
- Variety of enclosures.
- Complete line of accessories.

Mounting or Enclosure

Dead-front Switchboard

Breaker is not enclosed, except for arc quenchers. Dead-front steel plate not furnished, except as an accessory.

General-purpose, for Indoor Mounting, NEMA Type 1

Breaker is mounted in a steel enclosure. For indoor use only. AK-1-15, -25, and -50 wall-mounted, with easily removable breaker element, including terminal connectors.

AK-1-75, and -100 floor-mounted, stationary, with removable covers.

Semi-dust-tight Enclosure, NEMA Type 1A

This enclosure is similar to the general-purpose enclosure, with the addition of a gasket around the cover and escutcheon.

Weatherproof, NEMA Type 3

Easily removable breaker is mounted in a weatherproof steel enclosure, including terminal connectors. For indoor or outdoor use.

Dust-tight, Watertight, NEMA Types 4 and 5

Easily removable breaker is mounted in a heavy-duty, welded-steel-plate enclosure with gasketed door, including terminal connectors.

Explosion-proof, NEMA Type 7

Breaker is mounted in a heavy-duty cast-iron enclosure, including terminal connectors. Suitable for Class I, Group D hazardous locations.

Voltage Rating A-C	D-C *	Current Ratings									
		Type AK-1-15		Type AK-1-25		Type AK-1-50		Type AK-1-75		Type AK-1-100	
		Continuous Range	Interrupting	Continuous Range	Interrupting	Continuous Range	Interrupting	Continuous Range	Interrupting	Continuous Range	Interrupting
600	250	15-225	15,000	35-600	25,000	200-1600	50,000	2000-3000	75,000	4000	100,000
480	250	25-225	25,000	100-600	35,000	100-1600	60,000	2000-3000	75,000	4000	100,000
240	250	35-225	30,000	150-600	50,000	600-1600	75,000	2000-3000	100,000	4000	150,000

Pricing Information

Breaker Type	Continuous Rating, Amperes	2 Poles		3 Poles		4 Poles	
		Manual	Electrical	Manual	Electrical	Manual	Electrical
Dead-front Switchboard Mounting							
AK-1-15	15-225	\$ 245.00	\$ 435.00	\$ 275.00	\$ 465.00	\$ 420.00	\$ 610.00
AK-1-25	35-600	530.00	770.00	600.00	840.00	820.00	1060.00
AK-1-50	200-1600	1135.00	1635.00	1275.00	1775.00	2200.00
AK-1-75	2000-3000	2800.00	3250.00
AK-1-100	4000	4150.00	4750.00
General-purpose Enclosure, For Indoor Mounting							
AK-1-15	15-225	\$ 455.00	\$ 545.00	\$ 385.00	\$ 575.00	\$ 530.00	\$ 720.00
AK-1-25	35-600	660.00	900.00	730.00	970.00	950.00	1190.00
AK-1-50	200-1600	1430.00	1935.00	1575.00	2075.00	2500.00
AK-1-75	2000-3000	3665.00	4115.00
AK-1-100	4000	5300.00	5900.00
Semi-dust-tight General-purpose Enclosure, For Indoor Mounting							
AK-1-15	15-225	\$ 390.00	\$ 580.00	\$ 420.00	\$ 610.00	\$ 565.00	\$ 755.00
AK-1-25	35-600	715.00	955.00	785.00	1025.00	1005.00	1245.00
AK-1-50	200-1200	1485.00	1985.00	1625.00	2125.00	2550.00
Weatherproof Enclosure							
AK-1-15	15-225	\$ 505.00	\$ 680.00	\$ 520.00	\$ 710.00
AK-1-25	35-600	850.00	1090.00	920.00	1160.00
AK-1-50	200-1200	1785.00	2285.00	1925.00	2425.00
AK-1-75	2000-3000	4225.00	4675.00
AK-1-100	4000	5875.00	6475.00
Dust-tight, Watertight Enclosure							
AK-1-25	35-600	\$1110.00	\$1345.00	\$1185.00	\$1410.00
AK-1-50	200-1200	2070.00	2570.00	2210.00	2710.00
Explosion-proof Enclosure							
AK-1-25	35-600	\$1530.00	\$1770.00	\$1600.00	\$1840.00
AK-1-50	200-1200	3175.00	3635.00	3275.00	3775.00

*Refer all transactions requiring 750-volt d-c breakers to Graybar.

G-E Air Circuit Breakers, Type AK-1

Accessories

Device	AK-1-15 and AK-1-25		Each* AK-1-50		AK-1-75	AK-1-100
	Manually Operated	Electrically Operated	Manually Operated	Electrically Operated		
Auxiliary Switch, four contacts (two N.O., two N.C.).....	\$ 45.00	†	\$ 45.00	†	†	†
Auxiliary Switch, four addit. contacts (8 total), inc. price.....	45.00	\$ 45.00	45.00	\$ 45.00	\$ 45.00	\$ 45.00
Undervoltage Device (self-resetting), instantaneous.....	65.00	65.00	75.00	75.00	110.00	110.00
Undervoltage Device (self-resetting), time-delay.....	105.00	105.00	115.00	115.00	135.00	135.00
Overcurrent Bell Alarm Device (hand-reset).....	70.00	70.00	70.00	70.00	70.00	70.00
Reverse-current Device (D-C only).....	130.00	130.00	215.00	215.00	300.00	300.00
‡Shunt-trip Device.....	70.00	†	80.00	†	†	†
Flat Steel Front Plate (for deadfront switchboard mounted breaker only).....	20.00	20.00	25.00	25.00	60.00	80.00
Selective Tripping Attachment (per pole).....	65.00	65.00	100.00	100.00	200.00	200.00
Neutral connection for enclosed breaker.....	65.00	65.00	100.00	100.00	200.00	200.00

*Prices apply only when accessories are mounted at factory.
 †Included with electrically operated breaker.
 ‡Includes 4-contact auxiliary switch.

Prices Include

Manually Operated

- Trip-free breaker, mounted on a metal base, with:
 - *Dual-magnetic time-overcurrent trip unit per pole. (Characteristic IB furnished unless otherwise specified; see "Tripping Characteristics.")
 - Arc-quenchers.
 - Push-button mechanical trip.
 - Position indicator.
 - Provision for up to three padlocks (for locking breaker in the trip-free position).
 - Bolted-type terminal connectors (enclosed breaker).
 - Revolving pistol-grip operating handle.
 - Selected enclosure (except breakers for dead-front switchboard mounting).

Electrically Operated

- Same as manually operated breaker (except omit handle), plus:
 - Electric closing mechanism with closing relay.
 - Shunt-trip device.
 - Four-contact auxiliary switch.
 - Push-button closing switch.
 - Maintenance closing handle.
- *Normally one overcurrent trip unit will be omitted if reverse-current device (see "Accessories") is furnished, since both units mount in the same location. In special cases, the reverse-current device can be mounted on a breaker housing three overcurrent units, but the size of breaker base or enclosing case will be increased.

Tripping Characteristics

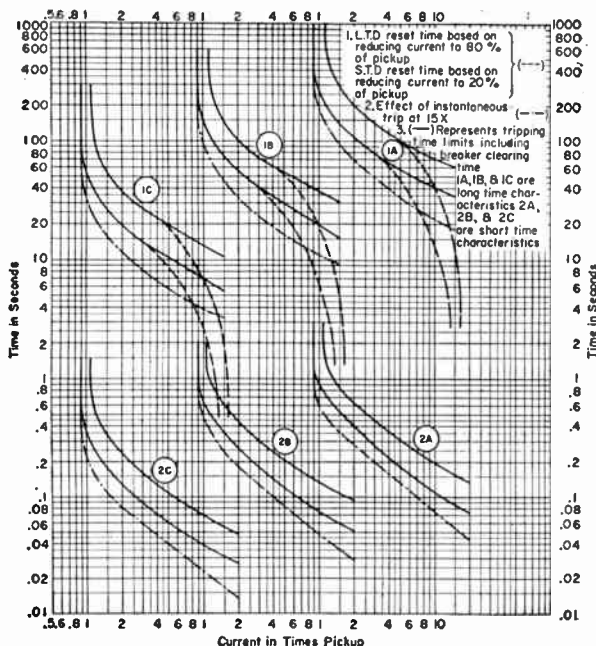

Time-current characteristics produced by individual elements of Type EC-1 trip device for Types AK-1-15, 25, and -50 breakers. For characteristics of AK-1-75 and AK-1-100 breakers, consult your G-E distributor.

Dual-Magnetic Trip

The overcurrent trip unit of the AK-1 breaker is of the dual-magnetic type. It consists essentially of an electromagnet which is excited by the current in a series coil, and a pivoted laminated-iron armature which is normally restrained by a spring whose tension can be increased or decreased by means of a calibration knob which, when set, indicates the tripping current values. The calibration range is from 80 to 160 per cent of the breaker rating.

Movement of the armature is further restrained by a piston in a sealed, fluid-filled cylinder, the armature is linked to the piston which is accurately machined and provided with a calibrated orifice for controlling the flow of the fluid. The piston fits into an accurately machined cylinder which is completely sealed to keep out all dirt. The movement of the piston is restrained by the flow of the silicone fluid through the orifice. Continuous overcurrent exerts a magnetic pull on the armature until it and the piston have traveled their full stroke, thus tripping the breaker.

The linkage between the armature and piston is connected by a heavy adjustable restraining spring. At currents exceeding 15 times normal breaker rating, the magnetic force exerted upon the armature is sufficient to overcome this heavy restraining spring and instantaneously trip the breaker without waiting for the piston to move.

The entire overcurrent trip device is assembled into a molded phenolic case and all external adjustments are thoroughly insulated from energized parts.

G-E Control Switchboard Components

Type SB-1 Control and Transfer Switches

For Panel Mounting—600 Volts, A-C or D-C
For Circuit-Breaker and Motor Control—For Instrument Transfer
(Specify Panel Thickness)

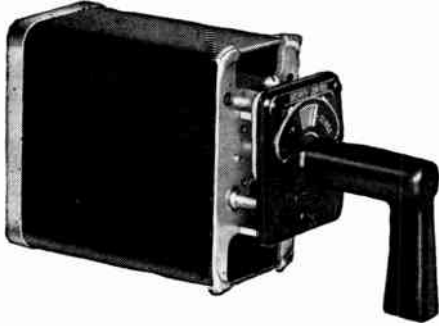

Fig. 1, Circuit-breaker control switch, 4-stage, with fixed handle

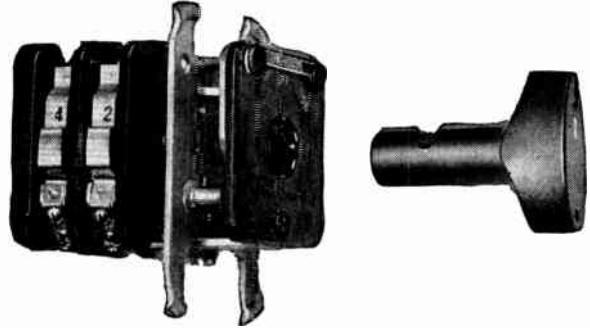

Fig. 2 Synchronizing switch with removable non-interchangeable handle (cover removed)

Pricing Information

Motor Control

Service, Poles, and Throws	Stages	Spring Return	Operating Handle		Escutcheon Marking (Front View)	No.††	Approx. Ship. Wt. Lbs.	Net Price, Each‡
			Fixed or Removable	Style				
Gov. motor-dt	4	With	Fixed	Radial	Raise-lower	16SB1A1X2	4	\$28.00
Gov. or exciter rheostat-dt	4	With	Fixed	Handwheel	Raise-lower	16SB1A2X2	4	28.00
Gov. motor-dt (a-c only)	1	With	Fixed	Pistol grip	Raise-lower	16SB1A1X2	3	22.00
Gov. motor-dt (a-c only)	2	None	Fixed	Pistol grip	Reverse-forward	16SB1A2X2	3	24.00

Circuit-Breaker Control

Close and trip	2	With	Fixed	Pistol grip	Trip close-with flag	16SB1B1X2	3	\$24.00
Close and trip, with aux. contacts	4	With	Fixed	Pistol grip	Trip close-with flag	16SB1B2X2	4	28.00
Trip, contacts normally open	1	With	Fixed	Pistol grip	Trip	16SB1B3X2	3	22.00
Trip, contacts normally closed	1	With	Fixed	Pistol grip	Trip	16SB1B4X2	3	22.00
Trip, contacts normally closed	2	With	Fixed	Pistol grip	Trip	16SB1B5X2	3	24.00
Close and trip, with aux. contacts	3	With	Fixed	Pistol grip	Trip close-with flag	16SB1B9X2	3	26.00
Close and trip, with aux. contacts	4	With	Fixed	Pistol grip	Trip close-with flag	16SB1B10X2	4	28.00
3 contacts operating 2 breakers	3	With	Fixed	Pistol grip	Trip close-with flag	16SB1B6X2	4	26.00
One throw closed—substitute for push-button station	2	With	Fixed	Pistol grip	Trip close-with flag	16SB1B7X2	3	24.00
For JR high-speed breaker	5	With	Fixed	Pistol grip	Trip close-with flag	16SB1B8X2	5	30.00

Instrument Transfer

Voltmeter, 3-phase, phase-to-phase	2	None	Fixed	Knurled	Off, 1-2, 2-3, 3-1	16SB1CC1	4	24.00
			Removable	Oval	Off, 1-2, 2-3, 3-1	Mod. 16SB1CC2	4	24.00
			Removable	Oval	Off, 1-2, 2-3, 3-1	Mod. 16SB1CC3	4	24.00
			Removable	Oval	Off, 1-2, 2-3, 3-1	Mod. 16SB1CC4	4	24.00
Voltmeter, 3-phase, phase-to-neutral	2	None	Fixed	Knurled	Off, 1, 2, 3	16SB1CC6X2	3	24.00
			Removable	Oval	Off, 1, 2, 3	Mod. 16SB1CC1	3	24.00
			Removable	Oval	Off, 1, 2, 3	Mod. 16SB1CC2	3	24.00
			Removable	Oval	Off, 1, 2, 3	Mod. 16SB1CC3	3	24.00
Voltmeter, dpst	1	None	Fixed	Knurled	Off, on	16SB1CA1X2	3	22.00
			Removable	Oval	Off, on	Mod. 16SB1CC2	3	22.00
			Removable	Oval	Off, on	Mod. 16SB1CC3	3	22.00
			Removable	Oval	Off, on	Mod. 16SB1CC4	3	22.00
Voltmeter, dpdt	2	None	Fixed	Knurled	1, off, 2	16SB1CE27X2	3	24.00
Voltmeter, phase-to-phase and phase-to-neutral	4	None	Fixed	Knurled	Off, 1-2, 2-3, 3-1, 1, 2, 3	16SB1CF16X2	4	28.00
					1, 2, 3	16SB1CA7X2	5	32.00
Ammeter, 3-phase, 3 independent circuits	6	None	Fixed	Knurled	1, off, 2, off, 3	16SB1CA15X2	5	32.00
			Removable	Knurled	1, off, 2, 3	Cat. 6119795G60	5	32.00
			Removable	Knurled	1, off, 2, 3	Cat. 6119795G61	5	32.00
			Removable	Knurled	1, off, 2, 3	Cat. 6119795G62	5	32.00
Ammeter, connected at end of c-t leads, 3 c-t's	3	None	Fixed	Pistol grip	1, 2, 3	16SB1CE24X2	4	26.00
			Fixed	Pistol grip	1, off, 2, off, 3	16SB1CA14X2	4	26.00
			Removable	Knurled	1, off, 2, 3	Cat. 6119795G60	4	26.00
			Removable	Knurled	1, off, 2, 3	Cat. 6119795G61	4	26.00
Ammeter, connected at end of c-t leads, 2 c-t's	2	None	Fixed	Knurled	1, 2, 3	16SB1CE25X2	3	24.00
					Off, 1, 2, 3, 4	16SB1CF17X2	5	32.00
Ammeter, 4 c-t's	6	None	Fixed	Oval	Off, 1, 2, 3, 4	16SB1CF18X2*	5	32.00
					Off, 1, 2, 3, 4	16SB1CF19X2*	5	32.00
Power factor or wattmeter reverse, 4pdt	4	None	Fixed	Knurled	In, out	16SB1CA10X2	4	28.00

*†‡§ See following page.

G-E Control Switchboard Components
Type SB-1 Control and Transfer Switches

Pricing Information
Instrument Transfer—Cont.

Service, Poles, and Throws	Stages	Spring Return	Operating Handle			Escutcheon Marking (Front View)	No. †	Approx. Ship. Wt. Lbs.	Net Price, Each ‡
			Fixed or Removable	Style	No.				
Power Factor { 1—current coil and 2 potential coils	2	None	Removable	Oval	Mod. 16SB1CC5	Off, on	16SB1CA8X2	3	\$24.00
	3	None	Removable	Oval	Mod. 16SB1CC6	Off, on	16SB1CF6X2	4	26.00
Watt-meter { 2—current coils 3—current coils	3	None	Removable	Oval	Mod. 16SB1CC6	Off, on	16SB1CF7X2	3	26.00
	5	None	Removable	Oval	Mod. 16SB1CC6	Off, on	16SB1CF8X2	6	30.00
Wattmeter/rva meter, 1pdt	4	None	Fixed	Knurled		W, off, rva	16SB1CB4X2	4	28.00
Revers. switch for 1 current coil	2	None	Fixed	Knurled		In, out	16SB1CF23X2	3	24.00
Synchroscope, spdt, 3-position	2	None	Removable	Oval	Mod. 16SB1CC7 ("I") Mod. 16SB1CC8 ("W")	R, (off), 1§	16SB1CB5X2	3	24.00
Synchroscope, sp run, dp start	2	None	Removable	Oval	Mod. 16SB1CC9 ("I") Mod. 16SB1CC10 ("R")	R, (off), 1§	16SB1CB6X2	3	24.00
Synchronizing, 4pst	2	None	Removable	Oval	Mod. 16SB1CC7	Off, on	16SB1CF9X2§	4	24.00
	2	None	Removable	Oval	Mod. 16SB1CC9	Off, on	16SB1CF10X2§	4	23.00
Synchronizing, 3pdt	3	None	Removable	Oval	Mod. 16SB1CC7 ("I") Mod. 16SB1CC8 ("W")	R, (off), 1§	16SB1CB10X2*	4	26.00
	3	None	Removable	Oval	Mod. 16SB1CC9 ("I") Mod. 16SB1CC10 ("R")	R, (off), 1§	16SB1CB11X2*	4	26.00
Synchronizing, 6spt	3	None	Removable	Oval	Mod. 16SB1CC7	Off, on	16SB1CF20X2*	4	26.00
	3	None	Removable	Oval	Mod. 16SB1CC9	Off, on	16SB1CF21X2*	4	26.00
Temperature Meter { 2 wires-3 coils & test 2 wires-3 coils, test, & off	4	None	Fixed	Knurled		Test, 1, 2, 3	16SB1CF28X2	4	28.00
	4	None	Removable	Oval	Mod. 16SB1CC18	Off, test, 1, 2, 3	16SB1CE56X2*	4	28.00
Temperature Meter { 2 wires-3 coils, test, & off 2 wires-3 coils, test, & off	4	None	Removable	Oval	Mod. 16SB1CC19	Off, test, 1, 2, 3	16SB1CE57X2*	4	28.00
	4	None	Removable	Oval					
Temperature Meter { 3 wires-3 coils & test 3 wires-3 coils, test, & off	6	None	Fixed	Knurled		Test, 1, 2, 3	16SB1CF29X2	6	32.00
	6	None	Removable	Oval	Mod. 16SB1CC18	Off, test, 1, 2, 3	16SB1CE54X2*	6	32.00
Temperature Meter { 3 wires-3 coils, test, & off 3 wires-3 coils, test, & off	6	None	Removable	Oval	Mod. 16SB1CC19	Off, test, 1, 2, 3	16SB1CE55X2*	6	32.00
	6	None	Removable	Oval					
Temperature Meter { 2 wires-4 coils, test, & off 2 wires-4 coils, test, & off	6	None	Removable	Oval	Mod. 16SB1CC19	Off, test, 1, 2, 3, 4	16SB1CE52X2*	6	32.00
	6	None	Removable	Oval	Mod. 16SB1CC21	Off, test, 1, 2, 3, 4	16SB1CE53XX*	6	32.00
Temperature meter, 2 wires—5 coils and test	6	None	Fixed	Knurled		Test, 1, 2, 3, 4, 5	16SB1CE33X2	6	32.00

General-purpose

Spst—double break	1	None	Fixed	Pistol grip		Off, on	16SB1CF1X2	3	\$22.00
Spdt and off—single break	1	None	Fixed	Knurled		1, off, 2	16SB1CF47X2	3	22.00
Sp3t—double break	3	None	Fixed	Pistol grip		Rev, off, for	16SB1CF2X2	4	26.00
Sp3t and off—double break	3	None	Fixed	Knurled		Off, 1, 2, 3	16SB1CF50X2	4	26.00
Sp4t—double break	4	None	Fixed	Pistol grip		1, 2, 3, 4	16SB1CF3X2	4	28.00
Sp4t—single break	2	None	Fixed	Knurled		1, 2, 3, 4	16SB1CF34X2	3	24.00
Sp6t—single break	3	None	Fixed	Knurled		1, 2, 3, 4, 5, 6	16SB1CF35X2	4	26.00
Sp8t—single break	4	None	Fixed	Knurled		1, 2, 3, 4, 5, 6, 7, 8	16SB1CF36X2	4	28.00
Sp12t—single break	6	None	Fixed	Knurled		1, 2, 3, 4, 5, 6, 7, 8, 9, 10, 11, 12	16SB1CF37X2	6	32.00
Dpst—double break	2	With	Fixed	Pistol grip		Off, test	16SB1CF4X2	3	24.00
Dpst—double break	2	None	Fixed	Knurled		Off, 1	16SB1CF40X2	3	24.00
Dpdt—double break	4	None	Fixed	Pistol grip		Stop, run	16SB1CF7X2	4	28.00
Dp3t and off—double break	6	None	Fixed	Knurled		Off, 1, 2, 3	16SB1CF51X2	6	32.00
Dp4t—single break	4	None	Fixed	Knurled		1, 2, 3, 4	16SB1CF9X2	4	28.00
Dp6t—single break	6	None	Fixed	Knurled		1, 2, 3, 4, 5, 6	16SB1CF10X2	6	32.00
Dp8t—single break	8	None	Fixed	Knurled		1, 2, 3, 4, 5, 6, 7, 8	16SB1CF11X2	7	36.00
Dp12t—single break	12	None	Fixed	Knurled		1, 2, 3, 4, 5, 6, 7, 8, 9, 10, 11, 12	16SB1CF12X2	8	44.00
3pst—double break	3	None	Fixed	Knurled		Off, on	16SB1CF16X2	4	26.00
3pdt—single break	3	None	Fixed	Knurled		Local, off, sup'r'vy	16SB1CF19X2	4	26.00
3pdt—double break	6	None	Fixed	Pistol grip		Start, off, run	16SB1CF18X2	6	32.00
4pst—single break	2	None	Fixed	Knurled		Off, 1	16SB1CF42X2	3	24.00
4pst—double break	4	None	Fixed	Knurled		Off, on	16SB1CF20X2	4	28.00
4pdt—single break	4	None	Fixed	Knurled		1, 2	16SB1CF22X2	4	28.00
4pdt and off—single break	4	None	Fixed	Knurled		1, off, 2	16SB1CF38X2	4	28.00
4pdt and off—double break	8	None	Fixed	Knurled		1, off, 2	16SB1CF48X2	7	36.00
5pst—double break	5	None	Fixed	Knurled		Off, 1	16SB1CF44X2	5	30.00
5pdt and off—single break	5	None	Fixed	Pistol grip		1, off, 2	16SB1CF21X2	5	30.00
6pst—single break	3	None	Fixed	Knurled		Off, 1	16SB1CF45X2	3	26.00
6pst—double break	6	None	Fixed	Knurled		Off, 1	16SB1CF46X2	6	32.00
6pdt and off—single break	6	None	Fixed	Knurled		1, off, 2	16SB1CF39X2	6	32.00

*Switches are constructed to use removable noninterchangeable handles. No other listed handle can be used to operate the switch.

†Switches are available for mounting on panels 1/8 to 2 in. thick. Model No. are listed only for the 1/8 in. thick panel; for other thicknesses, Model No. are derived by substituting the appropriate suffix no. following the "X" in the Model No. The suffix no. indicates the number of 1/16 in. panel thickness. For example: 3 = 3/16 in.

‡Fixed operating handles are included in switch Model No. and price. Removable handles must be ordered, and priced, separately.

§"Off" position furnished on switch, but not engraved on escutcheon plate.

•These meters are equipped with palladium contacts.

Note: Switches other than those listed are available. Information on application.

G-E Control Switchboard Components

Type SB-1 Control and Transfer Switches

†Switches for Hazardous Locations

**For Class I, Group D 250 Volts, D-C—500 Volts, A-C
For Panel Mounting (Specify Panel Thickness)**

It is recommended that where SB-1 switches are to be operated in explosive atmospheres that they be enclosed in explosion-proof housings. The front, or switch-support section of the housing is made so that sufficient size of conduit opening is provided to accommodate the maximum number of control wires, as determined by the switch connections.



Fig. 3. Explosion-proof box with cover on

The tank or cover section is made in three lengths, to accommodate:

- (a) A maximum of 4 stages.
- (b) A maximum of 8 stages.
- (c) A maximum of 12 stages.
- (d) Switch may also be furnished with removable handle or lock handle.

Any standard spring-return or sustained-contact Type SB-1 switch, with fixed handle, having a maximum of 12 stages, may be assembled with a housing as illustrated in Fig. 3.

Stages	SB-1 Switch and Explosion-proof Housing Poles	Outlet for Std. Pipe Thread, inches	Approx. Shipping Weight Lbs.	Net Price, Each, Includes Switch and Housing
1	Single-pole, double-break, or double pole, single-break . . .	1/2 or 3/4	9	\$64.00
2	Double-pole, double-break, or four-pole, single-break		9	66.00
3	Triple-pole, double-break, or 6-pole, single-break		10	68.00
4	4-Pole, double-break, or 8-pole, single-break		10	70.00
5	5-pole, double-break, or 10-pole, single-break	1 or 1 1/4	16	72.00
6	6-pole, double-break, or 12-pole, single-break		16	74.00
7	7-pole, double-break, or 14-pole, single-break		18	76.00
8	8-pole, double-break, or 16-pole, single-break	1 1/2 or 2	18	78.00
9	9-pole, double-break, or 18-pole, single-break		23	80.00
10	10-pole, double-break, or 20-pole, single-break	24	82.00	
11	11-pole, double-break, or 22-pole, single-break	25	25	84.00
12	12-pole, double-break, or 24-pole, single-break		25	86.00

†This control is designed to conform with the standards of the Underwriters' Laboratories, Inc., but has not been tested or listed by the Laboratories.

Control and Transfer Switch Housings

**Watertight, Dust-tight or Oil-immersed
For 600 Volt Service (Fig. 4)**

For flat surface vertical mounting, the top support is common to three sizes of tanks. Small — for 1 to 4 stages; Medium — for 5 to 8 stages, and Large — for 9 to 12 stages, or for 13 to 16 stages. Top support will be drilled and tapped to accommodate conduit or pipe of 1-inch maximum iron pipe size.

The same housing can be used for immersing the switches in oil when they are exposed to gaseous or explosive atmospheres. For such applications a 1 3/4 inch spacer is used to lower the switch contacts into the oil in the tank, and the number of stages per housing is one less, as indicated in table.

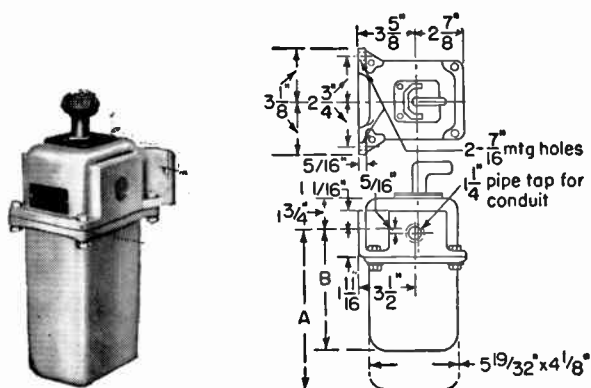

Fig. 4

Net Price per housing any size, when sold with SB-1 Switch **\$42.00**

Watertight or Dust-tight	Number of Stages	Switch Oil Immersed	Dimensions in Inches (Fig. 4)	
			A	B
1-4	1-3		10 7/8	7 1/16
	5-8		16 7/8	10 1/16
	9-12		22 7/8	13 1/16
	13-16		28 7/8	16 1/16

Control and Transfer Switch Housings

Fabricated Metal — For 600 Volts

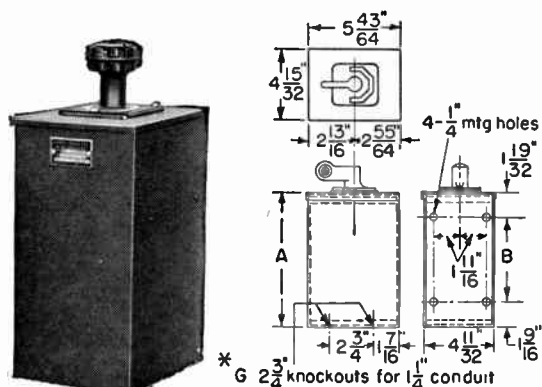

Fig. 5

For wall or flat — surface mounting. Made in five sizes to accommodate switches of 1 to 6 stages, 7 to 9 stages, 10 to 12 stages or 13 to 15 stages. Knockouts can be provided for pipe or conduit connections.

Type SB-1 switches mounted in these housings require different terminals. Therefore, if switch is ordered separately, requisition should specify "For mounting in fabricated housings."

Net Price per housing, any size, when sold with SB-1 switch **\$14.00**

No. of Stages	Dimensions in In. (Fig. 5)	
	A	B
1-6	8 21/32	5 1/2
7-9	10 29/32	7 3/4
10-12	13 5/32	10
13-15	15 13/32	12 1/4

*Reducer necessary for smaller sizes.

G-E Control Switchboard Components

Type PK-2 Test Blocks and Plugs

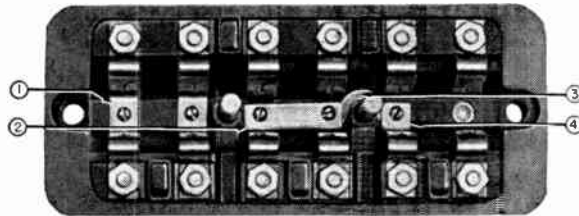

Fig. 9. 6-pole block with jumpers and connectors

The above illustration shows a composite assembly of a 6-pole test block with auxiliary contacts and jumpers, as follows:

No. 1—Auxiliary contact (Cat. No. 6179685G3) used as a bridge to maintain the circuit during the period that the cover or the plug is not in place. Without this connection, loss of revenue is possible because of interrupted operation if the replacement of the cover or plug is long delayed.

No. 2—Auxiliary contact (Cat. No. 6179685G2) to short-circuit the current transformer when the cover or plug is not in place.

No. 3—Jumper (Cat. No. 6179685G1) to be used in connection with auxiliary contact No. 2 or No. 4, to serve the same purpose as No. 2 in short circuiting a current transformer, or to inter-connect phases when the cover-fastening stud is to be by-passed.

No. 4—Auxiliary contact (Cat. No. 6179685G1) equal to one pole of contact No. 2, to be used in connection with jumper No. 3 as shown in Fig. 9. If all poles are to be interconnected, as indicated in Fig. 15, contact bars No. 2, with jumpers No. 3 would be used.

Typical Arrangements of Type PK-2 Test Blocks with Auxiliary Contacts and Jumpers

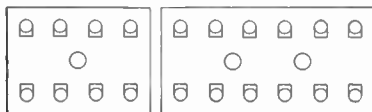

Fig. 10

Without auxiliary contacts, for potential circuits

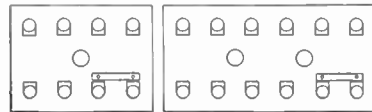

Fig. 11

With one auxiliary contact No. 2, for potential and current circuit

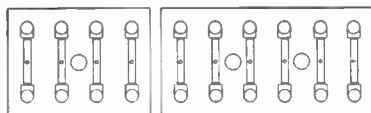

Fig. 12

With auxiliary contacts No. 1 for through-current connections

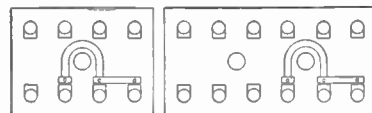

Fig. 13

With auxiliary contacts Nos. 2 and 4, and Jumper No. 3, for relay and trip connections

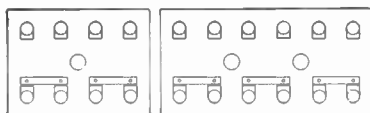

Fig. 14

With auxiliary contacts No. 2, for current circuits

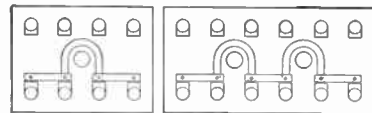

Fig. 15

With auxiliary contacts No. 2 and jumper No. 3, for current transformer short circuiting

NOTE—All test blocks are supplied with a sufficient quantity of auxiliary contacts and jumpers for any connection shown above.

Interchangeability of Type PK-2 with Type PK-1

Test blocks Type PK-2 can be surface-mounted on insulating panels in the PK-1 drilling, or surface-mounted on steel panels in the PK-1 drilling plus two small holes for mounting screw bolts. PK-2 plugs, 4- and 6-hole are interchangeable with PK-1 plugs.

However, the base of the PK-2 is 1-inch longer than that of the PK-1, therefore it may not always be possible to mount the PK-2 blocks in the same location as the PK-1.

G-E Control Switchboard Components

Types ET-5 and ET-6 Indicating Lamps

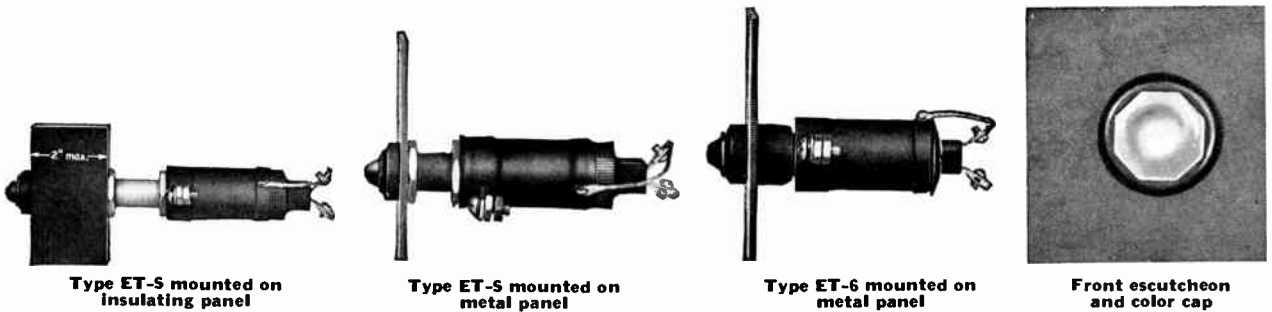

Application

For application where good visible indication, long lamp life, and low wattage consumption are desirable. They can be used for signal-light indication or in combination with control switches to show circuit-breaker position.

Description

Devices include G-E telephone lamp, Type T-2, slide base, rated 24 v., 0.032-0.038 amp. Special Code 24X lamp, Cat. No. 59X243, used in ET-5 device, is suitable for use in Type ET-6 also. However, the standard Code 24E lamp included with the Type ET-6 device, cannot be used in the Type ET-5 combination. Screw-type color caps, easily removed, are used and give positive indication. Color of cap desired should be specified when ordering.

The resistor element slides over the receptacle body from the rear. The complete device has provision for soldered or clamped connections.

Features

Each unit is compact and simple in construction. Requires only one hole for panel mounting.

Series resistor prevents the possibility of a short circuit from a broken lamp filament, thus eliminating the need for special fuses and assuring long lamp life.

Low-wattage consumption results in economy and cool operation.

Telephone Type T-2, slide base 24 v. lamp is used and is available the world over.

Color caps are designed for max. visibility and are available in six basic colors: red, green, yellow, blue, white, and clear.

Terminals are readily accessible and have facilities for soldered or clamped connections.

The new Type ET-6 lamp has a molded base and is designed for mounting in panels up to 1/4 in. thick. It is similar in appearance to Type ET-5 lamp and is interchangeable with the ET-5 on thin-panel applications.

Receptacle Complete Where Lamp Is Operated at One Brilliance

Rated	Circuit Voltage		Resistance of Series Resistor in Ohms	No.*		Net Price, Each	50 or More Net Price, Each	No.* for Type ET-6 for 1/2 & 3/4 in. Panels†	Net Price, Each	50 or More Net Price, Each
	Min.	Max.		Type ET-5 for 1/2 & 3/4 in. Panels†	Type ET-5 for 1 to 2 in. Panels					
24 D-C	22	28	110	6105700G1	6105700G19	\$4.35	\$3.90	6105700G41	\$3.80	\$3.40
48 D-C	44	56	900	6105700G2	6105700G20	4.35	3.90	6105700G42	3.80	3.40
125 D-C	110	140	3300	6105700G3	6105700G21	4.35	3.90	6105700G43	3.80	3.40
250 D-C	220	280	7200	6105700G4	6105700G22	4.35	3.90	6105700G44	3.80	3.40
600 D-C	580	750	20000	6105700G5	6105700G23	6.00	5.65	6105700G45	5.65	5.40
115 A-C	95	125	2800	6105700G9	6105700G27	4.35	3.90	6105700G49	3.80	3.40
230 A-C	190	250	6300	6105700G10	6105700G28	4.35	3.90	6105700G50	3.80	3.40
460 A-C	380	500	13000	6105700G11	6105700G29	6.00	5.65	6105700G51	5.65	5.40
575 A-C	500	630	17000	6105700G12	6105700G30	6.00	5.65	6105700G52	5.65	5.40

Receptacle and Resistor (Mid-tap) Connection Giving Dim-bright Operation

48 D-C	44	56	1300 (580 tap)	6105700G6	6105700G24	\$6.00	\$5.65	6105700G46	\$5.65	\$5.40
125 D-C	110	140	4300 (2150 tap)	6105700G7	6105700G25	6.00	5.65	6105700G47	5.65	5.40
250 D-C	220	280	9400 (5600 tap)	6105700G8	6105700G26	6.00	5.65	6105700G48	5.65	5.40
115 A-C	95	125	3600 (2200 tap)	6105700G13	6105700G31	6.00	5.65	6105700G53	5.65	5.40
230 A-C	190	250	7900 (5000 tap)	6105700G14	6105700G32	6.00	5.65	6105700G54	5.65	5.40

*Includes Lamp, Color Cap, and Resistor.

†A spacer will be supplied for mounting on panels of less than 1/8 in. thickness.

Dimensions

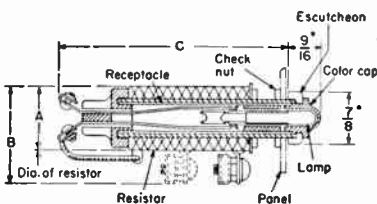

ET-5 Indicating Lamp

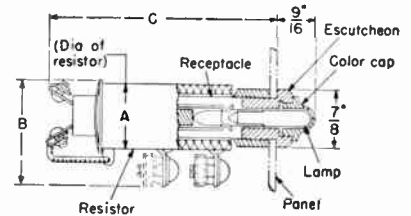

ET-6 Indicating Lamp

Indicating Lamp Combination Type	Panel Type	Drilling	Volts	Dimensions, Inches		
				A	B	C
ET-6	Metal, up to 1/4 in. thick	One 2 1/2 in. hole	24-250	1 1/8	1 11/16	3 11/16
			251-660	2	2 9/16	
ET-5	Insulating, up to 2 in. thick	One 4 1/4 in. hole	24-250	1 3/8	1 11/16	5 15/16
			251-660	2	2 9/16	
ET-5	Metal, up to 1/4 in. thick	One 4 1/4 in. hole	24-250	1 3/8	1 11/16	4 3/16
			251-660	2	2 9/16	

G-E Terminal Boards and Covers

Fabricated Types EB-5 and EB-6

Application

To be applied wherever leads are brought to any part for permanent or temporary connection, especially if many wires are involved.

Description

Type EB-5 are fabricated terminal boards. Each is equipped with the necessary washer-head binding screws for circuit wire connections, and also a white marking strip for circuit identification (See Notes A and B below). To mount, drill for No. 10 screw. Board will accommodate wire sizes No. 18 to No. 10 inclusive.

Type EB-6 are fabricated terminal boards of the same construction and dimensions as Type EB-5, except that clamp-type connectors are furnished for circuit wire connections. Boards will accommodate wire sizes No. 18 to No. 10 inclusive.

Boards are available with from 2 to 18 points, except those with short-circuit strips.

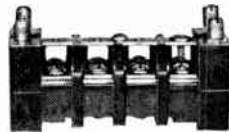
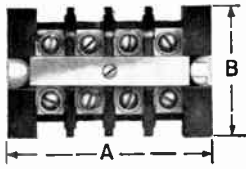

Fig. 1. 4-pole board Type EB-5 without short-circuit strips, Cat. 6422482G4

Fig. 2. 4-pole board Type EB-5 with four short-circuit strips, Cat. 6352652G1

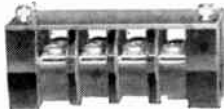

Fig. 3. 4-pole terminal board Type EB-6 with hinged cover in place, Cat. 6422494G104

30 Amperes—600 Volts

Type EB-5, With Washer-Head Screws for Connection (as in Fig. 1 and 2)

No. of Poles Per Board	Board Only, Without Cover Fig. 1		Without Short-circuit Strips Board With Cover Fig. 3		*With Short-circuit Strips Board Only, Without Cover Fig. 2		Dimensions in Inches			Approx. Ship. Wt., Lbs. Each
	Catalog No.	Net Price Each	Catalog No.	Net Price Each	Catalog No.	Net Price Each	A	B	C	
4	6422482G 4	\$1.20	6422494G 4	\$2.05	6353652G1	\$1.75	3 1/4	2	2 7/8	3/4
6	6422482G 6	1.55	6422494G 6	2.50	6353652G2	2.25	4 1/2	2	4 1/8	1
8	6422482G 8	1.95	6422494G 8	2.95	6353652G3	2.85	5 3/4	2	5 3/8	1
12	6422482G12	2.75	6422494G12	3.90	6353652G4	4.05	8 1/4	2	7 7/8	1 1/2

Type EB-6, With Pressure-Type Connectors (as in Fig. 3)

4	6422482G104	\$1.40	6422494G104	\$2.45	3 1/4	2	2 7/8	1
6	6422482G106	1.95	6422494G106	2.90	4 1/2	2	4 1/8	1 1/2
8	6422482G122	2.45	6422494G108	3.45	8 1/4	2	5 3/8	2
12	6422482G112	3.45	6422494G112	4.50	8 1/4	2	7 7/8	2

*Each board is furnished with a total of 4 short-circuit strips to provide for a total of 3 current transformer secondary circuits connected Y with grounded neutral. The short-circuit strips can be easily removed or added as required.

Molded-Type EB-4

Molded-composition terminal boards make possible neat, compact arrangements on the back of the switchboard. Especially desirable where a large amount of small wiring is necessary on the back of the switchboard and will be found very convenient for attaching the wires, not to exceed No. 8 in size. Each stud is furnished with four pronged washers.



Fig. 4. 6-point terminal board, Cat. No. 2860351G3

600 Volts

†Cat. No.	‡No. of Studs	Dimensions in Inches (Fig. 4)		Approx. Ship. Wt. Each, Lbs.	Net Price Each
		A	B		
2860351G1	2	1 1/4	1 3/4	1/4	\$1.55
2860351G2	4	2 1/2		1/2	1.75
2860351G3	6	3 3/4		3/4	2.10

†Boards for more than six circuits to be made up of combinations of 2-, 4-, and 6-stud boards.

‡When ordering, use Catalog Number.

Note A—Unless specified on the order, each board will be shipped with an all-white Fibre marking strip.

Note B—On request, we can furnish a bi-plastic marking strip (black on one side, white on the other, or all black) suitable for engraving or marking.

G-E Auxiliary Relays

Types HGA and HMA



Fig. 1. HGA11A, back-connected

Instantaneous in operation, positive in action and attractive in appearance.

Application

These relays are available for many applications, both on a-c and d-c circuits. They can be applied where several circuits are to be closed or opened as a result of closing one set of contacts in a protective or actuating relay. Where more than two circuits are to be controlled, the coils of two or more relays may be connected either in series or parallel on d-c, or parallel on a-c to obtain the desired results.

Features

Contacts are silver-to-silver, double-pole, double-throw (two normally open, two normally closed). Textolite base of high insulating qualities, molded in one piece, impervious to moisture. Cover, also of black Textolite, is held in place by two spring clips, easily removed and replaced.

Back-connected relays, with covers or front-connected relays without covers can be provided. The front-connected are generally used in enclosures where the back of panel is inaccessible.

‡Type HGA—Heavier Duty—Larger

Volts, D-C	Coil Ratings Amp., *Volts, A-C 60 Cycles	†Resistance, Ohms at 25C	Back-connected, with Cover and Studs Model No.	Front connected, No Cover or Studs Model No.
6	...	9	12HGA11A58	12HGA11I58
12	...	35	57	57
24	...	130	56	56
32	...	230	55	55
48	...	500	54	54
62.5	...	820	53	53
125	...	3000	52	52
250	...	12900	51	51
...	1	3.80	65	65
...	2	0.95	66	66
...	3	0.46	67	67
...	5	0.16	69	69
...	115	93	70	70
...	208	340	105	105
...	230	380	71	71
...	460	1900	72	72
...	575	2340	73	73

Net Price \$16.60 (for 53, 54, 55, 56, 57)
Net Price \$15.00 (for 52, 51, 65, 66, 67, 69, 70)

Approximate Weight, lbs. Net 2; Shipping, 3.

Type HMA—Lighter Duty—Smaller

Volts, D-C	Coil Ratings Amp., *Volts, A-C 60 Cycles	†Resistance, Ohms at 25C	Back-connected, with Cover and Studs Model No.	Front connected, No Cover or Studs Model No.
6	...	15.3	12HMA11A21	12HMA11B1
12	...	60	22	22
24	...	230	23	23
32	...	360	24	24
48	...	880	25	25
125	...	5660	26	26
...	115	...	31	31
...	125	...	54	54
...	230	...	32	32

Net Price \$12.50 (for 22, 23, 24, 25, 26)
Net Price \$11.10 (for 31, 54, 32)

Approximate Weight, lbs.

12HMA11A Series—Net, 7/8; Shipping, 1 1/4.

12HMA11B Series—Net, 1; Shipping, 2.

*For 25- or 50-cycle relays use same price as listed for corresponding 60-cycle relay. See "Ordering Directions."

†To obtain glass in cover of HGA relay add suffix letter "G" to Model No. and add \$0.85 to selling price. Example: Model 12HGA11A58G, selling price \$17.45. (This feature not available in HMA relays.)

‡Within plus or minus 10%.

Ordering Directions

Order d-c and 60-cycle a-c relays by Model No. For 25- or 50-cycle relays order "Similar to Model No." (give 60-cycle No., except state for 25- (or 50-) cycles).

If relays are to be mounted on a steel panel, specify "with short studs" and order as a separate item, insulating bushings for each live stud. (These bushings are furnished without charge when ordered with the relay.)

Unless otherwise specified, back-connected relays with short insulated studs suitable for steel panels up to 1/4-in. thick will be furnished.

Operation and Characteristics

Operation—These relays have an operating coil and an opening spring. When the coil is energized, the hinged armature is attracted, closing the normally open contacts and opening the normally closed contacts.

Characteristics—Both the a-c and d-c relays are normally adjusted to pick up at 80% of rating (hot). This is approximately 60% of the rating for d-c relays (cold), because the coil resistance changes with heating. The a-c relays will drop out at approximately 40 to 50% of normal voltage; the d-c at 2 to 10%.

These relays will withstand a 10% increase in voltage without injury to the operating coils.

Ratings of contacts—The current-closing rating of the contacts is 30 amperes. The current-carrying rating is 12 amperes continuously or 30 amperes for one minute. The interrupting ratings are listed in the following table.

Interrupting Ratings of Contacts in Amperes

Contact-circuit A-C	Volts D-C	Type HGA		Type HMA	
		Single Break	Double Break	Single Break	Double Break
...	6-32	20	50	15	30
...	48	10	35	10	20
...	125	3	20	1.5	3
...	250	0.75	2.5	0.25	0.5
115	...	30	50	20	30
230	...	20	30	13	25
460	...	10	15	5	10

Inductive Circuits

...	6-32	10	50	7.5	20
...	48	5	30	3	7.5
...	125	1	5	0.75	1.0
...	250	0.2	0.4	0.1	0.25
115	...	20	30	15	15
230	...	15	20	10	10
460	...	7.5	10	5	5

Call Graybar FIRST for . . .

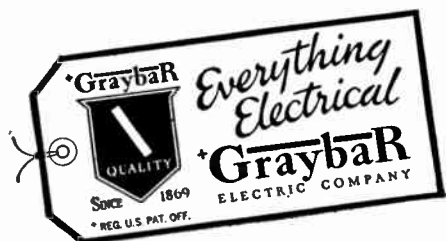

General Electric Load-Center Unit Substations

The New and Improved Way of Distributing Low-voltage Power in Industrial Plants, Commercial Buildings, and for Power-Station Auxiliaries.

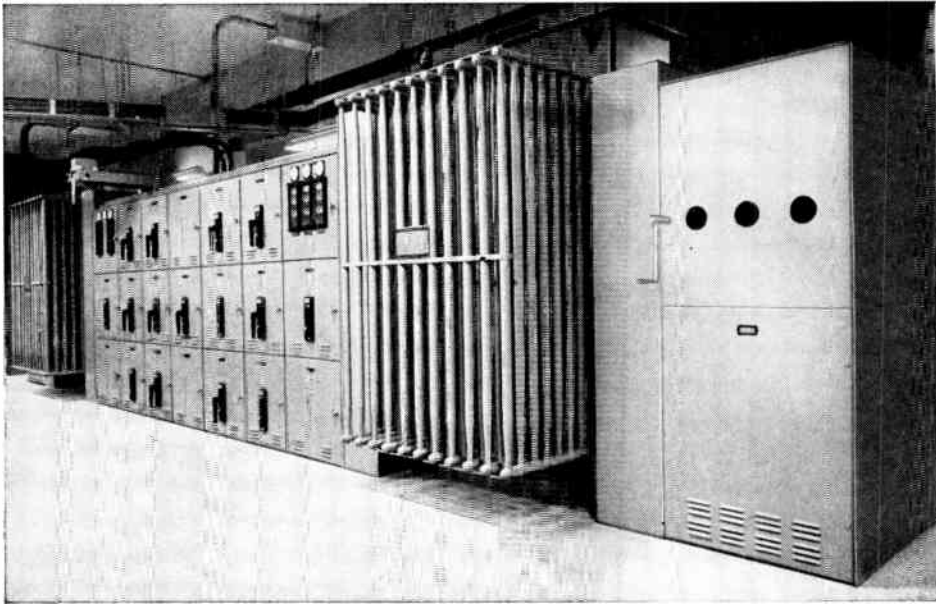

A G-E load-center unit substation, with Pyranol transformer and metal-enclosed drawout air circuit breakers, installed indoors at load center

Load center distribution has many big advantages. Elimination of long secondary cable runs, which cause voltage drop, results in better voltage conditions. Proper voltage at point of use means improved motor performance, bright and steady lights.

G-E metal-enclosed load-center unit substations are completely factory-engineered and factory-assembled and are shipped ready to install. They can be installed either indoors or outdoors, put underground in vaults, on the roof, on balconies, or in production areas, in a space that is otherwise unused.

Save Time — Only one purchase transaction is necessary. They can be selected and ordered quickly and easily from a line of standard units and standard arrangements that fill all requirements of a broad range of applications. The units are shipped in two or three complete sections ready to be bolted together and connected to power cables. They are standardized, completely assembled and wired at the factory — no special knowledge being required by purchaser's men to install or disconnect for removal to new locations.

Greater Safety — All live parts are metal-enclosed. Circuit breakers of adequate interrupting capacity insure adequate circuit protection. Pyranol, a noninflammable cooling and insulating liquid is normally used in the transformer, providing safety for indoor installations.

Flexibility — A wide variety of high- and low-voltage switching equipment is available, including oil, Pyranol or dry-type transformers, and circuit breakers for either manual or electrical operation, making these substations adaptable for practically every need.

Appearance — Compact and modern in appearance. No skeleton steel framework or exposed equipment. They require much less space than the old type.

Industrial Lighting — When the industrial load is not heavy, the same load-center unit substation which supplies motor power can be used. Dry-type lighting transformers (capacities 5-25 kva), which step 480 volts down to 120 volts can be mounted or hung any place in the plant to supply the lighting load.

Ratings — These unit substations serve loads 600 volts and below (208Y/120, 480 volts, etc.) from incoming lines up to 15 kv.

A complete unit substation may consist of metal-clad incoming-line section with magne-blast power circuit breakers, a Pyranol (or dry-type, or oil-filled) transformer section, and a low-voltage feeder section with drawout air circuit breakers.

Here is the modern equipment to help insure an adequate power supply at all times — more important now than ever in the light of present conditions.

We will be glad to help you select a low-cost load-center unit substation to meet all your requirements. Other apparatus can be combined in one of these units if, for instance, you need the addition of a power rectifier. For further information ask GRAYBAR for Bulletin GEA-3592

G-E Distribution Center Unit Substations Sectional Type

**Primary: 15,000 Volts or Less, Delta Connected.
 Secondary: 600 Volts or Less, Delta or Wye Connected.
 Transformer: Liquid Filled, 112½ Kva and above;
 Dry type, 300 Kva and above**

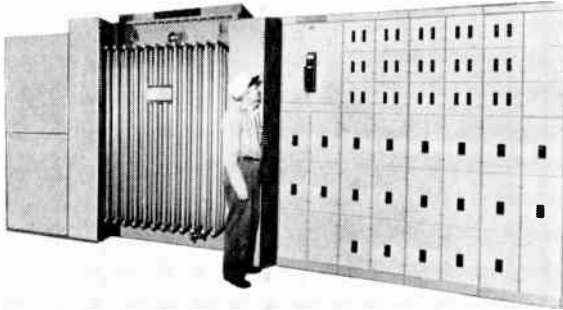

Provides a completely metal-enclosed, co-ordinated substation for indoor or outdoor installations. Used to step primary voltages in the range 601 through 15,000 volts down to more effectively utilized ratings of 600, 480, 480Y/277, 240, or 208Y/120 volts.

Usually eliminates the need for expensive, space-wasting vaults or transformer rooms.

Provides the additional power needed for extra motors, air conditioning, and increased lighting loads without disturbing existing high-voltage lines and existing substations.

Can be effectively used in small plants, warehouses, railroad terminals, airports, hospitals, office buildings, schools, and light-duty areas in utility systems. Helps assure safety for men and equipment, reduces maintenance costs, and lessens possibility of production shutdowns.

Easily installed. Components shipped separately as packaged units. It is simply necessary to spot equipment in desired location, bolt together, and make necessary electric connections. The low-voltage section control center or switchboard can be located remotely from the rest of unit and connected by G-E Type LVD feeder busway.

The equipment steps down incoming line voltage to a voltage suitable for serving utilization loads and for supplying power to various loads through individual feeder circuit protective devices.

Incoming power can enter transformer section either directly through a cable terminal compartment or through an interrupter device. Interrupter device enables the customer to disconnect substations from incoming line. Incoming line may consist of any one of the following: Terminal compartment; Cutout, fused or unfused; Unfused air interrupter switch; Fused air interrupter switch; Liquid-filled switch; Unfused air selector switch or Fused air selector switch.

The transformer section steps primary voltages of 2400 through 13,800 volts down to utilization voltages of 240, 480, 600, 208Y/120, or 480Y/277 volts and feeds the low-voltage section. The transformer section contains the transformer with primary and secondary leads as well as provisions for changing taps on the primary side. There are four approximately 2½ percent rated kva taps, two above and two below rated primary voltage. There are three types of transformers: Pyranol filled for installation indoors or outdoors; Oil-filled for use outdoors or in approved vaults; Open-dry for indoor use in clean, dry locations.

In some applications, a transition or metering section may be used.

The Low-Voltage Section may consist of a free-standing switchboard of either the fusible or circuit breaker type; free-standing distribution panelboard, either fusible or circuit breaker type; or a general purpose type motor control center.

Note: For further information contact Graybar.

G-E Distribution Centers Integral Units

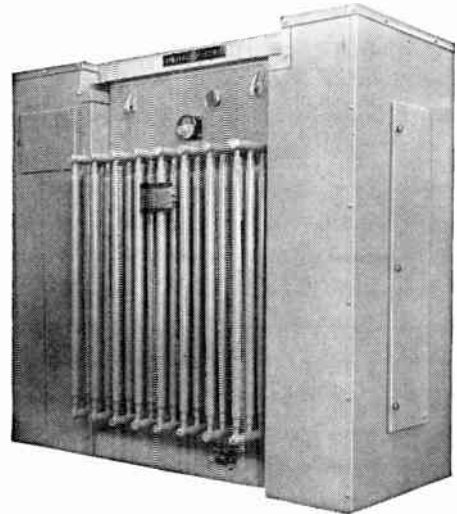

One compact unit of three co-ordinated components: an incoming-line section, a transforming section, and a low-voltage outgoing section consisting of a stationary molded-case feeder-breaker panel. Ideal for supplying up to 500 kva of power to light-load areas, either indoors or outdoors. This type of distribution center offers the additional advantage of having the low-voltage section integral with the transformer housing.

Incoming-Line Section: May consist of simple terminal compartments or high-voltage switch. Three types of high-voltage switches are available: air switch (fused or unfused), oil cutouts (fused or unfused), and liquid-filled switch (unfused).

Transforming Section: May consist of oil-filled, Pyranol filled, or open or sealed dry-type transformer. The transformer primary is rated 2400-15,000 volts and the secondary is rated 600 volts or less. There are four 2½ percent full-capacity externally operated taps, two above and two below normal.

Low-Voltage Section: Consists of a panel containing stationary molded-case air circuit breakers, manually operated, with thermal-magnetic overcurrent protection and clamp-type terminals.

Standard Transformer Ratings Available

KVA Oil-filled Pyranol Open Dry	Delta-connected Incoming Line Voltages	Outgoing Feeder Voltages
.....	2400
75	4160	120/208Y
112½	4800	240 Delta
150	6900	480 Delta
225	7200	480Y/277
300	12000	600 Delta
500	13200
.....	13800

G-E Load Center Units

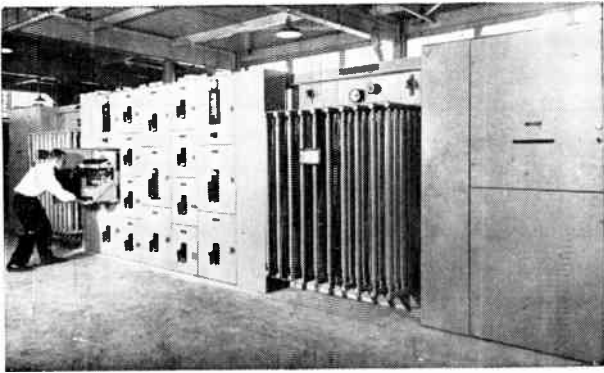

A load-center unit substation is a completely co-ordinated factory-built equipment for stepping down primary voltage and protecting and switching low-voltage (600 volts and less) power-distribution circuits. The equipment is contained within a grounded metal enclosure. The sections (incoming-line, transformer, and outgoing) are designed to be easily and quickly bolted together at the point of installation. Unit offers advantage of drawout low-voltage circuit breakers. Available in indoor or outdoor units, 300 to 2000 kva.

The sections are:

Incoming-Line Section: May consist of simple terminal compartments or high-voltage switch. Three types of high-voltage switches are available: air switch (fused or unfused), oil cutouts (fused or unfused), and liquid-filled switch (unfused).

Transforming Section: May consist of oil-filled, Pyranol filled, or open or sealed dry-type transformer. Transformer primary is rated 2400-15,000 volts and the secondary is rated 600 volts or less. There are four 2½ percent full-capacity externally operated taps, two above and two below normal.

Low-Voltage Section (outgoing): For the connection of one or more outgoing low-voltage feeders. Outgoing feeders are protected and switched by drawout Type AK magnetic air circuit breakers.

Standard Ratings For Utilization Voltage

Standard Primary Voltage Ratings	Drawout Switchgear Construction	
	208Y/120 240	480, 480Y/277 600
2400	300KVA	300KVA
4160	500KVA	500KVA
4800	750KVA	750KVA
6900 or 7200	1000KVA	1000KVA
12000	1500KVA
13200	2000KVA
13800

**I-T-E Unit Substations
Indoor Construction**

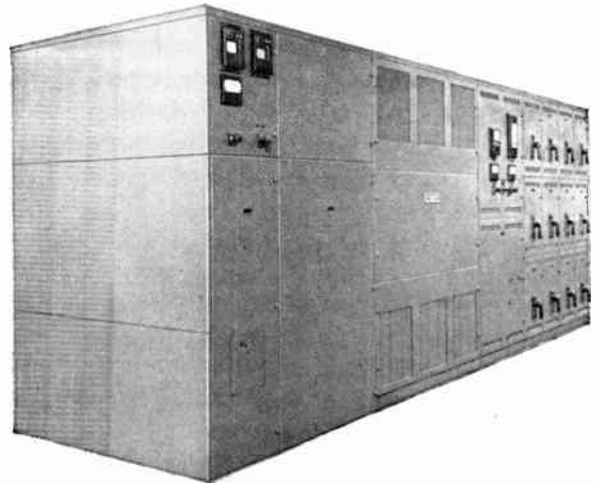

Available in liquid and dry types, indoor and outdoor. Conventional secondary unit substation rating from 75 to 2000 kva., primary voltage—14,100 and below; secondary voltage—600 volts and below. Primary unit substations having higher kva. and voltage ratings are also available.

Engineered, built and tested as one complete, coordinated unit. Obtainable in any combination of switchgear and transformer types to meet individual requirements.

Provides efficient means of stepping-down primary voltages to utilization values.

**I-T-E Metal-Clad Switchgears
Indoor Construction**

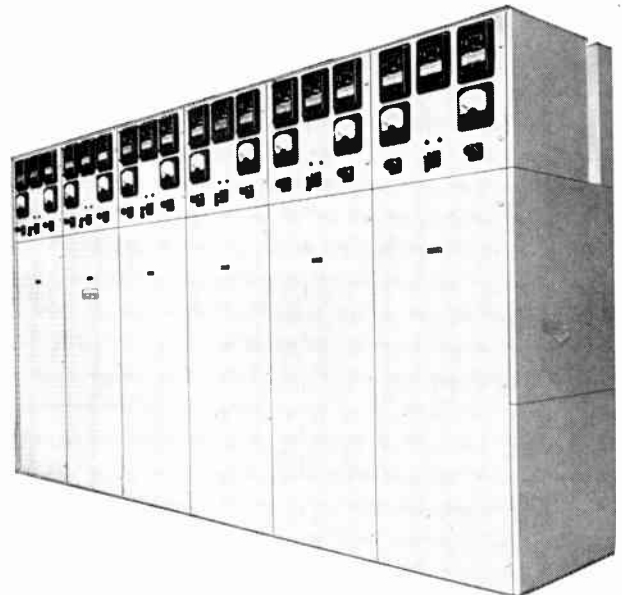

Metal enclosed for indoor or outdoor installations. Voltage ratings of 5, 7.5 and 15 kv., through 2000 amps. continuous, with interrupting ratings from 50,000 to 500,000 kva.

Provides safe, centralized electrical protection and control in industrial plants for incoming power lines, feeder and transformer circuits, heavy synchronous and induction motor drives.

Circuit breakers are properly coordinated with main buses, relays, meters, instruments, instrument transformers and other devices to form a complete unit designed to meet exact requirements.

**I-T-E Metal Enclosed Switchgears
Indoor Construction**

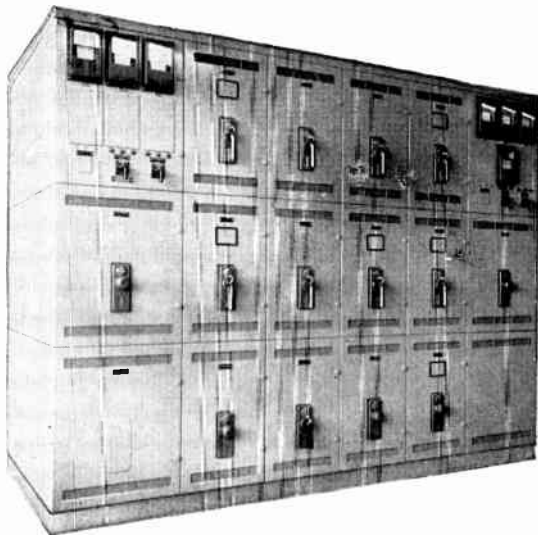

Low voltage, metal-enclosed drawout switchgear offers complete protection, indoor or outdoor, for voltages through 600 volts. Completely enclosed, self supporting structures containing one or more removable air circuit breakers and their associated equipment provide maximum service continuity and personnel safety.

Ideally suited as a centralized distribution system for low voltage power and lighting networks and may be installed in or above the production area for maximum space economy.

Square D Switchgears

High Voltage Metal Clad Switchgear

To control the high voltage circuits popular in so many modern distribution systems Square D offers Metal Clad Switchgear using high voltage switches to provide a safe, convenient and economical means for handling high voltage power.

Voltages up to 15,000 volts.

Incoming and outgoing cable terminations—potheads if required.

Load break air interrupter switches—fused or unfused.

High voltage main bussing.

Components completely enclosed in 1/2-in. steel housing.

Standard depth 54-in., height 91 1/2-in.

Facilities for high voltage metering.

Low Voltage Metal Enclosed Drawout Switchgear

For increased system reliability and easier equipment maintenance on systems up to 600 volts, Square D offers Low Voltage Metal Enclosed Switchgear. Drawout construction enables large air circuit breakers to project from their enclosures for quick, safe inspection, adjustment or replacement.

Air circuit breakers up to 4000A mounted on pantograph type drawout mechanisms in isolated compartments.

18-in. wide section accommodates 4 LA-25 (600 A.) or LA-15 (225 A.) air circuit breakers.

26-in. wide section accommodates 3 LA-50 (1600 A.) air circuit breakers.

34-in. wide sections for 3000 A. breakers, 40-in. for 4000 A. breakers.

Instruments and meters on hinged door of isolated compartment.

Silver plated bussing braced for at least 50,000 A.

Standard depth 54-in., height 91 1/2-in.

Weatherproof enclosures for outdoor applications.

**Square D Switchgears
Low Voltage Drawout Switchgear**

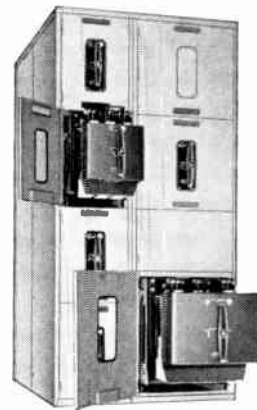

Circuit breakers projected from individual compartments on pantograph drawout mechanisms.

Back of projected breaker is beyond front of enclosure for easy inspection of drawout contacts and compartment interior.

Outdoor Low Voltage Drawout Switchgear



Standard indoor switchgear inside weatherproof housing.

Doors—front and rear.

“Walk-in” aisle space inside enclosure in front of circuit breakers.

Lights, space heaters and power outlets for tools.

Low Voltage Drawout Switchgear

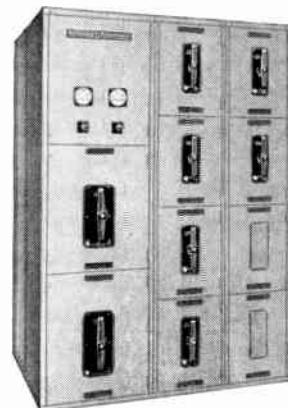

Two LA-50, 1600 A. and six LA-25 600 A. manually operated air circuit breakers.

Two future breaker compartments for LA-25 circuit breakers.

Meters in isolated compartment; instrument transformers.

Square D Unit Substations

Square D offers a complete line of indoor substations having primary voltages up to 15,000 volts and secondary voltages up to 600 volts.
 Designed in Power-style construction to match and include

Square D switchgear, switchboards and motor control centers these substations incorporate all applicable standards of NEMA, ASA and AIEE plus many Square D extras for better service.

Package Unit Substation

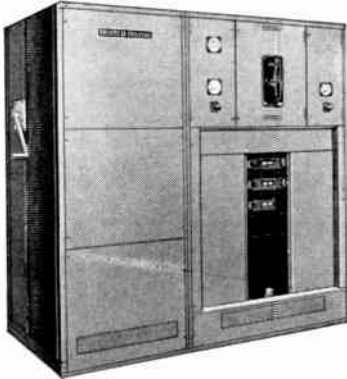

Package Unit Substation with combination type low voltage section.
 High voltage load break fused air interrupter switch.
 300 KVA transformer in rear.
 Main large air circuit breaker, 1000 A.; molded case feeder breakers.
 Instruments and instrument transformers.

Very compact yet versatile in design to accommodate a large variety of indoor application requirements, this substation is popular in schools, office buildings, shopping centers, factories and department stores.

Sizes from 75-500 3- KVA.

Primary voltages up to 5000 volts, secondary to 600 volts.

3 1φ dry type transformers in 3φ combination.

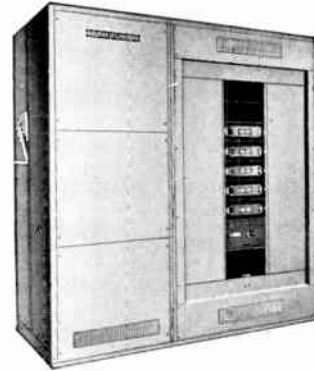

Package Unit Substation with full panel low voltage section
 High voltage load break fused air interrupter switch.
 300 KVA transformer in rear.
 Molded case circuit breakers in full 68-in. panel.

Transformers individually mounted on base for minimum noise, easier inspection and removal, and longer life due to more efficient cooling.

High voltage termination with air interrupter switch or oil cutouts—(fused or unfused).

Low voltage section with molded case circuit breakers, QMB fusible switches, large air circuit breaker and/or instrumentation.

88-in. wide, 44-in. deep, 91½-in. high.

Sectional Type Unit Substations

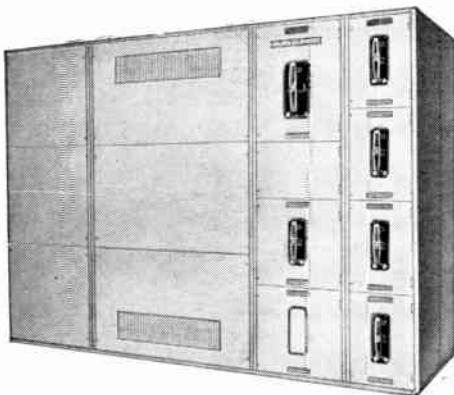

Sectional Type Unit Substation
 High voltage fused air interrupter switch section.
 500 KVA dry open ventilated transformer section.
 Low voltage drawout switchgear section.

Designed and manufactured to fill any load center substation requirements, this equipment combines high voltage and transformer sections with low voltage sections of switchgear, switchboards or motor control centers tailored to the systems needs.

Primary voltages up to 15000 volts, secondary to 600 volts.

Transformers—liquid filled or dry, up to 2000 KVA 3φ.

High voltage termination with air interrupter switch or oil cutouts (fused or unfused).

Low voltage air circuit breakers, molded case circuit breakers, switches, metering and motor control equipment.

Standard depth 54-in., height 91½-in.

G-E Medium-Voltage Switchgear

Standard Metal-Clad Equipments

With Magne-Blast Power Circuit Breakers

75,000 Kva Interrupting Capacity—3-Phase, 3-Wire

4160 Volts—1200 Amperes

Application

A brief description of metal-clad switchgear in this section will show the advantages obtainable in completely factory-assembled, metal-enclosed, safety-type switching equipments for general power service in power plant main and auxiliary circuits, steel mills and other types of industrial applications, distribution substations, office buildings, hotels, theaters, department stores, hospitals, educational and public build-

ings, and other similar locations. It will provide proper and reliable control for generators, transformers, incoming power and tie lines, feeder circuits, bus-tie and bus-sectionalizing circuits, synchronous and induction motor and condenser circuits, power capacitors, electric furnaces and other kinds of apparatus.

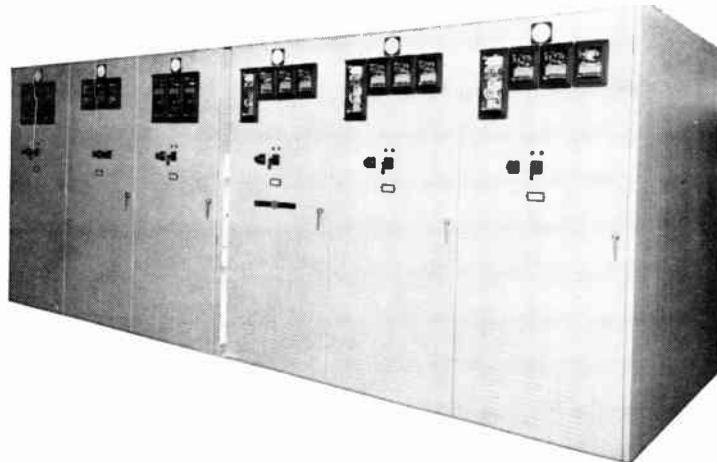

Standard Class M20 Metal-clad switchgear for the control of feeder and motor circuits

The equipment is available in standardized unit construction for installation where the interrupting rating requirements for the magne-blast power circuit breakers do not exceed 75,000 kva, and the service voltage does not exceed 4160 volts.

The factory-built standard units have been installed (at a minimum over-all installation cost), in many important applications where reliability in the performance of the switchgear equipment is of first importance.

Features

Advantages

- | | |
|--|---|
| Completely metal-enclosed; segregated metal compartments for bus, instrument transformers, breaker, etc. | No hazard to personnel—fire hazard minimized; long life. |
| Liberal insulation | Service continuity. |
| Easily removed vertical-lift breakers; drawout potential transformers and fuses; drawout relays and meters | Easy to maintain—short outage time. |
| Co-ordinated switchgear components | Balanced engineering and design. |
| Sequence interlocking | Safety to operators; continuity of service. |
| Complete primary and secondary control assembly, factory-built | Lower over-all installation cost and purchasing expense; a finished, tested job. |
| Shipped Assembled | Easy to install, and at low cost. |
| Standard unit construction | Low initial cost; flexibility in application; easy future expansion; simplifies station planning; high salvage value saves system investment. |

**G-E Medium Voltage Switchgear
Standard Metal-Clad Equipments
With Magne-blast Power Circuit Breakers**

Type AM (Oilless) Magne-Blast Power Circuit Breakers Stretch the Arc to Destruction

The magne-blast breaker used in these switchgear equipments interrupts by magnetically forcing the arc into a series of gradually interleaving, closely spaced, insulating barriers. These barriers elongate the arc and absorb its heat so that the electrical resistance in the path of the arc is greatly increased, reducing both the current and the phase angle of the circuit. At an early current zero the arc path is so long that the voltage is reduced and the gases produced by the arc so cooled that the arc cannot re-establish itself; and interruption occurs.

There are two sets of contacts on the magne-blast breakers — the silver-inlaid primary contacts, and the arcing contacts of an arc-resistant alloy.

On opening, the primary-contacts part first, shunting the current through the magnetic blowout coil and the arcing contacts. Thus the magnetic force will be sufficiently well established to drive the arc when it is drawn on the arcing contacts.

The solenoid mechanisms used on the magne-blast breakers are the same as those used for many years on oil breakers. Conventional control and familiar equipment are therefore used in the mechanism of magne-blast breakers.

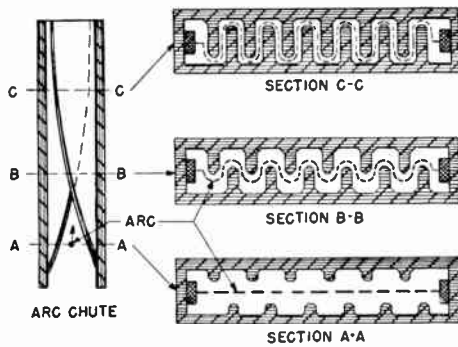

Schematic diagram showing the elongation of the arc in the magne-blast circuit

At section A-A the arc is formed in a line between the parting contacts. As the arc is forced into the chute, the fins constrict it and force it into a serpentine path as shown in Section B-B, and finally, C-C.

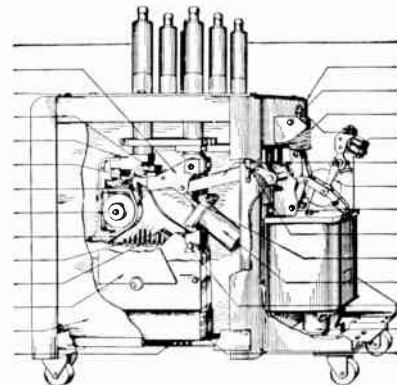
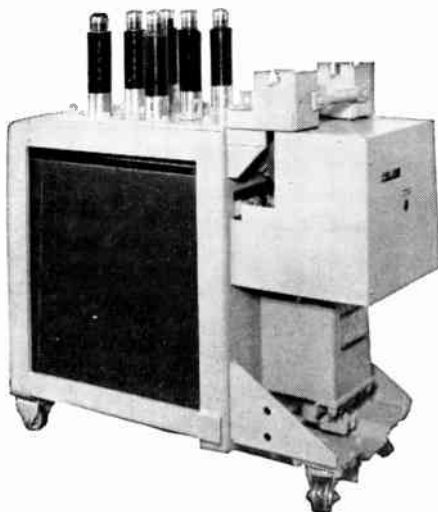

Diagram of section through magne-blast circuit breaker, showing contacts (in open position), blow-out coils, and one side of arc chute with fins other side of arc chute removed to show details of construction

Breakers are Safely Withdrawn or Replaced

The circuit breaker is easily lowered from the operating position to either a disconnected position, or for removal from the stationary structure for transportation to another location for inspection and maintenance. A spare breaker can be inserted to continue operation and reduce outage time to a minimum.



Removable element, consisting of power circuit breaker, solenoid mechanism, and disconnecting devices

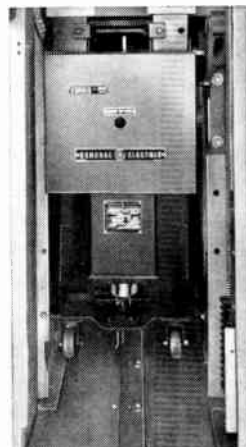

Breaker in operating position

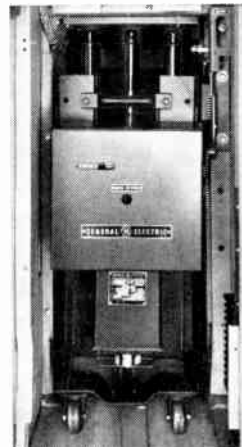

Breaker lowered, ready to be rolled out

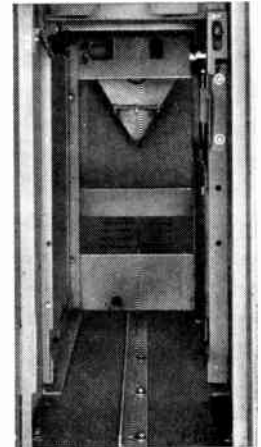

Structure with breaker and barrier removed to show pothead

G-E Medium-Voltage Switchgear

Standard Metal-Clad Equipments

Standard Light-Duty—Medium Voltage With Magne-blast Power Circuit Breakers

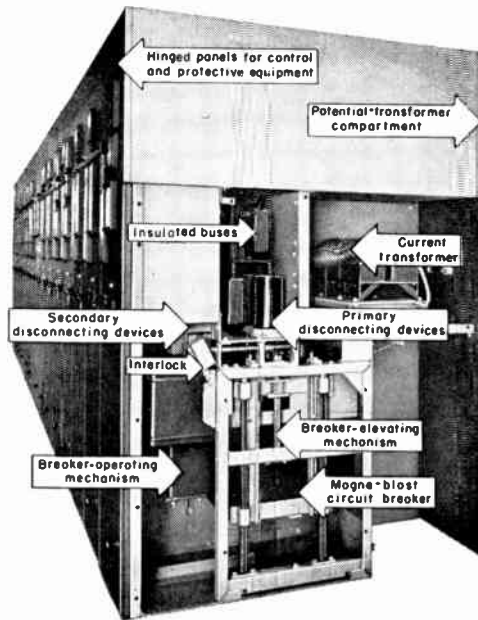

View of Standard, light-duty, metal-clad switchgear equipments—side plate removed to show relative location of component parts

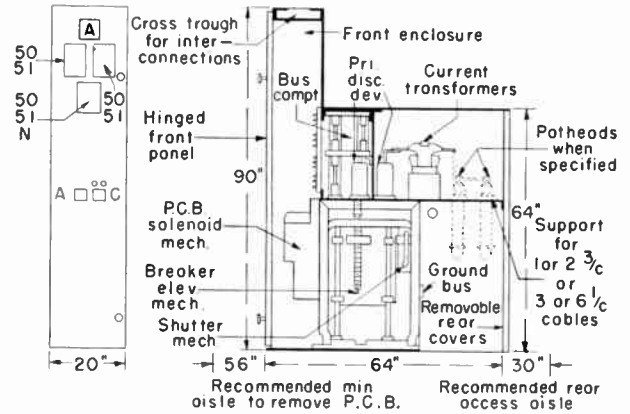

Front View Side View
Dimensions of standard feeder metal-clad unit.

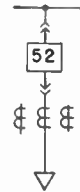

Schematic connections for feeder unit

For Additional Information Contact GRAYBAR

G-E Indoor Power Circuit Breakers

Type FK-33

2500 Volts—400 Amperes—15,000 Kva—12-Cycles Interrupting Time

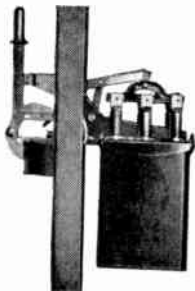

Fig. 1. Triple-pole, manually operated breaker for panel mounting. (Terminal connectors and trip coils not shown)

Application

These breakers are suitable for light-duty applications on circuits within their voltage and continuous-current ratings. The rated interrupting current of the breaker must be as great or greater than the maximum short-circuit current which it may be called upon to interrupt.

Prices Include

For Manually-Operated Breakers

Single-throw Breaker with Type IIA-2 trip-free manual mechanism, including necessary instantaneous or time trips. (Current transformers and relays not included.)

Standard bolted-type terminal connectors (no deduction for omission).

Necessary oil (2- and 3-pole breakers, 4 gallons; 4-pole breakers, 5 gallons).

Double-throw Breaker, complete with integral mechanical interlock and two operating levers, with mechanical cross trip.

Prices Include

For Electrically Operated Breakers, A-C or D-C

Single-throw Breaker, with Type MS-5B solenoid mechanism mounted back-to-back on a steel plate, direct-coupled.

Closing relay.

1—Potential trip coil (Current trip coils, relays, and current transformers not included).

4-stage auxiliary switch.

Terminal Board.

Standard bolted-type terminal connectors (no deduction for omission).

Necessary oil (2- and 3-pole breakers, 4 gallons; 4-pole breakers, 5 gallons).

Copper-oxide rectifier (if A-C operated).

Maintenance closing device, if required.

Double-throw Breaker, complete with two solenoid mechanisms, electrically interlocked.

G-E Indoor Power Circuit Breakers (Con't.)

Type FK-33

2500 Volts, 400 Amperes—15,000 Kva—12 Cycles Interrupting Time

Dimensions

Interrupting Kva.	Rated		Poles	Interrupting Rating		Approx. Net Wt., Lbs. Including Oil		Net Price Each — Single-throw Breaker*		
	Volts	Amperes at 25 and 60 Cycles		Rms. Total Amps.	At Rated Voltage	Maximum Rating	Manual Panel Mounted	Solenoid Operated D-C	Manually Operated Direct Operation for Panel Mounting	Solenoid D-C
15,000	2500	400	{ 2 or 3 4 }	3500	3800	{ 97 119 }	{ 248 270 }	\$360.00 500.00	\$640.00 780.00	\$815.00 965.00

Accessories and Attachments

Description	Net Price Each†	
	Manually Operated Breaker	Electrically Operated Breaker
Auxiliary Switch		
First stage.....	\$ 35.00	▲
Additional stages, up to a total of 8.....	5.00	\$ 8.00
Set of current trip coils.....	†	140.00
Undervoltage device, A-C or D-C		
Instantaneous (if current coils also are ordered).....	95.00	95.00
Instantaneous (if current coils are not ordered).....		175.00
Time delay (if current coils also are ordered).....	175.00	175.00
Time delay (if current coils are not ordered).....		255.00
Bell alarm switch.....	15.00

*For a DOUBLE-THROW breaker, the price is exactly twice that of the corresponding single-throw breaker.

†Included in price of breaker.

‡Prices apply only when sold with new breaker.

▲Four-stage switch included with breaker.

G-E Indoor Power Circuit Breakers

Following dimensions are subject to change and should not be used for construction without approval.

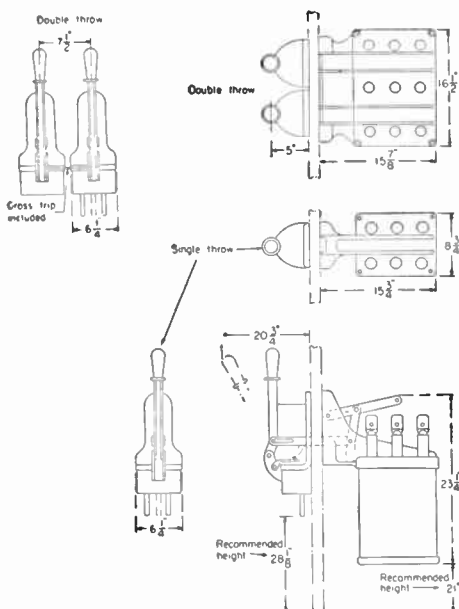

Fig. 2. Type FK-33 triple-pole, single- and double-throw manually operated breaker for panel mounting

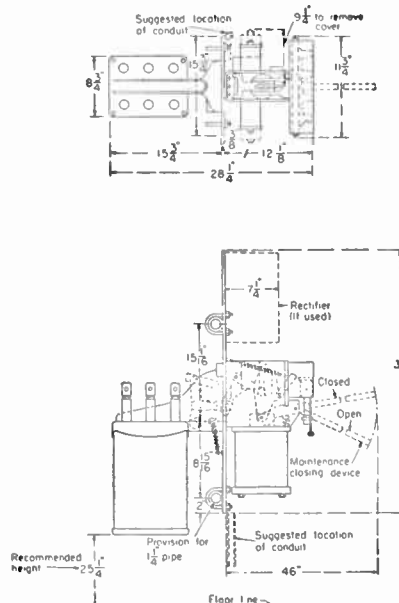
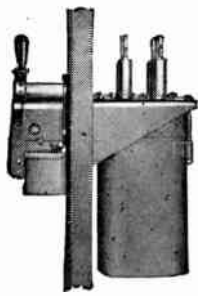
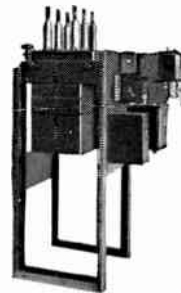
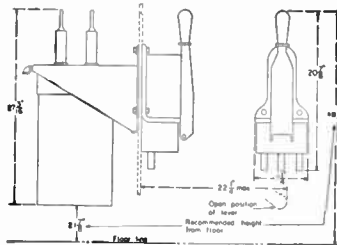
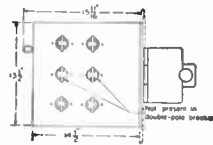

Fig. 3. Type FK-33 triple-pole, single-throw electrically operated breaker

G-E Indoor Power Circuit Breakers
Type FK-142 and FK-143



Type FK-142, triple-pole, 600 amp, manually operated, panel-mounted (Terminal connectors & trip coils not shown)



Type FK-143, triple-pole, 600 amp, electrically operated, frame-mounted (Terminal connectors not shown)

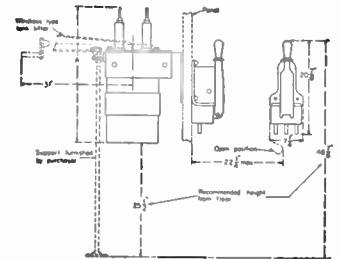
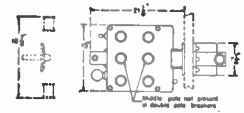

Application

These breakers are suited for medium-duty applications on circuits within their voltage and continuous-current ratings. The rated interrupting current of the breaker must be as great as, or greater than, the maximum short-circuit current which it may be called upon to interrupt.

Manually Operated

Single-throw Breaker: with Type HC-5 trip-free manual mechanism, including necessary instantaneous or time trips. (Current transformers and relays not included).

Standard bolted-type terminal connectors (no deduction for omission).

Necessary oil (2- and 3-pole FK-142 breakers, 6 gallons; 4-pole FK-142 breakers, 8 gallons; 2- and 3-pole FK-143 breakers, 9 gallons).

Double-throw Breaker: Consists of two single-throw breakers, with mechanical interlock and two operating levers with mechanical cross trip.

Prices Include

Electrically Operated A-C and D-C

Single-throw Breaker: with Type MS-5B trip-free solenoid mechanism, mounted back-to-back on a steel plate, direct-coupled, supported by steel framework.

Closing relay.

1-Potential trip coil. (Current-trip coils, relays and current transformers not included.)

4-stage Auxiliary switch.

Terminal board.

Standard bolted-type terminal connectors (no deduction for omission).

Necessary oil (2- and 3-pole FK-142 breakers, 6 gallons; 4-pole FK-142 breakers, 8 gallons; 2- and 3-pole FK-143, 9 gallons).

Copper-oxide rectifier (if a-c operated).

Maintenance closing device, if required.

Double-throw Breaker: Consists of two single-throw breakers and two solenoid mechanisms electrically interlocked.

Inter-rupting Kva and Type †	Rated		Poles	Interrupting Rating Rms. Total Amps. †		Approx. Net Wt. Lbs. Including Oil		Net Price Each Single-throw Breaker* Electrically Operated		
	Volts	Amps. at 60 Cycles ‡		At Rated Voltage	Maximum Rating	Manual Panel Mounted	Solenoid Operated D-C	Manually Operated Direct Operation for Panel Mounting	For Pipe Framework or Cell Mounting Solenoid D-C	Solenoid (Rectifier) A-C
25,000 FK-142	4160	600	2 or 3 4	3500	6300	225 235	390 460	\$ 565.00 795.00	\$ 850.00 1080.00	\$1025.00 1255.00
50,000 FK-143	7200 4160	600 1200	2 or 3	4000 7000	12,500	325 400	470 585	1230.00 1475.00	1480.00 1725.00	1765.00 2010.00

*For a double-throw breaker, the price is exactly twice that of the corresponding single-throw breaker.

†Interrupting rating of FK-142 breakers, based on CO-2 min-CO duty cycle, and of FK-143, based on CO-15 sec.-CO duty cycle.

‡25-cycle ratings, as compared with 60-cycle ratings, are 600-700, and 1200-1400.

Accessories and Attachments

Description	Net Price, Each*			
	Manually Operated FK-142	FK-143	Electrically Operated FK-142	FK-143
Auxiliary Switch				
First stage	\$ 35.00	\$ 35.00	†	†
Additional stages, up to a total of 8, each	5.00	5.00	\$ 8.00	\$ 8.00
Set of Current Trip Coils	†	†	140.00	140.00
Undervoltage Device, A-C or D-C				
Instanteous (if current coils are also ordered)	95.00	95.00	95.00	95.00
Instanteous (if current coils are not ordered)			175.00	175.00
Time Delay (if current coils also are ordered)	175.00	175.00	175.00	175.00
Time Delay (if current coils are not ordered)			255.00	255.00
Bell Alarm Switch	15.00	15.00		
Windlass-type Tank Lifter		175.00		175.00

*Prices apply only when sold with new breaker.

†Four-stage switch included with breaker.

‡Included in price of breaker.

G-E Outdoor Oil Circuit Breakers

Type FK-14.4—14.4 Kv.—600 to 1200 Amperes—100 to 250 Mva.

Interrupting Time—5 Cycles

Interrupting Ratings

Type	Ratings		Mva.	Interrupting Rating		Withstand Test Kv. 60-Cycle	Test Kv. Impulse
	Kv.	Amp. at 60 Cycles		At Rated Voltage	RMS Total Amp. Maximum Rating		
FK-14. 4-100	14.4	600	100	4,000	15,000	50	110
FK-14. 4-250	14.4	{ 600 1200 }	250	10,000	25,000	50	110

These ratings are based upon the standard duty cycle, consisting of two unit operations with either a 15 second or 2 minute interval. Any deviation from the standard duty cycle requires a modification of the standard ratings.

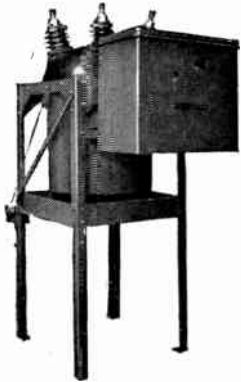

Type FK-14.4 Breaker

Interrupting Ratings

Breaker Type	Rating*			Breaker Only			Standard Automatic Reclosing Breaker			
	Kv.	Amp. at 60 Cycles	Mas.	Net Wt. Lbs. ▲Incl. Oil	Net Price Each Electrically Operated D-C	Net Price Each A-C	Net Wt. Lbs. ▲Incl. Oil	D-C Close D-C Trip	Net Price Each A-C Close D-C Trip	A-C Close A-C Trip
FK-14. 4-100	14.4	600	100	1555	\$3750.00	\$3750.00	1865	\$5910.00	\$5910.00	\$6365.00
FK-14. 4-250	14.4	600	250	1555	\$250.00	\$250.00	1865	7410.00	7410.00	7865.00
FK-14. 4-250	14.4	1200	250	1555	6200.00	6200.00	1865	8360.00	8360.00	8815.00

*Interrupting ratings are listed on next page.

▲FK-14.4 breaker uses 60 gallons of oil; F1.O, 25 gallons.

Prices Include

Electrical Operation A-C and D-C

- T-p, s-t breaker.
- Framework.
- Necessary trip coils (a-c or d-c).
- Auxiliary switch (10-stage).
- Latch checking switch.
- Closing relay.
- Clamp-type terminal connectors.
- Trip-free, motor-compressed-spring operating mechanism (for FK-14.4).
- 3-bushing transformers (relay type) in standard location (Bushings 1-3-5).
- Maintenance closing device.
- Operation counter.
- Necessary oil.
- Control power switch.

Standard Automatic Reclosing Breaker D-C Close and Trip

- Breaker complete, electrically operated, as listed under "Breaker Only," Plus:
- 1—Relay Cabinet, with:
 - 1—Reclosing relay (multi reclosures).
 - 3—Relays, time-overcurrent, single pole, arranged for d-c trip, with instantaneous unit if required.
 - 3—Miniature ammeters.
 - 1—Control switch, with red and green indicating lamps.
 - 1—Selector switch, to include or cut out reclosing feature.
 - Necessary small wiring.
 - Terminal boards, with designation strips.

A-C Close, D-C Trip

Same as d-c close and trip, Plus:

A-C Close and Trip

Same as a-c close, d-c trip, Plus:

Necessary modifications in trip coils to permit a-c tripping.

Optional Modifications

Standard Automatic Reclosing Breaker Only

One—Ground Relay, time-overcurrent, single pole, arranged for d-c trip, with instantaneous unit if required.....	\$200.00
Substitute 1 triplex thermal demand ammeter for 3 miniature ammeters.....	165.00

Accessories

Tank Lifter.....	160.00
------------------	---------------

G-E Small Outdoor Oil Circuit Breakers

Type FK-14.4

Dimensions are subject to change and should not be used for construction without approval

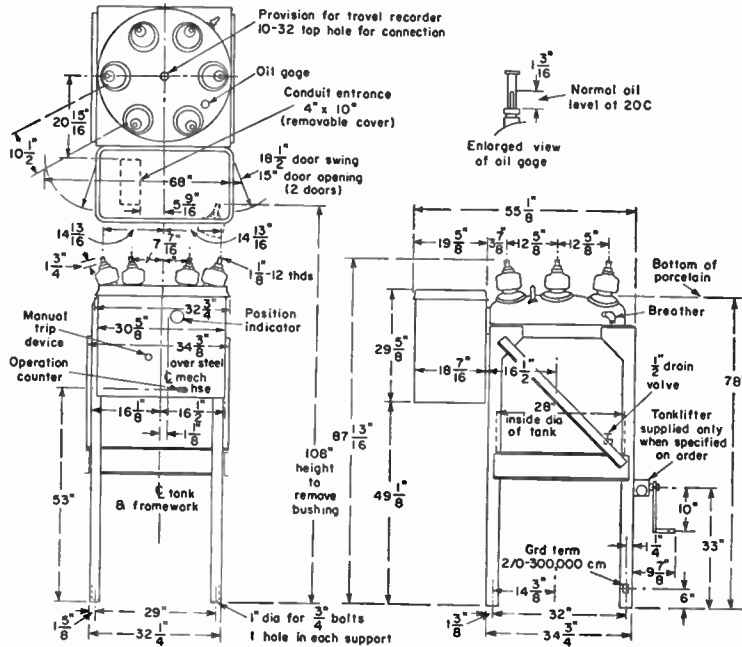

Frame-mounted, electrically operated, 600- and 1200-amp. Type FK-14.4 nonreclosing oil circuit breaker.

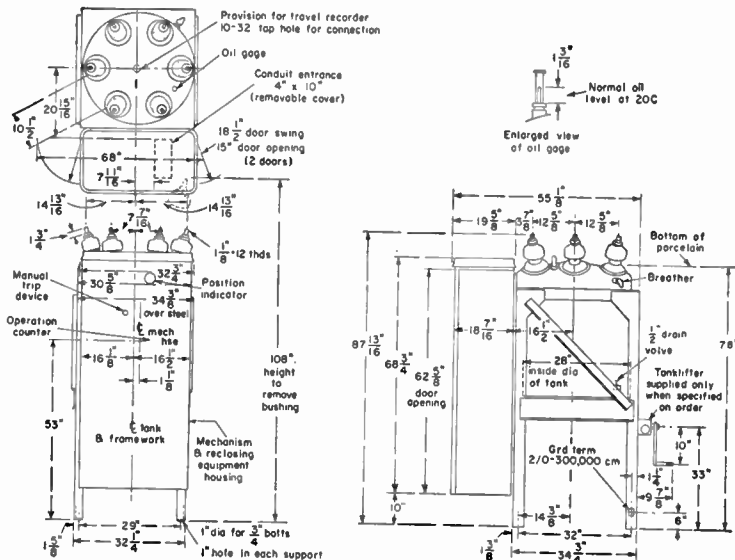

Frame-mounted, electrically operated, 600- and 1200-amp. Type FK-14.4 automatic reclosing oil circuit breaker

G-E Type HR Automatic Circuit Reclosers

50-Ampere Frame—2400-14,400 Volts (Line-to-Line)

60 Cycles—Single- and Three-Phase

Application

These reclosers provide overcurrent protection for rural and suburban distribution systems. They are designed for dependable year-round co-ordination between reclosers in series; and between reclosers and sectionalizing fuses, branch fuses, and external or internal transformer fuse fuses.

The rating of the recloser to be used is based primarily on normal load and maximum short-circuit current at the point of application.

The continuous current rating of the recloser should at least equal the normal load current. It is preferable to select a rating approximately $\frac{1}{3}$ higher than the load current to allow for future load growth. Reclosers have no overload rating and should not be applied beyond their continuous current rating.

The interrupting rating is given in terms of symmetrical short-circuit current. This simplifies the application by permitting the use of data from a conventional short-circuit study. All Type HR reclosers can interrupt off-set current up to 1.4 times the symmetrical value when the symmetrical value does not exceed the interrupting rating of the recloser. This factor of 1.4 is based on a system reactance to resistance ratio of 8 (maximum), which is seldom exceeded on distribution circuits.

Apply NEMA or AIEE derating factors for elevations above 3300 feet.



Fig. 1. Type HR single-phase recloser

Reclosers are available with different time-delay operating characteristics, providing a choice for "hold-closed" applications or for co-ordinating with reclosers of other manufacture. (See Fig. 2 and 3.)

Lightning Protection of Reclosers

Protection is required to limit to safe values voltage surges caused by lightning. Requirements are similar to those for distribution transformers on the same system.

Some protection can be had by connecting only one arrester to the side of the recloser having the longest length of line. As long as the recloser is closed, the internal Thyrite* unit will effectively by-pass a lightning surge from the other side. However, when the recloser is open, a lightning surge on the unprotected side could result in a bushing flashover and damage to the recloser. If this occurs on an unprotected source side, service is disrupted at least temporarily to additional customers.

It is preferable to provide complete protection by installing arresters on both sides of a recloser. One additional arrester is an especially good investment whenever the recloser serves a sizeable number of consumers.

The arresters should be a type which permits no sizeable 60-cycle follow-up current after a lightning surge. This will avoid unnecessary operations of the reclosers and needless blowing of fuses.

For Type HR 50-ampere frame reclosers, "Hi-stroke" rural lightning arresters are recommended. These may be conveniently mounted on either side of the recloser mounting bracket. These apply for altitudes up to 6000 feet and for systems where the line-to-ground symmetrical short-circuit current will not exceed 2000 rms amperes.

*Registered Trade-mark of General Electric Co.

Type HR Reclosers 14,400 Volts (Maximum Design Voltage 15,000 Volts) (Impulse-withstand Test—95 Kv)

Single-phase, 50-ampere Frame

*Recloser Basic Cat. No.	Continuous Current Rating RMS Amperes	Pick-up Current RMS Amperes (Nominal)	Interrupting Rating RMS Amperes	†Number of Instantaneous and Time-delay Trips (Maximum 4)	‡Type of Time Delay Desired See Curve Fig. 2 (Select One)	Hold-closed Operation §¶	Net Price, Each †	Approx. Wt., Lbs. Including Oil Net	Approx. Oil Capacity, Gal.
HR1-50-5	5	10	125						
HR1-50-10	10	20	250	Specify sequence	Specify B or C, depending on which	Specify sequence no.			
HR1-50-15	15	30	375	no. from Table	time curve is desired	21	\$175.00	98	115
HR1-50-25	25	50	625	2 e.g.: -22					5
HR1-50-35	35	70	875			(See Table 2)			
HR1-50-50	50	100	1250						

Three-phase, 50-ampere Frame

HR3-50-5	5	10	125						
HR3-50-10	10	20	250	Specify sequence	Specify B or C, depending on which	Not Available	\$640.00	340	425
HR3-50-15	15	30	375	no. from Table	time curve is desired				15
HR3-50-25	25	50	625	2 e.g.: -22					
HR3-50-35	35	70	875						
HR3-50-50	50	100	1250						

*Recloser Catalog Number does not include special mounting material; add from Table 3.

†Single-shot Lockout may be added by adding the suffix "SS" to the Catalog Number and increasing the price \$5.80 net.

‡Example: to specify a Type HR recloser, 1-phase, 50-ampere frame, 35-ampere rating with 2-instantaneous and 2-"B" time-delay trips, the Catalog Number would be HR1-50-35-22B.

§Example: To specify a Type HR recloser, 1-phase, 50-ampere frame, 35-ampere rating with "hold-closed" operation, the Catalog Number would be HR1-50-35-21.

¶In lieu of time delay. Single-phase only.

G-E Type HR Automatic Circuit Reclosers

Table 2—Tripping Sequences

*Sequence No.	Sequence Desired
13	One instantaneous & three time delay.
22	Two instantaneous & two time delay.
31	Three instantaneous & one time delay.
40	Four instantaneous & no time delay.
04	Four time delay.
21	Hold-closed operation.

*This sequence number is to be added to the basic catalog number to designate the desired tripping sequence.

Higher Ratings Available

Reclosers in the 100- and 200-ampere frame sizes are also available in both single- and three-phase units. They have interrupting ratings up to 2000 and 4000 amperes respectively, for the 100- and 200- ampere sizes for 14.4-kv service; and 3000 and 6000 amperes respectively for 4.8-kv service.

Table 3—Mounting Material

Cat. No.†	Recloser Type and Rating	Type of Mounting	Approximate Wt., Lb.		Net Price, Each	
			Net	Ship.	With Recloser Included	Separately
421A769G1 286B714G2	Single-phase 50-amp Frame	Direct-to-pole	5	8	\$ 3.00	\$ 3.30
		Crossarm	30	40	7.20	11.00
279B173G3	Three-phase 50-amp Frame	Extended Pole	50	70	17.75	17.75
		Crossarm				

†Basic catalog number of recloser includes provision for mounting.

Table 4—Hi-Stroke Rural Arrestors—For Mounting on 50-amp Reclosers

Model No.	Arrestor Maximum Permissible Line-to-ground Voltage, RMS	Maximum Phase-to-phase Circuit Voltage		Solidly Grounded Neutral	Approximate Wt., Lb.		List Price, Each
		Ungrounded Neutral			Net	Ship.	
9LA17E35	9000	6001-9000		9001-13800	7	9	\$37.00

Operating Characteristics

Lock-open Operation—Single- and Three-phase Reclosers

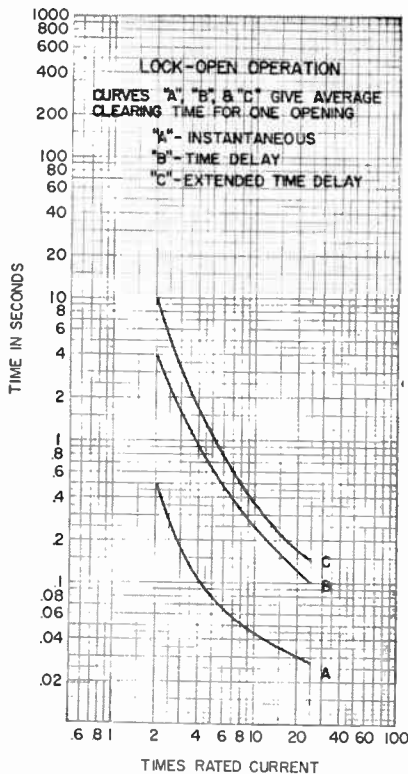

Fig. 2. Clearing time-current characteristic curves of 50-amp Type HR, single- and three-phase reclosers. Based on average values at 25° C. oil temperature. For co-ordination with reclosers of other manufacture.

Hold-closed Operation—Single-phase Recloser

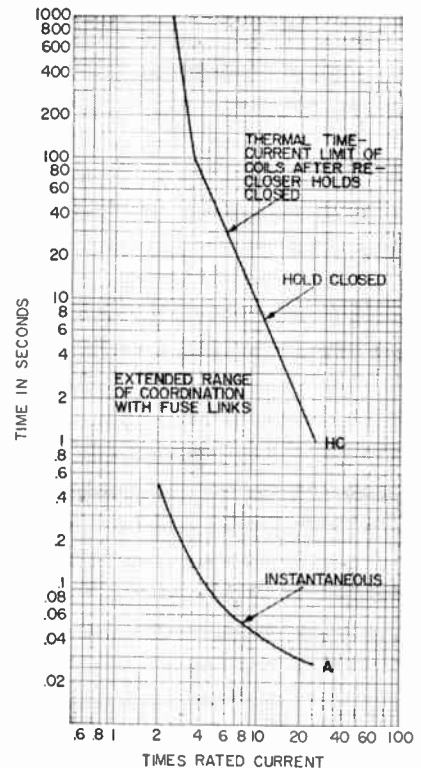
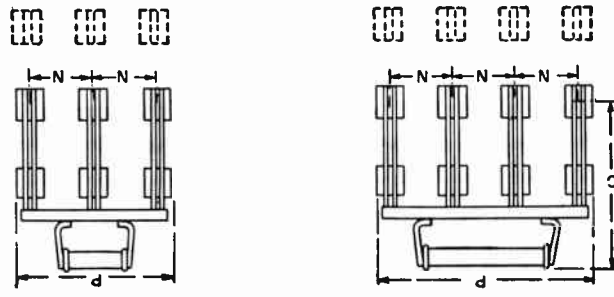
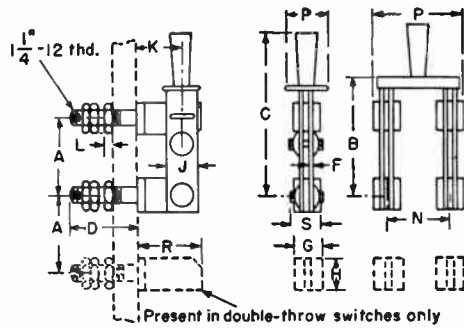

Fig. 3. Time-current characteristic curves of 50-amp, Type HR, single-phase recloser. Based on average values at 25° C. oil temperature.

G-E Indoor Knife Switches, Type LP-101

Back-Connected for Mounting on 1-, 1¼-, 1½-, or 2-Inch Panels

***Dimensions—Round Stud**



Voltage Rating		Ampere Rating	Throw	Dimensions in Inches													
D-C	A-C			A	B	C	D	F	G	H	J	K	L†	N	P	R	S
				Single-Pole													
250	500	1200	Single	6¾	10½	11½	4 ²¹ / ₃₂	¾	1⅝	3	3	3⅝	1	5¼ 5¼ 7 7	4 4 4 4	5⅜	1⅝
250	500	1200	Double	6¾	10½	11½											
600	600	1200	Single	9	12⅜	16⅝											
600	600	1200	Double	9	12⅜	16⅝											
				Double-Pole													
250	500	1200	Single	6¾	11	11⅜	4 ²¹ / ₃₂	¾	1⅝	3	3	3⅝	1	5¼ 5¼ 7 7	6⅞ 6⅞ 8⅝ 8⅝	5⅜	1⅝
250	500	1200	Double	6¾	11	11⅜											
600	600	1200	Single	9	13¼	16⅞											
600	600	1200	Double	9	13¼	16⅞											
				Triple-Pole													
250	500	1200	Single	6¾	11	15½	4 ²¹ / ₃₂	¾	1⅝	3	3	3⅝	1	5¼ 5¼ 7 7	12⅞ 12⅞ 15⅝ 15⅝	5⅜	1⅝
250	500	1200	Double	6¾	11	15½											
600	600	1200	Single	9	13¼	17⅝											
600	600	1200	Double	9	13¼	17⅝											
				Four-Pole													
250	500	1200	Single	6¾	11	15½	4 ²¹ / ₃₂	¾	1⅝	3	3	3⅝	1	5¼ 5¼ 7 7	17⅞ 17⅞ 22⅞ 22⅞	5⅜	1⅝
250	500	1200	Double	6¾	11	15½											
600	600	1200	Single	9	13¼	17⅞											
600	600	1200	Double	9	13¼	17⅞											

*Dimensions are subject to change without notice and therefore should not be used for construction without approval.

†When switch is mounted on 2-in. thick panel, dimension "L" becomes ½-in.

G-E Knife Switches

Type LP-101

Back-Connected, for Mounting on 1-, 1¼-, 1½-, or 2-Inch Panels Laminated Studs*†

Dimensions

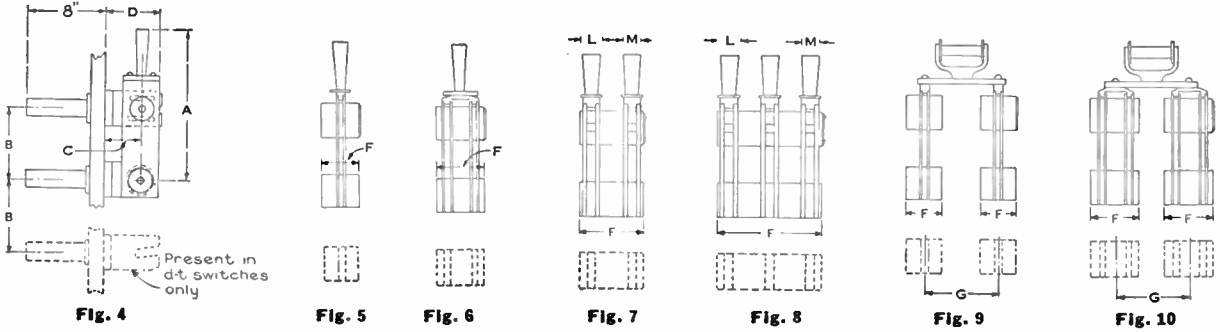

250 Volts D-C or 500 Volts A-C

Amp		Fig. No.	A				Dimensions in Inches				
D-C	A-C		S.P.	O.P.	T.P.	4P	B	C	D	F	G
1600	1600	4, 5, 9	13 ³ / ₁₆	11 ⁹ / ₁₆	14 ³ / ₈	14 ³ / ₈	5 ³ / ₄	4	5 ⁷ / ₈	3 ¹ / ₂	5 ³ / ₄
2500	2000	4, 6, 10	12 ³ / ₄	14 ¹ / ₈	13 ¹⁵ / ₁₆	13 ¹⁵ / ₁₆	5 ³ / ₄	4	5 ⁵ / ₈	4	6 ¹ / ₂
4000	3000	1, 6, 10	11 ¹ / ₈	15 ³ / ₄	15 ⁹ / ₁₆	15 ⁹ / ₁₆	6 ³ / ₄	4 ¹ / ₄	6 ³ / ₈	5	6 ¹ / ₂
6000	4000	4, 7	15 ¹ / ₁₆	7 ¹ / ₂	5 ¹ / ₈	7 ³ / ₄	6 ³ / ₄
8000	5000	4, 8	15 ¹ / ₁₆	7 ¹ / ₂	5 ¹ / ₈	7 ³ / ₄	10 ³ / ₄
10000	6000	4, 8	15 ¹ / ₁₆	7 ¹ / ₂	5 ¹ / ₈	7 ³ / ₄	10 ³ / ₄

600 Volts A-C or D-C

Amp		Fig. No.	A				Dimensions in Inches				
D-C	A-C		S.P.	O.P.	T.P.	4P	B	C	D	F	G
1600	1600	4, 5, 9	15 ¹ / ₁₆	16 ⁷ / ₁₆	16 ¹ / ₂	16 ¹ / ₄	7 ⁷ / ₈	4	5 ⁷ / ₈	3 ¹ / ₂	9 ⁷ / ₈
2500	2000	4, 6, 10	14 ⁵ / ₈	16	15 ¹³ / ₁₆	15 ¹³ / ₁₆	7 ⁹ / ₈	4	5 ⁵ / ₈	4	10 ³ / ₄
4000	3000	4, 6, 10	16 ⁵ / ₈	18	17 ¹³ / ₁₆	17 ¹³ / ₁₆	9	4 ¹ / ₄	6 ³ / ₈	4	10
6000	4000	4, 7	16 ¹ / ₁₆	8 ¹ / ₂	5 ¹ / ₈	7 ³ / ₄	6 ³ / ₄
8000	5000	4, 8	16 ¹ / ₁₆	8 ¹ / ₂	5 ¹ / ₈	7 ³ / ₄	10 ³ / ₄
10000	6000	4, 8	16 ¹ / ₁₆	8 ¹ / ₂	5 ¹ / ₈	7 ³ / ₄	10 ³ / ₄

*Dimensions apply whether stud laminations are horizontal or vertical.
†Dimensions are subject to change without notice.

Dimensions of Laminated Studs

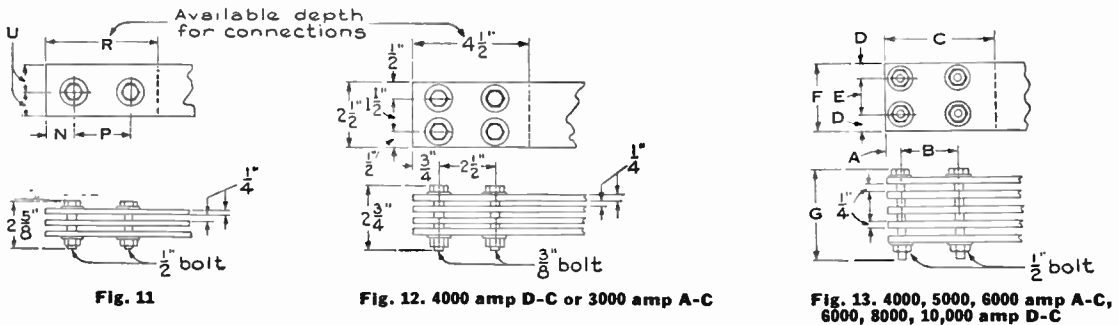

Dimensions in Inches

Fig.	D-C	Amp	A-C	Horizontal or Vertical Laminations No. of Laminations	Horizontal or Vertical Laminations No. of Laminations								
					N	P	R	U	A	B	C	D	E
11	1600	1600		3	5 ⁵ / ₈	13 ³ / ₄	3 ¹ / ₂	7 ⁷ / ₈		7 ⁷ / ₈	13 ³ / ₄	3 ¹ / ₂	3 ⁷ / ₈
11	2500	2000		3	3 ³ / ₄	2 ¹ / ₂	4 ¹ / ₂	1 ¹ / ₈		7 ⁷ / ₈	13 ³ / ₄	3 ¹ / ₂	2 ¹ / ₂
12	4000	3000		4	See fig. 12 above.								
13	6000	4000		5						7 ⁷ / ₈	13 ³ / ₄	4 ¹ / ₂	3 ⁷ / ₈
13	8000	5000		2 groups of 3—Total 6						7 ⁷ / ₈	13 ³ / ₄	4 ¹ / ₂	3 ¹ / ₂
13	10000	6000		2 groups of 4—Total 8						7 ⁷ / ₈	13 ³ / ₄	4 ¹ / ₂	3

*Dimensions are subject to change and should not be used for construction without approval.

G-E Components for Outdoor Substations

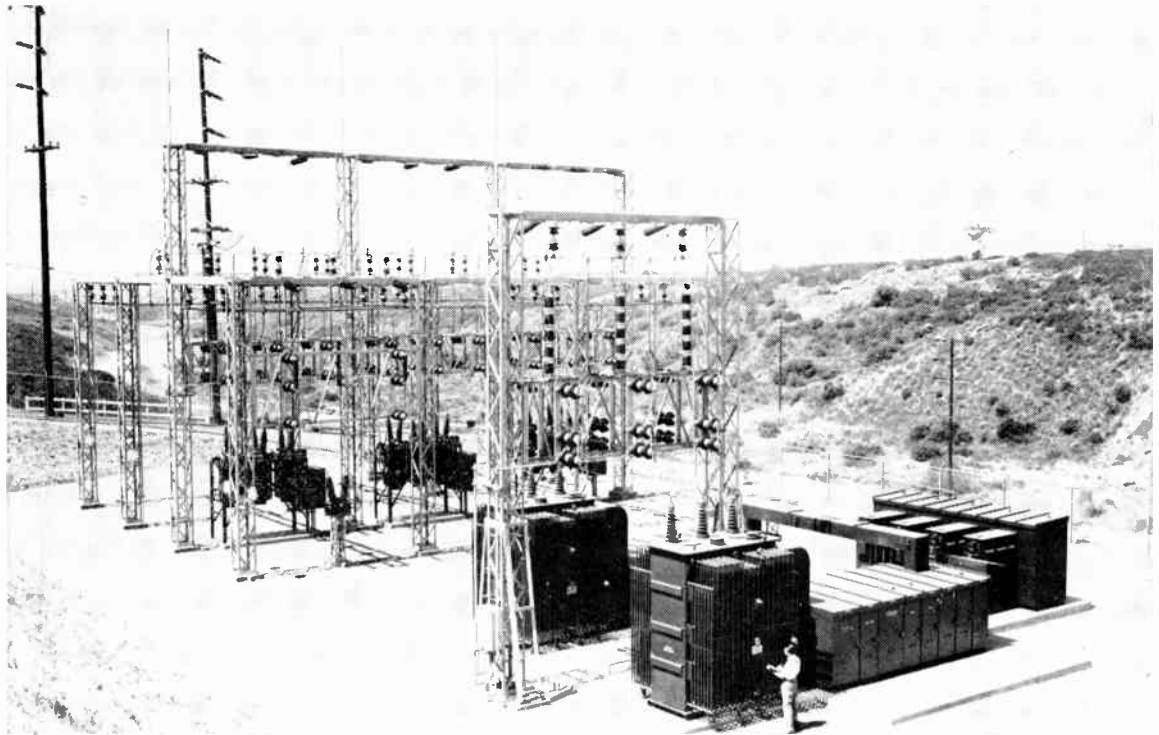

General Electric has designed and built thousands of outdoor substations many of which are the largest of their kind.

A variety of standardized completely co-ordinated, factory-built step-up and step-down stations in standard voltage and kva ratings are available.

These substations are carefully and completely engineered to meet the exacting requirements of outdoor service and to conform to NEMA Standards. Complete lines of General Electric apparatus such as transformers, power circuit breakers, power fuses, switches, lightning arresters, insulators, and connectors are available and they are used as components of these substation equipments. Full responsibility for design and manufacture of the entire station thus rests with General Electric and the purchaser is relieved of all details of design and co-ordination.

Inquiries for stations to meet any need are solicited and such inquiries should be accompanied by the following minimum of information to enable the engineers to prepare complete plans and specifications.

1. A one-line diagram of the proposed station upon which the following information should be recorded.
 - (a) Circuit layout
 - (b) Transformer ratings (kva)
 - (c) Line and feeder ratings (amps)
 - (d) Circuit voltages and frequency
 - (e) Circuit grounding
 - (f) Required metering and instrumentation
 - (g) Required protective relaying
 - (h) Maximum available short-circuit at the station terminal of each incoming line and tie feeder.
 2. Plan of available ground space showing:
 - (a) Dimensions
 - (b) Points and directions of entry of all lines and feeders.
 - (c) Any minimum clearance requirements of lines and feeders beyond boundaries of station plot.
 3. Size, type, and material of conductors of all lines and feeders.
 4. Automatic features required such as automatic reclosing or emergency line switching.
- Contact Graybar for full information.

G-E Components for Outdoor Substations (Cont.)

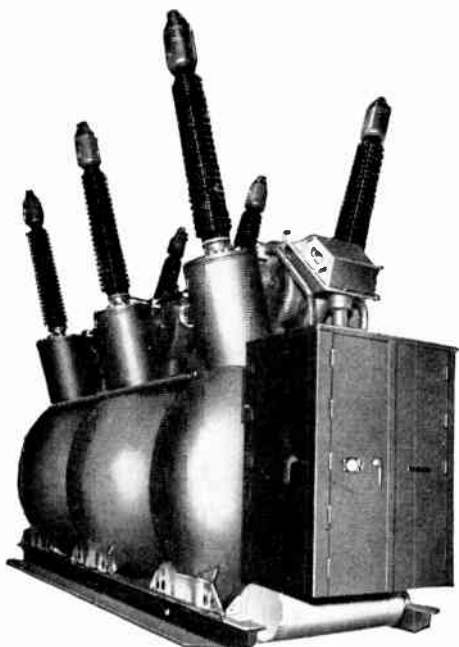

Type FGK-230-10000 power circuit breaker rated 230 kv, 1600 amperes. Available in ratings from 115 to 315 kv.

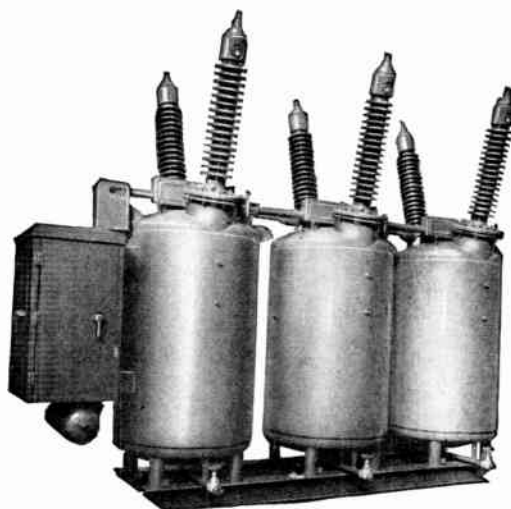

Floor-mounted Type FK-139 oil-blast power circuit breaker rated 138 kv, 1200 amperes. Available in ratings from 69 to 161 kv.

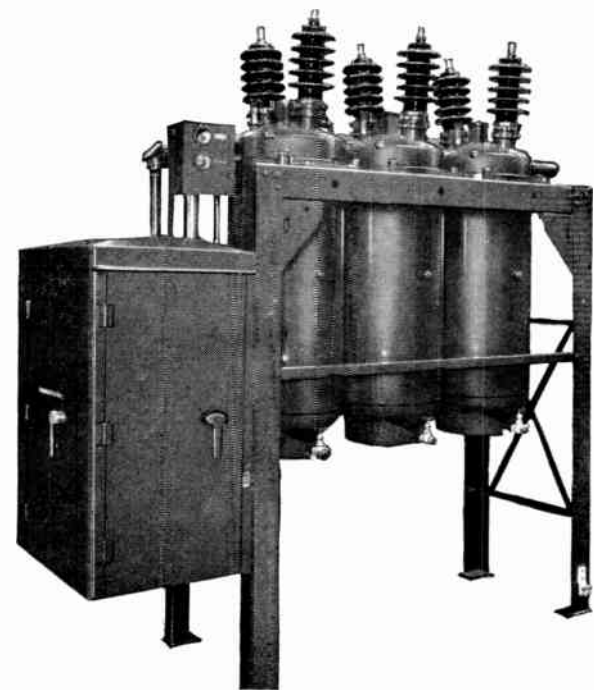

Framework mounted Type FK-34.5 oil-blast power circuit breaker rated 34.5 kv, 600 amperes. Available in ratings from 14.1 to 69 kv.

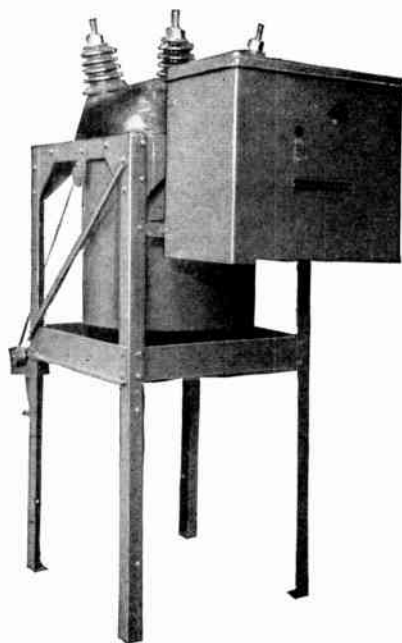

Framework mounted Type FK-11.4-100 oil-blast power circuit breaker rated 11.4 kv. Type FK-227 breaker also available for circuits rated 7.2 kv.

G-E Components for Outdoor Substations (Cont.)

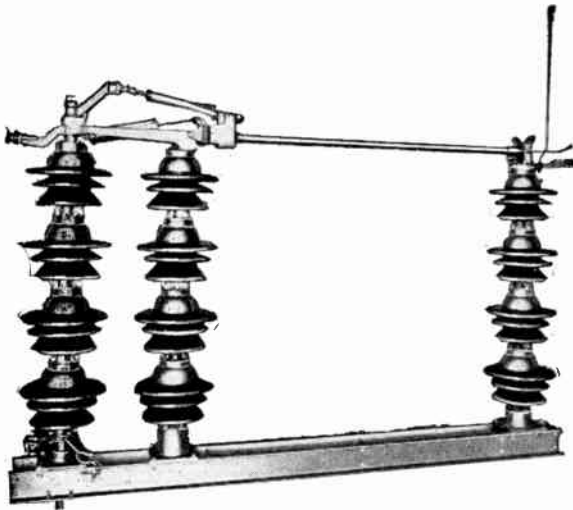

Single-pole element of Type RF group-operated switch rated 161 kv. Other ratings from 7.2 to 315 kv are available.

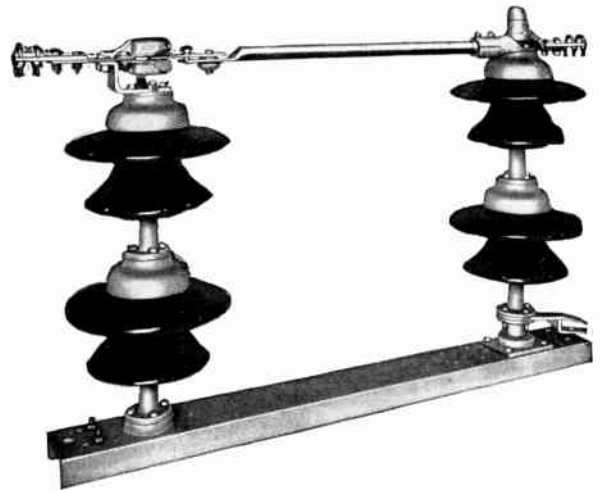

Single-pole element of Type RB group-operated switch rated 69 kv. Other ratings from 7.2 to 115 kv are available.

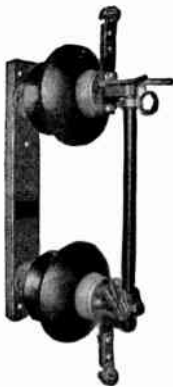

Type EF-1 non-dropout expulsion fuse disconnecting switch.



Type EF-2 dropout expulsion fuse disconnecting switch.

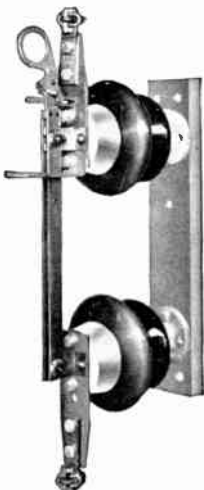

Type FA hook-operated disconnecting switch.

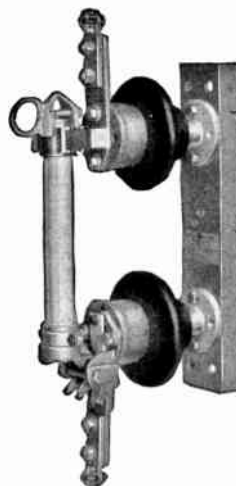

Type EKO-3C current-limiting fuse disconnecting switch.

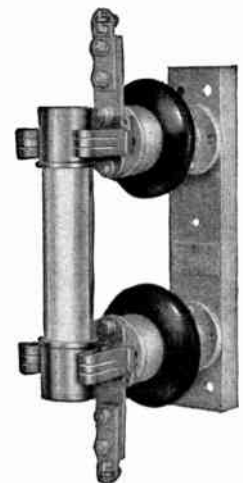

Type EKO-1D current-limiting fuse support (non-disconnecting).

G-E Components for Outdoor Substations (Cont.)

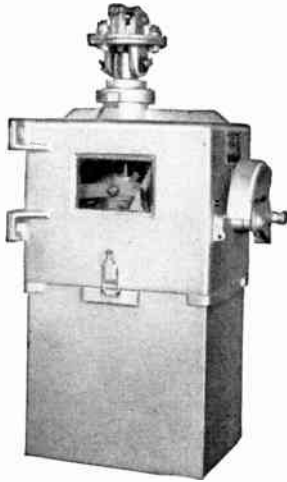

Type MR-8 motor operating mechanism may be applied to any group-operated switch.



Insulator rated 69 kv heavy duty. Ratings from 7.2 to 345 kv are available.



Variable-size bus support fitting.



Reamed-to-size bus support fitting.

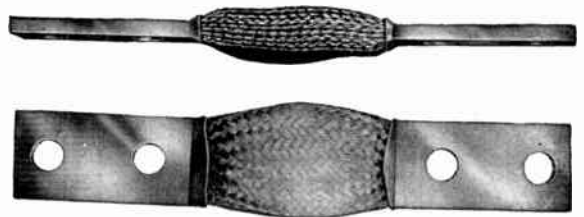

Class E flexible expansion connector.



Stud terminal connector.



Tee connector.



Single-bolt block terminal connector



Ground connector.

G-E Tilting Insulator Air Switch

**Type TA Outdoor, Group Operated
7.2 KV Thru 34.5 KV 400,600 Amps**

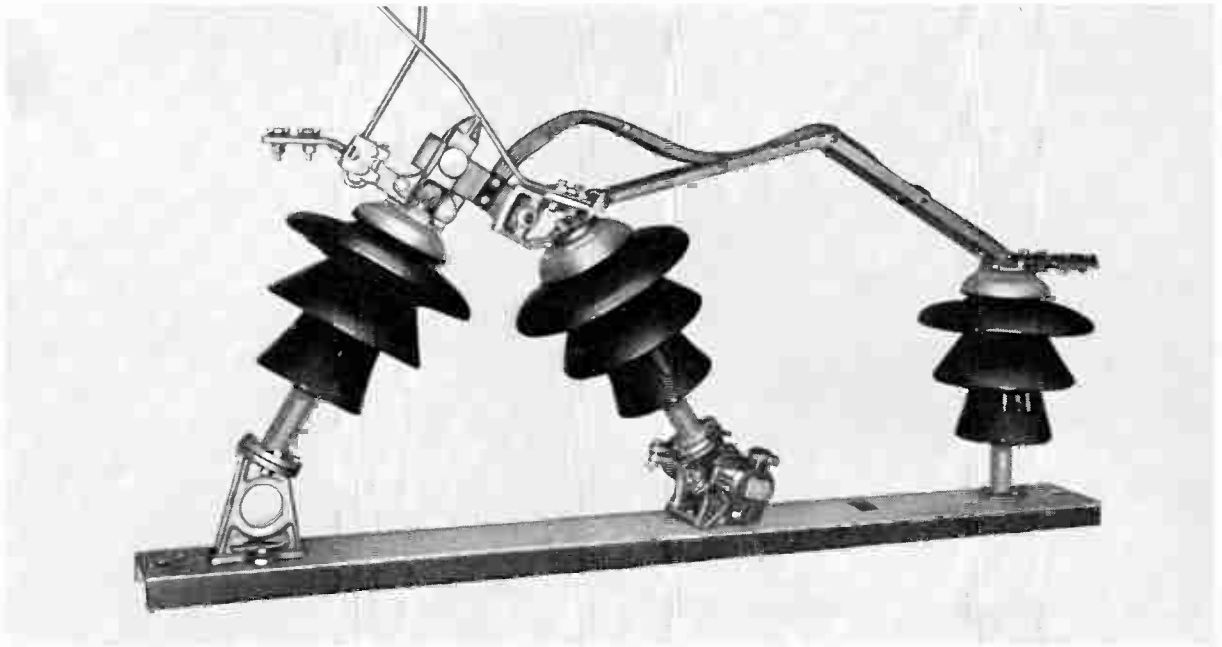

Type TA Switches provide highly dependable low-cost switching for power circuit breaker isolation, for opening primaries of power transformer banks and for sectionalizing transmission lines.

When arcing horns are used, the switch will interrupt magnetizing current of transformer banks. The TA horn gap

switch may be used to interrupt small load currents in an emergency, but it is not recommended for general load-breaking duty nor for breaking line-charging currents of appreciable magnitude.

Consult Graybar for complete information and prices.

Rated Kv *	Voltage Ratings		Insulation Level Withstand Test		Insulator NEMA Technical Reference No.	Current Rating in Amperes		
	Max. Design Kv †		Low Frequency RMS Kv (Drz)	Impulse (Crest Value) Kv ‡		Continuous at 60 Cycles	Momentary §	4 Second ¶
7.2	8.25		36	95	1	400	20000	12500
						600	40000	25000
14.4	15.5		50	110	4	400	20000	12500
						600	40000	25000
23	25.8		70	150	7	400	20000	12500
						600	40000	25000
34.5	38		95	200	10	400	20000	12500
						600	40000	25000

*Rated voltage is the highest nominal system voltage on which the switch is intended to be applied. Nominal system voltage refers to the general voltage class designation by EEI-NEMA Joint Committee on "Preferred Voltage Ratings for A-c Systems and Equipment," EEI Publication R-6, NEMA 117.

†The maximum design voltage is the highest rms voltage at which the switch is designed to operate.

‡Positive or negative 1.5 x 40 ms wave. Impulse values listed are phase-to-phase and phase-to-ground.

§The momentary current rating is the maximum rms total

current which the switch shall be required to carry for at least one cycle. The current shall be the rms value, including the d-c component, during the maximum cycle as determined from the envelope of the current wave, and the test period shall be at least one second.

¶The four-second rating is the total rms current, including the d-c component if present, which the switch shall be required to carry for four seconds. For practical purposes, this current shall be taken as the integrated heating equivalent of the four-second rating; the maximum test period shall not exceed eight seconds.

G-E Tilting Insulator Air Switch (Cont.)

Outdoor, Group Operated
 Type TA 7.2 KV Thru 34.5 KV 400,600 Amps

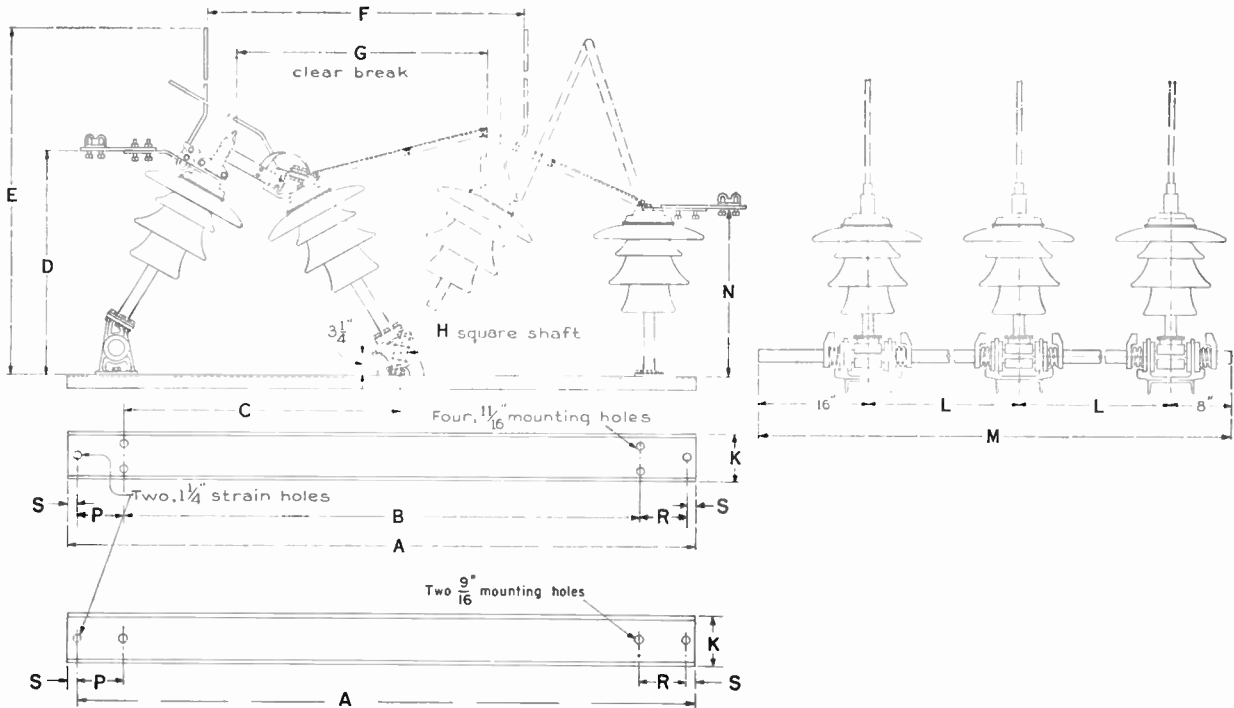

Rating		Approximate Dimensions in Inches																	
Kv	Amp.	Fig. No.	A	B	C	D	E	F	G	H	K	L	Disc. Sw.	M	Disc. Sw.	N	P	R	S
7.2	400	102	41"	36"	18 1/2"	8"	32"	16"	9 1/2"	1 1/4"	3" [4.1#/Ft.]	36"	18"	96"	60"	7 3/4"	1 1/4"	1 1/4"	1 1/4"
14.4	400	102	41"	39"	19 1/4"	10 1/2"	31 1/2"	18"	12 3/4"	1 1/4"	3" [4.1#/Ft.]	36"	24"	96"	72"	10 1/4"	1 1/4"	1 1/4"	1 1/4"
23	400	101	62 1/2"	45"	32"	21 3/4"	59"	26"	18"	1 1/2"	5" [6.7#/Ft.]	48"	...	120"	...	12 3/4"	1 1/4"	13 3/4"	1 1/4"
34.5	400	101	62 1/2"	51"	32 1/2"	21 1/4"	61 1/2"	31"	22"	1 1/2"	5" [6.7#/Ft.]	60"	...	141"	...	15 3/4"	1 1/4"	7 3/4"	1 1/4"
7.2	600	101	48"	43"	20 1/2"	17 3/4"	55 1/4"	20"	14"	1 1/2"	5" [6.7#/Ft.]	36"	...	96"	...	7 3/4"	1 1/4"	1 1/4"	1 1/4"
14.4	600	101	62 1/2"	39"	28"	20"	57 1/4"	20"	16"	1 1/2"	5" [6.7#/Ft.]	36"	...	96"	...	10 1/4"	5"	15 3/4"	1 1/4"
23	600	101	62 1/2"	45"	32"	21 1/2"	59"	26"	18"	1 1/2"	5" [6.7#/Ft.]	48"	...	120"	...	12 3/4"	1 1/4"	15"	1 1/4"
34.5	600	101	62 1/2"	51"	32 1/2"	21 1/4"	61 1/2"	31"	22"	1 1/2"	5" [6.7#/Ft.]	60"	...	144"	...	15 3/4"	1 1/4"	7 3/4"	1 1/4"

Dimensions are subject to change and should not be used for construction without approval.

Substation Fence Enclosures

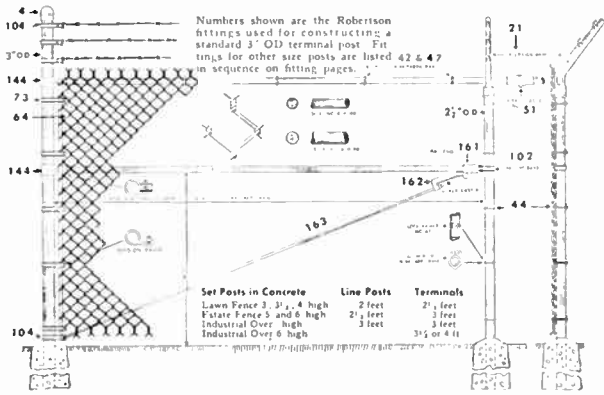

Fabric is 1-ft. less than height of fence. 2-in. diamond mesh, 9 gauge wire galvanized after weaving (also 11 gauge and 6 gauge). Advise if special galvanizing coat is required.

Top rail and braces 1 5/8-in. O.D. heavy galvanized steel pipe.

Line posts of heavy galvanized pipe, set 2 1/2 to 3-ft. in concrete.

Barb wire extension 45 degree or vertical pressed steel arms on malleable base to take 3 strands, 4 point, 12 1/2 gauge barb wire.

End, Corner and Gate Posts 2 1/2-in. O.D. or 3-in. O.D. heavy galvanized pipe, 4-in. O.D. for larger gates.

Gates to match. Single walk or double drive, 1 5/8-in. O.D. or 2-in. O.D. galvanized pipe frames; locking device. State opening between gate posts.

No. 64TR Line Post O.D. 2-in.
 No. 65TR Line Post O.D. 2 1/2-in.

Note—Mail in diagrams of fence enclosures with dimensions and any specifications other than above styles for delivered net prices.

Usual height is 84-in. overall including 3 strands of barb wire. (Also furnished 6 to 10-ft. high.)

Chance Hookstick Disconnecting Switches

Single-Pole, Single-Throw

Type BT

100-600-1200 Amp
Full NEMA-Rated

For substation and line applications where maximum mechanical and electrical reliability are required.

Rigid blade design and self-aligning contacts mean positive closing even when operated with heavy side thrusts.

Feature blade latching, pryout opening and centered contact pressure. Silver-to-silver contacts; 400 and 600 amp switches also available with copper-to-copper contacts.

Flanged base furnished as standard; channel base also available when specified.

Specify size and type of conductor on order.

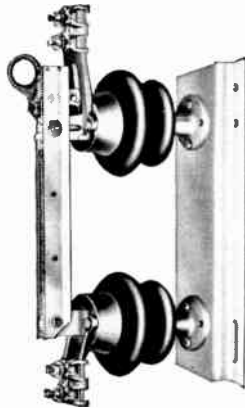

‡400 Amp

KV	*No. Vertical Mounting	*No. Underhung Mounting	Approx. Shipping Wt. Lbs.	Each
7.5	82000	82100	58	\$82.00
15	82006	82106	78	92.00
23	82012	82112	96	105.00
34.5	82024	82124	143	135.00

‡600 Amp

7.5	82001	82101	58	\$82.00
15	82007	82107	78	92.00
23	82013	82113	96	105.00
34.5	82025	82125	147	135.00

1200 Amp

7.5	82002	82102	63	\$145.00
15	82008	82108	83	155.00
23	82014	82114	101	175.00
34.5	82026	82126	156	210.00

‡When desired with copper-to-copper contacts, specify and deduct \$5.00 each.

*With cap and pin insulators. When specified, station post insulators will be furnished at no extra cost; add prefix "S" to catalog number.

Type BTH

2000 Amp
Full NEMA-Rated

Rugged, high-current switch for vital industrial circuits. Toggle-jaw action combines high-pressure contact performance with unusual ease of operation.

High-pressure silver-to-copper hinge and jaw contacts, and the bus-bar copper hot parts provide a high-conductivity, straight-line current path.

Double-latch holds blade securely in closed position. Available with flanged steel base, or channel base when specified.

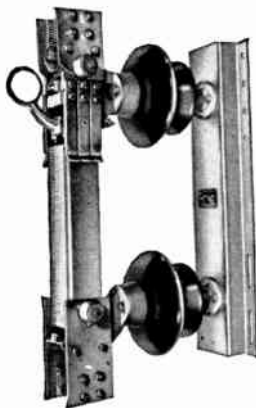

KV	*No. Vertical Mounting	*No. Underhung Mounting	Approx. Shipping Wt. Lbs.	†Each
7.5	82300	82310	116	\$270.00
15	82301	82311	128	285.00
23	82302	82312	150	320.00
34.5	82303	82313	196	390.00

†Less terminals. Contact Graybar for complete data.

*With standard strength cap and pin insulators. When specified, station post insulators will be furnished at no extra cost; add prefix "S" to catalog number.

Type BTL

200 Amp
NEMA-Insulated

An economical unit for light-load circuits where full NEMA insulation is required.

Has "big switch" features for ease and reliability of operation. Rigid truss blade resists side thrusts; has 90° stop. Positive latch holds blade in closed position; opens with pryout action.

Multi-finger contacts are self-wiping; have phosphor bronze back-up springs.

Galvanized flanged base has pull-off eyes for dead-ending direct to switch.

General purpose terminals

take No. 6 to 4/0 copper or No. 6 to 3/0 ACSR.

KV	*No. Vertical Mounting	*No. Underhung Mounting	Approx. Shipping Wt. Lbs.	Each
7.5	82270	82273	51	\$48.00
15	82271	82274	60	55.00
23	82272	82275	81	69.00

Crossarm hanger No. 92851 also available, \$2.00 each.

*With cap and pin insulators. When specified, station post insulators will be furnished at no extra cost; add prefix "S" to catalog number.

Type M

200 & 400 Amp

Distribution-Level Insulated
Ideal for rural lines, suburban circuits, small subs, or wherever an inexpensive, distribution-level insulated switch is required.

Simple to install; no adjustments. Self-aligning contacts. Rigid double blade made of high-conductivity bus-bar copper; latch secures blade in closed

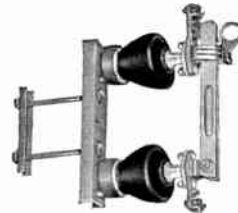

position. Pryout action makes opening easy. Furnished complete with crossarm hanger.

200 Amp

Terminals take from No. 6 to 2/0 copper or No. 6 to 2/0 ACSR.

KV	With Channel Base as Illustrated			With Dead-Ending Base		
	No.	Approx. Shipping Wt. Lbs.	Each	No.	Approx. Shipping Wt. Lbs.	Each
7.5	3171	21	\$32.40	3171-H	22	\$33.40
15	3181	33	35.60	3181-H	36	36.60
23	3191	40	46.40	3191-H	43	47.40

400 Amp

Terminals take from No. 6 to 400 MCM copper or No. 6 to 336.4 (26/7) ACSR.

7.5	3173	23	\$43.20	3173-H	24	\$44.20
15	3183	35	46.40	3183-H	38	47.40
23	3193	42	57.20	3193-H	45	58.20

**For Complete Information
on all your
Power Switching Equipment Needs
Contact Graybar**

Chance Tilting Insulator Switches

3-Pole, Single Throw

Have Compensator Control Mechanism that automatically absorbs structural distortion and provides positive contact in all phases regardless of crossarm warpage, prevents shock in closing, simplifies installation and gives extra leverage for easy operation under the severest operating conditions. Blades have Crow Bar Action for ice-breaking.

Full NEMA-rated, with silver-to-silver contacts and self-aligning clips. Deep-drawn galvanized steel base houses Compensator Control; flanges prevent cutting of crossarm. All mounting holes $\frac{9}{16}$ in. diameter.

Standard terminal clamps take $\frac{1}{2}$ in. and $\frac{3}{4}$ -in. IPS tubing or No. 4 through 600 MCM copper cable. For other sizes and types of conductor, specify size and type on order.

Type WN—3-Insulator

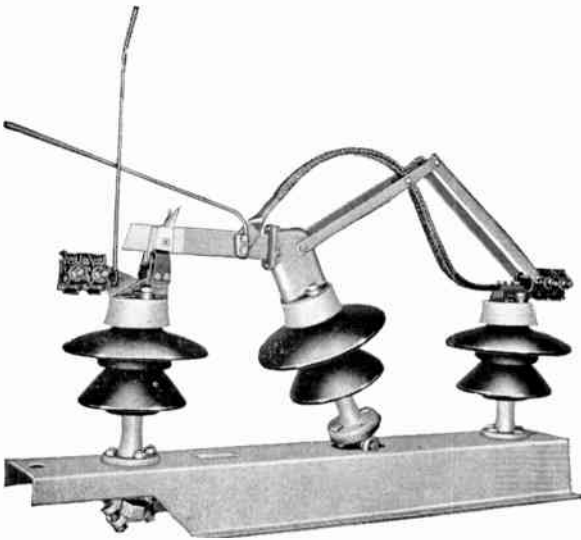

200 Amp

KV	With Steel Interphase Shaft		With Wood Interphase Shaft	
	*No.	†Each	*No.	†Each
7.5	F-54750	\$418.00	F-54750-W	\$453.00
15	F-54752	429.00	F-54752-W	464.00
23	F-54754	591.00	F-54754-W	626.00
34.5	F-54758	663.00	F-54758-W	698.00

400 Amp

7.5	F-54000	\$580.00	F-54000-W	\$615.00
15	F-54003	597.00	F-54003-W	632.00
23	F-54006	669.00	F-54006-W	704.00
34.5	F-54012	758.00	F-54012-W	793.00

600 Amp

7.5	F-54001	\$640.00	F-54001-W	\$675.00
15	F-54004	658.00	F-54004-W	693.00
23	F-54007	736.00	F-54007-W	771.00
34.5	F-54013	832.00	F-54013-W	867.00

Type VN—2-Insulator

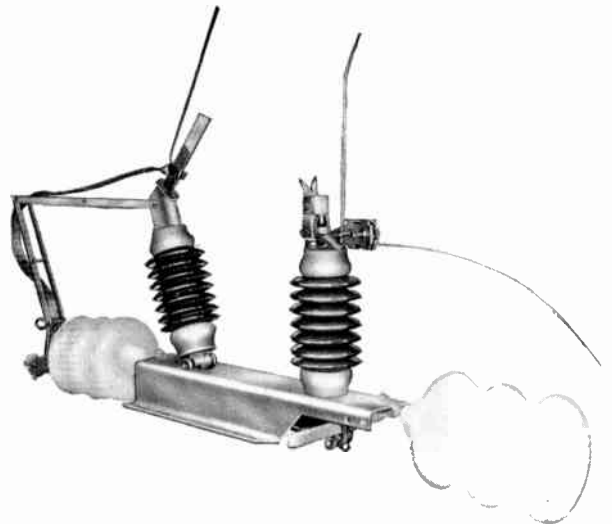

200 Amp

KV	With Steel Interphase Shaft		With Wood Interphase Shaft	
	*No.	†Each	*No.	†Each
7.5	F-55750	\$373.00	F-55750-W	\$408.00
15	F-55752	381.00	F-55752-W	416.00
23	F-55754	540.00	F-55754-W	575.00
34.5	F-55758	592.00	F-55758-W	627.00

400 Amp

7.5	F-55000	\$550.00	F-55000-W	\$585.00
15	F-55003	563.00	F-55003-W	598.00
23	F-55006	613.00	F-55006-W	648.00
34.5	F-55012	672.00	F-55012-W	707.00

600 Amp

7.5	F-55001	\$597.00	F-55001-W	\$632.00
15	F-55004	607.00	F-55004-W	642.00
23	F-55007	674.00	F-55007-W	709.00
34.5	F-55013	736.00	F-55013-W	771.00

*With cap and pin insulators. When specified, station post insulators will be furnished at no extra cost; change catalog number prefix from "F" to "E".

†Price includes 3-phase unit complete with control from list below.

Chance Switch Control Mechanisms

With Steel Interphase Shaft and Steel Vertical Control Rod.

Interphase Shaft Lgth. Ft.	Select Catalog No. Below for Total Vertical Control Rod Desired				
	20 ft.	25 ft.	30 ft.	35 ft.	40 ft.
† 8	2700	2701	2702	2703	2780
†10	2704	2705	2706	2707	2781
§12	2708	2709	2710	2711	2782

With Wood Interphase Shaft and Wood Section in Vertical Control Rod.

Interphase Shaft Lgth. Ft.	Select Catalog No. Below for Total Vertical Control Rod Desired				
	20 ft.	25 ft.	30 ft.	35 ft.	40 ft.
† 8	2724	2725	2726	2727	2786
†10	2728	2729	2730	2731	2787
§12	2732	2733	2734	2735	2788

†For use with 7.5, 15, and 23 KV switches only.

§For use with 34.5KV switches only.

Universal Transformer Mounts

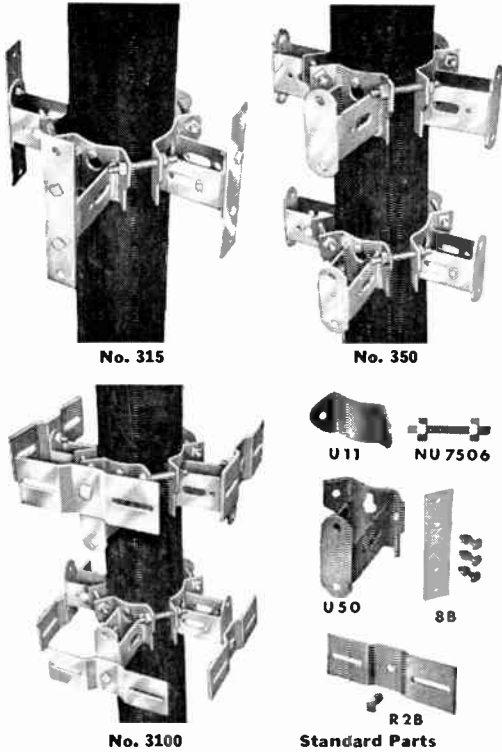

Universal pole brackets are known throughout the industry for economy, mounting ease and outstanding versatility. Brackets to meet any transformer mounting requirement from one 3 KVA to three 167 KVA may be ordered by the standard catalog numbers listed below, by half-unit packages or by individual parts. Write for complete catalog.

All parts are made of heavy material, hot dip galvanized to rigid A.S.T.M. specifications, and are completely salvageable.

No.	Description	Each
115	Mounts one 3 KVA through 25 KVA transformer (or any 12-in. lug spacing—EEL-NEMA Type A).....	511. 60
150	Mounts one 3 KVA through 100 KVA transformer (or any 12-in. or 24-in. lug spacing—EEL-NEMA Type A or B).....	18. 70
1100	Mounts one 3 KVA through 167 KVA transformer (or any 12-in. or 24-in. lug spacing—EEL-NEMA Type A, B or C).....	22. 68
215	Mounts two 3 KVA through 25 KVA transformers (or any 12-in. lug spacing—EEL-NEMA Type A).....	18. 75
250	Mounts two 3 KVA through 50 KVA transformers, any combination (or any 12-in. or 24-in. lug spacing—EEL-NEMA Type A or B).....	30. 76
2100	Mounts two 3 KVA through 167 KVA transformers, any combination (or any 12-in. or 24-in. lug spacing—EEL-NEMA Type A, B or C).....	38. 52
315	Mounts three 3 KVA through 25 KVA transformers, any combination (or any 12-in. lug spacing—EEL-NEMA Type A).....	24. 60
350	Mounts three 3 KVA through 100 KVA transformers, any combination (or any 12-in. or 24-in. lug spacing—EEL-NEMA Type A or B).....	39. 59
3100	Mounts three 3 KVA through 167 KVA transformers, any combination (or any 12-in. or 24-in. lug spacing—EEL-NEMA Type A, B or C).....	51. 77

Detailed specifications for Universal brackets and capacitor racks available.

Prices slightly higher west of the Rockies, or in other zones.

Hubbard Hub-Mounts

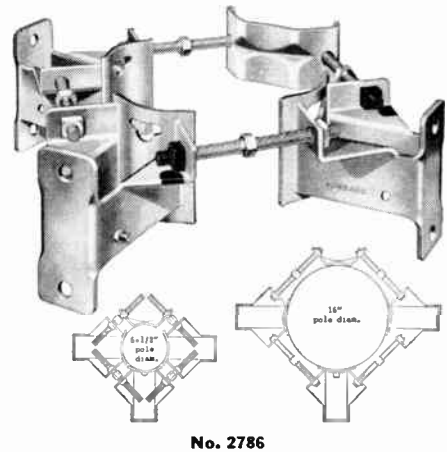

The Hub-Mount, developed for single pole mounting, will hold one to three transformers with a combined vertical load of 15,000 lbs. reducing the cost of double pole platform structures for transformers.

The small diagrams above, which are drawn to scale, show how a Hub-Mount is assembled (left) on a 6½ in. diameter pole and (right) on a 16 in. diameter pole. The same size Hub-Mount is suitable for these and all intervening sizes.

The turnbuckle bolts, made of long-life, corrosion resistant Cor Ten Steel, are wrenched downward for tightening to prevent the possibility of the lineman from "cutting out" on a pole. The left hand nuts, bolts and boxes are color coded for easy identification for assembling. Only one lineman on the pole is required to install the mount.

No.	Description	Wt., Lbs.
2790	Vertical Adapter Plate for Hub-Mount, 3 in. x 14½ in. x ½ in.....	6.15
2791	Offset Horizontal Adapter (13/16 in.) Plate, 5 in. x 16 in. x 3/8 in.....	8.51
2792	Turnbuckle bolt with nuts, 3/4-in. diam., Cor-Ten steel.....	1.9
2793	Quarter Plate.....	2.9
2794	Hub-Mount box.....	9.3
2781	Single—1 box, 1 No. 2790 adapter, one 3 to 15 KVA.....	33.56
2782	Single—2 boxes, 2 No. 2790 adapters, two 3 to 15 KVA.....	47.69
2783	Single—3 boxes, 3 No. 2790 adapters, three 3 to 15 KVA.....	61.82
2784	Double—1 box each, no adapter, one 25 to 50 KVA.....	52.33
2785	Double—2 boxes each, no adapters, two 25 to 50 KVA, or one 25 to 50 KVA and one 3 to 15 KVA.....	66.27
2786	Double—3 boxes each, no adapters, any combination of three 3 to 50 KVA.....	80.21
2787	Double—1 box each, 2 No. 2791 adapters, one 75 to 167 KVA.....	70.87
2788	Double—2 boxes each, 4 No. 2791 adapters, any combination of two 75 to 167 KVA.....	103.35
2789	Double—3 boxes each 6 No. 2791 adapters, any combination of three 75 to 167 k.....	135.83

G-E Type HS Oil-Immersed Distribution Transformers

Single-Phase, 60 Cycles, Self-Cooled

The G-E Type HS distribution transformer offers the highest degree of service reliability, backed by careful attention to all details of manufacture, including the selection and preparation of the raw materials used, the adoption of the most progressive manufacturing processes, and the constant improvement of transformer design.

Among the most recent of these improvements is the wound-core construction, identified by the G-E trade-mark Spirakore.*

This new design, now furnished on all sizes, results in higher efficiency at heavy loads, better voltage regulation at higher power factors, low exciting current, smaller size, and lighter weight.

The tanks are of all-welded steel with fins, corrugations, or cooling tubes in the larger sizes to provide ample radiating surface for the dissipation of heat. Each tank is given a coat each of primer and super-melaglyp paint, and oven-dried, resulting in an attractive and durable finish. For complete information, ask Graybar for Bulletins GEA-6070 and GEC-781.

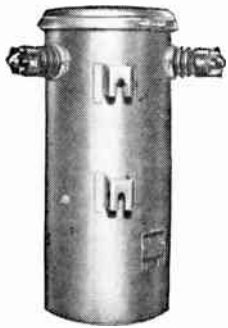

Small Distribution Transformer with Low-Voltage Tank-wall Bushings

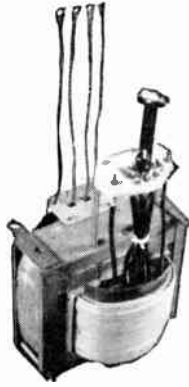

Interior Assembly of Small Spirakore Transformer

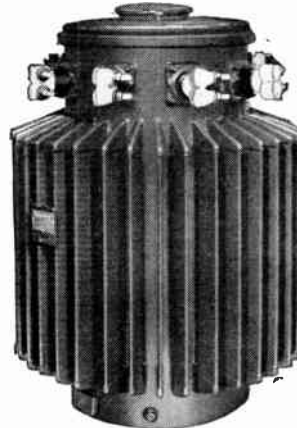

Large Distribution Transformer with Cooling Tubes and High- and Low-voltage Cover Bushings

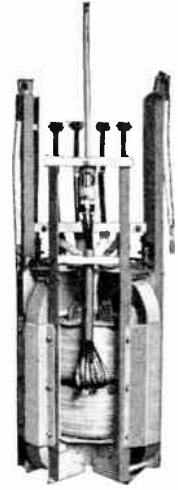

Typical Interior Assembly of Larger Spirakore Transformer

For 480 or 600-Volt Circuits

Application: By connection of the low-voltage leads, transformers are arranged for series or multiple two-wire service, or for three-wire service.

High Voltage Taps (Rated Kva.): Above rated voltage, none; below rated voltage, two 5%.

Service: Suitable for outdoor or indoor installation.

Mounting: Sizes 167 kva. and smaller are suitable for direct pole mounting.

High-Voltage Rating, 480

Kva, Cont, 55° C. Rise	Cat. No. Low Voltage 120/240	Oil Required, Gals.	Approx. Net Wt. Lbs.	List Price, Each, Including Oil and Boxing
3	2611314	4 1/2	145	\$ 141
5	2611315	5 1/2	185	219
10	2611317	8	235	340
15	2611318	11 3/4	320	434
25	2611319	17	450	599
37.5	2611320	20 3/4	625	785
50	2611321	28 3/4	790	962
75	2611322	41	1015	1284
100	2611323	42 1/4	1180	1599

High-Voltage Rating, 600

Kva, Cont, 55° C. Rise	Cat. No. Low Voltage 120/240	Oil Required, Gals.	Approx. Net Wt. Lbs.	List Price, Each, Including Oil and Boxing
3	2611325	4 1/2	145	\$ 141
5	2611326	5 1/2	185	219
10	2611328	8	235	340
15	2611329	11 3/4	320	434
25	2611330	17	450	599
37.5	2611331	20 3/4	625	785
50	2611332	28 3/4	790	962
75	2611333	41	1015	1284
100	2611334	42 1/4	1180	1599

For 2400- and 4160Y-Volt Circuits, No Taps

Application: By connection of the low-voltage leads, transformers having low-voltage rating of 120/240 are arranged for series or multiple two-wire service, or for three-wire service.

Service: Suitable for outdoor or indoor installation.

Mounting: Sizes 167 kva. and smaller are suitable for direct pole mounting.

Kva, Cont, 55° C. Rise	Cat. No. Low Voltage 120/240	Oil Required, Gals.	Approx. Net Wt. Lbs.	List Price, Each, Including Oil and Boxing
3	26112	4 1/2	145	\$131
5	26113	5 1/2	185	208
10	26115	8	235	323
15	26116	11 3/4	320	412
25	26117	17	450	569
37.5	26118	20 3/4	625	745
50	26119	28 3/4	790	913

*Registered trade-mark of General Electric Co.

G-E Type HS Oil-Immersed Distribution Transformers

Single-Phase, 60 Cycles, Self-Cooled

For 2400- and 4160Y-Volt Circuits

Application: By connection of the low-voltage leads, transformers having low-voltage rating of 120/240 or 240/480 are arranged for series or multiple two-wire service, or three-wire service.

Transformers having low-voltage rating of 240x480 are arranged for series or multiple two-wire service.

Service: Suitable for outdoor or indoor installation.

Mounting: Sizes 167 kva. and smaller are suitable for direct pole mounting.

With Taps

Low Voltage	Kva. Cont. 55 C Rise	Cat. No.	High-voltage Taps (Rated Kva.)		Oil Required Gal.	List Price Each
			Above 2400	Below 2400		
120/240			None	(1) 2½%		
240/480, 240X480, 600			(2) 2½%	(2) 2½%		
120/240	10	261121	235	8		\$ 340
	15	261122	320	11¾		434
	25	261123	450	17		599
	37 5	261124	625	20¾		785
	50	261125	790	28¾		962
	75	261126	1015	41		1284
	100	261127	1180	42¼		1599
240/480	10	261137	235	8		340
	15	261138	320	11¾		434
	25	261139	450	17		599
	37 5	261140	625	20¾		785
	50	261141	790	28¾		962
	75	261142	1015	41		1284
	100	261143	1180	42¼		1599
240x480	167	7111772	1450	39		2301
600	25	261155	450	17		599
	50	261157	790	28¾		962
	100	261159	1180	42¼		1599
	167	7111773	1450	39		2301

For 4160-Volt Circuits

Application: These transformers are to provide service where it is more economical or desirable to connect transformers across phases than between line and neutral on 2400/1160-volt Y circuits. The use of this transformer gives the same service voltages as 10:1-ratio transformers connected between line and neutral.

By connection of low-voltage leads, transformers having low-voltage ratings of 120/240 or 240/480 are arranged for series or multiple two-wire service, or for three-wire service.

Service: Suitable for outdoor or indoor use.

Mounting: Sizes 167 kva. and smaller are arranged for direct pole mounting.

High-Voltage Rating, 4160/7200Y

Low Voltage	Kva. Cont. 55 C Rise	Cat. No.	High-voltage Taps (Rated Kva.)		Oil Required, Gals.	Ship. Wt. Lbs.	List Price, Each
			Above 4160	Below 4160			
120/240			None	(4) 2½%			
240/480			(2) 2½%	(2) 2½%			
120/240	3	2611336	281166	4½	145	\$ 154	
	5	2611337	281167	5½	185	234	
	10	2611339	281169	8	235	372	
	15	2611340	281170	11¾	330	470	
	25	2611341	281171	17	450	664	
	37 5	2611342	281172	20¾	625	862	
	50	2611343	281173	28¾	790	1050	
	75	2611344	281174	41	1015	1394	
	100	2611345	281175	42¼	1180	1716	

For 4800-, and 8320Y-Volt Circuits

Application: By connection of the low-voltage leads, transformers having a low-voltage rating of 120/240 or 240/480 are arranged for series or multiple two-wire service, or for three-wire service.

Transformers having low-voltage rating of 240x480 are arranged for series or multiple two-wire service.

Service: Suitable for outdoor or indoor use.

Mounting: Sizes 167 kva. and smaller are suitable for direct pole mounting.

High-Voltage Rating, 4800/8320Y

No Taps

Kva. Cont. 55 C Rise	Cat. No.	Low Voltage 120/140	Oil Required Gals.	Approx. Net Wt. Lbs.	List Price Each
3	261166	4½		145	\$ 146
5	261167	5½		185	221
10	261169	8		235	353
15	261170	11¾		320	446
25	261171	17		450	629
37 5	261172	20¾		625	817
50	261173	28¾		790	996
75	7111866	41		1015	1323
100	7111867	42¼		1180	1630
167	7111868	39		1450	2433

With Taps

Low Voltage	Kva. Cont. 55 C Rise	Cat. No.	High Voltage Taps (Rated Kva.)		Oil Required Gals.	List Price Each
			Above 4800	Below 4800		
240/480, 240X480, 600			(2) 2½%	(2) 2½%		
240/480	10	2611101	235	8		\$ 372
	15	2611102	320	11¾		470
	25	2611103	450	17		663
	37 5	2611104	625	20¾		861
	50	2611105	790	28¾		1049
	75	2611106	1015	41		1393
	100	2611107	1180	42¼		1716
240X480	167	7111775	1450	39		2433
600	25	2611119	445	15		663
	50	2611121	750	33		1049
	100	2611123	1225	47		1716
	167	7111776	1420	43		2433

Call Graybar FIRST for . . .



G-E Type HS Oil-Immersed Distribution Transformers

For 2400-, 4160Y-, 4800-, and 8320Y-Volt Circuits

Application: By connection of the low-voltage leads, transformers having a low-voltage rating of 120/240 or 240/480 are arranged for series or multiple two-wire service. Transformers having low-voltage rating of 240/480 are arranged for series or multiple two-wire service.

Service: Suitable for outdoor or indoor use.

Mounting: Sizes 167 kva and smaller are suitable for direct pole mounting.

High-Voltage Rating, 2400X4800/8320Y

No Taps					
Kva Cont. 55 C. Rise	Cat. No. Low Voltage 120/240	Oil Required Gals.	Approx. Net Wt. Lbs.	List Price Each	
3	2611130	4 1/2	145	\$ 154.00	
5	2611131	5 1/2	185	232.00	
10	2611133	8	235	372.00	
15	2611134	11 3/4	320	470.00	
25	2611135	17	450	663.00	
37.5	2511136	20 3/4	625	858.00	
50	2611137	28 3/4	790	1046.00	
75	2611138	41	1015	1390.00	
100	2611139	42 3/4	1180	1712.00	

For 7200- and 12,470Y Volt Circuits

Same application and service as above.

Sizes 250-500 kva are also available.

High-Voltage Rating, 7200/12,470Y

No Taps					
Kva Cont. 55 C. Rise	Cat. No. Low Voltage 120/240	Oil Required Gals.	Approx. Net Wt. Lbs.	List Price Each	
3	7111489	6 1/2	150	\$ 160.00	
5	7111490	6 3/4	170	251.00	
10	7111491	9	265	401.00	
15	7111492	12 3/4	325	515.00	
25	7111493	19	490	704.00	
37.5	7111494	35	755	922.00	
50	7111495	34	825	1119.00	

With Taps

Low-Voltage Rating	Kva Cont. 55 C. Rise	Catt. No.	High-voltage Taps (Rated Kva)		List Price Each
			Above 7200	Below 7200	
120/240	3	3311306	160	6 1/2	\$ 169.00
	5	3311307	185	6 1/4	265.00
	10	3311308	280	8 1/2	423.00
	15	3311309	345	12	543.00
	25	3311310	505	19 1/2	742.00
	37.5	3311311	750	32 1/2	971.00
	50	3311312	830	31 1/2	1178.00
	75	3311313	1075	37	1562.00
	100	3311314	1270	43 1/4	1864.00
	167	7111780	1500	38	2553.00
240/480	10	3311318	280	8 1/2	423.00
	15	3311319	345	12	543.00
	25	3311320	505	19 1/2	742.00
	37.5	3311321	750	32 1/2	971.00
	50	3311322	830	31 1/2	1178.00
240x480	75	3311323	1075	37	1562.00
	100	3311324	1270	43 1/4	1864.00
800	167	7111781	1500	38 1/2	2437.00
	25	3311333	505	19 1/2	742.00
	50	3311335	830	31 1/2	1178.00
	100	3311337	1270	43 1/4	1864.00
2400	167	7111782	1500	38 1/2	2437.00
	50	3311943	1050	43	1178.00
	100	3311944	1360	49	1864.00
4800	167	7111783	1500	39 1/4	2321.00
	50	3311958	1050	43	1354.00
	100	3311959	1360	49	2143.00
167	7111784	1550	43	2495.00	

For 12,470, GrY/7200-Volt Circuits

Application: For use on circuits having a common electrical neutral. By connection of low-voltage leads, transformers having a low-voltage rating of 120/240 are arranged for series or multiple two-wire service, or for three-wire service.

Service: Suitable for indoor or outdoor service.

Mounting: Suitable for direct pole mounting.

High-Voltage Rating, 12,470 GrY/7200

No Taps (Single Mounting Position)					
Kva Cont. 55 C. Rise	Cat. No. Low Voltage Rating 120/240	Approx. Net Wt. Lbs. Incl. Oil	Oil Required Gals.	List Price Each	
3	2611533	155	6 1/2	\$ 152.00	
5	2611534	180	6 1/4	243.00	
10	7111496	275	8 1/2	393.00	
15	7111497	340	12	507.00	
25	7111498	500	19 1/2	696.00	
37.5	7111499	745	32 1/2	914.00	
50	7111500	825	31 1/2	1111.00	

No Taps (Two Mounting Positions)

3	841111	155	6 1/2	\$ 154.00
5	841112	180	6 1/4	245.00
10	841137	275	8 1/2	395.00
15	841138	340	12	509.00
25	841139	500	19 1/2	698.00

With Taps (Single Mounting Position)

Kva Cont. 55 C. Rise	Low Voltage 120/240	Catt. No. Low Voltage Rating 120/240	High-voltage Taps Above 7200		List Price Each
			None	(Rated Kva) Below 7200 (1) 2 1/2%	
3		3311347	155	6 1/2	\$ 161.00
5		3311348	180	6 1/4	257.00
10		3311349	275	8 1/2	415.00
15		3311350	340	12	535.00
25		3311351	500	19 1/2	734.00
37.5		3511860	745	32 1/2	963.00
50		3511861	825	31 1/2	1170.00

With Taps (Two Mounting Positions)

3	3111882	155	6 1/2	\$ 163.00
5	3111883	180	6 1/4	259.00
10	3111885	275	8 1/2	417.00
15	3111886	340	12	537.00
25	3111887	500	19 1/2	736.00

For 13,200 GrY/7620-Volt Circuits

Same Application, Service and Mounting as above.

High-Voltage Rating, 13,200 GrY/7620

No Taps (Single Mounting Position)					
Kva Cont. 55 C. Rise	Cat. No. Low Voltage Rating 120/240	Approx. Net Wt. Lbs. Incl. Oil	Oil Required Gals.	List Price Each	
3	2611725	155	6 1/2	\$ 152.00	
5	2611726	180	6 1/4	243.00	
3	841117	155	6 1/2	\$ 154.00	
5	841118	180	6 1/4	245.00	

With Taps (Single Mounting Position)

Kva Cont. 55 C. Rise	Low Voltage 120/240	Catt. No. Low Voltage Rating 120/240	High-voltage Taps Above 7620		List Price Each
			(2) 2 1/2%	(Rated Kva) Below 7620 (2) 2 1/2%	
3		3311352	155	6 1/2	\$ 161.00
5		3311353	180	6 1/4	257.00
10		3311354	275	8 1/2	415.00
15		3311355	340	12	535.00
25		3311356	500	19 1/2	734.00
37.5		3511862	745	32 1/2	963.00
50		3511863	825	31 1/2	1170.00
3		3111889	155	6 1/2	\$ 163.00
5		3111890	180	6 1/4	259.00
10		3111892	275	8 1/2	417.00
15		3111893	340	12	537.00
25		3111894	500	19 1/2	736.00

G-E Type HS Oil-Immersed Distribution Transformers

For 7620 and 13,200Y-Volt Circuits

Application: By connection of the low-voltage leads, transformers having low-voltage rating of 120/240 or 240/480 are arranged for series or multiple two-wire service, or three-wire service.

Transformers having low-voltage rating of 240/480 are arranged for series or multiple two-wire service.

Service: Suitable for indoor or outdoor use.

Mounting: Sizes 167 kva and smaller are arranged for direct pole mounting.

Sizes 250-500 kva are also available.

High-Voltage Rating, 7620/13,200Y

Low-voltage Rating	Kva. Cont. 55 C Rise	Cat. No.	High Voltage Taps (Rated Kva)		List Price, Each
			Above 7620	Below 7620	
120/240, 240/480, 240x480, 600, 2400, 4800 (2) 2 1/2% (2) 2 1/2%					
120/240	3	3311357	160	6 1/2	\$ 169.00
	5	3311358	185	6 1/4	265.00
	10	3311359	280	8 1/2	423.00
	15	3311360	315	12	543.00
	25	3311361	505	19 1/2	742.00
	37.5	3311362	750	32 1/2	971.00
	50	3311363	830	31 1/2	1178.00
	75	3311364	1075	37	1562.00
	100	3311365	1270	43 1/4	1864.00
	167	7111785	1500	38 3/4	2553.00
24/480	10	3311372	280	8 1/2	423.00
	15	3311373	315	12	543.00
	25	3311374	505	19 1/2	742.00
	37.5	3311375	750	32 1/2	971.00
	50	3311376	830	31 1/2	1178.00
	75	3311377	1075	37	1562.00
240x480	100	3311378	1270	43 1/4	1864.00
	167	7111786	1500	38 3/4	2437.00
600	25	3311387	505	19 1/2	742.00
	50	3311389	830	31 1/2	1178.00
	100	3311391	1270	43 1/4	1864.00
	167	7111787	1500	38 3/4	2437.00

For 12,000-Volt Circuits

Same Application, Service and Mounting as above. Sizes 250-500 kva are also available.

High-Voltage Rating, 12,000

Low-voltage Rating	Kva. Cont. 55 C Rise	Cat. No.	High-voltage Taps (Rated Kva)		List Price, Each
			Above 12,000	Below 12,000	
240/480, 240x480, 600, 2400, 4800 (2) 2 1/2% (2) 2 1/2%					
120/240	5	2611870	185	6 1/4	\$ 283.00
	10	2611872	280	8 1/2	434.00
	15	2611873	315	12	547.00
	25	2611874	505	19 1/2	742.00
	37.5	2611875	750	32 1/2	971.00
	50	2611876	830	31 1/2	1178.00
	75	2611877	1075	37	1562.00
	100	2611878	1270	43 1/4	1864.00
	167	2611890	1485	38 3/4	2553.00
	240/480	10	3311411	280	8 1/2
15		3311412	315	12	547.00
25		3311413	505	19 1/2	742.00
37.5		3311414	750	32 1/2	971.00
50		3311415	830	31 1/2	1178.00
75		3311416	1075	37	1562.00
240x480 B	100	3311417	1270	43 1/4	1864.00
	167	7111791	1485	39	2437.00
600	25	3311426	505	19 1/2	742.00
	50	3311428	830	31 1/2	1178.00
	100	3311430	1270	43 1/4	1864.00
	167	7111792	1485	39	2437.00
2400	50	341131	900	37	1178.00
	100	341132	1360	49	1864.00
	167	7111793	1500	39 1/4	2321.00
4800	50	341149	900	37	1354.00
	100	341150	1360	49	2143.00
	167	7111794	1550	43	2495.00

For 12,000-Volt Circuits—Continued

Low-voltage Rating	Kva. Cont. 55 C Rise	Cat. No.	High-voltage Taps (Rated Kva)		List Price, Each
			Above 12,000	Below 12,000	
240/480, 240x480 None (4) 2 1/2%					
240/480	10	2611920	280	8 1/2	\$ 434.00
	15	2611921	345	12	547.00
	25	2611922	505	19 1/2	742.00
	37.5	2611923	750	32 1/2	971.00
	50	2611924	830	31 1/2	1178.00
	75	2611925	1075	37	1562.00
240x480	100	2611926	1270	43 1/4	1864.00
	167	7111805	1485	39	2437.00

For 13,200- and 13,800-Volt Circuits

Application: By connection of low-voltage leads, transformers having low-voltage rating of 120/240 are arranged for series or multiple two-wire service, or for three-wire service.

Transformers having low-voltage rating of 240/480 are arranged for series or multiple two-wire service.

Service: Suitable for outdoor or indoor installation.

Mounting: Sizes 167 kva and smaller are arranged for direct pole mounting.

Sizes 250-500 kva are also available.

High-Voltage Rating, 13,200

Low-voltage Rating	Kva. Cont. 55 C Rise	Cat. No.	High-voltage Taps (Rated Kva)		List Price, Each
			Above 13,200	Below 13,200	
240x480, 600, 2400, 4800 (2) 2 1/2% (4) 2 1/2%					
120/240	37.5	2611987	750	32 1/2	\$ 998.00
	50	2611988	830	31 1/2	1201.00
	75	2611989	1075	37	1562.00
	100	2611990	1270	43 1/4	1864.00
	167	7111795	1500	38	2553.00
	240x480	167	7111796	1485	38 1/2
600		7111797	1485	38 1/2	2437.00
2400		7111798	1485	38 1/2	2321.00
4800		7111799	1550	43	2495.00

High-Voltage Rating, 13,800

Low-voltage Rating	Kva. Cont. 55 C Rise	Cat. No.	High-voltage Taps (Rated Kva)		List Price, Each	
			Above 13,800	Below 13,800		
120/240, 240x480, 600, 2400, 4800 14,400 14,100 13,500 13,200						
120/240	167	7111800	1485	38 1/4	\$2553.00	
	240x480	167	7111801	1485	38 1/2	2437.00
	600	167	7111802	1485	38 1/2	2437.00
	2400	167	7111803	1500	43	2321.00
	4800	167	7111804	1550	43	2495.00

High-Voltage Rating, 14,400

Low-voltage Rating	Kva. Cont. 55 C Rise	Cat. No.	High-voltage Taps (Rated Kva)		List Price, Each
			Above 14,400	Below 14,400	
120/240, 240/480, 13,800/13,200/12,870V rated kva 12,540V reduced kva					
120/240	10	2811568	280	8 1/2	\$471.00
	15	2811569	345	12	592.00
	25	2811570	505	19 1/2	783.00
	37.5	2811571	750	32 1/2	998.00
	50	2811572	830	31 1/2	1201.00
	75	2811573	1075	37	1562.00
240/480	100	2811574	1270	43 1/4	1864.00
	10	2811582	280	8 1/2	471.00
	15	2811583	345	12	592.00
240x480	25	2811584	505	19 1/2	783.00
	37.5	2811585	750	32 1/2	998.00
	50	2811586	830	31 1/2	1201.00
	75	2811587	1075	37	1562.00
600	100	2811588	1270	43 1/4	1864.00
	25	2811598	505	19 1/2	783.00
	50	2811600	830	31 1/2	1201.00
2400	100	2811602	1270	43 1/4	1864.00
	50	2811614	900	37	1201.00
4800	100	2811616	1360	43 1/4	1864.00
	50	3411173	900	37	1381.00
4800	100	3411174	1360	43 1/4	2143.00

G-E Type HSBA Oil-Immersed Distribution Transformers

With Self-Contained Lightning Protection and Overcurrent Protection—Single-phase, 60 Cycles

With High-Voltage Tank-Wall Bushings

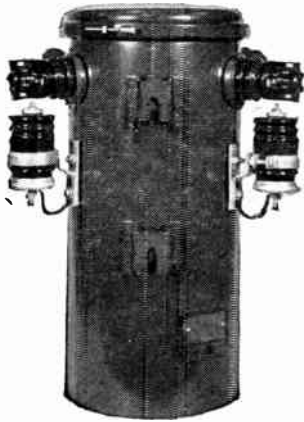

Class A: For universal use on delta and Y circuits.

Complete with: Two high-voltage bushings; two magnetic lightning arresters; low-voltage neutral gap; internal high-voltage fuses; low-voltage circuit breaker; overload signal lamp (5-kva and above); support lugs for direct pole mounting.

Class B-1: For application on Y circuits having solidly grounded neutrals.

Complete with same features as Class A transformers, except omit one arrester.

For 2400 & 4160Y-Volt Circuits

Application: By connection of the low-voltage leads to the bushing terminals inside the tank, transformers with low-voltage rating of 120/240 are arranged for series of multiple two-wire service, or for three-wire service.

**High-voltage Rating 2400/4160Y
Low-voltage Rating 120/240* No Taps**

Kva, Cont. 55 C Rise	2 Bushings 2 Arresters		2 Bushings 1 Arrester		Oil Req'd. Gal.	Net Wt. Incl. Oil, Lb.
	No.	Each	No.	Each		
3	3511207†	\$ 203.00	3511545†	\$ 183.00	7	185
5	3511201	292.00	3511513	272.00	7	210
10	3511202	407.00	3511514	387.00	8	215
15	3511203	496.00	3511515	476.00	11¾	330
25	3511204	653.00	3511516	633.00	17	460
37.5	3511205	869.00	3511517	849.00	20¾	610
50	3511206	1037.00	3511518	1017.00	28¾	810

High-voltage Rating 2400/4160Y

Low-voltage Rating 120/240* with Taps (4) 2½%

Kva, Cont. 55 C Rise	Below 2400		Above 2400		Oil Req'd. Gal.	Net Wt. Incl. Oil, Lb.
	No.	Each	No.	Each		
10	3511210	\$ 424.00	3511520	\$ 404.00	8	215
15	3511211	518.00	3511521	498.00	11¾	330
25	3511212	683.00	3511522	663.00	17	460
37.5	3511213	909.00	3511523	889.00	20¾	610
50	3511214	1086.00	3511524	1066.00	28¾	810
75	3511215	1408.00	3511547	1388.00	41	1040
100	3511216	1803.00	3511548	1783.00	47¼	1200

High-voltage Rating 2400/4160Y

Low-voltage Rating 240/480* with Taps (2) 2½%

Kva, Cont. 55 C Rise	Below 2400, (2) 2½%		Above 2400		Oil Req'd. Gal.	Net Wt. Incl. Oil, Lb.
	No.	Each	No.	Each		
10	3511550	\$ 424.00	3511557	\$ 404.00	8	215
15	3511551	518.00	3511558	498.00	11¾	330
25	3511552	683.00	3511559	663.00	17	460
37.5	3511553	869.00	3511559	849.00	20¾	610
50	3511554	1046.00	3511560	1026.00	28¾	810
75	3511555	1408.00	3511561	1388.00	41	1040
100	3511556	1723.00	3511562	1703.00	47¾	1200

High-voltage Rating 4160/7200Y

Low-voltage Rating 120/240* with Taps (4) 2½%

Kva, Cont. 55 C Rise	Below 4160		Above 4160		Oil Req'd. Gal.	Net Wt. Incl. Oil, Lb.
	No.	Each	No.	Each		
3	3511227†	\$ 248.00	3511567†	\$ 216.00	7	185
5	3511219	341.00	3511525	309.00	7	210
10	3511220	480.00	3511526	448.00	8	215
15	3511221	578.00	3511527	546.00	11¾	330
25	3511222	771.00	3511528	739.00	17	460
37.5	3511223	1009.00	3511529	977.00	20¾	610
50	3511224	1197.00	3511530	1165.00	28¾	810
75	3511225	1541.00	3511565	1509.00	41	1100
100	3511226	1944.00	3511566	1912.00	47¼	1200

With High-Voltage Tank-Wall Bushings

**High-voltage Rating 4160/7200Y
Low-voltage Rating 240/480* with Taps (2) 2½%
Below 4160 (2) 2½% Above 4160**

Kva, Cont. 55 C Rise	2 Bushings 2 Arresters		2 Bushings 1 Arrester		Oil Req'd. Gal.	Net Wt. Incl. Oil, Lb.
	No.	Each	No.	Each		
10	3511568	\$ 480.00	3511575	\$ 448.00	8	215
15	3511569	578.00	3511576	546.00	11¾	330
25	3511570	771.00	3511577	739.00	17	460
37.5	3511571	969.00	3511578	937.00	20¾	610
50	3511572	1157.00	3511579	1125.00	28¾	810
75	3511573	1541.00	3511580	1509.00	41	1040
100	3511574	1864.00	3511581	1832.00	47¼	1200

For 4800- and 8320Y-Volt Circuits

**High-voltage Rating 4800/8320Y
Low-voltage Rating 120/480* No Taps**

Kva, Cont. 55 C Rise	Below 4800, (2) 2½%		Above 4800		Oil Req'd. Gal.	Net Wt. Incl. Oil, Lb.
	No.	Each	No.	Each		
3	3511235†	\$ 240.00	3511589†	\$ 208.00	7	185
5	3511229	329.00	3511583	297.00	7	210
10	3511230	461.00	3511584	429.00	8	245
15	3511231	554.00	3511585	522.00	11¾	330
25	3511232	737.00	3511586	705.00	17	460
37.5	3511233	965.00	3511587	933.00	20¾	610
50	3511234	1144.00	3511588	1112.00	28¾	810
75	7111869	1471.00	7111949	1439.00	41	1040
100	7111870	1834.00	7111950	1826.00	47	1200

**High-voltage Rating 4800/8320Y
Low-voltage Rating 240/480* with Taps (2) 2½%
Below 4800, (2) 2½% Above 4800**

Kva, Cont. 55 C Rise	Below 4800, (2) 2½%		Above 4800		Oil Req'd. Gal.	Net Wt. Incl. Oil, Lb.
	No.	Each	No.	Each		
10	3511600	\$ 480.00	3511607	\$ 448.00	8	245
15	3511601	578.00	3511608	546.00	11¾	330
25	3511602	771.00	3511609	739.00	17	460
37.5	3511603	969.00	3511610	937.00	20¾	610
50	3511604	1157.00	3511611	1125.00	28¾	810
75	3511605	1541.00	3511612	1509.00	41	1040
100	3511606	1864.00	3511613	1832.00	47¼	1200

For 2400-, 4160Y, 4800-, and 8320Y-Volt Circuits

**High-voltage Rating 2400/4160Y X 4800/8320Y
Low-voltage Rating 120/240* No Taps**

Kva, Cont. 55 C Rise	Below 2400, (2) 2½%		Above 2400		Oil Req'd. Gal.	Net Wt. Incl. Oil, Lb.
	No.	Each	No.	Each		
3	3511253†	\$ 248.00	3511625†	\$ 216.00	7	185
5	3511247	340.00	3511617	308.00	7	210
10	3511248	480.00	3511618	448.00	8	245
15	3511249	578.00	3511619	546.00	11¾	330
25	3511250	771.00	3511620	739.00	17	460
37.5	3511251	1006.00	3511621	974.00	20¾	610
50	3511252	1194.00	3511622	1162.00	28¾	810
75	3511619	1538.00	3511623	1506.00	41	1040
100	3511615	1940.00	3511624	1902.00	47¼	1200

With High-Voltage Cover Bushings

**Class A: High-voltage Rating 7200/12,470Y
Low-voltage Rating 120/240 No Taps**

Kva, Cont. 55 C Rise	No. Low-voltage 120/240	Each	Oil Req'd. Gal.	Net Wt. Incl. Oil, Lb.
5	7111502	367.00	6¼	195
10	7111503	517.00	8½	290
15	7111504	631.00	12	355
25	7111505	820.00	19½	515
37.5	7111506	1078.00	32½	760
50	7111507	1275.00	31½	840

*Low-voltage connection: series, 3-wire, and multiple.

†Without signal lamp and emergency overload reset device.

*Low-voltage connection: series, 3-wire, and multiple.

†Without signal lamp and emergency overload reset device.

G-E Type HSBA Oil-Immersed Distribution Transformers

With Self-Contained Lightning Protection and Overcurrent Protection—Single-phase, 60 Cycles

**High-Voltage Cover Bushing
For 7200- and 12,470Y-Volt Circuits**

Low-voltage Rating 120/240*
With Taps Approx. (4) 2½% Below 7200
Low-voltage Rating 240/480 With Taps (2) 2½% Rated
Kva above and (2) 2½% Rated below 7200 Volts

Kva, Cont. 55 C Rise	Low-voltage 120/240		Low-voltage 240/480		Oil Reqd., Gal.	Net. Wt. Incl. Oil, Lb.
	No.	Each	No.	Each		
3	711132†	\$ 271.00	6½	170
5	711124	381.00	6¼	195
10	711125	539.00	711133	539.00	8½	290
15	711126	659.00	711134	659.00	12	355
25	711127	858.00	711135	858.00	19½	515
37.5	711128	1127.00	711136	1087.00	32½	760
50	711129	1334.00	711137	1294.00	31½	840
75	711130	1718.00	711138	1718.00	37	1085
100	711131	2100.00	711139	2020.00	43¼	1280

**For 7620- and 13,200Y-Volt Circuits
Class A**

High-voltage Rating 7620/13,200Y
Low-voltage Rating 120/240* or 240/480*
With Taps (2) 2½% Above and (2) 2½% Below 7620

Kva, Cont. 55 C Rise	Low-voltage 120/240		Low-voltage 240/480		Oil Reqd., Gal.	Net. Wt. Incl. Oil, Lb.
	No.	Each	No.	Each		
3	711149†	\$ 271.00	6½	170
5	711141	381.00	6¼	195
10	711142	539.00	711150	\$ 539.00	8½	290
15	711143	659.00	711151	659.00	12	355
25	711144	858.00	711152	858.00	19½	515
37.5	711145	1127.00	711153	1087.00	32½	760
50	711146	1334.00	711154	1294.00	31½	840
75	711147	1718.00	711155	1718.00	37	1085
100	711148	2100.00	711156	2020.00	43¼	1280

**For 12,000-Volt Circuits
Class A**

High-voltage Rating 12,000
Low-voltage Rating 120/240* or 240/480*
With Taps (4) 2½% Below 12,000—Low-voltage 120/240
With Taps (2) 2½% Above and (2) 2½% Below 12,000
Low-voltage 240/480

Kva, Cont. 55 C Rise	Low-voltage 120/240		Low-voltage 240/480		Oil Reqd., Gal.	Net. Wt. Incl. Oil, Lb.
	No.	Each	No.	Each		
5	2811448	\$ 451.00	8¼	240
10	2811450	602.00	3511660	\$ 602.00	8½	290
15	2811451	715.00	3511661	715.00	12	355
25	2811452	910.00	3511662	910.00	19½	515
37.5	2811453	1179.00	3511663	1139.00	32½	760
50	2811454	1386.00	3511664	1346.00	31½	840
75	35H658	1770.00	3511665	1770.00	37	1085
100	3511659	2152.00	3511666	2072.00	43¼	1280

Low-voltage Rating 240/480*
With Taps (4) 2½% rated Kva below 12,000 volts

10	3511926	\$ 602.00	8½	290
15	3511927	715.00	12	355
25	3511928	910.00	19½	515
37.5	3511929	1139.00	32½	760
50	3511930	1346.00	31½	840
75	3511931	1770.00	37	1085
100	3511932	2072.00	43¼	1280

*Low-voltage connection series, 3-wire, and multiple.
†Without signal lamp and emergency overload reset device.

For 12,000-Volt Circuits

Class B-2

High-voltage Rating 12,470GrY/7200
Low-voltage Rating 120/240*
(Single Mounting Position)

Kva, Cont. 55 C Rise	No Taps No.	(4) 2½% Taps Below		Oil Reqd., Gal.	Net. Wt. Incl. Oil, Lb.	
		Each	Each			
3	71113	\$ 216.00	5¼	165	
5	7111378	307.00	6¼	190	
3	711111	\$ 225.00	5¼	165
5	7111379	321.00	6¼	190
10	7111508	471.00	71116	493.00	8½	285
15	7111509	585.00	71117	613.00	12	350
25	7111510	774.00	71118	812.00	19½	510
37.5	7111511	1032.00	71119	1081.00	32½	755
50	7111512	1229.00	711110	1288.00	31½	835

High-voltage Rating 12,470GdY/7200
Low-voltage Rating 120/240
(Two-Mounting Positions)

3	841142†	\$218.00	84111†	\$227.00	5¼	165
5	841143†	309.00	84112†	323.00	6¼	190
10	841145	473.00	84113	495.00	8½	285
15	841146	587.00	84114	615.00	12	350
25	841147	776.00	84115	814.00	19½	510

High-voltage Rating 13,200GrY/7620
Low-voltage Rating 120/240*
(Single Mounting Position)

Kva, Cont. 55 C Rise	No Taps No.	(2) 2½% Taps Above and Below		Oil Reqd., Gal.	Net. Wt. Incl. Oil, Lb.	
		Each	Each			
3	711114†	\$218.00	5¼	165	
5	7111380	308.00	6¼	190	
3	711122†	\$ 225.00	5¼	165
5	7111381†	321.00	6¼	190
10	711117	443.00	8½	285
15	711118	613.00	12	350
25	711119	812.00	19½	510
37.5	711120	1081.00	32½	755
50	711121	1288.00	31½	835

(Two-Mounting Positions)

3	841154	\$218.00	841156†	\$227.00	5¼	165
5	841155†	309.00	841157†	323.00	6¼	190
10	841159	495.00	8½	285
15	841160	615.00	12	350
25	841161	814.00	19½	510

Class A

High-voltage Rating 13,200
Low-voltage Rating 120/240
With Taps (4) 2½% Rated Kva Below 13,200 Volts

Kva, Cont. 55 C Rise	Low-voltage 120/240		Low-voltage 240/480		Oil Reqd., Gal.	Net. Wt. Incl. Oil, Lb.
	No.	Each	No.	Each		
37.5	3511933	\$1206.00	32½	760
50	3511934	1409.00	31½	840
75	3511935	1770.00	37	1085
100	3511936	2152.00	43¼	1280

High-voltage Rating 14,400/13,200
Low-voltage Rating 120/240* and 240/480*
With Taps 13,800/13,200/12,870 Volts Rated Kva;
12,540 Volts Reduced Kva

10	2811648	\$ 639.00	3511669	\$ 639.00	8½	290
15	2811649	760.00	3511670	760.00	12	355
25	2811650	951.00	3511671	951.00	19½	515
37.5	2811651	1206.00	3511672	1166.00	32½	760
50	2811652	1409.00	3511673	1369.00	31½	840
75	3511667	1770.00	3511674	1770.00	37	1085
100	3511668	2152.00	3511675	2072.00	43¼	1280

*Low-voltage connection series, 3-wire, and multiple.
†Without signal lamp and emergency overload reset device.

G-E Type HSBA Oil-Immersed Distribution Transformers



Class B2: For use on solidly grounded common-neutral circuits with the tank solidly grounded.

Complete with: One high-voltage bushing; one clamp-terminal tank-grounding connector; one mangle-valve lightning arrester; low-voltage neutral link bolted to tank externally; internal high-voltage fuse; low-voltage circuit breaker; overload signal lamp (10-kva and above); support lugs for direct pole mounting.

G-E Type HS Oil-Immersed Rural-Line Transformers
In Accordance with R. E. A. Requirements

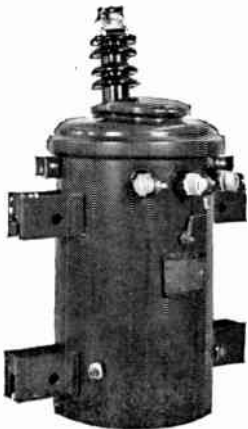

Transformers are of the single-high-voltage-bushing design, with one end of the high voltage winding permanently connected to the tank which, in turn, is to be solidly grounded by connection to the common system neutral.

Each unit complete with: One high-voltage cover bushing; handhole in cover; three low-voltage tank-wall bushings; provision for direct pole mounting with the low-voltage bushings 90 degrees from the pole; two mounting positions, on opposite sides of tank; two clamp-terminal tank-grounding connectors; low-voltage neutral grounded to tank.

Application: By connection of the low-voltage leads to the bushing terminals inside the tank, transformers are arranged for series or multiple two-wire service, or for three-wire service.

For 12,470-GrY-Volt Circuits

High-voltage 12,470 GrY/7200, Low-voltage 120/240

Kva, Cont. 55 C Rise	No Taps No.	Each	High-voltage Taps (4) 2 1/2% Rated Kva Below	Each	Oil Reqd., Gal.	Net WL Incl. Oil, Lb.
			7200 Volts			
3	841111	\$154.00	3111882	\$163.00	6 1/2	135
5	841112	245.00	3111883	259.00	6 1/4	170
7.5	841136	335.00	3111884	353.00	8	215
10	841137*	395.00	3111885	417.00	8 1/2	280
15	841138*	509.00	3111886	537.00	12	345
25	841139*	698.00	3111887	736.00	19 1/2	500

*Although not listed by REA, these transformers are available by Cat. No.

G-E Type HS Oil-Immersed Rural-Line Transformers
For 13,200-GrY-Volt Circuits

High-voltage Rating, 13,200-GrY/7620

Low-voltage	High-voltage Tap (Rated Kva)		Oil Reqd., Gal.	Approx. Net WL Lb., Incl. Oil
	Above 7620	Below 7620		
120/240	(2) 2 1/2%	(2) 2 1/2%		
Kva, Cont. 55 C Rise	No.	Each		
3	3111889	\$163.00	6 1/2	135
5	3111890	259.00	6 1/4	170
7.5	3111891	353.00	8	215
10	3111892	417.00	8 1/2	280
15	3111893	537.00	12	345
25	3111894	736.00	19 1/2	500

High-voltage Rating, 24,940 GrY/14,400
Low-voltage: 120/240, No Taps

3	841123	\$250.00	7 1/4	195
5	841124	337.00	7	215

High-Voltage Rating, 24,940 GrY/14,400

Low-voltage	Rated Kva	High-voltage Taps	Reduced Kva
120/240	12,870/13,200/13,800		12,540

Kva, Cont. 55 C Rise	No.	Each	Oil Reqd., Gal.	Approx. Net WL Lb., Incl. Oil
3	351118	\$264.00	7 1/4	195
5	351119	345.00	7	215
7.5	351120	418.00	9 3/4	300
10	351121	512.00	12 1/4	335
15	351122	627.00	17 1/2	460
25	351123	836.00	25	535

High-voltage Rating, 14,400/24, 940Y

Low-voltage	Rated Kva	High-voltage Taps	Reduced Kva
120/240 & 240/480	12,870/13,200/13,800		12,540

Kva, Cont. 55 C Rise	Low-voltage 120 240		Low-voltage 240 480		Oil Reqd., Gal.	Approx. Net WL Lb., Incl. Oil
	No.	Each	No.	Each		
3	3511264	\$ 274.00	351136	\$ 274.00	19	210
5	3511265	355.00	351137	355.00	17	335
7.5	3511266	428.00	351138	428.00	16 3/4	370
10	3511267	522.00	351139	522.00	17	350
15	3511268	637.00	351140	637.00	18	460
25	3511269	846.00	351141	846.00	25	555
37.5	3511757	1073.00	3511759	1073.00	32 1/2	800
50	3511758	1293.00	3511760	1293.00	36	950

High Voltage: 7200/12,470Y—Low Voltage 120/240
High-voltage Taps: (4) 2 1/2% Below 7200 Volts

Kva, Cont. 55 C Rise	No.	Each	Oil Reqd., Gal.	Approx. Net WL, Lb.
7 1/2	7111285	\$359.00	8	215

High Voltage: 7200/12,470Y—Low Voltage 240/480
High-voltage Taps: (2) 2 1/2% Above and (2) 2 1/2% Below 7200 Volts

7 1/2	7111286	\$359.00	8	215
-------	---------	----------	---	-----

High Voltage: 7620-13,200Y—Low Voltage 120/240
High-voltage Taps: (2) 2 1/2% Above and (2) 2 1/2% Below 7620 Volts

7 1/2	7111287	\$359.00	8	215
-------	---------	----------	---	-----

High Voltage: 7620/13,200Y—Low Voltage 240/480
High-voltage Taps: (2) 2 1/2% Above and (2) 2 1/2% Below 7620 Volts

7 1/2	7111288	\$359.00	8	215
-------	---------	----------	---	-----

G-E Type HSBA Oil-Immersed Rural-Line Transformers

In Accordance with R. E. A. Requirements

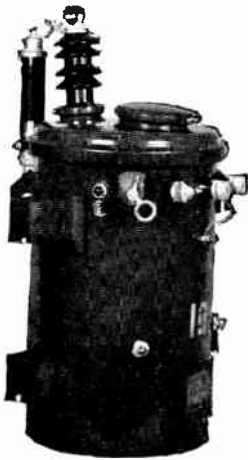

Embodies the same reliability as the conventional Type HSBA transformer. Lightning protection is afforded by a Hi-Stroke rural arrester mounted directly on the tank, and overcurrent protection is provided by a low-voltage circuit breaker mounted inside the tank, under oil.

Each unit complete with: One high-voltage cover bushing; one Hi-Stroke rural arrester; internal high-voltage fuse; handhole in cover; overload signal lamp (on sizes 7½ kva and larger); three low-voltage tank-wall bushings; internal low-voltage circuit breaker with external operating

handle; provision for direct pole mounting with low-voltage bushings 90 degrees from the pole; two mounting positions, on opposite sides of tank; two clamp-terminal tank-grounding connectors; low-voltage neutral grounded to tank.

Application: By connection of the low-voltage leads to the bushing terminals inside the tank, transformers are arranged for series or multiple two-wire service, or for three-wire service.

For 12,470-GrY-Volt Circuits

High Voltage: 12,470 GrY/7200, Low-Voltage: 120/240, No Taps

Kva, Cont. 55 C Rise	No Taps No.	Each	Oil Req'd. Gal.	Net WL, Lb.
3	841115	\$218.00	5¼	155
5	841116	309.00	6¼	175
7.5	841150	413.00	8	225
10	841151*	473.00	8½	300
15	841152*	587.00	12	355
25	841153*	776.00	19½	515

*Although not listed by R.E.A., these transformers are available by Catalog Number.

High Voltage Rating, 12,470 GrY/7200

Low-voltage 120/240	High-voltage Taps (Rated Kva)		Oil, Req'd. Gal.	Approx. Net Wt., Lb. Incl. Oil
	Above 7620	Below 7620		
	None	(1) 2½%		
Kva, Cont. 55 C Rise	No.	Each	Oil, Req'd. Gal.	Approx. Net Wt., Lb. Incl. Oil
3	3111924	\$227.00	5¼	155
5	3111925	323.00	6¼	175
7.5	3111926	431.00	8	225
10	3111927	495.00	8½	300
15	3111928	615.00	12	355
25	3111929	814.00	19½	515

For 13,200-GrY-Volt Circuits

High-Voltage Rating, 13,200 GrY/7620

Low-voltage 120/240	High-voltage Taps (Rated Kva)		Oil, Req'd. Gal.	Approx. Net Wt., Lb. Incl. Oil
	Above 7200	Below 7200		
	(2) 2½%	(2) 2½%		
Kva, Cont. 55 C Rise	No.	Each	Oil, Req'd. Gal.	Approx. Net Wt., Lb. Incl. Oil
3	3111931	\$227.00	5¼	155
5	3111932	323.00	6¼	175
7.5	3111933	451.00	8	225
10	3111934	495.00	8½	300
15	3111935	615.00	12	355
25	3111936	814.00	19½	515

G-E Type HSBA Oil-Immersed Rural-Line Transformers

For 13,200-GrY-Volt Circuits

High Voltage: 24,940 GrY/14,400

Low Voltage: 120/240, No Taps

Kva, Cont. 55 C Rise	No Taps No.	Each	Oil Req'd. Gal.	Net Wt., Lb.
3	841125	\$340.00	9	215
5	841126	417.00	9	225

High-Voltage Rating, 24,940 GrY/14,400

Low-voltage 120/240	Rated Kva		High-voltage Taps	Reduced Kva 12,510
	12,870	13,200/13,800		

Kva, Cont. 55 C Rise	No.	Each	Oil, Req'd. Gal.	Approx. Net Wt., Lb. Incl. Oil
3	351124	\$354.00	9	215
5	351125	435.00	9	225
7.5	351126	522.00	12	310
10	351127	616.00	12¼	350
15	351128	731.00	18	460
25	351129	940.00	25	555

G-E Type HSA, Oil Immersed Rural-Line Transformers With Cutout and Arrester Combination

In Accordance with R.E.A. Requirements

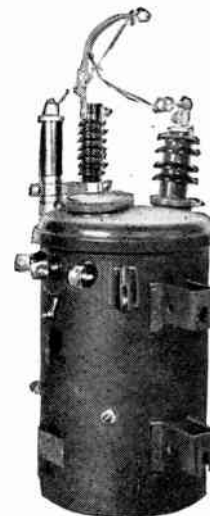

High-voltage: 12,470 GrY/7200, Low-voltage: 120/240

Kva, Cont. 55 C Rise	No Taps No.	Each	(4) 2% Rated Kva Below 7200 Volts		Oil Req'd. Gal.	Net Wt., Lb.
			Each	Each		
3	841168	\$195.00	3511771	\$204.00	6½	135
5	841169	386.00	3511772	200.00	6¼	170
7.5	841170	376.00	3511773	394.00	8	215
10	841171*	436.00	3511774	458.00	8½	280
15	841172*	550.00	3511775	578.00	12	315
25	841173*	739.00	3511776	777.00	19½	500

*Although not listed by R.E.A., these transformers are available by Catalog Number.

High-voltage: 13,200 GrY/7620, Low-voltage: 120/240, with Taps

Kva, Cont. 55 C Rise	No.	Each	(2) 2% Rated Kva Above and Below 7200V		Oil Req'd. Gal.	Net Wt., Lb.
			Each	Each		
3	3511777	\$204.00			6½	135
5	3511778	300.00			6¼	170
7.5	3511779	394.00			8	215
10	3511780	458.00			8½	280
15	3511781	578.00			12	315
25	3511782	777.00			19½	500

G-E Type HS Oil-Immersed Rural-Line Transformers and Gap and Internal High-Voltage Fuse

In Accordance with R. E. A. Requirements

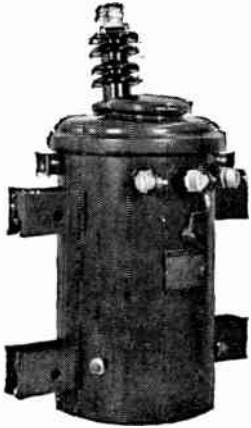

Transformer with gap and fuse is for service on solidly grounded, common-neutral 7200-, 7620- and 14,400- volt circuits.

Each unit complete with: One high-voltage cover bushing with double bushing gap; internal high-voltage fuse; handhole in cover; three low-voltage tank-wall bushings with low-voltage neutral grounded to the tank externally; bracket for future mounting of lightning arrester; two clamp-terminal tank-grounding connectors; two sets of support lugs for direct pole mounting in either of two positions. The support lugs are 90 degrees from the low-voltage bushings; name-plate; lifting lugs.

High-voltage: 12,470 Gr Y/7200, Low-voltage: 120/240, No Taps

Kva, Cont. 55 C Rise	No Taps No.	Each	Oil Req'd., Gal.	Net Wt., Lb.
3	841113	\$170.00	6½	155
5	841114	261.00	6¼	180
7.5	841164	351.00	8	215
10	841165*	411.00	8½	275
15	841166*	525.00	12	340
25	841167*	714.00	19	500

*Although not listed by R.E.A., these transformers are available by Catalog Number.

High-voltage Rating, 12,470 GrY/7200

Kva, Cont. 55 C Rise	No.	Each	High-voltage Taps (Rated Kva)		Oil Req'd., Gal.	Net Wt., Lb.
			Low-voltage 120/240	Above 7200 None		
3	3111896	\$179.00			6½	155
5	3111897	275.00			6¼	180
7.5	3111898	369.00			8	215
10	3111899	433.00			8½	275
15	3111890	553.00			12	340
25	3111891	752.00			19	500

High-voltage Rating, 13,200 GrY/7620

Kva, Cont. 55 C Rise	No.	Each	High-voltage Taps (Rated Kva)		Oil Req'd., Gal.	Net Wt., Lb.
			Low-voltage 120/240	Above 7620 (2) 2½%		
3	3111903	\$179.00			6½	155
5	3111904	275.00			6¼	180
7.5	3111905	369.00			8	215
10	3111906	433.00			8½	275
15	3111907	553.00			12	340
25	3111908	752.00			19	500

High-voltage: 24,940 Gr/Y14,400, Low-voltage: 120/240, No Taps

Kva, Cont. 55 C Rise	No.	Each	Oil Req'd., Gal.	Net Wt., Lb.
3	841127	\$266.00	9¼	200
5	841128	343.00	9	215

High-voltage Rating, 24,940 GrY/14,400

Kva, Cont. 55 C Rise	No.	Each	High-voltage Taps		Oil Req'd., Gal.	Net Wt., Lb.
			Low-voltage 120/240	Rated Kva 12,870/13,200/13,800		
3	351130	\$280.00			9¼	200
5	351131	361.00			9	215
7.5	351132	434.00			12	320
10	351133	528.00			12	340
15	351134	643.00			18	450
25	351135	852.00			25	550

G-E Portable Oil Testers 35,000-Volt 0.5 Kva



This oil tester affords a compact, convenient, and accurate means for testing oil in the field, as it combines in a single unit, a step-up transformer, a means for gradually raising the test voltage, a voltmeter to measure breakdown values, an automatic circuit breaker, and an oil-testing receptacle.

The successful operation of high-voltage oil-insulated apparatus requires that the dielectric strength of the oil be maintained at a high value. Assurance that the oil is always satisfactory dielectrically is possible only by testing oil regularly.

All live parts of the equipment are enclosed and complete safety features assure full protection to the operator.

Furnished complete with 15 feet of 3-conductor attaching cord and plug.

For price and description information consult Graybar.

G-E Insulating and Cooling Oil No. 10-C

G-E No. 10-C oil is a specially prepared insulating and cooling oil for use in transformers, feeder voltage regulators, and oil fuse cutouts.

The development of this oil and the attainment of proper characteristics and uniform quality have required the closest co-operation for many years between G-E engineers and oil refiners, and involve a careful selection of proper crude oil, as well as the use and control of special refining processes applicable only to insulating oil.

Refined from selected grades of crude oil by refiners experienced in producing oil for this highly special application, this oil has the characteristics which provide both the cooling and insulating factors essential to transformer operation; it does not affect the transformer insulation, and is unaffected by these insulating materials. An important quality in transformer oil is its long service life, the inherent resistance to sludge formation. To have such properties should be used for it

G-E Type HS Pyranol Distribution Transformers



This transformer generally affords substantial savings over the total installed cost of oil-filled equipment for all installations indoors or in confined locations.

Filled with Pyranol, G-E's synthetic insulating and cooling liquid, which has all of the desirable characteristics of mineral oil and, in addition, is non-flammable. Pyranol transformers can, therefore, be safely installed indoors or in confined locations without expensive fireproof vaults. They can usually be

installed at the load center, giving additional savings by the elimination of long and costly runs of secondary copper, with improved voltage regulation at the load.

Pyranol transformers have made possible savings on overall installed costs of as high as twenty-three per cent, compared with the cost of oil-filled equipment.

It is recognized by the National Electrical Code.

Pyranol is suitable for use only in Pyranol transformers, designed especially for the purpose.

For complete information, ask for Bulletin GEA-2048.

†Reg. trade-mark of General Electric Co.

Single-phase, 60 Cycles, Self-cooled

For 480- and 600-Volt Circuits

Application: By connection of the low-voltage leads to the bushing terminals inside the tank, transformers are arranged for series or multiple two-wire service.

Service: Suitable for indoor or outdoor installation.

Kva Cont. 55 C Rise	Line No. 1 Cat. No.	Line No. 2 Cat. No.	Net WL, Lbs.	Pyranol Required Gallons	List Price, Each	High-voltage Taps (Rated Kva)	
						Above 480	Below 480
	Line No. 1	Line No. 2				High-voltage	Low-voltage
						480	120/240
						None	(2) 5%
						Above 600	Below 600
						None	(2) 5%
3	2811711	2811724	165	4 1/2	\$ 389.00		
5	2811712	2811725	220	5 1/2	419.00		
10	2811714	2811727	280	8	515.00		
15	2811715	2811728	385	12	629.00		
25	2811716	2811729	550	17	846.00		
37.5	2811717	2811730	745	20 3/4	1081.00		
50	2811718	2811731	950	28 3/4	1304.00		
75	2811719	2811732	1295	43 3/4	1708.00		
100	2811720	2811733	1475	46 1/2	2096.00		

For 2400- and 4160Y-Volt Circuits

Application: By connection of the low-voltage leads inside the tank to the bushing terminals, transformers are arranged for series or multiple two-wire service, or for three-wire service.

**High-voltage Rating: 2400/4160Y
Low-voltage: 120/240—No Taps**

Kva Cont. 55 C Rise	Cat. No.	Approx. Net WL, Lbs.	Pyranol Required Gallons	List Price, Each
3	2811737	165	4 1/2	\$ 327.00
5	2811738	220	6 1/2	406.00
10	2811740	280	8	499.00
15	2811741	385	12	610.00
25	2811742	550	17	820.00
37.5	2811743	745	20 3/4	1048.00
50	2811744	950	28 3/4	1264.00

For 2400-, 4160- 4800-, and 8320Y-Volt Circuits

Application: By connection of the low-voltage leads to the bushing terminals inside the tank, transformers having low-voltage rating of 120/240 or 240/480 are arranged for series or multiple two-wire service or for three-wire service.

Transformers having low-voltage rating of 240x480 are arranged for series or multiple two-wire service.

Service: Suitable for outdoor or indoor installation.

High Voltage Ratings, 2400/4160Y

Kva Cont. 55 C Rise	Line No. 1 Cat. No.	Line No. 2 Cat. No.	Net WL, Lbs.	Pyranol Required Gallons	List Price, Each	High-voltage Taps (Rated Kva)	
						Above 2400	Below 2400
	Line No. 1	Line No. 2				Low-voltage	High-voltage Taps (Kva Rated)
						120/240	Above 4160
						240/480†	Below 4160
							None
							(1) 2 1/2%
							(2) 2 1/2%
10	2711756	2711771	280	8	\$ 576.00		
15	2711757	2711772	385	12	630.00		
25	2711758	2711773	550	17	846.00		
37.5	2711759	2711774	745	20 3/4	1082.00		
50	2711760	2711775	950	28 3/4	1304.00		
75	2711761	2711776	1295	43 3/4	1708.00		
100	2711762	2711777	1475	46 1/2	2096.00		
167	7111894	2711918	1710	39	2980.00		

Low Voltage: 600

High-voltage Taps (Kva Rated): Above 2400—(2) 2 1/2% 2017

Below 2400—(2) 2 1/2%

25	2711788	550	17	\$ 846.00
50	2711790	950	28 3/4	1304.00
100	2711792	1475	46 1/2	2096.00
167	7111896	1710	46 1/2	2979.00

†240x480 for 167 kva only.

High Voltage Rating, 4160/7200Y

Kva Cont. 55 C Rise	Line No. 1 Cat. No.	Line No. 2 Cat. No.	Approx. Net WL, Lbs.	Pyranol Required Gallons	List Price, Each	High-voltage Taps (Kva Rated)	
						Above 4160	Below 4160
	Line No. 1	Line No. 2				Low-voltage	High-voltage Taps (Kva Rated)
						120/240	Above 4160
						240/480	Below 4160
							None
							(4) 2 1/2%
							(2) 2 1/2%
3	2711800	165	4 1/2	\$ 419.00		
5	2711801	220	5 1/2	454.00		
10	2711803	2811755	280	8	558.00		
15	2711804	2811756	385	12	682.00		
25	2711805	2811757	550	17	936.00		
37.5	2711806	2811758	745	20 3/4	1186.00		
50	2711807	2811759	950	28 3/4	1425.00		
75	2711808	2811760	1295	43 3/4	1853.00		
100	2711809	2811761	1475	46 1/2	2248.00		

G-E Type HS Pyranol Distribution Transformers

Application: By connection of the low-voltage leads to the bushing terminals inside the tank, transformers having a low-voltage rating of 120/240 or 240/480 are arranged for series for series or multiple two-wire service, or three-wire service.

Transformers having low-voltage rating of 240x480 are arranged for series or multiple two-wire service.

Service: Suitable for outdoor or indoor installation. Sizes 250-500 kva are also available.

For 4800/8320Y Volt Circuits High-Voltage Rating, 4800/8320Y

Line No.	Low-voltage	High-voltage Taps (Kva Rated)		Net Wt., Lb.	Pyranol Req'd. Gals.	List Price, Each
		Above 4800	Below 4800			
Line No. 1	120/240	None	None			
Line No. 2	120/240	None	(1) 2 1/2%			
Line No. 3	240/480†	(2) 2 1/2%	(2) 2 1/2%			
Line No. 4	600	(2) 2 1/2%	(2) 2 1/2%			

Kva Cont. 55 C Rise	Cat. Nos.		Net Wt., Lb.	Pyranol Req'd. Gals.	List Price, Each
	Line No. 1	Line No. 2			
3	2711850	2711865	165	1 1/2	\$406.00
5	2711851	2711866	220	5 1/2	440.00
10	2711853	2711868	280	8	541.00
15	2711854	2711869	385	12	661.00
25	2711855	2711870	550	17	907.00
37.5	2711866	2711871	715	20 3/4	1150.00
50	2711857	2711872	950	28 3/4	1382.00
75	7111969	2711873	1295	43 3/4	1792.00
100	7111970	2711974	1475	46 1/2	2180.00
167	7111971	3511920	1710	39	3210.00
10	2711883	280	8	\$ 558.00
15	2711884	385	12	682.00
25	2711885	2711900	550	17	936.00
37.5	2711886	745	20 3/4	1186.00
50	2711887	2711902	950	28 3/4	1425.00
75	2711888	1295	43 3/4	1854.00
100	2711889	2711904	1475	46 1/2	2248.00
167	7111898	7111899	1710	39	3150.00

†240x480 for 167 kva only.

High-Voltage Rating, 2400x4800/8320Y No Taps

Kva Cont. 55 C Rise	Cat. No.	Net Wt., Lbs.	Pyranol Req'd. Gals.	List Price, Each
3	2811922	165	1 1/2	\$ 427.00
5	2811923	220	5 1/2	462.00
10	2811925	280	8	569.00
15	2811926	385	12	595.00
25	2811927	550	17	954.00
37.5	2811928	745	20 3/4	1208.00
50	2811929	950	28 3/4	1453.00
75	3311491	1295	43 3/4	1888.00
100	3311492	1475	46 1/2	2290.00

For 7200-, and 12,470Y-Volt Circuits High-Voltage Rating, 7200/12,470Y (2 H-V Cover Bushings, No Taps) No Taps-Low Voltage, 120/240

Kva Cont. 55 C Rise	Cat. No.	Net Wt., Lbs.	Pyranol Req'd. Gals.	List Price, Each
5	7111963	220	6 1/4	504.00
10	7111964	310	8 3/4	615.00
15	7111965	400	12 1/4	763.00
25	7111966	590	20	1013.00
37.5	7111967	950	33 1/4	1297.00
50	7111968	1050	33	1550.00

Line No.	Low-voltage	High-voltage Taps (Kva Rated)	
		Above 7200	Below 7200
Line No. 3	600	(2) 2 1/2%	(2) 2 1/2%

Kva Cont. 55 C Rise	Cat. Nos.		Net Wt., Lbs.	Pyranol Req'd. Gals.	List Price, Each
	Line No. 3	Line No. 3			
25	2811820	615	19 1/2	\$1045.00
50	2811822	1050	33	1598.00
100	2811824	1575	48	2442.00
167	7111905	1830	40 1/4	3161.00

High-Voltage Ratings, 7200/12,470Y (2 H-V Cover Bushings)

For 7200- and 12,470Y Circuits High-Voltage Rating, 7200/12,470Y (2 H-V Cover Bushings)

Line No.	Low-voltage	High-voltage Taps (Rated Kva)		Net Wt., Lb.	Pyranol Req'd. Gals.	List Price, Each
		Above 7200	Below 7200			
Line No. 1	120/240	None	(1) 2 1/2%			
Line No. 2	240/480†	(2) 2 1/2%	(2) 2 1/2%			

Kva Cont. 55 C Rise	Cat. Nos.		Net Wt., Lb.	Pyranol Req'd. Gals.	List Price, Each
	Line No. 1	Line No. 2			
3	2811301	205	6 1/2	\$ 488.00
5	2811302	220	6 1/4	520.00
10	2811804	2811811	310	8 3/4	635.00
15	2811805	2811812	400	12 1/4	787.00
25	2811806	2811813	590	20	1045.00
37.5	2811807	2811814	950	33 1/4	1338.00
50	2811808	2811815	1050	33	1598.00
75	2811809	2811816	1450	46	2077.00
100	2811810	2811817	1575	46	2442.00
167	7111903	7111904	1830	40 1/4	3312.00

†240x480 for 167 kva only.

High-Voltage Rating, 7200/12,470Y

Line No.	Low-voltage	High-voltage Taps (Rated Kva)	
		Above 7200	Below 7200
Line No. 4	2100	(2) 2 1/2%	(2) 2 1/2%
Line No. 5	4800	(2) 2 1/2%	(2) 2 1/2%

Kva Cont. 55 C Rise	Cat. No.	Net Wt., Lbs.	Pyranol Req'd. Gals.	List Price, Each
100	3311984	1550	44	2442.00
167	7111906	1750	38 1/4	3011.00
50	3311965	1290	43	1837.00
100	3311966	1550	44	2808.00
167	7111907	1850	43	3236.00

For 7620/13,200Y-Volt Circuits High-Voltage Rating, 7620/13,200Y

Line No.	Low-voltage	High-voltage Taps (Rated Kva)	
		Above 7620	Below 7620
Line No. 1	120/240	(2) 2 1/2%	(2) 2 1/2%
Line No. 2	240/480†	(2) 2 1/2%	(2) 2 1/2%
Line No. 3	600	(2) 2 1/2%	(2) 2 1/2%

Kva Cont. 55 C Rise	Cat. Nos.		Net Wt., Lb.	Pyranol Req'd. Gals.	List Price, Each
	Line No. 1	Line No. 2			
3	2811319	205	6 1/2	\$ 488.00
5	2811320	220	6 1/4	520.00
10	2711934	2711946	310	8 3/4	635.00
15	2711935	2711947	400	12 1/4	787.00
25	2711936	2711948	590	20	1045.00
37.5	2711937	2711949	950	34	1338.00
50	2711938	2711950	1050	33	1598.00
75	2711939	2711951	1450	46	2077.00
100	2711940	2711952	1575	48	2442.00
167	7111908	7111909	1830	40 1/4	3161.00
25	2711960	615	19 1/2	1045.00
50	2711962	1050	33	1598.00
100	2711964	1450	46	2442.00
167	7111910	1830	40 1/4	3161.00

†240x480 for 167 kva only.

G-E Thyrite Line and Station-Type Arresters

Line-Type Lightning Arresters

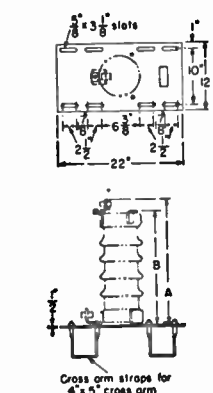

Cat. No. 5213764G5
base plate for double-crossarm mounting

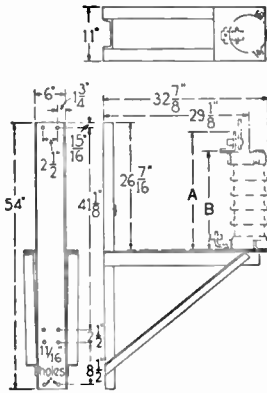

Cat. No. 298143G13
bracket for station-structure mounting

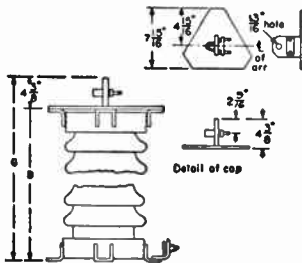

Cat. No. 246B711G1
eyebolt cap for suspension mounting

Cat. No.	Description	Shp. Wt. Lbs., Mtg. Device only	For Use with Arrester Model No.	List Price Addition Each, When Purchased With Arresters
*9532854G4	Single crossarm bracket	18	91.A21157 91.A21159 91.A21161† 91.A21162	\$12. 00
9532854G3	Two-crossarm bracket	40	91.A21157 91.A21159 91.A21161 91.A21162 91.A21181	24. 00
*5213764G5	Double-crossarm Base Plate	45	91.A21157 91.A21159 91.A21161 91.A21162 91.A21181 91.A21164 91.A21165 91.A21166	24. 00
2981434G13	Wall Bracket	100	91.A21164 91.A21165 91.A21166	45. 00

The standard top cap fitting of all of these arresters has a 1 3/8 inch diameter hole by which the arrester can be suspended.

This fitting is included with suspension mounting arrester at no increase in price, if specified on order.

The fitting is known as Eyebolt Cap, Cat. No. 246B711G1, and is for use with suspension mounting ratings 20-21 inclusive.

*These mountings include crossarm straps or U-bolts for 4-by-5-inch crossarms.

It is not recommended that these heavier arresters be mounted on a single crossarm, unless the crossarm is one of two parallel double arms or is otherwise mechanically supported to prevent torsional twisting of the arm by the weight of the arrester.

Station-Type Lightning Arresters

Altitude, 0 to 6000 Feet

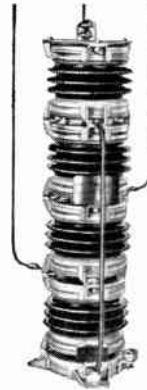

Three-phase Thyrite arrester, 3- or 6-kv max., arranged in a single stack



Model No. 91A1H61
Thyrite arrester (one-pole only) for 34.5 kv. grounded-neutral system

Model No. 91A1H46
Thyrite arrester (one pole only) Max. rated 3kv for 4160-v grounded- or 2400-v ungrounded-neutral systems (half-unit shown)

Model No. 91A1H66
Thyrite arrester (one pole only) for 69 kv ungrounded-neutra system

The G-E Form II Thyrite magne-valve station-type lighting arrester combines improved electrical characteristics and refinements of mechanical construction which establish a new standard of protective efficiency and over-all dependability.

Designed for protection of service continuity as well as apparatus insulation, the Thyrite magne-valve arrester provides excellent valve performance which prevents system disturbances or outages as the result of lightning discharges.

The Thyrite magne-valve arrester can be applied indoors or outdoors for the protection of either large or small generating or substation equipment, on either grounded- or ungrounded-neutral systems, and over a voltage range of 2.3 to 330 kv.

The simplicity of design and the small space requirement make this arrester ideal for mounting directly on power transformers and unit substations or for mounting on substation steel structures, as well as on concrete foundations or piers.

Possessing every mechanical and electrical feature known to the art of reliability, endurance, fidelity of protective performance, and economies of application, the Thyrite magne-valve station-type arrester should be applied at generating stations and substations where either the investment in equipment to be protected or the importance of service continuity warrants the highest degree of protection.

The unexcelled protection record established by Thyrite station-type arresters in service operation over the past fourteen years and the demonstrated economies of their interchangeable unit construction, are notable evidence of the soundness of protection.

G-E Thyrite Line and Station-Type Arresters

Station-Type Lightning Arresters

Distinctive features of these Thyrite magne-valve station-type arresters include: (1) Excellent protective efficiency 20 per cent lower IR drop). (2) Exceptionally large discharge capacity—3 times greater than heretofore available. (3) Thyrite shunted and shielded gap construction. (4) Interchangeable sealed-unit construction. (5) Freedom from moisture or

atmospheric influences. (6) Ease of installation.

The following information applies to single-pole arresters. For 3-phase circuits, use three single-pole arresters.

For a complete discription, ask Graybar for Bulletin GEA-1304L.

Single-pole Arrester Model No.	Normally Used on Circuit Voltage, Class		‡Max. Valve Rating & Max. Permissible Line-to-ground Voltage - Rms.	Approx. Ship. Wt. Lbs. Single-pole Arrester	List Price, Each Single-pole Arrester Only
	Ungrounded Neutral	*Grounded Neutral			
9LA11146	2400 volts	4160 volts	3‡	90	\$ 120.00
9LA11148	1160 or 1800 volts	4800 or 6900 volts	6‡	100	146.00
9LA11150	6900 volts	11500 volts	9‡	110	180.00
9LA11151	11500 volts	13800 volts	12‡	120	211.00
9LA11153	13800 volts	18 kv	15‡	200	297.00
9LA11157	18 kv	23 kv	20	245	333.00
9LA11159	23 kv	28.5 kv	25	260	364.00
9LA11161	28.5 kv	34.5 kv	30	355	476.00
9LA11162	34.5 kv	...	37	405	541.00
9LA11181	...	46 kv	40	450	627.00
9LA11164	46 kv	57.5 kv	50	475	718.00
9LA11165	57.5 kv	69 kv	60	590	895.00
9LA11166	69 kv	...	73	690	1072.00
9LA11167	92 kv	115 kv	97	935	1426.00
9LA11HD68Φ	...	126.5	109	1025	1663.00
9LA11168	...	126.5	109	1025	1663.00
9LA11HD69Φ	115	138	121	1220	1840.00
9LA11H69	115	138	121	1220	1840.00
9LA11HD70Φ	138	161	145	1350	2330.00
9LA11H70	138	161	145	1460	2194.00
9LA11H71	161	...	169	1700	2548.00
9LA11HD84Φ	126.5	...	133	1350	2153.00
9LA11184	126.5	...	133	1350	2017.00
9LA11135	230	...	242	1700	4916.00
9LA11134	...	230	182⊕	1300	3982.00
9LA11131	...	230	195	4650	4166.00

Suspension Earthquake-proof Design

9LA11HF108	...	230	195	3350	4400.00
9LA11HF112	...	230	264	3350	5363.00

‡Low-voltage Arresters for Mounting in 3-phase Single-stack Assembly

9LA11HK46	2400 volts	4160 volts	3000#	...	\$ 360.00
9LA11HK48	1160 and 1800 volts	4800 and 6900 volts	6000#	...	438.00
9LA11HK50	6900 volts	11500 volts	9000#	...	540.00
9LA11HK51	11500 volts	13800 volts	12000#	...	633.00

*Use only when system is solidly grounded.
 †Select arrester according to "Circuit Voltage." However the "Maximum Permissible Line-to-ground Voltage" denotes the margin for rises above the normal line-to-ground system voltage, and should be considered for poorly regulated systems or for doubtful reliability of system neutral grounding, or any other operating conditions by which the line-to-ground voltage might exceed this "Maximum Permissible" rating.
 ΦSelf-supporting construction, utilizing specially reinforced units at bot-

tom of arrester, and special foundation base. Maximum allowable load pull on top of arrester is 150-lbs.
 ⊕Reduced rating (75%) arrester for 230-kv grounded-neutral service.
 ‡Can be supplied for mounting in 3-phase single-stack assembly as shown.
 #If this mounting is ordered; one base casting, one special insulating unit, three-single-pole arrester units and one cap casting will be supplied.
 #Arrester Voltage Rating, Rms.

Parts For Station-Type Thyrite Arresters

Model No.	Description	Max. Kv Rating Rms	Ship. Wt. Lbs.	Price Each
§9LA1116	Full Unit	12	105	\$177.00
§9LA1115	Three-quarter Unit	9	100	146.00
§9LA1113	Half Unit	6	90	112.00
§9LA1111	Quarter Unit	3	85	86.00
'118B929G1	Cap Only	..	12	10.00
'258B810G1	Base and Grounding	..	14	24.00
'118B929G3				
¶2981434G13	Mounting Bracket	..	75	24.00

'Cat. No.
 §Does not include cap or base.
 ¶Can be supplied instead of standard base.

Shown at right: Cat. No. 2981434G13 bracket for mounting from one to four Thyrite units.

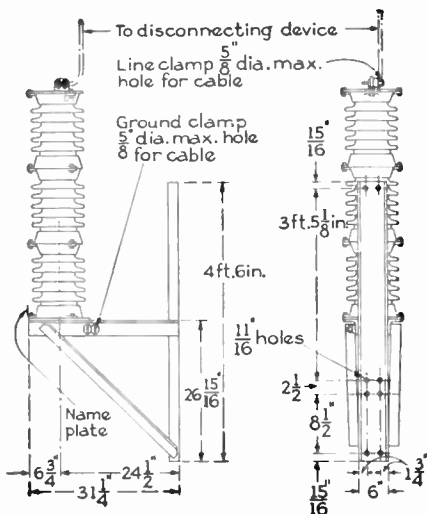

G-E Distribution Lightning Arresters

Pellet-type

For Circuits 1 to 15 Kv.

Altitude 0 to 6000 Feet

The electric elements of these arresters consist of a pellet column that forms the valve element and prevents the flow of system current following discharge, and a series-gap assembly sealed in nitrogen-filled gap chamber which isolates the valve element from the line until it is sparked over by a surge.

The dry nitrogen gas in gap-chamber prevents entrance of moisture, makes arrester proof against atmospheric conditions and assures freedom from leakage and corrosion permanently.

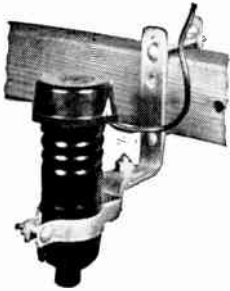

3-KV pellet arrester Model No. 9LA10C21, Showing EE1-NEMA Standard Mounting Bracket

Porcelains are wet-process type, well glazed. They have flexible leads securely soldered for line connection.

Clamp-type ground terminal permits clamping either one or two solid or stranded ground wires to arrester, does away with connectors, splicing, soldering and taping—saves both labor and material.

Hangers and Mountings

Standard EE1-NEMA mounting bracket and T bracket are available for all pellet arresters and can be used alone, in combination with primary fuse cutouts, or on transformer tanks.

Arresters have two mounting grooves on porcelain providing for alternate positions in either standard or special hangers, making it possible to balance either the clearances or the appearance of the installation. The arrester can be inserted in any hanger either before or after hanger has been mounted.

In addition to the EE1-NEMA standard mounting bracket, pellet arresters can be furnished with special hangers as shown in the detail at right. Arresters with special hangers have same prices as arresters of the same rating with standard mounting brackets. To determine number of arrester with a special hanger—Select the standard arrester from Tables 1, 2, 3, or 4, then refer to Table 5 for the number of the corresponding arrester with special hanger desired. (For complete description write for Bulletin GEA-2975).

Number of Arresters Required at Installation

For Table 1. Use two at each single-phase and three at each three-phase installation.

For Table 2. Use one on phase wire at a single-phase installation made between phase wire and neutral. Use also on neutral wire, a neutral gap if voltage to ground is not over 300 volts; if, because of unbalancing, voltage is between 300 and 1000 volts, use Model No. 9LA10C11, 9LA10CA11 or 9LA10CB11 arrester, depending on altitude. Use two arresters at a single-phase installation between outside phase wires. Use three arresters at each 3-phase installation.

For Table 3. Use one arrester at each installation.

***Pellet-type Arresters with Standard Hangers**

Table 1—For Systems with Ungrounded Neutral

Model No.	Circuit Voltage Constant Potential		Maximum Permissible Line-to-ground Voltage, Rms.	Ship. Wt. Lbs.	Each
	Min.	Max.			
9LA10C11	300	1000	1000	8	\$18 50
9LA10C21	1000	3000	3000	11	21 00
9LA10C41	3000	6000	6000	17	31 00
9LA10C51	6000	9000	9000	26	37 00
9LA10C61	9000	12000	12000	31	50 00
9LA10C71	12000	15000	15000	37	64 00

Table 2—For Systems with Solidly Grounded Neutral

9LA10C21	3000	5000	3000	11	\$21 00
9LA10C41	5000	9000	6000	17	31 00
9LA10C51	9000	12800	9000	26	37 00
9LA10C61	12800	15000	12000	31	50 00
9LA10C71	15000	18000	15000	37	64 00

Table 3—For Single-phase Circuits with One Conductor—Solidly Grounded at Source and Multigrounded along Line

Model No.	Primary-circuit Operating Voltage	Maximum Permissible Line-to-ground Voltage, Rms.	Ship. Wt. Lbs.	Each
9LA10C41	4800-5000	6000	17	31 00
9LA10C51	6900-7200	9000	26	37 00
9LA10C81	7620-7940	10000	27	37 00

Table 4—For Protection of Load Side of A-C Series-Lighting Transformers

Model No.	Kva Rating of Transformers, Secondary Amperes (6.6 and 7.5)	Approx. Ship. Wt. Lbs.	Each
9LA10C21	5, 7.5, 10, 15	11	21 00
9LA10C41	20, 25, 30	17	31 00
9LA10C51	35, 40	26	37 00
9LA10C61	50	31	50 00
9LA10C71	60, 70	37	64 00

Special Hangers

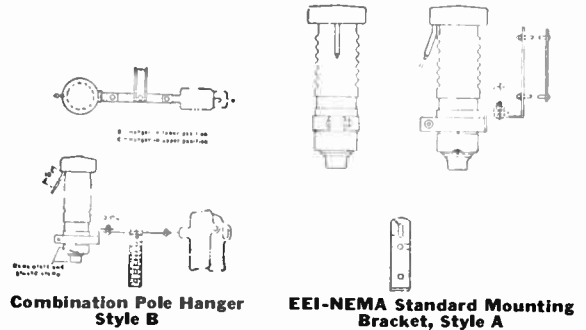

Combination Pole Hanger Style B

EE1-NEMA Standard Mounting Bracket, Style A

Table 5—Pellet-type Arresters with Special Hangers

Arrester Model No. with EE1-NEMA Standard Mounting Bracket, Style A	Model No.	Type of Hanger
9LA10C21	9LA10C28	Combination Pole, Style B
9LA10C41	9LA10C48	Combination Pole, Style B
9LA10C51	9LA10C58	Combination Pole, Style B
9LA10C61
9LA10C71
9LA10C81	9LA10C88	Combination Pole, Style B

*These arresters in the Model No. 9LA10C series include the new EE1-NEMA Standard mounting bracket. For detail drawing, see Style A.

G-E Rural Lightning Arresters

Hi-Stroke

Heavy-duty expulsion type, with many exclusive features of construction, designed specifically for Rural Systems. They have high lightning discharge capacity and combine highest efficiency in impulse protective level and long operating life.

For separate mounting these arresters utilize the same arrester element (0-2000 amperes rms. interrupting rating) and have the same performance characteristics as those furnished since 1914 on Type HBA rural line transformers and which have established an excellent service operating record on many rural systems.

Separate Mounting



Mounted on Crossarm, Using Clamp-type Hanger

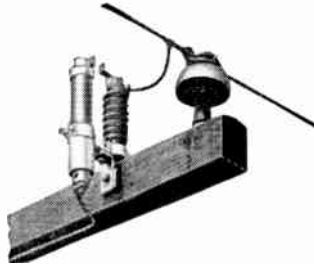

Mounted on Crossarm, Using Bracket for Through-bolt or Lag Screw

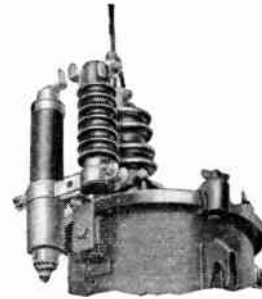

*Mounted on Transformer

Model No.	Circuit Kv.	Approx. Wt., Lbs.		Each
		Net	Ship.	
9LA17B21	4.8/6.9GrY	9	11	\$31
9LA17B31	{ 7.2/12.47GrY 7.62/13.2GrY }	9½	12	37
9LA17B71	14.4/23.9GrY	20	24	69

Model No.	Circuit Kv.	Approx. Wt., Lbs.		Each
		Net	Ship.	
9LA17B22	4.8/6.9GrY	7½	10	\$31
9LA17B32	{ 7.2/12.47GrY 7.62/13.2GrY }	8	11	37

Model No.	Circuit Kv.	Approx. Wt., Lbs.		Each
		Net	Ship.	
9LA17B32*	{ 7.2/12.47GrY 7.62/13.2GrY }	8	11	\$37

*Interchangeable with 9-kv. pellet arrester mounted on tank bracket of early designs of Type HBA, 7200-volt single-bushing transformer.

Typical Combination Mountings of Hi-Stroke Arrester and G-E Distribution Fuse Cutouts

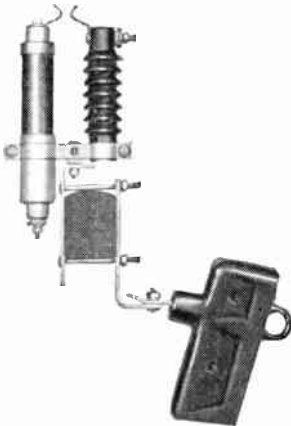

Mounted on Clamp-type Crossarm,† with G-E Enclosed Primary Fuse Cutout

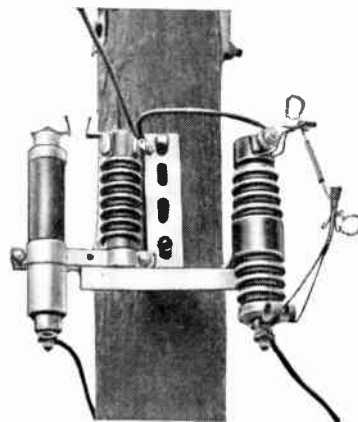

Arrester with T-Bracket‡ Mounted Direct-to-pole, with G-E Flip-open Fuse Cutouts

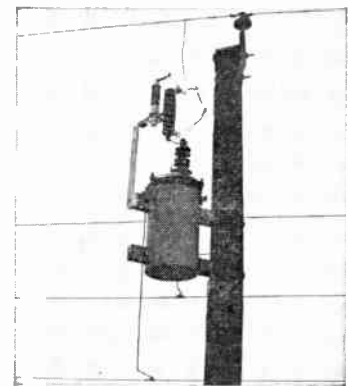

Unit-combination Shown with Mounting Bracket for Transformer Installations

Table 1

Model No.	Circuit Kv.	Description	Approx. Wt., Lbs.		Each
			Net	Ship.	
9LA17B21	4.8/6.9GrY	Arrester & Clmp. Cutout & hngr.	9	11	\$31.00
9F19A11	4.8/6.9GrY	Arrester & Clmp. Cutout & hngr.	8	10	16.20
9LA17B31	{ 7.2/12.47GrY 7.62/13.2GrY }	Arrester & Clmp. Cutout & hngr.	9½	12	37.00
9F19A21	§7500	Arrester & Clmp. Cutout & hngr.	11	13	20.60

Table 2

Model No.	Circuit Kv.	Description	Approx. Wt., Lbs.		Each
			Net	Ship.	
9LA17B23	4.8/6.9GrY	Arrester & brkt.	14	15	\$30.00
9LA17B33	{ 7.2/12.47GrY 7.62/13.2GrY }	Arrester & brkt.	14½	16	37.00
9F17C21	§7500	Cutout	8	10	15.84

Table 3

Cat. No.	Circuit Kv.	Mounting Bracket for	Approx. Wt., Lbs.		Each
			Net	Ship.	
9FLA1A281	{ 7.2/12.47 GrY and 7.62/13.2 GrY }	Transformer Mounting	14½	17½	\$46.00
*9FLA1A21		Crossarm Mounting	12½	15½	46.00

†Will also accommodate flip-open cutouts listed in Table 2 or open-type dropout cutouts.

‡Will also accommodate enclosed cutouts listed in Table 1 and open-type dropout cutouts.

§Cutouts rated 7.8 kv. max. can be used on grounded-neutral circuits where the voltage that an individual cutout is required to interrupt does not exceed 7.8 kv. rms.

*Includes EEF-NEMA Standard mounting bracket for crossarm or direct-to-pole mounting.

Ohio Brass Thorex Dynagap Arresters Distribution Lightning Arresters

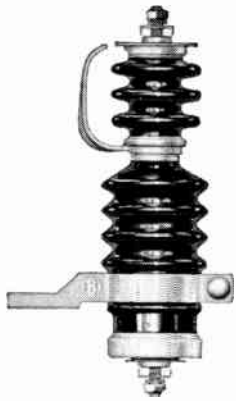

DV-6 with External Cap

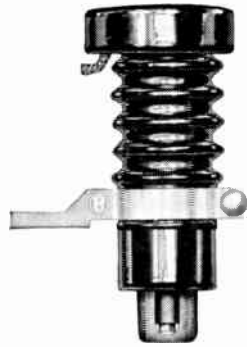

DV-6 with Ground Lead Isolator

Sparkover distance is stretched 140 times its original length by the Dynagap. This transfers a major share of power-follow current limitation to the gap element and permits

compounding of valve blocks to embody greater durability and high immunity to low-current, long-duration system disturbances, including damaging components of natural lightning strokes.

Thorex DV supplied in two models: (1) with external gap, and (2) with supplementary internal gap and automatic ground lead isolator. Standard NEMA brackets are provided when units are to be pole-mounted. Size and weight of each type has been kept to a minimum. Spring-pressure-follow sealing (imposing a dynamic loading on gasket joints) makes the Type DV completely air-tight and moisture-tight.

Arrester Rating, kv	Type No.	With Line Lead and Isolator		With External Gap	
		Arrester Only No.	With EEI-NEMA Bracket - No.	Arrester Only No.	With EEI-NEMA Bracket - No.
1	DV-1	46130	46160		
3	DV-3	46131	46161	46151	46171
6	DV-6	46132	46162	46152	46172
9	DV-9	46133	46163	46153	46173
10	DV-10	46134	46164	46154	46174
12	DV-12	46135	46165	46155	46175
15	DV-15	46136	46166	46156	46176
18	DV-18	46137	46167	46157	46177

Intermediate and Station Class Lightning Arresters

The Type GP Thorex, classed as "Intermediate," provides protection required in average station applications. Single unit GP arresters cover the range between 3 and 37 kv., while larger arresters are formed by stacking units in combination. The GP spark gap structure features improved nonlinear resistance grading system.

Types MP and MPR Thorex arresters are for applications where maximum durability and equipment protection is desired and/or where severe contamination exists. Type MP arresters are single units up to 37 kv and two-unit stacks

from 40 to 73 kv. Above 73 kv the MPR offers single unit arresters with electrically continuous porcelain housings.

For voltage ratings up to 15 kv, both the GP and MP are available with choice of metal caps at both ends or with a porcelain top. The latter is denoted by an "A" after the type number. A much smaller terminal is featured on the porcelain top which reduces phase and ground clearances and permits closer grouping. The GP, MP, and MPR Thorex arresters are compact in size and self-supporting, from the lowest to the highest kv rating.

Arrester Rating—kv	Normal Application		Type No.	MPR Cat. No.	Ht.—in.	Type No.	MP Cat. No.	Ht.—in.	Type No.	GP Cat. No.	Ht.—in.
	Effect. Grounded Neutral—Volts	Ungrounded Neutral—Volts									
3	4,160	2,400				MP-3A	46740	10 ³ / ₄	GP-3A	46700	10 ³ / ₄
4.5	4,800	4,160				MP-4.5A	46741	10 ³ / ₄	GP-4.5A	46701	10 ³ / ₄
6	6,900	4,800				MP-6A	46742	14	GP-6A	46702	10 ³ / ₄
7.5		6,900				MP-7.5A	46743	14	GP-7.5A	46703	14
9	11,500					MP-9A	46744	14	GP-9A	46704	14
12	13,800	11,500				MP-12A	46745	20 ¹ / ₂	GP-12A	46705	18 ¹ / ₂
15	18,000	13,800				MP-15A	46746	20 ¹ / ₂	GP-15A	46706	18 ¹ / ₂
20	23,000	18,000				MP-20	46757	27 ¹ / ₂	GP-20	46717	20 ³ / ₄
25	28,500	23,000				MP-25	46758	31 ¹ / ₄	GP-25	46718	22 ³ / ₄
30	34,500	28,500				MP-30	46759	36	GP-30	46719	27 ¹ / ₄
37		34,500				MP-37	46760	40 ¹ / ₂	GP-37	46720	31 ³ / ₄
40	46,000					MP-40	46761	50 ¹ / ₄	GP-40	46721	41 ¹ / ₂
45						MP-45	46762	54 ¹ / ₄	GP-45	46722	43 ¹ / ₂
50	55,000	46,000				MP-50	46763	58 ¹ / ₄	GP-50	46723	45 ¹ / ₄
60	69,000	55,000				MP-60	46764	67 ¹ / ₄	GP-60	46724	54 ¹ / ₄
73		69,000				MP-73	46765	76 ¹ / ₂	GP-73	46725	63 ¹ / ₄
79	92,000		MPR-79	46780	43				GP-79	46726	72 ¹ / ₂
85		81,000	MPR-85	46781	43				GP-85	46727	77
90			MPR-90	46782	46 ¹ / ₂				GP-90	46728	81 ¹ / ₂
97	115,000	92,000	MPR-97	46783	46 ¹ / ₂				GP-97	46729	86
109	126,500		MPR-109	46784	56 ³ / ₄				GP-109	46730	95
121	138,000	115,000	MPR-121	46785	56 ³ / ₄				GP-121	46731	108 ¹ / ₂
133		126,500	MPR-133	46786	61 ³ / ₄						
145	161,000	138,000	MPR-145	46787	61 ³ / ₄						
169		161,000	MPR-169	46788	78 ³ / ₄						
182			MPR-182	46789	86						
195	230,000		MPR-195	46790	86						
212		230,000	MPR-212	46791	100 ³ / ₄						
258	345,000		MPR-258	46792	114 ¹ / ₄						
264	345,000		MPR-264	46793	114 ¹ / ₄						
276	345,000		MPR-276	46794	114 ¹ / ₄						

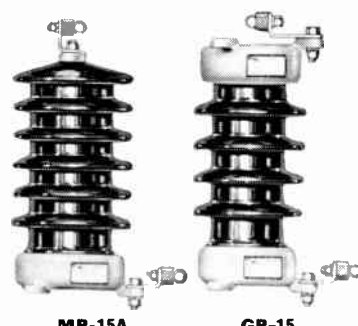

For a general technical discussion on the Thorex arrester including its construction, functioning of parts, and electrical performance, ask your Graybar representative for O-B publication No. 1366-11.

Prices on application.

Hubbard Standard Autogap Arresters



All Hubbard Autogap Lightning Arresters are furnished with mounting brackets of the user's choice. Mounting brackets are designed for all normal arrester usages and where specially designed brackets are required they will be furnished.

No. 2330

No.	Max. Permiss. Line-to-Ground Voltage	Limits of Normal System		Ungrounded		Approx. Ship. Wt., Lbs.
		Grounded Neutral Min.	Max.	Min.	Max.	
2330	3000V	1001V	4500V	1001V	3000V	12¾
2331	6000V	4501V	9000V	3001V	6000V	14½
‡2332	9000V	9001V	13200V	6001V	9000V	14½
2333	12000V	13201V	15000V	9001V	12000V	20
2334	15000V	15001V	25000V	12001V	15000V	20
*2327	18000V	15001V	25000V	12001V	18000V	16

‡REA Standard "AE."
*REA 14.4/24.9 systems.

G-E Pellet Meter or Service Protectors

115/230 Volts—Altitude, 0 to 6000 Feet



Model No. 9LA15A1
Pellet Protector for Direct Metal-clad Mounting to Bottom Knockout Hole

Pellet Protector with Bracket for Separate Mounting, Model No. 9LA15A4

The indoor protector is designed to permit direct mounting in the knockout holes of a service switch, fuse box, meter-connection cabinet, or meter case. In some applications, it may be preferable to locate the protector on the building wall at the point where the exposed secondary circuit enters the conduit goose-neck or the service cap of the enclosed service wiring. Therefore, another design is provided for such separate outdoor mounting.

For 115-volt, single-phase, 2-wire; or 115/230-volt, single-phase, 3-wire grounded-neutral, secondary services. For indoor or outdoor service.

Model No.	Maximum Permissible Line-to-ground Voltage, Rms.	Type of Mounting	Net Wt. Lbs.	Each
9LA15A1	175	Mounting to Bottom Knockout Hole	2	\$10.50
9LA15A4	175			

For complete description, ask for Bulletin GEA-2977.

G-E Thyrite Meter or Service Protectors

0 to 650 Volts—Altitude, 0 to 6000 Feet



Thyrite Protector, Three-pole, for Indoor Installation, Model No. 9LA15A13



Thyrite Protector, Three-pole, for Outdoor Installation, Model No. 9LA15A23

For protection of watt-hour meters, industrial power-service entrances, or consumer apparatus and appliances on single-phase or polyphase secondary circuits or services in the 0- to 650-volt class.

The case of the protector is of aluminum. Each single-pole assembly has a series gap and a Thyrite disk valve element 3 inches in diameter and ⅝ inch thick. These single-pole elements are mounted in a Textolite container, and one, two, or three of these assemblies (for single-, double-, or three-pole protectors respectively) are sealed within the outer aluminum case. The side of the case bears complete nameplate data.

Indoor Service—For Mounting to Knockout Hole

The indoor design is arranged for mounting directly in a knockout hole in the meter case or connection box.

Model No.	No. of Poles	Circuit Voltage Rating, Rms.	Maximum Permissible Line-to-ground Voltage, Rms.	Net Wt. Lbs.	Each
9LA15A11	1	0-650	650	4	\$16.00
9LA15A12	2	0-650	650	4½	22.00
9LA15A13	3	0-650	650	5	32.00

Outdoor Service—For Separate Bracket Mounting

The outdoor design is provided with a bracket for separate mounting as illustrated.

Model No.	No. of Poles	Circuit Voltage Rating, Rms.	Maximum Permissible Line-to-ground Voltage, Rms.	Net Wt. Lbs.	Each
9LA15A21	1	0-650	650	4½	\$18.00
9LA15A22	2	0-650	650	5	24.00
9LA15A23	3	0-650	650	5½	34.00

Number of Arresters Required at Installation

Use two single-pole arresters at each single-phase installation. Use three single-pole arresters at each 3-phase installation. Use one 2-pole arrester at each single-phase installation. Use one 3-pole arrester at each 3-phase installation.

Call Graybar **FIRST** for . . .

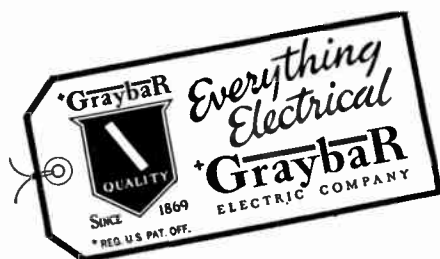

G-E Isolating Gaps

For Distribution Circuits, 15 Kv. and Below



Model No. 9LA11A1, A2, and A3 with Mounting Hanger



Model No. 9LA11A5, A7, and A9 with Mounting Hanger

G-E porcelain-enclosed isolating gaps effect efficient interconnection through a gap, where it is desired to isolate the primary lightning-arrester ground from the secondary neutral. These gaps can also be used wherever distribution-transformer tanks are to be grounded through a gap.

Standard spark-potential ratings have been established at 6, 11, and 15 kv., rms. These ratings are average values subject to about 10 per cent tolerance, plus or minus.

Model No. 9LA11A1, A2, and A3 gaps are sturdily constructed, and have no exposed live parts. Model No. 9LA11A5, A7, and A9 gaps are smaller and designed for mounting on a pole, crossarm, transformer tank, or for suspension from a line conductor.

Model No. 9LA11A1 gap (6 kv. spark potential) is recommended as a primary-neutral arrester for protecting the neutral side of distribution transformers operating on grounded-neutral systems with the system neutral grounded only at the substation, and where the neutral potential does not exceed 300 volts, rms.

Model No.	Primary-circuit Voltage	60-Cy. Rms. Spark Potential, Kv.	Impulse Spark Potential, Kv.	Each
9LA11A5	‡2100	6	11	\$7.00
9LA11A7	‡4160 and ‡4800	11	17.5	7.00
9LA11A9	{ ‡6900, ‡8320 and } { Higher-voltage Circuits }	15	25	7.00

‡Isolated neutral.

‡Grounded neutral.

For complete description, ask for Bulletin GEA-2976.

G-E Low-Voltage Pellet-Type Lightning Arresters

0 to 650 Volts—Altitude, 0 to 6000 Feet



Model No. 9LA10A202 Single-pole Pellet Arrester with Mounting Bracket

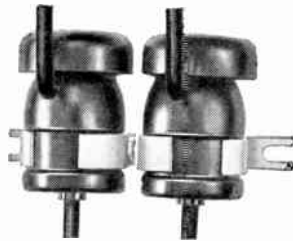

Model No. 9LA10A204 Double-pole Pellet Arrester with Mounting Bracket

For outdoor service, crossarm or pole mounting, on railway-signal lines or secondary power lines, for protection of railway-signal transformers, distribution-transformer secondaries,

autotransformer boosters, cables, and other line apparatus in the 0- to 650-volt class.

The single-pole arrester unit consists of a series gap and a pellet valve column completely housed in a wet-process porcelain container.

The double-pole arrester consists of two single-pole units mounted in a single hanger. This arrester is economically advantageous on single-phase, 2-wire circuits.

Model No.	No. of Poles	Circuit Voltage Rating, Rms.	Maximum Permissible Line-to-ground Voltage, Rms.	Ship. Wt. Lbs.	Each
9LA10A202	1	0-650	650	2	\$ 9.50
9LA10A204	2	0-650	650	4	19.00

G-E Neutral Gaps

Altitude, 0 to 6000 Feet

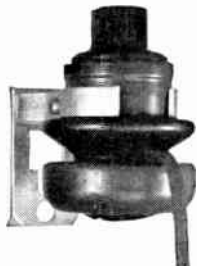

Model No. 9LA11A1



Cat. No. 146187

These neutral gaps are plain gaps having an impulse sparkover voltage of about 11 kv. crest on the AIEE standard impulse test, and embody no valve element. They are for application on the neutral wire of the usual grounded-neutral 3-phase, 4-wire primary systems, where the neutral-wire voltage to ground does not exceed 300 volts, rms.

Model No. 9LA11A1 embodies the same desirable features of construction and mounting that are incorporated in the standard pellet arresters for protection of the phase wires.

Cat. No. 146187, being less expensive, does not possess the refinements of Model No. 9LA11A1. Unit has a ground lead similar to the line lead, and is mounted on crossarm by wood screws.

Model No. 9LA11A1, Ship. Wt. 4 Lbs. Each **\$11.00**
Cat. No. 146187, Ship. Wt. 1.3 Lbs. Each **4.00**

Use on neutral wire of 3-phase, 4-wire circuits having the neutral solidly grounded only at the substation, if voltage of neutral wire to ground is not over 300 volts rms. If, because of unbalancing, voltage of neutral wire is between 300 and 1000 volts, use Model No. 9LA10B1 pellet arrester. Use standard pellet arresters on phase wires.

For complete description ask for Bulletin GEA-2975.

G-E Lightning Protection Equipment For A-C Rotating Machines

The problem of protection of a-c rotating machines from lightning voltages applies to a-c generators, synchronous condensers, and large motors subjected to impulse voltages, either from directly connected exposed overhead lines or from those transmitted to the machine through transformers.

Protection from these sources can be obtained by a combination of line-type arresters located a short distance out of the station on each exposed line which is directly connected to the machine; by Pyranol filled protective capacitors and by station-type Thyrite lightning arresters in parallel with the protective capacitors, installed on the bus or at the machine terminals.

Thousands of equipments representing the advanced form of protection from lightning have been applied since 1929, some of the earlier ones being made for protection of machines which had failed repeatedly, but since the protective equipment was installed, no further failures have occurred.

This equipment easily installed; requires no maintenance.

In the table below is listed equipment required for any given service application, and is applicable for protection of machines of practically any type or manufacture.

Machine		Protective Equipment For Installation at Machine Terminals or on Machine Bus					For Installation of Directly Connected Exposed Overhead Lines		
		G-E Protective Capacitor for Indoor and Outdoor Service		G-E Station-type Thyrite Arrester for Indoor and Outdoor Service		§G-E Line Type Pellet Arresters			
Normal Phase-to- phase Voltage Rating	Connection	Cat. No.	No. of		Units Required Per In- stallation	Model No.	Units Required Per In- stallation	Model No.	Units Required Per In- stallation
			Line Leads	Poles					
0-650	Single-phase, 1 side grd	21F830*	3	3	1	9LA15B11*†	1	9LA10A202	1
0-650	Single-phase, nongrd	21F830*	3	3	1	9LA15B12*†	1	9LA10A204	1
0-650	3-phase, nongrd or grd Y	21F830*	3	3	1	9LA15B13*†	1	9LA10A202	3
2400	Single-phase, 1 side grd	18F26	▲	1	1	9LA11HC46	1	9LA10C21	1
2400	Single-phase, nongrd	18F27	▲	2	1	9LA11HC46	2	9LA10C21	2
2400	2-phase, 4-wire	18F27	▲	2	2	9LA11HC46	4	9LA10C21	4
2400	3-phase, nongrd or grd Y	18F28	▲	3	1	9LA11HC46	3	9LA10C21	3
4160	Single-phase, 1 side grd	18F107	▲	1	1	9LA11HC47	1	9LA10C41	1
4160	3-phase, nongrd	18F58	▲	3	1	9LA11HC47	3	9LA10C41	3
4160	3-phase, grd Y	18F58	▲	3	1	9LA11HC46	3	9LA10C21	3
4800	3-phase, nongrd	18F29	▲	1	3	9LA11HC48	3	9LA10C41	3
4800	3-phase, grd Y	18F29	▲	1	3	9LA11HC47	3	9LA10C41	3
6900	3-phase, nongrd	18F30	▲	1	3	9LA11HC50 or 9LA11HC49	3	9LA10C51	3
6900	3-phase, grd Y	18F30	▲	1	3	9LA11HC48	3	9LA10C41	3
11500	3-phase, nongrd	18F35	▲	1	#3, ‡6	9LA11HC51	3	9LA10C61	3
11500	3-phase, grd Y	18F35	▲	1	3	9LA11HC50	3	9LA10C51	3
13800	3-phase, nongrd	18F451	▲	1	#3, ‡6	9LA11HC53	3	9LA10C71	3
13800	3-phase, grd Y	18F451	▲	1	3	9LA11HC51	3	9LA10C61	3
14400	3-phase, nongrd	18F467	▲	1	3	9LA11HC54	3	§ Unit system of generation with Y-delta transformers and with no directly con- nected exposed overhead lines use 0.125 mu f capac- itance phase to ground.	
15000	3-phase, nongrd	18F467	▲	1	3	9LA11HC54	3		
15500	3-phase, nongrd	18F467	▲	1	3	9LA11HC54	3		
16500	3-phase, nongrd	18F467	▲	1	3	9LA11HC55	3		
18000	3-phase, nongrd	18F467	▲	1	3	9LA11HC56	3		
20000	3-phase, nongrd	18F467	▲	1	3	9LA11HC57	3		
22000	3-phase, nongrd	18F467	▲	1	3	9LA11HC59	3		
24000	3-phase, nongrd	18F467	▲	1	3	9LA11HC60	3		

¶The same capacitors are applicable to either grounded- or ungrounded-neutral circuits. However, the arresters for machines 2400 volts and above have lower valve ratings for grounded-neutral circuits than for ungrounded-neutral circuits. The listing of arresters for grounded-neutral machines is premised on the circuit neutral's being solidly and directly grounded. If the machine neutral or circuit neutral is grounded through resistance or reactance, ask Graybar for assistance in making selection of arresters.

*For indoor service only.

†These arresters are Thyrite meter protectors.

▲Clamp-type terminals.

#Where machines have no direct connection to exposed overhead lines, and where connection to transmission lines is not through Y-Y or auto-transformers, use only one capacitor unit (0.25 mfd.), line-to-ground.

‡Where machines are directly connected to exposed-overhead lines, or are connected through Y-Y or autotransformers to transmission lines, use two capacitor units in parallel per phase to obtain a capacitance phase-to-ground of 0.5 mfd. This method will limit reflections within the winding of delta-connected machines or at the neutral point of Y-connected machines which have their neutrals isolated or grounded through a resistance that is higher than the surge impedance of the machine winding. In general, if the neutral of a machine is grounded through a resistance of less than 50 ohms, positive reflections at the machine neutral will not occur. If a machine neutral is grounded through a reactance of less than 5 ohms

(60-cycle basis), positive reflections at the machine neutral will be negligible when 0.25 mfd. capacitance phase-to-ground at the machines is used. Hence, when the machine neutral is grounded through a resistance of less than 50 ohms or through a reactance of less than 5 ohms (60-cycle basis), only one capacitor unit (0.25 mfd. phase-to-ground) will be required. Where two or more machines are operated in parallel, with the neutral of only one machine grounded, the capacitor applied on the machine bus for protection of all machines, or applied at the terminals of machines having neutrals ungrounded, should be 0.5 mfd. capacitance phase-to-ground (2 capacitor units in parallel per phase). This method limits impulse-voltage reflections at the neutrals of those machines that have ungrounded neutrals.

§This arrester, Model No. 9LA1G295, rated 7.5 kv., provides somewhat better protection than the Model 9LA1G292 unit rated 9 kv., and can be used wherever there is little, if any, risk of the system line-to-ground voltage exceeding the arrester's maximum line-to-ground rating of 7.5 kv., rms., under any condition of operation.

¶The pellet arresters listed for machines 2400 volts and above, can also be used in place of station-type Thyrite arresters for application at the terminals of rotating machines below 1000 kva. This application is recommended if economy of protection necessitates lower cost though less efficient protection.

Note: For altitudes above 6000 ft. ask Graybar for engineering recommendations. **Prices on application.**

**G-E Lightning Protection Equipment
For A-C Rotating Machines**

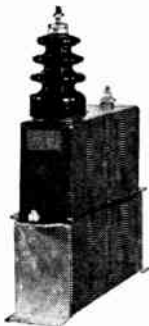

Cat. No. 18F30
Capacitor Unit



Cat. No. 18F28
Capacitor Unit



Model No. 9LA1G291
Thyrite Station-type
Lightning Arrester

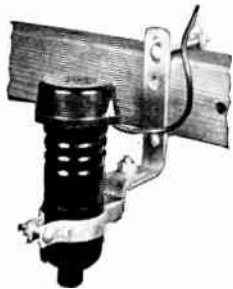

Line-type Pellet Lightning
Arrester

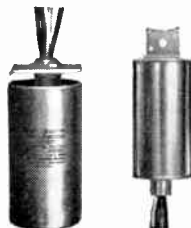

Cat. No. 21F830 and Cat.
No. 21F831 Capacitor Units

**Special Pyranol Protective Capacitors with Built-in
Discharge Resistors**

Catalog Numbers		*Voltage Rating	Poles per Unit	Mfd. per Pole	Net Wt. Lbs.	Ship. Wt. Lbs.	Each
Indoor	Outdoor						
21F830	0-650	3	1.0	3	4	\$ 14.00
	21F831	0-650	3	1.0	4	5	14.50
18F26	18F26	2400	1	0.5	24	35	75.00
18F27	18F27	2400	2	0.5	21	35	85.00
18F28	18F28	2400	3	0.5	30	40	120.00
18F107	18F107	4160	1	0.5	21	35	125.00
18F58	18F58	4160	3	0.5	65	80	170.00
18F29	18F29	4800	1	0.5	35	45	120.00
18F30	18F30	6900	1	0.5	50	65	135.00
18F35	18F35	11500	1	0.25	65	80	200.00
18F451	18F451	13800	1	0.25	80	100	250.00
18F467	18F467	24000	1	0.125			415.00

*Capacitor rating should be selected according to the normal phase-to-phase voltage rating of rotating machine, regardless of whether circuit is grounded- or ungrounded-neutral. Capacitor can be used where machine phase-to-phase voltage does not exceed 10 per cent above listed capacitor rating. These protective capacitors are suitable for 25-, 40-, 50-, or 60-cycle systems.

Station-type Thyrite Arresters

Model Numbers		Arrester Max. Voltage Rating Line-to-ground, Rms.	Poles per Unit	Net Wt. Lbs.	Ship. Wt. Lbs.	Each
Indoor	Outdoor					
9LA15A11	650	1	3	4	\$ 16.00
	9LA15A21	650	1	3 1/2	4 1/2	18.00
9LA15A12	650	2	3 1/2	4 1/2	22.00
	9LA15A22	650	2	4	5	24.00
9LA15A33	650	3	4	5	32.00
	9LA15A23	650	3	4 1/2	5 1/2	34.00
9LA11HC46	9LA11HC46	3000	1	55	65	120.00
9LA11HC47	9LA11HC47	4500	1	58	67	146.00
9LA11HC48	9LA11HC48	6000	1	60	70	146.00
9LA11HC49	9LA11HC49	7500	1	65	80	180.00
9LA11HC50	9LA11HC50	9000	1	70	85	180.00
9LA11HC51	9LA11HC51	12000	1	75	90	211.00
9LA11HC53	9LA11HC53	15000	1	90	105	297.00

G-E Porcelain Enclosed Fuse Cutouts

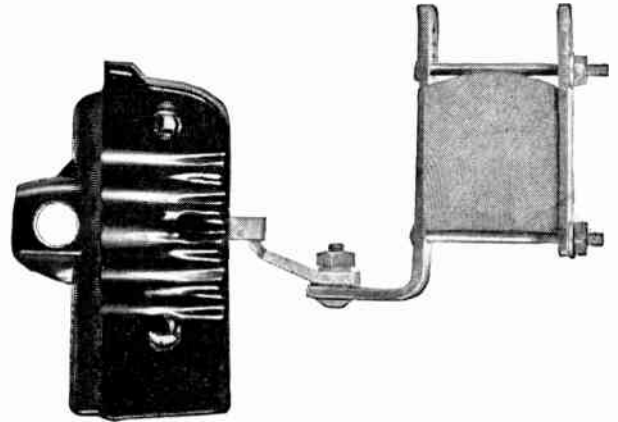

Typical G-E Enclosed Fuse Cutout Mounted in a Vertical Position

Now, all functions are available in one basic design with four interchangeable doors for each voltage and current rating.

Any housing of a given voltage and current rating can easily be converted to the desired function by simply interchanging any of the following doors.

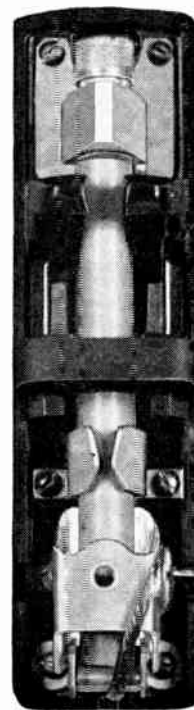

Normal-duty indicating or drop-out door

(1) **Normal-duty Indicating or Drop-out Door**—provides visual inspection of a blown fuse by a flip-out semaphore or drop-out action of the door. Drop-out indication is provided by removing the converting bar.

(2) **Normal-duty Indicating Non-drop-out Door**—provides visual inspection of a blown fuse by a flip-out semaphore only. This door is specifically designed for those users who desire that the door remain closed after a fuse is blown.

(3) **Heavy-duty Door (or Extra-heavy Door)**—of the indicating drop-out type, is particularly applicable on system locations where high or extra-high short-circuits can occur.

(4) **Disconnect Door**—with hinged blade, which has continuous current rating double that of the standard fuse-holder door, combines maximum safety with ready accessibility.

Doors for normal-duty indicating or drop-out, indicating non-drop-out, heavy-duty, extra-heavy-duty, and disconnecting make this cutout usable practically everywhere on the system. In most cases only two cutout housings will meet every need, enabling lower investments and simplified stocking. The interchangeable doors avoid the necessity of discarding or changing-out the cutouts when systems grow and available short-circuit currents of the system increase; instead, merely up-rate the cutout by substituting the heavy-duty or the extra-heavy-duty door.

**G-E Porcelain Enclosed Fuse Cutouts
Data and Prices**

Model No.	Operating Function *†	Rating Amperes 100% Basis	Current Interrupting Rating Rms Amperes 60 Cycles	Approx. Wt. Lb.	List Price Each
†5.2 kv Maximum—†50 Amperes					
9F6D11	A**	50	2000@ 5.2 kv• 3000@ 2.6 kv•	12	\$13.53
9F6DN11	B	50	2000@ 5.2 kv• 3000@ 2.6 kv•	12	13.53
9F6DI11	C	50	5000@ 5.2 kv 8000@ 2.6 kv	12	16.15
9F6DB11	D	100	11¾	13.53
†5.2 kv Maximum—†100 Amperes					
9F6D31	A**	100	3000@ 5.2 kv• 5000@ 2.6 kv•	16½	21.10
9F6DI131	C	100	5000@ 5.2 kv 8000@ 2.6 kv	16½	23.06
9F6DX31	XC	100	10000@ 5.2 kv 14000@ 2.6 kv	16½	29.86
9F6DB31	D	200	16	21.10
†7.8 Maximum—†50 Amperes					
9F6D21	A**	50	2000•	13¾	15.53
9F6DN21	B	50	2000•	13¾	15.53
9F6DI121	C	50	4000	13¾	18.34
9F6DB21	D	100	12¾	15.53
†7.8 kv Maximum—†100 Amperes					
9F6D41	A**	100	3000	17½	27.19
9F6DN41	B	100	3000	17½	27.19
9F6DX41	XC	100	3000	17½	35.47
9F6DB41	D	200	17¼	27.19

*For heavy-duty cutouts rated 200 amp., consult Graybar.
†These ratings conform to maximum design ratings of distribution fuse cutouts in accordance with NEMA standards. Cutouts rated 7.8 kv maximum may be used on grounded-neutral circuits where the voltage that an individual cutout has to interrupt does not exceed 7.8 kv and where the insulation to ground meets the operating conditions.

‡Current Rating—The fuse cutouts listed above, rated 50 and 100 amperes are designed to take fuse links of these capacities or less when the fuse links are rated on the 100 per-cent basis. Also, coordinating fuse links can be used in these cutouts. When these cutouts are used with fuse links that meet NEMA specifications, the cutout will carry its rating continuously with a maximum temperature of 30° C for the conducting parts of the fuse holder above and ambient of 40° C. All G-E universal cable-type fuse links meet these specifications.

#EEI-NEMA standard mounting bracket for separate mounting on crossarm, direct to pole, or wall, and for combination mounting with lightning arresters on crossarms, included in Model No. given.

•All 9F6D cutouts, including those now in service, are capable of interrupting these higher interrupting ratings.

** (1) Normally furnished as indicating, non-drop-out cutout, but easily convertible to drop-out operation by removing the converting bar.

(2) Where large usage of drop-out function only is required, cutouts can be furnished for drop-out operation only.

§Operating Function—Letters indicate following:

- A—Indicating or Drop-out—Normal-duty (Field Convertible).
- B—Indicating Only—Normal-duty.
- C—Indicating Only—Heavy-duty.
- XC—Indicating Only—Extra-heavy-duty.
- D—Disconnect.

G-E Porcelain Enclosed Fuse Cutouts

**Supply-Part Doors
Complete Assembly—Interchangeable in any 9F6D
Series Cutouts of Same Voltage and Current Ratings**

Cat. No.	Operating Function *†	Approx. Wt. Lbs. Stdp.	Net	List Price Each
†5.2 kv Maximum—†50 Amperes				
367C314G1	A	1¾	1½	\$ 6.34
367C314G2	B	1¾	1½	6.34
367C314G3	C	1¾	1½	8.96
367C314G5	D	1½	1¼	6.34
†5.2 kv Maximum—†100 Amperes				
367C320G1	A	3	2½	9.57
367C320G3	C	3	2½	11.52
367C320G4	XC	3	2½	18.33
367C320G5	D	2½	2	9.57
7.8 kv Maximum—†50 Amperes				
367C315G1	A	2	1¾	6.64
367C315G2	¾	2	1¾	6.64
367C315G3	C	2	1¾	9.46
367C315G5	D	1½	1¼	6.64
†7.8 kv Maximum—†100 Amperes				
367C321G1	A	3¼	2¾	11.55
367C321G2	B	3¼	2¾	11.55
367C321G4	XC	3¼	2¾	19.83
367C321G5	D	3	2½	11.55

See Footnotes in left hand column for explanation of — above symbols.

Heavy-Duty Enclosed Fuse Cutouts



200-amp., 5.2-kv Cutout Mounted on Crossarm

5.2 kv, 200 amp. indicating fuse cutouts having same advantages of fuse renewal as the porcelain-enclosed indicating and dropout fuse cutouts.

Have interrupting rating of 10,000 to 14,000 rms amp. at 60 cycles. Applicable for use on banks of transformers feeding industrial plants or for sectionalizing heavy feeders.

200-amp fuse cutout convertible to a 400-amp. disconnect cutout by replacing fuse holder door with a disconnect door.

Call Graybar FIRST for . . .



G-E Porcelain Enclosed Fuse Cutouts

How the Cutout Operates

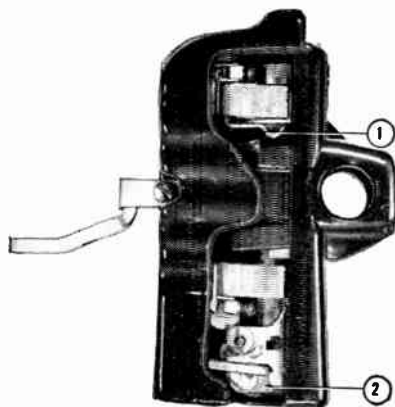

1. Fuse link in place. Plastic-to-metal latch holds door closed.

2. Spring-actuated flip-out semaphore held in position by the fuselink cable.

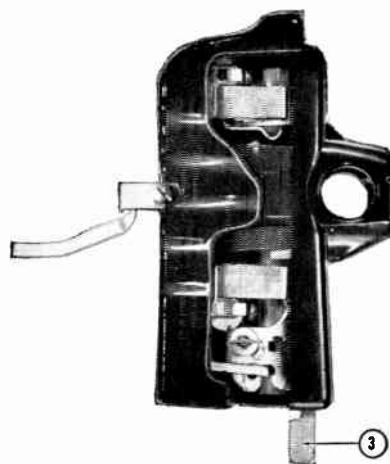

As an Indicating Cutout

3. Fuse link melts, flip-out semaphore flips to position shown, aids interruption of low fault current, provides visual indication of blown fuse. With converting bar in place door remains closed as shown above.

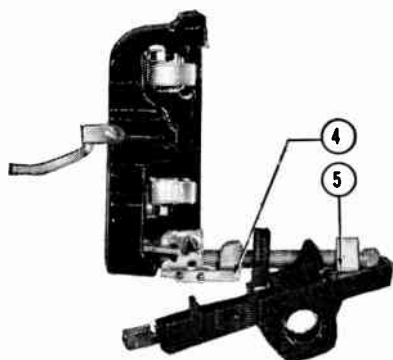

As a Drop-out Cutout

4. Remove converting bar and bottom of door is free to kick out when the fuse link has been ejected.

5. Compressed spring and weight of door lets door latch disengage from housing and drop open as shown. Allows plenty of time to permit clearing of the arc within fuse-holder.

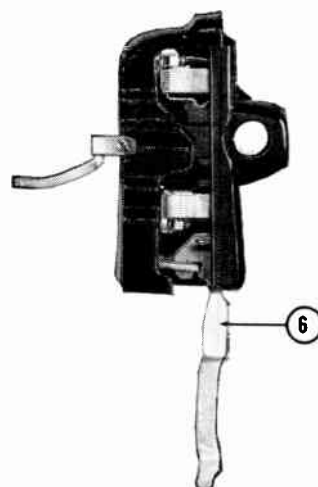

As a Disconnect

6. Install a disconnect-blade door, and housing converts to a disconnect. Door has a one-piece, silver-plated, copper blade hinged at the lower end. When disconnected, blade hangs below the housing where it is electrically isolated from the circuit yet always available and ready for use. Lineman can tell at a glance when the circuit is open.

G-E Porcelain Enclosed Fuse Cutouts

Dimensions of Cutouts with EEI-NEMA Standard Mounting Brackets

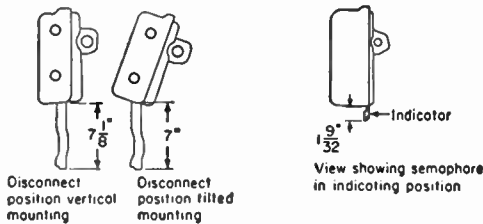
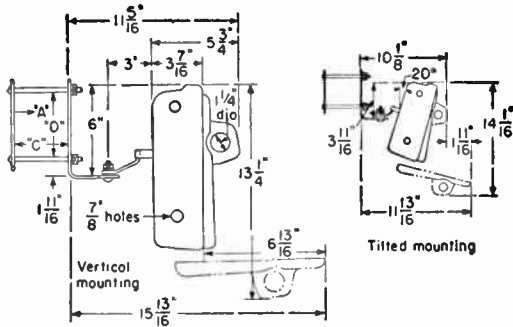

5.2-kv, 50-ampere enclosed fuse cutout

Dimensions, Inches

Model No.	C	D
All with EEI-NEMA Std. mounting brackets	B3 1/4-min. B4-max.	4 1/4-min. 5-max.

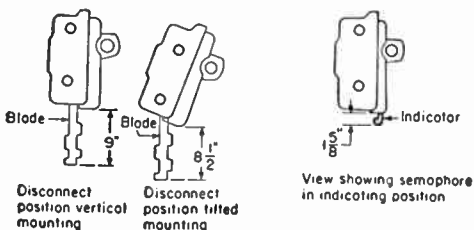
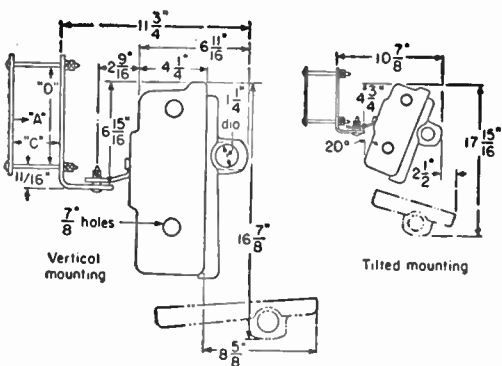

7.8-kv, 100-ampere enclosed fuse cutout

G-E Heavy-Duty Fuse Cutouts

Fuse Cutout Complete with Fuse Holder and Hanger

Model No.	Voltage Rating*	Current Rating, Amp., 100% Basis	Current Interrupting Rating, Rms Amp. at 60 Cycles	Approx. WL Lb. Net	Ship.	List Price, Each
9F16C76	5.2 Kv	200	10000@ 5.2 kv† 14000@ 2.5 kv††	35	45	\$58.95
	Max.					

Cutout Having Disconnect Blade Instead of Fuse Holder

9F16CB76	5.2 kv	400		35	45	53.37
	Max.					

Parts for the Cutouts Listed Above

79X307	Door, complete with fuse holder	6 1/2	7 1/2	25.86		
79X311	Door, complete with 400-amp. disconnect blade	6 1/2	7 1/2	20.53		

Note: The above doors can be used with superseded Model No. 9F16A7, 9F16A70, 9F16B76, and 9F16BB76 cutouts. When so used the interrupting rating of the Cat. No. 79X307 will be limited to 8000 amperes at 5.2 kv and 12000 amperes at 2.5 kv.

*These ratings conform to maximum design ratings of distribution fuse cutouts in accordance with NEMA standards.

†For single-phase, line-to-neutral installations on 8330 volt, 4-wire circuits, or wherever voltage across a single cutout does not exceed 5.2 kv.

††On 4160- or 4330- volt, 4-wire circuits, or wherever voltage across a single cutout does not exceed 2.5 kv.

G-E Open-Type Fuse Cutouts

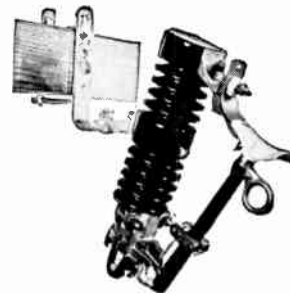

Provides overcurrent protection throughout full range of fault currents up to their rated interrupting capacity, on distribution circuits of 15 kv and below.

Wet - process - porcelain insulator has undercut petticoats for greater insulating strength. Solid construction prevents insects from nesting inside.

Birds and animals prevented from bridging insulator, and blowing fuses by a compression-clamped through porcelain mounting support, free of outside clamps

All hardware is made from nonferrous metals.

Fuse holder drops to completely open position for easy identification of blown fuse.

Have EEI-NEMA Standard mounting bracket for separate mounting on crossarm, direct to pole or wall, and for combination mounting with lightning arresters on crossarm.

Cutouts with Fuse Holder and Having Heavy-Duty Interrupting Rating

Model No.	Voltage Rating Kv.*	Current Rating, Amperes	Ship. WL Lb.	List Price, Each
9F3K71	7.8	100	18 1/2	\$21.23
9F3K81	15	100	20 3/4	26.32

Cutouts Having Disconnecting Blade Instead of Fuse Holder

9F3KB21	7.8	200	18	21.23
9F3KB31	15	200	20 1/4	26.32

*These ratings conform to maximum design ratings of distribution fuse cutouts in accordance with NEMA Standards. Cutouts rated 7.8 kv max. may be used on grounded-neutral circuits where the voltage that an individual cutout has to interrupt does not exceed 7.8 kv and where the insulation to ground meets the operating conditions.

G-E Open-Type Fuse Cutouts

Supply-part Fuse Holder Complete and Disconnect Blades, Which Are Interchangeable in Equivalent-voltage-rated Open Fuse Cutouts

Fuse Holder Cat. No.	Disconnect Blade Cat. No.	Max. Voltage Rating Kv	Current Rating 100% Basis Amp.	Inter. Cap. Rms Amp. at 60 Cycles	Approx. Wt. Lb.	List Price, Each
482B941G7		7.8	100	3000†	2 1½	\$ 9.64
	482B941G11	7.8	200	2 1½	9.64
482B941G8		15	100	2000	2½	10.87
	482B941G12	15	200	2½	10.87

Equipped With Load-Break Device

Provides not only fault protection but also a means for opening circuits under load. Advantageous for simplified sectionalizing of main feeders, isolation of branch circuits, switching transformers, capacitor banks and other loads. Load currents up to 100-amp., 15-kv or less interrupted easily.

Sharp downward pull of the load-break device with switch-hook breaks fusible section of fuse link and current interruption occurs within the fuse-holder similar to when a low fault current is interrupted.

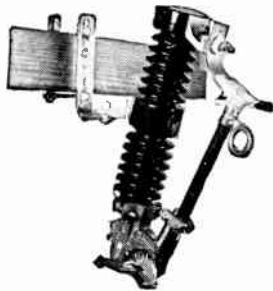

Cutouts w/Fuse-Holder—Heavy-duty Interrupting Rating, 5000 Amperes

Model No. of Cutout with Load Break Device†	Max. Design Voltage Rating Kv*	Cutout Cont. Current Ratings Amperes 100% Basis	Shp. Wt. Lb.	List Price, Each
9F3KC71	7.8#	100	19	\$21.23
9F3KC81	15¶	100	21¼	26.32

Supply-part Fuse Holders, Complete with Load-break Device, Interchangeable with Equivalent-voltage-rated Cutouts Above

Cat. No. Fuse Holder with Load-break Device	Max. Voltage Rating Kv	Current Rating Amp.	Interrupting Rating Rms Amp. at 60 Cycles	Load-Break Rating Rms Amp.	Approx. Wt. Lb. Shp. Net	List Price, Each
482B941G9	7.8	100	5000	100	3 2½	\$11.46
482B941G10	15	100	4000	100	3½	12.69

§Can also be used with corresponding ratings of Cat. No. 9F3F... and 9F3G... open-type cutouts.

†This 3000-amp. interrupting rating conforms to latest NEMA Standards and applies only with fuse-holders that have this 3000-amp. rating shown on the fuseholder's nameplate. Fuse-holders of this same Model No. (furnished on earlier designs of 9F3H21 or 9F3HC21 cutouts) which have no interrupting rating on the nameplate conformed to the previous NEMA Standard and are capable of interrupting only 2000-amp.

*These ratings conform to maximum design ratings of distribution fuse cutouts in accordance with NEMA standards. Cutouts rated 7.8 kv. max. may be used on grounded-neutral circuits where the voltage that an individual cutout has to interrupt does not exceed 7.8 kv and where the insulation to ground meets the operating conditions.

#The 7.8-kv rating will break any capacitive or inductive load current within the voltage rating and load-break of cutout.

¶Will break any capacitive load current within the voltage rating and load-break rating of the cutout. Will also break any inductive load current within voltage rating and load-break of the cutout providing eight miles or more of energized line remains on the system. This small mileage of connected line is advantageous with the 15-kv load-break to slow the rate of rise of the recovery voltage which is inherently faster on higher-voltage systems; and thereby prevent restriking after current interruption by load-break.

‡Includes EEE-NEMA Standard mounting bracket.

G-E Flip-Open Fuse Cutouts

***50 Amperes**

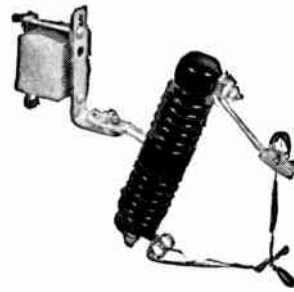

A fuse link provides over-current protection without the conventional hinged fuseholder tube. Expulsion action obtained entirely by the fuse-link tube—a unitary part of the fuse-link. Spring contact arms pull the lower cable terminal out of the fuse-link tube when the fuse-link melts.

An inexpensive cutout for rural-line service where the circuit conditions impose a less-severe interrupting duty on the cutout, and where the advantage of the hinged fuseholder type of conventional cutout may be dispensable.

Mechanically and electrical reliability is embodied in these cutouts. Their ability to meet the shocks and stresses of service has been demonstrated by flashover tests, both wet and dry, short-circuit tests, tension test of the metal-to-porcelain joints, and accelerated life tests.

Model No.	Voltage Rating Max. Kv	Mounting Bracket	Shp. Wt. Lb.	List Price, Each
9F17E21	7.8	EEE-NEMA Std.†	10	\$11.23
9F17EA218	7.8	Bushing‡	6½	9.63
9F17E31	15	EEE-NEMA Std.†	12	13.61
9F17E41	18	EEE-NEMA Std.†	18	22.70

*These ratings conform to maximum design ratings of distributor fuse cutouts proposed by EEE-NEMA report on preferred voltage ratings. Cutouts rated 7.8 kv maximum may be used on grounded-neutral circuits where the voltage that an individual cutout has to interrupt does not exceed 7.8 kv and where the insulation to ground meets the operating conditions.

†EEE-NEMA Standard mounting bracket for separate mounting on crossarm, direct to pole, or wall and for combination mounting with lightning arresters on crossarm or direct to pole.

‡For mounting to high-voltage bushing of type IIS or IISA distribution transformer.

Fuse Links For Flip-Open Fuse Cutouts Rated 15 KV or Less**

Fuse Model No.	Cap. Amp. 100% Rating	Shp. Wt. Lb. Per Ctn. of 25 Fuse Links	List Price, Each
9F1F1	1	2	\$0.71
9F1F2	2	2	.71
9F1F3	3	2	.71
9F1F4	5	2	.71
9F1F5	8	2	.71
9F1F6	10	2	.71
9F1F7	15	2	.71
9F1F8	20	2	.71
9F1F9	25	2	.71
9F1F10	30	3¼	.71
9F1F11	40	3¼	.71
9F1F12	45	3¼	.71
9F1F13	50	3¼	.71

**These fuse links cannot be used in Model No. 9F17C41 cutout rated 18 kv.

Hubbard Heavy-Duty Cutouts
Open Type Fuse



No. 2468

Rugged metal and porcelain parts withstand damage by handling, gun shot and vandalism. Optional addition of load break to meet local service conditions.

Conveniently placed line connectors with non-separable parts, insuring tight connections with aluminum or copper conductor, either stranded or solid.

Easy and convenient opening and closing, insertion or removal of fuse tube by any length of fuse stick under all weather conditions. The fuse link clamp with non-turning washer prevents mutilation of fuse cable strands for proper dropout with low current operations.

Std. Duty Load Break Dropout Fuse

No.	Max. Voltage Rating—Volts	Current Rating, Amps.	Interrupting Capacity, Amps.	*Approx. Ship. Wt., Lbs.	For Crossarm Mtg.	Std. Mounting Bracket No.	For Pole Mtg.
2530	5200	100	3000	15.0	2337	2338	
2531	7800	100	3000	15.6	2337	2338	
2532	15000	100	2000	17.0	2337	2338	

Heavy Duty Dropout Fuse

2467	5200	100	5000	21.0	2357	2356
2468	7800	100	5000	21.6	2357	2356
2469	15000	100	4000	23.0	2357	2356

Open Type Flipout Fuse

2550	5200	50	1200	12.8	2337	2338
2551	7800	50	1200	12.8	2337	2338
2552	15000	50	1200	13.0	2337	2338

*With Bracket.

Important—When ordering, please specify Bracket required, otherwise recommended bracket will be shipped.

Call Graybar **FIRST** For . . .



Hubbard Arrester and Fuse Cutout Combinations
(With Load Break Drop-Out Fuse Holder)

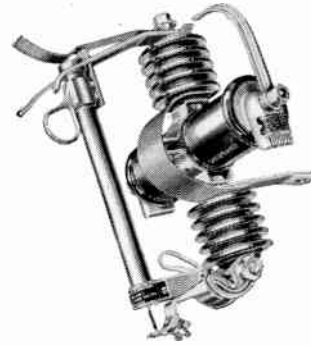

No. 2315

All of the features of the Autogap and the Drop-Out mechanism combined into one unit. NEMA standard bracket furnished. No. 2337 for pole or crossarm mounting.

A section of the fuse cable is exposed at the bottom of the Drop-Out mechanism so that without accessories, standard fuse links up to 50 amps. may be mechanically disconnected without external arcing.

Complete bird and animal protection. Heavy duty weather-proof fuse holder—positive acting. Positive closure of Drop-Out mechanism from any angle due to properly designed guides and large bearing surface.

Lightning Arrester

No.	Max. Permiss. Line-to-Ground Voltage	Limits of Normal System		Ungrounded		Approx.* Ship. Wt., Lbs.
		Grounded Min.	Neutral Max.	Min.	Max.	
†2315	9000V	9001V	13200V	6001V	9000V	24½
*2558	18000V	15001V	25000V	12001V	15000V	27¼

Fuse-Holder Data

No.	Interr. Capacity, Std. Link	Current Rating	Max. Voltage Rating	Leakage Distance	Pole	Recomm. Mtg. Bracket	Cross-Arm
†2315	3000 Amp.	100 Amp.	7800V	7½"	2338	2337	
*2558	3000 Amp.	100 Amp.	18000V	13½"	2356	2357	

*Wt. of combination with Bracket.

†R.E.A. Standard Ax.

*R.E.A. 14.4/24.9 KV systems.

G-E Fast-Blowing Universal Cable-Type Co-ordinating Fuse Links

The 51-, 52-, 101-, and 102-ampere fuse links have time-current characteristics of 75-, 100-, 150-, and 200-ampere fast-blowing fuse links respectively. The 103-ampere fuse link has time-current characteristics of 200-ampere slow-blowing fuse link. These co-ordinating fuse links are rated only 1, 2, and 3, amperes higher than the 50- and 100-amp. links, as this is the limit of their 100% continuous current carrying ability. They will save the expense for larger cutouts where neither the load current nor the short-circuit current exceeds the safe operating ability of either the 50- or 100-ampere cutout. These links require more than 230 per cent of their rating to melt within five minutes and are, therefore, not "N"-rated to NEMA Standards.

Packed 25 in a carton.

Over-all length of fuse link—20-inches.

Fuse Link Model No.	Fuse Link Cap. Amp.	For Use In Cutouts Rated, Amp.	Ship. Wt. Lb. Per Carton	List Price, Each
9F1C80	51	50	4½	\$0.86
9F1C81	52	50	4½	.86
9F1C82	101	100	7	1.20
9F1C83	102	100	7	1.20
9F1C84	103	100	7	1.62

G-E EEI-NEMA Universal Cable-Type Fuse Links

These fuse links, in accordance with NEMA Standards SG9-90, will carry rated current continuously with a maximum temperature rise of 30 C for conducting parts of the fuse holder above an ambient temperature of 40°C.

The relation of the 300-second (or 600-second) minimum melting current to the fuse-link rating is approximately 200% for fuse links rated 100-amperes or below and 240% for fuse links rated over 100-amperes. Because of superior low-melting-point characteristics, these fuse links have over-current continuous ratings. These ratings parallel the current ratings of G-E "N"-rated fuse links.

Type "K" (Fast) Model No.	Type "T" (Slow) Model No.	Current Rating [§] in Rms Amperes EEI-NEMA #	Cont. Overload	Shp. Wt. Lbs. Per Ctn.	List [¶] Price, Each
9F1K1	†	1	1	2	\$0.57
9F1K2	†	2	2	2	.57
9F1K3	†	3	3	2	.57
9F1K4	9F1T4	6#	8	2	.57
9F1K5	9F1T5	8	10	2	.57
9F1K6	9F1T6	10#	15	2	.57
9F1K7	9F1T7	12	20	2	.57
9F1K8	9F1T8	15#	25	3¼	.57
9F1K9	9F1T9	20	30	3¼	.57
9F1K10	9F1T10	25#	40	3¼	.57
9F1K11	9F1T11	30	45	3¼	.59
9F1K12	9F1T12	40#	50	3¼	.59
9F1K13	9F1T13	50	75††	7	.59
9F1K14	9F1T14	65#	85	7	.80
9F1K15	9F1T15	80	95	7	.80
9F1K16	9F1T16	100#	100	7	.80
9F1K17	9F1T17	140#	150	4½	2.01
9F1K18	9F1T18	200#	200	4½	2.19

*The Type letters "K" and "T" identify a series of fast and slow fuse links respectively as established by the EEI-NEMA Standards for distribution links. The terms fast and slow are used only to indicate the relative speeds of "K" and "T" fuse links. EEI-NEMA current rating and type letter (K or T) are stamped into the top of the button-head cap. When packaged, they can be identified by color-code stamping of descriptive data on one end of the carton—green for Type K and blue for Type T.

†Use 1-, 2-, and 3-amp. ratings of 5-amp. series Hi-surge fuse links.

††This overload rating applies only when the fuse is used in 100-, or 200-ampere cutouts.

§These fuse links can be substituted for G-E "N"-rated fuse links to obtain a comparable degree of protection.

#EEI-NEMA preferred ratings.

¶Conform to 20-in. NEMA Std. min. spec. If extra length is required, fuse links can be supplied at the stated price additions over and above the prices listed above.

24-in. over-all length—no extra price.

24- to 30-in. incl.—add \$0.05 per link.

30- to 36-in. incl.—add \$0.10 per link.

G-E High-Surge Universal Fuse Links

100% "N"-Rated Double-Duty Fuses

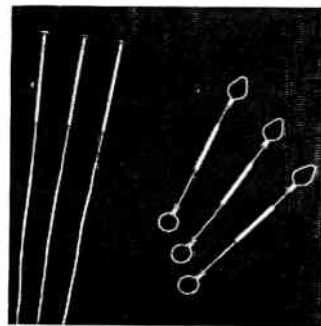

For use in expulsion or flip-open-type distribution fuse cutouts.

Provide maximum overcurrent protection for distribution transformers (at 1, 2 or 3 amperes) yet provide the same freedom from surge blowing as a conventional 5-ampere fuse.

Hi-Surge, Universal, Cable-type Fuse Links

Cat. No.	Hi-surge Fuse-link Rating, Amperes		Shp. Wt. Lbs. per Carton of 25 Fuse Links	Each
	100% or Continuous Rating	Surge Rating		
9F1CH1	1	{ Equivalent to conventional 5-amp fuse }	2	\$0.59
9F1CH2	2		2	.59
9F1CH3	3		2	.59
9F1CH22	2	{ Equivalent to conventional 10-amp fuse }	2	.59
9F1CH23	3		2	.59
9F1CH24	5		2	.59
9F1CH25	8		2	.59

Hi-surge, Flip-open Fuse Links

9F1FH1	1	{ Equivalent to conventional 5-amp fuse }	2	\$0.80
9F1FH2	2		2	.80
9F1FH3	3		2	.80
9F1FH22	2	{ Equivalent to conventional 10-amp fuse }	2	.80
9F1FH23	3		2	.80
9F1FH24	5		2	.80
9F1FH25	8		2	.80

5-Ampere Series (red auxiliary tube):

Low Current—1-, 2-, 3-ampere rating for over-current protection.

High Current—5-ampere characteristic for withstanding surges.

10-Ampere Series (black auxiliary tube)

Low Current—2-, 3-, 5- or 8-ampere rating for overcurrent protection.

High Current—10-ampere characteristic for withstanding surges.

For Transformer Installations they offer these Outstanding Advantages:

- Improved Overcurrent Protection where 5-ampere minimum fusing has previously been used.
 - With the same freedom from blowing by motor-starting, inrush lightning, or other surge currents.
 - Without rechecking their co-ordination with line-sectionalizing devices.
- Reduced Blowing by surges where 1-, 2-, or 3-ampere conventional fuses have previously been used.
 - With the same overcurrent protection.
 - With no need for rechecking their co-ordination with line-sectionalizing devices, in the majority of applications.

Note—In these applications of Hi-Surge Fuse Links the only factors to consider are:

- That overload currents do not exceed the fuse rating.
- That they co-ordinate with service-entrance fuses.

G-E Fast-Blowing Universal Cable-Type Fuse Links

For Use with All G-E Reclosing, Enclosed Indicating and Dropout, Enclosed Nonindicating, and Open-type Fuse Cutouts

These fuse links are rated on the 100 per cent basis, and are designed to carry their rated current without blowing, and to blow at not over 230 per cent rating within five minutes. All G-E fast-blowing universal cable-type fuse links may be operated safely and continuously at 100 per cent rating, with a maximum temperature rise of 30° C. for conducting parts of the fuse holder above an ambient temperature of 40° C.

Packed 25 in a carton.

No.	Ampere Rating "N" (100%) Basis	Ship. Wt., Lbs. per Carton	Each	No.	Ampere Rating "N" (100%) Basis	Ship. Wt., Lbs. per Carton	Each
9F1C16	1	2	\$0.59	9F1C26	40	3 1/4	\$0.63
9F1C17	2	2	.59	9F1C27	45	3 1/4	.63
9F1C18	3	2	.59	9F1C28	50	3 1/4	.63
9F1C19	5	2	.59	9F1C29	75	7	.86
9F1C20	8	2	.59	9F1C30	85	7	.86
9F1C21	10	2	.59	9F1C31	95	7	.86
9F1C22	15	2	.59	9F1C32	100	7	.86
9F1C23	20	2	.59	9F1C106	125	4 1/2	2.13
9F1C24	25	2	.59	9F1C88	150	4 1/2	2.13
9F1C25	30	3 1/4	.63	9F1C89	200	4 1/2	2.31

For complete description, ask for Bulletin GEA-1994.



Cutaway View

G-E Indicating Secondary Fuses

Outdoor Type

The G-E indicating secondary fuse is an outdoor cartridge-type, nonrenewable fuse designed to permit transformer-secondary banking, transformer-secondary protection, and the isolating of service-entrance faults at minimum initial expense.

The fuse element is totally enclosed, protected from the weather, and cannot be twisted when swayed by the wind.

It can easily be installed with any type of overhead secondary construction by means of conventional solderless connectors.

For circuits 600 volts and below.

Packed 25 fuses in a carton, 200 amp and less.

Packed 5 fuses in a carton, 250 and 300 amp.

No.	Amperes	Ship. Wt., Lbs. per Carton	Each
9F13A1	5	3	\$1.13
9F13A2	8	3	1.13
9F13A3	10	3	1.13
9F13A4	15	3	1.13
9F13A5	20	3	1.13
9F13A6	25	3	1.13
9F13A7	30	3	1.13
9F13A8	40	3	1.13
9F13A9	45	3	1.13
9F13A10	50	3	1.13
9F13A11	75	4 1/2	1.26
9F13A12	85	4 1/2	1.26
9F13A13	95	4 1/2	1.26
9F13A14	100	4 1/2	1.26
9F13A17	125	10 1/2	2.52
9F13A15	150	10 1/2	2.52
9F13A16	200	10 1/2	2.52
9F13A18	250	6 1/4	4.75
9F13A19	300	6 1/4	4.75

G-E Secondary Indicating Fuse Cutouts

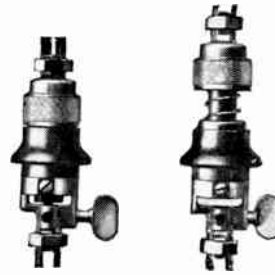

Closed

Indicating

The G-E secondary fuse cutout gives positive indication that the circuit is open whenever a fuse link is blown, by pushing the Textolite housing down from the upper terminal cap and displaying the red fuse-holder tube which is readily visible from the ground. This secondary cutout makes transformer-secondary banking, transformer-secondary protection, and the isolating of service-entrance faults economically possible.

The fuse link is protected from the weather; in this way, maintenance is minimized. The small size and light weight of the cutout enable it to be mounted in the space between secondary lines, attached directly to the line conductor, or mounted directly on the clamp terminals of a distribution transformer (using an adapter). Cutout can be easily and safely refused.

Model No.	Voltage Rating	Current* Rating Amp.	Ship. Wt. Lbs. Per Carton	List Price Each
9F7A1	250	100	16	\$5.67
5215202†	Adapter for mounting cutout on transformer terminal		3	.52

*Rated interrupting capacity, 3000 rms amperes at 60 cycles.

†Cat. No.

For complete description, ask for Bulletin GEA-2261.

G-E Secondary Fuse Links

For Use with Cat. No. 9F7A1 Secondary Fuse Cutouts

The time-current characteristics of these links are identical with those of the G-E fast-blowing cable-type fuse links designed for co-ordination with motor-starting currents, with primary or secondary fuse links of other ratings, and with relays.

Packed 25 in a carton.

No.	Ampere Rating "N" (100%) Basis	Ship. Wt., Lbs. per Carton	Each	No.	Ampere Rating "N" (100%) Basis	Ship. Wt., Lbs. per Carton	Each
9F1S1	5	1 1/2	\$0.42	9F1S8	40	2	\$0.44
9F1S2	8	1 1/2	.42	9F1S9	45	2	.44
9F1S3	10	1 1/2	.42	9F1S10	50	2	.44
9F1S4	15	1 1/2	.42	9F1S11	75	3	.49
9F1S5	20	1 1/2	.42	9F1S12	85	3	.49
9F1S6	25	1 1/2	.42	9F1S13	95	3	.49
9F1S7	30	2	.44	9F1S14	100	3	.49

Call Graybar FIRST for . . .

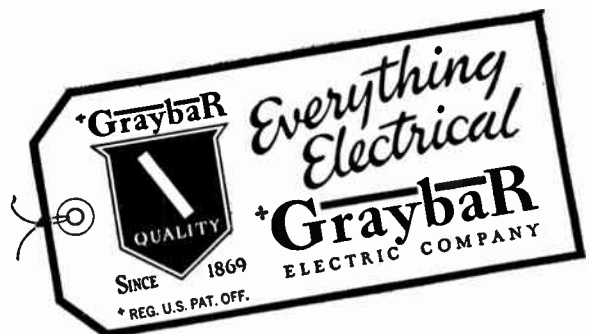

G-E Oil Fuse Cutouts



Pole Type 5000 Volts, 100 to 200 Amperes; 7500 Volts, 100 Amperes



Subway Type 5000 Volts, 100 and 300 Amperes; 7500 Volts, 100 Amperes

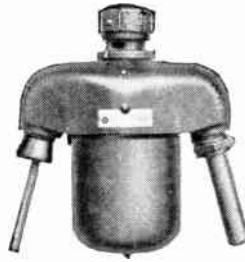

Pothead Type, 100 and 200 Amperes

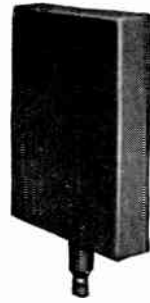

Cat. No. 242B58862 Expansion Chamber for Subway-type Cutouts



Subway-type Cutout with Expansion Chamber

The G-E oil fuse cutout is completely metal-enclosed, with a fusible element under oil, by which the circuit is broken safely and rapidly. Standard oil fuse cutouts are available in three designs for pole, subway, or pothead service on circuits up to 7500 volts and 300 amperes.

The "U"-shaped universal fuse links consist of laminated-metal terminal strips, forming the vertical legs and supporting a horizontal section of fusible alloy having a low melting temperature. This horizontal section is housed in a specially formed expulsion tube of insulating material. Fuse carrier is locked in place before circuit is closed.

Flame from arc is confined within housing, and prevents ignition of explosive gases and external damage.

Fuse link is under oil—this prevents deterioration from oxidation or electrolysis. Gases are released, but oil is confined. Subway fuse cutouts have operated for years while submerged in water.

Fuse links are quickly and easily replaced. Oil level can be maintained without removing cutouts from service.

Heavy self-aligning contacts make possible repeated opening under load.

Cutouts may be fused closely to load, providing simultaneously protection against overload and heavy short circuits.

G-E oil fuse cutouts are particularly applicable for subway service, for replacement of potheads, and for installations where high current-interrupting ability is required and where high-speed operation is essential. Other locations in which they can be used to advantage are:

- Where quiet operation is desirable.
- Where the cutouts are exposed to smoke, corrosive fumes, salt air, explosive gases, or inflammable dust.
- All indoor installations.
- Where it is desired to have no exposed live parts, whether the cutout is in the open or the closed position.

They are ideal for indoor industrial applications. As no flame is expelled, and as all live parts are completely enclosed, the oil fuse cutout best meets the requirements of the National Electrical Code.

† Volts	Rated Cap. Amps.	Inter-rupting Cap. At 60 Cycles	* Model No.	POLE TYPE			SUBWAY TYPE††			POTHEAD TYPE††			Cutouts for Metal-Enclosed Assemblies					
				Ship. Wt. Lbs.	Oil	Each	* Model No.	Ship. Wt. Lbs.	Oil	Each	* Model No.	Ship. Wt. Lbs.	Oil	Each				
4500	100	6000	9F2F2	62	9	\$79.00	9F2F7	70	9	\$81.50	#9F2F10	64	9	\$80.00	9F2F38	41	9	\$88.00
5200	100	5000									#9F2F11							
4500	200	11000	9F2F3	113	21	112.00	9F2F8	127	21	118.00	#9F2F12	116	21	114.00	9F2F39	82	27	126.00
5200	200	10000									#9F2F13							
4500	300	11000	9F2F4	205	31	175.00	#9F2F15	200	26	242.00					9F2F33	195	36	190.00
5200	300	10000																
7800	100	3750	9F2F5	200	31	175.00	#9F2F9	200	26	242.00					9F2F35	195	36	190.00

*Cutouts and Model No. in the 9F2D- and 9F2E- series have a notch in the lower end of the wood carrier plug to accommodate the universal fuse links. These cutouts will also accommodate the superseded design of the plain- and reactive-type fuse links.

†Maximum design voltages are maximum tolerable zone voltages for nominal system voltages listed in the heading.

††All pothead-type and subway-type oil-filled cutouts, Model No. 9F2E7 and 9F2E1, are provided with petrolatum for filling the entrance terminals. Petrolatum is shipped in a separate container.

§With right-hand subway sleeve bushing.

#With left-hand subway sleeve bushing.

G-E Oil Fuse Cutout Accessories

Gang-operating Racks and Mechanisms

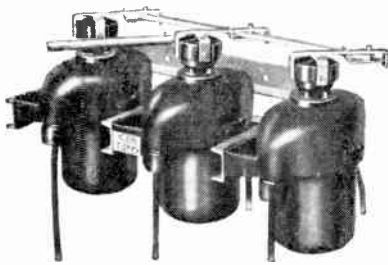

A simple and low-cost, gang-operated, three-phase assembly of standard G-E oil fuse cutouts can readily be made by the addition of a mounting rack and lever-operated mechanism for safely opening or closing the full-rated current on all three phases simultaneously.

Rack and Mechanism Only

Cat. No.*	Volts	Rating	Amp.	Approx. Ship. Wt., Lbs.	List Price Each
Single-Phase—2 Units#					
79X787a	5200		100	50	\$22.00
79X788b	5200		200	60	25.00
79X808c	5200 & 7800		300 & 100	75	30.00

Locking bar for use with above mechanisms, \$0.65 Net additional.

*For mounting cutouts Cat. No.: a. 9F2F2, 9F2F10, 9F2F11. b. 9F2F3, 9F2F12, 9F2F13. c. 9F2F4, 9F2F5. d. 9F2F7, 9F2F27#. e. 9F2F8, 9F2F26#.

#Similar racks and mechanisms can be purchased in three phase (3-unit) assemblies.

Metal-enclosed Assemblies

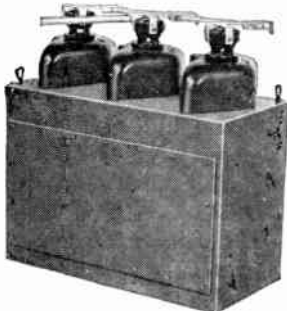

Three-phase Assembly for Separate Mounting

These assemblies of two or three gang-operated cutouts mounted in a sheet-metal connecting box with removable front cover and bottom or side openings for pothead or conduit are particularly adaptable to industrial use for wall mounting or direct mounting on metal-enclosed apparatus.

Rating of Oil Fuse Cutouts

Model No.	Volts	Amp.	Interrupting Cap., Rms. Amp.† at 60 Cycles	*List Price Each
Single-phase				
9F2K1	4500	100	6000	\$250.00
	5200	100	5000	
9F2K2	4500	200	11000	329.00
	5200	200	10000	
9F2K3	4500	300	11000	515.00
	5200	300	10000	
9F2K4	7800	100	3750	515.00
Three-phase				
9F2K5	4500	100	6000	345.00
	5200	100	5000	
9F2K6	4500	200	11000	445.00
	5200	200	10000	
9F2K7	4500	300	11000	690.00
	5200	300	10000	
9F2K8	7800	100	3750	690.00

*List prices do not include fuse links or disconnect blades. Fuse links or disconnecting blades must be ordered separately. No. 10C oil is supplied for dilling cutouts.

†Based on the use of universal fuse links in listed cutouts.

Disconnecting Blades

Copper disconnecting blades with notched ends formed up and insulated with Herkolite sleeve.

For Cutouts of Present Design, or for Cutouts of Superseded Design Having Notched Fuse Carriers, Model No.

Cat. No.	Each
9218955G1 (9F2(D, E, or F)2, -7, -10, -11, -27, -38, 9F2D5, -D9, 9F2F5, -F9)	\$0.80
9218955G2 (9F2(D, E, or F)3, -8, -12, -13, -26, -39, -50)	1.25
9218955G3 (9F2D4, 9F2D15, -33, -35, 9F2F4, 9F2F15, -33, -35)	1.90

Pole-base Switching Mechanism

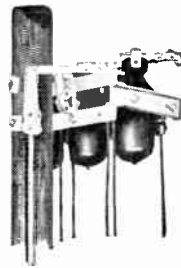

This mechanism permits ease of switching pole-mounted, gang-operated G-E oil fuse cutouts from the ground.

It is especially suitable for primary control of sports lighting and for fused-sectionalizing of lines.

Switch handle can be mechanized.



Specify Pole-base Switching Mechanism Cat. No.	With Rack and Mechanism Cat. No.	For Mounting Model No.	Cutouts Rated Volts	Rated Amps.	Shp. Wt., Lbs.	Net Price Each
9F20A1	79X789	9F2F2	5 Kv.	100	42	\$66.00
9F20A11	79X787	9F2F2	5 Kv.	100	47	66.00
9F20A2	79X790	9F2F3	5 Kv.	200	42	67.00
9F20A21	79X788	9F2F3	5 Kv.	200	47	67.00
9F20A3	78X809	9F2F4	5 Kv.	300	45	79.00
9F20A31	79X808	9F2F4	5 Kv.	300	50	79.00

New G-E Universal Fuse Links For Oil Fuse Cutouts Having Notched Carrier Plugs



Universal Fuse Link Mounted in Notched Fuse-carrier Plug



Universal Fuse Link

Time-Current Characteristics

Universal fuse links, when used in G-E oil fuse cutouts of the proper rating, will carry continuously 100 per cent of the rated current of the fuse link. They will melt at approximately 150 per cent of their rating in 300 seconds (5 minutes).

Application

These universal fuse links are designed for use in all oil fuse cutouts, 100 to 300 amperes, with Model No. in the 9F2D, -E, and -F series. These cutouts all have notched fuse-carrier plugs, as illustrated.

Universal fuse links can also be used in all superseded designs of G-E oil fuse cutouts, in the Cat. No. 9F2C series or earlier (except 50-ampere, 2500-volt rating), simply by cutting a notch in the lower end of the wooden fuse-carrier plug. A template is included in each carton of universal fuse links to facilitate correct notching.

Model No.	Capacity, Amps. 100% Rating	Shp. Wt., Lbs. per Carton of 10 Fuse Links	Each
9F18B1	5	1/2	\$1.15
9F18B2	10		
9F18B3	15		
9F18B4	20		
9F18B5	25	1	1.45
9F18B6	30		
9F18B7	40		
9F18B8	50	1 1/2	1.65
9F18B9	60		
9F18B10	75		
9F18B11	100	3	2.15
9F18B12	125		
9F18B13	150		
9F18B14	200	300	
9F18B15	250		
9F18B16	300		

These fuse links are packed 2 in a box with 5 boxes per carton.

G-E Power Capacitors for Kilovar Supply
 Pyranol* Capacitors

Individual Outdoor Units — Class ID

Single- or Three-phase, 60 Cycles
 240 to 13,800 Volts, 5 to 50 Kvar

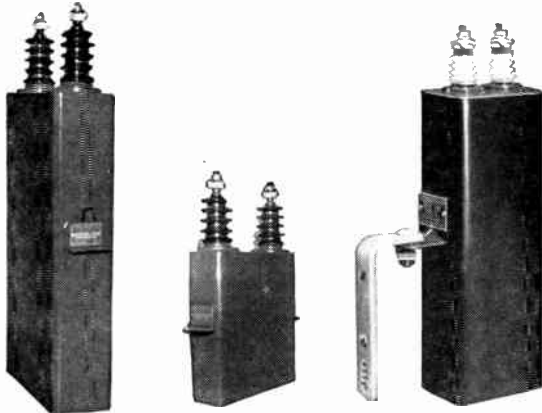

Compact and easily installed, with hangers available for crossarm mounting or for direct bolting to the pole, these units are especially suited for gaining kw carrying capacity and reducing voltage drop on distribution circuits.

They permit extremely effective distribution of the capacitor kvar in small blocks and at many points over an entire feeder. In small blocks, they supply reactive kva economically and with great flexibility for future arrangement.

For application data, see Bulletin GET-2360.

**Individual Enclosed Units
 Type EDT and EWT**

For Low-voltage Industrial Application
 Single-phase or Polyphase, 60 Cycles
 230 Volts, 0.5 to 7.5 and 15 Kvar
 460 and 575 Volts, 1, 2, 5, 10, 15 and 20 Kvar



Dust-tight design
 Class EDT

Weather-proof design
 Type EWT

These units are for indoor and outdoor applications for improvement of power factor directly at individual motors or other small loads. Group installations, consisting of a small number of enclosed units, can be made if the kilovars required exceed those of a single unit.

For larger loads, enclosed units may be grouped in a bank and in these applications small housed units (type LSO or DTSR) are recommended. Ask for Bulletins GEA-2742 and GEC-1331.

**Small Rack-Type Equipments —
 Type DTSR and LSO**

Single-phase or Polyphase
 230 Volts — 30 to 120
 460 and 575 Volts — 40 to 240 Kvar.

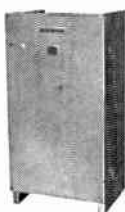

In the improvement of plant power factor, it is very often desired to locate capacitor equipment in one group on the low-voltage circuit, or perhaps in several smaller groups. The total kva rating generally exceeds the output of a single individual capacitor unit.

Ask for Bulletin GEC-1331A.

Prices on application.

Dust-tight design for indoor service,
 Class DTSR

*Registered trade-mark of General Electric Co.

Open-Type Stack-Rack Equipments
 For High-voltage Transmission Lines and Substation
 Application—24 to 138,000 Volts

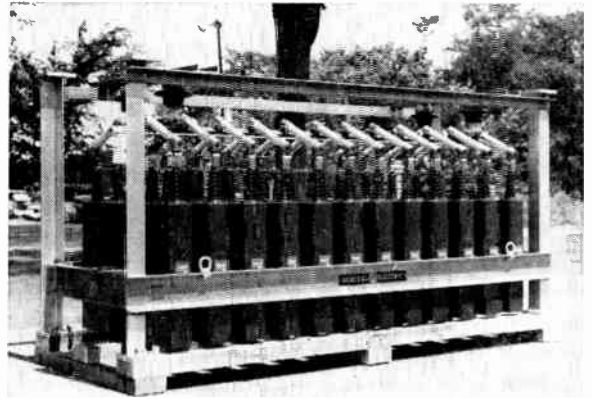

These factory assembled racks are designed to minimize installation time and provide reliability and economy where housed equipments are not required. A wide range of kvar and voltage ratings may be obtained by omitting units or combining racks. Each individual rack is a complete "building block" assembly and is designed so that relocation or changes in bank size may be easily accomplished. The racks consist of capacitors, individual bus-mounted fuses, interconnecting material, and insulators.

Large Equipments — Class LLI and LLO

For Low-voltage Applications
 Single-phase or Polyphase
 230 to 575 Volts — 270 to 1320 Kvar

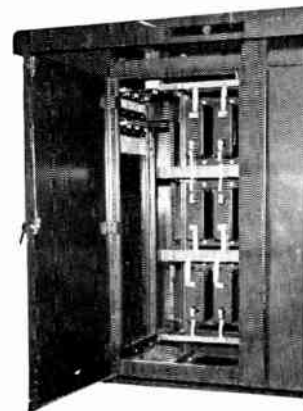

Large capacitor equipments afford a means of applying large blocks of kilovars as, for example, in substations or large industrial plants. These equipments are available for either indoor or outdoor service, with or without air circuit breakers. The units are easily accessible through hinged doors in the sides, and adequate ventilation is assured through screened openings in the housings.

G-E Power Capacitors For Kilovar Supply Small Equipments — Class HSO

For High-voltage Industrial & Substation Applications Single-phase or Polyphase
2400/4160Y Volts, 45-180 Kvar.
4800 and 7200 Volts, 90 and 180 Kvar.

Class HSO equipments are for use on indoor or outdoor circuits where small blocks of power-factor-improvement capacity are desired.

In the application of capacitors on circuits of 2300 volts and higher in small industrial plants, ratings 180 kvar and less are often desired. These small equipments are ideal for this purpose, and in large plants a number of these installed at various load centers may prove more advantageous than one large equipment.

HSO equipments are also used on outdoor circuits where small blocks of power-factor-improvement capacity are desired.

In applying capacitors on outdoor primary circuits for small industrial plants, ratings 180 kvar and less are often desired. This is especially the case where the power is metered on the primary side of the transformer bank. These HSO equipments are ideal for this purpose, and in larger plants, a number of these installed at various points may prove more advantageous than one large equipment. Ask for Bulletin GEA-2860.

Large Equipments — Class HLO

For High-voltage Industrial Substation Applications Single-phase or Polyphase
2400-13,800 Volts
600-5400 Kvar.

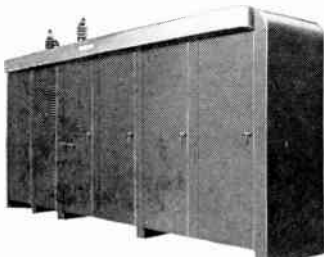

Class HLO,
for indoor and outdoor service

Large capacitor equipments afford a means of applying large blocks of power - factor - improvement capacity which are frequently desirable in substations or large industrial plants. These equipments are available for either indoor or outdoor service, with or without oil or magne-blast circuit breakers.

G-E Auto-Switch Equipments

For High-voltage Power-distribution Lines, 3-phase
2400-13,800 Volts. 150, 300, 450, and 600 Kvar

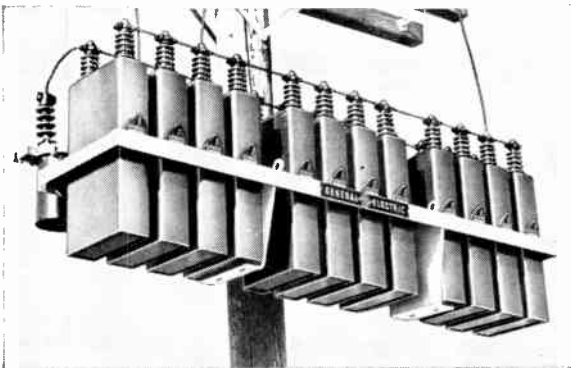

Open-Type Auto-Switch Capacitor Equipment

For distribution circuits requiring adjustable power-factor improvement because, where permanently connected capacitors would result in over-voltage or leading power factor at light loads, switched pole-top open capacitor equipments are available. These equipments are switched on and off automatically.

For further information, please contact Graybar.

G-E Specialty Capacitors Standard Commercial Types

For A-C and D-C Applications Fixed Paper-dielectric Capacitors

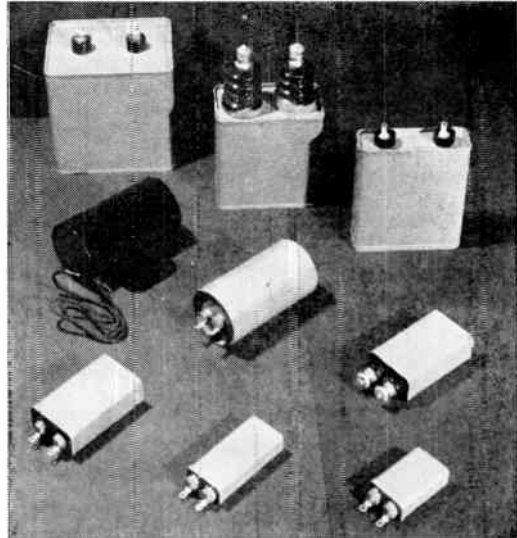

A-c/d-c dual-rated Pyranol capacitors for motors, controls, electronic equipments, and other applications will: reduce inventories, simplify design problems, and increase standardization. Capacitors in the voltage ranges 236 through 660 volts, a-c, and 400 through 1500 volts, d-c, are now dual-rated and can be used for either a-c or d-c applications. Other a-c and d-c ratings available: 0.01 to 75 mu f, 236 to 660 volts, a-c, and 400 to 100,000 volts, d-c.

Ask for Bulletin GEC-809.

Prices on application.

Capacitors to Meet Joint Army-Navy Specification MIL-C-25A

100 to 12,500 Volts, D-C — 0.01 to 15 Microfarads

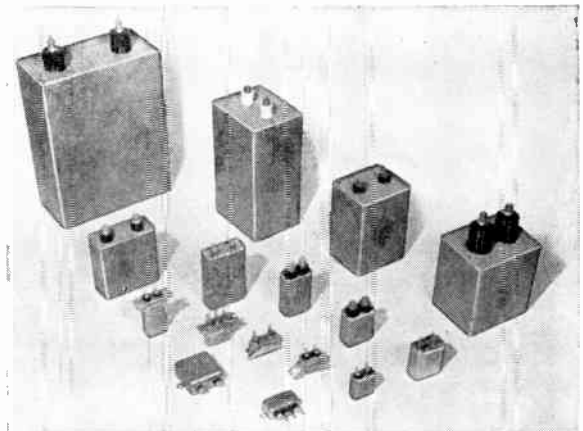

These fixed paper-dielectric capacitors are designed to meet the rigid requirements of the joint Army-Navy specifications for use in electronic equipment for the armed forces. Hermetically sealed in metallic containers, these capacitors for d-c applications are available in Characteristics E and F and in case styles CP-53, -51, -61, -63, -67, -69, and -70.

In addition to regular applications, these units may also be used at higher temperatures, higher voltages for short-life applications, and with a-c voltages.

Ask for Bulletin GEC-810.

G-E Specialty Capacitors

Permafil Capacitors

For High-temperature Operation
0.01 to 10 Microfarads—100 to 1500 Volts, D-C

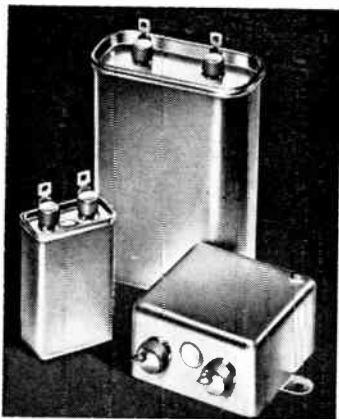

Permafil d-c paper-dielectric capacitors are especially designed for operation in high ambient temperatures. They require no derating for temperatures up to 125 C. Their function is to provide suitable components for the many recent applications involving operation at ambient temperatures above 85 C.

Hermetically sealed in metallic containers and provided with permanently sealed silicone bushings, permafil capacitors, meeting MIL-C-25A characteristic K requirements, are available in case styles 53 and 61.

Ask for Bulletin GEC-811.

Tantalytic* Capacitors

3.75 to 150 Volts, D-C—0.1 to 250 Microfarads

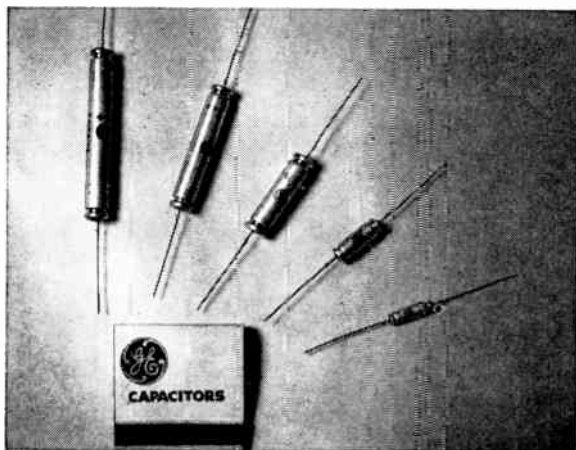

The tantalytic capacitor was developed to fit certain direct-current, low-voltage applications where aluminum electrolytics and paper capacitors have not proved entirely satisfactory, and is suggested for applications where superior performance and small size are the major factors.

The tantalytic capacitor is a foil-type, tantalum electrode, electrolytic unit, similar in construction to an aluminum electrolytic capacitor, but because of the characteristics of tantalum foil and the electrolyte employed, is smaller in size. The tantalytic capacitor has lower leakage currents, longer shelf life, and a wider range of temperature operation (-55C to $+85\text{C}$) than the conventional aluminum electrolytic capacitor. Currently, they are being used in telephone and military communication equipment.

Ask for Bulletin GEC-808.

*Trademark of General Electric Co.

High-Temperature Tantalytic* Capacitors

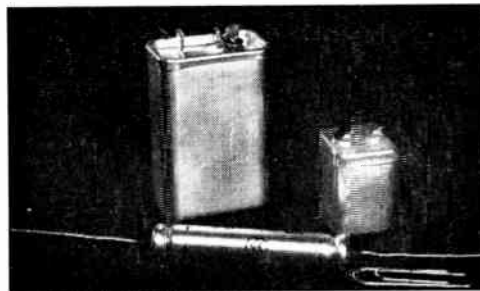

High-temperature Tantalytic capacitors are rated for operation at 125 C. These capacitors come in rectangular- and double-case, cylindrical designs. They are now being applied in missiles and other military communication and ordnance equipment. They feature low leakage current, small size, long shelf life, and a wide range of temperature operation.

*Trademark of General Electric Co.

Capacitor Networks

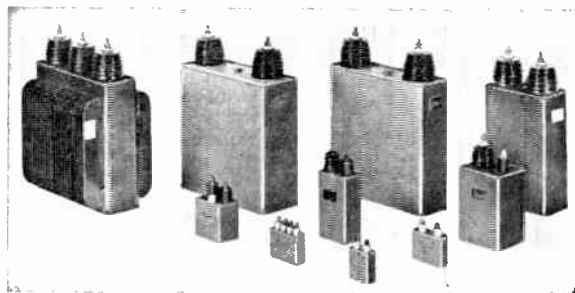

For guided missiles, aircraft, and land and sea radar equipments. Whether for a service life of 10,000 hours, or just 100 hours, G-E networks, designed to meet exacting specifications, will give you the reliable performance you require.

These pulse-forming network capacitors are used for radar equipment where the normal (exponential) capacitor discharge shape is not suitable and where an impulse having a definite energy content and duration is required.

For more information, see Bulletin GEA-4996.

Low-Voltage, High Mu-F Capacitors



These small-size, lightweight capacitors were developed to provide aircraft and communication fields with a high-quality replacement for many of the applications where metallized paper capacitors are not entirely satisfactory. Selected ratings for the MIL-C-25A case styles CP-53 and CP-61 are available.

The units are intended primarily for low-voltage, d-c applications.

Contact Graybar for further information.

G-E Specialty Capacitors

Drawn-Oval and Drawn-Rectangular Capacitors

330 A-C/600 D-C to 660 A-C/1500 D-C Volts—1 to 40 Microfarads

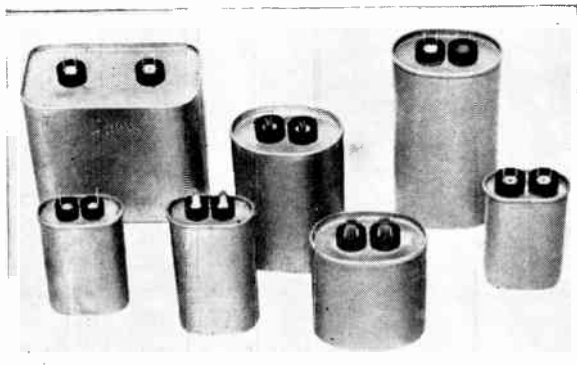

These are a-c and d-c capacitors in drawn seamless containers. They are designed for use in fluorescent lamp ballasts, air-conditioning equipment, voltage stabilizers, business machines, luminous-tube transformers, and submersible pumps. Drawn-oval and drawn rectangular capacitors are smaller, lighter, mechanically stronger, use less critical material, and cost 10 to 20 per cent less than standard fixed paper-dielectric capacitors.

Ask for bulletin GEA-5777.

High-Frequency Paper-Dielectric Capacitors

For Blocking and By-pass Applications
5000, 15,000, 20,000 Volts D-C

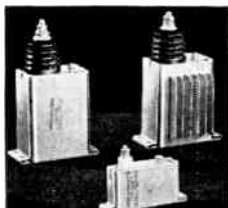

Class HF paper-dielectric capacitors are for use in electronic oscillator circuits of high-frequency induction - heating equipments. These capacitors may also be used advantageously in other high-frequency circuits of a similar nature.

G-E high-voltage paper-dielectric capacitors are of relatively high capacitance for high - frequency units, and yet they are more economical than conventional high-

frequency units of considerably smaller capacitance values. They can, therefore, be applied with savings in cost, as well as with reduced losses and lower voltage drop across the capacitor.

Oscillator-Tank-Circuit Capacitors

Class HFP—Series 300



High - frequency, liquid - filled, parallel-plate capacitors designed specifically for use in the resonant circuit, or "tank circuit" of high-frequency electronic oscillators, such as those used in electronic-heater equipments. The unique synthetic liquid dielectric, lectronol, coupled with an improved water-cooled design, permits an unusually compact assembly whose case measures 9x9x9 inches. This results in high current rating per unit volume.

Designers find these smaller, low-loss units contribute materially to more compact, powerful, efficient heaters.

The capacitor, when connected in parallel with an inductance coil, constitutes the resonant circuit which determines the frequency of the oscillator.

These units are built in a standard size which is convenient to handle and install. Available in ratings which will meet most requirements.

For further information, please contact Graybar.

Pyranol Energy-Storage and -Discharge Capacitors

2000 to 6000 Volts, D-C
12.8 to 100 Microfarads



General Electric d-c Pyranol capacitors for light-duty energy-storage applications are the result of years of experience in the design and manufacture of capacitors for this type of service. The use of Pyranol provides a relatively small, lightweight, stable capacitor which has a life consistent with the application involved. They are completely liquid-filled and hermetically sealed in terneplate containers. Their gray-lacquer finish is attractive, durable, and corrosion-resistant. For full information, see Bulletin GEC-1357.

Molded PVZ* Tubular Capacitors

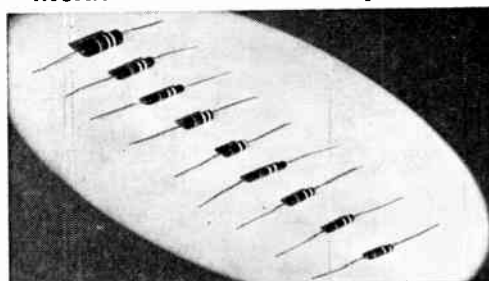

These capacitors have applications in computers, missiles, telephone equipment, and other high-grade military and commercial electronic equipment.

Ratings: 100 to 400 volts. Can be supplied from 0.00017 to 0.022 uf in the 400-volt range and from 0.00017 to 0.15 uf in the 100 volt range. Tolerances: $\pm 5\%$, $\pm 10\%$, $\pm 20\%$. Temperature range is from -55°C to $+125^{\circ}\text{C}$.

*Trademark of General Electric Co.

D-C Alumalytic* Capacitors

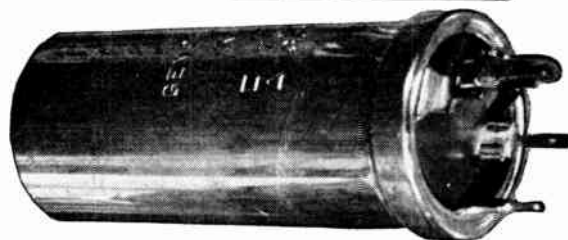
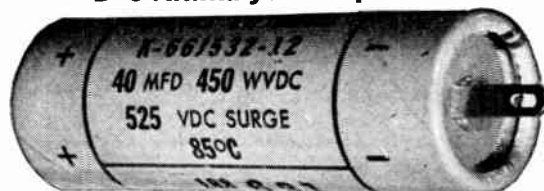

For radio, television, and other communications equipment manufacturers, General Electric supplies d-c aluminum electrolytic capacitors of high quality, in ratings to meet varied industry requirements, in high production quantities which assure availability.

Extensive test data and performance data of General Electric electrolytic capacitors is readily available on request, or sample capacitors built to your specifications will be supplied for testing purposes. Units may be supplied to meet particular specifications or to the industry general use specifications (RETMA RS-154).

Tubular units may be insulated or uninsulated, single or dual-sectional, with a choice of various leads and terminals. The "can-type" units may be insulated or non-insulated, in standard diameter and length cans, with either solder-lug or bayonet pin terminals.

*Trademark of General Electric Co.

G-E Watthour Meters

General Electric provides a complete line of single-phase and polyphase watthour meters and watthour demand meters, meter sockets and water-heater time switches.

The single-phase line of watthour meters now includes the new I-60-S, Class 200 meter. The polyphase line has been expanded by the addition of the new V-60 family of polyphase meters.

Both the I-60 and the V-60 family of meters incorporate all the time-proven features of magnetic suspension with its resultant savings in bearing replacement and greater sustained accuracy.

**Index of Types
For Alternating Current**

Type	Max. Rated Amp.	Max. Volts	Circuit
Wall Mounting Type			
I-60	30	240	1-stator, 3-wire, 1-phase
I-50	50	240	1-stator, 2 or 3-wire, 1-phase
V-62	30	600	2-stator, 3-wire, 1, 2, 3-phase
V-63	30	600	2-stator, 3-wire, 3-phase
V-4	50	120	3-stator, 4-wire, Y, 3-phase
V-5	50	120	2-stator, 4-wire, Y, 3-phase
V-6	50	240	2-stator, 4-wire, Δ, 3-phase
V-7	50	240	2-stator, 4-wire, Δ, 3-phase
V-9	50	240	Tot. 3-wire, 2 or 3-phase and 2 or
V-10	50	240	3-wire, 1-phase
Switchboard Mounting Type			
IS-8	..	240	1-stator, 2-wire, 1-phase
DS-19	..	600	2-stator, 3-wire, 1, 2 or 3-phase, and 4-wire, 2-phase
DS-20	..	120	3-stator, 4-wire, Y, 3-phase

**Single-Phase, Single-Stator
60-Cycle**

Types I-60, I-55 and I-50



Type I-60-S

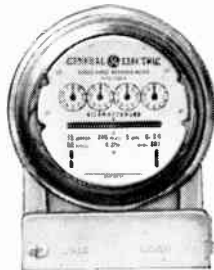

Type I-50-A

The single-stator product line comprises a complete group of watthour meters, each one designed to meter one of your particular single-phase loads; yet each design incorporates the time-proven, yet extremely modern features that signify the name I-50.

The newest addition to the line, the Type I-60-S, is a Class 200 meter, which means it can accurately meter loads up to 200 amperes. The I-60 meter, however, not only extends the range to 200 amperes, but also provides outstanding accuracy at light loads

In the preceding paragraph, mention was made to meter class. The meter class is a recently established industry standard which defines the current capacity of a meter. For example, the I-60 is a Class 200 meter and the I-55 is a Class 100 meter (100 ampere current capacity).

G-E Watthour Meters

Type Register	I-60-S Cat. No.	Each	I-60-S Cat. No.	Each
30 Amp (Class 200) 240V, 3-wire, 60-cycles				
Pointer	720X1G1			\$26.50
Cyclometer	720X1G4			29.50

Type Register	I-55-S Cat. No.	Each	I-55-A Cat. No.	Each
15 Amp (Class 100) 240V, 3-wire, 60-cycles				
Pointer	630X62	\$26.50	630X63	\$27.50
Cyclometer	630X64	29.50	630X65	30.50

Type Register	I-50-S Cat. No.	Each	I-50-A Cat. No.	Each
15 Amp (Class 100) Universal, 2/3-wire, 120/240V, 60-cycles				
Pointer	644X68	28.50	644X71	29.50
Cyclometer	644X69	31.50	644X72	32.50

Type Register	I-50-S Cat. No.	Each	I-50-A Cat. No.	Each
15 Amp (Class 60), 120V, 2-wire, 60-cycles				
Pointer	462X87	\$25.50	462X91	\$26.50
Cyclometer	493X87	28.50	493X91	29.50

Type Register	I-50-S Cat. No.	Each	I-50-A Cat. No.	Each
50 Amp (Class 200) 240V, 3-wire, 60-cycles				
Pointer	*	583X24	27.50
Cyclometer	*	583X28	30.50

*Class 200, Type I-50-S meters have been superseded by Class 200, Type I-60-S meters.

Approximate Weight per Meter

Amp	Socket-connected		Bottom-connected	
	Net	Ship.	Net	Ship.
15 & 30	4.8 lb	5.7 lb	5.5 lb	6.0 lb
50	5.5	6.4	6.0	6.5

Meters for Use with Instrument Transformers

Volts	Amps	Circuit Rating	I-50-S Cat. No.	Each	I-50-A Cat. No.	Each
120	2.5	2-wire	627X31	\$27.50	627X27	\$28.50
240	2.5	3-wire (2-wire meter)	627X33	27.50	627X29	28.50
240	2.5	3-wire	629X33	28.50	629X30	29.50

Approximate shipping weight of meters, 8 lb.

Popular Plastic Socket-Meter Covers

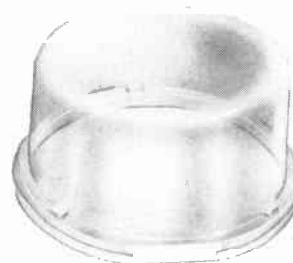

Designed and engineered to meet new requirements of socket meter users.

Constructed of unbreakable clear plastic.

Weather-tests indicate covers are not affected by temperatures of almost 200° F.

Seal-tight rim eliminates use of gasket.

Furnished for all modern meter types and street light controllers.

Prices on application.

G-E Watthour Meters

Types V-62-S and V-62-A
3-Wire

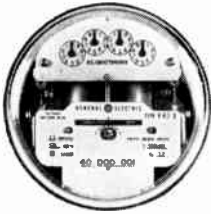

Intended for use on circuits consisting of two "line" wires and the "neutral" obtained from a 4-wire Y, 3-phase circuit. These meters can also be used on 3-wire, 1, 2, or 3-phase circuits.

Extended-range current capacity of the 15-ampere meter is 100 amperes (Class 100) and of the 30 ampere meters is 200 amperes (Class 200).

Type V-62-S is for socket connection and the V-62-A for bottom connection. Approximate dimensions for the "S" type are 7 by 7 1/4 in.; for "A" type, 7 1/2 by 8 3/8 in. Approximate shipping weight, 12 lbs.

Amp.	*120 Volts			†240 Volts		
	Type V-62-S	Type V-62-A	Each	Type V-62-S	Type V-62-A	Each
15	700X1G1	700X4G1	\$64.00	700X1G3	700X4G3	\$64.00
30	700X1G2	700X4G2	84.00	700X1G4	700X4G4	84.00

*Potential coils are wound and rated for line-to-neutral voltage and these are the values listed.

†Line to line voltage.

Types V-5-S and V-5-A
4-Wire Y

These meters have two potential circuits and three current circuits and are intended for use in 4-wire Y, 3-phase circuits. (Their external appearance is similar to Types V-3-A and V-3-S meters.)

Catalog numbers are for ball-type bearings.

Volts	Amp.	Type V-5-S		Type V-5-A	
		Cat. No.	List Price Each	Cat. No.	List Price Each
120Y	15	86X6	\$ 84.00	85X930	\$ 90.00
120Y	50	86X8	109.00	85X932	115.00

Meter for Use With Instrument Transformers

120Y	2.5	629X85*	\$ 94.00	85X952	\$100.00
------	-----	---------	----------	--------	----------

Approximate shipping weights: Type V-5-S—10 lbs.

Type V-5-A—12 lbs.

*13-terminal meter provides separate terminals for all coils (10 terminals) plus contact device (3 terminals) when required.

Call GraybaR FIRST For . . .



Types V-63-S and V-63-A
3-Wire

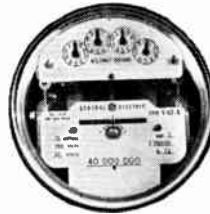

Type V-63-S



Type V-63-A

Type V-63 meters in both self-contained and transformer ratings are intended for use on 3-wire, 1, 2, or 3-phase circuits. Transformer-rated meters are provided with potential-indicating lamps.

Extended-range current capacity of the 15 ampere meter is 100 amperes (Class 100), and of the 30 ampere meter is 200 amperes (Class 200).

Type V-63-A is for bottom connection and the Type V-63-S is for socket mounting. Approximate dimensions for the "S" type are 7 by 7 1/4 in.; for the "A" type, 7 1/2 by 6 1/4 by 9 1/2 in.

120 Volts

Amp.	Type V-63-S		Type V-63-A	
	Cat. No.	Each	Cat. No.	Each
15	700X7G1	\$ 72.00	700X13G1	\$ 78.00
30	700X7G2	92.00	700X13G8	98.00

240 Volts

15	700X7G3	72.00	700X13G2	78.00
30	700X7G4	92.00	700X13G3	98.00

480 Volts

15	700X7G5	88.00	700X13G4	94.00
30	700X7G6	108.00	700X13G5	114.00

600 Volts

15	700X7G7	92.00	700X13G6	98.00
30	700X7G8	112.00	700X13G7	118.00

Meters for Use With Instrument Transformers.

120 Volts

2.5	700X8G1	80.00	700X14G1	86.00
-----	---------	-------	----------	-------

240 Volts

2.5	700X8G6	80.00	700X14G6	86.00
-----	---------	-------	----------	-------

480 Volts

2.5	700X8G10	96.00	700X14G12	102.00
-----	----------	-------	-----------	--------

600 Volts

2.5	700X8G15	100.00	700X14G17	106.00
-----	----------	--------	-----------	--------

Types V-6-S and V-6-A
4-Wire Δ

These meters have two 240-volt potential circuits and three current circuits, and are intended for use on 4-wire Δ, 3-phase circuits, provided the two 120-volt voltages of the lighting circuit are reasonably balanced. (Their external appearance is similar to Types V-3-A and V-3-S meters.)

Type V-6-S

Volts	Amp.	Type V-6-S		Type V-6-A	
		Cat. No.	List Price Each	Cat. No.	List Price Each
240	15	86X31	\$78.00	85X960	\$ 84.00
240	50	86X33	98.00	85X962	104.00

Meters for Use With Instrument Transformers.

240	2.5	629X87	86.00	97X134	92.00
-----	-----	--------	-------	--------	-------

Approximate shipping weights: Type V-6-S—10 lbs.

Type V-6-A—12 lbs.

G-E Watthour Meter Sockets

For Use With Meters Listed on Preceding Pages

Available with or without circuit-closing device.

†For Types I-30-S and I-50-S Meters

Four Terminal—Die Cast

With 1-Inch Conduit Outlets

Mounting	Out-lets	Without Circuit-Closing Cat. No.	List Price Each	With Circuit-Closing Cat. No.	List Price Each
Vertical†	2	550X62	\$6.40	583X48	\$8.75
Vertical†	3	550X64	6.80	65X925	9.00

With 1½-Inch Conduit Outlets

Vertical†	2	550X67	6.40	67X978	8.75
Vertical†	3	550X69	6.80	67X926	9.00

With ¼-Inch Conduit Outlet

Vertical†	2	550X61	6.40		
-----------	---	--------	------	--	--

†High-capacity meter sockets for use at 200 amperes, single-phase, are also available. Prices and information on request.

‡The vertical and horizontal forms are identical, except for the position in which the clips are assembled. If horizontal form is required, state on order. Approximate shipping weight 2½ lbs.

For Type V-62-S Meters

With 1-Inch Conduit Outlets

Vertical	2	550X86	\$7.15	583X46	\$9.75
Horizontal	2	550X87	7.15	583X47	9.75
Vertical	3	550X73	7.55	76X46	10.00
Horizontal	3	550X74	7.55	76X47	10.00

With 1½-Inch Conduit Outlets

Vertical	2	550X75	7.15	76X56	9.75
Horizontal	2	550X76	7.15	76X57	9.75
Vertical	3	550X77	7.55	76X58	10.00
Horizontal	3	550X78	7.55	76X59	10.00

Approximate shipping weight 4 lbs.

For Type V-3-S Meters

Cat. No.	Rating	Circuit-Closing Device	Conduit Outlet, Inches	List Price Each
94X994	Self-contained	No	1½	\$33.40
94X995	Self-contained	No	2	34.80
83X788	Transformer-rated	Yes	1½	36.20
83X789	and self-contained	Yes	2	37.60

Approximate shipping weight, 15 lbs.

For Type V-5-S Meters

Cat. No.	Rating	Circuit-Closing Device	Conduit Outlet, Inches	List Price Each
83X784	Self-contained	No	1½	\$32.90
83X785	Self-contained	No	2	34.30
94X996	Self-contained	Yes	1½	35.70
94X997	Self-contained	Yes	2	37.10
630X13	Transformer-rated	Yes	1½	57.60
630X14	and self-contained	Yes	2	59.00

Approximate shipping weight, 15 lbs.

For Type V-6-S Meters

Cat. No.	Rating	Circuit-Closing Device	Conduit Outlet, Inches	List Price Each
83X784	Self-contained	No	1½	\$32.90
83X785	Self-contained	No	2	34.30
94X996	Self-contained	Yes	1½	35.70
94X997	Self-contained	Yes	2	37.10
630X13	*Trans-rated	Yes	1½	57.60
630X14	*Trans-rated	Yes	2	59.00

Approximate shipping weight, 15 lbs.

*13-Terminal.

G-E Watthour Meters

3-Station, Polyphase, 60-Cycle

Types V-4-A, V-7-A, V-9-A and V-10-A

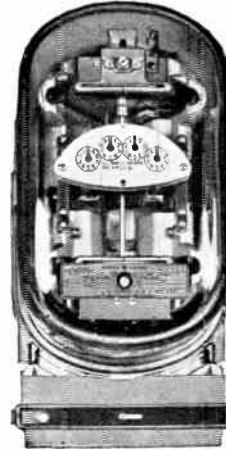

Type V-4-A

Type V-7-A

Type V-4-A is intended for 4-wire Y, 3-phase circuits. It has three potential and three current circuits.

Type V-7-A is for 4-wire Δ, 3-phase circuits. Has one 240-volt (200-volt) stator and two 120-volt stator.

Types V-9-A and V-10-A are used for totalizing one 3-wire, 2- or 3-phase power circuit and one single-phase lighting circuit, either 2- or 3-wire. Write us for information and prices.

Cat. No.	Volts	Amps.	List Price Each	Cat. No.	Volts	Amps.	List Price Each
86X422	120Y	15	\$128.00	86X427	240	15	\$158.00
86X423	120Y	50	158.00	86X428	240	50	188.00

Meters For Use With Current Transformers

86X424	120Y	2.5	\$140.00	86X429	240	2.5	\$170.00
--------	------	-----	----------	--------	-----	-----	----------

G-E Portable Meter-Testing Standard

Type IB-10

Here is a portable standard which combines, for the first time, the capacity essential for the testing of both high and low-current-rated meters with the light weight and small size of the best low-capacity standards.

The use of four current coils has resulted in wide operating range and excellent flexibility. All coils will carry 200% current continuously making it possible to test service meters of all ratings up to 100 amperes.

It has a completely new electromagnet, with low inherent errors, and excellent load, voltage and temperature characteristics; has also excellent balance (accuracy) between current circuits.

This is the first portable standard to use the G-E anti-parallel arrangement of dial and pointers, which promotes speed and accuracy as the reading is always the same regardless of the angle from which the scale is viewed. The large sweep hand, coupled to the disk shaft makes one revolution for each one of the disk. The anti-parallel scale is divided in 100 clearly marked divisions in order that readings, even closer than 1/100th of a revolution can easily be taken. Small dials within the large one make it possible to take readings up to 100 revolutions of the disk.

Cat. No.	Volts	Amps.	Dimensions, inches			Approx. Wt., Lbs.	List Price Each	
			High	Wide	Deep	Net	Ship.	
99X943	{ 120- 210	{ 1-5- 12.5- 50	8½	6¾	6½	11¾	16	\$540.00
582X58	{ 120- 240	{ 1-5- 15-15	8½	6¾	6½	11¾	16	\$540.00

Multiplier Boxes

For increasing the voltage range. They are calibrated and furnished with the standard at the following prices.

Description	Add to List
Single Rating, 480 Volts.....	\$150.00
Double Rating, 480 to 600 Volts.....	250.00

**G-E Switchboard Watthour Meters
For Use With Instrument Transformers**



These back-connected single phase and polyphase meters combine elements of front-connected meters with narrow 5½-inch universal-type switchboard case.

For use with instrument transformers in 2.5 ampere rating. Used with good accuracy on loads up to 400% of normal load.

Test links are not provided for these meters. Separate test blocks can be furnished for this purpose.

The listed switchboard watthour meters are of surface mounted construction. Semi-flush and drawout construction are available.

Switchboard meters are also available for use on circuits other than those listed. Information and prices on request.

**Single-Stator, Single-Phase
Type IS-8**

Available only in 2-wire construction. For 3-wire service, we recommend Type DS-19. Three-wire, single-phase circuits can be metered with the 2-wire meter (Cat. No. 97X335) when connected with double primary, single-secondary, 3-wire type current transformers.

Approximate size: 6 x 5½ x 7-inches. Ship. wt. 20 lbs.

Cat. No.	Volts	Amps.	List Price Each
97X333	120	2.5	\$ 90.00
97X335	*240	2.5	90.00

**Two-Stator, 3-Wire, 1-, 2- or 3-Phase;
4-Wire, 2-Phase
Type DS-19**

Approximate size: 12 x 5½ x 7-inches. Ship wt. 25 lbs.

97X339	120	2.5	\$156.00
97X341	*240	2.5	156.00
97X342	*480	2.5	172.00
97X343	*600	2.5	176.00

**Three-Stator, 4-Wire Y, 3-Phase
Type DS-20**

Approximate size: 12 x 5½ x 7-inches. Ship. wt. 35 lbs.

97X346	120	2.5	\$226.00
--------	-----	-----	----------

*No potential transformers.

Catalog numbers cover meters with ball-type bearings.

Instrument transformers are not included with above meters. Specify ratios of transformers with which meter is to be used. It is standard practice (for meters of modern construction) to use 2.5 ampere meters with current transformers having 5 ampere secondary rating.

**G-E Type MC Phase-Shifting
Transformers**

For Var (reactive volt-ampere) Metering

These phase-shifting transformers can be used on circuits where the voltage may be 10 per cent above or below the rated voltage of the phase-shifting transformer. When ordering these phase-shifting transformers for voltages outside these limits, the normal operating voltage should be specified. Types listed are without test switches.

Type MC-21, 3-wire, 3-phase

Cat. No.	Primary	Secondary	Frequency Cycles	List Price Each
546X6	120	120	50-60	\$50.00
546X7	240	240	50-60	52.00

Type MC-31, 4-wire, 3-phase

546X10	240	240	50-60	50.00
--------	-----	-----	-------	-------

Type MC-22, 4-wire Y, 3-phase

546X11	120	120	50-60	60.00
--------	-----	-----	-------	-------

Other ratings and types available, contact GRAYBAR.

**G-E Bearings and Components
for Watthour Meters**

Oil-Tight Jewel Screw With Removable Plug



For single-phase meters types I-14, I-15, I-16, I-18, I-20, I-30, IS-4, IS-5, IS-6, IS-7, IS-8, IS-9, IS-10 and IS-11.

For polyphase meters types D-6, D-7, D-8, D-14, D-15, DS-6, DS-7, DS-11, DS-12, DS-19, DS-20, DS-21, DS-23, DS-34, DS-35, DS-38, DS-39, DS-40, DS-41 and V-2 to V-10 inclusive. For test meters types IB-5, IB-6, IB-7, IB-8, IB-9 and IB-10.

Cat. No. 68X1—Std. Pkg. of 10 List Price Each \$0.70

Jewel Only (Replacement)

Mounted in plugs for use in Cat. No. 68X1.

Cat. No. 68X2—Std. Pkg. of 10 List Price Each \$0.40



Pivots

For use in combination with jewels listed above.

Cat. No. 4133755G24—In boxes of 25 . List Price Per Box \$7.60

Meter Jewel Oil

Cat. No.	Description	List Price Each
4126220	1-Dram Bottle in Container	\$2.00
66X727	1 Ounce Bottle	3.60

Jewel-Ball-Type Bearings

Enclosed-type ball bearings; for meters types I-16, I-20, I-30, IS-8, IS-9, IS-10, IS-11 and V-2 to V-10 inclusive, in 50- and 60-cycle ratings; also these meters with letter M or W added to the type designation.

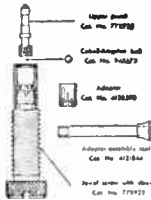

Cat. No.	Description	List Price Each
94X672	Jewel-Screw Assembly with Ball	\$1.40

In standard package of 10.

Replacement Parts for Catalog No. 94X672

Cat. No.	Description	List Price Each
77X922	Lower jewel screw with sleeve	\$0.70
77X925	Upper jewel	.60

In standard packages of ten.

94X673	Balls (25 in Vial)	2.00
8906955	Adapter Assembly Tool	1.00

Cat. No.	Description	Per 100
4130598	Adapter for Use With Meters Having Originally Pivot-type Bearings	\$0.10

Open-Type Ball Bearings

For meters types I-14, I-18, IS-4, IS-5, IS-6, IS-7, D-6, D-7, D-14, D-15, DS-6, DS-7, DS-19, DS-20, DS-21, DS-23, DS-34, DS-35, DS-38, DS-39, DS-40, and DS-41 in 50- and 60-cycle ratings; also these meters with the letter M or W added to the type designation.

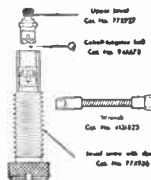

Cat. No.	Description	List Price Each
77X926	Lower Jewel-Screw With Sleeve	\$0.70
77X927	Upper Jewel	.60

In standard packages of ten.

4133755G25	Ball (25 in Vial)	\$2.00
4131823	Wrench for use on Upper Jewel	1.00

G-E Watthour Demand Meters

All catalog numbers call for "Universal Type" M-30 Register. If nonuniversal register is desired, add \$4.00 to list price.

**Types IM-60-S and IM-55-S
With Type M-30 Register**

These meters can be used on circuits where operating voltage limits vary plus or minus 10 per cent.

240 Volts, 3-wire, 4 terminal

15-Min. Interval	30-Min. Interval	Type	Amps.	Full Scale Kw.	List Price Each
630X71	630X73	IM-55-S	15	2.0X6	\$ 78.50
720X2G1	720X2G2	IM-60-S	30	2.0X12	78.50

Type IM-50-S

For use with Instrument Transformers
2-wire Circuit

15-Min. Interval	30-Min. Interval	Volts	Amps.	Full Scale Kw.	List Price Each
627X51	627X53	120	2.5	2X0.5	\$79.50

3-wire Circuit (2-wire meter)

627X59	627X61	*240	2.5	2	79.50
--------	--------	------	-----	---	-------

3-wire Circuit

629X45	629X57	*240	2.5	2	80.50
--------	--------	------	-----	---	-------

*No Potential Transformers.

**Types IM-55-A and IM-50-A
With Type M-30 Register**

15-Min. Interval	30-Min. Interval	Type	Amps.	Full Scale Kw.	List Price Each
630X70	630X72	IM-55-A	15	2.0X6	\$79.50
625X48	625X49	IM-50-A	50	2.0X20	79.50

Type IM-50-A

For use with Instrument Transformers
2-wire Circuit

15-Min. Interval	30-Min. Interval	Volts	Amps.	Full-Scale Kw.	List Price Each
627X35	627X37	120	2.5	2X0.5	\$80.50

3-wire Circuit (2-wire meter)

627X43	627X45	*240	2.5	2	80.50
--------	--------	------	-----	---	-------

3-wire Circuit

627X47	627X49	*240	2.5	2	81.50
--------	--------	------	-----	---	-------

*No Potential Transformers.

Approximate shipping weight, 15 lbs.

Type VM-62-S

With Type M-30 Register

These meters are intended for use on circuits consisting of two "line" wires and the "neutral" obtained from a 4-wire Y, 3-phase circuit. These meters can also be used on 3-wire, 1, 2, or 3-phase circuits.

Extended range current capacity of the 15-ampere meter is 100-amperes (Class 100), and of the 30-ampere meter is 200-ampere (Class 200).

15-Min. Interval	30-Min. Interval	Volts	Amps.	Full-Scale Kw.	List Price Each
700X2G3	700X2G4	*120	15	2X6	\$116.00
700X2G16	700X2G17	*120	30	2X12	136.00
700X2G30	700X2G31	240	15	2X12	116.00
700X2G40	700X2G41	240	30	2X24	136.00

Type VM-62-A

With Type M-30 Register

700X5G3	700X5G4	*120	15	2X6	\$116.00
700X5G12	700X5G13	*120	15	2X12	136.00
700X5G19	700X5G20	240	30	2X12	116.00
700X5G25	700X5G26	240	30	2X24	136.00

*Potential coils are wound and rated for "line-to-neutral" voltage and these are the values used in the listing above.

Approximate shipping weight, 14 lbs.

All meters listed are in a 60 cycle rating.

Type VM-63-S

With Type M-30 Register

The Type V-63 meters in both self-contained and transformer ratings are intended for use on 3-wire, 1, 2, or 3-phase circuits. Transformer-rated meters are provided with potential-indicating lamps.

Extended-range current capacity of the 15-ampere meter is 100-amperes (Class 100), and of the 30-ampere meter is 200-amperes (Class 200).

15-Min. Interval	30-Min. Interval	Volts	Amps.	Full Scale Kw.	List Price Each
700X9G4	†	240	15	2X12	\$124.00
700X9G10	700X9G11	240	30	2X24	144.00

Meters for use with Instrument Transformers

700X10G12	700X10G13	*240	2.5	2X2	132.00
-----------	-----------	------	-----	-----	--------

Type VM-63-A

With Type M-30 Register

700X15G7	700X15G8	240	15	2X12	\$130.00
700X15G17	700X15G19	240	30	2X24	150.00

Meters for use with Instrument Transformers

700X16G15	700X16G17	*240	2.5	2X2	138.00
-----------	-----------	------	-----	-----	--------

*No potential transformers.

†These models and other ratings not listed are available on request. Specify complete rating when requesting information or prices.

Approximate shipping weight, 16 lbs.

Type VM-4-A

For use on circuits obtained from a bank of three power transformers connected in Y and with the neutral brought out.

15-Min. Interval	Catalog Number	30-Min. Interval	Volts	Amps.	Full Scale Kw.	List Price Each
489X74		489X82	120Y	15	2X9	\$180.00
489X76		489X84	120Y	50	2X30	210.00

Meters for Use With Instrument Transformers

15-Min. Interval	Catalog Number	30-Min. Interval	Volts	Amps.	Full-Scale Kw.	List Price Each
489X88		489X90	120Y	2.5	2X1.5	192.00

*No potential transformers.

Approximate shipping weight 30 lbs.

Types VM-6-S and VM-6-A

For use on the circuit obtained from a bank of two or three power transformers connected in Δ with the center tap of one transformer brought out, provided the 120-volt voltages of the lighting circuit (between the center tap and the outer wires) are balanced within limits that would permit the use of a 3-wire, single-phase watthour meter on the lighting circuit.

All have two 240-volt potential coils and three current circuits, with the 3-wire current coil located on the left-hand element.

Type VM-6-S

15-Min. Interval	30-Min. Interval	Volts	Amps.	Full-Scale Kw.	List Price Each
490X71	490X81	240	15	2X12	\$130.00
490X75	490X85	240	50	2X40	150.00

Type VM-6-A

15-Min. Interval	30-Min. Interval	Volts	Amps.	Full-Scale Kw.	List Price Each
490X47	490X53	240	15	2X12	\$136.00
490X57	490X61	240	50	2X40	156.00

Meters for Use with Instrument Transformers

15-Min. Interval	30-Min. Interval	Volts	Amps.	Full-Scale Kw.	List Price Each
490X65	490X67	240	2.5	2X2	\$144.00

Approximate shipping weight 18 lbs.

All meters listed are in a 60 cycle rating.

G-E Square Watthour Meter Sockets Without Circuit-Closing Device

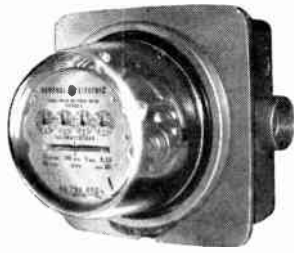

Square socket with Type 1-55-S meter horizontal mounting

Used with single-phase and network meters of four, five, and six terminals. The S-1 is extremely versatile, as illustrated by the numerous features included in every socket.

Easily converted from vertical to horizontal mounting and fifth and sixth terminals may be added with use of screwdriver only.

To convert from vertical to horizontal mounting:

- Remove socket cover.
- Interchange adjacent line terminals.
- Interchange adjacent load terminals.
- Rotate meter socket 90 degrees.
- Replace cover so that rain lip is on top and locking clip is on bottom.

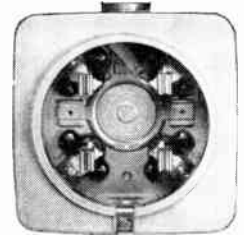

Square socket with cover, 4 terminal vertical mounting

With Serrated Ground Strap

Circuit	Meter Type	No. of Terminals	Threaded Conduit Size In.	Hubs No. of Hubs	Without Sealing Ring		With Slip Lock Sealing Ring		With Snap-action Sealing Ring	
					No.	Each	No.	Each	No.	Each
Single-phase 2 and 3-wire	I-50-S	4	...	None	696X90	\$7.20	696X91	\$7.60	696X92	\$8.00
	1M-50-S	4	1	1	694X48	7.20	694X49	7.60	694X50	8.00
	1-55-S	4	1 1/4	1	696X72	7.20	696X73	7.60	696X74	8.00
	1M-55-S	4	1 1/4	2	641X95	7.20	642X96	7.60	641X97	8.00
Single-phase 240-volt, 3-wire	IR-50-S	4	1 1/2	1	696X81	7.20	696X82	7.60	696X83	8.00
	IR-55-S			2	643X25	7.20	643X26	7.60	643X27	8.00
Single-phase	IR-50-S IR-55-S	5	...	None	696X93	8.00	696X94	8.40	696X95	8.80
				1	694X51	8.00	694X52	8.40	694X53	8.80
				1 1/4	696X75	8.00	696X76	8.40	696X77	8.80
2 and 3-phase 3-wire	V-2-S Self contained	5	1 1/4	2	641X98	8.00	641X99	8.40	643X21	8.80
		5	1 1/2	1	696X84	8.00	696X85	8.40	696X86	8.80
		5	1 1/2	2	643X28	8.00	643X29	8.40	643X30	8.80
Single-phase 240-volt, 3-wire	IR-50-S IR-55-S	6	...	None	696X96	8.80	696X97	9.20	696X98	9.60
				1	694X54	8.80	694X55	9.20	694X56	9.60
				1 1/4	696X78	8.80	696X79	9.20	696X80	9.60
				1 1/4	643X22	8.80	643X32	9.20	643X24	9.60
				1 1/2	696X87	8.80	696X88	9.20	696X89	9.60
				1 1/2	643X31	8.80	643X32	9.20	643X33	9.60

With Lay-In Bus-Type Ground Terminals

Single-phase 2 and 3-wire	I-50-S	4	...	None	687X55	8.00	687X56	8.40	687X57	8.80
	1M-50-S	4	1	1	694X57	8.00	694X58	8.40	694X59	8.80
	1-55-S	4	1 1/4	1	683X89	8.00	683X90	8.40	683X91	8.80
	1M-55-S	...	1 1/4	2	696X54	8.00	696X55	8.40	697X56	8.80
Single-phase 240-volt, 3-wire	IR-50-S IR-55-S	4	1 1/2	1	683X98	8.00	683X99	8.40	687X48	8.80
				2	696X63	8.00	696X64	8.40	696X65	8.80
Single-phase	IR-50-S IR-55-S	5	...	None	687X58	8.80	687X59	9.20	687X60	9.60
				1	694X60	8.80	694X61	9.20	694X62	9.60
				1 1/4	683X92	8.80	683X93	9.20	683X94	9.60
2 and 3-phase 3-wire	V-2-S Self contained	5	1 1/4	2	696X57	8.80	696X58	9.20	696X59	9.60
		5	1 1/2	1	687X49	8.80	687X50	9.20	687X51	9.60
		5	1 1/2	2	696X66	8.80	696X67	9.20	696X68	9.60
Single-phase 240-volt, 3-wire	IR-50-S IR-55-S	6	...	None	687X61	9.60	687X62	10.00	687X63	10.40
				1	694X63	9.60	699X91	10.00	694X64	10.40
				1 1/4	683X95	9.60	683X96	10.00	683X97	10.40
				1 1/4	696X60	9.60	696X61	10.00	696X62	10.40
				1 1/2	687X52	9.60	687X53	10.00	687X54	10.40
				1 1/2	696X69	9.60	696X70	10.00	696X71	10.40

Note—To order extra Fifth or Sixth terminal assembly, specify Cat. No. 680X34, Price..... Each \$0.80
Standard shipping cartons contain 12 sockets; shipping weight approximately 46 lbs.

G-E Box-Type Sockets
With a Manual and Visible By-Pass



Single Phase with Manual By-Pass

For use with single-phase and network meters that require a manual by-pass such as for all transformer-rated meters and for self-contained meters when it is imperative not to interrupt service upon removal of meter.

Sockets available with four, five, or six terminals.

Specifications:

Rating: 100 amp.

Terminal Clamp Capacity: Maximum wire size is 3/0 stranded copper or aluminum wire.

Conduit Outlets: Boxes may be obtained with hubs suitable for 1/4-in., 1/2-in., or 2-in. conduit.

Knockouts: Sides—Concentric knockouts for 1-in., 1/4-in., 1 1/2-in. conduit located at bottom of each side. Bottom—Concentric knockouts for 1-in., 1/4-in., 1 1/2-in., 2-in. conduit. Also has grounding knockouts of 1/4-in. and 1/2-in. diam. on the bottom.

Material: Boxes made of galvanized steel. Aluminum supplied on request. Finished with gray paint, baked on, or sheet aluminum.

Terminals: J-shaped open top type and equipped with maximum diam. screws with specially formed bottom ends that secure copper or aluminum wires firmly and without injury. Maximum wire sizes are 3/0 on line and load.

Grounds: Ground terminals are the same as the line and load terminals. Available with either single or double terminals.

Manual By-pass: Circuit can be completed manually by inserting and fastening the by-pass links on the studs, allowing meter to be removed from the socket without interrupting service.

By-pass consists of two porcelain blocks in which stubs are provided for link type by-passes. Wiring connections from line and load terminals to by-pass stubs are furnished. Cover over by-pass compartment cannot be replaced in the by-pass lines are in the circuit.

Construction: Outdoor weatherproof.

Dimensions: Overall—13 1/4-in., by 7 1/4-in., by 3 1/2-in.

Shipping Weight: Approximately 13 lbs.; if aluminum 9 lbs.

With Single Terminal Ground

No. of Hubs	Conduit Size In.	No. of Terminals	Without Sealing Ring		With Slip-Lock Sealing Ring	
			No.	Each	No.	Each
1	1 1/4	4	688 X 31	\$17.60	688 X 29	\$18.20
1	1 1/2	4	688 X 49	18.00	688 X 47	18.60
1	2	4	688 X 67	18.50	688 X 65	19.10
1	1 1/4	5	688 X 37	18.40	688 X 35	19.00
1	1 1/2	5	688 X 66	18.80	688 X 53	19.40
1	2	5	688 X 73	19.30	688 X 71	19.90
1	1 1/4	6	688 X 43	19.20	688 X 41	19.80
1	1 1/2	6	688 X 61	19.60	688 X 59	20.20
1	2	6	688 X 79	20.10	688 X 77	20.70

With Double Terminals Ground

1	1 1/4	4	909 X 3	18.20	909 X 1	18.80
1	1 1/2	4	909 X 12	18.60	909 X 10	19.20
1	2	4	909 X 21	19.10	909 X 19	19.70
1	1 1/4	5	909 X 6	19.00	909 X 4	19.60
1	1 1/2	5	909 X 15	19.40	909 X 13	20.00
1	2	5	909 X 24	19.90	909 X 22	20.50
1	1 1/4	6	909 X 9	19.80	909 X 7	20.40
1	1 1/2	6	909 X 18	20.20	909 X 16	20.80
1	2	6	909 X 27	20.70	909 X 25	21.30

Fifth Terminals Alone, No. 909X37..... Each **\$0.80**

Fifth and Sixth Terminals, No. 909X38..... Each **\$1.60**

By-Pass Link, No. 909X39..... Per Pr. **\$1.50**

If sockets having aluminum cases are desired specify "Similar to standard Cat. No. except with aluminum case." Add **\$2.40** each.

By-Pass Links not furnished with the sockets and must be ordered separately.

Sockets also available with Snap-action Sealing Ring.

For further information, contact Graybar.

G-E High-Capacity, Box-Type Sockets
Specifications

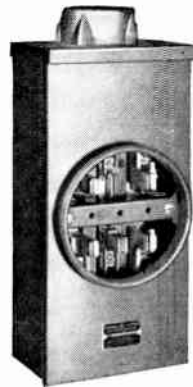

Conduit Outlets: Cabinets with hub suitable for use with 2 1/2-in. conduit, or less, are standard. Hubs are of the removable type.

Knockouts: Sides—Concentric knockouts for 1 1/2-in., 2-in., and 2 1/2-in. conduit are located at the bottom of each of the two sides. Back—Concentric knockout for 1 1/2-in., 2-in., and 2 1/2-in. conduit. Bottom—Two sets of concentric knockouts, one set 1 1/2-in., 2-in., and 2 1/2-in., and the other set 1/2-in., 3/4-in. and 1-in.

Material: 16-gauge galvanized steel. Aluminum supplied on request. Finished with gray paint, baked on, or sheet aluminum.

Jaw Contacts: The four high-capacity contacts are 3/16-in. silver-plated copper. Good contact is further assured by heavy duty back-

up springs. Four terminal sockets are standard, five contact sockets are available.

Terminal Block Assembly: Jaw contacts and cable terminals are mounted on large porcelain base assuring rigid and permanent alignment of the jaws. The whole assembly is removable to facilitate mounting the box, pulling in and preparing the cable for making the final connections to the socket.

Cable Terminals: Six pressure-type connectors, four accommodate 4/0 cable, while the two grounding terminals 2/0 cable. Cable terminals and jaw contacts have unit construction, minimizing potential sources of heat.

Sealing Ring: One piece, stainless steel, snap-action is standard. Supplies on request with slip-lock ring or with no ring.

Circuit-closing Device (By-pass): Supplied with or without this feature. This spring loaded circuit-closing device automatically opens when the meter is inserted, and closes again before the meter is fully removed from the socket.

Test Links: None.

Construction: Outdoor weatherproof.

Rating: Maximum continuous rating of the socket when wired with 4/0 cable is 200 amp. Combined rating of socket and meter depends on thermal rating of meter. When the I-50, 50 amp. meter is used, the maximum continuous rating is 200 amp.

Dimensions: Overall 15-in. by 7 1/4-in. by 4 1/2-in.

Without Circuit-Closing Device

No.	Threaded Hubs—Conduit		No. of Terminals	Each
	No. of Hubs	Size In.		
642 X 4	None	...	4	\$44.10
642 X 7	1	1 1/2	4	43.10
642 X 6	1	2	4	43.70
642 X 3	1	2 1/2	4	45.60

With Circuit-Closing Device

642 X 2	None	...	4	45.10
642 X 12	1	1 1/2	4	47.10
642 X 5	1	2	4	47.70
642 X 1	1	2 1/2	4	49.60
680 X 32	Fifth Terminal (for neutral channel)			0.50
680 X 33	Fifth Terminal (for mounting on crossbar)			0.50

† "No hub" and "2 1/2 in. hub" are standard. Sockets with 2 in. hub. available but not stocked.

Note—Sockets listed have galvanized steel cases. If aluminum case is desired, specify "similar to standard Cat. No. except with aluminum case." Add **\$3.60** each.

If no sealing ring is desired, specify "without sealing ring." Deduct **\$1.10** each.

If slip-lock sealing ring is desired, specify "with slip-lock sealing ring." Deduct **\$0.50** each.

Complete fifth-terminal sockets are supplied on request at the price of socket plus terminal. Specify by Cat. No. of socket and terminal desired.

Prices include G-E snap-action sealing ring.

G-E Standard Polyphase Box-Type Sockets

Circuit	For Watthour Meters Type	Rating	No. of Terminals	*Hub Size In.	Standard		Sub-base		Semi-floating	
					No.	Each	No.	Each	No.	Each
Without Circuit-Closing Device										
3-phase, 3-wire	V-3-S	Self-contained	8	1 1/4	642X23	\$25.50	94X994	\$33.40	642X25	\$34.50
					642X24	26.90	94X995	34.80	642X26	35.90
3-phase, 4-wire, wye	V-5-S	Self-contained	7	1 1/4	642X27	24.90	83X784	32.90	642X29	33.90
					642X28	26.30	83X785	34.30	642X30	35.30
3-phase, 4-wire, delta	V-6-S	Self-contained	7	1 1/4	642X27	24.90	83X784	32.90	642X29	33.90
					642X28	26.30	83X785	34.30	642X30	35.30
With Circuit-Closing Device										
3-phase, 3-wire	V-3-S	Self-contained	8	1 1/4	642X31	27.90	83X788	36.20		
					642X32	29.30	83X789	37.60		
3-phase, 3-wire	V-3-S	Trans-rated	8	1 1/4	642X31	27.90	83X788	36.20		
					642X32	29.30	83X789	37.60		
3-phase, 4-wire, wye	V-5-S	Self-contained	7	1 1/4	642X35	27.40	94X996	35.70		
					642X36	28.80	94X997	37.10		
3-phase, 4-wire, wye	V-5-S	Trans-rated	7	1 1/4	642X39	27.40	83X786	35.70		
					642X40	28.80	83X787	37.10		
3-phase, 4-wire, wye	V-5-S	Trans-rated	13	1 1/4	630X13	57.60				
					630X14	59.00				
3-phase, 4-wire, delta	V-6-S	Self-contained	7	1 1/4	642X35	27.40	94X996	35.70		
					642X36	28.80	94X997	37.10		
3-phase, 4-wire, delta	V-6-S	Trans-rated	13	1 1/4	630X13	57.60				
					630X14	59.00				

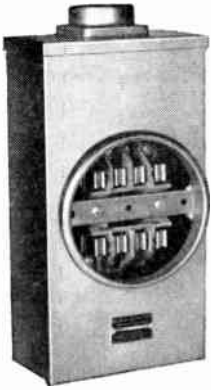

*Hub size is actually the conduit size that can be used with the corresponding hub: "Less hub" can be supplied. From list price of corresponding socket with 1 1/4-in. hub, deduct . . . Each **\$1.20**. "2 1/2-in. hub" can be supplied. To price of corresponding socket with 2-in. hub, add . . . Each **\$1.90**.

Prices listed include G-E snap-action sealing ring.

Sockets listed have galvanized steel case. If sheet aluminum case is desired, order as "similar to standard Cat. No. except with aluminum case." Add . . . Each **\$2.00**.

If no sealing ring is desired, specify "without sealing ring." Deduct . . . Each **\$1.10**.

If slip-lock sealing ring is desired, specify "with slip-lock sealing ring." Deduct . . . Each **\$0.50**.

G-E High-Capacity Connection Boxes

For Use with A-Type Meters



Applications

Single-phase, 3-wire circuits rated 240 volts, 200 amp. for use with the 1-50-A 50-amp. meter.

Specifications:

Conduit Outlets: Boxes with a hub suitable for use with 2 1/2-in. conduit are standard. The hubs are of the removable type.

Knockouts: Sides — Concentric knockouts for 1 1/2-in., 2-in. and 2 1/2-in. conduit are located at the bottom of each of the two sides. Back — Concentric knockouts for 1 1/2-in., 2-in. and 2 1/2-in. conduit are located on the back. Bottom— (with hub)—Two sets of concentric knockouts, one set 1 1/2-in., 2-in. and 2 1/2-in.; the other set 1/2-in.,

3/4-in. and 1-in. (Without hub)—Three sets of concentric knockouts, two sets 1 1/2-in., 2-in. and 2 1/2-in.; other set 1/2-in., 3/4-in. and 1-in.

Material: 16-gauge galvanized steel with gray paint baked on. Outdoor, weatherproof construction.

Ventilation: Natural draft through sheltered vents at bottom and top of cover.

Dimensions: Overall 21 1/8-in. by 9 1/2-in. by 4 5/16-in.

Shipping Weight: 18 lbs.

Maximum continuous rating when wired with 4/0 cable is 200-amps. Combined rating of mount and meter depends upon the thermal rating of meter. When the 1-50-A 50-amps. meter is used, the maximum continuous rating is 200 amps.

The cable terminals are mounted on a large porcelain block which is easily removable to facilitate mounting the box and pulling in and preparing the cable for making final connections to the terminal block.

The line and load terminals are pressure type connectors and accommodate 4/0 cable. Two neutral terminals are of similar size joined by a bus on which is mounted a terminal for 2/0 cable for connection to ground.

A steel collar and rubber gasket effectively seals glass meter cover opening.

No.	Threaded Hubs		Each
	No. of Hubs	Conduit Size In.	
642X51	1	2 1/2 hub	\$51.20
642X52	1	2 hub	49.30
642X53	None	No hub	46.70

G-E High-Capacity Polyphase Box-Type Sockets



Specifications:

Conduit Outlets: A hub suitable for 3-in. conduit is standard. No hub or hubs suitable for 2-in. or 2½-in. conduit are available on a special basis. Hubs are removable.

Knockouts: Sides — Concentric knockouts for 2-in., 2½-in., and 3-in. conduit are located at the bottom of each of the two sides. Back — Concentric knockout for 2-in., 2½-in. and 3-in. conduit. Bottom — Two sets of concentric knockouts, one set 2-in., 2½-in. and 3-in. and the other set ½-in., ¾-in. and 1-in.

Material: Galvanneal steel or sheet aluminum finished in gray paint baked on or natural aluminum.

Jaw Contacts: The six high-capacity contacts are ¾-in. silver-plated copper. Good contact is further assured by heavy-duty contact springs. The seventh contact is used for potential and is standard contact clip.

Terminal Block Assembly: Jaw contacts and the cable terminals are mounted on large porcelain base, assuring rigid and permanent alignment of the jaws, the whole assembly being removable to facilitate mounting the box, pulling in and preparing cable for making final connections to the socket.

Cable Terminals: The six cable terminals which accommodate 1/0 cable and the jaw contacts have a unit construction, minimizing potential sources of heat. Grounding terminals are also of the pressure type and accommodate 1/0 cable.

Sealing Ring: Snap-action, stainless steel sealing ring is standard. Slip-lock ring or no ring can be supplied on request.

Circuit Closing Device (by-pass): Supplies with or without this feature. This spring-loaded circuit-closing device automatically opens when the meter is inserted and closes again before the meter is fully removed from the socket.

Test Links: None.

Construction: Weatherproof.

Rating: Maximum continuous rating of the socket when wired with 1/0 cable is 200 amps. The combined rating of socket and meter depends on the thermal rating of meter. The V-5-S and V-6-S have a maximum continuous rating of 125 amps. when used in this socket.

Dimensions: Overall height 19-in. (including hub), Width 9½-in., Depth 5¼-in.

No.	Threaded Hubs No. of Hubs	Conduit Size In.	No. of Terminals	Shp. WT. Lbs.	Each
Without Circuit-Closing Device					
581X96	1	2	7	25	\$61.45
581X97	1	2½	7	25	63.35
581X98	1	3	7	25	64.85
With Circuit-Closing Device					
582X1	1	2	7	26	66.70
582X2	1	2½	7	26	68.60
582X3	1	3	7	26	70.10

Prices listed include G-E snap-action sealing rings.

If no sealing ring is desired, specify "without sealing ring." Deduct... Each \$1.10.

If slip-lock sealing ring is desired, specify "with slip-lock sealing ring." Deduct... Each \$0.50.

Sockets listed have galvannealed steel cases. If sheet aluminum case is desired, order as "similar to standard Cat. No. except with aluminum case." Add... Each \$4.50.

G-E CT Sockets

For Use with Transformer-Rated Watthour Meters

Current transformers are included and are properly wired making the sockets ready for immediate installation in the line.

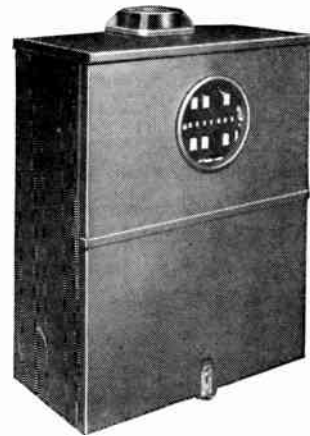

Specifications:

Sealing Ring: One-piece all-welded, stainless-steel, snap-action ring is standard.

Terminal-block Assembly: Remains in position when cover is removed.

Circuit-closing Device: Automatically opens when meter is inserted in the socket and closes again before meter is fully removed from socket.

Hubs: Removable type.

Knockouts: Sides—Concentric knockouts for 3-in. and 3½-in. conduit located at bottom of each side. Bottom—Concentric knockouts for 3-in. and 3½-in. conduit located in the bottom.

Grounding Knockouts: ½-in., ¾-in., 1-in. located in the bottom.

Construction: Outdoor type.

Material: Galvanized steel, with baked gray finish.

Transformers: Type JCA-O, butyl-molded.

Rating: Maximum for 200-amp. CT's, 200% load (400 amp); maximum for 400-amp. CT's, limit of entrance cable (one 600 MCM or two 250 MCM per terminal).

Shipping Weight: 70-lb. for sockets with two transformers; 115 lbs. for sockets with three transformers.

No.	Meter Type	Circuit	No. of Terminals	*Hub Size In.	Transformers	Each
642X60	1-50-S	1-phase, 3-wire	6	3	2-200/5	\$248.00
642X61	1-50-S	1-phase, 3-wire	5	3	2-400/5 in parallel	274.00
642X62	V-3-S	3-phase, 3-wire	8	3	2-200/5	255.00
642X63	V-6-S	3-phase, 4-wire delta	13	3½	3-200/5	348.00
642X64	V-5-S	3-phase, 4-wire wye	13	3½	3-200/5	348.00
642X65	V-3-S	3-phase, 4-wire delta	8	3½	2-400/5 1-200/5	361.00
642X66	V-3-S	3-phase, 3-wire	8	3	2-400/5	281.00

*Hub size is given as the conduit size that can be used with each hub.

G-E Switchboard Instruments

Long-Scale Models

Type AB-18 (A-C)—Type DB-18 (D-C)

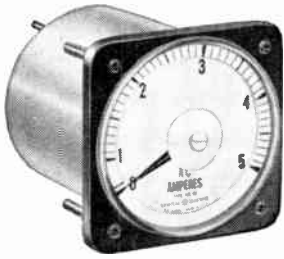

Type AB-18 Ammeter

These compact long-scale instruments are intended for general switchboard service on both large and small equipments. They are excellent for control stations, test equipment and other installations where space is limited. Five instruments can be mounted on a 24-inch panel.

They are particularly attractive because of their long concentric scales, which are very accurate and easily read. Readability is also improved

by a new cover designed for shadow elimination. The scale angle is 250 degrees for all except power-factor meters (which are calibrated over 180 or 360 degrees) and synchrosopes.

Drawn steel, dustproof cases, with molded front, designed for semi-flush mounting. Anti-parallax scale and pointer, magnetic damping, and external zero adjusters are standard features. White scales with black markings are standard. Black scales with white markings can be supplied on all listed ratings. Numbered major divisions are accented to save time in reading.

A-C Voltmeters

All ratings, except 300, 600 and 750 volts, have the resistance housed in a ventilated molded cage on back of case. 300-volt ratings require one 2-tube external resistor. Those rated 600 and 750 volts require one 4-tube external resistor.

Type.....	AB-18
Operating Principle.....	Moving-iron
Va. Burden at 120v./60 cycles.....	4.8
Accuracy.....	1%
Scale Length.....	7.1 in.
Frontal Dimensions.....	4 1/4 in. by 4 3/4 in.
Projection behind Panel.....	A-C Ammeters—1 1/16 in. A-C Voltmeters—6 5/8 in.
Mounting.....	Semiflush

Volts	Volts per Scale Div.	List Price Each	Volts	Volts per Scale Div.	List Price Each
*150	*	\$107.00	600	10.0	\$133.00
150	2.0	107.00	750	10.0	133.00
300	10.0	116.00			

*Transformer-rated.

Approximate weight—Net, 3 lbs.; Shipping, 6 lbs.

A-C Wattmeters

Those rated 120 volts or less have self-contained potential resistors. 240-volt wattmeters require one 1-tube external resistor; those rated 600 and 750 volts require one 2-tube external resistor. Zero-center scales can be furnished at standard prices. Only 120-volt instruments are listed below; 240-volt ratings can be supplied at \$9.00 list additional.

Type.....	AB-18
Operating Principle.....	Electrodynamometer
Va. Burden at 60 Cycles: 5-Amp. Current Circuit.....	1.6
120-Volt Potential Circuit.....	2.2
Accuracy.....	1%
Service.....	Single-Phase, 2-Wire
Protection behind panel.....	6 3/8 in.

Amps.	Volts	Kw.	List Price Each	Amps.	Volts	Kw.	List Price Each
*5	120	*	\$188.00	10	120	1.0	\$196.00
1	120	0.1	188.00	15	120	1.5	196.00
5	120	0.5	188.00	20	120	2.0	196.00

*Transformer-rated.

Approximate weight—net, 3 1/2 lbs.; shipping, 7 lbs.

In addition to the types and ratings listed above, we can also supply a complete line covering all standard and many special ratings, of frequency meters, power-factor meters, synchrosopes, varmeters and polyphase wattmeters.

A-C Ammeters

These ammeters will withstand up to 100 times normal current instantaneously, and, in normal applications, motor-starting current has no injurious effect.

Type.....	AB-18
Operating Principle.....	Moving-iron
Va. Burden at 5 Amps./60 Cycles.....	2.15
Accuracy.....	1%

Amps.	Amps. per Scale Div.	List Price Each	Amps.	Amps. per Scale Div.	List Price Each
*5	*	\$99.00	10	0.2	\$99.00
2	0.05	99.00	15	0.2	99.00
5	0.1	99.00	20	0.5	99.00

*Transformer-rated.

Approximate weight—net, 2 1/2 lbs.; shipping, 6 lbs.

Direct Current Types

Type.....	DB-18
Operating Principle.....	Permanent-Magnet, Moving-Coil
Accuracy.....	1%
Scale.....	Zero-left is Standard; Zero-Center Available at Standard Prices.
Protection behind panel DC amps and volts.....	6 3/8 in.

D-C Voltmeters

Sensitivity—1.5 to 250 volts..... 100 ohms per volt
250 to 750 volts..... 200 ohms per volt

Volts	List Price Each	Volts	List Price Each
30	\$110.00	300	\$116.00
75	110.00	600	134.00
150	110.00	750	142.00

D-C Ammeters

These ammeters are normally self-contained in ratings up to and including 60 amperes. Higher ratings are supplied with external 50-mv. shunts and 6-ft. leads, which are included in the price of the instrument. Longer shunt leads can be furnished at an additional price. If the one-way lead length exceeds 45 feet (or the two resistance exceeds 0.170 ohms) a 100-mv. instrument and shunt are required.

Amps.	List Price Each	Amps.	List Price Each	Amps.	List Price Each	Amps.	List Price Each
1	\$119.00	40	\$119.00	200	\$119.00	800	\$138.00
10	119.00	60	119.00	300	121.50	1000	148.00
15	119.00	80	119.00	400	124.00	1500	166.00
20	119.00	100	119.00	500	128.50	2000	174.00
		150	119.00	600	131.00	3000	208.00

Approximate weight—net, 3 3/4 lbs.; shipping, 7 lbs.

**D-C Ammeters with Lead-Length Compensator
For Use with External Shunts**

For use when it is not practical to specify the length or resistance of the shunt lead when ordering, ammeters, less shunt and leads (Millivoltmeters) are available with internal lead-length compensators. Compensation for lead resistance can be made after installation by means of a shaft extension with a screw driver slot, accessible from the back of the instrument.

Shunts are not included, but should be ordered separately. Leads can be ordered separately or supplied by the user.

Rating, Mv.	Range of Compensator Adjustment	Scale Marking	List Price Each
100	0-1.0 Ohms	Specify	\$136.00

Approximate weight—Net, 3 1/2 lbs.; shipping, 6 lbs.

D-C Milliammeters

Ma.	Approx. Res. Ohms	List Price Each	Ma.	Approx. Res. Ohms	List Price Each
1	3-13	\$108.00	100	0.5	\$108.00
10	8	108.00	500	0.1	108.00

D-C Microammeters

Micro-Amps.	Approx. Res. Ohms	List Price Each
500	1000	\$121.00

Approximate weight—Net, 3 3/4 lbs.; shipping, 7 lbs.

G-E Switchboard Instruments

6-Inch Rectangular Class

Type AD (A-C)—Type DD (D-C)



Here is a general-purpose line of instruments that has long been used for instrumentation of power switchgear, control boards, test benches and similar industrial apparatus. We have a most complete line, including such specialized forms as heavy-duty types for steel mills and similar industries, alarm contacts, tachometers, voltmeters and high-

frequency instruments for induction-heating applications, besides more standard forms listed in this catalog.

All have welded, pressed steel cases (except heavy-duty type, not listed) with a durable black finish. Non-glare glass, anti-parallax scale and pointer, magnetic damping and external zero adjusters are standard features. White scales with black markings are standard—black scales with white markings can be supplied.

Scale Length.....5 In.
Accuracy Class.....1%
Mounting.....Surface or Semiflush
Size: Surface.....6 x 5½ In.
Semiflush.....7 x 6½ In.

Thorough shielding is provided by the steel cases which are rendered dustproof by resilient rubber gaskets.

The bold, monument-shaped pointer and prominent scale markings facilitate reading from a distance.

Listings below are for surface-mounted, Type AD-6. Unless otherwise noted, add \$4.00 for semi-flush Type AD-7.

In addition to these listings a complete line is available including polyphase wattmeters, varmeters, frequency meters and power factor meters.

A-C Voltmeters

Single-range voltmeters rated 300 volts or lower have self-contained resistance. Those rated 600 and 750 volts require one 2-tube external resistor.

Dual-range voltmeters are self-contained for the low range; an external resistor is used for the high range.

Operating Principle.....Moving-Iron, Inclined-Coil
Burden at 120 Volts.....5.3 Va.
Accuracy.....1%
Frequency Range.....25-125 Cycles

Single-Range

Volts	Volts per Scale Div.	List Price Each	Volts	Volts per Scale Div.	List Price Each
150	5.0	\$ 93.00	600	20.0	\$116.00
300	10.0	100.00	750	20.0	116.00

Dual-Range

75/150	2/4	\$113.00	150/300	5/10	\$120.00
--------	-----	----------	---------	------	----------

Approximate weight—Net, 5 lbs.; shipping, 8 lbs.

A-C Triplex Voltmeters

Type AD-10—Surface; Type AD-12—Semiflush

Complete with external resistors. Prices given are for AD-10 surface-mounted type. For AD-12, semiflush, add \$22.00.

Volts	Volts per Scale Div.	List Price Each	Volts	Volts per Scale Div.	List Price Each
150	5	\$254.00	300	10	\$277.00

Approximate weight—Net, 9 lbs.; shipping, 25 lbs.

A-C Ammeters

Types AD-6 and AD-7

Burden at 5 Amperes.....1.9 Va.

These ammeters are outstanding for their high overload characteristics. The 5-amp rating will withstand 100 times normal current instantaneously without mechanical or electrical damage. In normal applications, motor-starting current has no adverse effect.

All listed ratings are self-contained.

Single-Range

Amps.	Amps. per Scale Div.	List Price Each	Amps.	Amps. per Scale Div.	List Price Each
5	0.1	\$86.00	80	2.0	\$ 96.00
10	0.2	86.00	100	2.0	101.00
15	0.5	86.00	150	5.0	106.00
20	0.5	86.00	200	5.0	111.00
30	1.0	91.00	300	10.0	120.00
40	1.0	91.00	400	10.0	130.00
60	2.0	96.00	600	20.0	130.00

Approximate weight—

5 to 40 Amp.—Net, 5 lbs.; shipping, 8 lbs.

60 to 600 Amp.—Net 6 lbs.; shipping, 9 lbs.

Dual-Range

Furnished complete with four studs to permit series-parallel connection of the current windings. Scales are double-marked. Transfer switches are not furnished, but are available as accessories.

Amps.	Amps. per Scale Div.	List Price Each
2.5/5	0.5/0.1	\$106.00
5/10	0.1/0.2	106.00

Approximate weight—Net, 5 lbs.; shipping, 11 lbs.

Pointer-Stop Ammeters

Type.....AD-6 (Surface)
AD-7 (Semiflush)

Operating Principle.....Moving-Iron, Inclined-Coil
Burden at 5 Amperes.....1.9 Va.
Accuracy......5% for Current Impulses of 1/20 Second or More
Marked Scale Range.....2/3 of Full-Scale Value

For measuring currents of short duration, such as resistance-welder current, pointer-stop ammeters are available. An adjustable lower stop, moved by a small knob protruding from the cover front, may be used to advance the pointer upscale to the point of minimum observable "kick" in response to a current impulse, this indicating the rms current.

Amps.	Scale Marking	List Price Each
5	*	\$106.00
2.5/5.0	*	126.00
5/10	*	126.00

Approximate weight—Net, 5 lbs.; shipping, 11 lbs.

*Scale marking depends on current-transformer rating. Lower third of scale is not marked, because readings there are meaningless.

G-E Switchboard Instruments
6-Inch Rectangular Class—(Continued)

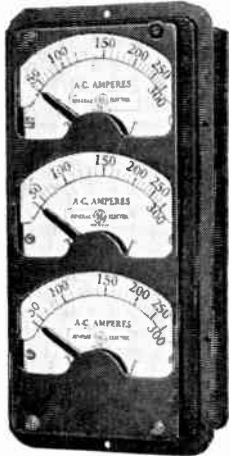

Type AD (A-C)
Type DD (D-C)
A-C Triplex Ammeters

Types
AD-10.....Surface
AD-12.....Semiflush
Operating Principle...Moving-Iron, Inclined-Coil
Burden at 5 Amperes...1.9 Va.
Accuracy.....1%
Scale Length.....4.1 In.

Amps.	Each	AD-10	AD-12
5		\$248.00	\$260.00

Approximate weight—Net, 9 lbs.; shipping, 25 lbs.

A-C Wattmeters

Normally furnished with zero-left scale and self-contained potential resistance for 120-volt potential rating. Zero-center scales can be supplied at standard prices.

Type AD-6 Single-Phase

The following listings are for potential of 120 volts. For 240 volts add \$8.00; for 480 or 600 volts add \$18.00.

Note—We can also furnish a complete line of polyphase wattmeters.

Amps.	Kw.	List Price Each	Amps.	Kw.	List Price Each	Amps.	Kw.	List Price Each
1	0.1	\$165.00	4	0.4	\$165.00	10	1.0	\$165.00
2	0.2	165.00	5	0.5	165.00	15	1.5	172.00
3	0.3	165.00	7.5	0.75	165.00	20	2.0	172.00

Approximate weight—Net, 7 lbs.; shipping, 12 lbs.

Direct-Current Types

Types.....DD-6, Surface
DD-7, Semiflush
Operating Principle.....Permanent-Magnet, Moving-Coil
Scale.....Zero-Left is standard; Zero-Center can be furnished at standard prices.

Type DD-6 D-C Voltmeters

All those listed have a sensitivity of approximately 100 ohms per volt, and are self-contained. Higher-sensitivity instruments are available.

Suppressed-zero voltmeters, such as 50-150 volts, or 100-150 volts are available at \$10.00 additional. Such instruments, however, are not recommended, since accuracy is not increased and the absence of a natural zero reference makes it difficult to maintain standard accuracy.

Volts	List Price Each	Volts	List Price Each
150	\$ 95.00	600	\$116.00
300	101.00	750	124.00

Approximate weight—Net, 5½ lbs.; shipping, 12 lbs.

Type DD-6 D-C Ammeters

Are normally self-contained in ratings of 60 amperes and lower. Higher ratings, up to 3000 amperes, have an external Form 15—50-mv. shunt and 6-ft. leads included in price. If the one-way lead length exceeds 45 feet, or the two-way resistance exceeds 0.170 ohms, a 100-mv. instrument and shunt are required.

Amps.	List Price Each	Amps.	List Price Each	Amps.	List Price Each
15	\$104.00	150	\$104.00	800	\$123.00
30	104.00	200	104.00	1000	133.00
40	104.00	300	106.00	1500	151.00
60	104.00	400	109.00	2000	159.00
80	104.00	500	113.00	3000	193.00
100	104.00	600	116.00		

Approximate weight—less shunt—Net, 5½ lbs.; shipping, 12 lbs.

G-E Strip-Chart Recording Instruments
Switchboard and Portable Models
Type CH—For A-C 60 Cycles and D-C

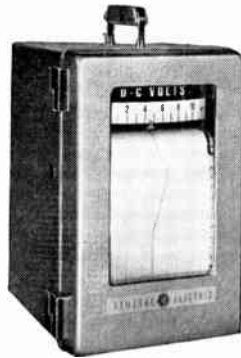

Portable



Switchboard, Back-Connected

Available as switchboard instruments for surface or semiflush mounting and also as portable instruments. There is a complete line for a-c and d-c circuits, including ammeters, voltmeters, wattmeters, varimeters, and frequency meters. They can be furnished with a variety of chart speeds and drives. Single speed, inches per hour, are standard on switchboard instruments, and double speed inches per hour and minute are standard on multirated portables. Gears are available to provide as many as 28 various chart speeds, from ¼-inch per hour to 2-inches per second. Driving mechanism is either a 120-volt, 60-cycle or a 120/240-volt, 60-cycle synchronous motor. Special voltage ratings and frequencies are also available. A double-speed handwound clock can be furnished. This clock will run 60 days without winding at speeds of one inch per hour or slower. Type CH recorders are all of the ink type. Have a new-design spillproof throw-away 3-oz. inkwell which comes sealed for easy insertion with no spilling, and needs no refilling or cleaning. Record rolls are 150-ft. long, require less-frequent changing, and are six-in. wide with a 4½-in. calibrated width.

Switchboard instrument dimensions are 16⅝ x 10⅞ x 12⅝-inches.

Approximate net weight, 30-lb.; shipping weight, 40-lb.

Only a partial listing of the available standard ratings is given here. For additional ratings, consult Graybar.

Representative Type CH A-C Models
Ammeters

Single-rated Amperes	Semiflush Mounted List Price Each	Multirated Amperes	Portable List Price Each
0-5	\$555.00	0-2.5/5	\$655.00
		0-5/10	665.00

Voltmeters

Single-rated Volts	Semiflush Mounted List Price Each	Multirated Volts	Portable List Price Each
0-150	\$570.00	0-150/300/600	\$695.00

Wattmeters

Single-rated Phase-to-Phase (2-elements) Volts	Amperes	Semiflush Mounted List Price Each	Multirated Phase-to-Phase (2-elements) Volts	Amperes	Portable List Price Each
120	5	\$660.00	120/240	5	\$770.00
240	5	670.00	120/240/480	5	790.00

Representative Type CH D-C Models
Voltmeters

Single-rated Volts	Semiflush Mounted List Price Each	Multirated Volts	Portable List Price Each
0-150	\$580.00	0-50/100/250/500	\$715.00
0-300	585.00	0-100/250/500/750	725.00

Ammeters (External-shunt Type Millivoltmeters)

Single-rated Millivolts	Semiflush Mounted List Price Each	Multirated Millivolts	Portable List Price Each
0-50	\$580.00	0-50/100	\$680.00

G-E Strip-Chart Recording Instruments

Portable, Inkless, Type CF

For A-C and D-C

Type CF-1 for A-C

Designed to provide recording voltmeters, ammeters, milliammeters, microammeters, wattmeters and tachometers for application where reliability and maximum convenience are important to the user. (Information on items not described below furnished on request.)

For either indoor or outdoor service. The instrument illustrated is the portable type, but can be wall- or pole-mounted. Switchboard models can also be furnished.



The special feature of this instrument is inkless recording, no ink to dry up, freeze or spill. Type CF recording instruments having a chart speed of one inch per hour (optional) make possible continuous operation for 30 days without attention. They are ideal for installations where frequent servicing is impractical.

Chart size 4 inches wide, 65 ft. long. Chart speed, Standard 3 inches per hour (1 inch and 2 inch per hour type available). 1 inch per day type can be furnished at \$15.00 additional. Size—10³/₄ x 8³/₄ x 6 inches. Weight, 12 lbs.

A-C Voltmeters—Type CF-1

60 cycles—Accuracy 1¹/₂% within Normal Range.

Volts..... 0-140/280
List Price Each..... **\$235.00**

Telechron* motor circuits internally connected to element terminals. Instruments can be supplied with separate motor terminals at \$11.00 additional.

*Registered trade-mark of General Electric Co.

A-C Ammeters—Type CF-1

25-125 cycles—Accuracy 2% of full scale.

Has 120/240-volt or 240/480-volt Telechron motor circuit. Connections to separate terminals on terminal block. Motor ratings changed by link arrangement on terminal block.

Amperes..... 0-5/10
List Price Each..... **\$235.00**

Type CF-2 for D-C

The G-E Type CF line, previously offered only for a-c applications has been extended to include d-c instruments in the usual ratings of voltmeters, ammeters, milliammeters and microammeters, which makes it now economical to apply recording instruments to many applications where heretofore the expense of suitable equipment could not be justified. (Information on items not described below furnished on request.)

All d-c instruments listed are accurate to within 2% of full-scale value.

Type CF-2 voltmeters and ammeters are insulated for and designed for use in circuits not exceeding 750 volts to ground.

All listed instruments have 60-cycle, 120/240-volt motor circuit brought out to separate terminals. 25- or 50-cycle motors or 240/480-volt motor circuit may be specified at no addition in price.

D-C Voltmeters—Type CF-2

Resistance Approximately 233 Ohms per Volt.

Volts	List Price Each	Volts	List Price Each
0 15	\$342.00	0 300	\$364.00
0 150	353.00	0 750	385.00

D-C Ammeters—Type CF-2

Amps.	Approx. Res. Ohms	List Price Each	Amps.	Approx. Res. Ohms	List Price Each
0 1.5	.03	\$342.00	0-15	.003	\$342.00
0-3	.017	342.00	0-30	.0017	342.00
0 7.5	0.007	342.00			

Switchboard Models

Type CF recorders can now be furnished in attractively styled cases for switchboard mounting—Type CF-4 for a-c, Type CF-5 for d-c. For complete information, contact Graybar.

Accessories for Type CF Instruments

Ribbon on Spool.....	Per Spool	\$2.00
Empty Spool.....	Each	.60
Rate-Gear Unit, 1, 2 or 3-In. per Hr.....	Each	6.50
Rate-Gear Unit, 1-In. per Day.....	Each	21.00
Record Rolls (minimum quantity lots).....	Standard	1.75
	Special	3.40
Lamps.....	Each	.30

G-E Type CF-7 Recording Volt-Ammeter

For Recording Current on Circuits Rated up to 8700 Volts; Also Records Voltages up to 750 Volts. A-C Only.

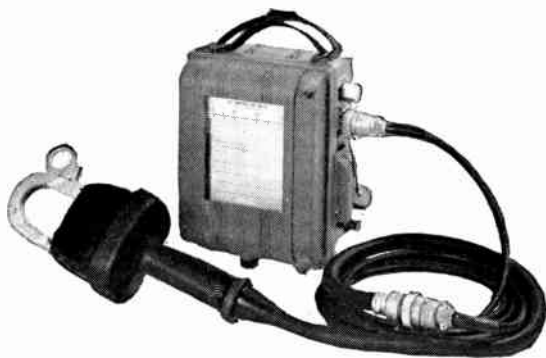

Very convenient for measuring current in transformers and feeder circuits; permits measurement to be made without interrupting service.

Equipment includes a Type CF-7 recording volt-ammeter, 10-ft. lead, and a butyl-insulated hook-on current transformer.

When in use, the transformer hook is clamped around the cable or lead in which the current is to be measured.

Accuracy—3 per cent, except above 625 amp., 4 per cent.

Length of Lead.....10-ft. (add **\$14.00** for 50-ft. lead)

Approx. Wt.....19-lb.

Current Amperes	Rating	Voltage	Frequency Cycles	Chart Speed	List Price Each
15/30/75/150/300/750		150/300/750	60	3-in. per hr.	\$512.00

50-cycle operation or 1-inch-per-hour chart speed available at same price.

G-E Panel Instruments

General-purpose type, particularly suitable for use in radio equipment and industrial applications where medium accuracy and high quality are required and space is at a premium.

The direct-current instruments operate on the permanent-magnet, moving-coil principle; the alternating-current instruments are of the moving-iron type.

All are accurate to within 2% of full scale.

Voltmeters, ammeters, milliammeters and micro-ammeters can be furnished in all required ranges and in 2½-inch, 3½-inch and 4x1¼-inch sizes.

Two styles are available in each of the 3½-inch and 2½-inch classes, all in *Textolite. In addition to the round, flush-mounted model, there is a flush-mounted square style available at the same price.

*Reg. trade-mark of General Electric Co.

The 4¼-inch rectangular type listed is a standard, flush model in Textolite. There are also available in illuminated types—one using rear illumination through a clear Lucite case, at an additional price.

All instruments are unshielded, but external magnet shields can be supplied for 3½-in. and 4¼-in. sizes.

Description	2½-Inch D-C	3½-Inch A-C	D-C	4¼-Inch A-C	D-C
Depth behind Panel — In. (less Terminal Studs†)	0.93	1.58	1.0	1.22	1.22
Radius of Mounting Holes — In. (Round Types).....	1.22	1.58	1.58

†Standard terminal studs are 2½/32 in. long.

When ordering, specify rating, size, mounting, and, in 4¼-inch models, whether standard or illuminated. (See price additions above for change from standard.)

Direct-Current Types

Types DW-71, 2½-in.; DO-71, 3½-in.; DO-78, 4¼-in.



Permanent-magnet, moving-coil type, with an accuracy of ±2% full scale. Voltmeters are self-contained up to 500 volts, ammeters up to 50 amperes for DO-71 and DO-78 types; 300 volts and 30 amperes for DW-71.

External resistors and shunts are available for higher ratings.

Description	Type DW-71	Type DO-71	Type DO-78
Scale Length, Inches.....	1.76	2.46	3.5
Approximate Weight, Lbs.....	0.4	.75	1.0

D-C Voltmeters

Approximate Resistance—1000 Ohms per Volt

Volts	Type DW-71 List Price Each	Type DO-71 List Price Each	Type DO-78 List Price Each
1	\$20.00	\$21.00	\$25.00
2	20.00	21.00	25.00
5	20.00	21.00	25.00
10	20.00	21.00	25.00
15	20.00	21.00	25.00
30	20.00	21.00	25.00
50	20.00	21.00	25.00
80	20.00	21.00	25.00
150	22.00	22.00	27.00
300	24.00	25.00	29.50
500	29.00	33.00

D-C Ammeters

Amps.	Approx. Res. Ohms	Type DW-71 List Price Each	Type DO-71 List Price Each	Type DO-78 List Price Each
1	.050	\$20.00	\$21.00	\$25.00
2	.025	20.00	21.00	25.00
5	.010	20.00	21.00	25.00
10	.0050	20.00	21.00	25.00
15	.0033	20.00	21.00	25.00
20	.0025	20.00	21.00	25.00
30	.00167	20.00	21.00	25.00
50	.0010	20.00	21.00	25.00
50 Mv.	*	18.00	19.00	23.50

*Ammeters are self-contained for ratings up to and including 50 amperes (DW-71—30 amperes). Higher ratings are supplied with shunts having a 50-mv. drop. Shunt leads are normally supplied in 5-ft. lengths. Longer leads can be supplied. External shunts and leads must be ordered as separate items. Above prices are for instruments only.

D-C Milliammeters

Ma	DW-71		DO-71		DO-78	
	Approx. Res. Ohms	List Price Each	Approx. Res. Ohms	List Price Each	Approx. Res. Ohms	List Price Each
1	70	\$18.00	70	\$19.00	70	\$23.50
3	7	18.00	7	19.00	7	23.50
5	3.6	18.00	3.6	19.00	3.6	23.50
10	3.6	18.00	3.6	19.00	3.6	23.50
15	3.0	18.00	3.4	19.00	3.6	23.50
30	1.67	19.00	1.67	23.50
50	1.0	18.00	1.0	19.00	1.0	23.50
100	.5	18.00	.5	19.00	.5	23.50
200	.25	18.00	.25	19.00	.25	23.50
300	.17	18.00	.17	19.00	.17	23.50
500	.10	18.00	.10	19.00	.10	23.50

D-C Microammeters

Mu A	DW-71		DO-71		DO-78	
	Approx. Res. Ohms	List Price Each	Approx. Res. Ohms	List Price Each	Approx. Res. Ohms	List Price Each
20	*	*	2030	\$36.00	*	*
50	1625	\$33.00	1625	34.00	1625	\$38.00
100	1080	31.00	1080	32.00	1625	36.50
200	300	24.00	300	25.00	300	29.50
500	70	22.00	70	23.00	70	27.00

*Not available.

G-E Panel Instruments

Alternating Current Types

Types	AO-72	AO-58
Size, Inches	3 1/2	4 1/4
Scale Length, Inches	2.2	3
Approximate Weight, Lbs.	0.4	0.6

Magnetic-vane type, for use on 25 to 125 cycles. Voltmeters normally self-contained up to and including 500 volts, ammeters up to and including 100 amperes for AO-72 and AO-58 types.

Accurate to within 2% of full scale.

A-C Voltmeters

Volts	Approx. Res. Ohms	Type AO-72 List Price Each	Type AO-58 List Price Each
1 5	4.7	\$24.00	\$29.00
3	17.9	24.00	29.00
5	53.3	24.00	29.00
10	156	24.00	29.00
15	235	24.00	29.00
30	1006	24.00	29.00
50	2665	24.00	29.00
*150	15000	26.00	31.00
150	15000	26.00	31.00
300	50000	28.00	33.00
500	100,000	34.00	39.00

*Transformer-rated. In ordering, specify transformer rating in terms of primary and secondary volts.

A-C Ammeters

Amps.	Approx. Res. Ohms	Type AO-72 List Price Each	Type AO-58 List Price Each
1	0.138	\$24.00	\$29.00
3	.0128	24.00	29.00
5*	.0057	24.00	29.00
5	.0057	24.00	29.00
8	.0032	24.00	29.00
10	.0025	24.00	29.00
15	.0009	24.00	29.00
20	.0009	24.00	29.00
30	.0003	24.00	29.00
50	24.00	29.00
80	35.00	40.00
100	39.00	44.00

A-C Milliammeters

Ma.	Approx. Res. Ohms	Type AO-72 List Price Each	Type AO-58 List Price Each
10	1000	\$22.00	\$27.00
25	165	22.00	27.00
50	33	22.00	27.00
100	8.5	22.00	27.00
200	2.1	22.00	27.00
500	.40	22.00	27.00

*Transformer-rated. In ordering, specify transformer ratio in terms of primary and secondary current.

G-E Indicating Instruments

Portable

Type AP-9

For General A-C Measurement



Designed for general utility testing and made for rough usage. Ideal for motor testing, maintenance work and trouble investigation. Their high accuracy makes them suitable for measurement work in school and industrial laboratory. The dustproof case of dark-red Textolite has top of simulated leather, and a leather handle. Large window opening, knife-edge pointer and mirror scale are standard.

Over-all Size—2 7/16 x 6 9/16 x 4 1 3/16 in.

Weight—2 1/2 lbs.

Accuracy—3/4 of 1%.

Frequency—25-133 cycles.

Scale Length—4.1 in.

Operating Principle—Ammeters and Voltmeters; Thomson Inclined-Coil; Wattmeters and Voltwattmeters; Electrodynamometer.

Damping—Magnetic.

Shielding—Excellent Shielding from Stray Fields.

A-C Voltmeters

25-125 Cycles

Volts	Scale Div.	List Price Each	Volts	Scale Div.	List Price Each
150	150	\$ 89.50	15/30	150	\$ 99.00
250	50	91.50	30/60	60	99.00
300	60	93.00	75/150	150	100.50
600	60	106.00	150/300	150	103.00
5/10	100	99.00	150/300/600	150	132.50
10/20	100	99.00	150/300/750	150	135.50

A-C Ammeters

Amps.	Scale Div.	List Price Each	Amps.	Scale Div.	List Price Each
1	100	\$86.00	50	100	\$95.00
2	100	86.00	1/2	100	107.00
3	60	86.00	2 5/5	50	107.00
5	100	86.00	5/10	100	107.00
10	100	86.00	10/20	100	115.00
15	150	95.00	1/2 5/10	100	198.00
25	50	95.00	*3/7 5/15/30	150	208.00
30	60	95.00	*5/10/20/50	100	208.00

*Four-range ammeters have internal transformers and can be used only on alternating-current circuits.

**A-C Milliammeters
25-125 Cycles**

Ma.	Scale Div.	Approx. Res. Dhms	List Price Each
30	60	528	\$86.00
75	75	150	86.00
100	100	70	86.00
200	100	18	86.00
300	60	9.5	86.00
500	100	2.8	86.00
750	75	1.5	86.00

**A-C Single-Phase Wattmeters
Single-Current—Double-Voltage**

Volts	Amps. (Normal)	Scale Capacity, Watts	Scale Div.	Potential Circuit Res., Dhms (Approx.)	List Price Each	
120/240	150/300	1	150/300	150	18500/37000	\$170.00
	150/300	2	300/600	60	18500/37000	170.00
	150/300	5	750/1500	75	18500/37000	170.00
	150/300	10	1500/3000	150	18500/37000	182.00
	150/300	20	3000/6000	60	18500/37000	182.00
150/300	50	7.5/15 kw	75	18500/37000	182.00	

Double-Current—Double-Voltage

Volts	Amps.	Scale Capacity, Watts	Scale Div.	Potential Circuit Res., Dhms (Approx.)	List Price Each	
60/120	75/150	1/2	75/150/300	150	9250/18500	\$197.00
	75/150	5/10	375/750/1500	75	9250/18500	197.00
	75/150	10/20	750/1500/3000	150	9250/18500	200.50
120/240	150/300	1/2	150/300/600	150	18500/37000	200.50
	150/300	5/10	750/1500/3000	150	18500/37000	200.50
	150/300	10/20	1500/3000/6000	150	18500/37000	200.50

G-E Indicating Instruments Portable Type DP-9—For D-C Measurement



Accurate and dependable. For general utility testing these instruments will find wide application in general plant testing, electrolysis measurements, equipment maintenance, battery testing and electronic measurement.

Has sturdy dustproof, Textolite case, with hinged cover and leather handle.

The large clearance between moving parts affords maximum readability, long service and sustained accuracy.

Knife-edge pointer and mirror scale are standard features. Size— $2\frac{1}{16} \times 6\frac{3}{16} \times 4\frac{1}{16}$ in. Weight—Approximately 2 Lbs. Accuracy— $\frac{1}{2}$ of 1%. Scale Length—4.1 in. Operating Principle—Permanent Magnet. Moving-Coil. Damping—Magnetic. Shielding—Shielded for Stray Magnetic Fields.

D-C Voltmeters

Volts	Scale Div.	200 Ohms per Volt	1000 Ohms per Volt
3	150	\$97.00	\$100.50
50	100	97.00	100.50
150	150	98.50	101.50
300	150	101.00	105.00
600	120	119.00	124.00
750	150	126.00	129.00
150/300	150	119.00	123.00
3/7.5/30	150	121.00	136.00
7.5/30/75	150	121.00	136.00
3/15/150	150	122.00	136.00
3/150/300	150	125.00	140.00
7.5/300/750	150	135.00	152.00
150/300/750	150	135.00	152.00

D-C Ammeters

Are self-contained up to and including 50 amperes. Higher ratings are available for use with external shunts and leads.

Amps.	Scale Div.	List Price Each	Amps.	Scale Div.	List Price Each
1	100	\$105.00	0.1/1/10	100	\$134.00
3	100	105.00	1/5/10	100	134.00
5	150	105.00	0.15/3/15	150	134.00
7.5	100	105.00	3/15/30	150	134.00
15	150	105.00	0.5/5/50	100	134.00
30	150	105.00	2/10/50	100	134.00
50	100	105.00	5/20/50	100	134.00
0.05/0.5/5	100	134.00			

D-C Millivoltmeters

For use with External Shunts

Mv.	Scale Div.	List Price Each	Mv.	Scale Div.	List Price Each
50	†	\$105.00	100	†	\$105.00
*50	100/150	115.00	*100	100/150	115.00

*Universal scale marking with double scale. Recommended when instrument is for use with shunts of various current ratings.

†Scale marking depends on capacity of shunt. Specify scale desired.

High Resistance—1000 Ohms per Volt

Zero-center scales available at no addition in price.

Mv.	Scale Div.	List Price Each	Mv.	Scale Div.	List Price Each
10/20/50/100	100	\$172.50	20/50/100/500	100	\$172.50

D-C Milliammeters

Ma.	Scale Div.	Approx. Res., Ohms	List Price Each
1	100	64	\$98.00
7.5	150	6	98.00
15	150	5	98.00
150	150	0.82	98.00
300	150	0.40	98.00
750	150	0.16	98.00

In addition to the above we can furnish a complete line of triple-range milliammeters.

D-C Microammeters

These instruments depend upon external circuits for damping. External-shunt resistance in values up to twice the critical resistance can be used satisfactorily.

Micro-Amps.	Scale Div.	Approx. Res. Ohms	External Res. for Critical Damping, Ohms	List Price Each
15	150	3300	17000	\$184.00
30	150	1000	4500	141.50
100	100	75	400	128.80
200	100	20	130	116.00
300	...	10	50	116.00
500	...	5	30	116.00

G-E High-Accuracy Instruments D-C Portables Type DP-12

For testing portable and switchboard instruments in power plants and substations. High accuracy suits them for college and commercial laboratory testing and research work.

Housed in molded Textolite case with leather handle. Precision-calibrated scale, arc-shaped mirror in scale, and knife-edge pointer are standard features. Molded, break-resistant window for improved readability.

Available as voltmeters, millivoltmeters, ammeters, milliammeters, and microammeters.

- Accuracy..... $\frac{1}{4}$ of 1 per cent of full-scale
- Scale length..... $5\frac{1}{2}$ -in.
- Operating principle..... Permanent-magnet, moving-coil
- Dimensions..... $8 \times 8 \times 3\frac{1}{4}$ -inches
- Weight..... 5-lb.
- Pivot bearing.... Spring-mounted jewels

Voltmeters

Volts	List Price, Each	200 Ohms per Volt	1000 Ohms per Volt	Volts	List Price, Each	200 Ohms per Volt	1000 Ohms per Volt
150	\$254.00	\$266.00		150/300	\$284.00	\$294.00	
3/15/150	296.00	306.00		150/300/750	320.00	330.00	

Many other readings available.

Ammeters

Are self-contained up to and including 50 amperes. For higher ratings use a 50-mv millivoltmeter and one or more Form 41 precision shunts.

Amp.	List Price, Each	Amp.	List Price, Each	Amp.	List Price, Each
1	\$250.00	10	\$250.00	20	\$250.00
5	250.00	15	250.00	30	250.00

Millivoltmeters for Use with External Shunts

(Precision portable 50-mv Form 41 shunts are standard)

Use with Shunts Rated, -mv*	List Price, Each
50-	\$232.00
100-	232.00
50-/100-	276.00

*Order must specify scale marking and legend required.

Milliammeters

Ma	Approx. Res., Ohms	List Price, Each
5	20	\$260.00

Microammeters

Mu A	Approx. Res. Ohms	Each	Mu A	Approx. Res. Ohms	Each
15	3300	\$324.00	300	8	\$274.00
50	575	305.00	500	6	274.00
150	58	282.00			

G-E High Accuracy Instruments

Type AP-11—A-C Instruments

Conform to ASA specifications C-39.1—1951, for 0.5% accuracy class portables.

Accuracy— $\frac{1}{2}$ of 1% of full-scale values; Standard Temperature—25C (77F); Temperature Compensation—Variations of 25 ± 10 C have negligible effect (about $\frac{1}{4}$ rated accuracy); Frequency Range—25 to 125 cycles; Scale Length—5.5 inches; Pointer—Knife-edge over mirrored scale; Operating Mechanism—Ammeters and voltmeters: repulsion vane.

Wattmeters: electro-dynamometer. Burden — 5 amp. ammeter: 1.5 volt-amps.; 150 volt voltmeter: 6 volt amps.; 5 amp., 150 volt wattmeter. Current circuit: 2.5 volt-amps. Potential circuit: 1.0 volt-amps.

Adjustments—External screw-type zero set; Internal screw-type full-scale set (ammeters and voltmeters).

Has molded Textolite Case with carrying strip. Terminals designed for spade, plug or wire-lead connectors.

Size $7\frac{3}{4} \times 7\frac{7}{8} \times 3\frac{1}{4}$ inches. Shipping wt. 10 lbs.

Type AP-11 Voltmeter

Volts	Resistance Ohms	List Price Each
150	3750	\$121.00
300	7500	125.00
600	15000	143.00
750	18750	156.00
5/10	4.2/8.4	134.00
10/20	17/33	134.00
15/30	37.5/75	134.00
30/60	150/300	134.00
75/150	938/1875	136.00
150/300	3750/7500	139.00
150/600	7500/30000	164.00
150/750	7500/37500	172.00
75/150/300	1875/3750/7500	179.00
150/300/600	7500/15000/30000	183.00
150/300/750	7500/15000/37500	189.00

Type AP-11 Ammeters

Amperes	List Price Each	Amperes	List Price Each
1	\$125.00	.5/1.0	\$155.00
2	125.00	1.0/2.0	155.00
5	125.00	1.5/3.0	155.00
10	125.00	2.5/5.0	155.00
15	138.00	5/10	155.00
20	138.00	10/20	167.00
25	138.00	15/30	172.00
30	142.00		

Type AP-11 Milliammeters

No.	Milliamps	Scale Divisions	List Price Each
683X31	25/50	100	\$155.00
683X32	50/100	100	155.00
683X33	100/200	100	155.00
683X34	250/500	100	155.00

Type AP-11—A-C Instruments

Type AP-11 Single-phase Wattmeters

Single-Current, Double-Voltage Ranges

100/200 Volts Normal—150/300 Volts Maximum
Potential circuit resistance: 10000/30000 ohms

No.	Amperes	Scale Range (Watts)	List Price Each
682X91	1.0	100/200	\$179.00
682X92	2.0	200/400	179.00
682X93	5.0	500/1000	179.00
682X94	10	1/2 Kw	191.00
682X95	20	2/4 Kw	191.00
682X96	30	5/10 Kw	191.00

Double-Current, Double-Voltage Ranges

100/200 Volts Normal—150/300 Volts Maximum
Potential circuit resistance: 10000/20000 ohms

683X5	.5/1.0	50/100/200	\$211.00
683X6	1.0/2.0	100/200/400	211.00
683X7	1.5/3.0	150/300/600	211.00
683X8	2.5/5.0	250/500/1000	211.00
683X9	5.0/10	500/1000/2000	211.00
683X10	10/20	1/2/4 Kw	215.00
683X11	15/30	1.5/3.0/6.0 Kw	219.00

Double-Current, Triple-Voltage Ranges

50/100/200 Volts Normal—75/150/300 Volts Maximum
Potential circuit resistance: 5000/10000/20000 ohms

683X12	.5/1.0	25/50/100/200	\$219.00
683X13	1.0/2.0	50/100/200/400	219.00
683X14	1.5/3.0	75/150/300/600	219.00
683X15	2.5/5.0	125/250/500/1000	219.00
683X16	5.0/10	250/500/1000/2000	219.00
683X17	10/20	500/1000/2000/4000	223.00
683X18	15/30	750/1500/3000/6000	227.00

Note: In addition, a line of Double Voltage (50/100 volts normal), Double Current, and a line of Triple Voltage (100/200/500 volts normal) Double Current Type AP-11 wattmeters are available.

Call Graybar FIRST For



G-E High Accuracy Instruments

A-C—D-C Portables
Type AP-12

Type AP-12 portable standards are suitable for a-c as well as d-c current, voltage, and power measurements. They are recommended for calibrating or checking lower-accuracy instruments. Rated accuracy of 0.25% (ASA class) is maintained over a wide range of operating conditions. These newly designed instruments are recommended for laboratory and electric-utility, as well as factory and field use whenever highest accuracy is an important factor.

Type AP-12 instruments conform to ASA specifications C-39:1-1951, for 0.25% accuracy class portables. Essential data, including temperature-correction factors are given on a leather tag attached to each instrument.

Accuracy—1/4 of 1% of full-scale values; Standard Temperature—25 C (77F); Frequency Range—25 to 125 cycles; D-C measurements—Rated accuracy obtained from average of a direct and a reversed polarity reading; Scale Length—5.5-in.; Pointer—Knife-edge over mirrored scale; Operating Mechanism—Ammeters and voltmeters: repulsion-vane; wattmeters: electro-dynamometer; Burden—5 amp. ammeter: 1.5 volt-amp.; 150-volt voltmeter: 6 volt-amp.; 5-amp., 150-volt wattmeter: current circuit: 2.5 volt-amp.; potential circuit: 1.0 volt-amp.

Adjustments: (Ammeters and voltmeters). External screw-type zero set. Internal screw-type full-scale set.

Has molded Textolite case with carrying strap. Terminals designed for spade, plug or wire-lead connectors.

Size 7 3/4 x 7 7/8 x 3 1/4-in. Shipping wt. 10-lbs.

Single-phase Wattmeters

Cat. No.	Amperes	Scale Ranges, Watts	List Price, Each
----------	---------	---------------------	------------------

Single-Current, Double-Voltage Ranges
100/200 volts normal—150/300 volts maximum
Potential-circuit Resistance: 10,000/20,000 Ohms

682X28	1.0	100/200	\$351.00
682X29	2.0	200/400	351.00
682X30	5.0	500/1000	351.00

Double-Current, Double-Voltage Ranges
100/200 volts normal—150/300 volts maximum
Potential-circuit Resistance: 10,000/20,000 Ohms

682X41	.5/1.0	50/100/200	\$368.00
682X43	1.5/3.0	105/300/600	368.00
682X44	2.5/5.0	250/500/1000	368.00
682X45	5.0/10	500/1000/2000	358.00
682X47	15/30	1.5/3.0/6.0 kw	408.00

Double-Current, Triple-Voltage Ranges
50/100/200 volts normal—75/150/300 volts maximum
Potential-circuit Resistance: 5000/10,000/20,000 Ohms

682X48	.5/1.0	25/50/100/200	\$386.00
682X49	1.0/2.0	50/100/200/400	386.00
682X51	2.5/5.0	125/250/500/1000	386.00
682X52	5.0/10	250/500/1000/2000	377.00
682X54	15/30	750/1500/3000/6000	415.00

In addition, a line of double voltage (50/100 volts normal) double current, and a line of triple voltage (100/200/500 volts normal), double current Type AP-12 wattmeters are available.

Voltmeters

Volts	List Price, Each	Volts	List Price, Each	Volts	List Price, Each	Volts	List Price, Each
150	\$289.00	15/30	\$288.00	150/300	\$297.00	75/150/300	\$318.00
300	194.00	30/60	292.00	150/600	317.00	150/300/600	330.00
600	310.00	75/100	294.00	150/750	321.00	150/300/750	336.00
750	314.00						

Ammeters

Amperes	List Price, Each	Amperes	List Price, Each	Amperes	List Price, Each	Amperes	List Price, Each
1	\$292.00	15	\$292.00	.5/1.0	\$309.00	5/10	\$301.00
2	292.00	20	295.00	1.0/2.0	309.00	10/20	313.00
5	292.00	25	298.00	1.5/3.0	305.00	15/30	322.00
10	292.00	30	302.00	2.5/5.0	301.00		

Accurate D-C Portables

Type DP-11 Portable Indicating Instruments

Conforming to all applicable requirements of ASA 0.5% Class Portable Instrument Specification C39.1-1951, these instruments are intended for general testing where dependability, readability, and durability are paramount.

Sturdy, break-resistant molded Textolite case and molded shadow-reducing window enclose the shock-resistant mechanism. Knife-edge pointer and mirror scale and spring-mounted jewel bearings provide accurate measurement under adverse operating conditions.

Size, 8x8x3 1/2-in.; Weight, 5-lb.; Accuracy 1/2 of 1% of full scale; Scale Length, 5 1/2-in.; Operating Principle, Permanent magnet, moving coil; Damping, Magnetic; Shielding, Shielded against stray magnetic fields; Pivot Bearing, Spring-mounted jewels.

Voltmeters

Volts	List Price, Each		Volts	List Price, Each	
	200 Ohms per Volt	1000 Ohms per Volt		200 Ohms per Volt	1000 Ohms per Volt
3	\$140.00	\$150.00	150/300	\$160.00	\$170.00
15	140.00	150.00	3/7.5/30	172.00	182.00
50	140.00	150.00	7.5/30/75	172.00	182.00
150	140.00	150.00	3/15/150	172.00	182.00
300	150.00	160.00	3/150/300	180.00	190.00
600	170.00	180.00	7.5/300/750	206.00	216.00
750	180.00	190.00	150/300/750	206.00	216.00

Ammeters

Ammeters are self-contained up to and including 50 amperes. Higher ratings require millivoltmeter and external shunt.

Amp.	List Price, Each	Amp.	List Price, Each	Amp.	List Price, Each
1	\$164.00	15	\$164.00	1/15/10	\$190.00
3	164.00	30	164.00	1.5/3/15	190.00
5	164.00	50	164.00	3/15/30	190.00
7.5	164.00	0.05/0.5/5	190.00	2/10/50	190.00
10	164.00	0.1/1/10	190.00	5/20/50	190.00

Millivoltmeters for Use with External Shunts
100 Ohms per Volt

Millivolts	Scale Div.	List Price, Each	Millivolts	Scale Div.	List Price, Each
50	†	\$150.00	100	†	\$150.00
*50	100/150	160.00	*100	100/150	160.00

*Universal scale marking with double scale. Recommended when instrument is to be used with shunts of various current ratings.

†Scale marking depends on capacity of shunt. Specify scale desired.

Millivoltmeters 1000 Ohms per Volt

Millivolts	List Price, Each	Millivolts	List Price, Each
10/20/50/100	\$216.00	20/50/100/200	\$216.00

Milliammeters

Milli-amperes	Resistance, Ohms	List Price, Each	Milli-amperes	Resistance, Ohms	List Price, Each
1	63	\$160.00	0.03/0.3/3	970/910/990	\$188.00
7.5	6	160.00	0.15/1.5/15	1700/640/69	188.00
15	5	160.00	1.5/15/150	64/22/2.5	188.00
150	0.8	160.00	15/150/1500	6/1/0.1	196.00
300	0.4	160.00	30/300/3000	3.5/0.4/0.04	196.00
750	0.16	160.00			

D-C Microammeters

These instruments depend upon external circuits for damping. External-shunt resistance in values up to twice the critical resistance can be used satisfactorily.

Microamperes	Resistance, Ohms	External Resistance for Critical Damping-Ohms	List Price Each
15	3300	17,000	\$220.00
50	1000	4,500	200.00
100	78	400	190.00
200	23	130	170.00
300	8	45	170.00
500	7	30	170.00

G-E Hook-On Wattmeters

Type AK-2



Provides a convenient method of measuring power on single-phase and polyphase a-c circuits. This handy portable instrument will solve easily and quickly many power-generation and industrial measurement problems.

Will help make quick and accurate checks on active and reactive power for survey and trouble-shooting applications.

Assembled in a sturdy Textolite case, molded in one unit for maximum strength and safety. The over-all appearance, including the hook arrangement is

similar to that of the popular G-E Type AK-1 hook-on volt-ammeter.

Strong 6-ft. voltage leads are mounted permanently through the handle of the instrument. The leads have sheathed alligator clips for connection to non-insulated points on the conductors. Range selections can be made by simple one-hand switching of the potential circuit.

Rating—Full-Scale, Single-Phase Kw.: Voltage Range—100 to 600 Volts A-C. Current Range—15 to 600 Amperes, A-C 3-6-20-60-200-300. Frequency Range—50-70 Cycles. Accuracy—5% of Full Scale. Scale Length—2½ Inches. Size—14x4x2¼ Inches. Diameter of Hook Opening—2 In. High Potential—4000 Volts (rms). A-C volts hook to potential circuit.

Cat. No.	Description	List Price Each
378X88	Type AK-2 hook-on wattmeter.....	\$129.00
8941377	Leather carrying case.....	14.00
	Weight complete with leads 3.65 lbs.	

G-E Hook-On Polyphase Power-Factor Meters

Type AK-3



This meter has all the portability and convenience of the AK-1 and AK-2 meters. Permits direct measurement of power factor without cutting conductors or interrupting service. Can be used on any balanced three-phase circuit. Measures both lagging and leading power factor on circuits of 100 to 600 volts

and 15 to 600 amperes.

Especially desirable and handy for industrials to check requirements for corrective equipment to reduce power costs. Central stations will find it useful in determining how best to utilize existing distribution facilities.

Range—Scale A:0.5-0-0.5 Lag-Lead
Scale B:1.0-0-1.0 Lead
Scale C:0.5-1.0 Lag

Circuit Limitations—
Volts 100-600 Nominal
Amperes 15-600

Accuracy.....0.05 Power Factor
Frequency Range.....50-90 Cycles
Scale Length, Inches.....13½
Size, Overall, Inches.....14x4x2¼
Weight, Lbs.....4½

Cat. No.	Description	List Price Each
548X13	Type AK-3 hook-on power factor meter....	\$129.00
8941377	Leather carrying case.....	14.00

G-E Portable Instruments

Hook-on Volt-ammeter, Type AK-4



Has an exclusive range and scale selector to eliminate the possibility of misreading scales with multiple markings.

By means of a rotating scale drum, each selection of a current or voltage range simultaneously exposes the corresponding scale. The needlethin pointer, moving across the clearly marked straight scale, permits fast, accurate readings. Current scales are marked in black, voltage scales in red.

The voltage leads of the AK-4 screw in and are provided with recessed terminals thus preventing accidental pullout and protecting the operator when the leads are removed. One set of terminals serves all voltage ranges, which are switched by the selector knob.

The insulated hook is trigger-operated, providing safe operation near bare conductors. Each instrument is tested to withstand 4000 volts a-c. A pointer-stop mechanism permits quick determination of peak currents in welding equipment and surges, such as starting currents.

Ranges: 0-10/30/100/300/800 amperes, a-c
0-150/300/750 volts, a-c

Accuracy: 3% of full scale.

Scale length: 2⅜-inches

Dimensions: 9½x3½x1½-inches. Hook admits conductors up to 2-inches diameter.

Weight: 1¼-lb. net, 5-lb. shipping

Type AK-5

Similar to Type AK-4, except covering a lower range of currents, 0-5/20/80/350 amperes a-c, and not provided with pointer stop. Note the new low range, 0-5 amperes.

All come complete with leads and leather carrying case.

Cat. No.	Type	List Price, Each
583X63	AK-4	\$78.25
583X64	AK-5	63.00

G-E Portable Transformers

For use with meters, instruments and similar devices. For laboratory and general testing work.

Current Transformers

2500 Volts—25-60 Cycles



Type JP-1

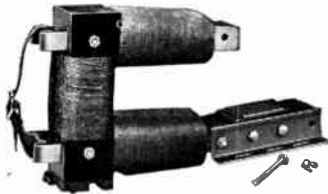

Type JP-6



Type JP-7

Current transformers are available to cover a wide range of primary currents.

The Type JP-1 covers a wide range of 10 amperes to 1000 amperes by using a wound-primary construction for the lower current ratings and a window construction for the higher currents.

The Type JP-2 uses the window construction for currents over a range of 1200 to 2500 amperes.

The Type JP-3 is designed with a combination of self-contained wound-primary and window or through-primary construction. The wound primary is tapped to give either three or four current ratings.

The Type JP-6 uses a window construction but it is also a split-core type for clamping over conductors without interrupting the circuit.

The Type JP-7 is of the wound-primary construction for all current ratings. The primary winding is divided into four coils and the ends of these coils are brought out through eight studs on top of the transformers. These studs are connected by removable links with wing nuts which permit connection of the coils in series, series-multiple and multiple to give three primary current ratings. Three additional ratings on the six rated transformers are obtained by a tap in the secondary winding.

Type JP-1

Cat. No.	Volts	Current Ratio, Amperes		List Price Each
		Primary	Secondary	
88X593	2500	10/20/50/100/600/800:5		\$134.00
89X866	2500	10/25/50/100/600/1000:5		134.00

Type JP-2

89X867	2500	1200:5		260.00
89X868	2500	1200/1500/2000/2500:5		350.00

Type JP-3

89X947	2500	25/50/100/1000:5		300.00
89X948	2500	10/20/50/100/1200:5		350.00

Type JP-6

414X39	600	400:5		260.00
414X40	600	600:5		260.00
414X41	600	800:5		260.00
414X42	600	1200:5		280.00
414X43	600	1500:5		280.00
414X44	600	2000:5		300.00
414X45	600	3000:5		320.00

Type JP-7

548X58	2500	15/30/60:5		340.00
548X59	2500	25/50/100:5		340.00
548X60	2500	50/100/200:5		340.00
548X62	2500	10/15/20/30/40/60:5		350.00
548X64	2500	20/25/40/50/80/100:5		350.00
548X67	2500	37.5/50/75/100/150/200:5		360.00

Potential Transformers



Type E-6

Type E-6 is rated 25-volt-amperes, and is compensated for 12.5 volt-amperes.

Type JE-9 is rated 200 volt-amperes and is compensated for 50 volt-amperes.

Type E-6

Cat. No.	Volt-Amps.	Cycles	Voltage Primary	Ratio	List Price Each
48X486	25	50/60	210/480	2/4:1	\$130.00
48X487	25	50/60	480	4:1	120.00
48X488	25	50/60	600	5:1	130.00
48X489	25	50/60	2400	20:1	140.00

Type JE-9

71X225	200	60	240	2:1	100.00
71X227	200	60	480	4:1	100.00
71X228	200	60	600	5:1	100.00
71X229	200	60	2400	20:1	100.00

**G-E Double Bridges
Portable**

For measuring low values of resistance in electric apparatus, such as motors, generators, transformers, cable, appliances, etc. Simple and very practical.

All internal parts, galvanometer ratio switch, dial, binding posts, are mounted on the top panel which is easily removable for checking or adjusting.



- Accuracy—0.1% of full scale.
- Scale—Potentiometer dial calibrated in ohms.
- Range—0.0001 to 22 ohms.
- Size—9x13x8 inches.

Double Bridge—Complete with One Set of 5-Ft. Connection Leads List Price Each \$545 00
Weight each 16 lbs., net shipping weight, 30 lbs.

**G-E Gauss Meters
For Measurement of Flux Density**

An efficient and simple device for direct measurement of density of flux of permanent magnets and d-c electromagnets. Compact and low cost, but equal or superior to electronic fluxmeters.



Operated by holding the meter in one hand and placing the rigid exploring rod, protruding from the back of the meter, in the field to be checked. A small magnet in the end of the tubular rod is connected by a movable shaft to the pointer. The magnet lines up, in direction and polarity, with the field. Manual rotation of the instrument case gives

direction of flux, when pointer is at 0 position, and magnitude of flux when pointer is at maximum deflection.

- Accuracy—±5%
- Dimensions—
Case, 2-in. diameter, 1-in. deep.
Prod, 0.075-in. diameter, 1¼-in. long, or 0.090-in. diameter, 5-in. long. (0.052-in. diam. by 1¼-in. long at slightly higher price.)

Complete with carrying case and standard magnet.

When ordering, specify range in gaussses, and give prod length.

List prices range from **\$119.00 to \$176.00.**

Weight each, 3-ozs.; net shipping weight, 1 lb.

**G-E Thermocouple
Vacuum Gauge**

Portable and Self-Contained



These gauges provide a convenient means of measuring pressure from 1-1000 microns Hg. They work on the principle that the heat-loss of the gauge-tube filament is a function of pressure of the medium enclosing the filament.

By use of tubes installed at desired locations, pressure readings at several points in the vacuum system can be obtained.

Description
With scale marked 0-1000 microns; with standard gauge tube. **List Price Each \$141. 00**

G-E Halogen Leak Standard



A portable precision device used to calibrate a halogen leak detector making possible quantitative leak checking.

Enables accurate leak size determination ± 10% full scale. Plug in to 110-120 volt, 50-60 cycle power supply and turn on power. Adjust leak standard to desired leak rate value. Then insert probe of leak detector firmly into gun fitting of leak standard and read output indicator.

Dimensions 7½ in. wide x 9 in. high x 16 in. deep. Ruggedly designed and equipped with rechargeable containers providing low cost maintenance.

Shipping wt. 25 lbs.

Halogen Leak Standard

No.	Range Oz. Yr.	Each
5469050G1	0.0—0.1 Freon-12* leak rate	\$1131. 00
5469050G2	0.0—1.0 Freon-12* leak rate	1131. 00
5469050G3	0—10 Freon-12* leak rate	1131. 00

Halogen Leak Standard Calibrator

No.	Description	Each
5469660G1	For use with leak standard No. 5469050G1 and G2	\$266. 00
5469660G2	For use with leak standard No. 5469050G3	266. 00

*Registered trade-mark E. L. Du Pont.

Note: Order by name and Catalog Number covering range desired.

G-E Portable Instruments

Leak Detector. Type H-1 For Locating Leaks in Closed Systems

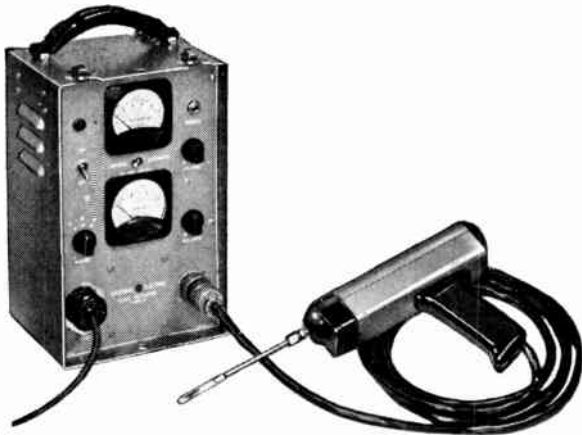

The Type H-1 leak detector, which detects the presence of halogen vapors, is used for rapid location of minute leaks in closed systems that must be leaktight. Extremely sensitive, it can locate a leak of 1/100 of an ounce of Freon per year. Durable construction, it is used in the field, in testing, or on the assembly line.

Leaks can be located in systems in which one of the halogen family of gases is present or can be introduced. Among the many applications of this instrument it can be used to detect

leaks in: Refrigeration and air-conditioning systems; Transformer casings; Hermetically sealed products; Tanks; Instrument tubing, and Sports equipment.

The leak detector consists of a detector unit and control unit. The detector unit is a hand-held probe with a plastic-tipped metal nozzle. It has an element sensitive to halogen vapors and a blower which draws in a continuous air sample. The control unit contains the power supply, amplifier, indicating instruments, loudspeaker, and necessary controls. The loudspeaker gives an audible indication when a leak is detected. A jack is provided on the front of the cover for optional use of earphones. A sensitive electronic relay is available to operate a light, horn or other indicator or control when leaks are detected.

Many of its advantages are: High sensitivity, detects leaks in a moment; Versatility, designed for production line, as well as field use; Economical, minimizes risk of breakdowns caused by leaks; Time saving, provides fast efficient means of inspecting seams, welds and it's compact, lightweight in a portable design.

Specifications:

Power: 105-125 volts, 60-cycles, 85 watts.

Dimensions and Weights:

Detector unit—6½ x 2 x 10 inches; 2½ lb.

Control unit—14½ x 8 x 6½ inches; 15 lb.

Leak detector, Type H-1, includes: Detector unit, Cat. No. 9159532G7 with 10 ft. of cable lead, and control unit, Cat. No. 9159506G4, with 25 ft. lead, carrying case and strap.

Cat. Nos. **9159532G7 & 9159506G4** List **\$792.00**

G-E Halogen Leak Detectors

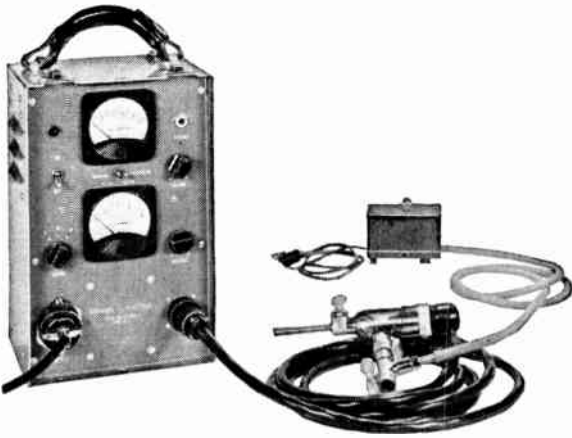

Type H-1 Control Unit and Fixed-Head Unit with Pumping Assembly

Specifically designed to facilitate automatic, high-production leak testing at low cost. Used by the container manufacturing industry, and manufacturers who package in pressurized cans which utilize Freon* or its equivalent as a propellant. Used also in area monitoring. Has high sensitivity: 1-3 ppm. Easily installed and sturdily designed.

Halogen gas concentration of 1 part per million can be detected. Sensitivity is varied by selector switch.

No.	Description	Each
	Fixed-head leak detector, Type H-1, for 120-volt, 60 cycle operation, consisting of control unit (1) and fixed-head detector unit (2).....	\$730.00
9159506G4	(1) Standard control unit (purchased separately).....	472.00
5469797G1	(2) Fixed-head detector unit (purchased separately).....	301.00
	Renewal Parts	
5467845G1	Halogen-sensitive element.....	121.80

*Registered trade-mark E. L. Du Pont.

Note: Order fixed-head leak detector, Type H-1, complete or parts, by name and Catalog Number.

**G-E Portable Instruments
Measures Vacuum with External Detectors**



The molecular vacuum gage measures and continuously indicates pressures encountered in many manufacturing and chemical processes. Entirely new in its principle of operation the F-E molecular vacuum gage eliminates the need for external detectors. Instrument is valuable in vacuum metallurgy, metal purification, refrigeration, vacuum coating, plating etc.

The gage is a complete unit in itself. Two calibration types are available: one for dry air indicates pressures between 0 and 20 millimeters, while another type with a linear scale of 100 uniform divisions is available for other gases.

Detecting cylinders, constructed of thin vane brass, are coaxially aligned. A driving motor rotates one detecting cylinder, mounted in ball bearings lubricated for life, which sets gas molecules in motion. The movement of the molecules rotates the other detecting cylinder (jewel-bearing mounted). The indicating pointer is coupled directly to the cylinder rotated by the moving molecules.

Advantages are that the unit is self-contained with no external detectors; has a wide range of 0 to 20 millimeters; is low in cost; completely mechanical, no tube burnouts; easy to use, no controls to adjust; and is direct reading, the calibration is unaltered through continuous operation.

Cat. No.	Description	Each
8947991G3	(0-20 mm dry air)	\$350.00
8947991G4	(0-100 uniform divisions)	350.00

For full specifications, order Bulletin GEC-986.

Weston Switchboard Instruments

Models 267, 269, 271, 273

D-C — For Power Distribution Panels



Model 269

Fan-Shaped

Type: Permanent magnet moving coil; magnetically shielded.

Prices below are for surface type pressed steel cases, with back connections, dull black finish.

D-C Voltmeters

Approximate Resistance 100 Ohms per Volt.

Model 267

Range	Scale Div.	Each	Range	Scale Div.	Each
*50 mv.	50	\$42.25	50	50	\$42.25
*100 mv.	50	42.25	75	75	42.25
10 volts	50	42.25	150	75	43.00
15	75	42.25	†250	50	55.00
25	50	42.25	†300	60	55.75
30	60	42.25			

*Approximate resistance of 2.5 ohms for 50 mv and 5 ohms for 100 mv ranges includes 5 ft. (0.065 ohm) leads furnished with each instrument.

†With external resistor.

Model 269

Range	Scale Div.	Each	Range	Scale Div.	Each
*50 mv	50	\$49.50	50	50	\$49.50
*100 mv	50	49.50	75	75	49.50
10 volts	50	49.50	150	75	50.25
15	75	49.50	250	50	51.75
20	40	49.50	300	60	51.75
30	60	49.50			

*Approximate resistance of 4.2 ohms for 50 mv and 8.3 ohms for 100 mv ranges includes 5 ft. (0.065 ohm) leads furnished with each instrument.

Model 271

Range	Scale Div.	Each	Range	Scale Div.	Each
*50 mv	50	\$75.50	50	50	\$75.50
*100 mv	50	75.50	75	75	75.50
10 volts	50	75.50	150	75	76.25
15	75	75.50	250	50	77.75
20	40	75.50	300	60	78.50
30	60	75.50			

*Approximate resistance of 2.5 ohms for 50 mv and 5 ohms for 100 mv ranges includes 5 ft. (0.065 ohm) leads furnished with each instrument.

Model 273

Range	Scale Div.	Each	Range	Scale Div.	Each
*50 mv	50	\$87.50	50	50	\$87.50
*100 mv	100	87.50	75	75	87.50
10 volts	100	87.50	150	75	88.25
15	75	87.50	250	50	89.75
20	100	87.50	300	60	90.50
30	60	87.50			

*Approximate resistance of 2.5 ohms for 50 mv and 5 ohms for 100 mv ranges includes 5 ft. (0.065 ohm) leads furnished with each instrument.

Dimensions and Weights

Model	267	269	271	273
Width, inches	4 ³ / ₃₂	5 ⁵ / ₈	7 ⁷ / ₈	9 ⁵ / ₁₆
Height, inches	3 ³ / ₈	4 ¹ / ₁₆	6 ¹ / ₄	7 ¹³ / ₃₂
Projects from Panel, inches	1 ¹ / ₃₂	1 ¹³ / ₃₂	1 ³ / ₄	2 ¹ / ₁₆
Length of Scale, inches	2 ¹ / ₂	4	6	7 ¹⁹ / ₃₂
Approximate weight, lbs.	1	1 ¹ / ₂	4	5

D-C Ammeters

Model 267

Normally supplied with self-contained shunts up to and including 50 amperes. Higher ranges are provided with external shunts and 5 ft. (0.065 ohm) leads. Any range can be provided with an external shunt.

Range	Scale Div.	Each	Range	Scale Div.	Each	Range	Scale Div.	Each
1	50	\$51.50	25	50	\$51.50	400	40	\$54.75
1.5	75	51.50	30	60	51.50	500	50	57.25
2	40	51.50	50	50	51.50	600	60	60.25
3	60	51.50	75	75	51.50	750	75	63.75
5	50	51.50	100	50	51.50	1000	50	75.25
10	50	51.50	150	75	51.50	1500	75	91.00
15	75	51.50	200	40	51.50	2000	40	97.50
20	40	51.50	300	60	52.25	3000	60	126.25

Model 269

Normally supplied with self-contained shunts up to and including 50 amperes. Higher ranges are provided with external shunts and 5 ft. (0.065 ohm) leads. Any range can be provided with an external shunt.

Range	Scale Div.	Each	Range	Scale Div.	Each	Range	Scale Div.	Each
1	50	\$58.75	30	60	\$58.75	500	50	\$64.50
1.5	75	58.75	50	50	58.75	600	60	67.50
2	40	58.75	75	75	58.75	750	75	71.00
3	60	58.75	100	50	58.75	1000	50	82.50
5	50	58.75	150	75	58.75	1500	75	98.25
10	50	58.75	200	40	58.75	2000	40	104.75
15	75	58.75	300	60	59.50	3000	60	133.50
25	50	58.75	400	40	62.00			

Model 271

Supplied with 50 mv external shunts and 5 ft. (0.065 ohm) leads.

Range	Scale Div.	Each	Range	Scale Div.	Each	Range	Scale Div.	Each
5	50	\$84.75	100	50	\$84.75	600	60	\$93.50
10	50	84.75	150	75	84.75	750	75	97.00
15	75	84.75	200	40	84.75	1000	50	108.50
25	50	84.75	300	60	85.50	1500	75	124.25
50	50	84.75	400	40	88.00	2000	40	130.75
75	75	84.75	500	50	90.50	3000	60	159.50

Model 273

Supplied with external 50 mv. shunts and 5 ft. (0.065 ohm) leads.

Range	Scale Div.	Each	Range	Scale Div.	Each	Range	Scale Div.	Each
5	50	\$96.75	100	100	\$96.75	600	60	\$105.50
10	100	96.75	150	75	96.75	750	75	109.00
15	75	96.75	200	100	96.75	1000	100	120.50
25	50	96.75	300	60	97.50	1500	75	136.25
50	50	96.75	400	40	100.00	2000	100	142.75
75	75	96.75	500	50	102.50	3000	60	171.50

Weston Switchboard Instruments

Models 267, 269, 271, 273

Continued

D-C Microammeters and Milliammeters

Model 267

Ranges of 30 ma and up are shunted and have a drop of approximately 100 mv.

Range Microamps	Approx. Res. Ohms	Scale Div.	Each	Range Milliamp.	Approx. Res. Ohms	Scale Div.	Each
100	1250	50	\$62.50	25	1.3	50	\$42.25
200	950	40	55.75	50	...	50	42.25
500	500	50	51.25	100	...	50	42.25
Milliamp.				150	...	75	42.25
1	37	50	42.25	200	...	40	42.25
5	10.5	50	42.25	300	...	60	42.25
10	3.3	50	42.25				

Model 269

Ranges of 30 ma and up are shunted and have a drop of approximately 100 mv.

Range Microamps	Approx. Res. Ohms	Scale Div.	Each	Range Milliamp.	Approx. Res. Ohms	Scale Div.	Each
100	1500	50	\$69.75	25	1.5	50	\$49.50
200	1250	40	63.00	50	...	50	49.50
500	230	50	58.50	100	...	50	49.50
Milliamp.				150	...	75	49.50
1	60	50	49.50	200	...	40	49.50
5	9.7	50	49.50	300	...	60	49.50
10	2.8	50	49.50				

Model 271

Ranges of 30 ma and up are shunted and have a drop of approximately 50 mv.

Range Microamps	Approx. Res. Ohms	Scale Div.	Each	Range Milliamp.	Approx. Res. Ohms	Scale Div.	Each
100	1500	50	\$107.00	25	1.3	50	\$75.50
200	590	40	89.00	50	...	50	75.50
500	280	50	84.50	100	...	50	75.50
Milliamp.				200	...	40	75.50
1	110	50	75.50	300	...	60	75.50
5	20	50	75.50				
10	3.2	50	75.50				

Model 273

Ranges of 30 ma and up are shunted and have a drop of approximately 50 mv.

Range Microamps	Approx. Res. Ohms	Scale Div.	Each	Range Milliamp.	Approx. Res. Ohms	Scale Div.	Each
100	2000	100	\$119.00	25	...	50	\$87.50
200	430	100	101.00	50	...	50	87.50
500	270	50	96.50	100	...	100	87.50
Milliamp.				200	...	100	87.50
1	69	100	87.50	300	...	60	87.50
5	12.2	50	87.50				
10	6.5	100	87.50				

Models 921 and 924



Model 924

The instruments have black japanned Bonderized steel cases, and are available in flush or surface type, with either embossed or smooth fronts. The smooth front cases harmonize with the Model 496 Group. Size at Base 5 3/4 x 6 in.

Unless otherwise specified all instruments will be furnished with embossed fronts.

Prices below are for flush type cases; if surface type are wanted deduct \$3.00 from list.

D-C Voltmeters — Model 921

Accurate within 1%. Scale length 5.12 in.
Type: Permanent magnet moving coil.
Resistance 100 Ohms per volt, self-contained.

Range	Scale Div.	Each
15	30	\$97.00
150	30	97.75
300	30	100.00

Can be supplied with a sensitivity of 1 ma for use with tubular resistors.

D-C Ammeters — Model 921

Ranges up to and including 50 amperes are normally supplied with self-contained shunts. All external shunt ammeters are supplied with standard 5 ft. shunt leads. Higher ranges available through the use of external shunts.

Instead of the standard 5 ft. leads furnished, any leads having a total resistance of 0.065 ohm can be used. This model can be supplied with leads of higher resistance up to 1.5 ohms at a surcharge of \$4.50.

Range	Scale Div.	Each	Range	Scale Div.	Each	Range	Scale Div.	Each
10	50	\$106.25	100	50	\$106.25	500	50	\$112.00
15	30	106.25	150	30	106.25	600	30	115.00
25	50	106.25	200	40	106.25	750	30	118.50
50	50	106.25	300	30	107.00	1000	50	130.00
75	30	106.25	400	40	109.50	2000	40	152.25

A-C Voltmeters — Model 924

Accurate within 1%. Scale length 5.12 in.

Type: Movable iron.

Power Consumption: 150 volt range at 115 volts, 60 cycles — 4.6 watts, 4.6 volt-amperes.

For use on frequencies from 25 to 125 cycles. Ranges above 750 volts require a potential transformer.

Range and *Scale	Approx. Res.	Scale Div.	Type Box	Each
150	2900	30	Self-Contained	\$ 90.25
250	7700	50		91.75
300	9250	30		92.50
500	24400	50		95.50
600	34500	60		14
750	43000	30	14	114.25

*Where potential transformers are used the instrument will be scaled in terms of transformer primary.

A-C Ammeters — Model 924

Accurate within 1%. Scale length 5.12 in.

Type: Movable iron.

Power Consumption: 5 ampere range at 5 amperes, 60 cycles — 0.55 watt, 0.59 volt-ampere.

For use on frequencies from 25 to 125 cycles.

Range	*Scale	Scale Div.	Each	Range	*Scale	Scale Div.	Each
1	1	50	\$86.50	5	150	30	\$86.50
2	2	40	86.50	5	400	40	86.50
5	5	50	86.50	5	600	60	86.50
5	75	30	86.50	10	10	50	86.50

*Where current transformers are used the instrument will be scaled in terms of transformer primary.

Wattmeters, Power Factor Meters, Frequency Meters and Synchrosopes

We can furnish a complete line for the conventional switchboard, in designs matching the voltmeters and ammeters listed above. Contact Graybar for complete bulletin and prices.

Weston Portable Instruments

For Testing Direct Current

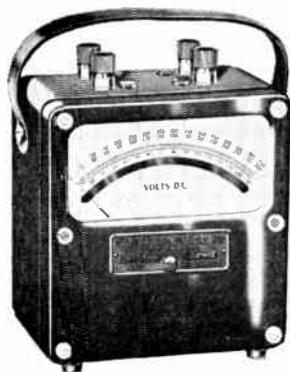

Model 931 Voltmeter

Model 931

Accurate within 1/2 of 1%.

Scale length 4.04 in.

Type: Self-shielded permanent magnet moving coil (shielded from external magnetic fields).

Well compensated for temperature changes.

Size Case: 3 1/4 x 5 x 5 1/4 in.

Approximate wt. 2 lbs.

D-C Voltmeters

Ranges are self-contained up to 1000 volts inclusive. Up to four ranges can be provided on binding posts, or 11 ranges with a switch and two binding posts. On instruments of 1000 ohms per volt sensitivity, higher ranges to 5000 volts may be obtained with external resistors. Instruments with a sensitivity of 5000 ohms per volt can obtain ranges to 3000 volts with external resistors.

Ranges	Scale Div.	1000 Dhms Per Volt Each	5000 Dhms Per Volt Each
75/30/7.5	150	\$106.00	\$121.00
150/15/3	150	106.75	121.75
300/150/3	150	109.00	124.00
750/300/150	150	115.75	130.75

D-C Ammeters

Ranges are self-contained up to 50 amperes inclusive. A maximum of three self-contained ranges can be supplied on binding posts.

Range	Scale Div.	Each	Range	Scale Div.	Each
1	100	\$94.00	10/1/0.1	100	\$109.00
5	100	94.00	15/3/01.5	150	109.00
15	150	94.00	25/10/2.5	100	109.00
30	150	94.00	30/15/3	150	109.00
5/0.5/0.05	100	109.00	50/5/0.5	100	109.00
			50/25/10	100	109.00

Note—For maximum flexibility and where one instrument is required to measure current of a few amperes to hundreds of amperes, a 50 mv. instrument with 5-ft. leads and a group of external shunts is recommended. External shunt ammeters are calibrated with scales to suit the shunts selected. When these instruments are desired add price of appropriate shunts to instrument price.

D-C Milliammeters

Ranges up to four can be provided self-contained on binding posts, a maximum of 10 ranges can be provided with a switch and two binding posts.

Range	Approx. Res. Dhms	Scale Div.	Each	Range	Scale Div.	Each
1	55	100	\$89.50	150/15/1.5	150	\$104.50
15	1.0	150	89.50	1500/150/15	150	109.00
150	...	150	89.50	3000/300/30	150	109.00
3/0.3/0.03	...	150	119.50			

Note—Single range milliammeters with ranges above 30 ma are shunted and have a drop of 50 mv. ±5%.

D-C Microammeters

Up to four self-contained ranges can be provided on binding posts, a maximum of 10 ranges can be provided with a switch and two binding posts.

Range	Scale Div.	High Resistance		Low Resistance	
		Approx. Res. Dhms	Each	Approx. Res. Dhms	Each
30	150	2300	\$113.50	150	\$121.00
100	100	1500	106.00	40	113.50
200	100	450	98.50	10	106.00

Carrying Cases—For all standard ranges \$20.00 List. For instruments requiring extended cases, \$25.00 List.

For Testing Direct Current and Single-phase Alternating Current



Model 432

D-C and Single-Phase A-C Wattmeters

Accurate within 1/2 of 1%.

Scale length 4.04 in.

Type: Electrodynamicometer (shielded from external magnetic fields).

Size case: 3 1/4 x 5 x 5 1/4 in.

Approximate wt., 3 1/4 lbs.

Model 432 Wattmeter

Power Consumption: Potential circuit at 115 volts, 60 cycles—1.2 watts, 1.2 volt-amperes. Current circuit at 5 amperes, 60 cycles—0.65 watt, 0.68 volt-amperes.

Frequency Coverage: Alternating current at frequencies from 25 to 125 cycles. Can be compensated at a surcharge, to cover a frequency span up to 1000 cycles at an accuracy with 1/2%, or to 2500 cycles within 1% accuracy.

Self-contained Ranges: Double voltage and single or double current ranges, self-contained up to 300 volts and 50 amperes.

Range Extension: Potential Ranges can be obtained up to 750 volts with external multipliers. Higher ranges require the use of potential transformers.

For General Use

Volts	Normal	Max.	Amperes		Watts, Range		Scale Div.	Each
			Normal	Max.	High	Low		
150/75	200/100		1	1.5	150	75	75	\$173.75
			2	3	300	150	75	173.75
			5	7.5	750	375	75	173.75
			10	15	1.5 Kw.	75 Kw.	75	181.25
			20	30	3 Kw.	1.5 Kw.	75	181.25
			50	75	7.5 Kw.	3.75 Kw.	75	181.25
300/150	400/200		1	1.5	300	150	75	176.00
			2	3	600	300	60	176.00
			5	7.5	1.5 Kw.	.75 Kw.	75	176.00
			10	15	5 Kw.	1.5 Kw.	75	183.50
			20	30	6 Kw.	3 Kw.	60	183.50
			50	75	15 Kw.	7.5 Kw.	75	183.50

Y-Boxes for Model 432 Wattmeters

A Model 432 single-phase a-c wattmeter can be used to measure the power in a balanced 3-phase, 3-wire system by means of an external Y-Box.

Type Box	Normal Voltage Instr.	Y-Box Multiplying Constant	Normal Line Voltage With Y-Box	Maximum Voltage With Y-Box	Each
51	75	3	150	170	\$51.25
52	150	3	300	340	51.25
52	150	4	400	450	51.25
53	150	5	500	550	51.25
53	150	6	600	650	51.25

Note—All orders for Y-Boxes must give the instrument potential range with which the box will be used and the line voltage of the 3-phase system to be measured.

Carrying Cases—For all standard ranges \$20.00 List. For instruments requiring extended cases, \$25.00 List.

Weston Portable Instruments

For Testing Alternating Current

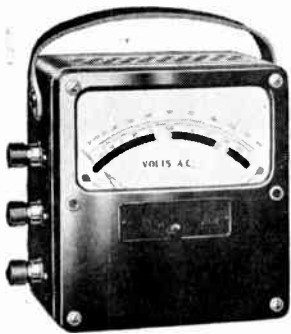

Model 433 Voltmeter

Model 433

Accurate within 3/4 of 1%.

Scale length 4.04 in.

Type: Movable iron shielded from external magnetic fields).

Well compensated for temperature changes.

Size Case: 3 1/4 x 5 x 5 1/4 in.

Approximate wt., 2 1/2 lbs.

A-C Voltmeters

Power Consumption: 150 volt range at 115 volts, 60 cycles —2.5 watts, 2.5 volt-amperes.

Frequency Coverage: Standard, alternating current 25 to 125 cycles. High frequencies, at a surcharge, as many as 3 self-contained ranges can be supplied for a coverage of 25 to 1000 cycles providing the ratio of the highest to the lowest range is not greater than 4. Lowest practical range is 15 volts, highest 750 volts. About 3.3 watts minimum is required to operate single range instruments or the low range of multi-range units.

Coverage to 2500 cycles is possible in single range voltmeters only, with an accuracy within 1 1/4%. Single ranges from 20 to 750 volts are practical and have an extension on the case to accommodate the additional resistance necessary. Approximately 10 watts are required for operation.

Self-contained Ranges: Single, double and triple volt ranges up to 750 volts. Higher ranges can be obtained with multipliers or by using a Model 311 Potential Transformer in connection with a 150 volt range.

Single Range

Range, Volts	Resist. Ohms	Scale Div.	Each	Range, Volts	Resist. Ohms	Scale Div.	Each
10	80	100	\$90.00	125	4100	125	\$90.75
15	168	150	90.00	150	5300	150	90.75
30	425	150	90.00	250	18200	125	92.25
50	1140	100	90.00	300	22000	150	90.75
75	2680	150	90.00				

Double Range

10/5	40/20	100	\$97.50	*150/15	5300/530	150	\$98.25
20/10	160/80	100	97.50	150/75	5300/2680	150	98.25
30/15	336/168	150	97.50	300/150	22000/11000	150	100.50
60/30	850/425	150	97.50				

Triple Range

Range Volts	Resistance, Ohms	Scale Div.	Each
450/300/150	33000/22000/11000	150	\$119.25
**600/300/150	41000/22000/11000	150	121.50
**750/300/150	55000/22000/11000	150	123.75

*The low range of this combination has an accuracy of 3%.

**Have an extension on the case to accommodate the additional resistance necessary.

A-C Milliammeters

Frequency Coverage: Standard, single and double ranges only, for use on frequencies from 25 to 500 cycles. Double range instruments have a range selector switch. Higher frequencies subject to a nominal surcharge—can be adjusted to cover a frequency span from 25 to 1000 cycles at a normal 3/4% accuracy. At a slightly higher surcharge these instruments can be specially compensated to cover a frequency span from 25 to 2500 cycles within 3/4% accuracy.

Range Milli-Amp.	Resist. Ohms	Scale Div.	Each	Range Milli-Amp.	Resist. Ohms	Scale Div.	Each
30	460	150	\$88.50	250	6.0	125	\$88.50
75	78	150	88.50	300	3.9	150	88.50
100	49	100	88.50	500	2.0	100	88.50
150	13	150	88.50	750	0.74	150	88.50
200	8.8	100	88.50				

Carrying Case for above \$20.00 List.

For Testing Alternating Current

Model 433 A-C Ammeters

Power Consumption: 5 ampere range at 5 amperes, 60 cycles—0.50 watt, 0.52 volt-ampere.

Frequency coverage: Standard, single, double and triple ranges for use on 25 to 500 cycles. All instruments have two binding posts, double and triple range instruments are provided with a range-selector switch. High frequencies, single and double range instruments, subject to a nominal surcharge, can be adjusted to cover a frequency span from 25 to 1000 cycles at the normal 3/4% accuracy. At a slightly higher surcharge, these instruments can also be specially compensated to cover a frequency span of 25 to 2500 cycles, with 3/4% accuracy.

Self-contained Ranges: Single, double and triple ranges up to 50 amperes. Higher ranges can be obtained by using the Model 461 Type I Current Transformer in conjunction with a 5 ampere instrument.

Single Range

Range, Amp.	Resist. Ohms.	Scale Div.	Each	Range, Amp.	Resist. Ohms	Scale Div.	Each
1	0.48	100	\$88.50	10	0.007	100	\$88.50
1.5	0.20	150	88.50	15	0.0038	150	94.50
2	0.12	100	88.50	25	0.0016	125	94.50
3	0.053	150	88.50	30	0.00063	150	94.50
5	0.020	100	88.50	50	0.00038	100	94.50

Double Range

Range, Amps.	Resist. Ohms	Scale Div.	Each
10/5	0.0083/0.028	100	\$103.50
20/10	0.004/0.0108	100	109.50

Triple Range

3/1.5/0.75	0.18/0.043/0.59	150	\$148.50
5/2.5/1	0.13/0.26/0.37	100	148.50
10/5/1	0.030/0.070/0.37	100	148.50
10/5/2.5	0.030/0.060/0.075	100	148.50
15/7.5/1.5	0.023/0.044/0.19	150	154.50
20/5/2	0.040/0.19/0.30	100	154.50
30/7.5/3	0.0090/0.036/0.040	150	154.50
50/20/5	0.0084/0.011/0.020	100	154.50
50/20/10	0.0073/0.0080/0.010	100	154.50

For Testing Alternating Current

Model 330



Model 330

A compact multi-range a-c voltmeter recommended for use wherever the current drain of the instrument must be limited to a low value, as in testing railway signal circuits, etc.

All ranges are fused for protection of overloads, and a range-changing switch is incorporated for range selection. Parallax errors are eliminated by use of a knife-edge pointer and mirror scale.

Contained in a black molded Bakelite case with hinged cover and leather carrying handle.

Accuracy: 1% at 60 cycles; 2% at 25 to 100 cycles. Scale length 2.67 in.

Type: Iron core dynamometer.

Size Case: 3 5/8 x 4 7/8 x 1 3/8 in.

Approximate weight 1 3/4 lbs.

A-C Voltmeters

Range	Sensitivity, Ohms per Volt	Scale Div.	Each
125/25/12.5	21	50	\$127.00
*125/25/5/1	21	50	123.50
150/30/15/1.5	21	75	134.50
150/50/10/1	21	50	134.50

*Conforms to A.R.A. Specifications.

Weston Portable Instruments

For Testing Direct Current



Model 904 Voltmeter

Model 904

Highly efficient—keeps the instrument load on the circuit to a minimum. The more linear scale permits good readability over 90% of full scale.

Accurate within 1/2 of 1%.

Scale length 5.5 in.

Type: Radial vane, moving iron (shielded from external magnetic fields).

Size case: 7 1/2 x 7 1/4 x 3 5/8 in.

Approximate weight, 4 3/4 lbs.

A-C Voltmeters

Power Consumption: 150 volt range at 115 volts, 60 cycles—2.2 watts, 2.2 volt-amperes.

Frequency—Normally supplied for 25 to 125 cycles.

Rating: Lowest practical range is 5 volts, the highest self-contained range is 750 volts. Higher ranges are obtained by the use of multipliers, or by using Model 311 Potential Transformers in conjunction with an instrument having a 150-volt range.

Range	Approx. Resist. Ohms	Scale Div.	Each
150	6000	150	\$152.75
300	22000	150	155.00
300/150	12000/6000	150	162.50
*600/300/150	24000/12000/6000	150	174.50
*750/300/150	30000/12000/6000	150	177.75

*Complete with non-locking contact key in high range.

A-C Ammeters

Power Consumption: 5 ampere range at 5 amperes, 60 cycles—0.38 watt, 0.44 volt-ampere.

Frequency: Normally supplied for 25 to 500 cycles.

Rating: Self-contained to 50 amperes inclusive. Higher current ranges are obtained by using a 5 amp instrument in conjunction with a Model 461 Current Transformer. Double ranges are supplied with a range changing switch and are limited to a range ratio of 2:1.

Range	Approx. Resist. Ohms	Approx. Inductance Henrys	Scale Div.	Each
5	0.016	0.023	100	\$150.50
10	0.0060	0.0061	100	150.50
25	0.0025	0.00097	125	150.50
1/5	0.30/1.2	0.61/2.4	100	173.00
2/1	0.085/0.34	0.15/0.61	100	173.00
5/2.5	0.012/0.046	0.025/0.10	100	173.00
10/5	0.005/0.018	0.0062/0.025	100	

A-C Milliammeters

For use on frequencies from 25 to 500 cycles.

50	142	230	100	\$150.50
150	13	24	150	150.50
500	1.1	2.3	100	150.50
750	0.36	.94	150	150.50

Weston Portable Instruments
For Testing Direct Current

Model 901



Model 901 D-C Voltmeter

For general testing where easily read scales and high shielding are desired.

Accuracy within 1/2 of 1%.

Scale length: 5.5 in.

Type: Self-shielded permanent magnet moving coil.

Hand-calibrated mirror scales. Knife-edge pointers.

Size Case: 7 1/2 x 7 1/4 x 3 5/8 in.

Approximate weight, 3 3/4 lbs.

D-C Voltmeters

Range	Scale Div.	1000 Ohms Per Volt Each	5000 Ohms Per Volt Each
0.2-0.2.8	150	\$163.50	\$178.50
150	150	164.25	179.25
150/15/3	150	179.25	194.25
300/150/3	150	181.50	196.25
750/300/150	150	188.25	203.25

Note—Available up to four ranges on special order. Maximum self-contained range 1000 volts.

D-C Volt-Ammeters

750/300/150 volts (200 ohms/volt) and 50 mv. ampere ranges obtained with external shunts of ranges required. List price, less shunts, but with 5 ft. leads \$180.75.

D-C Ammeters

Range	Scale Div.	Each	Range	Scale Div.	Each
5	100	\$166.50	15/7.5/3	150	\$181.50
50	100	166.50	30/7.5/1.5	150	181.50
2/1/.5	100	181.50	50/25/10	100	181.50
10/5/1	100	181.50			

D-C Milliammeters

Range	Approx. Resist. Ohms	Scale Div.	Each
200 μ	900	100	\$168.00
500 μ	250	100	168.00
1	47	100	162.00
300	.170	150	162.00
30/7.5/1.5	3.3/12/23	150	177.00
750/300/30	.067/.168/1.68	150	177.00

Model 540
D-C Fused Six Range Volt-Ammeters



Designed especially for railway signaling testing, for school use and for general industrial work.

Accurate within 1%.

Scale length 2.7 in.

Type: Permanent magnet moving coil.

Size Case: 3-15/16 x 4 7/8 x 2 1/2 in.

Approximate weight 2 lbs.

All ranges are fused and brought out through a selector switch to three binding posts; a common +, a current, and a potential post. The arrangement facilitates connections so that both current and voltage readings can be taken by turning the switch without changing connections. The line is closed at all times when connected to the ammeter binding post regardless of the position of the range selector switch.

Black bakelite case, hinged cover and leather carrying strap.

Range, Volts	Range, Amperes	Scale Div.	Each
30/3	15/1.5/0.15/0.03	60	\$133.00
30/3/1.5	30/3/0.03	60	133.00
60/30/6	6/0.6/0.03	60	133.00
150/15/1.5	15/1.5/0.15	75	133.75
150/15/3	15/1.5/0.15	60	133.75
150/15/3	15/1.5/0.3	60	133.75
150/15/3	30/3/0.3	60	133.75
150/15/3	30/15/3	60	133.75
150/30/3	30/3/0.3	60	133.75
150/30/3	30/0.6/0.06	60	133.75

Weston Portable Instruments

Model 461

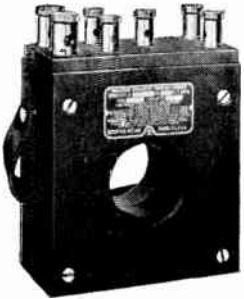

A general purpose current transformer with wide varieties of ranges in three types, with adequate accuracy for most industrial measurements.

Type 1 — Primarily for use with ammeters.

Type 2 — Has a nickel alloy core and corresponding low phase angle, and is preferable for wattmeters and ammeters.

Type 5 — Similar to Type 2, but designed primarily to standardize ammeters, particularly in the lower ranges, but can be used with wattmeters and ammeters to measure load currents and power. Because of the relatively high voltage drop in the low ranges it may be necessary to increase the voltage source to the load by the amount of the transformer drop, in order to maintain the voltage across the load.

For voltages beyond the ratings listed, Model 9960 High Voltage Insulating Sleeve should be used. A secondary short-circuiting switch is provided.

Types 1 and 5 are in black Bakelite cases; Type 2 in a tan or natural color canvas filler Bakelite Case. Size: 8 x 6⁵/₈ x 2³/₄ in.

Approximate weight 8 lbs.

Ranges, Amperes	Type 1 Each	Type 2 Each	Type 3 Each
*800/*400/*200/100/50/20/10 Pri. to 5 Sec.	\$132.00	\$169.00
*1000/*500/*250/100/50/25/10 Pri. to 5 Sec.	132.00	169.00
*500/*250/*100/50/25/10/ 5/2.5/1/0.5 Pri. to 5 Sec.	\$182.00

*These ranges are obtained by inserting one, two, etc. turns, respectively, of the primary through the core opening; other ranges are on binding posts.

For Testing Direct Current

Model 281



Accurate within 1%.

Scale length 2.97-in.

Type: Core magnet moving coil. (Shielded from external magnetic fields.)

Size Case: 4-2/5 x 4-3/5 x 1 1/2 in.

Approximate weight 14 oz.

Hand calibrated scales; knife-edge pointers, combined with mirrors to eliminate parallax errors.

Recommended wherever precision d-c testing is required.

D-C Voltmeters

Resistance approximately 100 Ohms per Volt.

Range	Scale Div.	Each	Range	Scale Div.	Each
1.5	75	\$51.00	25/10/2.5	50	\$58.50
3	60	51.00	30/3/1.5	60	58.50
7.5	50	51.00	30/15/3	60	58.50
10	50	51.00	50/5/2.5	50	58.50
15	75	51.00	50/25/5	50	58.50
50	50	51.00	100/25/2.5	50	58.50
75	75	51.00	100/50/5	50	58.50
150	75	51.75	150/15/1.5	75	59.25
*400/10	40	73.50	150/15/3	60	59.25
*500/50	50	75.00	150/30/3	60	59.25
			150/60/3	60	59.25
			150/75/3	75	59.25

*Push button for low range. Sensitivity 1000 ohms per volt.

All voltmeters listed are self-contained.

D-C Millivoltmeters

Range	Scale Div.	Each	Range	Scale Div.	Each
*50	50	\$52.50	250	50	\$49.50
*100	50	52.50	500	50	49.50
150	75	52.50	750	75	49.50

*Complete with 5 ft. leads.

D-C Ammeters

Range	Scale Div.	Each	Range	Scale Div.	Each
1	50	\$49.50	10/1/0.1	50	\$57.00
5	50	49.50	10/5/0.5	50	57.00
10	50	49.50	10/2.5/1	50	57.00
15	75	49.50	15/3/0.15	60	57.00
30	60	49.50	15/3/1.5	60	57.00
*100	50	64.00	25/2.5/0.5	50	57.00
*150	75	64.00	25/5/2.5	50	57.00
5/2.5/0.25	50	57.00	25/10/5	50	57.00
			30/3/1.5	60	57.00
			30/15/3	60	57.00

*Provided with external shunt having a drop of 50 mv. For ranges higher than those listed, add price of shunt to the instrument base price of \$52.50.

D-C Milliammeters

Range	Approx. Resist.	Scale Div.	Each	Range	Approx. Resist.	Scale Div.	Each
1	88	50	\$49.50	30/15/3	—	60	\$57.00
1.5	45	75	49.50	50/10/1	—	50	57.00
10	1.6	50	49.50	125/25/5	—	50	57.00
50	2.0	50	49.50	150/15/1.5	—	75	57.00
100	1.0	50	49.50	600/120/30	—	60	57.00
500	0.2	50	49.50				

Milliammeters with ranges above 30 milliamperes are shunted and have a drop of approximately 100 mv.

D-C Volt-Ammeters

Volts		Amperes		Scale Div.	Each
30/3/1.5		30/3/1.5		60	\$70.50
30/15/3		15/3/0.15		60	70.50
30/3/1.5		30/3/0.3		60	70.50
50/5/2.5		10/1/0.1		50	70.50
50/25/2.5		25/2.5/0.5		50	70.50
60/30/6		6/0.6/0.03		60	70.50
150/15/1.5		15/1.5/0.15		75	71.25
150/15/3		15/1.5/0.15		60	71.25
150/15/3		30/3/1.5		60	71.25
150/15/3		30/15/3		60	71.25
150/30/3		30/15/1.5		60	71.25
150/30/3		30/0.6/0.06		60	71.25
150/60/3		30/0.6/0.06		60	71.25
30/3/0.5		300/30/3		60	93.25
250/125/12.5		125/12.5/2.5ma		50	86.25
300/150/6		15a/150/15ma		60	87.00
600/150/15		600/150/15ma		60	91.50

Weston Portable Instruments
For Testing Alternating Current



Double Range Voltmeter

Model 528

Miniature portables for checking small electrical products and for servicing them in the field; also for use in research and educational laboratories and for general testing.
Accurate within 2%.
Scale length 2.03 in.
Type: Movable iron.
Size: 3²⁷/₃₂ x 3⁵/₃₂ x 2¹/₈ in.
Approximate weight 11 ozs.

In black molded Bakelite Case. All single and double range instruments have binding post connections. Triple range voltmeters have pin jacks to receive standard pin-tipped leads which are supplied at no extra charge.

A-C Voltmeters

For use on frequencies from 25 to 125 cycles. Made in double and triple range combinations, having high internal resistance with correspondingly low current consumption. Self-contained for all listed ranges. Complete with 48 in. tests leads.

Double Range

Range	Approx. Res. Ohms.	Scale Div.	Each
150/15	7800/780	30	\$36.25
300/150	31600/15800	30	38.50
600/150	100000/25000	30	43.00
600/300	100000/50000	30	43.00

Triple Range

Range	Approx. Res. Ohms.	Scale Div.	Each
150/15/3	10000/150/30	30/30	39.25
150/8/4	10000/80/40	30/40	43.75
300/8/4	43000/80/40	30/40	46.00

A-C Ammeters

For use on Frequencies from 25 to 500 Cycles.

Single Range

Range	Approx. Res. Ohms	Scale Div.	Each
1	0.17	50	\$32.50
3	0.025	30	32.50
5	0.011	50	32.50
10	0.0046	50	32.50

Double Range

Range	Approx. Res. Ohms.	Scale Div.	Each
15/3	0.0058/0.053	30	\$38.50
15/5	0.0058/0.024	30/50	43.00
30/3	0.0018/0.091	30	38.50
30/5	0.0018/0.030	30/50	43.00

A-C Milliammeters

For use on Frequencies from 25 to 500 Cycles.

Range	Approx. Res. Ohms.	Scale Div.	Each
15	2300	30	\$32.50
50	171	50	32.50
100	34	50	32.50
500	1.14	50	32.50

Weston Portable Instruments
For Testing Direct Current



Model 489

Model 489

Accurate within 2%.
Scale length 2.36 in.
Type: Permanent magnet moving coil.
Size: 3²⁷/₃₂ x 3⁵/₃₂ x 1²⁹/₃₂ in.
Approximate weight 11 ozs.
For all-around checking where a more precisely accurate instrument is not required.

In Black molded Bakelite case. Binding post connections on all single and double range instruments. Triple range voltmeters have pin jacks to receive standard pin-tipped leads which are supplied at no extra charge.

D-C Voltmeters

Made in double and triple range combinations having sensitivities of 125 and 1000 ohms per volt. All are supplied with 48-in. test leads.

Range	125 Ohms per Volt. Scale Divisions	Each
150/7.5	75	\$43.00
200/8	40	49.75

Range	1000 Ohms per Volt Scale Div.	Each
200/8	40	\$35.75
250/50	50	36.50
150/7.5/3	75	37.25

Range	1000 Ohms per Volt Scale Div.	Each
300/7.5/3	75/60	\$43.00
750/250/10	75/50	49.75

D-C Ammeters

Range	Scale Div.	Each
1	50	\$30.50
10	50	30.50
30	60	30.50

D-C Milliammeters

Range	Approx. Res. Ohms	Scale Div	Each
150/15	0.7/4.1	75	\$34.75
150/30	0.7/2.6	60	34.75

Leather Case for Above..... Each \$5.00

Weston Portable Instruments

Current Transformers

Model 539 — Miniature



Small, light weight and inexpensive. For use where only moderate accuracy is required with low burden ammeters having a range of 1 amp. Ordinarily it cannot be used with a wattmeter since its phase angle, while satisfactory for current measurements, precludes its use for power measurements. Has a secondary short-circuiting switch.

Black Bakelite case 5¹/₂ x 4¹/₈ x 1⁷/₈ in.

Approximate weight 3 lbs.

Inserted primary opening 1¹/₂ in.

Ranges, Amperes	Each
*200/*100*50/20/10/5/2 Primary to 1 Secondary....	\$82.50

*These ranges are obtained by inserting one, two, etc. turns respectively, of the primary through the core opening; other ranges are on binding posts selected through a switch.

**Weston Panel Instruments
Model 301**



Voltmeter

Case Styles:

	Diam. In.
Round	
Flush, Bakelite.....	3.5
Flush, Bakelite.....	3.38
Flush, Metal.....	3.25
Surface, Bakelite.....	2.94
Surface, Metal.....	2.75
Rectangular:	Size, In.
Flush, Bakelite.....	3.13 x 3

Group Instruments

Normally calibrated for use on non-magnetic panels. If instruments are for use on magnetic panels, state panel thickness.

If wanted for use on circuits above 300 volts, Bakelite cases should be specified, when it is not possible to connect in grounded side of line.

Accurate within 2%. Scale length 2.36 in.
Type: Permanent magnet moving coil.

D-C Voltmeters

Approximate Resistance per Volt:

Meter Range, Volts	Ohms per Volt
1.5 to 30.....	62
50 to 150.....	200
200.....	250

Range	Scale Div.	Each	Range	Scale Div.	Each
1.5	75	\$19.00	30	60	\$19.00
3	60	19.00	50	50	19.00
5	50	19.00	80	40	19.00
8	40	19.00	100	50	19.75
10	50	19.00	150	75	20.50
15	75	19.00	200	40	21.25

D-C Voltmeters

*Resistance, 1000 Ohms per Volt.

Range	Scale Div.	Each	Range	Scale Div.	Each	Range	Scale Div.	Each
1.5	75	\$19.75	15	75	\$19.75	150	75	\$21.25
3	60	19.75	30	60	19.75	200	40	22.00
5	50	19.75	50	50	19.75	300	60	23.50
8	40	19.75	80	40	19.75	†500	50	28.00
10	50	19.75	100	50	19.75	†800	40	32.50

*JAN-1-6 and/or MIL-M-6A specifications require 1000 ohms per volt sensitivity.

†Type WF instruments (flush type only) are equipped with a sub-base containing hermetically sealed, wire wound resistors as protection against excessive humidity.

D-C Ammeters

Range	Scale Div.	Each	Range	Scale Div.	Each	Range	Scale Div.	Each
1	50	\$19.00	3	60	\$19.00	15	75	\$19.00
1.5	75	19.00	5	50	19.00	30	60	19.00
2	40	19.00	10	50	19.00	50	50	19.00

D-C Zero Center Ammeters

Range	Scale Div.	Each	Range	Scale Div.	Each	Range	Scale Div.	Each
5-0-5	50	\$19.00	15-0-15	60	\$19.00	30-0-30	60	\$19.00
10-0-10	40	19.00	20-0-20	40	19.00	50-0-50	50	19.00

Regularly supplied with self-contained shunts up to and including 50 amperes, but can be supplied with external 50 mv shunts and 5 ft. (0.065 ohm) leads. When external shunt instruments are wanted add price of shunt to instrument base price of \$19.00.

D-C Milliammeters

Range	Approx. Res. Ohms	Scale Div.	Each	Range	Approx. Res. Ohms	Scale Div.	Each
1	105	50	\$19.00	30	1.2	60	\$19.00
1.5	27	75	19.00	50	2.0	50	19.00
2	27	40	19.00	100	1.0	50	19.00
3	18	60	19.00	150	0.66	75	19.00
5	5.7	50	19.00	200	0.5	40	19.00
10	2.0	50	19.00	300	0.33	60	19.00
15	2.0	75	19.00	500	0.2	50	19.00
20	2.0	40	19.00				

Ranges of 10 ma. and up are shunted and have a drop of approximately 100 mv. Model 301, range 1 ma., resistance 27 ohms can be supplied for requirements where low resistance is the first consideration. Each \$19.00.

D-C Microammeters

Range	Approx. Res.	Scale Div.	Each
100	600	50	\$30.25
*200	55	40	29.25
†500	195	50	22.75

*Recommended for use in horizontal or 45° position.

†Recommended for use with Weston Photoelectric Cell.

Ohmmeters

To compensate for battery changes, it is recommended that rheostats of the value shown below be used. The required rheostat and battery are not supplied—any commercial battery and rheostat of the values listed can be used.

Ohm Scale	Battery Voltage	Ext. Rhe. Ohms	Each
0-1000	1.5	100	\$23.75
0-10000	4.5	250	23.75
0-100000	4.5	2000	24.50
0-500000	15.0	2000	25.25
0-2000000	90.0	2000	25.25

A-C Rectifier Type Instruments

These instruments are offered as the only practical means of measuring minute a-c currents. They can be relied upon to within about 5% of full scale value on wave forms closely approximating the sine wave of ordinary room temperatures.

A-C Voltmeters—Rectifier Type

Range	Scale Div.	Ohms per Volt		Range	Scale Div.	Ohms per Volt	
		1000 Each	2000 Each			1000 Each	2000 Each
1	50	\$32.50	25	50	\$29.50	\$32.50
1.5	75	32.50	50	50	29.50	32.50
3	60	\$29.50	32.50	100	50	30.25	33.25
5	50	29.50	32.50	150	75	31.00	34.00
10	50	29.50	32.50	300	60	33.25
15	75	29.50	32.50				

A-C Milliameters—Rectifier Type

Range	Approx. Res. Ohms	Scale Div.	Each
0.5	1030	50	\$32.50
1	470	50	28.75
2	270	40	28.75
5	150	50	28.75

A-C Microammeters—Rectifier Type

500	1030	50	\$32.50
-----	------	----	---------

Weston Panel Instruments For General Small Panel Requirements

Models 425 and 476 Round and Square

Case Styles and Sizes:



Round	Diam. In.
Flush	
Bakelite	3.5
Bakelite	3.38
Metal	3.25
Surface	
Bakelite	2.94
Metal	2.75
Rectangular	Inches
Flush	
Bakelite	3 13 x 3



Model 425 Thermocouple Instruments

Accurate within 2%. Scale Length 2.36 in.

Frequency errors of Model 425 instruments are less than 2% up to 65 megacycles. Contact Graybar on applications involving the use of these instruments on higher frequencies.

All ranges listed are self-contained. Similar or higher ranges can be obtained with external heating elements.

A-C Thermo Ammeters

Power Consumption: 1 to 4 amp inclusive — varies from 0.2 to 0.4 watt per ampere, approx. 5 amperes and above — 0.2 watt per ampere.

Range	Scale Div.	Each	Range	Scale Div.	Each
1	50	\$28.25	5	50	\$28.25
1.5	60	28.25	10	50	28.25
2	40	28.25	15	60	28.25
3	60	28.25	20	40	28.25

A-C Thermo Milliammeters

Range	Approx. Res. Ohms	Scale Div.	Each	Range	Approx. Res. Ohms	Scale Div.	Each
*10	85	50	\$70.00	120	5.2	60	\$32.25
*20	22	40	70.00	300	1.8	60	32.25
*50	5	50	70.00	500	1.3	50	32.25
†115	5.2	50	32.25				

*Vacuum Thermocouple Type.

†Supplied as a current squared galvanometer, with a uniformly divided scale figured 0.100. Scale indicates values proportional to square of current, and is uniform throughout. A curve is supplied from which the approximate value of the current can be derived from instrument indications.

Call Graybar FIRST for . . .



Model 476 A-C Instruments

Accurate within 2%. Scale length 2.03 in.

A-C Voltmeters

Power Consumption: 150 volt range at 115 volts; 0.84 watt. At 60 cycles, 0.84 Volt-ampere.

Normally adjusted for use on frequencies of 25 to 125 cycles; they can be adjusted for use on 400, 800 or 1600 cycles or any specified frequency up to 2500 cycles for a nominal surcharge. An accuracy of 2% will be maintained at the specified frequency. Can also be furnished compensated for a frequency band from 25 to 1000 or 25 to 2500 cycles — Write Graybar.

Range	Approx. Ohms per Volt	Scale Div.	Each	Range	Approx. Ohms per Volt	Scale Div.	Each
1.5	3	30	\$19.00	50	52	50	\$19.00
3	6	30	19.00	100	110	50	19.75
5	10	50	19.00	130	110	26	20.50
8	10	40	19.00	150	110	30	20.50
10	14	50	19.00	250	167	25	22.00
15	14	30	19.00	300	167	30	22.75
30	26	30	19.00	500	167	50	25.75

Higher ranges require external resistors or potential transformers.

A-C Ammeters

Power Consumption: 5 ampere range at 5 amperes, 0.25 watt. At 60 cycles, 0.26 volt-ampere.

For use on frequencies from 25 to 500 cycles. On special order ammeters and milliammeters can be furnished, at a surcharge, adjusted for higher frequencies.

Range	Approx. Res.	Scale Div.	Each	Range	Approx. Res.	Scale Div.	Each
1	0.17	50	\$19.00	10	0.0037	50	\$19.00
1.5	0.092	30	19.00	15	0.0027	30	19.00
2	0.052	40	19.00	20	0.0012	40	19.00
3	0.024	30	19.00	30	0.00085	30	19.00
5	0.010	50	19.00	50	0.00072	50	19.00

For higher ranges, 5 ampere instruments should be used with Model 604 Current Transformer.

A-C Milliammeters

For use on Frequencies from 25 to 500 cycles

Range	Approx. Res.	Scale Div.	Each	Range	Approx. Res.	Scale Div.	Each
15	2300	30	\$19.00	100	34	50	\$19.00
25	650	25	19.00	250	4.61	25	19.00
50	171	50	19.00	500	1.14	50	19.00

Weston Panel Instruments

Models 861, 862, 863
(Illuminated)



Model 861-Milliammeter

Models 961, 962, 963
(Not Illuminated)

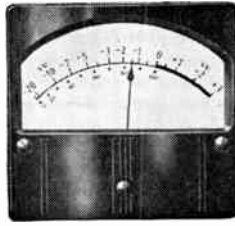

Model 962 VU Meter

These matched groups of large, rectangular panel, semi-flush, bakelite instruments combine well proportioned mechanical design with easy readability of long scales through large openings.

Both groups have removable molded bakelite fronts. All are mounted the same as round types — only one round opening for instrument body and four small holes for mounting studs being necessary.

The a-c movable iron type instruments incorporate excellent magnetic damping, high sensitivity, good torque to weight ratio and low response time consistent with well-balanced design. A dielectric test of 5000 volts a-c is given each instruments. Steel cases provide magnetic shielding and make it unnecessary to specify the panel material, since mounting on magnetic panels will not change the calibration. The a-c scales approach uniformity for the upper 90%.

The d-c, thermo and rectifier type instruments have bakelite cases, and if used on steel panels, thickness of panel should be specified to assure proper adjustment. They are also subjected to the 5000 volts a-c dielectric test.

Instruments in Model 861 Group (Models 861, 862 and 863) are equipped with two self-contained miniature base 6-volt 0.15 amp. lamps, ordinarily connected for dial illumination. (Illumination feature is not included in the Model 961 Group — Models 961, 962 and 963.)

Accurate within 2%. Scale length 3.17 in.

Type: Thermocouple.

Size: 4.25 x 3.94 in., Depth 2.5 in., Diameter of panel hole required 3.25 in.

D-C Voltmeters

Approx. weight 1 lb.

Ranges listed below are self-contained and have a sensitivity of approximately 200 ohms per volt up to and including 200 volts; higher ranges are 1000 ohms per volt.

Range	Scale Div.	Model 861 Each	Model 961 Each	Range	Scale Div.	Model 861 Each	Model 961 Each
1	50	\$38.50	\$31.00	80	40	\$38.50	\$31.00
2	40	38.50	31.00	100	50	39.25	31.75
3	60	38.50	31.00	130	65	40.00	32.50
5	50	38.50	31.00	150	75	40.00	32.50
7.5	75	38.50	31.00	200	40	40.75	33.25
10	50	38.50	31.00	250	50	42.25	34.75
15	75	38.50	31.00	300	60	43.00	35.50
25	50	38.50	31.00	500	50	46.00	38.50
50	50	38.50	31.00				

D-C Ammeters

Regularly supplied with self-contained shunts up to and including 50 amperes, but can be supplied with external 50 mv. shunts and 5 ft. (0.065 ohm) leads. When external shunt instruments are wanted, add price of shunt to instrument base price.

Range	Scale Div.	Model 861 Each	Model 961 Each	Range	Scale Div.	Model 861 Each	Model 961 Each
1	50	\$38.50	\$31.00	5	50	\$38.50	\$31.00
1.5	75	38.50	31.00	10	50	38.50	31.00
2	40	38.50	31.00	25	50	38.50	31.00
3	60	38.50	31.00	50	50	38.50	31.00

D-C Milliammeters

Ranges above 25 milliamperes are shunted and have a drop of approximately 100 millivolts.

Range	Approx. Res. Ohms	Scale Div.	Mod. 861 Each	Mod. 961 Each	Range	Approx. Res. Ohms	Scale Div.	Mod. 861 Each	Mod. 961 Each
1	80	50	\$38.50	\$31.00	50	2	50	\$38.50	\$31.00
3	7.3	60	38.50	31.00	100	1	50	38.50	31.00
5	2.8	50	38.50	31.00	200	0.5	40	38.50	31.00
10	1.25	50	38.50	31.00	300	0.33	60	38.50	31.00
25	1.0	50	38.50	31.00	500	0.2	50	38.50	31.00

D-C Microammeters

Range	Approx. Res. Ohms	Scale Div.	Model 861 Each	Model 961 Each	Range	Approx. Res. Ohms	Scale Div.	Model 861 Each	Model 961 Each
30	1950	60	\$54.25	\$46.75	200	400	40	\$42.25	\$34.75
50	900	50	52.50	45.00	300	175	60	42.25	34.75
75	450	75	52.50	45.00	500	80	50	42.25	34.75
100	1110	50	51.25	43.75					

A-C Rectifier Type Instruments

Models 862 and 962

These instruments are offered as the only practical means of measuring small a-c currents. They may be relied upon to within about 5% of full scale value on wave forms closely approximating sine wave at ordinary room temperatures.

Rectifier Type A-C Voltmeters

Range	Scale Div.	Model 862		Model 962	
		1000 Ohms Per Volt Each	2000 Ohms Per Volt Each	1000 Ohms Per Volt Each	2000 Ohms Per Volt Each
1	50		\$51.50		\$44.00
1.5	75	\$48.50	51.50	\$41.00	44.00
3	60	48.50	51.50	41.00	44.00
5	50	48.50	51.50	41.00	44.00
10	50	48.50	51.50	41.00	44.00
15	75	48.50	51.50	41.00	44.00
50	50	48.50	51.50	41.00	44.00
100	50	49.25	52.25	41.75	44.75
150	75	50.00	53.00	42.50	45.50
300	60	52.25	55.25	44.75	47.75

Rectifier Type A-C Milliammeters

Range	Approx. Res. Ohms	Scale Div.	Mod. 862 Each	Mod. 962 Each
1	500	50	\$47.75	\$40.25
2	360	40	47.75	40.25
5	240	50	47.75	40.25

Rectifier Type A-C Microammeters

Range	Approx. Res. Ohms	Scale Div.	Mod. 862 Each	Mod. 962 Each
100	4000	50	\$60.50	\$53.00
200	2100	40	51.50	44.00
500	900	50	51.50	44.00

Type 30 VU Meters

Available with a choice of two scales, and because of their size and balanced design are most practical.

Type A scale stresses the level in VU and is used largely in monitoring wire lines.

Type B scale emphasizes per cent use of transmitter output and is the standard for broadcast service.

Model	Scale	Each
862	A or B	\$59.00
962	A or B	51.50

Thermo Ammeters

Power Consumption: 1 to 4 amperes inclusive varies from 0.2 to 0.4 watt per ampere. Approx. 5 amperes and above — 0.2 watt per ampere.

Frequency errors less than 2% up to 65 megacycles.

Amps.	Scale Div.	Model 863 Each	Model 963 Each	Amps.	Scale Div.	Model 863 Each	Model 963 Each
1	50	\$47.00	\$39.50	5	50	\$47.00	\$39.50
1.5	75	47.00	39.50	6	60	47.00	39.50
2	40	47.00	39.50	8	40	47.00	39.50
2.5	50	47.00	39.50	10	50	47.00	39.50
3	60	47.00	39.50	15	75	47.00	39.50
4	40	47.00	39.50	20	40	47.00	39.50

Weston Panel Instruments



1301 and 1306 Line

Available for d-c and a-c rectifier types, in both round and rectangular cases. Instrument can be mounted interchangeably on magnetic or non-magnetic panels without need for special adjustment.

Accuracy: D-C, +2% of full scale range. Rectifier type A-C +3% of full scale when used on sine wave of 60 cycles at normal room temperature of 25°C. Lance type pointer. Self-shielded Cormag mechanism. Case 3½-in. round or rectangular flush bakelite. Terminals: Solder type up to 10 amperes.

D-C Microammeters—Model 1301

Range	Approx. Res.	Scale Div.	Each	Range	Approx. Res.	Scale Div.	Each
100	1700	50	\$17.75	50/0/50	1700	50	\$17.75
200	600	40	15.25	100/0/100	600	40	15.25
500	230	50	15.25	500/0/500	88	50	14.75

The highest practical sensitivity retaining the desirable characteristics of the 1301 line is 100 microamperes d-c. For sensitivities greater than 100 microamperes, the higher torque, unshielded Model 1306 is available as listed below:

D-C Microammeters—Model 1306

Range	Approx. Res.	Scale Div.	List Price
20	1170	40	\$28.50
30	1050	60	28.50
50	1140	50	27.50

D-C Milliammeters—Model 1301

Range	Approx. Res.	Scale Div.	Each	Range	Approx. Res.	Scale Div.	Each
1	88	50	\$14.75	100	1	50	\$14.75
3	18	60	14.75	200	0.5	40	14.75
5	8	50	14.75	300	0.33	60	14.75
10	1.1	50	14.75	500	0.2	50	14.75
15	1.1	75	14.75	1/0/1	45	10	14.75
20	1.1	40	14.75	10/0/10	1.1	10	14.75
30	1.0	60	14.75	100/0/100	1	10	14.75
50	2.0	50	14.75				

D-C Ammeters—Model 1301

Range Self-Contained	Scale Div.	Each	External Shunt Type	Scale Amps.	Scale Div.	Each
1	50	\$14.75	50MV	100	50	\$15.00
2	40	14.75	50MV	150	75	15.00
3	60	14.75	50MV	200	40	15.00
5	50	14.75	50MV	300	60	15.00
10	50	14.75	50MV	500	50	15.00
15	75	15.75				
30	60	15.75				
50	50	15.75				

D-C Voltmeters**—Model 1301

Range	Scale Div.	Each	Range	Scale Div.	Each
0.05	50	*	50	50	\$15.25
1.5	75	\$15.25	100	50	15.25
3	60	15.25	150	75	15.25
5	50	15.25	200	40	15.75
10	50	15.25	300	60	15.75
15	75	15.25	500	50	16.25
30	60	15.25			

*Does not include shunt or leads. Leads provided only when specifically called for on order. Unless otherwise specified 0.065 ohm is allowed in adjustment of the 50 millivolt instrument for shunt lead resistance. Where specified, 5 ft. shunt leads, PN-131412 (instrument end of wire stripped and tinned-eye terminals at shunt end) will be provided for specific use with this instrument at a price of \$1.00 list per pair. List price for this millivoltmeter is \$15.00 when provided with any of the listed ammeter scales. Other scales are available on special order.

**All d-c voltmeters have sensitivity of approximately 1000 ohms per volt. Resistors are precision metal film Weston Vanistors. Wire wound resistors are available on special order.

Weston Sight Meters

Model 703



Sightmeter

Pocket-size, direct-reading instruments for measuring light. Size: 4½ x 2½ x 1½. Can be used by anyone. Can be placed on chair, desk or machine in home, office or factory — or held in the hand in whatever position the light is to be measured. The scale on the Sight Meter instantly indicates whether or not the light is adequate for a particular seeing task.

They are invaluable aids for the promotion of better sight through the use of better light; and ideal for use in the selling of home lighting equipment, such as lamps and reflectors.

The use of the Sight Meter Multiplier Disc over the *Photronic Cell will extend the range ten times its normal full scale value.

Model	Description	Each
Model 703, Type 7	Sight Meter, 0-100 foot-candles (with †VISCOR and Cosine correction filters)	\$53.00
Model 703, Type 6A	Sight Meter, 0-75 foot-candles (with †VISCOR filter)	50.00
Model 703, Type 3A	Sight Meter, 0-75 foot-candles (Unfiltered)	38.00
Model 9924	Multiplier Disc (x10) not usable with Cosine corrected instruments	1.50
Model 9959	Leather Carrying Case	3.00

*Photronic and †Viscor — Registered Trade Marks.

Weston Foot-Candle Meters

Model 614



This versatile instrument is for making general commercial lighting surveys and measurements requiring a wide range of light values. No correction factors are necessary. Any type of commercial lighting can be measured directly with this compact Foot - Candle Meter.

Ranges are selected through the operation of a conveniently located range-changing switch.

The *Photronic Cell is mounted on a hinge, so that with the instrument lying flat, the cell can be tilted at an angle to facilitate measurements such as reflected light from a wall or ceiling. Entirely self-contained in a sturdy bakelite case equipped with a hinged cover and leather carrying handle; Size 7¾ x 3¾ x 2¼ in.

Model 614	— 0-100/250/500 foot-candles (with *Viscor and Cosine correction filters)	Each \$113.00
Model 614	— 0-60/120/600 foot-candles (with *Viscor filter)	Each 110.00

*Photronic and Viscor — Registered Trade Marks.

Weston Plug-In Illumination Control



This instrument provides automatic "on-off" control of artificial lighting. Operates automatically on the basis of light level in terms of foot-candles.

No resistors or capacitors are used, nor phototubes or vacuum tubes. Consists primarily of a Photoelectric photoelectric cell, a relay, a clock motor, one or two mercury switches and a limit switch.

Complete unit is ruggedly constructed and enclosed in standard weatherproof watt-hour meter glass case. To install simply plug it into a standard watt-hour meter receptacle.

An ideal control for aircraft obstruction markers; air-way beacon and airstrip lights; industrial lighting and street lighting.

No. 1089 Types 1, 1R, 4, 5 Plug-In Illumination Control (One Mercury Switch)..... Each \$75.00

No. 1089 Types 2, 3, 6 Plug-In Illumination Control (Two Mercury Switches). Each \$90.00

Weston All Purpose Electronic Tubechecker



A new functional tubetester of the Proportional Mutual Conductance type. For industrial, laboratory and general testing of receiving tubes, voltage regulator tubes and low power thyratron tubes.

Provides meter measurement of leakage resistance as high as 5 megohms between tube elements, nine single circuit, twelve position selector switches protect against obsolescence, three toggle switches make it possible to check and compare sections of twin section tubes at only one setting of the selector switch.

Filament Voltages: 0.6a, 0.65, 1.1, 1.5, 2, 2.5, 3.3, 5, 6.3, 7.5, 10, 13, 20, 27.5, 35, 47, 70, 85, 115.

Plate Voltages: 90, 130, 220 volts d-c; 22, 44, 160 volts a-c.

Grid Bias: 0-5V, 0-20 volts d-c.

Signal Voltages: 5.2, 2.6, 1.3, 0.65 volts peak to peak. Gm Ranges up to 30,000 micromhos.

Power Requirements: 100 to 125 volts, 60 cycles single phase, a-c, 30 watts.

Meter measurement of high leakage resistance provides accurate meter measurement of leakage resistance as high as 5 megohms between tube elements, thus being particularly useful for TV servicing and TV line production assembly.

Roll index chart provides comprehensive, up-to-date test data on commonly encountered tubes as well as those used infrequently.

Case is gray hammertone finished steel.

No.	Size, In.	Approx. Wt., Lbs.	Each
981 Type 3	17 1/2 x 13 1/4 x 6	23 1/2	\$199.50

Weston Volt-Ohm-Milliammeter



A highly sensitive, accurate and rugged instrument with an etched circuit and a combination of functional ranges which provide a wide range of test measurement applications in the electronic field.

Has a d-c sensitivity of 20,000 ohms/volt, and an a-c sensitivity of 1000 ohms/volt. Accuracy is 2% d-c, 3% a-c.

Range and functional switching greatly simplified by use of a single dial for all ranges and functions.

Scale length 4.63-in. Black bakelite case.

No.	Size, In.	Approx. Wt., Lbs.	Each
980	6.25 x 7.50 x 3.25	2 11	\$43.50

Weston All Purpose Oscilloscopes

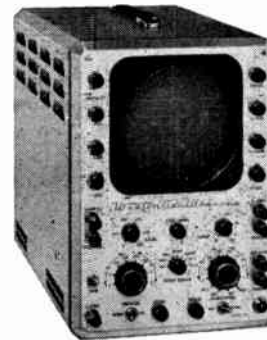

A high gain, wideband oscilloscope designed to accurately reproduce waveforms comprising a wide band of frequencies.

The high sensitivity of 15 millivolts per inch RMS makes the oscilloscope ideal for setting resonant traps; signal tracing in low-level stages; as a general null indicator; for phase characteristic measurement in Industrial Applications and for sweep frequency visual alignment of TV receivers.

Scope contains identical vertical and horizontal push-pull amplifiers with choice of a-c or d-c coupling without affecting either sensitivity or band width. Both amplifiers have compensated step attenuators and cathode follower input.

Specifications

Wide Band Frequency Response: Flat within 1.5 db from 0-3.6 mc and within-3 db to 4.5 mc on both vertical and horizontal amplifiers. Transient response: overshoot 2 to 5%. Rise time: 0.1 microsecond.

High Deflection Sensitivity: 15.0 millivolts per inch RMS, on both vertical and horizontal amplifiers.

Phase Shift: Between horizontal-vertical amplifiers. 0-500 kc-0°, to 1 mc within 2°; by internal adjustment with gain controls at max. 0° phase shift possible on any specific frequency to 6 mc.

Calibrating Voltages: 500 millivolts, 5 volts, 50 volts, 500 volts, peak to peak.

Sweep Frequencies: 10-500,000 cps., variable. Preset TV/V position-30 cps. Preset TV/H position-7875 cps. Retrace time-better than 2% to 100 kc; at 500 kc less than 10%.

Internally Phased Sine Wave: Adjustable through 170°.

Vertical and Horizontal Polarity: Reversible.

Input Impedance: Vertical Amplifier (without Shielded Cable), 1 meg. shunted by 60 mmf. Vertical Amplifier (with Shielded Cable, 1 meg. shunted by 120 mmf. Vertical Amplifier (with Low Capacitance Probe), 2 meg. shunted by 15 MMF. Horizontal amplifier (without Shielded Cable), 1 meg. shunted by 60 mmf.

Power Supply: 105/125 volts, 50/60 cycles. Case: Grey hammertone finished steel. Approx. weight 40 lbs.

No.	Description	Size, In.	Each
983	Oscilloscope	10 x 14 x 19 1/2	\$328.50

Weston Industrial Circuit Testers
Type 6A Multi-Purpose—Multi-Range

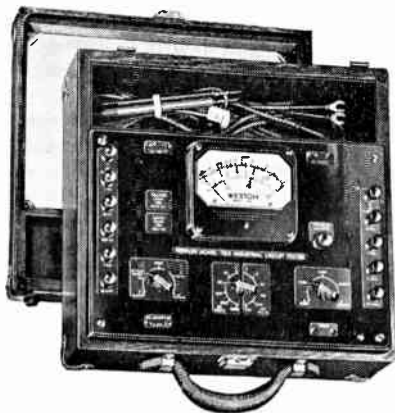

For testing communication systems, telephone, radio, etc. Electronic circuits and equipment. Lighting and power circuits. Resistance in all types of circuits. Signal systems, police, fire and burglar alarm. Transformers, loads and wiring.

Size: 13 x 12½ x 5½ in.

A most complete ultra-sensitive single unit 28-range tester for general maintenance and test purposes. General maintenance work, such as checking motors, lighting circuits, etc. can be accomplished with a minimum expenditure of time. Current and potential leads can be connected to the instrument at the same time for instantaneous current and voltage readings.

Specifications

Standard Weston 4¼ in. instrument. D-c sensitivity 50 microamperes. New temperature compensated rectifier circuit gives greater a-c accuracy.

Ranges

A-C Volts, Six Full Scale Ranges:

5/15/30/150/300/750 volts (1000 ohms per volt). Accurate within 3%.

A-C Current, Four Full Scale Ranges:

.5/1/5/10 amperes. Accurate within 3% on 60 cycles. Slightly less on 25 and 133 cycles. Higher ranges with external current transformers.

D-C Volts, Seven Full Scale Ranges:

1/10/50/200/500/1000 volts (20,000 ohms per volt), and 100 millivolts direct or for use with external shunts. Accurate within 2% to 500 volts — 3% at 1000 volts.

D-C Current, Six Full Scale Ranges:

50 microamps . . . 1/10/100 Milliamps . . . 1/10 Amps. Accurate within 2%. Higher ranges, at full scale reading, with 100 mv external shunts.

Resistance, Five Full Scale Ranges:

3000/30000/300000 Ohms 3/30 Megohms
 25/250/2500/25000/250000 Ohms Center Scale
 (Self-contained Batteries). Accurate within 2% of linear arc length on any ohmmeter range.

Model 785, Type 6A in Oak Carrying Case . . . Each **\$185.25**

Model 785, Type 6A in Steel Case for Bench Use Each **155.25**

Weston Power Analyzers

Model 639 — Type 2

A complete power analyzer designed to analyze industrial loads by measuring a-c current, voltage and power, in single and polyphase circuits; as well as power factor in 3-phase, 3-wire balanced circuits. It is convenient, safe, compact, light in weight, rugged and portable.

Ideal for use in industrial plant maintenance; by utility service engineers, electrical contractors, marine service men and in general testing and installation work.

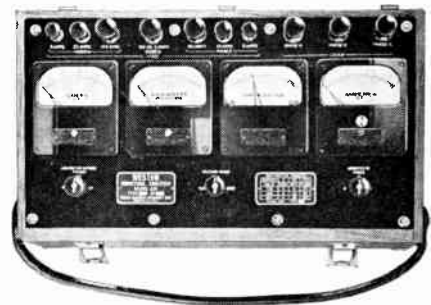

Accurate within 1% for voltmeter, ammeter and power factor meter, and 2% for wattmeter.

Scale lengths 3.5 in. Size case: 18¾ x 10¾ x 6¾ in.

Approximate weight 32 lbs.

Unit consists of four Model 610 instruments (4 x 4½ in.) a voltmeter, ammeter, wattmeter and a power factor meter, all in a rugged oak carrying case. These instruments contain the large, rugged mechanisms as used in the Weston 6 in. Line.

The ammeter has an adjustable pointer stop making it possible to quickly determine the maximum of starting currents. The wattmeter has a single scale with multiplying factors given on the instrument panel.

Internal connections eliminate possibility of "outages" due to improper connections; or damage to individual meters. Heavy insulated binding posts are located at top away from the operator. Instruments are placed along a horizontal center-line, with all switches below. Danger of interference with other equipment is minimized, due to less external wiring.

Insulated for 1000 volt service.

Self-contained — All interconnections are made within the unit, saving considerable time when power studies are being made. Only a few simple connections are necessary to place this instrument in circuit. Internal switches facilitate rapid measurement of all line currents and voltages. Fine line scales with knife-edge pointers, and "Straightline" grouping of identical instruments, provides easy readability.

Low Burdens — Potential circuit per phase, 7 volt-amperes. Current circuit per phase, 6 volt-amperes.

High Overload Capacity — Current circuits are designed to be used continuously at 25% above their rated values and may be subject to greater overloads for shorter periods of time.

Built-in Accuracy — Current transformers are hand-wound on nickel alloy ring type cores, making it possible to maintain the phase angle and ratio errors at a minimum. The overall accuracy of the wattmeter and power factor meter is maintained even at low power factors as a result of the low phase angle of the transformers.

Series resistors, consisting of inert cards which are wire wound, and well spaced throughout provide maximum cooling for sustained operation and accuracy.

Model 639, Type 2 Each **\$763.00**

Weston Portable Standards

For A-C and D-C Power Measurements

Model 310

Accurate within 1/4 of 1%.
Scale length 5.25 in.

Type: Electrodynamometer (shielded from external magnetic field).

Size Case: 8 1/2 x 10 3/8 x 5 7/8 in.

Approximate weight, 12 lbs.

Power Consumption:

Forms 1 and 3—Potential circuit at 115 volts, 60 cycles—2.9 watts, 2.9 volt-amperes. Current circuit at 5 amperes, 60 cycles—0.81 watt, 0.95 volt-ampere.



Form 2—Potential circuit at 115 volts, 60 cycles—4.4 watts, 4.4 volt-amperes. Current circuit at 5 amperes, 60 cycles—3.5 watts, 3.9 volt-amperes.

This is a true electro-dynamometer and will measure true rms values when used on commercial wave forms, since the wave form error in general is exceedingly small and practically unreadable.

All are calibrated at 25°C. A certificate provided with each instrument supplies all essential data.

Description of Forms

Form 1—For general service on d-c, and on frequencies to 125 cycles. Not compensated for instrument losses, ranges based on product of normal volts and amperes. Compensated for normal temperature changes. Potential circuit has push button switch.

Form 2—For low power factor service. Potential circuit power compensation is provided as ranges are usually quite low, and the power consumed by the instrument is therefore an appreciable portion of the total. Switch is provided in potential circuit to omit or include compensation. Ranges are based on 20% of the product of maximum volts and amperes. Frequency coverage same as Form 1. Special instruments, without potential circuit power compensation can be built, at a surcharge, to cover a frequency span up to 1000 cycles with the standard accuracy.

Form 3—Similar to Form 1, except that the potential circuit is designed for use on higher frequencies and therefore is not so well compensated for temperature changes as Form 1. On 50 volt range, frequency coverage is from 25 to 600 cycles; 100 volts and above, 25 to 1200 cycles. Special instruments can be built, at a surcharge, to cover a frequency span up to 2500 cycles with an accuracy within 1/2% above 1200 cycles.

Summary

	Form 1	Form 2	Form 3
Compensated for large temperature changes.....	Yes	No	No
Compensated for potential circuit power.....	No	Yes	No
Equipped with push button switch..	Yes	No	Yes
†Current circuit overload capacity..	100%	None	100%
*Potential circuit overload capacity..	50%	None	50%

Frequency range for normal accuracy:

Form 1—d-c & 25-125.

Form 2—d-c & 25-125.

Form 3—d-c & 25-600; 100 volts and above, d-c & 25-1200.

†100/50 ampere range 50% overload only.

*Applies to ranges up to 400 volts; above 400 volts overload is 20%.

Model 310 — Form 1 or 3

Approximate Sensitivity at Normal Voltage—22 Ma.

Volts Normal	Amperes Normal		Watt Ranges		Range Figured	Scale Div.	Each
	High	Low	High Current Range	Low Current Range			
200/100/50 (Max. 300/150/75)	1	.5	200/100/50	100/50/25	50	100	\$423.00
	2	1	400/200/100	200/100/50	100	100	423.00
	2.5	1.25	500/250/125	250/125/62.5	125	125	423.00
	5	2.5	1000/500/250	500/250/125	250	125	415.50
	10	5	2000/1000/500	1000/500/250	500	100	415.50
	20	10	4/2/1 Kw.	2/1/.5 Kw.	1 Kw.	100	475.50
	40	20	8/4/2 Kw.	4/2/1 Kw.	2 Kw.	100	475.50
	60	30	12/6/3 Kw.	6/3/1.5 Kw.	3 Kw.	150	475.50
	100	50	20/10/5 Kw.	10/5/2.5 Kw.	5 Kw.	100	475.50
	500/200/100 (Max. 600/300/150)	1	.5	500/200/100	250/100/50	50	100
2		1	1000/400/200	500/200/100	100	100	460.50
2.5		1.25	1250/500/250	625/250/125	125	125	460.50
5		2.5	2500/1000/500	1250/500/250	250	125	453.00
10		5	5000/2000/1000	2500/1000/500	500	100	453.00
20		10	10/4/2 Kw.	5/2/1 Kw.	1 Kw.	100	513.00
40		20	20/8/4 Kw.	10/4/2 Kw.	2 Kw.	100	513.00
60		30	30/12/6 Kw.	15/6/3 Kw.	3 Kw.	150	513.00
100		50	50/20/10 Kw.	25/10/5 Kw.	5 Kw.	100	513.00

Model 310 — Form 2 — For Low Power Factor Use

Volts Max.	Amperes Max.		Watt Ranges		Approx. Sensitivity Ma	Range Figured	Scale Div.	Each
	High	Low	High Current Range	Low Current Range				
150/75	1	.5	30/15	15/7.5	35	15	150	\$430.50
	2	1	60/30	30/15	35	30	150	430.50
	5	2.5	150/75	75/37.5	48	75	150	423.00
	10	5	300/150	150/75	48	150	150	423.00

*This range is not compensated for potential circuit power and is useful for special conditions only. Power required for instrument operation will often equal, and in some cases be more than, the power to be measured. Correspondence giving full particulars of the problem is usually required before placing the order.

All ranges listed are self-contained. Higher current ranges are obtained by using a 5 ampere range in conjunction with Model 461, Type 2 or Model 327, Types 1 or 2 Current Transformers. Higher potential ranges are obtained with multipliers or Model 311 Potential Transformers.

Leather Cases—For all Standard Ranges Each \$44.00

Weston Portable Standards

For Testing Alternating and Direct Current

Model 341

Accurate within 1/4 of 1%.

Scale length: 5.25 in.

Type: Electrodynamometer (shielded from external magnetic fields.)

Size Case: 8 1/2 x 10 3/8 x 5 7/8 in.

Approximate weight 11 lbs.

Power consumption: (300/150 and 300/150/75 volt instruments) 150 volt range at 115 volts, 60 cycles—4.0 watts, 4.0 volt-amperes.

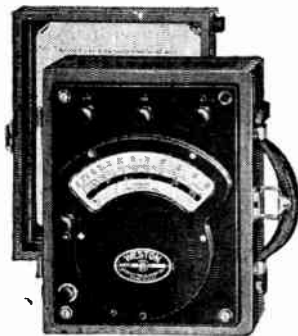

Model 341

A true electro-dynamometer, self-contained, and suitable for d-c and a-c voltage measurements. Will

measure true rms voltage when used on common wave forms since the wave form error, in general, is exceedingly small and practically unreadable.

All are calibrated at 25° C. A certificate provided with each instrument supplies all essential data, true temperature correction factors and true frequency correction factors.

Instruments with all ranges of 7.5 volts and above are accurate to within 1/4 of 1% of full scale and are usable on d-c, and a-c from 25 to 125 cycles. They are calibrated on d-c and have a negligible frequency error at 60 cycles.

All instruments with one or more ranges below 7.5 volts are accurate to within 1/2 of 1% of full scale and are calibrated on 60 cycles. The sustained operation influence is, of necessity, somewhat greater for the 1.5 range than for higher ranges. All ranges may be used on d-c, or a-c frequencies from 25 to 125 cycles by applying a small correction factor.

A-C and D-C Voltmeters

Ranges	Approx. sensitivity Ma	Approx. Resist. Ohms	Scale Div.	Each
*†3/1.5	500	6/3	150	\$345.75
*†7.5/3	500	15/6	150	345.75
*†15/1.5	280	51/27	150	345.75
30/15	150	200/100	150	345.75
75/30	65	1150/460	150	345.75
120/60	45	2660/1330	120	345.75
150/75	45	3340/1670	150	347.25
300/150	45	6680/3340	150	351.75
600/150	30	20000/5000	150	360.75
600/300	30	20000/10000	150	360.75
300/150/75	45	6680/3340/1670	150	365.75
600/300/150	30	20000/10000/5000	150	375.25
750/300/150	30	25000/10000/5000	150	380.25

*Accuracy 1/2 of 1%.

†Provided with 5 ft. leads.

For higher ranges use Model 311 Potential Transformers or external multipliers.

Leather Cases—For all Standard Ranges Each **\$44.00**

Weston Portable Standards

For Testing Alternating and Direct Current

Model 370

Accurate within 1/4 of 1%.

Scale length 5.25 in.

Type: Electrodynamometer (shielded from external magnetic fields).

Size Case: 8 1/2 x 10 3/8 x 5 3/4 in.

Approximate weight, 10 lbs.

Power Consumption: 5 ampere range at 5 amperes, 60 cycles — 4.5 watts, 4.7 volt-amperes.



Model 370

For measuring a-c and d-c current. True electro-dynamometers of the shunted moving coil type in all double range combinations, and all ranges above .5 amperes.

Will measure true rms current on commercial wave forms since the wave form error is unreadable.

Instruments can be supplied for d-c, and a-c from 25 to 125 cycles, or d-c, and a-c from 25 to 1000 cycles at a rated accuracy within 1/4% of full scale. At a surcharge these instruments can be compensated for frequencies up to 2500 cycles. The accuracy of such instruments will be within 1/4% for d-c, and a-c from 25 to 1000 cycles. From 1000 cycles to 2500 cycles the accuracy will be within 1/2%. All are calibrated at 25° C. A certificate provided with each instrument supplies all essential data.

A-C and D-C Ammeters

Range	Scale Div.	D-C, and 25 to 125 cycles A-C Each	D-C, and 25 to 1000 Cycles A-C Each
1/.5	100	\$370.00	\$394.75
2/1	100	370.00	394.75
5/2.5	100	360.50	387.25
10/5	100	362.50	387.25
20/10	100	372.50	397.25

A-C and D-C Milliammeters

Range	Approx. Resist. Ohms	Scale, Div.	D-C and 25 to 125 cycles D-C Each	D-C and 25 to 1000 cycles A-C Each
30/15	915/1470	150	\$394.75
150/75	44/110	150	\$370.00	394.75
300/150	13/12	150	370.00	394.75
500/250	4.2/5.1	100	370.00	394.75

All ranges listed above are self-contained. For higher ranges use Model 461, Type 2 or Model 327, Types 1 or 2 Current Transformers.

Leather Carrying Cases—For all Standard Ranges Each **\$44.00**

Weston Portable Standards

Model 329



Model 329

Accurate within 1/2 of 1%.
 Scale length 5.25 in.
 Type: Electro-dynamometer (shielded from external magnetic fields).
 Size Case : 9 1/2 x 10 1/2 x 8 1/16 in.
 Approx. weight, 18 lbs.
 Power Consumption per element: Potential circuit at 115 volts, 60 cycles — 3.4 watts, 3.4 volt-amperes. Current circuit at 5 amperes, 60 cycles — 0.80 watts, 0.91 volt-ampere.

rent circuit at 5 amperes, 60 cycles — 0.80 watts, 0.91 volt-ampere.

Made in three types: Form 1, 2 and 3, with characteristics comparable to those of Model 310 Wattmeters.

Consist of two electrically independent single-phase wattmeters having their movable coils mounted on a common shaft, with each coil surrounded by its own system of field coils. Each system may be used independently with scale errors of less than 1/2%, which is of great importance for measurements on unbalanced polyphase circuits, or on balanced three-phase circuits at low power factor.

Have double current and triple voltage ranges. Current ranges changed by means of links, and voltage ranges have independent binding posts. Power measurements on direct current — single-phase a-c, two- or three-wire circuits — two-phase, three- or four-wire circuits, and on three phase circuits, may be made directly. All instruments have "On" and "Off" switch in the potential circuit. Calibrated at 25° C. A certificate, provided with each instrument, supplies all essential data.

Model 329 Form 1 or 3

Approximate Sensitivity per Element at Normal Voltage — 26 Ma. Polyphase Wattmeters

Volts Normal	Amperes Normal		Watt High Current Range
	High	Low	
200/100/50 (Max. 300/150/75)	5 10 20	2.5 5 10	2000/1000/500 4/2/1 kw 8/4/2 kw
500/200/100 (Max. 600/300/150)	5 10 20	2.5 5 10	5000/2000/1000 10/4/2 kw 20/8/4 kw

Watt Low Current Range	Range Figure	Scale Div.	Each
1000/500/250	500	100	\$761.00
2/1/5 kw	1 kw	100	761.00
4/2/1 kw	2 kw	100	821.00
2500/1000/500	500	100	798.50
5/2/1 kw	1 kw	100	798.50
10/4/2 kw	2 kw	100	858.50

All ranges listed are self-contained. Higher current ranges are obtained by using a 5 amp. range in connection with two Mode 461, Type 2, or two Model 327, Type 1 or 2, Current Transformers. Potential ranges are extended by using multipliers of two Model 311 Potential Transformers.

Weston Portable Multi-Purpose Instruments

Model 633 Clamp Volt-Ammeters and Clamp Ammeters



Type VA-1

Dependable magnetic circuit. Rugged bakelite case and solid bakelite handle. Completely insulated for 750 volt service. Fast, well-damped movement, accurate within 3% of full scale value. Non-shatterable scale glass. Easily-read double scale. Pear-shaped pointer. Adjustable pointer stop for measuring motor-starting currents. Successive voltage and current readings at the flick of switch. Positive 6-position range and selector switch. Safety type trigger — designed for glove or bare hand use. Can be hung on a conductor 2 in. diameter, leaving operators' hands free.

Note — Can be used for continuous duty up 500 amperes.

A-C Clamp Volt-Ammeters

Combines in one instrument 3 a-c voltage ranges and 5 a-c current ranges. Provides complete coverage of the voltages and currents most frequently encountered in industrial and utility service work. It is the ideal maintenance tool for on-the-job testing.

Model 633 — A-C Clamp Ammeters

These are basically of the same design as the Clamp Volt-Ammeter, except that they are not provided with the voltage features or regularly equipped with an adjustable pointer stop.

Current measurements can be made at a distance from the clamping jaws when the instrument is used in conjunction with Model 9958 50-ft. Extension Cable. This is done by removing the indicating instrument from the clamp-ammeter and inserting it in the receptacle provided on one end of the extension cord. The plug end of the cable is then inserted in the clamp-ammeter.

Note — Extension cannot be used with Type VA-1 Clamp Volt-Ammeter.

Type VA-1 — For 750/350/175 Volts; 1000/250/100/25/10 Amperes: Includes Potential leads.....	\$125.00
Type A-1 — 500/250/100/50/25/10 Amperes.....	117.00
Type A-2 — 1000/500/250/100/25/10 Amperes.....	117.00
Type A-3 — 2000/1000/500/250/100/50 Amperes...	125.00
Model 9958, 50-ft. Extension Cable, Plug and Receptacle.....	72.00
Leather Carrying Case for Types VA-1, A-1, A-2 and A-3.....	13.50
Leather Carrying Case for Model 9958 Cable, Plug and Receptacle.....	22.50

Weston Clamp Volt-Ammeter
A-C Pocket Size



Lightweight, compact clamp volt-ammeter designed for the electrician, service man, engineer and motor repair shop.

Contains six current ranges and three voltage ranges that are quickly readable from any angle on one large size scale.

Precision ground faces provide positive jaw contact. Shatter-proof wrap-around plastic window.

Accommodates conductors up to 1-inch round or 1 3/4 x 3/8 in. rectangular.

New shock-mounted core magnet mechanism. Fully insulated for 750 volt service. Accurate within ±3% of full scale value when used on 50-60 cycles. Scale length, 2.36 inch.

Supplied complete with sturdy carrying case, voltage test leads with insulated battery clips and three accessory probes.

Ranges

300/150/60/30/15/6 amperes a-c; 600/300/150 volts a-c.

No.	Size, In.	Approx. Wt., Oz.	Each
749	7 1/2 x 3 x 1 1/4	14	\$40.50

Plug-In Adapter

Model 9886 Plug-in Adapter is designed for use with the Model 749, facilitates current measurements of double conductor leads without breaking the circuit. Handy receptacles on either side, for direct reading or as a 10 to 1 divider for low current measurements. Also simplifies voltage testing during current checks.

It is rated at 250 volts a-c and can be used to measure current up to 25 amperes for "Direct Reading" connection and up to 10 amperes for the "Amperes Divided by 10" connection.

No.	Description	Each
9886	Plug-in Adapter.....	\$4.75

Call Graybar FIRST For . . .

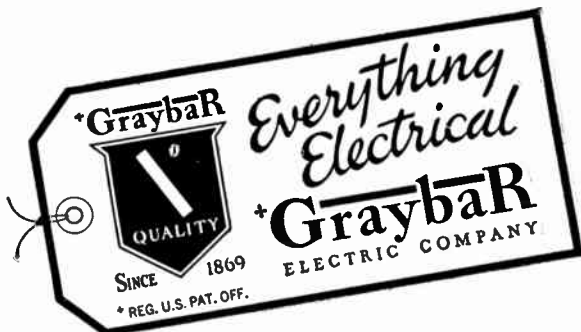

Simpson Dynamometer Instruments
For A-C and D-C



Precision portable instruments offered in a wide selection of ranges to meet most requirements for general purpose. Accurate to 1% of full scale and built to maintain that accuracy.

Large, 4 1/2 in. hand drawn scale, mirrored for easy reading, carries a knife edge pointer.

Cases are heavy molded bakelite. Instruments are for a-c or d-c service.

Model 880 Single Phase Wattmeters

Max. Volts	Amperes		Watts		Each
	Normal	Maximum	Low Range	High Range	
150-300	1	1.5	100	200	\$60.45
150-300	2	3.0	200	400	60.45
150-300	5	7.5	500	1000	60.45
150-300	10	15.0	1000	2000	60.45
150-300	20	30.0	2000	4000	66.00
150-300	50	75.0	5000	10000	66.00

Model 880 Double Current Range Wattmeters

150-300	2.5-5	3.75-7.5	250-500	500-1000	76.95
150-300	5-10	7.5-15	500-1000	2000	76.95

Model 880 Voltmeters

Range	Each	Range	Each
0-150	\$60.45	0-75-150-300	
0-150-300		(Triple Range)	\$76.95
(Double Range)	71.55	0-150-300-600	
		(Triple Range)	76.95

Portable Laboratory Instruments

Same heavy bakelite case as Model 880 above. Mirrored, 4 1/2 in. hand drawn scale with knife edge pointer.

Model 9 has a D'Arsonval movement accurate to 1/2 of 1% of full scale. Model 10 has an iron vane movement accurate to 1% of full scale.

Volts			Milliamperes		
Range	Model 9 D-C	Model 10 A-C	Range	Model 9 D-C	Model 10 A-C
50	\$49.50	\$43.95	1	\$57.15
100	49.50	43.95	50	49.50	\$43.95
150	49.50	43.95	100	49.50	43.95
300	55.00	49.50	500	49.50	43.95
Double Range Volts			Amperes		
15-150	55.00	5	49.50	43.95
150-300	60.45	55.00	15	49.50	43.95
300-750	66.00	60.45	30	49.50	43.95
50	49.50	43.95	50	49.50	43.95
100	49.50	43.95	100	49.50
Triple Range Volts			Triple Range Amperes		
15-150-300	63.75	2-5-10-25		\$60.45
150-300-600	66.00	60.45	10-25-50		60.45
Double Range Milliamps			Microampers		
10-100		\$55.00	50		71.55
25-250		55.00	100		67.00
100-500		55.00	200		64.95
Double Range Amperes					
2.5-5		55.00			
5-10		55.00			

Simpson Panel Meters

2½, 3½, and 4½ in. round and rectangular a-c and d-c panel meters. Engineered and constructed for long life and lasting accuracy. D-C models are supplied with D'Arsonval movements. A-C models have iron-vane movements. Highly polished pivots are set in jewel bearings. All meters are damped and have heavy bakelite cases. Meters are supplied with mounting hardware and template.



Model 125

2½ in. round case, open face style. Flange diameter, 2¾ in. Depth over-all, 2⅝ in. Body diameter, 2⅛ in. Scale length, 1⅞ in.



Model 25

3½ in. round case, open face style. Flange diameter, 3½ in. Depth over-all, 2¼ in. Body diameter, 2¾ in. Scale length, 2⅞ in.



Model 127

2½ in. rectangular case. Width, 2⅜ in. Height, 2⅜ in. Mounts in round hole. Body diameter, 2⅜ in. Scale length, 1⅞ in.



Model 27

3½ in. rectangular case. Width, 3 in. Height, 3⅜ in. Mounts in round hole. Body diameter, 2¾ in. Scale length, 2⅞ in.



Model 29

4½ in. rectangular case. Width, 4½ in. Height, 4⅜ in. Mounts in round hole. Body diameter, 2¾ in. Scale length, 3⅞ in.

Milliammeters

Range	Approx. Resistance Ohms	Model 125 Each	Model 127 Each	Model 25 D-C Each	Model 27 D-C Each	Model 29 Each
0-1	46.00	\$10.20	\$10.20	\$10.65	\$10.65	\$11.85
0-1.5	46.00	10.20	10.20	10.65	10.65	11.85
0-3	46.00	10.20	10.20	10.65	10.65	11.85
0-5	23.00	10.20	10.20	10.65	10.65	11.85
0-10	7.00	10.20	10.20	10.65	10.65	11.85
0-15	1.50	10.20	10.20	10.65	10.65	11.85
0-20	1.00	10.20	10.20	10.65	10.65	11.85
0-25	2.20	10.50	10.50	10.95	10.95	12.45
0-50	3.00	10.50	10.50	10.95	10.95	12.45
0-75	2.00	10.50	10.50	10.95	10.95	12.45
0-100	1.50	10.50	10.50	10.95	10.95	12.45
0-150	1.00	10.50	10.50	10.95	10.95	12.45
0-200	.75	10.50	10.50	10.95	10.95	12.45
0-250	.60	10.50	10.50	10.95	10.95	12.45
0-300	.50	10.50	10.50	10.95	10.95	12.45
0-500	.30	10.50	10.50	10.95	10.95	12.45
0-750	.20	10.50	10.50	10.95	10.95	12.45
0-1000	.15	10.50	10.50	10.95	10.95	12.45

Microammeters

Range	Approx. Resistance Ohms	Model 125 Each	Model 127 Each	Model 25 D-C Each	Model 27 D-C Each	Model 29 Each
0-15	4800			\$21.00	\$21.00	\$22.95
0-25	2200	\$17.85	\$17.85	18.60	18.60	20.70
0-50	2000	15.30	15.30	15.75	15.75	17.10
0-100	2000	13.20	13.20	13.80	13.80	15.45
0-200	1000	11.10	11.10	11.85	11.85	13.20
0-500	200	10.65	10.65	11.25	11.25	12.60
25-0 25	2000			15.90	15.90	17.25
50-0 50	2000			13.95	13.95	15.60
100-0-100	1000			12.00	12.00	13.50
500-0-500	46			10.80	10.80	12.00

Ammeters

Range	Approx. Resistance Ohms	Model 125 Each	Model 127 Each	Model 25 D-C Each	Model 27 D-C Each	Model 29 Each
0-1	.050	\$10.35	\$10.35	\$10.80	\$10.80	\$12.00
0-1.5	.033	10.35	10.35	10.80	10.80	12.00
0-2	.025	10.35	10.35	10.80	10.80	12.00
0-3	.0166	10.35	10.35	10.80	10.80	12.00
0-5	.010	10.35	10.35	10.80	10.80	12.00
0-10	.005	10.35	10.35	10.80	10.80	12.00
0-15	.0033	10.35	10.35	10.80	10.80	12.00
0-25	.002	10.35	10.35	10.80	10.80	12.00
0-30	.00166	10.35	10.35	10.80	10.80	12.00
0-50	.001	10.35	10.35	10.80	10.80	12.00
0-75	5.0	10.35	10.35	10.80	10.80	12.00
0-100	5.0	10.35	10.35	10.80	10.80	12.00
0-150	5.0	10.35	10.35	10.80	10.80	12.00
0-200	5.0	10.35	10.35	10.80	10.80	12.00
0-250	5.0	10.35	10.35	10.80	10.80	12.00
0-300	5.0	10.35	10.35	10.80	10.80	12.00
0-500	5.0	10.35	10.35	10.80	10.80	12.00
0-750	5.0	10.35	10.35	10.80	10.80	12.00
0-1000	5.0	10.35	10.35	10.80	10.80	12.00
15-0-15	.0033	10.95	10.95	11.55	11.55	12.75
30-0-30	.00166	10.95	10.95	11.55	11.55	12.75
50-0-50	.001	10.95	10.95	11.55	11.55	12.75

Voltmeters

Range*	Approx. Resistance Ohms/Volt	Model 125 Each	Model 127 Each	Model 25 D-C Each	Model 27 D-C Each	Model 29 Each
0-1.5	1000	\$10.95	\$10.95	\$11.40	\$11.40	\$12.60
0-3	1000	10.95	10.95	11.40	11.40	12.60
0-5	1000	10.95	10.95	11.40	11.40	12.60
0-8	1000	10.95	10.95	11.40	11.40	12.60
0-10	1000	10.95	10.95	11.40	11.40	12.60
0-15	1000	10.95	10.95	11.40	11.40	12.60
0-25	1000	10.95	10.95	11.40	11.40	12.60
0-30	1000	10.95	10.95	11.40	11.40	12.60
0-50	1000	10.95	10.95	11.40	11.40	12.60
0-100	1000	10.95	10.95	11.40	11.40	12.60
0-150	1000	10.95	10.95	11.40	11.40	12.60
0-200	1000	10.95	10.95	11.40	11.40	12.60
0-250	1000	10.95	10.95	11.40	11.40	12.60
0-300	1000	10.95	10.95	11.40	11.40	12.60
0-500	2000	11.40	11.40	12.00	12.00	13.05
0-750	2000	11.40	11.40	12.00	12.00	13.05
0-1000	2000	13.65	13.65	14.25	14.25	15.45
0-1500	2000	13.65	13.65	14.25	14.25	15.45
0-2000	2000	13.65	13.65	14.25	14.25	15.45
0-2500	2000	13.65	13.65	14.25	14.25	15.45
0-3000	2000	13.65	13.65	14.25	14.25	15.45
0-4000	2000	13.65	13.65	14.25	14.25	15.45
0-5000	2000	13.65	13.65	14.25	14.25	15.45

*External resistors are furnished on a-c meters having a range of 500 volts or higher; d-c, 1000 volts or higher.

Millivoltmeters

Range	Approx. Resistance Ohms	Model 125 Each	Model 127 Each	Model 25 D-C Each	Model 27 D-C Each	Model 29 Each
0-50	5	\$10.35	\$10.35	\$10.80	\$10.80	\$12.00
0-100	10	10.35	10.35	10.80	10.80	12.00

Simpson Wide-Vue Panel Meters



All Wide-Vue meters listed below are supplied with new core magnet movement (except 0-25, 0-50 d-c microammeters and V. U. meters).

The core magnet movement is self-shielded and requires no calibration allowances for mounting on steel panels.

One-piece covers for these 3 1/2 in. size meters are molded from clear methyl methacrylate. Scale lengths are extra long for easy reading. Meters supplied complete with hardware and mounting template.

3 1/2-in. D-C Voltmeters

Range Volts	Approx. Resistance Ohms/Volt	Model 1327 Each	Range Volts	Approx. Resistance Ohms/Volt	Model 1327 Each
0-10	1000	\$12.00	0-100	1000	\$12.00
0-15	1000	12.00	0-150	1000	12.00
0-25	1000	12.00	0-300	1000	12.00
0-30	1000	12.00	0-500	2000	12.60
0-50	1000	12.00			

3 1/2-in. D-C Millivoltmeter

Range	Approx. Resistance Ohms	Model 1327 Each
0-50	5	\$11.40

3 1/2-in. D-C Ammeters

D-C ammeters for ranges up to and including 50 amperes have internal shunts.

Range Amperes	Approx. Resistance Ohms	Model 1327 Each	Range Amperes	Approx. Resistance Ohms	Model 1327 Each
0-1	.050	\$11.40	0-10	.005	\$11.40
0-2	.025	11.40	0-15	.0033	11.40
0-3	.0166	11.40	0-25	.002	11.40
0-5	.010	11.40	0-50	.001	11.40

3 1/2-in. D-C Milliammeters

Range Milli-Amps.	Approx. Resistance Ohms	Model 1327 Each	Range Milli-Amps.	Approx. Resistance Ohms	Model 1327 Each
0-1	46.00	\$11.25	0-100	1.50	\$11.55
0-5	23.00	11.25	0-150	1.00	11.55
0-10	7.00	11.25	0-200	.75	11.55
0-25	2.00	11.55	0-250	.60	11.55
0-50	3.00	11.55	0-300	.50	11.55
			0 500	.30	11.55

3 1/2-in. D-C Microammeters

Range Micro-Amps.	Approx. Resistance Ohms	Model 1327 Each	Range Micro-Amps.	Approx. Resistance Ohms	Model 1327 Each
0-25*	2200	\$18.60	0-200	1000	\$12.45
0-50*	2000	15.75	0-500	200	11.85
0-100	2000	14.40	50-0-50	2000	14.55

*Has external magnet type movement.

3 1/2-in. D-C Galvanometers

Scale	Sensitivity Microamperes	Resistance Ohms	Model 1327 Each
50-0-50	500-0-500	46	\$11.40
50-0-50	75-0-75	2000	13.35

Simpson Horizontal Edgewise Panel Meters

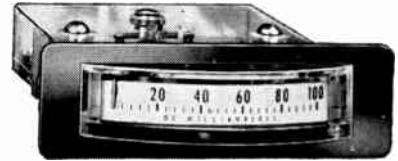

Edgewise meters require only half the panel area yet provide a scale length comparable to a conventional 2 1/2-in. meter. Choice of two self-shielded core magnet meter movements offers a wide range of sensitivities.

Edgewise meters are supplied complete with mounting hardware and meet these specifications:

Accuracy: D-C, 2% of full scale. A-C rectifier type, 5% of full scale.

Types: D-C and A-C rectifier.

Pointers: Knife-edge, lance, and spade types.

Scale length: 1 7/8 in.

Case: Dustproof, molded lucite.

Standard scale: Black numbers on white background.

Terminals: Solder or stud type.

Weight: Approximately 5 oz.

Model 1502—2 1/2-in. D-C

Type	Each	Type	Each
0-50 Voltmeter	\$12.60	0-10 Milliammeter	\$13.05
0-150 Voltmeter	12.60	0-100 Milliammeter	13.05
0-500 D-C Voltmeter	12.75	0-500 Milliammeter	13.05
0-5 Ammeter	13.35	0-50 Microammeter	18.15
0-10 Ammeter	13.35	0-100 Microammeter	16.05
0-1 Milliammeter	13.05		

Model 1507—2 1/2-in. VU

Description	Each
VU Meter "A" Scale	\$21.60
VU Meter "B" Scale	21.60

Simpson Elapsed Time Meters

No.	Operating Current	Each
55ET	120 volts—60 cycle	\$16.95
56ET	120 volts—60 cycle	16.95
57ET	120 volts—60 cycle	16.95
55ET	240 volts—60 cycle	17.25
56ET	240 volts—60 cycle	17.25
57ET	240 volts—60 cycle	17.25

Models 55ET and 56ET are 2 1/2-in. round meters.

Simpson Plate Conductance Tube Testers



Tests any receiving tube, including 9 pin miniatures and sub-miniatures with base arrangements in a line or circle. Extra low volt leakage test will not damage any tube.

The Model 1000 is ideal for radio-TV and industrial control servicing.

Plate conductance method provides simple, positive and accurate tests.

Snap-out snap-in transparent plastic windows are provided over the roll chart. Add new tube data at any time.

Model 1000 operates on a line voltage of 105-125 volts, 50-60 cycles. Supplied complete with operator's manual.

No.	Length In.	Depth In.	Height In.	Shpg. Wt. Lbs.	Each
1000	15 3/4	6	11 3/4	19	\$135.00

Simpson Line-O-Meters



Line current capacity tester pre-tests the ability of existing electrical circuits to furnish motor starting current from 13 to 50 amps. Size 3 1/16x5 1/2x2 1/2 in. Weight 2 lbs.

No. 397.....Each \$29.95

**Simpson Volt-Ohm-Milliammeters
For A-C and D-C**

Model 260

Multi-purpose tester provides quick, accurate electrical checks.

29 ranges . . . 20,000 ohms per volt d-c . . . 5,000 ohms per volt a-c.

Volts, a-c and d-c: 2, 5, 10, 50, 250, 1000, 5000.

AF, output: 2.5, 10, 50, 250.

Decibels: -20 to +50 decibels in 4 ranges.

Current, d-c; 50 mca; 1, 10, 100, 500 ma; 10 a.

Ohms: 0-2K (12 ohms center), 0-200K (1200 ohms center), 0-20 meg. (120K center).

Supplied complete with test leads and operator's manual.

No.	Width In.	Height In.	Depth In.	Shpg. Wt. Lbs.	Each
260	5 1/4	7	3 1/8	6	\$43.95
260IRT	As above but in roll top safety case				49.95



Model 262

Deluxe instrument offers 33 ranges on big 7-in. scale.

Shielded core magnet meter movement permits compact design for easy portability.

D-C volts: 1.6, 8, 40, 160, 400, 1600, 4000 . . . 20,000 ohms per volt.

A-C volts: 3, 8, 40, 160, 800 . . . 5000 ohms per volt.

AF output voltage: 3, 8, 40, 160 volts.

Volume level in decibels: -12 to +45.5 decibels in 4 ranges.

D-C resistance: 0-500 ohms (4.5 center); 0-5K ohms (45 ohms center); 0-50K ohms (450 ohms center); 0-500K ohms (4500 ohms center); 5 megohms (45K ohms center); 0-50 megohms (450K ohms center).

D-C current: 80, 160 ua; 1.6, 16, 160 ma; 1.6, 16 a.

Supplied complete with leads and operator's manual.

No.	Width In.	Height In.	Depth In.	Shpg. Wt. Lbs.	Each
262	7 1/16	6	2 1/16	6	\$59.50



Model 240

Designed for radio testing . . . 1000 ohms per volt, a-c and d-c.

A-C volts: 15, 150, 750, 3000.

D-C volts: 15, 75, 300, 750, 3000.

D-C milliamperes: 15, 150, 750.

Ohms: 0-3000 (center scale 30); 0-300,000 (center scale 3000).

Supplied complete with leads and operator's manual.

Model 240 Each \$28.95



Model 230

Low cost multi-purpose tester ideal for many industrial test needs.

A-C volts: 10, 250, 1000, (400 ohms per volt).

D-C volts: 10, 50, 250, 1000, (1000 ohms per volt).

D-C milliamperes: 10, 50, 250.

Ohms: 0-1000, 0-100,000.

Model 230 supplied complete with leads and operator's manual.

Model 230 Each \$27.95



**Simpson Volt-Wattmeters
For A-C and D-C**

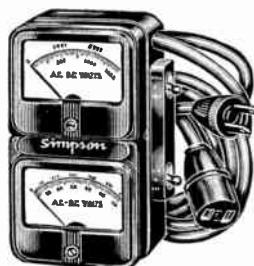

Model 391



Model 392

A-C, d-c volt-wattmeters used for simultaneous readings of volts and watts. Each has 2 separate 3-in. sq. meters, built-in cord and plug for connection to the line outlet, and separate toggle switches for range selection, a-c or d-c. Supplied complete with cord, plug and operator's manual.

No.	Ranges	Volts	Watts	Each
391	A-C, D-C	0-130	0-1500	\$34.95
		0-260	0-3000	
392	A-C, D-C	0-130	0-1000	37.95
		0-260	0-5000	

Simpson A-C Volt-Amp-Wattmeters



Ruggedly built tester provides four wattage ranges which cover testing requirements for practically any appliance.

Volts: 0-150, 300.

Amps: 0.3, 15.

Watts: 0-300, 600, 1500, 3000.

Tester supplied complete with break-in plug, leads, and operator's manual.

Model 390 Each \$43.95

Simpson Vacuum Tube Volt-Ohmmeters



Unusually versatile instrument with easy-to-read 4 1/2 in. scale may be used as an electronic d-c voltmeter, ohmmeter, a-c or AF voltmeter, RF voltmeter (with accessory probe), output-meter, and other applications.

Model 303 is supplied with DCV probe, ACV-ohms probe, ground lead and operator's manual.

D-C voltage: ranges—1.2, 12, 60, 300, 1200.

Ohms: 1K ohms (10 ohms center); 100K ohms (1000 ohms center); 1 megohm (10K ohms center); 10 megohms (100K ohms center); 1000 megohms (10 megohms center).

A-C voltage: ranges—1.2, 12, 60, 300, 1200.

AF voltage: ranges—1.2, 12, 60.

Decibels: -20 to +63 decibels in 5 ranges.

RF voltage: range—20 volts maximum. Frequency flat 20 Kc to 100 Mc.

Line voltage: 105-125 volts, 50/60 cycles.

Model 303 Each \$68.00

Simpson Carrying Cases

Simpson Ever-Ready instrument carrying cases protect instruments and save time.

Large, one-piece lid folds back to expose meter and selection switches. Flip the lid and the tester is ready for instant operation.



No. 4326

No.	Description	Each
4236	Vinyl case for Models 260, 303	\$9.75
1818	Leather case for Model 260	7.75

**Simpson Volt-Ohm Microammeters
For A-C and D-C**



Self-shielded movement for dependable performance. 100,000 ohms per volt capacity makes the Model 269 a suitable replacement for VTVM's for many voltage and resistance checks.

D-C Volts: 1.6, 8, 40, 160, 400, 1600, 4000 . . . 100,000 ohms per volt.

A-C Volts: 3, 8, 40, 160, 800 . . . 5000 ohms per volt.

AF output voltage: 3, 8, 40, 160 volts.

Volume level in decibels: -12 to +45.5 decibels in 4 ranges.

D-C resistance: 0-2K ohms (18 ohms center); 0-20K ohms (180 ohms center); 0-200K ohms (1800 ohms center); 0-2 megohms (18K ohms center); 0-20 megohms (180K ohms center); 0-200 megohms (1.8 megohms center).

D-C current: 0-16, 0-160 ua; 0-1.6, 0-16, 0-160 ma; 0-1.6, 0-16 a.

Tester supplied complete with leads and operator's manual. Weight, 4 lbs.

No.	Length, In.	Height, In.	Depth, In.	Shpg. Wt. Lbs.	Each
269	7 ¹⁵ / ₁₆	6	2 ¹⁵ / ₁₆	6	\$88.00

Simpson Midgetesters



Self-shielded a-c d-c volt-ohmmeter that fits in your shirt pocket. Rated at 10,000 ohms per volt a-c or d-c. Ideal for appliance repair, radio-TV service. Utilizes a rugged core magnet meter movement.

D-C voltage: 3, 12, 60, 300, 1200.

A-C voltage: 3, 12, 60, 300, 1200.

D-C resistances: 0-10K ohms (120 ohms center); 0-100K ohms (1200 ohms center); 0-1 megohm (12K ohms center); 0-10 megohms (120K ohms center).

Supplied complete with leads and operator's manual.

No.	Width, In.	Height, In.	Depth, In.	Weight, Oz.	Each
355	2 ³ / ₄	4 ¹ / ₂	1	7	\$34.95

Simpson Low-Ohm-Meters

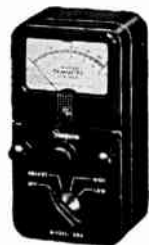

Features greater accuracy from 0.1 to 25 ohms and low circuit current. Utilizes currents of only 5 ma maximum, which assures damage-free testing of low current components. Accuracy is 3% of the full scale value, in two ranges, 0-5 ohms and 0-25 ohms.

Checking motor armatures and fields, switch and relay contact resistances, shorts between generator windings and grounds, shorts in TV and radio chassis wiring, electrical equipment in industrial plants are typical uses.

Supplied with calibrated test leads.

No.	Height, In.	Width, In.	Depth, In.	Each
362	5 ⁷ / ₈	3	2 ¹ / ₂	\$24.95

Simpson Ohmmeters



Broadly useful instrument features a wide range of measurements from 0.2 ohm to 50 megohms in 6 ranges.

Center scale values are 5 ohms, 50 ohms, 500 ohms, 5000 ohms, 50,000 ohms, and 500,000 ohms.

Ohmmeter supplied complete with leads and operator's manual.

Model 372 Each \$27.95

Simpson Handiscopes



Handles practically any TV-radio job. Small, handy size and rugged construction mean you can carry it anywhere. Take reading of 5-in. screen.

Frequency response of vertical amplifier: from 15 cycles/sec. to 100 Kc/sec., flat within ±1 db.; 6 db. down at 250 Kc/sec.; usable to 1 Mc/sec.

Maximum vertical deflection sensitivity: 30 millivolts RMS/inch.

Frequency response of horizontal amplifier: from 15 cycles/sec. to 20 Kc/sec., flat within ±1 db.; 6 db. down at 100 Kc/sec.

Maximum horizontal deflection sensitivity: 0.7 volt RMS/inch.

Z-axis sensitivity (voltage required to extinguish beam): 20 volts RMS.

Calibrating voltage (at 117.5 vac power source): 1 volt P-P ±10%.

Maximum input voltage: 100 volts peak.

Input resistance: 0.1 Meg (at atten. x 1); 0.5 Meg (at atten. x 100).

Input capacitance: 40 uuf (at atten. x 1); 35 uuf (at atten. x 100).

Sawtooth sweep range: 15 cycles/sec. to 80 Kc/sec.

Power consumption: (at 117.5 volts a-c) 50 watts ±10%.

Handiscope supplied complete with lead and operator's manual.

No.	Height, In.	Width, In.	Depth, In.	Each
466	12 ¹ / ₄	8	16 ¹ / ₄	\$144.95

Simpson Therm-O-Meters



Takes temperature of air, gases, solids, or liquids with 7¹/₂ in. thermocouple leads.

Measures -50° to +1000°F.

Two models, each supplied with internal battery and one 7¹/₂ in. general purpose probe.

Size is 7¹⁵/₁₆ x 6 x 2¹⁵/₁₆ inch. Operator's manual included.

Model 388-3L (for up to 3 probes) supplied with one general purpose probe. Each \$64.50

Model 388 (for 1 probe) supplied with one general purpose probe. Each \$59.50

Simpson Temperature Meters



Compact instrument developed principally for refrigeration equipment measures temperatures from +70°F. to as low as -50°F. Operator's manual included.

Model 385-3L (for up to 3 probes) supplied with 1 general purpose, 15-in. Thermistor lead. Each \$33.95

Model 385 (for 1 probe) supplied with 1 general purpose, 15-in. Thermistor lead. Each \$30.00

**Simpson Millivoltmeters
For Servicing Gas-Fired Equipment**



Check the millivolt output of safety thermocouples by simply placing probe leads across the thermocouple terminals and taking your reading.

Ranges: 10, 30, 100, 300, 100 millivolts. Accuracy: 3% of full scale from 50-120°F.

Supplied with 48-in. leads with alligator clips and instructions.

No.	Height, In.	Width, In.	Depth, In.	Wt. Lbs.	Each
387	3 ³ / ₈	3	2 ¹ / ₂	1 ¹ / ₂	\$29.95

Associated Research Electrical Testing Instruments

Vibrotest Insulation Resistance Testers



Vibrotest megohmmeters give fast, accurate insulation resistance measurements for complete electrical testing of circuits, panels, motors, circuit-breakers, cable and wiring. Many models have ohm and a-c and d-c voltage ranges. All-electric, self-contained, push-button operation, requiring no cranking or leveling. All tests made from one set of binding posts, readings made on large 4½-in. meter. All steel case size 8⅞-in. x 6-in. x 8¼-in. Complete with test leads, batteries, record cards and instruction manual.

Model	Megohm Range	D-C Test Volts	Ohm Range	Voltage A-C	Ranges D-C	Each
For General Industrial Maintenance						
201	0-200	500	0-2000	0-150/300/600	0-150/300/600	\$136.50
For Production Testing and Maintenance						
218	0-100	500				114.75
224	0-100/1000	500				187.50
For Utilities and Heavy Duty Industrial Use						
211	0-200/2000	1000	0-200,000			249.50
For Railway Applications						
205	0-200	500	0-20,000	0-150/300/750	0-150/750/1500	182.00

Vibroground Ground Resistance Testers



Vibroground tests are the quick, sure way to check resistance to earth of man-made grounds to insure safety of personnel and equipment from lightning or superimposed voltages from other circuits. No cranking, leveling or complex calculations are necessary with Vibroground. Accurate readings are made directly from instrument panel with null balance meter, potentiometer and range selector. Fully portable in enameled steel cases, size 6-in. x 9-in. x 8½-in. Furnished with batteries and instruction manual.

Model	Ranges	Each
251	0-12.5, 0-125, 0-1250 ohms	\$120.50
255	0-3, 0-30, 0-300, 0-3,000 ohms	142.50

Vibroground Test Kit

Consists of 2 T-shaped reference ground rods, 18-in. long; 1 test lead 40-ft. long; 1 test lead 20-ft. long; 1 test lead 5-ft. long; durable carrying case for complete kit. Leads are kinkless, rubber-covered, with spade terminals at both ends. No. **7104**.....Each **\$27.50**

Vibroground Model 263A

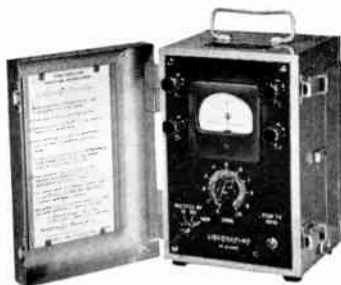

Designed for testing soil resistivity, anode-ground resistance and circuit resistance. Rugged, lightweight self-contained field instrument, powered by 8 standard flashlight batteries. Accurate, highly sensitive, simple to use and read directly from instrument panel.

Provided with all steel enameled case with removable cover 9-in. x 6-in. x 6½-in.

Model	Ranges	Each
263A	0-1, 0-10, 0-100, 0-1000 ohms	\$152.50

For additional information contact Graybar.

Phase Sequence Indicator



Fast, positive phase sequence indication with this A.R.I. instrument saves time and guesswork, speeds wiring 3-phase circuits operating at 120, 240 or 480 volts. Instant reading light indication of sequence. No batteries, moving parts or binding posts.

Pocket size only 3-in. x 5-in. x 2-in. Weighs less than a pound.

Model	Cycle	Each
40	60	\$27.50
44	400	34.75

For additional information contact Graybar.

**Associated Research
Electrical Testing Instruments**

"Hypot" High Potential Testers



Model 412

Makes high-voltage a-c tests for leakage, breakdown and shorts; gives clear visual indications by means of glow lights on the instrument panel. Actual voltage output across transformer secondary shown on 1½-in. meter. Breakdown or short causes automatic voltage collapse for safety and non-destructive testing of circuits, components, small meters, etc.

Provided with all steel enameled case, size 6-in. x 9-in. x 8½-in. Furnished complete with leads and instruction manual.

Model	Output Range A-C Volts	Primary Cap. V. A.	Each
412	0-1500	50	\$137.50
411	0-2500	75	144.50
404	0-4000	100	150.00
405	0-5000	100	167.50
414	0-6000	140	182.50

Direct-Current



Model 424

Direct-current Hypots of comparable test capacities are generally smaller and much less expensive than equivalent a-c instruments. In addition, they show true leakage current directly when testing wire and cable, large motors, transformers, bushings, etc.

Soundly engineered and built for dependable, accurate operation under production-line or field conditions.

Case is gray wrinkle-finish steel, rack and panel type, 22-in. wide, 11¾-in. deep and 12⅝-in. high.

Input 115 V. A.C., 50/60 cycle.

Model	Output Voltage Continuously Variable	Metering	Each
424	0-5000 V. D.C.	1½-in. d-c voltmeter Calibrated 0-5 KV d-c. 4½-in. micro ammeter, ranges 0-5/10/50/100 microamps...	\$397.50
*421	0-10,000 V. D.C.	1½-in. d-c voltmeter Calibrated 0-10 KV d-c. 4½-in. micro ammeter, range 0-500 microamps.....	387.50

*Same as Model 421 except equipped with high-voltage bushing which stands 1¾-in. above case. For additional information contact Graybar.

Jackson Wire Tracers

Trace-O-Meter



Fast, low cost circuit tracer for multi-conductor cables does complete job without need for color coding.

Built-in neon lamp shows whether voltage is a-c or d-c also gives indication of amount by brightness of glow. Range: 60 to 600 volts a-c. 80 to 600 volts d-c.

Traces 30,000 ft. #10 AWG or 2,500 ft. #22 AWG with nine test blocks.

Black non-metallic case. Blue-gray carrying case, battery and test leads furnished.

Meter marked for "opens", "shorts" and nine conductor circuits.

No.	Width In.	Length In.	Depth In.	Ship. Wt. Lbs.	Each
90	3¾	6¼	2½	5	\$39.95

Biddle Meg Type Megger Insulation Testers

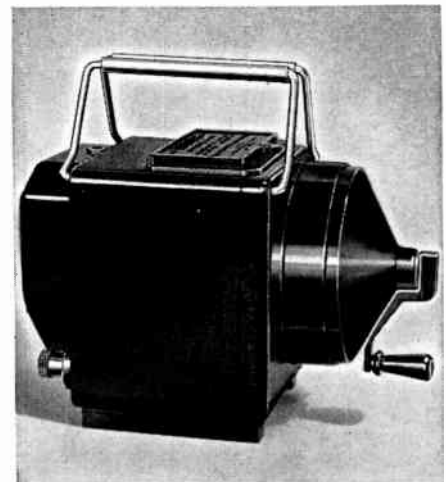

This popular Meg type of Megger insulation tester is a conveniently portable instrument with constant voltage hand generator. This compact, easy-to-use instrument has become the most popular of all Megger Testers simply because of its quick availability for service at any time—no dependence on batteries or other current supply.

Easy to use—easy to read—and rugged in constant service.

Weight 8 lbs.

No.	Description	Each
7676	0 to 200 megohms, 500 volt d-c, complete with No. 7699 Fabrikoid case and 12 Ft. lead...	\$250.00

Note: Other ranges up to 2000 megohms, 1000 volts d-c available.

Biddle Midget Megger Insulation Resistance Testers

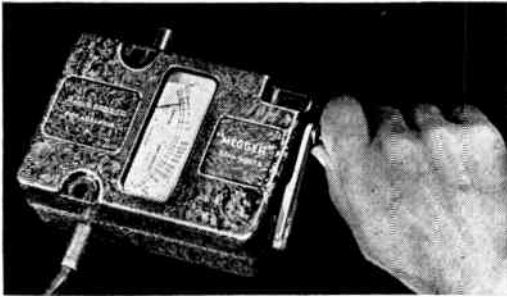

A compact and rugged little set for detecting and diagnosing faulty insulation before serious and costly damage occurs.

Camera-type leather case permits operation without removal from case.

For rugged shop and field use. Range 50 megohms, 500 volts d-c.

Weight complete 4 lbs.

No. 705 with No. 7716 leather case and 12-ft. leads..... Each **\$115.00**

Biddle Meg Type Megger Ground Testers

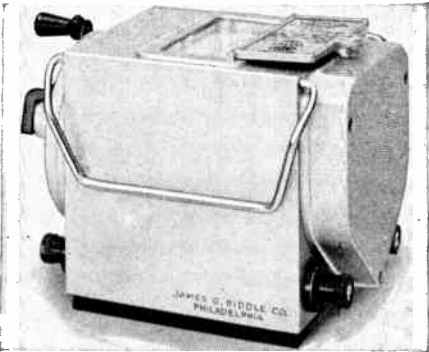

For measuring resistance to earth of ground connections. The method is quick, easy and economical, requiring no previous experience. Weight 7½ lbs., mounted in cast aluminum case. Scales are logarithmic in character, so as to cover as wide range as possible within the limits of practical field accuracy. Range 0 to 300 ohms.

No.	Description	Each
563	Meg Type Megger Ground Tester with No. 693 Fabrikoid Case.....	\$262.00

Note: Other models available, ranges 0 to 30,000 ohms.

Biddle Motor Rotation Testers

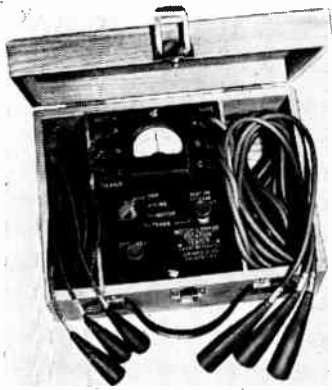

Saves time in electric motor hook-ups, eliminates guesswork and danger.

With it you can easily and quickly determine the direction of rotation of any size of 1, 2 or 3-phase motor and make your first connection permanent; also test circuits, check phase sequence and identify windings of multi-speed or multi-voltage motors.

Weight, approx. 10 lbs.

No. 7370 Complete with leads..... Each **\$80.00**

Biddle "Seely" Motor Testers

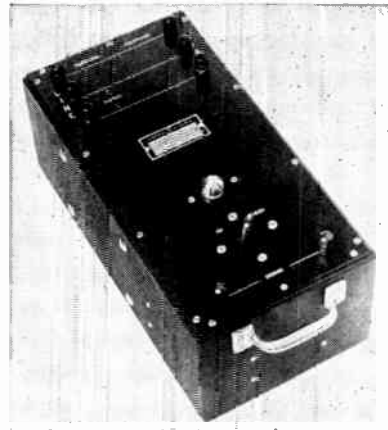

For measuring the electric resistance of a-c energized windings while at the same time observing winding temperatures under actual load conditions.

Particularly effective for testing hermetic refrigeration motors, since thermocouples cannot be readily used and since motors cannot be shut down during test for resistance readings, without disrupting the test.

No.	Description	Each
7400	Seely Motor Tester single phase 120 volt, 15 amperes, frequency 50/400 cps., resistance ohms 0.2—200, weight 29 lbs.....	\$345.00

Biddle Jagabi® Speed Indicators



The Jagabi speed indicator for measuring average number of revolutions per minute without any calculations, for speeds up to 20,000 rpm. After a short interval of 3 or 6 seconds of running time, the hands stop automatically at positions which indicate the measured speed.

The instruments do not show instantaneous speeds or speed variations. The spindle is set in ball bearings thereby eliminating need for lubrication. Weight 1 lb.

No.	Description	Each
9920	Complete with case and accessories.....	\$44.00

Note: Other ranges available up to 100,000 rpm.

**Biddle Hand Tachometer
Frahm Miniature**

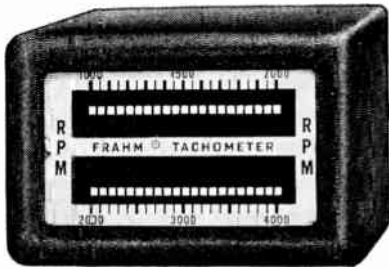

Frahm miniature hand tachometer range 1000-4000 rpm for measuring speed simply by touching the instrument to the operating equipment . . . no need to come in contact with moving parts. Accurate and dependable, direct reading in rpm easily and quickly. Approx. wt. 1 lb.

No.	Description	Each
2516	Tachometer 1000-4000 rpm	\$40.00

Note: Other ranges available 1000 to 100,000 rpm.

**Biddle Jagabi® DO Type Precision Hand
Tachometers**

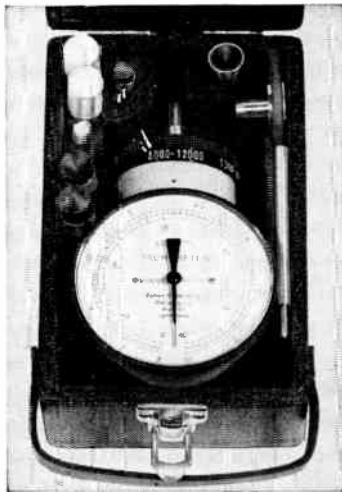

Has 5 ranges 30-120, 100-400, 300-1200, 1000-4000, 3000-12,000 rpm. It is direct indicating, shows instantaneous speeds and speed variations.

Built-in refinements include ball bearings, thrust plates, ample size gears, overspeed protection and jewel bearings for the indicating mechanism.

Ranges up to 48,000 rpm available. Weight 2 lbs.

No. 554 Complete with case and accessories . . . Each \$72.00

**Biddle "TTR" Transformer Turn Ratio
Test Set**



A portable, simple-to-use and highly accurate device for measuring turn ratio in power and distribution transformers, including auto-transformers. Invaluable for checking new units and units during and after repairs. Size 14½ x 8 x 9½ in.; weight approximately 31 lbs.

No. 55903, Model 3 Each \$790.00

**Biddle Frahm Resonant Reed Miniature
Frequency Meters**



Frahm resonant reed miniature frequency meter having 11 reeds calibrated 55/65 cps. One cycle interval between reeds, for operation on 100/150 volts. Inherent simplicity, accurate, long life, low power consumption. Approx. wt. 1 lb.

No.	Description	Each
4967	Frahm resonant reed miniature frequency meters	\$22.00

Note: Other ranges available from 10 to 1000 cps.

Sunshine GEL Time Meter

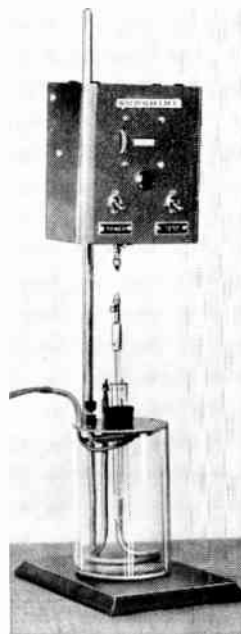

To identify gelation point of thermosetting compositions.

During polymerization, fluid thermosetting compositions such as monomers, resins, and varnishes pass through a critical point at which the viscosity increases suddenly.

The length of time required to reach this point of gelation is important for both quality control and research because it is a relative measure of the rate of the polymerization process.

The gel time meter is a comparative viscosimeter designed to measure this characteristic property.

No. 22 Each \$276.00

Sunshine Switchboard Electric Clocks

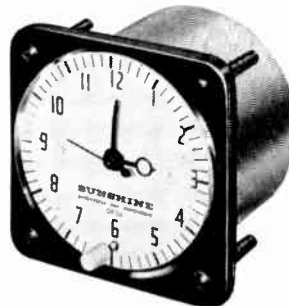

An attractive electric clock matching G. E. Switchboard types AB-18 and DB-18 in frontal appearance and mounting dimensions.

Case design eliminates scale shadow caused by overhead lighting and is dust tight.

Also available equipped with a timing switch for process or alarm timing.

No. 31A Each \$70.00

Sunshine Coil Turn Counter



The coil-turn counter is used in factories and laboratories for determining or checking the number of turns in air-core electric coils which can be placed over a $\frac{1}{16}$ -inch or $\frac{1}{4}$ -inch core.

Three models are available with the following ranges: 0-11, 110 turns; 0-31, 110 turns; or 0-61, 110 turns.

This unit indicates a coil turn count with an accuracy of 0.1 percent and makes it possible to meet the most exacting specifications.

No.	Description	Each
16-1A	Counter—Less Rods	\$1825 00
16-1B	Counter—Less Rods	1900 00
16-1C	Counter—Less Rods	1975 00
A16	Magnetizing Rods	256 00
B16	Magnetizing Rods	335 00

Sunshine Coil Tester



A single short circuited turn of #12 AWG copper wire can be detected with this sensitive tester.

Valuable before assembly of coils in relays, radios, small transformers, instruments, etc.

No.	Description	Each
10	Coil Tester—Complete	\$355 00
T10	Less Core and Coil Assembly	195 00
A10	Core and Coil Assembly— $\frac{1}{2}$ "	160 00
B10	Core and Coil Assembly— $\frac{5}{16}$ "	160 00

Sunshine Metals Comparator

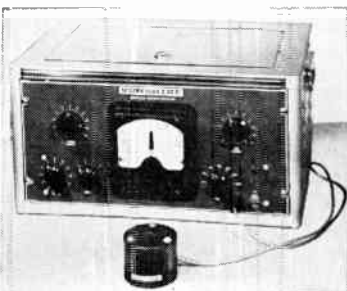

Ferrous or non-ferrous parts are compared against a pre-selected standard to detect differences in composition, heat treatment, hardness, plating thickness, case depth, or other characteristics which alter the resistivity or magnetic properties.

No. 27 Comparator—Less Test Heads and Coils. . . . \$898. 00

No.	Description	Per Pair	No.	Description	Per Pair
L27A&1127A	$\frac{1}{4}$ In. Coils	\$97 00	L275&11275	5 In. Coils	\$159 00
L27B&1127B	$\frac{3}{8}$ In. Coils	97 00	L278&11278	8 In. Coils	197 00
L271&11271	1 In. Coils	97 00	No.	Description	Each
L272&11272	2 In. Coils	97 00	T27A	Test Head	\$63 00
L273&11273	3 In. Coils	109 00	T27B	Test Head	99 00

Sunshine Magnetic Comparator

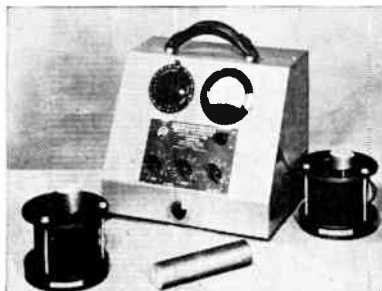

Ferrous parts are compared against a pre-selected standard to detect differences in composition, heat treatment, hardness or other characteristics which alter the resistivity or magnetic properties.

No. 26 Comparator—Less Gage Heads and Coils. . . . \$470 00

No.	Description	Per Pair	No.	Description	Per Pair
T26	Gage Heads	\$126 00	262	2 In. Coils	\$80 00
A26	$\frac{1}{4}$ In. Coils	72 00	263	3 In. Coils	87 00
B26	$\frac{3}{8}$ In. Coils	80 00	264	4 In. Coils	129 00
C26	$\frac{1}{2}$ In. Coils	80 00	265	5 In. Coils	149 00
261	1 In. Coils	80 00	266	6 In. Coils	179 00

Sunshine Anodized Aluminum Tester

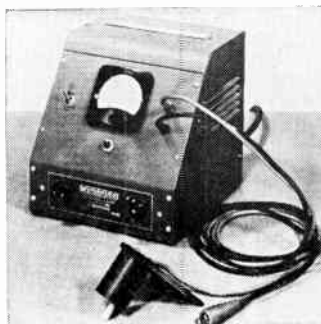

The tester quickly and accurately determines the effectiveness with which either a chromic or sulphuric acid type anodized coating has been applied to an aluminum surface.

No. 12 . . . Each \$295 00

Sunshine Analog Field Plotter

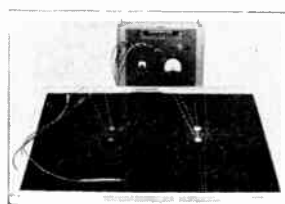

The plotter solves problems by means of electric flow patterns set up in a sheet of semi-conducting paper.

There is an analogy between the electrical field and similar fields as found in electrostatics, electromagnetics, aerodynamics, thermal flow and fluid flow.

No.	Description	Each
24-1A	Industrial Model	\$295 00
24-1B	Educational Model	295 00
P24	Conducting Paper—Roll	7 50
C24	Conducting Paint—Bottle	8 00

Sunshine Lamp Type Ground Detector



A Switchboard-type instrument matching the G.E. AB-18 long scale instrument cases, using lamps as a means of detection.

Lamps are rated at 120 volts or 240 volts.

Under normal operation all lamps glow dimly. When a ground occurs the corresponding lamp goes out and the remaining ones glow brightly.

No. 32. Each \$60. 00

Exide Storage Batteries

In Multi-cell

These new batteries in plastic have been designed and engineered to give—

Long, Trouble-free Life.

Unsurpassed Dependability for the most vital applications.

Low Operating Cost. Extremely low internal resistance and losses, hence minimum charge currents are required.

Low Maintenance Cost. No solutions to change, nothing to renew, require water only once or twice a year. Smooth, streamline design facilitates cleaning.

Increased Power (watt) output per unit of space.

Less Weight per ampere-hour output.

More Attractive Installations.

Less Space Required.

Highly-sustained Useful Voltage even under heavy discharge.

Damage Resistant.

Transparent as glass, the plastic containers and covers are lighter in weight, more compact and possess much greater shock-resistance. The plastic is polystyrene—impervious to electrolyte—annealed for high mechanical strength and heat resistance. The cover seal is permanent—electrolyte will not leak out. Container surface is smooth and easily kept clean.

Elements are precision-fit and cover-suspended. Adequate water space is provided. Lines on all four sides of the container show recommended upper and lower electrolyte levels. Pilot balls indicate approximate state of charge. Units are supplied filled and charged (charged and wet) ready for use. They can be supplied charged and dry without electrolyte in the cells. Terminals come equipped with connector bolts. Interunit connectors are furnished when two or more units are ordered.

Type PLX



Type 3-PLX-13

For telephone, emergency lighting, laboratory and many other services. Batteries assembled in two and three compartment plastic containers. Two cell unit equipped with one set of pilot balls. Three cell unit has two sets of pilot balls.

Have double insulation of Mipor rubber separators and Vitrex retainers. Width 7⁵/₁₆-in., hgt. 10³/₈-in.

Full charge specific gravity 1.200—1.220.

Plate Dimensions

Description	Hgt., In.	Width, In.	Thick., In.
Type PLX Positive	4 ¹⁵ / ₁₆	5 ¹¹ / ₁₆	5 ⁷ / ₃₂
Type PLX Negative (inside)	4 ¹⁵ / ₁₆	5 ¹¹ / ₁₆	7 ⁷ / ₈
Type PLX Negative (outside)	4 ¹⁵ / ₁₆	5 ¹¹ / ₁₆	5 ⁷ / ₃₂

Table of Capacities

With Explosion Control Feature	W/O Explosion Control Feature	Type	Ampere Hours to 1.75 V.P.C.		Lgth., In.
			8 Hrs.	3 Hrs.	
41040	50093	2-PLX-7	50	38	4 ¹⁵ / ₁₆
41042	50095	3-PLX-7	50	38	6 ⁷ / ₁₆
41044	50097	2-PLX-13	100	76	7 ³ / ₄
41046	50099	3-PLX-13	100	76	11 ³ / ₈

Manchex



Type 3-CME-5 Side-to-Side

Small power in plastic. Has the famous Exide long life manchester positive plate.

Double insulation with microporous separators together with slotted plastic separators. These provide maximum insulation with minimum resistance between plates.

Unbreakable and sprayproof plastic vent plugs. Addition of water made easy by molded-in-cover funnel filling vent.

Available in three styles of containers in capacities of 8, 16, and 24 A. H. at the 8 hour rate.

†End-to-End Assembly

No.	Type & Size of Unit	*Capacity Amp. Hrs.	Length Inches	Approx. Wt. Net	Lbs. Ship.
43849	2-CME-3	8	2 ⁷ / ₁₆	10.5	14.0
43851	2-CME-5	16	2 ⁷ / ₁₆	14.0	17.0
43875	2-CME-7	24	3 ¹ / ₄	19.5	24.0

‡Side-to-Side Assembly

No.	Type & Size of Unit	*Capacity Amp. Hrs.	Length Inches	Approx. Wt. Net	Lbs. Ship.
43859	2-CME-3	8	4 ¹⁵ / ₃₂	10.5	14.0
43867	3-CME-3	8	6 ¹⁹ / ₃₂	15.5	20.0
43861	2-CME-5	16	4 ¹⁵ / ₃₂	14.0	17.0
43869	3-CME-5	16	6 ¹⁹ / ₃₂	20.5	25.0
43880	2-CME-7	24	6 ¹ / ₈	19.5	24.0
43884	3-CME-7	24	9	29.0	34.0

*Ampere Hours capacity at 8 hour rate to 1.75 final volts per cell.

†End to End assembly width and height are 8" and 8¹/₂" respectively.

‡Side to Side assembly width and height are 4¹/₄" and 8¹/₂" respectively.

Tytex

#End-to-End Assembly

No.	Type & Size of Units	*Capacity Amp. Hrs.	Length Inches	Approx. Wt. Net	Lbs. Ship.
43850	2-COE-3	10	2 ⁷ / ₁₆	9.5	13.0
43852	2-COE-5	20	2 ⁷ / ₁₆	12.0	15.0
43876	2-COE-7	30	3 ¹ / ₄	17.0	21.0

¶Side-to-Side Assembly

No.	Type & Size of Units	*Capacity Amp. Hrs.	Length Inches	Approx. Wt. Net	Lbs. Ship.
43860	2-COE-3	10	4 ¹⁵ / ₃₂	9.5	13.0
43868	3-COE-3	10	6 ¹⁹ / ₃₂	14.0	18.0
43862	2-COE-5	20	4 ¹⁵ / ₃₂	12.0	15.0
43870	3-COE-5	20	6 ¹⁹ / ₃₂	18.0	22.0
43881	2-COE-7	30	6 ¹ / ₈	17.0	21.0
43885	3-COE-7	30	9	25.0	30.0

*Ampere Hours capacity at 8 hour rate to 1.75 final volts per cell.

#End to End assembly width and height are 8" and 8¹/₂" respectively.

¶Side to Side assembly width and height are 4¹/₄" and 8¹/₂" respectively.

Small power in plastic. A flat plate battery providing long life with less weight per ampere hour output. Where space is limited, operating conditions satisfactory, service requirements light and price a consideration, Tytex is recommended.

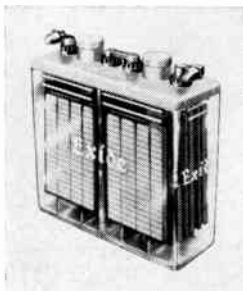

Type 2-COE-7 End-to-End

Exide Manchex Batteries

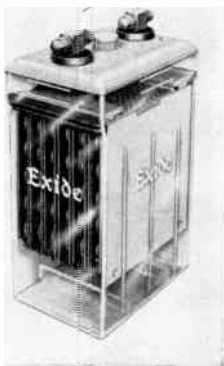

Type EMP-13

For all stationary power applications. Batteries equipped with Manchester Plante positive plates assembled in shock-absorbing, leakproof polystyrene container.

Heavy terminal post provides ample electrical path for high current requirements at maximum sustained voltages. Ample electrolyte enables cells to deliver all rated capacities.

Cells furnished with necessary connector bolts and lead plated copper intercell connections for 1/2-in. spacing between cells. Full charge specific gravity 1.200—1.220.

No.	Type and Size	Capac., Amp. Hrs.	Lgh., In.	Approx. Net	Wt., Lbs. Ship.
53400	DMP-5	40	3 1/8	23	28
53401	DMP-7	60	4 1/8	31	37
53402	DMP-9	80	5 1/8	39	46

DMP 7 1/2-in. wide, 13 1/2-in. high

55899	2-EMP-5	80	6 7/8	79	95
52810	3-EMP-5	80	10 1/4	124	146

2-EMP-5 is a 2 cell unit. 3-EMP-5 is a 3 cell unit.

52812	EMP-7	120	4 1/2	54	62
52814	EMP-9	160	5 5/8	69	79
52815	EMP-11	200	6 7/8	87	102
52816	EMP-13	240	6 7/8	95	110

52817	EMP-15	280	8 1/2	113	133
52818	EMP-17	320	10 1/4	131	153
53069	EMP-19	360	10 1/4	141	163

EMP 10 1/8-in. wide, 17-in. high

56028	FMP-11	415	7 1/2	172	186
56029	FMP-13	498	7 1/2	187	201
56030	FMP-15	581	8 1/2	222	240
56031	FMP-17	664	10 1/2	257	276

56032	FMP-19	747	10 1/2	273	292
56033	FMP-21	830	13 3/16	318	340
56034	FMP-23	913	13 3/16	333	355
56035	FMP-25	996	13 3/16	348	370

FMP 14 1/2-in. wide, 22 5/16-in. high

Exide Calcium Grid Batteries

These batteries are recommended only for applications where regulated full float charging methods are used.

The Exide Tytex with Calcium cells correspond in capacity, dimensions, and weight with the Exide Tytex with Silivium DOP and EOP cells. They are designated as DCP and ECP cells.

Type EW Exide Calcium Grid cells are available corresponding in capacity, etc. to EWA cells with Silivium. Data on cells with capacities up to 1680 ampere-hours at the 8-hour rate of discharge supplied on request.

Counter EMF cells are also available.

All steel battery racks can be supplied for any battery.

For complete information and prices, contact your Graybar representative.

Exide Lead Calcium Grid Batteries

Type EW and FW

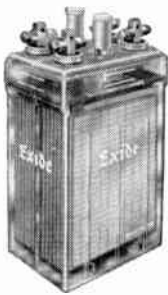

2-EW-7

In plastic containers capacities of 2 and 3 cell 180 A.H. Single cell 240 to 660 A.H. all at 8 hour rate.

Double insulation of microporous rubber separators and Vitrex retainers. Lead plated inter-unit or intercell connectors furnished provides 1/2-in. spacing between units.

Full charge specific gravity 1.200—1.220. Dimension Type EW: 10 1/8-in. wide, 18 1/4-in. high. Type FW 14 1/2-in. wide, 23-in. high.

Plate Dimension

Description	Height, In.	Width, In.	Thick., In.
Type EW Positive	10 1/2	8	1/4
Type EW Negative	10 1/2	8	11/64
Type FW Positive	13 3/4	12 1/8	1/4
Type FW Negative	13 3/4	12 1/8	11/64

**Table of Capacities
Rated Cap. In. 1.210 Sp. Gr. at 77° F**

No.	Type	Cells	Ampere Hours				Length In.
			To 1.85 v.p.c.* 72 Hr.	To 1.75 v.p.c.* 8 Hr.	3 Hr.	1 Hr.	
44740	2-EW-7	2	246	180	125	74	6 7/8
44741	3-EW-7	3	246	180	125	74	10 1/4
44749	EW-9	1	328	240	167	98	4 1/2
44750	EW-11	1	410	300	209	123	5 5/8
44751	EW-15	1	574	420	292	172	6 7/8
44752	EW-19	1	738	540	375	221	8 1/2
44753	EW-23	1	902	660	459	271	10 1/4
52130	FW-15	1	1115	840	588	342	7 1/2
52131	FW-19	1	1476	1080	756	439	8 1/2
52132	FW-23	1	1804	1320	924	537	10 1/2
52133	FW-29	1	2296	1680	1176	683	13 3/16

*Cell final volts at all discharge ratings includes the resistance drop across the standard intercell connector in series with the cell.

**Exide Storage Batteries
Type EWA**

With Silivium for Telephone Service in Plastic (Polystyrene) Containers



Type EWA-23

Batteries were developed especially for float operation in telephone service. A most desirable quality is greater capacity per unit of space.

Explosion control construction prevents harmful amounts of explosive gas from accumulating in cells.

Microporous separators and Vitrex retainers which are inert to electrolyte immersion are used. 2-EWA-7 is a 2 cell unit. 3-EWA-7 is a 3 cell unit. Dimensions: 10 1/8 in. wide, 18 1/4 in. high.

No.	Type and Size	*Capacity Amp. Hrs.	Lgh., In.	Approx. Net	Wt., Lbs. Ship.
55751	2-EWA-7	180	6 7/8	86	102
55752	3-EWA-7	180	10 1/4	129	149
55753	EWA-9	240	4 1/2	54	64
55754	EWA-11	300	5 5/8	67	77
55755	EWA-15	420	6 7/8	89	105
55756	EWA-19	540	8 1/2	110	128
55757	EWA-23	660	10 1/4	132	152

*Ampere hour capacity at 8 hour rate of discharge to 1.75 final volts per cell.

Information on cells with capacities up to 1680 ampere-hours will be furnished on request.

Exide Steel Battery Racks

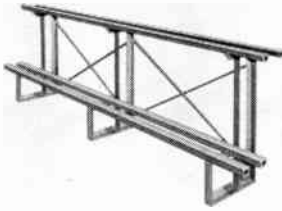

All steel racks, strong and of modern design. Provides maximum safety and easy servicing for your battery.

Steel frames are fabricated from structural steel 2 x 1½ x ⅛-in. or 2 x 1½ x ¼-in. angle iron with welded joints throughout. Steel rails for supporting the cells are made from 1⅞-in. x 1⅞-in. steel channels. Plastic insulating channels, having a dielectric strength of 5000 volts, are fitted snugly over the channels to insulate the cells from the steel rails. Finish: Two coats acid resisting gray. Shipped unassembled. Four basic types of racks available, single row—1 tier, single row—2 tier, two step and 3 step.

Schauer Battery Chargers Rectifier

Type "G"

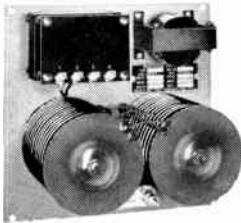

Trickle charger for small common battery exchanges and small storage battery used in telephone service.

Battery charger consists of transformer having adjustment taps for varying charging rate; rectifying element; ample choke to eliminate d-c ripple; sturdy output terminal block; rubber cord and plug. Unit mounted on steel base, no housing.

Standard Capacities

Type	O-C Output		Size In.
	Volts	Amps.	
G-05008	6-8	0.5	8¼ x 8 x 5
G-1008	6-8	1.0	8¼ x 8 x 5
G-2008	6-8	2.0	9½ x 9½ x 5
G-3008	6-8	3.0	9½ x 10 x 6
G-05012	12	0.5	5¼ x 8 x 5
G-1012	12	1.0	8¼ x 8 x 6
G-2012	12	2.0	9⅝ x 9½ x 6
G-4012	12	4.0	9⅝ x 9½ x 6
G-1024	24	1.0	9⅝ x 9½ x 6
G-2024	24	2.0	10¾ x 15¾ x 6
G-1048	48	1.0	11½ x 15 x 6
G-2048	48	2.0	9½ x 10⅝ x 6

Call Graybar **FIRST** For . . .



Schauer Rectifiers, Battery Eliminators

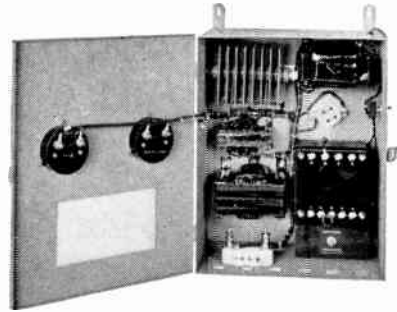

Type "RB"

Automatically maintains the terminal voltage of a set of batteries at a relatively constant value regardless of load condition.

Battery charger consists of transformer; continuously rated full wave Selenium rectifier; magnetic regulating equipment; ample choke-type filtering system; d-c voltmeter; rubber cord and plug. Housed in ventilated steel cabinet and designed for wall mounting.

Standard Capacities

No.	O.C. Output		Meters	Size In.
	Volts	Amps.		
RB-1024	24	1.0	VM	10 x 12 x 6
RB-2024	24	2.0	VM	12 x 15 x 7
RB-3024	24	3.0	VM-AM	12 x 15 x 7
RB-4024	24	4.0	VM-AM	12 x 15 x 7
RB-6024	24	6.0	VM-AM	16 x 18 x 7
RB-12024	24	12.0	VM-AM	16 x 18 x 7
RB-30024	24	30.0	VM-AM	21 x 36 x 8½
RB-1048	48	1.0	VM	12 x 15 x 7
RB-2048	48	2.0	VM	12 x 15 x 7
RB-3048	48	3.0	VM-AM	12 x 15 x 7
RB-4048	48	4.0	VM-AM	16 x 18 x 7
RB-6048	48	6.0	VM-AM	16 x 18 x 7
RB-12048	48	12.0	VM-AM	20 x 28 x 8
RB-20048	48	20.0	VM-AM	24 x 29 x 9½
RB-24048	48	24.0	VM-AM	21 x 29 x 9½

For Small Telephone Common Battery System

Type A

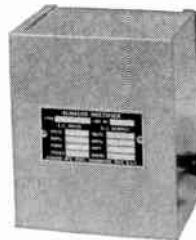

Designed for supplying direct current of suitable smoothness to operate small telephone common battery system, apartment house and inter-communicating telephone systems, which are not of lamp signal type.

Type PA05004 is commonly used for operators circuit in magneto switchboards. This model is equipped with power-off relay for automatically transferring power to stand-by dry cells in the event of a-c power failure.

Battery eliminator consists of a transformer; full wave copper-oxide or selenium rectifying element; ample choke and condenser filtering system; cord and plug. All parts housed in a ventilated steel case. Designed for wall mounting.

Model with taps for 60 cycle a-c ringing also available.

Standard Capacities

No.	O-C Output		Ringing Volts	Size In.
	Volts	Amps.		
PA-05004	4	0.5	5½ x 6¼ x 4
A-05008	6-8	0.5	6-12-18	6 x 8 x 5
A-1008	6-8	1.0	6-12-18	8 x 10 x 6
A-05012	12	0.5	6-12-18	8 x 10 x 6
A-1012	12	1.0	6-12-18	8 x 10 x 6
A-2012	12	2.0	6-12-18	10 x 12 x 6
A-05024	24	0.5	12-18-24	8 x 10 x 6
A-1024	24	1.0	6-12-18-24	10 x 12 x 6
A-2024	24	2.0	6-12-18-24	10 x 12 x 6
A-4024	24	4.0	6-12-18-24	12 x 15 x 7
A-5024	24	5.0	6-12-18-24	12 x 15 x 7
A-05030	30	0.5	6 x 8 x 5

**Schauer Rectifiers, Battery Eliminators
For Lamp Signal and Automatic Switchboard**

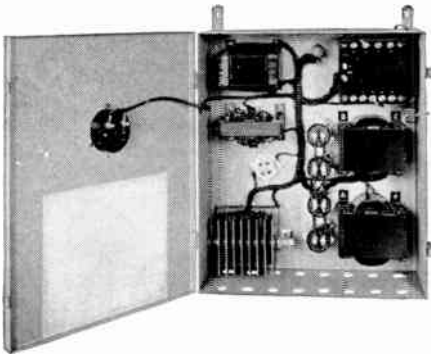

Type "RA"

Automatically provides constant voltage output. Consists of transformer; full wave Selenium rectifier; magnetic regulator; ample choke and condenser filtering system; precision d-c voltmeter; cord and plug. Housed in ventilated steel cabinet that is designed for wall mounting. Power-off relay optional.

Standard Capacities

No.	D-C Output		Ringings	Size
	Volts	Amps.	Volts	In.
RA-05024	24	0.5	12-18-24	10 x 12 x 6
RA-1024	24	1.0	6-12-18-24	10 x 12 x 6
RA-2024	24	2.0	12 x 15 x 7
RA-3024	24	3.0	12 x 15 x 7
RA-4024	24	4.0	12 x 15 x 7
RA-6024	24	6.0	12 x 18 x 7
RA-12024	24	12.0	18 x 21 x 7
RA-1030	30	1.0	10 x 12 x 6
RA-2030	30	2.0	12 x 15 x 7
RA-3030	30	3.0	12 x 18 x 7
RA-4030	30	4.0	12 x 18 x 7
RA-2048	48	2.0	12 x 18 x 7
RA-3048	48	3.0	16 x 18 x 7
RA-4048	48	4.0	16 x 18 x 7
RA-6048	48	6.0	18 x 21 x 7
RA-12048	48	12.0	20 x 28 x 8

For AM and FM 2-Way and Marine Radios

Adjustable 6-12 Volt

A-c input 115 volts, 60 cycle, single phase. D-c output 6 volt up to 48 amperes or 12 volt d-c up to 24 amperes. Equipped with dial type tap switch which provides adjustment from less than 1 ampere up to maximum rated output. Case finished in durable grey wrinkle is designed for bench or wall mounting.



No.	Width, In.	Depth, In.	Height, In.
SA-48006	10	9½	15

To Replace Dry Cells In Magneto Telephones

Provides sufficient smooth, noiseless d-c current to operate one magneto telephone transmitter, replacing the two dry cells used for this purpose.



Consists of a transformer, full wave copper-oxide rectifier, filter choke and condenser, housed in tubular steel case.

No.	D-C Output		Size
	Volts	Amps.	In.
Type A3V	3	0.150	2½ (diam) x 3½

**Raytheon Battery Charger Rectifiers
New 48-Volt Recticharger Series
Designed and Produced for Telephone Industry**

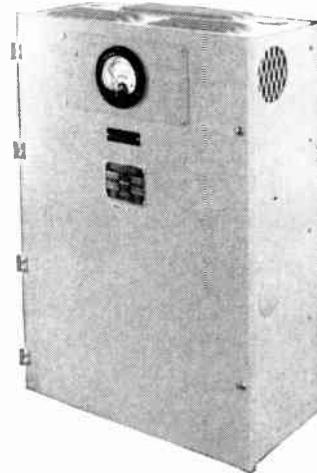

The Recticharger is a completely automatic, constant-voltage battery charger developed specifically for use by the telephone industry.

New design, smaller, compact and lighter cabinet. The Recticharger uses no tubes and no moving parts. It can literally be installed and forgotten. Recticharger automatically maintains battery at full charge under all normal load conditions by means of small trickle charge which offsets "local action" at the battery plates. Recticharger supplies power at constant voltage to normal battery load, with no discharge/charge cycle of the battery. Increases charging current to proper value after an overload has drawn power from the battery. Recticharger restores a completely discharged battery to full charge at optimum charging rate without battery gassing and heating.

All controls, connectors, and fuses are mounted on a panel, conveniently mounted inside hinged door of cabinet.

48 Volt Constant Voltage Rectichargers (Filtered)

No.	Volts	Input	Phase	Output Amps.	Mounting
RC-50A3	115		1	3	Rack, wall or floor
RC-50A6	115		1	6	Rack, wall or floor
RC-50C12	115/230		1	12	Rack, wall or floor
RC-50C25	115/230		1	25	Rack, wall or floor
RC-50K 25	208/225/240		3	25	Rack, wall or floor
RC-50K 50	208/225/240		3	50	Rack or floor
RC-50K 100	208/225/240		3	100	Floor
RC-50K 200	208/225/240		3	200	Floor
RC-50K 400	208/225/240		3	400	Floor

48 Volt Constant Current Chargers (Filtered)

NA50C3	115	1	3	Rack or wall
NA50C6	115	1	6	Rack or wall
NA50C12	115/230	1	12	Rack or wall
NA50C25	115/230	1	25	Rack or wall

Control Relays for Constant Current Chargers

No.	Amps.	No.	Amps.
RIS-3	3	RIS-24	24
RIS-6	6	RIS-50	50
RIS-12	12	RIS-100	100

Raytheon Battery Charger Rectifiers 24 Volt Recticharger Series For Telephone Switchboard Power Supply



These battery chargers are of the constant potential type for use in telephone service. They are essentially rectifiers of the dry-dise type, combined with a control circuit which maintains a constant voltage output over a complete load range regardless of the wide line voltage fluctuations found in many communities.

For emergency and peak period a small storage battery is floated across the output terminals and is kept at an essentially constant cell voltage, making a complete and permanent a-c to d-c telephone power unit, and regardless of outside conditions it produces constant d-c voltages. The battery is maintained at a given cell voltage and never becomes overcharged or undercharged. This operation is performed automatically without moving parts of any kind.

Because of this constant potential method of charging, battery gassing is prevented and there is no loss of water aside from normal evaporation.

By maintaining the close voltage limits required by dial systems, such trouble as short lamp life, incorrect ringing, noise on the line, etc., is eliminated.

All equipment is enclosed in a steel cabinet, finished with durable paint and provided with hinged door. Cabinet is arranged for wall mounting. Brackets are available for wall or floor mounting.

24-Volt Rectichargers (Filtered) Input 95-130 Volts, 60 Cycles, Stabilized Frequency, Single Phase

No.	Batt. Cells	Amps. Cont.	Overall Width, Inches	Overall Depth, Inches	Overall Hgt., Inches	Ship. Wt. Lbs.
RCR-1066B	11/12	1.0	13 1/2	7 1/8	12 1/4	62
RCR-1058B	11/12	3.0	19 1/4	9 1/2	19 7/8	163
RCR-1067B	11/12	6.0	19 1/4	9 1/2	19 7/8	233

Brackets For Floor Mounting Per Pair

No.	Used With Recticharger
DV17-1750	RCR-1066B
DV17-1747	RCR-1058B
DV17-1747	RCR-1067B

Separate Relay For Constant Current Combination

No.	Used With Recticharger
CR-1093	RCR-1066B
CR-1090	RCR-1058B
CR-1091	RCR-1067B

Raytheon Voltage Stabilizers



Style "E"

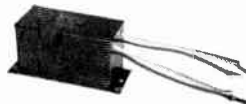

Style "F"

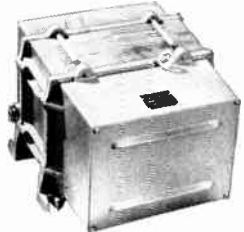

Style "C"



Style "H"

Voltage regulation is very essential to most electrical and electronic equipment.

Magnetic type regulator, the performance of which remains constant throughout many years of useful life. Rapid in voltage correction and precise in operation. Compensates within 1/20 of a second, a voltage output that may vary from 95 to 130 volts or a fluctuation of more than ±15% of rated output and controls it to ±1/2%. Protects most sensitive electronic devices against adverse effects of voltage change.

Regulators have no moving parts . . . nothing to wear out; compact design, rugged construction. Requires no adjustment or maintenance as stabilizer is completely automatic.

Regulators are self-protecting and cannot be damaged by overload. Current is limited to about 200% or rated load. Their principal operating characteristic is their ability to maintain constant voltage with varying input voltage. Degree of control is maintained at any load, and change from no load to full load results in small change in output voltage when load is pure resistance (100% power factor).

Style "C" Stabilizers

No.	Output Cap. Volt Amps.	Voltage Input	Voltage Output	Lgth. in.	Wdth. in.	Hgt. in.
VR7B	2000	115/230	115/230	16 1/4	14 3/4	11 1/16

Style "D" Stabilizers

VR61DO**	15	115	6.3	3 1/16	2 5/8	4 1/16
----------	----	-----	-----	--------	-------	--------

Style "E" Stabilizers

VR6101	30	115	6.0/7.5	7 1/2	3 3/8	4 1/8
VR6111	30	115	115	7 1/2	3 3/8	4 1/8
VR6111CP*	30	115	115	7 1/2	3 3/8	4 1/8
VR6221	30	230	230	7 1/2	3 3/8	4 1/8
VR6112	60	115	115	7 1/2	3 3/8	4 3/16
VR6112CP*	60	115	115	7 1/2	3 3/8	4 3/16
VR6222	60	230	230	7 1/2	3 3/8	4 3/16
VR6931**	60	95/130	115	7 1/2	3 3/8	4 3/16
VR6113	120	115	115	7 1/2	3 3/8	5 15/16
VR6113CP*	120	115	115	7 1/2	3 3/8	5 15/16
VR6223	120	230	230	7 1/2	3 3/8	5 15/16
VR6827**	120	95/130	115	7 1/2	3 3/8	5 15/16
VR6114	250	115	115	12 3/8	5	7 5/8
VR6114CP*	120	95/130	115	12 3/8	5	7 5/8
VR6224	250	230	230	12 3/8	5	7 5/8
VR6115	500	115	115	12 3/8	5	7 5/8
VR6225	500	230	230	12 3/8	5	7 5/8

Style "F" Stabilizers

VR6110	15	115	115	6 1/4	2 5/16	3
VR61FO**	15	115	6.3	5 3/4	2 5/8	4 1/16

Style "H" Stabilizers

VR6116	1000	115	115	13 3/16	14 1/16	9 5/8
VR6226	1000	230	230	13 3/16	14 1/16	9 5/8
VR6117	2000	115	115	36 1/4	14 5/8	10 1/8
VR6227	2000	230	230	36 1/4	14 5/8	10 1/8
VHF6114†	250	95/130	115	14 1/16	13 3/16	9 5/8
VHF6115†	500	95/130	115	14 1/16	13 3/16	9 5/8
VHF6116†	1000	95/130	115	29 1/4	14 3/8	10 1/4

Style "W" Stabilizers

VR6710A**	25	115	6.0	7 5/8	3 1/8	3 3/8
-----------	----	-----	-----	-------	-------	-------

*CP denotes cord and plug. **Isolated secondary models.

†Harmonic filtered models.

Note: 50 cycle models available on request.

Raytheon Rectifiers

For Telephone Communications Service

Rectifiers offer a modern and economical method of obtaining d-c power direct from an a-c source. They provide full, filtered, noise-free power for the best operation of telephones and reduce cost of maintenance to a minimum. Their compact design permits quick and easy installation in a small space.

They operate entirely without moving parts, units consisting of a power transformer, dry disc rectifier element, a retardation coil and condenser for filtering, and in the 1.0 ampere and larger sizes, a saturable core reactor for voltage control, all mounted in a gray lacquered steel cabinet, with hinged front. Each one complete with built-in voltmeter.

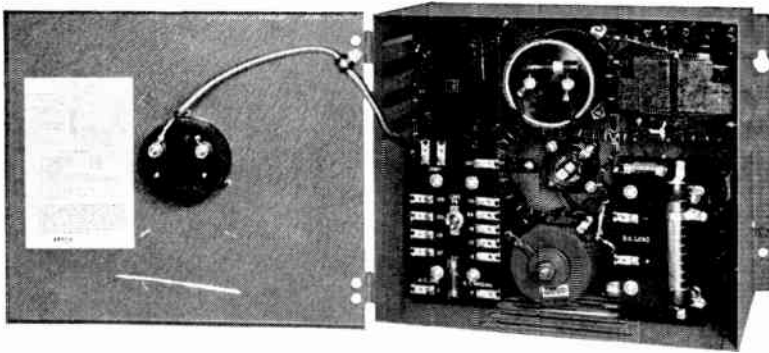

Rectifier Uses:

The economy and efficiency of these Rectifiers have been definitely established by many time-tested installations for various uses:

- ... to eliminate the installation of storage batteries and provide operation direct from an a-c source.
- ... to operate one or more PBX direct from an a-c source.
- ... to operate one or more equipments direct from an a-c source.
- ... to operate in series with the regular 24-volt central office battery to give 48 volts for toll service. When placed in series with the large central office battery, it eliminates the use of a supplementary battery.
- ... to use for seasonal installations, such as resort areas to eliminate the necessity for installing a battery at the beginning of each season, and removing it when the season closes.
- ... to release for revenue-producing service cable pairs for supply of d-c power to remote installations.

Steady D-C Voltage

To provide uniform voltage for proper operation of communication systems, the 1.0 ampere and larger sizes include an exclusive a-c stabilizing circuit which operates magnetically and requires neither adjustment nor maintenance; also insures closely stabilized d-c voltage for proper operation of switchboards under conditions of changing traffic load normally encountered.

For Continuity of Service

Continuous d-c supply is normally assured from the Rectifier without auxiliary power sources, as the a-c source is generally dependable; however there may be certain applications that require an alternate power source for continuity of service. In such cases relays can be provided that will automatically connect to a standby power source (dry cells, etc.) the instant the a-c power fails.

Also Available

The Rectiringer, a combination of the Rectifier and a 20-cycle ringer, is also available. Contact Graybar for complete information and prices.

Input 110-125 Volts, A-C Single-Phase

No.	D-C Output For Talking		No. Load Output Volts	Full Load Output Volts	A-C Supply Frequency	60 Cycle Output for Ringing		*Approximate Cabinet Size in Inches			Shipping Wt. Lbs.
	Volts	Amps.				Volts	Amps.	High	Wide	Deep	
RFR-1057-BR	4	0.23	...	4	50/60	None	...	8 ⁵ / ₈	3 ³ / ₈	3 ⁵ / ₈	10
RFR-1024-B	6	0.5	8.5	5.5	50/60	6-12-18-24 A-C	4.0	8 ⁵ / ₈	3 ³ / ₄	5 ³ / ₈	10
RFR-1026-A	12	0.5	15.5	11.5	50/60	6-12-18-24 A-C	4.0	7 ¹ / ₄	7 ¹ / ₄	6 ³ / ₄	11
RFR-1027-C	24	0.5	28	20	50/60	6-12-18-24 A-C	4.0	8 ⁵ / ₈	3 ³ / ₄	5 ³ / ₈	13
RFR-1027-CH	24	0.5	28	20	50/60	6-12-18-24 A-C	4.0	8 ⁵ / ₈	3 ³ / ₄	5 ³ / ₈	13
RFR-1044-GR	24	1.0	26	24	60	6-12-18-24	4.0	10 ¹ / ₂	12 ¹ / ₈	7 ¹ / ₈	47
RFR-1043-AR	24	1.5	26	24	60	75-100A-C	4.0	10 ¹ / ₂	12 ¹ / ₈	7 ¹ / ₈	53
RFR-1040-A	24	3.0	26	24	60	24 V. D-C	...	12 ¹ / ₄	12 ⁵ / ₈	7 ¹ / ₈	60
RFR-1040-AR	24	3.0	26	24	60	24 V. D-C	1040-A	With change of source relay			—
RFR-1041-AR	24	4.5	26	24	60	24 V. D-C	...	16 ⁷ / ₈	16 ¹ / ₈	8 ¹ / ₂	—
RFR-1042-AR	24	6.0	26	24	60	24 V. D-C	...	16 ⁷ / ₈	16 ¹ / ₈	8 ¹ / ₂	—
RFR-1079-AR	48	1.0	52	48	60	48 V. D-C	...	16 ⁷ / ₈	16 ¹ / ₈	8 ¹ / ₂	—
RFR-1080-AR	48	6.0	52	48	60	48 V. D-C	...	19 ⁷ / ₈	18	9 ¹ / ₂	—

*For detailed dimensions contact Graybar.

Change of source relay can be applied on all models.

When not listed, order by adding suffix "R". Example: RFR-1041-AR.

Brach Rare Gas Arresters

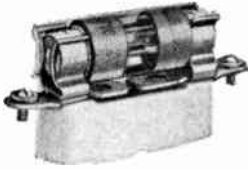

Exposed wires are subject to the effects of lightning induction. When exposed wires are near other exposed wires carrying high voltage, they are subject to induced voltages from the high voltage circuit. Rare Gas Arresters are the recommended type for protection from both these conditions.

The electrodes of the Rare Gas Arrester are in a sealed chamber and free from effects of atmospheric conditions, dirt, insects, or other maintenance problems that generally affect the operation of arresters.

Combines speed of operation with capacity for heavy currents, and ability to restore itself to normal functional characteristics after discharges in protecting low-voltage circuits. Provides high normal insulation and functions repeatedly within a predetermined voltage range. It is highly conductive and restores itself instantly after the passing of the abnormal voltage. Can be mounted in small space and easily installed and maintained.

The Arresters are treated chemically and constructed to function at a relatively low voltage. They are made in two general classes, one having plain electrodes with the ability to carry high currents for short duration, the other having thermostatic electrodes with the advantage of carrying currents for long periods. Other types are available having plain electrodes with external thermostats to protect the arresters from leaks from adjacent high-voltage circuits.

No.	Length In.	Width In.	Height In.	Each
36	4 ³ / ₄	1	2 ¹ / ₄	\$3.44
171	3 ³ / ₈	1	4 ³ / ₈	3.70
184	9 ¹ / ₂	4 ¹ / ₂	1	6.41
272	8 ¹ / ₄	4 ³ / ₈	1	4.25

Brach Vincent Rare Gas Relays

For Elimination Of Noise On Telephone Lines



Type RTC-2

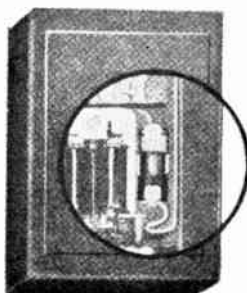

Vincent Rare Gas Relay In Bell Box

The Vincent Rare Gas Relay may be used on magneto or common battery lines. Either harmonic or coded bells may be used.

Relay consists of small glass tube containing special combination of rare inert gases acting in contact with special metal electrodes which allow current to pass above closely pre-determined voltage. Enclosed in heavy bakelite shell and equipped with "single hole" mounting clip.

Relay has no moving parts and is not affected by temperature or atmospheric changes.

No.	Length In.	Each
RTC-2	2 ¹ / ₂	\$3.62

Siemon Connecting Blocks

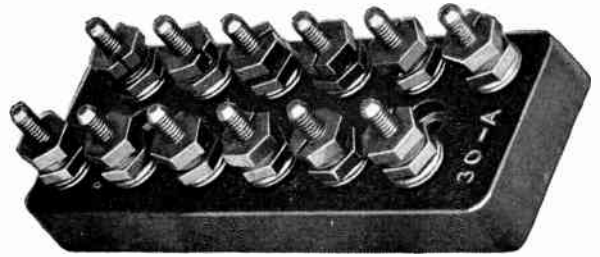

Type 30 A

Two binding posts on each connector. Composition base, width 1¹/₂-in., thickness, 1/2-in.

No.	No. of Connectors	Length of Base, In.	Min. Ordering Quantity
GB30A	6	4 ³ / ₁₆	100
GB30B	11	7 ⁷ / ₁₆	50
GB30C	16	10 ¹ / ₁₆	40
GB30D	26	16 ¹¹ / ₁₆	25

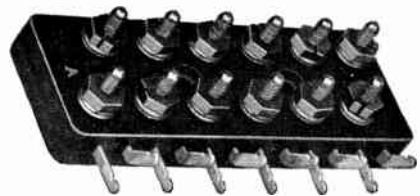

Type 31 A

Each connector has one binding post and one soldering terminal, brought out on the side. Composition base, width 1¹/₂-in., thickness, 1/2-in.

No.	No. of Connectors	Length of Base, In.	Min. Ordering Quantity
GB31A	6	4 ³ / ₁₆	100
GB31B	11	7 ⁷ / ₁₆	50
GB31C	16	10 ¹ / ₁₆	40
GB31D	26	16 ¹¹ / ₁₆	25

Reliable Connecting Blocks

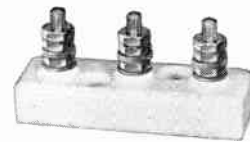

No.	No. of Binding Posts	Size In.	Std. Pkg.	Ship. Wt. Lbs. Per 100	Net Price Each
2102	2	1 x 2 x 1 ³ / ₈	20	15	\$0.31
2103	3	1 x 3 x 1 ³ / ₈	20	17	.40

Connecting blocks may be assorted for quantity prices.

Reliable Sawtooth Discharge Blocks



These blocks are self-cleaning and do away with dirty carbons. They dissipate static discharges with no time lag and do not ground the line unnecessarily. They operate in the plant just as sensitively as carbon to carbon discharge gaps. Rivetless ceramic insulation.

No.	AC RMS Arc-Over Voltage	Std. Pkg.	Wt. Lbs. Per 100	Net Price Per 100
P495	350-500	100	1 ¹ / ₄	\$10.09
P495L	650-750	100	1 ¹ / ₄	10.09
P495Y	1000-1200	100	1 ¹ / ₄	10.09

Cook Cable Terminals

For Plastic Cable

**Protected Or Unprotected
6, 11, 16, 26 Pairs**



Terminal designed for use on plastic cable in which cable is looped through terminal without cutting wires and the desired pairs terminated for distribution.

Can be used for junctioning and terminating cable. Grommets are used to seal cable entrance. When ordering specify cable sizes, so correct grommets will be furnished.

Heavy galvanized steel frame, deep drawn chamber, welded zinc cover, and XB bakelite face plate with Everdur studs comprise some of the major features. No stubbing, no splicing, no potting make it simple and more economical.

Protection provided by Minigap arresters mounted in a convenient arrester plate.

Protection provided by Minigap arresters mounted in a convenient arrester plate.

PLX Plastic Loop Cable Terminal

Unprotected

No.	Description	Lgth. In.	Width In.	Depth In.	Net Wt. Lbs.
452-1106	6 Pairs	12	6 ³ / ₄	5 ¹ / ₈	10
452-1111	11 Pairs	12	6 ³ / ₄	5 ⁷ / ₈	10 ¹ / ₄
452-1116	16 Pairs	12	6 ³ / ₄	5 ⁷ / ₈	10 ¹ / ₂
452-1126	26 Pairs	15 ⁷ / ₈	6 ³ / ₄	6	14

Equipped For Protection — Less Arresters

452-1330	6 Pairs	12	6 ³ / ₄	5 ¹ / ₈	10 ¹ / ₄
452-1331	11 Pairs	12	6 ³ / ₄	5 ⁷ / ₈	11
452-1332	16 Pairs	12	6 ³ / ₄	5 ⁷ / ₈	11 ¹ / ₂
452-1333	26 Pairs	15 ⁷ / ₈	6 ³ / ₄	6	15

Equipped For Protection With Arresters

452-1306	6 Pairs	12	6 ³ / ₄	5 ¹ / ₈	10 ³ / ₄
452-1311	11 Pairs	12	6 ³ / ₄	5 ⁷ / ₈	11 ¹ / ₂
452-1316	16 Pairs	12	6 ³ / ₄	5 ⁷ / ₈	12
452-1326	26 Pairs	15 ⁷ / ₈	6 ³ / ₄	6	14 ³ / ₄

Protector Conversion Kit

452-1340	6 Pairs
452-1341	11 Pairs
452-1342	16 Pairs
452-1343	26 Pairs
41-310	Minigap Arresters

***Grommets for PLX Terminals**

No.	No. of Holes	Hole Dia. In.	No.	No. of Holes	Hole Dia. In.
452-1139	1	1.050	452-1176	2	.790
452-1138	1	.875	452-1195	2	.960
452-1137	1	.714	452-1180	2	.429 and .509
452-1136	1	.615	452-1181	2	.429 and .615
452-1135	1	.509	452-1182	2	.429 and .714
452-1134	1	.429	452-1183	2	.429 and .874
452-1133	2	1.050	452-1184	2	.509 and .615
452-1132	2	.874	452-1185	2	.509 and .714
452-1131	2	.714	452-1186	2	.509 and .874
452-1130	2	.615	452-1187	2	.615 and .714
452-1125	2	.509	452-1188	2	.615 and .874
452-1115	2	.429	452-1189	2	.714 and .874
452-1179	2	.670	452-1195	2	.790 and .900

*Since these grommets are designed to compress in order to seal around the cable, it is necessary to choose a grommet size than is somewhat larger than the cable size.

**Cook Building Terminals
With Lead Or Plastic Cable Stub**

No. 60



Gas-tight, moistureproof building terminal that is designed for interior cable distribution.

Furnished with surface type steel cabinet with hinged black enamel cover with snap lock.

Core section has same design feature as Cook Stranterm. Made of special unsaturated polyester thermo-setting plastic with fiber-glass filler in which heavy studs are embedded. Cable studs are soldered to these studs.

With 5¹/₂ Ft. Plastic Stub

No.	Description	Hgt. In.	Width In.	Depth In.	Net Wgt. Lbs.
352-1384	11 Pairs	14	4	3	5
352-1385	16 Pairs	14	4	3	6

With 5¹/₂ Ft. Lead Stub

352-1386	11 Pairs	14	4	3	9
352-1387	16 Pairs	14	4	3	9
352-1389	26 Pairs	15	10	3	12

Cook Underground Cable Terminals

**Unprotected Type UX
6, 11, and 16 Pairs**

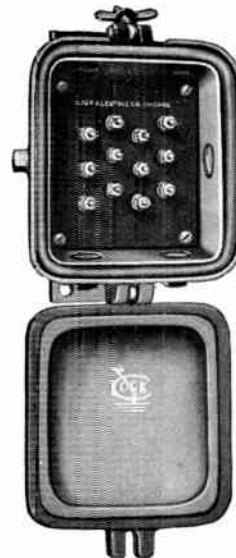

Cable terminal designed to facilitate installation and service in manhole termination and distribution of underground cable systems.

Body and cover made of cast, nonporous red brass; locking screw and hinge pins made of brass. Silicon bronze mounting bracket. None of these materials are affected by dampness or water. Cover fits tightly making a water-tight seal. Heavy Everdur studs are rigidly set in molded bakelite face plate.

Terminal may be mounted with cable stub out of top or bottom. Service outlets provided in sides of terminal and sealed with ³/₈ in. brass pipe plug.

Terminal is available with or without stub.

Less Stub

No.	Description	Hgt. In.	Width In.	Depth In.	Net Wgt. Lbs.
512-3702	6 Pair	7 ³ / ₄	6	3 ¹ / ₂	11
512-3700	11 Pair	11 ¹ / ₂	6 ¹ / ₂	5 ¹ / ₂	18
512-3705	16 Pair	11 ¹ / ₂	6 ¹ / ₂	5 ¹ / ₂	20

With 5¹/₂ Foot Stub

512-3703	6 Pair	7 ³ / ₄	6	3 ¹ / ₂	18
512-3701	11 Pair	11 ¹ / ₂	6 ¹ / ₂	5 ¹ / ₂	27
512-3706	16 Pair	11 ¹ / ₂	6 ¹ / ₂	5 ¹ / ₂	29

Accessories

506-548 Stuffing Box Complete for ³/₈-inch cable.

Cook Building Terminal Boxes

Type WXB



This box is the usual method of housing the WXB terminal inside buildings.

Made of heavy gauge steel, enameled both inside and out, available in four sizes to accommodate the different sizes of terminals.

Equipped with a close fitting cover to protect the terminal from dust and dirt. Lock and key optional.

Box available for flush or surface mounting. When ordering, specify type also with or without lock.

Cook Utility Substation Protectors

Type "U"

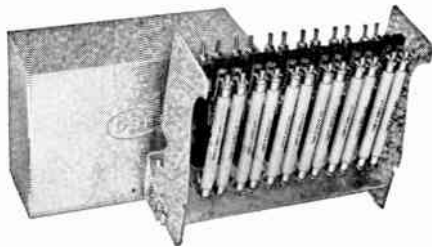

Has variety of uses in the outside plant. Provides protection for small cables and open wires, up to six pairs per unit, at railroad crossings, power line crossovers and parallels. Especially valuable for protection of subscriber drops where several instruments are closely grouped.

As many as six type II protector units can be mounted on the heavy-gauge, galvanized steel base. Galvanized hood and insulated entrance holes in base makes entire unit weather-proof. Brackets for pole or wall mounting are such that the base unit may be brought to horizontal position for easy wiring. Dimensions: 6 in. high, 9 in. wide and 6 1/2 in. deep.

No.	Description	Net Wgt. Lbs.
517-1	6 Pair U Mount less protectors	4 1/4
517-1722	Unit complete with six type-II protector	6 3/4

Cook Fuseless Protectors

No. 2

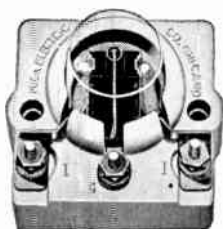

Indoor arrester consisting of solid piece of glazed porcelain fitted with Everdur binding posts, nuts, washers and Phosphor bronze springs.

Arresters are nongrounding Tru-Gap dischargers and plain ground carbons set in recess and covered with ventilating metal cap. Dimensions: 2-in. high; 3-in. wide; and 3-in. long.

No.	Description	Net Wgt. Lbs.
244-1606	With Tru Gap Dischargers	1 1/2

Cook Power-Cross Protectors

The continued extension of the practice of joint occupancy of wood poles by communication and power circuits of higher voltages has created a need for heavy-duty arresters on communication circuits. Arresters must be capable of carrying the fault current long enough to allow the power breakers to operate and de-energize the power circuit. For this protection, below is listed, two power-cross protectors which also furnish protection from lightning damage.



Single Circuit



Five Circuit

Single Circuit Hy-Cap Power-Cross Protector

Miniature protector consists essentially of three carbon electrodes mounted on porcelain base with metal cover, held in place by suitable spring. Each electrode equipped with fusible element which melts and further reduces impedance of fault-current path when fault current continues over an extended period.

Three insulated copper wire leads are attached to protector for easy installation. Steel angle bracket permits direct mounting on pole or crossarms.

Five Circuit Hy-Cap Power-Cross Protector

With this unit five circuits can be protected at low cost. Only one ground wire. Ten carbon electrodes are fixed to porcelain base which has weatherproof aluminum cover. Each electrode has a fusible element which forms direct path to ground when an extended discharge occurs.

Ten insulated copper wire leads are factory connected to protector and are cut to correct lengths for installation on a 19B crossarm. Wire entrances sealed with rubber grommets. Steel bracket permits easy mounting.

No.	Description	Hgt. In.	Width In.	Depth In.	Net Wgt. Lbs.
501-40	Single Pair	6	3	3	1
501-50	Five Pairs	8	4 1/2	4 1/2	4 1/2

Cook Precision Rated Fuses



Telephone fuses designed for use in Cook protectors and terminals. Interchangeable with corresponding types of telephone fuses.

No.	Description	Used in
59-0700	A-7 Wood, 5 Amperes	S-6, II-29D, O-7, UA-20
146-0900	A-9 Lavite, 5 Amperes	B-7, O-9, RO
*146-217	A-9u Lavite, 7 Amperes	O-9u, RO-9u
424-5200	A-52 Fiber, 5 Amperes	O-52
149-1600	A-16 Wood, 5 Amperes	O-16
494-6200	A-62 Fiber, 5 Amperes	O-62
214-2200	A-22 Lavite, 5 Amperes	10-W, 105
499-6400	A-64 Wood, 5 Amperes	O-64
307-4600	A-46 Wood, 5 Amperes	II-36, O-46
306-4500	A-45 Lavite, 5 Amperes	II-36, O-45
91-1200	A-12 Lavite, 5 Amperes	II-51, O-12

Note: Part numbers on all fuses should be as shown above except last digit to be the same as amperage required.

*Listed as standard by Underwriters' Laboratories.

Cook Indicator Alarm Type Fuses

(Grasshopper Fuses)



These fuses can be used to set off an alarm when fuse wire has separated causing the bottom spring to contact an alarm circuit.

This type fuse normally used on circuits operating up to 90 volts, but are also made for circuits up to 160 volts limited current, with fuse wire enclosed in glass or porcelain tube to prevent side flash.

When ordering, specify catalog number and rated capacity.

Grasshopper Fuses

No.	Ref.	Known As	Rated Capacity Amp.	Amp.	Operates on In Less Than	Insulating Strip Color	Slotted for Screws No.	Slot Width	Dimensions, Inches Mounting Centers	Length Overall
170-10	(a)	35A	1 1/3	2	1 1/2 Min.	White	10	13/64	1 3/16	1 43/64
170-11	(a)	35B	1 1/3	2	1 1/2 Min.	White	6	5/32	1 3/16	1 43/64
170-12	(a)	35B	2	3	3 Min.	Orange	6	5/32	1 3/16	1 43/64
170-13	(a)	35C	2	3	3 Min.	Orange	10	13/64	1 3/16	1 43/64
170-14	(a)	35D	1 1/3	2	1 1/2 Min.	White	6	5/32	1 1/8	1 5/8
170-15	(a)	35E	3	4	5 Min.	White	6	5/32	1 1/2	1 43/64
170-16	(a)	35F	1/2	3/4	1 1/2 Min.	Red	10	13/64	1 3/16	1 43/64
170-17	(a) (b)	35G	3	4 1/2	5 Min.	Blue	6	5/32	1 3/16	1 43/64
170-18	(a) (c)	35H	5	6 1/2	5 Min.	Green	6	5/32	1 3/16	1 43/64
170-19	(d)	35J	1/2	3/4	1 1/2 Min.	Red	10	13/64	1 3/16	1 43/64
170-20	(e)	35K	1 1/3	2	3 Min.	White	10	13/64	1 3/16	1 43/64
170-21	(e)	35L	2	3	3 Min.	Orange	10	13/64	1 3/16	1 43/64
170-22	(e)	35M	3	4 1/2	5 Min.	Blue	6	5/32	1 3/16	1 43/64
170-23	(e)	35N	5	6 1/2	5 Min.	Green	6	5/32	1 3/16	1 43/64
170-24	(d)	35P	3/4	1 1/3	1 1/2 Min.	Tan	10	13/64	1 3/16	1 43/64
170-25	(a) (f)	35R	.180	.270	1 1/2 Min.	Yellow	10	13/64	1 3/16	1 43/64
170-26	(g)	35S	1/4	3/8	1 1/2 Min.	Pink	10	13/64	1 3/16	1 43/64

References:

- (a) For circuits operating on voltages up to 90 volts.
- (b) Replaces 35B, 3-ampere fuse.
- (c) Replaces 35B, 5-ampere fuse
- (d) For circuits operating on voltages 90 to 160 volts. Fuse wire enclosed in glass tube.
- (e) For circuits operating on voltages 90 to 150 volts. Fuse wire enclosed in porcelain tube to prevent side flash.
- (f) Satisfactory for circuits operating on voltages up to 160 volts if current is limited as covered in standard equipment information on fuse boards.
- (g) For circuits operating on voltages up to 160 volts. Fuse wire enclosed in glass tube to prevent side flash.

Cook Resettable Grasshopper Fuses



Combination of grasshopper fuse and heat coil provides a new economical and positive acting fuse, arc free, with accurate operation time. Is now available to wire communications and electronic equipment. Resettable by re-engaging heat coil ratchet. Parts easily replaceable.

Heat coil operation simple and positive. When subject to more than rated current, the ratchet releases the ground and alarm spring. After trouble has been cleared, and current flow is normal, fuse can be reset manually by ratchet which is again locked into position.

Table Showing Interchangeability of Heat Coil Type Grasshopper Fuses

No. Note 1	Code No. Note 2	Rated Resistance (Ohms) Max.	Rated Resistance (Ohms) Min.	Will Carry for 3 Hr. Current of (Ampere)	Will Operate in 210 Seconds on Current of (Ampere)	Size Screw Slotted for No.	Mounting Centers
170-510	74-B	4.1	3.7	.24	.40	10	1 3/16
170-512	74-E	8.0	6.5	.185	.265	10	1 3/16

Note 1: Cook Electric Company Reusable Fuse
 Note 2: Western Electric Heat Coil Replaceable Fuse

Table Showing Interchangeability of Grasshopper Fuses* & Resettable Grasshopper Fuses

Cook Part No.	Known As	Rated Capacities (Amp.)	Amp.	Operates On Less Than Min.	Color Insulating Strip	Size Screw Slotted for No.	Slot Width, In.	Mounting Centers
170-550	35A	1 1/3	2	1 1/2	White	10	13/64	1 3/16
170-552	35B	2	3	3	Orange	6	5/32	1 3/16
170-557	35G	3	4 1/2	5	Blue	6	5/32	1 3/16
170-558	35H	5	6 1/2	5	Green	6	5/32	1 3/16
170-559	35J	1/2	3/4	1 1/2	Red	10	13/64	1 3/16
170-564	35P	3/4	1 1/3	1 1/2	Tan	10	13/64	1 3/16
170-565	35R	.180	.270	1 1/2	Yellow	10	13/64	1 3/16
170-566	35S	1/4	3/8	1 1/2	Pink	10	13/64	1 3/16

Overload Failure Warning Relay

Accessory item for operation with Grasshopper fuses. It energizes when Grasshopper fuse operates and shorts against the bus. The relay coil connected in series with bus then energizes and warning contacts close. Operates at 24 or 48 volts, d-c; or with external shunt removed 135 and 165 volts, d-c.

Reliable Protected Cable Terminals

Type B

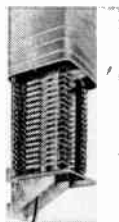

Designed for terminating lead-covered cable and to facilitate drop wire distribution. Add greatly to the convenience of installation of wiring and maintenance. Has detachable mounting bracket to simplify installation.

Square aluminum cover, will stay in any raised position and cannot be tilted into contact with live parts. Cover, bracket and base assembly are of corrosion-resistant aluminum alloys.

Binding posts are at front, accessible to lineman without removing fuses or reaching around cable terminal. Binding post insulation is high grade molded plastic.

Discharge blocks are the self-cleaning sawtooth type and are held by individual springs and cannot be accidentally loosened or crossed.

Cable terminals are very close to pole or building — no tilting.

Binding posts, fuse clips and carbon springs are corrosion-resistant and are free from season cracking.

Complete with 5-amp. fuses, No. P195-L saw-tooth discharge blocks; No. P1384 carbons and a 7 ft. No. 24 A.W.G. stub.

Type B27 is fitted with No. 27L Ceramic fuse; Type B56 is fitted with No. 56 Fibre fuse; Type B55 is fitted with No. 55L Ceramic fuse. Specify Type and Number of pairs required.

The following table applies to Types B27, B56 and B55:

Cap. Pairs	Stub Ft.	Over-all Ht. In.	Wt Lbs.	Net Price Each
11	None	14½	11	\$26.30
11	7	14½	17	31.50
16	None	17½	13	36.15
16	7	17½	19½	42.65
26	None	23¾	21	49.55
26	7	23¾	27	58.10

Quantity prices on request.

Reliable Protected Cable Terminals

Type RP



Compactly designed and made of corrosion resistant aluminum alloy throughout making it light in weight, but substantial. Meets the requirements of a small protected terminal of high quality and fine workmanship.

Ruggedly constructed; cable chamber is a heavy casting. Sliding cover is reversible, eliminating bother of handling separates types for installation with stub at top and bottom. Mounting bracket is detachable for easy installation.

Molded bakelite insulation. Discharge blocks are of the self-cleaning type and are held by individual springs and cannot be accidentally loosened or crossed.

Complete with 5-amp. fuses, No. P195-L sawtooth discharge blocks, No. P663 Carbons and a 6-ft. No. 24 A.W.G. stub out of top.

Capacity 6 Pairs; Height overall 11 in.

No.	5-Ampere Fuses	Wt. Lbs.	Net Price Each
RP-27	27-L Ceramic	15	\$22.40
RP-56	56 Fibre	15	22.40

Reliable Unprotected Cable Terminals

Type RU



Reversible; protects terminals from weather and permits installation with stub at top or bottom.

Has ribbed aluminum alloy sliding cover. Chamber filled and sealed with Reliable cable compound when supplied with stub.

Flat fanning plate simplifies wiring and, in combination with a cover which surrounds the wires at the back, makes an unusually weather-proof terminal. Gives the lineman more convenient working space.

Equipped with gravity catches to hold cover in raised position, glide rings for jumpers and bead chain. Silicon-bronze screws — free from season cracking — are mounted on bosses to increase surface leakage distances and are locked in panels of highest grade molded insulation.

Furnished with 6 ft. of No. 24 A.W.G. Double-wrap paper-insulated cable unless otherwise specified.

Capacity, No. of Pairs	Ht. In.	Less Stub		With 6-Ft. Stub	
		Ship. Wt. Ea., Lbs.	Net Price Each	Ship. Wt. Ea., Lbs.	Net Price Each
6	11	5	\$ 7.70	9	\$10.50
11	11	6	9.15	10	13.85
16	12½	7	10.90	11	16.50
26	16	11	15.60	17	22.80

Type GR

Capacity	Ht., In.	Stub Data	Ship. Wt., Lb.	Net Price Each
11 Pair	8½	Less Stub	5½	\$10.50
		With 6' Stub	9½	16.00
16 Pair	11	Less Stub	9	12.60
		With 6' Stub	13	19.00
26 Pair	15½	Less Stub	12¼	18.00
		With 6' Stub	16¼	26.30



Cable Terminal Compound
One gal. cans—Ship. Wt. 8½ lb. \$1.97

Extra length cable stubs will be furnished on request at an additional charge.

All cable terminals except GR type can be made gastight at an additional charge of \$1.20 each.

Type RUG



Capacity	Ht., In.	Stub Data	Ship. Wt., Lb.	Net Price Each
11 Pair	8¼	With 6' Stub	26	\$34.95
		With 15' Stub	32	37.60
16 Pair	10½	With 6' Stub	32	46.45
		With 15' Stub	37	50.40

Stuffing Boxes for RUG Terminal **86**

General Machine Six-Pair Terminals



Serves as a speedy and handy means for making multiple connections on a pole, house or other outside location. Frame is of electro-galvanized steel. Terminal body is of high dielectric plastic. Top is rust-proof steel and provides completely weatherproof cover. Connections can be made for five additional party lines to the main trunk.

Finish: Cadmium plated. Weight 1 lb., 3 oz.

No. 11-A Price on application

Reliable High Voltage Protectors



No.	Approximate Air Gap Breakover	Ship. Wt. Lbs. Each	Net Price Each
20HVP	2000 volts	1 1/4	\$3.30
30HVP	3000 volts	1 1/4	3.30

Reliable Single Pair Protectors



No. 451

Designed to drain lightning and static voltages from open wires and long drop wires that are connected to cable. When used with a good ground, it can be depended upon to reduce these voltages at the cable-open wire junction, thereby reducing cable trouble.

Equipped with sawtooth discharge blocks, porcelain base, aluminum cover with stainless bead chain and cover locking screw.

Aluminum bracket has two 5/32-in. round holes for wood screw mounting, and one 13/32-in. square hole for carriage bolt mounting. Units measure 4-in. x 2 1/2-in. diameter.

No.	Discharge Blocks	Carbon Blocks	Std. Pkg.	Ship. Wt. Lbs.	Net Price Each
450	P-495	P-1385	2	1	\$1.55
451	P-495L	P-1385	2	1	1.55

Reliable Fuseless Station Protectors



No. 700

For Indoor and Outdoor Mounting

No.	Std. Pkg.	Ship. Wt. Lbs. Per 100	Net Price Each
700	2	27	\$1.75
800	2	40	2.55
801	2	31	1.95
504	10	2 1/2	.60

(504 protector unit sold only in multiples of 10)

Reliable Fuseless Cable Protectors



No. 801A

For Indoor and Outdoor Mounting

No.	Std. Pkg.	Ship. Wt. Lbs. Per 100	Net Price Each
700A	2	27	\$1.75
800A	2	40	2.55
801A	2	31	1.95
506	10	2 1/2	.60

(506 protector unit sold only in multiples of 10)

Reliable Ten-Wire Crossarm Arrester

Porcelain Mounting Plate

Aluminum Bracket and Cover

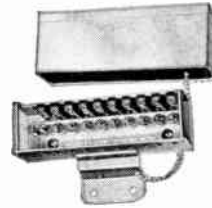

No.	Discharge Blocks	Carbon Blocks	Size Inches	Ship. Wt. Lbs. Each	Net Price Each
222	P-495-L	P-663	8 1/4 x 3 1/8 x 4 1/2	4	\$6.00

Reliable Indoor Protectors and Arresters



955 and 955A equipped with P495 Sawtooth Discharge Blocks and P197 Carbons.

955C equipped with Grounding Type Discharge Blocks and Carbons.

One piece low absorption porcelain base.

No.	Fuse No.	Amperes	Type Fuse	Size Inches	Ship. Wt. Lbs. Each	Net Price Each
955	Two 55L	7	Ceramic	3 1/2 x 5 9/16	2	\$2.00
955A	Two 77L	7	Ceramic	3 1/2 x 5 9/16	2	1.95
955C	Two 55L	7	Ceramic	3 1/2 x 5 9/16	2	2.10

Reliable Arrester and Protector Carbons

No.	Description	Size, In.	Net Price Per 100
P164	Carbon Block with 2 Mounting Holes	1 1/2 x 1/2 x 5/16	\$4.80
P197	Carbon Block with Groove	1 1/4 x 25/64 x 1/4	4.80
P367	Carbon Block with Groove	1 1/4 x 25/64 x 3/16	4.80
P663	Carbon Block	1 1/4 x 25/64 x 3/16	4.80
P1384	Carbon Block	1 1/4 x 25/64 x 7/32	4.80
P1385	Carbon Block	1 1/4 x 25/64 x 5/32	4.80

P4374	Carbon Block with Groove	1.00 x .300 x .187	4.80
P4375	Carbon Block	1.00 x .300 x .187	4.80

Reliable Fuses

For Protectors and Cable Terminals

Capacities: 1, 3, 5 and 7 Amp. Unless otherwise specified 7 ampere will be shipped.



Ceramic; Tip 13/64 in. Diameter

No.	†Lth. In.	Std. Pkg.	Wt. Lbs. Per 100	Net Price Per 100
27L	4 3/4	50	7	\$16.50
35L	3 7/8	50	5	15.25
*77L	4 3/4	50	6	23.50
95L	4	50	5	16.50
31L	3	50	4	15.25

Reliable Fuses

For Protectors and Cable Terminals (Cont.)

Capacities: 1, 3, 5 and 7 Amp.
Unless otherwise specified 7 ampere will be shipped

Fiber; Tip 11/64 in. Diameter

106	3 1/16	50	3	\$20.62
114	3 1/8	50	3	20.62



Ceramic; 7/16 in. Diameter, with 3/8 in. Hexagon Nuts both Ends

No.	†Lgth. In.	Std. Pkg.	Wt. Lbs. Per 100	Net Price Per 100
53L	3 3/4	50	5	\$30.25
*55L	4 1/16	50	5 1/4	30.25



Fiber; 7/16 in. Diameter, with 7/16 in. Hexagon Nut one End

No.	†Lgth. In.	Std. Pkg.	Wt. Lbs. Per 100	Net Price Per 100
56	4 1/16	50	5	\$31.80

*Approved and listed by Underwriters' Laboratories in 7-ampere capacity.

†Shoulder to shoulder.

3/8 In. Round Fibre Telegraph Fuse



No.	Material	Overall Lgth., In.	Amperes	Std. Pkg.	Ship. Wt. Lbs. Per 100	Net Price Per 100
80	Fibre	4 1/2	1 to 10	50	7	\$23.10
81	Fibre	5 1/2	1 to 10	50	7	23.10

7/16 In. Round Fibre With Flat Tip



52	Fibre	3 1/2	50	3	\$25.85
----	-------	-------	----	---	---------

Flat Wood Fuse (Wire Lies in Open Slot)

44	Wood	3 1/2	100	20	\$27.05
----	------	-------	-----	----	---------

Heat Coil Fuse



Indicating type fibre fuses with wire wound coils. Indicator protrudes from end.

No.	Size - Tip Dia.	Inches Dia.	Shoulder to Shoulder	Std. Pkg.	Amperes	Ship. Wt. Lbs. Per 100	Net Price Per 100
107	11/64	3/8	3 1/16	50	.35	3	\$49.50
115II	11/64	5/16	3 1/16	100	.35	3	49.50
52B		3/8	Overall Length 2 5/8	100	.8	2 3/4	\$49.50

Blow-Rite Fuse Wire

Made in 1, 2, 3, 5 and 7 ampere capacities, and is supplied on 300-foot spools.

Blow-Rite 300 ft. spools.....Net price Each \$1.70

Churchill Indoor Telephone Booths

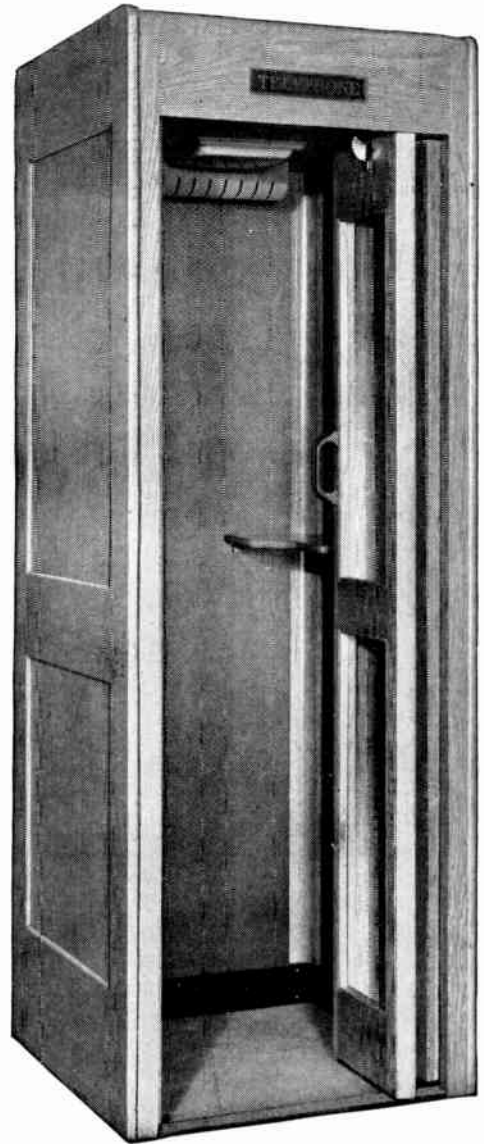

No. 100

Indoor telephone booths with new metal lining are acoustically built assuring you of privacy.

New automatic electric ventilator completely changes air every three minutes. Equipped with new and improved automatic light.

Durable metal "telephone" sign. No floors in both which provides better sanitation. Wood writing shelf included, seat is optional and must be ordered separately.

Dimensions: 81 3/4-in. high, 29-in. wide and 30 1/2-in. deep.

No.	Description
100-A	Selected Oak, Medium Oak Finish
100-B	Selected Birch, Medium Mahogany Finish

Burgess-Manning Acousti Telephone Booths

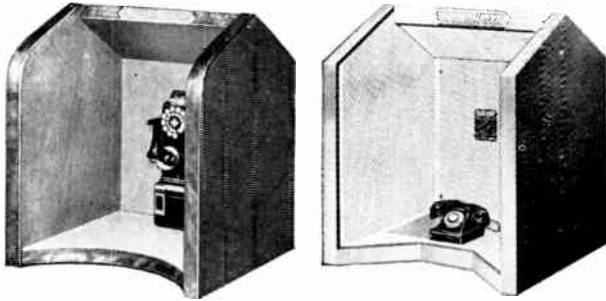

No. 601

No. 602

No. 601 wood wall model: reinforced plywood construction with walnut stain exterior finish or unfinished. Walls of thick sound absorbing material.

No. 602 steel wall model: rigid, durable steel construction. Gray wrinkle finish. Heavy gauge steel sheets protect acoustic material.

No.	Width, In.	Depth, In.	Height, In.	Net Wt., Lbs.	Ship. Wt., Lbs.
601	28	26	32	60	75
602	28	26	32	85	91

Note: No. 601 furnished unfinished.



Unique booth design makes possible multiple installations in less space.

Designed for use in locations of excessive noise and where privacy of conversation is essential.

Welded metal construction. Sound absorbing materials are combined to provide maximum quiet. Silver gray hammered finish.

Wall Model

No.	Width, In.	Depth, In.	Height, In.	Net Wt., Lbs.	Ship. Wt., Lbs.
45	35½	32	34½	115	137

Floor Model

45SL	35½	32	76	198	237
------	-----	----	----	-----	-----

Burgess-Manning Acousti Telephone Booths

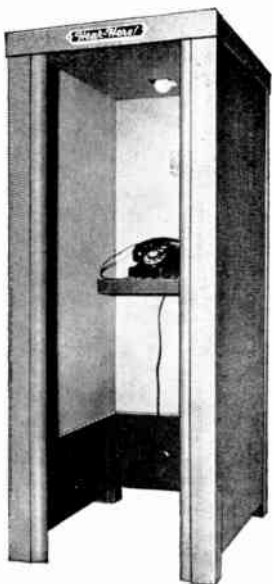

Heavy duty, all steel construction.

Durable gray wrinkle finish. Highly efficient acoustic construction.

Ideal for use in stores, restaurants, hotel lobbies, power stations, factories, public buildings where outside noises make telephoning difficult.

Equipped with light fixture and shelf. Outside dimension: 31-in. wide; 38½-in. deep; 79¾-in. high.

No.	Net Wt., Lbs.	Ship. Wt., Lbs.
211	350	375

Sherron Outdoor Telephone Booths

Special

Reinforced construction of zinc coated cold rolled steel with integral rigid steel base and safety plate floor.

Constructed with equal-leaf folding door. Has backboard for mounting coin collector, corner shelf, tubular wiring standard. Half panel construction with lower half panels on three sides and upper rear half panel steel acoustic filled, upper right and left side half panels of wire glass.

Equipped with flush incandescent light fixture with ceiling. Provided with solid lintel panels, decal "Telephone" sign with weatherproof entry fittings in rear lintel panel.

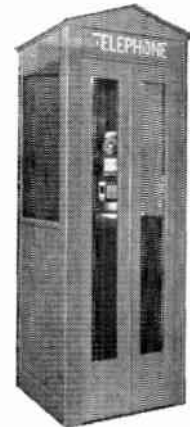

Booth has positive action door closer and peaked steel roof. Finished in DuPont baked synthetic enamel, standard color flame red. Booth completely packaged, set up, as described, no extras or substitutions.

No.	Height In.	Width In.	Depth In.	Ship. Wt., Lbs.
15-S Type 1	89¼	30	30	500

Sherron Outdoor Telephone Booths

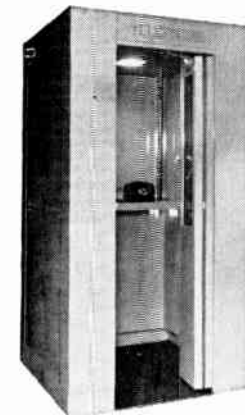

Designed for increased acoustic efficiency. Booth is of Cold Rolled Steel fireproof construction. Has cold rolled steel base with linoleum covered steel floor. Booth has perforated metal linings backed by 3-in. thick acoustic sound absorbing material.

Equipped with extra thick insulated equal-leaf folding door with half-length glass panels. Door panels are double glass with ¼ in. dead air space between.

Regularly equipped with standard flush ceiling light with self closing lens and automatic door switch.

Furnished as specified with either standard backboard corner shelf and tubular standard for pay station use or with straight 10-in. wide shelf across rear fitted with tubular standard and having provision for up to three hand-set telephones.

Finished in DuPont baked synthetic enamel, standard colors: Exterior of booth light brown, dark brown, maroon, red, gray; Interior of booth gray. Special finishes available at extra charge.

Extra Equipment Available: Seat Assembly, cold rolled steel, linoleum covered. Ventilating Unit, for concealed installation (115v. 60 Cycle a-e). Stainless Steel Base, for added protection at floor line. Kick Plates, for door, stainless steel. Signal Light Arrangement for visual outside summons.

No.	Width In.	Depth In.	Ship. Wt., Lbs.
150-S Type 1	42	42	800

Note: For further information, please contact GRAYBAR.

Sherron Outdoor Telephone Booths

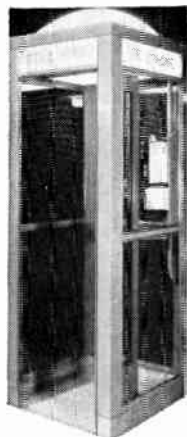

Standard

Reinforced construction of zinc-coated cold rolled steel. Stainless steel base with safety plate floor, equal leaf folding door.

Translucent plastic hinged ceiling assembly and "Telephone" signs on front and two sides. Equipped with incandescent light fixtures; backward for mounting coin collector; corner shelf, weatherproof entry fittings.

Baked synthetic enamel finish in choice of flame red, alert green, highway yellow, hunter green color. Please specify color desired.

Optional Extra Equipment: Door closing device; wire duct; photo-electric control switch with adjustable light sensitivity switch; circline 2-10 watt fluorescent fixture; model AA directory unit; seat assembly; kick plate and ventilating unit.

No.	Roof	Ht., In.	Width, In.	Depth, In.	Ship. Wt., Lbs.
17-S Type 7	Peaked	89 1/4	30	30	650
17-S Type 7	Astra-Dome	92 1/2	30	30	650
17-S Type 7	Flat Steel	85	30	30	650

Sherron Indoor Telephone Booths

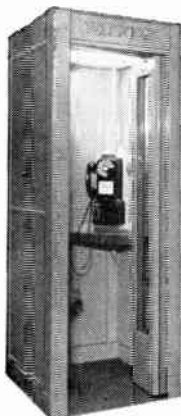

Steel fireproof construction. Integral steel base with linoleum covered steel floors. Equal leaf folding door.

Perforated metal linings backed by acoustic sound absorbing material. Equipped with drilled backboard and shelf mounted on tubular wiring; adjustable for standing or sitting position. Hinged bracket, hinged ceiling assembly. Concealed automatic door switch and decal "Telephone" sign on front lintel. Large area translucent plastic light. Dimensions: 30-in. wide, 30-in. deep, 83 3/4-in. high. Shipping weight 500 lbs.

Optional extra equipment such as linoleum covered seat assembly, stainless steel shelf and base; directory lights, etc., also available.

No. 18-S Type 1A: Constructed of zinc-coated cold rolled steel. Baked enamel finish. Exterior of booth available in light and dark brown, maroon, red, gray; interior of booth gray.

No. 19-S Type 3A: Constructed of stainless steel, interior and exterior for free standing installations. Includes stainless steel base, shelf and backboard.

No. 19-S Type 3B: Same as model 19-S Type 3A except for recessed installations. Zinc-coated cold rolled steel exterior side, rear post and back panels.

Sherron Outdoor Telephone Booths

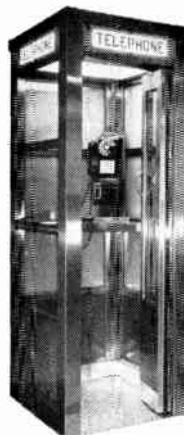

Clearview

Reinforced construction of zinc-coated cold rolled steel. Stainless steel base with safety plate floor, equal leaf-folding door.

Quarter panel construction. Lower panels solid steel clad with ventilating louvers, upper three panels each side clear safety glass. Specify if solid steel panels are preferred.

Translucent plastic hinged ceiling assembly and telephone signs on front and two sides. Equipped with door switch, stainless steel shelf assembly and kick plate, door closing device, spring door stop, weatherproof entry fittings and two 40-watt circline fluorescent fixture.

Booths finished in baked synthetic enamel and colors available are flame red, alert orange, highway yellow and hunter green. Please specify.

Optional Extra Equipment: Cold rolled steel seat assembly; wire duct at rear for incoming services from ground; photo electric light control switch with adjustable light sensitivity control.

No.	Roof	Ht., In.	Width, In.	Depth, In.	Ship. Wt., Lbs.
17-S Type 2	Peaked Steel	89 1/4	30	30	650
17-S Type 2	Astra-Dome	92 1/2	30	30	650
17-S Type 2	Flat Steel	85	30	30	650

Clearview Stainless

Reinforced main construction of stainless steel. Upper structure, panels, ceiling and roof, solid clad panels and backboards are of zinc-coated rolled steel finished in bright baked enamel. Other specifications and design comparable to model 17-S type 2 telephone booth.

No.	Roof	Ht., In.	Width, In.	Depth, In.	Ship. Wt., Lbs.
25-S Type 2	Peaked Steel	89 1/4	30	30	650
25-S Type 2	Astra-Dome	92 1/2	30	30	650
25-S Type 2	Flat Steel	85	30	30	650

U. S. Instrument Sound Powered Telephone Sets and Accessories

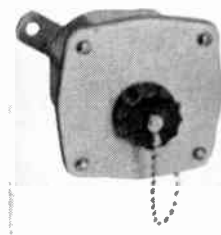

Jack Boxes

No. A531: Watertight brass enclosure. Equipped with single jack on cover to accommodate No. A529 plug and with molded phenolic terminal block in case.

No. A532: Same except has two jacks on cover.

No. A533: Same except has four jacks on cover.

U. S. Instrument Dial P. X. Switchboards

Private Automatic Exchanges Dial Telephone Switching Equipment

Type 50B Dial PX

Completely new, completely automatic dial telephone switching system designed to provide private, self-operative internal telephone service for industrial plants, offices, department stores, ships, institutions and other installations.

The 50B PX requires no operator. Compactly constructed in single units for 50 station lines and a maximum of seven connecting links. An unlimited number of units may be furnished.

Exchanges with 100 lines or less, two digit numbers are used and connecting links consist of connectors. Larger exchanges, three digit numbers are used and selectors and connectors are required.

The Line Racks have sufficient space for 50 pre-selectors and seven connectors with relay sets. One ringing and signaling machine provided for each two line racks. Line racks are 7½-ft. high, 20¼-in. wide, and 13-in. deep. Plug-in type ringing machines. 24-volt storage battery with charger, or battery eliminator required. Maximum conductor loop is 500 ohms or about 2.9 miles of 22 gauge cable.

The Selector Racks accommodate 15 selectors with relay sets. Selector racks are 7½-ft. high, 18½-in. wide and 13-in. deep. All racks wired for the full complement of equipment.

Emergency right-of-way may be installed to permit an executive to interrupt a call in progress. Minimum maintenance.

For full information contact GRAYBAR.

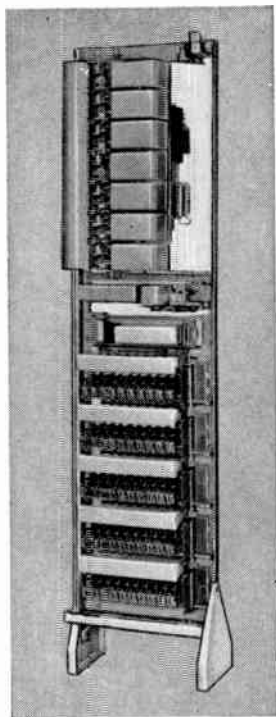

Line Rack

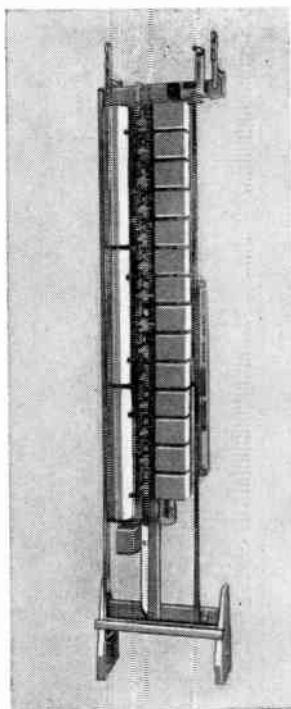

Selector Rack

Type 50A Dial PX

Telephone System For Industrial Plants, Institutions, Offices, Department Stores, Ships And Other Installations

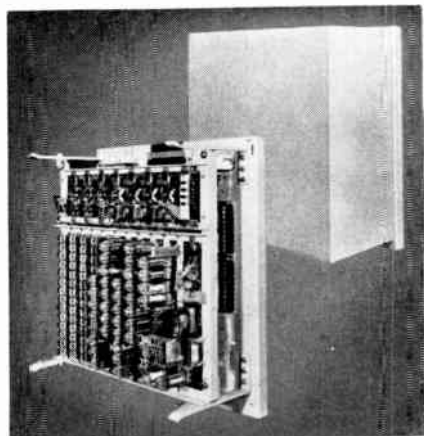

Switching Equipment Type 50A

Completely automatic dial telephone switching system designed to provide private, self-operative internal telephone service. The new 50A PX requires no operator. It contains its own switching equipment enclosed in an attractive wall cabinet. The compact wall mounted cabinet is 25-in. high, 23½-in. wide, 12-in. deep and weighs 128 pounds.

The dial telephone switching system enables extension users to dial their own calls. Unit operates on a 24 volts d-c power supply outside the cabinet. Commercial power with or without a standby battery may be used.

Connection to central office lines or to other PX's can be made available with supplementary equipment. Up to 28 stations and four interconnecting links are available, although equipment may be furnished with an initial installation of fifteen stations and three connecting links.

For full information contact GRAYBAR.

U. S. Instrument Sound Powered Telephone Sets

Equipped with Magneto-Howler Call

The voice of the user supplies all the power necessary to operate sound powered telephones. The voice causes fluctuations in the magnetic circuit of transmitter creating alternating current. This current is transmitted to receiver where sound waves are created, reproducing speaker's voice.

Designed to withstand exacting shock, vibration, salt water corrosion, temperature and pressure tests. Molded parts are of impact material. Metal parts made of non-corrosive materials wherever possible.

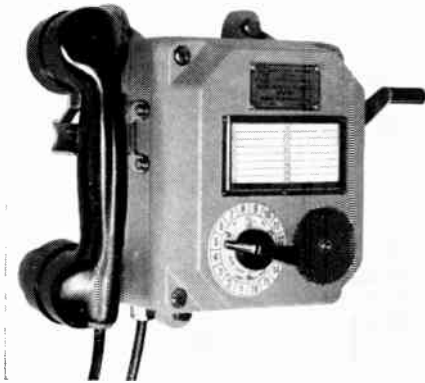

No. A543

Each station consists of a sound powered telephone handset mounted on a waterproof cast aluminum case, which contains a 1000 cycle magneto generator, a howler unit with connecting horn, the necessary terminal blocks and, if selective ringing is required, a rotary selector switch.

Common Talking—Common Ringing No. A541 Station

Four stations per system with maximum separation between any two stations of four miles. Wiring reduced to minimum. Two twisted pairs per system of No. 22 AWG or larger. One for calling and one for the telephone. To call, turn generator crank, this operates howlers at all stations except originating station. To talk simply press and hold down button on handset.

Common Talking—Selective Ringing No. A542 and A543 Station

No. A542: Maximum number of stations per system is eight. No. A543: Maximum number of stations per system is sixteen. Twisted pairs of No. 22 AWG or larger recommended for both telephone and calling lines to avoid cross talk. To call simply turn selector switch to desired station and turn generator handle. Howler operates only at selected station. To talk, press and hold down the button on the handset.

Master Station Systems No. A540 Substation

Designed to be used in conjunction with a master station. Any selective ringing station. No. A542 or A543 may be used as master stations. Master station may call any substation, but substation may only call master station. Three twisted pairs wiring required between each substation and master station.

No.	Description	Lgth. In.	Width In.	Depth In.	Wgt. Lbs.
A541	Station	9 ³ / ₄	10 ³ / ₄	4 ³ / ₄	9
A542	Station	9 ³ / ₄	10 ³ / ₄	5 ³ / ₄	10
A543	Station	9 ³ / ₄	10 ³ / ₄	5 ³ / ₄	11

Optional Accessories

No.	Description	Lgth. In.	Width In.	Depth In.	Wt. Lbs.
A547	Extension Howler	4	4	3 ³ / ₄	2
A537	Generator Oper. Relay	4 ¹ / ₁₆	4 ¹ / ₁₆	2 ¹⁵ / ₁₆	1 ³ / ₄
2961	Hood	13	12	6 ¹ / ₈	2 ³ / ₄

Approved by Bureau of Mines

These sound powered telephone stations have been tested and approved by the Bureau of Mines, U. S. Department of the Interior, for use in mines. The Bureau states: "Permissible" as used in the schedule means formally approved by the Bureau for use in mine atmospheres that may contain methane or coal dust. The approval plate will be placed on all stations listed below. No shielding or special protection is required to make these systems explosion-proof throughout, other than caution against contact with power or light lines noted on the approval plate.



No. A544 Station
With No. 2961 Hood

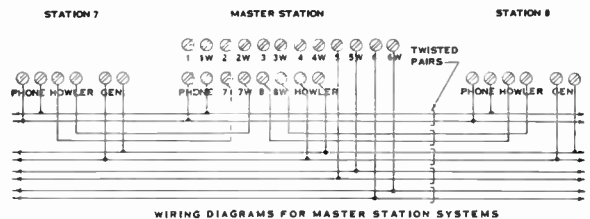
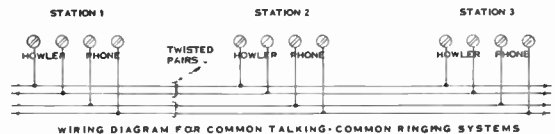

Common Talking—Common Ringing No. A544 Station

Four stations per system with maximum separation between any two stations of four miles using No. 22 AWG wire will give good performance. 11¹/₄-in. long, 10³/₄-in. wide, 4³/₄-in. deep. Approximate weight 9 lbs.

Common Talking—Selective Ringing No. A545 Station

Maximum number of stations per system is eight. Specifications similar to A542 but is supplied with terminal tube. 11¹/₄-in. long, 10³/₄-in. wide, 5³/₄-in. deep. Weight 10 lbs.

No. A546 Station

For sixteen station common talking—selective ringing system. Specifications similar to No. A543 station but is supplied with terminal tube. 11¹/₄-in. long, 10³/₄-in. wide, 5³/₄-in. deep. Approximate weight, 10 lbs.

No. 2961 Hood

Can be used with any station listed on this page. It is particularly useful in mine areas where falling rocks or dirt is an ever-present hazard.

U. S. Instrument Sound Powered Telephone Sets and Accessories

Sound Powered Handsets



No. A560

No. A560 Weatherproof Handsets

With built-in press-to-talk switch, recommended for heavy duty uses or where portability is desired. When button of press-to-operate switch is depressed, the handset is connected to the line. Supplied with 4 ft. of rubber covered cord. Weight without cord is 22 ounces.

No. A555 Weatherproof Handset

Without built-in switch. Has 4 feet of rubber covered cord. Weighs 20 ounces without cord.

No. A257-2 Underwriters' Laboratory Handsets

With built-in press-to-talk switch. Approved by Underwriters' Laboratories, Inc. for hazardous locations Class 1, Group D. Supplied with 4½-ft. rubber covered cord. All other interconnecting lines are to be enclosed in grounded rigid metal conduit to safeguard against accidental contact of telephone circuits with power lines or other circuits.

Type 333 Approved Coast Guard Handsets

A weatherproof sound powered handset for use where Coast Guard approval is required.

Special Handsets

Handsets providing special switching requirements can be made up on order as can handsets with three or four conductor cords.

Mounting Hooks



No. A-281



No. 5200

No. 5200 Mounting Hooks: Standard mounting hook for left hand mounting. Stainless steel. Weight 2¾ ounces.

No. 5201 Mounting Hooks: Similar to No. 5200 but for right hand mounting.

No. A281 Mounting Hooks: For use where there is motion, vibration or shock. Receiver end of handset is held by a rubber padded fork; transmitter end by a coil spring covered by bakelite rollers. Aluminum frame is finished black. Weight is 9½ ounces.

No. A325-1 Mounting Hooks: Similar to No. A281, but provides for various switching arrangements in base which are activated by removing or replacing the handset.

For more complete information contact GRAYBAR.

Head-Chest Sets



No. A602

No. A602: Heavy duty design, recommended as an all around instrument wherever it is desirable to have operator's hands free.

Furnished with built-in press-to-talk switch which controls transmitter only. Supplied with 10-ft. rubber cord.

No. A603: Sound powered weatherproof single receiver head-chest set is same as A602 except has single receiver.

Headsets

No. A331: A sound powered weatherproof double receiver headset supplied with 19-in. rubber covered cord.

Weight without cord, 16 ounces.

Pocket Telephone



No. A278

This sound powered pocket telephone is a combined receiver and transmitter that is easily carried. Convenient for tests or periodic reports.

Equipped with 3½-ft. rubber covered cord. Weight without cord is 7 ounces.

Instrument Units

No. UA1614



Sound powered units serve as microphone and receiving units in diversified products such as gas masks, power megaphones and geophysical instruments. Standard units available with warble frequency impedances of approx. 6 to 25,000 ohms. Supplied with a chemically treated aluminum diaphragm grill and nylon cover.

When ordering specify exact requirements.

Plug and Panel Mounted Jack



No. A529



No. A689



No. A530

No. A529 Plug: Designed for use with portable sound powered telephone equipment and can be supplied separately or attached to telephone cord.

No. A689 Portable Jack: For use with A529 plug.

No. A530 Panel Mounted Jack: For use with A529 plug.

Crouse-Hinds "ET" Series Telephone Sets Explosion-Proof and Dust-Tight

Manual, Dial, and Magneto Types With Built-In Ringer

- Class I, Groups C and D (NEMA Type VII)**
- Class II, Groups E, F, and G**
- Class III (NEMA Types IXA, IX, and V)**

Manual and dial type telephones for use on common battery systems. Magneto telephones for local battery talking and magneto signaling, but in some cases can be arranged for common battery talking and magneto signaling.

Telephones used only on straight line or divided ringing circuits. They are not suitable for use on harmonic ringing circuits.

Telephones available for either desk use or wall mounting and are equipped with a built-in ringer mounted in base. Telephone housing and handset cradle made of cast aluminum. The desk and wall type are equipped with explosion-proof handsets. Each handset furnished with a 5-foot length of flexible cord and a factory-sealed connector. Two conduit hubs in base.

Manual and Dial Types—Common Battery



For Desk Use



For Wall or Panel Mounting

Conduit With Telephone Equipment No.	Hub Size	Housing Western Electric Co.	Style	Telephone Interior	D. C. Resistance of Ringer
ETDA23	..	Desk Use	Dial	4600 ohms	
ETDM23	..	Desk Use	Manual	4600 ohms	
ETWA23	3/4	Wall or Panel Mtg.	Dial	4600 ohms	
ETWM23	3/4	Wall or Panel Mtg.	Manual	4600 ohms	

Magneto Type—Local Battery Talking Magneto Signaling



For Desk Use



For Wall or Panel Mounting

ETDG23	..	Desk Use	Magneto	4600 ohms
ETWG23	3/4	Wall or Panel Mtg.	Magneto	4600 ohms

Battery Housing



Battery Housing

Furnished with terminal block. Arranged for Ray-O-Vac 386C, or equal dry cell battery. Battery is not included.

Without choke coil. For ETDG23 and ETWG23 with Western Electric Company interior.

No.	Size, Hub
ETG22	3/4

Installation

The table below lists accessories required for telephone installations both with and without auxiliary signals. This does not include the miscellaneous items such as junction condulets, sealing condulets, conduit and other material which will be required.

In hazardous locations all conduits entering the line switch, battery housing, power cut-off switch, relay, or wall type telephone must be sealed with explosion-proof sealing condulets. Where elbows, tees and junctions are required in the conduit installation, the GUA series are especially suitable. The ETS22 line switch is so arranged that when it is turned to the "off" position the line is opened and the condensers discharged at the same time.

Telephones with Western Electric Company interiors are equipped with bleeder resistors which discharge the condensers. This allows the use of type ETS terminal block condulets, in place of the ETS22. The ETS26t should be used with Western Electric telephones.

When these terminal block condulets are used in place of the line switch it will be necessary to remove the fuses or disconnect line wires from the telephone line protector in the non-hazardous area before opening the telephone housing for service.

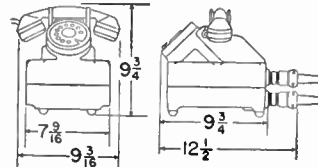
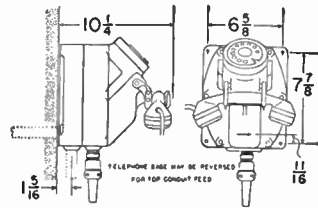

Manual and Dial Telephones

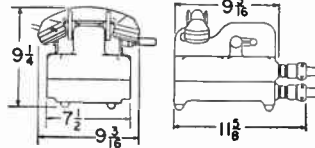
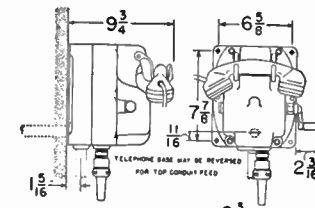

Magneto Telephones

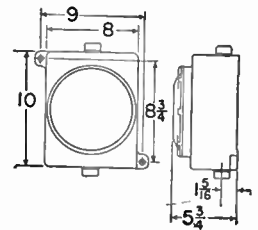

Battery Housing

Accessories Required

Telephone Condulet With Built-In Ringer Manual & Dial	Without Auxiliary Signal	With Aux. Ringer Oper. On Telephone Ringing Circuit (65 to 90 Volts, 19 or 20 Cycles)	With Aux. Bell or Horn Oper. on Sep. 115 V. A-C, 60 Cy. Source of Power
ETDA23		ETS22	ETS22 Line Sw.*
ETDM23	ETS22	Switch*	ETC29 Relay
ETWA23	Line Switch*	ETR281 Ringer	ETS24 Pow. Cutoff Sw.
ETWM23			ESR Bell or ETH Horn

Magneto Type

ETDG23	ETS22 Line Sw.	ETS22 Line Sw.*	ETS22 Line Sw.*
ETWG23	ETG22 Battery Housing	ETG22 Bat. Hous.	ETG22 Bat. Hous.
		ETR282 Ringer	ETC29 Relay
			ETS24 Pow. Cutoff Sw.
			ESR Bell or ETH Horn

*Line switch optional.

Crouse-Hinds "ET" Series Telephone Sets

Wiring Diagram

For ET Series Manual Or Dial Telephone Condulets

Hazardous Locations

TELEPHONE BELL SIGNAL

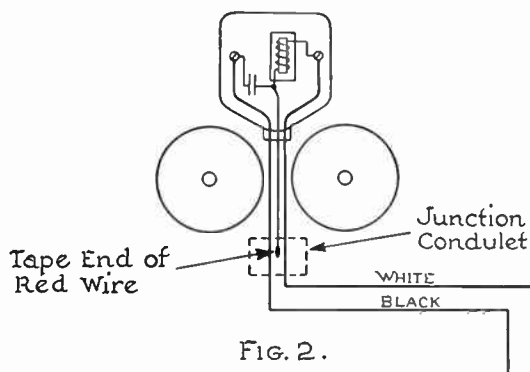

HORN SIGNAL

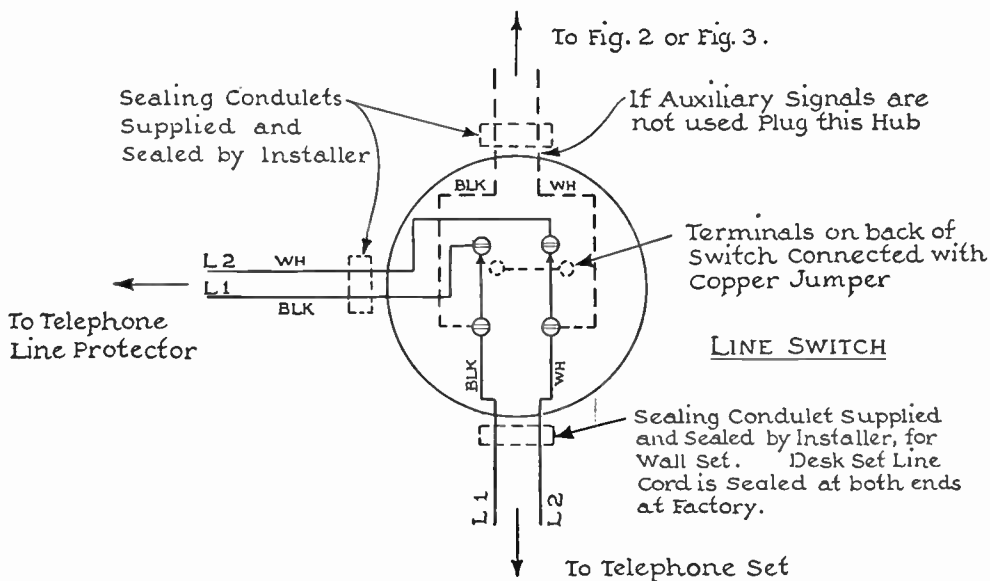
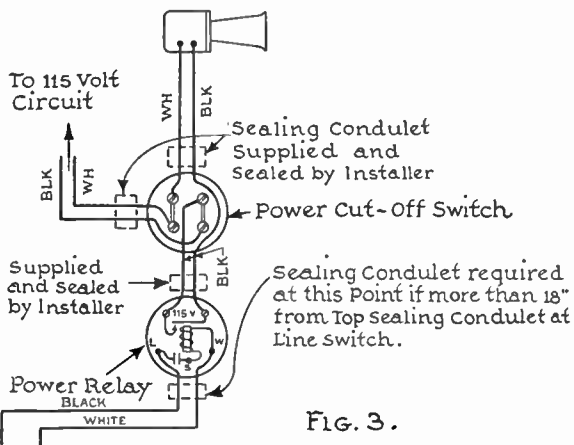

When ET series telephones are to be installed without auxiliary signals, only the lower part of the above wiring diagram need be used. These telephones, manual or dial, are available in both desk and wall types and each type is equipped with a built-in bell in the base.

The upper parts of the diagram show the connections and the equipment required when auxiliary signals are to be installed. Figure 2 shows the connections for the ringer which

operates on the telephone ringing current. Figure 3 shows connections for horn or bell signals which operate through a relay on a separate 115 volt a-c, 60 cycle source of power.

Sealing condulets are indicated in the diagram at several points. Types EYS, EZS, and EZD listed in section J are recommended for this application. Where elbows, tees, and junctions are required in the conduit installation, the GUA series condulets listed in section G are especially suitable.

Crouse-Hinds Magneto Telephone Sets

Types ETG and ETWG

Installation Drawing

Hazardous Locations

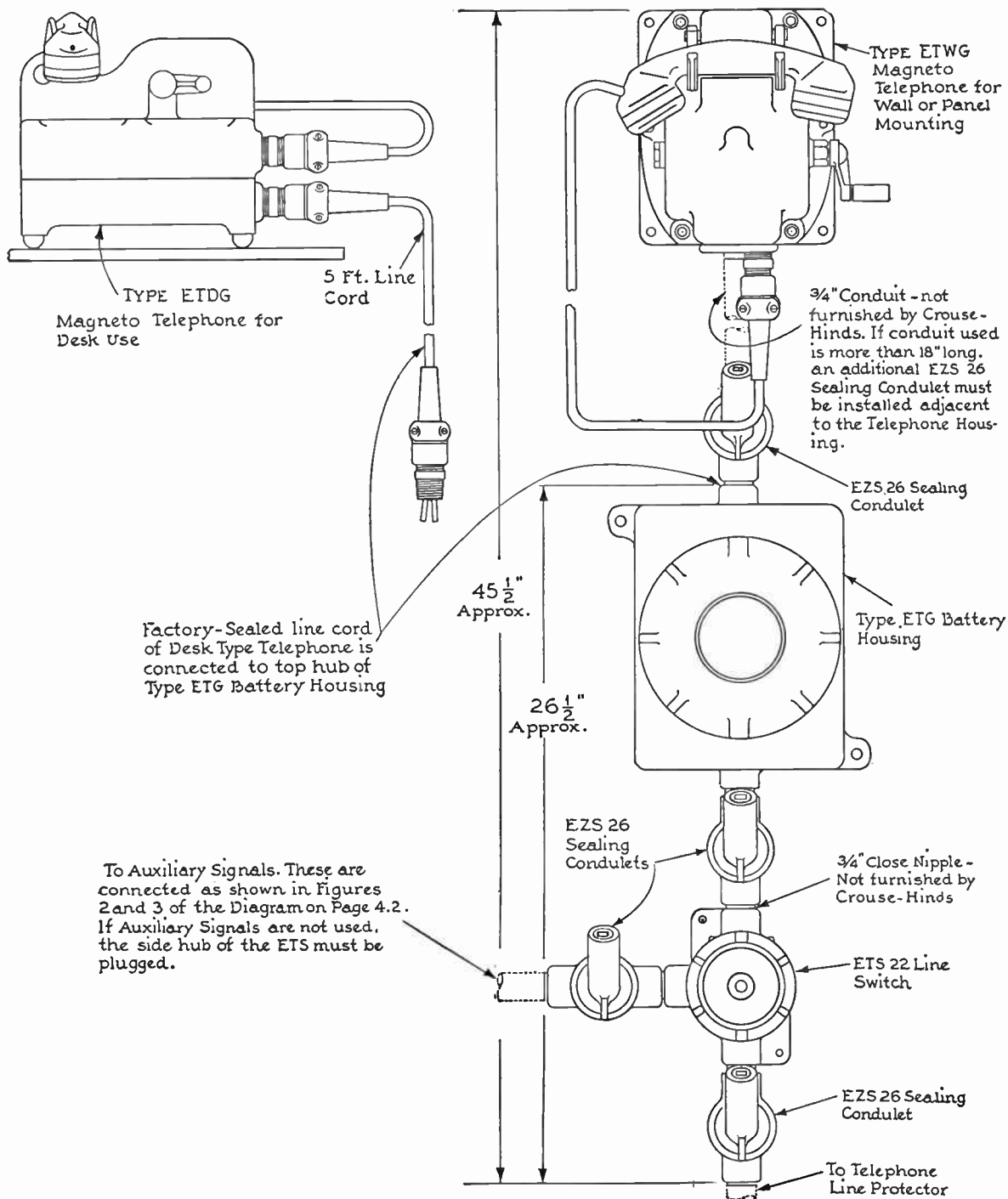

Crouse-Hinds Telephone Sets and Accessories

Explosion-Proof and Dust-Tight

Auxiliary Ringers: Type ETR ringers used with manual, dial or magneto type telephones. Used as auxiliary loud ringers and in conjunction with built-in ringer in base of telephones.

Line Switch: ETS22 condulet equipped with tumbler switch used to open the line to telephone unit, at same time discharge the condenser. Three threaded hubs in housing for 3/4-in. rigid conduit; mounting set with fastening holes and threaded cover.

Power Cut-Off Switch: ETS24 Condulet has switch used to disconnect separate source of power from relay contacts and the horn signal.



No. ETR



Nos. ETS22 & ETS24

Dialing Unit: The ETD211 used to convert manual telephones to dial telephones. Housing provided with round threaded covers, through-feed threaded hubs for 3/4-in. rigid conduit and mounting feet with fastening holes.



No. ETC29



No. ETS206



No. ETD211

Extension: The "ETF" designed for use with manual telephones. Housing contains a double pole, double throw tumbler switch which is operated by handset and fork in which it rests. Housing has threaded hub for 3/4-in. rigid conduit at top and mounting feet with fastening holes.

Line Selector Switch: Type ETS Condulets provided with double pole rotary selector switches which make it possible to mechanically select any one of several telephone lines for purpose of monitoring or making calls. Equipped with 3/4-in. hubs and mounting feet with fastening holes.

Terminal Block: Type ETS Condulet provided with 4 or 6 terminal blocks. Provided with 3/4-in. hubs for rigid conduit and round threaded cover.



No. ETF



Nos. ETS206 & ETS211



No. ETS264

No.	Description	Size Hub
ETF2	Extension with Line Switch and handset	3/4
ETS206	Line Selector switch, 6 position	3/4
ETS211	Line selector switch, 11 position	3/4
ETS264	With Western Elec. Co. 4 terminal block	3/4
ETR281	Ringer for Manual or Dial telephones	3/4
ETR282	Ringer for Magneto telephones	3/4
ETS22	Line Switch, two-pole, double-throw	3/4
ETS24	Power Cut-Off Switch, two-pole	3/4
ETC29	Relay for Horn Signal .75A, 115 V. a-c 60 cy.	3/4
ETC232	Relay for Horn Signal 5.0A, 115 V. a-c 60 cy.	3/4
ETD211	Dial for converting W.E. manual telephone	3/4

Crouse-Hinds Sound Powered Telephone Sets Type ETWS

Explosion-Proof and Dust-Tight—Hazardous Locations

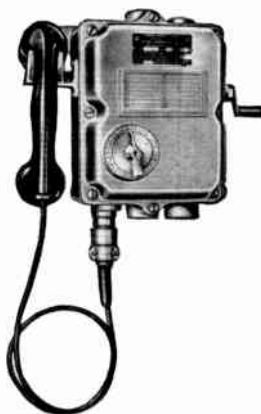

No. ETWS3160 With Built-in Relay



No. ETWS3166 With Built-in Howler

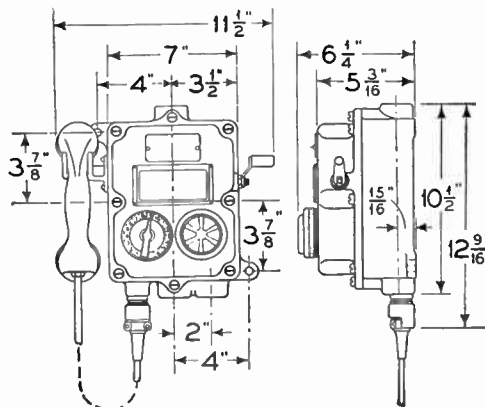

Dimension—Type ETWS

Type ETWS sound powered telephones for common talking, selective magneto signaling. Satisfactory transmission assured under normal conditions for 30 miles or more, using No. 22AWG wire. Available with either 16 or 21 circuit selector switches.

Designed for wall mounting, Handset is furnished with a 5-foot length of cord and a factory-sealed connector. Telephones provided with through-feed threaded hubs for 1-inch rigid conduit and an additional 1-inch threaded hub at the bottom. Selector switch controls only the magneto signaling.

Housings are in two sections which are held in flame-tight relationship by large cover screws. The body and cover are approximately the same depth. Terminal block for connection of the line wires is mounted in the body. All other interior parts are mounted in cover, with a cable assembly connecting them to the block.

No.	Type	Number Circuits	Size Hub
ETWS3166	ETWS	16	1*
ETWS3246	ETWS	24	1*
Furnished with U. S. Instrument Co. Magneto, Howler and Handset. Interior Includes 1200 Cycle Magneto and Built-in Howler. No Separate Signal Required. Howler has Loudness Rating at 10 FL of 86 Decibels or 27200 ASA Units.			
ETWS3160	ETWS	16	1*
ETWS3240	ETWS	24	1*
Furnished with U. S. Instrument Co. Magneto and Handset. Interior Includes 1200 Cycle Magneto and Built-in Relay and Separate 115-V. a-c 60 Cycle Source of Power Allows Use of Type ESR Bell or ETH Horn.			

*1-inch through-feed hubs with an additional 1-inch hub at bottom.

Crouse-Hinds Sound Powered Telephone Sets
Type ETWS
Wiring Diagram

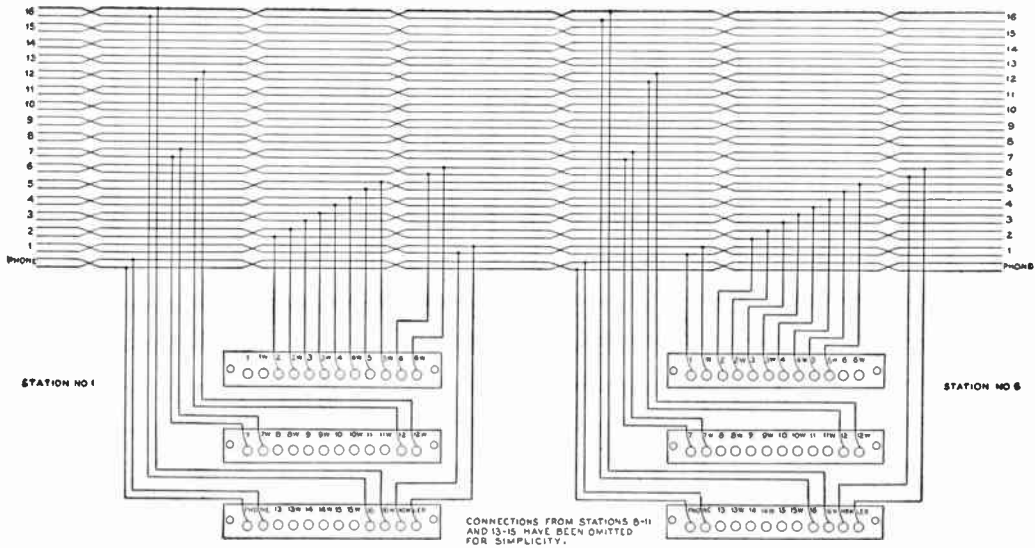

For wiring in hazardous locations, twisted pairs of telephone cable of No. 22AWG run in conduit are recommended. For overhead wiring on poles in non-hazardous locations, No. 22AWG lead covered telephone cable should be used.

Wire size given is the minimum size. On long runs, somewhat better performance may be expected when wire sizes larger than those given are used.

Installation Drawings

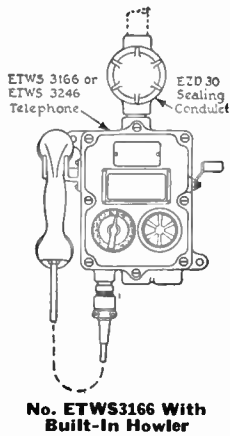

The installation drawings immediately above show the auxiliary equipment required when installing type ETWS sound powered telephones.

In both types of installation, the EZD30 inspection seal condulet is recommended for sealing the incoming telephone wires or cable. This sealing condulet is selected as its design allows inspection while the seal is being poured, to make certain that each of the many conductors is surrounded by compound.

When installing a type ETWS telephone with built-in relay for horn or bell signals operating on a separate 115-v. a-c, 60 cycle source of power, the ETS24 power cut-off switch is recommended, but is not necessary when a convenient

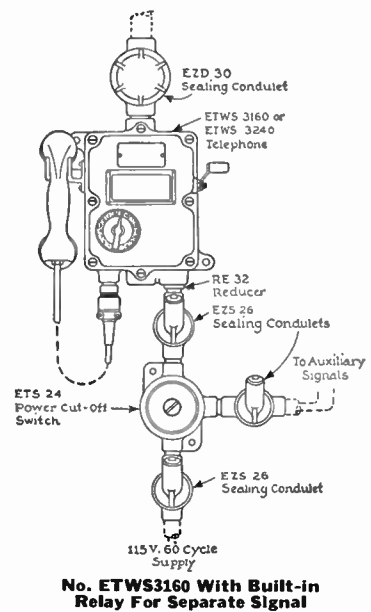

means of disconnecting the power is available. EZS26 sealing condulets for horizontal or vertical conduit are used to seal at the power cut-off switch.

Where elbows, tees, and junctions are required in the conduit installation, the GUA series condulets are especially suitable.

**Crouse-Hinds Magneto Telephone Sets
Graybar Type GB**

Weatherproof—With Built-In Ringer
Local Battery Talking, Magneto Signaling
(Similar to Western Electric No. 1336E Telephone)

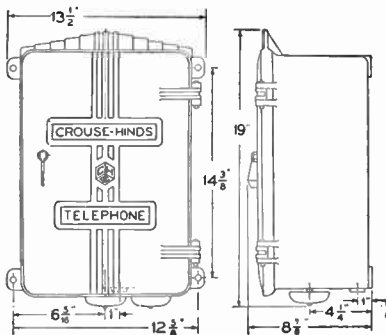
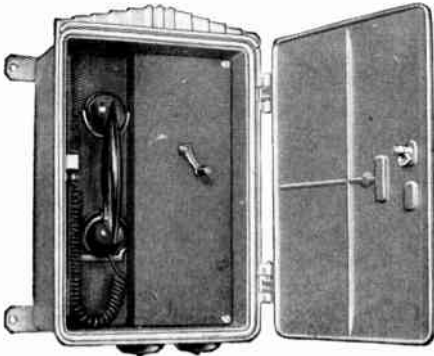

A complete magneto telephone station in an attractive weatherproof enclosure for local battery talking and magneto signaling. Suitable for use in industrial plants, outdoor locations, and non-hazardous areas of mines.

Cabinet and hinged door made of cast aluminum. Mounting straps with fastening holes at each end are attached to back of cabinet. A cam catch firmly tightens the door against gasket cemented to cabinet, providing a raintight joint. If desired a lock and key can be supplied in place of the cam catch at a slight additional charge.

Handset, handset hanger and magneto crank mounted on front of hinged plate. Removal of two screws allows plate to be opened outward, exposing the magneto, condenser, induction coil, hook switch and terminal block which are attached to the back of the plate. Ringer is fastened to the bottom of the cabinet.

Space is provided in bottom of cabinet for two No. 6 Gray Label dry cells used to supply necessary 3 volt d-c for the talking circuit. (Batteries not included.)

A 1/2-in. conduit opening is provided in bottom near the back for entrance of the circuit wires. Insulating bushing with a 1/2-in. hole is also supplied.

Magneto Telephone With Built-In Ringer

No.	Description	Size Conduit Opening	Ship. Wt., Lbs.
GB1436-E	Arrange for two No. 6 Gray Label dry cells or equivalent.	1/2	40

Stromberg-Carlson Intercommunication Telephone Systems

**All Sub-Station TS-51, TS-52, TS-53
Common Ringing . . . Common Talking**

All sub-station, or party line, inter-communicating telephone systems are used extensively where an economical system of two to six telephones is required. When only two telephone instruments are needed, a two wire system (TS-51) or a three-wire system (TS-52) can be used. When three to six telephones, or a two-instrument system that might be expanded, are needed, a four-wire system (TS-53) is required.



TD-11

Sub-stations are common talking. Only one conversation can take place at a time but any or all telephones can be in on the conversation.

Code ringing is employed on systems of three to six telephones. Each telephone equipped with single push-button which, when depressed, rings all other telephones in the system. A pre-arranged code of signals is used to call desired party.

The telephones which can be used in these systems, and mixed in the system when desired are the TD-11 and the TW-31. The TD-11 may be converted to wall-mounting by means of TK-3 conversation kit.

Installation Material

System	Max. Lgth. of Line (a)	Wire No. 19 Gauge	Retard Coil	1 1/2 Volt Batteries (b)
TS-51	4350 Ft.	2 conductor	None	3 to 16
TS-52	4350 Ft.	3 conductor	1 No. 51-II	4 to 8
TS-53	1150 Ft.	4 conductor	1 No. 51-II	4 to 8

(a) Max. lgth. using No. 19 gauge conductors, heavier gauge wire increases maximum length.

(b) 2 conductor system, batteries divided and installed at each end of line. 3 and 4 conductor systems, batteries and retard coil at one instrument. Raytheon Rectifier Model 1024 is satisfactory on TS-53 system only.

Call Graybar FIRST For . . .

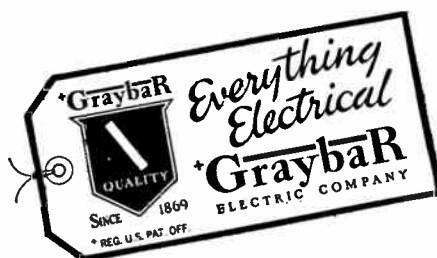

Stromberg-Carlson Intercommunication Telephone Systems

**Master to Sub-Station TS-41
Selective Ringing—Common Talking**

The "Master to Sub-Station TS-41" system is ideal for installation where there is little need for communication between sub-stations. An inter-communication telephone system which provides a single master station that can call and be called by a number of sub-stations.



TD-11



**TD-11
Wall Mounted**



TW-31

Although only one conversation can take place at a time, any number of stations may be in on the conversation. While sub-stations cannot call each other, they can call the master and request the master to ring the desired sub-station.

Master stations available are the TD-18 for desk use, the TW-28 and 2527-C8 for wall mounting. Sub-stations used in the system are the TD-11 and the TW-31, which can be mixed in the system. The TD-11 can be converted to wall mounting by means of the TK-3 conversion kit.

The TD-18 Master Station and the TD-11 Sub-station telephones supplied complete with a 5 ft. line and cord and terminal block to facilitate installation. TW-28 and TW-31 telephones provided with terminals in telephones to which building wiring is terminated.

Installation Materials

Master Telephone	Wiring to Sub-Stations	Power Supply*
TD-18	Three common wires to all sub-stations plus one individual wire from master to each sub-station	Dry Cell or Battery Eliminator
TW-28		

*4 to 8, 1½ volt dry cell batteries or battery eliminator.
Contact Graybar for full information.

Terminal Accessories

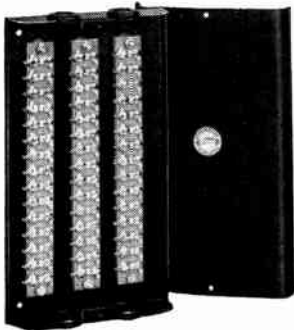

18-12

No.	Capacity
18-12	12 terminals
19-AC	15 pair
19-BC	27 pair

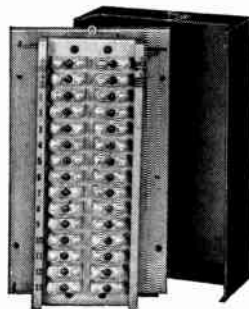

No. 19

Size, In.
7½ x 3 x 1½
8½ x 5½ x 2½
14½ x 5½ x 2½

No.	Description	Size, In.
TA-42	Phenolic terminal box with 4 plates	2 x 2 x ¾

Contact Graybar for full information.

Stromberg-Carlson Intercommunicating Telephone Systems

**All Master TS-31
Selective Ringing—Common Talking**

"All Master" TS31 system is an inter-communicating telephone system for master-to-master operation especially suited to small offices, banks and residences. Has selective ringing so that any master can select and ring individually any other master telephone in the system.



Model TD-18



Model TW-28

A common talking system using only one pair of wires for talking purposes. Only one conversation can take place at a time although any number of stations can be in on the conversation. Very satisfactory for systems of nine telephones or less.

Three master station models available that are interchangeable and can be mixed in the system.

Desk set Model TD-18 is

supplied complete with a 5 ft. line cord and terminal box to facilitate installation.

Models TW-28 and 2527-C8 provide two types of wall mounting instruments.

Altec Lansing Velocity Microphones



Has an improved sensitivity and frequency range. A compact microphone providing excellent broadcast quality, high signal-to-noise ratio, and extremely low hum pickup.

Frequency response 30 to 16,000 cycles. Directivity, bidirectional. Impedance 30/50, 150/250 ohms. Output level —54 dbm/10 dynes/cm². Hum (max.) —130 dbm ref 10⁻³ gauss.

Has 5/8-in. x 27 swivel head. Finished in dark gray.

No.	Height In.	Width In.	Depth In.	Wt. Oz.	Each
671B	4½	2½	3¾	14	\$114.00

Altec Lansing Dynamic Microphones



Designed to properly fill the requirements for a close talking, rugged microphone for use in announcing and public address systems. Not intended for music pickup.

Frequency response 100 to 10,000 cycles. Output impedance 30/50 ohms. Output level —58 dbm/10 dynes/cm².

Finished in gray.

No.	Length In.	Width In.	Wt. Oz.	Each
632C	2½	2	8¼	\$52.00

Altec Lansing Dynamic Microphones



"Salt Shaker"

Famous for its ruggedness, dependability and quality.

Normally omnidirectional, but the addition of the 8B baffle provides semidirectional pattern.

Frequency response 35 to 12,000 cycles. Output impedance 633A—30/50 ohms—633C—30/50, 150/250 ohms. Output level —58 dbm/10 dynes/cm².

Finish is gray.

No.	Length In.	Diam. In.	WL. Oz.	Each
633A	3½	2	10	\$69.00
633C	3½	2	13	78.00

No. 660 Dynamic Microphone



Rugged, efficient unit of broadcast quality. Adapted for public address and outdoor use where its high output level, excellent signal-to-noise ratio, and durability are particularly advantageous.

Frequency response 35 to 12,000 cycles. Output level —58 dbm/10 dynes/cm². Output impedance 660A—30/50 ohms—660B—30/50, 150/250 or 20,000 ohms. Has 5/8-in. x 27 swivel head. Finished in satin silver.

Microphone equipped with 15-ft. of cable.

No.	Length In.	Diam. In.	WL. Oz.	Each
660A	4	1 11/16	11	\$49.50
660B	4	1 11/16	13	59.40

Altec Lansing Cardioid Microphones



A combination of a dynamic pressure element and an improved ribbon type velocity element.

Has a wide variety of directional patterns which are easily selected through screwdriver operated switch on back of the microphone.

Frequency response 40 to 10,000 cycles. Output impedance 30/50 ohms. Output level —56 dbm/10 dynes/cm². Discrimination, average front to back 20 db. Hum —120 db (ref: 10-3 gauss).

Has stand or suspension mounting. Finished in dark gray.

No.	Height In.	Width In.	Depth In.	WL. Lbs.	Each
639	7½	3 7/16	4 7/16	3 1/4	\$235.00

When ordering add the suffix "A" for three directional patterns. Add suffix "B" for six directional patterns.

No. 670B Cardioid Microphone



Provides high quality performance and excels in frequency response, front-to-back discrimination and low hum pickup.

Three directional pattern, omnidirectional, bi-directional and cardioid are easily selected by means of adjusting screw at back of microphone.

It is possible by shutter adjustment between the patterns to shift the null points of the microphone over a 90° angle and effectively suppress undesired sounds.

Screwdriver switch permits selection of proper output impedance.

Frequency response 30-16,000 cycles. Output impedance 30/50, 150/250 ohms. Output level —56 dbm/10 dynes/cm². Discrimination average front to back, 20 db. Hum (max.) —130 dbm ref 10-3 gauss.

Has 5/8-in. x 27 swivel head. Finish is dark gray.

No.	Height In.	Width In.	Depth In.	WL. Lbs.	Each
670B	6½	2½	3 3/8	1 1/4	\$138.00

Altec Lansing Microphones



This slim unit with the exclusive "Acoustic Gate" feature is a broadcast dynamic that eliminates high frequency peaks inherent in conventional microphones and provides outstanding performance throughout an extended frequency range.

Unaffected by wind, water, dirt or weather. Offers dependable broadcast quality combined with rugged durability.

Frequency response 30-15,000 cps; output impedance, low 30/50 ohms, medium 150/250 ohms, high 20,000 ohms; output level —58 dbm/10 dynes/cm².

Has "Sliden" holder mounting with 5/8-in.—27 swivel head.

Finished in black and green.

No.	Length In.	Diam. In.	WL. Oz.	Each
680A	7	1	8	\$99.00

Altec Lansing M-11 Microphone Systems



No. 21D Microphone with No. 150A Base No. 152A Cable Set No. 518A Power Supply

This system using the 21D microphone represents the ultimate in quality reproduction. Its graceful, slender shape presents a minimum of obstruction when used on a microphone stand and fits comfortably in the hand for mobile use.

The M-11 system is omnidirectional in pickup characteristic, completely shock and blast resistant, and not affected by strong winds, magnetic fields or dampness.

M-11 system complete..... \$296.00

M-11 Microphone System Components are as follows:

21D Microphone

Condenser type with frequency range 20 to 15,000 cycles. Pickup, omnidirectional. Not susceptible to magnetic fields. Capacitance 6 mmf. Length 3 3/8-in.; diameter 5/8-in. Weight 1/4-oz. Finish is stainless steel. Each \$67.00

150A Base

Contains a vacuum tube used as a cathode follower and an 8 pin cannon connector for connection of the microphone to the power supply. Length 8 3/8-in.; diameter 1 1/8-in. Weight 5 3/4 oz. Finish is satin black. Each \$63.00

152A Cable Set

For stand mounting microphone. Mounting 5/8-in.—27 thread. Length 25-ft. Weight 1 lb. 11 oz. Each \$26.00

153A Cable Set

For hanging suspension mounting of the microphone system (may be ordered extra as extension cable for 152A cable set). Length 25-ft. Weight 1 lb. 11 oz. Each \$26.00

518A Power Supply

Supplies necessary voltages to 150 base and 21D microphone. Power requirements 117 volts, 60 cycles a-c; System output level from power supply —48 dbm/10 dynes/cm²; Load impedance 30, 150/250, 500/600 ohms; Low frequency cutoff 20, 40, 120 cycles. Height 7 1/2-in. Width 8 1/4-in. Depth 6-in. Weight 11 1/2 lbs. Each \$144.00

Altec Lansing M-20 Microphone Systems



No. 21D Microphone with No. 165A Base—No. 166A Stand Attachment



No. 525A Power Supply

The M-20 "Lipstik"® microphone system provides the outstanding features of the Altec M-11 system with the latest developments in miniaturization and printed circuit applications making it the smallest quality microphone on the market.

It is no larger than a lipstick and is practically invisible when mounted on microphone stand.

M-20 system complete..... **\$236.00**

M-20 Microphone System Components are as follows:

21D Microphone

Condenser type with frequency range 20 to 15,000 cycles. Pickup, omnidirectional. Not susceptible to magnetic fields. Capacitance 6 mmf. Length 3/8-in.; diameter 5/8-in. Weight 1/4-oz. Finish is stainless steel. Each **\$67.00**

165A Base

Contains the subminiature impedance matching vacuum tube and provides the interconnection between the 21D microphone and the 525A power supply. The attached flexible 15-ft. cable is covered with an abrasion resistant fiber glass webbing. Each **\$60.00**

166A Stand Attachment

Provides swivel stand holder for Lipstik microphone. Mounting 5/8-in. with 27 thread. Finish is gray plastic. No. 166A..... Each **\$7.00**

525A Power Supply

Supplies necessary voltages to 165A base and 21D microphone. Power requirements 117 volts, 60 cycles, 15 watts. System output level from power supply unbalanced. High impedance (10,000 ohms or higher) —30db re 1 v/10 dynes/cm² (open circuit voltage—not power measurement); 600 ohms —49 dbm/10 dynes/cm²; 150 ohms —53 dbm/10 dynes/cm²; 30 ohms —59 dbm/10 dynes/cm². Balanced; using 4665 plug-in transformer for 30, 150 and 600 ohms —48 dbm/10 dynes/cm². Load impedance 30, 150, 600 balanced (using 4665 transformer); 30, 150, 600, 10,000 ohms unbalanced.

Dimensions: height 2 3/8-in. Width 8 5/8-in. Depth 7 1/2-in. Each **\$100.00**

Lipstik® Microphone Accessories



No. 4665 Plug-in transformer for balanced output. Height 2 3/16-in. Width 2-in. Depth 1 1/2-in. Each **\$27.00**

No. 11853 Rack mounting assembly holds two 525A power supplies. Requires 3 1/2-in. of rack space. Each **\$20.00**

No. 167A Extension cable with connectors (uses 5126 cable). Lgth 25-ft. Each **\$23.00**

No. 1883-116 Cable-slim fiber glass covered cable as supplied with 165A base. Each **\$0.35**

No. 1883-116.....Per Foot **\$0.35**

Altec Lansing M-14 Microphone System "High Intensity"



No. 21BR Microphone with No. 165A Base



No. 526A Power Supply

Designed for the measurement of sound pressures beyond the dynamic range of the normal commercial microphone.

Applicable for the measurement of high explosive blasts, drop forges, horns and sirens, and the analysis of the characteristics of noises created by air craft, jet engines, missiles, factory, etc.

May be operated safely from —30°F to 300°F.

Each microphone system supplied with its frequency-response calibration.

M-14 system complete..... **\$350.00**

M-14 Microphone System Components as follows:

21BR-150 Microphone

Condenser type with frequency range 5-17,000 cps. Sound pressure range 68-164 db. Pickup, omnidirectional. Not susceptible to magnetic field. Capacitance 6 mmf. Length 3/8-in.; diameter 5/8-in. Weight 1/4-oz. Finish is stainless steel.

Or 21BR-180 Microphone

Same as 21BR-150 except the sound pressure range is 83-179 db; frequency range is 5-20,000 cps.

Or 21BR-200 Microphone

Same as 21BR-150 except the sound pressure range is 98-191 db; frequency range 5-25,000 cps.

No.	Description	Each
21BR-150	Calibrated	\$175.00
21BR-150	Uncalibrated	120.00
21BR-180	Calibrated	175.00
21BR-180	Uncalibrated	120.00
21BR-200	Calibrated	175.00
21BR-200	Uncalibrated	120.00

165A Base

Contains subminiature impedance matching tube and 15-ft. of cable for the interconnection of microphone and 526A power supply. Finish is anodized gray. Each **\$56.00**

526A Power Supply

Furnishes the necessary voltages to the impedance matching tube in the 165A base and to the condenser microphone. Microphone output, transmitted through the impedance matching tube and power supply, is available on the two-conductor shielded output cable. Power requirements, 117 volts, 50-400 cps, 15 watts.

System output voltage:

21BR-150	—55 to —65 db/1 v/dyne/cm ²
21BR-180	—70 to —80 db/1 v/dyne/cm ²
21BR-200	—85 to —95 db/1 v/dyne/cm ²

Output impedance 250 ohms, unbalanced; load impedance 50,000 ohms or higher.

No.	Height In.	Width In.	Depth In.	Wt. Lbs.	Each
526A	2 3/8	8 3/8	7 1/2	7	\$143.00

For balanced load impedances 600, 150 or 30 ohms, the 4665 plug-in transformer is supplied. Order as 526A power supply, low impedance.

Available with the following accessories: No. 159B probe tube, No. 167A extension cable with connectors and No. 12185 acoustic calibrator.

Altec Lansing Microphone Accessories

25A Desk Stand



Constructed of cast iron and designed to insure stability. Base is machined for a 5A microphone switch kit. Has a 5/8-in.—27 thread and is equipped with 5/8-in.—21 adapter.

No.	Length In.	Width In.	Height In.	Wt. Lbs.	Each
25A	5 9/16	3 3/4	3 1/2	3	\$22.50

5A Microphone Switch Kits

Designed to assemble into the base of the 25A microphone desk stand. Incorporates two single pole, double throw microswitches, operated by a single press-to-talk or lock-to-talk slider. Provides microphone on-off positions and remote relay muting facility for priority announcements.

No.	Length In.	Height In.	Width In.	Wt. Oz.	Each
5A	2 7/8	1	1/2	1/2	\$9.00

Altec Lansing Microphone Accessories

6A Microphone Switches



Incorporates two single pole, double-throw microswitches operated by a single press-to-talk or lock-to-talk slider.

Provides microphone on-off positions and remote relay muting facility for priority announcements.

Switch assembly designed to fit between any microphone and its stand, and has lock ring for orientation.

Has 5/8-in.—27 thread, male and female.

No.	Length In.	Diam. In.	Wt. Oz.	Each
6A	4 3/8	1	3 1/2	\$19.00

Floor Stands

No. 22C

Heavy weight, rugged floor stand, gray base with chrome stand.

Adjustable from 35-in. to 64-in. Has 5/8-in.—27 thread and equipped with 5/8-in.—24 adapter.

No. 22C..... Each **\$19.00**

No. 10821 Gale Screen

For use on 21C and D microphones to provide suppression of wind noises under extreme conditions.

No. 10821..... Each **\$1.95**

Altec Lansing Microphone Accessories

Desk Stand

No. 24C

Short desk stand that provides minimum microphone height on speakers' tables.

Has 5/8-in.—24 thread and adapter for 5/8-in.—27 thread.

Finished in gray.

No. 24C..... Each **\$8.50**



Altec Lansing Amplifiers



A compact, 165 watt, medium gain power amplifier designed for public address applications, either portable or fixed location.

Negative feedback is carried around all stages from a tertiary winding on the heavy duty output transformer permitting output to feed an ungrounded load or load with one side grounded as the case may be.

Especially designed for stable 70 volt line operation under all output load conditions without impairment of program quality.

Two pairs of input connections are provided. Terminals one and two, which connect directly to the input potentiometer, are provided for unbalanced high impedance sources or for bridging unbalanced low impedance lines having signal voltage of one volt or more. Terminals three and four connect to standard octal socket which permits low impedance input with the accessory 4665 plug-in transformer.

Output taps for loudspeaker loads of 8, and 16 ohms, and 70 volt line (32 ohms) are provided.

Has two controls. Volume control and a-c power switch. If "push to talk" operation is desired, provision has been made for mounting an accessory relay.

Specifications

Gain 72 db; input sensitivity 1.0 volt rms for rated output; power output 165 watts at less than 3% thd. 70-20,000 cps; frequency response ±1.0 db, 10-50,000 cps; input impedance 100,000 ohm potentiometer; source impedance 30/50, 250/300, 500/600 ohms with 4665 plug-in transformer; load impedance 8, 16, 32 (70 v line) ohms; output impedance less than 10% of nominal load impedance; noise level, output noise —25 dbm: 77 db below rated output; power supply 117/125 volts, 60 cps, 350 watts; external power available 117 vac receptacle on chassis.

Finished in green.

No.	Height In.	Width In.	Depth In.	Wt. Lbs.	Each
1570A	9 3/8	17	13 3/4	58	\$318.00

Altec Lansing Amplifiers



No. 1568A

Rack mounted, a-c operated, 40 watt power amplifier for use in sound reinforcing, paging, and music distribution systems. Easy to install and service. Provides low distortion, wide frequency range, and complete stability with any load.

Occupies five units of rack space and has a hinged front panel which contains the power switch, pilot light, and continuously variable gain control.

All circuitry is completely accessible for installation and servicing when the panel is opened. The output provides for 70 volt and 25 volt lines as well as a variety of load impedances.

The Altec No. 12066 Cabinet may be used for mounting this amplifier on wall or table when rack mounting is not desired.

Specifications

Gain: 65 db; Input Sensitivity: 0.9 volt; Power Output: 40 watts at less than 2% T.H.D. 40 to 20,000 cps; Frequency Response: ±1 db 5 to 30,000 cps, ±4 db 1 to 100,000 cps; Input Impedance: 70,000 ohms volume control; Source Impedance: 30/50, 125/150, 250/300, 500/600 ohms with 4665 Plug-in Transformer; Load Impedance: 4 (12.6v), 8 (18v), 16 (25v), 124 (70v) ohms; Output Impedance: Less than 15% of nominal load impedance; Noise Level: 80 db below rated output; Controls: Volume control, continuously variable, composition; Power Supply: 117 volts, 60 cps, 125 watts; External Power Available: 117 volt a-c receptacle on chassis; Tubes: 2-6CG7, 2-6CA7/EL34, 1-5U4GB; Color: dark green; Accessory: 4665 Plug-in Transformer.

No.	Height In.	Width In.	Depth In.	Wt. Lbs.	Each
1568A	8¾	19	7¾	22	\$199.00

No. 1569A Amplifier

Identical to the No. 1568A Amplifier except in power output. This rugged unit provides 80 watts of stable, low distortion power for use in larger sound reinforcing, paging, and music distribution installations.

Specifications

Gain: 68 db; Input Sensitivity: 0.9 volt; Power Output: 80 watts at less than 2% T.H.D. 60 to 20,000 cps, 80 watts at less than 5% T.H.D. 40 to 20,000 cps; Frequency Response: ±1 db 5-30,000 cps, ±5 db 1 to 100,000 cps; Input Impedance: 70,000 ohm volume control; Source Impedance: 30/50, 125/150, 250/300, 500/600 ohms with No. 4665 Plug-in Transformer; Load Impedance: 4 (18v), 8 (25v), 16 (36v), 62 (70v) ohms; Output Impedance: Less than 15% of nominal load impedance; Noise Level: 80 db below rated output; Controls: Volume control, continuously variable, composition; Power Supply: 117 volts, 60 cps, 240 watts; External Power Available: 117 volt a-c receptacle on chassis; Tubes: 2-6CG7, 4-6CA7/EL34, 2-5U4GB; Color: dark green; Accessory: No. 4665 Plug-in Transformer.

No.	Height In.	Width In.	Depth In.	Wt. Lbs.	Each
1569A	8¾	19	8	27.5	\$258.00

Altec Lansing Amplifiers

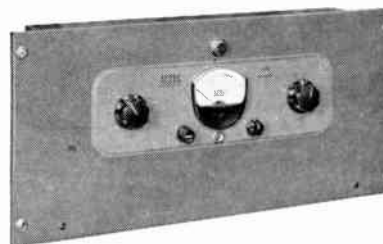

A 30 watt power amplifier for professional applications, such as recording and broadcasting studios, requiring the highest quality and reliability.

An improved version of the 127 type amplifier, retaining all the sturdy features of the 127, including metering, step-type gain control and the trouble-free class AB₁ circuit.

Provision for plug-in input transformer and accommodation of the full variety of load impedances make for wide versatility.

Amplifier mounts on a relay rack or in 12066 cabinet.

Specifications

Gain 68 db; Input Sensitivity .66 volts rms for rated output; Power Output 30 watts at less than 2% thd, 30-20,000 cps, 15 watts at less than ½% thd, 30-20,000 cps; Frequency Response ±1 db, 5-50,000 cps; Input Impedance 100,000 ohm potentiometer; Source Impedance 30/50, 125/150, 250/300, 500/600 ohms with 4665 plug-in transformer; Load Impedance 16 ohms grounded, 150 ohms (70 v. line) balanced, 270 ohms grounded, 600 ohms with CT balanced; Output Impedance less than 20% of nominal load impedance; Noise Level —37 dbm; 80 db below rated output; Power Supply 117/125 volts, 50/60 cps, 140 watts; External Power available 380 v. d-c at 10 ma, 6.3 vac at .6 a.

No.	Height In.	Width In.	Depth In.	Wt. Lbs.	Each
128A	8¾	19	8	18	\$260.00

Available accessory No. 4665 "plug-in" transformer..... Each \$27.00

Altec Lansing Amplifiers

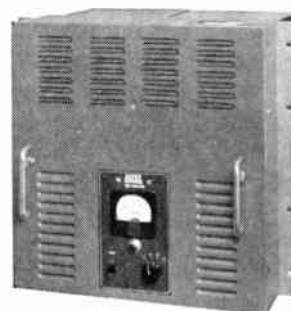

A 260 watt amplifier of low distortion and wide frequency range for public address and industrial control applications.

Protected by thermal cut-out. Filament warm-up period controlled by delay relay, permitting remote full on-off control.

Instantaneous on-off control of tube plates available by installing additional relay powered externally.

Designed for rack mounting; accessory brackets permit mounting to wall.

Specifications

Gain 50 db; 30 db, bridging 600 ohm line; input sensitivity 1.2 v rms/600 ohms; power output 260 watts @ less than 2% thd, 45 cycles—15 kc; frequency response @ 10 watts ±0.5 db, 20-20,000 cps; ±3 db, 5-70,000 cps; source impedance 500/600 ohms and 5,000 ohms bridging; load impedance 9, 19, (70 v line), 65 (130 v line) ohms; output impedance less than 12% of nominal load impedance; noise level—16 dbm; 70 db below rated output; power supply 105/117/125 v, 60 cycles, 600 watts.

No.	Height In.	Width In.	Depth In.	Wt. Lbs.	Each
260A	18	19	14¼	186	\$860.00

Available accessory No. 12156 wall mounting assembly. Each \$74.00

Altec Lansing Limiter Amplifiers

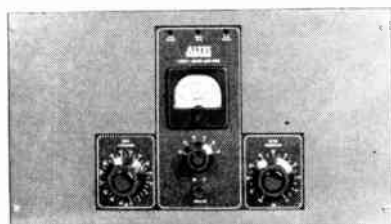

Allows higher average level recording, broadcast, and public address amplification without danger of distortion, feedback, or damage to speaker load.

Operates as true linear amplifier up to a specified level and limits the volume output beyond this point. The 100% db limiting meter may be used for tube testing.

Both input and output gain controls are provided and a switch that provides equalization for the NARTB high frequency recording pre-emphasis.

Specifications

Gain 68 db at 1,000 cps, equalizer out; 60 db at 1,000 cps, equalizer in (31 db less gain from bridging input); Limiting Threshold normal, +25.2 dbm, high 33.2 dbm; Frequency Response ± 1 db, 20-20,000 cps, equalizer out NARTB recording characteristic, equalizer in; Source Impedance 600 ohms; Load Impedance 600 ohms; Attack Time .0002 second; Limiting Ratio 10:1; Noise Level -37 dbm; 62 db below normal limiting threshold; Power Supply 275 vdc at 100 ma regulated, 6.3 vac at 2.0 a.

Finished in metallic gray.

No.	Height In.	Width In.	Depth In.	WL Lbs.	Each
322C	10 1/2	19	9 1/2	25	\$470.00

Altec Lansing Power Supplies



Regulated d-c power supply designed to accurately maintain a value of high voltage direct current over wide range of primary voltage variations as found in commercial power lines.

This rack mounting unit particularly suited for use with the 322C Limiter Amplifier which requires accurately regulated plate supply for stable operation and is ideal whenever a closely regulated supply of fixed voltage is needed.

Specifications

Power Supply 105/117/130 volts, 50/60 cps, 120 watts; External Power available 275 vdc at 100 ma, and 6.3 vac at 3.0 a., d-c output regulated to 1% from no load to full load, and $\pm 10\%$ line voltage change. Less than .001 v. ripple on d-c output at full load.

Finished in blue gray.

No.	Height In.	Width In.	Depth In.	WL Lbs.	Each
511A	5 1/4	19	8 1/2	23 1/2	\$137.00

Altec Lansing Compressor Amplifiers



Self-powered unit capable of driving any Altec power amplifier to full output from low impedance microphone.

Occupies 3 1/2-in. of rack space and equipped with level control, power switch, fuse, pilot light and compression meter mounted on a hinged front panel.

Provided with two inputs: a microphone input and a bridging input.

For use in automatic level control applications in recording, TV broadcasting and public address systems.

Specifications

Gain 90 db from microphone input; 40 db bridging 600 ohm line; input sensitivity 6.5 millivolts on bridging input; reach compression threshold; maximum compression 30 db (50 db change in input results in 20 db change in output); power output +19 dbm at 30 db compression; +21 dbm as straight amplifier; frequency response +1.5 db, 40 to 10,000 cps; input impedance bridging, 20,000 ohms unbalanced; source impedance microphone input, 30/50 ohms; load impedance 150 and 600 ohms; power supply 117 volts, 60 cps, 22 watts.

No.	Length In.	Height In.	Depth In.	WL Lbs.	Each
438A	19	3 1/2	6	8 1/2	\$199.00

Available accessory No. 12495 cabinet.

Altec Lansing Compressor Amplifiers



No. 436A

Small, self-powered PA and industrial amplifier providing line level output and automatic gain control.

Occupies 3 1/2-in. of rack space and contains a front panel meter to indicate db of compression, a power switch, fuse and pilot light.

Specifications

The input employs a high impedance transformer which can bridge a 600 ohm line or the output of the 1510A and 1511A preamplifiers. The output transformer provides load taps of 150 and 600 ohms or may be operated directly into the high impedance input of the 1520A or 1530A amplifiers. Frequency response is ± 1.5 db, 30-15,000 cps. Gain is 56 db from 15,000 ohm source; 42 db bridging 600 ohm line. Maximum compression is 30 db (50 db change in input results in 20 db change in output). Harmonic distortion at 25 db compression is less than 1.5%, 35-15,000 cps; at 30 db of compression, less than 2.5%, 35-10,000 cps. Power output is +19 dbm at 30 db compression; +26 dbm as straight amplifier. The attack time is approximately 50 milliseconds with 63% recovery in 1 second.

No. 436A	Each	\$168.00
----------	------	----------

Altec Lansing Amplifiers



Compact 20 watt amplifier and control preamplifier for paging and music distribution systems in offices, factories, churches, restaurants, nightclubs, and wherever sound is required.

Features individual gain controls for each channel which may be pre-set so that the proper level is established automatically when the selected button is pushed.

Has separate bass and treble controls and an a-c line switch. The three inputs may be used for phono, microphone, tuner, tape, telephone line programing, or music distribution service. Phono input is equalized for standard RIAA curve.

Altec 4665 Transformer may be plugged in for use with balanced lines.

Specifications

Gain: phono 95 db 1 KC tone controls flat, microphone 95 db 1 KC tone controls flat, line 82 db 1 KC tone controls flat; Input Sensitivity: phono 0.02 volt for rated output, microphone 0.0085 volt for rated output, line 0.16 volt for rated output; Power Output: 20 watts at less than 2% THD; Frequency Response: ± 2 db 20-22,000 cps; Load Impedance: 8, 16, 250 ohms (70 v. line); Output Impedance: Less than 20% of nominal load impedance; Noise Level: phono 50 db below rated output, microphone 51 db below rated output, line 74 db below rated output; Controls: Push button switches select phono, microphone, or line output, individual volume controls for each channel, separate bass-treble controls and a-c line switch; External Power Available: 117 volts 60 cps 85 watts; Tubes: 2-12AX7, 1-6CG7, 2-6L84 and 1-6Z81; Special Features: Printed circuit board with eyelets for components; Accessories: One 3 prong male connector supplied with equipment. No. 12116 cabinet in blonde or mahogany may be ordered separately. No. 4665 Plug-in Transformer is available.

No.	Height In.	Width In.	Depth In.	Wt. Lbs.	Each
346A	4 $\frac{5}{8}$	13 $\frac{3}{4}$	7 $\frac{1}{8}$	18	\$123.00

Altec Lansing Monitor Amplifiers

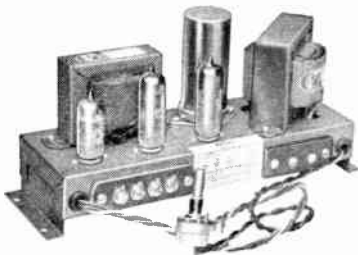

Provides power to a monitor loudspeaker. Not supplied with any sort of case and must be mounted inside the 625 monitor speaker cabinet or some other suitable enclosure.

Specifications

Gain 43.5 db from a 10,000 ohm source; Input Sensitivity 1.2 volts rms for rated output; Power Output 3 $\frac{3}{4}$ watts at less than 5% thd, voice frequency range; Frequency Response ± 1 db, 40-20,000 cps; Input Impedance 10,000 ohm potentiometer; Load Impedance 8 ohms; Noise Level -22 dbm; 57.8 db below rated output; Power Supply 117 volts, 50/60 cps, 30 watts.

Finished in gray hammertone.

No.	Height In.	Width In.	Depth In.	Wt. Lbs.	Each
336A	4 $\frac{3}{4}$	3	9	4 $\frac{3}{4}$	\$56.00

Altec Lansing Amplifiers

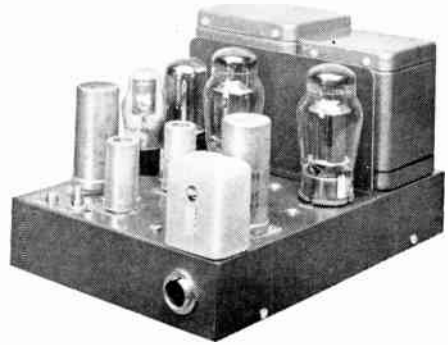

A wide-band, general purpose amplifier of very low distortion similar in appearance to the 310 Amplifier used in High Fidelity music systems.

Adapted to a variety of applications including public address and commercial sound systems.

Plug-in transformer No. 4665 may be used to convert immediately to low impedance inputs.

Specifications

Gain 63.5 db; Input Sensitivity 1.2 volts rms (across input potentiometer) for rated output; Power Output 35 watts at less than 0.5% thd, 25-20,000 cps; Frequency Response ± 0.5 db, 5-50,000 cps; Input Impedance 100,000 ohm potentiometer; Source Impedance 30/50, 125/150, 250/300, 500/600 ohms with "plug-in" input transformer; Load Impedance 8, 16 ohms and 70 v. line. Output Impedance less than 3.5% of nominal load impedance; Noise Level 85 db below full output; Power Supply 117 volts, 60 cps, 160 watts.

No.	Height In.	Width In.	Depth In.	Wt. Lbs.	Each
341A	6 $\frac{3}{4}$	8 $\frac{1}{4}$	12 $\frac{1}{2}$	21 $\frac{1}{2}$	\$171.00

Available accessory No. 4665 "plug-in" transformer.

Altec Lansing Preamplifier Mixers

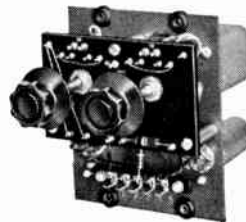

Constructed with two low noise input channels with individual gain controls on each channel and a single output circuit for use in public address and commercial sound systems.

May be mounted in the 1560A console or 10956 assembly.

Specifications

Gain 47 db into a 100,000 ohm load; Power Output 23.0 volts rms maximum into a 100,000 ohm load; Frequency Response ± 1 db, 30-15,000 cps; Source Impedance each channel 30/50, 125/150, 250/300, 500/600 ohms. Center tap available for 125/150 and 500/600 ohm connections. Load Impedance 10,000 ohms minimum; Output Impedance 10,000 ohms nominal; Noise Level, output noise -73 dbm into a 100,000 ohm load. Equivalent input noise -120 dbm; Power Supply required 300 vdc at 5 ma, 6.3 vac at 0.45 a.

Finished in gray hammertone.

No.	Height In.	Width In.	Depth In.	Wt. Lbs.	Each
1510A	5 $\frac{5}{16}$	4 $\frac{7}{16}$	5	2 $\frac{3}{4}$	\$99.00

Altec Lansing Preamplifiers

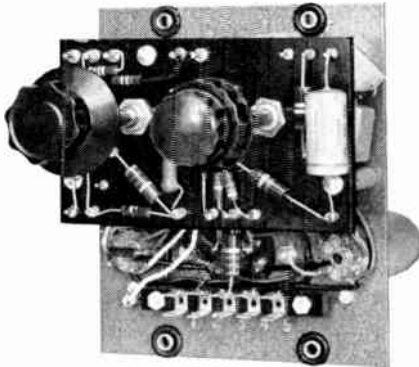

Provides a single phono input equalized for variable reluctance pickups with gain control and bass and treble controls. Input No. 2 can be used as bass and treble tone controls to serve all elements of 1500 series amplifier system.

Can be mounted in 1560A console, or rack mounted on 10956 mounting assembly with 530A power supply in custom installations.

Specifications

Gain: Input No. 1, 43 db voltage gain into 100,000 ohm load at 1,000 cps, tone controls normal. Input No. 2, 0 db voltage gain into 100,000 ohm load, tone controls normal; Power Output 15 volts rms, maximum into 100,000 ohm load; Frequency Response: Input No. 1, equalized for magnetic pickup. Input No. 2, flat response; Input Impedance: Input No. 2, 200,000 ohms; Source Impedance: Input No. 1, magnetic pickup; Load Impedance not less than 10,000 ohms; Output Impedance cathode follower, 1,000 ohms nominal; Noise Level equivalent input noise —100 dbm; Power Supply 300 vdc at 12 ma, 6.3 vac at 0.6 a.

Finished in gray hammertone.

No.	Height In.	Width In.	Depth In.	Wt. Lbs.	Each
1511A	5 ³ / ₁₆	4 ³ / ₁₆	5	1 ³ / ₄	\$85.00

Power can be supplied by the 530A power supply. The 1511A can mount in rack on 10956 rack mounting assembly, or in 1560A console.

Altec Lansing Line Amplifiers

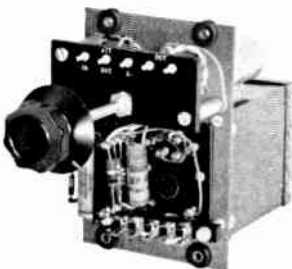

Two-stage line amplifier featuring low distortion and high signal-to-noise ratio.

Provides the ideal microphone to line mixing amplifying system when used with the 1510A preamplifier.

Capable of feeding telephone or other transmission lines which require levels up to +25 dbm.

Mounts on 10956 assembly. Finished in gray hammertone.

Specifications

Gain 65 db from a 100,000 ohm source; input sensitivity 56 millivolts rms for +20 dbm out; power output +22 dbm at less than 2% thd, 20-20,000 cps; frequency response ±1 db, 20-20,000 cps; input impedance 100,000 ohm potentiometer; load impedance 62.5/75, 125/150, 250/300, 500/600 ohms. Center tap available on 500/600 ohm connection; noise level —55 dbm; 80 db below rated output; power supply 300 vdc at 12 ma, 6.3 vac at 0.15 a.

Finished in gray hammertone.

No.	Height In.	Width In.	Depth In.	Wt. Lbs.	Each
1540A	5 ³ / ₁₆	3 ¹ / ₂	6 ³ / ₄	3 ¹ / ₂	\$80.00

Altec Lansing Power Supplies

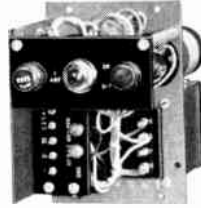

Used to provide the necessary power for the 1510A, 1511A, or 1540A amplifiers.

Equipped with power switch, pilot light and fuse. Mounts in 10956 assembly.

Specifications

Power supply 117 volts, 50/60 cps, 40 watts at full load; External power available 300 vdc at 50 ma, 6.3 vac at 2.3 a. Two B+ terminals provide separate filtering. Ripple less than .001 v at term. B1 with 20 ma current. Ripple less than .02 v at term. B2 with 50 ma current.

Finished in blue gray.

No.	Height In.	Width In.	Depth In.	Wt. Lbs.	Each
530A	5 ³ / ₁₆	3 ¹ / ₂	6 ³ / ₄	4 ¹ / ₂	\$67.00

Altec Lansing Mounting Assemblies

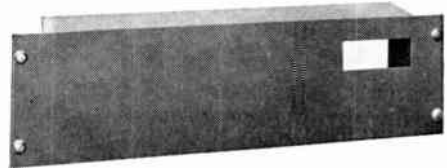

Rack mounting frame for use with 1510A, 1511A, 1540A, 1550A and 530A when the mixer controls of these units are mounted separately. Front mat has cut-out to expose the fuse, pilot light, and power switch of 530A power supply.

No.	Height In.	Length In.	Each
10956	5 ¹ / ₂	19	\$13.50

No. 10968 mounting assembly same as 10956, but without front mat cut-out for 530A power supply controls. Each \$13.50

Altec Lansing Driver Loudspeakers



For use with Altec multicellular horns in public address and high quality sound systems. The diaphragm assembly is field replaceable.

Power 40 watts (with N-500C network); frequency response 500-12,000 cycles; impedance 2 $\frac{1}{2}$ ohms; average sound level (warble frequency 500-2,500 cycles 4-ft. from mouth 30-in. trumpet) 115.2 db ref. .0002 dynes/cm² for 1 volt-amp input.

Finished in gray.

No.	Diam. In.	Height In.	Wt. Lbs.	Each
288B	6 ¹ / ₂	4 ⁷ / ₈	20	\$138.00

Altec Lansing Horns

No. 31A



For use with Altec driver loudspeakers. Notable for their heavy weather-resistant construction that keeps them free from all resonances and vibrations.

Sectoral type horn for use with 720A and 730A driver speakers. Distribution 40° x 120°; low frequency cutoff 300 cycles.

No. 31A with No. 27A Throat

Available with 27A throat.

No.	Length In.	Width In.	Height In.	Wt. Lbs.	Each
31A	15	23	9	9 ¹ / ₂	\$58.00

Altec Lansing Horn and Driver

No. 50A

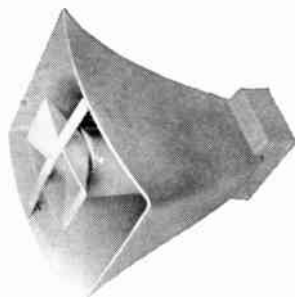

New wide range public address speaker for either outdoor or indoor use. Based on a new technique in speaker design, the 50A combines an "Acoustic Filter" with a long air column to give an extremely good low frequency response and is flat through the higher register.

Provides excellent reproduction of both speech and music under any critical conditions. May be easily used in large numbers from a single

system without loss of frequency response or efficiency.

The transducer, containing a heavy magnet, durable phenolic diaphragm, and a high impedance voice coil, is integrally mounted on a high impact plastic horn with a three-foot air column.

Facilities are included for encasing the Altec 15075 Transformer within the weatherproof housing.

Specifications

Power: 30 watts; Frequency Response: 175 to 12,000 cps; Impedance: 16 ohms; Horizontal Distribution: 90°; Vertical Distribution: 50°; Mounting Facilities: Arranged for mounting at any vertical or horizontal angle; Acoustical Cross-Over: 1000 cps.

No.	Height In.	Width In.	Depth In.	Each
50A	12½	15½	17¼	\$49.50

Altec Lansing "Biflex" Loudspeakers



Nos. 408A, 412B, 415A

No. 408A

Small light speaker using a large magnet and carefully designed magnetic structure to achieve outstanding efficiency. Guaranteed frequency response 60 to 16,000 cycles. Power 15 watts; impedance 8 ohms; mounting hole diameter 6¼-in.

No. 412B

Employs Altec multiple concentric compliances to obtain outstanding efficiency, quality of reproduction, smoothness and breadth of frequency response. Guaranteed frequency response 40 to 15,000 cycles. Power 20 watts; impedance 8 ohms; mounting hole diameter 10¼-in.

No. 415A

Designed to provide full bass and wide range high fidelity reproduction. Utilizes the Altec Biflex principle of multiple concentric compliances to achieve amazing performance. Guaranteed frequency response 30 to 14,000 cycles. Power 25 watts; impedance 8 ohms; mounting hole diameter 13¼-in.

No.	Diam. In.	Depth In.	WL Lbs.	Each
408A	8¼	3⅞	6	\$31.00
412B	12¼	5⅝	15	54.00
415A	15⅝	7	25	67.00

Altec Lansing Duplex® Loudspeakers

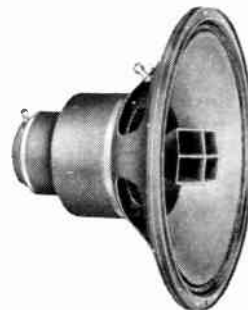

No. 604D

No. 604D

Improved 15-in. cone and newly designed exponential multi-cellular horn and 1600 cycle network makes it possible for this unit to have a guaranteed frequency response from 30 cycles to 22,000 cycles. Handles 50 watts of peak power without distortion. Power 35 watts (50 watts peak); Impedance 16 ohms; horizontal distribution 90°; vertical distribution 10°; mounting hole diameter 13¼-in.

No. 601B

Combines 12-in. low frequency speaker with high frequency driver unit and horn and a 3000 cycle crossover network. Frequency response 40 cycles to 22,000 cycles. Power 20 watts (30 watts peak); impedance 8 ohms; horizontal distribution 90°; vertical distribution 10°; mounting hole diameter 10¼-in.

No. 602B

Companion piece and identical to the 601B, except it is mounted on 15-in. frame with larger low frequency magnet and new high frequency driver and horn. Power 25 watts (30 watts peak); impedance 8 ohms; horizontal distribution 90°; vertical distribution 10°; mounting hole diameter 13¼-in.

No.	Diam. In.	Depth In.	WL Lbs.	Each
604D	15⅝	11⅞	40	\$189.00
601B	12¼	5⅝	17	120.00
602B	15⅝	7¼	25	143.00

Altec Lansing Portable Consoles



Meets all requirements for field use in AM, FM, and TV remote pickup. Wired for high level mixing, it incorporates two 1510A preamplifiers, one 1510A line amplifier, 530A power supply, a large illuminated VU meter and a master volume control providing control of four microphone inputs.

May be operated from either 110 v. a-c or from an external battery supply. Facilities are provided for headphone monitoring.

May be ordered with either AB carbon or Daven mixing potentiometers.

Specifications

Gain 102 db maximum, each channel; power output +25 dbm at 2% thd, 50-7,500 cps; frequency response ±1 db, 30-15,000 cps; source impedance 30/50, 125/150, 250/300, 500/600 ohms, each channel; load impedance 125/150 or 500/600 ohms; power supply 117 v., 50/60 cps, 50 watts or 270 v and 6 v batteries.

No.	Height In.	Width In.	Depth In.	WL Lbs.	AB Carbon Each	Daven Type Each
220B	12¼	24½	6½	26½	\$598.00	\$670.00

Altec Lansing Console Mounting Assemblies



This assembly houses the complete 1500 system in a console-type enclosure for use on a desk or table.

Accommodates one 1568A or one 1569A power amplifier and the equivalent of four 1510A, 1511A, or 1550A units, or any combination of these units.

Finished in blue gray.

No.	Height In.	Width In.	Depth In.	Wt. Lbs. Without Amplifiers	Each
1560A	10 $\frac{1}{4}$	24	21 $\frac{3}{4}$	40	\$135.00

Altec Lansing Consoles



Exceeds F.C.C. standards of quality. Hinged front panel permits fast servicing of mixing pots, switches, tubes and immediate access to the plug-in power supplies.

Eight low level microphone or turntable inputs are controlled by four mixing knobs. The other two knobs control four line inputs providing a control of twelve inputs with facilities for mixing six at any one time.

The output channel can be switched to either of two output lines and automatically connects the control room telephone to the unused line.

The eight watt monitor amplifier normally used for talk-back and public address can be switched to replace line amplifier in case of emergency.

The large VU meter monitors program output channel, remote lines, or the plate supply and relay supply voltages.

Cue in circuits provided on the line input controls. The console is completely self-contained.

Specifications

Gain 100 db, microphone inputs: 45 db, line-level inputs; power output +20 dbm at 1/2% thd, 30-15,000 cps; +24 dbm at 1% thd, 30-15,000 cps; frequency response ±1 db, 20-20,000 cps, any input to program output; source impedance 30/50, 125/150, 250/300, 500/600 ohms, mic. inputs. 600 ohms, line level inputs (150 or 600 ohms if repeat coils are used); load impedance 150 or 600 ohms, line outputs 2, 4, 8, 16 ohms, loudspeaker outputs; noise level 74 db below +24 dbm (mixer and master controls adjusted for 70 db net gain)—equivalent input noise—120 dbm; power supply 117 volts, 60 cps, 100 watts; external power available 12 vdc for relay operation.

Finished in blue gray.

No.	Height In.	Width In.	Depth In.	WL Lbs.	Each
230B	9 $\frac{3}{4}$	36 $\frac{1}{4}$	18	90	\$1980.00

Altec Lansing Consoles



No. 250A

Contains five 428B preamplifiers for microphone preamplification, two 428B preamplifiers for boosters, two 429B line amplifiers, and one 429B, 8 watt monitor amplifier, two 522B power supplies, and one 523B power supply. These provide a total of nine mixing controls and eighteen input channels.

As equipped, five of the mixing controls connect with ten low level microphone inputs. Each of the other four mixers connect to one line input and one utility input. Two of these line inputs can be converted for microphone use by insertion of two extra 428B preamplifiers in the pre-wired receptacles.

The output of any of the mixer controls can be switched to either of two output channels. Each output channel has its own master mixing control and illuminated VU meter and phone jack for headset monitoring.

An independent channel for loudspeaker monitoring of either output, any of the incoming lines or the cue circuits, is provided. This channel may also be used to feed cue programs back to the remote line circuits or for talk-back or either of the two studio loudspeaker circuits.

Console wired for four 15036 line input repeating coils. Controls are color-coded according to function and placed for efficient and convenient operation.

Tube checking facilities provided. Console completely self-contained.

Specifications

Gain 100 db, microphone inputs: 60 db, utility inputs: 40 db, remote line inputs; power output +20 dbm at less than 1/2% thd, 30-15,000 cps; +24 dbm at less than 1% thd, 30-15,000 cps; frequency response ±1 db, 30-15,000 cps; source impedance 30/50, 125/150, 250/300, 500/600 ohms, mic. inputs. 600 ohms all other inputs (150 or 600 ohms when repeat coils are installed); load impedance 600 ohms, line, audition or cueing outputs 2, 4, 8, 16 ohms, loudspeaker outputs; noise level 70 db below +18 dbm output (mixer and master controls adjusted for 68 db net gain); power supply 117 volts, 60 cps, 200 watts; external power available 12 vdc for relay operation.

Console finished in blue gray. Table top finished in dark green.

No.	Height In.	Width In.	Depth In.	WL Lbs.	Each
250A	36	55	31	280	\$5180.00

Note—Dimensions and weight include table.

Webster Teletalk Intercommunicating Systems and Speakers

Listed by Underwriters' Laboratories, Inc.

Teletalk Systems

Dependable, economical two-way intercommunications systems. Save time; relieve congestion of telephone lines; provide crystal clear, sensitive intercommunication at the flick of a switch.

Available in designs to meet the specialized needs of all businesses. All models are housed in attractive cabinets to harmonize with the finest office furniture.

Master Stations



1100 Series: A master station in walnut grain plastic cabinet, with gold tone front and back metal panels. Sessions clock mounted on front panel. Operates on 110-125 volts, 60 cycle current only. Models of from five to ten station capacity available.

No. **1000 Series:** Same as the 1100 series but without Sessions clock. Models of from five to ten station capacity available.

No. **W606M Series:** Similar to 1000 Series except for wall mounting.

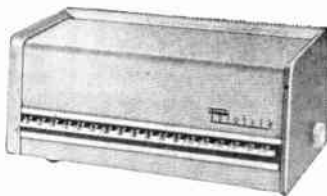

Administrative 2000 and 2100 Series

Available in two great new units; the new 2000 Series Vacuum Tube Models and the new 2100 Series Transistor Models. Both series have a host of custom features styled-in, at no extra cost; Printed Circuits;

Telear Central Control that provides, at the option of the user, completely private conversation or "remote reply" without manual operation; separate Busy Signal Light and Pilot Light; Built-in Silencing Circuit; incoming signal Volume Control; Executive Priority for rush calls; Plug-in Junction Box Connectors for easy replacement of units. Additional optional features available are Visible and Audible Annunciators, All-Call, Three Position Selector Keys, Handset and Booster Amplifier Connectors.

Units housed in Brooks Stevens styled cabinets, in driftwood or walnut finish, with rich gold-tone grille and transparent controls.

Available in a wide range of models with facilities for connecting from 6 to 60 stations.

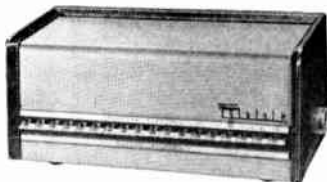

Executive 3000 and 3100 Series

Provides instant contact with key people, however complex the organization.

Available in the 3000 Series vacuum tube models or the 3100 Series transistor models with all the fine custom features styled-

in to the Administrative Series as well as these additional optional features; Visible and Audible Annunciators and Three Position Selector Keys, Handset, and Booster Amplifier Connectors.

May be equipped with telephone-type handset for private conversations. Up to 60 stations can be obtained in standard models. Greater capacities available upon request.

Available in walnut or driftwood finished cabinets with gold-tone grilles.

Teletalk Speakers

For use with Teletalk Master Stations

Model 3D45

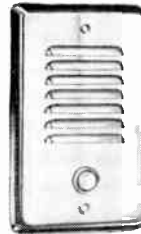

Flush mounting 3-in. Speaker combined with push button for operating bell, chimes, buzzer or other signaling device. Push button operates independently of speaker.

Weather-proofed construction permits installation on door jambs and other exposed areas.

Model 5G45

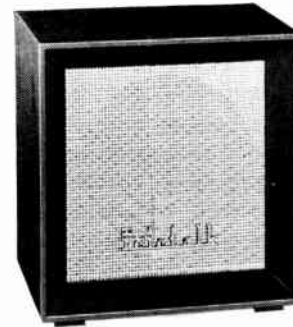

Has 5-inch speaker housed in a molded bakelite cabinet, simulated walnut finish.

For use in most indoor locations where noise level is not excessive.

Can be used with all master station models in the M series for receiving and replying to calls, and with the S series for receiving calls.

Also available with push buttons for use with annunciator-type master stations, with switch for originating calls by voice, or with switch to operate in connection with silencing circuit system.

Model 4H45

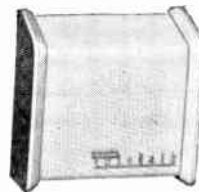

Type P.M. Dynamic (Alnico V) speaker. Equipped with silencing switch on top of cabinet.

Chassis diam. 4-in. Speaker size: Width 6 $\frac{3}{8}$ -in.; Height 3 $\frac{3}{8}$ -in.; Depth 6 $\frac{7}{8}$ -in. Power Capacity Maximum 5 watts.

Cabinet has walnut finished Side Panels and Gold-tone Grille. Can be placed on desk or hung on wall. Also available with call-in switch on left side of cabinet and push button on top of cabinet.

Model 5E45

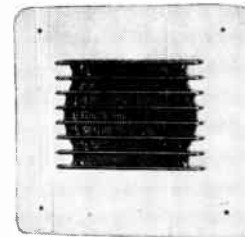

A flush-mounting 5-in. speaker for interior locations where only a moderate area is to be covered and where the noise level is relatively low.

Face plate is finished in white enamel with a plastic grille over speaker opening.

Also available with annunciator push button and silencing circuit switch (Model 5E45BS).

Model 8C45-2



Type P.M. Dynamic (Alnico V) speaker. Furnished with Universal wall mounting bracket.

Moisture Proofed Cone Chassis 8-in. in diam. Speaker size: Depth 5-in.; diam. 8 $\frac{3}{4}$ -in.

Cabinet is round metal housing with baked brown crackle finish. Power Capacity Maximum 8 watts.

Electrical Symbols for Architectural Plans

In accordance with American Standards Association Standard ASA Y32.9-1943

General Outlets

Symbol		Description
Ceiling	Wall	
○	—○	Outlet.
Ⓟ	—Ⓟ	Blanked Outlet.
Ⓞ		Drop Cord.
ⓔ	—ⓔ	Electrical Outlet — for use only when circle used alone might be confused with columns, plumbing symbols, etc.
ⓕ	—ⓕ	Fan Outlet.
ⓙ	—ⓙ	Junction Box.
Ⓛ	—Ⓛ	Lamp Holder.
Ⓛ _{ps}	—Ⓛ _{ps}	Lamp Holder with Pull Switch.
Ⓢ	—Ⓢ	Pull Switch.
Ⓥ	—Ⓥ	Outlet for Vapor Discharge Lamp.
Ⓧ	—Ⓧ	Exit Light Outlet.
Ⓒ	—Ⓒ	Clock Outlet. (Specify Voltage).

Convenience Outlets

Ⓢ	Duplex Convenience Outlet.
Ⓢ _{1,3}	Convenience Outlet other than Duplex. 1 = Single, 3 = Triplex, etc.
Ⓢ _{wp}	Weatherproof Convenience Outlet.
Ⓢ _r	Range Outlet.
Ⓢ _s	Switch and Convenience Outlet.
Ⓢ _r	Radio and Convenience Outlet.
Ⓢ _{sp}	Special Purpose Outlet (Des. in Spec.).
Ⓢ _f	Floor Outlet.

Switch Outlets

S	Single Pole Switch.
S ₂	Double Pole Switch.
S ₃	Three-Way Switch.
S ₄	Four-Way Switch.
S _d	Automatic Door Switch.
S _e	Electrolier Switch.
S _k	Key Operated Switch.
S _p	Switch and Pilot Lamp.
S _{cb}	Circuit Breaker.
S _{wcb}	Weatherproof Circuit Breaker.
S _{mc}	Momentary Contact Switch.
S _{rc}	Remote Control Switch.
S _{wp}	Weatherproof Switch.
S _f	Fused Switch.
S _{wf}	Weatherproof Fused Switch.

Special Outlets

○_{a,b,c-etc.}
Ⓢ_{a,b,c-etc.}
S_{a,b,c-etc.}

Any Standard Symbol as given above with the addition of a lower case subscript letter may be used to designate some special variation of Standard Equipment of particular interest in a specific set of architectural plans.

When used they must be listed in the Key of Symbols on each drawing and if necessary further described in the specifications.

Panels, Circuits and Miscellaneous

Symbol	Description
■	Lighting Panel.
▨	Power Panel.
—	Branch Circuit; Concealed in Ceiling or Wall.
---	Branch Circuit; Concealed in Floor.
----	Branch Circuit; Exposed.
→	Home Run to Panel Board. Indicate number of Circuits by number of arrows.

Note: Any circuit without further designation indicates a two-wire circuit. For a greater number of wires indicate as follows: +++ (3 wires) ++++ (4 wires), etc.

—	Feeders. Note: Use heavy lines and designate by number corresponding to listing in Feeder Schedule.
Ⓢ	Underfloor Duct and Junction Box. Triple System. Note: For double or single systems eliminate one or two lines. This symbol is equally adaptable to auxiliary system layouts.

Ⓢ	Generator.
Ⓢ	Motor.
Ⓢ	Instrument.
Ⓢ	Power Transformer. (Or draw to scale.)
Ⓢ	Controller.
Ⓢ	Isolating Switch.

Auxiliary Systems

Ⓢ	Push Button.
Ⓢ	Buzzer.
Ⓢ	Bell.
Ⓢ	Annunciator.
Ⓢ	Outside Telephone.
Ⓢ	Interconnecting Telephone.
Ⓢ	Telephone Switchboard.
Ⓢ	Bell Ringing Transformer.
Ⓢ	Electric Door Opener.
Ⓢ	Fire Alarm Bell.
Ⓢ	Fire Alarm Station.
Ⓢ	City Fire Alarm Station.
Ⓢ	Fire Alarm Central Station.
Ⓢ	Automatic Fire Alarm Device.
Ⓢ	Watchman's Station.
Ⓢ	Watchman's Central Station.
Ⓢ	Horn.
Ⓢ	Nurse's Signal Plug.
Ⓢ	Maid's Signal Plug.
Ⓢ	Radio Outlet.
Ⓢ	Signal Central Station.
Ⓢ	Interconnection Box.
Ⓢ	Battery.
Ⓢ	Auxiliary System Circuits.

Note: Any line without further designation indicates a 2-Wire System. For a greater number of wires designate with numerals in manner similar to 12 — No. 18W-3/4"-C., or designate by number corresponding to listing in Schedule.

Ⓢ _{abc}	Special Auxiliary Outlets. Subscript letters refer to notes on plans or detailed description in specifications.
------------------	---

**Allowable Current-Carrying Capacities of Insulated Conductors in Amperes
Based on Room Temperature of 30°C, 86°F**

N.E.C. Table 1

Not More Than Three Conductors in Raceways or Cable

Size A.W.G. or MCM	Rubber Type R, Type RW, Type RU, Type RUW, (14-2); Thermo- plastic Type TW	Paper Thermoplastic Asbestos Type TA; Var-Cam Type V; Asbestos Var-Cam Type AVB	Asbestos Var-Cam Type AVA, Type AVL	Impreg- nated Asbestos Type AI (14-8); Type AIA	Asbestos Type A (14-8); Type AA
	Rubber Type RH	Asbestos Type AVB	Asbestos Type AVL	Asbestos Type AIA	Asbestos Type AA
14	15	25	30	30	30
12	20	30	35	40	40
10	30	40	45	50	55
8	40	45	50	60	65
6	55	65	70	80	85
4	70	85	90	105	115
3	80	100	105	120	130
2	95	115	120	135	145
1	110	130	140	160	170
1/0	125	150	155	190	200
2/0	145	175	185	215	230
3/0	165	200	210	245	265
4/0	195	230	235	275	310
250	215	255	270	315	335
300	240	285	300	345	380
350	260	310	325	390	420
400	280	335	360	420	450
500	320	380	405	470	500
600	355	420	455	525	545
700	385	460	490	560	600
750	400	475	500	580	620
800	410	490	515	600	640
900	435	520	555
1000	455	545	585	680	730
1250	495	590	645
1500	520	625	700	785	...
1750	545	650	735
2000	560	665	775	840	...

N.E.C. Table 2

Single Conductor in Free Air

Rubber Type R, Type RW, Type RU, Type RUW, (14-2); Thermo- plastic Type TW	Rubber Type RH	Thermo- plastic Asbestos Type TA, Var-Cam Type V, Asbestos Var-Cam Type AVB	Asbestos Var-Cam Type AVA, Type AVL	Impreg- nated Asbestos Type AI (14-8) Type AIA	Asbestos Type A (14-8) Type AA	Slow- Burning Type SB, Weather- proof Type WP, Type SBW
20	20	30	40	40	45	30
25	25	40	50	50	55	40
40	40	55	65	70	75	55
55	65	70	85	90	100	70
80	95	100	120	125	135	100
105	125	135	160	170	180	130
120	145	155	180	195	210	150
140	170	180	210	225	240	175
165	195	210	245	265	280	205
195	230	245	285	305	325	235
225	265	285	330	355	370	275
260	310	330	385	410	430	320
300	360	385	445	475	510	370
340	405	425	495	530	...	410
375	445	480	555	590	...	460
420	505	530	610	655	...	510
455	545	575	665	710	...	555
515	620	660	765	815	...	630
575	690	740	855	910	...	710
630	755	815	940	1005	...	780
655	785	845	980	1045	...	810
680	815	880	1020	1085	...	845
730	870	910	905
780	935	1000	1165	1240	...	965
890	1065	1130
980	1175	1260	1450	1215
1070	1280	1370
1155	1385	1470	1715	1405

Correction Factor For Room Temperatures Over 30°C., 86°F

°C	°F
40	104	.82	.88	.90	.94	.95
45	113	.71	.82	.85	.90	.92
50	122	.58	.75	.80	.87	.89
55	131	.41	.67	.74	.83	.86
60	14058	.67	.79	.83
70	15835	.52	.71	.76
75	16743	.66	.72
80	17630	.61	.69
90	19450	.61
100	21251
120	24869
140	28459

...
...	.82	.88	.90	.94	.95	...
...	.71	.82	.85	.90	.92	...
...	.58	.75	.80	.87	.89	...
...	.41	.67	.74	.83	.86	...
...58	.67	.79	.83	.91
...35	.52	.71	.76	.87
...43	.66	.72	.86
...30	.61	.69	.84
...50	.61	.80	...
...51	.77	...
...69	...
...59	...

Aluminum Conductors. For aluminum conductors, the allowable current-carrying capacities shall be taken as 84 per cent of those given in the table for the respective sizes of copper conductor with the same kind of insulation.

Bare Conductors. If bare conductors are used with insulated conductors, their allowable current-carrying capacity shall be limited to that permitted for the insulated conductor with which they are used.

Application of Table. For open wiring on insulators and for concealed knob-and-tube work, the allowable current-carrying capacities of Table 2 shall be used. For all other recognized wiring methods, the allowable current-carrying capacities of Table 1 shall be used unless otherwise provided in the code.

More Than Three Conductors in a Raceway. Table 1 gives the allowable current-carrying capacity for not more than three conductors in a raceway or cable. If the number of conductors in a raceway or cable is from 4 to 6, the allowable current-carrying capacity of each conductor shall be reduced to 80 per cent of the values in Table 1. If the number of conductors in a raceway or cable is from 7 to 9, the allowable current-carrying capacity of each conductor shall be reduced to 70 per cent of the values in Table 1. Exceptions to the foregoing are permitted in the code for certain applications.

Neutral Conductor. A neutral conductor which carries only the unbalanced current from other conductors, as in the case of normally balanced circuits of three or more conductors, shall not be counted in determining current-carrying capacities as provided for in the preceding paragraph. (In a 3-wire circuit consisting of two phase wires and the neutral of a

4-wire, 3-phase system, a common conductor carries approximately the same current as the other conductors and is not therefore considered as a neutral conductor).

Ultimate Insulation Temperature. In no case shall conductors be associated together in such a way with respect to the kind of circuit, the wiring method employed, or the number of conductors, that the limiting temperature of the conductors will be exceeded.

Use of Conductors with Higher Operating Temperatures. If the room temperature is within 10°C of the maximum allowable operating temperature of the insulation, it is desirable to use an insulation with a higher maximum allowable operating temperature; although insulation can be used in a room temperature approaching its maximum allowable operating temperature limit if the current is reduced in accordance with the table of correction factors for different room temperatures.

Voltage Drop. The allowable current-carrying capacities in Tables 1 and 2 are based on temperature alone and do not take voltage drop into consideration.

Overcurrent Protection. If the standard ratings and settings of overcurrent devices do not correspond with the ratings and settings allowed for conductors, the next higher standard rating and setting may be used, but not exceeding 150 per cent of the allowable carrying capacity of the conductor.

Deterioration of Insulation. It should be noted that even the best grades of rubber insulation will deteriorate in time, so eventually will need to be replaced.

Number of Conductors in Conduit or Tubing

The following applies only to complete conduit systems, and does not apply to short sections of conduit used for the protection of exposed wiring from mechanical injury.

1 to 9 Conductors
Rubber Covered: Types RF-32, RUF, R, RH, RW, RU and RUW
Thermoplastic: Types TF, T and TW

N.E.C. Table 4

Size Conductor A.W.G.	Minimum Size of Conduit, Inches								
	No. of Conductors								
	1	2	3	4	5	6	7	8	9
18	1/2	1/2	1/2	1/2	1/2	1/2	1/2	3/4	3/4
16	1/2	1/2	1/2	1/2	1/2	1/2	3/4	3/4	3/4
14	1/2	1/2	1/2	1/2	3/4	3/4	1	1	1
12	1/2	1/2	1/2	3/4	3/4	1	1	1	1 1/4
10	1/2	3/4	3/4	3/4	1	1	1	1 1/4	1 1/4
8	1/2	3/4	3/4	1	1 1/4	1 1/4	1 1/4	1 1/4	1 1/2
6	1/2	1	1 1/4	1 1/4	1 1/2	1 1/2	2	2	2
4	1/2	1 1/4	1 1/4	1 1/2	1 1/2	2	2	2	2 1/2
3	3/4	1 1/4	1 1/4	1 1/2	2	2	2	2 1/2	2 1/2
2	3/4	1 1/4	1 1/4	2	2	2	2 1/2	2 1/2	2 1/2
1	3/4	1 1/2	1 1/2	2	2 1/2	2 1/2	3	3	3
1/0	1	1 1/2	2	2	2 1/2	2 1/2	3	3	3
2/0	1	2	2	2 1/2	2 1/2	3	3	3	3 1/2
3/0	1	2	2	2 1/2	3	3	3	3 1/2	3 1/2
4/0	1 1/4	2	2 1/2	3	3	3	3 1/2	3 1/2	4
MCM									
250	1 1/4	2 1/2	2 1/2	3	3	3 1/2	4	4	4 1/2
300	1 1/4	2 1/2	2 1/2	3	3 1/2	4	4	4 1/2	4 1/2
350	1 1/4	3	3	3 1/2	3 1/2	4	4 1/2	4 1/2	5
400	1 1/2	3	3	3 1/2	4	4	4 1/2	5	5
500	1 1/2	3	3	3 1/2	4	4 1/2	5	5	6
600	2	3 1/2	3 1/2	4	4 1/2	5	6	6	6
700	2	3 1/2	3 1/2	4 1/2	5	5	6	6	6
750	2	3 1/2	3 1/2	4 1/2	5	6	6	6	6
800	2	3 1/2	4	4 1/2	5	6	6	6	6
900	2	4	4	5	6	6	6	6	6
1000	2	4	4	5	6	6	6	6	6
1250	2 1/2	4 1/2	4 1/2	6	6	6	6	6	6
1500	3	5	5	6	6	6	6	6	6
1750	3	5	6	6	6	6	6	6	6
2000	3	6	6	6	6	6	6	6	6

*Where a service run of conduit or electrical metallic tubing does not exceed 50 feet in length and does not contain more than the equivalent of two quarter-bends from end to end, two No. 4 insulated and one No. 4 bare conductors may be installed in 1-inch conduit or tubing.

Dimensions of Rubber-Covered and Thermoplastic Covered Conductors

N.E.C. Table 13

Size A.W.G.	Types RF-32 R, RH, RW		Types TF, T, TW, RU, RUF, RUW		Size MCM	Types RF-32 R, RH, RW		Types TF, T, TW, RU, RUF, RUW	
	Approx. Diam. Inches	Approx. Area Sq. In.	Approx. Diam. Inches	Approx. Area Sq. In.		Approx. Diam. Inches	Approx. Area Sq. In.	Approx. Diam. Inches	Approx. Area Sq. In.
18	.146	.0167	.106	.0088	250	.868	.5917	.788	.4877
16	.158	.0196	.118	.0109	300	.933	.6837	.843	.5581
*14	.171	.0230	.131	.0135	350	.985	.7620	.895	.6291
†14	‡.204	‡.0327	400	1.032	.8365	.942	.6969
*12	.188	.0278	.148	.0172	500	1.119	.9834	1.029	.8316
†12	‡.221	‡.0384	600	1.233	1.1910	1.143	1.0261
10	.242	.0460	.168	.0224	700	1.304	1.3355	1.214	1.1575
8	.311	.0760	.228	.0408	750	1.339	1.4082	1.249	1.2252
6	.397	.1238	.323	.0819	800	1.372	1.4784	1.282	1.2908
4	.452	.1605	.372	.1087	900	1.435	1.6173	1.345	1.4208
3	.481	.1817	.401	.1263	1000	1.494	1.7531	1.404	1.5482
2	.513	.2067	.433	.1473	1250	1.676	2.2062	1.577	1.9532
1	.588	.2715	.508	.2027	1500	1.801	2.5475	1.702	2.2748
1/0	.629	.3107	.549	.2367	1750	1.916	2.8895	1.817	2.5930
2/0	.675	.3578	.595	.2781	2000	2.021	3.2079	1.922	2.9013
3/0	.727	.4151	.647	.3288
4/0	.785	.4840	.705	.3904

*With 3/64 in. insulation.
 †With 3/4 in. insulation.
 ‡Dimensions for Type RW; also to be used for new work in computing size of conduit or tubing for combinations of conductors not shown in Table 4.
 §Type RU conductors recognized in sizes No. 14 to No. 2, No. 18 to No. 8, solid; No. 6 and larger, stranded.

Number of Conductors in Conduit or Tubing

Lead-Covered — Types RL, and RHL — 600 Volts
N.E.C. Table 5

Size Conductor A.W.G.	Minimum Size of Conduit, Inches											
	Single Conductor Cable			2-Conductor Cable				3-Conductor Cable				
	1	2	3	1	2	3	4	1	2	3	4	
14	1/2	3/4	3/4	1	3/4	1	1	1 1/4	3/4	1 1/4	1 1/2	1 1/2
12	1/2	3/4	3/4	1	3/4	1	1 1/4	1 1/4	1	1 1/4	1 1/2	2
10	1/2	3/4	1	1	3/4	1 1/4	1 1/4	1 1/2	1	1 1/2	2	2
8	1/2	1	1 1/4	1 1/2	1	1 1/4	1 1/2	2	1 1/4	2	2	2 1/2
6	3/4	1 1/4	1 1/2	1 1/2	1 1/4	1 1/2	2	2 1/2	1 1/4	2 1/2	3	3
4	3/4	1 1/4	1 1/2	1 1/2	1 1/4	2	2 1/2	3	1 1/2	3	3	3 1/2
3	3/4	1 1/4	1 1/2	2	1 1/4	2	2 1/2	3	1 1/2	3	3	3 1/2
2	1	1 1/4	1 1/2	2	1 1/4	2	2 1/2	3	1 1/2	3	3 1/2	4
1	1	1 1/2	2	2	1 1/2	2 1/2	3	3 1/2	2	4	4 1/2	5
1/0	1	2	2	2 1/2	2	2 1/2	3	3 1/2	2 1/2	4	4 1/2	5
2/0	1	2	2	2 1/2	2	2 1/2	3	3 1/2	2 1/2	4 1/2	5	5
3/0	1 1/4	2	2 1/2	2 1/2	2	2 1/2	3	3 1/2	4	4 1/2	5	6
4/0	1 1/4	2 1/2	2 1/2	3	2 1/2	3	3 1/2	4 1/2	3	5	6	6
MCM												
250	1 1/4	2 1/2	3	3	3	6	6	6
300	1 1/2	3	3	3 1/2	3 1/2	6	6	6
350	1 1/2	3	3	3 1/2	3 1/2	6	6	6
400	1 1/2	3	3	3 1/2	3 1/2	6	6	6
500	1 1/2	3	3 1/2	4	4	6	6	6
600	2	3 1/2	4	4 1/2
700	2	4	4	5
750	2	4	4	5
800	2	4	4 1/2	5
900	2 1/2	4	4 1/2	5
1000	2 1/2	4 1/2	4 1/2	6
1250	3	5	5	6
1500	3	5	6	6
1750	3	5	6	6
2000	3 1/2	6	6	6

The above sizes apply to straight runs or with nominal offsets equivalent to not more than two quarter-bends.

More Than 9 Conductors — Rubber-Covered Types RF-32, RUF, R, RH, RU, RUW and RW — 600 Volts; Thermoplastic, Types TF, T and TW
N.E.C. Table 9

More than 9 conductors are permitted in a single conduit for conductors between a motor and its controller; stage pocket and border circuits; sign flashers; elevator control conductors; and signal and control circuits.

Max. No. of Conductors in Conduit or Tubing

Size A.W.G.	Minimum Size of Conduit, Inches						
	3/4	1	1 1/4	1 1/2	2	2 1/2	3
18	12	20	35	49	80	115	176
16	10	17	30	41	68	97	150
14	10	18	25	40	59	90
12	15	21	35	50	77
10	13	17	29	41	64
8	10	17	25	38
6	15	23

Bends

Bends of rigid conduit or tubing shall be so made that the conduit or tubing will not be injured and that the internal diameter of the conduit or tubing will not be effectively reduced. The radius of the curve of the inner edge of any field bend shall not be less than shown in the following table:

Radius of Conduit and E.M.T. Bends

Size of Conduit Inches	Min. Radius, Inches		Size of Conduit Inches	Min. Radius, Inches	
	For Conductors Without Lead Sheath	For Conductors With Lead Sheath		For Conductors Without Lead Sheath	For Conductors With Lead Sheath
1/2	3.7	6.2	3	18.4	30.6
3/4	4.9	8.3	3 1/2	21.3	35.5
1	6.3	10.5	4	24.1	40.2
1 1/4	8.3	13.8	4 1/2	27.0	45.0
1 1/2	9.6	16.1	5	30.3	50.4
2	12.4	20.6	6	36.4	60.6
2 1/2	14.8	24.6

Definitions of Electrical Terms

- Alternating Current**—Current which reverses its direction of flow twice in each cycle.
- Ampere**—The unit of measurement for electrical current. That amount of current which will be caused to flow in a circuit of one ohm resistance when a potential of one volt is applied.
- Arrester**—A device to conduct lightning surges to the ground and limit the following line current, thus protecting the line and associated equipment.
- Carrier**—In telephony, a carrier wave impressed on a metallic circuit making possible the transmission of more than one conversation simultaneously.
- Circuit**—The complete path of an electric current including the originating device, the using device and a means of opening or closing the circuit.
- Common Battery**—A single battery, usually in the central office, which supplies direct current to all of the associated telephone circuits.
- Condenser**—(Also a capacitor) A device to introduce capacitance into an electrical circuit. Commonly used to correct low power-factor.
- Contactors**—An electro magnetic switch which may be operated by a control circuit from a remote point. Generally not fused.
- Controls**—Generally motor controls which include switches for starting, stopping, reversing and regulating the speed of electric motors.
- Cut-Out**—A fused switch for disconnecting the primary circuit from a distribution transformer.
- Decibel**—A unit of measurement for sound.
- Delta**—An alternating current, three-phase power source connected in the form of the Greek letter Δ or Delta.
- Direct Current**—Current which flows steadily in one direction in a circuit.
- Distribution Line**—The conductors with laterals serving transformers which feed secondary circuits.
- Follow Current**—That line current which tends to follow a lightning discharge through an arrester to ground.
- Footcandle**—A unit for measuring illumination. The illumination produced at a surface, all points of which are at a distance of one foot from a standard candle.
- Footlambert**—The average brightness of any surface emitting or reflecting light at the rate of one lumen per square foot.
- Fused Disconnect**—Generally an air break switch with a fusing unit in the blade. For opening and closing high voltage circuits.
- Grounded Circuit**—In telephony, a circuit where the current flow in one direction is through a metallic conductor while the return is through the ground. In power use a circuit is grounded when one wire of the circuit is connected to ground at one or more points.
- Kilowatt**—A unit of measurement equivalent to one thousand watts.
- Line Loss**—The voltage drop resulting from the passage of electrical current through the resistance of the line.
- Lumen**—The total amount of light falling on an area of one square foot, all points of which are one foot from a source equal to one standard candle.
- Metallic Circuit**—In telephony, a two wire or completely metallic circuit, no part of which is through the ground.
- Microwave**—A very high frequency radio transmission with line-of-sight characteristics. Now replacing long distance telephone lines.
- Motor Starter**—A switch with current limiting characteristics or delayed fusing to accommodate the high initial current of motors being started.
- Network**—An assembly, usually consisting of capacitors and resistors, to provide the required electrical characteristics in a telephone circuit. The network in the base of a telephone set is a very good example.
- Normally Closed**—Contacts which open when the switch is operated.
- Normally Open**—Contacts which close when the switch is operated.
- Ohm**—The unit of electrical resistance or the resistance of a circuit in which a potential difference of one volt will produce a current of one ampere.
- Panel**—Commonly a device to provide individual switching and circuit protection to circuits branching from the consumers service entrance.
- Power Factor**—The ratio of active power to apparent power.
- Protector**—A device to protect a telephone circuit from the effects of lightning or other high voltages accidentally impressed on the line.
- Receiver**—The telephone device which transforms the transmitted electrical impulses back to audible sound waves.
- Recloser**—A cutout which automatically recloses a specified number of times after each operation of the fuse element.
- Resistor**—A device used to limit or reduce the flow of current in a circuit.
- Ringer**—In telephony, the signalling bell which rings to indicate there is an incoming call on the line.
- Secondary Line**—The conductors connected between the secondaries of distribution transformers and the consumers service entrances.
- Single Phase**—A two-wire circuit energized by a single alternating electromotive force.
- Sub-Station**—An assemblage of equipment for changing transmission voltages to distribution voltages. Generally includes transformers, switching and protective equipment, support structures and enclosing fence.
- Three Phase**—A combination of three circuits energized by alternating electromotive forces that differ in phase by 120 degrees or one-third of a cycle.

Definitions of Electrical Terms

Concluded

Three Phase, Four Wire System—A three phase four wire system is a system of alternating-current supply comprising four conductors, three of which are connected as in a three-phase three-wire system, the fourth being connected to the neutral point of the supply, which may be grounded.

Transformer—An electrical device without continuously moving parts which transforms electrical energy from one circuit to another with changed values of voltage and current.

Transmitter—The telephone device into which a person speaks and which transforms the voice into electrical impulses for transmission.

Transmission Line—The conductors which transmit electric power from generating station transformers to remote transformers feeding distribution lines.

Volt—A unit of electromotive force which, when steadily applied to a circuit whose resistance is one ohm, will produce a current of one ampere.

Voltage Regulator—A device for maintaining a constant voltage on a line.

Watt—The electrical unit of measurement for power which is roughly equivalent to the work done by one ampere of current at a potential of one volt.

Wye—An alternating-current three-phase power source connected in the form of a Y.

Equivalent Values of Electrical, Mechanical and Heat Units

Unit	Equivalent Value in Other Units
1 Watt =	1 joule per second 0.001341 hp. 3.415 heat units per hour 0.73756 ft.-lb. per second 0.0035 lb. water evap. per hour 44.254 ft.-lb. per minute
1 Kilowatt =	1000 watts 1.3410 horsepower 2,655,200 ft.-lb. per hour 44,254 ft.-lb. per minute 737.56 ft.-lb. per second 3,415 heat units per hour 56.92 heat units per minute 0.9486 heat units per second 0.234 lb. carbon oxidized per hour 3.52 lb. water evap. per hr. from and at 212° F.
1 Kw.-hour =	1000 watt-hours 1.341 horsepower-hours 2,655,200 ft.-lb. 3,600,000 joules 3,415 heat units 367,100 kilogram-meters 0.234 lb. carbon oxidized with perfect efficiency 3.52 lb. water evap. from and at 212° F. 22.77 lb. of water raised from 62 to 212° F.
1 Hp. =	745.7 watts 0.7457 kw. 33,000 ft.-lb. per minute 550 ft.-lb. per second 2,546.5 heat units per hour 42.44 heat units per minute 0.707 heat units per second 0.174 lb. carbon oxidized per hour 2.62 lb. water evap. per hour from and at 212° F.
1 Hp.-hr. =	0.7457 kw.-hour 1,980,000 ft.-lb. 2,546.5 heat units 273,740 kilogram-meters 0.174 lb. carbon oxidized with perfect efficiency 2.62 lb. water evap. from and at 212° F. 17.0 lb. water raised from 62 F., to 212° F.
1 Joule =	1 watt-second 0.00000278 kw.-hour 0.10197 kilogram-meter 0.0009486 heat units 0.73756 ft.-lb.

Unit	Equivalent Value in Other Units
1 Ft.-lb. =	1.3558 joules 0.13826 kilogram-meter 0.000003766 kw.-hour 0.0012861 heat unit 0.000005 hp.-hour
1 Kilogram-meter =	7.233 ft.-lb. 0.00003653 hp.-hour 0.000002724 kw.-hour 0.009302 heat unit
1 Watt per Sq. In. =	8.20 heat units per sq. ft. per minute 6.373 ft.-lb. per sq. ft. per minute 0.1931 hp. per sq. ft.
1 Heat-Unit =	1,054.2 watt-seconds 777.54 ft.-lb. 107.5 kilogram-meters 0.0002928 kw.-hour 0.0003927 hp.-hour 0.0000685 lb. carbon oxidized 0.001030 lb. water evap. from and at 212° F.
1 Heat Unit per Sq. Ft. per Min. =	0.1220 watt per sq. in. 0.01757 kw. per sq. ft. 0.02356 hp. per sq. ft.
1 Lb. Carbon Oxidized with Perfect Efficiency =	14,600 heat units 1.11 lb. anthracite oxidized 2.5 lb. dry wood oxidized 22 cu. ft. illuminating gas 4.75 kw.-hour 5.733 hp.-hour 11,352,000 ft.-lb. 15.05 lb. of water evap. from and at 212° F
1 Lb. Water Evap. from and at 212° F. =	0.2841 kw.-hour 0.3811 hp.-hour 970.4 heat units 104,320 kilogram-meter 1,023,000 joules 754,525 ft.-lb. 0.066466 lb. carbon oxidized.

Electrical Formula for Determining Amperes, Horsepower, Kilowatts and Kilovolt-Amperes

Desired Data	Alternating Current	
	Single Phase IxE _x Cos.θ	*Two-Phase Four-Wire IxE _x 2xCos.θ
Kilowatts	$\frac{1000}{IxE}$	$\frac{1000}{IxE \times 2}$
	$\frac{1000}{IxE \times \% \text{Eff.} \times \text{Cos.} \theta}$	$\frac{1000}{IxE \times 2 \times \% \text{Eff.} \times \text{Cos.} \theta}$
Kva.	$\frac{1000}{IxE}$	$\frac{1000}{IxE \times 2}$
	$\frac{1000}{IxE \times \% \text{Eff.} \times \text{Cos.} \theta}$	$\frac{1000}{IxE \times 2 \times \% \text{Eff.} \times \text{Cos.} \theta}$
Horsepower Output	$\frac{746}{IxE}$	$\frac{746}{IxE \times 2}$
	$\frac{746}{IxE \times \% \text{Eff.} \times \text{Cos.} \theta}$	$\frac{746}{IxE \times 2 \times \% \text{Eff.} \times \text{Cos.} \theta}$
Amperes when Hp. is Known	$\frac{Hp. \times 746}{E}$	$\frac{Hp. \times 746}{E}$
	$\frac{Ex \times \% \text{Eff.} \times \text{Cos.} \theta}{Kw. \times 1000}$	$\frac{2 \times Ex \times \% \text{Eff.} \times \text{Cos.} \theta}{Kw. \times 1000}$
Amperes when Kilowatts is Known	$\frac{Kw. \times 1000}{Ex \text{Cos.} \theta}$	$\frac{2 \times Kw. \times 1000}{2 \times Ex \text{Cos.} \theta}$
	$\frac{Kva. \times 1000}{E}$	$\frac{Kva. \times 1000}{E}$
Amperes when Kva. is Known	$\frac{E}{IxE}$	$\frac{2xE}{IxE}$
	Desired Data	
Kilowatts	A-C. Three-Phase $\frac{IxE \times 1.73 \times \text{Cos.} \theta}{1}$	D-C. $\frac{IxE}{1}$
	$\frac{1000}{IxE \times 1.73}$	$\frac{1000}{IxE}$
Kva.	$\frac{1000}{IxE \times 1.73}$
	$\frac{1000}{IxE \times 1.73 \times \% \text{Eff.} \times \text{Cos.} \theta}$	$\frac{1000}{IxE \times \% \text{Eff.}}$
Horsepower Output	$\frac{746}{IxE \times 1.73}$	$\frac{746}{IxE}$
	$\frac{746}{IxE \times 1.73 \times \% \text{Eff.} \times \text{Cos.} \theta}$	$\frac{746}{IxE \times \% \text{Eff.}}$
Amperes when Hp. is Known	$\frac{Hp. \times 746}{E}$	$\frac{Hp. \times 746}{E}$
	$\frac{1.73 \times Ex \times \% \text{Eff.} \times \text{Cos.} \theta}{Kw. \times 1000}$	$\frac{Ex \times \% \text{Eff.}}{Kw. \times 1000}$
Amperes when Kilowatts is Known	$\frac{Kw. \times 1000}{1.73 \times Ex \text{Cos.} \theta}$	$\frac{E}{E}$
	$\frac{Kva. \times 1000}{1.73 \times E}$

*In two-phase, three wire circuits the current in the common conductor is 1.11 times that in either other conductor.
Note: E = Volts; I = Amperes; % Eff. = Per Cent Efficiency; Cos.θ = Power Factor.

Wiring Formula For Copper Wire

For determining the correct wire size for a particular installation, an adaptation of ohms law may be used. The formula below permits such a determination, and considers the effect of voltage drop. To use it, the distance of the circuit one way (D) must be known, and the allowable voltage drop (V) must be selected. The conductor area in circular mils, then is:

$$C.M. = \frac{2D \times C \times R}{V}$$

Where r is the resistivity (ohm-circular mil per foot) of the conductor. For annealed copper conductors used r=10.8; for hard drawn copper conductors use r=11.06. Note: these values are based on a temperature of 30°C, and will be larger at higher temperature.

For allowable current carrying capacity for the selected conductor size, consult the National Electric Code.

Miscellaneous Information

- Latent heat of vaporization of water = 970 BTU per lb.
- Latent heat of melting of water = 144 BTU per lb.
- To evaporate 1 lb. water from and at 212° = 16.859 Kw. minutes.
- To evaporate 1 lb. water from and at 212° = 0.281 Kw. hours.
- Weight per cu. ft. of water = 62.42 lb.
- Weight per gallon of water = 8.33 lb.

Units of Measure

The following mechanical units of the Metric system are International Standards. From these Metric units electrical units are derived and converted for engineering use.

Meter—The fundamental unit of length in the Metric system; one ten-millionth of the distance along a meridian from the pole to the equator; approximately 39.37 inches.

Gram—The fundamental unit of mass or, practically, of weight. Equals the weight of a cubic centimeter of water at a temperature of 4 degrees Centigrade.

Second—A unit of time, 1/60 of a minute; a unit of angular measure, 1/60 of a minute of arc.

Electrical Units

Volt—The practical unit of electromotive force; the electrical pressure which will cause a current of one ampere to flow through a resistance of one ohm. The force which will charge a condenser of one farad capacity with a coulomb of electricity.

Ohm—The practical unit of the resistance of a material to the flow of current. That resistance which will permit the flow of one ampere when a voltage of one volt is imposed across the resistance.

Ampere—The practical unit of the rate of flow of electrical charge; one coulomb per second across any given cross-section of a circuit. The current that will flow in a resistance of one ohm when an electromotive force of one volt is impressed across the resistance.

Coulomb—A quantity of electrons; the quantity of electrons passing any given cross-section of a circuit when a current of one ampere flows for one second. The quantity of charge stored in a condenser of one farad when subjected to an e.m.f. of one volt.

Farad—The practical unit of electrical capacity. The capacitance of a condenser whereby a stored charge of one coulomb produces an e.m.f. of one volt.

Watt—The practical unit of electrical power. The rate of expenditure of electrical energy. One joule per second.

Joule—The practical unit of energy or work. The work done to raise the potential of one coulomb one volt.

The Circular Mil

The standard unit of wire cross-section in English and American wire tables. Equals the area of a circle whose diameter is one mil (0.001 inch).

To obtain the number of circular mils in a solid wire of a given diameter, express the diameter in mils and then square it.

To obtain the diameter of a solid wire having a given number of circular mils, take the square root of the circular mils and the result is the diameter in mils.

One circular mil equals 0.7854 square mils.

Ohm's Law

The relationships between current, voltage and resistance in a circuit are expressed by Ohm's law. Where I = current in amperes, E = voltage in volts, and R = resistance in ohms, the following relations permit any one value to be found when the other two are known:

(1) To find the current through a circuit when the voltage across the circuit and the resistance of the circuit are known:

$$I = \frac{\text{Voltage}}{\text{Resistance}} = \frac{E}{R}$$

(2) To find the voltage across a circuit when the resistance of the circuit and the current through it are known:

$$E = \text{Current} \times \text{Resistance} = IR$$

(3) To find the resistance of a circuit when the current through it and the voltage across it are known:

$$R = \frac{\text{Voltage}}{\text{Current}} = \frac{E}{I}$$

CATALOG NUMBER INDEX

Cat. No.	Page	Cat. No.	Page	Cat. No.	Page	Cat. No.	Page
A	1246	ABG0204 to ABG1550	Gr. Con-nectors	AL-7080 to AL-7150	Pulleys	B	211
A	836	AC1 to AC23-IV	Switches	AL-8181	Lock Boxes	B	Reel-O-
A	238	AC22 to AC66	Clamps	AL-9284 to AL-9286M	Holders	B	Matics
A	547	ACB-CBI	Switchboards	ALAI to ALA2216	Hangers	B	Switches
A	761	ACB-ML, ACB-QMB	Switchboards	ALC1 to ALC3216	Hangers	B	1356
A	206	ACL	Cable	ALS2-80RS to ALS2-96	Light Units	B	1512
A	212	ACO-50	Transformers	AN	Dynamome- ters	B	865
A	46	AD-6	Cable	AN-12 to AN-22	Wire	B-1	148
A	225	AD-6 to AD-12	Instruments	AN22	Flashlights	BI	682
A	682	AD-10, AD-12	Instruments	ANW	Cable	BI	1342
A	859	AE321 to AE348	Receptacles	AO-58, AO-72	Instruments	BIB	1342
A	46	AE621 to AE648	Receptacles	AP-1	Fuse Bl ecks	BIBXX to BIXXH	1344
A	817	AEI021 to AEI048	Receptacles	AP-9	Instruments	B-2XX	812
A	1232	AED13 to AEE56	Unilets	AP-11	Instruments	B-3, B-7	700
A	698	AEDF13 to AEDF56	Unilets	AP-12	Instruments	B-4	699
A	865	AEE3211 to AEE6485	Receptacles	AP-160 to AP-1210	Contact Units	B-5, B-7	1155
A	66	AEEA6213 to AEEA10486	Receptacles	AP-420-G to AP-1210-G	Contact Units	B6S to B10	775
A	406	AEI-321 to AEI-1012	Interiors	AP20255 to AP20468	Plugs	B10	1499
A	1504	AEJ13 to AEJK56	Unilets	AP40257 to AP40468	Plugs	B-10-JH	1155
A	682	AEJP13 to AEJP56	Unilets	AP402510 to AP404612	Plugs	B11AXA, B11BXX	1345
A	1489	AEJ2 to AEP35	Unilarms	APC-2001, APC-2002	Plug Shells	B11-6 to B11-14	196
A	258	AEP3211 to AEP3461	Plugs	APC3251 to APC10463	Connectors	B11-6F to B11-14G	197
A	171	AEP6212 to AEP6462	Plugs	APD-2003 to APD-2008L	Plug Shells	B16	1499
A	770	AEP10253 to AEP10463	Plugs	APP-320-CR to APP-3120-GR	Contact Units	B17 to B107	379
A	825	AEPA-3211 to AEPA-6422	Adapters	APFD-2003 to APFD-2006	Plug Shells	B17-MT to B37-MT	381
A	1505	AEP1-321 to AEP1-1012	Interiors	APJ2251 to APJ2253	Plugs	B18	713
A	735	AERA13 to AERP56	Unilets	APJ2271 to APJ2273	Plugs	B21-010	171
A	1345	AERH13 to AERH56	Unilets	APJ3253 to APJ3563	Plugs	B26	1499
A	1344	AF	Wire	APJ3273 to APJ3583	Plugs	B-33	1072
A	1499	AFD-213 to AFD-540-AJ	Joint Assy.	APJ6253 to APJ6465	Plugs	B-41, B-44-SH	1155
A	1077	AFD-2135-EJ to AFD-5400-EJ	Joints	APJ6253 to APJ6465	Plugs	B50 to B600	239
A	1499	AFD-2135-FE to AFD-2135-L	Ends	APJ6273 to APJ6465	Plugs	B13812 to B125T18100	1300
A	379	AFD-2135-R to AFD-5400-L	Elbows	APJ6273 to APJ6465	Plugs	B139/21 to B180/24	1138
A	381	AFD-2135-R to AFD-5400-R	Reducers	APJ10255 to APJ10467	Plugs	B158/36-3	1137
A	196	AFD-2135-S to AFD-5400-S	Ducts	APJ10275 to APJ10487	Plugs	B197 to B697	381
A	197	AFD-2135-T to AFD-5400-T	Tees	APSYI	Relays	B601	1281
A	171	AFD-2135-TB to AFD-5400-TB	Boxes	AR-160 to AR-2110	Contact Units	B634	775
A	1499	AFD-2135-X to AFD-5400-X	Crosses	AR221 to AR354	Receptacles	B-700S to B-710S	211
A	1333	AFM-208 to AFM-510-AJ	Joint Assy.	AR225 to AR358	Receptacles	B-905, B-907	253
A	1137	AFM-2080-EJ to AFM-5100-EJ	Joints	AR320G	Contact Units	B-910 to B-912	253
A	340	AFM-5100-EC to AFM-5100-EC	Closures	AR420-G to AR1210-G	Contact Units	B-915 to B-935	253
A	1180	AFM-5100-EC to AFM-5100-EC	Closures	AR625 to AR648	Receptacles	B-926, B-927	253
A	338	AFM-5100-EJ to AFM-5100-EJ	Joints	AR1021 to AR1044	Receptacles	B-936 to B-939	255
A	338	AFM-2080-FE to AFM-5160-FE	Ends	AR1025 to AR1048	Receptacles	B-940-1	255
A	339	AFM-2080-R to AFM-5100-R	Reducers	AR2021 to AR2042	Receptacles	B-941	255
A	381	AFM-2080-S to AFM-5160-S	Ducts	AR40212 to AR40422	Receptacles	B-942, B-945	255
A	1519	AFM-2080-T to AFM-5160-T	Tees	AR6 to AR144	Hangers	B-943, B-945	255
A	1519	AFM-2080-TB to AFM-5100-TB	Boxes	ARB31 to ARB34	Lt. Fixtures	B-5248-A/A to B-9496P1-1	1100
A	1519	AFM-2080-X to AFM-5160-X	Crosses	ARB31 to ARB44	Lt. Fixtures	B-13248 to B-14496	1101
A	1518	AG, AG1	Hoists	ARD13 to ARDF56	Condulets	BB2 to BB4	738
A	1518	AGA to AGY	Fuses	ARD-2003 to ARD-2008	Housings	BB50 to BB600	238
A	1519	AHG1102 to AHG21111	Hangers	ARDC-2001	Housings	BC	316
A	1519	AI	Wire	ARDC-2002	Housings	BC	1282
A	118	AIA	Cable	ARE13 to ARE56	Condulets	BC	1314
A	118	AIA	Wire	ARE2211 to ARE6445	Receptacles	BC3 to BC10	384
A	67	AIA	Wire	ARE2251 to ARE6485	Receptacles	BC7286, BC-15233	268
A	118	AIA	Wire	ARE6213 to AREA10446	Receptacles	BCD-14S to BDO-18S	1050
A	67	AIA	Wire	ARE6253 to AREA10486	Receptacles	BDP-14S to BDP-18S	1050
A	118	AIA	Wire	AREA20215 to AREA20427	Receptacles	BDDP202 to BDDP410	490
A	118	AIA	Wire	AREX40216 to AREX402212	Receptacles	BEE3 to BEE10	384
A	118	AIA	Wire	AREX40216 to AREX402212	Receptacles	Robot Oper- ators	707
A	118	AIA	Wire	AREX40216 to AREX402212	Receptacles	BG47 to BG98	384
A	118	AIA	Wire	AREX40216 to AREX402212	Receptacles	BH455L to BH557L	301
A	118	AIA	Wire	AREX40216 to AREX402212	Receptacles	BH-L	208
A	118	AIA	Wire	AREX40216 to AREX402212	Receptacles	BH30W3/8"	208
A	118	AIA	Wire	AREX40216 to AREX402212	Receptacles	BHS, BID	304
A	118	AIA	Wire	AREX40216 to AREX402212	Receptacles	BL0508 to BL6124	258
A	118	AIA	Wire	AREX40216 to AREX402212	Receptacles	BL0508 to BL6000	228
A	118	AIA	Wire	AREX40216 to AREX402212	Receptacles	BLB3 to BLB10	384
A	118	AIA	Wire	AREX40216 to AREX402212	Receptacles	BODS-1, BODSF-1	364
A	118	AIA	Wire	AREX40216 to AREX402212	Receptacles	BOS14221 to BOS16426	489
A	118	AIA	Wire	AREX40216 to AREX402212	Receptacles	BP49 to BP79	459
A	118	AIA	Wire	AREX40216 to AREX402212	Receptacles	BP202 to BP248	714
A	118	AIA	Wire	AREX40216 to AREX402212	Receptacles	BP221 to BP4237	489
A	118	AIA	Wire	AREX40216 to AREX402212	Receptacles	BP6422 to BP8834	359
A	118	AIA	Wire	AREX40216 to AREX402212	Receptacles	BP-B	208
A	118	AIA	Wire	AREX40216 to AREX402212	Receptacles	BRC8432 to BRC8834	359
A	118	AIA	Wire	AREX40216 to AREX402212	Receptacles	BRD302 to BRD8304	389
A	118	AIA	Wire	AREX40216 to AREX402212	Receptacles	BRG1302 to BRG58302	396
A	118	AIA	Wire	AREX40216 to AREX402212	Receptacles	BRM70432 to BRM70834	359
A	118	AIA	Wire	AREX40216 to AREX402212	Receptacles	BRME1302 to BRME83304	358
A	118	AIA	Wire	AREX40216 to AREX402212	Receptacles	BRS239, BRS240	1344
A	118	AIA	Wire	AREX40216 to AREX402212	Receptacles	BS-14S to BS-18S	1050
A	118	AIA	Wire	AREX40216 to AREX402212	Receptacles	BSB-5CH, BSB-6CH	969
A	118	AIA	Wire	AREX40216 to AREX402212	Receptacles	BT3 to BTB10	1146
A	118	AIA	Wire	AREX40216 to AREX402212	Receptacles	BT1500	1146
A	118	AIA	Wire	AREX40216 to AREX402212	Receptacles	BUB3 to BU600	384
A	118	AIA	Wire	AREX40216 to AREX402212	Receptacles	BUB3 to BU610	384
A	118	AIA	Wire	AREX40216 to AREX402212	Receptacles	BU50 to BUC400	237
A	118	AIA	Wire	AREX40216 to AREX402212	Receptacles	BW12 to BW42	170
A	118	AIA	Wire	AREX40216 to AREX402212	Receptacles	BX3 to BX10	384
A	118	AIA	Wire	AREX40216 to AREX402212	Receptacles	Cable	17, 44, 76
A	118	AIA	Wire	AREX40216 to AREX402212	Receptacles	Cord	91, 131
A	118	AIA	Wire	AREX40216 to AREX402212	Receptacles	Couplings	225
A	118	AIA	Wire	AREX40216 to AREX402212	Receptacles	Drilling Machines	859
A	118	AIA	Wire	AREX40216 to AREX402212	Receptacles	Knobs	213
A	118	AIA	Wire	AREX40216 to AREX402212	Receptacles	Pipe	225
A	118	AIA	Wire	AREX40216 to AREX402212	Receptacles	Plates	682
A	118	AIA	Wire	AREX40216 to AREX402212	Receptacles	Supports	274
A	118	AIA	Wire	AREX40216 to AREX402212	Receptacles	Switches	440
A	118	AIA	Wire	AREX40216 to AREX402212	Receptacles	Tape	181
A	118	AIA	Wire	AREX40216 to AREX402212	Receptacles	Unipaks	865
A	118	AIA	Wire	AREX40216 to AREX402212	Receptacles	Wire	148
A	118	AIA	Wire	AREX40216 to AREX402212	Receptacles	Plates	682
A	118	AIA	Wire	AREX40216 to AREX402212	Receptacles	Bushings	258

Cat. No.	Page
C-6, C-7	Lt. Fixtures. 1152
C10-6 to C10-516	Terminals. 196
C10-6A to C10-14F	Terminals. 197
C-10-X, C-12-X	Coverlites. 1059
C11SH to C12SH-12	Swivelites. 1155
C-13 to C-27V	Water Coolers. 1271
C17 to C107	Condulets. 379
C17-MT to C67-MT	Condulets. 381
C18 to C148	Condulets. 393
C20 to C-28	Chimes. 1247
C21, C21T	Extinguishers. 1227
C21	Conducting Paint. 1499
C26	Coils. 1499
C31, C31T	Extinguishers. 1227
C-32	Chimes. 1247
C-34 to C-47	Chimes. 1248
C45P, C45PA	Extinguishers. 1227
C50	Gins. 833
C-50, C-51	Chimes. 1248
C-51	Gins. 888
C-51-1	Adapters. 888
C55	Gins. 834
C55B	Beams. 834
C-60 to C-62	Chimes. 1248
C65	Gins. 834
C65B	Beams. 834
C75, C85	Brackets. 834
C85ANA, C85BXX	Re-lays. 1345
C-100-21, C-100-S-21	Stem & Canopy. 1040
C101 to C104	Cord. 91
C-101 to C-105	Chimes. 1248
C-105	Straps. 255
C105P, C105PM	Extinguishers. 1227
C111 to C125	Cord. 91
C-112-PC to C-116-PC	Coverlites. 1059
C-137	Clamps. 254
C-139	Hangers. 254
C197 to C697	Condulets. 381
C200T	Tongs. 812
C-201 to C-201-8	Lt. Units. 1153
C-210 to C-216-D	Tapes. 719
C214 to C641	Lt. Units. 1137
C231 to C233	Hammers. 714
C-216 to C-239	Clamps. 254
C-250 to C-256	Tapes. 719
C316	Screwdrivers. 713
C331, C331R	Hammers. 715
C351 to C360	Unilets. 329
C500-II	Brewers. 1211
C504 to C6004	Supports. 274
C710	Couplings. 492
C-824	Lt. Units. 1156
C-926, C-928	Rules. 719
C-1901MA to C-1957A	Climbers. 800
C-5240 to C-9150-8	Lt. Fixtures. 1100
C-5400	Lt. Units. 1156
C-7496	Relays. 1347
C-7516	Switches. 1347
C-9210, C-9212	Rules. 719
C12806-10 to C12806-48	Hangers. 1113
C-32625 to C-88306	Cord Sets. 151
CA2, CA4	Caps. 511, 524
CA1A, CA22A	Luminaires. 1068
CA-248-B, CA-248-B-4	Luminaires. 1088
CA-296-B	Luminaires. 1088
CAC75 to CAC500	Terminators. 276
CAN75 to CAN500	Terminators. 276
CB	Boxes. 307
CB	Cord. 91
CB	Terminals. 206
CB1	Connectors. 169
CB81 to CB344	Term. Blocks. 401
CB308	Blocks. 417
CB611	Blocks. 422
CBBCS to CBBES	Panel Accessories. 1216
CBBLDP	Thermostat & Switch. 1216
CBH	Box Cleats. 301
CBN	Cord. 91
CBP to CBP-15	Plates. 290
CRS2020 to CRSW44311	Starters. 449
CC to CC-RS	Robot Operators. 707
CC2 to CC5	Clamps. 983
CC6 to CC18	Panels. 702
CC231R	Hammers. 714
CC503	Clamps. 1095
CCB	Panelboards. 598, 599
CD	Boxes. 307
CD	Motors. 1326, 1327
CDP202 to CDP410	Crosses. 490
CDV	Boxes. 307
CE	Caps. 511, 524, 550, 551
CE52213 to CESD1234	Condulets. 360
CF	Cable. 17
CF-1, CF-2	Instruments. 1464
CF2-603-6 to CF2-615	Strips. 475
CF2-607, CF3-607	Clips. 475
CF2-616L to CF2-617-R	Boxes. 475
CF2-618, CF3-618	Boxes. 474
CF2-623, CF3-623	Gages. 474
CF2-629, CF3-629	Covers. 474
CF2-637, CF2-638	Elbows. 474
CF2-644, CF3-644	Capping. 474
CF2-645, CF3-645	Straps. 475
CF2-680, CF3-680	End Blanks. 474

Cat. No.	Page
CF3-606-18 to CF4-606-18	Strips. 475
CF3-637, CF3-638	Elbows. 474
CF-67	Volt-Ammeters. 1464
CF22A	Reels. 168
CF209, CF210	Blocks. 395
CF534 to CF539	Covers. 384
CF-5240 to CF-5296	Lt. Fixtures. 1100
CFA	Flasher Assy. 1261
CG2004 to CG8150	Gr. Connectors. 264
CGB184 to CGB3893	Connectors. 405
CGE-12-40 (M)	Troffer Assy. 1102
CGE192 to CGE498	Connectors. 404
CGY2242 to CGY3422	Connectors. 245
CH	Caps. 511, 524, 550, 551
CH	Instruments. 1463
CH2 to CH4T	Stoves. 1261
CHF-120 to CHF-240	Heaters. 1288
CHP	Clamps. 206
CHRP1 to CHRP62	Hangers. 407
CHS143 to CHS343	Susp. Clamps. 419
CL	Boxes. 307
CL-9 to CL-26	Clamps. 299
CL-21 to CL-26	Clamps. 303
CL-90	Shoes. 738
CLB-12-40 (M)	Troffer Assy. 1102
CLC50 to CLN600	Terminators. 276
CLR	Controls. 1215
CLV	Boxes. 307
CMFP2-40 to CMV2-96	Reflectors. 1043
CO	Outlets. 171
CO	Swivelites. 1155
CO17 to COV677	Condulets. 380
COR-2-140RS to COR-2-196RS	Troffers. 1118
COR-140RS to COR-196RS	Troffers. 1118
COR-140-UAC to COR-240-UAC	Lt. Fixtures. 1101
COSH/S	Swivelites. 1155
CP	Clamps. 207
CPH713 to CPH7934	Plugs. 360
CPP312 to CPP512	Plugs. 360
CPS14-20 to CPS124	Condulets. 360
CPS212 to CPS2162-S33	Condulets. 359
CPS1028 to CPS3428	Condulets. 409
CPS10181 to CPS34286	Condulets. 400
CR	Reels. 893
CR1 to CR17	Enclosures. 440
CR2, CR4	Rechargers. 1227
CR101	Switches. 1335
CR106	Starters. 1335
CR109	Controllers. 1339
CR123H	Heaters. 1335
CR208 to CR430	Crosses. 488
CR1034	Starters. 1337
CR1062	Switches. 1336
CR-1090 to CR-1093	Relays. 1406
CR297, CR2931	Switches. 1340
CR290, CR2943	Stations. 1339
CR7006	Starters. 1335
CR7008	Starters. 1338
CR7009	Controllers. 1339
CR7051	Starters. 1337
CR7504A12G1 to CR7504A12G4	Timers. 1351
CR7505-200G1	Lenses. 1351
CR7505-B20IG1	Lenses. 1351
CR7505-C20IG1	Lt. Sources. 1349
CR7505-C20G1 to CR7505-C20G1	Lt. Sources. 1350
CR7505-K100 to CR7505-K202G2	Relays. 1349
CR7505-N210G2 to CR7505-N212G2	Relays. 1350
CR7505-P202G2	Holders. 1351
CR7505-P203G2	Holders. 1349
CR7505-P211G1	Relays. 1351
CR7511-A126G2	Switches. 1341
CR9440	Switches. 1342
CR9516	Brakes. 1334
CRCS50 to CRC600	Terminators. 277
CRN50 to CRN600	Terminators. 277
CS-8	Water Coolers. 1271
CS24 to CS84	Reelites. 170
CSC	Insulators. 960
CSE2 to CSE12	Receptacles. 372
CSE2 to CSE12	Connectors. 372
CT-1	Bender. 738
CT-240RS-4 to CT-496-8	Lt. Units. 1116
CT-1101 to CT-38301	Connectors. 223
CTL31B, CTL41B	Aireels. 174
CUB127 to CUB677	Condulets. 380
CUC75 to CUN600	Terminators. 276
CV2-40P to CVC4-40S	Lt. Fixtures. 1094
CVM	Meters. 819
CW	Teleheights. 882
CW, CWW, CV	Boxes. 307
CWT11A to CWT31A	Aireels. 174
CW14, CW24	Reelites. 170
D	Cable. 44, 76
D	Connectors. 865
D	Drilling Machines. 859
D	Plates. 682
D	Sirens. 1232
D	Supports. 274
D	Switches. 699

Cat. No.	Page
D	Transformers. 1357, 1358
D	Wire. 148
D2AA to D2DF	Switches. 1342
D8-10 to D8-516	Terminals. 196
D-10, D-12	Saw Blades. 715
D10C18C to D100C18D	Elec. Plants. 1299
D99	Batteries. 1224
D-255	Inserts. 253
D502 to D6002	Supports. 274
D705, D710	Ducts. 492
D801	Cutters. 727
D840	Downlights. 1163
D-980-2 to D-980-10	Inserts. 253
D-982	Caps. 253
D100011 to D5000-6P	Light Controls. 590
D-7240 to D-7480	Luminaires. 1103
D8021-D1F-RS to D8485-D1F-SER	Lt. Fixtures. 1048
D8575-D1F-RS	Diffusers. 1049
D8585-D1F-RS	Diffusers. 1049
D91251 to D99311	Switches. 511
DA3P18BE	Elec. Plants. 1299
DA3P18DE	Elec. Plants. 1299
DA-21, DA-31	Controls. 1343
DA-35	Controls. 1270
DA105P18AE	Elec. Plants. 1299
DA105P18BE	Elec. Plants. 1299
DA-521, DA-531	Controls. 1343
DA605P18BE	Elec. Plants. 1299
DA605P18DE	Elec. Plants. 1299
DA7093	Control Centers. 1329
DA51201 to DA61210	Panelboard Boxes. 594
DA51201 to DA61214	Panelboard Boxes. 593
DA51301AB to DA51310AB	Panelboard Fronts. 594
DA51301AB to DA51314AB	Panelboard Fronts. 593
DA51308AB to DA51411AB	Panelboard Fronts. 595
DAC-12-40 (M)	Troffer Assy. 1102
DACB2809 to DACB2848	Panelboard Boxes. 596
DACB3109S to DACB3545S	Panelboard Fronts. 598
DACB3509 to DACB3545	Panelboard Boxes. 598
DAE, DAW	Controls. 1270
DAEEB322, DAEEB422	Elbows. 504
DAGN34, DAGN36	Busways. 507
DAH44C to DAH890L	Wireways. 500
DAIFB322, DAIFB422	Elbows. 504
DAOCB222 to DAOFEB422	Elbows. 504
DAPC261BC to DAPD365	Trolleys. 508
DAROP221 to DARP221B	Plugs. 503
DASW2809S to DASW3548S	Panelboard Fronts. 595
DASW3109 to DASW3145	Panelboard Boxes. 598
DASW3109 to DASW3548	Panelboard Boxes. 596
DATH261 to DATH362	Trolleys. 508
DATK03 to DATK3365S	Busways. 508
DATK36B to DATKMB365S	Boxes. 508
DATL2115 to DATP221B	Plugs. 503
DATS221 to DATSF362	Trolleys. 508
DAUC221 to DAUC221	Plugs. 503
DB1A2F to DB1A8S	Panelboard Fronts. 595
DB1A306BE to DB1A42LE	Panelboards. 595
DB2A3N18B2ES to DB2A4N54L6ES	Panel-Bases. 592
DB-3 to DB-1513845	Nuts. 224
DB-18	Instruments. 1461
DB30	Thermostats. 1272
DBDT, DBDT-O	Thermostats. 1272
DBF-3 to DBF-161516	Nuts. 224
DBR56342 to DBR56742-WT100-3	Condulets. 420
DC1P4-2500	Lt. Controls. 590
DCT6M-1000	Lt. Controls. 590
DC-25 to DC-150	Clamps. 252
DCF15-3 to DCL600-3	Circuit Breakers. 529
DCF221 to DCF2214C	Plugs. 503
DD1D1 to DD1S6	Panelboards. 597
DD-6	Instruments. 1463
DE1HED, DE1HES	Hangers. 502
DE-6-P-1 to DE-14-D-2	Deadends. 993
DFCBB22 to DFEB422	Boxes. 504

Cat. No.	Page
DFCE2FO15 to DFCE41.600	Busways. 507
DFD225 to DFLN323	Busways. 507
DFP-21	Plugs. 504
DFPB321 to DFPB462	Plugs. 502
DFPTQ13, DFPTQL4	Plugs. 502
DG0204 to DG1250	Gr. Connectors. 264
DGP	Box Partitions. 294
DH1A31 to DH1AFF41	Busway. 501
DH1ABC31 to DH1ABS41	Boxes. 502
DH1AED41 to DH1AEU41	Elbows. 502
DH1ATDS41 to DH1ATUC41	Tees. 502
DH1AXE41, DH1AXF41	Crosses. 502
DH1E1	Boxes. 502
DH1F	Flanges. 502
DH1HU1	Hangers. 502
DH1P3TB2, DH1P4TB2	Plugs. 502
DIR2-40RS to DIR6-96S	Lt. Fixtures. 1095
DK-308	Chimes. 1248
D-L	Links. 715
DL1, DL2	Covers. 409
DL3, DL24	Reflectors. 409
DL24 to DL68	Louvers. 1095
DL103, DL222	Guards. 409
DL-150-B to DL-300-E	Downlights. 1102
DL436	Reels. 816
DLA101 to DLA2022	Lt. Fixtures. 409
DLC20F to DLC722F	Lt. Fixtures. 409
DLC-101-8, DLC-102-8	Downlights. 1103
DLP406-15 to DLP524-15	Circuit Breakers. 436
DLTGB222 to DLTGB422-5	Busways. 504
DLTGBT22 to DLTGBTTP4	Couplings. 504
DLTG-EC to DLTG-UFS	Hanging Devices. 504
DLV	Thermostats. 1272
DLVDP3-368 to DLVDP5-4630SN	Busways. 510
DMY5000-2E2P to DM75000-3P	Lt. Controls. 590
DO-71, DO-78	Instruments. 1465
DP8N to DP20H	Reflectors. 1056
DP-9, DP-12	Instruments. 1467
DP-11	Instruments. 1469
DP132 to DP32023	Plugs. 421
DPH415D to DPL430D	Panelboards. 443
DR1 to DR12	Enclosures. 440
DR3P18BE, DR3P18DE	Elec. Plants. 1299
DR35-220X, DR35-240X	Lt. Fixtures. 1114
DR605P18BE, DR605P18DE	Elec. Plants. 1299
DR-HM-1 to DR-HM-6	Boxes. 1260
DS8 to DSS100	Covers. 387
DS-19, DS-20	Meters. 1452
DS24 to DSS49	Covers. 388
DS-25 to DS-30-V	Switches. 309
DS32 to DS82	Reelites. 170
DS81 to DS93	Housings. 388
DS135 to D336S	Housings. 388
DS171C to DS171G	Covers. 388
DS-221, DS231	Controls. 1343
DS1012 to DS1832	Covers. 390
DS1263 to DS1283	Covers. 391
DS1264 to DS1284	Covers. 392
DS-IT	Bonds. 969
DTSR	Capacitors. 1448
DUV	Clamps. 207
DV-1 to DV-18	Arresters. 1434
DV17-1747, DV17-1750	Brackets. 1506
DVS23 to DVS46-DT100-3	Condulets. 452
DVSP402-15 to DVSP506-15	Circuit Breakers. 436
DW12 to DW42	Reelites. 170
DW-71	Instruments. 1465
DWC215 to DWC330	Cabinets. 444
DWP415D to DWP1630D	Panelboards. 443
DWST	Temperature. 760
E	Boxes. 284
E	Drilling Machines. 859
E	Guards. 969
E	Plates. 682
E	Reel-O-Matics. 817
E	Switches. 699
E	Swivelites. 1155
E	Wire. 150
E 4	Pressure Guns. 865
E6-10 to E6-516	Terminals. 196
E10 to E107	Condulets. 379
E17-MT to E37-MT	Condulets. 381
E48 to E68	Clamps. 926
E50 to E600	Fittings. 238
E58 to E448	Condulets. 393
E-75 to E-75-8	Lt. Units. 1153
E-150 to E-230-8	Lt. Units. 1153
E-160, E-165	Clamps. 254
E186-A1 to E200-C1	Poles. 1033

Cat. No.	Page	Cat. No.	Page
E186-D1 to E200-F1	Poles..... 1034	ESW2112 to ESW3363	Condulets... 424
E197 to E897	Condulets... 381	ET.....	Telephone
E-231 to E-233	Clamps..... 254	ET-0780 to ET-0790	Circuit
E-243	Flanges..... 253	ET-5, ET-6	Breakers... 528
E-244, E-245	Connectors... 253	ET-1551-E1-N to	Lamps..... 1388
E301 to E303	Lt. Units..... 1157	ET-6129-KL1B-N	Circuit
E351 to E360	Unilets..... 329	ET-1561-E1A to	Breakers... 526
E-500 to E-500-8	Lt. Units..... 1153	ET-8185-LM1A-8	Circuit
E521 to E522	Lt. Units..... 1157	ET-8186-LM1B-8-N	Breakers... 528
E531	Hangers..... 1157	ET-8140-LM1-6-N to	Circuit
E532	Clips..... 1157	ET-8186-LM1B-8-N	Breakers... 527
E2000 to E14000	Bit Adaptors... 859	ETC29	Relays..... 1520, 1523
E8536-DIF to		ETC232	Relays..... 1523
E8551-AL	Lt. Fixtures..... 1049	ETD211	Dials..... 1523
EB-5, EB-6	Boards..... 1389	ETDA23 to ETD2M3	Telephone
EB1000 to EB1750	Bit Adaptors... 859	ETD211	Sets..... 1520
EBL-10 to EBLU-14	Nut Setters... 776	ETFD	Extensions... 1523
EC021 to EC142	Starters..... 448	ETG, ETWG	Telephone
EC208 to EC430	Closers..... 488	ETG22	Housings... 1520
ECD111 to ECD383	Valves..... 402	ETH2313 to ETH2703	Condulets... 454
ECD15, ECD385	Breathers... 402	ETR281, ETR282	Ringers..... 1520
ECF44 to ECKF28	Hangers..... 418	ETS22, ETS24	Switches... 1523
ECG14 to ECL636	Couplings... 404	ETS206 to ETS264	Switches... 1523
ECN, ECS	Fuses..... 538	ETS-1543-E1A to	Breakers... 528
ECF6, ECP10	Closers..... 490	ETS-8187-LM1A-8	Circuit
ECT211, ECT215	Condulets... 453	ETS-1543-E1-N to	Breakers... 528
ED0 to ED111	Drills..... 773	ETS-6130-KL1B-N	Circuit
ED11 to ED52	Screwdrivers... 776	ETS-8157-LM1-8-N to	Breakers... 527
EDP101-15 to		ETS-8187-LM1B-8-N	Circuit
EDP1106-15	Panelboards... 435	ETWA23 to ETWM23	Telephone
EDT.....	Capacitors... 1448	ETWS	Telephone
EE.....	Wire..... 150	ETWS3160 to	Telephone
EE208 to EE410	Ends..... 488	ETWS3246	Telephone
EEP2 to EEP30	Closers..... 490	EV181 to EV681	Lt. Fixtures... 408
EF-1, EF-2	Switches... 1410	EV710 to EV720	Globes..... 408
EFB712	Couplings... 492	EVA101 to EVCX263	Lt. Fixtures... 407
EFD118-T8 to		EVF021, EVF20	Saddles..... 408
EFD3419	Condulets... 431	EVF21	Hooks..... 408
EFD1437 to EFD3454	Condulets... 427	EVF114 to EVF214	Lt. Fixtures... 408
EFD1473 to EFD3475	Condulets... 430	EVH081	Guards..... 408
EFD1476 to EFD31012	Condulets... 428	EVH4	Globes..... 408
EFD3690 to EFD3694	Condulets... 425	EVH40, EVH110	Hand Lamps... 408
EFD1101 to		EVSR80 to EVSR82	Lamps..... 408
EFD31102	Condulets... 432	EW5 to EW10	Wrenches... 775
EFD1476 to		EW5KC to EW10KC	Kits..... 775
EFD3477	Condulets... 428	EW14 to EWM45	Reelites... 170
EFHC2601 to		EX2-40 to EX4-96TR	Lt. Fixtures... 1094
EFHC3602	Fixture	EX-16 to EX-46	Ladders..... 830
	Hangers..... 417	EXP11 to EXP41	Extensions... 387
EFHF-50, EFHF-75	Hooks..... 340	EXP12, EXP42	Extensions... 386
EFHM-50, EFHM-75	Hooks..... 340	EXP13, EXP43	Covers..... 391
EFISW116	Stations..... 445	EXP14, EXP44	Extensions... 392
EFIS111 to EFIS214	Stations..... 445	EXG14 to EXL630	Couplings... 343
EFIS111 to EFIS3192	Condulets... 426	EYS1 to EZ-86	Condulets... 406
EFIS118 to EFIS3240	Condulets... 425	F.....	Binders..... 836
EFIS121-J1 to		F.....	Caps..... 245
EFIS3858-J1	Condulets... 429	F.....	Carts..... 818
EFIS1162 to EFIS2696	Condulets... 427	F.....	Covers..... 295
EFIS1199 to EFIS31100	Condulets... 431	F.....	Plates..... 683
EFIS1524 to EFIS3561	Condulets... 428	F.....	Switches... 698
EG22 to EG44	Reelites... 170	F01263, F01463	Caps..... 245
EGP311 to EGP3317	Condulets... 429	F-1, F-2	Bushings... 258
EH-420 to EH-2407	Heaters..... 1288	F-2X	Ferrules... 812
EJ0 to EJ9	Drills..... 773	F-3-SH	Hooks..... 825
EJ12 to EJ27	Nut Setters... 776	F4-10 to F4-516	Terminals... 196
EJB286 to EJB12168	Condulets... 401	F475/CW to	Lamps..... 1200
EJB886 to EJB12236	Condulets... 402	F13T5/WW	Water
EJH50 to EJK80	Condulets... 399	F-10WE	Coolers... 1271
EKO-1D	Supports... 1410	F14T12/CW to	Lamps..... 1200
EKO-3C	Switches... 1410	F90T17/WWX	Lamps..... 1200
EKP	Visualarms... 1263	F175/BL to F96T8/BL	Lamps..... 1209
EKP132-1 to		F17 to F0147	Condulets... 380
EKP143-9	Plates 1263, 1264	F30B, F31B	Horns..... 1234
EL1 to EL496	Couplings... 406	F40T12/CW/RS to	Lamps..... 1201
EL5 to EL7	Drills..... 774	F40T12/RS, F40T12/SS	Ballasts... 1133
EL60 to EL72	Grinders..... 778	F41B	Horns..... 1234
EL82	Sanders..... 778	F50 to F400	Ent. Fittings... 242
EL92	Polishers... 778	F96T12/RS	Ballasts... 1133
EL208 to EL430	Elbows..... 488	F-100, F-200	Alarms... 1241
ELA	Lenses..... 1262	F186 to F586	Caps..... 245
ELG106 to ELG2500	Lt. Fixtures... 417	F200, F201	Conduit..... 1000
ELP222-215 to		F236-A1 to F250-C1	Poles..... 1033
ELP421-1630	Panelboards... 345	F236-D1 to F250-F1	Poles..... 1033
ELPJ-2	Outlets..... 345	F250-A2E to F250-N2E	Poles..... 1029
EMH511-00001 to		F260, F261	Conduit..... 1000
EMH521-20000	Condulets... 453	F-305 to F-60025	Fuses..... 538
EMP10 to EMP8111	Condulets... 434	F-321 to F-426	Switches... 1166
EMS33-M2 to EMS345	Conduit	F340 to F368	Downlights... 1163
	Parts..... 422	F500, F600	Ent. Fittings... 243
EMS-M2 to EMS25	Switches... 422	F-610	Glass Fillers... 1271
EN5, EN6	Drills..... 774	F766 to F1066	Caps..... 245
EN7, EN8	Drills..... 775	F-1560 to F-1570-TS	Lt. Units... 1156
EN62, EN72	Grinders... 778	F-1814	Lt. Units... 1156
EN82, EN87	Sanders... 778	F3600 to F3691	Conduit..... 1000
EN92	Polishers... 778	F-54000 to F-55758-W	Switches... 1415
EPC426-DT100-2 to		F75012 to F87545	Bits..... 859
EPC460-DT600-3	Condulets... 450	FA	Switches... 1410
EPC627 to		FA, FC	Bushings... 653
EPC441-DT50-3	Condulets... 437	FA-1560	Lt. Units... 1156
EPC615 to		FA-2604, FA-2682	Wash..... 875
EPC669-D643	Condulets... 438	FA-12035, FA-12037	Kits..... 875
EPC1049 to EPC11163	Condulets... 439		
DT100-D623	Condulets... 439		
EPC46242 to EPC66742	Condulets... 420		
WT100-3	Condulets... 420		
EQP204-15 to			
EQP524-15	Panelboards... 435		
ER	Couplers... 207		
ERS41 to ERS463	Switch Units... 424		
ES	Sealing		
	Fittings..... 316		
ES24 to ES84	Reelites... 316		
ESC1 to ESC10	Condulets... 402		
ESD-50, ESD-75	Swivels... 340, 347		
ESH	Swivelites... 1155		
ESR2611 to ESR2695	Condulets... 454		
ESS-50, ESS-75	Swivels... 340		

Cat. No.	Page	Cat. No.	Page
FA-12260	Packets..... 875	FL510254-1-55 to	Condulets... 423
FA-12560	Foille..... 875	FL560354-1-44	Condulets... 423
FA-12519	Outfits..... 875	FOH120 to FOH322	Hanger Eq... 419
FA25045 to FA62545	Bits..... 859	FP23	Condulets... 420
FA321 to FA358	Housings... 349	FP323, FP334	Condulets... 419
FB	Boxes..... 315	FP-323, FP-334	Plugs..... 352
FB-A1 to FB-B4	Ext. Sets... 317	FQ	Grips..... 633
FBC3102 to FBC3144W	Ent. Fittings... 245	FR-1	Starters... 437
FBM145	Receptacles... 373	FR1, FR2	Rules..... 718
FC	Fittings..... 245	FR-2 to FR-389	Trolleys... 498
FC FCC	Cable..... 149	FR-6 to FR-972	Trolleys... 497
FCB712	Fittings... 243	FR-59	Starters... 497
FCB712	Couplings... 492	FR75 to FR500	Bushings... 275
FCE	Fittings... 238	FR-100 to FR-236	Track..... 496
FD01 to FD097	Connectors... 386	FR-102 to FR-121	Track..... 497
FD1 to FD3-MT	Condulets... 385	FR-103 to FR-108G	Boxes..... 497
FD12 to FD32-MT	Condulets... 386	FR-105	Supports... 495
FD23 to FD393	Condulets... 391	FR-107	End Caps... 497
FD24 to FD34-MT	Condulets... 392	FR-111 to FR-121	Track..... 497
FD181 to FD2639	Condulets... 433	FR-124	Hangers... 497
FD191 to FD391	Condulets... 385	FR-129	Insulators... 497
FD192 to FD392	Condulets... 386	FR-211 to FR-221	Track..... 497
FD294, FD394	Condulets... 392	FR-321 to FR-354	Switches... 516
FD1211 to FD3212	Condulets... 437	FR-40, FR-41, FR-42	Lt. Fixtures... 1093
FD-2060-EJ to		FRN-1/10 to FRS600	Fuses..... 536
FD-5400-EJ	Joints..... 486	FRS-1 to FRS-96	Trolleys... 496
FD-2060-FE to		FRS-28	Dust Rmover... 496
FD-5400-FE	Ends..... 486	FRS-40 to FRS-42	Jacks..... 496
FD-2060-L to		FRS-77	Bar Cleaner... 496
FD-5400-L	Elbows..... 486	FRS-100 to FRS-228-5	Track..... 495
FD-2060-R	Reducers... 486	FRS-102	Couplings... 495
FD-2060-S to FD-5400-S	Ducts..... 486	FRS-103	Center Feed... 495
FD-2060-T to		FRS-104	Insulators... 495
FD-5400-T	Tees..... 487	FRS-105, FRS-108	Hangers... 495
FD-2060-TB to		FRS-106	End Feed... 495
FD-5400-TB	Boxes..... 487	FRS-107	End Caps... 495
FD-2060-X to		FRS-110	Boxes..... 495
FD-5400-X	Crosses... 487	FRS-111	Hangers... 496
FD-5135-EC to		FRS-116, FRS-117	Couplings... 496
FD-5400-EC	Closures... 487	FS	Boxes..... 284
FDA1 to FDA3	Condulets... 385	FS01 to FS097	Condulets... 384
FDA12 to FDA32	Condulets... 386	FS1 to FS3-MT	Condulets... 385
FDA23, FDA33	Condulets... 391	FS2 to FS850	Starters... 1126, 1127, 1128
FDA24, FDA34	Condulets... 392	FS12, FS18	Swivelites... 1155
FDB12 to FDB312	Condulets... 386	FS12 to FS37	Condulets... 386
FDB14 to FDB314	Condulets... 392	FS12 to FS393	Condulets... 391
FDC1 to FDC3	Condulets... 385	FS24 to FS34-MT	Condulets... 392
FDC12 to FDC392	Condulets... 386	FS152 to FS391	Condulets... 385
FDC23 to FDC393	Condulets... 391	FS180 to FS2913U	Condulets... 433
FDC24 to FDC34-MT	Condulets... 392	FS192 to FS392	Condulets... 386
FDC181 to FDC2639	Condulets... 433	FS294, FS394	Condulets... 392
FDC294, FDC394	Condulets... 392	FS1311 to FS1616	Receptacles... 332
FDC1211 to FDC3212	Condulets... 437	FS1910 to FS2913U	Condulets... 430
FDCT1-MT to		FSA1 to FSA3	Condulets... 385
FDCT3-MT	Condulets... 387	FSA12 to FSA32	Condulets... 386
FDD1 to FDX3	Condulets... 385	FSA23, FSA33	Condulets... 391
FDE-12	Condulets... 386	FSA24, FSA34	Condulets... 392
FDS222	Condulets... 386	FSCI to FSC3-MT	Condulets... 385
FDS223	Condulets... 391	FSC12 to FSC37	Condulets... 386
FDW-2060-S to		FSC23 to FSC393	Condulets... 391
FDW-5400-S	Ducts..... 487	FSC24 to FSC34-MT	Condulets... 392
FDX191 to FDX391	Condulets... 387	FSC28MS to	
FE	Bartaps..... 206	FSC40MTF	Fusible Serv. Eq... 532
FE208 to FE430	Ends..... 488	FSC152 to FSC391	Condulets... 385
FE100012 to		FSC180 to FSC2813U	Condulets... 433
FE1400012	Bits..... 859	FSC192 to FSC392	Condulets... 386
FEB	Ent. Fittings... 243	FSC294, FSC394	Condulets... 392
FEBR	Ent. Fittings... 242	FSC1311 to FSC1616	Receptacles... 332
FEBRS	Ent. Fittings... 242	FSC1910 to FSC2913U	Condulets... 430
FED2-40PRS to		FSCA1 to FSC37	Condulets... 385
FED2-96P	Ltg. Fixtures... 1093	FSC1-MT to	
FED281, FED384	Caps..... 245	FSC373-MT	Condulets... 387
FEF2 to FEE8	Caps..... 245	FSC191 to FSC391	Condulets... 387
FEH	Bartaps... 206	FSD12 to FSD312	Condulets... 386
FEL	Ent. Ells... 247	FSD14 to FSD314	Condulets... 392
FEF6 to FEP10	Ends..... 490	FSE	Boxes..... 284
FF-3-1-SH-7	Hooks..... 825	FSE-12	Condulets... 386
FF-648-1 to FFL-848-I	Luminaires... 1091	FSL1 to FSL3	Condulets... 385
FF-648-O	Luminaires... 1090	FSP24M to FSP40M	Fusible Serv. Eq... 532
FFE to FFM	Frames..... 1091	FSP130 to FSP260	Fuse Sections... 532
FFL-648-O, FFL-848-O	Luminaires... 1090	FSPC21 to FSPC230	Condulets... 432
FG, FGI	Hoists..... 836	FSPQ28	Condulets... 421
FGF	Ground	FSPQ29 to FSPC333	Condulets... 419
	Fittings... 259	FSPQ-23 to FSPQ-26	Condulets... 352
FGK-230	Breakers... 1409	FSR1 to FSX3	Condulets... 385
FK14.4	Breakers... 1401, 1402, 1409	FSS23	Condulets... 391
FK-33	Circuit	FSS222	Condulets... 386
	Breakers... 1398, 1399	FSX1-MT to FSX3-MT	Condulets... 387
FK34.5	Breakers... 1409	FSX191 to FSX391	Condulets... 387
FK-142, FK-143	Circuit	FT	Pendants... 653

Cat. No.	Page
LR18 to LR888	Condulets... 393
LR197 to LR897	Condulets... 391
LR351 to LR1360	Unilets... 329
LSG-DS to LSM-VL	Robot
Operators...	707
LSO	Capacitors... 1448
LSRQ	Ventilators... 1280
L.T.G.	Busways... 503, 504
LVD	Busways... 509
L.VDP	Busways... 510
LW	Wire... 148
LX to LXWLE	Boxes... 307
LXMW to LXWV	Boxes... 306
LX-11	Switches... 1356
M	Clamps... 207
M	Connectors... 865
M	Motors... 1309
M	Plates... 682
M	Transformers
	1357, 1358
M1, M2	Circuit
	Breakers... 559
M1 to M28	Trim & Glass... 1144
M-2	Starters... 1127
M-2 MB	Lamps... 1206
M12	Microphone
	Syst... 1527
M-14	Microphone
	Syst... 1528
M-18-BE to M-18-DS	Winches... 893
M-20	Microphone
	Syst... 1528
M91 to M96	Trim... 1144
M115 to M265	Lt. Fixtures... 1139
M-209, M-210	Magnifiers... 1075
M-270	Magnifiers... 1076
M311 to M1161	Lt. Fixtures... 1139
M807 to M823	Lt. Fixtures... 1142
M824 to M903	Lt. Fixtures... 1143
M839 to M1496	Lt. Fixtures... 1140
M-1106, M-1107	Magnifiers... 1076
M1175 to M1190	Lt. Fixtures... 1141
M1492 to M1555	Lt. Fixtures... 1142
M1728-4 to M1728-6	Clevises... 885
M1729 to M1729-3	Bands... 885
M1729-1	Tong Bands... 883, 884
M1741-1 to M1741-7	Supports... 886
M1760 to M1770	Poles... 890
M1761	Storm Tools... 887
M1804 to M1816	Lt. Fixtures... 1143
M1840-4 to M1840-12	Cradles... 889
M1843-6, M1843-7	Carriers... 889
M1845-9, M1849	Hooks... 888
M1846	Brackets... 884, 886
M1847	Chains... 885, 886
M1855-1 to M1855-26	Sticks... 890
M1855-3 to 1855-22	Heads... 890
M1855-26	Sticks... 883, 884
M1863-4, M1863-5	Hooks... 889
M1864-4 to M1874-8	Sticks... 892
M1869-4, M1869-6	Amortoms... 891
M1871-4 to M1875-6	Cutters... 887
M1880-4	Cutters... 883, 884
M1890-4 to M1890-6	Splice Tools... 994
M1889	Brushes... 850
M1891-2 to M1892-1	Wrenches... 891
M1904-12, M1904-14	Ladders... 828
M1913, M1913-1	Safety Tread... 830
M1941 to M1941-5	Butts... 885
M1942	Chains &
	Hooks... 889
M1950-8	Carriers... 889
M1951	Tie Wire
	Ass. &
	890
M1954-6, M1954-8	Sticks... 888
M1970, M1970-10	Poles... 835
M2402, M2401	Lt. Fixtures... 1142
M2943-6 to M2944-10	Insulator
	Tools... 889
M2945-11	Yoke Assy... 889
M3002	Guards... 884
M3002, M3002-1	Guards... 892
M3046-5 to M3046-16	Sticks... 892
M3048 to M3048-2	Heads &
	Poles... 892
M3357	Splices... 890
M3396 to M3396-15	Heads... 885
M4007 to M4802	Lt. Fixtures... 1142
M4455 to M4455B	Heads... 890
M4455-2	Holders... 891
M4455-12	Removers... 891
M4455-13	Disconnects... 891
M4455-18	Installing
	Tools... 891
M4455-22	Adjusters... 891
M4455-39	Hooks... 891
M4455-52	Splice Tools... 994
M4455-61	Brushes... 850
M4455-63	Storm Tools... 887
M4455-67	Forks... 891
M4455-69	Heads... 883, 884
M4455-69, M4455-70	Heads... 889
M4455B	Heads... 888
M4655-2, M4657-1	Tones... 883
M4655-2 to M4678-14	Tones & Ftgs... 885
M4655-3 to M4657-5	Tones... 884
M4707 to M4718-1	Sticks... 889
M4710-4 to M4711-6	Sticks... 888
M4711-1	Heads... 888
M4740-3	Saddles... 884
M4740-3 to M4741	Saddles... 885
M4740-6	Extensions... 886
M4740-11	Clevises... 884, 886
M4740-18	Saddles... 883, 884

Cat. No.	Page
M4741-1	Clamps... 883
M4742 to M4742-4	Saddles... 886
M4743	Clamps... 885
M4760, M4760-1	Supports... 886
M4766 to M4766-25	Sockets... 891
M4800	Arms... 883, 884
M4800	Braces... 884
M4800-9A	Arms... 884
M4800-10, M4801-10	Tool Sets... 883
M4800-11	Holders... 883
M4800-15, M4801-15	Tool Sets... 884
M4800-16	Tong Att... 883
M4800-17	Clamp Att... 883
M4800-18	Stirrups... 883
M4800-30, M4800-31	Arms... 888
M4800-51	Arms... 883
M-4810 to M4810-2	Guards... 882
M4901 to M4901-7	Platforms... 968
M4901-10 to M4901-15	Attachments... 968
M4901-35, M4901-45	Railings... 968
M4903-8 to M4908	Ladders... 828
M4912 to M4912-3	Hoods... 878
M4950 to M4960-42	Platforms... 968
M5606 to M5616	Housings... 1144
M5618 to M5696	Lt. Fixtures... 1144
M5675, M5676	Lites... 1144
M5678 to M5699	Lt. Fixtures... 1145
MAEP34 to MAVT31	Unilarms... 1262
MC	Cable... 149
MC-25 to MC-400	Clamps... 249
MC-302	Chimes... 1248
MD	Cord... 90
MDR-14 #1466A	Floodlights... 1175
MET-2-40A to	MET-4-40S
	Troffers... 1097
MFP2-40 to MFS3-96	Reflectors... 1043
MH801-35 to MH902-50	Circuit
	Breakers... 521
MHP	Panel-
	boards... 553, 559
ML	Circuit
	Breakers... 557,
	558
ML	Plates... 1259
ML	Switchboards... 560
ML015 to ML3927R	Circuit
	Breakers... 525
ML015F to ML3927S	Circuit
	Breakers... 524
ML-1 to ML-4	Lights... 1259
MLN	Panelboards... 553
MLP	Alarm Units... 1261
MM	Circuit
	Breakers... 559
MM4800-1, M4800-2	Arms... 883
M-0 to M-2	Hangers... 251
MIP-3A to MIP-276	Arresters... 1434
MIP-5, MIP-10	Pullers... 836
MP26	Pumps... 738
MPU34	Unilarms... 1262
MUR6	Control Units... 702
MS	Stands... 175
MT-1 to MT0-2	Heaters... 1292
MT-175 to MT-230	Heaters... 1292
MTA2 to MTA4	Adapters... 716
MTGF-240RS-4H to	MTLPP-396-8H
	Troffers... 1117
MT0-110 to MT0-230	Heaters... 1292
MT054 to MT618	U-Bolts... 256
MVB-14 to MVM	Floodlights... 1174
MVP2-40 to MVS2-96	Reflectors... 1043
MV	Wire... 148
MY29	Term. Tools... 730
N00 to N3	Views... 730
N00C	Cutters... 727
N1/2MS to N3MS	Punches... 743
N1 to N14	Cable Straps... 720
N1-DC	Cable Chasers... 721
N1HS to N3HS	Punches... 743
N1R-0, N1R-4	Sticks... 721
N2-DC	Cable Chasers... 725
N2-R0, N2-R1	Sticks... 725
N2-R1 to N2-R3	Sticks... 725
N2-RG	Guides... 725
N2-RH	Ratchets... 725
N2-RS	Screws... 725
N3W-30 to N3W-31-0	Sticks... 721
N10 to N10-12	Swivelites... 1155
N22, N22T	Flashlights... 1225
N22T	Testers... 767
N258B	Cutters... 727
N42, N44	Reamers... 720
N50-2 to N50-5	Sticks... 721
N50-H	Lite Heads... 721
N50-P	Pawls... 721
N50-R	Ratchets... 721
N50-X	Boxes... 721
N51B	Threaders... 725
N51DC	Dies... 725
N60-4 to N60-31	Sticks... 721
N60-H to N60-H1 1/4	Lite Heads... 721
N60-P	Pawls... 721
N60-R	Ratchets... 721
N60-X	Boxes... 721
N88A to N88C	Vises &
	Stands... 730
N88AP to N88PR	Visé Parts... 730
N101 to N170	Cord... 89
N3380 to N3386	Aligners... 1054
N-6408 to N-6422	Covers... 1060
N-8546-12V to	N-8795-230V
	Howlers... 1236
N-8652-12V to	N-8652-230V
	Howlers... 1237
N35251 to N40832	Luminaires... 1109
NA	Terminals... 206

Cat. No.	Page
NA50C3 to NA50C25	Chargers... 1505
NAB	Panelboards
	553, 557, 558
NAB308AB to	NAB442L
	Panelboards... 593
NAW-4 to NAW-12	Wrenches... 728
NCB	Bushings... 721
NCB	Panelboards... 600
NCW-4 to NCW-6C	Wrenches... 728
ND	Connectors... 206
ND-1	Dies... 720
ND-1 to ND-4	Dies... 722
NDR, NE	Connectors... 207
ND-T	Dies... 721
NE	Locking Nuts... 551
NE-1 to NE-3	Cable... 122
NE-2 to NE-58	Lamps... 1208
NE-600	Crimp Tools... 475
NEX24 to NEX2548	Wireway Ext... 601,
	606
NF-1	Saw Blades... 769
NF-351 to NFR-351	Switches... 516
NFB56	Boxes... 601, 606
NH	Locking Nuts... 551
NHS-W1 to NH10-W2	Power Units... 1298
NHF	Bartaps... 206
NHPS	Pumps... 743
NL	Elbows... 206
NLAB308AB to	NLAB442L
	Panelboards... 594
NLP	Panelboards... 595
NM	Cable... 7, 52, 94, 142
NMC	Cable... 7, 52, 142
NMC/UF	Cable... 94
NO-1, NO-5, NO-55	Oil... 725
NON1 to NOS600	Fuses... 535
NP-16-3L to NP-32-4L	Electri-
	Centers... 603
NPB08-3L to	NPB32-4L
	Electri-
	Centers... 605
NQB	Panels... 556
NQO	Panelboards... 553,
	554, 555, 557
NR-321 to NR-421	Switches... 516
NRR	Reamers... 720
NRR-B to NRR-RS	Reamer
	Parts... 720
NS	Couplers... 206,
	207
NS-B	Couplers... 208
NSBHS-NSBHD	Boxes... 254
N-SD	Cable... 17, 18, 19
NT	Connectors... 206,
	207
NT-0	Stock... 720
NT1 to NT9	Staps... 720
NT-30, NT-31	Stock... 720
NT-BS	Screws... 720
NTB248	Boxes... 601,
	606
NT-G	Guides... 720
NT-H	Handles... 720
NTRP	Panelboards... 553
NTS94-3L to	NTS20-4L
	Load Centers... 534
NT-T	Connectors... 208
NT-TPS	Plates... 720
NVT, NVTT	Connectors... 207
NW	Locking Nuts... 551
NYB	Panelboards... 553
O	Plates... 682
O-26, O-27	Bodies... 667
O-47	Bodies... 667
OCF, OCP 3/4	Plates... 290
OCR1-1 to OCR54	Rings... 290
OD-6-1J to OD-14-D-2	Sleeves... 992
OF-1, OF-2	Ent. Fittings... 244
OF-248-1 to OFL-348-1	Luminaires... 1091
OF-248-O, OFL-248-O	Luminaires... 1090
OF-15275 to OF-15277	Clamps... 210
OFC2101 to OFC3139	Condulets... 434
OF-15275 to OF-15277	Clamps... 210
OF-15275 to OF-15277	Clamps... 210
OFE to OFM	Frames... 1091
OHD-50C	Dryers... 1213
O-PA to O-PZ	Caps... 667
OSA3, OSA4	Susp.
	Hangers... 419
OST	Gins... 835
OZAS1	Lamps... 1204
P	Cabinets... 548
P	Controls... 1021
P	Fans... 1283
P	Guards... 969
P	Guards... 682, 683
P42-221X to P88-291X	Lt. Fixtures... 1114
P-66	Cleaners... 765
P-69	Sealing
	Fittings... 316
P1	Injection Fig... 865
P-1, P-2	Clamps... 993
P1-14-3LF to P1-20-4LS	Electri-
	Centers... 602
P2	Unipak
	Spouts... 865
P2-28-3L to P2B-40-4L	Electri-
	Centers... 603
P3, P1	Tapes... 865
P3-4, P3-4SH	Swivelites... 1155
P3B12-4AB to	P3B42-4L
	Electri-
	Centers... 605
P-8 to P-750	Pots... 757
P13	Extin-
	guishers... 1227
P24	Conducting
	Paper... 1499
P-33-RO	Enclosures... 559

Cat. No.	Page
P-100	Irons... 753
P100 to P117	Cord... 91
P106 to P118	Drive Pins... 858
P-150	Cleaners... 765
P161 to P4375	Blocks... 1513
P-182, P-254	Pumps... 747
P-225-B to P-225-TS	Boxes... 659
P314, P318	Soldering
	Pencils... 755
P-495, P-495L	Blocks... 1513
P495 to P495Y	Blocks... 1508
P-182, P-254	Fans... 1283
P630-18	Bags... 883
P630-20	Bags... 884
P631-1 to P631-12	Bags... 892
P-901-S to P-909	Cleaners... 765
P-950	Vac Clean-
	ing Syst... 764
P-1385	Blocks... 1513
P-2121 to P-2134	Lamps... 1075
P4817	Keys... 918
P-6022-B to P-6033-M	Floodlights... 1191
P6970	Lt. Fixtures... 1160
P-20225B to P-20225TS	Boxes... 559
PA to PE	Caps... 653
PA to PD	Caps... 667
PA-05001	Battery Syst... 1504
PA2	Penlights... 1226
PAD-325221 to	PAD-3125421-G
	Plugs... 363
PB-1 to PB-16	Pushbuttons... 1251
PB-80	Lt. Fixtures... 1152
PCD101 to PC9292	Clamps... 192
PD2PN to PD4PN	Extin-
	guishers... 1227
PD-3B-A to PD-4B-A	Cable... 9
PD-3VC-A to	PD-4VC-A
	Cable... 8
PD-14-3L to PDB20-4L	Electri-
	Centers... 603
P.E.	Diggers... 893
PE	Fans... 1283
PEC-12-40 (M)	Troffer Assy... 1102
Ped13 to Ped443	Pedestals... 407
PEF250	Caps... 492
PF-240-ES to	PF-4396A-4
	Troffers... 1102
PF368 to PF3068	Fuses... 537
PF-2	Plates... 601
PG116-AA to	PG120-AGP
	Connectors... 983
PGR6214, PGR6314	Plugs... 489
PH	Hangers... 252
PH	Screw-
	drivers... 713
PH/1 to PH/50B	Lamps... 1206
PH/IM/PS40-1 (ECV)	Lamps... 1206
PH/IM/T120 (DPT)	Lamps... 1206
PH/IM/T12P to	PH/750T12P
	Lamps... 1205
PH/111 to PH/302	Lamps... 1206
PH375/34R4, PH500/	32R7 (EAL)
	Lamps... 1206
PH/500PS25/5 (ECT)	Lamps... 1206
PH/500T20 (DMS)	Lamps... 1206
PHD	Hangers... 252
PHI-1, PHI-2	Hdl. Devices... 601
PH/RF12, PH/RSP2	Lamps... 1206
PHS	Hangers... 252
PH/SM	Lamps... 1206
PK2	Penlights... 1226
PK-2	Test Blocks...
	1386, 1387
PK2FL	Flush Locks... 550
PK62-07 to PK128-50	Terminators... 277
PLG1 to PLG105	Plugs... 403
PMD-20, PMD-21	Doors... 601, 602
PMR-214 to	PMS-218-HM
	Luminaires... 1087
PNL4D-2003	Lamps... 1206
PNLD-2008	Plug Shells... 364
PP-2X	Pike Points

Cat. No.	Page	Cat. No.	Page	Cat. No.	Page	Cat. No.	Page
QA5A to Q405D	Subbases 1266	RFR-1024-B to	Rectifiers 1507	S0 to S3	Arbors 716	SD-1241-FX-1 to	Ends 484
QA1C-B to QA48-1B	Terminals 204	RFR-1080-AR	Rectifiers 1507	S9 to S96	Saws 716	SD-1855-FX-1	Ends 484
QA-B	Terminals 204	RF	Switches 677	S1	Suspension Att 418	SD-1341-FE	Ends 484
QA-F	Barbarts 206	RG	Grommets 678	S1, S-2	Saw Blades 766	SD-3145-FE	Ends 484
QB	Circuit Breakers 556	RG-4, RG-6	Wrenches 728	S1 to S14	Fustats 539	SD-3241 to SD-3855	Boxes 484
QB	Terminals 207	RG16 to RG818	Boxes 678	S5 to S-8	Pipe & Bolt Machines 735	SD-4000-9 to SD-5000-9	Hoists 637
QD-IHT	Handle Ties 554	RG12	Covers 678	S6	Bulbs 1259	SD-9241 to SD-9154	Plug-in Units 483
QGF	Bar Taps 207	RGM-1 to RGM-3	Moldings 911	S6	Lamps 676	SD-69448 to SD-69766	Clamp-on Units 483
QMB	Motor Centers 563	RH	Wire 2, 50	S6	Switches 699	SD-75216 to SD-78727	Plug-in Units 483
QMB	Panelboards 552, 553	RHB	Clamps 207	S8N to S2011	Reflectors 1058	SD-SDC	Cable 95
QMB	Switchboards 560	RHD-6, RHD-9	Bonds 969	S11, S14	Lamps 1259	SE	Cable 16, 52
QMR	Panelboards 596, 597	RHDL	Cable 3, 51, 92	S13	Extin-guishers 1227	SE00	Covers 397
QO	Circuit Breakers 550, 554, 555, 557	RHDP/RWD	Wire 3, 51, 92	S14	Screwdrivers 713	SE1 to SE3	Condulets 396
QO	Load Centers 549, 550, 554	RHL	Cable 1, 50, 92	S15 to S30	Fustats 536	SE2 to SE912	Receptacles 372
QO1CP	Closure Plate 550, 554	RHL	Wire 1, 50, 92	S21 to S26	Bar Hangers 301	SE83, SE84	Covers 397
QO1HT	Handle Ties 550	RHML	Cable 15, 51	S-26, S-27	Bodies 667	SE-802 to SE-4312	Heaters 1292
QO1LO	Handle Lock-Off 550, 554	RHML	Wire 15, 51	S38	Screwdrivers 713	SE-A	Cable 4
QO2PA	Handle Att 550, 554	RHNL	Cable 92	S-47	Bodies 667	SE-ABN	Cable 95
QO-100SF, QO-200SF	Lug Kits 554	RHNL	Wire 92	S48 to S68	Clamps 926	SECI to SEHC3	Condulets 396
QPX	Connectors 207	RHRL	Cable 92	S50 to S200	Blanks 240	SEH00, SEH000	Covers 397
QPX2C2C to QPX144	Connectors 205	RHRW	Wire 2, 13, 92, 56, 116	S83, S83G	Covers 391	SEH83, SEH84	Covers 397
QR	Couplers 207	RH-RW	Wire 2, 13, 92, 56, 116	S84, S84G	Covers 392	SEHTY to SEHX3	Condulets 396
QR1C to QR48	Links 204	RH/RW	Cable 50	S105 to S130	Shields 854	SEO-1075 to SEO-11150	Connectors 246
QS	Motors 1311	RH/RW	Wire 50	S106 to S210	Studs 858	SEO-8100-S	Connectors 246
QT	Connectors 207	RHRWL, RH/RWL	Cable 14	S-130 to S-140	Benders 747	SER1075 to SER7100S	Connectors 246
R	Cable 2, 50, 92	RHRWL, RH/RWL	Wire 14	S141	Screwdrivers 713	SET1 to SET3	Condulets 396
R	Carts 818	RHRWD	Cable 14	S212 to S322	Covers 390	SE-U	Cable 4
R	Cleats 212	RHRWD	Wire 14	S-300 to S-401	Lampholders 1058	SE-UBN	Cable 95
R	Connectors 191	RHW	Cable 2, 13, 50, 92	S-301 to S-328	Lt. Ftgs. 1059	SEX1 to SEX3	Condulets 396
R	Covers 295	RHW	Wire 2, 13, 50, 92	S310A to S360A	Clamps 983	SFE4 to SFE30	Fuses 539
R	Supports 274	RHW	Cable 14, 93	S322G	Covers 390	SGP	Box Par-titions 294
R	Thermostats 1288	RHW	Wire 14, 93	S323, S323G	Covers 391	SH	Cable 33, 36, 64
R	Thermostats 1270	RHW	Wire 14	S324, S324G	Covers 392	SH1 to SH7	Shades 413
R	Wire 1, 50, 92	RHWL	Cable 14	S403A, S403B	Switches 1268	SH2 to SH68	Reflectors 413
R1DC to R8F	Lt. Fixtures 1073	RHWL	Wire 14	S500	Supports 274	SH327 to SH368	Reflectors 416
R-3, R-4	Insulators 967	RHWL	Wire 14	S500 to S6000	Screwdrivers 713	SH-A to SH-C	Cable 36, 64, 65
R14, R38	Screwdrivers 713	RHS-3 to RIS-100	Relays 1505	S516	Covers 391	SH-D	Cable 36, 64, 65, 111
R-24 to R-68GP	Condulets 983	RK-1	Switches 677	S523	Covers 392	SHVH	Clamps 206
R-40	Sunlamps 1211	RL	Wire 50, 92	S524	Connectors 982	SIN-10 to SIN-18	Ladders 830
R101 to R121	Cord 90	RL25, RL31	Recfits 175	S610AA to S650AA	Covers 390	SJ	Cord 7, 89, 130
R115L to R353	Anchors 917	RLJFJ	Cable 96, 97	S712 to S732	Covers 390	SJ	Switches 1356
R-150	Kits 858	RMC19	Pins 911	S-802 to S-4312	Heaters 1292	SJO	Cord 7, 38, 61, 89, 115, 127, 130
R192 to R197	Clamps 162	RML	Cable 3, 15, 51, 92	S-1000-36 to S-2000-36	Hoists 837	SJT	Cord 138, 139
R-203 to R-6600	Links 539	RML	Wire 3, 15, 51, 92	S1002, S1003G	Covers 386	SK2, SK4	Signalks 1233
R-334A	Jacks 843	RMN	Cable 58	S1004, S1004G	Covers 392	SK12 to SK33	Condulets 394
R482A to R488E	Relays 1268	RMS	Switches 677	S1515-AA to S1545-GP	Clamps 979	SK83 to SK86	Hub Covers 394
R501 to R6001	Supports 274	RN-6 to RN-12	Rule Blades 719	S-1628-3BH	Grips 804	SK809	Covers 394
R516	Screwdrivers 713	RN-211 to RN-321	Switches 515	S1725-AA to S1735-GP	Clamps 979	SK-3986	Caps 551
R847A, R847B	Relays 1268	RNF-2000	Housings 364	S-5001 to S-5011	Lt. Fixtures 1059	SK-4052, SK-4053	Lugs 559
R879A, R879B	Sw. Relays 1267	RNL-R-2000	Outlets 678	S5300-1 to S5300/5	Luminaires 1135	SK-5400 to SK-5455	Handle Lock-Offs 559
R882A to R888E	Relays 1268	ROI, RO2	Trans-formers 1020	S5400	Lt. Units 1156	SKA	Holder & Cover 544
R9117	Handles 725	RO-2, ROC-2	Trans-formers 1020	S6201-73177 to S6202-74294	Naval Switches, etc. 1198	SKC12 to SKX33	Condulets 394
R80127, R80137	Lt. Fixtures 1165	ROB-550-4 to ROB-556-7	Brackets 911	S6201-73823 to S6201-73145	Naval Distr. Boxes & Panels 1196	SK123 to S1802	Solderall 187
R-80140	Downlights 1162	R0P11 to RP3	Plates 677	S6202-73002 to S6202-74372	Naval Plugs & Recep. 1197	S14500C to S15382P-8	Lt. Fixtures 1145
RA-65024 to RA-12045	Rectifiers 1505	RP3 to RP8A	Pumps 843	S6202-73286, S6505-74249	Naval Cable Conn 1197	S15502-4 to S15604-8	Troffers 1112
RA89A	Relays 1268	RP24	Plates 677	S6202-73772 to S6405-74396	Naval Marine Eq. 1195	S19811-4 to S19811-8	Strip, Ltg. 1111
RA101 to RA203	Crossarms 910	RP-27, RP-56	Terminals 1512	S6202-74292	Naval Rheostats 1198	S19811-4 to S19811-8	Fittings 243, 247
RA423BC to RA426BC	Receptacles 366	RP101, RP121	Plates 677	S6405-73065 to S6504-74055	Naval Contact Makers 1196	SLAY	Lamps 1206
RA425221 to RAD-3125421-G	Connectors 363	RP-121-RH	Lt. Units 1162	S6501-73495 to S6501-590485	Naval Inter-com. Eq. 1197	SN2-40RS to SN4-96	Lt. Fixtures 1096
RAPF-325221 to RAPF-425421-G	Receptacles 363	RP181	Plates 677	S6501-73892 to S6504-74246	Naval Plugs 1197	SN321 to SN428	Switches 516
RAW-25221 to RAW-25421-G	Receptacles 362	RP851-RH	Lt. Units 1162	S21232 to S32242	Naval Dimmers 1198	SO	Cord 7, 38, 61, 89, 115, 127, 130
RB-41	Joints 197	RP5001A to RP5005A	Lt. Fixtures 1136	S23242, S23242	Covers 390	SO-1/0 to SO-8	Lugs 195
RB50 to RB600	Bushings 239	RP6713	Plugs 492	S3A1, SB	Covers 386	SO-500	Lugs 195
RB50-38 to RB400-350	Reducers 235	RPL	Lights 678	S3A1 to S430	Caps 660	SOU to SOY	Holder & Cover 544
RB212, RB213	Receptacles 492	RR	Cable 5, 108, 120, 121, 123	S41 to S430	Adapters 536	SP	Cord 7, 91
RB-1024 to RB-30024	Rectifiers 1504	RR	Relays 677	S45006	Rectifiers 1505	SP-1, SP-2	Cord 131
RB4212-5 to RB7236	Braces 931	RR-122	Tags 894	S45006	Switches 1383	SP-49, SP-49-4	Receptacles 646
RBE-170, RBE-180	Lamp & Relay Assy. 678	RRW3	Cable 678	S45006	Switches 1385	SP50 to SP500	Couplings 231
RBR2 to RBWR3	Wire 2, 50, 92	RS	Stunlamps 1211	S45006	Switches 1385	SPI1415B to SPI2830B	Panelboards 443
RC 6 to RC-12	Rule Blades 719	RS1 to RSS1	Condulets 403	S45006	Switches 1385	SPT-1, SPT-2	Cord 131
RC-50A3 to RC-50K400	Rectifiers 1505	RS-1 to RS-12	Covers 289	S45006	Switches 1385	SR	Switches 1356
RC-55	Joints 197	RS73	Relays 1344	S45006	Switches 1385	SR3	Recharges 1227
RC102 to RC6010	Rams 843	RS-240-TT	Lt. Fixtures 1047	S45006	Switches 1385	SR-6 to SR-24W	Water Coolers 1271
RC-121-RH	Lt. Units 1162	RS350-4 to RS382P-8	Lt. Fixtures 1113	S45006	Switches 1385	SR21, SR31	Recfits 171
RC200C, RC200PH	Benders 737	RS5012-4 to RS5610	Troffers 1112	S45006	Switches 1385	SRA-R	Holder & Cover 544
RC-851-RH	Lt. Units 1162	RSB	Strip Ltg. 1111	S45006	Switches 1385	SR1R, SRHV	Wire 148
RCR-1058B to RCR-1067B	Rectifiers 1506	RSB50 to RSB600	Supports 678	S45006	Switches 1385	SRM-18	Reels 175
RCS	Switches 677	RS1100, 6SL100	Lugs 198	S45006	Switches 1385	SRQ	Ventilators 1280
RD	Cable 3, 93	RSP10 to RSP122	Plates 403	S45006	Switches 1385	SRR	Reels 175
RD	Wire 3, 93	RSP0 to RSP555	Plates 403	S45006	Switches 1385	SRU to SRY	Holder & Cover 544
RDL	Cable 3, 51, 92	RSS	Switches 677	S45006	Switches 1385	SS-35 to SS-650	Lugs 195
RDL	Wire 3, 51, 92	RT	Barbarts 206	S45006	Switches 1385	SS83	Covers 391
RE21 to RE3828	Reducers 405	RT277	Trans-formers 677	S45006	Switches 1385	SS84	Covers 392
REA-1, REA-2	Lt. Fixtures 333	RTC-2	Relays 1508	S45006	Switches 1385	SS102	Canopies 1094
REA-3	Guards 333	RTG	Hoists 836	S45006	Switches 1385	SS102, SS105	Canopies 1093
REA-4, REA-7	Receptacle Fittings 333	RTG712	Plugs 492	S45006	Switches 1385	SS110, SS117	Stem Sets 1095
REA-10 to REA-16	Switch Fittings 333	RTH	Barbarts 206	S45006	Switches 1385	SS323, SS523	Covers 391
REA-20	Light Fixtures 333	RU, RUG	Terminals 1512	S45006	Switches 1385	SS324, SS524	Covers 392
REA-25, REA-26	Ent. Fittings 243	RU6	Control Units 702	S45006	Switches 1385	SS1002, SS1002G	Covers 386
REA-33	Globes 333	RW	Cable 2	S45006	Switches 1385	SS1003	Covers 391
REA-44 to REA-49	Receptacle Fittings 333	RW	Wire 2	S45006	Switches 1385	SS1004	Covers 392
RELN03	Relays 1251	RXF-25221 to RXF-25421-G	Receptacles 362	S45006	Switches 1385	SS-21240-DAC to SS-84840-DAC	Lt. Fixtures 1101
REN13 to RES600	Fuses 535	S	Connectors 865	S45006	Switches 1385	SSB	Boxes 306
RF	Wire 51	S	Cord 7, 89, 130	S45006	Switches 1385	SSH	Clamps 206
RF-211, RF-221	Switches 515	S	Covers 295	S45006	Switches 1385	SSH	Hangers 292
		S	Guards 969	S45006	Switches 1385	SSM	Robot Operators 707
		S	Knobs 213	S45006	Switches 1385	SSU to SSY-RL	Holder & Cover 544
		S	Plates 682, 683	S45006	Switches 1385	ST	Cord 138, 139
		S	Supports 274	S45006	Switches 1385	ST	Gins 835
		S	Thermometers 1288	S45006	Switches 1385		

Cat. No.	Page
ST-1, ST-3	769
ST-38 to ST-90100	222
STF-38 to STF-100	222
STG-50 to STG-100	222
STG-A, STG-B	1500
STH-10	1232
STJ-50 to STJ-100	222
STKR-3052	784
STY	544
SU50, SU75	240
SV	89
SVT	138
SWB	306
SWC215 to SWC630	444
SWG-DS, SWG-SS	707
SWM110 to SWM242	422
SWP815B to SWP320B	443
SX-115, SX-160	300
SX115-40 1/2 to SX-115-57 1/2	300
SXRL	1227
T	213
T	682
T	768
T	13
T-1	769
T2	1260
T2MC	1260
T2SLC, T2SLC-P	1260
T34	1260
T4	1260
T6 to T12	777
T-6 x 14-16-1 to T-17-18-B-2	992
T7 to T56	250
T10	1499
T-10 to T-20A	151
T-12	752
T-12H	1356
T15 to T30	536
T17 to TB107	379
T17-MT to T127-MT	381
T18 to T448	393
T-22 to T-30	151
T-25	715
T25, T35	493
T26	1499
T27A, T27B	1499
T-30	752
T-30M	1356
T40A to T44A	1265
T-75	715
T86A29 to T87A	1266
T131 to T134	493
T-150A	860
T-153 to T-153B	859
T197 to T10097	381
T201D, T201R	135
T301H to T321D	135
T331 to T334	493
T351 to T360	329
T401H to T406D	135
T-410EXT to T-420EXT	860
T415A	1269
T-430, T-442	860
T-440	859
T615A, T631A	1269
T852A	1265
T-1560	1156
T-1600	1224
T-2300, T-2600	1224
T-3018, T-3025	752
T13101 to T33202	493
T-30146 to T-30175	112
T-30176 to T-30315	114
T-31177 to T-31972	111
T-32182 to T-32266	115
T-32563 to T-32574	114
T-32885 to T-33056	112
T-410415 to T-420415	860
TA	65
TA	639
TA	1412
TA	1413
TA	74
TA, TC	653
TA17 to TA67	380
TA-42	1526
TA42A	1265
TA802D	1266
TAL	737
TB18 to TB448	393
TB208-1 to TB430-3	491
TBM5	803
TBR2, TBR1	936
TC2CH to TC4WH	519
TC-4 to TC-7	851
TC7 to TC899	520
TC3721 to TC9229	521
TC12225 to TC24425	518
TC2311WP2 to TC24324WP4	520
TC26325 to TC60463	517
TC44321R2 to TC44424SNR4	519
TC52325SN to TC60426SN	517
TCH202 to TCH2220	453
TD010 to TD310RS	494

Cat. No.	Page
TD-11, TD-18	1526
TDF3	494
TDH3	494
TDP202 to TDP410	490
TDS111	858
TE21 to TE3	530
TE131015 to TE36Y100	530
TE100G to TF100NS	531
TE208 to TE430	488
TE11015 to TE32100	530
TEC2-40PRS to TEC2-96S	1042
TEC210	492
TEM2-40A to TEM4-40S	1097
TEZ1100NF to TEZ1100NSR4	591
TF	38
TF0 to TF3	530
TF126Y100, TF136Y100	530
TF-448-I, TFI-448-I	530
TF-448-O, TFI-448-O	1090
TF126015 to TF136100	530
TFE to TFM	1091
TFE	38
TGF-240RS-4H to TGF-396-8H	1117
TH-111	858
THK-114	858
THT-102	531
TIP614	489
TJ-10 to TJ-50	842
TJ-12H	1356
TJ225G to TKM400NS	531
TK3	508
TL241	1016
TL242, TL245	1016
TL246 to TL248	1016
TL600G to TL600NS	531
TL982	1194
TL988	1012
TL996, TL1257	1016
TL1462, TL1495	1014
TL1731	1015
TL1751, TL1752	1016
TL1761	1016
TLPL-240RS-4H to TLPL-396-8H	1117
TM-295 to TM-309	151
TMG	58
TP-1 to TP-4	808
T-P 200	1374
TPG712	492
TPH415J to TPL1430J	443
TQ	653
TQL21WY15, TQL21WY20	531
TQL1110 to TQL32050	502
TQL1110 to TQL32070	502
TQL2110 to TQL2170	502
TR-14-B to TR-24-E	1089
TR131-1 to TR331-2	493
TRB23	494
TRP2040FL, TRP2040SL	591
TRM1210F to TRP2420SL	591
TRP1115 to TRP1150	502
TRP1515 to TRP2020	531
TRR-21451-B to TRR-42451-E	1089
TRS-21451-B to TRS-21851-E	1089
TRT-100	531
TRT-42251-B, TRT-42251-E	1089
TRX1210F to TRX3020SL	591
TS	960
TS	1311
TS-51 to TS-53	1552
TS1232 to TS1234	530
TS-14	1352
TSA-40 to TSA47L	1352
TSA-41	1353
TSJ-20 to TSJ-30	151
TT-10 to TT-30	151
TT-57	737
TT208 to TT430	488
TT-324-I, TTI-624-I	1091
TT-324-O to TTI-424-O	1090
TTD2 to TTD10	490
TTI	1091
TTG712	492
TU	175

Cat. No.	Page
TUMS	175
TUS	175
TVR-1	702
TW	13
TW	93, 116
TW	620
TW	960
TW	1, 13, 51
TW-28, TW-31	143
TW40325 to TW72365	519
TWC2-40 to TWC1-96	1096
TWGF-240RS-4H to TWLPP-496-8H	1118
TWP215J to TWP1230J	443
TWT	1448
TWY2F-240RS-4H to TWY2F-496-8H	1118
TW-W1125, TW-W5075	747
U	211
U-3S, U3Z	256
U12F to U22FD	775
U16F to U22F-P	776
U-17 to UB777	380
U-40 to U-46	1181
U100	778
U-818 to U-851	1071
UA1614	1519
UC	207
UC510A to UC510AGP	980
UCP-50 to UCP-300	227
UCM20, UCM48	1212
UCM-125 to UCM-300	227
UF	17, 16, 17, 29, 94
UH	206
UH-B	208
UHR	206
UNA1 to UNA3	403
UNA16 to UNA36	403
UNB1 to UNE26	419
UNF012 to UNF1005	403
UNF50 to UNF1400	332
UNH1 to UNH26	419
UNHC12 to UNHC261	419
UNJ1 to UNJ2308	419
UNJC12 to UNJC232	419
UNL84 to UNL86	332
UNL125 to UNL265	403
UNY012 to UNY1005	403
UNY50 to UNY100	332
UNY84, UNY85	340
UNYL17 to UNYL37	403
UNYL50 to UNYL100	332
UR	620
URC	10, 44, 84, 85
URC	10, 21, 44, 84, 85
USE	16, 17, 123
V	129
V	683
V	210, 275
V1 to V389	413
V-4 to V-10	1452
V-5-A to V-6-S	1453
V18 to V183	414
V18 to V206	413
V-41-5	792
V46, V56	413
V50, V75	337
V-62-A to V-63-S	1453
V95 to V948	413
V105, V205	415
V175 to V32009	410
V623 to V625	413
V916 to V919	413
V932 to V938	414
V1005 to V5005	376
V1050 to V2075G	235
V4166 to V9171	1054
V5317 to V9481	1053
VA	207
VA-1	1489
VA50, VA75	337
VA1050 to VA2075G	336
VAD-1, VAD-2	337
VB	210
VC11 to VC3389	411
VC-40	1152
VC50 to VD75	317
VC175 to VE22009	410
VC1050 to VC2075G	336
VDA1 to VDA389	414
VDB3 to VDB8	414
VDB13 to VDB245	414
VDB19 to VDB225	414
VE1 to VE389	411
VE	207
VE	210
VE	411
VE	410
VGA50 to VGAT75	337
VGL-1AM to VGL-1RU	337
VGR110 to VGR216	411
VGR120 to VGR226	411
VGR129 to VGR1239	410

Cat. No.	Page
VGU-1, VGU-2	337
VH1 to VH389	413
VH99 to VH949	413
VH626	413
VHC11 to VHC3389	411
VHDA1 to VHE389	411
VHP6114 to VHP6116	1506
VHG1 to VHG289	411
VHJ11 to VHL3389	411
VHT11 to VHT3389	411
VI to VIII	129
VIG	1261
VJ11 to VL3389	411
VJ175 to VL32009	410
VL50, VL75	337
VI-240RS-4S to VI-496-8S	1116
VLA	1262
VLG215 to VLG280	412
VMI, VM2	416
VM-4-A to VM-6-S	1456
VM10, VM20	416
VM-62-A to VM-63-S	1456
VM946, VM947	416
VMI757 to VMA22009	415
VMA1 to VMC2	416
VMC1757 to VMG22009	415
VMG1, VMG2	416
VMGR5 to VMGR9	416
VMRB5, VMRB6	416
VMXHA1, VMXHA2	416
VMXHA1197 to VMXHA2299	415
VN71 to VN86	413
VO-1 to VP-2-HR	1057
VO9P to VO18H-IRR	1057
VP	207
VP1-S to VP1-S-2-SW-R	447
VP18-IRR	1057
VP9P to VP18H-IRR	446
VR	207
VRB2 to VR6710A	1506
VR110, VRB110	337
VRE-1AN to VRE-15ST	332
VS20 to VS92	414
V595, V597	414
VT	207
VT50, VT75	337
VTI11 to VT3389	411
VT175 to VT32009	410
VU100, VU200	337
VX50 to VXHA75	337
VX175 to VX32009	410
VXHA11 to VXHA3299	412
W	35, 37, 114
W	62-65, 112, 114, 127, 128, 145
W1 to W4	858
W2 to W8	1226
W-2X	812
W3 to W30	537
W11 to W32	1356
W13	1227
W100R to W113	1159
W116, W117	1160
W606M	1536
W5300/1 to W5301/3	1135
WA	537
WB-50, WB-75	1228
WBA	537
WBD360	590, 701
WC021 to WC182	448
WCF15-3 to WCL600-3	529
WDA, WEA	537
WE	536
WG9 to WG15	836
WGA, WHA	537
WH1303 to WH1503	454
WJB	316
WL	148
WL-1625, WL-1630	1170
WM	175
WM-13	808
WMK302-1-22 to WMK60354-1-14	422
WMK51632 to WMK51620235	421
WM5	175
WP-1	793
WP221 to WP831	389
WP4298 to WP4298S31	448
WPA	537
WRI	1227
WRP70F/100 to WRP70F/150	1136
WS102 to WS543	449
WS710B	492
WSA	537
WT	835
WT-105M to WT-165	198
WT-116	198
WT-181	198

Table with 4 columns: Cat. No., Page, Description, Page. Contains a comprehensive list of electrical components such as switches, breakers, motors, and wiring devices, organized in three main sections.

Cat. No.	Page	Cat. No.	Page	Cat. No.	Page	Cat. No.	Page
9F2K1 to 9F2K8	Cutouts. 1447	10DCP	Extin- guishers. 1229	16SBA1X2 to 16SB1CF19X2	Switches. 1383	23-008...	Scaters... 762
9F3K71 to 9F3K81	Cutouts. 1441	10F	Extin- guishers. 1228	16SB1CA8X2 to 16SB1CE48X2	Switches. 1384	23-SW...	Wrenches... 796
9F3K71, 9F3K81	Cutouts. 1442	10FC	Heaters. 1213	16X897...	Bulbs. 1296	24-001 to 24-033	Ammeters. 1226
9F6D11 to 9F6DX41	Cutouts. 1439	10-H, 10-L	Horns. 1233	16WF	Furnaces. 1214	21-045, 21-046	Tapes. 181
9F7A1	Cutouts. 1445	10LB6	Balancers. 772	17	Bells. 1252	21-073, 21-074	Grinders. 766
9F13A1 to 9F13A19	Fuses. 1445	10L-D-1 to 14L-C-2	Sleeves. 989	17-S	End Caps. 1087		Tool Heads. 765
9F16C76, 9F16CB76	Cutouts. 1441	10P8	Panels. 546	17-S to 19-S			Dust Col- lectors... 765
9F17E21 to 9F17E41	Cutouts. 1442	10P8N to 11S14/1F	Lamps. 1204	17T200, 17T201	Clamps. 273	21-270-2PMS	Ent. Panels. 604
9F17E2A18	Cutouts. 1442	10T-1	Extin- guishers. 1228	18	Bits. 712	21-270-2PMS	Jacks. 839
9F18B1 to 9F18B16	Links. 1447	10WFN	Heaters. 1213	18	Chimes. 1247	21-A, 21-C	Clips. 190
9F19A11, 9F19A21	Arresters. 1433	10-XMJ, 10-XPJ	Squeeze Tools. 994	18CU14	Heaters. 1215	24-C to 24Q	Covers. 285
9F20A1 to 9F20A31	Switching Mech. 1447	11	Kits. 203	18F26 to 18F467	Capacitors. 1437	21-C-1 to 21-C-35	Covers. 280
9FLA1A21, 9FLA1A281	Arresters. 1433	11, 11B	Threaders. 724	18F26 to 18F831	Capacitors. 1438	24CL	Drills. 774
9LA1H46 to 9LA1H66	Arresters. 1430	11, 12	Lamps. 1206	18XC	Reels. 174	24CQ, 26CQ	Box Covers. 124
9LA1H46 to 9LA1HK51	Arresters. 1431	11 to 13	Tape. 182	19	Shears. 802	24H/2 to 24KL	Covers. 285
9LA1HC46 to 9LA1HC60	Arresters. 1437	11-009 to 11-081	Straps. 395	19-22-A-3, 19-21-A-3	Sleeves. 990	25	Irons. 755
9LA1A533	Arresters. 1438	11-A	Etchers. 766	19-AC, 19-BC	Terminal Ac- cessories. 1526	25	Shears. 746
9LA2H57 to 9LA2H69	Arresters. 1429	11-A, 11-C	Terminals. 1513	19-B, 19-C	Tips. 757	25 to 28	Tap. 182
9LA10A202, 9LA10A204	Arresters. 1436	11-B	Clips. 190	19-C, 23-C	Anchors. 917	25 to 29	Switches. 696
9LA10A202 to 9LA10C71	Arresters. 1437	11B-3 to 11PA6	Heaters. 833	19C03 to 19C36V	Snapiicol. 456	25-001 to 25-048	Meters. 1491
9LA10C to 9LA10C88	Arresters. 1432	11-W-91	Plates. 704	19-SW	Wrenches. 796		Undercutters. 766
9LA11A1 to 9LA11A9	Gaps. 1436	12	Blocks. 830	20	Cutters. 727	1202, 1207, 1209	Lamps. 1208
9LA15A1 to 9LA15A23	Protectors. 1435	12	Bars. 916	20	Irons. 755	Microphone Accessories. 1529	Jacks. 839
9LA15B11 to 9LA15B13	Arresters. 1437	12	Boxes. 481	20	Outlets. 650	25A	Clips. 190
9LA17B21 to 9LA17B71	Arresters. 1433	12	Canopy Assy. 1086, 1087	20	Pins. 876	25A to 25A17/RS	Covers. 285
9LA17E35	Arresters. 1404	12	Couplings. 1388	20	Plugs. 668	25A to 25T10/RF/L	Covers. 280
9PB to 16PB	Enclosures. 1342	12	Tags. 894	20	Shears. 746	25C	Drills. 774
9-S-2034-L to 9-S-5613-L	Naval Marine Eq. 1195	12-067 to 12-079	Testers. 1499	20, 20WJ	Kits. 196	25CW-IX	Box Covers. 124
9-S-2524-L to 9-S-5514-L	Naval Switches, etc. 1198	12-072, 12-074	Sold. Tool. 756	20, 21	Horns. 1234	25F to 25G181/5	Covers. 285
9-S-2972-L to 9-S-5115-L	Naval Con- tact Makers. 1196	12-091	Sold. Tools. 756	20-006	Sockets. 672	25H7.5, 25H9.3	Irons. 755
9-S-4112-L to 9-S-5407-L	Naval Cable Conn. 1197	12 x 14-C-1 to 12 x 19-22-C-11	Att. 756	20-007, 20-009	Scrapers. 765	25-N	Shears. 746
9-S-4228-L to 9-S-5525-L	Naval Distr. Boxes & Panels. 1196	12-70-PMF, 12-70-PM5	Sold. Tools. 756	20A17/5	Files. 765	25-PH	Booths. 1516
9-S-4426-L to 9-S-5406-L	Naval Inter- com. Eq. 1197	12-115, 12-116	Sold. Tools. 756	20A11 to 20A1-L	Lamps. 1204	25-S	Wrenches. 796
9-S-4440-L to 9-S-5058-L	Naval Plugs & Recep. 1197	12-120	Sold. Tool. 756	20B	Balancers. 772	25-SW	Lamps. 1207
9T2 to 9T76	Trans- formers. 1357	12-123, 12-124	Att. 756	20CL	Drills. 774	25WF	Tapes. 181
9T21Y4 to 9T23Y61	Trans- formers. 1357	12-141 to 12-157	Soldering Tools. 755	20CR, 20CRB	Heaters. 1216	25W	Furnaces. 1214
9T21Y64	Trans- formers. 1360	12-1A to 12-157	Sold. Tool. 755	20CU14	Heaters. 1215	20CW-IX	Drill Std. 775
9T21Y3501 to 9T23Y3119	Transformers 1357, 1358	12-A	Att. 755	20CW-IX	Furnaces. 1215	20D30 to 20S60V	Drops. 1258
9T21Y6254 to 9T21Y6454	Trans- formers. 1360	12-BH-1	Compressors. 994	20DC	Raceways. 457	20DC	Saws. 806
9T51Y1104 to 9T51Y6836	Transformers 1362, 1363	12B-1	Heaters. 1213	20DCP	Extin- guishers. 1228	20DDC	Comparators. 1499
9T51Y5600 to 9T51Y5617	Autotrans- formers. 1364	12C-1 to 12-D-5-190	Sleeves. 990	20H11S, 20HJ	Jacks. 842	20HVP	Saw Sheaths. 807
9T51Y5682	Trans- formers. 1358	12CU12, 12CU14	Heaters. 1215	20F	Protectors. 1513	20F	Covers. 285
9T51Y6164 to 9T51Y6177	Trans- formers. 1360	12D-C	Sockets. 671	20PB, 25PB	Extin- guishers. 1228	20PB, 25PB	Trans- formers. 1417
9T51Y6237 to 9T51Y6837	Trans- formers. 1357	12FC	Heaters. 1213	20PD, 20PDB	Enclosures. 1342	20T-1	Trans- formers. 1419
9T53Y8026 to 9T53Y8058	Trans- formers. 1351	12H9	Jacks. 842	20T-1	Heaters. 1214	20T-1	Trans- formers. 1420
9T55Y2 to 9T55Y36	Trans- formers. 1367	12HGA11A, 12HGA11H	Relays. 1390	20WD	Extin- guishers. 1228	20WD	Threaders. 723
9T91Y70 to 9T91Y221	Trans- formers. 1372	12HJ	Jacks. 842	20WF	Heaters. 1214	20WF	Cars. 833
9T1750 to 9T1758	Trans- formers. 1357	12HMA11A, 12HMA11B	Relays. 1390	20X672	Furnaces. 1214	20X672	Lamps. 1210
9XC	Reels. 174	12-I.H.	Holders. 481	20XXA5, 20XXH5	Heaters. 1213	20XXA5, 20XXH5	Splices. 988
10	Bodies. 652	12-J.H.	Panels. 546	21	Bulbs. 1296	21	Tape. 180
10	Guards. 811	12K10	Nails. 925	21, 21	Heaters. 1213	21	Clips. 190
10	Handles. 916	12LW	Furnaces. 1214	21, 21-22	Bells. 1252	21	Tap. 182
10	Testers. 1499	12WF	Heaters. 1213	21-182	Bodies. 652	21	Bits. 711
10, 12	Bars. 914	12WFN	Bulbs. 1296	21-182	Lamps. 1210	21	Winders. 749
10 to 12	Switches. 695	12X825	Bells. 1252	21-A, 21-C	13 to 32	21-A, 21-C	Clips. 190
10 to 12	Chisel & Punch Sets. 717	13	Bodies. 652	21A to 21K	13 to 32	21A to 21K	Boxes. 291
10 to 14	Wire. 970	13, 14	Lamps. 1210	21A-6 to 21A-15	14	21A-6 to 21A-15	Fluorescent Units. 467
10 x 12-C-1 to 10 x 17-18-J-21	Sleeves. 991	13 to 32	Insulators. 190	21A-90L to 21A-91	14 to 17	21A-90L to 21A-91	Reflectors. 467
10-A, 10-C	Arms. 887	13-SD to 18-SD	Screwdrivers. 713	21BR-150 to 21BR-200	14 x 16-C-21, 14x17-18-C-21	21BR-150 to 21BR-200	Micro- phones. 1528
10AL to 10ALWW	Connectors. 981	14	Hoses. 738	21D	14-B-3 to 14-D-2	21D	phones. 1527
10B, 10BX	Balancers. 772	14 to 17	Bandages. 877	21DD to 21LD	14B-3 to 14D-2	21DD to 21LD	Deadends. 984
10BH-1	Heaters. 1213	14 x 16-C-21	Bolts. 856	21F830	15	21F830	Capacitors. 984
10-C	Oil. 1425	14x17-18-C-21	Sleeves. 991	21F831	15	21F831	Micro- phones. 1527
10C to 16C	Splicers. 198	14B-3 to 14D-2	Sleeves. 990	21FD to 21LDS	15, 16	21FD to 21LDS	Deadends. 985
10-C to 12S	Anchors. 917	15	Panels. 546	21L, 21-O	15	21L, 21-O	Capacitors. 1438
10-C-1 to 10-J-2-85	Stewies. 990	15	Bars. 915	21SP	15	21SP	27-SW
10C7 to 10M/20BU	Lamps. 1207	15	Bodies. 652	21SW48 to 21SW96	15	21SW48 to 21SW96	27W, 28
10CBH-48	Panels. 1216	15	Buzzers. 1252	21XM-1 to 21XMC-3	15, 16	21XM-1 to 21XMC-3	27XN-1 to 27XMC-3
10CU12	Heaters. 1215	15	Pullers. 748	22	15A	22	27XN-1 to 27XMC-3
		15	Tape. 183	22	15A to 15S14/1F	22	27XN-1 to 27XMC-3
		15	Lamps. 1204	22	15A to 15S17DC	22	27XN-1 to 27XMC-3
		15	Lamps. 1207	22	15A15	22	27XN-1 to 27XMC-3
		15	Lamps. 1202	22	15AC1 to 15AC4-L	22	27XN-1 to 27XMC-3
		15	Switches. 687	22	15B11, 15B11-2	22	27XN-1 to 27XMC-3
		15	Heaters. 1213	22	15CR, 15CRB	22	27XN-1 to 27XMC-3
		15	Heaters. 1216	22	15CW-IX	22	27XN-1 to 27XMC-3
		15	Heaters. 1215	22	15D	22	27XN-1 to 27XMC-3
		15	Furnaces. 1215	22	15DK	22	27XN-1 to 27XMC-3
		15	Hammers. 777	22	15F	22	27XN-1 to 27XMC-3
		15	Kits. 777	22	15FC	22	27XN-1 to 27XMC-3
		15	Extin- guishers. 1228	22	15F-C	22	27XN-1 to 27XMC-3
		15	Heaters. 1213	22	15F-C	22	27XN-1 to 27XMC-3
		15	Lamps. 1203	22	15-PC to 19-PC	22	27XN-1 to 27XMC-3
		15	Plugs. 618	22	16-2-S to 18-2-SJT	22	27XN-1 to 27XMC-3
		15	Booths. 1515	22	16-2-S to 18-3-S	22	27XN-1 to 27XMC-3
		15	Sockets. 671	22	16-3	22	27XN-1 to 27XMC-3
		15	Extin- guishers. 1228	22	16-C to 16S-1	22	27XN-1 to 27XMC-3
		15	Time Switch. 1213	22	16CL	22	27XN-1 to 27XMC-3
		15	Heaters. 1213	22	16DS	22	27XN-1 to 27XMC-3
		15	Reels. 174	22	16P14	22	27XN-1 to 27XMC-3
		15	Bits. 711				
		15	Mauls. 915				
		15	Studs. 241				
		15	Switches. 700				
		15	Insulators. 959				
		15	Counters. 1499				
		15	Cords. 612				
		15	Cords. 613				
		15	Sleeves. 990				
		15	Anchors. 917				
		15	Drills. 773				
		15	Drill Std. 775				
		15	Panels. 546				

Cat. No.		Page
30FFE	Furnaces	1214
30H4.5, 30H11	Jacks	842
30H1	Jacks	842
30HVP	Protectors	1513
30PD, 30PDB	Heaters	1214
30 TG, 30 TG-1	Gins	833
30WD	Heaters	1214
30WF	Furnaces	1214
31, 31B	Lamps	1206
31, 33	Switches	693
31 to 31-A-MF-BH	Sockets	671
31-004 to 31-081	Tapes	749
31-007 to 31-016	Pullers	748
31-082	Leaders	749
31-083, 31-084	Balls	749
31-180, 31-181	Winders	749
31-185	Pullers	748
31-191 to 31-217	Tapes	749
31-230 to 31-234	Guides	845
31-247 to 31-265	Lubricants	864
31A	Clocks	1498
31A	Horns	1533
31H882 to 31H863	Transformers	1419
31H882 to 31H894	Transformers	1423
31H896 to 31H935	Transformers	1425
31H924 to 31H982	Transformers	1424
31L	Fuses	1513
31-L, 31-O	Lt. Fixtures	1123
31-SV	Wrenches	796
32	Detectors	1499
32	Sockets	671
32-001 to 32-007	Clamps	545
32CL	Drills	774
32DS	Drill Std.	775
33	Compounds	863
33	Tapes	180
33	Wrench & Reamer	748
33, 33LE	Boxes	302
33-001 to 33-039	Reducers	545
33-C, 33-LC	Sprayers	1229
33H357 to 34H174	Transformers	1420
33H491 to 33H981	Transformers	1427
33PC	Boxes	305
34	Bodies	652
34	Canopy Assy.	1086, 1087
34	Outlets	650
34	Threaders	723
34-001 to 34-003	Pullers	544
34-012	Pullers	545
34-013, 34-014	Leads	545
34H38 to 34H177	Transformers	1428
35	Irons	755
35, 35-3	Controls	1270
35, 36	Horns	1234
35-15 to 35-19	Gloves	877
35-22IX, 35-42IX	Lt. Fixtures	1114
35H9.7	Jacks	842
35H18 to 35H760	Transformers	1423
35H201 to 35H625	Transformers	1421
35H660 to 35H936	Transformers	1422
35L	Fuses	1513
35-UC, 35-UC-A	Connectors	980
36	Arresters	1508
36A/RV, 36A/RVH	Lamps	1207
37790 to 37793	Ent. Eils	247
38A	Voltmeters	1226
39 to 43	Switches	695
39-7	Pliers	792
40	Boxes	279
40	Carbon Brushes	767
40	Irons	755
40, 40-41	Sleeves	876
40, 44	Indicators	1495
40 to 47	Lamps	1210
40A	Lamps	1202, 1208
40A to 40T10/RFL	Lamps	1204
40A15/1, 40A15/22	Lamps	1207
40CR, 40CRB	Heaters	1216
40CW-1X	Furnaces	1215
40C	Lamps	1203
40PD, 40PDB	Heaters	1214
40T10P	Lamps	1208
40WD	Heaters	1214
40WF	Furnaces	1214
41	Cover Assy	1086
41	Lampholders	666
41	Saws	806
41	Saw Sheaths	807
41	Splices	988
41	Switches	693
41 to 43X	Horns	1234
41 to 44	Cable	150
41-001	Testers	766
41-4 to 41-6	Pliers	792
41-310	Arresters	1509
41DD to 41LD	Deadends	984
41-E	Threaders	723
41FD to 41LDS	Deadends	985
41-L, 41-O	Lt. Fixtures	1123
41XM-1 to 41XMC-3	Splices	987
42 to 45	Insulators	959
42-22IX to 45-28IX	Lt. Fixtures	1114
42A	Voltmeters	1226

Cat. No.		Page
43	Canopy Assy.	1086
43, 43S	Clamps	993
43N6-E, 43N8-E	Spotlights	1172
44	Bits	711
44	Canopy Assy	1086, 1087
44	Fuses	1514
44	Saws	805
44, 44LE	Boxes	302
44, 45	Voltmeters	1226
44 to 46	Connectors	1258
44 to 46	Tapes	186
44LR to 44VB	Boxes	303
44PC	Boxes	305
44W12 to 44WE90	Wireway	499
44-WF	Heads	805
45	Bits	712, 713
45, 45-C	Clips	190
45	Irons	755
45	Saws	806
45, 45S1	Booths	1515
45, 45-41	Sleeves	876
45-009	Strippers	742
45-018	Ripper & Gauge	741
45-064 to 45-098	Strippers	742
45-079	Cutters	741
45-101, 45-104	Strippers	743
45-107	Strippers	742
45-120	Strippers	741
45-170 to 45-182	Strippers	742
45-200 to 45-205	Strippers	741
45X674	Bulbs	1296
46-4	Pliers	792
47, 49	Insulators	190
48	Drills	711
48XX39 to 48XXB39	Relays	1345
48-B, 48-C	Clips	190
48X486 to 48X489	Transformers	1471
49	Insulators	190
49	Tapes	180
49, 50	Reflectors	1086
50	Hickies	738
50	Horns	1234
50	Irons	755
50	Saws	806
50	Splices	740
50	Tapes	185
50	Wrenches	196
50, 50-41	Sleeves	876
50, 55	Furnaces	787
50, 50B	Lamps	1206
50, 50-C	Shields	787
50, 50-P	Lockers	786
50-001, 50-002	Tachometers	766
50-6 to 50-8	Pliers	792
50/150 to 50/150R/W	Lamps	1205
50/150M/DPK to 50/150M/SUN	Lamps	1203
50A	Horns & Drivers	1534
50A	Lamps	1202
50A, 50B	Switchboards	1517
50A to 50A/VS	Lamps	1209
50A19/RS, 50A21	Lamps	1208
50A21 to 50GA/DPK	Lamps	1207
50A/CL/VS	Lamps	1208
50-C, 51-C	Clips	190
50CR, 50CRB	Heaters	1216
50CW-1X	Furnaces	1215
50D	Boxes	288
50FFE	Furnaces	1214
50GA/DPK	Lamps	1203
50H11, 50H1J	Jacks	842
50-N	Heaters	1283
50PD, 50PDB	Heaters	1214
50-U-C, 50-UC-A	Connectors	980
50W	Tapes	718
50WD	Heaters	1214
50WF	Furnaces	1214
51 to 53	Boxes	1476
51 to 53-E1	Switches	685
51 to 57	Lamps	1210
51-1A to 51-2U	Insulators	960
52	Fuses	1514
52, 53	Vises	722
52 to 57	Troffers	1089
52B	Fuses	1514
52-C-01 to 52-C-45	Covers	282
53, 54	Horns	1234
53L	Fuses	1514
53-PT	Bits	707
54	Lampholders	666
54	Stocks	722
54 to 57-8	Lt. Units	1154
54-C-1 to 54-C-45	Covers	280
55	Bells	1252
55	Carbon Brushes	767
55	Irons	755
55 to 56X	Horns	1234
55ET to 57ET	Meters	1492
55L	Fuses	1513, 1514
56	Fuses	1514
56, 57	Bits	711
56A21, 56P25	Lamps	1207
56-PT	Bits	709
58-C-1 to 58-C-40	Clamps	258
58	Covers	287
58C690	Ballasts	1131
59	Push Buttons	1255
59-0700	Fuses	1510

Cat. No.		Page
60	Covers	790
60	Irons	755
60	Splicers	284
60	Tape Assy.	845
60, 61	Horns	1234
60 to 60-S	Clips	190
60 to 62	Bodies	662
60 to 71	Connectors	191
60A to 60A/SB	Lamps	1202
60A21, 60A/DPK	Lamps	1203
60A21/X	Lamps	1204
60A21/TS to 69A21/TS	Lamps	1207
60A/W	Lamps	1206
61	Splices	988
61	Vises	722
61 to 63-I	Switches	685
61-004 to 61-007	Testers	1500
61-015 to 61-040	Testers	767
61DD to 61LD	Deadends	984
61-E, 61-EX	Threaders	723
61FD to 61LDS	Deadends	985
61XM-1 to 61XMC-3	Splices	987
62	Anchors	915
62	Insulators	190
62 to 63S	Clamps	993
63, 63-C	Clips	190
63 to 68	Lamps	1210
63 to 69	Tape	185
64	Bits	711
64-PT	Bits	709
64TR, 65TR	Enclosures	1413
65	Conduit Straps	248
65 to 69-A	Adapters	670
65X925 to 67X926	Sockets	1454
66X727	Oil	1455
68	Power Drives	731
68-10	Ceiling Ltg.	1092
68X1	Screws	1455
68X2	Jewels	1455
70	Covers	790
70	Irons	755
70 to 70-NI	Portable Lamps	607
70 to 75	Bodies	653
70B	Threaders	724
70-MTBT	Sprayers	1229
71	Pushes	1255
71 to 77	Tape	183
71, 71A	Sockets	672
71, 71-P	Switches	696
71H13 to 71H512	Transformers	1422
71H40	Transformers	1428
71H226 to 71H240	Transformers	1428
71H285 to 71H288	Transformers	1423
71H489 to 71H781	Transformers	1419
71H501 to 71H507	Transformers	1421
71H771 to 71H868	Transformers	1418
71H785 to 71H805	Transformers	1420
71H869 to 71H950	Transformers	1421
71H869 to 71H968	Transformers	1427
71H894, 71H896	Transformers	1426
71H911 to 71H926	Transformers	1428
71X225 to 71X229	Transformers	1471
72, 72-3	Controls	1343
72-C-1 to 72-C-48	Covers	287
73	Bodies	663
73X90, 73X91	Connectors	273
73T90 to 73T92	Elbows	247
74	Canopy Assy	1088
74	Hickies	738
75	Irons	755
75	Splices	740
75, 75-41	Sleeves	876
75A	Lamps	1202
75A/DPK to 75R30/SP	Lamps	1203
75C16-1 DC	Lamps	1172
75-N	Heaters	1283
75-UC, 75-UC-A	Connectors	980
75W	Tapes	718
76X13	Bulbs	1296
76X46 to 76X59	Sockets	1454
77-22IX to 77-48IX	Lt. Fixtures	1114
77L	Fuses	1513
77X922 to 77X927	Jewels & Screws	1455
78	Compounds	863
78, 78A	Tags	894
78-A	Power Drives	731
78X354 to 78X915	Lampholders	1129
78X715, 78X723	Lampholders	1128
78X769	Sockets	1130
79X307, 79X311	Doors	1441
79X787a to 79X808c	Racks & Mech.	1447
80	Drops	1242
80	Irons	755
80, 81	Fuses	1514
80-012 to 80-496	Resurfacers	762
80FFE	Furnaces	1214

Cat. No.		Page
80N90 to 80N99	Connectors	227
80T30 to 80T35	Unilets	230
80T59 to 80T65	Adapters	230
81	Adapters	670
81 to 94	Lamps	1210
81D224 to 81D559	Heaters	1336
82, 84	Anchors	915
82 to 83S	Clamps	993
82-001 to 82-005	Resurfacers	762
82-4 to 82-24	Annunciates	1240
82-A to 82-B1	Kits	865
82N70, 82N71	Elbows	233
82N80 to 82N93	Couplings	227
82T050 to 82T100	Connectors	230
82X to 84X	Wins	738
83, 83-A	Adapters	670
83SP91	Splints	973
83X784 to 83X789	Sockets	1454, 1459
84	Adapters	696
84	Canopy Assy	1088
84	Tape Ext.	845
84A to 86A	Jacks	839
84XB to 84XXH	Relays	1344
84H1 to 84H61	Transformers	1422
84H11 to 84H31	Transformers	1419, 1423
84H13 to 84H67	Transformers	1425
84H15 to 84H73	Transformers	1424
85	Hammers	808
85, 85-41	Sleeves	876
85, 85-C, 85-T	Clips	190
85 to 85-8	Lt. Units	1154
85 to 86-L	Ext. Arms	696
85X930 to 86X43	Meters	1453
86X422 to 86X429	Meters	1454
87	Bits	709
87	Insulators	190
88	Clips	190
88	Finishes	873
88	Hammers	808
88	Power Drives	731
88-50 to 88-500	Transformers	1258
88-22IX to 88-29IX	Lt. Fixtures	1114
88C to 88T	Duct Fts.	482
88X593 to 89X918	Transformers	1471
89	Covers	790
89G319 to 89G899	Ballasts	1133
89G325 to 89G839	Ballasts	1132
89G635	Ballasts	1131
90	Irons	755
90	Tracers	1496
90, 91	Clips	277
90, 91	Push Buttons	700
90, 91	Vises	722
90 to 92S	Switches	697
90-1 to 91-18	Wrenches	793
90-B1	Kits	865
91	Extensions	1058
91	Gaskets	389
91, 92	Punches	744
91-1200	Fuses	1510
92T050 to 92T100	Connectors	230

at. No.	Page	Cat. No.	Page	Cat. No.	Page	Cat. No.	Page
10-A, 100-B	Booths 1514	123, 123-3	Controls 1343	160, 162	Cable 147	205L, 205NL	Saddles 799
10A, 100GA	Lamps 1207	123-021 to 123-431	Cable 142	160 to 162	Bodies 663	206	Bells 1233
10A to 100A23/28	Lamps 1209	124	Anchors 915	160 to 163	Conduit 999	206	Covers 458
10A to 100A/18B	Lamps 1202	124, 125	Outlets 668	160-P	Poles 607	207	Switches 696
10-A-12	Jacks 841	124-021 to 124-431	Cable 142	160SC	Lamps 1260	207	Splices 988
10A21/FL	Lamps 1172	124-24	Saws 807	161 to 166	Fuses 752	207	Taps 618
10A21/TS	Lamps 1207	124-B	Saws & 807	162	Routers 772	207, 208	Chimes 1246
10A23 to 100A/SUN	Lamps 1203	124-C	Gloves 807	163, 164	Wire 147	207CPL/5, 207PL/5	Lt. Fixtures 1146
10A/W	Lamps 1206	124V1 to 124V3L	Heaters 876	163A	Brackets 933	207FD, 207LDS	Deadends 985
10B-M	Batteries 814	125	Tapes 180	164	Viso Parts 729	207FDN, 207LD	Deadends 984
10-BX-7	Pliers 792	125, 127	Meters 1491	164	Beacons 1217	208	Gaskets 394
10G16-1/29DC	Lamps 1172	125G30, 125R40	Lamps 1211	164V1 to 164V3L	Bells 1246	209, 210	Lamps 1210
10H12, 100HJ	Jacks 842	1251, 618G3 to 1251, 619G26	Starters 1337	165A	Heaters 1285	209-5 to 210-6C	Pliers 790
10-N	Heaters 1283	1258SD	Serewdrivers 713	165VC144	Bases 1528	210	Bells 1233
10-TC, 100-UC-A	Connectors 990	126, 127	Jacks 840	166	Splints 973	210, 212	Tapes 870
10W	Tapes 718	127, 128	Mica Tapes 872	166 to 167B	Cable 147	210, 215	Braces 912
11	Bells 1233	127, 128	Sheaths 807	166A	Hand Lamps 1218	210 to 212	Wire 133
11	Tapes 870	127, 128	Sockets 664	166A	Connectors 616	210 to 213	Conduit 1000
11, 107	Splices 988	127, 128	Horns 1235	166V707P21	Stand At- 1218	210M to 220SPM	Lt. Fixtures 1146
11 to 130	Bushings 235	128A	Amplifiers 1530	167	tachment 1528	210-OB	Poles 812
11D to 101VR	Luminaires 1019	128VC128	Splints 973	167	Tips 751	210R	Transform- 1251
11ED to 107LDS	Deadends 985	130	Bodies 620	170, 170F	Ext. Cables 1528	211	Reamers 720
11FDN to 107LD	Deadends 984	130, 132	Gloves 876	170, 170SW	Receptacles 616	211	Booths 1515
11-OB	Transform- 1251	130, 135	Cable 147	170 to 173	Saws & 807	211	Elbows 458
12	Lens Assort- 1223	130-UNS to 134-UNS	Braces 912	170-10 to 170-26	Sheaths 807	211	Testers 1495
12 to 110	Clamps 251	131	Heaters 1283	170-510 to 170-566	Covers 382	211, 212	Hand Lamps 1218
12-30	Clamps 802	131	Lt. Fixtures 1152	170-N	Lamps 1259	211, 213	Switches 693
12-261 to 102-287	Wire 143	131	Lamps 1210	171	Fuses 1511	212	Penlites 1223
12PT128, 102VC102	Splints 973	132	Mica Plates 871	171F to 173FVB	Fuses 1511	212	Tags 894
13	Bodies 620	132-15, 132-46	Gloves 876	171T49 to 171T55	Heaters 1283	212, 214	Wire 144
13	Sockets 664	132-L to 133-S	Clamps 803	172T50, 172T51	212-6 to 212-8NE	212U666	Pliers 788
13	Anchors 915	134	Horns 1235	173, 174	212UH666	213	Wire 88
13	Beacons 1217	134, 136	Gloves 876	174	213, 216	213-9, 213-9NE	Reducers 545
13	Outlets 650	134, 136	Horns 1235	175 to 187	213A139 to 213C379	213A139 to 213C379	Motor 1321
13-067 to 105-147	Wire 145	134, 136	Peavies 810	176	213A239 to 213C379	213A239 to 213C379	Motor 1323
13-17	Clamps 802	134, 136	Splints 973	176-A-80	213A714 to 215A716	213A714 to 215A716	Motor 1325
13	Bells 1233	134, 136	Gaskets 878	177, 180	214	214	Pull Boxes 459
13	Conduit 1001	134, 136	Jacks 840	180, 180SW	214-2200	214-2200	Fuses 1510
13	Fuses 1514	134, 136	Viso Parts 729	180 to 182	214B666	214B666	Wire 87
13	Luminaires 1018	134, 136	Vises 730	180 1/4 to 185 1/2	214DH666, 214UH666	214V1 to 214V3L	Heaters 1285
13	Tapes 718	135 to 150	Clamps 251	180-2	214V1 to 214V3L	215	Frames 1306
13	Markings 718	135 to 150	Elbows 469	180A to 180Z	215	215	Mounts 1416
13	Fuses 1514	135 to 150	Sanders 769	182	215	215	Switches 700
13	Panels 1256	135 to 150	Caps 469	182A129 to 184C369	215A, 216A	215A, 216A	Frames 1327, 1328
13	Twisters 802	137, 138	Adapters 470	182A229 to 184C369	215A139 to 215C379	215A139 to 215C379	Motor 1322
13	Lamps 1207	139, 140	Stations 1247	182A713 to 184A813	215A239 to 215C379	215A239 to 215C379	Motor 1324
13	Covers 770	140	Mica Plates 871	183	216DH666, 216UH666	216DH666, 216UH666	Wire 88
13	08A420IG3	140, 145	Braces 912	181	217	217	Elbows 459
13	08F	140 to 143	Conduit 999	181A	217-6	217-6	Pliers 789
13	09 to 112	140 to 153	Locknuts 229	187A	217D/666 to 217DZ966	217D/666 to 217DZ966	Wire 88
13	09 to 115	140-C	Locknuts 229	188 to 189A	218	218	Testers 1495
13	09PT134, 109SP109	141	Recep. & 470	190	218C666	218C666	Wire 87
13	10	141 to 142-I	Plates 470	190 to 193	218D	218D	Wire 88
13	10	142	Outlets 649	190 to 191A	218D	218D	Wire 88
13	10	142BX, 143BX	Reamers 720	190-C, 190-TN	218D	218D	Wire 88
13	10, 111	142BX, 143BX	Viso Stands 731	190CS, 190XC	218D	218D	Wire 88
13	10, 115	142BX, 143BX	Viso Parts 729	191, 198	218D	218D	Wire 88
13	10 to 113	144	Couplings 470	196-2	218D	218D	Wire 88
13	10GC585	144 to 146	Gaskets 389	199	218D	218D	Wire 88
13	10WE/M	144-C	Gloves 876	199 to 200A	218D	218D	Wire 88
13	11	144-U to 148-U	Horns 1235	199-18 to 199-G24	218D	218D	Wire 88
13	11 to 111VB	144-C	Reflectors 1067	199-CH-35, 199-DB-30	218D	218D	Wire 88
13	11 to 116	145 to 154	Serewdrivers 713	199-H to 199-M	218D	218D	Wire 88
13	11 to 117 1/2 R	146	Buttons 1255	199K	218D	218D	Wire 88
13	11-228 to 111-587	146	Mica Plates 871	200	218D	218D	Wire 88
13	12	146, 146S	Saws 770	200	218D	218D	Wire 88
13	12, 114	146, 146S	Push But- 1256	200	218D	218D	Wire 88
13	12A515ACG1 to 114A21AAG1	146-0900, 146-217	Fuses 1510	200	218D	218D	Wire 88
13	12GC585, 112TW566	147, 149	Horns 1235	200	218D	218D	Wire 88
13	12NAX	149-1600	Fuses 1510	200	218D	218D	Wire 88
13	13	150	Cable 146	200	218D	218D	Wire 88
13	13	150	Compounds 862	200	218D	218D	Wire 88
13	14	150	Lamps 1259	200	218D	218D	Wire 88
13	14, 114-B	150	Mounts 1416	200	218D	218D	Wire 88
13	14, 115	150	Routers 772	200	218D	218D	Wire 88
13	14GC585	150, 155	Braces 912	200	218D	218D	Wire 88
13	15	150 to 153	Caps 663	200	218D	218D	Wire 88
13	15	150 to 153	Conduit 999	200	218D	218D	Wire 88
13	15	150-334	Hangers 211	200	218D	218D	Wire 88
13	15	150A	Bases 1527	200	218D	218D	Wire 88
13	15 to 130	150A to 150/SB	Lamps 1202	200	218D	218D	Wire 88
13	15H	150A/DPK to 150R/Y	Lamps 1203	200	218D	218D	Wire 88
13	16	150-CA, 151-CA	Changers 607	200	218D	218D	Wire 88
13	16, 117	150PAR/B to 150PAR/Y	Lamps 1205	200	218D	218D	Wire 88
13	16 to 119	150PAR/FL	Lamps 1166	200	218D	218D	Wire 88
13	16A21/TS	150PAR/SP	Lamps 1166	200	218D	218D	Wire 88
13	17R to 120	150PAR/3FL	Lamps 1205	200	218D	218D	Wire 88
13	17R to 120	150PAR/3SP	Lamps 1205	200	218D	218D	Wire 88
13	18B929G1, 118B929G3	150R/FL, 150R/SP	Lamps 1166	200	218D	218D	Wire 88
13	18-C	150/RS, 150/VS	Lamps 1209	200	218D	218D	Wire 88
13	19 to 122	150-S	Booths 1515	200	218D	218D	Wire 88
13	20	150SC	Lamps 1260	200	218D	218D	Wire 88
13	20	151 to 153-I	Switches 685	200	218D	218D	Wire 88
13	20, 121	151 to 161	Nipples 228	200	218D	218D	Wire 88
13	20, 125	152, 154	Door Open- 1257	200	218D	218D	Wire 88
13	20-4 ft. to 133-5 ft.	152A, 153A	Anchors 916	200	218D	218D	Wire 88
13	20-019 to 120-409	152-C to 156-C	Cable Sets 1527	200	218D	218D	Wire 88
13	20-C	154, 156	Changers 607	200	218D	218D	Wire 88
13	21 to 125	155 to 170	Saws 771	200	218D	218D	Wire 88
13	21 to 134	155SD	Clamps 251	200	218D	218D	Wire 88
13	21-021 to 121-431	156	Serewdrivers 713	200	218D	218D	Wire 88
13	21-U to 124	157	Bells 1252	200	218D	218D	Wire 88
13	22	157	Brackets 1067	200	218D	218D	Wire 88
13	22-021 to 122-431	157-C, 158-C	Changers 607	200	218D	218D	Wire 88
13	22-A	159	Lights 1067	200	218D	218D	Wire 88
13	22-C	159-6	Globes 1067	200	218D	218D	Wire 88
13	22	160	Lamps 1259	200	218D	218D	Wire 88
13	22	160	Lamps 1259	200	218D	218D	Wire 88

Cat. No.	Page	Cat. No.	Page	Cat. No.	Page	Cat. No.	Page
240, 241	271	288	757	325C, 325C/EMT	737	390 to 392	1493
240 to 243	1000	288B		326A964121		390 to 396	950
240-5 to 240-6	788			326A964122		390 to 399	264
240-201 to 240-711	1373	289				390-C, 390-TN	801
240B-RS		289A				390CS	802
240-TR-EC-RS	1124	290				391 to 397	1168
241	729	290 to 293				392	669
241	730	290-C, 290-CN				392	662
241 to 245	181	290XC				395, 396	1168
241-5 to 242-SW-6	791	291				397	1492
242	460	291R, 291R				398	1167
242 to 244R	720	292				398	1225
243	460	295 to 300				399	1168
243, 244	1231	296 to 299A				400	656
244-221 to 244-701-200	1373	299 to 303				400	234
244-1606	1510	300				400	738
244V1 to 244V3L	1285	300				400	754
245-5, 245-5W	788	300, 300C				400	816
245-5C	790	300, 300E				400, 400-E	878
246	182	300, 300/R				400, 402	1020
249	862	300-820, 300-830				400, 405	912
250	1416	300, 300/F				400 to 401S	318
250	768	300 to 306				400 to 402	654
250	756	300 to 313				400 to 406	696
250	988	300 to 316				400 to 406	719
250, 251	1253	300 to 316				400C/FL	1204
250 to 259	138	300 to 300/SBIF				402 to 404	320
250-820	138	300-CL20 to 300-L24				403 to 442	249
250A	1535	300PAR56MFL				403/2, 403/24	1241
250FD, 250LDS	985	300PAR56/WFL				403/3, 403T	320
250FDN, 250LD	984	300R/FL, 300R/SP				404, 405	1328
250G/FL	1211	300R/FL to 300R/3SP				404, 405	1496
250G/FL	1204	301				404A, 405A	1327, 1328
250P25	1208	301 to 303				404P	546
250R40/1, 250R40/10	1205	301-5 to 301-7				404U to 405US	1306
251	461	301-5C to 301-7C				405 to 408	321
251, 255	1495	301-F to 324-1HS				406	1233
251 to 255	708	301-OB				406 to 408	472
251-3	138	301-S to 324-S				406S	316
251-420 to 253-840	798	302-6, 303-6				407	1018
252-65W	1328	303				407S	709
254, 256	138	303 to 315				408	997
254-020 to 254-840	791	304-6, 305-6				408F	988
254-61	1134	304V1 to 304V3L				408FD, 407LDS	985
254-111 to 254-768	1327, 1328	306				407FDN, 407LD	984
254A, 256A	1328	306, 307				408A	1534
254A149 to 256C379	1322	306-51/2, 307-51/2				408F	1217
254A249 to 256C389	1324	306-51/2C, 307-51/2C				409	1223
254U, 256U	1305	306-4500				409, 410	321
255	1253	307				410	1233
255-420 to 257-640	139	307-4600				410	1233
258, 259	825	307FD, 307LDS				410	1233
258-109 to 258-184	139	307FDN, 307LD				410	1233
258B81001	1431	310				410	1233
259-P-6 to 259-S-8	791	310				410	1233
260, 260RT	1493	310, 311				410	1233
260 to 263	1000	310-820 to 310-850				410	1233
260 to 268	270	310A				410	1233
260A	1530	311, 312				410	1233
261	988	311-51/2, 313-6				410	1233
261 to 266	1499	314, 315				410	1233
261-210-A	1275	315				410	1233
261FD to 261LD	984	315-5C				410	1233
262	1493	317-790 to 317793				410	1233
262-402 to 262-804	140	318-1 to 318-6				410	1233
263	545	318BC666				410	1233
263A	1495	319				410	1233
265	696	319XC668 to				410	1233
265, 266	271	319XC685-I				410	1233
265 to 269	1474, 1475	320-820 to 320-850				410	1233
267 to 273	1494	320A				410	1233
269	382	320BC666				410	1233
270, 270F	1000	321				410	1233
270 to 273	270	321				410	1233
270 to 279	1230	321 to 323				410	1233
270-DOC to 271-SPO	988	321 to 331				410	1233
271	615, 616	321 to 339				410	1233
271 to 274	384	322C				410	1233
271FD to 271LD	984	322NC484-B to				410	1233
272	1508	322NC984-I				410	1233
272 to 276	696	322NC876				410	1233
275-P	769	322-X				410	1233
276, 276AA	1172	322XC685-B				410	1233
279B17373		322XC685-I				410	1233
280	1404	323				410	1233
280 to 283	616	323				410	1233
280-022 to 281-062	235	323				410	1233
281	145	323				410	1233
282	1479	323				410	1233
282	695	323				410	1233
284, 286	1328	324, 326				410	1233
284A, 286A	1327, 1328	324A, 326A				410	1233
284A159 to 284C379	1322	324A159 to 326C279				410	1233
284A259 to 286C389	1324	324A259 to 326C389				410	1233
284U, 286U	1306	324U to 326U				410	1233
285, 285A	273	325				410	1233
286A159 to 286C279	1323	325				410	1233
286B714G2	1404	325				410	1233
287EX	1217	325, 326				410	1233
		325, 329				410	1233

Table with 4 columns: Cat. No., Description, Page, and Cat. No. This is a comprehensive catalog listing various electrical and mechanical components such as cutters, lamps, sockets, and transformers, organized in a grid-like format.

Cat. No.	Page	Cat. No.	Page	Cat. No.	Page	Cat. No.	Page	
720	Bells	1252	813	Connectors	980	925	Extensions	710
720	Drills	712	813, 814	Gear Frames	1325	925, 928	Rules	719
720	Sockets	689	815 to 817	Lighting	138	931	Instruments	1476
720XIG1, 720XIG4	Meters	1452	815 to 823	Pennies	234	933, 934C	Vises & Stands	729
721	Tapes	183	815-F-1197017	Naval Marine Eq.	1195	935	Grips	996
721	Bits	713	815-F-1197117	Eq.	1195	935	Batteries	1224
721	Caps	621	816	Anchors	916	941-941RR	Batteries	1224
725	Buzzers	1252	816	Fans	1273	941-B to 941-FB	Relays	709
725 to 727	Extensions	240	818	Protectors	921	948, 954	Chisels	709
725-R to 750-RS	Ext. Cords	606	818 to 822	Supports	811	948K	Switches	1355
728	Tapes	183	819-4 to 819-12	Screwdrivers	714	950	Chisel Sets	717
730	Bells & Buzzers	1252	820, 821	Push Buttons	1257	950 to 952	Batteries	1224
730	Points	852	820 to 831	Box Parts	322	952	Buildings	829
730 to 733	Punches	746	820-4 to 820-12	Screwdrivers	714	954 to 958	Grips	996
730 to 733	Wire	132	820-JF, 821-JF	Fans	1272	956	Protectors	1513
730 to 761	Cable Straps	230	821 to 828	Grips	996	957	Floors	829
731	Batteries	1223	822 to 836	Anchors	915	957	Buildings	829
731 to 761	Adapters	383	825 to 832	Clevises	949	960, 961	Couplings	1167
733 to 747	Supports	256	826	Plate & Covers	470	960 to 965	Downlights	258
733-A	Ducts	477	829, 830	Receptacles	664	961 to 963	Clamps	258
735, 737	Punch Sets	746	830, 832	Lt. Units	1071	963 to 969	Instruments	1483
736	Jewels	679	830, 833	Eyes	937	965	Handles	810
738	Plugs	616	830-2	Screwdrivers	714	966	Lamps	1210
738 to 743	Punches	747	830-228 to 830-480	Cable	141	970 to 974	Plugs	616
738-B	Elbows	477	831	Fans	1273	971 to 973	Covers	382
739-A, 740-AR	Adapters	478	832-241 to 832-493	Footlights	1173	971 to 993-A	Handles	811
740, 744	Bells	1252	832-D	Cable	141	974 to 978	Pins	942
740	Cutters	746	833B-X	Lt. Units	1070	975, 978	Grips	997
740	Supports	811	836	Vises & Stands	729	980	Lampholders	654
740	Wire	132	836 to 838	Covers	316	980, 980F	Instruments	1485
740-A	Elbows	478	839, 840	Elbows	470	980 to 983	Covers	393
744 to 744-S	Portable Lamps	607	839-S	Boxes	478	981	Downlights	1167
744AL, 744ALC	Clamps	980	840, 841	Boxes	470	982 to 986	Tube Checkers	1485
745	Holders	852	840 to 853	Sw. & Boxes	470	983	Handles	811
745-A	Straps	477	841 to 843	Screw	470	990-T	Ocilloscopes	1485
745-A	Jewels	679	842, 843	Fixtures	937	990-T	Cutters	802
746	Portable Lamps	607	845 to 848	Nipples	229	991, 992	Tapes	184
747, 747-S	Ranges	1490	848, 849	Clips	470	993 to 996	Handles	809
749	Service Ftg.	478	850, 854	Switches	696	995	Reels	173
749-A to 751-A	Holders	852	855 to 885RT	Grips	996	996	Connectors	980
750	Lamps	1209	859 to 862E	Supports	810	998	Lampholders	666
750 to 750/SBLF	Lamps	1202	860 to 865-36C	Supports	811	998, 999	Lights	1168
750 to 759	Couplings	226	861 to 863	Push Buttons	1254	999	Pipe Machines	733
750-8	Pliers	792	862, 863	Rods	850	999 to 999SR	Pruners	807
750-8	Lamps	1204	867 to 870	Fans	1273	1000	Guards	609
750/F, FL	Lamps	1203	868, 869	Pushes	1255	1000	Braces	912
750/152	Lamps	1172	869	Spuds	810	1000	Hand Lamps	1218
750/T14	Seats	967	870, 871	Awls	710	1000	Lamps	1209
753 to 758	Gaskets	478	870 to 875	Couplings	470	1000	Raceways	455
753-A	Holders	852	870-024 to 870-114	Bars	809	1000	Stations	1536
755	Yokes	679	872	Thermostats	1270	1000	Testers	1492
756	Signal Devices	1244	876	Spoons	808	1000, 1001	Cabinets	779
760 to 761	Benders	736	876	Hooks	828	1000, 1003	Bends	999
761	Fan Guards	1279	876 to 885RT	Brackets	1189	1000 to 1009	Wire	749
761-B, 761-L-P	Duct Fns	477	885 to 885E	Instruments	1483	1000 to 1200	Fittings	165
761-HP, 761-HPG	Receptacles	477	886 to 887	Grips	997	1000 to 1000/SB1F	Lamps	1202
762	Tacs	894	888, 869	Shovels	809	1000F	Raceways	458
762	Luminaires	1147	869	Covers	316	1000T3	Lamps	1211
764-A	Bases	477	870, 871	Clamps	935	1001	Couplings	458
765	Pullers	845	870 to 875	Fans	1272	1001 to 1004	Straps	944
765-A	Elbow Att.	845	870-024 to 870-114	Covers	382	1001 to 1009	Cable	133
765-A, 766-BA	Caps	477	872	Trans-formers	1258	1002	Bushings	458
770 to 770T	Benders	736	876	Mold. Ftg.	470	1002	Blocks	589
771 to 779	Gaskets	381	880	Instruments	1490	1003	Chips	458
775 to 775R	Benders	736	880, 880F	Covers	393	1004, 1005	Lamps	1210
776	Handles	750	880 to 880-B	Benders	737	1004 to 1012	Shields	854
777	Pruners	807	880L, 880R	Ells.	470	1005 to 1009	Handles	809
778, 782	Tags	894	881	Fans	1272	1008LP	Boxes	546
780, 782	Switches	706	881-A	Benders	737	1009	Switches	458
785	Testers	1486	888	Moldings	470	1010, 1010L	Switches	695
785 to 807	Loops	257	890 to 896	Trans-formers	1258	1010, 1013	Bends	999
785-BE	Benders	736	891 to 898	Supports	936	1011	Elbows	458
785-BE-23 to 785-BE-30	Shoes	736	892 to 898LLS	Boxes	305	1011	Elbows	459
787	Tacs	894	897	Reels	815	1012	U-Bolts	938
791A, 792A	Bolt C. Machines	734	898	Clamps	935	1014, 1018	Generators	1300
792, 792A	Pipe Machines	734	899	Irons	755	1018C to 1018T	Blades	716
797E-SA to 798AC	Pumps	843	899X1 to 909X27	Ventilators	1275	1020, 1020L	Switches	695
798	Pumps	844	900	Vises	722	1022 to 1027	Canopies	1055
800	Awls	710	900X48 to 909X99	Clevises	949	1022-CR	Jacks	840
800	Benders	738	912, 915	Reels	815	1023	Blanking Plates	481
800	Recls	173	912 to 936	Extensions	710	1023 to 1027E	Spoons	808
800 to 801A	Protectors	1513	915	Cable	140	1023 to 1048	Grips	997
800 to 802-3/4	Boxes	322	915E, 916B	Poles	1029	1024	Jacks	844
800 to 805	Receptacles	647	915EE, 915EM	Instruments	1478	1024C to 1024T	Blades	716
800 to 813	Fans	1273	915R	Downlights	1167	1025	Push Buttons	1261
800-433 to 800-780	Cable	140	915S	Adapters	710	1026 to 1032	Cable	133
800A to 802P	Box Parts	322	916	Plugs	670	1028	Boxes	460
800S to 802SN	Boxes	306	916 to 939	Tapes	869	1029	Jacks	844
801, 801-K	Switches	1355	916T	Lt. Fixtures	1152	1030CR	Jacks	840
801, 802	Lights	1219	917	Instruments	1478	1032 to 1035	Shovels	809
801 to 807	Rings	936	917	Sockets	1458	1032C to 1032T	Blades	716
801 to 818	Grips	997	918	Meters	1353	1033-2	Blanking Plates	481
803 to 809	Serv. Fittings	323	918	Batteries	1224	1033-6, 1033-7	Pliers	792
803C to 809C	Serv. Fittings	322	918	Streamers	659	1034	Lamps	1210
803-S to 805-S	Boxes	309	918	Ceiling Ltg.	1092	1035, 1039	Boxes	460
805	Box Parts	322	918	Cloths	868	1039	Switches	695
805	Compounds	872	918	Trimmers	805	1040, 1043	Bends	999
805	Kodemasters	1239	918	Blades	805	1040S	Anchors	915
805C to 809V	Gaskets	393	918	Plades	805	1041AT to 1064BT	Hangers	1149
806 to 808	Poles	811	918	Blades	805	1042 to 1071	Reflectors	1055
806LP	Boxes	546	918	Saws	805	1044	Bars	809
806-S to 807-SW	Boxes	307	918	Downlights	1167	1048	Sw. & Boxes	461
808, 809	Annunciators	1241	918	Tighteners	805	1050	Batteries	1224
810	Links	662	918	Instruments	1475	925	Benders	740
810 to 827	Rings	937	918	Shelves	779	1054 to 1056	Bars	809
810-4 to 810-12	Screwdrivers	714	918	Lamps	1210	1055 to 1057	Lamps	1074
812 to 836	Streamers	659	918	Bends	999	1060, 1063	Bends	999
812-A to 814-A	Augers	914	918	Bars	809	1061 to 1066	Bars	809
			918	Canopies	1055	1066, 1067	Canopies	1055
			918	Reinforce-ments	779	1070	Reinforce-ments	779
			918	Bars	810	1071 to 1075	Bars	810
			918	Lamps	1210	1073	Lamps	1210
			918	Benders	740	1075	Benders	740
			918	Guards	608	1075 to 1075-RA	Guards	608
			918	Plates	703	1078	Plates	703
			918	Bars	810	1081 to 1085	Bars	810
			918	Anchors	914	1082	Anchors	914
			918	Connectors	461	1082, 1089	Connectors	461
			918	Connectors	461	1087	Connectors	461
			918	Plates	461	1087	Plates	461
			918	Controls	995	1088	Controls	995
			918	Bends	995	1089	Bends	995
			918	Shovels	808	1090, 1093	Shovels	808
			918	Handles	808	1090 to 1092S	Handles	808
			918	Benders	740	1091, 1093	Benders	740
			918	Braces	912	1090	Braces	912
			918	Mounts	1416	1100	Mounts	1416
			918	Stations	1536	1100, 1101	Stations	1536
			918	Hubeys	920	1100 to 1100-RA	Hubeys	920
			918	Guards	608	1100 to 1112	Guards	608
			918	Clips	977	1101	Clips	977
			918	Push Buttons				

Cat. No.	Page	Cat. No.	Page	Cat. No.	Page	Cat. No.	Page
1282	872	1435 to 1449	1210	1570-3	795	1761 to 1763	317
1285 to 1288	137	1447	617	1570A	1529	1769	872
1287	872	1448, 1449	868	1575, 1579	1168	1770 to 1774	382
1290, 1293	999	1450 to 1452	609	1580 to 1587	342	1770 to 1775	869
1291 to 1299	976	1451 to 1456	240	1581	1168	1779	317
1292 to 1298	133	1458	1210	1582T, 1585	463	1780	473
1300	816	1459 to 1462	316	1587	1168	1786	874
1300, 1303	999	1460, 1463	999	1590 to 1592	240	1786, 1786-C	Push But-
1300 to 1305	612	1460 to 1462	133	1590 to 1599	342		tons... 1253
1300 to 1310	241	1460 to 1461		1591, 1597	1168	1790	Hangers... 472
1300 to 1317	341	1460 to 1465	295	1599	463	1790 to 1795	Ent. Fittings... 243
1301	1484	1461, 1462	237	1600, 1601	615	1792	Tapes... 869
1302, 1305	1169	1470A to 1470FG	1224	1600, 1606	759	1800	Track Sect... 498
1302 to 1306	954	1471A	1147	1600L	1248	1800 to 1814	Boxes... 311
1305-2	794	1472 to 1474	1147	1602	950	1802	Couplings... 498
1305-3A	794	1475	740	1602, 1603	133	1802-30 to 1802-60	Tackles... 892
1306	1484	1475 to 1478	674	1602C to 1608G	974	1802-H	Cord Sets... 615
1310, 1313	999	1478	135	1603 to 1616	951	1803	Boxes... 498
1311 to 1314-L	674	1478	953	1604-10 to 1604-20L	805	1803-60 to 1801-75	Lines... 824
1311-4 ft. to 1319-E+ft.	1110	1480 to 1481	235	1606 to 1612	854	1805	Hangers... 498
1311X, 1313X	1110	1481	316	1607	872	1807	Caps... 498
1312, 1315	1169	1481	868	1607 to 1667	950	1808	Boxes... 498
1312.0 to 1315.4	976	1490	303	1607A to 1609M	1333	1808 to 1815	Stools... 779
1312.0 to 1317.1	977	1490	1210	1608-CE to 1615-CE	615	1808-IIT	Cord Sets... 615
1316, 1318	941	1490, 1493	999	1610 to 1613	238	1809 to 1812	Pots... 758
1318	1169	1490 to 1497	248	1610 to 1616H	539	1810	Boxes... 323
1320	674	1490-C, 1490-TN	801	1611 to 1611-D	539	1810-CE	Cord Sets... 615
1320 to 1339	341	1491, 1493	674	1611-20 to 1611-50	1158	1815-D	Switches... 615
1321	675	1498	687	1611 to 1611-D	803	1815D, 1815DL	Switches... 686
1322	675	1498, 1499	686	1612	133	1816	Box Parts... 323
1323, 1326	675	1498, 1499	674	1612-30 to 1613-50B	803	1818	Cases... 1493
1323, 1327	1210	1500	456	1614-P	546	1820	Boxes... 323
1325, 1327	235	1500	169	1614Q	1333	1820-25 to 1832-40	Ceiling Ltg... 1092
1326	228	1500	777	1617A to 1625Q	866	1820-CE, 1825-CE	Cord Sets... 615
	228	1500	922	1619TD to 1622TP	866	1823	Reflectors... 1161
	674	1500, 1500-I	646	1620	868	1825D, 1825DL	Switches... 686
	1492	1500, 1500-IF	1202	1620, 1621	615	1830	Boxes... 323
	952	1500 to 1509	617	1622, 1623	1167	1830-CE, 1831-CE	Cord Sets... 615
	676	1500-3R/2 to		1624RS, 1648RS	1104	1831-1, 1832-2	Screwdrivers... 714
	951	1500/3R/10	1146	1625-20	805	1834	Instrument... 1242
	872	1500/325C	1146	1625-3BH to 1628-16BP	804	1835-D	Switches... 686
	674	1500G 48/6	1204	1625-5, 1628-5B	803	1835D, 1835DL	Switches... 686
	999	1500WC	461	1628-30B, 1628-40B	804	1840 to 1848	Lights... 1168
	342	1501	922	1629, 1629-A	804	1842, 1843	Grips... 996
	674	1502	461	1630, 1631	615	1844D, 1844DL	Switches... 686
	248	1502	1169	1630, 1631	871	1850	Track... 498
	676	1502	660	1630 to 1634	663	1850, 1860	End Fittings... 242
	676	1502, 1503	End	1634	655	1850 to 1894	Boxes... 311
	676		Fittings... 922	1637 to 1639	615	1852	Reflectors... 1161
	675	1502, 1507	Meters... 1492	1640	247	1855, 1857	Plates... 945
	675	1504	Straps... 461	1640 to 1643	868	1858 to 1865	Stools... 779
	816	1504 to 1512	Shields... 854	1644	1167	1862, 1863	Grips... 997
	1147	1506, 1509	Guy Arms... 922	1645 to 1656	209	1871, 1873	Switches... 687
	132	1507, 1509	Jacks... 841	1645 to 1680	1168	1875 to 1878	Reflector
	1231	1508T	Tubing... 461	1648 to 1650	132		Units... 1059
	1222	1510A	Mixers... 1532	1650	804	1878, 1887	Plates... 945
	676	1511	Connectors... 922	1656-20 to 1656-50B	804	1881 to 1884	Straps... 944
	952	1511	Connectors... 462	1656-AB	238	1883-116	Cable... 1528
	675	1511 to 1511-D	Lt. Fixtures... 1158	1660	137	1900	Nails... 928
	132	1511 to 1532G	Reelites... 169	1660	1224	1900	Raceways... 455
	1222	1512	Preamplifiers... 1533	1662	949	1900A	Controls... 1242
	999		Fittings... 922	1664	1167	1901	Couplings... 463
	342	1515	Floodlights... 1169	1664, 1665	247	1901M to 1901MAL	Climbers... 800
	1172	1515, 1515-I	Lt. Fixtures... 1148	1665	323	1901-MG	Guards... 799
	132	1515-1	Outlets... 651	1666	324	1902	Bushings... 463
	1147	1515-2	Knives... 796	1666 to 1675	324	1903-6, 1904-4	Head-Lights... 1220
	1147	1516-2	Ceiling Ltg... 1092	1673	873	1907, 1907A	Climbers... 800
	1147	1517, 1518	Elbows... 462	1674	873	1908 to 1915	Stools... 779
	953	1517A	Adapters... 462	1674	949	1910A to 1914C	Connectors... 464
	674	1518, 1519	Struts... 922	1680, 1681	1168	1910B	End Fittings... 464
	675	1518A	Generators... 1300	1680, 1690	939	1911	Elbows... 464
	606	1520	Outlets... 646	1695	543	1912 to 1916	Yardlights... 1059
	1054	1521	Pole Plates... 922	1700	472	1915	Tees... 464
	999	1521 to 1534	Caps... 247	1700, 1701	668	1915-D	Switches... 655, 686
	674		Fittings... 922	1700 to 1703	317	1917, 1918	Elbows... 464
	999	1522, 1523	Covers... 646	1700 to 1708	759	1917 to 1935	Bases... 540
	702	1522, 1528	Jacks... 839	1700 to 1716	383	1919	Brackets... 802
	703	1524, 1524A	Outlets... 462	1700 to 1748	209	1921	Extensions... 317
	137	1527, 1527-1	Outlets... 646	1700 to 1790	209	1925D	Switches... 686
	854	1528	Boxes... 462	1700-30	804	1927, 1927V	Receptacles... 465
	1158	1530, 1530-I	Outlets... 646	1700L	1212	1930	Blocks... 465
	671	1532, 1533	Outlets... 649	1701 to 1708	473	1930	Reflectors... 1161
	703	1534, 1535-S	Outlets... 651	1702-20	804	1934, 1936	Lampholders... 655
	999	1535	Plugs... 669	1704-8	1220	1935, 1935-30	Floodlights... 1191
	229	1536, 1537	Receptacles... 669	1705 to 1712	323	1935-60	Fuse Cutouts... 542
	674	1536A	Generators... 1300	1705-5 to 1706-E10	1108	1935-D	Fusible... 543
	135	1537	Cloths... 868	1708 to 1715	779	1935-60	Cutouts... 541
	546	1538	Jacks... 838, 844	1710-CB, 1710-RS	473	1937 to 1943	Switches... 655, 686
	1066	1540	Reflectors... 1161	1713	868	1940	Bases... 541
	703	1540, 1540-I	Outlets... 646	1715	473		Control
	617	1540 to 1554	Boxes... 311	1716	1217	1942	Boards... 1243
	617	1541	Amplifiers... 1533	1717-8	472	1942 to 1949	Boxes... 465
	675	1542	Pole Plates... 922	1719	472	1944D	Nipples... 229
	675		Fittings... 922	1723 to 1743	472	1945 to 1945AL	Switches... 686
	868	1542, 1545	Lights... 1168	1723 to 1785	383	1945-G	Climbers... 800
	209	1542A to 1542G	Boxes... 462	1724, 1728	110	1950 to 1950	Guards... 799
	675	1542B	Bases... 462	1725	950	1950 to 1960	Nails... 792
	675	1546A to 1546T	Boxes... 463	1728 to 1748	84	1950-50 to 1950-8	Pliers... 996
	1065	1547	Connectors... 617	1729 to 1749	317	1954 to 1958	Grips... 317
	674	1550-2 to 1550-5	Knives... 795	1729-15, 1729-30	1220	1956	Extensions... 800
	609	1552 to 1556	Clives... 949	1730	759	1957A, 1957AL	Climbers... 800
	135	1555	Cloths... 868	1731	472	1962	Clothes... 1243
	316	1558, 1559	Covers... 646	1734	655	1962 to 1963ZSK	Switches... 1355
	608	1560 to 1567	Unilets... 341	1735	473	1970	Light Units... 1189
	712	1560-3	Knives... 795	1736	472	1971, 1973	Switches... 687
	1108	1560A	Mtg. Assys... 1535	1737, 1738	472	1972	Clocks... 1243
	999	1562	Batteries... 1224	1739, 1740	473	1972	Connectors... 466
	232	1565, 1565-I	Outlets... 645	1744	759	1974	Connectors... 466
	674	1566, 1568	Lights... 1168	1744-8	472	1974 to 1978	Couplings... 927
	316	1568A, 1569A	Amplifiers... 1530	1754	1221	1978	Grips... 1043
	676	1570, 1670-I	Outlets... 645	1755	872	1981 to 1982	Ent. Switches... 543
	676	1570 to 1575	Push-Pennies... 234	1756	238	1983	Buzz Units... 1189
	676	1570 to 1579	Unilets... 241	1758 to 1765	749	1983	Treatments... 868
						1984	Chimes... 1245

Cat. No.	Page	Cat. No.	Page	Cat. No.	Page	Cat. No.	Page
1989 to 1989E	Connectors... 466	2135 to 2199	Fuse	2128 to 2148-A	Racks... 953	2800 to 2825	Downlights 1164
1998	Bases... 540		Cutouts... 542	2128-49	Ceiling Ltg... 1092	2820-2 to 2830-6	Blades... 1004
2000	Markers... 928	2135-30	Cutouts... 541	2132 to 2146	Connectors... 246	2827	Pliers... 793
2000	Raceways... 257	2140, 2140B	Switches... 465	2134	Lamps... 1075	2828	Outlets... 651
2000	Stations... 1536	2140-1, 2140-3	Lanterns... 1222	2156	Switches... 694	2833, 2834	Switches... 694
2000	Switches... 694	2141	Splices... 988	2167 to 2169	Cutouts... 1443	28351-2, 28351-2S	Boxes... 298
2000, 2005	Bells... 1246	2141, 2144	Sw. & Boxes... 465	2171 to 2176	Racks... 995	2842	Switches... 704
2000 to 2018	Floodlights... 1182	2143	Connectors... 124	2175	Benders... 740	2862, 2865	Boxes... 126
2000F, 2000S	Electri-	2144 to 2151	Downlights 1172	2500 to 2505	Boxes... 290	2863	Switches... 704
	Centers... 602	2150	Bushings... 124	2500 to 2525	Downlights 1164	2880	Switches... 616
20001	Circuitors... 1212	2151	Ext.	2500/66	Lamps... 1207	2900, 2901	Boxes... 284
2000WC	Clips... 463		Adapters... 466	2500T3	Lamps... 1211	2900 to 2925	Downlights 1164
2001	Couplings... 463	2151 to 2153	Tapes... 868	2501	Canopy Units... 1162	2900BHS to	
2001	Reels... 174	2151 to 2156	Plugs... 209	2502	Caps... 663	2901NSBHS	Boxes... 284
2001 to 2003	Plus... 209	2155	Track... 499	2502	Connectors... 618	2904	Ext. Rings... 284
2002, 2003	Straps... 944	2155, 2156	Connectors... 124	2502 to 2505	Benches... 780	2904 to 2910	Timers... 1354
2005 to 2009	Connectors... 272	2157	Fasteners... 124	2502 to 2509	Boxes... 315	2919, 2920	Screws... 941
2005 to 2009	Handles... 809	2159 to 2161	Fasteners... 124	2504, 2505	Rins... 290	2923 to 2926-L	Switches... 688
2005E	Trolleys... 499	2161	Splices... 988	2508	Connectors... 618	2927	Floodlights... 1169
2008	Tapes... 869	2163-EZ	Connectors... 124, 265	2509-C-2 to 2510-C-2	Jacks... 841	2932	Guards... 609
2009	Clamps... 463	2165 to 2170	Frontlights 1172	2510	Covers... 288	2936 to 2943	Lampholders... 1127
2010	Bells... 1246	2165-30, 2165-60	Cutouts... 541	2510 to 2511S	Starters... 565, 566	2944	Brackets... 941
2010A	Connectors... 464	2165-EZ to 2169-EZ	Connectors 271	2510 to 2512	Downlights... 1166	2956, 2958	Connectors... 618
2010B	End	2171	Tapes... 868	2510 to 2519	Starters... 564	2961	Hoods... 1518
	Fittings... 464	2172-2	Lanterns 1221	2511 to 2519C	Boxes... 290	2961 to 2963NSBHS	Boxes... 284
2011	Elbows... 464	2173, 2174	Connectors 466	2511 to 2519C	Boxes... 315	2965 to 2965-100	Fuse Cutouts... 542
2012	Generators... 1300	2174 to 2176M	Holders... 1148	2514	Connectors... 246	2965-0	Fuseholders... 543
2014	Covers	2175	Connectors 272	2516	Tachometers	2968, 2969	Clevises... 952
2014E	End Ftz. & Covers	2175	Lights... 1166	2518	eters... 1498	2968, 2969	Switches... 704
	2015	2175 to 2177M	Holders... 1149	2519	Generators... 1300	2971 to 2974-L	Switches... 688
	2017, 2018	2179 to 2181	Connectors 124	2519	Treatments... 868	2972	Covers... 382
	2017TC	2180	Connectors 472	2520	Covers... 288	2978	Clevises... 952
	2018 to 2020SS	2182A	End Fitting... 466	2522 to 2525	Benches... 780	2992, 2992-1	Outlets... 651
	2018A to 2018D	2192-EZ	Couplings... 228	2530	Cloths... 868	2994, 2999	Sw. & Out-
	2018C	2195 to 2200	Benders... 740	2530 to 2532	Cutouts... 1443		lets... 680
	2020	2197	Switches... 697	2539, 2540	Covers... 288	3000	Box... 780
	2020	2199-0	Fuseholders... 543	2548 to 2553	Tapes... 869	3000	Raceways... 456
	2021 to 2023S	2199-30, 2199-60	Cutouts... 541	2550 to 2552	Cutouts... 1443	3000	Reels... 172
	2022, 2023	2200	Mast Kits... 939	2555	Connectors... 288	3000	Stations... 1536
	2023 to 2027E	2200, 2201	Raceways... 257	2558	Arresters... 1443	3000 to 3001-G	Ext. Sets... 317
	2025E	2200 to 2200-B	Track... 499	2558	Fuse-	3000 to 3006	Conduit... 999
	2025-F to 2026-P	2201	Guards... 608	2569, 2570	Holders... 1443	3000WC	Clips... 463
	2028	2201	Ext. Sets... 317	2569 to 2587-30	Nozzles... 315	3001	Couplings... 463
	2029	2202	Fuse Cutouts... 542	2569-30, 2569-60	Ext. Sets... 317	3001	Wire Dis-
	2030	2203	Cutouts... 541	2572	Fuse Cutouts... 542		pensers... 819
	2030 to 2036	2203	Switches... 704	2580, 2580G	Outlets... 541	3001 to 3007	Switches... 1354
	2030 to 2048	2204	Boxes... 315	2581	Switches... 704	3001A to 3003A	Blocks... 822
	2031, 2032	2205, 2207	Boxes... 315	2587-0	Boxes... 315	3002 to 3005R	Guards... 610
	2032 to 2035	2208	Boxes... 498	2587-60	Boxes... 315	3002 to 3019	Boxes... 294
	2035	2208	Pittings... 939	2590	Fuseholders... 543	3003, 3006	Clips... 463
	2040	2208-EZ to 2218-EZ	Connectors... 272	2599 to 2599	Cutouts... 541	3005	Trolleys... 499
	2040 to 2052	2210	Fans... 1277	2600	Boxes... 290, 315	3006, 3006R, 3007	Guards... 610
	2041 to 2043	2211	Thermometers... 1289	2601	Covers... 456	3008, 3009	Ext. Sets... 317
	2046	2212 to 2236	Troughs... 499	2601	Raceways... 456	3008A	Clamps... 463
		2213	Desks... 779	2601	Circuitors... 1212	3008D	Hooks... 463
		2213	Lamps... 1260	2605	Switches... 566	3008F, 3008M	Hangers... 463
		2220 to 2232/PR	Switches... 694		Compensators	3010	Cabinets... 780
		2231, 2234	Lt. Fixtures... 1166	2608	564	3010A, 3010C	Connectors... 464
		2225	Lamps... 1075	2609 to 2699	Connectors... 618	3010B	End Fittings... 464
		2231 to 2246	Racks... 996	2611	Caps... 241	3010C to 3010S	Hoists... 835
		2232, 2233	Connectors... 246	2614 to 2627	2614	3011	Elbows... 464
		2234-EZ	Connectors... 272	2617T	Connectors... 246	3012A to 3018D	Generators... 1300
		2236A, 2236A3	Generators... 1300	2618, 2620	Elbows... 462	3015	Tees... 464
		2241 to 2250	Lt. Units... 1164	2618, 2620	Sockets... 663	3017, 3018	Lights... 1188
		2250 to 2254	Desks... 779	2619, 2620	Flanges... 317	3017C, 3018A	Couplings... 464
		2251	Flashlights... 1223	2619TD to 2622TP	Kits... 866	3019	Post & Brackets... 1212
		2254 to 2264	Racks... 996	2621	Reducers... 545	3020, 3021	Ext. Sets... 317
		2255	Track... 499	2620	Boxes... 298	3020, 3025	Anchor... 856
		2257	Reflectors... 1164	2632 to 2635	Sockets... 663	3020 to 3020S	Clamps... 465
		2261	Thermometers... 1289	2642	Boxes... 462	3020 to 3026	Conduit... 999
			Hangers... 298	2642D	Outlets... 462	3025	Lights... 814
			Tapes... 868	2642H	Cloths... 868	3025, 3029	Trolleys... 499
			Fans... 1277	2653	Luminaires... 1147	3026, 3029	Pins... 945
			Racks... 996	2658	Tapes... 869	3028	Boxes... 465
			Hooks... 995	2662, 2665	Boxes... 124	3029, 3030	Cloths... 868
			Pliers... 792	2665 to 2680	Rins... 124	3030, 3033	Carts... 781
			Circuitors... 1212	2666	Sockets... 663	3032, 3033	Anchor... 856
			Lights... 1184	2666 to 2669	Rods... 925	3040	Anchor... 856
			Keys... 688	2686 to 2688-G	Cloths... 868	3040 to 3043	Conduit... 999
			Switches... 704	2690	Sockets... 663	3041A to 3043K	Blocks... 821
			Arresters... 1443	2694	Ext. Sets... 317	3046A to 3046L	Covers... 466
			Fuse-Holders 1443	2694 to 2697-G	Cloths... 868	3046K D	Housings... 466
			Switches... 694	2700 to 2702	Switches... 704	3050	Anchor... 856
			Cloths... 868	2700 to 2702	Ext. Sets... 317	3050 to 3053	Conduit... 999
			Lamps... 1075	2700 to 2711	Connectors... 285	3051	Brackets... 946
			Arresters... 1435	2700 to 2718	Sw. Cont.	3060, 3070	Anchor... 856
			Lamps... 1210	2701	Mech... 1415	3071	Fixtures... 1061
			Hangers... 252	2708	Receptacles... 353	3075H	Blocks... 824
			Flashlights... 1223	2709 to 2739	Ext. Rings... 285	3080	Anchor... 856
			Switches... 704, 705	2714, 2715	Connectors... 618	3080 to 3083	Conduit... 999
			Floodlights... 1184	2717, 2720	Elle... 241	3080-9	Boxes... 309
			Drawer Cases 779	2721	Boxes... 285	3082, 3086	Connectors... 466
			Boxes... 298	2721 to 2766	Lights... 814	3083	Lt. Fixtures... 1061
			Receptacles... 616	2722 to 2735	Splices... 988	3088, 3089	Lt. Fixtures... 1061
			Lights... 1185	2724	Covers... 383	3088R	Rings... 1061
			Switches... 694	2725, 2730	Sw. Cont.	3089E	Connectors... 466
			Parts Cases... 779	2731	Mech... 1415	3090 to 3093	Conduit... 999
			Switches... 704	2730, 2755	3100	3100	Anchor... 856
			Floodlights... 1184	2761	3100	3100	Mounts... 1416
			Boxes... 285	2769	3100	3100	Stations... 1536
			Boxes... 316	2770 to 2776	3100	3100	Tapes... 719
			Downlights 1164	2777, 2779	3100, 3101	3100, 3101	Back Plates... 290
			Lanterns... 1221	2780 to 2788	3100, 3101	3100, 3101	Connectors... 272
			Covers... 280	2781 to 2789	3100, 3101	3100, 3101	Track... 499
			Caps... 618	2790	3106 to 3148W	3100 to 3106	Conduit... 999
			Ext. Rings... 285	2790	3108	3101A	Couplings... 463
			Caps... 618	2790, 2793	3102 to 3114W	3102 to 3114W	Receptacles... 373
			Boxes... 285	2792	3103	3103	Boxes... 498
			Outlets... 1188	2794	3105, 3106	3105, 3107	Signs... 1165
			Lights... 1184	2794	3105, 3107	3106 to 3148W	Stands... 780
			Floodlights 1184	2794	3106 to 3148W	3108	Plugs... 373
			Ceiling Ltg... 1092	2794	3110 to 3122	3110, 3111	Boxes... 498
					3115	3115	Connectors... 271
							Fuseholders... 543

Cat. No.	Page	Cat. No.	Page	Cat. No.	Page	Cat. No.	Page
3115, 3116	Signs... 1165	3520-A	Lights... 1188	3943 to 3959-P	Brackets... 1036	4001 to 4404	Switches... 692
3118 to 3120-SCP	Irons... 752	3525 to 3527	Wire... 136	3951 to 3954-L	Switches... 686	4402	Saw Sheaths... 807
3118-A to 3138-A	Casings... 752	3530, 3540	Holders... 1188	3971 to 3974	Switches... 691	4411 to 4416N5	Switches... 441
3120	Anchors... 856	3540	Mica Plates... 871	3989 to 3995	Hooks... 811	4412, 4412A	Lamps... 1210
3120 to 3126	Conduit... 999	3540, 3555, 3555A	Reflectors... 1161	3996 to 3998	Lampholders... 656	4413	Outlets... 647
3123	Gaskets... 1062	3555, 3555A	Reels... 815	4000	Guards... 609	4416 to 4421	Anchors... 856
3124, 3125	Lt. Fixtures... 1062	3557 to 3559	Sockets... 669	4000, 4003	Lampholders... 655	4418 to 4472	Troughs... 499
3125, 3126	Signs... 1165	3600, 3601	Boxes... 781	4000 to 4091	Conduit... 1000	4420	Pins... 943
3125, 3127	Stands... 780	3600 to 3603	Conduit... 1000	4000F, 4000S	Electric	4420 to 4424-PL	Lampholders... 665
3128, 3128A	Irons... 753	3600 to 3603	Tapes... 748		Centers... 602	4421 to 4423	Switches... 705
3130 to 3142	Connectors... 271	3610, 3611	Boxes... 781	4001	Reels... 174	4421 to 4426N5	Switches... 441
3131, 3132	Lt. Fixtures... 1062	3615 to 3617	Balls... 748	4001 to 4221	Cords... 168	44301 to 4439VII	Sealing
3135, 3136	Signs... 1165	3620, 3621	Boxes... 781	4001-23 to 4030-6	Cords... 168	Fittings... 316	Switches... 692
3136	Pins... 945	3620 to 3623	Conduit... 1000	4003	Receptacles... 664	4431 to 4453	Lamps... 1210
3136, 3137	Sockets... 662	3623RS, 3648RS	Lt. Fixtures... 1104	4003 to 4005	Sockets... 668	4435	Switches... 692
3138, 3138A	Irons... 753	3629 to 3630B	Starters... 447	4004 to 4006	Hooks... 810	4442 to 4444	Lt. Fixtures... 1050
3140 to 3143	Conduit... 999	3632, 3633	Boxes... 781	4005D.C. to 4006S.C.	Sockets... 671	4443-RS, 4447-RS	Receptacles... 366
3144	Brackets... 946	3639 to 3640B	Starters... 447	4006	Shells... 657	4450 to 4465	Plugs... 366
3146, 3146-A	Wrenches... 796	3640 to 3643	Conduit... 1000	4010D.C., 4010S.C.	Receptacles... 672	4466, 4467	Brackets... 950
3150 to 3153	Conduit... 999	3649 to 3650B	Starters... 447	4011, 4012	Lampholders... 667	4471-SER to 4493-RS	Lt. Fixtures... 1050
3151, 3151-A	Floodlights... 1184	3649 to 3659	Conduit... 1000	4012 to 4015A	Lamps... 1210	4473, 4474	Brackets... 939
3155	Track... 499	3650 to 3662	Grounding	4012D.C., 4012S.C.	Sockets... 672	4482 to 4486	Switches... 442
3158	Irons... 753	3668	Wedges... 257	4013	Lampholders... 654	4491 to 4495	Starters... 447
3160	Holders... 1188	3680 to 3693	Cradles... 812	4015, 4016	Sockets... 668	4500A to 4501W	Lt. Fixtures... 1113
3160	Lights... 1188	3693, 3694	Conduit... 1000	4016	Shells... 657	4501 to 4518	Lt. Fixtures... 1063
3160	Toters... 780	3698-7 to 3698A-9	Luminaires... 1147	4026-2	Lampholders... 667	4519 to 4519.1	Locknuts... 929
3162 to 3196	Pins... 945	3700 to 3703	Bars & Handles... 810	4033 to 4039	Tips... 750	4520 to 4544	Lamps... 1210
3171 to 3193-H	Switches... 1414	3700 to 3711	Conduit... 1000	4035	Htg. Units... 750	4521 to 4525	Switches... 680
3178	Irons... 753	3700 to 3715	Bar, Pipe, Rod Racks... 781	4036A, 4036A3	Generators... 1300	4526 to 4528	Lt. Fixtures... 1063
3180	Holders... 1188	3700 to 3718	Boxes... 326	4040-61, 4040-602	Boxes... 310	4529	Sw. & Outlets... 680
3180	Lights... 1188	3700 to 3718	Washers... 234	4041, 4042-12	Covers... 310	4530 to 4534-1	Locknuts... 929
3190 to 3194	Te-Taps... 668	3700 to 3718	Plates... 1038	4043	Rings... 310	4535	Lamps... 1210
3198	Irons... 753	3700 to 3718	Switches... 442	4046, 4046-2	Lampholders... 667	4538 to 4542	Washers... 929
3200, 3201	Track... 499	3705 to 3709F2	Receptacles... 383	4049, 4049-1	Covers... 310	4543	Outlets... 649
3202, 3202'	Boxes... 290	3710 to 3718	Lt. Fixtures... 1148	4060-3, 4060-302	Lampholders... 667	4544 to 4558SLG	Lt. Fixtures... 1063
3202 to 3244W	Plugs & Cable Conn... 373	3710 to 3760B	Plugs... 375	4062	Bodies... 660	4559 to 4572	Hand Lamps... 1063
3203	Boxes... 498	3714	Brackets... 1038	4063	Lampholders... 654	4585, 4587	Shades... 1063
3206 to 3248W	Boxes... 498	3718, 3720	Tips... 753	4073	Receptacles... 664	4586	Lt. Fixtures... 1063
3208	Fuseholders... 543	3719 to 3735	Boxes... 326	4100, 4101	Lampholders... 666	4593 to 4599	Lt. Fixtures... 1063
3215	Caps... 638	3720 to 3723	Conduit... 1000	4100, 4104	Lampholders... 653	4610, 4613	Bodies... 661
3221, 3222	Boxes... 481	3724, 3728	Lt. Fixtures... 1104	4100, 4104	Receptacles... 664	4620A to 4623R	Pilot Lights... 440
3222	Lights... 1188	3724 to 3766	Covers... 383	4100 to 4103	Switches... 1347	4621 to 4624-L	Switches... 690
3222-LH	Holders... 481	3725 to 3729F2	Switches... 442	4100 to 4104-PL	Sockets... 665	4621-SER, 4625-SER	Lt. Fixtures... 1050
3223	Bodies... 638	3728	Brackets... 1038	4109	Lampholders... 655	4621RS, 4618RS	Lt. Fixtures... 1104
3230	Wire... 136	3728, 3728-S	Tips... 753	4109	Receptacles... 664	4632, 4652	Anchors... 856
3235	Reflectors... 1161	3738, 3738-S	Lampholders... 660	4110, 4112	Aligners... 316	4661, 4663	Switches... 673
3238, 3239	Outlets... 1188	3740	Conduit... 1000	4112 to 4118	Receptacles... 657	4665	Transformers... 1528
3240 to 3250	Wire... 136	3740 to 3753	Stations... 446	4114, 4118	Lampholders... 666	4666, 4667	Lampholders... 673
3242	Boxes... 481	3741 to 3759	Receptacles... 375	4120 to 4124-PL	Sockets... 665	4668	Rosettes... 673
3242 to 3255-S	Lights... 1188	3742 to 3774	Outlets... 650	4123	Bodies... 660	4669	Boxes... 673
3242-LH	Holders... 481	3750, 3751	Bushings... 1039	4128-OB to 4132-OB	Pendants... 1050	4670, 4672	Outlets... 673
3246	Boxes... 1188	3751	Tips... 753	4135	Outlet Boxes... 1050	4675, 4675-R	Guards... 609
3247	Shp Fitters... 1188	3758	Bodies... 653	4146, 4147	Lampholders... 655	4676 to 4704-L	Switches... 691
3248	Nipples... 1188	3770, 3773	Covers... 382	4159 to 4181	Lampholders... 660	4724	Pins... 943
3250	Plugs... 1188	3770 to 3776	Tips... 753	4160, 4161	Pipe Straps... 248	4724, 4734	Covers... 383
3255	Track... 499	3778	Outlets... 647	4161	Lampholders... 660	4725, 4730	Plates... 1038
3262 to 3271	Lights... 1188	3780, 3781	Boxes... 326	4162 to 4188	Splices... 988	4731	Outlets... 649
3271	Holders... 1188	3781, 3782	Outlets... 649	4170S-1	Bolts... 932	4732, 4736	Plates... 1038
3276	Lights... 1060	3795	Tips... 753	4172S-1	Boxes... 124	4741	Splices... 988
3279 to 3292	End Fittings... 1039	3798	Floodlights... 1183	4185	Nuts... 942	4752, 4755	Plates... 1039
3280 to 3294	Lights... 1188	3800 to 3809	Bins... 782	4185, 4186	Benders... 740	4770 to 4776	Covers... 382
3281	Holders... 1188	3800 to 3830	Stations... 446	4193 to 4196	Lampholders... 668	4780, 4782	Outlets... 647
3291, 3294	Holders... 1188	3801 to 3817	Switches... 442	4195 to 4197	Switches... 1347	4781	Switches... 706
3300	Cloths... 868	3802 to 3806F2	Gr. Bushings... 264	4200, 4201	Boxes... 316	4800 to 4890	Conduit... 1000
3300-3	End Caps... 1105	3802 to 3811	Rings... 655	4200, 4201	Covers... 316	4801 to 4804-L	Switches... 690
3301	Connectors... 270	3803 to 3805	Switches... 442	4201BC to 4205BC	Dies... 976	4803	Switches... 1348
3301 to 3304	Connectors... 272	3812 to 3816F2	Floodlights... 1183	4201BCC to 4202FBCC	Floodlights... 1182	4803, 4804	Connectors... 366
3302 to 3305	Receptacles... 374	3817 to 3829	Plugs... 375	4207 to 4211	Pins... 943	4812	Outlets... 647
3302 to 3344	End Fittings... 1039	3818 to 3830B	Outlets... 640	4210-P to 4221-P	Lampholders... 656	4831 to 4832-1	Outlets... 647
3303	Boxes... 290	3823	Gr. Clamps... 262	4220 to 4222	Elbows... 242	4832	Outlets... 647
3304	Plugs... 374	3826 to 3826-WG	Straps... 640	4229	Receptacles... 366	4833	Louvers... 1040
3306 to 3348	Wire... 133	3827	Cord Sets... 640	4230 to 4295	Enclosures... 442	4834	Shields... 1040
3310 to 3312	Hangers... 1085	3829 to 3830-C	Switches... 442	4233BC to 4264BC	Switches... 442	4836, 4856	Anchors... 856
3312-A to 3328-A	Wire... 133	3832 to 3836F2	Connectors... 640	4235-1, 4235-2	Outlets... 640	4886 to 4896	Braces... 931
3320, 3322	Caps... 638	3833	Stations... 446	4235DP to 4235TW	Stations... 446	4891	Plugs... 619
3321	Bodies... 638	3836 to 3836-WG	Gr. Clamps... 265	4236	Gr. Clamps... 265	4900 to 4960	Conduit... 1000
3323	Troffers... 1105	3837	Lampholders... 660	4237BC, 4238BC	Lampholders... 660	4901 to 4903-L	Switches... 690
3324RS-X to 3568RS	Cable... 136	3840 to 3843	Receptacles... 644	4240C to 4243	Lt. Fixtures... 1105	4908 to 4924	Lt. Fixtures... 1065
3340, 3341	Wire... 136	3842	Outlets... 644	4241RS to 4281RS	Elbows... 234	4929A to 4944	Switches... 692
3342 to 3345-S	Lights... 1188	3845	Jewels... 679	4250 to 4255	Lampholders... 660	4961 to 4967	Meters... 1498
3350-NP to 3364WSH1	Floodlights... 1183	3846	Receptacles... 679	4267BC, 4268BC	Plugs... 366	4967	Lt. Fixtures... 1065
3355, 3366	Aligners... 1058	3847	Outlets... 640	4270	Couplings... 231	4983, 4984	Lt. Fixtures... 1065
3355 to 3357	Brackets... 953	3850	Reflectors... 1161	4271	Connectors... 231	4999 to 5003	Strandlinks... 987
3372-101, 3372-102	Barricades... 813	3851 to 3856	Switches... 442	4273 to 4278	Lampholders... 654	5000	Sockets... 671
3381 to 3388	End Fittings... 1039	3852	Connectors... 621	4296, 4299	Wireholders... 949	5000 to 5000-SR	Guards... 610
3400 to 3403	Conduit... 999	3852 to 3879	Stations... 446	4298D to 4298S31	Starters... 448	5000 to 5004	Lt. Fixtures... 1066
3400-3	End Caps... 1105	3882	Gr. Bushings... 264	4300 to 4304-PL	Lampholders... 665	5000-C to 5000-SRC1	Guards... 611
3402, 3404	Boxes... 290	3885 to 3885F2	Outlets... 649	4300 to 4307-W	Lampholders... 1125	5001 to 5005	Saddles... 944
3402 to 3444	Plugs & Connectors... 374	3886 to 3891	Switches... 692	4300D1 to 4300T4	Switches... 441	5001-1HS, 5001-VS	Elements... 1161
3406 to 3448	Connectors... 374	3891 to 3893-W	Lampholders... 652	4303 to 4330	Lampholders... 1126	5002, 5002D	Cases... 551
3415	Fuseholders... 543	3893	Boxes... 781	4309	Fuses... 537	5005	Signals... 1240
3420	Torches... 797	3894	Conduit... 1000	4310 to 4315	Sockets... 1125	5006 to 5008	Testers... 551
3420 to 3426	Conduit... 999	3894	Starters... 447	4310 to 4315	Bodies... 653	5010	Sockets... 671
3421	Caps... 638	3901, 3907	Outlets... 649	4314, 4320	Anchors... 856	5010-C-2	Jacks... 841
3423	Bodies... 638	3902 to 3924	Plates... 1038	4320 to 4322	Pins... 943	5011 to 5015	Hooks... 826
3424	Boxes... 481	3908 to 3921	Connectors & Plugs... 375	4320 to 4324-PL	Lampholders... 665	5013	Hooks... 826
3424-LH	Holders... 481	3911 to 3914	Receptacles... 375	4326, 4327	Outlets... 621	5015	Outlets... 650
3425-A	Clamps... 1085	3912 to 3934	Switches... 692	4328, 4328-E	Lampholders... 1126	5018 to 5018A43	Generators... 1300
3440 to 3453	Conduit... 999	3916	Connectors... 621	4330, 4330-W	Lampholders... 1125	5020	Boxes... 310
3464	Receptacles... 664	3926	Stations... 446	4331 to 4346	Switches... 704	5021, 5023	Blocks... 822
3480, 3481	Lights... 1188	3929, 3930	Gr. Bushings... 264	4345	Anchors... 916	5022	Blocks... 822
3487	Luminaires... 1147	3930	Outlets... 649	4350D1 to 4350T4	Switches... 441	5022-P	Strandlinks... 987
3490 to 3496	Conduit... 999	3930, 3932	Switches... 693	4350-W to 4367-W	Lampholders... 1125	5024, 5	

Table with 4 columns: Cat. No., Page, Cat. No., Page. Lists various electrical and mechanical parts such as caps, boxes, supports, relays, and connectors with their corresponding page numbers.

Table with 4 columns: Cat. No., Page, Description, Page. Lists various electrical components like adapters, switches, lights, and tools with their corresponding catalog numbers and page references.

Cat. No.	Page	Cat. No.	Page	Cat. No.	Page	Cat. No.	Page
76026	961	83248RS to 83396	1044	96266-8 to 96469-8	1079	2860351G1 to	
76026	966	83636	963	96355 to 99351R0	511	2860351G3	Boards..... 1389
76200 to 76300Y	525	83831, 83832	966	96922 to 96923-16	1040	2881146G2 to	
76510 to 76528	874	83832	963			2881146G5	Pots..... 758
77520	871	83834, 83835	963	97011 to 97141	676	2981434G13	Brackets..... 1430, 1431
77851 to 77869	871	84247 to 84258	512	97071 to 97543	684		
78017 to 78927Y	522	84323	966	97200-8 to 97495-8	1082	3887186G2	Pots..... 758
78017 to 78927Y	525	84347 to 84448	512	97256-8	1080	4126220	Oil..... 1455
78050 to 78056	870	85465	965	98011 to 98043	676	4130598	Adapters..... 1455
78420	965	86248RS to 87496	1123	98071 to 98643	684	4131823	Wrenches..... 1455
78500, 78501	964	86347, 86348	512	99011 to 99043	676	4133755G21	Pivots..... 1455
78600 to 78700Y	525	86534 to 86548	963	99071 to 99543	684	4133755G25	Balls..... 1455
78617 to 78727Y	523	86664 to 87206	961	107101	988	5213764G5	Plates..... 1430
78645	778	87509	965	146187	1436	5215202	Adapters..... 1445
78721, 78728	961, 963	87603	965	161206	546	5467845G1	Elements..... 1473
	966	87650 to 87695	962	189048, 189049	1296	5469050G1 to	
78721, 78728	966	87780 to 87782	966	201606, 202006	546	5469050G3	Leak Stds... 1472
78732, 78845	966	87834 to 87848	963	206501	1296	5469660G1, 5469660G2	Calibrators... 1472
79085	961, 963	88100 to 88135-1	914	207101, 207107	988	5469797G1	Detector Units..... 1473
	966	88248	512	217283	1296		
79085	966	88296RS-PG	1044	242006, 242408	546	6052371G1 to	
79600 to 79609	965	88500	964	250407	988	6159258G2	Switches.... 1405
79631, 79632	966	89650, 89651	962	278608, 278610	1290	6105700G1 to	
79688	965	90211 to 90351	511	296569	1290	6105700G54	Lamps..... 1388
80112 to 80117	1165	90211-8, 90311-8	1046	302006 to 302408	546	6119795G60 to	
80141 to 80175	1162	90922TD, 90922TP	866	307107, 307207	988	6119795G62	Switches.... 1383
80160 to 80166	1165	91011 to 91041	685	362406 to 363008	546	6129533G1, 6129533G2	Test Plugs... 1386
80209	963	91071 to 91181	684	400142	765	6353652G1 to 6353652G4	Boards..... 1389
80211-8, 80311-8	1046	91248 to 92496	1123	407107 to 407307	988	6422120G1 to	
80425	964	91252-8	1046	422408 to 423608	546	6422120G4	Test Blocks... 1386
80435 to 80641	963	91351 to 91356	511	482408 to 483608	546	6422482G4 to	
80500	964	91512 to 92572	685	525691 to 525696	541	6422494G112	Boards..... 1389
81000, 81005	964	92071 to 92181	684	544208	546	6808345AA P2 to	
81252-8	1046	92245 to 92456F	514	601375-2	765	6851775P22	Tips..... 751
81460	957	93011 to 93251	511	603608 to 606012	546	8906955	Adapter Tools..... 1455
81500	964	94071 to 94073	683	700025, 700151	765		
82000 to 82313	1414	94071 to 94572	681	700312	764	8941377	Cases..... 1470
82250 to 82252	956	94101, 94102	684	726010, 726012	546	8947991G3, 8947991G4	Instruments... 1473
82252 to 82454F	514	94512 to 94543	684	997217 to 997327	559		
82336	956	94631	679	224498G2	1340	9159506G4, 9159532G7	Instruments... 1473
82825	964	96002 to 96052-16	1040	2246093G1	1340		
82860	957			2246094G1	1340	9218955G1 to	
82865, 82891	966	96071 to 96572	681	2246900G1	1340	9218955G3	Blades..... 1447
82891 to 82896	961	96122 to 96123-16	1040	2666404G1 to	758	9532854G3, 9532854G4	Brackets.... 1430
83002	965			2666407G2		9817171P22	Tips..... 751
83044 to 83126	961						

ALPHABETICAL INDEX

A	Page
Absorbers, Shock, Lighting	
Fixture, Thompson	1077
A-C Brakes, G-E	1334
A-C Switchboards, Metal-	
Enclosed, G-E	1380
Accent Lights—	
Amplex	1155
Day-Brite	1165
Litecraft	1138
Moe	1139, 1141, 1142
Accessories—	
Anchor, Chance	914
Baseboard Heating Unit,	
Wesix	1216
Border Light, Stage, Hub	1170
Cable Wiring Support Tray,	
Globe	166
Chain Hoist, Coffing	837
Circuit Breaker—	
Bulldog Pushmatic	601, 606
G-E	531, 592
Square D	550
Air, G-E	1382
Indoor Power, G-E	1400
Flexible Metallic Conduit,	
Appleton	222
Floodlight—	
Crouse-Hinds	1173-1177
Wide-Lite	1190
Hand Lamp, Crouse-Hinds,	
Type VS	414
Lighting Fixture—	
Fluorescent—	
Appleton, Type EFU	340
Crouse-Hinds, Type	
EVF	408
Garcy	1111, 1113
Incandescent—	
Appleton—	
Series AA51	335
Series V51	337
Crouse-Hinds—	
Series V and VH	413
Series VM	416
Wheeler	1060
Lighting Fixture Hanger—	
Crouse-Hinds, Type EFHC	417
Kindorf	255
Linemen's Belt, Klein	798
Luminaire, Wakefield	1086-1088
Mercury Lamp Ballast,	
Outdoor Lighting, Jefferson	1022
Microphone, Altec	
Lansing	1528, 1529
Oil Fuse Cutout, G-E	1447
Photoelectric Relay,	
G-A	1349, 1350
Pipe Hanger, Appleton	252
Pole Band, Adjustable,	
Hubbard	933
Pressure Testing, General	
Machine	881
Remote Control Switch	
System, Touch-Plate	702
Soldering Gun, WEN	757
Telephone, Crouse-	
Hinds	1520, 1523
Telephone Terminal,	
Stromberg-Carlson	1526
Troffer Installing, Curtis	1108
Tubing Support Tray, Globe	166
Water Cooler, Cordley	1271
Wiring, Alcoa	155-157
Acetate Cloth Tape, Permacel	181
Acetate Fibre Tape, Permacel	181
Acetate Film Tape,	
Permacel	181, 182, 184
Acid Core Solder—	
Dunton	186
Kester	186
Adaptabels, Signal Bells,	
Edwards	1238

A	Page
Adaptahorns, Signal Horns,	
Edwards	1238
Adapter-Guard Assemblies,	
Lighting Fixture, Crouse-	
Hinds, Series VM	416
Adapter Plates, Junction Box,	
R&S	316
Adapter Sockets, Angle,	
Adjustable, Hubbell	669
Adapters—	
Attachment Plug, Combina-	
tion, Hubbell	631
Bit Brace, Greenlee	710
Conduit, Fibre, Orangeburg	1004
Condulet, Crouse-Hinds—	
Oround Series	383
Series YYP	379
Grounding, Outlet—	
Bryant	623
Hubbell	629
Junction Condulet, Crouse-	
Hinds, Series GUA	
and GUF	399
Knockout, T&B	234
Lamp Socket, All Types	670
Lampholder, P&S	669
Levolier Switch, McGill	696
Lighting Fixture, Crouse-	
Hinds, Series VM	416
Panelboard, Connector Barrel,	
Electrical, Pyle-National	365
Plug, Appleton, Series AE	351
Receptacle, Appleton,	
Series AE	351
Screw-Base—	
Bryant	669
Hubbell	634, 669
Socket, Bryant	669
Unilet, Unilet to EMT,	
Appleton	230
Unilet Body, Appleton,	
Series GS	326
Volt-Ammeter, Plug-In,	
Weston	1490
Adjustable-Arm Lights—	
Dazor	1074
White	1073
Woodward	1072
Adjustable-Arm Magnifiers,	
Dazor	1076
Adjustable Lights, Amplex	1155
Adjustable Wrenches—	
Klein	793
Nye	728
Utica	793
Aerial and Duct Cable—	
Telephone—	
Anaconda	48, 49
Plastic W&C	146
Whitney Blake	134
Aerial Cable, Telephone, Self-	
Supporting, Anaconda	49
Aerial Cable and Wire	
Tensioning Jacks, Simples	827
Aerial Cable Guides—	
B&L	827
General Machine	827
Aerial Cable Guides and	
Straighteners, B&L	826
Aerial Cable Rollers, B&L	827
Aerial Cable Straighteners,	
General Machine	827
Aerial Cable Supports,	
Diamond	936
Aerial Hand Lines, B&L	824
Aerial Tents, General Machine	831
Air Circuit Breaker	
Accessories, G-E	1382
Air Circuit Breakers—	
I-T-E	527, 528
Switchgear and Industrial	
Applications, G-E	1381, 1382

A	Page
Air-Circulating Fan Brackets,	
Fresh'nd-Aire	1212
Air-Circulating Fans,	
Fresh'nd-Aire	1212
Air-Conditioning Temperature	
Controls, Mercoid	1270
Air-Conditioning Unit	
Transformers, Nutone	1251
Air Hammers, Star and	
Chipping, Portable, Thor	777
Aircraft Fuses, Buss	538
Aircraft Marker Lamps, G-E	1208
Aircraft Wire, General Cable	74
Airport Lighting Cable,	
Anaconda	21
Airport Lighting Equipment,	
Crouse-Hinds	1192-1194
Aisle Chair Lights, Hub	1160
Aisle Lights—	
Louvered, Moe	1145
Stock Bin and Book Stack,	
Multi	1062
Aisle Markers, Brady	178
Alarm and Coding Horns—	
Faraday	1235
Federal	1233, 1234
Alarm Bells, Edwards	1252
Alarm Box Grounders, Hubbard	924
Alarm Systems—	
Manufacturing and	
Processing—	
Crouse-Hinds	
"Visularm"	1263, 1264
R&S "Unilarms"	1262
Alarm Type Fuses, Indicator,	
Cook	1511
Aligners—	
Ball, Junction Box,	
Waterproof, R&S	316
Canopy, Benjamin	1058
Fixture, Box Cover Mounted,	
Benjamin	1054
All-Purpose Cable, Anaconda	25-27
All-Purpose Saw Blades,	
Capewell	715
Alley-Arm Braces, Hubbard	930
Aluminum Alloy Street	
Lighting Standards,	
Hapco	1025, 1026
Aluminum Solder, Bar, Allen	186
Aluminum Tags, Embossed,	
Standard	894
Aluminum Testers, Anodized,	
Sunshine	1499
Ammeter Tongs, Insulated,	
Chance	891
Ammeters—	
Battery, Pocket, Sterling	1226
Clamp-On Type, Weston	1489, 1490
Indicating, Portable, A-C and	
D-C, G-E	1466-1469
Laboratory, Portable,	
Simpson	1490
Panel—	
A-C and D-C—	
G-E	1465, 1466
Simpson	1491
Weston	1481-1484
D-C, Simpson	1492
Portable, A-C and D-C,	
Weston	1476-1480
Recording—	
Portable, A-C and D-C,	
G-E	1463, 1464
Switchboard, A-C, G-E	1463
Switchboard, A-C and D-C—	
G-E	1461, 1462
Weston	1474, 1475
Amplifier Console Mounting	
Assemblies, Altec Lansing	1535
Amplifier Consoles, Altec	
Lansing	1534, 1535

A	Page	A	Page	A	Page
Amplifier Mounting Assemblies, Altec Lansing	1533	Appliance and Stove Lead Wire, General Cable.....	66	Arresters—	
Amplifier Power Supply, Altec Lansing	1533	Appliance Lamps, G-E.....	1207	Rural, G-E	1433
Amplifiers—		Appliance Lead Wire, Phelps Dodge	7	Station Type—	
Compressor, Altec Lansing.....	1531	Appliance Plugs, Bryant.....	616	Thorex Dynagap, Ohio Brass	1434
General Purpose, Altec Lansing	1532	Appliance Replacement Cords, Seeger-Williams	615	Thyrite, G-E	1429-1431, 1438
Limiters, Altec Lansing.....	1531	Appliance Switches, Toggle, Hubbell	697	Rare Gas, Brach.....	1508
Line, Altec Lansing.....	1533	Appliance Wire—		Arresters and Protectors, Indoor, Telephone Service, Reliable	1513
Monitor, Altec Lansing.....	1532	Anaconda	39	Asbestos-Varnished Cambric Insulated Power Cable—	
Sound, Altec Lansing.....	1530-1533	Gavitt	149	General Cable	69-73
Amplifiers and Control Preamplifiers, Altec Lansing	1532	General Cable	75	Triangle	100
Analog Field Plotters, Sunshine	1499	Plastic W&C	143	Asphalt Paint, Rapid-Drying, Ruberoid	866
Analizers, Power, Industrial Loads, Weston	1486	Appliance Wiring Materials, General Cable	75	Asphalt Paint Thinners, Ruberoid	866
Anchor Accessories, Chance.....	914	Arbors and Pilot Drills, Hole Saw, Capewell	716	Assemblies—	
Anchor and Pole Diggers, Adams	893	Arc Lamp Cable, General Cable	66	Adapter-Guard, Lighting Fixture, Crouse-Hinds, Series VM	416
Anchor Clips, Kindorf.....	254	Arc Welding Cable—		Altec Lansing	1535
Anchor End Caps, Kindorf.....	253	Anaconda	37	Clevis, Insulated, Ohio Brass..	956
Anchor Hole Augers, Chance.....	914	Phelps Dodge	9	Disconnecting and Lowering Hanger Suspension, Thompson	1076
Anchor Hooks, Tackle, Klein.....	825	Architectural Lighting Equipment, Century	1167, 1168	Harness and Cable, Special, Gavitt	150
Anchor Installing Bars, Chance	915	Area Lighting Fixtures, Fluorescent, Crouse- Hinds	1178, 1179	Mounting, Amplifier, Altec Lansing	1533
Anchor Logs, Creosoted Pine....	900	Area Lights—		Oil Fuse Cutout, G-E.....	1447
Anchor Rods—		Reverse	1188	Panel-Base, G-E.....	592
Hubeye, Hubbard	918	Wide-Lite	1190	Splicing, Insulated, Reliable....	989
Oval Eye, Hubbard.....	918	Area/Liter Lighting Fixtures, Fluorescent, All-Brite.....	1122	Attachment Plug Adapters, Combination, Hubbell	631
Anchor Shackles, Ohio Brass....	965	Armor Cutters, BX, Ideal.....	741	Screw Base,	
Anchors—		Armor Rod Clamps, Alcoa.....	977	Attachment Plug Bodies, Screw Base,	
Guy—		Armor Rod Clips, Alcoa.....	977	Bryant	620
Chance	914, 915, 917	Armor Rod Tie Wire, Alcoa.....	977	Hubbell	628
Everstick	915, 917	Armor Rods—		P & S	639
Hubbard	916, 917	Preformed—		Attachment Plug Caps—	
Hammer Drive, Diamond.....	856	Alcoa	975	Bryant	618, 620, 621
Hollow Wall, Diamond "Wing Ding"	855	Crapo	971	Carling	700
Lag Screw, Rawlplug.....	853	Straight, Alcoa	978	Hubbell	619, 627, 628, 631, 638
Machine Bolt, Rawl Hammer- Sets	855	Tapered, Aloe	976	P & S	639
Machine Screw—		Armor Wire, Flat, Alcoa.....	977, 978	P&S Despard, Interchangeable	675
Diamond	856	Armored Bushed Cable, National	124, 125	Attachment Plug Receptacles, Condulet, Crouse-Hinds, Obround Series	383
Rawl Calk-Ins	855	Armored Bushed Cable Fittings, National	124	Attachment Plug Receptacles and Housings, Condulet, Crouse-Hinds, Series FD and FS	388
Screw, Lead, Rawl.....	857	Armored Cable—		Attachment Plugs—	
Wood Screw—		Anaconda	33	Swivel, Benjamin	670
Diamond	853	Phelps Dodge	8, 9	Weatherproof—	
Rawlplug	853	Triangle	93, 94, 98-100	Bryant	670
Annunciator Components and Indicating Lamps, Kirkland	1259, 1260	Armored Cable Fittings, T&B....	271	Union	670
Annunciator Drops, Edwards....	1242	Armored Conductor Clamps, Appleton	249	Woodhead	671
Annunciator Wire, Anaconda....	39	Armored Leaded Cable, National	125	Attachments—	
Annunciators—		Arms—		Corner Drill, Electric Drill, R.C.S.	769
Desk-Type, Edwards	1241	Auxiliary, Dual, Chance.....	884	Dust Collector, Grinder, Ideal	765
Industrial Plant, Kirkland.....	1261	Cable Extension, Hubbard.....	934	Fixture Hanger Suspension, Crouse-Hinds, Series AL.....	418
Power Plant, Kirkland.....	1261	Cross, Temporary—		Guy Arm, Hubbard	922
Return-Call, Edwards.....	1240	Chance	888	Periscope, Potential Detector, Minerallac	1500
Surface, Edwards	1241	Coffing	887	Pipe Bender, Tal.....	738
Annunciettes—		Extension, Levolver Switch, McGill	696	Pressure Switch, G-E.....	1340
Flush, Edwards	1241	Guy, Sidewalk, Hubbard.....	922	Push Button Station, Square D	582
Surface, Edwards	1240	Arresters—		Saber Saw, Electric Drill, Thor	777
Anodized Aluminum Testers, Sunshine	1499	Crossarm, Telephone Service, Reliable	1513	Sheet-Metal Cutting, Kett.....	76
Antenna Wire, Loop, Anaconda	39	Lighting—		Soldering Tool, Ideal	755, 756
Anti-Short Bushings, Armored Cable, National	125	Autogap, Hubbard	1435	Strain Insulator, Hubbard.....	947
Apparatus—		Distribution—			
Resistance-Measuring, Double-Bridges, G-E.....	1472	Pellet-Type, G-E	1432		
Apparatus Cable—		Thorex Dynagap, Ohio Brass	1434		
General Cable	67	Intermediate, Thorex Dynagap, Ohio Brass.....	1434		
National	117, 119	Line-Type, Thyrite, G-E	1429, 1430		
Apparatus Lead Cable, General Cable	68	Low-Voltage, Pellet-Type, G-E	1436		
Appliance and Fixture Mounting Outlets, Screw- Ring, Bryant	649				
Appliance and Range Lead Wire, General Cable.....	66, 67				

A	Page
Attachments—	
Super-Saw, Electric Drill, R.C.S.	768
Traffic Signal and Sign Mounting, Crouse-Hinds	1016
Vacuum Cleaner, Ideal.....	763
Vacuum Switch, G-E.....	1340
Audio Speaker Cable, Plastic	
W&C	144
Audio Wire, Plastic W&C.....	144
Auger Bits—	
Bit Brace, Greenlee.....	711
Joist Boring, Kett.....	708
Auger Handles, Everstick.....	916
Augers, Anchor Hole, Chance.....	914
Automatic Door Switches,	
Bryant	704
Automatic Gun Tackers,	
Arrow	715
Automobile Fuses, Buss.....	539
Automotive Service Lamps,	
G-E	1210
Autotransformers, Light and	
Power, General Purpose, G-E	1358, 1364
Voltage Boosting and Grounding Circuit Type, G-E	1364
Auxiliary-Arm Tool Sets And	
Components, Hot Line, Chance	883
Auxiliary Arms, Dual, Chance.....	884
Auxiliary Emergency Lights,	
Exide	1222
Auxiliary Light Mounting	
Brackets, Exide	1222
Auxiliary Relays, Power and	
Light Control Switchboard, G-E	1390
Aviation Lamps, G-E.....	1208
Aviation Lighting Equipment,	
Crouse-Hinds	1192, 1194
Awls, Scratch, Greenlee.....	710

B	
Bags—	
Glove, Linemens', Salisbury....	877
Line Hose, Salisbury.....	877
Sleeve, Linemens', Salisbury..	877
Tool—	
Electrical Inspectors', Klein	796
Tool Raising, Salisbury.....	797
Balancers, Safety, Tool	
Suspension, Thor	772
Balconies, Pole, Linemens',	
Hubbard	967
Ball Aligners, Junction Box,	
Waterproof, R&S	316
Ball Bearings, Watthour	
Meter, G-E	1455
Ball Clevises, Ohio Brass.....	965
Ball Eyes, Ohio Brass.....	966
Ball Pein Hammers,	
Capewell	714, 715
Ball Socket Adjuster Heads,	
Universal Pole, Chance.....	891
Ballasts—	
Fluorescent Lamp—	
G-E	113, 1133
Jefferson	1134
Mercury Lamp, Jefferson	1022, 1023, 1135
Balls, Fish Tape, T&B.....	748
Band Saws, Electric, Portable,	
Porter-Cable	771
Bandages, Cable, Rubber,	
Salisbury	877
Bands—	
Pole, Hubbard	948
Pole Bracket, Street Lighting Hubbard	1036
Pole-Reinforcing, Hubbard.....	983

B	Page
Bar, Pipe and Rod Units, Shop,	
Steel, Lyon	781
Bar Solder, Kester.....	187
Bare Cable—	
Aluminum, General Cable.....	81-83
Aluminum-Steel (ACSR), Anaconda	47
Copper—	
Anaconda	45
General Cable	76, 78
Bare Conductors—	
Aluminum (ACSR), Alcoa....	160
Copper—	
Overhead—	
Anaconda	46
General Cable	79, 80
Transmission Line, Phelps Dodge	10
Copper-Alloy, General Cable..	81
Bare Wire—	
Aluminum, General Cable.....	81-83
Aluminum-Steel (ACSR) General Cable	81-83
Copper—	
Anaconda	45
General Cable	75-77
Barrel and Tank Inspection	
Lights, Justrite	1220
Barricades—	
Folding, Steel, Oshkosh.....	813
Public Utility, Neo-Flasher....	814
Bars—	
Bus, Copper, Rectangular, Phelps Dodge	12
Crow and Digging, Oshkosh..	809
Digging, Oshkosh	810
Expanding and Tamping, Chance	914
Guy Anchor Installing, Chance	915
Tamping—	
Everstick	915
Oshkosh	809, 810
Tamping and Digging, Oshkosh	810
Baseboard, Plugmold, Snapicoll	
Wiremold	457
Baseboard Fittings, Plugmold,	
Wiremold	457
Baseboard Heating Unit	
Accessories, Wesix	1216
Baseboard Heating Unit	
Controls, Wesix	1216
Baseboard Panel Heating	
Units, Wesix	1216
Bases—	
Connector, Bryant	620, 622, 623
Flush, Midget, Hubbell.....	633, 635
Fuse Cutout, Cartridge, Bryant	540, 541
Lampholder—	
Candelabra, Bryant	661
Metal Sign, Intermediate Base, Bryant	661
Miniature, Bryant	661
Light Pole, Hope.....	1185
Motor Plug, Hubbell.....	619, 626, 636
Motor Plug Connector, Hubbell	626, 635
Pole and Pedestal, Traffic Signal, Crouse-Hinds.....	1017
Plug Connector, Bryant.....	623
Surface, Hubbell	642
Warning Flag, Fairmount.....	813
Bases and Brackets, Floodlight,	
Crouse-Hinds	1175, 1176
Batch and Conveyor Ovens,	
Infrared, Triangle	1294
Bathroom Blower Fans, Nutone.....	1272
Bathroom Exhaust Fans,	
Nutone	1272

B	Page
Bathroom Heaters—	
Automatic, Fan-Type, Portable, Flush Wall and Bracket Types, Wesix.....	1214
Built-In, Wesix	1213, 1214
Bathroom Lighting Fixtures,	
Moe	1139, 1142, 1145
Batteries—	
Dry, Eveready	1223
Ignition—	
Eveready	1223
Ray-O-Vac	1224
Railroad and Industrial, Eveready	1223
Emergency Lighting,	
Eveready	1223
Exit and Searchlight,	
Eveready	1223
Flashlight—	
Eveready	1224
Ray-O-Vac	1224
Industrial—	
Air Cell, Eveready.....	1224
Dry, Eveready	1223
Lantern—	
Big Beam	1217
Eveready	1223
Ray-O-Vac	1224
Penlight—	
Eveready	1224
Ray-O-Vac	1225
Railroad, Air Cell, Eveready.....	1224
Storage—	
Power, Exide	1501-1503
Telephone, Exide	1501
Telephone—	
Air Cell, Eveready.....	1224
Dry, Eveready	1223
Warning Light, Neo-Flasher..	814
Battery Ammeters, Pocket	
Sterling	1226
Battery Cases, Warning Light,	
Neo-Flasher	814
Battery Charger Rectifiers—	
Telephone Industry, Raytheon	1505, 1506
Telephone Switch-Board Power Supply, Raytheon.....	1506
Battery Chargers,	
Farm and Home, G-E.....	1296
Fast, G-E	1296
General Purpose, G-E.....	1295, 1296
Heavy Duty, Walker.....	1296
Telephone Common Battery Exchanges, Schauer	1504
Trickle, Telephone Service, Small Storage Batteries, Schauer	1504
Battery Eliminators—	
Rectifiers—	
AM and FM 2-Way Radios, Schauer	1505
Constant Voltage, Schauer.....	1504
Lamp Signal and Automatic Switchboard, Schauer.....	1505
Marine Radios, Schauer	1505
Small Telephone Common Battery Systems, Schauer	1504
Battery Housings, Telephone,	
Crouse-Hinds	1520
Battery Switches—	
G-E	520
Trumbull	520
Battery Voltmeters, Pocket,	
Sterling	1226
Bayonet Saws, Electric,	
Portable, Porter-Cable	771
Bayonet Sockets—	
Candelabra, Morse	671, 672

B	Page
Bayonet Sockets—	
Double End, Morse.....	671
Miniature, Morse.....	671
Beacon and Hand Lamp	
Combination, Big Beam.....	1217
Beacon Light Flashers, Aviation,	
Crouse-Hinds.....	1193
Beacon-Ray Warning Lights,	
Federal.....	1233
Beacons—	
Flare, Flashing, Big Beam.....	1217
Flashing, w/o Motor	
Flashing Switch, Crouse-	
Hinds.....	1009
Fresnel, Airport Identification	
and Hazard Marking,	
Crouse-Hinds.....	1193
Rotating, Aviation,	
Crouse-Hinds.....	1194
Beacons and Warning Signs,	
Flashing, w/o Motor	
Flashing Switch,	
Crouse-Hinds.....	1009
Beam and Angle Clamps,	
Disconnecting and Lowering	
Hanger, Thompson.....	1078
Beam Clamps—	
Kindorf.....	254
Minerallac.....	251
Bearings, Ball, Watthour Meter,	
G-E.....	1455
Bearings and Components,	
Watthour Meter, G-E.....	1455
Bed Lights, Wall Type,	
Incandescent, Hub.....	1161
Bedroom Lighting Fixtures,	
Moe.....	1139-1141, 1145
Bell Ends, Conduit, Fibre,	
Orangeburg.....	1004
Bell Hangers' Drill Bits, Bit	
Brace, Greenlee.....	711
Bell Pushes, Interchangeable,	
P&S Despard.....	676
Bell-Ringing Transformers,	
Nutone.....	1251
Bell Signal, B/F, Crouse-	
Hinds, Type ESR.....	454
Bells—	
Alarm, Edwards.....	1252
Burglar Alarm, Edwards.....	1252
Fire Alarm System, Edwards.....	1238
Industrial, Federal.....	1233
Monitor—	
Edwards.....	1252
Faraday.....	1253
Signal—	
Fire Alarm System,	
Edwards.....	1238
Industrial, Federal.....	1233
Lungen, Edwards.....	1252
Bells and Buzzers—	
Door, Edwards.....	1252
Lungen, Edwards.....	1252
Bells and Chimes, Signal,	
Faraday.....	1246
Belts—	
Derrick, Klein.....	797
Steelworkers', Klein.....	797
Tool, Linemens', Klein.....	797, 798
Tree Trimmers', Klein.....	798
Waist, Linemens', Klein.....	798
Bench Legs, Shop, Steel, Lyon.....	780
Benches—	
Cabinet, Shop, Steel, Lyon.....	780
Work, Shop, Steel, Lyon.....	780
Benders—	
Bus-Bar, Hydraulic—	
Greenlee.....	736
Tal.....	737, 738
Cable, General Machine.....	846
Conduit—	
Hand—	

B	Page
Benders—	
Appleton.....	741
Greenlee.....	736
National.....	740
Republic.....	740
Steel City.....	740, 741
Tal.....	738
Hydraulic—	
Blackhawk.....	747
Greenlee.....	736, 737
Tal.....	737, 738
Pipe—	
Hand—	
Greenlee.....	736
Lidseen.....	739
Hydraulic—	
Blackhawk.....	747
Greenlee.....	736, 737
Tal.....	737, 738
Power, Hydraulic, Greenlee.....	736
Raceway, Wiremold.....	468
Tubing—	
Hand—	
Appleton.....	741
Greenlee.....	736
Republic.....	740
Steel City.....	741
T&B.....	740
Tal.....	737, 738
Hydraulic, Tal.....	737, 738
Bending Hickeys, Appleton.....	741
Bends—	
Cast Iron, Underground	
Conduit Construction,	
Fairmount.....	225
Conduit, Fibre, Orangeburg.....	1003
Bicycle Lamp Bulbs, G-E.....	1210
Bin Units, Shop, Steel, Lyon.....	782
Binders, Load, Coffing.....	836
Bit Brace Adapters, Greenlee.....	710
Bit Extensions—	
Bit Brace, Greenlee.....	710
Power Bit, Greenlee.....	710
Bits—	
Auger—	
Bit Brace, Greenlee.....	711
Joist Boring, Kett.....	708
Car, Bit Brace, Greenlee.....	711
Countersink, Bit Brace,	
Greenlee.....	711
Drill, Bell Hangers', Bit	
Brace, Greenlee.....	711
Drilling Machine, Truco.....	859
Electric-Drill, Greenlee.....	709, 769
Electricians' Power,	
Greenlee.....	712
Expansive, Greenlee.....	712
Pipe, Power, Greenlee.....	709, 712
Screw Driver—	
Greenlee.....	713
Ryan.....	713
Black-Light Lamps—	
G-E—	
Filament.....	1209
Fluorescent.....	1209
Mercury.....	1209
Blade Heads, Rotary, Universal	
Pole, Chance.....	891
Blades—	
Field Tooling Lathe, Fibre	
Conduit, Orangeburg.....	1004
Saw—	
All-Purpose, Capewell.....	715
Electric, Thor.....	777
Hack—	
Capewell.....	716
Wiremold.....	468
Sheet-Metal Cutting, Kett.....	768
Super, R.C.S.....	769
Blank Caps, Condulet, Crouse-	
Hinds, Type GUH.....	397

B	Page
Blank Covers—	
Condulet, Crouse-Hinds—	
FD and FS	
Series.....	386, 387, 391, 392
Form 8 Series.....	393
GRF Series.....	394
GS Series.....	396
Mogul Series.....	384
Obround Series.....	382
RSMP and RSP Series.....	403
SE and SEH Series.....	397
SK Series.....	394
Unilet, Appleton—	
FD and FS Series.....	331
GS Series.....	326
"35" Line.....	328, 329
Blank Inserts, Interchangeable,	
P&S Despard.....	676
Blank Plates—	
Condulet, Crouse-Hinds,	
Series YYP.....	379
Flush—	
Bryant.....	677, 683, 684
Hubbell.....	682
Blanket Canisters, Linemens',	
Salisbury.....	879
Blankets—	
Protector, Salisbury.....	878
Rubber, Slotted, Salisbury.....	878
Blankets and Jackets, Snap-	
Button, Salisbury.....	878
Blanks—	
Knockout, Snap-in—	
Appleton.....	240
Steel City.....	240
Block Tackles, Klein.....	822
Blocks—	
Cable—	
B&L.....	826
General Machine.....	826
Connecting, Siemon.....	1508
Connection, Condulet—	
Crouse-Hinds, Series GS.....	395
Fixture Hanger, Crouse-	
Hinds—Type EFHC.....	417
Contact, Push Button	
Station, Square D.....	581
Discharge, Sawtooth,	
Reliable.....	1508
Fuse—	
Circuit Control	
Transformer, Square D.....	551
Condulet, Crouse-Hinds,	
Series GS.....	395
Ladder, Bond.....	830
Pulling or Snubbing, B&L.....	822
Push Button, Edwards.....	1255
Snatch, B&L.....	822, 823, 824
Snubbing, B&L.....	822
Tackle, B&L.....	821, 822
Terminal, Marathon.....	588, 589
Test, Power and Light	
Control Switchboard,	
G-E.....	1386, 1387
Blow Torches, Unique.....	787
Boards, Control, Program	
Signal, Edwards.....	1243
Boards and Covers, Terminal,	
Power and Light Control	
Switchboard, G-E.....	1389
Bodies—	
Attachment Plug, Screw Base—	
Bryant.....	620
Hubbell.....	628
P & S.....	639
Box, Floor Outlet, Steel City.....	325
Condulet, Lighting Fixture,	
Crouse-Hinds, Series VM.....	416
Cord Connector—	
Bryant.....	618, 619, 621-624

B	Page
Bodies—	
Hubbell618, 619, 625, 627, 629, 630, 633, 635-638, 642, 643	
Woodhead617, 618	
Globe and Guard Adapter, Lighting Fixture, Appleton Series V51 337	
Lighting Fixture, Appleton Series V51 337	
Motor Plug, Connector, Hubbell 626	
Receptacle Connector, Machine Tool, Reelite, Appleton 169	
Socket—	
Brass—	
Bryant 652, 653	
Hubbell 662, 663	
Composition, Bryant 653	
Electrolite, Hubbell 663	
Lampholder, Porcelain, P&S 667	
Porcelain—	
Bryant 653	
Hubbell 663	
Unilet Adapter, Appleton Series GS 326	
Bodies and Receptacles, Unilet, Appleton, Type AEEA. 349, 350	
Boiler Room Cable, National. 118	
Boiler Room Wire, General Cable 68	
Bolt and Rod Stocks and Dies, Armstrong 723	
Bolt Cutters, Porter. 801	
Bolt Dieheads and Dies, Beaver 723	
Bolt Dies—	
Nye 722	
Oster 722	
Bolt-Eye Nuts, Hubbard. 920	
Bolt Eyes, Hubbard. 920	
Bolt Holder Heads, Universal Pole, Chance 891	
Bolt Hubeyes, Hubbard. 920	
Bolt Stocks and Dies, Oster 722	
Bolt Threaders, Beaver. 723	
Bolts—	
Bracket, Telephone, Hubbard. 94	
Bus Bar, Aluminum Alloy, Alcoa 159	
Carriage, Hubbard 927	
Crossarm, Hubbard 927, 928	
Double-Arming, Hubbard 926, 927, 933	
Expansion—	
Hubbard 855, 856	
Rawl-Drives 855	
Fork, Insulated, Hubbard. 952	
Guy, Rock, Hubbard. 917	
Hook, Insulator, Hubbard 953	
Hubeye, Hubbard 919	
Insulator, Hubbard 947	
Oval Eye, Hubbard 927	
Screw-Eye, Hubbard 919	
Stove, Seeger-Williams 860	
Stud, Hubbard 926	
Toggle—	
Diamond 857	
Rawl Spring-Wings. 857	
"U"—	
O.Z. 256	
Crossarm, Hubbard 938	
Rack, Frame and Trapeze, Kindorf 255	
Bonding Meter Rings, Appleton. 260	
Bondnuts, Conduit, Appleton. 228	
Bonds, Rail, Hanlon & Wilson. 969	
Booster Hooks, B&L 825	
Boosting and Bucking Transformers, G-E 1360	

B	Page
Booth Spotlights, Dyna-Beam, Kliegl 1172	
Booths—	
Telephone—	
Indoor—	
Burgess-Manning 1515	
Churchill 1514	
Outdoor, Sherron 1515, 1516	
Wall-Type, Burgess-Manning 1515	
Border Light Accessories, Stage, Hub 1170	
Border Light Lampholders, Flush, Porcelain, Hubbell. 654	
Border Light Winch Rigging, Stage, Hub 1170	
Border Lights—	
Stage—	
Century 1168	
Hub 1170	
Kliegl 1173	
Borehole Cable, Anaconda. 29	
Borers, Joist, Electric, Kett-Tall 708	
Boring Tools, Joist and Beam, Toledo 709	
Bowls, Glass, Lighting Fixture, Graybar 1150	
Box and Box Hanger Combinations—	
Cable, Conduit, Etc.—	
Appleton 300, 301	
National 298	
Steel City 296	
Box Bodies, Floor Outlet, Steel City 325	
Box Connectors—	
Appleton 230, 268, 269	
Crouse-Hinds, Type UNA 403	
National 124, 265, 272	
Steel City 265-267	
T&B 229, 231, 270-273	
Box-Cover Fustat Units, Buss. 544	
Box Covers—	
Conduit, Appleton 286	
Gang—	
Appleton 295	
Bryant, Multi-Control. 678	
National 294	
Steel City 293, 295	
Handy—	
Appleton 288	
Union 310	
Junction, R&S 316	
Outlet—	
Appleton 279, 281, 286	
National 284-285	
P&S Interchangeable. 675	
Steel City 280, 282, 287	
Union 310	
Surface Wiring, Union. 310	
Switch and Device—	
Appleton 291	
National 291	
Utility, Steel City. 287	
Box Hangers—	
Appleton 300, 301	
National 298	
Steel City 297	
Box-Mounting Lampholders, Porcelain, P&S 666, 667	
Box Plates, Ceiling, Steel City. 297	
Box Supports, Steel City. 283	
Boxes—	
Building Terminal, Telephone Service, Cook 1509	
Carrying, Stock and Die, Nye 721	
Ceiling, Cable, Conduit, Loom, Etc.—	
Appleton 298	
National 298	

B	Page
Boxes—	
Steel City 295, 297	
Combination, Cable, Conduit, Tubing, Etc.—	
Appleton 299, 300	
Steel City 296, 297	
Concrete, National 290	
Conduit—	
Appleton 286	
R&S 326	
Door Switch—	
Appleton 305	
Hubbell 705	
Floor—	
National 323	
R&S 315	
Steel City 318-321	
T&B 317, 323	
Flush Device, National. 291	
Gang—	
Appleton 294	
Bryant, Multi-Control. 678	
National 294	
Steel City 293	
Touch-Plate, Remote Control 703	
Handy, Appleton 288	
Junction—	
Benjamin Vapolets 1067	
Hope 312-314	
R&S 316	
T&B 310, 311	
Surface Wiring—	
Bryant 673	
P&S 673	
Lens, Incandescent, Litecontrol 1105	
Miter, Metal Raceway, Wiremold 468	
Multiple Lamp, Annunciator, Kirkland, 1259, 1260	
Multiplier, Meter-Testing Standard, G-E 1454	
Outlet—	
Appleton 279, 281, 283, 286	
National 124, 284, 285	
Steel City 280, 282, 283, 287	
Union 309, 310	
Woodhead, Multi-Tap 645	
Pull—	
Appleton 311	
Electri-Center, Pushmatic, Bulldog 601, 606	
Fire Alarm, Federal. 1232	
Shop, Steel, Lyon. 781	
Surface Wiring, Insulated, Union 310	
Switch—	
Appleton 302-305	
National 124, 308	
Steel City 306, 307, 309	
Union 309	
Telephone Jack, U.S. Instrument 1516	
Utility, Steel City. 287	
Wall—	
Convenience, Steel City. 283	
Standard Device, Steel City 309	
Watthour Meter Connection G-E 1459	
Wiring, Electrical, Hoffman. 546	
Boxes and Fronts, Panelboard, G-E 598	
Boxes and Panels, Fuse and Distribution, Modern Metal. 1196	
Braces—	
Alley-Arm, Hubbard. 930	
Cross, Wood, Rainier. 912	
Crossarm—	
Hubbard 931	

B	Page
Braces—	
Rainier	912, 931
Guard Arm, Hubbard	934
Timber, Simplex	844
Trench, Simplex	844
Vee and Knee, Wood, Rainier ..	912
Bracket and Pole Cable,	
General Cable	60
Bracket Arms, Floodlighting,	
Hope	1186
Bracket Bolts, Telephone,	
Hubbard	941
Bracket Lights, Incandescent,	
Perfectlite	1152
Bracket Straps, Hubbard	945
Bracket Type Heaters,	
Automatic, Wesix	1216
Brackets—	
Air-Circulating Fan,	
Fresh'nd-Aire	1212
Cable, Hubbard	949
Corner, Telephone, Hubbard ..	941
Dead-End, Hubbard	952
Dead-Ending and Take-Off,	
Hubbard	940
Extension, Secondary Rack,	
Hubbard	953
Floodlight, Revere	1187
House—	
Insulator, Knox	954
Telephone, Hubbard	941
Insulator, Wood, Rainier	911
Insulator Pin, Pole Top,	
Hubbard	946
Light—	
Incandescent, Decorative,	
Litecraft	1137
Roof and Wall, Revere	1189
Mounting—	
Auxiliary Light, Exide	1222
Lighting Unit, Outdoor	
Sub-Station, Holophane ..	1071
Neutral, Offset, Hubbard	939
Neutral Wire, Hubbard	950
Pinch and Transposition,	
Hubbard	939
Pole, Street Lighting—	
Hapco	1035, 1036
Hubbard	1034, 1036, 1037
Pole Hood, Street Lighting,	
Hubbard	1038
Pole Lamp Lead, Hubbard	1039
Rope Snubbing, Chance	886
Sagger, Secondary	
Distribution, Hubbard	952
Service, Hubbard	939
Telephone, Dead-End,	
Hubbard	941
Transformer—	
Hubbard	1416
Universal	1416
Transposition,	
Hubbard	937, 938, 940
Valance, Moe	1142
Wall Light, Incandescent,	
Perfectlite	1152
Brakes, A-C, G-E	1334
Branch Circuit Breakers,	
G-E	592, 595
Break Iron Brackets—	
Dead-Ending and Take-Off,	
Hubbard	910
Transposition, Hubbard	940
Breakers—	
Circuit—	
Bulldog Pushmatic	601
G-E	530, 531, 591, 592, 595
I-T-E	527, 528
R&S	444
Commercial Building and	
Service Equipment,	
I-T-E	526, 527

B	Page
Breakers—	
Current-Limiting, Hope	529
Indoor Power, G-E	1398-1400
Industrial, Square D	550
Load Center, Square D	550
Magnetic, Heinemann	521
Oil, Outdoor, G-E	1401, 1402
Panelboard—	
Distribution, Square D	559
Lighting, Square D	554
Switchgear, G-E	1379
Power Substation, G-E	1409
Switchgear and Industrial	
Applications, G-E	1381, 1382
Brewers, Coffee, Electronic	
Electric, Commercial, Cory ..	1211
Brewery Cord, Diamond	91
Bridle Rings, Diamond	936, 937
Bridle Wire—	
Telephone—	
Graybartel	87
Whitney Blake	132
Brushes—	
Carbon, Assortment, National	
Carbon	767
Cleaning, Conductor, Chance ..	850
Buckets, Mud, General	
Machine	808
Bucking and Boosting	
Transformers, G-E	1360
Building Cable—	
Anaconda	13-15
General Cable	50, 51
National	116
Phelps Dodge	1-3
Plastic W&C	143
Triangle	92, 93
Building Terminal Boxes,	
Telephone Service, Cook	1509
Building Terminals, Telephone	
Service, Cook	1509
Building Wire—	
Anaconda	13-15
General Cable	50, 51
National	116
Phelps Dodge	1-3
Plastic W&C	143
Triangle	92, 93
Buildings, Portable, Steel,	
Pennington	829
Bulbs—	
Bicycle Lamp, G-E	1210
Rectifier, G-E Tungar	1296
Bulkhead Mounting Kits,	
Connector Barrel,	
Electrical, Pyle-National ..	365
Eunghole Lamps, Woodhead	612
Burglar Alarm Bells, Edwards ..	1252
Burial or Duct Cable, Plastic	
W&C	142
Burring Reamers—	
Bit Brace, Armstrong	720
Ratchet, Armstrong	720
Bus-Bar Benders—	
Hydraulic—	
Greenlee	736
Tal	737, 738
Bus-Bar Bolts, Aluminum Alloy,	
Alcoa	159
Bus-Bar Clamps, Burndy	208
Bus-Bar Fittings, Flat and	
Tubular, Burndy	206
Bus-Bar Nuts and Washers,	
Aluminum Alloy, Alcoa	159
Bus-Bars, Copper, Rectangular,	
Phelps Dodge	12
Bus Cable, Switchboard,	
General Cable	74
Bus Conductors—	
Aluminum, Alcoa	158, 159
Copper, Anaconda	40

B	Page
Bus Door-Step Light Switches,	
Edwards	1257
Bus Drop Cable—	
General Cable	58
Plastic W&C	140
Bus-Support Fittings,	
Substation, G-E	1411
Bus Tubes—	
Copper—	
Anaconda	41, 42
Phelps Dodge	12
Bushing Closers, Conduit, Steel	
City	240
Bushing Messenger Supports,	
Efficiency	210
Bushing Racks, Efficiency	211
Bushing Supports, Wire and	
Cable, Efficiency	210
Bushings—	
Anti-Short, Armored Cable,	
National	125
Cable, Knox	954
Cable Hanger, Porcelain,	
Minerallac	251
Compound, O.Z.	275
Conduit—	
Appleton	237
National	237, 238
O.Z.	238, 239
Steel City	235, 238
T&B	236
Union	237
Grounding, Conduit—	
Appleton	260
O.Z.	257, 258
Steel City	264
T&B	264
Knockout—	
Porcelain, Federal	258
Snap-In—	
Appleton	240
Steel City	240
Metallic, Insulated, T&B	233
Pipe Thread, Porcelain,	
Federal	258
Pole Plate, Hubbard	1039
Reducing, Conduit, Rigid,	
Steel City	236
Sealing, O.Z.	275
Socket—	
Hubbell	662
Union	259
BUStriction DUCT Systems,	
Bulldog	488-491
Busways—	
Feeder, G-E	509
Trolley, G-E	508
Busways and Fittings, Power,	
Plug-In, G-E	501-507
Butt Chisels, Greenlee	709, 710
Buttons—	
Push—	
Door Bell, Edwards	1253-1255
Door Chime, Nutone	1251
Entrance, Edwards	1253
Executive, Edwards	1256
Flush, Edwards	1255
High-Voltage,	
Edwards	1254, 1257
Miniature, Edwards	1254
Momentary Contact,	
Edwards	1254, 1257
Multiple-Contact, Edwards ..	1253
Watertight, Benjamin	1256
Weatherproof, Edwards	1253
Buzzers—	
Classroom, Edwards	1245
Industrial, Benjamin	1236
Buzzers and Bells, Door,	
Edwards	1252

B	Page
Buzzers and Howlers,	
Industrial, Benjamin 1236, 1237	
BX Armor Cutters, Ideal	741
Bypass Valves, Pressure	
Testing, General Machine....	881
C	
"C" Hooks, B&L	826
Cabinet Benches, Shop, Steel,	
Lyon	780
Cabinets—	
Circuit Breaker, R&S.....	444
Fuse, Square D.....	534
Shop, Steel, Lyon.....	779
Storage, Steel, Allen.....	785
Tool Stand, Shop, Steel, Lyon	780
Wiring, Columbia	547, 548
Cabinets and Covers, Terminal,	
Cast Iron, Weatherproof	
and Dust-Tight, Hope.....	314
Cable—	
Aerial and Duct, Plastic W&C	146
Airport Lighting, Anaconda....	21
All-Purpose, Anaconda	25-27
Apparatus—	
General Cable	67
National	117, 119
Arc Lamp, General Cable.....	66
Armored—	
Phelps Dodge	8, 9
Triangle	93, 94, 98-100
Armored Bushed, National 124,	125
Armored Leaded, National.....	125
Armored Non-Metallic,	
Anaconda	33
Audio Speaker, Plastic W&C..	144
Bare—	
Aluminum, General Cable.81-83	
Aluminum-Steel (ACSR),	
Anaconda	47
Copper—	
Anaconda	45
General Cable	76, 78
Boiler Boom, National.....	118
Borehole, Anaconda	29
Building—	
Anaconda	13-15
General Cable	50, 51
National	116
Phelps Dodge	1-3
Plastic W&C	143
Triangle	92, 93
Burial or Duct, Plastic W&C..	142
Bus, Switchboard, General	
Cable	74
Bus Drop—	
Anaconda	28
General Cable	58
Plastic W&C	140
Cathodic Protection,	
Anaconda	48
Coaxial—	
General Cable	65
Times	151
Communication Equipment—	
Gavitt	149
Graybar	149
Control—	
Anaconda	23
Kaiser	128
National	120
Plastic W&C	139, 141
Triangle	101
Railway Signal, Anaconda..	22
Remote, Anaconda	37
Station—	
National	120
Plastic W&C	140
Thermostat, Anaconda	39
Traffic Signal —	
General Cable	58
Phelps Dodge	11

C	Page
Cable—	
Copperweld-Copper Com-	
posite, Anaconda	44
Direct Burial and Duct,	
Phelps Dodge	5
Drive-In Theater, General	
Cable	60
Exchange Area, Telephone,	
Whitney Blake	134
Farm and Home, Plastic	
W&C	142
Fire Alarm, General Cable....	58
Flat, Multi-Conductor,	
Special, Gavitt	150
General Purpose, Phelps	
Dodge	5
High-Voltage, General Cable	64, 65
Hinge, General Cable.....	65, 68
Ignition, Oil Burner—	
Anaconda	39
General Cable	60
Plastic W&C	140
Intercommunication, Kaiser ..	129
Lead—	
National	122
Apparatus, General Cable..	67
Motor—	
General Cable	68
National	117, 119
Phelps Dodge	7
Simplex	13
Locomotive, Gathering,	
Anaconda	34
Microphone, Whitney	
Blake	133, 136
Miniature, Communication—	
Gavitt	149
Graybar	149
Mining Machine—	
Anaconda	34
General Cable	62
Plastic W&C	145
Motion Picture—	
General Cable	66
National	119
Motor Lead—	
General Cable	68
National	117, 119
Simplex	113
Multi-Control, Bryant	678
Neon Sign—	
General Cable	60
Plastic W&C	140
Network, Anaconda	24
Non-Metallic Sheathed—	
Anaconda	15, 25-27, 29
General Cable	52
National	116
Phelps Dodge	7
Plastic W&C	142
Triangle	94
Oil and Gasoline Resistant,	
General Cable	52
Parkway—	
General Cable	59
Triangle	96, 97
Pole and Bracket—	
Anaconda	20
General Cable	60
Power—	
Anaconda	28, 30, 31
General Cable	58
National	118, 120-122
Phelps Dodge	6, 9
Plastic W&C	140
Simplex	108-111
Triangle	93, 103-111
Asbestos-Varnished	
Cambric Insulated—	
General Cable	69-73
National	117, 118
Triangle	100

C	Page
Cable—	
Conduit and Duct—	
Simplex	113
Triangle	104, 105
Direct Burial or Aerial,	
Triangle	104, 105
General Distribution, Kaiser	125
Heat-Resisting, General	
Cable	66, 67
Mine, Anaconda	28
Overhead Duct or Cable,	
Simplex	110, 111
Portable—	
Anaconda	33-37
General Cable	61, 63-65
Kaiser	127, 128
Simplex	111, 112, 114
Triangle	102, 103
Railway Signal, Anaconda....	33
Rheostat, National	118
Romex, General Cable.....	52
Secondary—	
Alcoa	152-154
Anaconda	17-19
General Cable	53, 54
Service Drop—	
Alcoa	152-154
Anaconda	17-19
General Cable	53, 54
Phelps Dodge	4
Triangle	95
Service Entrance—	
Anaconda	16
General Cable	52
Kaiser	125, 126
National	123
Phelps Dodge	4
Triangle	95
Shielded Jacketed, Gavitt.....	150
Shuttle-Car—	
Plastic W&C	145
Simplex	112
Sign—	
Gas-Tube, Anaconda	39
Neon—	
General Cable	60
Plastic W&C	140
Signal, General Cable.....	58
Slow-Burning, Phelps Dodge..	12
Sound System, Plastic W&C..	144
Street Lighting, Series—	
Anaconda	20
General Cable	55, 58
Triangle	94
Telephone—	
Aerial—	
Self-Supporting—	
Anaconda	49
Plastic W&C	147
Aerial and Duct—	
Anaconda	48, 49
Plastic W&C	146
Whitney Blake	134
Direct Burial—	
Anaconda	48
Plastic W&C	147
Whitney Blake	134
Exchange, Plastic W&C.....	146
Exchange Area, Whitney	
Blake	134, 137
Inside, Multi-Pair—	
Plastic W&C	145
Whitney Blake	133
Outside, Whitney Blake....	134
Underground Service,	
Whitney Blake	137
Anaconda	16, 17
Varnished Cambric Insulated—	
Anaconda	32
General Cable	60
Phelps Dodge	6
Triangle	102, 103

C	Page
Cable—	
Weatherproof—	
Anaconda	44
General Cable	81, 84-87
Phelps Dodge	10
Welding—	
Anaconda	37
General Cable	62
Kaiser	129
Phelps Dodge	9
Simplex	113
Wire Armored, Semi-Portable, General Cable.....	60
Cable and Harness Assemblies,	
Special, Gavitt	150
Cable and Wire Clamps,	
Parallel Groove, Alcoa.....	162, 163
Cable and Wire Pulling Grips,	
Klein	803-805
Cable and Wire Tensioning	
Jacks, Aerial Simplex.....	827
Cable Bandages, Rubber,	
Salisbury	877
Cable Benders, General Machine	846
Cable Block Pushers, General	
Machine	826
Cable Blocks, B&L.....	826
Cable Brackets, Hubbard.....	949
Cable Bushings, Knox.....	954
Cable Cars, Adjustable, Chance	833
Cable Clamps—	
Appleton	244
Chance	933
Diamond	249, 250
Hubbard	935
Reliable	993
O.Z.	192
Cable Clamps and Plugs, Steel	
City	209
Cable Clips—	
Appleton	278
Minerallac	251
Steel City	278
T&B	277
Cable Connectors—	
Burndy	200, 201, 205
National	124
O.Z.	192
R&S	368-377
Sherman	191
T&B	192, 195
Circuit Breaking, R&S	376, 377
Extension—	
Appleton, Series APC.....	351
Crouse-Hinds, Type BEC.....	359
Plug Receptacle, R&S.....	366
Cable Connectors, Boxes and	
Lugs, Naval Modern Metal.....	1197
Cable Crossarms, Hubbard.....	934
Cable Cutters—	
Porter	801, 802
T&B	801
Cable Duct Shields, Hubbard.....	995
Cable End Fittings—	
Appleton	238
Steel City	242
Cable Entrance Caps, T&B.....	242
Cable Entrance Connectors—	
Crouse-Hinds	245
T&B	246
Cable Entrance Fittings,	
Appleton	244
Cable Entrance Insulators, T&B.....	247
Cable Extension Arms, Hubbard	934
Cable Fasteners, Armored,	
National	124
Cable Feeders and Nozzles,	
General Machine	845
Cable Fittings, Burndy.....	207
Cable Guard Straps, "U",	
Hubbard	935

C	Page
Cable Guards—	
General Machine	935
Hubbard	935
Cable Guides, Aerial, General	
Machine	827
Cable Guides and Straighteners,	
Aerial, B&L	826
Cable Hanger Bushings,	
Porcelain, Minerallac	251
Cable Hanger Tie Straps,	
Reliable	936
Cable Hangers—	
Minerallac	251
Reliable	936
Cable Housing Grips, Electrical,	
Pyle-National	365
Cable Housings, Connector	
Barrel, Electrical, Pyle-National	365
Cable Joint Filling Compounds,	
Anaconda	862
Cable Jointing Materials,	
Anaconda	862
Cable Jumper Clamps, Chance.....	887
Cable Jumper Sleeves, Chance.....	887
Cable Jumper Spindle and	
Nuts, Chance	887
Cable Lashers, General	
Machine	832, 833
Cable Lashing Clamps,	
Diamond	935
Cable Lashing Wire, Crapo.....	972
Cable Lift Reels, Appleton.....	170, 171
Cable Lubricators, General	
Machine	850
Cable Outlets, Reelite,	
Appleton	171
Cable Plugs, R & S.....	370-372
Cable Pullers—	
Barth	845
Greenlee	845
Cable-Pulling Compounds,	
Minerallac	864
Cable Pulling Condulets,	
Crouse-Hinds, Types ESC and LBH	402
Cable Pulling Grips—	
Klein	804
Reliable	996, 997
Cable Rack Extensions,	
Hubbard	995
Cable Rack Hooks, Under-	
ground, Hubbard	995, 996
Cable Rack Insulators, Under-	
ground, Hubbard	995
Cable Racks, Underground,	
Hubbard	995, 996
Cable Reel Trailers, Adams.....	893, 894
Cable Ripper and Wire Gauge,	
Ideal	741
Cable Sets, Heating, G-E.....	1293
Cable Sheath Chipping Knives,	
Klein	796
Cable Sheath Splitting Knives,	
Klein	796
Cable Shelves and Shackles,	
B&L	850
Cable Sleeves, Split, Reliable.....	989
Cable Splicers' Seats, Bond.....	831
Cable Splicers' Tent Heaters,	
Perfection	833
Cable Staples, Appleton	278
Cable Straighteners, Aerial,	
General Machine	827
Cable Straps—	
National	124
T&B	248
Cable Supports—	
Diamond	936
Knox	954
O.Z.	274, 275

C	Page
Cable Suspension Clamps—	
Hubbard	923
Ohio Brass	961
Cable Suspension Hooks,	
General Machine	827
Cable Suspension Links,	
Hubbard	923
Cable Suspension Screws,	
Hubbard	923
Cable Terminal and Protector	
Fuses, Telephone Service, Reliable	1513, 1514
Cable Terminal Compound,	
Reliable	1512
Cable Terminals—	
Burndy	201, 204, 205
Telephone Service, Cook.....	1509
General Machine	1513
Reliable	1512
Underground, Telephone Service, Cook	1509
Cable Terminations, Shielded,	
Burndy	200
Cable Terminators, O.Z.	276, 277
Cable Wall Plates, T&B.....	247
Cable Wiring Support Frame	
Fittings, Globe	165
Cable Wiring Support Tray	
Accessories, Globe	166
Cable Wiring Support Trays,	
Globe	164
Calibrators, Halogen Leak	
Standard, G-E	1472
Calking Tools, Diamond	854
Call Signal and Code Controls—	
Faraday Kodemasters	1239
Federal Signakall	1233
Call Systems, Locator,	
Edwards	1240
Candelabra Base Lampholders,	
Bryant	661
Candelabra Bayonet Sockets,	
Morse	672
Candelabra Lampholder Bases,	
Bryant	661
Canisters, Blanket, Linemens',	
Salisbury	879
Canopies—	
Fixture, Junction Condulet, Crouse-Hinds, Series GUA and GUF	399
Light Reflector, Wheeler	1055, 1056
Lighting Fixture, Appleton.....	336
Canopy Aligners, Benjamin	1058
Canopy and Stem Sets,	
Lighting Fixture, Smithcraft	1093, 1094
Canopy Covers, Junction Box,	
R&S	316
Canopy Cutters, Fluorescent,	
Fixture, Wiremold	468
Canopy Switches—	
Bryant	706
McGill	695, 696
Cant Hooks, Oshkosh	811
Cap Screws, Rack, Frame and	
Trapeze, Kindorf	255
Capacitor Networks, G-E	1450
Capacitors—	
A-C and D-C, G-E.....	1451
Army-Navy, G-E	1449
Commercial, G-E	1449
Energy-Storage and Discharge, G-E	1451
High-Frequency, G-E	1451
High-Temperature, G-E	1450
Low-Voltage, High Mu-F, G-E	1450
Molded PVZ, G-E.....	1451
Oscillator-Tank-Circuit, G-E,	1451

C	Page
Capacitors—	
Power, Kilovar Supply, G-E	1448, 1449
Protective, Pyranoil, G-E.....	1438
Radio, Television, Etc., G-E.....	1451
Specialty, G-E	1449-1451
Caps—	
Anchor End, Kindorf.....	253
Attachment Plug—	
Bryant	618, 620, 621
Carling	700
Hubbell	619, 627, 628, 631, 638
P&S	639
P&S Despard, Interchangeable	675
Blank, Condulet, Crouse- Hinds GUH Type.....	397
Cord Connector—	
Bryant	620-624
Hubbell 625, 627, 629, 630, 633, 635-639, 642-644	
Hubbellock	632
P&S	644, 645
Woodhead	617, 618
Range, Bryant	640
Entrance—	
Cable, T&B	242
Conduit—	
Steel City	241
T&B	247
Filter, Infrared, Photoelectric, G-E	1351
Lampholder, Mogul Base, Bryant	660
Socket—	
Brass—	
Bryant	652, 653
Hubbell	662, 663
Composition, Bryant	653
Electrolier, Hubbell	663
Porcelain—	
Bryant	653
Hubbell	663
P&S	667
Car Bits, Bit Brace, Greenlee.....	711
Car-Lighting Control Switches, Bryant	694
Carbon Holders, Assortment, National Carbon	767
Card Holders, Wire Marker, Label, Etc., Brady.....	177
Cargo Trailers, Adams	893
Carriage Bolts, Hubbard	927
Carriers—	
Cradle, Dead-End, Chance.....	889
Strain, Rural, Dead-End, Chance	889
Carrying Boxes, Stock and Die, Nye	721
Carrying Cases—	
Hook-On Wattmeter, G-E.....	1470
Portable Instrument, Simpson	1493
Carrying Handles, Electric Plant, Graybar	1297
Carrying Hooks, Oshkosh	810
Cars, Cable, Adjustable, Chance	833
Cartridge Fuses—	
Bus, Fusetron Dual- Element	536
ECO	539
Economy Dual-Element	538
One-Time, Buss	535
Renewable—	
Buss	535
Economy	538
Carts—	
Reel, Allen	818
Service, Shop, Steel, Lyon.....	781

C	Page
Cases—	
Battery, Warning Light, Neo-Flasher	814
Carrying—	
Hook-On Wattmeter, G-E.....	1470
Portable Instrument, Simpson	1493
Drawer, Shop, Steel, Lyon.....	779
Parts, Shop, Steel, Lyon.....	779
Tool, Hip Pocket, Klein.....	795
Cast Iron Bends, Underground Conduit Construction, Fairmount	225
Catholic Protection Cable, Anaconda	48
Cedar Poles, National	895, 896
Ceiling Bowl Lights, Incandescent, Hub	1170
Ceiling Box Plates, Steel City.....	297
Ceiling Boxes—	
Cable, Conduit, Loom, Etc.—	
Appleton	298
National	298
Steel City	295, 297
Ceiling Flanges, Kindorf	253
Ceiling Globe Hangers—	
Perfectlite	1148
Wakefield	1149
Ceiling Lampholders—	
Brass Covered, Bryant.....	653
Porcelain, Bryant	654
Ceiling Lighting, Magic, Wakefield	1092
Ceiling Lighting Fixtures—	
Incandescent—	
Kliegel	1166
Perfectlite	1148
R&S	1147
Ceiling Lighting Units, Incandescent, Perfectlite	1152
Ceiling Lights, Incandescent—	
Hub	1170
Perfectlite	1148, 1152
R&S	1147
Ceiling Pull Switches, Bryant....	704
Ceiling Receptacles—	
Brass Covered, Hubbell.....	664
Porcelain, Hubbell	664
Ceiling Tracks, Cord Hung Fixture, Moe	1142
Ceilings, Luminous, Pittsburgh....	1103
Cellophane Tape, Permacel	136
Cellophane Tape Dispensers, Permacel	136
Cement—	
Duct and Fitting, Goodrich....	476
Sealing, Floor Outlet, Steel City	321
Centers—	
Control, Switching and Operation, G-E	1329
Load—	
Circuit Breaker—	
G-E	591
Square D	549, 550
Fusible, Square D.....	534
Motor-Control, G-E	1330, 1331
Motor Starter, Control, Etc., Square D	563
Power Control—	
Commercial, Industrial and Institutional, Square D....	562
Special Purpose, Industrial, Square D	562
Stage Lighting Control, Square D	563
Central and Automatic Heating System Controls, Wesix.....	1215
Central Vacuum Cleaning Systems, Premier	764

C	Page
Centrifugal Fans—	
Direct-Connected, ILG	1282
Pressure Type, ILG.....	1283
Centrifugal Volume Fans—	
Gasoline Engine Drive, ILG....	1281
Motor Drive, ILG 1280, 1281, 1283	
Chain, Pull, Socket, Bryant.....	662
Chain and Rope Hooks, B&L....	825
Chain Fixture Switches, Lever, McGill	695
Chain Hoist Accessories, Coffing	837
Chain Hoists—	
Electric, Coffing	837
Lever—	
Chance	835
Coffing	836
Load-Indicating, Chance	835
Spur Gear, Coffing	838
Chain Saws, Electric, Portable, Porter-Cable	771
Chain Tapes, Steel Blade, Michigan, Lufkin	719
Chain Vise Jaws, Armsstrong....	729
Chain Vises, Armstrong	729
Chain Wrenches—	
Nye	723
Toledo	723
Chains, Extension, Wire Tong Saddle, Chance	885
Chandeliers, Lighting, Incandescent, Decorative, Litecraft	1137
Changers—	
Lamp—	
Chance	606
McGill	607
Channel Nuts, Kindorf	253
Channels, Steel, Kindorf	253
Chargers—	
Battery—	
Farm and Home, G-E.....	1296
Fast, G-E	1296
General Purpose, G-E	1295, 1296
Heavy Duty, Walker.....	1296
Telephone Common Battery Exchanges, Schauer	1504
Trickle, Telephone Service, Small Storage Batteries, Schauer	1504
Chase Nipples, T&B	229
Chasers, Die, Pipe Threader, Nye	725
Checkers, Tube, Electronic, All- Purpose, Weston	1485
Chicago Grips, Wire and Cable, Klein	803, 804
Chimes—	
Classroom, Edwards	1245
Door—	
Door-Knocker Type, Edwards	1248
Electric—	
Edwards	1247, 1248
Nutone	1249, 1250
Industrial, Edwards	1247
Chimes and Bells, Signal, Faraday	1246
Chipping Knives, Cable Sheath, Klein	796
Chisel Sets—	
Machinists', Ryan	717
Wood, Ryan	717
Chisels—	
Butt—	
Greenlee	709, 710
Ryan	709
Firmer, Greenlee	710
Chocks, Wheel, Bond	831

C	Page
Chucks—	
Drill, Hammer, Rawl.....	851
Gripping, Strandvise, Reliable	987
Circline Lamps, Fluorescent,	
G-E	1201
Circuit Breaker Accessories—	
Bulldog Pushmatic	601, 606
G-E	531, 592, 1382, 1400
Square D	550
Circuit Breaker Cabinets, R&S..	444
Circuit Breaker Condulets—	
Crouse-Hinds—	
Type DBR	420
Type DVS	452
Type EPC	420, 437, 450
Type FLB	451
Type GUSC	434
Circuit Breaker Distribution	
Panelboards—	
G-E	598, 599
Square D	559
Circuit Breaker Enclosures,	
G-E	531
Circuit Breaker Equipment,	
Heinemann	521
Circuit Breaker Lighting	
Panelboards, Square	
D	554, 555, 556, 557, 558
Circuit Breaker Load Center	
Condulets, Crouse-Hinds—	
Type GUSC	435, 436
Type YSW	436
Circuit Breaker Load Centers,	
G-E	591
Square D	549, 550
Circuit Breaker-Motor Starter	
Enclosures, Spin Top,	
Square D	440
Circuit Breaker Panelboards—	
Appleton, Type ELP	345
Crouse-Hinds—	
Type DLP	436
Type DVSP	436
Type EDP	435
Type EQP	435
R&S	443
Circuit Breaker Plugs,	
Condulet, Crouse-Hinds,	
Type APJ	420
Circuit Breaker Plugs and	
Receptacles, Crouse-Hinds,	
Type EPC	353-358, 420
Circuit Breaker Units, Electric-	
Center, Pushmatic, Bulldog	601
Circuit Breakers—	
Bulldog Pushmatic	601
G-E	530, 531, 591, 592, 595
I-T-E	527, 528
R&S	444
Commercial Building and	
Service Equipment,	
I-T-E	526, 527
Current-Limiting, Hope	529
Indoor Power, G-E.....	1398-1400
Industrial, Square D.....	522-524
Load Center, Square D.....	550
Magnetic, Heinemann	521
Oil, Outdoor, G-E.....	1401, 1402
Panelboard—	
Distribution, Square D.....	559
Lighting, Square D.....	554
Power, Substation, G-E.....	1409
Switchgear, G-E.....	1379
Switchgear and Industrial	
Applications, G-E.....	1381, 1382
Circuit Breakers and Motor	
Starters, R&S	449
Circuit Breaking Cable	
Connectors, R&S	376, 377
Circuit Breaking Receptacle	
Plugs, R&S	376, 377

C	Page
Circuit Breaking Receptacles,	
R&S	376, 377
Circuit Continuity Film	
Cutouts, G-E	1021
Circuit Continuity Testers—	
Ideal	767
Ray-O-Vac	767
Circuit Interrupters, Industrial,	
Square D	525
Circuit Layout and Shapes,	
Self-Sticking, Brady	178
Circuit Protectors, Multiple	
Control, G-E	1021
Circuit Reclosers, Automatic,	
G-E	1403, 1404
Circuit Testers—	
Brach, Test-O-Lite	768
Ideal	767
Industrial, Multi-Purpose,	
Weston	1486
Portable—	
Simpson	1493, 1494
Weston	1476-1480
Circulator Fans, Floor	1212
Clamp Sticks—	
Grip-All, Insulated, Chance....	892
Positive Grip, Chance	888
Clamps—	
Armor Rod, Alcoa	977
Armored Conductor, Appleton	249
Beam—	
Kindorf	254
Minerallac	251
Clamps—	
Beam and Angle, Disconnect-	
ing and Lowering Hanger,	
Thompson	1078
Bus-Bar, Burndy	208
Cable—	
Appleton	244
Chance	983
Diamond	249, 250
Reliable	993
O.Z.	192
Cable and Wire, Parallel	
Groove, Alcoa	162, 163
Cable Jumper, Chance.....	887
Cable Lashing, Diamond.....	935
Clip, Fuse—	
Buss	545
Ideal	545
Conduit—	
Appleton	249, 250
Diamond	249
Kindorf	254
Crossover, Messenger,	
Hubbard	934
Drop Wire, Telephone,	
Reliable	993
Fixture Hanger, Suspension,	
Crouse-Hinds, Type CHS....	419
Flange, Pressure Plug,	
General Machine	879
Fuse-Clip—	
Buss	545
Ideal	545
Grade—	
Hubbard	935
Ground—	
Hubbard	934
Mueller	258
Sherman	257, 265
T&B	258, 262, 265
Ground Rod—	
Reliable	926
Ground Wire, Hubbard.....	924
Grounding, Temporary,	
Chance	887
Guy—	
Coffing	835
Hubbard	921

C	Page
Clamps—	
Hot-Line, Chance	979
Insulator, Suspension, Ohio	
Brass	957
Neutral, Ohio Brass.....	964
Pipe—	
Appleton	249
Diamond	249, 252
Service Wire, Wedge Type,	
Reliable	994
Span, Drop Wire—	
Diamond	935
Hubbard	941
Reliable	992
Splicing, Klein	802
Strain—	
Conductor, Ohio Brass.....	963
Universal, Ohio Brass.....	964
Strateline, Ohio Brass.....	962
Structural Steel, Kindorf.....	254
Suspension, Cable—	
Hubbard	923
Ohio Brass	961
Tap, Flip-On, Reliable.....	980
Wire and Cable, Alcoa.....	162, 163
Wire and Sleeve, Klein.....	803
Wire Connector, Chance	
Uniclamp	980
Clamps and Plugs, Cable,	
Steel City	209
Clasps and Clasp Lugs, Wire,	
Burndy	200
Classroom Buzzers, Edwards	1245
Classroom Chimes, Edwards	1245
Claw Hammers, Capewell	714, 715
Clay Conduit, Underground,	
Natco	999-1001
Clay Conduit Wrapping Tape,	
Natco	1001
Cleaners—	
Duct, General Machine.....	846
Vacuum—	
Hand Type, Ideal	763
Tank-Type—	
Ideal	763
Premium, Heavy Duty.....	765
Cleaning Brushes, Conductor,	
Chance	850
Cleaning Rods—	
Conduit and Sewer, Empire....	850
Duct, Diamond	850
Pressure Gun, General	
Machine	879
Cleat Lampholders—	
Bryant	655, 656, 660
Hubbell	654, 663
P&S	666
Cleat Mounting Hangers,	
Efficiency	211
Cleat Receptacles, Mogul,	
Hubbell	664
Cleats—	
Marine Wiring, Morse.....	278
Porcelain—	
Knox	212, 214
Porcelain Prod	212, 213
Wire and Cable, Efficiency.....	210
Clevis Assemblies, Insulated,	
Ohio Brass	956
Clevis Eyes, Ohio Brass.....	966
Clevis Shackles, Hubbard.....	952
Clevis Thimbles, Pierce.....	948
Clevises—	
Ball, Ohio Brass.....	965
Dead-End, Universal,	
Hubbard	948
Flexible Bail, Hubbard.....	949
Insulated, Hubbard	951, 952
Insulator, Railway, Hubbard..	952
Shackle, Hubbard	949
Socket, Ohio Brass.....	965

C	Page
Clevises—	
Strain Insulator, Hubbard.....	949
Thimble, Hubbard	948
Climber Gaff Gauges,	
Linemens', Klein	801
Climber Gaff Guards,	
Linemens', Klein	799
Climber Pads, Linemens',	
Klein	800, 801
Climber Straps, Linemens',	
Klein	800, 801
Climbers, Linemens', Klein.....	800
Clinching Clips, Knockout Plug,	
T&B	240
Clip-Clamps—	
Fuse—	
Buss	545
Ideal	545
Clip Punches—	
Metalworkers', Lever Type,	
Hand, Whitney	745
Tinners', Lever Type, Hand,	
Whitney	745
Clips—	
Anchor, Kindorf	254
Armor Rod, Alcoa.....	977
Cable—	
Appleton	278
Minerallac	251
Steel City	278
T&B	277
Clinching, Knockout Plug,	
T&B	240
Conduit, Minerallac	251
Loom Wire, National.....	123
Pipe, Minerallac	251
Strand Vise and Safety,	
Hubbard	940
Test—	
Mueller	190
Reliable	189
Wire Rope, Hubbard.....	940
Clock Hanger Outlets—	
Bryant	651
Hubbell	651
P&S	651
Clock System Control	
Instruments, Edwards	1242
Clock System Controls,	
Edwards	1242
Clock Systems, Program,	
Centrally-Controlled,	
Edwards	1242
Clocks—	
Electric—	
Program Clock System,	
Edwards	1242
Switchboard, Sunshine	1498
Synchronous, Faraday	1244
Telechron, Commercial,	
General Electric	1243
Clocks and Accessories,	
Programming, Fire Alarm,	
Federal	1232
Closers, Bushing, Conduit,	
Steel City	240
Closure Plugs, Flush Receptacle,	
Twist-Tite, Hubbell	639
Cloth—	
Insulating—	
Asbestos, Atlas	868
Glass, Graybar	867
Glass Fiber, Graybar.....	867
Varnished—	
G-E	874
Graybar	867
Cloth Tape, Permacel.....	181, 185
Clothes Lockers—	
Steel—	
Allen	786
Lyon	781

C	Page
Clothing, Linemens', Static-	
Resisting, Salisbury	876
Cloths, Joint-Wiping, Unique.....	189
Cluster Lights, Low-Mounting,	
Reverse	1188
Coating—	
Electrical, Scotchkote	864
Pike Pole, Oshkosh.....	811
Coaxial Cable—	
General Cable	65
Times	151
Code and Call Signal Controls—	
Faraday Kodemasters	1239
Federal Signakall	1233
Code Wire Markers, Brady.....	176, 177
Coffee Brewers, Electronic	
Electric, Commercial, Cory.....	1211
Cog Wrenches, All-Angle,	
Insulated, Chance	891
Coil Testers, Sunshine.....	1499
Coil-Turn Counters, Sunshine.....	1499
Coiled Cords—	
Diamond	90
Retractile	168
Colling and Reeling Machines,	
Wire and Cable, Allen	817
Reel-O-Matic	817
Coiling Machines, Wire, Allen.....	818
Coils, Magnet, Contactor and	
Starter, Square D.....	585
Collars, Extension, Junction	
Box, R&S	316
Color Equipment, Floodlight,	
Steber	1181
Coloramic Lamps, G-E	1203
Colored Lamps, Natural, G-E.....	1204
Combination Box and Box	
Hanger Sets—	
Cable, Conduit, Etc.—	
Appleton	300, 301
National	298
Steel City	296
Combination Boxes—	
Cable, Tubing, Conduit, Etc.—	
Appleton	299, 300
Steel City	296, 297
Combination Cradles, Dead-End,	
Chance	889
Come-Along Hooks, B&L.....	825
Commercial Building and Serv-	
ice Equipment, I-T-E	
Circuit Breakers	526, 527
Commercial Fans	1212
Commercial Lighting Fixtures—	
Fluorescent—	
All-Brite	1120-1123
Benjamin	1116
Day-Brite	1079-1083
Garcy	1111, 1113
Gibson	1114
Litecontrol	1104, 1105
Pittsburgh	1100, 1101
Silvray	1123
Smithcraft	1093, 1096
Incandescent—	
Litecraft	1137
Silvray	1146
Skylike	1136
Communication Cords, Coiled,	
Retractile	168
Communication Equipment	
Cable—	
Gavitt	149
Graybar	149
Communications Insulators—	
Armstrong	960
Continental Rubber	967
Hemingray	959
Commutator and Slip Ring	
Grinders, Ideal	766
Commutator Mica Slotters and	
Scrapers, Ideal	765

C	Page
Commutator Mica	
Undercutters, Ideal	766
Commutator Milling Cutters,	
Ideal	766
Commutator Resurfacers, Ideal	762
Commutator Slotting Files,	
Ideal	765
Commutator Slotting Saws,	
Ideal	766
Commutator-Turning Tool	
Heads, Ideal	765
Comparators, Metals, Sunshine.....	1499
Compass Saws, Fowle.....	715
Compensators, Motor Starter,	
Square D	564
Components—	
Power and Light Control	
Switchboard, G-E	1383-1388
Terminal Block, Field	
Assembly, Marathon	589
Compound Bushings, O.Z.....	275
Compound Guns, Pressure,	
General Machine	879
Compound Pots, Salisbury.....	863
Compounds—	
Cable Joint Filling, Anaconda	862
Cable-Pulling, Minerallac.....	864
Cable Terminal, Reliable.....	1512
Electrical Joint, Alcoa.....	863
Insulating—	
G&W	863
Minerallac	863
Pothead, Anaconda	862
Pothead and Joint Flushing,	
Anaconda	862
Pull-In, Minerallac	864
Sealing—	
Crouse-Hinds	406
G&W	864
General Machine	864
R&S	316
Sealing and Filling, G-E.....	872
Splicing, Rubber Tape—	
Amazon	179
Okonite	179
Weatherproof, Appleton	243
Compression Accessory	
Compressors, Tubular,	
Hydraulic, Alcoa	994
Compression Fitting Fillers,	
Alcoa	863
Compression Lugs, T&B.....	195
Compression Tools, Wire, T&B.....	803
Compressor Amplifiers, Altec	
Lansing	1531
Compressors, Tubular Compres-	
sion Accessory, Hydraulic,	
Alcoa	994
Concealed Wiring Lampholders,	
Bryant	656
Concealed Wiring Rosettes,	
Bryant	660
Concrete Box Plates—	
Appleton	290
National	290
Steel City	290
Concrete Box Rings—	
Appleton	290
Steel City	290
Concrete Boxes, National.....	290
Concrete Drills, Rotary, Core,	
Tilden	851
Concrete Inserts, Kindorf.....	253
Concrete Street Lighting	
Standards, American	1024
Conductor and Insulator Hoods,	
Chance	878
Conductor Cleaning Brushes,	
Chance	850
Conductor Racks, Efficiency.....	211
Conductor Strain Clamps, Ohio	
Brass	963

C	Page
Conductor Stringing Snatch Blocks, B&L	823
Conductor Thimbles, Hubbard ..	921
Conductors—	
Bare—	
Aluminum (ACSR), Alcoa ..	160
Copper—	
Overhead—	
Anaconda	46
General Cable	79, 80
Transmission Line, Phelps Dodge	10
Copper-Alloy, General Cable	61
Bus—	
Aluminum, Alcoa	158, 159
Copper, Anaconda	40
Power, Aluminum, General Cable	53
Power Distribution, Copperweld	973
Power Transmission, Copperweld	973
Steel, Galvanized, Crapo	972
Conduit—	
Clay, Underground, Natco	999-1001
Fibre, Orangeburg	1002
Flexible—	
Plastic, Triangle	221
Sealtite, American Brass	220
Steel—	
National	221
Triangle	221
Rigid—	
Alcoa	219
Anaconda	218
National	217
Republic	215
Triangle	216
Semi-Rigid, Triangle	216
Thin-Wall (EMT)—	
Alcoa	219
Anaconda	218
National	220
Republic	220
Triangle	219
Conduit Adapters, Fibre, Orangeburg	1004
Conduit and Pipe Dieheads and Dies, Nye	721
Conduit and Pipe Dies, Nye	720, 721
Conduit and Pipe Diestocks, Nye	720, 721, 722
Conduit and Pipe Stocks and Dies—	
Armstrong	723
Nye	720, 721
Conduit and Sewer Cleaning Rods, Empire	850
Conduit and Wire Hangers, Crouse-Hinds	407
Conduit Beam Clamps, Kindorf	254
Conduit Bell Ends, Fibre, Orangeburg	1004
Conduit Benders—	
Hand—	
Appleton	741
Greenlee	736
National	740
Republic	740
Steel City	740, 741
Tal	738
Hydraulic—	
Blackhawk	747
Greenlee	736, 737
Tal	737, 738
Conduit Bending Hickeys—	
T&B	740
Tal	738
Conduit Bending Shoes, Tal	738

C	Page
Conduit Bends, Fibre	
Orangeburg	1003
Conduit Bondnuts, Appleton	228
Conduit Box Mounting Outlets, Bryant	649
Conduit Box Receptacles—	
Hubbell	637
R&S	369
Conduit Boxes—	
Appleton	286
R&S	326
Conduit Bushing Closers, Steel City	240
Conduit Bushings—	
Appleton	237
National	237, 238
O.Z.	238, 239
Steel City	235, 238
T&B	236
Union	237
Conduit Clamps—	
Appleton	249, 250
Diamond	249
Kindorf	254
Minerallac	249, 250
Conduit Clips, Minerallac	251
Conduit Connectors—	
Flexible, Liquid-Tight—	
Pyle-National	223
T&B	232
Rigid—	
Appleton	227
Conduit Cord and Cable Grips, Pyle-National	224
Conduit Coupling and Connector Tools, Utility, Appleton	747
Conduit Couplings—	
BX Cable to Rigid, Appleton	232
Erickson, T&B	229
Fibre, Orangeburg	1003
Flexible to EMT, Appleton	230
Flexible to Rigid—	
Appleton	232
National	228
Steel City	226
T&B	231
Rigid—	
Alcoa	219
Anaconda	218
Appleton	227
Fairmount	225
National	217
O.Z.	228, 231
Republic	215
Steel City	226
T&B	231
Triangle	216
Thin-Wall (EMT)—	
Appleton	230
T&B	231
Triangle	219
Conduit Dieheads and Dies—	
Armstrong	726
Beaver	723
Conduit Dies, Diestock, Armstrong	726
Conduit Diestocks and Dies, Armstrong	726
Conduit Elbow Formers, T&B	740
Conduit Elbows—	
Fibre, Orangeburg	1003
Rigid—	
Alcoa	219
Anaconda	218
Appleton	233
Conduit Pipe	225
Crouse-Hinds	245
National	217, 226
Republic	215
Steel City	235

C	Page
Conduit Elbows—	
T&B	233-235
Triangle	216
Thin Wall, (EMT)—	
Anaconda	218
Pipe Prod.	221
Republic	220
T&B	242
Conduit End Fittings—	
Appleton	243
Crouse-Hinds	245
O.Z.	238
Steel City	242
Conduit Enlargers—	
Rigid—	
Appleton	227
Steel City	228
T&B	234
Conduit Entrance Caps—	
Steel City	241
T&B	247
Conduit Entrance Connectors, Appleton	246
Conduit Entrance Elbows—	
Appleton	247
Steel City	241
T&B	242, 248
Conduit Entrance Fittings—	
Appleton	242, 243
Crouse-Hinds	245
Conduit Expansion Fittings, T&B	229
Conduit Fittings—	
Fibre, Orangeburg	1004
Flexible Metallic, Appleton Series ST	222
REA, Appleton	333
Conduit Grounding Bushings—	
Appleton	260
O.Z.	257, 258
Conduit Grounding Equipment, Crouse-Hinds	261
Conduit Grounding Locknuts, Appleton	260
Conduit Hangers—	
Kindorf	254
Minerallac	251
T&B	256
Conduit Hub Plates—	
Unilet, Crouse-Hinds, Series RSMP and RSP	403
Conduit Insulets, T&B	238, 247
Conduit Laying Mandrels, General Machine	846
Conduit Locknuts—	
National	237
Steel City	235
T&B	229
Conduit Nipples—	
Chase, Steel City	228
Rigid, Appleton	227
Conduit Pennies, T&B	234
Conduit Plugs, R&S	368
Conduit Racks, Steel, Allen	784
Conduit Reducers—	
Fibre, Orangeburg	1004
Rigid—	
Appleton	235
Steel City	235
T&B	234
Conduit Reducing Bushings—	
Rigid, Steel City	236
Conduit Spacer Links, Fibre Conduit, Orangeburg	1005
Conduit Spacers, Fibre Conduit, Orangeburg	1005
Conduit Straps—	
Kindorf	255
Minerallac	249
T&B	248

C	Page
Conduit Supports—	
Korns	252
T&B	256
Conduit Tees, Rigid, Crouse-	
Hinds	245
Conduit Threaders, Beaver.....	723
Conduit Threading Device Dies,	
Toledo	724
Conduit Threading Devices,	
Toledo	724
Conduit Unions, Rigid,	
Appleton	227
Condulets, Crouse-Hinds—	
Bell Signal, Type ESR	454
Type ESR	454
Cable Pulling—	
Types ESC and LBH.....	402
Circuit Breaker—	
Type DBR.....	420
Type DVS.....	452
Type EPC.....	420, 437, 450
Type FLB.....	451
Type GUSC.....	434
Circuit Breaker Load Center—	
Type GUSC.....	435, 436
Type YSW.....	436
Circuit Breaker Panelboard—	
Types EDP and EQP.....	435
Types DLP and DVSP.....	436
Drain Sealing, Type EZS.....	406
Electric Clock, Type TCH.....	453
Fixture Hanger, Flexible,	
Condulet, Series AL	417
Fuse Cut-Out, Series Y	423
Horn and Siren Signal,	
Type ETH	454
Horn Signal, Type WH	454
Instrument, Type EMH	453
Junction—	
CPS Series.....	400, 409
EJB Type.....	401, 402
EJH Type.....	399
GU Type.....	400
GUA Series.....	397, 398
GUB Type.....	397
GUE Type.....	400
GUF Series.....	397
GUJ Series.....	399
GUP Series.....	397
RS Series.....	402
Lighting, Fixture—	
Series GS	395
Series VM	416
Motor Sentinel—	
Series EFD.....	432
Series FD.....	437
Motor Starter, Type EPC	439
Motor Starter and Circuit	
Breaker, Type EPG	439
Multiple Gang,	
Types FD and FS.....	384
Panel Mounting, Type EMP..	434
Pilot Light, Series EFD	
and EFS	428
Plug Receptacle—	
Type BRME.....	358
Type CPS	358, 359, 360
Pulling and Splicing,	
Type ESC	402
Push Button Station,	
Series EFD.....	427
Series EFS.....	426, 427
Series FS.....	430, 433
Type OFC.....	434
Push Button Station—	
Light—	
Series EFD.....	429, 430
Series EFS.....	429
Type EGP.....	429
Series FD and FS.....	433

C	Page
Condulets—	
Receptacle and Switch,	
Series FSQ	419
Sealing,	
Types EYS, EZD and EZS..	406
Switch—	
Motor Circuit, Type FLS.....	423
Motor Starting—	
Series EFD and EFS	431
Type FLF and GUB	432
Type GUSC	431
Push Button, Type EGP	
Safety—	
Series FSQ	421
Type WMK	422
Type WMKS	421
Selector, Series EFD and	
EFS	428
Tumbler—	
Series EFD and EFS	425
Type ESW	424
Type FLS	423
Type FSFC	432
Type GUSC	424
Thermometer, Type HRC	453
Thermostat, Type HRC	453
Transformer, Type ECT	455
Form Type	
6 LB	245
8 C	393
E	393
F	245
FED	245
FEE	245
LB	393
LL	393
LR	393
T	393
TB	393
X	393
Mogul	
Series	
BC	384
BEE	384
BLB	384
BT	384
BTB	384
BUB	384
BX	384
Obround	
Series	
A	379, 381
B	379, 381
C	379, 381
CO	380
COV	380
CUB	380
E	379, 381
F	380
L	380, 381
LB	380, 381
LF	380
LL	380, 381
LR	380, 381
T	379, 381
TA	380
TB	379
U	380
UB	380
X	380, 381
XA	380
AJ	378, 379
AJC	378, 379
AL	417
ALC	417
AR	373
ARD	373
ARDF	373
ARE	373
ARJ	373
ARJG	373
ARJK	373
ARJP	373

C	Page
Condulets—	
ARRA	378
ARRC	378
ARRH	378
CPS	
Dead End	400, 409
Through Feed	400, 409
L	400, 409
T	400
X	400, 409
EFD	
EFD	425, 427, 428, 430-432
EFDC	425, 427, 428, 430-432
EFS	
EFS	425-429, 431
EFSC	425-429, 431
FD	
FD	384-387, 391, 392, 437
FDA	385, 386, 391, 392
FDB	386
FDC	385, 386, 391, 392, 437
FDCA	385
FDCC	385
FDCT	385, 387
FDD	385
FDE	386
FDL	385
FDR	385
FDS	386, 392
FDT	385
FDX	385, 387
FS	
FS	332, 384-387, 391, 392
FSA	385, 386, 391, 392
FSC	332, 385m 386, 391, 392, 430, 433
FSCA	385
FSCC	385
FSCT	385, 387
FSD	386
FSE	386
FSL	385
FSR	385
FSS	385, 386
FST	385
FSX	385, 387
FSQ	
FSQ	419
FSQC	419
GS	
BRG	396
GS	394
GSA	394
GSC	394, 395
GSE	395
GSL	395
GST	395
GSX	395
GUA	
GUA	398
GUAB	398
GUAC	398
GUAD	398
GUAF	398
GUAG	398
GUAH	398
GUAL	398
GUAN	397
GUAP	398
GUAQ	398
GUAT	397
GUAW	397
GUAX	397
GUF	
GUF	397
GUFC	397
GUFL	397
GUFT	397
GUF	397
GUJ	
GUJ	399
GUJB	399
GUJC	399
GUJL	399
GUJT	399
GUJX	399

C		Page
Condulets—		
RS	RS	402
	RSM	402
	RSS	402
RSMP		403
RSP		403
SE	SE	396
	SEC	396
	SET	396
	SEX	396
SEH	SEH	396
	SEHC	396
	SEHT	396
	SEHX	396
SK	SK	394
	SKC	394
	SKL	394
	SKX	394
VM	VM	416
	VMA	416
	VMC	416
	VMG	416
	VMGR	416
	VMRB	416
	VMXHA	416
Y	Y	423
	YAC	423
	YC	423
	YYC	423
	AJX	379
	AP	357, 358
	APJ	353-356, 420
	AR	353-358, 420
	ARE	353, 354
	AREA	355, 356, 358
	AREX	357
	BP	419
	BRD	389
	BRME	358
	BRP	358
	CES	360
	CESD	360
	CGY	245
	CHS	419
	CPH	360
	CPP	360
	CPS	359, 360
	DBR	420
	DLP	436
	DP	421
	DS	388, 389
	DT	409
	DVS	452
	DVSP	436
	ECD	402
	ECT	453
	EDP	435
	EGP	429
	EJB	401, 402
	EJH	399
	EKC	399
	EL	406
	EMH	453
	EMP	434
	EMS	422
	EPC	420, 437-439, 450
	EQP	435
	ERS	424
	ESC	402
	ESR	454
	ESW	424
	ETH	454
	EZD	406
	EZS	406
	EYS	406
	FAR	389
	FBA	245
	FBB	245
	FBM	245

C		Page
Condulets—		
FLB		451
FLF		432
FLS		423
FP		419, 420
FOH		419
FSPC		432
FSQ		421
GRF		394
GS		417
GU		400
GUB		400, 432
GUE		400
GUP		397
GUSC		424, 431, 434-436
HRC		453
LBD		383
LBH		402
LG		409
OFS		434
OSA		419
TCH		453
UNA		403
UNE		419
UNF		403
UNH		419
UNHC		419
UNL		403
UNY		403
WH		454
WMK		422
WMKS		421
WP		389
WR		409
YSW		436
Condulet Covers, Crouse-Hinds—		
Form 8 Series		393
Mogul Series		384
Obround Series		382
Series CPS		409
Series FD and FS 386-388, 391, 392		
Series GRF		394
Series GS		396
Series GUA		399
Series GUF		399
Series GUJ		399
Series RSMP and RSP		403
Series SE and SEH		397
Series SK		394
Type GUB		400
Condulet Gaskets, Crouse-Hinds—		
Form 8 Series		393
Mogul Series		384
Obround Series		381
FD and FS Series		389
LBD Type		383
SE and SEH Series		397
SK Series		394
Condulet Mercury Limit		
Switch Parts, Crouse-Hinds, Type EMS		422
Condulet Plugs, Safety Switch, Crouse-Hinds, Type DP		
		421
Condulet Unions, Crouse-Hinds—		
Conduit to Conduit, Type UNF		403
Conduit to Condulet, Type UNL and UNY		403
Conduit Joint, Type UNA		403
Expansion, Type UNY and UNYL		403
Connecting Blocks, Siemon		1508
Connection Blocks—		
Condulet, Crouse-Hinds, Series GS		395
Fixture Hanger, Crouse-Hinds		417
Connector Barrel Dust Covers, Electrical, Pyle-National		
		365

C		Page
Connector Barrels With Contact		
Inserts, Electrical, Pyle-National		365
Connector Bases, Plug, Bryant		
		620, 622, 623
Connector Bodies—		
Cord—		
Bryant		618, 619, 621-624
Hubbell		618, 619, 625, 627, 629, 630, 633, 635-638, 642, 643
Woodhead		617, 618
Motor Plug, Hubbell		626
Connector Cap Covers, Rubber, Twist-Lock, Hubbell		
		637
Connector Caps—		
Cord—		
Bryant		620-624
Hubbell		625, 627, 629, 630, 633, 635-638, 639, 642-644
Hubbellock		632
P&S		644, 645
Woodhead		617, 618
Range, Bryant		640
Connector Covers, Rubber, Twist-Lock, Hubbell		
		637
Connector-End Line Hose, Rib-Grip, Salisbury		
		877
Connector Troughs, T-V Studio Lighting, Century		
		1169
Connectors—		
Angle, Kindorf		253
Armored Cable or Flexible		
Conduit, Crouse-Hinds, Type CGB		
		405
Box—		
Appleton		230, 268, 269
Condulet, Crouse-Hinds, Type UNA		
		403
National		124, 265, 272
Steel City		265-267
T&B		229, 231, 270-273
Building Rack, Etc. Kindorf		
		255
Cable—		
Burndy		200, 201, 205
O.Z.		192
R&S		368-375
Sherman		191
T&B		192, 195
Armored, National		124
Circuit Breaking, R&S		
		376, 377
Entrance,		
Crouse-Hinds		
		245
T&B		246
Extension,		
Appleton, Series APC		351
Crouse-Hinds, Type BRC		359
Plug Receptacle, R&S		366
Cable and Cord, Crouse-Hinds,		
Type CGE		
		404
Type CGB		
		405
Conduit—		
Entrance, Appleton		
		246
Flexible, Liquid-Tight, Pyle-National		
		223
T&B		232
Rigid, Appleton		227
Thin-Wall (EMT), Appleton		
		230
Cord—		
Morse, Eureka		616
Pyle-National, Tribloc		363
R&S		375
Woodhead		617
Electrical, Environmental, Pyle-National		
		365
Expansion, Substation, G-E		
		1411
Fixture Wire, Sherman		
		191
Fusible, R&S		
		371
Ground—		
Burndy		262, 263
O. Z.		263, 264

C	Page
Connectors—	
Substation, G-E.....	1411
Industrial System, Burndy.....	208
Junction Box to Flexible Metallic Conduit, Appleton, Series ST	222
Lighting Fixture Union, Appleton	340
Line Hose, Rib-Grip, Salisbury	877
Loom Wire.....	123
Meter, Appleton.....	233
Outlet Box to Flexible Metallic Conduit, Appleton, Series ST	222
Pipe, Clay to Iron, Natco.....	1001
Plate, Kindorf.....	253
Rack, Frame and Trapeze, Kindorf	255
Service Entrance, Reliable	982, 983
Side Beam, Kindorf.....	253
Solderless, O. Z.....	193
Special Bus Shape, Burndy.....	208
Spring, Electrical, Scotchlok.....	865
Strand, Hubbard.....	934
Swinging, Kindorf.....	253, 255
Tee, Substation, G-E.....	1411
Terminal, Substation, G-E.....	1411
Underground, Burndy.....	208
Wire—	
Chance	980, 982
Ideal	191
Ideal (Wire Nuts).....	191
Reliable	980-982
Scotch-Lok	191
Sherman	191, 192
T&B	197
Connectors and Plugs, Male, Pyle-National, Tribloc.....	363
Connectors, Boxes and Lugs, Cable, Naval, Modern Metal	1197
Consoles, Amplifier, Altec Lansing	1534, 1535
Constant-Ringing Drops, Edwards	1258
Construction Wire, Galvanized, Crapo	972
Contact Blocks, Push Button Station, Square D.....	581
Contact Makers, Naval, Modern Metal	1196
Contact Units, Receptacle Plug, Pyle-National, Tribloc.....	361, 362
Contact Alarm Terminals, General Machine	880
Contacts—	
D-C, G-E.....	1333
Door and Window, Edwards.....	1258
Motor Load, Magnetic— Square D.....	569
Start, Stop and Reverse Square D.....	576, 577
Pressure Alarm, General Machine	880
Continuity Tester and Flashlight, Ray-O-Vac.....	1225
Continuity Testers—	
Circuit—	
Ideal	767
Ray-O-Vac	767
Control and Transfer Switch Housings, G-E.....	1385
Control Boards, Program Signal, Edwards	1243
Control Cable—	
Anaconda	23
Kaiser	128
National	120
Plastic W&C	139, 141
Triangle	101

C	Page
Control Cable—	
Railway Signal, Anaconda	22
Remote, Anaconda	37
Station—	
National	120
Plastic W&C	140
Thermostat, Anaconda	39
Traffic Signal—	
General Cable	58
Phelps Dodge	11
Control Centers—	
Motor, G-E.....	1330, 1331
Motor Starter, Etc. Square D	563
Power—	
Commercial, Industrial and Institutional, Square D....	562
Special Purpose, Industrial, Square D.....	562
Stage Lighting, Square D.....	563
Switching and Operation, G-E	1329
Control Circuit Transformers, Square D.....	551
Control Instruments, Clock System, Edwards.....	1242
Control-Panel and Machine-Tool Transformers, G-E.....	1365-1371
Control Panel Enclosures, Hoffman	546
Control Preamplifiers and Amplifiers, Altec Lansing.....	1532
Control Relays, Battery Charger Rectifier, Raytheon.....	1505, 1506
Control Switches, Power and Light Control Switch- board, G-E	1383-1385
Control Transformers, Jefferson	1374
Control Units, Remote, Touch-Plate	702
Control Wire, Anaconda.....	15
Controllers—	
Dehumidifier, Automatic, Minneapolis-Honeywell	1269
Motor-Reversing, Magnetic G-E	1339
Traffic—	
Pedestrian Pushbutton and Sign, Crouse-Hinds.....	1015
Semi-Vehicle-Actuated, Crouse-Hinds	1015
Traffic Signal—	
Automatic Synchronous, Crouse-Hinds	1010, 1011
Super-Trafflex, Crouse- Hinds	1013
Synchronous, Crouse- Hinds	1014
Controls—	
Call Signal and Code—	
Faraday Kodemasters.....	1239
Federal Signakall	1233
Clock System, Edwards.....	1242
Electric, Photoelectric—	
Aviation, Crouse-Hinds.....	1192
General Service, Crouse- Hinds	1192
Heating Cable, G-E.....	1294
Heating System, Central and Automatic Wesix.....	1215
Heating Unit, Baseboard, Wesix	1216
Illumination, Plug-In, Weston	1484
Limit, Motor Ampere, G-E "Limitamp"	1332
Limitamp, Motor Ampere Control, G-E	1332
Liquid-Level, Mercoid.....	1343
Pressure—	
Mercoid	1343

C	Page
Controls—	
Steam-Heating Systems, Minneapolis-Honeywell	1269
Remote, "Switch-O-Lite", Hoffman	702
Street Lighting, Photoelectric, G-E.....	1021
Temperature, Refrigeration and Air-Conditioning, Mercoid	1270
Temperature Limit, Clamp-On, Mercoid	1270
Vacuum Pump, Square D.....	586
Convenience Outlets—	
Flush—	
Hubbell	629, 630, 646, 648
P&S	644, 645
P&S Despard Interchangeable	674, 675
Box Cover, Bryant	647
Hubbell	630, 646, 648
P&S	644
Combination—	
Hubbell	630
Surface—	
Bryant	673
P&S	673
Convenience Receptacles, R&S	375
Convenience Wall Boxes, Steel City	283
Conversion Packs—	
Vacuum Cleaner—	
Blower to Tank, Ideal.....	763
Hand to Large Industrial, Ideal	764
Conversion Units, Power, G-E.....	1295
Converters, Power, Add-a-phase, System Analyzer	1374
Conveyor and Batch Ovens, Infrared, Triangle	1294
Coolers, Water, Electric, Cordley	1271
Cooling and Heating Equipment Thermostats—	
Mercoid	1270
Minneapolis-Honeywell 1265, 1266	
Cooling and Insulating Oil, G-E.....	1425
Cooling and Insulating Oil Testers, Portable, G-E.....	1425
Copperweld-Copper Composite Cable, Anaconda	44
Copperweld Nails, Hubbard.....	926
Coppers, Soldering, General Machine	847
Cord—	
Brewery, Diamond.....	91
Drill, Heavy Duty, Anaconda	37
Heater—	
Diamond	91
Whitney Blake.....	131
Hospital—	
Silent Call, Simplex.....	115
Lamp—	
Parallel, Rip Type, Diamond	91
Twisted Pair, Whitney Blake	131
Microphone, Plastic W&C.....	144
Motor Plant, Plastic W&C....	139
Parallel, Rip Type, Phelps Dodge	7
Portable—	
Diamond	89, 90
Kaiser	127
Phelps Dodge.....	7
Plastic W&C.....	138, 139
Simplex	115
Whitney Blake	130, 131
Portable and Pendant, Anaconda	38

C	Page	C	Page	C	Page
Cord—		Counters, Coil-Turn, Sunshine.	1499	Covers—	
Power—		Countersink Bits, Bit Brace,		Canopy, Junction Box, R&S..	316
Diamond	89, 90	Greenlee	711	Condulet, Crouse-Hinds—	
General Cable	61	Country Home Lamps, G-E.....	1207	Form 8 Series.....	393
Pull-Socket, Bryant.....	662	Coupling and Connector Tools,		Mogul Series.....	384
Telephone, Replacement Sets,		Conduit, Utility, Appleton..	747	Obround Series.....	382
Whitney Blake	135	Couplings—		Series CPS.....	409
Cord and Cable Grips, Conduit,		Conduit—		Series FD and	
Pyle-National	224	BX Cable to Rigid Cable,		FS	386-388, 391, 392
Cord and Cube Tap Sets,		Appleton	232	Series GRF.....	394
Bryant	616	Erickson, T&B.....	229	Series GS.....	396
Cord and Plug Sets, Bryant.....	616	Fibre	1003	Series GUA.....	399
Cord Connector Bodies—		Flexible to EMT, Appleton	230	Series GUF.....	399
Bryant	618, 619, 621-624	Flexible to Rigid—		Series GUJ.....	399
Hubbell	618, 619, 625, 627, 629,	Appleton	232	Series RSMP and RSP.....	403
630, 633, 635-638, 642, 643		National	228	Series SE and SEH.....	397
Woodhead	617, 618	Steel City	226	Series SK.....	394
Motor Plug—		T&B	231	Type GUB.....	400
Hubbell	626	Insulated, O. Z.....	228	Connector, Rubber, Hubbell..	637
Cord Connector Caps—		Rigid—		Connector Cap, Rubber,	
Bryant	620-624	Alcoa	219	Twist-Lock, Hubbell.....	637
Hubbell	625, 627, 629, 630, 633,	Anaconda	218	Cord Connector, Industrial,	
635-639, 642-644		Appleton	227	Hubbellock	632
P&S	644, 645	Fairmount	225	Drop Cord, Condulet,	
Woodhead	617, 618	National	217	Obround Series.....	382
Industrial, Hubbellock	632	O. Z.....	231	Dust, Connector Barrel,	
Range, Bryant	640	Republic	215	Electrical, Pyle-National... 365	
Cord Connector Covers,		Steel City	226	Hub—	
Industrial, Hubbellock.....	632	T&B	231	Condulet, Crouse-Hinds,	
Cord Connectors—		Triangle	216	Series GRF.....	394
Morse Eureka	616	Thin-Wall (EMT)—		Series SE and SEH.....	397
Pyle-National Tribloc.....	363	Appleton	230	Series SK.....	394
R&S	375	T&B	231	Unilet, Appleton, Series	
Woodhead	617	Triangle	219	GS	326
Cord Grips, Lampholder,		Flexible—		Junction Condulet,	
Benjamin	1058	Appleton, Series EX.....	343	Crouse-Hinds,	
Cord Rosettes, Condulet,		Crouse-Hinds, Type EC.....	404	CPS Series.....	409
Crouse-Hinds,		Hanger Rod, Kindorf.....	255	GUA Series.....	399
Obround Series	383	Knockout, T&B.....	229	GUB Type.....	400
Cord Sets—		Pipe, Conduit Pipe Prod.....	221	GUF Series.....	399
Heavy Duty, Bryant.....	624	Coverlites, Steber	1059	GUJ Series.....	399
Range—		Covers—		Knockout, Condulet,	
Hubbell	641	Blank—		Crouse-Hinds	382
P&S	640	Condulet, Crouse-Hinds,		Light Reflector, Benjamin.....	1060
Range and Dryer, Plastic		FD and FS		Lighting Fixture Hanger,	
W&C	141	Series	386, 387, 391, 392	Appleton	292
Rubber, Seeger-Williams.....	615	Form 8 Series.....	393	Nipple—	
Cord Switches—		GRF Series.....	394	Condulet, Crouse-Hinds,	
Bryant	616	GS Series	396	Obround Series.....	383
Hubbell	615	Obround Series.....	382	Series FD and FS.....	387
Cords—		Mogul Series.....	384	Partition, Outlet Box,	
Coiled—		RSMP and RSP Series... 403		Steel City.....	282
Diamond	90	SE and SEH Series.....	397	Pendant, Junction Box, R&S	316
Retractable	168	SK Series.....	394	Plier Handle, Klein.....	790
Communication, Coiled,		Unilet, Appleton,		Receptacle—	
Retractable	168	FD and FS Series.....	331	Lamp,	
Heater, Coiled, Retractable... 168		GS Series.....	326	Unilet, Appleton,	
Portable Tool, Parallel,		35 Line.....	328, 329	GS Series.....	326
Plastic W&C.....	141	Box—		"35" Line	328
Power, Coiled, Retractable..... 168		Conduit, Appleton.....	286	Plug,	
Power Supply, Television,		Gang—		Condulet, Crouse-Hinds,	
Seeger-Williams	615	Appleton	295	Series FD and FS.....	387
Replacement—		Bryant, Multi-Control..... 678		Unilet, Appleton,	
Appliance, Seeger-		National	294	Series FD and FS.....	331
Williams	615	Steel City.....	293, 295	Series GS.....	326
Radio, Retractable	168	Handy—		"35" Line.....	328
Retractable, Coiled.....	168	Appleton	288	Receptacle and Pilot Lamp,	
Corner Brackets, Telephone,		Union	310	Condulet, Crouse-Hinds,	
Hubbard	941	Junction, R&S.....	316	FD and FS Series.....	386
Corner Drill Attachments,		Outlet—		Switch—	
Electric Drill, R.C.S.....	769	Appleton	279, 281, 286	Condulet, Crouse-Hinds,	
Corridor Lights—		National	284, 285	Obround Series.....	383
Fluorescent, Commercial,		P&S Interchangeable		Series GS.....	396
Benjamin	1118	Device	675	Push Button,	
Incandescent, Holophane... 1156		Steel City	280, 282, 287	Condulet, Crouse-Hinds,	
Cotter Key Installing Heads,		Union	310	Series FD and	
Universal Pole, Chance.....	891	Surface Wiring, Union.....	310	FS	387, 388, 390-392
Cotter Key Remover Heads,		Switch and Device—		Unilet, Appleton Series	
Universal Pole, Chance.....	891	Appleton	291	FD and FS.....	331
Counter Lights, Incandescent,		National	291		
Recessed, Holophane	1156	Utility, Steel City	287		

C	Page
Covers—	
Push Button Motor Control, Condulet, Crouse-Hinds, Series FD and FS.....	388
Lock, Unilet, Appleton, Series GS.....	326
Tumbler, Condulet, Crouse-Hinds, Obround Series.....	383
Series FD and FS.....	387, 390-392
Unilet, Appleton, Series FD and FS.....	331
Switch and Receptacle, Condulet, Crouse-Hinds, Series FD and FS.....	390
Unilet, Appleton, Series FD and FS.....	331
Unilet, Appleton, Series FD and FS.....	331
Series GS.....	326
35 Line.....	328, 329
Wathour Socket-Meter, G-E.....	1452
Wire Hole—	
Condulet, Crouse-Hinds, Form 8 Series.....	393
Obround Series.....	382
Cradle Carriers, Dead-End, Chance.....	889
Cradles—	
Combination, Dead-End, Chance.....	889
Pole, Oshkosh.....	812
Creosote-Burn Wash, M-S-A.....	875
Creosoted Crossarms, Fir, Rainier.....	906-909
Creosoted Poles—	
International.....	897-905
National.....	895, 896
Crimp Nuts, Sheet-Metal Fastener, Diamond.....	853
Crimping Tools, Plug-In Strip National.....	475
Cross Braces, Wood, Rainier.....	912
Crossarm Arresters, Telephone Service, Reliable.....	1513
Crossarm Bolts, Hubbard.....	927, 932
Crossarm Braces—	
Metal, Hubbard.....	930, 931
Wood—	
Hubbard.....	931
Rainier.....	912, 931
Crossarm Centering Washers, Hubbard.....	945
Crossarm Extension Fixture, Hubbard.....	930
Crossarm Pole Gains, Hubbard.....	928
Crossarm Reinforcing Plates, Hubbard.....	928, 944
Crossarm Saddle Washers, Hubbard.....	945
Crossarm Saddles, Hubbard.....	944
Crossarm Straps, Hubbard.....	944
Crossarm U-Bolts, Hubbard.....	938
Crossarms—	
Cable, Hubbard.....	934
Distribution, Temporary, Chance.....	888
Fir.....	906-909
Temporary, Coffing.....	387
Transmission Line, Wood, Rainier.....	913
Wood, Rainier.....	910
Crossover Clamps, Messenger Hubbard.....	934
Cross-Plate Anchors, Chance.....	918
Crow and Digging Bars, Oshkosh.....	809
Cube-Tap and Cord Sets, Bryant.....	616
Cube Taps, Bryant.....	618

C	Page
Cum-A-Long Hooks, Chance.....	888
Curb Lights, R&S.....	1183
Current Testing, Instruments, A-C—D-C, Portable, Weston.....	1486, 1487
Current Transformers—	
Portable—	
G-E.....	1471
Weston.....	1480
Cutout Assemblies, Oil Fuse, G-E.....	1447
Cutout Bases, Fuse, Cartridge, Bryant.....	540, 541
Cutout Racks and Mechanisms, Oil Fuse, G-E.....	1447
Cutout Switches, Furnace and Attic Fan, Minneapolis-Honeywell.....	1269
Cutouts—	
Film, Circuit Continuity, G-E.....	1021
Fuse—	
Cartridge, Knox.....	541, 542
Disconnect, G-E.....	1438-1440
Drop-Out—	
G-E.....	1438-1440
Hubbard.....	1443
Flip-Open Type, GE.....	1442
Flip-Out Type, Hubbard.....	1443
Heavy Duty—	
G-E.....	1439, 1441
Hubbard.....	1443
Indicating, G-E.....	1438-1440
Oil, G-E.....	1446
Open Type, G-E.....	1441, 1442
Plug—	
Bryant.....	543
Knox.....	542, 543
Secondary Indicating, G-E.....	1445
Cutters—	
Bolt, Porter.....	801
BX Armor, Ideal.....	741
Cable—	
Porter.....	801, 802
T&B.....	801
Canopy, Fluorescent Fixture, Wiremold.....	468
Knockout, Greenlee.....	746
Milling, Commutator, Ideal.....	766
Pipe—	
Armstrong.....	726, 727
Nye.....	727
Toledo.....	727
Rod, Porter.....	801
Steel Strap, Porter.....	802
Tube—	
Armstrong.....	727
Toledo.....	727
Washer, General Machine.....	726
Wire—	
Bartlett.....	837
Porter.....	801, 802
Pole, Lever Type, Chance.....	887
Cutting and Threading Machines—	
Pipe—	
Oster.....	732-734
Toledo.....	733
Pipe and Bolt, Beaver.....	735
Rod, Oster.....	733
D	
Dampers, Stockbridge, Alcoa.....	974
Data—	
Cable Size Selection Guide, Phelps Dodge.....	9
Power Cable, General Cable.....	55-57
Recommended Insulation Thickness—	
Anaconda.....	20
Portable Cable, Anaconda.....	33
Soil Classification.....	914

D	Page
Daylight Lamps, G-E.....	1202
Dead End Brackets, Hubbard.....	952
Dead-End Clevises, Universal, Hubbard.....	948
Dead-End Insulator Tools, Single-String, Chance.....	889
Dead-End Plugs—	
Unilet, Appleton—	
Type CPH.....	352
Type CPP.....	351
Dead-End Pulling Hooks, Reliable.....	986
Dead-End Receptacles, Unilet, Appleton, Series CES.....	352
Dead-End Receptacles and Plugs, Unilet, Appleton, Series CPSI.....	347
Dead-End Sleeves, Squeeze Type, Reliable.....	992
Dead-End Thimbles, Ohio Brass.....	964
Dead-End Tools, Chance.....	889
Dead-Ending Devices, Strand, Reliable.....	986
Dead Ends—	
Line Conductor, Squeeze Type, Reliable.....	993
Service, Squeeze Type, Reliable.....	991
Snub, Reliable.....	986
Straight-Thru, Reliable.....	984, 985
Telephone Line, Crapo.....	972
D-C Contactor Interlocks, G-E.....	1333
D-C Contactors, G-E.....	1333
D-C Relays, General Purpose, G-E.....	1333
Decorative Lamps, G-E.....	1203, 1204
Decorative Lighting Fixtures, Incandescent, Litecraft.....	1137, 1138
Dehumidifier Controllers, Automatic, Minneapolis-Honeywell.....	1269
Dehydrating and Baking Ovens, Infrared, Triangle.....	1294
Demand Meters, Wathour, G-E.....	1456
Derrick Belts, Klein.....	797
Desiccant Injectors, General Machine.....	882
Desk and Office Fans.....	1212
Desk and Table Lamps, Swing-Arm, Dazor.....	1074
Desk Stands, Microphone, Altec Lansing.....	1529
Desks, Shop, Steel, Lyon.....	779
Detachable Pole Steps, Hubbard.....	928
Details, Street Lighting Standard Bracket, Arm and Base, Hapco.....	1027
Detectors—	
Ground, Switchboard, Lamp Type, Sunshine.....	1499
High-Tension, "Saf-T-Glow", Brach.....	1500
Leak, Halogen, G-E.....	1473
Mercury Vapor, Portable, Sunshine.....	1500
Potential, "Statiscope", Minerallac.....	1500
Devices—	
Interchangeable, P&S Despard.....	674-676
Paging, Federal.....	1233
Photoelectric, G-E.....	1349-1351
Signaling, Flushcall, Edwards.....	1244
Surface Wiring—	
Bryant.....	673
P&S.....	673

D	Page	D	Page	D	Page
Devices—		Disconnect Sticks, Insulated,		Door Chime Transformers—	
Tagging, Disconnect Switch,		Chance	892	Nutone	1251
Salisbury Marshall	975	Disconnect Switch Tagging		Door Chimes—	
Dial PX Switchboards,		Devices, Salisbury		Door-Knocker Type,	
U.S. Instrument	1517	Marshall	875	Edwards	1248
Dials and Accessories, Traffic		Disconnecting and Lowering		Electric—	
Signal, Crouse-Hinds	1014	Hanger Beam and Angle		Edwards	1247, 1248
Diamond Drilling Water Swivels		Clamps, Thompson	1078	Nutone	1249, 1250
and Equipment, Truco	860	Disconnecting and Lowering		Door Openers, Edwards	1257
Die Chasers, Pipe Threader,		Hanger Equipment and		Door Panels, Electric-Center,	
Nye	725	Accessories, Lighting,		Pushmatic, Bulldog	601
Dieheads and Dies—		Thompson	1076-1078	Door Signal Trips, Edwards	1258
Bolt, Beaver	723	Disconnecting and Lowering		Door-Step Light Switches,	
Conduit—		Hanger Pulleys, Thompson	1076	Bus, Edwards	1257
Armstrong	726	Disconnecting and Lowering		Door Switch Boxes—	
Beaver	723	Hanger Suspension		Appleton	305
Pipe—		Assemblies, Thompson	1076	Hubbell	705
Armstrong	726	Disconnecting and Lowering		Door Switches—	
Beaver	723	Hanger Terminal Fittings,		Bryant	704
Pipe and Conduit, Nye	721	Thompson	1078	Hubbell	705
Pipe Threading Device,		Disconnecting and Lowering		Steel City	309
Toledo	724	Hangers, Thompson	1077	Double-Arming Bolts,	
Dies—		Disconnecting Switches,		Hubbard	926, 927, 933
Bolt—		Hookstick, Chance	1414	Double Bridges, Resistance-	
Nye	722	Dispensers—		Measuring Apparatus, G-E	1472
Oster	722	Cellophane Tape, Permacel... ..	186	Double Sockets, Screw-Base,	
Conduit, Armstrong	726	Guy Wire, Chance	819	Woodhead	669
Pipe—		Dispensing Reels, Wire, Hykon... ..	175	Dowel Pins, Clay Conduit,	
Armstrong	725, 726	Display Rack and Wire Cord,		Natco	1001
Solid, Skip-Tooth, Nye	722	Diamond	90	Downlights—	
Pipe and Conduit, Nye	720, 721	Displays, Remote Control,		Incandescent—	
Pipe Threading—		Touch-Plate	703	Century	1167, 1168
Armstrong	724	Distance-Measuring Wheels,		Curtis	1164
Nye	725	Mainco	718	Day-Brite	1162
Pipe Threading Device,		Distributing Frame Wire, Tele-		Kliegl	1166, 1172
Toledo	724	phone, Whitney Blake	137	Litecraft	1163
Diestocks—		Distribution and Fuse		Moe	1144
Pipe—		Boxes and Panels,		Pittsburgh	1102, 1103
Armstrong	725	Modern Metal	1196	Drain and Breather Valves,	
Nye	721	Distribution Center Unit		Crouse-Hinds, Type ECD... ..	402
Pipe and Conduit,		Substations, G-E	1392, 1393	Drain Sealing Condulets,	
Nye	720, 721, 722	Distribution Circuit Isolating		Crouse-Hinds, Type ESD... ..	406
Diestocks and Dies, Conduit,		Gaps, G-E	1436	Draw Knives, Greenlee	710
Armstrong	726	Distribution Lightning		Drawer Cases, Shop, Steel,	
Diggers—		Arresters—		Lyon	779
Pole and Anchor Hole,		Pellet-Type, G-E	1432	Drawer Files, Shop, Steel, Lyon	780
Adams	893	Thorex Dynagap, Ohio Brass... ..	1434	Drift Plugs, Bond	831
Pole Hole, Oshkosh	809	Distribution Cross Arms,		Drill and Saw Combination,	
Digging and Crow Bars,		Temporary, Chance	888	TEC	713
Oshkosh	809	Distribution Panelboards—		Drill and Water Swivel Kits,	
Digging and Tamping Bars,		G-E	596, 597	Electric, Truco	858
Oshkosh	810	Square D	552, 553	Drill Bits, Bell Hangers', Bit	
Digging Bars, Oshkosh	810	Circuit Breaker—		Brace, Greenlee	711
Digging Spuds, Oshkosh	810	G-E	598-600	Drill Chucks, Hammer, Rawl... ..	851
Dimmer Units, "Dim-A-Lite",		Square D	559	Drill Cord, Heavy Duty,	
Minneapolis-Honeywell	703	Distribution Systems,		Anaconda	37
Dimmerboards, Stage,		Electrical, Feedrail,		Drill-Hammers, Electric Drill	
Square D	563	Pre-Fabricated	495-499	Type, Rawl	852
Dimmers and Switchboards,		Distribution Transformers—		Drill Holders, Masonry,	
Stage, Century	1169	Oil-Immersed, G-E	1417-1423	Diamond	852
Dining Room Lighting Fixtures,		Pyranol, G-E	1426-1428	Drill Points, Masonry, Diamond	
Moe	1139-1142	Distribution Wire, Telephone,		"N"	852
Direct Burial and Duct Cable,		Whitney Blake	132, 133	Drill-Routers, TEC	712
Phelps Dodge	5	Dollies, Electric Plant,		Drill Stands, Electric, Thor	775
Direct Burial Cable—		Graybar	1297	Drill, Water Swivel and Stand,	
Telephone—		Dome Lights, Incandescent,		Electric, Truco	858
Anaconda	46	Decorative, Litecraft	1138	Drilling Machine Bits, Truco	859
Plastic, W&C	147	Door and Gate Operators,		Drilling Machine Water	
Whitney Blake	132, 134	Remote Control Robot	707	Pick-Up, Truco	859
Direct-Drive Undercutters,		Door and Window Contactors,		Drilling Machines, Masonry,	
Ideal	766	Edwards	1258	Electric, Portable, Truco... ..	859
Directional Lights, Hub	1171	Door Bell Transformers—		Drills—	
Directional Signs, Lumiline,		Edwards	1258	Concrete, Core, Tilden	851
Hub	1161	Jefferson	1373	Electric, Portable, Thor... ..	773, 774
Discharge Blocks, Sawtooth,		Door Bells and Buzzers,		Hammer, Hand or Electric,	
Reliable	1508	Edwards	1252	Diamond Di-Forge	712
Disconnect Hanger Hooks,		Door Chime Pushbuttons,		Hand, Rawl	851
T&B	257	Nutone	1251	Masonry—	
Disconnect Hanger Loops,		Door Chime Relays, Nutone	1251	Percussion, Rawl	851
T&B	257	Door Chime Transformers—		Spiral Twist, Diamide... ..	851
Disconnect Hangers, T&B	257	Edwards	1258	Pilot, Hole Saw, Capewell... ..	716
		Jefferson	1373	Power Hammer, Rawl... ..	852

D	Page
Drills—	
Spiral, Carbide, Rawl.....	850
Star, Electric Hammer, Thor..	789
Drills and Reamers, Electric,	
Portable, Thor	775
Drip-Trays, X-Ray Film	
Illuminator, Appleton	338, 339
Drive Hooks—	
Hubbard	941
Reliable	936
Drive-In Theater Cable, General	
Cable	60
Drive Pin Fasteners, Ramset	
Hammer-In	858
Drive Rings, Diamond.....	936
Driver Loudspeakers, Altec	
Lansing	1533
Drivers—	
Knockout Punch, Hydraulic,	
Greenlee	743
Screw—	
Ryan	713
Utica	714
Flush Plate Screw, Hubbell	682
Insulated, Porter	713
Meterman's, Porter	713
Spiral, Greenlee	714
Drives—	
Power—	
Beaver	735
Toledo	731
Drop Cable, Telephone, Whitney	
Blake	137
Drop Cord Covers, Condulet,	
Obround Series	382
Drop Wire—	
Telephone—	
Graybartel	88
Whitney Blake	132
Drop Wire Clamps, Telephone,	
Reliable	993
Drop Wire Span Clamps—	
Diamond	935
Hubbard	941
Reliable	992
Drops—	
Annunciators, Edwards.....	1242
Constant-Ringing, Edwards ..	1258
Dry Batteries—	
Eveready	1223
Ignition—	
Eveready	1223
Ray-O-Vac	1224
Railroad and Industrial,	
Eveready	1223
Dryer and Range Cord Sets,	
Plastic W&C	141
Duct—	
Wiring—	
Lay-In, Square D.....	482
Plug-In, Square D.....	483, 484
Surfaceduct, National	472
Duct and Aerial Cable—	
Plastic W&C	146
Telephone, Plastic W&C.....	146
Duct and Fitting Cement,	
Goodrich	476
Duct and Fittings—	
Wiring—	
Feed-In, Square D.....	486, 487
Flexible Rubber, Winders	
& Geist	476
Fluoduct, National	477, 478
Nepcoduct, National	478, 479
Rubaduct, Goodrich	476
Duct Cleaners, General Machine	846
Duct Cleaning Rods, Diamond...	850
Duct Rod Rollers, General	
Machine	846
Duct Systems—	
BUStribution, Bulldog	488-491

D	Page
Duct Systems—	
Trol-E-Duct, Bulldog	
Universal	492-494
Duct Wire, Telephone,	
Graybartel	88
Dust and Moisture-Proof	
Lights, Multi	1062
Dust Collector Attachments,	
Grinder, Ideal	765
Dust Covers, Connector Barrel,	
Electrical, Pyle-National	365
Dual Arm Tool Sets and	
Components, Hot Line,	
Chance	884
Dual Auxiliary Arms, Chance...	884
Dynamometer Instruments,	
A-C—D-C, Portable,	
Simpson	1490
Dynamometers, Wire Stringing,	
Dillon	882
Dryers, Hand, Electric, Ozo.....	1213
Drying and Baking Ovens,	
Infrared, Triangle	1294
E	
Elapsed-Time Meters, A-C,	
Simpson	1492
Elbows—	
Conduit—	
Fibre, Orangeburg	1003
Rigid—	
Alcoa	219
Anaconda	218
Appleton	233
Conduit Pipe	225
Crouse-Hinds	245
National	217, 226
Republic	215
Steel City	235
T&B	235
Triangle	216
Thin-Wall (EMT)	
Anaconda	218
Conduit Pipe Prod.	221
Republic	220
T&B	242
Condulet—	
Type EL	406
Entrance—	
Conduit—	
Appleton	247
Steel City	241
T&B	242, 243
Pipe—	
Conduit Pipe Prod.	221
Electri-Centers, Pushmatic,	
Bulldog	602-606
Electric Band Saws,	
Portable, Porter-Cable	771
Electric Chain Saws, Portable,	
Porter Cable	771
Electric Clock Condulets,	
Crouse-Hinds, Type TCH....	453
Electric Clocks—	
Program Clock System,	
Edwards	1243
Switchboard, Sunshine	1493
Synchronous, Faraday	1244
Telectron, Commercial,	
General Electric	1243
Electric Coffee Brewers,	
Electronic, Commercial,	
Cory	1211
Electric Controls—	
Photoelectric—	
Aviation, Crouse-Hinds	1192
General Service,	
Crouse-Hinds	1192
Electric Drill and Water Swivel	
Kit, Truco	858
Electric-Drill Bits, Greenlee.	709, 769

E	Page
Electric Drill Stands, Thor.....	775
Electric Drill, Water Swivel	
and Stand, Truco	858
Electric Drills, Portable,	
Thor	773, 774
Electric Drills and Reamers,	
Portable, Thor	775
Electric Etchers, Ideal.....	766
Electric Fans	1212, 1272-1283
Electric Floodlight and Power	
Units, Portable, Graybar.....	1299
Electric Generating Equipment,	
Diesel, White	1301
Electric Generators—	
Belt and Direct Drive,	
Graybar	1300
Tractor Drive, Graybar.....	1300
Electric Grinders—	
Bench, Thor	775
Portable, Thor	778
Electric Hammers, Portable,	
Thor	778
Electric Hand Dryers, Ozo.....	1213
Electric Heaters, Wesix.....	1213, 1214
Electric-Heating Sets,	
Minneapolis-Honeywell	1267
Electric Hoists, Chain, Coffing..	837
Electric Impact Wrenches,	
Portable, Thor	775
Electric Light and Power	
Plants—	
Diesel Engine, Graybar.....	1299
Gasoline Engine,	
Graybar	1297, 1298
Electric Masonry Drilling	
Machines, Portable, Truco..	859
Electric Motor Information,	
G-E	1302-1304
Electric Motors, G-E—See	
Motors, Electric	
Electric Nut Setters and	
Screw Drivers, Portable,	
Thor	776
Electric Plant Carrying	
Handles, Graybar	1297
Electric Plant Dollies, Graybar.	1297
Electric Polishers, Portable,	
Thor	778
Electric Power and Light	
Plants—	
Diesel Engine, Graybar	1299
Gasoline Engine,	
Graybar	1297, 1298
Electric Routers, Portable,	
Porter-Cable	772
Electric Sanders—	
Portable—	
Porter-Cable	769, 770
Thor	777, 778
Electric Saw Blades, Thor	777
Electric Saws—	
Bayonet, Portable,	
Porter-Cable	771
Portable—	
Porter-Cable	770, 771
Thor	777
Electric Screw Drivers,	
Portable, Thor	776
Electric Screw Drivers and	
Nut Setters, Portable,	
Thor	776
Electric Solder Pots, Vulcan.....	759
Electric Tachometers, Ideal.....	766
Electric Water Coolers,	
Cordley	1271
Electrical Testing Instruments,	
Associated Research.....	1495, 1496
Electronic Timers, G-E	1351
Electronic Tube Checkers,	
All-Purpose, Weston	1495

E	Page
Electrical and Electronic Equipment Wire, Gavitt	148, 149
Electrical Coating, Scotchkote..	864
Electrical Connectors, Environmental, Pyle-National	365
Electrical Distribution Systems, Feedrail, Pre-Fabricated	495-499
Electrical Inspectors' Tool Bags, Klein	796
Electrical Inspector's Tool Kits, Klein	794
Electrical Insulating Materials—Atlas	868-869
G-E	870-874
Graybar	867
Electrical Insulation Putty, Scotchfil	864
Electrical Interlock Installing Kits, Square D	585
Electrical Joint Compounds, Alcoa	863
Electrical Spring Connectors, Scotchlok	865
Electrical Tape—Bishop, Self-Bonding	180
Permacel	181-186
Electrical Wiring Troughs, Hoffman	499
Electricians' Auger Bits, Bit Brace, Greenlee	711
Electricians' Bits, Power, Greenlee	712
Electricians' Hammers, Champion DeArment	808
Electricians' Knives, Klein	795
Electricians' Pliers, Klein	788, 789
Electricians' Scissors, Klein	794
Electrode Housings, Glass, Knox Pyrex	545
Electronic and Electrical Equipment Wire, Gavitt	148, 149
Electronic Electric Coffee Brewers, Commercial, Cory	1211
Elements—Heating, Soldering Iron—American Beauty	753
Drake	754
G-E	751
Elevating Scaffold, Portable and Adjustable, Allen	785
Eliminators—Battery—Small Telephone Common Battery Systems, Schauer	1504
Battery Rectifiers—Schauer	1504
AM and FM 2-Way Radios, Schauer	1505
Lamp Signal and Automatic Switchboard, Schauer	1505
Marine Radios, Schauer	1505
Ells, Pressure Testing, General Machine	881
Emergency Jacks, Simplex	838
Emergency Lighting Batteries, Eveready	1223
Emergency Lighting Units, Automatic, Big Beam	1219
Emergency Lights, Auxiliary, Exide	1222
Emergency Storm Tools, Chance	887
Enclosures—Circuit Breaker, G-E	531
Control Panel, Hoffman	546
Motor Starter Circuit Breaker, Spin Top, Square D	440
Push Button, Switch and Pilot Light, Hoffman	1342

E	Page
Enclosures—Substation Fence, G-E	1413
End Anchors, Prestressed Concrete, Strandvises, Reliable	987
Enlarger Lamps, Photographic, G-E	1206
Enlargers—Conduit—Rigid, Appleton	227
Steel City	228
T&B	234
Entrance Caps—Cable, T&B	242
Conduit—Steel City	241
T&B	247
Entrance Connectors—Cable—Crouse-Hinds	245
T&B	246
Conduit, Appleton	246
Entrance Elbows—Conduit—Appleton	247
Steel City	241
T&B	242, 248
Entrance Fittings—Cable, Appleton	244
Conduit—Appleton	242, 243, 247
Crouse-Hinds	245
Entrance Insulets—Cable, T&B	247
Conduit, T&B	247
Entrance Push Buttons, Edwards	1253, 1254
Entrance Sill Plates, Appleton	243
Entrance Switches, Fixed-Blade, Bryant	543
Equipment—Airport Lighting, Crouse-Hinds	1192-1194
Architectural Lighting, Century	1167, 1168
Aviation Lighting, Crouse-Hinds	1192-1194
Circuit Breaker, Heinemann	521
Diamond Drilling Water Swivel, Truco	860
Electric Generating, Diesel, White	1301
Fusible Service, Square D	532-534
Grounding—Conduit, Crouse-Hinds	261
Temporary, Chance	886
Light Control, Superior "Luxtrol"	590
Lighting Unit Suspension, Fluorescent, Benjamin	1040
Lightning Protection, A-C Rotating Machine, G-E	1437, 1438
Marine, Naval, Modern Metal	1195-1198
Naval Marine, Modern Metal	1195-1198
Plug Receptable, Crouse-Hinds—Type ARE	353, 354
Type AREA	355, 356, 358
Type AREX	357
Type CES and CESD	360
Type SPS	360
REA Wiring—Appleton	333
Crouse-Hinds Condulet	332
Stage Lighting—Century	1168, 1169
Hub	1170, 1171

E	Page
Equipment—Switchgear—G-E	1378, 1379, 1396-1398
I-T-E	1393, 1394
Square D	1394, 1395
T-V Studio Lighting, Century	1169
Telephone and Intercommunication, Naval, Modern Metal	1197
Etchers, Electric, Ideal	766
Exhaust Fans, Bathroom, Nutone	1272
Exit and Searchlight Batteries, Eveready	1223
Exit Light Globes, Graybar	1166
Exit Lights, Hub	1171
Exit Signs, Incandescent, Day-Brite	1165
Expanding and Tamping Bars, Chance	914
Expansion Bolt Sleeves, Hubbard	856
Expansion Bolts—Diamond	855
Hubbard	856
Rawl-Drives	855
Expansion Connectors, Substation, G-E	1411
Expansion Fittings, Conduit, O.Z.	229
Expansion Nuts, Hubbard	856
Expansion Unions—Appleton, Series UNF and UNY	332
Crouse-Hinds Condulet, Type UNY and UNYL	403
Expansive Bits, Greenlee	712
Explosion-Proof and Explosion-Resistant Products—Alarm and Coding Horns, Federal	1234
Alarm Systems, Manufacturing and Processing, R&S	1262
Barrell and Tank Inspection Lights, Justrite	1220
Cable Connectors, R&S	366
Centrifugal Fans, ILG	1282
Circuit Breakers—G-E	1381
Hope	529
I-T-E	528
Square D	522, 523
Circuit Interrupters, Square D	525
Condulets, Crouse-Hinds—Plug Receptacle, Type CPS	359, 360
Sealing, Types EYS, EZD, EZS	408
Dead-End Plugs, Unilet, Appleton—Type CPH	352
Type CPP	351
Dead-End Receptacles, Unilet, Appleton, Series GES	352
Drain and Breather Valves, Condulet, Crouse-Hinds, Type ECD	402
Expansion Unions, Appleton, Series UNY	332
Floodlights, Crouse-Hinds	1178
Hand Lanterns, Big Beam	1217
Head-Lights, Justrite	1220
Howler and Buzzer Relays, Benjamin	1239
Howlers and Buzzers, Benjamin	1237
Induction Motors, Squirrel-Cage, G-E	1307, 1308

E	Page
Explosion-Proof and Explosion-Resistant Products—	
Industrial Sirens, Federal.....	1232
Inspection Lights, Barrel and Tank, Justrite.....	1220
Junction Boxes, Hope.....	314
Lighting Fixture Accessories—	
Appleton—	
Series AA51.....	335
Type EFU.....	340
Lighting Fixture Swivels, Unilet, Appleton, Type ESD.....	340-347
Lighting Fixtures, Industrial—	
Fluorescent, Appleton, Type EFU.....	340
Incandescent—	
Appleton, Series AA51.....	334, 335
Crouse-Hinds, Series EV.....	407
Lighting Units, Fluorescent—	
Benjamin.....	1041
Wheeler.....	1050
Liquid Level Controls, Mercoid.....	1343
Motor Starters, Square D—	
Magnetic.....	570, 572-575
Manual.....	564, 565
Motor Starting Switches, G-E.....	1335, 1336
Photoelectric Relays, G-E.....	1350
Plug Receptacle Equipment, Crouse-Hinds, Types	
CES, CESD, CPS.....	360
Plug Receptacles, R&S.....	366
Propeller Fans, ILG.....	1278
Push Button Stations, Square D.....	580
Receptacle Plugs—	
Crouse-Hinds, Type CPH, CPP.....	360
R&S.....	366
Safety Switches, Square D.....	513, 514
Sealing Fittings, Appleton, Series EYS.....	347
Timing Relays, Square D.....	584
Socket-Reflector Units, Benjamin.....	1062
Unilets, Appleton, Series CPSI.....	347
X-Ray Film Illuminators, Appleton, Type EFUX.....	338, 339
Explosion-Proof and Dust-Tight Products—	
Alarm Systems, Manufacturing and Processing—	
Crouse-Hinds.....	1263
R&S.....	1262
Circuit Breakers, R&S.....	444
Condulet Box Connectors, Crouse-Hinds, Type UNA.....	403
Condulet Covers, Crouse-Hinds, Type GUB.....	400
Condulet Elbows, Crouse-Hinds, Type EL.....	406
Condulets, Crouse-Hinds—	
Type EKC.....	399
Bell Signal, Type ESR.....	454
Cable Pulling, Type LBH.....	402
Electric Clock, Type TCH.....	453
Horn and Siren Signal, Type ETH.....	454
Instrument, Type EMH.....	453
Junction—	
Series CPS.....	400
Type EJB.....	401
Type EJH.....	399
Type GU.....	400
Type GUB.....	401

E	Page
Explosion-Proof and Dust-Tight Products—	
Motor Sentinel, Series EFD.....	432
Panel Mounting, Type EMP.....	434
Pilot Light, Series EFD and EFS.....	428
Pulling and Splicing, Type ESC.....	402
Push Button Station—	
Series EFD.....	434
Series EFS.....	426, 427
Push Button Station and Pilot Light—	
Series EFD.....	429, 430
Series EFS.....	429
Type EGP.....	429
Receptacle and Switch, Series FSQ.....	419
Switch—	
Motor Starting, Types EFD and EFS.....	431
Selector, Series EFD and EFS.....	428
Tumbler—	
Series EFD and EFS.....	425
Type ESW.....	424
Type GUSC.....	424
Thermostat, Type HRC.....	453
Thermostat and Thermometer, Type HRC.....	452
Junction Boxes, R&S.....	316
Lighting Fixtures—	
Flourescent, Crouse-Hinds, Type EVF.....	408
Incandescent, R&S.....	1063
Motor Starters, R&S.....	447-449
Motor Starters and Circuit Breakers, R&S.....	449
Panelboards, Circuit Breaker—	
Appleton, Type ELP.....	345
Crouse-Hinds, Type EQP.....	435
R&S.....	443
Pil t Lights, R&S.....	446
Plug Receptacles, R&S.....	366
Push Button, Selector Switch and Pilot Light Station, R&S.....	445
Push Button Selector Switch Station, R&S.....	445
Receptacle and Switch Plugs, Crouse-Hinds, Series	
FSQ.....	419, 420
Receptacle Plugs—	
Crouse-Hinds—	
Type BP.....	419
Type FP.....	419, 420
R&S.....	366
Switch and Plug Receptacles, Appleton, Type FSQX.....	352
Switch Plugs, Appleton, Type FSQX.....	352
Switch Receptacle Plugs, R&S.....	441
Switch Receptacles, R&S.....	441
Telephone Sets, Crouse-Hinds, Series ET.....	1520-1524
Tumbler Switches, R&S.....	441, 442
Unilets, Appleton—	
Series ER.....	344
Series GR.....	327, 336
Series GRJ.....	327
Series GRUJ.....	328
Push Button Station, Series EFS.....	347
Switch and Plug Receptacles, Type FSQX.....	352
Tumbler Switch, Series EFS.....	346
Unions, Condulet, Crouse-Hinds—	
Conduit to Conduit, Type UNE.....	403

E	Page
Explosion-Proof and Dust-Tight Products—	
Codulet to Conduit, Type UNY.....	408
Expansion, Types UNY and UNYL.....	408
Universal, Type UNA.....	408
Explosion-Proof and Weather-Resistant—	
Hand Lamps, Crouse-Hinds, Type EVH and EVS.....	408
Lighting Fixtures—	
Gauge, Crouse-Hinds, Series ELG.....	411
Incandescent, Industrial, Crouse-Hinds, Series EV.....	408
Explosion-Proof, Dust-Tight and Weather-Resistant Products—	
Circuit Breaker Plugs, Condulet, Crouse-Hinds, Type APJ.....	420
Circuit Breaker Receptacles and Plugs, Condulet, Crouse-Hinds, Type EPC.....	420
Condulets, Crouse-Hinds—	
Circuit Breaker—	
Type EPC.....	437, 451
Type FLB.....	451
Type GUSC.....	438
Circuit Breaker Load Center, Type GUSC.....	435, 436
Junction—	
Type EJB.....	401
Type GUA.....	397, 399
Series GUF.....	397
Series GUP.....	397
Motor Starter, Type EPC.....	438, 439
Push Button Station, Type OFC.....	438
Switch—	
Motor Circuit, Type FLS.....	420
Motor Starting—	
Type FLF.....	438
Type GUB.....	438
Type GUSC.....	438
Tumbler—	
Type FLS.....	420
Type FSPC.....	438
Transformer, Type ECT.....	451
Flexible Couplings—	
Appleton, Type EX.....	344
Crouse-Hinds, Type EC.....	408
Lighting Fixture Hangers, Crouse-Hinds—	
Series EC.....	411
Type EFHC.....	411
Panelboards, Circuit Breaker, Crouse-Hinds, Type EDP.....	438
Extension Arms—	
Cable, Hubbard.....	938
Levolier Switch, McGill.....	690
Extension Brackets, Secondary Rack, Hubbard.....	938
Extension Cable Connectors—	
Appleton, Series APC.....	351
Crouse-Hinds, Type BRC.....	351
Extension Chains, Wire Tong Saddle, Chance.....	881
Extension Collars, Junction Box, R&S.....	310
Extension Fixtures, Crossarm, Hubbard.....	938
Extension Ladders—	
Babcock.....	760
Oshkosh.....	820
White Metal.....	760
Extension Rings—	
Handy Box, Appleton.....	281
Outlet Box—	
Appleton.....	281

E	Page	F	Page	F	Page
Extension Rings—		Fasteners—		First-Aid Emergency Treatment—	
National124, 284, 285, 290		Sheet Metal, Crimp Nuts,		Burns, M-S-A Foille.....	875
Steel City 289		Diamond 853		First Aid Kits—	
Extension Rules, Folding,		Fault Locators, Telefaults,		All-Weather, M-S-A 875	
Lufkin 719		Chance 882		Pocket, M-S-A 875	
Extension Sets, Floor,		Feed-Thru Cord Switches—		First-Aid Pocket Packets—	
Combination, R&S 317		Bryant 616		Minor Injury, M-S-A 875	
Extensions—		Hubbell 615		Fish Tape Balls, T&B.....	748
Bit, Greenlee 710		Feed-Thru Switches, Surface,		Fish Tape Leaders, Ideal.....	749
Cable Rack, Hubbard..... 995		P&S 673		Fish Tape Leads, Barth "Snake	
Condulet, Crouse-Hinds,		Feeder Busways, G-E.....	509	Charmer" 748	
Type ExF386, 387, 391, 392		Feeders and Nozzles, Cable,		Fish Tape Pullers—	
Fixture—		General Machine 845		Ideal 748	
Appleton 240		Feet, Ladder, Rubber, White		Klein 748	
Steel City 240		Metal 761		Fish Tape, Reels and Pullers,	
T&B 240		Ferrules, Flexible Metallic		Ideal 748	
Junction Condulet,		Conduit Fitting, Appleton,		Fish Tape Winders, Ideal.....	749
Crouse-Hinds, Type GUA.... 399		Series ST 222		Fish Tapes—	
Lampholder, Benjamin 1058		Fibre Conduit, Orangeburg.....	1002	Appleton 750	
Panel Connector, T&B..... 232		Fibre Conduit Field Tooling		Ideal 749	
Socket, Morse 669		Lathes, Orangeburg 1004		T&B 748	
Wireway, Electric-Center,		Field Plotters, Analog,		Fish Wire, Steel City.....	749
Pushmatic, Bulldog 601, 606		Sunshine 1499		Fish Wire Pullers, Steel City.....	748
Extinguishers—		Field Rheostats, Plate-Type,		Fittings—	
Fire—		G-E 1332		Armored Bushed Cable,	
C-O-Two 1228		Field Tooling Lathe Blades,		National 124	
Kidde 1228, 1229		Fibre Conduit, Orangeburg 1004		Armored Cable, T&B..... 271	
Pyrene 1227		Field Tooling Lathes, Fibre		Bus Bar, Flat and Tubular,	
Eye-Ball Lighting Fixtures,		Conduit, Orangeburg 1004		Burdy 206	
Incandescent, Moe 1145		Figure-Eight Links, Ohio Brass	965	Bus-Support, Substation, G-E	1411
Eyes—		Figures and Letters, Aluminum,		Cable, Burdy 207	
Ball, Ohio Brass 966		Premax 894		Cable End—	
Bolt, Hubbard 920		Files—		Appleton 238	
Clevis, Ohio Brass..... 966		Drawer, Shop, Steel, Lyon.... 780		Steel City 242	
Screw, Insulated, Diamond .. 937		Flat, Simonds 717		Cable Wiring Support Tray,	
Socket, Ohio Brass..... 966		Mill, Simonds 717		Globe 165	
		Round, Simonds 717		Conduit—	
		Slotting, Commutator, Ideal.. 765		Fibre, Orangeburg 1004	
		Filler Plates, Electric-Center,		Flexible Metallic, Appleton,	
		Pushmatic, Bulldog 601		Series ST 222	
		Filler Tape, Electrical, Bishop..	180	REA, Appleton 333	
		Fillers, Compression Fitting,		Conduit End—	
		Alcoa 863		Appleton 243	
		Filling and Sealing Compounds,		Crouse-Hinds 245	
		G-E 872		O.Z. 238	
		Filling Compound Melting and		Steel City 242	
		Pouring Kettles, Anaconda.. 862		Entrance—	
		Film, Insulating, Graybar.....	867	Cable, Appleton 244	
		Film Cutouts, Circuit		Conduit—	
		Continuity, G-E 1021		Crouse-Hinds 245	
		Film Illuminator Drip-Trays,		Expansion, Conduit, T&B..... 229	
		X-ray, Appleton 338, 339		Floodlight, Steber 1059	
		Film Illuminators, X-Ray		Floor Box Service,	
		Appleton, Type EFUX..... 338, 339		National 322, 323	
		Filter Caps, Photoelectric,		Ground—	
		Infrared, G-E 1351		Appleton 259, 260	
		Finders—		T&B 261	
		Height, Teleheights, Chance... 882		Loom Wire, National..... 123	
		Pull, Guy Wire, General		Machinery Wiring, Flexible	
		Machine 879		Metallic Conduit, Appleton,	
		Finishes, Insulating, G-E.....	873	Series ST 222	
		Fir Crossarms, Rainier.....	906-909	Mast Arm End, Hubbard.....	1039
		Fir Poles, National.....	895, 896	Metal Molding—	
		Fire Alarm Cable, General		La-In, National 469	
		Cable 58		La-In X-tensionduct,	
		Fire Alarm Stations,		National 469-472	
		Edwards 1230, 1231		National 468	
		Fire Alarm Pull Boxes, Federal	1232	Pike Pole, Chance..... 812	
		Fire Alarm System Bells,		Pipe Arm End, Hubbard..... 1039	
		Edwards 1238		Pipe Arm Leveling, Hubbard.. 1039	
		Fire Alarm Systems—		Plugmold Baseboard,	
		Home Type, Edwards..... 1231		Wiremold 457	
		Industrial, Edwards 1230		Receptacle, Outdoor, REA,	
		Fire Extinguisher Recharges,		Appleton 333	
		Pyrene 1227		Sealing—	
		Fire Extinguishers—		Appleton, Series EYS..... 347	
		C-O-Two 1228		Junction Box, R&S..... 316	
		Kidde 1228, 1229		Suspension—	
		Pyrene 1227		Looped-Top, Benjamin 1058	
		Fire Pot and Furnace Safety		Shock-Absorbing,	
		Shields, Folding, Unique..... 787		Benjamin 1058	
		Firmer Chisels, Greenlee.....	710		

F	Page
Fittings—	
Switch, Outdoor, REA, Appleton	333
Tube-To-Cable, Burndy	207
Tubing Support Tray, Globe.....	165
Wire Tong Saddle, Chance.....	886
Wiring Duct, Surfaceduct, National	472, 473
Wiring Duct Device, Surfaceduct, National	473
Wiring Strip, Plug-In, National	474
Wiring System, Surface, Wiremold	459-466
Fittings and Duct—	
Wiring—	
Feed-In, Square D.....	485-487
Flexible Rubber, Winders & Geist	478
Florduct, National	477, 478
Nepcoduct, National	478, 479
Rubaduct, Goodrich	476
Fixture Aligners, Box Cover Mounted, Benjamin	1051
Fixture Canopies—	
Junction Condulet, Crouse-Hinds—	
Series GUA	399
Series GUF	399
Series GUJ	399
Fixture Extensions—	
Appleton	240
Steel City	240
T&B	240
Fixture Hanger Accessories—	
Lighting—	
Crouse-Hinds, Type EFHC..	417
Kindorf	255
Fixture Hanger Channel and Fittings, Fluorescent	
Fixture, Kindorf	255
Fixture Hanger Clamps, Suspension, Crouse-Hinds, Type CHS	419
Fixture Hanger Condulets, Flexible, Condulet, Crouse-Hinds, Series AL.....	417
Fixture Hanger Suspension Attachments, Crouse-Hinds, Series AL	418
Fixture Hanger Unilets, Flexible, Appleton, Series AL	341, 342
Fixture Hangers—	
Lighting—	
Appleton	241
Crouse-Hinds Condulet, Types UNE, UNH, UNHC	419
Steel City	241
Flexible—	
Appleton Unilet, Series AL	341, 342
Crouse-Hinds, Types AHG, ARB, EC	418
Crouse-Hinds Condulet—	
Series AL	417
Type GS	417
Fluorescent—	
Appleton	292
Crouse-Hinds, Type FOH	419
Commercial—	
Day-Brite	1085
Smithcraft	1094, 1095
Incandescent—	
Industrial, Day-Brite.....	1085
Pendant, Crouse-Hinds, Type EFHC	417
Suspension, Crouse-Hinds, Type OSA	419
Swivel, Appleton	241, 292

F	Page
Fixture Joint and Hickey, Flexible, Appleton	240
Fixture Lampholders, Bryant.....	655
Fixture Stems, Appleton.....	241
Fixture Stud and Strap Combination, Steel City.....	240
Fixture Studs—	
Appleton	241
T&B	241
Fixture Testers, Fluorescent, Ideal	767
Fixture Wire—	
Anaconda	38
General Cable	51
National	119
Plastic W&C	143
Fixture Wire Connectors, Sherman	191
Fixtures—	
Crossarm Extension, Hubbard	930
Gauge Lighting, Crouse-Hinds—	
Type ELG	417
Type VLG	412
Lighting—	
Fluorescent—	
Area, Tunnel and Underpass, Crouse-Hinds	1178, 1179
Area-Liter, Ceiling Mounted, All-Brite	1122
Bathroom, Moe	1139
Commercial—	
All-Brite	1120-1123
Benjamin	1116
Day-Brite	1079-1083
Garcy	1111, 1113
Gibson	1114
Litecontrol	1104, 1105
Pittsburgh	1100, 1101
Silvray	1123
Smithcraft	1093, 1096
Gauge, Crouse-Hinds—	
Type ELG	417
Type VLG	412
Industrial—	
All-Brite	1044
Appleton, Type EFU.....	340
Crouse-Hinds, Type EVF	408
Day-Brite	1045-1047
Gibson	1114
Garcy	1111
Wheeler	1048-1050
Kitchen, Moe	1141
Modu-Liter, All-Brite	1122
Recessed, Moe	1144, 1145
Residential—	
Moe	1139-1145
Silvray	1123
Showcase, Garcy	1113
Strip—	
All-Brite	1121
Curtis	1110
Garcy	1111
Moe	1142
Incandescent—	
Accent—	
Amplex Swivelites	1155
Day-Brite	1165
Litecraft	1138
Moe	1139, 1141, 1142
Adjustable, Amplex Swivelites	1155
Adjustable Arm—	
Dazor	1074
White	1073
Woodward	1072
Bathroom, Moe	1139, 1142, 1145
Built-In, Recessed, Kirlin	1158, 1159

F	Page
Fixtures—	
Ceiling—	
Kliegl	1166
Perfectlite	1148
R&S	1147
Commercial—	
Litecraft	1137
Silvray	1146
Skylike	1136
Decorative, Litecraft	1137, 1138
Dining Room, Moe.....	1139-1142
Dust and Moisture Proof, Multi	1062
Eyeball, Moe	1145
Gauge, Crouse-Hinds, Type ELG	417
Gymnasium—	
Kliegl	1166
Multi	1061
Hallway, Moe	1139-1141
High-Hats—	
Amplex	1155
Moe	1145
Indoor-Outdoor, Vapolets, Benjamin	1063
Industrial—	
Appleton—	
AA51 Series	334, 335
GS Series	326
V51 Series	336, 337
Benjamin	1062
Crouse-Hinds—	
ARB Type	411, 412
DL Series	409
DLA Type	409
EV Series	407
EVA Type	407
GS Series	395
V Series	410, 411
VDB Type	414
VGR Type	415
VH Series	411
VM Series	415
VXHA Type	412
R&S	1063-1066
Wheeler	1050, 1057
Kitchen, Moe	1139-1142, 1145
Living Room, Moe.....	1139-1142
Moisture-Proof, Perfectlite	1152
Pendant, Perfectlite	1148
Outdoor, Moe	1139, 1142, 1143, 1145
Porcelain, Alabax	1151
REA—	
Appleton	333
Crouse-Hinds	332
Residential—	
Litecraft	1137, 1138
Moe	1139, 1145
Roadway and Walkway, Crouse-Hinds	1180
Shovel-Lights, Kliegl	1166
Shower—	
Moe	1144
Multi	1061
Silver-Dot, Silvray	1159
Silver-Spot, Silvray	1159, 1160
Spot, Moe	1144
Spot-Display, Garcy	1160
Spot or Flood, Garcy.....	1160
Spotlight, Curtis	1164
Step, Crouse-Hinds	1180
Utility, Perfectlite.....	1152
Walk and Floor, Crouse-Hinds	1180
Wide Light, Recessed, Garcy	1160
Lumiline—	
Gauge, Crouse-Hinds—	
Type ELG	417

F	Page
Fixtures—	
Type VLG	412
Screw, Angle, Diamond	937
Wind Cone, Illuminated, Aviation, Crouse-Hinds	1194
Fixtures, Parts and Accessories, Lighting, Naval Marine, Modern Metal	1195
Flag Bases, Warning, Fairmount	813
Flagman's Lanterns, Justrite.....	1221
Flags, Warning Road Sign, Bartlett	813
Flags and Flag Holders, Warning, Coffing	813
Flange Clamps, Pressure Plug, General Machine	880
Flanged Washers, Tapped, Hubbard	932
Flanges—	
Ceiling, Kindorf	253
Pressure Plug, General Machine	879
Flare Beacons, Flashing, Big Beam	1217
Flare Lights, Linemens', Fusee, Standard Railway	814
Flasher Warning Lights, Neo-Flasher	813, 814
Flashers—	
Beacon Light, Aviation, Crouse-Hinds	1193
Warning, Utility, Neo-Flasher	814
Flashing Beacons, w/o Motor Flashing Switch, Crouse- Hinds	1009
Flashing Beacons and Warning Signs, w/o Motor Flashing Switch, Crouse-Hinds	1009
Flashing Lamps, Transista, Big Beam	1217
Flashlight and Continuity Tester, Ray-O-Vac	1225
Flashlight Batteries—	
Eveready	1224
Ray-O-Vac	1224
Flashlight Lamps, G-E	1210
Flashlight Lenses, Eveready.....	1223
Flashlight Pockets, Electricians', Klein	794
Flashlight Signal Wands, Ray-O-Vac	1226
Flashlights—	
Eveready	1222, 1223
Justrite	1217, 1220
RayO-Vac	1225, 1226
Flat Cable, Multi-Conductor, Special, Gavitt	150
Flat Files, Simonds.....	717
Flexible Ball Clevises, Hubbard..	949
Flexible-Cable Plugs, Crouse- Hinds, Type BP.....	359
Flexible Conduit—	
Plastic, Triangle	221
Sealtite, American Brass.....	220
Steel—	
National	221
Triangle	221
Flexible Connectors, R&S.....	371
Flexible Couplings—	
Appleton, Series EX	343
Crouse-Hinds, Type EC.....	404
Flexible Metallic Conduit Accessories, Appleton	222
Flexible Metallic Conduit Fittings, Appleton	222
Flexible Wrench Sockets, Chance	891
Flexible Wrenches, Insulated, Chance	891
Float Switches—	
G-E	1340

F	Page
Float Switches—	
Square D	587
Floating-Arm Lamps—	
Fluorescent, Dazor	1075
Incandescent, Dazor	1074
Floating-Arm Lamps and Magnifiers, Fluorescent, Dazor	1075, 1076
Floatrope, American	820
Floodlight Accessories—	
Crouse-Hinds	1173, 1177
Wide-Lite	1190
Floodlight and Power Units, Electric, Portable, Graybar.....	1299
Floodlight Bases and Brackets, Crouse-Hinds	1175, 1176
Floodlight Brackets, Revere	1187
Floodlight Fittings, Steber	1059
Floodlight Color Equipment, Steber	1181
Floodlight Lamps, G-E	1204
Floodlight Poles, Revere	1187
Floodlighting Bracket Arms, Hope	1186
Floodlighting Projectors, Benjamin	1191
Floodlighting Standards, Hope.....	1186
Floodlights—	
Aircraft Hangars, etc. Wide-Lite	1190
Aircraft Maintenance, Crouse-Hinds	1178
Broad Area, Outdoor, Wide-Lite	1190
Eliptor, Revere	1183
Enclosed-Type, Revere	1182
Fluorescent, General Electric	1180
General Purpose—	
Incandescent, Crouse-Hinds	1175, 1176
Mercury, Crouse- Hinds	1173, 1174
Handy, General Electric	1180
Hazardous Areas, Crouse-Hinds	1178
Home and Business, Benjamin	1191
Floodlights, Industrial, Area, Etc.—	
Benjamin	1191
Crouse-Hinds	1177
Revere	1182
Lantern Type, Crouse-Hinds.....	1180
Long Range—	
Crouse-Hinds	1177
Revere	1182
Low-Mounting, Revere	1188
Marine Service, Crouse-Hinds	1177
Mercury and Incandescent Revere	1183
Outdoor and Indoor, Steber.....	1181
Service Station, Crouse-Hinds	1175
Service Stations, Inns, etc., Benjamin	1190
Sports and Play Area—	
Benjamin	1191
General Electric	1181
Revere	1182
Stage Lighting, Century.....	1169
Steber	1058, 1059
Swimming Pool, Underwater—	
Crouse-Hinds	1179
R&S	1184
T-V Studio Lighting, Century	1169
Underneath Lighting, Revere	1184
Utility, Benjamin	1191

F	Page
Floor and Sidewall Boxes and Covers, Cast Iron, Weatherproof, Hope	313
Floor and Walk Lights, Crouse-Hinds	1180
Floor Box Receptacles, T&B	324
Floor Box Service Fittings, National	322, 323
Floor Box Nozzles—	
National	323
R&S	315
Floor Box Parts—	
National	322
T&B	323
Floor Boxes—	
National	322
R&S	315
Steel City	318-321
T&B	317, 323
Floor Circulator Fans.....	1212
Floor Extension Sets, Combina- tion, R&S	317
Floor Fans, Industrial, ILG.....	1276
Floor Finishing Machines, Electric, Premier	764
Floor Furnaces, Automatic, Wesix	1214
Floor Outlet Adjusting Frames, Steel City.....	325
Floor Outlet Box Bodies, Steel City	325
Floor Outlet Frames, Adjusting, Steel City.....	325
Floor Outlet Nozzles, Steel City	321, 323
Floor Outlet Parts, Steel City	319-321, 325
Floor Outlet, Plate and Cover Combination, Flush, P&S.....	649
Floor Outlets, Steel City	318-321, 324, 325
Floor Pocket Lights, Stage, Hub	1171
Floor Receptacles and Plates, Twist-Tite, Hubbell	648
Floor Signaling Treads, Edwards	1256
Fluid, Soldering, Nokorode.....	189
Fluorescent Fixture Hanging Channel and Fittings, Kindorf	255
Fluorescent Fixture Testers, Ideal	767
Fluorescent Lamp Ballasts—	
G-E	1131-1133
Jefferson	1134
Fluorescent Lamp Starter Sockets—	
Bryant	1125
G-E	1130
Fluorescent Lamp Starters—	
Bryant	1126
G-E	1128
Hubbell	1127
Fluorescent Lampholders—	
Bryant	1124-1126
G-E	1128-1131
Hubbell	1127
Fluorescent Lampholders and Starter Sockets—	
Bryant	1125
G-E	1128, 1129
Hubbell	1127
Fluorescent Lamps—	
G-E—	
Back-Light	1209
Circline	1201
General Line	1200
Rapid Start	1201
Slimline	1201

F	Page
Fluorescent Light Accessories, Garcy	1111, 1113
Fluorescent Light Reflectors, Wiremold	467
Fluorescent Lighting Fixture Accessories, Appleton, Type EFU	340
Fluorescent Lighting Fixtures, See Lighting Fixtures, Fluorescent	
Fluorescent Lighting Units, Wiremold	467
Fluorescent Luminaries— Commercial—	
Curtis	1106, 1107, 1109
Kirlin	1124
Pittsburgh	1103
Wakefield	1086-1088, 1090, 1091
Fluorescent Pylon-Lites, Revere	1189
Fluorescent Showcase Lamp- holders—	
Bryant	1126
G-E	1131
Fluorescent Showcase Lighting Units, Wiremold.....	467
Fluorescent Strip-Lighting Units—	
All-Brite	1121
Curtis	1110
Garcy	1111
Moe	1142
Fluorescent Trofferlites, Com- mercial, Benjamin.....	1117, 1118
Fluorescent Troffers— Recessed—	
Curtis	1108
Day-Brite	1084
Garcy	1112
Litecontrol	1105
Pittsburgh	1102
Smithcraft	1096-1099
Wakefield	1089
Flush Bases, Midget, Hubbell	633, 635
Flush-Cut Kits, Super-Saw, R.C.S.	769
Flush Device Boxes, National.	291
Flush Outlets—	
Bryant	621-624, 647, 649
Hubbell	639
P&S	640
Box Cover—	
Bryant	621-623
Hubbell	639
P&S	640
Flush Plate Screws, Hubbell.....	682
Flush Plates—	
Bryant	624, 677, 679, 683-685
Hubbell	636, 641-644, 681, 682
P&S Despard	676
Minneapolis-Honeywell	704
Flush Receptacle Closure Plugs, Hubbell	639
Flush Receptacles—	
Bryant	620
Hubbell	625, 626, 628, 634-637, 642-644, 648
Box Cover Mounted—	
Bryant	620, 625
Hubbell	626, 634, 635, 636, 643, 648
Woodhead	647
Combination—	
Hubbell	631, 634
Box Cover Mounted—	
Hubbell	631
Flush Switches— Push Button—	
Bryant	690
Hubbell	692

F	Page
Flush Switches— Toggle—	
Hubbell	688, 689, 692, 693
Tumbler—	
Bryant	685, 686, 690-692, 706
P&S	686, 687
Hubbell	688
Flushcall Signaling Devices, Edwards	1244
Flux—	
Rosin Liquid, Neutral, Allen	188
Silver-Brazing, Allen	188
Soldering—	
Dunton	187, 188
Stainless Steel, Dunton.....	188
Flux-Density Measuring Meters, Gauss, G-E	1472
FM Transmission Lines, Flat-Twin, General Cable....	65
Folding Barricades, Steel, Oshkosh	813
Folding Rules—	
Evans	718
Lufkin	719
Follow Spot Lights, Stage, Century	1168
Foot-Candle Meters, Weston.....	1484
Foot Lights— Stage—	
Century	1168
Hub	1170, 1171
Kliegl	1173
Foresters' Hand Saws, Bartlett	807
Fork Bolts, Insulated, Hubbard	952
Forks, Insulator, Adjustable, Universal Pole, Chance	891
Formers, Elbow, Conduit, T&B	740
Frames, Floor Outlet, Adjusting, Steel City	325
Hack Saw—	
Capewell	715
K-D	715
Plaster—	
Fluorescent Troffer—	
Garcy	1112
Smithcraft	1099
Wakefield	1089
Frequency Meters, Portable, Biddle Frahm	1498
Fresnel Beacons, Airport Identification and Hazard Marking, Crouse-Hinds.....	1193
Fresnel-Lens Spotlights, Kliegl.....	1172
Fresnelites—	
Stage Lighting, Century.....	1169
T-V Studio Lighting, Century	1169
Friction Tapes—	
Amazon	179
Manson	179
Sticka	179
Victor	179
Frontlights, Stage and Floor Show, Kliegl	1172
Furnace and Fire Pot Safety Shields, Folding, Unique....	787
Furnaces—	
Electric, Wesix	1214, 1215
Floor, Automatic, Wesix.....	1214
Melting, Solder, Unique.....	787
Wall, Automatic, Wesix	1214, 1215
Furniture and Equipment, Shop, Steel, Lyon	779-782
Fuse and Distribution Boxes and Panels, Modern Metal.....	1196

F	Page
Fuse Blocks—	
Circuit Control Transformer, Square D	551
Conduit, Crouse-Hinds, Series GS	395
Fuse Cabinets, Square D.....	534
Fuse Clip Clamps—	
Buss	545
Ideal	545
Fuse Cutout Accessories, Oil, G-E	1446
Fuse Cutout Bases, Cartridge, Bryant	540, 541
Fuse Cutout Condulets, Crouse-Hinds, Series Y.....	423
Fuse Cutout Switching Mechanisms, Pole Base, G-E	1447
Fuse Cutouts—	
Cartridge, Knox	541, 542
Disconnect, G-E	1438-1440
Drop-Out—	
G-E	1438-1440
Hubbard	1443
Flip-Open Type, G-E	1442
Flip-Out Type, Hubbard.....	1443
Heavy Duty—	
G-E	1439, 1441
Hubbard	1443
Indicating, G-E	1438-1440
Oil, G-E	1446
Open-Type, G-E	1441, 1442
Plug—	
Bryant	543
Knox	542, 543
Secondary, Indicating, G-E.....	1445
Fuse Cutouts and Lightning Arresters, Hubbard	1443
Fuse Holders and Fuse Assemblies, Buss	543
Fuse Links—	
Flip-Open Fuse Cutout, G-E	1442
Oil Fuse Cutout, G-E	1447
Renewal, Cartridge—	
Buss	535
Economy	539
Secondary Fuse Cutout, G-E	1445
Universal Cable-Type, G-E	1443-1445
Fuse Pullers—	
Ideal	544
Seeger Williams	541
Fuse Pullers and Testlites, Ideal	545
Fuse Reducers—	
Buss	545
Ideal	545
Fuse Strips, Buss	544
Fuse Supports, Substation, G-E	1410
Fuse Wire—	
Buss	544
Reliable	1514
Fuseless Plugs, Neutral Wire, Bryant	543
Fuseless Protectors— Telephone Service—	
Cook	1510
Reliable	1513
Fuses—	
Aircraft, Buss	538
Alarm Type, Indicator, Cook	1511
Automobile, Buss	539
Cartridge, Bus, Fusetron Dual Element	536
ECO	539
Economy Dual Element	538
One-Time, Buss	535
Renewable—	
Buss	535
Economy	538

F	Page
Fuses—	
Glass Tube, Buss	539
Grasshopper, Alarm Type, Cook	1511
Instrument Protection, Buss ..	539
Open Link, Buss	537
Plug—	
Buss	537
Economy	537
Fusetron, Dual Element, Buss	536
Fustat, Boss	536
Renewable, Economy	537
Power Circuit, High- Interrupting, G-E	540
Protector and Cable Termi- nal, Telephone Service, Reliable	1513, 1514
Radio, Buss	539
Secondary, Indicating, G-E ..	1445
Telegraph, Reliable	1514
Telephone Service, Termi- nal and Protector, Cook	1510
Television, Buss	539
Fusible Plugs, R&S	371
Fusible Service Equipment, Square D	532-534
Fustat Box-Cover Units, Buss ..	544
Fustats, Plug, Buss	536
G	
Gaff Gauges, Climber, Linemens', Klein	801
Gaff Guards, Climber, Linemens', Klein	799
Gain Plates, Tie and Flat, Hubbard	945
Gains, Pole, Crossarm, Hubbard	928
Gang Box Covers—	
Appleton	295
Bryant, Multi-Control	678
National	294
Steel City	293, 295
Gang Box Partitions, Steel City	294
Gang Boxes—	
Bryant, Multi-Control	678
National	294
Steel City	293
Touch-Plate Remote Control	703
Gang Switch Boxes, Appleton ..	294
Galvanometers, Panel, D-C, Simpson	1492
Gaps—	
Isolating, Distribution Circuits, G-E	1436
Neutral, G-E	1436
Gas and Liquid Thermometers—	
Dillon	1288
Weston	1289
Gas-Fired Equipment Servicing Meters, Millivoltmeters, Portable, Simpson	1494
Gas-Tube Sign Cable, Anaconda	39
Gaskets—	
Conduit, Crouse-Hinds Form 8 Series	393
Mogul Series	384
Oround Series	381
FD and FS Series	389
LBD Type	383
SE and SEH Series	397
SK Series	394
Flexible Metallic Conduit Fitting, Appleton, Series ST	222
Gasoline and Oil Resistant Cable, General Cable	52
Gasoline and Oil Resistant Wire, Plastic W&C	145

G	Page
Gathering Locomotive Cable, Anaconda	34
Gauge Lighting Fixtures—	
Fluorescent—	
Crouse-Hinds—	
Type ELG	417
Type VLG	412
Incandescent—	
Crouse-Hinds, Type ELG ..	417
Limiline—	
Crouse-Hinds—	
Type ELG	417
Type VLG	412
Gauges—	
Gaff, Climber, Linemens', Klein	801
Pressure Testing, General Machine	881
Vacuum, Molecular, G-E	1473
Vacuum System, Thermo- couple, G-E	1472
Wire, Ideal	741
Gauss Meters, Flux-Density Measuring, G-E	1472
Gel Time Meters, Sunshine	1498
General Control Relays, Indus- trial, Struthers-Dunn	1344
General Purpose Amplifiers, Altec Lansing	1532
General Purpose Cable, Phelps Dodge	5
General Purpose Insulators, Hemingray	959
General Purpose Relays, Edwards	1346
General Purpose Switches, Power and Light Control Switchboard, G-E	1384
General Purpose Wire, Gavitt	148, 149
General Service Lamps, G-E ..	1202
Generating Plants, Electric, Mobile, White	1301
Generator Sets, Motor, Industrial, G-E	1328
Generators—	
Electric—	
Belt and Direct Drive, Graybar	1300
Tractor Drive, Graybar ..	1300
Germicidal Lamps, G-E	1211
Gin Poles, Insulated, Chance ..	835
Gins—	
Pole-Top, Chance	833
Transformer, Cofing	835
Gins and Accessories, Multi-Duty, Chance	834
Glass Bowls, Lighting Fixtures, Graybar	1150
Glass Globes—	
Lighting Fixture—	
Alabax	1151
Graybar	1149, 1150
Glass Shades—	
Lighting Fixture—	
Alabax	1151
Graybar	1150
Glass-Tube Fuses, Buss	539
Glassware—	
Lighting Fixture—	
Alabax	1152
Graybar	1149, 1150
Globe and Guard Adapter Bodies, Lighting Fixture, Series V51, Appleton,	337
Globe Guards—	
Lighting Fixture—	
Appleton, Series AA51	335
REA—	
Appleton	333
Conduit, Course-Hinds ..	332
Globe Hangers—	
Ceiling—	

G	Page
Globe Hangers—	
Perfectlite	1148
Wakefield	1149
Pendant, Perfectlite	1148, 1149
Globes—	
Exit Light, Graybar	1166
Glass, Lighting Fixture, Alabax	1151
Graybar	1149, 1150
Hand Lamp, Crouse-Hinds, Type VS	414
Lighting Fixture—	
Appleton—	
Series AA51	335
Series V51	337
Crouse-Hinds—	
Series V and VH	413
Series VDB	414
Series VM	414
REA—	
Appleton	333
Crouse-Hinds	332
Glove Bags, Linemens', Salisbury	877
Glove Pouches, Linemens', Klein	878
Gloves—	
Linemens', Rubber, Salisbury	876
Protector, Gauntlet Type—	
Salisbury	876
Rubber Cuff, Salisbury	876
Glue Pots, Electric—	
General Electric	758
Vulcan	758
Grade Cable Clamps, Hubbard ..	935
Grapples, Rod, General Machine	847
Grasshopper Fuses, Alarm Type, Cook	1511
Grinders—	
Commutator and Slip Ring, Ideal	766
Electric—	
Bench, Thor	775
Portable, Thor	778
Gripping Chucks, Strandvisse, Reliable	987
Grips—	
Cable and Wire Pulling, Klein	803-805
Cable Housing, Electrical, Pyle-National	365
Cable Pulling—	
Klein	804
Reliable	996, 997
Chicago, Wire and Cable, Klein	803, 804
Cord and Cable, Conduit, Pyle-National	224
Haven's, Wire and Cable, Klein	805
Hot Line Pulling, Klein	804
Toolholder, Rawl	851
Wire, Lashing, General Machine	833
Wire and Cable Pulling, Klein	803-805
Wire Pulling—	
Bare, Klein	803
Chicago, Klein	803, 804
Conductor, Klein	804
Guy Strand, Klein	804, 805
Haven's, Klein	805
Messenger, Klein	803, 804
Reliable	997
Weatherproof, Klein	803
Grommets, Terminal, Cable, Telephone Service, Cook	1509
Groove and Sleeve Squeeze Tools, Reliable	994
Ground Clamps, Hubbard	934
Mueller	258

G	Page
Ground Clamps—	
Sherman	257, 265
T&B	258, 262, 265
Ground Connectors—	
O.Z.	263, 264
Substation, G-E	1411
Ground Detectors, Switchboard,	
Lamp Type, Sunshine	1499
Ground Fitting Parts, T&B	262
Ground Fittings—	
Appleton	259, 260
T&B	261
Ground Resistance Testers—	
Portable—	
Associated Research	1495
Biddle	1497
Ground Rod Clamps, Reliable	926
Ground Rods—	
Chance	886
Hubbard	923-925
Ground Tents, General Machine	828
Ground Wire—	
Bare—	
Crapo	970
National	125
Phelps Dodge	12
Triangle	93
Telephone—	
Graybartel	87
Whitney Blake	133
Ground Wire Clamps,	
Hubbard	924
Ground Wire Mouldings,	
Wood, Rainier	911
Ground Wire Staples,	
Hubbard	925
Grounders, Alarm Box,	
Hubbard	924
Grounding Adapters—	
Outlet—	
Bryant	623
Hubbell	629
Grounding Bushings—	
Appleton	260
O.Z.	257, 258
Steel City	264
T&B	264
Grounding Clamps,	
Temporary, Chance	887
Grounding Connectors,	
Burndy	262, 263
Grounding Equipment—	
Conduit, Crouse-Hinds	261
Temporary, Chance	886
Grounding Locknuts, Conduit,	
Appleton	260
Grounding Outlets, Hubbell	630
Grounding Reels, Static	
Discharge, Benjamin	172
Grounding Shunts, Water	
Meter, Appleton	260
Guard Arm Braces, Hubbard	934
Guard Arm Hooks, Hubbard	934
Guards—	
Cable—	
General Machine	935
Hubbard	935
Fan, Propeller, ILG	1279
Gaff, Climber, Linemens',	
Klein	799
Globe—	
Lighting Fixture—	
Appleton, Series AA51	335
Crouse-Hinds, Series	
V and VH	413
REA—	
Appleton	333
Crouse-Hinds	332
Hand, Pole, Safety, Chance	892
Hand Lamp, Course-Hinds,	
Type VS	414
Lamp—	
Lighting Fixture—	

G	Page
Guards—	
Appleton, Series V51	337
Crouse-Hinds, Type	
DLA	409
Portable, McGill	608, 609
Pike Pole, Oshkosh	811
Pole, Safety, Chance	882
Receptacle, Box Cover,	
McGill	608
Reflector, Lighting Fixture—	
Benjamin	1054
Course-Hinds	414
Tree	830
Tree and Trolley, Eond	831
Wall Socket, Box Cover,	
McGill	608
Guides—	
Aerial Cable—	
B&L	927
General Machine	827
Die Stock, Nye Triplex	720
Wire, Ideal	845
Guides and Straighteners,	
Aerial Cable, B&L	826
Gum-Perma, Graybar	863
Gun Tackers, Automatic,	
Arrow	715
Guns—	
Compound, Pressure,	
General Machine	879
Soldering, WEN	756, 757
Guy Anchor Installing Bars,	
Chance	915
Guy Anchors—	
Chance	914, 915, 917
Everstick	915, 917
Hubbard	916, 917
Guy and Load Plates,	
Hubbard	920
Guy Arm Attachments,	
Hubbard	922
Guy Arms, Sidewalk, Hubbard	922
Guy Bolts, Rock, Hubbard	917
Guy Clamps—	
Coffing	835
Hubbard	921
Guy Hooks, Hubbard	919
Guy Shims, Pole, Hubbard	919
Guy Strand, Crapo	971
Guy Strand Spreader Plugs,	
Steel City	209
Guy Thimbles, Hubbard	921
Guy Wire Dispensers, Chance	819
Guy Wire Protectors,	
Hubbard	921, 922
Guy Wire Pull Finders,	
General Machine	879
Gymnasium Lighting Fixtures—	
Incandescent—	
Benjamin	1061
Kliegl	1166
Multi	1061
Gymnasium Lighting Units,	
Incandescent, Benjamin	1061

H	Page
Hacksaw Blades—	
Capewell	716
Wiremold	468
Hacksaw Frames—	
Capewell	715
K-D	715
Hallway Lighting Fixtures,	
Moe	1139-1141
Halogen Leak Detectors, G-E	1473
Halogen Leak Standard, G-E	1472
Halogen Leak Standard	
Calibrator, G-E	1472
Hammer Drill Chucks, Rawl	851
Hammer Drills, Hand or Elec-	
tric, Diamond Di-Forge	712
Hammer Drive Anchors,	
Diamond	856

H	Page
Hammers—	
Air, Star Drill and Chipping,	
Portable, Thor	777
Ball Pein, Capewell	714, 715
Claw, Capewell	714, 715
Drill, Electric Drill Type,	
Rawl	852
Electric, Portable, Thor	778
Electricians', Champion	
DeArment	808
Jar, General Machine	847
Linemens'—	
Champion DeArment	808
Vaughan & Busheell	808
Nail, Capewell	714, 715
Ripping, Capewell	714, 715
Hand Drills, Rawl	851
Hand Dryers, Electric, OZO	1213
Hand Guards, Pole, Safety,	
Chance	892
Hand Lamp Accessories,	
Crouse-Hinds, Type VS	414
Hand Lamp and Flashing	
Beacon Combination,	
Big Beam	1217
Hand Lamp Globes,	
Crouse-Hinds, Type VS	414
Hand Lamp Guards,	
Crouse-Hinds, Type VS	414
Hand Lamps, Portable—	
Appleton Reelite	169
Big Beam	1217-1219
Crouse-Hinds—	
Type EVH	408
Types LPG and LPH	414
Type VS	414
R&S	1063
Hand Lantern Batteries,	
Big Beam	1217
Hand-Lantern Lamps, G-E	1210
Hand Lanterns—	
Big Beam	1217
Justrite	1221
Ray-O-Vac	1225
Hand Line Hooks—	
Chance	888
Klein	824
Hand Lines—	
B&L, Aerial	824
Klein	824
Hand Pruners, Bartlett	807
Hand Saws—	
Foresters', Bartlett	807
Tree Trimmers', Bartlett	806, 807
Hand Tools, Insulated,	
Chance	891, 892
Hand Wheels, Retract-O-Reel,	
Appleton	171
Handiscopes, TV-Radio	
Servicing Instrument,	
Portable, Simpson	1494
Handles—	
Auger, Everstick	916
Dye Stock, Nye	720, 721
Carrying, Electric Plant,	
Graybar	1297
Lug Hook, Oshkosh	810
Peavy, Oshkosh	810
Pipe Threader, Nye	725
Pole Hole Digger, Oshkosh	809
Shovel, Oshkosh	808, 809
Soldering Copper, Unique	755
Soldering Iron, Pencil,	
Electric, Ungar	750
Spoon, Pole Hole, Oshkosh	809
Switch, Rotary, Bryant	705
Pipe-Threading Device,	
Toledo	724
Tie, Electric-Center,	
Pushmatic, Bulldog	601
Wire-Raising Tool,	
General Machine	820
X-Ray Illuminator,	
Appleton	338, 339

H	Page
Handles and Guards—	
Portable, Lamp—	
Ericson	607
McGill	609-612
Woodhead	613-615
Handy Box Covers—	
Appleton	238
Union	310
Handy Box Extension Rings,	
Appleton	239
Handy Boxes, Appleton	238
Hanger Rod Couplings,	
Kindorf	255
Hanger Rods, Kindorf	255
Hangers—	
Box—	
Appleton	300, 301
National	298
Steel City	297
Cable—	
Minerallac	251
Reliable	936
Cleat Mounting, Efficiency	211
Conduit—	
Kindorf	253
Minerallac	251
T&B	256
Conduit and Wire,	
Crouse-Hinds	407
Disconnect, T&B	257
Disconnecting and Lowering,	
Thompson	1076, 1077
Globe—	
Ceiling—	
Perfectlite	1148
Wakefield	1149
Pendant, Perfectlite	1148, 1149
Lighting Fixture	
Appleton	241
Crouse-Hinds Condulet,	
Types UNE, UNH,	
UNHC	419
Steel City	241
Flexible—	
Appleton Unilet, Series	
AL	341, 342
Crouse-Hinds, Types	
AHG, ARB, EC	418
Crouse-Hinds Condulet—	
Series AL	417
Type GS	417
Fluorescent—	
Appleton	292
Crouse-Hinds, Type FOH	419
Commercial—	
Day-Brite	1085
Smithcraft	1094, 1095
Incandescent—	
Industrial, Day-Brite	1085
Pendant, Crouse-Hinds,	
Type EFHC	417
Suspension, Crouse-Hinds,	
Type OSA	419
Swivel, Appleton	241, 292
Messenger—	
Hubbard	934
Minerallac	251
Pipe, Appleton	252
Strap, Minerallac	256
Hangers and Supports,	
Kindorf	253-255
Hardware, Static-Proof,	
Hubbard	932, 933
Harness, Safety, Linemen's,	
Klein	797
Harness and Cable Assemblies,	
Special, Gavitt	150
Haven's Grips, Wire and Cable	805
Haymow Lights, Incandenscent,	
Union	1067

H	Page
Head-Lights—	
Justrite	1220
Ray-O-Vac	1225
Headlight Lamps—	
Automotive	1210
Locomotive, G-E	1208
Headlight Wire, Locomotive,	
General Cable	68
Heads—	
Ball Socket Adjuster,	
Universal Pole, Chance	891
Blade, Rotary, Universal	
Pole, Chance	891
Bolt Holder, Universal	
Pole, Chance	891
Cotter Key Installing,	
Universal Pole, Chance	891
Cotter Key Remover, Uni-	
versal Pole, Chance	891
Disconnect, Snap-Out,	
Universal Pole, Chance	891
Prong, Rotary, Universal	
Pole, Chance	891
Shepherd Hook, Universal	
Pole, Chance	891
Heads and Butts, Wire Tong,	
Chance	885
Heat Lamps, Infrared,	
Reflector, G-E	1025
Heater Cord—	
Diamond	91
Whitney Blake	131
Heater Cords—	
Coiled, Retractable	168
Heater Switches, Rotary,	
Bryant	705
Heaters—	
Bathroom—	
Automatic, Fan-Type, Por-	
table, Flush Wall and	
Bracket Types, Wesix	1214
Built-In, Wesix	1213, 1214
Bracket Type, Automatic,	
Wesix	1216
Electric, Wesix	1213-1216
Immersion—	
Oils, Chromalox	1292
Water—	
Chromalox	1292
G-E	1289, 1290
Overload, Thermal, G-E	1335
Portable, Automatic, Wesix	1216
Strip, Chromalox	1292
G-E	1291
Tent, Cable Splicers',	
Perfection	833
Unit—	
Convection-Type—	
Chromalox	1288
G-E	1286, 1287
Electric—	
Chromalox	1288
ILG	1284
Wesix	1215
Gas-Fired, ILG	1283
Steam, ILG	1285
Heaters and Tips, Soldering	
Iron, G-E	751
Heating and Cooling Equipment	
Thermostats—	
Mercoild	1270
Minneapolis-Honeywell	1265, 1266
Heating Cable Controls, G-E	1294
Heating Cable Sets, G-E	1293
Heating Elements—	
Soldering Iron—	
American Beauty	753
Drake	754
G-E	752
Heating Sets, Electric,	
Minneapolis-Honeywell	1267

H	Page
Heating System Controls,	
Central and Automatic,	
Wesix	1215
Heating System Transformers,	
Nutone	1251
Heating Thermostats,	
Industrial, G-E	759
Heating Unit Controls,	
Baseboard, Wesix	1216
Heating Units—	
Baseboard Panel, Wesix	1216
Melting Pot, General Electric	758
Heating Wire Sets, G-E	1294
Heavy Duty Cleaners, Electric,	
Premier	765
Height Finders, Teleheights,	
Chance	882
Hickeys—	
Bending—	
Conduit—	
Tal	738
T&B	740
EMT, Appleton	741
High-Hat Lighting Fixtures—	
Incandescent—	
Amplex	1155
Moe	1145
High-Potential Testers, Port-	
able, Associated Research	1496
High-Tension Detectors,	
"Saf-T-Glow", Brach	1500
High-Voltage Cable, General	
Cable	64, 65
High-Voltage Lamps, G-E	1209
High-Voltage Protectors,	
Telephone Service, Reliable	1513
High-Voltage Push Buttons,	
Edwards	1257
Highway Traffic Signals,	
Crouse-Hinds	1008
Hinge Cable, General Cable	65, 68
Hinged-Cover Wireways and	
Fittings, Hoffman	500
Hoists—	
Chain—	
Electric, Coffing	837
Lever—	
Chance	835
Coffing	836
Load-Indicating, Chance	835
Spur Gear, Coffing	838
Holders—	
Card, Wire Marker, Label,	
Etc., Brady	177
Drill, Masonry, Diamond	852
Pressure Gun, General	
Machine	879
Reflectors, Lighting Fixture,	
Crouse-Hinds, Series V and	
VH	413
Shade—	
Benjamin	1052
Bryant	658
Hubbell	657, 662
Soldering Iron, Vulcan	754
Tool, Wiremen's, Klein	794
Wire, Hubbard	949, 950
Holders and Assemblies, Fuse,	
Buss	543
Hole Saw Arbors and Pilot	
Drills, Capewell	716
Hole Saws, Capewell	716
Hollow Wall Anchors, Diamond,	
"Wing Ding"	855
Home and Office Fans	1212
Home-Cooling Fans, ILG	1274
Home Indicator Lamps, G-E	1207
Home Lighting Lamps, Semi-	
Indirect, G-E	1207
Hoods—	
Insulator, Rubber, Rib-Grip,	
Salisbury	877

H	Page
Foods—	
Insulator and Conductor, Chance	878
Night Light, P&S Despard	676
Pilot Light, P&S Despard	676
Hook Bolts, Insulator, Hubbard	953
Hook-Up Wire, Times	151
Hooks—	
Anchor, Tackle, Klein	825
Booster, B&L	825
"C" B&L	826
Cable Rack, Underground, Hubbard	995, 996
Cant, Oshkosh	811
Carrying, Oshkosh	810
Chain and Rope, B&L	825
Come-Along—	
B&L	825
Chance	888
Disconnect Hanger, T&B	257
Drive—	
Hubbard	941
Reliable	936
Guard Arm, Hubbard	934
Guy, Hubbard	919
Hand Line—	
Chance	888
Klein	824
Ladder—	
Chance	828
General Machine	829
Lighting Fixture, Appleton	340
Lug, Oshkosh	810
Manhole Cover, Diamond	828
Pulling, Dead-End, Reliable	986
Safety, Coffing	825
Scraping, Lead, General Machine	796
Shepherd, Dead-End, Self- Aligning, Chance	889
Snap, Utility, Klein	824
Storm, Hubbard	919
Suspension—	
General Machine	827
Ohio Brass	965
Telephone Mounting, U.S. Instrument	1519
Winch Rope, B&L	825
Horn and Siren Signal Con- dulets, Crouse-Hinds, Type ETH	454
Horn Signal Condulets, Crouse- Hinds, Type WH	454
Horns—	
Alarm and Coding—	
Faraday	1235
Federal	1233, 1234
Industrial, Federal	1233
Loudspeaker, Altec Lansing	1533
Signal—	
Industrial—	
Edwards	1239
Faraday	1235
Federal	1233, 1234
Horns and Drivers, Loud- speaker, Altec Lansing	1534
Hose, Line, Rubber, Salisbury	877
Hospital Cord, Silent Call, Simplex	115
Hospital Pushes, Locking Type, Edwards	1255
Hospital Signaling Systems and Equipment, Edwards	1245
Hot-Line Clamps, Chance	979
Hot Line Pulling Grips, Klein	804
Hot Line Tie Sticks, Chance	890
Hot Line Tool Sets and Compo- nents—	
Auxiliary-Arm, Chance	883
Dual Arm, Chance	884
Hot Plate Switches, Rotary, Bryant	705

H	Page
Hot-Shot Batteries, Eveready	1224
House Brackets—	
Insulator, Knox	954
Telephone, Hubbard	941
Housings—	
Battery, Telephone, Crouse- Hinds	1520
Cable, Connector Barrel, Elec- trical, Pyle-National	365
Control and Transfer Switch, G-E	1385
Electrode, Glass, Knox Pyrex	545
Light Unit, Moe	1144
Plug Receptacle—	
Outlet Box, Crouse-Hinds, Type BRP	358
Pendant or Cord Connector, Pyle-National, Tribloc	362
Receptacle Plug—	
Crouse-Hinds Arktite—	
Types AJ and AR	353-358
Type AJX	357
Type FAR	389
Crouse-Hinds Condulet—	
Type BRD	389
Type BRG	396
Type DS	389
Type GS	396
Pyle-National, Tribloc	363, 364
Housings and Receptacles, At- tachment Plug Condulet, Crouse-Hinds, Type DS	388
Howlers, Industrial, Benjamin	1236, 1237
Howlers and Buzzers, Indus- trial, Benjamin	1236, 1237
Hub Covers—	
Condulet, Crouse-Hinds—	
Series GRF	394
Series SE and SEH	397
Series SK	394
Unilet, Appleton, Series GS	326
Hub-Mounts, Transformer, Hubbard	1416
Hub Plates—	
Conduit, Crouse-Hinds Condu- let, Series RSMP and RSP	403
Condulet, Crouse-Hinds, Series YYP	379
Hub Nuts and Sleeves, Union, Condulet, Crouse-Hinds, Series GUA	397
Hubeye Bolts, Hubbard	919
Hubeye Rods, Anchor, Hubbard	918
Hubeyes, Bolt, Hubbard	920
Hubs—	
Interchangeable, Raintight	511, 516, 519, 524, 550, 551
Humidity Control Thermostats, Minneapolis-Honeywell	1269
Hung Ceiling Boxes, Steel City	295
Hydraulic Jacks—	
Duff-Norton	842
Simplex	842
Hydraulic Power Pumps, Greenlee	843
Hydraulic Pumps, Blackhawk	747
Simplex	843
Hydraulic Pumps and Rams, Simplex	843

I	Page
Immersion Heaters—	
Non-Circulating Oils, G-E	2190
Oils, Chromalox	1292
Water—	
Chromalox	1292
G-E	1289, 1290
Impact Wrenches, Electric, Portable, Thor	775
Incandescent Lamps, G-E	
Aircraft Marker	1208
Appliance	1207
Automotive Services	1210
Aviation	1208
Black-Light	1209
Coloramic	1203
Colored, Natural	1204
Country Home	1207
Daylight	1202
Decorative	1203, 1204
Enlarger, Photographic	1206
Flashlight	1210
Floodlight	1204
Germicidal	1211
Glow, Neon	1208
Hand Lantern	1210
Headlight—	
Automotive	1210
Locomotive	1208
High-Voltage	1209
Home Indicator	1207
Home-Lighting, Semi- Indirect	1207
Indicator, Miniature	1210
Infrared, Industrial	1211
Infrared Heat, Reflector	1205
Locomotive Headlight	1208
Miniature	1210
Night Light	1207
Ozone	1204
Photo-Flash	1206
Photo-Flood	1206
Photographic Enlarger	1206
Projection	1205
Projector	1205
Quartz, Tubular	1211
Radio Panel	1210
Reflector	1203
Rough Service	1209
Sealed-Beam, Automotive	1210
Showcase, Tubular	1204
Sign	1204
Silvered Bowl	1202
Street Lighting, Series	1207
Street Railway	1207
Sun	1211
Toy Train	1210
Traffic Signal	1207
Train-Lighting	1204
Tubular—	
Quartz	1211
Showcase	1204
Vibration	1209
White, Deluxe	1206
Incandescent Lens Boxes, Litecontrol	1105
Incandescent Lighting Systems, Louvered, Skylike	1136
Incandescent Lighting Units, See Lighting Units, Incan- descent	
Incandescent Luminaires—	
Commercial—	
Skylike	1135
Wakefield	1147
Industrial—	
All-Purpose, Holophane	1069
Residential, Skylike	1135
Special Effect, Silvray	1147
Indicating Instruments—	
Accurate, G-E	1469
General Utility, G-E	1466, 1467
High Accuracy, G-E	1467-1469

	Page		Page		Page
Indicating Lamps, Power and Light Control Switchboard, G-E	1388	Industrial Sockets, Levolver, McGill	665	Instruments—	
Indicating Lamps and Annunciator Components, Kirkland	1259-1261	Industrial Step Ladders, Magnesium, White Metal	761	Testing, Electrical, Associated Research	1495, 1496
Indicator Lamps, G-E	1210	Industrial System Connectors, Burndy	208	TV-Radio Servicing, "Handiscope", Portable, Simpson	1494
Indicators—		Industrial Temperature Controls, Mercoid	1270	Insulated Clevis Assemblies, Ohio Brass	956
Phase Sequence, Portable, Associated Research	1495	Industrial Toggle Switches, Carling	698, 699	Insulated Clevises, Hubbard	951, 952
Pressure Flow, General Machine	881	Information—		Insulated Fork Bolts, Hubbard	952
Speed, Biddle	1497	Cable Wiring and Tubing Support Tray	167	Insulated Hand Tools, Chance	891, 892
"Tachometers", Portable, Biddle	1498	Electric Motor, G-E	1302-1304	Insulated Splicing Assemblies, Reliable	989
Weight, Dillon	767	Installing Flexible Metallic Conduit	222	Insulated Staples, Emerson	278
Indoor-Outdoor Lighting Fixtures, Incandescent, Benjamin	1068	Infrared Wire and Cable, Phelps Dodge	11	Insulating and Cooling Oil, G-E	1425
Inductors, Voltage Regulators, G-E	1375, 1376	Switchgear, G-E	1377	Insulating and Cooling Oil Testers, Portable, G-E	1425
Industrial Batteries—		Infrared Batch and Conveyor Ovens, Triangle	1294	Insulating and Moisture Sealing Resin, Scotchcast	865
Air Cell, Eveready	1224	Infrared Heat Lamps, Reflector, G-E	1205	Insulating Cloth—	
Dry, Eveready	1223	Infrared Industrial Lamps, G-E	1211	Asbestos, Atlas	869
Industrial Bells, Federal	1233	Injectors, Desiccant, General Machine	882	Glass, Graybar	867
Industrial Buzzers, Benjamin	1236	Inserts—		Glass Fibre, Graybar	867
Industrial Chimes, Edwards	1247	Blank, Interchangeable, P&S Despard	676	Varnished—	
Industrial Circuit Breakers, Square D	522-524	Concrete, Kindorf	253	G-E	874
Industrial Circuit Interrupters, Square D	525	Inside Cable, Telephone, Whitney Blake	133	Graybar	867
Industrial Fire Alarm Systems, Edwards	1230	Inspection Lights, Barrel, Tank, etc., Justrite	1220	Insulating Compounds—	
Industrial Floor Fans, ILG	1276	Inspection Lights and Cord Sets, Woodhead	613	G&W	863
Industrial Heating Thermostats, G-E	759	Inspection Sealing Condulets, Crouse-Hinds, Type EZZ	406	Minerallac	863
Industrial Horns, Federal	1233	Inspector's Lanterns, Railroad Car, Justrite	1221	Insulating Film, Graybar	867
Industrial Howlers, Benjamin	1236, 1237	Installing Tools, Burndy	202, 203	Insulating Finish Thinners, G-E	872
Industrial Howlers and Buzzers, Benjamin	1236, 1237	Lug and Terminal, T&B	198	Insulating Finishes, G-E	872
Industrial Lanterns, Justrite "Pendragon"	1221	Instrument Condulets, Crouse-Hinds, Type EMH	453	Insulating Materials, Electrical—	
Industrial Lighting Fixtures—		Instrument-Controlled Relays, Struthers-Dunn	1344	Atlas	868, 869
Fluorescent—		Instrument Protection Fuses, Buss	539	G-E	870-974
All-Brite	1044	Instrument Transformer Meters, Watthour Demand, G-E	1452-1456	Graybar	867
Crouse-Hinds, Type EVF	408	Instruments—		Insulating Papers, Asbestos, Graybar	867
Day-Brite	1045-1047	Clock System Control, Edwards	1242	Insulating Rope, Glaspun, Atlas	868
Gibson	1114	Current Testing, A-C—D-C, Portable, Weston	1486, 1487	Insulating Tapes—	
Garcy	1111	Dynamometer, A-C—D-C, Portable, Simpson	1490	Aluminum Foil, Scotch	180
Wheeler	1048-1050	Indicating—		Asbestos, Atlas	869
Incandescent—		Accurate, G-E	1469	Ceramic Fiber, Atlas	868
Appleton—		General Utility, G-E	1466, 1467	Electrical, Plastic, Scotch	180
Series AA51	334, 335	High Accuracy, G-E	1467-1469	Fibre, Atlas	868
Series GS	326	Laboratory, Portable, Simpson	1490	Glaspun, Atlas	868
Series V51	336, 337	Leak Detecting, G-E	1472, 1473	Glass Cloth Backing, Scotch	180
Benjamin	1062	Panel—		Hydro-Proof, Elkhart	180
Crouse-Hinds—		Simpson	1491	Water-Proof, Ruberoid	179
Type ARB	411, 412	Weston	1481-1484	Woven, Atlas	868
Series DL	409	Horizontal Edgewise Type, Simpson	1492	Insulating Textiles, Asbestos, Atlas	869
Type DLA	409	Radio and Industrial, G-E	1465, 1466	Insulating Tubing, Braided Asbestos, Atlas	869
Series EV	407	Wide-Vue, Simpson	1492	Insulating Varnish Thinners, G-E	873
Type EVA	407	Power Measuring, A-C—D-C, Portable, Weston	1487	Insulating Varnishes, G-E	872, 873
Series GS	495	Recording, Strip Chart, G-E	1463, 1464	Insulating Webbing, Glaspun, Atlas	868
Series V	410, 411	Switchboard—		Insulation—	
Type VDB	414	General Service, G-E	1461-1463	Mica, Tapes, G-E	872
Type VGR	411, 412	Power Distribution, Weston	1474, 1475	Mica Mat, G-E	870, 871
Type VH	411			Insulation Putty, Electrical, Scotchfil	864
Type VM	415			Insulation Resistance Testers, Portable—	
Type VXHA	412			Associated Research	1495
R&S	1063-1066			Biddle	1497
Wheeler	1050, 1057			Insulation Testers—	
Industrial Plant Annunciators, Kirkland	1261			Biddle	1496
Industrial Safety Switches, G-E	517, 519			Ideal	766
Industrial Scales, Balance, Dillon	767			Insulator and Conductor Hoods, Chance	878
Industrial Signal Horns, Faraday	1235			Insulator Attachments, Strain, Hubbard	047
Industrial Sirens, Federal	1232			Insulator Bolts, Hubbard	947
				Insulator Bracket Washers, Clip, Hubbard	945

	Page
Insulator Brackets, Wood,	
Rainer	911
Insulator Clamps, Suspension,	
Ohio Brass	957
Insulator Clevises—	
Railway, Hubbard	952
Strain, Hubbard	948
Insulator Forks, Adjustable,	
Universal Pole, Chance	891
Insulator Hoods, Rubber, Rib-	
Grip, Salisbury	877
Insulator Hook Bolts, Hubbard	953
Insulator House Brackets, Knox	954
Insulator Pin Brackets, Pole	
Top, Hubbard	946
Insulator Pins—	
Clamp-Type, Hubbard	943
Corner Pole Top, Hubbard	945
Corner Type, Hubbard	943
Low-Voltage, Hubbard	942
OB Type, Hubbard	943
Pole Top, Hubbard	945
Signal-Type, Hubbard	942
Steel, Hubbard	944
Western Union Type,	
Hubbard	942
Wood, Rainer	911
Wood Top, Hubbard	942
Insulator Racks, Light-Type,	
Hubbard	953
Insulator Strain Yokes,	
Ohio Brass	966
Insulator Supports—	
Efficiency	208, 212
Steel City	209
Insulator Switch Control	
Mechanisms, Chance	1415
Insulator Switches, Tilting,	
Chance	1415
Insulator Ties, Copperweld	969
Insulator Tools, Dead-End,	
Single-String, Chance	889
Insulators—	
Cable Rack, Underground,	
Hubbard	995
Communications—	
Armstrong	960
Continental Rubber	967
Hemingray	959
General Purpose, Hemingray	959
Line Post, Ohio Brass	958
Low-Voltage, Ohio Brass	955
Pin-Type, Ohio Brass	958
Power, Armstrong	960
Signal Service, Armstrong	960
Spool—	
Hubbard	951
Ohio Brass	956
Strain—	
Hubbard	948
Ohio Brass	954
Porcelain Prod.	955
Substation, G-E	1411
Suspension, Ohio Brass	957
Tapered Hole, Ohio Brass	956
Test Clip, Mueller	190
Wire Connector, Ideal	191
Wire Holder, Hubbard	949
Insulets—	
Conduit, T&B	238
Entrance—	
Cable, T&B	247
Conduit, T&B	247
Insulliner Sleeves, T&B	228
Interchangeable Device Plates—	
Flush, Bryant	685
Hubbell	685
P&S Despard	676
Interchangeable Devices,	
P&S Despard	676
Interchangeable Hubs, Raintight	511, 516, 519, 524, 550, 551

	Page
Intercommunicating Speakers,	
Webster Teletalk	1536
Intercommunicating Systems,	
Webster Teletalk	1536
Intercommunication and Tele-	
phone Equipment, Naval	
Modern Metal	1197
Intercommunication Cable,	
Kaiser	129
Interior Wire, Telephone,	
Graybartel	88
Whitney Blake	135
Interiors—	
Plug, Appleton, Series AE ...	351
Receptacle, Appleton, Series	
AE	351
Socket, Bryant	662
Interlocks, D-C Contactor,	
G-E	1333
Intermediate Base Lampholder	
Socket Bodies and Caps,	
Bryant	661
Intermediate Lightning Ar-	
resters, Thorex Dynagap,	
Ohio Brass	1434
Intermediate Relays, Line-Volt-	
age, Load Switching, Min-	
neapolis-Honeywell	1268
Interrupters, Circuit, Indus-	
trial, Square D	525
Interval Timers—	
Paragon	1354
Sangamon	1356
Irons—	
Pulling-In, Manhole, Hubbard	995
Ridge, Hubbard	947
Soldering, Electric—	
American Beauty	752, 753
Drake	754
G-E	751
Vulcan	755
Industrial, G-E	751
Midget, G-E	751
Miniature, G-E	752
Pencil Type—	
American Beauty	753
Vulcan	755
Isolating Gaps, Distribution	
Circuit, G-E	1436

	Page
J	
Jacketed Wire, Times	151
Jacketing Tape, Electrical,	
Bishop	181
Jackets and Blankets, Snap-	
Button, Salisbury	878
Jacks—	
Emergency, Simplex	838
Hydraulic—	
Duff-Norton	842
Simplex	842
Journal, Duff-Norton	841
Pole-Pulling, Duff-Norton	838
Pole-Pulling and Straight-	
ening, Simplex	838
Push and Pull, Duff-Norton...	844
Pushing and Pulling, Pipe,	
Simplex	843
Ratchet Lowering—	
Duff-Norton	839
Simplex	839, 840
Reel—	
Duff-Norton	840, 841
Simplex	841
Telephone, U. S. Instrument ..	1519
Tensioning, Aerial Cable	
and Wire, Simplex	827
Jar Hammers, General Machine	847
Jaw Clamp Pins, Curved, Salis-	
bury	876
Jaws—	
Chain Vise, Armstrong	729

	Page
J	
Jaws—	
Vise Stand, Armstrong	729
Jewel Oil, Watthour Meter, G-E	1455
Jewel Screws and Plugs,	
Watthour Meter, G-E	1455
Jewels—	
Night Light, P&S Depsard...	676
Pilot Light—	
Bryant	679
Hubbell	679
P&S Depsard	676
Watthour Meter, G-E	1455
Joint-Wiping Cloths, Unique	189
Jointing Materials, Cable,	
Anaconda	862
Joints—	
Twisting, Alcoa	978
Wire, T&B	197
Joist and Beam Boring Tools,	
Toledo	709
Joist Borers, Electric, Kett Tall	708
Joist Boring Auger Bits, Kett	708
Journal Jacks, Duff-Norton	841
Jumper and Duct Wire,	
Telephone—	
Graybartel	87
Whitney Blake	137
Jumper Sleeves, Cable, Chance	887
Junction Box Adapter Plates,	
R&S	316
Junction Box Ball Aligners,	
Waterproof, R&S	316
Junction Box Canopy Covers,	
R&S	316
Junction Box Covers, R&S	316
Junction Box Extension Collars,	
R&S	316
Junction Box Sealing Fittings,	
R&S	316
Junction Box Pendant Covers,	
R&S	316
Junction Boxes—	
Benjamin, Vapolets	1067
Hope	312-314
R&S	316
T&B	310, 311
Surface—	
Bryant	673
P&S	673
Junction Condulet Adapters,	
Threaded, Crouse-Hinds—	
Series GUA	399
Series GUF	399
Junction Condulet Covers,	
Crouse-Hinds—	
CPS Series	409
GUA Series	399
GUB Type	400
GUF Series	399
GUJ Series	399
Junction Condulet Extensions,	
Crouse-Hinds—	
Type GUA	399
Junction Condulets, Crouse-Hinds—	
CPS Series	400, 409
EJB Series	401, 402
EJH Type	399
GU Type	400
GUA Series	397, 398
GUB Type	397
GUE Type	400
GUF Series	397
GUJ Series	399
GUP Series	397
RS Series	402
K	
Kettles, Filling Compound Melt-	
ing and Pouring, Anaconda	862
Keys, Pole, Chance	918
Kit Pipe Vises—	
Clamp Type, Armstrong	730

K	Page
Kit Pipe Vises—	
Nye	722
Kitchen Cabinet Fans, Nutone	1272
Kitchen Lighting Fixtures,	
Moe	1139-1142, 1145
Kitchen Ventilators—	
Electric—	
Built-In Type, ILG	1275
Ceiling Type, ILG	1275
Kits—	
Drill and Water Swivel,	
Electric, Truco	858
Electric Interlock Installing,	
Square D	585
First Aid—	
All-Weather, M-S-A	875
Pocket, M-S-A	875
Flush-Cut Super-Saw, R.C.S.	769
Modification—	
Contactor and Starter,	
Square D	585
Pressure, Float and Vacuum	
Snitch, Square D	585
Starter, Contactor and	
Relay, Square D	585
Pressure-Testing, General	
Machine	881
Service Mast, Hubbard	939
Snake-Bite, M-S-A	875
Soldering, Electric, Ungar	750
Splicing—	
Scotchcast	856
Cable—	
Light and Power, G&W	866
Telephone, G&W	866
Super-Saw, R.C.S.	768
Terminal Assortment, T&B	196
Tool, Electrical Inspector's,	
Klein	794
Stud-Fastening, Ramset	
Hammer-in	858
Wire Connector, Burndy	203
Klieglights, Kliegl	1172
Knee and Vee Braces, Wood,	
Rainier	192
Knife Pockets, Skinning, Klein ..	795
Knife Switches—	
Indoor, G-E	1405-1407
Open Type, G-E	521
Knives—	
Chipping, Cable Sheath, Klein ..	796
Draw, Greenlee	710
Electricians', Klein	795
Linemens', Klein	795
Skinning, Electricians', Klein ..	795
Splitting, Cable Sheath, Klein ..	796
Knob Screws, Telephone, In-	
sulated, Hubbard	941
Knobs—	
Porcelain—	
Knox	212
Porcelain Prod.	213
Telephone—	
Knox	214
Porcelain Prod.	213
Knockout Adapters, T&B	234
Knockout Blanks—	
Snap-In—	
Appleton	240
Steel City	240
Knockout Bushings—	
Porcelain, Federal	258
Snap-In—	
Appleton	240
Steel City	240
Knockout Couplings, T&B	229
Knockout Covers, Condulet, Ob-	
round Series, Crouse-Hinds	382
Knockout Cutters, Greenlee	746
Knockout Plug Clinching	
Clips, T&B	240

K	Page
Knockout Punch Drivers,	
Hydraulic, Greenlee	743
Knockout Punches—	
Hand—	
Greenlee	747
Nye	743
Hydraulic—	
Blackhawk	747
Nye	743
Knockout Reducing Washers—	
Appleton	236
Steel City	236
T&B	234
L	
Laboratory Instruments, Port-	
able, Simpson	1490
Ladder Blocks, Bond	830
Ladder Feet, Rubber, White	
Metal	761
Ladder Hooks—	
Chance	828
General Machine	829
Ladder Supports, General	
Machine	830
Ladder Tents, General Machine ..	832
Ladders—	
Extension—	
Babcock	760
Oshkosh	830
White Metal	761
Maintenance, Swivel Hook,	
Chance	828
Manhole, Hubbard	830
Sectional, Oshkosh	828
Step—	
Babcock	760
White Metal	761
Industrial—	
White Metal	761
Platform—	
Babcock	760
White Metal	761
Straight—	
Oshkosh	830
White Metal	761
Ladles, Solder, Unique	759
Lag Screw Anchors, Rawlplug	853
Lag Screw Shields—	
Di-En-Key	854
Diamond	854
Rawl	854
Lag Screws, Hubbard	932
Lamp and Extension Cord	
Sets—	
Portable—	
Ericson	606
McGill	612
Woodhead	613, 614
Lamp Base Removers, Lamp	
Changer, McGill	670
Lamp Bulbs and Resistors,	
Indicating Lamp, Kirk-	
land	1259-1261
Lamp Changer Poles—	
Chance	606
McGill	607
Lamp Changers—	
Chance	606
McGill	607
Lamp Control Relays, Emer-	
gency, Struthers-Dunn	1345
Lamp Cord—	
Parallel, Rip Type, Diamond ..	91
Twisted Pair, Whitney Blake ..	131
Lamp Guards—	
Lighting Fixture, Crouse-	
Hinds, Type DLA	409
Portable, McGill	608, 609
Lamp Handles and Guards—	
Portable, Ericson	607
McGill	609-612
Woodhead	613-615

L	Page
Lamp Receptacle Covers—	
Appleton, Unilet—	
"35" Line	328
Series GS	326
Lamp Receptacles—	
Crouse-Hinds, Condulet—	
Obround Series	383
Series GS	395
Neotex, Woodhead	651
Lamp Socket Adapters, All	
Types	670
Lamp Starters—	
Fluorescent—	
Bryant	1126
G-E	1128
Hubbell	1127
Lamp Suspension Units,	
Benjamin	1053
Lampholder Adapters, P&S	669
Lampholder Bases—	
Candelabra, Bryant	661
Metal Sign, Intermediate	
Base, Bryant	661
Miniature, Bryant	661
Lampholder Caps, Mogul Base,	
Bryant	660
Lampholder Cord Grips,	
Benjamin	1058
Lampholder Extensions,	
Benjamin	1058
Lampholder Reducers,	
Benjamin	1058
Lampholder Screw Rings,	
Bryant	655
Lampholder Socket Bodies,	
Porcelain, P&S	667
Lampholder Socket Bodies and	
Caps, Intermediate Base,	
Bryant	661
Lampholder Socket Caps, Por-	
celain, P&S	667
Lampholder Sockets, Fixture	
Bryant	656
Lampholders—	
Aluminum—	
Bryant	656
P&S	659
Border Light,	
Porcelain, Hubbell	654
Box-Mounting, Porcelain,	
P&S	666, 667
Candelabra Base, Bryant	661
Ceiling—	
Brass Covered, Bryant	653
Porcelain, Hubbell	654
Cleat—	
Bryant	655, 656, 660
Hubbell	654, 663
P&S	666
Concealed Wiring, Bryant	656
Fixture, Bryant	655
Fluorescent—	
Bryant	1124-1126
G-E	1128-1131
Hubbell	1127
Lumiline, Bryant	652
Marine, Bryant	660
Outlet Box, Knox	655
Pin-Type, P&S	659
Prefocusing, Bryant	660
Screw-Ring, Porcelain, P&S ..	666
Sign Porcelain—	
Bryant	655
Hubbell	654
P&S	666
Sign and Fixture, Inter-	
mediate, Bryant	661
Surface—	
Bryant	673
Knox	655
P&S	673
P&S Cigarettes	668

L	Page
Lampholders—	
Watertight, Bryant	660
Weatherproof—	
Benjamin	668
Bryant	656
P&S	659
Wood Molding, Bryant	656
Lampholders and Starter	
Sockets, Fluorescent—	
Bryant	1125
G-E	1128, 1129
Hubbell	1127
Lamps—	
Aircraft Marker, G-E	1208
Appliance, G-E	1207
Automotive Service, G-E	1210
Aviation, G-E	1208
Black-Light—	
Filament, G-E	1209
Fluorescent, G-E	1209
Mercury, G-E	1209
Circline, Fluorescent, G-E	1201
Bunghole, Woodhead	612
Coloramic, G-E	1203
Colored Natural, G-E	1204
Country Home, G-E	1267
Daylight, G-E	1202
Decorative, G-E	1203, 1204
Desk and Table, Swing-Arm,	
Dazor	1074
Enlarger, Photographic, G-E	1206
Flashing, Transista, Big	
Beam	1217
Flashlight, G-E	1210
Floating-Arm—	
Fluorescent, Dazor	1075
Incandescent, Dazor	1074
Floodlight, G-E	1204
Fluorescent, G-E—	
Black-Light	1209
Circline	1201
General Line	1200
Rapid-Start	1201
Slimline	1201
Germicidal, G-E	1211
Glow, Neon, Clear, G-E	1208
Hand, Portable—	
Appleton Reelite	169
Big Beam	1217-1219
Crouse-Hinds—	
Type EVH	408
Types LPG and LPH	414
Type VS	414
R&S	1063
Hand-Lantern, G-E	1210
Headlight, Automotive, G-E	1210
Locomotive, G-E	1208
High-Voltage, G-E	1209
Home Indicator, G-E	1207
Home Lighting, Semi-	
Indirect, G-E	1207
Incandescent, G-E	
See Incandescent Lamps	
Indicating, Power and Light-	
ing Control Switchboard,	
G-E	1388
Indicator, Miniature, G-E	1210
Infrared, Industrial	1211
Infrared Heat, Reflector,	
G-E	1205
Locomotive Headlight, G-E	1208
Lubricator Gauge, Crouse-	
Hinds, Type LG	409
Lumiline, G-E	1202
Mercury, G-E	1209
Miniature, G-E	1210
Night Light—	
G-E	1207
P&S Despard	676
Ozone, G-E	1204
Photoflash, G-E	1206

L	Page
Lamps—	
Photoflood, G-E	1206
Photographic Enlarger, G-E	1206
Pilot Light—	
Bryant	676
P&S Despard	676
Portable, Crouse-Hinds,	
Type EVS	508
Post, Moe	1143
Projection, G-E	1205
Projector, G-E	1205
Quartz, Tubular, G-E	1211
Radio Panel, G-E	1210
Rapid-Start, Fluorescent,	
G-E	1201
Reflector, G-E	1203
Rough-Service, G-E	1209
Sealed Beam, Automotive,	
G-E	1210
Showcase, Tubular, G-E	1204
Sign and Decorative, G-E	1204
Silvered-Bowl, G-E	1202
Slimline, Fluorescent, G-E	1201
Steam and Air Gauge,	
Crouse-Hinds, Type LG	409
Street Lighting, Series, G-E	1207
Street Railway, G-E	1207
Sun, G-E	1211
Toy Train, G-E	1210
Traffic Signal, G-E	1207
Train Lighting, G-E	1208
Tubular—	
Quartz, G-E	1211
Showcase, G-E	1204
Vibration, G-E	1209
Water Gauge, Crouse-Hinds,	
Type LG	409
White, DeLuxe, G-E	1206
Lamps and Magnifiers, Floating	
Arm, Fluorescent,	
Dazor	1075, 1076
Lantern Batteries—	
Eveready	1223
Ray-O-Vac	1224
Lantern Posts and Name	
Brackets, Moe	1143
Lanterns—	
Flagman's, Justrite	1221
Hand—	
Big Beam	1217
Justrite	1221
Ray-O-Vac	1225
Industrial, Justrite	
"Pendragon"	1221
Inspectors', Railroad Car,	
Justrite	1221
Post, Moe	1142, 1143, 1145
Railroad Trainman's,	
Justrite	1222
Lashers, Cable, General	
Machine	832, 833
Lashing Wire, Cable, Crapo	972
Lashing Wire Grips, General	
Machine	833
Lathes, Fibre Conduit Tooling,	
Field, Orangeburg	1004
Laundry Receptacles and	
Boxes, Appleton	295
Layout Tapes and Shapes,	
Circuit, Self-Sticking, Brady	178
Lead Cable—	
National	122
Apparatus, General Cable	68
Motor—	
General Cable	68
National	117, 119
Phelps Dodge	7
Simplex	113
Lead Scraping Hooks, General	
Machine	796
Lead Screw Anchors, Rawl	857

L	Page
Lead Sleeve Spreaders, General	
Machine	857
Lead Wire—	
Appliance—	
General Cable	66, 67
Phelps Dodge	7
Motor, Phelps Dodge	7
Range, General Cable	66, 67
Stove, General Cable	66
Switchboard, Phelps Dodge	7
Transformer, Phelps Dodge	7
Leaders—	
Fish Tape—	
Barth "Snake Charmer"	748
Ideal	749
Snake, Raceway, Wiremold	468
Leak Detecting Instruments,	
G-E	1472, 1473
Leak Detectors, Halogen, G-E	1473
Legs, Bench, Shop, Steel, Lyon	780
Lekolites, Stage, Century	1168
Lens Boxes, Incandescent,	
Litecontrol	1105
Lenses—	
Flashlight, Eveready	1223
Traffic Signal, Crouse-Hinds	1012
Letters and Figures, Aluminum,	
Premax	894
Leveling End Fittings, Pipe	
Arm, Hubbard	1039
Lever Switches—	
Multiple-Contact, Mossman	1347
Telephone, Key-Type,	
Mossman	1348
Levolier Sockets, Industrial	
McGill	665
Levolier Switch Adapters,	
McGill	696
Levolier Switch Extension	
Arms, McGill	696
Levolier Switches, McGill	695, 696
Lifters, Cable Block, General	
Machine	826
Lifts, Wire Reel, Hykon	175
Light and Power Cable Splicing	
Kits, G&W	866
Light and Power Control	
Switchboard Components,	
G-E	1383-1388
Light and Power Plants—	
Electric—	
Diesel Engine, Graybar	1299
Gasoline Engine,	
Graybar	1297, 1298
Light and Power Transformers,	
G-E	1357-1364
Light Brackets—	
Decorative, Litecraft	1137
Roof and Wall, Reverse	1189
Light-Control Equipment,	
Superior "Luxtrol"	590
Light-Control Systems,	
Superior "Luxtrol"	701
Light Reflector Canopies,	
Wheeler	1055, 1056
Light Reflector Covers,	
Benjamin	1060
Light Reflector Units,	
Benjamin	1060
Light Reflectors, Benjamin	1053
Light-Source Transformers,	
Photoelectric, G-E	1351
Light Sources, Photoelectric,	
G-E	1350
Light Standards, Reverse	1187
Light Unit Housings, Moe	1144
Lighting, Magic Ceiling,	
Wakefield	1092
Lighting Chandellers, Incan-	
descent, Decorative,	
Litecraft	1137

L	Page
Lighting Equipment—	
Airport, Crouse-Hinds, 1192-1194	
Aviation, Crouse-Hinds 1192-1194	
Architectural, Century 1167, 1168	
Stage—	
Century 1168	
Hub 1170, 1171	
Lighting Equipment Disconnect and Lowering Hangers and Accessories, Thompson	1076-1078
Lighting Fixture Accessories—	
Fluorescent—	
Appleton, Type EFU 340	
Crouse-Hinds, Type EVF 408	
Garcy 1111, 1113	
Incandescent—	
Appleton—	
Series AA51 335	
Series V51 337	
Crouse-Hinds—	
Series V and VH 413	
Series VM 416	
Wheeler 1050	
Lighting Fixture Adapters, Crouse-Hinds, Series VM	415
Lighting Fixture Bodies, Appleton, Series V51	337
Lighting Fixture Canopies, Appleton	336
Lighting Fixture Canopy and Stem Sets, Smithcraft	1093, 1094
Lighting Fixture Condulets, Crouse-Hinds, Series VM	416
Lighting Fixture Connectors, Union, Appleton	340
Lighting Fixture Glassware—	
Alabax 1151	
Graybar 1149, 1150	
Lighting Fixture Globe and Guard Adapter Bodies, Appleton, Series V51	337
Lighting Fixture Globe Guards—	
Appleton, Series AA51 335	
Crouse-Hinds, Series V and VH 413	
REA—	
Appleton 333	
Crouse-Hinds 332	
Lighting Fixture Globes—	
Appleton—	
Series AA51 335	
Series V51 337	
Crouse-Hinds—	
Series V 415	
Series VDB 414	
Series VH 413	
Series VM 415	
REA—	
Appleton 333	
Crouse-Hinds 332	
Lighting Fixture Hanger Accessories—	
Crouse-Hinds, Type EFHC 417	
Kindorf 255	
Lighting Fixture Hanger Covers, Appleton	292
Lighting Fixture Hangers—	
Appleton 241	
Crouse-Hinds Condulet	
Types UNE, UNH, UNHC 419	
Steel City 241	
Flexible—	
Appleton Unilet, Series AL 341, 342	
Crouse-Hinds, Types AHG, ARB, EC 418	
Crouse-Hinds Condulet, Series AL 417	
Type GS 417	

L	Page
Lighting Fixture Hangers—	
Fluorescent—	
Appleton 292	
Crouse-Hinds, Type FOH 419	
Commercial—	
Day-Brite 1085	
Smithcraft 1094, 1095	
Incandescent—	
Industrial, Day-Brite 1085	
Pendant, Crouse-Hinds, Type EFHC 417	
Suspension, Crouse-Hinds, Type OSA 419	
Swivel, Appleton 241, 292	
Lighting Fixture Hooks, Appleton	340
Lighting Fixture Lamp Guards—	
Appleton, Series V51 337	
Crouse-Hinds, Type DLA 409	
Lighting Fixture Louvers, Fluorescent, Smithcraft	1095
Lighting Fixture Mounting Units—	
Appleton, Series V51 337	
Smithcraft 1042	
Lighting Fixture Receptacles, Crouse-Hinds, Series V and VH	413
Lighting Fixture Reflector Guards, Crouse-Hinds	414
Lighting Fixture Reflector Holders, Crouse-Hinds, Series V and VH	413
Lighting Fixture Reflectors—	
Fluorescent—	
Smithcraft 1095	
Wiremold 467	
Incandescent—	
Appleton—	
Series AA51 335	
Series V51 337	
Benjamin 1053, 1060, 1067	
Crouse-Hinds—	
Series EV 406	
Series V and VH 413	
Series VM 416	
Hubbell 1062	
Multi 1060	
Pittsburgh Perma-factors 1153, 1154	
Lighting Fixture Shades—	
Alabax 1151	
Benjamin 1060	
Crouse-Hinds, Series V and VH 413	
Graybar 1150	
Lighting Fixture Shock Absorbers, Thompson	1077
Lighting Fixture Supports, Appleton, Type LSH	340
Lighting Fixture Swivels—	
Appleton—	
Series ESD 340, 347	
Type ESS 340	
Lighting Fixture Unilets, Incandescent, Industrial, Appleton, Series GA	326
Lighting Fixtures—	
Flourescent—	
Area, Tunnel and Underpass, Crouse-Hinds 1178, 1179	
Area-Liter, Ceiling Mounted, All-Brite 1122	
Bathroom, Moe 1139	
Commercial—	
All-Brite 1120-1123	
Benjamin 1116	
Day-Brite 1079-1083	
Garcy 1111, 1113	
Gibson 1114	
Litecontrol 1104, 1105	
Pittsburgh 1100, 1101	

L	Page
Lighting Fixtures—	
Silvray 1123	
Smithcraft 1093, 1096	
Gauge, Crouse-Hinds, Type ELG 417	
Type VLG 412	
Industrial—	
All-Brite 1044	
Appleton, Type EFU 340	
Crouse-Hinds, Type EVF 408	
Day-Brite 1045, 1047	
Garcy 1111	
Gibson 1114	
Wheeler 1048-1050	
Kitchen, Moe 1141	
Modu-Liter, All-Brite 1122	
Recessed, Moe 1144, 1145	
Residential—	
Moe 1139-1145	
Silvray 1123	
Showcase, Garcy 1113	
Strip—	
All-Brite 1121	
Curtis 1110	
Garcy 1111	
Moe 1142	
Incandescent—	
Accent—	
Amplex Swivelites 1155	
Day-Brite 1165	
Litecraft 1138	
Moe 1139, 1141, 1142	
Adjustable, Amplex Swivelites 1155	
Adjustable Arm—	
Dazor 1074	
White 1073	
Woodward 1072	
Bathroom 1139, 1142, 1145	
Built-In, Recessed, Kirlin 1158, 1159	
Ceiling—	
Kliegl 1166	
Perfectlite 1148	
R&S 1147	
Commercial—	
Litecraft 1137	
Silvray 1146	
Skylike 1136	
Decorative, Litecraft 1137, 1138	
Dining Room, Moe 1139-1142	
Dust and Moisture-Proof, Multi 1082	
Eyeball, Moe 1145	
Gauge, Crouse-Hinds, Type ELG 417	
Gymnasium—	
Kliegl 1066	
Multi 1061	
Hallway, Moe 1139-1141	
High-Hats—	
Amplex 1155	
Moe 1145	
Indoor-Outdoor, Vapolets, Benjamin 1068	
Industrial—	
Appleton—	
AA51 Series 334, 335	
GS Series 326	
V51 Series 336, 337	
Benjamin 1062	
Crouse-Hinds—	
ARB Type 411, 412	
DL Series 409	
DLA Type 409	
EV Series 407	
EVA Type 407	
GS Series 395	
V Series 410, 411	
VDB Type 414	
VGR Type 411, 412	
VH Series 411	

L	Page
Lighting Fixtures—	
VM Series	415
VXHA Type	412
R&S	1063-1066
Wheeler	1050, 1057
Kitchen, Moe	1139-1142, 1145
Living-Room, Moe	1139-1142
Moisture-Proof, Perfectlite	1152
Pendant, Perfectlite	1148
Outdoor, Moe	1139, 1142, 1143, 1145
Porcelain, Alabax	1151
REA—	
Appleton	333
Crouse-Hinds	332
Residential—	
Litecraft	1137, 1138
Moe	1139-1145
Roadway and Walkway, Crouse-Hinds	1180
Shovel-Lights, Kliegl	1166
Shower—	
Moe	1144
Multi	1061
Silver-Dot, Silvray	1159
Silver-Spot, Silvray	1159, 1160
Spot, Moe	1144
Spot-Display, Garcy	1160
Spot or Flood, Garcy	1160
Spotlight, Curtic	1164
Step, Crouse-Hinds	1180
Utility, Perfectlite	1152
Walk and Floor, Crouse-Hinds	1180
Wide-Light, Garcy	1160
Lumiline—	
Gauge, Crouse-Hinds—	
Type ELG	417
Type VLG	412
Lighting Fixtures, Parts and Accessories, Naval Marine, Modern Metal	1195
Lighting Panelboards—	
G-E	593-595
Square D	553
Circuit Breaker—	
Square D	554-558
Lighting Pole Bases, Hope	1185
Lighting Streamers, Decorative, Union	659
Lighting Systems—	
Incandescent, Louvered, Skylike	1136
Translucent, Benjamin	1119
Lighting Unit Louvers, Fluores- cent, Benjamin	1040
Lighting Unit Mounting Brackets, Outdoor Sub-Station, Holophane	1071
Lighting Unit Shields, Fluores- cent, Benjamin	1040
Lighting Unit Suspension Equipment, Fluorescent, Benjamin	1040
Lighting Units—	
Emergency, Automatic, Big Beam	1219
Fluorescent—	
Commercial, Holophane	1115
Industrial—	
Benjamin	1040, 1041
Smithcraft	1042, 1043
Wiremold	467
Showcase, Wiremold	467
Strip—	
All-Brite	1121
Curtis	1110
Garcy	1111
Moe	1142
Incandescent—	
Ceiling, Perfectlite	1152

L	Page
Lighting Units—	
Commercial—	
Holophane	1156
Litecraft	1157
Gymnasium, Benjamin	1061
Industrial—	
Benjamin	1067, 1068
Holophane	1068-1070
Night Light, Day-Brite	1162
Outdoor, Holophane	1070, 1071
Outdoor Substation, Holo- phane	1071
Pit, Benjamin	1054
Post-Top, Holophane	1071
Recessed—	
Day-Brite	1162
Hub	1159
Moe	1144
Reflector, Hub	1161
Socket-Reflector—	
Benjamin	1051-1054, 1061
Wheeler	1055, 1056, 1058
Tunnel, Benjamin	1054
Mercury Vapor—	
Industrial, Holophane	1068, 1069
Socket-Reflector, Benjamin	1054, 1061
Lightning Arrester Parts, Station- Type, G-E	1431
Lightning Arresters—	
Autogap, Hubbard	1435
Distribution—	
Pellet-Type, G-E	1432
Thorex Dynagap, Ohio Brass	1434
Intermediate, Thorex, Dyna- gap, Ohio Brass	1434
Line-Type, Thyrite, G-E	1429, 1430
Low-Voltage, Pellet- Type, G-E	1436
Rural, G-E	1433
Station-Type—	
Thorex Dynagap, Ohio Brass	1434
Thyrite, G-E	1429-1431, 1438
Lightning Arresters and Fuse— Cutouts, Hubbard	1443
Lightning Protection Equipment, A-C Rotating Machine, G-E	1437, 1438
Lights—	
Accent—	
Amplex	1155
Day-Brite	1165
Litecraft	1138
Moe	1139, 1141, 1142
Adjustable, Amplex	1155
Adjustable-Arm—	
Dazor	1074
White	1073
Woodward	1072
Aisle—	
Moe	1144
Stock Bin and Book Stacks, Multi	1062
Aisle Chair, Hub	1160
Area—	
Crouse-Hinds	1178, 1179
Revere	1188
Wide-Lite	1190
Bathroom, Moe	1139, 1142, 1145
Eed, Wall Type	1161
Eorder, Stage—	
Century	1168
Hub	1170
Kliegl	1173
Built-In, Kirlan	1158, 1159
Ceiling, Incandescent—	
Hub	1170
Perfectlite	1148, 1152
R&S	1147

L	Page
Lights—	
Cluster, Low-Mounting, Revere	1188
Corridor—	
Fluorescent, Commercial, Benjamin	1118
Incandescent, Holophane	1156
Counter, Incandescent, Re- cessed, Holophane	1156
Curb, R&S	1185
Dining Room, Moe	1139-1142
Directional, Hub	1171
Dome, Incandescent, Litecraft	1138
Down, Incandescent—	
Century	1167, 1168
Curtis	1164
Day-Brite	1162
Kliegl	1166, 1172
Litecraft	1163
Moe	1144
Pittsburgh	1102, 1103
Dust and Moisture-Proof, Multi	1062
Emergency, Auxiliary, Exide	1222
Exit, Hub	1171
Eye-Ball, Moe	1145
Flare, Linemens', Fusee, Standard Railway	814
Flash, Eveready	1222, 1223
Justrite	1217, 1220
Ray-O-Vac	1225, 1226
Flood—	
Aircraft Hangars, etc. Wide-Light	1190
Aircraft Maintenance, Crouse-Hinds	1178
Broad Area, Outdoor, Wide-Lite	1190
Eliptor, Revere	1183
Enclosed-Type, Revere	1182
Fluorescent, G-E	1180
General Purpose—	
Incandescent, Crouse- Hinds	1175, 1176
Mercury, Crouse- Hinds	1173, 1174
Handy, G-E	1180
Hazardous Areas, Crouse- Hinds	1178
Home and Business, Benjamin	1191
Industrial—	
Benjamin	1191
Crouse-Hinds	1177
Revere	1182
Lantern, Type, Crouse- Hinds	1180
Long Range—	
Crouse-Hinds	1177
Revere	1182
Low-Mounting, Revere	1188
Marine Service	1177
Mercury and Incandes- cent, Revere	1183
Outdoor and Indoor, Steber	1181
Service Station, Crouse- Hinds	1175
Service Stations, Inns, etc. Benjamin	1190
Sports and Play Areas—	
Benjamin	1191
G-E	1181
Revere	1182
Stage, Century	1169
Steberlites	1058, 1059
Swimming Pool, Under water—	
Crouse-Hinds	1179
R&S	1184
TV Studio Lighting, Century	1169

L	Page	L	Page	L	Page
Lights—		Lights—		Linemens' Flare Lights, Fusee,	
Underneath Lighting,		Step—		Standard Railway	81
Revere	1184	Crouse-Hinds	1180	Linemens' Glove Bags, Salisbury	87
Utility, Benjamin	1191	Hub	1160	Linemens' Glove Pouches,	
Floor and Walk, Crouse-		R&S	1185	Klein	87
Hinds	1180	Strip—		Linemens' Gloves, Rubber	
Floor Pocket, Stage, Hub	1171	All-Brite	1121	Salisbury	87
Follow Spot, Stage, Century	1168	Curtis	1110	Linemens' Hammers—	
Foot, Stage—		Garcy	1111	Champion DeArment	80
Century	1168	Moe	1142	Vaughan & Bushnell	80
Hub	1170, 1171	Swimming Pool, Multi	1060	Linemens' Knives, Klein	79
Kliegl	1173	Taxi Marker, Aviation,		Linemens' Platforms, Safety,	
Gauge, Crouse-Hinds	412, 417	Crouse-Hinds	1192	Hubbard	96
Gymnasium—		Threshold Marker, Aviation,		Linemens' Pole Balconies,	
Benjamin	1061	Crouse-Hinds	1192	Hubbard	96
Kliegl	1166	Tunnel, Crouse-Hinds	1178, 1179	Linemens' Pole Seats, Hubbard	96
Mutli	1061	Twin, Incandescent,		Linemens' Pullers, Mighty	
Hallway, Moe	1139-1141	Decorative, Litecraft	1137	Midget, Coffing	83
Haymow, Incandescent,		Underpass, Crouse-		Linemens' Safety Harness,	
Union	1067	Hinds	1178, 1179	Klein	79
Head—		Utility, Perfectlite	1152	Linemens' Safety Saddles,	
Justrite	1220	Wall Bracket, Incandescent,		Bartlett	79
Ray-O-Vac	1225	Perfectlite	1152	Linemens' Safety Straps, Klein	79
High-Hat—		Wall Pocket, Stage, Hub	1171	Linemens' Sleeve Bags,	
Amplex	1155	Warning—		Salisbury	87
Moe	1145	Beacon-Ray, Federal	1233	Linemens' Sleeves, Rubber,	
Indoor-Outdoor, Benjamin	1068	Neo-Flasher	813, 814	Salisbury	87
Inspection, Barrel, Tank,		Water Fountain, R&S	1184, 1185	Linemens' Snatch Blocks, B&L	82
etc. Justrite	1220	Yard—		Linemens' Tool Bags, Klein	79
Kitchen, Moe	1139-1142, 1145	Benjamin	1059	Linemens' Tool Belt Suspenders,	
Klieg, Kliegl	1172	Steber	1059	Klein	79
Living Room, Moe	1139-1142	Light and Cord Sets, Inspection		Linemens' Tool Belts, Klein	79
Moisture-Proof, Perfectlite	1152	Woodhead	613	Linemens' Torches, Klein	79
Night—		Lightstrips, Fluorescent,		Linemens' Waist Belt Sup-	
Hub	1160	Curtis	1110	porters, Klein	79
P&S Despard, Interchange-		Limit Controls, Motor Ampere,		Linemens' Waist Belts, Klein	79
able	674	G-E "Limitamp"	1332	Linemens' Wire Pulling Tools,	
Obstruction, Aviation,		Limit Switch Condulet Parts,		Klein	80
Crouse-Hinds	1193	Mercury, Crouse-Hinds,		Linemens' Wrenches, Klein	79
Outdoor—		Type EMS	422	Linens Tapes, Lufkin	71
Holophane	1070, 1071	Limit Switches—		Lines— Hand—	
Moe	1139, 1142, 1143, 1145	Lever-Type, G-E	1341, 1342	B&L	82
Pen—		Machine Tool, Square D	583	Klein	82
Eveready	1223	Limitamp Controls, Motor		Tape—	
Ray-O-Vac	1226	Ampere Control, G-E	1332	Linen Tape, Lufkin	71
Pendant, Perfectlite	1048	Limiter Amplifier Power		Steel Blade—	
Pilot—		Supply, Altec Lansing	1531	Evans	71
P&S Despard, Inter-		Limiter Amplifier, Altec		Lufkin	71
changeable	674, 675	Lansing	1531	Transmission, TV, Flat-Twin,	
R&S	446	Line Amplifiers, Altec Lansing	1533	General Cable	6
Multi-Control, Bryant	678	Line Conductor Dead-ends,		Links—	
Push Button Station,		Squeeze Type, Reliable	993	Cable Suspension, Hubbard	92
Square D	581	Line Current Capacity Testers,		Conduit Spacer, Fibre Con-	
Porcelain, Alabax	1151	Line-O-Meters, Simplex	1492	duit, Orangeburg	100
Projector, Architectural,		Line Hose, Rubber, Salisbury	877	Figure-Eight, Ohio Brass	96
Century	1167	Line Hose Bags, Salisbury	877	Fuse—	
REA—		Line Hose Connectors, Rib-		Flip-Open Fuse Cutout,	
Appleton	333	Grip, Salisbury	877	G-E	144
Crouse-Hinds	332	Line Post Insulators, Ohio		Oil Fuse Cutout, G-E	144
Regressed, Kliegl	1166	Brass	958	Pull Chain, Bryant	66
Residential—		Line-O-Meters, Line Current		Renewal, Cartridge—	
Lightcraft	1137, 1138	Capacity Testers, Simpson	1492	Buss	53
Moe	1139-1145	Line-Type Lightning Arresters,		Economy	53
Roadway and Walkway,		Thyrite, G-E	1429, 1430	Secondary Fuse Cutout,	
Crouse-Hinds	1189	Line Wire—		G-E	144
Runway, High Intensity,		Weather Resistant—		Universal Cable-Type,	
Aviation, Crouse-Hinds	1192	Alcoa	161	G-E	1443-1444
Runway Marker, Aviation,		Triangle	98	Splicing, Strand, Reliable	98
Crouse-Hinds	1192	Linemens' Belt Accessories,		Strand, Reducer, Reliable	98
Shovel, Kliegl	1166	Klein	798	Liquid, Soldering, Allen	18
Showcase, Garcy	1113	Linemens' Blanket Canisters,		Liquid and Gas Thermometers—	
Shower—		Salisbury	879	Dillon	128
Moe	1144	Linemens' Climber Gaff Gauges,		Weston	128
Multi	1061	Klein	801	Liquid-Level Controls, Mercoid	134
Spot, Recessed—		Linemens' Climber Pads,		Living Room Lighting Fix-	
Curtis	1164	Klein	800, 801	tures, Moe	1139-1144
Garcy	1160	Linemens' Climber Straps,		Load Binders, Coffing	83
Moe	1144	Klein	800, 801	Load-Center Unit Substations,	
Silvray	1159, 1160	Linemens' Climbers, Klein	800	G-E	1391, 139
Spot or Flood, Recessed,		Linemens' Climbers, Klein	800	Load Centers—	
Garcy	1160	Linemens' Clothing, Static-		Circuit Breaker—	
		Resisting, Salisbury	876	G-E	59
				Square D	549, 53
				Fusible, Square D	53

L	Page
Load or Breast Plates, Hubbard	920
Locator Call Signals, Edwards	1240
Locator Call System Power Supply Units, Edwards	1240
Locator Call Systems, Edwards	1240
Locators, Fault, Telefaults, Chance	882
Lock Switch Covers, Unilet, Appleton Series GS	326
Lock Switches—	
Hubbell	689
P&S Despard Interchangeable	674
Lock Washers, Hubbard	929
Lockers—	
Clothes, Steel—	
Allen	786
Lyon	781
Locknuts—	
Conduit—	
Appleton	260
National	237
Steel City	235
T&B	229
Palnut, Hubbard	929
Square, Hubbard	929
Locomotive Cable, Gathering, Anaconda	34
Locomotive Headlight Wire, General Cable	68
Locomotive Lamps, G-E	1208
Logs, Anchor, Creosoted Pine	900
Loom Switches, Motor Starter, Manual, Square D	566
Loom Wire, Canvas-Back, National	123
Loom Wire Clips, National	123
Loom Wire Connectors, National	123
Loom Wire Fittings, National	123
Loom Wire Straps, National	123
Loop Antenna Wire, Anaconda	39
Loops, Disconnect Hanger, T&B	257
Loudspeaker Horns and Drivers, Altec Lansing	1534
Loudspeaker Horns, Altec Lansing	1533
Loudspeakers—	
Biflex, Altec Lansing	1534
Driver, Altec Lansing	1533
Duplex, Altec Lansing	1534
Louvers—	
Lighting Fixture, Fluorescent, Smithcraft	1095
Lighting Unit, Fluorescent, Benjamin	1040
Low-Voltage Insulators, Ohio Brass	955
Low-Voltage Lightning Arresters, Pellet-Type, G-E	1436
Lowering and Disconnecting Hanger Pulleys, Thompson	1076
Lubricants, Wire-Pulling—	
Ideal	864
Y-er Eas	864
Lubricator Gauge Lamps, Crouse-Hinds, Type LG	409
Lubricators, Cable, General Machine	850
Lug Hook Handles, Oshkosh	810
Lug Hooks, Oshkosh	810
Lug Wrenches, T&B	196
Lugs—	
Compression, T&B	195
Soldering Sherman	194, 195
Solderless—	
O.Z.	193
Sherman	195
T&B	196
Wire, Wedge-On, T&B	198
Lugs and Studs, Circuit Breaker, G-E	530

L	Page
Lumiline Lampholders, Bryant	652
Lumiline Lamps, G-E	1202
Luminaire Accessories, Wakefield	1086-1088
Luminaires—	
Flourescent—	
Commercial—	
Curtis	1106, 1107, 1109
Kirlin	1124
Pittsburgh	1103
Wakefield	1086-1088, 1090, 1091
Incandescent—	
Commercial—	
Skyline	1135
Wakefield	1147
Industrial, All-Purpose, Holophane	1069
Residential, Skylike	1135
Special Effect Silveray	1147
Parking Area, Revere	1189
Playground, Revere	1189
Street Lighting—	
Filament, G-E	1019
Flourescent, G-E	1018
Mercury, G-E	1020
Swimming Pool, Revere	1189
Luminous Ceilings, Pittsburgh	1103
Lungen Bells and Buzzers, Edwards	1252

M	
Machine Bolt Anchors, Rawl Hammer-Sets	856
Machine Bolt Shields, Expansion, Keystone	854
Machine Screw Anchors—	
Diamond	856
Rawl Calk-Ins	855
Machine Screw Nuts, Seeger-Williams	860
Machine Screws, Seeger-Williams	861
Machine-Tool and Control-Panel Transformers, G-E	1365-1371
Machine Tool Control Transformers, Jefferson	1373
Machine Tool Receptacle Connector Bodies, Reelite, Appleton	169
Machine Tool Relays, Square D	567, 568
Machine Tool Wire—	
Anaconda	15
General Cable	75
Plastic W&C	143
Machinery Wiring Fittings—	
Flexible Metallic Conduit, Appleton, Series ST	222
Machines—	
Coiling, Wire, Allen	818
Coiling and Reeling, Wire and Cable, Allen Reel-O-Matic	817, 818
Cutting and Threading—	
Pipe—	
Oster	732-734
Toledo	733
Rod—	
Oster	733
Drilling, Masonry, Electric, Portable, Truco	859
Floor Finishing, Electric, Premier	764
Machinists' Chisel Sets, Ryan	717
Machinists' Punch and Chisel Sets, Ryan	717
Machinists' Punch Sets, Ryan	717
Magic Ceiling Lighting, Wakefield	1092
Magnet Coils, Contactor and Starter, Square D	585

M	Page
Magnetic Relays—	
Square D	567
Struthers-Dunn	1344
Magnifiers, Adjustable-Arm, Dazor	1076
Magnifiers and Lamps, Floating-Arm, Fluorescent, Dazor	1075, 1076
Maintenance Ladder Hooks, Chance	828
Maintenance Ladders, Swivel Hook, Chance	828
Maintenance Tools, Motor, Ideal	765, 766
Mandrel Springs, Tubing Bender, Republic	740
Mandrels—	
Conduit Laying, General Machine	846
Test, General Machine	846
Manhole Cover Hooks, Diamond	828
Manhole Ladders, Hubbard	830
Manhole Pulling-in Irons, Hubbard	995
Manhole Sheaves, Simplex	845
Manhole Sumps, Fairmount	828
Manhole Tents, General Machine	828
Manila Rope, American	819, 820
Marine Lampholders, Bryant	660
Marine (Naval) Electric Wiring Equipment	1195-1198
Marker Strips, Terminal Block, Marathon	589
Markers—	
Aisle, Brady	178
Pipe, Self-Sticking, Brady	178
Pole, Hubbard	928
Special, Made-To-Order, Brady	178
Wire, Code, Brady	176, 177
Marline, Tarred, American	819
Masking Tape—	
Brady	177
Permacel	183
Masonry Drill Holders, Diamond	852
Masonry Drill Points, Diamond "N"	852
Masonry Drilling Machines, Electric, Portable, Truco	859
Masonry Drills—	
Percussion, Rawl	851
Spiral Twist, Diamide	851
Mast Arm End Fittings, Hubbard	1039
Mast Kits, Service, Hubbard	939
Master Switches, Multi-Control, Bryant	677
Masts, Warning Sign, General Machine	812
Materials—	
Cable Jointing, Anaconda	862
Insulating, Electrical—	
Atlas	868, 869
G-E	870-874
Graybar	867
Wiring, Appliance, General Cable	75
Matting, Switchboard, Rubber, Salisbury	878
Mauls, Rod Driving, Chance	915
Measuring Equipment, Wire, Hykon	175
Measuring Meters, Wire, Cable, Etc. Allen Reliable	819
Measuring Units, Wire, Hykon	175
Mechanical Latch-in and Electric Release Relays, Struthers-Dunn	1345
Melting and Pouring Kettles, Filling Compound, Anaconda	862
Melting Furnaces, Solder, Unique	787

M	Page
Melting Pots—	
Metal, Electric—	
Chromalox	757
General Electric	758
Mercury Contact Relays,	
Struthers-Dunn	1345
Mercury Lamp Ballast Acces-	
sories, Outdoor Lighting,	
Jefferson	1022
Mercury Lamp Ballasts—	
Jefferson	1022, 1023, 1135
Mercury Lamps, G-E	1209
Black-Light, G-E	1209
Mercury Limit Switch Con-	
dulet Parts, Crouse-Hinds,	
Type EMS	422
Mercury Plunger Relays,	
H-B	1346, 1347
Mercury Switch Relays, Panel	
Heating Control, Minneapo-	
lis-Honeywell	1267
Mercury Switches—	
Mercoind	1270
Toggle, Flush, Hubbell	688
Tumbler, Flush, Bryant	691
Mercury Vapor Detectors,	
Portable, Sunshine	1500
Messenger Crossover Clamps,	
Hubbard	934
Messenger Hangers—	
Hubbard	934
Minerallac	251
Messenger Strand, Crapo	971
Messenger Straps, Conduit	
Box, Minerallac	251
Metal-Cutting Shears,	
Bartlett	718, 746, 802
Metal-Finishing Rectifiers,	
Walker	1295
Metal Foli Tape, Permacel	182
Metal Melting Pots—	
Electric—	
Chromalox	757
General Electric	758
Metal Molding and Molding	
Fittings, La-In and Xtension-	
duct, National	468-472
Metal Sign Lampholder Bases,	
Intermediate Base, Bryant	661
Metal Sign Lampholders, Flush,	
Porcelain, Hubbell	654
Metal Solder and Flux, Brach	
Solderall	187
Metallic Bushings, Insulated,	
T&B	233
Metals Comparators, Sunshine	1499
Metalworkers' Punches,	
Hand, Whitney	744, 745
Hydraulic, Whitney	745
Meter and Panel Wire, Gavitt ..	148
Meter and Service Protectors—	
Pellet Type-GE	1435
Thyrite, G-E	1435
Meter Bearings and Compon-	
ents, Watthour, G-E	1455
Meter Connection Boxes,	
Watthour, G-E	1459
Meter Connectors, Appleton	233
Meter Rings, Bonding, Appleton	
260	260
Meter Sockets—	
Watt-Hour—	
G-E	1454
Box Type	1458-1460
Square	1457
Box-Type, G-E	1458-1460
Square, G-E	1457
Meter-Testing Standards,	
Portable, G-E	1454
Meters—	
Demand, Watthour, G-E	1456
Elapsed-Time, A-C, Simpson	1492
Foot-Candle, Weston	1484
Frequency, Portable, Biddle	
Frahm	1498

M	Page
Meters—	
Gauss, Flux-Density Measur-	
ing, G-E	1472
Gel Time, Sunshine	1498
Instrument Transformers—	
Watthour, G-E	1452-1455
Watthour Demand, G-E	1456
Measuring—	
Wire, Hykon	175
Wire and Cable, Allen	
Reliable	819
Power-Factor, Polyphase,	
Hook-On, G-E	1470
Sight, Pocket-Type,	
Weston	1484
Temperature—	
Gas, Liquid, Etc., Portable	
Simpson	1494
Refrigeration Equipment,	
Portable, Simpson	1494
Time, G-E	1353
Volt-Ohm-Milliamp, Portable,	
Weston	1485
Watthour, G-E	1452-1455
Watthour Demand, G-E	1456
Mica Insulation, Plate, G-E	871
Tapes, G-E	872
Mica Mat Cloth Insulation,	
G-E	870
Mica Mat Insulation, G-E	870, 871
Mica Mat Tapes and Wrappers,	
G-E	871
Mica Slotters and Scrapers,	
Commutator, Ideal	765
Microammeters—	
Indicating, Portable, D-C,	
G-E	1467-1469
Laboratory, Portable, Simp-	
son	1490
Panel—	
A-C and D-C—	
Simpson	1491
Weston	1481-1484
D-C—	
G-E	1465
Simpson	1492
Switchboard, D-C—	
G-E	1461
Weston	1474
Microphone Accessories, Altec	
Lansing	1528, 1529
Microphone Cable, Whitney	
Blake	133, 136
Microphone Cord, Plastic W&C..	144
Microphone Desk Stands, Altec	
Lansing	1529
Microphone Switches, Altec	
Lansing	1529
Microphone Systems, Altec	
Lansing	1527, 1528
Microphone Wire, Whitney	
Blake	136
Microphones—	
Cardioid, Altec Lansing	1527
Dynamic, Altec Lansing	1526, 1527
Velocity, Altec Lansing	1526
Midget Receptacles, R&S	367-369
Mill Files, Simonds	717
Milliammeters—	
Indicating, Portable, A-C and	
D-C, G-E	1466-1469
Laboratory, Portable, Simp-	
son	1490
Panel—	
A-C and D-C—	
G-E	1465-1466
Simpson	1491
Weston	1481-1484
D-C, Simpson	1492
Portable, A-C and D-C,	
Weston	1476-1480
Switchboard, D-C—	
G-E	1461
Weston	1474

M	Page
Milling Cutters, Commutator,	
Ideal	766
Millivoltmeters—	
Gas-Fired Equipment Servic-	
ing, Portable Simpson	1494
Indicating, Portable, D-C,	
G-E	1467, 1469
Panel—	
A-C and D-C—	
Simpson	1491
D-C, Simpson	1492
Portable, D-C, Weston	1479
Recording—	
Portable, D-C, G-E	1463
Switchboard, D-C, G-E	1463
Mine Power Cable, Anaconda	29
Miniature Cable—	
Communication—	
Gavitt	149
Graybar	149
Miniature Instrument Wire,	
Gavitt	149
Miniature Lampholder Bases,	
Bryant	661
Miniature Lamps, G-E	1210
Mining Machine Cable—	
Anaconda	34
General Cable	62
Plastic W&C	145
Miter Boxes, Metal Raceway,	
Wiremold	468
Mixers, Altec Lansing	1532
Lansing	1532
Modification Kits—	
Contactor and Starter,	
Square D	585
Pressure, Float and Vacuum	
Switch, Square D	585
Starter, Contactor and Relay,	
Square D	585
Moduliter Lighting Fxtures,	
Fluorescent, All-Brite	1122
Mogul Base Lampholder Caps,	
Bryant	660
Mogul Base Lampholders,	
Bryant	660
Moisture-Proof Lights,	
Perfectlite	1152
Molding, Ground Wire, Wood,	
Rainier	911
Molding and Molding Fittings,	
Metal, La-In and Xtension-	
duct, National	468-472
Molecular Vacuum Gauges,	
G-E	1473
Momentary Contact Push But-	
tons, Edwards	1254, 1257
Momentary Contact Switches—	
Push—	
Carling	700
Hubbell	697
Toggle, Diamond-H	1346
Monitor Amplifiers, Altec Lan-	
sing	1532
Monitor Bells, Edwards	1252
Faraday	1253
Motion Picture Cable—	
General Cable	66
National	119
Motor Accessories, Utility,	
G-E	1318
Motor Ampere Limit Controls,	
G-E "Limitamp"	1332
Motor Base Outlets, Hubbell	630
Motor Base Plugs, Hubbell	630
Motor Circuit Switch Condu-	
lets, Crouse-Hinds Type	
FLS	423
Motor-Control Centers,	
G-E	1330, 1331
Motor Control Push Button	
Switch Covers, Condulet,	
Crouse-Hinds, Series FD	
and FS	388

M	Page
Motor Control Switches—	
Lever, McGill	695
Push Button Station, Unilet,	
Appleton, Series EFS	347
Rotary, Surface, Bryant	706
Motor-Driven Howlers, Indus-	
trial, Benjamin	1237
Motor Flashing Switches, Traffic	
Signal, Crouse-Hinds	1012
Motor-Generator Sets, Indus-	
trial, G-E	1328
Motor Lead Cable, General Cable	68
National	117, 119
Phelps Dodge	7
Simplex	113
Motor Lead Wire, Phelps Dodge	7
Motor Load Contactors—	
Magnetic, Square D	569
Magnetic, Start, Stop and Re-	
verse, Square D	576, 577
Motor Maintenance Tools,	
Ideal	765, 766
Motor-Operating Mechanism,	
Substation, G-E	1411
Motor Plant Cord, Plastic W&C	139
Motor Plug Bases,	
Hubbell	619, 626, 636
Motor Plug Conuector Bodies,	
Hubbell	626, 635
Motor Plug Receptacles, Hub-	
bell	619
Motor Pumps, Pipe Bender, Tal	738
Motor-Reversing Controllers,	
Magnetic, G-E	1339
Motor-Rotation Testers, Biddle	1497
Motor Sentinel and Starter	
Switches, Flush, Tumbler,	
Bryant	706
Motor Sentinel Condulets,	
Crouse-Hinds—	
Series EFD	432
Series FD	437
Motor-Speed Variators, G-E	1329
Motor Starter and Circuit	
Breaker Condulets, Crouse-	
Hinds, Type EPC	439
Motor Starter and Control Cen-	
ters, Square D	563
Motor Starter-Circuit Breaker	
Enclosures, Spin Top,	
Square D	440
Motor Starter Compensators,	
Square D	564
Motor Starter Condulets—	
Crouse-Hinds, Type EPC	438, 439
Motor Starter Loom Switches,	
Manual, Square D	556
Motor Starters—	
A-C Combination, G-E	1338
Combination Starter and Cir-	
cuit Breaker, Magnetic—	
Magnetic—	
G-E	1335, 1337
R&S	449
Square D	573
Combination Starter and	
Switch, Magnetic, Square D	572
R&S	449
Square D 570, 572, 573, 578,	579
Manual—	
R&S	447, 448
Square D 564, 565, 574, 575,	578
Motor Starting and Reversing	
Switches, Drum, Square D.	566
Motor Starting Switch Condulets—	
Crouse-Hinds—	
Series EFD	431
Series EFS	431
Type Gub	432
Type FLF	432
Type GUSC	431
Motor-Starting Switches,	
G-E	1335, 1336

M	Page
Motor Testers, Portable, Biddle	1497
Motors, Electric, G-E—	
Fractional-HP—	
Gear	1319, 1320
Industrial	1312-1315
Replacement	1316, 1317
Utility	1318
General	
Purpose	1305-1307, 1309-1311
Induction—	
Integral-HP Single Phase.	1310
Squirrel-Cage	1305-1308
Wound-Rotor	1309
Industrial—	
D-C	1314, 1315, 1326, 1327
Fractional-HP	1312-1315
Integral-HP	1321-1325
Replacement—	
Belt-Driven or Coupled	
Pump	1317
Belted Fan and Blower	1317
Heating and Ventilation.	1316
Oil Burner	1316
Jet Pump	1317
Pump and Water System.	1317
Small Fan and Blower	1316
Sump Pump	1317
Synchronous	1311
Mounting Assemblies, Ampli-	
fier, Altec Lansing	1533
Mounting Brackets—	
Auxiliary Light, Exide	1222
Lighting Unit, Outdoor Sub-	
Station, Holophane	1071
Mounting Kits, Bulkhead, Con-	
connector Barrel, Electrical,	
Pyle-National	365
Mounting Outlets, Screw Ring—	
Appliance and Fixture,	
Bryant	649
Conduit Box, Bryant	649
Mounting Straps—	
Interchangeable Devices,	
P&S Despard	675
Multi-Control, Bryant	678
Mounting Units, Lighting Fixture—	
Appleton, Series V51	337
Wheeler	1042
Mounting Yokes, Tumbler	
Switch-Plate Fill-In, Bry-	
ant	679
Mounts, Transformer, Uni-	
versal	1416
Mud Buckets, General Machine	808
Multi-Control Cable, Bryant	678
Multi-Control Gang Box Covers,	
Bryant	678
Multi-Control Gang Boxes, Bry-	
ant	678
Multi-Control Outlets and	
Plates, Bryant	678
Multi-Control Pilot Lights,	
Bryant	678
Multi-Control Relays, Bryant	677
Multi-Control Switch Supports,	
Bryant	678
Multi-Control Switches, Bryant	677
Multi-Control Transformers,	
Bryant	677
Multi-Control Wire, Bryant	678
Multi-Control Wiring Systems,	
Bryant	677, 678
Multi-Duty Glns and Acces-	
sories, Chance	834
Multiple-Circuit Switches, Push-	
Button, Mossman	1348
Multiple-Contact Switches,	
Lever-Type, Mossman	1347
Multiple Control Circuit Pro-	
tectores, G-E	1021
Multiple Gang Condulets,	
Crouse-Hinds, Types, FD	
and FS World Radio History.	348

M	Page
Multiple Lamp Boxes, Annun-	
ciator, Kirkland	1259, 1260
Multiplier Boxes, Meter-Test-	
ing Standard, G-E	1454
Municipal Sirens, Federal	1232
Mylar-Film Tape, Parmacel	182
N	
Nail Hammers, Capewell	714, 715
Nails, Copperweld, Hubbard	926
Pole-Dating, Hubbard	926
Pole Marking, Hubbard	928
Wire, Insulating, Seeger-	
Williams	928
Name Plates—	
Plate Opening, P&S Despard	676
Self-Bonding, Brady	178
Naval Cable Connectors, Boxes	
and Lugs, Modern Metal	1197
Naval Contact Makers, Modern	
Metal	1196
Naval Marine Equipment, Mod-	
ern Metal	1195-1198
Naval Plugs and Receptacles,	
Modern Metal	1197
Naval Rheostats, Modern Metal	1198
Naval Switches, Parts and Ac-	
cessories, Modern Metal	1198
Naval Telephone and Intercom-	
munication Equipment,	
Modern Metal	1197
Neon Glow Lamps, Clear, G-E	2108
Neon Sign Cable, General Cable	60
Plastic W&C	140
Network Cable, Anaconda	24
Networks, Capacitor, G-E	1450
Neutral Brackets, Offset, Hub-	
bard	938
Neutral Clamps, Ohio Brass	964
Neutral Gaps, G-E	1436
Neutral Wire Brackets, Hub-	
bard	950
Night Light Hoods, P&S	
Despard	676
Night Light Jewels, P&S	
Despard	676
Night Light Lamps—	
G-E	1207
P&S Despard	676
Night Light Reflectors,	
P&S Despard	676
Night Light Units, Incandes-	
cent, Day-Brite	1162
Night Lights, Hub	1160
P&S Despard Interchangeable	676
Nipple Covers, Condulet,	
Crouse-Hinds—	
Obround Series	588
Series FD and FS	387
Nipples—	
Chase—	
Steel City	228
T&B	228
Conduit, Rigid, Appleton	227
Pipe, Conduit Pipe Prod.	226
Nokorode Core Solder, Dunton.	186
Non-Metallic Armored Cable,	
Anaconda	39
Non-Metallic Sheathed Cable—	
Anaconda	15, 25-27, 28
General Cable	52
National	116
Phelps Dodge	7
Plastic W&C	142
Triangle	94
Non-Metallic Sheathed Wire,	
Anaconda	15
Nozzles—	
Floor Box—	
National	325
R&S	315
Floor Outlet, Steel City	321, 322

N	Page
Numbering Dies, General	
Machine	847
Nut Setters and Screw Drivers,	
Electric, Portable, Thor	776
Nut Wrenches, TEC	
One-Hander	729
Nuts—	
Bolt-Eye, Hubbard	920
Channel, Kindorf	253
Crimp, Sheet Metal Fastener,	
Diamond	853
Expansion, Hubbard	856
Machine Screw, Seeger-	
Williams	860
Rack, Frame and Trapeze,	
Kindorf	255
Washer, Static-Proof,	
Hubbard	932
Wire Connectors, Ideal	191
Nuts and Sleeves, Union, Hub,	
Condulet, Crouse-Hinds,	
Series GUA	397
Nuts and Washers, Bus Bar,	
Aluminum Alcoa	159
Nylon Rope, American	819

○

Obstruction Lights, Aviation,	
Crouse-Hinds	1193
Office and Desk Fans	1212
Office Wire, Anaconda	38
Ohmmeters—	
Panel, D-C, Weston	1481
Portable, Simpson	1494
Oil—	
Insulating and Cooling, G-E	1425
Pipe Threading—	
Armstrong	725
Nye	725
Oster	725
Toledo	725
Oil, Watthour Meter	
Jewel, G-E	1455
Oil and Gasoline Resistant Cable,	
General Cable	52
Oil and Gasoline Resistant Wire,	
Plastic W&C	145
Oil Burner Ignition Cable—	
Anaconda	39
General Cable	60
Plastic W&C	140
Oil-Burner Switches—	
Tumbler, Box Cover, Bryant	692
Hubbell	693
P&S	693
Oil Circuit Breakers,	
Outdoor, G-E	1401, 1402
Oil Fuse Cutout Accessories,	
G-E	1447
Oil Fuse Cutout Assemblies,	
G-E	1447
Oil Fuse Cutout Pole-Base	
Switching Mechanisms,	
G-E	1447
Oil Fuse Cutout Racks and	
Mechanisms, G-E	1417
Oil Fuse Cutouts, G-E	1446
Oil, Gasoline and Moisture	
Resistant Wire,	
Anaconda	13
Oil-Resistant Sockets, Neo-	
prene, Ericson	658
Oil Testers, Insulating and	
Cooling, Portable, G-E	1425
Open Link Fuses, Buss	537
Openers, Door, Edwards	1257
Operators, Door and Gate,	
Remote Control, Robot	707
Oscilloscopes, All-Purpose,	
Weston	1485
Outdoor Lighting Fixtures	
Moe	1139, 1142, 1143, 1145

O	Page
Outdoor Lighting Units—	
Incandescent, Holophane,	
1070, 1071	
Post-Top, Holophane	1071
Outdoor Substation Com-	
ponents, G-E	1403-1411
Outlet and Plate Combination,	
Flush—	
Bryant	647
P&S Despard	680
Outlet and Switch, Pendant,	
Bryant	705
Outlet and Switch Combination,	
Flush—	
Bryant	680
Hubbell	680
Outlet Box Covers—	
Appleton	279, 281, 286
National	284, 285
P&S Interchangeable	675
Steel City	280, 282, 287
Union	310
Outlet Box Extension Rings—	
Appleton	289
National	284, 285, 290
Steel City	289
Outlet Box Lampholders, Knox	655
Outlet Box Partition Covers,	
Steel City	282
Outlet Box Plates, Flush,	
Hubbell	682
Outlet Box Receptacles—	
Hubbell	664
Pyle-National, Tribloc	363, 364
R&S	368
Outlet Box Rosettes, Bryant	662
Outlet Boxes—	
Appleton	279, 281, 286, 293
National	124, 284, 285
Steel City	280, 282, 283, 287
Union	309, 310
Woodhead, Multi-Trap	645
Outlet Cluster Receptacles,	
Hubbell	626
Outlet Grounding Adapters—	
Bryant	623
Hubbell	629
Outlet, Pilot Light and Plate	
Combination, Flush—	
Bryant	680
Hubbell	679
Outlet, Pilot Light, Switch and	
Plate Combination,	
Flush, Bryant	623, 680
Outlet, Plate and Cover Com-	
bination, Flush—	
Bryant	623, 649
Hubbell	629
P&S	649
Outlet Plates, Flush—	
Bryant	624, 683, 684
Hubbell	641-643, 681, 682
Multi-Control System,	
Bryant	677
Outlet, Switch and Plate Com-	
bination, Flush—	
Bryant	680
Hubbell	680
P&S Despard	680
Outlet, Switch, Pilot Light and	
Plate Combination, Flush,	
Bryant	623, 680
Outlets—	
Cable, Reelite, Appleton	171
Clock Hanger—	
Bryant	651
Hubbell	651
P&S	651
Convenience—	
Flush—	
Hubbell	629, 630, 646, 648
P&S	465, 644

O	Page
Outlets—	
P&S Interchangeable	674, 675
Box Cover Mounted—	
Bryant	647
Hubbell	630, 646, 648
P&S	644
Surface—	
Bryant	673
P&S	673
Fan Hanger—	
Bryant	650
Hubbell	650
P&S	651
Floor, Steel City 318-321, 324, 325	
Flush—	
Bryant	621-624, 647, 649
Hubbell	630, 639
P&S	640
Box Cover Mounted—	
Bryant	621-623
Hubbell	639
Motor Base, Hubbell	630
Mounting, Screw Ring—	
Appliance and Fixture,	
Bryant	649
Conduit Box, Bryant	649
Panel or Plate Mounting,	
Bryant	650
Power—	
Flush—	
Hubbell	641
P&S	640
Box Cover Mounted,	
Hubbell	641
Weatherproof, Hoffman	650
Radio, P&S Despard, Inter-	
changeable	675
Range, Surface—	
Bryant	621, 624, 650
P&S	640
Utility, National "Spigots"	284
Outlets and Plates, Multi-	
Control, Bryant	678
Outside Cable, Telephone,	
Whitney Blake	134
Oval Eye Bolts, Hubbard	927
Ovens—	
Baking, Drying, Preheating,	
and Dehydrating, Infrared,	
Triangle	1294
Batch and Conveyor, Infrared,	
Triangle	1294
Drying and Baking, Infrared,	
Triangle	1294
Overhead Conductors, Bare	
Copper—	
Anaconda	46
General Cable	79, 80
Overload Heaters, Thermal,	
G-E	1335
Overload Motor Relay Units,	
Thermal, Square D	571
Ozone Lamps, G-E	1204

P

Packing, Sealing, R&S	316
Packs, Tool, Electricians',	
Klein	795
Pads, Climber, Linemens',	
Klein	800, 801
Paging Devices, Federal	1233
Paint Can, Brush and Case,	
Tree, Bartlett	808
Pancake, Wiremold	456
Panel-Base Assemblies, G-E	592
Panel Connector Extensions,	
T&B	232
Panel-Cutting Saws, Electric,	
Kett Master	708
Panel Instruments—	
Simpson	1491
Weston	1481-1484

P	Page
Panel Instruments—	
Horizontal Edgewise Type,	
Simpson	1492
Radio and Industrial,	
G-E	1465, 1466
Wide-View, Simpson	1492
Panel Mounting Condulets,	
Crouse-Hinds, Type EMP ..	434
Panel Mounting Receptacle	
Plugs, R&S	369
Panel Mounting Receptacles,	
R&S	369
Panel or Plate Mounting Outlets,	
Bryant	650
Paint—	
Asphalt, Rapid-Drying,	
Ruberoid	866
Tree, Bartlett	807
Palnut Locknuts, Hubbard	929
Panelboard Adapters, Connector	
Barrel, Electrical, Pyle-	
National	365
Panelboard Boxes and Fronts,	
Distribution, G-E	596, 598
Panelboards—	
Circuit Breaker—	
Appleton, Type ELP	345
Crouse-Hinds—	
Type DLP	
Type DVSP	436
Type EDP	435
Type EQP	435
R&S	443
Distribution—	
G-E	596, 597
Square D	552, 553
Circuit Breaker, G-E	598-600
Lighting—	
G-E	593-595
Square D	553
Panels—	
Baseboard Heating, Wesix	1216
Door, Electric-Center, Push-	
matic, Bulldog	601
Push Button, Edwards	1256
Remote Control, Touch-Plate	702
Wiring Box, Electrical,	
Hoffman	546
Paper Tape, Permacel	182, 183
Papers, Insulating, Asbestos,	
Graybar	867
Parallel Cord, Rip Type,	
Phelps Dodge	7
Parking Area Luminaires,	
Revere	1189
Parkway Cable—	
General Cable	59
Triangle	96, 97
Partition Covers, Outlet Box,	
Steel City	282
Partitions, Gang Box,	
Steel City	294
Parts—	
Condulet, Mercury Limit	
Switch, Crouse-Hinds,	
Type EMS	422
Floor Box—	
National	322
T&B	323
Floor Outlet,	
Steel City	319-321, 325
Ground Fitting, T&B	272
Lightning Arrester, Station-	
Type, G-E	1451
Parts Cases, Shop, Steel, Lyon..	779
Paste—	
Soldering—	
Allen	187
Burnley	187
Nokorode	187
Zinc Chromate, Alcoa	863

P	Page
Pay-Out and Take-Up Wire	
Reels, Oshkosh	815
Pay-Out Wire Reels—	
Allen	816
Oshkosh	815
Peavies, Oshkosh	810
Peavy Handles, Oshkosh	810
Pedestal Receptacles, R&S	368
Pedestals—	
Condulet, Crouse-Hinds	407
Traffic Signal, Crouse-Hinds..	1017
Traffic Signal Control Box,	
Crouse-Hinds	1017
Pendant and Portable Cord,	
Anaconda	38
Pendant Covers, Junction Box,	
R&S	316
Pendant Globe Hangers,	
Perfectlite	1148, 1149
Pendant Lights, Perfectlite	1048
Pendent Push Switches, Bryant	704
Pendant Pushes, Edwards	1255
Pendant Switch and Outlet,	
Bryant	705
Pendants, Pull Cord, Bryant	662
Penlight Batteries—	
Eveready	1224
Ray-O-Vac	1225
Penlights—	
Eveready	1223
Ray-O-Vac	1226
Pennies, Conduit, T&B	234
Penthouses, Power Roof	
Ventilator, ILG	1279
Perforated Strapping,	
Minerallac	256
Periscope Attachments, Poten-	
tial Detector, Minerallac	1500
Permagum, Graybar	863
Phase Sequence Indicators,	
Portable, Associated Re-	
search	1495
Phase-Shifting Transformers,	
G-E	1455
Phasing Units, Power, T-P	1374
Photoelectric Devices, G-E 1349-1351	
Photoelectric Electric Controls—	
Aviation, Crouse-Hinds	1192
General Service, Crouse-	
Hinds	1192
Photoelectric Street Lighting	
Controls, G-E	1021
Photoelectric Filter Caps,	
Infrared, G-E	1351
Photoelectric Light-Source	
Transformer, G-E	1351
Photoelectric Light Sources,	
G-E	1350
Photoelectric Relay Accessories,	
G-E	1349, 1350
Photoelectric Relays, G-E 1349, 1350	
Photoelectric Tube Holders	
and Infrared Filters, G-E	1351
Photoflash Lamps, G-E	1206
Photoflood Lamps, G-E	1206
Photographic Enlarger Lamps,	
G-E	1206
Picture-Lighting Projectors,	
Kliegl	1172
Pike Pole Coating, Oshkosh	811
Pike Pole Fittings, Chance	812
Pike Pole Guards, Oshkosh	811
Pike Poles—	
Chance	812
Oshkosh	811
Pilot Drills, Hole Saw,	
Capewell	716
Pilot Lamp and Receptacle	
Covers, Condulet, Crouse-	
Hinds, Series FD and FS	390

P	Page
Pilot Lamp and Switch Covers,	
Condulet, Crouse-Hinds,	
Series FD and FS	390
Pilot Lamp Receptacle Covers,	
Condulet, Crouse-Hinds,	
Series FD and FS	388
Pilot Lamp Receptacles,	
Hubbell	679
Pilot Lamps, Bryant	679
Pilot Light and Buzzer Plates,	
Flush, Bryant	679
Pilot Light Condulets, Crouse-	
Hinds, Series EFD	
and EFS	428
Pilot Light Hoods, P&S	
Despard	676
Pilot Light Jewels, P&S	
Despard	676
Pilot Light Lamps, P&S	
Despard	676
Pilot Light, Outlet and Plate	
Combination—	
Bryant	680
Hubbell	679
Pilot Light, Outlet, Switch and	
Plate Combination, Flush,	
Bryant	623, 680
Pilot Light Plates, Flush,	
Hubbell	682
Pilot Light Receptacles—	
Bryant	679
Carling	700
Pilot Light Reflectors, P&S	
Despard	676
Pilot Light, Switch and Plate	
Combination, Flush Hubbell	679
Pilot Light, Switch, Outlet and	
Plate Combination, Flush,	
Bryant	623, 680
Pilot Lights—	
P&S Despard Interchange-	
able	674, 675
R&S	446
Multi-Control, Bryant	678
Push Button Station,	
Square D	581
Pin-Type Insulators, Ohio Brass	958
Pin-Type Lampholders, P&S	659
Pin-Type Sockets—	
Bryant	652
Hubbell	657
Union	659
Pinch and Transposition	
Brackets, Hubbard	939
Pine Poles, International	897-905
Pins—	
Dowel, Clay Conduit, Natco..	1001
Insulator—	
Clamp-Type, Hubbard	943
Corner Pole Top, Hubbard..	945
Corner-Type, Hubbard	943
Low Voltage, Hubbard	942
OB Type, Hubbard	943
Pole Top, Hubbard	845
Signal-Type, Hubbard	942
Steel, Hubbard	944
Western Union Type,	
Hubbard	942
Wood, Rainier	911
Wood Top, Hubbard	942
Jaw Clamp, Curved,	
Salisbury	876
Transformer, Hubbard	942
Pipe, Running Thread, Conduit..	225
Pipe and Bolt Cutting and	
Threading Machines,	
Beaver	735
Pipe and Conduit Dieheads and	
Dies	721
Pipe and Conduit Dies, Nye 720, 721	
Pipe and Conduit Pipe Die-	
stocks, Nye	720, 721, 722

P	Page
Pipe and Conduit Stocks and Dies—	
Armstrong	723
Nye	720, 721
Pipe Arm Leveling Fittings, Hubbard	1039
Pipe, Bar and Rod Storing Units, Shop, Steel, Lyon	781
Pipe Bender Attachments, Tal.	738
Pipe Bender Repairs, Lidseen	739
Pipe Benders—	
Hand—Greenlee	736
Lidseen	739
Hydraulic—Blackhawk	747
Greenlee	736, 737
Tal	737, 738
Pipe Bending Shoes—	
Greenlee	736
Tal	738
Pipe Bits, Power, Greenlee	709, 712
Pipe Bracket End Fittings, Hubbard	1039
Pipe Clamps—	
Appleton	249
Diamond	249, 252
Pipe Clips, Minerallac	251
Pipe Connectors, Clay to Iron, Natco	1001
Pipe Couplings, Conduit Pipe Prod.	221
Pipe Cutter Wheels, Pins and Rolls, Armstrong	726
Pipe Cutters—	
Armstrong	726, 727
Nye	727
Toledo	727
Pipe Cutting and Threading Machines—	
Oster	732-734
Toledo	733
Pipe Dieheads and Dies, Armstrong	726
Pipe Dies—	
Armstrong	725, 726
Nye	722
Oster	722
Pipe Diestocks—	
Armstrong	725
Nye	721
Pipe Elbows, Conduit Pipe Prod.	221
Pipe Hanger Accessories, Appleton	252
Pipe Hangers, Appleton	252
Pipe Markers, Self-Sticking, Brady	178
Pipe Nipples, Conduit Pipe Prod.	226
Pipe Plugs, Condulet, Crouse-Hinds, Type PLG	403
Pipe Pushing and Pulling Jacks, Simplex	843
Pipe Reamers—	
Bit Brace, Nye	720
Ratchet—Nye	720
Toledo	720
Pipe Rippers, General Machine	847
Pipe Spreaders, General Machine	847
Pipe Stocks and Dies—	
Armstrong	725, 726
Nye	721
Oster	722
Pipe Straps—	
Steel City	248
T&B	248
Pipe Taps, Nye	720
Pipe Thread Bushings, Porcelain, Federal	258
Pipe Threader Die Chasers, Nye	725
Pipe Threader Dieheads and Dies, Beaver	723

P	Page
Pipe Threader Dies—	
Armstrong	724
Nye	725
Pipe Threader Handles, Nye	725
Pipe Threader Stocks—	
Armstrong	724
Nye	725
Pipe Threaders—	
Armstrong	724
Beaver	723
Nye	725
Pipe Threading Device Dieheads and Dies, Toledo	724
Pipe Threading Device Dies, Toledo	724
Pipe Threading Device Handles, Toledo	724
Pipe Threading Devices, Toledo	724
Pipe Threading Oil—	
Armstrong	725
Nye	725
Oster	725
Toledo	725
Pipe Vise Repairs, Armstrong	729
Pipe Vises—	
Armstrong	720
Kit, Clamp Type—	
Armstrong	730
Nye	722
Open-Side, Toledo	729
Self-Locking, Nye	722, 730
Pipe Vises and Stands, Nye	730
Pipe Wrenches—	
Nye	728
TEC One-Hander	729
Toledo	728
Pit Lighting Units, Incandescent, Benjamin	1054
Pivots, Watthour Meter, G-E	1455
Plants—	
Electric Generating, Mobile, White	1031
Electric Light and Power—	
Diesel Engine, Graybar	1299
Gasoline Engine, Graybar	1297, 1298
Plaster Frames—	
Fluorescent Troffer—	
Garcy	1112
Smithcraft	1099
Wakefield	1089
Plastic Tape, Permacel	184
Plates—	
Adapter, Junction Box, R&S	316
Blank—	
Condulet, Crouse-Hinds, Series YYP	379
Flush—	
Bryant	677, 683, 684
Hubbell	682
Box, Ceiling, Steel City	297
Concrete Box—	
Appleton	290
National	290
Steel City	290
Crossarm Reinforcing, Hubbard	928, 944
Filler, Electri-Center, Pushmatic, Bulldog	601
Flush—	
Bryant	624, 677, 679, 683-685
Hubbell	636, 641-644, 681, 682
P&S Despard	676
Minneapolis-Honeywell	704
Gain, Tie and Flat, Hubbard	945
Guy and Load, Hubbard	920
Hub—	
Conduit, Crouse-Hinds Condulet, Series RSMP and RSP	403

P	Page
Plates—	
Condulet, Crouse-Hinds, Series YYP	379
Interchangeable Device—	
Bryant	685
Hubbell	682
P&S Despard	676
Load or Breast, Hubbard	920
Name—	
Plate-Opening, P&S	
Despard	676
Self-Bonding, Brady	178
Outlet—	
Bryant	624, 683, 684
Hubbell	641, 642, 681, 682
Multi-Control System	
Bryant	677
Outlet Box, Hubbell	682
Pilot Light, Hubbell	682
Pilot Light and Buzzer, Bryant	679
Pole Bracket, Street Lighting, Hubbard	1038, 1039
Receptacle, Hubbell	636, 642-644
Sill, Entrance, Appleton	243
Strain, Pole, Hubbard	919
Switch—	
Multi-Contact, Bryant	677
Push Button—	
Bryant	683
Hubbell	682
Tumbler—	
Bryant	683, 684
Hubbell	681, 682
Switch and Bull's-Eye, Hubbell	682
Switch and Outlet, Bryant	684, 685
Switch and Receptacle, Hubbell	682
Tap-lite, Minneapolis-Honeywell	704
Telephone—	
Bryant	683, 684
Hubbell	681, 682
Multi-Control System	677
Utility, Toggle Switch, Hubbell	628
Wall, Cable, T&B	247
Wood-Pole, Crouse Hinds	1017
Plates and Covers, Receptacle—	
Hubbell	634, 636, 637
Hubbellock	632
Platform Rope Railings, Chance	968
Platform Step Ladders—	
Babcock	760
White Metal	761
Platforms—	
Linemens', Safety, Hubbard	967
Pole—Universal, Chance	968
Utility, Chance	968
Tower, Universal, Chance	969
Playground Luminaires, Revere	1189
Plier Handle Covers—	
Klein	790
Utica	790
Plier Pockets, Klein	795
Pliers—	
ACSR, Klein	768
Angle Lock Nut, Utica	792
Armor Cutting	792
Chain Nose—Klein	789
Utica	791
Cord Tip Closing, Klein	790
Curved Nose, Klein	789
Diagonal Cutting—	
Champion DeArment	793, 794
Utica	791, 792
Duck Bill, Klein	789
Electricians'—Klein	788-790
Utica	790, 792

P	Page
Pliers—	
End Cutting, Klein	788
Gripping, Champion De-Arment	793
Heat Coil, Klein	789
Ignition—	
Champion DeArment	793
Utica	792
Linemens'—	
Utica	791, 792
Long Chain Nose, Side	
Cutting, Utica	792
Long Flat Nose, Klein	789
Long Needle Nose, Klein	789
Utica	791
Long Nose—	
Klein	789, 790
Utica	791
Long Nose Cutting, Klein	789
Long Nose Duck Bill, Klein	789
Long Nose Side Cutting—	
Klein	789
Utica	791
Long Nose Sleeve, Klein	789
Needle Nose, Klein	789
Oblique Cutting, Klein	788, 790
Bell System	788
Heavy Duty	788
Skinning Hole	788
Stripping Notches	788
Pump—	
Champion DeArment	793
Klein	790
Utica	791
Side Cutting, Klein	788
Leverage	788
Sleeve Joint Twister	788
Slim Long Nose, Klein	789
Slip-Joint, Utica	791
Telephone—	
Diagonal Cutting, Utica	792
Heat Coil, Utica	793
Insulation Skinning, Utica	792
Lamp Extracting, Utica	791
Straightening and Adjusting, Utica	793
Telephone Adjusting, Utica	791
Plotters, Field, Analog,	
Sunshine	1499
Plug Adapters, Appleton,	
Series AE	351
Plug and Cord Sets, Bryant	616
Plug Connector Bases, Bryant	623
Plug Fuses—	
Buss	536
Economy	537
Fustat, Buss	536
Fusteron, Dual-Element,	
Buss	536
Renewable, Economy	537
Plug-In Busways, G-E	510
Plug-In Power Busways and	
Fittings, G-E	501-507
Plug Interiors, Appleton,	
Series AE	351
Plug Receptacle and Safety	
Switch Unilets, Appleton	
Type FSQX	352
Plug Receptacle Condulets—	
Crouse-Hinds Arktite—	
Type BRME	358
Type CPS	359, 360
Plug Receptacle Covers—	
Appleton Unilet—	
Series FD and FS	331
Series GS	326
"35" Line	328
Plug Receptacle Equipment—	
Crouse-Hinds, Types CES	
and CESD	360
Crouse-Hinds Arktite—	
Type ARE	353, 354

P	Page
Plug Receptacle Equipment—	
Type AREA	355, 356, 358
Type AREX	357
Type CPS	360
Plug Receptacle Housings—	
Crouse-Hinds Arktite—	
Type AJ	353-358
Type AJX	357
Type AR	353-358
Type FAR	389
Crouse-Hinds Condulet—	
Type BRD	389
Type BRG	396
Type DS	389
Type GS	396
Pyle-National, Tribloc	363, 364
Outlet Box, Crouse-Hinds,	
Type BRP	358
Pendant or Cord Connector,	
Pyle-National, Tribloc	362
Plug Receptacle Plates and	
Covers, Hubbell	634, 637
Plug Receptacle Pylets, Pyle-	
National, Tribloc	364
Plug Receptacles—	
Appleton, Series AE	349, 350
Carling	700
Crouse-Hinds—	
Type BP	419
Type BRC	359
Type CPH and CPP	360
Type FP	419, 420
Type WP	389
Hubbell	628
Morse, Eureka	616
R&S	366, 372-375, 441
Plug Receptacles and Covers,	
Appleton, Series FD and FS	331
Plug Receptacles and Housings,	
R&S	366
Plug Shells, Pyle-National	
Tribloc	364
Plugmold, Wiremold	455-457
Plugmold Baseboard, Snapicoil,	
Wiremold	457
Plugmold Baseboard Fittings,	
Wiremold	457
Plugmold Snapicoil,	
Wiremold	457
Plugs—	
Appliance, Bryant	616, 670
Attachment—	
Benjamin, Swivel	670
Union	670
Woodhead	671
Cable, R&S	370-372
Circuit Breaker, Crouse-	
Hinds Condulet, Type APJ	420
Closure, Flush Receptacle,	
Hubbell	639
Conduit, R&S	368
Dead-End, Appleton Unilet—	
Series CPH	352
Type CPP	351
Drift, Bond	331
Flexible-Cable, Crouse-	
Hinds, Type BP	359
Fuseless, Neutral Wire,	
Bryant	543
Fusible, R&S	371
Motor Base, Hubbell	630
Pipe, Condulet, Crouse-Hinds	
Type PLG	403
Plural, Bryant	668
Receptacle—	
Appleton, Type AEP	349, 350
Crouse-Hinds—	
Type BP	419
Type BRC	359
Type CPH and CPP	389
Type FP	419, 420
Type WP	389

P	Page
Plugs—	
Crouse-Hinds Arktite,	
Type APJ	353-358
R&S	366, 373-375
Automatic Press and Tool	
Control, R&S	372
Circuit Breaking, R&S	376, 377
Panel Mounting, R&S	369
Screw Base, Woodward	669
Receptacle and Switch—	
Crouse-Hinds Condulet—	
Type BP	419
Type FP	419, 420
Series FSQ	419, 420
Receptacle Equipment,	
Crouse-Hinds Arktite,	
Type CPP	360
Receptacle Socket and Screw-	
Base, Woodhead	669
Safety Switch—	
Appleton, Type FSQX	352
Crouse-Hinds Condulet,	
Type DP	421
Spreader, Guy Stand, Steel	
City	209
Switch and Receptacle—	
Crouse-Hinds Condulet,	
Type BP	419, 420
Type FP	419, 420
Series FSQ	419, 420
Switch Receptacle, R&S	441
Test, Power and Light	
Control Switchboard,	
G-E	1386, 1387
Plugs and Connectors, Male,	
Pyle-National, Tribloc	363
Plugs and Receptacles—	
Appleton, Series AE	349, 350
Circuit Breaker—	
Crouse-Hinds	353-358
Naval, Modern Metal	1197
Wall and Floor Pocket, Hub	1171
Plugtrim, Wiremold	455
Plural Plugs, Bryant	668
Pocket Tapes, Evans	718
Pocket Telephones, U.S.	
Instrument	1519
Pockets—	
Flashlight, Electricians',	
Klein	794
Knife, Skinning, Klein	795
Plier, Klein	795
Tool, Electricians', Klein	794
Points, Drill, Masonry,	
Diamond "N"	852
Poison Ivy Wash, M-S-A	875
Pole and Anchor Hole Diggers,	
Adams	893
Pole and Bracket Cable—	
Anaconda	20
General Cable	60
Pole and Pedestal Bases,	
Traffic Signal, Crouse-	
Hinds	1017
Pole Balconies, Linemens',	
Hubbard	967
Pole Band Accessories, Ad-	
justable, Hubbard	933
Pole Bands, Adjustable,	
Hubbard	948
Pole Bracket Bands, Street	
Lighting, Hubbard	1036
Pole Bracket Plates, Street	
Lighting, Hubbard	1038, 1039
Pole Brackets, Street Lighting—	
Hapco	1035, 1036
Hubbard	1034, 1036, 1037
Pole-Butt Pullers, B&L	820
Pole Clamps and Mounting At-	
tachments, Traffic Signal	
and Control Box, Crouse-	
Hinds	1017

P	Page	P	Page	P	Page
ole Cradles, Oshkosh	812	Porcelain Knobs—		Power Analyzers, Industrial	
ole Dating Nails, Hubbard	928	Knox	212	Loads, Weston	1486
ole Gains, Crossarm, Hubbard	928	Porcelain Prod.	213	Power and Light Control	
ole Guards, Safety, Chance	882	Telephone—Knox	214	Switchboard Components,	
ole Hand Guards, Safety,		Porcelain Prod.	213	G-E	1383-1388
Chance	892	Porcelain Lighting Fixtures,		Power and Floodlight Units,	
ole Hole Digger Handles,		Incandescent, Alabax	1151	Electric, Portable, Gray-	
Oshkosh	809	Porcelain Tubes—		bar	1299
ole Hole Diggers, Oshkosh	809	Knox	215	Power and Light Plants—	
ole Hole Shovels, Oshkosh	809	Porcelain Prod.	213	Electric—	
ole Hole Spoons, Oshkosh	808	Portable and Pendant Cord,		Diesel Engine, Graybar	1299
ole Hood Brackets, Street		Anaconda	38	Gasoline Engine, Gray-	
Lighting, Hubbard	1038	Portable Buildings, Steel, Pen-		bar	1297, 1298
ole Keys, Chance	918	nington	829	Power and Light Substations—	
ole Lamp Lead Brackets, Hub-		Portable Cable, Power,		I-T-E, Secondary	1393
bard	1039	Kaiser	127, 128	Square D	1395
ole Markers, Hubbard	928	Portable Cord—		Power and Light Transformers,	
ole Marking Nails, Hubbard	928	Diamond	89, 90	G-E	1357-1364
ole Plate Bushings, Hubbard	1039	Kaiser	127	Power and Outlet Taps—	
ole Platforms—		Phelps Dodge	7	Bryant	668
Universal, Chance	968	Plastic W&C	138, 139	Hubbell	668
Utility, Chance	969	Simplex	115	Power Bits, Electricians',	
ole-Pulling and Straightening		Whitney Blake	130, 131	Greenlee	712
Jacks, Simplex	838	Portable Heaters, Automatic,		Power Busways and Fittings,	
ole-Pulling Jacks, Duff-Norton	838	Wesix	1216	Plug-In, G-E	501-507
ole-Reinforcing Bands, Hub-		Portable Lamp Guards,		Power Cable—	
bard	933	McGill	608, 609	Anaconda	28, 30, 31
ole Saws, Tree Trimmer,		Portable Lamp Sockets, McGill	668	General Cable	58
Bartlett	805, 806	Portable Lamp and Cord Sets—		National	118, 120-122
ole Seats, Linemens', Hubbard	967	Ericson	606	Phelps Dodge	6, 9
ole Steps, Detachable,		McGill	612	Plastic W&C	140
Hubbard	928	Portable Lamps and Cord Sets—		Simplex	108-111
ole Struts, Hubbard	922	Woodhead	613, 614	Triangle	93, 104-107
ole Supports, Oshkosh	810, 811	Portable Lamp Handles and		Asbestos—Varnished Cam-	
ole Tongs, Chance	812	Guards—		bric Insulated—	
ole-Top Gins, Chance	833	Ericson	607	General Cable	69-73
ole Trailers, Adams	893	McGill	609-612	National	117, 118
ole Unloaders, Chance	837	Woodhead	613, 614	Triangle	100
ole Wire Cutters, Lever Type,		Portable Lamps, Crouse-Hinds,		Conduit and Duct—	
Chance	887	Type EVS	408	Simplex	113
oles—		Lo-Volt Transformer Type,		Triangle	104, 105
Cedar, National	895, 896	Woodhead	615	Direct Burial or Aerial,	
Crescot—		Portable Lovolt Lighting		Triangle	104, 105
International	897-905	Units—Woodhead	615	General Distribution, Kaiser	125
National	895, 896	Portable Tool Cords, Parallel,		Heat-Resisting, General	
Fir, National	895, 896	Plastic W&C	141	Cable	66, 67
Floodlight, Revere	1187	Porto-Mite Super-Power Drives,		Mine, Anaconda	29
Gin, Insulated	835	Beaver	735	Overhead, Duct or Burial,	
Lamp Changer—		Post Lamps, Moe	1143	Simplex, Portable	110, 111
Chance	606	Post Lanterns, Moe	1142, 1143, 1145	Portable—	
McGill	607	Post-Top Outdoor Lighting		Anaconda	33-37
Pike—		Units, Holophane	1071	General Cable	61, 63-65
Chance	812	Post Vises, Armstrong	729	Kaiser	127, 128
Oshkosh	811	Posts—Lantern, Moe	1143	Simplex	111, 112, 114
Pine, International	897-905	Sign, Traffic, Steel, Span		Triangle	102, 103
Power Distribution, Steel,		Type, Union Metal	1031	Power Capacitors, Kilovar	
Union Metal	1028	Potential Director Periscope		Supply, G-E	1448, 1449
Steel—		Attachments, Minerallac	1500	Power Circuit Breakers, Sub-	
Fluorescent Luminaire, Un-		Potential Detectors, "Stati-		station, G-E	1409
ion Metal	1029	scope", Minerallac	1500	Power Circuit Fuses, High-	
Power Distribution, Un-		Potential Transformers, Port-		interrupting, G-E	540
ion Metal	1028	able, G-E	1471	Power-Circuit Transformers,	
Telegraph—		Pothead and Joint Flushing		Jefferson	1373
International	897-905	Compounds, Anaconda	862	Power Conductors, Aluminum,	
National	895, 896	Pothead Filling Compounds,		General Cable	53
Telephone—		Anaconda	862	Power Control Centers—	
International	897-905	Potheads—		Commercial, Industrial and	
National	895, 896	Anaconda	998	Institutional, Square D	562
Traffic Signal—		G&W	998	Special Purpose, Industrial,	
Crouse-Hinds	1017	Pots—		Square D	562
Union Metal	1031	Compound, Salisbury	863	Power-Conversion Units, G-E	1295
Tree Pruner, Bartlett	805	Glue, Electric—		Power Converters, Add-a-Phase,	
les and Accessories, Hot		General Electric	758	System Analyzer	1374
Line, Universal Chance	890	Vulcan	758	Power Cord—Portable	
les and Brackets, Street		Metal Melting—		Diamond	89, 90
Lighting, Steel, Union		Chromalox	757	General Cable	61
Metal	1033, 1034	General Electric	758	Power Cords, Coiled, Retractable	168
lsh, Stainless Steel, Allen	189	Solder, Vulcan Electric	759	Power-Cross Protectors, Tele-	
lshers, Electric, Portable,		Pouches—		phone Service, Cook	1510
Thor	778	Glove, Linemens', Klein	878	Power Distribution Conductors,	
rcelain Cleats—		Tool, Electricians', Klein	794	Copperweld	973
Knox	212	Utility, Electricians' and		Power Distribution Poles, Steel,	
Porcelain Prod.	212, 213	Wiremen's, Klein	795	Union Metal	1028

P	Page
Power Drives—	
Beaver Porto-Mite, Super	735
Toledo	731
Power Factor Meters, Poly-	
phase, Hook-On, G-E	1470
Power Hammer Drills, Rawl	852
Power Insulators, Armstrong	960
Power Measuring Instruments,	
A-C—D-C, Portable, Wes-	
ton	1487
Power Outlet Plates, Flush,	
Hubbell	641, 642
Power Outlets—	
Flush—	
Hubbell	641, 642
P&S	640
Box Cover Mounted—	
Hubbell	641
Weatherproof, Hoffman	650
Power Phasing Units, T-P	1374
Power Pipe Benders, Greenlee	736
Power Pipe Bits, Greenlee	709, 712
Power Plant Annunciators,	
Kirkland	1261
Power Pumps—	
Hydraulic, Greenlee	843
Portable, Greenlee	844
Power Rectifiers, Walker	1295
Power Reels—	
General Machine	816
Collapsible—Adams	893
General Machine	894
Power Roof Ventilator Pent-	
houses, ILG	1279
Power Roof Ventilators,	
ILG	1279, 1280
Power-Style Switchboards,	
Commercial, Industrial and	
Institutional, Square D 560, 561	
Power Supply—	
Amplifier, Altec Lansing	1533
Limiter Amplifier, Altec	
Lansing	1531
Power Supply Cords—	
Television, Seeger-Williams ..	615
Power Supply Units, Locator	
Cal. System, Edwards	1240
Power Take-Offs, Adams	894
Power Tool Switches, Toggle,	
McGill	695-697
Power Transmission Con-	
ductors, Copperweld	973
Power Vise Stands, Portable,	
Oster	731, 732
Powerduct Bus Drop Cable,	
Anaconda	28
Preamplifier Mixers, Altec	
Lansing	1532
Preamplifiers, Altec Lansing	1533
Prefocusing Lampholders,	
Bryant	666
Preformed Armor Rods, Alcoa	975
Preheating and Dehydrating	
Ovens, Infrared, Triangle	1294
Pressers, Sleeve, General	
Machine	805
Pressure Alarm Contractors,	
General Machine	880
Pressure Compound Guns, Gen-	
eral Machine	879
Pressure Controls—Mercoid	1343
Steam-Heating Systems,	
Minneapolis-Honeywell	1269
Pressure Flow Indicators,	
General Machine	881
Pressure Gun Cleaning Rods,	
General Machine	879
Pressure Gun Holders, General	
Machine	879
Pressure Plug Flange Clamps,	
General Machine	880
Pressure Plug Flanges, Gen-	
eral Machine	879

P	Page
Pressure Spllces, Resin,	
Scotchcast	865
Pressure Switch Attachments,	
G-E	1340
Pressure Switches—	
Air Compressor, Square D ...	586
Machine, Machine Tool,	
Welder, Etc. Square D	586
Small Motor-Starting etc.,	
G-E	1340
Water Pump, Square D	586
Pressure Testing Accessories,	
General Machine	881
Pressure Testing Bypass	
Valves, General Machine ...	881
Pressure Testing Ells, General	
Machine	881
Pressure Testing Gauges, Gen-	
eral Machine	881
Pressure Testing Kits, General	
Machine	881
Program Clock Systems, Cen-	
trally-Controlled, Edwards	1242
Program Signal Control Boards,	
Edwards	1243
Programing Cocks and Ac-	
cessories, Fire Alarm,	
Federal	1232
Projection Lamps, G-E	1205
Projector Color Lamps, G-E	1205
Projector Lamps, G-E	1205
Projector Lights, Architectural,	
Century	1167
Projectors—	
Floodlighting, Benjamin	1191
Picture-Lighting, Kliegl	1172
Signal, Traffic Control, Air-	
port, Crouse-Hinds	1194
Prong Heads, Rotary, Uni-	
versal Pole, Chance	891
Propeller Fan Guards, ILG	1279
Propeller Fan Shutters, Auto-	
matic, ILG	1279
Propeller Fans, ILG	1276-1278
Protective Capacitors, Pyranol,	
G-E	1438
Protector and Cable Terminal	
Fuses—	
Telephone Service, Re-	
liable	1513, 1514
Protector Blankets, Salisbury ..	878
Protector Gloves, Salisbury	876
Protectors—	
Circuit, Multiple Control,	
G-E	1021
Guy Wire, Hubbard	921, 922
Protectors, Service, G-E	1378
Pruners—	
Hand, Bartlett	807
High-Voltage, Telephone	
Service, Reliable	1513
Meter and Service—	
Pellet-Type, G-E	1435
Thyrite, G-E	1435
Protectors, Substation, Tele-	
phone Service, Cook	
Utility	1510
Telephone Service, Cook—	
Fuseless	1510
Power-Cross, Cook	1510
Protectors—	
Single-Pair, Reliable	1513
Protectors and Arresters, In-	
door, Telephone Service,	
Reliable	1513
Tree, Bartlett	805
Pruning Saw Sheaths, Bartlett ..	807
Pruning Saws, Bartlett	807
Public Utility Barricades,	
Neo-Flasher	814
Publications, Switchgear, G-E ..	1377
Pull and Push Jacks, Duff-	
Norton	844

P	Page
Pull Boxes—	
Appleton	311
Electri-Center, Pushmatic,	
Bulldog	601, 606
Fire Alarm, Federal	1232
Pull Chain, Socket, Bryant	662
Pull Chain Links, Bryant	662
Pull Chain Switches, McGill	695
Pull Condulets, Crouse-Hinds,	
Type ESC	402
Pull Cord, Socket, Bryant	662
Pull Cord Pendants, Bryant	662
Pull Finders, Guy Wire, Gen-	
eral Machine	879
Pull-In Compounds, Minerallac ..	864
Pull-Socket Cord, Bryant	662
Pull Sockets, Screw-Base,	
Hubbell	669
Pull Switches, Ceiling, Bryant ..	704
Pullers—	
Cable—	
Barth	945
Greenlee	845
Fish Tape—	
Ideal	748
Klein	748
Fish Tape and Reel, Ideal	748
Fish Wire, Steel City	748
Fuse—	
Ideal	544
Seeger Williams	541
Linemens', Mighty Midget,	
Coffing	836
Pole-Butt, B&L	820
Slack, General Machine	846
Pullers and Testlites, Fuse,	
Ideal	545
Pulling and Pushing Jacks,	
Pipe, Simplex	843
Pulling Hooks, Dead-End,	
Reliable	986
Pulling and Splicing Condulets,	
Crouse-Hinds, Type ESC	402
Pulling-In Irons, Manhole, Hub-	
bard	995
Pulling or Snubbing Blocks,	
B&L	822
Pump Pliers—	
Champion DeArment	793
Klein	790
Utica	791
Pumps—	
Hydraulic—	
Blackhawk	747
Greenlee	843
Simplex	843
Motor, Pipe Bender, Tal	738
Power, Portable, Greenlee ...	844
Water Collector, Drilling Ma-	
chine, Truco	859
Pumps and Rams, Hydraulic,	
Simplex	843
Punch and Chisel Sets,	
Machinists', Ryan	717
Punch Sets, Machinists', Ryan ..	717
Punches—	
Knockout—	
Hand—	
Greenlee	747
Nye	743
Hydraulic—	
Blackhawk	747
Nye	743
Metalworkers'—	
Hand, Whitney	744, 745
Hydraulic, Whitney	745
Radio Chassis, Greenlee	746
Tinners'—	
Hand, Whitney	744, 745
Hydraulic, Whitney	745
Push and Pull Jacks, Duff-	
Norton	844
Push and Turn Switches,	
Mossman	1348

P	Page
Push Button Blocks, Edwards	1255
Push Button Panels, Edwards	1256
Push Button, Selector Switch and Pilot Light Stations, R&S	445-447
Push Button Station and Pilot Light Condulets, Crouse-Hinds—	
Series EFD	429, 430
Series EFS	429
Type EGP	429
Series FD and FS	433
Push Button Station Attachments, Square D	582
Push Button Station Condulets, Crouse-Hinds—	
Series EFD	427
Series EFS	426, 427
Series FS	430, 433
Type OFC	434
Push Button Stations—	
Appleton Unilet, Series EFS	347
G-E	1339
Square D	580-582
Push Button, Switch and Pilot Light Enclosures, Hoffman	1342
Push Button Switch Plates—	
Flush, Bryant	690
Hubbell	692
Push Button Switches, Flush, Bryant	690
Hubbell	692
Multiple-Circuit, Mossman	1348
Push Buttons—	
Door Bell, Edwards	1253-1255
Door Chime, Nutone	1251
Entrance, Edwards	1253, 1254
Executive, Edwards	1256
Flush, Edwards	1255
High-Voltage, Edwards	1254
Miniature, Edwards	1254
Momentary Contact, Edwards	1253, 1254, 1257
Watertight, Benjamin	1256
Weatherproof, Edwards	1253
Push Switches—	
Momentary Contact—	
Carling	700
Hubbell	697
Pendant, Bryant	704
Pushers, Cable Block, General Machine	826
Pushes—	
Bell, Interchangeable, P&S	
Despard	676
Hospital, Locking Type, Edwards	1255
Pendant, Edwards	1255
Pushing and Pulling Jacks, Pipe, Simplex	843
Putty, Insulation, Electrical, Scotchfil	864
Pylets, Plug Receptacle, Pyle-National, Tribloc	364
Pylon-Lites, Fluorescent, Reverse	1189
Pyrene Fire Extinguishers	1227

Q

Quartz Lamps, Tubular, G-E 1211

R

Raceway Benders, Wiremold	468
Raceway Snake Leaders, Wire-Mold	468
Raceway Trim, Lopo-Trim, National	473
Raceways, Wiremold	455-457
Racks—	
Bushing, Efficiency	211
Cable, Underground, Hubbard	995, 996
Conductor, Efficiency	211
Conduit Storing Steel, Allen	784

R	Page
Racks—	
Insulator, Light-Type, Hubbard	953
Secondary, Hubbard	953
Stacking, Steel, Allen	784
Storage, Steel, Allen	784
Storage Battery, Exide	1504
Wire Cleat, Efficiency	210
Radio Attachment Plug Caps, Interchangeable, P&S	
Despard	675
Radio Chassis Punches, Greenlee	746
Radio Fuses, Buss	539
Radio Outlets, Interchangeable, P&S Despard	675
Radio Panel Lamps, G-E	1210
Radio Replacement Cords, Retractable	168
Rail Bonds, Hanlon & Wilson	969
Railings, Rope, Platform, Chance	969
Railroad Batteries, Air Cell, Eveready	1224
Railroad Car Inspectors' Lanterns, Justrite	1221
Railroad Trainman's Lanterns, Justrite	1222
Railway Signal Cable, Anaconda	33
Railway Signal Control Cable, Anaconda	22
Railway Signal Wire, Anaconda	21, 22
Range and Appliance Lead Wire, General Cable	66, 67
Range and Dryer Cord Sets, Plastic W&C	141
Range Cord Sets—	
Hubbell	641
P&S	640
Range Outlets, Surface, P&S	640
Range Receptacles—	
Surface—	
Hubbell	641
Knox	649
Rapid-Start Lamps, Fluorescent, G-E	1201
Rare Gas Arresters, Brach	1508
Rare Gas Relays, Brach Vincent	1508
Ratchet-Lowering Jacks—	
Duff-Norton	839
Simplex	839, 840
Ratchet Wrenches, General Machine	796
Ratline, Tarred, American	820
Rayon-Film Tape, Permacel	182
REA Lighting Fixtures—	
Incandescent, Appleton	333
Crouse-Hinds	332
REA Wiring Equipment—	
Appleton	333
Crouse-Hinds Condulet	332
Reamer and Wrench Combination, EMT, T&B	748
Reamers—	
Burring—	
Bit Brace, Armstrong	720
Ratchet, Armstrong	720
Pipe—	
Bit Brace, Nye	720
Ratchet—Nye	720
Toledo	720
Receptacle Adapters, Appleton, Series AE	351
Receptacle and Pilot Lamp Covers, Condulet, Crouse-Hinds, Series ED and FS	386, 290
Receptacle and Switch Condulets, Crouse-Hinds, Series FSQ	419

R	Page
Receptacle and Switch Covers, Condulet, Crouse-Hinds, Series FD and FS	390
Receptacle and Switch Plugs, Condulet, Crouse-Hinds—	
Type BP	419
Type FP	419, 420
Series FSQ	419, 420
Receptacle, Box and Cover, R&S	367, 370
Receptacle Connector Bodies, Machine Tool, Reelite, Appleton	169
Receptacle Covers—	
Lamp—	
Unilet, Appleton—	
"35" Line	328
GS Series	326
Pilot Lamp—	
Condulet, Crouse-Hinds, Series FD and FS	388
Plug—	
Condulet, Crouse-Hinds, Series FD and FS	387
Unilet, Appleton—	
Series FD and FS	331
Series GS	326
"35" Line	328
Receptacle Equipment Plugs—	
Crouse-Hinds, Arktite—	
Type CES	360
Type CESD	360
Type, CPP	360
Receptacle Fittings, Outdoor, REA, Appleton	333
Receptacle Guards, Box Cover, McGill	608
Receptacle Housings, Pyle National, Tribloc	364
Receptacle Interiors, Appleton, Series, AE	351
Receptacle Plates—	
Flush—	
Hubbell	632, 643, 644
Hubbellock	632
Receptacle Plates and Covers, Flush, Hubbell	634-637
Receptacle Plug Contact Units, Pyle-National, Tribloc	361, 362
Receptacle Plug Shells, Pyle-National, Tribloc	361, 362, 364
Receptacle Plugs—	
Appleton, Type AEP	349, 350
Crouse-Hinds—	
Type BP	419
Type BRC	359
Type CPH and CPP	389
Type FP	419, 420
Type WP	389
Crouse-Hinds Arktite, Type APJ	353-358
R&S	366, 373-375
Automatic Press and Tool Control, R&S	372
Circuit Breaking, R&S	376, 377
Panel Mounting, R&S	369
Screw Base, Woodward	669
Receptacle Socket and Screw-Base Plugs, Woodhead	669
Receptacles—Attachment Plug, Condulet, Crouse-Hinds, Obround Series	383
Ceiling—	
Brass Covered, Hubbell	664
Porcelain, Hubbell	664
Circuit Breaking, R&S	376, 377
Cleat, Mogul, Hubbell	664
Conduit Box—	
Hubbell	637
R&S	369
Convenience, R&S	375
Dead-End, Unilet, Appleton, Series CES	352

R	Page
Receptacles—	
Floor Box, T&B	324
Flush—	
Bryant	620
Hubbell	625, 626, 628, 631, 634-637, 642-645, 648
Hubbellock	632
Box Cover—	
Bryant	620, 625
Hubbell	626, 631, 634-636, 643, 648
Lamp—	
Condulet, Crouse-Hinds—	
Obround Series	383
Series GS	395
Neotex, Watertite, Wood-head	651
Lighting Fixture, Crouse-Hinds, Series V and VH	413
Metal Raceway R&S Ever-Lok	367
Midget R&S	367-369
Motor Plug, Hubbell	619
Outlet Box—	
Hubbell	664
Pyle-National, Tribloc	363, 364
R&S	368
Outlet Cluster, Hubbell	626
Panel Mounting, R&S	369
Pedestal, R&S	368
Pilot Lamp, Hubbell	679
Pilot Light—	
Bryant	679
Carling	700
Plug—	
Carling	700
Hubbell	628
Morse Eureka	616
R&S	366, 372-375
Range Surface—	
Hubbell	641
Knox	649
REA, Condulet, Crouse-Hinds, Series FS	332
Reverse Service, Conduit, R&S	369
Sign—	
Hubbell	657, 664
Union	658
Surface—	
Hubbell	625, 628, 631, 635
Conduit Box, R&S	367
Gang or Panel Mounting, R&S	367
Switch, R&S	441
Switch and Plug, Safety, Unilet, Appleton, Type FSQX	352
Receptacles and Boxes, Laundry, Appleton	295
Receptacles and Covers—	
R&S	367
Automatic, Press and Tool Control, R&S	372
Plug, Appleton, Series FD and FS	331
Receptacles and Enclosures, Plug, R&S	366
Receptacles and Housings, Attachment Plug, Condulet, Crouse-Hinds, Series FD and FS	388
Receptacles and Outlet Boxes, R&S	368
Receptacles and Plates, Flush—	
Hubbell	648
Hubbellock	632
R&S	367, 370, 371
Receptacles and Plugs—	
Appleton, Series AE	349, 350
Circuit Breaker, Condulet, Crouse-Hinds, Type EPC ..	420

R	Page
Receptacles and Plugs—	
Dead-End, Unilet, Appleton, Series CPSI	347
Naval, Modern Metal	1197
Wall and Floor Pocket, Hub	1171
Rechargers, Fire Extinguisher, Pyrene	1227
Reclosers, Circuit, Automatic, G-E	1403, 1404
Recording Instruments, Strip-Chart, G-E	1463, 1464
Rectifier Bulbs, G-E Tungar	1296
Rectifiers—	
Battery Charger—	
Telephone Industry, Raytheon	1505, 1506
Telephone Switchboard Power Supply Raytheon	1506
Battery Eliminators, Schauer	1504, 1505
Metal-Finishing, Walker	1295
Power, Walker	1295
Rectifiers, Telephone Communication Service, Raytheon	1507
Reducers—	
Conduit—	
Fibre, Orangeburg	1004
Rigid—	
Appleton	235
Steel City	235
T&B	234
Condulet, Crouse-Hinds	405
Fuse—	
Buss	545
Ideal	545
Lampholder, Benjamin	1058
Socket, Hubbell	662
Tubelet, Threaded, T&B	233
Unilet, Appleton, Series GRUJ	323
Reducing Bushings, Conduit, Rigid, Steel City	236
Reducing Washers—	
Conduit, Appleton	236
Knockout—Steel City	236
T&B	234
Reel Carts, Allen	818
Reel Jacks—	
Duff-Norton	840, 841
Simplex	841
Reelites, Appleton	168-171
Reels—	
Cable Lift, Appleton	170, 171
Grounding, Static Discharge, Benjamin	172
Power—	
General Machine	816
Collapsible—	
Adams	893
General Machine	894
Take-Up—	
Cloth-Cutting Machine, Reelites, Appleton	169
Electric Hoist, Appleton	171
Extension Cord—	
Appleton, Reelites	168, 169
Benjamin	173
Ericson	174
Hykon	174
Hose—	
Appleton	174
Appleton Reelites	168
Power and Light Cord, Reelites, Appleton	169
Tool Support, Reelites, Appleton	168, 171
Wire—	
Pay-Out, Allen	816
Oshkosh	815
Pay-out and Take-up—	
General Machine	815
Oshkosh	815

R	Page
Reels—	
Take-Up, Folding, Oshkosh ..	815
Terminal Room, General Machine	815
Wire Dispensing, Hykon	175
Wiring, Hykon	174
Reflector Covers, Benjamin	1060
Reflector Holders, Lighting Fixture, Crosse-Hinds, Series V and VH	413
Reflector Lamps, G-E	1203
Reflector Lighting Units, Incandescent, Hub	1161
Reflector Locking Guards, Benjamin	1054
Reflector Units—	
Light, Benjamin	1060
Sign, Benjamin	1061
Stock-Bin-Lite, Benjamin	1059
Reflectors—	
Lighting Fixture—	
Flourescent—	
Smithcraft	1095
Wiremold	467
Incandescent—Appleton—	
Series AA51	335
Series V51	337
Benjamin	1053, 1060, 1067
Crouse-Hinds—	
Series EV	408
Series V and VH	413
Series VM	416
Hubbell	1062
Multi	1060
Pittsburgh Permafactors	1153, 1154
Night Light, P&S Despard	676
Pilot Light, P&S Despard	676
Shade-Holder, Benjamin	1052
Socket Extension, Steber	1059
Regressed Lights, Kliegl	1166
Refrigeration Temperature Controls, Mercoid	1270
Regulators, Voltage, G-E "Inductrol"	1375, 1376
Reinforcing and Safety Straps, Hubbard	923
Reinforcing Plates, Crossarm, Hubbard	944
Relay Units, Motor Overload, Thermal, Square D	571
Relays—	
Auxiliary, Power and Light Control Switchboard, G-E	1390
Control, Battery Charger Rectifier, Raytheon	1505, 1506
D-C, General Purpose, G-E	1333
Door Chime, Nutone	1251
General Control, Industrial, Struthers-Dunn	1344
General Purpose, Edwards	1346
Instrument-Controlled, Struthers-Dunn	1344
Intermediate, Line-Voltage Load Switching, Minneapolis-Honeywell	1268
Lamp Control, Emergency, Struthers-Dunn	1345
Machine Tool—	
Square D	567, 568
Struthers-Dunn	1344
Mechanical Latch-In and Electrical Release, Struthers-Dunn	1345
Mercury Contact, Struthers, Dunn	1345
Mercury Plunger, H-B	1346, 1347
Mercury Switch, Panel Heating Control, Minneapolis-Honeywell	1267
Multi-Control Wiring System, Bryant	677

R	Page
Relays—	
Photoelectric, G-E	1349, 1350
Rare Gas, Brach Vincent	1508
Sensitive, Struthers-Dunn	1345
Sequence, Ratchet Type, Struthers-Dunn	1345
Siren Control, Remote Control, Federal	1232
Street-Lighting Control, H-B	1347
Switching—	
Cooling Compressor Load Control, Minneapolis- Honeywell	1268
Line or Low-Voltage, Minneapolis- Honeywell	1268
Telecode, Benjamin	1239
Telephone, Auxiliary Signaling, Struthers-Dunn	1345
Time Delay, Struthers-Dunn	1346
Timing—	
Electronic, Square D	584
Pneumatic, Square D	584
Remote Control Cable, Anaconda	37
Remote Control Displays, Touch-Plate	703
Remote Control Door and Gate Operators, Robot	707
Remote Control Gang Boxes, Touch-Plate	703
Remote Control Panels, Touch- Plate	702
Remote Control Siren Control Relays, Federal	1232
Remote Control Switch System Accessories, Touch-Plate	703
Remote Control Switch Systems, Touch-Plate	702, 703
Remote Control Switches—	
Robot, Mat-Type	707
Touch-Plate	702
Remote Control Transverters, Touch-Plate	702
Remote Control Units, Touch-Plate	702
Remote Controls, "Switch- O-Lite", Hoffman	703
Removers, Lamp Base, Lamp Changer, McGill	607
Renewable Fuses, Cartridge, Buss	535
Renewal Fuse Links—	
Cartridge—	
Buss	535
Economy	539
Repair Sleeves, Reliable	989
Repairs—	
Pipe Bender, Lidseen	739
Pipe Vise, Armstrong	729
Replacement Cords—	
Appliance, Seeger-Williams	615
Radio, Retractable	168
Residential Lighting Fixtures—	
Fluorescent—Moe	1139-1145
Silvray	1123
Incandescent—	
Litecraft	1137, 1138
Moe	1139-1145
Resin, Insulating and Moisture Sealing, Scotchcast	865
Resin Pressure Splices, Scotchcast	865
Resistance-Measuring Apparatus, Double-Bridges, G-E	1472
Resistance Testers—	
Ground, Portable—	
Biddle	1497
Associated Research	1495
Insulation, Portable—	
Associated Research	1495
Biddle	1497

R	Page
Resurfacers, Commutator, Ideal	762
Retract-O-Reels, Appleton	171
Retractable Cords, Coiled	168
Return-Call Annunciators, Edwards	1240
Return-Call Stations, Edwards	1247
Reverse Service Receptacles, Conduit, R&S	369
Rheostat Cable, National	118
Rheostate Wire, General Cable	66, 67
Rheostats—	
Field, Plate-Type, G-E	1332
Naval, Modern Metal	1198
Ribbonized Wire, Special, Gavitt	150
Ridge Irons, Hubbard	947
Rigging, Winch, Border Light, Stage, Hub	1170
Rigid Conduit—	
Alcoa	219
Anaconda	218
National	217
Republic	215
Triangle	216
Rings—	
Bridle, Diamond	936, 937
Concrete Box—	
Appleton	290
Steel City	290
Drive, Diamond	936
Extension—	
Handy Box, Appleton	289
Outlet Box—	
Appleton	289
National	284, 285, 290
Steel City	289
Lampholder, Screw, Bryant	655
Meter, Bonding, Appleton	260
Wall, Double Opening, Appleton	283
Rippers— Cable, Ideal	741
Pipe, General Machine	847
Ripping Hammers, Capewell	714, 715
Road Signs, Bartlett	813
Roadway and Walkway Lighting Fixtures, Crouse-Hinds	1180
Rock Anchors, Guy, Hubbard	917
Rock Expanding Anchors, Chance	917
Rock Guy Anchors, Hubbard	917
Rock Guy Bolts, Hubbard	917
Rod and Bolt Stocks and Dies, Armstrong	723
Rod Cutters, Porter	801
Rod Cutting and Threading Machines, Oster	733
Rod Driving Mauls, Chance	915
Rod Grapples, General Machine	847
Rod, Pipe and Bar Storing Units, Shop, Steel, Lyon	781
Rods—	
Anchor, Hubbard	918
Armor—	
Preformed—	
Alcoa	975
Crapo	971
Straight, Alcoa	978
Tapered, Alcoa	976
Cleaning—	
Conduit and Sewer, Empire	850
Duct, Diamond	850
Pressure Gun, General Machine	879
Ground—Chance	886
Hubbard	923-925
Hanger, Kindorf	255
Roller Link Sticks, Chance	888
Rollers—	
Aerial Cable, B&L	927
Duct Rod, General Machine	946

R	Page
Rolls, Tool, Electricians', Pocket, Klein	794
Romex Cable, General Cable	52
Roof and Wall Light Brackets, Reverse	1189
Roof Ventilators, Power, ILG	1279, 1280
Rope—	
Float, American	820
Insulating, Glaspun, Atlas	868
Manila, American	819, 820
Nylon, American	819
Sisal, American	819
Rope Railings, Platform, Chance	968
Rope Snubbing Brackets, Chance	886
Rope Winders, Winch, Adams	892
Rosettes—	
Concealed Wiring, Bryant	660
Cord, Condulet, Crouse-Hinds, Obround Series	383
Outlet Box, Bryant	662
Surface—Bryant	673
P&S	673
Rosin Core Solder—	
Dunton	186
Kester	186
Rosin Liquid Flux, Neutral, Allen	188
Rotary Switch Handles, Bryant	705
Rotary Switches—	
Carling	699
Heater, Bryant	705
Hot Plate, Bryant	705
Motor Control, Surface, Bryant	706
Motor Sentinel, Surface, Bryant	706
Surface, Bryant	694, 697
Rotating Beacons, Aviation, Crouse-Hinds	1194
Rough-Service Lamps, G-E	1209
Round Files, Simonds	717
Routers, Electric, Portable, Porter-Cable	772
Routers-Drill, TEC	712
Rubber Blankets, Slotted, Salisbury	878
Rubber Cord Sets, Seeger- Williams	615
Rubber Gloves, Linemens', Salisbury	876
Rubber Line Hose, Rib-Grip, Salisbury	877
Rubber Sleeves, Linemens', Salisbury	876
Rules—	
Extension, Folding, Lufkin	719
Folding—Evans	718
Lufkin	719
Tape, Lufkin	719
Running Thread Pipe, Conduit	225
Runway Lights, High-Intensity, Aviation, Crouse-Hinds	1192
Runway Marker Lights, Aviation, Crouse-Hinds	1192
Rural Distribution Wire, Tele- phone, Plastic W&C	146
Rural Lightning Arresters, G-E	1433
Rural-Line Transformers, Oil- Immersed, G-E	1423-1425
Rural Line Wire, Telephone, Rural Strain Carriers, Dead-End, Chance	889
S	
Saber Saw Attachments, Electric Drill, Thor	777
Saddles—	
Crossarm, Hubbard	944
Safety, Linemens', Bartlett	799
Wire Tong, Chance	885, 886

S	Page
Safety and Reinforcing Straps, Hubbard	923
Safety Balancers, Tool Suspension, Thor	772
Safety Harness, Linemens', Klein	797
Safety Hooks, Coffing	825
Safety Platforms, Linemens', Hubbard	967
Safety Saddles, Linemens', Barlett	799
Safety Straps, Linemens', Klein	799
Safety Switch and Plug Receptacles, Unilet, Appleton, Type FSQX	352
Safety Switch Condulet Plugs, Crouse-Hinds, Type DP	421
Safety Switch Condulets—	
Crouse-Hinds—	
Type FSQ	421
Type WMK	422
Type WMKS	421
Safety Switch Plugs, Unilet, Appleton, Type FSQX	352
Safety Switches—	
Bulldog	515, 516
G-E	517-520
Square D	511-514
Safety Tread, Non-Slip Coating, Chance	830
Sagger Brackets, Secondary Distribution, Hubbard	952
Sal Ammoniac, Solid, Allen	188
Salts—	
Soldering—	
Allen	188
Burnley	188
Nokorode	188
Sanders—	
Electric, Portable—	
Porter-Cable	769, 770
Thor	777, 778
Saw and Drill Combination, TEC	713
Saw Blades—	
All-Purpose, Capewell	715
Hack—	
Capewell	716
Wiremold	468
Sheet-Metal Cutting, Kett	768
Super, R.C.S.	769
Saw Frames—Hack—	
Capewell	715
K-D	715
Saw Kits, Super, R.C.S.	768
Saws—	
Band, Electric, Portable, Porter-Cable	771
Chair, Electric, Portable, Porter-Cable	771
Compass, Fowle	715
Electric, Portable—	
Porter-Cable	770, 771
Thor	777
Hand—	
Foresters', Bartlett	807
Tree Trimmers', Bartlett	806, 807
Hole, Capewell	716
Panel-Cutting, Electric, Kett Master	708
Pole, Tree Trimmer, Bartlett	805, 806
Pruning, Bartlett	807
Sheet-Metal Cutting, Electric, Portable, Kett	768
Slotting, Commutator, Ideal	766
Super, Electric, R.C.S.	768
Tree—	
Bartlett	805
Oshkosh	803

S	Page
Scaffold, Elevating, Portable and Adjustable, Allen	785
Scales, Balance, Industrial Dillon	767
Scissors, Electricians', Klein	794
Scissors Tables, Steel, Allen	785
Scraping Hooks, Lead, General Machine	796
Scratch Awls, Greenlee	710
Screw-Base Adapters—	
Bryant	669
Hubbell	634, 669
Screw Driver Bits—	
Greenlee	713
Ryan	713
Screw Drivers—	
Ryan	713
Utica	714
Electric, Portable, Thor	776
Flush Plate Screw, Hubbell	682
Insulated, Porter	713
Meterman's, Porter	713
Spiral, Greenlee	714
Screw Drivers and Nut Setters, Electric, Portable, Thor	776
Screw-Eye Bolts, Hubbard	919
Screw Eyes, Insulated, Diamond	937
Screw Fixtures, Angle, Diamond	937
Screw-Ring Lampholders, Porcelain, P&S	666
Screw Rings, Lampholder, Bryant	655
Screws—	
Cable Suspension, Hubbard	923
Flush Plate, Hubbell	682
Knob, Telephone, Insulated, Hubbard	941
Lag, Hubbard	932
Machine, Seeger-Williams	861
Sheet Metal, Seeger-Williams	860
Wood, Seeger-Williams	861
Sealed Beam Lamps, Automotive, G-E	1210
Sealing and Filling Compounds, G-E	872
Sealing Bushings, O.Z.	275
Sealing Cement, Floor Outlet, Steel City	321
Sealing Compounds—	
Crouse-Hinds	406
General Machine	864
O.Z.	864
R&S	316
Sealing Condulets—	
Crouse-Hinds—	
Type EZS	406
Type EYS	406
Type EZD	406
Sealing Fittings—	
Junction Box, R&S	316
Unilet, Appleton, Series EYS	347
Sealing Packing, R&S	316
Seats—	
Cable Splicers', Bond	831
Pole, Linemens', Hubbard	967
Secondary Cable—	
Alcoa	152-154
Anaconda	17-19
General Cable	53, 54
Secondary Racks, Hubbard	953
Sectional Ladders, Oshkosh	828
Sectional Wireways and Fittings, Hoffman	499
Secondary Fuses, Indicating, G-E	1445
Selector Switch Condulets, Crouse-Hinds, Series EFD and EFS	428
Semi-Rigid Conduit, Triangle	216
Sensitive Relays, Struthers-Dunn	1345

S	Page
Sequence Relays, Ratchet Type, Struthers-Dunn	1345
Series Street Lighting Cable—	
Anaconda	20
Triangle	94
Series Street Lighting Lamps, G-E	1207
Series Street Lighting Wire, General Cable	55, 58
Service and Meter Protectors—	
Pellet-Type, G-E	1435
Thyrite, G-E	1435
Service Brackets, Hubbard	939
Service Carts, Shop, Steel, Lyon	781
Service Dead-Ends, Squeeze Type, Reliable	991
Service Drop Cable—	
Alcoa	152-154
Anaconda	17-19
General Cable	53, 54
Phelps Dodge	4
Triangle	95
Service Entrance Cable—	
Anaconda	16
General Cable	52
Kaiser	125, 126
National	123
Phelps Dodge	4
Triangle	95
Service Entrance Connectors—	
Reliable	982, 983
Sherman	192
Service Entrance Sleeves, Compression, Reliable	992
Service Equipment, Fusible, Square D	532-534
Service Fittings, Floor Box, National	322, 323
Service Mast Kits, Hubbard	939
Service Protectors, G-E	1378
Service Sleeves, Guy Strand, Hubbard	921
Service Station Floodlights, Crouse-Hinds	1175
Service Wire Clamps, Wedge Type, Reliable	994
Sets—	
Cord—	
Heavy Duty, Bryant	624
Range—	
Hubbell	641
P&S	640
Telephone—	
Crouse-Hinds—	
Series ET	1520, 1521
Series ETG and ETWG	1522
Series ETWS	1523, 1524
U.S. Instrument	1519
Sewer and Conduit Cleaning	
Rods, Empire	850
Shackle Clevises, Hubbard	949
Shackles—Anchor, Ohio Brass	968
Clevis, Hubbard	952
Shade-Holder Reflectors, Benjamin	1052
Shade Holders—	
Bryant	658
Hubbell	657, 662
Reflector Light, Benjamin	1052
Shades—	
Lighting Fixture—	
Alabax	1151
Benjamin	1060
Crouse-Hinds, Series V and VH	411
Graybar	1151
Shears—	
Metal Cutting, Bartlett	718, 746, 801
Steel-Slitting, Whitney	741
Sheaths, Pruning Saw, Bartlett	801

S	Page	S	Page	S	Page
Sheaves, Manhole, Simplex	845	Sign and Decorative Lamps,		Sleeve and Groove Squeeze	
Sheaves and Shackles,		G-E	1204	Tools, Reliable	994
Cable, B&L	850	Sign and Fixture Lampholders,		Sleeve and Wire Clamps, Klein	803
Sheet-Metal Cutting Saw		Intermediate Base, Bryant	661	Sleeve Bags, Linemens',	
Attachments, Kett	768	Sign Cable—		Salisbury	877
Sheet-Metal Cutting Saws,		Gas-Tube, Anaconda	39	Sleeve Pressers, General	
Electric, Portable, Kett	768	Neon—		Machine	803
Sheet Metal Fasteners, Crimp		General Cable	60	Sleeve Splice Tools—	
Nuts, Diamond	853	Plastic W&C	140	Chance Nico-Press	994
Sheet Metal Screws,		Sign Lampholders—		Chance Universal	994
Seeger-Williams	860	Bryant	654, 655	Sleeve Twisters, Klein "Die-	
Shells—		P&S	666	Stock"	802
Receptacle Plug, Pyle-		Sign Posts, Traffic, Steel, Span		Sleeves—	
National, Tribloc	361, 362, 364	Type, Union Metal	1031	Cable, Split, Reliable	989
Socket, Aluminum, Hubbell	662	Sign Receptacles—		Cable Jumper, Chance	887
Shelving, Shop, Steel—		Hubbell	657, 664	Dead-End, Squeeze Type	
Allen	783	Union	658	Reliable	992
Lyon	782	Sign Reflector Units,		Expansion Bolt, Hubbard	856
Shepherd Hook Heads,		Benjamin	1061	Insuliner, T&B	228
Universal Pole, Chance	891	Signal and Sign Mounting		Linemens', Rubber, Salisbury	876
Shepherd Hooks, Dead-End,		Attachments, Traffic		Repair, Reliable	989
Self-Aligning, Chance	889	Crouse-Hinds	1016	Service, Guy Strand, Hubbard	921
Shielded Jacketed Cable, Gavitt	150	Signal Bells—		Service Entrance, Compres-	
Shields—		Fire Alarm System, Edwards	1238	sion, Reliable	992
Cable Duct, Hubbard	995	Industrial, Federal	1233	Transposition, Reliable	989
Furnace and Fire Pot, Safety,		Lungen, Edwards	1252	Wire, Squeeze Type,	
Folding, Unique	787	Signal Bells and Chimes,		Reliable	990, 991
Lag Screw—		Faraday	1246	Slide Switches, Carling	699
Diamond	854	Signal Cable, General Cable	58	Slimline Lamps, Fluorescent,	
Di-En-Key	854	Signal Horns—		G-E	1201
Rawl	854	Industrial—		Slotting Files, Commutator,	
Lighting Unit, Fluorescent,		Edwards	1239	Ideal	765
Benjamin	1040	Faraday	1235	Slotting Saws, Commutator,	
Machine Bolt, Expansion,		Federal	1233, 1234	Ideal	766
Keystone	854	Signal Projectors, Traffic		Slow-Burning Cable,	
Shims, Guy Pole, Hubbard	919	Control, Airport, Crouse-		Phelps Dodge	12
Ship Auger Car Bits, Bit		Hinds	1194	Slow-Burning Wire,	
Brace, Greenlee	711	Signal Service Insulators,		Phelps Dodge	12
Shock Absorbers, Lighting		Armstrong	760	Small Motor Undercutters,	
Fixture, Thompson	1077	Signal Trumpets, Industrial,		Ideal	766
Shoes—		Faraday	1235	Snake Bite Kits, M-S-A	875
Bending—		Signal Wands, Flashlight,		Snake Leaders, Raceway,	
Conduit, Tal	738	Ray-O-Vac	1226	Wiremold	468
Pipe—		Signaling Devices, Flushcall,		Snap Hooks, Utility, Klein	824
Greenlee	736	Edwards	1244	Snap-Out Disconnect Heads,	
Tal	738	Signaling Systems and Equip-		Universal Pole, Chance	891
Shop Bin Units, Steel, Lyon	782	ment, Hospital, Edwards	1245	Snapicoid Plugmold, Wiremold	457
Shop Boxes, Steel, Lyon	781	Signaling Transformers—		Snatch Blocks—B&L	322-324
Shop Furniture and Equipment,		Edwards	1258	Conductor Stringing, B&L	323
Steel, Lyon	779-782	Jefferson	1373	Linemens', B&L	824
Shop Shelving, Steel—		Signals—		Snub Dead-End Pulling Hooks,	
Allen	783	Locator Call, Edwards	1240	Reliable	986
Lyon	782	Traffic, Crouse-Hinds	1006-1008	Snub Dead-Ends, Reliable	986
Shovel Handles—		Signals and Signs, Traffic,		Snubbing Blocks, B&L	822
D and Long, Oshkosh	808	Neon, Crouse-Hinds	1016	Snubbing Brackets, Rope,	
Pole Hole, Oshkosh	809	Signs—		Chance	886
Shovel-Lights, Incandescent,		Accident Prevention, Self-		Snubbing or Pulling Blocks,	
Kliegl	1166	Sticking, Brady	178	B&L	822
Shovels—		Directional, Lumiline, Hub	1161	Socket Adapters, Bryant	669
D-Handle, Oshkosh	808	Exit, Incandescent, Day-		Socket Bodies—	
Pole Hole, Oshkosh	809	Brite	1165	Brass—Bryant	652, 653
Short-Handled, Oshkosh	808	Road, Bartlett	813	Hubbell	662, 663
Showcase Lamps, Tubular, G-E	1204	Taxi-Guidance, Aviation,		Composition, Bryant	653
Showcase Lighting Fixtures,		Crouse-Hinds	1193	Electrolier, Hubbell	663
Fluorescent, Garcy	1113	Warning—		Lampholder, Porcelain, P&S	667
Showcase Lighting Units,		General Machine	812	Porcelain—	
Fluorescent, Wiremold	467	Oshkosh	813	Bryant	653
Shower Lighting Fixtures—		Sill Plates, Entrance,		Hubbell	663
Incandescent, Moe	1144	Appleton	243	Socket Bodies and Caps, Lamp-	
Multi	1061	Silver-Brazing Flux, Allen	188	Holder, Intermediate Base,	
Shunts, Grounding, Water		Silvered-Bowl Lamps, G-E	1202	Bryant	661
Meter, Appleton	260	Single-Pair Protectors, Tele-		Socket Bushings—Hubbell	662
Shutters, Fan, Propeller,		phone Service, Reliable	1513	Union	659
Automatic, ILG	1279	Siren Control Relays, Remote		Socket Caps—	
Shuttle-Car Cable—		Control, Federal	1232	Brass—	
Plastic W&C	145	Sirens—		Bryant	652, 653
Simplex	112	Industrial, Federal	1232	Hubbell	662, 663
Sidewalk Boxes and Covers,		Municipal, Federal	1232	Composition, Bryant	653
Cast Iron, Weatherproof,		Sisal Rope, American	819	Electrolier, Hubbell	663
Hope	313	Skinning Knives, Electricians',		Lampholder, Porcelain, P&S	667
Sight Meters, Pocket-Type,		Klein	795	Porcelain—Bryant	653
Weston	1484	Slack Pullers, General Machine	846	Hubbell	663

S	Page
Socket Clevises, Ohio Brass.....	965
Socket Extension Reflectors, Stebler	1059
Socket Extensions, Morse	669
Socket Eyes, Ohio Brass	966
Socket Interiors, Bryant	662
Socket-Meter Covers, Watt-hour, G-E	1452
Socket Reducers, Hubbell	662
Socket-Reflector Lighting Units— Industrial, Incandescent— Benjamin	1051-1054, 1061
Wheeler	1055, 1056, 1058
Mercury Vapor, Benjamin	1054, 1061
Socket Shells, Aluminum, Hubbell	662
Socket Wrenches, Spintight Type Porter	796
Sockets— Adapter, Angle, Adjustable, Hubbell	669
Aluminum Shell, Hubbell	657
Bayonet— Candelabra, Morse	671
Double End, Morse	671
Miniature, Morse	671
Brass, Hubbell	663
Candelabra, Bayonet, Morse	672
Double, Screw-Base, Woodhead	669
Flexible Wrench, Chance	891
Industrial, Levolier, McGill	665
Lamp, Neotex Covered, Woodhead	651
Lampholder, Fixture, Bryant	656
Meter, Transformer-Rated Watt-hour Meter, G-E	1460
Oil-Resistant, Neoprene, Ericson	658
Outlet Box Cover, Watertite- Weatherproof, Woodhead	651
Pin-Type— Bryant	652
Hubbell	657
Union	659
Porcelain, Hubbell	654
Portable Lamp, McGill	668
Pull, Screw-Base, Hubbell	669
Starter, Fluorescent Lamp— Bryant	1125
G-E	1130
Wall, Pon, Hubbell	657
Watertite-Weatherproof, Woodhead	651
Watt-hour Meter— G-E	1454
Box-Type, G-E	1458-1460
Square, G-E	1457
Weatherproof— Hubbell	657
Union	658, 659
Soll Classification	914
Solder— Bar, Kester	187
Acid Core— Dunton	186
Kester	186
Aluminum, Allen	186
Nokorode Core, Dunton	186
Rosin Core— Dunton	186
Kester	186
Stainless Steel, Allen	187
Solder and Flux, Metal, Brack Solderall	187
Solder Ladles, Unique	759
Solder Melting Furnaces, Unique	787
Solder Pots, Electric, Vulcan	759
Soldering Copper Handles, Unique	755

S	Page
Soldering Coppers, General Machine	847
Soldering Fluid, Nokorode	189
Soldering Flux— Dunton	187, 188
Stainless Steel, Dunton	188
Soldering Gun Accessories, WEN	757
Soldering Guns, WEN	756, 757
Soldering Iron Handles,— Pencil, Electric, Ungar	750
Soldering Iron Heating Elements— American Beauty	753
Drake	754
G-E	751
Soldering Iron Holders, Vulcan	754
Soldering Iron Tips— American Beauty	753
Drake	754
G-E	751
Ungar, Pencil Type	750
Vulcan	755
Soldering Iron Tips and Heaters, G-E	751, 752
Soldering Iron Transformers, G-E	751, 752
Soldering Irons, Electric— American Beauty	752, 753
Drake	754
G-E	751
Vulcan	755
Midget, G-E	751
Miniature, G-E	752
Pencil Type— American Beauty	753
Vulcan	755
Soldering Kits, Electric, Ungar	750
Soldering Liquid, Allen	189
Soldering Lugs, Sherman	194, 195
Soldering Paste— Allen	187
Burnley	187
Nokorode	187
Soldering Salts— Allen	188
Burnley	188
Nokorode	188
Soldering Solution, Burnley	189
Soldering Sticks, Allen	187
Soldering Tool Attachments, Ideal	755, 756
Soldering Tools— Thermo-Grip, Ideal	756
Thermo-Tip, Ideal	755
Solderless Connectors, O.Z.	193
Solderless Lugs— O.Z.	193
Sherman	195
T&B	196
Solution, Soldering, Burnley	189
Sound Amplifiers, Altec Lansing	1530-1533
Sound System Cable, Plastic W&C	144
Sound System Wire, Shielded, Whitney Blake	136
Spacers, Conduit, Fibre Conduit, Orangeburg	1005
Span Clamps—Drop Wire— Diamond	935
Hubbard	941
Reliable	992
Specialty Capacitors, G-E 1449-1451	
Speakers, Intercommunicating, Webster Teletalk	1536
Speed Indicators, Biddle	1497
Speed Indicators, "Tachom- eters", Portable, Biddle	1498
Speed Variators, Motor, G-E	1239
Spindles and Nuts, Cable Jumper, Chance	887

S	Page
Spiral Drills, Carbide, Rawl	850
Splice Boxes and Accessories, Floodlight and Cluster Light, Revere	1888
Splice Tools—Sleeve— Chance Nico-Press	994
Chance Universal	994
Splicers, Wire, Wedge-On, T&B	198
Splices— Pressure, Resin, Scotchcast	865
Wire— Reducer, Reliable	988
Straight Line, Reliable	988
Tension, Reliable	987, 988
Splices and Dead-Ends— Tension, Wirelink and Wire- vise, Reliable	986
Splicing Assemblies, Insulated, Reliable	989
Splicing Clamps, Klein	802
Splicing Compounds— Rubber Tape— Amazon	179
Okonite	179
Splicing Kits— Scotchcast	865
Light and Power Cable, G&W	866
Telephone Cable, G&W	866
Splicing Links, Strand, Reliable	987
Splicing Tape— High-Voltage— Bishop	180
Okolite	181
Rubber, Amazon	179
Weather-Resistant, Okoprene	181
Splints, Tie, Telephone Line, Crapo	973
Splitting Knives, Cable Sheath, Klein	796
Spool Insulators—Hubbard	951
Ohio Brass	956
Spoon Handles, Pole Hole, Oshkosh	809
Spoons, Pole Hole, Oshkosh	808
Spot or Flood Lights, Recessed, Garcy	1160
Spotlights— Booth, Dyna-Beam, Kliegl	1172
Fresnel-Lens, Kliegl	1172
Recessed— Curtis	1164
Garcy	1160
Moe	1144
Silvray	1159, 1160
Spreader Plugs, Guy Strand, Steel City	209
Spreaders— Lead Sleeve, General Machine	847
Pipe, General Machine	847
Spring Connectors, Electrical, Scotchlok	865
Spring Washers, Static-Proof, Hubbard	929
Springs, Mandrel, Tubing Bender, Republic	740
Spuds, Digging, Oshkosh	810
Spur Gear Hoists, Chain, Coffing	838
Stabilizers, Voltage, Electrical and Electronic Equipment, Raytheon	1506
Stacking Racks, Steel, Allen	784
Stage and Floor Show Front- lights, Kliegl	1172
Stage Dimmerboards Square D	563
Stage Lighting Control Centers, Square D	563
Stage Lighting Equipment— Century	1168, 1169
Hub	1170, 1171

S	Page
Stainless Steel Polish, Allen.....	189
Stainless Steel Solder, Allen.....	187
Standard Control Transformers, G-E	1361-1363
Standards—	
Floodlighting, Hope	1186
Light, Revere	1187
Meter-Testing, Portable, G-R	1454
Street Lighting—	
Aluminum Alloy, Hapso	1025, 1026
Concrete, American	1024
Traffic Signal, Steel, Union Metal	1030
Stands—	
Desk, Microphone, Altec Lansing	1529
Electric Drill, Thor	775
Temperature Regulating, Soldering Iron, American Beauty	753
Tool, Shop, Steel, Lyon	780
Vise—Armstrong	729
Toledo	730
Power, Portable, Oster 731, Warning Sign, General Machine	732
Warning Sign and Flasher, General Machine	812
Warning Sign and Flasher, General Machine	814
Staples—	
Cable, Appleton	278
Ground Wire, Hubbard	925
Insulated, Emerson	278
Star Drills, Electric Hammer, Thor	778
Starter Sockets—	
Fluorescent Lamp—	
Bryant	1125
G-E	1130
Starters—	
Fluorescent Lamp—	
Bryant	1126
G-E	1128
Hubbell	1127
Motor—	
A-C Combination, G-E	1338
Combination Starter and Cir- cuit Breaker, Magnetic— R&S	449
Square D	573
Combination Starter and Switch, Magnetic, Square D	572
Magnetic—	
G-E	1335, 1337
R&S	449
Square D	570, 572, 573, 578, 579
Manual—	
R&S	447, 448
Square D	564, 565, 574, 575, 578
Static Discharge Grounding Reels, Benjamin	172
Static-Proof Hardware, Return-Call, Edwards	1247
Hubbard	932, 933
Static-Resistant Linemens' Clothing, Salisbury	876
Station Control Cable—	
National	120
Plastic W&C	140
Station Lightning Arresters—	
Thyrite, G-E	1429-1431, 1438
Thorex, Dynagap, Ohio Brass	1434
Station Protectors, Fuseless, Telephone Service, Reliable	1513
Stations—	
Fire Alarm, Edwards	1230, 1231
Push Button—	
Appleton Unilet, Series EFS	347

S	Page
Stations—	
G-E	1339
Square D	580-582
Push Button, Selector Switch and Pilot Light, R&S	445, 447
Return-Call, Edwards	1247
Statiscope, Potential Detector, Minerallac	1500
Steam and Air Gauge Lamps, Crouse-Hinds, Type LG	409
Steel Buildings, Portable, Pen- nington	829
Steel Channel, Kindorf	253
Steel Conductors, Galvanized, Crapo	972
Steel-Pole Steps, Hubbard	928
Steel Poles—	
Flourescent Luminaire, Union Metal	1029
Power Distribution, Union Metal	1028
Steel Shelving—	
Allen	783
Lyon	782
Steel-Slitting Shears, Whitney ..	745
Steel Strand, Galvanized, Crapo ..	971
Steel Strap Cutters, Porter	802
Steel Tapes—	
Evans	718
Lufkin	719
Steel-Tower Steps, Hubbard	928
Steel Washers, Hubbard	929
Steelworkers' Belts, Klein	797
Stems, Fixture, Appleton	241
Step Ladders—	
Babcock	760
White Metal	761
Industrial, White Metal	761
Platform—	
Babcock	760
White Metal	761
Step Lights—	
Crouse-Hinds	1180
Hub	1160
R&S	1185
Steps—	
Pole, Detachable, Hubbard	928
Steel-Pole, Hubbard	928
Steel-Tower, Hubbard	928
Wood-Pole, Hubbard	928
Sticks—	
Clamp—	
Grip-All, Insulated, Chance ..	892
Positive Grip, Chance	888
Disconnect, Insulated, Chance ..	892
Roller Link, Chance	888
Soldering, Allen	187
Strain Link, Chance	889
Suspension Link, Chance	888
Tie, Hot Line, Chance	890
Wire-Holding, Chance	888
Stock and Die Carrying Boxes, Nye	721
Stock-Bin-Lite Reflector Units, Benjamin	1059
Stockbridge Dampers, Alcoa	974
Sticks—	
Pipe Threader—	
Armstrong	724
Nye	725
Stocks and Dies—	
Bolt, Oster	722
Bolt and Rod, Armstrong	723
Conduit, Armstrong	726
Conduit and Pipe, Armstrong ..	723
Pipe—	
Armstrong	725, 726
Nye	721
Oster	722
Pipe and Conduit—	
Armstrong	723
Nye	720, 721
Rod and Bolt, Armstrong	723

S	Page
Stools, Shop, Steel, Lyon	779
Storage Battery Racks, Exide.....	1504
Storage Batteries—	
Power, Exide	1501-1503
Telephone, Exide	1501
Storage Cabinets, Steel, Allen.....	785
Storage Racks, Steel, Allen.....	784
Storm Hooks, Hubbard	919
Storm Tools, Emergency, Chance	887
Stove and Appliance Lead Wire, General Cable	66
Stove Bolts, Seeger-Williams	860
Straight Ladders—	
Oshkosh	830
White Metal	761
Straighteners, Aerial Cable, General Machine	827
Straightening and Pole-Pulling Jacks, Simplex	838
Strain Carriers, Rural, Dead- End, Chance	889
Strain Clamps—	
Conductor, Ohio Brass	963
Universal, Ohio Brass	964
Strain Insulator Attachments, Hubbard	947
Strain Insulator Clevises, Hub- bard	949
Strain Insulators—	
Hubbard	948
Ohio Brass	954
Porcelain Prod.	955
Strain Link Sticks, Dead-End, Chance	889
Strain Plates, Pole, Hubbard.....	919
Strain Yokes, Insulator, Ohio Brass	966
Strand—Guy, Crapo	971
Strand Connectors, Hubbard	934
Strand Dead-Ending Devices, Reliable	986
Strand Reducer Links, Reliable ..	987
Strand Splicing Links, Reliable ..	987
Strand Vise and Safety Clips, Hubbard	940
Strandvise, Dead-Ending De- vice, Reliable	986
Strandvise Gripping Chucks, Reliable	987
Strandvise Wax Wraps, Re- liable	987
Strandvises, End Anchors, Prestressed Concrete, Re- liable	987
Strap Hangers, Minerallac	256
Strapping, Perforated, Mineral- lac	256
Strapping Tape, Permacel	183
Straps—	
Bracket, Hubbard	945
Cable—National	124
T&B	248
Cable Guard, Hubbard	935
Climber, Linemens', Klein 800, Conduit— Kindorf	801
Minerallac	255
T&B	249
T&B	248
Crossarm, Hubbard	944
Loom Wire, National	123
Messenger, Conduit Box, Minerallac	251
Mounting—	
Interchangeable Devices, P&S Despard	675
Multi-Control, Bryant	678
Pipe—Steel City	248
T&B	248
Reinforcing and Safety, Hub- bard	923
Safety, Linemens', Klein	799
Tie, Cable Hanger, Reliable.....	936

S	Page
Strateline Clamps, Ohio Brass ..	962
Streamers, Lighting, Decorative, Union	659
Street Lighting Cable, Series—	
Anaconda	20
General Cable	55, 58
Triangle	94
Street-Lighting Control Relays, H-B	1347
Street Lighting Controls, Photoelectric, G-E	1021
Street Lighting Lamps, Series, G-E	1207
Street Lighting Luminaires—	
Filament G-E	1019
Fluorescent, G-E	1018
Mercury, G-E	1020
Street Lighting Pole Bracket Bands, Hubbard	1036
Street Lighting Pole Bracket Plates, Hubbard	1038, 1039
Street Lighting Pole Brackets—	
Hapco	1035, 1036
Hubbard	1034, 1036, 1037
Street Lighting Pole Hood Brackets, Hubbard	1038
Street Lighting Poles and Brackets, Steel, Union Metal	1033, 1034
Street Lighting Standard Bracket, Arm and Base Details, Hapco	1027
Street Lighting Standards—	
Alumirum Alloy, Hapco	1025, 1026
Concrete, American	1024
Street Lighting Transformers—	
Aerial Type, G-E	1021
Constant-Current, G-E	1020
Pole Base, G-E	1021
Street Lighting Wire—	
Series—	
Anaconda	20
General Cable	55, 58
Street Railway Lamps, G-E	1207
Strip Heaters—	
Chromalox	1292
G-E	1291
Strip-Lighting Units, Fluorescent—	
All-Brite	1121
Curtis	1110
Garcy	1111
Moe	1142
Strip-Lights, Incandescent—	
All-Brite	1121
Curtis	1110
Garcy	1111
Moe	1142
Striplites, T-V Studio Lighting, Century	1169
Strippers—	
Wire—	
Bench Type, Ideal	742
Hand Type, Ideal	741, 742
Hot Blade, Ideal	742
Power, Ideal	742, 743
Strips—	
Fuse, Buss	544
Marker, Terminal Block, Marathon	589
Wiring, Plug-In, National	475
Structural Steel Clamps, Kindorf	254
Stud and Strap Combination, Fixture, Steel City	240
Stud Belts, Hubbard	926
Stud Fastening Tool Kits, Ramset Hammer-In	858
Stud Fastening Tools, Ramset Hammer-In	858
Studs—Fixture—	
Appleton	241
T&B	241

S	Page
Studs and Lugs, Circuit Breaker, G-E	530
Struts, Pole, Hubbard	922
Substation Components, Outdoor, G-E	1408-1411
Substation Fence Enclosures, G-E	1413
Substation Protectors, Telephone Service, Cook Utility	1510
Substations—	
Distribution Center Unit, G-E	1392, 1393
Load-Center Unit, G-E	1391, 1393
Sump Pump Control Switches, Square D	587
Sumps, Manhole, Fairmount	823
Sun Lamps, G-E	1211
Super-Saw Attachments, Electric Drill, R.C.S.	763
Super-Saw Blades, R.C.S.	769
Super-Saw Kits, R.C.S.	768
Super-Saws, Electric, R.C.S.	768
Supplies and Tools, Telephone Company's, General Machine	847-849
Supporters, Waist Belt, Line-men's, Klein	798
Supports—	
Box, Steel City	285
Bushing—	
Messenger, Efficiency	210
Wire and Cable, Efficiency	210
Cable—	
Diamond	936
Knox	954
O.Z.	274, 275
Conduit—	
Korns	252
T&B	256
Insulator—	
Efficiency	208, 212
Steel City	209
Ladder, General Machine	830
Lighting Fixture, Appleton, LSH Type	340
Pole, Oshkosh	810, 811
Switch, Multi-Control, Bryant	678
Switch Box, Appleton	305
U, Kindorf	253
Wire, Static, Hubbard	946
Wire Tong, Chance	886
Zee, Kindorf	253
Supports and Hangers, Lindorf	253-255
Surface Bases, Hubbell	642
Surface Lampholders—	
Bryant	673
Knox	655
P&S	673
P&S Cabettes	668
Surface Outlets, Bryant	621, 624, 650
Surface Receptacles, Hubbell	625, 628, 631, 635
Conduit Box, R&S	367
Gang or Panel Mounting, R&S	367
Surface Wiring Box Covers, Union	310
Surface Wiring Boxes, Insulated, Union	310
Surface Wiring Devices—	
Bryant	673
P&S	674
Surface Wiring Systems, Wiremold	455-466
Suspenders, Tool Belt, Line-men's, Klein	798
Suspension Clamps—	
Cable—	
Hubbard	923
Ohio Brass	961

S	Page
Suspension Fittings—	
Looped-Top, Benjamin	1058
Shock-Absorbing, Benjamin	1058
Suspension Hooks—	
General Machine	827
Ohio Brass	965
Suspension Insulator Clamps, Ohio Brass	957
Suspension Insulators, Ohio Brass	957
Suspension Link Sticks, Chance	888
Suspension Links, Cable, Hubbard	923
Suspension Screws, Cable, Hubbard	923
Suspension Tool Balancers, Safety, Thor	772
Suspension Units, Lamp Unit, Benjamin	1053
Swamp Anchors, Screw Chance	916
Swimming Pool Lights, Multi	1060
Swimming Pool Luminaires, Revere	1189
Swinging Connectors, Kindorf	253, 255
Switch and Bull's-Eye Plates, Flush, Hubbell	682
Switch and Device Box Covers—	
Appleton	291
National	291
Switch and Outlet, Pendant, Bryant	705
Switch and Outlet Combination, Flush—	
Bryant	680
Hubbell	680
Switch and Plate Combination, Flush, Bryant	705
Switch and Outlet Plates—	
Flush, Bryant	684, 685
Hubbell	681, 682
Switch and Pilot Lamp Covers, Condulet, Crouse-Hinds, Series FD and FS	390
Switch and Plate Combination, Flush, P&S Despard	680
Switch and Plug Receptacles, Safety, Unilet, Appleton, Type FSQX	352
Switch and Receptacle Condulets, Crouse-Hinds, Series FSQ	419, 420
Switch and Receptacle Covers—	
Appleton, Unilet, Series FD and FS	331
Crouse-Hinds Condulet, Series FD and FS	390
Switch and Receptacle Plates, Flush, Hubbell	682
Switch and Receptacle Plugs—	
Crouse-Hinds Condulet—	
Series FSQ	419, 420
Type BP	419, 420
Type FP	419
Switch Box Supports, Appleton	305
Switch Boxes—	
Appleton	302-305
National	124, 308
Steel City	306, 307, 309
Union	309
Door—	
Appleton	305
Hubbell	705
Gang, Appleton	294
Snap-In Bracket, Union	309
Switch Condulets—	
Motor Circuit, Crouse-Hinds, Type FLS	423
Motor Starting—	
Crouse-Hinds—	
Series EFD and EFS	431
Type FLF and GUB	432
Type GUSC	431

S	Page
Switch Condulets—	
Push Button—	
Crouse-Hinds, Type EGP	429
Safety, Crouse-Hinds—	
Type FSQ and WMKS	421
Type WMK	422
Selector, Crouse-Hinds,	
Series EFD and EFS	428
Tumbler, Crouse-Hinds—	
Series EFD and EFS	425
Type ESW	424
Type FLS	423
Type FSFC	432
Type GUSC	424
Switch Control Mechanisms, In-	
 sulator, Chance	1415
Switch Covers—	
Condulet, Crouse-Hinds—	
Obround Series	383
Series GS	396
Push Button—	
Condulet, Crouse-Hinds,	
Ser. FD and FS	387, 388, 390-392
Unilet, Appleton Ser. FD	331
and FS	331
Push Button Motor Control—	
Condulet, Crouse-Hinds,	
Ser. FD and FS	388
Lock, Unilet, Appleton, Series	326
GS	326
Tumbler—	
Condulet, Crouse-Hinds—	
Obround Series	383
Series FD and FS	387, 388, 390-392
Unilet, Appleton, Ser. FD	331
and FS	331
Switch Extension Arms, Levo-	
 lier, McGill	696
Switch Fittings, Outdoor, REA	333
 Appleton	333
Switch Handles, Rotary, Bryant	705
Switch, Outlet and Plate	
Combination, Flush—	
Bryant	680
Hubbell	680
P&S Despard	680
Switch, Pilot Light and Plate	
Combination, Flush, Hubbell	679
Switch, Pilot Light, Outlet and	
 Plate Combination, Flush—	
Bryant	623, 680
Switch Plates—	
Flush—	
Bryant	677, 683, 684
Hubbell	681, 682
Switch Receptacle Plugs, R&S.	441
Switch Receptacles, R&S	441
Switch Replacement Units,	
Condulet, Crouse-Hinds, Type	
ERS	424
Switch Supports, Multi-Control,	
 Bryant	678
Switch Systems, Remote Con-	
 trol, Touch-Plate	702, 703
Switch Unilets, Tumbler, Ap-	
 pleton, Series EFS	346
Switchboard Bus Cable, Gen-	
 eral Cable	74
Switchboard Clocks, Electric,	
 Sunshine	1498
Switchboard Ground Detectors,	
 Lamp Type, Sunshine	1499
Switchboard Instruments—	
General Service, G-E	1461-1463
Power Distribution,	
Weston	1474, 1475
Switchboard Lead Wire, Phelps	
Dodge	7
Switchboard Matting, Rubber,	
 Salisbury	878
Switchboard Watthour Meters,	
 G-E	1455

S	Page
Switchboard Wire—	
Anaconda	15
General Cable	74, 75
National	117
Switchboards—	
A-C, Metal-Enclosed, G-E—	
Power-Style, Commercial,	
Industrial and Institutional,	
Square D	560, 561
PX, Dial Type, U.S. Instru-	1517
ment	1517
Switchboards and Dimmers,	
 Stage Lighting, eCntury	1169
Switches—	
Appliance, Toggle, Hubbell	697
Battery—	
G-E	520
Trumbull	520
Canopy—	
Bryant	706
McGill	695, 696
Car-Lighting Control, Bryant	694
Ceiling, Pull, Bryant	704
Chain Fixture, Lever, McGill	695
Control, Power and Light	
Control Switchboard,	
G-E	1383-1385
Cord—Feed-Thru—	
Bryant	616
Hubbell	615
Cutout, Furnace and Attic	
Fan, Minneapolis-Honey-	
well	1269
Disconnecting—	
Hookstick, Chance	1414
Substation, G-E	1410
Door—Bryant	704
Hubbell	705
Steel City	309
Door-Step Light, Bus,	
Edwards	1257
Entrance, Fixed-Blade,	
Bryant	543
Feed-Thru, Surface, P&S	673
Float—	
G-E	1340
Square D	587
Flush—	
Push Button—	
Bryant	690
Hubbell	692
Toggle—	
Hubbell	688, 689, 692, 693
Tumbler—	
Bryant	685, 686, 690-692, 706
P&S	686, 687
Hubbell	688
Fuse Disconnecting, Substa-	1410
tion, G-E	1410
General Purpose, Power and	
Light Control Switchboard,	
G-E	1348
Group-Operated, Substation,	
G-E	1410
Heater, Rotary, Bryant	705
Hot Plate, Rotary, Bryant	705
Knife—Indoor, G-E	1405-1407
Open Type, G-E	521
Lever-Type, Multiple-Contact,	
Mossman	1347
Levolier, McGill	695-697
Limit—	
Lever-Type, G-E	1341, 1342
Machine Tool, Square D	583
Lock—	
Flush, Hubbell	689
Interchangeable Device,	
P&S Despard	674
Loom, Motor Starter, Man-	566
ual, Square D	566
Mercury—Mercoind	1270
Toggle, Flush, Hubbell	688
Tumbler, Flush, Bryant	691

S	Page
Switches—	
Microphone, Altec Lansing	1529
Momentary Contact—	
Carling, Push	700
Hubbell	697
Toggle, Diamond-H	1346
Motor Control—	
Lever, McGill	695
Rotary, Bryant	706
Motor Flashing, Traffic	
Signal, Crouse-Hinds	1012
Motor Sentinel and Starter,	
Flush, Tumbler, Bryant	706
Motor Starting, G-E	1335, 1336
Motor Starting and Revers-	
ing Drum, Square D	566
Multi-Control System, Bry-	
ant	677
Multiple-Circuit, Push-But-	
ton, Mossman	1348
Multiple-Contact, Lever Type,	
Mossman	1347
Oil-Burner—	
Tumbler, Box Cover Mounted—	
Mounted—	
Bryant	692
Hubbell	693
P&S	693
Power Tool, Toggle,	
McGill	695-697
Pressure—	
G-E	1340
Air Compressor, Square D.	586
Machine, Machine Tool,	
Welder, Etc. Square D	586
Water Pump, Square D	586
Pull Chain, McGill	695
Push—	
Momentary Contact—	
Carling	700
Hubbell	697
Pendant, Bryant	704
Push and Turn, Mossman	1348
Push Button—	
Flush—	
Bryant	690
Hubbell	692
Multiple-Circuit, Mossman	1348
Push Button Station, Apple-	
ton Unilet, Series EFS	347
REA, Condulet, Crouse-Hinds,	
Series FS	332
Remote Control—	
Robot, Mat-Type	707
Touch-Plate	702
Rotary—	
Carling	699
Surface—	
Bryant	694, 697
Motor Control, Bryant	706
Safety—Bulldog	515, 516
G-E	517-520
Square D	511-514
Slide, Carling	699
Special-Use, McGill	696
Sump Pump Control, Square	
D	587
Tap-Lite, Flush, Minneapolis-	
Honeywell	703
Telephone—	
G-E	520
Trumbull	520
Lever-Key Type, Mossman	1348
Tilting Insulator, G-E	1412, 1413
Time—	
Sangamo	1356
Tork	1355
Electric Equipment Con-	
trol, Minneapolis-Honey-	
well	1268
Power and Light Control—	
G-E	1352, 1353
Paragon	1354

S	Page
Switches—	
Toggle—	
Carling	698, 699
Flush—	
Hubbell	688, 689, 693
Box Cover Mounted, Hubbell	692
Mercury, Hubbell	686
Surface—	
Hubbell	692, 697
Box Cover Mounted, Hubbell	692
Transfer, Power and Light Control Switchboard, G-E	1383-1385
Tumbler—	
Carling	700
R&S	441, 442
Unilet, Appleton, Series EFS	346
Flush—	
Bryant	685, 686, 690-692
P&S	686, 687
Mercury, Bryant	691
Motor Sentinel and Starter, Bryant	706
Oil Burner, Box Cover Mtd.—	
Bryant	692
Hubbell	693
Interchangeable Device, P&S Despard	674
Surface—	
Bryant	673, 692, 693
P&S	673
Box Cover Mtd.—	
Bryant	692, 693
P&S	693
Vacuum, G-E	1340
Switches and Plates, P&S Despard	680
Switches, Parts and Accessories Naval, Modern Metal	1198
Switchgear—	
G-E	1378, 1379, 1396-1398
I-T-E	1393, 1394
Square D	1394, 1395
Switchgear Circuit Breakers, G-E	1379
Switchgear Equipment—	
G-E	1378, 1379, 1396-1398
I-T-E	1393, 1394
Square D	1394, 1395
Switchgear Publications, G-E	1377
Switching and Operation Control Centers, G-E	1329
Switching Mechanisms, Oil Fuse Pole-Base Cutout, G-E	1447
Switching Relays—	
Cooling Compressor Load Control, Minneapolis-Honeywell	1268
Line or Low-Voltage, Minneapolis-Honeywell	1268
Wivel Fixture Joint and Hickey, Appleton	240
Wivels, Lighting Fixture—	
Appleton—	
Series ESD	340, 347
Type ESS	340
Systems—	
Alarm, Manufacturing and Processing—	
Crouse-Hinds "Visual-arms"	1263, 1264
R&S "Unilarms"	1262
Call, Locator, Edwards	1240
Duct—	
BUStribution, Bulldog	488-491
Trol-E-Duct, Bulldog Universal	492-494

S	Page
Systems—	
Electrical Distribution, Feed-rail, Pre-Fabricated	495-499
Fire Alarm, Home Type, Edwards	1231
Intercommunicating, Webster Teletalk	1536
Light-Control, Superior "Lustrol"	701
Lighting—	
Incandescent, Louvered, Skylike	1136
Translucent, Benjamin	1119
Microphone, Altec Lansing	1527, 1528
Program Clock, Centrally-Controlled, Edwards	1242
Switch, Remote Control, Touch-Plate	702, 703
Telephone, Intercommunication, Stromberg-Carlson	1525, 1526
Vacuum Clearing, Central, Premier	764
Wiring—	
Multi-Control, Bryant	677, 678
Surface, Wiremold	455-466
T	
T-Parallel Taps—	
Burndy	205
O.Z.	193
T&B	198
Table Taps and Cord Sets, Hubbell	644
Tables, Scissors, Steel, Allen	785
Tachometers—	
Electric, Ideal	766
Speed Indicators, Portable, Biddle	1498
Tackers, Gun, Automatic, Arrow	715
Tackle Anchor Hooks, Klein	825
Tackle Blocks, B&L	821, 822
Tackles, Block, Klein	822
Tagging Devices, Disconnect Switch, Salisbury Marshall	875
Tags, Aluminum, Embossed, Standard	894
Take-Offs, Power, Adams	894
Take-Up and Pay-Out Wire Reels, Oshkosh	815
Take-Up Reels—	
Cloth-Cutting Machine, Reelites, Appleton	169
Electric Hoist Cord, Appleton	171
Extension Cord—	
Benjamin	173
Appleton Reelites	168, 169
Ericson	174
Hykon	174
Hose—	
Appleton	174
Appleton Reelites	168
Power and Light Cord, Reelites, Appleton	169
Tool Support, Reelites, Appleton	168, 171
Take-Up Wire Reels, Folding, Oshkosh	815
Tamping and Digging Bars, Oshkosh	810
Tamping and Expanding Bars, Chance	914
Tamping Bars—	
Everstick	916
Oshkosh	809, 810
Tangent Support Wire, Crapo	973
Tank and Boiler Thermostats, Remote-Bulb, Minneapolis-Honeywell	1269
Tap and Cord Sets, Table, Hubbell	644

T	Page
Tap Clamps, Flip-On, Reliable ..	980
Tap-Lite Flush Plates, Minneapolis-Honeywell	704
Tap-Lite Switches, Flush, Minneapolis-Honeywell	703
Tape Lines—	
Linen Tape, Lufkin	718
Steel Blade—Evans	718
Lufkin	719
Tape Rules, Lufkin	719
Tapes—	
Acetate Cloth, Permacel	181
Acetate Fibre, Permacel	181
Acetate Film, Permacel	181, 182, 184
Cellophane, Permacel	186
Chain, Steel Blade, Michigan, Lufkin	719
Cloth, Permacel	181, 185
Electrical—	
Permacel	181-186
Self-Bonding, Bishop	180
Filler, Electrical, Bishop	180
Fish—Appleton	750
Ideal	749
T&B	748
Friction—	
Amazon	179
Manson	179
Sticka	179
Victor	179
Insulating—	
Aluminum Foil, Scotch ..	180
Asbestos, Atlas	869
Ceramic Fibre, Atlas	868
Electrical, Plastic, Scotch ..	180
Fiber, Atlas	868
Glaspun, Atlas	868
Glass Cloth Backing, Scotch	180
Hydro-Proof, Elkhart	180
Waterproof Ruberoid	179
Woven, Atlas	868
Jacketing, Electrical, Bishop ..	181
Linen, Lufkin	719
Masking—Brady	177
Permacel	183
Metal Foil, Permacel	182
Mylar-Film, Permacel	182
Paper, Permacel	182, 183
Plastic, Permacel	184
Pocket, Evans	718
Rayon-Film, Permacel	182
Sealing, Splicing, Insulating, Bishop	180
Splicing—High-Voltage—	
Bishop	180
Okolite	181
Rubber, Amazon	179
Weather-Resistant, Okoprene ..	181
Okoprene	181
Steel—Evans	718
Lufkin	719
Strapping Tape, Permacel	183
Weather-Resistant, Okoprene ..	181
Wrapping, Clay Conduit, Natco	1001
Tapes and Shapes, Circuit Layout, Self-Sticking Brady	178
Tapes and Wrappers, Mica Mat, G-E	871
Taps—	
Attachment Plug, Hubbell	627
Cube, Bryant	618
Pipe, Nye	720
Power and Outlet—	
Bryant	668
Hubbell	668
T-Parallel—Burndy	205
O.Z.	193
T&B	198
Wire, Squeeze Type, Reliable	992

T	Page
Tarred Marline, American	819
Tarred Ratline, American	820
Taxi-Guidance Signs, Aviation, Crouse-Hinds	1193
Taxi Marker Lights, Aviation, Crouse-Hinds	1192
Tee Connectors, Substation, G-E	1411
Tees—	
Conduit, Rigid, Crouse-Hinds	245
Wind, Illuminated, Aviation, Crouse-Hinds	1194
Telecode Relays, Benjamin	1239
Telefaults, Fault Locators, Chance	882
Telegraph Fuses, Reliable	1514
Telegraph Poles—	
International	897-905
National	895, 896
Telegraph Wire, Galvanized, Crapo	970
Teleheights, Height Finders, Chance	882
Telephone Accessories, Crouse- Hinds	1520, 1523
Telephone and Intercommunica- tion Equipment, Naval, Modern Metal	1197
Telephone Battery Housings, Crouse-Hinds	1520
Telephone Batteries—	
Air Cell, Eveready	1224
Dry, Eveready	1223
Storage, Exide	1501
Telephone Booths—	
Indoor—	
Burgess-Manning	1515
Churchill	1514
Outdoor, Sherron	1515, 1516
Wall-Type, Burgess- Manning	1515
Telephone Bracket Bolts, Hubbard	941
Telephone Brackets, Dead-End, Hubbard	941
Telephone Cable—	
Aerial, Self-Supporting, Anaconda	49
Aerial and Duct—	
Anaconda	48, 49
Plastic W&C	146
Whitney Blake	134
Direct Burial—	
Anaconda	48
Plastic W&C	147
Whitney Blake	134
Drop, Whitney Blake	137
Exchange, Plastic W&C	146
Exchange Area, Whitney Blake	134, 137
Inside—	
Plastic W&C	145
Whitney Blake	133
Outside, Whitney Blake	134
Self-Supporting, Plastic W&C	147
Telephone Cable Splicing Kits, G&W	866
Telephone Company's Tools and Supplies, General Ma- chine	847-849
Telephone Cord, Replacement Sets, Whitney Blake	135
Telephone Corner Brackets, Hubbard	941
Telephone Drop Cable, Whitney Blake	137
Telephone Drop Wire Clamps, Reliable	
Telephone House Brackets, Hubbard	941
Telephone Instrument Units, U.S. Instrument	1519

T	Page
Telephone Jack Boxes, U.S. Instrument	1516
Telephone Jacks, U. S. In- strument	1519
Telephone Knob Screws, In- sulated, Hubbard	941
Telephone Knobs—	
Porcelain—	
Knox	214
Porcelain Prod.	213
Telephone Line Dead-Ends, Crapo	972
Telephone Line Fasteners, Ramset Hammer-In	858
Telephone Line Tie Splints, Crapo	973
Telephone Line Wire—	
Copperweld	974
Crapo	970
Telephone Mounting Hooks, U.S. Instrument	1519
Telephone Outlet Plates—	
Flush—Bryant	683, 684
Hubbell	681, 682
Telephone Poles—	
International	897-905
National	895, 896
Telephone Relays, Auxiliary Signaling, Struthers-Dunn	1345
Telephone Service Fuses, Term- inal and Protector, Cook	1510
Telephone Sets—	
Crouse-Hinds—	
Series ET	1520, 1521
Series ETG and ETWG	1522
Series ETWS	1523, 1524
U.S. Instrument	1518, 1519
Telephone Switches—	
G-E	520
Trumbull	520
Lever Key Type, Mossman	1348
Telephone Terminal Acces- sories, Stromberg-Carlson	1526
Telephone Systems, Intercom- munication, Stromberg- Carlson	1525, 1526
Telephone Wire—	
Bridle	87
Graybartel	87
Whitney Blake	132
Direct Burial, Whitney Blake	132
Distributing Brame, Whitney Blake	137
Distribution, Whitney Blake	132, 133
Drop—	
Graybartel	88
Whitney Blake	132
Duct, Graybartel	88
Galvanized, Crapo	970
Ground—	
Graybartel	87
Whitney Blake	133
Interior—	
Graybartel	88
Whitney Blake	135
Jumper and Duct—	
Graybartel	87
Whitney Blake	137
Outside, Whitney Blake	131, 132
Parallel, Whitney Blake	132
Rural Distribution, Plastic W&C	146
Rural Line, Plastic W&C	144
Station, Graybartel	87
Tree—Graybartel	87
Whitney Blake	133
Twisted-Pair, Whitney Blake	132
Underground Burial—	
Graybartel	88
Whitney Blake	137
Urban Distribution, Plastic W&S	147

T	Page
Telephones, Pocket, U.S. In- strument	1519
Television Fuses, Buss	539
Television Power Supply Cords, Seeger-Williams	615
Temperature Controls—	
Liquid and Gas, Mercoide	1270
Refrigeration and Air-Cond- itioning, Mercoide	1270
Temperature Limit Controls, Clamp-On, Mercoide	1270
Temperature Meters—	
Gas, Liquid, Etc. Portable, Simpson	1494
Refrigeration Equipment, Portable, Simpson	1494
Temperature Regulating Stands, Soldering Iron, American Beauty	753
Temperature Thermostats, Elec- tric Heating, Wesix	1272
Thermometers, Wiping Solder, Dillon	760
Tension Splices, Wire, Re- liable	987, 988
Tension Splices and Dead-Ends, Wirelink and Wirewise, Reliable	986
Tent Heaters, Cable Splicers', Perfection	833
Tents—	
Aerial, General Machine	831
Ground, General Machine	828
Ladder, General Machine	832
Manhole, General Machine	828
Terminal Block Components, Field Assembly, Marathon	589
Terminal Block Marker Strips, Marathon	589
Terminal Blocks, Marathon	589
Terminal Boards and Covers, Power and Light Control Switchboard, G-E	1389
Terminal Cabinets and Covers, Cast Iron, Weatherproof and Dust-Tight, Hope	314
Terminal Connectors, Sub- station, G-E	1411
Terminal Fittings, Disconnect- ing and Lowering Hanger, Thompson	1078
Terminal Grommets, Cable Ter- minal, Telephone Service, Cook	1509
Terminal Room Wire Reels, General Machine	815
Terminals—	
Building, Telephone Service, Cook	1509
Cable—	
Burndy	201, 204, 205
Telephone Service—	
Cook	1509
General Machine	1513
Reliable	1512
Underground, Telephone Service, Cook	1509
Contactor Alarm, General Machine	880
Wire—	
Burndy	199-201
T&B	196, 197
Terminations, Cable, Shielded, Burndy	200
Terminators, Cable, O.Z.	276, 277
Test Blocks, Power and Light Control Switchboard, G-E	1386, 1387
Test Clip Insulators, Mueller ...	190
Test Clips—Mueller	190
Reliable	189
Test Mandrels, General Machine	846

T	Page
Test Plugs, Power and Light Control Switchboard, G-E	1386, 1387
Test Sets, Turn Ratio, Transformer, Portable, Biddle	1498
Testers—	
Anodized Aluminum,	
Sunshine	1499
Circuit—	
Brach Test-O-Lite	768
Ideal	767
Industrial, Multi-Purpose—	
Weston	1486
Portable—	
Simpson	1493, 1494
Weston	1476-1480
Circuit Continuity—	
Ideal	767
Ray-O-Vac	767
Coil, Sunshine	1499
Fluorescent Fixture, Ideal	767
High-Potential, Portable, Associated Research	1496
Insulation—Biddle	1496
Ideal	766
Line Current Capacity, Line-O-Meters, Simpson	1492
Motor, Portable, Biddle	1497
Motor-Rotation, Biddle	1497
Oil, Insulating and Cooling, Portable, G-E	1426
Resistance—	
Ground, Portable—	
Associated Research	1495
Biddle	1497
Insulation, Portable—	
Associated Research	1495
Biddle	1497
Tube, General Purpose, Simpson	1492
Voltage—Ideal	1500
Square D	551
Testlights and Fuse Pullers, Ideal	545
Textiles, Insulating, Asbestos, Atlas	869
Thermal Overload Motor Relay Units, Square D	571
Thermocouple, Vacuum System Gauges, G-E	1472
Therm-O-Meters, Gas and Liquid Temperature Meters, Portable, Simpson	1494
Thermostat and Thermometer Condulets, Crouse-Hinds, Type HRC	453
Thermostat Condulets, Crouse-Hinds, Type HRC	453
Thermostat Control Cable, Anaconda	39
Thermostat Wire, Plastic W&C	142
Thermostats—	
Electric Resistance Heating, Minneapolis-Honeywell	1265, 1266
Heating, Industrial, G-E	759
Heating and Cooling Equipment—	
Mercoind	1270
Minneapolis-Honeywell	1265, 1266
High Humidity Applications, Minneapolis-Honeywell	1269
Thermometers—	
Liquid and Gas—	
Dillon	1288
Weston	1289
Tank, Boiler, etc., Remote-Bulb, Minneapolis-Honeywell	1269
Temperature, Electric Heating, Wesix	1272

T	Page
Thimble Clevises, Hubbard	948
Thimbles—	
Clevis, Pierce	948
Conductor, Hubbard	921
Dead-End, Ohio Brass	964
Guy, Hubbard	921
Thin-Wall Conduit, (EMT)—	
Alcoa	219
Anaconda	218
National	220
Republic	220
Triangle	219
Thinners—	
Asphalt Paint, Ruberoid	866
Insulating Finish, G-E	873
Insulating Varnish, G-E	873
Threaders—	
Bolt, Beaver	723
Conduit, Beaver	723
Pipe—	
Armstrong	724
Beaver	723
Nye	725
Threading Device Dieheads and Dies, Pipe, Toledo	724
Threading Device Dies—	
Conduit, Toledo	724
Pipe, Toledo	724
Threading Device Handles, Pipe, Toledo	724
Threading Devices—	
Conduit, Toledo	724
Pipe, Toledo	724
Threshold Marker Lights, Aviation, Crouse-Hinds	1192
Tie and Flat Gain Plates, Hubbard	945
Tie Handles, Electric-Center, Pushmatic, Bulldog	601
Tie Splints, Telephone Line, Crapo	973
Tie Sticks, Hot Line, Chance	890
Tie Straps, Cable Hanger, Reliable	936
Tie Wire—	
Armor Rod, Alcoa	977
Galvanized, Crapo	970
Ties, Insulator, Copperweld	969
Tilting Insulator Switches—	
Chance	1415
G-E	1412, 1413
Timber Braces, Simplex	844
Timbers, Transmission Line, Wood, Rainier	913
Time Delay Relays, Struthers-Dunn	1346
Time Meters, G-E	1353
Tork	1355
Time Switches—	
Sangamo	1356
Tork	1355
Electric Equipment Control, Minneapolis-Honeywell	1268
Power and Light Control—	
G-E	1352, 1353
Paragon	1354
Timers—	
Electronic, G-E	1351
Interval—Paragon	1354
Sangamon	1356
Timing Relays—	
Electronic, Square D	584
Pneumatic, Square D	584
Tinners' Punches—	
Hand, Whitney	744, 745
Hydraulic, Whitney	745
Tips—Soldering Iron—	
American Beauty	753
Drake	754
G-E	751, 752
Ungar, Pencil	750
VulcanWorldRadioHistory	755

T	Page
Tips and Heaters, Soldering, Iron, G-E	751, 752
Toggle Appliance Switches, Hubbell	69
Toggle Bolts—	
Diamond	85
Rawl Spring-Wings	85
Toggle Switch Utility Plates, Hubbell	62
Toggle Switches—	
Carling	698, 699
Flush, Hubbell	688, 689, 691
Box Cover Mounted, Hubbell	692
Mercury, Hubbell	686
Surface, Hubbell	692, 693
Box Cover Mounted, Hubbell	692
Tread, Safety Non-Slip Coating, Chance	830
Treads, Floor Signaling, Edwards	1250
Tong Block Clamps and Clevises, Wire, Chance	88
Tongs—	
Ammeter, Insulated, Chance	89
Pole, Chance	81
Tongs and Fittings, Wire, Chance	88
Tool Bags—	
Electrical Inspectors', Klein	79
Linemens', Klein	79
Tool Raising, Salisbury	79
Tool Belt Suspenders, Linemens', Klein	79
Tool Belts, Linemens', Klein	797, 798
Tool Cases, Hip Pocket, Klein	79
Tool Cords, Portable, Parallel, Plastic W&C	141
Tool Heads, Commutator-Turning, Ideal	76
Tool Holder Grips, Rawl	85
Tool Holders, Wiremen's, Klein	79
Tool Kits—	
Electrical Inspector's, Klein	79
Stud Fastening, Ramset Hammer-Drive	85
Tool Packs, Electricians', Klein	79
Tool Pockets, Electricians', Klein	79
Tool Pouches, Electricians', Klein	79
Tool Raising Tool Bags, Salisbury	79
Tool Rolls, Electricians', Pocket, Klein	79
Tool Sets and Components, Hot Line Auxiliary-Arm, Chance	88
Tool Stand Cabinets, Shop, Steel, Lyon	78
Tool Stands, Shop, Steel, Lyon	78
Tool Toters, Shop, Steel, Lyon	78
Tools—	
Boring, Joist and Beam, Toledo	70
Calking, Diamond	85
Compression, Wire, T&B	80
Coupling and Connector, Conduit, Utility, Appleton	74
Crimping, Plug-In Strip, National	47
Dead-End, Chance	88
Hand, Insulated, Chance	891, 892
Installing—	
Electrical Connector, Burndy	202, 203
Lug and Terminal, T&B	19
Insulator, Dead-End, Single-String, Chance	88
Motor Maintenance, Ideal	765, 766

T	Page
Tools—	
Sleeve Splice—	
Chance Nico-Press	994
Chance Universal	994
Soldering—	
Thermo-Grip, Ideal	756
Thermo-Tip, Ideal	755
Squeeze, Sleeve and Groove,	
Reliable	994
Storm, Emergency, Chance	887
Stud Fastening, Ramset	
Hammer-In	858
Wire Pulling, Linemen's,	
Klein	804
Wire Raising—	
Bartlett	806
General Machine	820
Wire Stringing, Hubbard	946
Tools and Supplies, Telephone	
Company's, General	
Machine	847-849
Torches—	
Blow, Unique	787
Linemens', Klein	797
Toters, Tool, Shop, Steel Lyon..	780
Tower Platforms, Universal,	
Chance	968
Tower Steps, Steel Tower,	
Hubbard	928
Toy Train Lamps, G-E	1210
Trace-O-Meters, Wire and	
Circuit Tracers, Portable,	
Jackson	1496
Tracers, Wire and Circuit,	
"Trace-O-Meter", Portable,	
Jackson	1496
Tracks, Ceiling, Cord Hung	
Fixture, Moe	1142
Traffic Control Signal	
Projectors, Airport,	
Crouse-Hinds	1194
Traffic Controllers, Pedestrian	
Pushbutton and Sign,	
Crouse-Hinds	1015
Traffic Sign Posts, Span Type,	
Steel, Union Metal	1031
Traffic Signal and Control Box	
Pole Clamps and Mounting	
Attachments, Crouse-Hinds	1017
Traffic Signal and Sign	
Mounting Attachments,	
Crouse-Hinds	1016
Traffic Signal Control Box	
Pedestals, Crouse-Hinds	1017
Traffic Signal Control Cable—	
General Cable	68
Phelps Dodge	11
Traffic Signal Controllers—	
Automatic Synchronous,	
Crouse-Hinds	1010, 1011
Semi-Vehicle-Actuated,	
Crouse-Hinds	1015
Super-Trafflex,	
Crouse-Hinds	1013
Synchronous, Crouse-Hinds	1014
Traffic Signal Dials and	
Accessories, Crouse-Hinds	1014
Traffic Signal Lamps, G-E	1207
Traffic Signal Lenses, Crouse-	
Hinds	1012
Traffic Signal Motor Flashing	
Switches, Crouse-Hinds	1012
Traffic Signal Pedestals,	
Crouse-Hinds	1017
Traffic Signal Pole and Pedestal	
Bases, Crouse-Hinds	1017
Traffic Signal Poles—	
Crouse-Hinds	1017
Union Metal	1031
Traffic Signal Standards,	
Union Metal	1030, 1032

T	Page
Traffic Signals, Crouse-	
Hinds	1006-1008
Traffic Signals and Signs,	
Neon, Crouse-Hinds	1016
Trailers—	
Cable Reel, Adams	893
Cargo, Adams	893
Pole, Adams	893
Train Lamps, G-E	1208
Transfer and Control Switch	
Housings, G-E	1385
Transfer Switches, Power and	
Light Control Switch-	
board, G-E	1383-1385
Transformer Brackets,	
Universal	1416
Transformer Condulets, Crouse-	
Hinds, Type ECT	453
Transformer Gins, Coffing	835
Transformer Hub-Mounts,	
Hubbard	1416
Transformer Lead Wire,	
Phelps Dodge	7
Transformer Mounting	
Brackets, Hubbard	1416
Transformer Mounts, Universal	1416
Transformer Pins, Hubbard	942
Transformer Turn Ratio Test	
Sets, Portable, Biddle	1498
Transformers—	
Air-Conditioning Unit,	
Nutone	1251
Bell-Ringing, Nutone	1251
Boosting and Bucking, G-E	1360
Circuit Control, Square D	551
Control, Jefferson	1374
Control-Panel and Machine-	
Tool, G-E	1365-1371
Current, Portable—	
G-E	1471
Weston	1480
Distribution—	
Oil-Immersed, G-E	1417-1423
Pyranol, G-E	1426-1428
Door Bell—	
Edwards	1258
Jefferson	1373
Door Chime—	
Edwards	1258
Jefferson	1373
Nutone	1251
Heating System, Nutone	1251
Light and Power—	
G-E	1357-1364
Commercial Building,	
G-E	1359, 1360
General-Purpose,	
G-E	1357, 1358
Light-Source, Photoelectric,	
G-E	1351
Machine Tool Control,	
Jefferson	1373
Multi-Control, Bryant	677
Phase-Shifting, G-E	1455
Potential, Portable, G-E	1471
Power-Circuit, Jefferson	1373
Rural-Line, Oil-Immersed,	
G-E	1423-1425
Signaling—	
Edwards	1258
Jefferson	1373
Soldering Iron, G-E	751, 752
Standard Control, G-E	1361-1363
Street Lighting—	
Aerial Type, G-E	1021
Constant-Current, G-E	1020
Pole Base, G-E	1021
Tri-Volt—	
Edwards	1258
Jefferson	1373
Nutone	1251
Voltage-Stabilizing, G-E	1372

T	Page
Translucent Lighting Systems,	
Benjamin	1119
Transmission Line Conductors,	
Bare Copper, Phelps Dodge	10
Transmission Line Crossarms,	
Wood, Rainier	913
Transmission Line Timbers,	
Wood, Rainier	913
Transmission Lines—	
FM, Flat-Twin, General	
Cable	65
TV, Flat-Twin, General Cable	65
Transposition Brackets,	
Hubbard	937, 938, 940
Transposition Conduit, Clay,	
Underground, Natco	1001
Transposition Sleeves, Reliable	989
Transverters, Remote Control,	
Touch-Plate	702
Trays—Support—	
Cable, Globe	164
Tubing, Globe	164
Tree and Trolley Guards, Bond	831
Tree Guards, Bond	830
Tree Paint, Bartlett	807
Tree Paint Can, Brush and	
Case, Bartlett	808
Tree Pruner Poles, Bartlett	805
Tree Pruners, Bartlett	805
Tree Saws—	
Bartlett	805
Oshkosh	805
Tree Trimmer Pole Saws,	
Bartlett	805, 806
Tree Trimmers—	
Bartlett	806
Oshkosh	805
Tree Trimmers' Belts, Klein	798
Tree Trimmers' Hand Saws,	
Bartlett	806, 807
Tree Wire—	
General Cable	55
Triangle	95
Telephone—	
Graybartel	87
Whitney Blake	133
Tree Wire Guards, Plastic	
Macoid	969
Trench Braces, Simplex	844
Tri-Volt Transformers—	
Edwards	1258
Jefferson	1373
Nutone	1251
Trickle Battery Chargers, Tele-	
phone Service, Small Stor-	
age Batteries, Schauer	1504
Trim, Raceway, Lopo-Trim,	
National	473
Trimmers—Tree—	
Bartlett	806
Oshkosh	805
Trips, Door Signal, Edwards	1258
Troffer Installing Accessories,	
Curtis	1108
Trofferlites, Fluorescent, Com-	
mercial, Benjamin	1117, 1118
Troffers—	
Fluorescent, Recessed—	
Curtis	1108
Day-Brite	1084
Garcy	1112
Litecontrol	1105
Pittsburgh	1102
Smithcraft	1096-1099
Wakefield	1089
Trol-E-Duct Duct Systems,	
Bulldog Universal	492-494
Trolley Busways, G-E	508
Trolley Wire—	
Anaconda	43
General Cable	80, 81
Phelps Dodge	11

T	Page
Troughs—	
Connector, T-V Studio	
Lighting, Century	1169
Wiring, Electrical, Hoffman	499
Trumpets, Signal, Industrial,	
Faraday	1235
Tube Benders—	
Hand, Tal	737
Hydraulic, Tal	737
Tube Checkers, Electronic, All-	
Purpose, Weston	1485
Tube Cutters—	
Armstrong	727
Toledo	727
Tube Testers, General Purpose,	
Simpson	1492
Tube-To-Cable Fittings,	
Burndy	207
Tubelet Reducers, Threaded,	
T&B	233
Tubes—	
Bus, Copper—	
Anaconda	41, 42
Phelps Dodge	12
Porcelain—	
Knox	215
Porcelain Prod.	213
Tubing, Insulating, Braided	
Asbestos, Atlas	869
Tubing Benders—	
Hand—	
Appleton	741
Greenlee	736
Republic	740
Steel City	741
T&B	740
Tal	738
Hydraulic, Tal	738
Tubing Support Tray Acces-	
sories, Globe	166
Tubing Support Tray Fittings,	
Globe	165
Tubing Support Trays, Globe	164
Tubular Compression Accessory	
Compressors, Hydraulic,	
Alcoa	994
Tubular Lamps—	
Quartz, G-E	1211
Showcase, G-E	1294
Tumbler Switch Condulets—	
Crouse-Hinds—	
Series EFD and EFS	425
Type ESW	424
Type FLS	423
Type FSPC	432
Type GUSC	424
Tumbler Switches—	
Appleton Unilet, Type EFS	446
Carling	700
R&S	441, 442
Unilet, Appleton, Series	
EFS	346
Flush—	
Bryant	685, 686, 690-692
P&S	686, 687
Mercury, Bryant	691
Motor Sentinel and Starter,	
Bryant	706
Oil Burner, Box Cover Mtd.—	
Bryant	692
Hubbell	693
Interchangeable Device, P&S	
Despard	674
Surface—	
Bryant	673, 692, 693
P&S	673
Box Cover Mtd.—	
Bryant	692, 692
P&S	693
Tunnel Lighting Fixtures,	
Fluorescent, Crouse-	
Hinds	1178, 1179

T	Page
Tunnel Lighting Units,	
Incandescent, Benjamin	1054
Turn Ratio Test Sets, Trans-	
former, Portable, Biddle	1498
TV-Radio Servicing Instrument,	
"Handiscope", Portable,	
Simpson	1494
T-V Studio Lighting Equipment,	
Century	1169
TV Transmission Lines, Flat-	
Twin, General Cable	65
Twin Lights, Incandescent,	
Decorative, Litecraft	1137
Twisters, Sleeve, Klein,	
"Die-Stock"	802
Twisting Joints, Alcoa	978
U	
U-Bolts—	
O.Z.	256
Crossarm, Hubbard	938
Rack, Frame and Trapeze,	
Kindorf	255
U-Cable Guards, Fairmount	225
U Supports, Kindorf	253
Undercutters—	
Commutator Mica, Ideal	766
Direct-Drive, Ideal	766
Small Motor, Ideal	766
Underfloor Wiring Distribution	
Systems, Preset-Locked-In,	
Walker	480, 481
Underground Cable Terminals,	
Telephone Service, Cook	1509
Underground Burial Wire—	
Telephone—	
Graybartel	88
Whitney Blake	137
Underground Cable Rack	
Hooks, Hubbard	995, 996
Underground Cable Rack	
Insulators, Hubbard	995
Underground Cable Racks,	
Hubbard	995, 996
Underground Clay Conduit,	
Natco	999, 1001
Underground Service Cable,	
Anaconda	16, 17
Underground Connectors,	
Burndy	208
Underpass Lighting Fixtures,	
Fluorescent, Crouse-	
Hinds	1178, 1179
Uniarms, Alarm Systems,	
Manufacturing and	
Processing, R&S	1262
Unilet Adapter Bodies, Appleton,	
Series GS	326
Unilet Adapters, Unilet to EMT,	
Appleton	230
Unilet Bodies and Receptacles,	
Appleton, Type AEEA	349, 350
Unilet Covers—Appleton—	
Series FD and FS	331
Series GS	326
"35" Line	328, 329
Unilet Lighting Fixture	
Hangers, Flexible, Apple-	
ton, Series AL	341, 342
Unilet Lighting Fixture Swivels—	
Appleton—	
Series ESD	340, 347
Type ESS	340
Unilet Lighting Fixtures,	
Incandescent, Industrial,	
Appleton, Series GS	326
Unilet Plugs, Dead-End, Appleton—	
Type CPH	352
Type CPP	351
Unilet Push Button Stations,	
Motor Control, Appleton,	
Series EFS	341

U	Page
Unilet Receptacles, Dead-End,	
Appleton, Series CES	352
Unilet Reducers, Appleton,	
Series GRUJ	328
Unilet Sealing Fittings,	
Appleton, Series EYS	347
Unilet Switch and Plug Recep-	
tacles, Safety, Appleton,	
Type FSQX	352
Unilet Switch Plugs, Appleton,	
Type FSQX	352
Unilet Switches, Tumbler,	
Appleton, Series EFS	346
Unilets, Appleton—	
Fixture Hanger, Flexible,	
Appleton Series AL	341, 342
Push Button Station,	
Appleton, Series EFS	347
Switch, Tumbler, Appleton,	
Series EFS	346
Switch and Plug Receptacle,	
Appleton, Type FSQX	352
Series Type	
AE	AED 348
	AEDF 348
	AEE 348
	AEJ 348
	AEJG 348
	AEJK 348
	AERA 348
	AERC 348
	AERH 348
AJ	AJA 348
	AJAC 348
	AJS 348
	AJSC 348
AL	ALA 341
	ALC 341
	ALL 342
	ALT 342
CES	CEST 352
CPSI	CPSIA 347
	CPSIC 347
	CPSIE 347
	CPSIL 347
	CPSIT 347
	CPSIX 347
EFS	EFS 346, 347
ER	ERC 344
	ERLB 344
	ERLL 344
	ERLR 344
	ERT 344
	ERTB 344
	ERX 344
FD	FD 330
	FDC 330
	FDD 330
FS	FS 330
	FSC 330
	FSCC 330
	FSCT 330
	FSD 330
	FSL 330
	FSR 330
	FSX 330
Series Type	
GR	GRC 327
	GRCA 327
	GRE 327
	GRFC 336
	GRFS 336
	GRFT 336
	GRFX 336
	GRL 327
	GRLA 327
	GRLB 327
	GRT 327
	GRTA 327
	GRX 327
GRJ	GRJC 327
	GRJCA 327

U		Page
Unlets—		
GRJEA	327
GRJL	327
GRJN	327
GRJT	327
GRJTA	327
GRJXA	327
GRUJ		
GS	GS	325
	GSA	325
	GSC	325
	GSS	325
"35"		
Line		
	C	328
	E	328
	LB	328
	LL	328
	LR	328
	LRL	328
	T	328
Type		
	FSQX	352
	AE	349, 350
	AEE	350
	AEEA	349
	AE	349, 350
Union Hub Nuts and Sleeves,		
Condulet, Crouse-Hinds,		
Series GUA		397
Unions—		
Conduit, Rigid Appleton		227
Conduit to Conduit, Crouse-		
Hinds Condulet, Type UNF		403
Conduit to Condulet—		
Appleton Type UNL		332
Crouse-Hinds Condulet,		
Type UNL and UNY		403
Conduit Joint, Crouse-Hinds,		
Condulet, Type UNA		403
Expansion—		
Appleton Series UNF and		
UNY		332
Crouse-Hinds Condulet,		
Type UNY and UNYL		403
Unit Heaters—		
Convection-Type—		
Chromalox		1288
G-E		1286, 1287
Electric—		
Chromalox		1288
ILG		1284
Wesix		1215
Gas-Fired, ILG		1283
Steam, ILG		1285
Unit Substations—		
Power and Light—		
I-T-E, Secondary		1393
Square D		1395
Units—		
Circuit Breaker, Electric-		
Center, Pushmatic, Bulldog		601
Light Reflector, Benjamin		1060
Lighting—		
Fluorescent—		
Commercial Holophane		1115
Industrial—		
Benjamin		1040, 1041
Smithcraft		1042, 1043
Wiremold		467
Showcase, Wiremold		467
Strip—		
All-Brite		1121
Curtis		1110
Garcy		1111
Moe		1142
Incandescent—		
Ceiling, Perfectlite		1152
Commercial—		
Holophane		1156
Litecraft		1157
Gymnasium, Benjamin		1061

U		Page
Units—		
Industrial—		
Benjamin		1067, 1068
Holophane		1068-1070
Night-Light, Day-Brite		1162
Outdoor,		
Holophane		1070, 1071
Outdoor Sub-Station,		
Holophane		1071
Pit, Benjamin		1054
Post-Top, Outdoor,		
Holophane		1071
Recessed—		
Day-Brite		1162
Hub		1159
Moe		1144
Reflector, Hub		1161
Socket-Reflector—		
Benjamin		1051-1054, 1061
Wheeler		1055, 1056, 1058
Tunnel, Benjamin		1054
Mercury Vapor—		
Industrial,		
Holophane		1068, 1069
Socket-Reflector,		
Benjamin		1054, 1061
Portable, Low-Volt, Trans-		
former Type, Woodhead		615
Reflector—		
Sign, Benjamin		1061
Stock-Bin-Lite, Benjamin		1059
Universal Poles and Accessories,		
Chance		890
Unloaders, Pole, Chance		837
Urban Distribution Wire,		
Telephone, Plastic W&C		147
Utility Box Covers, Steel City		287
Utility Boxes, Steel City		287
Utility Lights, Perfectlite		1152
Utility Outlets, National		
"Spigots"		284
Utility Plates, Toggle Switch,		
Hubbell		628
Utility Pouches, Electricians' and		
Wiremens', Klein		795
Utility Snap Hooks, Klein		824
Utility Switch Plates, Hubbell		628
Utility Warning Flashers,		
Neo-Flasher		814
Utility Wire Reels, Allen		816
V		
Vacuum Cleaner Attachments,		
Ideal		763
Vacuum Cleaner Conversion		
Packs—		
Hand Type, Ideal		763
Hand to Large Industrial,		
Ideal		764
Vacuum Cleaners—		
Hand Type, Ideal		763
Tank Type—		
Ideal		763
Premier, Heavy Duty		765
Vacuum Cleaning Systems,		
Central, Premier		764
Vacuum Gauges,		
Molecular, G-E		1473
Vacuum Pump Controls,		
Square D		586
Vacuum Switch Attachments,		
G-E		1340
Vacuum Switches, G-E		1340
Vacuum System Gauges,		
Thermocouple, G-E		1472
Valance Brackets, Moe		1142
Valves—		
Bypass, Pressure Testing,		
General Machine		881
Drain and Breather, Condulet,		
Crouse-Hinds, Type ECD		402

V		Page
Vaportight and Vaporproof		
Products—		
Alarm Systems, Manufactur-		
ing and Processing, R&S		1262
Bunghole Lamps, Woodhead		612
Condulet Covers, Crouse-		
Hinds—		
Blank, Series GS		396
Tumbler Switch—		
Obround Series		383
FD and FS Series		392
Condulets, Lighting Fixture—		
Crouse-Hinds—		
Series GS		395
Series VM		416
Floodlights—Revere		1182
Wide-Lite		1190
Hand Lamp Accessories,		
Crouse-Hinds, Type VS		414
Hand Lamps, Crouse-Hinds,		
Type LPG, LPH and VS		414
Haymow Lights, Union		1067
Industrial Luminaires, In-		
candescent, Holophane		1069
Lamp Handles and Guards—		
McGill		610
Woodhead		613
Lighting Fixture Accessories,		
Crouse-Hinds—		
Series V and VH		413
Series VM		416
Lighting Fixture Hangers,		
Crouse-Hinds, Type AHG		418
Lighting Fixtures—		
Gauge, Crouse-Hinds,		
Type VLG		412
Incandescent Industrial—		
Appleton, Series V51		336, 337
Crouse-Hinds—		
Series V		410, 411
Series VH		411
Series VM		415
Type ARB		412
Type VDB		414
Type VGR		412
Type VXHA		412
R&S		1064-1066, 1147
Lighting Units, Fluorescent,		
Industrial—		
Benjamin		1041
Day-Brite		1047
Wheeler		1050
Shower Room Lights, Multi		1061
Socket-Reflector Units—		
Benjamin		1067
Wheeler		1057
Swimming Pool Lights, Multi		1060
Unilet Covers, Appleton		326, 331
Unilets Appleton,		
Type GS		325, 326
Variators, Motor-Speed, G-E		1329
Varnished Cambric Insulated		
Cable—		
Anaconda		32
General Cable		60
Phelps Dodge		6
Triangle		103, 120
Varnished Insulating Cloth—		
Graybar		867
G-E		874
Varnishes, Insulating, G-E		872, 873
Vee and Knee Braces, Wood,		
Rainier		912
Ventilating Fans—		
Ceiling Type, Nutone		1272, 1273
Wall Type, Nutone		1273
Ventilators—Kitchen, Electric—		
Built-In Type, ILG		1275
Ceiling Type, ILG		1275
Roof, Power, ILG		1279, 1280
Window, Electric, Portable,		
ILG		1275, 1276

V	Page
Vibration Lamps, G-E	1209
Vise Stand Jaws, Armstrong	729
Vise Stands—	
Armstrong	729
Toledo	730
Power—	
Portable, Oster	731, 732
Vises—	
Chain, Armstrong	729
Pipe, Armstrong	230
Kit, Clamp Type—	
Armstrong	730
Nye	722
Open-Side, Toledo	729
Self-Locking, Nye	722, 730
Post, Armstrong	729
Vises and Stands, Pipe, Nye	730
Visularms, Alarm Systems, Manufacturing and Proc- essing, Crouse-Hinds 1263, 1264	
Volt-Ammeter Plug-In Adap- ters, Weston	1490
Volt-Ammeters—	
Clamp-On Type, Weston	1489, 1490
Hook-On, G-E	1470
Portable, D-C, Weston 1478, 1479	
Volt-Ammeters, Recording, Portable, G-E	1464
Volt-Amp-Wattmeters, Port- able, A-C—D-C, Simpson	1493
Voltmeters—	
Battery, Pocket, Sterling	1226
Indicating, Portable, A-C and D-C, G-E	1466-1469
Laboratory, Portable, Simp- son	1490
Panel—	
A-C and D-C—	
G-E	1465, 1466
Simpson	1491
Weston	1481-1484
D-C—	
Simpson	1492
Portable—	
A-C—D-C—	
Simpson	1490
Weston	1476-1480
Recording—	
Portable, A-C and D-C, G-E	1463, 1464
Switchboard, A-C and D-C, G-E	1463
Switchboard, A-C and D-C, G-E	1461, 1462
Weston	1474, 1475
Volt-Ohm-Microammeters, Portable, A-C—D-C, Simp- son	1493
Volt-Ohm-Milliammeters—	
Portable, A-C—D-C—	
Simpson	1493
Weston	1485
Volt-Ohmmeters, Portable, A-C—D-C, Simpson 1493, 1494	
Volt-Wattmeters, Portable, A-C—D-C, Simpson	1493
Voltage Regulators, G-E "In- ductrol"	1375, 1376
Voltage Stabilizers, Electrical and Electronic Equipment, Raytheon	1506
Voltage-Stabilizing Transform- ers, G-E	1372
Voltage Testers—	
Ideal	1500
Square D	551
Volume Fans—	
Centrifugal—	
Gasoline Engine Drive, ILG	1281
Motor Drive, ILG	1280, 1281, 1283

W	Page
Waist Belt Supporters, Line- mens', Klein	798
Waist Belts, Linemens', Klein ..	798
Walk and Floor Lighting Fix- tures, Crouse-Hinds	1180
Wall Boxes—	
Convenience, Steel City	283
Standard Device, Steel City ..	309
Wall Fans, Nutone	1272
Wall Furnaces, Automatic, Wesix	1214, 1215
Wall Light Brackets, Incan- descent, Perfectlite	1152
Wall Plates, Cable, T&B	247
Wall Pocket Lights, Stage, Hub	1171
Wall Rings, Double Opening, Appleton	283
Wall Socket Guards, Box Cover, McGill	608
Wall Sockets, Pony, Hubbell	657
Wall Switches, Tap-Lite, Flush, Minneapolis-Honey- well	703
Wands, Signal, Flashlight, Ray-O-Vac	1226
Warning Flag Bases, Fairmount	813
Warning Flags, Road Sign, Bartlett	813
Warning Flags and Flag Holders, Coffing	813
Warning Flashers, Utility, Neo- Flasher	814
Warning Light Batteries, Neo- Flasher	814
Warning Light Battery Cases, Neo-Flasher	814
Warning Lights—	
Beacon-Ray, Federal	1233
Neo-Flasher	813, 814
Warning Sign and Flasher Stands, General Machine	814
Warning Sign Masts, General Machine	812
Warning Sign Stands, General Machine	812
Warning Signs—	
General Machine	812
Oshkosh	813
Washer Cutters, General Ma- chine	726
Washer Nuts, Static-Proof, Hubbard	932
Washers—	
Crossarm Centering, Hubbard	945
Flanged, Tapped, Hubbard	932
Insulator Bracket, Clip, Hubbard	945
Lock, Hubbard	929
Rack, Frame and Trapeze, Kindorf	255
Reducing, Knockout—	
Appleton	236
Steel City	236
T&B	234
Spring, Static-Proof, Hubbard	929
Steel, Hubbard	929
Washes—	
Creosote-Burn, M-S-A	875
Poison Ivy, M-S-A	875
Water Collector Pumps, Drilling Machine, Truco	859
Water Cooler Accessories, Cordley	1271
Water Coolers, Electric, Cordley	1271
Water Fountain Lights, R&S	1184, 1185
Water Gauge Lamps, Crouse- Hinds, Type LG	409
Water Meter Grounding Shunts, Appleton	260

W	Page
Water Pick-Up, Drilling Ma- chine, Truco	859
Waterproof and Water-Tight Products—	
Cable Connectors—	
Appleton	246
Crouse-Hinds, Type BRC ..	359
R&S	374, 377
Condulets, Crouse-Hinds—	
Cutout, Series Y	423
Motor Sentinel, Series FD ..	437
Push Button Station, Series FS	433
Push Button Station and Pilot Light, Series FD and FS	433
Safety Switch, Type WMK	422
Cord connectors and Plugs, R&S	375
Floor Boxes—	
R&S	315
T&B	317, 323
Fountain Lights, R&S	1185
Howler and Buzzer Relays, Benjamin	1239
Junction Boxes—	
R&S	316
T&B	311
Lampholders, Bryant	660
Lamp Receptacles, Woodhead	651
Motor Reversing Controllers, G-E	1339
Motor Starters—	
G-E	1335
R&S	447
Plug Shells, Pyle-National, Tribloc	364
Push Button, Selector Switch and Pilot Light Stations, R&S	446
Push Button Stations, G-E ..	1339
Push Buttons, Heavy Duty, Benjamin	1256
Receptacle Housings, Pyle- National, Tribloc	364
Receptacle Plugs—	
Crouse-Hinds—	
Type BRC	359
Type WP	389
R&S	374, 375, 377
Receptacles—	
Circuit Breaker, R&S	377
Convenience, R&S	375
Sockets, Woodhead	651
Terminal Cabinets, Hope ..	314
Tumbler Switches, R&S	442
Waterproof and Dust-Tight and Water-Tight and Dust- Tight Products—	
A-C Brakes, G-E	1334
Circuit Breaker Cabinets, R&S	444
Circuit Breakers—	
G-E	1381
Hope	529
I-T-E	528
R&S	444
Square D	522, 523
Circuit Interrupters, Square D	525
Floodlights, Revere	1182, 1183
Magnetic Contactors, Square D	569, 570
Motor Starters—	
R&S	447-449
Square D—	
Magnetic	570, 572-575, 577
Manual	564, 565
Motor Starters and Circuit Breakers, R&S	449
Motor-Starting Switches, G-E	1335

W	Page
Waterproof and Dust-Tight Products	
Panelboards, Circuit Breaker, R&S	443
Push Button Stations, Square D	580
Safety Switches, Square D	513
Switchboard Control and Transfer Switch Housings	1385
Timing Relays, Square D	584
Waterproof and Vaportight Products—	
Condulet Covers, Crouse-Hinds—	
Push Button Switch, Series FD and FS	388, 390
Tumbler Switch, Series FD and FS	388, 390
Receptacles and Housings, Attachment Plug, Crouse-Hinds, Series FD and FS	388
Selector Switch and Pilot Light Station, R&S	447
Water Swivels and Equipment,	
Diamond Drilling, Truco	860
Watertight Lampholders,	
Bryant	660
Watertight Push Buttons, Benjamin	1256
Wathour Demand Instrument Transformer Meters, G-E	1456
Wathour Demand Meters, G-E	1456
Wathour Instrument Transformer Meters, G-E	1452-1455
Wathour Meter Ball Bearings, G-E	1455
Wathour Meter Bearings and Components, G-E	1455
Wathour Meter Connection Boxes, G-E	1459
Wathour Meter Jewel Oil, G-E	1455
Wathour Meter Jewel Screws and Plugs, G-E	1455
Wathour Meter Jewels, G-E	1455
Wathour Meter Pivots, G-E	1455
Wathour Meter Sockets—	
G-E	1454
Box-Type, G-E	1458-1460
Square, G-E	1457
Wathour Meters, G-E	1452-1455
Wathour Socket-Meter Covers, G-E	1452
Wattmeters—	
Hook-On Type, G-E	1470
Indicating, Portable—	
A-C, G-E	1466, 1468
A-C—D-C, G-E	1469
Panel, A-C—D-C, Weston	1481
Portable, A-C—D-C, Simpson	1490
Recording—	
Portable, A-C, G-E	1463
Switchboard, A-C, G-E	1463
Switchboard—	
A-C and D-C, G-E	1461, 1463
Wax Wraps, Strandvise, Reliable	987
Weatherproof—Weather-Resistant—Weather-Tight Products—	
Attachment Plugs—	
Bryant	670
Union	670
Woodhead	671
Box Connectors, Conduit, EMT—	
Appleton	230
T&B	229, 231
Cable—	
Anaconda	44
General Cable	81, 84-87
Phelps Dodge	10

W	Page
Weatherproof Products—	
Cable Connectors, R&S	372, 373, 376
Circuit Breaker Load Centers—	
Crouse-Hinds, Type YSW ..	436
G-E	591
Square D	549
Circuit Breakers—	
Hope	529
I-T-E	526, 527
Square D	524
Circuit Breaking Receptacles, R&S	376
Compound, Appleton	243
Conduit Couplings, EMT—	
Appleton	230
T&B	231
Conduit Elbows, EMT, T&B ..	242
Conduit Fittings, REA, Appleton	333
Condulet Plugs, Safety Switch, Crouse-Hinds, Type DP	421
Condulets, Crouse-Hinds—	
Circuit Breaker Load Center, Type YSW	436
Horn Signal, Type WH	454
Plug Receptacle, Type BRME	358
Push Button Station, Series FS	430
Push Button Station and Pilot Light, Series FD and FS	433
Safety Switch, Type WMKS ..	421
Convenience Receptacles, R&S ..	375
Floodlights—	
Revere	1182
Widelite	1190
Fusible Service Equipment, Square D	533, 534
Junction Boxes—	
Hope	312-314
T&B	311
Junction Vapolets, Benjamin ..	1067
Lamp Holders—	
Benjamin	668
Bryant	653, 656
P&S	659
Lamp Receptacles, Woodhead ..	651
Line Wire—	
Alcoa	101
Triangle	98
Motor Starters, R&S	447
Outlet, Plate and Cover Combination—	
Bryant	623, 649
Hubbell	629
P&S	649
P&S Despard	680
Plug Receptacle Housings, Crouse-Hinds, Type DRP ..	358
Plug Receptacles—	
Hubbell	628
R&S	372, 373, 375
Plugs and Receptacles, Crouse-Hinds	353-358
Circuit Breaker, Power Outlets, Hoffmann	650
Push Buttons, Edwards	1253
Receptacle Plugs, R&S	372, 373, 375, 376
Safety Switches—Bulldog	516
Square D	511, 512
Socket-Reflector Units, Benjamin	1032
Sockets—	
Hubbell	657
Union	658, 659
Switch and Plate Combination—	
Bryant	705
Hubbell	705
P&S Despard	680

W	Page
Weatherproof Products—	
Switch, Outlet and Plate Combination, P&S Despard	680
Traffic Signal Controllers, Crouse-Hinds	1010, 1011, 1013
Tumbler Switches, R&S	442
Wire—	
Anaconda	44
General Cable	81, 84-87
Phelps Dodge	10
Weatherproof and Dust-Tight and Weather-Resistant and Dust-Tight Products—	
Alarm Systems, Manufacturing and Processing, Crouse-Hinds	1264
Condulets, Crouse-Hinds—	
Circuit Breaker—	
Type DER	420
Type DVS	452
Lighting Fixture Junction, Series CPS	409
Floodlights, Revere	1182
Lighting Fixtures, Crouse-Hinds—	
Incandescent, Industrial—	
Series DL	409
Type DLA	409
Motor-Starting Switches, G-E	1335
Panelboards, Circuit Breaker, Crouse-Hinds—	
Type DLP	436
Type DVSP	436
Photoelectric Relays, G-E	1350
Webbing, Insulating, Glaspun, Atlas	868
Weight Indicators, Dillon	767
Welding Cable—	
Anaconda	37
General Cable	62
Kaiser	129
Phelps Dodge	9
Simplex	113
Wheel Chocks, Bond	831
Wheels, Distance-Measuring, Mainco	718
Hand, Retract-O-Reel, Appleton	171
Wire Stripper, Ideal	743
Wheels, Pins and Rolls, Pipe Cutter	726
White Lamps, Deluxe, G-E	2106
Winch Rigging, Border Light, Stage, Hub	1170
Window and Door Contactors, Edwards	1258
Winch Rope Hooks, B&L	825
Winch Rope Winders, Adams	892
Winches, Adams, Adaloy	893
Winches and Power Take-Offs, Adams	892
Wind-Cone Fixtures, Illuminated, Aviation, Crouse-Hinds	1194
Wind Tees, Illuminated, Aviation, Crouse-Hinds	1194
Winders—	
Fish Tape, Ideal	749
Rope, Winch, Adams	892
Window Fans—	
Exhaust and Intake, ILG	1274
Portable, ILG	1274
Window Ventilators, Electric, Portable, ILG	1275, 1276
Wiping Solder Temperometers, Dillon	760
Wire—	
Aircraft, General Cable	74
Annunciator, Anaconda	39
Antenna, Loop, Anaconda	39
Appliance—	
Anaconda	39
Gavitt	149

W	Page
Wire—	
General Cable	75
Plastic W&C	143
Audio, Plastic W&C	144
Bare—	
Aluminum, General Cable..	81-83
Aluminum-Steel (ACSR), General Cable	81-83
Copper—	
Anaconda	45
General Cable	75-77
Boiler Room, General Cable ..	68
Bridle, Telephone—	
Graybartel	87
Whitney Blake	132
Building—	
Anaconda	13-15
General Cable	50, 51
National	116
Phelps Dodge	1-3
Plastic W&C	143
Triangle	92, 93
Construction, Galvanized, Crapo	972
Control, Anaconda	15
Drop, Telephone—	
Graybartel	88
Whitney Blake	132
Duct, Telephone, Graybartel..	88
Electrical and Electronic Equipment, Gavitt	148, 149
Electronic and Electrical Equipment, Gavitt	148, 149
Fish, Steel City	749
Fixture—	
Anaconda	38
General Cable	51
National	119
Plastic W&C	143
Flat Armor, Aluminum, Alcoa	977, 978
Fuse—	
Buss	544
Reliable	1514
Gasoline and Oil Resistant, Plastic W&C	145
General Purpose, Gavitt.....	148, 149
Ground—Bare—	
Crapo	970
National	125
Phelps Dodge	12
Triangle	93
Telephone—	
Graybartel	87
Whitney Blake	133
Hook-Up, Times	151
Interior, Telephone—	
Graybartel	88
Whitney Blake	135
Jacketed, Times	151
Jumper and Duct, Telephone—	
Graybartel	87
Whitney Blake	137
Lashing, Cable, Crapo	972
Lead—	
Appliance—	
General Cable	66, 67
Phelps Dodge	7
Motor, Phelps Dodge	7
Range, General Cable	66, 67
Stove, General Cable	66
Switchboard, Phelps Dodge	7
Transformer, Phelps Dodge	7
Line, Weather Resistant—	
Alcoa	161
Triangle	98
Locomotive Headlight, Gen- eral Cable	68
Loom, Canvas-Back, National	123
Machine Tool—	
Anaconda	15
General Cable	75
Plastic W&C	143
Meter and Panel, Gavitt	148

W	Page
Wire—	
Microphone, Whitney Blake ..	136
Miniature Instrument, Gavitt	149
Multi-Control, Bryant	678
Non-Metallic Sheathed, Anaconda	15
Office, Anaconda	38
Oil, Gasoline and Moisture Resistant, Anaconda	13
Railway Signal, Anaconda ..	21, 22
Rheostat, General Cable	66, 67
Ribbonized, Special, Gavitt ..	150
Slow-Burning, Phelps Dodge..	12
Sound System, Shielded, Whitney Blake	136
Street Lighting, Series—	
Anaconda	20
General Cable	55
Switchboard—	
Anaconda	15
General Cable	74, 75
National	117
Tangent Support, Crapo	973
Telegraph, Galvanized, Crapo	970
Telephone—	
Bridle	87
Graybartel	87
Whitney Blake	132
Direct Burial Whitney Blake	132
Distributing Brame, Whit- ney Blake	137
Distribution, Whitney Blake	132, 133
Drop—	
Graybartel	88
Whitney Blake	132
Duct, Graybartel	88
Galvanized, Crapo	970
Ground—	
Graybartel	87
Whitney Blake	133
Interior—	
Graybartel	88
Whitney Blake	135
Jumper and Duct—	
Graybartel	87
Whitney Blake	137
Outside, Whitney Blake	131, 132
Parallel, Whitney Blake ..	132
Rural Distribution, Plastic W&C	146
Rural Line, Plastic W&C ..	144
Station, Graybartel	87
Tree—	
Graybartel	87
Whitney Blake	133
Twisted-Pair, Whitney Blake	132
Underground Burial—	
Graybartel	88
Whitney Blake	137
Urban Distribution, Plastic W&C	147
Telephone Line—	
Copperweld	974
Crapo	970
Thermostat, Plastic W&C	142
Tie—	
Armor Rod, Alcoa	977
Galvanized, Crapo	970
Tree—	
General Cable	55
Triangle	95
Telephone—	
Graybartel	87
Whitney Blake	133
Trolley—	
Anaconda	43
General Cable	80, 81
Phelps Dodge	11
Varnished Cambric Insulated—	
Anaconda	32
General Cable	60

W	Page
Wire—	
Weatherproof—	
Anaconda	44
General Cable	81, 84-87
Phelps Dodge	10
Wire and Cable Bushing Sup- ports, Efficiency	210
Wire and Cable Clamps, Paral- lel Groove, Alcoa	162, 163
Wire and Cable Cleats, Effi- ciency	210
Wire and Cable Coiling and Reeling Machines, Allen Reel-O-Matic	817, 818
Wire and Cable Measuring Meters, Allen Reliable	819
Wire and Cable Pulling Grips, Klein	803-805
Wire and Circuit Tracers, "Trace-O-Meter" Port- able, Jackson	1496
Wire and Sleeve Clamps, Klein..	803
Wire-Armored Cable, Semi- Portable, General Cable	60
Wire Clasps and Clasp Lugs, Burndy	200
Wire Cleat Racks, Efficiency ..	210
Wire Coiling Machines, Allen ..	818
Wire Compression Tools, T&B	803
Wire Connector Clamps, Chance Uniclamp	980
Wire Connector Insulators, Ideal	191
Wire Connector Kits, Burndy ..	203
Wire Connectors—	
Chance	980, 982
Ideal	191
Ideal (Wire Nuts)	191
Reliable	980-982
Scotch-Lok	191
Sherman	191, 192
T&B	197
Wire Cord and Display Rack, Diamond	90
Wire Cutters—	
Bartlett	837
Porter	801, 802
Pole, Lever Type, Chance	887
Wire Dispensing Reels, Hykon..	175
Wire Gauge and Cable Ripper, Ideal	741
Wire Grips, Lashing, General Machine	833
Wire Guards, Tree, Plastic Macoid,	969
Wire Guides, Ideal.....	845
Wire Holder Insulators, Hubbard	949
Wire Holders, Hubbard	949, 950
Wire-Holding Sticks, Chance ..	888
Wire Hole Covers, Crouse-Hinds Condulet—	
Form 8 Series	393
Obround Series	382
Wire Joints, T&B	197
Wire Lugs, Wedge-On, T&B	198
Wire Markers, Code, Brady.....	176, 177
Wire Measuring Equipment, Hykon	175
Wire Measuring Meters, Hykon	175
Wire Measuring Units, Hykon..	175
Wire Nails—	
Insulating, Seeger-Williams ..	925
Wire Nuts, Connectors, Ideal ..	191
Wire Pulling Grips—	
Bare, Klein	803
Chicago, Klein	803, 804
Conductor, Klein	804
Guy Strand, Klein	804, 805
Haven's, Klein	805
Messenger, Klein	803, 804
Reliable	997
Weatherproof, Klein	803

W		W		W	
	Page		Page		Page
Wire Pulling Lubricants—		Wiremen's Tool Holders, Klein..	794	Wood-Pole Plates, Crouse-	
Ideal	864	Wirewise Tension Splices and		Hinds	1017
Y-er Eas	864	Dead-Ends, Reliable	986	Wood-Pole Steps, Hubbard	928
Wire Pulling Tools, Linemens',		Wireway Extensions, Electrici-		Wood-Screw Anchors—	
Klein	804	Center, Pushmatic Bull-		Diamond	853
Wire-Raising Tool Handles,		dog	601, 606	Rawlplug	853
General Machine	820	Wireways and Fittings—		Wood Screws, Steel, Seeger-	
Wire Raising Tools—		Hinged-Cover, Hoffman	500	Williams	861
Bartlett	806	Sectional, Hoffman	499	Work Benches, Shop, Steel,	
General Machine	820	Wiring Accessories, Alcao	155-157	Lyon	780
Wire Reducer Splices, Reliable..	988	Wiring Box Panels, Electrical,		Wrappers and Tapes, Mica	
Wire Reel Lifts, Hykon	175	Hoffman	546	Mat, G-E	871
Wire Reels—		Wiring Boxes, Electrical, Hoff-		Wrapping Tape, Clay Conduit,	
Pay-Out—		man	546	Natco	1001
Allen	816	Wiring Cabinets—		Wraps, Wax, Strandwise,	
Oshkosh	815	Flush, Columbia	549	Reliable	987
Pay-Out and Take-Up—		Surface, Columbia	547, 548	Wrench and Reamer Combina-	
General Machine	815	Wiring Cleats, Marine, Morse	278	tion, EMT, T&B	748
Oshkosh	815	Wiring Distribution Systems,		Wrenches—	
Take-Up, Folding, Oshkosh	815	Underfloor, Preset-		Adjustable—	
Terminal Room, General		Locked-In, Walker	480, 481	Nye	728
Machine	815	Wiring Duct—		Utica	793
Wire Rope Clips, Hubbard	940	Lay-In, Square D	482	Chain, Toledo	728
Wire Sets, Heating, G-E	1294	Plug-In, Square D	483, 484	Cog, All-Angle, Insulated,	
Wire Sleeves, Squeeze Type,		Surfaceduct, National	472	Chance	891
Reliable	990, 991	Wiring Duct and Fittings—		Flexible, Insulated, Chance	891
Wire Splicers—		Feed-In, Square D	482	Impact, Electric, Portable,	
Straight Line, Reliable	987	Flexible Rubber, Winders &		Thor	775
Wedge-On, T&B	198	Geist	476	Linemens', Klein	796
Wire Stringing Dynamometers,		Florduct, National	477, 478	Lug, T&B	196
Dillon	882	Nepcoduct, National	478, 479	Nut, TEC One-Hander	729
Wire Stringing Tools, Hubbard..	946	Rubaduct, Goodrich	476	Pipe—	
Wire Stripper Wheels, Ideal.....	743	Wiring Duct Device Fittings,		Nye	728
Wire Strippers—		Surfaceduct, National	473	Toledo	728
Bench Type, Ideal	742	Wiring Duct Fittings, Surface-		TEC One-Hander	729
Hand Type, Ideal	741, 742	duct, National	472, 473	Ratchet, General Machine	796
Hot Blade, Ideal	742	Wiring Materials, Appliance,		Socket, Spintight Type,	
Power, Ideal	742, 743	General Cable	75	Porter	796
Wire Supports, Static, Hubbard	946	Wiring Reels, Hykon	174		
Wire Taps, Squeeze Type,		Wiring Strip Fittings, Plug-In,			
Reliable	992	National	474		
Wire Tension Splices, Re-		Wiring Strips, Plug-In, Na-			
liable	987, 988	tional	475		
Wire Terminals—		Wiring System Fittings, Sur-			
Burndy	199-201	face, Wiremold	455-466		
T&B	196, 197	Multi-Control, Bryant	677, 678		
Wire Tong Block Clamps and		Surface, Wiremold	455-466		
Clevises, Chance	885	Wiring Troughs, Electrical,			
Wire Tong Heads and Butts,		Hoffman	499		
Chance	885	Wiremold Pancake	456		
Wire Tong Saddle Extension		Wiremold Plugmold	455-457		
Chains, Chance	885	Wiremold Plugtrim	455		
Wire Tong Saddle Fittings,		Wiremold Raceways	455-457		
Chance	886	Wiremold Snapicoil Plugmold...	457		
Wire Tong Saddles, Chance	885, 886	Wiremold Surface Wiring			
Wire Tong Supports, Chance	886	Systems	455-466		
Wire Tongs and Fittings,		Wood Chisel Sets, Ryan	717		
Chance	885	Wood Molding Lampholders,			
Wirelink Tension Splices and		Bryant	656		
Dead-Ends, Reliable	986				

X

X-Ray Film Illuminator Han-	
dles, Appleton	338, 339
X-Ray Film Illuminators, Ap-	
pleton, EFUX Type	338, 339

Y

Yard Lights—	
Benjamin	1059
Steber	1059
Yokes—	
Mounting, Tumbler-Switch-	
Plate Fill-In, Bryant	679
Strain, Insulator, Ohio Brass..	966

Z

Zinc Chromate Paste, Alcoa.....	863
---------------------------------	-----

Call Graybar First for:

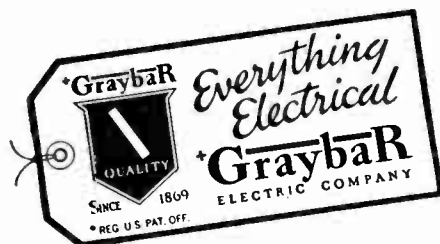

ALABAMA

Birmingham
Huntsville
Mobile

ARIZONA

Phoenix
Tucson

ARKANSAS

Little Rock

CALIFORNIA

Fresno
Long Beach
Los Angeles
Oakland
Oceanside
Sacramento
San Bernardino
San Diego
San Francisco
Santa Ana
Van Nuys

COLORADO

Colorado Springs
Denver

CONNECTICUT

New Haven
West Hartford

DELAWARE

Wilmington

DIST. OF COLUMBIA

Washington

FLORIDA

Ft. Lauderdale
Jacksonville
Miami
Orlando
St. Petersburg
Tampa
West Palm Beach

GEORGIA

Atlanta
Columbus
Savannah

IDAHO

Boise

ILLINOIS

Melrose Park
Peoria
Springfield

INDIANA

Evansville
Hammond
Indianapolis

IOWA

Davenport
Des Moines
Sioux City

KANSAS

Wichita

KENTUCKY

Lexington
Louisville

LOUISIANA

Baton Rouge
Lake Charles
New Orleans
Shreveport

MAINE

Portland

MARYLAND

Baltimore

MASSACHUSETTS

Boston
Springfield
Worcester

MICHIGAN

Detroit
Flint
Grand Rapids
Lansing

MINNESOTA

Duluth
Minneapolis
St. Paul

MISSISSIPPI

Jackson

MISSOURI

Kansas City
Springfield
St. Louis

MONTANA

Butte

NEBRASKA

Omaha

NEW HAMPSHIRE

Manchester

NEW JERSEY

New Brunswick
Newark

NEW YORK

Albany
Binghamton
Buffalo
New York City
Rochester
Roosevelt Field, L. I.
Syracuse

NORTH CAROLINA

Asheville
Charlotte
Durham
Rocky Mount
Winston-Salem

OHIO

Akron
Cincinnati
Cleveland
Columbus
Dayton
Portsmouth
Toledo
Youngstown

OKLAHOMA

Oklahoma City
Tulsa

OREGON

Eugene
Portland

PENNSYLVANIA

Allentown
Erie
Greensburg
Harrisburg
Philadelphia
Pittsburgh
West Reading

RHODE ISLAND

Providence

SOUTH CAROLINA

Columbia
Greenville

SOUTH DAKOTA

Sioux Falls

TENNESSEE

Bristol
Chattanooga
Knoxville
Memphis
Nashville

TEXAS

Abilene
Amarillo
Arlington
Austin
Beaumont
Corpus Christi
Dallas
El Paso
Ft. Worth
Houston
Lubbock
Port Arthur
San Antonio

UTAH

Salt Lake City

VERMONT

Rutland

VIRGINIA

Norfolk
Richmond
Roanoke

WASHINGTON

Seattle
Spokane
Tacoma

WISCONSIN

Green Bay
Madison
Milwaukee

A Single Source for Local Service

