

radio  
transmitters  
& accessories



**HARRIS**

COMMUNICATIONS AND  
INFORMATION HANDLING



# INTRODUCTION

The Harris Corporation — Broadcast Products Division proudly presents its first catalog devoted exclusively to radio transmitting and RF products. This equipment, along with the company's broad line of radio studio equipment, television transmitting and television studio equipment, makes Harris one of the world's leading manufacturers of broadcast products.

Among the new radio products in this catalog are the world's first FCC type accepted 1 kW solid-state medium wave transmitter, an advanced series of FM monitors, a recently developed 10 kW short wave transmitter and super power and directional FM transmitting antennas. Together with Harris' outstanding studio equipment, the broad RF product line meets virtually every requirement of the radio broadcaster.

Field sales and service facilities are extensive. Sales offices are located in New York City, Washington, D.C., and Houston. Harris' Service Centers carry a large inventory of equipment and service parts, serving the Eastern Seaboard from the Service Center located in New York City, and the entire South and Southwest from the Houston Service Center. In Canada, sales are handled by Harris-Intertype (Canada) Limited. Harris' International Sales Department, located in Quincy, coordinates all international market activities with representatives located in most countries of the world.

The Broadcast Products Division is one of thirteen divisions of Harris Corporation, a world leader in Communications and Information Handling Equipment, and one of the nation's 500 largest corporations. Harris' electronics divisions, in addition to Broadcast Products Division, include Controls Division, Electronic Systems Division, RF Communications Division, Harris Semiconductor Division, PRD Electronics Division and Composition Systems Division. Several research centers within Harris' electronic group enable the Broadcast Products Division to draw from a large staff of scientists and engineers, as well as from the large engineering organization in Quincy, to assure our customers that Harris broadcasting and communications equipment is synonymous with product leadership.

Harris has built its reputation on quality of craftsmanship, excellence of engineering design and pioneering of outstanding new products. We invite your patronage and will justify your confidence.



# HARRIS CORPORATION — BROADCAST PRODUCTS DIVISION

## OUR MODERN MANUFACTURING FACILITIES



Situated on an attractive 40-acre plot in Quincy, Illinois, the Harris factory has a total floor space of 108,000 square feet—and is one of the nation's most modern facilities devoted to the manufacturing of broadcast and electronics equipment.



# SALES AND SERVICE FACILITIES

NEW YORK—Harris' centralized Eastern facilities, including Radio and Television Field Sales Offices and the Harris New York Service Center are located at:  
130 East 34th Street  
New York, New York 10016  
Phone: Area (212) 889-0790

Harris' New York and Houston Service Centers carry thousands of sundry items just for the broadcaster. Fast and efficient service is available from the New York Service Center to broadcasting stations on the East Coast and from the Houston Service Center to those stations located in the South/Southwest.



HOUSTON SERVICE CENTER  
4019 Richmond Avenue  
Houston, Texas 77027  
Phone: Area (713) 623-6655

LOS ANGELES—Western Field Sales Office  
10960 Wilshire Blvd.  
Los Angeles, California 90024  
Phone: Area (213) 477-2577

WASHINGTON, D.C. OFFICE  
730 Federal Building, 1522 K Street, N.W.  
Washington, D.C. 20005  
Phone: Area (202) 223-5508

CANADIAN SALES  
MONTREAL OFFICE—Harris Intertype (Canada) Ltd.  
212 Brunswick Blvd.  
Pointe-Claire, Quebec, Canada  
Phone: Area (514) 695-3751

Harris Service Department personnel are on duty 24 hours a day to aid customers when service or parts are needed. Write or call:  
123 Hampshire Street  
Quincy, Illinois 62301  
Phone: Area (217) 222-8200



# TABLE OF CONTENTS

	PAGE
<b>AM BROADCAST TRANSMITTERS</b> .....	<b>5</b>
100 kW to 1000 watt medium wave transmitters • Phasing and antenna coupling equipment • Modulation and frequency monitors • AM transmitter accessories	
<b>FM BROADCAST TRANSMITTERS</b> .....	<b>39</b>
Stereo and SCA generators • Dual FM transmitters • 40 kW to 10 watt transmitters • FM transmitting antennas • FM modulation and frequency monitors	
<b>BROADCAST TRANSMITTER ACCESSORIES</b> .....	<b>67</b>
Tower lights • Inductors and capacitors • Transmission line • Limiters • Enhancer • Automatic gain control amplifier • Proof of performance equipment • Utility, single program and dual channel amplifiers • Rack cabinets • Transmitter remote control • Remote pickup equipment • STL equipment • Transmitting tubes • Semiconductors	
<b>HIGH FREQUENCY BROADCAST TRANSMITTERS</b> .....	<b>93</b>
100 kW to 10 kW shortwave transmitters • Reference information	
<b>INDEX</b> .....	<b>107</b>

The mechanical and electrical design of the equipment described herein is subject to change without notice as deemed necessary by the Broadcast Products Division of Harris Corporation or its suppliers in the interest of advancing industry requirements or the state of the art.

Copyright © 1976 Broadcast Products Division of Harris Corporation

Price: \$10.00

# AM BROADCAST TRANSMITTERS





**HARRIS**  
COMMUNICATIONS AND  
INFORMATION HANDLING

## VP-100A

### 100,000 Watt Medium Wave Broadcast Transmitter

- Overall efficiency better than 65%
- Exclusive Pulse Duration Modulator [PDM]\* for high level plate modulation
- Redundancy in solid state circuits
- Continuous 100% modulation rating
- Vapor phase cooling for quiet operation and extended tube life
- Only five tubes, with three tube types
- Designed for a wide climate range

\* Patented







Front view, doors removed, with heat exchanger

Featuring Harris' exclusive high level Pulse Duration Modulator\*, the VP-100A provides the finest performance of any medium wave broadcast transmitter in the same power range on the market today...at significantly lower operating costs.

**EFFICIENCY EXCEEDS 65%.** The VP-100A has an unusually high overall efficiency of more than 65%. This is made possible by the almost 90% efficiency of the Pulse Duration Modulator—and means about one-third less power consumption than other high level plate modulated 100 kilowatt transmitters.

**CONTINUOUS 100% MODULATION RATING.** The continuous sine wave modulation capability permits a higher average modulation (such as trapezoidal) to boost signal strength, without increasing transmitter carrier power. Another feature of this high efficiency series type modulator is convenient front panel carrier power adjustment over a wide range.

**ONLY FIVE TUBES.** The entire transmitter employs just five tubes—with a modern ceramic 4CV100,000C power tetrode in the modulator and final RF power amplifier sockets. All power supplies utilize long-life solid state silicon rectifiers. High quality components, conservatively rated, are used throughout the VP-100A to assure greatest reliability.

**VAPOR PHASE COOLING.** Cooling by the Vapor Phase method produces quiet operation by eliminating the need for large blowers—the heat exchanger is cooled by a two horsepower blower. This method of cooling also extends tube life by helping

\* U.S. Patent No. 3440566

to eliminate "hot spots" and by maintaining tube anode temperatures far below those attained by other methods.

**RF SECTION.** The RF chain is conventional, using a transistorized oscillator, buffer, emitter follower, and a 4CX1500A tetrode tube amplifier to drive a single 4CV100,000C tetrode Class C power output stage.

An automatic drive control limits the PA screen current, eliminating the usual problem of over dissipating the screen of a tetrode during tune-up.

**THE MODULATION SYSTEM.** Harris' exclusive Pulse Duration Modulator is characterized by low plate dissipation and low peak currents; peak cathode currents are about one-half that of the other 100 kilowatt transmitters. Average plate dissipation runs substantially below rated levels, and all peak voltages are maintained well below component ratings.

Wide frequency response is possible as large reactive components are not used in the modulation system.

Control of the transmitter power output over a wide range is accomplished in a low-level stage of the modulator by means of a convenient front panel vernier control. No adjustment is necessary in any high power RF circuit, including the loading coil.

**PROTECTIVE CIRCUITS.** All major components of the VP-100A are protected by circuit breakers. Tubes and transistors are protected by overload relays or current-limiting devices

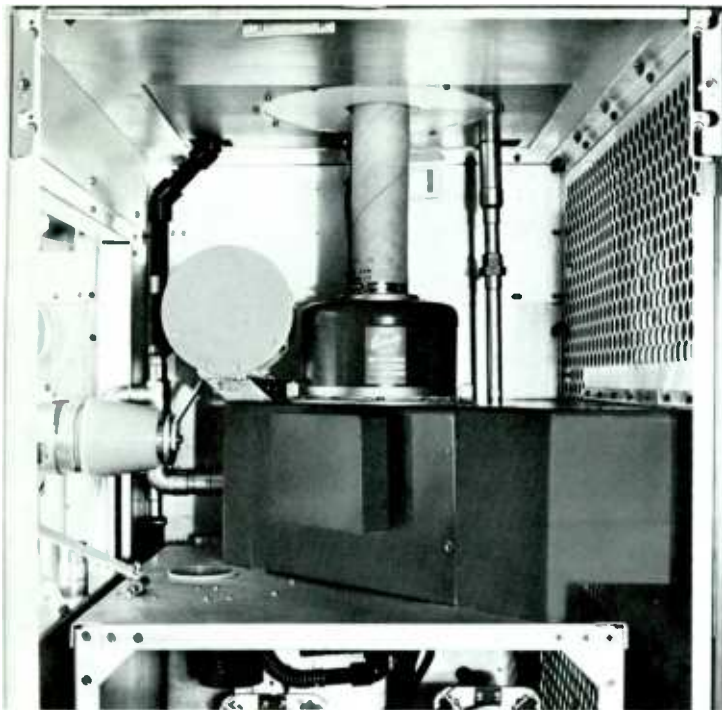

Power amplifier tube compartment, rear view.

A quick-acting circuit protects against damage by high voltage arcs by limiting the energy in such arcs to less than 10 watt seconds.

Protection against voltage standing wave ratios of greater than 1.2:1 is provided. Both forward and reflected power are metered at the front panel.

In case of momentary RF overloads the VP-100A will recycle twice automatically. Should a third overload occur within a thirty second period, the transmitter will remain off until manually reset. However, if the time between overloads is greater than thirty seconds, continuous recycling will occur.

**DUAL OSCILLATOR AND MODULATOR.** Harris has provided redundancy in all transistor sections to relieve any concern over solid state circuitry in high-powered transmitters. Although the reliability of transistor circuitry has been proven in transmitters now operating under extreme conditions, this duplication is your double assurance of complete dependability.

**DESIGNED FOR WIDE RANGE OF CLIMATES.** The transmitter will give top performance in a wide range of climates—from hot and humid, to dry and dusty. With Vapor Phase cooling, ducting outside air into the transmitter is not necessary. All transformers and similar components are hermetically sealed, encased, or vacuum impregnated. All high power radio frequency networks contain silver-plated inductors and vacuum capacitors.

**GREATLY REDUCED FLOOR SPACE.** Due to the high efficiency of the transmitter and the elimination of large iron core components (no modulation transformer and reactor), the VP-100A requires only 7.0 square meters (76 square feet) of floor space. Careful cabinet design provides easy accessibility to all components.

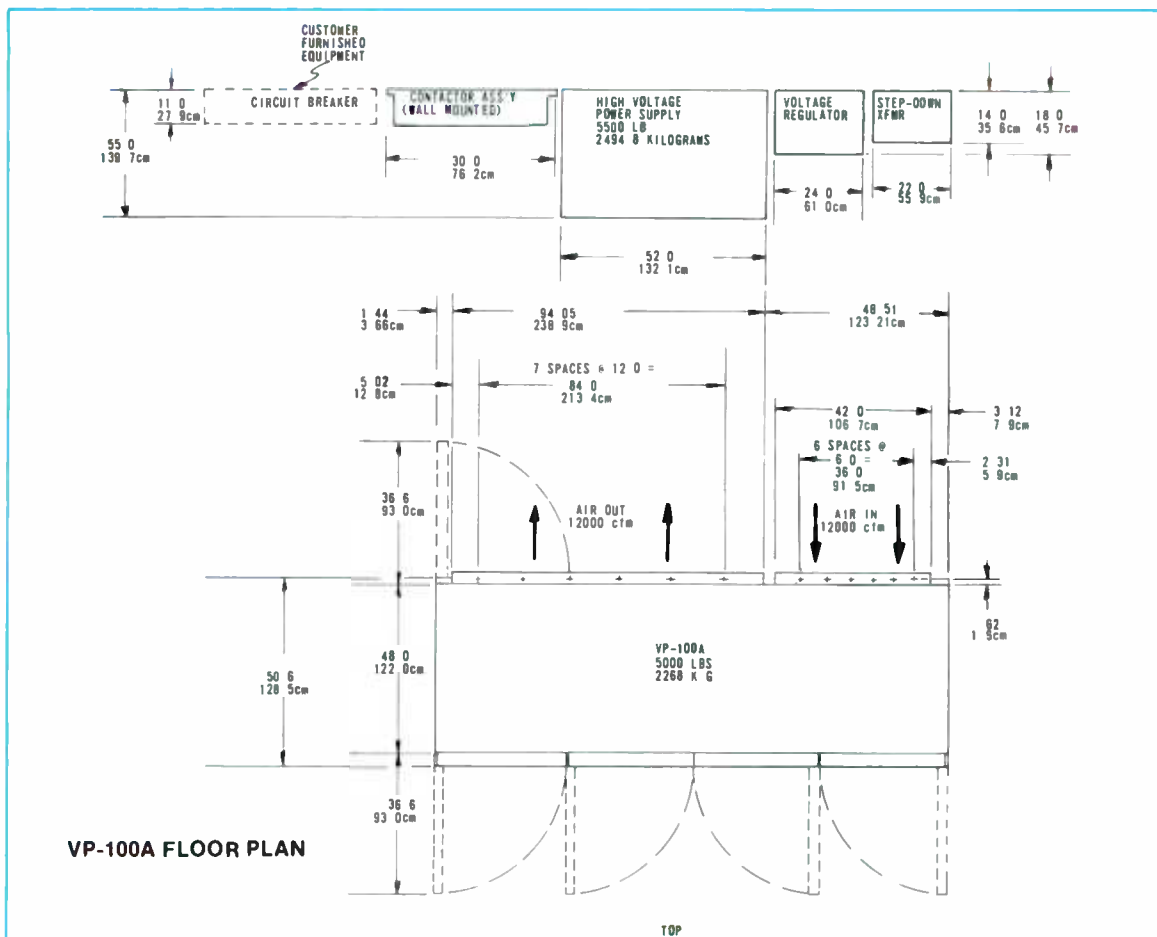

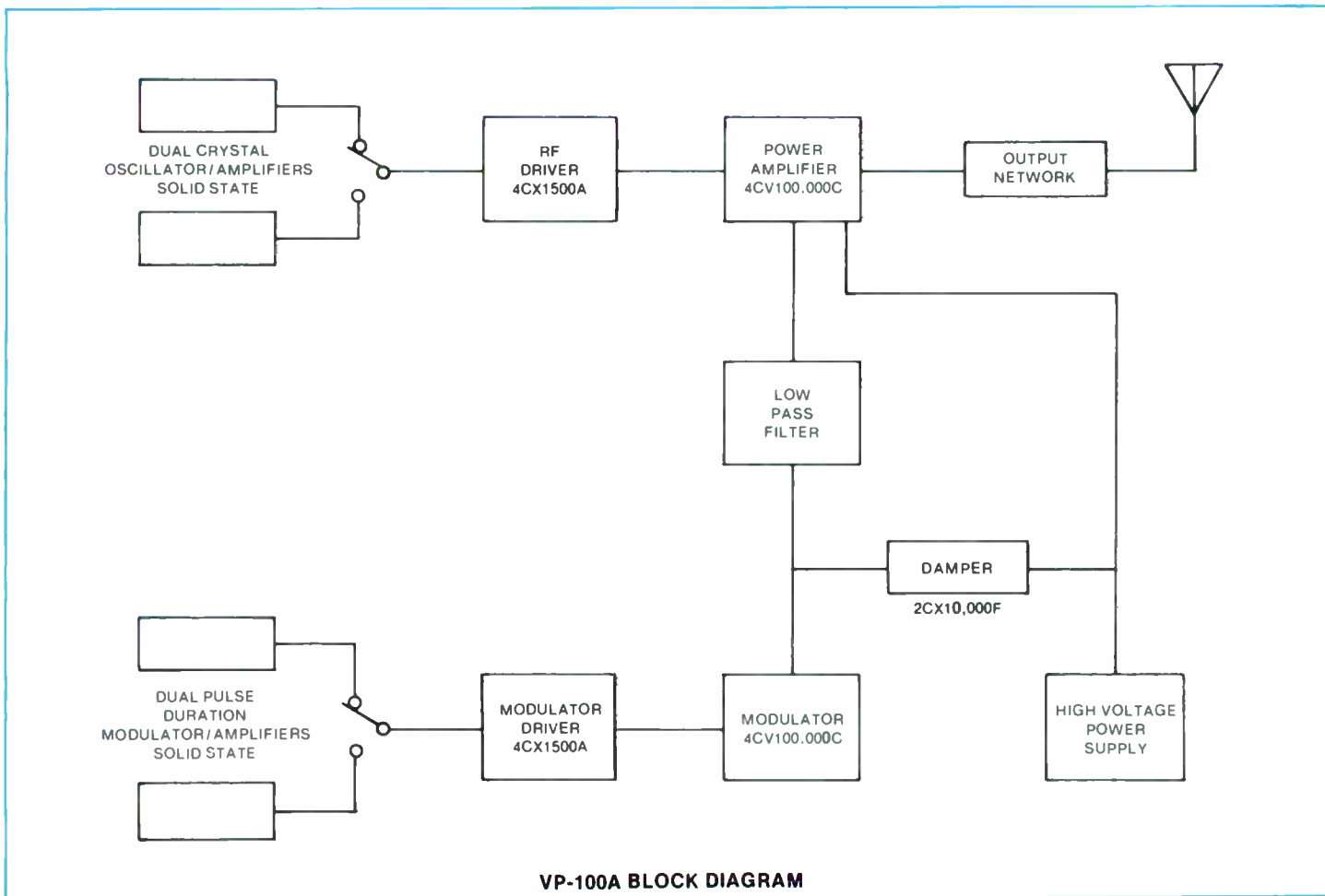

VP-100A BLOCK DIAGRAM

### VP - 100A SPECIFICATIONS

**POWER OUTPUT:** 100,000 watts nominal unmodulated, capable 110,000 watts.

**RF FREQUENCY RANGE:** 535 kHz to 1620 kHz.

**RF OUTPUT IMPEDANCE:** 230 ohms, unbalanced.

**RF FREQUENCY STABILITY:**  $\pm 5$  Hz.

**SPURIOUS AND HARMONIC EMISSION:** Less than 50 mW.

**CARRIER SHIFT:** Less than 5% at 100% modulation at 1,000 Hz.

**AUDIO FREQUENCY RESPONSE:**  $\pm 1.5$  dB from 40 to 10,000 Hz referenced to 1,000 Hz at 95% modulation.

**AUDIO FREQUENCY DISTORTION:** Less than 3% from 40 to 10,000 Hz at 95% modulation.

**NOISE:** 55 dB below 100% modulation at 1,000 Hz.

**AUDIO INPUT LEVEL:** 10 dBm  $\pm 2$  dB for 100% modulation.

**AUDIO INPUT IMPEDANCE:** 600/150 ohms, balanced or unbalanced.

**MODULATION LEVEL:** 100% sinusoidal, continuous, 50 to 5,000 Hz.

**TRAPEZOIDAL MODULATION:** Less than 5% tilt or over-shoot, 100 Hz to 2,000 Hz.

**POWER INPUT:** Any specified voltage 380V to 480V, 3 phase, 50 or 60 Hz.

**POWER CONSUMPTION:** 155 kW—No modulation  
160 kW—30% modulation  
215 kW—100% modulation

**POWER FACTOR:** 95%.

**VOLTAGE REGULATOR:** Electronic voltage regulation for all power supplies other than high voltage.

**OVERALL EFFICIENCY:** 65% at average modulation.

**TUBES:** Two 4CV100,000C; two 4CX1500A; one 2CX10,000F.

**TEMPERATURE RANGE:** 0-50°C ambient air temperature.

**HUMIDITY:** 95% relative humidity, maximum.

**STORAGE TEMPERATURE:** -35°C to +60°C (with no water in system).

**ALTITUDE:** Up to 1,829 meters (6,000 feet) above sea level.

**CABINET DATA:** Each of two cabinets measures 1.83 meters (6 feet) wide, 1.37 meters (4.5 feet) deep, and 1.98 meters (6.5 feet) high. The heat exchanger adds another 1.06 meters (3.5 feet) in height.

### ORDERING INFORMATION

**VP-100A, 100,000 watt medium wave transmitter with one set of tubes, crystals and silicon rectifiers, for operation from 380 to 480 volts, 3 phase, 50 or 60 Hz** .....994-7651-001

**100% set of spare tubes for VP-100A** .....990-0761-000



**HARRIS**  
COMMUNICATIONS AND  
INFORMATION HANDLING

## MW-50

### 50,000 Watt Medium Wave Broadcast Transmitter

- High level plate modulated, using a Pulse Duration Modulator [PDM]\*
- High overall efficiency . . . exceeds 60%
- Minimum power consumption . . . only 87 kW at 30% modulation
- Only five tubes, with three tube types
- Only one power amplifier tube and one modulator tube
- Quiet, air-cooled operation
- Compact design
- High level design with no modulation transformer or reactor
- Power level is adjusted in low level PDM stage. No loading adjustment is required
- Switches smoothly from high to low power with carrier on
- Automatic return to operation after a power failure
- Easily remote controlled

\*Patented





**THE MOST ADVANCED 50 KILOWATT MEDIUM WAVE TRANSMITTER IN THE WORLD.** Harris' MW-50 provides an overall performance superior to that of any other AM broadcast transmitter in the same power range, at lower operating costs. With Harris' exclusive high level plate modulation, using a Pulse Duration Modulator (PDM), this transmitter represents the latest state of the art in high power broadcast equipment.

**HIGH EFFICIENCY—EXCEEDS 60%.** The Pulse Duration Modulator employed in the MW-50 is nearly 90% efficient (instead of the usual 50% or 60%), enabling the transmitter to achieve an unusually high overall efficiency of greater than 60%. This means less power consumption than that of the other 50 kilowatt medium wave transmitters currently available.

**ONLY FIVE TUBES.** The entire transmitter employs just five tubes—with modern ceramic 4CX35,000C tetrode power tubes operating well below manufacturer's dissipation ratings. Only three tube types are used, which simplifies the stocking of spares. All power supplies use long-life solid state silicon rectifiers. Highest quality components, conservatively rated, are used throughout the MW-50 to assure a maximum degree of reliability.

**CONTINUOUS 100% MODULATION RATING.** This continuous sine wave modulation capability permits a higher average modulation to boost signal strength without increasing transmitted carrier power. The MW-50 provides 125% positive peak capability when operating at full 50 kilowatt RF power output. Another feature of this high efficiency series type modulator is that the carrier power may be adjusted from the front panel without changing the loading.

**MAXIMUM CARRIER POWER 60 KILOWATTS.** The Harris MW-50 provides a maximum carrier power of 60 kilowatts, which

allows more reserve for driving directional arrays than any other 50 kilowatt medium wave broadcast transmitter. The MW-50 uses DC feedback for power output stability, which insures a minimum RF power output change with a change of the power line voltage. The MW-50 can be switched smoothly from high to low power with the carrier on.

**EASY TUNING.** Output network tuning is accomplished by PA plate tune and loading control of the power amplifier stage, which operates essentially as a Class D amplifier. Automatic gain control on the power amplifier screen allows tuning of the Type 4CX35,000C tetrode as if it were a triode, without any risk of over-dissipating the screen. After PA tuning and loading controls are optimized, power output is controlled in the low level PDM stage. In case of a power line failure, the MW-50 is equipped to automatically return to full power operation.

**RF SECTION.** The RF chain is conventional, using a transistorized oscillator, buffer, emitter follower, and a 4CX1500A tetrode tube amplifier to drive a single 4CX35,000C tetrode Class D power output stage.

An automatic drive control limits the PA screen current to 1.8 amps, eliminating the usual problem of over-dissipating the screen of a tetrode during tune-up.

**THE MODULATION SYSTEM.** Harris' Pulse Duration Modulator is characterized by low plate dissipation and low tube peak currents. Peak cathode currents are about one-half that of other 50 kilowatt transmitters. Average plate dissipation runs substantially below rated levels, and all peak voltages are maintained well below component ratings. In addition, the PDM design allows continuous 100% sine wave modulation.



MW-50, front doors removed



The modulator efficiency is about 90%, and a wide frequency response is possible, as large reactive components are not used in the modulation system.

Control of the transmitter power output over a wide range is accomplished in a low-level stage of the modulator by means of a convenient front panel vernier control. No adjustment is necessary in any high power RF circuit, including the loading capacitor.

**PROTECTIVE CIRCUITS.** All major components of the MW-50 are protected by circuit breakers. Tubes and transistors are protected by overload relays or current-limiting devices.

A quick acting "crowbar" circuit protects against damage from high voltage arcs by limiting the energy in such arcs to less than 10 watt seconds.

Protection against voltage standing wave ratios of greater than 1.2 to 1.0 is provided. Both forward and reflected power are metered at the front panel.

In case of momentary RF overloads, the MW-50 will recycle automatically. Should a repeated overload occur within a thirty-second period, the transmitter will remain off until manually reset. However, if the time between overloads is greater than thirty seconds, continuous recycling will occur.

**QUIET AIR COOLING.** Cooling of the

MW-50 is accomplished by a 3 horsepower blower, 2300 CFM at 2" water, located in the transmitter cabinet, which provides cooling for the power tubes at a very low noise level. The transmitter cabinet air is flushed with a low speed fan which also operates at a very low noise level. Provisions are made at the top of the transmitter for ducting the exhaust air to the outside of the transmitter building.

**DESIGNED FOR A WIDE RANGE OF CLIMATES.** The MW-50 provides top performance in all types of climates, from hot and humid to dry and dusty. All transformers and similar components are

hermetically sealed, encased, or vacuum impregnated.

**EASY ACCESS.** All components are readily accessible through the four rear doors and one front access door. Meter panels are hinged for easy inspection and maintenance.

**TRANSMITTER LAYOUT.** The MW-50 consists of two cabinets and an external high voltage power transformer. External connections to the transmitter are made through either the top or the bottom of the unit, as desired, for great installation flexibility.

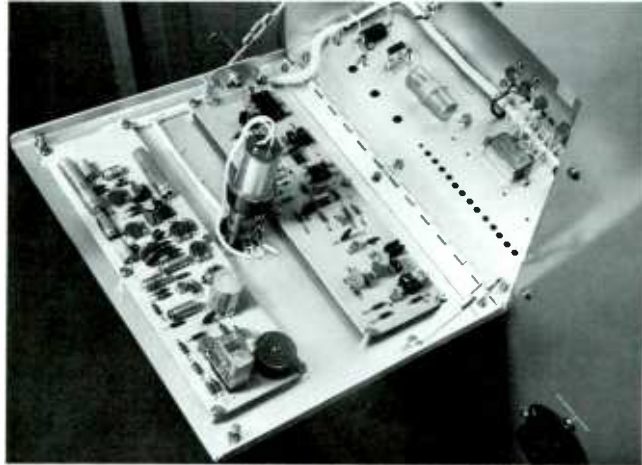

Low level Pulse Duration Modulator chassis, showing power control, low level Pulse Duration Modulator and audio input/control board.

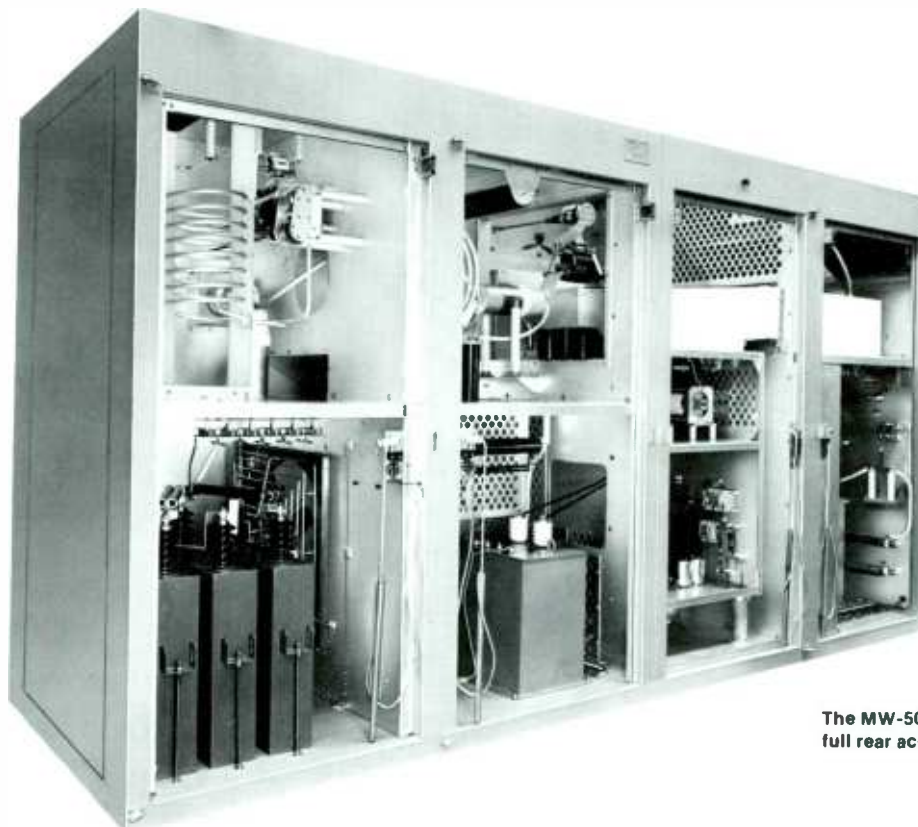

The MW-50 offers full rear accessibility

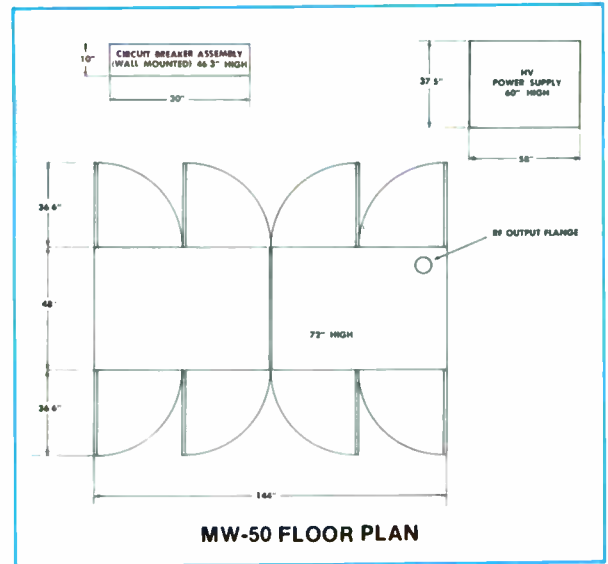
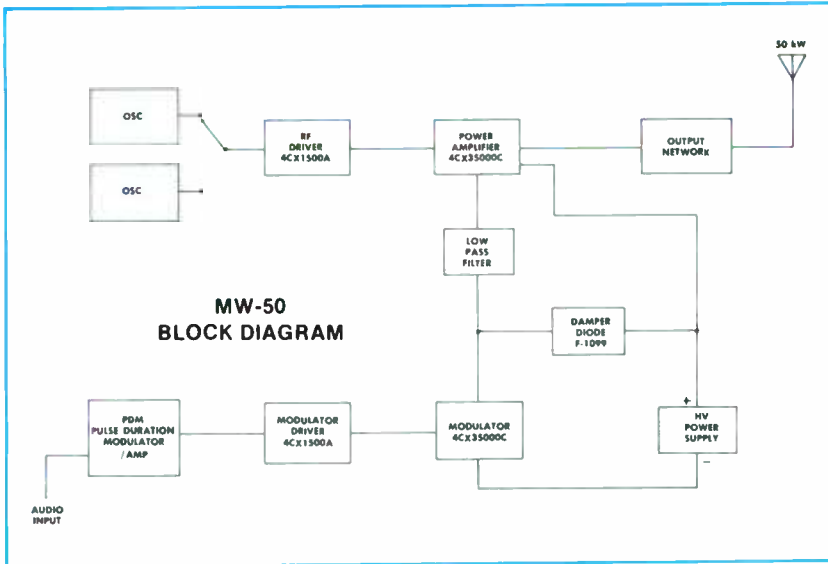

### MW-50 SPECIFICATIONS

**POWER OUTPUTS:** 50,000 watts (rated), 60,000 watts (capable). Convenient power reduction to 25,000 or 10,000 watts.

**RF FREQUENCY RANGE:** 535 kHz to 1620 kHz, supplied to frequency as ordered.

**RF OUTPUT IMPEDANCE:** 50 ohms (other as specified).

**RF FREQUENCY STABILITY:**  $\pm 5$  Hz.

**RF HARMONICS:** Exceeds FCC and CCIR specifications.

**CARRIER SHIFT:** Less than 2% at 100% modulation.

**AUDIO FREQUENCY RESPONSE:**  $\pm 1.5$  dB, from 20 to 10,000 Hz, referenced to 1,000 Hz, at 95% modulation.

**AUDIO FREQUENCY DISTORTION:** Less than 3%, 20 to 10,000 Hz at 95% modulation.

**NOISE:** (Unweighted)-60 dB or better below 100% modulation.

**AUDIO INPUT:** 600/150 ohms at +10 dBm  $\pm 2$  dB, for 100% modulation.

**POWER INPUT:** 480 V  $\pm 5\%$ , 3 phase, 60 Hz. Available for 380 V  $\pm 5\%$ , 3 phase, 50 Hz.

**POWER CONSUMPTION:** 80 kW at 0% modulation  
87 kW at 30% modulation  
110 kW at 100% modulation

**OVERALL EFFICIENCY:** Better than 60% at average modulation.

**POWER FACTOR:** 95%

**TUBES USED:** (2) 4CX35,000C; (2) 4CX1500A; (1) F-1099.

**TEMPERATURE RANGE:** -20°C to + 50°C.

**HUMIDITY:** 95%.

**ALTITUDE:** Up to 2,286 meters (7,500 feet) above sea level. (Higher on special order.)

**SIZE:** 78 inches high, 144 inches wide, 48 inches deep (transmitter cabinet). External components include high voltage power supply and wall mounted circuit breaker assembly.

**FLOOR SPACE:** Main transmitter assembly 48 square feet. Power supply 15 square feet.

**WEIGHT: (APPROXIMATE)**

Main transmitter assembly		Power Supply	
Net unpacked	5,000 lbs.	Net unpacked	1,370 lbs.
Domestic packed	6,000 lbs.	Domestic packed	1,500 lbs.
Export packed	7,200 lbs.	Export packed	1,800 lbs.

**CUBAGE:** Packed: 700 cubic feet.

**FINISH:** Beige-gray.

### ORDERING INFORMATION

Model MW-50, with one set of tubes and two crystals, 60 Hz ..... 994-6994-003  
 Model MW-50, with one set of tubes and two crystals, 50 Hz ..... 994-6994-005  
 100% set of spare tubes for MW-50 transmitter ..... 990-0711-001  
 Recommended minimum spare tubes for MW-50 transmitter ..... 990-0712-001



# BC-20H

## 20,000 Watt Medium Wave Broadcast Transmitter

The BC-20H, 20 kW transmitter consists of two standard BC-10H 10 kW transmitters, a 20 kW combiner, and a common drive unit. All components are housed within the transmitter cabinet, eliminating the need for external ducting and enclosures. Askarel (oil) filled modulation transformers are provided as standard equipment for added reliability.

**SOLID STATE CIRCUITRY.** The BC-20H employs transistors in all circuitry except the RF driver, power amplifier and modulator for superior performance. Only ten tubes are used in the entire transmitter.

**RF SECTION.** In addition to the oscillator/exciter incorporated in each 10 kW transmitter, a third oscillator is provided in the BC-20H to permit maximum operating flexibility. This independent exciter is used as a common drive to each transmitter and is enclosed in the center cabinet. Output of this unit is split and drives independent buffer amplifiers for isolation and phase adjustment. The RF signal then feeds individual oscillators in each 10 kW transmitter, which in turn excites the 4-400 driver and the high level plate modulated 3CX2500F3 power amplifiers. Overall efficiency of the power amplifiers is typically 85% or better, a direct benefit of the high efficiency RF circuits that are utilized.

RF output of each transmitter is fed into a bridged-tee combiner network, housed in the middle cabinet. A 10 kW dummy load is provided with an in-line RF ammeter for visual indication of current to the reject branch of the combiner network. Under optimum conditions, no current will exist in this branch. No critical adjustments are required and simplified overall operation is stable.

In the event that maintenance or adjustment, such as initial tune-up of the transmitters is required, the 10 kW dummy load may be switched manually so that the output of one power amplifier feeds the load directly while the other amplifier can drive the antenna system. While in the combined mode, monitoring is accomplished by a pickup loop at the combiner output for indication of modulation level of the entire transmitter system.



**AUDIO SECTION.** Audio is processed by a transistorized audio amplifier which drives the Class B 3CX2500F3 modulators. High level plate modulation techniques are used with enhanced performance obtained by applying audio to the RF driver stage.

**RELIABILITY.** The design philosophy employed in the BC-20H assures long term operation with no lost air time. 100% redundancy of equipment means that a signal can remain on the

air with no down time for maintenance. One transmitter can be turned off while the other continues to operate.

**ADDITIONAL FEATURES.** Important features include reliable silicon diodes in all power supplies; built-in circuitry for remote control; ample cooling for all climatic conditions with quiet, low-speed blowers; and low operating cost, with only two tube types used in the BC-20H.

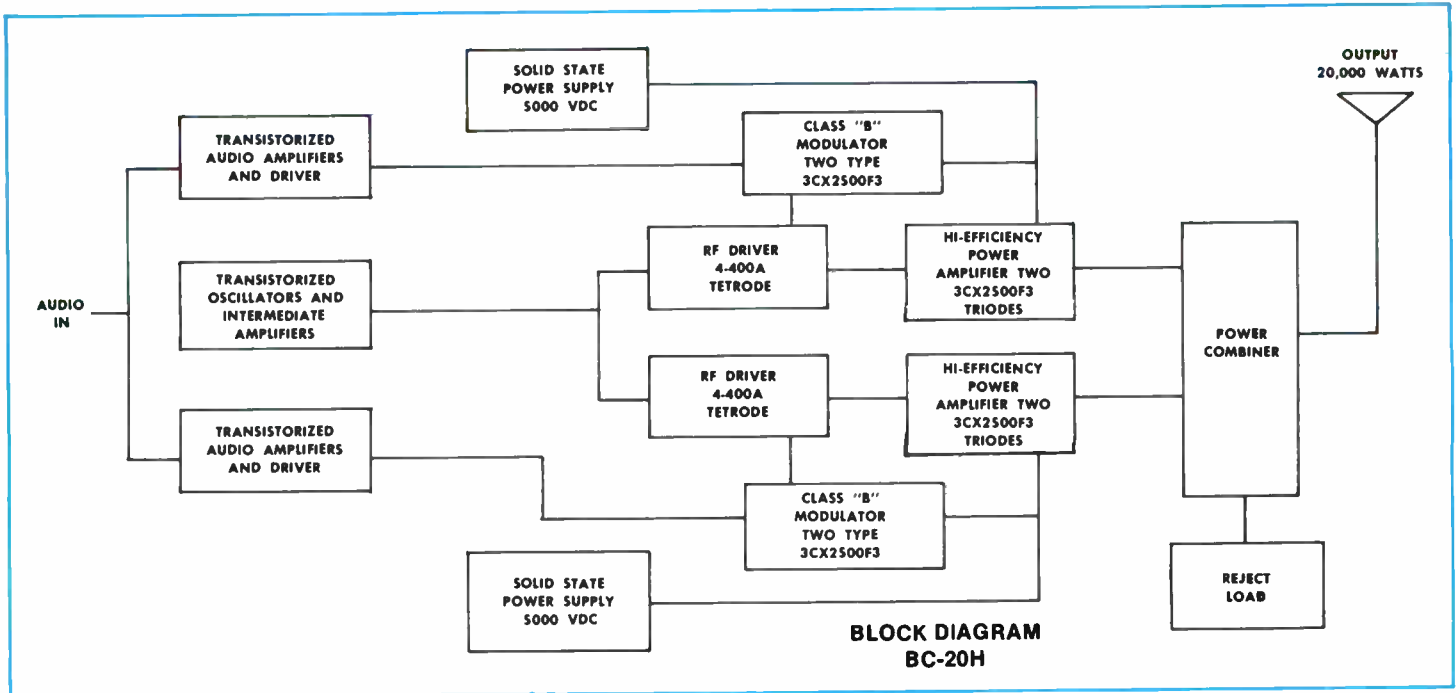

### BC-20H SPECIFICATIONS

**POWER OUTPUT:** (Rated) 20,000 watts. (Capable) 21,600 watts.

**RF FREQUENCY RANGE:** 535 kHz to 1620 kHz, supplied to one frequency as ordered.

**RF OUTPUT IMPEDANCE:** Supplied for 50 ohms, or other as specified.

**RF FREQUENCY STABILITY:**  $\pm 2$  Hz.

**CARRIER SHIFT:** Less than 3% at 100% modulation.

**RF HARMONICS:** Meets or exceeds FCC specifications.

**AUDIO FREQUENCY RESPONSE:**  $\pm 1$  dB, 50 to 10,000 Hz;  $\pm 1\frac{1}{2}$  dB, 30-12,000 Hz.

**AUDIO FREQUENCY DISTORTION:** 2.5% or less 50 Hz to 10,000 Hz at 95% modulation.

**NOISE:** (Unweighted) 60 dB or better below 100% modulation.

**AUDIO INPUT:** 600/150 ohms at +10 dBm,  $\pm 2$  dB.

**POWER INPUT:** 208/230 volts, 3 phase, 50 or 60 Hz. 37 kW no modulation. 42 kW average modulation. 55 kW 100% modulation.

**AMBIENT TEMPERATURE RANGE:**  $-20^{\circ}$  to  $+50^{\circ}$ C.

**ALTITUDE:** To 7,500 feet standard (higher altitudes on special order).

**SIZE:** 78" high, 177" wide, 32" deep (completely self-contained).

**WEIGHT:** 5200 lbs. unpacked (approximate). 6800 lbs. export packed (approximate).

**CUBAGE:** 390 cubic feet packed.

**FINISH:** Beige-gray.

**TUBES USED:** (8) 3CX2500F3; (2) 4-400A. Total: 10.

**GENERAL INFORMATION:** Monitors: 10 RF volts output at 50/70 ohms for frequency and modulation monitors.

### ORDERING INFORMATION

Model BC-20H transmitter, consisting of two standard BC-10H 10 kW transmitters, a 20 kW combiner and a common drive unit . . . . . 994-6669-002



**HARRIS**  
COMMUNICATIONS AND  
INFORMATION HANDLING

# BC-10H

## 10,000 Watt Medium Wave Broadcast Transmitter

- Low operating costs
- Solid state circuitry in all areas except the RF driver, power amplifier and modulator
- Low tube cost
- Dual crystal/oscillators
- High PA efficiency
- Solid state audio driver
- 125% positive peak capability
- Askarel filled modulation transformer
- Only two tube types
- Easy accessibility--front and rear





The most outstanding 10,000-watt AM transmitter available today, Harris' BC-10H is capable of providing the maximum positive modulation peaks allowed by the FCC (125%), with plenty of reserve for great reliability. Excellent signal quality and low operating costs are other proven features that help make the BC-10H number one in its power range.

**SOLID-STATE CIRCUITRY.** The BC-10H uses transistors in all circuits except the RF driver, power amplifier and modulator to provide a richer, fuller sound for the listener, and increased reliability for the broadcaster.

**LOW TUBE COST.** Ceramic type 3CX2500F3 triode tubes are used in the power amplifier and modulators, and a type 4-400A tetrode is used as the RF driver. This combination provides the lowest cost tube complement of any 10 kW AM transmitter on the market. All tubes are operated well below their maximum ratings for long tube life. Typically, 16,000 to 18,000 hours have been reported by many BC-10H users.

**RF SECTION.** Two transistor oscillators are instantly switchable, and oscillator output is amplified to provide the proper signal level for the driver, a 4-400A tetrode, which is modulated to improve the overall transmitter performance. The 4-400A drives two 3CX2500F3 power amplifiers which are high level plate modulated. These air-cooled power amplifiers have an efficiency as high as 90%, delivering full power through a full Pi-Tee network. The RF output capability of the BC-10H, 10,800 watts, easily accommodates complicated multi-tower phasors.

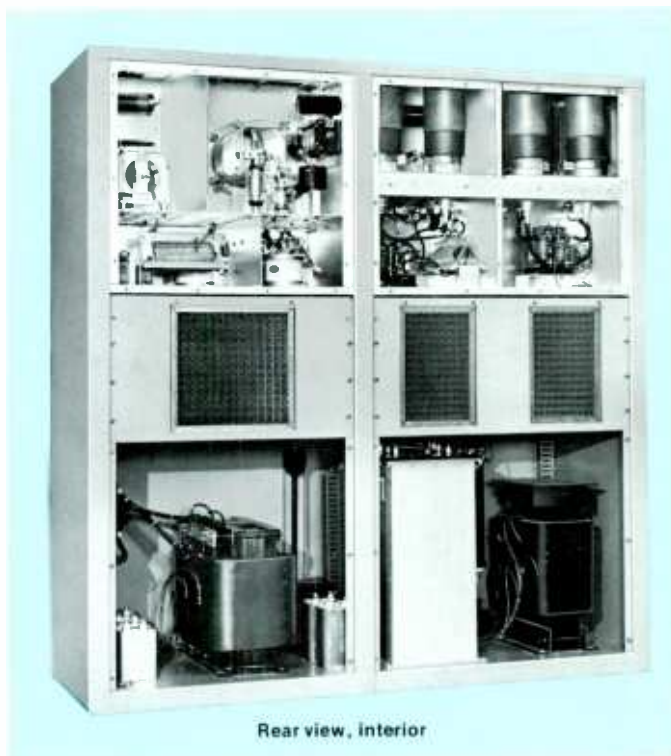

Rear view, interior



Front view, doors open

**AUDIO SECTION.** A solid-state audio driver provides full audio power direct to the grids of the two 3CX2500F3 modulator tubes. This combination is capable of more than 125% positive peak modulation if not limited by external amplifiers. Inverse feedback, and an advanced design low-leakage reactance modulation transformer/reactor group, results in signal quality of the highest fidelity. The modulation transformer is oil (Askarel) filled.

**INTERCHANGEABILITY.** Added tube life may be achieved from the 3CX2500F3 triodes by interchanging the modulators and the power amplifiers, as the same tube type is used in both stages.

**SOLID-STATE POWER SUPPLIES.** Life-time avalanche type silicon rectifiers in all power supplies provide a 2-to-1 voltage and a 5-to-1 current safety factor for normal operation and 150 times current ratings for surge currents. This high margin of safety assures trouble-free performance.

**CONTROL CIRCUITRY.** Careful attention has been given to the design of the control circuitry in the BC-10H. Complete AC and DC overload protection is standard equipment. A recycling feature, which will automatically turn the transmitter off when an overload occurs, is built in.

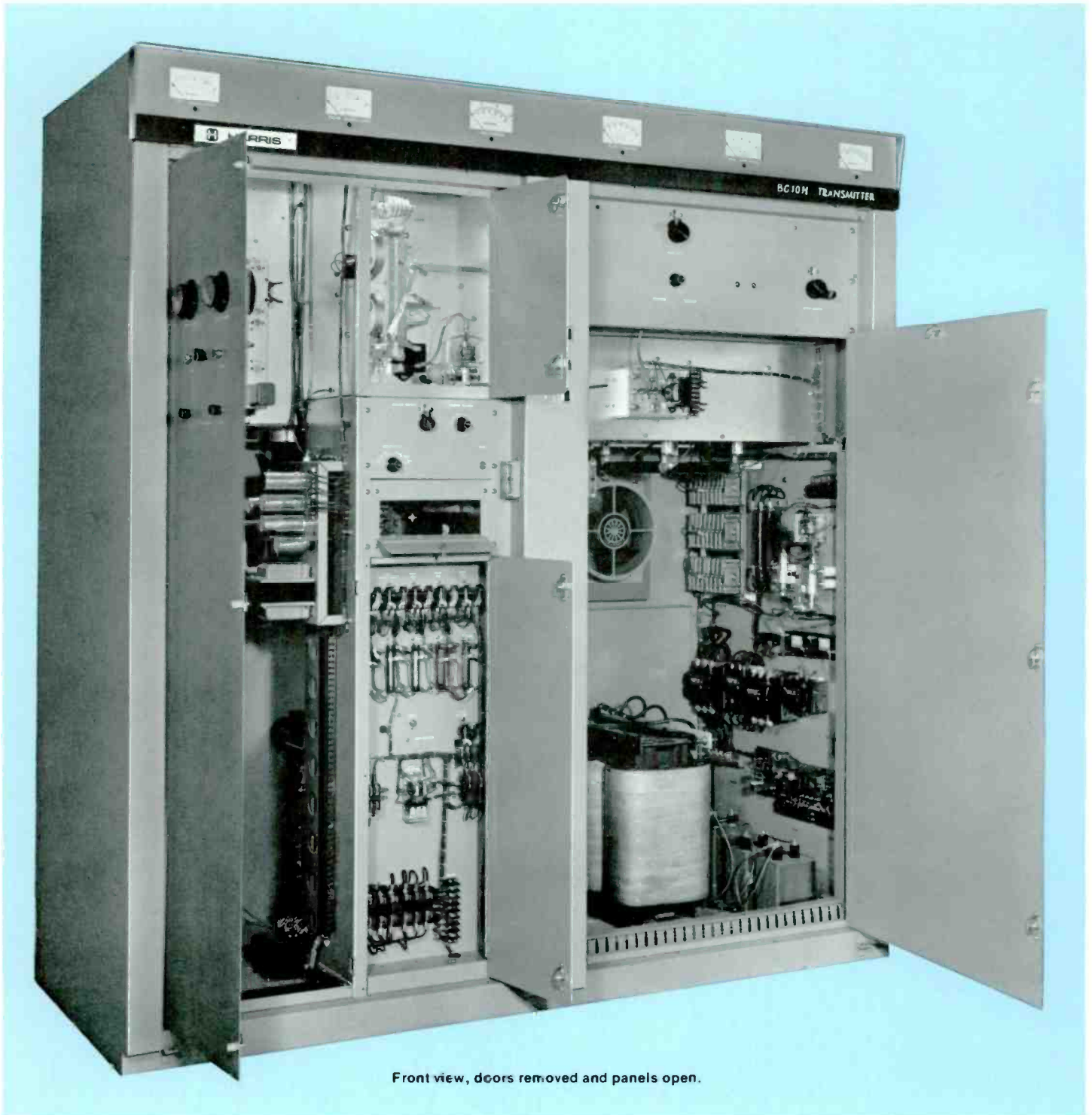

Front view, doors removed and panels open.

**HARMONIC RADIATION.** In addition to the full Pi-Tee output circuit, the BC-10H contains a second and a third harmonic trap to provide a bonus factor in meeting all harmonic attenuation requirements without relying on any other device in the system.

**EFFICIENT COOLING.** Individual Rotron blowers in the RF and modulator stages, and a specially designed air exhaust, allow only a limited amount of direct heat to be

dissipated into the interior of the BC-10H for extra-cool operation.

**OPERATING ECONOMY.** Long tube life, low tube cost, and the highly efficient tank circuit combine to make economy of operation an important feature of the BC-10H.

**ACCESSIBILITY.** Designed for easy servicing, the transmitter front features 2 full-length doors, with operational controls located between the two. Meters

which indicate transmitter operating parameters are located across the front of the cabinet, above the doors. All necessary tuning controls are adjustable in full view of these meters. Further access to the transmitter from the front may be gained by releasing the catches on various front access panels. In addition, 4 panels may be removed from the rear of the transmitter for 100% accessibility. The BC-10H is completely self-contained within one cabinet.

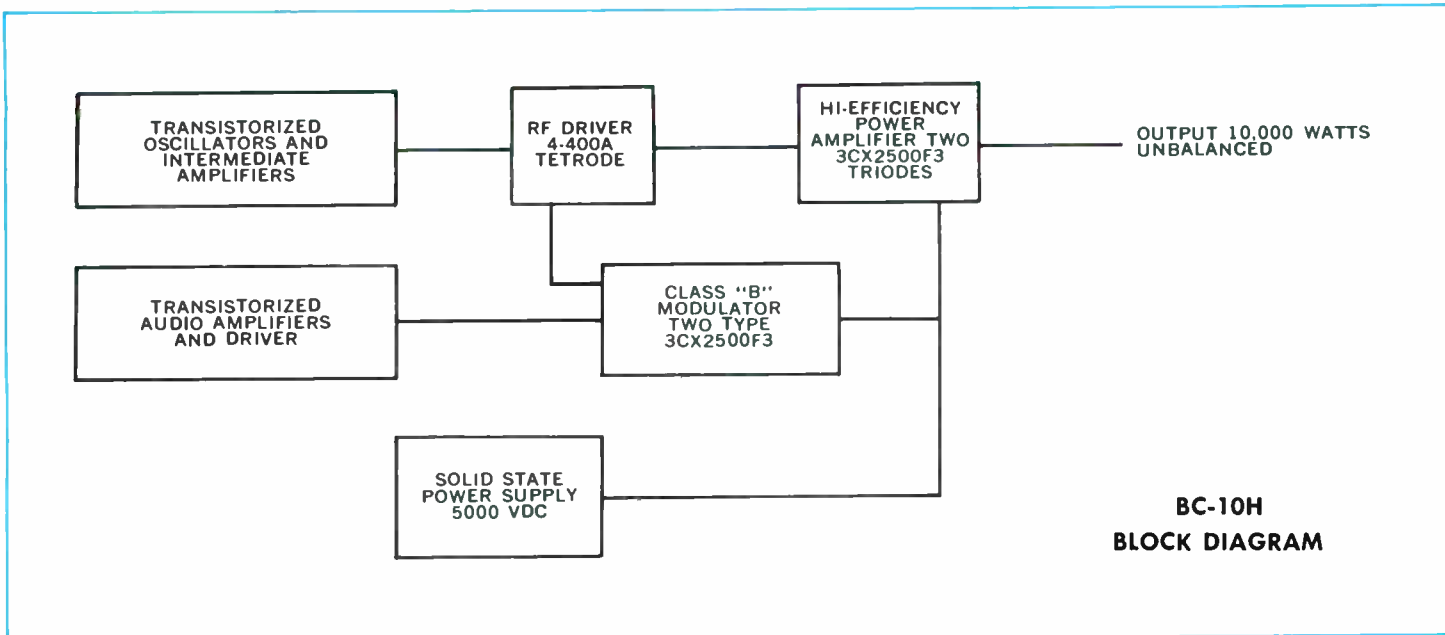

### BC-10H SPECIFICATIONS

**POWER OUTPUT:** (Rated) 10,000 watts. (Capable) 10,800 watts. Power reduction to 5,000, 2,500 or 1,000 watts available.

**RF FREQUENCY RANGE:** 535 kHz to 1620 kHz supplied to one frequency as ordered.

**RF OUTPUT IMPEDANCE:** Supplied for 50 ohms, or other as specified.

**RF FREQUENCY STABILITY:**  $\pm 2$  Hz.

**CARRIER SHIFT:** Less than 3% at 100% modulation.

**RF HARMONICS:** Meets or exceeds FCC specifications.

**MODULATION CAPABILITY:** Positive peaks 125%, negative peaks 100%.

**AUDIO FREQUENCY RESPONSE:**  $\pm 1$  dB, 50 to 10,000 Hz.  $\pm 1\frac{1}{2}$  dB, 30-12,000 Hz.

**AUDIO FREQUENCY DISTORTION:** 2.5% or less 50 Hz to 10,000 Hz at 95% modulation.

**NOISE:** (Unweighted) 60 dB or better below 100% modulation.

**AUDIO INPUT:** 600/150 ohms at +10 dBm,  $\pm 2$  dB.

**POWER INPUT:** 208/230 volts, 3 phase, 50 or 60 Hz. 18.5 kW zero modulation. 21.0 kW average modulation. 27.5 kW 100% modulation.

**AMBIENT TEMPERATURE RANGE:** -20°C to +50°C.

**ALTITUDE:** To 7,500 ft. standard (higher altitudes on special order).

**SIZE:** 78" high, 72" wide, 32" deep (completely self-contained).

**WEIGHT:** 2,500 lbs. unpacked (approximate). 3,050 lbs. domestic packed (approximate). 3,250 lbs. export packed (approximate).

**CUBAGE:** 184 cubic feet packed.

**FINISH:** Beige-gray.

**TUBES USED:** (4) 3CX2500F3, (1) 4-400A. Total—5.

**GENERAL INFORMATION:** Monitors—10 RF volts output at 50/70 ohms for frequency and modulation monitors.

### ORDERING INFORMATION

Model BC-10H transmitter with one set of tubes and two crystals .....	994-6522-005
100% set spare tubes for BC-10H transmitter .....	990-0539-001
Set of spare transistors for BC-10H [diodes not included] .....	990-0760-001
Kit for remote control of power output .....	994-6548-001





**HARRIS**  
COMMUNICATIONS AND  
INFORMATION HANDLING

## MW-5

### 5,000 Watt Medium Wave Broadcast Transmitter

- High level plate modulation, using a Pulse Duration Modulator (PDM)\*
- High overall efficiency—low power consumption
- 125% positive peak modulation capability at 5600 watts
- Only two tubes—one power amplifier and one modulator
- Type accepted at 5,000, 2,500 and 1,000 watts
- Excellent accessibility to all components
- Extremely quiet air-cooled operation, using a low-speed blower
- No modulation transformer or reactor
- Automatic return to full power after power failure
- All remote control accessories built in
- Power level is adjusted in low level PDM stage. No PA loading adjustment required

\*Patented





Front view, doors open.

Similar in design to its big brother, Harris' 50,000-watt MW-50, the MW-5 provides an overall performance superior to other AM broadcast transmitters in the 5-kilowatt power range—at an unusually low operating cost. The MW-5 uses Harris' patented Pulse Duration Modulator (PDM) to obtain conventional high level plate modulation of the single ceramic 3CX2500F3 power amplifier tube. Designed to handle the highly processed audio used in today's competitive market, the MW-5 provides low distortion, excellent transient response, wide frequency response, and high positive peak capability for the loudest, cleanest possible signal.

**HIGH EFFICIENCY—EXCEEDS 52%.** The Pulse Duration Modulator employed in the MW-5 is nearly 90% efficient (instead of the usual 50% or 60%), enabling the transmitter to achieve an unusually high overall efficiency of greater than 52%. This means less power consumption than other 5-kilowatt AM transmitters.

**125% POSITIVE PEAK MODULATION CAPABILITY.** The MW-5 is capable of providing the maximum positive modulation peaks allowed by the FCC (125%), with plenty of reserve for great reliability. This can mean higher average modulation levels for louder, clearer signals, with no increase in transmitter carrier power and no increase in distortion. A wide frequency range is possible, as large reactive components are not used in the modulation system.

**ONLY TWO TUBES.** The entire transmitter employs just two tubes—a 3CX2500F3 PA

and a 4CX3000A modulator—both operating well below manufacturer's dissipation ratings. All power supplies use long-life solid-state silicon rectifiers. Highest quality components, conservatively rated, are used throughout the MW-5 to assure a maximum degree of reliability.

**MAXIMUM CARRIER POWER 5600 WATTS.** The Harris MW-5 provides a maximum carrier power of 5600 watts, which allows more reserve for driving directional arrays. The transmitter uses DC feedback for power output stability, which insures a minimum of RF power output change with a change of the power line voltage. This is especially important where brownouts occur, and where transmitters are only logged every three hours. The MW-5 provides for easy power reduction to one kilowatt—and power may be switched from high to low with carrier on. The PA utilizes 3rd harmonic wave shaping for improved efficiency.

**2.5 KILOWATT USE.** The MW-5 is an excellent choice for stations authorized for operation at 2,500 watts. At this power level the reliability and tube life are truly outstanding. The extra investment is more than recovered if it becomes necessary to increase power to 5 kW. However, the greatest benefit is the increased loudness and coverage of a PDM transmitter over other transmitter designs.

**EASY TUNING.** Tuning is similar to that for a conventional Class C amplifier. Just peak the "relative efficiency" meter on the front panel, using the grid and plate efficiency resonator controls, for proper tuning and maximum efficiency.

**EASY ACCESSIBILITY.** Accessibility is quick and easy to all components—front, rear, inside and out. For instance, the oscillator, RF driver, PDM exciter and audio driver are all immediately available through swing down front panels. The two low voltage power supplies may be lifted out by removing four screws and a few wires. Front and rear doors remove in an instant for ease and maintenance. The entire control circuit panel swings out, allowing relays to be easily cleaned. And meter panels lift up for quick access. Fault indicating devices and a spacious overall transmitter layout will also help the engineer isolate and repair problems in a minimum time.

**RF SECTION.** The RF chain consists of two switchable crystals and oscillators, a buffer, divider, RF amplifier, IPA, RF driver, and PA. Only 15 transistors are used in the entire RF chain.

The crystals and oscillators, buffer, divider and RF amplifier are located on one printed circuit board. The divider is a single IC which is socket mounted for easy replacement. Indicating lamps on the PC board show if voltage is available and if RF is being generated.

The IPA and RF driver are on a swing-down chassis, and consist of five identical Class D, push-pull amplifier modules. One module is used in the IPA and four modules are used in the RF driver. The four RF driver modules are connected so that if one should fail, the remaining three will provide adequate drive to keep the transmitter on the air at full power. Fault lamps indicate which one of the modules failed.

The PA is a standard Class C amplifier and the output network is a conventional Pi/L.

**PROTECTIVE CIRCUITS.** All major components of the MW-5 are protected by circuit breakers, which are easily resettable from the front panel.

Protection against voltage standing wave ratios of greater than 1.2 to 1.0 is provided. Both forward and reflected power are metered at the front panel.

In case of momentary RF overloads, the MW-5 will recycle automatically. Should a repeated overload occur within a thirty-second period, the transmitter will remain off until manually reset. However, if the time between overloads is greater than thirty seconds, continuous recycling will occur.

Five resettable status/overload indicators are located on the meter panel. Remote readout and reset of these indicators are also provided to help the engineer determine if a trip to the transmitter site is required when the transmitter has recycled. For example, VSWR recycles (as determined at the remote control point)



may be caused by lightning or icing of the transmission line. A switch to low power may be all that is necessary, and can be accomplished by remote control.

**QUIET AIR COOLING.** A standard one-half horsepower, single phase motor is used on a quiet, low-speed, belt-driven blower. Provisions are made on the top of the transmitter for ducting the exhaust air to the outside of the transmitter building.

**GENERAL.** An ovenless crystal oscillator is used in the MW-5, allowing all voltages to be removed from the transmitter during maintenance periods or power failures without having an off-frequency condition, due to a cold crystal, when the power is restored.

Lighted front panel pushbuttons indicate operation and power mode of the transmitter.

Automatic recycling is provided and an automatic return after power failure is standard—especially important at remote controlled sites.

A large air filter at the rear of the transmitter may be removed during operation of the transmitter, for cleaning.

**TRANSMITTER LAYOUT.** The MW-5 is completely self-contained in one cabinet—there are no external components.

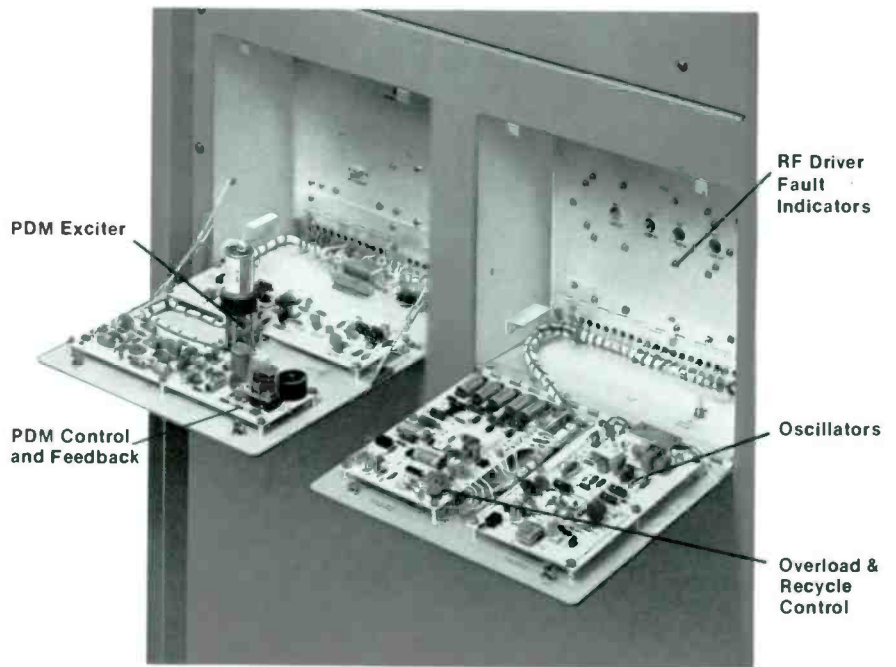

PDM and RF Driver Chassis swing down for easy access.



Rear view, doors open.

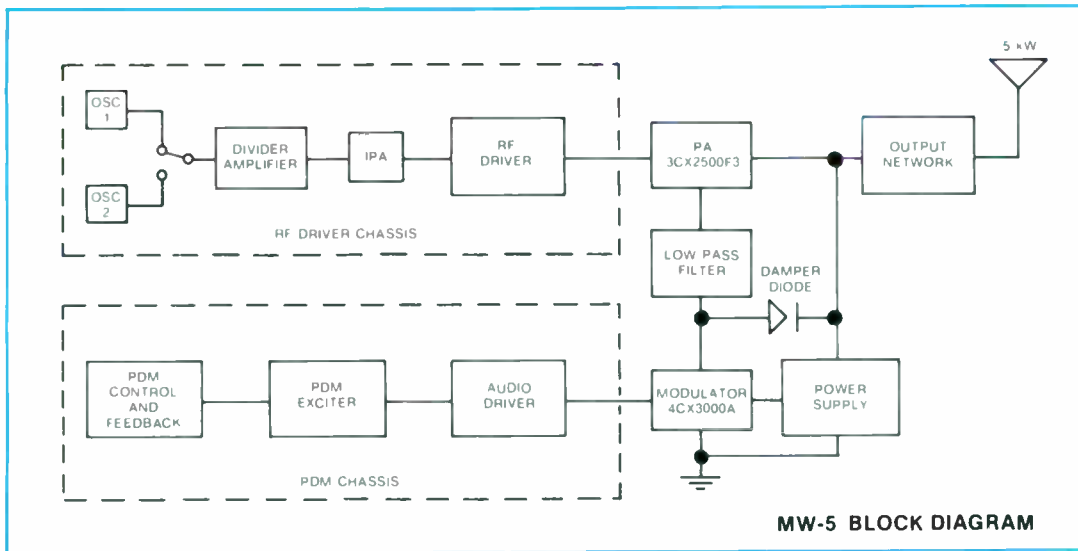

The MW-5 offers convenient access to most components from the front of the transmitter.

## MW-5 SPECIFICATIONS

**POWER OUTPUT.** (Rated) 5000 watts. (Capable) 5600 watts. Type accepted at 5000, 2500, and 1000 watts. High and low power modes can be set between 1000 and 5600 watts.

**RF FREQUENCY RANGE:** 535 kHz to 1620 kHz. Supplied to one frequency as ordered.

**RF OUTPUT IMPEDANCE:** 50 ohms, unbalanced. 40 to 250 ohms available.

**CARRIER SHIFT:** Less than 2% at 100% modulation.

**AUDIO FREQUENCY RESPONSE:**  $\pm 1$  dB, 20 to 10,000 Hz.

**AUDIO FREQUENCY DISTORTION:** 2% or less 20 to 10,000 Hz at 95% modulation.

**NOISE (Unweighted):** 60 dB or better below 100% modulation.

**AUDIO INPUT:** 600/150 ohms at +10 dBm,  $\pm 2$  dB.

**POWER INPUT:** 208/230 volts, 3 phase, 60 Hz and 208/230/380 volts, 3 phase, 50 Hz.

**POWER CONSUMPTION:** 9.5 kW at 0% modulation; 10.0 kW at 40% modulation; 13.0 kW at 100% modulation.

**PLATE EFFICIENCY:** 90% or better.

**OVERALL EFFICIENCY:** Better than 52%.

**POWER FACTOR:** 95%.

**RF HARMONICS:** Meets or exceeds FCC specifications.

**SPURIOUS OUTPUT:** 80 dB or more below 5 kW output.

**POSITIVE PEAK CAPABILITY:** 125% positive peak modulation capability at 5 kW and at 5.6 kW output.

**AMBIENT TEMPERATURE RANGE:**  $-20^{\circ}\text{C}$  to  $+50^{\circ}\text{C}$ .

**ALTITUDE:** Sea level to 7500 feet.

**SIZE:** 78" H x 72" W x 32" D. (198.12 cm x 182.88 cm x 81.28 cm.).

**WEIGHT:** 1250 lbs. unpacked (approximate). (566.99 kg.)

1600 lbs. domestic packed (approximate). (725.75 kg.)

1850 lbs. export packed (approximate). (839.15 kg.)

**CUBAGE:** 120 cubic feet packed. (3.398 cu. meters.)

**FINISH:** Beige gray.

**TUBES USED:** (1) 3CX2500F3 and (1) 4CX3000A.

**MONITOR PROVISIONS:** 10 RF volts output at 50/70 ohms for frequency monitor. 10 RF volts output at 50/70 ohms for modulation monitor.

**REMOTE CONTROL:** Normal interface.

## ORDERING INFORMATION

MW-5 Transmitter with one set of tubes and two crystals, for 208/230 volts, 3 phase, 60 Hz operation. [Specify high and low power desired] ..... 994-7117-001

MW-5 Transmitter with one set of tubes and two crystals, for 208/230/380 volts, 3 phase, 50 Hz operation. [Specify high and low power desired] ..... 994-7117-003

100% set spare tubes for MW-5 ..... 990-0764-001

100% set spare transistors for MW-5 (diodes not included) ..... 990-0765-001

100% set spare diodes (includes HV rectifiers, but no transistors) ..... 990-7067-001

Low voltage and filament regulator, and line regulator for MW-5 available.



**HARRIS**  
COMMUNICATIONS AND  
INFORMATION HANDLING

12,495

# MW-1

## 1000 Watt Medium Wave Broadcast Transmitter



- 100% solid state, including PA and modulator
- High level modulation, using a Progressive Series Modulator [PSM]
- 125% positive peak modulation capability at 1100 watts
- Redundant power amplifier and modulator
- Automatic return to air after power failure
- DC feedback and voltage regulator are standard, for stable power output in the event of varying line voltage or brownouts
- Carrier-on switching from high-to-low or low-to-high power, with no loss of programming
- No modulation transformer, modulation reactor or filter inductor
- Excellent transient response
- All remote control accessories built in
- VSWR protection
- Excellent accessibility to all components
- Extensive use of plug-in modules for easy maintenance
- High overall efficiency—low power consumption
- Quiet, air-cooled operation, using a single fan
- Status/overload indicators on front meter panel with remote readout and reset built in
- Instant “on”—no warmup time
- Resettable front panel circuit breakers to protect all power supplies
- Power level is adjusted in low level PSM stage. No PA loading adjustment is required
- Low voltage used [160 volts]

The newest model in Harris' widely acclaimed MW Series of AM (medium wave) broadcast transmitters, the MW-1 represents another breakthrough from Harris in transmitter design. The one-kilowatt MW-1 introduced two entirely new state-of-the-art features never before included in any FCC type accepted AM transmitter—total solid-state design and a Progressive Series Modulator! Built to handle the highly processed audio used in today's competitive market, the MW-1 provides low distortion, excellent transient response, wide frequency response, and high positive peak capability for the loudest, cleanest signal available in this power range.

**100% SOLID-STATE.** Twelve transistorized power amplifier modules (which include modulators) are operated in parallel to provide 1100 watts output at 125% modulation. Failure of one module will not affect the transmitter's rated performance. Even in the unlikely event that several modules should fail, the transmitter still stays on the air, although at a reduced power level. All other active devices in the MW-1 are also solid state.

**POWER AMPLIFIER.** The PA of each module consists of two transistors operating Class D push-pull (square wave switching mode). This method allows an efficiency of close to 90%



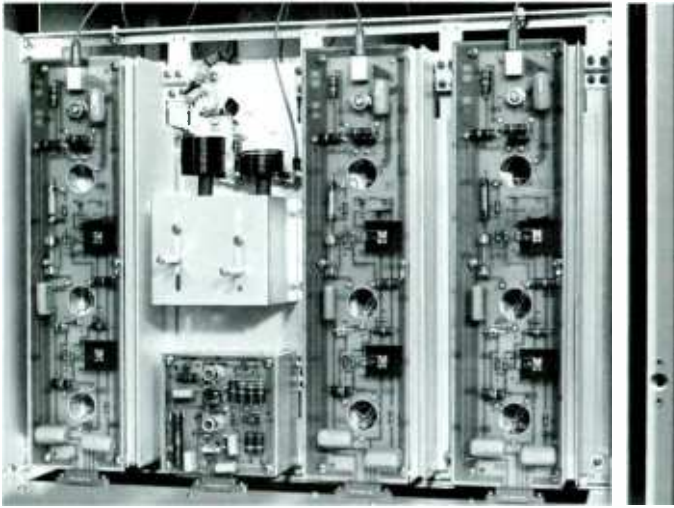

From left to right: one of the PA/Modulator modules, IPA module, RF Driver module, and another PA/Modulator module—all easily accessible from the front of the transmitter.

without the use of special shaping circuits used in tube designs. Each of the twelve PA modules is capable of at least 100 watts carrier and 500 watts peak, to provide full carrier power and modulation capability even with the failure of one modulator or PA.

**PROGRESSIVE SERIES MODULATOR.** The modulator used in the MW-1 is a simple series regulator, connected in such a way as to provide efficient high level modulation without the use of a modulation transformer, modulation reactor, power supply choke or 70 kHz filter. This eliminates components which have limited transmitter performance in the past. Control of the transmitter power over a wide range is accomplished in a low-level stage of the modulator by means of a convenient front panel vernier control. No adjustment is necessary in any high power RF circuit, including the loading coil.

**125% POSITIVE PEAK MODULATION CAPABILITY.** The MW-1 is capable of providing the maximum positive modulation peaks allowed by the FCC (125%). This can mean higher average modulation levels for louder, clearer signals, with no increase in transmitter carrier power and no increase in distortion.

**EASY TUNING.** Tuning is as easy as that of a conventional Class C amplifier. Just dip the PA voltage, and load for the proper current. No grid or plate efficiency resonators are required for maximum efficiency.

**MAXIMUM CARRIER POWER 1100 WATTS.** The Harris MW-1 provides a maximum carrier power of 1100 watts, which allows more reserve for driving directional antenna arrays. The transmitter uses DC feedback and a power supply regulator for power output stability, which insures a minimum of RF power output change with a change of the power line voltage. This is especially important where brownouts occur, and where transmitters are only logged every three hours. The MW-1 provides for easy power reduction to 500 or 250 watts—and power may be switched with carrier and program on!

**EASY ACCESSIBILITY.** Accessibility to all components is quick and easy through front and rear of transmitter. The following modules are plug-in design for easy maintenance: PA/modulator (12 modules), RF driver (identical to PA/modulator modules), IPA, oscillator, audio driver, and audio input and overload. The two low voltage power supplies may be lifted out by removing four screws and a few wires. Front and rear doors remove in an instant. The entire control circuit panel swings out

allowing relays to be easily cleaned. And meter panels lift up for quick access.

Fault indicating devices and a spacious overall transmitter layout will also help the engineer isolate and repair problems in a minimum time.

**RF SECTION.** The RF chain consists of a crystal oscillator, divider, amplifier plug-in module, a plug-in IPA module, a plug-in RF driver module and 12 plug-in PA/modulator modules. Fault indicator lamps are located on the oscillator, IPA, and audio input and overload. Fault indicator lamps for the 12 PA modules are located at eye level on the front panel of the MW-1 for easy visual trouble-shooting.

The RF driver module is identical to the PA modules for redundancy. Should the driver fail, a PA module can be placed in the RF driver location, and the PA allowed to operate with one module short while the failed module is repaired at the engineer's convenience.

The oscillator module is located on a swing-down chassis for easy access.

**PROTECTIVE CIRCUITS.** The two power supplies of the MW-1 are protected by circuit breakers, which are easily reset from the front panel.

Protection against voltage standing wave ratios of greater than 1.2 to 1.0 is provided. Both forward and reflected power are metered at the front panel.

In case of momentary RF overloads, the MW-1 will recycle automatically. Should a repeated overload occur within a thirty-second period, the transmitter will remain off until manually reset. However, if the time between overloads is greater than thirty seconds, continuous recycling will occur.

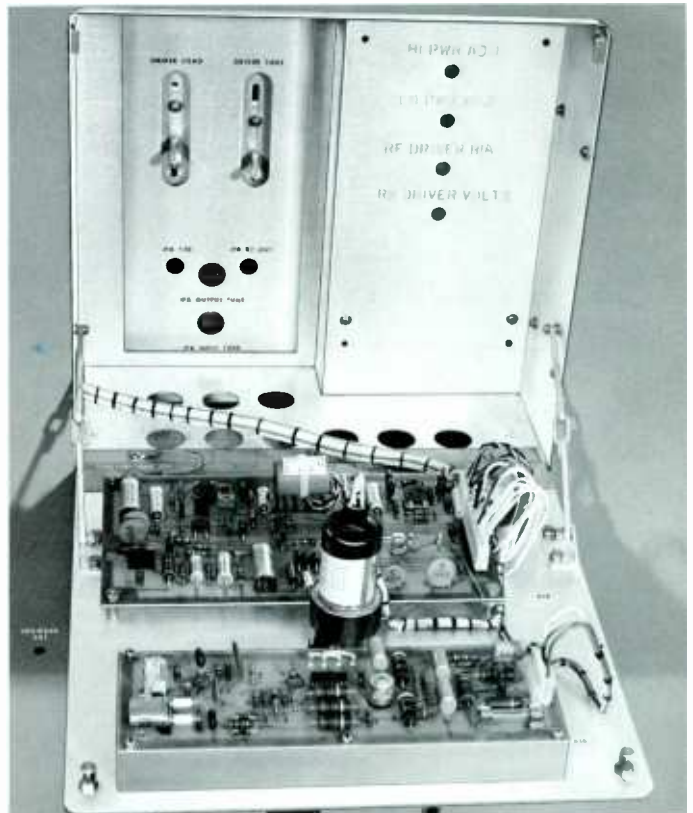

Oscillator and audio input/overload modules, and the remote power control are located on a swing-down panel on the front of the transmitter.

Resettable status/overload indicators are located on the meter panel. Remote readout and reset of these indicators are also provided to help the engineer determine if a trip to the transmitter site is required when the transmitter has recycled. For example, VSWR recycles (as determined at the remote control point) may be caused by lightning or icing of the transmission line. A switch to low power may be all that is necessary, and can be accomplished by remote control. Advanced circuit design provides lightning protection.

**QUIET AIR COOLING.** A single, small fan cools the entire transmitter. No noisy blower is required.

**BUILT-IN DUMMY LOAD.** The MW-1 may be tested at a full kilowatt output with 100% sine wave or full program modulation, using this built-in feature.

**REMOTE CONTROL.** All functions required for remote control are built in, including raise/lower power control, and PA voltage and current metering. A local/remote switch is provided on the control panel so the remote control point cannot turn the

transmitter on while being operated locally. All electrical connections for remote control are brought out to a single terminal board.

**GENERAL.** Normally, no components are removed from the MW-1 for shipment—on delivery, just connect the main AC, audio input and the antenna to the transmitter, make a few adjustments and you are on the air!

An ovenless crystal oscillator is used in the MW-1, allowing all voltages to be removed from the transmitter during maintenance periods or power failures without having an off-frequency condition, due to a cold crystal, when power is restored.

Lighted front panel pushbuttons indicate operation and power mode of the transmitter.

A large air filter at the rear of the MW-1 may be removed for cleaning while the transmitter is in operation.

The MW-1 is completely self-contained in one cabinet—there are no external components.

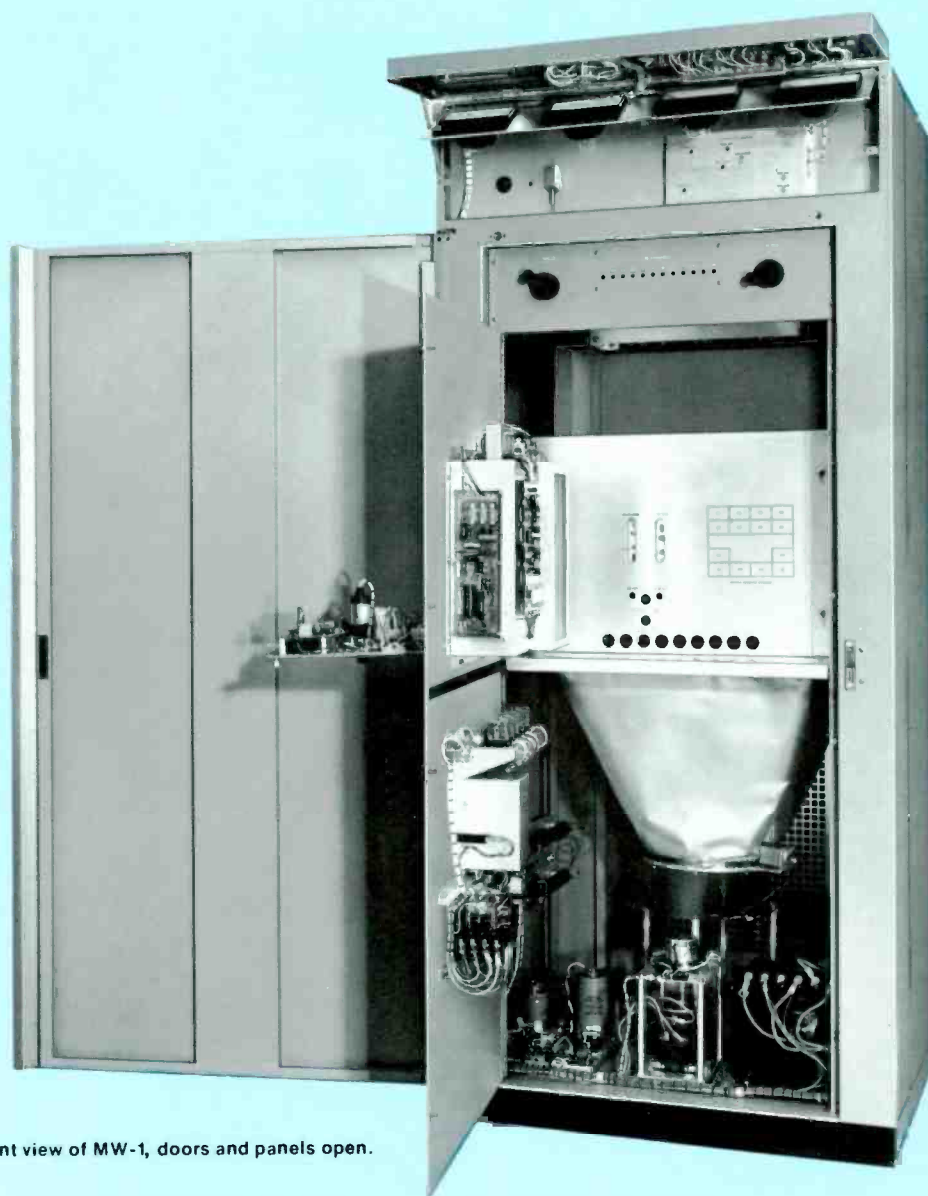

Front view of MW-1, doors and panels open.



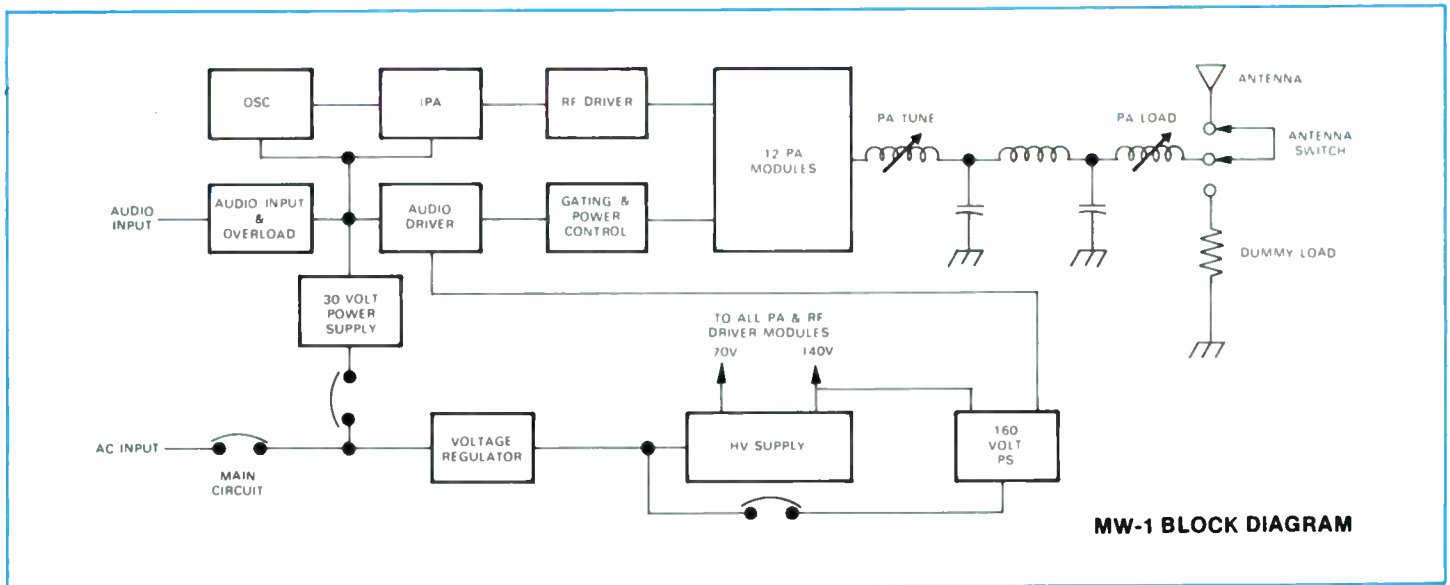

**MW-1 BLOCK DIAGRAM**

### MW-1 SPECIFICATIONS

#### ELECTRICAL

- POWER OUTPUT:** (Rated) 1000 watts. (Capable) 1100 watts. Power reduction to 500 watts or 250 watts.
- RF FREQUENCY RANGE:** 535 kHz to 1620 kHz. Supplied to one frequency as ordered.
- RF OUTPUT INPEDANCE:** 50 ohms, unbalanced.
- CARRIER SHIFT:** Less than 2% at 100% modulation.
- RF HARMONICS:** Meets or exceeds FCC and CCIR specifications.
- AUDIO FREQUENCY RESPONSE:**  $\pm 1$  dB, form 20 to 10,000 Hz.
- AUDIO FREQUENCY DISTORTION:** 1.5% or less at 1 kW, 20 to 10,000 Hz, 95% modulation. 2% or less at 500 and 250 watts, 20 to 10,000 Hz, 95% modulation.
- NOISE (Unweighted):** 60 dB or better below 100% modulation.
- AUDIO INPUT:** 10 dBm,  $\pm 2$  dB, 600 ohms balanced.
- POWER INPUT:** 208/230 volts, 50 or 60 Hz balanced or unbalanced.
- EFFICIENCY:** PA—approaches 90%; overall transmitter—50% or greater.
- POWER CONSUMPTION:** 2.0 kW at 0% modulation at 1000 watts carrier. 3.0 kW at 100% modulation at 1000 watts carrier.
- SPURIOUS OUTPUT:** Meets or exceeds FCC and CCIR requirements.
- POSITIVE PEAK CAPABILITY:** 125% positive peak program modulation capability at 1.0 kW and at 1.1 kW.

- MONITOR PROVISIONS:** 10 volts RF (RMS) modulated output sample at 50 ohms and High/Low balance control.
- REMOTE CONTROL:** Self-contained interface for all standard systems.
- TYPE OF MODULATION:** Progressive Series Modulation (PSM). (Patent Pending.)
- IM DISTORTION:** 2% or less 4/1 or 1/1, 60/2000 Hz or 60/7000 Hz.

#### MECHANICAL

- AMBIENT TEMPERATURE RANGE:** -20° C to + 50° C.
- AMBIENT HUMIDITY RANGE:** 95%.
- ALTITUDE:** Sea level to 10,000 feet.
- SIZE:** 72" H x 31 1/2" W x 31 1/2" D. (183 cm x 80 cm x 80 cm.)
- WEIGHT:** Unpacked, 595 lbs. (270 kg.) - approximate. Domestic packed, 785 lbs. (356 kg.) - approximate. Export packed, 895 lbs. (406 kg.) - approximate.
- CUBAGE:** 68.7 cubic feet (2 cubic meters). packed.
- FINISH:** Beige gray.
- TYPE OF ACTIVE COMPONENTS:** 100% solid state.
- POWER SUPPLY:** Self-contained, dry.
- EXTERNAL COMPONENTS:** None.

### ORDERING INFORMATION

MW-1 transmitter, complete with all solid-state devices and one crystal, for 208/230 volts, single phase, 60 Hz or 50 Hz operation [specify 208 or 230-volt primary service]	994-7707-001
Spare PA module	992-4201-001
Spare plug-in IPA module	992-4202-001
Spare plug-in oscillator module	992-4207-001
Spare plug-in audio driver module	992-4206-001
Spare plug-in audio input/overload module	992-4205-001
100% spare rectifier kit	990-0810-001
Recommended spare rectifier kit	990-0807-001
100% spare transistor kit	990-0811-001
Recommended spare transistor kit	990-0812-001
Spare crystal	444-XXXX-000



**HARRIS**  
COMMUNICATIONS AND  
INFORMATION HANDLING

# PDM

## Pulse Duration Modulator

Harris' patented Pulse Duration Modulation (PDM) is used in the Harris VP-100A, SW-100, SW-50, MW-50, and MW-5 broadcast transmitters. PDM produces conventional high level plate modulation . . . the difference is simply the manner in which the audio signal is amplified and applied in series with the RF amplifier plate supply. However, this one difference provides several distinct advantages . . . particularly a much higher efficiency, and the elimination of large iron core components.

The Pulse Duration Modulator operates as follows:

1. The audio input (A) is added to a 75 kHz sawtooth wave (B) to form (C).
2. A threshold level (power control) is set and determines the point on the sawtooth wave at which the pulse amplifier will conduct. After clipping and amplification, squared pulses (D), which vary in duration with the input audio, are formed.
3. A low pass filter removes the 75 kHz pulse rate, leaving very high audio power to fully modulate the PA. No modulation transformer or reactor is required.

The duty cycle of the pulse determines the voltage at the plate of the PA. For instance, a 50% duty cycle will produce 13 kV at the PA or the 100 kW carrier; a 100% duty cycle will place the full supply voltage of about 28 kV on the PA which conforms to over 100% positive modulation peak; a 0% duty cycle will produce 0 voltage at the PA or the 100% negative modulation tip. The rate of variation of the pulse width is the audio signal . . . hence a Pulse Duration Modulator.

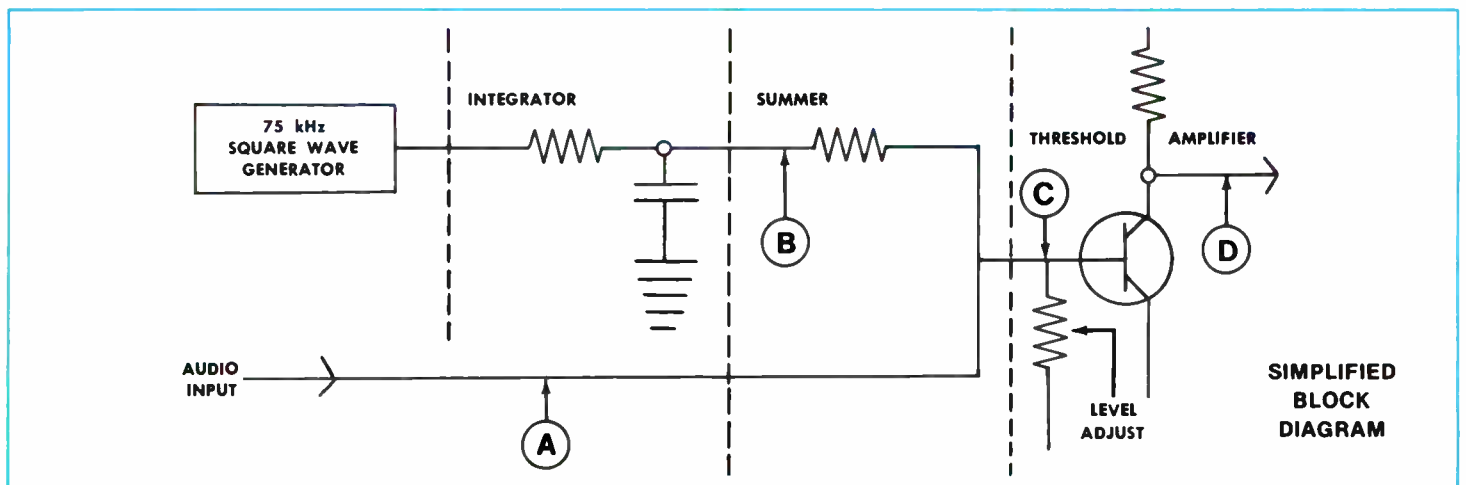
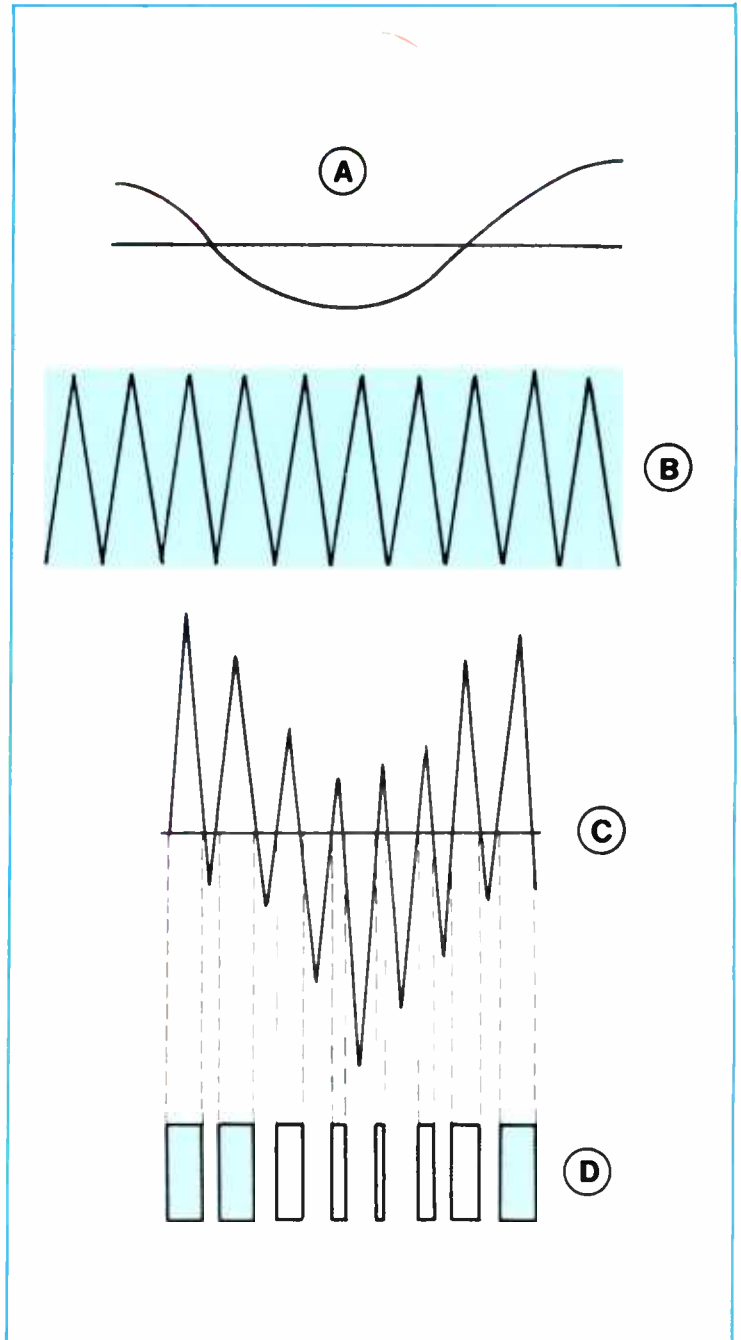

# PSM

## Progressive Series Modulator

Up to now, series modulators—which have the advantage of great operational simplicity—have been too inefficient to be used effectively. Now, with the introduction of Harris' Progressive Series Modulator, simplicity and high efficiency have been combined into one excellent high-level modulation method which is used in Harris' solid-state 1 kilowatt AM transmitter, the MW-1.

A conventional series modulator is shown in Figure A. It has one active device, Q1 (modulator), which regulates the 100 volt power supply to provide the proper voltage at carrier and the modulation voltage to the PA. Its only drawback is its inefficiency. Under carrier conditions, only 50 volts is required at the PA. This means 50 volts is also across the modulator, Q1. Whatever current is required at the PA must flow through Q1.

Assume 24 amps and 50 volts is required at the PA to achieve the 1000-watt carrier. This means 24 amps is also flowing in Q1 and the power lost in Q1 is 1200 watts (all heat). This is much too inefficient, even for a one kilowatt transmitter. The PA and output network operate at about 85%, so the loss in the PA and output network is only 200 watts. (1200 watts input and 1000 watts rf output = 85% efficiency.)

If the advantages of a DC coupled series modulator are to be utilized, a more efficient method must be found—hence a Progressive Series Modulator (PSM). PSM is two series modulators, in series, as shown in Figure B. Two power supply voltages are now used. One is a little higher than that required to produce the proper PA voltage at carrier conditions, and the second is high enough to provide the positive peak required.

Now, during carrier, all the PA voltage comes from the 52-volt supply through CR1 and Q1. Only about 2 volts is lost across the modulator, so the required 50 volts, 24 amps is provided the PA. The loss across the modulator at carrier is now  $2 \times 24$ , or 48 watts, and the power to the PA is  $50 \times 24$ , or 1200 watts.

During the positive peak the PA voltage is supplied from the 104-volt supply through Q2 and Q1 (CR1 disconnects the 52-volt supply when Q2 turns on). During the negative peak Q2 is open, and the voltage is supplied from the 52-volt supply through CR1 and Q1.

Thus PSM—a Progressive Series Modulator which is highly efficient, is DC coupled, has excellent transient response, and requires no modulation transformer or reactor or filter inductor.

NOTE: Voltages used in the MW-1 vary slightly from the example above, to provide 125% positive peak modulation capability.

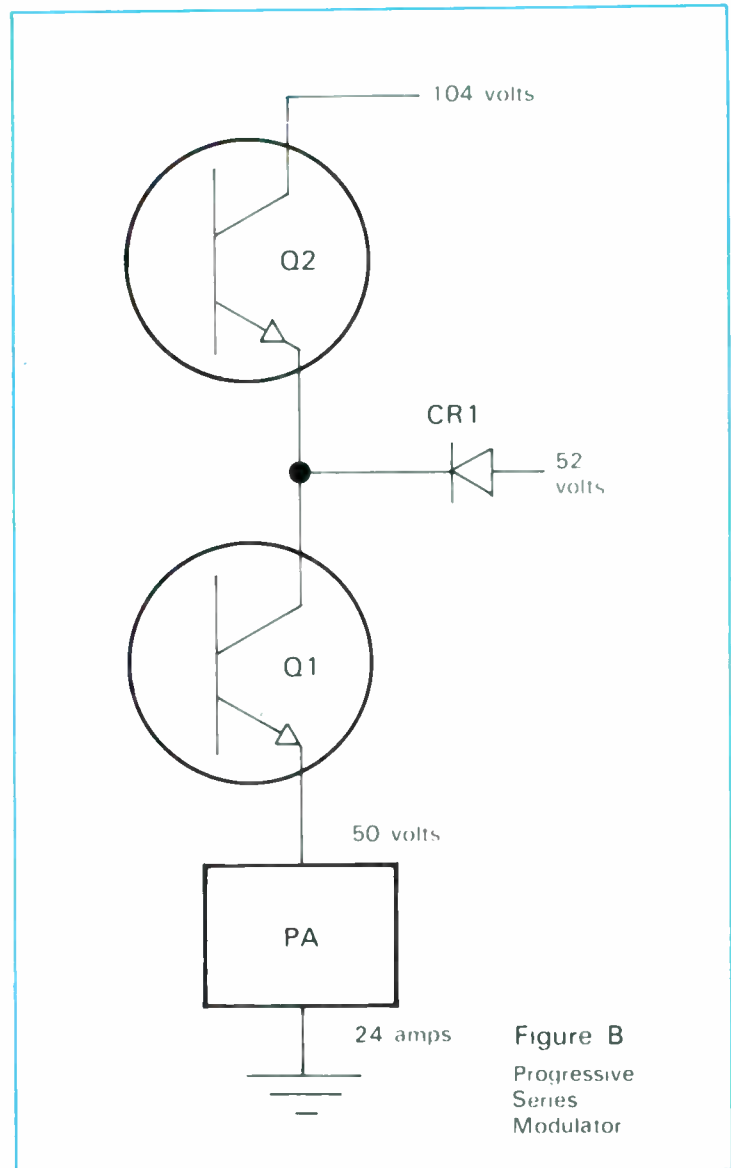
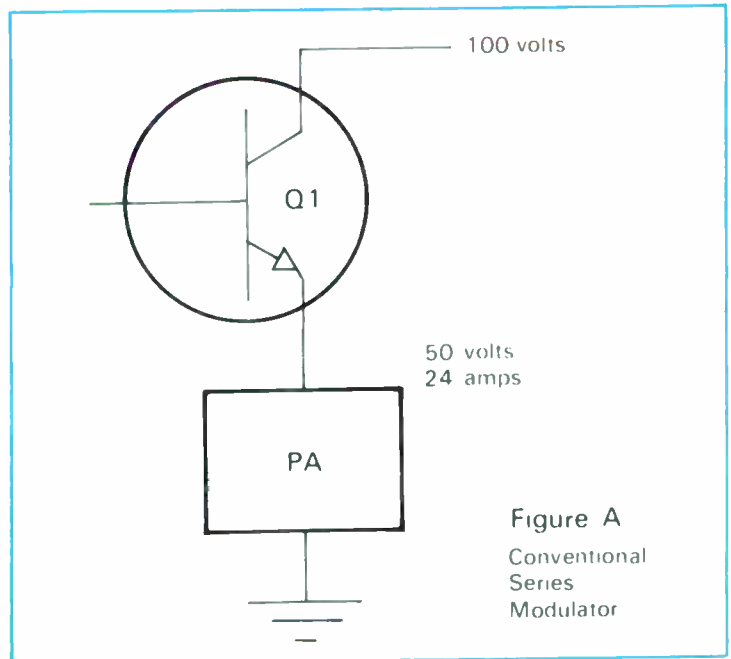



**HARRIS**  
COMMUNICATIONS AND  
INFORMATION HANDLING

## ANTENNA PHASING EQUIPMENT

Harris phasing equipment is custom built, utilizing Harris manufactured inductors and other quality components for precise coverage patterns requiring a minimum of adjustment and a maximum of stability. Some of the most complex phasing systems in existence have been built by Harris.

**ADVANCED RESEARCH.** As the world leader in the design and manufacture of phasing equipment, Harris engages in highly advanced phasor research and development. All Harris phasing systems are computer designed to assure maximum accuracy and most efficient circuitry. Phasor construction is carried out by a group of design and production experts, with years of experience in specialized phasing equipment. This group is under the direction of a registered professional engineer.

**CONSTRUCTION.** Antenna tuning units are constructed as a panel and shelf type for wall mounting in a doghouse, or in weatherproof metal cabinets. Phasor cabinetry built to your specifications is available, and becomes an integral planning factor in the coordination of design and styling to reflect over-all system compatibility and appearance.

Harris manufactures phasing equipment for any power, for any number of towers; 250 watt to 250 kilowatt tuning units; diplexers for medium wave and for 2-30 MHz short wave; triplexers, rejection filters, and a wide range of radio frequency networks. Each is custom tailored for the particular application.





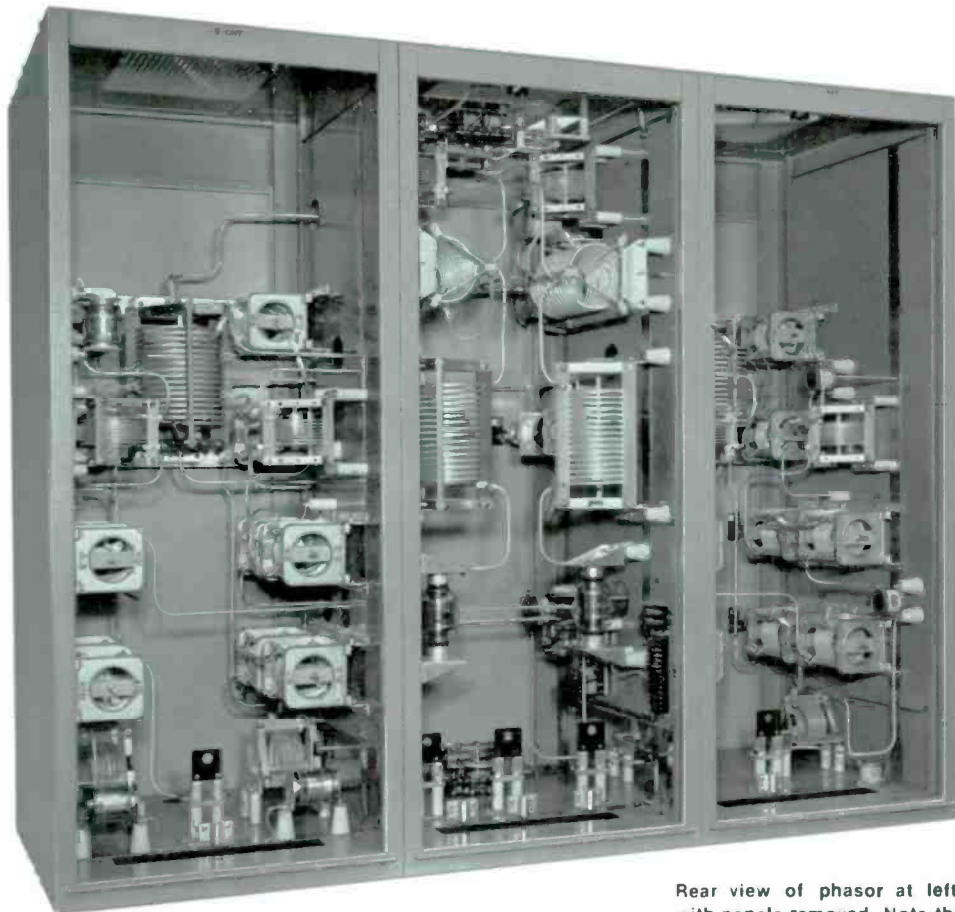

Rear view of phasor at left, with panels removed. Note the clean mechanical layout.

**STABILITY AND EFFICIENCY.** All directional phasing equipment is designed to the parameters provided by the station's consulting engineer, and work is not initiated until the consultant and customer approve the design. To furnish custom designed phasors suited for specific broadcasting needs, Harris provides detailed specifications for your equipment, so you may determine exactly what you are buying. The full range of adjustment can be precisely determined by computer—before it is delivered. This avoids the possibility of having to replace inadequate components, or make costly field modifications of design to relieve difficult adjustment.

The careful design and construction practices maintained by Harris give you more than reasonable assurance of the best possible long term stability and efficiency. This avoids expensive readjustments and reproof of pattern later on.

Harris phasors are constructed with a capability of 1.4 times carrier RMS current and a peak voltage capability 5 times RMS carrier voltage based on expected operating adjustments.

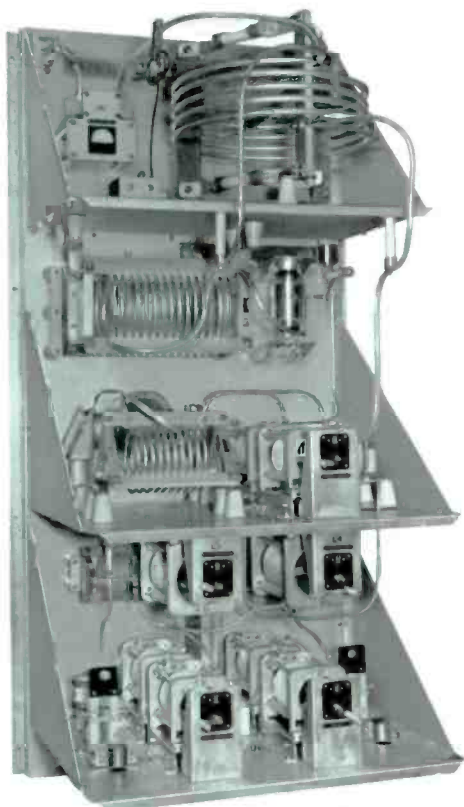

Custom-built open panel phasor.



**10 kW MEDIUM WAVE DIPLEXER**

Numerous diplexers, triplexers, RF filters and custom designed networks are considered normal design and construction activity at Harris. The above illustrates a 10 kW medium wave diplexer that permits two AM transmitters to feed a common vertical radiator.



## COMMON POINT IMPEDANCE BRIDGE

The Model CPB-1 and CPB-1A Common Point Impedance Bridges are operating impedance bridges similar to the Model OIB-1, but designed for permanent installation in your phasing equipment at the antenna common point. Instruments have two 4" dials calibrated directly in resistance and reactance. A panel meter is provided for a null detector. The R & X dials are manipulated as a normal bridge while the transmitter is operating at full or reduced power to give a null indication on the panel meter. The value of the common point resistance and reactance can then be read directly from the two dials.

It has been found that many directional antennas have common point impedances which vary from time to time due to seasonal changes in the ground system and minor tuning drift of the antenna parameters. On many occasions it was found from remeasurement of the common point impedance that the station had been transmitting with somewhat less than full power for some time because of these changes. The CPB-1 and CPB-1A permit the station operator to determine the common point

impedance at any time, even during normal operating hours. By minor adjustment of the common point resistance control, he can maintain his radiated power at the full license value at all times. He also has a method of detecting changes in his antenna system which affect the common point. This may alert him to equipment faults and prevent citations for antenna misadjustment.

CPB-1 and CPB-1A bridges are normally supplied mounted on a standard 19" x 7" rack panel. A cutout can be made in the antenna phasing equipment for mounting this panel. Both bridges are also available without the rack panel. A drill template is then supplied, permitting the station engineer to mount the bridge in the existing panel of the antenna phasor.

### SPECIFICATIONS

**FREQUENCY RANGE:** 500-1650 kHz.

**POWER RATING:** CPB-1—5 kW—100% amp. mod. continuous.  
CPB-1A—50 kW—100% amp. mod. continuous.

**RESISTANCE RANGE:** 30-100 ohms.

**REACTANCE RANGE:**  $\pm 50$  ohms (1000 kHz).

**ACCURACY:** Resistance  $\pm 2\%$   $\pm 1$  ohm. Reactance  $\pm 5\%$   $\pm 1$  ohm.  
(Provision is made for your consultant to adjust the calibration to agree exactly with your licensed resistance value).

**RF SOURCE:** Your transmitter operating at normal or reduced power acts as source—no generator is required.

**DETECTOR:** Tuned internal detector with 25 ua panel meter—no external detector is required.

**AMMETER:** Panel hole is provided for Weston Model 308, 3 1/2" square ammeter. A meter recessing bracket is supplied for high power applications. A matching meter for your power and resistance can be supplied.

**TERMINALS:** Screw terminals or standoff insulators at rear of bridge box for connection to tubing, strap, or jumper to coax is provided.

**MOUNTING:** Standard 7" x 19" engraved gray rack panel—can be supplied without panel for mounting behind your phasor panel (drill template supplied).

**DIMENSIONS:** Bridge box without panel: Height: 7", Width: 9", Depth: 9 1/4". Panel dimensions: 7" x 19".

### ORDERING INFORMATION

CPB-1 Common Point Impedance Bridge, 5 kW . . . . . 700-0055-000

CPB-1A Common Point Impedance Bridge, 50 kW . . . . . 700-0056-000





**HARRIS**  
COMMUNICATIONS AND  
INFORMATION HANDLING

## OPERATING IMPEDANCE BRIDGE

- Measures "in circuit" operating impedance—500 kHz to 5 MHz.
- Handles through power up to 10 kW.
- No signal generator or external detector required for measurement under power.
- Can be used with signal generator and receiver as a normal bridge.
- Measures negative impedance loads.
- Ideal for use in adjusting multi-tower directional antennas.



The Model OIB-1 Operating Impedance Bridge measures the operating impedance of the individual radiators, networks, transmission line sections, and common point of directional antenna systems while they are functioning normally and under power. This "operating impedance" cannot be measured by normal impedance bridge methods because the system characteristics are disrupted when the bridge is inserted in the circuit. The OIB-1 thus satisfies a critical requirement long felt by consulting and broadcast station engineers. In addition, it has many applications in other fields that cannot be duplicated by any other instrument.

The OIB-1 is inserted directly in series with the transmission line, network, or antenna. The transmitter power is applied and a bridge balance is obtained by manipulating the R and X dials on the face of the bridge. Balance is indicated by a null reading on the meter, which is mounted on the front panel of the bridge. Operating resistance and reactance are then read directly from the bridge dials. The VSWR on a transmission line can be read directly from a scale on the meter.

### SPECIFICATIONS

**FREQUENCY RANGE:** 500 kHz to 5 MHz.

**THROUGH POWER RATING:** 10 kW, carrier only, no modulation with VSWR 3:1.

**INSERTION EFFECT:** Equal to 9" of 150-ohm line.

**FUNCTIONS:** Direct reading in R, -400 to +400 ohms. Direct reading in X, -300 to +300 ohms. Measures VSWR,  $Z_0 = 0$  to 400 ohms. Indicates relative forward and reflected power.

**ACCURACY:** R and X,  $\pm 2\%$   $\pm 1$  ohm. Dials individually calibrated and engraved.

**RF SOURCE:** Transmitter, transmission line, etc., or signal generator with adapting connector.

**DETECTOR:** Internal for high power source. Connector on front panel for external detector when used with signal generator. Amplifier for internal detector available as factory installed option if high sensitivity is desired.

**TERMINALS:** Input and output are large UHF receptacles (UG-357/U). 12" input and output clip leads are supplied as standard with bridge. 18" leads optional at no extra cost when specified with order. External detector connection is BNC.

**ACCESSORIES:** Aluminum polyurethane-lined transport case.

**DIMENSIONS:** 12½" x 9½" x 5¼" deep.

**WEIGHT:** 10 lbs.

### ORDERING INFORMATION

Model OIB-1 Operating Impedance Bridge, with 12 inch leads .....	700-0063-000
Model OIB-1 Operating Impedance Bridge, with 18 inch leads .....	700-0146-000
D.C. Amplifier. Used to increase sensitivity of Bridge for use with power sources as low as 25 watts .....	700-0064-000
TC-1 Transport Case. For OIB-1 .....	700-0065-000



# AM ANTENNA COUPLERS AND ACCESSORIES

## WEATHERPROOF 5-10 KW ANTENNA COUPLING UNITS



Housed in aluminum cabinet with double front doors. Porthole for meter reading and heavy duty meter shorting switch operates with doors closed. Large micalex insulated silver plated coils combined with capacitors of generous voltage and current ratings to assure a lifetime of service under extreme heat or cold. A large antenna lead in bowl is provided. Mounting is with metal flanges on the back of the tuning unit for attachment to wooden poles set in ground or for mounting on wall.

### SPECIFICATIONS

**CARRIER POWER:** M-5309A 5,000 watts AM, M-5309B 10,000 watts AM.  
**FREQUENCY:** 525-1,700 KHz as ordered.  
**LINE IMPEDANCE:** 40-230 ohms as ordered.  
**TO MATCH:** Series fed tower of from 70° to 95° electrical length.  
**CIRCUIT:** Full Tee Network.  
**WEIGHT:** Approximately 200 lbs.  
**SIZE:** 38" high, 37" wide, 21 1/2" deep.

### ORDERING INFORMATION

Antenna Coupling Unit, 5 kW . . . . . 994-5309A  
 Antenna Coupling Unit, 10 kW . . . . . 994-5309B  
**NOTE:** When ordering, state carrier frequency, transmission line impedance, power, tower height and tower measurements, if known. Couplers to match unusual loads such as short or tall towers, shunt feed, etc., are available on special order, at extra cost.

## RF ANTENNA METERS

Internal thermocouple standard scale. Weston Model 308, three-inch square case. Other ranges not listed below are available with many carried in stock. Also expanded scale meters in inventory.

### ORDERING INFORMATION

Meter, 0-3 R.F. amperes . . . . . 634-0206-000  
 Meter, 0-6 R.F. amperes . . . . . 634-0238-000  
 Meter, 0-8 R.F. amperes . . . . . 634-0209-000  
 Meter, 0-10 R.F. amperes . . . . . 634-0210-000

## METER JACK AND SHORTING BAR-MOUNTING PLUG



A great convenience to allow RF current measurements to be made by simply plugging in a meter. Will accommodate most 3" or 4" meters. A "must" in critical RF circuit areas in phasors, couplers, etc. Rating up to 50 kW on a 50 ohm line.

### ORDERING INFORMATION

Meter jack and shorting bar . . . . . 994-3280-002  
 Meter mounting plug . . . . . 994-3281-001

## METER SHORTING SWITCH



A heavy duty, make-before-break meter shorting switch of the plunger or push type. Heavy bronze tempered spring grips on both sides assure accuracy and durability.

### ORDERING INFORMATION

Meter Shorting Switch, rating 15 amperes . . . . . 994-3493-001  
 Meter Shorting Switch, rating 40 amperes . . . . . 994-6527-001

## WEATHERPROOF SERIES—FED ANTENNA COUPLER, 1250 WATTS

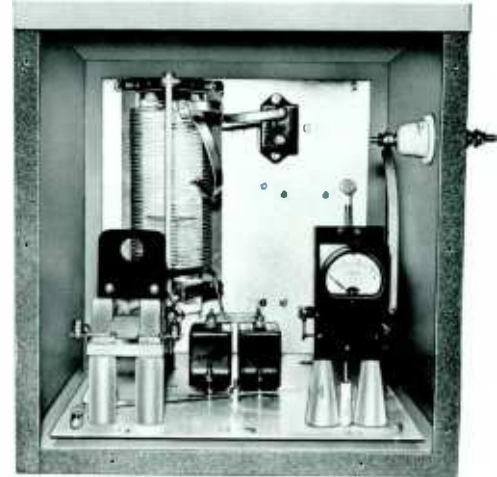

Recommended for broadcast transmitter powers of 1,000, 500 and 250 watts, 100% modulated. Heavy edgewound micalex insulated silver plated coil has generous inductance for a full Tee network along with fixed mica capacitors supplied. Extra room is provided to install either diode or thermocouple remote metering equipment. Heavy duty meter shorting switch eliminates antenna meter from the circuit when not in use for lightning protection. Meter is observed through plexiglass porthole.

Front door of cabinet has been removed for illustrative purposes.

### SPECIFICATIONS

**CARRIER POWER:** Up to 1250 watts AM.  
**FREQUENCY:** 525-1700 kHz as ordered.  
**LINE IMPEDANCE:** 40-230 ohms as ordered.  
**TO MATCH:** Series-fed tower of from 70° to 95° electrical length.  
**CIRCUIT:** Full Tee Network.  
**WEIGHT:** 98 lbs.  
**SIZE:** 20" high, 20 1/4" wide, 18 3/4" deep.

### ORDERING INFORMATION

Antenna Coupler with antenna meter . . . . . 994-3494-001  
**NOTE:** When ordering, state transmission line impedance, frequency, tower height, and tower measurements, if known. For remote meters, see facing page. Couplers to match unusual loads such as short or tall towers, shunt feed, etc., are available on special order at extra cost.





## SOLENOID TOWER CHOKES

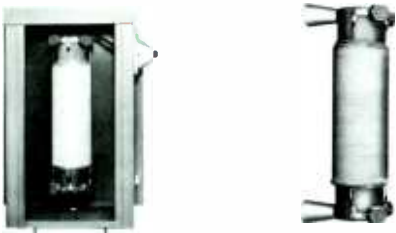

**A** (20 AMP AC RATING) **B**

Most popular of all tower light isolation chokes. Available in 2 or 3 section and in open type, or weatherproof as illustrated. Wound on heavy triple X tubing with mica-by-pass condensers on each circuit end. Inductance approximately 350 uH. 3" stand-off insulators are part of coil. (Weatherproof type), 24" high, 17 3/4" wide, 10 1/4" deep. Illustration to left shows weatherproof unit with front cover removed.

### ORDERING INFORMATION

**Tower Choke, 2 wire, weatherproof,**  
**Fig. A** ..... 994-3937-001  
**Tower Choke, 3 wire, weatherproof,**  
**Fig. A** ..... 994-3938-001  
**Tower Choke, 2 wire, open type,**  
**Fig. B** ..... 994-3935-001  
**Tower Choke, 3 wire, open type,**  
**Fig. B** ..... 994-3936-001

## ISOLATION COIL

This isolation coil is quickly made to customer's order by carrying all basic materials in stock. The same type of coaxial cable is used in winding the coil as is used for sampling line. If the customer used Heliac sampling line, then the isolation coil would be wound with Heliac coaxial cable. Nominal inductance 85 uH. Available in weatherproof or open model. Sizes (weatherproof model), 20" wide, 12 1/2" high and 18 1/2" deep. (Open model), 16" wide, 10" high and 16" deep. When ordering, please state type or make of sampling line or preferred coaxial cable for coil construction. Resonating capacitor is not included.

### ORDERING INFORMATION

**Weatherproof unit** ..... 994-3073-006  
**Open unit, less cabinet** ..... 994-4561-007

## LARGE INVENTORY OF METERS

In the manufacture of transmitting and audio equipment for broadcasting, communications and defense, Harris is required to carry thousands of meters in inventory. Whether AC, DC, or RF, or microammeter, milliammeter or ammeter, it is very likely the meter you need in emergency or expansion is quickly available. Give us desired case size, range and type of movement and we will serve you speedily. Many meters are also carried at our Houston and New York branches.

## RADIO FREQUENCY CONTACTOR

A heavy duty solenoid operated RF contactor for most switching applications through 50 kW power. Available in DPDT type in two voltage ratings. Will operate on 115/230 volts AC, latching type. Will handle up to 25 amperes per contact, and has four auxiliary switches mechanically linked with the contactors.

### ORDERING INFORMATION

**Contactor DPDT insulated**  
**22 kV peak voltage** ..... 994-7807-001

## DIODE TYPE REMOTE METER EQUIPMENT



For remote indication of RF current. Consists of a carefully constructed pickup loop attached through a short coaxial cable to a solid-state rectifier assembly. RF current is measured without breaking the main lead. No AC power is required. May be used with any good 1 MA DC meter. Power range: 250 watts to 50,000 watts. Frequency range: 540 kHz to 1600 kHz.

### ORDERING INFORMATION

**Diode remote meter unit,**  
**less meter** ..... 994-6112-001  
**Meter 3" sq. case,**  
**scale 0-3 R.F. amperes** ..... 632-0418-000  
**Meter 3" sq. case,**  
**scale 0-5 R.F. amperes** ..... 632-0419-000  
**Meter 3" sq. case,**  
**scale 0-8 R.F. amperes** ..... 632-0420-000  
**Meter 3" sq. case,**  
**scale 0-10 R.F. amperes** ..... 632-0421-000  
**Meter 4" sq. case,**  
**scale 0-3 R.F. amperes** ..... 632-0424-000  
**Meter 4" sq. case,**  
**scale 0-8 R.F. amperes** ..... 632-0426-000  
**Meter 4" sq. case,**  
**scale 0-10 R.F. amperes** ..... 632-0361-000  
**Meter 4" sq. case,**  
**scale 0.15 R.F. amperes** ..... 632-0428-000  
**NOTE: Other meter scale ranges available at extra cost. Above for use with diode remote unit, not thermocouple.**

## HEAVY DUTY SAMPLING LOOP



This is a very rugged fixed non-shielded RF sampling loop. It is heavily galvanized after welding, and is fitted with large steatite insulators and heavy duty tower leg clamps for easy and positive mounting. Complete with type "N" jack. For 50 to 70 ohm sampling line.

### ORDERING INFORMATION

**Heavy duty sampling loop** ..... 994-6126-001

## FEED-THRU BOWLS



**M-2870D Feed-thru Bowl.**

A large feed-thru bowl with 50 kW modulated rating. Available in single and double units and with solid or hollow studs as listed below. Bowls are Alsimag. Hardware, heavy brass. Velutex seals are provided for weathertight installation.

### ORDERING INFORMATION

**Solid stud, 2 bowls, for walls**  
**to 1 1/2" thick** ..... 994-2870-001  
**Same as above but hollow stud** ..... 994-3254-001  
**Solid stud, single bowl, for**  
**walls 1" thick** ..... 994-5280-001  
**Same as above but hollow stud** ..... 994-5281-001





**HARRIS**  
COMMUNICATIONS AND  
INFORMATION HANDLING

# AM-80

## Medium Wave Modulation Monitor

Harris' AM-80 medium wave modulation monitor is an FCC type-accepted solid-state instrument designed to meet or exceed all requirements for measuring modulation percentages of broadcast and short-wave stations in the frequency range 540 kHz to 30 MHz. It will provide the accurate and dependable monitoring required by the FCC, and is suitable for proof-of-performance measurements.

**METERS.** There are two meters on the front of the AM-80. The Carrier Meter provides a continuous indication of the RF carrier amplitude. The % of Modulation Meter provides continuous indication of the modulation percentage on the RF carrier. Two Flasher Lamps are provided to indicate both positive and negative peaks when the percent of modulation exceeds the present levels.

**AUDIO OUTPUTS.** Proof-of-performance measurements can be taken from the monitor's high-fidelity output with absolute assurance that readings of transmitter performance are accurate. A 600-ohm audio output is also provided to supply aural monitoring in the control rooms.

**REMOTE OPERATION.** Modulation readings by meter and flashers at a distant location are obtainable with a Harris optional remote meter panel. Three separate output circuits provide (1) a ballistically correct signal for a remote meter with a total loop resistance of 5,000 ohms or less, (2) a remote negative peak flasher and (3) a remote positive peak flasher.

**TRANSIENT PROTECTION.** A special limiter is provided for use on the RF input to clip transients which may damage the input diodes.

### SPECIFICATIONS

**FREQUENCY RANGE:** 540 kHz to 30 MHz.

**RF INPUT:** For 50-ohm line at 6 to 20 volts.

**POWER SOURCE:** 105-125/210-250 volts, 50/60 Hz, 10 watts.

#### MODULATION INDICATION

**METER:** 0% to 100% on negative peaks.

0% to 130% on positive peaks.

**NEGATIVE FLASHER:** 50% to 100% on negative peaks, continuously adjustable.

**POSITIVE FLASHER:** 50%, 90%, 95%, 100%, 105%, 110%, 115%, 120%, 125%, 130% and off.

**ACCURACY:** Meter is  $\pm 2\%$  of full scale at 1,000 Hz. Flashers are  $\pm 2\%$  at 1,000 Hz.

#### AUDIO MONITOR OUTPUT

**FREQUENCY RESPONSE:**  $\pm 0.5$  dB from 20 Hz to 20 kHz.

**DISTORTION:** Less than 0.3% with 600-ohm load at 100% modulation.

**OUTPUT VOLTAGE:** At 100% modulation, output is 0.55 volts into a 600-ohm load, approximately -10 dBm average.

**OUTPUT IMPEDANCE:** 600 ohms, unbalanced.

#### FIDELITY MEASURING OUTPUT

**FREQUENCY RESPONSE:**  $\pm 0.5$  dB, 20 Hz to 20 kHz.

**DISTORTION:** Less than 0.3%

**OUTPUT VOLTAGE:** At 100% modulation, output is 4.4 volts with a load resistance greater than 100,000 ohms.

**OUTPUT IMPEDANCE:** 4,000 ohms, unbalanced.

**NOISE:** 70 dB below nominal outputs of both monitoring and fidelity outputs.

**REMOTE OUTPUT:** For meter and flasher indications at another location, use Harris' remote meter panel 994-7097-001.

#### GENERAL

**SIZE:** 19" long x 7" high x 7" deep. (48.26 cm x 17.78 cm x 17.78 cm.) Will mount in a standard relay rack.

**WEIGHT:** Domestic, 12 lbs. (5.44 kg). Export, 21 lbs. (9.53 kg). Cubage: 3 cubic feet.

**AMBIENT TEMPERATURE RANGE:** -4° to 125° F. (-20° to 52° C.)

**AMBIENT HUMIDITY RANGE:** 0% to 95% relative humidity.

**ALTITUDE:** Sea level to 7500 feet (2286 meters).

### ORDERING INFORMATION

AM-80 Solid-state AM Modulation Monitor ..... 994-7084-001

AM-80 Remote Meter Panel ..... 994-7097-001

100% Spare Fuse, Diode, Lamp & Transistor Kit for AM-80 . 994-7180-001





# MEDIUM WAVE FREQUENCY MONITOR

Harris' medium wave frequency monitors are FCC type accepted instruments designed to meet or exceed all requirements for measuring carrier frequencies of standard AM broadcast transmitters.

Available in a digital read-out model, or in a version with conventional analog (meter) display, these frequency monitors employ solid-state integrated circuits throughout, and feature light-emitting diode (LED) indicators.

The monitors will accept as input any standard AM frequency, and will indicate the deviation from assigned frequency. The input may be a modulated RF signal of 0.2 volts to 10 volts RMS. Unlike other designs, there is no loss of indication when the sample RF is modulated above 95%. A unique circuit remembers" the last valid measurement until the modulation of the RF input is less than 95% for a normal one-second counting period.

In the digital model, a two-digit display indicates the magnitude of the frequency error, and a plus-minus indicator shows if the frequency is above or below the assigned frequency. Above  $\pm 31$  Hz error, the digits are blanked, but the sign indicator continues to operate.

In the analog version, a zero-center analog meter indicates the magnitude and sign of the frequency error. With a deviation greater than  $\pm 31$  Hz, the meter indicates in a red "off-scale" zone. In both models an "Alarm" indicator and relay contact closures warn of frequency errors greater than  $\pm 20$  Hz.

After A.C. power is applied the monitors stabilize to reliable readings within 5 minutes. There are no delicate thermostats or heater controls. The reference oscillator is heated by a proportional oven which maintains the unit's accuracy at a constant level over a wide range of ambient temperatures.

Only one crystal is needed to cover the entire broadcast band. Setting up to the station frequency simply entails "programming" the counter. The procedure is so simple that it can easily be accomplished in the field should the station change frequencies.

A test button, when depressed, checks all LED's and read-out tubes (or the meter in the analog model).

Remote indicators for the digital unit may be operated over telephone lines of up to 5000 ohms loop resistance. The optional remote accessory may be factory installed or added later in the field. The remote panel contains an analog meter display. One control adjusts calibration of the remote meter, and the test button confirms that the meter is polarized correctly.

## SPECIFICATIONS

- FREQUENCY RANGE:** 540-1600 kHz as ordered.
- RF INPUT IMPEDANCE:** 50 ohms.
- RF INPUT CONNECTOR:** BNC.
- RF INPUT SENSITIVITY:** (Unmodulated) 10 mV to 10 V RMS carrier. (Modulated) 0.2 V to 10 V RMS RF, 0-95% modulation.
- A.C. POWER INPUT:** 115/230 VAC, 50/60 Hz, 40 watts.
- REFERENCE OSCILLATOR:** Crystal-controlled in proportional oven.
- ACCURACY:** Better than 1.85 ppm (0.5 Hz @ 540 kHz).
- DEVIATION INDICATOR RANGE:**  $\pm 31$  Hz deviation.
- STATUS INDICATORS [LED]:** Low input alarm;  $\pm 20$  Hz deviation alarm; Count period.
- ALARM RELAY:** 120VAC/28 VDC @ 5A N/O & N/C contacts at  $\pm 20$  Hz or greater deviation.
- REMOTE:** Maximum remote loop resistance... 5000 ohms.
- AMBIENT TEMPERATURE RANGE:** 0 to 55°C.
- AMBIENT HUMIDITY RANGE:** 0 to 95% relative humidity.
- ALTITUDE:** 0 to 7500 feet above sea level.
- DIMENSIONS:** 19" wide, 3.5" high, 10.25" deep.
- WEIGHT:** (Domestic packed) 20 lbs. (Export packed) 45 lbs. (Cubage) 2.4 cu. ft.

## ORDERING INFORMATION

- Medium wave frequency monitor, digital read-out . . . . . 994-6698-001
- Medium wave frequency monitor, analog [meter] display . . . 994-6865-001
- Remote [analog] meter panel for Model 994-6698 above . . . . . 994-6863-001

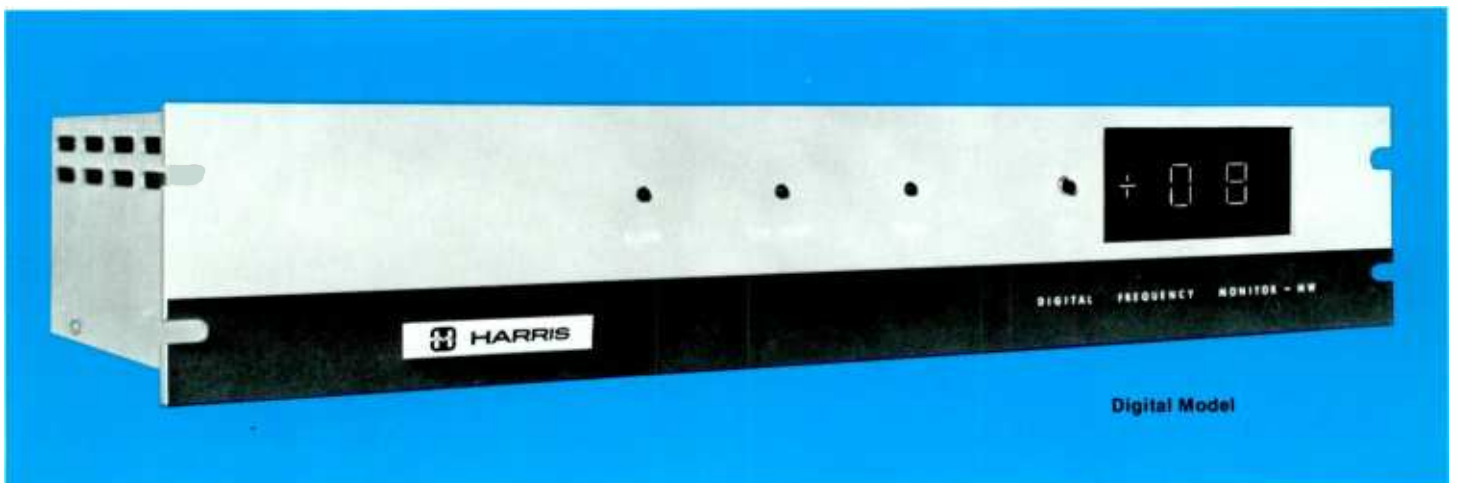



**HARRIS**  
COMMUNICATIONS AND  
INFORMATION HANDLING

## AM ACCESSORIES



### MODEL SD-31 SYNTHESIZER-DETECTOR

The Model SD-31 Synthesizer-Detector is a high output signal generator of precisely known frequency combined with a sensitive, selective detector for RF bridge measurements of AM antenna impedance. Packaged in a single lightweight battery-powered unit, the SD-31 complements bridges such as the OIB-1.

#### SPECIFICATIONS

- FREQUENCY:** 100.00-1999.5 kHz switch selected, 500 Hz steps
- FREQUENCY ACCURACY:**  $\pm .005\%$ ,  $+ 20^\circ\text{F}$  to  $100^\circ\text{F}$ .
- FREQUENCY VERNIER ( $\Delta\text{f}$ ) ADJUSTMENT RANGE:**  $\pm .01\%$  of frequency (approximately)
- OUTPUT LEVELS:** HI Z: 20 V RMS with 1000 ohm load  
LO Z: 8 V RMS with 50 ohm load  
VAR: 100 mV RMS approximately with 50 ohm load
- AM MODULATION:** Internal: 40 Hz (approximately) square wave  
External: 1.0 mV max. required to produce 50% modulation, 300 Hz - 3 kHz.  
Input impedance, 1 Megohm
- DETECTOR INPUT REQUIREMENT: (From External Receiver)** 1 V RMS approximately across 100 K ohms for 100% modulation of receiver RF input at 40 Hz
- AC POWER INPUT:** 105-130 VAC, 50-60 Hz, 15 VA (when charging)
- DIMENSIONS:** Height - 9 1/2 inches  
Width - 11 1/2 inches  
Depth - 6 1/2 inches
- WEIGHT:** 12 lbs.
- BATTERY OPERATION TIME:** 8 hours (approx.) after full charge, depending on frequency and load
- BATTERY RECHARGE TIME:** 16 hours (unit not in operation)

#### ORDERING INFORMATION

Model SD-31 Synthesizer-Detector [less batteries] ..... 700-0389-000



### PHASE MONITOR

A completely solid-state AM phase monitor for directional systems up to 12 towers. Phase readings are not affected by modulation, and are accurate to  $\pm 1^\circ$ . Silicon transistors and tautband meters assure greatest reliability.

The Model AM-19 phase monitor is easy to operate, easy to read, and it is fully adaptable to remote control operation. Available in digital and analog models.

#### SPECIFICATIONS

- FREQUENCY RANGE:** 540-1600 kHz.
- ACCURACY:**  $\pm 1^\circ$ . Phase resolution:  $0.5^\circ$ .
- INPUT IMPEDANCE:** 50 or 75 ohms.
- NUMBER OF INPUTS:** Up to 12.
- INPUT LEVEL:** .5 to 20 volts RMS.
- RF INPUT CONNECTOR:** UHF Female (SO 239)
- POWER REQUIRED:** 105/130 VAC, 80 watts, 50/60 Hz.
- SIZE:** 19" W X 7" H x 12 3/4" D.
- WEIGHT:** 20 pounds.

#### ORDERING INFORMATION

Model AM-19 Phase Monitor [State number of towers; State whether Digital or Analog Model] ..... 731-0239-xxx

### FIELD INTENSITY METER



The solid-state battery operated Model FIM-21 field intensity meter is universally used to measure field strength in the 540-1600 kHz broadcast band. Voltage regulation insures the circuit operation is independent of power supply voltage changes due to battery aging or extreme temperatures.

#### SPECIFICATIONS

- FREQUENCY RANGE:** 535-1605 kHz.
- MEASUREMENT RANGE:** 10 microvolts to 10 volts per meter.
- ACCURACY:** 2%.
- OUTPUT INDICATOR:** 4" mirrored scale meter. Provision for recorder.
- BATTERIES:** (6) 1.5 volt flashlight type "D" cells.
- SIZE:** 8 3/4" H x 11 1/2" W x 5 1/8" D.
- WEIGHT:** 11 1/2 pounds.

#### ORDERING INFORMATION

Model FIM-21 Field Intensity Meter [less batteries] ..... 700-0077-000

**FM  
BROADCAST  
TRANSMITTERS**







# TE-3

## SOLID-STATE FM EXCITER

Harris' advance-design solid-state TE-3 Exciter, combining the superior stereo performance of Direct Carrier Frequency Modulation (DCFM) with the extreme frequency stability of Digital Automatic Frequency Control (DAFC), is the heart of every Harris "H3" transmitter.

The TE-3 Exciter was designed to upgrade FM transmitter reliability by using solid-state devices. A full 10 watts of composite RF signal at carrier frequency is easily produced by this 100% solid-state exciter. The TE-3 can be used to drive most modern FM transmitters requiring 10 watts.

The oscillator in the TE-3 Exciter operates at the carrier frequency, eliminating frequency multipliers. The Digital Automatic Frequency Control provides carrier stability and excellent frequency response by means of a phase locked loop.

The TE-3 is composed of seven modules, each individually shielded, and connected within the exciter enclosure by an efficient intercabling technique. Connections are made at the front of each module with premium quality quick-disconnect plugs. Test voltage measurements and adjustments can be made easily by this modular mechanical design. Modular construction allows the addition of stereo or SCA at a later date by simply plugging in the factory adjusted module(s). The standard and optional TE-3 modules are listed below.

**MODULATED OSCILLATOR MODULE.** Operating at carrier frequency, the oscillator is modulated by the direct application of mono, stereo and SCA input signals. Harris' "DCFM" is generated in this module, and feeds the solid-state 10 watt amplifier module.

**POWER AMPLIFIER MODULE.** The power amplifier of the TE-3 FM Exciter is all solid state and provides a 10 watt signal at carrier frequency.

**AUDIO INPUT CONTROL MODULE.** Control, processing and input switching of mono, stereo and 41 kHz SCA inputs to the modulated oscillator are provided in this module.

**POWER SUPPLY MODULE.** The solid-state regulated DC power supply provides 24 volts DC to all modules in the TE-3 Exciter.

**AUTOMATIC FREQUENCY CONTROL MODULE.** Continuous carrier stability, within  $\pm 1$  kHz ( $\pm .001\%$ ) of the assigned center frequency, is provided by a phase locked loop. Digital devices count down the output of the modulated oscillator and the crystal frequency for phase comparison.

**STEREO GENERATOR MODULE (OPTIONAL).** With the modular construction of the Harris TE-3 Exciter, you may order a Harris FM transmitter for monophonic operation, and add the factory aligned stereo generator later for stereo operation.

**SCA MODULE(S) (OPTIONAL).** The Harris SCA module(s) provide(s) 41 kHz and/or 67 kHz SCA operation of excellent quality, with very low distortion.

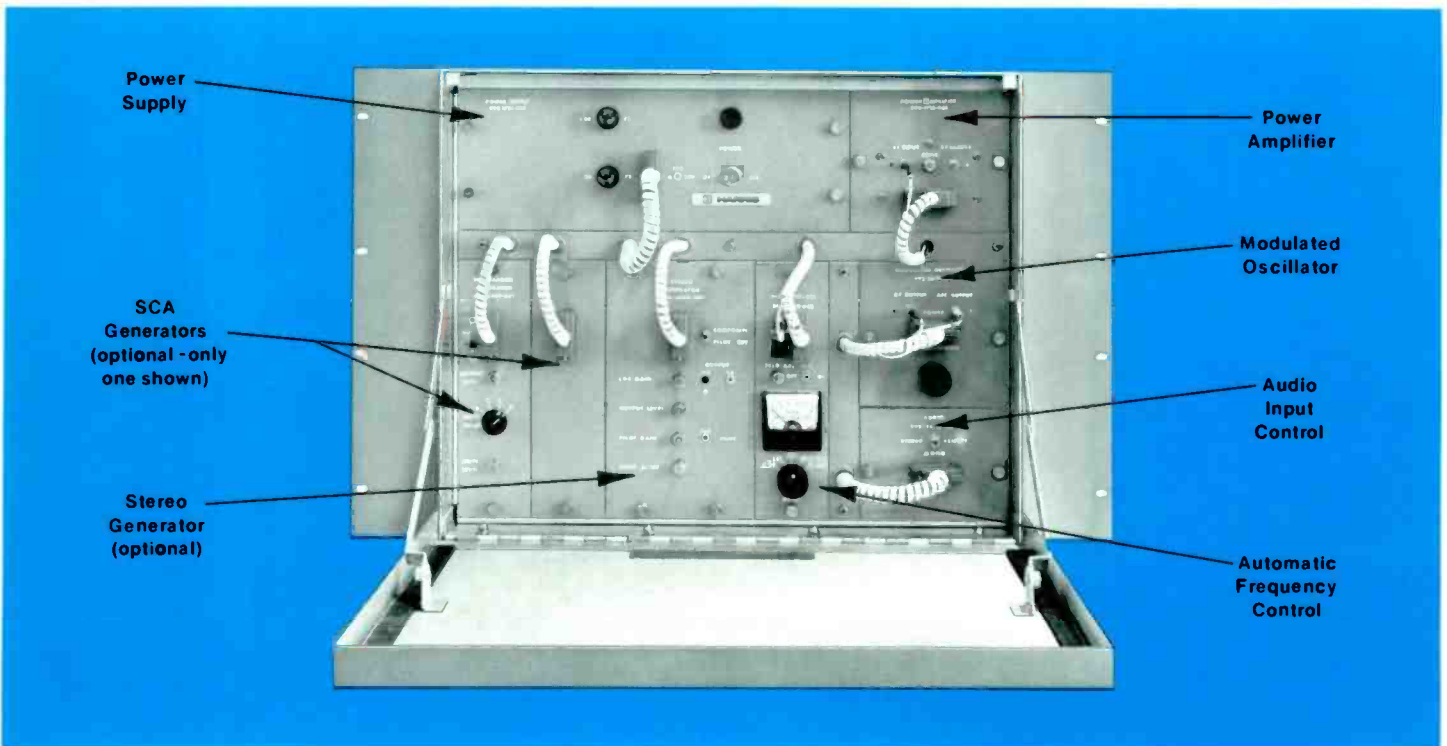



**HARRIS**  
COMMUNICATIONS AND  
INFORMATION HANDLING

## DUAL FM TRANSMITTER SYSTEMS



Harris' dual FM transmitters offer total reliability through total redundancy. You get complete protection from expensive "down" time, plus the superb mono or stereo performance of Harris' "DCFM" design.

Dual FM transmitters from Harris are available in the following power ranges: FM-40H3 (a 40 kilowatt system consisting of two FM-20H3, 20 kilowatt transmitters, and a center control cabinet); FM-10/10H3 (a 20 kilowatt system consisting of two FM-10H3, 10 kilowatt transmitters, and a center control cabinet); and the FM-5/5H3 (a 10 kilowatt system consisting of two FM-5H3, 5 kilowatt transmitters, and a center control cabinet). In all three models the center cabinet contains the exciter(s), plus switching and control equipment.

Each of the three dual FM transmitters is available in three different configurations. The basic dual system provides redundancy in all areas except the exciter—and provides for one-quarter normal power output in case emergency operation is required. With the addition of the Automatic Exciter/IPA Switching Kit to the basic system, automatic back-up exciter protection is provided. And with the further addition of the RF Output Switching System, power output becomes one-half the normal output, instead of one-quarter, during emergency operation.

Either or both of the options may be added to a Harris basic dual FM transmitter system at any time in the field, or may be included in the original system.

In addition to complete protection from "down" time, Harris' dual FM transmitters offer all of the advantages provided by our standard "DCFM" transmitters...including high efficiency, high reliability from extensive use of solid-state circuitry, and outstanding mono and stereo performance specifications.

Operation of a Harris dual system is as simple as operating a single transmitter, and the system is readily adaptable to remote control!

The TE-3 exciter(s) employed in Harris' dual FM transmitters is 100% solid state and employs Direct Carrier Frequency Modulation (DCFM) and Digital Automatic Frequency Control for unsurpassed frequency response and great carrier stability. Modular construction of the TE-3 allows easy addition of stereo and SCA at any time by simply plugging in the appropriate generator modules.

Environmental tests, in conditions surpassing those of any location a transmitter is likely to encounter, have been imposed on Harris' dual FM systems. The transmitter systems are capable of operating at altitudes to 7,500 feet, in an ambient temperature range of  $-20^{\circ}\text{C}$  to  $+45^{\circ}\text{C}$ .

Pictured at left is the center control cabinet of a Dual FM Transmitter

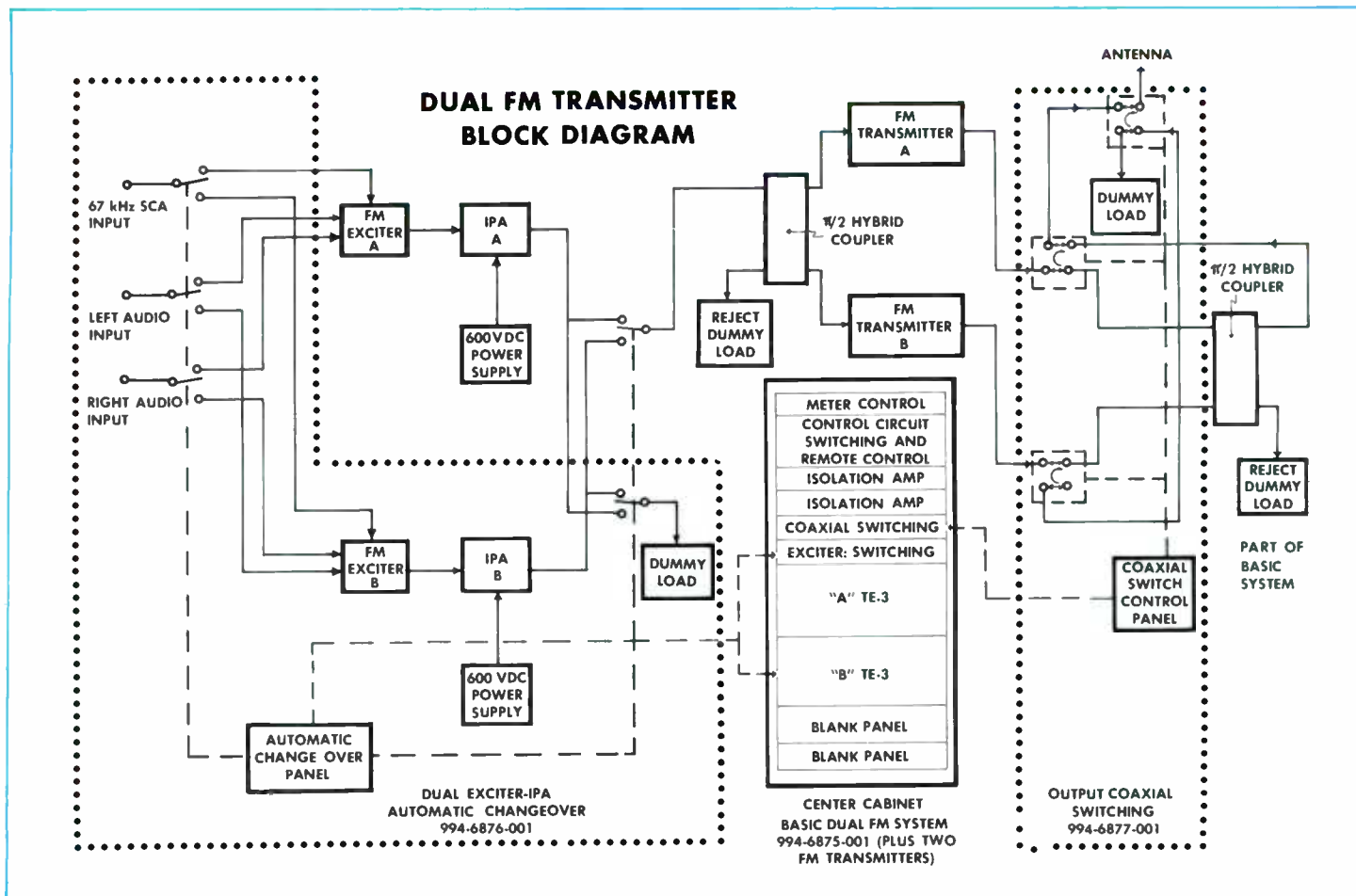

## DUAL FM TRANSMITTER CONFIGURATIONS

Employing two standard FM transmitters (less excitors).

### BASIC DUAL SYSTEM

- One TE-3 exciter.
- One isolation amplifier with power supply.
- One center cabinet.
- One high-power hybrid coupler (combiner) with plumbing to interconnect two transmitters.
- One low-power hybrid coupler.
- One reject load.
- One 50-watt reject load.

### AUTOMATIC EXCITER/I.P.A. SWITCHING KIT

For exciter redundancy, the following additional equipment may be added to the basic system:

- One TE-3 exciter.
- One isolation amplifier with power supply.
- One dummy load for isolation amplifier.
- One automatic change-over contact panel (mounts in center cabinet).

### RF OUTPUT SWITCHING

For RF switching of the high-power output amplifiers, the following equipment may be added to the basic system:

- One control panel (mounts in center cabinet).
- 3 coaxial transfer switches.
- One kit consisting of rigid coaxial line, elbows and flanges.
- One dummy load required—select from Optional Equipment below.

### OPTIONAL EQUIPMENT FOR DUAL FM TRANSMITTERS

- Stereo generators.
- SCA generators
- VSWR overload protection for each transmitter.
- Status light system for each transmitter.
- 50 kilowatt air-cooled dummy load.
- Water-cooled dummy load.
- Thru-line wattmeter with element.

## ORDERING INFORMATION

Basic Dual FM System (does not include transmitters) .....	994-6875-001
Automatic Exciter/I.P.A. Switching Kit .....	994-6876-001
RF Output Switching .....	994-6877-001
FM-40H3, 40,000 Watt FM transmitter .....	994-6746-001
FM-10/10H3, 20,000 Watt FM transmitter .....	994-7082-001
FM-5/5H3, 10,000 Watt FM transmitter .....	994-7941-001



**HARRIS**  
COMMUNICATIONS AND  
INFORMATION HANDLING

# FM-40H3

## 40,000 Watt FM Transmitter

Harris' FM-40H3 consists of two 20 kilowatt amplifiers, and a center control cabinet containing the exciter(s), plus switching and control equipment. Outputs of each 20 kilowatt amplifier are fed through harmonic filters to the output combining network. This hybrid network adds the two 20 kilowatt signals to produce a 40 kilowatt output to the transmission line. However, the two amplifiers remain isolated from each other.

Should one power amplifier fail, the other will continue feeding the combining network, and the combiner will continue to operate as a power divider. However, in this case, 10 kW is fed

to the output transmission line, and 10 kW is fed into a 10 kW dummy load connected to the combiner. This is necessary to maintain almost complete isolation of the non-operating amplifier and to permit servicing without unwanted RF coupling.

**HIGH EFFICIENCY, LOW OPERATING COSTS.** Each 20 kilowatt amplifier has an efficiency of 80%, which combines with a high efficiency in all amplifier circuits and very conservatively rated components to give it the lowest operating cost of any FM transmitter in its power range.

The basic FM-40H3 provides redundancy in all areas except the exciter and isolation amplifier—and provides one-quarter normal power output in case emergency operation is required. With the addition of the Automatic Exciter/IPA Switching Kit to the basic system, automatic backup exciter protection is provided. And with the further addition of the RF Output Switching System, power output becomes one-half the normal output during emergency operation. Either or both of the options may be included in the original transmitting system.

**HIGH POWER PERFORMANCE.** Modern ceramic tetrodes are used in the FM-40H3 for reliability and low-cost operation. Output tuning in each amplifier is accomplished with an inductively tuned silver plated tank circuit. This eliminates the need for vacuum capacitors in the tank circuit of the amplifier.

A "Tee" notch harmonic filter and a low pass filter on the output of each amplifier reduce harmonic radiation of the required minimum. Power supplies are fully protected against overloads by "Power Guard" — an exclusive Harris developed circuit. 100% solid state rectifiers are operated with ample safety factors on each cell. A Harris developed transient protective circuit assures maximum protection from transient voltages or on-off power surges.





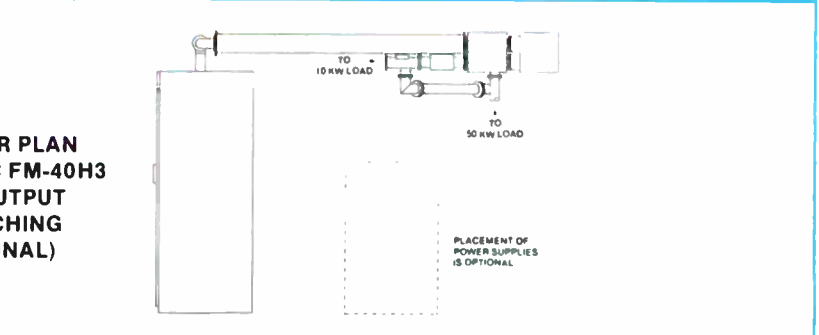
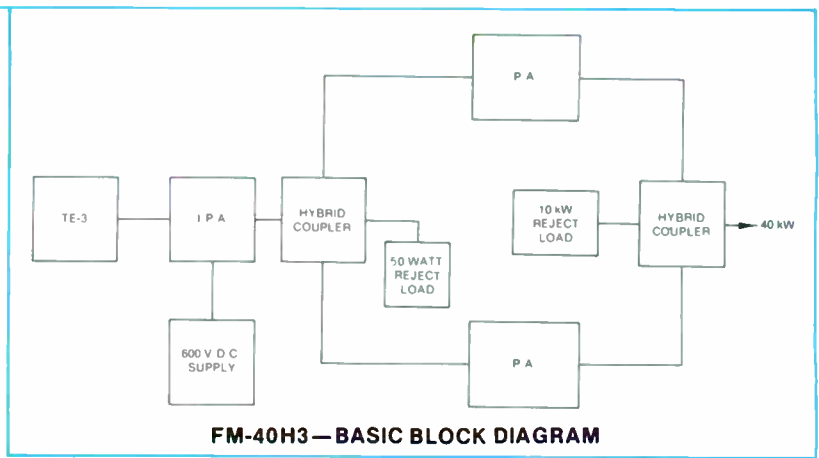
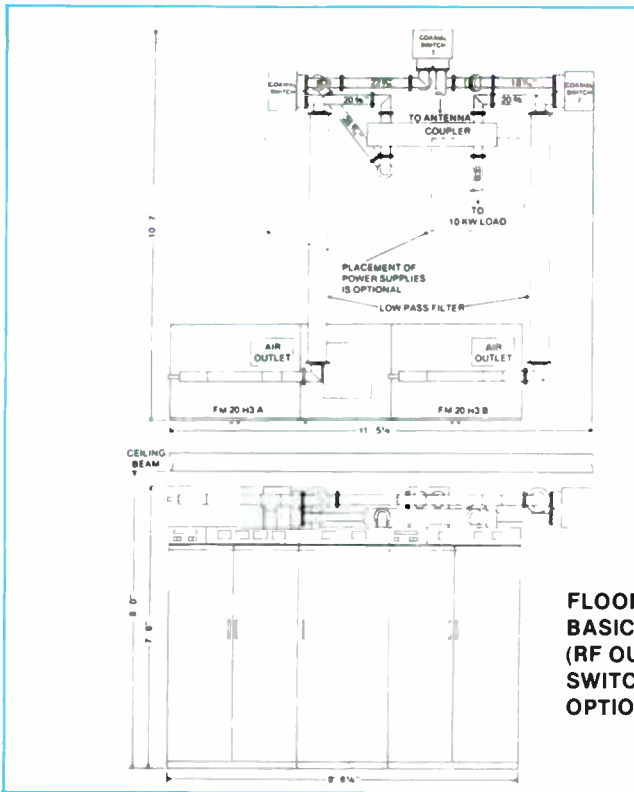

**FLOOR PLAN  
BASIC FM-40H3  
(RF OUTPUT  
SWITCHING  
OPTIONAL)**

**FM-40H3—BASIC BLOCK DIAGRAM**

**FM-40H3 SPECIFICATIONS**

**GENERAL**

**POWER OUTPUT:** 40 kW.  
**FREQUENCY RANGE:** 87.5 to 108 MHz, tuned to specified operating frequency.  
**RF OUTPUT IMPEDANCE:** 50 ohms.  
**OUTPUT TERMINATION:** 3 1/8" EIA flange.  
**FREQUENCY STABILITY:** ± .001% or better.  
**TYPE OF MODULATION:** Direct Carrier Frequency Modulation.  
**MODULATION CAPABILITY:** ± 100 kHz.  
**AC INPUT POWER:** 208/240 V, 3 phase 60 Hz. 115 V single phase 60 Hz. Power consumption 60,000 watts (approx.) (50 Hz available on special order).  
**RF HARMONICS:** Suppression meets all FCC requirements.  
**POWER SUPPLY RECTIFIERS:** Silicon.  
**ALTITUDE:** 7500 feet.  
**AMBIENT TEMPERATURE RANGE:** -20°C to + 45°C.  
**MAXIMUM VSWR:** 1.7 to 1.  
**OVERALL CABINET SIZE:** Transmitter cabinet 113" W x 78" H x 32 3/4" D. HV power supply cabinet 30" W x 30" D x 49" H. (Two supplied).  
**FRONT DOOR SWING:** 21".  
**FINISH:** Two-tone beige-gray.

**MONAURAL MODE**

**AUDIO INPUT IMPEDANCE:** 600 ohms balanced.  
**AUDIO INPUT LEVEL:** + 10 dBm ± 2 dB for 100% modulation at 400 Hz.  
**AUDIO FREQUENCY RESPONSE:** Standard 75 microsecond, FCC pre-emphasis curve ± 1 dB, 30-15,000 Hz.  
**DISTORTION:** 0.5% or less, 30-15,000 Hz.  
**FM NOISE:** 65 dB below 100% modulation (ref. 400 Hz).  
**AM NOISE:** 50 dB below reference carrier AM modulated 100%.  
**IM DISTORTION:** 0.5% 60 Hz/7 KHz in 4:1 ratio.

**STEREOPHONIC MODE**

**PILOT OSCILLATOR:** Crystal controlled.

**PILOT STABILITY:** 19 kHz ± 1 Hz.

**AUDIO INPUT IMPEDANCE:** (left and right) 600 ohms balanced.  
**AUDIO INPUT LEVEL:** (left and right) + 10 dBm ± 1 dB for 100% modulation at 400 Hz.  
**AUDIO FREQUENCY RESPONSE:** (left and right) Standard 75 microsecond, FCC pre-emphasis curve ± 1 dB, 50-15,000 Hz.  
**DISTORTION:** (left or right) 1% or less, 50-15,000 Hz.  
**FM NOISE:** (left or right) 60 dB minimum below 100% modulation, reference 400 Hz.  
**IM DISTORTION:** 0.5% 60 Hz/7 KHz in 4:1 ratio.  
**STEREO SEPARATION:** 35 dB minimum 50-15,000 Hz.  
**SUB-CARRIER SUPPRESSION:** 42 dB below 90% modulation.  
**CROSSTALK:** (main to sub-channel or sub to main channel) 40 dB below 90% modulation.

**SCA SPECIFICATIONS**

**FREQUENCY STABILITY:** ± 500 Hz.  
**FREQUENCY:** Between 25 and 75 kHz.  
**OSCILLATOR TYPE:** Two colpitts heterodyned to produce desired output frequency.  
**MODULATION:** Direct FM.  
**MODULATION CAPABILITY:** ± 7.5 kHz.  
**AUDIO INPUT IMPEDANCE:** 600 ohms balanced.  
**AUDIO INPUT LEVEL:** ± 8 dBm, ± 3 dB for 100% modulation at 400 Hz.  
**AUDIO FREQUENCY RESPONSE:** 41 kHz and 67 kHz, 50 microsecond, modified pre-emphasis. 67 kHz response modified for proper operation when used with stereo to conform to FCC specifications.  
**DISTORTION:** Less than 1.5% 30-7,000 Hz.  
**FM NOISE:** (main channel not modulated) 55 dB minimum (ref. 100% modulation 400 Hz).  
**CROSSTALK:** (sub-channel to main channel): -60 dB or better.  
**CROSSTALK:** (main channel to sub-channel): 50 dB below 100% modulation (ref. 400 Hz).  
**AUTOMATIC MUTE LEVEL:** Variable from 0 to -40 dB below 100% modulation.

**ORDERING INFORMATION**

FM-40H3, 40,000 watt FM Transmitter, with TE-3 exciter.....	994-6746-001
100% spare tube kit.....	990-0552-001
Stereo Generator (add for stereo operation).....	994-6533-001
SCA sub-carrier generator [add for SCA operation].....	994-6507-002



**HARRIS**  
COMMUNICATIONS AND  
INFORMATION HANDLING

# FM-20H3

## 20,000-Watt FM Transmitter

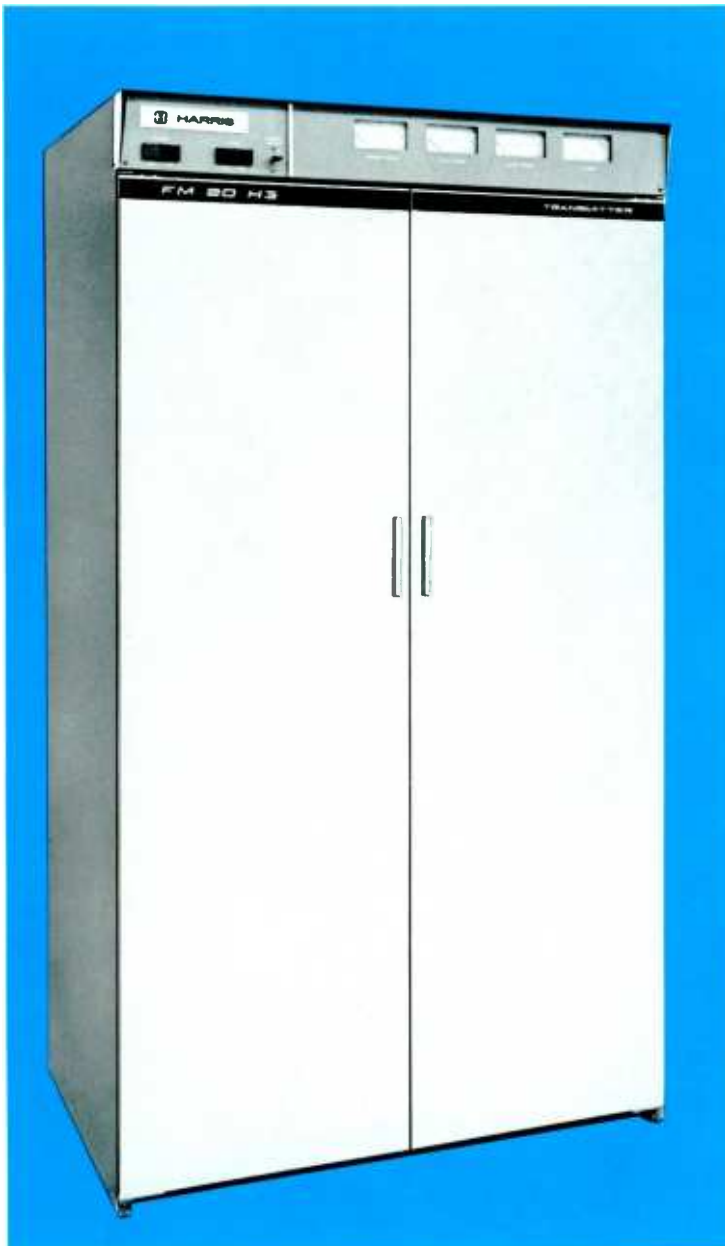

**LOW OPERATING COST, HIGH RELIABILITY.** 80% efficiency in the final amplifier, plus high efficiency in all amplifier circuits, plus very conservatively rated components combine to give the FM-20H3 the lowest operating cost of any FM transmitter in its power range.

The power amplifier tube is also operated at a fraction of its actual rating and this in turn guarantees maximum service life.

In day-to-day operation, the FM-20H3 has solid-state reliability. Harris' solid-state TE-3 Exciter...with Harris-pioneered Digital AFC and Direct Carrier FM...delivers 10 watts to drive the intermediate power amplifier consisting of two parallel 4CX250B's. The final single-ended power amplifier is a 4CX15000A ceramic tetrode that is very conservatively rated for the 20,000 watts output.

**VARI-LINE™ SILVER PLATED TANK.** Vari-Line is an advanced, Harris-developed method of tuning a single-ended FM amplifier for optimum output efficiency. A portion of a parallel tubular 2 5/8 -inch copper transmission line (silver plated for efficient RF service) is made variable in order to inductively tune the line to operating frequency.

With Vari-Line tuning, greater reliability is possible. Mica capacitors are not used in the tank circuit. This reduces the complexity of sliding contacts and consequent maintenance problems.

**DUAL HV SILICON POWER SUPPLY.** Two separate three-phase all-silicon power supplies are used for the FM-20H3.

One three-phase supply for PA plate voltage is housed in a separate enclosure. The other three-phase supply powers the IPA plate and screen circuit, and the PA screen.

The FM-20H3 is protected by a Harris-developed transient protective circuit. This assures maximum protection from transient voltages or on-off power surges damaging the power transformer and related components.

Silicon rectifiers are used throughout the transmitter. The result is greatly improved performance, as silicon cells are particularly resistant to aging, moisture and wide temperature variations.

**AUTOMATIC RECYCLING.** In case of momentary overload, the transmitter recycles automatically. Should the overload reoccur in excess of the desired number of times preset in the transmitter, the transmitter will then remain off the air until the plate is turned on, either locally or by remote control.

**OPERATIONALLY TESTED.** Environmental tests that surpass conditions of any location a transmitter is likely to encounter have been imposed on the FM-20H3. In addition, the transmitter is fully tuned and tested on your frequency before shipment.

**FULL METERING.** Eight easy-to-read meters, including a multimeter, provide full monitoring of the seventeen parameters of the operating tubes and exciter. There is also a directional coupler which measures either forward power or VSWR, and an elapsed time meter.

**PLUG-IN STEREO/SCA GENERATOR MODULES.** You may equip your FM-20H3 for stereo or SCA at any time and within a matter of minutes. The modular design of the solid-state exciter allows ordering a Harris FM transmitter for monophonic service and adding the plug-in stereo, or either 41 kHz or 67 kHz SCA module, later.

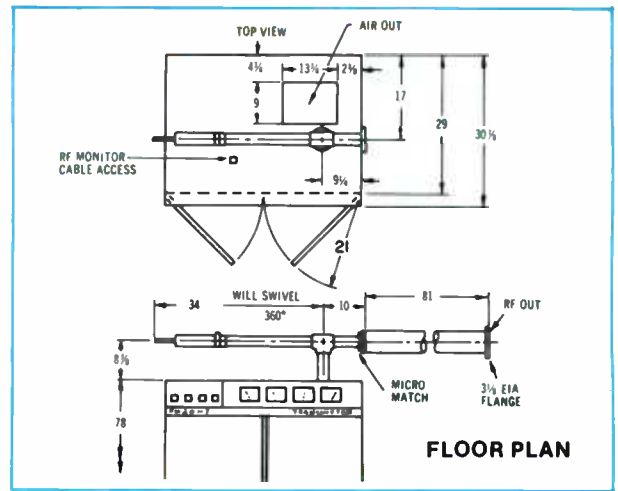
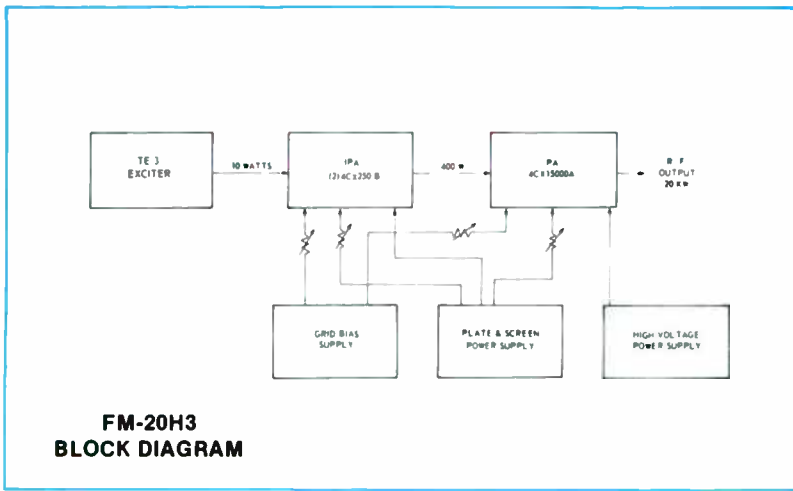

### FM-20H3 SPECIFICATIONS

#### GENERAL

- POWER OUTPUT:** 21.5 kW.
- FREQUENCY RANGE:** 87.5 to 108 MHz, tuned to specified operating frequency.
- RF OUTPUT IMPEDANCE:** 50 ohms.
- OUTPUT TERMINATION:** 3 1/8" EIA flange.
- FREQUENCY STABILITY:** .001% or better.
- TYPE OF MODULATION:** Direct Carrier Frequency Modulation.
- MODULATION CAPABILITY:** ± 100 kHz.
- AC INPUT POWER:** 208/240 V., 3-phase 60 Hz., 115 V., single phase 60 Hz. Power consumption 30,000 watts (approx.) (50 Hz available on special order).
- FINAL AMPLIFIER EFFICIENCY:** 80% or better (subject to normal tolerances).
- RF HARMONICS:** Suppression meets all FCC requirements.
- POWER SUPPLY RECTIFIERS:** Silicon.
- ALTITUDE:** 7500 feet.
- AMBIENT TEMPERATURE RANGE:** -20°C to +45°C.
- MAXIMUM VSWR:** 1.7 to 1.
- OVERALL CABINET SIZE:** Transmitter cabinet 42" W x 78" H x 32 3/4" D.  
HV power supply cabinet 30" W x 30" D x 49" H.
- FRONT DOOR SWING:** 21".
- FINISH:** Two-tone, beige-gray.
- WEIGHT & CUBAGE:** Export 3200 lbs., Domestic 2700 lbs., 130 cu. ft.

#### MONAURAL MODE

- AUDIO INPUT IMPEDANCE:** 600 ohms balanced.
- AUDIO INPUT LEVEL:** +10 dBm ± 2 dB for 100% modulation at 400 Hz.
- AUDIO FREQUENCY RESPONSE:** Standard 75 microsecond, FCC pre-emphasis curve ± 1 dB, 30-15,000 Hz.
- DISTORTION:** 0.5% or less, 30-15,000 Hz.
- FM NOISE:** 65 dB below 100% modulation (ref. 400 Hz).
- AM NOISE:** 50 dB below reference carrier AM modulation 100%.
- IM DISTORTION:** 0.5%, 60 Hz/7 KHz, 4:1 ratio.

#### STEREOPHONIC MODE

- PILOT OSCILLATOR:** Crystal controlled.
- PILOT STABILITY:** 19 kHz ± 1 Hz.
- AUDIO INPUT IMPEDANCE:** (left and right) 600 ohms balanced.
- AUDIO INPUT LEVEL:** (left and right) +10 dBm ± 1 dB for 100% modulation at 400 Hz.
- AUDIO FREQUENCY RESPONSE:** (left and right) Standard 75 microsecond, FCC pre-emphasis curve ± 1 dB. 50-15,000 Hz.
- DISTORTION:** (left or right) 1% or less, 50-15,000 Hz.
- FM NOISE:** (left or right) 60 dB minimum below 100% modulation (ref. 400 Hz).
- IM DISTORTION:** 0.5%, 60 Hz/70 KHz, 4:1 ratio.
- STEREO SEPARATION:** 35 dB minimum 50-15,000 Hz.
- SUB-CARRIER SUPPRESSION:** 42 dB below 90% modulation.
- CROSSTALK:** (main to sub-channel or sub- to main channel) 42 dB below 90% modulation.

#### SCA SPECIFICATIONS

- FREQUENCY STABILITY:** ± 500 Hz.
- FREQUENCY:** Between 25 and 75 kHz.
- OSCILLATOR TYPE:** Two Colpitts heterodyned to produce desired output frequency.
- MODULATION:** Direct FM.
- MODULATION CAPABILITY:** ± 7.5 kHz.
- AUDIO INPUT IMPEDANCE:** 600 ohms balanced.
- AUDIO INPUT LEVEL:** +8 dBm, ±3 dB for 100% modulation at 400 Hz.
- AUDIO FREQUENCY RESPONSE:** 41 kHz and 67 kHz, 50 microsecond, modified pre-emphasis. 67 kHz response modified for proper operation when used with stereo to conform to FCC specifications.
- DISTORTION:** Less than 1.5%, 30-7000 Hz.
- FM NOISE:** (main channel not modulated) 55 dB minimum (ref. 100% modulation 400 Hz).
- CROSSTALK:** (sub-channel to main channel): -60 dB or better.
- CROSSTALK:** (main channel to sub-channel): 50 dB below 100% modulation (ref. 400 Hz), with main channel modulated 70% by frequencies 30-15,000 Hz.
- AUTOMATIC MUTE LEVEL:** Variable from 0 to -40 dB below 100% modulation.

### ORDERING INFORMATION

FM-20H3, 20,000 watt FM broadcast transmitter, with TE-3 exciter .....	994-6745-001
100% spare tube kit .....	990-0552-001
Stereo generator [add for stereo operation] .....	994-6533-001
SCA sub-carrier generator [add for SCA operation] .....	994-6507-002



# FM-10H3

## 10,000 Watt FM Transmitter



Harris' FM-10H3 is the most advanced 10,000 watt FM transmitter ever offered. It incorporates the TE-3 solid-state "DCFM" exciter for unsurpassed stereophonic and monaural sound, and only two tubes are required to produce a full 10,000 watts. Harris' model FM-10H3 is fully FCC type accepted for stereophonic (with optional stereo generator) and monaural FM broadcasting in the 88 to 108 MHz band.

**TWO TUBES.** Only two tubes are used in the entire transmitter. 10 watts are delivered from the model TE-3 transistorized exciter to the 4CX300A driver, which supplies a nominal 250 watts to drive the 4CX10,000D power amplifier. This power tetrode operates at a leisurely pace, providing ample power to deliver a high fidelity signal with proven economy.

**TYPE 4CX10,000D POWER OUTPUT TUBE.** Use of the power packed ceramic 4CX10,000D tube as the final amplifier assures excellent performance. It was selected because of its 10 kW plate dissipation, its ability to produce more power...and its proven longer, useful life.

**SELF-CONTAINED.** Except for the top-mounted Tee notch and low pass filters, the FM-10H3 transmitter is completely self-contained. The power transformer, solid-state exciter, and optional stereo/SCA generating equipment are all housed in one attractively styled cabinet.

**"DCFM" EXCITER.** As in other "H3" series transmitters, the FM-10H3 employs the 100% solid-state TE-3 exciter. An advanced design used first by Harris, the exciter employs Direct Carrier Frequency Modulation (DCFM) and Digital Automatic Frequency Control. This makes possible improved carrier stability and unsurpassed frequency response.

**BUILT-IN REMOTE CONTROL.** Connect the transmitter control unit to the transmitter, tie in the telephone line to the studio control unit, and you are ready for complete remote control operation. All necessary functions can be controlled remotely—and no additional equipment is required for a Harris remote control system.

**POWER GUARD.** The FM-10H3 employs a special power supply protective circuit, Power Guard, to assure maximum protection from transient voltages or on-off power surges.

**AUTOMATIC RECYCLING.** Should a momentary overload occur, the FM-10H3 will recycle automatically. If the overload reoccurs in excess of the number of times preset in the transmitter, the transmitter will remain off the air until the plate is turned on, either locally or by remote control.

**SILICON RECTIFIERS.** For increased reliability, silicon power rectifiers are used in all FM-10H3 power supplies. Operated well below their rated levels, they provide years of dependable service in the transmitter. In the HV power supply, a generous number of 16 ampere silicon cells operate in a three phase bridge, and are so rugged that maximum transmitter current demand is only 50% of the peak rating of the supply. Three solid-state power supplies are used: high voltage, bias, and exciter.



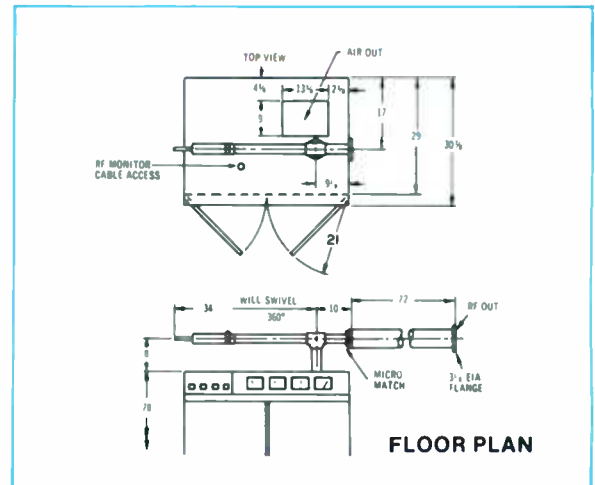
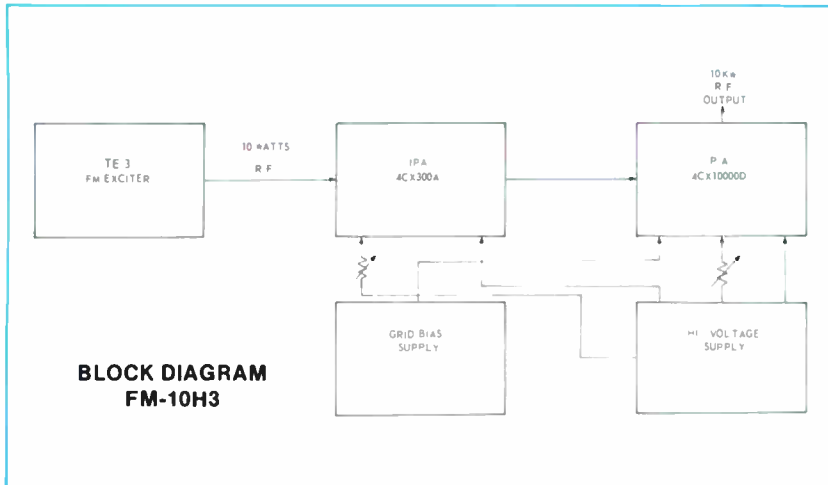

## FM-10H3 SPECIFICATIONS

### GENERAL

**POWER OUTPUT:** 10 kW.  
**FREQUENCY RANGE:** 87.5 to 108 MHz, tuned to specified operating frequency.  
**RF OUTPUT IMPEDANCE:** 50 ohms.  
**OUTPUT TERMINATION:** 3 1/8" EIA flange.  
**FREQUENCY STABILITY:** .001% or better.  
**TYPE OF MODULATION:** Direct Carrier Frequency Modulation.  
**MODULATION CAPABILITY:** ± 100 kHz.  
**AC INPUT POWER:** 208/240 V, 3 phase, 60 Hz at 17 kW. 115 V, single phase, 60 Hz, 300 watts.  
**POWER SUPPLY RECTIFIERS:** Silicon.  
**RF HARMONICS:** Suppression meets all FCC requirements.  
**ALTITUDE:** 7,500 feet.  
**BLOWER:** 430 cfm @ 2.6 inches.  
**AMBIENT TEMPERATURE RANGE:** -20°C to +45°C.  
**MAXIMUM VSWR:** 1.7 to 1.  
**OVER-ALL CABINET SIZE:** 42" W x 78" H x 32 3/4" D.\*  
 \*32 3/4" is over-all dimension. With rear door and front door handles removed, minimum depth is 29 3/4".  
**FRONT DOOR SWING:** 21".  
**FINISH:** Two-tone, beige-gray.  
**WEIGHT & CUBAGE:** Export: 975 lbs. Domestic: 825 lbs. 110 cu. ft.

### MONAURAL MODE

**AUDIO INPUT IMPEDANCE:** 600 ohms balanced.  
**AUDIO INPUT LEVEL:** +10 dBm ± 2 dB for 100% modulation at 400 Hz.  
**AUDIO FREQUENCY RESPONSE:** Standard 75 microsecond, FCC pre-emphasis curve ± 1 dB, 30-15,000 Hz  
**DISTORTION:** 0.5% or less, 30-15,000 Hz.  
**IM:** 0.5%, 60/7000 Hz, 4:1 ratio.  
**FM NOISE:** 65 dB below 100% modulation (ref. 400 Hz).  
**AM NOISE:** 50 dB below reference carrier AM modulated 100%.

### STEREOPHONIC MODE (Stereo Generator optional)

**PILOT OSCILLATOR:** Crystal controlled.  
**PILOT STABILITY:** 19 kHz ± 1 Hz.  
**AUDIO INPUT IMPEDANCE:** (left and right) 600 ohms balanced.  
**AUDIO INPUT LEVEL:** (left and right) +10 dBm ± 1 dB for 100% modulation at 400 Hz.  
**AUDIO FREQUENCY RESPONSE:** (left and right) Standard 75 microsecond, FCC pre-emphasis curve ± 1 dB, 50-15,000 Hz.  
**DISTORTION:** (left or right) 1% or less, 50-15,000 Hz.  
**IM:** 0.5%, 60/7000 Hz, 4:1 ratio.  
**FM NOISE:** (left or right) 60 dB minimum below 100% modulation, reference 400 Hz.  
**STEREO SEPARATION:** 35 dB minimum 50-15,000 Hz.  
**SUB-CARRIER SUPPRESSION:** 42 dB below 90% modulation.  
**CROSSTALK:** (main to sub-channel or sub to main channel) 42 dB below 90% modulation.

### SCA MODE (SCA Generator optional)

**FREQUENCY STABILITY:** ± 500 Hz.  
**FREQUENCY:** Between 25 and 75 kHz.  
**OSCILLATOR TYPE:** Two Colpitts heterodyned to produce desired output frequency.  
**MODULATION:** Direct FM.  
**MODULATION CAPABILITY:** ± 7.5 kHz.  
**AUDIO INPUT IMPEDANCE:** 600 ohms balanced.  
**AUDIO INPUT LEVEL:** +8 dBm, ± 3 dB for 100% modulation at 400 Hz.  
**AUDIO FREQUENCY RESPONSE:** 41 kHz and 67 kHz, 50 microsecond, modified pre-emphasis. 67 kHz response modified for proper operation when used with stereo to conform to FCC specifications.  
**DISTORTION:** Less than 1.5%, 30-7000 Hz.  
**FM NOISE:** (main channel not modulated) 55 dB minimum (ref. 100% modulation 400 Hz).  
**CROSSTALK:** (sub-channel to main channel) -60 dB or better.  
**CROSSTALK:** (main channel to sub-channel) 50 dB below 100% modulation (ref. 400 Hz).  
**AUTOMATIC MUTE LEVEL:** Variable from 0 to 40 dB below 100% modulation.

## ORDERING INFORMATION

FM-10H3, 10,000 watt FM broadcast transmitter, with TE-3 exciter, 60 Hz ..... 994-6744-001  
 FM-10H3, 10,000 watt FM broadcast transmitter, with TE-3 exciter, 380 V, 3 phase, 50 Hz ..... 994-6744-003  
 100% spare tube kit ..... 990-0551-001  
 Stereo generator (add for stereo operation) ..... 994-6533-001  
 SCA sub-carrier generator (add for SCA operation) ..... 994-6507-002



**HARRIS**  
COMMUNICATIONS AND  
INFORMATION HANDLING

# FM-3H3, 5H3, 7.5H3

## 3000, 5000, 7500 Watt FM Transmitters

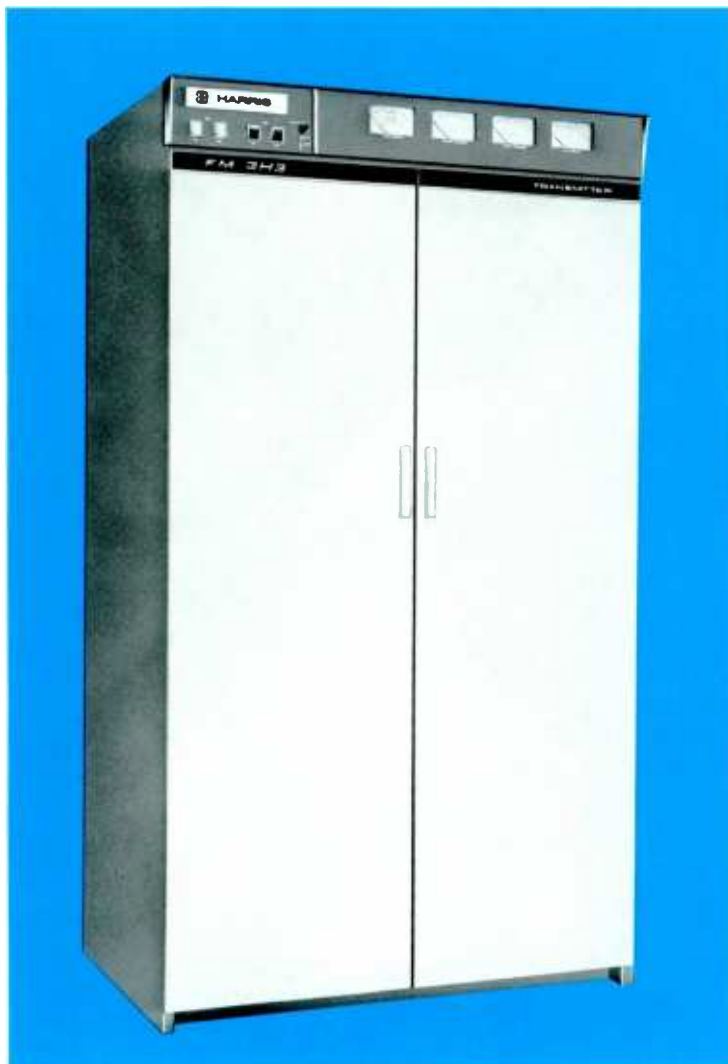

Harris FM-3H3, FM-5H3 and FM-7.5H3 transmitters provide 3,000-5,000-7,500 watts output with just two tubes—and feature the performance proven solid-state TE-3 exciter, employing Direct Carrier Frequency Modulation. Quality all the way, both transmitters combine the reliability of solid-state circuitry and the superb performance of “DCFM” for outstanding stereo (with optional stereo generator) and monaural transmission. Each transmitter is FCC type accepted for stereophonic and monaural FM broadcasting in the 88 to 108 MHz band.

**ONLY TWO TUBES.** With the transistorized 10 watt model TE-3 exciter incorporated into these transmitters, only two tubes are needed. A type 4CX250B tube amplifies the solid-state exciter output and supplies a nominal 250 watts to drive the ceramic 4CX5000A final tube. This power tetrode operates as a single ended amplifier to produce 3, 5 or 7.5 kilowatts of power.

**“DCFM” PERFORMANCE.** The superior engineering design of Harris' TE-3 exciter includes Direct Carrier Frequency Modulation for superior stereo performance and Digital Automatic Frequency Control for maximum stability.

In all three transmitters stereo separation is 35 dB minimum from 50 Hz to 15 kHz.

Self-contained within these transmitters, the “DCFM” exciter is of modular construction so that the solid-state stereo and SCA modules may be plugged in at any time.

**VARI-LINE TUNING.** Field proven for dependability, Harris' Vari-Line tuning is used in the FM-3H3, FM-5H3 and FM-7.5H3 transmitters. This is an advanced method of tuning a single ended FM amplifier to achieve optimum output efficiency.

**HARMONIC REDUCTION.** Included as standard equipment in the transmitters is a Tee type notch filter for second harmonic reduction, a directional coupler VSWR section for direct meter reading of both power output and standing wave ratio, and a low pass filter which effectively eliminates third and higher order harmonics.

**SPECIAL PROTECTIVE CIRCUIT.** The transmitters are protected by Power Guard, a Harris developed power supply protective circuit, that provides maximum protection from transient voltages.

If a momentary overload occurs, the transmitter will recycle automatically up to the number of times preset.

For increased dependability, solid-state rectifiers are standard in these transmitters.

**OPERATING CONVENIENCE.** “On-off” functions in the transmitters are controlled by two lighted pushbuttons at the top left of the transmitter. The multimeter control switch is located just to the right of these pushbuttons.

Full metering is provided with four large, front panel meters, including a power indicator that permits direct reading of both power output and standing wave ratio.

**SELF-CONTAINED.** The power supply, exciter, power transformers and optional stereo generating/SCA equipment are all housed in one cabinet, for simplified transmitter installation.

**REMOTE CONTROL.** In the FM-3H3, FM-5H3 and FM-7.5H3, all functions can be remote controlled. Simply connect the transmitter control unit of the Harris remote control system and remote operation is ready.

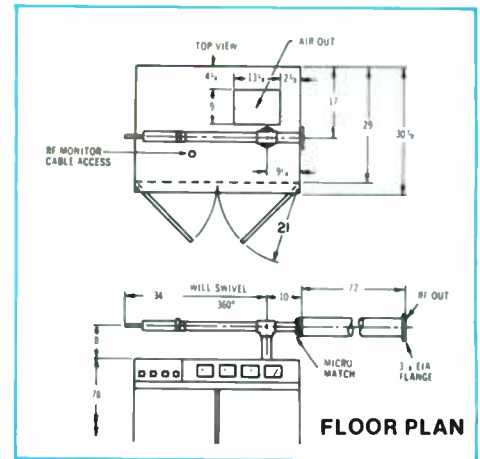
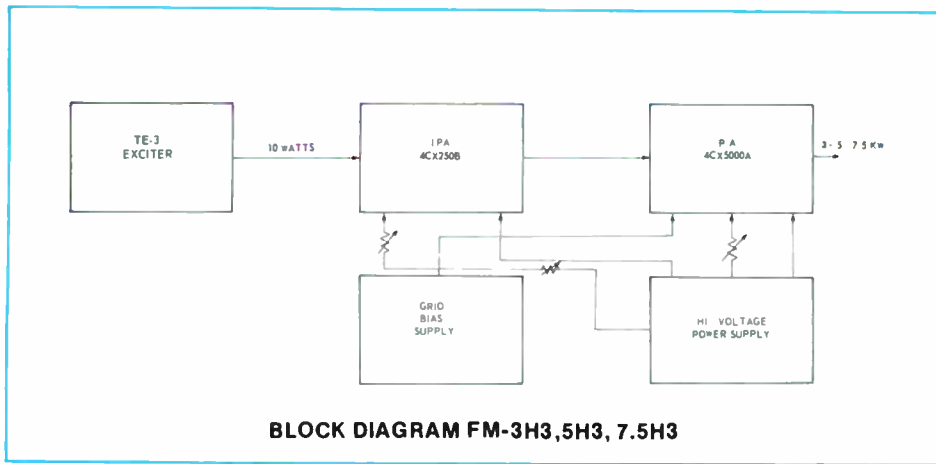

## FM-3H3, 5H3, 7.5H3 SPECIFICATIONS

### GENERAL

**POWER OUTPUT:** 3, 5 or 7.5 kW.  
**FREQUENCY RANGE:** 87.5 to 108 MHz, tuned to specified operating frequency.  
**RF OUTPUT IMPEDANCE:** 50 ohms.  
**OUTPUT TERMINATION:** 3 1/8" EIA flange.  
**FREQUENCY STABILITY:** .001% or better.  
**TYPE OF MODULATION:** Direct Carrier Frequency Modulation.  
**MODULATION CAPABILITY:** ± 100 kHz.  
**AC INPUT POWER:** 208/240 V, 3 phase. 6.8 kW consumption at 3 kW output. 10 kW consumption at 5 kW output. 15 kW consumption at 7.5 kW output. 115 V single phase, 60 Hz 300 watts.  
**POWER SUPPLY RECTIFIERS:** Silicon.  
**RF HARMONICS:** Suppression meets all FCC requirements.  
**ALTITUDE:** 7,500 feet.  
**BLOWER:** 390 cfm @ 3.2 inches.  
**AMBIENT TEMPERATURE RANGE:** -20°C to +45°C.  
**MAXIMUM VSWR:** 1.7 to 1.  
**OVER-ALL CABINET SIZE:** 42" W x 78" H x 32 3/4" D.\*  
 \*32 3/4" is over-all depth dimension. With rear door and front door handles removed, minimum depth is 29 3/4".  
**FRONT DOOR SWING:** 21".  
**FINISH:** Two-tone beige-gray.  
**WEIGHT AND CUBAGE:** Export: 900 lbs. Domestic: 750 lbs. 110 cu. ft.

### MONAURAL MODE

**AUDIO INPUT IMPEDANCE:** 600 ohms balanced.  
**AUDIO INPUT LEVEL:** +10 dBm ± 2 dB for 100% modulation at 400 Hz.  
**AUDIO FREQUENCY RESPONSE:** Standard 75 microsecond, FCC pre-emphasis curve ± 1 dB, 30-15,000 Hz.  
**DISTORTION:** 0.5% or less, 30-15,000 Hz.  
**IM:** 0.5%, 60/7000Hz, 4:1 ratio.  
**FM NOISE:** 65 dB below 100% modulation (ref. 400 Hz).  
**AM NOISE:** 50 dB below reference carrier AM modulated 100%.

### STEREOPHONIC MODE (Stereo Generator optional)

**PILOT OSCILLATOR:** Crystal controlled.  
**PILOT STABILITY:** 19 kHz ± 1 Hz.  
**AUDIO INPUT IMPEDANCE:** (left and right) 600 ohms balanced.  
**AUDIO INPUT LEVEL:** (left and right) +10 dBm ± 1 dB for 100% modulation at 400 Hz.  
**AUDIO FREQUENCY RESPONSE:** (left and right) Standard 75 microsecond, FCC pre-emphasis curve ± 1 dB, 50-15,000 Hz.  
**DISTORTION:** (left or right) 1% or less, 50-15,000 Hz.  
**IM:** 0.5%, 60/7000Hz, 4:1 ratio.  
**FM NOISE:** (left or right) 60 dB minimum below 100% modulation, reference 400 Hz.  
**STEREO SEPARATION:** 35 dB minimum 50-15,000 Hz.  
**SUB-CARRIER SUPPRESSION:** 42 dB below 90% modulation.  
**CROSSTALK:** (main to sub-channel or sub to main channel) 42 dB below 90% modulation.

### SCA MODE (SCA Generator optional)

**FREQUENCY STABILITY:** ± 500 Hz.  
**FREQUENCY:** Between 25 and 75 kHz.  
**OSCILLATOR TYPE:** Two Colpitts heterodyned to produce desired output frequency.  
**MODULATION:** Direct FM.  
**MODULATION CAPABILITY:** ± 7.5 kHz.  
**AUDIO INPUT IMPEDANCE:** 600 ohms balanced.  
**AUDIO INPUT LEVEL:** +8 dBm, ± 3 dB for 100% modulation at 400 Hz.  
**AUDIO FREQUENCY RESPONSE:** 41 kHz and 67 kHz, 50 microsecond, modified pre-emphasis. 67 kHz response modified for proper operation when used with stereo to conform to FCC specifications.  
**DISTORTION:** Less than 1.5%, 30-7000 Hz.  
**FM NOISE:** (main channel not modulated) 55 dB minimum (ref. 100% modulation 400 Hz).  
**CROSSTALK:** (sub-channel to main channel) -60 dB or better.  
**CROSSTALK:** (main channel to sub-channel) 50 dB below 100% modulation (ref. 400 Hz).  
**AUTOMATIC MUTE LEVEL:** Variable from 0 to 40 dB below 100% modulation.

## ORDERING INFORMATION

FM-3H3, 3000 watt FM broadcast transmitter with TE-3 exciter, 60 Hz .....	994-6742-001
FM-3H3, same as above except for 50 Hz operation .....	994-6742-002
FM-5H3, 5000 watt FM broadcast transmitter with TE-3 exciter, 60 Hz .....	994-6736-001
FM-5H3, same as above except for 50 Hz operation .....	994-6736-002
FM-7.5H3, 7500 watt FM broadcast transmitter with TE-3 exciter, 60 Hz .....	994-6743-001
FM-7.5H3, same as above except for 50 Hz operation .....	994-6743-002
100% spare tube kit for all of above .....	990-0549-001
Stereo generator [add for stereo operation] .....	994-6533-001
SCA sub-carrier generator [add for SCA operation] .....	994-6507-002



**HARRIS**  
COMMUNICATIONS AND  
INFORMATION HANDLING

# FM-2.5H3

## 2500 Watt FM Transmitter

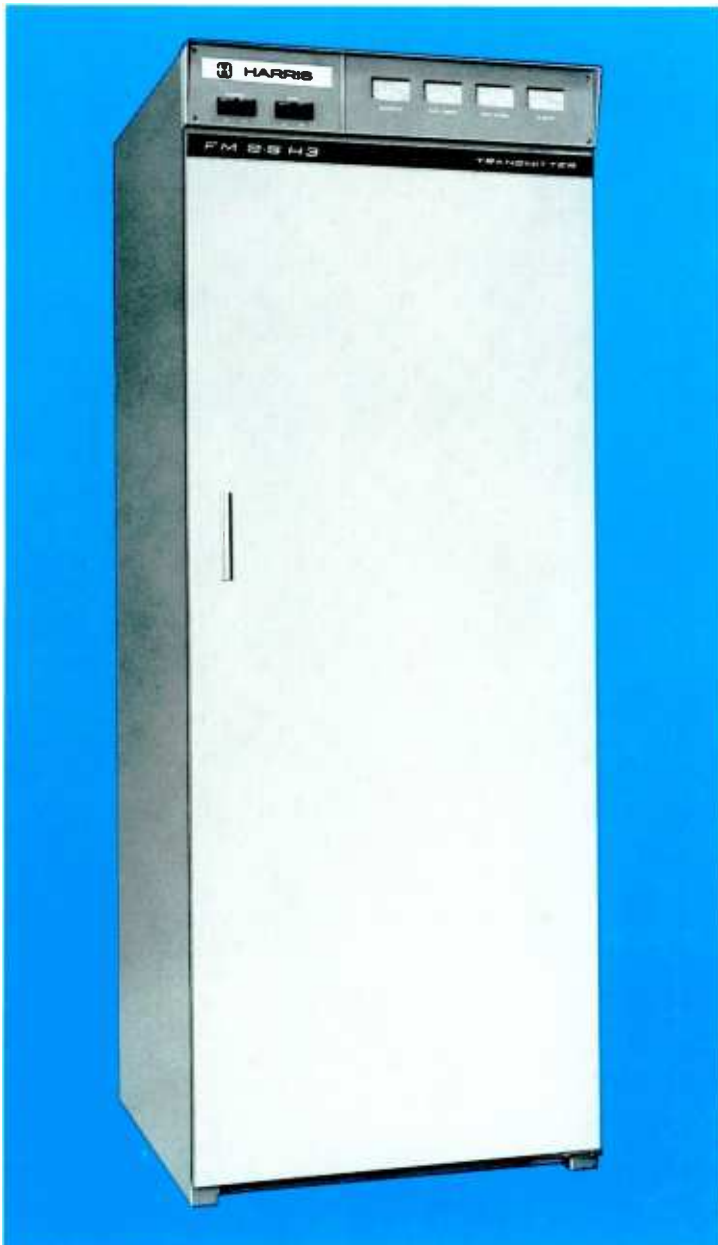

The FM-2.5H3 employs only two tubes for an output of 2,500 watts, assuring greater reliability. Driven by Harris' TE-3 solid-state exciter, the two stages are a 4X150A intermediate power amplifier, and the 5CX1500A single-ended final amplifier.

Sophisticated broadband circuitry assures maximum stereo separation and minimum crosstalk to provide listeners with the finest sound in FM. The FM-2.5H3 is FCC type accepted for power outputs of 800 to 2,500 watts for both monaural and stereophonic transmission in the 88 to 108 MHz band.

**STABLE, EASY OUTPUT TUNING.** Plate tuning of the final amplifier is stable and easily adjusted. The plate circuit is a shorted, one-quarter wave-length configuration, with the plate-line operated at DC ground potential. Coarse plate tuning is pre-set for the operating frequency on the quarter wave plate circuit. Fine adjustment is made with the plate tuning knob on the front panel. Amplifier loading is changed by a variable output loading control.

**POWER OUTPUT CONTROL.** The transmitter has a built-in motor-operated rheostat connected to the screen supply for adjusting the power output. A built-in reflectometer with a VSWR power meter makes adjustments of the power output easy and accurate.

**PUSHBUTTON OPERATION.** Manual operation of the transmitter is simple. On-Off functions are controlled by lighted, dual pushbuttons at the top left of the cabinet. They are clearly marked Filament On and Off, Plate On and Off. After the filaments of the tubes are turned on, a time-delay relay allows the cathodes to reach operating temperatures before the Plate power can be turned on.

**AUTOMATIC RECYCLING.** In case of momentary overload, the transmitter will recycle automatically. If the overload repeats more than the desired number of times pre-set in the transmitter, the transmitter will then stay off the air until the plate is turned on locally or by remote control.

**REMOTE CONTROL.** All necessary operating functions can be remote controlled. No additional equipment is required to adapt a Harris Remote Control System to the transmitter. Connections are easily made at a terminal on the side of the cabinet.

**PLUG-IN STEREO AND SCA.** A station engineer can equip the transmitter for stereo and/or SCA operation at any time. Harris' unique modular design of the TE-3 solid-state exciter makes this possible using plug-in units.

Initially, the transmitter can be ordered for monophonic service. Later, plug-in stereo and SCA can be added.

Stereo separation of 35 dB minimum from 50 to 15,000 Hz makes the FM-2.5H3 outstanding for stereophonic broadcasting.

**HARMONIC FILTERS STANDARD.** Supplied with a Harris designed harmonic filter, the transmitter fully meets FCC requirements for spurious radiation. All filtering is mounted inside the transmitter cabinet and provides rapid cut-off of second and higher order harmonics.

**QUALITY COMPONENTS.** Every transmitter component is conservatively operated and chosen to give optimum performance in continuous duty service. In Harris' TE-3 exciter, only performance-proven solid-state devices and precision temperature compensated components are used throughout.



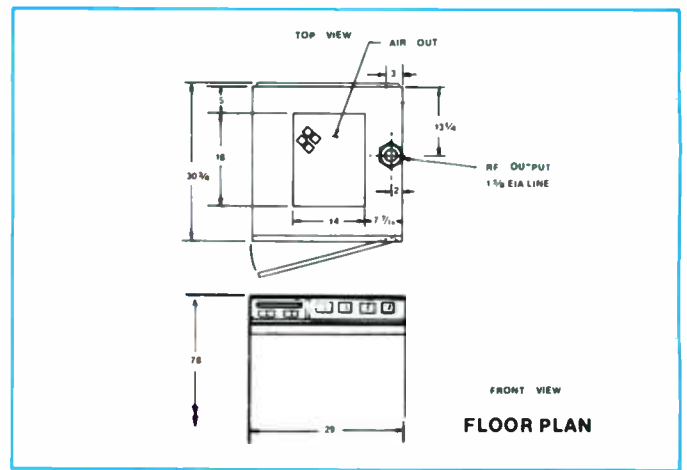
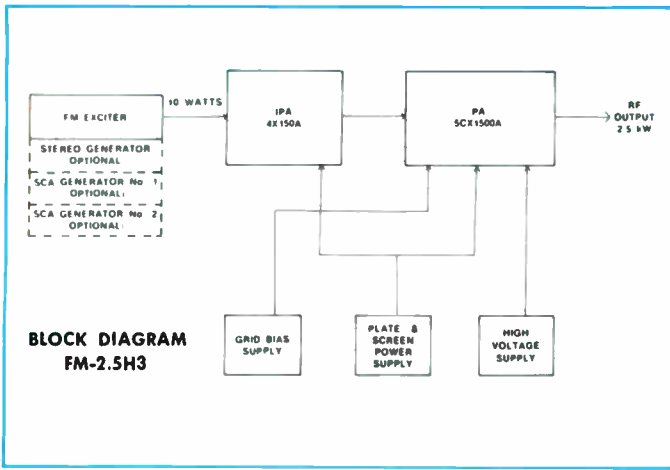

## FM-2.5H3 SPECIFICATIONS

### GENERAL

- POWER OUTPUT:** 800 W to 2.5 kW.
- FREQUENCY RANGE:** 87.5 to 108 MHz, tuned to specified operating frequency.
- RF OUTPUT IMPEDANCE:** 50 ohms.
- OUTPUT TERMINATION:** 1 1/2" EIA flange.
- FREQUENCY STABILITY:** .001% or better.
- TYPE OF MODULATION:** Direct Carrier Frequency Modulation.
- MODULATION CAPABILITY:**  $\pm 100$  kHz.
- AC INPUT POWER:** 197/250 V., 60 or 50 Hz, single phase, two wire. Power consumption: 4800 watts (approx.) 115 V., 60 or 50 Hz, 100 watts for TE-3.
- RF HARMONICS:** Suppression meets all FCC requirements.
- POWER SUPPLY RECTIFIERS:** Silicon.
- ALTITUDE:** 7500 feet.
- AMBIENT TEMPERATURE RANGE:**  $-20^{\circ}\text{C}$  to  $+45^{\circ}\text{C}$ .
- MAXIMUM VSWR:** 1.7 to 1.
- OVERALL CABINET SIZE:** 29" W. x 78" H. x 33" D.
- FRONT DOOR SWING:** 29".
- FINISH:** Two-tone, beige-gray.
- WEIGHT & CUBAGE:** Export: 700 lbs. Domestic: 580 lbs. 72 cu. ft.

### MONAURAL MODE

- AUDIO INPUT IMPEDANCE:** 600 ohms balanced.
- AUDIO INPUT LEVEL:**  $+10$  dBm  $\pm 2$  dB for 100% modulation at 400 Hz.
- AUDIO FREQUENCY RESPONSE:** Standard 75 microsecond, FCC pre-emphasis curve  $\pm 1$  dB, 30-15,000 Hz.
- DISTORTION:** 0.5% or less, 30-15,000 Hz.
- IM:** 0.5%, 60/7000 Hz, 4:1 ratio.
- FM NOISE:** 65 dB below 100% modulation (ref. 400 Hz).
- AM NOISE:** 55 dB below reference carrier AM modulation 100%.

### STEREOPHONIC MODE

- PILOT OSCILLATOR:** Crystal controlled.
- PILOT STABILITY:** 19 kHz  $\pm 1$  Hz.
- AUDIO INPUT IMPEDANCE:** (left and right) 600 ohms balanced.
- AUDIO INPUT LEVEL:** (left and right)  $+10$  dBm  $\pm 1$  dB for 100% modulation at 400 Hz.
- AUDIO FREQUENCY RESPONSE:** (left and right) Standard 75 microsecond, FCC pre-emphasis curve  $\pm 1$  dB, 50-15000 Hz.
- DISTORTION:** (left or right) 1% or less, 50-15,000 Hz.
- IM:** 0.5%, 60/7000 Hz, 4:1 ratio.
- FM NOISE:** (left or right) 60 dB minimum below 100% modulation. Reference 400 Hz.
- STEREO SEPARATION:** 35 dB minimum 50-15,000 Hz.
- SUB-CARRIER SUPPRESSION:** 42 dB below 90% modulation.
- CROSSTALK:** (main to sub-channel or sub-to main channel) 42 dB below 90% modulation.

### SCA SPECIFICATIONS

- FREQUENCY STABILITY:**  $\pm 500$  Hz.
- FREQUENCY:** Between 25 and 75 kHz.
- OSCILLATOR TYPE:** Two Colpitts heterodyned to produce desired output frequency.
- MODULATION:** Direct FM.
- MODULATION CAPABILITY:**  $\pm 7.5$  kHz.
- AUDIO INPUT IMPEDANCE:** 600 ohms balanced.
- AUDIO INPUT LEVEL:**  $+8$  dBm,  $\pm 3$  dB for 100% modulation at 400 Hz.
- AUDIO FREQUENCY RESPONSE:** 41 kHz and 67 kHz, 50 microsecond modified pre-emphasis. 67 kHz response modified for proper operation when used with stereo to conform to FCC specifications.
- DISTORTION:** Less than 1.5%, 30-7000 Hz.
- FM NOISE:** (main channel not modulated) 55 dB minimum (ref. 100% modulation 400 Hz).
- CROSSTALK:** (sub-channel to main channel):  $-60$  dB or better.
- CROSSTALK:** (main channel to sub-channel): 50 dB below 100% modulation (ref. 400 Hz), with main channel modulated 70% by frequencies 30-15,000 Hz.
- AUTOMATIC MUTE LEVEL:** Variable from 0 to  $-40$  dB below 100% modulation.

## ORDERING INFORMATION

FM-2.5H3 2500-watt FM broadcast transmitter with TE-3 exciter, 60 Hz .....	994-6871-001
FM-2.5H3 2500-watt FM broadcast transmitter with TE-3 exciter, 50 Hz .....	994-6871-003
100% spare tube kit .....	990-0587-001
Stereo generator (add for stereo operation) .....	994-6533-001
SCA generator (add for SCA operation) .....	994-6507-002



# BFE-10G and BFE-50G

## 10 and 50 Watt FM Transmitters

**MODEL BFE-10G3.** The BFE-10G3 10-watt FM transmitter is FCC type approved for educational FM broadcasting, and is equally suitable for STL service, or for any applications where 10 watts FM output is required. A compact, self-contained unit designed specifically for desk or wall mounting, this 10-watt model incorporates Harris' TE-3 exciter, featuring Direct Carrier Frequency Modulation.

Immediate "full view" access is available by removing the front grill or the rear full-length slip-off door. This complete 10-watt FM transmitter is used by many schools, colleges, universities and overseas broadcasters in conjunction with the Harris FM-11 single-ring or the FM-22 double-ring FM antenna.



**MODEL BFE-50G3.** For 88 to 108 MHz FM service, the BFE-50G3 is similar in design to the BFE-10G3 transmitter, but delivers five times as much power, or 50 watts. A 50-watt power amplifier is driven by the 10-watt section to provide the higher powered output. The amplifier utilizes two 6146 tubes and a separate 600 volt power supply. Identical in external appearance to the standard BFE-10G3 transmitter, the BFE-50G3 also incorporates the TE-3 exciter.

### BFE-10G, BFE-50G SPECIFICATIONS

#### GENERAL

**POWER OUTPUT:** BFE-10G3, 10 watts; BFE-50G3, 50 watts.  
**FREQUENCY RANGE:** 87.5 to 108 MHz, tuned to specified operating frequency.  
**RF OUTPUT IMPEDANCE:** 50 ohms.  
**FREQUENCY STABILITY:** .001% or better.  
**TYPE OF MODULATION:** Direct Carrier Frequency Modulation.  
**MODULATION CAPABILITY:**  $\pm 100$  kHz.  
**AC INPUT POWER:** 117 volts, 50/60 Hz.  
**RF HARMONICS:** Suppression meets all FCC requirements.  
**ALTITUDE:** 7500 feet.  
**AMBIENT TEMPERATURE RANGE:**  $-20^{\circ}\text{C}$  to  $+45^{\circ}\text{C}$ .  
**MAXIMUM VSWR:** 1.7 to 1.  
**OVER-ALL CABINET SIZE:** 26½" H, 28" W, 14" D.  
**FINISH:** Two-tone, beige-gray.  
**WEIGHT & CUBAGE:** BFE-10G3: 100 lbs., 15 cu. ft. BFE-50G3: 125 lbs., 16 cu. ft.

#### MONAURAL MODE

**AUDIO INPUT IMPEDANCE:** 600 ohms balanced.  
**AUDIO INPUT LEVEL:** +10 dBm  $\pm 2$  dB for 100% modulation at 400 Hz.  
**AUDIO FREQUENCY RESPONSE:** Standard 75 microsecond FCC pre-emphasis curve  $\pm 1$  dB, 30-15,000 Hz.  
**DISTORTION:** 0.5% or less, 30-15,000 Hz.  
**IM:** 0.5%, 60-7000 Hz, 4:1 ratio.  
**FM NOISE:** 65 dB below 100% modulation (ref. 400 Hz).  
**AM NOISE:** 50 dB below reference carrier AM modulated 100%.

#### STEREOPHONIC MODE [Stereo Generator optional]

**PILOT OSCILLATOR:** Crystal controlled.  
**PILOT STABILITY:** 19 kHz  $\pm 1$  Hz.  
**AUDIO INPUT IMPEDANCE:** (left and right) 600 ohms balanced.  
**AUDIO INPUT LEVEL:** (left and right) +10 dBm  $\pm 1$  dB for 100% modulation at 400 Hz.  
**AUDIO FREQUENCY RESPONSE:** (left and right) standard 75 microsecond, FCC pre-emphasis curve  $\pm 1$  dB, 50-15,000 Hz.  
**DISTORTION:** (left and right) 1% or less, 50-15,000 Hz.  
**IM:** 0.5%, 60-7000 Hz, 4:1 ratio.  
**FM NOISE:** (left and right) 60 dB minimum below 100% modulation, reference 400 Hz.  
**STEREO SEPARATION:** 35 dB minimum 50-15,000 Hz.  
**SUB-CARRIER SUPPRESSION:** 42 dB below 90% modulation.  
**CROSSTALK:** (Main to sub-channel or sub to main channel) 42 dB below 90% modulation.

### ORDERING INFORMATION

**BFE-10G3, 10-watt FM transmitter utilizing**  
**TE-3 solid-state exciter** ..... 994-6737-001  
**BFE-50G3, 50-watt FM transmitter utilizing**  
**TE-3 solid-state exciter** ..... 994-6738-001  
**100% set spare rectifiers, tubes and**  
**transistors for BFE-50G3** ..... 990-0726-001



## FMH SUPER-POWER CIRCULARLY POLARIZED FM ANTENNA

- High power handling capability
- Internal feed point to radiating element
- Multi-station capability
- Excellent bandwidth characteristics
- Rugged brass construction
- Silver plated inner-conductor connectors
- Radiused element tips to avoid corona problems
- Stainless steel support brackets and hardware
- Special vertical/horizontal power splits available

The Harris super-power FMH circularly polarized FM antennas feature unusually high power handling capabilities, excellent bandwidth characteristics, and multi-station capability.

**RADIATING ELEMENT.** The radiating element is of brass construction, and has an outside diameter of 3-1/8". The feed point is completely internal, with a pressurized environment up to the feed point. Each element is rated at 40 kW, with the exceptions of the "A" series end fed 1 and 2 bay antennas and the center fed 2 bay, which are rated at 32, 35 and 39 kW respectively. Element ratings are limited only by the average power handling capability of the 3-1/8" rigid coaxial line, which we have conservatively derated from 48 kW to 40 kW.

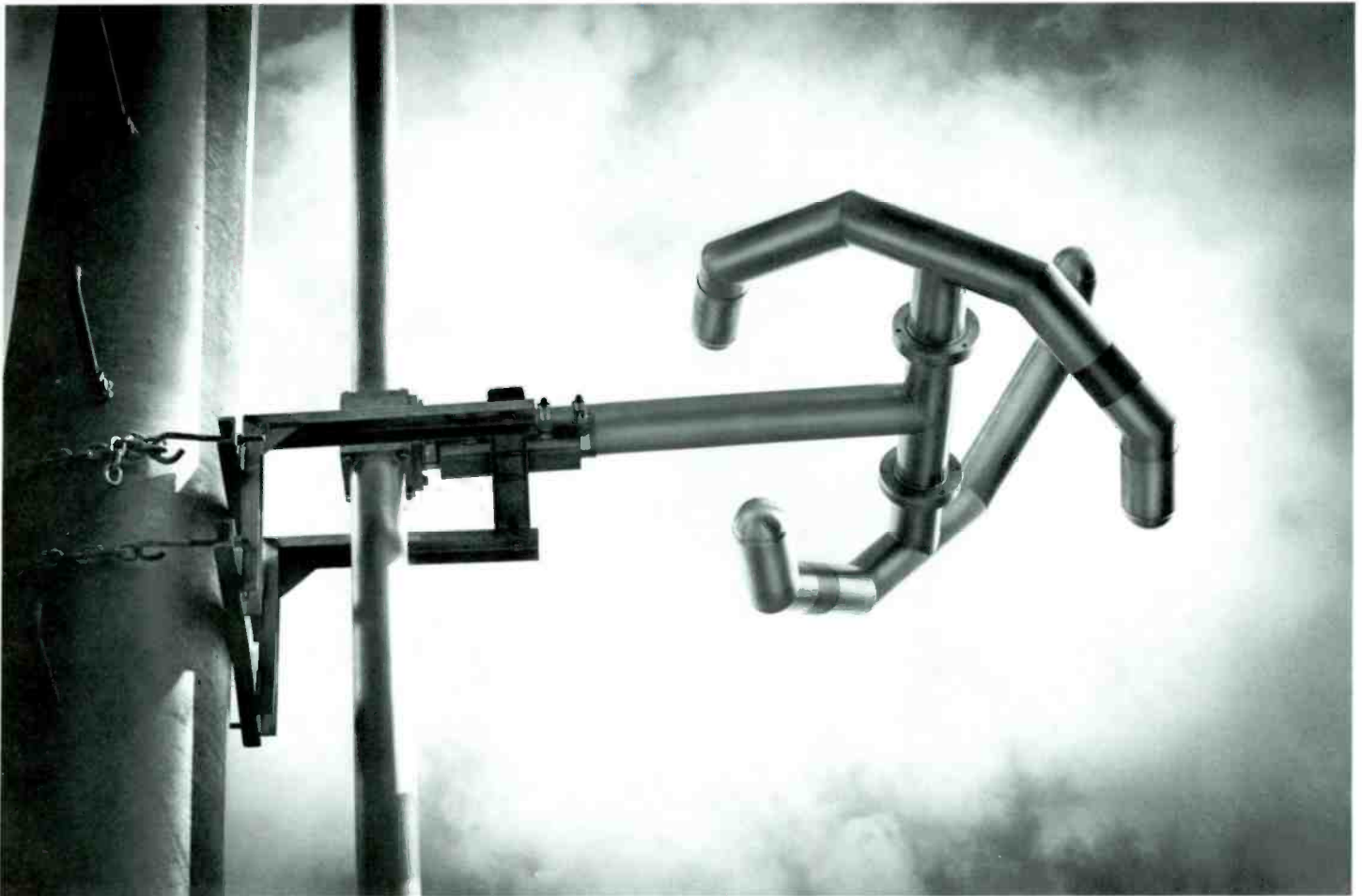



The rugged construction means these antennas will withstand the most severe weather extremes and wind velocities up to 150 miles per hour.

**BANDWIDTH CAPABILITY.** The FMH antenna has a low standing wave ratio of 1.07:1 or less,  $\pm$  200 kHz per given channel with field trimming. VSWR at antenna input without field trimming is 1.1:1 for pole mounting atop a tower. VSWR at antenna input without field trimming is 1.5:1 or less when side mounted on a tower.

Due to the excellent bandwidth characteristics of the radiating element, multi-station operation is possible using a common antenna system. The necessary filtering components are available from Harris for such diplexing or multiplexing operations. Stations having a frequency separation of up to 4 MHz may be diplexed on a common antenna. However, in the case of 40 kW transmitters, a minimum frequency separation of 1.2 MHz is advisable to avoid excessive heating of filter components.

**CIRCULARITY.** The horizontal plane radiation pattern is omni-directional when the antenna is pole mounted atop a tower, and circularity is typically  $\pm$  2 dB when the antenna is mounted on a 14" diameter steel pole. When side mounted, the antenna pattern will be somewhat affected by the supporting structure.

**DEICING.** Deicers are not required in a normal environment, as the typical VSWR is 1.5:1 or less with 1/2-inch of radial ice. However, heaters for deicing are available.

**ANTENNA MODELS.** The Harris FMH super-power FM antenna is available in three versions. The "A" version uses a 3-1/8" element feed stem, and 3-1/8" rigid interbay line. It is available in 3-1/8" end fed, 3-1/8" center fed and 6-1/8" center fed models, in arrays of up to 12 bays.

The FMH "B" version uses a 4-1/8" element feed stem, and a 4-1/8" rigid interbay line. It is available in either 6-1/8" end fed or 6-1/8" center fed models in arrays of up to 12 bays.

The FMH "C" version uses a 4-1/8" element feed stem, and 6-1/8" rigid interbay line, with 6-1/8" end feed. It is available in arrays of up to 6 bays.

Each antenna is supplied with a 6-foot input transformer. The input is 50 ohm EIA with either a 3-1/8" flange or a 6-1/8" flange, depending on the model type. All antennas are completely assembled and tuned to the customer's frequency at the factory. Also, pressure testing is done at that time to assure the customer of a leak-free antenna, provided the antenna is properly installed by a qualified erector and is free of damage.

**MOUNTING.** Stainless steel mounting brackets and hardware are supplied for standard constant cross section towers or steel poles at no additional cost. Brackets for mounting on tapered towers are available at additional cost.

**DIMENSIONS.** Each FMH element is approximately 47-1/2 inches long, and 30 inches high. Weight is approximately 57 pounds per element with line block.

**MODEL NUMBERS.** Because of the many variations within each FMH model category, it is helpful in ordering to understand the Harris model numbers:

FMH-1BE

1 = 1 bay

B = "B" Model

E = End Fed

FMH-4AC6

4 = 4 bay

A = "A" Model

C = Center Fed

6 = 6-1/8" input

"A" Model, 3-1/8" Interbay Line, 3-1/8" Element Stem

TYPE NO.	POWER GAIN <sup>1</sup>		FEMALE 50 OHM INPUT	POWER INPUT CAPABILITY <sup>2</sup>	CALCULATED WT. [LBS]	CALCULATED WIND-LOAD [LBS] <sup>3</sup>
	POWER	dB				
FMH-1AE	0.5	-3.36	3 1/8"	32kW	114	137
FMH-2AE	1.0	-0.01	3 1/8"	32kW	225	304
FMH-2AC	1.0	-0.01	3 1/8"	39kW	250	319
FMH-2AC6	1.0	-0.01	6 1/8"	64kW	301	421
FMH-3AE	1.5	1.93	3 1/8"	32kW	336	470
FMH-4AE	2.1	3.29	3 1/8"	32kW	447	637
FMH-4AC	2.1	3.29	3 1/8"	39kW	472	652
FMH-4AC6	2.1	3.29	6 1/8"	64kW	523	758
FMH-5AE	2.7	4.34	3 1/8"	32kW	558	804
FMH-6AE	3.3	5.19	3 1/8"	32kW	669	971
FMH-6AC	3.3	5.19	3 1/8"	39kW	694	986
FMH-6AC6	3.3	5.19	6 1/8"	64kW	745	1096
FMH-7AE	3.9	5.90	3 1/8"	32kW	780	1138
FMH-8AE	4.5	6.52	3 1/8"	32kW	891	1305
FMH-8AC	4.5	6.52	3 1/8"	39kW	916	1320
FMH-8AC6	4.5	6.52	6 1/8"	64kW	967	1433
FMH-10AC	5.7	7.54	3 1/8"	39kW	1138	1653
FMH-10AC6	5.7	7.54	6 1/8"	64kW	1189	1770
FMH-12AC	6.9	8.37	3 1/8"	39kW	1360	1987
FMH-12AC6	6.9	8.37	6 1/8"	64kW	1411	2108

"B" Model, 4-1/8" Interbay Line, 4-1/8" Element Stem

TYPE NO.	POWER GAIN <sup>1</sup>		FEMALE 50 OHM INPUT	POWER INPUT CAPABILITY <sup>2</sup>	CALCULATED WT. [LBS]	CALCULATED WIND-LOAD [LBS] <sup>3</sup>
	POWER	dB				
FMH-1BE	0.5	-3.36	6 1/8"	40kW	159	201
FMH-2BE	1.0	-0.01	6 1/8"	56kW	297	407
FMH-2BC	1.0	-0.01	6 1/8"	80kW	336	468
FMH-3BE	1.5	1.93	6 1/8"	56kW	435	613
FMH-4BE	2.1	3.29	6 1/8"	56kW	573	818
FMH-4BC	2.1	3.29	6 1/8"	112kW	612	879
FMH-5BE	2.7	4.33	6 1/8"	56kW	711	1024
FMH-6BE	3.3	5.19	6 1/8"	56kW	849	1229
FMH-6BC	3.3	5.19	6 1/8"	112kW	888	1290
FMH-7BE	3.9	5.90	6 1/8"	56kW	987	1435
FMH-8BE	4.5	6.52	6 1/8"	56kW	1125	1641
FMH-8BC	4.5	6.52	6 1/8"	112kW	1164	1702
FMH-10BC	5.7	7.54	6 1/8"	112kW	1440	2113
FMH-12BC	6.9	8.37	6 1/8"	112kW	1716	2524

"C" Model, 6-1/8" Interbay Line, 4-1/8" Element Stem

TYPE NO.	POWER GAIN <sup>1</sup>		FEMALE 50 OHM INPUT	POWER INPUT CAPABILITY <sup>2</sup>	CALCULATED WT. [LBS]	CALCULATED WIND-LOAD [LBS] <sup>3</sup>
	POWER	dB				
FMH-1CE	0.5	-3.36	6 1/8"	40kW	205	260
FMH-2CE	1.0	-0.01	6 1/8"	80kW	410	520
FMH-3CE	1.5	1.93	6 1/8"	120kW	615	780
FMH-4CE	2.1	3.29	6 1/8"	120kW	820	1040
FMH-5CE	2.7	4.33	6 1/8"	120kW	1025	1300
FMH-6CE	3.3	5.19	6 1/8"	120kW	1230	1560

**FOOTNOTES-(Apply to all models)**

1. Horizontal and vertical power gain and dB gain are the same. 2. Power input capability up to 2,000 ft. above mean sea level. Derating required above 2,000 ft. 3. Windload based on 50/33 PSF. 112 m.p.h. actual wind velocity NOTE: Brackets included in weight and windload calculations.





**HARRIS**  
COMMUNICATIONS AND  
INFORMATION HANDLING

# FMS DUAL-CYCLOID

## CIRCULARLY POLARIZED FM ANTENNA

The Harris Dual-Cycloid Type FMS antenna transmits circular polarization as authorized by FCC rules and regulations. The station's effective radiated power will still be determined by the signal radiated in the horizontal plane. This is determined by the antenna gain (see table ) in the horizontal plane multiplied by the power input to the antenna.

Any number of elements from one to sixteen may be utilized, providing maximum flexibility in the selection of power gain for a particular installation. Antennas with null fill, beam tilt, and special horizontal to vertical power splits (other than 50/50) are available. Radomes or deicers are available for climates that experience icing conditions.

The Dual-Cycloid consists of two basic parts: (1) the radiating element and, (2) interconnecting transmission line sections. The radiating elements in an array are all identical electrically and mechanically. Utilizing the effective ring design of the Cycloid as the basic unit, two vertical elements have replaced the fixed end plates; the rear terminal block is now a matching balun mating the antenna impedance to the interconnecting transmission line.

The vertical sections have adjustable caps for a fine adjustment of the horizontal/vertical radiation ratio which is set at the factory. Corona suppression balls are included as a standard item. Designed for rugged trouble-free operation, all antenna elements are fabricated of a durable weather resistant brass alloy with excellent electrical properties.

Antenna elements are normally spaced one wave length apart with interconnecting transmission line sections and feed through a common system input termination of 50 ohms, which is a standard 3 1/8 " EIA female flange.

**CIRCULARITY.** Both the horizontal and vertical radiation pattern of the Dual-Cycloid antenna have been measured within  $\pm 2$ dB in free space. When side mounted, the antenna pattern will be somewhat affected by the supporting structure.

Supplied on a standard 3 1/8 " EIA line, the antenna is complete with mounting brackets for standard AM and FM towers.

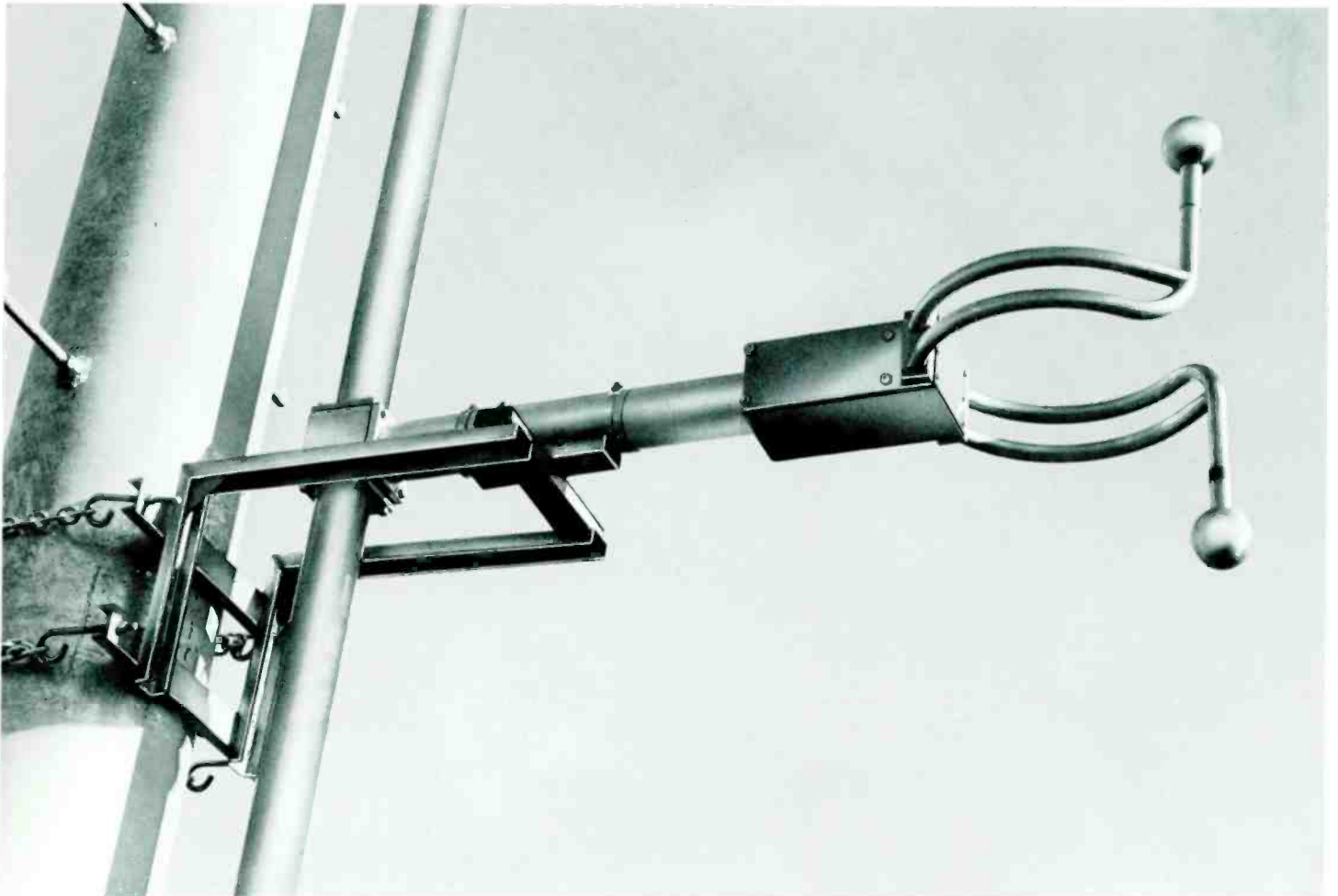

**FEED POINT.** Antennas of 8 bays or less are usually end fed; a 6 foot matching transformer is connected to the bottom bay. Antennas of 9 bays or more are center fed if an even number of bays, or at a point one-half way below the antenna center if an odd number of bays; a 10 foot matching transformer is connected to an elbow attached to the center feed tee.

**MOUNTING.** The antenna is mounted on a specially designed stainless steel supporting bracket, fabricated to mate with the tower in a mounting arrangement specified by the purchaser. Antennas are usually mounted on the leg or tower face of a guyed or self supporting tower. A special quotation will be made for brackets on TV towers and non-standard radiators and poles.

Order Type FMS - (X) (X indicates number of bays required).



Radomes available for FMS Antenna

## FMS DUAL CYCLOID SPECIFICATIONS

**FREQUENCY RANGE:** Factory tuned to one frequency in the 88 to 108 MHz band.

**POLARIZATION:** Circular, clockwise.

**POWER GAIN:** See table below. Referred to a half-wave dipole in free space.

**AZIMUTHAL PATTERN:** Circular  $\pm 2.0$  dB in free space for horizontal polarization: same for vertical polarization.

**VSWR AT INPUT (Without field trimming):** Top mounting, 1.1:1 or better. Side mounting, 1.5:1 or better.

**VSWR AT INPUT (With field trimming):** Top or side mounting, 1.1:1 or better over  $\pm 100$  kHz.

**INPUT IMPEDANCE:** 50 ohms.

**INPUT CONNECTION:** 3 1/8 inch, 50 ohm EIA female flange.

**POWER INPUT RATING:** Approximately 10 kW per bay (see table).

**WINDLOAD:** 50 lbs. per square foot for flat surfaces; 33 lbs. per square foot for cylindrical surfaces. Figures available for other wind loading.

**DIMENSIONS:** (One bay) 30 in. high x 35 1/2 in. typical.

**FEED POINT:** One to eight bays, end fed. Nine bays and over, center fed with even number of bays, or at a point 1/2 bay below center with odd number of bays.

## FMS DUAL-CYCLOID ANTENNA

TYPE NO.	POWER GAIN [in each polarization]			INPUT POWER RATING KW	APPROX. LENGTH FT. <sup>2</sup>	WEIGHT [INCL. BRACKETS] LBS. <sup>3</sup>	WIND LOAD LBS. <sup>4</sup>	WIND LOAD W/RADOMES LBS. <sup>4</sup>
	POWER	dB	FIELD <sup>1</sup>					
FMS-1	0.46	-3.37	0.678	10	—	80	133	259
FMS-2	1.0	0	1.00	20	10	176	296	547
FMS-3	1.5	1.76	1.23	30	20	262	458	835
FMS-4	2.1	3.22	1.45	40	30	348	620	1123
FMS-5	2.7	4.31	1.64	40	40	434	783	1411
FMS-6	3.2	5.05	1.79	40	50	520	945	1699
FMS-7	3.8	5.80	1.95	40	60	606	1108	1987
FMS-8	4.3	6.34	2.07	40	70	692	1270	2275
FMS-9	4.9	6.87	2.21	40	80	799	1506	2636
FMS-10	5.5	7.40	2.35	40	90	885	1668	2924
FMS-11	6.0	7.78	2.46	40	100	971	1831	3212
FMS-12	6.6	8.20	2.57	40	110	1057	1993	3500
FSM-13	7.2	8.56	2.68	40	120	1143	2156	3788
FMS-14	7.8	8.92	2.79	40	130	1229	2318	4076
FMS-15	8.3	9.19	2.88	40	140	1315	2480	4364
FMS-16	8.9	9.49	2.98	40	150	1401	2643	4652

### FOOTNOTES

1. To obtain the effective free space field intensity at one mile in mv/m for one kilowatt antenna input power, multiply field gain by 138. 2. When determining coax line length on end feed antenna, add 10' to allow for matching stub. When determining coax line lengths on center feed antenna, termination will be 6' below center due to matching stub. 3. Radome weight is 20 lbs. additional per bay. Heaters are not included in weights given. Heater weight, including junction boxes and interbay cable is 7 lbs. additional per bay. Heater elements replaceable in the field. 4. Based on 50 psf wind pressure on flat surfaces, 33 psf on cylindrical surfaces (112 mph actual wind velocity). Antenna will withstand velocities up to 150 mph.

**EQUIPMENT FURNISHED:** Antenna elements as ordered; antenna mounting hardware (specify tower manufacturer and type); interconnecting rigid coax transmission line; standard 3 1/8 inch EIA female flange.

**ACCESSORY EQUIPMENT:** RF shield deicer system, 300 watts or 500 watts per bay, 115 volts or 230 volts, 50/60 Hz...complete with conduit boxes and RF shielded interbay wiring harness.



# DUAL-CYCLOID II

# DUAL-CYCLOID III

## Circularly Polarized FM Antennas

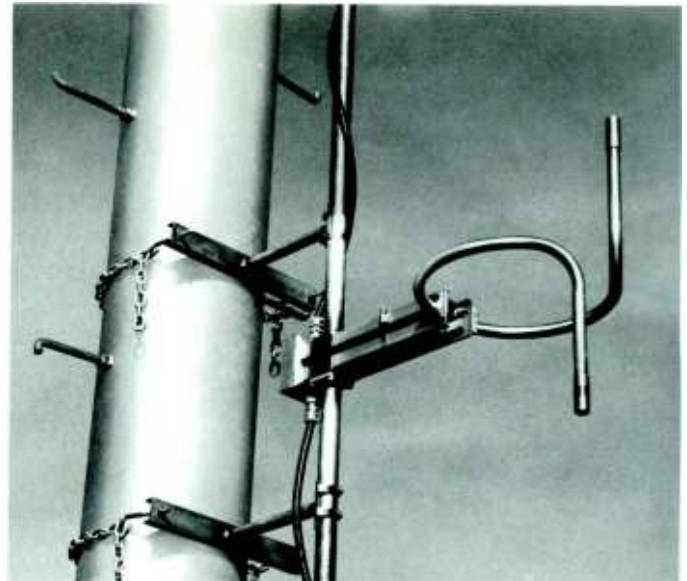

**DUAL-CYCLOID II.** Harris' Dual-Cycloid II circularly polarized FM antenna provides all of the electrical advantages of the Dual-Cycloid, in a lighter weight, low silhouette design for minimum windloading. The antenna features center feed for medium power handling capabilities—from four to twelve bays handle transmitter powers through 10 kilowatts. Antenna elements are normally spaced one wavelength apart with interconnecting transmission line sections and feed through a common antenna system input termination of 50 ohms, with a standard 3 1/8 inch EIA female flange.

The vertical sections have factory adjustable caps for the fine adjustment of the horizontal/vertical radiation ratio. All antenna elements are fabricated of a durable, weather-resistant brass alloy. Null fill and beam tilt are available. Standard stainless steel brackets for mounting the antenna on the tower leg are included with the antenna. Optional deicers consist of two 150-watt heating elements per bay, for either 115 volts or 230 volts, as specified. The heater elements are replaceable in the field. Junction boxes and shielded interbay wiring is included. Heater weight including junction boxes and interbay cable, is 6 lbs. additional per bay. Order type FMC-(X) B (X indicates number of bays).

### FMC-[X] B SPECIFICATIONS

- FREQUENCY RANGE:** Factory tuned to one specific frequency in the 88 to 108 MHz band.
- POLARIZATION:** Circular, clockwise.
- FREE SPACE PATTERN:** Horizontal component circular  $\pm 2$  dB. Vertical component circular  $\pm 2$  dB.
- VERTICAL TO HORIZONTAL POWER RATIO:** Fixed at 50/50.
- VSWR:** 1.2 to 1 or better  $\pm 200$  kHz as tuned at the factory. VSWR when tower mounted 1.5 to 1 or better  $\pm 200$  kHz as tuned at the factory. VSWR when tower mounted 1.5 to 1 or better  $\pm 200$  kHz. Capable of adjustment 1.1 to 1  $\pm 100$  kHz with field tuning.
- POWER GAIN:** Horizontal polarization: see table. Vertical polarization: see table. Referred to a half wave dipole in free space.
- POWER INPUT RATING:** Maximum of 12 kW.
- INPUT CONNECTION:** 3 1/8" EIA female flange, 50 ohm.
- WINDLOAD:** Designed for 50 psf for flat surfaces, 33 psf for cylindrical surfaces.
- WEIGHT:** Single bay 24 lbs., less brackets. 1 5/8" interbay coaxial line weighs approximately 13 lbs. per section.
- DIMENSIONS:** Single bay height approximately 30". Length approximately 27".

**DUAL-CYCLOID III.** Designed for lower power stations, Harris' Dual-Cycloid III circularly polarized FM antenna is an end-fed version of the Dual-Cycloid II—it is lighter in weight, and has less windloading. From one to eight bays handle transmitter powers through 7.5 kilowatts.

The antenna consists of 1 5/8-inch transmission line with individual bays separated by approximately one wavelength at the operating frequency. All antenna elements are fabricated of durable, weather-resistant brass alloy. Null fill and beam tilt are not available on the Dual-Cycloid III.

Deicers consist of two 150-watt heating elements per bay for either 115 volts or 230 volts, as specified. Junction boxes and shielded interbay wiring harness are included. These elements are factory installed, and are replaceable in the field. Heater weight, including junction boxes and interbay cable, is 6 lbs. Standard stainless steel brackets for mounting the antenna on the tower leg are included with the antenna. Order type FMC-(X)A (X indicates the number of bays required).

### FMC-[X] A SPECIFICATIONS

- FREQUENCY RANGE:** Factory tuned to one specific frequency in 88-108 MHz band.
- POLARIZATION:** Circular, clockwise.
- FREE SPACE PATTERN:** Horizontal component circular  $\pm 2$  dB. Vertical component circular  $\pm 2$  dB.
- VERTICAL TO HORIZONTAL RATIO:** Fixed at 50/50.
- VSWR:** 1.2 to 1 or better  $\pm 200$  kHz as tuned at the factory. VSWR when tower mounted 1.5 to 1 or better  $\pm 200$  kHz. Capable of adjustment to 1.1 to 1  $\pm 100$  kHz with field tuning.
- POWER GAIN:** Horizontal polarization: see table. Vertical polarization: see table. Referred to a half wave dipole in free space.
- POWER INPUT RATING:** Maximum of 7.5 kW for three to eight bays. 3 kW for single bay, 6 kW for two bays.
- INPUT CONNECTION:** A six foot transformer section is attached to the bottom bay of each antenna system which has a 1 5/8" 50 ohm EIA female connector.
- WINDLOAD:** Designed for 50 psf for flat surfaces, 33 psf for cylindrical surfaces.
- WEIGHT:** Single bay 24 lbs., less brackets. 1 5/8" interbay coaxial line weighs approximately 13 lbs. per section.
- DIMENSIONS:** Single bay height approximately 30". Length approximately 27".



## DUAL-CYCLOID II

TYPE NO.	POWER GAIN <sup>1</sup>			POWER INPUT [kW]	WT. <sup>2</sup> [LBS.]	WIND-LOAD <sup>3</sup> [LBS.]	WIND-LOAD <sup>3</sup> W/RAD-OMES [LBS.]
	POWER	dB	FIELD				
FMC-4B	2.025	3.064	1.423	12	181	365	764
FMC-5B	2.577	4.111	1.605	12	218	442	941
FMC-6B	3.134	4.961	1.770	12	255	520	1118
FMC-7B	3.695	5.676	1.922	12	292	597	1296
FMC-8B	4.258	6.292	2.063	12	329	675	1473
FMC-9B	4.823	6.833	2.196	12	366	752	1650
FMC-10B	5.390	7.316	2.322	12	403	830	1828
FMC-11B	5.958	7.751	2.411	12	440	907	2005
FMC-12B	6.527	8.147	2.555	12	447	985	2182

## DUAL-CYCLOID III

TYPE NO.	POWER GAIN <sup>1</sup>			POWER INPUT [kW]	WT. <sup>2</sup> [LBS.]	WIND-LOAD <sup>3</sup> [LBS.]	WIND-LOAD <sup>3</sup> W/RAD-OMES [LBS.]
	POWER	dB	FIELD				
FMC-1A	0.438	-3.585	0.662	3	32	61	161
FMC-2A	0.947	-0.237	0.973	6	69	139	338
FMC-3A	1.480	1.702	1.216	7.5	106	216	515
FMC-4A	2.025	3.064	1.423	7.5	143	294	693
FMC-5A	2.577	4.111	1.605	7.5	180	371	870
FMC-6A	3.134	4.961	1.770	7.5	217	449	1047
FMC-7A	3.695	5.676	1.922	7.5	254	526	1224
FMC-8A	4.258	6.292	2.063	7.5	291	604	1402

**FOOTNOTES.** 1. Power gain in each polarization. To obtain effective free space field intensity at one mile MV/M for one kilowatt antenna power, multiply field gain by 137.6. 2. Weights given include brackets, interbay transmission line and transformer section (center fed tee section and elbow weight also included in Dual-Cycloid III weight). Weight per radome is 18 lbs. for Dual-Cycloid II and 18 lbs. for Dual-Cycloid III (should be multiplied times the number of bays). 3. Windload based on 50 psf on flat surfaces and 33 psf for cylindrical surfaces (actual wind velocity 112 mph). Computed for 100 MHz antenna with mounting brackets but less heater junction boxes and heater cables.

**DUAL-CYCLOID II**-Length of 4 bay antenna is approximately 30 feet. To determine the length of other antennas, add 10 feet per additional bay. Dual-Cycloid II antennas fed at center if an even number of bays, or at a point ½-bay below antenna center if an odd number of bays. A 10-ft. matching transformer is attached to an elbow attached to the center feed tee.

**DUAL-CYCLOID III**-Length of 2 bay antenna is approximately 10 feet. To determine length of other antennas, add 10 feet per additional bay. When determining coax length, add six feet to antenna length.

## EDUCATIONAL FM ANTENNAS

The Harris FM-11 series of FM antennas uses lightweight horizontally polarized ring type radiators having a horizontal plane radiation pattern that is essentially omni-directional. The FM-11 uses a single ring element; the FM-22 uses two ring elements; the FM-33 uses three elements; and, the FM-44 uses four ring elements. Antennas having more than one ring element use a vertical spacing of one wavelength between elements.

The antennas are designed for mounting on a pipe or pole having an outside diameter of 2 to 2½ inches. Two "U" bolts are provided on each antenna element for mounting. The mounting pole is not supplied, but can be provided at additional cost, as can the proper coaxial cable.

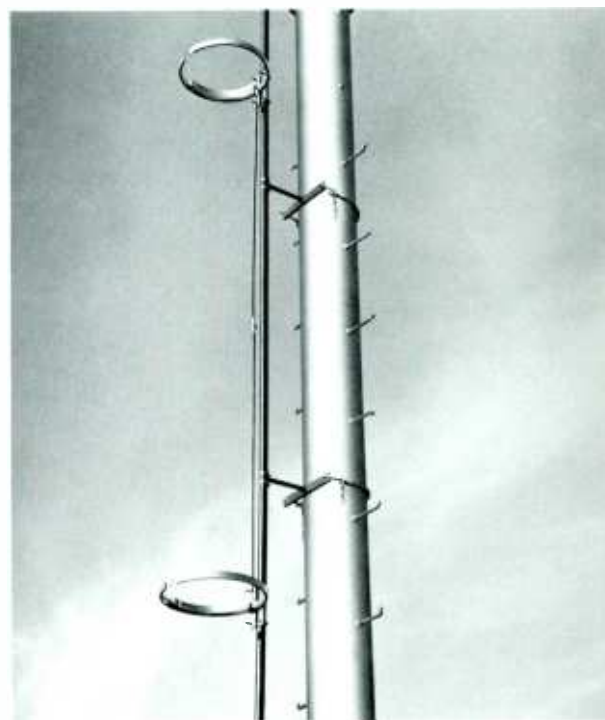

### FM-11 SERIES SPECIFICATIONS

**FREQUENCY RANGE:** Factory tuned to one specific frequency in the 88-108 MHz band.

**POLARIZATION:** Horizontal.

**TYPICAL PATTERN WHEN MOUNTED ON SMALL STEEL POLE:** Horizontal plane pattern circularity of approximately ± 3 dB.

**TYPICAL VSWR:** 1.5 to 1, or less. ± 1.2 MHz.

**INPUT CONNECTOR:** Type UHF female which mates with the type UHF male (PL-259 or 83-1SP).

**WINDLOAD CALCULATION:** Based on 50 lbs./sq. ft. for flat surfaces, 33 lbs./sq. ft. for cylindrical surfaces (wind velocity of 112 miles per hour).

**DIMENSIONS:** Single bay height approximately 9". Length approximately 23". Two bay antenna 11 ft. high; 3 bay is 22 ft.; 4 bay is 33 ft.

### ORDERING INFORMATION

FM-11A Single ring antenna ..... 710-0102-000  
 FM-22A 2-ring antenna ..... 710-0103-000  
 FM-33A 3-ring antenna ..... 710-0201-000  
 FM-44A 4-ring antenna ..... 710-0202-000

### FM-11 SERIES

TYPE NO.	POWER GAIN			POWER RATING [WATTS]	WT. [LBS.]	WIND-LOAD [LBS.]
	POWER	dB	FIELD			
FM-11	0.80	-0.969	0.894	500	7.5	52.5
FM-22	1.80	2.55	1.342	800	16.5	117
FM-33	2.75	4.39	1.658	800	27.5	196
FM-44	3.72	5.70	1.929	800	36	257



## DIRECTIONAL DUAL POLARIZED FM ANTENNA

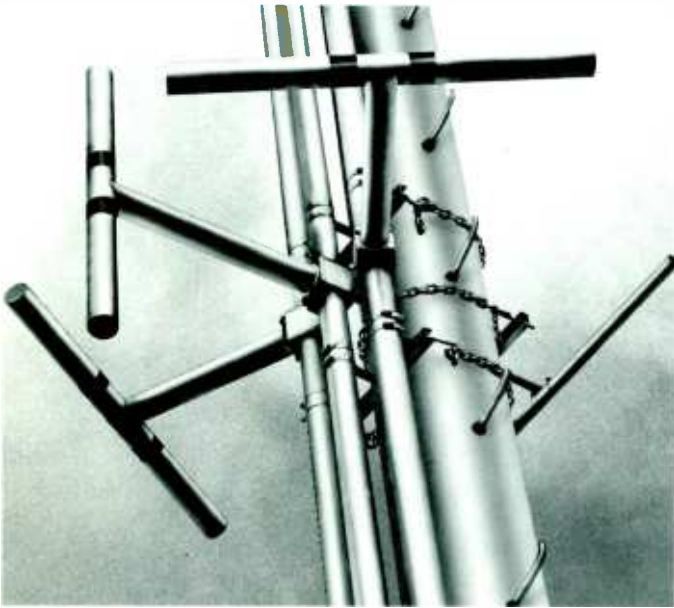

Harris' FMD-(X) is a directional dual polarized FM antenna designed for pole mounting. It is available with up to eight bays and with either 1- $\frac{5}{8}$  inch or 3- $\frac{1}{8}$  inch EIA 50 ohm female input. The "X" in the type number indicates the number of bays. The suffix "A" following the complete type number signifies 1- $\frac{5}{8}$ " input and the suffix "B" indicates 3- $\frac{1}{8}$ " input. (Example—FMD-4A is a 4-bay antenna with 1- $\frac{5}{8}$ " input).

The maximum power input capability for the "A" series is 12 kilowatts. The maximum power input capability for the "B" series is 20 kilowatts for a single bay, and 40 kilowatts for two (2) through eight (8) bays.

The interbay lines use 3- $\frac{1}{8}$  inch rigid, with three such lines used between bays, two for the horizontal element feeds and one for the vertical element feeds. A combiner, for combining the three transmission line feeds, is used below the bottom bay. A six foot transformer section is used immediately below this combiner.

The antenna uses broad-band 3- $\frac{1}{8}$ " diameter dipole elements, and these will not require deicing under normal environmental conditions. Each bay level normally uses two driven horizontal elements, one horizontal parasitic reflector and one driven vertical element. In some cases, vertical parasitic elements may be used on each bay for the purpose of further shaping the vertical polarization component.

Heaters are not normally required for antenna deicing purposes due to the excellent bandwidth characteristics exhibited by the antenna. Typically, as measured between 1.5:1 VSWR points, the bandwidth is in the region of 5 to 7 MHz. As a result, the antenna could probably experience icing of up to  $\frac{3}{4}$  inch thickness without the VSWR going above 1.5:1.

The antenna system is designed to be pressurized, using dry air or dry nitrogen, and the system should be purged and then pressurized to a positive pressure of approximately 2 to 5 pounds per square inch (0.14 to 0.35 kilograms per square centimeter) immediately following installation. The FMD antenna is supplied with a custom matching pole,\* thereby permitting the support pole to be drop shipped directly to the customer. The pole is a hot dip galvanized pedestal mount, with removable step bolts. A plate is provided on the top of the pole as a support for a beacon. Should a buried pole support be required, specific requirements will be needed for a special price quotation.

Each Harris FMD directional antenna is patterned on a pattern range, not at the customer's site. A single bay of the antenna is mounted on a pole identical to that on which the antenna is to be finally installed.

The antenna is patterned with the test pole erected vertically on a turntable on the antenna range, and measurements made in the xy, or horizontal plane, for both the horizontal and vertical polarization components. Normally, the antenna bay being patterned is operated in the transmitting mode. A special dipole receiving antenna, located a sufficient distance away, is used with its output feeding an accurate field intensity meter, and the pattern of the antenna plotted as the test pole is rotated. Patterns for each of the two polarization components are plotted separately. Adjustments are made to the antenna bay in order to achieve a suitable antenna radiation pattern.

The complete antenna is assembled on a steel pole and carefully tuned at the factory. As a result, field trimming should normally not be required.

The final pattern achieved may be expected to differ slightly from the initial pattern proposed, so the customer should be cautioned that he may be required to file an application to modify the construction permit to comply with the exact measured pattern, which the customer will receive upon the completion of the antenna pattern tests.

Following the completion of the final patterning of the antenna, Harris will provide the station, and/or its consultant, with the final measured antenna radiation pattern, calculated gain data, and the details of the antenna pattern measurement procedure. This final data is then submitted by the station to the FCC.

Orders for the Harris Dual Polarized Directional FM Antenna should specify the desired true azimuth orientation, maximum ERP permitted, radiated power limitations and their true orientation, transmission line efficiency (or specify the type of transmission line and its length), and the transmitter power output capability. Such antenna pattern requirements are normally specified by the stations's consultant. Ideally, a copy of the FCC construction permit should be supplied so that the manufacturer can assure full compliance with the requirements of such authorization relative to the antenna.

Detailed information about the Harris FMD antenna, such as typical patterns, power gain figures, weights and windloading will be supplied free of charge upon request by contacting Harris.

\* The directional antenna may be purchased without the pole only on a special quotation basis, in which case there will be an added engineering charge made, and the cost of the Harris pole deducted from this total price.



**HARRIS**  
COMMUNICATIONS AND  
INFORMATION HANDLING

## FM ANTENNA ACCESSORIES

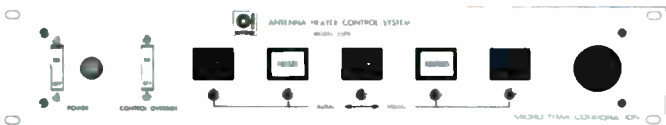

### AUTOMATIC ANTENNA HEATER CONTROL SYSTEM

Fully automated control of FM, TV and other types of electrically operated broadcast and communications antenna heater systems. Suitable alarms indicate visually and aurally existing weather conditions and register partial and total heater failure.

#### SPECIFICATIONS

- POWER INPUT:** 115 VAC, 60 Hz.
- INPUTS:** Temperature sensors; precipitation sensor; heater failure sensor.
- INDICATORS:** Rain, freeze, low temperature, heaters, heater fail. Selectable aural alarm for any or all of those listed.
- MOUNTING:** Standard 3 1/2" x 19" rack panel. 8 inches deep.
- OPTIONS:** 12 VDC function outputs for telemetering status data. Model 2570-CA calibration box. Power contactors and enclosures.

#### ORDERING INFORMATION

Antenna Heater Control System ..... 710-0139-000



### REPLACEMENT ANTENNA HEATER ELEMENTS

#### ORDERING INFORMATION

Dual-Cycloid Antennas [2 elements per bay] ..... 710-0136-000  
Dual-Cycloid II [2 elements per bay] ..... 710-0137-000  
Cycloid Antenna [2 elements per bay] ..... 710-0138-000

## FM ISOLATION TRANSFORMERS



10 kW MODEL

The FM isolation transformer is designed to couple the FM power across the base insulator of a transmitting tower used jointly as an AM and FM radiator without introducing objectionable mismatch into the FM antenna feed line. An isolation transformer is especially desirable for feeding high impedance AM radiators, or AM radiators which are part of an AM directional antenna system, which might be adversely affected by a "bazooka" type isolation system. Isolation transformers are available from Harris in 10 kW and 25 kW models (25 kW model not pictured).

#### SPECIFICATIONS

- FREQUENCY:** 88 to 108 MHz. Tuned to the station's FM carrier frequency at the factory.
- VSWR:** (10 kW unit) Less than 1.05 to 1 at the FM station frequency,  $\pm$  1.0 MHz when terminated in a matched 50 ohm load. (25 kW unit) Less than 1.05 to 1 at the FM station frequency,  $\pm$  0.5 MHz when terminated in a matched 50 ohm load.
- INSERTION LOSS:** (10 kW unit) Less than 0.05 dB. (25 kW unit) 0.10 dB or less.
- INPUT:** (10 kW unit) 1 5/8" EIA 50 ohm captive male swivel flange. (25 kW unit) 3 1/8" EIA 50 ohm male flange.
- OUTPUT:** (10 kW unit) 1 5/8" EIA 50 ohm female swivel flange. (25 kW unit) 3 1/8" EIA 50 ohm male flange (will mate with a 3 1/8" EIA 50 ohm female flange).
- WEIGHT:** (10 kW unit) Approx. 105 lbs. (25 kW unit) 255 lbs.
- FLANGE TO FLANGE LENGTH:** (10 kW unit) 67 to 73 inches, depending on the FM frequency. (25 kW unit) 44 inches.
- MOUNTING:** (10 kW unit) In a cradle supplied. The cradle is fitted with a 2-inch pipe flange on the bottom. Two stainless steel straps secure the tank to the cradle. The 2-inch mounting pipe is not supplied with the transformer. (25 kW unit) Separate 3-inch pipe flange on bottom. Two stainless steel straps secure tank to cradle.
- PRESSURIZATION:** Designed for use in a pressurized system with gas passing through the unit.

#### ORDERING INFORMATION

10 kW FM Isolation Transformer, standard 1 5/8" EIA flanges, adjusted to customer's operating frequency at the factory. For use with a maximum transmitter power of 10 kW ..... 620-1027-000  
10 kW FM Isolation Transformer, same as above except supplied with 1 5/8" - 3 1/8" adapters. Input and output 3 1/8" EIA 50 ohm female ..... 620-1028-000  
25 kW FM Isolation Transformer, standard 3 1/8" EIA flanges, adjusted to customer's operating frequency at the factory. For use with a maximum transmitter power of 25 kW ..... 620-0444-000



**HARRIS**  
COMMUNICATIONS AND  
INFORMATION HANDLING

# MODEL FT-80

## FM Modulation Monitor

The Harris FT-80 is a solid-state FM modulation monitor designed to meet FCC requirements for measuring total modulation of any monaural or multiplexed FM signal.

The FCC type approved FT-80 may be used alone for monaural monitoring, or in conjunction with the Harris FS-80 FM Stereo Monitor and the Harris FC-80 FM SCA Monitor for stereo and SCA monitoring.

This unit furnishes extremely accurate measurement, due to the inherent stability of the circuit design. And it remains accurate even after years of service. Reliability has been proven by rugged environmental chamber tests with varying line voltage. Another important feature of the FT-80 is the "easy-to-use-and-understand" design. Only often used controls and terminals are on the front panel; occasionally used controls and terminals are on the rear; and alignment controls are easily accessible inside.

The FT-80 accommodates a wide range of RF input signals, from 0.1 volt to 10 volts VRMS. Input sensitivity is excellent, so that in many cases direct RF off-air monitoring is possible without an RF amplifier.

All circuits of the FT-80 are easily accessible for maintenance. The layout of the six printed circuit boards is exceptionally clean—all integrated circuits are in sockets, and any component or sub-assembly can be removed without disturbing other circuit elements. All potentiometer adjustments are clearly marked and immediately accessible upon removal of the top cover.

A Remote FM Modulation Monitor Panel is available as an accessory, for added monitoring flexibility in unattended transmitter applications. It may be used with up to 5,000 ohms loop resistance.

### SPECIFICATIONS

**FREQUENCY RANGE:** 87.5 to 107.9 MHz, as ordered.

**RF INPUT IMPEDANCE:** 50 ohms.

**RF INPUT SIGNAL LEVEL:** 0.1 to 10 volts RMS (normal operation).  
Minimum of 1.0 volt RMS for AM noise measurement.

**POWER REQUIREMENTS:** 100-130/200-260 volts, 50/60 Hz, 40 watts  
maximum with companion units connected.

#### SIGNAL OUTPUTS [COMPOSITE]

**FREQUENCY RESPONSE:** 50 Hz to 53 kHz,  $\pm 0.3$  dB maximum.

**DISTORTION:** 0.25% maximum, 50 Hz to 53 kHz.

**PHASE LINEARITY:** 50 Hz to 53 kHz, 2° maximum.

**IMPEDANCE:** (Stereo, test) 300 ohms. (SCA) 2,000 ohms.

**SIGNAL LEVEL [100% into 10 k ohms]:** 750 mVRMS minimum.

#### SIGNAL OUTPUTS [AUDIO TEST]

**FREQUENCY RESPONSE:** 30 Hz to 15 kHz  $\pm 0.5$  dB maximum, relative to 75 microseconds de-emphasis.

**HARMONIC DISTORTION:** 50 Hz to 15 kHz, 0.25% maximum.

**OUTPUT IMPEDANCE:** 1,000 ohms.

**SIGNAL LEVEL [100% into 10 k ohms]:** 3.0 VRMS minimum.

**DE-EMPHASIS:** Within  $\pm 0.5$  dB of 75 microsecond curve.

#### SIGNAL OUTPUTS [MONITOR]

**FREQUENCY RESPONSE:** 50 Hz to 15 kHz,  $\pm 0.5$  dB maximum relative to 75 microseconds de-emphasis.

**OUTPUT IMPEDANCE:** 600 ohms floating.

**SIGNAL LEVEL [100% into 600 ohms]:** 0 dBm  $\pm 2$  dB.

**SIGNAL-TO-NOISE RATIO [75 microseconds de-emphasis]:** 70 dB minimum.

#### GENERAL

**AMBIENT TEMPERATURE RANGE:** 0 to 55°C.

**AMBIENT HUMIDITY RANGE:** 0 to 95% relative humidity.

**ALTITUDE:** 0 to 10,000 feet above sea level.

**DIMENSIONS:** 19" (48 cm) W x 3.5" (8.9 cm) H x 15" (38 cm) D (17" D including knobs and connectors).

**WEIGHT:** 13 pounds (6 kg) net, 28 pounds (13 kg) domestic packed.

### ORDERING INFORMATION

FT-80 Monaural Modulation Monitor, complete with crystal, calibrated to specified operating frequency .....	994-7070-001
Remote FM Monaural Modulation Monitor Panel .....	994-7071-001
100% Transistor/IC Kit for FT-80 .....	990-0792-001







# MODEL FS-80

## FM Stereo Monitor

The Harris FS-80 is a solid-state FM stereo modulation monitor designed to meet FCC requirements for measuring the modulation components of stereophonic programming and the accuracy of the 19 kHz pilot frequency.

The FCC type approved FS-80 must be used with the Harris FT-80 FM Modulation Monitor, which supplies power and composite signal.

The inherent stability of the FS-80 circuit design guarantees great measurement accuracy...year after year. Reliability has been proven by rugged environmental chamber tests with varying line voltage—and is insured by the use of high-quality parts at low stress levels.

FS-80 circuits are cleanly laid out on seven printed boards, with field-effect transistors, bipolar transistors, and linear and digital integrated circuits. A remote FM stereo monitor panel is available as an accessory for added monitoring flexibility in unattended transmitter applications.

Only often-used controls are located on the front panel, and are logically arranged and easy to interpret and adjust. The pilot meter provides a continuous display of deviation from the 19 kHz pilot frequency. The pilot presence light, utilizing a light-emitting diode for reliability, is extinguished when the pilot level drops below 5% of total modulation. The analog modulation meter may be adjusted with the range switch to allow readings to 70 dB below peak modulation. A meter setting is also provided for measuring AM noise and FM noise directly.

A front panel scope output allows observation of meter driving waveforms as an aid in checking such functions as separation problems and SCA crosstalk.

### SPECIFICATIONS

#### SIGNAL OUTPUTS [AUDIO TEST, LEFT OR RIGHT]

**FREQUENCY RESPONSE:**  $\pm 0.25$  dB maximum, 50 Hz to 15 kHz, with flat input and no de-emphasis.

**HARMONIC DISTORTION:** 0.2% maximum, 50 Hz to 15 kHz.

**SIGNAL-TO-NOISE RATIO:** 70 dB minimum below 100% modulation with 75 microseconds de-emphasis.

**DE-EMPHASIS:** 75 microseconds, switchable from front panel,  $\pm 0.5$  dB from ideal.

**SCOPE SIGNAL:** Up to several volts, depending on attenuator setting.

**PURPOSE:** Oscilloscope input to observe average voltmeter driving waveform.

#### MEASUREMENT CAPABILITY

##### CROSSTALK

Main to Sub: 50 dB minimum.

Sub to Main: 60 dB minimum.

67 kHz SCA to Main: 70 dB (FM = 400 Hz) minimum.

67 kHz SCA to Sub: 70 dB (FM = 400 Hz) minimum.

##### PILOT FREQUENCY METER

Measures: Deviation from 19 kHz.

Range:  $\pm 2$  Hz (of 19 kHz center zero).

Accuracy:  $\pm 0.4$  Hz.

**SEPARATION:** Left into Right or Right into Left: Can be measured to 40 dB with  $\pm 3$  dB accuracy.

##### SIGNAL-TO-NOISE RATIO

Total [No Modulation]: 70 dB minimum.

Main Channel [9% Pilot]: 60 dB minimum.

Sub-Channel [9% Pilot]: 60 dB minimum.

Left [or Right]: 70 dB minimum (with de-emphasis).

**38 kHz Suppression:** 50 dB minimum for left and right modulation over 5 kHz.

**19 kHz Amplitude:** Accurate in MOD position as low as 1%.

**FM Noise:** 70 dB minimum.

**AM Noise:** 70 dB minimum.

#### SIGNAL OUTPUTS [MONITOR]

**FREQUENCY RESPONSE:**  $\pm 0.5$  dB maximum, 50 Hz to 15 kHz, relative to 75 microseconds de-emphasis.

**HARMONIC DISTORTION:** 0.5% maximum, 50 Hz to 15 kHz.

**OUTPUT IMPEDANCE:** For 600 ohm load impedance (floating).

**SIGNAL LEVEL [100% Modulation]:** 0 dBm,  $\pm 2$  dB into 600 ohms.

**REMOTE METERING:** Pilot presence lamp, modulation meter and pilot frequency meter may be remotely metered with up to 5,000 ohms loop resistance.

**MODULATION METER RANGE:** 133% full scale, for peak modulation measurements and -70 dB range for average modulation readings.

#### GENERAL

**AMBIENT TEMPERATURE RANGE:** 0 to 55° C.

**AMBIENT HUMIDITY RANGE:** 0 to 95% relative humidity, non-condensing.

**ALTITUDE:** 10,000 feet above sea level.

**DIMENSIONS:** 19" (48 cm) W x 3½" (8.9 cm) H x 15" (38 cm) D + 2" (5 cm) for knobs and connectors.

**WEIGHT:** 13 pounds (6 kg) net. 28 pounds (13 kg) domestic packed.

### ORDERING INFORMATION

FS-80 FM Stereo Modulation Monitor .....	994-7072-001
Remote FM Stereo Monitor Panel .....	994-7073-001
100% transistor and IC kit for FS-80 .....	990-0795-001







# MODEL FC-80

## FM SCA Monitor

The Harris FC-80 is a solid-state FM SCA modulation monitor designed to meet FCC requirements for measuring the modulation components of the SCA frequency.

The FC-80 must be used with the Harris FT-80 FM Modulation Monitor, which supplies power and composite signal. A remote FM SCA monitor panel is available as an accessory for added monitoring flexibility in unattended transmitter applications.

Reliability is insured by the use of high-quality parts at low stress levels—and has been proven by rugged environmental chamber tests with varying line voltage. The inherent stability of the FC-80 circuit design guarantees great measurement accuracy over long periods of time.

Only controls that are used frequently are located on the front panel, and these are logically arranged and easy to interpret and adjust. Front panel meters and controls include: A peak flasher; two pushbutton switches for selection of either of two SCA sub-carriers; a pushbutton switch for de-emphasizing the metering; an analog SCA frequency meter; an analog modulation meter; and a front panel scope feed.

Either or both of the standard 41 kHz and 67 kHz SCA sub-carrier frequencies are available in the FC-80. Automatic muting of SCA modulation is provided in the absence of a carrier. 100% modulation of the SCA sub-carrier can be set to either 5 kHz or 7.5 kHz. A distortion mode switch is provided for bypassing SCA filters, thus allowing accurate measurement of SCA distortion.

### SPECIFICATIONS

#### SIGNAL OUTPUTS (AUDIO TEST)

**FREQUENCY RESPONSE:**  $\pm 1.0$  dB maximum 50 to 7500 Hz with 5 kHz or 7.5 kHz deviation, flat input and no de-emphasis.

**HARMONIC DISTORTION:** Distortion mode: 1.0% maximum, 50 to 7500 Hz with 5 kHz or 7.5 kHz deviation.

**SIGNAL-TO-NOISE RATIO:** 60 dB minimum below 100% modulation at 400 Hz rate with 75 microseconds de-emphasis.

**DE-EMPHASIS:** 75 microseconds, switchable from rear panel,  $\pm 0.5$  dB from ideal.

#### SIGNAL OUTPUTS (MONITOR)

**FREQUENCY RESPONSE:**  $\pm 1.0$  dB maximum, 50 to 7500 Hz with 5 kHz or 7.5 kHz deviation, flat input and no de-emphasis.

**HARMONIC DISTORTION:** Distortion mode: 1.0% maximum, 50 to 7500 Hz with 5 kHz or 7.5 kHz deviation.

**OUTPUT IMPEDANCE:** For 600 ohm load impedance (floating).

**SIGNAL LEVEL [100% MODULATION]:** 0 dBm,  $\pm 2$  dB into 600 ohms.

#### MEASUREMENT CAPABILITY

##### CROSSTALK

**Main to SCA:** 55 dB minimum below 7.5 kHz deviation, with 30% SCA injection and 70% main channel modulation.

**SCA to Main:** 70 dB minimum with 30% SCA injection, measured below peak modulation.

**Stereo Sub to SCA:** 55 dB minimum below 7.5 kHz deviation, with 10% SCA injection and 80% stereo sub-channel modulation.

##### MODULATION METER

**Range:** 70 dB in 10 dB steps with range switch.

##### FREQUENCY METER

**Measures:** Deviation from SCA sub-carrier center frequency.

**Range:**  $\pm 2$  kHz (of SCA sub-carrier center frequency).

**Accuracy:**  $\pm 50$  Hz.

**Threshold:** 5% SCA injection level, below which meter will return to center scale rest point.

**SCA FREQUENCIES:** 41 kHz and/or 67 kHz selectable by front panel interlocking pushbutton switches. Read Frequency deviation (+ or -) from selected SCA frequency directly from frequency meter in kHz.

**REMOTE METERING:** SCA peak flasher, SCA frequency deviation, and SCA sub-carrier modulation ( or total modulation or main channel modulation if selected by FC-80 Function Switch with the Range Switch in the MOD position) may be remotely metered with up to 5,000 ohms external loop resistance.

**PEAK MODULATION INDICATOR:** 50% to 120%, sensitive relay in remote SCA modulation monitor (panel) provides operation with up to 5,000 ohms external loop resistance.

**MODULATION METER RANGE:** 133% full scale, for peak modulation measurements; to -70 dB in 10 dB steps, for average modulation readings.

### ORDERING INFORMATION

FC-80 FM SCA Modulation Monitor .....	994-7074-001
Remote panel for FC-80 .....	994-7075-001
100% transistor/IC kit for FC-80 .....	990-0796-001





# MODEL FF-80

## FM Frequency Monitor

The Harris FF-80 solid-state FM Frequency Monitor offers high-quality performance, exceptional reliability, and economical operation and maintenance. The FF-80 is designed to meet present FCC requirements for on-frequency transmitter operation.

Besides supplying continuous frequency monitoring with digital readout, the FF-80 provides an immediate indication and alarm in case of transmitter frequency error for any cause. The unit has auxiliary contact closures at  $\pm 2$  kHz for remote alarms in unattended operation. It also provides an instant indication and alarm in case of insufficient transmitter RF output or transmitter failure. An accessory remote panel, with analog readout, is available for such remote applications as central control room monitoring.

A major advantage of the FF-80 is its ease of readout and interpretation. The digital presentation requires no time-consuming adjustments and interpretations, and no special operator training is required. Also, the FF-80 is a specialized unit—it performs continuous and highly accurate FM frequency monitoring and its design is not compromised by the addition of modulation monitoring functions.

The FF-80's inherent accuracy of better than 1.85 ppm is over ten times greater than the FCC's allowable FM transmitter frequency tolerance of  $\pm 2$  kHz. The FF-80 is FCC type approved, even though this approval is not presently required by the FCC.

A two-digit display indicates the magnitude of the frequency error, and a "plus-minus" indicator shows error direction. The characteristics of the monitor provide a non-ambiguous display, and allow a transmitter to be quickly tuned back to frequency if a sudden offset occurs. A frequency error of  $\pm 2$  kHz activates an

"Alarm" LED (light-emitting diode). Above  $\pm 3.1$  kHz error, the digits are blanked. From  $\pm 3.1$  kHz to  $\pm 800$  kHz error, only the "plus-minus" indicator is displayed. For frequency deviations greater than  $\pm 800$  kHz, the "plus-minus" indicator is blanked.

The FF-80 utilizes the latest high-reliability semiconductors, and the unit has been thoroughly proven by environmental chamber and field testing. The frequency standard and timing circuit generates the following: two-second "counting" pulses for the frequency counter circuit; "store" pulses which store the error information in the memory and decoding circuitry; and "reset" pulses that initialize the counter for the next two-second counting period. A crystal-controlled oscillator mounted in a proportionally-controlled oven provides a 2.097152 MHz signal from which the two-second pulse is derived. The incoming RF signal is averaged for two seconds once every four seconds. The RF input section accepts an RF input signal of from 1.0 V to 10 V RMS, and provides a square wave, zero to five volt signal to the frequency counter.

The additional warning of transmitter output failure is provided by the "Low Input" light-emitting diode on the front panel. This circuit is activated if the incoming RF signal falls below the required threshold of the circuit for the entire two-second count period.

### SPECIFICATIONS

- FREQUENCY RANGE:** 88.1 to 107.9 MHz, as ordered. Field programmable.
- RF INPUT:** Impedance: 50 ohms. Sensitivity: 1.0 V to 10 V RMS Carrier.
- POWER INPUT:** 115/230 VAC, 50/60 Hz, 40 watts.
- INSTRUMENT ACCURACY:** Better than 1.85 ppm.
- INDICATORS:** Deviation Indicator range:  $\pm 3.1$  kHz. Status Indicators (LED): Low input alarm, count period alarm. Alarm relay: activated at  $\pm 2$  kHz deviation, has N/O and N/C contacts, 5 amp at 120 VAC or 28 VDC.
- REMOTE METERING:** Remote frequency meter (analog only) showing  $\pm 3$  kHz deviation from center carrier frequency, up to 5,000 ohms external loop resistance, is available as an option.
- TEST SWITCH:** Illuminates all segments of the readouts and LED's located on front panel.
- AMBIENT TEMPERATURE RANGE:** 0°C to 55°C.
- AMBIENT HUMIDITY RANGE:** 0 to 95% relative humidity, non-condensing.
- ALTITUDE:** 0 to 10,000 feet above sea level.
- DIMENSIONS:** Width, 19 inches (48 cm). Height, 3½ inches (8.9 cm). Depth, 10¼ inches (26 cm).
- WEIGHT:** 9.2 pounds (4.2 kg) net, 20 pounds (9 kg) domestic packed.

### ORDERING INFORMATION

- FF-80 FM Frequency Monitor,  
calibrated to specified operating frequency ..... 994-6998-001
- Remote FM Frequency Monitor (Remote Panel) ..... 994-6999-001
- 100% Transistor/IC Kit ..... 990-0797-001

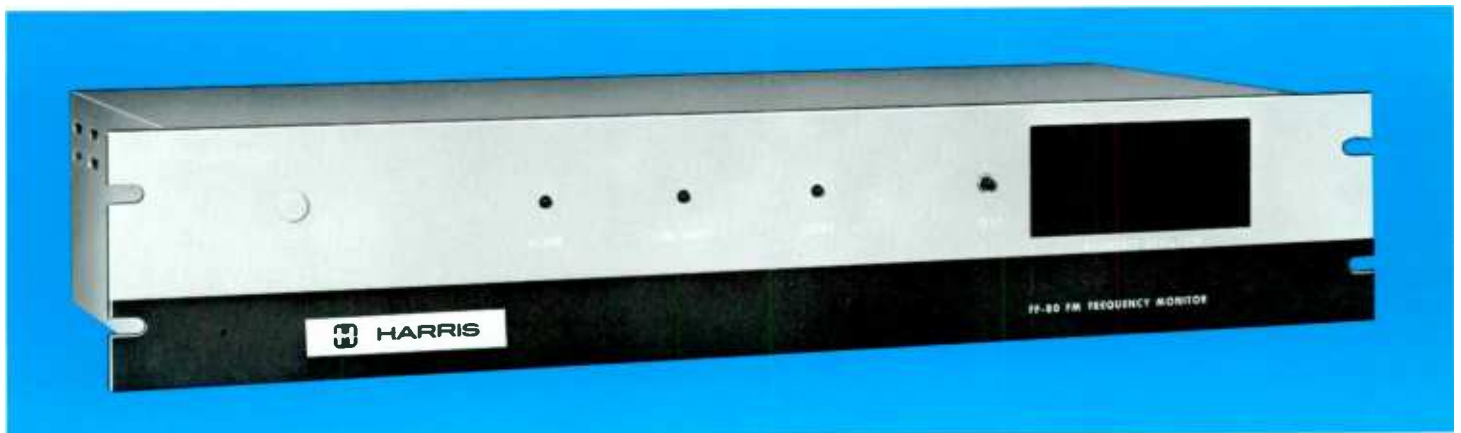



# FM RF AMPLIFIER



The Harris GTM-88R RF Amplifier is designed for use at remote locations to provide sufficient RF power to drive the new Harris FM monitors. It is also readily adaptable to other current FM monitors.

More than adequate bandwidth and selectivity assure optimum recovery of the transmitted signal. A large dynamic range provides constant output with wide input signal variations. Loss of transmitted signal activates an alarm.

A minimum number of controls simplifies operation, with normal operating controls consisting of only a power switch and a pilot light. RF outputs for the FM frequency and modulation monitors are provided on the rear of the unit. These outputs are isolated by a resistive pad to prevent any interaction between monitors. Input sensitivity can be adjusted where necessary, depending on the distance the GTM-88R is located from the transmitting antenna, and the sensitivity of the monitor.

Complete solid-state circuitry combined with a crystal controlled oscillator and double balanced mixers contribute to high stability, isolation, and extended reliability. Each GTM-88R is inspected, aligned, and tested on the customer's frequency.

### SPECIFICATIONS

- FREQUENCY RANGE:** 87.5 to 108 mHz.
- INPUT SENSITIVITY:** Factory adjusted for 0.40 watt output with a 400 microvolt input. (100 microvolts input for 0.30 watt output. 500 microvolt input produces .5 watt at each of two outputs with full limiting.)
- SELECTIVITY:** 500 kHz bandwidth, adjacent channel rejection 50 dB at 800 kHz.
- DYNAMIC RANGE:** 70 dB.
- MONO SIGNAL/NOISE RATIO:** 65 dB.
- LO RADIATION:** -75 dBm.
- IMAGE REJECTION:** 60 dB.
- I.F. REJECTION:** 55 dB.
- INPUT IMPEDANCE:** 75 ohms, unbalanced, UHF connector.
- OUTPUT IMPEDANCE:** 50 ohms, unbalanced, UHF connector.
- CARRIER FAILURE RELAY:** SPDT, contact rated 115V rms, 2 amp. max.
- TEST POINTS:** Relative RF input level (rear panel).
- POWER SOURCE:** 115V, 50/60 Hz, 12 watts.
- SIZE:** 5 1/4" H x 10" D x 19" W.
- WEIGHT:** 10 pounds.
- ENVIRONMENT:** 10° C to 55° C, ambient temperature range. Relative humidity, 0 to 95%. Altitude, 0 to 10,000 feet.

## ANTENNAS FOR USE WITH FM RF AMPLIFIER

The Models CH-6065 and CH-6060 provide the very finest FM and FM stereo reception. They are excellent choices for use with the Harris FM RF amplifier or for home reception. Modern design considerations include anodized aluminum finish and weatherproof cartridge housing for downlead, preamplifiers and filter modules.

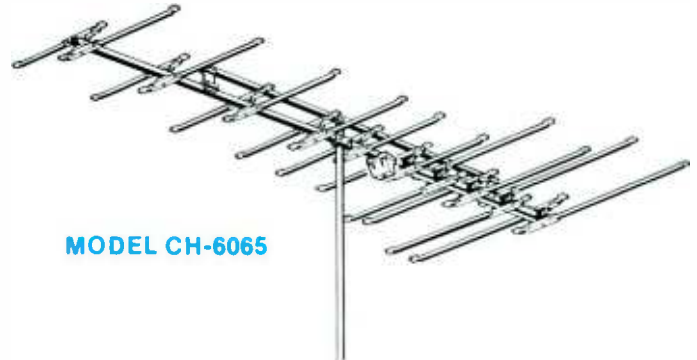

MODEL CH-6065

### SPECIFICATIONS

- TOTAL ELEMENTS:** 10
- BOOM LENGTH:** 142"
- TURNING RADIUS:** 78"
- MAXIMUM WIDTH:** 69"
- NET WEIGHT:** 7 lb.
- SHPG. WT.:** 9 1/2 lb.
- OUTPUT IMPEDANCE:** 75 or 300 ohms

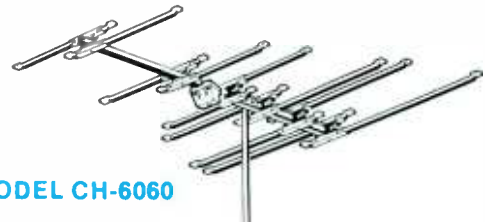

MODEL CH-6060

### SPECIFICATIONS

- TOTAL ELEMENTS:** 6
- BOOM LENGTH:** 60"
- TURNING RADIUS:** 42"
- MAXIMUM WIDTH:** 68"
- NET WEIGHT:** 5 lb.
- SHPG. WT.:** 6 1/2 lb.
- OUTPUT IMPEDANCE:** 75 or 300 ohm

### GAIN FOR MODELS CH-6065 and CH-6060

GAIN	MODEL	88MHz	98MHz	108MHz
% over reference dipole	CH-6065	202	220	239
	CH-6060	169	160	157
dB over reference dipole	CH-6065	9.6	10.1	10.6
	CH-6060	8.6	8.3	8.2
beamwidth at half power points	CH-6065	60°	53°	47°
	CH-6060	70°	67°	63°
front-to-back ratio	CH-6065	20	20	20
	CH-6060	20	20	20

### ORDERING INFORMATION

- GTM-88R FM RF amplifier, includes coax cable connector
- 75 ohm input. Specify operating frequency ..... 994-6614-003
- CH-6065 FM Antenna ..... 710-0246-000
- CH-6060 FM Antenna ..... 710-0124-000
- T-28 M Matching Transformer, 300 ohms to 75 ohms, for CH-6060 above ..... 710-0127-000



**RADIO  
BROADCAST  
TRANSMITTER  
ACCESSORIES**

**HARRIS**



**COMMUNICATIONS AND  
INFORMATION HANDLING**





**HARRIS**  
COMMUNICATIONS AND  
INFORMATION HANDLING

## TOWER LIGHTING AND ACCESSORIES



### TALL TOWER OBSTRUCTION LIGHTING

A wide choice of control equipment is available:

- Indoor or outdoor housings.
- Multi-circuit Beacon Flashers are provided to reduce voltage fluctuations and peak load requirements.
- With or without LAMP FAILURE Indicator Panel. Generally, one indicator lamp is provided for each beacon, and one for each sidelight level.



### CODE BEACON(300 mm)



Conduit Tap	Cable	Type No. with 2 Red Filters
1"	2 wire	KG 114-2W
1"	3 Wire no grd.	KG 114-3W
1"	3 wire grn. grd.	KG 114-3G
1"	4 wire grn. grd.	KG 114-4G

300 MM Code Beacon is standard size, fully approved FCC and CAA. Supplied with 2 red filters.

Beacon Lamp, 620 watt, 620PS40 ..... 396-0129-000  
Clear Traffic Signal Lamp, 107 W, 115 V, 107821/TS ..... 396-0141-000

### OBSTRUCTION LIGHTS

#### SINGLE OBSTRUCTION LIGHT w/side conduit tap



Type No. OB21-3 ¾" conduit tap  
Type No. OB21-4 1" conduit tap

#### SINGLE OBSTRUCTION LIGHT w/bottom conduit tap



Type No. OB20-3 ¾" conduit tap  
Type No. OB20-4 1" conduit tap

#### DOUBLE OBSTRUCTION LIGHT w/bottom conduit tap



Type No. OB22-3 ¾" conduit tap  
Type No. OB22-4 1" conduit tap  
Type No. OB22TR-4 1" conduit tap with Lamp Transfer Relay

#### DOUBLE OBSTRUCTION LIGHT w/side conduit tap



Type No. OB24-3 ¾" conduit tap  
Type No. OB24-4 1" conduit tap  
Type No. OB24TR-4 1" conduit tap with Lamp Transfer Relay



Typical Lamp Failure Indicator Panel



# TOWER LIGHTING CONTROL UNITS

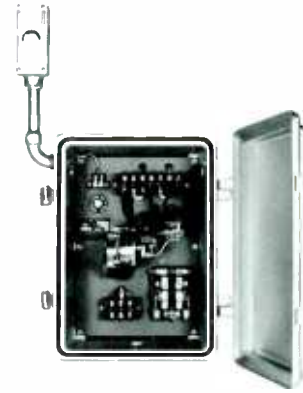

## PHOTOELECTRIC CONTROL AND BEACON FLASHER

LC700A-2 Photo/Flasher Outdoor Housing

CATALOG NUMBERS		PHOTO CABLE	LIGHT LEVELS	LOAD CAPACITY	LINE VOLTAGE	LOAD CONTACTOR	FLASHER CIRCUIT	HOUSING TYPE	TAP
NON FUSED	FUSED								
LC 700 A-1	LC 700 F-1	21 FT.	A-2	2 KW	117 V,	Single Pole	ONE	INDOOR	—
LC 700 A-2	LC 700 F-2	1 FT.	or		60 Hz	25A		OUTDOOR	3/4"
LC 700 A-3	LC 700 F-3	11 FT.	A-3					OUTDOOR	3/4"
LC 701 A-1	LC 701 F-1	21 FT.	A-4	4 KW	120/240 V,	Double Pole	TWO	INDOOR	—
LC 701 A-2	LC 701 F-2	1 FT.	or	(2 KW/pole)	3 wire	25A	(Alternate flash)	OUTDOOR	1"
LC 701 A-3	LC 701 F-3	11 FT.	A-5		60 Hz			OUTDOOR	1"
LC 703 A-1	LC 703 F-1	21 FT.	A-4	4 KW	120/240 V,	Double Pole	TWO	INDOOR	—
LC 703 A-2	LC 703 F-2	1 FT.	or	(2 KW/pole)	3 wire	25A	Simultaneous flash	OUTDOOR	1"
LC 703 A-3	LC 703 F-3	11 FT.	A-5		60 Hz			OUTDOOR	1"

HC 4813 Set of two clamps (specify O.D. of pipe)

Fisher-Pierce Photo-Cell Unit, weatherproof, fully approved, 105/130 V, 3000 watt rating, SPST, double break ..... 670-0007-000

## ISOLATION TRANSFORMERS FOR TOWER OBSTRUCTION LIGHTING



Isolation Transformer, Typical Installation

The isolation transformer provides a highly reliable, low capacity means of supplying power across the base insulator of an insulated radio tower employed as a radiator. The stability and low capacity between windings makes these isolation transformers highly desirable for use in directional arrays, and in particular with radiators which develop extremely high voltages across the base insulators. In addition to the Hughey & Phillips, Inc. isolation transformers listed below, Harris carries a full line of Austin isolation transformers. Contact Harris for information on either model.

TYPE NUMBER	KVA RATING	FREQ. CYCLES	PRIMARY VOLTS & TAPS	SEC-ONDARY VOLTS & TAPS	EFFI-CIENCY RATED LOAD	PEAK BREAK-DOWN PRI.-SEC.	CAPA-CITY PRI.-SEC.	NET WT. LBS.	SHIP WT. LBS.
TI-2250	0.50	60	220 (2-5%)	220	94%	80KV	20 pfd	86	120
TI-2070	0.75	60	115 (2-6%)	117/120	94%	80KV	20 pfd	78	110
TI-2017	1.75	60	115 (2-6%)	117/120	94%	80KV	25 pfd	88	130
			230 (4-3%)						
TI-2217	1.75	50	220 (4-5%)	220	94%	80KV	28 pfd	95	140
TI-2218	1.75	60	220 (4-5%)	220	94%	80KV	28 pfd	88	130
TI-2035	3.5	60	115 (2-6%)	117/120	94%	80KV	32 pfd	138	170
			230 (4-3%)						
TI-2052	5.2	60	208 (2-5%)	#1-120 #2-120	93%	80KV	40 pfd	150	190
TI-5223	5.2	60	230 (4-4%)	120/240	93%	80KV	40 pfd	175	225
TI-2087	7.5	60	208 (2-5%)	208	93%	120KV	40 pfd	300	345
TI-2027	7.5	60	208 (2-5%)	220	93%	120KV	40 pfd	300	345



**HARRIS**  
COMMUNICATIONS AND  
INFORMATION HANDLING

# HEAVY-DUTY INDUCTORS AND CAPACITORS

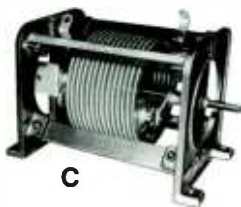
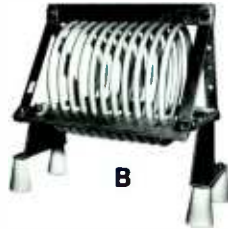
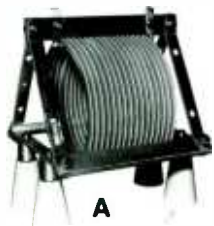

Harris manufactured inductors put the emphasis on solid mechanical construction. Variable coils have double gripping contact wheels. Other sizes and ratings available on special order.

### SPECIFICATIONS ORDERING INFORMATION

ORDER NO.	TYPE NO.	FIG.	LENGTH [INCHES]
931-6138-010	87FA4634	A	12
931-6138-039	6FC0854	A	6 1/4
931-6138-040	10FC0855	A	6 1/4
931-6138-041	13FC0856	A	6 1/4
931-6138-025	17FC1654	A	8 3/4
931-6138-026	24FC1655	A	8 3/4
931-6138-027	32FC1656	A	8 3/4
931-6138-036	42FC2266	A	12 1/2
931-6138-030	67FC2856	A	13
931-6337-007	10FBT1066	B	12 1/2
931-6337-002	20FBT1656	B	15
931-6337-003	32FBT1658	B	15
931-6337-004	45FBT2158	B	18 1/2
931-6372-002	65FBT2559	B	24 1/2
931-6337-001	17FCT1178	B	14
931-6372-001	35FCT1679	B	24 1/2
931-6583-008	6VC0854	C	8
931-6583-001	15VC1444	C	9
931-6583-002	26VC2144	C	10 3/4
931-6583-003	42VC2145	C	10 3/4
931-6583-004	62VC2845	C	12 1/2

Figure D-Counter dial for variable coils reads 1/10 turns.  
Size: 3" wide, 3 1/2" high.

- With removable crank handle ..... 994-8233-001
- With non-removable crank handle ..... 926-5509-003
- Coil clip for FA coils ..... 994-7784-001
- Coil clip for FC coils ..... 994-7784-003
- Coil clip for FBT coils ..... 994-7785-001
- Coil clip for FCT coils ..... 994-7785-002

### EXPLANATION OF TYPE NUMBER

87	F	A	46	3	4	
Inductance in microhenries.	F—Fixed V—Variable	A—1/4" B—3/8" C—1/2"	No letter here indicates ribbon. "T" indicates tubing.	Number of turns.	Pitch of winding in 1/16" for ribbon, 1/8" for tubing.	Inside diameter in inches.

### MICA CAPACITORS FOR TRANSMITTERS AND PHASORS



Designed for continuous service with each sheet of mica carefully gauged for thickness and inspected for absence of impurities. Tolerance plus or minus 5%. Cast end bells and ceramic insulated. Sizes over-all: Model G1: 3 3/4" x 2 1/2". Model G2: 4 1/4" x 3". Model G3: 6 1/2" x 4". Model G4: 6 1/2" x 5 3/4". Usually all sizes carried in stock. Please order by type number and capacity. Example: Model G2, capacity .0003 mfd. Other sizes and ratings available on special order.

CAPACITY mfd.	MODEL G1		MODEL G2		MODEL G3		MODEL G4	
	Amps (1 MHz)	Volts	Amps (1 MHz)	Volts	Amps (1 MHz)	Volts	Amps (1 MHz)	Volts
.0002	3	6000	4.3	10,000	5.6	20,000	---	---
.00025	---	---	5.1	10,000	---	---	8.2	30,000
.0003	---	---	5.6	10,000	6.8	20,000	9.1	30,000
.0004	4.7	6000	6.2	10,000	8.2	20,000	---	---
.0005	5.1	6000	6.8	10,000	9	20,000	12	30,000
.0008	---	---	---	---	12	20,000	15	30,000
.001	7.5	6000	10	10,000	13	20,000	16	30,000
.0015	9.1	6000	12	10,000	16	15,000	20	25,000
.002	11	6000	13	10,000	20	15,000	22	20,000
.003	13	6000	16	8,000	24	12,000	27	20,000
.004	15	6000	18	8,000	27	12,000	30	20,000
.005	16	4000	20	6,000	30	10,000	33	15,000
.006	18	4000	22	5,000	33	10,000	36	15,000
.008	---	---	---	---	36	10,000	39	12,000
.01	20	4000	24	5,000	39	8,000	43	10,000
.02	---	---	---	---	47	5,000	---	---



**HARRIS**  
COMMUNICATIONS AND  
INFORMATION HANDLING

## COAXIAL AND RIGID TRANSMISSION LINES

**FLEXIBLE COAXIAL CABLE.** Produced in continuous splice-free lengths, Heliax® low-loss cable is ideally suited for any application where use of coaxial transmission line is indicated. For medium wave VHF and UHF applications, long, continuous lengths provide ease of installation and maintenance-free service. Corrugated copper conductors provide a combination of flexibility and low loss. Although Heliax connectors and fittings are easily attached, it is recommended that all cable assemblies be ordered with fittings factory attached with specialized manufacturing equipment. Please order by part number.

® Registered trademark, Andrew Corporation.



### AIR DIELECTRIC

	7/8"	1 5/8"	3"	4"	5"
<b>SIZE:</b>	7/8"	1 5/8"	3"	4"	5"
<b>PART NUMBER, JACKETED:</b>	618-0148-000	618-0198-000	618-0170-000	618-0338-000	618-0195-000
<b>IMPEDANCE: OHMS</b>	50	50	50	50	50
<b>ATTENUATION @ 100 MHz, dB/100 FT.:</b>	0.37	0.21	0.14	0.11	0.080
<b>VELOCITY: %:</b>	91.6	92.1	92.3	92.0	93.0
<b>AVERAGE POWER, @ 100 MHz-kW:</b>	6.4	14.5	37.0	56.0	73.0
<b>BEND RADIUS [MINIMUM]—INCHES:</b>	10	20	30	40	50
<b>NET WEIGHT—UNJACKETED: POUNDS/FT.:</b>	.43	—	—	—	—
<b>NET WEIGHT—JACKETED: POUNDS/FT.:</b>	.53	1.04	1.8	2.5	3.3

### RIGID TRANSMISSION LINES



**RIGID LINE**

Foam Heliax is used in those broadcast installations requiring low loss coaxial cable in which pressurizing is not desirable. A corrugated copper outer conductor and foam dielectric provide a combination of high strength, low loss and power handling not available in solid dielectric cables. The flexibility of foam Heliax provides maximum resistance to crushing, kinking or denting, and enables it to be pulled through conduits and around obstructions. Please order by part number.

#### SPECIFICATIONS

	1/2"	7/8"
<b>SIZE:</b>	1/2"	7/8"
<b>PART NUMBER, JACKETED:</b>	618-0171-000	618-0172-000
<b>IMPEDANCE:</b>	50 ohms	50 ohms
<b>ATTENUATION @ 100 MHz, dB/100 FT.:</b>	0.82	0.44
<b>VELOCITY, %:</b>	79	79
<b>AVERAGE POWER, @ 100 MHz, kW</b>	2.3	4.8
<b>BENDING RADIUS [MINIMUM]—INCHES:</b>	5	10
<b>NET WEIGHT—JACKETED:</b>	.185 lbs.	.42 lbs.

#### SPECIFICATIONS

Teflon insulated rigid copper coaxial transmission lines for broadcast application. Line and connectors meet all EIA applicable standards. Mitered elbows are compensated to provide low VSWR. All rigid sections and components include inner connectors, "O" ring and hardware. Please order by part number, and specify frequency.







#### SPECIFICATIONS

	1 3/8"	3 1/8"
<b>SIZE:</b>	1 3/8"	3 1/8"
<b>PART NUMBER:</b>	618-0096-000	618-0306-000
<b>IMPEDANCE:</b>	50 ohms	50 ohms
<b>ATTENUATION @ 100 MHz, dB/100 FT.:</b>	0.20	0.11
<b>VELOCITY, %:</b>	99.8	99.8
<b>AVERAGE POWER, @ 100 MHz:</b>	15.0 kW	48.0 kW
<b>NET WEIGHT—POUNDS/FEET:</b>	1.25	2.75



## COAXIAL TRANSMISSION LINE ACCESSORIES

Fittings: Flanged items are EIA standard and include inner connector, "O" ring, silicon grease and hardware kit.





EIA FLANGE	EIA FLANGE	REDUCER CONNECTOR	END TERMINAL	TYPE N JACK	SPLICE
					
Use with copper Heliax cable.	Includes gas barrier.	Reduce cable size to EIA flange sizes.	For strap connection to center conductor.	Female, mates with (-).	Use with copper Heliax cable.

### FOAM DIELECTRIC CONNECTORS

1/2" 620-0489	---	---	1/2" 620-0340	(UG21) 620-0368	620-0423
7/8" 620-0393	---	---	7/8" 620-0340	(UG21) 620-0343	620-0443

### AIR DIELECTRIC CONNECTORS

7/8" 620-0192	620-0388	---	7/8" 620-0268	(UG21) 620-0195	620-0452
1 3/8" 620-0351	620-0385	1 1/2" - 7/8" 620-0353	1 1/2" 620-0354	(UG21) 620-0352	620-0400
3" 620-0312	620-0376	3 3/8" - 1 1/2" 620-0435	3" (620-0312 + 620-0265)	---	620-0485
4" ---	---	---	4" ---	---	620-1069
5" 620-1485	620-1484	6 1/2" - 3 1/4" (620-1485 + 620-0001)	5" ---	---	620-0349
6" ---	---				

TYPE UHF JACK	NON-INSULATED HANGER	INSULATED HANGERS	INSULATED HANGERS	HANGER ADAPTERS	
				<b>INSULATED</b>	
Female	Kit of 10 hangers. Spacing 3' for 1 3/8" cables, 5' for 3" and 5" cables.	Use on insulated tower spacing 3 feet apart.	Use on insulated tower spacing 3' apart for 1 1/2", 5' for larger sizes.	Adapters used to mount insulated hangers to tower without drilling.	
				Angle Members 620-0079 Round Members up to 3" 620-0078	
				<b>NON-INSULATED</b>	
				Kit consists of 10 adapters to mount hangers to tower.	
				<b>ANGLE MEMBER TOWERS</b>	
				1 3/8" hangers 620-1071 3" and 5" hangers 620-1096	

### FOAM DIELECTRIC HANGER KITS

1/2" 620-0301	<b>WRAPLOCK</b> 620-0111	1/2" 620-0519	---	7/8" 620-0304	---
7/8" 620-0317					

### AIR DIELECTRIC HANGER KITS

7/8" 620-0318	<b>WRAPLOCK</b> 620-0625	7/8" 620-0304	---		
1 3/8" ---	620-0474	1 1/2" ---	620-0426		
3" ---	620-1070	3" ---	620-0425		
4" ---	620-0476	4" ---	620-1075		
5" ---		5" ---	620-0424		

ROUND MEMBER TOWERS		
Member Diameter	use with	
	1 3/8"	3-5"
1"-2"	620-0467	---
2"-3"	620-0468	620-0478
3"-4"	620-0469	620-1072
4"-5"	620-0470	620-1489
5"-6"	620-0471	620-1488

### WRAPLOCK

One hundred feet of stainless steel wraplock, complete with fasteners. Use at three-foot intervals for all cables 1 3/8" and smaller.  
620-0111

### GROUNDING KITS











Cable Size	Jacketed
1/2"	620-0371
7/8"	620-0372
1 3/8"	620-0373
3"	620-0375
4"	620-1074
5"	620-1490

### HOISTING

Jacketed
---
620-0303
620-0221
620-0341
620-1073
620-1486

## COAXIAL TRANSMISSION LINE ACCESSORIES

**Fittings:** Flanged items are EIA standard and include inner connector, "O" ring, silicon grease and hardware kit.  
All hangers require round member or angle adapters for attachment to tower.

90° MITER ELBOW	GAS BARRIER	REDUCER	END TERMINAL	INNER CONNECTOR																														
																																		
<p>Brass construction with swivel flanges on both ends. Includes one inner connector.</p>	<p>With fixed male connector on both ends. May be used as gas inlet fitting.</p>	<p>Reduces line size.</p>	<p>For strap connection. Gas tight with vent plug. Includes inner connector.</p>	<p>With Teflon anchor bead.</p>																														
<table style="width: 100%; border: none;"> <tr> <td style="width: 15%;">7/8"</td> <td style="width: 15%;">620-0054</td> </tr> <tr> <td>1 5/8"</td> <td>620-0055</td> </tr> <tr> <td>3 1/8"</td> <td>620-0056</td> </tr> </table>	7/8"	620-0054	1 5/8"	620-0055	3 1/8"	620-0056	<table style="width: 100%; border: none;"> <tr> <td style="width: 15%;">7/8"</td> <td style="width: 15%;">620-0019</td> </tr> <tr> <td>1 5/8"</td> <td>620-0145</td> </tr> <tr> <td>3 1/8"</td> <td>620-0021</td> </tr> </table>	7/8"	620-0019	1 5/8"	620-0145	3 1/8"	620-0021	<table style="width: 100%; border: none;"> <tr> <td style="width: 15%;">7/8"-1 5/8"</td> <td style="width: 15%;">620-0089</td> </tr> <tr> <td>1 5/8"-3 5/8"</td> <td>620-0090</td> </tr> <tr> <td>3 1/8"-6 1/8"</td> <td>620-0091</td> </tr> </table>	7/8"-1 5/8"	620-0089	1 5/8"-3 5/8"	620-0090	3 1/8"-6 1/8"	620-0091	<table style="width: 100%; border: none;"> <tr> <td style="width: 15%;">7/8"</td> <td style="width: 15%;">---</td> </tr> <tr> <td>1 5/8"</td> <td>620-0180</td> </tr> <tr> <td>3 1/8"</td> <td>620-0265</td> </tr> </table>	7/8"	---	1 5/8"	620-0180	3 1/8"	620-0265	<table style="width: 100%; border: none;"> <tr> <td style="width: 15%;">7/8"</td> <td style="width: 15%;">---</td> </tr> <tr> <td>1 5/8"</td> <td>620-0016</td> </tr> <tr> <td>3 1/8"</td> <td>620-0017</td> </tr> </table>	7/8"	---	1 5/8"	620-0016	3 1/8"	620-0017
7/8"	620-0054																																	
1 5/8"	620-0055																																	
3 1/8"	620-0056																																	
7/8"	620-0019																																	
1 5/8"	620-0145																																	
3 1/8"	620-0021																																	
7/8"-1 5/8"	620-0089																																	
1 5/8"-3 5/8"	620-0090																																	
3 1/8"-6 1/8"	620-0091																																	
7/8"	---																																	
1 5/8"	620-0180																																	
3 1/8"	620-0265																																	
7/8"	---																																	
1 5/8"	620-0016																																	
3 1/8"	620-0017																																	
RIGID HANGER	SLIDING HANGER	SPRING HANGERS	ROUND MEMBER CLAMP	ANGLE ADAPTER																														
																																		
<p>Mounts to 7/8" diameter hole with 1 1/2" bolt or angle adapter. Use at 300' intervals.</p>	<p>7/8" size use at 6' intervals. 1 5/8" use at 10 foot intervals.</p>	<p>7/8" size use at 100' intervals. 1 5/8" size use at 50' intervals. 3 1/8" size use at 10' intervals.</p>	<p>Attaches hangers to tower members up to 3" diameter.</p>	<p>Galvanized clamp for attaching hangers to tower angle members up to 7/8" thick.</p>																														
<table style="width: 100%; border: none;"> <tr> <td style="width: 15%;">1 5/8"</td> <td style="width: 15%;">620-0080</td> </tr> <tr> <td>3 1/8"</td> <td>620-0253</td> </tr> </table>	1 5/8"	620-0080	3 1/8"	620-0253	<table style="width: 100%; border: none;"> <tr> <td style="width: 15%;">1 5/8"</td> <td style="width: 15%;">620-0150</td> </tr> <tr> <td>3 1/8"</td> <td>---</td> </tr> </table>	1 5/8"	620-0150	3 1/8"	---	<table style="width: 100%; border: none;"> <tr> <td style="width: 15%;">1 5/8"</td> <td style="width: 15%;">620-0151</td> </tr> <tr> <td>3 1/8"</td> <td>620-0254</td> </tr> </table>	1 5/8"	620-0151	3 1/8"	620-0254	<table style="width: 100%; border: none;"> <tr> <td style="width: 15%;">7/8"</td> <td style="width: 15%;">620-0078</td> </tr> <tr> <td>1 5/8"</td> <td>620-0078</td> </tr> <tr> <td>3 1/8"</td> <td>620-0078</td> </tr> </table>	7/8"	620-0078	1 5/8"	620-0078	3 1/8"	620-0078	<table style="width: 100%; border: none;"> <tr> <td style="width: 15%;">7/8"</td> <td style="width: 15%;">620-1491</td> </tr> <tr> <td>1 5/8"</td> <td>620-0079</td> </tr> <tr> <td>3 1/8"</td> <td>620-0079</td> </tr> </table>	7/8"	620-1491	1 5/8"	620-0079	3 1/8"	620-0079						
1 5/8"	620-0080																																	
3 1/8"	620-0253																																	
1 5/8"	620-0150																																	
3 1/8"	---																																	
1 5/8"	620-0151																																	
3 1/8"	620-0254																																	
7/8"	620-0078																																	
1 5/8"	620-0078																																	
3 1/8"	620-0078																																	
7/8"	620-1491																																	
1 5/8"	620-0079																																	
3 1/8"	620-0079																																	

**INNER CONNECTOR ADAPTER, 50-51 ohms**— 1 5/8" size . . . 620-0014; 3 1/8" size . . . 620-0273  
**HARDWARE KIT** for use on one pair of flanges— 1 5/8" size . . . 620-0183; 3 1/8" size . . . 620-0520  
**"O" RING GASKET**— 7/8" size . . . 620-0073; 1 5/8" size . . . 620-0074; 3 1/8" size . . . 620-0377

## COAXIAL TRANSMISSION LINE PRESSURIZATION EQUIPMENT

**AUTOMATIC DEHYDRATORS.** Types 1920D and 1930B are heatless, fully automatic dehydrators capable of delivering continuous supplies of dry air. No down time is necessary to activate the dry agent. Both units will operate over an ambient range of 0° to 120° F with an input humidity of 95%.

### SPECIFICATIONS

<b>TYPE:</b>	1920D	1930B
<b>OUTPUT:</b>	1.2 CFM @ 4 psig	.2 CFM
<b>POWER:</b>	120V, 60 Hz	120V, 60 Hz
<b>INTERNAL OPERATING PRESSURE:</b>	60 psig	30 psig
<b>OUTLET DEWPOINT:</b>	Below -37° F	Below -20° F
<b>DIMENSIONS, INCHES:</b>	15 3/8 x 24 x 14 1/4	13 1/4 x 7 1/4 x 14 7/8

1920D Automatic Dehydrator .....	620-1430-000
1930B Automatic Dehydrator .....	620-1431-000



### DRY AIR HAND PUMP



Type 878A, dry air hand pump, pressurizes up to 1000 feet of 7/8" cable or 250 feet of 1 3/8" line. One pound of silica gel and seven feet of hose is supplied.

**878A Dry Air Hand Pump .....** 620-0132-000

### NITROGEN TANK FITTINGS



Type 858C, nitrogen tank fittings—includes pressure regulator, high and low pressure gauges and 10 feet of 3/8" O.D. poly tubing and fittings to fit 1/2" MPT.

**858C Nitrogen Tank Fittings .....** 620-0131-000

## OPEN WIRE TRANSMISSION LINE



**M-3327 Bracket**



**M-3328 End Plate**

**TRANSMISSION LINE BRACKET.** For 5 or 6 wire transmission line. Rating up to 150 kW modulated. Made of 1/4" steel 3" wide with welded L section on each side to fully prevent twisting under ice or wind load. Supplied with 8 1/4" ribbed insulator, wire guides and all hardware. Galvanized throughout.

**Line Bracket .....** 994-3327-001

**LINE END PLATE.** To terminate the open wire line at each end. Plate is 1/4" thick, 20" square. Fully galvanized. Includes turnbuckles, 25 1/2" strain insulator and all hardware. Rating up to 150 kW modulated.

**End Plate .....** 994-3328-001

**HORN GAP.** A very desirable item where higher power is employed. Connects to hot side of line and ground to drain off lightning and heavy static discharges. Usually one is employed for each 200 feet of line. Insulator for 150 kW. Arc gaps heavy chrome plate. Galvanized throughout.

**Horn Gap .....** 994-3322-001



**M-3322 Horn Gap**



**M-3864 Center Post**

**CENTER POST ASSEMBLY.** Has variety of uses such as end or corner angling of transmission line, support insulator for two wire line or rhombic antennas, and a guide insulator such as end of building or coupling unit. Rating 150 kW. Galvanized throughout.

**Center Post Insulator .....** 994-3864-001

**HARD DRAWN WIRE.** If desired, when ordering transmission line components, Harris will gladly supply No. 6, 8 or 10 hard drawn copper wire at current market prices. State length in feet desired, remembering to multiply the length of line by the number of wires in line, either 5 or 6.

**SPECIAL OPEN WIRE LINES.** Harris engineers have designed many special open wire lines for both short and long distances. Most celebrated was a 30-mile line supplied for use in the Arctic Circle. Upon receipt of a sketch or word description of the requirements, Harris engineers will gladly submit layout and quotation.



## AM PEAK LIMITER

The Harris AM Peak Limiter can be tailored to individual needs in program control as it features an adjustable attack time from a few microseconds to a millisecond. A station can now choose between ultra-fast and slower limiting, with output clipping protection to prevent overmodulation. The limiter also provides an adjustable positive modulation clipping level, in addition to peak phasing with no discernable switching noise.

**ADJUSTABLE CLIPPING LEVEL.** The clipping level is factory set at 100% negative, and is adjustable by diode strapping (between the output transformer secondary and output terminals) for 110% to 150% positive in approximately 4% steps. This offers essentially instantaneous (less than 1 microsecond) over-modulation protection regardless of selected limiter attack time.

**DUAL/ADJUSTABLE RECOVERY TIME.** Fast-acting recovery time (milliseconds) is controlled by program content, while the slow-acting portion is switch-selected from the front panel for FAST (3 seconds), MEDIUM (5 seconds) or SLOW (7 seconds). Distortion is very low—typically 0.3% from 50 Hz to 16 kHz with 10 dB of limiting, and less than 1.0% with up to 30 dB of limiting. Frequency response remains uniform with or without limiting.

**HIGH MODULATION LEVELS.** Variable attack time (in microseconds) and variable release time provide adjustment for complete freedom from "thumping" with limiting of 15 to 20 dB on most program content. A 30:1 compression ratio allows up to 99.5% negative modulation without overmodulation. For AM stations, asymmetrical limiting permits positive peak modulation levels from 100% to 125%.

**AUTOMATIC PHASE REVERSAL.** The highest peak of the audio signal is made positive to produce the highest AM modulation level in the transmitter. This, plus asymmetrical limiting, causes no base line shift in the limiter, and does not artificially alter the balance of the program content. It does permit greater modulation of the natural positive peaks with the resultant increase in transmitter power. Neon LDR's (light-dependent resistors) provide phase reversal switching with complex wave programming.

Symmetrical limiting is also available for operation where phasing of the signal is not desired. A front panel control also permits the limiter to be disabled for proof-of-performance tests. The limiter will then operate without limiting, with levels higher than normal to permit full modulation without losing calibration of the system.

**EASY ACCESSIBILITY.** All operating controls are located on the front panel. Circuit components are all accessible through a removable dust cover panel. Input and output connections are provided on a barrier terminal block on the rear of the unit, along with the AC power. Only 3½ inches of standard rack space is required for mounting the limiter.

### SPECIFICATIONS

**GAIN:** 44 dB,  $\pm 2$  dB maximum @1 kHz. (May be reduced by built-in input and/or output attenuators.)

**FREQUENCY RESPONSE:**  $\pm 1.0$  dB maximum, 30 to 16,000 Hz (with or without limiting).

**HARMONIC DISTORTION:** Less than 1.0% from 30 to 16,000 Hz, from 0 to 10 dB of limiting; long recovery; less than 3.0% at 30 to 16,000 Hz where, with fast recovery on low frequencies, there is partial recovery on each one-half cycle.

**NOISE:** 70 dB below threshold of limiting, 30 to 16,000 Hz.

**CLIPPING LEVEL:** Positive: adjustable from 110% to 150% in approximately 4% steps. Negative: factory set at 100%.

**ATTACK TIME:** 30 microseconds, adjustable to 1 millisecond.

**RECOVERY OR RELEASE TIME:** Dual/adjustable: fast, 3 seconds; medium, 5 seconds; slow, 7 seconds.

**AMOUNT OF LIMITING:** 30 dB with a 30:1 compression ratio—an increase of 30 dB input will increase output level 1 dB.

**INPUT LEVEL:** Adjustable —24 to +16 dBm for threshold of limiting.

**OUTPUT LEVEL:** Adjustable to +20 dBm maximum with compression, +26 dBm without compression.

**INPUT AND OUTPUT IMPEDANCE:** 600 ohms, balanced or unbalanced.

**DIMENSIONS:** 3½" H x 13 5/8" D x 19" W (standard rack).

**WEIGHT:** 12.5 pounds net, 22 pounds shipping.

**TEMPERATURE RANGE:** -20° to +55°C.

**INPUT VOLTAGE:** 117/234 volts, 50/60 Hz.

**INPUT POWER:** 5 watts.

### ORDERING INFORMATION

AM Peak Limiter ..... 994-7059-001







# ME-1

## AM Modulation Enhancer

The ME-1 is designed to enhance the modulation of a Harris MW Series AM transmitter. Depending on its setting, the ME-1 can increase the loudness by 3dB, over and above that increase already attained by using an MW transmitter. Because of the increased power caused by the ME-1, and the transient response required from the transmitter, it is recommended that it be used only with Harris' MW Series—other transmitters may not be able to handle this type of heavy processing.

The ME-1 is basically an adjustable clipper which has been designed to clip in such a fashion as to reduce the "fuzzy" sound usually associated with a hard clipper. However, the clipping action is square enough not to add a large amount of distortion to the average program level.

When adjusted properly to the station's format, the ME-1 will reduce the small peaks, which have little power but are holding the average level down, and allow the larger and more powerful levels of the audio signal to modulate the transmitter at the maximum limit.

Only a listening test will determine how much enhancing is desired. The more enhancing (3 dB maximum), the louder the signal. To employ the ME-1 enhancer, first the transmitter is adjusted for maximum legal modulation, using the limiter output control with the ME-1 in the calibrate position. Then the desired enhancing is switched in and the positive and negative controls of the ME-1 are adjusted for maximum modulation.

ME-1 controls include separate adjustments for both positive and negative peaks; a pushbutton for disabling and calibrating; and one pushbutton each to set the ME-1 for 1, 2 or 3 dB of signal enhancing.

The ME-1 must be placed between the AM peak limiter and the transmitter, with no transformers or other circuitry.

### SPECIFICATIONS

**AUDIO DISTORTION:** Dependent on enhancing level.

**NOISE:** 65 dB down from + 10 dBm output.

**FREQUENCY RESPONSE:** ± .5 dB from 20 Hz to 20 kHz.

**COMPRESSION RATIO:** 4/1 dB.

**AUDIO INPUT AND OUTPUT:** 600/600 ohms.

**INPUT LEVEL:** Requires 16 dBm input for + 10 dBm to transmitter.

**CONTROLS:** One negative peak adjust, one positive peak adjust, one disable/calibrate pushbutton, one pushbutton each for 1, 2 or 3 dB enhancing.

**LAMPS:** One green power lamp, one negative peak enhancing, one positive peak enhancing.

**POWER CONSUMPTION:** 10 watts.

**PRIMARY POWER INPUT:** 117 volts, 60 Hz.

**DIMENSIONS:** 19 inches (48 cm) wide, 4 inches (10 cm) deep, 3.5 inches (8.9 cm) high.

**WEIGHT:** 3 pounds (1.4 kg) net.

### ORDERING INFORMATION

ME-1 AM Modulation Enhancer ..... 994-7757-001





**HARRIS**  
COMMUNICATIONS AND  
INFORMATION HANDLING

## SOLID STATESMAN FM LIMITER

Harris' Solid Statesman FM Limiter is designed to prevent FM over-modulation, while retaining the original fidelity of the program material. This is accomplished through a combination of limiting, pre-emphasis, instantaneous peak controlling and de-emphasis.

A wide control range, low distortion and rapid attack time are outstanding features of the Limiter — made possible by the extremely close balance of the "Differential Amplifier" used as the gain control device.

Another important feature is the selectable recovery time, which allows each station to choose the best recovery time (FAST, MEDIUM, SLOW) for its type of programming.

In the FAST mode of operation, the FM Limiter has dynamic gated recovery. This permits very fast (200 millisecond) recovery times for the highest possible modulation levels, while distortion figures are almost as low as 30 Hz operation as at 1000 Hz.

The MEDIUM and SLOW positions are conventional and offer slower recovery times for stations desiring protection from over-modulation, but more subtle operation.

The selectable frequency threshold for instantaneous peak controlling permits the local station to select the frequency at which the instantaneous peak controller starts operating. This

control function is related to the FCC 75 microsecond pre-emphasis curve, and is intended to offer stations positive protection, but lesser amounts of control action if desired.

Two FM Limiters may be synced together for stereo operation with a small phono jumper.

A front panel control permits the user to disable the unit for proof of performance tests.

Only 3½" of standard rack space is required for the FM Limiter. All operating controls are located behind the easily-removed front access panel. Circuit components are readily accessible by removing the top cover. Input and output connections are provided on a barrier terminal block on the rear of the unit along with the stereo sync jack and AC power and fuse.

### SPECIFICATIONS

**GAIN:** 50 dB, ± 2 dB max. @1 kHz. (May be reduced by built-in input and/or output attenuators).

**FREQUENCY RESPONSE:** ± 1.0 dB, 30 Hz to 16 kHz, below threshold of instantaneous limiter.

**HARMONIC DISTORTION:** 1% Max. 30 Hz to 16 kHz. below limiting, or at 10 dB of limiting in any recovery mode.

**NOISE:** 70 dB below the threshold of limiting. (Limiting Threshold 30 Hz to 16 kHz.)

**ATTACK TIME:** 40 microseconds, maximum (no "thumping").

**RECOVERY TIME:** —Selectable:

FAST: Dynamically Gated for 200 milliseconds

MEDIUM: 2 seconds

SLOW: 10 seconds

**AMOUNT OF LIMITING:** 30 dB.

**LIMITING SLOPE:** Better than 50:1. (A 30 dB increase in the input signal will produce less than a .6 dB rise in the output level.)

**INPUT LEVEL:** —17 dBm to + 23 dBm for 10 dB of limiting.

**OUTPUT LEVEL:** Adjustable to + 23 dBm maximum with limiting, + 30 dBm amplifier maximum.

**INPUT AND OUTPUT IMPEDANCE:** 600 ohms, balanced or unbalanced.

**DIMENSIONS:** 3½" H x 13 ¾" D x 19" W (standard rack).

**WEIGHT:** 14 lbs. net; 23 lbs. shipping.

**TEMPERATURE RANGE:** —20°C to + 55°C. —4°F to + 130°F.

**INPUT POWER:** 117/234 volts, 50/60 Hz, 5 watts.

### ORDERING INFORMATION

Solid Statesman FM Limiter ..... 994-6631-005

Matched pair of FM Limiters [for stereo] ..... 994-6631-006





# SOLID STATESMAN AUTOMATIC GAIN CONTROL AMPLIFIER

Harris' Solid Statesman AGC Amplifier is the most versatile automatic gain control system available today. A wide range of control on the amplifier, and an adjustable attack/recovery time feature, insure programming flexibility. The high compression ratio and rapid attack time generate consistently high modulation levels, while the slow attack/recovery mode will maintain control over average program material and extend dynamic range.

The wider control range, lower distortion and rapid attack time are made possible by the use of a "differential amplifier" as the gain controlling device. Another feature is the selectable attack/recovery time which allows each station to select the control time best suited to its program format.

In the FAST mode, the reaction time is similar to that of other limiters now on the market. This operating mode is most desirable for those stations wanting the highest possible modulation levels.

In the MEDIUM and SLOW modes, reaction times are considerably slower. These operating modes are available to those stations which desire a lesser amount of control action than that found in the FAST mode.

Two Solid Statesman AGC Amplifiers may be interconnected for maintaining stereo balance. A small jumper cable is all that is required.

Front panel controls permit the user to disable both the expansion and compression functions separately for proof of

performance tests. Under these conditions the unit has the same gain as when 15 dB of compression, the ideal operating point, is being used. This provides a test position and at the same time maintains system calibration.

Only 3½" of standard rack space is required for the Harris AGC. All operating controls are located behind the easily removable access panel. Circuit components are readily accessible by removal of the top cover. Input and output connections are provided on a barrier terminal block on the rear of the unit, along with the stereo sync jack and AC power and fuse.

## SPECIFICATIONS

- GAIN:** All figures given with no attenuation in input and output controls (wide open).
- MAXIMUM GAIN:** 50 dB ± 2 dB @ 1 kHz with maximum expansion.
- NOMINAL GAIN:** 35 dB ± 2 dB @ 1 kHz with nominal signal (15 dB of compression) or no signal condition.
- MINIMUM GAIN:** 20 dB ± 2 dB @ 1 kHz with full (30 dB) compression.
- FREQUENCY RESPONSE:** ± 1.0 dB, 30 Hz to 16 kHz with or without compression.
- NOISE:** 70 dB below the threshold of compression.
- COMPRESSION ATTACK TIME:** 30 dB, selectable. Fast: 100 μ Sec. Medium: 1-2 M Sec. Slow: 30 M Sec.
- COMPRESSION RECOVERY TIMES:** 30 dB, dependent upon compression attack time. Fast: 12 Sec. Medium: 22 Sec. Slow: 53 Sec.
- EXPANSION ATTACK TIMES:** 15 dB, dependent upon compression attack time. Fast: 7.5 Sec. Medium: 15 Sec. Slow: 35 Sec.
- EXPANSION RECOVERY TIMES:** 15 dB, dependent upon compression attack time. Fast: 4 Sec. Medium: 5 Sec. Slow: 10 Sec.
- AMOUNT OF COMPRESSION:** 30 dB.
- AMOUNT OF EXPANSION:** 15 dB.
- COMPRESSION RATIO:** Better than 30:1, a 30 dB increase in the input signal will produce less than 1 dB rise in the output level.
- INPUT LEVEL:** -15 dBm to +25 dBm for 15 dB of compression.
- OUTPUT LEVEL:** Adjustable to +20 dBm maximum with compression, +30 dBm amplifier maximum.
- INPUT AND OUTPUT IMPEDANCE:** 600 ohms, balanced or unbalanced.
- DIMENSIONS:** 3½" H x 13 5/8" D x 19" W (Standard rack).
- WEIGHT:** 14 lbs. net, 23 lbs. shipping.
- TEMPERATURE RANGE:** -20°C to +55°C. -4°F to +131°F.
- INPUT VOLTAGE:** 117/234 V ± 10%, 50/60 Hz.
- INPUT POWER:** 5 watts.

## ORDERING INFORMATION

- Solid Statesman Automatic Gain Control Amplifier ..... 994-6629-004
- Matched pair of Automatic Gain Control Amplifiers ..... 994-6629-006





**HARRIS**  
COMMUNICATIONS AND  
INFORMATION HANDLING

# PROOF OF PERFORMANCE PRODUCTS

FCC regulations require that official measurements of station performance be recorded for inspection at least once a year. Harris can provide you with all the equipment required to perform these tests in accordance with FCC rules.

The equipment includes three basic units: (A) Model 210 audio oscillator, (B) Stereo Gain Set, and (C) Model 410 distortion meter.

When the units are used together they can measure accurately from low level microphone circuits or high level input circuits. A single amplifier may be tested as conveniently as a complete studio transmitter installation. Full instructions are supplied with each equipment.

## ORDERING INFORMATION

Stereo Gain Set .....	994-7023-001
Model 210 Audio Oscillator .....	700-0045-000
Model 410 Distortion Meter .....	700-0040-000

**STEREO GAIN SET.** The Stereo Gain Set (Figure B) has excellent stereo amplitude and phase balance for convenient FM proof-of-performance measurements, as well as a mono output for AM proofs. It may be used for individual amplifier measurements of overall systems.

Output connections are selectable by a front-panel switch for "Right", "Left", "L + R", "L - R", and a noise termination for stereo measurements. Also, a mono output is selectable for feeding an AM transmitter system.

A range and associated three-level attenuator provides 1 dB steps from -64 to +16 dBm, with the two higher levels at 600 ohms and the lower level at 150 ohms output to match typical circuit impedances.

The Stereo Gain Set is completely shielded and may be operated in simultaneous AM/FM/TV RF fields encountered at the transmitter.

## SPECIFICATIONS

**INPUT IMPEDANCE:** 600 ohms, floating.

**LOAD IMPEDANCE:** 600/150 ohms, balanced or unbalanced, grounded or ungrounded.

**OUTPUT LEVEL:** -64 to +16 dBm.

**FREQUENCY RESPONSE:** 30-20,000 Hz,  $\pm .5$  dB maximum.

**ATTENUATION ACCURACY:**  $\pm 0.5$  dB maximum error over specified range.

**TOTAL HARMONIC DISTORTION:** 0.5% or less, 30 Hz-20 kHz.

**STEREO BALANCE ACCURACY:** Amplitude and phase error, less than 1% and 1° respectively.

**SIZE:** 12 $\frac{3}{4}$ " wide, 8 $\frac{3}{4}$ " high, 4" deep.

**MODEL 410 DISTORTION METER.** The Model 410 distortion meter (Figure C) measures audio distortion, noise level, audio gain or loss in dB and AC voltages. This unit measures distortion on fundamental frequencies from 20 to 20,000 Hz and indicates harmonics up to 100 kHz. Distortion levels as low as 0.1% can be measured, and distortion measurements may be made on signal levels from 0.1 volt to 30 volts. The unit is 11 $\frac{1}{4}$ " wide, 9" high, and weighs 11 pounds.

**MODEL 210 AUDIO OSCILLATOR.** The Model 210 audio oscillator (Figure A) provides audio signals from 10 to 100,000 Hz with  $\pm 2\%$  calibration accuracy. Response over the entire frequency range is  $\pm 1$  dB with wave form distortion of less than 0.2% at a 5 volt output.

Output impedances are 600 ohms balanced, 600 ohms unbalanced and 150 ohms unbalanced. Maximum output is 10 volts into a 600 ohm load. The unit is 6" wide, 9" high, and 12" deep, including a self-contained power supply. Weighs 11 pounds.







**HARRIS**  
COMMUNICATIONS AND  
INFORMATION HANDLING

## AMPLIFIERS, AUDIO ACCESSORIES



### UTILITY AMPLIFIER

The Harris Utility Amplifier is a high gain, low distortion, general purpose amplifier which includes a self-contained power supply. In addition to providing amplification for low-level sources such as microphones, it also functions as a bridging, program, or line amplifier. The amplifier housing contains provisions for stacking when multiple units are required for stereophonic or quadraphonic operation.

The amplifier includes an integrated circuit preamplifier section and a power output stage consisting of an integrated circuit and current booster output transistors. The unit has input and output transformers, and features internal RFI protection to permit operation in strong RF fields.

The design incorporates an interstage gain control which provides a wide dynamic input range, high signal-to-noise ratio, and a convenient means for setting the output level. The gain control (LEVEL) for the Utility Amplifier is recessed and available as a screwdriver adjustment through an access hole in the front cover.

#### SPECIFICATIONS

**MAXIMUM GAIN:** 84 dB matching, 40 dB bridging  
**FREQUENCY RESPONSE:**  $\pm 1$  dB, 30 Hz to 15 kHz  
**MAXIMUM INPUT LEVEL:** -20 dBm matching, +24 dBm bridging  
**MAXIMUM OUTPUT LEVEL:** +20 dBm  
**DISTORTION:** Less than 0.5% maximum THD, 30 Hz to 15 kHz @ +8 dBm. Less than 1.0% maximum THD, 30 Hz to 15 kHz @ +18 dBm  
**NOISE:** More than 70 dB below +18 dBm output  
**SOURCE AND LOAD IMPEDANCE:** 150 or 600 ohms, balanced or unbalanced  
**OPERATING TEMPERATURE RANGE:** 0° to +55° C.  
**POWER:** 117 or 234 volts  $\pm 10\%$ , 50 to 60 Hz, 2 watts  
**SIZE:** 8.36" wide x 3" high x 4.50" deep (21.2 cm wide x 7.6 cm high x 11.4 cm deep)  
**WEIGHT:** 2.33 pounds, 1.06 kg

#### ORDERING INFORMATION

Utility Amplifier ..... 994-7681-001



### SINGLE PROGRAM AMPLIFIER

The Harris Single Program Amplifier matches the Utility Amplifier in performance and multi-purpose application, yet adds the further dimension of being rack mountable in a standard 19-inch equipment rack for ease of operation.

The gain control is adjusted from the front of the panel, which aids in operator control of the unit.

#### SPECIFICATIONS

**MAXIMUM GAIN:** 84 dB matching, 40 dB bridging  
**FREQUENCY RESPONSE:**  $\pm 1$  dB, 30 Hz to 15 kHz  
**MAXIMUM INPUT LEVEL:** -20 dBm matching, +24 dBm bridging  
**MAXIMUM OUTPUT LEVEL:** +20 dBm  
**DISTORTION:** Less than 0.5% maximum THD, 30 Hz to 15 kHz @ +8 dBm. Less than 1.0% maximum THD, 30 Hz to 15 kHz @ +18 dBm  
**NOISE:** More than 70 dB below +18 dBm output  
**SOURCE AND LOAD IMPEDANCE:** 150 or 600 ohms, balanced or unbalanced  
**OPERATING TEMPERATURE RANGE:** 0° to +55° C.  
**POWER:** 117 or 234 volts  $\pm 10\%$ , 50 to 60 Hz, 2 watts  
**SIZE:** 19" wide x 3.5" high x 4.68" deep (48.26 cm wide x 8.9 cm high x 11.9 cm deep)  
**WEIGHT:** 3.63 pounds, 1.65 kg

#### ORDERING INFORMATION

Single Program Amplifier ..... 994-7682-001



### DUAL CHANNEL AMPLIFIER

The Crown D-60 dual-channel amplifier is recommended for use as a medium-power audio amplifier for headphones, for driving efficient speaker systems, as a power source for test instrumentation, or as a power source for variable-frequency drive systems. The dual channel amplifier may be field modified by simply moving a switch to produce a balanced 25 volt monaural output. The completely solid-state circuits provide instant start-up with no thumps or program delay.

#### SPECIFICATIONS \*

**OUTPUT POWER:** 32 watts per channel minimum RMS (both channels operating) into an 8 ohm load over a bandwidth of 20-20 kHz at a rated RMS sum total harmonic distortion of 0.05% of the fundamental output voltage.  
**VOLTAGE GAIN:** 26 dB  
**INPUT SENSITIVITY:** 0.78 volts  $\pm 2\%$  for 32 watts into 8 ohms  
**NOISE:** 106 dB below 30 watts RMS output  
**FREQUENCY RESPONSE:**  $\pm 0.1$  dB 20-20 kHz

\*These specifications are for stereo application, and will change when the unit is used monaurally.

#### ORDERING INFORMATION

D-60 Dual Channel Amplifier ..... 740-0098-000



### POWER CONTROL PANEL

Each rack of audio and radio frequency equipment should have a master power control panel. The Harris power control panel combines convenient on-off switching of 110 VAC and/or 220 VAC with the reliability of a modern magnetic circuit breaker. The circuit breaker eliminates the need to replace fuses and provides more accurate sensing of overload conditions. A neon pilot light indicates "power on" status. 19" x 3½" x 3½". (48.26 cm x 8.9 cm x 8.9 cm).

Power Control Panel ..... 994-7001-001



### VU METER PANEL

Harris' VU Meter Panel provides a standard instrument for interpreting program levels in terms of Volume Units. It uses a VU meter with the correct ballistic characteristics (ANSI Standard) to permit an industry-accepted measurement of complex waveforms. A precision variable attenuator extends the measurement capability to cover the most used range of program line levels. A 10-position channel selector switch is provided. The frequency is very nearly flat over the entire audio frequency range. Nominal input impedance: 7500 ohms. 19" x 5¼" x 2¾". (48.26 cm x 13.3 cm x 6.98 cm).

VU Meter Panel ..... 994-6973-001



Illustrated above are two PJ-341 jack strips on a PD-2 jack mat to supply 48 pairs or 96 jacks in a 19" x 5¼" rack space.

### PATCH PANELS

Industry standard double jack panels. Jack strips and jack mats are listed separately below for ease in ordering. Jacks are closed circuit type to normal through audio circuits when patch cord plugs are not inserted.

Single row jack strip only [PJ-343], 24 jacks or 12 pairs [no jack mat required] ..... 612-0307-000  
 Double row jack strip only [PJ-341], 48 jacks or 24 pairs [less mat] ..... 612-0306-000  
 Jack mat for one PJ-341 jack strip [PD-1] ..... 994-4399-001  
 Jack mat for two PJ-341 jack strips [PD-2] ..... 994-4400-001  
 Jack mat for three PJ-341 jack strips [PD-3] ..... 944-4401-001

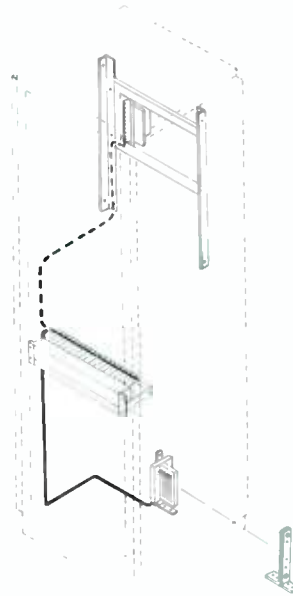

### PRE-WIRED JACK PANEL AND TERMINAL BOARD

This assembly provides a 24-pair patch panel which is mounted on a Harris PD-1 mat and connected to a 120-terminal audio block. The connecting cord is eight feet long, and contains 24 shielded cables. The unit is ready for mounting in a rack or similar cabinet. All hardware for mounting is supplied.

Pre-wired jack panel and terminal board ..... 994-6891-000

### WIRE

Harris has a complete line of quality wire and cable to fill any broadcasting or communication need. Cable for every purpose—shielded, unshielded, multi-conductor, power, audio system and more.

The following wire recommended for microphone and shielded power supply cable has high abrasion resistance and extra flexibility. It is especially suited for installations where cable must take tight bends or lie perfectly flat. The cable has tinned conductors with tinned copper-braided shield.

8410 Belden single conductor shielded, black rubber jacket ..... 250-0059-000  
 8412 Belden 2 conductor stranded 20 AWG Braided shield cotton wrap heavy rubber jacket ..... 250-0036-000  
 8428 Belden neoprene jacketed heavy duty mic cable. 2 conductor 18 AWG braided shield ..... 253-0024-000  
 SH-2-20 2 conductor stranded 20 AWG, 2/push back braided shield not insulated ..... 253-0018-000  
 1261 2 conductor stranded 24 AWG, braided shield, not insulated ..... 253-0001-000

The following are 2 conductor, color-coded broadcast audio cables which come in standard and miniature size. Type 8437 has a braided, tinned copper shield; types 8450 and 8451 have spiral-wrap aluminum-Mylar shields. All types have tinned drain wires. Available in 100, 500 or 1000 foot spools. Average shipping weight per 100 feet, 2½ lbs. Type 8451 available in black vinyl or gray jacket.

8437 Belden 2 conductor 22 AWG solid, w/drain wire and braided shield, black vinyl jacket ..... 253-0062-000  
 8450 Belden miniature audio cable, 2 conductor, 22 AWG solid, drain wire, foil shield vinyl jacket ..... 253-0054-000  
 8451 Belden miniature audio cable, 2 conductor 22 AWG stranded, drain wire, foil shield, vinyl jacket ..... 253-0059-000  
 Cable 6 conductor, 3 pair, wire size 22 AWG ..... 250-0081-000  
 Wire 18 AWG stranded, yellow ..... 252-0247-000  
 High voltage wire 8 AWG 40 kV ..... 255-0006-000



**HARRIS**  
COMMUNICATIONS AND  
INFORMATION HANDLING

## RACK CABINETS

### RAK-70

Designed with the flexibility to accommodate all types of equipment. Whether used as a rack only, or a complete cabinet with all accessories, the RAK-70 can fill almost any special requirement of the individual broadcaster. Included with the RAK-70 are two panel mounting angles; an air filter mounted in rear of cabinet base; knock-outs for wiring in bottom and sides of base; universal-standard EIA panel hole spacing; and 10-32 panel hardware.

#### RAK-70 SPECIFICATIONS

**SIZE:** Height, 78"; Width, 22 1/8"; Depth, 22".

**PANEL SPACE:** 19" X 70".

**WEIGHT:** Domestic packed 175 lbs., Export packed 275 lbs.;  
Cubage, 28 cubic feet.

**FINISH:** Beige-gray.

(NOTE: Each side panel adds 3/4" to overall width, and door adds 1 1/8" depth.)

### RAK-70A

The RAK-70A and included items are similar to the RAK-70, except for height.

#### RAK-70A SPECIFICATIONS

**SIZE:** Height, 72"; Width, 22 1/8"; Depth, 22".

**WEIGHT:** Domestic packed 170 lbs., Export packed 265 lbs.;  
Cubage, 26 cubic feet.

**FINISH:** Beige-gray.

### RAK-80

The RAK-80 is designed with more depth than normally found in a standard rack cabinet to accommodate television monitors and test equipment. Provided are two panel-mounting angles, an air filter mounted in the rear of the cabinet base, knock-outs for wiring in bottom and sides of base, universal standard EIA panel hole spacing and 10-32 hardware. The RAK-80 may be used as a complete cabinet with all accessories or as a rack only.

#### RAK-80 SPECIFICATIONS

**SIZE:** Height, 72"; Width, 22 1/8"; Depth, 25 1/2".

**PANEL SPACE:** 19" X 64 3/4".

**WEIGHT:** Domestic packed approx. 180 lbs., Export packed 350 lbs.;  
Cubage, 34.3 cubic feet with doors.

### RAK-7

Solid-side rack cabinet built of lightweight steel. Has solid sides, solid base, full size rear door with louvers at top and bottom.

#### RAK-7 SPECIFICATIONS

**SIZE:** Height, 78"; Width, 23 1/8"; Depth, 19 1/2".

**OVERALL PANEL SPACE:** 19" X 71 3/4".

**WEIGHT:** Domestic packed 115 lbs., Export packed 200 lbs.;  
Cubage, 18 cubic feet.

Universal standard EIA panel hole spacing, 10-32 panel hardware provided.

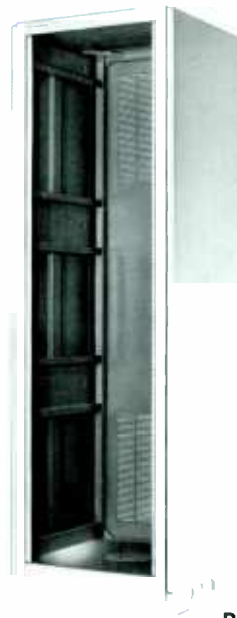

RAK 7

RAK 70, RAK 70A, RAK 80

## ORDERING INFORMATION

### RAK-70

Basic cabinet assembly	994-6643-002
Side panel	994-6664-001
Louvered top	994-6665-001
Door with louvers	994-6671-001
Door without louvers	994-6671-002
Key-type lock for doors	448-0320-000
Fan kit	994-6666-001
Air filter kit (Recommended when using fan kit)	994-6668-001
(2) Rear panel mounting angles	994-7035-001
Panel mounting hardware (30 provided with basic racks)	992-2539-001

### RAK-70A

Basic cabinet assembly	994-6713-001
Side panel	994-6714-001
Louvered top	994-6665-001
Door with louvers	994-6715-001
Door without louvers	994-6715-002
Key-type lock for doors	448-0320-000
Fan kit	994-6717-001
Air filter (replacement)	448-0288-001
(2) Rear panel mounting angles	994-6716-001
Panel mounting hardware (30 provided with basic racks)	992-2539-001

### RAK-80

Basic cabinet assembly	994-6761-001
Side panel	994-6762-001
Louvered top	994-6892-001
Door with louvers	994-6715-001
Door without louvers	994-6715-002
Key-type lock for doors	448-0320-000
Fan kit	994-6763-001
Air filter replacement	448-0288-000
(2) Rear panel mounting angles	994-6716-001
Panel mounting hardware (30 provided with basic racks)	992-2539-001

### RAK-7

Rack cabinet	994-5527-003
Joiner strip	994-5577-001
Extra panel mounting hardware kit	994-6582-001





# REMOTE CONTROL SYSTEM



With 15 metering channels and 30 individual control functions, the all solid-state Model TRC-15A Remote Control System has sufficient versatility to fulfill current requirements and future needs. Two versions of the TRC-15A are available—Models TRC-15AW and TRC-15AR. The only interconnection requirement of the TRC-15AW is any duplex, voice-grade circuit. True wireless remote control can be accomplished with the TRC-15AR. Control subcarrier equipment is standard in this version for multiplexing control information on an Aural Studio-Transmitter Link. Field conversion to either configuration is possible without rewiring... simply exchange the appropriate modules.

**CIRCUITRY.** The circuitry of the TRC-15A is of modular construction, and is noiseless in operation, employing no stepper relay. Binary numbers generated by the front-panel pushbutton assembly of the Studio Unit are encoded to command channel selection. The use of individual relays in the Transmitter Unit makes system operation noiseless.

Channel selection is simplified by the use of pushbuttons on the Studio Unit. Optional external meters for display of any selected channel are simply connected to the appropriate barrier terminals. Four external meters may be used with the TRC-15A. Long-life, light emitting diodes (LED) are used as visual indicating devices on the TRC-15A. Indicators are provided on the Transmitter Unit to show the selected channel.

**CONTROL.** Fail-safe provisions in the TRC-15A meet all existing FCC requirements and will function with the loss of primary power, interconnecting circuit failure, or an actual malfunction of the equipment itself.

Channel selection is accomplished with the front-panel pushbutton. Two functions, designated RAISE and LOWER, can be performed on each channel selected. While performing a RAISE or LOWER control function, a parameter can be monitored simultaneously. As only one shift rate can be accomplished at any point in time, RAISE and LOWER functions cannot be activated while a channel relay is being selected.

**TELEMETRY.** Telemetry is accomplished through the use of an additional tone. DC sample voltages representing parameters to be remotely observed are converted to an audio tone in the Transmitter Unit. This signal is then relayed to the Studio Unit and converted back to a DC voltage proportional to the input sample voltage for display on the 4-inch, taut-band, panel-mounted meter. Either of two audio spectrums may be used for conveying this information. These spectrums are 20 Hz to 30 Hz, or 800 Hz to 1200 Hz. Multiturn calibration controls for each channel are provided on the Transmitter Unit for ease of calibration.

## TRC-15AW SPECIFICATIONS

**METERING FUNCTIONS:** 15 telemetry channels, plus calibration

**CONTROL FUNCTIONS:** 15 RAISE, 15 LOWER (30 total)

**CONTROL OUTPUT:** Momentary contact closure or redistribution of externally-supplied control voltage up to 120V AC or DC. Maximum load 50 watts non-inductive.

**METER:** 1, taut-band with carefully controlled ballistics, 100 microamperes F.S. Provisions for 4 external meters.

**METERING STABILITY:** With weekly transmitter-unit checks and daily studio-unit checks, better than 1% exclusive of operator setting or reading error.

**METERING ACCURACY:** 2% or better of full scale.

**TELEMETRY INPUT REQUIREMENTS:** + or -1V to 10 VDC for full-scale deflection. All inputs fully isolated from ground. Maximum 350V potential to ground. Input impedance 20,000 ohms.

**TELEMETRY FREQUENCIES:**

[Audible]: 800 Hz to 1200 Hz. [Subaudible]: 20 Hz to 30 Hz.

**CONTROL FREQUENCIES:** 300 Hz and 375 Hz, nominal.

**TRC-15AW INTERCONNECTION REQUIREMENTS:** Voice-grade, data-channel telephone circuit (Interstate FCC Tariff 260, type 3002 channel), 600 ohms, 30 dB allowable loss from 300 Hz to 1200 Hz. DC continuity not required.

**TRC-15AR INTERCONNECTION REQUIREMENTS:**

**Control Circuit:** Control subcarrier generator and detector provided internally. (Studio Unit Output and Transmitter Unit Input): 0.5V rms, 2,000 ohms, nominal, unbalanced. Nominal subcarrier operating frequencies 26 kHz to 110 kHz.

**Telemetry Circuit:** Telemetry return path capable of handling 20 Hz to 30 Hz. (Transmitter Unit Output): Up to 6V P-P (adjustable) behind 600 ohms, unbalanced. (Studio Unit Input): 1.5V P-P, bridging, unbalanced.

**Optional Telemetry Subcarrier [SCA] Generator:** 26 kHz to 100 kHz, internally mounted, 0.5V rms, 2,000 ohms, unbalanced, nominal.

**OPERATING TEMPERATURE RANGE:** -20°F (-30°C) to 160°F (70°C)

**POWER REQUIREMENTS:** 120/240 VAC, ± 10%, 50-60 Hz. (Studio Unit): 20 watts, nominal. (Transmitter Unit): 20 watts, nominal.

**SIZE:** [Studio Unit]: 5¼" H x 19" W x 13¾" D (133mm x 483mm x 345 mm). (Transmitter Unit): 5¼" H x 19" W x 13¾" D (133mm x 483mm x 345mm).

**SHIPPING WEIGHT (approx.):** 65 lbs. (29.5 kg), 5.7 cubic ft. (0.16 cu. m)

## ORDERING INFORMATION

TRC-15A Wire remote control system ..... 731-0329-000

TRC-15AR Radio [STL] remote control system ..... 731-0330-000



# REMOTE CONTROL AND TELEMETRY ACCESSORIES



## MODEL TSK-3 TEMPERATURE SENSING KIT

The TSK-3 measures transmitter building, inlet or exhaust air temperatures from 0°F to 140°F, and operates from a 120/240 VAC, 50-60 Hz power source.

**Model TSK-3 Temperature Sensing Kit . . . . .**  
**731-0452-000**

## PLATE VOLTAGE UNIT

One unit is used with voltages up to and including 6000 volts. For higher voltages, additional units may be connected in series. Also available as an accessory item for metering additional stages of transmitters.

**Plate Voltage Unit . . . . .** 994-4719-002



## MODEL LVK-2 LINE VOLTAGE KIT

The LVK-2 enables observation of AC power mains or other AC power circuits in the range of 120 to 440 VAC.

**Model LVK-2 Line Voltage Kit . . . . .**  
**731-0302-000**



## RF DIODE UNIT

The solid-state M-6112 RF Diode Unit is designed for use as a remote RF indicating device in broadcast installations for sampling base currents or common point currents. It is not a directly calibrated RF ammeter, but is adjustable to indicate current linearity with the RF meter. The power range of the M-6112 is 250 to 50,000 watts, and the frequency range is 540 to 1600 kHz.

**RF Diode Unit . . . . .** 994-6112-001



## MODEL CSA-3 CHOPPER-STABILIZER DC AMPLIFIER

Solid-state chopper - stabilized DC amplifier allows sampling of sensitive DC meter circuits as found in frequency monitors and reflectometers without affecting the normal readings of these meters, or any other low-current circuit. The circuit to be sampled can be positive, negative or isolated from ground, and may be as much as 350 volts above ground potential. Operates from 0°F to 150°F. Power requirements are 120/240 VAC, 50-60 Hz.

**Model CSA-3 Chopper-Stabilized DC Amplifier . . . . .** 731-0300-000

## TUNING MOTOR ASSEMBLY

For operating rheostat, variable condenser, or any variable control. Three wire reversible motor 1 rpm. Torque 15 lb.-inches. 115 volts, 50/60 Hz.

**Tuning Motor . . . . .** 994-4800-001

## PLC-1 POWER-TO-LINEAR CONVERTER

The PLC-1 (not pictured) accepts a low-level DC current sample representing the power output of a broadcast transmitter reflectometer and amplifies it to a level suitable for driving remote control and automatic logging equipment. Logarithmic and linear outputs are provided. Accuracy of the linear output of the PLC-1 is better than 1% from 0 to 130% indicated power. The operating temperature range is 0°F to 150°F. Requires 120/240 VAC, 50-60 Hz.

**Model PLC-1 Power-To-Linear Converter . . . . .**  
**731-0379-000**

## OVERLOAD RELAY

Replaces circuit breakers in current or older models, as circuit breakers are usually undependable for remote control. Tripping current adjustable. Inserted in cathode circuit of RF power amplifier. Some engineers prefer an additional unit in modulator circuit.

**Overload Relay . . . . .** 994-5129-001

## OUTPUT LOADING CONTROL KITS

Complete kits to control output loading of Harris' BC-5P-2 and BC-5H 5 kW transmitters. Kits include motor, relay and all necessary mounting hardware.

**Kit for BC-5P-2 . . . . .** 994-4848-003  
**Kit for BC-5H . . . . .** 994-6548-001



## TUNING MOTOR

This unit for tuning variable inductor, capacitor or other controls, has built-in limit switches. Five wire reversible motor 1 rpm. Requires M-4806 relay assembly for control. 115 volt, 50/60 Hz.

**Tuning Motor . . . . .** 994-5066-001



## MODEL TLK-2 TOWER LIGHT KIT

Can be used for observation of tower light circuits or any other AC circuits.

**Model TLK-2 Tower Light Kit .** 731-0301-000

## PLATE CURRENT UNIT

Furnishes a sample of plate current which is returned to the studio unit and measured on the directly calibrated plate current meter. The unit is provided with a high voltage protective fuse, and can be used for current ranges of 0-0.8 and 0-3 amperes. Units can be used in parallel if higher current range is required.

**Plate Current Unit . . . . .** 994-4720-002



# STUDIO- TRANSMITTER LINK 148 MHz-960 MHz

The ultimate in aural studio-transmitter link performance is provided by the Model PCL-505 and PCL-505/C Aural Studio-Transmitter Links (STL). Advanced techniques, solid-state circuitry, and true modular construction enhance the performance of the PCL-505. The system is available for operation in all commonly used STL bands from 148 MHz to 960 MHz.

Replacing leased telephone circuits for program feed, the PCL-505 affords better performance and savings. Likewise, the system can accommodate wireless remote control systems and secondary program subcarrier systems for even greater savings. The monaural Model PCL-505 can be used in the dual configuration for stereo program feed. The Model PCL-505/C Composite system enables the transmission of the composite stereo waveform on a single RF carrier.

**SYSTEM.** The PCL-505 and PCL-505/C systems provide aural programming feed for AM, FM, FM stereo and TV. FM stereo operation is described separately. Also considered in the design of the PCL-505 system was quadraphonic stereo. The PCL-505/C has the capability of accepting a quadraphonic stereo signal. Overall capabilities have also been carefully

assessed. The system accepts one program feed, monaural or stereo, and two additional subcarriers. Careful consideration has been given to the physical construction of the PCL-505 Transmitter and Receiver. Individual shielded modules are utilized for all RF and I.F. circuits throughout the system. Unique passively illuminated pushbuttons allow front-panel metering of all important operating parameters.

**TRANSMITTER.** Direct FM modulation is employed in the PCL-505 Transmitter. An extremely stable basic oscillator is locked to a crystal-controlled reference oscillator through the use of phase-locked loop techniques. A new approach to AFC circuit design enables a 100% duty cycle greatly improving AFC locking capability and providing frequency stability previously unavailable in aural studio-transmitter links. The basic oscillator operates on a sub-multiple of the final desired operating frequency. Frequency multipliers and power amplifiers are utilized to produce the final desired signal. All systems include a true strip-line directional coupler for indication of forward and reflected powers.

**RECEIVER.** The PCL-505 Receiver is of the dual-conversion, crystal-controlled, superheterodyne type. An active RF preamplifier is used in all PCL-505 Receivers from 148 MHz to 960 MHz. High-Q helical resonators are used on the 450 MHz and 950 MHz receivers. I.F. frequencies employed are 74 MHz and 10.7 MHz. A carefully selected L-C filter is employed in the I.F. sections.

**STEREO FM.** The PCL-505 offers the broadcaster a choice of using either a single or dual STL to transmit stereo programming.

**DUAL STL.** Two Model PCL-505 STL's can be operated in one 500 kHz channel assignment in full compliance with FCC Rule 74.502 to provide the L & R program channels. When two separate STL systems are used, there is no measurable amount of cross talk between channels. The dual system has the capability for transmission of remote control and SCA multiplex subcarriers.

**SINGLE STL.** It is possible to transmit a composite stereo waveform including a 67 kHz subcarrier over the PCL-505/C Composite STL. This achievement is mainly attributable to the use of true, direct FM—rather than phase modulation—in the transmitter, and a wide-band, phase linear I.F. amplifier in the receiver.



The field-proven PCL-505/C is of an advanced design that allows faithful transmission of the complete FM composite stereo - phonic waveform from a studio location to a remote FM broadcast transmitter. With only one basic RF link, this differs from the dual configuration employing two aural STL systems for the left and right channels. With the PCL-505/C, the stereo generator is located in the studio away from strong RF fields. Additionally, all audio processing equipment is at the studio. A 67 kHz SCA subcarrier generator may also be located at the

studio if there is no need to add additional information (such as telemetry information for a remote control system) to the SCA channel at the transmitter site.

The output of the PCL-505/C receiver is designed to feed the wide-band input of a direct FM exciter. Two subcarriers may be relayed by the Composite STL. As with the PCL-505, this capability allows for remote control and additional programming to be fed to the transmitter site.

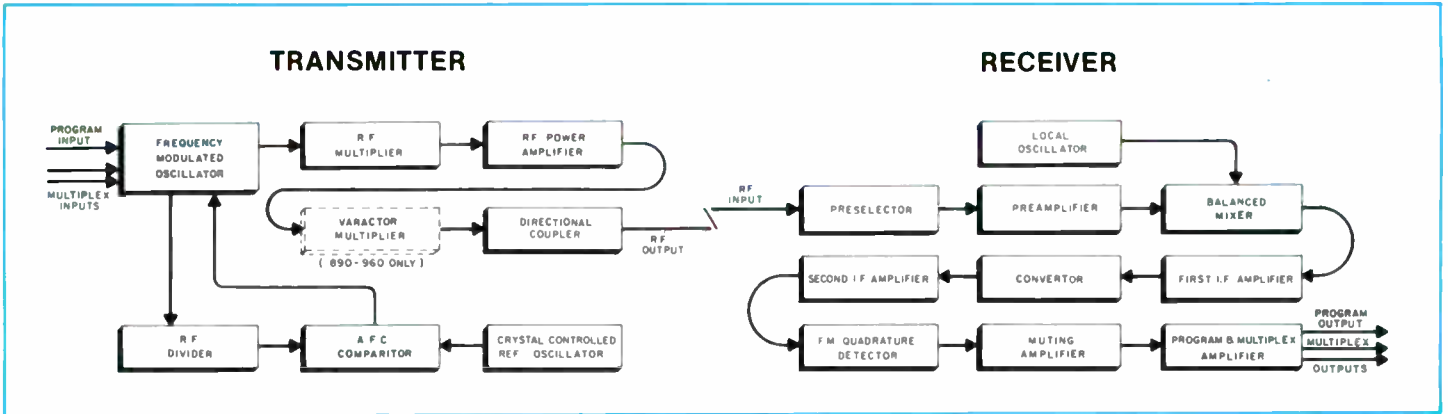

## MODELS PCL-505 AND PCL-505/C SPECIFICATIONS

### TRANSMITTER

**TYPE:** Direct FM

**RF POWER OUTPUT:** 890-960 MHz: 9 watts maximum, 7 watts minimum, 148-470 MHz: 15 watts maximum, 10 watts minimum, Above powers into 50  $\Omega$  resistive load. Type N female connector.

**FREQUENCY STABILITY:** Better than 0.0005% (-20°C to +60°C)

**SPURIOUS AND HARMONIC EMISSION:** More than 60 dB below carrier

**AM NOISE:** Better than 70 dB below carrier

**DEVIATION:**

Monaural [PCL-505]:  $\pm 40$  kHz for 100% modulation (890-960 MHz)

Composite [PCL-505/C]:  $\pm 60$  kHz for 100% modulation (890-960 MHz) Lower deviation is used for 148-470 MHz operation.

**MODULATION INPUT:**

Monaural [PCL-505]: +10 dBm, 600  $\Omega$  balanced, floating, screw barrier strip connector.

Composite [PCL-505/C]: 3.5V p-p, 2,000  $\Omega$ , unbalanced, Type BNC female connector. Other levels on special order.

Multiplex: 1.5V p-p, 2,000  $\Omega$ , unbalanced, Type BNC female connector. Subcarrier spectrum: Monaural (PCL-505): 22-85 kHz. Composite (PCL-505/C): 100-240 kHz

**DIMENSIONS:** 8.9 cm (3.5") high, 48.4 cm (19") wide, 40.6 cm (16") deep

**PRIMARY POWER SOURCE:** 120/240 VAC,  $\pm 10\%$ , 50-60 Hz, 80 watts

### RECEIVER

**TYPE:** Superheterodyne, dual-conversion, crystal-controlled.

**RF INPUT:** 50  $\Omega$ , Type N female connector.

**SENSITIVITY:** Less than 2  $\mu$ V required for 20 dB quieting (for PCL-505/C L + R demodulated). Path evaluation information for all frequencies available on request.

**SELECTIVITY:**

Monaural [PCL-505]: 180 kHz, 3 dB I.F. Bandwidth; 2.5 MHz, 80 dB I.F. Bandwidth

Composite [PCL-505/C]: 330 kHz, 3 dB I.F. Bandwidth; 3 MHz, 80 dB I.F. Bandwidth

Multiplex: 1.5V p-p, 2,000  $\Omega$ , unbalanced, Type BNC female connector. Subcarrier spectrum: Monaural (PCL-505): 22-85 kHz; Composite (PCL-505/C): 100-240 kHz

**DIMENSIONS:** 4.5 cm (1 7/8") high, 48.4 cm (19") wide, 34.9 cm (13 3/4") deep

**PRIMARY POWER SOURCE:** 120/240 VAC,  $\pm 10\%$ , 50-60 Hz, 12 watts.

### SYSTEM

**FREQUENCY RANGE:** 148-174 MHz, 215-240 MHz, 300-330 MHz, 450-470 MHz, 890-960 MHz. Specify exact operating frequency.

**TRANSMISSION CHARACTERISTICS:**

Monaural [PCL-505]: Frequency Response:  $\pm 0.4$  dB, 30 Hz - 15 kHz; Distortion: Less than 0.4%, 30 Hz to 15 kHz; Signal-to-Noise Ratio: Better than 68 dB below 100% modulation.

Composite [PCL-505/C]: Baseband Frequency Response:  $\pm 0.2$  dB, 30 Hz - 60 kHz;  $\pm 0.5$  dB, 30 Hz - 75 kHz; Baseband Distortion (Harmonic and I.M.): Less than 0.4%, 30 Hz - 60 kHz; Signal-to-Noise Ratio: Demodulated L + R better than 65 dB below 100% modulation; Stereo Separation: Better than 35 dB (assumes input stereo signal better than 38 dB).

**MODULATION CAPABILITY:** One program and two subcarrier channels.

## ORDERING INFORMATION

PCL-505 STL transmitter and receiver [specify frequency] ..... 731-0538-000  
 PCL-505/C Composite STL transmitter and receiver [specify frequency] ..... 731-0539-000





**HARRIS**  
COMMUNICATIONS AND  
INFORMATION HANDLING

**STUDIO-  
TRANSMITTER  
LINK  
942MHZ-960MHZ**

The STL and Remote Control equipment currently being manufactured is the most reliable and maintenance-free equipment ever produced. Use is made of the latest technology when clear advantages are realized, but unproven or marginal concepts and components are never used. Exhaustive time and testing is devoted to all products to insure that each design represents the simplest and most reliable answer to providing the necessary performance.

Due to the advancements made in the present day "state of the art" techniques relating to printed circuits, integrated circuits, solid-state components, and improved manufacturing methods, there is no reason whatever that this equipment could not be depended upon to operate reliably and satisfactorily for many years.

A close inspection of the many features of the solid-state STL system will reveal a Direct FM Modulator for extremely low Noise and Distortion characteristics and RF Sensing for Automatic Changeover to a "hot standby" system. Plug-in or bolt-in Modular construction allows fast and accurate diagnosis of circuit or component failure and is a means of quick replacement of the defective module from a limited number of spares.

High performance, maximum reliability and sensible cost are reflected in our "Dual" or "Split" channel approach to FM Stereo, whereby two transmitters and two receivers are used, each being combined into a common antenna system. This method assures two identical FM Broadcast-quality channels with 65 dB Separation, maximum Signal-to-Noise Ratio, Phase



**STL-8F  
FM  
Transmitter**



**R-200/950F  
FM  
Receiver**



Linearity, extremely Low Distortion and Flat Frequency Response.

These outstanding performance characteristics of the Stereo STL System, when coupled with the REDUNDANCY factor presented by the "Dual" channel system, make this the logical approach to STL. Program transmission and Control Circuits can be maintained, even though in a Mono mode of operation, and precious "lost air" time is no longer a consideration.

The "Dual" channel concept allows the Stereo Generator to remain at the FM transmitter site, preventing continual adjustment from unauthorized and uninstructed personnel and eliminates the need for expensive interface equipment between the STL System and the FM Broadcast Transmitter. In addition,

such problems as Separation can be more easily diagnosed when the Stereo Generator is not combined with the STL system.

We welcome your particular problem. For those of you who have clear un-obstructed microwave paths, you have only to purchase the necessary equipment for your particular application to immediately realize the benefits of STL. To those who have a path problem, we have the capability to help you work it out so that you too can reap the profits by using STL.

Present day economic factors make STL, Remote Control and Telemetry well worth looking at, particularly for the AM or FM Broadcaster who looks toward Broadcasting as an interesting and profitable future.

## SPECIFICATIONS

### System Specifications for AM Application:

**FREQUENCY RESPONSE:**  $\pm 1.0$  dB from 50 Hz to 12,500 Hz.  
**DISTORTION:** 1% or less, 50 Hz to 12,500 Hz.  
**SIGNAL-TO-NOISE:**  $-60$  dB or better. Ref. 400 Hz, Mod. 100%.  
**CARRIER FREQUENCY STABILITY:**  $\pm .0005\%$ .  
**TEMPERATURE RANGE:**  $-30^{\circ}\text{C}$  to  $+60^{\circ}\text{C}$ .

### STL-8A SOLID- STATE TRANSMITTER

#### For AM Broadcast Application

**APPLICATION:** Studio-Transmitter Link (AM) and Inter City Relay  
**CARRIER FREQUENCY RANGE:** 942-960 MHz.  
**RF POWER OUTPUT:** Maximum Licensed power 8 watts, nominal 6 watts. Set at factory.  
**OUTPUT IMPEDANCE:** Nominal 50 ohms.  
**RF CARRIER CONNECTOR:** UG-58A/U (Type N Female).  
**CARRIER FREQUENCY STABILITY:**  $\pm .0005\%$ ,  $-30^{\circ}\text{C}$  +  $60^{\circ}\text{C}$  (+  $25^{\circ}\text{C}$  Ref.).  
**TYPE OF MODULATION:** Direct FM 200F3. (200 F9 with remote control and/or Sub Carrier).  
**DEVIATION:**  $\pm 52.5$  kHz (at 400 Hz).  
**AUDIO INPUT:** Balanced 600 ohms, +10 dBm ( $\pm 2$  dB) for 100% modulation.  
**MULTIPLEX INPUTS:** Two BNC Connectors, for Remote Control and Sub Carrier inputs. .5V RMS for 20% Carrier Deviation. 50 to 600 ohms max. unbalanced.  
**AUDIO RESPONSE:**  $\pm 1$  dB, 50 Hz to 12,500 Hz.  
**DISTORTION:** Less than 1% THD, 50 Hz to 12,500 Hz.  
**FM NOISE:** Better than  $-60$  dB below 100% Modulation (400 Hz Ref.).  
**AM NOISE:** Better than  $-55$  dB below carrier reference.  
**POWER REQUIREMENTS:** 115/230 Volts 50-60 Hz. 110 watts.  
**AC POWER SUPPLY:** Precision electronically regulated integrated circuit power supply with current limiting. Regulator circuitry contained in plug-in module.  
**SPURIOUS EMISSIONS:** More than 60 dB below carrier.  
**OUTPUT FAILURE ALARM:** Adjustable RF output sensing provides fail-safe contact closure for alarm or automatic switching as standard equipment.  
**REMOTE LOCATION:** Terminals provide for simple remote off-on control of transmitter. Built-in RF sensing relay provides remote indication of transmitter status.  
**METERING:** Precision taut-band meters for RF power and circuit testing.  
**COOLING:** Advanced thermal design provides conduction, convection and forced air cooling from high quality fan.  
**SOLID-STATE DEVICES:** 38 Solid-state silicon devices; 11 transistors, 3 varactor diodes, 21 diodes, 2 IC, 1 solid-state proportional temperature control oven.  
**DIMENSIONS:** (Vertical) Panel 7" high x 8½" wide (half rack) x 15" deep. (Horizontal) 8¾" x 19" x 8¼".  
**WEIGHT:** (Vertical) Transmitter 15.5 lbs. plus 10 lbs. for rack shelf adapter. Rack shelf adapter is 7" x 19". (Horizontal) 20 lbs.

### System Specifications for FM Application:

**FREQUENCY RESPONSE:**  $\pm .5$  dB from 40 Hz to 15,000 Hz.  
**DISTORTION:** 0.6% or less, 50 Hz to 15,000 Hz.  
**SIGNAL-TO-NOISE:**  $-65$  dB or better. Ref. 400 Hz, Mod. 100%.  
**CARRIER FREQUENCY STABILITY:**  $\pm .0005\%$ .  
**TEMPERATURE RANGE:**  $-30^{\circ}\text{C}$  to  $+60^{\circ}\text{C}$ .

### STL-8F SOLID- STATE TRANSMITTER

#### For FM Broadcast Application

**APPLICATION:** Studio-Transmitter Link, (FM)  
**CARRIER FREQUENCY RANGE:** 942-960 MHz.  
**RF POWER OUTPUT:** Maximum Licensed power 8 watts, nominal 6 watts. Set at factory.  
**OUTPUT IMPEDANCE:** Nominal 50 ohms.  
**RF CARRIER CONNECTOR:** UG-58A/U (Type N Female).  
**CARRIER FREQUENCY STABILITY:**  $\pm .0005\%$ ,  $-30^{\circ}\text{C}$  +  $60^{\circ}\text{C}$  (+  $25^{\circ}\text{C}$  Ref.).  
**TYPE OF MODULATION:** Direct FM 200F3. (200 F9 with remote control and/or Sub Carrier).  
**DEVIATION:**  $\pm 52.5$  kHz.  
**AUDIO INPUT:** Balanced 600 ohms, +10 dBm ( $\pm 2$  dB) for 100% modulation.  
**MULTIPLEX INPUTS:** Two BNC Connectors, for Remote Control and Sub Carrier inputs. .5V RMS for 20% Carrier Deviation. 50 to 600 ohms unbalanced.  
**AUDIO RESPONSE:**  $\pm 0.5$  dB, 40 Hz to 15,000 Hz.  
**DISTORTION:** Less than 0.6% THD, 50 Hz to 15,000 Hz.  
**FM NOISE:** Better than  $-65$  dB below 100% Modulation (400 Hz Ref.).  
**AM NOISE:** Better than  $-55$  dB below carrier reference.  
**POWER REQUIREMENTS:** 115/230 Volts 50-60 Hz. 110 watts.  
**AC POWER SUPPLY:** Precision electronically regulated integrated circuit power supply with current limiting. Regulator circuitry contained in plug-in module.  
**SPURIOUS EMISSIONS:** More than 60 dB below carrier.  
**OUTPUT FAILURE ALARM:** Adjustable RF output sensing provides fail-safe contact closure for alarm or automatic switching as standard equipment.  
**REMOTE LOCATION:** Terminals provide for simple remote off-on control of transmitter. Built-in RF sensing relay provides remote indication of transmitter status.  
**METERING:** Precision taut-band meters for RF power and circuit testing.  
**COOLING:** Advanced thermal design provides conduction, convection and forced air cooling from high quality fan.  
**SOLID-STATE DEVICES:** 38 Solid-state silicon devices; 11 transistors, 3 varactor diodes, 21 diodes, 2 IC, 1 solid-state proportional temperature control oven.  
**DIMENSIONS:** (Vertical) Panel 7" high x 8½" wide (half rack) x 15" deep. (Horizontal) 8¾" x 19" x 8¼".  
**WEIGHT:** (Vertical) Transmitter 15.5 lbs. plus 10 lbs. for rack shelf adapter. Rack shelf adapter is 7" x 19". (Horizontal) 20 lbs.



**HARRIS**  
COMMUNICATIONS AND  
INFORMATION HANDLING

## REMOTE PICKUP EQUIPMENT 150 MHZ-470 MHZ



RPT-40 transmitter



R-30/150 receiver

### RPT-40 TRANSMITTER

**FREQUENCY:** 150-172 MHz.

**CRYSTAL MULTIPLICATION:** 12.

**FREQUENCY STABILITY:**  $\pm .0005\%$  —30 deg. C to + 60 deg. C.

**SPURIOUS EMISSION:** Spurious radiation attenuated more than 60 dB below carrier level.

**RF OUTPUT:** Maximum 40 watts, nominal 36 watts into 50 ohms.

**VSWR PROTECTION:** High VSWR will not damage transmitter.

**TEMPERATURE RANGE:** —20 deg. C to + 45 deg. C.

**MODULATION:** 30 F3; normally adjusted for  $\pm 6$  kHz deviation. Plug-in direct FM modulator.

**AUDIO INPUTS:** Four microphone inputs standard (one push-to-talk) with individual mixing gain controls. Optional balanced line level input may be substituted for a mic input.

**AUDIO INPUT LEVEL:** Microphone input level can be from —70 dB to —45 dB. Line input level can be from —20 dBm to + 4 dBm.

**AUDIO INPUT IMPEDANCE:** Will accept microphones from 150 to 600 ohms.

**AUDIO CONNECTORS:** Input No. 1 (XLR-4-31). Inputs Nos. 2, 3, and 4 (XLR-3-31).

**POWER REQUIREMENTS:** 115/230 volts AC, 50/60Hz, 155 watts transmitting, 30 watts standby. 13.6 volts DC negative ground. 7 amp. transmitting, 0.5 amp. standby.

**MODULATION CONTROL:** Solid - State Compressor/Limiter.

**METERING:** Selector switch for measuring audio level, compressor gain reduction, RF output, etc.

**WEIGHT:** 20 lbs. net, 26 lbs. gross.

**DIMENSIONS:** 6 $\frac{1}{4}$ " high x 15" wide x 12" deep.

### R-30/150 RECEIVER

Mates with RPT-40 transmitter

**CARRIER FREQUENCY RANGE:** 150-172 MHz.

**DUAL FREQUENCY OPERATION:** Provisions for dual frequency operation are standard. The second crystal adjusted to specified frequency and switch assembly are optional at additional cost.

**SENSITIVITY:** 0.5 microvolt for 20 dB quieting.

**INPUT IMPEDANCE:** 50 ohms. 50-239 Connector.

**FREQUENCY STABILITY:**  $\pm .0005\%$  —30 deg. C. to + 60 deg. C.

**SELECTIVITY:** 10.7/F30 filter module band width: 6 dB at  $\pm 17.5$  KHz, 60 dB at  $\pm 22.0$  KHz, 90 dB at  $\pm 23.5$  KHz, 100 dB + ultimate. (Optional filters available)

**SPURIOUS RESPONSE:** At least —95 dB.

**AUDIO OUTPUT:** Balanced 600 ohms + 10 dBm.

**FREQUENCY RESPONSE:**  $\pm 1$  dB 50 Hz to 8000 Hz when used with RPT-40 transmitter.

**SQUELCH:** Adjustable squelch provides audio muting, plus auxiliary contacts for external signal circuit.

**RF FILTERING:** Extensive RF filtering and shielding for use in high RF fields.

**POWER REQUIREMENTS:** 115/230 VAC, 50/60Hz, 30 watts.

**AC POWER SUPPLY:** Precision, electronically regulated integrated circuit, with current limiting. Plug-in module.

**METERING:** Precision taut-band meter with front panel test selector switch. Tests signal strength, discriminator zero, power supply, audio level.

**SOLID- STATE DEVICES:** 17 transistors, 22 diodes, 2 IC's.

**WEIGHT:** 16 lbs. net, 20 lbs. gross.

**DIMENSIONS:** 8 $\frac{3}{4}$ " high x 19" wide x 8 $\frac{1}{4}$ " deep.

## RPT-25 TRANSMITTER

**FREQUENCY:** 450-470 MHz.  
**CRYSTAL MULTIPLICATION:** 36.  
**FREQUENCY STABILITY:**  $\pm .0005\%$  —30 deg. C. to + 60 deg. C.  
**SPURIOUS EMISSION:** Spurious radiation attenuated more than 60 dB below carrier level.  
**RF OUTPUT:** Maximum 25 watts, nominal 20 watts into 50 ohms.  
**VSWR PROTECTION:** High VSWR will not damage transmitter.  
**TEMPERATURE RANGE:** —20 deg. C to + 45 deg. C.  
**MODULATION:** 50 F3; normally adjusted for  $\pm 9$  kHz deviation. Plug-in direct FM modulator.  
**AUDIO INPUTS:** Four Microphone inputs standard (one push-to-talk) with individual mixing gain controls. Optional balanced line level input may be substituted for a mic input.  
**AUDIO INPUT LEVEL:** Microphone input level can be from —70 dB to —45 dB. Line input level can be from —20 dBm to + 4 dBm.  
**AUDIO INPUT IMPEDANCE:** Will accept microphones from 150 to 600 ohms.  
**AUDIO CONNECTORS:** Input No. 1 (XLR-4-31). Inputs Nos. 2, 3, and 4 (XLR-3-31).  
**POWER REQUIREMENTS:** 115/230 volts AC, 50/60 Hz., 155 watts transmitting, 30 watts standby. 13.6 volts DC negative ground. 7 amp. transmitting, 0.5 amp. standby.  
**MODULATION CONTROL:** Solid-State Compressor/Limiter Module. Selector switch for measuring audio level, compressor gain reduction, RF output, etc.  
**WEIGHT:** 20 lbs. net, 26 lbs. gross.  
**DIMENSIONS:** 6¼" high x 15" wide x 12" deep.

## R-50/450 RECEIVER

Mates with RPT-25 transmitter

**CARRIER FREQUENCY RANGE:** 450-470 MHz.  
**DUAL FREQUENCY OPERATION:** Provisions for dual frequency operation are standard. The second crystal adjusted to specified frequency and switch assembly are optional at additional cost.  
**SENSITIVITY:** 0.5 microvolt for 20 DB quieting.  
**INPUT IMPEDANCE:** 50 ohms. UG-58A/U Connector.  
**FREQUENCY STABILITY:**  $\pm .0005\%$  —30 deg. C. to + 60 deg. C.  
**SELECTIVITY:** 10.7/F50 filter module band width: 6 dB at  $\pm 21$  KHz, 60 dB at  $\pm 28$  KHz, 80 dB at  $\pm 32$  KHz, 100 dB + ultimate. (Optional filters available).  
**SPURIOUS RESPONSE:** At least —95 dB (Better than —100 dB with optional pre-selector.)  
**AUDIO OUTPUT:** Balanced 600 ohms. + 10 dBm.  
**FREQUENCY RESPONSE:**  $\pm 1$  dB 50 Hz to 10,500 Hz when used with RPT-25 transmitter.  
**SQUELCH:** Adjustable squelch provides audio muting, plus auxiliary contacts for external signal circuit.  
**RF FILTERING:** Extensive RF filtering and shielding for use in high RF fields.  
**POWER REQUIREMENTS:** 115/230 VAC, 50/60 Hz, 30 watts.  
**AC POWER SUPPLY:** Precision, electronically regulated integrated circuit, with current limiting. Plug-in module.  
**METERING:** Precision taut-band meter with front panel test selector switch. Tests signal strength, discriminator zero, power supply, audio level.  
**SOLID- STATE DEVICES:** 19 transistors, 23 diodes, 3 IC's.  
**DIMENSIONS:** 8¾" high x 19" wide x 8¾" deep.  
**WEIGHT:** 16 lbs. net, 20 lbs. gross.

## SYSTEM SPECIFICATIONS

450 - 470 MHz: RPT - 25 Transmitter with R - 50/450 Receiver

**AUDIO RESPONSE:**  $\pm 1.5$  dB 30 Hz-12000 Hz with 10.7/F100 Receiver I.F. Filter.  $\pm 1.5$  dB 30 Hz-10500 Hz with 10.7/F50 Receiver I.F. Filter. The 10.7/F50 Filter is recommended because reduced bandwidth minimizes interference.

**DISTORTION:** Less than 2% THD within receiver Filter Bandwidth.

**SIGNAL-TO-NOISE RATIO:** Better than 50 dB below 100% modulation.

150 - 172 MHz: RPT - 40 Transmitter with R - 30/150 Receiver.

**AUDIO RESPONSE:**  $\pm 1.5$  dB 30 Hz-7500 Hz with 10.7/F30 Receiver I.F. Filter. The 10.7/F30 Filter is recommended because reduced bandwidth minimizes interference.

**DISTORTION:** Less than 2% THD within receiver Filter Bandwidth.

**SIGNAL-TO-NOISE RATIO:** Better than 50 dB below 100% modulation. (High Level Input)

## TYPICAL ONE-WAY PACKAGES

### ORDERING INFORMATION

#### 150 MHz

1—RPT-40 Transmitter, 40-watt, complete with crystal and tuned to frequency. 120 VAC&12 VDC. 4 audio inputs [one push to talk] ..... 731-0369-000  
1—TPS-TC-1 mobile control for RPT-40 transmitter ..... 731-0317-000  
1—ASP-143 bumper mount for MA-1 antenna ..... 710-0087-000  
1—MA-1 Mobile Single Ring Antenna ..... 710-0089-000  
1—PA-1 Portable Single Ring Antenna ..... 710-0088-000  
1—R-30/150 Receiver, rack mount, broadcast quality continuous-duty, with crystal and tuned. 120 VAC. 600 ohm output ..... 731-0371-000  
1—RA-4 4-bay Base Antenna ..... 710-0086-000  
150—feet FHJ4-50B Heliac foam filled, ½", jacketed transmission line ..... 618-0171-000  
2—44AU UHF Jack, for use with FHJ4-50B ..... 620-0301-000  
1—PG-4A pigtail, 4' RG-8A/U cable with plugs ..... 731-0218-000  
1—PG-4B pigtail, 4' RG-8A/U cable with connectors ..... 731-0182-000

#### 450 MHz

1—RPT-25 Transmitter, 25-watt, complete with crystal and tuned to frequency. 120 VAC and 12 VDC. 4 audio inputs [one push to talk] ..... 731-0370-000  
1—TPS-TC-1 mobile control for RPT-25 transmitter ..... 731-0317-000  
1—R-50/450 Receiver, rack mount, broadcast quality, 120 VAC, 600 ohm output ..... 731-0372-000  
1—ASP-700 Base Antenna, colinear, 8 dB gain ..... 710-0245-000  
2—ASP-320 Mounting Clamps for ASP-700 ..... 710-0113-000  
150—feet FHJ5-50A heliex, ⅞", 50 ohm jacketed ..... 618-0172-000  
2—45AU UHF Jack, for use with FHJ5-50A ..... 620-0317-000  
1—PG-4B pigtail, 4' RG-8A/U cable with connectors ..... 731-0182-000  
1—PG4C pigtail, 4' RG-8U with UG-21C/U and UG-23B/U connectors ..... 731-0257-000  
1—DB-705 Mobile Whip antenna, vertically polarized, 5 dB gain ..... 710-0153-000

### ACCESSORIES

DFT Dual Frequency Kit for RPT-25, RPT-40, less crystal ..... 731-0162-000  
DFR Dual Frequency Kit for R-50/450, R-30/150, less crystal ..... 731-0163-000  
XT-1A/0-1A Hi-Accuracy Crystal and Oven Set for RPT-25, RPT-40 ..... 731-0165-000  
XR-1A/0-1A Hi-Accuracy Crystal and Oven Set for R-50/450, R-30/150 ..... 731-0166-000  
MCD-70 Dynamic Microphone, modified for push-to-talk ..... 731-0251-000





**HARRIS**  
COMMUNICATIONS AND  
INFORMATION HANDLING

## TRANSMITTING TUBES



8916



4CX35000C



833-A



4CX5000A

**FAST MOVING INVENTORY.** Harris carries thousands of tubes in inventory—which, because of fast turnover, are always fresh. This is of vital importance, particularly for large transmitting tubes, where long shelf periods can make tubes gaseous. Listed on this page are a few of the popular tubes in stock—many others are also on hand. All tubes carry manufacturer's warranty.

**HOW TO ORDER.** Tubes may be ordered from Quincy, Houston, or New York. Shipment will be made as you direct—air freight, UPS, P.P., etc. Prices are no more at Harris... and you have the assurance of tube freshness. Please place your order by tube type and Harris part number.

**Example: Type 4CX300A . . . . 374-0014-000**

### TRANSMITTING TUBES

Type	Number	Type	Number
3CX2,500F3	374-0093-000	575A	374-0026-000
4X150A	374-0018-000	673	374-0027-000
4-125A	374-0008-000	807	374-0030-000
4-250A	374-0009-000	810	374-0031-000
4-400A	374-0010-000	813	374-0034-000
4R4GY	374-0020-000	833A	374-0039-000
4CX250B	374-0081-000	845	374-0040-000
4CX300A	374-0014-000	866A	374-0042-000
4CX1,000A	374-0015-000	6146	374-0051-000
4CX1,500A	374-0121-000	6360A	374-0054-000
4CX3,000A	374-0074-000	8008	374-0058-000
4CX5,000A	374-0016-000	8806	374-0118-000
4CX10,000D	374-0077-000	8807	374-0119-000
4CX15,000A	374-0097-000	8916	374-0124-000
4CX35,000C	374-0099-000	8122	374-0096-000
5CX1,500A	374-0120-000		





**HARRIS**  
COMMUNICATIONS AND  
INFORMATION HANDLING

# SEMICONDUCTOR DIRECTORY

The following is a partial list of transistors, silicon diodes, Zener diodes, and integrated circuits used in Harris manufactured products. When ordering, please specify the type number of the item and the Harris part number.

## TRANSISTORS

Type	Number
MPS-U45	380-0179-000
MPS-U95	380-0183-000
2N214	380-0011-000
MPS-404A	380-0145-000
2N697	380-0042-000
DTS804	380-0205-000
2N1183A	380-0022-000
TZ-1218	380-0147-000
2N1307	380-0018-000
2N1414	380-0014-000
2N1539	380-0016-000
2N2369	380-0083-000
PT3134B	380-0037-000
PT3134E	380-0039-000
2N3417	380-0111-000
2N3440	380-0058-000
2N3704	380-0088-000
2N3740	380-0066-000
2N4036	380-0045-000
2N4401	380-0125-000
2N4356	380-0151-000
2N4870	380-0141-000
2N4905	380-0107-000
2N4914	380-0128-000
2N5087	380-0112-000
2N5088	380-0115-000
2N5109	380-0114-000
2N5550	380-0158-000
2N6254	380-0519-000
2N6340	380-0513-000
39772	380-0057-000
40310	380-0062-000
40311	380-0143-000
40312	380-0100-000
40314	380-0053-000
40317	380-0050-000
40319	380-0044-000
40360	380-0097-000

## INTEGRATED CIRCUITS

Type	Number
TD101	382-0020-000
LM301AH	382-0056-000
CA641T	382-0108-000
LM741CN	382-0187-000
946DC7340	382-0203-000
LH0002CH	382-0172-000
MC1013P	382-0033-000
MC1468L	382-0220-000
MM1702AQ	382-0303-000
SN7400N	382-0070-000
SN7402N	382-0071-000
SN7403N	382-0072-000
SN7437N	382-0139-000
SN7474N	382-0121-000
SN7476N	382-0074-000
MLZR42050	382-0141-000
SN75453P	382-0125-000

## HIGH VOLTAGE RECTIFIERS

Type	Number
S-5373	384-0274-000
67-6099	384-0159-000
67-6130	384-0167-000
67-6246	384-0322-000
67-6247	384-0323-000
67-6329	384-0362-000
7030A	384-0149-000
67-7800	384-0185-000

## ZENER DIODES

Type	Number
1N754	386-0019-000
1N2974	386-0016-000
1N2992A	386-0101-000
1N3007A	386-0127-000
1N3015	386-0097-000
1N3031B	386-0034-000
1N3337A	386-0227-000
1N3340	386-0096-000
1N3582	386-0047-000
1N4099	386-0183-000
1N4732A	386-0123-000
1N4733A	386-0135-000
1N4737	386-0106-000
1N4738	386-0091-000
1N4744	386-0092-000
1N4747A	386-0100-000
1N4749A	386-0077-000
1N5352A	386-0169-000
1N5352B	386-0298-000

## SILICON DIODES

Type	Number
1N21B	384-0001-000
1N276	384-0267-000
1N457A	384-0249-000
1N914	384-0134-000
1N1695	384-0017-000
1N2069	384-0018-000
1N2070	384-0019-000
1N2071	384-0020-000
MZ2361	384-0256-000
1N3253	384-0282-000
1N3254	384-0258-000
1N3255	384-0263-000
1N3495	384-0111-000
1N4003	384-0371-000
1N4246	384-0352-000
1N4247	384-0353-000
1N4720	384-0165-000
1N5054	384-0368-000
18D88A	384-0220-000

# HIGH FREQUENCY BROADCAST TRANSMITTERS

HARRIS



COMMUNICATIONS AND  
INFORMATION HANDLING



**HARRIS**  
COMMUNICATIONS AND  
INFORMATION HANDLING

## SW-100

### 100,000 Watt Short Wave Broadcast Transmitter

- High level Pulse Duration Modulation
- Exceeds 55% overall efficiency
- 10-Channel pre-set tuning
- Low power consumption
- Only five tubes for 100 kW
- Vapor phase cooling
- Rated 100% continuous sine wave modulation
- Designed for trapezoidal programming
- Minimum floor space
- Full front and rear accessibility



Harris' SW-100 is a high-level, plate modulated short wave broadcast transmitter, featuring automatic 10-channel pre-set tuning. Utilizing the exclusive Pulse Duration Modulator, the SW-100 provides higher efficiency, lower operating costs and overall performance superior to that of any other short wave transmitter in the 100 kilowatt power range. The transmitter is capable of operating at any frequency between 3.2 and 22 MHz at a continuous 100% sine wave modulation.

**HIGH EFFICIENCY . . . . . EXCEEDS 55%.** The Pulse Duration Modulator employed in the SW-100 is almost 90% efficient (instead of the usual 50% to 60%), enabling the transmitter to achieve an unusually high overall efficiency of greater than 55%. This means about one third less power consumption than that of other high level plate modulated 100 kW transmitters.

**10-CHANNEL PRE-SET TUNING.** Few controls and ample metering make the SW-100 the easiest tuning high power transmitter available. The servo system will automatically tune to any of ten pre-set channels in about 10 seconds. Auxiliary switching is possible for each channel for antenna switching, synthesizer programming, etc. Up to ten different frequencies from 3.2 to 22 MHz can be remembered, which allows pushbutton re-tuning to any pre-set frequency.

**FIVE TUBE DESIGN.** The entire transmitter employs just five tubes. . . with modern ceramic 4CV 50,000E tetrode power tubes operating well above manufacturer's dissipation ratings. All power supplies utilize long-life solid-state silicon rectifiers. Highest quality components, conservatively rated, are used throughout the SW-100 to assure a maximum degree of reliability.

**CONTINUOUS 100% MODULATION RATING.** This continuous sine wave modulation capability permits a higher average modulation (such as trapezoidal) which results in greater loudness at the receiver without increasing transmitted carrier power. Another feature of this high efficiency series type modulator is convenient front panel carrier power adjustment over a wide range.

**VAPOR PHASE COOLING.** The SW-100 employs the vapor cooling technique. This highly efficient method of heat transfer results in constant anode temperatures and extended tube life. This system allows a much smaller and more efficient heat exchanger than older water cooling systems.

**MINIMUM FLOOR SPACE.** Due to the elimination of large iron core components such as the modulation transformer and modulation reactor, the SW-100 requires only 7 square meters (76 square feet) of floor space. Advanced cabinet design provides easy accessibility to all components.

**RF SECTION.** The RF chain is conventional using a transistorized oscillator, buffer, emitter follower and a 4CX1500A tetrode tube amplifier to drive a single 4CV50,000E tetrode Class C power output stage.

An automatic drive control maintains the PA screen current at 1.75 amps, eliminating the usual problem of over-dissipating the screen of a tetrode during tune-up.

**THE MODULATION SYSTEM.** Harris' Pulse Duration Modulator is characterized by low plate dissipation and low peak tube currents; peak cathode currents are about one-half that of other 100 kW transmitters. Average plate dissipation runs substantially below rated levels, and all peak voltages are maintained well below component ratings. In addition, the PDM design allows continuous 100% sine wave modulation.

Wide frequency response is possible as large reactive components are not used in the modulation system. Control of the transmitter power output over a wide range is accomplished in a low-level stage of the modulator by means of a convenient front panel vernier control. No adjustment is necessary in any high power RF circuit.

**PROTECTIVE CIRCUITS.** All major components of the SW-100 are protected by circuit breakers. Tubes and transistors are guarded by overload relays or current-limiting devices.

A quick-acting circuit protects against damage by high voltage arcs by limiting the energy in such arcs to less than 10 watt seconds. Protection against voltage standing wave ratios of greater than 1.5 to 1.0 is provided. Both forward and reflected power are metered at the front panel.

In case of momentary RF overloads the SW-100 will recycle three times automatically. Should a third overload occur within a thirty second period, the transmitter will remain off until manually reset. However, if the time between overloads is greater than thirty seconds, continuous recycling will occur.

The SW-100 employs a unique method of transmitter protection. The modulator tube may be turned off in a low level state in

## TRAPEZOIDAL RESPONSE

Trapezoidal audio processing may be used to develop greater intelligence carrying sideband power without increasing the transmitter carrier power. To do this the audio input wave (A) is flattened at the top, by clipping, then reamplified to form a trapezoidal wave (B). The shaded areas in the diagram indicate the power gain.

The desired power gain is lost, however, if this clipped, or flattened wave tilts downward due to poor low frequency response, or is rounded out again to its original shape by sub-standard high frequency response.

The SW-100 has the capability of passing a 100 Hz 12 dB clipped wave at 100% modulation with minimum tilt or rounding of the wave. As the transmitter is capable of continuous 100% sine wave modulation it is more than able to operate with trapezoidal program material.

All the additional power gained by clipping the audio input is delivered at the output of the transmitter, thus increasing volume at the receiver.

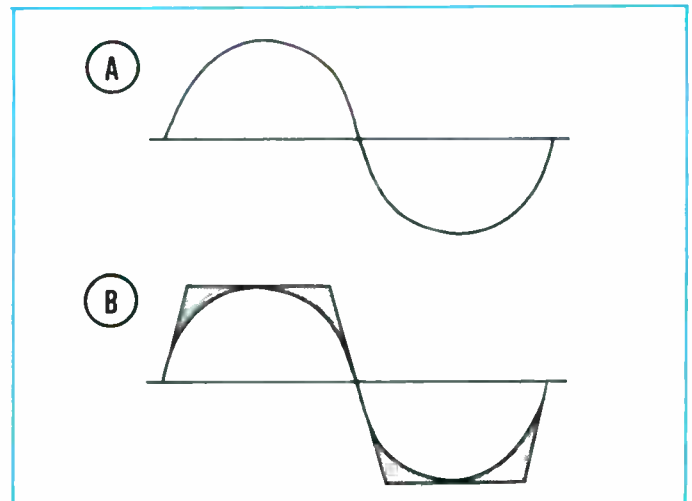



about five microseconds. This removes the HV from the plate of the tube, thus eliminating most faults which normally occur. The HV supply (diodes and transformer) is capable of withstanding repeated short circuits without harming the unit.

An automatic gain control monitors the PA screen. The PA may be operated with no HV but with screen voltage and under any condition of tuning with no damage being done to the PA tube.

Additional protection is provided by the HV circuit breaker. Tubes and transistors are also protected by current limiting impedances.

**THE SERVO SYSTEM.** The all solid-state servo system will automatically tune any of 10 pre-set channels in about ten seconds. Each channel is "remembered" on one plug-in card. Auxiliary switching also is provided on each pre-set channel card for antenna switching, synthesizer, programming, etc. The fast tuning time is made possible because the HV supply is not disabled during the tune cycle; the RF drive is turned off in a low level solid-state stage, and all tuning is done in parallel. When the tuning has been accomplished, the modulator is turned back on silently and smoothly.

**TRANSMITTER LAYOUT.** The standard SW-100 consists of two cabinets, a heat exchanger designed for mounting on top of the cabinets and an external high voltage power transformer and voltage regulator. Front and rear doors and meter panel are magnetically latched. The SW-100 can be supplied with the heat exchanger for roof top mounting.



High power tetrode, 4CV50,000E, used in both the RF amplifier and modulator. Weighs only 35 pounds, and can easily be handled by one man.



SW-100 with heat exchanger [front doors removed]



SW-100 with rear doors removed  
[heat exchanger not shown]

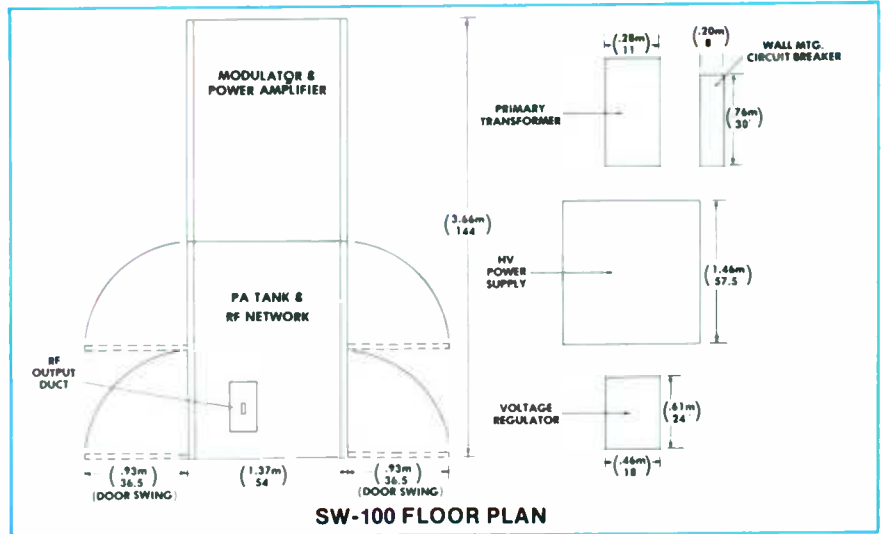
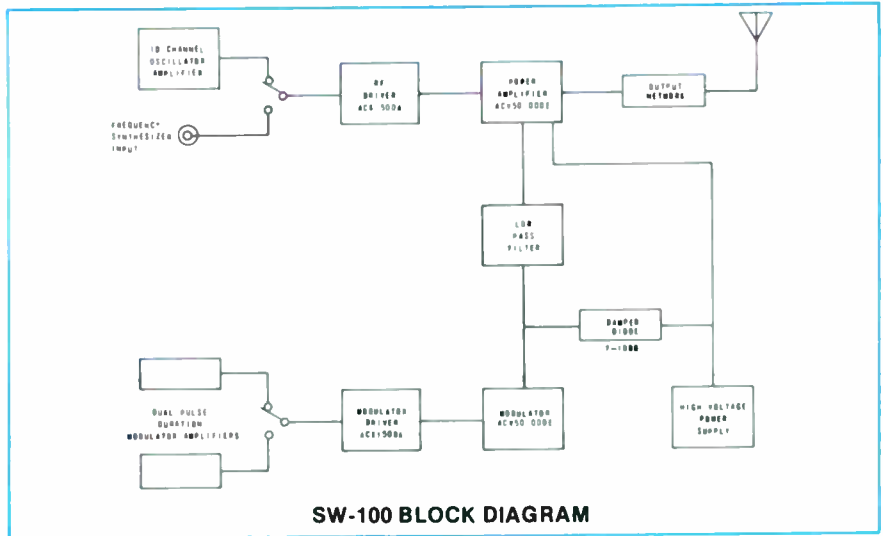

### SW-100 SPECIFICATIONS

- POWER OUTPUT:** 100,000 watts nominal unmodulated; capable 110,000 watts.
- RF FREQUENCY RANGE:** 3.2 to 22.0 MHz.
- METHOD OF TUNING:** Manual, or selection of 10 pre-set channels.
- RF OUTPUT IMPEDANCE:** 300 ohms balanced, 1.6 to 1 maximum VSWR; others available on special order.
- RF FREQUENCY STABILITY:**  $\pm 1 \times 10^{-6}$  ( $\pm 22$  Hz at 22 MHz).
- SPURIOUS AND HARMONIC EMISSION:** Less than 50 mW.
- CARRIER SHIFT:** Less than 2% at 95% modulation.
- AUDIO FREQUENCY RESPONSE:**  $\pm 1.5$  dB from 50 to 10,000 Hz referenced to 1,000 Hz at 95% modulation.
- AUDIO FREQUENCY DISTORTION:** Less than 3% from 50 to 10,000 Hz at 95% modulation.
- NOISE:** 55 dB below 1,000 Hz, 100% modulated level.
- AUDIO INPUT LEVEL:** 0 dBm  $\pm 2$  dB for 100% modulation.
- AUDIO INPUT IMPEDANCE:** 600/150 ohms, balanced or unbalanced.
- MODULATION LEVEL:** 100% sinusoidal, continuous, 50-5000 Hz.
- TRAPEZOIDAL MODULATION:** Less than 5% tilt or overshoot, 100 Hz to 2000 Hz.

- POWER INPUT:** Any specified voltage 380V to 480V, 3 phase, 50 or 60 Hz.
- POWER CONSUMPTION:**
  - No modulation 180 kW
  - 30% modulation 190 kW
  - 100% modulation 250 kW
- POWER FACTOR:** Greater than 95%.
- VOLTAGE REGULATOR:** Electronic voltage regulation for all power supplies other than high voltage.
- OVERALL EFFICIENCY:** 55% @ average modulation.
- TUBES:** Two-4CV50,000E; two-4CX1500A; one-F-1099.
- TEMPERATURE RANGE:** 0 to + 50°C ambient air temperature.
- HUMIDITY:** 95% relative humidity, maximum.
- STORAGE TEMPERATURE:** -35°C to + 60°C.
- ALTITUDE:** Up to 1829 meters (6000 feet) above sea level.
- CABINET DATA:** Each of two cabinets measures 1.83 meters (6 feet) wide, 1.37 meters (4.5 feet) deep, and 1.98 meters (6.5 feet) high. The heat exchanger adds another 1.06 meters (3.5 feet) in height.

### ORDERING INFORMATION

- SW-100, 100,000 watt short wave broadcast transmitter [3.2 to 22 MHz] . . . . . 994-6734-001
- 100% spare tube kit for SW-100 . . . . . 990-0692-001



**HARRIS**  
COMMUNICATIONS AND  
INFORMATION HANDLING

# SW-50

## 50,000 Watt Short Wave Broadcast Transmitter

- High level Pulse Duration Modulation
- Low power consumption
- Vapor phase cooling
- 10-Channel pre-set tuning
- Only five tubes for 50kW
- Rated 100% continuous sine wave modulation
- Full front and rear accessibility
- Minimum floor space
- Designed for trapezoidal programming



The Harris SW-50 is a rugged, reliable 50 kW short wave transmitter which uses the same design and engineering criteria as the popular Harris SW-100. The SW-50 provides overall performance superior to that of any other short wave broadcast transmitter in the same power range—and at significantly lower operating costs. This is made possible by Harris' exclusive high level Pulse Duration Modulator.

**HIGH EFFICIENCY—EXCEEDS 46%.** The Pulse Duration Modulator employed in the transmitter is almost 90% efficient (instead of the usual 50% or 60%), allowing an unusually high overall efficiency of more than 46%.

**ONLY FIVE TUBES.** The transmitter employs just five tubes—with a modern ceramic 4CV50,000E power tetrode in the modulator and final RF power amplifier sockets. All power supplies utilize long-life solid-state silicon rectifiers. Highest quality components, conservatively rated, are used throughout the SW-50 to assure greatest reliability.

**CONTINUOUS 100% MODULATION RATING.** The high efficiency series type Pulse Duration Modulator permits continuous 100% sine wave or trapezoidal modulation. Another feature of this high efficiency series type modulator is convenient front panel carrier adjustment over a wide range.

**PRE-SET TUNING.** After the SW-50 has been tuned to the desired frequency manually, the exact position of each variable tuning element is stored in a simple "memory". Up to ten different frequencies from 3.2 to 22 MHz can be "remembered", which allows pushbutton re-tuning to any preset frequency without further manual tuning. Few controls and ample metering make this the easiest tuning 50 kW transmitter available.

**RF SECTION.** The RF chain is conventional using a transistorized oscillator, buffer, emitter follower and a 4CX1500A tetrode tube amplifier to drive a single 4CV50,000E tetrode Class C power output stage.

An automatic drive control maintains the PA screen current at 1.75 amps, eliminating the usual problem of over-dissipating the screen of a tetrode during the tune-up.

**PROTECTIVE CIRCUITS.** All major components of the SW-50 are protected by circuit breakers. Tubes and transistors are guarded by overload relays or current-limiting devices.

A quick-acting circuit protects against damage by high voltage arcs by limiting the energy in such arcs to less than 10 watt seconds. Protection against voltage standing wave ratios of greater than 1.5 to 1.0 is provided. Both forward and reflected power are metered at the front panel.

In case of momentary RF overloads the SW-50 will recycle three times automatically. Should a third overload occur within a thirty second period, the transmitter will remain off until manually reset. However, if the time between overloads is greater than thirty seconds, continuous recycling will occur.

The SW-50 employs a unique method of transmitter protection. The modulator tube may be turned off in a low level state in about five microseconds. This removes the HV from the plate of the tube, thus eliminating most faults which normally occur. The HV supply (diodes and transformer) is capable of withstanding repeated short circuits without harming the unit.

**THE SERVO SYSTEM.** The all solid-state servo system will automatically tune any of 10 pre-set channels in about ten seconds. Each channel is "remembered" on one plug-in card. Auxiliary switching also is provided on each pre-set channel card for antenna switching, synthesizer, programming, etc. The fast tuning time is made possible because the HV supply is not



Rear view of RF isolation box showing power amplifier tube assembly and vapor phase cooling boiler.



High power tetrode, 4CV50,000E, used in both the RF amplifier and modulator. Weighs only 35 pounds, and can easily be handled by one man.



disabled during the tune cycle; the RF drive is turned off in a low level solid-state stage, and all tuning is done in parallel. When the tuning has been accomplished, the modulator is turned back on silently and smoothly.

**VAPOR PHASE COOLING.** Vapor phase cooling eliminates the need for large blowers moving high velocity air. Vapor phase cooling also extends tube life by helping to eliminate "hot spots" and maintaining anode temperatures far below those attained by other methods.

**GREATLY REDUCED FLOOR SPACE.** Due to the high efficiency of the transmitter and the elimination of large iron core components (no modulation transformer and reactor), the SW-50 requires only 7.0 square meters (76 square feet) of floor space. Careful cabinet design provides easy accessibility to all components.

**TRANSMITTER LAYOUT.** The standard layout of the transmitter consists of two cabinets, a heat exchanger designed for mounting on top of the cabinets, and an external high voltage power transformer. Front and rear doors, and meter panel are magnetically latched. External connections to the transmitter are made through the top so that floor ducts are not necessary.

Ideal for use in all types of climate, this transmitter greatly reduces the problems of cleaning and filtering of outside air. With vapor phase cooling, ducting outside air into the transmitter is not necessary. Also, the cooling system requires little attention other than maintaining the proper purity and water level in the reservoir tank.

#### TRAPEZOIDAL RESPONSE

Trapezoidal audio processing may be used to develop greater intelligence carrying sideband power without increasing transmitter carrier power. To do this the audio input wave (A) is flattened at the top, by clipping, then reamplified to form a trapezoidal wave (B). The shaded areas in the diagram indicate the power gain.

The desired power gain is lost, however, if this clipped, or flattened, wave tilts downward due to poor low frequency response, or is rounded out again to its original shape by sub-standard high frequency response.

The SW-50 has the capability of passing a 100 Hz 12 dB clipped wave at 100% modulation with minimum tilt or rounding of the wave. As the transmitter is capable of continuous 100% sine wave modulation it is more than able to operate with trapezoidal program material.

All the additional power gained by clipping the audio input is delivered at the output of the transmitter, thus increasing volume at the receiver.

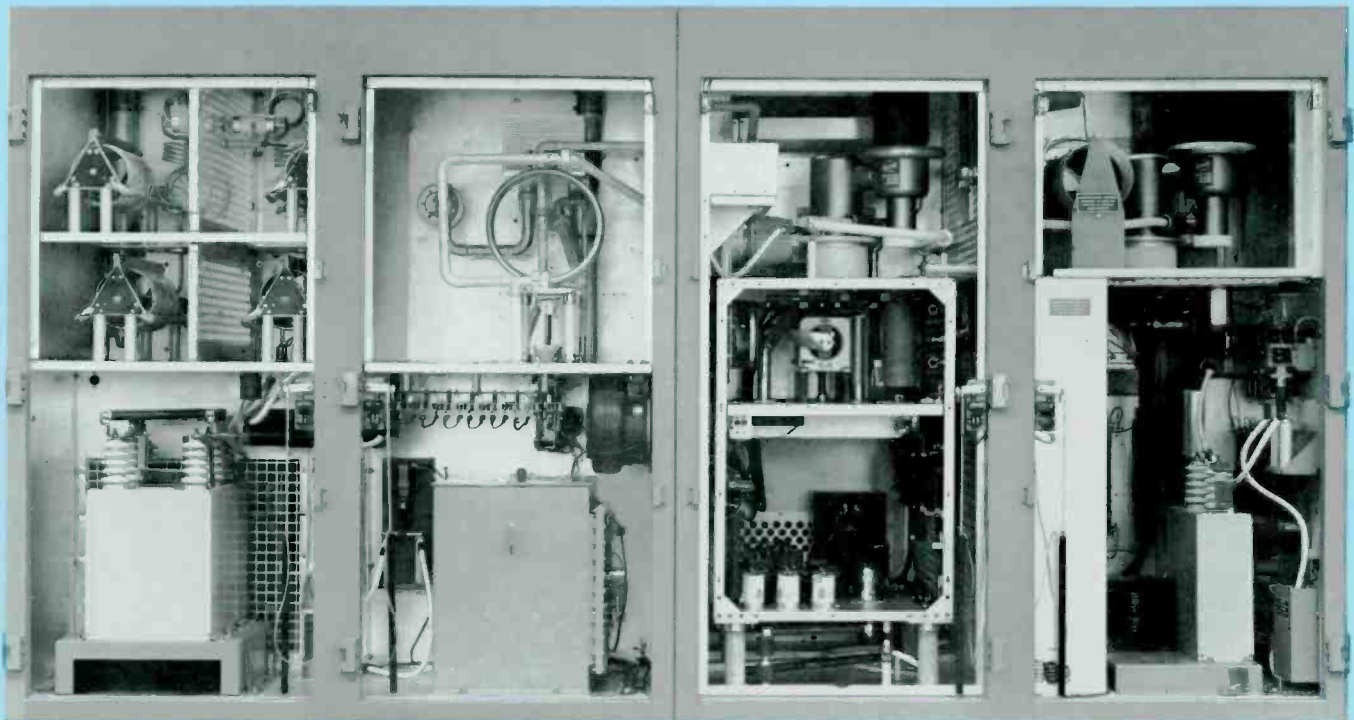
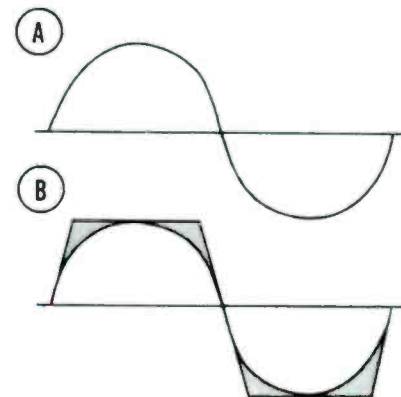

SW-50 rear view, doors off [heat exchanger not shown]



SW-50 with heat exchanger [front doors removed]

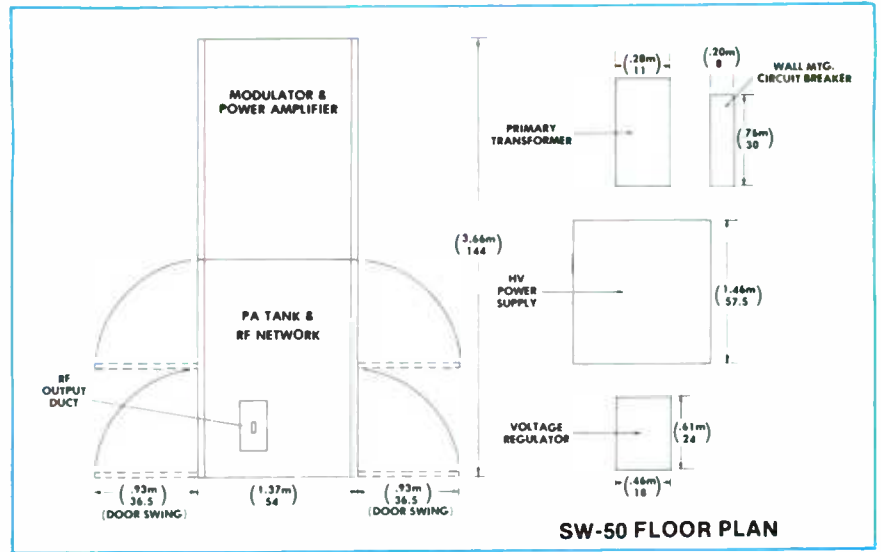

SW-50 FLOOR PLAN

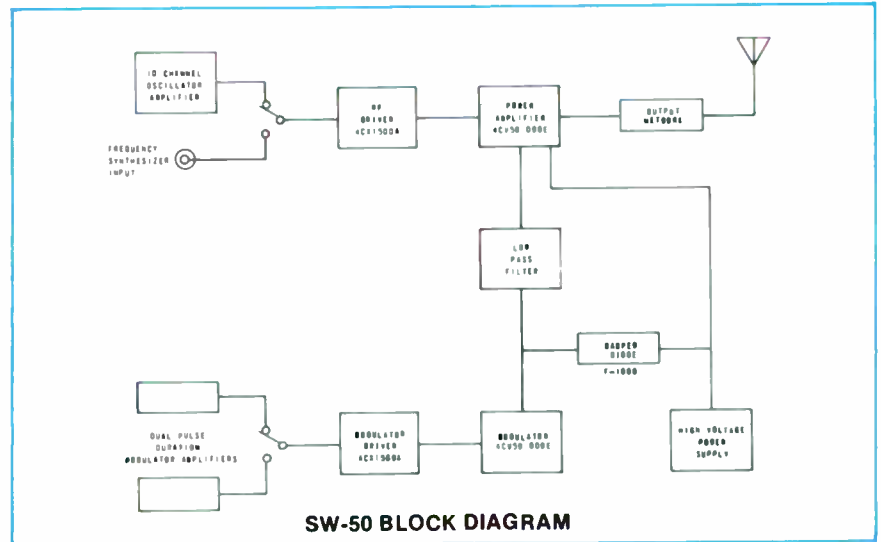

SW-50 BLOCK DIAGRAM

## SW-50 SPECIFICATIONS

**POWER OUTPUT:** 50,000 watts nominal unmodulated; capable 55,000 watts.

**RF FREQUENCY RANGE:** 3.2 to 22.0 MHz

**METHOD OF TUNING:** Manual, or selection of 10 pre-set channels.

**RF OUTPUT IMPEDANCE:** 300 ohms balanced, 1.6 to 1 maximum VSWR, others available on special order.

**RF FREQUENCY STABILITY:**  $\pm 1 \times 10^{-6}$  ( $\pm 22$  Hz at 22 MHz).

**SPURIOUS AND HARMONIC EMISSION:** Less than 50 mW.

**CARRIER SHIFT:** Less than 2% at 95% modulation. Less than 5% at 100% modulation.

**AUDIO FREQUENCY RESPONSE:**  $\pm 1.5$  dB from 50 to 10,000 Hz referenced to 1,000 Hz at 95% modulation.

**AUDIO FREQUENCY DISTORTION:** Less than 3% from 50 to 10,000 Hz at 95% modulation.

**NOISE:** 55 dB below 1,000 Hz, 100% modulated level.

**AUDIO INPUT LEVEL:** 0 dBm  $\pm 2$  dB for 100% modulation.

**AUDIO INPUT IMPEDANCE:** 600/150 ohms, balanced or unbalanced.

**MODULATION LEVEL:** 100% sinusoidal, continuous, 50-5000 Hz.

**TRAPEZOIDAL MODULATION:** Less than 5% tilt or overshoot, 100 Hz to 2000 Hz.

**POWER INPUT:** Any specified voltage 380 V to 480 V, 3 phase, 50 or 60 Hz.

**POWER CONSUMPTION:** 110 kW—no modulation; 114 kW—30% modulation; 145 kW—100% modulation.

**POWER FACTOR:** Greater than 95%.

**VOLTAGE REGULATOR:** Electronic voltage regulation for all power supplies other than high voltage.

**OVERALL EFFICIENCY:** 46% @ average modulation.

**TUBES:** Two—4CV50,000E; two—4CX1500A; one—F-1099.

**TEMPERATURE RANGE:** 0 to +50°C ambient air temperature.

**HUMIDITY:** 95% relative humidity, maximum.

**STORAGE TEMPERATURE:** -35°C to +60°C.

**ALTITUDE:** Up to 1829 meters (6000 feet) above sea level.

**CABINET DATA:** Each of two cabinets measures 1.83 meters (6 feet) wide, 1.37 meters (4.5 feet) deep, and 1.98 meters (6.5 feet) high. The heat exchanger adds another 1.06 meters (3.5 feet) in height.

## ORDERING INFORMATION

SW-50, 50,000 watt short wave broadcast transmitter [3.2 to 22 MHz] ..... 994-6808-001

100% spare tube kit for SW-50 ..... 990-0692-001



**HARRIS**  
COMMUNICATIONS AND  
INFORMATION HANDLING

## BC-10HT

### 10,000 Watt Short Wave Broadcast Transmitter

The Harris BC-10HT, 10,000 watt short wave transmitter combines excellent signal quality and low operating costs to give the best overall performance of any transmitter in its power range. The transmitter is factory tuned to a single frequency in the tropical band, between 2.3 and 5 MHz.

**SOLID-STATE CIRCUITRY.** The BC-10HT uses transistors in all circuits except the RF driver, power amplifier and modulator to provide a richer, fuller sound for the listener, and increased reliability for the broadcaster.

**LOW TUBE COST.** Ceramic type 3CX2500F3 triode tubes are used in the power amplifier and modulators, and type 4-400A and 6146 tetrodes are used as RF drivers. This combination provides the lowest cost tube complement of any 10 kW tropical band transmitter on the market. All tubes are operated well below their maximum ratings for long tube life.

**RF SECTION.** Two transistor oscillators are instantly switchable, and oscillator output is amplified to provide the proper signal level for the driver, a 4-400A tetrode, which is modulated to improve the overall transmitter performance. The 4-400A drives two 3CX2500F3 power amplifiers which are high level plate modulated. These air-cooled power amplifiers deliver full power through a full Pi-Tee network.





**AUDIO SECTION.** A solid-state audio driver provides full audio power direct to the grids of the two 3CX2500F3 modulator tubes. This combination is capable of more than 125% positive peak modulation if not limited by external amplifiers. Inverse feedback, and an advanced design low-leakage reactance modulation transformer/reactor group, results in signal quality of the highest fidelity. The modulation transformer is oil (Askarel) filled.

**INTERCHANGEABILITY.** Added tube life may be achieved from the 3CX500F3 triodes by interchanging the modulators and the power amplifiers, as the same tube type is used in both stages.

**SOLID-STATE POWER SUPPLIES.** Lifetime avalanche type silicon rectifiers in all power supplies provide a 2-to-1 voltage and a 5-to-1 current safety factor for normal operation and 150 times current ratings for surge currents. This high margin of safety assures trouble-free performance.

**CONTROL CIRCUITRY.** Careful attention has been given to the design of the control circuitry in the BC-10HT. Complete AC and DC overload protection is standard equipment.

**EFFICIENT COOLING.** Individual Rotron blowers in the RF and modulator stages, and a specially designed air exhaust, allow only a limited amount of direct heat to be dissipated into the interior of the BC-10HT for extra-cool operation.

**OPERATING ECONOMY.** Long tube life, low tube cost, and the highly efficient tank circuit combine to make economy of operation an important feature of the BC-10HT.

**ACCESSIBILITY.** Designed for easy servicing, the transmitter front features 2 full-length doors, with operating controls located between the two. Meters which indicate transmitter operating parameters are located across the front of the cabinet, above the doors. All necessary tuning controls are adjustable in full view of these meters. Further access to the transmitter from the front may be gained by releasing the catches on various front access panels. In addition, 4 panels may be removed from the rear of the transmitter for 100% accessibility. The BC-10HT is completely self-contained within one cabinet.



Front view BC-10HT, doors open.



Rear view BC-10HT, doors removed.

## BC-10HT SPECIFICATIONS

**POWER OUTPUT:** 10 kW. Convenient power reduction to 2.5 kW.

**RF FREQUENCY RANGE:** 2.3 to 5 MHz (supplied to one frequency as specified)

**RF OUTPUT IMPEDANCE:** 50 ohms unbalanced

**RF FREQUENCY STABILITY:**  $\pm 5$  Hz per MHz/day or better

**RF HARMONICS:** Meets or exceeds CCIR specifications.

**MAXIMUM VSWR:** 1.5:1

**CARRIER SHIFT:** Less than 4%, at 100% modulation

**AUDIO FREQUENCY RESPONSE:**  $\pm 1$  dB, from 50 to 7500 Hz at 95% modulation

**AUDIO FREQUENCY DISTORTION:** Less than 3%, 50 to 7500 Hz at 95% modulation, when operated from commercial power. Distortion 4% or less when operated from 50-80 Hz diesel powered generator.

**NOISE [Unweighted]:** -55 dB, or better, below 100% modulation

**AUDIO INPUT:** 600 ohms at +10 dBm,  $\pm 2$  dB, for 100% modulation

**PRIMARY POWER INPUT:** 208/230 volts  $\pm 5\%$ , 3 phase, 50/60 Hz or

380 V  $\pm 5\%$ , 4 wire, 50 Hz as ordered

**POWER CONSUMPTION [Typical]:** 20 kW at 0% modulation, 25 kW at 30% modulation, 29 kW at 100% modulation

**MONITOR OUTPUTS:** 10 volts P-P RF output at 50-70 ohms for frequency and modulation monitors

**TUBES USED:** (4) 3CX2500FS (PA and Modulator), (1) 4-400A (IPA), (1) 6146B (RF driver)

**DIMENSIONS:** Width, 72 inches (182.88 cm), Depth, 32 inches (81.28 cm), Height, 78 inches (198.12 cm)

**FLOOR SPACE:** 16 Sq. Ft. (1238.71 sq. cm)

**WEIGHT [approximate]:** Net Unpacked, 2500 pounds (1134 kg), Domestic packed, 3050 pounds (1383.4 kg), Export packed, 3250 pounds (1474 kg)

**OPERATING TEMPERATURE RANGE:** 0°C to +50°C

**HUMIDITY:** 95%, maximum

**ALTITUDE:** 7500 Ft. (2286 meters) above sea level, maximum

## ORDERING INFORMATION

Model BC-10HT transmitter with one set of tubes and two crystals .....	994-7813-001
100% spare tube kit .....	990-0539-001
Spare semiconductor kit, less high voltage rectifiers .....	990-0819-001





**HARRIS**  
COMMUNICATIONS AND  
INFORMATION HANDLING

## REFERENCE INFORMATION

### COMMONLY USED FORMULAS

#### Resistance

In series:  $R_t = R_1 + R_2 + R_3$

In parallel:  $R_t = \frac{1}{\frac{1}{R_1} + \frac{1}{R_2} + \frac{1}{R_3}}$

Two in parallel:  $R_t = \frac{R_1 R_2}{R_1 + R_2}$

#### Inductance

In series:  $L_t = L_1 + L_2 + L_3$

In parallel:  $L_t = \frac{1}{\frac{1}{L_1} + \frac{1}{L_2} + \frac{1}{L_3}}$

Two in parallel:  $L_t = \frac{L_1 L_2}{L_1 + L_2}$

#### Capacitance

In series:  $C_t = \frac{1}{\frac{1}{C_1} + \frac{1}{C_2} + \frac{1}{C_3}}$

In parallel:  $C_t = C_1 + C_2 + C_3$

Two in series:  $C_t = \frac{C_1 C_2}{C_1 + C_2}$

#### Reactance

Inductive reactance:  $X_L = 2\pi fL$

Inductive capacitance:  $X_C = \frac{1}{2\pi fC}$

f = frequency in Hz

L = inductance in Henries

c = capacitance in Farads

## FREQUENCY VERSUS TOWER HEIGHT

For medium wave broadcast frequencies, the most used one-quarter wave tower height is shown as related to the operating frequency. For  $\frac{3}{8}$  wave length, multiply height shown by  $1\frac{1}{2}$  and for  $\frac{1}{2}$  wave length, multiply height shown by 2. For insulated towers, the height is above the base insulators.

Frequency in Kilohertz	Tower Height in Feet	Tower Height in Meters	Frequency in Kilohertz	Tower Height in Feet	Tower Height in Meters
550	446.8	136.2	1080	227.7	69.4
560	439.5	133.9	1090	225.6	68.7
570	431.3	131.4	1100	223.6	68.1
580	423.9	129.2	1110	221.6	67.5
590	417.3	127.2	1120	219.7	66.9
600	410.0	125.0	1130	217.7	66.3
610	403.1	122.8	1140	215.6	65.7
620	396.8	120.9	1150	213.9	65.2
630	390.3	118.9	1160	211.9	64.6
640	386.5	117.8	1170	210.2	64.0
650	378.8	115.4	1180	208.6	63.5
660	373.1	113.7	1190	206.7	63.0
670	367.3	111.9	1200	205.0	62.5
680	361.1	110.0	1210	203.2	61.9
690	356.2	108.5	1220	201.5	61.4
700	351.2	107.0	1230	199.7	60.8
710	346.8	105.7	1240	198.4	60.4
720	341.9	104.2	1250	196.8	60.0
730	337.0	102.7	1260	195.2	59.4
740	332.1	101.2	1270	193.6	59.0
750	328.0	100.0	1280	192.2	58.5
760	323.4	98.5	1290	190.7	58.1
770	319.8	97.5	1300	189.2	57.6
780	315.7	96.2	1310	187.7	57.2
790	311.6	95.0	1320	186.5	56.8
800	307.5	93.7	1330	184.9	56.3
810	303.4	92.5	1340	183.6	55.9
820	300.1	91.4	1350	182.2	55.5
830	296.0	90.2	1360	180.5	55.0
840	292.7	89.2	1370	179.5	54.7
850	289.4	88.2	1380	178.1	54.2
860	286.1	87.2	1390	176.5	53.8
870	282.9	86.2			
880	279.6	85.2	1400	175.6	53.5
890	276.3	84.2	1410	174.2	53.1
			1420	173.4	52.8
900	273.0	83.2	1430	172.0	52.4
910	270.6	82.5	1440	170.9	52.1
920	267.3	81.4	1450	169.6	51.7
930	264.8	80.7	1460	168.5	51.3
940	261.5	79.7	1470	167.3	51.0
950	259.1	78.9	1480	166.5	50.7
960	256.6	78.2	1490	165.0	50.3
970	253.3	77.2			
980	250.9	76.4	1500	164.0	50.0
990	248.4	75.7	1510	162.9	49.6
			1520	161.7	49.2
1000	246.0	75.0	1540	159.9	48.7
1010	243.7	74.2	1550	158.6	48.3
1020	241.1	73.5	1560	157.8	48.1
1030	238.8	72.8	1570	156.7	47.7
1040	236.5	72.1	1580	155.8	47.5
1050	234.2	71.4	1590	154.7	47.1
1060	232.0	70.7			
1070	229.9	70.0	1600	153.7	46.8

## FIXED ATTENUATOR DATA

The data shown below provides information to construct H pads, commonly used in audio applications. Usually 1/2 watt resistors are sufficient. 5% resistors are recommended. For T pads, double the values of R1 and R2 and delete R4 and R5.

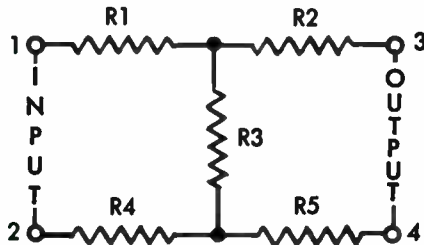

dB LOSS	R1, R4 OHMS	R2, R5 OHMS	R3 OHMS
<b>600 OHMS INPUT/600 OHMS OUTPUT</b>			
1	18	18	5100
2	33	33	2700
3	51	51	1800
4	68	68	1300
5	82	82	1000
6	100	100	820
7	110	110	680
8	130	130	560
9	150	150	470
10	160	160	430
12	180	180	330
15	200	200	220
20	240	240	120
25	270	270	68
30	270	270	39
35	300	300	22
40	300	300	12
<b>600 OHMS INPUT/150 OHMS OUTPUT</b>			
12	270	4.7	160
15	270	24	110
20	270	47	62
25	270	56	33
30	300	68	20
35	300	68	11
40	300	75	6.2
<b>150 OHMS INPUT/150 OHMS OUTPUT</b>			
1	4.3	4.3	1300
2	8.2	8.2	620
3	13	13	430
4	18	18	300
5	20	20	240
6	24	24	200
7	30	30	160
8	33	33	150
9	36	36	120
10	39	39	100
12	47	47	82
15	51	51	56
20	62	62	30
25	68	68	16
30	68	68	10
35	75	75	5.6
40	75	75	3
<b>150 OHMS INPUT/50 OHMS OUTPUT</b>			
10	62	0	62
12	62	5.1	47
15	62	11	33
20	68	16	18
25	68	20	10
30	75	22	5.6
35	75	24	3.3
40	75	24	2.2

## FM FREQUENCIES BY CHANNEL NUMBER

For convenience, the frequencies available for FM broadcasting (including those assigned to noncommercial educational broadcasting) are given numerical designations which are shown in the table below:

Channel No.	Frequency (MHz)	Channel No.	Frequency (MHz)
<b>EDUCATIONAL CHANNELS</b>			
201	88.1	211	90.1
202	88.3	212	90.3
203	88.5	213	90.5
204	88.7	214	90.7
205	88.9	215	90.9
206	89.1	216	91.1
207	89.3	217	91.3
208	89.5	218	91.5
209	89.7	219	91.7
210	89.9	220	91.9
<b>COMMERCIAL CHANNELS</b>			
221	92.1	261	100.1
222	92.3	262	100.3
223	92.5	263	100.5
224	92.7	264	100.7
225	92.9	265	100.9
226	93.1	266	101.1
227	93.3	267	101.3
228	93.5	268	101.5
229	93.7	269	101.7
230	93.9	270	101.9
231	94.1	271	102.1
232	94.3	272	102.3
233	94.5	273	102.5
234	94.7	274	102.7
235	94.9	275	102.9
236	95.1	276	103.1
237	95.3	277	103.3
238	95.5	278	103.5
239	95.7	279	103.7
240	95.9	280	103.9
241	96.1	281	104.1
242	96.3	282	104.3
243	96.5	283	104.5
244	96.7	284	104.7
245	96.9	285	104.9
246	97.1	286	105.1
247	97.3	287	105.3
248	97.5	288	105.5
249	97.7	289	105.7
250	97.9	290	105.9
251	98.1	291	106.1
252	98.3	292	106.3
253	98.5	293	106.5
254	98.7	294	106.7
255	98.9	295	106.9
256	99.1	296	107.1
257	99.3	297	107.3
258	99.5	298	107.5
259	99.7	299	107.7
260	99.9	300	107.9

NOTE: The frequency 108.0 MHz is assigned to aircraft navigation service subject to the condition that there will be no interference with the reception of FM broadcast stations, present or future.

## CONVERSION TABLES

### U.S. Measure To Metric System

#### LENGTH

Fractional Inches	Millimeters
1/16	1.6 (0.16 cm)
1/8	3.2 (0.32 cm)
3/16	4.8 (0.48 cm)
1/4	6.4 (0.64 cm)
5/16	7.9 (0.79 cm)
3/8	9.5 (0.95 cm)
7/16	11.1 (1.11 cm)
1/2	12.7 (1.27 cm)
9/16	14.3 (1.43 cm)
5/8	15.9 (1.59 cm)
11/16	17.5 (1.75 cm)
3/4	19.1 (1.91 cm)
13/16	20.6 (2.06 cm)
7/8	22.1 (2.21 cm)
15/16	23.8 (2.38 cm)

Inches	Centimeters
1	2.54
2	5.08
3	7.62
4	10.16
5	12.70
6 (1/2')	15.24
7	17.78
8	20.32
9	22.86
10	25.40
11	27.94
12 (1')	30.48
13	33.02
14	35.56
15	38.10
16	40.64
17	43.18
18 (1 1/2')	45.72
19	48.26
20	50.80
21	53.34
22	55.88
23	58.42
24 (2')	60.96
25	63.50
26	66.04
27	68.58
28	71.12
29	73.66
30 (2 1/2')	76.20
31	78.74
32	81.28
33	83.82
34	86.36

Inches	Centimeters
35	88.90
36 (1 yd)	91.44
37	93.98
38	96.52
39	99.06
40	101.60
41	104.14
42 (3 1/2')	106.68
43	109.22
44	111.76
45	114.30
46	116.84
47	119.38
48 (4')	121.92
49	124.46
50	127.00
51	129.54
52	132.08
53	134.62
54 (4 1/2')	137.16
55	139.70
56	142.24
57	144.78
58	147.32
59	149.86
60 (5')	152.40
61	154.94
62	157.48
63	160.02
64	162.56
65	165.10
66 (5 1/2')	167.64
67	170.18
68	172.72
69	175.26
70	177.80
71	180.34
72 (2 yd)	182.88
73	185.42
74	187.96
75	190.50
76	193.04
77	195.58
78 (6 1/2')	198.12
79	200.66
80	203.20
81	205.74
82	208.28
83	210.82
84 (7')	213.36
85	215.90
86	218.44
87	220.98
88	223.52
89	226.06
90 (7 1/2')	228.60
91	231.14
92	233.68
93	236.22
94	238.76
95	241.30
96 (8')	243.84
97	246.38
98	248.92
99	251.46
100	254.00
101	256.54
102 (8 1/2')	259.08
103	261.62
104	264.16
105	266.70
106	269.24

Inches	Centimeters
107	271.78
108 (3 yd)	274.32
109	276.86
110	279.40
111	281.94
112	284.48
113	287.02
114 (9 1/2')	289.56
115	292.10
116	294.64
117	297.18
118	299.72
119	302.26
120 (10')	304.80

#### CAPACITY

Gallons	Liters
1/2	1.89
1	3.79
1 1/2	5.68
2	7.57
2 1/2	9.46
3	11.36
3 1/2	13.25
4	15.14
4 1/2	17.03
5	18.93
5 1/2	20.82
6	22.71
6 1/2	24.61
7	26.50
7 1/2	28.39
8	30.28
8 1/2	32.18
9	34.07
9 1/2	35.96
10	37.85
11	41.64
12	45.42
13	49.21
14	53.00
15	56.78
20	75.7
25	94.6
30	113.6
35	132.5
40	151.4
45	170.3
50	189.3
55	208.2
60	227.1
65	246.1
70	265.0
75	283.9
80	302.8
85	321.2
90	340.7
95	359.6
100	378.5

#### MASS

1 grain	0.0648g
1 oz (Av)	28.3495g
1 lb (Av)	453.59g

# INDEX

ITEM	PAGE	ITEM	PAGE
AM Antenna Couplers, Accessories	34, 35	FM Monitors	62 thru 65
AM Broadcast Accessories	38	FM RF Amplifier	80
AM Frequency Monitor	37	FM SCA Generator	40
AM Limiting Amplifier	75	FM Stereo Generator	40
AM Modulation Enhancer	76	FM Transmitters (See also Transmitters, FM)	41 thru 53
AM Modulation Monitor	36	Feed-Thru Bowls	35
AM Transmitters (See also Transmitters, AM)	6 thru 27	Field Intensity Meter	38
Air Dielectric Coaxial Cable	71	Flexible Coaxial Cable	71
Amplifier, Dual Channel	80	Foam Dielectric Coaxial Cable	71
Amplifiers, Limiting	75, 77	Frequency Monitor, AM	37
Amplifiers, Monitor	36 thru 38, 62 thru 65	Frequency Monitor, FM	65
Amplifiers, Program	80	Gain Measuring Set	79
Amplifier, RF FM	66	Generator, Stereo	40
Amplifier, Single Program	80	Generator, Sub-Carrier	40
Amplifier, Utility (Single Channel)	80	HF Transmitters, Broadcast (See also Transmitters, High Frequency Broadcast)	94 thru 103
Antenna Couplers	34, 35	Heliac Coaxial Cable	71
Antenna Diode Units for Remote Control	84	Inductors	70
Antenna Meter, Remote	35	Isolation Transformers, FM	61
Antenna Phasing Equipment	30, 31	Isolation Transformers, Tower Lighting	69
Antenna Tower Accessories	68, 69	Jack Strips and Accessories	81
Antenna Tuning Equipment	34, 35	Lights, Tower, and Accessories	68, 69
Antennas, Dual-Cycloid	56 thru 59	Limiting Amplifiers	75, 77
Antennas, FM Circular	54 thru 59	Meter, Field Intensity	38
Antennas, FM Directional	60	Meter, RF	34, 35
Antennas, FM Educational	59	Meter, Remote Antenna	35
Antennas, FM Receiving	66	Meter Shorting Switch	34
Antennas, FM Super Power	54, 55	Meter, VU Panel	81
Audio Accessories	80	Mica Capacitors	70
Audio Oscillator	79	Modulation Monitor, AM	36
Automatic Gain Control Amplifier, Audio	78	Modulation Monitors, FM	62 thru 64
Base Station, Remote Pickup	89, 90	Monitor Amplifier	80
Beacon Flashers	68, 69	Monitor, Frequency, AM	37
Bowls, Feed-Thru	35	Monitor, Frequency, FM	65
Cabinets, Rack	82	Monitor, Modulation, AM	36
Cable, Audio	81	Monitor, Modulation, FM	62 thru 64
Cable, Coaxial	71	Monitor, Phase	38
Capacitors, Mica	70	Multiplex Generator, SCA	40
Chokes, Tower	35	Open Wire Transmission Line	74
Circularly Polarized FM Antennas	54 thru 59	Operating Impedance Bridge	33
Coaxial Cable and Accessories	71 thru 74	Oscillator, Audio	79
Coils, RF	70	Patch Panels and Patch Cords	81
Common Point Impedance Bridge	32	Peak Limiting Amplifiers	75, 77
Control, Remote	83, 84	Phasing Equipment	30, 31
Couplers, Antenna	34, 35	Phase Monitor	38
Diode and Pickup Coil	35, 84	Power Control Panel	81
Directional Antenna, FM	60	Pressurization Equipment	74
Directional Antenna Phasing Equipment	30, 31	Pre-Wired Jack Panel	81
Distortion Meter	79	Program Amplifiers, Rack Mount	80
Dual Channel Amplifier	80	Proof of Performance Equipment	79
Dual-Cycloid FM Antenna	56, 57	RF Amplifier, FM	66
Dual-Cycloid II FM Antenna	58, 59	RF Contactor	35
Dual-Cycloid III FM Antenna	58, 59	RF Meter	34, 35
Educational FM Antennas	59	RF Meter Jack	34
Exciter, FM	40	Rack Cabinets	82
FM Antennas	54 thru 60	Relay System, FM	85 thru 88
FM Antenna Accessories	61	Remote Antenna Meter	35
FM Exciter, DCFM	40		
FM Frequency Monitor	65		
FM Isolation Transformers	61		
FM Limiting Amplifier	77		



# INDEX

ITEM	PAGE	ITEM	PAGE
Remote Control Accessories .....	84	Transmitters (Broadcast/AM)	
Remote Control Systems .....	83	100,000 Watt Model VP-100A Transmitter .....	6 thru 9
Remote Pickup Equipment .....	85 thru 90	50,000 Watt Model MW-50 Transmitter .....	10 thru 13
Rigid Transmission Line .....	71	20,000 Watt Model BC-20H Transmitter .....	14, 15
		10,000 Watt Model BC-10H Transmitter .....	16 thru 19
Sampling Loops .....	35	5,000 Watt Model MW-5 Transmitter .....	20 thru 23
SCA Multiplex Generator .....	40	1,000 Watt Model MW-1 Transmitter .....	24 thru 27
SCA Modulation Monitor .....	64	Transmitters (Broadcast/FM)	
Semiconductor Directory .....	92	Dual FM Transmitters .....	41, 42
Stereo Generator .....	40	40,000 Watt Model FM-40H3 Transmitter .....	43, 44
Stereo Modulation Monitor .....	63	20,000 Watt Model FM-20H3 Transmitter .....	45, 46
STL Systems, FM .....	85 thru 88	10,000 Watt Model FM-10H3 Transmitter .....	47, 48
Sub-Carrier Generator .....	40	3,000-5,000-7,500 Watt Models	
Super Power FM Antenna .....	54, 55	FM-3H3/5H3/7.5H3 Transmitters .....	49, 50
Switch, Meter Shorting .....	34	2,500 Watt Model FM-2.5H3 Transmitter .....	51, 52
SW-100 HF Transmitter .....	94 thru 97	50 Watt Model BFE-50G3 Transmitter .....	53
SW-50 HF Transmitter .....	98 thru 101	10 Watt Model BFE-10G3 Transmitter .....	53
Synthesizer/Detector .....	38	Transmitters (High Frequency Broadcast)	
		100,000 Watt Model SW-100 Transmitter .....	94 thru 97
Test Equipment, Audio .....	79	50,000 Watt Model SW-50 Transmitter .....	98 thru 101
Tower Chokes .....	35	10,000 Watt Model BC-10HT Transmitter .....	102, 103
Tower Lights and Accessories .....	68, 69	Transmitter, Remote Pickup .....	89, 90
Transformers, FM Isolation .....	61	Transmitter, STL .....	85 thru 88
Transformer, Tower Lighting Isolation .....	69	Transmitting Tubes .....	91
Transistors .....	92	Tubes, Transmitting .....	91
Transmission Line, Coaxial .....	71	Tuning Units, Antenna .....	34, 35
Transmission Line, Open Wire .....	74	Utility Audio Amplifier .....	80
		VU Meter Panel .....	81

The mechanical and electrical design of the equipment described herein is subject to change without notice as deemed necessary by the Broadcast Products Division of Harris Corporation or its suppliers, in the interest of advancing industry requirements or the state of the art.

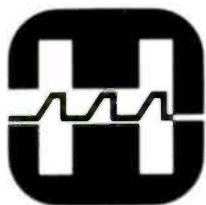

**HARRIS**

**COMMUNICATIONS AND  
INFORMATION HANDLING**

# **PRICE LIST**

**DOMESTIC**

**Radio Transmitters  
and Accessories  
Catalog 76RT**

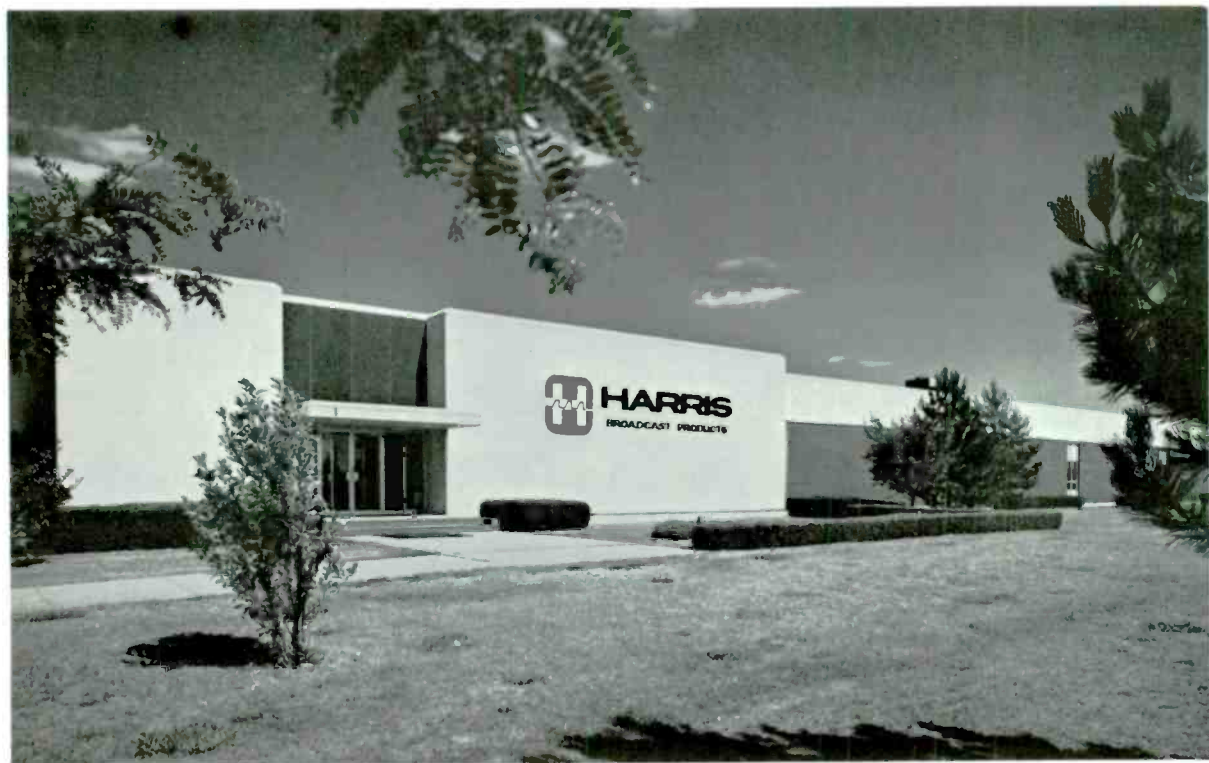

## PRICE LIST

(Applies to Harris Radio Transmitters & Accessories Catalog 76RT Effective July 16, 1976)

This is your price list for items listed in your Harris Radio catalog. Each price has been carefully checked for accuracy. Rapidly changing conditions as well as the human element will necessitate price changes or corrections from time to time. Therefore, the prices herein are subject to change without notice — All prices are F.O.B. Quincy, Illinois or point of manufacture.

## HOW TO ORDER

**ORDERING PROCEDURE:** All sales are made in accordance with the standard Harris Terms and Conditions of Sale. No order shall be binding upon Harris until accepted by the company in writing at its home office in Quincy, Illinois.

**PRICES:** Catalog prices are net, f.o.b. Quincy, Illinois, or point of shipment. Our prices are based on cash transactions and all applicable discounts have been deducted. Prices are subject to change without notice. Orders are filled at prices in effect at time of shipment. You will be billed for any price increase and credited for any price reduction. We reserve the right to add any federal, state, or local taxes required by law. If you have a tax exemption number, please include it with your order. These prices and terms apply only to the U.S. For prices and terms in other countries, please contact International Sales Department, 123 Hampshire Street, Quincy, Illinois 62301.

**PAYMENT:** There are four ways to pay for your equipment purchases:

- (1) **CASH** — This means full payment with order.
- (2) **C.O.D.** — A 25% down payment is required on C.O.D. orders.
- (3) **OPEN ACCOUNT** — A 25% down payment is recommended. The balance is payable upon receipt of invoice. If you do not have an established account, please provide a current financial statement, plus trade and bank references with your order. Allow at least two weeks for processing.
- (4) **FINANCING** — On major purchases, by domestic customers, a portion of the cost may be financed through a monthly payment arrangement:
  - (a) 25% down payment; Balance in three installments, 30-60-90 days, no interest.
  - (b) 25% down payment; Balance payable in one payment, 90 days 1% interest charge.
  - (c) Where extended terms are desired, or a leasing arrangement requested, Harris will assist in securing third party financing or a leasing proposal.

The Harris Financing Department will be happy to give you further information or to discuss any questions you may have.

**RETURNS AND EXCHANGES:** Do not return any merchandise without our written approval and Return Authorization. We will provide special shipping instructions and a code number that will assure proper handling and prompt issuance of credit. Please furnish complete details as to circumstances and reasons when requesting return of merchandise. Custom built equipment or merchandise specially ordered for you is not returnable. Where return is at the request of, or for the convenience of the customer, a restocking fee of 15% will be charged. All returned merchandise must be sent freight prepaid and properly insured by the customer. When writing to Harris about your order, it will be helpful if you specify the Harris factory order number or invoice number.

**SHIPPING:** Please specify method of shipment on your order. Shipping charges, insurance, and C.O.D. fees (when applicable) will be collected at time of delivery when shipment is made by air, rail or motor freight, or express. If you request parcel post shipment, postage and insurance fees will be billed to your account. Purchaser assumes all responsibility for and risk of loss of, or damage to equipment upon shipment from Harris shipping point(s). Should you receive merchandise damaged in shipment, it is your responsibility to file a damage claim immediately with the delivering carrier. Export packing for overseas shipment is available at slight extra charge.

**WARRANTY ADJUSTMENTS:** In the event of equipment failure during the warranty period, replacement or repair parts may be provided in accordance with the provisions of the Harris Warranty. In most cases you will be required to return the defective merchandise or part to Harris Corp., f.o.b. Quincy, Illinois, for replacement or repair. Repairs, within the warranty period will be done on a no charge basis. Warranty replacements of defective merchandise will be billed to your account. This billing will be cleared by a credit issued upon return of the defective item.

**MODIFICATIONS:** Harris reserves the right to modify the design and specifications of the equipment shown in this catalog without notice or to withdraw any item from sale, provided, however, that any modification shall not adversely affect the performance of the equipment so modified.

CAT. PAGE	PART NUMBER	PRODUCT DESCRIPTION	UNIT PRICE	CAT. PAGE	PART NUMBER	PRODUCT DESCRIPTION	UNIT PRICE
9	994-7651-001	Model VP-100A, 100 kW Medium wave transmitter--	180,000.00		992-4201-001	Spare PA module-----	435.00
	990-0761-000	100% set of spare tubes for VP-100A-----	On request		992-4202-001	Spare plug-in IPA module-	325.00
13	994-6994-003	Model MW-50, with one set of tubes and two crystals, 60 Hz-----	112,500.00		992-4207-001	Spare plug-in oscillator module-----	340.00
	994-6994-005	Model MW-50, with one set of tubes and two crystals, 50 Hz-----	114,000.00		992-4206-001	Spare plug-in audio driver module-----	330.00
	990-0711-001	100% set of spare tubes for MW-50 transmitter----	7,229.00		992-4205-001	Spare plug-in audio input overload module-----	300.00
	990-0712-001	Recommended minimum spare tubes for MW-50 transmitter-----	4,000.00		990-0810-001	100% spare rectifier kit-	618.00
15	994-6669-002	Model BC-20H transmitter, consisting of two standard BC-10H 10 kW transmitters, a 20 kW combiner and a common drive unit-----	67,150.00		990-0807-001	Recommended spare rectifier kit-----	158.00
19	994-6522-005	Model BC-10H transmitter with one set of tubes and two crystals-----	29,995.00		990-0811-001	100% spare transistor kit	1,455.00
	990-0539-001	100% set spare tubes for BC-10H transmitter-----	963.00		990-0812-001	Recommended spare transistor kit-----	243.00
	990-0760-001	Set of spare transistors for BC-10H (diodes not included)-----	377.00		444-XXXX-000	Spare crystal-----	54.00
	994-6548-001	Kit for remote control of power output-----	534.00	32	700-0055-000	CPB-1 Common Point Impedance Bridge, 5 kW---	1,018.00
23	994-7117-001	MW-5 Transmitter with one set of tubes and two crystals, for 208/230 volts, 3 phase, 60 Hz operation. (Specify high and low power desired)---	28,000.00		700-0056-000	CPB-1 Common Point Impedance Bridge, 50 kW--	1,095.00
	994-7117-003	MW-5 Transmitter with one set of tubes and two crystals, for 208/230/380 volts, 3 phase, 50 Hz operation. (Specify high and low power desired)---	28,000.00	33	700-0063-000	Model OIB-1 Operating Impedance Bridge, with 12 inch leads-----	930.00
	990-0764-001	100% set spare tubes for MW-5-----	679.00		700-0146-000	Model OIB-1 Operating Impedance Bridge, with 18 inch leads-----	930.00
	990-0765-001	100% set spare transistors for MW-5 (diodes not included)-----	445.00		700-0064-000	D.C. Amplifier. Used to increase sensitivity of Bridge for use with power sources as low as 25 watts-----	88.00
	990-0767-001	100% set spare diodes (includes HV rectifiers, but no transistors)-----	2,368.00		700-0065-000	TC-1 Transport Case. For OIB-1-----	121.00
27	994-7707-001	MW-1 transmitter, complete with all solid-state devices and one crystal, for 208/230 volts, single phase, 60 Hz or 50 Hz operation (specify 208 or 230-volt primary service)	10,700.00			R. F. ANTENNA METERS	
				34	994-5309A	Special Antenna Coupling unit for 5000 watts AM. NOTE: Does not include tower chokes, diode or line current meter-----	1,510.00
					994-5309B	Special Antenna Coupler for 10,000 watts AM. NOTE: Does not include tower chokes, diode or line current meter-----	2,050.00
					634-0206-000	308 Weston 0-3 RF Int. Thermo Std. Scale-----	103.00
					634-0238-000	308 Weston 0-6 RF Int. Thermo Std. Scale-----	141.00
					634-0209-000	308 Weston 0-8 Rf Int. Thermo Std. Scale-----	90.00
					634-0210-000	308 Weston 0-10 RF Int. Thermo Std. Scale-----	94.50



CAT. PAGE	PART NUMBER	PRODUCT DESCRIPTION	UNIT PRICE	CAT. PAGE	PART NUMBER	PRODUCT DESCRIPTION	UNIT PRICE
		METER JACK AND SHORTING BAR-MOUNTING PLUG			632-0426-000	Same as above, 0-8 amp scale face-----	On request
34	994-3280-002	Meter jack and shorting bar-----	30.00		632-0361-000	Same as above, 0-10 amp scale face-----	On request
	994-3281-001	Meter mounting plug-----	28.00		632-0428-000	Same as above, 0-15 amp scale face-----	On request
		METER SHORTING SWITCH				HEAVY DUTY SAMPLING LOOP	
	994-3493-001	Meter Shorting Switch, rating 15 amperes-----	On request		994-6126-001	Fixed, non-shielded sampling loop-----	265.00
	994-6527-001	Meter Shorting Switch, rating 40 amperes-----	130.00			FEED THRU BOWLS	
		ANTENNA COUPLER 1250 WATTS			994-2870-001	Solid stud, 2 bowls, for walls to 10 $\frac{1}{2}$ " thick--	On request
	994-3494-001	Antenna coupling unit for 1000 watts or less. Note: does not include tower chokes, diode or line current meter-----	925.00		994-3254-001	Same as above but hollow stud-----	110.00
		SOLENOID TOWER CHOKES			994-5280-001	Solid stud, single bowl, for walls 1" thick-----	32.00
35	994-3937-001	Tower choke, 2 section, weatherproof-----	206.00		994-5281-001	Same as above but hollow stud-----	34.00
	994-3938-001	Tower choke, 3 section, weatherproof-----	255.00			RADIO FREQUENCY CONTACTOR	
	994-3935-001	Tower choke, 2 section, unhused-----	115.00		994-7807-001	Contacto DPDT insulated 22 kV peak voltage-----	On request
	994-3936-001	Tower choke, 3 section, unhused-----	160.00			MEDIUM WAVE MODULATION MONITOR	
		ISOLATION COIL		36	994-7084-001	AM-80 Solid-state AM Modulation Monitor-----	950.00
	994-3073-006	Uses $\frac{1}{2}$ " , 50 ohm foam heliax FH4, coil only on mfg. plate. In weather-proof housing-----	525.00		994-7097-001	AM-80 Remote Meter Panel	210.00
	994-4561-007	Uses $\frac{1}{2}$ " , 50 ohm foam heliax FH4, coil only on mfg. plate. Less cabinet-----	395.00		994-7180-001	100% Spare Fuse, Diode, Lamp & Transistor Kit for AM-80-----	80.00
		DIODE TYPE REMOTE METER EQUIPMENT				MEDIUM WAVE FREQUENCY MONITOR	
	994-6112-001	Solid state diode assembly. For all powers 250 watts through 50 kW. Meter not included-----	120.00	37	994-6698-001	Medium wave frequency monitor, digital read-out-----	1,150.00
	632-0418-000	Meter 0-1 MA DC. Westinghouse RX351. With 0-3 amps RF scale face. 3" case-----	On request		994-6865-001	Medium wave frequency monitor, analog (meter) display-----	1,150.00
	632-0419-000	Same as above, 0-5 amp scale face-----	On request		994-6863-001	Remote (analog) meter panel for Model 994-6698 above-----	245.00
	632-0420-000	Same as above, 0-8 amp scale face-----	On request			AM ACCESSORIES	
	632-0421-000	Same as above, 0-10 amp scale face-----	On request	38	700-0389-000	Model SD-31 Synthesizer-Detector (less batteries)	995.00
	632-0424-000	Meter 0-1MA DC RX-371 Westinghouse with 0-3 amp scale face-----	On request		731-0239-XXX	Model AM-19 Phase Monitor (State number of towers; State whether Digital or Analog Model)-----	On request
					700-0077-000	Model FIM-21 Field Intensity Meter (less batteries)-----	1,250.00

CAT. PAGE	PART NUMBER	PRODUCT DESCRIPTION	UNIT PRICE	CAT. PAGE	PART NUMBER	PRODUCT DESCRIPTION	UNIT PRICE
FM BROADCAST TRANSMITTERS							
42	994-6875-001	Basic Dual FM System (does not include transmitters-	On request		994-6736-001	FM-5H3, 5,000 watt FM broadcast transmitter, with TE-3 exciter, 60 Hz-	19,250.00
	994-6876-001	Automatic Exciter/I.P.A. Switching Kit for dual FM system-----	6,950.00		994-6736-002	FM-5H3, same as above except for 50 Hz operation-----	19,750.00
	994-6877-001	RF Output Switching for dual FM system-----	9,600.00		994-6743-001	FM-7.5H3, 7,500 watt FM broadcast transmitter with TE-3 exciter, 60 Hz-	21,400.00
	994-6746-001	FM-40H3, consisting of two FM-20H3 transmitters. Includes TE-3 exciter, couplers, reject loads---	74,300.00		994-6743-002	FM-7.5H3, same as above except for 50 Hz operation-----	21,900.00
	994-7082-001	FM-10/10H3, 20,000 Watt FM Transmitter-----	54,900.00		990-0549-001	100% spare tube kit for all of above-----	606.00
	994-7941-001	FM-5/5H3, 10,000 Watt FM Transmitter-----	44,200.00		994-6533-001	Stereo generator (add for stereo operation)-----	1,495.00
44	994-6746-001	FM-40H3, consisting of two FM-20H3 transmitters. Includes TE-3 exciter, couplers, reject loads---	74,300.00		994-6507-002	SCA sub-carrier generator (add for SCA operation)--	735.00
	990-0552-001	100% spare tube kit-----	911.00	52	994-6871-001	FM-2.5H3 2,500 watt FM broadcast transmitter with TE-3 exciter, 60 Hz-	14,450.00
	994-6533-001	Stereo Generator (add for stereo operation)-----	1,495.00		994-6871-003	FM-2.5H3 2,500 watt FM broadcast transmitter with TE-3 exciter, 50 Hz-	14,450.00
	994-6507-002	SCA sub-carrier generator (add for SCA operation)--	735.00		990-0587-001	100% spare tube kit-----	450.00
46	994-6745-001	FM-20H3, 20,000 watt FM broadcast transmitter, with TE-3 exciter-----	34,300.00		994-6533-001	Stereo generator (add for stereo operation)-----	1,495.00
	990-0552-001	100% spare tube kit-----	911.00		994-6507-002	SCA Generator (add for SCA operation)-----	735.00
	994-6533-001	Stereo generator (add for stereo operation)-----	1,495.00	53	994-6737-001	BFE-10G3, 10 watt FM broadcast transmitter with TE-3 solid-state exciter-----	4,495.00
	994-6507-002	SCA sub-carrier generator (add for SCA operation)--	735.00		994-6738-001	BFE-50G3, 50 watt FM broadcast transmitter with TE-3 solid-state exciter-----	4,775.00
48	994-6744-001	FM-10H3, 10,000 watt FM broadcast transmitter, with TE-3 exciter, 60 Hz-	24,600.00		990-0726-001	100% set spare rectifiers, tubes and resistors for BFE-50G3-----	353.00
	994-6744-003	FM-10H3, 10,000 watt FM broadcast transmitter, with TE-3 exciter, 380V, 3 phases, 50 Hz-----	29,915.00	SUPER POWER CIRCULARLY POLARIZED FM ANTENNA			
	990-0551-001	100% spare tube kit-----	624.00	55	FMH-1AE	1-bay 3-1/8" line, end feed-----	1,665.00
	994-6533-001	Stereo generator (add for stereo operation)-----	1,495.00		FMH-2AE	2-bay 3-1/8" line, end feed-----	3,335.00
	994-6507-002	SCA sub-carrier generator (add for SCA operation)--	735.00		FMH-2AC	2-bay 3-1/8" line, center feed-----	3,935.00
50	994-6742-001	FM-3H3, 3,000 watt FM broadcast transmitter with TE-3 exciter, 60 Hz-	17,200.00		FMH-2AC6	2-bay 6-1/8" line, center feed-----	5,235.00
	994-6742-002	FM-3H3, same as above except for 50 Hz operation-----	17,700.00		FMH-3AE	3-bay 3-1/8" line, end feed-----	5,000.00
					FMH-4AE	4-bay 3-1/8" line, end feed-----	6,665.00

CAT. PAGE	PART NUMBER	PRODUCT DESCRIPTION	UNIT PRICE	CAT. PAGE	PART NUMBER	PRODUCT DESCRIPTION	UNIT PRICE
55	FMH-4AC	4-bay 3-1/8" line, center feed-----	7,266.00		FMH-8BC	8-bay 6-1/8" line, center feed-----	19,915.00
	FMH-4AC6	4-bay 6-1/8" line, center feed-----	8,566.00		FMH-10BC	10-bay 6-1/8" line, center feed-----	24,583.00
	FMH-5AE	5-bay 3-1/8" line, end feed-----	8,335.00		FMH-12BC	12-bay 6-1/8" line, center feed-----	29,250.00
	FMH-6AE	6-bay 3-1/8" line, end feed-----	10,000.00		FMH-1CE	1-bay 6-1/8" line, end feed-----	2,665.00
	FMH-6AC	6-bay 3-1/8" line, center feed-----	10,600.00		FMH-2CE	2-bay 6-1/8" line, end feed-----	5,125.00
	FMH-6AC6	6-bay 6-1/8" line, center feed-----	11,900.00		FMH-3CE	3-bay 6-1/8" line, end feed-----	7,790.00
	FMH-7AE	7-bay 3-1/8" line, end feed-----	11,666.00		FMH-4CE	4-bay 6-1/8" line, end feed-----	10,460.00
	FMH-8AE	8-bay 3-1/8" line, end feed-----	13,333.00		FMH-5CE	5-bay 6-1/8" line, end feed-----	13,125.00
	FMH-8AC	8-bay 3-1/8" line, center feed-----	13,933.00		FMH-6CE	6-bay 6-1/8" line, end feed-----	15,790.00
	FMH-8AC6	8-bay 6-1/8" line, center feed-----	15,235.00			DUAL CYCLOID CIRCULARLY POLARIZED FM ANTENNA	
	FMH-10AC	10-bay 3-1/8" line, center feed-----	17,265.00	57	FMS-1	1-bay 3-1/8" line----- Same as above with 300 or 500 watt heaters-----	1,270.00 1,520.00
	FMH-10AC6	10-bay 6-1/8" line, center feed-----	18,565.00		FMS-2	2-bay 3-1/8" line----- Same as above with 300 or 500 watt heaters-----	2,535.00 3,035.00
	FMH-12AC	12-bay 3-1/8" line, center feed-----	20,600.00		FMS-3	3-bay 3-1/8" line----- Same as above with 300 or 500 watt heaters-----	3,800.00 4,550.00
	FMH-12AC6	12-bay 6-1/8" line, center feed-----	21,900.00		FMS-4	4-bay 3-1/8" line----- Same as above with 300 or 500 watt heaters-----	5,070.00 6,070.00
	FMH-1BE	1-bay 6-1/8" line, end feed-----	2,335.00		FMS-5	5-bay 3-1/8" line----- Same as above with 300 or 500 watt heaters-----	6,335.00 7,585.00
	FMH-2BE	2-bay 6-1/8" line, end feed-----	4,665.00		FMS-6	6-bay 3-1/8" line----- Same as above with 300 or 500 watt heaters-----	7,600.00 9,100.00
	FMH-2BC	2-bay 6-1/8" line, center feed-----	5,915.00		FMS-7	7-bay 3-1/8" line----- Same as above with 300 or 500 watt heaters-----	8,780.00 10,530.00
	FMH-3BE	3-bay 6-1/8" line, end feed-----	7,000.00		FMS-8	8-bay 3-1/8" line----- Same as above with 300 or 500 watt heaters-----	9,930.00 11,930.00
	FMH-4BE	4-bay 6-1/8" line, end feed-----	9,335.00		FMS-9	9-bay 3-1/8" line----- Same as above with 300 or 500 watt heaters-----	11,060.00 13,310.00
	FMH-4BC	4-bay 6-1/8" line, center feed-----	10,585.00		FMS-10	10-bay 3-1/8" line----- Same as above with 300 or 500 watt heaters-----	12,160.00 14,660.00
	FMH-5BE	5-bay 6-1/8" line, end feed-----	11,665.00		FMS-11	11-bay 3-1/8" line----- Same as above with 300 or 500 watt heaters-----	13,240.00 15,990.00
	FMH-6BE	6-bay 6-1/8" line, end feed-----	14,000.00				
	FMH-6BC	6-bay 6-1/8" line, center feed-----	15,250.00				
	FMH-7BE	7-bay 6-1/8" line, end feed-----	16,335.00				
	FMH-8BE	8-bay 6-1/8" line, end feed-----	18,665.00				

CAT. PAGE	PART NUMBER	PRODUCT DESCRIPTION	UNIT PRICE	CAT. PAGE	PART NUMBER	PRODUCT DESCRIPTION	UNIT PRICE
57	FMS-12	12-bay 3-1/8" line----- Same as above with 300 or 500 watt heaters-----	14,290.00 17,290.00				
	FMS-13	13-bay 3-1/8" line----- Same as above with 300 or 500 watt heaters-----	15,315.00 18,565.00				
	FMS-14	14-bay 3-1/8" line----- Same as above with 300 or 500 watt heaters-----	16,315.00 19,815.00				
	FMS-15	15-bay 3-1/8" line----- Same as above with 300 or 500 watt heaters-----	17,290.00 21,040.00				
	FMS-16	16-bay 3-1/8" line----- Same as above with 300 or 500 watt heaters-----	18,240.00 22,240.00				
	DUAL CYCLOID II CIRCULARLY POLARIZED FM ANTENNA						
59	FMC-4B	4-bay----- Same as above with heaters	3,070.00 3,970.00				
	FMC-5B	5-bay----- Same as above with heaters	3,835.00 4,960.00				
	FMC-6B	6-bay----- Same as above with heaters	4,600.00 5,950.00				
	FMC-7B	7-bay----- Same as above with heaters	5,370.00 6,945.00				
	FMC-8B	8-bay----- Same as above with heaters	6,135.00 7,935.00				
	FMC-9B	9-bay----- Same as above with heaters	6,900.00 8,925.00				
	FMC-10B	10-bay----- Same as above with heaters	7,670.00 9,920.00				
	FMC-11B	11-bay----- Same as above with heaters	8,435.00 10,910.00				
	FMC-12B	12-bay----- Same as above with heaters	9,200.00 11,900.00				
	DUAL CYCLOID III CIRCULARLY POLARIZED FM ANTENNA						
	FMC-1A	1-bay----- Same as above with heaters	770.00 995.00				
	FMC-2A	2-bay----- Same as above with heaters	1,535.00 1,985.00				
	FMC-3A	3-bay----- Same as above with heaters	2,300.00 2,975.00				
	FMC-4A	4-bay----- Same as above with heaters	3,070.00 3,970.00				
	FMC-5A	5-bay----- Same as above with heaters	3,835.00 4,958.00				
	FMC-6A	6-bay----- Same as above with heaters	4,600.00 5,950.00				
	FMC-7A	7-bay----- Same as above with heaters	5,370.00 6,945.00				
	FMC-8A	8-bay----- Same as above with heaters	6,135.00 7,935.00				
						EDUCATIONAL FM ANTENNAS	
					710-0102-000	FM-11A Single ring antenna	270.00
					710-0103-000	FM-22A 2-ring antenna----	445.00
					710-0201-000	FM-33A 3-ring antenna----	935.00
					710-0202-000	FM-44A 4-ring antenna----	1,160.00
					FM ANTENNA ACCESSORIES		
				61	710-0139-000	Antenna heater control system-----	1,150.00
					710-0136-000	Dual-Cycloid replacement antenna heater elements (2 elements per bay)----	70.00
					710-0137-000	Dual-Cycloid II replace- ment antenna heater elements (2 elements per bay)-----	70.00
					710-0138-000	Cycloid replacement ant- enna heater elements (2 elements per bay)-----	31.00
					620-1027-000	10 kW FM Isolation Trans- former, standard 1-5/8" EIA flanges, adjusted to customer's operating fre- quency at the factory. For use with a max. trans- mitter power of 10 kW----	1,250.00
					620-1028-000	10 kW FM Isolation Trans- former, same as above except supplied with 1-5/8" - 3-1/8" adapters. Input and output 3-1/8" EIA 50 ohm female-----	1,375.00
					620-0444-000	25 kW FM Isolation Trans- former, standard 3-1/8" EIA flanges, adjusted to customer's operating fre- quency at the factory. For use with a max. trans- mitter power of 25 kW----	2,600.00
					FM MODULATION MONITORS		
				62	994-7070-001	FT-80 Monaural Modulation Monitor, complete with crystal, calibrated to specified operating fre- quency-----	1,175.00
					994-7071-001	Remote FM Monaural Modu- lation Monitor Panel----	300.00
					990-0792-001	100% Transistor/IC Kit for FT-80-----	92.00
					FM STEREO MONITORS		
				63	994-7072-001	FS-80 FM Stereo Modula- tion Monitor-----	1,660.00
					994-7073-001	Remote FM Stereo Monitor Panel-----	320.00



CAT. PAGE	PART NUMBER	PRODUCT DESCRIPTION	UNIT PRICE	CAT. PAGE	PART NUMBER	PRODUCT DESCRIPTION	UNIT PRICE
63	990-0795-001	100% transistor and IC kit for FS-80-----	128.00	931-6138-036	42FC2266 42 UH, 12-5/8" I., 6" d., fixed 1/2" edgewise, 20 amp rating--	83.00	
	FM SCA MONITORS			931-6138-030	67FC2856 67 UH, 13-1/16" I., 6" d., fixed 1/2" edgewise, 20 amp rating--	113.00	
64	994-7074-001	FC-80 FM SCA Modulation Monitor-----	1,895.00	931-6337-007	10F8T1066 10 UH, 21-1/2" I., 6" d., fixed 3/8" copper tubing, 30 amp rating-----	151.00	
	994-7075-001	Remote panel for FC-80---	315.00	931-6337-002	20F8T1656 20 UH, 15" I., 6" d., fixed 3/8" copper tubing, 30 amp rating----	On request	
	990-0796-001	100% transistor/IC kit for FC-80-----	315.00	931-6337-003	32F8T1658 32 UH, 15" I., 8" d., fixed 3/8" copper tubing, 30 amp rating---	227.00	
	FM FREQUENCY MONITOR			931-6337-004	45F8T2158 45 UH, 18-1/2" I., 8" d., fixed 3/8" copper tubing, 30 amp rating-----	258.00	
65	994-6998-001	FF-80 FM Frequency Monitor, calibrated to specified operating frequency-----	825.00	931-6372-002	65F8T2559 65 UH, 24-1/2" I., 9" d., fixed 3/8" copper tubing, 30 amp rating-----	190.00	
	994-6999-001	Remote FM Frequency Monitor (Remote Panel)---	270.00	931-6337-001	17FCT1178 17 UH, 14" I., 8" d., fixed 1/2" copper tubing, 40 amp rating----	179.00	
	990-0797-001	100% Transistor/IC Kit---	234.00	931-6372-001	35FCT1679 35 UH, 24-1/2" I., 9" d., fixed 1/2" copper tubing, 40 amp rating-----	248.00	
	FM RF AMPLIFIER			931-6583-008	6VC0854 6 UH, 8" I., 4" d., variable 1/2" edgewise, 20 amp rating-----	117.00	
66	994-6614-003	GTM-88R FM RF amplifier, includes coax cable connector 75 ohm input. Specify operating frequency-----	600.00	931-6583-001	15VC1444 15 UH, 10-3/4" I., 4" d., variable 1/2" edgewise, 20 amp rating--	117.00	
	710-0246-000	CH-6065 FM Antenna-----	50.00	931-6583-002	26VC2144 26 UH, 10-3/4" I., 4" d., variable 1/2" edgewise, 20 amp rating--	117.00	
	710-0124-000	CH-6060 FM Antenna-----	30.00	931-6583-003	42VC2145 42 UH, 10-3/4" I., 5" d., variable 1/2" edgewise, 20 amp rating--	223.00	
	710-0127-000	T-28 M Matching Transformer, 300 ohms to 75 ohms-	4.00	931-6583-004	62VC2845 62 UH, 11" I., 5" d., variable 1/2" edgewise, 20 amp rating-----	757.00	
	TOWER LIGHTING AND ACCESSORIES			994-6233-001	M-5521 veeder counter geared type, reads to 1/10 turn, 3/8" shaft diameter. With removable crank handle-----	99.00	
68-69	-----	-----	On request	926-5509-003	Same as above except with non-removable crank handle	55.00	
	INDUCTORS			994-7784-001	Coil clip for FA coils---	6.00	
70	931-6138-010	87FA4634 87 UH. 12-1/6" I. 87RA4634 fixed 1/4" edgewise, 10 amp rating-----	111.00	994-7784-003	Coil clip for FC coils---	5.00	
	931-6138-039	6FC0854 6UH, 6-1/2" I., fixed 1/2" edgewise, 20 amp rating-----	76.00				
	931-6138-040	10FC0855 10 UH, 6-1/4" I., 5" d., fixed 1/2" edgewise, 10 amp rating-----	55.00				
	931-6138-041	13FC0856 13 UH, 6-1/4" I., 6" d., fixed 1/2" edgewise, 20 amp rating-----	55.00				
	931-6138-025	17FC1654 17 UH, 8-3/4" I., 4" d., fixed 1/2" edgewise, 20 amp rating-----	66.00				
	931-6138-026	24FC1655 24 UH, 8-3/4" I., 5" d., fixed 1/2" edgewise, 20 amp rating-----	76.00				
	931-6138-027	32FC1656 32 UH, 8-3/4" I., 6" d., fixed 1/2" edgewise, 20 amp rating-----	76.00				

CAT. PAGE	PART NUMBER	PRODUCT DESCRIPTION	UNIT PRICE	CAT. PAGE	PART NUMBER	PRODUCT DESCRIPTION	UNIT PRICE
70	994-7785-001	Coil clip for FBT coils--	12.00		994-4399-001	Jack mat for one PJ-341 jack strip (PD-1)-----	18.00
	994-7785-002	Coil clip for FCT coils--	10.00		994-4400-001	Jack mat for two PJ-341 jack strips (PD-2)-----	38.00
	MICA CAPACITORS				994-4401-001	Jack mat for three PJ-341 jack strips (PD-3)-----	54.00
		G1, G2, G3 and G4-----	On request		994-6891-000	Pre-wired jack panel and terminal board-----	285.00
	COAXIAL AND RIGID TRANSMISSION LINES AND ACCESSORIES				AUDIO WIRE		
71-73-----			On request		250-0059-000	8410 Belden single conductor shielded, black rubber jacket-----	.24/ft
	COAXIAL TRANSMISSION LINE PRESSURIZATION EQUIPMENT				250-0036-000	8412 Belden 2 conductor stranded 20 AWG Braided shield cotton wrap heavy rubber jacket-----	.35/ft
74-----			On request		253-0024-000	8428 Belden neoprene jacketed heavy duty mic cable. 2 conductor 18 AWG braided shield-----	.33/ft
	OPEN WIRE TRANSMISSION LINE				253-0018-000	SH-2-20 2 conductor stranded 20 AWG, 2/push back braided shield not included-----	.06/ft
	994-3327-001	M-3327 transmission line bracket-----	106.00		253-0001-000	1261 2 conductor stranded 24 AWG, braided shield, not insulated-----	.16/ft
	994-3328-001	M-3328 end plate-----	185.00		253-0062-000	8437 Belden 2 conductor 22 AWG solid, w/drain wire and braided shield, black vinyl jacket-----	.11/ft
	994-3322-001	M-3322 horn gap-----	176.00		253-0054-000	8450 Belden miniature audio cable, 2 conductor, 22 AWG solid, drain wire, foil shield vinyl jacket-----	.09/ft
	994-3864-001	M-3864 center post assembly	91.50		253-0059-000	8451 Belden miniature audio cable, 2 conductor 22 AWG stranded, drain wire, foil shield, vinyl jacket-----	.09/ft
	AMPLIFIERS				250-0081-000	Cable 6 conductor, 3 pair, wire size 22 AWG-----	.25/ft
75	994-7059-001	AM Peak Limiter-----	895.00		252-0247-000	Wire 18 AWG stranded, yellow-----	.27/ft
76	994-7757-001	ME-1 AM Modulation Enhancer	325.00		255-0006-000	High voltage wire 8 AWG 40 kV-----	5.17/ft
77	994-6631-005	Solid Statesman FM Limiter	995.00		RACK CABINETS		
	994-6631-006	Matched pair of FM Limiters (for stereo)-----	1,815.00	82	994-6643-002	RAK-70 basic cabinet assembly-----	250.00
78	994-6629-004	Solid Statesman Automatic Gain Control Amplifier---	875.00		994-6664-001	Side panel for RAK-70----	42.00
	994-6629-006	Matched pair of Automatic Gain Control Amplifiers---	1,700.00		994-6665-001	Louvered top for RAK-70--	7.80
	PROOF OF PERFORMANCE PRODUCTS				994-6671-001	Door with louvers for RAK-70-----	69.00
79	994-7023-001	Stereo Gain Set-----	495.00				
	700-0045-000	Model 210 Audio Oscillator	375.00				
	700-0040-000	Model 410 Distortion Meter-----	420.00				
	AMPLIFIERS AND AUDIO ACCESSORIES						
80	994-7681-001	Utility Amplifier-----	225.00				
	994-7682-001	Single Program Amplifier-	290.00				
	740-0098-000	D-60 Dual Channel Amplifier-----	298.00				
81	994-7001-001	Power Control Panel-----	175.00				
	994-6973-001	VU Meter Panel-----	325.00				
	612-0307-000	Single row jack strip only (PJ-343), 24 jacks or 12 pairs (no jack mat required)-----	58.00				
	612-0306-000	Double row jack strip only (PJ-341), 48 jacks or 24 pairs (less mat)---	96.00				

CAT. PAGE	PART NUMBER	PRODUCT DESCRIPTION	UNIT PRICE	CAT. PAGE	PART NUMBER	PRODUCT DESCRIPTION	UNIT PRICE
82	994-6671-002	Door without louvers for RAK-70-----	69.00		994-5527-003	RAK-7 basic rack cabinet-	225.00
	448-0320-000	Key-type lock for doors for RAK-70-----	5.95		994-5577-001	Joiner strip for RAK-7---	24.00
	994-6666-001	Fan kit for RAK-70-----	165.00		994-6582-001	Extra panel mounting hardware kit for RAK-7-----	6.00
	994-6668-001	Air filter kit (recommended when using fan kit) for RAK-70-----	16.00			REMOTE CONTROL SYSTEM	
	994-7035-001	(2) Rear panel mounting angles for RAK-70-----	25.00	83	731-0329-000	TRC-15AW Wire remote control system-----	1,990.00
	992-2539-001	Panel mounting hardware (30 provided with basic racks) for RAK-70-----	3.60		731-0330-000	TRC-15AR Radio (STL) remote control system---	2,290.00
	994-6713-001	RAK-70A basic cabinet assembly-----	300.00			REMOTE CONTROL AND TELEMETRY ACCESSORIES	
	994-6714-001	Side panel for RAK-70A---	38.40	84	731-0452-000	Model TSK-3 Temperature Sensing Kit-----	90.00
	994-6665-001	Louvered top for RAK-70A-	7.80		731-0301-000	Model TLK-2 Tower Light Kit-----	60.00
	994-6715-001	Door with louvers for RAK-70A-----	95.00		731-0302-000	Model LVK-2 Line Voltage Kit-----	45.00
	994-6715-002	Door without louvers for RAK-70A-----	53.00		994-6112-001	RF Diode Unit-----	120.00
	448-0320-000	Key-type lock for doors for RAK-70A-----	5.95		731-0300-000	Model CSA-3 Chopper-Stabilized DC Amplifier----	135.00
	994-6717-001	Fan kit for RAK-70A-----	82.00		731-0379-000	Model PLC-1 Power-to-Linear Converter-----	250.00
	448-0288-001	Air filter (replacement) for RAK-70A-----	2.40		994-5129-001	M-5129 adjustable DC overload relay assembly--	53.50
	994-6716-001	(2) Rear panel mounting angles for RAK-70A-----	25.00		994-5066-001	M-5066 tuning motor, 7 RPM, 5 wire (generally used for coupling to an existing variable capacitor or inductor, to control transmitter output or loading)-----	968.00
	992-2539-001	Panel mounting hardware (30 provided with basic racks) for RAK-70A-----	3.60		994-4800-001	M-4800 tuning motor assembly, 3 wire motor, 1 RPM for a rheostat and other control (similar to that used on above motor and rheostat assemblies)-----	168.00
	994-6761-001	RAK-80 basic cabinet assembly-----	295.00		994-4719-002	M-4719A plate voltage metering kit-----	106.00
	994-6762-001	Side panel for RAK-80----	60.00		994-4848-003	Output loading control kit for BC-5P-2-----	1,005.00
	994-6892-001	Louvered top for RAK-80--	23.00		994-6548-001	Output loading control kit for BC-5H-----	535.00
	994-6715-001	Door with louvers for RAK-80-----	95.00		994-4720-002	M-4720A plate current metering kit-----	114.00
	994-6715-002	Door without louvers for RAK-80-----	53.00			STUDIO TRANSMITTER LINK - 148 MHz - 960 MHz	
	448-0320-000	Key-type lock for doors for RAK-80-----	5.95	86	731-0538-000	PCL-505 STL transmitter and receiver (specify frequency)-----	3,880.00
	994-6763-001	Fan kit for RAK-80-----	95.00		731-0539-000	PCL-505/C Composite STL transmitter and receiver (specify frequency)-----	4,190.00
	448-0288-000	Air filter replacement for RAK-80-----	2.40				
	994-6716-001	(2) Rear panel mounting angles for RAK-80-----	25.00				
	992-2539-001	Panel mounting hardware (30 provided with basic racks)-----	3.60				

CAT. PAGE	PART NUMBER	PRODUCT DESCRIPTION	UNIT PRICE	CAT. PAGE	PART NUMBER	PRODUCT DESCRIPTION	UNIT PRICE
		REMOTE PICKUP EQUIPMENT					
90	731-0369-000	RPT-40 transmitter, 40 watt, complete with crystal and tuned to frequency. 120 VAC & 12 VDC. 4 audio inputs (one push to talk)-----	975.00		731-0257-000	PG-4C pigtail, 4' RG-8U with UG-21C/U and UG-23B/U connectors-----	10.00
	731-0317-000	TPS-TC-1 mobile control for RPT-40 transmitter---	60.00		710-0153-000	DB-705 Mobile whip antenna, vertically polarized, 5 dB gain-----	37.00
	710-0087-000	ASP-143 bumper mount for MA-1 antenna-----	13.00		731-0162-000	DFT Dual frequency kit for RPT-25, RPT-40, less crystal-----	25.00
	710-0089-000	MA-1 Mobile single ring antenna-----	26.00		731-0163-000	DFR Dual frequency kit for R-50/450, R-30/150, less crystal-----	25.00
	710-0088-000	PA-1 Portable single ring antennna-----	26.00		731-0165-000	XT-1A/0-1A Hi-Accuracy Crystal and Oven Set for RPT-25, RPT-40-----	32.50
	731-0371-000	R-30/150 receiver, rack mount, broadcast quality continuous-duty, with crystal and tuned. 120 VAC. 600 ohm output----	495.00		731-0166-000	XR-1A/0-1A Hi-Accuracy Crystal and Oven Set for R-50/450,R-30/150-----	36.00
	710-0086-000	RA-4 4-bay base antenna--	170.00		731-0251-000	MCD-70 Dynamic Microphone, modified for push-to-talk	65.00
	618-0171-000	FHJ-4-50B Heliax foam filled, 1/2", jacketed transmission line-----	.97/ft			TRANSMITTING TUBES	
	620-0301-000	44AU UHF jack, for use with FHJ4-50B-----	7.90	91	374-0093-000	3CX2,500F3-----	225.00
	731-0218-000	PG-4A pigtail, 4' RG-8A/U cable with plugs-----	10.00		374-0018-000	4X150A-----	35.00
	731-0182-000	PG-4B pigtail, 4' RG-8A/U cable with connectors----	10.00		374-0008-000	4-125A-----	56.00
	731-0370-000	RPT-25 transmitter, 25-watt, complete with crystal and tuned to frequency. 120 VAC & 12 VDC. 4 audio inputs (one push to talk)-----	1,145.00		374-0009-000	4-250A-----	65.00
	731-0317-000	TPS-TC-1 mobile control for RP-25 transmitter---	60.00		374-0010-000	4-400A-----	67.00
	731-0372-000	R-50/450 receiver, rack mount, broadcast quality, 120 VAC, 600 ohm output--	695.00		374-0020-000	4R4GY-----	3.02
	710-0245-000	ASPD-700 base antenna, colinear, 8 dB gain----	175.00		374-0081-000	4CX250B-----	39.00
	710-0113-000	ASP-320 mounting clamps for ASPD-700-----	11.50		374-0014-000	4CX300A-----	92.00
	618-0172-000	FHJ5-50A heliax, 7/8", 50 ohm jacketd-----	2.46/ft		374-0015-000	4CX1,000A-----	245.00
	620-0317-000	45AU UHF jack, for use with FHJ5-50A-----	21.60		374-0121-000	4CX1,500A-----	280.00
	731-0182-000	PG-4B pigtail, 4' RG-8A/U cable with connectors----	10.00		374-0074-000	4CX3,000A-----	572.00
					374-0016-000	4CX5,000A-----	571.00
					374-0077-000	4CX10,000D-----	629.00
					374-0097-000	4CX15,000A-----	843.00
					374-0099-000	4CX35,000C-----	3,000.00
					374-0120-000	5CX1,500A-----	415.00
					374-0026-000	575A-----	32.00
					374-0027-000	673-----	27.65
					374-0030-000	807-----	6.05
					374-0031-000	810-----	40.00
					374-0034-000	813-----	40.71
					374-0039-000	833A-----	75.90
					374-0040-000	845-----	40.00



CAT. PAGE	PART NUMBER	PRODUCT DESCRIPTION	UNIT PRICE	CAT. PAGE	PART NUMBER	PRODUCT DESCRIPTION	UNIT PRICE
91	374-0042-000	866A-----	6.78		380-0143-000	40311-----	1.78
	374-0051-000	6146-----	7.20		380-0145-000	MPS-404A-----	1.36
	374-0054-000	6360A-----	8.00		380-0147-000	TZ-1218-----	1.26
	374-0058-000	8008-----	14.00		380-0151-000	2N4356-----	1.54
	374-0118-000	8806-----	1,286.00		380-0158-000	2N5550-----	2.08
	374-0119-000	8807-----	1,429.00		380-0179-000	MPS-U45-----	3.44
	374-0124-000	8916-----	1,943.00		380-0183-000	MPS-U95-----	3.82
	374-0096-000	8122-----	51.00		380-0205-000	DTS804-----	28.60
	TRANSISTORS				380-0513-000	2N6340-----	26.90
92	380-0011-000	2N214-----	2.05		380-0519-000	2N6254-----	2.35
	380-0014-000	2N1414-----	3.63		INTEGRATED CIRCUITS		
	380-0016-000	2N1539-----	4.48		382-0020-000	TD101-----	5.17
	380-0018-000	2N1307-----	1.83		382-0033-000	MC1013P-----	10.92
	380-0022-000	2N1183A-----	8.00		382-0056-000	LM301AH-----	10.87
	380-0037-000	PT31348-----	19.12		382-0070-000	SN7400N-----	1.38
	380-0039-000	PT3134E-----	95.63		382-0071-000	SN7402N-----	1.38
	380-0042-000	2N697-----	1.44		382-0072-000	SN7403N-----	1.38
	380-0044-000	40319-----	2.50		382-0074-000	SN7476N-----	2.06
	380-0045-000	2N4036-----	2.69		382-0108-000	CA641T-----	8.62
	380-0050-000	40317-----	1.85		382-0121-000	SN7474N-----	2.41
	380-0053-000	40314-----	2.45		382-0125-000	SN75453P-----	4.16
	380-0057-000	39772-----	9.16		382-0139-000	SN7437N-----	4.37
	380-0058-000	2N3440-----	2.80		382-0141-000	MLZR42050-----	57.54
	380-0062-000	40310-----	2.88		382-0172-000	LH0002CH-----	23.80
	380-0066-000	2N3740-----	5.84		382-0187-000	LM741CN-----	2.69
	380-0083-000	2N2369-----	3.79		382-0203-000	946DC7340-----	5.68
	380-0088-000	2N3704-----	1.38		382-0220-000	MC1468L-----	15.00
	380-0097-000	40360-----	2.38		382-0303-000	MM1702AQ-----	39.00
	380-0100-000	40312-----	2.81		HIGH VOLTAGE RECTIFIERS		
	380-0107-000	2N4905-----	8.20		384-0274-000	S-5373-----	93.84
	380-0111-000	2N3417-----	1.69		384-0159-000	67-6099-----	83.00
	380-0112-000	2N5087-----	2.45		384-0167-000	67-6130-----	28.00
	380-0114-000	2N5109-----	8.50		384-0322-000	67-6246-----	51.61
	380-0115-000	2N5088-----	2.27		384-0323-000	67-6247-----	16.69
	380-0125-000	2N4401-----	2.27		384-0362-000	67-6329-----	97.15
	380-0128-000	2N4914-----	6.42		384-0149-000	7030A-----	35.00
	380-0141-000	2N4870-----	2.30		384-0185-000	67-7800-----	354.20

CAT. PAGE	PART NUMBER	PRODUCT DESCRIPTION	UNIT PRICE	CAT. PAGE	PART NUMBER	PRODUCT DESCRIPTION	UNIT PRICE
		ZENER DIODES			384-0165-000	1N4720-----	2.21
92	386-0016-000	1N2974-----	2.42		384-0368-000	1N5054-----	1.24
	386-0019-000	1N754-----	1.44		384-0220-000	18088A-----	13.80
	386-0034-000	1N3031B-----	10.43			HIGH FREQUENCY BROADCAST TRANSMITTERS	
	386-0047-000	1N3582-----	27.17	97	994-6734-001	SW-100, 100,000 watt short wave broadcast transmitter (3.2 to 22 MHz)-----	210,000.00
	386-0077-000	1N4749A-----	5.84		990-0692-001	100% spare tube kit for SW-100-----	7,514.00
	386-0091-000	1N4738-----	3.82	101	994-6808-001	SW-50, 50,000 watt short wave broadcast transmitter (3.2 to 22 MHz)-----	205,000.00 <del>20,500.00</del>
	386-0092-000	1N4744-----	3.79		990-0692-001	100% spare tube kit for SW-50-----	7,514.00
	386-0096-000	1N3340-----	11.38	103	994-7813-001	Model BC-10HT transmitter with one set of tubes and two crystals-----	On request
	386-0097-000	1N3015-----	18.22		990-0539-001	100% spare tube kit for BC-10HT-----	On request
	386-0100-000	1N4747A-----	5.76		990-0819-001	Spare semi-conductor kit, less high voltage rectifiers-----	On request
	386-0101-000	1N2992A-----	17.76				
	386-0106-000	1N4737-----	3.82				
	386-0123-000	1N4732A-----	5.76				
	386-0127-000	1N3007A-----	2.23				
	386-0135-000	1N4733A-----	1.51				
	386-0169-000	1N5352A-----	6.67				
	386-0183-000	1N4099-----	11.69				
	386-0227-000	1N3337A-----	12.14				
	386-0298-000	1N5352B-----	7.43				
		SILICON DIODES					
	384-0001-000	1N21B-----	2.45				
	384-0267-000	1N276-----	1.38				
	384-0249-000	1N457A-----	.66				
	384-0134-000	1N914-----	1.08				
	384-0017-000	1N1695-----	1.99				
	384-0018-000	1N2069-----	1.44				
	384-0019-000	1N2070-----	1.38				
	384-0020-000	1N2071-----	1.44				
	384-0256-000	MZ2361-----	1.72				
	384-0282-000	1N3253-----	1.38				
	384-0258-000	1N3254-----	1.21				
	384-0263-000	1N3255-----	1.69				
	384-0111-000	1N3495-----	3.10				
	384-0371-000	1N4003-----	1.44				
	384-0352-000	1N4246-----	1.44				
	384-0353-000	1N4247-----	1.81				

Rapidly changing conditions may necessitate price corrections from time to time. Therefore, the prices herein are subject to change without notice. All prices are F.O.B. Quincy, Illinois or point of manufacture.

## WHO TO CALL AT HARRIS SERVICE

**PHONE (217) 222-8200**

		EXT.
	<b>RADIO EQUIPMENT</b>	
Tom Leschak (Acting)	Supervisor, Radio Service, Technical Assistance Radio Equipment, Field Service Requirements, Equipment Inquiries and Orders	520
Karl Lahm	Technical Assistance — Radio	516
Lewis Pifer	Technical Assistance — Radio	515
Joe De Angelo	Technical Assistance — Radio	514
Lee Rector	Technical Assistance — Radio High Power AM, FM and HF International Service	518
Ed Barton	Technical Assistance — Radio High Power AM, FM and HF International Service	523
George Stephenson	Supervisor, Automation Service Assistance-all Automation Products	511
Ed Young	Technical Assistance — Program Automation and Criterion Equipment	525
Jim Gilmore	Technical Assistance — Program Automation and Criterion Equipment	510
David Grimes	Technical Assistance — Program Automation and Criterion Equipment	512
Rick Stevens	Technical Assistance — Program Automation and Criterion Equipment	525
	<b>TELEVISION EQUIPMENT</b>	
Don Manion	Supervisor, Television Service, Technical Assistance — Television Equipment, Field Service Requirements, Equipment Inquiries and Orders	528
Jerry Powell	Technical Assistance, Requirements — Television Transmitters — UHF and VHF	527
Don Carpenter	Technical Assistance, Television Transmitters — UHF and VHF	526
Paul Rutledge	Technical Assistance — Television Transmitters — VHF	522
Bob Fairchild	Technical Assistance — Television Transmitters — UHF and Television Cameras	541
Jim Brown	Supervisor, Video Service, Assistance — All Video Products, Video Field Service and Video Equipment Demo	540
George Owens	Technical Assistance — Television Cameras	541
Ed Yarbrough	Technical Assistance — Television Cameras	541
	<b>SERVICE PARTS — REPAIRS — RETURNS &amp; USED EQUIPMENT</b>	
Bob Buck	Manager, Service Parts and Repairs	508
Madge O'Brien	Supervisor, Service Parts Order Department	504
Order Editors	For Around-The-Clock Radio and TV Parts	500-501-506
	Rich Fairchild                      Mike Likes	
	Billy Jackson                      Jack O'Dear	
	Karen Jones                      Dean Saathoff	
	Les Kaufman                      Mike Pfanschmidt	
	Jack Smith	
Nick Kraft	Supervisor, Service Parts, Stock, Shipping and Receiving	505
Bill Genck	Assistant Supervisor, Service Parts, Stock, Shipping and Receiving	505
Kim Hermann	Supervisor, Customer Repairs and Used Equipment	503-507
Ray Dearing	Used Equipment and Repair Inquiries	503-507
Rick Scott	Used Equipment and Repair Inquiries	503-507

**(217)  
222-8200**

**This  
number  
puts the  
Harris  
service  
team  
at your beck  
and call**

**The Harris Service Department  
is ready to help if broadcast  
equipment problems should  
arise.**

**Emergency service. Field  
service. Technical assistance.  
Installation. Check-out.  
Parts. Repairs.**

**What we want to do is  
make your life easier. And we  
mean it when we say Harris  
takes "Pride In Service."**

**Remember our number—  
24 hours a day—  
(217) 222-8200. Harris  
Corporation, Broadcast  
Products Division,  
123 Hampshire Street,  
Quincy, Illinois 62301.**



**HARRIS**  
**COMMUNICATIONS AND  
INFORMATION HANDLING**



**HARRIS**



**COMMUNICATIONS AND  
INFORMATION HANDLING**

---

**HARRIS CORPORATION Broadcast Products Division**  
123 Hampshire Street, Quincy, Illinois 62301 U.S.A.