

GATES
TRANSMITTING EQUIPMENT
ALL OVER THE WORLD

MODEL BC-1E BROADCAST TRANSMITTER

1000 WATTS

HIGH LEVEL MODULATION

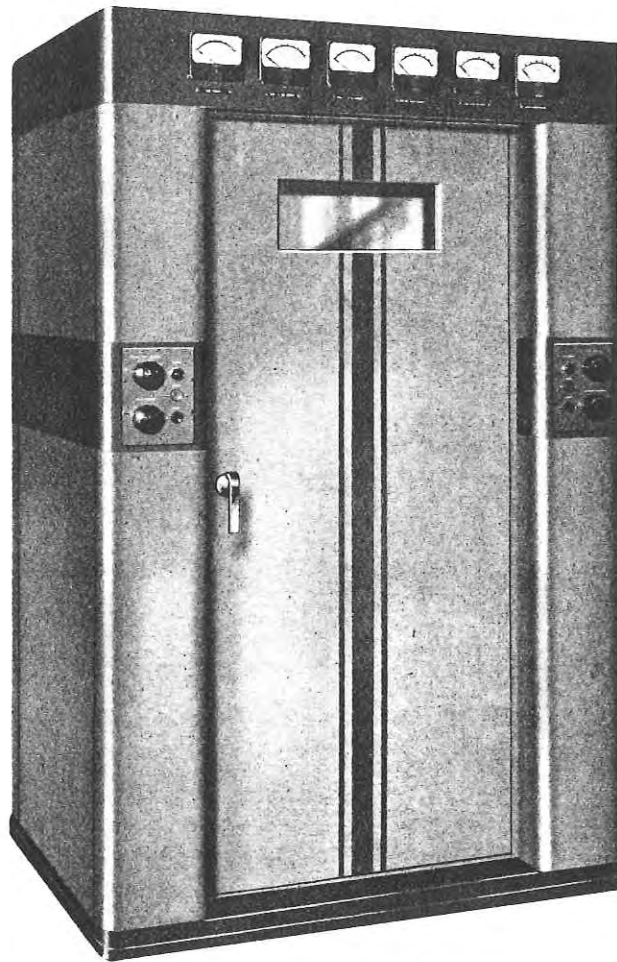

Here is a 1000 watt transmitter that is better than has heretofore been offered. Outstanding among its many features are style, accessibility, good workmanship, the very best components, economical operation and a pressure type cabinet.

GATES RADIO COMPANY
MANUFACTURERS, ENGINEERS, SINCE 1922
QUINCY, ILLINOIS, U.S.A.

GATES TRANSMITTING EQUIPMENT ALL OVER THE WORLD

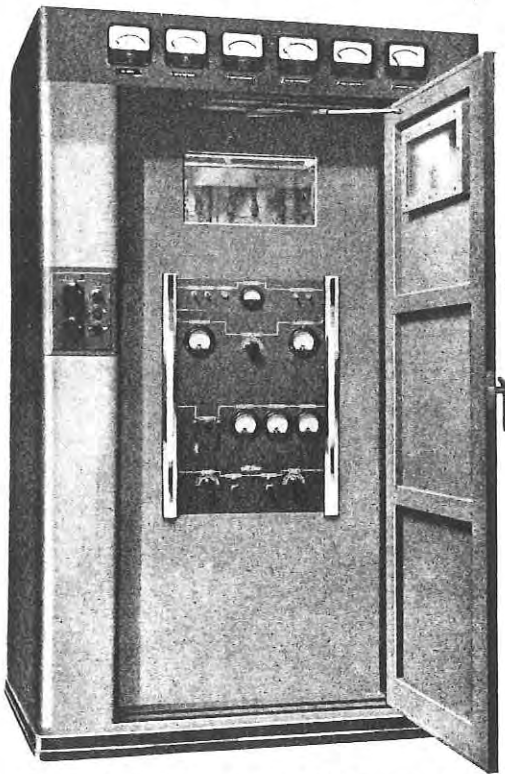

(21.11)
When the front door is open all low power radio frequency tuning adjustments and metering are available. No interlocks are required on the front door as the inside panel is of dead front construction. Final and modulator tubes are easily viewed thru the glass in the front panel and the door even if the door is closed.

GENERAL CONSTRUCTION

Both appearance and reliability are stressed in the design of the BC-1E transmitter. Modern lines are evident in the cabinet construction and the arrangement of the manual controls and meters is such that they are most convenient for the operator and pleasing to the eye. The cabinet is enhanced by using a multi-coat synthetic enamel, baked and hand rubbed to produce a smooth, lustrous finish. It is exceptionally easy to clean and will retain its original sheen for many years.

Internal framework chassis and panels are

copper plated and masked in appropriate places from the enamel finish to secure a good electrical bond throughout the transmitter. Welded joints throughout the angular framework assure maximum strength.

Considerable advantage in making tuning adjustments is obtained because the panel behind the front door is electrically dead and consequently the front door does not require interlocks. The back doors are, of course, interlocked to prevent access to harmful voltages when they are open.

Another major advantage is the pressure type cabinet. Dirt and dust are kept out of the equipment by building up a slight air pressure inside. This is accomplished by drawing air into the cabinet by a fan mounted inside the left back door and exhausting it thru the filtered opening in the top. The inlet is also filtered to prevent the entrance of dirt and foreign matter. These filters are easily cleaned and can be used indefinitely.

Tube life of the 833-A tube is lengthened for over normal expectancy by the small blowers located beneath them.

MAINTENANCE ACCESSIBILITY

All of the normal functions of maintenance may be accomplished thru the back doors of the BC-1E as the major circuits and components are easily reached from the back. The frequency control unit is easily removed by slipping off the style strips, taking out the few screws that hold it to the panel and sliding it out on its runners. The components on either side of the transmitter are exposed by taking off the panels on either side. Inspection is required in these sections very infrequently.

FREQUENCY CONTROL UNIT

The radio frequency signal in the BC-1E is started in the frequency control unit, separately designated as the Model 25-A. It contains the oscillator circuit, using a type 802 tube,

GATES RADIO COMPANY
MANUFACTURERS, ENGINEERS, SINCE 1922
QUINCY, ILLINOIS, U.S.A.

GATES
TRANSMITTING EQUIPMENT
ALL OVER THE WORLD

THE R.F. DRIVER STAGE

Just above the 25-A frequency control unit is the driver chassis which contains one 813 tube and the grid and plate components necessary for its proper functioning. The R.F. from the 25-A is fed to the grid circuit of the driver thru a low capacity flexible shielded cable. Power for the tube elements is brought in on the rear of the chassis. Two meters for indicating grid and plate current in this stage are located on the front panel.

THE FINAL R.F. AMPLIFIER

The upper portion of the cabinet contains the final radio frequency amplifier. Shunt feed is used to supply the two parallel connected type 833-A tubes in this stage. Particular attention has been given to the mechanical design to obtain sturdiness and enhance the electrical characteristics. Every component operates substantially under its rating. Supporting members are made of copper plated steel angle or heavy gauge sheet accurately formed. The final plate inductor is made of edgewise wound silver plated copper ribbon mounted on mycalex spacer bars. Final tuning is accomplished by an oversize capacitor having cast aluminum plates with a rounded polished bead on all edges to reduce corona discharge. Overmodulation tests show that it is virtually impossible to induce breakdown or component heating even though applied over long periods of time.

POWER SECTION

The bottom portion of the transmitter contains the power supply components, the modulation transformer and reactor and associated parts. Type 575-A tubes are used to provide high voltage to the R.F. final amplifier and modulator. Medium voltages are supplied to all other stages except the frequency control unit by a pair of 8008 tubes.

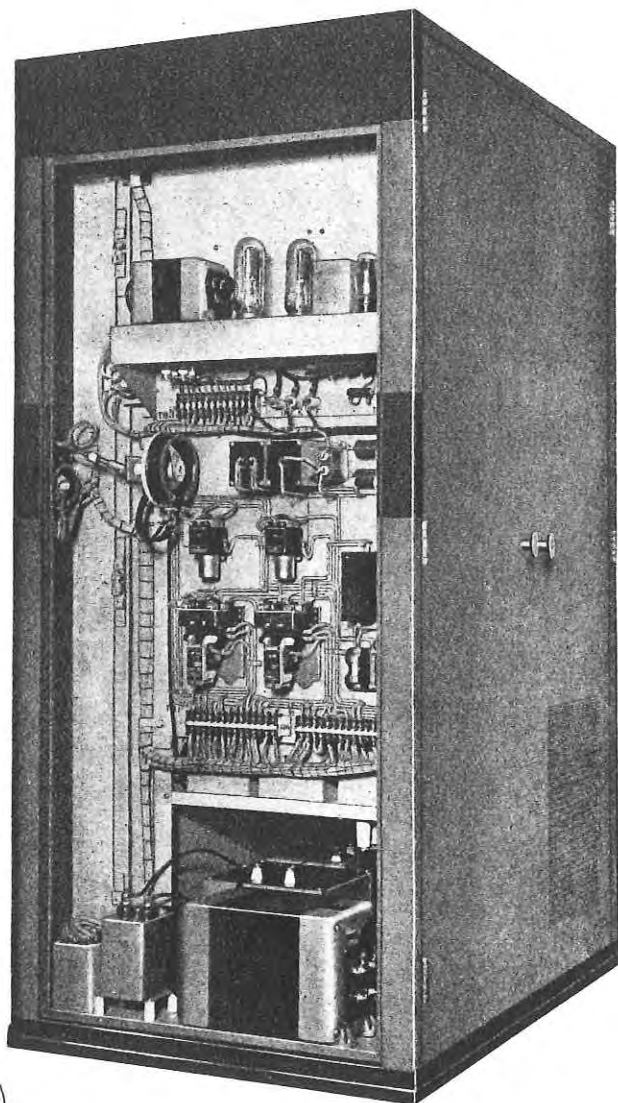

(15.66)

The audio amplifier deck at the top, control panel below and modulation transformer and reactor on the bottom are shown here. Notice the neat arrangement of the components and wiring—not crowded, easy to find your way around. Each electrical part here as well as in other sections of the transmitter is coded to correspond with symbols on the schematic diagram and parts lists in the instruction book.

GATES RADIO COMPANY
MANUFACTURERS, ENGINEERS, SINCE 1922
QUINCY, ILLINOIS, U.S.A.

GATES TRANSMITTING EQUIPMENT ALL OVER THE WORLD

and two buffer stages which use a type 45 tube and a type 802 tube in that sequence. A carefully selected crystal is used to secure accurate control of the oscillator frequency. The two lightly loaded buffer stages effectively isolate the oscillator from the power amplifiers. The crystals used in the 25-A have exceptionally low drift and are mounted in Bliley BC46T temperature controlled ovens. Two may be installed and a switch is provided so that instant change may be made from one to the other.

The 802 oscillator is of the un-tuned plate type, very stable in operation. Average deviation over long periods of time in the field shows experience of only a few cycles variation. The first buffer, a type 45, is also un-tuned and lightly coupled to obtain utmost stability. The third stage, an 802 is terminated in a high impedance circuit from which the output is fed directly to the grid of the radio frequency driver stage. Power for all tube elements is obtained from a self-contained power supply on the 25-A chassis. A separate AC power line to the 25-A is terminated at the back of the transmitter and is left connected to the source at all times to permit the crystal ovens to heat at all times.

In addition to front panel switching of crystals controls are provided for making minor frequency adjustments on the oscillator and tuning the second buffer plate circuit, individual switches for application of plate power to the oscillator and buffer stages and pilot lights to show heating cycles of the crystals and power application. Three inch meters indicate oscillator plate current, second buffer grid current and second

buffer plate current. The temperature of the crystals can be easily read on the thermometers viewed through apertures on the front panel.

Particular attention has been given to maintenance of the 25-A. All terminations, including "take off" for a frequency monitor are on terminals in the rear and may be easily reached from the back of the transmitter. To make removal of the entire 25-A easy the chassis is mounted on slides and is held firmly in place by four screws in the front panel.

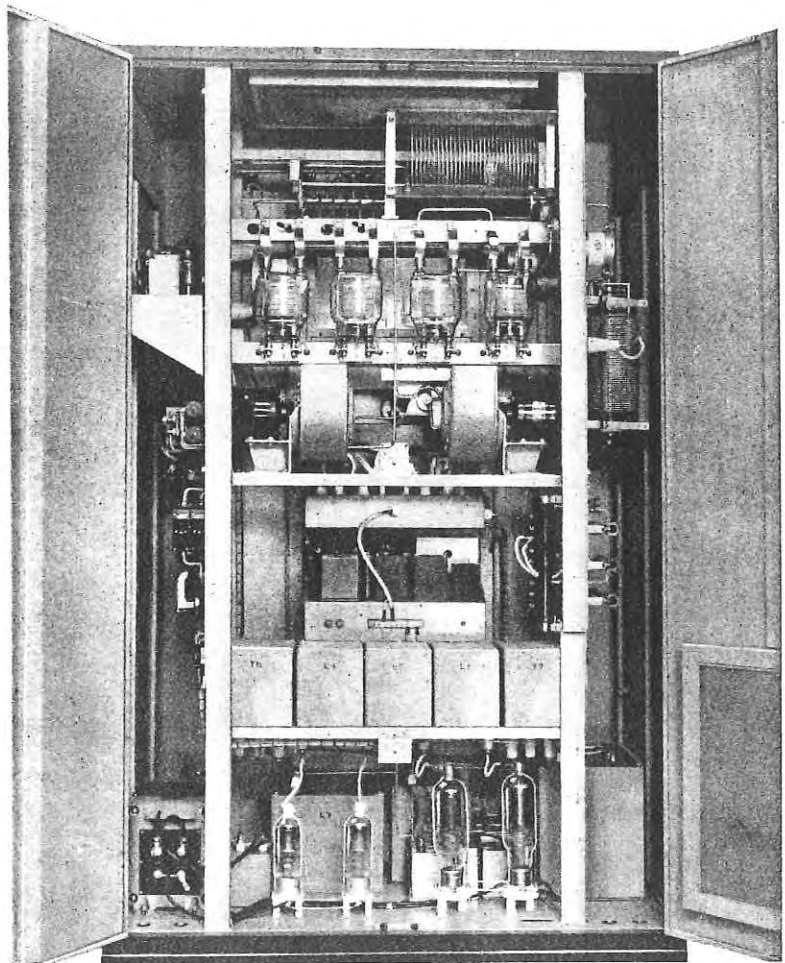

The entire rear of the transmitter opens up so that maintenance and inspection is easy.

GATES RADIO COMPANY
MANUFACTURERS, ENGINEERS, SINCE 1922
QUINCY, ILLINOIS, U.S.A.

GATES TRANSMITTING EQUIPMENT ALL OVER THE WORLD

CONTROL SECTION

This portion of the circuit is incorporated on a single panel on the right side of the transmitter. The control circuits consist of the power application relays for high voltage and filament voltage and overload and timing relays. The incoming AC power line fuses and main power switch of the thermal overload type are also located on this panel. Manual control of the plate voltage and filament voltage for the final R.F. amplifier is accomplished by two rheostats which are operated by knobs on the left side on the front of the BC-1E transmitter. Push button stations on the right side operate the filament start relay which also applies bias voltages. Push button stations on the left side on the front of the cabinet operate the high voltage relay. Directly adjacent are controls for tuning the final amplifier.

At the top of the control section is the bias supply which provides a fixed negative voltage for the modulator grids. This consists of a power transformer, dual selenium rectifiers and filter. The use of selenium rectifiers assures an efficient and well regulated bias supply with the inherent long life obtainable from selenium units. Balancing the bias voltages is easily done by means of two potentiometers located just inside the front door. Bias may be adjusted while full power is applied.

AUDIO SECTION

Directly above the control section is a chassis containing the first audio amplifier and the driver stages. Two type 6B4G tubes are used in the first stage and two 845's in the driver. All low voltage terminations are brought out on a sturdy barrier type phenolic terminal strip. Three ceramic insulated posts accommodate the high voltage connections.

The 833A modulator tubes are near the top of the transmitter in line with the R.F. power amplifier tubes. Associated components are located on the bottom of the cabinet.

R.F. OUTPUT COUPLING

The R.F. power amplifier of the BC-1E radio transmitter is connected single ended and couples to the transmission line or antenna through a combination harmonic filter and im-

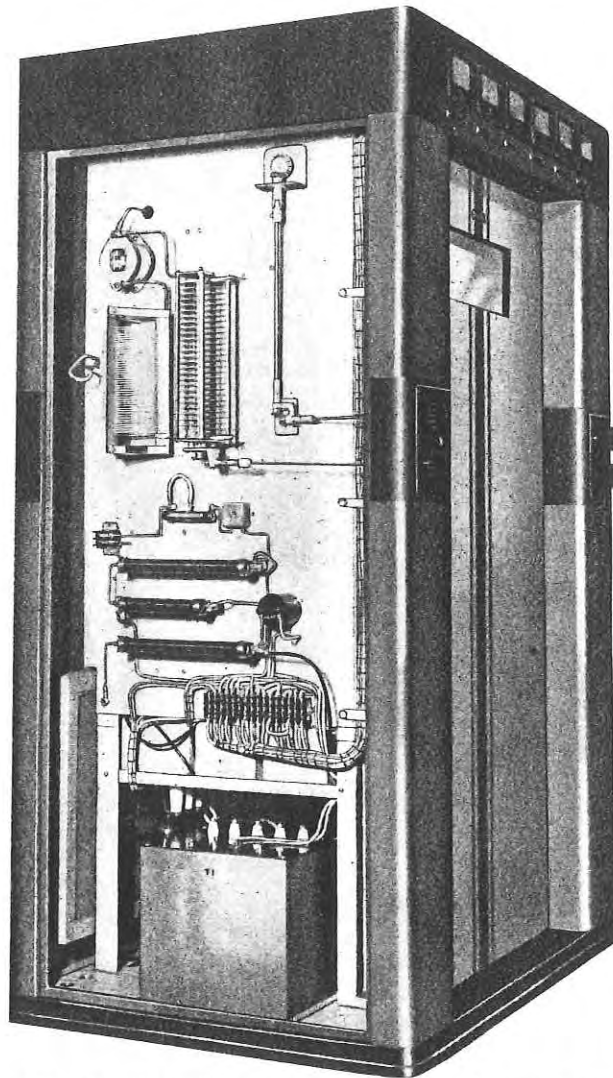

This view shows the output coupling section, large resistors and main power transformer. Notice the intake air filters at the lower left. If desired coaxial line may be brought up thru the bottom of the cabinet for convenient termination to the R. F. output.

GATES TRANSMITTING EQUIPMENT ALL OVER THE WORLD

pedance matching section. The capacity tuning in the power amplifier forms a radio frequency potentiometer, thereby adjusting by selection of components the impedance match between the modulated plate circuit and the load. The coupling adjustment consists of an L section circuit of parallel capacitance and series inductance. The loading inductance may be tapped at any point along its length and in conjunction with adjustments of the variable capacitor may be arranged to match a wide range of line impedances. The variable loading capacity is

adjusted by a knob on the left side of the front of the cabinet. Directly above is the final plate tuning knob. Positive action gear reduction and shaft assemblies assure quick easy adjustments in both the final plate tuning and loading operations.

Below the loading components are found the high voltage bleeder and bias resistors, meter multiplier and audio monitoring circuits. This latter circuit is a capacitor resistor arrangement connected to give true monitoring of carrier output.

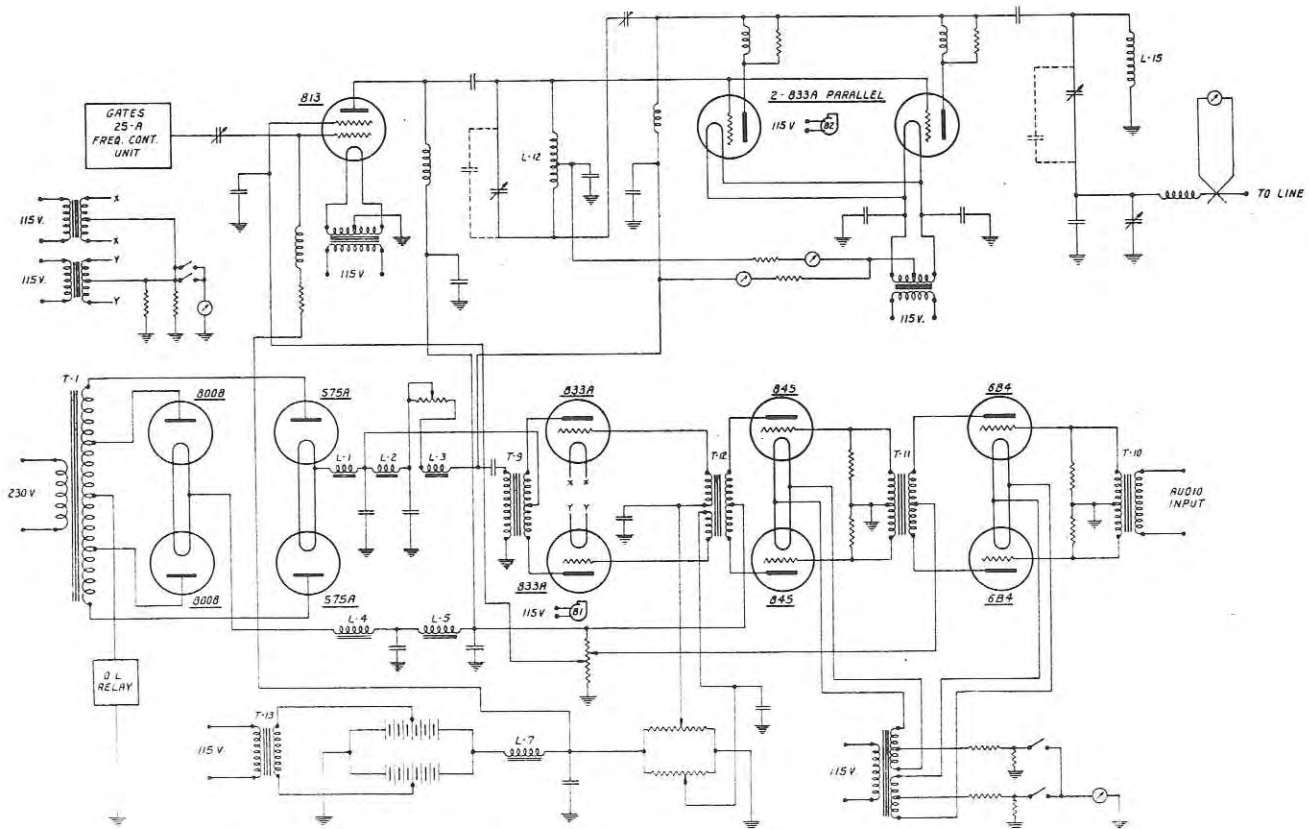

This simplified schematic of the BC-1E transmitter shows the fundamental electrical arrangement.

GATES RADIO COMPANY
 MANUFACTURERS, ENGINEERS, SINCE 1922
 QUINCY, ILLINOIS, U.S.A.

TRANSMITTING EQUIPMENT



METERING

The meter complement for the BC-1E transmitter is complete in every way. Along the top of the cabinet are located large four inch meters for indicating R.F. line current, power amplifier grid current, power amplifier plate current, modulator plate current, power amplifier plate voltage and filament voltage for the modulator and power amplifier filaments.

Just inside the front door is found a panel containing a single meter and four switches. Two of these switches are used to connect the modulator plate current meter so that it will indicate the plate current of either or both modulator tubes. The other two connect the small meter on this panel to indicate plate current in either the first audio or driver stages. The functions of the meters found on the radio frequency driver and frequency control panels are described in the sections concerning these panels.

Metering is available for indicating plate current in every stage and grid current for the radio frequency driver and final stages.

NEUTRALIZING

The final R.F. amplifier is the only stage requiring neutralization. This adjustment is made by a screwdriver slot adjustment located next to the meter used for indicating plate current in the audio stages.

POWER CHANGING

Provision may be made for operating the BC-1E transmitter at 500 or 250 watts output by means of a series of voltage dropping resistors for the final R.F. amplifier plate voltage and an attenuator circuit to reduce the audio input to the proper level. A switch located on the front panel inside the door actuates a relay that makes the proper connections.

ACCESSORY EQUIPMENT

The normal meter complement includes an RF line current meter on the left end of the row of large meters at the top. This meter is of the external thermocouple type. If desirable a remote reading antenna current meter may be installed in place of the line current meter. It may be of the external thermocouple type or the remote diode rectifier type. The MO-2765-A diode rectifier remote antenna current meter consists of a meter having a one milliampere movement with a scale calibrated in R.F. amperes and a small unit containing a current transformer and rectifier. The rectifier and current transformer unit are generally located inside the antenna tuning unit at the antenna. Negligible power is required by the current transformer to operate this device.

A complete line of antenna tuning units are available for use with the BC-1E transmitters. Detailed information on them will be found in catalog sheets devoted to the subject. The MO-2786-A series of antenna tuning units incorporate the MO-2765-A diode type remote antenna current meter and also two or three coil lighting chokes.

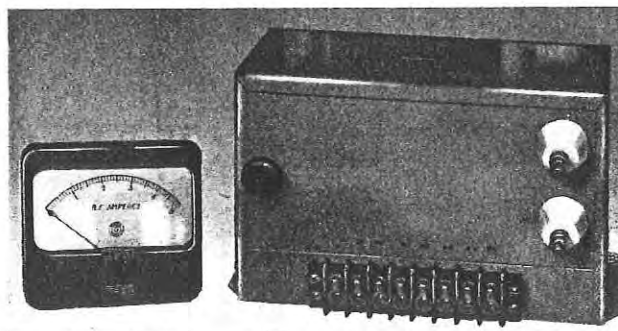

Remote antenna current diode unit, MO-2765-A. The meter provided matches those along the top of the BC-1E transmitter.

GATES RADIO COMPANY
MANUFACTURERS, ENGINEERS, SINCE 1922
QUINCY, ILLINOIS, U.S.A.



TRANSMITTING EQUIPMENT

SPECIFICATIONS

POWER OUTPUT—1000 watts. May be operated as 1000/500 watt, 1000/250 watt, 500/250 watt, or as a 500 watt transmitter. Power reduction may be incorporated to suit requirements.

FREQUENCY RANGE—Any frequency from 530 to 1600 KC. (To be specified by customer.)

FREQUENCY STABILITY—Plus or minus 10 cycles maximum.

POWER INPUT—Average program modulation, 1000 watts output, approximately 5.6 KW; 500 watts output, approximately 4.0 KW.

POWER SUPPLY—230 volts, 50/60 cycles, single phase. Variation not to exceed plus or minus 10%.

TYPE OF MODULATION—High level Class "B".

A.F. INPUT LEVEL—For 100% modulation, plus 6 vu.; at average program level plus 3 vu.

FREQUENCY RESPONSE—Within 1½ db. from 30 to 10,000 cycles.

DISTORTION—Approximately 3% from 50 to 7500 cycles. 0-95% mod.

NOISE LEVEL—60 db. below 100% modulation unweighted.

R.F. HARMONICS—Less than .03%.

TUBE COMPLEMENT—

1—802 Oscillator	} In 25-A Frequency Control Unit
1—45 Buffer	
1—802 I.P.A.	
1—813 I.P.A.	
2—833-A Power Amplifiers	
2—6B4-G Speech Amplifiers	
2—845 Audio Drivers	
2—833-A Modulators	
2—575-A Rectifiers	
2—8008 Rectifiers	
1—5Z3 Rectifier	

SALES OFFICES

123 Hampshire	40 Exchange Place
Quincy, Illinois	New York 5, N. Y.

Distributors are conveniently located
in other sections of the United States



GATES RADIO COMPANY
MANUFACTURERS, ENGINEERS, SINCE 1922
QUINCY, ILLINOIS, U.S.A.