

**BROADCAST AND
COMMUNICATIONS
EQUIPMENT**



INTRODUCTION

Gates proudly presents one of the most comprehensive selections of broadcast equipment ever assembled in one catalog. Here you will find a complete range of AM, FM and short wave broadcast transmitters, together with the world's most extensive line of audio control consoles and studio equipment. Many models of commercial communications equipment for single-sideband transmission will also be found in a section devoted exclusively to HF communications transmitters.

Gates broadcast products are noted for their quality of craftsmanship and excellence of engineering design. Our goal has always been to set the standards for others to meet—and in recent years this determination has led to the pioneering of such outstanding products as: the first FCC type accepted 100% solid state FM exciter; a complete line of FM monitors using integrated circuits and the first 50 kW AM transmitter with Vapor Phase Cooling manufactured in the United States. You will find these, and many more Gates "firsts", listed on the following pages.

Field sales and service is extensive. Branch offices are located in New York, Washington, Houston, and Los Angeles. Direct Gates employee sales engineers cover all of the continental United States. The Houston Service Center, carrying a large inventory of equipment and service parts, serves the entire south and southwest. In Canada, sales are handled by Gates Radio Company, (Canada), a division of Harris-Intertype Limited (Canada). Overseas, local agents are in most countries of the world, with most international marketing co-ordinated by Rocke International Corporation at 13 E. 40th Street, New York City.

In 1966, Automatic Tape Control (ATC), a pioneer in tape cartridge equipment and broadcast automation systems, became a division of Gates, rounding out our complete line of quality broadcast equipment.

Gates is a division of Harris-Intertype Corporation, a world leader in graphic arts and electronics, and one of the nation's 500 largest corporations, as listed by Fortune Magazine. The corporation's electronic divisions, in addition to Gates, include Radiation, Incorporated, a leader in digital communications systems and microelectronics, and PRD Electronics, Incorporated, producer of microwave instruments and electronic checkout systems. A new dimension has been added to Gates' research and development effort by the establishment of a corporate product development center at Melbourne, Florida. This facility will enable Gates to draw from the staff of approximately one thousand scientists and engineers at Radiation, Inc., as well as from the large engineering group at Quincy, to assure our customers that Gates' broadcasting and communications equipment is synonymous with product leadership.

If your need is in radio broadcasting or HF communications, we wholeheartedly invite your patronage. Each member of the Gates organization will do his very best to justify your confidence.

GATES RADIO COMPANY

A division of Harris-Intertype Corporation
QUINCY, ILLINOIS 62301

Our Modern Manufacturing Facilities



Situated on an attractive 40-acre plot in Quincy, Illinois, the new Gates factory has a total floor space of 108,000 square feet—and is one of the nation's most modern facilities devoted to the manufacturing of broadcast and electronics equipment.

100,000 Watt Medium Wave Broadcast Transmitter—VP-100

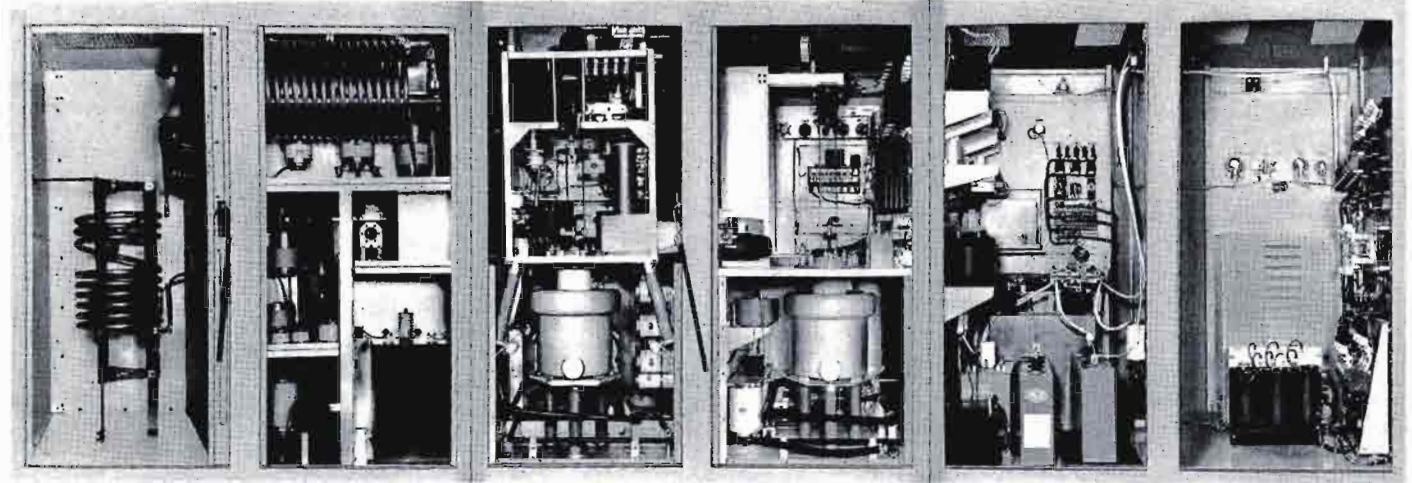

RF Output Cabinet.

Power Amplifier and Modulator Cabinet.

AC Control Cabinet.

Rear View of VP-100 with doors removed.

RF SECTION: The RF chain is conventional, using a transistorized oscillator, buffer, emitter follower, and a 4CX1500B tetrode tube amplifier to drive a single 4CV100,000C tetrode Class C power output stage. An automatic drive control limits the PA screen current to 2.2 amps, eliminating the usual problem of over dissipating the screen of a tetrode during tune-up. A convenient efficiency meter peaks as the efficiency of the transmitter increases, to allow rapid tuning. No "trial-and-error" tune-up methods are necessary.

THE MODULATION SYSTEM: This advanced system is characterized by low plate dissipation and low tube peak currents; peak cathode currents are about one-half that of other 100 kW transmitters. Average plate dissipation runs substantially below rated levels, and all peak voltages are main-

tained well below component ratings. Wide frequency response is possible as large reactive components are not used in the system. Control of the transmitter power output over a wide range is by means of a front panel vernier control. No adjustment is necessary in any high power RF circuits, including the loading coil.

PROTECTIVE CIRCUITS: All major components of the VP-100 are protected by circuit breakers. Tubes and transistors are protected by overload relays or current-limiting devices. A quick-acting series "crowbar" circuit protects against damage from high voltage arcs by limiting the energy in such arcs to less than 10 watt seconds. Protection against voltage standing wave ratios of greater than 1.2 to 1.0 is provided . . . both forward and reflected power is metered at the front panel. In case of momentary RF overloads the VP-100 will recycle twice automatically. Should a third overload occur within a thirty second period, the transmitter will remain off until manually reset. However, if the time between overloads is greater than thirty seconds, continuous recycling will occur.

TRAPEZOIDAL RESPONSE: Trapezoidal modulation may be used to gain additional power on the air without increasing transmitted carrier power. To do this the audio input wave (A), at left, is flattened at the top, by clipping, then reamplified to form a trapezoidal wave (B). The shaded areas in the diagram indicate the power gain. All the additional power gained by clipping the audio input is delivered at the output of the transmitter, thus increasing volume at the receiver.

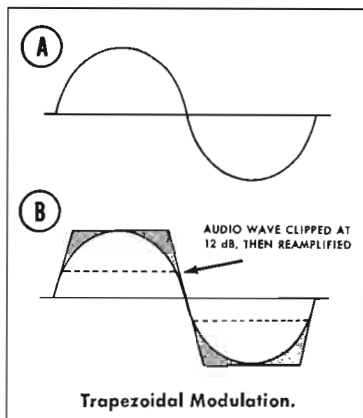

100,000 Watt Medium Wave Broadcast Transmitter—VP-100

DUAL OSCILLATOR AND MODULATOR: Gates has provided redundancy in all transistor sections to relieve any concern over solid state circuitry in high-power transmitters. Although the reliability of transistor circuitry has been proven in transmitters now operating under extreme conditions, this duplication is your double assurance of dependability.

DESIGNED FOR A WIDE RANGE OF CLIMATES: The VP-100 will give top performance in a wide range of climates—from hot and humid, to dry and dusty. With Vapor Phase Cooling, ducting outside air into the transmitter is not necessary. All transformers and similar components are hermetically sealed, encased, or vacuum impregnated. All high power radio frequency networks contain silver-plated inductors and vacuum capacitors.

TRANSMITTER LAYOUT: The standard VP-100 consists of three cabinets, a heat exchanger designed for mounting on top of the cabinets, and an external high voltage power transformer. Front and rear doors, and meter panel are magnetically latched. External connections to the transmitter are made through the top of the units so that floor ducts are not necessary.

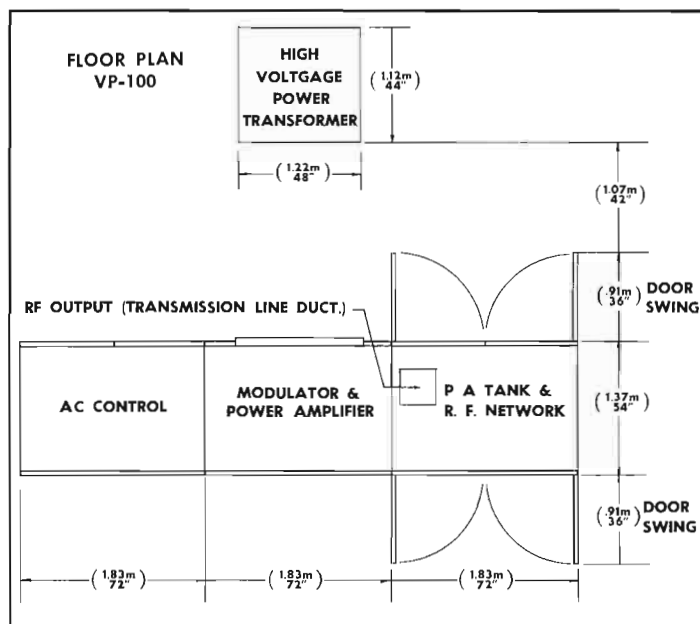

SPECIFICATIONS

POWER OUTPUT: 100,000 watts nominal unmodulated; capable 110,000 watts.

RF FREQUENCY RANGE: 535 kHz to 1620 kHz.

RF OUTPUT IMPEDANCE: 230 ohms, unbalanced. Other output impedances available as specified.

FREQUENCY STABILITY: ± 10 Hz of assigned frequency.

CARRIER SHIFT: Less than 4% at 100% modulation.

MODULATION: High level.

TRAPEZOIDAL MODULATION: Less than 5% tilt or overshoot 100 Hz to 2,000 Hz.

MODULATION LEVEL: 100% sinusoidal, continuously, over an audio frequency range of 50-5000 Hz.

RF HARMONICS: -80 dB below fundamental (well within CCIR requirements).

AUDIO FREQUENCY RESPONSE: ± 1.5 dB from 20 to 12,000 Hz, referenced to 1,000 Hz at 95% modulation.

AUDIO FREQUENCY DISTORTION: Less than 3% from 100 to 7500 Hz; 4% from 50 to 10,000 Hz at 95% modulation.

NOISE: -55 dB below 1000 Hz, 100% modulated level.

AUDIO INPUT IMPEDANCE: 600/150 ohms, balanced or unbalanced.

AUDIO INPUT LEVEL: +10 dBm ± 2 dB at 1000 Hz for 100% modulation.

POWER CONSUMPTION: 155 kW—No Modulation.

160 kW—30% Modulation.

215 kW—100% Modulation.

POWER INPUT: Any specified voltage 380 V to 480 V, $\pm 5\%$, 3 phase, 50 or 60 Hz as ordered.

POWER FACTOR: 95%.

VOLTAGE REGULATOR: Built-in electronic voltage regulator for all power supplies other than high voltage.

CROWBAR RESPONSE: Less than 5 microsecond operate time.

OVER-ALL EFFICIENCY: 65% @ average modulation.

ALTITUDE: Up to 1829 meters (6000 feet) above sea level (higher on special order).

TEMPERATURE RANGE: Ambient air temperature from -20°C to $+50^{\circ}\text{C}$ (with Dowanol* in water system).

STORAGE TEMPERATURE: -35°C to $+60^{\circ}\text{C}$.

HUMIDITY: Up to 95% maximum within the above temperature range.

SIZE: Each of the three cabinets measures 1.83 meters (6 feet) wide, 1.37 meters (4.5 feet) deep, and 1.98 meters (6.5 feet) high. The heat exchanger adds another 1.21 meters (4 feet) in height. The HV transformer measures 1.21 x 1.12 x 1.52 meters (48" x 44" x 60").

WEIGHT: Export packed 8165 kilograms (18,000 lbs.). Main transmitter assembly 5443 kg (12,000 lbs.). Power transformers 2268 kg (5000 lbs.). Heat exchanger 454 kg (1000 lbs.).

CUBAGE: Export packed 39.6 cubic meters (1400 cubic feet). Main transmitter assembly 31.6 cu. meters (1,115 cu. ft.). Power transformer 3.8 cu. meters (135 cu. ft.). Heat exchanger 4.2 cu. meters (150 cu. ft.).

FINISH: Two-tone beige-gray.

TUBES: Two, 4CV100,000C; two, 4CX1500B; one, WL-22801 (damper diode).

ORDERING INFORMATION

Model VP-100 with one set of tubes and two crystals.....994-6561

100% set spare tubes for VP-100 transmitter.....990-0566

Recommended minimum spare tubes for VP-100 transmitter.....990-0567

* Trademark of Dow Chemical Company.



50,000 Watt Medium Wave Broadcast Transmitter

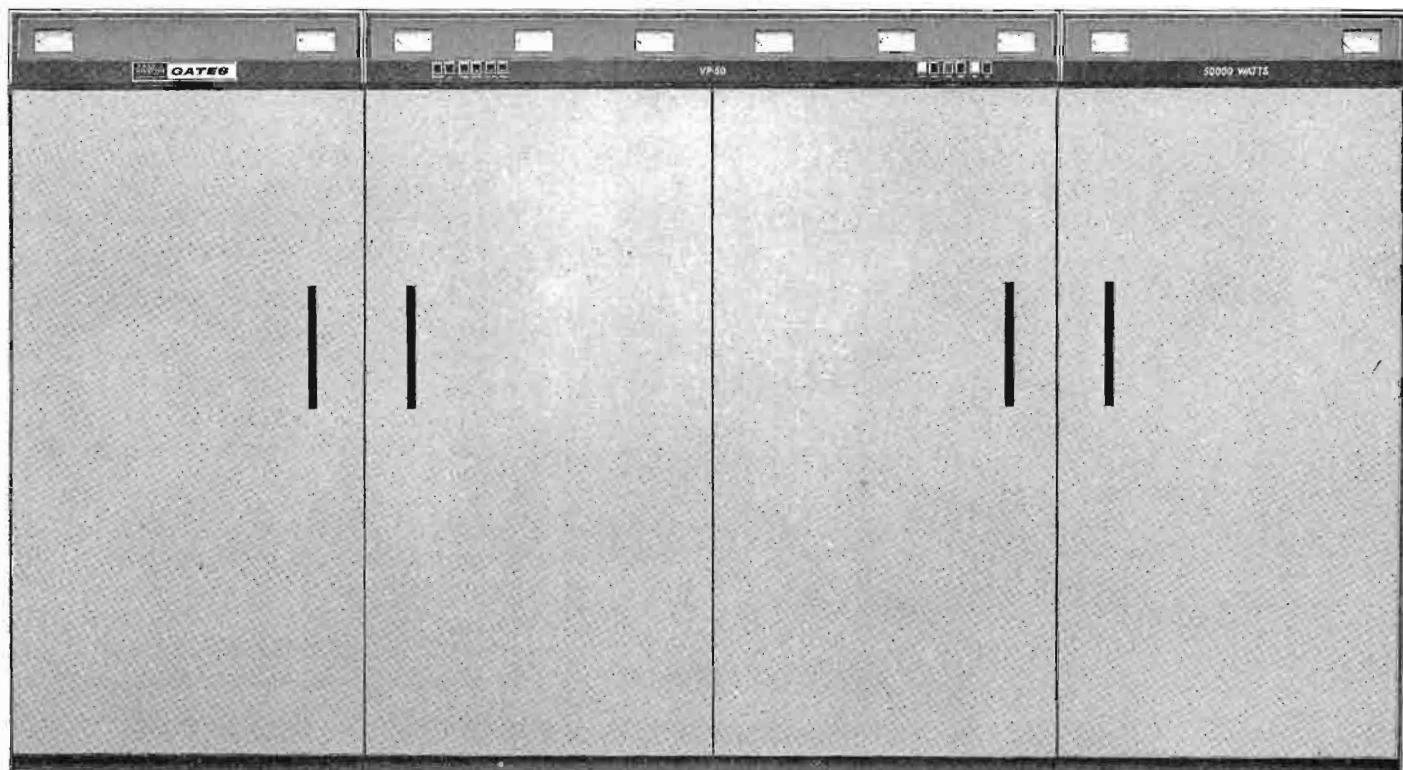

MODEL VP-50

Inside and out, the VP-50 is the first really new 50,000 watt AM transmitter produced in the last decade. Advanced engineering in the cooling system design has produced the coolest, quietest, and most efficient 50 kW broadcast transmitter ever manufactured.

OPERATING ECONOMY: Vapor cooling of the single triode PA tube and the two triode modulator tubes produces a high level plate modulated transmitter with a power consumption of only 85 kW at 0% modulation. Tube costs are the lowest of any 50 kW transmitter, yet the constant temperature maintained by the cooling system helps to extend tube life. All transmitter components are operated well below manufacturers' ratings for longer, more dependable operation.

WHISPER QUIET OPERATION: With the vapor cooling method employed in the VP-50, large blowers, and associated noise, are eliminated. As a result, the VP-50 is the quietest 50 kW transmitter on the market today.

INSTALLATION FLEXIBILITY: The VP-50 is compact in size—designed to fit most existing buildings or to permit construction of low-cost new buildings. It can be installed without complex under-floor wiring ducts, as all high voltage lines are run into the top of the cabinets.

SOLID STATE POWER SUPPLIES: Silicon rectifiers are used throughout the VP-50. The result is greatly improved performance, as silicon cells are particularly resistant to aging, moisture, and extreme temperature variations.

DUAL SOLID STATE EXCITER: Both the oscillator and intermediate RF amplifier are all transistor. In addition, the exciter has a duplicate oscillator and intermediate amplifier for highest reliability. If one unit should fail to operate, the back-up exciter can be switched into service immediately.

POWER AMPLIFIER: A single 4CX3000A IPA tube drives the conservatively rated 7480 triode PA tube to produce a full 50 kW power output.

HIGH LEVEL PLATE MODULATION: The VP-50 uses two 3CV30,000H3 triodes operating Class B to modulate the single 7480 triode final RF amplifier. A conventional three stage audio amplifier is used to drive the modulator tubes. High level plate modulation has the advantage of simplicity, since final amplifier tuning is simplified. Unlike other techniques, high level modulation is not affected by changes in the final RF amplifier loading.

50,000 Watt Medium Wave Broadcast Transmitter—VP-50

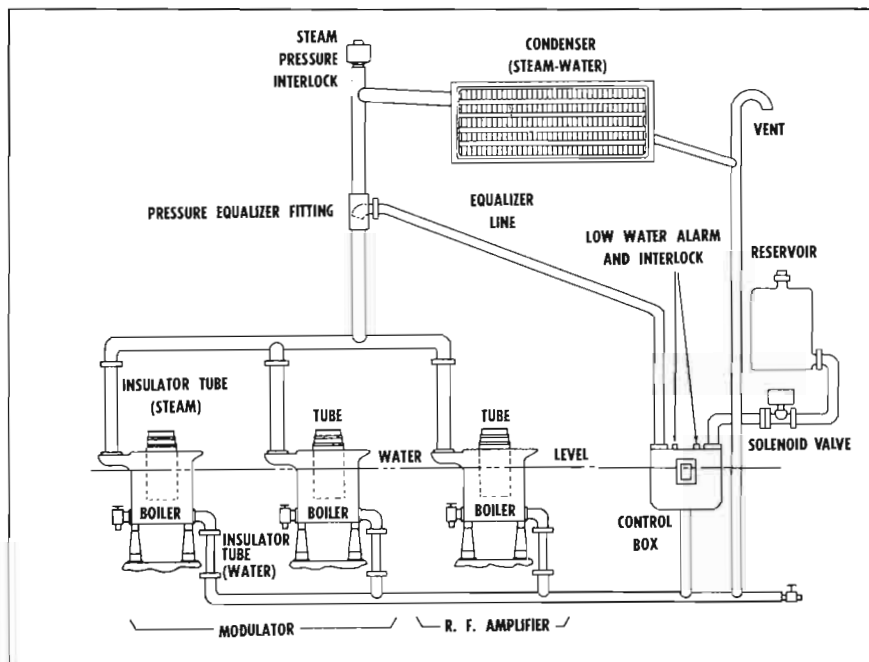

Vapor Phase Cooling.

VAPOR PHASE COOLING:

Cooling by vapor takes advantage of the latent heat of vaporization of water. Raising the temperature of one pound of water 1°F requires one BTU; however, changing a single pound of water at 212°F to steam vapor takes 970 BTU's. Thus, vapor cooling will remove nearly twenty times as much energy as a circulating water system.

As power is applied to the tube anode, dissipation heats the water to 212°F. Further heating causes the water to boil and change to steam. This vapor is passed through a heat exchanger, where it is converted to liquid. Water is returned to the boiler reservoir for re-use.

Water losses are compensated for by the reserve tank, which will replenish the boiler if the water level drops one-quarter inch. Tube anodes have a constant supply of water with fail-safe protection. The vapor system operates near atmospheric pressure and is fully vented.

In the Gates VP-50 transmitter water pumps are not required, as normal vapor pressure will move the steam from the boiler to the heat exchanger, and return water is gravity fed back to the boilers.



Easy to handle PA tube.

PROTECTIVE DEVICES: DC overload relays are provided, as well as AC overload relays, which are used in conjunction with the start contactors in the HV power supply. Magnetic breakers protect the bias, screen and intermediate high voltage supplies. In case of RF overload, the output VSWR circuit will automatically turn off the transmitter and recycle up to three times, giving momentary troubles a chance to clear.

OPERATING SIMPLICITY: Automatic sequence control circuits are provided. This assures simple and fool-proof operation, and helps avoid costly errors. With a total of 14 meters, including 10 located on the front of the main transmitter assembly, all vital transmitter circuits can be monitored constantly. The few tuning controls that require adjustment are readily accessible through the front doors.

EASY MAINTENANCE: Full front and rear access to all components makes the VP-50 one of the easiest to maintain high power transmitters ever designed. Ideal for use in all climates, this transmitter greatly reduces the problems of cleaning and filtering of outside air required in forced air systems. The cooling system requires little attention other than maintaining the proper purity and water level in the reservoir tank.

50,000 Watt Medium Wave Broadcast Transmitter-VP-50

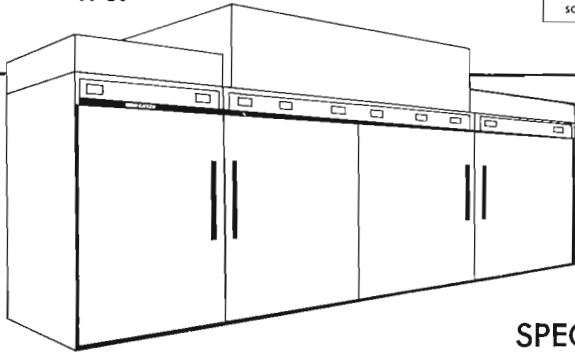
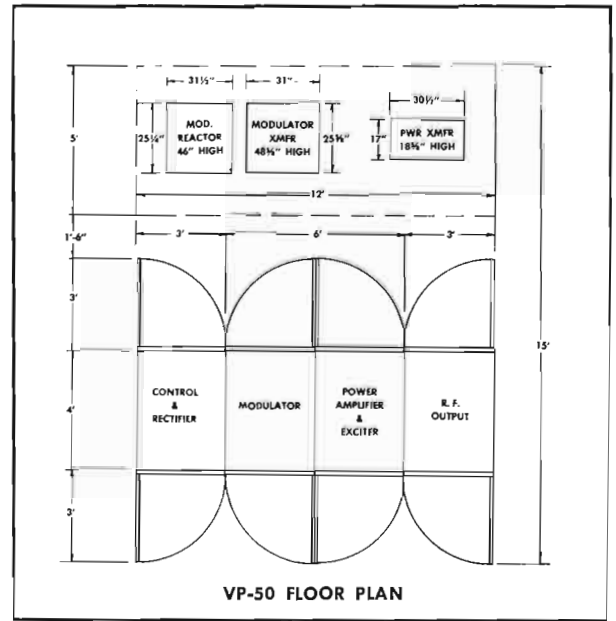
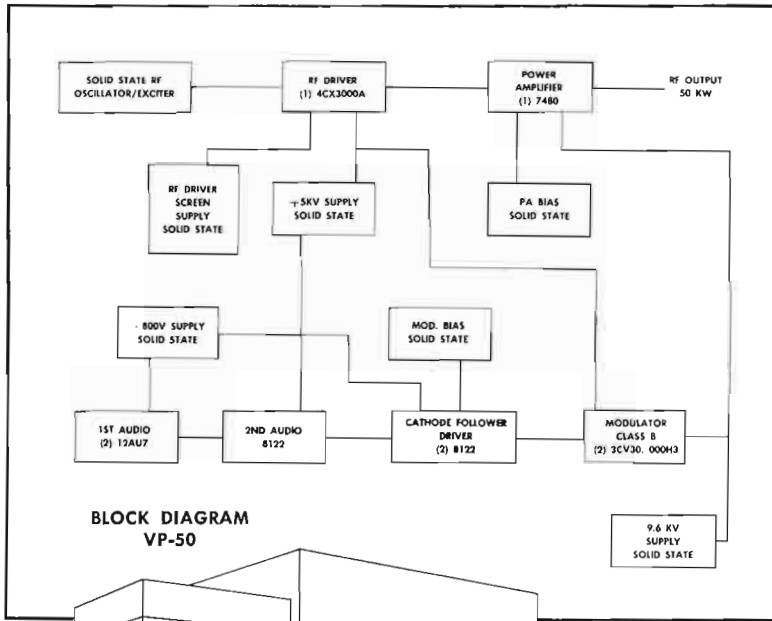

SPECIFICATIONS

POWER OUTPUTS: 50,000 watts (rated), 55,000 watts (capable). Convenient power reduction to 25,000 or 10,000 watts.

RF FREQUENCY RANGE: 535 kHz to 1620 kHz, supplied to frequency as ordered.

RF OUTPUT IMPEDANCE: Any impedances from 50 to 300 ohms.

FREQUENCY STABILITY: ± 2 Hz.

CARRIER SHIFT: Less than 3% at 100% modulation.

RF HARMONICS: Exceeds FCC and CCIR specifications.

AUDIO FREQUENCY RESPONSE: ± 1 dB, 50 to 7500 Hz $\pm 1\frac{1}{2}$ dB, 30 to 12,000 Hz.

AUDIO FREQUENCY DISTORTION: Less than 3%, 50 to 7500 Hz at 95% modulation.

NOISE: (Unweighted) -60 dB or better below 100% modulation.

AUDIO INPUT: 600/150 ohms at +10 dBm ± 2 dB for 100% modulation.

POWER CONSUMPTION:	50 kW Output	25 kW Output
0% modulation	85 kW	48 kW
30% modulation	95 kW	53 kW
100% modulation	125 kW	69 kW

POWER INPUT: 380 V, or 460 V, 3 phase, 50 or 60 Hz as ordered.

POWER FACTOR: 90% or better.

ALTITUDE: To 6,000 feet standard (higher on special order).

TEMPERATURE RANGE: -20°C to $+50^{\circ}\text{C}$ (with Dowanol* in water system).
*Trademark Dow Chemical Co. (Used only where temperatures go below 0°C .)

HUMIDITY: 95%.

SIZE: 78" high, 144" wide, 48" deep (transmitter cabinet). External components include: Modulation transformer, modulation reactor, and power transformer. Heat exchanger mounted on top of VP-50 adds 48" to overall height.

WEIGHT: 12,000 lbs. unpacked (approximate).
14,250 lbs. domestic packed (approximate).
15,500 lbs. export packed (approximate).

CUBAGE: 1003.5 cu. ft.

FINISH: Beige-gray.

TUBES USED: (1) 7480; (2) 3CV3000H3; 4CX3000A; (4) 8122; (3) 12AU7.

ORDERING INFORMATION

Model VP-50 with one set of tubes and two crystals	994-6523
100% set of spare tubes for VP-50 transmitter	990-0537
Recommended minimum spare tubes for VP-50 transmitter	990-0538



10,000 Watt Medium Wave Broadcast Transmitter

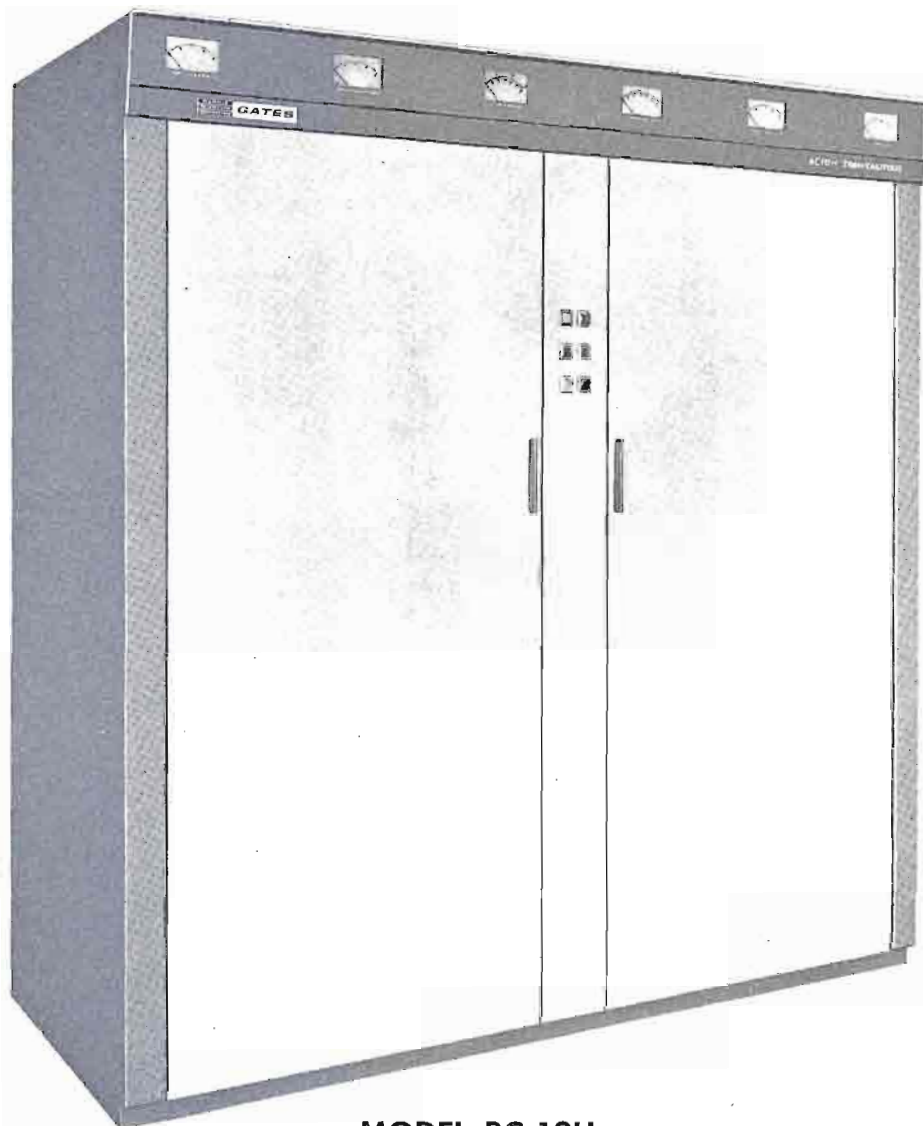

MODEL BC-10H

The most outstanding 10,000 watt AM transmitter on the market today, the BC-10H has gained wide acceptance and approval from broadcasters throughout the country in the two years since its introduction. Excellent on-the-air quality, high reliability, and low operating costs are proven features that have helped to make the BC-10H so popular.

SOLID STATE CIRCUITRY: The BC-10H uses transistors in all circuits except the RF driver, power amplifier and modulator to provide a richer, fuller sound for the listener, and increased reliability for the broadcaster.

LOW TUBE COST: Ceramic type 3CX2500F3 triode tubes are used in the power amplifier and modulators, and a type 4-400A tetrode is used as the RF driver. All tubes are operated well below their maximum ratings for long tube life. This combination provides the lowest cost tube complement of any 10 kW AM broadcast transmitter on the market today.

RF SECTION: Two transistor oscillators are instantly switchable, and oscillator output is amplified to provide the proper signal level for the driver, a 4-400A tetrode, which is modulated to improve the over-all transmitter performance. The 4-400A drives two 3CX2500F3 power amplifiers which are high level plate modulated. These air-cooled power amplifiers have an efficiency as high as 90%, and feed a full Tee network. The RF output capability of the BC-10H, 10,800 watts, easily accommodates complicated multi-tower phasors.

AUDIO SECTION: Four push-pull solid state audio amplifier stages amplify the audio signal from input level to full drive power for the modulator stage. The modulator consists of two 3CX2500F3 triodes, operated Class AB₁. Inverse feedback, and an advanced design low leakage reactance modulation transformer/reactor group, results in signal quality of the highest fidelity. The modulation transformer is oil (Askarel) filled.

10,000 Watt Medium Wave Broadcast Transmitter—BC-10H

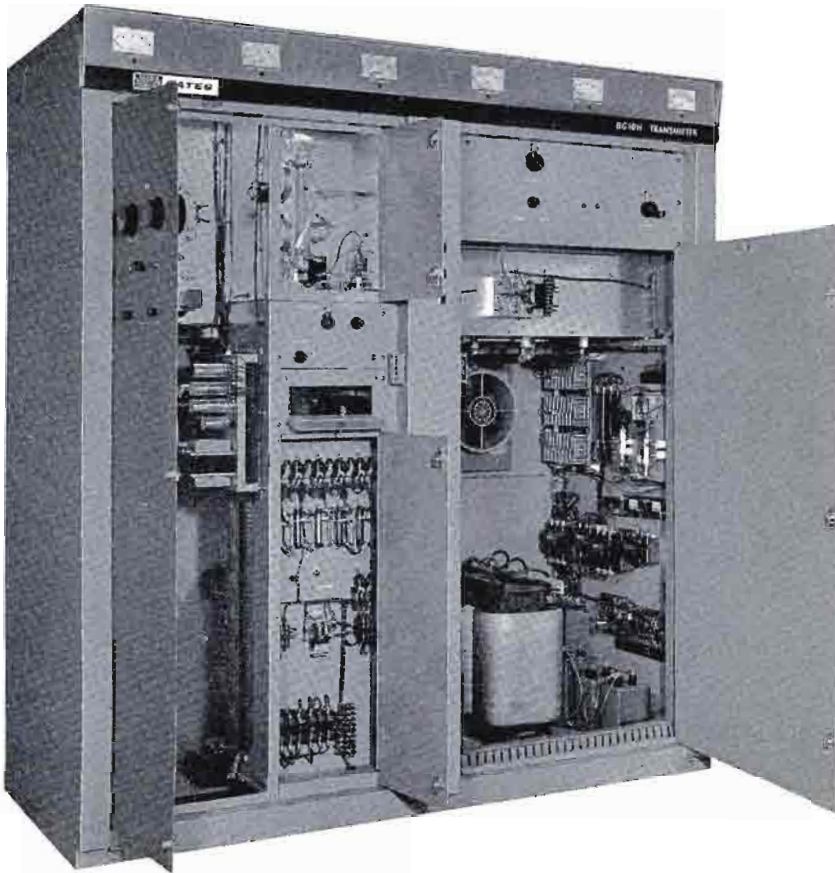

Front view, interior.

antenna coupler. Either of these then becomes a bonus factor in harmonic suppression.

EFFICIENT COOLING: Individual low-speed Rotron blowers in the RF and modulator stages, and a specially designed air exhaust, allow only a limited amount of direct heat to be dissipated into the interior of the BC-10H—for extra-cool operation.

OPERATING ECONOMY: Long tube life, low tube cost, and the highly efficient tank circuit combine to make economy of operation an important feature of the BC-10H.

ACCESSIBILITY: Designed for easy servicing, the transmitter front features 2 full length doors, with operational controls located between the two. Meters which indicate transmitter operating parameters are located across the front of the cabinet, above the doors. All necessary tuning controls are adjustable in full view of these meters. Further access to the transmitter from the front may be gained by releasing the catches on various front access panels. In addition, 4 panels may be removed from the rear of the transmitter for 100% accessibility.

The BC-10H is completely self-contained within one cabinet.

INTERCHANGEABILITY: Added tube life may be achieved from the 3CX2500F3 triodes by interchanging the modulators and the power amplifiers, as the same tube type is used in both stages.

SOLID STATE POWER SUPPLIES: Lifetime silicon rectifiers in all power supplies provide a 2 to 1 voltage and a 5 to 1 current safety factor. This high margin of safety assures trouble-free performance.

CONTROL CIRCUITRY: Careful attention has been given to the design of the control circuitry in the BC-10H. Complete AC and DC overload protection is standard equipment. A recycling feature, which will automatically turn the transmitter off when an overload occurs, is built-in.

HARMONIC RADIATION: A full Tee network and second harmonic trap are assurance that the BC-10H can exceed harmonic reduction regulations within the transmitter itself without relying on the harmonic attenuation of a phasor or

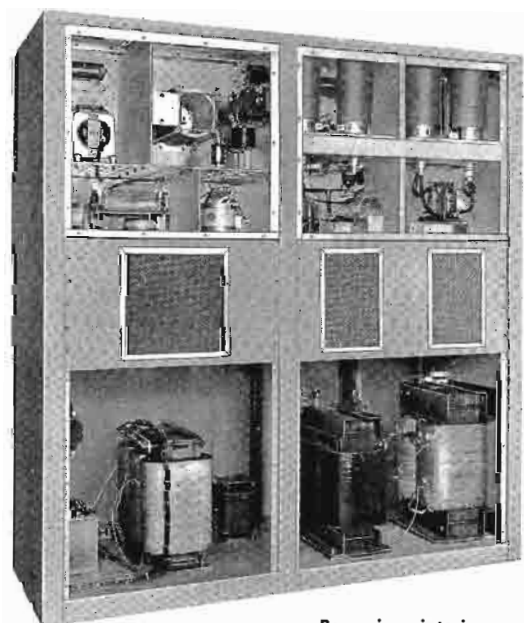

Rear view, interior.

10,000 Watt Medium Wave Broadcast Transmitter—BC-10H

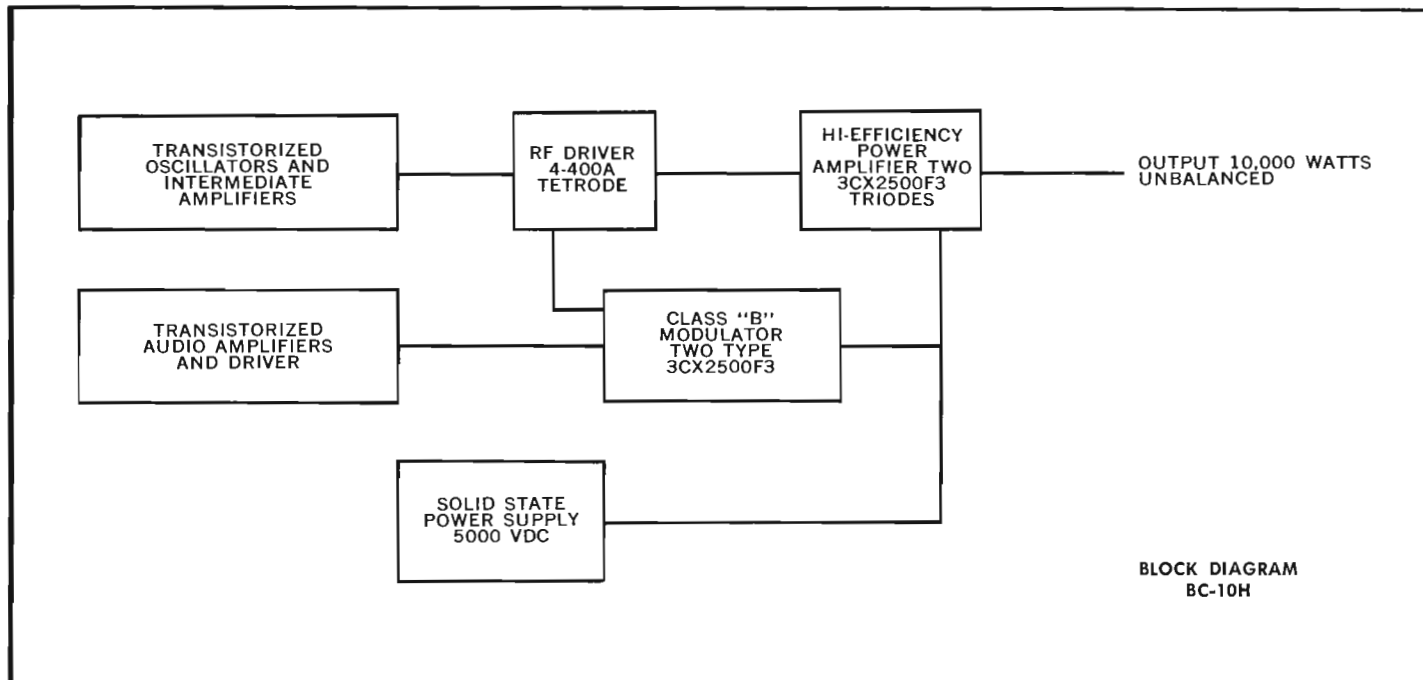

SPECIFICATIONS

POWER OUTPUT: (Rated) 10,000 watts. (Capable) 10,800 watts. Power reduction to approximately 2,500 watts included.

RF FREQUENCY RANGE: 535 kHz to 1620 kHz supplied to one frequency as ordered.

RF OUTPUT IMPEDANCE: Supplied for 50 ohms, or other as specified.

RF FREQUENCY STABILITY: ± 2 Hz.

CARRIER SHIFT: Less than 3% at 100% modulation.

RF HARMONICS: Meets or exceeds FCC specifications.

AUDIO FREQUENCY RESPONSE: ± 1 dB, 50 to 10,000 Hz. $\pm 1\frac{1}{2}$ dB, 30-12,000 Hz.

AUDIO FREQUENCY DISTORTION: 2.5% or less 50 Hz to 10,000 Hz at 95% modulation.

NOISE: (Unweighted) 60 dB or better below 100% modulation.

AUDIO INPUT: 600/150 ohms at +10 dBm, ± 2 dB

POWER INPUT: 208/230 volts, 3 phase, 50 or 60 Hz. 18.5 kW zero modulation. 21.0 kW average modulation. 27.5 kW 100% modulation.

AMBIENT TEMPERATURE RANGE: -20°C to $+50^{\circ}\text{C}$.

ALTITUDE: To 7,500 ft. standard (higher altitudes on special order).

SIZE: 78" high, 72" wide, 32" deep (completely self-contained).

WEIGHT: 2,500 lbs. unpacked (approximate). 3,050 lbs. domestic packed (approximate). 3,250 lbs. export packed (approximate).

CUBAGE: 184 cubic feet packed.

FINISH: Beige-gray.

TUBES USED: (4) 3CX2500F3, (1) 4-400A. Total—5.

GENERAL INFORMATION Monitors: 10 RF volts output at 50/70 ohms for frequency and modulation monitors.

ORDERING INFORMATION

Model BC-10H transmitter with one set of tubes and two crystals.....	994-6522
100% set spare tubes for BC-10H transmitter.....	990-0539
Set of spare transistors for BC-10H (diodes not included).....	990-0540
Kit for remote control of power output.....	994-6548

5000 Watt Medium Wave Broadcast Transmitter

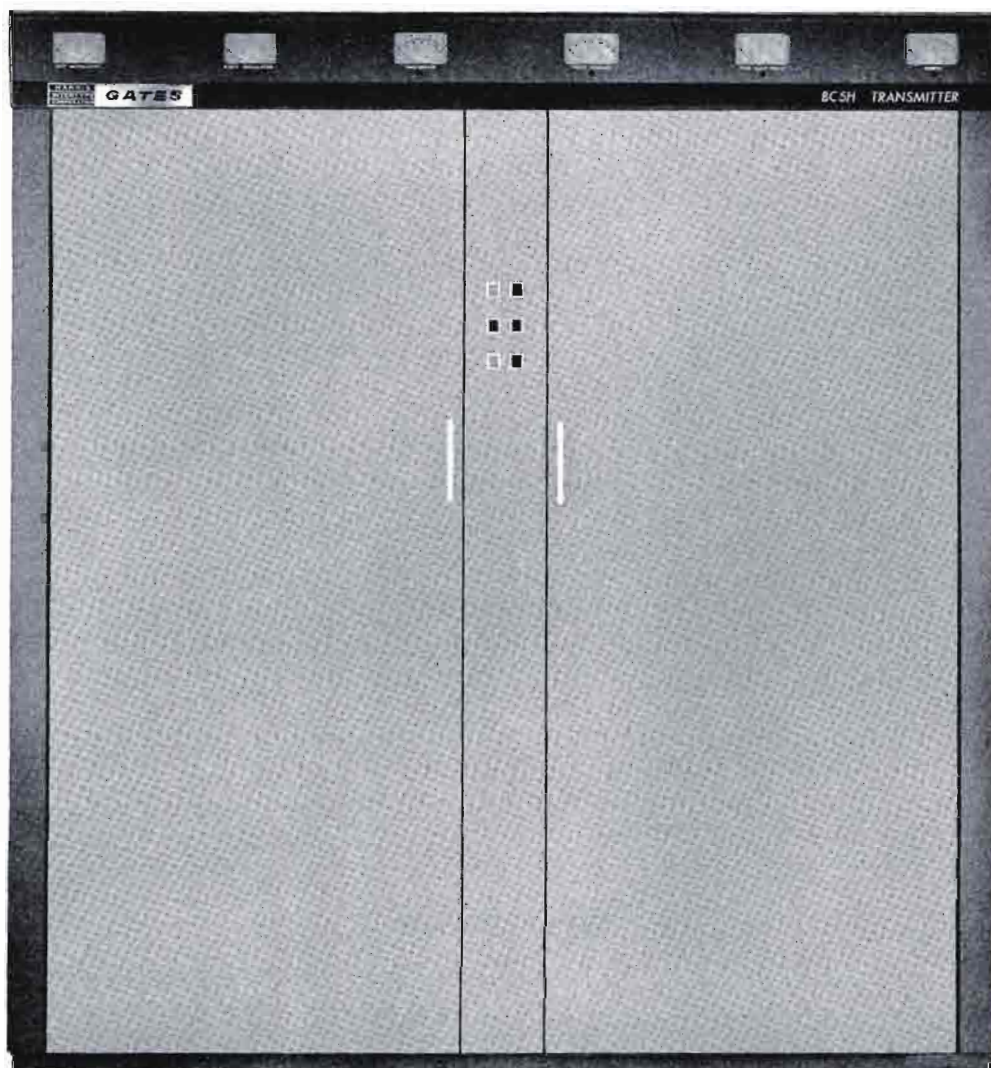

MODEL BC-5H

Representing the finest in engineering design, the BC-5H provides superb over-all performance, with top quality audio, high reliability, and extra low power consumption through the use of high efficiency power amplifier circuits.

The transmitter is completely self-contained, and requires a floor space of only 72 inches (wide) and 32 inches (deep). The over-all height is 78 inches.

Other features that have helped to make the BC-5H the most popular broadcast transmitter in its power range are: large edgewound silver plated tank and Tee network coils; a low leakage reactance modulation transformer for excellent sound quality; a design that permits easy attachment of remote control; unusually high efficiency; and lowest tube cost of any 5000 watt AM transmitter.

TRANSMISSION FIDELITY: Wide frequency response and low carrier shift are important considerations in the design of an AM transmitter. The extremely wide audio response and superior reproduction of audio dynamic range in the BC-5H testify to its advanced engineering development—evident to all who hear this transmitter's excellent broadcast signal.

RF SECTION: In the RF circuit, a transistor oscillator (instantly switchable to a back-up oscillator), drives a transistorized amplifier, which provides drive for the type 4-400A tetrode RF driver. This driver stage is modulated to improve the over-all performance of the transmitter. The 4-400A drives a single 3CX2500F3 power amplifier tube, which is high level plate modulated, and uses high efficiency RF circuits to improve the power amplifier efficiency to 90%. The power amplifier feeds a full Tee network.

5000 Watt Medium Wave Broadcast Transmitter—BC-5H

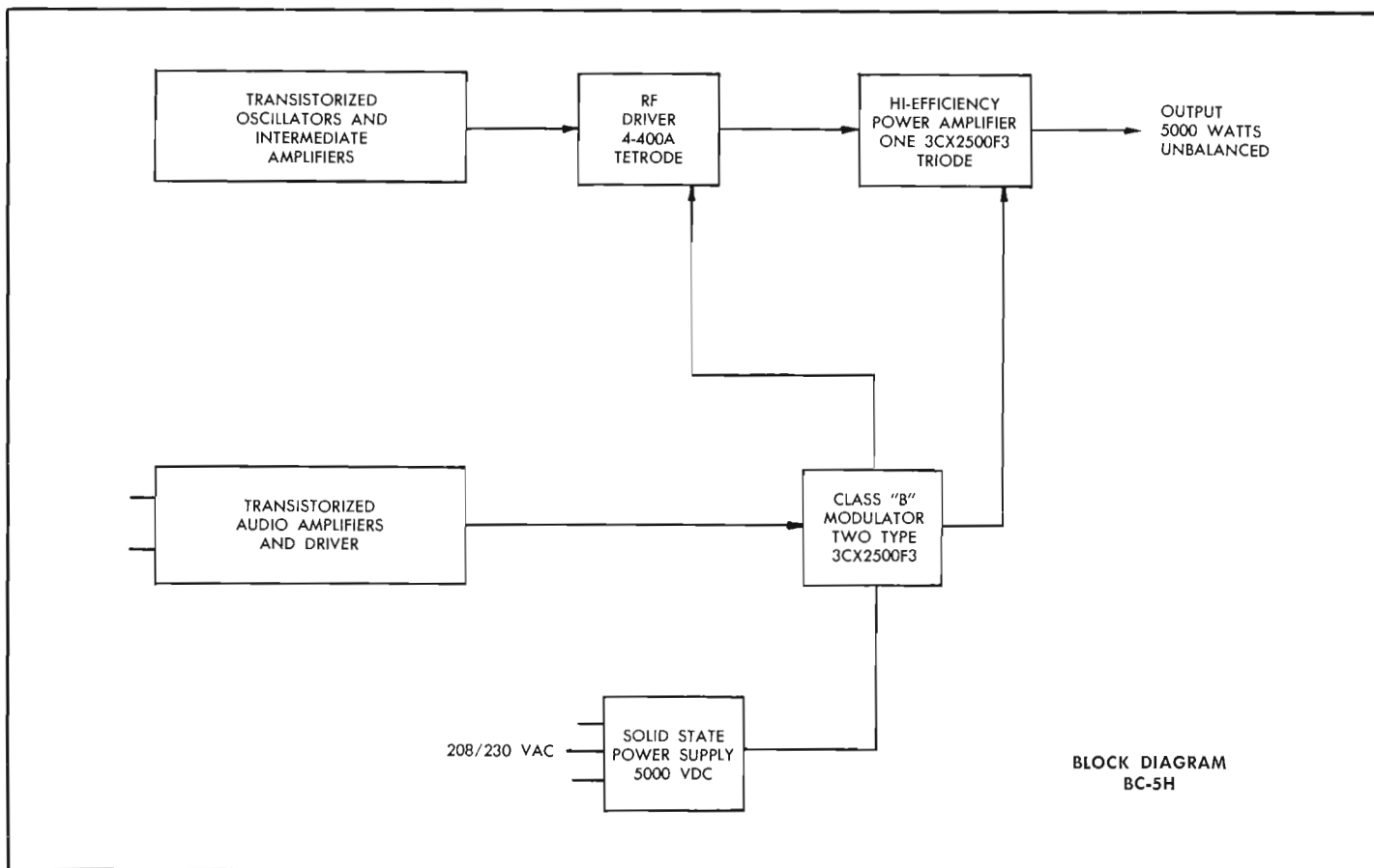

Front view, doors open.

AUDIO SECTION: Four push-pull solid state audio amplifier stages amplify the audio signal from input level to full drive power for the modulator stage. The modulator stage, consisting of two Class B type 3CX2500F3 triodes, provides more than ample power to high level modulate the power amplifier, and modulate the RF driver. Inverse feedback, and an advanced design low leakage reactance modulation transformer/reactor group, results in signal quality of the highest fidelity. The rugged modulation transformer is oil (Askarel) filled for additional protection.

TUBE INTERCHANGE: Both the RF power amplifier and modulator stages use 3CX2500F3 long-life triodes. By periodic rotation many added tube life hours may be gained. Only four tubes of two different types are used in the entire transmitter.

SOLID STATE POWER SUPPLIES: Five separate power supplies assure fine regulation, and add to reliability. Lifetime silicon rectifiers in all power supplies provide a 2 to 1 voltage and a 5 to 1 current safety factor.

HARMONIC ATTENUATION: Harmonic reduction meets rigid FCC regulations, and is achieved through the use of a Tee network in the output circuit, and a second harmonic filter. The harmonic attenuation from the phasor or antenna coupler thus becomes a bonus for still greater harmonic reduction.

5000 Watt Medium Wave Broadcast Transmitter—BC-5H

REMOTE CONTROL: Use of relays in the transmitter control circuits makes installation of remote control simple. Terminals are factory installed in the transmitter, so that circuits to be remote controlled may be easily connected.

PROTECTIVE CIRCUITS: Relays are provided for overload, start/stop and interlock circuits, along with pressure type switches. An output power/VSWR meter is standard equipment, and is interlocked in the transmitter control circuitry as a protective device against antenna system malfunction.

RECYCLING: In the event of a direct short in the high voltage supply, the transmitter will recycle three times and then shut down. In the event of flashover, due to an electrical storm, the transmitter will momentarily shut down and then return to the air with no mechanical limit on the number of times recycling may occur.

EFFICIENT COOLING: One low speed Rotron blower cools all tubes, and a special air exhaust vents heat directly to the transmitter exterior to prevent heat circulation within the transmitter cabinet.

ACCESSIBILITY: The BC-5H is 100% accessible, with full length front doors, drop down front panels and removable rear panels. The transmitter control panel is located between the two front doors, and necessary tuning controls are adjustable from the front, in full view of meters which indicate operating parameters.

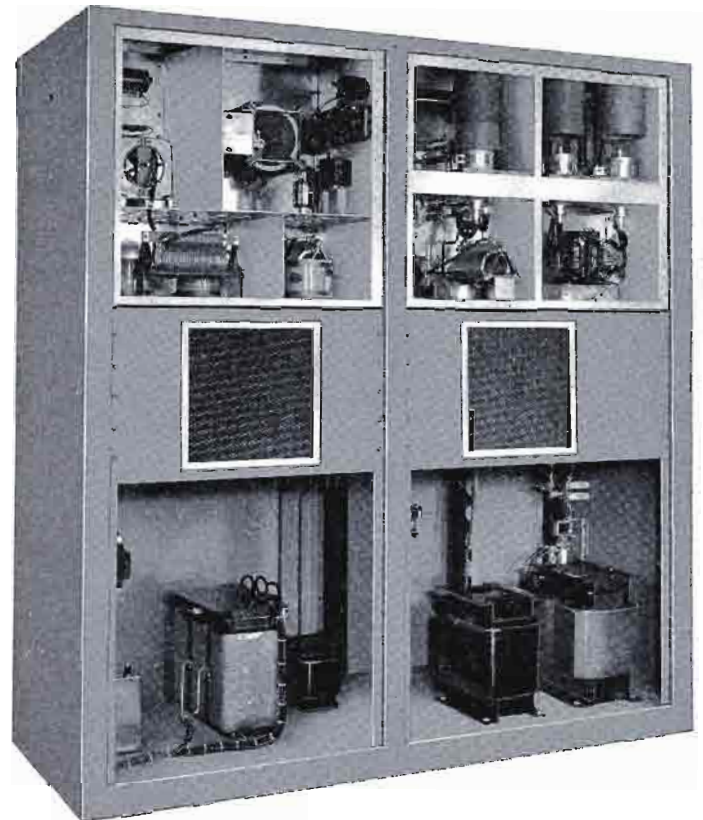

Rear view, dust covers removed.

SPECIFICATIONS

POWER OUTPUT: (Rated) 5000 watts. (Capable) 5600 watts. Power reduction to approximately 1000 or 500 watts available.

RF FREQUENCY RANGE: 535 kHz to 1620 kHz—supplied to one frequency as ordered.

RF OUTPUT IMPEDANCE: Supplied for 50 ohms, or other as specified.

RF FREQUENCY STABILITY: ± 2 Hz.

CARRIER SHIFT: Less than 3% at 100% modulation.

RF HARMONICS: Meets or exceeds FCC specifications.

AUDIO FREQUENCY RESPONSE: ± 1 dB 50 to 10,000 Hz. $\pm 1\frac{1}{2}$ dB 30 to 12,000 Hz.

AUDIO FREQUENCY DISTORTION: 2.5% or less 50 Hz to 10,000 Hz at 95% modulation.

NOISE: (Unweighted) 60 dB or better below 100% modulation.

AUDIO INPUT: 600/150 ohms at +10 dBm, ± 2 dB.

POWER INPUT: 208/230 volts, 3 phase, 50 or 60 Hz. 10.7 kW zero modulation. 11.9 kW average modulation. 15.6 kW 100% modulation.

AMBIENT TEMPERATURE RANGE: -20°C to $+50^{\circ}\text{C}$.

ALTITUDE: To 7500 feet standard (higher altitudes on special order).

SIZE: 78" high, 72" wide, 32" deep. Completely self-contained.

WEIGHT: 1850 lbs. unpacked (approximate); 2200 lbs. domestic packed (approximate); 2450 lbs. export packed (approximate).

CUBAGE: 120 cubic feet packed.

FINISH: Beige-gray.

TUBES USED: (3)3CX2500F3, (1)4-400A.

GENERAL INFORMATION: Monitors: 10 RF volts output at 50/70 ohms for frequency and modulation monitors.

ORDERING INFORMATION

Model BC-5H transmitter with one set of tubes and two crystals.....	994-6521
100% set spare tubes for BC-5H transmitter.....	990-0535
100% set spare transistors for BC-5H (diodes not included).....	990-0540
Kit for remote control of power output.....	994-6548

1000 Watt Transistorized AM Transmitter

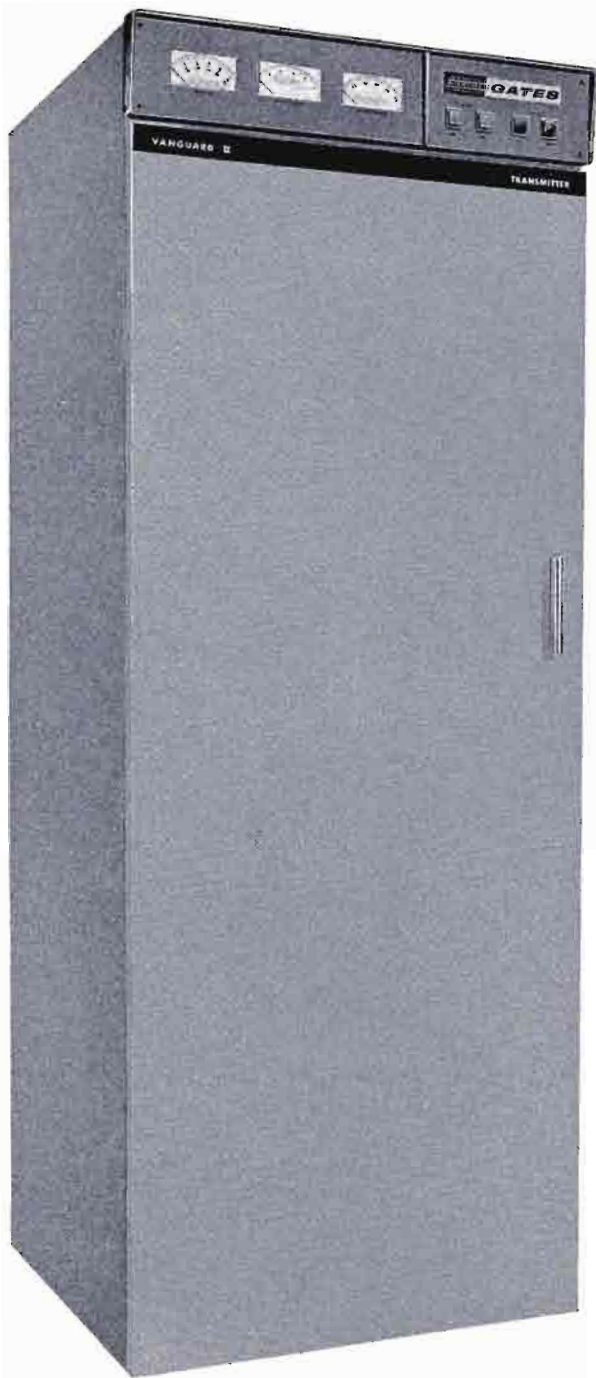

VANGUARD II

Field-proven for reliability and performance, the Vanguard II transmitter uses just one tube! All remaining circuits are solid state—producing a typical frequency response of ± 1 dB from 20-16,000 Hz, with distortion in the 1% range, and a noise ratio of 55 dB below 100% modulation. Your listeners will actually hear a superior sound quality. And you get the added bonus of "Solid-Statesman" reliability.

ONLY ONE TUBE: The Vanguard II uses a 4CX3000A tube as the final RF amplifier—the rest of the circuits are transistorized. This tube was selected to complement the solid state circuitry, as it operates well below rated capacity to assure longer life. The 4CX3000A is in a Class AB-1 circuit, which significantly reduces intermodulation distortion and substantially contributes to the high fidelity performance of the Vanguard II.

The low level transistorized circuitry accepts and amplifies the audio signal, generates the carrier frequency, then modulates the carrier wave with the audio signal for transmission to the final amplifier stage. Modulation takes place in this section with an audio level of about one watt, compared to about 700 watts in conventional transmitters.

The proven reliability of Vanguard II is brought about by the simplicity of the solid state design versus the elaborate array of components required to perform these functions in tube-type transmitters.

SOLID STATE OSCILLATORS: A single unit contains the two complete temperature controlled crystals, oscillators and first buffers. The frequency stability of these solid state oscillators greatly exceeds that of the conventional type. Crystal trimmers are adjustable from the front panel. A Zener controlled voltage supply to the oscillators assures stable operation with line voltage changes, and a front panel switch permits instant on-the-air change from one oscillator to the other.

POWER CHANGE: The Vanguard II transmitter provides instantaneous power change from a full one kilowatt, to 500 watts or 250 watts.

BUILT-IN DUMMY ANTENNA: The transmitter may be tested at a full one kilowatt output with 100% modulation using the built-in dummy antenna. This permits simulation of on-the-air conditions for thorough testing of all transmitter functions. No external load is required.

BUILT-IN TEE NETWORK: The complete built-in and adjustable Tee network permits exact matching of the transmitter to its load with greatest harmonic attenuation. The capacitors are large mica insulated units of the highest quality.

The final amplifier and Tee network are tuned by the large edgewound coils, manufactured by Gates. Tuning in the power amplifier stage is exclusively by variable coils.

COMPACT DESIGN—SAVES FLOOR SPACE: The Vanguard II takes less than six square feet of floor space, and is completely self-contained. There are no external sections that require additional floor space.

Note the narrow width of Vanguard II that permits a front door swing of only 28 inches. The back door is completely removable with just a twist of a latch handle.

EXTREMELY COOL RUNNING: The combination of cool operating solid state components, with a large capacity blower for the power tube, results in highly efficient internal cooling.

1000 Watt Transistorized AM Transmitter—Vanguard II

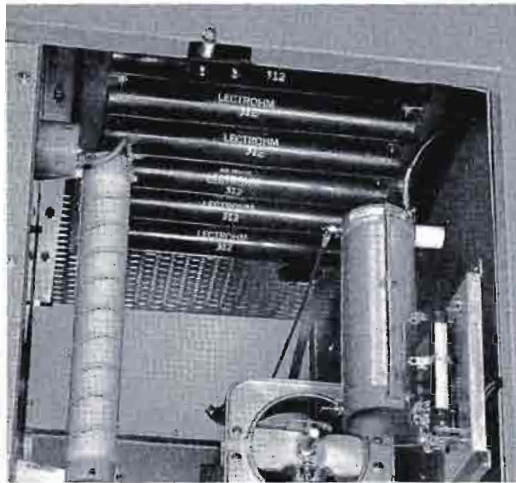

Built-in dummy antenna.



Final RF amplifier.

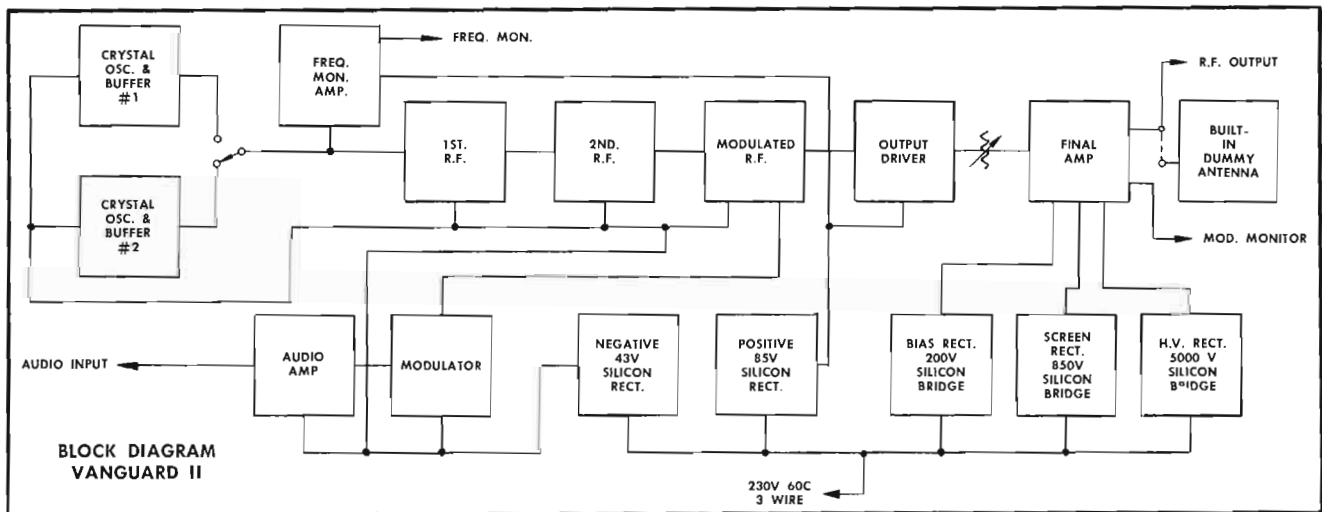

SPECIFICATIONS

POWER OUTPUT: 1150 watts.

FREQUENCY RANGE: 540-1700 kHz.

RF OUTPUT IMPEDANCE: 50/70 ohms.

FREQUENCY STABILITY: ± 2 Hz or better.

CARRIER SHIFT: Rated 3% or less. Typical less than 2%.

AUDIO RESPONSE: ± 1 dB, 20-16,000 Hz.

AUDIO DISTORTION: 1.5% or less, 20-15,000 Hz.

NOISE: 55 dB or better below 100% modulation.

AUDIO INPUT: 600 ohms at +5 dB.

POWER DEMAND: 100% modulation, 4500 watts, 90% power factor.

POWER INPUT: 230 volts, 3 wire, 60 Hz single phase (208 volts also available where specified).

DUMMY ANTENNA: 50 ohms for 1 kW output.

SIZE: 29" wide, 78" high, 30" deep.

WEIGHT: Net 700 lbs. Domestic packed, 800 lbs.; export packed, 935 lbs. Cubage: 72.

TUBE COMPLEMENT: 1—Type 4CX3000A.

ORDERING INFORMATION

Vanguard II, 1000 watt AM broadcast transmitter complete with two crystals, dummy antenna, and silicon rectifiers.....	994-6519
100% spare set of transistors.....	990-0515
Spare tube, 4CX3000A.....	374-0074

1000/250 Watt AM Broadcast Transmitter

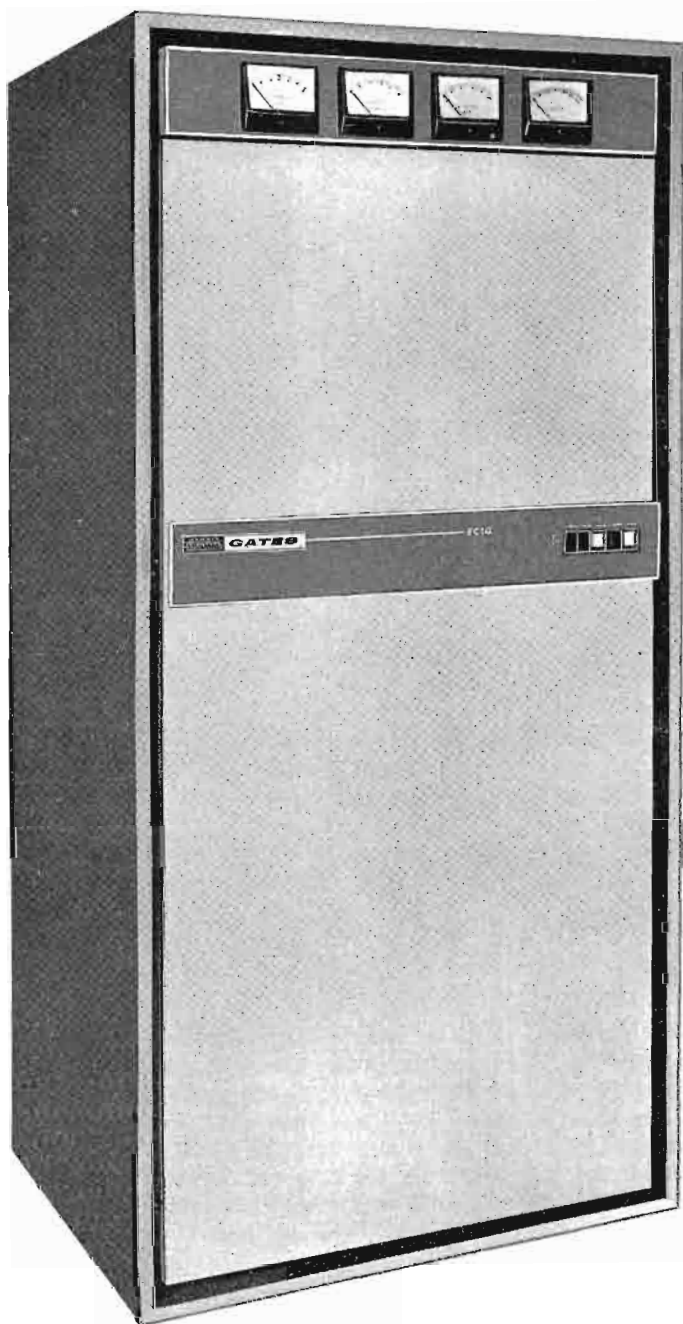

MODEL BC-1G

The "Big G" offers you all of the really important features you look for in a 1 kW AM transmitter . . . such as wide frequency response, great reliability and low operating costs. Another big feature is the high fidelity sound, achieved through low distortion—sound with an unusually rich quality that has become a "Big G" trade-mark.

AUDIO SECTION: Wider frequency response, low harmonic distortion, and low noise . . . the basis of the "Big G's" fine sound . . . result from a unique circuit arrangement. A new low leakage modulation transformer, combined with superb high frequency response has produced typical distortion readings of 1.5% or less at the critical 7000 Hz audio frequency. Push-pull 807 tubes modulate the husky 833A high level modulator tubes, producing an abundance of extra power to provide full performance as tubes age.

RF SECTION: Dual vacuum-type ovenless crystal units provide utmost stability. Frequency adjustment and crystal changeover are made from the front, as are all transmitter control functions. There are four RF stages to assure good frequency stability. Dual long-life 833A tubes feed a generous 1000 watts into a Tee network for exact loading and superior harmonic attenuation. The final amplifier and Tee network are tuned by large, variable edgewound coils.

BUILT-IN DUMMY ANTENNA: The BC-1G may be tested at a full 1 kilowatt output with 100% modulation, using this built-in antenna feature.

POWER REDUCTION: Class IV stations will particularly appreciate the quick and efficient way the BC-1G reduces power to 250 watts. Switching in the primary of the main plate transformer eliminates power consuming, voltage dropping resistors. Plate voltage is reduced on both the power amplifier and modulator tubes, resulting in the possibility of hundreds of added tube hours, as well as savings in power costs.

POWER AMPLIFIER TUBES: In search of the most reliable power tube, based both on performance and cost per hour, Gates engineers tested every known tube type available for this service. The result was the selection of the 833A tube for both RF and modulator circuits. The 833A provides a combined hourly tube cost of approximately 2¢, and has worldwide availability. Being a solid, husky triode, it is more tolerant to spurious emissions, and changing operating conditions caused by variances in load or fluctuations in cooling.

REMOTE CONTROL: Built-in metering kits are provided for both plate voltage and plate current. The use of relays throughout permits almost instantaneous adaption to remote control, and eliminates the need for outboard attachments. All electrical connections for remote controlling are brought out to terminal boards.

RECTIFIER SYSTEM: The BC-1G solid state model has three separate power supplies, all with large silicon rectifiers for lower power consumption, lifetime reliability. The three are: (1) main HV supply, (2) intermediate supply, and (3) bias supply.



1000/250 Watt AM Broadcast Transmitter-BC-1G

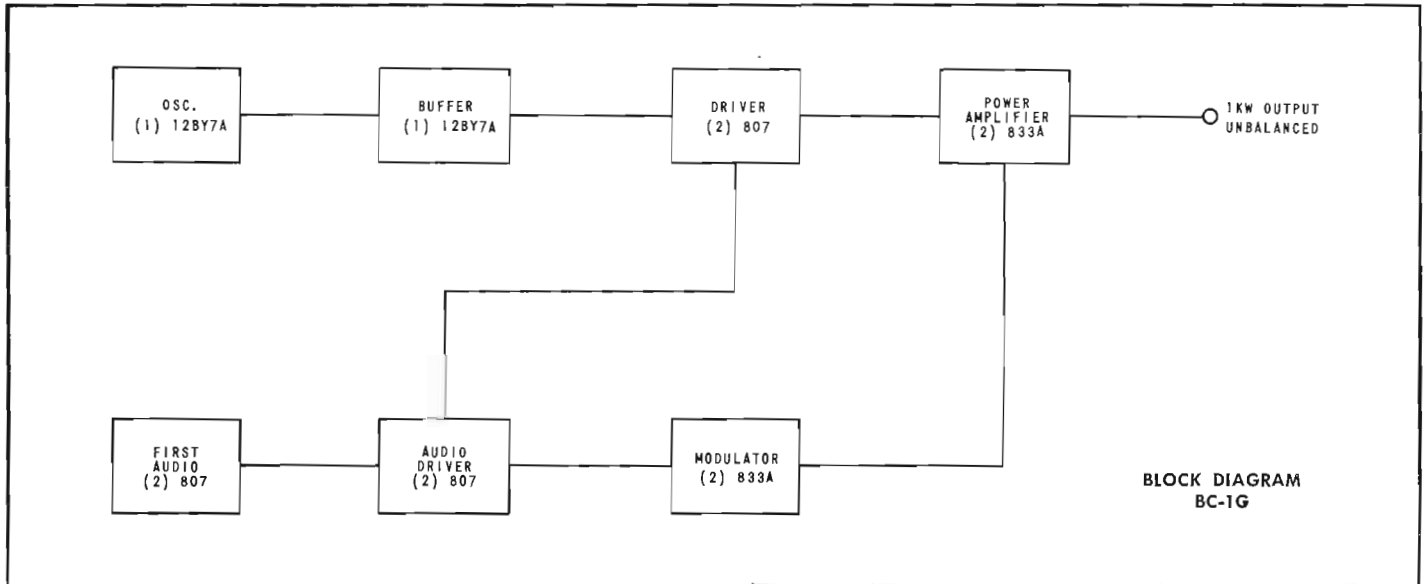

BLOCK DIAGRAM
BC-1G

COOLING: The "Big G" was designed from the outset with ideal cooling as a major engineering objective. In the transmitter, parts location is of great importance, and is combined with an intelligent convection cooling system and suction fan ventilation in the top of the cabinet. Fresh air is drawn through dual removable filters at the back base of the transmitter, circulated through every part of the equipment, and then exhausted at the top. Heat generating power tubes are located in the direct air stream. Component and tube life are greatly lengthened by the cool-running operation.

GENERAL DESIGN: The transmitter is completely self-contained in a sturdy steel cabinet. An attractive front door is hinged on the left and opens to expose all tuning controls. Color-coded switches for start-stop and power change functions are accessible from the front when the door is closed. These switches illuminate to show the transmitter operating status at a glance. Behind the front door is a full-length perforated grill for protection when the transmitter is operating . . . it may be removed in seconds by means of snap locks. The back panel is easily removed by turning two thumb screws.

SPECIFICATIONS

POWER OUTPUT: 1000/250 watts. Capable output to accommodate phasor loss, etc., 1100 watts. Also available in a 1000/500 watt model.

RF FREQUENCY RANGE: 540-2000 kHz (as ordered).

RF OUTPUT IMPEDANCE: 50/70 ohms. Other output impedances available on special order.

FREQUENCY STABILITY: ± 5 Hz or better.

CARRIER SHIFT: 3% or less with adequate power mains. Typical is 2%.

MODULATION: High level Class B.

AUDIO RESPONSE: $\pm 1\frac{1}{2}$ dB 30-12,000 Hz 95% modulation. Under practical programming conditions $\pm 1\frac{1}{2}$ dB 30-16,000 Hz.

AUDIO DISTORTION: 3% or less 50-10,000 Hz 90% modulation. Under practical programming conditions 2% or less 50-16,000 Hz.

NOISE: (1000 watts) 60 dB or better below 100% modulation. (250 watts) 55 dB or better below 100% modulation.

AUDIO INPUT IMPEDANCE: 150 or 600 ohms at $+16$ dBm ± 2 dB.

POWER CONSUMPTION: 1 kW; 0 modulation, 2650 watts; program modulation, 3150 watts; 100% modulation, 3850 watts. 250 watts; 0 modulation, 1650 watts; programming modulation, 1825 watts; 100% modulation, 2050 watts.

POWER INPUT: 230 volt, 1 phase, 3 wire, 50/60 Hz. (208 volts also available when specified).

DUMMY ANTENNA: 50 ohms. Capable 100% program modulation continuous or 100% sine wave modulation for 20 minutes on and 5 minutes off.

TEMPERATURE: -20° to $+50^{\circ}$ C (silicon). $+5^{\circ}$ to $+50^{\circ}$ C (mercury rectifier).

SIZE: 78" high, 37" wide, 29" deep. Front door swing 32".

WEIGHT: Net, 1000 lbs. Domestic packed, 1140 lbs. Export packed, 1490 lbs. Cubage: 110.

TUBES: (2) 12BY7A crystal oscillator and buffer, (2) 807 intermediate driver amplifiers, (2) 833A RF power amplifiers, (2) 807 1st audio amplifiers, (2) 807 2nd audio amplifiers, (2) 833A modulators. If tube rectifier model purchased, add: (2) 800B HV rectifiers, (2) 866/866A intermediate voltage rectifiers.

ORDERING INFORMATION

BC-1G transmitter, 1000/250 watts, solid state rectifier model, with tubes, and 1 vacuum crystal.....994-6245

BC-1G transmitter, 1000/250 watts, tube rectifier model, with tubes and 1 vacuum crystal.....994-6245B

Spare 100% tube complement for 994-6245 model.....990-0471

Spare 100% tube complement for 994-6245B model.....990-0472

Output power remote control kit.....994-6326

NOTES: (1) Be sure to specify carrier frequency when ordering. (2) Available for 208 volts, 3 wire, at slight additional cost. (3) Packed weight of 994-6245B tube rectifier model is 25 lbs. greater. (4) Power consumption of the BC-1G with tube rectifiers is slightly higher due to addition of filament transformers.

500 Watt AM Broadcast Transmitter

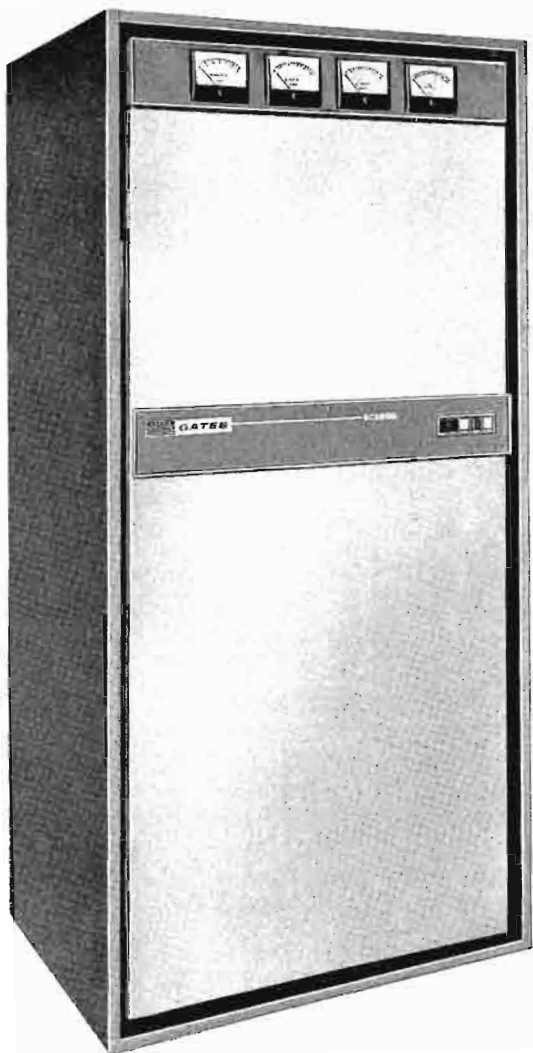

MODEL BC-500G

The B-500G broadcast transmitter is essentially the same transmitter as the BC-1G, 1,000 watt model described on pages 18 and 19. It differs only in the use of a single type 833A RF power tube. So complete is standardization that an increase to 1,000 watts at any later date is easily accomplished. As the basic design is around 1,000 watt construction, a bonus of conservatism is built into this 500 watt model.

All of the features found in the 1,000 watt BC-1G are also found in the BC-500G. These features include: a built-in dummy antenna for easier maintenance, solid state power supplies throughout, total accessibility from the front, modulation of the RF driver and power amplifiers, inverse feedback and lower distortion. RF harmonic reduction meets FCC regulations within the transmitter itself as the Pi-Tee output network does not assume that the outside antenna coupler will perform this function. The specifications herein are pertinent to the Model BC-500G, 500 watt transmitter. Any other data is the same as the Model BC-1G.

SPECIFICATIONS

POWER OUTPUT: FCC rated 500 watts. Capability 550 watts.
RF FREQUENCY RANGE: 540 kHz to 2000 kHz (as ordered).
RF OUTPUT IMPEDANCE: 50/70 ohms.
FREQUENCY STABILITY: ± 5 Hz.
CARRIER SHIFT: 3% or less at 100% modulation.
AUDIO RESPONSE: $\pm 1\frac{1}{2}$ dB, 30-12,000 Hz. (Typical: $\pm 1\frac{1}{2}$ dB, 30-16,000 Hz under practical programming conditions.)
AUDIO DISTORTION: 3% or less 50-10,000 Hz at 95% modulation.
NOISE: 60 dB, or better, below 100% modulation level.
AUDIO INPUT: 150 or 600 ohms, +9 dBm, ± 2 dB for 100% modulation.
POWER INPUT: 230 volts, 3 wire, 50/60 Hz single phase. Power consumption (0 modulation) 1900 watts; (program modulation) 2200 watts; (100% modulation) 2600 watts.
DUMMY ANTENNA: 50 ohms.
MONITORS: Will accommodate all current models. Gates FCC approved M-4990 Frequency Monitor and M-5693 Modulation Monitor recommended.

SIZE: 78" high, 37" wide, 29" deep. Front door swing 32".
WEIGHT AND CUBAGE: (Domestic) 950 lbs. net., 1100 lbs. packed. (Export) 1350 lbs. packed. Cubage: 100.
FINISH: Two-tone beige-gray.
TUBES: 12BY7A oscillator, 12BY7A 1st IPA, (2) 807 2nd IPA, (1) 833A power amplifier, (2) 807 1st audio, (2) 807 2nd audio, (2) 833A modulators.

ORDERING INFORMATION

Model BC-500G AM broadcast transmitter, 500 watts, with tubes, one crystal, silicon rectifiers.....994-6333
Spare 100% tube complement for BC-500G.....990-0481
Recommended minimum spare tube kit for BC-500G.....990-0479

NOTES: (1) Be sure to specify carrier frequency when ordering. (2) Available for 208 volts, 3 wire, at slight additional cost. (3) Available on special order with tube rectifiers at no increase in price. (4) 500 watt stations may use a 1000 watt transmitter operated at 500 watts power. If 1000 watts is later contemplated, the customer should purchase the Model BC-1G.



250 Watt AM Broadcast Transmitter

MODEL BC-250GY

Gates 250 watt AM broadcast transmitter is a performance-plus, high fidelity transmitter, complete in every detail for today's modern broadcasting. Features include attractive shadow mold styling, vacuum crystal, and full size back door for 100% accessibility. Fully FCC type approved, Gates BC-250GY transmitter has a world-wide reputation for long, trouble-free service. From Greenland to the Marianas, broadcasters acclaim the excellence and simplicity of this most widely used 250 watt medium wave transmitter.

RADIO FREQUENCY AND AUDIO STAGES: The RF tube line-up consists of a 12BY7 in an oscillator circuit that utilizes a vacuum crystal. A second 12BY7 is used as an intermediate power amplifier to drive a rugged 813, which in turn feeds the parallel 810 power amplifiers. The audio section is push-pull with 6L6 driver tubes operating into the Class B 810 modulator tubes. Interchange of power amplifier and modulator tubes gives added economy and longer tube life.

OPERATING FEATURES: The emphasis is on accessibility, ease of service and well ventilated design. Convection cooling is employed. As a result, the BC-250GY transmitter is silent in operation, and may be operated adjacent to a microphone. Vertical construction permits "walk-in" access. The audio section is a hinged sub-section. Seven meters allow direct simultaneous reading of all important functions. For a conservative, superb performing transmitter, the Model BC-250GY will fill the needs of most discriminating broadcasters.



SPECIFICATIONS

POWER OUTPUT: Rated 250 watts, capable 280 watts.

FREQUENCY RANGE: 540-1620 kHz, as ordered.

RF OUTPUT IMPEDANCE: 30/300 ohms unbalanced, as ordered.

FREQUENCY STABILITY: ± 5 Hz.

CARRIER SHIFT: 3% or less, 100% modulation.

MODULATION: High-level plate.

AUDIO RESPONSE: ± 1.5 dB 30-10,000 Hz.

AUDIO DISTORTION: 3% or less, 50-7500 Hz at 90% modulation.

NOISE: 55 dB below 100% modulation.

AUDIO INPUT: 500/600 ohms at +8 dBm ± 2 dB, 100% modulation.

POWER CONSUMPTION: 1.6 kW at 90% modulation.

POWER INPUT: 230 volts AC, 2 wire, single phase, 50/60 Hz.

POWER FACTOR: Better than 90%.

MONITORS: Will accommodate all modern frequency and modulation monitors.

SIZE: 78" high, 34" wide, 33" deep.

WEIGHT: Domestic, packed—770 lbs.; export—900 lbs.

CUBAGE: 112.

FINISH: Two-tone beige-gray.

TUBES: (4) 810, (2) 6L6, (2) 12BY7, (1) 813, (2) 8008, (1) 5Y4G.

ORDERING INFORMATION

BC-250GY Transmitter, 250 watts, complete with one set of tubes and one vacuum crystal.....994-3760

Spare 100% set of tubes.....990-0507

Recommended minimum set of spare tubes.....990-0508

NOTE: Please state carrier frequency and RF output impedance when ordering.

Antenna Phasing Equipment

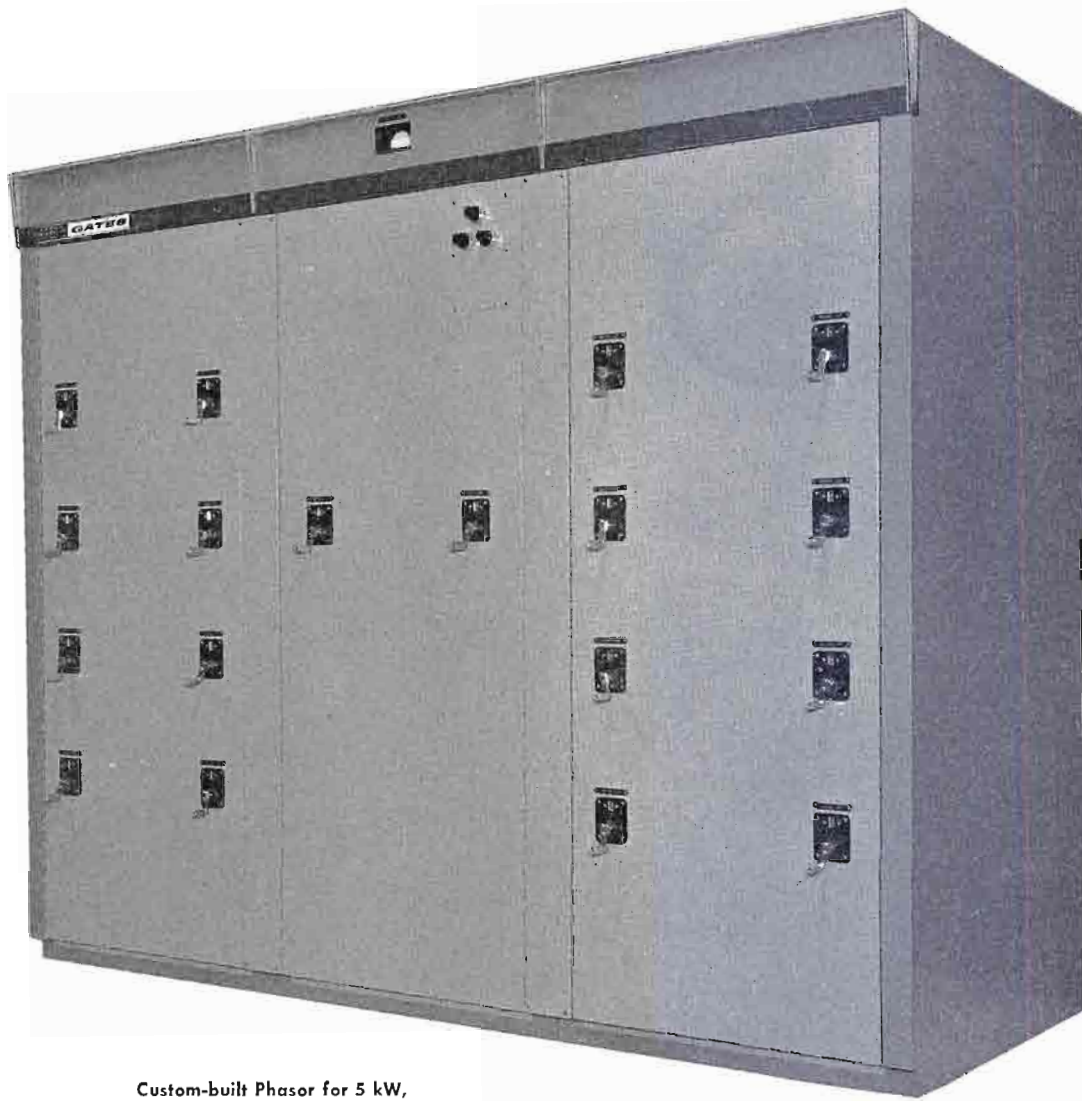

Custom-built Phasor for 5 kW,
5-tower directional AM station.

Gates phasing equipment is custom built, utilizing Gates manufactured inductors and other quality components for precise coverage patterns requiring a minimum of adjustment and a maximum of stability. Some of the most complex phasing systems in existence have been built by Gates.

ADVANCED RESEARCH: As the world leader in the design and manufacture of phasing equipment, Gates engages in highly advanced phasor research and development. All Gates phasing systems are computer designed to assure maximum accuracy and most efficient circuitry. Phasor construction is carried out by a group of design and production experts, with years of experience in specialized phasing equipment. This group is under the direction of a registered professional engineer.

CONSTRUCTION: Antenna tuning units are constructed as a panel and shelf type for wall mounting in a doghouse, or in weatherproof metal cabinets. Phasor cabinetry built to your specifications is available, and becomes an integral planning factor in the coordination of design and styling to reflect over-all system compatibility and appearance.

Gates manufactures phasing equipment for any power, for any number of towers; 250 watt to 250 kilowatt tuning units; duplexers for medium wave and for 2-30 MHz short wave; triplexers, rejection filters, and a wide range of radio frequency networks. Each is custom tailored for the particular application, to assure the broadcaster's complete satisfaction.

Table Of Contents

	PAGE
AM BROADCAST TRANSMITTERS	
100 kW to 250 watt transmitters • Phasing and coupling equipment • Monitors • Dummy antennas	4
FM BROADCAST TRANSMITTERS	
40 kW to 10 watt transmitters • Stereo and SCA generators • FM relay packages • Antennas • Monitors	32
BROADCAST TRANSMITTER ACCESSORIES	
Remote control • Transmission line • Antenna towers • Tower lights • Inductors and mica capacitors	63
TELEVISION TRANSMITTERS	
5 kW to 100 watt transmitters • Television antennas • Monitors	76
AUDIO CONTROL CONSOLES	88
PROGRAM AUTOMATION	120
AUDIO EQUIPMENT	
Solid state limiter • Automatic gain control amplifiers • System-type audio amplifiers • Accessories • Speakers and baffles • Microphones • Remote amplifiers • Turntables • Equipment cabinets • Proof of performance • Tape recorders	136
HIGH FREQUENCY BROADCAST TRANSMITTERS	
100 kW to 1000 watt transmitters • High speed modulation monitor	186
SINGLE SIDEBAND AND COMMUNICATIONS TRANSMITTERS	
ISB Exciters • HF linear amplifiers • ISB HF transmitters • LF beacon transmitter • HF matching transformers • HF antenna system • Transmitter consoles • Transportable systems	197
ACCESSORY EQUIPMENT	
Remote pick-up equipment • STL equipment • Transmitter logging • Wire • Emergency generators • Transmitting tubes • Transistors	216
REFERENCE INFORMATION	232
INDEX	236

The mechanical and electrical design of the equipment described herein is subject to change without notice as deemed necessary by Gates Radio Company or its suppliers in the interest of advancing industry requirements or the state of the art.

100,000 Watt Medium Wave Broadcast Transmitter

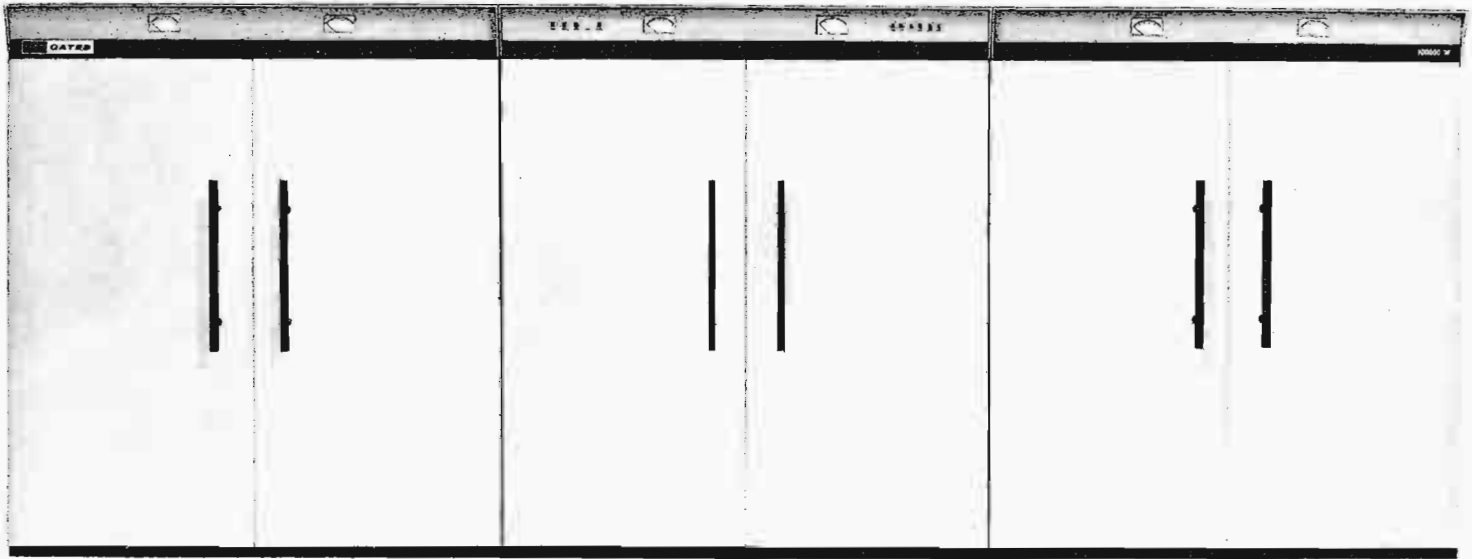

MODEL VP-100

Gates VP-100 is the most advanced 100 kW medium wave transmitter in the world. It provides an over-all performance superior to that of any other AM broadcast transmitter in the same power range—at lower operating costs. With its amazingly high efficiency, and advanced cooling system design, this transmitter represents the latest state-of-the-art in high power broadcast equipment.

HIGH EFFICIENCY—EXCEEDS 65%: The modulation system employed in the VP-100 transmitter is almost 90% efficient (instead of the usual 50% or 60%), enabling the transmitter to achieve an unusually high over-all efficiency of greater than 65%. This means about one-third less power consumption than that of other high-level plate modulated 100 kW transmitters.

ONLY FIVE TUBES: The entire transmitter employs just five tubes—with modern ceramic 4CV100,000C tetrode power tubes operating well below manufacturer's dissipation ratings. All power supplies utilize long-life solid state silicon rectifiers. Highest quality components, conservatively rated, are used throughout the VP-100 to assure a maximum degree of reliability.

CONTINUOUS 100% MODULATION RATING: This continuous sine wave modulation capability permits a higher average modulation (such as trapezoidal) to boost signal strength, without increasing transmitted carrier power. Another feature of this high efficiency modulation system is convenient front panel carrier power adjustment over a wide range.

QUIET OPERATION: Cooling by the Vapor Phase method reduces noise by eliminating the need for large blowers. The heat exchanger is cooled by a single two horsepower blower, resulting in whisper-quiet operation. Vapor Phase Cooling also extends tube life by helping to eliminate "hot spots" and maintains tube anode temperatures far below those attained by other methods.

GREATLY REDUCED FLOOR SPACE: Due to the high efficiency of the transmitter, and the elimination of large iron core components such as the modulation transformer and modulation reactor, the VP-100 requires only 8.8 square meters (95 square feet) of floor space. The advanced cabinet design provides easy accessibility to all components.



VP-100 with heat exchanger.

Antenna Phasing Equipment

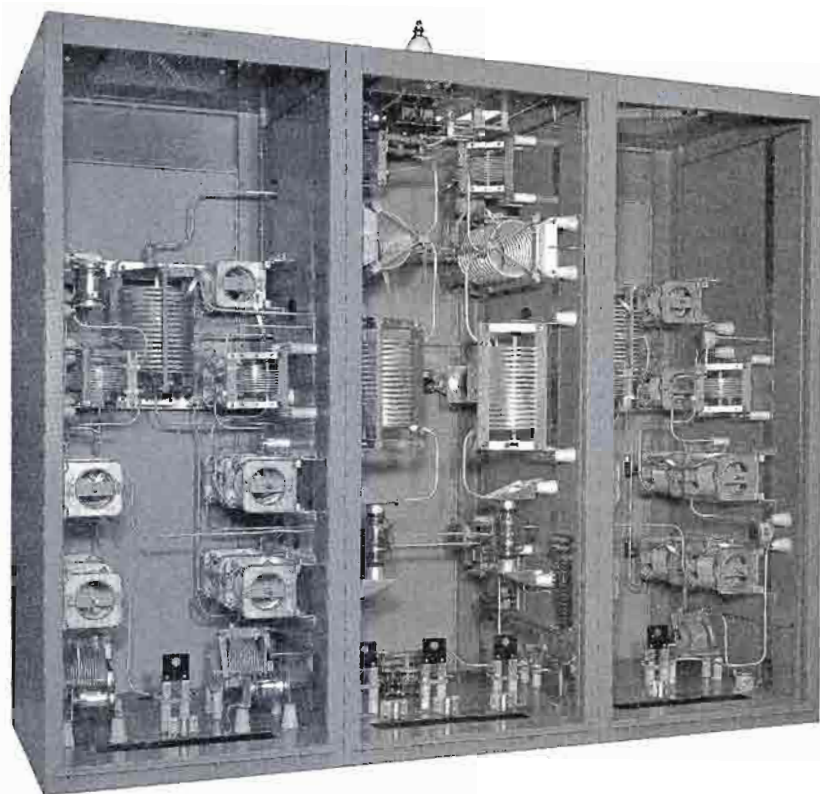

Rear view of Phasor at left, with panels removed. Note the clean mechanical layout.

STABILITY AND EFFICIENCY: All directional phasing equipment is designed to the parameters provided by the station's consulting engineer, and work is not initiated until the consultant and customer approve the design. To furnish custom designed phasors suited for specific broadcasting needs, Gates provides detailed specifications for your equipment, so you may determine exactly what you are buying. The full range of adjustment can be precisely determined by computer—before it is delivered. This avoids the possibility of having to replace inadequate components, or make costly field modifications of design to relieve difficult adjustment.

The careful design and construction practices maintained by Gates give you more than reasonable assurance of the best possible long term stability and efficiency. This avoids expensive readjustments and reproof of pattern later on.

Gates phasors are constructed to give a safety factor of 1.4 times on RMS current and four times on maximum RMS voltage based on expected operating adjustments.

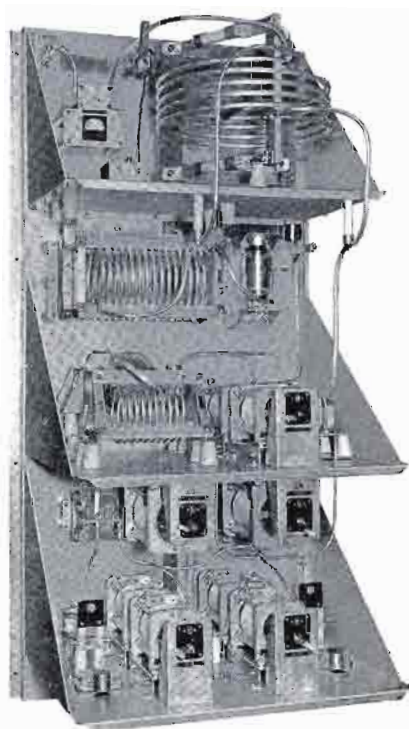

CUSTOM-BUILT OPEN PANEL PHASOR.

Gates phasing equipment is manufactured specifically to the customer's need, either in cabinets or on open panels.

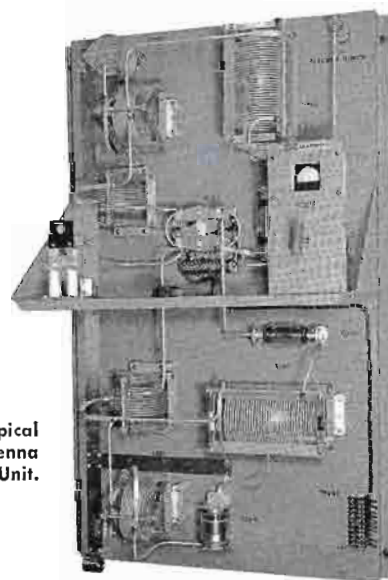

Typical Antenna Tuning Unit.

AM Antenna Couplers

WEATHERPROOF SERIES—FED ANTENNA COUPLER, 1250 WATTS

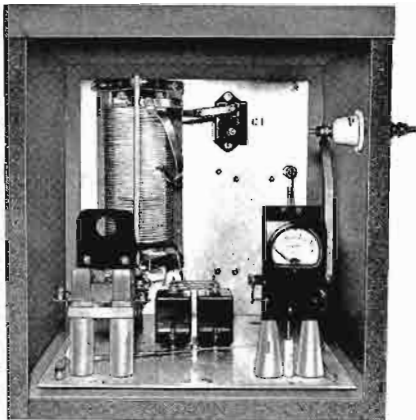

Recommended for broadcast transmitter powers of 1,000, 500 and 250 watts, 100% modulated. Heavy edgewound micalex insulated silver plated coil has generous inductance for a full Tee network along with fixed mica capacitors supplied. Extra room is provided to install either diode or thermocouple remote metering equipment. Heavy duty meter shorting switch eliminates antenna meter from the circuit when not in use for lightning protection. Meter is observed through plexi-glass porthole. Front door of cabinet has been removed for illustrative purposes.

SPECIFICATIONS

CARRIER POWER: Up to 1250 watts AM.
FREQUENCY: 525-1700 kHz as ordered.
LINE IMPEDANCE: 40-230 ohms as ordered.
TO MATCH: Series-fed tower of from 70° to 95° electrical length.
CIRCUIT: Full Tee Network.
WEIGHT: 98 lbs.
SIZE: 20" high, 20 1/4" wide, 18 3/4" deep.

ORDERING INFORMATION

Antenna Coupler with antenna meter 994-3494
NOTE: When ordering, state transmission line impedance, frequency, tower height, and tower measurements, if known. For remote meters, see below. Couplers to match unusual loads such as short or tall towers, shunt feed, etc., are available on special order at extra cost.

SERIES AND SHUNT FED COUPLERS



Both series and shunt fed models are constructed in a non-weatherproof cabinet with slip-off front door and large lead in bowl at top. Coil is micalex insulated edgewaund silver plated and capacitors are supplied to tune to buyer's specific frequency. Size: 21" high, 10" wide, 9" deep. Usually mounted in small dog house at base of tower. Rating 1250 watts, 100% modulated.

***SERIES FEED MODEL:** Provides full Tee network inductance with capacitors to match wide range of input and output impedances. State frequency line impedance, and tower height when ordering. 994-5178

***SHUNT FEED MODEL:** Includes inductor and capacitors to tune out reactance in shunt fed antenna coupling. If tower measurements are known, these are always especially helpful. State line impedance and frequency 994-5179

***NOTE:** METER NOT INCLUDED.

ISOLATION COIL

This isolation coil is quickly made to customer's order by carrying all basic materials in stock. The same type of coaxial cable is used in winding the coil as is used for sampling line. If the customer used Heliax sampling line, then the isolation coil would be wound with Heliax coaxial cable. Nominal inductance 85 uH. Available in weatherproof or open model. Sizes (weatherproof model), 20" wide, 12 1/2" high and 18 1/2" deep. (Open model), 16" wide, 10" high and 16" deep. When ordering, please state type or make of sampling line or preferred coaxial cable for coil construction. Resonating capacitor is not included.

ORDERING INFORMATION

Weatherproof isolation unit 994-3073
 Open unit coil only, less cabinet 994-4561

WEATHERPROOF 5-10 KW ANTENNA COUPLING UNITS

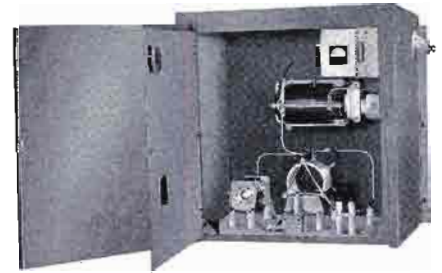

Housed in aluminum cabinet with double front doors. Porthole for meter reading and heavy duty meter shorting switch operates with doors closed. Large micalex insulated silver plated coils combined with capacitors of generous voltage and current ratings to assure a lifetime of service under extreme heat or cold. A large antenna lead in bowl is provided. Mounting is with metal flanges on the back of the tuning unit for attachment to wooden poles set in ground or for mounting on wall.

SPECIFICATIONS

CARRIER POWER: M-5309A 5,000 watts AM.
 M-5309B 10,000 watts AM.
FREQUENCY: 525-1,700 kHz as ordered.
LINE IMPEDANCE: 40-230 ohms as ordered.
TO MATCH: Series fed tower of from 70° to 95° electrical length.
CIRCUIT: Full Tee Network.
WEIGHT: Approximately 200 lbs.
SIZE: 38" high, 37" wide, 21 1/2" deep.

ORDERING INFORMATION

Antenna Coupling Unit, 5 kW 994-5309A
 Antenna Coupling Unit, 10 kW 994-5309B
NOTE: When ordering, state carrier frequency, transmission line impedance, power, tower height and tower measurements, if known. Couplers to match unusual loads such as short or tall towers, shunt feed, etc., are available on special order, at extra cost.

R. F. ANTENNA METERS

Internal thermocouple standard scale. Weston Model 308, three-inch square case. Other ranges not listed below are available with many carried in stock. Also expanded scale meters in inventory.

ORDERING INFORMATION

Meter, 0-3 R. F. amperes 634-0206
 Meter, 0-6 R. F. amperes 634-0238
 Meter, 0-8 R. F. amperes 634-0209
 Meter, 0-10 R. F. amperes 634-0210

DIODE TYPE REMOTE METER EQUIPMENT



For remote indication of RF current. Consists of a carefully constructed pickup loop attached through a short coaxial cable to a solid state rectifier assembly. RF current is measured without breaking the main lead. No AC power is required. May be used with any good 1 MA DC meter. Power range: 250 watts to 50,000 watts. Frequency range: 540 kHz to 1600 kHz.

ORDERING INFORMATION

Diode remote meter unit, less meter 994-6112
 Meter 3" sq. case, scale 0-3 R. F. amperes 632-0418
 Meter 3" sq. case, scale 0-5 R. F. amperes 632-0419
 Meter 3" sq. case, scale 0-8 R. F. amperes 632-0420
 Meter 3" sq. case, scale 0-10 R. F. amperes 632-0421
 Meter 4" sq. case, scale 0-3 R. F. amperes 632-0424
 Meter 4" sq. case, scale 0-8 R. F. amperes 632-0426
 Meter 4" sq. case, scale 0-10 R. F. amperes 632-0361
 Meter 4" sq. case, scale 0.15 R. F. amperes 632-0428

NOTE: Other meter scale ranges available at extra cost. Above for use with diode remote unit, not thermocouple.



AM Antenna Coupling Accessories

SOLENOID TOWER CHOKES

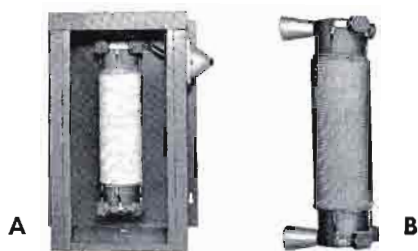

(20 AMP AC RATING)

Most popular of all tower light isolation chokes. Available in 2 or 3 section and in open type, or weatherproof as illustrated. Wound on heavy triple X tubing with mica-by-pass condensers on each circuit end. Inductance approximately 350 uH. 3" stand-off insulators are part of coil. (Weatherproof type), 24" high, 17 $\frac{3}{4}$ " wide, 10 $\frac{1}{4}$ " deep. Illustration to left shows weatherproof unit with front cover removed.

ORDERING INFORMATION

Tower Choke, 2 wire, weatherproof,
Fig. A 994-3937
Tower Choke, 3 wire, weatherproof,
Fig. A 994-3938
Tower Choke, 2 wire, open type,
Fig. B 994-3935
Tower Choke, 3 wire, open type,
Fig. B 994-3936

RADIO FREQUENCY CONTACTOR

A heavy duty solenoid operated RF contactor for most switching applications through 50 kW power. Available in either SPDT or DPDT types and in two voltage ratings. Will operate on 115/230 volts AC, latching type. Will handle up to 25 amperes RF per contact.

ORDERING INFORMATION

Contactor SPDT insulated 17 kV peak
voltage 570-0001
Contactor DPDT insulated 17 kV peak
voltage 570-0002
Contactor SPDT insulated 22 kV peak
voltage 570-0003
Contactor DPDT insulated 22 kV peak
voltage 570-0004

LARGE INVENTORY OF METERS

In the manufacture of transmitting and audio equipment for broadcasting, communications and defense, Gates is required to carry thousands of meters in inventory. Whether AC, DC, or RF, or microammeter, milliammeter or ammeter, it is very likely the meter you need in emergency or expansion is quickly available. Give us desired case size, range and type of movement and we will serve you speedily. Many meters are also carried at our Houston, Texas branch.

HEAVY DUTY SAMPLING LOOP



This is a very rugged fixed non-shielded RF sampling loop. It is heavily galvanized after welding, and is fitted with large steatite insulators and heavy duty tower leg clamps for easy and positive mounting. Complete with type "N" jack. For 50 to 70 ohm sampling line.

ORDERING INFORMATION

Heavy duty sampling loop 994-6126

ROTATING PHASE SAMPLING LOOPS

This model is especially applicable where high current ratios are to be sampled. May be rotated so that phase monitor amplitude values are nearly equal. Electrostatically shielded and insulated from tower. May be used with or without isolation coil at base of tower. Coil is single loop, heavily insulated from base frame. Matches either 50 or 70 ohm line. Size: 48" wide, 32" high.

ORDERING INFORMATION

Rotating Sampling Loop 994-3283

METER JACK AND SHORTING BAR-MOUNTING PLUG



A great convenience to allow RF current measurements to be made by simply plugging in a meter. Will accommodate most 3" or 4" meters. A "must" in critical RF circuit areas in phasors, couplers, etc. Rating up to 50 kW on a 50 ohm line.

ORDERING INFORMATION

Meter jack and shorting bar 994-3280
Meter mounting plug 994-3281

METER SHORTING SWITCH



A heavy duty, make-before-break meter shorting switch of the plunger or push type. Heavy bronze tempered spring grips on both sides assure accuracy and durability.

ORDERING INFORMATION

Meter Shorting Switch, rating 15
amperes 994-3493
Meter Shorting Switch, rating 40
amperes 994-6527

AUSTIN RING TYPE TOWER CHOKE

ORDERING INFORMATION

Ring type tower choke is a transformer with clear air space between primary and secondary, and minimum antenna shunting effects. Independent of frequency. All models are for 115/230 volt primary and 115 volt secondary. Base insulator in photo for illustration purposes only.



CAP-KVA	MFG. STYLE	LBS.	ATTACHMENTS	ORDER NO.
1-1.75	Side Bracket	81	none	710-0051
1-1.75	Side Bracket	85	lightning gap	710-0052
1-1.75	Pedestal	82	none	710-0053
1-1.75	Pedestal	86	lightning gap	710-0054
2-3	Side Bracket	188	none	710-0055
2-3	Side Bracket	201	lightning gap	710-0031
2-3	Pedestal	182	none	710-0056
2-3	Pedestal	200	lightning gap	710-0057

AM Modulation Monitor

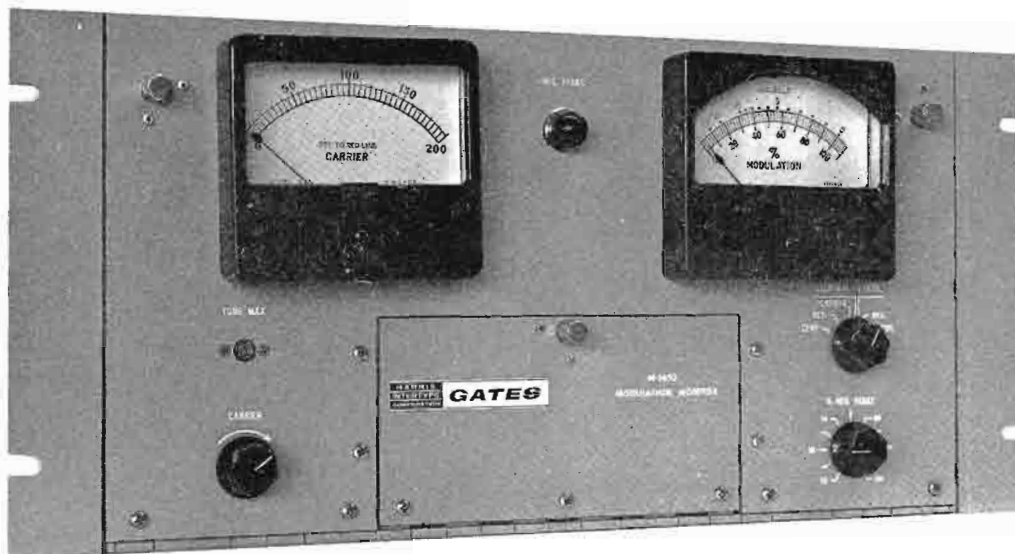

MODEL M-5693

Manufactured by Gates under U.S. Patents, the M-5693 monitor is not just an indicating device, but an instrument that will assure maximum transmitter performance through fullest utilization of the RF carrier. "Full performance" advantages include: (1) extremely accurate self-calibration—no oscilloscope or other external device is needed to calibrate for exact modulation percentage; (2) long term accuracy—no false modulation percentage readings to either reduce signal strength or over-modulate; (3) a derivative controller circuit, which provides high speed meter response to indicate even the fastest transient program peaks; (4) exclusive design—no need to down rate performance to prevent over-modulation.

MONITOR ACCURACY: Modulation monitor accuracy is retained even as the tubes age. The derivative controller provides high speed meter response. Correct peak indications on single program pulses as short as 50 milliseconds assure true peak measurement of program amplitude regardless of wave forms encountered.

OVER-MODULATION INDICATOR: The over-modulation light indicator is directly calibrated. It has the same superior accuracy as the meter. As all measuring circuits are direct-coupled to the detector output, carrier shift has no adverse effect on meter readings.

PROOF OF PERFORMANCE: Measurements may be obtained from the monitor output with full assurance that accurate readings of transmitter performance may be achieved. Noise is 65 dB below the -20 dBm output level and distortion is 0.25% between 20-15,000 Hz.

CONTROLS: All controls are located on the front panel, except the calibration control and power switch, which are conveniently located behind a small drop-down front panel. The monitor may be calibrated quickly and easily without the use of any other test or measuring instrument.

The hinged front panel permits nearly all maintenance and servicing operations from the front—and every part can be reached in a matter of seconds.

REMOTE CONTROL: Indication at a remote location is provided by Gates optional M-5837 remote meter panel. The M-5693 monitor can be used on any telephone pair not exceeding 1,500 ohms loop resistance. Controls for compensation of varying telephone line characteristics to permit location of the monitor at the transmitter site are included in the M-5693.



M-5837 remote meter panel is installed at studios and connected to the modulation monitor via a standard telephone line. The remote 4" meter reads modulation percentage corresponding to the monitor meter. Size: 19" x 5 1/4" x 3" deep.

AM Modulation Monitor—M-5693



Rear view showing easy access to tubes and termination.

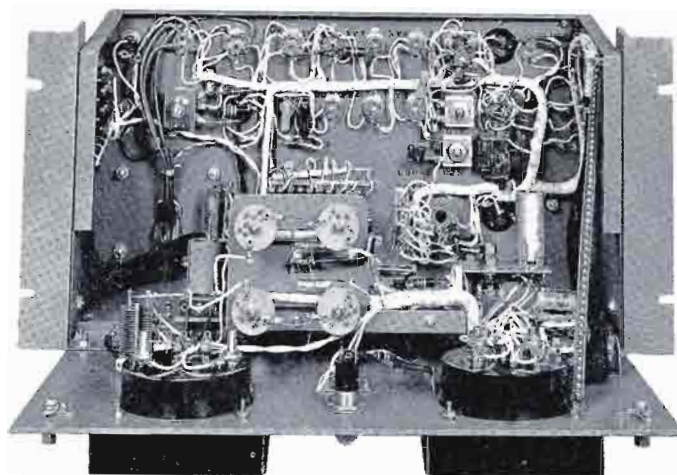

Front panel drops down for easy access to inner components.



Shown above are Gates M-5693 modulation monitor and M-4990 frequency monitor (described on next page), in a standard rack mounting. The two make excellent companion units, both in appearance and performance, for complete AM frequency and modulation monitor requirements.

SPECIFICATIONS

FREQUENCY RANGE: 540 to 1600 kHz.

RF INPUT: For 50/70 ohm line at approximately 10 volts.

MODULATION INDICATION:

(Meter) 0%—100% negative peaks.
0%—110% positive peaks.

(Flasher) 50% to 100% in 5% steps on negative peaks, 0.6 dB
20-7500 Hz.

(Accuracy) Meter: 2% full scale at 1000 Hz.
Flasher: 2% at 1000 Hz.

(Response time) Meter responds to correct reading with a 50 millisecond pulse. Returns to 10% of reading in 500-800 milliseconds after signal is removed.

DETECTOR LINEARITY: Negative peak clipping negligible up to 7500 Hz and 5% or less at 10,000 Hz.

LOADING EFFECT: 1000 mmF.

FIDELITY AT MEASURING OUTPUT: ± 0.5 dB 20-30,000 Hz at less than 0.5% distortion at 4.5 volts into a 100,000 ohm load. Noise: 75 dB below 4.5 volts RMS.

REMOTE OUTPUT: To extend modulation percentage meter, use Gates Model M-5837.

TUBES: (3) OA2, (2) 12B4A, and (1 each) 6X4, 5879, OB2, OC2, 5687, 12AU7, 2D21 and 8-4 (ballast tube).

POWER: 105/125 volts, 50/60 Hz, 70 watts.

MECHANICAL: 19" x 8 $\frac{3}{4}$ " x 11 $\frac{1}{2}$ " deep. Weight packed (domestic) 35 lbs., (export) 85 lbs. Cubage: 3 cu. ft. Finish: beige-gray.

LICENSE: Exclusively licensed to Gates (other than to U.S. Government) under U.S. Patent 2,984,796.

ORDERING INFORMATION

AM Modulation Monitor with tubes.....	994-5693
100% spare tube kit.....	990-0345
Remote Meter Panel.....	994-5837



AM Frequency Monitor

MODEL M-4990

The major requirements of a broadcast frequency monitor are reliability, and extreme accuracy in indication of the carrier frequency. Progressive engineering has provided both in Gates FCC type approved M-4990 Frequency Monitor.

Significant improvements include an amplified intermediate frequency that is limited prior to the discriminator circuit. As a result, heavy modulation or a wide change in RF input level will have essentially no effect on the accuracy of the frequency meter reading. The precision vacuum type crystal easily meets FCC stability requirements, and is mounted in a temperature controlled chamber, along with oscillator components. This results in one-half part per million frequency accuracy. Another engineering improvement is the greatly simplified balanced discriminator circuit. The older and often troublesome meter reactance box has been discarded.

For remote control operation, the M-4990 Frequency Monitor may be operated as an off-the-air monitor, or over telephone lines when used with the Gates M-5631 Extension Meter Panel.

Frequency is direct reading. The same meter, by switching, also indicates; (a) carrier level, and (b) oscillator current. Controls include: AF level for correct input signal; phone jack for 1,000 Hz tone; power switch and OVEN ON pilot light.

SPECIFICATIONS

FREQUENCY RANGE: 540-1600 kHz (as ordered).

METER: Reads direct 30-0-30 Hz above and below carrier frequency.

OSCILLATOR AND STABILITY: Electron coupled, 1,000 Hz below assigned frequency. Accuracy of ± 0.5 parts per million. Over-all monitor stability, ± 2.0 parts per million.

INPUT: 50/70 ohms. Will operate on input as low as 5 mV. When direct connected, will accommodate input voltages from 5 to 50 volts. The input signal may be either modulated or unmodulated.

POWER INPUT: 105/125 volts, 50/60 Hz, 85 watts.

TUBES: (5) 6AU6, (3) 6AQ5, (2) 6AL5 and (1 each) 12BY7A, 6C4, 12AT7, 6X4, OB2 and 13-4 ballast tube.

FCC APPROVAL: No. 3-102.

MECHANICAL: 19" x 10½" x 10½" deep. Weight packed (domestic) 53 lbs., (export) 77 lbs. Cubage: 4. Finish: beige-gray.

ORDERING INFORMATION

Frequency Monitor with tubes.....	994-4990
Remote Control Extension Meter (see Page 65).....	994-5631
Spare 100% tube kit for monitor.....	990-0281

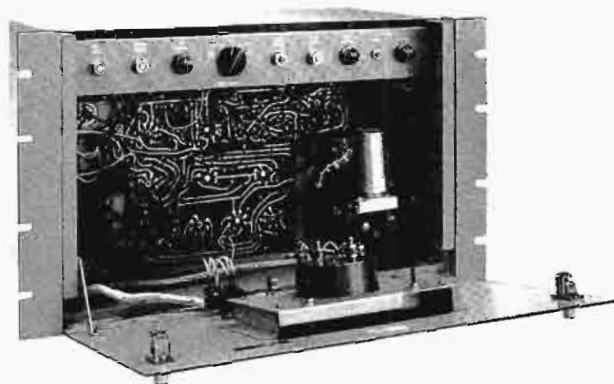

Front panel hinges down for easy maintenance and operating adjustments. Note the circular temperature-controlled oven containing all oscillator components and the precision vacuum type crystal. A slip-on dust cover protects tubes and terminations.



AM Accessories



PHASE MONITOR

A completely solid state AM phase monitor for directional systems up to 9 towers. Phase readings are not affected by modulation, and are accurate to $\pm 1^\circ$. Silicon transistors and taut-band meters assure greatest reliability. The Model 112 phase monitor is easy to operate, easy to read, and it is fully adaptable to remote control operation.

SPECIFICATIONS

FREQUENCY RANGE: 540-1600 kHz.
ACCURACY: $\pm 1^\circ$. Phase resolution: 0.5° .
INPUT IMPEDANCE: 50 or 75 ohms.
NUMBER OF INPUTS: Up to 9.
INPUT LEVEL: 1.5 to 20 volts RMS.
POWER REQUIRED: 115/230 VAC, 15 watts. 50/60 Hz.
SIZE: 19" W x 7" H x 14" D.
WEIGHT: 20 lbs.

ORDERING INFORMATION

Model 112 Phase Monitor (State number of towers).....731-020X

FIELD INTENSITY METER

The battery operated Model 120E field intensity meter is universally used to measure field strength in the 540-1600 kHz broadcast band. Accuracy of measurement is assured by a calibration method that compensates for variations in tube characteristics and for voltage variations in the self-contained battery power supply. The 120E is a necessary item for initial and periodic directional antenna measurement and proof of performance.

SPECIFICATIONS

FREQUENCY RANGE: 540-1600 kHz.
MEASUREMENT RANGE: 10 microvolts to 10 volts per meter.
ACCURACY: 2%.
OUTPUT INDICATOR: Direct reading. Provision for recorder.
TUBES: (4) 1T4, (2) 1R5, plus two IN34A diodes.
BATTERIES: (5) 1.5 volt flashlight type, (2) midget $67\frac{1}{2}$ volt "B".

Note: These standard type universally available batteries are not supplied, but may be purchased locally.

SIZE: 9" high, 13" wide, $5\frac{3}{4}$ " deep.
WEIGHT: 12½ pounds.



ORDERING INFORMATION

Model 120E Field Intensity Meter (less batteries).....700-0001

Dummy Antennas

The dummy antenna is perhaps the most needed test device in a broadcasting station. Principal use is tune-up, test and proof of performance without the signal being on the air. For daytime stations, this means routine work may be done after station sign off instead of after 1 a.m. The dummy antenna is most valuable in the event of a transmitting system malfunction. At this time the first problem is always locating

the source of the trouble. An open transmission line, a short in the coupler or phasor, a short in a tower light, etc., will usually react by operating the overload relay in the transmitter. By attaching the dummy antenna, the trouble spot is quickly isolated as either in the transmitter or elsewhere in the system.

5 KW AIR COOLED DUMMY ANTENNA

For use with standard broadcast transmitters in the 5 kW power range for tune-up, efficiency tests and proof of performance tests. Essentially non-reactive. Handles 5000 watts 100% sine wave modulated. For operation between 200 kHz and 2000 kHz. 27½" x 26" x 10¼" high. Available in 50 ohm (Model DU-551) and 70 ohm (Model DU-570).



10 KW AIR COOLED DUMMY ANTENNA

An air cooled 10,000 watt dummy antenna that will permit 100% sine wave modulation for long periods of time. Essentially non-reactive, it can be used at full rating between 200 kHz and 2000 kHz. Resistance, 50 ohms. This air cooled dummy antenna eliminates need for water connections and is a practical device for tune-up and measurement. 29½" x 26" x 16¾" high. Model M-6107.



50 KW WATER COOLED DUMMY ANTENNA

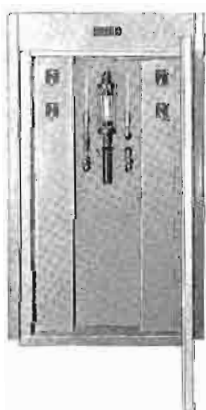

The Gates 50 kW water cooled dummy antenna is available either for medium wave or short wave application. The medium wave unit is essentially non-reactive in the 200-2000 kHz band, and does not usually require a matching network. Both models will easily handle a full 50 kW 100% modulated when provided with suitable water flow. Water of reasonable purity can be used; normal required flow is approximately 15 gallons per minute. Dual thermometers and flow meter

are provided for precise power measurement by the calorimetric method. Available in medium wave type with 50, 70, 150, 300 or 600 ohms input impedance as ordered. The high frequency model for operations between 2-30 MHz is available only for 300 or 600 ohms. Size: 78" high, 42" wide, 48½" deep.

100 KW WATER COOLED DUMMY ANTENNA



Designed for high power application, the Model WDL-1000A water cooled dummy load will dissipate a generous 100 kW AM at any frequency up to 30 MHz. Operating impedance is 300 ohms balanced. Other impedances available on special order. This model employs its own captive water system and an external heat exchanger. Water required for cooling need only be reasonably clean and free

from mineral content. Heat is dissipated in an external heat exchanger of the water-to-air type. Approximately 150 gallons of water fill the system.

Size, of the dummy load only, is approximately 4' wide, 5' high, 4' deep. Total weight, including heat exchanger, is 3850 pounds packed for shipment. Operates on 230 volts AC, single phase.

1 KW AIR COOLED DUMMY ANTENNA



This unit may be used for any medium wave transmitter at a maximum power rating of 1 kW, 100% modulated. Consists of non-inductive resistors heavily banded together to arrive at correct load resistance. For 200 kHz to 2000 kHz. 20¼" x 12¾" x 5" high. Available in 50 ohm and 70 ohm models.

ORDERING INFORMATION

DU-551 Dummy Antenna, 5 kW, 50 ohms.....	994-3968-001
DU-570 Dummy Antenna, 5 kW, 70 ohms.....	994-3968-002
M-6107 Dummy Antenna, 10 kW, 50 ohms.....	994-6107
M-5497 Dummy Antenna, 50 kW, medium wave (see Note 1)	994-5497-001
M-5497A Dummy Antenna, 50 kW, high frequency (see Note 1).....	994-5497-002
Dummy Antenna, 100 kW, high frequency (see Note 2).....	WDL-1000A
DU-151 Dummy Antenna, 1 kW, 50 ohms.....	994-4354
DU-170 Dummy Antenna, 1 kW, 70 ohms.....	994-3483

NOTES: (1) Be sure to state resistance, such as 50 ohms. (2) Give power line frequency when ordering, such as 50 or 60 Hz, etc.

AM Transmitter Installations



▲ 6½ miles off the Miami shoreline, Station WRIZ uses a Gates BC-10H (10 kW) main transmitter, with a Vanguard II (1 kW) transmitter as a stand-by.

Gates first Vapor Cooled 50 kW transmitter—delivered to Station KDAY, Los Angeles. ▶

Gates broadcast transmitters are in constant service throughout the world. From low power local stations to full 50,000 watt stations, Gates has produced hundreds of transmitters to meet every broadcasting need. Almost fifty years of Gates engineering know-how goes into every AM transmitter manufactured, and this is your assurance of receiving only the best equipment for the job. Each Gates AM transmitter incorporates the latest state-of-the-art advances, yet is easily operated and maintained.

▶ WIBC, Indianapolis—50,000 watt Model BC-50C and 10,000 watt Model BC-10P transmitters in an ultra-modern installation.

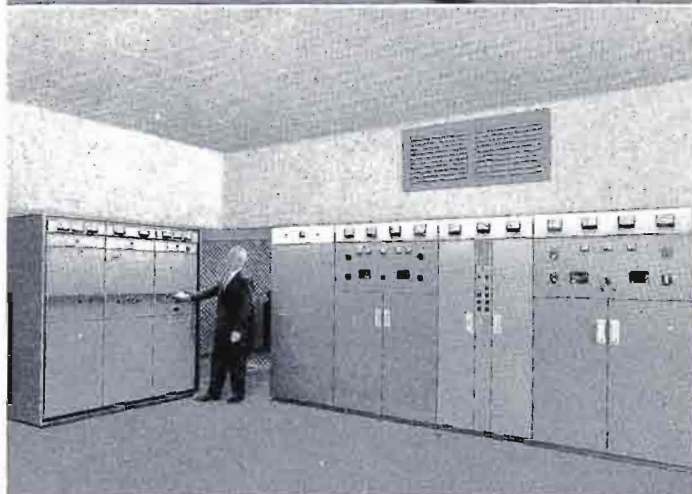
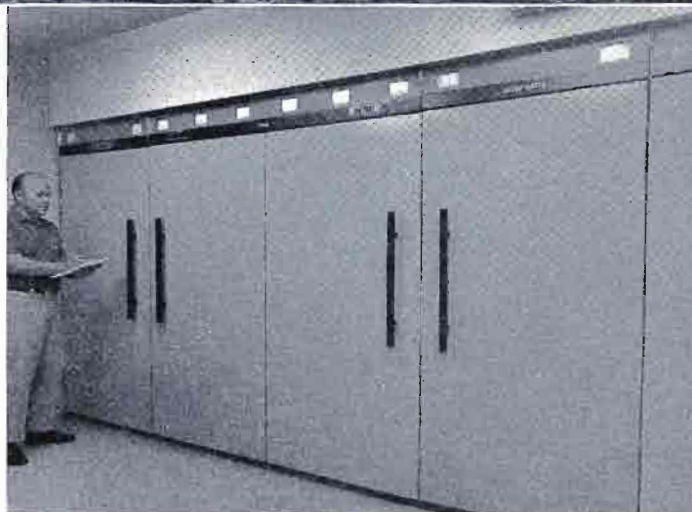

Solid State "DCFM" Exciter

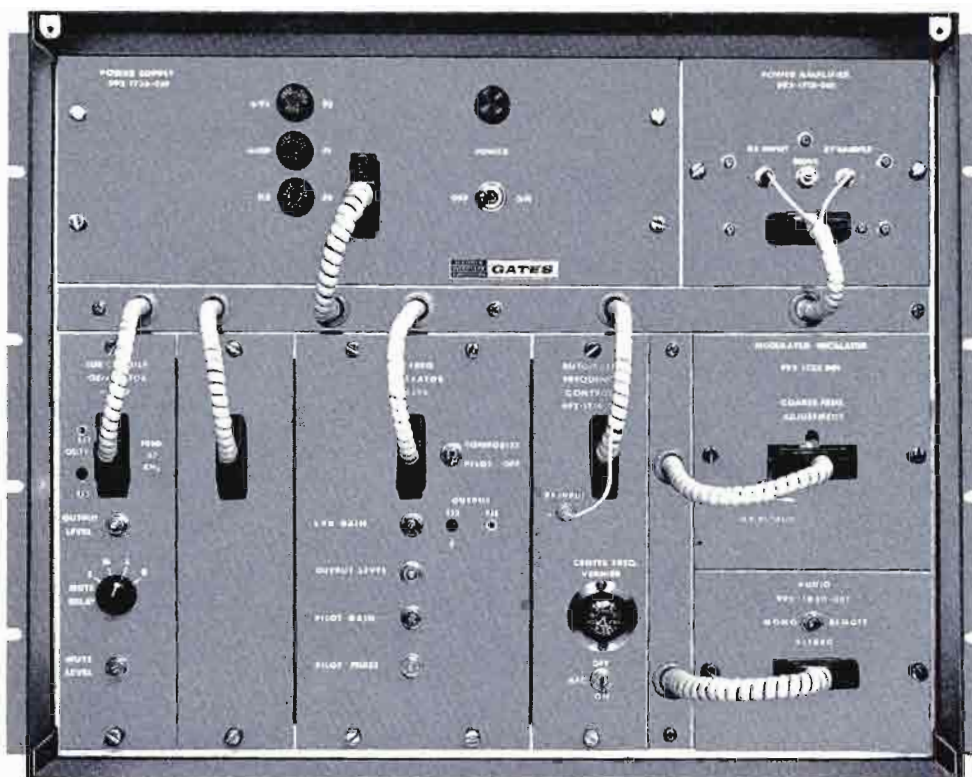

MODEL TE-1

Gates advanced engineering produced the first 100% solid state FM exciter employing Direct Carrier Frequency Modulation (DCFM). This technological breakthrough is now the heart of every Gates "H" series FM transmitter.

The "H" series, first to employ an all solid state DCFM exciter in an FM transmitter, is now thoroughly field proven, and consists of:

- A one tube 250 watt FM transmitter
- A one tube 1000 watt FM transmitter
- A two tube 3000 watt FM transmitter
- A two tube 5000 watt FM transmitter
- A two tube 7500 watt FM transmitter
- A two tube 10,000 watt FM transmitter
- A three tube 20,000 watt FM transmitter
- A six tube 40,000 watt FM transmitter.

FULL 10 WATTS OF RF SOLID STATE POWER: The Model TE-1 Exciter was designed to upgrade FM transmitter reliability by using solid state devices to reduce the greatest danger to electronic equipment—heat. Only performance-proven solid state devices and precision temperature-compensated components are used to assure continuous duty service. A full 10 watts of composite RF signal at carrier frequency is produced easily by this 100% transistorized exciter. The TE-1 can be used to drive most modern FM transmitters requiring 10 watts carrier frequency input.

ADVANCED DESIGN: The oscillator in the Model TE-1 Exciter operates at the carrier output frequency, eliminating frequency multipliers. This means improved carrier stability

and excellent frequency response. With this exciter, phase shift and distortion resulting from frequency multiplier tuned circuits are now a thing of the past. There is no longer a need to retune critical stages, which means more stable and efficient operation.

STEREO SEPARATION 35 DB MINIMUM: Optimum 35 dB separation is the result of Direct Carrier Frequency Modulation of the oscillator at the output frequency. As carrier generation and modulation take place "on frequency," the wide bandwidth needed for high fidelity reproduction is easily attained. The result is better FM stereo separation and better crosstalk between main channel and sub channels used for SCA and FM stereo.

MODULAR CONSTRUCTION: The Model TE-1 is composed of seven modules, each individually shielded, and connected within the exciter enclosure by an advanced intercabling technique. Connections are made at the front of each module with premium quality quick-disconnect plugs. Test voltage measurements and adjustments can be made easily by this advanced modular mechanical design. Modular construction allows the addition of stereo or SCA at a later date by simply plugging in the factory adjusted module(s).

SUPERB SCA OPERATION: In the TE-1 Exciter crosstalk from the main channel to the SCA channel is virtually eliminated through new filtering techniques, and cancellation of the second harmonic of the composite stereo signal.

Model TE-1 Exciter Modules



Modulated Oscillator Module

Operating at carrier frequency, the ultra stable emitter coupled oscillator is modulated by the direct application of mono, stereo and SCA input signals. For the most precise stability, the oscillator circuit is constructed with temperature compensated components and the entire assembly is enclosed in an oven. Gates "DCFM" is generated in this module, and feeds the solid state 10 watt amplifier module.

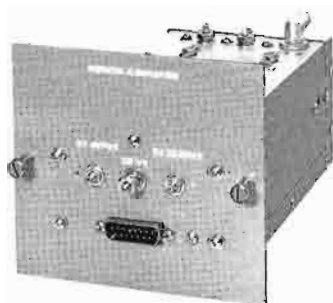

Power Amplifier Module

The power amplifier of the Model TE-1 FM Exciter is all solid state and provides a 10 watt signal at carrier frequency to the driver or final amplifier of Gates "H" Series Transmitters. Amplifier bandwidth is approximately 3 MHz, which assures optimum stereo separation.



Stereo Generator Module (Optional)

With Gates solid state stereo generator, stereo separation left to right and right to left is always better than 35 dB from 30 Hz to 15 kHz. This performance is assured by the Gates "DCFM" exciter design. The modular construction allows you to order a Gates FM transmitter for monophonic operation, and add the factory aligned stereo generator later.



Automatic Frequency Control Module

Continuous carrier stability, within ± 1 kHz ($\pm .001\%$) of the assigned center frequency, is provided by a precision crystal controlled oscillator. A linear pulse device compares the output frequency of the exciter with the reference oscillator to provide a correction voltage for the modulated oscillator of the Model TE-1 Exciter.



Audio Input Control Module

Control, processing and input switching of mono, stereo and 41 kHz SCA inputs to the modulated oscillator are provided in this module. During monophonic operation the right channel is automatically switched to the 41 kHz SCA input, which allows use of this program line for SCA operation.

Power Supply Module

The solid state regulated DC power supply provides 24 volts DC or 150 volts DC to all modules in the Model TE-1 Exciter. Temperature compensated zener diodes are used to provide constant voltages over a temperature range of -20° C to $+70^{\circ}$ C, and power line variations of $\pm 15\%$ from the 117 volt single phase AC power line. Ample power is available for the optional stereo and SCA modules.



SCA Module (Optional)

Stable, self-excited oscillators are used to provide 41 kHz or 67 kHz SCA operation of excellent quality, with very low distortion. Automatic muting is included, with provision for control of both mute level and mute time constant. Factory pre-aligned SCA modules can be installed in the Model TE-1 Exciter by simply plugging into the space provided.

40,000 Watt FM Transmitter



MODEL FM-40H

Gates largest standard model FM transmitter offers the ultimate in reliable performance, with superior FM monaural and multiplex operation. The FM-40H uses only six tubes to develop a 40 kW output, which, in combination with the appropriate antenna, is capable of producing the maximum effective radiated power permissible for a Class C station.

SOLID STATE "DCFM": Gates field proven 100% solid state TE-1 exciter, employing Direct Carrier Frequency Modulation, is the heart of the FM-40H transmitter. The modulated oscillator of the exciter operates at the carrier frequency for greatest stability and excellent frequency response. The 10 watt output of the exciter drives separate 10 watt solid state isolation amplifiers.

The isolation stages drive a pair of 4CX250B tubes in each amplifier, which produce 400 watts of drive for the single 4CX15000A power amplifier. Sufficient space is available to duplicate the exciter and isolation amplifier if desired.

HIGH POWER PERFORMANCE: Modern ceramic tetrodes are used in the FM-40H for reliability and low cost operation. Output tuning in each amplifier is accomplished with an induc-

tively tuned silver plated tank circuit. This eliminates the need for vacuum capacitors in the tank circuit of the amplifier. Tee notch and harmonic filters on the output of each amplifier reduce harmonic radiation beyond the required minimum.

COMBINING NETWORK: Outputs of each 20 kW amplifier are fed through Tee notch and harmonic filters to the combining network. This hybrid network adds the two 20 kW signals to produce a 40 kW output to the transmission line. However, the two amplifiers remain isolated from each other.

Should one power amplifier fail, the other will continue feeding the combining network, and the combiner will operate as a power divider. However, in this case, 10 kW is fed to the output transmission line, and 10 kW is fed into a 10 kW dummy load connected to the combiner. This is necessary to maintain almost complete isolation of the non-operating amplifier and to permit servicing without unwanted RF coupling.

The combining network, harmonic, and Tee notch filters, or "plumbing", can be physically tailored to fit specific installation requirements.

40,000 Watt FM Transmitter—FM-40H

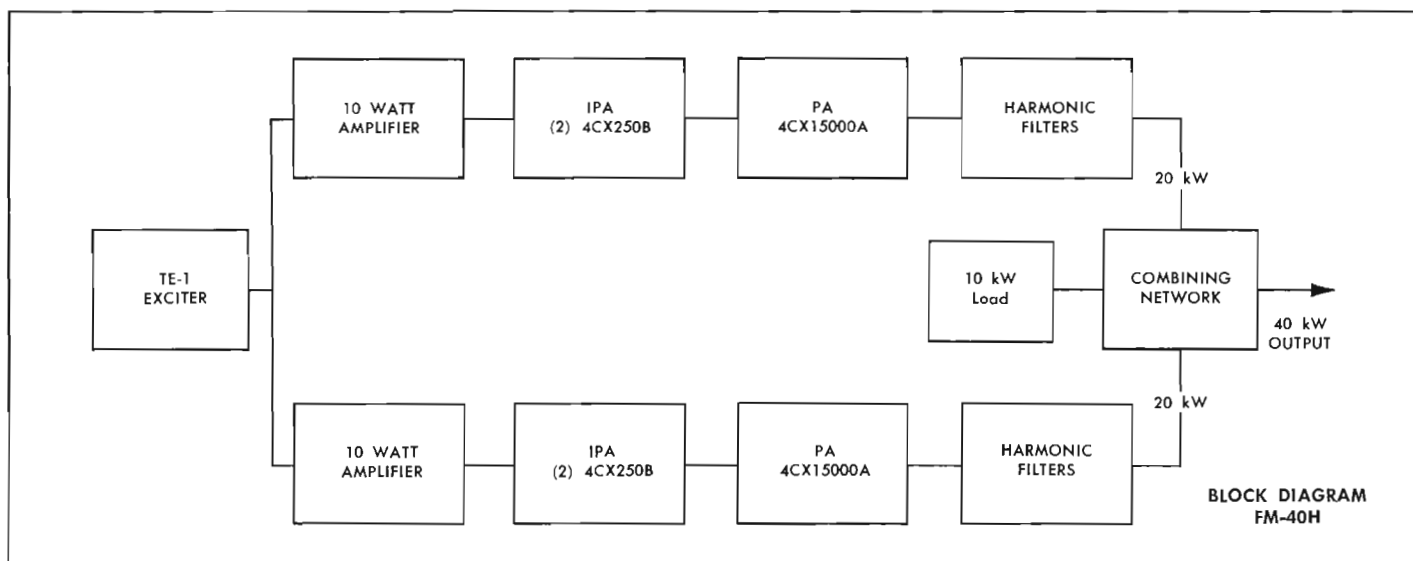

SPECIFICATIONS

GENERAL:

POWER OUTPUT: 40 kW.
FREQUENCY RANGE: 87.5 to 108 MHz, tuned to specified operating frequency.
RF OUTPUT IMPEDANCE: 50 ohms.
OUTPUT TERMINATION: 3/8" EIA flange.
FREQUENCY STABILITY: .001% or better.
TYPE OF MODULATION: Direct Carrier Frequency Modulation.
MODULATION CAPABILITY: ± 100 kHz.
AC INPUT POWER: 208/240 V, 3 phase 60 Hz. Power consumption 72,000 watts (approx.). 115 V single phase 60 Hz (50 Hz available on special order).
RF HARMONICS: Suppression meets all FCC requirements.
POWER SUPPLY RECTIFIERS: Silicon.
ALTITUDE: 7,500 feet.
AMBIENT TEMPERATURE RANGE: -20°C to $+45^{\circ}\text{C}$.
MAXIMUM VSWR: 1.7 to 1.
OVER-ALL CABINET SIZE: Transmitter cabinet 84" W x 78" H x 32 3/4" D. HV power supply cabinet 30" W x 30" D x 49" H. (Two supplied).
FRONT DOOR SWING: 21".
FINISH: Two-tone beige-gray.
WEIGHT AND CUBAGE: Export 6400 lbs. Domestic 5400 lbs., 260 cu. ft.

MONAURAL MODE

AUDIO INPUT IMPEDANCE: 600 ohms balanced.
AUDIO INPUT LEVEL: $+10$ dBm ± 2 dB for 100% modulation at 400 Hz.
AUDIO FREQUENCY RESPONSE: Standard 75 microsecond, FCC pre-emphasis curve ± 1 dB, 30-15,000 Hz.
DISTORTION: 0.5% or less, 30-15,000 Hz.
FM NOISE: 65 dB below 100% modulation (ref. 400 Hz).
AM NOISE: 50 dB below reference carrier AM modulated 100%.

STEREOPHONIC MODE (Stereo Generator optional)

PILOT OSCILLATOR: Crystal controlled.

PILOT STABILITY: 19 kHz ± 1 Hz.

AUDIO INPUT IMPEDANCE: (left and right) 600 ohms balanced.

AUDIO INPUT LEVEL: (left and right) $+10$ dBm ± 1 dB for 100% modulation at 400 Hz.

AUDIO FREQUENCY RESPONSE: (left and right) Standard 75 microsecond, FCC pre-emphasis curve ± 1 dB, 30-15,000 Hz.

DISTORTION: (left or right) 1% or less, 50-15,000 Hz.

FM NOISE: (left or right) 60 dB minimum below 100% modulation, reference 400 Hz.

STEREO SEPARATION: 35 dB minimum 50-15,000 Hz.

SUB-CARRIER SUPPRESSION: 42 dB below 90% modulation.

CROSSTALK: (main to sub-channel or sub to main channel) 42 dB below 90% modulation.

SCA MODE (SCA Generator optional)

FREQUENCY STABILITY: ± 500 Hz.

FREQUENCY: Between 25 and 75 kHz.

OSCILLATOR TYPE: Two Colpitts heterodyned to produce desired output frequency.

MODULATION: Direct FM.

MODULATION CAPABILITY: ± 7.5 kHz.

AUDIO INPUT IMPEDANCE: 600 ohms balanced.

AUDIO INPUT LEVEL: $+8$ dBm, ± 3 dB, for 100% modulation at 400 Hz.

AUDIO FREQUENCY RESPONSE: 41 kHz and 67 kHz, 50 microsecond, modified pre-emphasis. 67 kHz response modified for proper operation when used with stereo to conform to FCC specifications.

DISTORTION: Less than 1.5% 30-7000 Hz.

FM NOISE: (Main channel not modulated) 55 dB minimum (ref. 100% modulation 400 Hz).

CROSSTALK: (sub-channel to main channel) — 60 dB or better.

CROSSTALK: (main channel to sub-channel) 50 dB below 100% modulation (ref. 400 Hz).

AUTOMATIC MUTE LEVEL: Variable from 0 to -40 dB below 100% modulation.

ORDERING INFORMATION

FM-40H, 40,000 watt FM broadcast transmitter with TE-1 exciter.....	994-6626
FM-20/20H, 20,000/20,000 watt FM broadcast transmitter, with TE-1 exciter. No combining network—feeds horizontal and vertical antennas separately.....	994-6627
100% spare tube kit for either of above models.....	990-0573
Stereo Generator (add for stereo operation).....	994-6533
SCA Sub-carrier generator (add for SCA operation).....	994-6507

20,000 Watt FM Transmitter

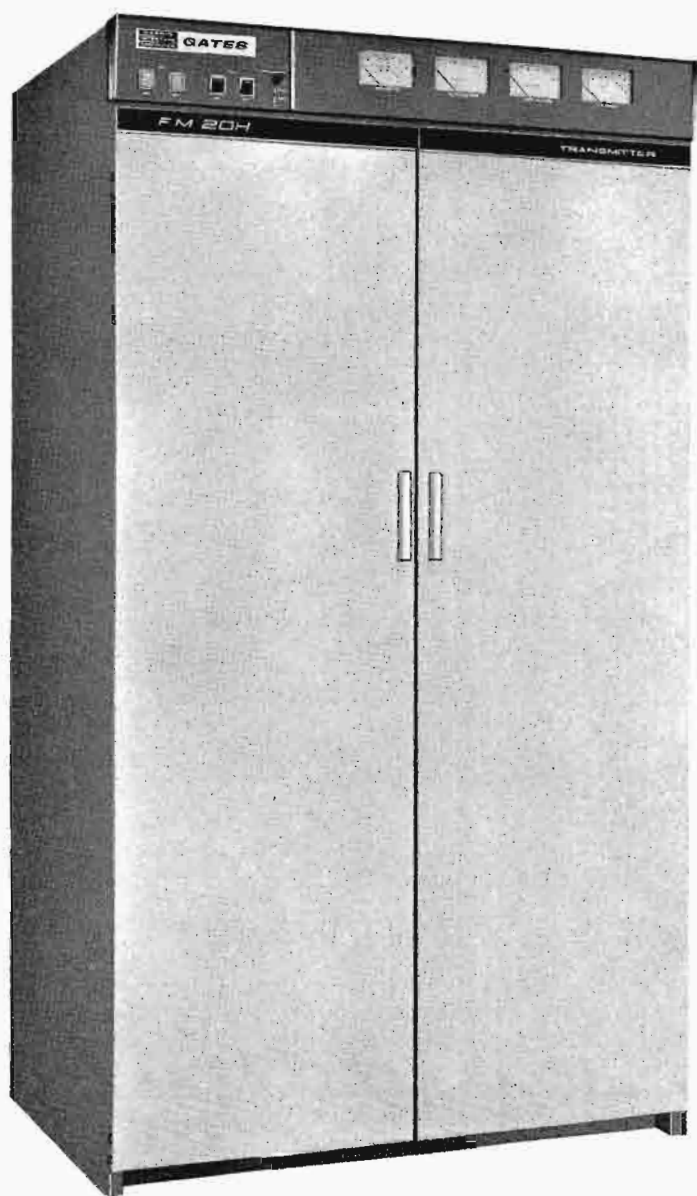

MODEL FM-20H

The pace-setting engineering which produced Direct Carrier Frequency Modulation (DCFM), as employed in the FM-20H, has made possible a three tube, 20,000 watt transmitter with the ultimate in performance standards. Fully FCC type accepted for stereo and monaural broadcasting in the 88 to 108 MHz FM band.

ONLY THREE TUBES: Solid state reliability is achieved, as the transmitter uses only three tubes for 20,000 watts output. The transistorized model TE-1 exciter delivers ten watts. This is followed by the only tubes employed—two parallel 4CX250B drivers and the rugged 4CX15000A single ended power amplifier.

POWER AMPLIFIER TUBE: The ceramic type 4CX15000A output tube assures excellent performance and long tube life for 20,000 watt FM service. This high power gain tetrode operates at a leisurely pace, and was selected for the FM-20H because of its proven, long-life performance in the previous FM-20G transmitter.

SOLID STATE "DCFM" EXCITER: The 100% solid state model TE-1 exciter employs an advanced Gates design wherein the oscillator is modulated at the carrier frequency (DCFM). The result is improved carrier stability and unsurpassed frequency response. Modular construction of the TE-1 exciter allows plugging in of the solid state individually shielded stereo and SCA modules at any time.

Superb stereophonic sound is achieved through Gates exclusive "DCFM" design—with optimum stereo separation of 35 dB minimum from 50 Hz to 15,000 Hz. As carrier generation and modulation take place "on frequency," the wide bandwidth needed for high fidelity reproduction is easily attained. This results in better stereo separation, and reduced crosstalk between main channel and sub-channels used for SCA and FM stereo.

PLUG-IN STEREO/SCA GENERATOR MODULES: To equip your FM-20H transmitter for stereo or SCA just plug the appropriate module into the TE-1 exciter. For SCA you have your choice of either a 41 kHz or a 67 kHz module.

OPERATIONALLY TESTED: Environmental tests that surpass conditions of any location a transmitter is likely to encounter were imposed upon the FM-20H before it entered production. In addition, each transmitter is fully tuned and tested to the assigned frequency before shipment.

PUSHBUTTON OPERATION: On-off functions are controlled by lighted pushbuttons at the top left of the transmitter. These are plainly marked "filament on-off"; "plate on-off".

POWER OUTPUT CONTROL: In the FM-20H transmitter, Gates supplies a built-in motor-operated screen voltage control, for power output adjustment.

REMOTE CONTROL BUILT IN: All necessary functions can be remote controlled in the FM-20H. No additional equipment is required for Gates remote control systems.

AUTOMATIC RECYCLING: In case of momentary overload, the FM-20H will recycle automatically. Should the overload reoccur in excess of the desired number of times preset in the transmitter, the transmitter will then remain off the air until reset locally or remotely.

HANDSOME STYLING: The main transmitter cabinet is attractively, yet functionally styled, with double front doors, and an eye-catching meter panel framed in contoured brushed aluminum. The finish is in two-tone beige-gray. A separate enclosure for the HV power supply complements the main FM-20H cabinet.

20,000 Watt FM Transmitter—FM-20H

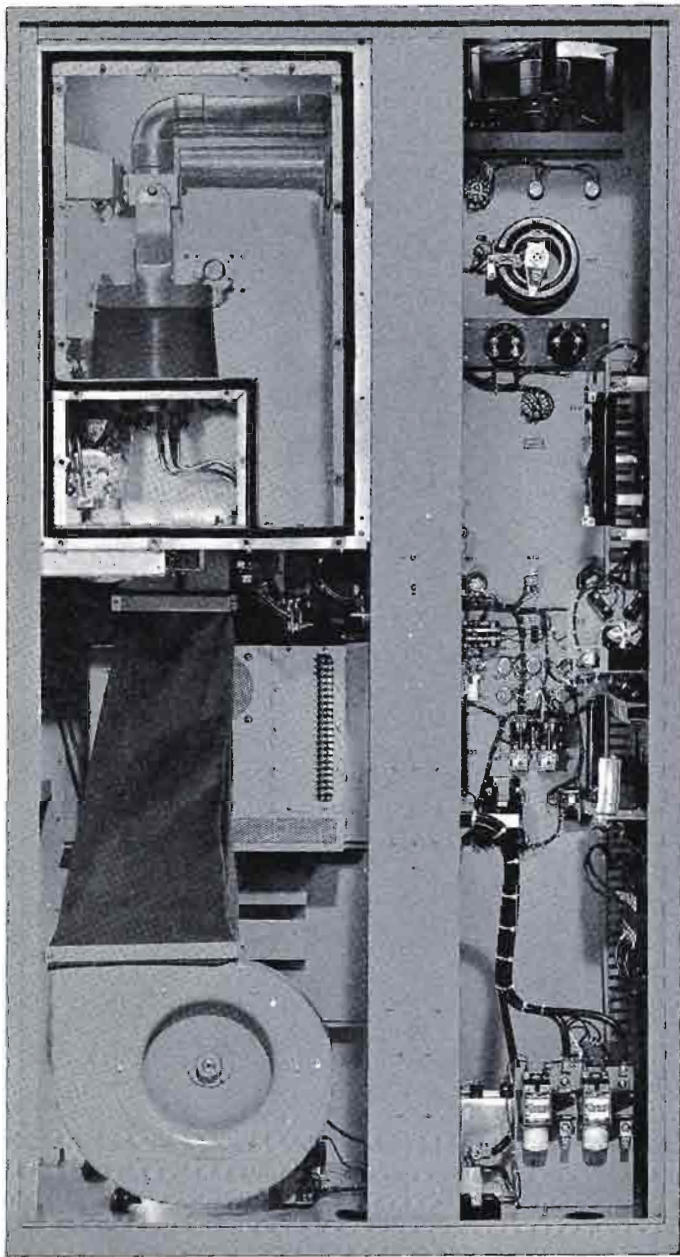

VARI-LINE TUNING/SILVER PLATED TANK: Vari-Line, an advanced, Gates-developed method of tuning a single ended FM amplifier for optimum output efficiency, is used in the model FM-20H. A portion of a parallel tubular 2 $\frac{3}{8}$ -inch copper transmission line (silver plated by Gates for efficient RF service) is made variable to inductively tune the line to operating frequency. With Vari-Line tuning, greater reliability is possible, as neither mica nor vacuum capacitors are needed in the tank circuit—thereby reducing the complexity of sliding contacts and corresponding maintenance problems.

POWER GUARD: The model FM-20H transmitter is protected by Power Guard, a Gates developed power supply protective circuit. This assures maximum protection from transient voltages or on-off power surges which might damage the power transformer and related components.

HV SILICON POWER SUPPLIES: Two separate three-phase all-silicon power supplies are used in the FM-20H. The 9,000 volt supply, for PA plate voltage, is housed in a separate high voltage enclosure, and includes a manual switch to allow power cutback to approximately 6 kW. The other three-phase power supply, which powers the IPA plate and screen circuit, and also the PA screen, is housed in the main transmitter cabinet.

The bias supply for both the IPA and the PA is a bridge circuit of four silicon rectifiers.

Silicon rectifiers are used throughout the FM-20H. The result is greatly improved performance, as silicon cells are particularly resistant to aging, moisture, and wide temperature variations. An ample safety factor is provided, as individual rectifier cells are rated several times the required voltage.

SEPARATE POWER SUPPLY CUBICLE: The 9,000 volt HV power supply for the FM-20H transmitter is contained in a separate interlocked enclosure measuring 49" high, 30" wide, and 30" deep. No circuit breakers, contactors, or moving parts critical to the transmitter operation are contained in the enclosure. Designed for convenient installation, the enclosure may be located in an unused area of the transmitter building, or adjacent to the transmitter. An exhaust fan provides cabinet cooling.

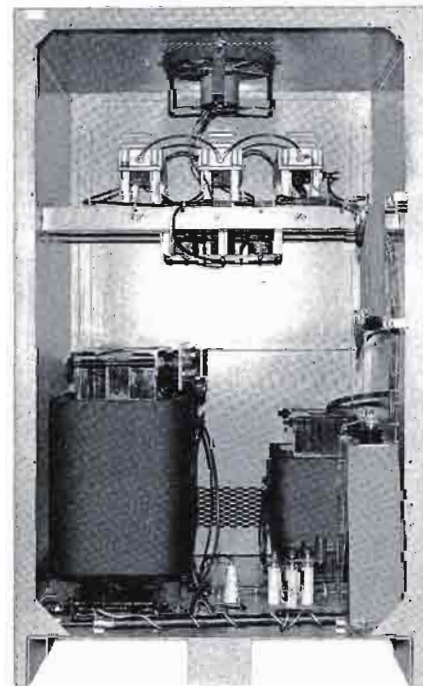

HV power supply.

20,000 Watt FM Transmitter—FM-20H

HARMONIC FILTERS STANDARD EQUIPMENT: Included as standard equipment is a Tee type notch filter for second harmonic reduction, a micromatch VSWR section for direct meter reading on the transmitter of both power output and standing wave ratio, and a low pass filter which substantially eliminates third and higher order harmonics. Tuning and testing, which includes adjustment of filters for maximum harmonic attenuation, is accomplished at the factory on the customer's frequency.

EFFICIENT AIR COOLING: A heavy-duty impeller type blower was selected for use in the FM-20H to help increase component life. This blower moves up to 33% more air than required for normal heat dissipation of the transmitter when operating at altitudes up to 7500 feet—which means fast, efficient cooling for all components.

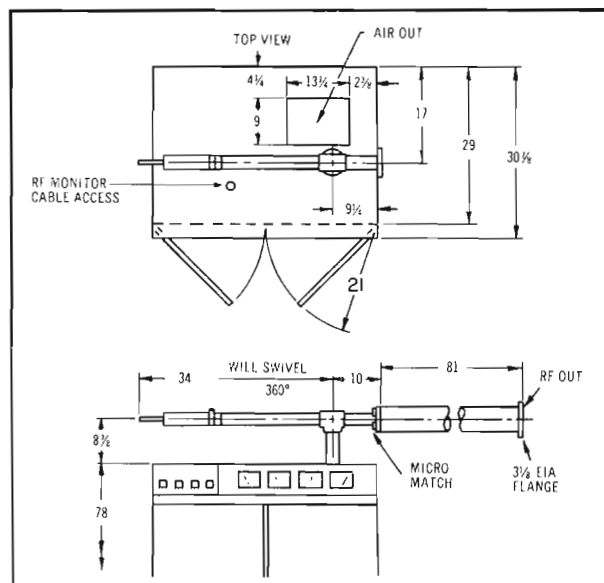

GENERAL

POWER OUTPUT: 20 kW.
FREQUENCY RANGE: 87.5 to 108 MHz, tuned to specified operating frequency.
RF OUTPUT IMPEDANCE: 50 ohms.
OUTPUT TERMINATION: 3/8" EIA flange.
FREQUENCY STABILITY: .001% or better.
TYPE OF MODULATION: Direct Carrier Frequency Modulation.
MODULATION CAPABILITY: ±100 kHz.
AC INPUT POWER: 208/240 V, 3-phase 60 Hz. Power consumption 36,000 watts (approx.). 115 V single phase 60 Hz (50 Hz available on special order).
RF HARMONICS: Suppression meets all FCC requirements.
POWER SUPPLY RECTIFIERS: Silicon.
ALTITUDE: 7,500 feet.
AMBIENT TEMPERATURE RANGE: -20°C to +45°C.
MAXIMUM VSWR: 1.7 to 1.
OVER-ALL CABINET SIZE: Transmitter cabinet 42" W x 78" H x 32 1/4" D. HV power supply cabinet 30" W x 30" D x 49" H.
FRONT DOOR SWING: 21".
FINISH: Two-tone, beige-gray.
WEIGHT & CUBAGE: Export: 3,200 lbs. Domestic: 2,700 lbs. 130 cu. ft.

MONAURAL MODE

AUDIO INPUT IMPEDANCE: 600 ohms balanced.
AUDIO INPUT LEVEL: +10 dBm ±2 dB for 100% modulation at 400 Hz.
AUDIO FREQUENCY RESPONSE: Standard 75 microsecond, FCC pre-emphasis curve ±1 dB, 30-15,000 Hz.
DISTORTION: 0.5% or less, 30-15,000 Hz.
FM NOISE: 65 dB below 100% modulation (ref. 400 Hz).
AM NOISE: 50 dB below reference carrier AM modulated 100%.

STEREOPHONIC MODE (Stereo Generator optional)

PILOT OSCILLATOR: Crystal controlled.

SPECIFICATIONS

PILOT STABILITY: 19 kHz ±1 Hz.
AUDIO INPUT IMPEDANCE: (left and right) 600 ohms balanced.
AUDIO INPUT LEVEL: (left and right) +10 dBm ±1 dB for 100% modulation at 400 Hz.
AUDIO FREQUENCY RESPONSE: (left and right) Standard 75 microsecond, FCC pre-emphasis curve ±1 dB, 30-15,000 Hz.
DISTORTION: (left or right) 1% or less, 50-15,000 Hz.
FM NOISE: (left or right) 60 dB minimum below 100% modulation, reference 400 Hz.
STEREO SEPARATION: 35 dB minimum 50-15,000 Hz.
SUB-CARRIER SUPPRESSION: 42 dB below 90% modulation.
CROSSTALK: (main to sub-channel or sub to main channel) 42 dB below 90% modulation.

SCA MODE (SCA Generator optional)

FREQUENCY STABILITY: ±500 Hz.
FREQUENCY: Between 25 and 75 kHz.
OSCILLATOR TYPE: Two Colpitts heterodyned to produce desired output frequency.
MODULATION: Direct FM.
MODULATION CAPABILITY: ±7.5 kHz.
AUDIO INPUT IMPEDANCE: 600 ohms balanced.
AUDIO INPUT LEVEL: +8 dBm, ±3 dB for 100% modulation at 400 Hz.
AUDIO FREQUENCY RESPONSE: 41 kHz and 67 kHz, 50 microsecond, modified pre-emphasis. 67 kHz response modified for proper operation when used with stereo to conform to FCC specifications.
DISTORTION: Less than 1.5% 30-7,000 Hz.
FM NOISE: (main channel not modulated) 55 dB minimum (ref. 100% modulation 400 Hz).
CROSSTALK: (sub-channel to main channel) -60 dB or better.
CROSSTALK: (main channel to sub-channel) 50 dB below 100% modulation (ref. 400 Hz).
AUTOMATIC MUTE LEVEL: Variable from 0 to -40 dB below 100% modulation.

ORDERING INFORMATION

FM-20H, 20,000 watt FM broadcast transmitter, with TE-1 exciter	994-6578
100% spare tube kit	990-0552
Stereo generator (add for stereo operation)	994-6533
SCA sub-carrier generator (add for SCA operation)	994-6507

10,000 Watt FM Transmitter

MODEL FM-10H

Gates FM-10H is the most advanced 10,000 watt FM transmitter ever offered. It incorporates the TE-1 solid state "DCFM" exciter for unsurpassed stereophonic and monaural sound, and only two tubes are required to produce a full 10,000 watts. Gates model FM-10H is fully FCC type accepted for stereophonic (with optional stereo generator) and monaural FM broadcasting in the 88 to 108 MHz band.

TWO TUBES: Only two tubes are used in the entire transmitter. An easy 10 watts is delivered from the model TE-1 transistorized exciter to the 4CX300A driver, which supplies a nominal 250 watts to drive the 4CX10,000D power amplifier. This power tetrode operates at a leisurely pace, providing ample power to deliver a high fidelity signal with proven economy.

TYPE 4CX10,000D POWER OUTPUT TUBE: Use of the power packed ceramic 4CX10,000D tube as the final amplifier assures excellent performance. It was selected because of its 10 kW plate dissipation, its ability to produce more power . . . and its proven longer, useful life.

SELF-CONTAINED: Except for the top-mounted Tee notch and low pass filters, the FM-10H transmitter is completely self-contained. The power transformer, solid state exciter, and optional stereo/SCA generating equipment are all housed in one attractively styled cabinet.

THOROUGH TESTING: Before entering production, the FM-10H was subjected to complete environmental tests to assure maximum performance under even the most difficult operating conditions. All transmitters are carefully tuned and tested to assigned frequencies before they are shipped.

BUILT-IN REMOTE CONTROL: Connect the transmitter control unit to the transmitter, tie in the telephone line to the studio control unit, and you are ready for complete remote control operation. All necessary functions can be controlled remotely—and no additional equipment is required for the remote system.

POWER GUARD: The FM-10H employs a special power supply protective circuit, Power Guard, to assure maximum protection from transient voltages or on-off power surges.

AUTOMATIC RECYCLING: Should a momentary overload occur, the FM-10H will recycle automatically. If the overload reoccurs in excess of the number of times preset in the transmitter, the transmitter will remain off the air until it is reset, either manually or by remote control.

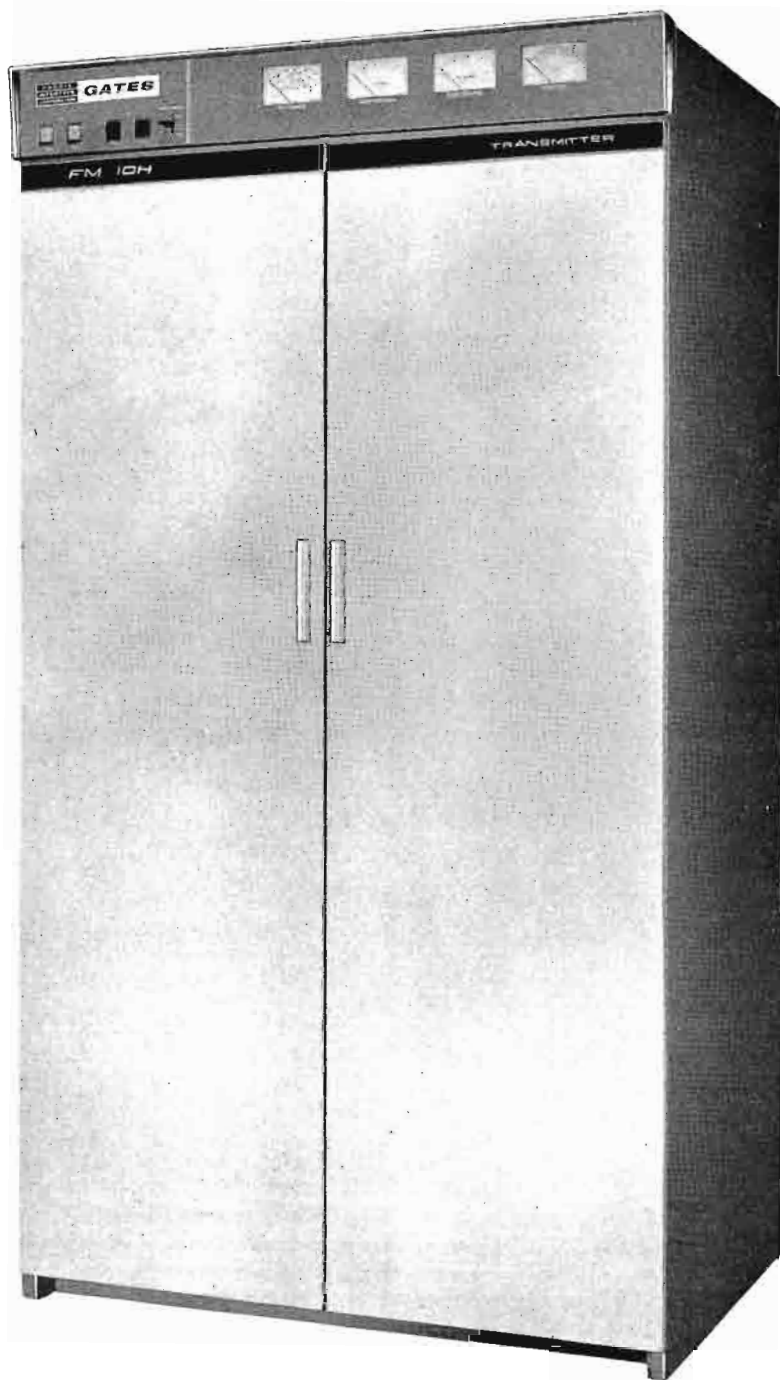

SILICON RECTIFIERS: For increased reliability, silicon power rectifiers are used in all FM-10H power supplies. Operated well below their rated levels, they provide years of dependable service in the transmitter. In the HV power supply, a generous number of 16 ampere silicon cells operate in a three phase bridge, and are so rugged that maximum transmitter current demand is only 50% of the peak rating of the supply. Three solid state power supplies are used; high voltage, bias, and exciter.

10,000 Watt FM Transmitter—FM-10H

PUSHBUTTON OPERATION: Daily operation of the FM-10H is simple, as on-off functions are controlled by lighted push-buttons, conveniently placed at the top left of the transmitter. The switch for control of the multimeter is located just to the right of the pushbutton switches. Consequently, there is no need to open the front doors to operate the transmitter.

EFFICIENT AIR COOLING: A heavy-duty impeller type blower is used in the FM-10H to provide maximum cooling throughout the cabinet. This blower moves up to 33% more air than required for normal heat dissipation of the transmitter when operating at altitudes up to 7,500 feet. . . which means fast, efficient cooling of all components, and increased component life.

HARMONIC FILTERS: To keep harmonic and spurious radiation to a minimum, and well within FCC specifications, a harmonic filter is standard equipment in the FM-10H. It consists of a Tee type notch filter for second harmonic reduction, and a low pass filter to substantially reduce third and higher order harmonics.

FULL METERING: Four large, illuminated, easy to read front panel meters are provided. One is for PA plate voltage, another for PA plate current, and a third is a multimeter which reads PA drive, PA filament, and IPA cathode current. The fourth is a reflectometer which measures either forward power or VSWR.

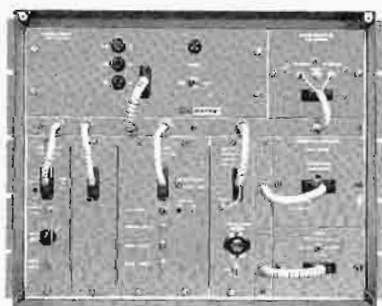

Model TE-1 Solid State exciter.

"DCFM" EXCITER: As in other "H" series transmitters, the FM-10H employs the 100% solid state TE-1 exciter. An advanced design used first by Gates, the exciter employs Direct Carrier Frequency Modulation (DCFM), whereby the oscillator is modulated at the carrier frequency. This makes possible improved carrier stability and unsurpassed frequency response.

Completely self-contained, the exciter has a convenient modular design, which allows easy plug-in of the optional solid state stereo and SCA modules at any time.

STEREO SEPARATION: Stereo separation in the FM-10H is 35 dB from 50 Hz to 15 kHz (with the optional plug-in solid state stereo generator).

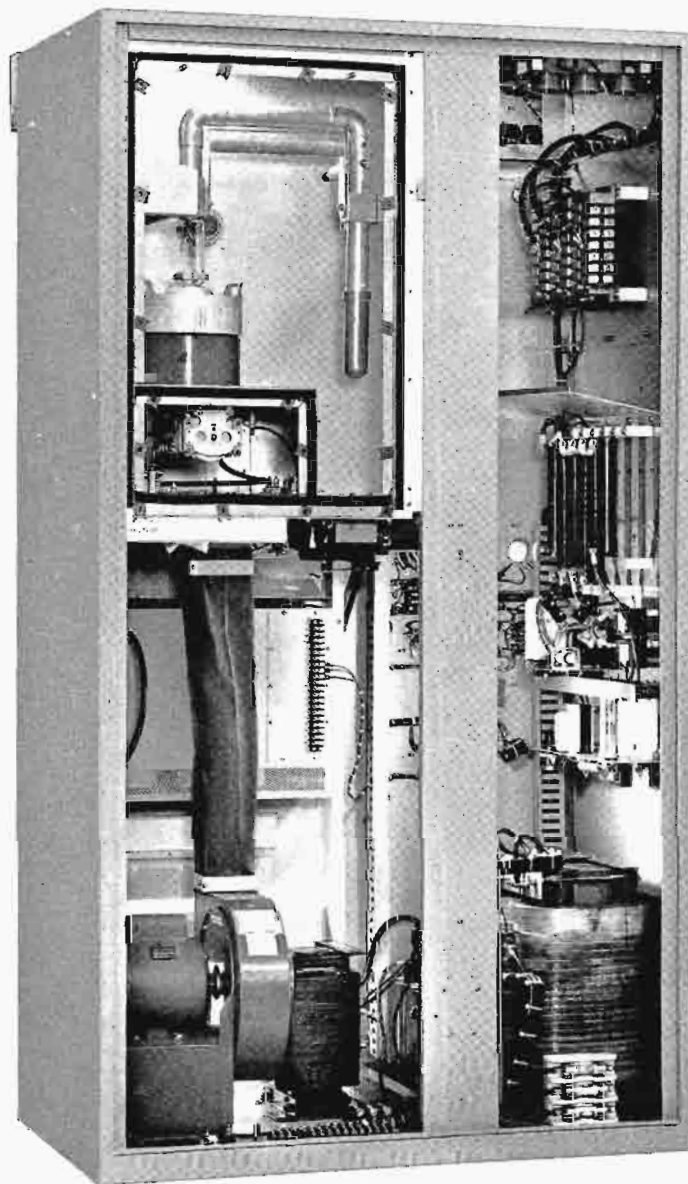

VARI-LINE TUNING/SILVER PLATED TANK: Another Gates engineering development, field proven Vari-Line, an advanced method of tuning a single ended FM amplifier for optimum output efficiency, is used in the FM-10H. A portion of a parallel tubular 1 $\frac{1}{8}$ -inch copper transmission line (silver plated by Gates for optimum RF performance) is made variable to inductively tune the line to operating frequency. With Vari-Line tuning, greater reliability is possible, as neither mica nor vacuum capacitors are needed in the tank circuit. This reduces the complexity of sliding contacts and corresponding maintenance problems. The efficiency of the tank circuit is greatly improved by providing optimum Q. Vari-Line tuning is found in all high power "H" series transmitters.

10,000 Watt FM Transmitter—FM-10H

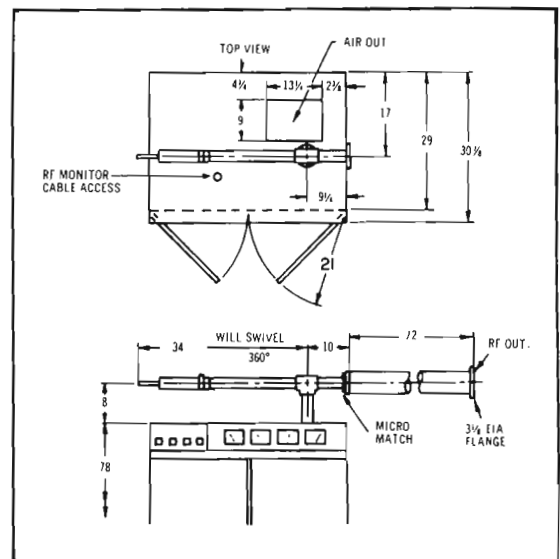
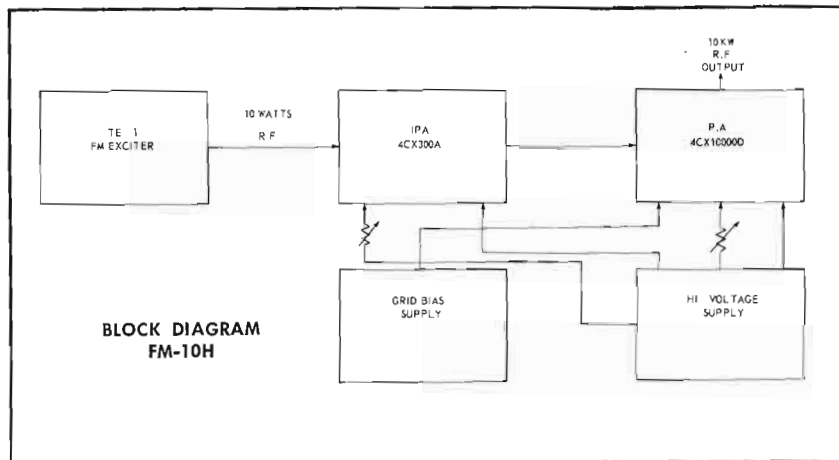

SPECIFICATIONS

GENERAL

POWER OUTPUT: 10 kW.

FREQUENCY RANGE: 87.5 to 108 MHz, tuned to specified operating frequency.

RF OUTPUT IMPEDANCE: 50 ohms.

OUTPUT TERMINATION: 3/4" EIA flange.

FREQUENCY STABILITY: .001% or better.

TYPE OF MODULATION: Direct Carrier Frequency Modulation.

MODULATION CAPABILITY: ±100 kHz.

AC INPUT POWER: 208/240 V, 3 phase, 60 Hz at 18 kW. 115 V, single phase, 60 Hz, (50 Hz available on special order).

POWER SUPPLY RECTIFIERS: Silicon.

RF HARMONICS: Suppression meets all FCC requirements.

ALTITUDE: 7,500 feet.

AMBIENT TEMPERATURE RANGE: -20°C to +45°C.

MAXIMUM VSWR: 1.7 to 1.

OVER-ALL CABINET SIZE: 42" W x 78" H x 32 3/4" D.*

*32 3/4" is over-all depth dimension. With rear door and front door handles removed, minimum depth is 29 3/4".

FRONT DOOR SWING: 29".

FINISH: Two-tone, beige-gray.

WEIGHT & CUBAGE: Export: 900 lbs. Domestic: 750 lbs. 72 cu. ft.

MONAURAL MODE

AUDIO INPUT IMPEDANCE: 600 ohms balanced.

AUDIO INPUT LEVEL: +10 dBm ±2 dB for 100% modulation at 400 Hz.

AUDIO FREQUENCY RESPONSE: Standard 75 microsecond, FCC pre-emphasis curve ±1 dB, 30-15,000 Hz.

DISTORTION: 0.5% or less, 30-15,000 Hz.

FM NOISE: 65 dB below 100% modulation (ref. 400 Hz).

AM NOISE: 50 dB below reference carrier AM modulated 100%.

STEREOPHONIC MODE (Stereo Generator optional)

PILOT OSCILLATOR: Crystal controlled.

PILOT STABILITY: 19 kHz ±1 Hz.

AUDIO INPUT IMPEDANCE: (left and right) 600 ohms balanced.

AUDIO INPUT LEVEL: (left and right) +10 dBm ±1 dB for 100% modulation at 400 Hz.

AUDIO FREQUENCY RESPONSE: (left and right) Standard 75 microsecond, FCC pre-emphasis curve ±1 dB, 30-15,000 Hz.

DISTORTION: (left or right) 1% or less, 50-15,000 Hz.

FM NOISE: (left or right) 60 dB minimum below 100% modulation, reference 400 Hz.

STEREO SEPARATION: 35 dB minimum 50-15,000 Hz.

SUB-CARRIER SUPPRESSION: 42 dB below 90% modulation.

CROSSTALK: (main to sub-channel or sub to main channel) 42 dB below 90% modulation.

SCA MODE (SCA Generator optional)

FREQUENCY STABILITY: ±500 Hz.

FREQUENCY: Between 25 and 75 kHz.

OSCILLATOR TYPE: Two Colpitts heterodyned to produce desired output frequency.

MODULATION: Direct FM.

MODULATION CAPABILITY: ±7.5 kHz.

AUDIO INPUT IMPEDANCE: 600 ohms balanced.

AUDIO INPUT LEVEL: +8 dBm, ±3 dB for 100% modulation at 400 Hz.

AUDIO FREQUENCY RESPONSE: 41 kHz and 67 kHz, 50 microsecond, modified pre-emphasis. 67 kHz response modified for proper operation when used with stereo to conform to FCC specifications.

DISTORTION: Less than 1.5% 30-7000 Hz.

FM NOISE: (main channel not modulated) 55 dB minimum (ref. 100% modulation 400 Hz).

CROSSTALK: (sub-channel to main channel) -60 dB or better.

CROSSTALK: (main channel to sub-channel) 50 dB below 100% modulation (ref. 400 Hz).

AUTOMATIC MUTE LEVEL: Variable from 0 to -40 dB below 100% modulation.

ORDERING INFORMATION

FM-10H, 10,000 watt FM broadcast transmitter, with TE-1 exciter.....	994-6577
100% spare tube kit.....	990-0551
Stereo generator (add for stereo operation).....	994-6533
SCA sub-carrier generator (add for SCA operation).....	994-6507



5000-7500 Watt FM Transmitters

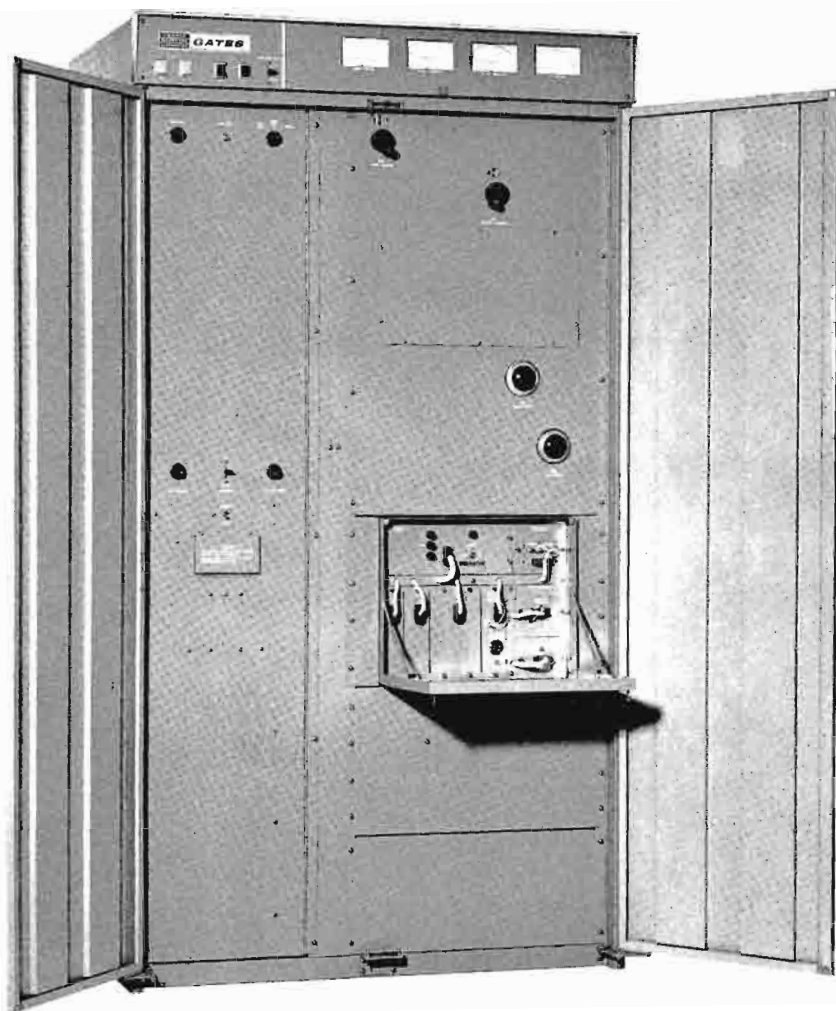

MODELS FM-5H — FM-7.5H

Gates FM-5H and FM-7.5H transmitters provide 5,000-7,500 watts output with just two tubes—and feature the performance proven solid state TE-1 exciter, employing Direct Carrier Frequency Modulation. Quality all the way, both transmitters combine the reliability of solid state circuitry and the superb performance of "DCFM" for outstanding stereo (with optional stereo generator) and monaural transmission. Each transmitter is FCC type accepted for stereophonic and monaural FM broadcasting in the 88 to 108 MHz band.

ONLY TWO TUBES: With the transistorized 10 watt model TE-1 exciter incorporated into these transmitters only two tubes are needed to produce a full 5,000 watts of power in the model FM-5H, and a full 7,500 watts in the FM-7.5H. A type 4CX250B tube amplifies the solid state exciter output and supplies a nominal 250 watts to drive the ceramic 4CX-5000A final tube. This proven power tetrode operates as a single ended amplifier to produce 5 to 7.5 kilowatts of power.



"DCFM" PERFORMANCE: The superior engineering design of Gates TE-1 exciter is truly an FM breakthrough. As the oscillator operates at the transmitter frequency, highly improved carrier stability and excellent frequency response are assured.

In both the FM-5H and the FM-7.5H stereo separation is 35 dB minimum from 50 Hz to 15 kHz.

Self-contained within these transmitters, the "DCFM" exciter is of modular construction so that the solid state stereo and SCA modules may be plugged in at any time.

VARI-LINE TUNING: Field proven for dependability, Gates Vari-Line tuning is used in the FM-5H and the FM-7.5H transmitters. This is an advanced method of tuning a single ended FM amplifier to achieve optimum output efficiency.

HARMONIC REDUCTION: Included as standard equipment in the transmitters is a Tee type notch filter for second harmonic reduction, a micro-match VSWR section for direct meter reading of both power output and standing wave ratio, and a low pass filter which substantially eliminates third and higher order harmonics.

SPECIAL PROTECTIVE CIRCUIT: The FM-5H and the FM-7.5H are protected by Power Guard, a Gates developed power supply protective circuit, that provides maximum protection from transient voltages.

If a momentary overload occurs, the transmitter will recycle automatically up to the number of times preset.

For increased dependability, solid state rectifiers are standard in these transmitters.

OPERATING CONVENIENCE: "On-off" functions in the FM-5H and the FM-7.5H are controlled by two lighted pushbuttons at the top left of the transmitter. The multimeter control switch is located just to the right of these pushbuttons.

Full metering is provided with four large, front panel meters, including a VSWR power indicator that permits direct reading of both power output and standing wave ratio.

SELF-CONTAINED: The power supply, exciter, power transformers and optional stereo generating/SCA equipment are all housed in one cabinet, for simplified transmitter installation.

REMOTE CONTROL: In both the FM-5H and the FM-7.5H all functions can be remote controlled. Simply connect the transmitter control unit of the remote control system (RDC-10 or RDC-200) and remote operation is ready.

5000-7500 Watt FM Transmitters-FM-5H-FM-7.5H

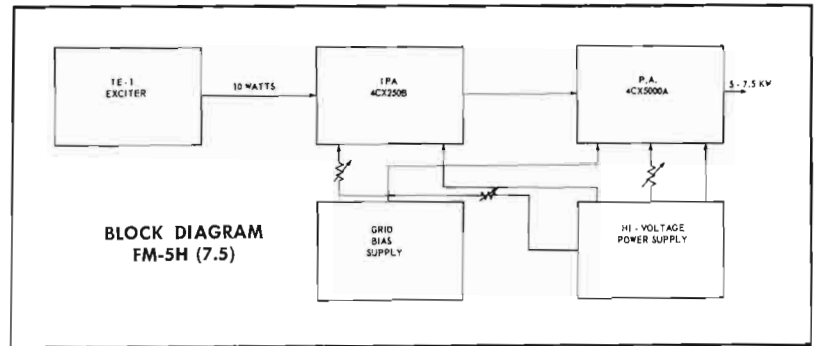
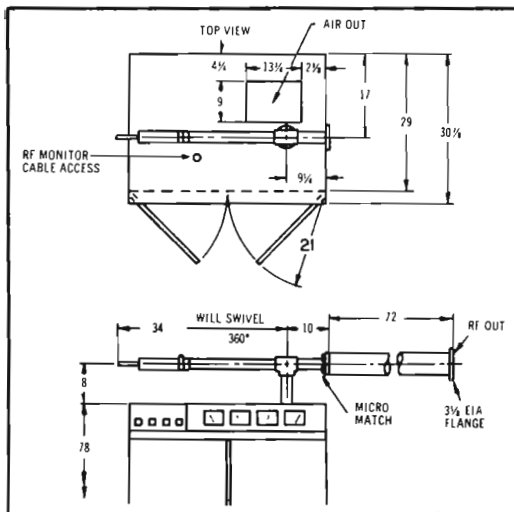

SPECIFICATIONS

GENERAL

- POWER OUTPUT:** 5 or 7.5 kW.
- FREQUENCY RANGE:** 87.5 to 108 MHz, tuned to specified operating frequency.
- RF OUTPUT IMPEDANCE:** 50 ohms.
- OUTPUT TERMINATION:** 3/8" EIA flange.
- FREQUENCY STABILITY:** .001% or better.
- TYPE OF MODULATION:** Direct Carrier Frequency Modulation.
- MODULATION CAPABILITY:** ± 100 kHz.
- AC INPUT POWER:** 208/240 V, 3 phase. 11 kW consumption at 240 volts. 115 V single phase, 60 Hz. (50 Hz available on special order.)
- POWER SUPPLY RECTIFIERS:** Silicon.
- RF HARMONICS:** Suppression meets all FCC requirements.
- ALTITUDE:** 7,500 feet.
- AMBIENT TEMPERATURE RANGE:** -20°C to $+45^{\circ}\text{C}$.
- MAXIMUM VSWR:** 1.7 to 1.
- OVER-ALL CABINET SIZE:** 42" W x 78" H x 32 3/4" D.*
*32 3/4" is over-all depth dimension. With rear door and front door handles removed, minimum depth is 29 3/4".
- FRONT DOOR SWING:** 21".
- FINISH:** Two-tone beige-gray.
- WEIGHT AND CUBAGE:** Export: 900 lbs. Domestic: 750 lbs. 72 cu. ft.

MONAURAL MODE

- AUDIO INPUT IMPEDANCE:** 600 ohms balanced.
- AUDIO INPUT LEVEL:** $+10$ dBm ± 2 dB for 100% modulation at 400 Hz.
- AUDIO FREQUENCY RESPONSE:** Standard 75 microsecond, FCC pre-emphasis curve ± 1 dB, 30-15,000 Hz.
- DISTORTION:** 0.5% or less, 30-15,000 Hz.
- FM NOISE:** 65 dB below 100% modulation (ref. 400 Hz).
- AM NOISE:** 50 dB below reference carrier AM modulated 100%.

STEREOPHONIC MODE (Stereo Generator optional)

- PILOT OSCILLATOR:** Crystal controlled.
- PILOT STABILITY:** 19 kHz ± 1 Hz.
- AUDIO INPUT IMPEDANCE:** (left and right) 600 ohms balanced.
- AUDIO INPUT LEVEL:** (left and right) $+10$ dBm ± 1 dB for 100% modulation at 400 Hz.
- AUDIO FREQUENCY RESPONSE:** (left and right) Standard 75 microsecond, FCC pre-emphasis curve ± 1 dB, 30-15,000 Hz.
- DISTORTION:** (left or right) 1% or less, 50-15,000 Hz.
- FM NOISE:** (left or right) 60 dB minimum below 100% modulation, reference 400 Hz.
- STEREO SEPARATION:** 35 dB minimum 50-15,000 Hz.
- SUB-CARRIER SUPPRESSION:** 42 dB below 90% modulation.
- CROSSTALK:** (main to sub-channel or sub to main channel) 42 dB below 90% modulation.

SCA MODE (SCA Generator optional)

- FREQUENCY STABILITY:** ± 500 Hz.
- FREQUENCY:** Between 25 and 75 kHz.
- OSCILLATOR TYPE:** Two Colpitts heterodyned to produce desired output frequency.
- MODULATION:** Direct FM.
- MODULATION CAPABILITY:** ± 7.5 kHz.
- AUDIO INPUT IMPEDANCE:** 600 ohms balanced.
- AUDIO INPUT LEVEL:** $+8$ dBm, ± 3 dB for 100% modulation at 400 Hz.
- AUDIO FREQUENCY RESPONSE:** 41 kHz and 67 kHz, 50 microsecond, modified pre-emphasis. 67 kHz response modified for proper operation when used with stereo to conform to FCC specifications.
- DISTORTION:** Less than 1.5% 30-7000 Hz.
- FM NOISE:** (main channel not modulated) 55 dB minimum (ref. 100% modulation 400 Hz).
- CROSSTALK:** (sub-channel to main channel) -60 dB or better.
- CROSSTALK:** (main channel to sub-channel) 50 dB below 100% modulation (ref. 400 Hz).
- AUTOMATIC MUTE LEVEL:** Variable from 0 to -40 dB below 100% modulation.

ORDERING INFORMATION

FM-5H, 5000 watt FM broadcast transmitter with TE-1 exciter.....	994-6575
FM-7.5H, 7500 watt FM broadcast transmitter with TE-1 exciter.....	994-6576
100% spare tube kit for either of above.....	990-0549
Stereo generator (add for stereo operation).....	994-6533
SCA sub-carrier generator (add for SCA operation).....	994-6507

3000 Watt FM Transmitter

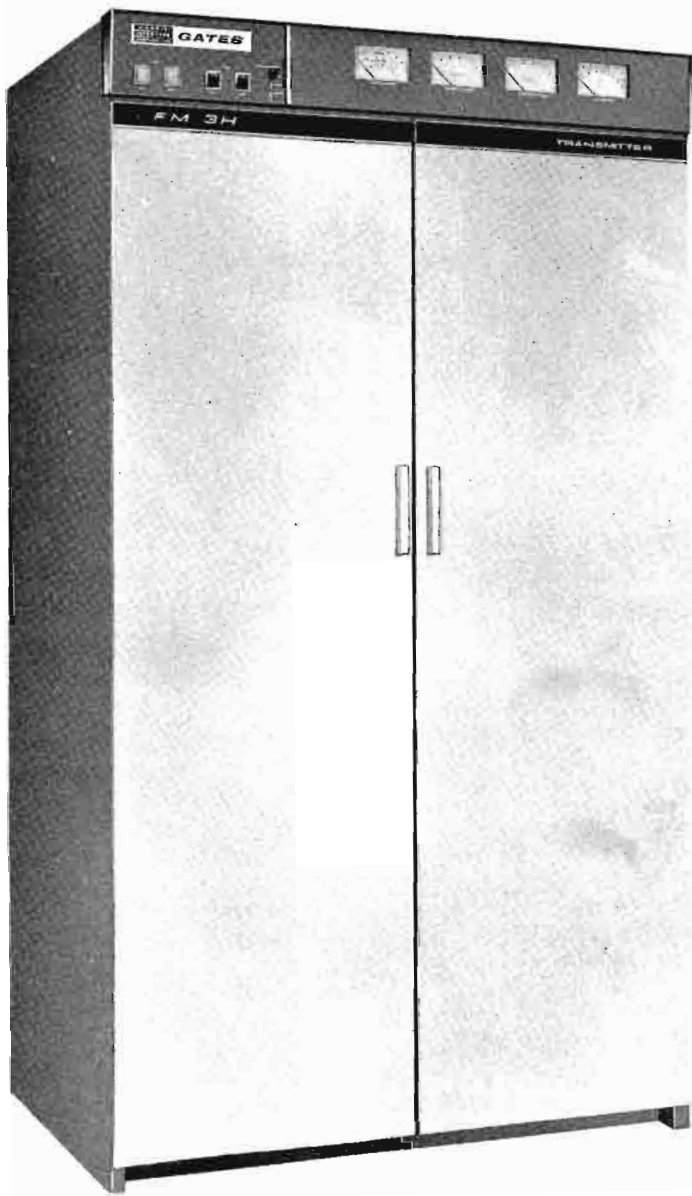

MODEL FM-3H

This is the 3,000 watt version of Gates exciting line of advanced engineered FM transmitters featuring "DCFM". Modern in every way, model FM-3H incorporates the 100% solid state TE-1 exciter employing Direct Carrier Frequency Modulation, for superb stereo and monaural FM sound.

In the TE-1 exciter, carrier generation and modulation occur at the transmitter operating frequency. The result is greatly improved carrier stability and unsurpassed frequency response. Self-contained within the FM-3H transmitter, the TE-1 exciter is all solid state, and of modular construction to permit easy plug-in of optional stereo and SCA transistorized modules at any time.

Gates model FM-3H is FCC type accepted for both monaural and stereophonic broadcasting in the 88 to 108 MHz FM band.

LONG TUBE LIFE: This transmitter uses the 4CX5000A power tube which is standard in most modern 5,000 watt FM transmitters. As this modern ceramic tetrode operates well below its rated output, the tube coasts along in 3,000 watt service.

VARI-LINE TUNING: An advanced method of tuning a single ended FM amplifier for optimum output efficiency, Vari-Line is built into the FM-3H. A portion of a parallel tubular transmission line is made variable to inductively tune the line to operating frequency. This means greater reliability as no mica or vacuum capacitors are needed in the tank circuit.

POWER GUARD: A Gates developed power supply protective circuit, Power Guard, assures maximum protection from transient voltages or on-off surges which might damage the power transformer and related electrical components.

EFFICIENT COOLING: A heavy-duty, impeller type self-cleaning blower provides effective component cooling throughout the FM-3H. This blower moves up to 33% more air than required for normal heat dissipation of the transmitter when operating between sea level and 7,500 feet, and helps provide longer component life.

PUSHBUTTON OPERATION: Simplified "on-off" control is provided with lighted pushbuttons at the top left of the transmitter. These are "filament on-off"; "plate on-off". Just to the right of these is a switch for control of the multimeter. With this arrangement there is no need to open the front doors to operate the FM-3H.

BUILT-IN REMOTE CONTROL: No additional transmitter equipment is needed for Gates remote control systems. Connect the FM-3H to a Gates transmitter control unit, and you are ready for remote control operation.

FILTERS ARE STANDARD EQUIPMENT: Included with the FM-3H transmitter is a Tee notch filter for second harmonic reduction and a low pass filter which substantially eliminates third and higher order harmonics. A micromatch VSWR section for direct meter reading of power output and standing wave ratio is also included.

AUTOMATIC RECYCLING: In case of momentary overload, the transmitter recycles automatically. However, should the overload reoccur in excess of the number of times preset in the transmitter, the FM-3H will remain off the air until it is reset.

3000 Watt FM Transmitter—FM-3H



Driver amplifier located directly below the 4CX5000A power amplifier for added efficiency of operation.

GENERAL

POWER OUTPUT: 3 kW.
FREQUENCY RANGE: 87.5 to 108 MHz, tuned to specified operating frequency.
RF OUTPUT IMPEDANCE: 50 ohms.
OUTPUT TERMINATION: 3/8" EIA female flange.
FREQUENCY STABILITY: .001% or better.
TYPE OF MODULATION: Direct Carrier Frequency Modulation.
MODULATION CAPABILITY: ± 100 kHz.
AC INPUT POWER: 208/240 V, 3-phase, 50/60 Hz. Power consumption 7000 watts (approx.) 60 Hz, single phase.
POWER SUPPLY RECTIFIERS: Silicon.
RF HARMONICS: Suppression meets all FCC requirements.
ALTITUDE: 7,500 feet.
AMBIENT TEMPERATURE RANGE: -20°C to $+45^{\circ}\text{C}$.
MAXIMUM VSWR: 1.7 to 1.
OVER-ALL CABINET SIZE: 42" W x 78" H x 32 3/4" D.*
*32 3/4" is over-all depth dimension. With rear door and front door handles removed, minimum depth is 29 3/4".
FRONT DOOR SWING: 21".
FINISH: Two-tone beige-gray.
WEIGHT & CUBAGE: Export: 1550 lbs. Domestic: 1425 lbs. 117 cu. ft.

MONAURAL MODE

AUDIO INPUT IMPEDANCE: 600 ohms balanced.
AUDIO INPUT LEVEL: +10 dBm ± 2 dB for 100% modulation at 400 Hz.
AUDIO FREQUENCY RESPONSE: Standard 75 microsecond, FCC pre-emphasis curve ± 1 dB, 30-15,000 Hz.
DISTORTION: 0.5% or less, 30-15,000 Hz.
FM NOISE: 65 dB below 100% modulation (ref. 400 Hz).
AM NOISE: 50 dB below reference carrier AM modulated 100%.

TWO-TUBE DESIGN: From the TE-1 exciter to transmission line there are only two tubes in the FM-3H. A type 4CX250B tube amplifies the ten watts from the solid state exciter and drives the 4CX5000A power tetrode.

STEREO SEPARATION: With a minimum stereo separation of 35 dB from 50 to 15,000 Hz, the FM-3H excels in stereophonic broadcasting, when equipped with the optional plug-in solid state stereo module. For monophonic service a full, rich response from 30 to 15,000 Hz, and extremely low distortion, assure superb audio quality.

SILICON POWER SUPPLY: This transmitter incorporates solid state rectifiers throughout. A generous number of silicon cells, operating in a three-phase bridge rectifier, are so rugged that maximum transmitter current demand is only 50% of the peak rating of the power supply. Exclusive use of silicon rectifiers and the 100% transistor exciter greatly enhance overall reliability.

SPECIFICATIONS

STEREOPHONIC MODE (Stereo Generator optional)

PILOT OSCILLATOR: Crystal controlled.
PILOT STABILITY: 19 kHz ± 1 Hz.
AUDIO INPUT IMPEDANCE: (left and right) 600 ohms balanced.
AUDIO INPUT LEVEL: (left and right) +10 dBm ± 1 dB for 100% modulation at 400 Hz.
AUDIO FREQUENCY RESPONSE: (left and right) Standard 75 microsecond, FCC pre-emphasis curve ± 1 dB, 30-15,000 Hz.
DISTORTION: (left or right) 1% or less, 50-15,000 Hz.
FM NOISE: (left or right) 60 dB minimum below 100% modulation, reference 400 Hz.
STEREO SEPARATION: 35 dB minimum 50-15,000 Hz.
SUB-CARRIER SUPPRESSION: 42 dB below 90% modulation.
CROSSTALK: (main to sub-channel or sub to main channel) 42 dB below 90% modulation.

SCA MODE (SCA Generator optional)

FREQUENCY STABILITY: ± 500 Hz.
FREQUENCY: Between 25 and 75 kHz.
OSCILLATOR TYPE: Two Colpitts heterodyned to produce desired output frequency.
MODULATION: Direct FM.
MODULATION CAPABILITY: ± 7.5 kHz.
AUDIO INPUT IMPEDANCE: 600 ohms balanced.
AUDIO INPUT LEVEL: +8 dBm, ± 3 dB for 100% modulation at 400 Hz.
AUDIO FREQUENCY RESPONSE: 41 kHz and 67 kHz, 50 microsecond, modified pre-emphasis. 67 kHz response modified for proper operation when used with stereo to conform to FCC specifications.
DISTORTION: Less than 1.5% 30-7,000 Hz.
FM NOISE: (main channel not modulated) 55 dB minimum (ref. 100% modulation 400 Hz).
CROSSTALK: (sub-channel to main channel) -60 dB or better.
CROSSTALK: (main channel to sub-channel) 50 dB below 100% modulation (ref. 400 Hz).
AUTOMATIC MUTE LEVEL: Variable from 0 to -40 dB below 100% modulation.

ORDERING INFORMATION

FM-3H 3000 watt FM broadcast transmitter with TE-1 exciter.....	994-6574
100% spare tube kit.....	990-0549
Stereo generator (add for stereo operation).....	994-6533
SCA sub-carrier generator (add for SCA operation).....	994-6507



1000 Watt FM Transmitter

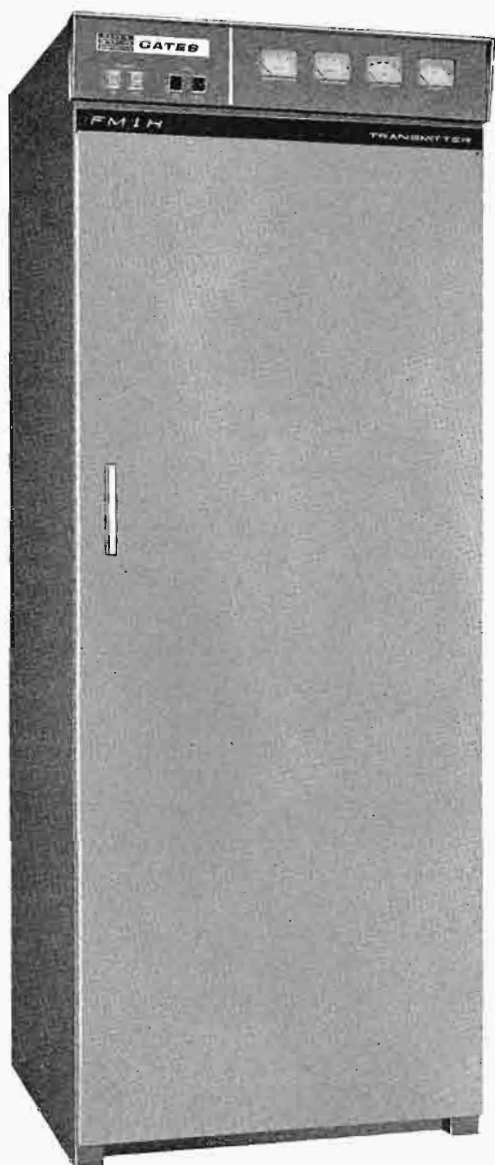

MODEL FM-1H

Superb for stereo, multiplex or monaural sound, the one tube, 1000 watt model FM-1H transmitter incorporates the all solid state TE-1 exciter, employing direct carrier frequency modulation. The FM-1H is FCC type accepted for 1000 watt output for both monaural and stereophonic transmission in the 88 to 108 MHz band.

ONE TUBE DESIGN: Just one tube—a modern type 4CX1000A tetrode—is all that is needed to supply 1000 watts output in the FM-1H. Driven directly by the 10 watt exciter, the 4CX-1000A serves as the power amplifier and is operated well within its ratings for longer useful tube life, and greater on-the-air reliability.

STABILITY AND EFFICIENCY: Forced air cooled, the 4CX-1000A power amplifier stage is mounted in a fully shielded enclosure to eliminate power losses by radiation or interaction. A distributed-constant type plate circuit reduces harmonics and spurious radiation to a minimum, and the entire amplifier has a high degree of stability.

ADVANCED TE-1 EXCITER: The 100% solid state direct carrier frequency modulation (DCFM) exciter provides a full 10 watts output, and is completely self-contained within the FM-1H. It employs an advanced Gates design whereby modulation occurs at the carrier frequency. This eliminates all frequency multipliers and results in highly improved carrier stability and excellent frequency response.

STEREO/MULTIPLEX OPERATION: In the FM-1H, stereo separation is 35 dB minimum from 50 to 15,000 Hz. Plugging in the optional stereo or SCA generators takes only a few seconds, as pre-wired spaces are provided in the TE-1 exciter for these modules.

SOLID STATE RECTIFIERS: Silicon rectifiers are standard equipment in this modern slimline transmitter. These dependable rectifiers provide generous voltage and current safety factors throughout.

HARMONIC FILTERS: Supplied with a Gates designed multi-section harmonic filter, the FM-1H transmitter fully meets FCC requirements regarding spurious radiation. The Tee filter section provides rapid cut off in the second harmonic region, and is located in the transmitter cabinet. The remaining filter elements, for further attenuation of the second and higher order harmonics, are housed in a six foot section of standard 3/8-inch transmission line. They may be considered as part of the over-all transmission line system for installation purposes.

READY FOR REMOTE CONTROL: Remote control capabilities are built into the FM-1H transmitter, including terminations to attach to most remote control equipment. A motor driven screen voltage control to vary power output from the remote point is supplied as standard equipment.

AUTOMATIC RECYCLING: The FM-1H recycles and is again turned on in case of momentary overload. If, after three or four consecutive overloads, it fails to turn itself on, the transmitter remains off until the "Plate On" function is activated either locally or by remote control.

STEREO AND SCA MODULES: Operating flexibility is assured by the all solid state stereo and SCA modules. Plugging directly into the model TE-1 exciter, these units provide unexcelled performance standards for modern FM broadcasting.

1000 Watt FM Transmitter-FM-1H



STEREO AND SCA MODULES: Operating flexibility is assured by the all solid state stereo and SCA modules. Plugging directly into the model TE-1 exciter, these units provide unexcelled performance standards for modern FM broadcasting.

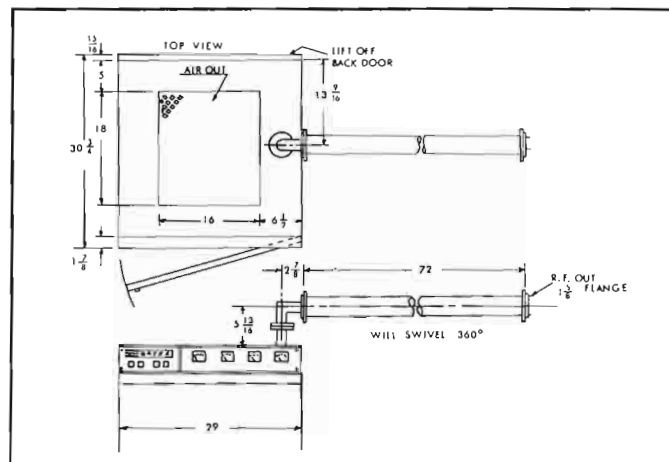

SPECIFICATIONS

GENERAL

- POWER OUTPUT:** 1 kW.
- FREQUENCY RANGE:** 87.5 to 108 MHz, tuned to specified operating frequency.
- RF OUTPUT IMPEDANCE:** 50 ohms.
- OUTPUT TERMINATION:** 1 1/8" EIA female flange.
- FREQUENCY STABILITY:** .001% or better.
- TYPE OF MODULATION:** Direct Carrier Frequency Modulation.
- MODULATION CAPABILITY:** ±100 kHz.
- AC INPUT POWER:** 208/240 V, 50/60 Hz, single phase, 3 wire. Power consumption: 2600 watts (approx.).
- POWER SUPPLY RECTIFIERS:** Silicon.
- RF HARMONICS:** Suppression meets all FCC requirements.
- ALTITUDE:** 7500 feet.
- AMBIENT TEMPERATURE RANGE:** -20°C to +45°C.
- MAXIMUM VSWR:** 1.7 to 1.
- OVER-ALL CABINET SIZE:** 29" W x 78" H x 32 3/4" D.
- FRONT DOOR SWING:** 29".
- FINISH:** Two-tone, beige-gray.
- WEIGHT & CUBAGE:** Export: 900 lbs. Domestic: 750 lbs. Cubage: 72.

MONAURAL MODE

- AUDIO INPUT IMPEDANCE:** 600 ohms balanced.
- AUDIO INPUT LEVEL:** +10 dBm ±2 dB for 100% modulation at 400 Hz.
- AUDIO FREQUENCY RESPONSE:** Standard 75 microsecond FCC pre-emphasis curve ±1 dB, 30-15,000 Hz.
- DISTORTION:** 0.5% or less, 30-15,000 Hz.
- FM NOISE:** 65 dB below 100% modulation (ref. 400 Hz).
- AM NOISE:** 50 dB below reference carrier AM modulated 100%.

STEREOPHONIC MODE (Stereo Generator optional)

- PILOT OSCILLATOR:** Crystal controlled.

- PILOT STABILITY:** 19 kHz ±1 Hz.
- AUDIO INPUT IMPEDANCE:** (Left and right) 600 ohms balanced.
- AUDIO INPUT LEVEL:** (Left and right) +10 dBm ±2 dB for 100% modulation at 400 Hz.
- AUDIO FREQUENCY RESPONSE:** (Left and right) standard 75 microsecond, FCC pre-emphasis curve ±1 dB, 30-15,000 Hz.
- DISTORTION:** (Left and right) 1% or less, 50-15,000 Hz.
- FM NOISE:** (Left and right) 60 dB minimum below 100% modulation, reference 400 Hz.
- STEREO SEPARATION:** 35 dB minimum 50-15,000 Hz.
- SUB-CARRIER SUPPRESSION:** 42 dB below 90% modulation.
- CROSSTALK:** (Main to sub-channel or sub to main channel) 42 dB below 90% modulation.

SCA MODE (SCA Generator optional)

- FREQUENCY STABILITY:** ±500 Hz.
- FREQUENCY:** Between 25 and 75 kHz.
- OSCILLATOR TYPE:** Two Colpitts heterodyned to produce desired output frequency.
- MODULATION:** Direct FM.
- MODULATION CAPABILITY:** ±7.5 kHz.
- AUDIO INPUT IMPEDANCE:** 600 ohms balanced.
- AUDIO INPUT LEVEL:** +8 dBm, ±3 dB for 100% modulation at 400 Hz.
- AUDIO FREQUENCY RESPONSE:** 41 kHz and 67 kHz, 50 microsecond, modified pre-emphasis. 67 kHz response modified for proper operation when used with stereo to conform to FCC specifications.
- DISTORTION:** Less than 1.5% 30-3000 Hz.
- FM NOISE:** (Main channel not modulated) 55 dB minimum (ref. 100% modulation 400 Hz).
- CROSSTALK:** (Sub-channel to main channel) -60 dB or better.
- CROSSTALK:** (Main channel to sub-channel) 50 dB below 100% modulation (ref. 400 Hz).
- AUTOMATIC MUTE LEVEL:** Variable from 0 to -40 dB below 100% modulation.

ORDERING INFORMATION

FM-1H, 1000 watt FM broadcast transmitter with TE-1 exciter.....	994-6573
100% spare tube kit.....	990-0550
Stereo generator (add for stereo operation).....	994-6533
SCA sub-carrier generator (add for SCA operation).....	994-6507

250 Watt FM Transmitter

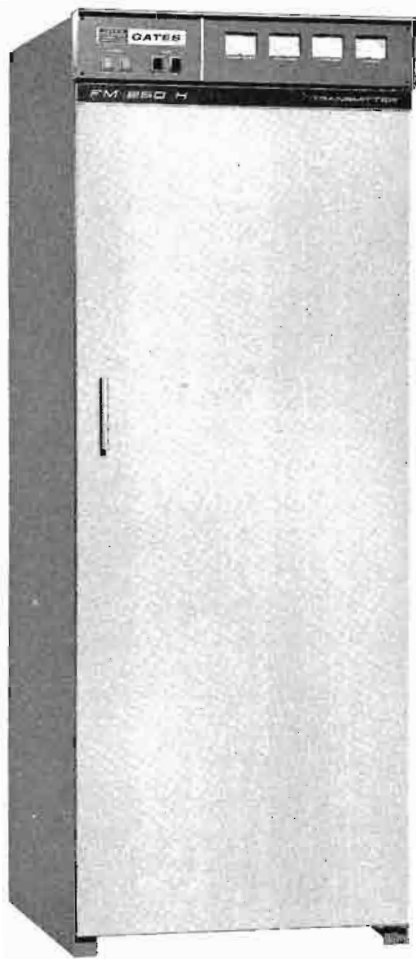

MODEL FM-250H

Only one tube, a 4CX250B tetrode power amplifier, is used in the FM-250H for a full 250 watts power output. This transmitter incorporates Gates exclusive TE-1 exciter, employing Direct Carrier Frequency Modulation for unsurpassed audio fidelity in FM broadcasting. The FM-250H transmitter is fully FCC type accepted for stereophonic and monaural transmission in the 88 to 108 MHz FM broadcast band.

The TE-1 exciter is completely self-contained within the transmitter. Modular construction allows the addition of stereo and/or SCA at any time by simply plugging in the appropriate module. Stereo separation in the FM-250H is a minimum of 35 dB from 30 Hz to 15 kHz.

SOLID STATE RECTIFIERS: Transmitter reliability is greatly enhanced by the use of silicon diodes in all power supplies in the FM-250H.

HARMONIC OUTPUT FILTER: Provided as standard equipment, the harmonic filter is contained within the FM-250H transmitter cabinet. Harmonics are attenuated well below FCC requirements.

AUTOMATIC RECYCLING: In case of momentary overload, the FM-250H will recycle automatically—a feature seldom provided in 250 watt FM transmitters.

REMOTE CONTROL: Wiring for remote control is built in, including a motor driven control to vary power output. No outboard components are needed in the transmitter, when used with a Gates remote control system.

SPECIFICATIONS

GENERAL

POWER OUTPUT: 250 watts.
FREQUENCY RANGE: 87.5 to 108 MHz, tuned to specified operating frequency.
RF OUTPUT IMPEDANCE: 50 ohms.
OUTPUT TERMINATION: Type N receptacle.
FREQUENCY STABILITY: .001% or better.
TYPE OF MODULATION: Direct Carrier Frequency Modulation.
MODULATION CAPABILITY: ± 100 kHz.
AC INPUT POWER: 115 volts, 60 Hz, 950 watts (approximate).
POWER SUPPLY RECTIFIERS: Silicon.
RF HARMONICS: Suppression meets or exceeds all FCC requirements.
ALTITUDE: 7,500 feet.

AMBIENT TEMPERATURE RANGE: -20°C to $+45^{\circ}\text{C}$.

MAXIMUM VSWR: 1.7 to 1.

OVER-ALL CABINET SIZE: 24" W x 78" H x 36½" D.

FINISH: Two-tone beige-gray.

WEIGHT AND CUBAGE: Packed, 850 lbs. Net 510 lbs. 70 cu. ft.

MONAURAL OPERATION

AUDIO INPUT IMPEDANCE: 600 ohms balanced.

AUDIO INPUT LEVEL: +10 dBm ± 2 dB for 100% modulation at 400 Hz.

AUDIO FREQUENCY RESPONSE: Standard 75 microsecond, FCC pre-emphasis curve ± 1 dB, 30-15,000 Hz.

DISTORTION: 0.5% or less 30-15,000 Hz.

FM NOISE: 65 dB below 100% modulation (ref. 400 Hz).

AM NOISE: 50 dB below reference carrier AM modulated 100%.

ORDERING INFORMATION

FM-250H, 250 watt FM broadcast transmitter.....	994-6572
Spare tube 4CX250B.....	374-0081
Stereo generator (add for stereo operation).....	994-6533
SCA sub-carrier generator (add for SCA operation).....	994-6507



10 and 50 Watt FM Transmitters



Model BFE-10C Ten Watt FM Transmitter.

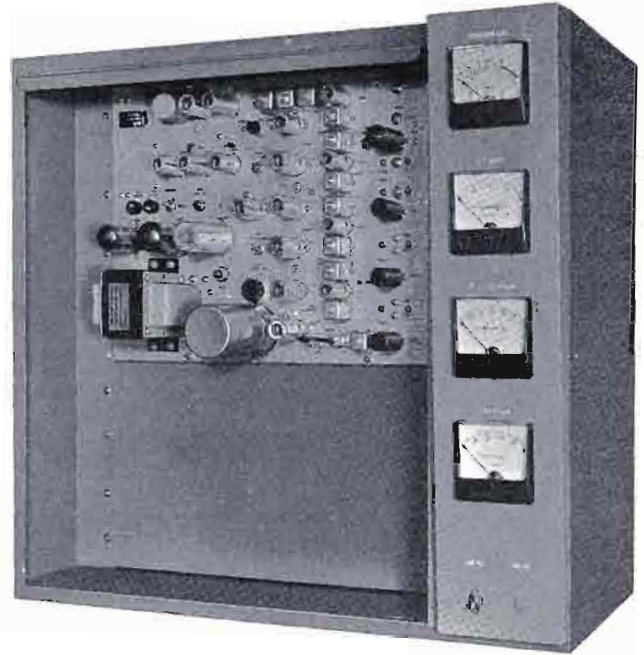

Front view (cover removed) of Model BFE-10C, ten watt FM transmitter. Models BFE-50C and BFR-50C are essentially the same in appearance.

THREE MODELS AVAILABLE

Gates has consistently offered the most complete line of low powered wide band FM broadcast transmitters in the industry. Especially designed for educational FM broadcasting and for STL (studio-transmitter link) service, three popular models featuring direct crystal controlled cascade modulation are available. Included are the 10 watt BFE-10C and 50 watt BFE-50C versions for the standard FM broadcast band of 88 to 108 MHz, and the 50 watt Model BFR-50C which operates in the 40 to 220 MHz FM band. The BFR-50C is specifically designed for high fidelity program relay and STL service and is very popular with broadcasters abroad. The same low distortion, wide frequency response and reliability, characteristic of Gates higher powered FM models, will be found in these three lower powered units.

Metering consists of an audio level meter to indicate proper modulation level and individual meters for RF output, plate current and plate voltage. The transmitters are 100% complete without external accessories other than antenna and audio equipment.

MODEL BFE-10C: The BFE-10C ten watt FM transmitter is FCC type approved for educational FM broadcasting and is equally excellent for STL service or in any applications where 10 watts FM output is required. A compact self-contained unit designed specifically for desk or wall mounting, this 10 watt model incorporates the M-6095 exciter featuring direct crystal controlled cascade modulation.

Immediate "full view" access is available by removing the front grill or the rear full length slip-off door. This complete

10 watt FM transmitter is used by many schools, colleges, universities and overseas broadcasters in conjunction with the Gates FM-11 single ring or the FM-22 double ring FM antenna.

MODEL BFE-50C: For 88 to 108 MHz FM service, the BFE-50C is similar in design to the BFE-10C transmitter but delivers 5 times as much power, or 50 watts. A 50 watt power amplifier is added to the 10 watt section to provide the higher powered output. The amplifier utilizes two 6146 tubes and a separate 600 volt power supply. Identical in appearance to the standard BFE-10C transmitter, the cabinet easily houses the 50 watt amplifier and power supply.

MODEL BFR-50C: This compact 50 watt transmitter is probably the world's most widely used FM relay transmitter. Designed to relay broadcast programs from studio to transmitter or between special program originating points, the Model BFR-50C operates on any one specific frequency (as ordered) within the 40 MHz to 220 MHz band. When operating below 80 MHz, the maximum deviation is ± 40 kHz. Above 80 MHz the frequency deviation is ± 75 kHz. The 50 watt amplifier consists of one radio frequency stage, powered by a 600 volt power supply. The range of this transmitter is greatly increased by use of a directional antenna. The corner reflector antenna, when used at both transmitting and receiving ends, will result in several hundred watts of effective power. A relay link up to nearly 100 miles is possible, depending on the antenna height of both transmitter and receiver, as well as the terrain.

10 and 50 Watt FM Transmitters

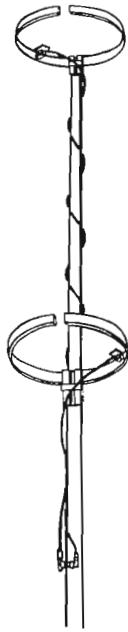

Left, FM-11 single ring omni-directional antenna with power gain of 0.8 dB. Right, two bay FM-22 omni-directional antenna with gain of 1.6 dB. These are broadband, easy to install antennas.

Front view (cover removed) of BFE-50C fifty watt FM transmitter.

SPECIFICATIONS

POWER OUTPUT: BFE-10C, 10 watts; BFE-50C, 50 watts; BFR-50C, 50 watts.
FREQUENCY RANGE: Models BFE-10C and BFE-50C, 88-108 MHz, as ordered. Model BFR-50C, 40 to 220 MHz, as ordered.
STABILITY: 0.001% or better.
MODULATION: Direct crystal controlled cascade modulation.
RESPONSE: Within 1 dB of standard 75 microsecond pre-emphasis curve or flat ± 1 dB, 50-15,000 Hz.
 Note: Will supply with 75 microsecond pre-emphasis curve unless ordered for flat curve.
FREQUENCY DEVIATION: ± 100 kHz; (± 75 kHz = 100% modulation in FM broadcasting). Model BFR-50C. Models below 80 MHz have maximum deviation of ± 40 kHz or less, as desired. Above 80 MHz may be ± 75 kHz or less, as desired.
DISTORTION: 1% or less 30-15,000 Hz. 0.5% 100-10,000 Hz.
RF HARMONICS: Suppression meets or exceeds all FCC requirements.
INPUT: +10 dBm ± 2 dB at 600 ohms impedance.
POWER: 117 volts, 50/60 Hz. BFE-10C, 120 watts; BFE-50C, 230 watts; BFR-50C, 230 watts.

RF OUTPUT: 50 ohms (Type N connector).
OSCILLATOR: Direct crystal controlled.
NOISE: 65 dB below 100% modulation (FM).
TEMPERATURE: -20° to $+45^{\circ}$ C.
TUBES:
 BFE-10C: (6) 6AU6, (3) 6J6, (3) 6201, (3) 7025, (2) OA2, and (1 each) 12AX7, 6AQ5, GZ34/5AR4, 6080, 6360.
 BFE-50C: Same as above, with (2) 6146 and (1) 5R4GYA tubes added.
 BFR-50C: Same as BFE-10C with (1) 5894, (1) 6AQ5, and (1) 5R4GYA tubes added.
ALTITUDE: 7500 feet.
FINISH: Gates two-tone beige gray with trim in brushed aluminum and black.
SIZE: 26½" high, 28" wide, 14" deep.
WEIGHT (Packed):
 BFE-10C (domestic) 100 lbs.; (export) 205 lbs.; 15 cu. ft.
 BFE-50C (domestic) 125 lbs.; (export) 230 lbs.; 16 cu. ft.
 BFR-50C (domestic) 125 lbs.; (export) 230 lbs.; 16 cu. ft.

ORDERING INFORMATION

BFE-10C, 10 watt FM transmitter, 88-108 MHz, with tubes and crystal..... 994-5594
 Spare 100% tube kit for BFE-10C..... 990-0391
 Manufacturer's recommended minimum tube kit for BFE-10C..... 990-0488
 BFE-50C, 50 watt FM transmitter, 88-108 MHz, with tubes and crystal..... 994-5595
 Spare 100% tube kit for BFE-50C..... 990-0489

Manufacturer's recommended minimum tube kit for BFE-50C..... 990-0490
 BFR-50C, 50 watt Relay Transmitter for 40-220 MHz, with tubes, crystal and oven..... 994-5599
 FM-11 Single Ring Educational (88-108 MHz) FM Antenna..... 710-0102
 FM-22 Double Ring Educational (88-108 MHz) FM Antenna..... 710-0103

State carrier frequency when ordering all models and antennas and frequency swing desired when ordering Model BFR-50C transmitter.



FM Broadcast Link and Relay System

SYSTEM A

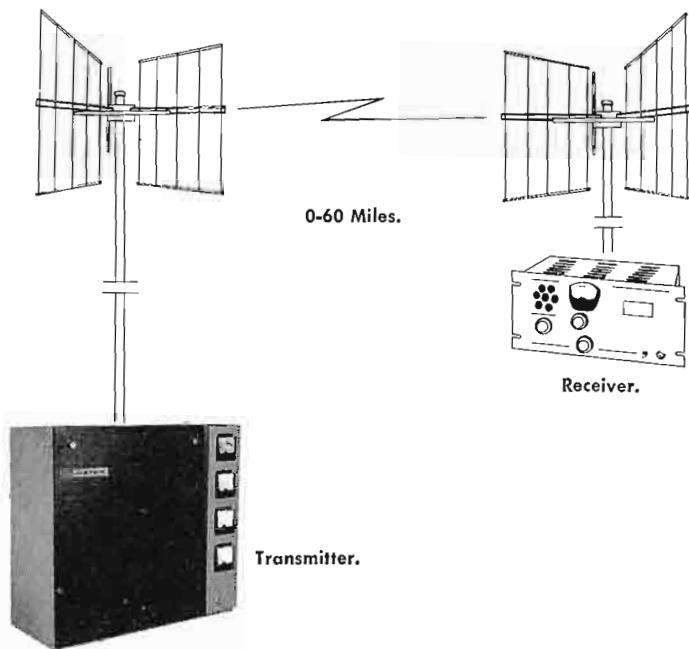

DIRECTIONAL: System A is a directional FM system operating in the 148-174 MHz band, which results in an effective 750 watts signal and will provide a line-of-sight high fidelity transmission link over distances up to 50 to 60 miles (subject to antenna heights and terrain). Applications include studio to transmitter link, point to point relay service, or remote pickup. Featured is the Gates BFR-50C, 50 Watt Transmitter.

ORDERING INFORMATION

1—50 watt FM transmitter (see pages 49-50).....	BFR-50C
1—Receiver, 125-175 MHz (see below).....	731-0009
2—Corner reflector, high gain, broadband antennas.....	3605A
100'—Coaxial Cable.....	RG-8/U
100'—Twin line 300 ohm.....	8235
Complete system as described above.....	FML-50D

SYSTEM B

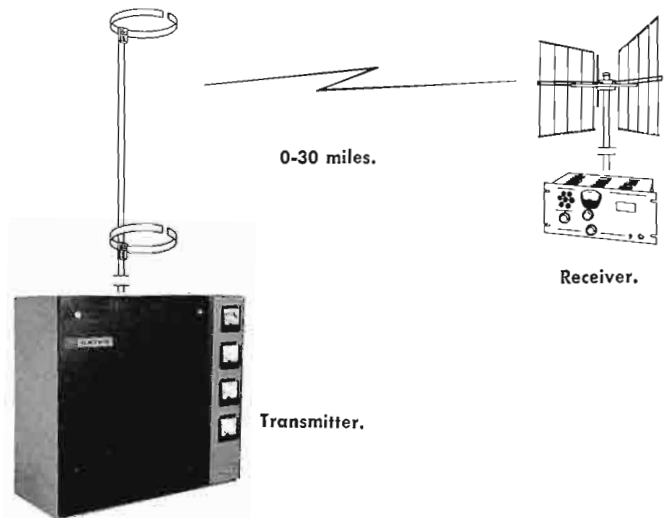

NON-DIRECTIONAL: System B is a non-directional 88-108 MHz FM system using a non-directional antenna for transmitting and a high gain directional antenna for receiving. This system provides a high fidelity studio-to-transmitter link, and, where regulations permit, allows simultaneous FM broadcasting of the AM program. The system features the Gates BFE-50C 50 watt transmitter, which has built-in RF output indicator and audio level meters. Line-of-sight reception with 50 watt transmitter is estimated at 30 miles.

ORDERING INFORMATION

1—50 watt FM transmitter (see pages 49-50).....	BFE-50C
1—Receiver, 88-125 MHz (see below).....	731-0003
Alternate Transmitter for shorter distances: 10 watt FM transmitter, 88-108 MHz (see pages 49-50).....	BFE-10C
1—Two ring FM transmitting antenna, gain 1.6.....	FM-22
1—FM receiving antenna.....	LPL-FM-6
100'—Coaxial Cable, for transmitter.....	RG-8/U
100'—Twin line 300 ohm, for receiver.....	8235
Complete 50 watt system as described above.....	FML-50ND
Complete 10 watt system using alternate transmitter described above.....	FML-10ND

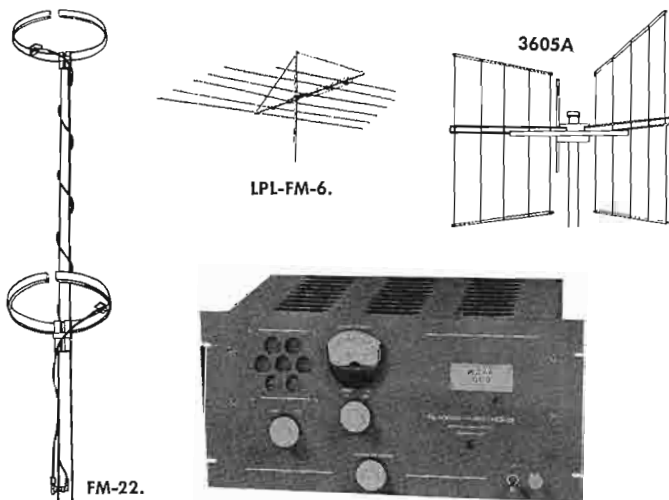

BROADCAST MONITOR AND RELAY RECEIVER

SPECIFICATIONS: Designed specifically for pickup of FM STL and retransmitting at full 30-15,000 Hz response at distortion of 1% or better, 50-15,000 Hz. Bandwidth 150 kHz, 88 to 225 MHz, antenna input 72 or 300 ohms, audio output 150/600 ohms. Crystal controlled oscillator for negligible drift. Sensitivity 2 mV for 20 dB quieting or 10 mV for 40 dB quieting. Has monitor speaker, signal strength meter and 12 tubes plus rectifier. Rack mount 8 3/4" x 19". Please state frequency when ordering.

Receiver, CM-150, 125-175 MHz*.....	731-0009
Receiver, CM-100 88-125 MHz*.....	731-0003

* Other frequencies available from 88-225 MHz.

Circularly Polarized FM Antenna

The Gates Dual-Cycloid Type FMC antenna transmits circular polarization as authorized by FCC rules and regulations. The station's effective radiated power will still be determined by the signal radiated in the horizontal plane. This is determined by the antenna gain (see table) in the horizontal plane multiplied by the power input to the antenna.

Any number of elements from one to sixteen may be utilized, providing maximum flexibility in the selection of power gain for a particular installation. Special antennas with null fill and beam tilt are available. Maximum power rating per bay is ten kilowatts; arrays will handle power inputs as high as forty kilowatts. De-icers are available and are recommended for climates that experience icing conditions.

The Dual-Cycloid consists of two basic parts: (1) the radiating element and, (2) the interconnecting transmission line sections. The radiating elements in an array are all identical electrically and mechanically. Utilizing the effective ring design of the Cycloid as the basic unit, two vertical elements have replaced the fixed end plates; the rear terminal block is now a matching balun mating the antenna impedance to the interconnecting transmission line.

The vertical sections have adjustable caps for a fine adjustment of the horizontal/vertical radiation ratio. Designed for rugged trouble-free operation, all antenna elements are fabricated of a durable weather resistant brass alloy with excellent electrical properties.

Antenna elements are normally spaced one wave-length apart with interconnecting transmission line sections and feed through a common system input termination of 50 ohms, which is a standard 3/8" EIA female flange.

MOUNTING: The antenna is mounted on a specially designed supporting bracket, fabricated to mate with the tower in a mounting arrangement specified by the purchaser. Antennas are usually mounted on the leg or tower face of a guyed or self supporting tower. Pole or top mounting is available on special order.

FEED POINT: Antennas of 9 bays or less are end fed through a 6 ft. transmission line section; 10 or more bays are usually center fed through a 6 ft. transmission line section, 90° elbow and coaxial "T" connector.

CIRCULARITY: Both the horizontal and vertical radiation pattern of the Dual-Cycloid antenna have been measured within ± 2 dB in free space. When side mounted, the antenna pattern will be somewhat affected by the supporting structure. This effect, however, has been minimized with the special supporting bracket and feed system which places the radiating element over 36" from the tower.

Supplied on a standard 3/8" EIA line, the antenna is complete with mounting brackets for standard AM and FM towers.

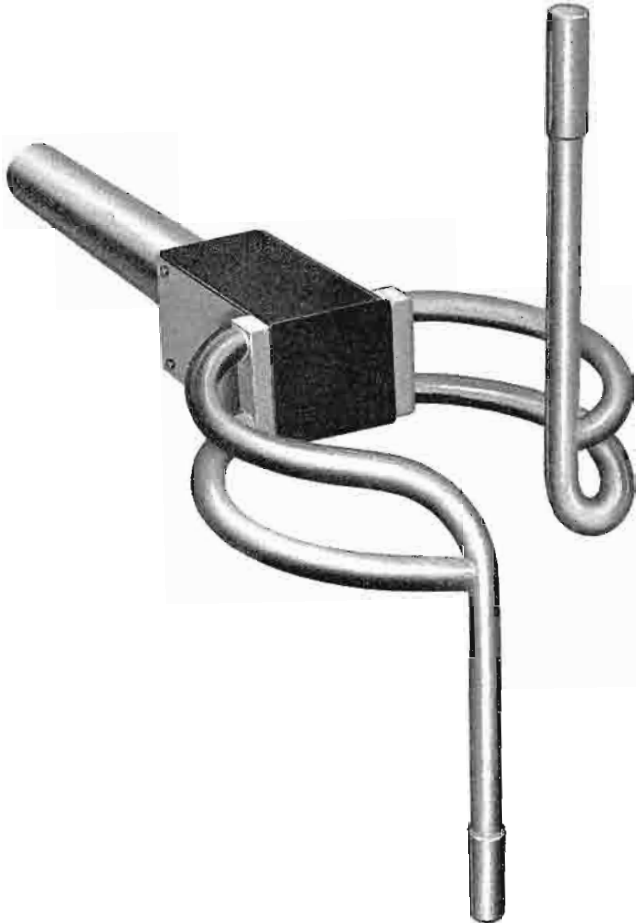

DUAL-CYCLOID

Gates Dual Cycloid FM Antenna with circular polarization has a radiation pattern intended to deliver an improved signal to FM receivers. A primary advantage of the Dual-Cycloid antenna is the reduction of antenna transmitting bays required when circular polarization is desired. Previously, individual elements, horizontal and vertical, and in most cases a power divider, had to be installed to obtain dual polarization. Now, only the Gates Dual-Cycloid is required.

Utilizing the time proven features of the Cycloid antenna, and other advantages of the Gates Type 300G vertical antenna, the Dual-Cycloid provides a radiating system with a low standing wave ratio over a bandwidth of 200 kHz. Ideal conditions are presented for the transmission of today's complex FM monaural, stereo, and SCA multiplex signals.

Circularly Polarized FM Antenna—Dual-Cycloid

Heavy-duty mounting brackets, designed to place the antenna element away from the supporting structure for the least effect on the radiation pattern, are supplied at no additional cost. Standard brackets are for use on tower legs or side mounting on the normal type AM radiator. A special quotation will be made for brackets on TV towers and non-standard radiators and poles.



SPECIFICATIONS

FREQUENCY RANGE: Factory tuned to one frequency in the 88 to 108 MHz band.

POLARIZATION: Circular, clockwise.

POWER GAIN (Over Dipole): Approximately equal to half the number of stacked bays for horizontal polarization; same for vertical polarization. See table below.

AZIMUTHAL PATTERN: Circular ± 2.0 dB in free space for horizontal polarization; same for vertical polarization. See table below.

VSWR AT INPUT (Without field trimming): Top mounting, 1.1:1 or better. Side mounting, 1.5:1 or better.

VSWR AT INPUT (With field trimming): Top or side mounting, 1.1:1 or better over ± 100 kHz.

INPUT IMPEDANCE: 50 ohms.

INPUT CONNECTION: 3/8-inch, 50 ohm EIA female flange.

POWER INPUT RATING: Approximately 10 kW per bay (see table).

WINDLOAD: 50 lbs. per square foot for flat surfaces; 33 lbs. per square foot for cylindrical surfaces.

DIMENSIONS: (One bay) 30 in. high, 45 1/2 in. long.

FEED POINT: One to nine bays, end fed. Ten bays and over, center fed with even number of bays, or at a point 1/2 bay below center with odd number of bays.

WEIGHT: Antenna bay, 41 lbs. (19 kg). Interconnecting feed line, 27.5 lbs. (12 kg). Mounting bracket, 22 lbs. (10 kg).

GATES TYPE	POWER GAIN		dB GAIN		FIELD GAIN ¹		POWER RATING	APPROX. ² LENGTH	WEIGHT ³ (lbs.)	WIND- ⁴ LOAD
	Horizontal	Vertical	Horizontal	Vertical	Horizontal	Vertical				
FMC-1	0.46	0.46	-3.37	-3.37	0.678	0.678	10 kW	0	41	172
FMC-2	1.0	1.0	0	0	1.0	1.0	20 kW	10 ft.	110	391
FMC-3	1.5	1.5	1.76	1.76	1.23	1.23	30 kW	20 ft.	178	610
FMC-4	2.1	2.1	3.22	3.22	1.45	1.45	40 kW	30 ft.	247	829
FMC-5	2.7	2.7	4.31	4.31	1.64	1.64	40 kW	40 ft.	315	1049
FMC-6	3.2	3.2	5.25	5.25	1.79	1.79	40 kW	50 ft.	384	1268
FMC-7	3.8	3.8	5.80	5.80	1.95	1.95	40 kW	60 ft.	452	1487
FMC-8	4.3	4.3	6.34	6.34	2.07	2.07	40 kW	70 ft.	520	1707
FMC-9	4.9	4.9	6.87	6.87	2.21	2.21	40 kW	80 ft.	589	1926
FMC-10	5.5	5.5	7.40	7.40	2.35	2.35	40 kW	90 ft.	658	2192
FMC-12	6.6	6.6	8.20	8.20	2.57	2.57	40 kW	110 ft.	795	2630
FMC-14	7.8	7.8	8.29	8.29	2.79	2.79	40 kW	130 ft.	931	3069
FMC-16	8.9	8.9	9.49	9.49	2.98	2.98	40 kW	150 ft.	1069	3507

Equipment furnished: antenna elements as required; antenna mounting hardware (specify tower manufacturer and type); interconnecting rigid coax transmission line section (6 ft.); standard 3/8-inch EIA female flange.

Accessory equipment: RF shielded deicer system, 300 watts per bay, 115 volts, 50/60 Hz . . . complete with conduit boxes and RF shielded interbay wiring harness. Thermo-switch for control of deicers. AC heater cable.

1. To obtain the effective free space field intensity at one mile in mv/m for one kilowatt antenna input power, multiply field gain by 138. 2. When determining coax line lengths on end feed antenna, add 6' to allow for matching stub. When determining coax line lengths on center feed antenna, termination will be 6' below center due to matching stub. 3. A typical leg mounting bracket weighs approximately 22 lbs. and is not included in weights given. 1 per bay required. Weights given included antenna bay and interconnecting feedline. 4. Based on 50 psf wind pressure on flat surfaces, 33 psf on cylindrical surfaces (110 mph actual wind velocity).

Horizontally Polarized FM Antenna

CYCLOID

The Cycloid FM antenna fills the need for a modern, easy to install, and highly efficient antenna, with minimum standing wave ratio for FM stereo and monaural service. The field proven Cycloid antenna offers high gain and high power handling capabilities incorporated in an electrical design available exclusively from Gates.

Binary adjustment permits the antenna to be tuned to a low standing wave ratio. Since all of the adjustment is incorporated in the antenna, it is not necessary to buy costly extras such as transformers, or field tuning kits, to achieve the optimum low standing wave ratio.

The Gates Cycloid FM antenna is factory pretuned to the customer's frequency, assuring optimum on-air performance. Mounting brackets are supplied as a standard item with the antenna.



ORDERING INFORMATION

The Cycloid antenna is available with any number of bays from one to sixteen and with 1 5/8" or 3 1/8" line. (See price list.)

SPECIFICATIONS

FREQUENCY RANGE: Factory tuned to specified frequency in 88-108 MHz band.

POLARIZATION: Horizontal.

HORIZONTAL PATTERN: Circular, ± 1.0 dB in free space.

INPUT IMPEDANCE: 50 ohms, on 1 5/8" or 3 1/8" coax.

FEED POINT: 1 to 8 bays inclusive—end feed. 9 to 16 bays inclusive—center feed.

POWER RATING: 3 kW per section on 1 5/8" line. (See note 1.)

VSWR: (With field tuning) Top mounting, 1.1 to 1. Side mounting, 1.1 to 1. (Factory tuned) Top mounting 1.2 to 1. Side mounting, 1.5 to 1.

WINDLOAD: 20 lbs. per square foot. (See note 2.)

DIMENSIONS: (One bay): Height (over-all), 6 inches. Ring diameter, approx. 18 inches (depends on frequency).

WEIGHT: Antenna, 25 lbs. per ring. 1 5/8" line, 12 1/2 lbs. per 10 ft. section. 3 1/8" line, 27 1/2 lbs. per 10 ft. section.

EQUIPMENT FURNISHED: Antenna mounting hardware (specify tower make, height and type number when ordering). Correct number of antenna elements as ordered. Interconnecting rigid coax (1 5/8" or 3 1/8") as ordered. Standard EIA (1 5/8" or 3 1/8") flanges as ordered.

ACCESSORY EQUIPMENT (Optional): Deicers: 300 watts (FMH-300), 600 watts (FMH-600). Thermo-switch for control of deicers.

GATES ³ TYPE	NO. OF BAYS	POWER ⁴ GAIN	dB GAIN	FIELD GAIN	APPROX. LENGTH IN FT. @ 98 MHz	WEIGHT (LBS.)		WINDLOAD ²	
						1 5/8" Line	3 1/8" Line	1 5/8" Line	3 1/8" Line
FMA-1	1	0.9	-0.45	.95	0	25	25	40	79
FMA-2	2	2.0	3.01	1.41	10	62	77	122	231
FMA-3	3	3.0	4.77	1.73	20	100	130	206	383
FMA-4	4	4.1	6.13	2.02	30	137	182	285	536
FMA-5	5	5.2	7.16	2.28	40	175	235	367	688
FMA-6	6	6.3	7.99	2.51	50	212	287	448	840
FMA-7	7	7.3	8.63	2.70	60	250	340	530	993
FMA-8	8	8.4	9.24	2.90	70	287	392	611	1145
FMA-9	9	9.4	9.73	3.07	80	325	445	693	1297
FMA-10	10	10.5	10.21	3.24	90	362	495	775	1450
FMA-12	12	12.5	10.97	3.54	110	437	600	941	1755
FMA-14	14	14.5	11.61	3.81	130	512	705	1107	2060
FMA-16	16	16.5	12.17	4.06	140	587	810	1273	2365

1. It is not advisable to use more than 7.5 kW on a 1 5/8" line. For powers above 7.5 kW, use 3 1/8" line.

2. Windloads are based on 20 pounds per sq. ft. on projected areas of cylindrical surfaces with all sections considered round.

3. Type number will be followed by "A" or "B" indicating coax cable size. Example—FMA-4(A), the A = 1 5/8" coaxial cable. FMA-4(B) = 3 1/8" coaxial cable (see price list for type number).

4. Power gains compared to 1/2 wave dipole.

Vertically Polarized FM Antenna

TYPE 300G

The 300G vertically polarized FM dipole antenna enables an FM station to transmit a supplemental vertically polarized signal to achieve elliptical or circular polarization as authorized in the FCC Rules and Regulations. It may be used in combination with any type of horizontally polarized FM antenna.

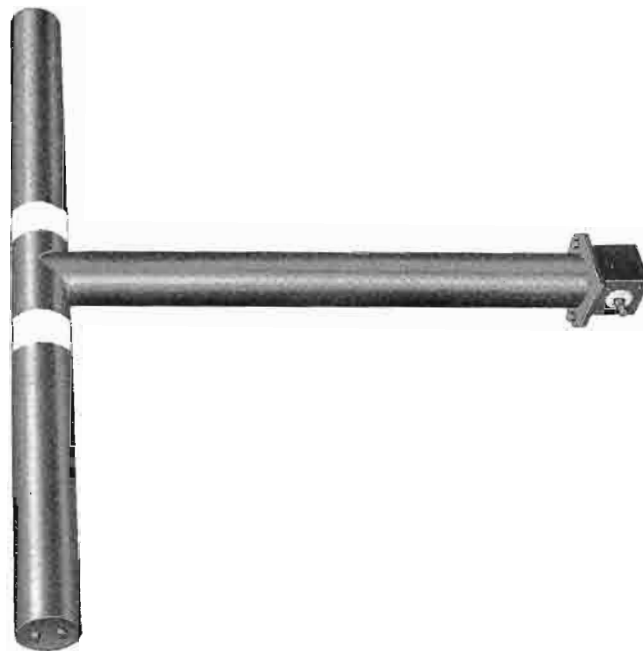

ORDERING INFORMATION

Both the 1½" and 3½" vertical antennas carry type number 300G. As these antennas are usually ordered as a system of several bays with connecting lines and breakers, the Gates price list is employed for more complete listings.

Power division networks, both variable and fixed, are available to combine vertical and horizontal antennas. For ease of listing, these are also part of the Gates price list.

SPECIFICATIONS

FREQUENCY RANGE: Factory tuned to specified frequency in 88-108 MHz band.

POLARIZATION: Vertical.

POWER GAIN: Approximately equal to number of dipoles. (See table.)

HORIZONTAL LINEARITY: Dipole circular ± 1 dB in free space.

INPUT IMPEDANCE: 50 ohms on 1½" or 3½" coax.

FEED POINT: For 9 bays or less, the antenna is end fed. For 10 bays or more, the antenna is center fed where number of bays is even, and for odd number of bays feed point is ½ bay length below center.

POWER RATING: 3 kW per dipole.

VSWR: Tuned to 1.1:1 or less; less than 1.5:1 when mounted on side of tower.

WINDLOAD: 60 psf. on flat surfaces, 40 psf. on cylindrical surfaces (123 mph actual wind velocity).

DIMENSIONS: Length of dipole—3.75 ft. From center of transmission line to center of dipole—2.83 ft.

WEIGHT: 1½" dipole—26.5 lbs. 3½" dipole—34.0 lbs. Typical mounting bracket—22.0 lbs. per bay.

DEICERS: Not required.

TYPE	NO. OF DIPOLES	POWER GAIN	FIELD GAIN	DB GAIN	POWER RATING		LENGTH		WEIGHT		WIND LOAD*		OVER TURNING MOMENT**	
					ON 1½" LINE	ON 3½" LINE	FEET & INCHES	ON 1½" LINE	ON 3½" LINE	ON 1½" LINE	ON 3½" LINE	ON 1½" LINE	ON 3½" LINE	
300G-1	1	.950	.975	-.002	3	3	3	9	50	55	104	104	0	0
300G-2	2	1.969	1.400	2.942	6	6	13	7	111	135	259	307	1,190	1,430
300G-3	3	3.120	1.767	4.942	9	9	23	4	171	215	414	510	3,900	4,840
300G-4	4	4.198	2.045	6.230	10	12	33	2	232	295	569	713	8,350	10,200
300G-5	5	5.310	2.305	7.251	10	15	42	11	292	375	724	916	14,300	17,600
300G-6	6	6.393	2.528	8.057	10	18	57	9	353	455	879	1119	21,100	27,000
300G-7	7	7.500	2.738	8.751	10	21	62	7	413	535	1034	1322	29,900	38,400
300G-8*	8	8.571	2.927	9.330	20	24	72	4	474	615	1189	1525	40,200	51,700
300G-9*	9	9.755	3.124	9.892	20	27	82	2	534	695	1344	1728	52,100	67,100
300G-10*	10	10.960	3.311	10.398	20	30	91	11	595	775	1499	1931	65,400	84,400
300G-12*	13	13.195	3.633	11.204	20	36	111	7	716	935	1809	2337	96,600	125,000
300G-14*	14	15.290	3.910	11.844	20	42	131	2	837	1095	2119	2743	133,965	173,000
300G-16*	16	17.483	4.181	12.426	20	48	150	9	958	1255	2429	3149	177,000	230,000

*Wind load in the direction through the mounting toward the tower computed for 60 lbs. on flat surfaces and 40 lbs. on projected areas of cylindrical surfaces.

**For 60 lbs. wind loading direction through the mounting toward the tower and referred to the center line of the bottom bay.

FM Isolation Transformers



7.5 kW AND 10 kW ISOLATION TRANSFORMERS.

The FM isolation transformer is designed to couple FM transmitter power across the base of an insulated tower used jointly as an AM and FM radiator, without objectionable mismatch being introduced into the FM transmission line. Single AM antennas and antennas which are part of an AM directional antenna system are not affected when the isolation transformer is used.

The transformer can be mounted at the base of the tower or directly on the tower structure. Full lightning protection is achieved by heavy duty DC shorts between the inner and outer conductors on both ends of the transformer. Discharge of lightning is then through the external gap across the tower base.

SPECIFICATIONS

(7.5 and 10 kW Units)

FREQUENCY: 88 to 108 MHz (adjusted to the customer's operating frequency at the factory).

VSWR: Less than 1.05 to 1 on specified frequency, ± 0.5 MHz when terminated in a matched 50 ohm load.

POWER RATING: (Into matched 50 ohm load)

7.5 kW—Model 620-0397

10 kW—Model 620-0415.

INSERTION LOSS: 0.10 dB or less.

INPUT AND OUTPUT: (7.5 kW unit) EIA 1 $\frac{1}{8}$ " flange, male* or female. (10 kW unit) EIA 3 $\frac{1}{8}$ " flange, female.

*Box has EIA male connector. The male to male adapter may be removed if box connects to female fitting. Subtract 6" from flange to flange length for each adapter if removed.

WEIGHT: 48 lbs.

LENGTH: 20" (flange to flange).

WIDTH OF BOX: 13 $\frac{5}{8}$ ".

HEIGHT OF BOX: 10".

MOUNTING: 2" pipe flange on bottom of box.

PRESSURIZATION: Designed for use in pressurized system—20 lbs. per square inch max. gas will pass through unit.

ORDERING INFORMATION

7.5 kW Isolation Transformer, adjusted to the customer's operating frequency at the factory. Standard EIA 1 $\frac{1}{8}$ " flanges. For use with a maximum transmitter power of 7.5 kW.....620-0397

10 kW Isolation Transformer, adjusted to the customer's operating frequency at the factory. Standard 3 $\frac{1}{8}$ " flanges. For use with a maximum transmitter power of 10 kW.....620-0415



25 kW ISOLATION TRANSFORMER.

Each isolation transformer is factory tuned to specified frequency. Factory tuning should introduce less than a 1.05 to 1 VSWR at the specified FM frequency, ± 0.5 MHz, when terminated in a matched 50 ohm load.

Every transformer is supplied with EIA 50 ohm male flanges with captive bullets for mating with EIA 50 ohm female flanges on either helical or rigid coaxial transmission line. Designed for pressurized operation, the FM isolation transformer requires a pressure of approximately 3 to 5 lbs. per square inch. Dry air or dry gas should be passed through the unit so that under pressure changes in temperature will not cause moisture condensation from outside air.

SPECIFICATIONS

(25 kW Unit)

FREQUENCY: 88 to 108 MHz (adjusted to the customer's operating frequency at the factory).

VSWR: Less than 1.05 to 1 on specified frequency, ± 0.5 MHz when terminated in a matched 50 ohm load.

BANDWIDTH: Over 2 MHz between 1.1 to 1 VSWR points terminated in a matched 50 ohm load.

POWER RATING: 25 kW maximum in a matched 50 ohm load.

INSERTION LOSS: 0.10 dB or less.

AM SHUNT CAPACITY TO GROUND: 60 to 70 pf.

LEAKAGE ISOLATION: At least 30 dB down at the FM frequency (as measured between the outside of the coaxial output line and the case).

INPUT AND OUTPUT: 3 $\frac{1}{8}$ " fifty ohm EIA male flange will mate with the 3 $\frac{1}{8}$ " fifty ohm EIA female flange such as the Andrew type 78-AR-F used on 3 $\frac{1}{8}$ " Heliax cable, or the flange on Andrew type 562A 50 ohm 3 $\frac{1}{8}$ " rigid coaxial transmission line.

WEIGHT: 255 lbs.

LENGTH: 39" (flange to flange).

TANK DIAMETER: 28 $\frac{1}{2}$ ".

MOUNTING: Separate 3" pipe flange on bottom. Two stainless steel straps secure tank to cradle.

PRESSURIZATION: Designed for use in a pressure system with gas passing through the unit. (Normal pressure 3 to 5 lbs. per square inch using dry air or dry gas.

ORDERING INFORMATION

25 kW Isolation Transformer, adjusted to the customer's operating frequency at the factory. Standard EIA 3 $\frac{1}{8}$ " flanges. For use with a maximum transmitter power of 25 kW.....620-0444

Directional FM Antennas And Accessories

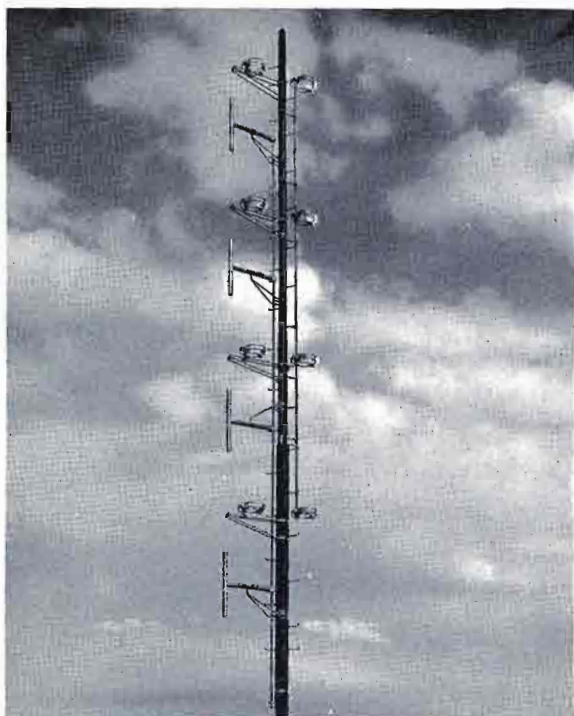

Directional FM antenna as supplied by Gates to Radio Station WMSH, Hershey, Pennsylvania. Antenna consists of four bays directional Cycloid and four bays non-directional 300G elements.

DIRECTIONAL FM ARRAYS

Directional FM Antennas can be supplied utilizing the Gates horizontally polarized Cycloid, the Gates vertically polarized Type 300G, or a combination of the two. A directional circularly polarized Dual-Cycloid antenna is available on special order.

Many considerations enter into the design and construction of a directional FM antenna, of which the desired pattern is probably the most important. Other factors are the supporting structure and effective radiated power. This information is required before a firm quotation can be made. In accordance with FCC requirements, all directional FM antennas must be tuned and tested at the factory on the customer's assigned operating frequency, while mounted on a tower simulating the final installation. A plotted radiation pattern must be filed with the commission.

For additional information, contact your Gates District Manager.

FM ANTENNA ACCESSORIES

REPLACEMENT ANTENNA HEATER ELEMENTS. For Cycloid and Dual-Cycloid antennas. Special order.

THERMO-SWITCH for control of antenna heaters. Switch will handle a maximum of 15 amperes.

Order number.....604-0287

AC HEATER CABLE AND CONDUIT, including installation. Only available when a tower or FM antenna is being installed. Special order.

CYCLOID MOUNTING BRACKETS. Antenna prices include standard mounting brackets for either leg or face mounting on guyed towers. The following are special brackets for mounting Cycloid antenna elements 36 inches off of tower face, at additional cost for each bracket. (See price list).

Antenna Type (A or B)	Brackets Required
FMA-2	2
FMA-3	4
FMA-4	6
FMA-5	8
FMA-6	10
FMA-7	12
FMA-8	14
FMA-9	16
FMA-10	18
FMA-11	20
FMA-12	22

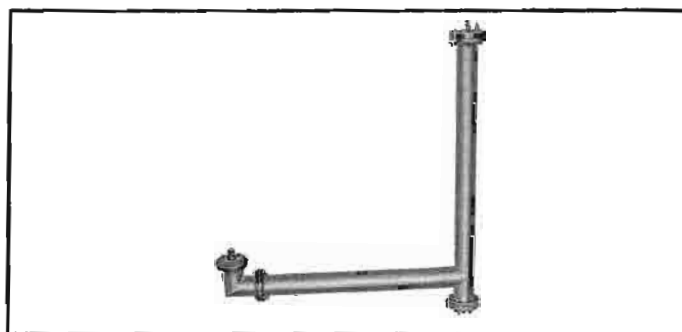

Power divider.

FIXED POWER DIVIDER—custom designed to divide power for vertical and horizontal antennas to customer's specifications. Special order.

With 3/8" EIA input and 3/8" EIA output for both horizontal and vertical antennas.

With 1 5/8" EIA input and 3/8" EIA output for both horizontal and vertical antennas.

With 3/8" EIA input and 1 5/8" EIA output for both horizontal and vertical antennas.

With 1 5/8" EIA input and 1 5/8" EIA output for both horizontal and vertical antennas.

FM Stereo Modulation Monitor



MODEL GTM-88S

The GTM-88S measures all modulation characteristics of an FM stereo or monaural signal in accordance with FCC requirements. All normal operating controls are accessible from the front panel. Instrument outputs for the right and left channels on the rear of the monitor can be connected to such auxiliary test equipment as oscilloscopes, distortion analyzers and frequency monitors, which may remain connected without affecting monitor performance or accuracy. Left channel instrument output is switchable to either channel by front panel control.

Printed circuit construction is used throughout, and, combined with the total solid state design, improves over-all dependability, and assures stable operation even under adverse operating conditions. Space age integrated circuits combine all circuit components into a single silicon semi-conductor device, thus eliminating many physical components as well as their associated interconnections, for the ultimate in performance and reliability. Provision has been made for the addition of an SCA adapter to measure SCA modulation in accordance with FCC rules and regulations.

SPECIFICATIONS

ELECTRICAL

OPERATING FREQUENCY: 87.5 to 108 MHz.
RF INPUT IMPEDANCE: 50 ohms, unbalanced.
RF INPUT SENSITIVITY: 0.1 to 1 watt.
COMP. INPUT SENSITIVITY: 0.7 V peak-to-peak for 100% modulation.
COMP. INPUT IMPEDANCE: 4000 ohms.
COMP. OUTPUT: 3 V peak-to-peak at 100% modulation.
COMP. OUTPUT IMPEDANCE: 600 ohms.
COMP. OUTPUT FREQ. RES.: ± 0.5 dB, 30 Hz to 100 kHz.
19 kHz OUTPUT: 0.75 V peak-to-peak into 20 K ohms load.
HEADPHONE OUTPUT: Levels for loads from 4 ohms to several megohms with distortion 1% or less. Separate level control.
POWER REQUIREMENTS: 100-130 VAC, 50/60 Hz, 40 watts.

INSTRUMENT OUTPUT (left or right)

IMPEDANCE: 20,000 ohms.
FREQUENCY RESPONSE: ± 0.5 dB, 50 Hz, to 15 kHz.
DISTORTION (Stereo): 0.5% or better from 50 Hz to 15 kHz at 100% modulation.
INTERNAL NOISE: -70 dB or better in mono or stereo below 100% modulation at 400 Hz.
CHANNEL SEPARATION: 35 dB or better 50 Hz to 15 kHz.

CROSSTALK CAPABILITY

MAIN TO SUB: 50 dB or better.
SUB TO MAIN: 55 dB or better.
SCA TO MAIN OR SUB: 70 dB or better.
SUBCARRIER SUPPRESSION: 50 dB or better with modulation from 5 to 15 kHz.

MODULATION METER

ACCURACY: $\pm 5\%$ or better.
BALLISTICS: Conform to FCC rules 73.322 (b).
PEAK MODULATION INDICATOR: Adjustable to indicate from 50% to 120% modulation.
AM NOISE MEASUREMENT: AM noise up to -70 dB from 30 Hz to 75 kHz.
FCC TYPE APPROVAL: No. 3-144.

MECHANICAL

RF INPUT CONNECTOR: UHF plug.
DIMENSIONS: 19" wide, 8 $\frac{3}{4}$ " high, 1 $\frac{1}{4}$ " deep.
WEIGHT: 26 lbs. (net).
AMBIENT TEMPERATURE: 10°C (50°F) to 55°C (131°F).
AMBIENT HUMIDITY: 0 to 95% relative.
ALTITUDE: Sea level to 10,000 feet.
MOUNTING: Standard 19" rack panel or free standing.

ORDERING INFORMATION

GTM-88S FM Stereo Modulation Monitor, complete with crystal, calibrated to specified operating frequency_____994-6569



FM Monaural Modulation Monitor



MODEL GTM-88M

Incorporating all of the advanced performance features of the stereo unit, the GTM-88M monophonic monitor can be readily converted to stereo operation with full FCC type approval. Printed circuit modular construction used in the GTM-88M allows conversion to stereo operation with no wiring changes. The conversion is accomplished by plugging in the appropriate modules and filters, then calibrating for stereo operation. The design also provides for the addition of an adapter for measurement of SCA modulation.

Silicon solid state and silicon integrated circuits used in the monitor were selected for their dependability.

All normal operating controls are on the front panel, with other controls behind a hinged front panel. When converted to stereo, the monophonic monitor requires no control changes. The peak modulation indicator is adjustable in 10 degree steps from 50% to 120%.

Separate headphone and instrument outputs receive an FM signal with de-emphasis, while the modulation meter receives the complete signal with pre-emphasis to provide accurate modulation readings. Compact in size, the GTM-88M is designed for standard rack mounting.

SPECIFICATIONS

ELECTRICAL

OPERATING FREQUENCY: 87.5 to 108 MHz.
RF INPUT IMPEDANCE: 50 ohms, unbalanced.
RF INPUT SENSITIVITY: 0.1 to 1 watt.
HEADPHONE OUTPUT: Load levels from 4 ohms to several megohms with 1% or less distortion. Separate level control.
POWER REQUIREMENTS: 100 to 130 VAC, 50/60 Hz, 40 watts.

INSTRUMENT OUTPUT

IMPEDANCE: 20,000 ohms.
FREQUENCY RESPONSE: ± 0.5 dB, 50 Hz to 15 kHz.
DISTORTION: 0.25%, 50 Hz to 15 kHz at 100% modulation.
INTERNAL NOISE: -70 dB below 100% modulation at 400 Hz.

MODULATION METER

ACCURACY: $\pm 5\%$.
BALLISTICS: Meet FCC rule 73.322 (b).
PEAK MODULATION INDICATOR: Adjustable from 50 to 120% modulation.
AM NOISE MEASUREMENT CAPABILITY: -70 dB, 30 Hz to 75 kHz.
FCC TYPE APPROVAL: No. 3-145.

MECHANICAL

RF INPUT CONNECTOR: UHF plug.
DIMENSIONS: 19" wide, 8 $\frac{3}{4}$ " high, 1 $\frac{1}{4}$ " deep.
WEIGHT: 24 lbs. (net).
AMBIENT TEMPERATURE: 10° to 55°C, (50° to 131°F).
AMBIENT HUMIDITY: 0 to 95% relative.
ALTITUDE: Sea level to 10,000 feet.
MOUNTING: Standard 19" rack panel or free standing.

ORDERING INFORMATION

GTM-88M FM Monaural Modulation Monitor, complete with crystal, calibrated to specified operating frequency.....

994-6581

SCA Modulation Monitor Adapter

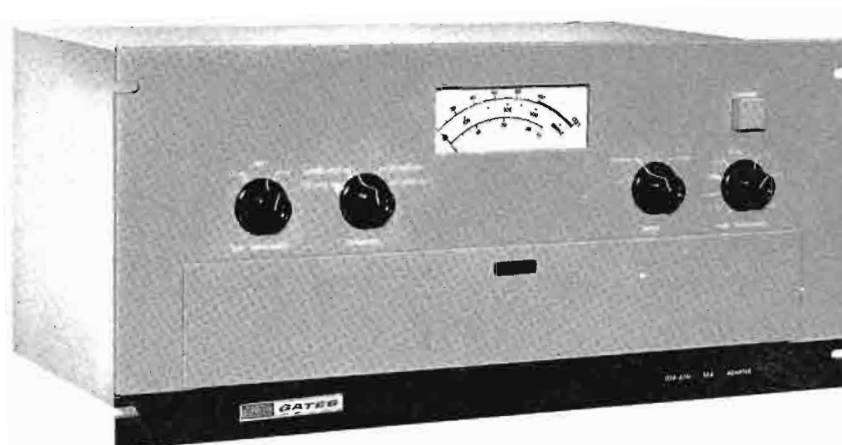

MODEL GTA-6741

Gates SCA modulation monitor adapter measures all modulation characteristics of an SCA signal when used in conjunction with Gates FM modulation monitors. This adapter can also be used with the GTA-88F SCA frequency comparator to measure the accuracy of SCA frequencies as specified by the FCC. Total solid state circuitry, plus integrated circuits throughout the GTA-6741, assures trouble-free operation.

A built-in peak modulation flasher provides indication of peak or over-modulation on the SCA channel. The GTA-6741 is also equipped with an instrument output for connection of external test equipment without affecting performance of the adapter. A separate audio output provides a +10 dBm signal to drive an external amplifier. A separate headphone jack is also provided.

Measurements that can be made using this SCA modulation monitor adapter and Gates GTM-88S stereo or GTM-88M monophonic modulation monitor include:

1. SCA channel modulation (41 and/or 67 kHz).
2. Crosstalk—SCA into main channel.
3. Crosstalk—SCA into stereo channel.
4. Crosstalk—Main into SCA channel.
5. Crosstalk—Stereo into SCA channel.
6. Crosstalk—67 kHz into 41 kHz SCA channel.
7. Crosstalk—41 kHz into 67 kHz SCA channel.
8. FM noise measurements—SCA channel.
9. SCA frequency accuracy (when used with Gates GTA-88F frequency comparator).
10. Distortion on the SCA channel (with external distortion analyzer).

SPECIFICATIONS

OPERATING FREQUENCY: 41 kHz and 67 kHz.

SCA PEAK MODULATION INDICATOR: Adjustable to indicate from 50% to 120% modulation. Meets FCC Rules 73.332D (4).

CROSSTALK CAPABILITY

SCA INTO MAIN OR SUB: (10% SCA) 70 dB or better.

MAIN INTO SCA: (SCA 8:1) 50 dB or better (30 Hz - 15kHz).

STEREO INTO SCA: (SCA 8:1) 40 dB or better (30 Hz - 15 kHz).

41 KHZ INTO 67 KHZ: (both SCA at 10%) 45 dB (30 Hz - 5 kHz).

67 KHZ INTO 41 KHZ: (both SCA at 10%) 45 dB (30 Hz - 5 kHz).

AUDIO OUTPUT

HEADPHONE OUTPUT: Provides sufficient level for headphones from 4 ohms to several megohms. Separate level control provided. ± 1 dB 30 to 7,500 Hz.

AUDIO OUTPUT: +10 dBm at 600 ohms (unbalanced).

INSTRUMENT OUTPUT

IMPEDANCE: 20,000 ohms.

DISTORTION: 1% or better (30 Hz - 7.5 kHz).

FREQUENCY RESPONSE: ± 0.5 dB (30 Hz - 7.5 kHz).

GENERAL

POWER SOURCE: All DC voltages provided from GTM-88M or GTM-88S FM modulation monitors.

SIZE: 19" wide, 8 $\frac{3}{4}$ " high, 11" deep. Including knobs and rear connectors, 13" deep.

WEIGHT: 20 lbs. (net).

AMBIENT TEMPERATURE: 10°C to 55°C (50°F to 131°F).

AMBIENT HUMIDITY: 0 to 95% relative.

ALTITUDE: Sea level to 10,000 feet.

MOUNTING: Standard 19-inch rack panel or free standing.

ORDERING INFORMATION

GTA-6741 SCA Modulation Monitor Adapter.....994-6591

FM FREQUENCY MONITOR



MODEL GTM-88F

Gates new all solid state FM frequency monitor measures the precise operating frequency of the FM transmitter by utilizing pulse counting techniques. A crystal controlled wide band pulse signal is compared with the FM transmitter center frequency to determine any frequency deviation from the assigned operating channel. The pulse counting technique assures a measurement accuracy of better than 0.0001%, and full compliance with all FCC requirements.

FREQUENCY RANGE: 88 to 108 MHz (fixed).

POWER: 100 to 130 VAC, 50/60 Hz, 40 watts, 19" W x 7" H x 10" D.

GTM-88F FM frequency monitor, complete with crystal, calibrated to specified operating frequency.....994-6588

PILOT-SCA FREQUENCY COMPARATOR

Gates pilot-SCA frequency comparator determines the accuracy of the pilot frequency when used with Gates GTM-88S stereophonic modulation monitor, and SCA frequencies when used with the GTA-6741 SCA modulation adapter. Three integrated circuits, one transistor, and nine diodes (all silicon) are used for stability and reliability. The GTA-88F is factory calibrated, and will provide years of dependable service in full compliance with existing FCC rules.

OPERATING FREQUENCIES: 19, 41 and 67 kHz as supplied.

POWER: 100 to 130 VAC, 50/60 Hz, 10 watts. 19" W x 5 1/4" H x 6 3/4" D. (8 3/4" deep with knobs and rear connectors.)

GTA-88F 19 kHz pilot/SCA 41 and 67 kHz frequency comparator...994-6603



MODEL GTA-88F

FM RF AMPLIFIER

Designed to operate in conjunction with Gates FM frequency and modulation monitors, the GTM-88R amplifier is used at a remote location to provide sufficient RF power to drive the monitors. This is ideal for applications where the monitors are located at the studio and the transmitter is at a remote location. It permits the operator to monitor the frequency and modulation of the transmitter as required by FCC regulations. Solid state silicon circuitry plus extensive use of integrated circuits throughout assures dependable, trouble-free operation.

FREQUENCY RANGE: 87.5 to 108 MHz.

POWER: 115 V, 50/60 Hz, 12 watts. 19" W x 5 1/4" H x 10" D.

GTM-88R FM RF amplifier complete with antenna, less interconnecting cable.....994-6614



MODEL GTM-88R

FM Installations

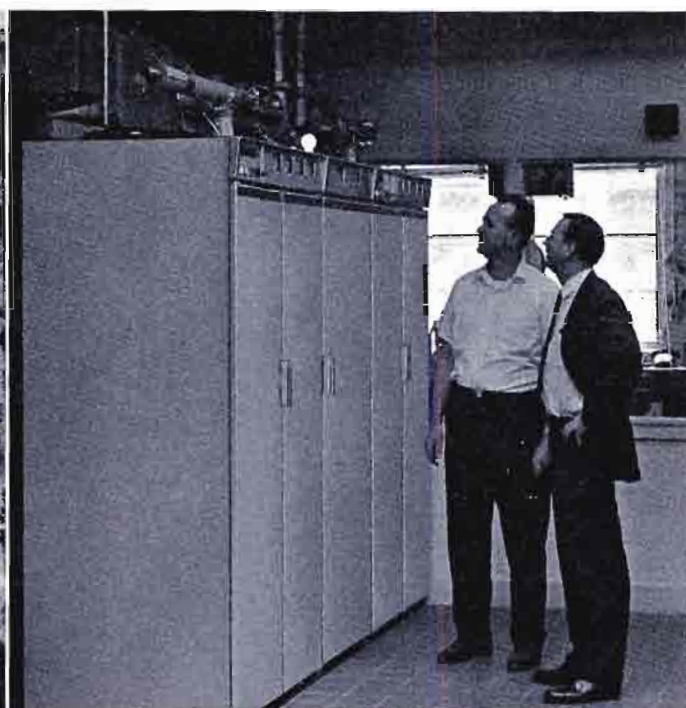

WGAN-FM, Portland, Maine—Gates 40 kW FM transmitter (above right), plus the Cycloid and vertical antenna combination (above left), 1460 ft. above average terrain, produces a 100,000 watt ERP signal.

Directional antenna consisting of combined Cycloid and vertical Type 300G, installed and operating at WMSH-FM, Hershey, Pennsylvania. ➔



Whatever the FM broadcasting need, from a 10 watt educational station to a full 100,000 watt ERP installation, Gates has the facilities and the experience to produce the finest FM transmitting equipment. Just a few short years ago, Gates introduced the first solid state Direct Carrier Frequency Modulation exciter. This unique exciter has revolutionized FM equipment, especially for stereo and SCA operation where it added the final dimension of solid state reliability.

Each Gates FM transmitter is designed for the most reliable, yet economical operation possible. Tube count has been kept extremely low by combining the solid state DCFM exciter with modern ceramic tetrodes throughout for most efficient operation. All power levels of transmitters are available for combination with the full line of Gates FM antennas to produce any effective radiated power up to the maximum permitted.

WJR-FM Detroit uses a Gates FM-10G Transmitter in combination with horizontal and vertical antennas to produce a 24 kW ➔ circularly polarized signal.



Remote Control System

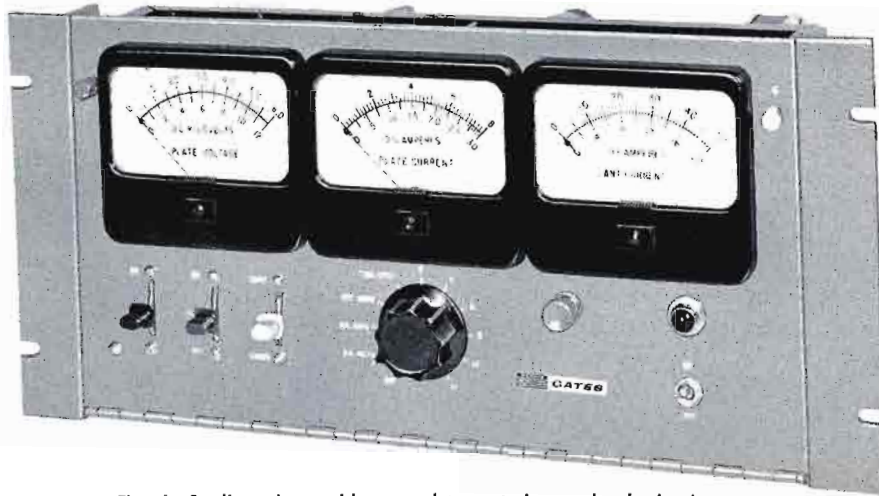

Fig. A. Studio unit provides complete metering and selection/operation of up to 23 control functions. Power supply is self-contained.

MODEL RDC-10AC

This Gates remote control equipment is a direct current system without tubes or transistors and has only one major moving part—the rugged gold contact stepper. Facilities are provided for as many as ten metering positions and 23 control functions. Capacity of the RDC-10AC equipment ranges from the one transmitter, one tower installation to a multi-tower directional system, as well as combination AM-FM separate transmitters with only one RDC-10AC system.

Standard equipment includes: (a) the studio control unit, Fig. A, (b) the transmitter control unit, Fig. B, (c) plate current and (d) plate voltage metering kits, plus (e) the tower light indicator unit. Studio and transmitter units are also available separately. Items (c), (d) and (e) are described on Page 65.

The studio control unit (Fig. A) has three large, easy-to-read meters that indicate plate voltage, plate current and AM antenna current or FM output. The meters may be switched

to several circuits on one or two transmitters, coupling units, etc. As an example, the tower light function can be indicated on the plate current meter. Many combinations are possible with the selection of the proper accessories as listed on Page 65. Relays are of highest quality to assure freedom from malfunction. A switch is provided on the transmitter control unit to transfer operation back to manual during transmitter maintenance or servicing.

Only two metallic telephone pairs are required. Usually the order phone between studio and transmitter is connected to one of the remote functions to eliminate the need for a third order phone line. The RDC-10AC system will operate on telephone lines up to 30 miles in length, or with 3000 ohms loop resistance, whichever is greater. Both studio and transmitter units are 19" wide, 8 $\frac{3}{4}$ " high and 10" deep. Front panels drop down for easier servicing. Shipping weight: domestic, 50 lbs.; export, 85 lbs. Cubage: 4 cubic feet.



Fig. B. Transmitter unit may mount in a rack, or directly in most transmitters. Power supply is self-contained.

ORDERING INFORMATION

- (A) Complete RDC-10AC system includes studio and transmitter units and items I, J and K below.....994-5862-001
- (B) Studio and transmitter units only.....994-5862-002
- (C) Antenna diode to remote control antenna meter.....994-6112
- (D) Motor driven rheostat for power control of 250 watt transmitter.....994-4703-001
- (E) Motor driven rheostat for power control of 500 watt transmitter.....994-4703-002
- (F) Motor driven rheostat for power control of 1000 watt transmitter.....994-4703-003
- (G) Motor assembly to drive variable coil for load power adjustment such as for 5 kW or 10 kW transmitters. (Relay below necessary).....994-5066
- (H) Relay assembly to operate 994-5066 motor.....994-4806
- (I) Plate current unit to extend plate current readings.....994-4720
- (J) Plate voltage unit to extend plate voltage readings.....994-4719
- (K) Tower light indicator.....994-5145

IMPORTANT: When ordering, give as much transmitter detail as possible: (a) make and type number, (b) plate rheostat in ohms and watts. If not a Gates transmitter, state method of power output control such as rheostat, variable loading, etc. If you are in doubt, please contact us. Gates will gladly assist.



Remote Control System

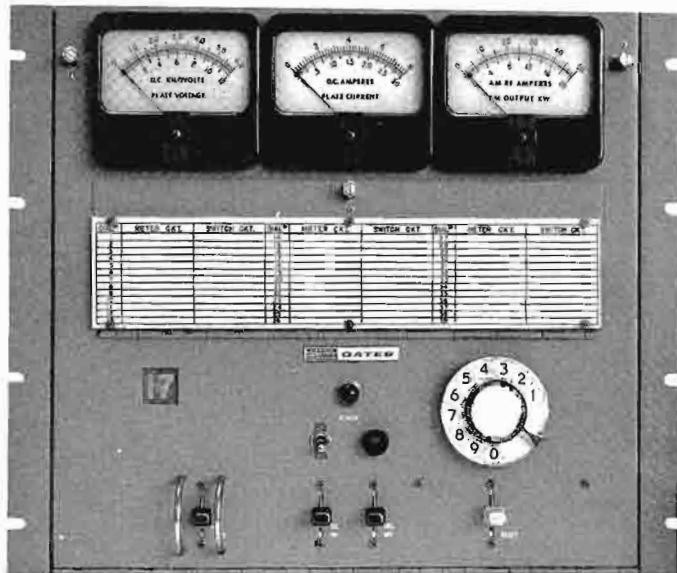

Studio Unit



Transmitter Unit

MODEL RDC-200A

Designed for the simplest or most complex unattended operation, the Gates RDC-200A system will handle as many as 39 metering functions and 78 switching operations. Remote functions are dialed on the studio unit, and a reference chart is mounted on the front of both the transmitter and studio units. If remote function No. 17 is dialed, for example, this appears in illuminated numerals on both units. By referring to the chart, position 17 may indicate you are ready to adjust the loading control, or whatever function is on circuit 17.

All powers of equipment from 250 watts to 50,000 watts, and the more complicated multi-tower directional system, may be easily handled with facilities left to accommodate the FM or standby transmitter. Only two metallic telephone pairs are required. If desired, the order phone may be on one of these pairs as a dialed function.

There are no tubes or transistors as the system operates on direct current. The greatest current used is only 6 mA. This permits very positive results over lines up to 60 miles in

length or 5,000 ohms loop resistance. All metering is with three large 4" meters, each with multi-scales. DC voltage, DC current and RF current or output is indicated. For AC voltage indications, the M-4825 rectifier (next page) may be added.

Power supplies for both units are self-contained. Each occupy 19" x 15 $\frac{3}{4}$ " of rack space. No simplex, phantom or ground return circuits are used. Oversize slave relays provide abundant contact rating for flawless switching. Combined with the sensitive control relays, polarizing diodes and biasing for low current operation, this insures a type of reliability expected from the modern, and often complex, broadcasting installation.

All switching functions, including pulse and reset, may be controlled from the transmitter unit for local operation during maintenance and servicing periods. The popular Gates drop-down front panels are standard construction. Weight: domestic, 110 lbs.; export, 170 lbs. Cubage: 15 cubic feet.

ORDERING INFORMATION

RDC-200A remote control system (see Notes 1 and 3).....994-5870
 Extra tower light indicators (see Note 2).....994-5145
 AC Rectifier to indicate AC Voltages.....994-4825

NOTES: (1) Standard equipment includes: plate voltage metering unit, plate current metering unit, plate start-stop relays for one transmitter and tower light indicator. (2) For more than 1 tower, order 994-5145 units for each additional tower. (3) See next page for other accessories such as additional metering units, motor driver, etc.



Remote Control System Accessories

FREQUENCY MONITOR EXTENSION METERS



For M-4990 AM Frequency Monitor. Meter is exact duplicate of the M-4990 monitor for extending frequency indication to studios.

Extension meter.....994-5631

For extending Gates M-2890 AM monitors. Has 4" frequency indicating meter reading 30-0-30 Hz. Includes resistor pad for sampling voltage. Tubes: 6AW6, 6AQ6, 6AL5, 6X4 and OA2. For 115 volts, 50/60 Hz. Size 7" x 19" x 7" deep.

Frequency Monitor Extension Unit.....994-5270

MONITOR EXTENSION METERS

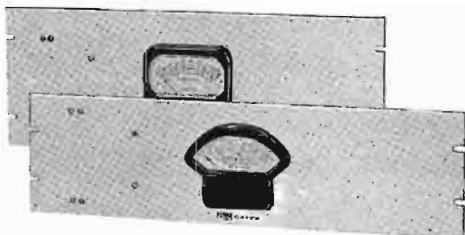

Several types available as listed below for extending both frequency and modulation monitors. Mounted on standard 19" rack panel. 5 1/4" high.

Remote Meter for M-5774 modulation monitor.....994-5836B

Remote meter for extending Gates M-5693 modulation monitor.....994-5837

For extending Gates M-2639 modulation monitor.....994-5210

For GR1931A or RCA WM43A modulation monitors.....994-5206

For GR1181A or RCA WF48A frequency monitors.....994-5208

AUXILIARY RELAY ASSEMBLY



Auxiliary relay assembly to provide one on-off momentary switching facility. These relays provide two sets of double pole double throw contacts rated at 8 amperes, 115 volts AC.

Auxiliary Relay Assembly.....994-5249

Same as above but latching (holding) type with 10 ampere contacts.....994-5248

MOTOR OPERATED RHEOSTAT



Recommended for regulating the plate voltage in transmitters of 1 kW and less. Available in three sizes for 250, 500 and 1000 watt transmitters. Motor is one rpm and operates from 115 volts, 60 Hz.

Motor Rheostat for 250 watts.....994-4703A

Motor Rheostat for 500 watts.....994-4703B

Motor Rheostat for 1 kW.....994-4703C

Motor Control for Rheostat in BC-500G and BC-1G.....994-6326

TUNING MOTOR



This unit for tuning variable inductor, capacitor or other controls, has built-in limit switches. Five wire reversible motor 1 rpm. Requires M-4806 relay assembly for control. 115 volt, 50/60 Hz.

Tuning Motor.....994-5066

TUNING MOTOR ASSEMBLY

For operating rheostat, variable condenser, or any variable control. Three wire reversible motor 1 rpm. Torque 15 lb.-inches. 115 volts, 50/60 Hz.

Tuning Motor.....994-4800

AC RECTIFIER

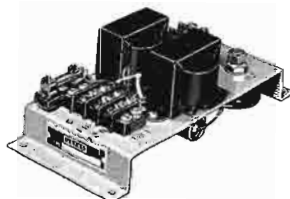

Rectifies the AC voltage, either line or filament, at the transmitter, and feeds back DC to studio unit for measuring AC by remote control.

AC Voltage Unit.....994-4825

PLATE CURRENT UNIT

Included with the Gates remote control system. Furnishes a sample of plate current which is returned to the studio unit and measured on the directly calibrated plate current meter. The unit is provided with a high voltage protective fuse, and can be used for current ranges of 0-0.8 and 0-3 amperes. Units can be used in parallel if higher current range is required.

Plate Current Unit.....994-4720A

TOWER LIGHT UNIT

This unit is used to provide a DC voltage for indication of proper tower light operation. Includes current transformer.

Tower Light Metering Kit.....994-5145

RF DIODE UNIT

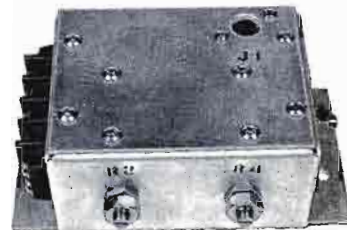

The M-6112 RF diode unit is designed for use as a remote RF indicating device in standard broadcast installations for sampling base currents or common point currents. It is not a directly calibrated RF ammeter, but is adjustable to indicate current linearity with the RF meter. It is not necessary to break the lead to the antenna to install the unit. The M-6112 RF diode consists of an inductive loop which is attached to a rectifier assembly, and is also clamped to the antenna lead. The M-6112 is a solid state device and requires no AC power.

POWER RANGE: 250 to 50,000 watts.

FREQUENCY RANGE: 540 to 1600 kHz.

RF Diode Unit.....994-6112

OVERLOAD RELAY

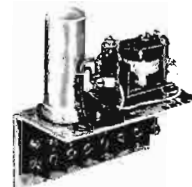

Replaces circuit breakers in current or older models, as circuit breakers are usually undependable for remote control. Tripping current adjustable. Inserted in cathode circuit of RF power amplifier. Some engineers prefer an additional unit in modulator circuit.

Overload Relay.....994-5129

FM OUTPUT INDICATOR



Designed to sample the 50 ohm transmission line of an FM transmitter for measuring transmitter output as required by FCC. Provides a DC voltage which is measured on the studio unit meter system. Solid state. Requires no AC power.

FM Output Indicator.....994-4845

PLATE VOLTAGE UNIT

Supplied with Gates remote control systems. One unit is used with voltages up to and including 6000 volts. For higher voltages, additional units may be connected in series. Also available as an accessory item for metering additional stages of transmitters.

Plate Voltage Unit.....994-4719A

OUTPUT LOADING CONTROL KIT

Complete kit to control output loading of Gates BC-5P-2 and BC-5H 5 kW transmitters. It includes M-5066 and M-4806 relay and all necessary mounting hardware.

Output Loading Control Kit.....994-4848A



Coaxial And Rigid Transmission Lines



**AIR
DIELECTRIC**

FLEXIBLE COAXIAL CABLE

Produced in continuous splice-free lengths, Heliax® low loss cable is ideally suited for any application where use of coaxial transmission line is indicated. For medium wave VHF and UHF applications, long, continuous lengths provide ease of installation and maintenance-free service. Corrugated copper conductors provide a combination of flexibility and low loss. For direct burial, exposure to rough handling, or where the outer conductor must be insulated, Heliax jacketed with polyethylene is also available. Although Heliax connectors and fittings are easily attached, it is recommended that all cable assemblies be ordered with fittings factory attached with specialized manufacturing equipment. Please order by type number.

® Registered trademark, Andrew Corporation.

SPECIFICATIONS

SIZE:	7/8"	1 1/8"	3"	5"	8"
TYPE NUMBER:	H5-50	H7-50A	H8-50A	H9-50	—
TYPE NUMBER, JACKETED:	HJ-50	HJ7-50A	HJ8-50A	HJ9-50	HJ10-50
IMPEDANCE: OHMS	50	50	50	50	50
ATTENUATION @ 100 MHz, dB/100 FT.:	0.37	0.21	0.14	0.080	.052
VELOCITY: %:	91.6	92.1	93.3	93.0	94.0
AVERAGE POWER, @ 100 MHz-kW:	6.4	14.5	34.0	95.0	170.0
BEND RADIUS (MINIMUM)—INCHES:	10	20	30	50	72
NET WEIGHT—POUNDS/FT.:	.43	.72	1.2	2.7	—
NET WEIGHT—JACKETED: POUNDS/FT.:	.51	.92	1.5	4.2	8.9



**FOAM DIELECTRIC
COAXIAL CABLE**

Foam Heliax is used in those broadcast installations requiring low loss coaxial cable in which pressurizing is not desirable. A corrugated copper outer conductor and foam dielectric provide a combination of high strength, low loss and power handling not available in solid dielectric cables. The flexibility of foam Heliax provides maximum resistance to crushing, kinking or denting, and enables it to be pulled through conduits and around obstructions. Please order by type number.

SPECIFICATIONS

SIZE:	1/2"	7/8"
TYPE NUMBER:	FH4-50B	FH5-50A
TYPE NUMBER, JACKETED:	FHJ4-50B	FHJ5-50A
IMPEDANCE:	50 ohms	50 ohms
ATTENUATION @ 100 MHz, dB/100 FT.:	0.82	0.44
VELOCITY, %:	79	79
AVERAGE POWER, @ 100 MHz, kW	2.3	4.8
BENDING RADIUS (MINIMUM)—INCHES:	5	10
NET WEIGHT—POUNDS/FT.:	.125 lbs.	.32 lbs.
NET WEIGHT—JACKETED:	.185 lbs.	.42 lbs.

RIGID TRANSMISSION LINES



RIGID LINE







Teflon insulated rigid copper coaxial transmission lines for broadcast application. Line and connectors meet all EIA applicable standards. Mitered elbows are compensated to provide low VSWR. All rigid sections and components include inner connectors, "O" ring and hardware. Please order by type number.

SPECIFICATIONS

SIZE:	7/8"	1 1/8"	3 1/8"
TYPE NUMBER:	560	561	562A
IMPEDANCE:	50 ohms	50 ohms	50 ohms
ATTENUATION @ 100 MHz, dB/100 FT.:	0.40	0.20	0.11
VELOCITY, %:	99.8	99.8	99.8
AVERAGE POWER, @ 100 MHz:	4.3 kW	15.0 kW	48.0 kW
NET WEIGHT—POUNDS/FEET:	.65	1.25	2.75

Coaxial Transmission Line Accessories

Fittings: Flanged items are EIA standard and include inner connector, "O" ring, silicon grease and hardware kit.





EIA FLANGE  <p>Use with copper Heliac cable.</p>	EIA FLANGE  <p>Includes gas barrier.</p>	REDUCER CONNECTOR  <p>Reduce cable size to EIA flange sizes.</p>	END TERMINAL  <p>For strap connection to center conductor.</p>	TYPE N JACK  <p>Female, mates with (-).</p>	SPLICE  <p>Use with copper Heliac cable.</p>
--	---	---	--	--	---

FOAM DIELECTRIC

1/2"	44AR	---	---	87S	1/2"	44AT	(UG23)	44AN	44AZ
7/8"	45AR	---	---	78S	7/8"	45AT	(UG21)	45AN	45AZ

AIR DIELECTRIC

7/8"	75AR	75AG	---	75AT	(UG21)	75AN	75AZ
1 1/8"	87R	87G	1 1/8"-7/8"	87S	1 1/8"	87N	87Z
3"	78ARM	78AGM	3 3/8"-1 1/8"	78S	3"	(79ARM + 2062A)	78AZ
5"	79R	79G	6 1/8"-3 1/8"	(79R+1872)	5"	(79R + 2073)	79Z
8"	80R	---	6 1/8"-3 1/8"	(80R+1872)	8"	(80R + 2073)	80Z

TYPE UHF JACK  <p>Female.</p>	NON-INSULATED HANGER  <p>Kit of 10 hangers. Spacing 3' for 1 1/8" cables, 5' for 3" and 5" cables.</p>	INSULATED HANGERS  <p>Use on insulated tower spacing 3 feet apart.</p>	INSULATED HANGERS  <p>Use on insulated tower spacing 3' apart for 1 1/8", 5' for larger sizes.</p>	HANGER ADAPTERS INSULATED Adapters used to mount insulated hangers to tower without drilling. Angle Members 13555 Round Members up to 3" 13550 NON-INSULATED Kit consists of 10 adapters to mount hangers to tower. ANGLE MEMBER TOWERS 1 1/8" hangers 31768 3" and 5" hangers 33981 ROUND MEMBER TOWERS Use with 1 1/8" hangers: Member dia. 1"-2" 31670-1 2"-3" 31670-2 3"-4" 31670-3 4"-5" 31670-4 5"-6" 31670-5 Use with 3", 5" and 8" hangers: Member dia. 1"-3" 33984
--	---	--	--	--

FOAM DIELECTRIC

1/2"	44AU	WRAPLOCK	1/2"	11662-3	---
7/8"	45AP	---	7/8"	11662-2	---







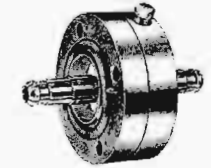
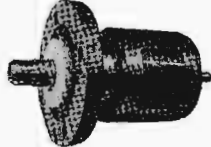
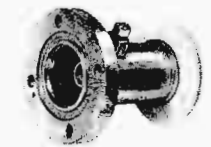

AIR DIELECTRIC

7/8"	75AU	Unjacketed	Jacketed	7/8"	11662-2	---
1 1/8"	87U	WRAPLOCK	---	1 1/8"	---	33948-3
3"	---	33598-2	33598-1	3"	---	33948-2
5"	---	33598-4	33598-3	5"	---	33948-1
8"	---	33598-6	33598-5	8"	---	---
		---	33598-9			

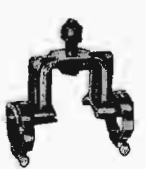
WRAPLOCK One hundred feet of stainless steel wraplock, complete with fasteners. Use at three-foot intervals for all cables 1 1/8" and smaller.	GROUNDING KITS <table border="1"> <tr> <th>Cable Size</th> <th>Unjacketed</th> <th>Jacketed</th> </tr> <tr> <td>1/2"</td> <td>26892-1</td> <td>26892-2</td> </tr> <tr> <td>7/8"</td> <td>24810-1</td> <td>24810-2</td> </tr> <tr> <td>1 1/8"</td> <td>24811-1</td> <td>24811-2</td> </tr> <tr> <td>3"</td> <td>28708-1</td> <td>28708-2</td> </tr> <tr> <td>5"</td> <td>30417-1</td> <td>30417-2</td> </tr> <tr> <td>8"</td> <td>---</td> <td>30417-2</td> </tr> </table>	Cable Size	Unjacketed	Jacketed	1/2"	26892-1	26892-2	7/8"	24810-1	24810-2	1 1/8"	24811-1	24811-2	3"	28708-1	28708-2	5"	30417-1	30417-2	8"	---	30417-2	HOISTING <table border="1"> <tr> <th>Unjacketed</th> <th>Jacketed</th> </tr> <tr> <td>---</td> <td>---</td> </tr> <tr> <td>29958</td> <td>19256B</td> </tr> <tr> <td>24312A</td> <td>24312A</td> </tr> <tr> <td>26985A</td> <td>26985A</td> </tr> <tr> <td>31031</td> <td>31031</td> </tr> <tr> <td>---</td> <td>31031</td> </tr> </table>	Unjacketed	Jacketed	---	---	29958	19256B	24312A	24312A	26985A	26985A	31031	31031	---	31031
Cable Size	Unjacketed	Jacketed																																			
1/2"	26892-1	26892-2																																			
7/8"	24810-1	24810-2																																			
1 1/8"	24811-1	24811-2																																			
3"	28708-1	28708-2																																			
5"	30417-1	30417-2																																			
8"	---	30417-2																																			
Unjacketed	Jacketed																																				
---	---																																				
29958	19256B																																				
24312A	24312A																																				
26985A	26985A																																				
31031	31031																																				
---	31031																																				

Coaxial Transmission Line Accessories

Fittings: All flanged items are EIA standard and include inner connector, "O" ring, silicon grease and hardware kit. All hangers require round member or angle adapters for attachment to tower.

90° MITER ELBOW	GAS BARRIER	REDUCER	END TERMINAL	INNER CONNECTOR	ROUND MEMBER CLAMP
					
Brass construction with swivel flanges on both ends. Includes one inner connector.	With fixed male connector on both ends. May be used as gas inlet fitting.	Reduces line size.	For strap connection. Gas tight with vent plug. Includes inner connector.	With Teflon anchor bead.	Attaches hangers to tower members up to 3" diameter.
7/8" 1060 1 1/8" 1061 3 1/8" 1062	7/8" 1260A 1 1/8" 1261A 3 1/8" 1262B	7/8"-1 1/8" 1860 1 1/8"-3/8" 1861 3 1/8"-6 1/8" 1872	7/8" — 1 1/8" 2061 3 1/8" 2062	7/8" 34389 1 1/8" 34660 3 1/8" 15093A	7/8" 13550 1 1/8" 13550 3 1/8" 13550
RIGID HANGER	SLIDING HANGER	SPRING HANGERS	INSULATED SLIDING HANGERS	INSULATED SPRING HANGER	ANGLE ADAPTER
					
Mounts to 3/16" diameter hole with 1 1/2" bolt or angle adapter. Use at 300' intervals.	7/8" size use at 6' intervals. 1 1/8" use at 10 foot intervals.	7/8" size use at 100' intervals. 1 1/8" size use at 50' intervals. 3 1/8" size use at 10' intervals.	Same as Type 14378 except includes insulator, 14063.	Same as spring hangers except includes insulator, 14063.	Galvanized clamp for attaching hangers to tower angle members up to 7/8" thick.
7/8" 14328 1 1/8" 13924 3 1/8" 13927	7/8" 14327 1 1/8" 14378 3 1/8" —	7/8" 13889 1 1/8" 14379 3 1/8" 13925	7/8" — 1 1/8" 14442 3 1/8" —	7/8" — 1 1/8" 14441 3 1/8" 13926	7/8" 13555 1 1/8" 13555 3 1/8" 13555

INNER CONNECTOR ADAPTER, 50-51 ohms—7/8" size, Type 4850A; 1 1/8", Type 4851; 3 1/8", Type 4852.

HARDWARE KIT for use on one pair of flanges—7/8" size, Type 11381-5; 1 1/8" size, Type 11381-2, 3 1/8" size, Type 11381-3.

"O RING GASKET, 7/8" size, Type 10683-1; 1 1/8" size, Type 10683-2; 3 1/8" size, Type 10683-3.

Coaxial Transmission Line Accessories

PRESSURIZATION EQUIPMENT

Automatic Dehydrators—Types 1920A and 1930 are heatless, fully automatic dehydrators capable of delivering continuous supplies of dry air. No down time is necessary to activate the dry agent. Both units will operate over an ambient range of 0° to 120°F with an input humidity of 95%.



TYPE:	1920A	1930
OUTPUT:	1.2 CFM @ 4 psig	.2 CFM
POWER:	120V, 60 Hz	120V, 60 Hz
INTERNAL OPERATING PRESSURE:	60 psig	30 psig
OUTLET DEWPOINT:	Below -37°F	Below -20°F
DIMENSIONS, INCHES:	15½ x 24 x 14¼	13¼ x 7¼ x 14¾

DRY AIR HAND PUMP

Type 878A, dry air hand pump, pressurizes up to 1000 feet of 7/8" cable or 250 feet of 1½" line. One pound of silica gel and seven feet of hose is supplied.

Please order by type number.....878A



NITROGEN TANK FITTINGS

Type 858C, nitrogen tank fittings—includes pressure regulator, high and low pressure gauges and 10 feet of 3/8" O.D. poly tubing and fittings to fit 1/8" MPT.

Please order by type number.....858C

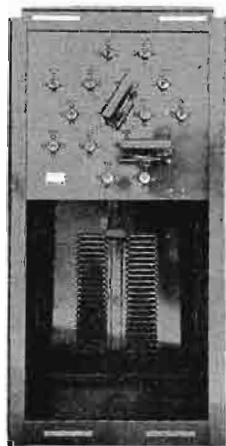

COAXIAL SWITCHING EQUIPMENT

These 1½", 3½" and 6½" coaxial transfer switches are used wherever RF power must be rerouted quickly. Should power fail, these motor driven switches may be cycled manually. Power source is 120V, 50/60 Hz.

LINE SIZE, INCHES:	1½	3½	6½
TYPE NUMBER:	6730C	6740A	6750
FREQUENCY BAND MHz:	0-200	0-860	0-750
CURRENT REQUIREMENT, AMPS:	0.3	2.0	3.0
POWER PEAK* kW:	100	300	1500
VSWR, MAXIMUM:	1.05-50 MHz	1.05 to 860 MHz	1.05 to 750 MHz
	1.20 to 200 MHz		
SWITCHING TIME, SECONDS:	1	2	2
DIMENSIONS, INCHES:	8 x 8 x 10	14 x 14 x 14	24 x 24 x 24
WEIGHT, POUNDS:	13	65	250

* At unity VSWR and 40°C (104°F) ambient temperature.

PATCH PANELS

A standard series of manual patch panels for 1½-inch and 3½-inch lines are offered in combinations up to 10 by 11. Typical specifications of the commonly used 1 by 2 and 2 by 2 are shown below.

TYPE NO.:	34600	34601	34602A	34603A
DESCRIPTION:	1 x 2	2 x 2	1 x 2	2 x 2
LINE SIZE:	1½"	1½"	3½"	3½"
VSWR:	-1.1 up to 1800 MHz		-1.05 up to 1000 MHz	
SIZE, INCHES:	14" high x 19" wide x 14" deep			

Open Wire Transmission Line

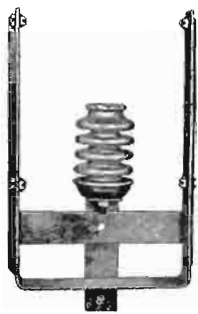

M-3327 Bracket.

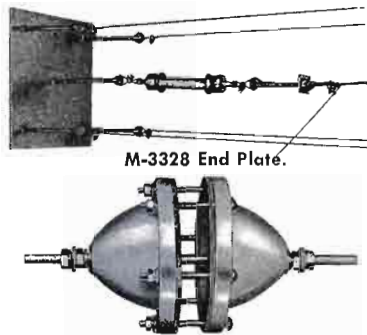

M-2870D Feed-thru Bowl.



M-3322 Horn Gap.



M-3864 Center Post.

TRANSMISSION LINE BRACKET

For 5 or 6 wire transmission line. Rating up to 150 kW modulated. Made of 1/4" steel 3" wide with welded L section on each side to fully prevent twisting under ice or wind load. Supplied with 8 1/4" ribbed insulator, wire guides and all hardware. Galvanized throughout.

Line Bracket 994-3327

LINE END PLATE

To terminate the open wire line at each end. Plate is 1/4" thick, 20" square. Fully galvanized. Includes turnbuckles, 25 1/2" strain insulator and all hardware. Rating up to 150 kW modulated.

End Plate 994-3328

FEED-THRU BOWLS

A large feed-thru bowl with 50 kW modulated rating. Available in single and double units and with solid or hollow studs as listed below. Bowls are Alsimag. Hardware, heavy brass. Velutex seals are provided for weathertight installation.

Solid stud, 2 bowls, for walls to 10 1/2" thick 994-2870
 Same as above but hollow stud 994-3254
 Solid stud, single bowl, for walls 1" thick 994-5280
 Same as above but hollow stud 994-5281

HORN GAP

A very desirable item where higher power is employed. Connects to hot side of line and ground to drain off lightning and heavy static discharges. Usually one is employed for each 200 feet of line. Insulator for 150 kW. Arc gaps heavy chrome plate. Galvanized throughout.

Horn Gap 994-3322

CENTER POST ASSEMBLY

Has variety of uses such as end or corner angling of transmission line, support insulator for two wire line or rhombic antennas, and a guide insulator such as end of building or coupling unit. Rating 150 kW. Galvanized throughout.

Center Post Insulator 994-3864

HARD DRAWN WIRE

If desired, when ordering transmission line components, Gates will gladly supply No. 6, 8 or 10 hard drawn copper wire at current market prices. State length in feet desired, remembering to multiply the length of line by the number of wires in line, either 5 or 6.

SPECIAL OPEN WIRE LINES

Gates engineers have designed many special open wire lines for both short and long distances. Most celebrated was a 30-mile line supplied for use in the Arctic Circle. Upon receipt of a sketch or word description of the requirements, Gates engineers will gladly submit layout and quotation.

DESIGN AND IMPEDANCE CHART

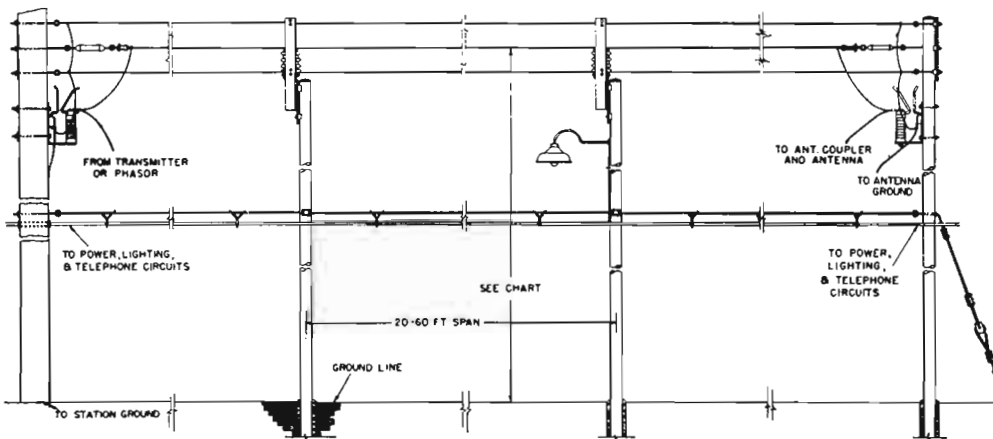

AVERAGE SURGE IMPEDANCE FOR 6 WIRE TRANSMISSION LINES

HEIGHT OF CENTER WIRE	WIRE SIZE		
	6	8	10
9'	232 Ω	246 Ω	250 Ω
10'	234 Ω	250 Ω	256 Ω
12'	240 Ω	252 Ω	260 Ω

AVERAGE SURGE IMPEDANCE FOR 5 WIRE TRANSMISSION LINES

HEIGHT OF CENTER WIRE	WIRE SIZE		
	6	8	10
9'	330 Ω	346 Ω	364 Ω
10'	333 Ω	350 Ω	365 Ω
12'	332 Ω	348 Ω	363 Ω

Chart above illustrates typical five or six wire open type transmission line. Table is provided to show impedances with various wire sizes at certain heights above ground. Transmission line brackets are M-3327, end plate M-3328. Horn gap is M-3322. The power, lighting and telephone circuits shown are optional, according to requirements of installation.



Antenna Towers

FOR AM, FM AND TV

Available in choice of design and exact height for your frequency and power.

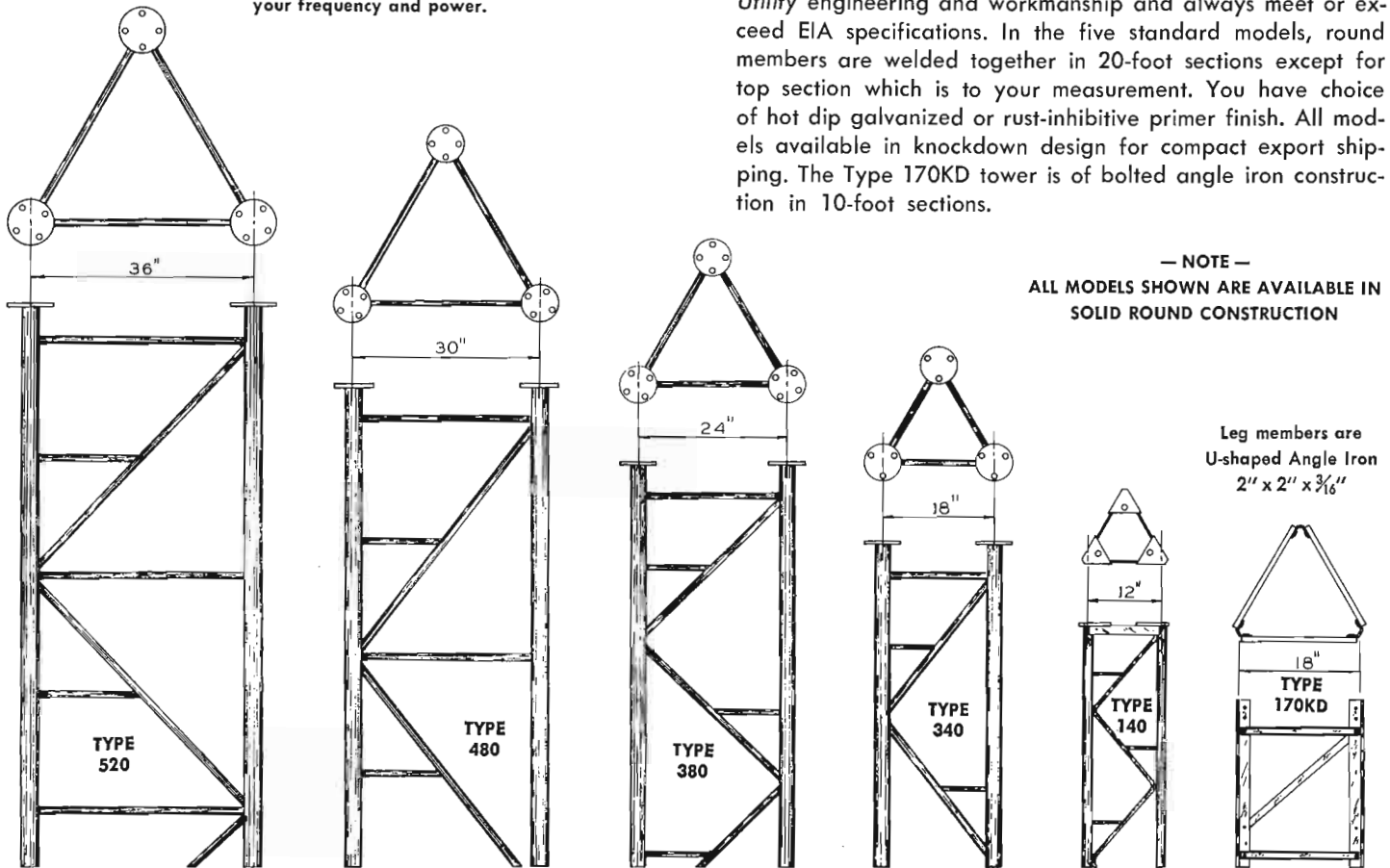

— NOTE —
ALL MODELS SHOWN ARE AVAILABLE IN SOLID ROUND CONSTRUCTION

Leg members are U-shaped Angle Iron 2" x 2" x 3/16"

RIGID ANCHOR BEAMS: Anchors are individually designed to meet the requirements of each tower installation. *Utility* uses the I-beam with its proven structural rigidity. When installed by *Utility* tower crews, on normal soil, this beam is imbedded in concrete slab reinforced with steel rods and with earth fill on top.

SOLID BASE INSULATORS: Insulated vertical radiators are equipped with the latest *Utility* 3401 or *Utility* 2201 pivot base insulators for positive insulation between base and ground. *Utility* base insulators have much higher compression rating than hollow insulators of similar size. They are resilient and shatter-proof. Each insulator is proof tested for a load approximately eight times greater than ever carried in normal broadcast service.

GALVANIZED HARDWARE: All *Utility* tower hardware is hot dipped galvanized to prevent rust and corrosion.

EASY MAINTENANCE: Round members and welded construction provide smooth surfaces for easy painting and servicing. Steps are built into bracing to eliminate need for scaffolding and to make entire height of tower easy for maintenance men to reach.

SPECIFICATIONS

TOWER TYPE	MAXIMUM RECOMMENDED HEIGHT	TOWER WIDTH	WEIGHT PER FOOT*	TYPE OF BASE INSULATION
520	500 FT.	36 IN.	31 LBS.	LOCKE OR LAPP
480	480 FT.	30 IN.	28 LBS.	
380	400 FT.	24 IN.	19 LBS.	UTILITY 3401
340	350 FT.	18 IN.	17 LBS.	UTILITY 3401
140	200 FT.	12 IN.	12 LBS.	UTILITY 2201
170KD	320 FT.	18 IN.	17 LBS.	UTILITY 3401

*Tower steel only—Weight of guys, insulators, etc., not included.

ORDERING INFORMATION

Specify: Type of tower; tower height; insulated or non-insulated; galvanized or non-galvanized. Self-supporting, tall TV towers, or towers over 520' will be quoted upon request. Installation services for towers, FM, TV antennas, transmission line, AC lighting and ground systems also available on request.

Tower Lights And Accessories

BEACON FLASHERS

NON-FUS.	FUSED	DESCRIPTION	NO. OF SWITCHES	MAX. RATING WATTS/SWITCH	HOUSING TYPE	TAPS or K.O.	WEIGHT SHIP	(LBS.) NET
BF 60A-1 BF 60A-2 BF 60A-3	BF 60F-1 BF 60F-2 BF 60F-3	Single Pole, Single Throw 117 Volt, 60 Hz	ONE	2800	OUTDOOR INDOOR PANEL	¾"	12 11 4½	11 10 3
BF 61A-1 BF 61A-2 BF 61A-3	BF 61F-1 BF 61F-2 BF 61F-3	Single Pole, Double Throw (for Load Balance Resistor) 117 Volt, 60 Hz	ONE	1500	OUTDOOR INDOOR PANEL	¾"	12 11 4½	11 10 3
BF 62A-1 BF 62A-2 BF 62A-3	BF 62F-1 BF 62F-2 BF 62F-3	Single Pole, Single Throw 240 Volt, 60 Hz	ONE	2800	OUTDOOR INDOOR PANEL	¾"	12 11 4½	11 10 3
BF 63A-1 BF 63A-2 BF 63A-3	BF 63F-1 BF 63F-2 BF 63F-3	Double Pole, Single Throw 117 Volt, 60 Hz, or 120/240 Volt, 60 Hz	TWO	2800	OUTDOOR INDOOR PANEL	1"	13 11 5	12 10 3½
BF 64A-1 BF 64A-2 BF 64A-3	BF 64F-1 BF 64F-2 BF 64F-3	Two Circuit 117 Volt, 60 Hz, or 120/240 Volt, 60 Hz	TWO	2800	OUTDOOR INDOOR PANEL	1"	13 11 5	12 10 3½
BF 65A-1 BF 65A-2 BF 65A-3	BF 65F-1 BF 65F-2 BF 65F-3	Single Pole, Single Throw 240 Volt, 50 Hz	ONE	2800	OUTDOOR INDOOR PANEL	¾"	13 11 5	12 10 3½
BF 66A-1 BF 66A-2 BF 66A-3	BF 66F-1 BF 66F-2 BF 66F-3	Single Pole, Single Throw 117 Volt, 60 Hz with BY-PASS	ONE	1500	OUTDOOR INDOOR PANEL	¾"	28 23 9	23 18 6
BF 67A-1 BF 67A-2 BF 67A-3	BF 67F-1 BF 67F-2 BF 67F-3	Single Pole, Double Throw 117 Volt, 60 Hz with BY-PASS (for Load Balance Resistor)	ONE	1500	OUTDOOR INDOOR PANEL	¾"	28 23 9	23 18 6
BF 68A-1 BF 68A-2 BF 68A-3	BF 68F-1 BF 68F-2 BF 68F-3	Two Circuit, Double Pole 120/240 Volt, 60 Hz	FOUR	2800	OUTDOOR INDOOR PANEL	1¼"	36 25 10	29 21 7
BF 69A-1 BF 69A-2 BF 69A-3	BF 69F-1 BF 69F-2 BF 69F-3	Three Circuit 120/240 Volt, 60 Hz or 120/208 Volt, 3 PH.	THREE	2800	OUTDOOR INDOOR PANEL	1¼"	35 24 10	28 20 7
BF 70A-1 BF 70A-2 BF 70A-3	BF 70F-1 BF 70F-2 BF 70F-3	Four Circuit 120/240 Volt, 60 Hz or 120/208 Volt, 3 PH.	FOUR	2800	OUTDOOR INDOOR PANEL	1¼"	36 25 10	29 21 7

ACCESSORIES

TOWER LIGHTS: Single obstruction light, bottom entrance conduit fitting furnished with lamp receptacle to accommodate either a 100 or 111 watt, 115 V medium screw base lamp, or lumen pre-focus series lamp.

Single obstruction light.....710-0012

Single obstruction light, same as above, but side entrance conduit fitting. Order.....710-0013

Double obstruction light, with two lamp receptacles, each accommodating either 100 or 111 watts, medium screw base. Bottom entrance fitting type for one-inch conduit.

Double obstruction light.....710-0014

Code Beacon 300 MM, standard fully approved FCC and CAA model supplied with two red filters.

For ¾" conduit.....710-0063

For 1" conduit.....710-0075

Clear traffic signal lamp. 107 watt, 115 V.

Signal lamp.....396-0141

Beacon lamp, 620 watt.....396-0129

PHOTO-CELL UNIT: Single unit, indoor housing, lighting control unit with outdoor remote weather photo tube, includes complete code flasher for flashing of three towers and photo-electric cell control for automatic turning on and off. 115/230 V, 50/60 Hz.

Photo-cell unit.....LC-2077

Single unit, indoor housing, same as above, except for 4 towers...LC-2076

PHOTO-CELL AND BEACON FLASHER: A combination unit in weatherproof housing. Photo-cell may be rotated to north regardless of mounting position on tower. Turns on at 35 foot candles and off at 58 foot candles.

For 1 pole 30 amperes, flashes one circuit.....710-0058

FISHER-PIERCE PHOTO-CELL UNIT: A unit completely weatherproof, fully approved for turning on and off tower lights; has time delay of 5-7 seconds to prevent operation by chance.

For 105/130 V, 3000 watt rating, SPST, double break.....670-0007

For 210/250 V, 3000 watt rating, SPST, double break.....670-0010



Heavy Duty Inductors and Capacitors

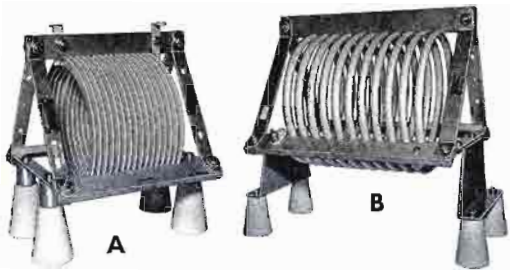

Gates manufactured inductors have the emphasis on solid mechanical construction. All coils are micalex insulated and silver plated with cold water dip to delay tarnishing. Variable coils have double gripping contact wheels. Other sizes and ratings available on special order.

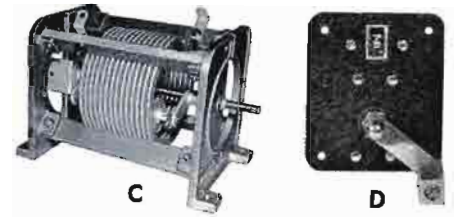

EXPLANATION OF TYPE NUMBER

87	F	A		46	3	4
Inductance in microhenries.	F—Fixed V—Variable	A— $\frac{1}{4}$ " B— $\frac{3}{8}$ " C— $\frac{1}{2}$ "	No letter here indicates ribbon. "T" indicates tubing.	Number of turns.	Pitch of winding in $\frac{1}{16}$ " for ribbon, $\frac{1}{8}$ " for tubing.	Inside diameter in inches.

SPECIFICATIONS AND ORDERING INFORMATION

ORDER NO.	TYPE NO.	FIG.	OVER-ALL LENGTH IN INCHES	ORDER NO.	TYPE NO.	FIG.	OVER-ALL LENGTH IN INCHES
931-6138-010	87FA4634	A	12	931-6337-003	32FBT1658	B	15
931-6138-039	6FC0854	A	6 $\frac{1}{4}$	931-6337-004	45FBT2158	B	18 $\frac{1}{2}$
931-6138-040	10FC0855	A	6 $\frac{1}{4}$	931-6372-002	65FBT2559	B	24 $\frac{1}{2}$
931-6138-041	13FC0856	A	6 $\frac{1}{4}$	931-6337-001	17FCT1178	B	14
931-6138-025	17FC1654	A	8 $\frac{3}{4}$	931-6372-001	35FCT1769	B	24 $\frac{1}{2}$
931-6138-026	24FC1655	A	8 $\frac{3}{4}$	931-6583-008	6VC0854	C	8
931-6138-027	32FC1656	A	8 $\frac{3}{4}$	931-6583-001	15VC1444	C	9
931-6138-036	42FC2266	A	12 $\frac{1}{2}$	931-6583-002	26VC2144	C	10 $\frac{3}{4}$
931-6138-030	67FC2856	A	13	931-6583-006	16VB1544	C	9
931-6138-045	78FC2568	A	16	931-6583-009	30VB2344	C	11
931-6337-007	10FBT1066	B	12 $\frac{1}{2}$	931-6583-010	105VB3735	C	12 $\frac{1}{2}$

Coil clip for FA coils.....	402-0029
Coil clip for FC coils.....	402-0031
Coil clip for FBT coils.....	402-0033
Coil clip for FCT coils.....	402-0034

Counter dial for variable coils reads 1/10 turns.	
Size: 3" wide, 3 $\frac{1}{2}$ " high. Figure D.	
With removable crank handle.....	994-6233-001
With non-removable crank handle.....	926-5509-003



MICA CAPACITORS FOR TRANSMITTERS AND PHASORS

Designed for continuous service with each sheet of mica carefully gauged for thickness and inspected for absence of impurities. Tolerance plus or minus 5%. Cast end bells and ceramic insulated. Sizes over-all: Model G1: 3 $\frac{3}{4}$ " x 2 $\frac{1}{2}$ ". Model G2: 4 $\frac{1}{4}$ " x 3". Model G3: 6 $\frac{1}{2}$ " x 4". Model G4: 6 $\frac{1}{2}$ " x 5 $\frac{3}{4}$ ". Usually all sizes carried in stock. Please order by type number and capacity. Example: Model G2, capacity .0003 mfd.

CAPACITY	MODEL G1		MODEL G2		MODEL G3		MODEL G4	
	Amps	Volts	Amps	Volts	Amps	Volts	Amps	Volts
.0001	2.0	6000	3	10,000	5.6	20,000	5.1	30,000
.00015	2.4	6000	—	—	—	—	6.2	30,000
.0002	3	6000	—	—	5.6	20,000	—	—
.00025	—	—	5.1	10,000	—	—	8.2	30,000
.0003	—	—	5.6	10,000	6.8	20,000	9.1	30,000
.0004	4.7	6000	6.2	10,000	8.2	20,000	—	—
.0005	5.1	6000	6.8	10,000	9	20,000	—	30,000
.0008	—	—	—	—	12	20,000	15	30,000
.001	7.5	6000	10	10,000	13	20,000	16	30,000
.0015	9.1	6000	12	10,000	16	15,000	20	25,000
.002	11	6000	13	10,000	20	15,000	22	20,000
.003	13	6000	16	8,000	24	12,000	27	20,000
.004	15	6000	18	8,000	27	12,000	30	20,000
.005	16	4000	20	6,000	30	10,000	33	15,000
.006	18	4000	—	—	—	—	36	15,000
.008	—	—	—	—	36	10,000	39	12,000
.01	20	4000	24	5,000	39	8,000	43	10,000
.015	20	3000	—	—	—	—	—	—
.02	22	2000	—	—	—	—	—	—

20,000 Watt Medium Wave Transmitter

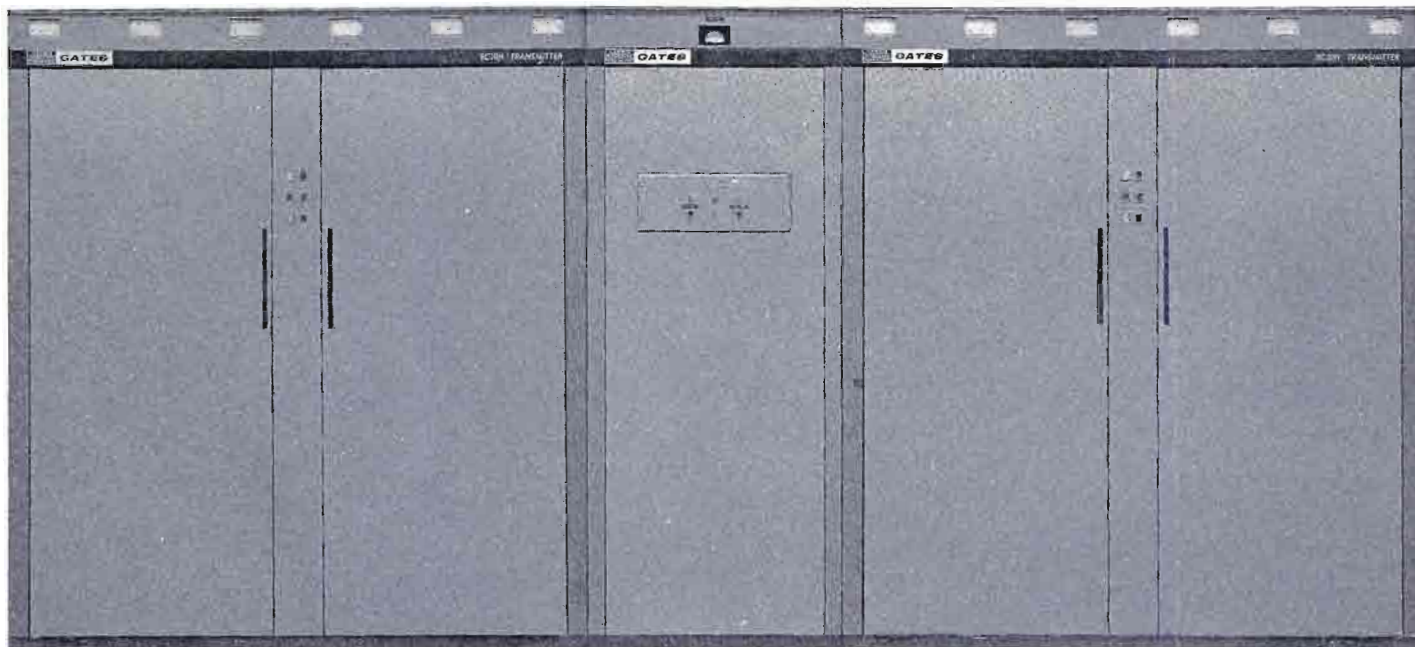

MODEL BC-20H

Now available from Gates, a 20,000 watt medium wave broadcast transmitter that utilizes solid state circuitry in the audio and RF driver sections for superior performance. Completely self-contained, only ten tubes are used in this 20 kW transmitter—which consists of two standard BC-10H 10 kW transmitters, a 20 kW combiner, and a common drive unit.

All components are housed within the transmitter cabinet, eliminating the need for external ducting and enclosures. Askarel (oil) filled modulation transformers are provided as standard equipment for added reliability.

In addition to the oscillator/exciter incorporated in each 10 kW transmitter, a third oscillator is provided in the BC-20H to permit maximum operating flexibility. This independent exciter is used as a common drive to each transmitter and is enclosed in the center cabinet. Output of this unit is split and drives independent buffer amplifiers for isolation and phase adjustment. The RF signal then feeds individual oscillators in each 10 kW transmitter, which in turn excites the 4-400 driver and the high level plate modulated 3CX2500F3 power amplifiers. Over-all efficiency of the power amplifiers is typically 85% or better, a direct benefit of the high efficiency RF circuits that are utilized.

Audio is processed by a transistorized audio amplifier which drives the Class B 3CX2500F3 modulators. High level plate modulation techniques are used with enhanced performance obtained by applying audio to the RF driver stage.

RF output of each transmitter is fed into a bridged-tee combiner network, housed in the middle cabinet. A 10 kW dummy load is provided with an in-line RF ammeter for visual indication of current to the reject branch of the combiner network. Under optimum conditions, no current will exist in this branch. No critical adjustments are required and simplified over-all operation is stable.

In the event that maintenance or adjustment, such as initial tune-up of the transmitters is required, the 10 kW dummy load may be switched manually so that the output of one power amplifier feeds the load directly while the other amplifier can drive the antenna system. While in the combined mode, monitoring is accomplished by a pickup loop at the combiner output for indication of modulation level of the entire transmitter system.

Use of the design philosophy employed in the BC-20H assures long term operation with no lost air time. One hundred per cent redundancy of equipment means that a signal can remain on the air with no down time for maintenance. One transmitter can be turned off while the other continues to operate.

Additional features include reliable silicon diodes in all power supplies, built-in circuitry for remote control, ample cooling for all climatic conditions with quiet, low-speed blowers, and low operating cost, with only two tube types used in the BC-20H.

SPECIFICATIONS

POWER OUTPUT: (Rated) 20,000 watts. (Capable) 21,600 watts.

POWER INPUT: 208/230 volts, 3 phase, 50 or 60 Hz. 37 kW zero modulation. 42 kW average modulation. 55 kW 100% modulation.

SIZE: 78" high, 177" wide, 32" deep (completely self-contained).

WEIGHT: 5200 lbs. unpacked (approximate). 6800 lbs. export packed (approximate).

CUBAGE: 390 cubic feet packed.

FINISH: Beige-gray.

OTHER SPECIFICATIONS: See BC-10H, Page 12.

ORDERING INFORMATION: On special order.



New Gates Factory Improves Service And Efficiency



Now all of Gates manufacturing and engineering facilities have been concentrated into a single ultra-modern building—the first step in a long-range expansion program. With 108,000 square feet of floor space, this is believed to be one of the largest single buildings devoted to the development and manufacturing of products for the broadcast industry.

One of the major benefits of the new facility has been the

improvement in liaison between engineering and manufacturing teams to improve product production, and to maintain highest quality control standards for every Gates product.

A unique, added feature is the capability of operating and testing all types of broadcasting equipment on any power source voltage. When the building was constructed special power circuits were installed, so that it is now possible to match almost any type of power found throughout the world.

5000 Watt VHF Television Transmitter

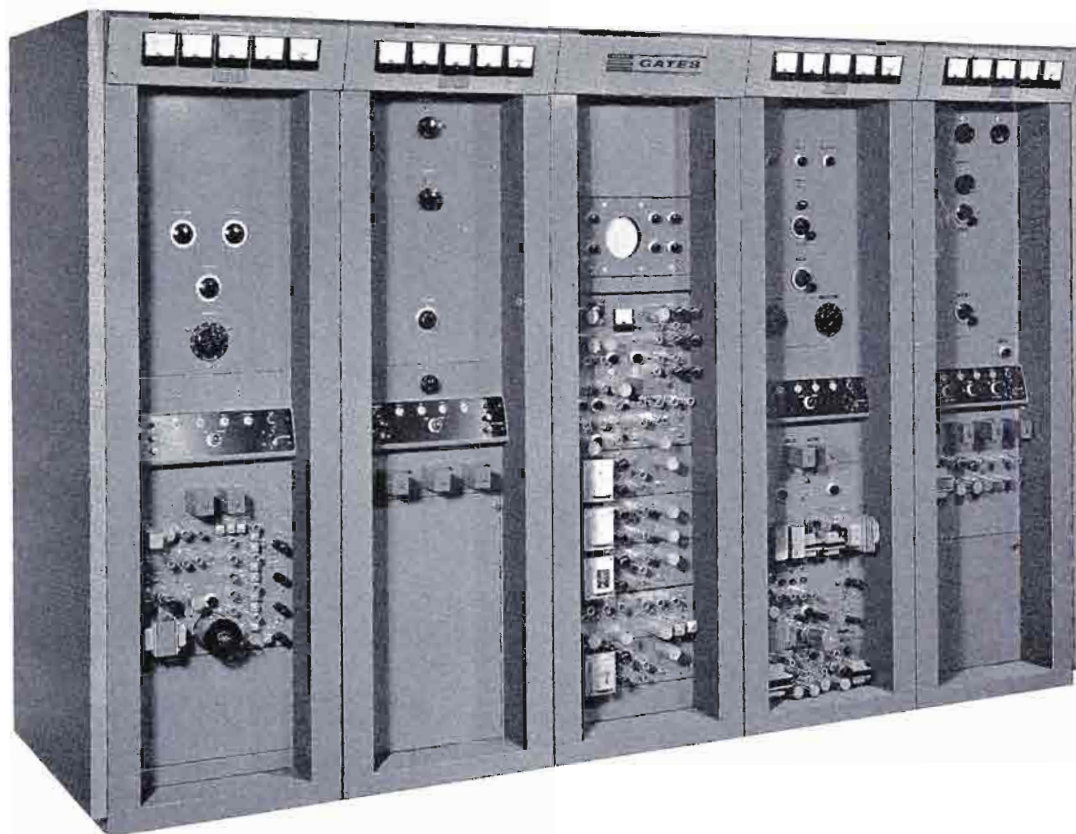

MODEL BT-5C

Designed for the most exacting color and monochrome television transmission on FCC Channels 2 to 13, the Gates BT-5C five kilowatt VHF TV Transmitter is completely self-contained. The two aural transmitter cabinets and three visual transmitter cabinets can be assembled in line to make the complete transmitter, or, they can be mounted in operating positions separate from one another. As the blowers and power components are mounted internally, the BT-5C transmitter requires a total floor space of only 10 feet by 3 feet. A vestigial side-band filter supplied as standard equipment is mounted externally. The same long life type 6076 tetrode tubes are used as final amplifiers for both visual and aural transmitters.

IMPROVED VIDEO MODULATOR: The BT-5C transmitter includes a video modulator with keyed clamping and automatic switchover to AC coupling with reduced carrier power in case of sync or program failure. Sync-tip keyed clamping is used to avoid disturbing color signal components. Sync-tip clamping means no "back porch" disturbances of the color synchronizing burst. Built-in and operating from the composite signal input, the keyer clamp generator uses a delay-line controlling keying pulse for maximum stability. Fail-safe protection circuits are provided which reduce power to mid-gray level in event of clamp or signal failure. The video modulator is also equipped with RF bias failure alarm lamp, test meter, and front panel test jacks.

VISUAL TRANSMITTER: The visual transmitter is grid-modulated in the 500 watt driver, which is followed by a linear amplifier output section. The final amplifier uses the 6076 tetrode, the same type as employed in the aural transmitter. The visual oscillator output is multiplied three times for low band and nine times for high band channels. Under normal operating conditions the oscillator will hold carrier frequency to within 300 Hz. This transmitter provides superb color performance and, of course, FCC requirements are exceeded whether used as a color or monochrome transmitter.

AURAL TRANSMITTER: The aural transmitter consists of a 10 watt exciter which drives a single intermediate power amplifier stage. With a conservatively rated tube complement and rugged construction, trouble-free performance may be expected. Lack of frequency multiplication after the exciter unit aids in eliminating spurious frequencies and increases tube life. The 250 watt aural intermediate power amplifier is totally enclosed in a non-ferrous housing containing air-cooled tubes and components. The 4CX250B tube drives the final amplifier which is a 6076 tetrode, providing the full 2500 watts of aural power for the BT-5C transmitter. Direct crystal controlled cascade modulation is employed to provide the high fidelity aural modulation. A flat frequency response within 1 dB of the standard 75 microsecond pre-emphasis curve from 50 to 15,000 Hz, is expected performance in the BT-5C.

5000 Watt VHF Television Transmitter—BT-5C

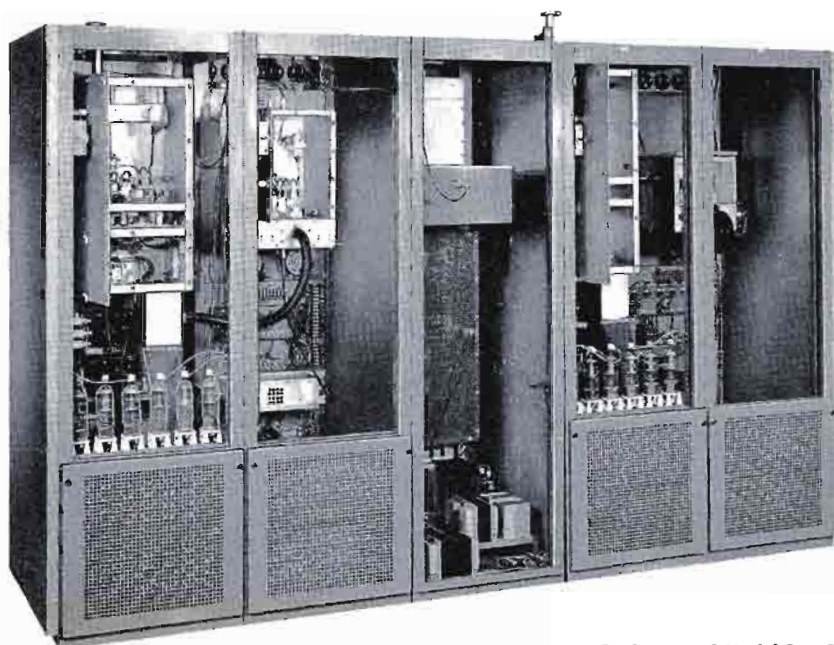

Back view of Model BT-5C.

SPECIFICATIONS

POWER OUTPUT: Channels 2 through 6: Visual 5000 watts. Aural 2500 watts. Channels 7 through 13: Visual 4000 watts. Aural 2000 watts. (Generous excess to rated power is available for sideband filter and system losses).

FREQUENCY RESPONSE: Visual +2 to -2 dB at 0.5 MHz. Visual +2 to -2 dB at 1.25 MHz. Visual +2 to -2 dB at 2.0 MHz. Visual +2 to -2 dB at 3.58 MHz. The amplitude response will not vary more than +1 dB to -2 dB from the 3.58 MHz response between 2.1 MHz and 4.18 MHz. The amplitude at 4.75 MHz is attenuated 20 dB and frequencies higher than 4.75 MHz are attenuated 20 dB or greater. Lower sideband response is: Visual -20 dB at 1.25 MHz and -42 dB at 3.58 MHz. Aural within 1.0 dB of standard 75 microsecond pre-emphasis curve, 50-15,000 Hz.

RF OUTPUT IMPEDANCE: 50 ohms, 1 1/2" EIA Flange.

FREQUENCY STABILITY: Visual ± 500 Hz. Aural ± 500 Hz.

MODULATION CAPABILITIES: Visual to 12 1/2%, $\pm 2 1/2\%$ of sync level. Aural ± 40 kHz.

AUDIO FREQUENCY DISTORTION: Between 50 and 15,000 Hz, 1 1/2% or less at 25 kHz swing. Distortion between 100 and 10,000 Hz is 1% or less.

NOISE: Aural 60 dB below 100% modulation (FM). 50 dB below equivalent 100% modulation (AM). Visual 40 dB below 100% AM modulation.

INPUT IMPEDANCE: Video signal 75 ohms, unbalanced. Audio signal 600 ohms, balanced.

POWER INPUT: 230 volts, 50/60 Hz, three phase. Power consumption, 20 kW.

HARMONIC ATTENUATION: 60 dB or better.

INPUT LEVEL: Visual 1.0 V ± 0.4 V peak to peak. Aural +10 dBm, ± 2 dB for 100% modulation.

SUBCHANNEL PHASE vs BRIGHTNESS: $\pm 7^\circ$ maximum.

LINEARITY: $\pm 15\%$ maximum.

REGULATION OF OUTPUT: 7% from black to all white.

INPUT POLARITY: Black negative.

ENVELOPE DELAY TOLERANCE: (From FCC Specified Curve). ± 0.08 microseconds from 0.2-2.1 MHz. ± 0.04 microseconds at 3.58 MHz. ± 0.08 microseconds at 4.18 MHz.

TYPE OF MODULATION: Phase shift employing pulse techniques (Aural).

TYPE OF OSCILLATOR: Direct crystal controlled (both aural and visual).

TUBES: Visual: (11) OA2, (9) 12AT7, (7) 6CA7, (6) 8008, (6) GZ34/5AR4, (5) 6080, (5) 0D2, (5) 12AX7, (4) 866/866A, (3) 6AU6, (3) 6AU8, (2) 4X25CB, (2) 6076, (2) 6CL6 and (1 each) 6AK6, 6X4 and 5R4. Aural: (7) 6AU6, (6) 8008, (3) 12AX7, (3) 6J6, (3) 12BH7, (2) OA2, (2) 866/866A and (1 each) 12AT7, 6360, 6AQ5, 6080, GZ45/5AR4, 4X250B, 6076, 6360 and 6CS6.

SIZE: (Over-all): Width 96" (less end bells), 99" (with end bells), Height 78", Depth 36 1/2".

WEIGHT: Packed (domestic) 3000 lbs., (export) 3700 lbs.

CUBAGE: 312.

SIDEBAND FILTER: Mounted external to cabinet. Supplied with transmitter.

COOLING: Forced air.

ORDERING INFORMATION

BT-5CL 5000 watt TV Transmitter for channels 2-6.....	994-6066
BT-5CH 5000 watt TV Transmitter for channels 7-13.....	994-6067
Spare 100% tube complement for BT-5CL.....	990-0341
Spare 100% tube complement for BT-5CH.....	990-0343

500 Watt VHF Television Transmitter

MODEL BT-500C

This 500 watt VHF television transmitter is used as the driver for the Gates BT-5C 5000 watt model, and can be increased in power at any time. Field proven, the fine performance of the BT-500C is acknowledged by world wide users in Alaska, the Virgin Islands, Panama, Korea and other areas using 525 line standards.

Designed to meet FCC color specifications on VHF Channels 2 to 13, the Gates BT-500C will provide the most exacting color and monochrome transmission. Rated power output is 500 watts peak visual and 250 watts aural. Except for the externally mounted vestigial sideband filter, the BT-500C transmitter is completely self-contained in three cabinets.

The left hand cubicle contains the aural transmitter while the center and right hand cubicles make up the visual transmitter. Separate high voltage power supplies are provided for the aural and visual section to assure better regulation and improve over-all performance. Interchangeable 4CX250B tetrode tubes are used as final amplifiers for both visual and aural amplifiers, reducing the number of spares and providing added operating economy.

VISUAL TRANSMITTER: Two type 4CX250B triode tubes, which are grid bias modulated by a dynamic cathode load modulator circuit, are used as final power amplifiers in the visual section. The video modulator is equipped with a bias failure alarm lamp, test meters, and front panel test jacks. Sync-tip keyed clamping is used to avoid disturbances of the color signal components and the color synchronizing burst. The keyed clamp generator uses a delay-line controlled keying pulse. Fail-safe protection circuits are provided to reduce power to mid-gray level in case of clamp or signal failure. A white peak clipper reduces the possibility of sync-buzz while a white stretcher circuit improves differential gain. In-built feedback restoration is used to reduce hum and/or tilt.



The visual oscillator output is multiplied three times for low band and nine times for high band channels. Under normal operating conditions, the oscillator will hold the carrier frequency to within ± 300 Hz.

AURAL TRANSMITTER: The high fidelity FM signal for aural transmission is supplied with a direct crystal controlled phase shift modulator, delivering a flat frequency response within 1 dB of the standard microsecond pre-emphasis curve, 50 to 15,000 Hz. Audio frequency distortion is a maximum of 1.5% over the frequency range of 50 to 15,000 Hz. The output of the 10 watt exciter is fed to a 4CX250B aural power amplifier tube which delivers a full 250 watts output.

OPERATIONAL FEATURES: Tuning adjustments are from the front and eleven meters provide monitoring of all essential circuits, either directly or by multi-metering. All incoming air is filtered through removable filters. Latches on back doors provide quick access for ease in maintenance.

With a conservatively rated tube complement, straight-forward design and quality construction, trouble free performance may be expected from this carefully engineered transmitter.

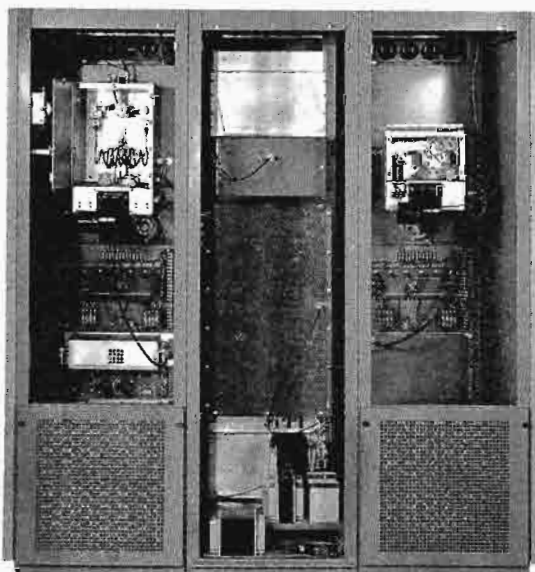

Rear view, Model BT-500C.

500 Watt VHF Television Transmitter—BT-500C

SPECIFICATIONS

POWER OUTPUT: Visual 500 watts peak. Aural 250 watts. (Excess to rated power is available for sideband filter and system losses).

RF OUTPUT IMPEDANCE: 50 ohms, type N female.

INPUT IMPEDANCE: Video—75 ohms, unbalanced. Audio—600 ohms, balanced.

FREQUENCY RESPONSE: Visual: +2 to -2 dB at 0.5 MHz, +2 to -2 dB at 1.25 MHz, +2 to -2 dB at 2.0 MHz, +2 to -2 dB at 3.58 MHz. (The amplitude response will not vary more than +1 dB to -2 dB from the 3.58 MHz response between 2.1 MHz and 4.18 MHz. The amplitude at 4.75 MHz is attenuated 20 dB and frequencies higher than 4.75 MHz are attenuated 20 dB or greater).

LOWER SIDEBAND RESPONSE: Visual: -20 dB at 1.25 MHz and -42 dB at 3.58 MHz. Aural: Within 1.0 dB of standard 75 microsecond pre-emphasis curve, 50-15,000 Hz.

FREQUENCY STABILITY: Visual: ± 500 Hz. Aural: ± 500 Hz.

MODULATION CAPABILITIES: Visual to 12½% $\pm 2½%$ of sync level. Aural 40 kHz.

INPUT LEVEL: Visual 1.0 V ± 0.4 V peak to peak. Aural +10 dBm ± 2 dB for 100% modulation.

NOISE: Aural 60 dB below 100% modulation (FM). 50 dB below equivalent 100% modulation (AM). Visual approximately 45 dB below 100% AM modulation.

AUDIO FREQUENCY DISTORTION: Between 50-15,000 Hz, 1½% or less at 25 kHz deviation. Distortion between 100-10,000 Hz is 1% or less.

AMPLITUDE VARIATION: 5% or less of peak sync. (one field).

SUBCARRIER PHASE vs BRIGHTNESS: $\pm 7^\circ$ maximum.

LINEARITY: $\pm 15%$ maximum.

ENVELOPE DELAY TOLERANCE: (From FCC Specified Curve) ± 0.08 microseconds from 0.2-2.1 MHz. ± 0.04 microseconds at 3.58 MHz. ± 0.08 microseconds at 4.18 MHz.

HARMONIC ATTENUATION: 60 dB or better.

REGULATION OF OUTPUT: 7% from black to all white.

INPUT POLARITY: Black negative.

TYPE OF MODULATION: Phase shift employing pulse techniques (Aural).

TYPE OF OSCILLATOR: Direct crystal controlled (both aural and visual).

TUBES: Visual: (3) 6AU6, (1) 6AK6, (4) 6080, (8) OA2, (9) 12AT7, (2) 6CL6, (7) 6CA7, (3) 5651, (4) OB2, (3) 6AU8, (1) 6CS6, (3) 12BH7, (4) 12AX7, (1) 6X4, (1) 5894, (2) 4CX250B, (2) 866, (1) 5R4, (1) 6360L, (5) 5AR4. Aural: (1) 12AT7, (7) 6AU6, (3) 12AX7, (3) 6J6, (2) OA2, (1) 6360L, (1) 6080, (1) 6AQ5, (1) 4CX250B, (2) 866, (1) 5AR4.

TOTAL NUMBER TUBES: Visual 65. Aural 23.

POWER INPUT: 230 volts, 50/60 Hz, single phase. (120 volts for crystal heaters). Power consumption, 3.5 kW.

SIZE (over-all): Width 72" (less end bells), 75" (with end bells), Height 78", Depth 36½".

WEIGHT AND CUBAGE: Domestic packed 2350 lbs. Export packed 3200 lbs. Cubage: 394 cu. ft.

SIDEBAND FILTER: Mounted external to cabinet. (Supplied with transmitter).

COOLING: Forced air.

ORDERING INFORMATION

BT-500CL Broadcast Television Transmitter, 500 watts with tubes, crystals and ovens for channels 2-6 as specified.....994-6068
 BT-500CH Broadcast Television Transmitter, 500 watts, with tubes, crystals and ovens for channels 7-13 as specified.....994-6069
 Spare 100% tube complement for BT-500CL.....990-0357
 Spare 100% tube complement for BT-500CH.....990-0358
 FCC minimum tube complement:
 For BT-500CL.....990-0365
 For BT-500CH.....990-0366

For information on TV Antennas see Pages 82 and 83.

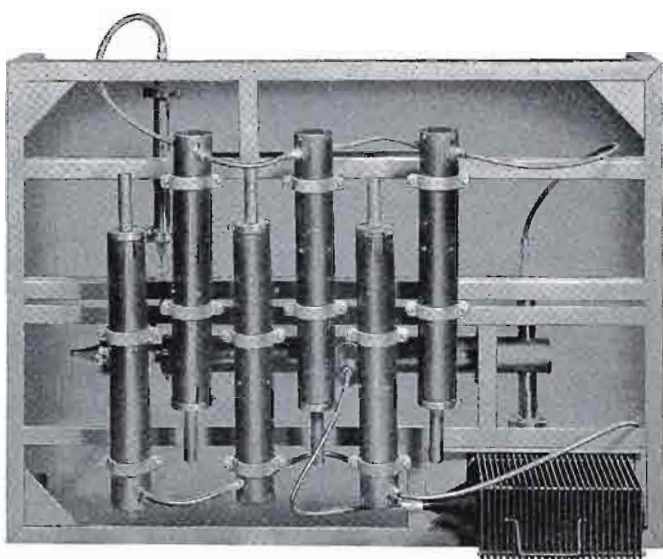

The vestigial sideband filter above, employed at the output of the visual amplifier, is supplied with the BT-500C VHF transmitter as standard equipment.

120 Watt VHF Television Transmitter

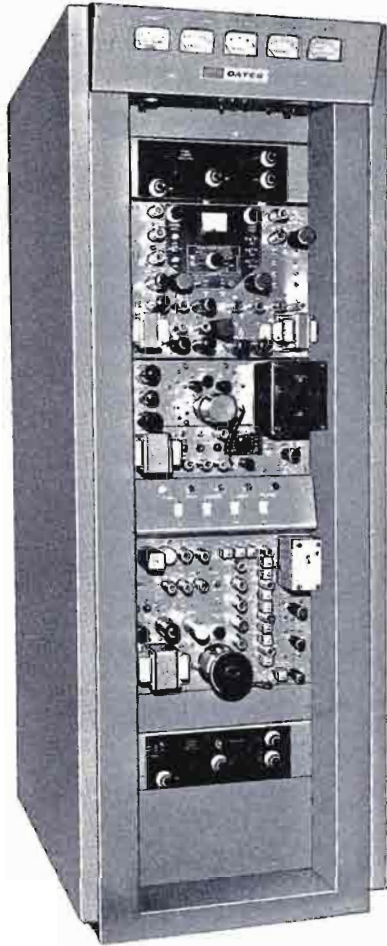

MODEL BT-100C

Designed for use as the main transmitter in low power VHF television stations, the BT-100C is also ideally suited as stand-by equipment for any size VHF television station. It provides sparkling picture and sound transmission quality, and is rated for continuous duty service at 120 watts peak visual and 60 watt aural power on Channels 2 through 13.

Compact and self-contained, the complete transmitter, including the vestigial sideband filter, is housed in one cabinet. All tuning is from the front panel, and lift off rear and side panels are provided for ease in servicing. A forced air cooling system is employed, and one quiet, low speed blower cools the entire transmitter.

The vestigial sideband filter is carefully tuned to the operating channel specified. A visual demodulator is included as standard equipment and provides a one volt peak to peak, 75 ohm monitoring output, terminated in a "UHF" conductor. A multimeter and test jacks are provided for ease of modulator adjustment. Remote control or unattended operation is a special design consideration, and the rugged construction and easy attachment of remote control equipment enhances satellite or high elevation unattended operation.

SPECIFICATIONS

FREQUENCY RANGE: 54-88 MHz FCC Channels 2-6 and 174-216 MHz FCC Channels 7-13 (any one channel as ordered).

RF POWER OUTPUT: 120 watts peak visual. 60 watts average aural. Type "LC" jack type output connectors both visual and aural. Output impedance 50 ohms, both visual and aural.

AC POWER INPUT: 107-120/214-240, 50/60 Hz single phase. Power consumption, aural and visual, at black level; 1500 watts maximum.

VIDEO INPUT IMPEDANCE: 75 ohms unbalanced, ± 15 ohms adjustable, type UHF female jack input connector.

VIDEO INPUT: 1.0 volt p-p ± 0.5 volt input polarity; black negative.

AUDIO INPUT: 600 ohms, balanced, +10 dBm ± 0 to -4 dBm.

VISUAL FREQUENCY RESPONSE: (below ideal demodulated curve; 200 kHz reference): Upper sideband ± 2 dB at 0.5 through 4.0 MHz more than -20 dB at 4.75 MHz or higher. Lower sideband +0, -4 dB at 0.75 MHz more than -20 dB at 1.25 MHz.

AURAL FREQUENCY RESPONSE: (below ideal 75 micro-second pre-emphasis curves): +0, -2 dB at 30-15,000 Hz.

AURAL HARMONIC DISTORTION: 50-100 Hz, 1.0% or less, 100-10,000 Hz, 0.5% or less. 10-15 kHz, 1.0% or less.

TYPE OF OSCILLATOR: Direct crystal control Visual and Aural. ± 500 Hz Visual and Aural stability.

VISUAL CARRIER FREQUENCY ABOVE BAND EDGE: 1.25 MHz.

AURAL CARRIER FREQUENCY ABOVE VISUAL: 4.5 MHz ± 1 kHz.

AURAL FREQUENCY MODULATION: Phase shift employing pulse techniques, ± 25 kHz. Capable of ± 40 kHz.

MODULATION, VISUAL: Amplitude.

VISUAL OUTPUT AMPLITUDE: Sync 100%. Black 75% $\pm 2.5\%$. White 12.5% $\pm 2.5\%$.

REGULATION OF VISUAL OUTPUT: (all white to all black picture), 7% maximum.

VISUAL AMPLITUDE VARIATION (hum and tilt over one frame): 5% of maximum of peak sync.

SYSTEM CAPABLE OF OPERATING INDEPENDENTLY OF POWER SUPPLY FREQUENCY: Yes.

BLACK LEVEL INDEPENDENT OF PICTURE CONTENT: Yes.

VISUAL MONITOR OUTPUT: Visual RF demodulator and white reference chopper built in with 1.0 volt p-p output across 75 ohms.

NOISE: Aural below 100% FM, -60 dB. Aural below 100% AM, -50 dB. Visual hum and noise, -40 dB.

AMBIENT TEMPERATURE: +5°C to +50° C.

ALTITUDE: 7500 ft. maximum. (Available for 10,000 ft.)

DIMENSIONS: 78" high x 36½" deep x 27" wide. If end bells omitted, width is 24 inches.

WEIGHT AND CUBAGE: Net 800 lbs. Domestic pack, 890 lbs. Export pack, 985 lbs. Cubage: 86.

ORDERING INFORMATION

BT-100CL Transmitter for Channels 2-6...994-6179

BT-100CH Transmitter for Channels 7-13...994-6180

Spare 100% Tube complement for BT-100CL.....990-0491

Spare 100% Tube complement for BT-100CH.....990-0418

100 Watt TV Transmitter—625 Line Standard

MODEL GTV-100

To serve viewers on Band I and Band III channels, Gates GTV-100, 100 watt, peak visual television transmitter was designed specifically for the CCIR 625 line standards. These transmitters are now on the air in countries such as Nigeria, Ghana, Sudan, Sierra Leone, Aden and Mauritius.

Housed in one cabinet, the GTV-100 is completely self-contained, including the in-built vestigial sideband filter. An air cooling system efficiently cools the entire transmitter with one low speed blower.

The video modulator includes linearity correction, white stretch, sync stretch, white clip and a DC restorer. The video modulator provides 50 volts output, which is more than adequate to grid modulate the 4CX250B visual final power amplifier to 100 watts peak power output.

The aural exciter supplies 2 to 10 watts average power to drive the aural power amplifier, also a type 4CX250B. The aural power amplifier can be operated from 20 to 75 watts—more than that required by CCIR standards.

Gates GTV-100 transmitter has a visual demodulator, with an electronic chopper for establishing visual modulation white reference level. The control circuit of the transmitter is designed so that remote control or unattended operation is easily accomplished, making the transmitter suitable for satellite or remote control installations.

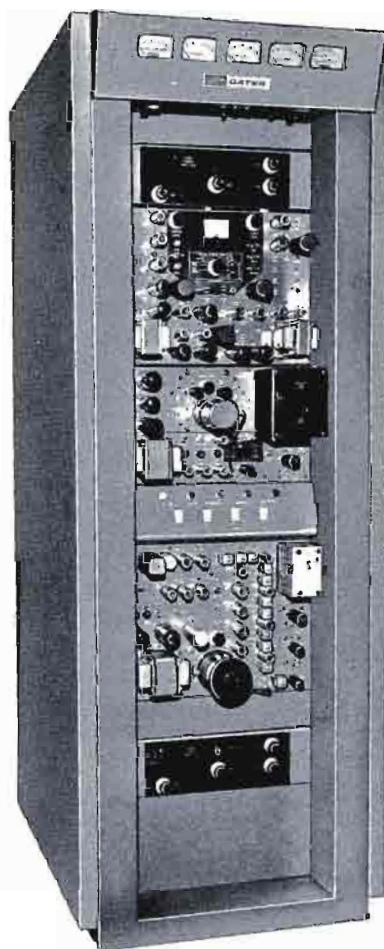

SPECIFICATIONS

FREQUENCY RANGE: 40 to 88 MHz Band I. 174 to 223 MHz Band III.

RF POWER OUTPUT: 100 watts peak visual, 20 watts average aural.

RF OUTPUT CONNECTOR: Type "N" female jack visual, 50 ohms. Type "N" female jack aural, 50 ohms.

AC POWER INPUT: 107-120/214-240, 50/60 Hz, single phase. Power consumption, aural and visual, at black level 1500 watts maximum.

VIDEO INPUT IMPEDANCE: 75 ohms unbalanced, ± 15 ohms adjustable, Type "UHF" female jack input connector.

VIDEO INPUT LEVEL: 1.0 V p-p ± 0.5 V.

VIDEO INPUT POLARITY: Black negative.

AUDIO INPUT IMPEDANCE: 600 ohms, balanced, $+10$ dBm ± 2 dB.

VESTIGIAL SIDEBAND FILTER: Built-in mounted inside transmitter cabinet.

VISUAL FREQUENCY RESPONSE: (Below ideal diode demodulated curve. 200 kHz reference). Upper Sideband: Less than 2 dB at 0.5 MHz, 2 dB at 1.25 MHz, 2 dB at 2.0 MHz, 3 dB at 3.0 MHz, 4 dB at 4.0 MHz, 6 dB at 5.0 MHz. Lower Sideband: Less than 4 dB at 0.75 MHz, more than 20 dB at 1.25 MHz.

AURAL FREQUENCY RESPONSE: 0 dB to -2 dB 30-15,000 Hz (50 microsecond pre-emphasis curve).

AURAL HARMONIC DISTORTION: 1.5% 50 to 15,000 Hz.

TYPE OF OSCILLATOR: Direct crystal control visual and aural.

CARRIER FREQUENCY STABILITY: ± 500 Hz visual and aural.

VISUAL CARRIER FREQUENCY ABOVE CHANNEL EDGE: 1.25 MHz.

AURAL CARRIER ABOVE VISUAL CARRIER FREQUENCY: 5.5 MHz ± 1 kHz.

AURAL FREQUENCY MODULATION: Phase shift employing pulse techniques.

MODULATION, AURAL: ± 50 kHz.

MODULATION, VISUAL: Amplitude (grid bias).

VISUAL OUTPUT AMPLITUDE: Sync 100%, Blanking 75% $\pm 2.5\%$, White 12.5% $\pm 2.5\%$.

REGULATION OF VISUAL OUTPUT: 7% maximum. (All white to all black picture.)

VISUAL AMPLITUDE VARIATION: 5% maximum of peak sync. (Hum and tilt over one frame.)

CAPABLE OF OPERATING INDEPENDENTLY OF POWER SUPPLY FREQUENCY: Yes.

BLACK LEVEL INDEPENDENT OF PICTURE CONTENT: Yes.

VISUAL MONITOR OUTPUT: Visual RF demodulator and white reference chopper built-in with 1.0 volt p-p output across 75 ohms.

NOISE: Visual: hum and noise—40 dB. Aural: below 100% AM—50 dB. Aural: below 100% FM 60 dB.

AMBIENT TEMPERATURE: $+5^{\circ}\text{C}$ to $+50^{\circ}\text{C}$.

ALTITUDE: 7500 ft. maximum. (Available for 10,000 ft.)

DIMENSIONS: 78" high x 36½" deep x 27" wide. Width if end bells removed is 24".

WEIGHT AND CUBAGE: Net 800 lbs. Domestic packed, 860 lbs. Export packed, 985 lbs. Cubage: 85.3.

ORDERING INFORMATION

GTV-100L for Band I 994-6110

GTV-100H for Band III 994-6111

Spare 100% tube complement for

GTV-100L 990-0491

Spare 100% tube complement for

GTV-100H 990-0418



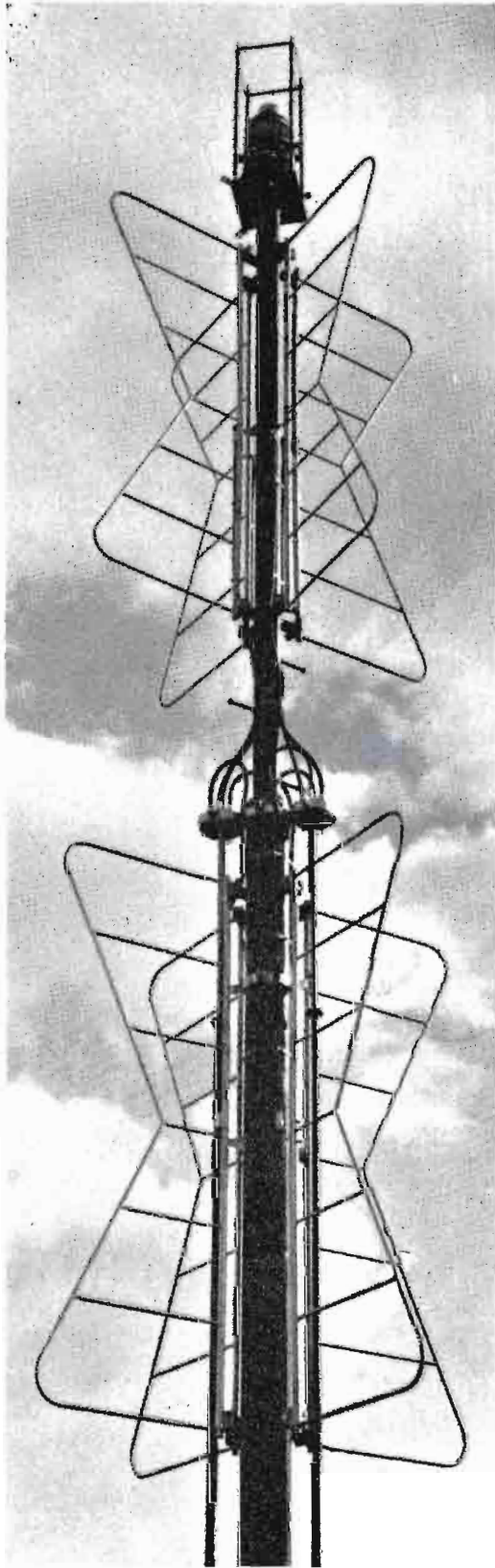

Jampro JAT 2/5 two bay Channel 5 batwing antenna.

TELEVISION BATWING ANTENNA

Popular batwing design.

Wide variety of gains.

Power rating to 50 kW.

Improved mechanical construction.

Antennas completely assembled and tested prior to shipment.

Beam tilting and null fill available without additional cost.

For channels 2-13—patterns generously meet FCC specifications.

The Jampro JAT series of low and high channel VHF transmitting antennas feature the time proven batwing design to radiate high power television signals on channels 2 through 13. With three or more bays, the antennas are designed to accept a full 50 kilowatts. The one and two bay antennas are rated at 20 kilowatts. The entire series is designed for tower top mounting. Special types are available.

These turnstile batwing TV antennas provide a means for radiating visual and aural transmitter power with definite gains and pre-determined patterns. Accessories include bridge diplexers, deicers and controls. Antennas are furnished with top beacon mounting plate, lightning rods, pole guide flange and pole socket flange. Jampro Batwing TV antennas are available from one through six bays for channels 2 to 6, and one through twelve bays for channels 7 through 13. This large variety permits choosing the antenna with the gain most favorable for the particular application.

ACCESSORIES: Also available are the following: towers to support all Jampro antennas; coaxial transmission line ($\frac{7}{8}$ "", $1\frac{1}{8}$ " and $3\frac{1}{8}$ ""); hybrid diplexers; visual and aural harmonic filters; tower lighting kits; and deicers for all Jampro JAT series of TV antennas. Deicers will be factory installed without cost when ordered with antennas.

Antennas will be shipped completely assembled whenever possible. Where transportation facilities do not permit one piece shipment, antennas will be shipped in smaller pieces for on the site assembly. Complete instruction books are provided. The services of a Jampro antenna engineer are also available at the installation site for assembly and test supervision where necessary.

Television Antennas

Channel Number	No. of bays	Type No.	Power Gain	dB Gain	L Series Power Rating	H Series Power Rating
2	1	JAT1/2	1.0	0	2.5 kW	20 kW
	2	JAT2/2	1.9	2.79	5.0 kW	20 kW
	3	JAT3/2	2.9	4.62	7.5 kW	50 kW
	4	JAT4/2	4.0	6.02	10 kW	50 kW
	5	JAT5/2	5.1	7.08	12.5 kW	50 kW
	6	JAT6/2	6.0	7.78	15 kW	50 kW
3	1	JAT1/3	1.0	0	2.5 kW	20 kW
	2	JAT2/3	2.1	3.22	5.0 kW	20 kW
	3	JAT3/3	3.1	4.91	7.5 kW	50 kW
	4	JAT4/3	4.1	5.12	10 kW	50 kW
	5	JAT5/3	5.3	7.24	12.5 kW	50 kW
	6	JAT6/3	6.2	7.92	15 kW	50 kW
4	1	JAT1/4	1.0	0	2.5 kW	20 kW
	2	JAT2/4	1.9	2.79	5.0 kW	20 kW
	3	JAT3/4	2.9	4.62	7.5 kW	50 kW
	4	JAT4/4	4.0	6.02	10 kW	50 kW
	5	JAT5/4	4.9	6.90	12.5 kW	50 kW
	6	JAT6/4	6.1	7.85	15 kW	50 kW
5	1	JAT1/5	1.0	0	2.5 kW	20 kW
	2	JAT2/5	2.1	3.22	5.0 kW	20 kW
	3	JAT3/5	3.1	4.91	7.5 kW	50 kW
	4	JAT4/5	4.2	6.23	10 kW	50 kW
	5	JAT5/5	5.3	7.24	12.5 kW	50 kW
	6	JAT6/5	6.5	8.13	15 kW	50 kW
6	1	JAT1/6	1.0	0	2.5 kW	20 kW
	2	JAT2/6	2.2	3.42	5.0 kW	20 kW
	3	JAT3/6	3.3	5.19	7.5 kW	50 kW
	4	JAT4/6	4.4	6.44	10 kW	50 kW
	5	JAT5/6	5.4	7.32	12.5 kW	50 kW
	6	JAT6/6	6.6	8.20	15 kW	50 kW
7	1	JAT1/7	1.0	0	2.5 kW	10 kW
	2	JAT2/7	2.1	3.22	5.0 kW	20 kW
	4	JAT4/7	4.1	5.20	10 kW	25 kW
	6	JAT6/7	6.2	7.92	14 kW	33 kW
	8	JAT8/7	7.8	8.92	19 kW	41 kW
	12	JAT12/7	11.9	10.75	27.5 kW	50 kW
8	1	JAT1/8	1.0	0	2.5 kW	10 kW
	2	JAT2/8	2.1	3.22	5.0 kW	20 kW
	4	JAT4/8	4.1	6.20	10 kW	25 kW
	6	JAT6/8	6.3	7.99	14 kW	33 kW
	8	JAT8/8	7.9	8.98	19 kW	41 kW
	12	JAT12/8	12.2	10.86	27.5 kW	50 kW
9	1	JAT1/9	1.1	.41	2.5 kW	10 kW
	2	JAT2/9	2.2	3.42	5.0 kW	20 kW
	4	JAT4/9	4.2	6.23	10 kW	25 kW
	6	JAT6/9	6.7	8.26	14 kW	33 kW
	8	JAT8/9	8.3	9.19	19 kW	39 kW
	12	JAT12/9	12.6	11.00	27.5 kW	50 kW
10	1	JAT1/10	1.1	.41	2.5 kW	10 kW
	2	JAT2/10	2.2	3.42	5.0 kW	20 kW
	4	JAT4/10	4.2	6.23	10 kW	25 kW
	6	JAT6/10	6.7	8.26	14 kW	33 kW
	8	JAT8/10	8.4	9.24	19 kW	39 kW
	12	JAT12/10	12.9	11.11	27.5 kW	50 kW
11	1	JAT1/11	1.1	.41	2.5 kW	10 kW
	2	JAT2/11	2.2	3.42	5.0 kW	20 kW
	4	JAT4/11	4.2	6.23	10 kW	25 kW
	6	JAT6/11	6.8	8.33	14 kW	33 kW
	8	JAT8/11	8.4	9.24	19 kW	39 kW
	12	JAT12/11	12.3	10.90	27.5 kW	50 kW
12	1	JAT1/12	1.0	0	2.5 kW	10 kW
	2	JAT2/12	2.3	3.62	5.0 kW	20 kW
	4	JAT4/12	4.2	6.23	10 kW	25 kW
	6	JAT6/12	6.8	8.33	14 kW	33 kW
	8	JAT8/12	8.3	9.19	19 kW	39 kW
	12	JAT12/12	12.3	10.90	27.5 kW	50 kW
13	1	JAT1/13	1.0	0	2.5 kW	10 kW
	2	JAT2/13	2.4	3.80	5.0 kW	20 kW
	4	JAT4/13	4.3	6.26	10 kW	25 kW
	6	JAT6/13	6.9	8.39	14 kW	33 kW
	8	JAT8/13	8.3	9.19	19 kW	39 kW
	12	JAT12/13	12.2	10.86	27.5 kW	50 kW

TYPICAL SPECIFICATIONS

CHANNELS 2-3 6 BAYS

Mechanical

Antenna Weight.....14,000 lbs.
 Maximum weight of heaviest pole.....2,700 lbs.
 Maximum length of longest pole.....27 ft.
 O. D. of pole at guide socket.....16"
 O. D. of pole at guide flange.....20"
 Size, input transmission line flanges.....3/8"
 Location of antenna inputs.....1 ft. above tower
 Shear at tower top, lbs. @ 110 MPH.....6,600 lbs.
 Moment, in ft. lbs. @ 110 MPH.....287,000 ft. lbs.
 Suggested antenna base stability.....2°
 Structural design Assumptions.....50/30 psf.

Electrical

Power input rating.....50 kW
 Horizontal circularity better than.....±2 dB
 Antenna input impedance.....50 ohms
 VSWR across 6 MHz channel.....1.1/1

Type	Channel Number	Power Gain	dB Gain	Free Space Field (M/v)
JAT6/2	2	6.0	7.78	337
JAT6/3	3	6.2	7.92	342

ORDERING INFORMATION

Due to the wide variety of television antenna combinations, all antennas are quoted immediately on receipt of: (a) frequency of channel, (b) video ERP, (c) approximate length of transmission line between antenna and transmitter, (d) make and size of coaxial line if not to be supplied by Gates, and (e) approximate height of antenna above ground.

Television Monitors



CYB21/C AND CYB17/C COLOR MONITORS

SPECIFICATIONS

TECHNICAL DATA

INPUT POWER: 350 watts at 120/240 volts, 60 Hz (525/60 N.T.S.C.).

VIDEO SIGNAL: 0.2 volts, p-p minimum. Sync negative at monitor input.

VIDEO INPUT IMPEDANCE: Two, high impedance bridging. Each can be terminated by an internal 75 ohm load through a switch located on rear apron.

EXTERNAL SYNC: High impedance, 1-8 volts p-p, sync negative. Parallel coax input connectors.

VIDEO RESPONSE: Flat to 5 MHz in black and white position. A 3.58 MHz trap is automatically switched in during color operation while frequencies above 3.58 MHz are rolled off. Variable aperture correction from front panel control.

LINEARITY: Within 1% of picture height.

MECHANICAL SPECIFICATIONS

	Width	Height	Depth	Net Weight	Shipping Weight
CYB17/C	19"	21"	*22 $\frac{3}{4}$ "	101#	127#
CYB17/RS	19"	21"	**22 $\frac{1}{2}$ "	102#	128#
CYB17/Y	21 $\frac{1}{16}$ "	21"	*23 $\frac{3}{4}$ "	102#	128#
M3	3-Wheel Dolly			25#	27#
M4	Pedestal Mount			18#	25#
M5	Ceiling Mount			10#	16#

*Dimension does not include handles or knobs.

**Measured to mounting surface of rack. Overall depth of unit is 23 $\frac{3}{4}$ ".

CYB21/C	24"	25 $\frac{3}{16}$ "	*27 $\frac{1}{16}$ "	144#	210#
CYB21/Y	26 $\frac{1}{16}$ "	25 $\frac{3}{16}$ "	*27 $\frac{1}{16}$ "	145#	211#
CYB21/RS	24"	26 $\frac{1}{4}$ "	**27 $\frac{1}{16}$ "	145#	211#
M3	3-Wheel Dolly			25#	27#
M8	Pedestal Mount			18#	25#
M9	Ceiling Mount			10#	16#

*Dimension does not include handles or knobs.

**Dimension is to mounting surface of rack. Front panel is 1 $\frac{1}{16}$ ".



RLC 14

SPECIFICATIONS

TECHNICAL DATA

INPUT POWER: 65 watts at 120/240 volts 60 Hz (525/60 U.S.) or 50 Hz (625/50 CCIR).

VIDEO SIGNAL: 0.3 volt p-p (minimum for 50 volts at kinescope). Sync negative at monitor input.

VIDEO INPUT IMPEDANCE: High impedance bridging (equivalent to 50 K in parallel with 15 pF) can be terminated by an internal 75 ohm load $\pm 1\%$ through a switch located on rear apron.

VIDEO RESPONSE: 10 MHz ± 1 dB. Differential gain below 5% with 75 volts kinescope drive.

DC RESTORATION: 100% or zero, sync tip clamp.

EXTERNAL SYNC: 1 to 8 volts. Parallel connectors. Monitor will operate from either composite video and sync signals or separate external composite sync.

LINEARITY: Within 2% of picture height.

CONTROLS, CONNECTORS, ADJUSTMENTS

FRONT PANEL: Off-on switch, focus, horizontal hold, vertical hold, height, vertical linearity, contrast, brightness, width.

REAR APRON: Paralleled video input connectors, video terminating switch, DC restorer switch, external-internal sync switch, paralleled sync input connectors, AC line fuse, AC outlet (wired through off-on switch—capacity 2 amps).

TOP ADJUSTMENTS: Horizontal linearity, high voltage regulator adjustment.

CONNECTORS: All video and sync connectors are SO239 type.

MECHANICAL SPECIFICATIONS

	Width	Height	Depth	Net Weight	Shipping Weight
Rack Mounted					
RLC14	19"	10 $\frac{1}{2}$ "	17 $\frac{3}{8}$ "*	51#	68#

*Dimension is to mtg. surface of rack. Front panel is $\frac{5}{16}$ ".

Television Monitors

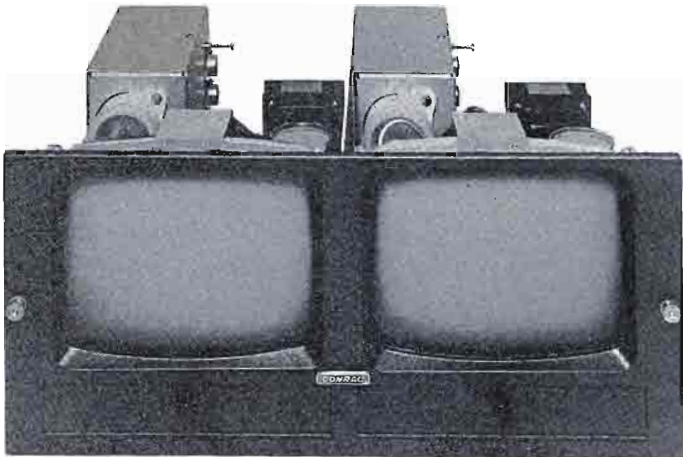

RND9/C

SPECIFICATIONS

TECHNICAL DATA

INPUT POWER: 65 watts at 117/234 volts 60 Hz (525/60 U.S.) or 50 Hz (625/50 CCIR).

VIDEO SIGNAL: 0.3 volt pp (minimum for 50 volts at kinescope). Sync negative at monitor input.

VIDEO INPUT IMPEDANCE: High impedance bridging (equivalent to 50K in parallel with 15 mmfd.) can be terminated by an internal 75 ohm load ($\pm 1\%$) through a switch located on rear apron.

VIDEO RESPONSE: 10 MHz ± 1 dB. Differential gain below 5% with 75 volts kinescope drive.

DC RESTORATION: 100% or zero, sync tip clamp.

EXTERNAL SYNC: 1 to 8 volts. Parallel connectors. Monitor will operate from either composite video and sync signals or separate external composite sync.

LINEARITY: Within 2% of picture height.

CONTROLS, CONNECTORS, ADJUSTMENTS

FRONT PANEL: Off-on switch, horizontal hold, vertical hold, height, vertical linearity, contrast, brightness, width, focus.

REAR APRON: Sync selector switch, video line termination switch, paralleled video input connectors, paralleled sync connectors, AC line fuse.

TOP ADJUSTMENTS: Vertical linearity, vertical hold range, DC restorer switch, high voltage regulator adjustment, horizontal linearity.

CONNECTORS: All video and sync connectors are SO239.

MECHANICAL SPECIFICATIONS

	Width	Height	Depth	Net Weight	Shipping Weight
Chassis					
RND9/N	8½"	8¾"	14¾"***	18#	29#
Rack Mounted					
RND9/2R	19"	8¾"	15½"*	46#	61#

*To mtg. surface, front panel 5/16".

**Does not include knobs or connectors.



CZB17/N

SPECIFICATIONS

TECHNICAL DATA

INPUT POWER: 117/234 volts, 50/60 Hz, 180 watts.

VIDEO SIGNAL: 0.2 volt pp (minimum for 50 volts at kinescope). Sync negative at monitor input. Two input channels with built-in diode switcher.

VIDEO INPUT IMPEDANCE: High impedance bridging (equivalent to 100K in parallel with 5 mmfd.) can be terminated by an internal 75 ohm load ($\pm 1\%$) through a switch located on rear apron.

VIDEO RESPONSE: 10 Hz to 10 MHz ± 1 dB. Differential gain below 3% with 100 volts kinescope drive.

BLACK LEVEL SHIFT: Less than 2 volts between 10% and 90% duty cycle.

DC RESTORATION: Keyed backporch clamp.

EXTERNAL SYNC: 1 to 8 volts. Parallel connectors. Monitor will operate from either composite video and sync signals or separate external composite sync.

LINEARITY: Within 2% of picture height.

CONTROLS, CONNECTORS, ADJUSTMENTS

FRONT PANEL: On-off switch, brightness, width, horizontal hold, vertical hold, vertical size, vertical linearity, contrast, focus, input gain, input selector, local-remote, normal-horizontal delay or pulse-cross selector, AC line fuse (horizontal linearity on 14" and 17" units only).

SIDE CHASSIS: Ultor adjust, auxiliary brightness (horizontal linearity on 8" units only).

REAR: Channel "A": Video parallel input and termination switch. Channel "B": Video parallel input and termination switch. Parallel sync input, sync selector, remote control, Jones plug, low voltage adjust, AC fan receptacle, horizontal frequency, horizontal drive, B+ test jack, size switch, twist lock, AC input.

CHASSIS DECK: Vertical feedback, DC restorer, in-out.

CONNECTORS: All video and sync connectors are SO239 type.

Audio Installations



VOICE OF AMERICA
GATES CUSTOM AUDIO SYSTEM



DIPLOMAT CONSOLE AND CUSTOM AUDIO SWITCHING
KGO, SAN FRANCISCO

Gates standard and custom audio equipment is designed to meet the highest quality standards, with special attention given to both the performance and reliability of every unit. Because of this insistence on quality, and proven superior capabilities in design and manufacturing, Gates has long been the leader in filling the audio equipment needs of the entire broadcast industry—from the smaller individual stations to the largest major networks.

TELEVISION AUDIO CONSOLE
CBS TELEVISION
NEW YORK



CUSTOM CONSOLE
WABC, NEW YORK
AMERICAN BROADCASTING COMPANY



Audio Installations



GATESWAY II CONSOLE AND CARTRIDGE TAPE EQUIPMENT
WEEL, BOSTON



CUSTOM AUDIO CONSOLE
WXYZ, DETROIT



PRODUCER MIXER AND CB-77 TURNTABLES
KAYT, RUPERT, IDAHO

TV-15 AUDIO CONSOLE WITH TWO TVS-6 SUB-MIXERS
KPRC, HOUSTON, TEXAS



Photographs on these pages illustrate how Gates audio systems contribute to the total communications flexibility of a dynamic media. In planning new installations, assistance is available to every AM, FM, TV, and educational station or government agency upon request.

Television Audio Control Console

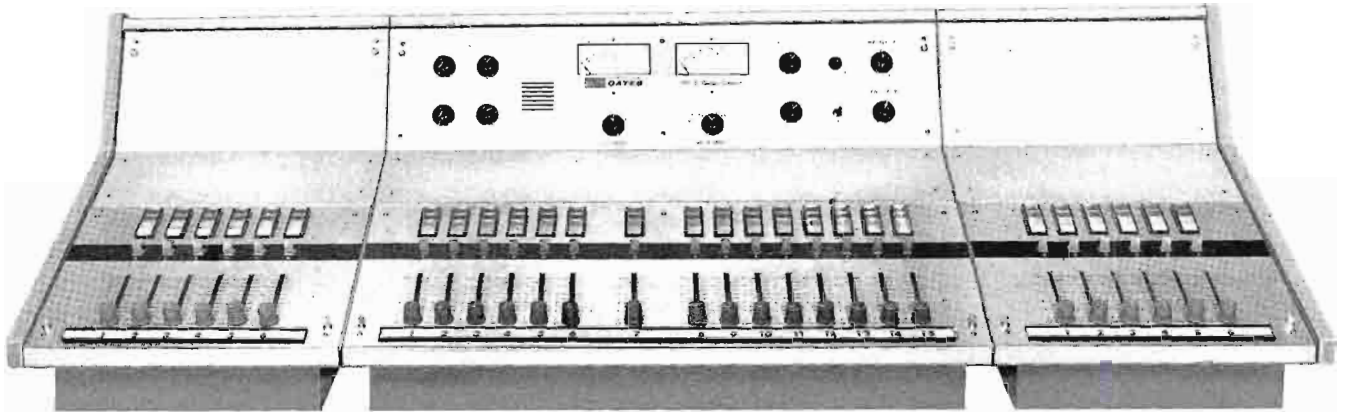

The TV-15 with two TVS-6 Sub-Mixer Units gives you 27 mixing channels and 108 inputs.

THE TV-15

Gates TV-15 audio control console provides extensive facilities for a wide range of audio control situations where a maximum number of inputs and/or mixing channels are required in a nominal amount of space. It was designed for the medium to large television station, where its flexibility can be adapted to many requirements.

The basic TV-15 is capable of mixing 15 signals from up to 60 sources. It is a dual-channel console, providing completely independent program and audition line outputs for on-air work, or rehearsal or production simultaneously.

To increase facilities as your station grows just add on Gates TVS-6 sub-mixer units. Each unit provides six additional channels, with four inputs each. There is virtually no limit to the number of units that may be added.

COMPACT DESIGN: The compact basic console measures only 31 11/16" wide, yet provides ample space for expansion or addition of special facilities to "customize" the standard unit.

MIXING CHANNELS: Six studio microphone channels, an announce booth channel, and eight medium level channels are provided—for a total of fifteen mixing channels. Each of these fifteen channels has an illuminated four-station interlocked push-button selector to expand the total number of inputs to sixty. This means that the same source may appear on two channels for cross-fading, or 60 different sources may be accommodated.

All channels contain an isolation transformer with 150/600 ohms on the primary. All channels also have a plug-in card receptacle to accept a medium level jumper card or plug-in microphone preamplifier. The 994-6549 preamplifier in the TV-15 will accept input levels up to -17 dBm without overload, and is provided as standard on microphone input chan-

nels 1 through 7. By purchasing additional preamplifiers, every channel can accommodate microphone inputs if desired. Each of the 60 inputs will mute any of the 4 studio speakers, as assigned by simple jumper connectors.

VERTICAL ATTENUATORS: High-quality vertical attenuators are used, on 1½" spacing, for operating ease. Every attenuator, including microphone channels, has a cue position feeding the inbuilt cueing amplifier.

AUDIO-FOLLOW-VIDEO: Each input channel also has a relay socket wired, and relays can be easily added for audio-follow-video remote-controlled operation in large systems.

SUB-MASTERS OR DUAL-CHANNEL: The mixing bus of the TV-15 is split into seven channels on one bus, and eight channels on the other, to reduce bus loss and maintain satisfactory signal-to-noise ratios. These bus sections are then fed through 994-6549 booster amplifiers, thence to a combining pad and into the sub-master control.

Sub-masters can be combined and fed through a program amplifier or operated independently with the "A" bus feeding output line 1, and the "B" bus feeding a second program amplifier into output line 2. The sub-masters and following combining pad allow "A + B" operation for multiple microphone fading. Normal dual-channel operation may be used for regular programming or simultaneous rehearsals.

TWO MONITOR CHANNELS: Two separate eight-watt monitoring amplifiers allow selection from six sources, such as the main output, line A, line B, sub-master channels A or B, or from two external sources. The control room and studio monitors operate independently from one another. The announce microphone is considered a booth source, thus the control room speaker remains unmuted. Muting is provided only for studio speakers in the TV-15.

Television Audio Control Console—TV-15

The TV-15 with one TVS-6 Sub-Mixer Unit added—for a total of 21 mixing channels, and 84 inputs.



AMPLIFIERS: Only the preamplifier, booster amplifier cards, and associated power supply, are contained within the console cabinet. Program amplifiers, monitor amplifiers, and other power supplies are rack-mounted in standard 19" shelf assemblies near-by. Completely pre-wired and pre-formed interconnecting cable (25 ft.) is provided to interconnect the console proper with its associated rack-mounted components.

Gates modular equipment cabinetry provides a functional and attractive desk assembly for the TV-15, and also provides space for accessories such as: turntables, cartridge tape equipment, telco gear, etc. (Cabinets are optional.)

STYLING: The handsome TV-15 styling is low-silhouette — most popular for television operation. The lower panel contains vertical faders and input selector switches. All switches are illuminated, and a complete set of mylar transparencies with equipment nomenclature is provided for labeling all inputs and channels.

The top panel contains VU meters, auxiliary controls and switches for monitoring, sub-master assignment, master gain, etc.

A 5¼-inch high blank center panel is provided for use by the customer. Program equalizers, reverberation (echo) controls, remote control, etc., may be mounted in this area.

TVS-6 "ADD-ON" UNITS: Compact "add-on" or sub-mixer units are available with six additional channels, complete with 4-input push-button switching, like the input channels of the main TV-15 console. "Add-on" units have both the center and top panels blank for customizing. Units may be added at either or both ends of the TV-15, or used independently at an angle.

Each unit contains two bus-boosters that feed a network to bridge the output into the mixing bus of the main console without incurring additional bus losses. Extra power supplies are added to the external shelf assemblies when the capability of the main power system is reached.



Basic TV-15 Television Audio Control Console has 15 mixing channels, with 4 inputs each.

Television Audio Control Console—TV-15

SPECIFICATIONS

INPUT CHANNELS: Total—15. Instantly convertible to microphone (−60 dBm) or medium level (−20 dBm) channels by insertion of preamplifier or shorting card. Factory supplied with preamps in channel 1 through channel 7, jumper cards in channel 8 through channel 15.

INPUT CIRCUITS: 60 maximum. Four into each of the 15 channels, with push-button selection of desired input. Each input may direct speaker muting with any of the four muting relays built into the console.

OUTPUT CHANNELS: 2 line outputs with switching facilities to instantly convert both "A" and "B" program busses to either separate output channels, or to combine A+B into the "A" output channel only. 5 speaker outputs, one monitoring amplifier feeding a control room speaker (un-muted) only; the second monitoring amplifier feeding up to 4 studio speakers (with selective muting) through the factory supplied matching transformers. Individual monitor amplifier gain controls allow independent setting of levels.

SOURCE IMPEDANCE: 30/50-150/250 ohms on mic channels, 150/250-500/600 ohms on medium level channels. 10,000 ohm balanced bridging on external monitor and air monitor inputs allows wide latitude of source impedances on these inputs.

LOAD IMPEDANCE: 150/600 ohms (factory connected 600 ohms) on line output. 4-16 (8 ohms nominal) ohms total monitor load. Four matching transformers provided to allow paralleling up to four speakers off either monitor amplifier.

GAIN: 110 dB maximum, microphone to line. 80 dB maximum, proj. to line.

RESPONSE: ±1.0 dB, 30 to 15,000 Hz, program circuits. ±1.5 dB, 30 to 15,000 Hz, monitor circuits.

DISTORTION: 1% maximum, 30 to 15,000 Hz, program circuits @ +18 dBm output; monitor circuits @ +38 dBm output.

NOISE: 73 dB below −50 dBm input and +18 dBm output from 30 to 15,000 Hz on microphone inputs (−123 dBm relative input noise). 75 dB below −10 dBm input and +18 dBm output from 30 to 15,000 Hz on medium level inputs.

CROSSTALK: Less than 5 dB out of noise at +8 dBm.

AUDIO-FOLLOW-VIDEO RELAYS: 15 relay sockets provided with jumpers that can be removed to insert relays in every input channel, if desired.

ISOLATION TRANSFORMERS: 15 on the input channels to provide balanced inputs on every channel, with or without preamps.

CUE POSITION: On every channel attenuator and connected into cue amplifier and speaker.

SUB-MASTER CONTROLS: Provided to permit ganged control of "A" bus separate from "B" bus when in the A+B mode. In the individual output mode, the sub-masters can be used to ride level on the two output lines. Master controls are used more for range controls than operating controls.

VU METERS: 2—one connected permanently to Program Line Out, the other switchable to six points.

INDIVIDUAL MONITOR INPUT SELECTORS: Connect either monitoring amplifier to: Sub A, Sub B, Line A, Line B, Ext 1 or Ext 2 positions of front panel switches.

INTERCONNECTING CABLES: Terminated in plugs and receptacles furnished with console to quickly connect the remotely located shelf-mounted program amplifiers, monitoring amplifiers and power supplies. 25-foot inter-connecting cable allows flexibility of location.

INPUT CHANNEL EXTENSION UNITS: Provide multiples of six input channels in matching side cabinets to extend the facilities of the TV-15 console to any number of channels desired. A unique bridging bus feed from the side cabinet allows an almost unlimited number of input channels without degrading the signal-to-noise of the TV-15. Duplicate input channel facilities are provided on the six additional channels in each side cabinet. Thus, it is feasible to make up a 21, 27, 33, 39, 45, or even a higher numbered input channel console, with four inputs switched into each of the channels.

FINISH: Cabinet color—beige-gray.

SIZE: TV-15 Console: 31 $\frac{1}{16}$ in. wide, 27 in. deep, 12 $\frac{1}{2}$ in. above desk top.
TVS-6 Sub-Mixer unit: 14 $\frac{13}{16}$ in. wide, 27 in. deep, 12 $\frac{1}{2}$ in. above desk top.

SHIPPING DATA TV-15: Packed weight, domestic, 400 pounds.

ORDERING INFORMATION

TV-15 Audio Control Console. Complete with housing, 7 mic preamplifiers, 4 booster amplifiers, 2 program amplifiers, 2 monitor amplifiers, 1 cue amplifier, 1 power supply 30V, 1 power supply 33V, 1 power supply 24V, shelf assembly, and 25 feet of inter-connecting cable.....994-6610
TVS-6 Six channel Sub-Mixer. "Add-on" unit complete with housing and 2 booster amplifiers...994-6611

ACCESSORIES

Extra preamplifiers994-6549
Double equipment pedestal (for description see page 175).....994-6449
Single equipment pedestal (for description see page 175).....994-6448
Desk top section (for description see page 175).....994-6450
Double leg assembly (for description see page 175).....994-6456

Television Audio Control Console—TV-15

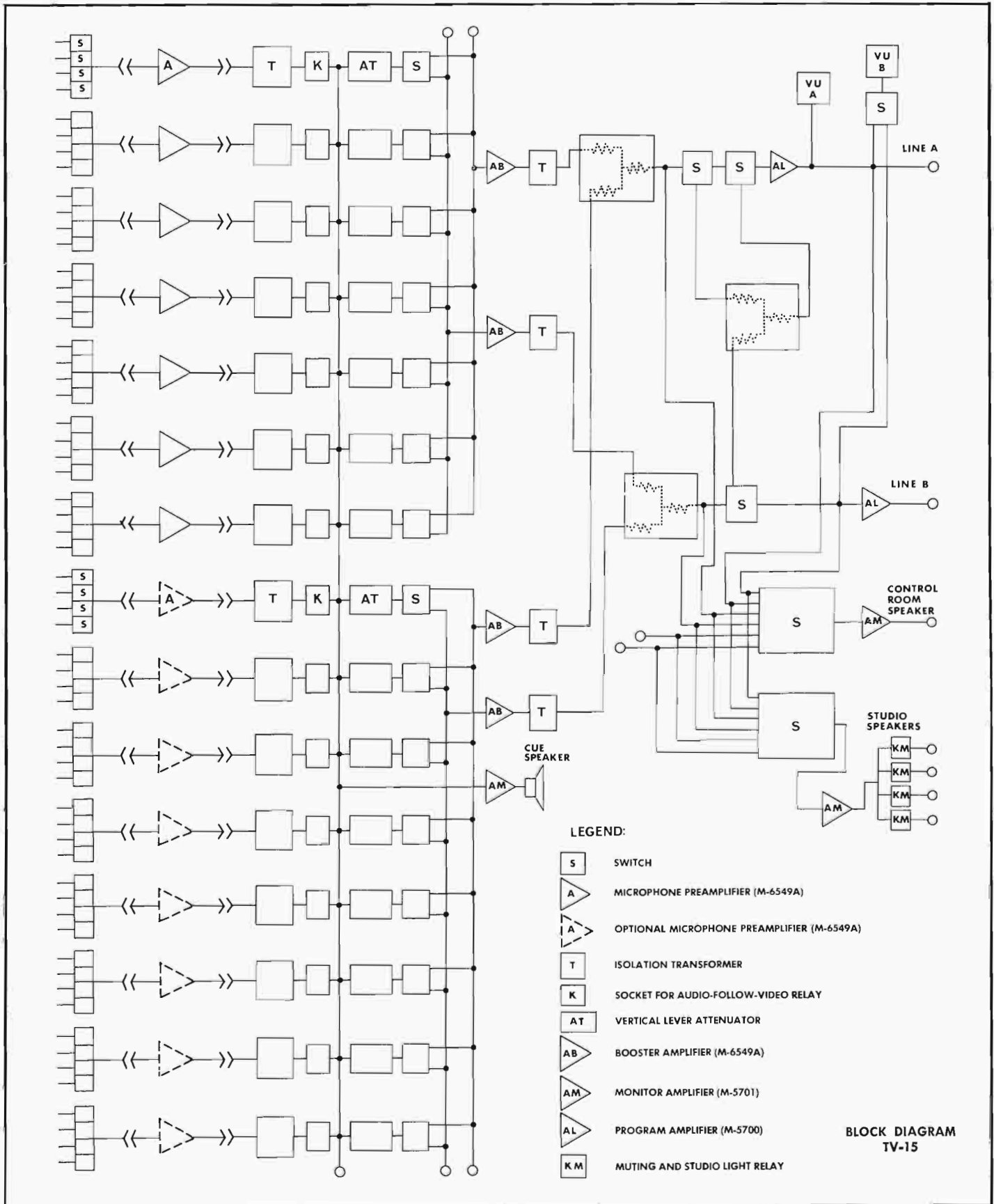

Dual Programming Transistor Console With Stereo



THE DUALUX II

One of the most versatile audio consoles on the market today, Gates Solid Statesman Dualux II is ideal for the broadcaster who wants to control AM, FM, FM Stereo and SCA from one control point during all or part of the broadcasting day.

With the extensive capabilities of the Dualux II, monophonic or stereophonic mixing can be done independently or simultaneously. Simplified control of any mode of broadcasting is achieved through the console's exclusive program output selector. An interlocking system guards against the programming of any unacceptable combinations.

WIDE CHOICE OF INPUTS: Twenty-two audio inputs can be fed to the Dualux II. These include: thirteen monophonic sources, six stereo sources, two automatic programming sources and an SCA channel. Four unwired utility keys allow the addition of sources of your choice.

MICROPHONE CHANNELS (1, 2 and 3): Four single monophonic microphones can be individually switched to channels 1 and 2. Either of two stereo microphone pairs can be mixed on channel 3, and a switch is provided to combine the output during monophonic broadcasting.

MEDIUM LEVEL CHANNELS (4, 5, 6, 7 and 8): Channels 4 and 5 will each mix four stereo sources, while channels 6 and 7 will mix four monophonic sources. These sources can be cartridge tape machines, reel-to-reel units or turntables.

Channel 8 will mix four remote monaural inputs and has a monaural network input. Cueing is provided on all medium level channels.

POSITIVE MIXING CONTROL: Low impedance ladder step type attenuators are used in the minimum loss mixing circuits. Large "feel-of-the-board" VA control knobs are used to make mixing more efficient. An illuminated key selector above each of the mixing knobs switches the mixer output to AM or FM.

Center position is off. Color inserts are provided for all mixer knobs to aid in identification.

MONITORING: The Dualux II has two solid state monitoring amplifiers for both stereo and mono monitoring. Monitoring outputs are for control rooms, Studio A, B, and lobby. Cue/intercom connections are provided to Studio A and B.

SOLID STATE MUTING: The Dualux II has Gates new "Micro-muting" which mutes loudspeakers in microseconds. The muting is so fast that a microphone placed directly in front of the monitor cannot possibly cause feedback. This instantaneous solid state muting is exceptionally quiet in operation.

OUTSTANDING AUDIO QUALITY: Audio response is excellent, with distortion at an unusually low level. Consequently, the Dualux II provides audio quality ideally suited to any type of broadcasting—AM, FM or FM Stereo/SCA.

AMPLIFIERS: The silicon transistor Solid-Statesman amplifiers used throughout provide high level, high fidelity output. Pre-amplifiers will provide a full +23 dBm output, and will handle input levels of -17 dBm without overload or distortion. The program amplifiers are capable of +32 dBm output, and the monitor amplifiers deliver +40 dBm (10 watts). All components are mounted on etched circuit boards for added reliability and excellent crosstalk and noise specifications. Silicon transistors are used to assure optimum console performance over a wide ambient temperature range.

All amplifiers are packaged in modular extruded aluminum housings, and are completely accessible when the top of the console is opened. Amplifiers and power supplies plug in for ease in servicing.

INTERCHANGEABILITY: Electrically, the program amplifiers, monitor amplifiers, and cue amplifier are identical, thus providing three backup program amplifiers as an integral part of the console.

Dual Programming Transistor Console With Stereo-Dualux II

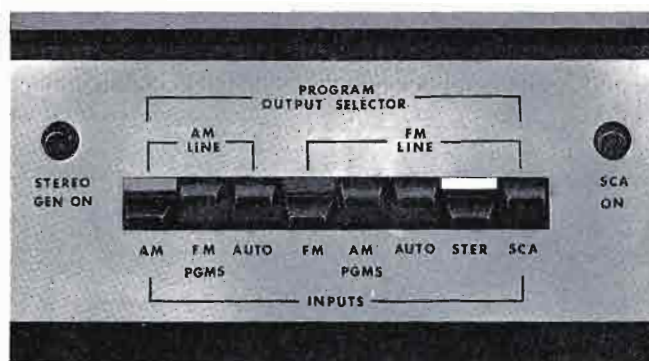

PROGRAM OUTPUT SELECTOR: Functions are logically presented and color-coded to channel keys and VU meter illumination for simplicity. Briefly, control provisions are: two separate transmitter inputs are marked "AM Line" and "FM Line." The AM transmitter may be programmed independently through any mixing channel when corresponding keys are operated to the left. Illuminated channel key, AM VU meter, and tab key #1 of the selector assembly are color-coded green.

Similarly, the FM transmitter may be programmed from the FM buss, when red tab key #4 is selected. In this mode FM may be stereo or mono, depending on the position of tab

key #7 of the program output selector. During non-stereo periods an SCA channel may be turned on and programmed from an external source by tab key #8. All keys are cleverly interlocked against any unacceptable combinations.

Either the AM or FM line may be programmed from external automation equipment by the mere flip of a tab key, without tying up a mixing channel. Dualux II provides a complete and economical means of complying with regulations on separate AM/FM programming. During other hours AM may program FM, or vice-versa, by selecting the appropriate key and operating the console conventionally.

SPECIFICATIONS

MIXING CHANNELS: Total 8. Two microphone—mono. One microphone—stereo. Two turntable/tape—stereo. Two turntable/tape—mono. One remote/network—mono.

AMPLIFIERS AND POWER SUPPLIES PROVIDED: Four preamplifiers, six output modules—program/monitor/cue (all interchangeable as supplied). Two muting modules, four power supply modules, and M-6556B transformer panel.

OPERATING MODE: Tri-channel—mono/stereo simultaneously.

INPUT CIRCUITS: Total 22. Four microphones—mono. Two microphones—stereo pair. Four turntable/tape—stereo pair. Four turntable/tape—mono. Four remote lines, one network, one SCA source—mono. One automation source—stereo pair. One automation source—mono.

OUTPUT CIRCUITS: Three program outputs @ +8 dBm, three record outputs @ -16 dBm, (bridged program line), two monitor speakers unmuted (left and right for lobby), six monitor speakers muted (left and right for Studios A & B & control room), two studio intercom outputs (Studio A, Studio B).

AUXILIARY INPUT/OUTPUT CIRCUITS SWITCHED THROUGH CONSOLE: Inputs: AM automation, FM—left automation (mono), FM—right automation (stereo), programming for SCA—41 kHz. Output: Programming for SCA—41 kHz.

MONITOR OUTPUT: 8 ohms nominal, for use as follows: (A) Single 8 ohm speaker. (B) Two 16 ohm speakers in parallel. (C) Up to six 48 ohm speak-

ers (using the 48/8 ohm transformer supplied) in parallel. (D) Any combination of speakers and/or transformers with a resultant network of 8 ohms or higher.

IMPEDANCES: Microphones: 30/50 or 150/250 ohms balanced. Turntable/tape: 150/250 ohms unbalanced. Network /remote: 500/600 ohms balanced. Record output: 600 ohms balanced.

GAIN: Microphone to line: 102 dB, ± 2 dB. Medium level to line: 60 dB, ± 2 dB.

RESPONSE: Program and monitor: ± 1.0 dB, 20 Hz to 20 kHz.

DISTORTION: Program circuits: 0.5% maximum, 20 Hz to 20 kHz @ +18 dBm. Monitor circuits: 1.0% maximum, 20 Hz to 20 kHz @ +40 dBm (10 watts).

NOISE: Program circuits: 74 dB below +18 dBm with -50 dBm input (-124 dBm equivalent input noise measured 20 Hz to 20 kHz). Monitor circuits: 74 dB below +40 dBm with -50 dBm input (-124 dBm equivalent input noise measured 20 Hz to 20 kHz). Medium level inputs: (Program) 74 dB below +18 dBm.

POWER: 117 volts, 50/60 Hz, 1-phase.

FINISH: Satin anodized aluminum panels, with lettering in black. Cabinet color—two-tone beige-gray.

SIZE: 51 $\frac{3}{4}$ " wide, 17" deep, 11 $\frac{1}{2}$ " high.

SHIPPING DATA: Packed weight: domestic, 140 lbs.; export, 220 lbs. Cubage: 16 cubic feet.

ORDERING INFORMATION

Dualux II, eight channel mono/stereo console for tri-channel operation. Complete with four M-6549B preamplifiers, six M-6550B program/monitor/cue output modules (interchangeable), two M-6553 and M-6553A solid state muting modules, and M-6551A and M-6552 power supply modules. An M-6556B transformer panel and eight speaker transformers (478-0275) are also supplied with the console.

994-6542



Dual Programming Transistor Console With Stereo-Dualux II

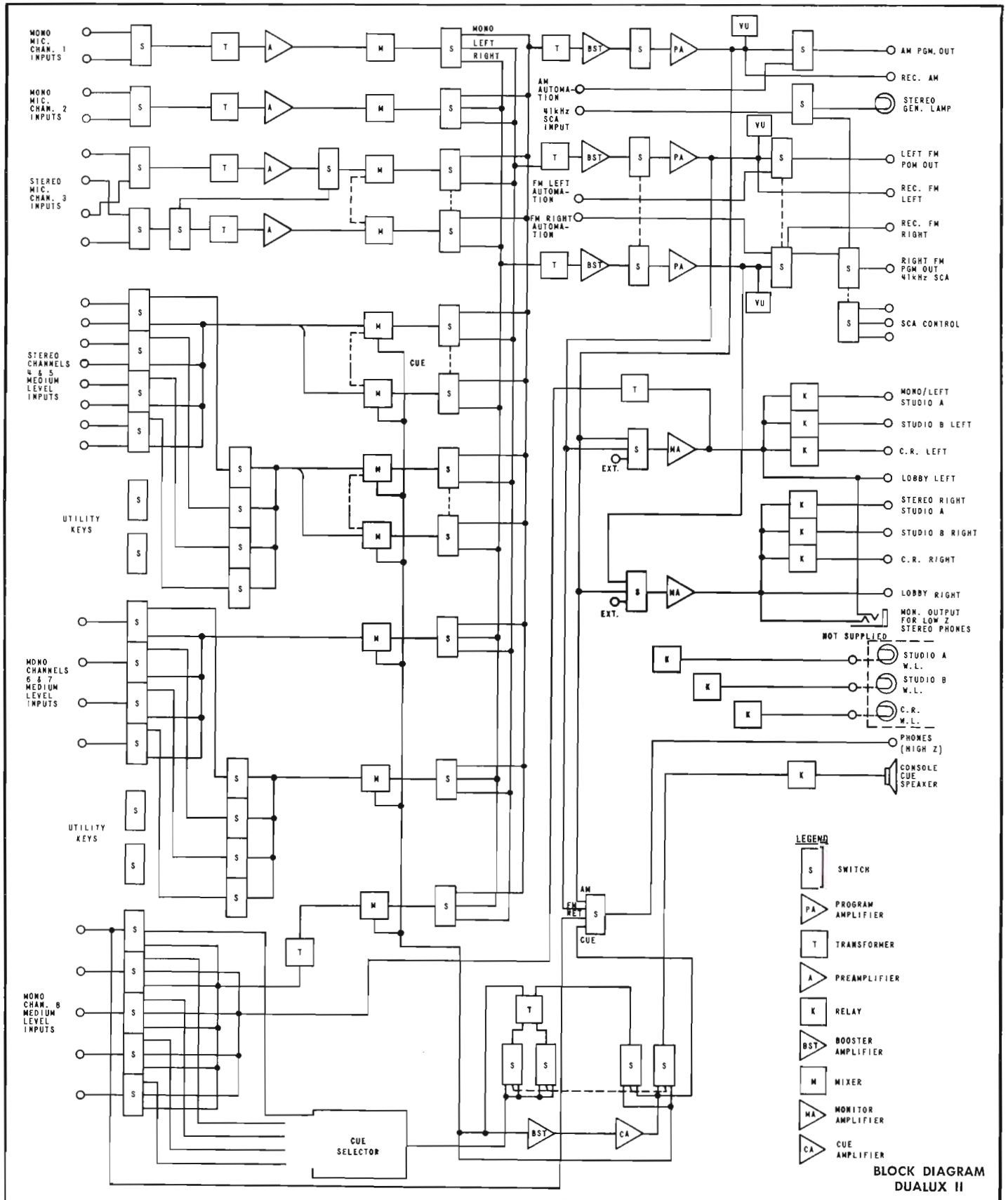

Eight Channel Monophonic Transistor Console



THE GATESWAY II

Field-proven successor to the world famous Gatesway, the Gatesway II blends excellent audio and unusual flexibility with handsome, functional styling. The result: a completely transistorized control board that gives you a wide choice of input facilities, *plus* operating simplicity.

Features include: eighteen inputs into eight mixing channels; inbuilt cue/intercom system; provision for remote announcer operation of studio microphone channels; a novel variable program equalizer which may be instantly switched into the circuit for special effects or line correction; instantaneous solid state "Micro-muting"; illuminated program keys; and large "feel-of-the-board" control knobs.

INPUTS: The versatility of the Gatesway II is in its wide selection of inputs. Eighteen inputs can be switched into eight mixing channels. These include six microphones, four turntables, four tapes (cartridge or reel-to-reel), three remotes and network. Four unwired utility keys are provided for expansion.

MICROPHONE CHANNELS: Six microphones from control room and two studios may be mixed on channels 1, 2 and 3. A flexible muting assignment terminal strip allows the engineer to tailor loudspeaker muting and warning light controls to the channels which fit a particular programming situation. On-off control of one microphone channel may be given to the announcer through the addition of a simple relay module on channel 2 (optional). Input capability of the Solid Statesman preamplifiers is -17 dBm, making this audio control console virtually immune to microphone overload.

SOLID STATE MUTING: The Gatesway II has Gates "Micro-muting" which mutes loudspeakers in microseconds—so fast that a microphone placed directly in front of the monitor speaker cannot feed back. This instantaneous solid state muting is exceptionally quiet in operation.

MEDIUM LEVEL CHANNELS: Four turntables or similar devices may be mixed in any combination through flexible input switching on channels 4 and 5. (The same four devices are controlled from either channel). Similarly, four cartridge or reel-to-reel tape recorders may be accommodated on channels 6 and 7. Channel 8 has input switching for three remote lines and network. All medium level faders are equipped with cue positions to the self-contained cue intercom amplifier.

PROGRAM EQUALIZER: An exclusive feature of the Solid Statesman Gatesway II is an inbuilt equalizer for correcting response deficiencies of tapes, remotes, etc., and also for special effects. Both low and high frequency correction may be made with separate controls which tailor the over-all console response ± 10 dB at 100 Hz and 10,000 Hz. A three position lever key instantly switches in equalization, either continuously or momentarily. In the "out" position the Gatesway II has a superb flat response from 20 to 20,000 Hz.

UNSURPASSED AUDIO: Gates advanced solid state plug-in amplifiers are one of the many reasons for the outstanding performance of the Gatesway II. Audio response is excellent, with distortion at a very low level. Consequently, the Gatesway II provides an audio quality which makes it the perfect console for high fidelity broadcasting.

MODULAR CONSTRUCTION: All amplifiers are packaged in extruded aluminum housings and use plug-in connections. All components are mounted on etched circuit boards to add reliability and contribute to the excellent crosstalk and noise specifications of the console. Silicon transistors are used to allow wide frequency response and assure optimum console performance over a wide ambient temperature range. All amplifiers are completely accessible when the top of the console is opened, simplifying maintenance.

Eight Channel Monophonic Transistor Console—Gateway II

HIGH LEVEL, HIGH FIDELITY OUTPUT: The wide dynamic range of the preamplifiers will accommodate microphone levels from -77 dBm to -17 dBm without overload or distortion. The program amplifiers deliver $+32$ dBm output and the monitor amplifiers $+40$ dBm, all with unsurpassed frequency response, low distortion and low noise.

STYLING: This "second generation" Solid-Statesman console is beautifully styled with anodized front panels, the exclusive Gates VA mixing control knobs, and a cabinet richly finished in beige-gray tones to complement any control room decor. Illuminated program keys complete the over-all leadership look of the Gateway II.

IMMEDIATE ACCESSIBILITY: You can reach every component in the Gateway II with ease. No console made is easier to maintain.

AMPLIFIER INTERCHANGEABILITY: Program, cueing and monitor amplifiers all have the same electrical design and construction and can be interchanged at random. As a result, three backup program amplifiers are provided as part of the console.



SPECIFICATIONS

MIXING CHANNELS: Total—8. Three microphone, two turntables, two tapes and one remote/network.

AMPLIFIERS AND POWER SUPPLIES PROVIDED: Three preamplifiers, three output modules—program, monitor and cue (interchangeable as supplied). Two muting modules (solid state speaker muting), three power supply modules.

OPERATING MODE: Single channel mono with audition positions.

INPUT CIRCUITS: Total—18. Six microphone, four turntables, four tapes, three remote lines, one network.

OUTPUT CIRCUITS: One program output @ $+8$ dBm, one audition output @ -14 dBm, one monitor speaker output unmuted for lobby, three monitor speakers muted, two studio intercom outputs (Studio A, Studio B), and one headphone output.

MONITOR OUTPUT: 8 ohms nominal, for use with only one of the following: (A) A single 8 ohm speaker. (B) Two 16 ohm speakers in parallel. (C) Up to six 48 ohm speakers (using the 48/8 ohm transformers supplied) in parallel. (D) Any combination of speakers and/or transformers with a resultant network impedance of 8 ohms or higher.

IMPEDANCES: Microphones: 30/50 or 150/250 ohms balanced. Turntable/tape: 150/250 ohms unbalanced. Network/remote: 500/600 ohms bal-

anced. Audition output: 600 ohms unbalanced. Monitor output: 8 ohms nominal unbalanced. Program output: 600/150 ohms balanced.

GAIN: Microphone to line: 100 dB ± 2 dB. Medium level to line: 60 dB, ± 2 dB.

RESPONSE: Program and monitor: ± 1.0 dB, 20 Hz to 20 kHz.

DISTORTION: Program circuit: 0.5% maximum, 20 Hz to 20 kHz @ $+18$ dBm. Monitor circuits: 1.0% maximum, 20 Hz to 20 kHz @ $+40$ dBm (10 watts).

NOISE: Program circuits: 74 dB below $+18$ dBm with -50 dBm input (-124 dBm equivalent input noise, measured 20 Hz to 20 kHz). Monitor circuits: 74 dB below $+40$ dBm with -50 dBm input (-124 dBm equivalent input noise, measured 20 Hz to 20 kHz). Medium level inputs: (Program) 74 dB below $+18$ dBm.

POWER: 117 volts, 50/60 Hz, 1-phase.

FINISH: Satin anodized aluminum panels, with lettering in black. Cabinet color—two tone beige-gray.

SIZE: 48 $\frac{1}{4}$ " wide, 17" deep, 8 $\frac{3}{4}$ " high.

SHIPPING DATA: Packed weight: Domestic, 210 lbs. Export, 250 lbs. Cubage, 17.5 cubic feet.

ORDERING INFORMATION

Gateway II, eight channel console, complete with three M-6549B preamplifiers, three M-6550B program/monitor/cue output modules (interchangeable), two M-6554A solid state muting modules, two M-6551B power supply modules, one M-6552 power supply module, one M-6556A transformer panel, and four speaker matching transformers (478-0275)-----994-6541

Eight Channel Monophonic Transistor Console-Gateway II

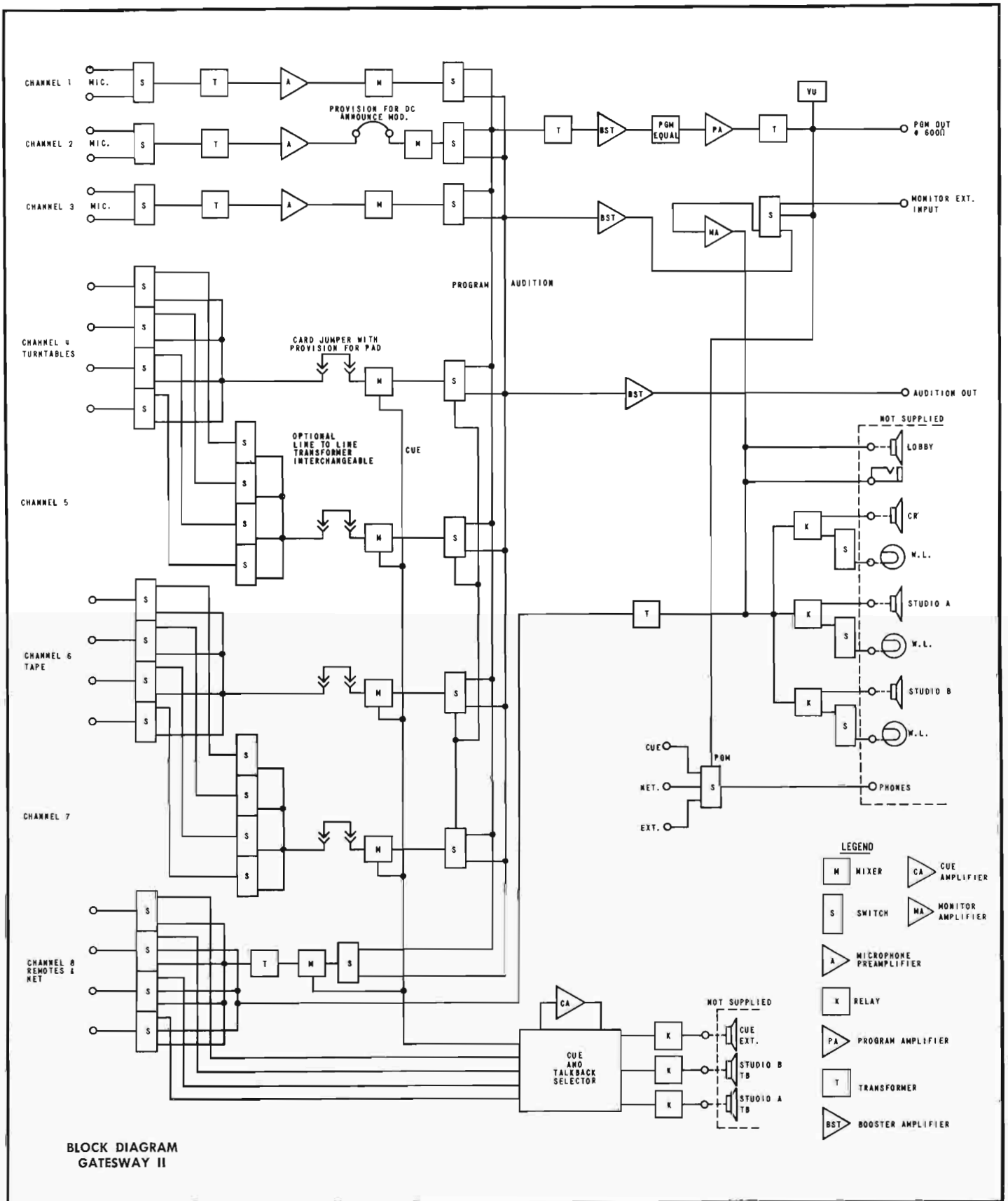

Five Channel Stereo Transistor Console

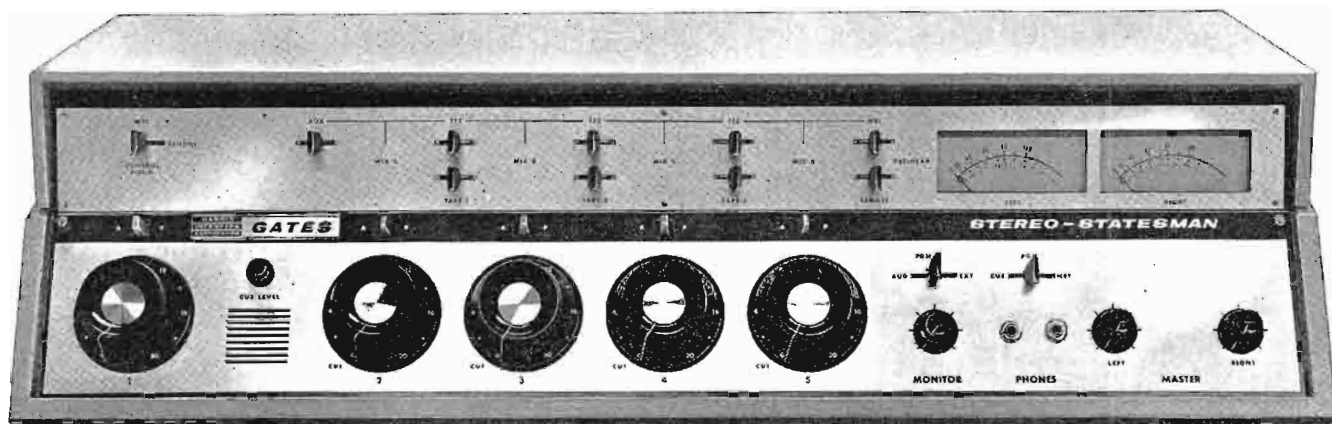

THE STEREO STATESMAN

Designed and built to provide the soundest sound for the new era of FM broadcasting, the completely transistorized Stereo Statesman console is equally at home in the studio of the small market broadcaster, or with the large, metropolitan broadcaster as a production or secondary control board.

The performance figures of this console are at the quality level which builds and holds listeners. Frequency response is 20 to 20,000 Hz with less than 1 dB variation. Distortion is less than 0.5% at all frequencies.

Other important features include: Full logic audio switching; cue/intercom to two studios; all solid state modular amplifiers with printed circuit boards; two monitor amplifiers; illuminated program keys; and Gates exclusive control knobs.

VERSATILE INPUT SWITCHING: Eleven inputs may be switched into the five stereo mixing channels in a manner that satisfies virtually any stereo programming requirement. These inputs can include: two stereo microphone pairs; three stereo turntables; three stereo tape reproducers; one remote; one network and one auxiliary stereo source.

MICROPHONE CHANNEL: Two stereo pairs of microphones may be selected into channel 1. One position is designated "Control Room" and the other position "Studio". Muting is automatically transferred when key is operated.

MEDIUM LEVEL CHANNELS: Channels 2, 3, 4 and 5 may be used for turntables, tape or other medium level inputs. Three tapes, three turntables and one auxiliary source may be switched into these four channels. Each tape and turntable input are switchable to either of two mixers, with tab switches for maximum flexibility. Channel 5 may also select from "Network" or "Remote". If these signals are monophonic, they may be split to drive both the right and left stereo mixer on that channel.

POSITIVE PROGRAM CONTROL: Three-position illuminated key switches above each mixing knob control program selection. The selector key glows green in "audition" position, red in "program" position and amber in center "off" position.

HIGH FIDELITY SOUND: The superb audio qualities of the Stereo Statesman—such as a frequency response of 20 to 20,000 Hz with less than 1 dB variation, and a signal to noise ratio of -74 dB—are achieved through the use of silicon transistors, and low impedance mixing.

AMPLIFIERS: All amplifiers are modular in construction, with plug-in connections for easy interchange and maintenance. Components are mounted on etched circuit boards to increase reliability and contribute to the excellent crosstalk and noise specifications of the console. Silicon transistors assure optimum console performance over a wide ambient temperature range. All amplifiers are completely accessible when the top of the console is opened, simplifying maintenance.

WIDE DYNAMIC RANGE: The preamplifiers in the Stereo Statesman will accommodate microphone levels from -77 to -17 dBm without overload or distortion. The program amplifiers deliver $+32$ dBm output and the monitor amplifiers $+40$ dBm output, all with excellent frequency response, low distortion and low noise.

MONITORING: Two monitor amplifiers, each capable of providing up to 10 watts each ($+40$ dBm) are included. Monitor input is selectable from "program", "audition" or "external source". Muting is provided for control room and studio loudspeakers and the console cue speaker. Conventional high impedance headset jacks for stereophonic headphones are provided on the front of the console and can be switched to monitor program, network or external.

Five Channel Stereo Transistor Console—Stereo Statesman

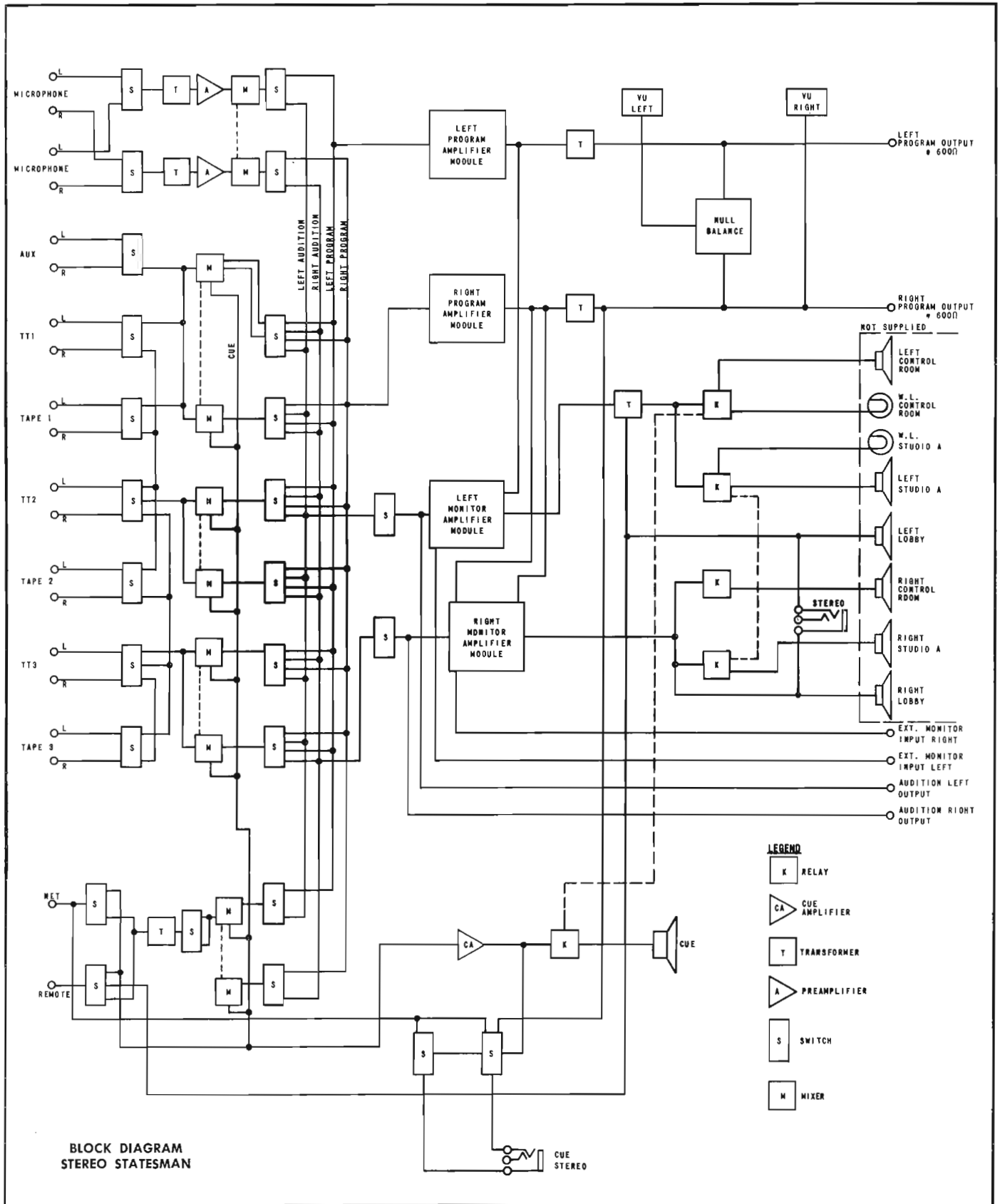

Five Channel Stereo Transistor Console—Stereo Statesman

SPECIFICATIONS

MIXING CHANNELS: Total—5. One microphone. Four tape, turntable, remote or network.

AMPLIFIERS AND POWER SUPPLIES PROVIDED: Two preamplifiers, five program/monitor/cue amplifiers (interchangeable as supplied), three power supply modules.

OPERATING MODE: Stereophonic.

INPUT CIRCUITS: Total—11. Two pairs of stereo microphones, three turntables, three tape, one remote, one network, one auxiliary.

OUTPUT CIRCUITS: Two program outputs at +8 dBm, two audition outputs at -12 dBm, two stereo pair muted speakers (control room, studio), one stereo pair unmuted speakers (lobby), headphone.

IMPEDANCES: Microphones: 30/50 or 150/250 ohms balanced. Turntable/tape: 150/250 ohms. Network/remote: 150/250 ohms. (478-0009 line matching transformer optional). Audition output: 600 ohms. Monitor output: 8 ohms nominal. Program output: 600/150 ohms balanced.

GAIN: Microphone to line: 102 dB, ± 2 dB. Medium level to line: 60 dB, ± 2 dB.

RESPONSE: Program and monitor: ± 1.0 dB, 20 Hz to 20 kHz @ +18 dBm.

DISTORTION: Program circuits: 0.5% maximum, 20 Hz to 20 kHz @ +18 dBm. Monitor circuits: 1.0% maximum, 20 Hz to 20 kHz @ +40 dBm.

NOISE: Program circuits: 74 dB below +18 dBm with -50 dBm input (-124 dBm equivalent input noise measured 20 Hz to 20 kHz). Monitor circuits: 74 dB below +40 dBm with -50 dBm input (-124 dBm equivalent input noise measured 20 Hz to 20 kHz). Medium level inputs: (Program) 80 dB below +18 dBm.

POWER: 117 volts, 50/60 Hz, 1 phase.

FINISH: Satin anodized aluminum panels with lettering in black. Cabinet color—two-tone beige-gray.

SIZE: 36 $\frac{3}{4}$ " wide, 17" deep, 8 $\frac{3}{4}$ " high.

SHIPPING DATA: Packed weight: Domestic, 170 lbs. Export, 210 lbs. Cubage, 13 cubic feet.

ORDERING INFORMATION

Stereo Statesman, five channel stereophonic audio console, complete with two M-6549A preamplifiers, five M-6550A program/monitor/cue modules (interchangeable), one M-6551 and two M-6552 power supply modules, and one M-6556 transformer panel.....994-6540

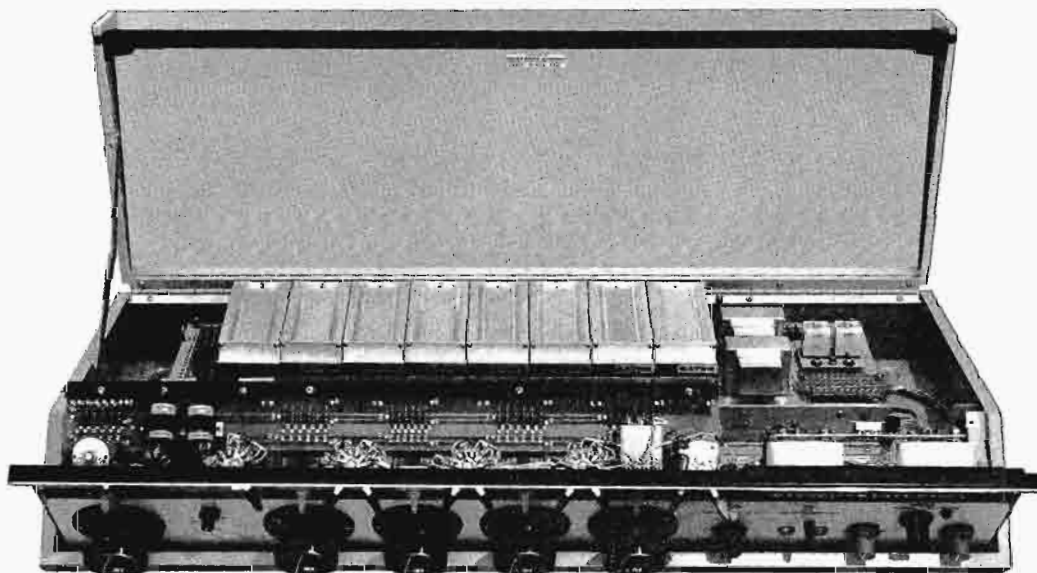

The Stereo Statesman top cover hinges up and the front panel swings down to reveal every "behind the panel" component. This layout and logical access is typical of the complete line of Gates consoles, and reflects the engineering and planning required for neat, professional installations.

Ten Channel Stereo Or Monaural Transistor Console

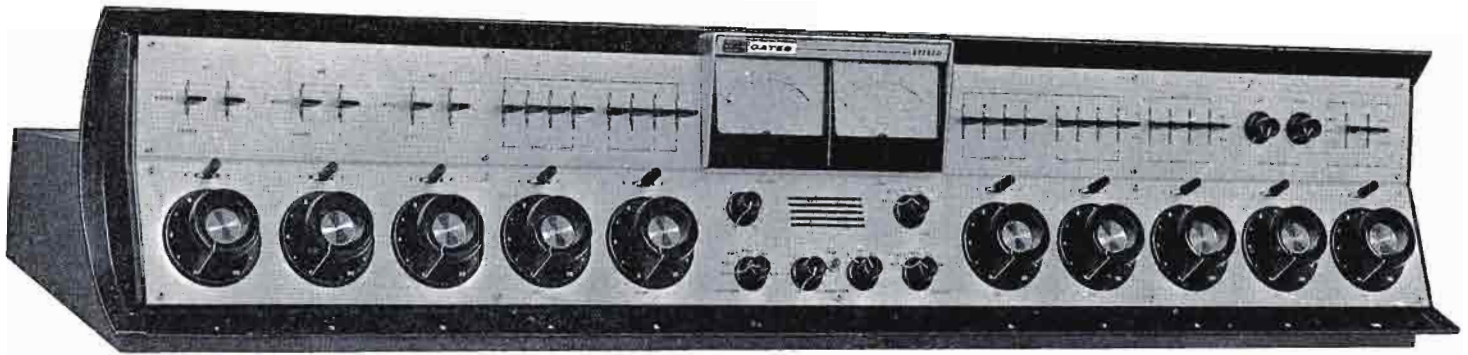

THE EXECUTIVE

With ten full stereo mixers, the dual channel Executive is one of the most complete transistorized audio consoles for stereo or monaural programming on the market today.

Amazingly versatile, this console is a member of Gates Solid-Statesman family—a term applied only to transistorized products that meet the most rigid engineering and manufacturing specifications.

STEREO AND MONAURAL: All ten mixing channels of the Executive are stereo, including network and remote inputs. These channels may also be operated monaurally. By simply adding a third plug-in program amplifier, a compatible “left plus right” signal is available to feed monaural and stereo programming simultaneously to AM and FM (monaural to AM, stereo to FM). Likewise, stereo may be carried on FM with completely different monophonic programming being broadcast on AM.

AMPLIFIERS: The amplifier complement includes six microphone preamplifiers (three stereo pairs), two program amplifiers, two high fidelity monitoring amplifiers, and a cue/intercom amplifier. Also supplied are two audition booster amplifiers, which are part of the internal circuit arrangement. Space is provided for two additional preamplifiers and one additional program amplifier. The power supply is also self-contained and is fully regulated. The amplifiers and power supply are completely solid state.

MIXING SYSTEM: The mixing system contains 10 channels, all with dual (stereo) controls. Channels 1, 2 and 3 are for microphones. Channels 4 and 5 will accept four stereo turntables in any combination, while channels 6 and 7 accommodate four stereo tape inputs. Channel 8 handles four remote lines, and channels 9 and 10 are network and auxiliary channels respectively. The separate fader for incoming network programming is especially convenient for taping delayed broadcast material without tying up the other high-level input to the console. Faders 4 through 10 are all cueing attenuators which feed the inbuilt cue/intercom system.

MICROPHONE INPUTS: Six preamplifiers in three stereo pairs are connected to dual-position input selector keys, permitting 12 microphones (6 stereo pairs) to be selected. Space is provided for two additional M-6034 preamplifiers.

TURNTABLE-TAPE INPUTS: Four turntables may be switched to mixers 4 and 5, and four tape sources may be switched into channels 6 and 7 in any sequence. All faders are stereo, and cue positions are provided on each of these attenuators.

REMOTE-NETWORK INPUTS: Four remote lines may be switched into channel 8 through a line isolation transformer provided. Channel 9 is for network input. Both channels are stereo control equipped, but have removable splitting pads attached for present monophonic signals. Cue positions are provided on these attenuators.

AUXILIARY CHANNEL: This tenth channel has dual line isolation transformers and is uniquely equipped to accommodate extra stereo or monaural functions, either in the studio or from an external source. A cue position is also provided on this fader.

CUE-INTERCOM SYSTEM: An inbuilt cue-intercom amplifier is included, with its speaker centered below the VU meters. The cue signals from mixers 4 through 10 feed the system. The cue-intercom also provides remote talk-back, studio intercom and network preview monitoring. The console muting system also protects against feedback from the cue-intercom speaker.

OPERATING MODES: Stereo only, or monaural only, may be fed to either program or audition mixer circuits. Likewise, monaural FM may be broadcast separately from monaural AM. When the optional M-5700 program amplifier is added, stereo FM and monaural AM may be broadcast either simultaneously, or separately.

Ten Channel Stereo Or Monaural Transistor Console—Executive

VU METERS: Dual 4-inch illuminated meters are provided. The left meter connects to the left channel, while the right meter connects to the right channel (or it may be switched to the output of the optional M-5700 program amplifier). The right meter also switches to parallel the left meter for stereo calibration or to check incoming network level. A third external VU meter, in an attractive "shadow mold" housing, is available for larger installations where simultaneous metering of three program channels is required.

MUTING RELAYS: Three are supplied to mute three pairs of loudspeakers. Warning light contacts are also provided. These relays operate from the microphone keys and cue-intercom system.

ADDITIONAL FACILITIES: These include: dual headphone jacks; a cue-intercom selector switch; left and right master gain controls for the program amplifier; a dual monitoring amplifier gain control; a fully regulated power supply; and 28 tab keys (top row) performing a large number of switching functions.

STYLING: Exclusively styled by one of America's leading industrial designers, the Executive's satin anodized aluminum control panel floats in a 3-dimensional setting, and the "shadow mold" styling is strikingly modern in appearance. The front panel hinges down and the cabinet top cover hinges up.

SPECIFICATIONS

MIXING CHANNELS: Total—10. All stereo. (3) microphone, (2) turntables, (2) tape or projectors, (1) remote, (1) network, (1) all purpose.

AMPLIFIERS PROVIDED: 2 program, 2 booster, 2 monitor, 6 preamplifiers (3 pairs), 1 cue amplifier. Space provided for two optional added preamplifiers and one optional added program amplifier.

OPERATING MODE: Stereo and monaural.

INPUT CIRCUITS: 12 for mics., 4 turntables, 4 tape/projectors, 4 remote lines, 1 network line, 1 all purpose utility.

OUTPUT LINES: 2 program, 6 muted speaker (3 pairs), 2 non-muted speaker, 2 intercom, 2 headphones, 2 record. NOTE: Add one more program output if optional program amplifier is purchased.

IMPEDANCES: Microphones: 30/50 or 150/250 ohms. Turntable/tape: 150/250 ohms unbalanced. Remote lines: 500/600 ohms, balanced. Network: 500/600 ohms. Utility: 500/600 ohms. Programming output: 500/600 ohms. Recording output: 500/600 ohms. Intercom output: 48 ohms. Monitor speaker output: 8/16 ohms.

GAIN: Turntable, tape, network (high level) input to program line output, 55 dB. To monitor amplifier output, 55 dB. From microphone input to program line output, 102 dB. To monitor amplifier output, 102 dB. NOTE: All measurements ± 2 dB.

RESPONSE: All segments of program circuit ± 1 dB, 30-15,000 Hz. Monitoring circuit $\pm 1\frac{1}{2}$ dB, 30-15,000 Hz. NOTE: Typical response all circuits: 20-20,000 Hz, ± 2 dB.

DISTORTION: Any segment of program circuit 0.5% or less between 30-15,000 Hz at +8 dBm output level or 0.5% at +18 dBm, 50-15,000 Hz. Monitor amplifier 1% at +39 dBm (8 watts).

NOISE: Program circuits 70 dB or better below +18 dBm output, with -50 dBm input (equivalent noise input is -120 dBm). Monitor circuits, 60 dB below +39 dBm output. Crosstalk: All circuits below noise level with normal gain settings for proper programming.

STEREO ISOLATION: Below noise level all channels.

POWER: 115 volts, 50/60 Hz, 1 phase. Power consumption, 50 watts at 60 Hz.

FINISH: Cabinet, beige-gray. Panel, natural anodized aluminum lettered in black. Knobs with decal color inserts.

SIZE: 53½" wide, 11½" high, 17½" deep.

SHIPPING DATA: Packed weight: Domestic, 220 lbs. Export, 270 lbs. Cubage: 27 cubic feet.

OPTIONAL ACCESSORIES: Space is provided to add two model 994-6034 preamplifiers, and one model 994-5700 program amplifier.

NOTE: For optimum performance the load on the monitor amplifier should not be less than 8 ohms. Where it is necessary to operate several loudspeakers on one amplifier, use the 478-0275 matching transformer. Four of these transformers are supplied with the console.

ORDERING INFORMATION

Executive Audio Console (includes 4 speaker matching transformers).....	994-6158
Optional Preamplifier.....	994-6034
Optional program amplifier.....	994-5700
Speaker matching transformer.....	478-0275
Optional 3rd VU meter.....	994-6208
Intercom sub-station.....	994-6424



Ten Channel Stereo Or Monaural Transistor Console—Executive

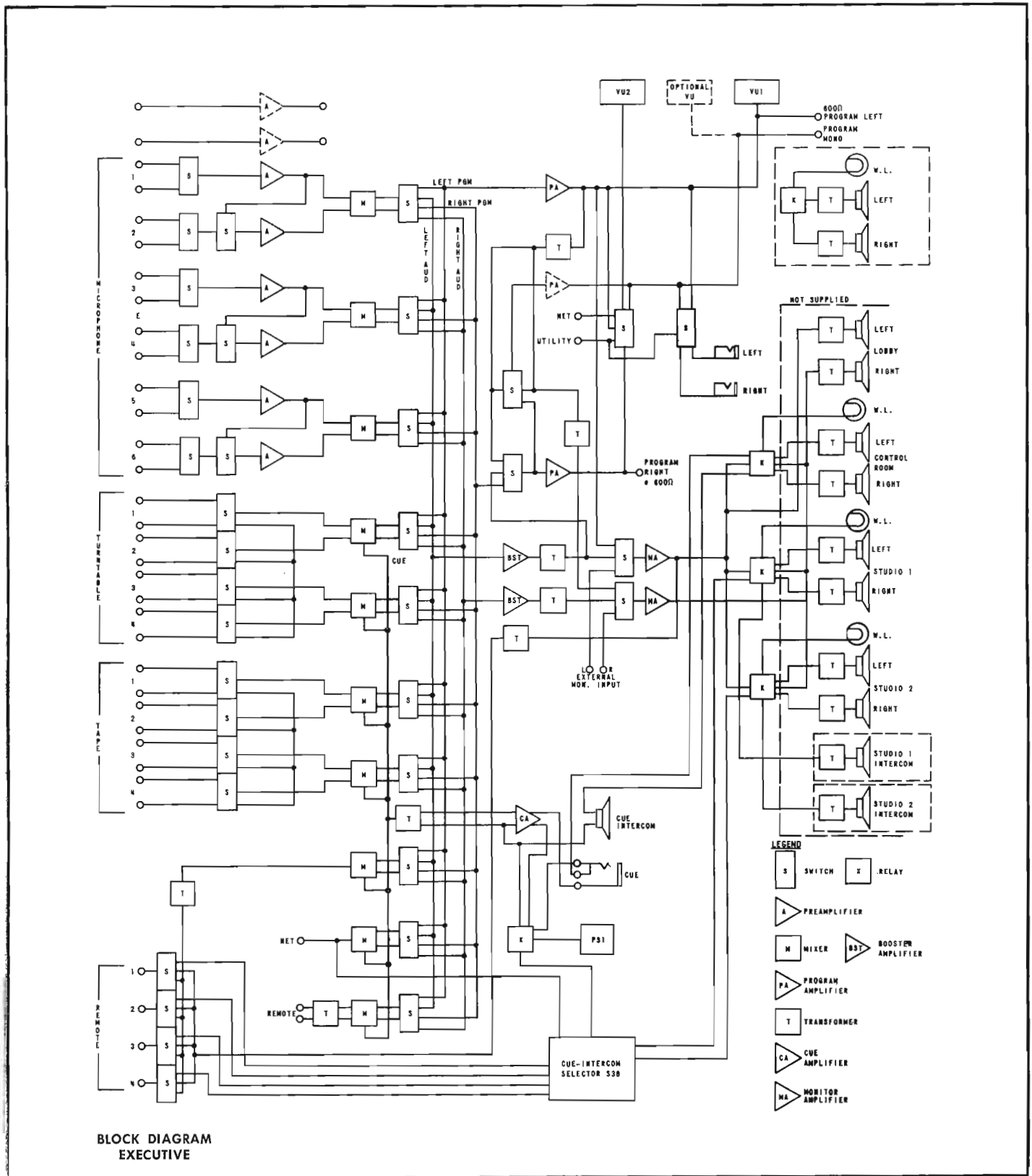

Dual Programming Ten Channel Transistor Console

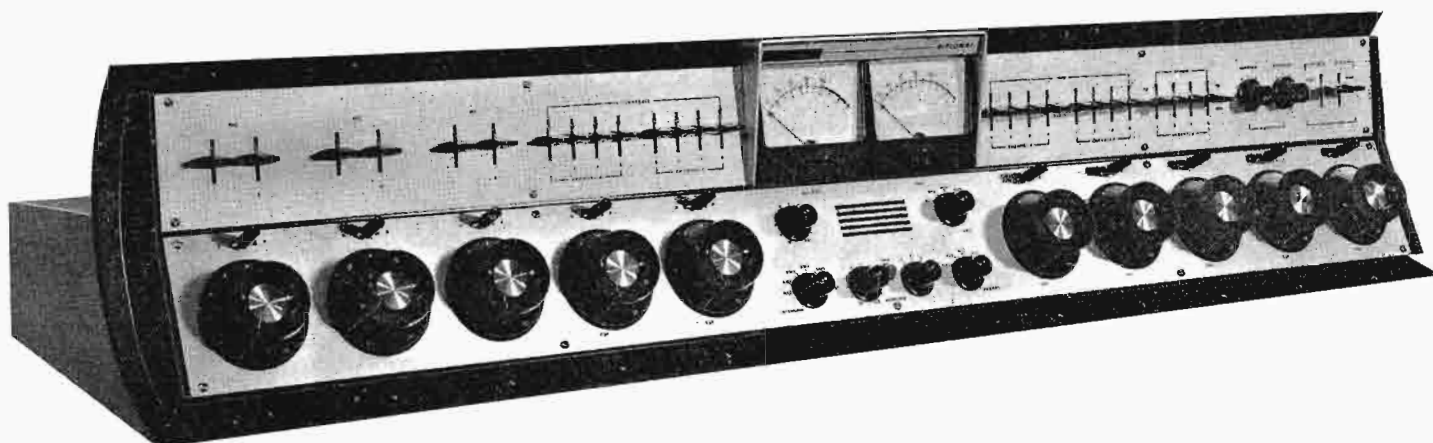

THE DIPLOMAT

The Diplomat is the senior partner in the fully transistorized Gates line of Solid-Statesman monaural consoles. This dual channel console has 10 mixing channels, cue-intercom, 28 upper level tab keys for nearly every conceivable input and output circuit function, and features the VA knob and "shadow mold" styling—designed exclusively for Gates by one of the country's leading industrial stylists.

MIXING SYSTEM: The mixing system is a ten channel, low impedance type, using ladder controls throughout in a minimum loss circuit design. The key switch above each channel control switches the mixer to either program amplifier.

MICROPHONE CHANNELS: Six microphones are tab key selected into 3 preamplifiers and associated mixing channels 1, 2 and 3. Channel keys operate the three muting relays.

TURNTABLE CHANNELS: Mixing channels 4 and 5 handle four turntables into either mixer in any sequence. Four upper level tab keys on each channel select the turntable to be used. Cue position on faders connects any turntable input to the cue amplifier.

TAPE CHANNELS: Mixing channels 6 and 7 handle four tape or projector inputs into either mixer in any sequence. Four upper level tab keys on each channel select the input to be used. Cue position on fader connects any tape input to cue amplifier.

REMOTE CHANNEL: Mixing channel 8 accommodates four remote lines by upper tab key selection. A line isolation transformer is part of this circuit. Cue position on fader connects any remote line to cue amplifier.

NETWORK CHANNEL: Mixing channel 9 is for network or similar input. Cue position on fader connects network to cue amplifier for preview.

AUXILIARY CHANNEL: Mixing channel 10 is for any input source such as a second network or much used remote. This auxiliary channel has a cue position on the fader connected to cue amplifier.

CUE-INTERCOM SYSTEM: The built-in intercom system provides network monitoring, remote over-ride, remote talk-back, studio intercom, turntable cueing, tape cueing and general previewing and cueing. The control room and studio speakers are muted by the channel keys and muting relays when there is a live microphone in any of these locations. The cue amplifier and speaker/microphone is self-contained, and the cue speaker/microphone is located directly under the VU meters.

PROGRAM SWITCHING FUNCTIONS: A single key changes the master operation of the console from simultaneous to separate operation as desired by the operator. Dual program amplifiers are standard equipment. Space is provided for an optional third program amplifier. If the third program amplifier is utilized, this will permit, for example, recording while broadcasting AM and FM simultaneously from the second of the dual channels.

VU METERS: Two 4" illuminated VU meters are supplied. The left meter is connected to program channel 1 at all times. The right meter may be switch selected to (a) program channel 1 for calibration, (b) program channel 2, (c) output of optional third program amplifier, (d) network input, or (e) external connections.

MONITORING AMPLIFIER: The self-contained 8 watt monitoring amplifier input may be switched to (a) output of master program channel, (b) output of program channel 2 or (c) external input. Amplifier output feeds the loudspeaker system.

MUTING RELAYS: Three relays mute speakers and operate studio warning lights in the control room and are controlled from microphone mixer channel keys. Intercom is also interlocked to prevent feedback.

Dual Programming Ten Channel Transistor Console—Diplomat

PHONE JACKS: Phone jacks are provided on a separate mounting plate which attaches to the desk, thus eliminating phone cords over the desk top.

POWER SUPPLY: The power supply is fully regulated and self-contained except for the small AC transformer, which is external to assure extremely low noise.

SERVICING: The Diplomat front panel hinges down and cabinet lid hinges up to expose all components for easy maintenance. All terminations are in the rear.

RECOMMENDED USE: The Diplomat may be described as an unusually wide facility audio console of network or large station caliber. It is excellent for TV as well as radio.

SPECIFICATIONS

MIXING CHANNELS: Total 10. Three microphone, two turntable, two tape/projector, one remote, one network and one auxiliary.

AMPLIFIERS PROVIDED: 2 program, 1 monitor, 3 preamplifiers, 1 cue amplifier. Room provided for 1 additional program amplifier and 2 additional preamplifiers.

OPERATING MODE: Dual channel monaural.

INPUT CIRCUITS: 6 for microphones, 4 turntables, 4 tape/projectors, 4 remote lines, 1 network line, 1 auxiliary line.

OUTPUT CIRCUITS: 2 program, 1 audition, 3 muted speakers, 1 non-muted speaker, 2 intercom, 2 headphones.

IMPEDANCES: Microphones: 30/50 or 150/250 ohms. Turntable: 600 ohms. Tape/projector: 600 ohms. Remote lines: 600 ohms. Network: 600 ohms. Auxiliary: 600 ohms. Programming output: 600 ohms. Audition output: 600 ohms. Intercom output: 48 ohms. Monitor speakers: 8/16 ohms. Recording outputs: 600 ohms.

NOTE: Where more than two loudspeakers are used, it is mandatory that the 478-0275 speaker matching transformer or similar be used with each loudspeaker. This assures correct loudspeaker performance and protects power transistors in the monitoring amplifier.

GAIN: Turntable, tape, network (medium level) input to program line output 55 dB. From microphone input to program line output 102 dB. All measurements ± 2 dB.

RESPONSE: All segments of program circuit ± 1 dB 30-15,000 Hz. Monitoring circuit $\pm 1\frac{1}{2}$ dB 30-15,000 Hz.

NOTE: Typical response: 20-20,000 Hz.

DISTORTION: Any segment of program circuit 0.5% or less between 30-15,000 Hz at +8 dBm output level, or at +18 dBm output 0.5% 50-15,000 Hz. Monitor amplifier 1% at +38 dBm (8 watts). Intermodulation distortion: 0.5% program and 1.0% monitor circuits.

NOISE: Program circuits: 70 dB or better below +18 dBm output, with -50 dBm input (equivalent noise input -120 dBm). Monitor circuits: 60 dB below +39 dBm output. Crosstalk: All circuits below noise level with normal gain settings for proper programming.

POWER: 117 volts, 50/60 Hz, 1 phase. Power consumption 34 watts at 60 Hz.

FINISH: Satin anodized aluminum panel with lettering in black. Cabinet in beige-gray, with shadow mold in black. Knob color insert decal kit included.

SIZE: 53 $\frac{1}{2}$ " wide, 11 $\frac{3}{8}$ " high, 17 $\frac{3}{4}$ " deep.

SHIPPING DATA: Packed weight: Domestic, 220 lbs.; export, 242 lbs. Cubage: 26 cubic feet.

ORDERING INFORMATION

Diplomat audio console complete with four speaker matching transformers	994-6377
Optional program amplifier	994-5700
Optional preamplifier	994-6034
Speaker matching transformer	478-0275
Spare 100% semi-conductor kit	990-0505
Studio cue/intercom speaker	994-6424

IMPORTANT: For optimum performance the load on the monitor amplifier should not be less than 8 ohms. Where it is necessary to operate several loudspeakers on one amplifier, use the 478-0275 matching transformer. Four of these transformers are supplied with the console.



STUDIO CUE-INTERCOM SPEAKER

Beautifully styled to match all Gates Solid Statesman products. Cast aluminum housing in non-reflecting black with heavy fabric grill cloth front. Speaker 600/48 ohms to match console intercom impedances. Size: 5 $\frac{1}{8}$ " wide, 6 $\frac{3}{8}$ " high, 4" deep. ORDER MODEL 994-6424.

Dual Programming Ten Channel Transistor Console—Diplomat

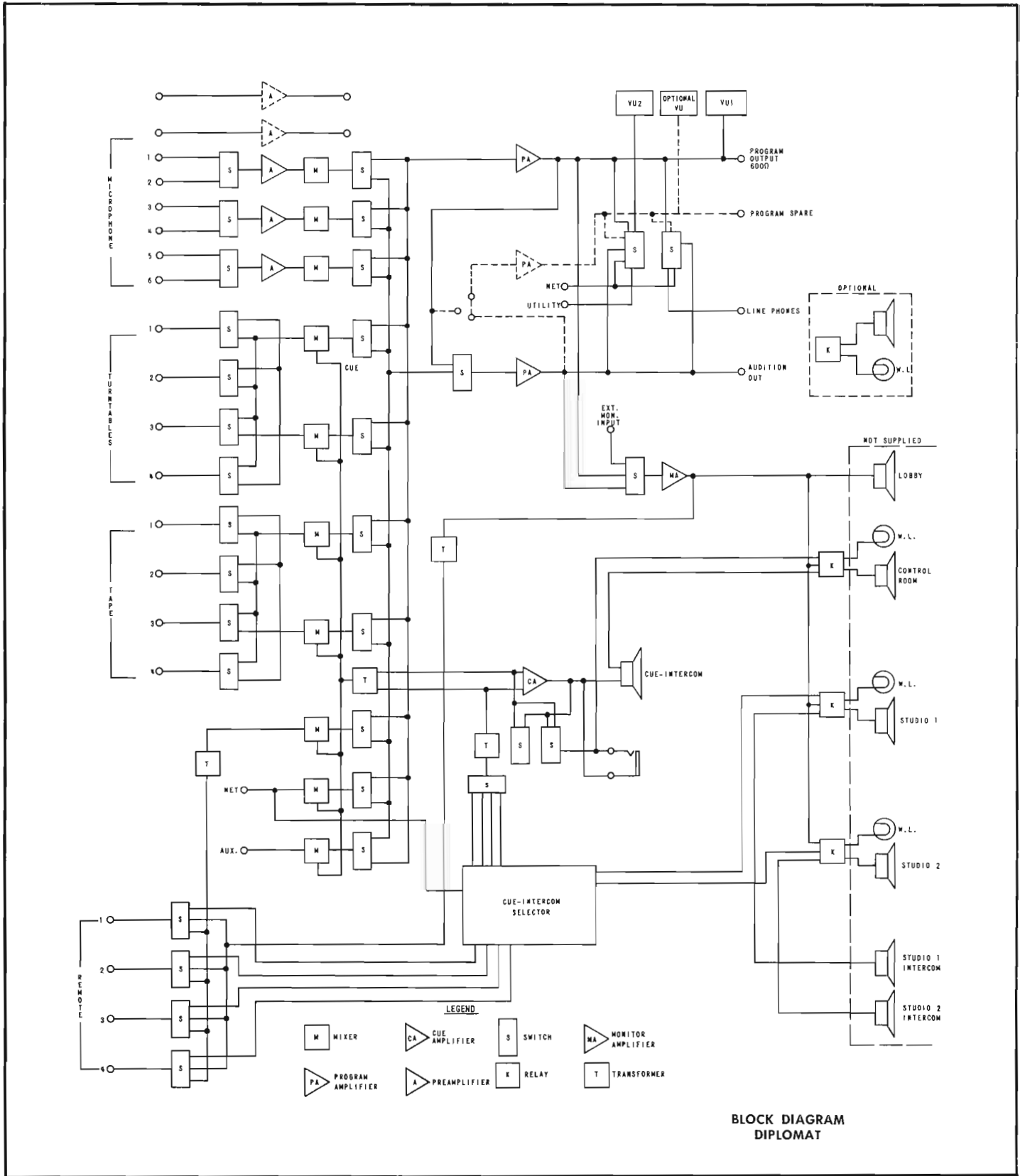

Dual Programming Eight Channel Transistor Console



THE PRESIDENT

The President is a completely transistorized dual channel, 8 mixer audio control console, featuring Gates unique Control Center, with its extreme versatility and operating simplicity. Control Center frees engineers from the mechanics of patching, yet all program inputs are available instantly.

With a full amplifier complement, the President console is particularly well suited for television operation. Six of twelve microphones can be mixed simultaneously, while still providing mixing facilities for the extensive medium level signals in television such as: film projectors, video tape recorders, auxiliary mixers, and the usual turntable, cartridge and reel-to-reel equipment.

MIXING SYSTEM: Eight monophonic mixing channels are provided, utilizing low impedance, ladder type controls. Key selection allows any mixer to feed either program channel. Cue positions are on several controls (see Cue-Intercom System).

MICROPHONE INPUTS: This standard console provides eight microphone inputs switchable into four mixing channels. Channels 3 and 8 each provide two medium level inputs, or may be converted to microphone level by use of the optional plug-in microphone preamplifiers. If the preamplifiers are connected ahead of the input selector switch on these channels, each fader can then fill the dual role of a microphone and medium level channel.

MEDIUM LEVEL INPUTS: Control Center consists of two banks of twelve push keys, plus OFF. The upper bank feeds the left mixer. The lower bank feeds the right mixer. Any push key when depressed automatically releases any other key in the same row. All push keys not in use automatically connect to the cue amplifier/speaker. Each bank of push keys has four red, four white, four blue colors, plus green for OFF.

They may be placed in any sequence, and illuminate when the respective key is depressed. Each push key is numbered with a large block figure. A typewritten identification card,

identifying each source in the system, may be substituted if desired.

Any of twelve medium level circuits may be punched into either mixing channel, assuring full fader control. Two faders do the work of twelve in the President Control Center. Isolation transformers are used in both circuit banks to assure balance, whether the input is in studio or out of studio.

Push key switches, utilizing gold program circuit contacts, provide reliable maintenance-free operation. Silver alloy DC switching contacts used to illuminate the "in use" stations also provide 30 volts DC for the control of external equipment. The Gates KCP-5 relay is available as optional equipment. It has D.P.D.T. contacts and requires 5 mA to operate.

CUE-INTERCOM SYSTEM: A fully interlocked cue-intercom system is incorporated. The cue position of mixing channels 3 and 8, the network input, or any of the twelve pushbutton stations may feed the cue amplifier, regardless of the position of the cue amplifier input selector switch. Completely self-contained, the cueing system also provides talk-back control to two studios and remote lines.

MUTING RELAYS: Speaker muting relays are provided for the control room and two studio speakers. These relays have extra intercom muting contacts to prevent feeding an intercom signal into the studios when a live microphone is in use. The control room muting relay is factory wired to mute the console speaker with any signal source when the control room microphone is in use. A cue phone jack permits headphone monitoring of the cue-intercom circuits at all times. Added contacts are provided for studio warning lights.

AMPLIFIER COMPLEMENT: The President is completely transistorized, incorporating Gates exclusive Solid-Statesman transistor amplifiers. The standard amplifier complement consists of four plug-in microphone preamplifiers, two plug-in program amplifiers, one cue-intercom amplifier, and an 8 watt transistorized monitoring amplifier. Space is provided for two optional additional preamplifiers. The power supply is self-contained and is fully regulated.

Dual Programming Eight Channel Transistor Console—President

The 10 dB overload capacity of the M-5700 program amplifiers used in the President, coupled with at least a 20 dB overload capacity in the microphone preamplifiers, makes the President almost impervious to excessive program levels. A 6 dB line isolation pad permits the connection of this console to highly reactive telephone lines without any noticeable interaction.

The +39 dBm (8 watts) rating of the transistor monitor amplifier is combined with flat response, and low harmonic and intermodulation distortion that is typical of Solid-Statesman engineering.

The regulated power supply protects the console amplifiers from variations due to line and load regulation. In addition, the power supply ripple is reduced to insure uniformly low noise in all of the console circuits. The power supply is short-circuit protected to prevent damage during operation or maintenance.

VU METERS: Four-inch, illuminated VU meters provide visual monitoring of both output channels. The meters can be mounted anywhere along the top rail of the console, or placed on the console desk.

SPECIFICATIONS

MIXING CHANNELS: Total—8. Monophonic.

AMPLIFIERS PROVIDED: 2 program, 1 monitor, 4 preamplifiers, 1 cue/intercom amplifier. (2 additional preamplifiers optional).

OPERATING MODE: Dual channel monaural.

INPUT CIRCUITS: 8 microphones into 4 preamplifiers, standard. 12 microphones into 6 preamplifiers, by use of two optional preamplifiers. 11 turntables, tape, projector or external inputs into 2 mixers. 4 remote lines. One network line into 1st "Control Center" push key.

OUTPUT LINES: 2 program lines, 3 muted speaker outputs, 1 unmuted speaker output, 2 interlocked studio intercom speakers, 1 intercom, 2 headphone outputs.

IMPEDANCES: (Input) Mics: 30/50 or 150/250 ohms. Mixing channels 3 and 8: 600 ohms unbalanced if optional preamplifiers are not used. (Output) 2 program lines each 500/600 ohms. Monitor amplifier: 8/16 ohms. Intercom speakers: 45 ohms.

GAIN: Microphone input to line output: 104 dB \pm 3 dB. Turntable input to line output: 56 dB \pm 2 dB. Microphone input to speaker output: 104 dB minimum. Turntable input to speaker output: 56 dB minimum.

RESPONSE: Rated \pm 1.0 dB from 30 to 15,000 Hz in all regular program circuits. Capable: 20-20,000 Hz. Rated \pm 1.5 dB from 30 to 15,000 Hz in all monitoring speaker circuits. Capable: 20-20,000 Hz.

DISTORTION: Rated 0.5% maximum, 30 to 15,000 Hz at +8 dBm output in all regular program circuits. Capable: 20-20,000 Hz. Rated 0.5% maximum, 50 to 15,000 Hz at +18 dBm output in all regular program circuits. Rated 1.0% maximum, 50 to 15,000 Hz at +39 dBm (8 watts) in speaker outputs. Capable: 1% or less 20-20,000 Hz at +38 dBm.

NOISE: Program circuits, 70 dB or better below +18 dBm with -50 dB input (equivalent noise input is -120 dBm). Turntable, tape and all Control Center input circuits 70 dB below +18 dBm output. Monitoring circuits 60 dB below +39 dBm output.

CROSSTALK: Below noise level in all channels.

POWER: 115 volts, 50/60 Hz, 44 watts.

FINISH: Panel, natural aluminum with knobs and lettering in black. Cabinet color—beige-gray. Mixer knobs supplied with decal color insert kit. Control Center knobs in four colors and illuminated.

SIZE: 52½" wide, 11½" high, 17½" deep.

SHIPPING DATA: Weight packed: domestic, 220 lbs.; export, 290 lbs. Cubage: 27 cubic feet.

OPTIONAL ACCESSORIES: Space provided for 2 added M-6034 plug-in amplifiers.

ORDERING INFORMATION

The President, dual channel audio control console, includes 2 external VU meters, 4 speaker matching transformers, 4 mic preamps, monitor amplifier, cue amplifier, and 2 program amplifiers	994-6209
Optional plug-in microphone preamplifiers	994-6034
External VU meter with housing	994-6208
Intercom sub-station, deluxe	994-6424
Spare 100% semi-conductor kit	990-0503
Speaker matching transformer	478-0275
KCP-5 Relay, 30 volt D.P.D.T. to start-stop external equipment	994-6482

Five Channel Monophonic Transistor Console



THE AMBASSADOR

A premium quality Solid-Statesman console, the Ambassador features Gates exclusive Control Center, plus superb electrical performance and great operating versatility in a compact size.

The unique Control Center has two mixing channels doing the work of 12. This, combined with the multiple microphone facilities, cue-intercom and many other features, results in a fine console for use in AM, FM and TV broadcasting.

AMPLIFIER COMPLEMENT: The Ambassador is completely transistorized, incorporating Solid-Statesman plug-in transistor amplifiers to meet superior performance and reliability standards. It includes: (2) plug-in microphone preamplifiers (space provided for optional 3rd preamplifier), (1) plug-in program amplifier, (1) plug-in audition booster amplifier, (1) plug-in cue/intercom amplifier and (1) eight-watt monitoring amplifier. The preamplifiers have a full 20 dB overload capacity. The distortion is actually lower than that of many test oscillators. The program amplifier has a full 10 dB overload factor above the +14 dBm rating used to feed the 6 dB line isolation pad to the program line. Performance standards are not altered by substantial level variations and high telephone line reactances, and provide quality that only the more sophisticated test systems are capable of measuring.

The monitoring amplifier provides a full +39 dBm (8 watts) output to the speakers with low harmonic and intermodulation distortion. The response of all amplifiers is flat over a wide audio spectrum. An isolation transformer bridges the output of the monitor amplifier for emergency program feed and remote program cue. The cue-intercom system is peaked for maximum intelligibility.

A fully regulated power supply protects the console amplifiers from variations due to line and load regulation. Power supply ripple is reduced almost to the point of non-existence to assure uniformly low noise in all of the console circuits.

The power supply is also protected to prevent damage to any of the transistors in either the power supply or amplifiers from a momentary or sustained short in any of the load circuits.

MIXING SYSTEM: Five monophonic input mixing channels are provided, utilizing low impedance, ladder-type controls. The Ambassador accommodates 22 inputs with expansion facilities to 31 by using the three unwired utility switches left available for the user. Key selection allows any mixer to feed program amplifier or audition output through the audition booster amplifier.

CONTROL CENTER: The heart of the Ambassador is Control Center, operating into mixers 4 and 5. It consists of two rows of 12 push-keys, plus an OFF key, with the upper bank of 12 push-keys feeding the left mixer (#4) and the lower bank of 12 push-keys feeding the right mixer (#5). Any push-key, when depressed, automatically releases any other key in the same row. Any push-keys which are not feeding either mixer 4 or 5 are connected to the cue amplifier/speaker. Push-keys are color-coded for convenience in identifying inputs such as turntables, tapes, etc.

To further expand the medium level facilities in the Ambassador, push-key #1 selects from any one of four remote lines or network as switched by the upper row tab keys above the Control Center. A large, numbered designation strip between the push-key rows may be replaced with typewritten identification cards. Any of the 12 circuits may be switched into either mixing channel, assuring full fader control.

The 30 volt circuit for illumination of each push-key is also brought to a pair of terminals. In this manner, the push-keys may start a mechanical device such as a Criterion, projector or turntable at the same time as the audio is engaged. A relay kit (994-6482) is available for this service and is listed on the next page.

Five Channel Monophonic Transistor Console—Ambassador

Mixing channels one through three provide six more inputs for either microphone or medium-level signals. The standard Ambassador is equipped with two plug-in preamplifiers to accommodate up to four studio and control room microphones through faders 1 and 2. Fader 3 has a cueing attenuator and is for medium-level inputs. Provision for a third, optional, plug-in preamplifier is included. This optional 994-6034 preamplifier may be connected ahead of the input selector switch of channel three for a dual function of microphone input plus medium-level input—or, it may be wired after the input selector to provide two additional microphone inputs.

CUE/INTERCOM SYSTEM: The inbuilt cue/intercom system permits preview listening from all Control Center circuits such as remotes, network, turntables, tapes, projectors. In addition, preview from mixing channel 3 and auxiliary is provided. Talk back is possible to two studios, remote lines and a spare input circuit. The 994-6424 sub-station listed below is suggested for studio use in talk back service.

MUTING RELAYS: Three muting relays, energized by microphone channel keys, disconnect loudspeakers adjacent to a live microphone, provide contacts for warning lights and

additional contacts to mute the intercom system when a studio is in use. A cue phone jack is provided to allow headphone monitoring of cue circuits where necessary.

MOVABLE VU METER: Mounted in a cast aluminum housing, the illuminated VU meter may be located where desired—along the top rail of the console cabinet or at either side of the console. In this way, the VU meter may be placed in the most convenient visual location, which varies from one station to another. A connecting cable and plug is part of the meter assembly.

VERSATILITY: The creative design of the Ambassador makes it very nearly a custom console. Control Center, with its array of 24 illuminated touch control keys into two channels, plus 3 additional mixing inputs with their associated switching, and three utility keys, provides many exciting possibilities in audio control.

The VA mixer knob is used on all faders. Designed first in similar style for the Voice of America Studios, it is a substantial advance in the "feel-of-the-board" concept. "Shadow-mold" styling is from one of America's leading industrial stylists, engaged by Gates for the Solid-Statesman line of equipment.

SPECIFICATIONS

MIXING CHANNELS: Total—5. Monophonic.

AMPLIFIERS PROVIDED: 1 plug-in program, 1 plug-in booster, 1 eight-watt monitor, 2 plug-in preamplifiers, 1 plug-in cue amplifier.

OPERATING MODE: Single channel monaural.

INPUT CIRCUITS: 4 microphones into 2 preamplifiers, as supplied; 6 microphones into 3 preamplifiers, 3rd preamplifier optional; 12 turntables, tape, projector, or any medium-level input into 2 mixers; 4 remote lines; 1 network line.

OUTPUT LINES: 1 program, 1 audition, 3 muted speaker, 1 non-muted speaker, 2 studio intercom, 1 spare intercom.

IMPEDANCES: Microphones 30/50 or 150/250 ohms; turntable/tape 600 ohms unbalanced; remote lines 600 ohms; network 600 ohms; programming output 600 ohms; audition output 600 ohms; intercom output 45 ohms; monitor output 8-16 ohms.

GAIN: Turntable, tape, network (high level) input to program line output 56 dB. To monitor amplifier output 56 dB minimum. From microphone input to program line output 104 dB. To monitor amplifier output 104 dB minimum. Note: All measurements ± 2 dB.

RESPONSE: All segments of program circuit: ± 1.0 dB, 30-15,000 Hz. Ca-

pable: 20-20,000 Hz. Monitoring circuit ± 1.5 dB, 30 to 15,000 Hz. Capable: 20-20,000 Hz.

DISTORTION: Any segment of program circuit 0.5% or less between 30-15,000 Hz at +8 dBm output level. Capable: 20-20,000 Hz. Monitor amplifier: 1.0% between 30-15,000 Hz, at +39 dBm (8 watts output level). Capable: 20-20,000 Hz.

NOISE: Program circuits: -70 dB or better below +18 dBm output, with -50 dBm (equivalent noise input is -120 dBm). Monitor circuits: 60 dB below +39 dBm output. Crosstalk: All circuits below noise level with normal programming gain settings.

POWER: 117 volts, 50/60 Hz, single phase. Power consumption 40 watts at 60 Hz.

FINISH: Panel: Natural satin anodized aluminum with black nomenclature. Decal color insert kit supplied for mixer knobs. Cabinet: beige-gray with black trim.

SIZE: 37½" long, 11¾" high, 17¾" deep.

SHIPPING DATA: Packed weight: Domestic, 245 lbs.; export, 265 lbs. Cubage: 20.5 cubic feet.

OPTIONAL ACCESSORIES: Space is provided to add, when desired, one model 994-6034 preamplifier.

ORDERING INFORMATION

Ambassador, single channel console, complete with 2 preamplifiers and 4 speaker matching transformers.....	994-5564
Extra plug-in microphone preamplifier.....	994-6034
Intercom sub-station, deluxe.....	994-6424
Speaker matching transformer.....	478-0275
Relay kit for use with Control Center to start mechanical device.....	994-6482
Spare 100% semi-conductor kit.....	990-0499
Plug-in jumper board.....	913-6060

NOTES: (1) Four speaker matching transformers are supplied with each console. If more than 4 speakers are to be used, order an added 478-0275 transformer for each added speaker. (2) If it is desired to use mixing channels 1 or 2 as medium level inputs, order 913-6060 plug-in jumper board to replace preamplifiers.

Eight Channel Monophonic Transistor Console

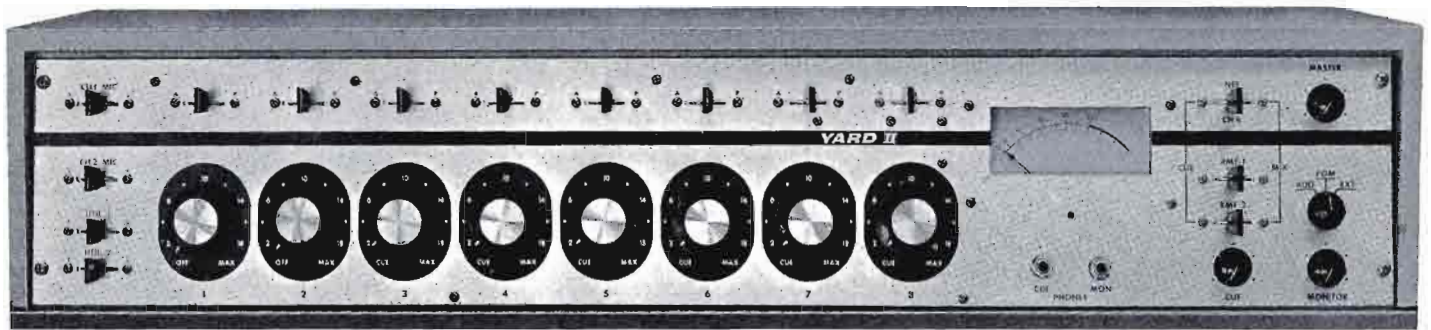

THE YARD II

Successor to the famous Yard console, the new Yard II now offers even greater versatility with the added reliability of total solid state design. Just over a yard wide, Gates Yard II console offers 12 inputs into 8 mixing channels. It is ideal as a full control facility for smaller AM and FM monophonic stations and a perfect submaster control or production console in larger operations. The low silhouette styling is a definite "plus" for television use.

Functionally arranged, the eight mixing channels are in the center of the board with the meter to the right, along with master gain controls. Preamplifiers used on microphone channels 1 and 2 may select from two low impedance microphones on each input. Five medium level channels can be used with any sources, such as turntables, tape recorders, etc. The eighth channel is specifically designed for use with network and two remote sources, and separate front panel switches provide selection of any of these inputs.

INDEPENDENT CHANNEL MONITORING AND RECORDING: Any of the 8 input channels may be switched to either the program or audition position to permit independent monitoring or recording of any incoming sources without disturbing programming.

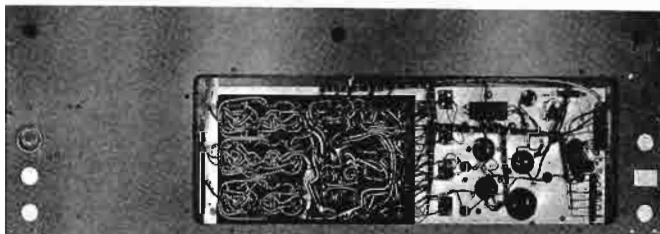

All wiring on the printed circuit board is accessible through a removable cover plate on the bottom of the console. The entire console is hinged to permit easy access.

HIGH FIDELITY PERFORMANCE: Frequency response of the Yard II is uniform ± 1 dB from 30 to 15,000 Hz. Noise is better than 73 dB below normal output with crosstalk below the noise at normal levels and control settings. Distortion is less than 0.75% from 30 to 15,000 Hz at a $+18$ dBm output.

LOW SILHOUETTE STYLING: Only 8½ inches high, the Yard II offers an excellent over the top view, especially adaptable for TV operation.

ACCESSIBILITY: All components can be quickly reached through the lift off top. The entire console is hinged at the rear for complete access to the under side of the console.

INPUTS: Four microphones, five medium level inputs, and three external line inputs. Cue bus is connected to mixers 3 through 8 to provide rapid cueing on all six channels.

CUE AMPLIFIER: Built-in cue speaker in the top of the console provides cue from channels 3 through 8 to either the speaker built into the console or through the separate cue headphone jack.

BOOSTER AMPLIFIER: A monitor booster amplifier is provided as standard equipment to allow switching the monitor amplifier from program to audition without changing level.

MUTING RELAYS: Two muting relays are supplied to operate warning lights as well as muting of the control room and studio speakers. A terminal strip on the console permits flexible selection of muting relay operation by simply changing jumper wires.

VU METER: A four-inch illuminated 'B' scale VU meter is flush mounted with the Yard II front panel for accurate level measurement.

COLOR CODED CONTROLS: Mixer knobs are supplied with various colored disc inserts to color code controls such as red for turntables, green for studio A, etc.

COMPACT AND LIGHTWEIGHT: The 38" Yard II console is one of the most compact, full facility consoles ever produced. It measures 38" wide, 8½" high, and 13" deep, and weighs only 54 pounds.

Eight Channel Monophonic Transistor Console—Yard II



Complete access to all components is via the easily removed cover of the Yard II. All input and output connections can be made through the rear or the bottom of the console. Convenient knock-outs on the rear apron provide entry for wiring cables.

SPECIFICATIONS

GENERAL

MIXING CHANNELS: Total of eight, all monaural. Two microphone, five medium level, one network/remote.

AMPLIFIERS PROVIDED: Two preamplifiers, two booster amplifiers, one program amplifier, one monitor amplifier, and one cue amplifier.

OPERATING MODE: Monaural.

INPUT CIRCUITS: Four for microphones, two for turntables, two for tape, one utility, three for network/remote.

OUTPUT LINES: One program, two muted speaker, one non-muted speaker, one cue speaker (muted), two headphone (monitor and cue).

MICROPHONE (CH. 1 & 2) TO PROGRAM LINE OUT

MAXIMUM GAIN: 103 ± 2 dB.

FREQUENCY RESPONSE: ± 1 dB, 30 to 15,000 Hz.

DISTORTION: Less than 0.75%, 30 to 15,000 Hz, at +18 dBm output.

NOISE: More than 73 dB below +18 dBm output with -50 dBm input. Equivalent input noise is better than -123 dBm, 30 to 15,000 Hz.

CROSSTALK: Below noise level, with normal levels and control settings.

MICROPHONE IMPEDANCE: 30/50 or 150/250 ohms, balanced.

MEDIUM LEVEL (CH. 3-7) TO PROGRAM LINE OUT

MAXIMUM GAIN: 63 ± 2 dB.

FREQUENCY RESPONSE: ± 1 dB, 30 to 15,000 Hz.

DISTORTION: Less than 0.75%, 30 to 15,000 Hz at +18 dBm output.

NOISE: More than 73 dB below +18 dBm output with -10 dBm input, 30 to 15,000 Hz.

CROSSTALK: Below noise level, with normal levels and control settings.

INPUT IMPEDANCE: 150 ohms, unbalanced.

NETWORK/REMOTES (CH. 8) TO PROGRAM LINE OUT

MAXIMUM GAIN: 43 ± 2 dB.

FREQUENCY RESPONSE: ± 1 dB, 30-15,000 Hz.

DISTORTION: Less than 0.75%, 30 to 15,000 Hz at +18 dBm output.

NOISE: More than 73 dB below +18 dBm output with +10 dBm input, 30 to 15,000 Hz.

CROSSTALK: Below noise level, with normal levels and control settings.

INPUT IMPEDANCE: 600 ohms, balanced.

MONITOR CIRCUITS

***GAIN:** Mic. —Pgm. —Mon. Out 124 ± 2 dB
Mic. —Aud. —Mon. Out 106 ± 2 dB
Med. —Aud. —Mon. Out 66 ± 2 dB
Ext. Mon. —Mon. Out 46 ± 2 dB

*Approximately 11 dB additional gain is available by shorting out the R37, 10,000 ohm resistor, connected between the Monitor Selector Switch and the Monitor Gain control.

FREQUENCY RESPONSE: ± 1 dB, 30 to 15,000 Hz.

DISTORTION: Less than 1%, 30 to 15,000 Hz at +40 dBm (10 watts) output.

NOISE: More than 73 dB below +40 dBm (10 watts) output, 30 to 15,000 Hz.

CROSSTALK: Below noise level, with normal levels and control settings.

POWER REQUIREMENTS

LINE VOLTAGE AND FREQUENCY: 117V (as shipped) /234V, 50/60 Hz.

POWER CONSUMPTION: 60 watts, maximum.

PHYSICAL SIZE

CONSOLE: 38" wide, 13" deep, 8½" high.

CONSOLE WEIGHT: 54 lbs.

POWER TRANSFORMER: Approximately 6½" long x 4" wide x 3½" high.

ORDERING INFORMATION

Yard II Audio Console994-6616

Eight Channel Monophonic Transistor Console—Yard II

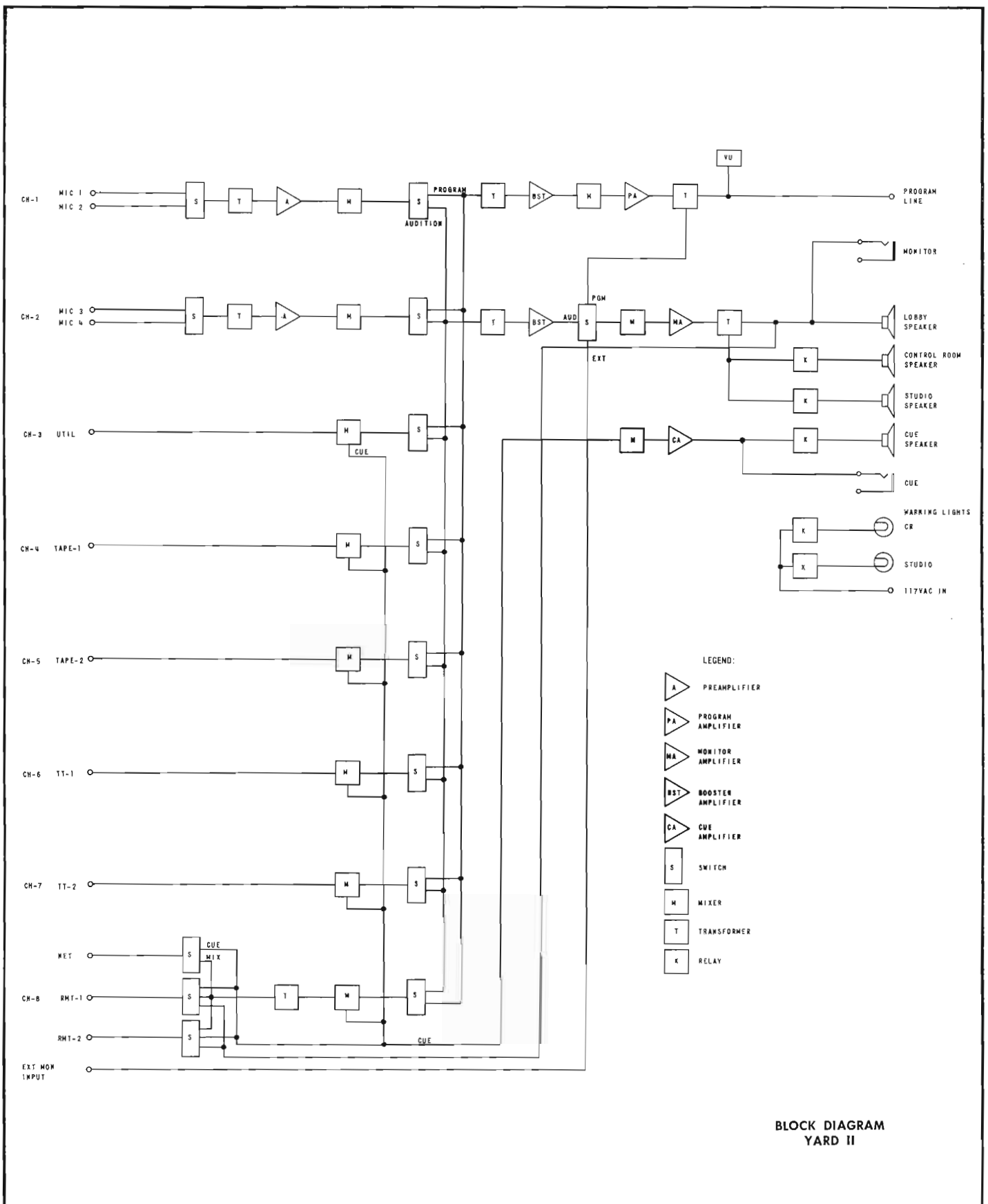

Eight Channel Monophonic Console



THE GATESWAY

Broadcasting's most widely used audio control console, the Gatesway, is in daily use in hundreds of AM, FM and TV stations the world over. A complete high fidelity speech input system, the Gatesway provides for easy audio control of multiple studios, and control room, with generous facilities for turntables, tape, cartridge tape, network and remote program sources.

Eight mixing channels handle 5 microphones, 4 turntables, 4 tape/projectors, 4 remote lines and network. A total of 18 inputs are provided. Inbuilt cue-intercom with speaker/microphone located in the center of the console allows preview of remote lines, turntables, tape/projectors, audition bus and one external line—plus talk back to studios and remote lines.

Another feature is the variable hi-pass filter for quick improvement of a low quality audio circuit, such as a poor telephone line or tape playback. Four preamplifiers, program amplifier, a 10-watt monitoring amplifier, cue-intercom amplifier and a fully regulated power supply are all standard equipment. Designed for maximum flexibility, 27 keys accommodate 52 switching functions. A study of the functional diagram will reveal facility after facility available to accommodate varied circuit combinations. Five unwired utility keys are provided for the specific needs of each individual broadcaster.

AMPLIFIERS: Preamplifiers, program and monitor amplifiers are all wide response, low noise units with an abundance of gain. The monitor amplifier is of the ultra-linear type, with 1% maximum distortion at full output of 10 watts.

CUE SELECTOR: Rotary switch selects cue speaker/amplifier for talk or listen to three studios, remote lines, and utility line. This selector switch provides monitoring to turntables, tapes, audition bus and one external source.

UTILITY KEYS: Five D.P.D.T. unwired upper level tab keys are provided for custom designed application.

OUTPUT EMERGENCY KEY: In case of failure in the program amplifier, the monitor amplifier may be instantly switched into the program circuit.

MONITOR INPUT KEY: This input key permits switching monitor input to (a) program amplifier output, (b) audition bus, and (c) external input.

MUTING: Three relays are provided to mute speakers in three studios and operate warning lights. Additional space is provided for two optional added relays for customers' particular needs.

POWER SUPPLY: Power supply is fully regulated and mounted on separate 19" x 7" rack panel. This panel also houses the 10-watt ultra-linear monitor amplifier and muting relays.

SPECIFICATIONS

MIXING CHANNELS: Total—8. Four microphone, two turntable*, one tape/network* and one remote*.
*Cue position on mixer faders.

AMPLIFIERS PROVIDED: 1 program, 1 monitor, 4 preamplifiers, 1 cue amplifier.

OPERATING MODE: Single channel monaural.

INPUT CIRCUITS: 5 microphones, 4 turntables, 4 remote lines, 1 network line, 4 tape/projectors, 1 external monitor input.

OUTPUT LINES: 1 program, 1 audition, 3 muted speaker, 1 non-muted speaker, 3 intercom.

IMPEDANCES: Microphones 30/50, 150/250 ohms. Turntable 150/250 ohms, unbalanced. Tape, network and remote lines 600 ohms. External monitor input 150 ohms. Programming output 600 ohms. Audition output 150 ohms. Intercom output 600 ohms. Monitor speakers 8-16 ohms.

NOTE: Where more than two loudspeakers are used, the 478-0275 speaker matching transformer should be used (see "Ordering Information").

GAIN: Turntable, tape, network (high level) input to program line output, 60 dB. From microphone input to program line output 104 dB. Monitor gain in excess of output capability in all circuits. All measurements ± 2 dB.



Eight Channel Monophonic Console-Gateway

SPECIFICATIONS (continued)

RESPONSE: All segments of program circuit $\pm 1\frac{1}{2}$ dB 30-15,000 Hz. Monitoring circuit ± 2 dB 30-15,000 Hz.

DISTORTION: Any segment of program circuit 1% or less between 30-15,000 Hz at +8 dBm output level or $1\frac{1}{2}\%$ at +18 dBm output. Monitor amplifier 1% at +40 dBm (10 watts).

NOISE: Program circuits: 70 dB or better below +18 dBm output, with -50 dBm input (equivalent noise input is -120 dBm). Monitor circuits: 60 dB below +40 dBm output. Crosstalk: All circuits below noise level with normal gain settings for proper programming.

POWER: 117 volts, 50/60 Hz, 1 phase. Power consumption 105 watts at 60 Hz.

FINISH: Cabinet: beige-gray.

SIZE: Console: 39" wide, 7 $\frac{1}{2}$ " high, 15" deep. Power/monitor unit: 19" wide, 7" high, 8" deep.

SHIPPING DATA: Packed weight: Domestic, 175 lbs.; export, 265 lbs. Cubage: 12 cubic feet.

TUBES: (13) EF86/6267, (4) 12AX7, (2) EL84, and (1 each) 12AU7, 6AK6, 6080, GZ34, OA2.

OPTIONAL ACCESSORIES: Space is provided to add, when desired, one model 994-5304 preamplifier.

ORDERING INFORMATION

Gateway audio console complete.....	994-5133
100% spare tube kit.....	990-0451
Optional preamplifier.....	994-5304
Speaker matching transformer.....	478-0275
Studio cue/intercom speaker.....	994-6424
Extra muting relay.....	572-0038

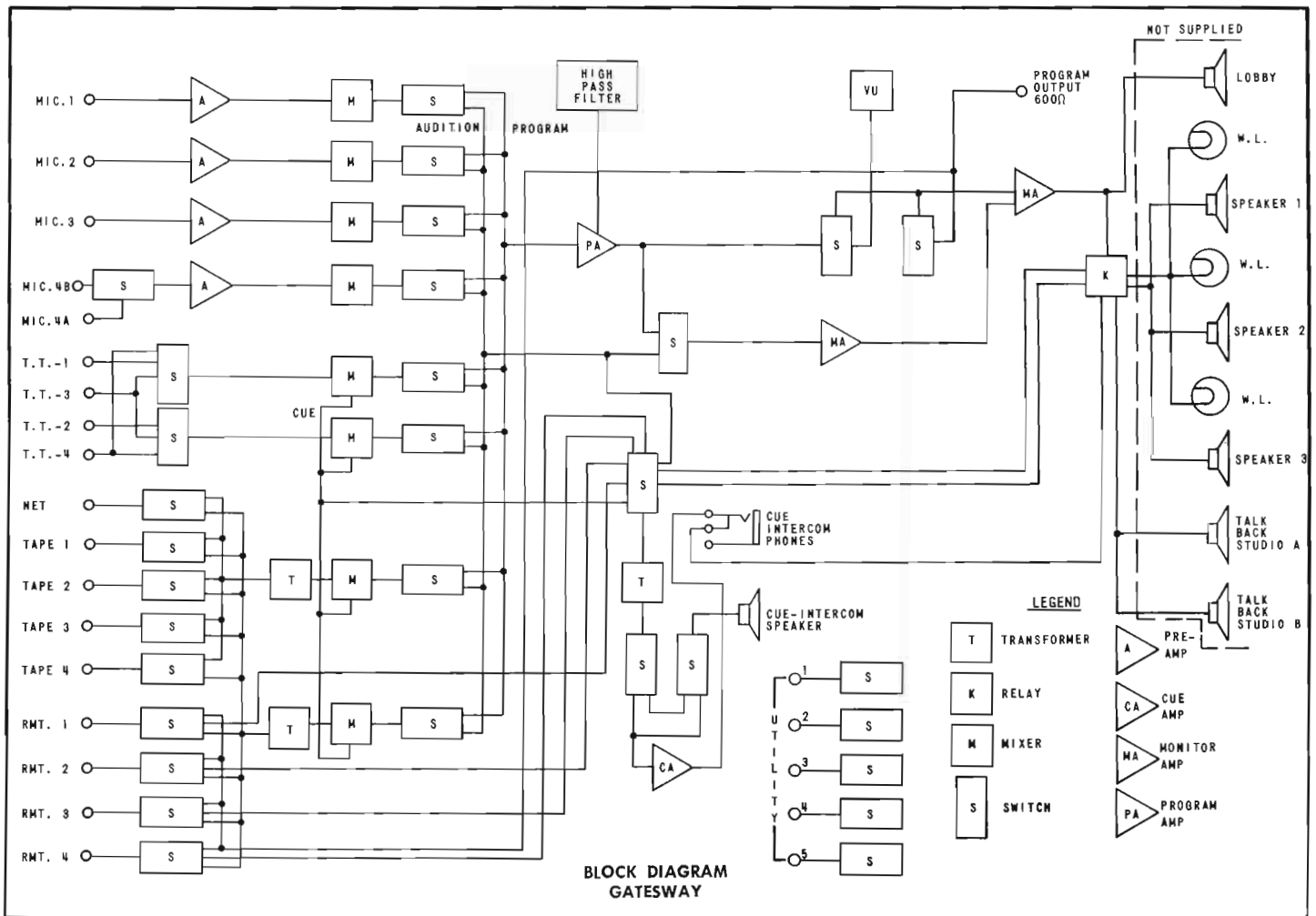

Four Channel All-Purpose Console



THE STUDIOETTE

A single channel monophonic console with 13 inputs into four mixing channels, the Studioette has found wide application as a main console in modest sized stations, as a sub-console for large installations, or as a second console for independent programming or recording. The demand for an attractive, compact, large facility console has made the Studioette equally popular in mobile audio installations.

OPERATION: Completely self-contained including power supply, the Studioette provides 4 mixing channels with channel keys, and a row of 14 tab keys for multiple circuit combinations. Three utility keys are provided for specialized station needs and may be wired into any input. Step type ladder mixing controls, illuminated 4" VU meter, and the same quality amplifiers found on larger Gates consoles are all included in the Studioette.

Four microphones may be key selected into two preamplifiers. Three turntables, two tape/projectors, three remote lines and network are also accommodated. The 10 watt ultra-linear monitoring amplifier is standard equipment. Dual muting relays handle speaker and warning light functions. Space is provided for a third (optional) preamplifier. The Studioette is a functional all-purpose console, performance proven by hundreds of broadcasting and recording users around the world.

When mixing channels 3 and 4 are in cue position, they automatically connect to terminals from which a cueing amplifier may be fed. Gates 994-5377 cueing amplifier is ideal for this service. With this feature, all circuits feeding mixing channels 3 and 4 may be prechecked, including turntables, network, tape inputs and remote lines.

MONITOR BOOSTER: A two-stage amplifier is located between the audition bus of the mixer and input to the monitoring amplifier. This feature provides balanced level between the program and audition outputs so that there is no need for readjustment of gain settings when switching.

RELAYS: Two relays are supplied for operating warning lights and muting loudspeakers. There is also space for two additional relays. These relays operate in conjunction with the microphone keys and almost any muting arrangement is possible with this design.

ADDITIONAL FACILITIES: Additional facilities include an output emergency key for switching the program line to the monitoring amplifier output in case of a noisy tube, etc., in the program amplifier. A monitor selector key switches the monitoring amplifier input to: (1) program line for monitoring, (2) terminals for external monitor input, and (3) audition output of the mixing system. A headphone jack is always available across the program line. The 4" illuminated VU meter is flush mounted. This meter is connected to the program line to indicate +8 VU at 0 scale reading.

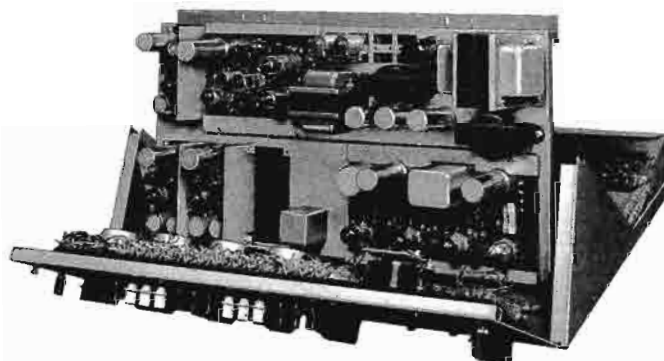

The Studioette top cover may be completely removed, and the front panel hinges up to reach every "behind the panel" component. The amplifier deck hinges up so that muting relay contacts are at your finger tips when touch-up burnishing is required.

Four Channel All-Purpose Console—Studioette

SPECIFICATIONS

MIXING CHANNELS: Total—4. Key selected to program or audition bus. Channels 1 and 2 for microphones, 3 and 4 for multi-input use such as turntables, tapes, etc. Cue position on faders 3 and 4.

AMPLIFIERS PROVIDED: 1 program, 1 monitor, 2 preamplifiers.

OPERATING MODE: Single channel monaural.

INPUT CIRCUITS: 4 microphones, 3 turntables, 2 tapes or projectors, 3 remote lines, 1 network line. (1 external monitor amplifier input).

OUTPUT LINES: 1 program, 1 audition, 2 muted speaker, 1 non-muted speaker, 1 turntable cue, 1 remote/tape cue.

IMPEDANCES: Microphones 30/50 or 150/250 ohms; turntable/tape 150/250 ohms unbalanced; remote lines 600 ohms; network 600 ohms; Programming output 600 ohms; audition output 20,000 ohms; monitor speakers 8/16 ohms. Note: Where more than two loudspeakers are used, the 478-0275 speaker matching transformer should be used.

GAIN: Turntable, tape, network (medium level) input to program line output 63 dB; to monitor amplifier output 100 dB. From microphone input to program line output 103 dB; to monitor amplifier output 103 dB. All measurements ± 2 dB.

RESPONSE: Program circuit $\pm 1\frac{1}{2}$ dB 30 to 15,000 Hz. Monitoring circuit ± 2 dB 30 to 15,000 Hz.

DISTORTION: Program circuit 1% or less between 30-15,000 Hz at +8 dBm output level. Monitor amplifier 2% at +40 dBm (10 watts).

NOISE: Program circuits: 70 dB or better below +18 dBm output, with -50 dBm input (equivalent noise input is -120 dBm). Monitor circuits: 55 dB below +40 dBm output. Crosstalk: all circuits below noise level with normal gain settings for proper programming.

POWER: 117 volts, 50/60 Hz, 1 phase. Power consumption 120 watts at 60 Hz.

FINISH: Panels, anodized black and gray. Cabinet, beige-gray.

SIZE: 24" wide, 8 $\frac{1}{4}$ " high, 17" deep.

SHIPPING DATA: Packed weight: Domestic, 70 lbs.; export, 110 lbs. Cubage: 12 cubic feet.

TUBES: (9) EF86/6267, (3) 12AX7, (2) EL84, (2) OAT and (1 each) 12AU7, GZ34.

OPTIONAL ACCESSORIES: Space is provided to add 1 model 994-5304 preamplifier and two 572-0072 muting relays.

ORDERING INFORMATION

Studioette audio console.....	994-5381
100% spare tube kit.....	990-0444
Optional preamplifier.....	994-5304
Speaker matching transformer.....	478-0275
Extra muting relay.....	572-0072
Optional cueing amplifier.....	994-5377

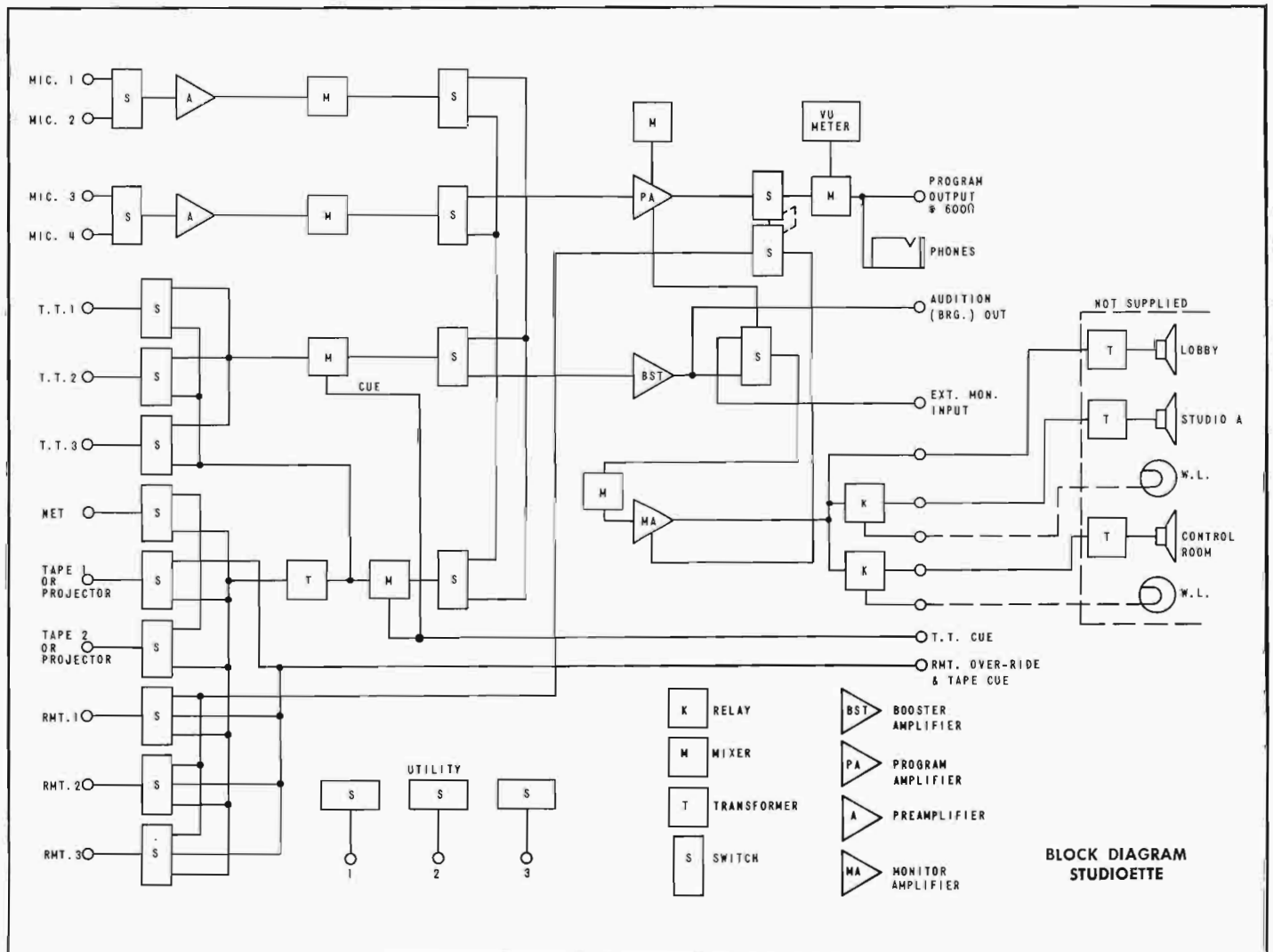

Four Channel Recording Mixer



THE PRODUCER

The rapid growth of cartridge tape recorders and increased use of reel-to-reel recorders in radio and television broadcasting demands an audio control system specifically designed for production mixing. Completely transistorized, Gates Producer provides the facilities for direct recording, dubbing, sound-on-sound recording, editing and monitoring. The use of the VA mixing control knob, the same as used on all Gates Solid Statesman consoles, adds to the accuracy and speed called for in the handling of a production operation.

ADAPTABILITY: Though designed primarily for recording, the Producer is adaptable to other services not requiring a complete speech input console. Such services might include news rooms, mobile units and small sub-stations.

INPUTS: Professional in every respect, the Producer provides transformer balanced inputs on each channel. Twelve inputs through the four mixing channels provide six microphones into two faders, plus six turntables, cartridges, or reel-to-reel recorders into two faders. Two-stage, 45 dB pre-amplifiers on microphone channels 1 and 2 provide high level mixing. Completely self-contained, the Producer also includes a high gain program amplifier which furnishes a 600 ohm balanced output at +8 VU, after a 6 dB pad. A monitor amplifier is provided, driving the 3" x 5" loudspeaker mounted internally (or an external speaker, if desired). Mon-

itor speaker muting on the microphone channels is standard. Muting defeat is also provided.

SOUND-ON-SOUND: An exclusive feature in the Producer is the ability to make "sound-on-sound" recordings with ease. The monitoring amplifier normally bridges the program amplifier output. If it is desired to add voice over a pre-recorded voice or music track, this amplifier is switched to monitor either high level input, ahead of the mixers, without fear of feedback.

A four-inch illuminated VU meter, a headphone monitor jack, and a self-contained power supply are all standard on the Producer.

DESIGN: This console is a fine example of functional design and versatility, tailored specifically for broadcast production requirements. All amplifier components are on two printed boards, one containing the two microphone preamplifiers and program amplifier, the other housing the monitor amplifier and power supply. All transistors are plug-in for ease of maintenance.

The regulated power supply is short-circuit protected by a self-restoring sealed circuit breaker, eliminating the need for fuses. Installation of the Producer is fast and simple, with all cable connections made to barrier-type terminal strips.

Four Channel Recording Mixer-Producer

Note complete transistorized construction and immediate access to all components. Self-contained 3" x 5" speaker located at top rear is ideal for cueing and production.

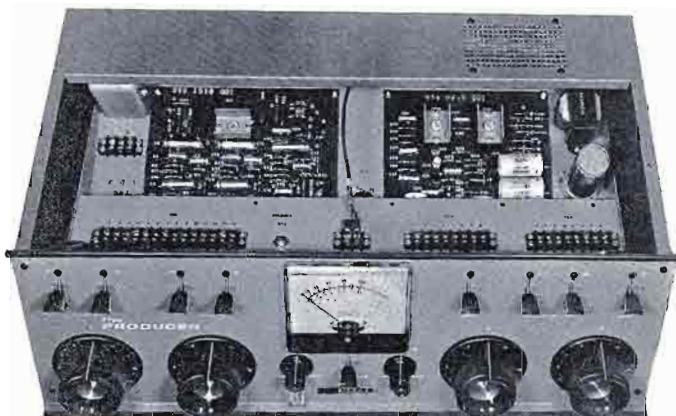

SPECIFICATIONS

MIXING CHANNELS: Total—4. 2 microphone channels, 2 TT/tape/projector channels. Cue provision on high level channels.

AMPLIFIERS PROVIDED: 1 program, 2 preamplifiers, 1 monitor amplifier and power supply.

OPERATING MODE: Single-channel monophonic.

INPUT CIRCUITS: 6 microphone or low level, 6 turntable/tape or high level.

OUTPUT LINES: 600 ohms balanced. One 45/48 ohm internal or external loudspeaker. One high-impedance headphone monitor.

IMPEDANCES: Microphone, 30/50 or 150/250 ohms. Turntable, tape, or cartridge, 150 or 600 ohms. Programming output, 600 ohms balanced. Loudspeaker, 45/48 ohms.

GAIN: Microphone input to line output, 100 dB \pm 3 dB. Turntable input to line output, 55 dB \pm 3 dB. Microphone input to speaker output, 125 dB \pm 3 dB. Turntable input to speaker output, 80 dB \pm 3 dB.

RESPONSE: \pm 1.0 dB from 30 to 15,000 Hz in program circuits. \pm 1.5 dB from 30 to 15,000 Hz in monitoring circuits.

HARMONIC DISTORTION: 0.5% maximum, 30 to 15,000 Hz at +8 dBm output in program circuits.

INTERMODULATION DISTORTION: 0.5% maximum in program circuits.

NOISE: -120 dBm relative input noise on microphone channels. -75 dBm relative input noise on turntable channels.

POWER: 117 volts, 50/60 Hz, power consumption 30 watts.

FINISH: Beige-gray with black trim.

SIZE: 24" long, 10½" high, 15" deep.

SHIPPING DATA: Packed weight, domestic, 50 lbs.; export, 80 lbs. Cubage; 4.6 cubic feet.

ORDERING INFORMATION

The Producer recording mixer.....994-6407
 100% spare semi-conductor kit.....990-0512
 Speaker matching transformer.....478-0275

NOTE: When using external monitoring loudspeakers, the 478-0275 matching transformer must be used to match the 45/48 ohm monitor output to the voice coil impedance of a loudspeaker.

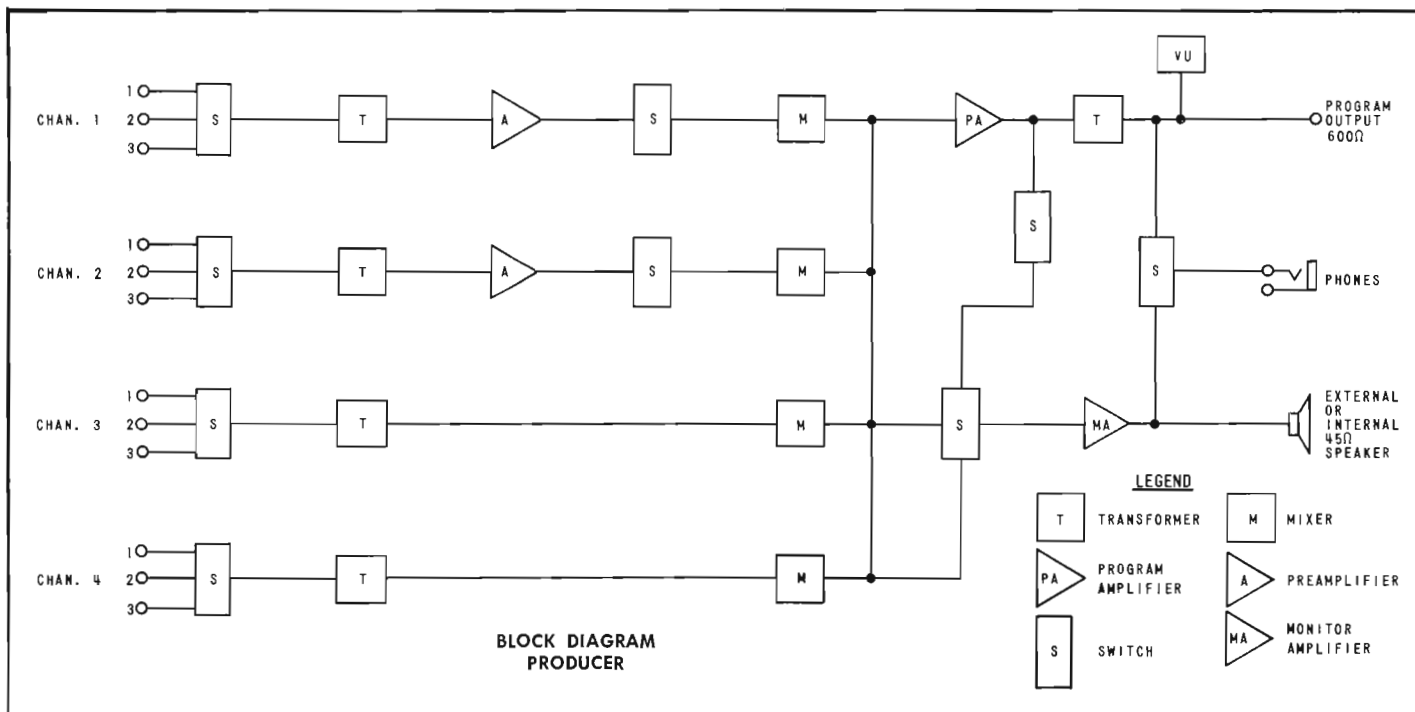

Program Automation Systems

As radio station operating costs continue to increase, and as improved program quality and additional services become more vital, many of today's broadcasters are turning to program automation to meet these challenges.

Modern program automation systems, when properly used and understood, can offer very substantial advantages to most broadcast operations . . . either AM or FM . . . large or small.

These advantages include: more efficient and effective utilization of existing manpower, resulting in lower operating costs; the relieving of station personnel from confining mechanical responsibilities to allow them more time for creative assignments and sales; and improved production, with tighter control over program policy and execution.

Thus, program automation offers a realistic means of achieving a successful operation through reduced costs and the building of a superior and more saleable program product.

When considering automation, however, the broadcaster must exercise great care in selecting the proper system. He must choose a system that fits his requirements exactly, in order to gain the maximum benefits available from automation.

At Gates the automation system is tailored to fit the needs of the particular operation. Each station is carefully studied and analyzed by automation experts before any recommendations are made. Then, working with the station management, Gates plans an automation system that can effectively improve the station's programming and operation. And Gates continues to advise the station until the system has been installed, and is operating satisfactorily. Also, Gates personnel are always on call in case a problem should arise later.

The philosophy behind Gates automation is to build the system to fit the format, rather than change the format to fit the system.

However, in the event a station should wish to enlarge its operation or change its format at a later date, Gates semi-custom automation systems can easily handle this. As the systems are built with standard control components, they provide an unusual degree of flexibility . . . at the lowest possible cost to the broadcaster, compatible with quality.

In fact, broadcasters have found the entire cost of a Gates automation system to be extremely low. And as the system usually pays for itself as it goes, through reduced operating costs, even stations on a tight budget have found it possible (and advantageous) to automate.

If you are interested in finding out what automation can do for you, now is the time to contact your Gates District Manager, or Gates Automatic Tape Control Division. We will be happy to discuss the possibilities, and map out a plan for automating your station to meet your own individual requirements.

The photographs below and on the following two pages show just a few of the Gates automation systems that have been installed recently in radio stations from coast to coast. A complete user's list of all stations with Gates automation is available upon request.

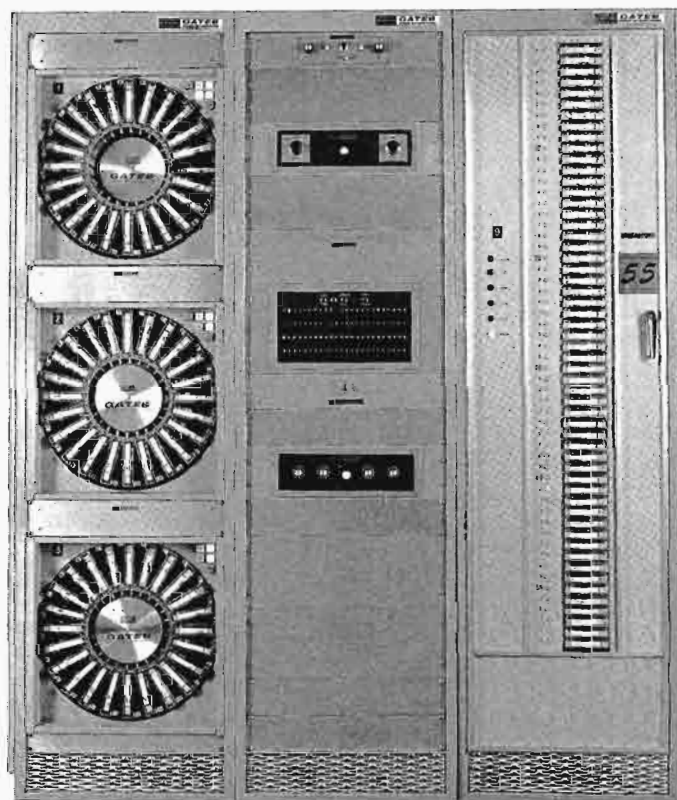

Small but highly flexible Gates automation system now being used successfully by a 3 kW Gulf Coast FM station. The system handles a "Top 40" format, and features automatic network joining with ABC for news and features.

Program Automation Systems

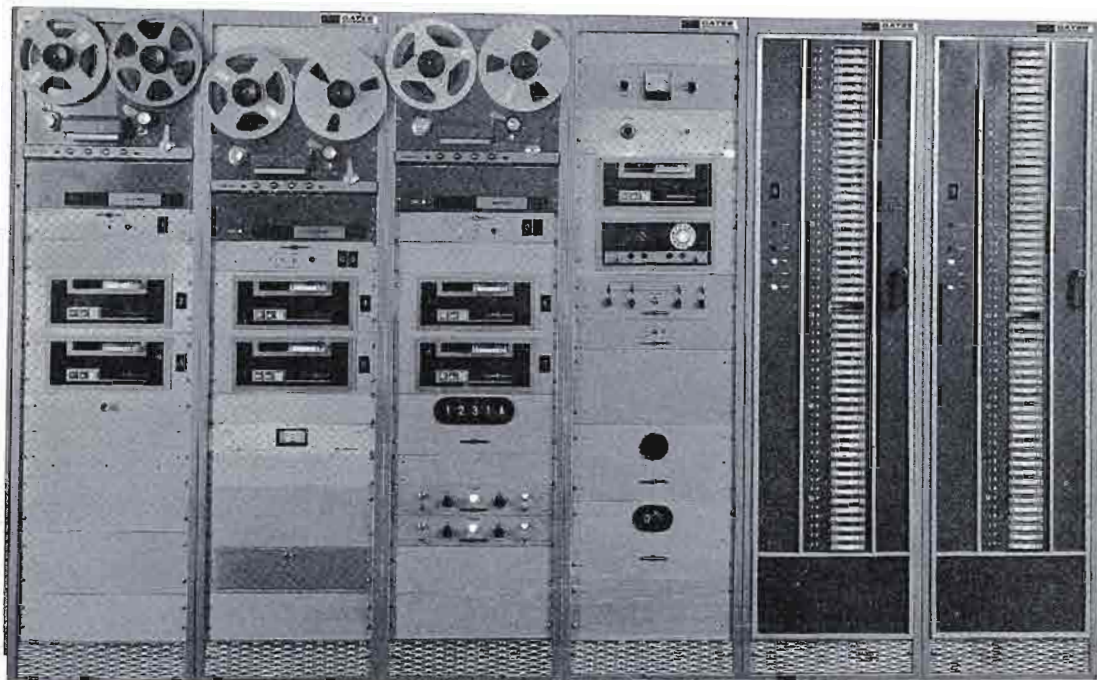

This system, designed for a large major market broadcaster (FM) in New England, handles varied programming through a combination of reel-to-reel tape machines, Criterion cartridge decks and Criterion 55 multiple cartridge reproducers. The system also employs automatic program logging (not shown).

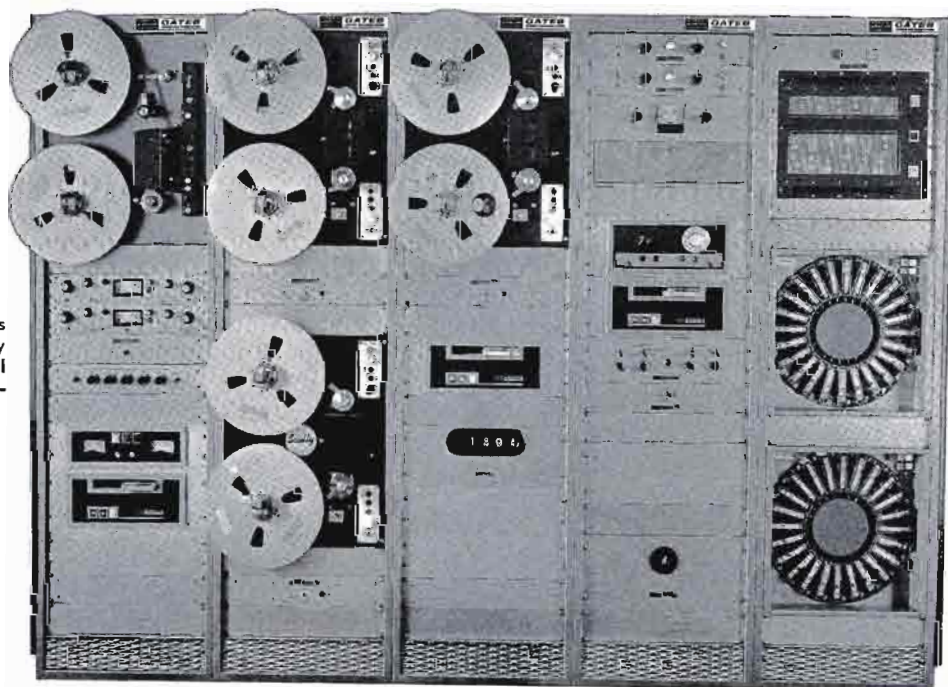

A new AM station in the west has employed this semi-custom automation system since its first day on the air. Note the extensive use of reel-to-reel tape machines—planned by Gates to fit the station's middle-of-the-road format.

Program Automation Systems

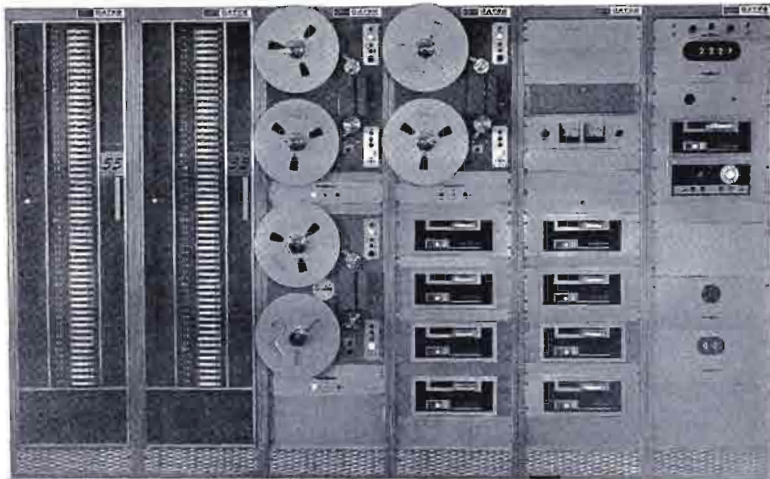

Top adult rated west coast AM/FM station with middle-of-the-road format carries its large commercial load in two Criterion 55's (capacity 55 cartridges each), with music on reel-to-reel tape. Time announcements are automatic, from two Criterion cartridge tape decks, and program logging is handled by an automatic logger (not shown).

Highly successful Florida FM stereo station, with country and western format, uses Criterion 55's for current C&W hits, reel-to-reel machines for hits of the past. Two rotary multiple cartridge handlers are brought in automatically for commercials. Other system features include automatic time announcing, automatic network joining, and an SP-10 dial programmer which can program up to 1000 sequential events in the system before repeating .

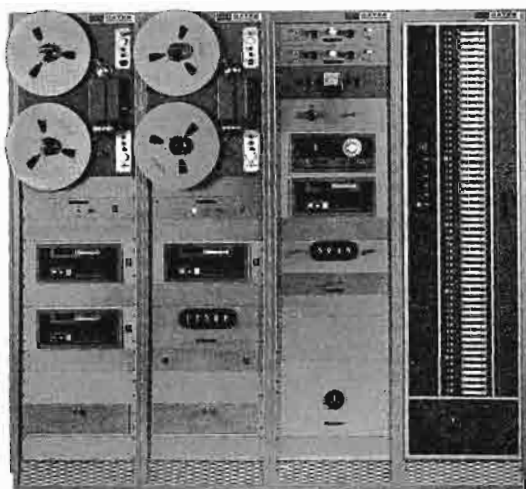
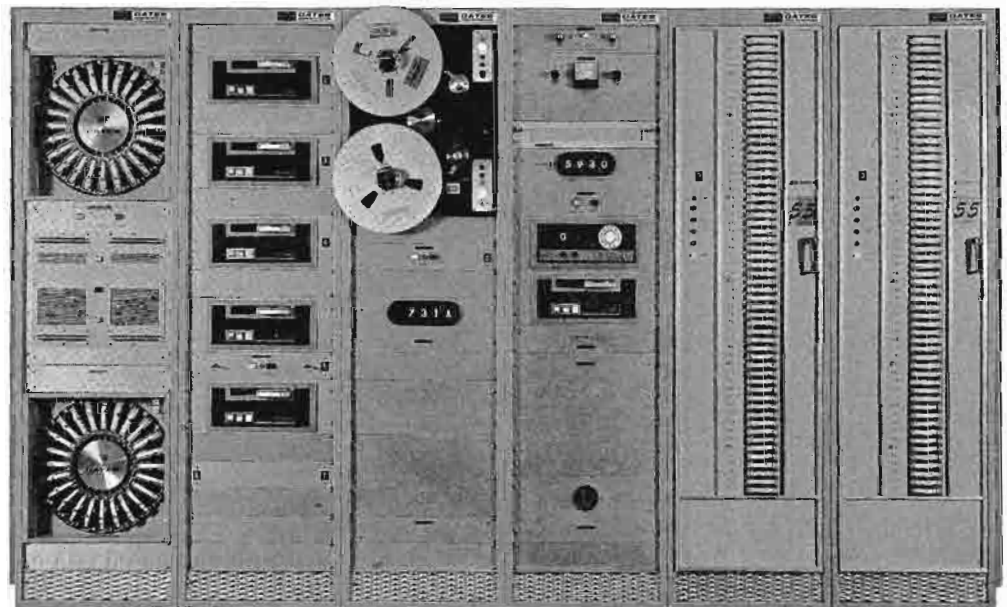

Use of Gates automation systems is by no means limited to the United States. This versatile system is now profitably employed by a French-language AM station in the Province of Quebec, Canada.

SP-10 And SP-19 Programmers



The SP-10 and SP-19 system programmer units are designed to operate in conjunction with the AMS-10 and AMS-19 master switcher units to provide fully automatic control of audio automation systems. The SP-10 unit will function with a maximum of 10 audio sources, and as many as 19 may be controlled with the SP-19 programmer. Adding to these systems is extremely simple. All that is required is plugging a cable from the new source into the switcher.

The programmer is only a device which automatically channels the "End of Message" pulse to the start circuit of the next selected source. The switcher is designed so that any source which is started will automatically connect to the program bus and disconnect the previous source. The switching concept, exclusive with Gates Automatic Tape Control Division, absolutely prevents such errors as the accidental simultaneous start of two or three sources on the air.

Storage of operating sequence is obtained by dialing digits associated with the various audio sources onto a tape cartridge. The sequence of digits dialed onto the cartridge is determined by the order of operation desired for the individual sources. Approximately two seconds of tape travel is required for the recording of each digit. This means that up to 1000 events can be stored on a thirty-one minute cartridge, allowing almost unlimited flexibility in hour to hour program variation. The system programmer establishes format, not content, allowing an extremely wide variety of programming without change in the programmer cartridge.

The digital information dialed onto the tape cartridge is stored as a cluster of 8 kHz tones. As an example, dialing a "6" for the audio source designated number six causes a cluster of six 8 kHz tones to be recorded on the tape. Upon playback during automated programming, this and other digits are read from the tape and operate a stepping switch to provide the sequential control required. The programmer reads each digit individually and shows this digit as the next source to be broadcast in the front panel readout.

A 1 kHz tone is used as the "cue" or reference tone on the cartridge so that the beginning of a program segment may be easily located. A 150 Hz tone is available for special switching applications and time entry when the TS-3 time selector is used in the system.

A unique feature of the Gates SP-10 and SP-19 system programmers is their ability to "skip" programmed events stored on the tape cartridge when exact time programming is required. An example would be automatic network joining. To assure sufficient programming time during the program segment preceding network joining, it would be desirable to schedule an extra selection or two of instrumental music. If the selections are not required to fill out the programming time, they are "skipped" and not used in the programming sequence. With this feature it becomes possible to pad a program time segment with "fill" music and obtain exact time programming without timing each program element with "to the second" accuracy.

A Criterion playback deck and standard tape cartridge are used as the tape memory unit in the SP-10 and SP-19 programmers. This means that most parts are interchangeable with any other Criterion equipment the station may use, and with the precision construction of the unit, exceptional operating reliability is assured.

It is necessary that an audio and control switcher be used with the system programmer to provide for audio switching. The AMS-10 master switcher is used with the SP-10 programmer, and the AMS-19 switcher with the SP-19 programmer.

NOTE: Other associated control components may be needed to meet desired operating requirements.

SPECIFICATIONS

INPUTS: SP-10 maximum of 10 sources—SP-19 maximum of 19 sources.
SOURCE SELECTION: By digits dialed with a standard telephone dial into a tape cartridge memory.
SEQUENTIAL EVENTS: Maximum of approximately 1000 before repetition.
TIME CORRECTIONS: Provided by program time control packages.
CONTROL VOLTAGES: From self-contained power supply.
POWER SOURCE: 105/125 volts, 1 amp, 60 Hz.
RELAYS: Automatic electric Class E telephone type—automatic electric stepping switch with gold-plated contacts.
HOUSING: Rack mount with a slide-out chassis.
DIMENSIONS: Control unit—7" high x 15" deep x 19" wide. Tape memory unit—7" high x 15" deep x 19" wide.

ORDERING INFORMATION

SP-10 system programmer (requires AMS-10 master switcher listed below).....900-0030
SP-19 system programmer (requires AMS-19 master switcher listed below).....900-0031
AMS-10 master switcher. Automatically connects program sources to audio output. Capable of stereo. For use with SP-10 system programmer.....900-0041
AMS-19 master switcher. Automatically connects program sources to audio output. Capable of stereo. For use with SP-19 system programmer.....900-0042



SC-48 Simplex Programmer



This easy-to-operate programmer is readily adapted to a sophisticated program schedule to provide variety in generating a "live" sound. The unit controls as many as nine sources in any combination of cartridge and reel-to-reel units. Thumb-wheel selectors are used to sequentially select the order of source appearance in the program. Up to 48 events can be sub-divided into two, four, or eight program segments with 24, 12 or 6 events in each segment.

A time pulse generator associated with the SC-48 programmer is capable of providing up to four individual time corrections each hour. The actual correction time of each is determined by four rotary switches marked in five minute increments. These switches are adjustable internally so that the exact time of correction may be offset from the true five minute point. The rotary selector switch of each time correction point may be disabled if less than four corrections per hour are desired.

The program will not fade when it is time to make a time correction. Rather, after the selection playing is completed, the programmer will skip to the first event of the next program segment. In this way it is not necessary to exactly time program content and "fill" material can easily be added to

each segment. Unused fill material is automatically skipped, assuring desired continuity.

With additional optional equipment it is possible, however, to use the SC-48 programmer in an exact time correction system which will fade out of program material immediately upon correction by the time pulse generator and skip to the first event of the next program segment, which could be either network news or a spot or cartridge intro preceding network news. A system of this type is fully capable of joining a network during unattended operation.

No changes in internal programmer wiring are needed to add or change audio sources controlled by the SC-48. A socket is provided for each source. To add or change sources, it is only necessary to plug-in the tape unit's connecting cable at the back of the unit.

All relays used in the programmer are plug-in and completely sealed to provide positive protection from dust and dirt. The relays all have gold contacts to assure dependable operation. The stepping switch also has gold contacts to provide years of trouble free service, even under demanding broadcast reliability standards. All components are hand wired to provide optimum dependability.

SPECIFICATIONS

INPUTS: Maximum of nine sources.

SOURCE SELECTION: Maximum of nine by thumbwheel switch.

SEQUENTIAL EVENTS: Forty-eight before repetition.

TIME CORRECTIONS: One, two, three or four may be inside each hour at any five minute time during the hour.

SENSING: 25 Hz, left channel only (silence sensing on special order).

FILTERING: 25 Hz filter, left and right channel output (-8 dB at 50 Hz, -35 dB at 25 Hz).

CONTROL VOLTAGES: 24-volt DC self-contained power supply.

POWER SOURCE: 105-125 volts, 60 Hz.

RELAYS: Plug-in with dust covers. AE stepping switch with gold-plated contacts.

AUDIO OUTPUT: 600 ohms, balanced, -4 dBm.

AUDITION CIRCUIT: Headphone and rear panel output.

TIMER PULSE: One circuit each 2½ minutes. Two circuits vernier adjustable within 2½ minute increments.

HOUSING: Rack mount with slide-out chassis.

SIZE: (SC-48 w/25 Hz detector) 8¾" H x 19" W x 15" D.
(Time pulse generator) 5¼" H x 19" W x 15" D.
(25 Hz filter) 3½" H x 19" W x 15" D.

ORDERING INFORMATION

SC-48 programmer with TPG-48 time pulse generator and 25 Hz filter.....900-0086



Random Access Programmers

MODEL RA-5

Gates Model RA-5 is a random access programmer designed to control as many as five Model G-24-M/S multiple cartridge reproducers.

This unit will program up to fifty events (individual shelf positions) on the machines it is associated with before recycle of the sequence. The event storage capacity may be extended in multiples of fifty by using the appropriate number of optional RA-5X event extenders.

Unique audio mixing is provided within the switching section of the RA-5, and overlap between any two inputs is available at the operator's option. The audio overlap is determined by the position and duration of the 150 Hz switching tone recorded during production.

A sophisticated feature of the RA-5 not found on similar random access equipment is the solid state logic and memory circuitry provided to cause "search ahead." During operation, the RA-5 will cause each cartridge reproducer to search and access the required shelf until it recognizes that the next machine to be searched has not yet played.

Two big advantages of the RA-5 are: simplicity in set-up over the method of having one programmer for each G-24; and the ease with which a system using less than five G-24 units may be expanded up to five (at the cost of the multiple cartridge units only).

Intended for rack mounting, the RA-5 measures 21" H x 19" W x 14" D (12 rack units). Power requirements are 115 volt AC, 60 Hz.

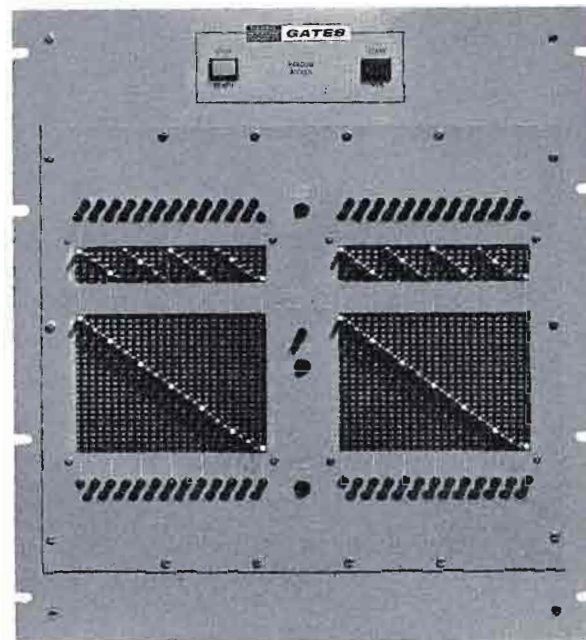

ORDERING INFORMATION

RA-5 random access programmer for use with G-24-M/S multiple cartridge units. Inputs for up to 5 Model G-24 units.....900-0137
RA-5X event extender for above unit. Any number of RA-5X units may be connected together to extend event storage of RA-5 in multiples of fifty. (Same size as RA-5, with plug-in connections).....900-0138

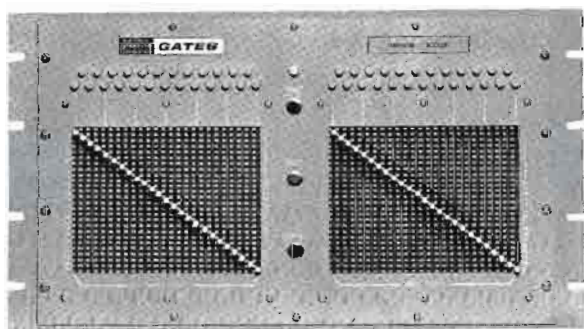

MODEL RA-1

Gates RA-1 random access unit is intended to provide random selection for a single Gates multiple cartridge reproducer (G-24-M/S).

Assignment of cartridge sequence is determined by the positions of fifty vertical slider switches located on the front panel of the equipment. Thus, fifty selections can be made from any of the 24 shelves in the G-24 before repetition or re-programming. The fifty step sequence is repetitive in that

step one follows step fifty, and the sequence may be shortened to less than fifty events by setting any of the sliders to the lowest, or 25th position. This is the "S" or SKIP position. The usual procedure for setting up the RA-1 involves setting slider number 1 (left side) to the shelf number containing the first desired tape cartridge. Each succeeding slider, in sequence, is set as required to indicate the desired sequence of shelf assignment for the G-24. The INDEX button is pressed once to initiate the action required to access the first selected tape cartridge.

It is possible to alter the sequence midway so that a cartridge already selected will be rejected. This may be accomplished through the use of the ADVANCE and INDEX buttons, even though a tape cartridge is playing at the time.

The RA-1 measures 10½" H x 19" W x 10" D, and is intended for standard rack mounting. The device is completely solid state, making use of SCR's for counting. Control signals and power are supplied from the service unit assembly of the G-24 unit.

ORDERING INFORMATION

RA-1 random access programmer for use with single G-24-M/S multiple cartridge reproducer.....900-0191

CRITERION 55

With ample capacity for broadcast and storage of 55 NAB type A tape cartridges, and using the performance-proven Criterion play-back unit, the Criterion 55 provides increased flexibility for automation systems, while assuring excellent audio broadcast quality. It can be added to any Gates automation system.

Up to 55 cartridges are placed in the rack in the exact order they appear on the broadcast schedule. The deck moves from top to bottom and stops only at the slots which have a cartridge. It pulls the cartridge into position on the deck, and positively locks it against the microset head assembly, assuring unsurpassed audio.

SPECIFICATIONS

AUDIO OUTPUT: 600 ohms +4 dBm maximum, (150 ohms optional) balanced.
FREQUENCY RESPONSE: ± 2 dB 70 to 12,000 Hz ± 4 dB 50 to 15,000 Hz.
DISTORTION: Record to playback, 2% at 0 VU record level, 400 Hz.
NOISE: 55 dB below tape signal reference of 400 Hz with 3% THD.
RECYCLE TIME: 62 seconds from rejection of bottom cartridge until top cartridge is ready. Four seconds from shelf to shelf.
SIZE: 77 $\frac{1}{2}$ " high x 22" deep x 23 $\frac{3}{4}$ " wide. Net weight, 405 lbs.

ORDERING INFORMATION

ATC-55 multiple cartridge handler, 60 Hz, monophonic.....900-0028
ATC-55-S multiple cartridge handler, 60 Hz, stereophonic.....900-0029

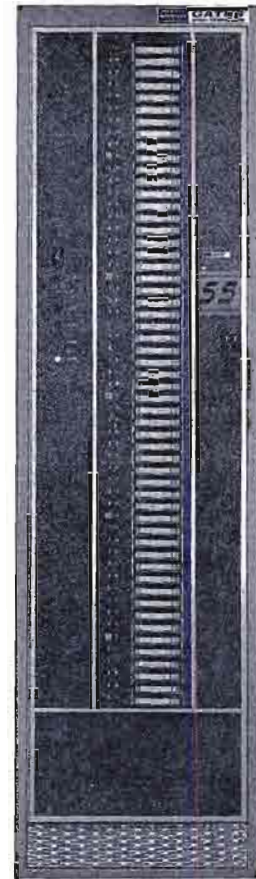

MULTIPLE CARTRIDGE REPRODUCER

Gates G-24 Carousel tape unit is a rotary drum mechanism for tape cartridges that can be operated by manual, automatic, and random access selectors. Each drum holds a maximum of 24 standard cartridges, and revolves to allow positioning of the cartridges against the stationary transport. The G-24 positions cartridges in sequence unless an optional random access unit is employed (see Page 125).

SPECIFICATIONS

AUDIO OUTPUT AND DISTORTION: +4 VU max. into 600 ohms (less than 1% THD) from NAB reference level tape.
FREQUENCY RESPONSE: +1 dB to -2 dB 50-12,000 Hz at 7 $\frac{1}{2}$ ips.
SIGNAL TO NOISE RATIO: -56 dB @ 7 $\frac{1}{2}$ ips (mono), -52 dB @ 7 $\frac{1}{2}$ ips (stereo).
SIZE: 19" wide x 19" deep x 19 $\frac{1}{4}$ " high. Net weight, 95 lbs.

ORDERING INFORMATION

G-24-M multiple cartridge unit, monophonic.....900-0134-001
G-24-S multiple cartridge unit, stereophonic.....900-0134-002

NOTE: For random access units to be used in conjunction with G-24 units please see Page 125. These random access units must be ordered separately.

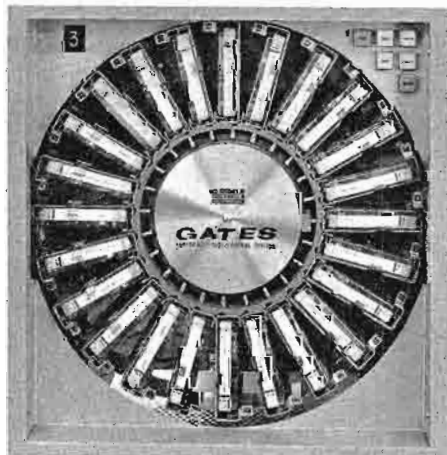

Automation Systems Equipment



Logging Encoder.



Digital Clock



Logging Decoder.



Logging Printer.

AUTOMATIC PROGRAM LOGGING

Gates system of automatic program logging provides an accurate, printed record of programming actually broadcast. This system has been the basis for FCC license renewal at many automated broadcast stations and meets FCC log verification requirements. A logging printer, similar to an adding machine, prints the time at which each source in the system is started, along with a five digit code for all entries which require identification. If identification is not required, the code is automatically replaced by five zeros, making all logging complete.

The program logging equipment consists of a logging encoder for recording a five digit logging code on the control track of any tape cartridge; a logging decoder for reading the five digit code during playback; a digital clock to furnish time of broadcast; and a logging printer to print the broadcast time and the logging code.

NETWORK JOINING

Network joining with an automation system is accomplished through one of two methods. The first involves initiating the joining or leaving of the network with logic apparatus synchronized by a clock driven from the local primary power source. To provide for normal variation between network and systems' clocks, automation usually incorporates fade-in or fade-out of program material.

The second method lies in the transmission, by the network, of signals which indicate various aspects of program content. Through the proper processing of these signals, accurate joining is accomplished without the clock control. All Gates automation systems, provided with the proper modular components, can accomplish network joining using either of the two methods.

TIME ANNOUNCER

Gates time announcer system provides pre-recorded time broadcasts either at the discretion of the station announcer or according to the pre-arranged schedule of an automation system. Once two Criterion cartridge tape playback units have been synchronized with correct time information (one for odd minutes, one for even) by the TA-1 control unit, operation is completely automatic. Pulsing at one minute intervals is required as a timer is not part of the TA-1.

ORDERING INFORMATION

TA-1 control panel (requires 2 Criterion cartridge playback units and the TPM one minute pulsing device for operational system).....900-0056
 CPR-11 Criterion playback unit. (System requires two)900-0001
 TPM time pulse module (requires one).....900-0192

SPECIFICATIONS

SYSTEM COMPONENTS: Logging encoder, logging decoder, digital clock and logging printer.
RECORD PRINT-OUT: Standard adding machine tape . . . may be set single, double or triple space.
PRINT-OUT INFORMATION: Time and five digit code.
TIME PRINT-OUT ACCURACY: Within 30 seconds of time shown on print-out tape.
OPERATION: Uses 8 kHz tone pulse clusters on cartridge control track to form digits.
POWER SOURCE: 105-125 volts, 2 amps, 60 Hz.

ORDERING INFORMATION

APL automatic program logging system (for use with SP-10 and SP-19 programmer units only).....900-0034
 APL-M automatic program logging system (5C-48 programmer units only).....900-0039
 CG-8 special code generator (optional). Provides 8 different five digit logging codes to identify non-cartridge automation inputs such as network, etc.....900-0040



GateSound Prelude Series Tapes

OUTSTANDING PRE-RECORDED MUSIC

GateSound is designed to provide you with a basic taped music library of selections with the widest possible appeal. These tapes are intended as a starter package of musical programming with automation systems, and are appropriately named the "Prelude" series. They are equally suitable for any broadcaster wishing to expand a tape library simply and economically.

TYPE OF MUSIC: All-time country and western favorites, show tunes, motion picture sound tracks and great standards are presented in vocal and instrumental arrangements, carefully selected for "middle-of-the-road" content, to serve as a sound base on which to build your future programming. Selections likely to become outdated are not included, to assure a modern, up-to-date sound for your listeners.

PRODUCTION QUALITY: Equal care is given to preparation of master tapes for technical perfection as is employed in the selection of music for content and performance.

The "Prelude" series is produced exclusively for Gates Automatic Tape Control Division by AltoFonic Programming, Inc. While these tapes are completely separate from the library services of AltoFonic, the same expert programming know-how and total dedication to professional recording techniques are utilized to produce tapes of amazing fidelity and consistency. These tapes are exclusive through GateSound, and not available elsewhere.

BASIC CATEGORIES: GateSound "Prelude" series separates music into these categories to give you the sound of your choice:

Prelude 200—Vocals, Male.

Up-tempo country and western selections.

Artists include: Buck Owens, Ferlin Husky, Carl Smith, Jimmy Dickens.

Prelude 300—Vocals, Male.

Medium and slow tempo country and western selections.

Artists include: Faron Young, Roy Clark, Marty Robins, Tex Williams.

Prelude 400—Vocals, Female and Group.

Mixed tempo country and western selections.

Artists include: Loretta Lynn, Patsy Cline, The Browns, Jean Shepard, Dottie West, The Statler Brothers.

Prelude 500—Instrumentals.

Mixed tempo country and western selections.

Artists include: Leon McAuliffe, Chet Atkins, The Buckaroos, Tom and Jerry, The Texas Troubadours.

Prelude 600—Instrumentals.

Standard and popular selections.

Artists include: Percy Faith, Hugo Winterhalter, Don Costa, Andre Previn, Henry Mancini, Lawrence Welk.

Prelude 700—Instrumentals.

Standard and popular selections.

Artists include: Herb Alpert, Les and Larry Elgart, Les Brown, Henry Mancini.

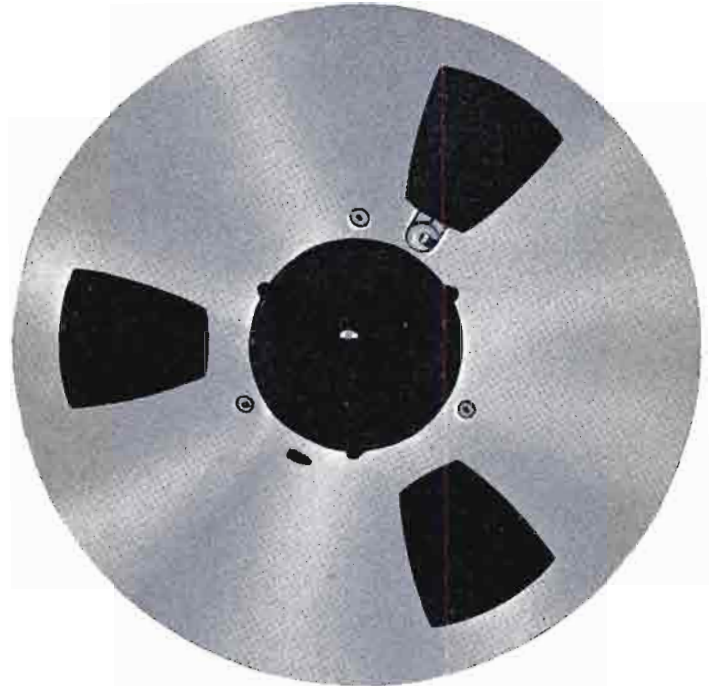

Prelude 800—Vocals, Mixed.

Standard and popular selections.

Artists include: Andy Williams, Doris Day, Barbra Streisand, Four Freshmen, Frank Sinatra, Ray Charles, Dean Martin.

Prelude 900—Instrumentals, Mixed.

Mixed tempo conservative standard selections.

Artists include: David Rose, Jackie Gleason, Ray Anthony, Les Baxter, Hollyridge Strings, Ray Coniff.

Comprehensive coverage of all recording companies provides the most extensive musical variety within the categories. Samples of program sheets are reproduced on the next page, illustrating the nature of music provided. Complete listings are available on request for ordering information.

TAPE DATA: Tapes are available in 10½ or 14-inch reel sizes, and in any popular track configuration. The entire GateSound library is available in monaural or stereo.

"Prelude" tapes are unannounced for maximum flexibility in any operation, and allow the use of local voices if desired. All tapes are supplied on 1.0 mil polyester tape. Bi-directional tapes are supplied with metallic foil at both ends for reversing systems. All music is matched at both ends (no fading).

A 25 Hz tone, 5 dB below program reference level and 1.5 seconds long, appears 1.5 seconds before the end of each selection. This tone is followed by one second of silence, then the next selection begins exactly 2.5 seconds after the beginning of the tone. On stereo tapes the tone appears on the left channel only. Specially adapted Ampex equipment, with ½" duplicating masters, is used for producing the high-fidelity tapes.

GateSound Prelude Series Tapes



PRELUDE 600
Instrumentals
Large Orchestras
Tempo: Medium & Up
Program No.
601-A

NO.	TIME	SELECTION	ARTIST	COPYRIGHT
1.	2:17	I Walk The Line	Clebanoff	BMI
2.	2:04	Shangri-La	Nelson Riddle	AS
3.	1:45	Baby Won't You Please Come Home	Blue Strings	
4.	2:36	Flight Of The Bumble Bee	Hugo Montenegro	
5.	2:20	You're The Top	Irving Joseph	AS
6.	2:00	Um, Um, Um, Um, Um, Um	Percy Faith	BMI
7.	2:59	A Swedish Rhapsody	Hugo Winterhalter	AS
8.	2:01	The Surrey With The Fringe On Top	Michel Legrand	
9.	2:10	More	Hugo Montenegro	BMI
10.	2:21	I've Got Your Number	Ray Ellis	AS
11.	1:55	Big Mamou	Clebanoff	BMI
12.	1:50	Come To The Mardi Gras	Mancini	
13.	3:00	Come With The Wind	Andre Previn	AS
14.	2:05	Anytime	Frank Pourcel	BMI
15.	2:20	If I Were A Rich Man ("Fiddler On The Roof")	Claus Ogerman	
16.	2:41	My Kind Of Town	Robert Farnon	AS
17.	2:16	Fools Rush In	Lawrence Welk	
18.	2:57	Secret Love	Russ Conway	
19.	2:00	The Continental	Hugo Winterhalter	
20.	2:40	See The Funny Little Clown	Percy Faith	BMI
21.	2:22	White Silver Sands	Clebanoff	
22.	2:59	Charade	Boston Pops	AS
23.	2:26	Theme From "Zorba The Greek"	Enoch Light	
24.	2:10	On The Beach, O WALEKI	Werner Muller	
25.	3:10	Arrivederci Roma	Melachrino	
26.	1:54	Marcia ("Camelot")	Percy Faith	AS
27.	2:05	Bonanza Theme	Nelson Riddle	
28.	2:17	I Concentrate On You	Hugo Montenegro	
29.	2:25	Whiffs	Manuel	BMI
30.	2:59	Blue Tango	Living Strings	AS
31.	2:14	Savoy Belle	Clebanoff	
32.	2:19	Love	Helmut Zacharias	
33.	1:54	English Little Girl	Don Costa	BMI
34.	2:53	Guaglione	Percy Faith	AS
35.	1:50	Von Ryan March	Enoch Light	BMI
36.	1:50	Around The World	Felix Slatkin	AS
37.	2:28	Love Is Sweeping The Country	Frederick Fennell	
38.	3:25	Begin The Beguine	Clebanoff	

PRODUCED FOR GATES BY ALTOFONIC PROGRAMING, INC., HOLLYWOOD, CALIFORNIA 90078



PRELUDE 700
Instrumentals
Small Orchestras and Bands
Tempo: Medium & Up
Program No.
701-A

NO.	TIME	SELECTION	ARTIST	COPYRIGHT
1.	1:38	I Left My Heart In San Francisco	Ralph Sharon Trio	AS
2.	2:37	Honey Bun	Les Brown	
3.	2:43	A Walk In The Black Forest	Ernie Heckscher	
4.	1:44	Tico Tico	Mancini	BMI
5.	2:15	Theme From "Dime With A Halo"	Eddie Cano Quartet	AS
6.	2:42	Green Eyes	Ray Conniff Group	BMI
7.	1:54	Rumpus	Al Hirt	
8.	2:07	My Love, Forgive Me	Al Caiola	AS
9.	2:13	Fadistas De Bairro Alto	Bert Kampfert	AS
10.	2:15	Puff (The Magic Dragon)	Lawrence Welk	AS
11.	2:23	Forget Domani	Enoch Light	
12.	2:08	Rambling Rose	Osvaldo Almeida Grp	
13.	2:47	The Tiger Twist	Mancini	
14.	2:08	The Trolley Song	Richard Marino	
15.	1:55	I Can't Get No Satisfaction	Gary McFarland	BMI
16.	2:22	The Third Man Theme	Laquibel	AS
17.	2:21	You Were Only Fooling	Sammy Kaye	
18.	2:15	Something's Cookin'	Howard Roberts	BMI
19.	1:46	Walk Don't Run	Herb Alpert	
20.	3:42	A Cool Shade of Blue	Mancini	AS
21.	1:43	You Came A Long Way From St. Louis	Ralph Sharon Trio	
22.	2:37	Swinging Safari	Al Caiola	BMI
23.	2:16	I Saw Her Standing There	Bob Leaper Band	
24.	2:10	Heartaches By The Number	Lawrence Welk	
25.	2:08	Yours Is My Heart Alone	Terry Snyder	AS
26.	1:35	Blow Gabriel, Blow	Lee Evans	
27.	1:59	Coffee Break Time (The Lively Set)	Sound Track	BMI
28.	2:55	Cast Your Fate To The Wind	Camaraia	
29.	2:29	Be My Love	Jimmy Sedar	AS
30.	2:32	Samba De Orfeu	Bill Perkins	BMI
31.	2:32	Jersey Bounce	Maury Laws	AS
32.	2:37	I Can Dream, Can't I	Los Admiradores	
33.	2:51	On Green Dolphin Street	Chuck Sagle	
34.	2:25	Rumsey	Lawrence Welk	
35.	2:06	South Of The Border	Herb Alpert	AS
36.	2:42	The Loneliness Of Evening (So. Pacific)	Les Brown	
37.	2:30	Chicken Talk	Bert Kampfert	BMI
38.	1:35	Willie Boy	Les & Larry Elgart	
39.	1:47	Theme From "Harry's Place"	The Boss Gustars	AS

PRODUCED FOR GATES BY ALTOFONIC PROGRAMING, INC., HOLLYWOOD, CALIFORNIA 90078

**SAMPLE PROGRAM SHEETS FROM GATESOUND "PRELUDE" 600 AND 700 SERIES.
SHEETS ARE AVAILABLE UPON REQUEST FOR THE ENTIRE "PRELUDE" SERIES LIBRARY.**

GENERAL: When ordering tapes, place your order by program number and letter suffix from the "Prelude" series program sheets (example: 701-A). Each sheet represents 90 minutes of music, and each "Prelude" series includes 16 pages of selections. For example: "Prelude" series 700 includes all selections on program sheets 701-A through 704-D.

Suffix letters (A, B, C or D) on each program segment designate their location on the stereophonic or monophonic master tape, as illustrated in the diagram below. Therefore, when ordering tapes, certain programs may be combined on one reel, while other combinations may not be combined.

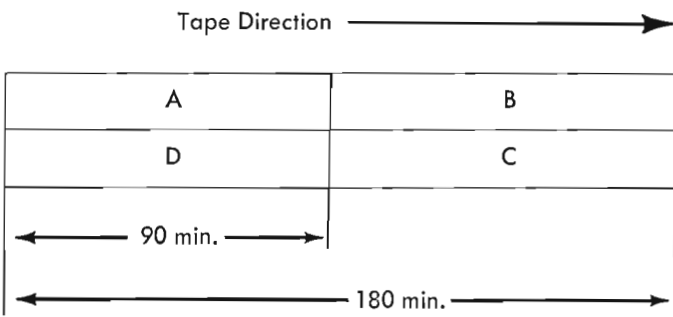

REEL CONFIGURATIONS: If you order 10½" reels, 1 direction (mono or stereo), playing time will be 90 minutes. Select

any program number and suffix from program sheets. Example: 701-A.

If you order 10½" reels, 2 direction (2 track mono or 4 track stereo) playing time is 3 hours per reel. Programs A and D will be supplied on one reel, or programs B and C. Example: The selections from program sheet 701-A and program sheet 701-D would be combined (701-AD) on a single bi-directional reel. A-C or B-D combinations are not acceptable.

If you order 14" reels, 1 direction (mono or stereo), playing time is 3 hours. Programs A and B will be supplied on one tape, or programs C and D. Example: All selections from program sheets 701-A and 701-B are combined to 701-AB on one reel.

For 14" reels, 2 direction (2 track mono or 4 track stereo), playing time totals 6 hours per reel. Programs ABCD are duplicated on one reel. Example: 701-ABCD is on one tape.

HOW TO ORDER: To order an entire "Prelude" series (200, 300, etc.) simply specify: Series number; reel size; mono or stereo; track configuration; and single or bi-directional. One series furnishes 24 hours of music. To order less than an entire series, you will find it more convenient to use the special order form, available on request from Gates.

Professional Tape Cartridge System



Record/playback,
desk mount.

CRITERION

From the originators of the cartridge tape system for the broadcasting industry comes the ultimate in cartridge unit design, the Criterion series. With sleek slide-out chassis and plug-in electronics, plus better timing, better wow and flutter, and dependable direct capstan drive for split second timing accuracy, the Criterion represents over nine years of actual experience in the design, engineering and manufacturing of broadcast tape cartridge equipment.

Renowned for their dependability and quality in broadcasting, these units are in continuous 24 hour service in the largest and most respected radio and TV stations throughout the world.

Registered under United States Patent Number 3,059,063, Gates Automatic Tape Control development of the tape control principle is used in all leading cartridge machines today.

MODELS AND TYPES: The Criterion series is available in playback and record/playback combination models for either rack or desk top mounting. The basic Criterion playback unit is a solid state machine available with slide-out rack panel mounting or trimline desk console, in either monophonic or stereophonic versions. The primary 1 kHz cue tone is standard. Second and third cue tone operation is optional at additional cost on both monophonic and stereophonic models. All versions of the Criterion series playback meet all National Association of Broadcasters specifications and offer features such as 24 volt DC external function switching for safety

in remote controlled applications. All monophonic reproducers are capable of recording when connected to a Criterion recording amplifier.

PRECISION MECHANICAL CONSTRUCTION: Major reasons for the excellence of the Criterion units are: outstanding engineering and quality of the tape deck, motor mechanism, head assembly, and control solenoid. The entire assembly is built on a heavy duty precision machined aluminum casting, which assists in providing proper cartridge alignment on the exclusive Micro-Set head assembly, and provides a rugged integral mounting base for the other tape transport components.

QUIET STUDIO OPERATION: Improved solenoid action and shock mounted relays reduce operating noise and contribute to the quiet mic-side operation of the unit. The fully proven automatic pressure wheel engagement makes actual studio operation easy, and noise free. Space-age alloy motor shielding keeps signal-to-noise ratio low.

POSITIVE DRIVE ACTION: The heart of the Criterion series playback unit is the heavy duty tape transport with its hysteresis synchronous positive speed direct capstan drive motor. The Criterion tape transport offers speed accuracy to within 0.1%—comparable to the finest reel-to-reel machines. Sealed precision instrument-type ball bearings are used which keep transport wow and flutter to less than 0.2% rms. The four pounds of tape pulling force developed by the Criterion transport virtually eliminates timing errors, regardless of cartridge size or tape length.

Professional Tape Cartridge System—Criterion

PRECISION MICRO-SET HEAD ASSEMBLY:

This assembly serves two purposes: to provide convenient and positive positioning of any rear-mount head used on Criterion equipment by screwdriver adjustment; and to positively guide the tape as it passes the heads.

The machined cast aluminum base ("A" in illustration at right) is the core of the entire assembly and provides the basis for positive mechanical mounting and adjustment of all components in the Micro-Set head assembly.

The two spring loaded adjustable cast head mounting assemblies (B) are aligned to the front-to-rear axis of each head for positive vertical height positioning. A single adjusting screw provides for positive azimuth alignment to micro-inch tolerances.

Three tape guides (C) are integrated as one in-line assembly which is attached to the mounting base by screws. The positioning of the guide assembly is referenced from the tape transport deck in accordance with the NAB standards for cartridge tape machines and assures proper tape height from the deck. Constant output quality, especially in audio response from cartridge to cartridge, is provided by the triple tape guide, as exact positioning of the tape on the head is assured, regardless of cartridge variations.

The cartridge hold-down spring (D) is directly attached to the mounting base by screws. Its position on the cartridge is not affected while making adjustments. An assembly cover provides added shielding. Improved laminated heads selected for the Criterion series playback unit are high quality metal-face heads providing for long wear and low oxide accumulation. The special design provides improved high frequency response, usually exceeding the rated specifications.

FULLY REGULATED POWER SUPPLY: A regulated power supply is used to power all circuit modules, assuring correct operating parameters for peak efficiency.

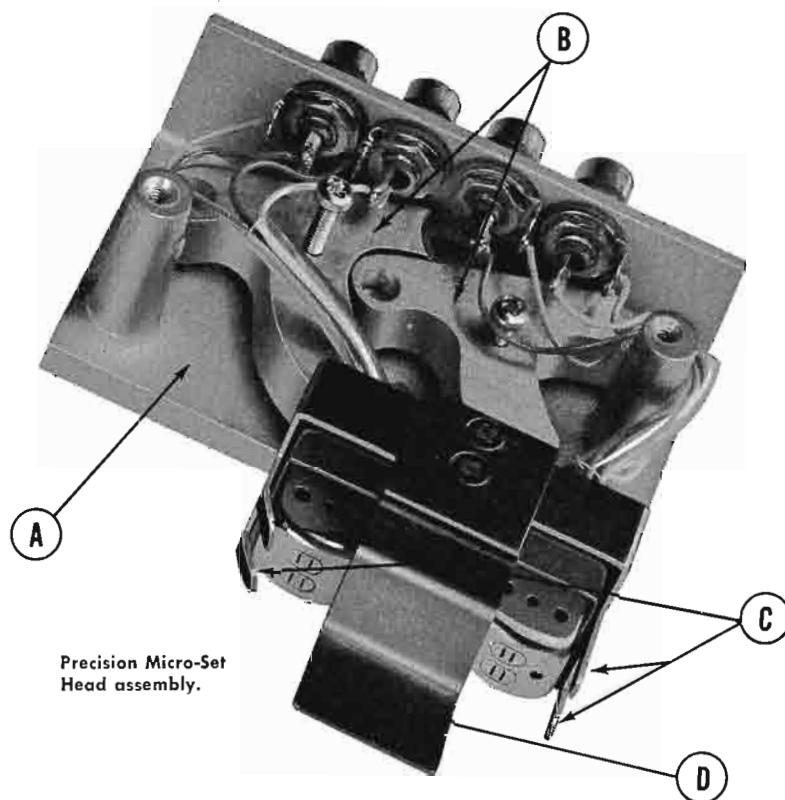

Precision Micro-Set Head assembly.

PRECISION MODULAR CONSTRUCTION: The plug-in modular construction, as used in the Criterion series, provides for modifications that may be required to make the Criterion compatible with almost any make of existing cartridge equipment. Quality pin terminal board construction is used throughout for easy component access.

RECORDING UNITS: The basic Criterion series recording amplifier is a solid state, primary cue device for use in association with any monophonic model Criterion playback. (Also available in stereo for use with stereo playback.)

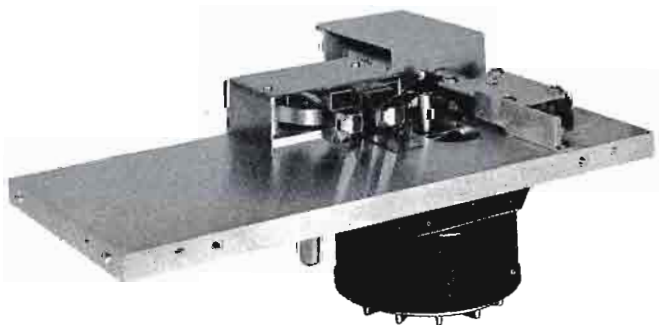

Rugged deck assembly and motor.

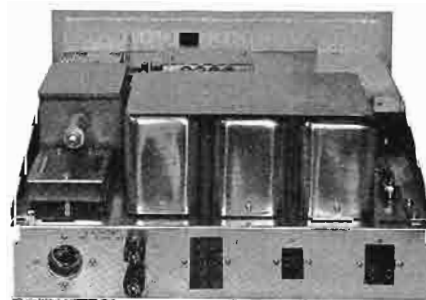

Convenient modular plug-in electronics.

Professional Tape Cartridge System—Criterion

SPECIFICATIONS

PLAYBACK UNIT

POWER SOURCE: 105-125 volts, 60 Hz, 50 Hz on special order.
POWER REQUIREMENTS: 60 watts maximum.
SYSTEM FREQUENCY RESPONSE: ± 2 dB 50 to 12,000 Hz. ± 4 dB 50 to 15,000 Hz.
NOISE: 55 dB below tape signal reference of 400 Hz, 3% THD.
DISTORTION: Record to playback, less than 2% at 0 VU record level, 400 Hz.
EQUALIZATION: NAB Standard Response.
AMBIENT TEMPERATURE: 55°C, maximum.
AUDIO OUTPUT: 600 ohms, balanced, 0 dBm, 150 ohms optional.
CUE SIGNALS: NAB Standard Cue Signals.
REMOTE CONTROL: All Control Functions.

HEAD ASSEMBLY: Laminated Hyperbolic heads in Micro-Set assembly.
TRANSISTOR AND DIODE COMPLEMENT: Monophonic Playback with 1000, 150 and 8000 Hz cue amplifiers, 1 Program Amplifier: (4) 2N1183; (11) 2N508; (15) 1N3255; (1) 1N729.
TAPE SPEED: 7½ inches per second.
TAPE DRIVE SYSTEM: Direct Capstan Drive, sealed ball bearings.
FLUTTER AND WOW: .2% or less.
TIMING ACCURACY: .1% or better.
TAPE START AND STOP TIME: Less than .1 second.
TAPE PULLING FORCE: Four pounds.
DIMENSIONS AND WEIGHT: Rack mount 7" high, 19" wide, 13½" deep. Desk top cabinet 5" high, 13½" wide, 14" deep. Net weight 30 lbs.

RECORDING AMPLIFIER

POWER SOURCE: From playback unit.
AMBIENT TEMPERATURE: 55°C maximum.
AUDIO INPUT: 600 ohms balanced line, input levels from -15 to +18 dBm.
REMOTE CONTROL: All functions.
BIAS OSCILLATOR: Push-pull, 70 kHz.

TRANSISTOR AND DIODE COMPLEMENT: Recording amplifier with 1000 Hz primary cue tone, 150 Hz secondary cue tone and 8000 Hz tertiary cue tones: (7) type 2N508; (2) type 2N1414; (1) type 1N462; (1) type 1N3255.
DIMENSIONS AND WEIGHT: Rack mount: 5¼" high, 19" wide, 11¾" deep. Desk top Cabinet: 4" high, 13¼" wide, 12¾" deep. Net Weight: 12 lbs.

CRITERION ORDERING INFORMATION

CPR-11 Playback, mono, one cue, rack mount.....	900-0001
CPD-11 Playback, mono, one cue, desk mount.....	900-0002
CPR-12 Playback, mono, dual cue, rack mount.....	900-0003
CPD-12 Playback, mono, dual cue, desk mount.....	900-0004
CPR-13 Playback, mono, three cue, rack mount.....	900-0005
CPD-13 Playback, mono, three cue, desk mount.....	900-0006
CBA Booster Amplifier for Playback Unit.....	900-0007
CAR-11 Recorder, mono, one cue, rack mount.....	900-0008
CAD-11 Recorder, mono, one cue, desk mount.....	900-0009
CAR-13 Recorder, mono, three cue, rack mount.....	900-0010
CAD-13 Recorder, mono, three cue, desk mount.....	900-0011
CPR-21 Playback, stereo, one cue, rack mount.....	900-0012
CPD-21 Playback, stereo, one cue, desk mount.....	900-0013
CPR-22 Playback, stereo, dual cue, rack mount.....	900-0014
CPD-22 Playback, stereo, dual cue, desk mount.....	900-0015
CPR-23 Playback, stereo, three cue, rack mount.....	900-0016
CPD-23 Playback, stereo, three cue, desk mount.....	900-0017
CAR-21 Recorder, stereo, one cue, rack mount.....	900-0018
CAD-21 Recorder, stereo, one cue, desk mount.....	900-0019
CAR-23 Recorder, stereo, three cue, rack mount.....	900-0020
CAD-23 Recorder, stereo, three cue, desk mount.....	900-0021
AMS-4A Automatic Master Switcher, mono.....	900-0024
AMS-4A-5 Automatic Master Switcher, stereo.....	900-0066
RC-P-4 Remote Control Panel for Playback Units.....	900-0025
RC-T Remote Control with Elapsed Time Indicator, for Recorder...	900-0027
RC-RA Remote Control Panel for Record/Playback system.....	900-0026

Tape Cartridges And Accessories

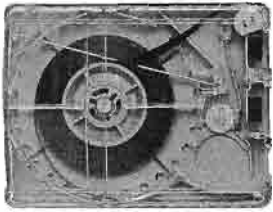

300 SERIES

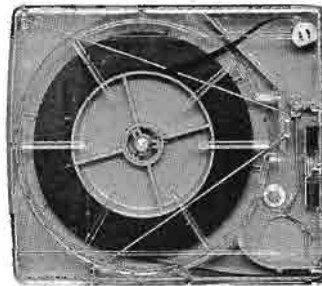

600 SERIES

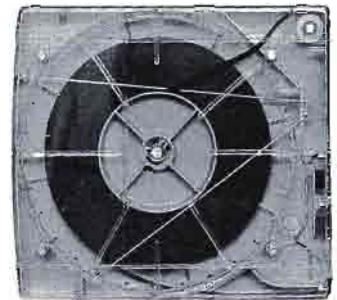

1200 SERIES

Gates tape cartridges are designed and manufactured to provide you with the finest over-all cartridge performance available today. Each careful production step assures this same high quality performance on the first and one-thousandth use of the cartridge. These tape cartridges meet and exceed all industry standards, and are fully compatible with all NAB standard tape machines.

In the manufacturing process, only the finest quality lubricated tape is used. It is wound on a precision automatic tape winding machine, and carefully spliced with magnifying glass attention. Special polyurethane pressure pads are installed in each cartridge to reduce wow and flutter to a minimum, while providing optimum tape-to-head contact.

The final production steps include a careful checkout on a tape deck attached to a precision wow and flutter meter, and an additional test involving recording and playback to assure audio excellence. Only after these tests have been completed is the Gates "Label of Quality" added to each cartridge.



Tape is wound onto cartridge turntables with a precision tape winding machine to assure exact tape length and playing time.

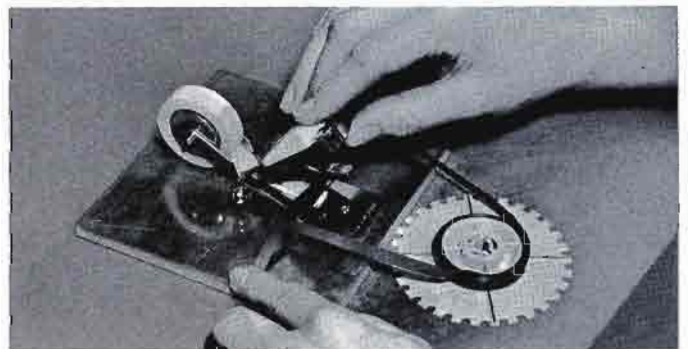

"Magnifying glass" attention is given to splicing tolerances to minimize "drop out" upon playback.

ORDERING INFORMATION

A-300, 40 second cartridge, packed 6/box.....	900-0077
A-300, 70 second cartridge, packed 6/box.....	900-0078
A-300, 100 second cartridge, packed 6/box.....	900-0079
A-300, 2½ minute cartridge, packed 6/box.....	900-0080
A-300, 3½ minute cartridge, packed 6/box.....	900-0081
A-300, 5½ minute cartridge, packed 6/box.....	900-0082
A-300, 10½ minute cartridge, packed 6/box.....	900-0083
B-600, 16 minute cartridge, packed 2/box.....	900-0084
C-1200, 31 minute cartridge, packed 2/box.....	900-0085
A-300 Empty cartridge, packed 6/box.....	900-0127
B-600, Empty cartridge, packed 2/box.....	900-0128
C-1200, Empty cartridge, packed 2/box.....	900-0129
Cartridge Pressure Pads—(50 replacement foam plastic pads)....	994-6430
Cartridge labels, 1000 (yellow, red, green, and white).....	900-0065
FAL-1A Test Cartridge. Full track, for mono or stereo systems. Includes tones for azimuth alignment, frequency response, and standard level reference.....	900-0090
Tape Eraser for Cartridges, Jiffy P-30, Hand Type.....	730-0102



Each cartridge is tested for recovery level of recorded tone to assure stable levels from cartridge to cartridge.

Tape Cartridge Storage Units

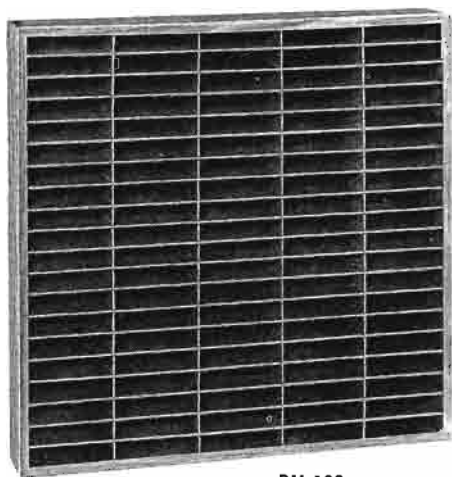

RM-100

M-5986 Storage Rack. Conveniently stores forty "Type A" Series 300 cartridges in only 10½" of standard rack space.



M-5986

RM-100 Wall Mount Cartridge Rack provides for storage of 100 Series 300 cartridges in minimum space. The unit can be wall or table top mounted. Walnut formica trim. Dimensions 2' H x 2' W x 4¾" D.

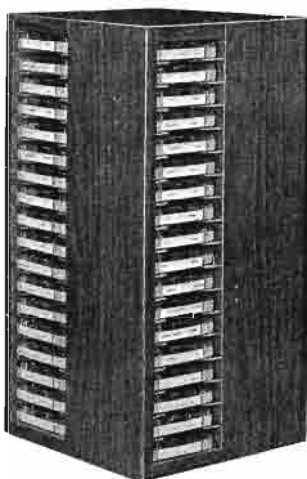

SECR-72

RS-200 Lazy Susan Revolving Cartridge Storage Rack—eight removable rack sections each store 25 "Type A" Series 300 cartridges, for a total of 200 for the unit. The RS-25 racks may be removed for use in other studios and are available separately.

SECR-72 Storage Cabinet. Attractive walnut formica trim blends with any decor. Storage space for 72 Series 300 cartridges. Cabinet rotates on ball bearings. Dimensions: 22" high x 11" wide x 11" deep.

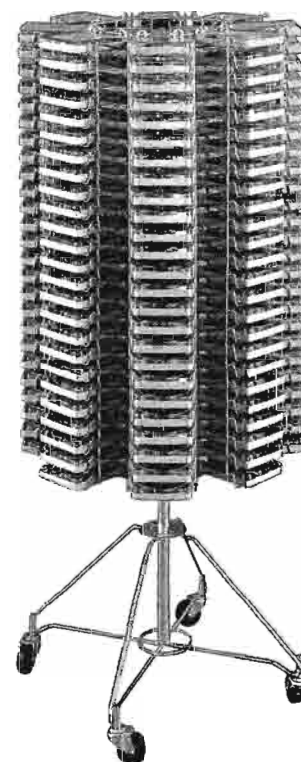

RS-200

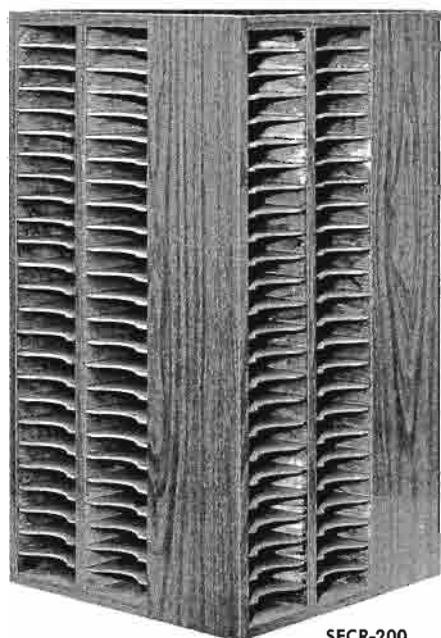

SECR-200

SECR-200 Storage Cabinet. Walnut formica trim for attractive over-all appearance. Capable of storing 200 Series 300 cartridges. Rotates on ball bearings. Dimensions: 29½" high x 15¾" wide x 15¾" deep.

ORDERING INFORMATION

M-5986 Storage Rack for 40 Series 300 cartridges.....	994-5986
RM-100 Storage Rack for 100 Series 300 cartridges.....	730-0834
RS-200 Storage Rack for 200 Series 300 cartridges.....	730-0835
RS-25 Storage Rack for 25 Series 300 cartridges (not shown).....	730-0836
SECR-72 Storage Cabinet for 72 Series 300 cartridges.....	900-0147
SECR-200 Storage Cabinet for 200 Series 300 cartridges.....	900-0148



DC-10 DIGITAL CLOCK

The DC-10 digital clock is used as a centralized source of time information in Gates automated broadcast systems. It may also be used to control the operation of auxiliary apparatus within the program automation system, or external non-related equipment. Visual time information is displayed on the front of the unit, with rear chassis connections for operation of other equipment.

Use of the DC-10 digital clock to control all time related functions assures fully synchronized operation of the broadcast facility. 115 VAC power required. Dimensions: 7" high, x 19" wide x 11" deep.

DC-10 digital clock (60 Hz).....	900-0037-001
DC-10 digital clock (50 Hz).....	900-0037-002



TS-3 TIME SELECTOR

The Model TS-3 time selector is an exact time control device that performs a switching function on a time programmed basis in Gates program automation systems. "Time assignment commands" are stored in the SP-10/19 programmer memory tape cartridge, and are supplied to the TS-3 as required. Real time information is provided by the DC-10 digital clock.

Typical operation of the Gates TS-3 would consist of exact time operation of the automation system for network joining or exact time station identifications. The time selector will operate only in conjunction with the digital clock and the SP-10/19 system programmer. Dimensions: 5¼" high x 19" wide x 11" deep.

TS-3 time selector (60 Hz).....	900-0141
---------------------------------	----------



RC-T REMOTE CONTROL

Most control functions of a Gates Criterion record—playback can be remotely controlled with this compact easy-to-use control. A built-in timer registers the elapsed time of a recording on the tape, simplifying recording of multi-message tapes.

Starting the machine activates the timer, and over 200 hours of recording may be made before the timer automatically recycles. A manual timer reset is also provided. Desk top unit measures 7¼" W x 7⅞" H x 4½" D.

RC-T remote control with elapsed time indicator (60 Hz)....	900-0027-001
RC-T remote control (as above except 50 Hz).....	900-0027-002
RC-RA remote control unit without elapsed time indicator. Controls one record/playback system from remote point.....	900-0026

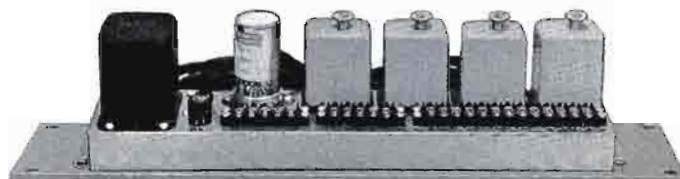

AUDIO SWITCHER PANEL

Allows up to four Criterion units to be switched into one console input through this panel, adding to the flexibility of control room operations.

AMS-4A Automatic master switcher (mono).....	900-0024
AMS-4A(S) Automatic master switcher (stereo).....	900-0066

CARTRIDGE TAPE DELAY

Combines Criterion record amplifier and playback units with play/erase/record head configuration. No cueing. Rack mount. Delay time determined by length of cartridge.

CTD Cartridge tape delay, 60 Hz (not shown).....	900-0023-001
CTD Cartridge tape delay, 50 Hz (not shown).....	900-0023-003

Solid Statesman Peak Limiting Amplifier



FOR AM, FM AND TV

Designed to outperform all others, the Gates Solid Statesman Peak Limiting Amplifier ushers in a new age of advanced limiter capabilities.

PERFORMANCE: True limiting without peak clipping is achieved with an average 3 to 5 microsecond attack time. This eliminates the several milliseconds of clipping found in most limiters while the limiting action "catches up". Thus, in this new Peak Limiting Amplifier, even the most critical ear cannot detect the audible distortions that are apparent as a result of slow attack time.

LOW DISTORTION: Distortion is typically 0.2% at 30 Hz and 0.3% at 16 kHz with 10 dB of limiting, and is less than 1.0% with up to 30 dB of limiting. Frequency response remains uniform with or without limiting.

HIGHER MODULATION LEVELS: Fast attack time (in microseconds) and variable release time provide complete freedom from "pumping" with limiting of 15 to 20 dB on most program content. A 30:1 compression ratio allows 99.5% negative modulation without overmodulation. For AM stations,

asymmetrical limiting permits positive peak modulation levels of 110% or 120%, yet negative peaks are limited to 100% or less. This produces a louder-sounding signal.

AUTOMATIC PHASE REVERSAL: The highest peak of the audio signal is made positive to produce the highest AM modulation level in the transmitter. This asymmetrical limiting causes no base line shift in the limiter, and does not artificially alter the balance of the program content. It does permit greater modulation of the natural positive peaks with the resultant increase in transmitter power.

Symmetrical limiting is also available for operation where peaking and phasing of the signal are not desired, such as FM or TV. Two Solid-Statesman limiters may be operated together with a jumper for FM stereo operation. A front panel control also permits the limiter to be disabled for proof of performance tests.

CONTROLS: All operating controls are located behind the front access panel. Input and output connections are provided on a barrier terminal block, in addition to the AC power cord, on the rear of the unit.

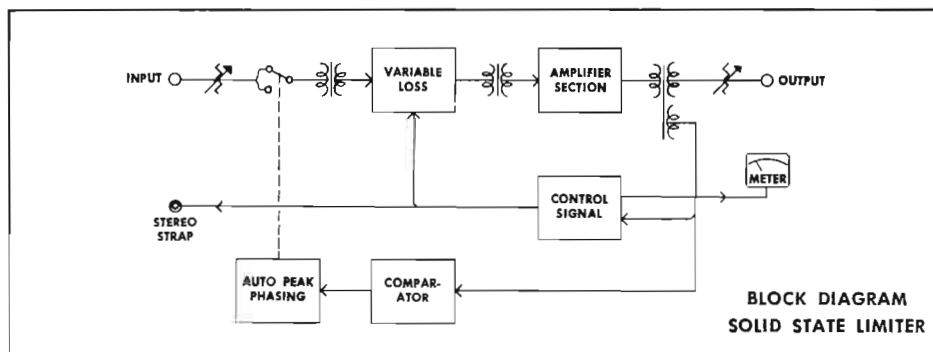

Solid Statesman Peak Limiting Amplifier



Front view, panel open.

The signal at "A" applied to a conventional limiter with a clipper produces output "B". Here the signal is first clipped, introducing distortion, and then several milliseconds later the true limiting is accomplished. Gates Solid Statesman Limiter completes the limiting action during the first half cycle of the pulse (output "C"). Any distortion produced would be during the first half cycle, and after that the signal would be truly limited without distortion.

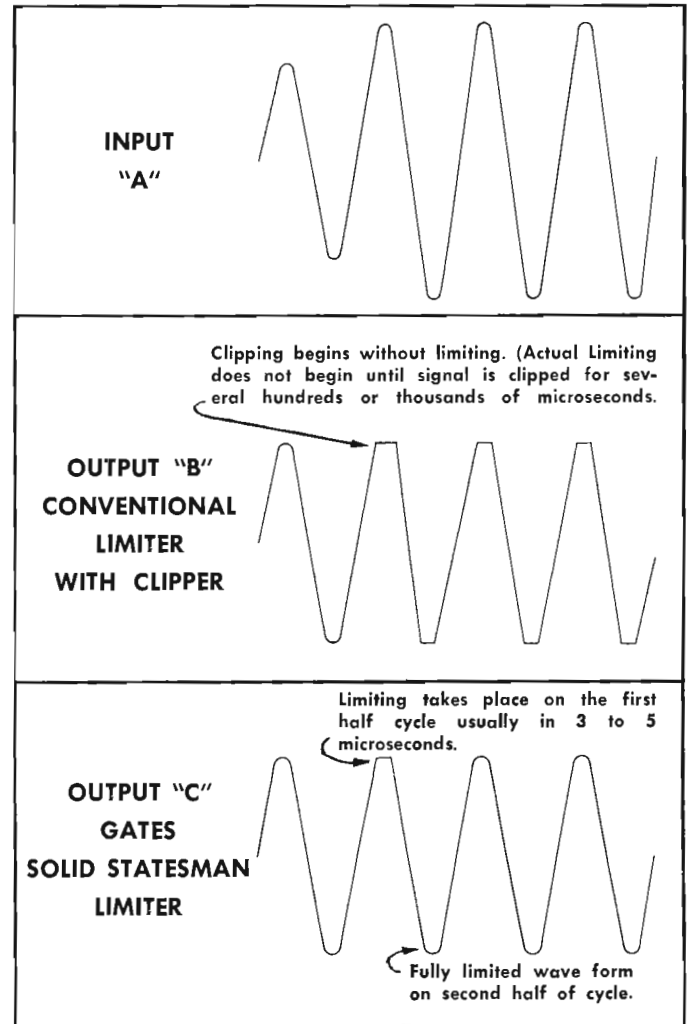

SPECIFICATIONS

GAIN: 50 dB, ± 2 dB max. @ 1 kHz. (May be reduced by built-in input and/or output attenuators).

FREQUENCY RESPONSE: ± 1.0 dB max., 30 to 16,000 Hz (with or without limiting).

HARMONIC DISTORTION: Less than 1.0% from 30 to 16,000 Hz, from 0 to 10 dB of limiting, except with fast recovery on low frequencies where there is partial recovery on each $\frac{1}{2}$ cycle.

NOISE: 70 dB below threshold of limiting, 30 to 16,000 Hz.

ATTACK TIME: Less than 10 microseconds (typical 3 to 5 microseconds).

RECOVERY OR RELEASE TIME: Gated to program content, with 3 positions for individual preferences.

AMOUNT OF LIMITING: 30 dB with a 30:1 compression ratio, an increase of 30 dB input level will increase output level 1 dB.

INPUT LEVEL: Adjustable -22 to +18 dBm for 5 dB of limiting.

OUTPUT LEVEL: Adjustable to +23 dBm maximum.

INPUT AND OUTPUT IMPEDANCE: 600 ohms, balanced or unbalanced.

TEMPERATURE RANGE: -20°C to $+55^{\circ}\text{C}$.

INPUT POWER: 115/230 volts, 50/60 Hz.

DIMENSIONS: $3\frac{1}{2}$ " H x 12" D x 19" W (standard rack).

WEIGHT: 13 lbs. net; 22 lbs. shipping.

ORDERING INFORMATION

Solid Statesman Peak Limiting Amplifier.....994-6543

FM Top Level



TOP LEVEL

With the advent of better recording equipment, reproducing systems, and the special equalization effects used by recording artists and studios, the high frequencies fed into today's FM broadcast transmitters are often of sufficient amplitude (after pre-emphasis) to cause overmodulation. Gates Top Level allows maximum modulation level without the usual fears of overmodulation. It is intended for use between a station's limiting amplifier and the FM transmitter.

ALL SOLID STATE: Top Level is a fully transistorized frequency sensitive audio processor for FM, utilizing a precise 75 microsecond pre-emphasis curve for its sampling. In FM, transmission amplifiers must handle high-frequency signals (15,000 Hz region), up to 17 dB higher than, as an example, a nominal 1000 Hz audio signal. When adequate signal levels are maintained at mid-range frequencies, there is a definite problem of overmodulation at the higher frequencies because of the pre-emphasis curve.

CLAMPING: Top Level samples the pre-emphasized audio material and instantaneously clamps the high frequency, high amplitude signals that cause overmodulation.

OPERATION: An FM receiver will reproduce a signal that is measurably louder when Top Level is employed, because average modulation can be higher. The signal will sound cleaner because of the effect of de-emphasizing (in the receiver) a non-pre-emphasized portion of the curve while clamping is in effect. Also, Top Level affords precision control with low distortion, while, in comparison, transmitter overmodulation contributes to serious intermodulation and distortion in the FM discriminator of average receivers.

SCA ADVANTAGE: For broadcasters with SCA, Top Level greatly reduces crosstalk and signal degradation due to pre-emphasis splatter from the main channel.

Top Level is not intended to replace a station limiter, but functions as an economical companion unit to increase protection against overmodulation.

MONAURAL OR STEREO: Featuring dual channel capability, Gates Top Level is ready for stereo or monaural broadcasting. With either, Top Level makes possible full-range reproduction at an audio level that pleases both the audience and the broadcaster.

SPECIFICATIONS

MODE: Dual channel, stereophonic or monophonic.

INPUTS: Two, 600 ohms balanced or unbalanced.

GAIN: 28 dB maximum.

RESPONSE: ± 1 dB, 30-15,000 Hz.

DISTORTION: 0.5% maximum, 30-15,000 Hz.

NOISE: 75 dB below normal output level.

ATTACK AND RELEASE TIMES: Instantaneous.

INPUT LEVEL: -10 to +24 dBm. Adjustable.

OUTPUT: 2 channels at +18 dBm (adjustable), 600 ohms balanced or unbalanced.

POWER: 117 volts, 50/60 Hz, 30 watts.

MECHANICAL DATA: 19" wide, 5 1/4" high, 12" deep. Finish: medium beige-gray and black. Weight packed, 24 lbs. Cubage: 4 cubic feet.

ORDERING INFORMATION

FM Top Level, complete994-6467



Dual Peak Limiting Amplifier



STEREO OR DUAL MONAURAL

Gates Dual Peak Limiting Amplifier may be used for stereo or as two totally separate monaural limiters for AM and FM operation. One solid state regulated power supply operates both limiter sections, and the complete dual limiter requires only seven inches of rack space. Direct current is applied to input stage filaments to assure extremely low noise.

STEREO OPERATION: For stereo operation, program balance is always retained. The stereo channel that is limiting the highest determines the amount of peak limiting applied to the other stereo channel. The limiters have essentially the same characteristics in response, distortion and phase to prevent undesirable differences in the two channels.

MONAURAL OPERATION: For dual limiter monaural operation, each limiter is independent in all functions. A switch instantly changes the mode from stereo to separate limiters.

SOLID STATE POWER SUPPLY: The common solid state power supply operates both limiting amplifiers. Complete balancing controls are built-in to insure uniform characteristics. No tubes are used in the power supply and direct current is applied to the low level filament circuits. A power transistor is connected in a "capacitor multiplier" circuit to essentially eliminate ripple on the low level filaments. This contributes greatly to the outstanding low noise level of -70 dB.

AUDIO STAGES: Each amplifier of the dual limiter has four audio stages: a push-pull variable gain stage; a voltage amplifier; a phase inverter; and a push-pull output stage. An extremely fast attack time of up to 600 microseconds is accomplished through advanced circuitry. The signal to thump ratio is extremely low because of dynamic and static balancing controls in the first audio stage. Intermodulation distortion is less than 1.5% up to 20 dB of limiting, while channel separation/crosstalk is well below noise frequencies at all levels.

SPECIFICATIONS

MODE: Stereo or dual monaural.

CONTROLS: Input and output both limiters. Input balance both limiters. Meter mode selector both limiters. Meter zeroing both limiters. Stereo-dual separate limiters switch. Power-on switch.

IMPEDANCES: 500/600 ohms input and output both limiters.

AUDIO LEVELS: Input -45 dBm at full open gain threshold of limiting or up to 0 dBm by reduced gain adjustment. Output $+24$ dBm into 6 dB self-contained isolation pad, also may be reduced with output level control. Maximum gain 63 dBm ± 2 dB.

RESPONSE: ± 1 dB 30-15,000 Hz.

DISTORTION: 1% or less at 10 dB limiting. 1½% or less at 25 dB limiting, 30-15,000 Hz.

NOISE: 70 dB below $+18$ dBm at output.

LIMITER ACTION: Attack time up to 600 microseconds. Signal to thump ratio typical -35 dB up to 25 dB limiting. Rated -20 dB. Crosstalk where used as stereo or separate limiters is -70 dB or better.

POWER: 117 volts, 50/60 Hz, 60 watts.

MECHANICAL: 19" x 7" x 16" deep; weight packed: 50 lbs. domestic, 65 lbs. export. Cubage: 3. Finish: beige-gray, trimmed in brushed aluminum and black.

DIODE TRANSISTOR COMPLEMENT: (1) 2N1539 or 2N554 and (4 each) X5A6, X5A2, GO-1.

TUBES: (4) 6K7, and (2 each) 12AX7, 12BH7, OB2.

ORDERING INFORMATION

Dual Peak Limiting Amplifier with tubes.....994-6144
Spare 100% tube kit.....99C-0420



Program Gated Amplifier



THE LEVEL DEVIL

Gates Level Devil accepts varying input signals and holds the output constant. Depending on input signal level, the Level Devil operates as (1) a linear amplifier, (2) a volume expander, or (3) a limiting amplifier. Unlike usual expander-compressors, however, the Level Devil does not expand or "pump" background noise.

PERFORMANCE: Level Devil accepts input signals over a 30 dB range and holds a constant output ± 3 dB. The expander threshold is -10 dB relative, and below this the amplifier operates as any other good linear amplifier. At -10 dB or above the amplifier will expand to 0 dB. Above 0 dB it will limit.

OPERATIONAL FEATURES: With average program content at normal input level, the Level Devil operates as a linear amplifier. With above normal audio input level it operates as a limiting amplifier, and maintains the desired output level. If the average input level should drop below normal by as much as 10 dB, the Level Devil functions as a volume expander. When there is no signal for a period of 1 to 4 seconds, the Level Devil returns to the linear amplifier mode of operation, and does not emphasize or increase background noise. This is ideal for controlling the audio of a show in which there are long periods of silence with only music in the background. The expansion of this background might destroy the desired audio effect.

VERSATILITY: Two switches are provided so that Level Devil may be used for expansion only, without limiting; or for

limiting only, without expansion. It is well suited to all types of broadcasting—AM, FM and TV.

APPLICATION: A peak limiting amplifier should be used with Level Devil. The limiter, often at the transmitter location, is the over-all guardian against overmodulation, and also permits high average audio levels. Level Devil, usually at the studio, preferably operates independently of other total equipment functions to obtain the fullest benefit of its outstanding capabilities. Radio and television stations alike have reported an increase in coverage with a louder sound, minimum background noise in absence of a signal, and constant output level as operating advantages obtained from Level Devil.

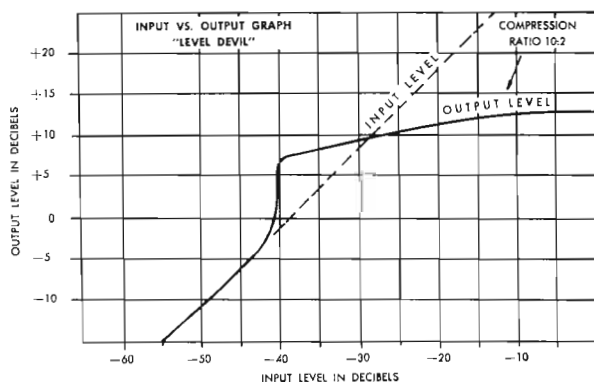

Graph shows compression or limiting curve as related to input.

Program Gated Amplifier—Level Devil

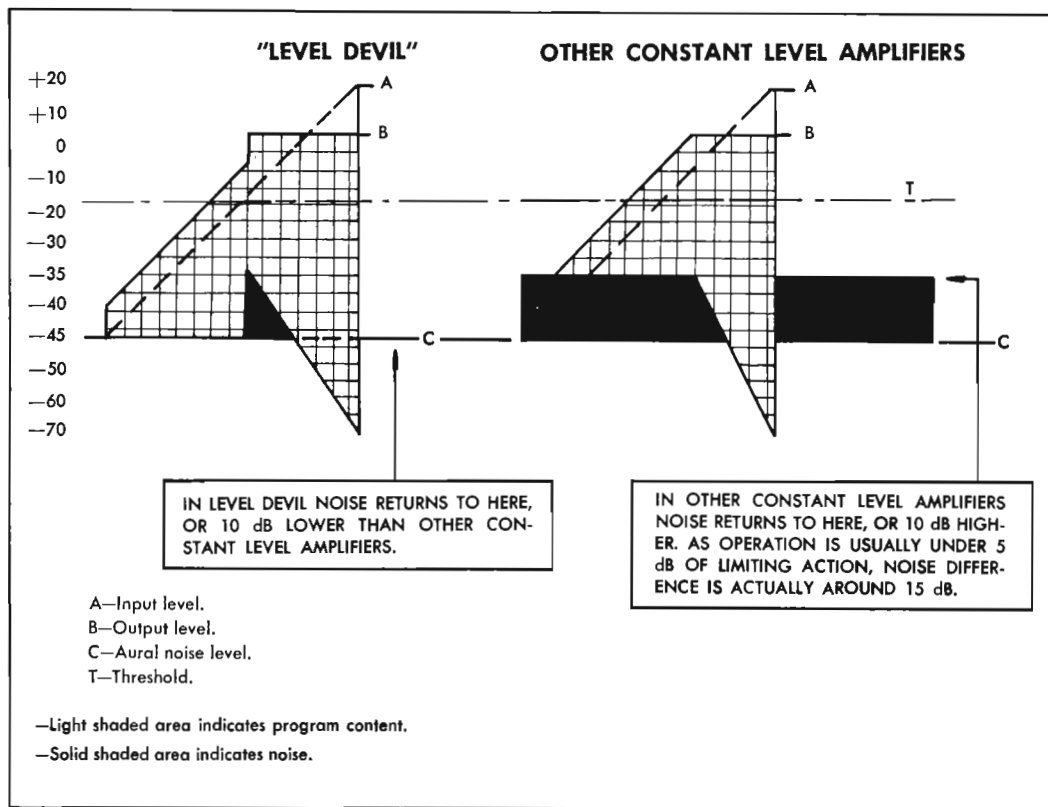

A graphic illustration of the difference between Level Devil and all other leveling amplifiers. Noise referred to in graphs is defined in this instance as lower level program content.

SPECIFICATIONS

MODE: Monaural.

CONTROLS: Input and output levels. Switches to select operating modes.

METER: Reads direct in (a) limiting, (b) normal, and (c) expansion.

IMPEDANCES: 500/600 ohms input and output.

INPUT LEVEL: -35 VU to +27 VU (10 dB and 20 dB input pads incorporated).

OUTPUT LEVEL: +8 VU after 6 dB line isolation pad.

GAIN: 50 dB without limiting or expansion.

RESPONSE: ± 1 dB 30-15,000 Hz.

DISTORTION: 1% or less 50-10,000 Hz to 10 dB limiting. 2% or less to 25 dB limiting.

MAXIMUM VOLUME EXPANSION: 10 dB. Note that Level Devil can release 5 dB of compression and expand 10 dB, giving effective signal increase of 15 dB.

EXPANSION RISE TIME: 2 seconds.

EXPANDER RECOVERY TIME: 4 seconds.

MAXIMUM LIMITING: 25 dB.

LIMITER ATTACK TIME: 10 milliseconds.

LIMITER RELEASE TIME: 1.5 to 2.0 seconds.

NOISE: -60 dB or better below 10 dB limiting.

POWER: 117 volts, 50/60 Hz, 55 watts.

SIZE: 19" x 8 $\frac{3}{4}$ " x 8 $\frac{1}{2}$ " deep.

WEIGHT: Domestic packed 35 lbs.; export packed 45 lbs. Cubage: 2 cu. ft.

FINISH: Beige-gray and black.

TUBES: (2 each) 5749, 12AU7, 12AT7, 12AX7, OB2. (1 each) EF86, 5V4G.

ORDERING INFORMATION

Level Devil with tubes 994-5546

Spare 100% tube kit 990-0452

Automatic Program Level Amplifier



THE STA-LEVEL

The basic function of Gates Sta-Level is to provide constant level output. When the volume is too low, Sta-Level will raise it; if volume is too high, Sta-Level will automatically reduce it. This automatic adjustment for different input levels allows average output levels to be higher, since there is automatic protection. Soft passages are automatically raised in level—resulting in a uniformly higher level of transmission and the equivalent of greater signal output.

RECOVERY SPEED: Sta-Level recovers $\frac{2}{3}$ level in 7 seconds and 90% level in about 28 seconds. This is considered typical. However, a kit of small fixed resistors is supplied. If the operator feels this is too slow or too fast, he may, by changing

two resistors, increase recovery to as fast as $\frac{2}{3}$ seconds for $\frac{2}{3}$ level, and 10 seconds for 90% level; or as slow as $11\frac{1}{4}$ seconds for $\frac{2}{3}$ level, and 45 seconds for 90% level.

ACCESSORIES: None are needed, as the Sta-Level is a self-contained, one-chassis unit complete with regulated power supply.

GAIN: Since Sta-Level has as much as 62 dB gain, if your present system is short of gain, Sta-Level will pick it up. Both input and output level controls are on the front panel to adjust for any gain you wish, down to unity or up to the full 62 dB.

SPECIFICATIONS

MODE: Single channel monaural.

CONTROLS: Input and output level controls.

METER: Reads decibels of compression.

IMPEDANCES: 500/600 ohms input and output.

GAIN: 62 dB adjustable at both input and output.

RESPONSE: ± 1 dB 30-15,000 Hz.

DISTORTION: Less than 1%, 50-15,000 Hz at +20 dBm output level, 0-30 dB compression.

NOISE: 65 dB below +20 dBm output level, 0-30 dB compression.

MAXIMUM VOLUME EXPANSION: Variable as set by input control.

EXPANSION RISE TIME: Factory set at 7 seconds. Kit provided for faster or slower action as desired.

EXPANSION RECOVERY TIME: Approximately 25 milliseconds.

MAXIMUM COMPRESSION: 30 dB. 40 dB at slightly greater distortion.

COMPRESSION ATTACK TIME: Approximately 25 milliseconds.

COMPRESSION RECOVERY TIME: Normal 7 seconds for 63% recovery. Faster as compression becomes greater.

SERVICING: Drap down front panel. Tubes at rear.

POWER: 117 volts, 50/60 Hz, 45 watts.

MECHANICAL: Size, 19" x 5 $\frac{1}{4}$ " x 7" deep. Weight packed: 40 lbs. domestic; 50 lbs. export. Cubage: 2 cubic feet. Finish: beige-gray.

TUBES: (2) 6V6, (1 each) 6386, 12AT7, 6AL5, OB2, 5Y3GT.

ORDERING INFORMATION

Sta-Level with tubes 994-5167
Spare 100% tube kit 990-0243

Rack Cabinets

RAK-1

Utilizing welded open frame construction, with removable side panels, each basic rack of the RAK-1 may be mounted singly or bolted to others to form a uniform multirack installation. This design permits mounting of equipment within the rack cabinet or flush with the front. Rear door may be hinged left or right. Vertical panel mounting angles have mounting holes at universal standard locations to provide 77 inches of standard 19-inch panel mounting. The basic RAK-1 cabinet includes 2 panel mounting angles, 2 terminal board mounting angles, full size rear door and panel mounting screws. Other accessories available:

SINGLE CORNER TRIM TRM-1: Covers the rack mounting bolts on each corner. Two used for single cabinet.

DOUBLE CORNER TRIM TRM-2: Covers rack mounting bolts and joins two cabinets together. One used to join second cabinet to first, third to second, etc.

LARGE SIDE SHIELD SH-1: A shield plate 15½" x 28" in size.

SMALL SIDE SHIELD SH-2: Same as SH-1 above only 15½" x 21" in size.

TERMINAL BOARD MOUNTING BRACKET BRK-1: Mounts at bottom rear of cabinet for the support of audio and power terminal blocks.

SIDE PANELS SP-1: Commonly known as end bell. Two used for single cabinet or any number of cabinets joined together.

SPECIFICATIONS

HEIGHT OVER-ALL: 84".

WIDTH: (Less SP-1 side panel), 22".

WIDTH OF SP-1 SIDE PANEL: 3".

DEPTH OVER-ALL: 21".

DOOR SWING: 22½".

PANEL SPACE: 19" x 77".

MAXIMUM CLEARANCE BEHIND FRONT PANEL: 17".

PANEL MOUNTING: Standard rack multiples 10-32 mounting screws provided.

FINISH: Beige-gray.

WEIGHT: Net 100 lbs.; Domestic packed 110 lbs.; Export packed 190 lbs. Cubage: 18 cu. ft.

TO ORDER: See "Ordering Information" below.

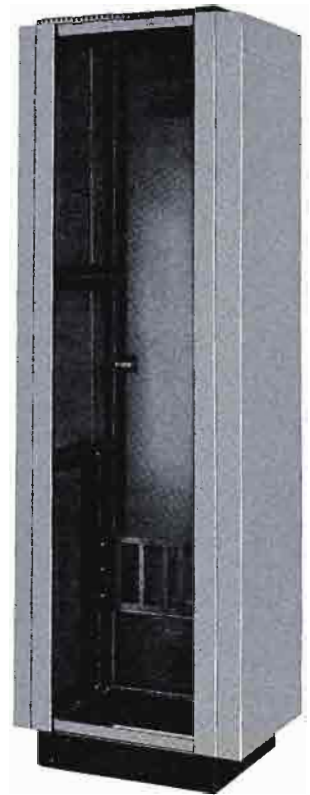

RAK-7

The RAK-7 is one of the finest solid side rack type cabinets designed specifically to accommodate all types of broadcast equipment. Built of lightweight steel, this cabinet has solid sides, a solid base, full size rear door with louvers at top and bottom for efficient ventilation.

SPECIFICATIONS

HEIGHT OVER-ALL: 78".

WIDTH OVER-ALL: 23½".

DEPTH OVER-ALL: 19½".

DOOR SWING: 20½".

PANEL SPACE: 19" x 71¾".

CLEARANCE BEHIND PANEL: 17".

PANEL MOUNTING: Standard rack multiples 10-32 mounting screws provided.

FINISH: Beige-gray.

WEIGHT: Net 100 lbs.; Domestic packed 115 lbs.; Export packed 200 lbs.; Cubage: 18 cu. ft.

TO ORDER: See "Ordering Information" below.

ORDERING INFORMATION

RAK-1:

Basic Cabinet assembly less side panels but including rear door.....	994-3706
Single Corner Trim.....	994-3708
Double Corner Trim.....	994-3707
Side Panel.....	994-3709
SH-1 Shield.....	994-3711
Terminal Board Mounting Bracket.....	994-3712
Ventilating Fan.....	994-4875

RAK-7:

Rack Cabinet.....	994-5527
Joiner Trim.....	994-5577

CR-70 (Not shown):

Waist-high rack cabinet. Heavy cold rolled furniture grade steel, resistance welded. Size: 37¾" H x 23¾" W x 23" D. Rack space 33¼" x 19".....	994-5651
--	----------

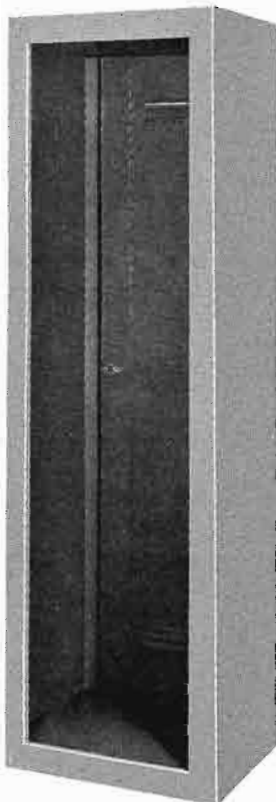

Premium Solid State Audio Amplifiers

6300 SERIES

Designed for custom audio equipment, these fully transistorized audio amplifiers incorporate engineering advances that provide excellent performance standards.

Thorough laboratory testing and extensive field use have proven the "6300" series amplifier family one of the finest in the broadcasting field.

"6300" amplifiers are noted for low noise, low distortion, wide frequency response and Solid-Statesman reliability.

Units may be installed in tandem with little or no equalizing, while maintaining an excellent signal-to-noise ratio. Modern plug-in design assures easy installation and maintenance.

Included in this complete line are: Pre-amplifier, program amplifier, program/AGC (automatic gain control) amplifier, power supplies, mounting trays and a compact shelf assembly for rack mounting.

For the most critical applications, Gates recommends the "6300" Solid-Statesman Series.



M-6313A



M6314A



Typical rear plug in detail.

TRANSISTORIZED PREAMPLIFIER

SPECIFICATIONS

GAIN: 40 dB, or 46 dB (by receptacle strapping), ± 0.3 dB.

FREQUENCY RESPONSE: ± 0.5 dB from 20 to 20,000 Hz, or ± 0.25 dB from 30 to 15,000 Hz.

DISTORTION: 0.25% maximum from 30 to 15,000 Hz @ +20 dBm output.

NOISE: -123 dBm relative input noise, 30 to 15,000 Hz.

SOURCE IMPEDANCE: 150/600 ohms balanced or unbalanced, center tapped.

LOAD IMPEDANCE: 150/600 ohms, balanced or unbalanced.

POWER: 48 volts DC @ 30 mA.

CONNECTORS: 16 terminal, self-aligning, recessed to prevent accidental damage.

MONITORING: Indicator lamp provides warning of short-circuit condition.

TEST POINT: Pin jacks provide audio output monitoring.

MOUNTING TRAY: M-6341 tray and receptacle. Tray attaches to M-6345 panel and shelf assembly for mounting up to eight preamplifiers in $3\frac{1}{2}$ " of vertical rack space.

SIZE: 2" wide x $3\frac{3}{8}$ " high x $14\frac{3}{4}$ " long.

WEIGHT: $4\frac{1}{2}$ lbs. net.

ORDER NUMBER994-6313A

TRANSISTORIZED PROGRAM/AUTOMATIC GAIN CONTROL AMPLIFIER

SPECIFICATIONS

GAIN: 62 dB, ± 0.3 dB; or 80 dB, ± 0.5 dB (by receptacle strapping).

FREQUENCY RESPONSE: ± 0.5 dB from 20 to 20,000 Hz or ± 0.25 dB from 30 to 15,000 Hz (62 dB gain). ± 0.5 dB from 30 to 15,000 Hz (80 dB gain).

DISTORTION: 0.25% maximum from 30 to 15,000 Hz, (62 dB gain @ +32 dBm output level). 0.5% maximum from 30 to 15,000 Hz, (80 dB gain @ +32 dBm output level).

NOISE: -116 dBm relative input noise (62 dB gain mode) from 30 to 15,000 Hz. -118 dBm relative input noise (80 dB gain mode) from 30 to 15,000 Hz.

GAIN REDUCTION: (AGC): Amplifier input/output characteristics linear below threshold of AGC @ +20 dBm output level. 6 dB gain reduction maximum in 62 dB gain mode. After maximum of 6 dB AGC, amplifier input/output characteristics become linear again. An input level of -24 dBm will result in 6 dB gain reduction and an output level of +32 dBm. Approximately 21 dB AGC in the 80 dB gain mode. Amplifier characteristics linear below the threshold of AGC @ +20 dBm output level. An input level of -27 dBm will result in 21 dB gain reduction and an output level of +32

dBm. An external switch permits disabling the AGC action without thumps or clicks in the program circuit.

ATTACK TIME: AGC attack time = 25, ± 3 milliseconds.

RECOVERY TIME: AGC recovery time = 0.5, ± 0.1 second.

SOURCE IMPEDANCE: 150/600 ohms, balanced or unbalanced, center tapped.

LOAD IMPEDANCE: 150/600 ohms, balanced or unbalanced, center tapped.

POWER: 48 volts DC @ 140 mA.

CONNECTORS: 16 terminal, self-aligning, recessed to prevent accidental damage.

MONITORING: Indicator lamp provides warning of short-circuit condition.

TEST POINT: Pin jacks provide audio output monitoring.

MOUNTING TRAY: M-6342 tray and receptacle. Six PGM/AGC amplifiers mount in $3\frac{1}{2}$ " of vertical rack space.

SIZE: $2\frac{3}{4}$ " wide x $3\frac{3}{8}$ " high x $14\frac{3}{4}$ " long.

WEIGHT: 5 lbs. net.

ORDER NUMBER994-6314A

Premium Solid State Audio Amplifiers



M-6338

TRANSISTORIZED POWER SUPPLY

SPECIFICATIONS

CAPACITY: Up to 50 M-6313 Transistor Preamplifiers, or up to 10 M-6314 Program/AGC amplifiers or any combination with a maximum rated current of 1.5 amps. Use for large systems or where growth is anticipated.

OUTPUT: 48 volts DC at 0 to 1.5 amps, continuous.

RIPPLE: Less than 1.0 mV from 0 to full load.

INTERNAL IMPEDANCE: 0.05 ohms.

REGULATION: 0.3%.

POWER: 117 volts nominal, 50/60 Hz, 130 watts maximum.

SHORT CIRCUIT PROTECTION: Resistive short circuit protection allows full operation to resume after momentary short circuits on the output. Primary fuse prevents component damage with sustained short circuits.

UNDERVOLTAGE ALARM: Self-contained relay actuates with approximately 10% undervoltage. Contacts are connected to the output plug to permit the operation of an external alarm.

CONNECTORS: 16 terminal, self-aligning, recessed to prevent damage.

SWITCH AND FUSE: Switch and illuminated indicating fuse holder located on the front escutcheon for AC control of the power supply.

MONITORING: Neon lamp (to indicate presence of AC supply voltage), and load lamp (to indicate output voltage). Output sampling jack located on the front escutcheon.

MOUNTING TRAY: M-6344 tray and receptacle. Four M-6338 power supplies mount in 3½" of vertical rack space.

SIZE: 4½" x 3½" high x 14¾" long.

WEIGHT: 7½ lbs. net.

ORDER NUMBER994-6338



M-6321

TRANSISTORIZED PROGRAM AMPLIFIER

SPECIFICATIONS

GAIN: 62 dB, ± 0.3 dB, unterminated input.

FREQUENCY RESPONSE: ± 0.5 dB from 20 to 20,000 Hz or ± 0.25 dB, 30-15,000 Hz.

DISTORTION: 0.25% maximum from 30 to 15,000 Hz @ +32 dBm output.

NOISE: -116 dBm relative input noise, 30 to 15,000 Hz.

SOURCE IMPEDANCE: 150/600 ohms, balanced or unbalanced, center tapped.

LOAD IMPEDANCE: 150/600 ohms, balanced or unbalanced, center tapped.

POWER: 48 volts DC @ 140 mA.

CONNECTORS: 16 terminal, self-aligning, recessed to prevent damage.

MONITORING: Indicator lamp provides warning of short-circuit condition.

TEST POINT: Pin jacks provide audio output monitoring.

MOUNTING TRAY: M-6426 tray and receptacle for up to six program amplifiers in 3½" of vertical rack space.

SIZE: 2¾" wide x 3½" high x 14¾" long.

WEIGHT: 4½ lbs. net.

ORDER NUMBER994-6321



M-6421

TRANSISTORIZED POWER SUPPLY

SPECIFICATIONS

CAPACITY: Up to ten M-6313 preamplifiers, or two M-6314 Program/AGC amplifiers, or any system combination with a maximum rated current not exceeding 300 mA for use in smaller systems.

OUTPUT: 48 volts DC at 0 to 300 mA continuous.

RIPPLE: Less than 1.0 mV from 0 to full load.

INTERNAL IMPEDANCE: 0.05 ohms.

REGULATION: 0.3%.

POWER: 117 volts nominal, 50/60 Hz, 30 watts.

SHORT CIRCUIT PROTECTION: Resistive for momentary short circuits on output. Primary fuse prevents damage from sustained short circuits.

CONNECTORS: 16 terminal, self-aligning, recessed to prevent damage.

SWITCH AND FUSE: Located on front escutcheon.

MOUNTING TRAY: M-6422 tray and receptacle. Six M-6421 power supplies mount in 3½" of vertical rack space.

SIZE: 2¾" wide x 3½" high x 14¾" long.

WEIGHT: 5½ lbs. net.

ORDER NUMBER994-6421



Preamplifier and accessory tray assembly. Plugs on all amplifiers are recessed to assure no damage to pins.

Audio Amplifier Accessories

ACCESSORIES

Complete mounting accessories are available for the "6300" series Solid-Statesman amplifiers. The M-6345 panel and shelf assembly unit occupies only 3½" x 19" of rack space. Built of heavy-gauge, plated, non-corrosive steel, finished in beige-gray, with hinged front panel. The shelf assembly is provided with an upper cross-bar to prevent damage to amplifier plugs or tray receptacles. Individual mounting trays have been designed for each model amplifier and power supply.

In system practice a typical audio input signal may pass through four amplifiers, four faders, nine transformers, and be bridged a dozen or more times, yet the system performance at the output is equal to or better than any individual amplifier specification. Of particular importance is the higher rated output levels of both preamplifiers and program amplifiers to accommodate greater dynamic range at no increase in distortion.

NOTE: The source of load impedance of the amplifiers as listed in the specifications is the recommended impedance of the connecting device (such as a microphone, attenuator, line or loudspeaker). However, the input impedance of all four amplifiers is approximately ten times higher than the source impedance, giving the systems designer greater flexibility.

The output impedance is approximately 1/10 the load impedance, which permits multiple bridging without any degradation of the output signal.

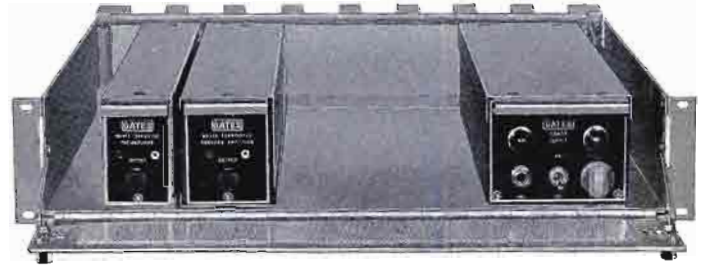

Above: M-6345 panel and shelf assembly, showing several "6300" series Solid-Statesman units. This assembly requires only 3½" x 19" of rack space.

ORDERING INFORMATION

Mounting tray for preamplifier	994-6341
Mounting tray for program amplifier	994-6426
Mounting tray for program/AGC amplifier	994-6342
Mounting tray for M-6421 power supply	994-6422
Mounting tray for M-6338 power supply	994-6344
Panel and shelf assembly	994-6345

TELEVISION AUDIO CONSOLE

The production console at the left is now in use in a leading television network, and houses 57 of the "6300" series Solid-Statesman transistorized units. The remarkable capabilities of this completely self-contained console include: mixing from 25 input audio sources simultaneously into nine separate program channels, each with automatic level control; built-in video monitoring, ten audio monitoring channels; twelve microphone equalizers; two graphic program equalizers; five sound effects filters; two reverberation send and return channels; vertical attenuators; three video controlled audio channels, plus many other special features.

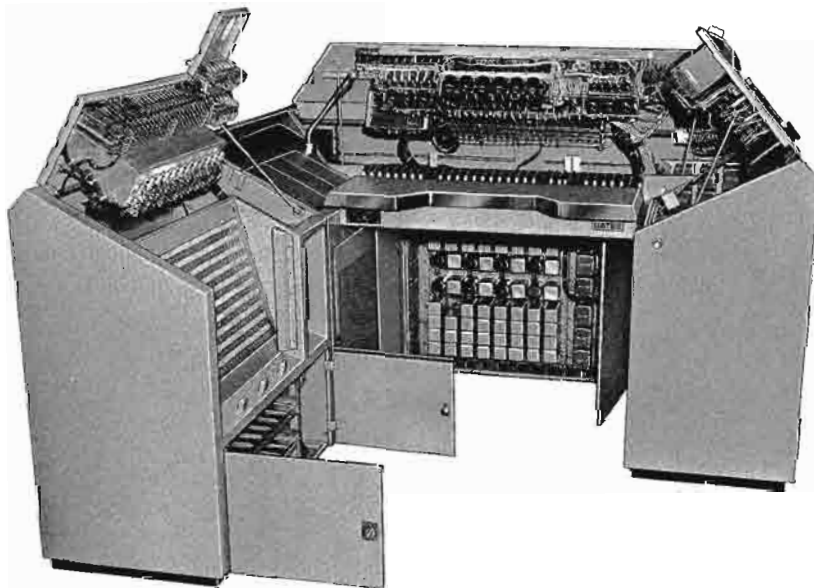

Solid Statesman Plug-In Audio Amplifiers

5700 SERIES

For any audio system application in AM, FM, TV, recording or sound distribution, the "5700" series Solid-Statesman transistor plug-in amplifiers offer uniformly high quality performance exceeding the capabilities of vacuum tube amplifiers. Conservative design provides a 50% safety factor so that all amplifiers are capable of operation with a continuous sine wave at maximum ambient temperatures, and at full rated output levels.

All circuits in the "5700" series utilize carefully chosen components with printed wiring on glass epoxy boards for uniformity, strength, and reliability. Connectors are gold-plated for absolute contact. Floating-type receptacles on the mating trays assure positive, fast alignment. All transistors are plug-in triple A industrial type, which essentially eliminates any possibility of thermal damage during operation.



PREAMPLIFIER

Usually used to feed a mixing bus or program amplifier, this preamplifier operates from a microphone or similar low-level source and has sufficient gain to drive a line or monitor amplifier.



PROGRAM AMPLIFIER

A high performance program or line amplifier. Has gain control mounted on front. As many as seven amplifiers mount in one 19" x 3½" rack panel and shelf assembly.

SPECIFICATIONS

GAIN: 40 dB.
RESPONSE: ± 0.5 dB, 30 to 15,000 Hz.
HARMONIC DISTORTION: Under 0.75% at 30 Hz, under 0.5% from 50 to 15,000 Hz at +18 dBm output.
NOISE: -122 dBm relative input noise, 30 to 15,000 Hz.
MOUNTING: Use Gates M-6030 mounting tray listed below.
POWER REQUIREMENTS: 30 volts DC at 30 mA.
SOURCE IMPEDANCE: 30/50—150/250—500/600 ohms (balanced or unbalanced).
LOAD IMPEDANCE: 150/250—500/600 ohms (balanced or unbalanced).
CONNECTORS: Gold-plated Blue Ribbon type.
SIZE AND FINISH: Size: 1¾" wide, 3½" high, 10¾" long. Finish: Cadmium plated enclosure with black anodized escutcheon plate.
WEIGHT: 3½ lbs. net.

ORDERING INFORMATION

Transistor plug-in preamplifier.....994-6028
Mounting tray for M-6028.....994-6030

SPECIFICATIONS

GAIN: 70 dB or less as adjusted by gain control.
RESPONSE: ± 1 dB from 30 to 15,000 Hz.
HARMONIC DISTORTION: Under 0.75% at 30 Hz; under 0.5% from 50 to 15,000 Hz at +24 dBm output.
NOISE: -115 dBm relative input noise, 65 dB below -50 dBm input.
MOUNTING: Use Gates M-6031 mounting tray listed below.
POWER REQUIREMENTS: 30 volts DC at 90 mA.
SOURCE IMPEDANCE: 150/250 or 500/600 ohms (balanced or unbalanced).
LOAD IMPEDANCE: 150/250—500/600 ohms (balanced or unbalanced).
CONNECTORS: Gold-plated Blue Ribbon type.
SIZE AND FINISH: Size: 2¼" wide, 3½" high, 10¾" long. Finish: Cadmium plated enclosure with black anodized escutcheon plate.
WEIGHT: 4¼ lbs. net.

ORDERING INFORMATION

Transistor plug-in program amplifier.....994-5700B
Mounting tray for M-5700B.....994-6031

Solid Statesman Plug-In Audio Amplifiers

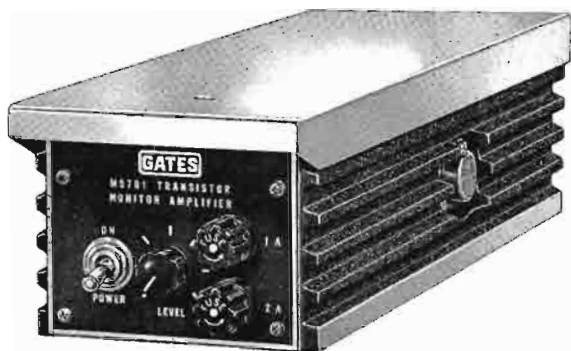

MONITOR AMPLIFIER

This 8-watt, low distortion monitoring amplifier is ideal for a flawless loudspeaker distribution system. The power supply is self-contained. Has gain control, on-off switch and fuse receptacle on front.

SPECIFICATIONS

- GAIN:** 90 dB or less as adjusted by gain control.
- RESPONSE:** ± 1 dB from 30 to 15,000 Hz.
- HARMONIC DISTORTION:** Under 1% from 50 to 15,000 Hz at +39 dBm (8 watts).
- NOISE:** -120 dBm relative input noise.
- MOUNTING:** Use Gates M-6032 mounting tray listed below.
- POWER REQUIREMENTS:** 117 volts, 50/60 Hz, 18 watts.
- SOURCE OF IMPEDANCE:** 30/50, 150/250 or 500/600 ohms (balanced or unbalanced).
- LOAD IMPEDANCE:** 8 ohms nominal (balanced). Order speaker matching transformer (478-0275), Page 152, for multiple speakers.
- CONNECTORS:** Gold-plated Blue Ribbon type.
- SIZE AND FINISH:** Size: 4 1/8" wide, 3 1/8" high, 12 3/4" long. Finish: Cadmium plated cover, black cast aluminum heat sink sides, and black anodized escutcheon plate.
- WEIGHT:** 8 1/2 lbs. net.

ORDERING INFORMATION

Transistor plug-in monitor amplifier.....	994-5701
Mounting tray for above.....	994-6032
Speaker matching transformer.....	478-0275



POWER SUPPLY

A fully regulated power supply designed for use with Gates "5700" series amplifiers. Features automatic short circuit protection, electronically preventing damage due to any type of short circuit or overload. Plug-in design. On-off switch and fuse receptacle on front.

SPECIFICATIONS

- OUTPUT:** 30 volts DC at 400 mA maximum.
- INPUT:** 117 volts, 50/60 Hz, 18 watts with maximum load.
- NOISE:** 0.1 millivolts (rms) ripple or better.
- MOUNTING:** Use Gates M-6032 mounting tray listed below.
- SUPPLIES POWER FOR:** (13) M-6028 preamplifiers, or (4) M-5700B program amplifiers, or (7) M-6028 preamplifiers and (2) M-5700B program amplifiers, or any combination not exceeding 400 mA load current. As power supply is fully regulated, any lesser number of units may be used without voltage change.
- CONNECTORS:** Gold-plated Blue Ribbon type.
- SIZE AND FINISH:** Size: 4 1/8" wide, 3 1/8" high, 12 3/4" long. Finish: Cadmium plated cover, black sides and black anodized escutcheon plate.
- WEIGHT:** 8 1/4 lbs. net.

ORDERING INFORMATION

Transistorized plug-in power supply.....	994-5702
Mounting tray for above.....	994-6032

ACCESSORIES

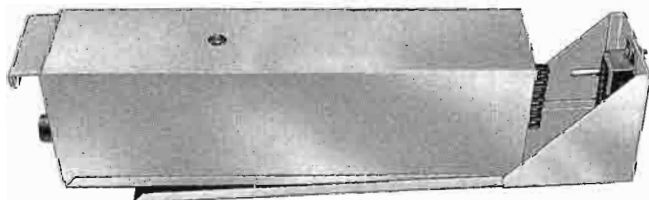

MOUNTING TRAY

Fast and foolproof connections are assured every time a Gates transistor plug-in amplifier is placed in its mounting tray. A flanging type receptacle gives positive alignment and the steel "key pin" prevents any possible mix-up of amplifiers in the system. Three types required for entire "5700" series of Solid-Statesman amplifiers and power supplies. For ordering information refer to specific amplifier or power supply listed on these pages.



PANEL AND SHELF ASSEMBLY

Designed to mount the "5700" series Solid-Statesman amplifiers and power supplies in conjunction with the mounting trays. Requires only 19" x 3 1/2" rack space and is 14 1/2" deep. Accommodates: 9 preamplifiers with M-6030 mounting trays. 7 program amplifiers with M-6031 mounting trays. 4 monitoring amplifiers with M-6032 mounting trays. 4 power supplies with M-6032 mounting trays—or any combination of the above.

Panel and shelf assembly.....	994-6029
-------------------------------	----------



Program And Monitoring Amplifiers

PROGRAM OR LINE AMPLIFIER

Studio equipment facilities often may be expanded by adding a second or third program amplifier. In single channel consoles the audition bus may be used for separate programming of FM by inserting the M-5576B program amplifier between the bus and the line. For bridging, standby and network feeds, this amplifier mounted in the equipment rack is ideal.

This high gain, low distortion, 4-stage program amplifier includes a self-contained power supply and requires only 5¼" of rack space. A dual gain control with one section in the second stage grid and the other section in the third stage grid assures a low noise ratio at any gain setting.

SPECIFICATIONS

GAIN: 75 dB, ± 2 dB.

RESPONSE: $\pm 1\frac{1}{2}$ dB, 30-15,000 Hz.

DISTORTION: 0.75% at +12 dBm output, 30-15,000 Hz. 1% at +22 dBm output, 50-15,000 Hz.

NOISE: 60 dB below +12 dBm output or equal to -120 dBm relative input noise.



IMPEDANCES: Input and output: 150/250 or 500/600 ohms.

POWER: 117 volts, 50/60 Hz, 45 watts.

TUBES: (3) EF86 and (1 each) 12AU7, 6X4.

MECHANICAL: 19" x 5¼" x 7½" deep. Weight packed (domestic), 27 lbs.; (export) 50 lbs. Cubage: 2 cubic feet. Finish: beige-gray.

ORDERING INFORMATION

Program amplifier with tubes.....994-5576B
Spare 100% tube kit.....990-0450



MONITORING AMPLIFIER

In quality audio systems, the need for excellence in loud-speaker distribution is paramount. Here is an outstanding ultra linear amplifier offering a variety of input impedances, very low distortion, excellent power output and high gain. Input impedances for matching 30/50 and 150/250 ohm lines or bridging at 30,000 ohms are available. An unusually high gain of 100 dB allows the M-5575 monitoring amplifier to be used directly from a mixer program bus, low level turntable output or a microphone. The distortion is less than 1%, though a full 10 watts of power is produced from a -60 dBm input.

SPECIFICATIONS

GAIN: 100 dB or bridging 50 dB.

RESPONSE: $\pm 1\frac{1}{2}$ dB, 30-15,000 Hz.

DISTORTION: 1% or less 50-15,000 Hz at +40 dBm (10 watts).

NOISE: 60 dB or better below +40 dBm, measured at -50 dBm input.

IMPEDANCES: (Input) 30/50 or 150/250 ohms at 100 dB gain. 30,000 ohms bridging at 50 dB gain. (Output) 8 and 16 ohms.

POWER: 117 volts, 50/60 Hz, 85 watts.

TUBES: (3) 12AX7, (2) EL84, (1) GZ34, (1) OA2, (1) OB2.

MECHANICAL: 19" x 7" x 8" deep. Weight packed (domestic), 34 lbs.; (export) 59 lbs. Cubage: 3 cubic feet. Finish: beige-gray.

ORDERING INFORMATION

Ultra linear monitoring amplifier, with tubes.....994-5575
Spare 100% tube kit.....990-0303
Speaker matching transformer, see Page 152.....478-0275



Monitoring And Utility Amplifiers

TRANSISTOR MONITOR AMPLIFIER

Offering the superb performance of transistors, Gates M-6108 professional 8-watt monitoring amplifier is designed for the exacting demands of modern broadcasting. Only 4½" x 8½" x 3½" including self-contained power supply, it will fit anywhere, even in the corner of a loudspeaker cabinet. The almost negligible operating temperature lends to its versatility.

The M-6108 will produce 20-20,000 Hz response within ±1 dB with no more than 1% distortion at a full eight watts output. Gain of 53 dB from a 600 ohm input or 39 dB from the 6,000 ohm bridging input assures wide versatility. The output of 4-16 ohms for direct speaker connection may be changed to other higher impedances through the use of an optional external matching transformer.



SPECIFICATIONS

GAIN: 53 dB using 600 ohm input; 39 dB using 6000 ohm bridging input.
RESPONSE: 20-20,000 Hz ±1 dB.
DISTORTION: 1% or less 8 watts output, 50-15,000 Hz. 1% or less 6 watts output, 30-15,000 Hz.
NOISE: 85 dB below +39 dBm output (8 watts).
IMPEDANCES: (Input) 600 ohms matching, 6000 ohms bridging, transformer input. (Output) 4 to 16 ohms.

POWER: 117 volts, 50/60 Hz, 18 watts.
SIZE: 4½" wide, 8½" long, 3½" high.
WEIGHT: 4 lbs. net.

ORDERING INFORMATION

Eight-watt transistorized monitor amplifier.....994-6108

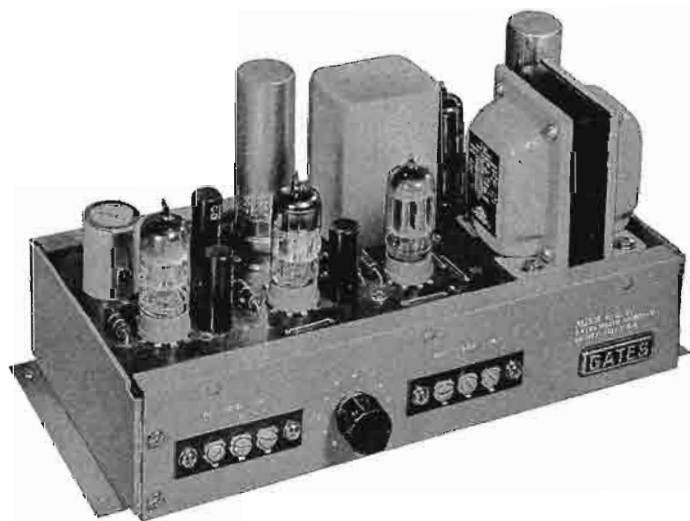

SINGLE CHANNEL UTILITY AMPLIFIER

Often called the most important of amplifiers, as it fills almost any amplifier need. AC operated and completely self-contained, the M-5530 all purpose amplifier operates as (a) a single microphone remote amplifier, (b) turntable preamplifier with ample gain for passive equalizers, (c) standby program amplifier, and (d) a microphone amplifier for medium level tape recording. Mounts nicely in turntable cabinet. Ideal for permanent remotes.

SPECIFICATIONS

GAIN: 81 dB.
RESPONSE: 30-15,000 Hz ±1½ dB.
DISTORTION: 1% or less 50 to 15,000 Hz at +8 dBm output or 2% at +18 dBm.
NOISE: 60 dB below +8 dBm.
IMPEDANCES: (Input) 30/50 or 150/250 ohms. (Output) 150/250 or 500/600 ohms.
POWER: 115 volts, 50/60 Hz. Consumption 15 watts.
TUBES: (2) EF86/6267, and (1 each) 12AU7, 6X4.

SIZE: 11" x 5" x 5¼" deep.
WEIGHT: Net 9½ lbs. Packed 20 lbs. Cubage: 2 cubic feet.

ORDERING INFORMATION

Single channel utility amplifier with tubes.....994-5530
Chassis connector (female).....612-0194
Microphone connector (male).....610-0182
Spare 100% tube kit.....990-0280



Audio Accessories

CUEING AMPLIFIER



Program preview of 10 audio circuits may be selected by a rotary switch with this high gain, compactly designed cueing amplifier. Requiring only 3½" of rack space, Gates Uni-Que amplifier has a self-contained loudspeaker and is easily adaptable to convenient desk mounting. High gain allows cueing direct from turntable, tape, projector circuits and microphone preamplifier outputs. Input is either low impedance or bridging. Speaker has terminals for muting when used in the control room. Front panel includes gain control, 10 selector switch (plus "off" position), power switch, pilot light and fuse.

SPECIFICATIONS

GAIN: 70 dB low impedance matching, 35 dB bridging, ±2 dB.
INPUT LEVEL: -20 dBm matching or +22 dBm bridging.
RESPONSE: Peaked for high intelligibility.
IMPEDANCES: (Input) 30/50, 150/250 or 10,000 ohms bridging. (Output) to self-contained speaker with muting terminals external.
NOISE: 50 dB or better below speaker level of about +30 dBm.
POWER: 105/125 volts, 50/60 Hz, 25 watts.
POWER SUPPLY: Solid state, transformer input (not AC/DC).
TUBES: (1) 12AX7, (1) 50C5.
MECHANICAL: 19" x 3½" x 6½" deep. Weight packed: (domestic) 16 lbs., (export) 30 lbs. Cubage: 2 cubic feet. Finish: Beige-gray.

ORDERING INFORMATION

Cueing Amplifier with tubes.....994-5377
 Spare 100% tube kit.....990-0305

SWITCH AND FUSE PANEL



Each rack of audio and radio frequency equipment should have a master switch and fuse panel. Usually mounted at the bottom of the rack, the Gates M-4242 switch and fuse panel includes dual pilot lamps to indicate input and output voltage, dual fuses and D.P.D.T. primary switch. Rating 15 amperes at 115 volts, AC. Size: 19" x 3½" x 3" deep. Finish: Beige-gray. Weight packed: 10 lbs. Cubage: 1 cubic foot.

ORDERING INFORMATION

Switch and fuse panel.....994-4242

VU METER AND RANGE PANEL



A 5% or better accuracy is maintained throughout the 2 VU per step, +4 to +42 VU range. The 10-position input selector switch permits permanent installation to regularly checked circuits. For proof of performance measurements, equipment calibration, input level measurements from remote circuits and output levels (up to 10 watts), the VU-22 meter panel offers complete versatility. Input: 7500 ohms to bridge a 500/600 ohm line. Frequency response: Flat 20-20,000 Hz. Size 19" x 5¼" x 3" deep. Finish: Beige-gray and black. Shipping weight packed: 12 lbs. Cubage: 1 cubic foot.

ORDERING INFORMATION

VU-22 VU meter and range panel.....994-4577
 Terminal board accessory for above.....994-4648

STUDIO WARNING LIGHTS



An unusually attractive studio fixture with edgewise lighting of a plexiglass transparent plate. Incandescent lamp is housed in gun-metal casing. Mounting is usually above studio door. "On Air" lettering is in red with other nomenclatures, such as Studio A", etc., supplied in black. Housing is well ventilated, without light leakage. Size: 18" wide, 3" front to back, and 6½" from bottom of glass to top of housing. 117 volts, 50 watts. UL approved.

ORDERING INFORMATION

LETTERING	ORDER
On Air (in red).....	406-0269
Special lettering up to 12 characters (specify).....	406-0278
On The Air (QF-15 Rollins).....	406-0285
Studio A (QF-15 Rollins).....	406-0280
Studio B (QF-15 Rollins).....	406-0281



Audio Accessories

VA PROGRAM FADER KNOBS



The VA program knobs are used on all Solid-Statesman consoles and are specifically recommended for mixer and master gain functions. Designed to meet human engineering concepts, these VA fader knobs are fashioned for the control operator's hands, where touch and feel are of major importance. Matching black anodized dial available.

ORDERING INFORMATION

VA knob only.....650-0130
 Dial for VA knob.....648-0045
 Knob decal kit (6 colors—5 of each).....646-0379

STUDIO CUE/INTERCOM SPEAKER

The studio cue/intercom speaker is a modern design, high efficiency cue speaker mounted in a cast aluminum housing and finished in black, with attractive grill. It may be used for cue listen or cue talk-back. Matches either 48 or 600 ohms. Size: 5 1/8" wide, 6 1/2" high and 4" deep, with a 30° slope when placed on desk.



ORDERING INFORMATION

Studio cue/intercom speaker.....994-6424

DESK OR CONSOLE TOP VU METER

Used on the President and Ambassador Solid-Statesman consoles, this completely housed VU meter is ideal for many audio applications. Standard scale B illuminated 4" VU meter in cast aluminum housing 5 1/8" x 6 1/2" x 4" deep.

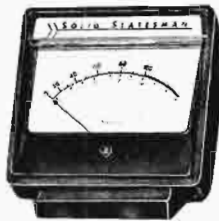

ORDERING INFORMATION

VU meter (30° slope when placed on desk).....994-6208

SPEAKER MATCHING TRANSFORMER

Where many speakers are used, the normal 8 ohm voice coil impedance will cause a mismatch. This transformer has a primary of 48 ohms and a secondary of 8 ohms. Thus, six transformers in parallel will reflect the normal 8 ohms output impedance of the studio monitor amplifier.

Speaker matching transformer (not shown).....478-0275

PATCH PANELS AND CORDS



Illustrated above are two PJ-341 jack strips on a PD-2 jack mat to supply 48 pairs or 96 jacks on a 19" x 5 1/4" rack space.



Twenty-four pairs or 48 jacks is a PJ-341 jack strip on a PD-1 jack mat. Rack space 19" x 3 1/2".



Shown above is the PJ-343 twenty-four jack, 12-pair unit requiring only 19" x 1 3/4" rack space. No jack mat is required.

Industry standard double jack panels. Jack strips and jack mats listed separately below for ease in ordering. Jacks are closed circuit type to normal through audio circuits when patch cord plugs are not inserted. Contacts are silver alloy with springs, non-aging, non-ferrous metal to assure lasting tension. Molded bakelite form, steel reinforced. Individual designation strips with slip-in holders for each jack pair.



Patch cords have double plug each end, with cords in 4 lengths. Cords shielded and covered with double black braid, with extra reinforcement 6" from each plug end.

ORDERING INFORMATION

Jack strip only (PJ-343), 24 jacks or 12 pairs (no jack mat required).....612-0307
 Jack strip only, (PJ-341), 48 jacks or 24 pairs (less mat).....612-0306
 Jack mat for one PJ-341 jack strip (PD-1).....994-4399
 Jack mat for two PJ-341 jack strips (PD-2).....994-4400
 Jack mat for three PJ-341 jack strips (PD-3).....994-4401
 Double patch cord with 2' cord (PJ-12).....250-0002
 Double patch cord with 3' cord (PJ-13).....250-0003
 Double patch cord with 4' cord (PJ-14).....250-0004
 Double patch cord with 5' cord (PJ-15).....250-0005



Audio Accessories

FIXED EQUALIZER



A general response correction equalizer of the parallel resonant type for 150 or 600 ohm circuits. A kit of resistors and capacitors is supplied to provide 1 ohm steps to 111 ohms and capacitance of .05 and .025 mfd. Though normally used to correct deficient telephone lines, it is excellent for other circuit corrections as well. Size: 2½" square and 3" high.

Fixed equalizer complete (LE-1).....994-4391

VARIABLE EQUALIZER



Consists of 2 Type LE-1 equalizers described at left, with two variable controls to insert resistance in 1 ohm steps to 111 ohms. A double jack input is provided for each of the two equalizers for parallel patching. Size: 19" wide and 3½" high. Finish: Beige-gray.

Variable equalizer (LE-2).....994-4392

TRANSCRIPTION STORAGE CABINETS

For convenient filing and protection of records or tapes, use modern Wallach storage cabinets. Models available for all sizes of discs and tape reels. Modular systems for desk and floor mounting, with doors and locks, also available.



DISC CABINET

Protect those expensive and fragile 12" LP's as they should be. Holds 540 12" LP's with a heavy red wallet for each. Includes two sets of numbers, 1620 printed catalog cards and card file. Size: 60" x 29" x 14" deep. Double door with lock and key.

Disc cabinet.....448-0134

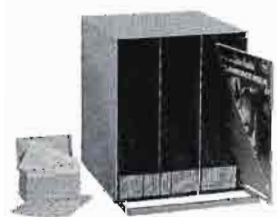

LP ALBUM CABINET

Holds sixty 7", 10" or 12" albums. Includes cataloging system with index cards for fingertip control. Size: 13½" x 15½" x 14" deep.

Cabinet for 60 albums.....448-0230
As above, with snap catch door.....448-0231

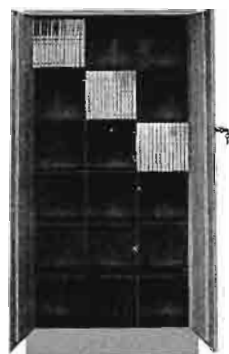

DOUBLE DOOR TAPE CABINETS, WITH LOCK

Cabinet for 7" reel boxes. 18 compartments — capacity to 288 reel boxes. 29" x 60" x 10" deep.

Cabinet.....448-0130

Cabinet for 10½" reel boxes. 12 compartments — capacity to 192 reel boxes. 29" x 60" x 10" deep.

Cabinet.....448-0178

TAPE CABINETS

Holds 42 reel boxes of 7" tape reels. Has six compartments. May be stacked as desired. 13½" wide, 12½" high, 8" deep.

Cabinet.....448-0043

Holds 21 reel boxes of 10½" tape reels. Has three compartments. May be stacked as desired. 13½" wide, 12½" high, 12" deep.

Cabinet.....448-0131



CONNECTORS

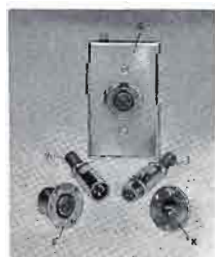

- (G) Single, 3 prong, female, 1 wall plate (XLR3-35).....612-0188
- (H) Cable plug, 3 prong, male. (XLR3-12C).....610-0182
- (I) Cable receptacle, female, 3 prong (XLR3-11X).....612-0182
- (J) Chassis receptacle, female, 3 prong (XLR3-13).....612-0194
- (K) Chassis receptacle, male, 3 prong (XLR3-14).....610-0194

AUDIO TERMINAL BLOCK

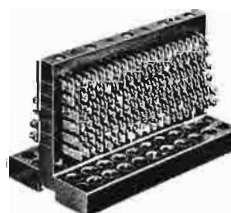

For inter-rack or jack field wiring. Molded one-piece black phenolic with base 3½" x 6½". 3½" high. Plated brass terminals. Polished phenolic finish. Mounts in Gates RAK-1 rack cabinet with BRK-1 bracket. 120 terminals in six rows.

Audio terminal block.....614-0339

Audio Accessories

BOOM STANDS



Provide convenient and proper microphone placement where correct position cannot be reached with conventional stands. Boom length 62 inches, height adjustable from 4 ft to 6 ft. Base diameter 17 inches, tubular sections superchrome plated. "Snap On" hangers provided for microphone cable. Shipping weight 33 lbs.
Boom Stand without casters.....720-0061
Boom Stand with silent casters.....720-0062

ADJUSTABLE MICROPHONE ARM



Flexo Mikester Mike Support Arm clamps or screws to any position. Swings to 36 inches fully extended. Mounts any microphone up to 4 lbs. Shipping weight 7 lbs.
Flexo Mikester.....720-0040

HEADPHONES



BA-200 Brush. Smartly styled, unusually sensitive high impedance crystal headset. Dual earpieces. Monophonic service.
Dual Headset.....721-0003
 BA-201 Brush. Single headpiece version of above. High impedance crystal type.
Single Headset.....721-0004
 TRIM economy headset. Featherweight dual earpiece model, recommended for utility monitoring use such as remotes, etc. Impedance 24,000 ohms.
Model 107 TRIM Dual Headset.....721-0006
 STEREOPHONIC Headphones. High impedance dual headset for control room monitoring with stereophonic consoles such as the Gates Executive or Stereo Statesman.
BA-206B Stereo Headset.....721-0009
511 TRIM Headphone Plug.....610-0273

DESK STANDS



Model 418. Heavy cast iron stand finished in medium gray. Specifically designed for microphones using small type stud such as Gates G-100 and G-200. Net weight 3 lbs.
Desk Stand.....720-0026
 Model 419. Heavy weight desk stand similar to the Model 418, but for use with the Gates G-300 or similar microphones.
Desk Stand.....720-0028
 DS-7. Adjustable desk stand for all popular microphones. Tubular section adjusts from 8 to 13 inches. Heavy chrome-plated stem and gray cast base with felt feet. Shipping weight 3 lbs.
Desk Stand.....720-0076
 DS-5. Non-adjustable desk stand. Chrome-plated tube 4" high. 6" diameter cast iron base with rubber feet. Weight 2 lbs.
Desk Stand.....720-0035
 TS-8. Banquet stand. Adjustable 14½" to 26". Chrome stem sections with velvet-action clutch adjustment. 8" diameter base. Wt. 5 lbs.
Banquet Stand.....720-0150

TAPE SPLICER



Deluxe "Stereo 4" tape splicer with integral tape dispenser for splicing tape. Two-position, replaceable cutting blades. Makes diagonal splice, cuts tiny trims on sides. Made of strong "Implex" plastic. With 100' roll of ½" splicing tape and instructions. Shipping wt., 1 lb. Made by Robbins.
"Stereo 4" Tape Splicer.....732-0099

EDIT-ALL PROFESSIONAL SPLICER



The standard editing device used by professional recording engineers. It is the only precision editing block especially designed with a curved groove to hold the tape firmly without damage. Designed by a network tape editor. Precision machined, will never wear out. Kit complete with block, Mylar splicing tape, blade, marking pencil, and instructions. Wt., 1 lb.
Edit-all Splicing Kit.....732-0167

FLOOR STANDS



MS-25. Professional microphone floor stand. "Air-Lock" cushion controls drop, prevents slippage and microphone damage. Adjusts from 37 to 66 inches. Heavy, triangular base 17 inches in diameter. Full chrome with medium gray base. Fits all microphones listed in this catalog. Weight, 25 lbs.
Professional Floor Stand.....720-0048
 MS-10C. Excellent for average weight microphones. Has 10" diameter base, chrome 2-section tube. Adjusts 35 to 64 inches. Wt., 13 lbs.
Utility Floor Stand.....720-0047
 BB-1. "Baby Boom" stand attachment. Converts any floor stand with ¾"-27 thread to boom-type stand. 32" boom, adjustable counter balance for various microphones. Wt., 6 lbs.
Baby Boom attachment (no stand).....720-0059
NOTE: All mic stands on this page have ¾"-27 thread, which is standard in the industry.

BULK TAPE ERASER



Professional model HD-11M. Heavy duty unit erases entire reel of tape at once, in seconds. Lowers residual noise 3 to 6 dB below most erase-head levels. Recommended for tape cartridges or reels up to 10½". Adaptor hub available for 10½" NAB reels. 117 volts, 50/60 Hz. Weight, 9 lbs. Made by Microtran.
Bulk Eraser.....732-0096
Adaptor Hub for 10½" reels.....732-0043

JIFFY TAPE ERASER



Compact unit erases tape conveniently. For cartridges or any size reel. Holds in hand, with momentary pushbutton operation. 117 volts, 60 Hz. Weight, 5 lbs.
Jiffy Hand-Type Tape Eraser.....730-0102

TAPE HEAD DEMAGNETIZER

Model 400. Removes residual magnetism from tape heads for optimum signal-to-noise ratio and protects tapes against deterioration. For 117 volts, 60 Hz. Wt., 1 lb.
Head Demagnetizer.....730-0180

Speakers and Speaker Systems

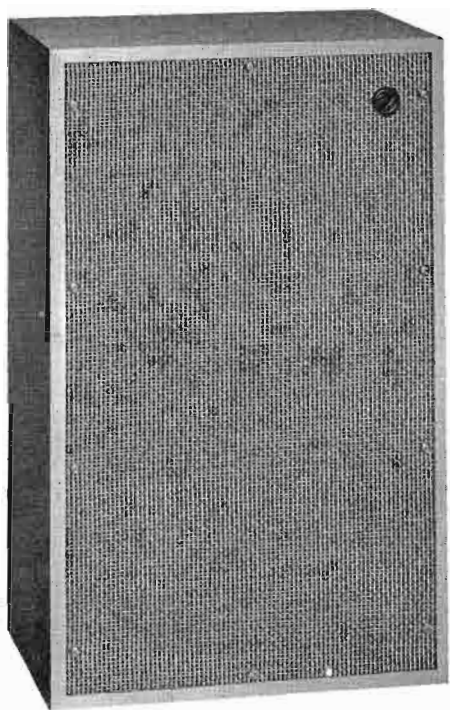

Sentry II floor model.



Sentry I wall or ceiling model

STUDIO MONITOR SYSTEMS

Designed specifically for monitor use in recording and broadcast studios, these loudspeaker systems permit precise monitoring and equalization uncolored by monitor speakers. Precision driver components include 12" Radax loudspeaker, diffraction horn, high frequency driver and special crossover. Quality hardwood cabinet, sanded and sealed, ready for finishing. Neutral cane grill cloth.

SPECIFICATIONS

FREQUENCY RESPONSE: 30 to 20,000 Hz.
 EIA SENSITIVITY RATING: 49 dB.
 POWER CAPACITY: 20 watts.
 IMPEDANCE: Tapped transformer accommodates 16, 150 or 600 ohms.

ORDERING INFORMATION

FLOOR MODEL: Finished on all four sides. Size: 32" x 20" x 13" deep. Net weight: 63 lbs.
 ORDER NUMBER722-0051
 WALL MODEL: Size 21½" x 37" x 16¾" deep. Net weight: 82 lbs.
 ORDER NUMBER722-0044



GATESPEAKER 12

This is an ideal monitor speaker for the broadcaster, with high-quality, wide range performance, plus heavy duty construction. Thirteen watts power handling capability and response from 35 to 17,000 Hz. 5½" over-all depth. An excellent replacement speaker.

SPECIFICATIONS

MAGNET WEIGHT: 4.64. POWER: 13 watts.
 VOICE COIL IMPEDANCE: 8 ohms. SIZE: 12 inches.

ORDERING INFORMATION

Gatespeaker 12722-1200



GATESPEAKER 8

Offering wide range, sturdy construction and minimum cost, the Gatespeaker 8 is one of the finest utility monitor speakers available. Will reproduce lows to 50 Hz and highs to 12,000 Hz.

SPECIFICATIONS

MAGNET WEIGHT: 2.64. POWER: 11 watts.
 VOICE COIL IMPEDANCE: 8 ohms. SIZE: 8 inches.

ORDERING INFORMATION

Gatespeaker 8722-0800

SPEAKER TRANSFORMERS AND PADS

TR-15 matching transformer. 15 watt capacity. 35-20,000 Hz, ±2 dB. Pri 333/500/1000/2000 ohms. Sec 4/8/16 ohms.

Matching transformer TR-15478-0250
 Transformer, primary 45/48 ohms, sec. 8 ohms478-0275*
 Volume control, 8-ohm T-pad554-0227
 Volume control, 4-ohm T-pad554-0180

*Use with Gates audio control consoles.



Wall and Corner Baffles

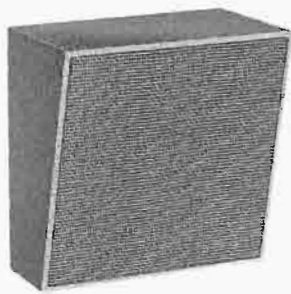

DWB-12A

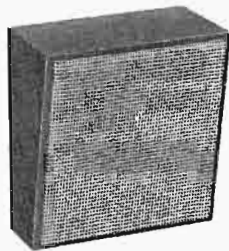

DWB-8A

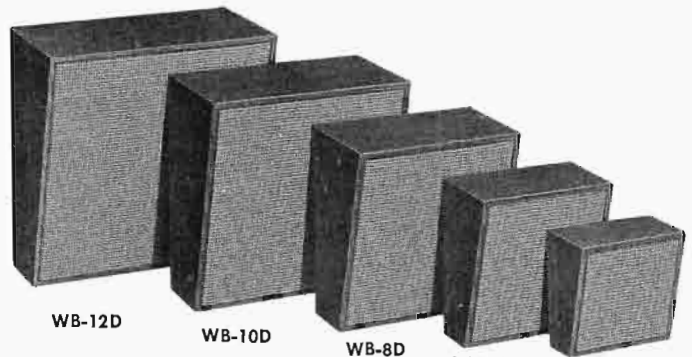

WB-12D

WB-10D

WB-8D

WB-6D

WB-4/5D

DELUXE WALL BAFFLES

Natural hardwood, richly finished in Dusk Walnut or Antique Birch . . . fits into the finest surroundings. Genuine birch has rich satin-smooth appearance. Grill cloth is attractive cane. Has many popular features for better sound and easy handling, including slanting front construction for increased cubic volume. Speaker hardware already firmly fixed in place. Mounting clip included.

DWB-8A—Takes 8-inch speaker, maximum speaker depth 4½".
Size: 10" x 10¾" x 6½". Shipping weight for 2, 5½ lbs. State birch or walnut finish.DWB-8A

DWB-12A—Takes 12" speaker, maximum speaker depth 6½".
Size: 13¾" x 14" x 9½". Shipping weight for 2, 9 lbs. State birch or walnut finish.DWB-12A

REGULAR WALL BAFFLES

Extremely durable, with rugged construction that not only increases rigidity but also eliminates the possibility of baffle resonance and sound distortion. A durable vinyl cover adds warmth and texture to the appearance. Cane grills provide a modern touch that blends with almost any installation decor. Topping off the appearance of these baffles is the sculptured look which dramatically frames the grill. Clips and all speaker hardware are included. Available in either blond or walnut wood-grained vinyl at the same price. State blond or walnut when ordering.

WB-4/5D—4" or 5" speaker, maximum speaker depth 2¾".
Shipping weight for 2, 3 lbs.WB-4/5D

WB-6D—For 6" speaker, maximum speaker depth 3¾". Shipping weight for 2, 4 lbs.WB-6D

WB-8D—For 8" speaker maximum speaker depth 4¾". Shipping weight for 2, 6 lbs.WB-8D

WB-10D—For 10" speaker, maximum speaker depth 5¾". Shipping weight for 2, 8 lbs.WB-10D

WB-12D—For 12" speaker, maximum speaker depth 6¾". Shipping weight for two, 11 lbs.WB-12D

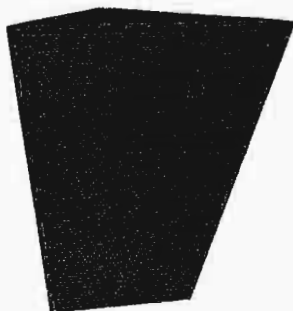

SLANTING CORNER BAFFLES

Rigid construction with wood-grain vinyl covering, and modern cane grill. Superb tone. Slant front aims sound down, corner location increases effective air mass.

Bass enhanced by acoustic padding. Bass reflex design. No screws to hold grill in place or mar its appearance. Mounting clips provide quick, sure, concealed mounting. All mounting hardware is included. State blond or walnut.

SCB-8D—Takes 8" speaker. Maximum speaker depth, 5½". Shipping weight 6 lbs.SCB-8D

SCB-12D—For 12" speaker. Maximum speaker depth, 6½". Shipping weight 8 lbs.SCB-12D

Regular and Deluxe Baffle Speaker Size

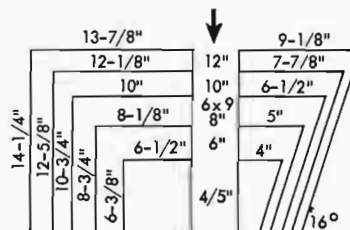

REDUCING RING

R-8/12—to mount 8" speaker in any 12" cabinet, console, or baffle. Made of ¾" plywood with all holes drilled and hardware included. Ship. Wt. 1 lb.R-8/12

Gates Professional Broadcast Microphones



**MODEL
G-100**

The Gates G-100 microphone is a dynamic, omnidirectional type designed for high quality pickup of music and speech. Recommended for news, sports, and general applications. Excellent as an announce microphone and for remote pickups.

SPECIFICATIONS

FREQUENCY RESPONSE: Uniform from 60-12,000 Hz.
IMPEDANCE: 150 ohms.
OUTPUT LEVEL: -55 dB.
POLAR PATTERN: Omnidirectional.
DIAPHRAGM: Acoustalloy.
FINISH: Non-reflecting medium gray.
CABLE: 18 ft. two-conductor, shielded, synthetic rubber jacketed.
STAND COUPLER: 5/8"-27 thread.
DIMENSIONS: Diameter: 2 in., Length: 6 1/4".
NET WEIGHT: 1 lb., microphone only.

ORDERING INFORMATION

Gates G-100 dynamic, omnidirectional microphone.....720-0143
 Matching desk stand.....720-0026



**MODEL
G-200**

A dynamic type, omnidirectional microphone, the Gates G-200 combines slim styling with outstanding performance characteristics. Ideal for control room work or floor-stand use as in television studios. This is a fine microphone for any broadcast pickup.

SPECIFICATIONS

FREQUENCY RESPONSE: Uniform from 60 to 13,000 Hz.
IMPEDANCE: 150 ohms.
OUTPUT LEVEL: -55 dB.
POLAR PATTERN: Non-directional.
DIAPHRAGM: Acoustalloy.
FINISH: Non-reflecting medium gray.
CABLE: 18 ft. two conductor, shielded, synthetic rubber jacketed, broadcast type.
STAND COUPLER: 5/8"-27 thread.
DIMENSIONS: Diameter: 1 1/8", length, 10 1/4".
NET WEIGHT: 15 oz. microphone only.

ORDERING INFORMATION

Gates G-200 dynamic, omnidirectional microphone.....720-0144
 Matching desk stand.....720-0026



**MODEL
G-300**

The G-300 is a cardioid microphone of the dynamic type. Provides discrimination against unwanted background sound. Excellent for music, live studio work and where a directional pickup is required. Also ideal as a sports, rostrum or church microphone.

SPECIFICATIONS

FREQUENCY RESPONSE: Uniform from 40-15,000 Hz.
IMPEDANCE: 150 ohms.
OUTPUT LEVEL: -55 dB.
POLAR PATTERN: Cardioid.
DIAPHRAGM: Acoustalloy.
FINISH: Non-reflecting medium gray.
CABLE: 18 ft. two conductor, shielded, synthetic rubber jacketed, broadcast type.
STAND COUPLER: 5/8"-27 thread on stud.
DIMENSIONS: Diameter: 1 7/8" maximum. Length: 7 3/8" not including stud.
NET WEIGHT: 1 lb. 10 oz., microphone only.

ORDERING INFORMATION

Gates G-300 dynamic, cardioid microphone.....720-0145
 Matching desk stand.....720-0028



**MODEL
G-500**

Dynamic lavalier microphone. A studio quality unit designed in size and performance for TV and similar applications where a miniature, tailored response microphone is required.

SPECIFICATIONS

RESPONSE: 50 to 12,000 Hz, rising to 6 kHz.
IMPEDANCE: 50-250 ohms.
OUTPUT LEVEL: -59 dB.
POLAR PATTERN: Omnidirectional.
FINISH: Non-reflecting gray with stainless steel grill.
CABLE: 30 foot, 2 conductor shielded.
DIMENSIONS: 25/32-inch diameter, 2 5/8" length.
NET WEIGHT: 2 ounces (less cable).

ORDERING INFORMATION

Gates G-500 dynamic lavalier microphone, with lavalier cord and clip...720-0197

STUDIO AND MICROPHONE CABLE

MIC-100 microphone cable. 2 conductor, stranded 20 AWG. Braided shield. Heavy rubber jacket.....250-0036
SH-2-20 General purpose audio cable. 2 conductor, stranded 20 AWG, with push-back braided shield. Not insulated.....253-0018
8450 Belden miniature audio cable. 2 conductor, 22 AWG. Drain wire, foil shield, vinyl jacket.....253-0054
8451 Belden miniature audio cable. As above, except solid conductor.....253-0059

Professional Broadcast Microphones

Gradient bidirectional microphone, for broadcasters who prefer the "warm" sound which is characteristic of ribbon microphones. The 300 is a wide-range, quality ribbon microphone with bidirectional pickup pattern, making it ideal for dialogs, interviews and other applications where front and back pickup is desirable. Equipped with live rubber shock mount. Made by Shure.

ORDERING INFORMATION

SH-300 microphone, complete with connector and 20-foot cable-----720-0023

RIBBON MICROPHONE MODEL 300



SPECIFICATIONS

TYPE: Moving ribbon, bidirectional.
RESPONSE: 40 to 15,000 Hz.
IMPEDANCE: 30/50, 150/250 and high impedance.
OUTPUT LEVEL: -59 dB.
FINISH: Bronze-tone enamel.
SIZE: 6" high, 1 1/8" wide, 2 1/16" deep.
WEIGHT: 1 lb., net.

CARDIODE MODEL 642

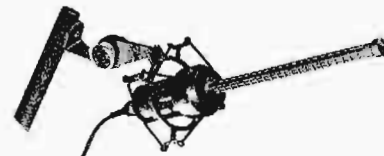

Perfect for television, film, sports, or wherever a highly directional top quality microphone is required. Essentially cardioid unidirectional up to 500 Hz. Highly directional over balance of range. Working distance several times greater than conventional microphones. Excellent for boom use. Must be used with model 356 shock mount. Made by Electro-Voice.

ORDERING INFORMATION

Model 642 microphone, complete with connector and 20-ft cable-----720-0163
 Model 356 shock mount (required)----720-0155

SPECIFICATIONS

TYPE: Dynamic, modified cordioid.
RESPONSE: Flat 30 to 10,000 Hz or choice of 5 to 10 dB low frequency reduction steps by screwdriver adjustment.
IMPEDANCE: 50, 150 or 250 ohms.
OUTPUT LEVEL: -48 dB.
FINISH: Cast aluminum with non-reflecting gray finish.
SIZE: 17 7/8" long; 3 3/16" max. diameter.
WEIGHT: 3 lbs. 4 oz., net.

A truly professional cardioid microphone, by Electro-Voice, widely used by network broadcasters and recording studios. Variable D principle for high discrimination against sounds from back. Permits close talking without base accentuation. Working distance increased 1.7:1 over pressure microphones. Supplied with clamp on stand mount, or use optional desk stand listed below.

ORDERING INFORMATION

Model 666 microphone, complete with 20-ft. cable and connector-----720-0016
 Desk Stand-----720-0029

DYNAMIC CARDIODE MODEL 666



SPECIFICATIONS

TYPE: Cardioid Dynamic.
RESPONSE: 30 to 16,000 Hz.
IMPEDANCE: 50, 150 or 250 ohms.
OUTPUT LEVEL: -58 dB.
FINISH: Cast aluminum with non-reflecting gray finish.
SIZE: 7 3/4" long; 1 3/4" diameter.
WEIGHT: 11 oz., net.

RE-15 DYNAMIC CARDIODE

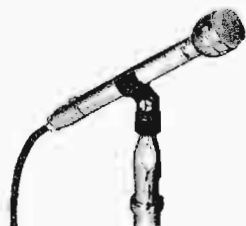

ORDERING INFORMATION

Model RE-15 microphone, complete with 18-ft. cable, XLR3-11 connector, metal carrying case, and clamp 720-0240

The RE-15, by Electro-Voice, is a dynamic cardioid microphone created especially for the most exacting professional applications. The RE-15 features a degree of directional control so effective that response is independent of angular location of sound source. A super cardioid, this microphone provides the greatest possible rejection of unwanted sounds. An easily operated "bass tilt" switch corrects spectrum balance for boom use and other longer reach situations.

SPECIFICATIONS

FREQUENCY RESPONSE: 60-15,000 Hz.
POLAR PATTERN: Super Cardioid.
IMPEDANCE: 150 ohms.
OUTPUT LEVEL: -55 dB.
DIAPHRAGM: Acoustalloy.
DIMENSIONS: 6 7/16" long, 1 3/8" diam. (3/4" shank dia.).
FINISH: Non-reflecting matte satin nickel.
NET WEIGHT: 8 oz. (not including cable).
CABLE: 18 feet, 2-conductor, shielded, broadcast type cable, synthetic rubber jacketed with Cannon XLR3-11 connector.
ACCESSORIES FURNISHED: Protective metal carrying case, Model 310 clamp.

DYNAMIC, OMNIDIRECTIONAL MODEL 635A

The Electro-Voice model 635A is a dynamic, omnidirectional microphone ideally suited for recording, FM, AM, and TV broadcasting. High output level and extremely low sensitivity to mechanical shock make it excellent for interview, for pass around use in audience participation, and for hand-held use by vocalists.



ORDERING INFORMATION

Model 635A microphone, complete with 18-ft. cable, XLR3-11 connector, lavalier neck cord, and model 310 clamp-----720-0005

SPECIFICATIONS

FREQUENCY RESPONSE: 100-13,000 Hz.
IMPEDANCE: 150 ohms.
POLAR PATTERN: Omnidirectional.
OUTPUT LEVEL: -55 dB.
DIAPHRAGM: Acoustalloy.
DIMENSIONS: 5 15/16" x 1 13/32" dia.
NET WEIGHT: 6 ounces, without cable.
CABLE: 18' 2-conductor shielded broadcast type, synthetic rubber jacketed.
CABLE CONNECTOR: Cannon XLR-3-11.
ACCESSORIES: Lavalier neck cord assembly and 310 clamp furnished.

Professional Broadcast Microphones



CARDIOID MICROPHONE
MODEL D-24E

Dynamic cardioid microphone used extensively by vocalists on television and in nightclubs. Excellent for stand use, or hand held, with screen protected element to reduce breath "popping". Bass attenuation switch for close speaking. Directional with 20 dB front to back discrimination.

SPECIFICATIONS

RESPONSE: 30-15,000 Hz.
IMPEDANCE: 200 ohms (excellent in 150/250 ohm circuits).
OUTPUT LEVEL: -54 dB.
FINISH: Low lustre gray.
SIZE: 6 1/8" long, 1 1/16" diameter.
WEIGHT: 6 oz., net.

ORDERING INFORMATION

AKG Model D-24E dynamic cardioid microphone with cable.....720-0199



CARDIOID MICROPHONE
MODEL D-25B

The D-25B is a high quality unidirectional microphone, of the dynamic cardioid type. Especially good for broadcast studio work and for music recording. Popular with FM stations. Supplied shock-mounted in a metal frame on rubber suspension. Made by AKG Div. of North American Phillips.

SPECIFICATIONS

RESPONSE: 30-16,000 Hz.
IMPEDANCE: 50 or 200 ohms.
OUTPUT LEVEL: -54 dB.
FINISH: Low lustre bronze tone.
SIZE: 7 3/8" x 5 7/8" x 3 1/8".
WEIGHT: 1 lb. 12 oz.

ORDERING INFORMATION

AKG Model D-25B microphone, complete with cable.....720-0205



PROBE MICROPHONE
MODEL 576

A superb dynamic probe microphone designed for television and radio broadcasting. Strikingly modern in ultra-slim case. An ideal interview microphone because of its feel and balance, with an 8-inch "reach". Clamp type swivel connector furnished. Omnidirectional. Made by Shure.

SPECIFICATIONS

RESPONSE: 40-20,000 Hz.
IMPEDANCE: 30/50 or 150/250 ohms.
OUTPUT LEVEL: -60 dB.
FINISH: Non-reflecting gray.
SIZE: 3/4" diameter, 8 3/4" length.
WEIGHT: 7 ounces (less cable).

ORDERING INFORMATION

Model SH-576 microphone, complete with 25' cable and swivel adapter.....720-0206

CONDENSER MICROPHONE



MODEL U-64

This linear admittance microphone is designed to provide a precise cardioid pattern at all frequencies, permitting a greater working distance from instrumentalists, as in orchestra pickups, with no coloration in frequency response. Perfect for "one microphone" symphony broadcasts or recording. Uses Nuvistor for low noise and flat response. Cable and separate power supply included.

SPECIFICATIONS

RESPONSE: 40-18,000 Hz.
IMPEDANCE: 30/50 or 150/250 ohms.
OUTPUT LEVEL: -43 dBm.
POWER REQUIREMENTS: N6U power supply, 110/127 volts, 50/60 Hz.
FINISH: Matte satin chrome.
SIZE: Mic.: 7/8" dia., 4" long. Power supply: 8 3/4" x 4" x 4".
WEIGHT: Mic.: 1 lb.; power supply, 4 lbs.

ORDERING INFORMATION

Model U-64 linear condenser microphone, with power supply.....720-0204

One of the finest professional microphones available. Frequency response perfectly linear ± 1 dB, 20-16,000 Hz. Electronically switched directional characteristics: cardioid, omnidirectional, or figure 8. Switchable for flat low end response below 10 Hz or voice cutoff at 100 Hz for TV and film. Sensitivity switch prevents overloading. 25 ft. cable, separate power supply.

CONDENSER MICROPHONE



MODEL U-67

RESPONSE: 20-16,000 Hz.
IMPEDANCE: 30/50 or 150/250 ohms.
OUTPUT LEVEL: -48 dBm.
POWER REQUIREMENTS: NU-67 power supply, 110/127/220 volts, 50/60 Hz.
FINISH: Matte satin chrome.
SIZE: Mic.; 2 1/4" dia., 7 7/8" length. Power supply 4" x 4" x 8 1/2".
WEIGHT: Mic., 1 lb.; power supply, 4 lbs.

ORDERING INFORMATION

U-67 Condenser microphone system with power supply and 25 ft. cable 720-0119
Elastic suspension for boom use.....720-0203

Four Channel Solid Statesman Remote Amplifier



THE DYNAMOTE "70"

Broadcasting's finest remote amplifier—with such outstanding features as: completely transistorized circuits, designed to allow longer battery life; nine switchable inputs into four mixing channels; illuminated slide rule VU meter; built-in tone oscillator; PA feed; and amplified studio cue.

INPUT CIRCUITS: All mixing is high level. Four microphones feed four preamplifiers. All four preamplifier inputs are balanced and have input transformers as standard equipment. Five other input circuits are switch-selectable into the mixing system. These are: (1) tone oscillator, (2) dual turntable inputs, and (3) two high level inputs.

VERSATILE MIXING: Mixing channel 1 is for a microphone only; channel 2 accommodates a microphone or the built-in tone oscillator; channel 3, one microphone, one turntable or one high level input; and channel 4, one microphone, one turntable, or one high level input.

PROGRAM CUE: A front panel key switches the studio line into the Dynamote program amplifier and PA feed for ease in monitoring studio cues.

AMPLIFIERS: Four preamplifiers, each with transformer input, feed four mixing controls, which in turn feed the program amplifier. Distortion is 1% or less at +18 dBm output (10 dB overload) to the line (after 6 dB isolation pad).

FRONT PANEL CONTROLS: Four mixing channels are operated by specially-designed control knobs, created specifically for remote functions. Knobs are coordinated with the panel slope for positive-feel mixing. Other panel controls are (1) master gain, (2) PA gain control, (3) amplified cue selector control, (4) VU meter light control (the VU meter light operates from separate batteries), and (5) the slide rule VU meter.

REAR PANEL CONTROLS: All secondary switching is at the rear. The tone oscillator, dual turntable and dual high level inputs switch into mixing channels 2, 3 and 4. All input and output circuits connect to a recessed panel with standard XL-type receptacles for the microphones.

VU METER: The VU meter is of the slide rule type with full lateral scale area. Illumination is from two separate batteries, and the meter light may be turned on by pulling out on the PA feed control. Batteries will light the meter for 60 hours. A rear panel switch allows the meter to read either VU or battery condition.

PA FEED: The Dynamote "70" supplies an isolated output adjustable from the front panel to provide 0.5 volts into a 100,000 ohm unbalanced load.

Four Channel Solid Statesman Remote Amplifier

TERMINAL FEATURES: Dual headphone jacks are provided for operator and director. The amplifier turns on when either headphone plug, or a dummy plug, is inserted. Microphone inputs are standard XL-type connectors. Jacks are provided for two turntables and two high level inputs, and terminals for telephone line and PA feed, and optional AC in-line power supply receptacle.

BATTERY AND AC POWER: Twelve "C" size standard 1½-volt dry batteries power the amplifier for 200 hours. As the amplifier design is based on full gain and output level at rated 1% distortion with as little as 12 volts, the useful battery life is greatly extended. The optional in-line power supply

operates about 2 volts above the batteries with diodes disabling the battery voltage. If power fails for any reason, batteries automatically take over without evidence in the program.

DYNAMOTE "70" PARALLELING: Any reasonable number of units may be paralleled for a large field broadcast. Rear panel jacks permit the feeding of additional Dynamotes directly to the mixer bus of the master Dynamote without losing a mixing channel on the master unit. For example, six Dynamotes will provide 24 microphone inputs—yet require only about 76 inches of width, or about 38 inches if two units are stacked on top of one another.



Rear view, Dynamote "70".

SPECIFICATIONS

OPERATING MODE: Single channel monaural.

MIXING CHANNELS: Total four; three switchable for other functions.

INPUT CIRCUITS: Channel 1, microphone input; Channel 2, microphone and tone oscillator; Channel 3, microphone, turntable and high level input; Channel 4, microphone, turntable and high level input. Input levels: Microphones -60 dBm, high level 600 ohm circuits rated -15 dBm to +8 dBm. Turntable inputs have RIAA equalization and accept standard VR-type phono cartridges without further preamplification.

OUTPUT CIRCUITS: 1 program line, 1 isolated PA feed, 1 mixer multiple output, 2 headphone monitoring jacks.

SOURCE IMPEDANCES: Microphones—30/50 and 150/250 ohms, balanced or unbalanced, with input transformers on all channels. High Level—600 ohms, unbalanced. (-15 dBm to +8 dBm input level.) Turntables—6200 ohms for VR type pickup cartridge equalization. Mixer Multiple Input—600,000 ohms.

INPUT IMPEDANCE: Preamplifiers, 1500 ohms or higher, 30-15,000 Hz.

LOAD IMPEDANCES: Program Output—600/150 ohms, balanced or unbalanced, (factory connected for 600 ohms). PA Feed—100,000 ohms unbalanced. Amplifier Paralleling—600,000 ohms bridging.

OUTPUT IMPEDANCE: Program Amplifier, 490 ohms nominal.

GAIN: Microphone input to line output, 97 dB \pm 2 dB.

RESPONSE: \pm 1½ dB, 25 to 16,000 Hz.

DISTORTION: 1.0% maximum, 30 to 15,000 Hz @ +18 dBm output (after 6 dB isolation pod).

NOISE: 62 dB or better below +8 dBm output with -60 dBm input. (Relative input noise -122 dBm.)

BATTERY COMPLEMENT: 12 Size "C" 1½ volt cells for amplifier. 2 Size "D" 1½ volt cells for VU light.

BATTERY LIFE: Approximately 200 hours for amplifier pack, and 60 hours for meter light.

EXTERNAL POWER: Four terminal plug on rear accepts optional 994-6435 in-line power pack for 117 volt AC operation.

CABINET DATA: Size: 12¾" wide, 4¾" high, 12½" deep. Finish: Charcoal gray vinyl with satin chrome trim accents. Weight: 12¼ pounds, including batteries.

SHIPPING DATA: Packed Weight: Domestic, 16 lbs.; Export, 35 lbs, Cubage, 2 cubic feet.

ORDERING INFORMATION

Dynamote "70" 4-channel remote amplifier, complete but less male microphone connectors and batteries.....	994-6434
Microphone plugs, male (four required).....	610-0182
Battery complement for Dynamote "70".....	994-6441
Vinyl cover with accessory pocket.....	725-0128
In-Line power supply for 117 volt operation.....	994-6435

Three Channel Solid Statesman Remote Amplifier



THE ATTACHE "70"

Unexcelled remote pickup performance is provided by this stylish, fully-transistorized audio remote amplifier. Attache "70" provides: three microphone channels with one magnetic phono and one high level input; 200-hour battery life; optional in-line AC power supply; slide rule VU meter; and superior performance with wider response, lower distortion.

INPUTS: Three channels, all with preamplifiers, include: channel 1, microphone only with input transformer; channel 2, microphone tone oscillator or high level input; channel 3, microphone or phono cartridge. The depth of only 12 1/8" allows switching of secondary circuits such as turntable and high level inputs at the rear.

TOTAL FACILITY: The front panel contains specially styled mixing knobs for "touch control" fading, master gain control and isolated PA feed control. The optional power supply is diode protected from the batteries when in use. If power fails, batteries take over automatically.

PERFORMANCE: Distortion is 1% or less at +18 dBm output, with an extended response of 25-16,000 Hz.

DESIGN: The Attache "70" is smoothly styled in lightweight aluminum and vinyl clad steel. A snap-on cover protects mixing controls when the remote is not in use.

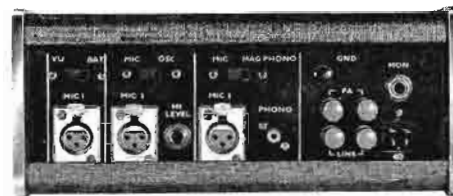

The rear panel shows the logical grouping of line terminations.

SPECIFICATIONS

OPERATING MODE: Monaural.

MIXING CHANNELS: 3, with channels 2 and 3 switchable to other functions.

INPUT CIRCUITS: Channel 1, microphone only, includes input transformer; Channel 2, microphone or 400 Hz tone oscillator or high level input; Channel 3, microphone or turntable.

OUTPUT CIRCUITS: Program line for 600/150 ohms, PA feed, and headphone monitoring jack.

SOURCE IMPEDANCES: Microphones, 30/50 ohms or 150/250 ohms. Turntable, 6200 ohms for VR pickup cartridges and RIAA equalized. High level, 600 ohms unbalanced -15 dBm to +8 dBm.

GAIN: Microphone input to program line output is 94 dB \pm 2 dB.

RESPONSE: \pm 1.5 dB 25-16,000 Hz.

DISTORTION: Less than 1% at +18 dBm output (10 dB overload) into the program line. (6 dB isolation pad incorporated).

NOISE: 62 dB below +8 dBm output with -60 dBm input. (Relative noise -122 dBm).

BATTERIES: 12 standard 1 1/2-volt type "C" cells for amplifier and 2 standard 1 1/2-volt type "D" cells for meter light.

AC POWER: Gates In-Line 994-6435 power pack for 117 volt, 50/60 Hz.

CABINET DATA: 10" wide, 4 3/8" high, 12 1/8" deep. Finish: Charcoal gray, black and satin chrome. Net weight with batteries, 10 lbs. Packed weight: Domestic 20 lbs. Export 35 lbs. Cubage: 1.5 cubic feet.

ORDERING INFORMATION

Attache "70" 3-channel remote amplifier, less batteries.....	994-6433
Microphone connector, 3 required.....	610-0182
Battery Kit complete.....	994-6441
Optional microphone input transformer.....	478-0285
Power Supply, In-Line type.....	994-6435
Pliable vinyl cover.....	725-0127

Two Channel Solid Statesman Remote Amplifier



THE COURIER "70"

Studio console quality in an all-transistorized audio remote amplifier no larger than a modern camera carrying case. Perfect for inexpensively handling those many remote situations where normally no more than two microphones are required. Premium features include: separate preamplifier for each mixing channel; slide rule illuminated VU meter; long battery life; optional in-line AC power supply; 1% or less distortion at high output levels; 25-16,000 Hz frequency response; and total weight of 9 pounds with batteries.



PERFORMANCE: The outstanding performance of the compact Courier "70" is a result of extensive product research. At full-rated +18 dBm output, distortion is less than 1%, even when full battery power is down more than 30%. Courier "70" battery life is normally in excess of 200 hours. Front panel controls in addition to mixers are: master gain control, meter light switch and slide-rule VU meter (which also checks battery condition).

POWER SUPPLY: An optional in-line AC power supply is diode protected from the batteries when in use. If power fails, change-over to batteries is instant and automatic. The amplifier turns on with the insertion of headphone plug or dummy plug.

STYLING: Sleek, flight-line styling in charcoal gray vinyl and satin aluminum, with special mixing knobs designed for "touch control" fading.

SPECIFICATIONS

OPERATING MODE: Monaural.

MIXING CHANNELS: 2 for microphones.

OUTPUT CIRCUITS: 1 program line, 1 headphone monitor.

SOURCE IMPEDANCE: Microphone 30/50 to 150/250 ohms, unbalanced. Input transformers optional.

LOAD IMPEDANCE: 600/150 ohms, balanced or unbalanced. Factory connected for 600 ohms.

MAXIMUM INPUT LEVEL: -35 dBm into either microphone channel.

MAXIMUM OUTPUT LEVEL: +18 dBm to program line. 6 dB line isolation pad built-in.

GAIN: Microphone input to line output, 94 dB \pm 2 dB.

RESPONSE: \pm 1½ dB, 25 to 16,000 Hz.

DISTORTION: 1% maximum, 30 to 15,000 Hz @ +18 dBm output.

NOISE: 62 dB or better below +8 dBm output with -60 dBm input. (Relative input noise -122 dBm).

BATTERIES: 12 size "C" cells for amplifier. 2 size "D" cells for VU light.

BATTERY LIFE: 200 hours or more for amplifier pack, and 60 hours for meter light.

AC POWER: Four-terminal plug on rear accepts external 994-6435 in-line power pack for 117 volt AC operation.

CABINET DATA: Size: 10" wide, 4½" high, 12½" deep. Finish: Charcoal gray vinyl with satin chrome trim. Weight: 8¾ lbs., including batteries. Packed weight (domestic), 14 lbs., (export), 32 lbs. Cubage, 1.5 cu. ft.

ORDERING INFORMATION

Courier "70" 2-channel remote amplifier, less batteries.....	994-6432
Microphone connectors, male (2 required).....	610-0182
Battery kit complete.....	994-6441
Optional microphone input transformer.....	478-0285
Power Supply, In-Line type for 117 volt AC operation.....	994-6435
Vinyl cover, with accessory pocket.....	725-0127

Single Channel Remote Or Microphone Amplifier



THE UNIMOTE "70"

Gates Unimote "70" is a transistorized single channel audio remote or utility amplifier, featuring compact, functional and attractive styling. Battery life is 300 hours or over (using standard "C" size flashlight cells). If AC power operation is desired, the in-line power unit is available. Smooth change-over to batteries occurs instantly and automatically in case of power failure. The printed circuit amplifier has less than 1% distortion at +18 dBm output.

DESIGN: All controls and terminations are on the front of the unit. Operation is of the turn on—turn off type after the gain control setting is determined. Unimote "70" may be desk mounted, attached to the wall by screws, mounted under a lectern or pulpit, or carried as easily as a camera case. This compact amplifier is a natural for church remotes, weather bureau, or other "set and forget" installations.

SPECIFICATIONS

OPERATING MODE: Monaural.
INPUT CIRCUIT: One 30/50 or 150/250 ohm microphone.
OUTPUT CIRCUITS: One program line, one headphone monitor.
LOAD IMPEDANCE: 600/150 ohms, balanced or unbalanced (factory connected for 600 ohms). 6 dB isolation pad self-contained.
GAIN: Microphone input to line output, 82 dB, ± 2 dB.
OUTPUT LEVEL: +18 dBm to program line.
RESPONSE: $\pm 1\frac{1}{2}$ dB 30 to 15,000 Hz.
DISTORTION: 1% maximum, 30 to 15,000 Hz @ +18 dBm output.
NOISE: -122 dBm relative input noise.
BATTERIES: 12 size "C" cells.

BATTERY LIFE: Approximately 300-400 hours, average duty cycle.
AC POWER: External 994-6435 in-line power pack for 117 volt AC operation.
CABINET DATA: Size: 10" wide, 5 $\frac{1}{4}$ " high, 4 $\frac{1}{4}$ " deep. Finish: anodized aluminum front panel with charcoal gray Royalite case. Weight: 5 lbs., including batteries. Shipping weight: packed 6 $\frac{1}{2}$ lbs. Cubage: 1 cu. ft.

ORDERING INFORMATION

Unimote "70" single channel remote amplifier, less batteries.....994-6431
 Microphone connector, male (1 required).....610-0182
 Battery complement for Unimote "70".....994-6441
 Optional input transformer.....478-0285
 In-line power supply for 117 volt operation.....994-6435

IN-LINE POWER SUPPLY

Compact accessory power unit for any of Gates Solid-State-man remote amplifiers: Dynamote "70", Attache "70", Courier "70", and Unimote "70". In-Line type with six-foot line cord and four-foot output cord terminating in mating plug for all remote units. For 117 volt, 50/60 Hz operation of Gates remote amplifiers in permanent installations. Dual supply design provides power for amplifiers and VU meter illumination. Easily carried in accessory pocket of vinyl remote amplifier covers.

SPECIFICATIONS

POWER INPUT: 117 volts, 50/60 Hz.
POWER OUTPUT: 4 prong plug, mates with remote amplifier.
SIZE: 5 $\frac{1}{2}$ " x 4" x 1 $\frac{3}{4}$ " case. DC supply cable, 48" long. AC power cord, 72" long.
FINISH: Charcoal gray vinyl-clad steel.
WEIGHT: 2 lbs. net.

ORDERING INFORMATION

In-line Power Supply, complete.....994-6435

All Purpose Remote Amplifier

MODEL M-6600

A compact, lightweight remote amplifier, the M-6600 Solid-Staterman provides fine remote performance, and makes an ideal all-purpose amplifier. Battery operated and 100% self-contained, it may be quickly installed to fill many studio requirements. Use it to temporarily replace a faulty program amplifier, as a preamplifier for cartridge or reel tape recorders, or as one of several feeder amplifiers for the extravaganza type of pickup. These are just a few of the possibilities.

The housing is all aluminum, and ribbed for added strength, providing complete electrical isolation for the floating printed board internal assembly. The gain control and combined on-off switch are on one end of the amplifier, and the microphone receptacle, phone jack, and line terminals are on the opposite end. The output transformer is "T" pad isolated and wired for 600 ohms, but internally changeable to 150 ohms where desired. For the installation requiring a number of widely spaced microphones, the use of the M-6600 amplifier permits connection to the central control point with unshielded telephone type wire, and individual gain adjustment for each microphone.

Two 8.4 volt standard mercury batteries, available nationwide, provide about 50 hours of service. Total weight is less than 2½ pounds with batteries and microphone connector.



SPECIFICATIONS

GAIN: 82 dB \pm 3 dB at 150/250 ohms source impedance. 77 dB \pm 3 dB at 50 ohms source impedance.

NOTE: With gain control setting reduced about 14 dB, this permits 68 dB operating gain for correct output level.

RESPONSE: 30-15,000 Hz \pm 2 dB.

DISTORTION: 1% maximum at +18 dBm, 30-15,000 Hz.

NOISE: -122 dBm relative input noise, 30-15,000 Hz.

BATTERIES: Two 8.4 volt mercury Eveready E146X or Burgess H146X. Expected life at maximum amplifier performance, 50 hours under average programming.

SOURCE IMPEDANCE: 30/50 or 150/250 ohms unbalanced.

LOAD IMPEDANCE: 600/150 ohms balanced, wired for 600 ohms.

SIZE AND FINISH: 8¾" long, 2½" wide, 3" high. Finish: Natural aluminum.

WEIGHT: Net, with male connector, 2 lbs. Shipping weight 8 lbs.

ORDERING INFORMATION

Amplifier (less batteries).....994-6600
Battery kit consisting of two batteries.....660-0022



Professional Transcription Turntables

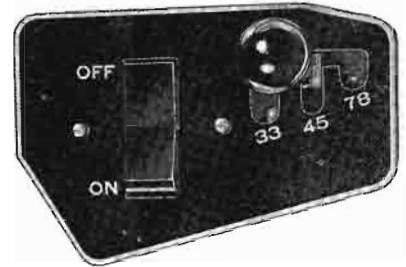

This cut-away illustration of a Gates turntable shows the fine machining and workmanship in the equipment. Oilite bearings are used at all bearing points, including the large center spindle bearing. Speed shift linkages are through monoball self-aligning bearings for smooth, silent, trouble-free operation. There are no belts, planetary drives or gear trains to wear.

Shift speeds to 78, 45 or 33 $\frac{1}{3}$ rpm by simply moving shift lever to the desired index point. Then touch the mercury-type switch to either start or stop. Complete one-hand operation leaves the other hand free for cueing or control boards.

PRECISION ENGINEERED

Recent advances in recording techniques, as well as stereo requirements, now place stronger demands on today's reproducing equipment. To meet these improved performance standards, Gates offers two outstanding turntables (one 16-inch model, one 12-inch model), designed to reduce rumble to an all-time low, without the sacrifice of quick cue.

The heart of Gates turntable design is a drive hub, which is part of the turntable platter—and about one-half the radius of a 45 rpm disc. A single idler wheel for all speeds is floating and self-aligning—and a 600 rpm hysteresis synchronous motor with 3-speed pulley, engages the idler wheel to the inner hub.

The combination of lower motor speed (one-third that of other models) and a drive located inside the playing surface, results in remarkably low rumble.

Speed change is exact and functionally correct. All three speeds shift across a single indexed plate. A mercury-type start/stop switch illuminates when on. The smooth felt platter surface offers slip-cueing if desired. A captive pop-up spindle is provided for 45 rpm discs.

Every Gates turntable is totally hand-assembled, micrometer checked under rigid quality-control standards and then individually tested in our laboratory for wow, flutter, and speed consistency.

As Gates turntables are precision machined devices they are not the lowest in initial cost, but are far less expensive on the basis of per-hour cost.

DRIVE DESIGN PRINCIPLE

OLD METHOD

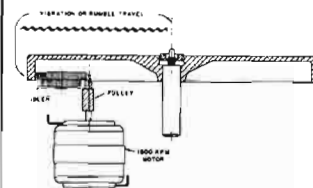

Rim drive turntables, as the word implies, drive against the outer rim of the platter. Vibration, commonly called rumble, is returned to the center spindle, or bearing, across the entire playing surface of the platter. This type of drive usually requires an 1800 rpm motor for proper speed ratios. The greater the motor speed, the greater the vibration. Also, higher motor speeds raise the audio frequency of this vibration or rumble.

GATES METHOD

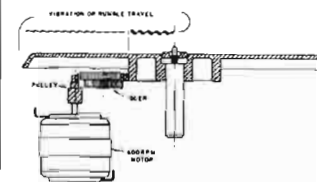

In both the 12- and 16-inch Gates turntables, the drive is against a solid inner hub, away from the usable playing surface of the platter. Likewise, any minute vibration or rumble is pushing against the center bearing instead of pulling away as in outer rim drive turntables. With this exclusive drive system, a 600 rpm hysteresis synchronous motor is used. Lower motor speed assures lower vibration or rumble. The lower speed substantially drops the audio frequency of this much-lower motor vibration so that nearly all of the rumble is in the sub-audible spectrum.

Professional Transcription Turntables—16-Inch



MODEL CB-500

Gates CB-500 is the most widely used 16-inch turntable in the broadcasting industry. Designed for continuous 24-hour commercial service, this turntable is ruggedly constructed to meet the strain of any control room operation, while maintaining its excellent quality of performance.

Time proven features include heavy machined aluminum platter, rubber-shock-mounted cast aluminum chassis, oilite hub bearing, self-centering neoprene idler wheel, monoball self-aligning speed shift bearings, and a functional speed selector mechanism. (Order pickup arm separately.)

SPECIFICATIONS

CHASSIS SIZE: 21¼" x 21¼" x 1⅝".

MOTOR HANG BELOW BOTTOM OF CHASSIS: 4⅞".

CONSTRUCTION: Both platter and base of machined aluminum.

FINISH: Beige-gray with escutcheon in black and turntable platter cover in heavy gray felt.

PLATTER SIZE: 17".

STROBOSCOPE: Built-in on platter for all three speeds.

CENTER SPINDLE: Spring-locking type, snaps up for 45 rpm hub, locks down for smaller-spindle records.

CENTER BEARING: 1" diameter hardened steel, rotates in oilite bearing.

MOTOR: Hysteresis synchronous, single phase, 600 rpm, with 40°C temperature rise.

CUEING: At 33⅓ rpm, ⅓ turn. At 45 rpm, ½ turn. At 78 rpm, 1¼ turn.

NOISE OR RUMBLE: At 33⅓ rpm, rated -45 dB. At 45 rpm, rated -40 dB. At 78 rpm, rated -35 dB.

WOW: Rated 0.1% at 33⅓ rpm, capable .08%.

FLUTTER: Rated 0.07% at 33⅓ rpm, capable .05%.

MOTOR START: Rocker-type illuminated mercury switch.

IDLER WHEEL: Special shear action neoprene, self-aligning.

SPEED CHANGE: To 33⅓, 45, or 78 rpm by single indexed lever control.

POWER: 117 volts, 60 Hz, 35 watts. (50 Hz available, see below.)

WEIGHT: Net: 34 lbs. Packed: domestic, 45 lbs.; export, 70 lbs. Cubage: 6 cubic feet.

ORDERING INFORMATION

CB-500 16-inch transcription turntable, chassis only, for 60 Hz.....994-5739-003

CB-500A 16-inch transcription turntable, chassis only, for 50 Hz.....994-5739-004

Professional Transcription Turntables—12-Inch



MODEL CB-77

Gates CB-77 is a professional 12-inch transcription turntable, with the same unique design principles as its companion 16-inch model. In the 12-inch CB-77 chassis will be found the same inner hub drive system, the same convenient speed change system, the same illuminated rocker arm on-off switch, etc. The only difference is the reduced size, affording broad-

casts a more compact turntable arrangement for today's busy control room, where space is at a premium.

The chassis is ready for you to attach the pickup arm of your choice (order separately), and is designed for 33 $\frac{1}{3}$, 45 and 78 rpm speeds.

SPECIFICATIONS

CHASSIS SIZE: 16" x 16" x 1 $\frac{1}{8}$ ". Motor hang below bottom of chassis: 5 $\frac{3}{4}$ ".

CONSTRUCTION: Platter and base of machined aluminum.

FINISH: Beige-gray with escutcheon in black and turntable platter cover in heavy gray felt.

PLATTER SIZE: 13 $\frac{3}{8}$ ".

STROBOSCOPE: Built-in for all 3 speeds.

CENTER BEARING: 1" diameter hardened steel, rotates in oilite bearing.

CENTER SPINDLE: Spring-locking type snaps up for 45 rpm, locks down for smaller spindle records.

MOTOR: Hysteresis synchronous, single phase, 600 rpm, with 40°C temperature rise.

CUEING: At 33 $\frac{1}{2}$ rpm, $\frac{1}{2}$ turn. At 45 rpm, $\frac{1}{4}$ turn. At 78 rpm, 1 turn.

NOISE OR RUMBLE: At 33 $\frac{1}{3}$ rpm, rated -45 dB. At 45 rpm, rated -40 dB. At 78 rpm, rated -35 dB. (Meets or exceeds NAB specifications for stereophonic reproduction.)

WOW: 0.1% maximum, capable .08%.

FLUTTER: .07% maximum, capable .05%.

MOTOR START: Rocker-type illuminated mercury switch.

IDLER WHEEL: Special shear action neoprene, self-aligning.

SPEED CHANGE: To 33 $\frac{1}{3}$, 45 or 78 rpm by single indexed lever control.

POWER: 117 volt, 60 Hz, 35 watts. (50 Hz model available, see below.)

WEIGHT: Net: 30 lbs. Packed: domestic, 40 lbs.; export, 65 lbs. Cubage: 3.6 cubic feet.

ORDERING INFORMATION

CB-77 12-inch transcription turntable, chassis only, 60 Hz.....994-5798-005

CB-77A 12-inch transcription turntable, chassis only, 50 Hz.....994-5798-006



Turntable System Components



16-INCH SYSTEM COMPONENTS

To make up a 16-inch turntable system, the following components are recommended:

MONOPHONIC SYSTEM

CB-500 turntable, 60 Hz (50 Hz available).....994-5739-003
 Gray 208-S 16" viscous damped tone arm.....723-0099
 or
 Gray 306 16" Micro-Trak tone arm.....723-0269
 Shure M-44-7 stereo dynetic cartridge w/.0007" diamond stylus 723-0236
 M-6244 equalized turntable preamplifier, transistorized.....994-6244
 NOTE: If Gray 208-SG tone arm is desired (723-0153), a General Electric VR-II turn-around cartridge should be used (723-0017).

STEREOPHONIC SYSTEM

CB-500 turntable, 60 Hz (50 Hz available).....994-5739-003
 Gray 208-S 16" viscous damped tone arm.....723-0099
 or
 Gray 306 16" Micro-Trak tone arm.....723-0269
 Shure M-44-7 stereo dynetic cartridge w/.0007" diamond stylus 723-0236
 M-6442 equalized turntable preamplifier, transistorized, stereophonic.....994-6442
 NOTE: To order cabinet, see below.

12-INCH SYSTEM COMPONENTS

The following components are recommended to make up your 12-inch turntable system.

MONOPHONIC SYSTEM

CB-77 turntable, 60 Hz (50 Hz available).....994-5798-005
 Gray 206-S 12" tone arm.....723-0259
 or
 Gray 303 12" Micro-Trak tone arm.....723-0268
 Shure M-44-7 stereo dynetic cartridge w/.0007" diamond stylus 723-0236
 M-6244 equalized turntable preamplifier, transistorized.....994-6244
 NOTE: If Gray 206-SG 12" tone arm is desired (catalog number 723-0250), order General Electric VR-II turn-around cartridge (catalog number 723-0017).

STEREOPHONIC SYSTEM

CB-77 turntable, 60 Hz (50 Hz available).....994-5798-005
 Gray 206-S 12-inch tone arm.....723-0259
 or
 Gray 303 12" Micro-Trak tone arm.....723-0268
 Shure M-44-7 stereo dynetic cartridge w/.0007" diamond stylus 723-0236
 M-6442 equalized turntable preamplifier, transistorized, stereophonic.....994-6442
 NOTE: To order cabinet, see below.



DUAL TURNTABLE CABINET

Beautifully styled, and dimensioned to accommodate either 12- or 16-inch Gates turntables. For description, see Page 175.

Dual turntable cabinet.....994-6449

SINGLE TURNTABLE CABINET

Fits any decor. Accommodates either 12-inch or 16-inch Gates turntable. For description, see page 175.

Single turntable cabinet.....994-6448

Transcription Tone Arms and Pickups



12" AND 16" MICRO-TRAK TONE ARMS

Especially designed for stereo, this durable arm will track distortion-free at micro-pressures of 1/10 gram. A new material never before used in a tone arm, wood impregnated with epoxy resins, was selected for this arm to achieve the extremely low tracking force and very low resonance characteristics. Sapphire bearings floating in a unique elastomer ring isolate the tone arm from its mounting and produce a tone arm with virtually no vertical friction.

Available for 12" and 16" turntables, this Gray arm will accept any broadcast type stereo cartridge.

Gray 303 Micro-Trak 12" tone arm.....	723-0268
Gray 306 Micro-Trak 16" tone arm.....	723-0269

MONOPHONIC PICKUP CARTRIDGES

Proven, rugged broadcast transcription cartridges for monophonic recordings. Response 20 to 20,000 Hz with output of 12 mV at 10 CM per second at 1000 Hz. Tracking force 4 grams. Replaceable clip-in styli for a wide range of recordings. Use high impedance type with M-6244 equalized pre-amplifier, low impedance with Gray 602-C passive equalizer.

GE TYPE VR-II PICKUP

High Impedance Cartridge with single stylus	
4G-040 Sapphire, 0.0025".....	723-0013
4G-041 Sapphire, 0.001".....	723-0014
4G-061 Diamond, 0.001".....	723-0016
4G-063 Diamond, 0.0025".....	723-0015
High Impedance Triple Play with Styli (turnaround cartridge)	
4G-050 Sapphire 0.001"; sapphire 0.0025".....	723-0017
4G-052 Diamond 0.001"; sapphire 0.0025".....	723-0018
4G-053 Diamond 0.001"; diamond 0.0025".....	723-0019
Low Impedance Cartridges with Single Stylus	
4GS-07D Diamond .0007".....	723-0272
4GS-02D Diamond 0.0025".....	723-0020
4GS-07S Sapphire .0007".....	723-0273
4GS-02S Sapphire 0.0025".....	723-0026
Low Impedance with Triple Play Stylus	
4GD-07D02D Dual diamond .0007" and 0.0025".....	723-0290
4GD-07S02S Dual sapphire .0007" and 0.0025".....	723-0291
Clip-in Styli for VR-II Cartridges	
4G-02S Sapphire 0.0025".....	723-0045
4G-01D Diamond 0.001".....	723-0041
4G-02D Diamond 0.0025".....	723-0042
RPJ-01D Diamond 0.001".....	723-0035
RPJ-02D Diamond 0.0025".....	723-0036
RPJ-01S Sapphire 0.001".....	723-0038
RPJ-02S Sapphire 0.0025".....	723-0039
Single Tip Replacement Styli for RPX-040, 041, 061, 063	
RPJ-005 Sapphire 0.001".....	723-0033
RPJ-006 Sapphire 0.0025".....	723-0034
RPJ-004 Diamond 0.001".....	723-0032
RPJ-002 Diamond 0.0025".....	723-0030



12" AND 16" TONE ARMS

Models 206-S and 208-S viscous damped tone arms come with slide and modular weights for mounting single play stereo or monophonic cartridges. Designed specifically for the GE turn-around cartridges, the models 206-SG and 208-SG have a slot cut out in the front of the arm to clear the stem of the GE cartridge, and are specially balanced for this cartridge. Accessory weights are also available.

Gray 206-S, 12" viscous damped tone arm.....	723-0259
Gray 206-SG, 12" viscous damped tone arm for turnaround cartridge.....	723-0250
Gray 208-S, 16" viscous damped tone arm.....	723-0099
Gray 208-SG, 16" viscous damped tone arm for turnaround cartridge.....	723-0153

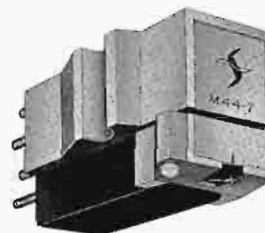

STEREOPHONIC PICKUP CARTRIDGE

Model M44-7 stereo dynetic cartridge is recommended for faithful reproduction of stereophonic recordings with the M-6442 stereo preamplifier. It offers superior stereo separation, smoother response, and is designed to complement the 15° effective cutting angle now being used on stereo recordings. The easily changed styli may be interchanged for various types of recordings.

SPECIFICATIONS

FREQUENCY RESPONSE: 20 to 20,000 Hz.
CHANNEL SEPARATION: More than 25 dB at 1000 Hz.
OUTPUT: 9 millivolts per channel at 1000 Hz at 5 cm/sec.
LOAD IMPEDANCE: 47,000 ohms per channel.
TRACKING: 1.5 to 3 grams.
STYLUS: Features "no scratch" retractable design.
INDUCTANCE: 680 millihenries.
D. C. RESISTANCE: 650 ohms.
MOUNTING: Standard 1/2" mounting center.
WEIGHT: 7 grams net.

ORDERING INFORMATION

Shure M44-7 stereo Dynetic Cartridge with 0.0007" diamond stylus.....	723-0236
Replacement Stylus N-44-7 0.0007" diamond.....	723-0237



Transistorized Turntable Preamplifiers



MONOPHONIC

Single-channel monophonic preamplifier designed for use in broadcasting, recording, and general sound requirements where low distortion and exacting frequency response characteristics are demanded. Featuring self-contained power supply and transformer output, the preamplifier includes two-position equalizer with escutcheon and knob for RIAA/NAB or roll off equalization. The input impedance of 47,000 ohms makes the M-6244 compatible with virtually all magnetic cartridges (including stereo).

SPECIFICATIONS

INPUT: 47,000 ohms.

OUTPUT: Adjustable from -22 dBm to -12 dBm with 12 mV input.

RESPONSE: Within ± 1 dB of RIAA/NAB standard curve. Additional high-frequency, roll-off filter position provided.

DISTORTION: Less than 0.5% at normal levels (-22 dBm to -12 dBm output). Less than 1.0% at 10 dB overload (above 12 mV input).

NOISE: 68 dB or lower, below -12 dBm output (with 12 mV input).

LOAD IMPEDANCE: 600 ohms or 150 ohms, balanced or unbalanced.

MAXIMUM OPERATING AMBIENT TEMPERATURE: +60°C (+140°F).

POWER: 115 volts, 50/60 Hz, 1 watt.

MOUNTING: Two holes for mounting to Gates turntable or inside of any cabinet. May be mounted in any position.

SIZE: 2 $\frac{1}{8}$ " wide, 8 $\frac{1}{2}$ " long, 2 $\frac{7}{8}$ " high.

WEIGHT AND CUBAGE: Net weight, 1 $\frac{1}{4}$ lbs. Packed weight, 8 lbs. Cubage, 1 cubic foot.

ORDERING INFORMATION

Monophonic transistor equalized turntable preamplifier 994-6244

STEREOPHONIC

Designed for superior performance in stereophonic transcription systems, the M-6442 offers these features: Three-position response selector switch for flat, RIAA/NAB, and roll off equalization; plus a two-position switch to provide a monophonic output from stereo discs, important in many AM/FM and special library situations. Fully shielded, and completely self-contained, including power supply. The M-6442 input impedance of 47,000 ohms makes it compatible with virtually all magnetic stereo cartridges.



SPECIFICATIONS

INPUT: 47,000 ohms.

OUTPUT LEVEL: Adjustable from -22 dBm to -12 dBm, from 8 mV input.

RESPONSE: Within ± 1 dB of RIAA/NAB standard curve. Additional high frequency roll off and flat response position switch selected.

DISTORTION: Less than 0.5% at normal level (-22 dBm to -12 dBm output). Less than 1.0% at 10 dB overload (above 8 mV input).

NOISE: 60 dB or lower, with -63 dBm input (-123 dBm relative input noise).

LOAD IMPEDANCE: 600 ohms or 150 ohms, balanced or unbalanced.

MAXIMUM OPERATING AMBIENT TEMPERATURE: +60°C (+140°F).

POWER: 117 volts, 50/60 Hz, 1 watt.

MOUNTING: Two holes for mounting with Gates turntable or inside of any cabinet. May be mounted in any position.

SIZE: 3" wide, 9 $\frac{1}{2}$ " long, 5" high.

WEIGHT AND CUBAGE: Net weight, 2 lbs. Packed weight, 8 lbs. Cubage, 1 cubic foot.

ORDERING INFORMATION

Stereophonic transistor equalized turntable preamplifier 994-6442

Modular Audio Equipment Cabinets



"Combo" desk system includes two dual pedestals (M-6449) and table top section (M-6450). Electronic equipment shown to demonstrate a typical installation.

MODERN, FLEXIBLE STYLING

The fullest flexibility of custom cabinetry, with the economy of standard production units, combine to offer broadcasters a totally modern concept in control room desks. Beautifully styled in walnut grain and textured Formica, these desks have the appearance of fine furniture, and the strength and durability to last for years.

"Building blocks" of single-width pedestal, double pedestal, uniform table top sections, plus two decorator leg sections can be assembled in dozens of configurations. Pedestal base sections have removable grill front and cabinet-finish rear doors that remove to reveal standard 19" rack mounting rails.

Cartridge tape equipment, leveling amplifiers, jack fields, etc., may be mounted for operator convenience. The interior of each cabinet is also finished, so cabinets may be used for disc or tape storage by removing the panels entirely.

When used with turntables, the pedestals conform to NAB standards for transcription cabinets. For console wiring, a cable trough is concealed under the table top section near the rear. The "horseshoe" or "combo" configuration shown above provides an attractive and functional control center in keeping with the aesthetic beauty of modern communications equipment.

ORDERING INFORMATION

Combo desk system, complete with 2 double pedestals and top section. For specifications on individual items that make up the system, see Page 175. Console, microphone and turntables pictured above are not included.-----994-6454

Modular Audio Equipment Cabinets

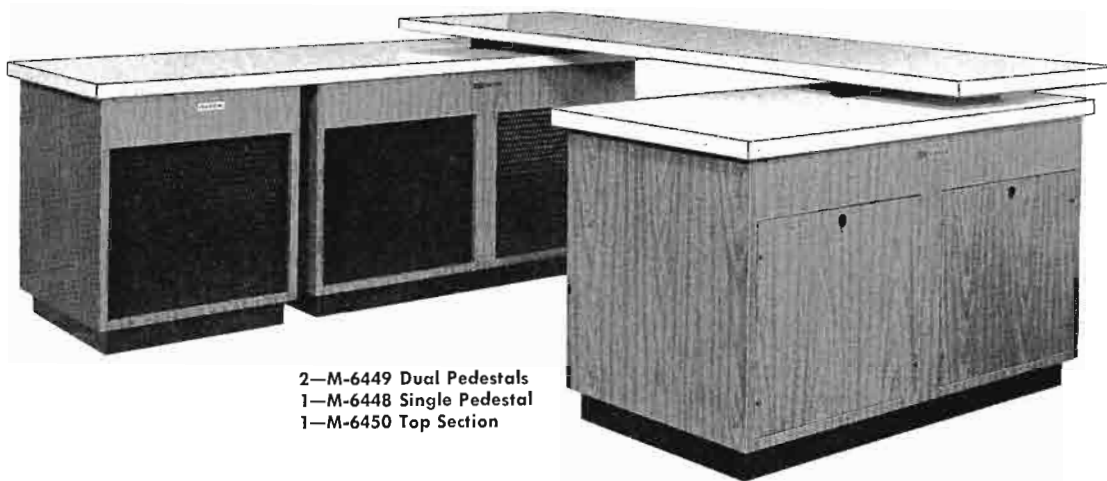

2—M-6449 Dual Pedestals
1—M-6448 Single Pedestal
1—M-6450 Top Section

WIDE VARIETY OF COMBINATIONS

By choosing combinations of modular desk components, large and complex control room arrangements are made possible. Shown above is a desk system with one extended "wing". This could easily accommodate an extra turntable, two-way radio, or other miscellaneous equipment. Or, the top can be left bare for counter space, with the grilled area used for mounting any rack-mounted equipment such as reel-to-reel recorders, utility amplifiers, etc.

Development of this tasteful equipment cabinetry encompassed human engineering studies, styling analysis and comparison with established mechanical specifications where available. For instance, the turntable pedestals conform to the height standards of the NAB, and are four inches lower than the desk top section for comfortable operation. Color and texture of the cabinets blend easily with any studio color scheme and provide a pleasant setting in keeping with the trend of modern office furniture.

Many interesting variations in control room desks allow tailor-made arrangements for specific station operations. The single pedestal, serving as a right hand desk base, may also provide rack space for Criterion tape cartridge equipment, reel-to-reel recorder or storage. All pedestals have sturdy black steel bases with leveling feet. Expanded metal grill or finished access door removes to reveal 16" of standard 19" rack space. Double and single leg assemblies are of sturdy 1" satin chrome square steel tubing with leveling feet. Both 12" and 16" Gates turntables and all types of speech input consoles may be used with these cabinets.

For ordering information and specifications on pedestals, top and leg assemblies see Page 175.

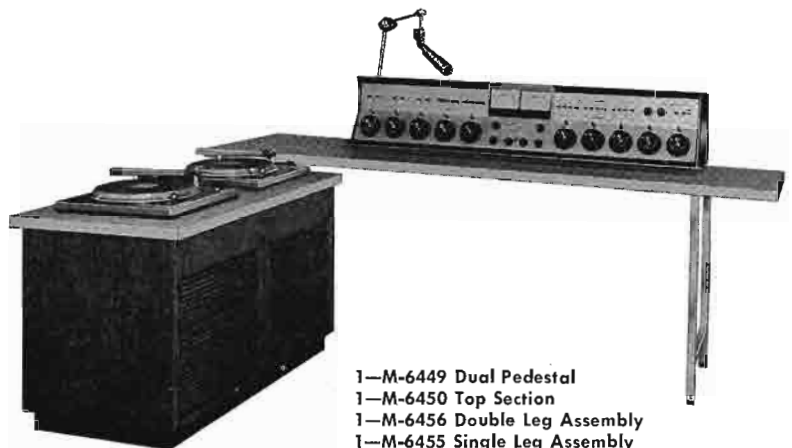

1—M-6449 Dual Pedestal
1—M-6450 Top Section
1—M-6456 Double Leg Assembly
1—M-6455 Single Leg Assembly



1—M-6449 Dual Pedestal
1—M-6448 Single Pedestal
1—M-6450 Top Section

Modular Audio Equipment Cabinets

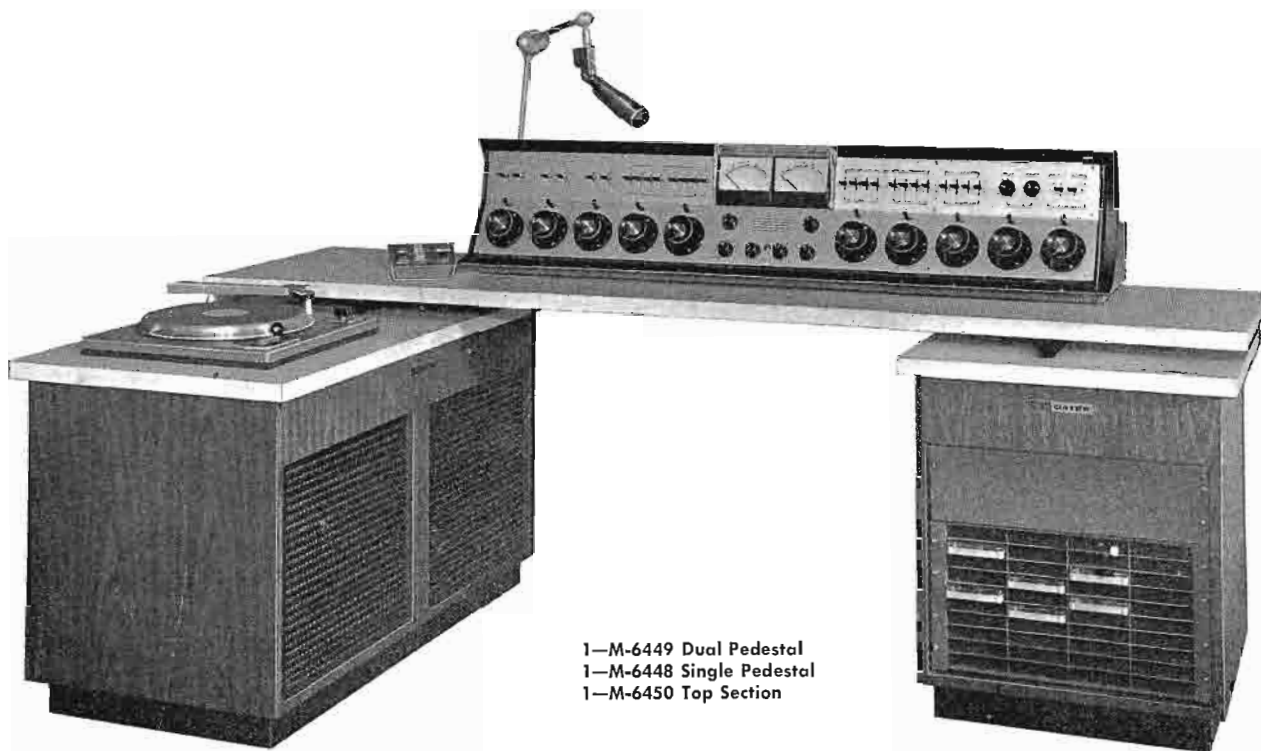

1—M-6449 Dual Pedestal
1—M-6448 Single Pedestal
1—M-6450 Top Section

TYPICAL SELECTIONS

Gates modular equipment cabinetry shown here serves to suggest how a modular system may be assembled to fit specific studio requirements. Note the convenient storage area provided by the double and single turntable pedestals.

In addition to modular studio furniture Gates also offers the world's most complete selection of standard production audio equipment. A Gates District Manager will be happy to discuss

particular programming requirements with you, and recommend a complete control room package suited to your individual needs.

For ordering information and specifications on audio equipment cabinetry items, see Page 175. Console, turntables, microphone, and cartridge tape equipment shown here are not included with the cabinet equipment.



M-6449 Double Turntable Pedestal.



M-6448 Single Turntable Pedestal.

Modular Audio Equipment Cabinets



SINGLE PEDESTAL, M-6448

Mounts one 12" or 16" turntable. 16" rack mount space front with expanded metal grill. 16" rack mount space rear with wood-grain door. Constructed of 3/4" solid flake board, laminated with Formica. Furnished with 2 1/2" steel base and floor levelers.

FINISH: Walnut formica. Top in champagne formica and trim painted satin black.

SIZE: Height 26", width 23", depth 23".

WEIGHT: Net, 60 lbs.; packed 70 lbs.

CUBAGE: 12 cubic feet.

ORDER NUMBER..... 994-6448



DOUBLE PEDESTAL, M-6449

Mounts two 12" or 16" turntables. Total 64" of 19" rack mount space available front and back, both sections. 3/4" flake board with Formica laminate. 2 1/2" steel base and floor levelers.

FINISH: Walnut formica. Top in champagne formica and trim painted satin black.

SIZE: Height 26", width 45", depth 23".

WEIGHT: Net, 108 lbs.; packed, 140 lbs.

CUBAGE: 18 cubic feet.

ORDER NUMBER..... 994-6449

NOTE: Cabinets normally supplied less cut-outs for turntables. If cut-outs desired, an added cost is involved.

METAL GRILL REPLACEMENTS

Where the expanded metal grill used on cabinet fronts, such as the M-6448 or M-6449, is to be eliminated in part for rack mounted items, other size grills are listed below to fill the unused portion. Example: full grill is 16" high. If 5 1/4" rack space used, order 994-6453B to fill remaining space.

Grill 10 1/2" high..... 994-6453B

Grill 5 1/4" high..... 994-6453C

Grill 3 1/2" high..... 994-6453D

UNIFORM TABLE TOP SECTION

Complete with wiring trough, and angle brackets for assembly with pedestals or legs. When assembled, desk surface is 29" from floor. (Not illustrated.)

FINISH: Neutral champagne formica.

SIZE: Length 84", depth 29", thickness 1 5/16". (Other lengths on special order.)

WEIGHT: Net, 55 lbs.; packed, 70 lbs.

CUBAGE: 7.5 cubic feet.

ORDER NUMBER..... 994-6450

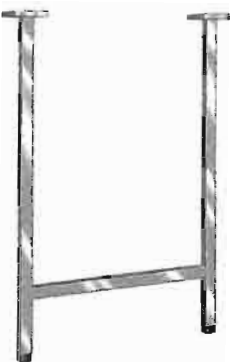

DOUBLE LEG, M-6456

For supporting top section. Square 1" steel welded construction with crossbrace. Complete with mounting flanges and floor levelers.

FINISH: Satin chrome steel.

SIZE: 1" x 1" x 28". Over-all width 21".

WEIGHT: Packed, 10 lbs.

CUBAGE: 2 cubic feet.

ORDER NUMBER..... 994-6456



SINGLE LEG, M-6455

Mounts beneath desk top section. Square 1" steel tubing with mounting flange and floor leveler.

FINISH: Satin chrome steel.

SIZE: 1" x 1" x 28".

WEIGHT: Packed, 5 lbs.

CUBAGE: 1 cubic foot.

ORDER NUMBER..... 994-6455

Portable Audio Turntable-Console



MODEL KD-20A

Rugged, compact, and all solid state, this economical unit is ideal for remote disc jockey shows and special on-the-spot broadcasts.

COMPLETE REMOTE CAPABILITY: Two high quality, three speed turntables, with individual mixing controls are provided. Two microphones and a remote input can also be mixed and are individually selectable by a three position switch. The remote input has a 50 dB pad which enables use of a high level source such as a tape recorder or remote amplifier, adding to the capability of the unit. Line feed and control, PA feed and monitoring are included.

COMPACT DESIGN: This unit is packaged for portability. Weighing only 68 pounds, the KD-20A has detachable legs which fasten underneath the base for ease in transporting. The base of this console is fiberglass to provide protection for the equipment. Side handles enable easy carrying, and the unit's over-all size enables it to fit into the rear of a standard size car.

EXCELLENT AUDIO: Both turntable channels have integral RIAA equalization to match their respective cartridges. Microphone channel frequency response is ± 2 dB from 50 to

15,000 Hz. Output level is +6 VU with 3% or less distortion from 50 to 10,000 Hz.

The KD-20A's output passes through a 3 dB pad before feeding the broadcast line. The output also passes through a resistive isolation network before going to the monitor phone jack. Feed to the PA system is isolated by a bridging transformer and a separate fader is used to control PA level.

SOLID STATE ELECTRONICS: All circuitry in this console from preamplifiers to power supply is solid state, using high quality, ruggedly mounted transistors and diodes. Etched wiring is used in all amplifiers. The full wave power supply is fully regulated.

EASE OF OPERATION: The control placement of this unit assures easy operation by one man. Faders for the two turntables and the microphone/remote input are on the lower portion of the control panel. The three position microphone/remote switch is in the center with the PA level control and master gain control to the right and left of the VU meter respectively. Cueing of the turntables can be accomplished through headphones; monitoring is done through the headphones or an external amplifier.

SPECIFICATIONS

MIXING CHANNELS: Three.

MODE: Monaural.

INPUTS: Total five—(2) turntables, (2) 50-250 ohm microphones, (1) high level 600 ohms.

CUEING: Pushbuttons on turntable channels to headphone jack.

FREQUENCY RESPONSE: (Audio system), ± 2 dB, 50-15,000 Hz. (Pickups) Standard RIAA curve.

DISTORTION: 3% or less.

OUTPUT: 600 ohms @ +6 VU (after built-in 3 dB pad).

NOISE: (Microphone channel) -56 dB (relative input noise -106 dBm).

POWER: 117 volts, single phase, 60 Hz.

SIZE: 44" long, 16½" wide, 10" high.

WEIGHT: 68 pounds net.

ORDERING INFORMATION

Portable KD-20A audio turntable/console-----740-0032



Proof Of Performance Equipment



A



B



C

SA-131

A proof of performance package that assures accurate results and complete equipment to check audio and radio frequency performance. There are three basic units, plus two optional units: (A) type 210 audio oscillator, (B) M-3625 gain

set, (C) type 410 distortion meter, and optional RF pickup coil and diode rectifier for AM transmitter measurements. For FM transmitters the signal can be obtained directly from the modulation monitor for proof of performance tests.

AUDIO OSCILLATOR

Fig. A. An excellent source for audio signals from 10 to 100,000 Hz, the type 210 oscillator consists of an RC audio circuit followed by an amplifier of extremely low distortion. Response over the entire frequency range is ± 1 dB with wave form distortion of less than 0.2% at a 5 volt output. Calibration over the 10 to 100,000 Hz range is $\pm 2\%$. Output impedances are 600 ohms balanced, 600 ohms unbalanced and 150 ohms unbalanced. Maximum output is 10 volts into a 600 ohm load. The unit is 6" wide, 9" high and 12" deep, including a self-contained power supply. Weight is 11 pounds.

GAIN SET

Fig. B. The M-3625 gain measuring set consists of a VU meter with switching to accommodate all usable ranges for measuring purposes. The attenuation circuit includes a 10 step 2 dB per step variable attenuator of the balanced ladder type, and fixed plug-in pads which may be used in any number from 1 to 3. Pads are used for attenuation and impedance matching. Two are supplied, providing 40 dB attenuation at 600/600 ohms and one with 20 dB at 600/250 ohms, all balanced H. The gain set is completely shielded.

DISTORTION METER

Fig. C. The type 410 distortion meter measures audio distortion, noise level, audio gain or loss in decibels and AC voltages. This unit measures distortion on fundamental frequencies from 20 to 20,000 Hz and indicates harmonics up to 100 kHz. Distortion levels as low as 0.1% can be measured, and distortion measurements may be made on signal levels from 0.1 volt to 30 volts. For noise and response measurements the instrument is calibrated in 1 dB steps from 0 to -15 dB. The attenuator provides additional ranges from -60 dB to $+50$ dB in 10 dB steps. The unit is 11½" wide and 9" high. Weight is 11 pounds.

PICKUP COIL AND RECTIFIER

Optional accessory for AM transmitters only. Designed for use with the type 410 distortion meter, the pickup coil is supplied ready to couple to the tank circuit of an AM transmitter. It is supplied with 15 feet of coaxial cable that connects the coil to the diode rectifier unit. Complete RF filtering guarantees a pure audio output signal free from RF disturbances. 4" long, 2" wide, and 1¼" high.

SPECIFICATIONS

INPUT IMPEDANCE: 600 ohms, balanced.
OUTPUT IMPEDANCE: Variable 30 to 600 ohms.
OUTPUT LEVEL: Variable from $+21$ dBm to -136 dBm.
RESPONSE: ± 0.5 dB, 30-15,000 Hz.
DISTORTION AND NOISE: Negligible.
SIZE: 12¾" wide, 8¾" high, 4" deep.

ORDERING INFORMATION

SA-131 proof of performance package, consists of one each
 Model 210, M-3625, and Model 410.....994-3663
 Model 210 audio oscillator.....700-0045
 Model 3625 gain set.....994-3625
 Model 410 distortion meter.....700-0040
 Pickup coil and rectifier (optional for AM only).....994-3626-002

Professional Tape Recorders

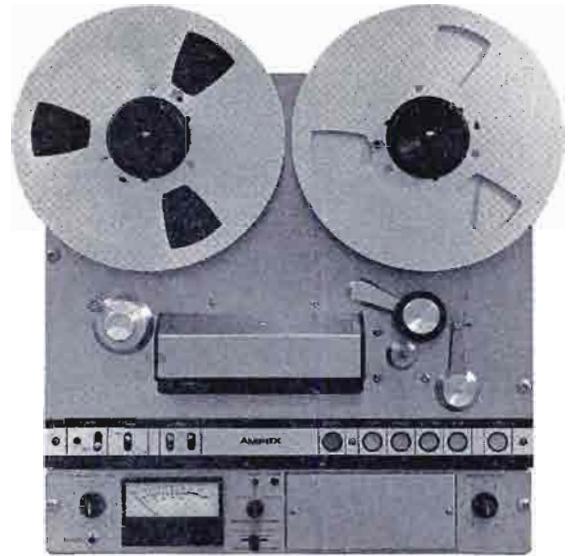

AMPEX 440 TAPE SYSTEM

One of the finest commercial tape recorders available anywhere. The all-transistor Ampex 440 series sets the highest standards in professional recording performance. Uncompromising quality characteristics, both electronic and mechanical, result in superiority of performance and long, trouble-free operation. Transport control buttons are recessed so that they cannot be accidentally pressed; all can be remote controlled. The 440 is the professional broadcast version of Ampex recorders used by leading Hollywood recording companies. Rack, Portable, or Console mount, monophonic or stereophonic versions, dual speed: 7½-15, or 3¼-7½ ips.

Rigid die-cast frame provides absolutely flat mounting of all mechanical components for precise tape alignment. The AG-440 series has been designed for easy, rapid maintenance, and minimum downtime. Modular design with front panel plug-in circuit boards permits fast servicing and replacement. Individual head stacks can be replaced with a single screw and plug-in connector. Transport motors, guides, and major components can be quickly removed and replaced in exact alignment because of the precision milled transport casting. All relays plug-in and are fully interchangeable.

SPECIFICATIONS

- TAPE SPEEDS:** 7½ and 15 ips, or 3¼ and 7½ ips.
 - SIGNAL TO NOISE RATIO:** 15 ips full track 68 dB, 2 track 60 dB; 7½ ips full track 68 dB, 2 track 60 dB; 3¼ ips full track 63 dB, 2 track 56 dB.
 - FREQUENCY RESPONSE (OVER-ALL):** 15 ips ±2 dB, 30 to 18,000 Hz; 7½ ips ±2 dB, 40 to 10,000 Hz; 7½ ips +2 to -4 dB, 30 to 15,000 Hz; 3¼ ips ±2 dB, 50 to 7500 Hz.
 - FLUTTER:** 15 ips below 0.08% rms; 7½ ips below 0.10% rms; 3¼ ips below 0.15% rms.
 - PLAYBACK OUTPUT:** +8 dBm into 600 ohms—restrappable for +4 dBm output balanced or unbalanced. Maximum of +29 dBm before clipping.
 - RECORD INPUT:** 100 K ohm unbalanced bridging with dummy plug or 20 K ohm bridging with plug-in transformer -17 dBm to produce recommended operating level.
 - START/STOP:** Start, tape at full speed in less than 1/10 second. Stop, tape travel 2" or less after depressing stop button.
 - PLAYBACK TIMING ACCURACY:** ±0.2% (±3.6 seconds in 30 minutes).
 - EQUALIZATION:** NAB standard, CCIR on special order.
 - POWER REQUIREMENTS:** 117 volts, 50 or 60 Hz @ 2.5 amp. for 2 channel.
 - DIMENSIONS:** Transport, 19" wide x 15¼" high. Electronics, 19" wide x 3½" high.
 - MOUNTING CONFIGURATIONS:** Portable, Console, or Unmounted.
 - REEL SIZE:** Standard up to 10½ inch, adjustable up to 11½" reels.
- Complete specifications on request.

ORDERING INFORMATION

- AG-440-U Recorder, full track, unmounted, 7.5/15 ips, 60 Hz.....730-0933
- AG-440-C, as above except console mounted.....730-0934
- AG-440-2U Recorder two track stereo, unmounted, 7.5-15 ips, 60 Hz.....730-0939
- AG-440-2C as above, except console mounted.....730-0940
- AG-440-2U +¼ Recorder two track stereo plus qtr. track playback, unmounted 7.5/15 ips.....730-0941
- MODEL AG-445 REPRODUCERS**
- AG-445-U reproducer, full track, unmounted, 7.5/15 ips, 60 Hz.....730-0947
- AG-445-½U reproducer, half track, unmounted, 7.5/15 ips.....730-0948
- AG-445-2U sterea reproducer two track and qtr. track stereo, unmounted, 7.5/15 ips.....730-0951
- AG-445-2U as above, except 3.75/7.5 ips.....730-0952
- Accessory remote control. Desk type for AG-440 or AG-445, with 30 ft. cable.....730-0953
- Portable transport case—for AG-440 or AG-445.....730-0960
- Portable electronics case. Accommodates monophonic or two track stereo electronics.....730-0961

Professional Tape Recorders



AMPEX AG-500 SERIES

The AG-500-1 is a versatile new one-channel recorder with full or half-track heads. This portable single channel solid state unit has input controls that can mix two incoming line signals. Use of mike pre-amp accessory converts line inputs to accept low impedance microphones. Narration over music, music/voice mixing or special sound-on-sound capabilities are possible. Recorder will feed 600 ohm remote broadcast phone line.

The two-channel version AG-500-2 provides complete stereo record and reproduce. A 2-track erase head used with the "record/safe" selector permits half-track recording of either track, sound-on-sound, cue track and special effects. Like the monophonic version, each electronics channel of the AG-500-2 has two inputs, thus offering a built-in four-position mixer.

The four track AG-500-4 offers all functions of AG-500-2 in quarter track stereo/mono version. Recorder has three one-fourth track stereo heads; erase, record, play . . . (tracks 1 and 3 of 4 tracks). Optional versions are available from factory with extra head and head transfer switch installed.

New precision milled die-cast tape transport is combined with complete solid state electronics and highest quality heads to assure studio quality performance for all field and portable broadcast applications.

A choice of 7½ and 15 ips or 3¾ and 7½ ips models adds to the versatility of the AG-500 series. A full line of mixers, remote control units, and matching transformers are available to meet a wide range of recording needs.

SPECIFICATIONS

- SPEEDS:** 7½ and 15 ips, or 3¾ and 7½ ips (AG-500-4 for 4 track stereo, 3¾ and 7½ ips only).
- FREQUENCY RESPONSE (OVER-ALL):** 15 ips ±2 dB, 30 to 18,000 Hz; 7½ ips ±2 dB, 30 to 15,000 Hz; 3¾ ips +2 dB -4 dB, 40 to 8,000 Hz.
- SIGNAL TO NOISE RATIO:** 7½ and 15 ips, full track (60 Hz) 60 dB (50 Hz) 57 dB, half or two track 55 dB. 3¾ ips full track 55 dB, half and quarter track 50 dB.
- WOW AND FLUTTER:** 15 ips less than 0.15% rms, 7½ ips less than 0.8% rms, 3¾ ips 0.25% rms.
- TIMING ACCURACY:** ±0.25%, 7½ and 15 ips; ±0.40%, 3¾ ips.
- OUTPUT:** +4 dBm into 600 ohm balanced load.
- INPUTS:** 2 per channel balanced or unbalanced (bridging transformer supplied) with provisions for plug-in 600 ohm transformers and low impedance plug-in microphone preamplifiers.
- POWER REQUIRED:** 117 Volts, 60 Hz, 1.50 Amp. 230 Volts, 50 Hz, 0.75 Amp.
- RACK SPACE:** Transport, 8¾" H x 19" W x 6" D. Electronics, 3½" H x 19" W x 6" D.
- WEIGHT:** 1 channel portable 42 lbs., 2 channel portable 52 lbs.

ORDERING INFORMATION

AG-500-1 Single channel Full track, rack mount, 7.5/15 ips, 60 Hz.....	730-0963
AG-500-1 Same as above except half-track.....	730-0964
AG-500-1 Single channel, full track, rack mount, 3.75/7.5 ips, 60 Hz.....	730-0965
AG-500-1 Same as above except half-track.....	730-0966
AG-500-2 Stereo, 2 track, rack mount, 7.5/15 ips, 60 Hz.....	730-0967
AG-500-2 Stereo as above except 3.75/7.5 ips.....	730-0968
Portable Case for AG-500 single channel.....	730-0970
Portable Case for AG-500 two channel.....	730-0971

Professional Tape Recorders



AMPEX AG-600

Now . . . Ampex offers a smaller, all new version of the 600 series; the world's finest low-cost professional audio recorder. Reliability of the 600 series is proven by more than 35,000 recorders in use throughout the world. The AG-600 is a portable all solid-state recorder/reproducer available in single channel (full or half track mono) or two channel (half or quarter track stereo/mono).

The AG-600 series is designed for broadcast, where compact lightweight professional quality recording equipment is needed or where budgets are limited.

The new two-speed transport (3¾ and 7½ ips) uses the same rugged die-cast aluminum frame which made the 600 series so dependable. This means a more rigid top plate which maintains critical alignment of heads and tape guides. There's also an improved clutch assembly and a new cooling system to add to reliability. And, to simplify indexing, a three digit counter has been added.

The new solid-state electronics package allows extreme versatility in small space. Each channel has one line and one mike input, providing a built-in mixer capability. The line input may be converted to mike input with an accessory plug-in preamplifier. All set-up controls are located on the front panel. An isolated output jack allows the use of either high or low impedance headsets for monitoring.

SPECIFICATIONS

FREQUENCY RESPONSE: 7½ ips: ±2 dB from 60 Hz to 10 kHz; +2.4 dB from 40 Hz to 15 kHz. 3¾ ips: ±2 dB from 50 Hz to 7 kHz; +2.4 dB from 40 Hz to 8 kHz.

SIGNAL TO NOISE: 7½ ips: Full track 57 dB; Half track 55 dB; 3¾ ips: Full track 52 dB; Half track 50 dB.

CROSSTALK REJECTION: Better than 40 dB mid-frequency.

FLUTTER AND WOW: (Measured by ASA Standards) 7½ ips less than 0.17%; 3¾ ips less than 0.25%.

TIMING ACCURACY: 7½ ips ±0.2% (±3.6 seconds in 30 minutes). 3¾ ips ±0.4% (±7.2 seconds in 30 minutes).

FAST FORWARD OR REWIND TIME: 90 seconds for full 1200 foot reel.

SPEEDS: Dual speed, 3¾ and 7½ ips.

REEL SIZE: 5" and 7".

INPUTS: Two inputs with individual gain control on each.

1. Low impedance mike input, 150 microvolts required for program record level. 30 to 250 ohm nominal impedance.
2. Line input (100 k unbalanced) -10 dBm required for program record level.

OUTPUTS: Two outputs for each channel.

1. +4 dBm into 600 ohms. Balanced or unbalanced load.
2. Headphone monitor jack permits monitoring either input source or tape playback, during recording.

EQUALIZATION: 117 volt, 60 Hz models: 3¾ ips, 120 microsecond. 7½ ips, NAB. 115/230 volt, 50 Hz models: 3¾ ips, 120 or 200 microsecond. 7½ ips, NAB or CCIR.

POWER REQUIREMENTS: For 117 volt operation 0.5 amperes. For 230 volt operation 0.3 amperes.

WEIGHT: Single channel: 28 lbs. portable. Dual channel 42 lbs. portable.

ORDERING INFORMATION

AG-600-1 NAB equalization, full track, unmounted, 60 Hz, 117 Volt	730-1018
AG-600-1, as above in portable case	730-1019
AG-600-1, NAB equalization, half track, unmounted, 60 Hz, 117 Volt	730-1020
AG-600-1, as above in portable case	730-1021
AG-600-2, two-channel, two track, one-half track stereo, NAB equalization, unmounted, 60 Hz, 117 volts	730-1022
AG-600-2 same as above in portable case	730-1023
AG-600-4, two channel, four track, one-quarter track stereo, NAB equalization, unmounted, 60 Hz, 117 volt	730-1026
AG-600-4, Same as above in portable case	730-1027
AA-620 Portable speaker-amplifier for AG-600 and AG-500 series. 10" woofer, 3½" tweeter, 20 watt solid state amplifier in enclosure	730-1030
Rack Mount AA-620	730-1031

Professional Tape Recorders

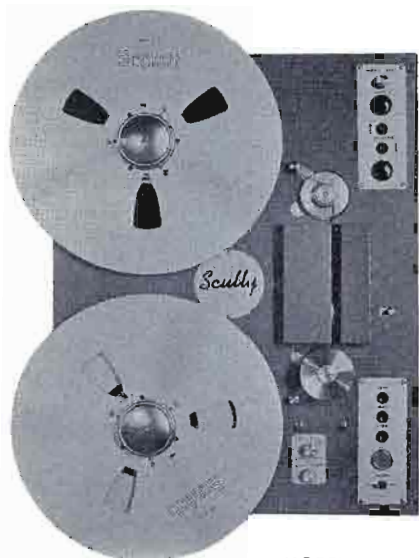

MODEL 270

SCULLY PRECISION TAPE EQUIPMENT

The portable Scully 270 Reproducer is intended for broadcasters, background music operators or any application where long life, reliability and exacting performance specifications in tape handling equipment are essential. The companion model 280 complete record/reproduce system has the same fine features plus quality all-transistor recording amplifier.

SPECIFICATIONS

TAPE SPEEDS: 3¾ ips-7½ ips or 7½-15 ips.
TAPE SIZE: ¼" or ½".
HEAD CONFIGURATION: Monophonic half or full track; stereo 2, 3, or 4 channel.
REEL SIZE: Up to 14".
REEL HUBS: NAB, CCIR.
STARTING TIME: 1/10th second.
STOPPING TIME: 1/5th second.
FAST WIND TIME: 4800 foot reel—105 seconds.
PLAYING TIME: 14" reel, 4800 feet 1½ mil tape @ 3¾ ips—8 hrs. 7½ ips—4 hrs; 14" reel, 9600 feet ½ mil tape @ 3¾ ips—16 hours; @ 7½ ips—8 hours.
FREQUENCY RESPONSE: ±2 dB 50-7500 Hz @ 3¾ ips. ±2 dB 50-15,000 Hz @ 7½ ips. ±1½ dB 50-15,000 Hz @ 15 ips.
FLUTTER AND WOW: 0.2% RMS @ 3¾ ips. 0.1% RMS @ 7½ ips. .08% RMS @ 15 ips.
SIGNAL TO NOISE RATIO (FULL TRACK): -60 dB @ 7½ and 15 ips.
TIMING ACCURACY: Better than 99.8% (30 minute reel).
AMPLIFIER: Solid State, plug-in.
AMPLIFIER EQUALIZATION: Front panel switch.
AMPLIFIER OUTPUT: +18 dBm 600 ohms balanced line.
AMPLIFIER DISTORTION: Less than 0.5% total HD at +18 dBm.
OPERATING CONTROLS: Play, fast, Direction Change, Stop, Speed Selector, Equalization.
REMOTE FEATURES: All controls except motor speed change.
REVERSING: Foil using low current transistor switching, with mechanical memory.
MOTORS: Two torque and one hysteresis synchronous speed reversible capstan motor.
POWER REQUIREMENTS: 117 V, 50/60 Hz, 275 watts.

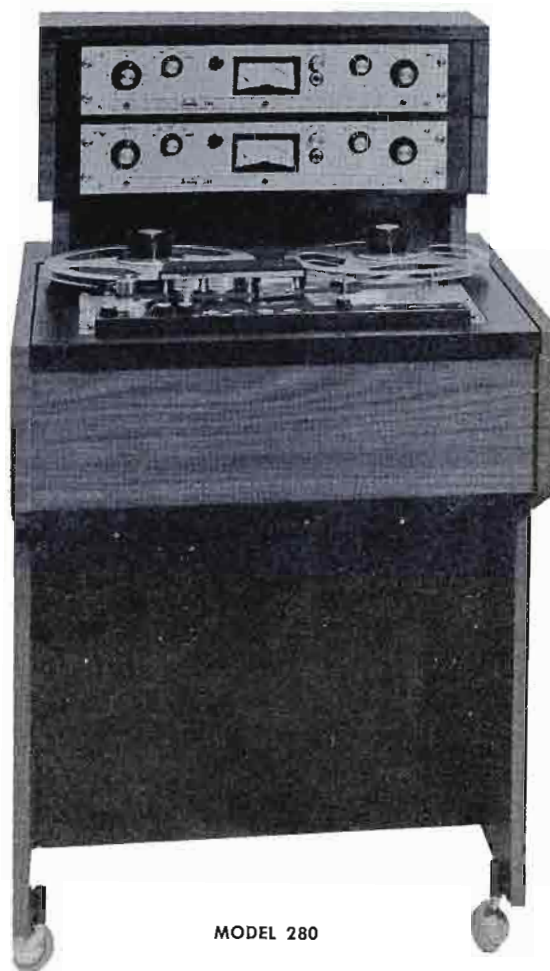

MODEL 280

CONTROL SYSTEM: All relays and solenoids 24 volts DC; plug-in relays.
CHASSIS FRAME: ¾" cast aluminum 2" depth.
MAIN PANEL: Precision aluminum plate.
FACE PLATE: Easily removable, permitting continuous operation.
BREAKING SYSTEM: Disc Type.
TAPE TENSION: Continuous adjustable electrical controls system.
WEIGHT: 79 lbs.
SHIPPING WEIGHT: 90 lbs.
SIZE: 19" x 24½" x 8¾".

ORDERING INFORMATION

Model 270-1 Rack mount reproducer, ½ track monophonic, 14" reel capacity. 7.5/15 ips.....	730-0927
Model 270-2 As above, except for stereophonic reproduction.....	730-0928
Model 280-1 Rack mount record/reproduce. ½ track monophonic, 10½ reel capacity. 7½-15 ips.....	730-0923
Model 280-2 As above, except for stereophonic.....	730-0924
Model 280-1 (SP-14) Rack mount model 280 monophonic recorder with 14" reel capacity.....	730-0925
Model 280-2 (SP-14) As above, except for stereo.....	730-0926



Professional Tape Recorders



**MAGNECORD MODEL 1028
STEREOGRAPHIC
RECORDER/REPRODUCER**

This popular stereophonic recorder with up to 10½" reel capacity features advanced circuit design, utilizing the latest tube types, and complete pushbutton control of all functions. Dual speed 7.5 and 15 ips. Excellent quality for studio or field use. Complete recorder is only 12⅞" high.

SPECIFICATIONS

FLUTTER AND WOW: 0.15% at 7.5 inches per second; 0.1% at 15 inches per second.

TIMING ACCURACY: ±0.2%.

REWIND TIME: 2400 ft., less than 60 sec.

FREQUENCY RESPONSE OVER-ALL RECORD/REPRODUCE: 35 to 16,000 Hz ±2 dB at 7.5 inches per second.

SIGNAL-TO-NOISE RATIO: 55 dB per channel.

INPUTS: Hi-Z microphone and Hi-Z unbalanced bridge; Lo-Z microphone and Hi-Z balanced bridge with input transformers.

INPUT SENSITIVITY: -90 dBm to -35 dBm.

OUTPUTS: Cathode follower, 2.5 volts ±.5 volt. 150/600 ohm balanced, +3 dBm with output transformers.

HEADS: Selectable erase 2-channel record and 2-channel play.

WEIGHT: 47 lbs. (55 lbs. encased).

DIMENSIONS: 17⅞" wide, 12⅞" high, 12" deep (17⅞" wide, 14⅞" high, 12" deep encased). Rack adapter panel available.

ORDERING INFORMATION

1028-2X, Stereo, 7½-15 ips, 2 track stereo, less case.....	730-0421
1028-24X, Stereo, as 1028-2X but with fourth head ¼ track stereo play, less case.....	730-0427
1028-4X, Stereo, 7½-15 ips, ¼ track stereo, less case.....	730-0428
1028-42X, Stereo, same as 1028-4X, but with fourth head 2 track stereo play, less case.....	730-0429
Portable carrying case for model 1028 recorder.....	730-0841



**MAGNECORD MODEL 1021
TRANSISTORIZED MONOPHONIC
RECORDER/REPRODUCER**

Fully transistorized with a regulated power supply, the Magnecord 1021 offers the stability of a two speed hysteresis synchronous capstan motor plus separate reel drive motors. Equalization meets NAB standards. Input and output impedances easily changed with adjustable transformers.

SPECIFICATIONS

TAPE SPEEDS: 3.75 and 7.5 ips.

FLUTTER AND WOW: 0.25% at 3.75 ips; 0.2% at 7.5 ips.

TIMING ACCURACY: ±0.2%.

FREQUENCY RESPONSE—OVER-ALL RECORD/REPRODUCE: 35 to 8000 Hz ±2 dB at 3.75 ips; 45 to 18,000 Hz ±2 dB at 7.5 ips.

SIGNAL-TO-NOISE RATIO: 53 dB, both speeds.

INPUTS—SWITCH SELECTED: Microphone, 50 to 150 ohms; Balanced Bridge, 160 K ohms; Unbalanced Bridge, 47 K ohms; Unbalanced Auxiliary, 75 K ohms.

OUTPUTS: 150/600-ohm balanced (+4 dBm), auxiliary A and auxiliary B unbalanced.

HEADS: Erase head—full-track. Record head—full-track. Play head—half-track.

WEIGHT: Transport 33 pounds. Amplifier 14 pounds.

DIMENSIONS: Transport, 19" wide, 10½" high, 7¼" deep; Amplifier, 19" wide, 5¼" high, 12" deep; Transport Reel Overhang, 1¼" (7-inch reel).

POWER REQUIREMENTS: 117 V, 60 Hz, 180 watts.

ORDERING INFORMATION

1021 Series—Fully Transistorized 1021X (manual operation) monaural, 3¾-7½ full track record, full track erase, half track play (plays full or half track) less case.....	730-0418
1022 Series—Fully Transistorized 1022X (manual operation) stereo, 7½-15 half track stereo, fourth head included for ¼ track stereo play, less case.....	730-0419
1024 Series—Fully Transistorized 1024X (manual operation) stereo, 3¾-7½: ¼ track stereo, less case.....	730-0420
A81D128-A transport case.....	730-0425
A81D129-1 electronics case.....	730-0426

Professional Tape Recorders—Recording Tape

UHER 4000-L

The first choice of radio and TV correspondents throughout the world, the Uher 4000-L offers the professional quality plus the portability demanded by the most critical broadcaster. The quiet, powerful motor is controlled by an 8-transistor DC voltage stabilizing circuit.

SPECIFICATIONS

TAPE SPEEDS: 15/16, 1 7/8, 3 3/4, and 7 1/2 ips.

MAXIMUM REEL SIZE: 5".

FREQUENCY RESPONSE: 40–5000 Hz @ 15/16 ips; 40–10,000 Hz @ 1 7/8 ips; 40–17,000 Hz @ 3 3/4 ips; 40–20,000 Hz @ 7 1/2 ips.

SIGNAL TO NOISE RATIO: 55 dB.

WOW AND FLUTTER: ±0.15% rms @ 7 1/2 ips (audible frequencies only).

HEADS: Standard half-track erase and record/play.

OUTPUTS: External Speaker, earphone.

INPUTS: Remote Control, microphone, power.

POWER SUPPLY: Rechargeable drylift storage battery, or 5 nickel-cadmium batteries, or power unit and battery charger.

POWER OUTPUT: 1 watt.

SIZE: 10 1/2" x 8 1/2" x 3 3/4".

WEIGHT: 7 lbs. 6 oz. (less battery).



ORDERING INFORMATION

Uher 4000-L Portable Recorder, complete with remote control dynamic microphone, leather case, AC power unit, battery charger and battery730-0844

MAGNETIC RECORDING TAPE



Fine quality "Scotch" brand audio recording tape is carried in generous quantities at both Quincy and Houston. Rapid turnover assures fresh stock at all times. Recording tape is shipped prepaid parcel post or rail express anywhere in the United States, and lowest quantity prices are available.

TYPE 111 GENERAL PURPOSE, 1/2 MIL ACETATE

Type 111-3 1/4" x 300', 3" reel. Qty. 1-11 ea.732-0010

Type 111-12 1/4" x 1200', 7" reel. Qty. 1-11 ea.732-0027

Type 111-25R 1/4" x 2500' aluminum, 10 1/2" reel. Qty. 1-11 ea.732-0025

TYPE 200 DOUBLE PLAY, 1/2 MIL POLYESTER

Type 200-12 1/4" x 1200' 5" reel. Qty. 1-11 ea.732-0152

Type 200-24 1/4" x 2400', 7" reel. Qty. 1-11 ea.732-0017

TYPE 150 EXTRA-LENGTH 1 MIL POLYESTER

Type 150-9 1/4" x 900', 5" reel. Qty. 1-11 ea.732-0072

Type 150-18 1/4" x 1800', 7" reel. Qty. 1-11 ea.732-0020

Type 150-36R 1/4" x 3600' aluminum 10 1/2" reel. Qty. 1-11 ea.732-0012

TYPE 153 LUBRICATED TAPE

Type 153 1/4" x 1600' 7" reel.732-0013

TYPE 190 EXTRA-LENGTH, HIGH OUTPUT

Type 190-9 1/4" x 900', 5" reel. Qty. 1-11 ea.732-0084

Type 190-18 1/4" x 1800', 7" reel. Qty. 1-11 ea.732-0075

Type 190-36R 1/4" x 3600', aluminum 10 1/2" reel. Qty. 1-11 ea.732-0015

TYPE 290-36 TRIPLE PLAY

Type 290-36 1/4" x 3600', 7" reel. Qty. 1-11 ea.732-0140

TYPE 175 HEAVY-DUTY TENZAR

Type 175-6 1/4" x 600', 5" reel. Qty. 1-11 ea.732-0170

Type 175-12 1/4" x 1200', 7" reel. Qty. 1-11 ea.732-0171

Gates Automatic Tape Control Division

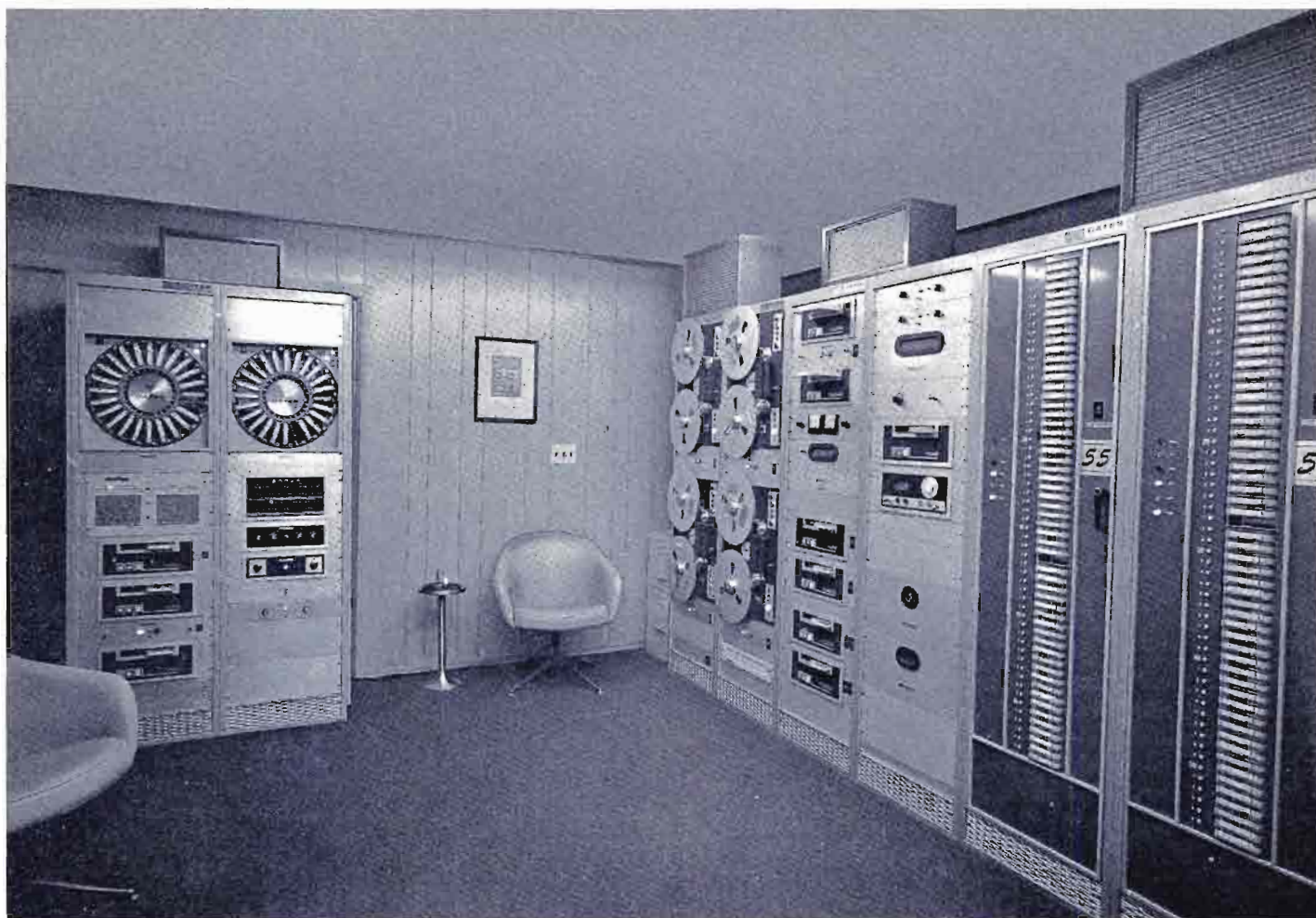

A complete broadcast automation system in the Automatic Tape Control demonstration room gives visitors a chance to see and hear automation in actual operation.

Located in Bloomington, Illinois, Gates Automatic Tape Control Division is a leading producer of broadcast automation systems, tape cartridge units and quality controlled tape cartridges. Plant facilities encompass approximately 11,000 square feet of office, engineering and manufacturing space. Here highly skilled employees design and produce products which are in current use from London, England to London, Ontario—from Melbourne, Florida to Melbourne, Australia—and many points in between.

In response to customer requirements, Automatic Tape Control carefully designs and forms automation systems from modular components to achieve the exact system configuration dictated by programming format. An extensive demonstration area is in constant use, as Gates District Managers usher a steady flow of customers through the facility in order to work out equipment needs, as well as to allow the unfamiliar an opportunity to actually program and operate automated systems.

It was in Bloomington, in 1959, that the era of modern tape cartridge broadcasting originated, and this pioneering experience is evident in the quality design and construction of all the division's products today.

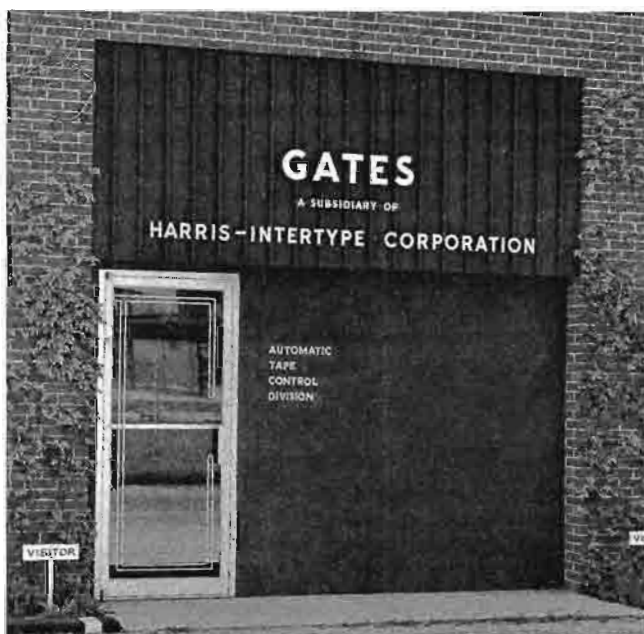

High Power Transmitter Installations

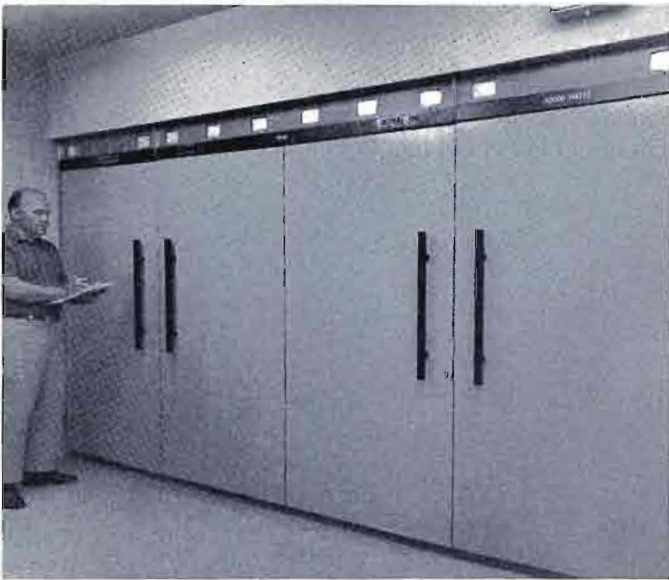

KDAY, LOS ANGELES—The first station to employ Gates VP-50 Vapor Cooled 50,000 watt AM transmitter.



WGAN-FM, PORTLAND, MAINE—Utilizes a Gates 40 kW FM transmitter (two 20 kW transmitters with combiner and common exciter).



VOICE OF AMERICA—Six Gates 50,000 watt Model HF-50C transmitters in use at the Greenville, N. C. transmitting station.

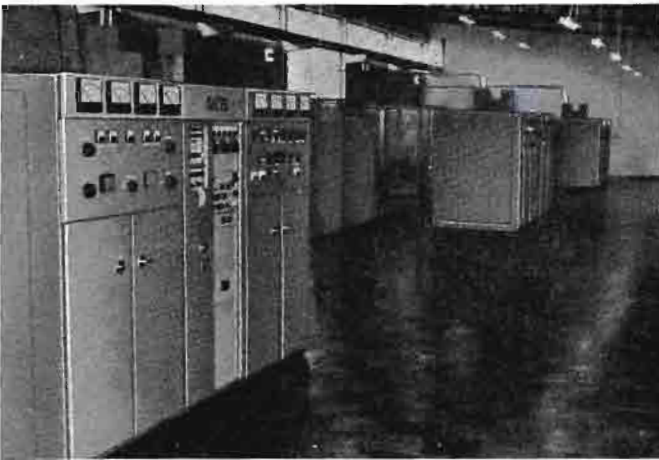

RADIO SINGAPORE—Three Gates 50,000 watt Model HF-50C transmitters used for high power short wave broadcasting.

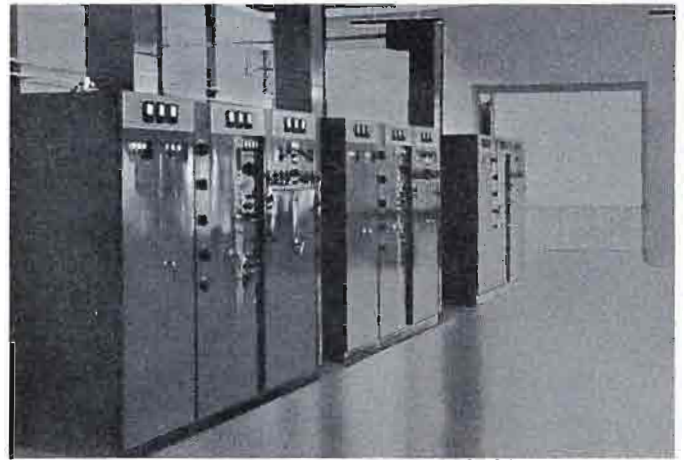

RADIO MALAYSIA—Three 100,000 watt short wave broadcast transmitters Model HF-100 now in operation at Kuala Lumpur.

100,000 Watt HF Broadcast Transmitter

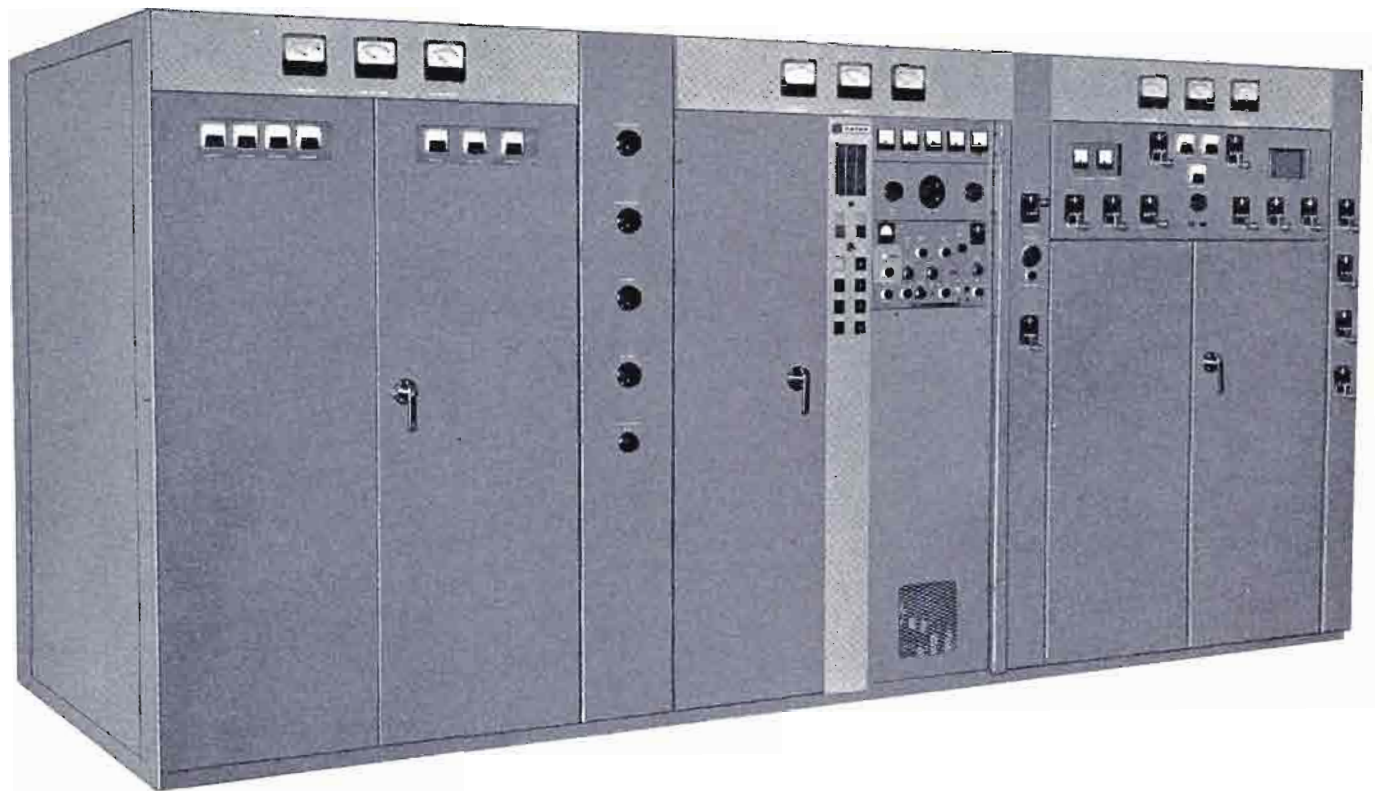

MODEL HF-100

Continuous tuning from the front panel over the entire high frequency band of 3 MHz to 26.1 MHz is one of the many outstanding features of Gates HF-100 transmitter. Delivering 100 kW power output, the transmitter employs high level modulation for broadcasting in the international short wave bands.

Air cooled and designed with conservatively rated components, the HF-100 provides unsurpassed reliability even when operated 24 hours a day in areas of extreme temperature and humidity. Silicon rectifiers that operate well below maximum ratings are included in all power supplies. Other reliability factors include oil-filled modulation and power components and variable vacuum capacitors in all major amplifier circuits.

Gates HF-100 transmitter is also available for telegraph service and can be supplied without the modulator for 100 kW CW operation, with high speed keying and frequency shift keying easily accommodated.

CONTINUOUS TUNING: An advanced, field-proven concept of plate tank circuit design permits continuous tuning over the entire frequency range from the front panel. This design incorporates only one tuned line tank circuit to allow continuous coverage of the wide frequency range (3 MHz to 26.1 MHz). As this circuit is permanently mounted within the transmitter, complete coverage is obtained without the in-

convenience of plug-in or manually changed power amplifier or output coils. Time-consuming internal component changes and storage problems are eliminated in this 100 kW transmitter. With continuous front panel tuning, the HF-100 can be adjusted from one pre-logged operating frequency to another within three minutes or less . . . allowing maximum on-the-air time for short wave broadcasters.

ACCESSIBILITY: All three main HF-100 transmitter cubicles are easily accessible from both front and rear. Vertical and walk-in construction design permits easy servicing and fast accessibility to components and tubes. Removable sides provide quick access to the power amplifier tank and output sections. Service lights and outlets are provided for convenience in servicing and maintenance.

The electrical design of the transmitter utilizes efficient, high-power, air-cooled tubes and tuned lines that permit a simplicity of mechanical construction—resulting in a convenient, space-saving size. Three main transmitter cubicles are mounted in line . . . modulator, control and power amplifier sections. Other equipment (blower, high voltage and magnetic components) is floor-mounted externally.

DUAL SILICON HIGH VOLTAGE POWER SUPPLIES: For greater reliability and better regulation, two separate HV supplies are used in the HF-100 transmitter. One HV supply provides 15 kV for the modulator and the other HV supply provides 12.5 kV for the power amplifier.

100,000 Watt HF Broadcast Transmitter—HF-100

RADIO FREQUENCY CIRCUITS: The exciter is an independent, self-powered unit, of pull-out construction, built into the control cubicle. It has provision for selecting from any one of ten crystal positions and also provides an input for an external VFO and for FSK operation.

Only three amplifier stages are employed to raise the output of the RF exciter to the rated 100 kW transmitter power output. The intermediate power amplifier utilizes one type 4-65 tube followed by two type 6076 RF drivers. Continuously adjustable, the RF driver is conservatively rated with a capability of 8 kW, providing generous reserve power to drive the final amplifier.

The power amplifier consists of two type F-8550 triode power tubes. This well-designed push-pull output stage has many

The exciter is located in the center cubicle which also includes the heart of the control system. There is sufficient space for optional dual exciters, permitting operation on twenty crystal controlled channels where desired.



advantages in feeding high frequency antennas, plus stability and tuning throughout the full frequency range. It also aids in suppression of spurious and harmonic emission.

AUDIO CIRCUITS: Only four amplifier stages are used in the HF-100 to raise the audio input level of +10 dBm to the required modulator output level. The first stage uses two type 6146 tubes followed by the second audio stage, using two type 4-250 tubes. The audio driver stage uses four type 304TH triodes operating as a direct coupled cathode follower. Two type F-8550 triodes are used as modulators. This system is straightforward in design, providing one of the highest quality audio signals obtainable with any system of modulation.

QUIET OPERATION: Rugged cabinet construction and the use of a highly efficient forced air cooling system helps provide unusually quiet operation. Air flow is controlled to insure maximum cooling with a minimum of air noise.



The F-8550 (PA and modulator) tube weighs 65 pounds and is a highly efficient, high-powered, long life, air-cooled triode. Standardization on this type tube for both the modulator and power amplifier permits interchangeability of tubes for longer useful life. This reduces the number of tubes required as spares and lowers the cost of operation.

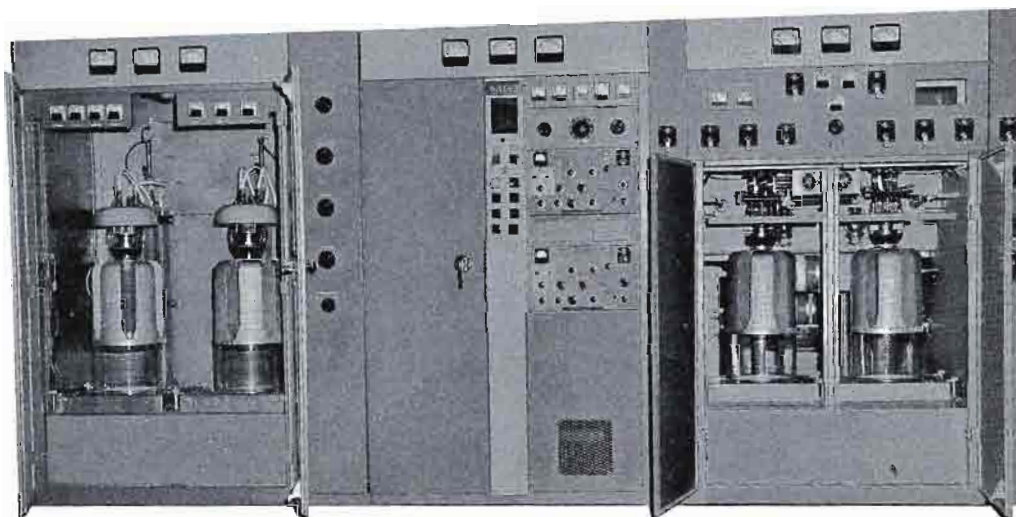

Three main transmitter cubicles house (from left to right) the modulator, transmitter control circuitry, and RF power amplifier.

100,000 Watt HF Broadcast Transmitter—HF-100

HIGH LEVEL PLATE MODULATION: The HF-100 transmitter utilizes high level plate modulation . . . the most reliable, best known, simplest to adjust type of modulation for broadcast service. One of its biggest advantages is that it is least sensitive to changes in RF loading.

INTERCHANGEABLE TUBES: Complete interchangeability between modulator and RF power amplifier reduces spare tube needs, and, through rotation, adds to tube life.

VARIABLE VACUUM CAPACITORS: Vacuum type variable capacitors are used in all stages above the 100 watt power level. They are operated well below maximum voltage and current ratings.

METERING: The operation of the HF-100 transmitter can be constantly monitored with the 30 indicating meters provided, nine of which are located along the top of the main transmitter assembly.

PROTECTIVE DEVICES: Protective devices are used in all circuits. DC overload devices protect all modulator tubes, power amplifier tubes, and RF driver, and each of the two high voltage supplies. AC overload devices are an integral part of the start contactors in the high voltage supply. Blower start contactors are provided with thermal overload protection. Magnetic circuit breakers protect the bias supplies, intermediate high voltage supplies, the RF driver screen supply, the 230 volt bus and control circuitry and other power sources.

INSTALLATION: The HF-100 transmitter has been designed for maximum installation flexibility to fit different types of buildings. Installation does not require any special tools and built-in inter-cubicle wiring ducts reduce installation time. The transmitter is completely air cooled . . . with an external centrifugal 20 hp. blower providing approximately 10,000



Power amplifier section with top cover removed showing the single continuously tuned line tank and separate tuned line output circuits. Note the accessibility and ease of service due to the excellent mechanical arrangement.

CFM of forced air to the cabinet assembly. The blower can be supplied for single floor or lower floor installation as specified.

All Gates transmitters are carefully tuned and checked to operating frequency before shipment. Here, two 100 kW broadcast transmitters are shown undergoing final tests.

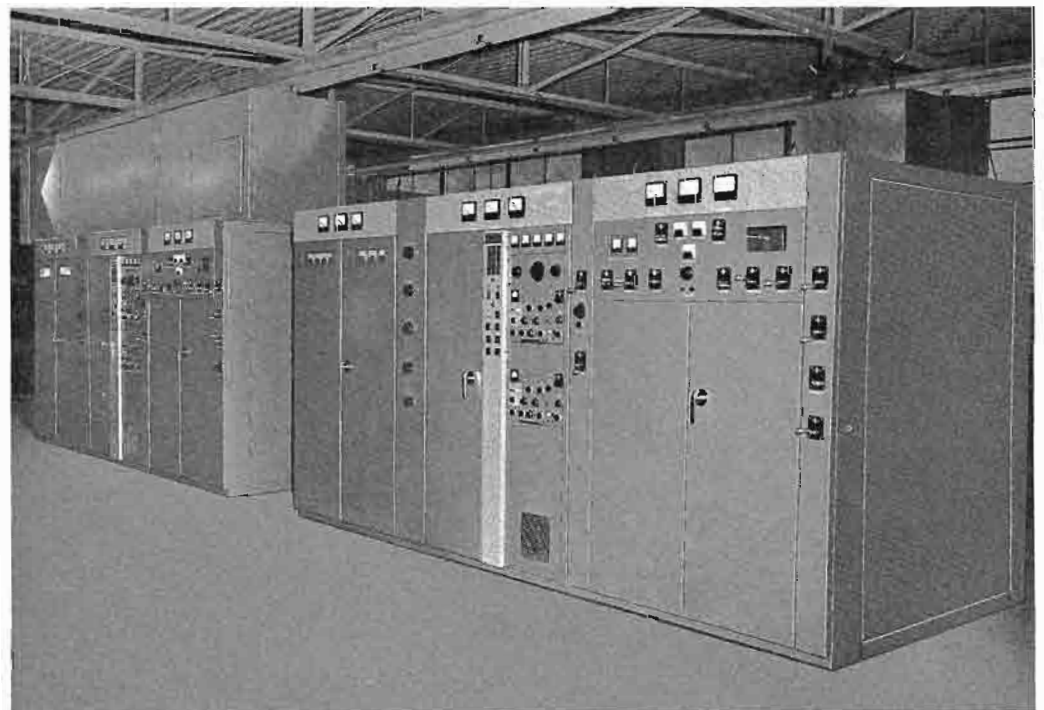

100,000 Watt HF Broadcast Transmitter—HF-100

SPECIFICATIONS

CARRIER POWER OUTPUT: 100 kW.

FREQUENCY RANGE: 3 MHz to 26.1 MHz. Continuously variable from front panel tuning.

TYPE OF EMISSION: A₃.

METHOD OF MODULATION: High level plate modulation.

FREQUENCY STABILITY: Rated .0015%. Capable of .0001%.

CARRIER SHIFT: 5% or less at 100% modulation.

RF HARMONICS: Suppression of harmonics meets or exceeds CCIR requirements.

CRYSTAL FREQUENCY: Ten, front panel selected on Gates exciter built into transmitter. Provision is made for external VFO.

OUTPUT IMPEDANCE: Supplied for 300 ohms balanced. VSWR 1.5 to 1. Other output impedances as specified.

POWER LINE REQUIREMENTS: Available for any one primary voltage 380 to 480 volts, 3 wire or 4 wire, 3 phase, 50 or 60 Hz, as specified.

POWER FACTOR: At least 90%.

POWER CONSUMPTION: 195 kW at 0% modulation; 215 kW at average modulation; 300 kW at 100% modulation.

FREQUENCY RESPONSE: ±1.5 dB, 50 to 10,000 Hz at 90% modulation.

AUDIO DISTORTION: 3% or less 50 to 7500 Hz at 90% modulation.

RESIDUAL CARRIER NOISE: 55 dB below 100% modulation.

AUDIO INPUT LEVEL: Approximately +10 dBm.

AUDIO INPUT IMPEDANCE: 500/600 ohms.

TUBE COMPLEMENT: Exciter (part of transmitter): (1 each) 5763 oscillator, 5763 buffer/multiplier, 6146 buffer amplifier, 6AQ5 screen clamper and OB2 voltage regulator. Transmitter (radio frequency section): (1) 4-65 intermediate amplifier, (2) 6076 driver amplifiers and (2) F-8550 power amplifiers. (Audio section): (2) 6146 first amplifier, (2) 4-250A second amplifier, (4) 304TH AF driver amplifier and (2) F-8550 modulators.

TEMPERATURE RANGE: -20°C to +50°C.

ALTITUDE: To 5000 feet, higher on special order.

SIZE: Largest individual cubicle dimensions: 5' wide x 6½' high x 5' deep. Main transmitter assembly: 14' wide x 6½' high x 5' deep (except PA tank and output circuit section, which is 4' high and 7½' deep). Transmitter assembly occupies 107.5 square feet of floor space. Blower, oil filled high voltage and modulation transformers and reactors mount externally.

WEIGHT: Export packed 29,000 lbs. Cubage: 2050 cubic feet.

ORDERING INFORMATION

Model HF-100 high frequency broadcast transmitter, 100,000 watts, with tubes, less crystals....994-5966

Model HF-100TX high frequency telegraph transmitter, 100,000 watts, with tubes, less crystals 994-5966A

Crystal (transmitter accommodates 10).....CR27A/U

Crystal oven (holds 2 crystals—transmitter accommodates 5).....JK-09C

Spare 100% tube complement for HF-100.....990-0510

Additional exciter with power supply.....994-5569F

NOTE: When ordering state: (a) primary voltage, (b) primary frequency, (c) RF output impedance and (d) carrier frequencies.

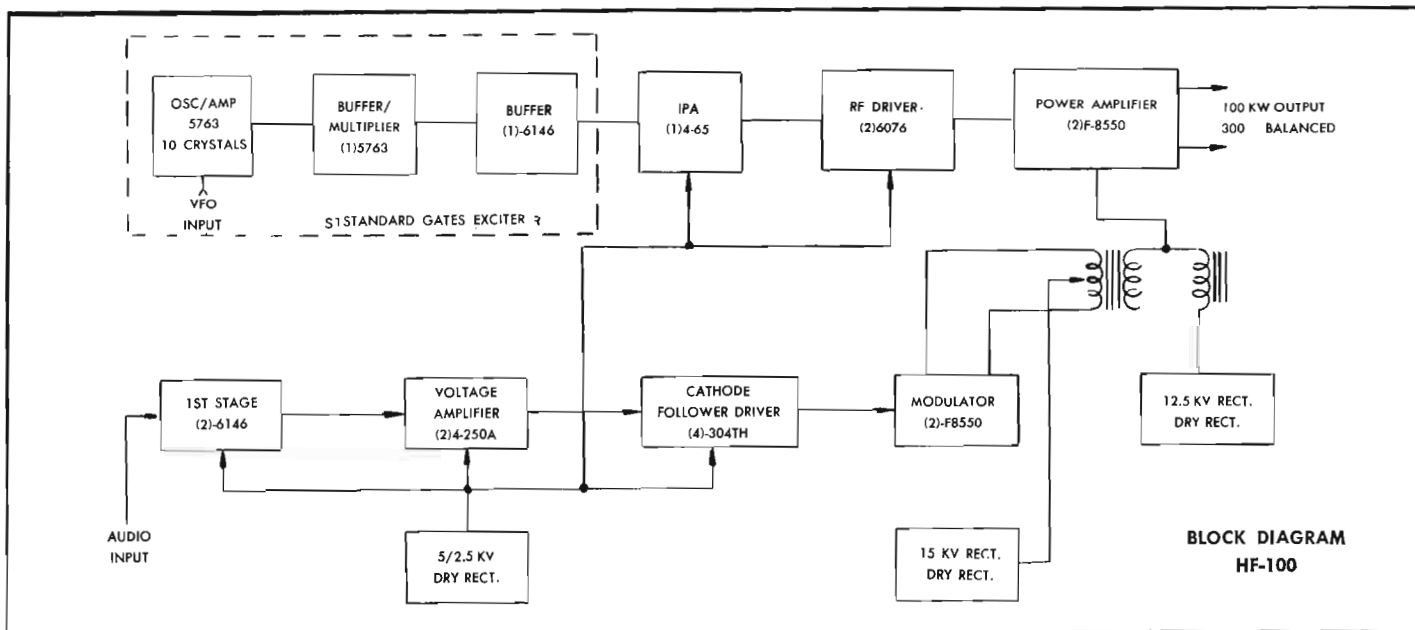

**BLOCK DIAGRAM
HF-100**

50,000 Watt HF Broadcast Transmitter

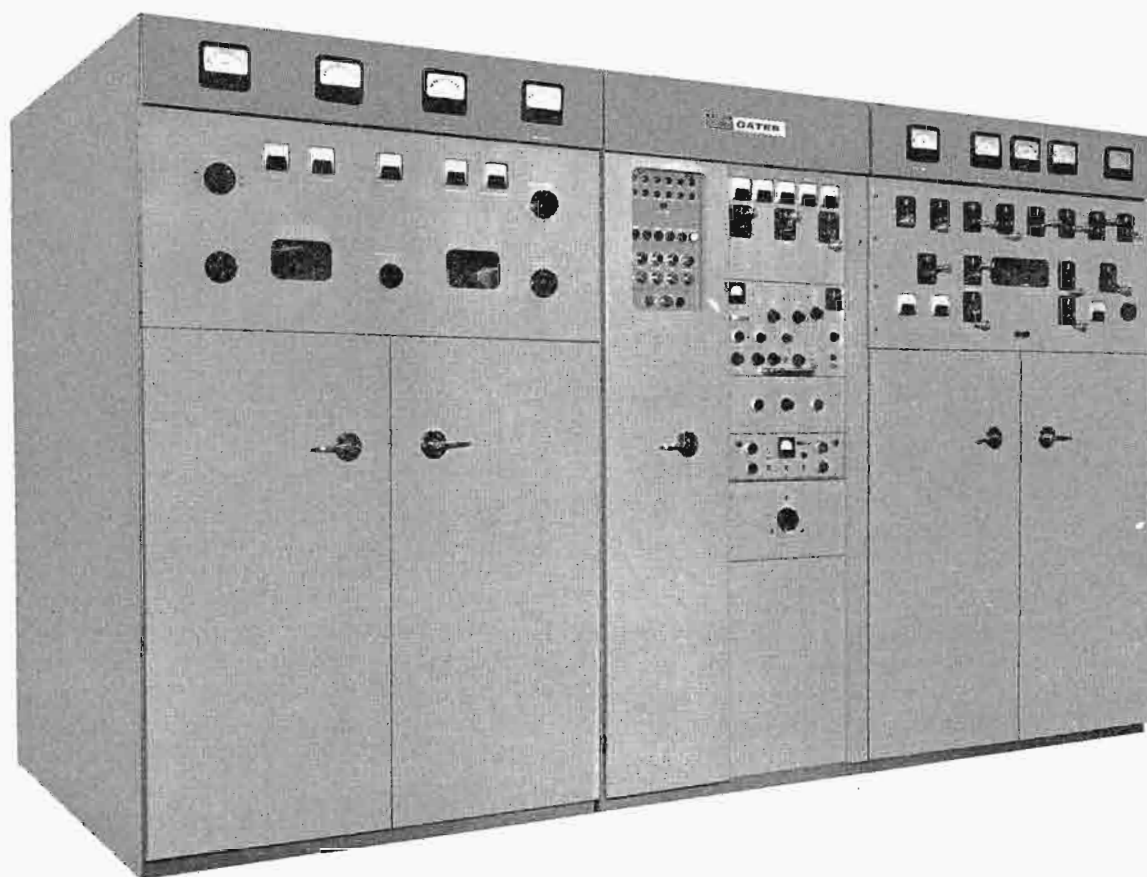

MODEL HF-50C

Probably the most widely used 50 kW high frequency transmitter in the world, dozens of Gates HF-50C's are serving world listeners from four continents, with a substantial number in Voice of America Stations.

The HF-50C transmitter has earned its worldwide acceptance with such features as: Continuous tuning between 3.9 MHz and 30 MHz; fast frequency change; solid state power supplies for reliability; oil-filled, fully cased modulation and power transformers that may be mounted outdoors, if desired; interchangeable power amplifier and modulator tubes for economical operation; carefully selected components that provide extra tolerances to assure conservative operation; and efficient air cooling for added dependability.

The precision engineered Gates M-5569D self-powered 85 watt exciter is an integral part of the HF-50C. This independent unit, featuring convenient pull-out construction, together with the RF driver and associated separate power supply, is built into the center cubicle. The exciter has provision for selection of any one of ten crystal positions and incorporates an input for an external VFO and Frequency Shift Keyer.

Two exciter units can be mounted in the transmitter, thus permitting operation on 20 channels where desired.

Design features that make the HF-50C transmitter convenient to operate with a minimum of maintenance include:

Control: Overload and undervoltage relays are provided. Every circuit, large or small, is well protected.

Protective Devices: Extensive use is made of interlocking protective circuitry to achieve a high degree of safety for personnel and components.

Metering: 22 meters are provided for complete monitoring of all circuits, with 8 primary meters located along the top of the power amplifier and modulator cubicles.

Filament regulation: Filament voltages for the entire transmitter are regulated. This is handled by a three-phase voltage regulator with electronically controlled motor driven variable transformers keeping filament voltage within 1% at all times.

Construction: All transmitter cabinets are accessible from front and rear, and are designed to permit easy walk-in servicing.

Quiet operation: Use of an efficient forced air cooling system provides quiet operation as air flow is controlled to assure maximum cooling of all important areas with a minimum of noise.

50,000 Watt HF Broadcast Transmitter—HF-50C

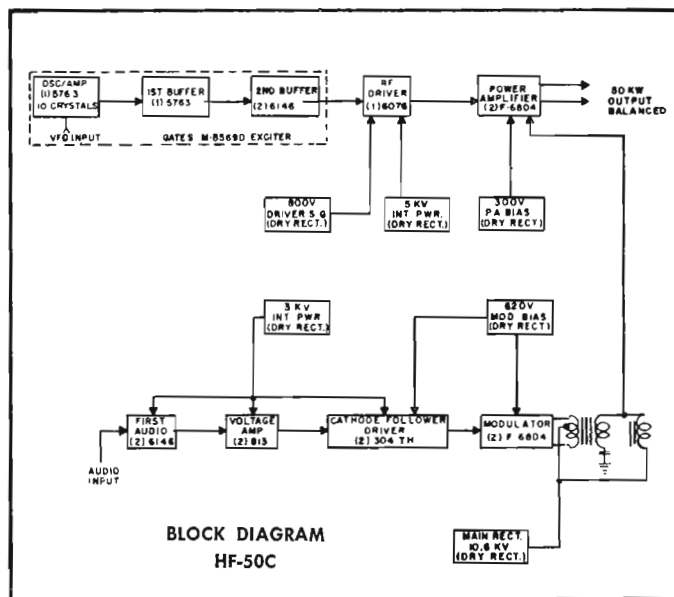
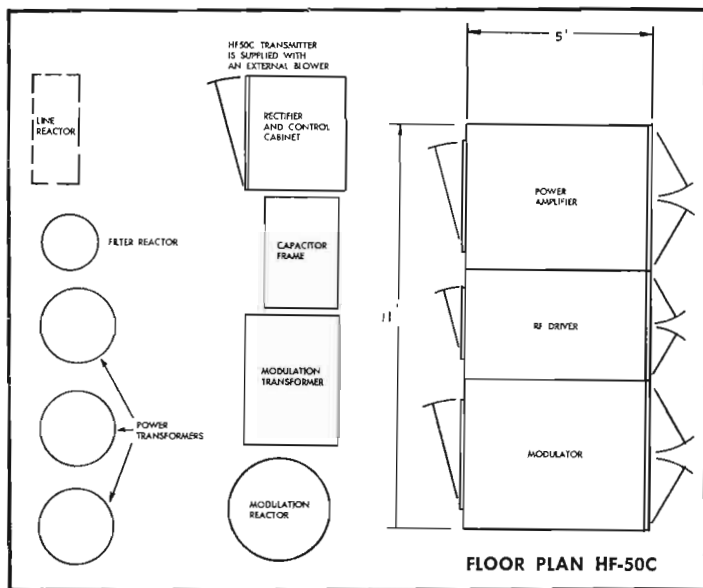

SPECIFICATIONS

CARRIER POWER OUTPUT: 50,000 watts.

FREQUENCY RANGE: 3.9 to 30 MHz or 3 to 26.5 MHz (as ordered) in one band with front panel tuning. (See Note 1.)

TYPE OF EMISSION: A1, A2, A3 and F1. (See Note 2.)

METHOD OF MODULATION: High level plate modulation.

FREQUENCY STABILITY: .0015% capable of .0001%.

CARRIER SHIFT: 5% or less at 100% modulation.

RF HARMONICS: -80 dB or better (exceeds CCIR requirements).

RF DRIVE: Provided by standard Gates M-5569D exciter built into transmitter. The exciter has 10 crystal positions and provisions for external VFO.

OUTPUT IMPEDANCE: Adjustable 300 to 800 ohms resistive balanced (500 ohms, VSWR 1.7 to 1).

POWER LINE REQUIREMENTS: Available for any one primary voltage 380 to 480 volts; 3 wire or 4 wire, 3 phase, 50 or 60 Hz. (See note 3).

POWER FACTOR: At least 90%.

POWER CONSUMPTION: 105 kW at 0% modulation; 130 kW at average modulation; 160 kW at 100% modulation.

FREQUENCY RESPONSE: ± 1.5 dB, 50 to 10,000 Hz.

AUDIO DISTORTION: 3.5% or less, 50 to 7500 Hz at 95% modulation.

RESIDUAL CARRIER NOISE: 55 dB below 100% modulation.

AUDIO INPUT LEVEL: +10 dBm, ± 2 dB.

AUDIO INPUT IMPEDANCE: 600 ohms.

TUBE COMPLEMENT: (Exciter): 5763 oscillator, 5763 buffer/multiplier, and two 6146 buffer amplifiers.
(Audio and RF sections): (1) 6076 RF driver, (2) F-6804 RF power amplifiers, (2) 6146 first audio amplifiers, (2) 813 second audio amplifiers, (2) 304TH cathode follower audio amplifiers, (2) F-6804 modulators. Power supplies are all solid state.

TEMPERATURE RANGE: -20° to +45°C.

ALTITUDE: To 5000 feet (higher on special order).

SIZE: Largest individual cubicle dimensions 4' wide x 6½' high x 5' deep. Transmitter assembly: 11' wide x 6½' high x 5' deep (except PA section which has 1½' extension of plate tank across rear top of cubicle). Transmitter assembly occupies 55 square feet of floor space. Blower, high voltage and modulation components mount externally.

WEIGHT: Domestic packed, 23,500 lbs.; export packed, 25,900 lbs. Cubage: 1700 cubic feet.

ORDERING INFORMATION

Model HF-50C high frequency broadcast transmitter. 50,000 watts with tubes, less crystals (see Notes 1 and 3)..... 994-5924

Same as above for 50 Hz operation..... 994-5924A

Crystals (see Note 4)..... CR-27A/U

Crystal oven (holds two crystals) (see Note 5)..... JK-09C

Spare 100% tube complement for HF-50C..... 990-0374

Additional exciter with power supply..... 994-5569D

NOTES: (1) When ordering, state preferred frequency range. (2) Optional frequency shift keyer required for F1 operation. (3) Please specify exact primary voltage and frequency when ordering. (4) Please state crystal frequencies when ordering. (5) Two crystals mount in one JK-09C temperature controlled oven. If ten crystals are ordered, then 5 ovens are required, etc.

20,000 Watt HF Broadcast Transmitter

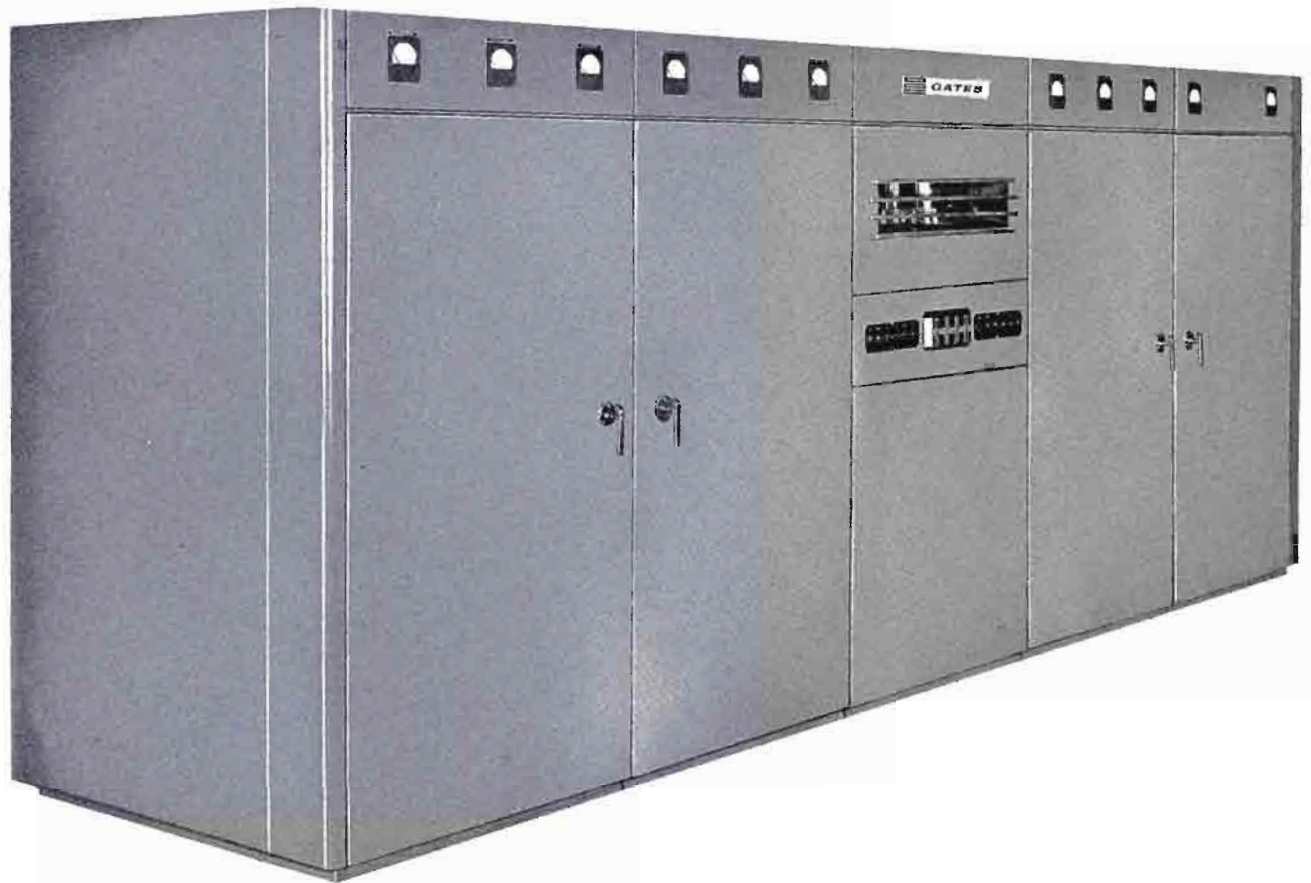

MODEL HF-20B

This remarkable transmitter, field proven in over 16 different countries, represents the ultimate in 20 kW high frequency transmitter performance. It is designed for continuous 24-hour-a-day operation in all parts of the world, including areas with tropical climates.

Air cooled and employing high level plate modulation, the HF-20B is tunable over the entire frequency spectrum between 4 and 22 MHz.

FAST TUNING: Once the frequency band is selected, transmitter tune-up can be made within one minute from front panel controls. Except for the final tank coil, all circuits are continuously variable and front panel tuned between 4 MHz and 22 MHz. Changing of the final tank coil, which sets on a sliding carriage in the PA tank frame assembly, is speedily accomplished. Five coils are supplied for full 4-22 MHz coverage. Counter type controls read to 1/10 turn to permit accurate logging of all tuned circuits and quick return to any previously employed frequency.

RADIO FREQUENCY AND AUDIO SECTIONS: A two-stage radio frequency exciter unit incorporates switching positions for four crystals and input provisions for an external VFO or frequency shift keyer. The 6146 straight amplifier or doubler stage is followed by two type 4-250A tubes which provide an abundance of RF drive to the final amplifier. Four 3X2500F3 triodes operate push-pull parallel in the power output stage. A superb audio system consisting of four stages, all push-pull, is employed in the HF-20B. Four type 3X3000F1 triodes operating push-pull are used as Class B modulators.

OUTPUT COUPLING: To accommodate a wide variety of transmission lines, a balanced matching output network is incorporated, using series variable coils and parallel variable vacuum capacitors designed to match 300 to 800 ohm resistive balanced lines (500 ohms, with VSWR 1.7 to 1). Both variable coils and capacitors have counter type tuning controls for accurate logging. (A 50 ohm unbalanced output is also available on special order).

20,000 Watt HF Broadcast Transmitter—HF-20B

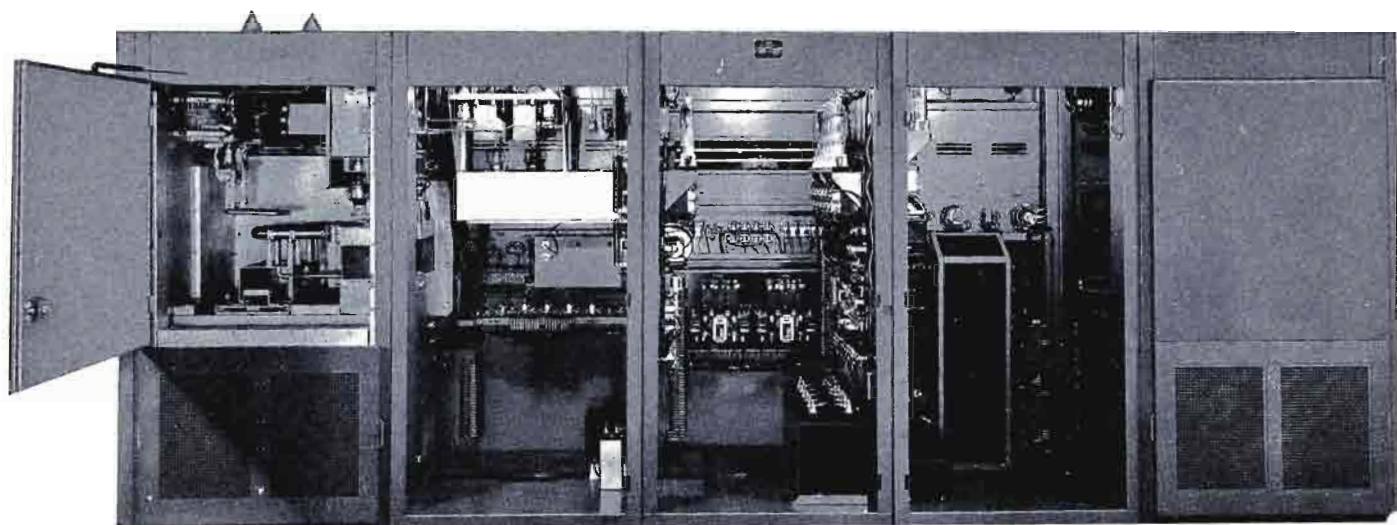

Rear view of the HF-20B.

POWER SUPPLIES: Five major power supplies deliver plate and bias voltages to the HF-20B transmitter. To assure greater reliability and better regulation, separate high voltage supplies are used for the modulator and power amplifier.

RELAYS AND PROTECTION: Magnetic AC contactors are inserted in all main primary lines. All major tubes are protected by individual supervisory overload relays. Protection devices included for door interlock and air failure.

MODEL HF-20BX: Identical to the HF-20B transmitter described herein, but has 400 word per minute keyer added. This model may be used for broadcasting, voice communications, telegraph, or with optional frequency shift keyer.

MODEL HF-20CX: The audio frequency response is for voice only in this model; otherwise it is the same as the HF-20BX, including keyer and provision for FSK. Audio response is rated 200-3,500 Hz ± 3 db.

SPECIFICATIONS

CARRIER POWER OUTPUT: 4-18 MHz, 20,000 watts. 18-22 MHz, 16,000 watts modulated (A3). Full 20 kW output 4-22 MHz telegraph.

FREQUENCY RANGE: 4-22 MHz.

RF STABILITY: .003% or better, with JK-09C oven.

OUTPUT IMPEDANCE: 300-800 ohms resistive balanced. (500 ohms, with VSWR 1.7 to 1.) (50 ohms unbalanced, optional).

POWER LINE REQUIREMENTS: 230 volts, 3 phase, 50/60 Hz. Other primary voltages or line frequencies available on special order.

POWER FACTOR: 90% or better.

POWER CONSUMPTION: 0% modulation, 37 kW. Average modulation, 43 kW. 100% modulation (sine wave), 55 kW.

POWER REDUCTION: Low power tune-up switch provided.

AUDIO RESPONSE: ± 1.5 dB, 50-10,000 Hz.

DISTORTION: 3% or less, 100-5000 Hz. 4% or less 50-7500 Hz.

NOISE: 55 dB or better below 100% modulation.

CRYSTAL POSITIONS: Four; input for external VFO or FSK provided.

KEYING: 400 wpm with essential square top wave form, on-off keying. Keyer supplied on Models HF-20BX and HF-20CX only.

TUBES: (RF section) 6AG7 oscillator, 6AG7 buffer, 6146 buffer/doubler, (2) 4-250A RF driver, (4) 3X2500F3 power amplifiers. (Audio section) (2) 6J7 first audio, (2) 807 second audio, (2) 845 audio driver, (4) 3X3000F1 modulators. (Power supplies) (12) 673 HV rectifiers, (4) 8008 LV rectifiers, (2) 866A LV rectifiers. (Keyer) (1) 812 keyer tube.

SIZE: HF-20B and HF-20BX, 205" wide, 48½" deep, 78" high. Door swing, 40" front and rear. Floor space for external transformers: 10' x 9'. Largest cabinet size uncrated: 45" wide, 50" deep, 78" high. HF-20CX, 175" wide, 48½" deep, 78" high. Door swing, 40" front and rear. Floor space for external transformers: 5' x 6'.

WEIGHT: (Packed) domestic, 11,000 lbs.; export, 13,900 lbs. Cubage: 1050 cubic feet.

ORDERING INFORMATION

HF-20B, 20 kW broadcast transmitter, 4-22 MHz, with one set of coils, tubes, less crystals.....	994-4748
HF-20BX, 20 kW broadcast transmitter, with tubes and with keyer added, 4-22 MHz, less crystals.....	994-4778A
HF-20CX, 20 kW telephone and telegraph transmitter, with tubes and keyer, 4-22 MHz, less crystals.....	994-4778B
Spare 100% tube kit for HF-20B.....	990-0139
Spare 100% tube kit for HF-20BX.....	990-0140
Crystal and holder, .02% accuracy (specify operating frequency).....	CR27A/U
Temperature controlled crystal oven holds two CR27A/U crystals for 0.003% accuracy.....	JK-09C

10,000 Watt High Frequency Broadcast Transmitter



MODEL HF-10B

POWER OUTPUT: 10,000 watts.

FREQUENCY RANGE: 2-22 MHz. (4-30 MHz on special order).

TYPE OF EMISSION: (Model HF-10B) A3. (Models HF-10BX, HF-10CX) A1, A2, A3 and F1 with external frequency shift keyer.

FREQUENCY STABILITY: .003%, with oven.

CARRIER SHIFT: 5% or less at 100% modulation.

RF HARMONICS: Suppression of harmonics meets or exceeds CCIR requirements.

OUTPUT IMPEDANCE: 300 to 800 ohms resistive balanced. (500 ohms with VSWR 1.7 to 1). (50 ohms unbalanced on special order).

POWER LINE REQUIREMENTS: 230 volts, 3 phase, 50 or 60 Hz (as ordered). (Other voltages or line frequencies available on special order.)

POWER FACTOR: 90% or better.

POWER CONSUMPTION: 0% modulation, 21 kW. Average modulation, 23 kW. 100% modulation, 30 kW.

FREQUENCY RESPONSE: (Model HF-10B) ± 1.5 dB, 30-10,000 Hz. (Model HF-10CX) ± 3 dB, 150-4000 Hz.

DISTORTION: (Model HF-10B) 3% or less 50 to 7500 Hz. (Model HF-10CX) 10% or less 150-4000 Hz.

AUDIO INPUT: $+15$ dBm ± 2 dB.

NOISE: (Model HF-10B) 60 dB or better below 100% modulation. (Model HF-10CX) 45 dB or better below 100% modulation.

CRYSTAL POSITIONS: 4, front panel selected.

TUBES: (2) 6AG7, (2) 4-250A, (2) 6J7, (4) 845, (4) 3X2500F3, (4) 8008, (6) 673, (3) 807, (Keyer is type 812A).

SIZE: 125" wide, 78" high, 48½" deep. Front door swing, 19"; back door swing 40". Size of largest cubicle uncrated: 45" wide, 50" deep, 78" high. (Space required to accommodate optional external oil-filled magnetic components 8' x 3').

WEIGHT AND CUBAGE:

MODEL DRY COMPONENTS

HF-10B 6600 lbs. domestic packed
6815 lbs. export packed
533 cu. ft.

HF-10CX 6150 lbs. domestic packed
6360 lbs. export packed
523 cu. ft.

OIL-FILLED COMPONENTS

(Optional)

8000 lbs. domestic packed
10,174 lbs. export packed
566 cu. ft.

6950 lbs. domestic packed
9125 lbs. export packed
533 cu. ft.

ALTITUDE: 6000 feet. (Higher on special order.)

ORDERING INFORMATION

HF-10B, 10 kW broadcast transmitter, with tubes, less crystals...994-3787

HF-10BX, 10 kW broadcast transmitter, with tubes, electronic keyer, less crystals...994-3789

HF-10CX, 10 kW communications telephone and telegraph transmitter, with tubes, less crystals...994-3793

HF-10TX, 10 kW communications telegraph transmitter, with tubes, less crystals...994-3795

Spare 100% tube kit for all models...990-0253

Crystal and holder (.02% accuracy) (specify operating frequency)...CR27A/U

Temperature controlled oven, holds two CR27A/U crystals, (.003% accuracy)...JK-09C

NOTES: (1) State line frequency as 50 or 60 Hz. (2) Above models are for 2-22 MHz and with self-contained dry type power components. (3) All models available for 4-30 MHz at slight extra cost. (4) All models available with external oil-filled plate transformer, modulation transformer, and modulation reactor at extra cost. (5) Be sure and state carrier frequency/s, primary voltage and frequency when ordering.

1000 Watt High Frequency Broadcast Transmitter

MODEL HF-1M

This 1000 watt high level modulated, high frequency transmitter may be used for (a) high quality short wave broadcasting, (b) as a voice communication transmitter, or (c) as a 1300 watt telegraph transmitter. Frequency range is from 3 MHz to 32 MHz, continuously tunable from the front panel. Operation between 2 MHz and 3 MHz is quickly attainable by inserting a padder capacitor provided. The RF exciter section accommodates as many as 10 crystals, rotary switch selected.

BROADCAST OPERATION: The HF-1M transmitter is an ideal short wave broadcast transmitter, with wide audio response, low distortion and noise. The heavy design allows 24-hour schedules under wide extremes in temperature and humidity.

COMMUNICATIONS OPERATION: The HF-1M may be used for point to point communication service with 1000 watt modulated output or up to 1300 watts output when operated as a CW transmitter. When operating in voice (A3) service, it is suggested that the Gates M-6543 limiter/amplifier be employed. This operation permits a very high level of voice modulation and intelligibility. In CW service, keying speeds of 60 words per minute are obtainable, and a frequency shift keyer may be added for radio teletype service.

GENERAL DESIGN: (RF section): A 3-stage, 85 watt exciter drives a single ended 4-1000A Class C power amplifier. Output to the 45-75 ohm transmission line is via a Pi-L network. Any frequency between 3 MHz and 32 MHz may be set from the front panel and logged for quick return. (Audio section): High level Class B modulators utilizing the long life 833A modulator tubes develop generous audio power to modulate the Class C power amplifier. There are 3 push-pull audio stages with inverse feedback adding to the already excellent performance.

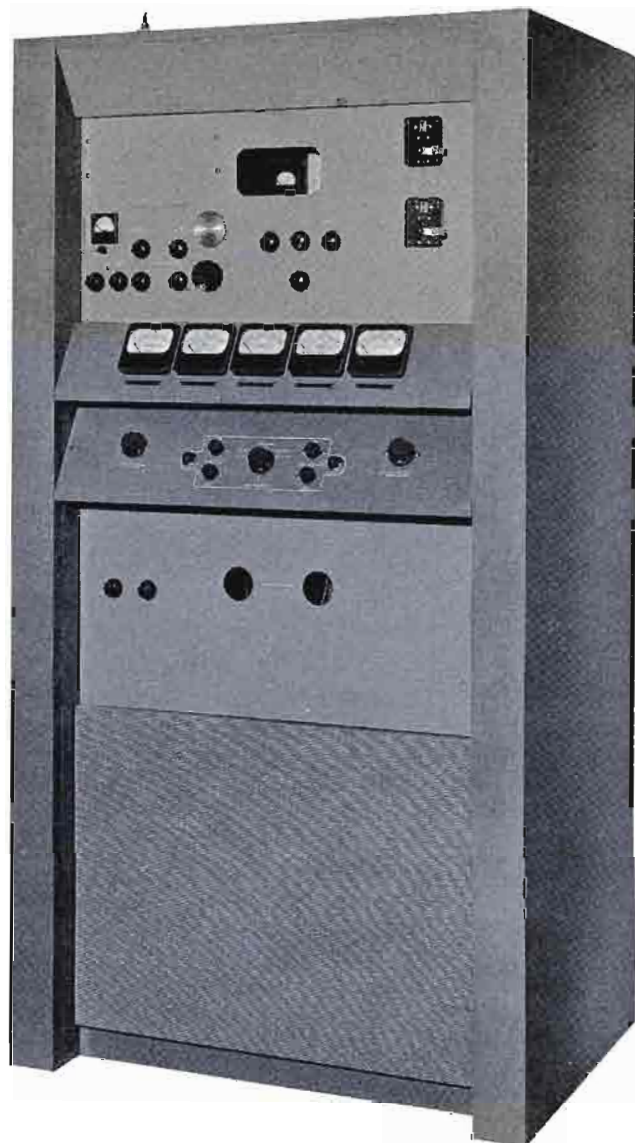

SPECIFICATIONS

POWER OUTPUT: 1000 watts (100% modulated) 2 to 26 MHz. 800 watts (100% modulated) 26 to 32 MHz.

FREQUENCY RANGE: 2 to 32 MHz. Continuously variable from 3 to 32 MHz.

TYPE OF EMISSION: A1, A2, A3 and F1 with external FSK.

FREQUENCY STABILITY: .003%.

RF HARMONICS: Meets or exceeds CCIR standards.

CRYSTAL POSITIONS: 10, with each JK-09C temperature controlled oven holding two CR27A/U crystals and holders.

RF OUTPUT: Single ended into Pi-L network to match 45 to 75 ohm lines unbalanced. Other RF output impedances accommodated by special coupler available to buyer's specific needs.

CARRIER SHIFT: 3% or better at 100% modulation when installed with adequate primary mains.

AUDIO PERFORMANCE: (Response) $\pm 2\frac{1}{2}$ dB, 30-10,000 Hz. (Distortion) $3\frac{1}{2}$ % or less 50-7500 Hz, 95% modulation. (Input) 150/600 ohms at +10 dB for 100% modulation.

NOISE: 55 dB or better below 100% modulation.

TUBES: (4 each) 1622, 5R4GY, (2 each) 6146, 6Y6G, 6SN7, 833A, 8008, 5763, and (1 each) 4-1000A, OB2, 6AQ5.

AC INPUT: 230 volts, 50/60 Hz, 1 phase, 3 wire. Power consumption at 0% modulation, 3.2 kW; at average modulation, 3.7 kW; at 100% modulation, 4.5 kW.

SIZE AND WEIGHT: 78" high, 42" wide, 30" deep. Weight packed (domestic) 1300 lbs., (export) 1450 lbs. Cubage: 152 cu. ft.

ORDERING INFORMATION

HF-1M 1000 watt HF transmitter with tubes, less crystals.....994-4964
100% tube complement for HF-1M.....990-0249
Crystal and holder to mount in JK-097 oven.....CR27A/U
Temperature controlled oven for 1 or 2 type CR27A/U crystals.....JK-09C
Limiter/amplifier.....994-6543

NOTE: Be sure to state carrier frequencies when ordering.

High Frequency Modulation Monitor

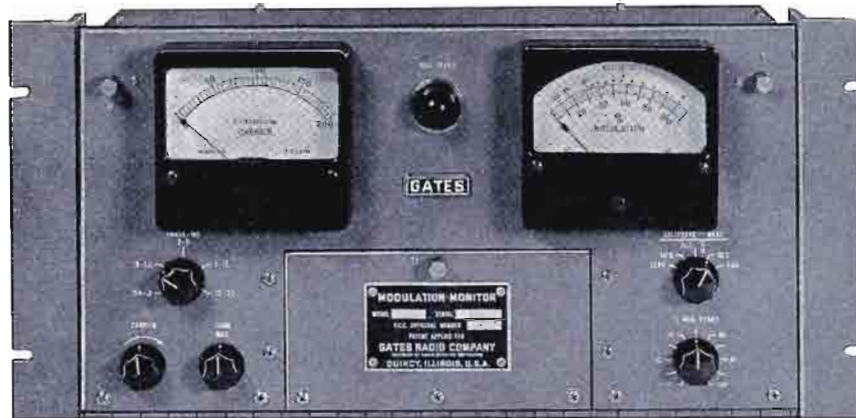

MODEL M-5774

Developed especially for use in the 2 MHz to 30 MHz short wave broadcast band, the Gates M-5774 modulation monitor gives the most reliable indication of modulation performance of any known meter device. The response time is extremely fast, with the meter within 90% of correct reading with only a 5 millisecond modulation pulse. This high accuracy is possible because of an advanced design derivative controller circuit. A self-calibrating feature eliminates dependence on other equipment such as an oscilloscope or tone modulator to check and correct accuracy. Recalibration, if needed, can be made in seconds.

DESIGN: The design objective was to provide short wave broadcasters with an instrument that would directly read mod-

ulation percentage faster and more accurately than any other known direct reading instrument. It is faster by 35 milliseconds than monitors used in standard broadcasting service. The maximum use of the carrier without overmodulation results in maximum total signal strength. In lower power stations, this value is indispensable. In higher power stations, the correct use of this monitor could have the same effect as several thousand additional watts of power.

PATENTED: The exclusive derivative controller circuit is used only by Gates under U. S. Patent 2,984,796. To add to performance, the detector is DC coupled to the measuring circuits to avoid errors when transmitted wave forms are not symmetrical.

SPECIFICATIONS

FREQUENCY RANGE: .54 MHz to 30 MHz.

MODULATION RANGE: (Meter) 0-100% on negative peaks; 0-110% on positive peaks. (Flasher) 50% to 100% on negative peaks in steps of 5%.

RESPONSE: (Meter) 0.2 dB, 50-15,000 Hz. (Flasher) 0.6 dB, 20-7500 Hz.

ACCURACY: (Meter) $\pm 2\%$ full scale at 1000 Hz any modulation percentage. (Flasher) $\pm 2\%$ at 1000 Hz.

RF INPUT: Approximately 70 ohms at 14 volts.

RESPONSE TIME: (Meter) Responds to within 90% of correct reading with a single 15 millisecond pulse of modulation. Needle returns to 10% of reading in 1100 to 1400 milliseconds after signal is removed. (Flasher) Responds to a 15 millisecond pulse of modulation and remains on for about $\frac{1}{5}$ second.

CIRCUITS: (Meter) (1) Direct coupled amplifier responds correctly to any modulation waveform. (2) High speed meter circuit. (3) Self-calibration without external equipment. (Flasher) (1) Direct coupled flasher shows accurately negative peaks of modulation regardless of waveform. (2) Flasher uses a DC plate supply permitting all overmodulation peaks to be indicated. (3) Self-calibration.

DIRECT LINEARITY: Negative peak clipping in the detector is negligible up to 7500 Hz. Does not exceed 5% at 15,000 Hz at 100% modulation.

OUTPUT TERMINATIONS: For (a) extension modulation meter, (b) extension flasher, (c) distortion analyzer and (d) a 600 ohm output at -20 dBm for proof of performance measurements. Performance at 600 ohm terminations is: (Response) ± 0.2 dB 50-15,000 Hz. (Distortion) 0.25%, 20-15,000 Hz. (Noise) 65 dB or better below output level.

POWER: 105-125 volts or 115-135 volts, 50/60 Hz, 100 watts.

MECHANICAL: Size: 19" x 8 $\frac{3}{4}$ " x 11 $\frac{1}{2}$ " deep. Weight packed: (domestic) 41 lbs., (export) 64 lbs. Cubage: 4 cubic feet. Finish: Beige-gray.

ORDERING INFORMATION

Modulation monitor, .54 MHz to 30 MHz, with tubes.....	994-5774
Spare 100% tube kit.....	990-0346
Extension modulation percentage meter.....	994-5836

NOTE: This monitor is also available as Model 994-5774A, which carries FCC approval 3-108. It varies only in the slower attack time which is 50 milliseconds. This model will be supplied without extra cost or delay, when specified.



SG-75A/B Communications Exciter



Gates SG-75 frequency synthesized independent sideband exciter features total solid state design plus extensive use of integrated circuits. It provides a power output of 100 milliwatts over the 2 to 30 MHz range, and has six separate operating modes. Direct digital frequency adjustments on the front panel permit selection of 280,000 frequencies in 100 Hz increments.

A self-contained wideband frequency shift keyer provides a full carrier shifted in frequency ± 400 to 425 Hz about the center frequency. This eliminates the need for an external keyer or tone oscillator and provides the advantages of direct reading of center frequency.

Automatic gain control is used to control the inputs to balanced modulator stages. Controlled carrier level is provided in the lower, upper and independent sideband modes. This carrier level control is automatically turned off in the FSK mode. Carrier level control is on the front panel along with all normal operating controls. The FSK inputs allow polar, neutral and dry contact keying.

The "B" version of the SG-75 provides selectable carrier insertion compatible with CCIR recommendations.

SPECIFICATIONS

FREQUENCY RANGE: 2 to 29.9999 MHz in 100 Hz steps (280,000 channels).

OPERATING MODES: CW (A0, A1), FSK (F1); AME (A3h); USB, LSB (A3a, i); ISB (A3b).

RATED POWER OUTPUT: 100 mW PEP/CW.

FREQUENCY CONTROL: Digital control of stabilized VFO, synthesized.

OUTPUT IMPEDANCE: 50 ohms nominal.

GAIN CONTROL: Automatic with manual override.

TUNING TIME: 10 seconds.

METHOD OF TUNING: Automatic.

SIGNAL TO NOISE RATIO: In band 50 dB. Out of band 60 dB, exclusive of harmonics.

SIGNAL TO DISTORTION RATIO: 50 dB at rated output. (Distortion products: At rated output, 3rd and higher order products are at least 50 dB below either tone of a standard two-tone test signal).

CARRIER LEVEL: Selectable: SG-75A, 0, -6, -20, -55 dB. SG-75B, 0, -6, -16, -26, -55 dB.

STABILITY: 1×10^{-7} per day (optional 5×10^{-9} per day).

UNWANTED SIDEBAND REJECTION: 60 dB at 500 Hz.

AUDIO INPUT: Two independent 600 ohm channels balanced or unbalanced, -20 to +10 dBm for full RF output with independent AGC amplifiers.

AUDIO FREQUENCY RESPONSE: 250 to 3000 Hz or 250 to 6000 Hz with 3 dB maximum ripple.

FSK CAPABILITY: Wideband FSK built in, adjustable from ± 400 to ± 425 Hz (other shifts optional).

POWER INPUT: 115/230 volts, $\pm 10\%$, 47 to 400 Hz, 50 watts maximum, 2 wire, single phase. All power supplies regulated.

TEMPERATURE: 0° to +50°C.

HUMIDITY: 0 to 95%.

ALTITUDE: Sea level to 10,000 feet.

OUTPUT CONNECTOR: Type BNC.

SIZE: 8 $\frac{3}{4}$ " high, 19" wide, 17" deep.

WEIGHT: 56 lbs. net; domestic pack 75 lbs.; export pack 110 lbs.; Cubage: 6 cubic feet.

OPTIONAL REMOTE CONTROL: Electronic with adapter.

COMPONENTS: All components meet MIL specifications where practicable.

NOTE: The SG-75 exciter operates with Gates 1, 3, or 10 kW linear power amplifiers.

ORDERING INFORMATION

SG-75A synthesized HF ISB exciter.....994-6562-003
SG-75B synthesized HF ISB exciter (CCIR compatible).....994-6562-004

10 kW Automatically Tuned ISB HF Power Amplifier

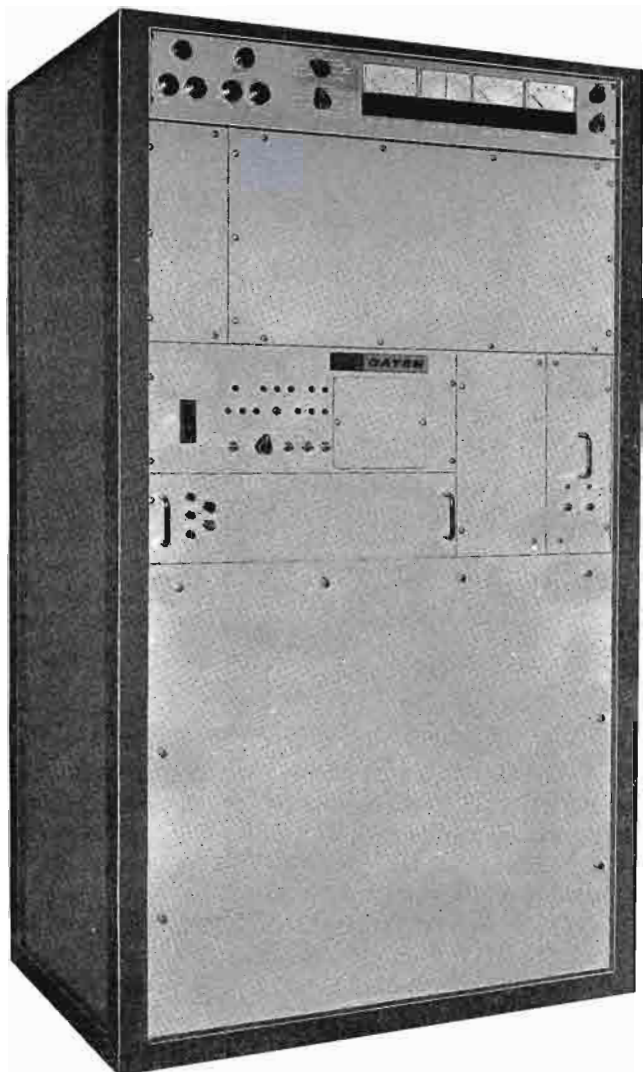

MODEL ATL-10

Designed for operation in high performance SSB transmitting systems, the Gates ATL-10 linear amplifier requires only 0.1 watt RF drive power to tune automatically from 2-30 MHz in 20 seconds or less. Power output is 10 kW peak envelope or average into an antenna load in any mode requiring linear amplification in a 16 kHz bandwidth. A reliable, simplified tune sequence control governs the automatic tuning circuits with a minimum of control information from the exciter. No band information is required. Prepositioning of the tuning elements is achieved directly from information taken from the input RF frequency, thus making the power amplifier suitable for use with any exciter capable of delivering 100 mW of drive power.

A unique feature of the ATL-10 is the use of DC torque motors to position the tuning elements. These are direct-drive motors

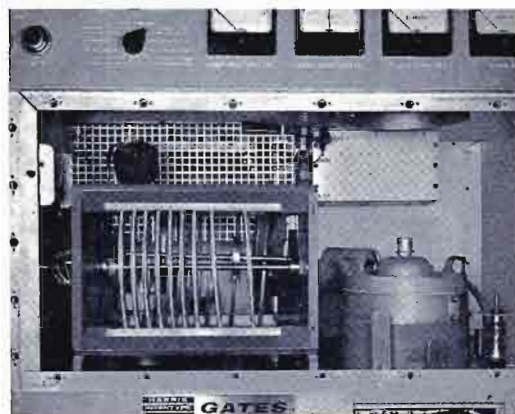

A single 8171/4CX10,000D ceramic tetrode, operating Class AB₁ in a grounded screen configuration, produces the full 10 kW PEP or CW output with maximum stability.

that eliminate much of the mechanical complexity heretofore inherent in automatically tuned equipment. As DC motors are insensitive to power line frequency, the Gates ATL-10 amplifier may be operated from various sources without the need for an optional frequency inverter.

The ATL-10 amplifier, when combined with the Gates SG-75A Exciter, offers full remote control capability. This optional remote control equipment is available to operate both units in a variety of configurations. Combining the SG-75A and ATL-10 produces the advanced STAR-10 sideband transmitter.

RF INPUT: A single type 8233 tube operating Class A in the broad-band input amplifier assures high gain with stability, while maintaining low distortion characteristics. A single type 8321/4CX350A second Class A amplifier also operates completely broad-band. The interstage networks up to and including the input to the driver amplifier are broad-banded and do not require servo tuning.

DRIVER AMPLIFIER: A pair of 8321/4CX350A tubes are operated Class AB₁ to develop satisfactory reserve drive power for the final amplifier grid. Efficiency of this stage is maximized by the use of a parallel tuned matching network to couple into the final amplifier. Approximately 8 dB of RF feedback is applied to the cathode of the driver from the plate circuit of the final amplifier to improve the linearity of these stages.

POWER AMPLIFIER: The final amplifier employs an 8171/4CX10,000D ceramic tetrode operating Class AB₁ in a grounded screen configuration for maximum stability. The grid drive network and plate tank circuits are automatically tuned to resonance by DC control amplifiers and torque motors. The output tuning and loading network is a pi-L filter designed for optimum harmonic rejection and load matching ability. This circuit is capable of matching into a 3:1 VSWR at a full rated power, with optimum loading obtained by the third DC motor and servo system.

10 kW Automatically Tuned ISB HF Power Amplifier—ATL-10

SPECIFICATIONS

- FREQUENCY RANGE:** 2 to 30 MHz.
- OPERATING MODES:** Dependent on type of exciter.
- RATED POWER OUTPUT:** 10 kW PEP or average.
- OUTPUT IMPEDANCE:** 50 ohms with VSWR up to 3:1.
- GAIN CONTROL:** Capable of automatic with proper exciter interface.
- GAIN VARIATION:** 4 dB maximum, 2-30 MHz.
- TUNING TIME:** 20 seconds maximum.
- METHOD OF TUNING:** Automatic, remote.
- HARMONIC OUTPUT:** 2nd, -56 dB below full output, all others 60 dB.
- SIGNAL TO NOISE RATIO:** 50 dB.
- SIGNAL TO DISTORTION RATIO:** Capable of 40 dB, 2 to 27.5 MHz; 38 dB, 27.5 to 30 MHz. (Distortion products: At rated output, third and higher order distortion products are at least 40 dB below either tone of a standard two-tone test signal 2 to 27.5 MHz, and at least 38 dB 27.5 to 30 MHz.)
- BANDWIDTH:** 25 kHz; 1.5 dB ripple 2 to 4 MHz, 1.0 dB ripple 4 to 30 MHz.
- INPUT IMPEDANCE:** 50 ohms, 1.5:1 VSWR (maximum).
- INPUT CONNECTOR:** Type BNC.
- RF INPUT POWER:** 100 mW maximum for both tune and operate.
- POWER INPUT:** 200, 210, 220, 230, 240 and 250 volts, $\pm 10\%$, 3 phase, 47-63 Hz, 24 kVA at 0.95 power factor, at 10 kW CW.
- TEMPERATURE:** 0° to 50°C.
- HUMIDITY:** 0 to 95%.
- ALTITUDE:** Sea level to 10,000 feet.
- OUTPUT CONNECTOR:** 1½" EIA flange.
- REMOTE CONTROL:** Optional.
- COMPONENTS:** All components meet MIL specifications where practicable.
- SIZE:** 69" high, 40" wide, 27" deep.
- WEIGHT:** 1300 lbs. net. Domestic pack, 1545 lbs. Export pack, 1700 lbs. Cu-
bage: 88.7 cubic feet.

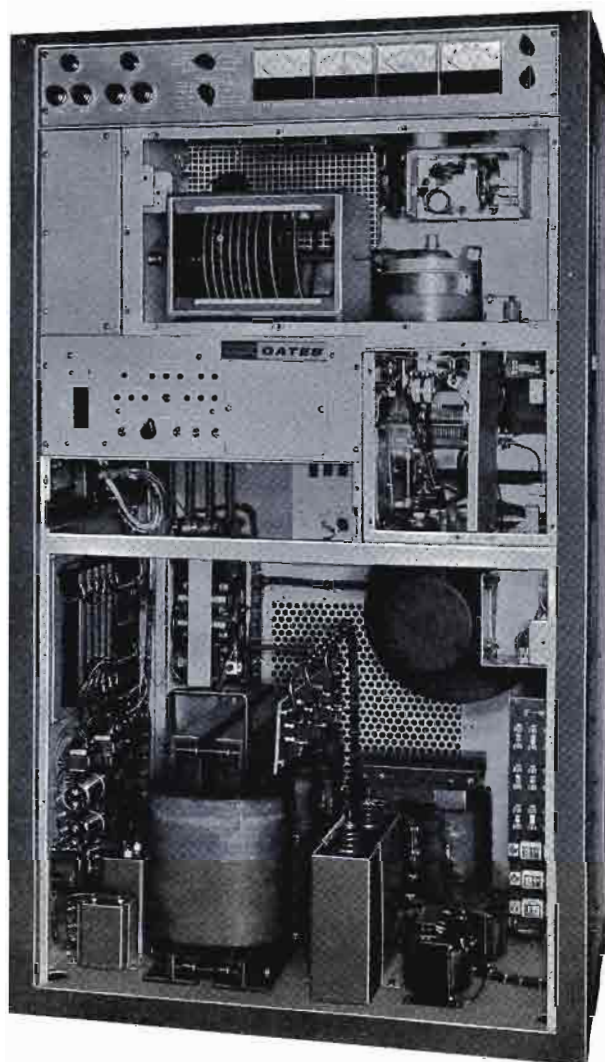

ORDERING INFORMATION

- ATL-10 10,000 watt automatically tuned ISB HF power amplifier, complete with cabinet.....994-6506
- 100% spare tube kit.....990-0574

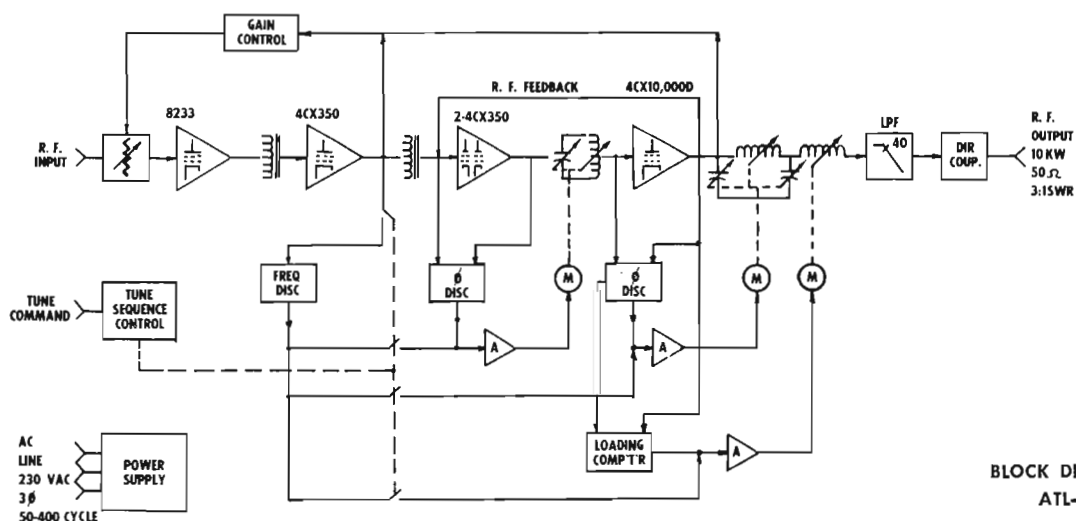

BLOCK DIAGRAM
ATL-10

10 kW Automatically Tuned ISB HF Transmitter

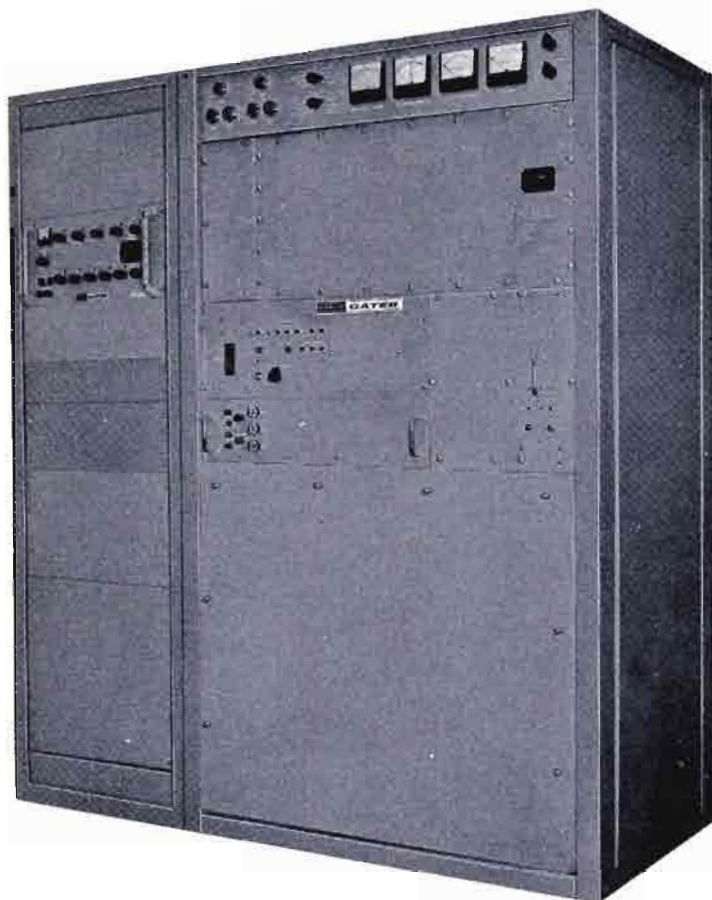

MODEL STAR-10

Totally modern in design, the STAR-10 is a complete 10 kW transmitter for HF communication service. It incorporates a synthesized exciter that generates a total of 280,000 discrete frequencies, spaced every 100 Hz in the 2-30 MHz band; and a linear power amplifier (ATL-10) which provides a full 10 kW on single tone, as well as 10 kW PEP.

An optional remote control system provides selection of ten preset channels. A second optional system provides remote selection of the full 280,000 discrete frequencies available from the exciter.

The STAR-10 can be retuned, and mode or power level changed in less than 25 seconds, from the time the remote control is actuated to the time the final loads.

All components are solid state except LPA tubes. Integrated circuits are used to control digital tuning of the synthesizer. Signal circuits of the exciter, plus the servo control circuit of the LPA, are discrete components.

LOW DISTORTION: Third order distortion products are at least 40 dB below either tone of a two-tone test at rated power output up to 27.5 MHz.

TUNING: Automatic frequency change is accomplished through a sequential control which is activated by a specific "Tune" command and a new reference frequency. The three DC servo motors are operated in closed loop proportional control servo systems to accomplish the actual adjustment. Tuning time is normally 20 seconds or less.

SENSORS AND DETECTORS: The change in frequency is sensed by a frequency discriminator which is coupled to the output of the second broad-band amplifier. This develops an analog signal from which coarse positioning of the tuning and loading components is accomplished. The output of both the driver and the final are sampled by phase detectors and compared with their input signals for a precise determination of resonance. This provides fine tuning adjustments for the plate tank circuit of the driver and final. Final amplifier loading is controlled by sensing the voltage gain of the output stage.

DC SERVO SYSTEMS: The input to the servo system is an operational amplifier with a feedback loop to shape the system response to an error signal. This method of response shaping reduces the system cost and complexity by replacing the tachometer generator with minor electrical components. The servo power amplifier is a direct coupled solid state DC proportional amplifier with a transistor bridge output which provides high efficiency and dynamic braking.

Use of direct-drive DC torque motors provide system stability due to the high torque to inertia ratio (Ta/Ja). Because the motors are directly coupled to the shafts there is no dead zone caused by gear backlash. Since there are no gears involved, and the motors turn at a relatively slow speed, no slip clutch is required.

RF INPUT: A unique light sensitive resistor and DC amplifier circuit in the input stage provides superior gain control while minimizing effects of distortion normally associated with less well isolated control circuits. A single type 8321/4CX350A, a second Class A amplifier, also operates completely broad-band. The interstage networks up to and including the input to the driver amplifier are broad-banded and therefore do not require servo tuning.

DRIVER AND FINAL AMPLIFIER: A pair of 8321/4CX350A's, followed by an 8171/4CX10,000D are operated Class AB₁ in a grounded screen configuration for maximum stability. The grid drive network and plate tank circuits are automatically tuned to resonance by DC control amplifiers and torque motors. The output tuning and loading network is a pi-L filter designed for optimum harmonic rejection and load matching ability. This circuit is capable of matching into a 3:1 VSWR at a full rated power, with optimum loading obtained by the third DC motor and servo system.

RF PROTECTIVE DEVICES: All stages of the amplifier are protected against overloading and/or overdriving. The driver input is protected by grid leak biasing. An anode dissipation limiter is utilized to protect the PA from excessive dissipation.

10 kW Automatically Tuned ISB HF Transmitter—Star-10



The SG-75A solid state synthesized exciter features front panel selection of 280,000 frequencies in the 2 to 30 MHz range. It operates in the ISB, LSB, USB, AME, CW and FSK modes.

The PA tube and plate supply are protected from current overload by a fast acting relay. A reflected power detector is used to unkey the amplifier and trigger an "excessive SWR" alarm. This protects the final stage against the effects of an SWR which exceeds 3:1.

ENCLOSURE: The entire ATL-10 linear amplifier is contained in a single enclosure measuring 40" wide, 69" high and 27" deep. The power supply is designed for immediate access from the front to all components. The servo control drawer is removable from the front panel and can be serviced while the amplifier is operating. The driver amplifier is also removable as a module for bench servicing. The final grid compartment as well as the final amplifier compartment are enclosed in air tight, RF tight enclosures, in which the cover panels may be removed for direct access.

COOLING: The air for cooling the ATL-10 amplifier is normally brought in through a filtered intake at the front or back of the cabinet. A blower forces the air up through the driver plenum, and into the power amplifier compartment. The majority of the air flows directly through the 8171/4CX-10,000D. The remainder of the air is used to circulate through the PA compartment. All air is exhausted horizontally at the top rear of the cabinet. The ATL-10A has a front air intake, and the ATL-10B has a rear air intake—otherwise the two amplifiers are identical.

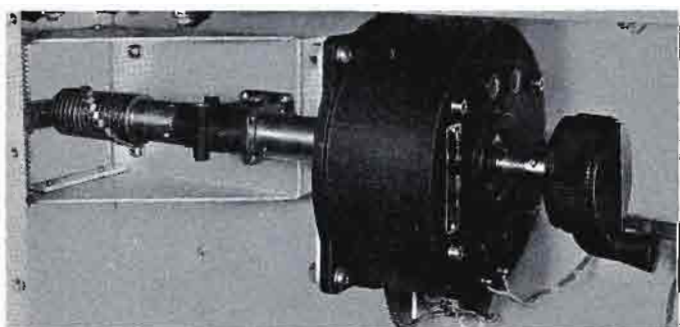

High torque DC servo motors direct coupled to PA circuits assure tuning accuracy. Reliability is enhanced through Gates design using fewer components.

SPECIFICATIONS

FREQUENCY RANGE: 29.9999 MHz in 100 Hz steps (280,000 frequencies).

OPERATING MODES AND RATED POWER OUTPUT:

CW (A ₀ , A1)	10 kW (av.)
FSK (F1)	10 kW (av.)
AME (A3h)	10 kW PEP
USB, LSB (A3a, j)	10 kW PEP
ISB (A3b)	10 kW PEP

FREQUENCY CONTROL: Digital control of stabilized VFO, synthesized.

OUTPUT IMPEDANCE: 50 ohms with VSWR up to 3:1.

GAIN CONTROL: Automatic with manual override.

LOAD CONTROL: Peak power control.

TUNING TIME: 25 seconds maximum.

METHOD OF TUNING: Automatic, remote.

HARMONIC OUTPUT: 2nd, 56 dB below full output. All others, 60 dB.

SIGNAL TO NOISE RATIO: 50 dB.

SIGNAL TO DISTORTION RATIO: 40 dB. (Distortion products: At rated output at least 40 dB below either tone of a standard two-tone test signal up to 27.5 MHz and 38 dB 27.5 to 30 MHz).

CARRIER LEVEL: Selectable: 0, -6, -20, -55 dB, or 0, -6, -16, -26, -55 dB.

CARRIER COMPRESSION: 1 dB maximum.

STABILITY: 1×10^{-7} per day (optional 5×10^{-9} per day).

UNWANTED SIDEBAND REJECTION: 60 dB at 500 Hz.

AUDIO INPUT: Two independent 600 ohm channels balanced or unbalanced, with independent AGC, -20 to +10 dBm for full RF output.

AUDIO FREQUENCY RESPONSE: 250 to 3000 Hz or 250 to 6000 Hz, with 3 dB maximum ripple.

FSK CAPABILITY: Wideband FSK built in, adjustable from ± 400 to ± 425 Hz (other shifts optional).

POWER INPUT: 200, 210, 220, 230, 240, 250 volts, $\pm 10\%$, 3 phase, 47-63 Hz, 24 kVA at 0.95 power factor at 10 kW CW.

TEMPERATURE: 0° to +50°C.

HUMIDITY: 0 to 95%.

ALTITUDE: Sea level to 10,000 feet.

OUTPUT CONNECTOR: 1½" EIA flange.

OPTIONAL REMOTE CONTROL: Frequency, operating mode, carrier level, power output, plate on/off and keying.

COMPONENTS: All components meet MIL specifications where practicable.

SIZE: Amplifier, 69" high, 40" wide, 27" deep. Exciter, 8¾" high, 19" wide, 17" deep. (Exciter rack optional.)

WEIGHT: Amplifier; net 1300 lbs., domestic pack 1545 lbs., export pack 1700 lbs. Cubage: 88.7 cubic feet. Exciter: net 56 lbs., domestic pack 75 lbs., export pack 110 lbs. Cubage: 6 cubic feet.

ORDERING INFORMATION

STAR-10 ISB HF Transmitter, with tubes and silicon rectifiers	994-6566
100% tube kit	990-0574
Model CA-10 remote adapter for STAR-10. Permits selection of any one of ten preset frequencies by remote control	994-6567A
Model CA-280K remote adapter for STAR-10. Permits selection of 280,000 frequencies by remote control	994-6567B

High Frequency Remote Control Systems

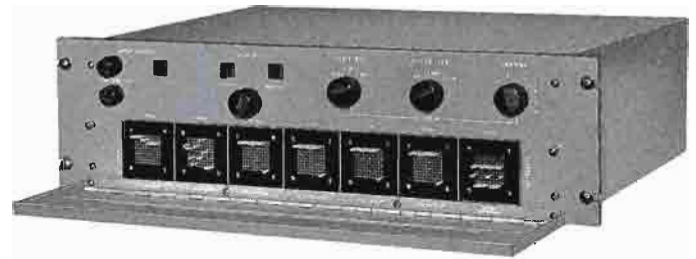

Remote control adapter panels.

Remote control systems for the Gates STAR-10 transmitter consist of two units, the remote control adapter panel located adjacent to the exciter and the remote selector panel which is located at the remote operator's position. This optional equipment provides selection of preset channels by remote control, or it may be implemented to provide remote selection of the full 280,000 discrete frequencies available from the SG-75A Exciter by remote control.

A typical adapter panel permits the remote selection of any one of ten preset frequencies with the mode or power being assigned to each channel. The presets are accomplished by means of a "plug-board" matrix located on the front panel of the adapter. The remote operator may dial any one of the ten channels without referring to the specific frequency required, eliminating operator error in the selection of a specific frequency. The power level, mode of operation and frequency may be changed by merely relocating the appropriate matrix shorting pin.

Remote selection of 280,000 channels can be supplied instead of preset channels. Operator selection of the desired frequency can be made at either local or remote location. For either system, a remote selector panel is supplied.

Specific supervisory functions are typically provided in the form of readback indications at the remote panel. These functions may include confirmation of power level, transmitter power on/off, transmitter power output, etc. Additional functions are available.

The primary functions of the system include:

- Remote selection of either preset channels or 280,000 discrete frequencies.
- Remote selection of mode (AME, USB, LSB, ISB, FSK and CW).
- Remote selection of five specified carrier levels.
- Remote plate control.
- Remote key control.
- Positive and direct supervision of function selected, in-

cluding keyline, power output, phase lock loop, and others.

In addition, the following characteristics are available in the system:

- The remote control panel up-dates the condition of the exciter or power amplifier whenever a control or push-button is changed. This provides immediate and positive indication of the function selected.
- Readback "status" information is continuously displayed when a fault or other abnormal condition exists. Regardless of the state of the control function, a readback signal will automatically be displayed until corrective action has cleared the cause of the readback signal.
- To guard against incorrect control information from operating the exciter and power amplifier, automatic data checks and comparisons are made before the system is allowed to operate. If a data error occurs, an illuminated pushbutton lights on the remote control panel indicating "reset". Depressing this button sets the correct control function at the remote control adapter.

Remote control can be accomplished by means of either a 2-wire control link (wireline) or a 4-wire link (carrier circuit) connecting the adapter panel with the remote panel. Audio tones in the form of digital pulses are used to transmit control information over the control link. Readback of faults or malfunctions in the exciter or power amplifier is accomplished over the same circuit as the control functions.

A typical remote control panel consists of:

- Decoding and logic circuitry.
- Shift register.
- Readback status detector and indicator.
- Signal processing circuitry.

A typical remote control adapter consists of:

- Shift registers.
- Decoding and logic circuitry.
- Malfunction or fault detectors.
- Channel selection matrices.

ORDERING INFORMATION

Remote control systems are custom designed for the specific users requirement. Price and delivery can be quoted when we are advised of specific system requirements.



SG-70 ISB High Frequency Exciter



Gates Model SG-70 ISB exciter is equipped to transmit single sideband, independent sideband, compatible AM, CW, MCW, or FSK with adapter. Provisions are incorporated for carrier suppression from -50 dB to 0 dB. A versatile and compact unit designed for accurate and rapid channel change and tune-up, the SG-70 has a self-contained silicon rectifier power supply, and requires only $8\frac{3}{4}$ inches in a standard 19-inch rack for mounting.

The input circuits of the SG-70 include two independent 600 ohm balanced or unbalanced input channels and one high impedance microphone channel. The 600 ohm channels will operate the exciter to full power with a minimum input audio level of -12 dB.

Mode selector switches are provided to switch all inputs to either upper sideband or lower sideband operation.

For the accurate and rapid tuning changes required in HF communications, Gates has designed the SG-70 sideband generator to provide increased utilization through simplified operation. Anyone of ten crystal controlled channels may be selected immediately by the turn of a knob. A second selector switch chooses one of 15 frequency bands within the 2-32 MHz range.

Then two final adjustments remain, RF tune and injection tune and the exciter is operational. Exceptional frequency stability is achieved through the use of an oven containing the master solid state transistorized frequency oscillator. The absolute drift never exceeds 8 Hz at any point in the spectrum. The solid state power supply is self-contained. The three generator modules—IF frequency generator, RF section, and Injection generator—are of the plug-in type.

SPECIFICATIONS

FREQUENCY RANGE: 2-32 MHz continuous, band switched.

POWER OUTPUT: 100 milliwatts PEP.

OUTPUT IMPEDANCE: 50 ohms nominal.

OPERATING MODES: USB, LSB, ISB, AME, CW, MCW, ESK with external adapter.

FREQUENCY CONTROL: Temperature controlled crystals, or optional external VFO or synthesizer.

CRYSTAL POSITIONS: 10. Selectable from front panel, with independent trimmer, or synthesizer.

STABILITY: Better than 1 PPM per day.

CARRIER SUPPRESSION: 0 to -50 dB.

SIGNAL TO DISTORTION RATIO: 45 dB @ rated output. (Distortion products: At rated output, 3rd and higher order products are at least 45 dB below either tone of a standard two-tone test signal.)

SIGNAL TO NOISE RATIO: 55 dB.

UNWANTED SIDEBAND REJECTION: 60 dB at 500 Hz.

AUDIO INPUT: Two independent 600 ohm channels balanced or unbalanced. -12 dBm for full RF output. One high impedance microphone channel requiring 1 mV for full PEP.

AUDIO RESPONSE: 250 to 6350 Hz with a 3 dB maximum ripple. Other bandwidths available.

ENVIRONMENTAL: 0° to $+50^{\circ}\text{C}$ operating, or -50° to $+70^{\circ}\text{C}$ non-operating.

POWER CONSUMPTION: 140 watts.

POWER INPUT: 115/230 volts, $\pm 5\%$, 50/60 Hz, 2 wire, single phase.

SIZE: 19" wide, $8\frac{3}{4}$ " high, 17" deep.

WEIGHT: 56 lbs. net; 90 lbs. export packed. Cubage: 7.5 cubic feet.

NOTE: The SG-70 exciter operates with Gates 1, 3, or 10 kW linear power amplifiers.

ORDERING INFORMATION

SG-70 ISB HF exciter.....994-6411
Complete set of spare tubes.....990-0517

1000 Watt ISB HF Transmitter

MODEL ST-1A

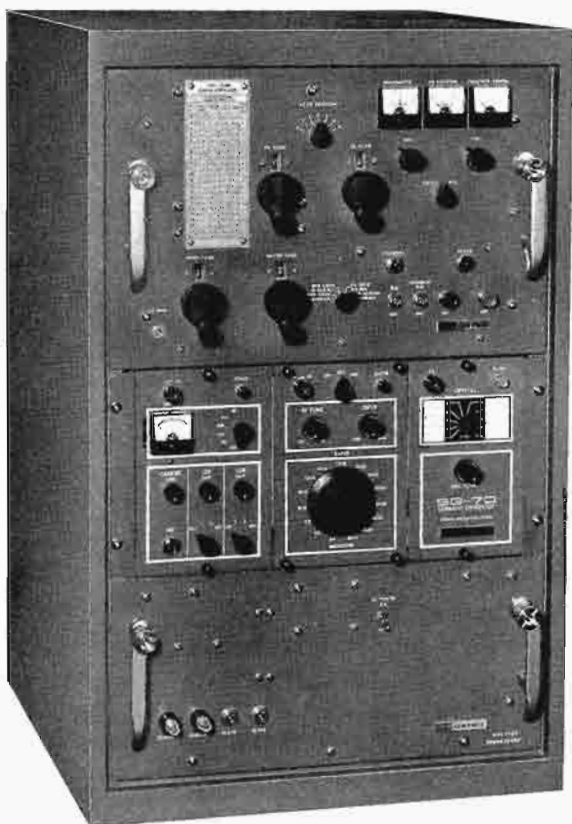

A continuous duty sideband transmitter, the ST-1A is conservatively rated at 1000 watts CW as well as PEP. Powers up to 1500 watts (50% overload) may be handled on an intermittent basis without damage to the equipment. The ST-1A is continuously tunable over the entire 2 to 32 MHz range. All tuning can be accomplished in less than two minutes by means of convenient front panel controls.

Designed for operation on any one of 10 crystal controlled channels, with all tuning accomplished by only seven front panel controls and one band switch. The ST-1A will transmit USB, LSB, ISB, AME, CW, MCW and FSK with adapter. Third order distortion products are at least 35 dB below the level one tone of a two-tone test. At maximum power, each of the two independent sidebands has a full 6 kHz capability.

Easy access to all components is assured with modular and tilt-over slide out construction used in the compact ST-1A. Maximum attention has been given to efficient cooling for the entire transmitter.

Exceptional frequency stability has been achieved by using a crystal oven containing a transistorized master frequency oscillator. Generator stability of two parts in 10^{-7} is approached at 32 MHz. Data and teletype tone transmission is possible since absolute drift never exceeds 8 Hz at any point in the operating spectrum.

A directional coupler and meter are provided in the ST-1A as standard equipment for power indications. Gates directional watt meter uses two separate circuits to measure forward and reflected RF power in the 50 ohm transmission line.

SPECIFICATIONS

FREQUENCY RANGE: 2-32 MHz continuous, band switched.

POWER OUTPUT: 1000 watts PEP, 1000 watts CW, continuous.

OUTPUT IMPEDANCE: 50 ohms; will match a VSWR up to 2:1.

OPERATING MODES: USB, LSB, ISB, AME, CW, MCW, FSK with external adapter.

FREQUENCY CONTROL: Temperature controlled crystals, or optional external VFO or synthesizer.

CRYSTAL POSITIONS: 10. Selectable from front panel, with independent trimmer, or synthesizer.

STABILITY: Better than 1 PPM per day.

CARRIER SUPPRESSION: 0 to -50 dB.

SIGNAL TO DISTORTION RATIO: 35 dB. (Distortion products: At rated output, 3rd and higher order products are at least 35 dB below either tone of a standard two-tone test signal.)

SIGNAL TO NOISE RATIO: 50 dB.

UNWANTED SIDEBAND REJECTION: 60 dB at 500 Hz.

HARMONICS: Second harmonic, at least 40 dB down; all higher order harmonics, at least 50 dB down.

AUDIO INPUT: Two independent 600 ohm channels balanced or unbalanced. -12 dBm for full RF output. One high impedance mic channel requiring 1 mV for full PEP.

AUDIO RESPONSE: 250 to 6350 Hz with 3 dB maximum ripple. Other bandwidths available.

AUTOMATIC LOAD CONTROL: Provided to limit distortion during high-drive peaks or load changes.

ENVIRONMENTAL: 0° to +50°C operating, or -50° to +70° C non-operating.

POWER CONSUMPTION: Key down CW 3.45 kw, @ approximately 90% power factor.

POWER INPUT: 115/230 volts, single phase, 3 wire, 50/60 Hz.

SIZE: Over-all with optional cabinet: 21" wide, 33½" high, 23½" deep. Amplifier: 12¾" high, standard 19" rack mount. Power supply: 8¾" high, standard 19" rack mount. Exciter: 8¾" high, standard 19" rack mount.

WEIGHT: 375 lbs. net. Domestic packed: 500 lbs. Export packed: 600 lbs. Cubage: 14 cubic feet.

ORDERING INFORMATION

ST-1A ISB HF communications transmitter with tubes and silicon rectifiers, less cabinet.....994-6418
Complete set of spare tubes.....990-0519
Optional ST-1A transmitter cabinet.....952-5967



3000 Watt ISB HF Transmitter



MODEL ST-3A

Gates offers an ISB transmitter with unexcelled performance for high frequency communications service in either fixed station or transportable operation. Conservatively rated at 3000 watts average as well as 3000 watts PEP, the ST-3A transmitter provides SSB, ISB, AME, CW, MCW, and FSK modes of operation.

The ST-3A is a complete transmitter consisting of the SG-70 ISB Exciter, power amplifier and solid state power supply, all in one extremely accessible cabinet.

Designed for operation on any one of 10 crystal controlled frequencies, all tuning is accomplished by only six front panel controls and one channel selector covering the 2 to 30 MHz frequency range.

Mode switches select operation on upper, lower or both sidebands. At maximum power, each of the two independent sidebands has a full 6 kHz capability. Flat crystal filter response provides the capability of effectively multiplexing four 3 kHz channels for voice and teletype communications. Third order distortion products are at least 40 dB below the level of one tone of a two tone test.

The ST-3A transmitter has been designed to provide accurate and rapid tuning. A compact and efficient turret tuner is used to switch each of the 10 crystal controlled positions into one of the 15 frequency bands. This permits tuning the transmitter to a pre-logged frequency, usually within one minute, and at widest extremes, no more than two minutes.

SPECIFICATIONS

FREQUENCY RANGE: 2-30 MHz continuous, band switched.
POWER OUTPUT: 3000 watts PEP, 3000 watts CW, continuous.
OUTPUT IMPEDANCE: 50 ohms; will match a VSWR up to 3:1.
OPERATING MODES: USB, LSB, ISB, AME, CW, MCW, and FSK with external adapter.
FREQUENCY CONTROL: Temperature controlled crystals or optional external VFO or synthesizer.
CRYSTAL POSITIONS: 10; selectable from front panel, with independent trimmer, or synthesizer.
STABILITY: Better than 1 PPM per day.
CARRIER SUPPRESSION: 0 to -50 dB.
SIGNAL TO DISTORTION RATIO: 40 dB. (Distortion Products: At rated output, 3rd and higher order distortion products are at least 40 dB below either tone of a standard two-tone test signal.)
SIGNAL TO NOISE RATIO: 50 dB.
UNWANTED SIDEBAND REJECTION: 60 dB at 500 Hz.

HARMONICS: Second harmonic, at least 50 dB down; all higher order harmonics, at least 60 dB down. Optional filter available.
AUDIO INPUT: Two independent 600 ohm channels balanced or unbalanced. -12 dBm for full RF output. One high impedance mic channel requiring 1 mV for full PEP.
AUDIO RESPONSE: 250 to 6350 Hz with 3 dB maximum ripple. Other bandwidths available.
AUTOMATIC LOAD CONTROL: Provided to limit distortion during high drive peaks or load changes.
ENVIRONMENTAL: 0° to +50°C operating, or -50° to +70°C non-operating.
POWER CONSUMPTION: Key down CW 7.5 kW, @ approx. 90% Power Factor.
POWER INPUT: 208/230/240 volts $\pm 5\%$ 50/60 Hz, 3-phase 3 or 4 wire, plus 115/230 volts, 2 wire.
SIZE: 22" Wide, 72" High, 24" Deep.
WEIGHT: 800 lbs. net. Domestic packed: 925 lbs. Export packed: 975 lbs. Cubage: 41 cubic feet.

ORDERING INFORMATION

ST-3A 3 kW ISB Transmitter with tubes, silicon rectifiers, less crystals.....	994-6492
ST-3A (same as above) with 78 dB factory installed harmonic filter.....	994-6492B
Spare tube kit for above.....	990-0520
HFT-5K 5 kW balun to match 50 ohms to 600 ohms.....	478-0246
Roll out base for ST-3A transmitter.....	994-6477

1000 Watt HF Linear Amplifier

MODEL HFL-1000



Gates HFL-1000 Linear Amplifier at 1000 watts PEP or 1000 watts CW is the smallest, completely self-contained amplifier in its power class. It features 90° tilt type slide mounting for the amplifier and a slide-out power supply which provides complete front panel servicing. Air intake is at the rear of the unit. The amplifier exhaust is on top, and the power supply exhaust is in the rear. The amplifier is designed to operate between 2.0 and 32 MHz and is capable of any type emission not exceeding its power and bandwidth capabilities. The final amplifier is operated class AB₁ at all times.

Ample metering is employed in the HFL-1000 linear amplifier to facilitate tuning and maintenance. A directional coupler with meter is provided as standard equipment for measuring forward or reflected power. The amplifier can be tuned and loaded to full rated output on any operating frequency, using only front panel controls. Tuning is continuous over the entire range without changing components. No air capacitors are used for tuning or loading. Loading is accomplished with band switched ceramic capacitors and a variable vacuum capacitor. Silicon rectifiers are used in all power supplies. The amplifier and power supply may be mounted in any standard 19" relay rack, or in an optional cabinet. The amplifier and power supply are manufactured for a wide range of temperature and humidity conditions and can be operated at altitudes up to 10,000 feet above sea level on a continuous basis.

SPECIFICATIONS

FREQUENCY RANGE: 2-32 MHz.

POWER OUTPUT: 1000 watts PEP, 1000 watts CW, continuous.

OUTPUT IMPEDANCE: 50 ohms; will match a VSWR up to 2:1.

OUTPUT CONNECTOR: Type UHF.

RF INPUT POWER: Less than 100 milliwatts driving power to obtain full rated output.

INPUT IMPEDANCE: 50 ohms, nominal.

INPUT CONNECTOR: Type BNC.

BANDWIDTH: 16 kHz or more to the 1 dB point.

HARMONICS: Second harmonic, at least 40 dB down; all higher order harmonics, at least 50 dB down.

SIGNAL TO DISTORTION RATIO: Capable of 35 dB. (Distortion products: At rated output, 3rd and higher order distortion products are at least 35 dB below either tone of a standard two-tone test signal.)

TUNING: Only four tuning controls, all on front panel and 1 band switch.

TUNING TIME: Maximum time required to change frequency between any two previously logged operating frequencies—two minutes.

AUTOMATIC LOAD CONTROL: Provided to limit distortion during high drive peaks or load changes.

POWER SUPPLY: Solid state.

DUTY CYCLE: Continuous at full rated output throughout the full environmental range specified.

ENVIRONMENTAL: 0° to +50°C; 0 to 95% humidity from sea level to 10,000 feet.

POWER INPUT: 115/230 volts, single phase, 3 wire, 50/60 Hz.

POWER CONSUMPTION: Key down CW 3.31 kW @ approximately 90% power factor.

SIZE: Amplifier, 12¼" high x 19" wide. Power supply, 8¾" high x 19" wide.

WEIGHT: 280 lbs. net; 350 lbs. export packed. Cubage: 8 cubic feet.

ORDERING INFORMATION

HFL-1000 1 kW linear amplifier with tubes and silicon rectifiers, less cabinet.....994-6161

Cabinet for HFL-1000.....952-5894

100% spare tube kit.....990-0447



3000 Watt HF Linear Amplifier

MODEL HFL-3000



The Gates HFL-3000 linear amplifier is rated at 3000 watts CW/PEP, and is designed to operate between 2 and 30 MHz. It features continuously variable tuning over the entire range and may be excited by any suitable generating equipment delivering 100 mW of power into 50 ohms. Any type of emission not exceeding the amplifier power output or bandwidth ratings is possible.

Important where compactness is desired, such as in multi-transmitter operations or portable installation, the total size of the 3000 watt unit, including self-contained power supply, is only 72" high, 22" wide, and 24" deep. Designed for operation at altitudes up to 10,000 feet on a continuous basis.

The power amplifier operates class AB₁ for all modes of emission. A 4CX3000A power tetrode is used as the final amplifier of the HFL-3000. The amplifier may be quickly tuned and loaded to full rated output at any operating frequency between 2-30 MHz by front panel controls. RF feedback is employed. A directional coupler and meter are provided as standard equipment for measuring either forward or reflected power.

The Gates HFL-3000 RF linear amplifier may be remote controlled through its normal start-stop functions up to nominal distances of several hundred feet.

SPECIFICATIONS

FREQUENCY RANGE: 2-30 MHz.

POWER OUTPUT: 3000 watts PEP, 3000 watts CW, continuous.

OUTPUT IMPEDANCE: 50 ohms; will match a VSWR up to 3:1.

OUTPUT CONNECTOR: Type LC.

RF INPUT POWER: Less than 100 milliwatts driving power to obtain full rated output.

INPUT IMPEDANCE: 50 ohms, nominal.

INPUT CONNECTOR: Type BNC.

BANDWIDTH: 16 kHz or more to the 1 dB point.

HARMONICS: Second harmonic, at least 50 dB down; all higher order harmonics, at least 60 dB down. Optional 78 dB filter available.

SIGNAL TO DISTORTION RATIO: Capable of 40 dB. (Distortion products: At rated output, 3rd and higher order distortion products are at least 40 dB below either tone of a standard two-tone test signal.)

SIGNAL TO NOISE RATIO: 50 dB.

TUNING: Only four tuning controls, all on front panel.

TUNING TIME: Maximum time required to change frequency between any two previously logged operating frequencies—two minutes.

AUTOMATIC LOAD CONTROL: Provided to limit distortion during high drive peaks or load changes.

DUTY CYCLE: Continuous at full rated output throughout the full environmental range specified.

ENVIRONMENTAL: 0° to +50°C; 0 to 95% humidity from sea level to 10,000 feet.

POWER INPUT: 208/230/240 volts $\pm 5\%$, 50/60 Hz, 3-phase, 3 or 4 wire, plus 115/230 volts, 2 wire.

POWER CONSUMPTION: Key down CW 7.45 kW @ approximately 90% power factor.

SIZE: 22" wide, 24" deep, 72" high.

WEIGHT: 660 lbs. net; 930 lbs. export packed. Cubage: 61.4 cubic feet.

ORDERING INFORMATION

HFL-3000 3 kW linear amplifier complete with tubes, silicon rectifiers, less roll out base.....	994-6466A
HFL-3000 with optional filter.....	994-6466B
Roll out base for HFL-3000.....	994-6477
Spare tube kit.....	990-0531

High Frequency Transmitting Antennas

For high frequency communications or broadcasting, and from microphone or keyer to antenna, Gates can supply the necessary equipment and materials for a "package" installation. Whatever the requirements may be, antennas to do the job are available from Gates. Choose from simple dipoles to modern "state-of-the-art" log periodic structures; from highly directional to omnidirectional types (either fixed or rotatable); all of them complete with the required accessories. A comprehensive selection of high quality antennas are available with all Gates transmitters, making Gates a single source for the best in high frequency transmitting facilities. Described below are some of the many types of antennas available. Write for complete information.

HORIZONTAL LOG PERIODIC ANTENNA

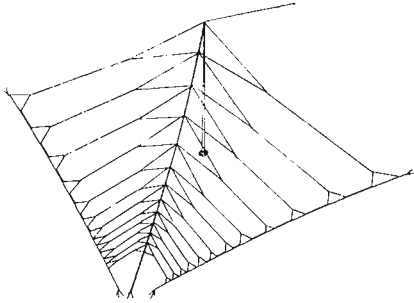

This Horizontal Log Periodic Antenna is designed for use with transmitters up to 50 kW as a broadband transmitting antenna in the range of 4 to 30 MHz. It may also be used for receiving. The antenna is supplied complete with steel cables, Fiberglas insulating blocks, Dacron drop ropes and all material ready to install. Consisting of twenty-four radiating elements, the antenna is designed for support at the back end from a 100 foot high structure of required vertical load and horizontal thrust (optional equipment). Typical characteristics are:

Frequency Range	4 to 30 MHz.
Polarization	Horizontal.
Azimuth Beam Width (average)	60 Degrees.
Input Impedance (nominal) at Feeder Line Assembly	300 ohms.
Antenna Element Input Impedance	100 ohms.
Operating Power (maximum peak)	50 kW.
VSWR (maximum)	2 to 1.

VERTICAL LOG PERIODIC ANTENNA

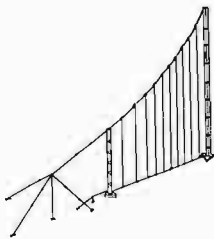

A vertically polarized broadband antenna designed for either transmitting or receiving in the range of 2.5 to 30 MHz, the Vertical Log Periodic Antenna consists of the antenna element, which is fabricated from steel cables and insulating blocks; and the antenna center support (optional equipment). Designed with a 50 ohm unbalanced input, this LP antenna matches the output of modern SSB communications transmitters. Normally, this antenna can be installed on less than one acre of ground. It measures 200 feet along the widest rod and extends 210 ft. from the single supporting tower.

Typical characteristics are:

Frequency Range	2.5 to 30 MHz.
Polarization	Vertical.
Azimuth Beam Width (average)	110 degrees.
Azimuth Plane Pattern	Cardioid
Elevation Plane Pattern	Upper half-power point less than 45 degrees above horizontal.
Input Impedance (nominal)	50 ohms.
Operating Power (maximum peak)	2.5 kW.
VSWR (maximum)	Between 3 MHz and 30 MHz: 2 to 1. Between 2.5 MHz and 3 MHz: 3 to 1.

BROADBAND VERTICAL RADIATOR

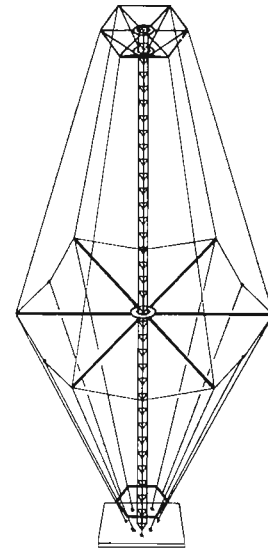

This antenna fills a need in applications requiring a broadband high frequency transmitting antenna for omnidirectional service. Input impedance, which is extremely constant over a wide frequency range; power handling capacity up to 150 kW or more (depending on coaxial line used); and radiation performance equal to or better than a conventional vertical radiator without the need and expense of special impedance matching equipment, are three of the outstanding features of the BVR series of antennas for high frequency transmitting, or receiving systems. Typical characteristics include:

Frequency Range; BVR 2-6	2 to 6 MHz.
BVR 4.5-13.5	4.5 to 13.5 MHz.
BVR 11-33	11 to 33 MHz.
Polarization	Vertical.
Input Impedance	50 or 70 ohms as specified.
Operating Power	Power handling capacity is limited only by the cable used. Example—5 kW with RG-17/U.
VSWR	Less than 2:1.

RHOMBIC ANTENNAS

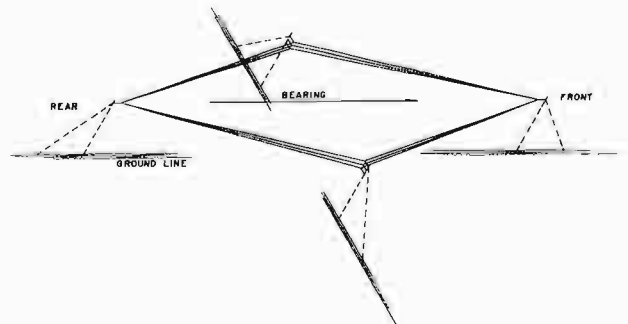

For applications where a highly directional fixed type antenna is needed, Gates offers a complete line of rhombic antenna kits. Each kit includes all the necessary materials and instructions for the installation of a rhombic antenna to operate on a specific frequency range with power up to 30 kW. In addition to the antenna materials, transmission line, dissipation line and towers are required, and can also be supplied by Gates. Typical characteristics are:

Frequency Range	4 to 22 MHz.
Polarization	Horizontal.
Input Impedance	600 ohms.
Operating Power	30 kW



HF Antenna System And Balun Transformers

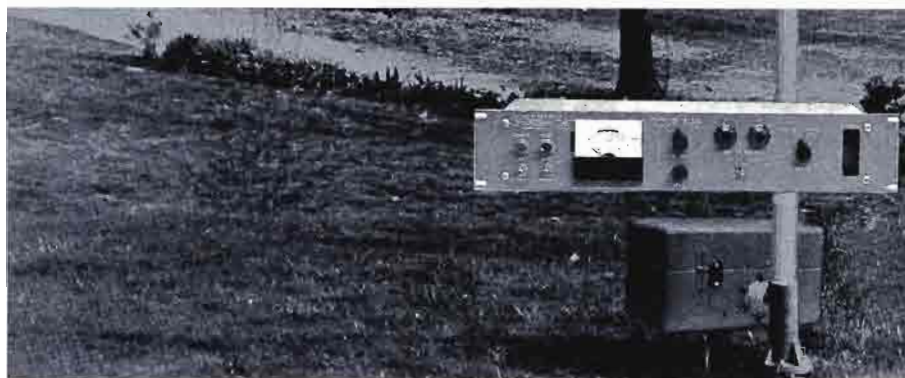

ANTENNA SYSTEM

The Model HFAS-4B antenna system has been designed to couple the unbalanced output of a 5 kW transmitter in the 4-30 MHz frequency range to an appropriate antenna. The system consists of a control unit, a coupling network, and a 35-foot vertical whip antenna. (Antenna is optional extra.)

The control unit contains completely solid state DC servo-amplifiers and ten-turn precision potentiometers for remotely adjusting the coupling network over the frequency range. It also contains a power meter, an SWR indicator, and an SWR interlock circuit. The interlock circuit de-energizes the transmitter when the VSWR exceeds a preset value.

The control unit also provides for preset tuning by means of a front panel receptacle which accepts plug-in printed circuit cards. Mounted on the cards are screwdriver adjusted servo-control potentiometers which permit storage of tuning data for preset tuning. The control unit metering circuit includes provisions for transfer of tuning data to the preset cards. Any number of cards may be used to store preset tuning data.

SPECIFICATIONS

FREQUENCY RANGE: 4-30 MHz.

ANTENNA: 35-foot vertical whip (optional extra).

INPUT VSWR: Less than 1.2:1.

POWER RATING: 5 kW average, 20 kW peak.

INPUT IMPEDANCE: 50 ohms.

COUPLING NETWORK EFFICIENCY: 90% or better over specified frequency range.

REMOTE TUNING CONTROLS: Two servo-control potentiometers and one switch.

PRESET TUNING CONTROLS: The control panel has a receptacle for a plug-in printed circuit card for preset tuning. Each card includes two servo-control potentiometers plus a switch to duplicate remote control functions. Any number of cards can be preset to meet circuit requirements (one preset card furnished with system).

VSWR INDICATOR: Panel meter on control unit.

TRANSMITTER INTERLOCK: VSWR interlock disables transmitter if reflected power exceeds preset value.

CONTROL CABLE: Supplied to customer's specified length.

AC POWER REQUIREMENTS: Less than 100 watts, 50/60 Hz, 105/125 volts.

DIMENSIONS: Control unit, 3½" standard rack panel. Coupling unit, 23½" x 10½" x 18".

ORDERING INFORMATION

High frequency antenna system including control unit with one preset card, and coupling unit.....HFAS-4B
Control cable for above (connectors included in basic system price).....No. of feet.
RCU-1 remote control unit, does not include preset cards.....RCU-1
Fiberglass whip antenna (35').....Style 222

BALUN TRANSFORMERS

For use with its complete line of communication transmitters, Gates has available several types of high frequency, high quality, broadband output transformers. These transformers, or baluns, are designed to match the 50 ohm unbalanced output of high frequency transmitters into 300 ohm or 600 ohm balanced transmission lines. Use of baluns permits the user to enjoy the advantages of coaxial lines inside the equipment building without sacrificing the efficiency and economy of open wire transmission lines between the shelter and the tower or antenna.

Model HFT-5K Five kilowatt transformer, 10 kW PEP, matching 50 ohm to 600 ohm (other impedances on request).....478-0246
Model 555-1 Twenty-five kilowatt transformer, 100 kW PEP, matching 50 ohm to 600 ohms.....478-0264

SPECIAL BALUNS—Baluns of other power ratings and impedances can be supplied on special order. To assist in making an accurate and prompt quotation, the following data will be helpful: (1) Power handling capacity in terms of anticipated PEP and Average ratings. (2) Input coaxial impedance rating. (3) Input connector type required if a preference. (4) Output transmission line impedance. (5) Output connector type required if a preference.

High Power HF Transmitter Multicouplers

Gates has been producing multicouplers and phasing equipment for domestic and international requirements for over a quarter of a century. Phasers, diplexers, triplexers, combining networks, filters, and antenna coupling equipment are being supplied to commercial and military organizations throughout the world.

Gates transmitter multicouplers are tunable networks that permit operation of two high power transmitters into the same antenna, without detrimental effect to either transmitter. These units are capable of providing close operation of two transmitters at any point within the 3 to 28 MHz band without restriction, except for a minimum frequency ratio of 1.1:1. Designed for shipboard, transportable or fixed station high frequency communications service and for short wave broadcasting, the multicouplers are a valuable asset to any installation where antenna space is at a premium.

Transmitter multicouplers are completely tunable across the 3 to 28 MHz band. Each of two pass-reject filters is tuned specifically for extremely low loss transmission and simultaneously for rejection of the directly coupled adjacent transmitter. Tuning and metering is so precise that a minimum of 30 dB isolation is possible between transmitters separated in frequency by as little as 10% of the higher frequency.

A typical 20 kW coupler is housed in one compact cabinet (72½" high, 40" deep, and 36" wide). This compact size permits installation adjacent to the transmitters for ease of tuning. All adjustments are made from the front panel, and retuning to a previously logged set of frequencies can be accomplished very rapidly.

REDUNDANT PAIR: For short wave broadcasting, two transmitters separated in frequency, but both modulated with the same program material, can be operated into one antenna. This eliminates independent antennas, and improves reliability of voice and data transmission.

FREQUENCY DIVERSITY: When ionospheric sounding is used to determine the frequency of optimum traffic (FOT), one transmitter may be tuned 5% above and the other 5% below the FOT, both operating into the same antenna. One antenna can be used to increase transmission reliability by straddling the FOT, or message diversity by doubling the subcarrier channels available to a given path.

TYPICAL SPECIFICATIONS

ELECTRICAL: Functions to combine the outputs of two 10 kW transmitters into a single 50 ohm transmission line.

INPUT FREQUENCY: 3-28 MHz. The ratio between input frequencies must be equal to or greater than 1.1:1.

INPUT POWER: 10 kW PEP, or average for each transmitter.

INPUT IMPEDANCE: 50 ohms unbalanced with VSWR 2:1 maximum.

INPUT ISOLATION: Greater than 30 dB for all allowable input frequency separation down to a minimum separation of 10% of the upper frequency.

INPUT INSERTION: Loss is less than 0.5 dB to each transmitter.

OUTPUT POWER: 20 kW PEP or average.

OUTPUT LOAD IMPEDANCE (ANTENNA): 50 ohms (nominal) unbalanced with a VSWR 2:1 maximum.

CONTROL AND MONITORING: All tuning and band switching controls are on the front panel for the total frequency range.

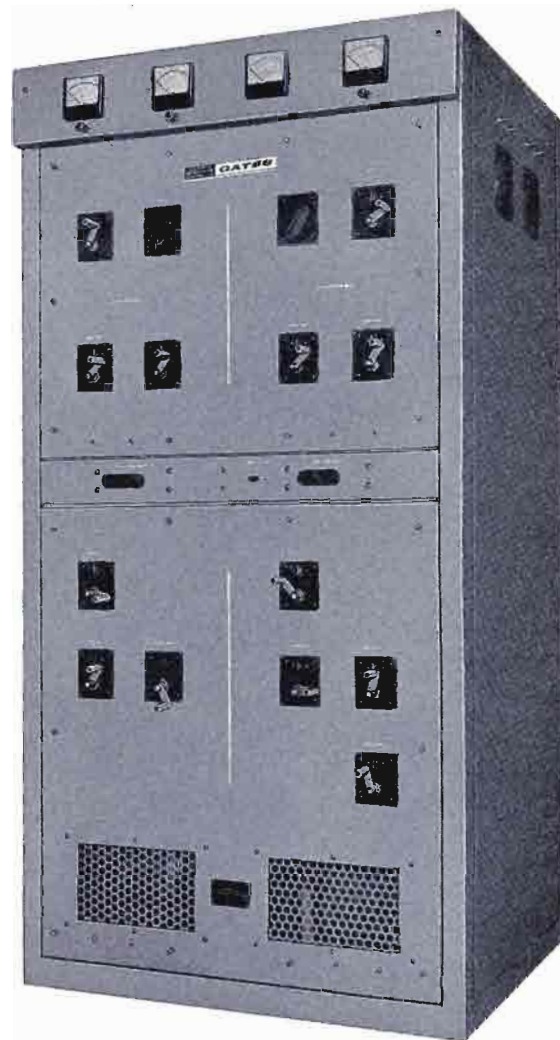

AZIMUTH AND SPACE DIVERSITY: The multicoupler may be loaded with appropriate direct and multihop frequencies to transmit to near and far locations via one antenna.

NOTE: Since specifications will depend on specific transmitter power, number of transmitters, and other critical factors, the specifications presented are for a typical 20 kW multicoupler. Other ratings are available, with information supplied upon request.

TUNING TIME: Units are capable of being retuned within 5 minutes. Meters are provided to measure forward and reflected power at diplexer input and at the common output. Forward and reflected power indicated by switching a common meter.

MAXIMUM DIMENSIONS: 72½" high, 36" deep, 36" wide.

MOUNTING: The diplexer cabinet has rails or mounting pads suitable for shock mounting the cabinet to the floor. The actual shock mounts are not supplied.

ENVIRONMENTAL: Cooling is air convection from two small enclosed fans. Equipment is designed to operate from 0° to +50°C, 95% humidity, up to 6000 feet altitude.

GENERAL: The multicoupler is designed for installation on shock mounts and operated as a fixed station with controlled environment.

ORDERING INFORMATION: On special order.



Low Frequency Homing Beacon Transmitter

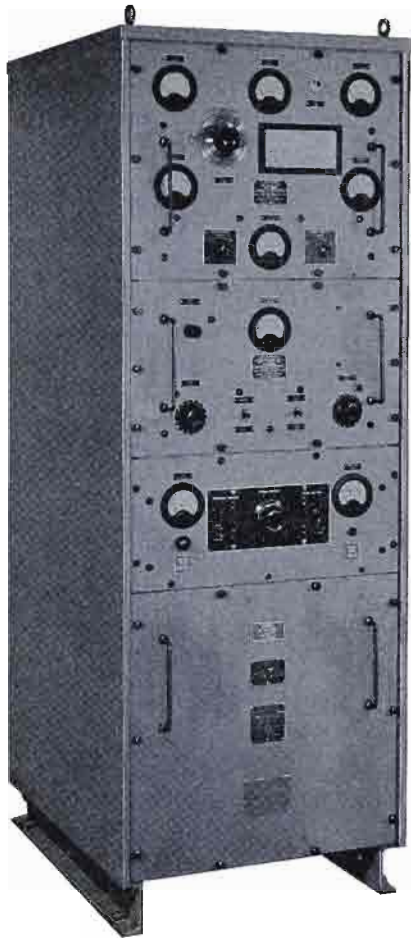

Manufactured for military use, the Gates low frequency homing beacon transmitter operates between 200 and 800 kHz at maximum power of 400 watts, with power reduction to 25 watts by means of a tapped auto transformer and front panel power selector switch. The main transmitter may be augmented with the remote control/audio amplifier unit (below center). By use of this accessory, the transmitter may be remotely operated over a 2-wire simplex telephone line or when located adjacent to the transmitter, a 3-wire line is employed. Another optional accessory is the M-4116 antenna coupler to match the 50 ohm transmitter output impedance to a T antenna 200 feet long, with a vertical down lead from 15 to 50 feet.

The transmitter is built to stand the extremes of -54°C to $+65^{\circ}\text{C}$ and Class B shock test. Pressurized forced air cooling, slide out decks for quick servicing, a 36 code keyer, high level modulation, automatic carrier reset, complete metering and 115 volt, single phase operation are all outstanding features. Also available is a prefabricated, insulated and ventilated shelter (illustrated below) specifically designed for use with this equipment.

Xenon gas type high voltage rectifier tubes are employed to permit operating in extremely low ambient temperatures.

The remote control/audio amplifier, illustrated below center, consists of a complete speech amplifier and a transmitter ON-OFF control. The amplifier is provided with decibel meter, level control, self-contained power supply and is designed for either desk or rack mount.



SPECIFICATIONS

POWER OUTPUT: 400 watts or less.

RF IMPEDANCE: (Transmitter) 51.5 ohms. When used with M-4116 coupler, will match typical T antenna.

FREQUENCY BAND: 200 to 800 kHz.

FREQUENCY STABILITY: 0.003%.

MODULATION: Class AB₁ high level modulation in either A₂ or A₃ mode of emission.

AUDIO INPUT: (Transmitter) 600 ohms approximately -10 dBm. (M-4033 remote/audio amplifier): Includes complete compression type amplifier to accommodate 50 ohm push-to-talk dynamic microphone, decibel meter, transmitter OFF-ON switch, and self-contained power supply. For operation over 3-wire line or 2-wire simplex telephone line to operate transmitter.

KEYING: 36 code keyer at 8 rpm equal to 4/6 rpm code wheel: 60 segments stainless steel for any 3 letter identification and code signal.

PERFORMANCE: Audio response: 400-3000 Hz ± 2 dB. Distortion: 6% or less. Noise: 40 dB below 100% modulation at 400 watts.

AC INPUT: 115 volts, 60 Hz, single phase at 2200 watts at maximum power of 400 watts modulated.

METERING: (Transmitter) AC line volts, elapsed time in hours, 2nd IPA plate, PA grid, PA plate, modulator plate and RF line current, one multi-meter indicator, oscillator plate, 1st IPA plate, 2nd IPA grid. (Remote/audio unit) Decibel output meter. (Antenna coupler) RF antenna current.

SIZE AND WEIGHT: (Transmitter) 72" high, 26" wide, 30" deep. Add 24" to depth for drawer pull out. Weight packed, 1400 lbs. Cubage: 60 cubic feet. (Remote control/audio amplifier) 19" wide, 10½" high, 12" deep. Weight packed, 80 lbs. Cubage: 4 cubic feet. (Antenna coupler) 8" wide, 8" deep, 30" high. Weight packed 120 lbs. Cubage: 8 cubic feet.

FINISH: Light medium gloss gray with escutcheons in black.

TUBES: (Transmitter) (3 each) VR150/OD3, VR105/OC3; (2 each) 4-250A, 6SJ7, 4B32, 5U4G, 6L7, 6SN7; (1 each) 5670/2C51, 6AC7, 807, 4-400A, 6X5, 6L6, 6H6, 6SH7, 6SL7. (Remote control/audio amplifier) (3 each) 6SJ7 and (1 each) 5U4G, VR105.

ORDERING INFORMATION

Transmitter with code keyer, tubes, less crystal.....	994-4031
Remote control/audio amplifier with tubes, less microphone.....	994-4033
Microphone, push-to-talk stand, cord and connector.....	994-4124
Antenna coupler.....	994-4116



Transportable 50,000 Watt Broadcast And SSB System

HELICOPTER SYSTEM AN/TRQ-20

Designed and manufactured by Gates for the U.S. Army, the AN/TRQ-20 represents one of the largest mobile broadcast and SSB communications systems ever produced. Helicopter transportable, the equipment is manufactured in S-280 shelters and portable skids with a maximum weight of 4000 lbs. each, permitting easy transportation by 6 x 6 vehicles and standard cargo planes.

SYSTEM DESCRIPTION: Two powerful 50 kW radio broadcasting stations, one medium wave and one high frequency, each complete with studio/control shelters, and diesel powered generators are portable down to their transmitting antennas. A complete 2.5 kW PEP single sideband communications link, using a Gates linear amplifier for 2-30 MHz operation, together with broadband log periodic antennas, is part of this system. Facilities are provided for 1 six kHz program channel, 2 three kHz voice channels and 2 teletype channels. Circuits are full duplex providing simultaneous communications in both directions over distances of 600 to 1200 miles.

Also included is a monitor facility with receiving and recording capabilities for MW, HF, and FM from 50 MHz to 260 MHz. Military nomenclature has been assigned to the various integral facilities of the complete AN/TRQ-20 system as follows:

- AN/TRT-22 () 50 kilowatt medium wave broadcasting station.
- AN/TRT-21 () 50 kilowatt short wave broadcasting station.
- AN/TRR-18 () An integrated receiving monitor station.
- OA-6021 () TRQ-20 Main studio control.
- AN/TRC-95 () 2.5 kW SSB communication link.

The entire system consists of four shelters for the 50 kW medium wave transmitter, four for the high frequency transmitter, four for the SSB link, two for each receiving station, three for master control equipment, three for studios, one for announce teletype and two shelters for 50 kW dummy antennas. Diesel generators provide all power needs. Studio and control shelters have individual heating and air conditioning.

LOG PERIODIC ANTENNAS: For High Frequency SSB transmitting and receiving, vertically polarized log periodic antennas are utilized. These broadband antennas require no adjustment or change throughout the entire frequency range of 3 to 30 MHz. Three identical antennas are used for each SSB link shelter; one for transmitting and two for diversity reception.

50,000 WATT TRANSMITTERS: A standard Gates 50,000 watt medium wave broadcast transmitter is used, redesigned mechanically to be housed in the S-280 shelters. With its own diesel power system, the complete 50 kW station consists of four shelters housing the transmitter, a 50 kW dummy load shelter and independent studio and control room shelters.

Completing the AN/TRQ-20 system is a short wave 50,000 watt broadcasting facility which is identical to the medium wave system, with the exception of its antenna system and the 3.9 to 30 MHz transmitter frequency coverage.



Transportable Systems Capabilities

In use—WORLD-WIDE . . . Gates pioneering in the manufacture of transportable broadcasting and communications systems goes back many years. Numerous mobile facilities built for commercial and for government applications with military nomenclature are now in use.

This long experience combined with Gates broad engineering and extensive manufacturing facilities have resulted in numerous contracts for both mobile broadcasting systems from 1 kW to the largest 50,000 watt capability, and for transportable SSB communications service.

OTHER SYSTEMS: The AN/TRQ-20 is one of many transportable systems manufactured by Gates. The AN/MRT-5 transmitting and AN/MRR-4 receiving systems, in addition to the Army air transportable television broadcasting systems, are some of the previous military units built by Gates. These, together with commercial mobile systems are illustrated herein.

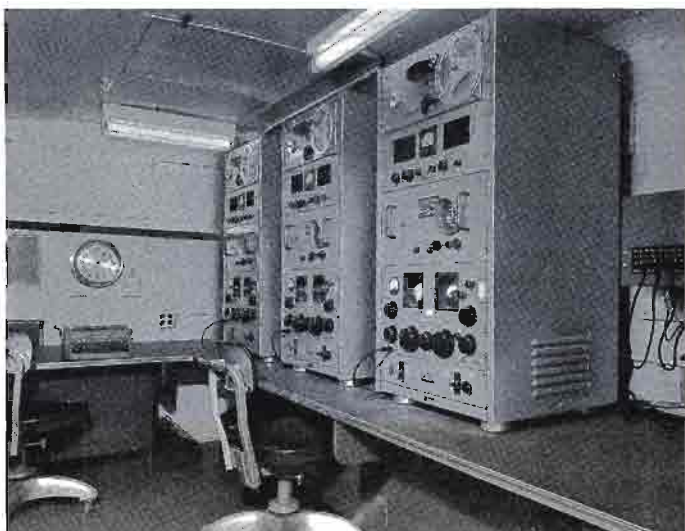

MOBILE RADIO STATION AN/MRT-5 and AN/MRR-4
For the U.S. Army, Gates designed and constructed a large number of complete mobile 5000 watt radio stations designated AN/MRT-5. A van containing a combined mobile studio and control room was acoustically treated and completely air conditioned. The transmitter van housed a 5000 watt AM broadcast transmitter. Military shelters contained the portable 200 ft. antenna tower, tuning unit, balloon antenna and other apparatus. The AN/MRR-4 was the companion radio receiving, monitor and teletype facility all housed in two shelters.

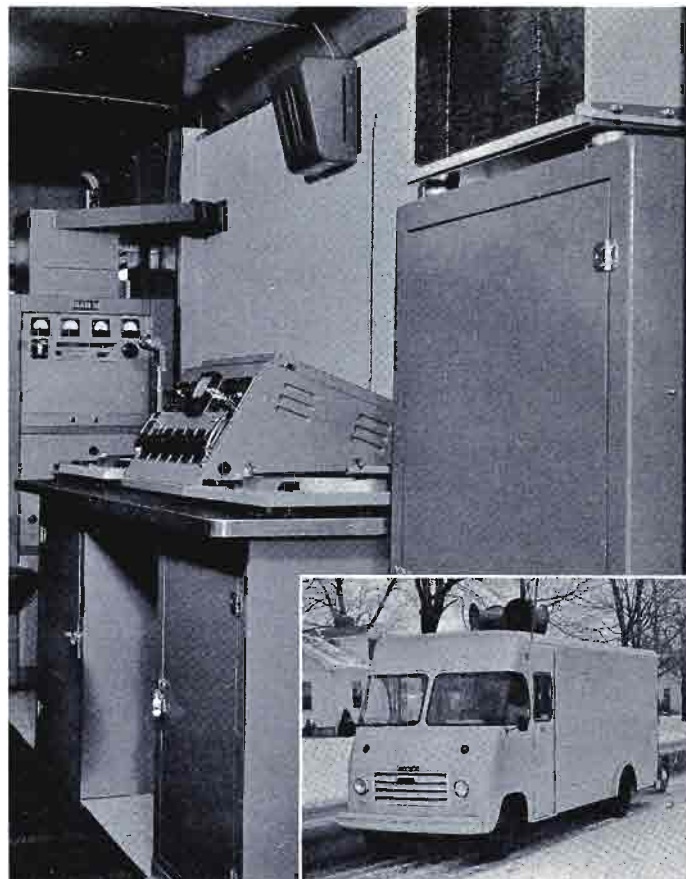

Mobile radio system designed and constructed by Gates for the Radio Bureau of the Republic of Korea provides complete medium and short wave broadcasting and public address facilities in a compact, specially designed van.

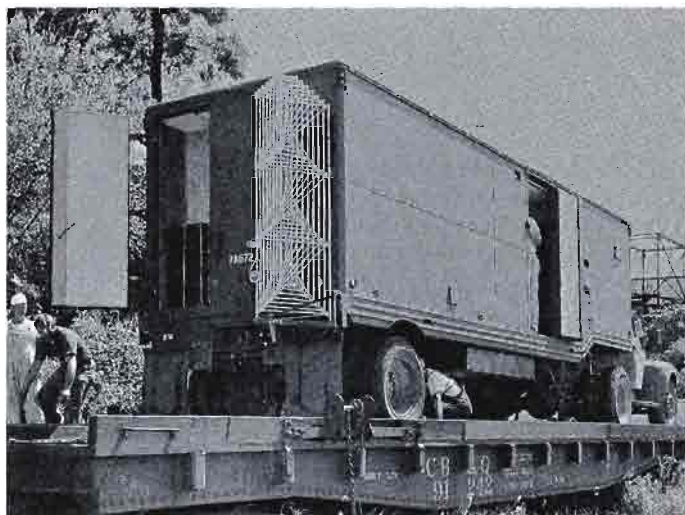

MOBILE TELEVISION STATION FOR SIGNAL CORPS
Gates designed, developed and constructed a complete 100 watt mobile television station for the U.S. Army. Housed in a 50' x 8' air-conditioned van were live pickup equipment, two film camera chains, and completely self-contained studio control room and transmitter. Several antennas for either omnidirectional or unidirectional coverage were supplied.

Transmitter Control



CCD-2 transmitter control console.

CONTROL CONSOLES



Custom transmitter control console.

Transmitter control consoles are designed for use with any medium wave or short wave transmitter to provide a convenient and centralized "control center" to operate the transmitter. The CCD-2 console pictured above is designed to accommodate the average single transmitter. Pictured above right is a custom designed console built to control three separate transmitters. Gates can design and build consoles for high powered 50 kW or 100 kW transmitters, or for any special application which cannot be served by the Model CCD-2 equipment.

TYPICAL SPECIFICATIONS

AUDIO INPUTS: Three 600 ohm channels provided with line isolation transformers.

OUTPUT: 600 ohms.

MASTER GAIN: Balanced 30 steps, 1.5 dB per step.

VU METER: 4" square case with range control.

MODULATION METER: 4" square case illuminated. (See Note.)

PUSHBUTTONS: Four pairs provided for transmitter start-stop functions.

PILOT LIGHTS: Indicate transmitter filament and plate on.

FINISH: Medium hand rubbed gloss gray with escutcheons in black.

SIZE: 24" wide, 10" high, 21½" deep.

SHIPPING WEIGHT: 60 lbs. Export packed 125. Cubage 6.0.

ORDERING INFORMATION

CCD-2 Transmitter Control Console.....994-4055

NOTE: Modulation extension meter supplied is to match Gates M-5693 or M-5774 modulation monitors. If other make of monitor is to be used, please specify. Price may be slightly higher in this case.

EXTENDED CONTROL AND METERING PANELS

Gates extended control and metering panels are designed to extend basic transmitter meter readings and control functions of a Gates transmitter from a room housing the transmitter to another room in the building. Interconnection over a reasonable distance between the panel and transmitter can be accomplished through the use of a multi-conductor cable. All units are standard 19-inch width for convenient rack mounting.

Metering is accomplished by three easy-to-read 4-inch meters. Plate voltage and plate current indications appear on separate meters. The third meter is used for indicating RF Amperes for an AM transmitter or RF output in kW for an FM transmitter. As remote meter sampling kits are included as standard items in current Gates transmitters, metering is

easily accomplished. For AM transmitters the Gates M-6112 diode units should be added for indication of RF Amperes. The M-6112 is described on page 65.

Control of transmitter filament and plate is facilitated through switches located below the meters. To comply with FCC regulations an additional switch is provided to activate a power raise/lower function. For some AM transmitters a motor-rheostat assembly is required—these units are described on page 65.

Ample space is provided on the panel so that a station can add additional switching or control functions, such as a stereo on-off switch.

Sales and Service Facilities



◀ **HOUSTON**—Gates stock carrying branch.
4019 Richmond Avenue,
Houston, Texas 77027
Telephone: Area (713) 666-4333

Gates Houston carries thousands of sundry items just for the broadcaster. Located adjoining a freeway direct to Houston International Airport, fast service is a speciality. The Houston branch of Gates is perhaps the only fully stocked supply center in the world devoted exclusively to broadcasters.

LOS ANGELES—Attractive Western field sales office. ▶
1945 South Figueroa,
Los Angeles, California 90007
Telephone: Area (213) 747-7129



WASHINGTON, D. C.—Gates Radio Company.
730 Federal Building, 1522 K Street, N.W.
Washington, D.C. 20005
Telephone: Area (202) 223-5508



◀ **NEW YORK**—Centralized Eastern Facilities of Gates field sales offices are located at:
800 Second Avenue,
New York, New York 10017
Telephone: Area (212) 687-7971

CANADIAN SALES

MONTREAL OFFICE—Gates Radio Company (Canada) Ltd.
212 Brunswick Boulevard,
Pointe-Claire, Quebec, Canada
Telephone: Area (514) 695-3751

TORONTO OFFICE—Gates Radio Company (Canada) Ltd.
19 Lesmill Road,
Don Mills, Ontario, Canada
Telephone: Area (416) 447-7234

Remote Pickup Equipment



TRANSMITTER

APPLICATION: Broadcast Remote pickup.
RF OUTPUT: 30 watts, continuous.
FREQUENCY: 152-172 MHz.
CRYSTAL MULTIPLICATION: 36.
SPURIOUS EMISSION: Spurious radiation attenuated at least 70 dB below carrier level. Harmonics suppressed at least 60 dB.
FREQUENCY STABILITY: $\pm 0.0005\%$.
TEMPERATURE RANGE: -30°C to $+60^{\circ}\text{C}$.
MODULATION: 30 F3 Maximum (Normally adjusted for ± 10 kHz swing).
AUDIO INPUTS: Two. Can be adjusted for either 150 ohm or 600 ohm input. Use of a 50, 150, or 250 ohm microphone will function satisfactorily into the 150 ohm input.
AUDIO INPUT LEVEL: -70 dB.
AUDIO CONNECTORS: Cannon XLR-3-31.
POWER REQUIREMENTS: 120 Volts AC or 12.6 Volts DC. (12 volt battery.)
MODULATION CONTROL: Push-pull Limiter.
NOISE LEVEL OF TRANSMITTER: Better than -45 dB.
OVER-ALL RESPONSE WITH MATCHED RECEIVER: ± 2 dB from 75 to 7500 Hz.
DISTORTION IN TRANSMITTER: Less than 3%.
NET WEIGHT: 16 pounds.
DIMENSIONS: 14" wide, 10" long, and 7" high.

ORDERING INFORMATION

Remote Pickup Transmitter (Specify frequency).....731-0045

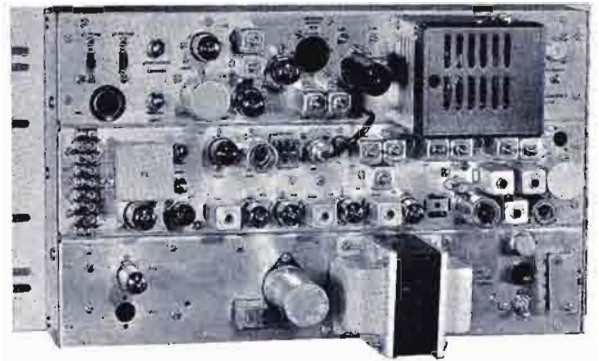

BASE STATION

APPLICATION: Base Station, communications quality.
RF OUTPUT: 25 Watts, Intermittent (EIA.)
FREQUENCY: 152-172 MHz.
CRYSTAL MULTIPLICATION: 36 times.
SPURIOUS EMISSION: Spurious Radiation attenuated at least 70 dB below carrier level. Harmonics suppressed at least 60 dB.
FREQUENCY STABILITY: $\pm 0.0005\%$.
TEMPERATURE RANGE: -30°C to $+60^{\circ}\text{C}$.
MODULATION: 25F3: Adjusted at factory; normally for a ± 7.5 kHz for 100% modulation at 1000 Hz.
AUDIO INPUTS: Two. One for local control—a carbon microphone. Other for remote control—a two-wire telephone line.
REMOTE CONTROL FACILITIES: Built-in line termination unit.
POWER REQUIREMENTS: 117-123 volts AC, 50 or 60 Hz.
DUTY CYCLE: Intermittent (EIA).
FREQUENCIES POSSIBLE: Two; maximum spacing 120 kHz.
POWER SUPPLY: Silicon Rectifiers.
DIMENSIONS: 10½" x 19" (standard relay rack mounting).
NET WEIGHT: 28 pounds.

ORDERING INFORMATION

Base Station (Specify frequency).....731-0050

REMOTE PICKUP RECEIVER



APPLICATION: Remote Pickup.
SENSITIVITY: 0.6 microvolts or less for 20 dB quieting.
FREQUENCY RANGE: 152-172 MHz.
SELECTIVITY: 100 dB at ± 32 kHz; -6 dB or less at ± 15 kHz.
SPURIOUS RESPONSE: All spurious and image responses attenuated at least 90 dB.
OVER-ALL RESPONSE: ± 2 dB; 60 to 7500 Hz with matching transmitter.
FREQUENCY STABILITY: $\pm 0.0005\%$ with crystal oven.
TEMPERATURE RANGE: -30°C to $+60^{\circ}\text{C}$.
AUDIO OUTPUT: $+8$ VU at 600 ohms.
METERING: Signal strength and VU brought out to test jacks. Visual metering optional.
DIMENSIONS: 10½" high, 19" wide, 9" deep. Panel finish—Hammer-tone-Gray.
NET WEIGHT: 20 pounds.

ORDERING INFORMATION

Remote Pickup Receiver (specify frequency).....731-0046

NOTE: Extended frequency response to 12,000 Hz available on special order.

Remote Pickup Equipment

SINGLE RING ANTENNA — MA-1

Non-directional, ± 3 dB. Horizontally polarized. Unity gain. Available with either a 22-inch support rod, tapped with a standard $\frac{1}{8}$ "-27 thread for mounting on a standard microphone floor stand (PA-1), or with a 50-inch support rod designed to be mounted on a standard communication type chain link bumper mount (MA-1).

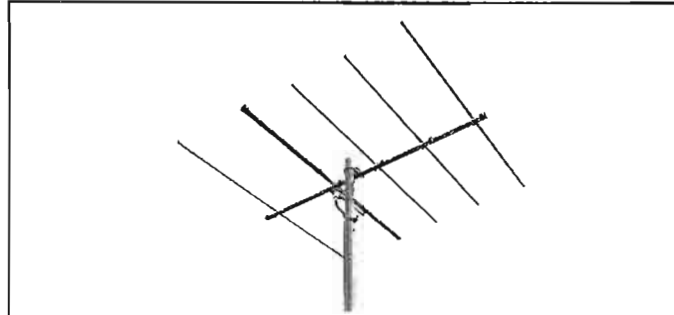

YAGI ANTENNAS — YC

NOMINAL IMPEDANCE: 50 ohms.
INPUT CONNECTOR: Type N jack.
POLARIZATION: Horizontal or vertical.
AVERAGE GAIN: 9 dB.

TYPICAL VSWR: Under 1.5.
TYPICAL REAR SIGNAL REJECTION: 25 dB.
POWER HANDLING CAPACITY: 60 watts.

OPERATING FREQUENCIES:

(Model)	(Frequencies—MHz)
YC-153	152.80-153.40
YC-161	161.30-161.90
YC-166	159.95-166.55
YC-170	169.85-170.45

AVERAGE COVERAGE OVER FLAT TERRAIN OF M-30B TRANSMITTER

RECEIVING ANTENNA HEIGHT	ANTENNA COMBINATIONS	EXPECTED COVERAGE IN MILES
* 75 ft.	Receiving 5 Element Yagi	Transmitting Single Ring 9
** 150 ft.	5 Element Yagi	Single Ring 13
* 75 ft.	Stacked 5 Element Yagi's	Single Ring 11
** 150 ft.	Stacked 5 Element Yagi's	Single Ring 15
* 75 ft.	5 Element Yagi	5 Element Yagi 14
** 150 ft.	5 Element Yagi	5 Element Yagi 18
* 75 ft.	Stacked 5 Element Yagi's	5 Element Yagi 16
** 150 ft.	Stacked 5 Element Yagi's	5 Element Yagi 20
** 150 ft.	RA-4 Antenna	Single Ring 10
*** 300 ft.	RA-4 Antenna	Single Ring 14
** 150 ft.	RA-4 Antenna	5 Element Yagi 16
*** 300 ft.	RA-4 Antenna	5 Element Yagi 20

The above measurements are based on a transmitting antenna height of 6 feet above surrounding objects.

CODE:

- * Measurement based on length of RG-8U Transmission Line not to exceed 80 ft.
- ** Measurement based on length of FH34 Transmission Line not to exceed 200 ft.
- *** Measurement based on length of $\frac{3}{8}$ " Heliac Line not to exceed 350 ft.

ORDERING INFORMATION

TRANSMITTERS (Specify Frequency)

- M-30B Broadcast quality, continuous duty, 30 watt, 120 VAC, for portable mobile operation in the 152 to 172 MHz band...731-0143
- M-30B/TPS Same as M-30B but with 12.6 VDC transistorized power supply in addition to 120 VAC supply...731-0045
- M-30B/CD Same as M-30B but modified for rack mounting and with one input modified for push-to-talk operation...731-0148
- M-25C Communications quality, continuous duty, 25 watt, 120 VAC for use as base station transmitter in 152-172 MHz band...731-0144

RECEIVERS (Specify Frequency)

- MR-30/150-170 Broadcast quality, continuous duty, 120 VAC, rack mount...731-0046
- MR-25/150-170C Communications quality, continuous duty, 120 VAC, rack mount, complete with speaker. For operation in the 152 to 172 MHz band...731-0147

ANTENNAS (Specify Frequency)

- RA-4 Four ring, horizontally polarized, 6 dB gain...710-0086
- RA-2 Two ring, horizontally polarized, 3 dB gain...710-0100
- PA-1 Single ring, horizontally polarized, unity gain: portable...710-0088
- MA-1 Same as above, except for use as a mobile antenna...710-0089
- YC Series Yagi, 5 element, vertically or horizontally polarized, 9 dB gain...710-0090
- 2 YC Stacking harness for stacking two YC Series Yagi antennas 710-0091
- ASP-177 Mobile, roof-top antenna, vertically polarized, 3 dB gain...710-0094
- SC-155 Base, vertically polarized, 6 dB gain complete with 12' mast and mounting clamps...710-0093
- SC-155B Same as above except brass...710-0101

TRANSMISSION LINE AND ACCESSORIES

- RG-8U foam filled, 50 ohm, jacketed transmission line, per ft....618-0007
- PL-259 Connector for use with RG-8U...610-0231
- PG-4 Pigtail, 4' RG-8U cable with PL-259 attached to each end...731-0141
- PG-4A Pigtail, 4' RG-8U cable with PL-259 and UG-21C/U connectors attached...731-0218

ACCESSORIES

- Gates G-100 microphone, dynamic omnidirectional...720-0143
- SR-90R Turner microphone, carbon, for local control of M-25C...720-0187
- RMC-1C remote control console, solid state, complete with transistors, power supply...731-0199
- TPS-TC Mobile assemblage for control of M-30B/TPS transmitter...731-0047
- ASP-143 Chain link bumper mount for use with MA-1 antenna...710-0087
- P-1 Audio bridging pad for feeding line level source to M-30B...731-0053
- DFT Dual frequency kit for M-30B, M-30B/TPS and M-30B/CD, less crystal...731-0162
- DFR Dual Frequency kit for MR-30/150-170 and MR-25/150-170C, less crystal...731-0163
- XT-1 Crystal for M-30B, M-30B/TPS, M-30B/CD and M-25C...731-0165
- XR-1 Crystal for MR-30/150-170 and MR-25/150-170C...731-0166

Studio-Transmitter Link—950 MHz

GENERAL DESCRIPTION OF 950 MHz STL SYSTEM

The basic system consisting of M-3/STL Transmitter, MR-200/942-952 Receiver, parabolic antennas and transmission line is designed and engineered to feed monaural program material from studio to transmitter.

The average system will use two 4' parabolic antennas with an approximate power gain of 18.9 dB each. Grid or mesh construction is recommended for minimum windloading on lightweight towers. Radomes and heaters are optional equipment. Transmission line is selected on the basis of attenuation and velocity and on a hop of up to 17 miles. Assuming a 17 mile hop from studio to transmitter, the isotropic path loss is 120 dB. Further assuming the 100' of transmission line on each end is sufficient to obtain 75' above line-of-sight clearance, the loss in 200' of 7/8" foam heliax is 3.8 dB. This gives a total loss of 123.8 dB.

For comparative purposes, transmitter output power is always in relation to 1 watt. Therefore, with a 2.5 watt transmitter, an additional 4 dB of gain is available making a total gain of 37.8 plus 4 or +41.8 dB. Subtracting the total gain from the total loss, leaves a net result of -82 dB. By interpolation, -82 dB is the equivalent of 575 microvolts of signal, which can be expected to be delivered to the receiver terminals.

Granting that conditions are not always ideal or even normal, for hops up to 17 miles a 25 dB fade factor is considered sufficient to take care of sudden, deep fades such as aircraft crossing the microwave path or multipath fades caused by atmospheric or tropospheric changes. This 25 dB fade allowance added to the net figure of -82 dB gives -107 dB. Again by interpolation, -107 dB is the equivalent of 30 microvolts, or in other words, it could normally be expected that at some given time there could be only 30 microvolts present at the receiver terminals.

In looking at the "sensitivity" spec on the MR-200/942-952 Receiver, it can be seen that this receiver requires only 32 microvolts for a 60 dB signal-to-noise ratio and 10 microvolts for a 50 dB signal-to-noise ratio; therefore, the 30 uv is ample to keep the receiver free of audible noise. Allowing a 25 dB fade factor, 99.99% program reliability is possible as related to high quality program material.

STEREO

In consideration of an STL for stereo transmission, with the use of a new Stripline Hybrid Ring Combiner, the outputs of two M-3/STL transmitters are combined into one common antenna and transmission line system. Likewise, the inputs of two MR-200/942-952 receivers are combined from one common antenna and transmission line system. Isolation between transmitters measures 27 to 28 dB and loss is less than 5 dB through the total of the two combiners. Because of the 5 dB loss encountered in the combiners, an antenna system employing 4' parabolic antennas will cover distances up to 12 miles. For distances greater than this, antennas and transmission lines are selected on the basis of their ability to deliver adequate signal voltage to the receiver terminals.

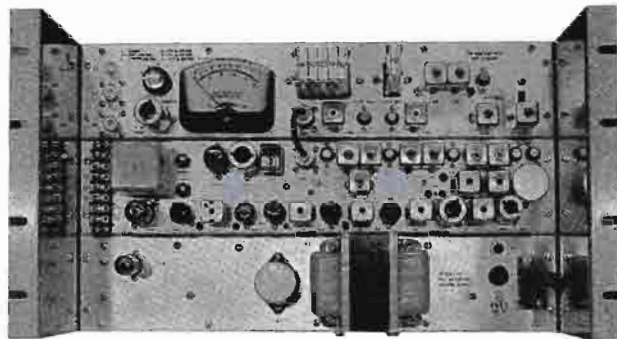

MR-200/942-952 Receiver.

ORDERING INFORMATION

Transmitter, 3 watt, 120 VAC, complete with tubes and crystal. Rack mount.....	M-3/STL
Low-pass filter for use with M-3/STL transmitter.....	LPF-15
Receiver, 120 VAC, complete with tubes and crystal, LPF-15 low-pass filter. Rack mount.....	MR-200/942-952
Remote control unit. Tone operated, 10 channel solid state. Semi- modular construction. Consists of one RMC-2A/T transmitter control and metering unit and one RMC-2A/S studio control and indicator unit.....	RMC-2A
Sub-carrier generator. Solid state, semi-modular construction. Tuned for operation on assigned frequency of 41 or 67 kHz. Less mute module.....	SCG-67
Hybrid ring combiner.....	HRC-1
Parabolic Antenna. 4' diameter, multi-element open grid. 18.9 dB gain. For operation in the 890-960 MHz band.....	P-948GN
Parabolic Antenna. 6' diameter, multi-element open grid. 22 dB gain. For operation in the 890-960 MHz band.....	P-972
Same as above, but with heaters.....	P-972/HC
Parabolic Antenna. 10' diameter, multi-element open grid. 27 dB gain. For operation in the 890-960 MHz band.....	P-9120
Same as above but with heaters.....	P-9120/HC
Foam Heliac transmission line, 7/8", 50 ohm, jacketed.....	FHJ5
Air Heliac transmission line, 7/8", 50 ohm, jacketed.....	HJ5-50
Type N plug, for FHJ5.....	45AW
Type N jack, for FHJ5.....	45AN
Type N plug, for HJ5-50.....	75AW
Type N jack, for HJ5-50.....	75AN
Type EIA flange for HJ5-50.....	75AR
Type EIA flange with gas barrier, for HJ5-50.....	75AG
Mitre elbow, 90 degree.....	1060

Please specify exact operating frequency on all frequency conscious items.

Studio-Transmitter Link—950 MHz

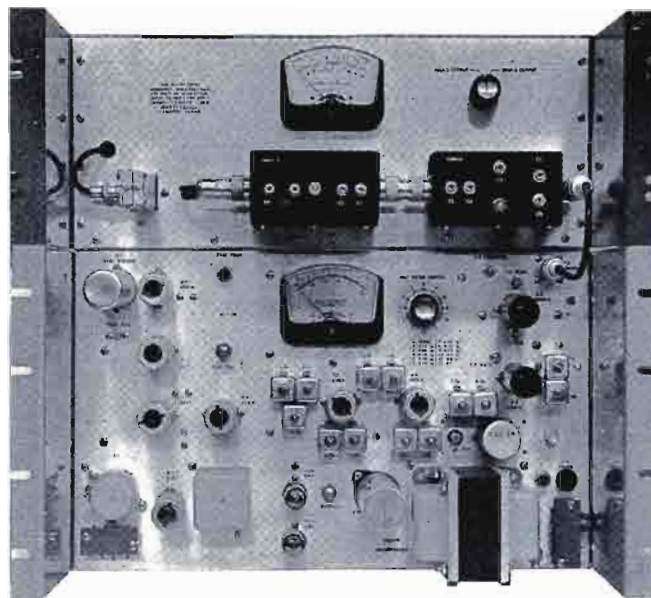

M-3/STL Transmitter.

The M-3/STL transmitter (above) and MR-200/942-952 receiver (pictured on opposite page), with antennas and transmission line, combine to form a microwave link to feed program material from studio to transmitter. Program quality is at least equal to a class AAA equalized telephone line.

A system, including transmitter, receiver and two parabolic antennas (each with 18.9 dB gain and 200' of $\frac{7}{8}$ " transmission

line) is designed to cover up to 18 miles, allowing a full 30 dB fade factor for 99.99% reliability. For greater distances, antennas and transmission lines are selected as necessary to obtain the desired gain. To be assured of a path, a minimum of 75 feet above line-of-sight is necessary to accommodate fresnel zone clearance.

SPECIFICATIONS

M-3/STL TRANSMITTER

APPLICATION: Studio-transmitter link and inter-city relay.
FREQUENCY RANGE: 942.5-952.5 MHz.
POWER OUTPUT: Maximum, 3 watts; normal, 2.5 watts as set at the factory.
OUTPUT IMPEDANCE: Nominal 50 ohms.
RF CONNECTOR: UG-997A/U (mates with UG-21D/U).
FREQUENCY STABILITY: .001% or better.
TYPE OF MODULATION: Phase.
MODULATION CAPABILITIES: ± 100 kHz (75 kHz considered as 100% modulation).
TYPE OF OSCILLATORS: Temperature controlled crystals.
AUDIO INPUT IMPEDANCE: 600 ohms.
AUDIO INPUT LEVEL: ± 2 dB of +10 dBm.
AUXILIARY INPUT: 41 or 67 kHz SCA.
FREQUENCY RESPONSE: ± 1 dB 40 to 15,000 Hz.
DISTORTION: (At 100% modulation) 1.25% max. 40 to 100 Hz. 0.80% max., 100 to 7500 Hz. 1.25% max., 7500 to 15,000 Hz.
FM NOISE LEVEL: Referenced signal 400 Hz modulated 100%. (± 75 kHz) exceeds -65 dB as measured with 75 micro-second pre-emphasis, and 15 kHz low-pass filter.
AM NOISE LEVEL: Exceeds -50 dB referred to carrier amplitude.
POWER LINE REQUIREMENTS: 120 VAC, 50/60 Hz, 150 watts.
DIMENSIONS: 17½" high, 19" wide, 9" deep.
ORDERING INFORMATION: See opposite page.

MR-200/942-952 RECEIVER

APPLICATION: Studio-transmitter link and inter-city relay.
FREQUENCY RANGE: 942.5 to 952.5 MHz.
BANDWIDTH: 200 MHz at 3 dB down.
SENSITIVITY:
2.0 microvolts for 30 dB signal-to-noise ratio.
3.2 microvolts for 40 dB signal-to-noise ratio.
10.0 microvolts for 50 dB signal-to-noise ratio.
32.0 microvolts for 60 dB signal-to-noise ratio.
OVER-ALL RESPONSE: 40 to 15,000 Hz ± 1 dB (75 microsecond curve).
OSCILLATORS: Two, both temperature controlled.
INPUT: Nominally 50 ohms (type N).
OUTPUT: 600 ohms at +10 dBm.
METERING: Audio, discriminator, limiter, last IF, oscillator number one output, oscillator number two output and CR-1 drive. Meter w/selector switch.
POWER REQUIREMENTS: 120 VAC, 50/60 Hz, 60 watts.
TUBE COMPLEMENT: Eight 6DS4; three 6HS6, two 6BH6; one 7059; one 6AL5; three 12AX7; one 6CG7; and one OB2. (20 required—8 types.)
DIMENSIONS: 10½" high, 19" wide, 9" deep. (Standard rack mounting.)
FINISH: Panel finished in gray hammertone.
NET WEIGHT: 20 pounds.
ORDERING INFORMATION: See opposite page.

Studio-Transmitter Link—890-960 MHz



The Model PCL-303 Studio-Transmitter Link provides a high-quality audio channel between a broadcast studio and a remote transmitting site.

It has been developed specifically for application in broadcast service. Designed for continuous service, it operates in accordance with Subpart E, Part 74, of the FCC Rules and Regulations. It is available for all STL bands—domestic and foreign.

From the operational maintenance standpoint, multicircuit metering has been provided. Utilizing front panel meters, all significant circuits can be measured at the turn of a knob. The equipment is furnished with rack-mounted slides for easy inspection. Interstage shielding is used where required, with equipment covers—top and bottom—being provided for each unit.

TRANSMITTER: The true, direct FM principle of modulation is employed in these STL transmitters. To ensure the required output frequency stability, a thoughtfully-engineered auto-

matic frequency control (AFC) system is utilized. Here's how it works:

An extremely stable basic oscillator is modulated with a pair of variable capacitance (varicap) diodes. The frequency of this basic FM oscillator (approximately 78 MHz) is divided by 1024 using a binary divider chain which employs high-speed, integrated circuit (IC) elements.

This divided output is phase compared to the output of a reference crystal (oven-controlled) oscillator, and the resultant error voltage is used to phase lock the basic oscillator to the crystal. Low-frequency modulation components have negligible effect on the AFC lock as a result of the high-frequency division ratio (1024) employed in the basic oscillator. The phase-locked output of the direct FM basic oscillator is multiplied and power amplified; in the PCL-303 it is further tripled to the output frequency with a parametric multiplying diode.

An RF cavity filter at the transmitter output attenuates spurious signals to at least 60 dB below rated power output, and

Studio-Transmitter Link—890-960 MHz

an integral sampling probe feeds a panel meter to continuously monitor relative output power. A quiet, dependable, blower fan cools the final transistor power chain. The fully-regulated and protected power supply is self-contained and maintains stable power output with line voltage variations from 105 VAC to 130 VAC.

An input audio filter removes unwanted program components above 17 kHz. This effectively reduces the crosstalk (in all multiplex channels) which may be caused by spurious high-frequency noise in the program line.

Standard 75 microsecond pre-emphasis is also incorporated in the program input. BNC connectors, for inserting remote control and SCA subcarriers, and a 5-pin connector, used when the STL transmitter is remotely controlled, appear on the rear of the chassis.

RECEIVER: This is a conventional double-conversion, crystal-controlled, superheterodyne receiver with a self-contained, regulated power supply. Signals from the antenna input are passed through a five-cavity RF pre-selector which is used

ahead of a low-noise, input mixer diode (Schottky barrier type).

The first IF (72 MHz) section consists of a three-stage FET amplifier employing AGC and designed for low noise and medium bandwidth characteristics. The second IF section (10.7 MHz) is an amplifier exhibiting exceptionally sharp skirts and linear phase characteristics. These characteristics are achieved by a ten-pole, active filter slightly overcoupled to give the desired response. Less distortion to high-frequency modulation components are ensured by this design. The ratio detector affords better rejection of impulse noise and adjacent channel interference.

The audio section, utilizing an operational amplifier, is a wide-band, low-noise, low-distortion type amplifier incorporating a 75 microsecond de-emphasis network. A carrier-operated squelch relay silences all output should the carrier be lost or if the power fails. Contacts for external carrier alarm use are located on the back of the chassis, as are the two BNC connectors for subcarrier outputs. A 600 ohm output-to-line transformer and a 17 kHz low-pass elliptical filter complete this section.

SYSTEM SPECIFICATIONS

FREQUENCY RESPONSE: $\pm 1/2$ dB from 30 Hz to 15,000 Hz.
DISTORTION: Less than 0.5% from 50 Hz to 15,000 Hz.
SIGNAL-TO-NOISE RATIO: Better than 68 dB (-65 dB for PCL-202) below 100% modulation.

MODULATION CAPABILITY: One program and two subcarrier channels.
PRIMARY POWER SOURCE: 120/240 VAC, $\pm 10\%$ 50-60 Hz.
PANEL SPACE REQUIRED: 5 $1/4$ " x 19"—transmitter or receiver.

OPERATING SPECIFICATIONS

TRANSMITTER

TYPE: Direct FM.
RF OUTPUT: 7 watts minimum; 8 watts maximum into nominal 50 ohm load—Type N female connector.
FREQUENCY STABILITY: Better than 0.001% (0° to 55°C); Crystal mounted in temperature controlled oven.
MULTIPLICATION: 12 times basic oscillator frequency.
AM NOISE: Better than 75 dB below carrier reference.
DEVIATION: ± 40 kHz for 100% modulation.
SPURIOUS EMISSIONS: More than 60 dB below carrier.
AUDIO INPUT: 600 ohms balanced; ± 10 dBm for 100% modulation.
MULTIPLEX INPUTS: Two BNC connectors provided for subcarrier channels in 25-100 kHz spectrum; approximately 1.0 volt rms for 20% deviation.
SOLID-STATE DEVICES: All silicon: 15 transistors (JEDEC), 14 diodes, 5 varicaps, 11 IC's, 1 varactor.
POWER SUPPLY: Fully regulated, self-contained.
COOLING: Convection and forced.
DIMENSIONS: 5 $1/4$ " x 19" x 16".

RECEIVER

TYPE: Superheterodyne—double conversion and crystal controlled.
ANTENNA INPUT: Nominal 50 ohms impedance—Type N female connector.
SENSITIVITY: Less than 3 microvolts for 20 dB quieting. Requires only 35 microvolt signal for 60 dB quieting.
SELECTIVITY: 200 kHz.
AUDIO OUTPUT: 600 ohms balanced; ± 10 dBm.
MULTIPLEX OUTPUTS: Two BNC connectors; 1.0 volt peak-to-peak per subcarrier for 20% subcarrier injection at transmitter.
SOLID-STATE DEVICES: All silicon; 19 diodes, 21 JEDEC registered transistors (18 bi-polar, 3 field effect), 1 IC.
POWER SUPPLY: Zener regulated—self-contained.
DIMENSIONS: 5 $1/4$ " x 19" x 14".

Automatic Transmitter Logging System



Output Writer types log in easy to read, easy to file, familiar log format.

MODEL ADP-101

The ADP-101 System records up to 10 transmitter readings, and log entries are automatically printed out every 10 minutes by the Output Printer in the familiar format of a typical manual log. An out-of-tolerance condition causes that particular reading to be printed in red, and the internal audible alarm to be sounded. A contact closure for an external alarm is also provided.

The designed-in dependability and reliability of the ADP-101 have been proven in the field. Only silicon transistors, integrated circuits and diodes are used, with all transistors having plug-in mountings. Standard logic circuitry found in computers is incorporated. Lamps are used liberally in both terminals to visually display the circuit status of the system. Most of the circuit intelligence is located in the Printer Unit installed at the attended location.

Installation is straightforward and closely resembles that of the usual remote control system. The system can be completely calibrated at the Sampler Unit (transmitter site) by one man. Although both terminals can be used back-to-back at the transmitter side, normally the Sampler Terminal is located at the transmitter and the Printer Terminal at the studio. For the latter, the terminals would be interconnected by a suitable communications channel capable of conveying the tone signals in either direction.

The ADP-101 Automatic Data Printer has been specifically designed as a digital transmitter logging device for the broadcaster. The printout is typed on sprocket-fed paper by an IBM Output-Writer to provide a continuous 24 hour record which can be conveniently stored for quick future examination. The advantages of this format are obvious. The first column is the time the readings were taken; the second column is an internal calibration reference; and the following ten columns represent the recorded data. Additionally, remarks can be entered by the operator by using the keyboard of the IBM Output-Writer. This method of transmitter logging is superior to, and more accurate than the narrow, industrial, strip chart recorders that are difficult to interpret.

As shown in the block diagram of the ADP-101, the Sampler Unit is located at the transmitter site while the Printer Unit and IBM Output-Writer are placed at the control point. The automatic (or manual) commands which initiate a complete sequence of data logging, as well as the binary coded FSK data signals, are applied to a single wire or radio channel. The bandwidth required for proper operation is less than 600 Hz.

All coded data is transmitted as a percentage of full scale, and as such provides a high degree of security to unauthorized reception. Most of the circuit intelligence is located in the Printer Unit.

Adequate status indicator lamps for circuit examination are included in the ADP-101. Fewer than 10 columns can be logged, and provisions are included to sound an aural alarm when any given data channel is out-of-tolerance. This condition may also be printed in red for a permanent record.

Dependability and reliability were designed into the ADP-101. Only JEDEC registered silicon semiconductors are used. A special plastic card is provided to permanently record the binary code values for calibration. The Printer Unit is mounted on slide rails for easy examination of the status lamps. The stepping switch with its gold-plated contacts is a plug-in assembly. Separate power supplies mounted on 3½" x 19" panels provide power for the Sampler and Printer Units. The Sampler Unit is mounted on a 7" x 19" panel; the Printer Unit is on a 12¼" x 19" panel. The ADP-101 will operate from a 120/240 VAC, 50-400 Hz power source.

Automatic Transmitter Logging System—ADP-101

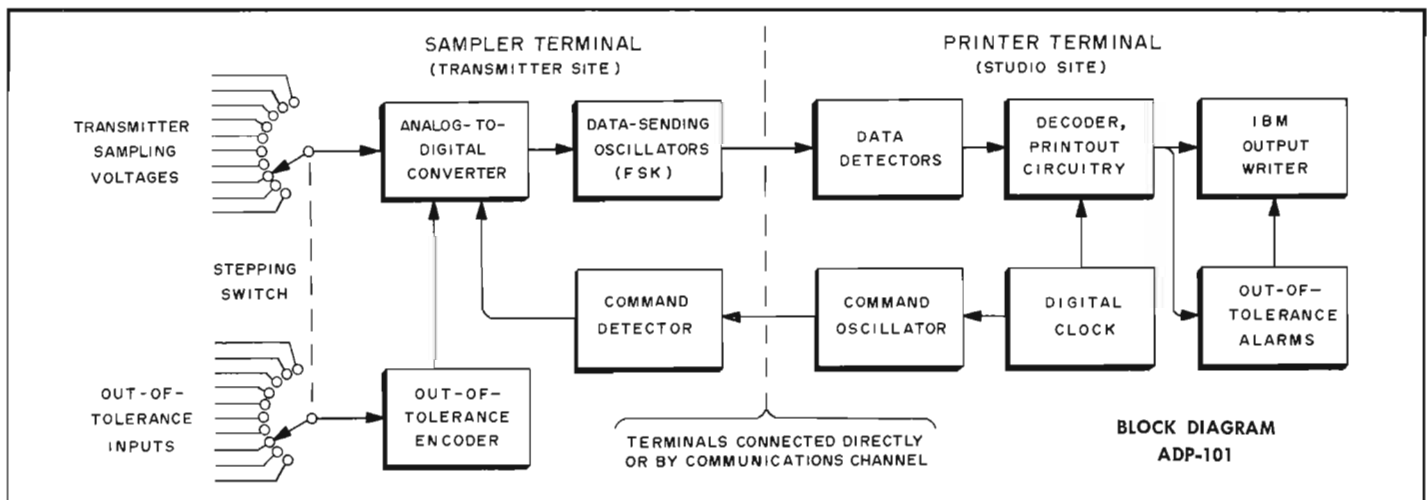

SPECIFICATIONS

- LOGGER TYPE:** Digital Automatic.
- LOG FORMAT:** Columnar; 12 columns: Time, calibration voltage, Transmitter parameters (10 maximum). Remarks may be entered manually.
- TRANSMITTER PARAMETER INPUTS:** 10 maximum.
- CALIBRATION REFERENCE:** Internal Zener diode.
- CLOCK:** Digital; 24 hour; resettable to nearest minute.
- ACCURACY:** 1% full scale or better.
- LOGGING INTERVAL:** 10 minutes; manual override.
- PRINTOUT TIME:** Approximately 1 minute maximum for all 12 columns.
- PAPER TYPE:** Standard sprocket-fed; continuous or single sheets; net size each sheet 8½" x 11".
- PAPER CONSUMPTION:** 1 inch per hour (6 single-spaced lines per inch).
- OUT-OF-TOLERANCE INDICATIONS:** Three: Reading printed in red, internal audible alarm, and external alarm contacts.
- OUT-OF-TOLERANCE INPUTS:** Requires contact closure; not part of ADP-101.
- SAMPLER INPUTS:** 30,000 ohm input impedance; +2 volts minimum, zero ground; individual multivibrator calibration controls.
- COMMUNICATIONS:** Single: DC continuity not.
- CHANNEL REQUIREMENTS:** Required; 30 dB allowable loss (for remote operation) between 1200 Hz and 1720 Hz.
- TELEPHONE LINE:** Nominal 600 ohms balanced, 0 dBm; barrier strip.
- SUBCARRIER CHANNELS:** Nominal 2000 ohms unbalanced, 0.5 V rms; BNC connectors.
- DATA TRANSMISSION METHOD:** Frequency-Shift Keying (FSK), modified (synchronizing pulses for noise rejection).
- tone FREQUENCIES:** Command 1720 Hz; Data 1200 Hz and 1440 Hz.
- OPERATING TEMPERATURE RANGE:** 0°-130°F.
- SEMICONDUCTOR DEVICES:** All silicon: JEDEC registered transistors, diodes, and integrated circuits.
- POWER REQUIREMENTS:** 117 VAC, 60 Hz; Sampler Terminal 30 watts; Printer Terminal 110 watts total.
- SAMPLER TERMINAL:** Sampler Unit: 7" x 19" x 10". Power Supply 3½" x 19" x 11".
- PRINTER TERMINAL:** Printer Unit: 12¼" x 19" x 12" (Chassis slide mounting). Power Supply: 3½" x 19" x 11". Output Printer: 11½" x 14¼" x 16¾".
- SHIPPING INFORMATION:** Wt. 200 lbs.; 15.9 cubic feet.

SAMPLE LOG

DATE

STANDARD
 DAYLIGHT

TIME	CAL.	1	2	3	4	5	6	7	8	9	10	REMARKS
0900	1000	1920	4400	0460	4080	2840	1720	3040	1440	0120	0200	
0910	1000	1920	4400	0470	4240	2880	1720	3040	1440	0120	0200	
0920	1000	1960	4560	0480	4240	2880	1720	3040	1440	0120	0200	
0930	1010	1960	4400	0470	4240	2840	1720	3000	1440	0120	0200	
0940	1010	1960	4400	0470	4080	2880	1720	3000	1440	0120	0200	
0950	1000	1960	4400	0470	4080	2880	1720	3040	1440	0130	0200	
1000	1000	1960	4400	0470	4080	2880	1720	3040	1440	0120	0200	
1010	1000	2000	4400	0470	4240	2880	1720	3040	1440	0120	0200	
1020	1000	2000	4480	0450	3920	2880	1720	3040	1440	0120	0200	
1030	1000	2000	4480	0440	3920	2880	1720	3040	1440	0120	0200	
1040	1000	2000	4480	0440	3920	2840	1720	3000	1440	0120	0200	
1050	1000	2000	4480	0440	3920	2840	1720	3040	1440	0120	0200	
1100	1000	2000	4480	0450	3920	2880	1720	3040	1440	0120	0200	
1110	1000	2040	4560	0460	3920	2880	1720	3040	1440	0120	0200	
1120	1000	2040	4560	0460	3920	2880	1720	3040	1440	0110	0280	
1130	1000	2000	4480	0440	3920	2880	1720	3040	1440	0120	0200	
1140	1000	2000	4480	0440	3920	2880	1720	3040	1440	0120	0200	
1150	1000	2000	4480	0440	3920	2840	1720	3040	1440	0130	0200	
1200	1000	2000	4480	0460	3920	2880	1720	3040	1440	0110	0280	
1210	1000	2000	4480	0460	3920	2880	1720	3040	1440	0110	0280	
1220	1000	2000	4480	0450	4080	2880	1720	3080	1460	0120	0200	
1230	1010	2000	4480	0440	3920	2880	1720	3040	1440	0110	0280	
1240	1000	2000	4480	0440	3920	2840	1720	3000	1440	0110	0280	
1250	1000	2000	4480	0460	3920	2880	1720	3040	1440	0120	0200	
1300	1000	2000	4480	0440	3760	2880	1720	3000	1440	0120	0200	
1310	1000	2040	4560	0450	3920	2880	1720	3000	1440	0120	0200	
1320	1000	2040	4560	0430	3840	2840	1720	3000	1440	0120	0200	
1330	1000	2000	4480	0440	3920	2880	1720	3040	1440	0110	0280	
1340	1000	2040	4560	0450	3920	2880	1720	3000	1440	0120	0200	
1350	1000	2000	4480	0450	3920	2880	1720	3040	1440	0120	0200	
1400	1000	2000	4480	0450	3920	2840	1720	3040	1440	0120	0200	
1410	1000	2040	4560	0440	3920	2840	1720	3000	1440	0110	0280	
1420	1000	2000	4480	0440	3920	2840	1720	3040	1440	0120	0200	

ORDERING INFORMATION

Automatic transmitter logging system.....ADP-101

Operating Impedance Bridge



- Measures "in circuit" operating impedance—500 kHz to 5 MHz.
- Handles through power up to 5 kW.
- No signal generator or external detector required for measurement under power.
- Can be used with signal generator and receiver as a normal bridge.
- Measures negative impedance loads.
- Ideal for use in adjusting multi-tower directional antennas.
- Based on new principle.

The Model OIB-1 Operating Impedance Bridge measures the operating impedance of the individual radiators, networks, transmission line sections, and common point of directional antenna systems while they are functioning normally and under power. This "operating impedance" cannot be measured by normal impedance bridge methods because the system characteristics are disrupted when the bridge is inserted in the circuit. The OIB-1 thus satisfies a critical requirement long felt by consulting and broadcast station engineers. In addition it has many applications in other fields that cannot be duplicated by any other instrument.

The OIB-1 is inserted directly in series with the transmission line, network, or antenna. The transmitter power is applied and a bridge balance is obtained by manipulating the R and X dials on the face of the bridge. Balance is indicated by a null reading on the meter which is mounted on the front panel

of the bridge. Operating resistance and reactance are then read directly from the bridge dials. The VSWR on a transmission line can be read directly from a scale on the meter.

SPECIFICATIONS

FREQUENCY RANGE: 500 kHz to 5 MHz.

THROUGH POWER RATING: 5 kW with VSWR 3:1.

INSERTION EFFECT: Equal to 9" of 150-ohm line.

FUNCTIONS: Direct reading in R, -400 to +400 ohms. Direct reading in X, -300 to +300 ohms. Measures VSWR, $Z_0=0$ to 400 ohms. Indicates relative forward and reflected power.

ACCURACY: R and X, $\pm 5\%$ ± 1 ohm. Dials individually calibrated and engraved.

RF SOURCE: Transmitter, transmission line, etc., or signal generator with adapting connector.

DETECTOR: Internal for high power source. Connector on front panel for external detector when used with signal generator. Amplifier for internal detector available as factory installed option if high sensitivity is desired.

TERMINALS: Input and output are large UHF receptacles (UG-357/U). 12" input and output clip leads are supplied as standard with bridge. 18" leads optional at no extra cost when specified with order. External detector connection is BNC.

ACCESSORIES: Aluminum polyurethane-lined transport case.

DIMENSIONS: 12½" x 9½" x 5¼" deep.

WEIGHT: 10 lbs.

ORDERING INFORMATION

Model OIB-1 Operating Impedance Bridge. Specify whether 12" or 18" leads are desired _____ 700-0063
 D. C. Amplifier. Used to increase sensitivity of Bridge for use with power sources as low as 25 watts _____ 700-0064
 TC-1 Transport Case. For OIB-1 _____ 700-0065

Common Point Impedance Bridge



An instrument for permanent installation in the common point of a directional antenna system. Permits the common point resistance and reactance to be measured during normal operation without transmitter shutdown. Panel ammeter reads common point current so that direct antenna power can be determined.

The Model CPB-1 and CPB-1A Common Point Impedance Bridges are operating impedance bridges similar to the Model OIB-1, but designed for permanent installation in your phasing equipment at the antenna common point. Instruments have two 4" dials calibrated directly in resistance and reactance. A panel meter is provided for a null detector. The R & X dials are manipulated as a normal bridge while the transmitter is operating at full or reduced power to give a null indication on the panel meter. The value of the common point resistance and reactance can then be read directly from the two dials.

It has been found that many directional antennas have common point impedances which vary from time to time due to seasonal changes in the ground system and minor tuning drift of the antenna parameters. On many occasions it was found from remeasurement of the common point impedance that the station had been transmitting with somewhat less than full power for some time because of these changes. The CPB-1 and CPB-1A permit the station operator to determine the common point impedance at any time, even during normal operating hours. By minor adjustment of the common point resistance control, he can maintain his radiated power at the full license value at all times. He also has a method of detecting changes in his antenna system which affect the common point. This may alert him to equipment faults and prevent citations for antenna misadjustment.

CPB-1 and CPB-1A bridges are normally supplied mounted on a standard 19" x 7" rack panel. A cutout can be made in

the antenna phasing equipment for mounting this panel. Both bridges are also available without the rack panel. A drill template is then supplied, permitting the station engineer to mount the bridge in the existing panel of the antenna phasor.

SPECIFICATIONS

FREQUENCY RANGE: 500-1650 kHz.

POWER RATING: CPB-1—5 kW—100% amp. mod. continuous. CPB-1A—50 kW—100% amp. mod. continuous.

RESISTANCE RANGE: 30-100 ohms.

REACTANCE RANGE: ± 50 ohms (1000 kHz).

ACCURACY: Resistance $\pm 2\%$ ± 1 ohm. Reactance $\pm 5\%$ ± 1 ohm. (Provision is made for your consultant to adjust the calibration to agree exactly with your licensed resistance value).

RF SOURCE: Your transmitter operating at normal or reduced power acts as source—no generator is required.

DETECTOR: Tuned internal detector with 25 μ a panel meter—no external detector is required.

AMMETER: Panel hole is provided for Weston Model 308, 3 $\frac{1}{2}$ " square ammeter. A meter recessing bracket is supplied for high power applications. A matching meter for your power and resistance can be supplied.

TERMINALS: Screw terminals or standoff insulators at rear of bridge box for connection to tubing, strap, or jumper to coax is provided.

MOUNTING: Standard 7" x 19" engraved gray rack panel—can be supplied without panel for mounting behind your phasor panel (drill template supplied).

DIMENSIONS: Bridge box without panel: Height: 7", Width: 9", Depth: 9 $\frac{1}{4}$ ". Panel dimensions: 7" x 19".

ORDERING INFORMATION

CPB-1 Common Point Impedance Bridge, 5 kW.....700-0055

CPB-1A Common Point Impedance Bridge, 50 kW.....700-0056

Wire—Audio And Ground System

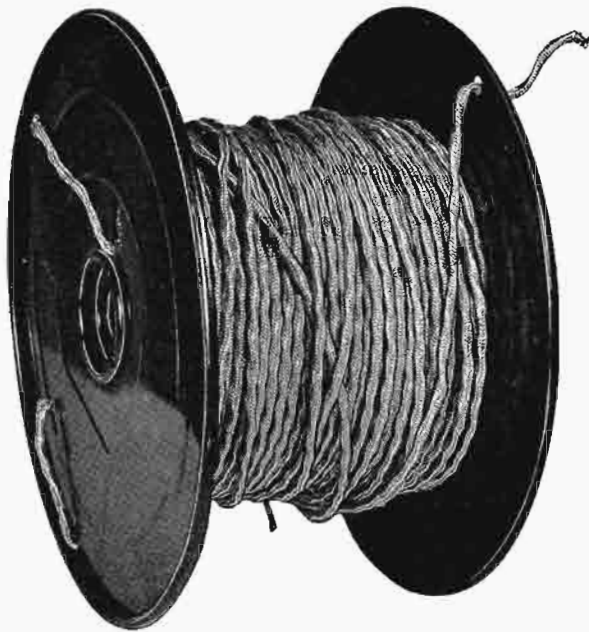

AUDIO

Gates Radio Company has a complete line of quality wire and cable to fill any broadcasting or communication need. Cable for every purpose—shielded, unshielded, multi-conductor, power, audio system and more. Contact Gates Quincy or Gates Houston service center for types that are not listed.

The following wire recommended for microphone and shielded power supply cable has high abrasion resistance and extra flexibility. It is especially suited for installations where cable must take tight bends or lie perfectly flat. The cable has tinned conductors with tinned copper-braided shield.

8410 Belden single conductor shielded, black rubber jacket.....	250-0059
8412 Belden (Gates MIC-100) 2 conductor stranded 20 AWG Braided shield cotton wrap heavy rubber jacket.....	250-0036
8428 Belden neoprene jacketed heavy duty mic cable. 2 conductor 18 AWG braided shield.....	253-0024
SH-2-20 2 conductor stranded 20 AWG, 2/push back braided shield not insulated.....	253-0018
1261 2 conductor stranded 24 AWG, braided shield, not insulated.....	253-0001

The following are 2 conductor, color-coded broadcast audio cables which come in standard and miniature size. Type 8437 has a braided, tinned copper shield; types 8450 and 8451 have spiral-wrap aluminum-Mylar shields. All types have tinned drain wires. Available in 100, 500 or 1000 foot spools. Average shipping weight per 100 feet, 2½ lbs. Type 8451 available in black vinyl or gray jacket.

8437 Belden 2 conductor 22 AWG solid, w/drain wire and braided shield, black vinyl jacket.....	253-0062
8450 Belden miniature audio cable 2 conductor, 22 AWG solid, drain wire, foil shield vinyl jacket.....	253-0054
8451 Belden miniature audio cable, 2 conductor 22 AWG stranded, drain wire, foil shield, vinyl jacket.....	253-0059
Cable 6 conductor, 3 pair, wire size 22 AWG.....	250-0081
Wire 18 AWG stranded, yellow.....	252-0247
High voltage wire 8 AWG 40 kV.....	255-0006

GROUND SYSTEM

#6 copper wire H. D. (12.5'/lb.).....	254-0019-000
#10 AWG soft drawn copper wire. 31.82 ft. per lb. 31.4 lbs. per 1000 ft.	254-0010-000
2" soft drawn copper strap .0216".....	003-4010-045
4" soft drawn copper strap .0216".....	003-4010-050
Expanded copper ground screen. 8' x 24' sheet.....	358-0455-000
6' ground rod 5/8".....	358-0454-000
8' ground rod 5/8".....	358-0452-000
1/2" plated copper strap for coil taps, etc.	003-4020-010

COAXIAL TRANSMISSION LINE HANGERS

	HANGERS NON-INSULATED	ADAPTORS		HANGERS INSULATED	ADAPTORS	
		Round Member	Angular		Round Member	Angular
7/8" H5-50 Coaxial Line	12395-1 Wraplock 1 can/300 ft.			11662-2	13550	13555
1 1/8" H7-50A Coaxial Line	33598-2 UNJAC 33598-1 JAC	31670-1 1-2 in. 31670-2 2-3 in. 31670-3 3-4 in. 31670-4 4-5 in. 31670-5 5-6 in.	31768	33948-3	13550	13555
3" H8-50A Coaxial Line	33598-4 UNJAC 33598-3 JAC	33948	33981	33948-2	13550	13555



Transmitting and Receiving Tubes



3CX2500F3



F-8550



4CX5000A



833-A

FAST-MOVING INVENTORY

Gates carries thousands of tubes in inventory—which, because of fast turnover, are always fresh. This is of vital importance, particularly for large transmitting tubes, where long shelf periods can make tubes gaseous. Listed below are a few of the popular tube types in stock—many others are also on hand. All tubes carry full warranty.

HOW TO ORDER

Tubes may be ordered from Quincy, Illinois or Houston, Texas. Shipment will be made as you direct—air freight, rail express, etc. Prices are no more at Gates—and you have the assurance of tube freshness. Please place your order by tube type and IBM number. Example: Type 3CV30000H3_____374-0108.

TRANSMITTING TUBES

Type	Number	Type	Number
3CV30000H3	374-0108	810	374-0031
3CX2500A3	374-0094	813	374-0034
3CX2500F3	374-0093	833A	374-0039
4-125A	374-0008	845	374-0040
4-250A	374-0009	866A	374-0042
4-400A	374-0010	872A	374-0043
4CX250B	374-0081	885	378-0008
4CX300A	374-0014	1612	370-0146
4CX1000A	374-0015	1622	370-0149
4CX3000A	374-0074	6076	374-0050
4CX5000A	374-0016	6146	374-0051
4CX10000D	374-0077	6360A	374-0054
4CX15000A	374-0097	6528	370-0160
4X250B	374-0019	7480	374-0107
575A	374-0026	8008	374-0058
673	374-0027	F-8550	374-0091
807	374-0030	WL5891	374-0067

RECEIVING TUBES

Type	Number	Type	Number
OA2	370-0144	6CA7	370-0066
OA3/VR75	370-0005	6CD6GA	370-0069
OD3/VR150	370-0008	6L6GC	370-0086
GZ34/5AR4	370-0133	6SH7	370-0093
5BP1A	378-0003	6SJ7	370-0094
5R4GY	374-0020	6SQ7	370-0098
5U4GB	370-0017	6V6GT	370-0102
5V4GA	370-0230	6X4	370-0105
5Y3GT	370-0020	6X5GT	370-0106
5749	370-0153	6080	370-0158
5879	370-0155	6386	370-0213
6AH6	370-0027	12A7	370-0112
6AL5	370-0030	12AU7A	370-0195
6AS7GA	370-0036	12AX7	370-0116
6BG6GA	370-0052	12AY7	370-0117
6C5	370-0065	12BY7A	370-0123

Semiconductor Directory

The following is a list of transistors, silicon diodes and Zener diodes, used in Gates manufactured products. When ordering please specify the type number of the item followed by the Gates part number.

Transistors	Gates Number	Transistors	Gates Number	Silicon Diodes	Gates Number
2N214	380-0011	40360	380-0097	1N541	384-0210
2N1183	380-0012	814-7550-001	380-0098	1N941	384-0211
2N1225	380-0013	2N3391A	380-0099	MDA920A-1	384-0212
2N1414	380-0014	TIS43	380-0101	MQ2	384-0214
2N553	380-0015	UC734	380-0103	1N1200	384-0215
2N1539	380-0016	40242	380-0105	1N54A	384-0216
2N1307	380-0018	2N4427	380-0106	814-6407-001	384-0219
2N1483	380-0019	2N4905	380-0107	814-6679-001	384-0222
2N696	380-0020	2N4906	380-0108	T1D40	384-0225
2N1183A	380-0022	2N3417	380-0111	67C100H20TTS	384-0235
2N2082	380-0025			MV1642	384-0238
2N1306	380-0033			S101	384-0239
2N2869	380-0034	Silicon Diodes	Gates Number	1N935	384-0241
2N3614	380-0035	1N54AS	384-0006	MDA920-2	384-0242
PT3134E	380-0039	1N2069	384-0018		
2N3054	380-0041	1N2070	384-0019	Zener Diodes	Gates Number
2N697	380-0042	1N2071	384-0020	1N2974	386-0016
2N3055	380-0043	1002A	384-0040	1N-725	386-0018
40319	380-0044	1N39B	384-0066	1N754	386-0019
2N4036	380-0045	DI44	384-0094	1N-2992B	386-0028
2N708	380-0046	67-7297	384-0098	1N-3027B	386-0030
2N3500	380-0047	1N3495	384-0111	1N747A	386-0032
2N3118	380-0048	1N3494	384-0116	1N3031B	386-0034
2N3053	380-0049	MR325R	384-0117	1N2767	386-0043
40317	380-0050	1N270	384-0128	1N821	386-0044
3N58	380-0051	TI71	384-0132	M2.4AZ	386-0045
40314	380-0053	MDA952-1	384-0133	6082	386-0046
2N2150	380-0054	1N914	384-0134	1N3582	386-0047
40321	380-0056	SG3209	384-0135	1N4746	386-0053
40322	380-0057	1N485	384-0143	1N4736	386-0057
2N3440	380-0058	7030A	384-0149	1N3024B	386-0058
U149	380-0060	18DB10A	384-0150	1N2813	386-0063
2N1724A	380-0061	814-2540-001	384-0151	1N4728	386-0066
40310	380-0062	67-6036	384-0154	1N3006B	386-0068
SE4010	380-0063	67-6037	384-0155	1.5R33A	386-0069
2N3766	380-0065	67-6035	384-0156	1.5R45A	386-0072
2N3740	380-0066	67-6099	384-0159	6046	386-0073
2N3819	380-0067	2N3528	384-0164	VR12A	386-0074
37913	380-0068	1N4720	384-0165	1.5R43B	386-0075
DTG2400	380-0069	1N643	384-0166	1N4749A	386-0077
PT2121D	380-0070	814-3336-001	384-0169	1N4734A	386-0078
2N706A	380-0071	1N1200A	384-0178	VR33A	386-0079
2N918	380-0073	1N60	384-0183	1N754	386-0080
2N708	380-0077	67-7747	384-0184	1N4729A	386-0081
2N709	380-0078	67-7800	384-0185	1N3331A	386-0089
2N2369	380-0083	MR327R	384-0194	1N4756A	386-0090
2N4391	380-0086	1N914	384-0195	1N4738	386-0091
2N3702	380-0087	1N3754	384-0197	1N4747A	386-0100
2N3704	380-0088	BR82C	384-0198	VR20	386-0109
TI409	380-0089	67-6136	384-0199	MZ1000-24	386-0111
2N4250	380-0091	384-0018	384-0201	1N4733	386-0112
TN323	380-0092	1N456A	384-0204	VR8.5A	386-0114
2N4360	380-0094	1N914	384-0205	1N2835A	386-0115
S59	380-0095	1N277	384-0208		
2N3903	380-0096				

Emergency Generators

Your radio station cannot afford a power blackout. The public has been trained to rely on their radio during an emergency. An emergency generator is essential for all operations, including transmission, wire services, lighting, heating, or air conditioning.

Gates offers the entire line of Kohler electric plants ranging from 750 watts through 230 kW for emergency power systems.

1500 AND 3000 WATT GENERATORS

Compact, lightweight, portable models, ideal for station stand-by or field use with mobile vans for powering public address systems, floodlights or small transmitters. Both models powered by Kohler cast iron, 4 cycle air-cooled engines. Portable units complete with fuel tank, carrying handle, 4 load receptacles and recoil starters. Remote start models available for stationary mounting. Single phase only.



5000, 6500, AND 7500 WATT GENERATORS

Air or liquid-cooled models in sizes large enough to handle a 1 kW transmitter and some lighting. Kohler's 2 cylinder air-cooled engine used with 5000 and 7500 watt models; 6500 watt unit has quiet, dependable Kohler 4 cylinder liquid-cooled engine. All models include plant mounted control panel with overcranking protection, load connections and automatic battery charging feature.

STAND-BY APPLICATIONS: To make the stand-by system completely automatic, remote control starting should be specified with the Kohler electric plant and an automatic transfer switch included in the system. With automatic transfer, the electric plant will start unattended, providing power for night lighting and heat. Manual transfer models available also if the station is attended at all times.

Sizing of the emergency generator set is important—provisions should be made to handle the entire station load in the event the power failure is sustained.

Gasoline and Diesel engine driven models are offered. Any gasoline model can be modified to operate on LP or natural gas. Fuel availability and storage should also be taken into consideration when selecting an electric plant.



10,000, 12,500, AND 15,000 WATT GENERATORS

Again offered with air or liquid-cooled gasoline or Diesel engines. Protection for larger stations. Revolving armature models 120 or 120/240 volt, single phase, 240 or 120/208 volt, 3 phase voltages. Kohler exciter cranking provides fast, sure starts with sustained cranking ability.

Emergency Generators

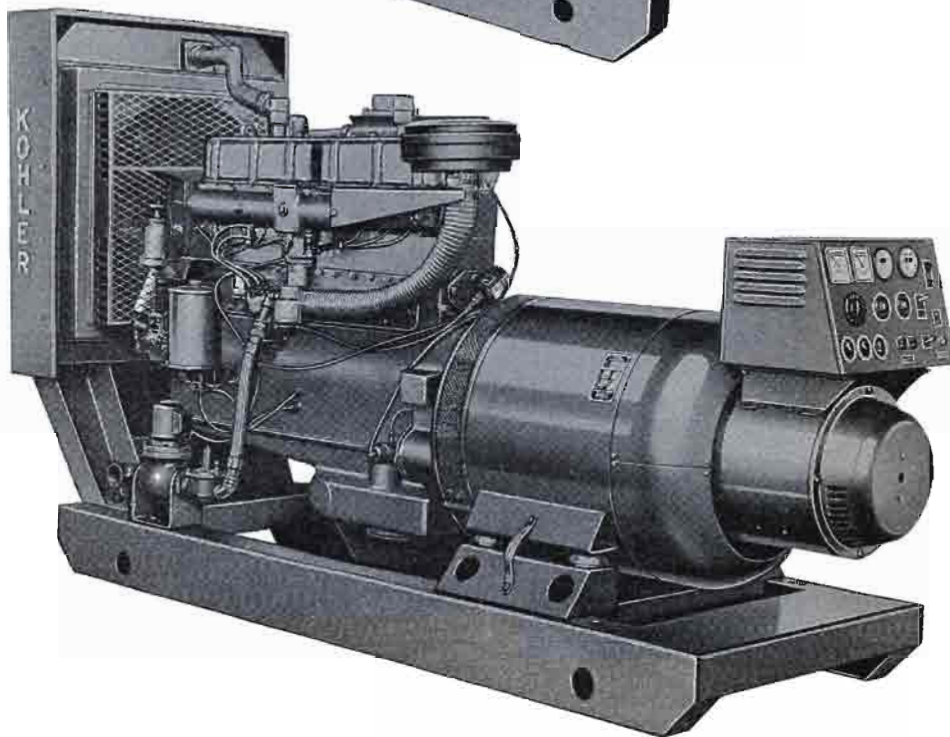
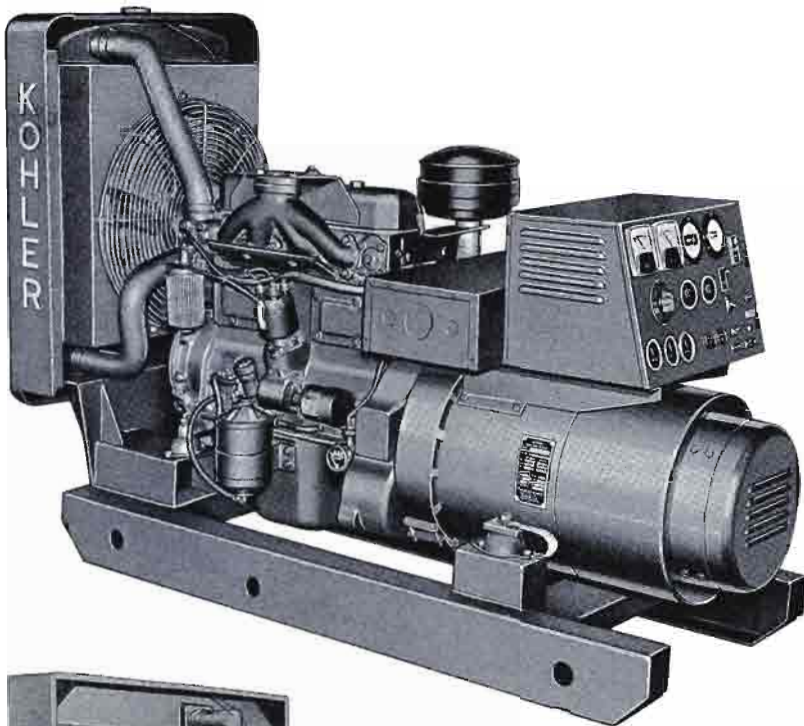

Kohler electric plants are backed by a one-year warranty and a network of distributors and dealers—factory and field-trained specialists in the selection of a proper electric plant for the application and planning of the installation. These specialists are ready to service units on the spot should service ever be necessary. Kohler engineers are well aware of today's rigid requirements for engine generator applications and the design of their products reflects this awareness.

LARGER SIZE GENERATORS

Gasoline and Diesel models available in sizes of 30, 45, 55, 65, 85, 110 kW and larger for all types of stand-by applications.

All models operate at 1800 RPM and feature revolving field generators to produce any standard voltage. Voltage regulation $\pm 2\%$, frequency within 3 Hz. Units skid-mounted for permanent alignment and installation ease.

Heavy-duty industrial engines rated for continuous operation have safety devices to protect them from low oil pressure or high water temperature.

ACCESSORIES

1. Fuel tanks for gasoline or Diesel fuel storage
2. Batteries
3. Battery charger
4. Cold weather starting aid
5. Metal housings for outdoor applications

FCC AND FAA SPECIFICATIONS

This chart illustrates the requirements for the standard lighting of antenna towers and supporting structures in accordance with "Indicated paragraphs of FCC Form 715 and FCC Rules Part 17", and "FAA Standards for Marking and Lighting Obstructions to Air Navigation, Sept. 1962".

Aeronautical study by the FCC and FAA may determine that other than standard lighting is required for a specific tower installation. The FCC Construction Permit will specify the required lighting for each installation and should be carefully checked for this information.

Antenna structures over 1500 feet up to and including 2100 feet in height above the ground shall be lighted in accordance with FCC Sections 17.34 through 17.37.

OVERALL HEIGHT 1351 TO 1500 FT. FCC ¶ No's. 3.10, 19.21, FAA SPEC. "A-10"
Standard lighting requires 5 Beacons, 15 Obstruction Lights (30 for square tower), and Beacon Flasher. Photo-Electric Control is required.

OVERALL HEIGHT 1201 TO 1350 FT. FCC ¶ No's. 3.9, 18.21, FAA SPEC. "A-9"
Standard lighting requires 4 Beacons, 12 Obstruction Lights (20 for square tower), and Beacon Flasher. Photo-Electric Control is required.

OVERALL HEIGHT 1051 TO 1200 FT. FCC ¶ No's. 3.8, 17.21, FAA SPEC. "A-8"
Standard lighting requires 3 Beacons, 9 Obstruction Lights (12 for square tower), and Beacon Flasher. Photo-Electric Control is required.

OVERALL HEIGHT 901 TO 1050 FT. FCC ¶ No's. 3.7, 16.21, FAA SPEC. "A-7"
Standard lighting requires 3 Beacons, 12 Obstruction Lights (9 for square tower), and Beacon Flasher. Photo-Electric Control is required.

OVERALL HEIGHT 751 TO 900 FT. FCC ¶ No's. 3.6, 15.21, FAA SPEC. "A-6"
Standard lighting requires 3 Beacons, 9 Obstruction Lights (12 for square tower), and Beacon Flasher. Photo-Electric Control is required.

OVERALL HEIGHT 601 TO 750 FT. FCC ¶ No's. 3.5, 14.21, FAA SPEC. "A-5"
Standard lighting requires 2 Beacons, 9 Obstruction Lights (12 for square tower), and Beacon Flasher. Photo-Electric Control is required.

OVERALL HEIGHT 451 TO 600 FT. FCC ¶ No's. 3.4, 13.21, FAA SPEC. "A-4"
Standard lighting requires 2 Beacons, 6 Obstruction Lights (8 for square tower), and Beacon Flasher. Photo-Electric Control is required.

OVERALL HEIGHT 301 TO 450 FT. FCC ¶ No's. 3.3, 12.21, FAA SPEC. "A-3"
Standard lighting requires 1 Beacon, 4 Obstruction Lights, and Beacon Flasher. Photo-Electric Control is required.

OVERALL HEIGHT 151 TO 300 FT. FCC ¶ No's. 3.1, 11.21, FAA SPEC. "A-2"
Standard lighting requires 1 Beacon, 2 Obstruction Lights, and Beacon Flasher. Photo-Electric Control is required.

Overall Height 21 to 150 Ft. FAA Spec. "A-1"
Standard lighting requires 1 Double Obstruction Light.

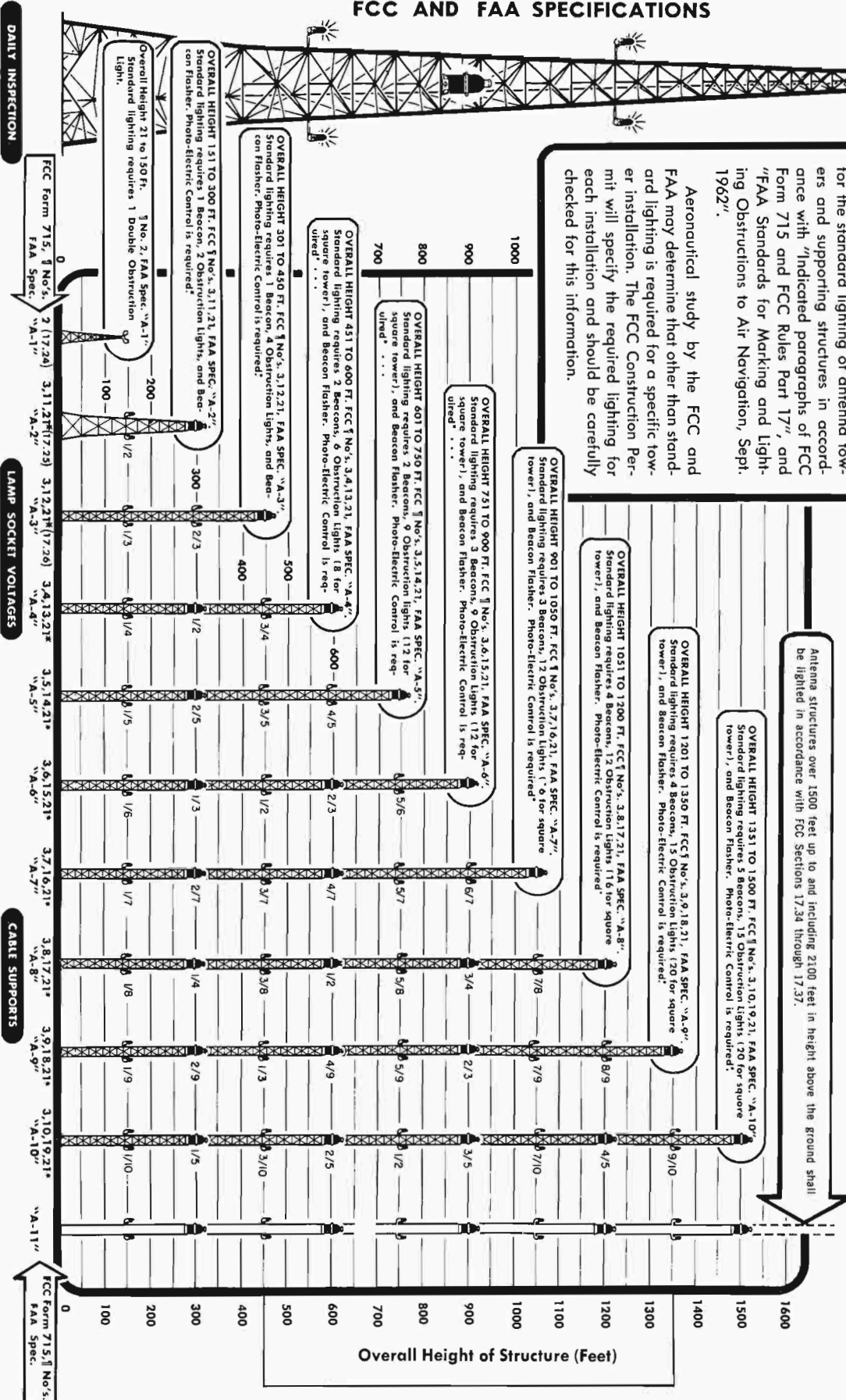

DAILY INSPECTION

FCC § 17.47 requires that the licensee . . . (1) shall make an observation of the tower lights at least once each 24 hours, either visually or by observing an automatic . . . indicator or alternatively (2) shall provide an automatic alarm system.

● FCC Form 715 Paragraph 21 states "All lights shall burn continuously or shall be controlled by a light sensitive device . . ."

LAMP SOCKET VOLTAGES

FCC § 17.54 and FAA "Standards for Marking and Lighting Obstructions to Air Navigation, Sept. 1962" specify that the lamp socket voltage correspond to or be within 3% of the rated voltage of the lamp used.

CABLE SUPPORTS

The National Electric Code specifies that conductors in vertical runs shall not be supported by terminals . . . and that cable supports shall be provided in each vertical run, and at intervals not greater than 100 ft.

Transmission Line Pressurization Systems

All air dielectric cable and rigid line should be pressurized with dry air or dry gas. Changes in temperature can cause moisture condensation from outside air and seriously impair the electrical efficiency of the line. For this reason, cable or rigid line should be under pressure at all times.

Pressurization can be accomplished by manual or automatic means, depending upon the amount of line in use at the station and whether or not the site is attended. Automatic electric dehydrators are recommended for unattended sites or those where larger amounts of cable or rigid line are employed. A dry air hand pump is usually satisfactory for attended sites using a relatively small amount of cable. A cylinder of dry nitrogen gas can also be used. All installations of air dielectric cable, line or microwave waveguide should be purged prior to putting the system in service and at any

time moist air enters the line. To purge the system, pressurize at the equipment end of the line (5-10 psig) with the Type 1920A automatic dehydrator, nitrogen gas cylinder, or Type 878 hand pump. Bleed the line using the gas port plug located at the antenna end of the line and allow the pressure to drop to zero.

Repeat this procedure three times to ensure that the moist air is replaced by dry air or dry gas.

When it is too difficult or inconvenient to bleed the air at the antenna end of the line, let the air escape at the transmitter or dehydrator end after pressurizing the line three times, allowing an hour each time for the air to mix.

Type 1920A dehydrator will automatically maintain from 3 to 8 psi while gas cylinder output pressure should be set between 2 and 10 psig.

Automatic Dehydrator System

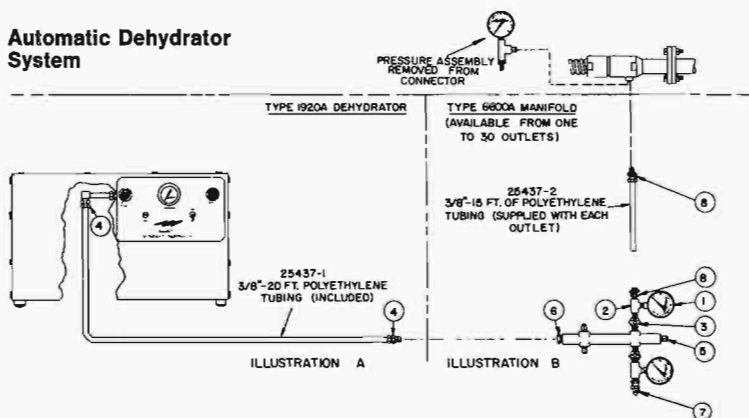

AUTOMATIC DEHYDRATOR SYSTEM

- 1) 3500 pressure gauge
- 2) 3028 tee (brass) 1/8 F.P.T. on all three
- 3) 4944 needle valve (40 P.S.I.) 1/8 male to 1/8 male
- 4) 25436-5 male fitting (brass) 3/8 tube to 1/8 M.P.T.
- 5) 9908-2 plug (brass) 1/4 M.P.T. Sq. Hd.
- 6) 4960 bushing (brass) 1/8 F.P.T. to 1/4 M.P.T.
- 7) 25436-1 cap (polyethylene) 3/8 O.D.
- 8) 25436-2 half union (brass) 3/8 tube to 1/8 M.P.T.

NOTE: For reference only. Parts listed are included with Types 1920A and 6600A.

Compressed Gas System

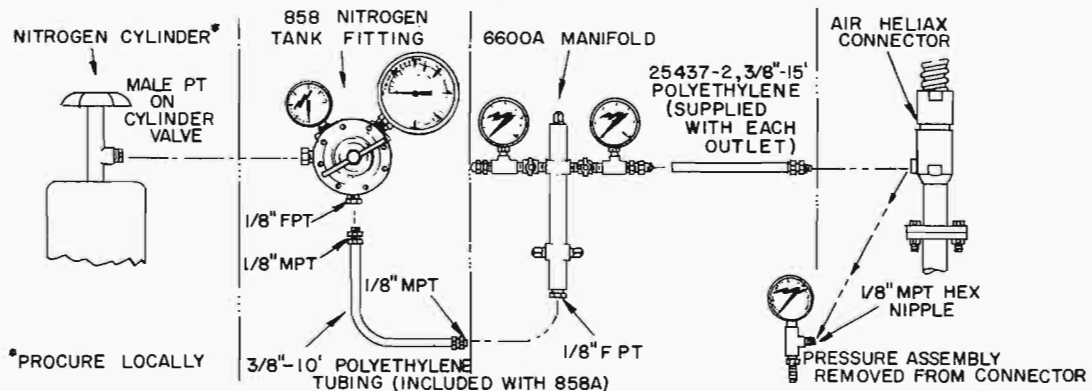

Manual System

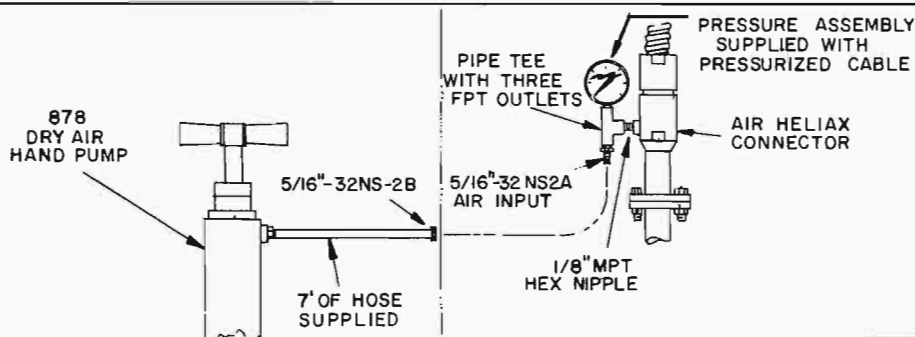

Reference Information

FIXED ATTENUATOR DATA

The data shown below provides information to construct H pads, commonly used in audio applications. Usually 1/2 watt resistors are sufficient. 5% resistors are recommended. For T pads, double the values of R1 and R2 and delete R4 and R5.

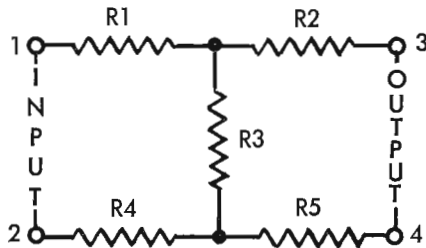

dB LOSS	R1, R4 OHMS	R2, R5 OHMS	R3 OHMS
---------	-------------	-------------	---------

600 OHMS INPUT/600 OHMS OUTPUT

1	18	18	2700
2	36	36	1300
3	51	51	820
4	68	68	620
5	82	82	470
6	100	100	390
7	110	110	330
8	130	130	240
9	150	150	220
10	160	160	200
12	180	180	150
15	220	220	110
20	240	240	62
25	270	270	33
30	270	270	18
35	300	300	10
40	300	300	5.6

600 OHMS INPUT/150 OHMS OUTPUT

12	270	±3.3	82
15	270	24	56
20	270	47	30
25	270	56	18
30	300	62	10
35	300	68	±4.7
40	300	75	±3.3

150 OHMS INPUT/150 OHMS OUTPUT

1	3.9	3.9	620
2	10	10	330
3	13	13	220
4	18	18	160
5	20	20	120
6	24	24	100
7	30	30	82
8	33	33	62
9	36	36	56
10	39	39	47
12	47	47	39
15	51	51	27
20	62	62	15
25	68	68	8.2
30	68	68	4.7
35	75	75	2.7
40	75	75	1.5

150 OHMS INPUT/50 OHMS OUTPUT

10	62	0	30
12	62	4.7	24
15	62	10	15
20	68	18	8.2
25	68	20	4.7
30	68	22	3.3
35	75	24	1.5
40	75	24	1.0

FM FREQUENCIES BY CHANNEL NUMBER

For convenience, the frequencies available for FM broadcasting (including those assigned to noncommercial educational broadcasting) are given numerical designations which are shown in the table below:

Channel No.	Frequency (MHz)	Channel No.	Frequency (MHz)
-------------	-----------------	-------------	-----------------

EDUCATIONAL CHANNELS

201	88.1	211	90.1
202	88.3	212	90.3
203	88.5	213	90.5
204	88.7	214	90.7
205	88.9	215	90.9
206	89.1	216	91.1
207	89.3	217	91.3
208	89.5	218	91.5
209	89.7	219	91.7
210	89.9	220	91.9

COMMERCIAL CHANNELS

221	92.1	261	100.1
222	92.3	262	100.3
223	92.5	263	100.5
224	92.7	264	100.7
225	92.9	265	100.9
226	93.1	266	101.1
227	93.3	267	101.3
228	93.5	268	101.5
229	93.7	269	101.7
230	93.9	270	101.9
231	94.1	271	102.1
232	94.3	272	102.3
233	94.5	273	102.5
234	94.7	274	102.7
235	94.9	275	102.9
236	95.1	276	103.1
237	95.3	277	103.3
238	95.5	278	103.5
239	95.7	279	103.7
240	95.9	280	103.9
241	96.1	281	104.1
242	96.3	282	104.3
243	96.5	283	104.5
244	96.7	284	104.7
245	96.9	285	104.9
246	97.1	286	105.1
247	97.3	287	105.3
248	97.5	288	105.5
249	97.7	289	105.7
250	97.9	290	105.9
251	98.1	291	106.1
252	98.3	292	106.3
253	98.5	293	106.5
254	98.7	294	106.7
255	98.9	295	106.9
256	99.1	296	107.1
257	99.3	297	107.3
258	99.5	298	107.5
259	99.7	299	107.7
260	99.9	300	107.9

NOTE: The frequency 108.0 MHz is assigned to aircraft navigation service subject to the condition that there will be no interference with the reception of FM broadcast stations, present or future.

Reference Information

FREQUENCY VERSUS TOWER HEIGHT

For medium wave broadcast frequencies, the most used one-quarter wave tower height is shown as related to the operating frequency. For $\frac{3}{8}$ wave length, multiply height shown by $1\frac{1}{2}$ and for $\frac{1}{2}$ wave length, multiply height shown by 2. For insulated towers the height is usually considered above base insulators.

Frequency in Kilohertz	Tower Height in Feet	Frequency in Kilohertz	Tower Height in Feet
550	446.8	1080	227.7
560	439.5	1090	225.6
570	431.3	1100	223.6
580	423.9	1110	221.6
590	417.3	1120	219.7
600	410.0	1130	217.7
610	403.1	1140	215.6
620	396.8	1150	213.9
630	390.3	1160	211.9
640	386.5	1170	210.2
650	378.8	1180	208.6
660	373.1	1190	206.7
670	367.3	1200	205.0
680	361.1	1210	203.2
690	356.2	1220	201.5
700	351.2	1230	199.7
710	346.8	1240	198.4
720	341.9	1250	196.8
730	337.0	1260	195.2
740	332.1	1270	193.6
750	328.0	1280	192.2
760	323.4	1290	190.7
770	319.8	1300	189.2
780	315.7	1310	187.7
790	311.6	1320	186.5
800	307.5	1330	184.9
810	303.4	1340	183.6
820	300.1	1350	182.2
830	296.0	1360	180.5
840	292.7	1370	179.5
850	289.4	1380	178.1
860	286.1	1390	176.5
870	282.9	1400	175.6
880	279.6	1410	174.2
890	276.3	1420	173.4
900	273.0	1430	172.0
910	270.6	1440	170.9
920	267.3	1450	169.6
930	264.8	1460	168.5
940	261.5	1470	167.3
950	259.1	1480	166.5
960	256.6	1490	165.0
970	253.3	1500	164.0
980	250.9	1510	162.9
990	248.4	1520	161.7
1000	246.0	1540	159.9
1010	243.7	1550	158.6
1020	241.1	1560	157.8
1030	238.8	1570	156.7
1040	236.5	1580	155.8
1050	234.2	1590	154.7
1060	232.0	1600	153.7
1070	229.9		

COMMONLY USED FORMULAS

Resistance

$$\text{In series: } R_T = R_1 + R_2 + R_3$$

$$\text{In parallel: } R_t = \frac{1}{\frac{1}{R_1} + \frac{1}{R_2} + \frac{1}{R_3}}$$

$$\text{Two in parallel: } R_t = \frac{R_1 R_2}{R_1 + R_2}$$

Inductance

$$\text{In series: } L_t = L_1 + L_2 + L_3$$

$$\text{In parallel: } L_t = \frac{1}{\frac{1}{L_1} + \frac{1}{L_2} + \frac{1}{L_3}}$$

$$\text{Two in parallel: } L_t = \frac{L_1 L_2}{L_1 + L_2}$$

Capacitance

$$\text{In series: } C_t = \frac{1}{\frac{1}{C_1} + \frac{1}{C_2} + \frac{1}{C_3}}$$

$$\text{In parallel: } C_t = C_1 + C_2 + C_3$$

$$\text{Two in series: } C_t = \frac{C_1 C_2}{C_1 + C_2}$$

Reactance

$$\text{Inductive reactance: } X_L = 2\pi fL$$

$$\text{Inductive capacitance: } X_C = \frac{1}{2\pi fC}$$

f = frequency in Hz

L = inductance in Henries

c = capacitance in Farads

Resonance

$$f_r = \frac{1}{2\pi \sqrt{LC}}$$

resonance occurs where —

$$X_L = X_C$$

in addition —

$$L = \frac{1}{\pi^2 f_r^2 C}$$

$$C = \frac{1}{4\pi^2 f_r^2 L}$$

f_r = resonant frequency in Hz

L = inductance in Henries

C = capacitance in Farads

$$2\pi = 6.28$$

$$4\pi^2 = 39.5$$

FREQUENCY/WAVELENGTH

$$f = \frac{3 \times 10^5}{\lambda} \text{ (kHz)}$$

λ expressed in meters

$$f = \frac{3 \times 10^4}{\lambda} \text{ (MHz)}$$

λ expressed in centimeters

$$\lambda = \frac{3 \times 10^5}{f} \text{ (meters)}$$

f expressed in kHz

$$\lambda = \frac{3 \times 10^4}{f} \text{ (centimeters)}$$

f expressed in MHz

INDEX

Item	Page	Item	Page
AM Antenna Accessories	25	Broadcast Modulation Monitors	26, 27, 58 thru 60
AM Broadcast Accessories	29	Broadcast Systems, Transportable	176, 212, 213
AM Frequency Monitor	28	Bowls, Feed-Thru	70
AM Modulation Monitor	26, 27	Broadcast Transmitters—AM, FM, TV	4 thru 21 34 thru 50, 74, 76 thru 81
AM Transmitters	4 thru 21	Cabinets, Console	172 thru 175
Air Dielectric Coaxial Cable	66	Cabinets, Compact Disc for LP Albums	153
Ambassador Audio Console	109, 110	Cabinets, Rack	143
Ampex Tape Recording Equipment	178 thru 180	Cabinets, Tape	153
Amplifiers, Audio Plug-In	144 thru 148	Cabinets, Transcription	153, 169, 172 thru 175
Amplifier, Cueing	151	Cable, Audio	226
Amplifiers, High Frequency Linear	198, 199, 206, 207	Cable, Coaxial	66
Amplifiers, Limiting	136, 137, 139	Capacitors, Mica	73
Amplifiers, Monitor	148 thru 150	Cartridge, Recorder/Reproducer Equipment	126 130 thru 135
Amplifier, Program or Line	149	Cartridges, Pickup	170
Amplifiers, Remote Broadcast	160 thru 165, 176	Cartridges, Tape	133
Amplifier, RF FM	61	Chokes, Tower	25
Amplifiers, Transistorized—System Type	144 thru 148	Coaxial Cable and Accessories	66 thru 69, 227
Amplifier, Utility (single channel)	150	Coils, Silver Plated RF	73
Antenna Couplers	24, 210	Coils, Isolation	24
Antenna Diode Units for Remote Control	65	Communications Equipment	186 thru 211
Antenna Meter, Remote	24	Connectors, Audio	153
Antenna Phasing Equipment	22, 23	Conrac TV Monitors	84, 85
Antenna Towers, AM, FM, TV	71	Consoles, Audio Control	88 thru 119
Antenna Tower Accessories	72	Console, Portable Audio	176
Antenna Tuning Equipment	24, 25, 209, 210	Consoles, Speech Input	88 thru 119
Antennas, Cycloid	54	Consoles, Transmitter Control	214
Antennas, Dual-Cycloid	52, 53	Console Desks	172 thru 175
Antennas, Dummy	30	Control, Remote	63 thru 65
Antennas, FM Circular	52, 53	Couplers, Antenna	24, 210
Antennas, FM Directional	57	Courier, 2-Channel Remote Amplifier	163
Antennas, FM Horizontal	50, 54	Criterion Tape Cartridge Equipment	130 thru 132
Antennas, FM Vertical	55	Cueing Amplifier	151
Antennas, High Frequency	208, 209	Cue-Intercom Speaker	152
Antennas, Television	82, 83	Cycloid Antenna	54
Arms, Pickup	170	Desks, for Audio Control Consoles	172 thru 175
Attache, 3-Channel Remote Amplifier	162	Demagnetizer, Tape Head	154
Audio Accessories	151 thru 159	Diode and Pickup Coil	24, 65
Audio Amplifiers, System Type	144 thru 148	Diplomat Audio Control Console	104 thru 106
Audio Consoles	88 thru 119	Directional Antenna, FM	57
Audio Installations	86, 87	Directional Antenna Phasing Equipment	22, 23
Audio Oscillator	177	Distortion Meter	177
Audio Terminal Blocks	153	Dual-Cycloid FM Antenna	52, 53
Automatic Gain Control Amplifiers, Audio	140 thru 142	Dual Limiter, Audio	139
Automatic Transmitter Logger	222, 223	Dualux II Audio Control Console	92 thru 94
Automation, Program Systems	120 thru 127	Dummy Antennas	30
Average Level Amplifier (Level Devil)	140, 141	Dynamote 70, 4-Channel Remote Amplifier	160, 161
Baffles and Speakers	155, 156	Engine Generators, Emergency Power	230, 231
Baluns, High Frequency Transformers	209	Equalizers, Audio	153
Base Station, Remote Pickup	216, 217		
Base, Turntable	172 thru 175		
Beacon Flasher	72		
Boom Stands	154		

INDEX

Item	Page	Item	Page
Equalized Preamplifiers	171	Inductors	73
Equalizers, Line	153	Installations, Audio	86, 87
Equalizers, Transcription Turntable	171	Installations, Transmitter	31, 62, 185
Eraser, Bulk-Type Tape	154	Intercom, Studio Sub-Station	152
Exciters, SSB	197, 203	Isolation Coil	24
Exciters, RF	32, 33, 197, 203	Isolation Transformers, FM	56
Executive Audio Control Console	101 thru 103		
		Jack Strips and Accessories	152
FM Antenna Towers	71		
FM Antennas	52 thru 57	KD-20A Portable Console	176
FM Exciter, DCFM	32, 33		
FM Frequency Comparator, Pilot-SCA	61	Level Devil Amplifier	140, 141
FM Frequency Monitor	61	Lights, Studio Warning	151
FM Isolation Transformers	56	Lights, Tower Accessories, etc.	72
FM Link and Relay System	51, 218 thru 221	Limiting Amplifiers	136, 137, 139
FM Monitors	58 thru 61	Linear Amplifiers, High Frequency	198, 199, 206, 207
FM RF Amplifier	61	Load, Dummy Antenna	30
FM Relay Receiver	51	Log Periodic Antenna	208
FM SCA Generator	33	Logging, Automatic Transmitter	222, 223
FM Stereo Generator	33	Loudspeakers & Enclosures	155, 156
FM Top Level	138	Low Frequency Homing Beacon Transmitter	211
FM Transmitters	34 thru 50		
Fader Knobs	152	Magnecord Recorder/Reproducers	182
Feed-Thru Bowls	70	Meter, Field Intensity	29
Fixed Equalizer	153	Meter, RF	24
Field Intensity Meter	29	Meter, Remote Antenna	24
Flexible Coaxial Cable	66	Meter, VU, Desk or Console Top Mounting	152
Foam Dielectric Coaxial Cable	66	Meter, VU and Range Panel	151
Frequency Comparator, FM Pilot-SCA	61	Meter Shorting Switch	25
Frequency Monitor, FM	61	Mica Capacitors	73
Frequency Monitor, AM Model M4990	28	Microphone Accessories	153, 154
Frequency Monitor Extension Meters	65	Microphones	157 thru 159
Frequency Monitor, FM	61	Modular Audio Equipment Cabinets	172 thru 175
Furniture, Control Room	172 thru 175	Modulation Monitor, AM	26, 27
		Modulation Monitors, FM	58 thru 60
Gain and Measuring Set	177	Modulation Monitor, HF	196
GateSound Tapes	128, 129	Monitor Amplifiers	148 thru 150
Gatesway Audio Control Console	114, 115	Monitor, Frequency, AM	28
Gatesway II Audio Control Console	95 thru 97	Monitor, Frequency, FM	61
Generating Plants, Emergency Power	230, 231	Monitor, Modulation, AM	26, 27
Generator, Stereo	33	Monitors, Modulation, FM	58 thru 60
Generator, Sub-Carrier	33	Monitor, Modulation, HF	196
		Monitor, Phase	29
HF Antennas	208	Monitors, Television	84, 85
HF Antenna System	209	Multicouplers, High Power HF Transmitter	210
HF Transmitters, Broadcast	186 thru 195	Multiplex Generator, SCA	33
HF Transmitters, Communications	198 thru 207	Music Tapes, Pre-recorded	128, 129
HF Transmitter Multicouplers	210		
Headphones	154	Open Wire Transmission Line	70
Heliac Coaxial Cable	66	Ordering Procedures	240
High Frequency Linear Amplifiers	198, 199, 206, 207	Oscillator, Audio	177
High Frequency Matching Transformers	209		
Homing Beacon Transmitter	211		

INDEX

Item	Page	Item	Page
Panel and Shelf Assemblies	148	Solid Statesman Peak Limiting Amplifier	136, 137
Patch Panels and Patch Cords	152	Speech Input Systems	88 thru 119
Peak Limiting Amplifier	136, 137	Speakers and Baffles	155, 156
Phasing Equipment	22, 23	Speaker Matching Transformer	152
Phase Monitor	29	Splicers, Tape	154
Pickup Arms	170	Sta-Level Amplifier	142
Pickup Cartridges	170	Stands, Microphone	154
Portable Tape Recorders	178 thru 183	Stereo Audio Limiting Amplifiers	136, 137, 139
Portable Turntable/Audio Console	176	Stereo Generator	33
Power Supply, Plug-In Audio Amplifiers	145, 148	Stereo Modulation Monitor	58
Preamplifiers, Turntable	171	Stereo Statesman Audio Control Console	98 thru 100
President Audio Control Console	107, 108	STL Systems, FM	51, 218 thru 221
Pressurization Equipment	69, 233	Studio Cue/Intercom Speaker	152
Producer, Audio Recording Mixer	118, 119	Studioette Audio Control Console	116, 117
Program Amplifiers, Rack Mount	144 thru 150	Studio Warning Lights	151
Program Automation Systems	120 thru 127	Sub-Carrier Generator	33
Program Logging, Automatic	127	Switch and Fuse Panel	151
Program Tapes, Pre-recorded	128, 129	Switch, Meter Shorting	25
Programmers, Automation System	123, 124		
Proof of Performance Equipment	177	Tape, Magnetic Recording	183
		Tape Cartridge Equipment	126, 130 thru 135
RF Amplifier, FM	61	Tape Cartridges and Accessories	133, 134
RF Contactor	25	Tape Eraser, Bulk-Type	154
RF Meter	24	Tape Head Demagnetizer	154
RF Meter Jack	25	Tape Recorders	178 thru 183
Rack Cabinets	143	Tape Splicer	154
Random Access Programmers	125	Television Antennas	82, 83
Recorders, Audio	130 thru 132	Television Audio Control Console	88 thru 91
	178 thru 183	Television Monitors	84, 85
Recorders, Audio Cartridge	130 thru 132	Television Transmitters	76 thru 81
Recorders, Reel-To-Reel	178 thru 183	Terminal Blocks, Audio	153
Reference Information	234, 235	Test Equipment, Audio	177
Relay System, FM	51, 218 thru 221	Tone Arms	170
Remote Amplifiers, Audio	160 thru 165, 176	Tower Chokes	25
Remote Antenna Meter	24, 65	Tower Lighting	232
Remote Control Accessories	65	Tower Lights and Accessories	72
Remote Control Systems	63 thru 65, 202	Towers, Antenna, AM, FM, TV	71
Remote Monitoring Meters	65	Top Level	138
Remote Pickup Equipment	51, 216, 217	Transcription Turntables, Amplifiers and Accessories	166 thru 171
Rhombic Antenna, HF Antennas	208	Transcription Tone Arms and Pickups	170
Rigid Transmission Line	66	Transfer Switch, RF	69
Ring Transformer	25	Transformers, FM Isolation	56
		Transformers, High Frequency (Baluns)	209
Sampling Loops	25	Transformers, Ring	25
SCA Modulation Monitor	60	Transformer, Speaker Matching	152
SCA Multiplex Generator	33	Transistors	229
SCA Multiplex Monitor	60	Transmission Line, Coaxial	66
Scully Tape Recording Equipment	181	Transmission Line, Open Wire	70
Semiconductor Directory	229	Transmitters (Broadcast/AM)	
Sideband Generator	197, 203	100,000 Watt Model VP-100 Transmitter	4 thru 6
Single Sideband Generator, SG-70	203	50,000 Watt Model VP-50 Transmitter	7 thru 9
Single Sideband Generator, SG-75A/B	197	20,000 Watt Model BC-20H Transmitter	74
Single Sideband Transmitters	200, 201, 204, 205		

How To Order

ORDERING PROCEDURE: All sales are made in accordance with the standard Gates Terms and Conditions of Sale. No order shall be binding upon Gates until accepted by the company in writing at its home office in Quincy, Illinois.

PRICES: Catalog prices are net, f.o.b. Quincy, Illinois, or point of shipment. Our prices are based on cash transactions and all applicable discounts have been deducted. Prices are subject to change without notice. Orders are filled at prices in effect at time of shipment. You will be billed for any price increase and credited for any price reduction. We reserve the right to add any federal, state, or local taxes required by law. If you have a tax exemption number, please include it with your order. These prices and terms apply only to the U.S. For prices and terms in other countries, please contact Export Department, Gates Radio Company.

PAYMENT: There are four ways to pay for your equipment purchases:

- (1) CASH—This means full payment with order.
- (2) C.O.D.—A 25% down payment is required on C.O.D. orders.
- (3) OPEN ACCOUNT—A 25% down payment is recommended. The balance is payable within 30 days of invoice date. If you do not have an established account, please provide a current financial statement, plus trade and bank references with your order. Allow at least two weeks for processing.
- (4) GATES FINANCE PLAN—On major purchases, by domestic customers, a portion of the cost may be financed through a monthly payment plan. Since Gates financing plans are subject to change from time to time, contact our Credit Manager or your nearest Gates District Manager for full information. The Gates finance plan applies only to the United States.

RETURNS AND EXCHANGES: Do not return any merchandise without our written approval and Return Authorization. We will provide special shipping instructions and a code number that will assure proper handling and prompt issuance of credit. Please furnish complete details as to circumstances and reasons when requesting return of merchandise. Custom built equipment or merchandise specially ordered for you is not returnable. Where return is at the request of, or for the convenience of the customer, a restocking fee of 15% will be charged. All returned merchandise must be sent freight prepaid and properly insured by the customer. When writing to Gates Radio Company about your order, it will be helpful if you specify the Gates factory order number or invoice number.

SHIPPING: Please specify method of shipment on your order. Shipping charges, insurance, and C.O.D. fees (when applicable) will be collected at time of delivery when shipment is made by air, rail or motor freight, or express. If you request parcel post shipment, postage and insurance fees will be billed to your account. Purchaser assumes all responsibility for and risk of loss of, or damage to equipment upon shipment from Gates shipping point(s). Should you receive merchandise damaged in shipment, it is your responsibility to file a damage claim immediately with the delivering carrier. Export packing for overseas shipment is available at slight extra charge.

WARRANTY ADJUSTMENTS: In the event of equipment failure during the warranty period, replacement or repair parts may be provided in accordance with the provisions of the Gates Warranty. In most cases you will be required to return the defective merchandise or part to Gates f.o.b. Quincy, Illinois, for replacement or repair. Repairs, within the warranty period, will be done on a no charge basis. Warranty replacements of defective merchandise will be billed to your account. This billing will be cleared by a credit issued upon return of the defective item.

MODIFICATIONS: Gates reserves the right to modify the design and specifications of the equipment shown in this catalog without notice or to withdraw any item from sale, provided, however, that any modification shall not adversely affect the performance of the equipment so modified.

INDEX

Item	Page	Item	Page
10,000 Watt Model BC-10H Transmitter	10 thru 12	Transmitters (High Frequency Broadcast)	
5,000 Watt Model BC-5H Transmitter	13 thru 15	100,000 Watt Model HF-100 Transmitter	186 thru 189
1,000/250 Watt Model BC-1G Transmitter	18, 19	50,000 Watt Model HF-50C Transmitter	190, 191
1,000 Watt Model Vanguard II Transmitter	16, 17	20,000 Watt Model HF-20B Transmitter	192, 193
500 Watt Model BC-500G Transmitter	20	10,000 Watt Model HF-10B Transmitter	194
250 Watt Model BC-250GY Transmitter	21	1,000 Watt Model HF-1M Transmitter	195
Transmitters (Broadcast/FM)		Transmitter, Remote Pickup	216, 217
40,000 Watt Model FM-40H Transmitter	34, 35	Transmitter, STL	218 thru 221
20,000 Watt Model FM-20H Transmitter	36 thru 38	Transmitter Logger, Automatic	222, 223
10,000 Watt Model FM-10H Transmitter	39 thru 41	Transmitting Tubes	228
5,000-7,500 Watt Models FM-5H/7.5H Transmitters	42, 43	Transportable Systems, AN/TRQ-20	212, 213
3,000 Watt Model FM-3H Transmitter	44, 45	Tubes, Transmitting, Receiving	228
1,000 Watt Model FM-1H Transmitter	46, 47	Tuning Units, Antenna	24, 25, 209, 210
250 Watt Model FM-250H Transmitter	48	Turntable Preamplifiers	171
50 Watt Model BFE-50C Transmitter	49, 50	Turntables and Accessories	166 thru 175
50 Watt Model BFR-50C Transmitter	49, 50	TV Towers	71
10 Watt Model BFE-10C Transmitter	49, 50	TV-15 Audio Console	88 thru 91
50 Watt FM Relay System	51	Uher Portable Tape Recorder	183
50 Watt STL System	51	Unique, Cueing Amplifier	151
Transmitters (Communications)		Unimote 70, 1-Channel Remote or Microphone Amplifier	164
20,000 Watt Model HF-20CX Transmitter	193	Utility Audio Amplifier	150
10,000 Watt Model HF-10CX Transmitter	194	Vanguard II 1000 Watt AM Transmitter	16, 17
Transmitter, Homing Beacon	211	VA Program Fader Knobs	152
Transmitters (Single Sideband)		Variable Equalizer	153
10,000 Watt Model STAR-10 Transmitter	200, 201	Vertically Polarized FM Antenna	55
10,000 Watt Model ATL-10 Amplifier	198, 199	VP-100, 100,000 Watt AM Transmitter	4 thru 6
3,000 Watt Model ST-3A Transmitter	205	VP-50, 50,000 Watt AM Transmitter	7 thru 9
3,000 Watt Model HFL-3000 Amplifier	207	VU Meter, Desk or Console Top	152
1,000 Watt Model ST-1A Transmitter	204	VU Meter and Range Panel	151
1,000 Watt Model HFL-1000 Amplifier	206	Wall Baffles	155, 156
Transmitters (Television)		Warning Lights, Studio	151
5,000 Watt Model BT-5C Transmitter	76, 77	Yagi Antennas, Remote Pickup Equipment	216, 217
500 Watt Model BT-500C Transmitter	78, 79	Yard II Audio Control Console	111 thru 113
120 Watt Model BT-100C Transmitter	80		
100 Watt Model GTV-100 Transmitter	81		

The mechanical and electrical design of the equipment described herein is subject to change without notice as deemed necessary by Gates Radio Company or its suppliers in the interest of advancing industry requirements or the state of the art.

